



---

# **NWS Partners Meeting**

## **Dissemination Strategy Discussion**

### **July 18, 2016**

National Weather Service  
Office of Planning and Programming for Service Delivery



# Agenda

---

- Historical Context
  - NOAA's Integrated Dissemination Program (IDP) System
  - FOS Current Situation
  - Review Need for Change
- Review of Recent Service Disruptions
- Review of DOC FOS Policy Changes



# Our Shared Interest in Building a Weather Ready Nation



**NATIONAL WEATHER SERVICE**  
NATIONAL OCEANIC AND ATMOSPHERIC ADMINISTRATION



**Provide weather, water, and climate information for the protection of life and property and enhancement of the national economy**

# Legacy NWS Dissemination Reality

- NWS Telecommunications Gateway & numerous data stores and websites across NWS regions
- Developed incrementally over time; not reflective of a coherent technical vision
- Primary gateway site located in Silver Spring in spaces not designed for data centers
- Application complexity contributes to failures and limits effectiveness of backup (75%)
- Recognized by 2013

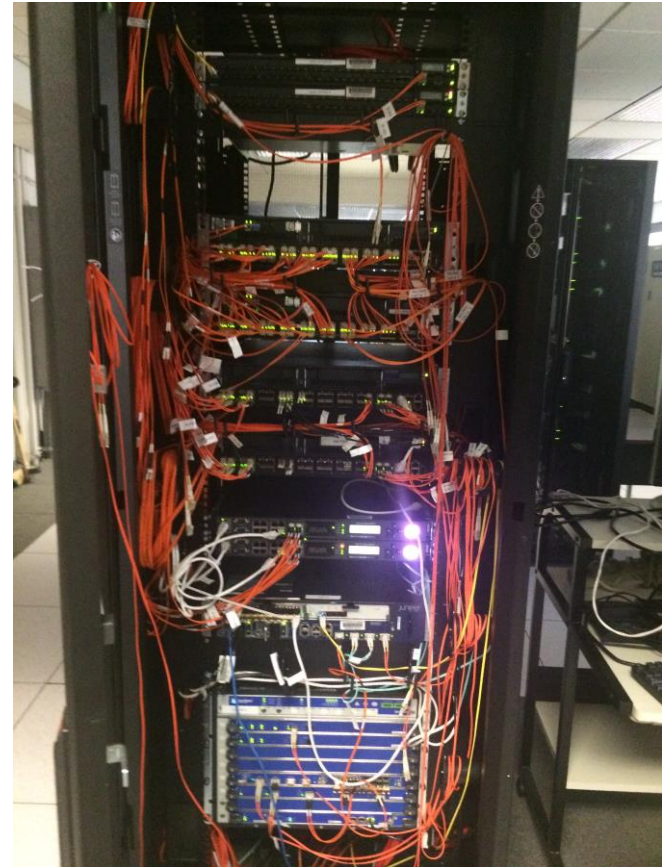

**Legacy dissemination systems not adequate for our mission – were headed towards a train wreck**

# NWS Dissemination Approach - Technical

- Started in 2013
- 100% primary & backup dissemination services and geographically diverse
- Improved bandwidth, resilience, redundant, scalable, **secure** operational networks & systems
- Increased access to environmental data using diverse methods & data formats
- Very capable but complex, involving continuing big effort



## Integrated Dissemination Program (IDP) OneNWS Network Long-Term Sustainable Solution

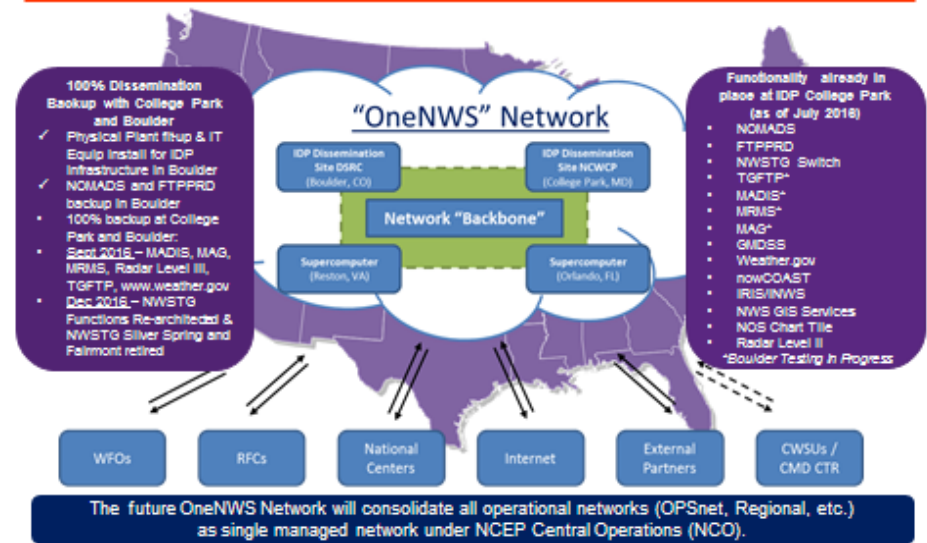

**IDP is the multi-year response to ensure reliable and secure information dissemination to support *our* mission**



# NWSTG Transition Approach to IDP



Status: July 2016

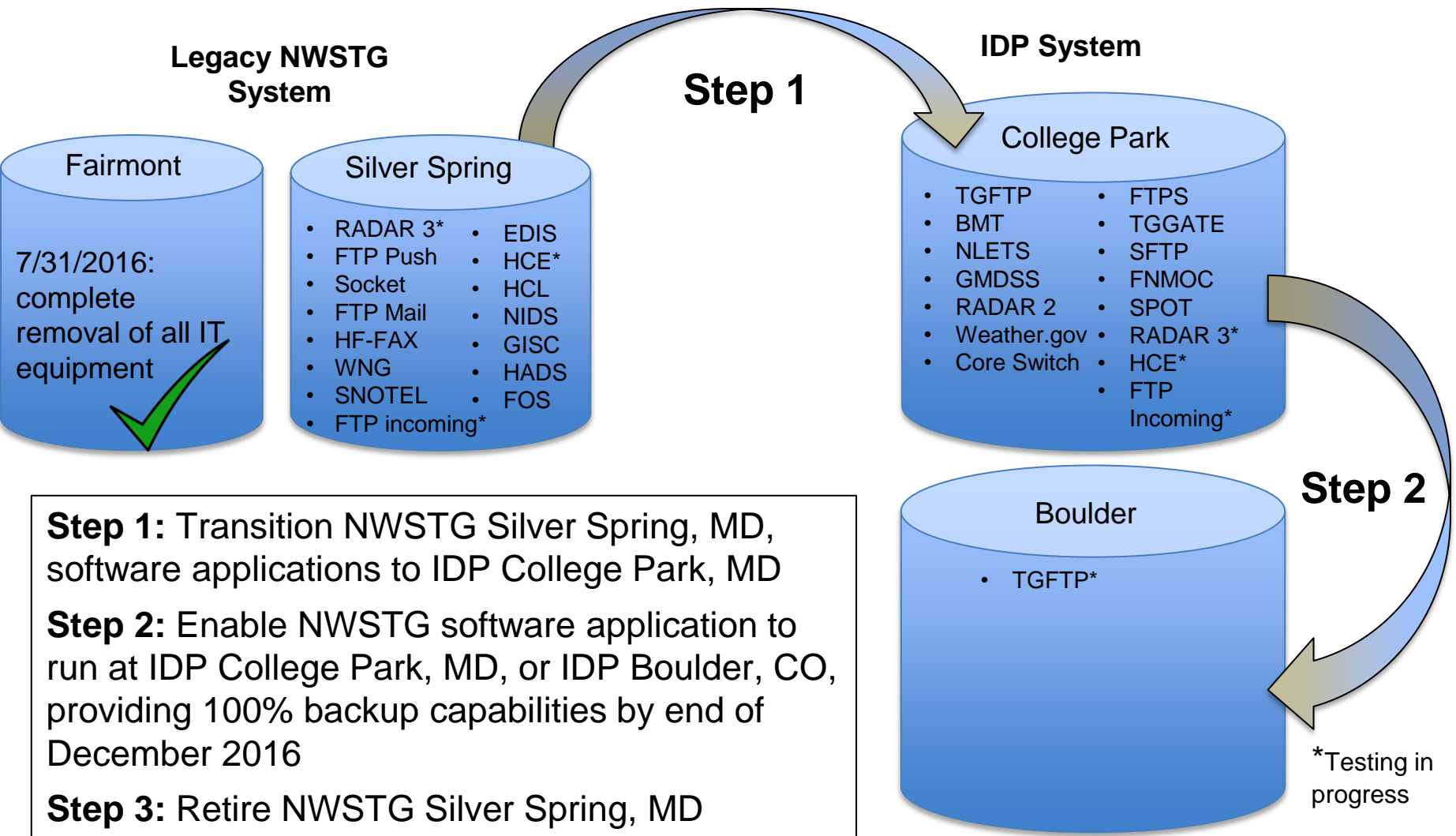

**Step 1:** Transition NWSTG Silver Spring, MD, software applications to IDP College Park, MD

**Step 2:** Enable NWSTG software application to run at IDP College Park, MD, or IDP Boulder, CO, providing 100% backup capabilities by end of December 2016

**Step 3:** Retire NWSTG Silver Spring, MD



# NWS Dissemination Approach - Technical

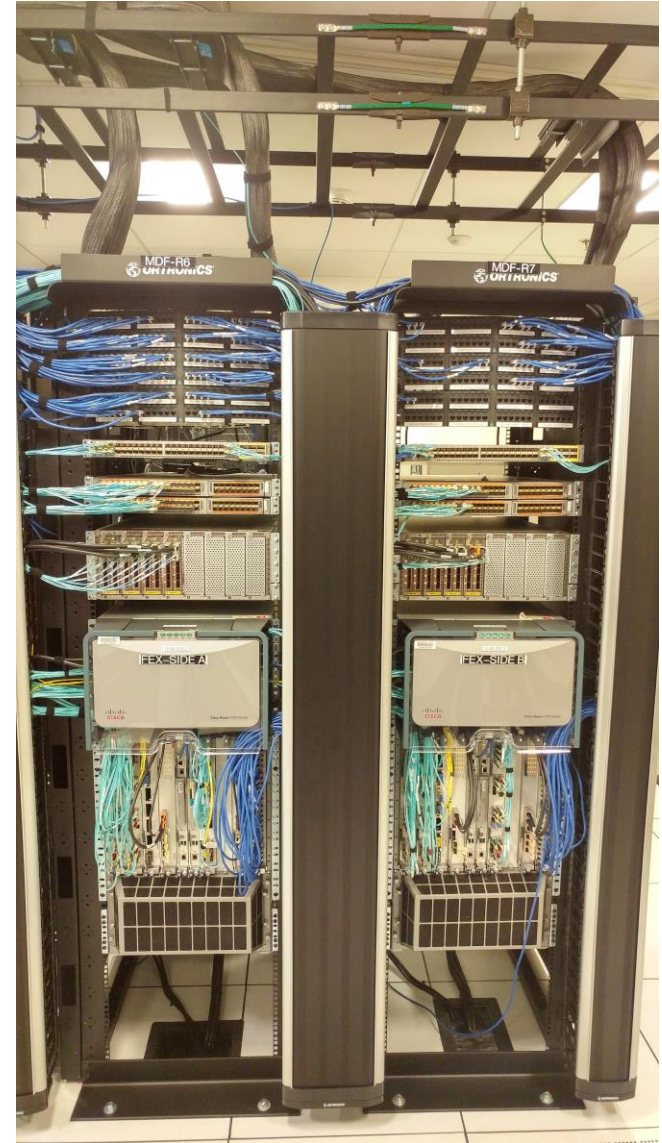



# NWS Dissemination Approach - Management

- Single accountable organization managing the monitoring and performance of a technically robust system
- Defined, repeatable 7/24 operational support including improved monitoring and problem resolution processes
- Improved reliability using mature configuration management, security patching and applications onboarding processes

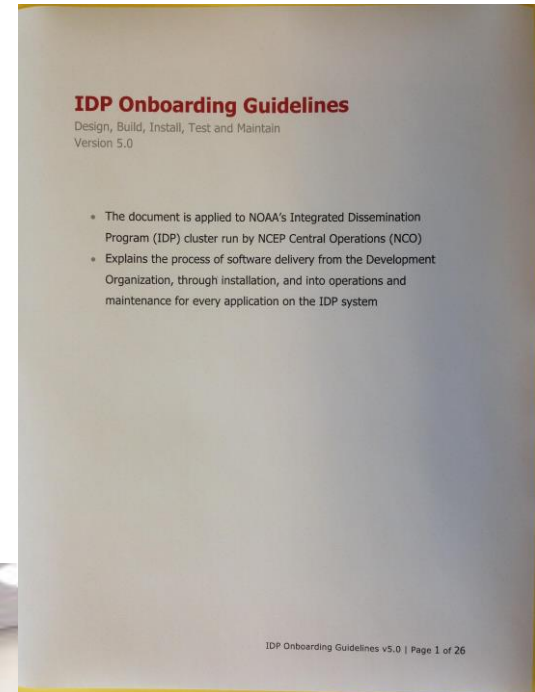





# NWS Dissemination Data Services

## IDP and FOS



NWS Dissemination Available Data (TB)

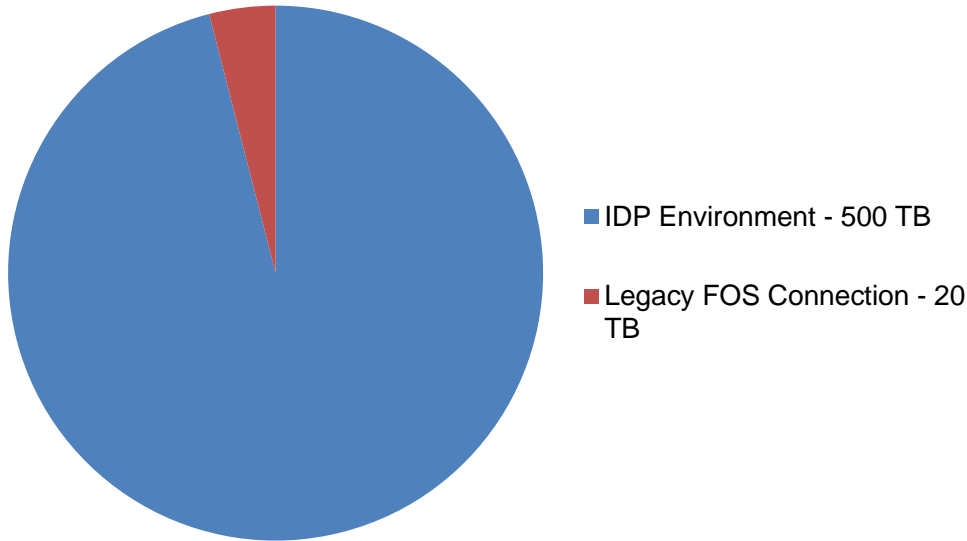

Data and services on IDP include:

- All resolutions for GFS including 0.25 degree
- HRRR, GEFS, SREF etc.
- MADIS
- MRMS
- [www.weather.gov](http://www.weather.gov)
- GIS
- NOMADS for customized gridded model products
- Plus all NWSTG/FOS applications (RADAR Level 3 - July 2016)

NWS Dissemination	IDP	FOS
100% Backup	Yes (FY17Q1)	No
Single Points of Failure	No	Yes
Meets security statutes & Policy	Yes	No - Violates FISMA, OMB 08-05 (TIC), and NOAA / NWS directives
Network capacity at Internet boundary	20Gbps (scalable to 100Gbps)	1Gbps
Typical message throughput per FTP session for FOS	18 Mbps – 250 Mbps	6 Mbps – 45 Mbps (HIGH estimate based on circuit size)
Uptime Availability	99.0% (99.9% with full backup)	99.9%



# Current FOS on NWSTG

## Pull - File Server Access (TGDATA)

- FTP download access to TGDATA server on OPSnet
- Data includes:
  - GRIB2 model (0.5 degree GFS, 40KM NAM)
  - GTS Text Products
  - Model Output Statistics (MOS)
  - NDFD Grids
  - Observational data and TAF

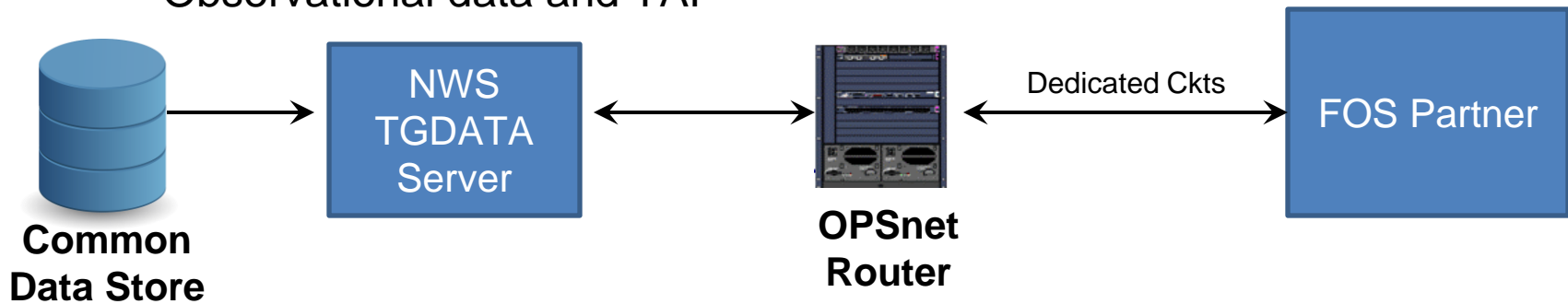

- TGDATA uses the same file system used to support other NWS customers



# Current FOS on NWSTG

## Push – RADAR Service

- LDM access to RADAR Level 3 systems at NWSTG Silver Spring
- Data includes:
  - Base Reflectivity
  - Radial Velocity
  - Composite Reflectivity
  - Echo Tops

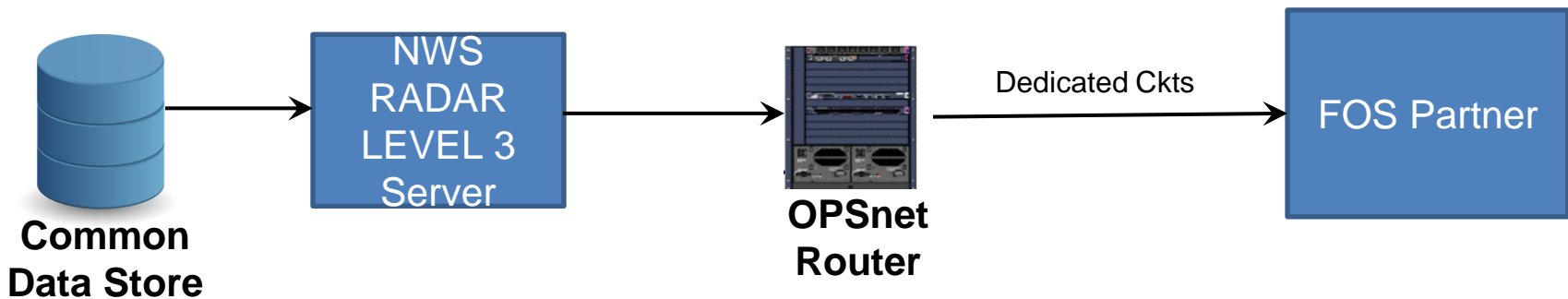

- RADAR uses the same file system used to support other NWS customers



# Why We Must Change



Issue	Impact
Unacceptable security risk	<ul style="list-style-type: none"><li>• Out of compliance with Federal IT security statute and NOAA policies (e.g., FISMA, OMB-08-05)</li><li>• All non-government network must be behind Trusted Internet Connection (TIC)</li></ul>
Requirement for datacenter consolidation: <ul style="list-style-type: none"><li>• Kundra (2/26/2010), Memorandum for Chief Information Officers: Federal Data Center Consolidation Initiative</li><li>• VanRoekel (3/19/2012), Memorandum for Chief Information Officers: Implementation Guidance for the Data Center Consolidation Initiative (FDCCI) Guiding principles for NOAA Data Center Consolidation</li></ul>	<ul style="list-style-type: none"><li>• No programmed funds starting in FY17 for NWSTG Silver Spring, MD and Fairmont, WV</li></ul>
Systems purchased in 2012 nearing end of life	<ul style="list-style-type: none"><li>• No capacity for new data/services (data unchanged on FOS system in last 2 years)</li></ul>



# We Had Service Disruptions Last Week

---

- Four in Total
  - One caused by defective software in a firewall
    - Created a 1 hour and 5 minute disruption to all IDP services
  - Three caused by human error
    - First created a 5 hour and 45 minute disruption to NWSTG services, including FOS. Data quality on all dissemination systems affected
    - Second created a 3 hour and 45 minute disruption to IDP web services. IDP file transfer protocol services not affected
    - Third created a 30 minute disruption to IDP web services





# One - July 12, 2016

12:00 – 1:05 ET

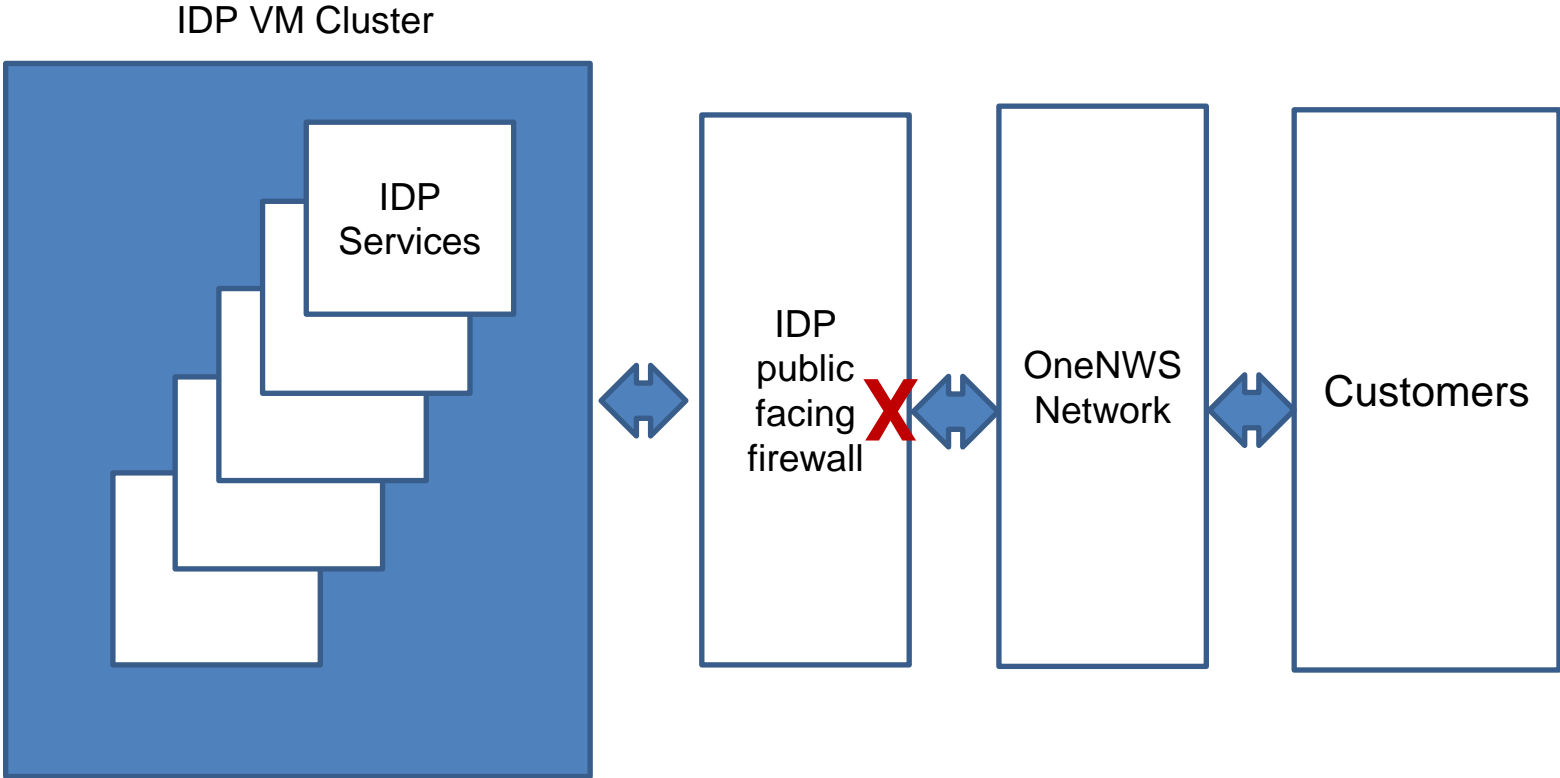

- Public facing IDP firewall failure due to a software bug activated during an automated failover condition
- IDP, College Park, MD, triggered disruption for all IDP services



# Two - July 13, 2016

10:45 – 16:30 ET



## AWIPS NCF and Legacy NWSTG

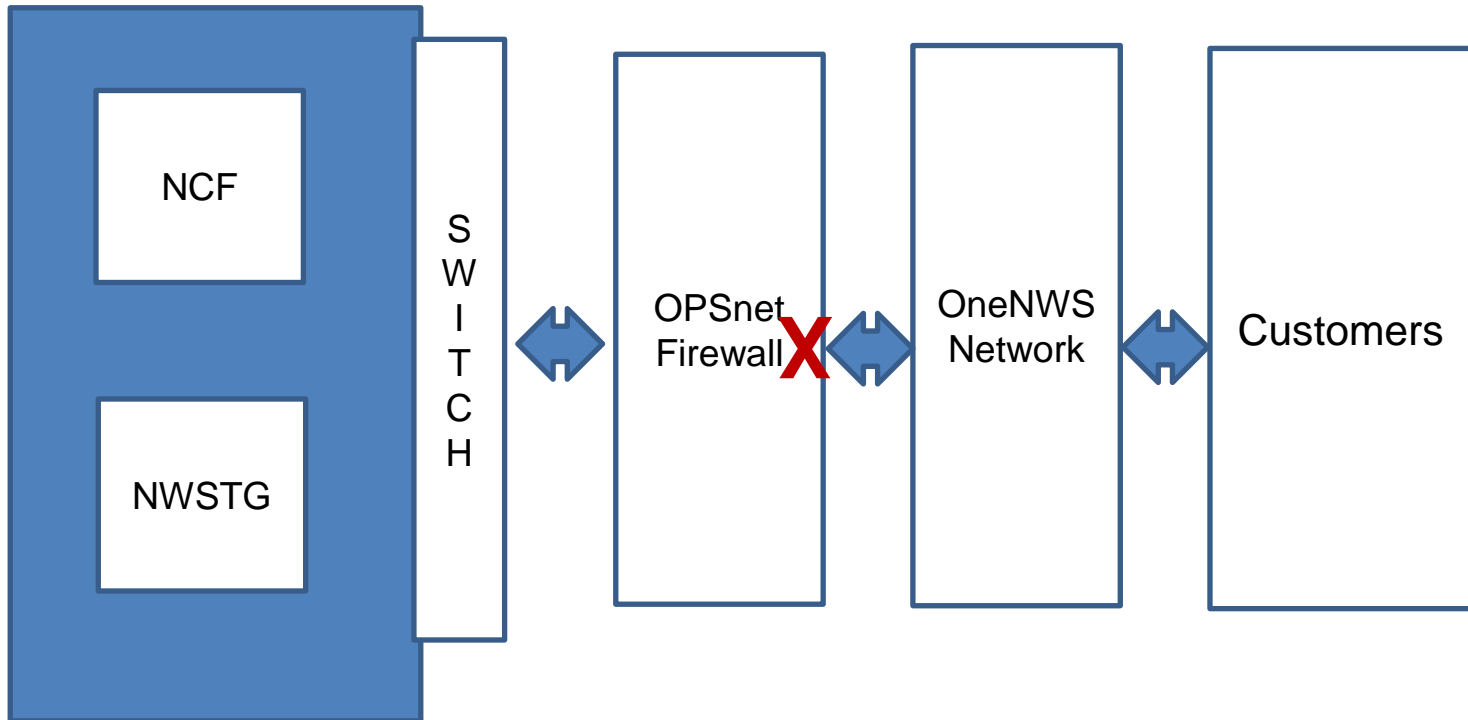

- Legacy OPSNet firewall failure due to debug (trace) being enabled which crashed the firewall
- 3 hours to diagnose and correct, 2.75 hours for all data flows to return to normal
- AWIPS NCF & NWSTG Legacy, Silver Spring, MD, triggered disruption for all NWSTG services

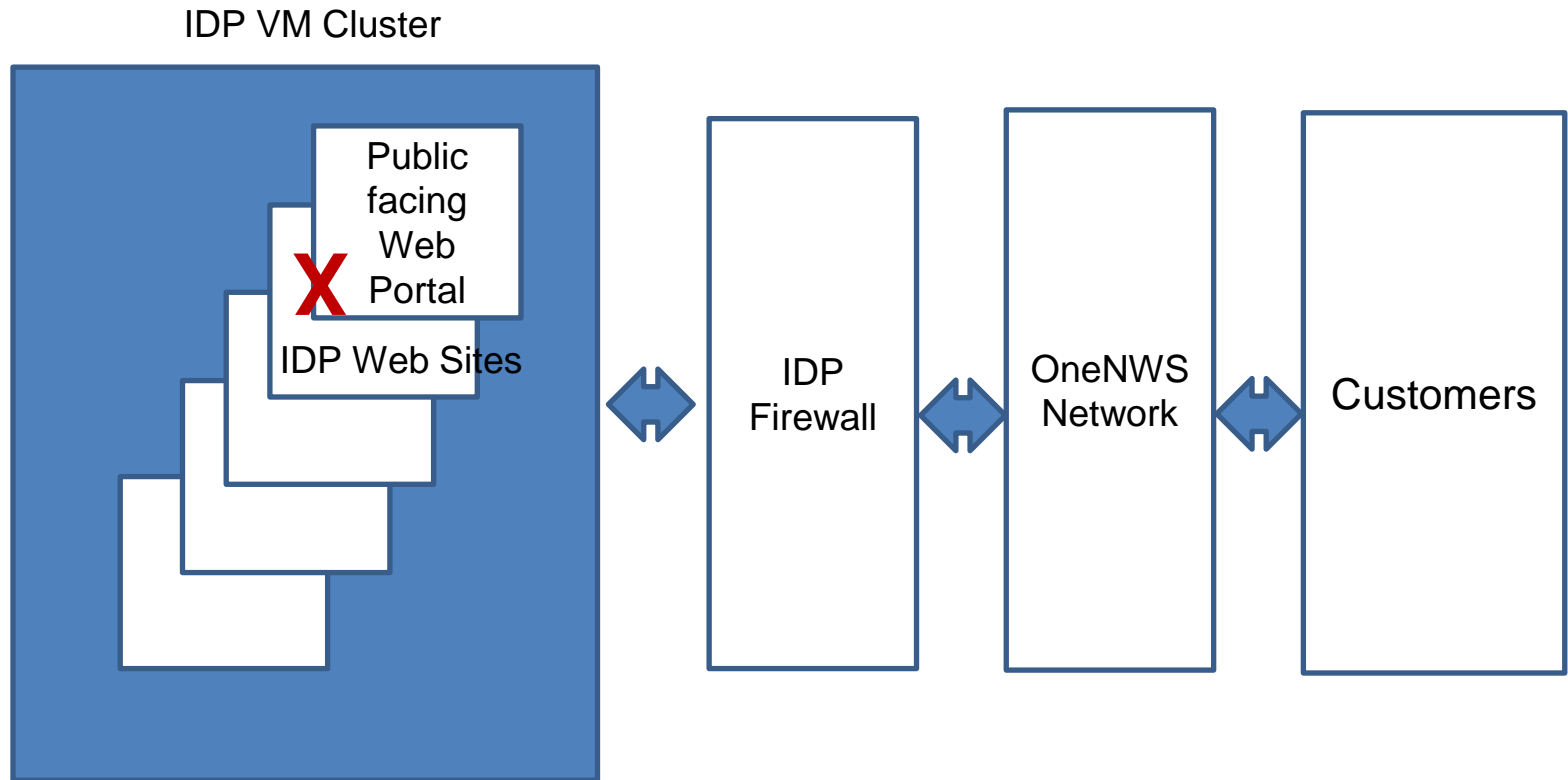

- The public facing IDP Web portal failed due to a memory leak caused by a bug in a MADIS Web script
- 3 hours to diagnose and correct, 45 minutes for servers to return to normal performance
- IDP, College Park, MD, triggered IDP web services disruption, IDP ftp and LDM services not impacted

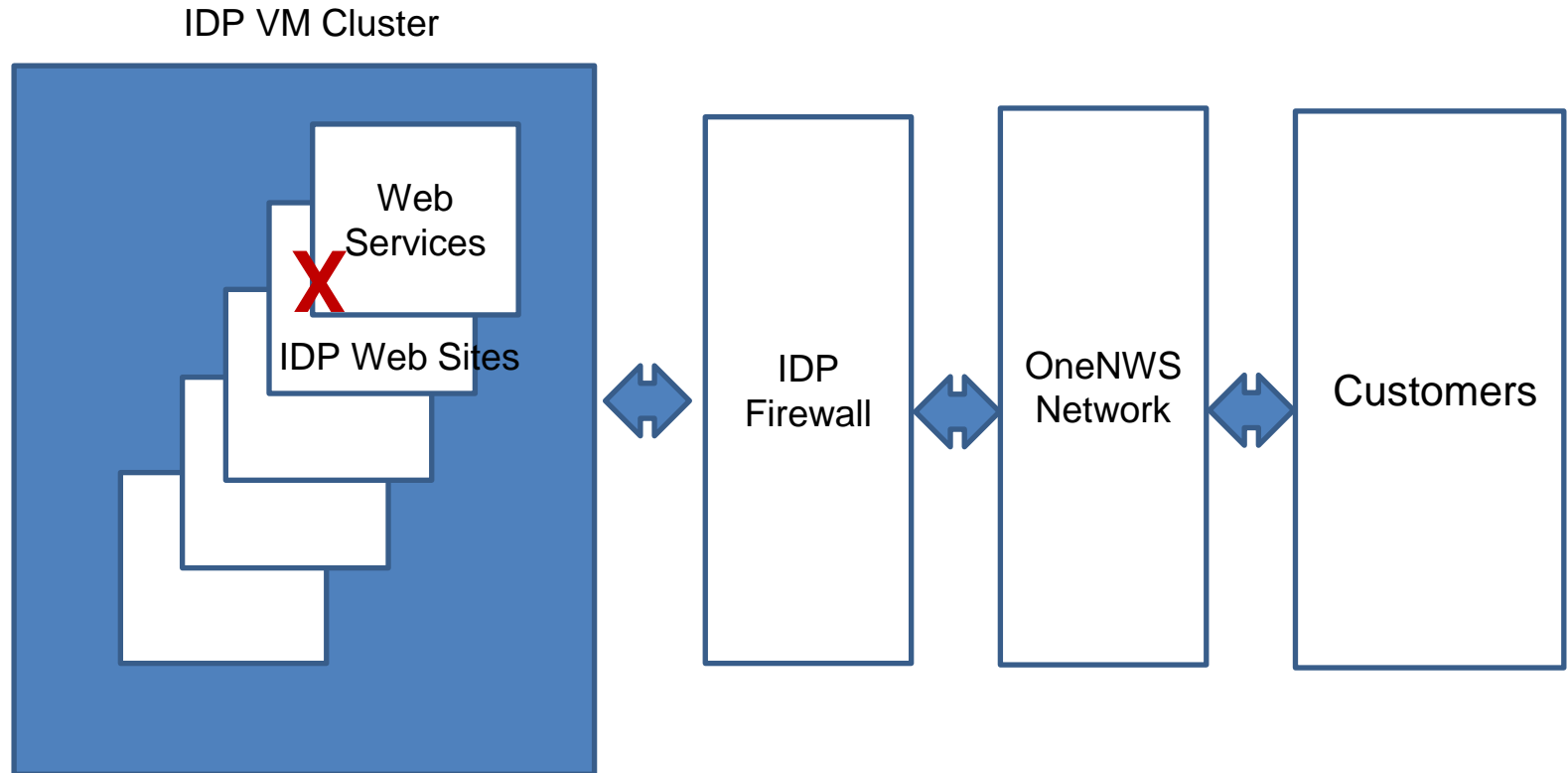

- Computing resources for IDP web services was misconfigured and resulted in slower Web response time
- IDP, College Park, MD, triggered IDP web services disruption (access slower), IDP ftp and LDM services not impacted



# We Had Service Disruptions Last Week

## Areas for Improvement

---

- Enabling additional technical monitoring capabilities
- More technical training for our NCO team members is needed and is planned
- We focused our initial diagnostic efforts on the most likely failure modes (switch, data store) based on experience
  - Turned out to not be the root causes in these cases
- We could have brought in direct vendor support earlier
  - Continual onsite assistance initiated (NetApp) and will be expanded





# We Had Service Disruptions Last Week

## Good Take Aways

---

- In each case, the disruption was recognized and response initiated prior to any call from outside partners
- Effective coordination among NWS and partner organizations was evident and this coordination helped to shorten what would have been longer disruptions in the past
  - Two major technical problems overlapping on the same day
  - Organizational strategy to drive to a single accountable service delivery organization is having the expected, positive impact



# We Had Service Disruptions Last Week

## Good Take Aways

---

- Service partitioning in IDP prevented web services disruption from impacting ftp and LDM services
- Limited backup across College Park and Boulder used; validates that 100% IDP backup set for year end will further enable us to limit the impact of outages from hours to minutes
- Procedures immediately changed to address human error root causes
- Transparency



# FOS Policy Adjustment

---

- The NOAA NWS will support the provision of environmental information to the FOS partners through hardware, software, network and personnel resources established using appropriated funds only

Meaning: The NOAA NWS will no longer accept funds from FOS partners to establish FOS specific systems for FOS only environmental information dissemination

- The hardware, software, network and personnel resources used to support the provision of environmental information to FOS partners will also be used to support the provision of environmental information to other entities on an equal access basis

Meaning: Access to environmental information on the NOAA NWS IDP will be equally available and accessible to all entities



# FOS Policy Adjustment

---

- Due to White House, Department of Commerce, and NOAA IT security policy, NOAA will support the interconnection from FOS partners to the NOAA NWS systems used to provide environmental information through a NOAA Trusted Internet Connection Access Points (TICAP) only

Meaning: Connection from FOS partners to IDP and other equal access NOAA environmental information dissemination systems will in all cases transit a NOAA TICAP, no specialized or direct connections from FOS partners into the NOAA computing environment will be continued or established

- NOAA will support the interconnection from FOS partners to the public side of the NOAA TICAP using Internet connections only

Meaning: No dedicated, point-to-point connections from FOS partners to the public side of a NOAA TICAP will be supported by NOAA



# FOS Policy Adjustment

---

- The NOAA NWS will consider the impact on the overall public good when prioritizing the resolution of problems that may occur with its environmental information dissemination systems; thus prioritizing the resolution of some problems over others in order to preserve the greatest public good.

Meaning:-The NOAA NWS will ensure equal and speedy access to NOAA NWS technical support resources (help desk, etc.), Problems reported by FOS partners generally have broad impact to the public good and as such will typically be prioritized highly for the fastest resolution





# FOS Policy Adjustment

## Notional Network View

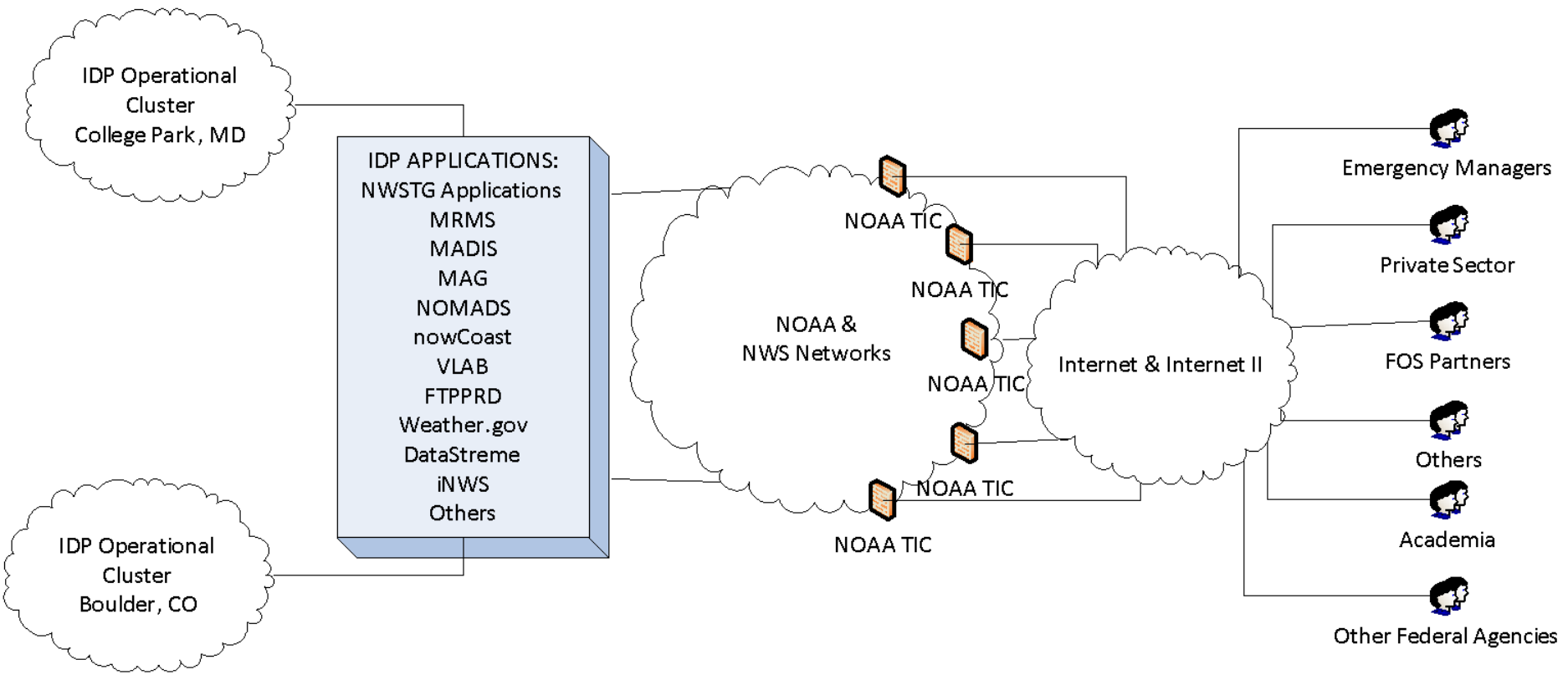



---

# THANK YOU!





# Guiding Principles for Discussion For Moving Forward

---



- IT Security Compliance
  - Federal Information Security Management Act (FISMA)
  - OMB-M-08-05 (TIC)
  - OMB-M-15-14 (FITARA)
  - NOAA security directives NAO 212-13 & NWSI 60-702
- Reliability
  - 99.9% monthly availability
  - Warm backup capability, 6-8 hours to activate on backup
- Accessibility
  - Standardized data formats (i.e. GRIB2, NetCDF)
  - Data transmission rate to NOAA boundary – HIGH estimate 45Mbps
- Monitoring / Problem Resolution
  - Automated problem notification with 7x24 monitoring
  - Defined, repeatable problem resolution
  - Average time to problem resolution for NWS infrastructure – 90 minutes