

ANNUAL REPORT 1988

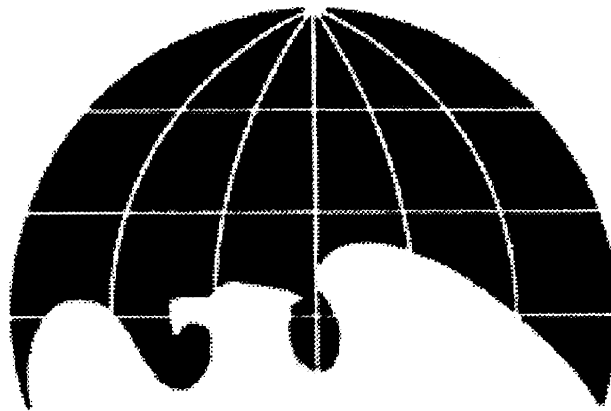

UNITED STATES

INTERNATIONAL

TRADE COMMISSION

Contents

| | |
|---|----|
| Message from the Acting Chairman | 3 |
| The Commissioners | 4 |
| Summary of Investigations Completed | 6 |
| Introduction | 7 |
| Part I. Highlights | 7 |
| Investigations Under Section 337 of the Tariff Act of 1930 | 7 |
| Investigations Under Title VII of the Tariff Act of 1930 | 7 |
| Investigations Under the Trade Act of 1974 | 8 |
| Investigations Under Section 332 of the Tariff Act of 1930 | 8 |
| 332 Studies Related to Trade With Japan | 8 |
| Other Major 332 Investigations | 8 |
| U.S. Global Competitiveness Studies | 9 |
| Part II. Organizational Activities | 13 |
| Office of Investigations | 13 |
| Office of Industries | 13 |
| Office of Economics | 15 |
| Office of Tariff Affairs and Trade Agreements | 16 |
| Office of Unfair Import Investigations | 16 |
| Trade Remedy Assistance Center | 17 |
| Office of Data Systems | 17 |
| Office of Administration | 17 |
| Office of Administrative Law Judges | 18 |
| Office of Congressional Liaison | 18 |
| Office of the Secretary | 18 |
| Office of Executive and International Liaison | 18 |
| Office of the General Counsel | 18 |
| Law Library | 19 |
| Office of Public Affairs | 19 |
| Part III. Management and Finance | 20 |
| Figures | |
| 1. Summary of Principal Activities, Fiscal Years 1985-88 | 21 |
| 2. Functions of Offices and Commission Organization | 22 |
| 3. Statutory Timetables for Antidumping and Countervailing Duty Investigations | 24 |
| Appendixes | |
| A. Summary of Investigations Completed During Fiscal Year 1988 and Pending on September 30, 1988 | 25 |
| B. Statutes Involving the U.S. International Trade Commission | 38 |
| C. Reports Submitted to Congress on Proposed Legislation, Fiscal Year 1988 | 42 |
| D. Litigation in Fiscal Year 1988 | 45 |

Message From the Acting Chairman

1988 was a significant year for U.S. international trade law, and therefore for the ITC. The Omnibus Trade and Competitiveness Act of 1988 was enacted in August, and those of us in the trade community are only just beginning to appreciate the impact it will have. Because it revises many of the statutes under which the Commission addresses trade cases, the new law will most certainly affect our decisionmaking in the coming years. The changes mandated by the act in the administrative area, among other things, broaden the responsibility of our Trade Remedy Assistance Center, revise the Commission's authority under the Paperwork Reduction Act, and mandate the release of confidential business information in dumping and countervailing duty cases.

During fiscal year 1988 the Commission continued to provide counsel, technical assistance, and support to the executive and legislative branches on a wide range of trade matters. In addition to advising Congress on selected provisions of the new trade bill, Commission staff was active in support of other trade efforts, including the United States-Canada Free-Trade Agreement and the Uruguay Round of Multilateral Trade Negotiations. Furthermore, in anticipation of implementation of the Harmonized System, staff cross-referenced that system with the Tariff Schedules of the United States and compiled the relevant import data for the past five years.

The number of cases brought before the Commission continued its decline in fiscal year 1988, with only 91 investigations initiated during the year. However, while the caseload declined, both the sophistication of the analysis and the breadth of the coverage of the typical ITC study advanced. The Commission completed some very complex, sophisticated studies. Perhaps the most unique of these was a section 332 investigation examining the pros and cons of initiating negotiations with Japan to explore the possibility of a United States-Japan free-trade agreement. Initiation of a similar study involving possible free-trade agreements with ASEAN and Pacific Rim countries followed. Five important studies to assess the global competitiveness of selected industries also were completed in fiscal year 1988, covering textiles, steel, automotive parts, optical fibers, and oilseeds.

In keeping with our continuing commitment to excellence, several important steps were taken during the year to enhance the Commission's ability to fulfill its mandate. Chief among these were programs designed to improve the accuracy and efficiency of the way we gather, verify, and analyze data, particularly for title VII investigations and section 332 studies. As part of our ongoing audit program, the Commission reviewed the agency's automated data processing security program and its information resources management needs. Finally, we implemented phase II of our office automation program, thus providing staff with an integrated network of personal computers and local area networks that encompasses virtually every Commission employee and establishes agencywide data processing capability. This is a crucial step in our professional growth.

With the move to our new headquarters building completed in January, the Commission now enjoys comfortable and efficient facilities and a more up-to-date work environment for staff and for all who conduct business here. And what a beautiful environment it is! All of us take great pride in our new home.

I am gratified by the accomplishments of the past year. Here at the Commission we are ever mindful of the importance of professionalism and quality in the performance of our mission. I look forward to 1989, a year that promises continued emphasis on the problems and challenges of international trade—and, in all likelihood, increased reliance on the resources of the U.S. International Trade Commission.

Anne Brundale

The Commissioners

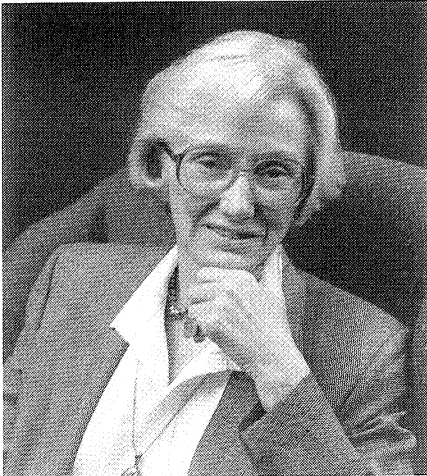

Anne E. Brunsdale, a Republican of the District of Columbia, was reappointed by President Reagan June 28, 1988, to a two-year term as Vice Chairman and in the absence of a Chairman, she is Acting Chairman. A native of Minnesota, she became a member of the Commission on January 3, 1986, for a term expiring June 16, 1993. She came to the ITC from the American Enterprise Institute for Public Policy Research, Washington, DC, where she had served most recently as Resident Fellow and Managing Editor of *Regulation*, a bi-monthly magazine.



Alfred E. Eckes, a Republican of Virginia, joined the Commission on September 21, 1981, for a term expiring June 16, 1990. He was designated by President Reagan as Chairman for a two-year period beginning in June 1982. A native of New Hampshire, Mr. Eckes came to the Commission from the Republican Conference of the U.S. House of Representatives, where he was Executive Director. Before that, he was Editorial Page Editor of the *Columbus (Ohio) Dispatch* (1977-79) and an associate professor of history at the Ohio State University in Columbus (1969-79).



Seeley G. Lodwick, a Republican of Iowa, was sworn in as a member of the Commission on August 12, 1983, for a term expiring December 16, 1991. A native of Iowa, Mr. Lodwick came to the Commission from the U.S. Department of Agriculture, where he served as Undersecretary of Agriculture for International Affairs and Commodity Programs from 1981 to 1983. He is a former Iowa State senator (1962-69) and was elected President Pro Tempore from 1968 to 1969. Mr. Lodwick maintains active farming interests in his home State.



Susan Liebeler, an Independent of California, was appointed to the ITC on April 20, 1984, for a term expiring on December 16, 1988. President Reagan named her Vice Chairman of the Commission on June 29, 1984, and appointed her to a two-year term as Chairman effective June 17, 1986. Prior to her appointment, Mrs. Liebeler was a law professor at the Loyola Law School in Los Angeles. From August 1981 until July 1982, she served as special counsel to the Chairman of the Securities and Exchange Commission.

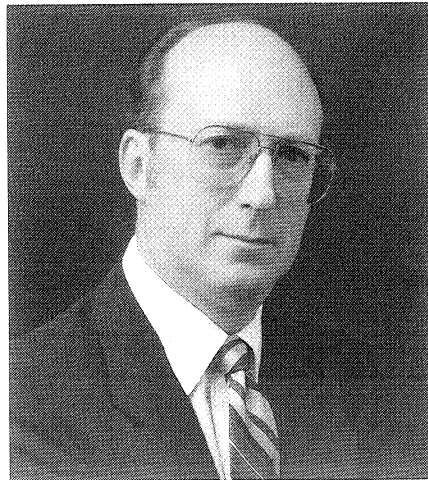

David B. Rohr, a Democrat of Maryland, became a member of the Commission on March 27, 1984, and was subsequently reappointed to a term ending December 16, 1994. Before his appointment to the ITC, Mr. Rohr was a staff director of the Subcommittee on Trade, Committee on Ways and Means, U.S. House of Representatives. He was a trade adviser and was principal liaison with the ITC, the Office of the United States Trade Representative, and other Federal agencies. Mr. Rohr also served as director of the Trade Negotiations and Agreements Division of the U.S. Department of Commerce. He joined Commerce in 1961 as an international economist.

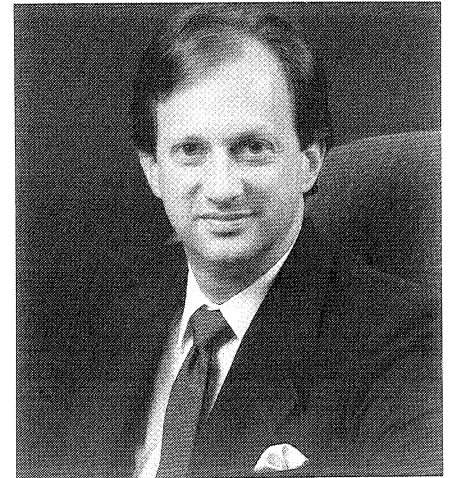

Ronald A. Cass, a Democrat of Massachusetts, was sworn in as a member of the Commission on January 20, 1988, on a recess appointment by President Reagan. On August 11, he was confirmed by the Senate for a term expiring June 16, 1996. Mr. Cass came to the Commission from the Boston University School of Law, where he had been an associate professor from 1981 to 1983 and professor since 1983. A native of Washington, DC, he practiced law in Washington from 1974 to 1976 and was assistant professor of law at the University of Virginia from 1976 to 1981.

The United States International Trade Commission is a quasi-judicial, independent, bipartisan agency established by Congress with broad investigative powers on matters of trade.

In its adjudicative role, the ITC makes determinations of injury and threat of injury by imports on U.S. industry.

As the Government's think tank on trade, the ITC is a national resource where trade data are gathered and analyzed. That information is provided to the President and Congress as part of the substance on which U.S. trade policy is based.

Commission activities include—

- Making recommendations to the President regarding relief for industries seriously injured by increasing imports;
- Determining whether U.S. industries are materially injured by imports that benefit from pricing below fair value or subsidization;
- Directing actions, subject to Presidential disapproval, against unfair trade practices such as patent infringement;
- Advising the President whether agricultural imports interfere with price-support programs of the U.S. Department of Agriculture;
- Conducting studies on trade and tariff issues and monitoring import levels; and
- Participating in the development of uniform statistical data on imports, exports, and domestic production and the establishment of an international harmonized commodity code.

Summary of Investigations Completed

Tariff Act of 1930:

| | |
|--|----|
| Section 332 investigations | 15 |
| Section 337 investigations of alleged unfair practices in the importation and sale of imported products | 21 |
| Antidumping and countervailing duty investigations (countervailing duty, 12, consisting of 9 preliminary and 3 final; antidumping investigations, 56, consisting of 38 preliminary, 17 final, and 1 review) | 68 |

Trade Act of 1974:

| | |
|---|----------|
| Section 201 escape-clause investigations | 1 |
| Section 503 advice on possible trade agreements | 1 |
| Section 603 preliminary investigations | <u>1</u> |

Total 107

Investigations completed during fiscal year 1988 and investigations pending on September 30, 1988, are shown in Appendix A: Summary of Investigations Completed During Fiscal Year 1988 and Pending on September 30, 1988.

Introduction

The United States International Trade Commission marked fiscal year 1988 as a historic one with its move to a new building. In January, for the first time since 1975, the ITC consolidated all of its elements in one location, 500 E Street SW.

The ITC's leadership also changed this year. Upon the expiration of Susan Liebeler's term as Chairman, Alfred E. Eckes served as Acting Chairman until President Reagan reappointed Anne E. Brunsdale Vice Chairman on June 28, 1988, thus making Commissioner Brunsdale Acting Chairman. In addition, the President nominated and the Senate confirmed two new Commissioners. Ronald A. Cass of Massachusetts received a recess appointment and was sworn in on January 20. He was confirmed by the Senate on August 11 for a term expiring June 16, 1996. The Senate also confirmed the appointment of Don E. Newquist of Texas on August 11 for a term expiring December 16, 1997. He was nominated to succeed Susan Liebeler.

The six Commissioners are appointed by the President and are confirmed by the Senate for terms of nine years unless appointed to fill an unexpired term. A Commissioner who has served for more than five years is not eligible for reappointment. Not more than three Commissioners may be members of the same political party. The Chairman is designated by the President and serves for a two-year term. The Chairman may not be of the same political party as the preceding Chairman, nor may the President designate two Commissioners of the same political party as the Chairman and Vice Chairman.

A summary of ITC's activities during fiscal years 1985-88 is shown in figure 1. An explanation of each office's functions and the organization of the Commission is shown in figure 2. Statutory timetables for countervailing and antidumping investigations are presented in figure 3.

Part I. Highlights

Investigations Under Section 337 of the Tariff Act of 1930

Under section 337 of the Tariff Act of 1930, the Commission conducts investigations with respect to unfair trade practices in import trade. Most complaints filed under this provision involve allegations of patent, copyright, or trademark infringement; other investigations include alleged violation of the antitrust laws, misappropriation of trade secrets, passing off, and false advertising. A more detailed explanation of section 337 of the Tariff Act of 1930 is discussed in Appendix B: Statutes Involving the U.S. International Trade Commission.

Two particularly noteworthy section 337 investigations were conducted primarily during fiscal year 1988. One of these investigations involved a type of semiconductor known as an erasable, programmable, read-only memory, or EPROM. The investigation (337-TA-276, *Certain Erasable Programmable Read-Only Memories, Components Thereof, Products Containing Such Memories, and Processes for Making Such Memories*) arose from allegations made by a domestic company that several foreign and domestic companies involved in manufacturing, importing, and selling imported semiconductors were infringing its EPROM-related U.S. patents. The parties litigated issues involving the validity, enforceability, and infringement of seven patents during a trial conducted before an administrative law judge. The trial spanned 11 weeks, and the administrative law judge is currently preparing an initial determination.

Another noteworthy section 337 investigation was 337-TA-281, *Certain Recombinant Erythropoietin*, which involved the genetically engineered prescription drug recombinant erythropoietin, or EPO. EPO is administered intravenously to patients suffering from anemia. It controls the synthesis of red blood cells, and it is a hormone that occurs naturally in the blood in minute amounts. The investigation, which was the ITC's first in the biotechnology field, resulted from allegations of patent infringement made by a domestic owner of a U.S. patent relating to host cells that are transfected with a recombinant DNA gene so as to produce EPO. Among the significant issues litigated was

whether the patent owner could prove that the alleged use overseas of its patented host cells, in connection with the manufacture of EPO imported into the United States, gave rise to an action entitling it to relief from the Commission. A trial has been held, and the administrative law judge is preparing an initial determination on the issues.

Investigations Under Title VII of the Tariff Act of 1930

The machinery sector filed a number of petitions with the Commission in fiscal year 1988, covering antifriction bearings, industrial belts, appliance thermostats, digital readout systems, and shock absorbers. Heavy industry also continued to be a significant, but no longer predominant, source of petitions. Several new cases involved light-walled rectangular pipes and tubes, fabricated structural steel, all-terrain vehicles, calcined bauxite proppants, and steel wheels. Other new title VII investigations were conducted on electrolytic manganese dioxide and granular polytetrafluoroethylene resin and such dissimilar products as sewn cloth headwear and 3.5-inch microdisks. For the first time in many years, no agricultural products were the subject of new petitions. See appendix B for a discussion of title VII.

Much of the Commission's title VII workload in fiscal year 1988 consisted of final countervailing duty and antidumping investigations for which petitions were filed during fiscal year 1987. These included cases on granite, brass sheet and strip, aluminum redraw rod, forklift trucks, bimetallic cylinders, and nitrile rubber. A high-visibility potassium chloride (potash) case was terminated following U.S.-Canadian negotiations that resulted in a suspension agreement.

One review investigation was conducted under section 751 of the Tariff Act of 1930 to determine whether liquid-crystal-display television receivers should be excluded from an existing antidumping order on television receivers.



Various cutlery products are displayed during a Commission hearing on August 18. The Commission instituted the investigation on certain knives in response to a petition filed on March 25, 1988, by the American Cutlery Manufacturers Association.

Investigations Under the Trade Act of 1974

The Commission conducted an escape-clause investigation on knives and determined, under section 201, that imports of such products were not being imported into the United States in such increased quantities as to be a substantial cause of serious injury or threat to a U.S. industry. The Commission also instituted a section 203 investigation to advise the President with respect to the probable economic effect on the domestic industry of termination of import relief on western red cedar shakes and shingles. See appendix B for a discussion of sections 201 and 203 of the Trade Act of 1974.

Investigations Under Section 332 of the Tariff Act of 1930

Under section 332 of the Tariff Act of 1930, the ITC conducts general investigations on any matter involving tariffs and international trade. See appendix B for a discussion of section 332 in detail. In addition to accomplishing the studies highlighted below that resulted from one-time requests, the ITC staff produces recurring industry surveys such as

332-167, the Quarterly Survey on Certain Stainless Steel and Alloy Tool Steel; 332-191, Nonrubber Footwear Quarterly Statistical Report; 332-207, U.S. Automobile Industry: Monthly Report on Selected Economic Indicators; and 332-252, Annual Surveys on Ammonium Paratungstate, Tungstic Acid, and Tungsten Oxide.

332 Studies Related to Trade With Japan

An Analysis of Recent Japanese Measures to Promote Structural Adjustment (332-251)

The Office of the United States Trade Representative (USTR) requested this two-phase investigation, which examined the effects that Japan's structural adjustment programs had on U.S. trade and production. The report includes an overview of Japan's programs, and it contains estimates of the benefits they provide, overall and by industry categories. Data were obtained through fieldwork in Japan.

The Pros and Cons of Initiating Negotiations With Japan to Explore the Possibility of a United States-Japan Free-Trade Area Agreement (332-255)

This investigation, requested by the Senate Finance Committee, summarized the view of recognized authorities on U.S.-Japanese relations on the pros and cons of negotiating a United States-Japan free-trade area agreement. The

Commission elicited candid views, primarily from a cross section of more than 100 U.S. and Japanese Government, academic, and private-sector experts on how such negotiations would affect U.S. relations with Japan and third countries, U.S. market access in Japan, and the Uruguay Round. The study also reported the views of experts on the current negotiating approach with Japan and possible alternative approaches.

Other Major 332 Investigations

The Use and Economic Impact of TSUS Items 806.30 and 807.00 (332-244)

The Commission instituted the investigation at the request of the Subcommittee on Trade, Committee on Ways and Means, U.S. House of Representatives. It provides an economic analysis of the use and impact of Tariff Schedules of the United States (TSUS) items 806.30 and 807.00. The principal findings were as follows:

- The nondutiable value (U.S. content) of all U.S. imports under items 806.30 and 807.00 increased at a 9-percent average annual rate during 1980-86, to \$6.3 billion. Mexico is the major supplier of nondutiable item 807 imports.
- Elimination of items 806.30 and 807.00 would cause employment to fall in U.S. component industries and increase in U.S. assembly industries. Net effect on U.S. employment levels would be minimal.

Foreign Protection of Intellectual Property Rights and the Effect on U.S. Industry and Trade (332-245)

This investigation, which was requested by the USTR, was instituted for the purpose of determining quantitative estimates of lost sales caused by counterfeit and other infringing products imported into the United States and lost U.S. export sales and revenues from both U.S. and foreign sources because of protection deficiencies. The study was also conducted to identify the products, source countries, markets, and protection deficiencies representing the most serious problems for U.S. firms. The principal findings were as follows:

- Extrapolating from survey results, 1986 aggregate worldwide losses were estimated at \$23.8 billion (2.7 percent of worldwide sales affected by intellectual property rights).⁸ Scientific and photographic goods re-

ported the greatest losses (21 percent of the total). The bulk of worldwide losses were, from greatest to least, fees and royalties, reduced profit margins, domestic sales displaced by infringing imports, damage to reputations, and business never attempted abroad. For the same year, U.S. exports, valued at \$6.2 billion, were reported lost, with the electronics and motor vehicles and parts industries suffering most.

- There were 186 respondents that reported losses from inadequate intellectual property protection in 68 countries. The most losses were attributed to Taiwan (\$753 million), followed by Mexico, the Republic of Korea, China, and Canada.

The Implications of Foreign-Trade Zones for U.S. Industries and the Competitive Conditions Between U.S. and Foreign Firms (332-248)

This investigation, which was requested by the House Subcommittee on Trade, Committee on Ways and Means, updated the Commission's 1984 report on the administration and operation of foreign-trade zones (FTZs) and sub-zones. The principal findings were as follows:

- The most rapid growth in the program occurred in subzones engaging in manufacturing and assembly. Almost 90 percent of the manufacturing and assembly activity involved autos and auto parts and components.
- Most economic activity now taking place in FTZs would continue to occur within the United States even if FTZ provisions were eliminated.

Agricultural and Tropical Products: Literature Search Regarding Trade Distortions and Effect of Trade Liberalization, and Calculation of Tariff Equivalents (332-258)

In another investigation requested by the USTR, the Commission will research the international trade distortions in agricultural and tropical products, with applications to the Uruguay Round of Multilateral Trade Negotiations. It will also provide the tariff equivalents of nontariff measures that affect agricultural and tropical U.S. imports and imports of other major trading countries.

U.S. Global Competitiveness Studies

At the request of the Senate Finance Committee, the Commission conducted

a series of investigations to assess the global competitiveness of selected major U.S. industries. The principal findings were as follows:

U.S. Global Competitiveness: U.S. Textile Mill Industry (332-229)

- The textile industry has become more efficient during the past decade, but increased apparel imports have cut its downstream sales of yarn and fabric.
- The industry's improved efficiency will not necessarily expand its world market share. Opportunities in the fast-growing markets in newly industrialized countries appear limited because of the presence of efficient textile industries there.

U.S. Global Competitiveness: Steel Sheet and Strip Industry (332-231)

- The U.S. sheet and strip industry is currently one of the more cost competitive among the major industrialized countries, largely because of the sharp decline in the value of the dollar and its effect on labor costs.
- U.S. labor productivity in the sheet and strip industry is currently estimated to be the highest among the principal competing countries, chiefly as a result of the greater flexibility U.S. producers have in adjusting manning levels during nonpeak operating periods.

U.S. Global Competitiveness: U.S. Automotive Parts Industry (332-232)

- The U.S. automotive parts industry is gaining competitive strength through the increased implementation of certain quality control, delivery, pricing, and production techniques. However, data indicate that all but one major country producing automotive parts held an overall cost advantage over the United States.
- The structure of the U.S. automotive parts industry has become increasingly complex and has undergone a large degree of internationalization. Changing demands on parts suppliers by automobile assemblers and foreign local-content requirements have increased the participation of U.S. parts makers in joint ventures, mergers, and licensing agreements.

U.S. Global Competitiveness: Optical Fibers, Technology and Equipment (332-233)

- Growth of the U.S. optical fibers industry has been rapid during the past several years. A headstart in production technology and the possession of important basic patents for manufacturing optical fibers have enabled the U.S. industry to retain a strong competitive position in the United States and important overseas markets.
- As some of the basic U.S. patents begin to expire within the next several years, the U.S. industry may face major challenges from foreign competitors in Japan, Western Europe, and Canada in both domestic and foreign markets.

U.S. Global Competitiveness: Oilseeds and Oilseed Products (332-240)

- World markets for oilseeds and oilseed products have grown significantly in recent years, but soybean products have declined in importance in these markets.
- Future demand for oilseeds and oilseed products is likely to grow. The growth rate for the demand in vegetable oil will probably surpass the growth rate for the demand in meal. The U.S. industry has built up competitive strengths in international trade that will continue to be important in the future.



1



2

10



1

Workers prepare to load file cabinets onto a moving van for a trip to the new headquarters across town.

2

The new ITC Building is located at 500 E Street SW. A view of the building from the north shows the building's proximity to the Southeast-Southwest Freeway and the southwest section of the city. The rooftop terrace provides a spectacular view of the Capitol, the monuments, and the Potomac River.

3

United States Trade Representative Clayton Yeutter addresses ITC staff members and guests during a building dedication ceremony at the new ITC Building on March 3.

4

The Main Hearing Room is located on the ground floor of the new ITC Building. It is one of six rooms in which the Commission conducts meetings and hearings.

3



4



Terry Hite of the Office of the Secretary receives stacks of petitions filed in June by the Gates Rubber Co. of Denver, CO, alleging that industrial belts are being sold in the United States at less than fair value.



In a blanket of January snow, a security officer lowers the flag for the last time at the old ITC Building at 701 E Street NW.

Part II. Organizational Activities

Office of Investigations

The Office of Investigations is responsible for coordinating the Commission's countervailing duty, antidumping, and review investigations under provisions of the Tariff Act of 1930, escape-clause and market disruption investigations under the Trade Act of 1974, and investigations under section 22 of the Agricultural Adjustment Act to determine whether imports of agricultural products are interfering with programs of the U.S. Department of Agriculture. The primary responsibility of the Office of Investigations staff is to present the Commission with an accurate and complete staff report in a timely and objective manner in order for the Commission to make an informed decision on the basis of the merits of the investigation.

Four investigative divisions make up the principal operating units of the Office of Investigations. The staff of 20 investigators and 4 supervisory investigators coordinates all facets of an investigation; the staff acquires a working knowledge of the industry and the product under investigation, principally from primary sources such as industry questionnaires and visits to production facilities. In the report to the Commission, the staff coordinates and presents data that reflect the economic condition and performance of the industry. Data include, but are not limited to, capacity, production, capacity utilization, domestic and export shipments, inventories, imports, domestic market shares held by U.S. and foreign suppliers, employment, hours worked, productivity, wages and total compensation, unit labor costs, pricing, distribution channels, and full financial data on the U.S. companies producing the product under investigation. The investigative staff also obtains and analyzes an abbreviated form of such information regarding the foreign industry producing the product under investigation.

The varieties of products and market structures studied require the staff to use various research methods, including sampling techniques involving large numbers of producers or importers. Staff members continue to develop computer skills that allow them to use data in such a way as to increase the ITC's ability to perform microeconomic analysis.

Growing emphasis is being placed on improving the quantity and quality of foreign-industry data. For example, in the ITC investigations on granite, fieldwork was conducted in Italy, which is known to be the largest and most technologically advanced producer of granite in the world.

This year, Investigations' staff members revised the questionnaire format and certain operating procedures to incorporate recommendations of the General Accounting Office. For example, increased efforts were made, including on-site verification visits, to ensure the accuracy of data submitted in questionnaires by U.S. producers. Consultants are working with the staff to improve and expand verification procedures. As the fiscal year drew to an end, staff members were instituting guidelines to implement changes in the office's functions required by the Omnibus Trade and Competitiveness Act of 1988.

Investigations' staff members worked closely with officials at the Department of Commerce and the Customs Service, parties to the investigations and their attorneys, and company officials for both U.S. producers and importers to obtain information and effectively manage the administrative details of an investigation. Investigators also provide assistance to the USTR following a recommendation to the President by the Commission of action to take in sections 201, 203, and 406 cases.

Office of Industries

The primary focus of the Office of Industries during the past year was research in support of U.S. multilateral trade negotiations, such as the Uruguay Round, with the beginning of a project that will evaluate the probable effects of liberalizing tariff and nontariff measures. In addition, the office took numerous initiatives in fiscal year 1988 to improve the quality of its investigative analyses and reports, specifically by increasing the use of computers and by changing questionnaire design and processing, data access, and report presentation.

The office enhanced the quality of questionnaire responses by improving sampling techniques and sharpening questionnaire focus. This effort not only

greatly reduced the burden on industry respondents and the time required for Office of Management and Budget approval of questionnaires, but also improved the value of data and increased the time available for analysis.

To expand its capabilities to analyze service industries, the office added three staff members who cover transportation, construction/architecture/engineering, and financial services. The new staff members joined 12 colleagues who cover 14 other service industries part time in addition to their product responsibilities. At yearend the analysts began a major services study that the USTR had requested.

During fiscal year 1988, the office, consisting of six divisions and 142 employees (accounting for more than 25 percent of the Commission's employees), conducted 26 investigations under section 332 of the Tariff Act of 1930, including both one-time factfinding studies and continuing industry surveys. Many of these studies explored areas in which there is little available information or investigative precedent. They included assessments of the use and economic impact of TSUS items 806.30 and 807.00, foreign protection of intellectual property rights, savings from certain temporary duty suspensions, and the implications of foreign-trade zones for U.S. industries. In addition, the office led studies on the international competitiveness of U.S. producers in such areas as textile mill products, oilseeds, steel sheet and strip, auto parts, optical fibers, certain vegetables, and steel.

Nine continuing industry surveys aided Congress or the executive branch in monitoring U.S. imports and domestic production of various products. Three of these were at the request of the President, five were at the request of Congress, and one was conducted on the Commission's own motion.

The office published surveys covering synthetic organic chemicals, trade under provisions 806.30 and 807.00 of the TSUS, stainless steel and alloy tool steel, steel subject to the President's program of voluntary restraint agreements (VRAs), competitive conditions in the steel industry and industry efforts to adjust and modernize, automobiles, rum, various tungsten compounds, and nonrubber footwear.

Toward the end of the year, the office began an analysis in anticipation of supporting the Uruguay Round of Multilateral Trade Negotiations under the General Agreement on Tariffs and Trade

(GATT). This study will be the largest, most comprehensive analysis undertaken by the office in recent years. Trade digests encompassing 8,000 tariff-rate line items will analyze the economic impact on U.S. trade of both tariff reductions and the removal of nontariff measures.

The Commission instituted an investigation (332-247) on the cost savings from temporary duty suspensions at the request of the House Subcommittee on Trade, Committee on Ways and Means. This study was to determine whether and to what extent miscellaneous temporary duty suspensions enacted in Public Law 98-573 (title I, subtitle C)

have decreased costs to U.S. consumers or caused other economic benefits.

Another investigation (332-253), which the USTR requested, will report on the competitive, technological, and economic factors affecting the performance of the California and Arizona vegetable industries producing asparagus, broccoli, and cauliflower in major U.S. markets. The study was to be completed on November 16, 1988.

A further investigation (332-256), which the Senate Finance Committee requested late in fiscal year 1988, will assess the effects of the steel VRAs on the Western U.S. steel market. This study will determine (1) structural



Don Nucci (right) of Mann Packing Co., near Monterey, CA, explains to Vice Chairman Anne E. Brunsdale and Commissioner Seeley G. Lodwick how asparagus is processed and packaged. The visit to the vegetable-packing plant was made in connection with the ITC's investigation on the competitive conditions in the U.S. market for asparagus, broccoli, and cauliflower. The Commission held a hearing on the topic in Monterey on May 17.



Susan Liebler inspects asparagus during processing at the Mann Packing Co. near Monterey, CA, while on a plant visit on May 16.

changes that have occurred in the Western steel industry in recent years, (2) factors limiting the use of domestically produced steel manufactured outside the Western United States, and (3) the economic implications of import restraints on producers of steel products subject to the VRAs and selected major steel-consuming industries in the Western United States. The study was to be completed on March 31, 1989.

Late in the fiscal year, the office received a request from the USTR for an investigation to expedite advice on the probable economic effects of the staged elimination of U.S. duties on tropical products with respect to U.S. industries and consumers (TA-131-12). Section 131 of the Trade Act of 1974 requires the advice for use during the Uruguay Round negotiations on agricultural and tropical products. The study involves a variety of GATT-defined products covered in the new Harmonized Tariff Schedule.

The USTR requested another investigation (332-257) late in the fiscal year that will provide sector profiles on certain U.S. and foreign service industries. This study will assess how nontariff measures—domestic and foreign—affect U.S. trade in services, and it will estimate the effect on U.S. service sectors of the removal of trade impediments. The 11 service sectors to be examined are accounting and related services; advertising; construction, engineering, and architectural services; educational and training services; equipment rental and leasing; franchising; health and medical services; insurance; management consulting; telecommunications and information services; and tourism.

Office of Economics

The Office of Economics provides economic analyses to help the Commission perform its two main functions: investigating the effects of imports on competing U.S. industries and providing expert advice to Congress and the President on international economic issues. The 1988 fiscal year activities of the office are as reported by each of its three divisions.

The Research Division staff devoted much of its time to section 332 investigations. They led investigations on the effects of recent Japanese measures to promote structural adjustment and on worldwide trade distortions in agricultural and tropical products, and they

have begun an investigation on the economic effects of significant U.S. import restraints (recently requested by the Senate Finance Committee). They also participated in other investigations, including those on the impact of the Caribbean Basin Economic Recovery Act on U.S. industries and consumers, the effects of trade liberalization in the Uruguay Round of Multilateral Trade Negotiations, the effects of voluntary restraint agreements on the steel market of the Western United States, and the effects of nontariff barriers against U.S. service exports. In addition to working on 332 investigations, the staff also devoted considerable time to import injury investigations and developed a comprehensive method for estimating the effects of unfair trade practices on domestic producers.

The Trade Reports Division worked on a wide range of issues in fiscal year 1988, conducting research under section 332 of the Tariff Act of 1930, producing statutory reports on U.S. trade, and providing policymakers and the public with information and analysis on bilateral and multilateral issues.

Division economists led a major research project on the pros and cons of entering into negotiations with Japan toward a possible United States-Japan free-trade area agreement (332-255). The report on the Commission's investigation presented the main policy arguments for and against such negotiations, along with a review of current United States-Japan negotiating forums, recent United States-Japan trade developments, barriers in the Japanese market, and the present approach for resolving bilateral trade conflicts. The Senate Finance Committee requested an investigation similar to 332-255 in order to examine possible free-trade agreements with the Republic of Korea, Taiwan, the Association of Southeast Asian Nations (ASEAN), and the entire Pacific Rim. This study is scheduled for completion in March 1989. The division staff also participated in the ITC's study on Japan's yen-related structural adjustment measures.

The Trade Reports Division prepared several recurring trade reports as required by statute. One was the annual *Operation of the Trade Agreements Program*. In July 1988, the Commission released the 39th report, which highlighted major developments in U.S. trade policy in 1987, including the realignment of exchange rates among

the major industrialized countries, the bilateral free-trade arrangement with Canada, and the start of the Harmonized Commodity Description and Coding System. The report also included data on U.S. trade under the Generalized System of Preferences (GSP) program and the Caribbean Basin Initiative, a comprehensive review of developments within the GATT and other multilateral forums, and actions taken under U.S. trade law. The report covered details of trade relations with seven major trading partners—the European Community, Canada, Japan, Mexico, Taiwan, the Republic of Korea, and Brazil.

Trade Reports Division staff also monitored the impact of the Caribbean Basin Economic Recovery Act on U.S. industries and consumers and studied several other issues, including the effects of the act on investment in Caribbean countries. Economists traveled to four Caribbean countries to obtain firsthand information on how the act affected their production and exports.

The *Report to the Congress and the Trade Policy Committee on Trade Between the United States and the Nonmarket Economy Countries*, the East-West Trade Report, was submitted quarterly. The ongoing report provides current data on U.S. trade with 16 nonmarket economy countries (NMEs) along with analyses of significant developments in commercial relations and trade. The report also presents the results of the East-West Trade Statistics Monitoring System, which analyzes imports of manufactured goods from NMEs. The system identified the manufacturing industries experiencing rapid growth in imports and significant import penetration by NME suppliers.

The division staff responded to numerous requests for specialized information and technical assistance from Congress, the public, and other Government agencies. They helped the USTR's Trade Policy Staff Committee (TPSC) develop a data base of nontariff measures for possible use in the Uruguay Round. The Trade Reports Division also produced a monthly review of trade and policy developments, the *International Economic Review*, which gives information on significant economic and policy developments abroad that may affect U.S. commerce. The review was distributed to Members of Congress and the public on request.

The Investigation Support Division¹⁵ economists analyzed a variety of indus-

tries, including granite, all-terrain vehicles, brass sheet and strip, micro-disks, color picture tubes, fabricated structural steel, bimetallic cylinders, and forklift trucks.

In fiscal year 1988, Investigation Support Division economists continued to apply new research methods. In a section 203 investigation (TA-203-18), an economist used an economic model to examine the probable effects of terminating section 201 relief for the wood shakes and shingles industry. Division staff also worked on a section 201 investigation on knives (TA-201-61), applying an economic model to determine whether certain tariffs and quotas would remedy the problem of increased imports.

In addition to providing the Commission with estimates of supply and characteristics of demand in all final investigations, Investigation Support Division economists provided such estimates to outside parties to investigations prior to Commission hearings so that these parties were able to review and comment on the estimates. In final investigations, staff economists were also including estimates of the effect of dumping on the price and volume of sales of the domestic product. These estimates were based on methodology developed in the office.

Office of Tariff Affairs and Trade Agreements

A major accomplishment of the office during fiscal year 1988 was the publication of concordances and trade tables providing U.S. import and export trade data for the past five years under the Harmonized Commodity Description and Coding System. The Commission expects the international trade community to make extensive use of the so-called bridge data tables as the United States moves to the Harmonized System.

Office attorneys prepared draft legislation at the request of the USTR to implement the new Harmonized Tariff Schedule. They continue to work on a Presidential proclamation to make the new tariff effective and to adopt conforming changes in various trade programs.

Office attorneys also coordinated the Commission's preparation of reports on 88 tariff bills, as shown in Appendix C: Reports Submitted to Congress on Proposed Legislation, Fiscal Year 1988. They assisted the House Ways and Means Committee and the Senate Fi-



Commissioner David Rohr (left) and ITC staff member John Ryan (right) discuss with Dennis Mehlstrom of the Sandy Shake Co. the mill's adjustment in response to the 35-percent tariff on imported western red cedar shakes and shingles. The visit in August to the Sandy Shake Co., Sandy, OR, was made in connection with the Commission's investigation on wood shakes and shingles.

nance Committee in their consideration of the tariff legislation.

The new tariff schedule will replace the existing TSUS on January 1, 1989. The office annually prepares the Commission's publication *Harmonized Tariff Schedule of the United States* (HTS) and periodic supplements updating its provisions. The HTS contains about 8,700 legal classifications and covers each article that may be imported into the United States.

During the year, the staff prepared two supplements to the 1987 TSUS to reflect modifications resulting from Presidential proclamations and other trade actions.

The staff also worked on other trade agreement activities that are the responsibility of the Commission and the TPSC. For example, international economists in the office revised the Commission's trade data base in preparation for U.S. implementation of the Harmonized System on January 1, 1989.

Office of Unfair Import Investigations

The Office of Unfair Import Investigations is a party to adjudicatory investigations conducted under section 337 of the Tariff Act of 1930, represents the public interest, and is responsible for ensuring that a complete record is developed in section 337 investigations and that the relevant issues are briefed

for the factfinders—the administrative law judges and the Commission. Investigative attorneys from the office actively participate with private parties throughout these investigations. Unlike the private litigants, the investigative staff represents the public interest rather than the private interests of a complainant or respondent. This is important because the remedies available in section 337 investigations may affect non-parties and U.S. consumers.

The office reviews section 337 complaints prior to instituting an investigation and advises the Commission whether the complaint alleges a cause of action under section 337 and complies with the governing Commission Rules. Prior to institution, the office engages in informal investigation of the factual and legal bases for the allegations in the complaint. On request, the office also provides informal advice to prospective complainants regarding filing a complaint.

During a section 337 investigation, attorneys take discovery, examine witnesses and present evidence at the hearing, and submit briefs on factual and legal issues to the administrative law judges. The staff also submits briefs to the Commission during the review and remedial phases. Given the public interest nature of section 337 investigations, the time constraints imposed by the statute, and the fact that many

parties do not want to participate, the investigative staff's participation "on the record" ensures that the factfinder has the relevant facts and is offered an independent focus on the myriad issues presented in these investigations.

The investigative staff also attempts to facilitate settlement negotiations among the parties. The staff reviews consent order agreements and settlement agreements to ascertain whether they are in the public interest and comply with the Commission's Rules and, when the parties seek a consent order, whether the order would constitute a proper exercise of the ITC's jurisdiction.

During fiscal year 1988, there were 34 active section 337 investigations. In these, producers sought protection from alleged infringement of intellectual property rights in a host of different industries including biotechnology, semiconductors, pharmaceuticals, medical instruments, industrial catalysts, reflective sheeting, and various consumer products. The Commission terminated seven investigations as a result of settlement agreements or consent orders entered into by the parties prior to an evidentiary hearing. Settlement agreements and consent orders were also entered in 11 other investigations. Of the 11 investigations in which the Commission made final determinations on the merits, a violation was found in 6 investigations.

Trade Remedy Assistance Center

The Trade Remedy Assistance Center was established by Congress to provide general information to the public on remedies and benefits available under U.S. trade laws and to provide technical assistance to eligible small businesses seeking relief under those trade remedy laws administered by the ITC.

In response to inquiries from the public, the center provides information on the statutes that the ITC administers (app. B). When appropriate, the center makes referrals to other offices within the Commission and to other agencies responsible for administering particular trade laws. The general information service of the center is available to all members of the public regardless of whether the person represents a small business.

The center provides technical assistance to eligible small businesses seeking a remedy under one or more of the trade remedy laws administered by the ITC if, because of their small size, they have neither adequate resources nor the

financial ability to obtain qualified outside assistance. Application for technical assistance involves certification by an officer or principal of the business that it qualifies as a small business under the Small Business Administration standards.

The center staff is available to meet with eligible small businesses to discuss the petition process and to help organize and assemble relevant background material. The center has assisted eligible small businesses at the preinstitution stage in analyzing their trade-related problems and deciding which statutes may offer relief. Technical assistance may include the review of initial drafts submitted by the eligible small business and advice on additions, deletions, and possible alternative presentations, leading to the final preparation of the petition for filing with the ITC. Such assistance may also include discussion of relevant ITC precedents and publications.

In fiscal year 1988, the center responded to approximately 230 inquiries. In addition to small businesses, the center received inquiries from Congress, Government agencies, law firms, trade associations, the press, and academia.

The Omnibus Trade and Competitiveness Act of 1988 provides for establishment of a separate office in the Commission to be known as the Trade Remedy Assistance Office. The functions of this office will encompass those formerly performed by the Trade Remedy Assistance Center.

Office of Data Systems

In fiscal year 1988, the office helped plan and implement the move of office automation and applications development equipment to the new building. This required installation of approximately 400 new personal computer (PC) work stations.

The Statistical Services Division staff served as advisors for the Commission's staff on the application of statistical theory, especially the use of sampling for obtaining information needed in the Commission's investigative and research studies. The division responded daily to inquiries for trade data and assisted in evaluating data reliability. The division also prepared four statistical bulletins summarizing import and export information for use in the trade community. In fiscal year 1988, Statistical Services staff performed 50 detailed statistical reviews of Commission investigative reports. It also assisted the Offices of Industries and Economics with statistics

and other information in several 332 investigations.

The Applications Development Division provided analysis and programming support for new agency applications requiring mainframe computer processing. It also provided technical support for existing production systems. The staff provided data processing support for the allocation of U.S. import and export trade data from the old *Tariff Schedules of the United States Annotated* (TSUSA)/schedule B nomenclature to the new Harmonized Tariff System nomenclature.

The National Library of International Trade, the main library of the Commission, is the newest Federal library facility in Washington. The Library Division staff used its new facilities to host the spring membership meeting of FEDLINK, the Federal library network.

A result of the upgrading of facilities was the library's expanded service to users. In addition to achieving more shelf capacity, which now allows the Library Division staff to shelve all of its volumes, an audiovisual room was installed, which enables users to listen to audio tapes and to view video tapes. A rare-book room was also installed. The library staff has begun establishing special collection areas for use with ongoing ITC projects.

Fiscal year 1988 data on library operations are as follows:

| | |
|---------------------------------------|--------|
| Reference or research inquiries from— | |
| Commission staff | 20,123 |
| Commissioners and their staff | 1,856 |
| Government agencies | 1,654 |
| The public | 3,232 |
| Congress | 11 |
| Total | 26,876 |
| Computer searches | 212 |
| Interlibrary loans: | |
| Books borrowed | 755 |
| Books loaned | 829 |
| Reference desk circulation | 9,867 |

Office of Administration

The Office of Administration managed the relocation and consolidation of all of the Commission's operations into the ITC Building at 500 E Street SW. Planning for the move began in fiscal year 1987 and continued into fiscal year 1988. The move took place during December 1987 and January 1988. The gain in space over the Commission's previous location enabled the Commission to house all of its offices at one site for the first time since 1975. The General Services Administration holds a 10-year lease on the Commission's building space.

During the year, the office contracted with Arthur Andersen & Co. to give the Commission two program reviews. One was an assessment of the Commission's handling of sensitive automated data, and the other was a study for the Commission on information resource systems and an associated management support plan. As a result of the security assessment, the office issued a Commission handbook of procedures for handling sensitive automated data. As of the end of fiscal year 1988, the Commission was continuing to review the information resources study recommendations for implementation.

The office streamlined the process of acquisition from the point of internal requisition notice to the delivery of goods and services. At the close of the fiscal year, the office had nearly completed the installation of an automated property inventory control system. The office automated several additional accounting systems and facilities management controls through increased automation capacity.

Extensive employee development program activity occurred during fiscal year 1988. Continuing education and development activities were provided to Senior Executive Service members, managers, and the professional and support staff. In addition, action was taken during the year to award, in fiscal year 1989, a comprehensive office automation training contract in order to provide a variety of computer-related training to the professional and support staff. This training will take place at the ITC Building and the contractor's site in the Washington metropolitan area.

Office of Administrative Law Judges

During fiscal year 1988, the Office of Administrative Law Judges held 10 evidentiary hearings on section 337 cases in accordance with the Administrative Procedure Act. These hearings ranged in length from 3 days to 11 weeks and involved products such as topical minoxidil (baldness remedy), erythropoietin (genetically engineered hormone), erasable programmable read-only memories (computer chips), plastic screw anchors, and recloseable plastic bags.

During this period, the judges disposed of 11 cases without an evidentiary hearing by settlement, withdrawal of the complaint, or summary determination.

Office of Congressional Liaison

The Office of Congressional Liaison serves as the primary point of contact between the ITC and Congress. Functions the office routinely performs include clarifying congressional intent in 332 investigation requests, responding to inquiries from Members of Congress, and ensuring that the Commission is apprised of legislative initiatives that, if enacted, would affect its operations. The office is active in communicating ITC concerns regarding developing legislation to cognizant congressional staff and Members and in ensuring that they receive the technical advice necessary to fashion pending legislation.

Fiscal year 1988 was one of extensive legislative activity in the domain of international trade. A major legislative focus was the Omnibus Trade and Competitiveness Act of 1988, the most comprehensive revision of U.S. trade law since the inception of the GATT. This act, signed into law on August 23, 1988, provides for a number of section 332 commodity studies and revises many of the statutes implemented by the ITC, including statutory provisions concerning the ITC Trade Remedy Assistance Office, ITC responsibility under the Paperwork Reduction Act, and the release of confidential business information in title VII dumping and countervailing duty cases. Following the signing of a free-trade agreement with Canada in January, Congress labored for the remainder of the year developing legislation to implement the agreement. Issues of ITC concern with regard to the United States-Canada Free-Trade Agreement include the development of efficient procedures for operation of binational panel proceedings, Commission participation in such proceedings, and legislative provisions relating to the implementation of panel decisions by the Commission.

Office of the Secretary

The Office of the Secretary compiles and maintains ITC's official records, such as petitions, briefs, and other legal documents. It issues the Commission's notices, reports, and orders, and it schedules and participates in all ITC meetings (32 in fiscal year 1988) and hearings (21 days of hearings in fiscal year 1988). The office also has been a depository for historical information on the Commission since 1916. It makes determinations on requests for confidential treatment of private information,

requests for information released under protective order, and requests under the Freedom of Information Act.

The following tabulation shows the volume of these requests for fiscal year 1988 compared with the number in fiscal year 1987:

| | Fiscal year 1987 | Fiscal year 1988 |
|--|------------------------|------------------------|
| Requests for confidential treatment | 399 | 253 |
| Requests for release of confidential business information under protective order | 81 | 59 |
| FOIA requests: | | |
| Received | 113 | 77 |
| Granted | 81 | 61 |

Facilities for research by the public are located in the Office of the Secretary, room 112, and in the ITC libraries. Inquiries should be directed to the specific organizational unit or to the Secretary, U.S. International Trade Commission, 500 E Street SW., Washington, DC 20436, telephone 202-252-1000. Publications may be ordered 24 hours a day, 7 days a week, by calling 202-252-1809.

Office of Executive and International Liaison

Major activities during the year included assistance to the USTR in its work on the Uruguay Round of Multilateral Trade Negotiations, support in the completion of negotiations on the Canada-United States Free-Trade Agreement, and advice and assistance in the preparation of legislation to implement the agreement and other actions taken in the execution of U.S. trade policy by the USTR.

Office of the General Counsel

The General Counsel is the Commission's chief legal advisor. The General Counsel and her staff of 25 attorneys represent the Commission in court, provide advice to the Commissioners in connection with statutory investigations, draft opinions and other legal documents, and offer other assistance in ethics, labor relations, and contracts matters. The office also from time to time provides technical assistance to the Congress and the executive branch on legislation and generates background information and support as, for example, in connection with the Canada-United States Free-Trade Agreement and certain GATT negotiations. A summary of fiscal year litigation involving the ITC is found in Appendix D: Litigation in Fiscal Year 1988.

Law Library

The Law Library is a resource of the Office of the General Counsel. The library contains more than 10,000 volumes, participates in an exchange program with other libraries, and is open to the public. In fiscal year 1988, the agency's relocation resulted in a doubling of shelf space and seating capacity in the library.

Office of Public Affairs

Through its determinations, investigations, and studies, the ITC received considerable attention from the world press in fiscal year 1988. The agency's study on the pros and cons of a possible

free-trade agreement between the United States and Japan drew intense interest from the international press corps.

The Commission received concentrated press coverage in California when, in the spring, it conducted a field hearing in Monterey on the impact of imports of cauliflower, broccoli, and asparagus.

The Commission unanimously adopted a new symbol for the agency, an eagle and globe logotype, to help sharpen the agency's identity. The logotype joined the official seal as one of two symbols of the ITC.



UNITED STATES

INTERNATIONAL

TRADE COMMISSION



Part III. Management and Finance

The Commission maintains an expert staff of professional international trade and nomenclature analysts, investigators, attorneys, economists, data systems programmers, and administrative support personnel to do the work mandated by Congress.

A total of 462 permanent employees were employed by the Commission on September 30, 1988, compared with 450 at the end of the previous fiscal year.

The breakdown of their assignments is as follows:

| Organizational unit | Number as of Sept. 30, 1988 |
|---|--------------------------------|
| Commissioners | 6 |
| Offices of the Commissioners | 21 |
| Office of the Administrative Law Judges | 12 |
| Office of the Secretary | 17 |
| Office of Public Affairs | 2 |
| Office of Executive and International Liaison | 3 |
| Office of Congressional Liaison | 2 |
| Office of the General Counsel | 41 |
| Office of the Director of Operations | 3 |
| Office of Data Systems | 38 |
| Office of Economics | 38 |
| Office of Industries | 142 |
| Office of Investigations | 32 |
| Office of Tariff Affairs and Trade Agreements | 23 |
| Office of Unfair Import Investigations | 17 |
| Office of the Director of Administration | 3 |
| Office of Finance and Budget | 10 |
| Office of Management Services | 40 |
| Office of Personnel | 12 |
| Total | 462 |

The U.S. International Trade Commission submits its budget to the President for transmittal to Congress. Because of the unique role of the Commission as a quasi-judicial, bipartisan, independent agency designed to provide trade expertise to both legislative and executive branches of Government, Congress provided in section 175 of the Trade Act of 1974 (19 U.S.C. 2232) that the ITC budget would not be subject to control by the Office of Management and Budget but would instead be submitted directly to Congress.

During fiscal year 1988, appropriated funds made available to the Commission amounted to \$34,750,000. Reimbursements received totaled \$16,000, making available a grand total of \$34,766,000. Obligations for fiscal years 1987 and 1988 were as follows (in thousands of dollars):

| Item | Fiscal year 1987 | Fiscal year 1988 |
|--|------------------------|------------------------|
| Salaries and personnel benefits | \$20,405 | \$21,812 |
| Travel and transportation .. | 532 | 638 |
| Rental and communications services | 3,186 | 6,170 |
| Other services | 2,009 | 2,213 |
| Printing and reproduction . | 221 | 353 |
| Equipment, supplies, and material | <u>2,290</u> | <u>2,639</u> |
| Subtotal | <u>28,643</u> | <u>33,825</u> |
| Relocation | <u>2,092</u> | <u>1,752</u> |
| Total | \$30,735 | \$35,577 |

Figure 1
 Summary of principal activities, fiscal years 1985-88

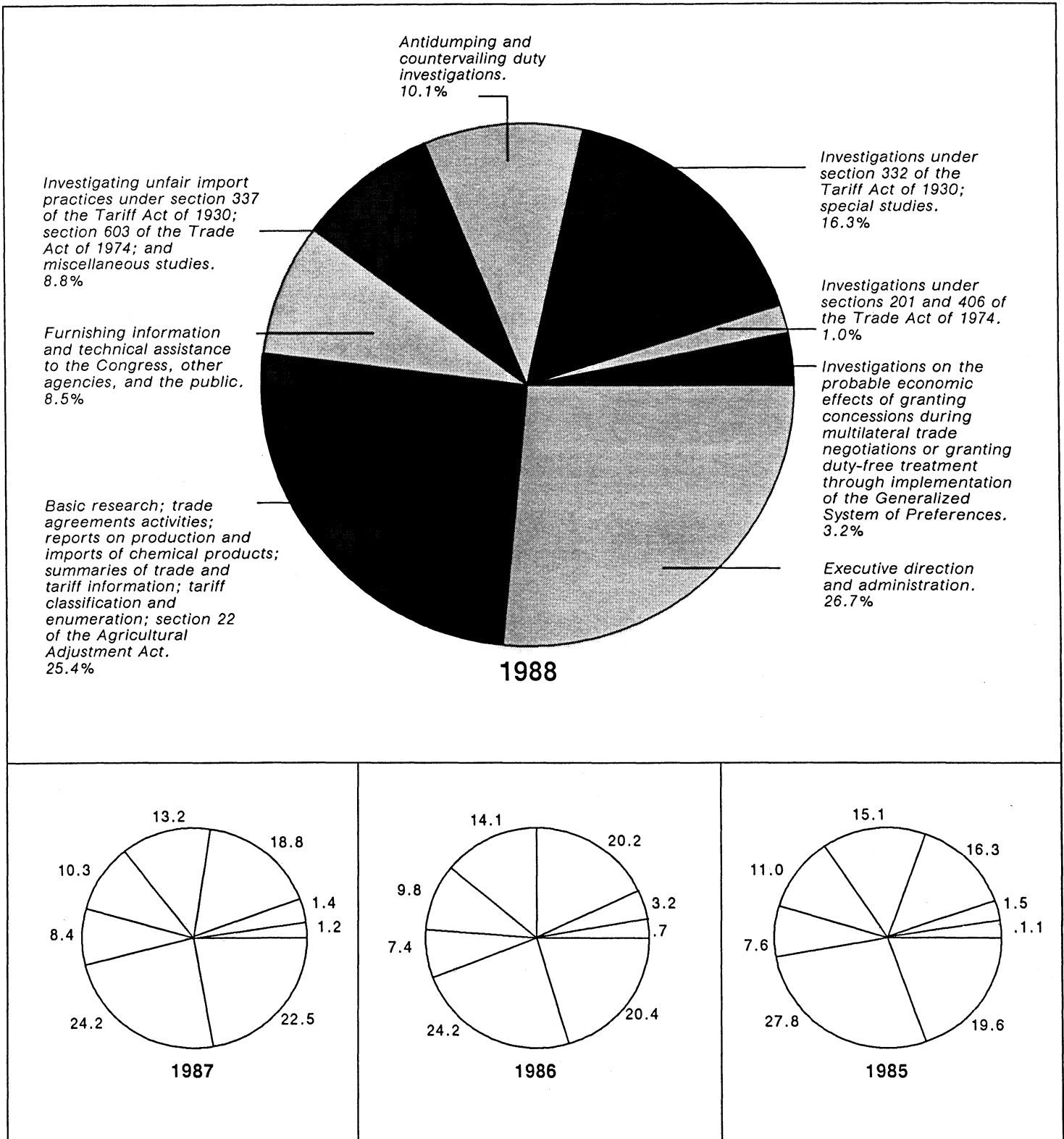

Figure 2

Functions of offices and Commission organization

| | |
|--|--|
| The Commission | The ITC is composed of six Commissioners nominated by the President and confirmed by the Senate. |
| Office of the Secretary | Compiles and maintains the Commission's official records and receives petitions and briefs. |
| Office of Administrative Law Judges | Hears and decides unfair trade practice cases brought under section 337 of the Tariff Act of 1930. |
| Office of Congressional Liaison | Coordinates activities between the Commission and Congress and responds to inquiries from congressional offices. |
| Office of Public Affairs | Advises Commissioners and senior staff in public relations matters and plans and administers the media relations program. |
| Office of Executive and International Liaison | Coordinates relations between the Commission and the United States Trade Representative and other Executive Branch offices. |
| Office of the General Counsel | The Commission's principal legal advisor, responsible for litigation, input on investigations, and reports on proposed legislation. |
| Office of Operations | Supervises all substantive work of the Offices of Investigations, Industries, Economics, Data Systems, Tariff Affairs and Trade Agreements, and Unfair Import Investigations. |
| Office of Data Systems | Provides information services and resources through the ongoing activities of its four divisions—Computer Services, Library, Statistical and Applications Development. |
| Office of Economics | Provides economic analyses to help the Commission investigate the effects of U.S. foreign trade on domestic production, employment, and consumption and to provide expert advice to Congress and the President on international economic issues. |
| Office of Industries | Provides technical and economic information and assessments of U.S. industries and merchandise trade. |
| Office of Investigations | Coordinates the Commission's countervailing duty, antidumping, and review investigations, escape-clause and market disruption investigations, and investigations under section 22 of the Agricultural Adjustment Act. |
| Office of Tariff Affairs and Trade Agreements | Prepares reports on tariff legislation, publishes U.S. tariff schedule, chairs import-export statistical committee, participates in Harmonized System Committee. |
| Office of Unfair Import Investigations | Participates in all investigations conducted under section 337 of the Tariff Act of 1930. |
| Trade Remedy Assistance Center | Provides information to the public on remedies and benefits available under U.S. trade laws and offers technical assistance to eligible small businesses seeking relief under the trade remedy laws. |
| Office of Administration | Supervises support services of the Commission, which include the Offices of Finance and Budget, Management Services, and Personnel. |
| Office of Finance and Budget | Responsibilities include the budget, payroll, and accounting functions. |
| Office of Management Services | Coordinates mail, supply, and building maintenance services, editorial, graphics and procurement functions. |
| Office of Personnel | Recruits, places, and trains employees and administers position classification, benefits, employee relations, and labor relations programs. |

International Trade Commission

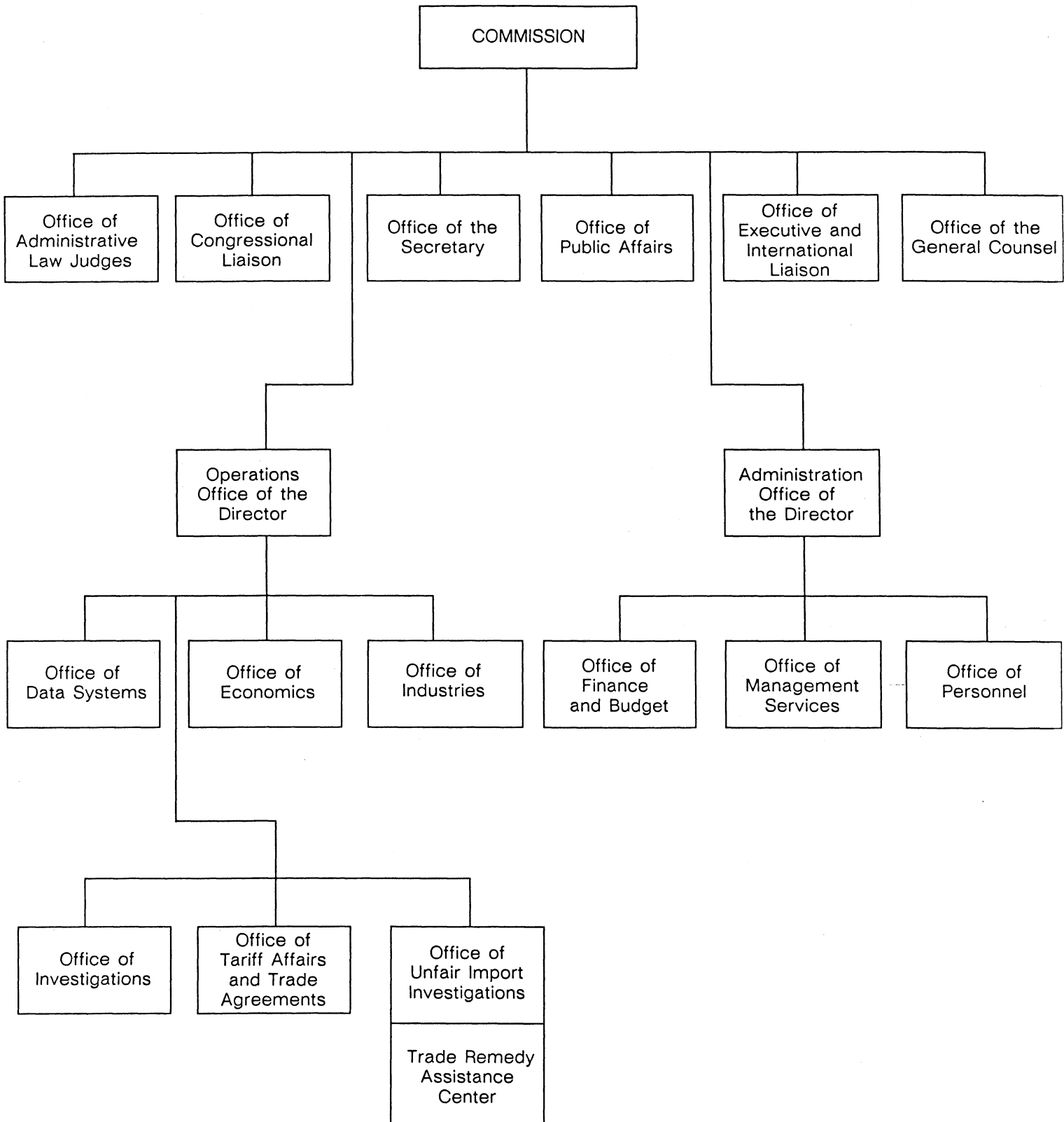
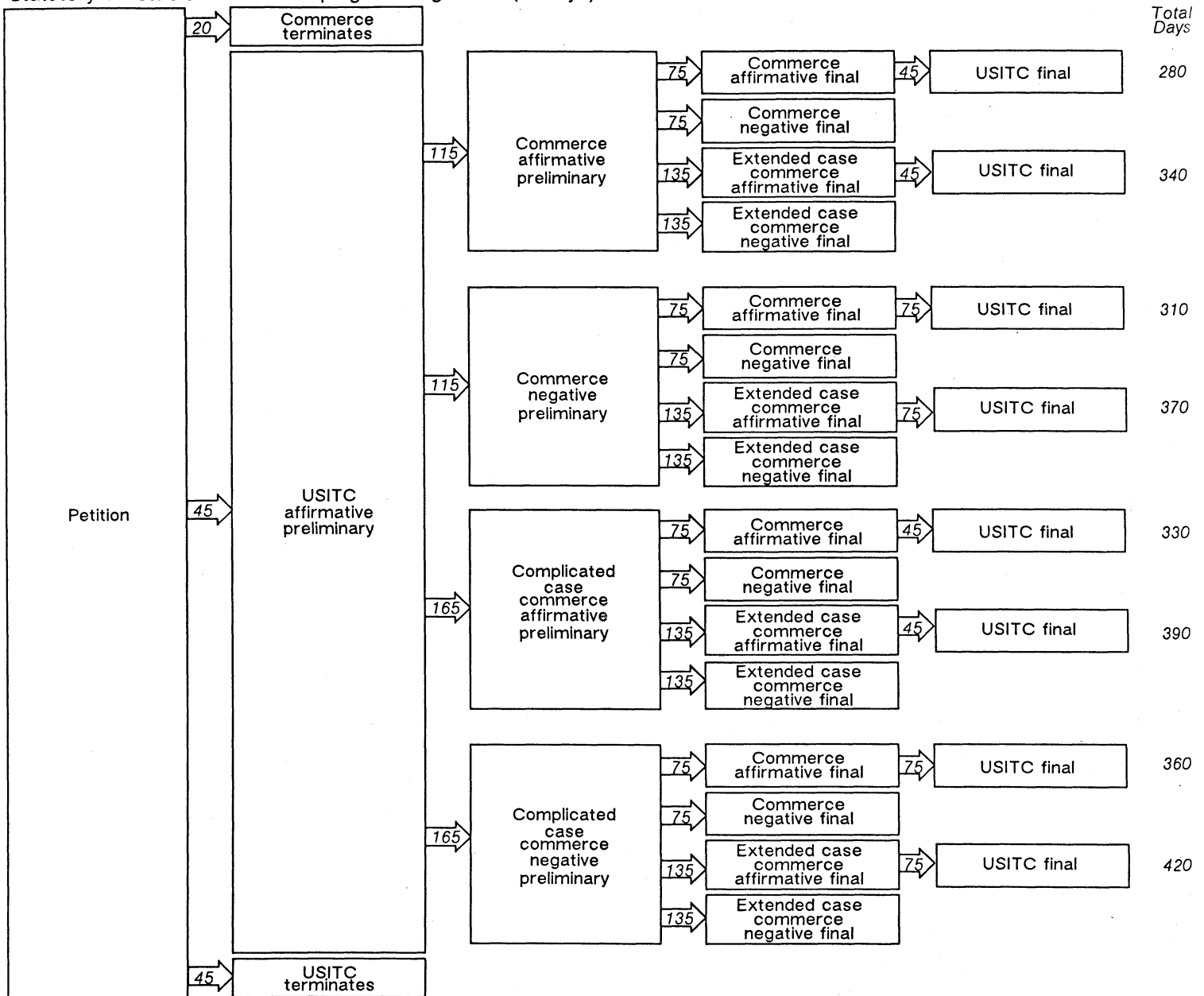
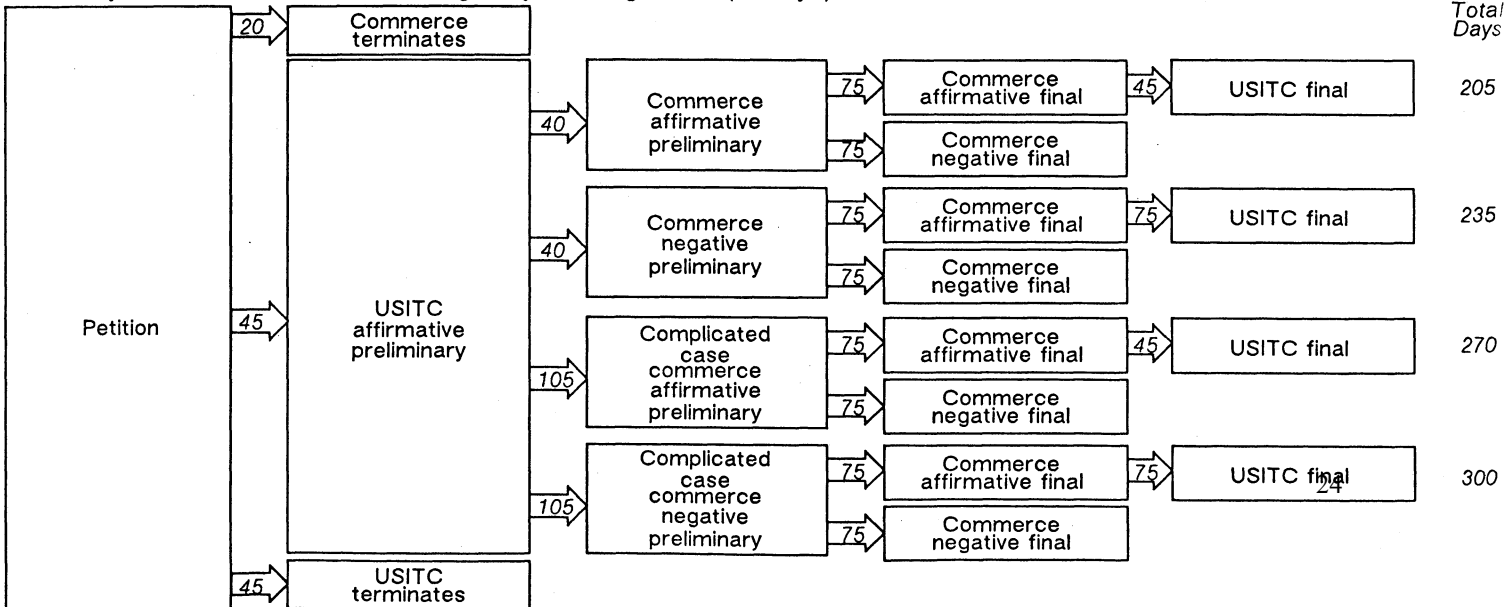

Figure 3
 Statutory timetables for antidumping and countervailing duty investigations
 Statutory timetable for antidumping investigations (in days)



Statutory timetable for countervailing duty investigations (in days)



Appendix A

Summary of Investigations Completed During Fiscal Year 1988 and Pending on September 30, 1988

Table 1
General investigations of trade and tariff matters completed
under sec. 332 of the Tariff Act of 1930, fiscal year 1988

| Investigation No. | Subject | Origin | USITC Publication | |
|-------------------------------------|---|--|-------------------|---------------|
| | | | No. | Date |
| 332-97 (terminated 9-9-87). | Report on consumption of corn brooms. | Public Law 89-241 and Executive Order No. 11377. | (1) | (1) |
| 332-164 (terminated 10-9-87). | Quarterly and annual reports providing information on heavyweight motorcycles. | Presidential Proclamation No. 5050. | (1) | (1) |
| 332-229 | U.S. global competitiveness: The U.S. textile mill industry. | Request from the Committee on Finance, U.S. Senate | 2048 | December 1987 |
| 332-231 | U.S. global competitiveness: Steel sheet and strip industry. | Request from the Committee on Finance, U.S. Senate | 2050 | January 1988 |
| 332-232 | U.S. global competitiveness: U.S. automotive parts industry. | Request from the Committee on Finance, U.S. Senate | 2037 | December 1987 |
| 332-233 | U.S. global competitiveness: Optical fibers, technology and equipment. | Request from the Committee on Finance, U.S. Senate | 2054 | January 1988 |
| 332-240 | U.S. global competitiveness: Oilseeds and oilseed products. | Request from the Committee on Finance, U.S. Senate | 2045 | December 1987 |
| 332-244 | The use and economic impact on TSUS items 806.30 and 807.00. | Request from the Subcommittee on Trade, Committee on Ways and Means, U.S. House of Representatives. | 2053 | January 1988 |
| 332-245 | Foreign protection of intellectual property rights and the effect on U.S. industry and trade | Request from the United States Trade Representative at the direction of the President. | 2065 | February 1988 |
| 332-247 | Cost savings or other benefits to U.S. con- sumers resulting from temporary duty sus- pensions in the Trade and Tariff Act of 1984. | Request from the Subcommittee on Trade, Committee on Ways and Means, U.S. House of Representatives. | 2060 | February 1988 |

See footnotes at end of table.

Table 1—Continued
General investigations of trade and tariff matters completed
under sec. 332 of the Tariff Act of 1930, fiscal year 1988

| Investi- gation No. | Subject | Origin | USITC Publication | |
|------------------------|--|---|--------------------------------------|------------------------------|
| | | | No. | Date |
| 332-248 | The implications of foreign trade zones (FTZs) for U.S. industries and for competitive conditions between U.S. and foreign firms (supplement and expansion). | Request from the Subcommittee on Trade, Committee on Ways and Means, U.S. House of Representatives. | 2059 | February 1988 |
| 332-249 | President's list of articles which may be designated or modified as eligible articles for purposes of the U.S. Generalized System of Preferences. | Request from the United States Trade Representative at the direction of the President. | 2041 | November 1987 |
| 332-250 | Continuity of import and export trade statistics after implementation of the Harmonized Commodity Description and Coding Systems. | Request from the United States Trade Representative at the direction of the President. | 2051 | January 1988 |
| 332-251 | An analysis of recent Japanese measures to promote structural adjustment. | Request from the United States Trade Representative at the direction of the President. | (²) (²) | April 1988 September 1988 |
| 332-255 | Report on the pros and cons of initiating negotiations with Japan to explore the possibility of a United States-Japan Free-Trade Area Agreement. | Request from the Committee on Finance, U.S. Senate. | 2120 | September 1988 |

¹ Not applicable.

² Confidential report; no publication number assigned.

Table 2
General investigations of trade and tariff matters under sec. 332
of the Tariff Act of 1930 pending on Sept. 30, 1988

| Investigation No. | Subject | Origin | USITC Publication | |
|-------------------|---|---|--|--|
| | | | No. | Date |
| 332-73 | Formulation of an international commodity code. | Sec. 608(c)(1) of the Trade Act of 1974. | (¹) | (¹) |
| 332-135 | Synthetic organic chemicals report. | Instituted by the U.S. International Trade Commission on its own motion. | (¹) | (¹) |
| 332-167 | Quarterly and annual reports on certain stainless steel and alloy tool steel. | Presidential Proclamation No. 5074 | 2066 | March 1988 |
| 332-175 | Rum: Annual report on selected economic indicators. | Request from the Committee on Finance, U.S. Senate. | 2084 | May 1988 |
| 332-191 | Nonrubber footwear quarterly statistical reports. | Request from the Committee on Finance, U.S. Senate. | 2044 2068 2091 2125 | December 1987 March 1988 June 1988 September 1988 |
| 332-200 | Competitive position of U.S. producers of semiconductors. | Instituted by the U.S. International Trade Commission on its own motion. | (¹) | (¹) |
| 332-207 | Monthly reports providing information on the U.S. auto industry. | Request from the Subcommittee on Trade, Committee on Ways and Means, U.S. House of Representatives. | 2028 2040 2047 2055 2063 2073 2078 2086 2094 2101 2116 2127 | October 1987 November 1987 December 1987 January 1988 February 1988 March 1988 April 1988 May 1988 June 1988 July 1988 August 1988 September 1988 |
| 332-209 | Annual survey concerning competitive conditions in the steel industry and industry efforts to adjust and modernize. | Request from the United States Trade Representative. | 2215 | September 1988 |
| 332-226 | Monthly reports on the status of the steel industry. | Request from the Subcommittee on Trade, Committee on Ways and Means, U.S. House of Representatives. | 2022 2029 2039 2049 2056 2064 2072 2074 2088 2092 2102 2114 | October 1987 November 1987 December 1987 January 1988 February 1988 March 1988 April 1988 May 1988 June 1988 July 1988 August 1988 September 1988 |
| 332-227 | Annual report of the impact of the Caribbean Basin Economic Recovery Act on U.S. industries and consumers. | Sec. 215(a), Caribbean Basin Economic Recovery Act. | 2122 | September 1988 |

See footnotes at end of table.

Table 2—Continued
General investigations of trade and tariff matters under sec. 332
of the Tariff Act of 1930 pending on Sept. 30, 1988

| Investi- gation No. | Subject | Origin | USITC Publication | |
|---------------------------------|--|--|-------------------|------------------|
| | | | No. | Date |
| 332-237 | Annual report on imports under items 806.30 and 807.00 of the Tariff Schedules of the United States. | Instituted by the U.S. International Trade Commission on its own motion. | 2053 | January 1988 |
| 332-252 | Annual surveys on ammonium paratungstate, tungstic acid, and tungsten oxide. | Presidential Proclamation No. 5718 | (²) | March 1988 |
| 332-253 | Competitive conditions in the U.S. market for asparagus, broccoli, and cauliflower. | Request from the United States Trade Representative at the direction of the President. | (¹) | (¹) |
| 332-254 | Men's and boys' woven manmade-fiber shirts from the People's Republic of China. | Request from the United States Trade Representative at the direction of the President. | (¹) | (¹) |
| TA-131(b)-12 | Tropical products: Probable economic effects on U.S. industries and consumers of elimination of U.S. tariffs. | Request from the United States Trade Representative. | (¹) | (¹) |
| 332-256 | The Western U.S. steel market: Analysis of market conditions and assessment of the economic effects of the voluntary restraint agreements on steel-producing and steel-consuming industries. | Request from the Committee on Ways and Means, U.S. House of Representatives. | (¹) | (¹) |
| 332-258 | Agricultural and tropical products: Literature search regarding trade distortions and effect of trade liberalization and calculation of tariff equivalents. | Request from the United States Trade Representative. | (¹) | (¹) |
| 332-259 | Report on the pros and cons of entering into negotiations on free-trade area agreements with Taiwan, the Republic of Korea, and ASEAN, or the Pacific Rim region in general. | Request from the Committee on Finance, U.S. Senate. | (¹) | (¹) |
| 332-260 and TA-503(a)-16. | President's list of articles which may be designated or modified as eligible articles for purposes of the U.S. Generalized System of Preferences. | Request from the United States Trade Representative. | (¹) | (¹) |
| 332-261 | Ethyl alcohol and mixtures thereof: Assessment regarding the indigenous percentage requirements for imports in sec. 423 of the Tax Reform Act of 1986. | Omnibus Trade and Competitiveness Act of 1986. | (¹) | (¹) |

¹ Not applicable.

² Confidential report; no publication number is assigned.

Table 3
Investigations completed under sec. 337 of the Tariff Act of
1930, fiscal year 1988

| Product | Complainant | Complaint filed | Date of publication of notice in <i>Federal Register</i> and investigation No. | Public hearing | Finding and remedy of Commission | Date orders issued | USITC Publication No. |
|---|---|--|--|----------------|----------------------------------|--------------------|-----------------------|
| Certain plastic fasteners and processes for manufacturing thereof. | Dennison Manufacturing Co.; Framingham, MA. | 5-12-86; 5-28-86 (supplement). | 6-18-86; 337-TA-248. | (1) | Terminated; no violation. | 12-21-87 | (1) |
| Certain electrically resistive mono-component toner. | Aunyx Corp.; Hingham, MA. | 7-15-86; 7-30-86 (amendment); 8-1-86, 8-5-86, and 8-12-86 (supplements). | 8-20-86; 337-TA-253. | (1) | Terminated; no violation. | 2-22-88 | 2069 |
| Certain small aluminum flashlights and components thereof. | Mag Instruments, Inc.; Ontario, CA. | 7-30-86 | 9-10-86; 337-TA-254. | (1) | terminated; no violation. | 1-25-88 | (1) |
| Certain feathered fur coats and pelts, and process for the manufacture thereof. | David Leinoff; New York, NY. | 11-10-86; 11-24-86 (amendment). | 12-29-86; 337-TA-260. | (1) | Violation ² | 12-28-87 | 2085 |
| Certain ink jet printers employing solid ink. | E/D Venture; Milford, NH. Exon Printing Systems, Inc. Brookfield, CT; Dataproducts Corp.; Woodland Hills, CA. | 12-23-86; 1-9-87 (amendment). ³ | 2-4-87; 337-TA-261. | (1) | Terminated ⁴ | 1-25-88 | (1) |
| Certain hard-sided molder luggage cases. | Samsonite Corp.; Denver, CO. | 12-31-86; 1-23-87 (supplement). | 2-4-87; 337-TA-262. | (1) | Terminated; no violation. | 12-22-87 | (1) |
| Certain office filing cabinets. | Supreme Equipment & Systems Corp.; Brooklyn, NY. | 2-6-87 | 3-19-87; 337-TA-263. | (1) | Terminated ⁴ | 12-7-87 | (1) |
| Certain mail extraction desks and components thereof | Opex Corp.; Cherry Hill, NJ. | 3-3-87 | 4-15-87; 337-TA-264. | (1) | Terminated ⁵ | 5-17-87 | (1) |
| Certain dental prophylaxis methods, equipment, and components thereof. | Dentsply International, Inc., York, PA. Dentsply Research & Development Corp.; Milford, DE. | 3-5-87 | 4-15-87; 337-TA-265. | (1) | Terminated ⁶ | 11-30-87 | (1) |
| Certain reclosable plastic bags and tubings. | Minigrips, Inc.; Orangeburg, NY. | 3-25-87; 4-9-87 (Supplement). | 4-29-87; 337-TA-266. | (1) | Violation ⁷ | 4-29-88 | 2058 |

See footnotes at end of table.

Table 3—Continued
Investigations completed under sec. 337 of the Tariff Act of
1930, fiscal year 1988

| Product | Complainant | Complaint filed | Date of publication of notice in <i>Federal Register</i> and investigation No. | Public hearing | Finding and remedy of Commission | Date orders issued | USITC Publication No. |
|--|---|---|--|----------------|----------------------------------|--------------------|-----------------------|
| Certain high intensity retro-reflective sheeting. | Minnesota Mining and Manufacturing Co.; St. Paul, MN. | 6-2-87; 6-15-87, 6-17-87, 6-18-87, and 6-22-87 (amendments). | 7-15-87; 337-TA-268. | (1) | Violation ⁸ | 7-15-88 | (1) |
| Certain picture-in-a-picture video add-on products and components. | Multivision Products, Inc.; San Jose, CA. | 6-17-87 | 7-22-87; 337-TA-269. | (1) | Terminated ⁹ | 12-9-87 | (1) |
| Certain noncontact tonometers. | Cambridge Instruments, Inc.; Buffalo, NY. | 6-18-87; 7-1-87 (supplement). | 7-22-87; 337-TA-270. | (1) | Terminated; no violation. | 4-1-88 | (1) |
| Certain buoyant metalized balloons. | Continental American Corp.; Wichita, KA. Gerald L. Hurst; Austin, TX | 6-26-87; 7-13-87 (supplement). | 8-5-87; 337-TA-271. | (1) | Terminated ¹⁰ | 1-12-88 | (1) |
| Certain electronic chime modules. | Lectron Products, Inc.; Rochester Hills, MI. | 6-30-87; 7-14-87, 7-15-87, and 7-17-87 (supplements). | 8-5-87; 337-TA-272. | (1) | Terminated ⁴ | 12-16-87 | (1) |
| Certain cellular mobile telephone and subassemblies and component parts thereof. | Motorola, Inc.; Schaunberg, IL. | 7-8-87 | 8-12-87; 337-TA-273. | (1) | Terminated ¹¹ | 3-9-88 | (1) |
| Certain toggle clamps for clamping, fixturing, processing, and original-equipment manufacturing. | DE-STA-CO Division, Dover Corp.; Troy, MI | 7-13-87; 7-24-87, 7-29-87, and 8-7-87 (supplements). | 8-19-87; 337-TA-274. | (1) | Terminated ⁴ | 3-1-88 | (1) |
| Certain nonwoven gas filter elements. | Freudenberg Nonwovens Limited Partnerships; Chelmsford, MA. | 7-24-87; 8-10-87 (supplement). | 8-26-87; 337-TA-275. | (1) | Terminated ¹² | 8-26-88 | (1) |
| Certain marine automatic pilots. | Electro-Mechanical Products, Inc., d/b/a First-mate Marine Auto Pilots; Jensen Beach, FL. | 9-9-87; 9-15-87 and 9-28-87 (supplements). | 10-15-87; 337-TA-277. | (1) | Terminated ⁴ | 6-24-88 | (1) |
| Certain programmable digital clock thermostats. | White-Rodgers Division, Emerson Electric Co.; St. Louis, MO. | 9-16-87; 10-9-87 (amendment); 10-13-87 (supplement). | 10-21-87; 377-TA-278. | (1) | Terminated ¹³ | 5-9-88 | (1) |
| Certain high geometric surface area catalysts and components thereof. | United Catalysts Inc.; Louisville, KY. | 12-24-87; 1-12-88 (supplement); 1-13-88 (amendment and supplement). | 1-27-88; 337-TA-280. | (1) | Terminated ⁴ | 4-20-88 | (1) |

¹ Not applicable.

² General exclusion order, President took no action; became final Feb. 28, 1988.

³ Exxon Printing Systems, Inc., changed to Reliance Printing System, Inc.

⁴ Settlement agreement.

⁵ With prejudice, withdrawal of complaint.

⁶ Settlement agreement; 1 respondent and 6 remaining respondents on prejudice.

⁷ General exclusion order, President took no action; became final June 29, 1988.

⁸ Limited exclusion order and cease and desist order.

⁹ With prejudice on basis of stipulations.

¹⁰ With prejudice.

¹¹ Consent order, President took no action; became final May 9, 1988.

¹² Limited exclusion order, President review period not over at the end of the fiscal year.

¹³ Consent order, President took no action; became final Aug. 8, 1988.

Table 4
Investigations of unfair trade practices under sec. 337 of the
Tariff Act of 1930 pending on Sept. 30, 1988

| Product | Complainant | Complaint filed | Date of publication of notice in <i>Federal Register</i> and No. |
|---|--|--|--|
| Certain cryogenic ultramicrotome apparatus and components thereof. ¹ | Research & Manufacturing Co., Inc.; Tucson, AZ. | 8-15-86; 9-3-86, 9-4-86, and 9-9-86 (supplements). | 9-17-86; 337-TA-256. |
| Certain erasable programmable read-only memories, components thereof, products containing same, and processes for making such memories. | Intel Corp.; Santa Clara, CA. | 8-5-87; 8-31-87 (supplement). | 9-16-87; 337-TA-276. |
| Certain plastic light-duty screw anchors. | Mechanical Plastics Corp.; Pleasantville, NY. | 12-11-87; 12-28-87 and 12-29-87 (supplements). | 1-27-88; 337-TA-279. |
| Certain recombinant erythropoietin. | Amgen Inc.; Thousand Oaks, CA. | 1-4-88; 1-20-88 (amendment). | 2-10-88; 337-TA-281. |
| Certain venetian blind components. | Hunter Douglas, Inc.; Upper Saddle River, NJ. | 4-28-88; 5-18-88 (supplement). | 6-2-88; 337-TA-282. |
| Certain electronic dart games. | Arachnid, Inc.; Rockford, IL. | 6-16-88; 7-6-88 (supplement). | 7-20-88; 337-TA-283. |
| Certain electric power tools, battery cartridges, and battery chargers. | Makita, USA, Inc.; Cerritos, CA. Makita Corp. of America; Buford, GA. | 4-1-88; 7-7-88, 7-25-88, 7-27-88, and 7-29-88 (supplements). | 8-17-88; 337-TA-284. |
| Certain chemiluminescent compositions and components thereof and methods of using the same. | American Cyanamid Co.; Wayne, NJ. | 7-21-88; 8-9-88 (supplement). | 8-25-88; 337-TA-285. |
| Certain track lighting system components, including plugboxes. | Cooper Industries, Inc.; Houston, TX. | 7-22-88; 8-5-88 (amendment and supplement). | 8-25-88; 337-TA-286. |
| Certain strip lights. | Vista Manufacturing, Inc.; Elkhart, IN. | 8-24-88; 9-8-88 (amendment and supplement). | 9-28-88; 337-TA-287. |

¹ Suspended Apr. 15, 1987, during the pending of a patent reexamination in the U.S. Patent and Trademark Office.

Table 5
Countervailing duty investigations completed under sec. 701 of
the Tariff Act of 1930, fiscal year 1988

| Investigation No. | Product | Preliminary investigation | | | | | Final investigation | | | | |
|-----------------------------------|---|---|---|--|-------------------|---|---|---------------------------------------|---|-------------------|-----------------------|
| | | (a) Request received (b) Conference (c) Report to Secretary of Commerce | Finding reasonable indication of injury | Finding no reasonable indication of injury | Not participating | USITC Publication No. | (a) Advice received from Commerce (b) Hearing (c) Report to Secretary of Commerce | Affirmative | Negative | Not participating | USITC Publication No. |
| 701-TA-282 | Certain forged steel crankshafts from Brazil | (¹) | (¹) | (¹) | (¹) | (¹) | (a) 1-8-87 (b) 11-5-87 (c) 11-24-87 | Brunsdale Eckes Lodwick Rohr | Liebeler | (¹) | 2038 |
| 701-TA-287 | Certain electrical conductor aluminum redraw rod from Venezuela | (¹) | (¹) | (¹) | (¹) | (¹) | (a) 10-14-87 (b) 6-23-88 (c) 8-5-88 | Eckes Lodwick Rohr Cass | Brunsdale Liebeler | (¹) | 2103 |
| 701-TA-289 | Certain granite from Spain. | (¹) | (¹) | (¹) | (¹) | (¹) | (a) 12-24-87 (b) 6-30-88 (c) 8-11-88 | (¹) | Brunsdale Eckes Lodwick Liebeler Rohr Cass | (¹) | 2110 |
| 701-TA-290 through 701-TA-292. | Thermostatically controlled appliance plugs and probe thermostats therefor from Canada, Malaysia, and Taiwan. | (a) 4-15-88 (b) 5-6-88 (c) 5-31-88 | Liebeler Brunsdale Eckes Lodwick Rohr Cass | (¹) | (¹) | 2087 | (¹) | (¹) | (¹) | (¹) | (¹) |
| 701-TA-293 through 701-TA-295. | Industrial belts from Israel, Singapore, and the Republic of Korea. | (a) 6-30-88 (b) 7-22-88 (c) 8-15-88 | Brunsdale Eckes Lodwick Liebeler Rohr Cass | (¹) | (¹) | 2113 | (¹) | (¹) | (¹) | (¹) | (¹) |
| 701-TA-296 | Certain steel wheels from Brazil. | (a) 7-29-88 (b) 8-19-88 (c) 9-12-88 | Brunsdale Eckes Lodwick Liebeler | (¹) | | Rohr ² 2124 Cass ³ | (¹) | (¹) | (¹) | (¹) | (¹) |

¹ Not applicable.

² Commissioner Rohr did not participate in order to avoid the appearance of a possible conflict of interest.

³ Commissioner Cass did not participate in the vote, as it was rescheduled for a time when he was out of the United States and could not be reached.

Table 6
Antidumping investigations completed under sec. 731 of the Tariff
Act of 1930, fiscal year 1988

| Investigation No. | Product | Preliminary investigation | | | | | Final investigation | | | | |
|-----------------------------------|---|---|---|--|-------------------|-----------------------|---|---|---|-----------------------|-----------------------|
| | | (a) Request received (b) Conference (c) Report to Secretary of Commerce | Finding reasonable indication of injury | Finding no reasonable indication of injury | Not participating | USITC Publication No. | (a) Advice received from Commerce (b) Hearing (c) Report to Secretary of Commerce | Affirmative | Negative | Not participating | USITC Publication No. |
| 731-TA-354 | Stainless steel pipes and tubes from Sweden. | (1) | (1) | (1) | (1) | (1) | (a) 5-22-87 (b) 10-13-87 (c) 11-18-87 | Brunsdale ² Eckes Lodwick Rohr ² | Liebeler Brunsdale ³ Rohr ³ | (1) | 2033 |
| 731-TA-367 through 731-TA-370. | Color picture tubes from Canada, Japan, the Republic of Korea, and Singapore. | (1) | (1) | (1) | (1) | (1) | (a) 6-30-87 (b) 11-19-87 (c) 12-22-87 | Brunsdale Eckes Lodwick Rohr | Liebeler | (1) | 2046 |
| 731-TA-371 | Fabric and expanded neoprene laminate from Taiwan. | (1) | (1) | (1) | (1) | (1) | (a) 5-14-87 (b) 10-6-87 (c) 11-12-87 | (1) | Liebeler Brunsdale Eckes Lodwick Rohr | (1) | 2032 |
| 731-TA-376 | Certain stainless steel butt-weld pipe fittings from Japan. | (1) | (1) | (1) | (1) | (1) | (a) 9-16-87 (b) 2-9-88 (c) 3-14-88 | Brunsdale Eckes Lodwick Rohr Cass | (1) | Liebeler ⁴ | 2067 |
| 731-TA-377 | Internal combustion engine forklift trucks from Japan. | (1) | (1) | (1) | (1) | (1) | (a) 11-24-87 (b) 4-13-88 (c) 5-31-88 | Liebeler Brunsdale Eckes Lodwick Rohr Cass | (1) | (1) | 2082 |
| 731-TA-378 | Certain electrical conductor aluminum redraw rod from Venezuela. | (1) | (1) | (1) | (1) | (1) | (a) 3-28-88 (b) 6-23-88 (c) 8-5-88 | Eckes Lodwick Rohr Cass | Brunsdale Liebeler | (1) | 2103 |
| 731-TA-379 | Certain brass sheet and strip from Japan. | (1) | (1) | (1) | (1) | (1) | (a) 2-1-88 (b) 6-28-88 (c) 7-29-88 | Eckes Lodwick Rohr | Brunsdale Liebeler Cass | (1) | 2099 |
| 731-TA-380 | Certain brass sheet and strip from the Netherlands. | (1) | (1) | (1) | (1) | (1) | (a) 2-8-88 (b) 6-28-88 (c) 7-29-88 | Eckes Lodwick Rohr | Brunsdale Liebeler Cass | (1) | 2099 |
| 731-TA-381 and 731-TA-382. | Certain granite from Italy and Spain. | (1) | (1) | (1) | (1) | (1) | (a) 2-29-88 (b) 6-30-88 (c) 8-11-88 | (1) | Brunsdale Eckes Lodwick Liebeler Rohr Cass | (1) | 2110 |
| 731-TA-383 | Certain bimetallic cylinders from Japan. | (1) | (1) | (1) | (1) | (1) | (a) 1-15-88 (b) 4-7-88 (c) 5-13-88 | (1) | Liebeler Brunsdale Eckes Lodwick Rohr | (1) | 2080 |

See footnotes at end of table.

Table 6—Continued
Antidumping investigations completed under sec. 731 of the Tariff
Act of 1930, fiscal year 1988

| Investigation No. | Product | Preliminary investigation | | | | | Final investigation | | | | |
|-----------------------------------|--|---|---|--|-------------------|---|---|---|------------------|-------------------|-----------------------|
| | | (a) Request received (b) Conference (c) Report to Secretary of Commerce | Finding reasonable indication of injury | Finding no reasonable indication of injury | Not participating | USITC Publication No. | (a) Advice received from Commerce (b) Hearing (c) Report to Secretary of Commerce | Affirmative | Negative | Not participating | USITC Publication No. |
| 731-TA-384 | Nitrile rubber from Japan. | (a) 9-1-87 (b) 9-23-87 (c) 10-16-87 | Liebeler Brunsdale Eckes Lodwick Rohr | (¹) | (¹) | 2027 | (a) 2-12-88 (b) 5-3-88 (c) 6-10-88 | Brunsdale Eckes Lodwick Rohr Cass | Liebeler | (¹) | 2090 |
| 731-TA-385 and 731-TA-386. | Granular polytetrafluoroethylene resin from Italy and Japan. | (a) 11-6-87 (b) 12-1-87 (c) 12-21-87 | Liebeler Brunsdale Eckes Lodwick Rohr | (¹) | (¹) | 2043 | (a) 4-19-88 (b) 7-13-88 (c) 8-16-88 | Brunsdale Eckes Lodwick Liebeler Rohr Cass | (¹) | (¹) | 2112 |
| 731-TA-387 | Certain fabricated structural steel from Canada. | (a) 1-11-88 (b) 2-5-88 (c) 2-25-88 | Eckes | Liebeler Brunsdale Lodwick Rohr | | Cass ⁵ 2062 | (¹) | (¹) | (¹) | (¹) | (¹) |
| 731-TA-388 | Certain all-terrain vehicles from Japan. | (a) 2-9-88 (b) 3-1-88 (c) 3-25-88 | Liebeler Brunsdale Eckes Lodwick Rohr Cass | (¹) | (¹) | 2071 | (¹) | (¹) | (¹) | (¹) | (¹) |
| 731-TA-389 | 3.5-inch microdisks and media therefor from Japan. | (a) 2-26-88 (b) 3-21-88 (c) 4-11-88 | Eckes Lodwick Rohr Cass | (¹) | | Liebeler ⁴ Brunsdale ⁴ 2076 | (¹) | (¹) | (¹) | (¹) | (¹) |
| 731-TA-390 | Digital readout systems and sub-assemblies thereof from Japan. | (a) 3-28-88 (b) 4-20-88 (c) 5-12-88 | Liebeler Brunsdale Cass | Eckes Lodwick Rohr | | (¹) 2081 | (¹) | (¹) | (¹) | (¹) | (¹) |
| 731-TA-391 through 731-TA-399. | Antifriction bearings (other than tapered roller bearings) and parts thereof from the Federal Republic of Germany, France, Italy, Japan, Romania, Singapore, Sweden, Thailand, and the United Kingdom. | (a) 3-31-88 (b) 4-21-88 (c) 5-16-88 | Liebeler Brunsdale Eckes Lodwick Rohr Cass | (¹) | (¹) | 2083 | (¹) | (¹) | (¹) | (¹) | (¹) |

See footnotes at end of table.

Table 6—Continued
 Antidumping investigations completed under sec. 731 of the Tariff
 Act of 1930, fiscal year 1988

| Investigation No. | Product | Preliminary investigation | | | | | Final investigation | | | | |
|--------------------------------|---|---|---|--|-------------------|---|-------------------------------------|------------------|------------------|-------------------|-----------------------|
| | | (a) Request received | Finding reasonable indication of injury | Finding no reasonable indication of injury | Not participating | USITC Publication No. | (a) Advice received from Commerce | Affirmative | Negative | Not participating | USITC Publication No. |
| | | (b) Conference | | | | | (c) Report to Secretary of Commerce | | | | |
| 731-TA-400 through 731-TA-404. | Thermostatically controlled appliance plugs and probe thermostats therefor from Canada, Hong Kong, Japan, Malaysia, and Taiwan. | (a) 4-15-88 (b) 5-6-88 (c) 5-31-88 | Liebeler Brunsdale Eckes Lodwick Rohr Cass | (¹) | (¹) | 2087 | (¹) | (¹) | (¹) | (¹) | (¹) |
| 731-TA-405 | Sewn cloth headwear from the People's Republic of China. | (a) 5-26-88 (b) 6-16-88 (c) 7-11-88 | Brunsdale Eckes Lodwick Rohr Cass | (¹) | (¹) | Lie- beler ⁶ 2096 | (¹) | (¹) | (¹) | (¹) | (¹) |
| 731-TA-406 through 731-TA-408. | Electrolytic manganese dioxide from Greece, Ireland, and Japan. | (a) 5-31-88 (b) 6-20-88 (c) 7-15-88 | Brunsdale Eckes Lodwick Rohr Cass | (¹) | (¹) | 2097 | (¹) | (¹) | (¹) | (¹) | (¹) |
| 731-TA-409 and 731-TA-410. | Certain light-walled rectangular pipes and tubes from Argentina and Taiwan. | (a) 6-6-88 (b) 6-29-88 (c) 7-21-88 | Brunsdale Eckes Lodwick Liebeler Rohr Cass | (¹) | (¹) | 2098 | (¹) | (¹) | (¹) | (¹) | (¹) |
| 731-TA-411 | Calcined bauxite proppants from Australia. | (a) 6-14-88 (b) 7-5-88 (c) 7-29-88 | Brunsdale Eckes Lodwick Liebeler Rohr Cass | (¹) | (¹) | 2100 | (¹) | (¹) | (¹) | (¹) | (¹) |
| 731-TA-412 through 731-TA-419. | Industrial belts from Israel, Italy, Japan, Singapore, the Republic of Korea, Taiwan, the United Kingdom, and West Germany. | (a) 6-30-88 (b) 7-22-88 (c) 8-15-88 | Brunsdale Eckes Lodwick Liebeler Rohr Cass | (¹) | (¹) | 2113 | (¹) | (¹) | (¹) | (¹) | (¹) |
| 731-TA-420 | Certain steel wheels from Brazil. | (a) 7-29-88 (b) 8-19-88 (c) 9-12-88 | Brunsdale Eckes Lodwick Liebeler | (¹) | (¹) | Rohr ⁴ 2124 Cass ⁷ | (¹) | (¹) | (¹) | (¹) | (¹) |
| 731-TA-421 | Shock absorbers and parts, components, and subassemblies thereof from Brazil. | (a) 8-9-88 (b) 8-30-88 (c) 9-23-88 | (¹) Brunsdale Eckes Lodwick Liebeler Cass | (¹) | (¹) | Rohr ⁴ 2128 | (¹) | (¹) | (¹) | (¹) | (¹) |

¹ Not applicable.

² With regard to imports of seamless stainless steel pipes and tubes.

³ With regard to imports of welded stainless steel pipes and tubes.

⁴ Did not participate in the vote in order to avoid the possible appearance of a conflict of interest.

⁵ This was the first title VII investigation following Commissioner Cass' appointment; he chose to observe rather than participate in this matter.

⁶ Commissioner Liebeler was unable to participate in this determination because of telecommunications difficulties. She notes that had she voted, she would have made an affirmative determination in the preliminary investigation.

⁷ Commissioner Cass did not participate in this vote because it was rescheduled for a time when he was out of the United States and could not be reached.

Table 7
Countervailing duty investigations completed under sec. 303 of
the Tariff Act of 1930, fiscal year 1988

| Investigation No. | Product | Preliminary investigation | | | | | Final investigation | | | | |
|--------------------------|---|---|---|--|-------------------|-----------------------|---|------------------|------------------|-------------------|-----------------------|
| | | (a) Request received (b) Conference (c) Report to Secretary of Commerce | Finding reasonable indication of injury | Finding no reasonable indication of injury | Not participating | USITC Publication No. | (a) Advice received from Commerce (b) Hearing (c) Report to Secretary of Commerce | Affirmative | Negative | Not participating | USITC Publication No. |
| 303-TA-19 and 303-TA-20. | Antifriction bearings (other than tapered roller bearings) from Singapore and Thailand. | (a) 3-31-88 (b) 4-21-88 (c) 5-16-88 | Liebeler Brunsdale Eckes Lodwick Rohr Cass | (¹) | (¹) | 2083 | (¹) | (¹) | (¹) | (¹) | (¹) |

¹ Not applicable.

Table 8
Antidumping and countervailing duty investigations pending on
Sept. 30, 1988

| Investigation No. | Product | Effective date |
|-----------------------------|---|----------------------|
| 701-TA-297 (P) | New Steel rails from Canada | 9-26-88 |
| 701-TA-284 (F) | Bicycle tires and tubes from Korea | Suspended 1-13-87 |
| 701-TA-292 (F) | Thermostatically controlled appliance plugs and probe thermostats therefor from Taiwan. | 7-22-88 |
| 731-TA-422 (P) | New steel rails from Canada | 9-26-88 |
| 731-TA-300 (F) | Dynamic random access memory semiconductors (DRAMs) of 256 kilobits and above from Japan. | Suspended 8-7-86. |
| 731-TA-374 (F) | Potassium chloride from Canada | Suspended 1-8-88. |
| 731-TA-390 (F) | Digital readout systems and subassemblies thereof from Japan | 12-12-88 |
| 303-TA-19 and 303-TA-20 (F) | Antifriction bearings (other than tapered roller bearings) and parts thereof from Singapore and Thailand. | 9-6-88 |

Table 9
Escape clause investigation completed under sec. 201 of the Trade
Act of 1974, fiscal year 1988

| Investigation No. | Product | Petitioner or requester | Petition or request filed | Public hearing | Finding of Commission | Commissioners' votes | | Commission's report | |
|-------------------|----------------|---|---------------------------|----------------|-----------------------|----------------------|---|---------------------|-----------------------|
| | | | | | | Affirmative | Negative | To the President | USITC Publication No. |
| TA-201-61 | Certain knives | The American Cutlery Manufacturers Association. | 3-25-88 | 6-15-88 | Negative | (¹) | Brunsdale Eckes Liebeler Rohr Lodwick Cass | 9-20-88 | 2107 |

¹ Not applicable.

Table 10
Review investigation under sec. 203 of the Trade Act of 1974
pending on Sept. 30, 1988

| Investigation No. | Product | Request received |
|-------------------|--------------------------|------------------|
| TA-203-18 | Wood shakes and shingles | 7-1-88 |

Table 11
Preliminary investigation completed under sec. 603 of the Trade Act of 1974, fiscal year 1988

| Investigation No. | Product | Date and basis for initiation | Hearing | Commission finding | USITC Publication No. |
|-------------------------------------|-----------------------------|--|----------|--------------------|-----------------------|
| 603-TA-10 (terminated 10-20-87). | Industrial forklift trucks. | 7-20-87 To gather information relevant to the question of whether certain firms supporting a petition for relief filed under sec. 201 of the Trade Act of 1974 with respect to imports of certain industrial forklift trucks are "representative of an industry" within the meaning of sec. 201(a)(1) of the Trade Act. | 10-22-87 | (¹) | (²) |

¹ Upon examination of the information developed during this investigation, the Commission found that the supporting firms would have standing to file a petition for an investigation of the scope proposed in the original petition.

² Not applicable.

Table 12
Review investigation completed under sec. 751 of the Tariff Act of 1930, fiscal year 1988

| Investigation No. | Product | (a) Request received (b) Hearing (c) Report to Secretary of Commerce | Modify order | Not modify order | USITC Publication No. |
|-------------------|---|--|-----------------------|--------------------------|-----------------------|
| 751-TA-14 | Liquid-crystal-display television receivers from Japan. | (a) 4-28-87 (b) 11-12-87 (c) 12-16-87 | Liebeler Brunsdale | Eckes Lodwick Rohr | 2042 |

Appendix B

Statutes Involving the U.S. International Trade Commission

Key Statutes

The Omnibus Trade and Competitive-ness Act of 1988, which the President signed into law on August 23, 1988, amended several of the statutory provisions under which the ITC is authorized to act. In particular, the 1988 act amended section 201 of the Trade Act of 1974 to place a greater emphasis on industry adjustment to import competition in the granting of relief, amended the antidumping and countervailing duty law provisions to provide new provisions relating to release of business proprietary information under protective orders, and amended section 337 of the Tariff Act of 1930 to eliminate the injury test in certain intellectual property cases. For the most part, the amendments became effective upon enactment and thus were in effect only during the last six weeks of the fiscal year. In order that its Rules of Practice and Procedure might reflect these statutory changes, the ITC published interim Rules in the *Federal Register* on August 29, 1988. The summaries below incorporate the 1988 act changes and describe the statutory provisions as they existed at the end of fiscal year 1988.

Section 201, Trade Act of 1974 (Escape-Clause Investigations), Import Relief for Domestic Industries

Section 201 provides a procedure whereby domestic industries seriously injured by increased imports can petition for import relief generally in the form of tariffs or quantitative restrictions. To be found eligible for relief under section 201, industries need not prove that an unfair trade practice exists, as is necessary under the antidumping and countervailing duty laws and section 337 of the Tariff Act of 1930. However, under section 201, a greater degree of injury, "serious" injury, must be found to exist, and imports must be a "substantial" cause (not less than any other cause) of that injury. In addition, relief under section 201, although temporary, should be tailored to the needs of the injured industry and facilitate positive adjustment to import competition.

Criteria for import relief set forth under section 201 are based on article XIX of the General Agreement on Tariffs and Trade (GATT), an international agreement to which the United States is a signatory. Article XIX of the GATT is referred to as the escape clause, because it permits a country to "escape" temporarily from its obligations under the GATT with respect to a product when increased imports of that product are causing or threatening to cause serious injury to domestic producers of a like or directly competitive product. ITC investigations under section 201 provide a basis for the President to invoke article XIX.

When: The ITC conducts investigations upon receipt of a petition from a firm, trade association, group of workers, or other entity representative of a domestic industry, upon receipt of a request from the President or the Office of the United States Trade Representative (USTR), upon receipt of a resolution of the House Committee on Ways and Means or the Senate Committee on Finance, or upon its own motion, to determine whether a product is being imported in such increased quantities as to be a substantial cause of serious injury, or the threat thereof, to the domestic industry producing an article like or directly competitive with the imported article.

Duration: In general, the ITC must make its injury finding within 120 days and must transmit its report, together with any recommendations with respect to relief, within 180 days of receipt of the petition, request, or resolution or institution on its own motion.

Finding: If the ITC's finding is affirmative, it must recommend a remedy to the President, who has discretion to take action to provide import relief, which could be in the form of a tariff increase, quantitative restrictions, or orderly marketing agreements.

Followup: The ITC reports with respect to developments within an industry that has been granted import relief and advises the President of the probable economic effect on the industry of the reduction, modification, or termina-

tion of the relief in effect. At the conclusion of any relief action, the ITC is required to report to the President and the Congress on the effectiveness of the relief action in facilitating the position adjustment of the domestic industry to import competition. (For further information, see sec. 201 of the Trade Act of 1974, 19 U.S.C. 2251.)

Section 337, Tariff Act of 1930, Investigations of Unfair Practices in Import Trade

Under section 337, the ITC applies U.S. statutory and common law of unfair competition to the importation of products into the United States and their sale. Section 337 declares unlawful unfair methods of competition and unfair acts in the importation or sale of products in the United States, the threat or effect of which is to destroy or substantially injure a domestic industry, prevent the establishment of such an industry, or restrain or monopolize trade and commerce in the United States. Section 337 also declares as unlawful per se infringement of a valid and enforceable U.S. patent, copyright, registered trademark, or maskwork; no resulting injury need be found.

Section 337 investigations require formal evidentiary hearings in accordance with the Administrative Procedure Act (5 U.S.C. 551 et seq.). The hearings are held before an administrative law judge (ALJ). Parties to these investigations include complainants, respondents, and the ITC attorney representing the public. Following a hearing, the ALJ issues an initial determination on all issues in relation to violations of section 337; the ITC may exercise its right to review and may reverse the ALJ's decision. Complainants may seek temporary relief pending final resolution of the case.

When: The ITC, after receipt of a complaint under oath from an interested party or upon its own motion, conducts investigations to determine whether unfair methods of competition or unfair acts are occurring in the importation of articles into the United States or in their sale.

Duration: The investigation must be completed in no more than 1 year, or 18 months in a more complicated case, after the date of publication of notice of investigation in the *Federal Register*.

Finding: In general, if the ITC finds that the importation of such articles is such that the threat or effect is to destroy or substantially injure an industry, prevent the establishment of such an industry, or restrain or monopolize trade and commerce in the United States, it may issue orders excluding the products from entry and/or directing the violating parties to cease and desist from certain actions. However, in the case of importations that infringe a U.S. patent, copyright, registered trademark, or mask work, the ITC may issue an exclusion and/or cease and desist order without having to find a threat or effect to destroy or substantially injure an industry, prevent the establishment of such an industry, or restrain or monopolize trade and commerce. ITC orders become effective unless disapproved by the President for policy reasons within 60 days of issuance. Appeals of Commission orders are heard by the Court of Appeals for the Federal Circuit. Violators of ITC section 337 orders are liable for civil penalties of up to \$100,000 a day or twice the value of the imported articles. (For further information, see sec. 337 of the Tariff Act of 1930, 19 U.S.C. 1337.)

Title VII of the Tariff Act of 1930

Under title VII of the Tariff Act of 1930 (19 U.S.C. 1671, as added by the Trade Agreements Act of 1979), the ITC conducts preliminary and final investigations to determine whether (in preliminary investigations) there is a reasonable indication or whether (in final investigations) a U.S. industry is materially injured or threatened with material injury, or the establishment of such an industry is materially retarded, by reason of imports of merchandise that is being sold at less than fair value (dumped) or is benefiting from foreign subsidies. The Department of Commerce determines whether dumping or subsidies exist and, if so, the margin of dumping or amount of the subsidy.

Section 703(a), Tariff Act of 1930 (Preliminary Countervailing Duty Investigations), Subsidized Imports

When: The ITC, after the simultaneous filing of proper petitions with it and the Department of Commerce, conducts investigations to determine, on the basis of the best information available to it at the time of the determination, whether there is a reasonable indication that an industry is materially injured, or is threatened with material injury, or the establishment of an industry is materially retarded, by reason of imports of the allegedly subsidized merchandise that is the subject of the investigation by Commerce.

Duration: The investigation must be completed within 45 days of the receipt of the petition.

Finding: If both the Commerce Department's and the ITC's determinations are affirmative, Commerce continues its investigation.

Section 705(b), Tariff Act of 1930 (Final Countervailing Duty Investigations), Subsidized Imports

When: The ITC, after a preliminary determination by the Secretary of Commerce that imported products are subsidized, conducts investigations to determine whether an industry in the United States is materially injured, or is threatened with material injury, or the establishment of an industry in the United States is materially retarded, by reason of imports of the subsidized merchandise.

Duration: The investigation must usually be completed within 120 days after an affirmative preliminary determination by the Secretary of Commerce or 45 days after an affirmative final determination by the Secretary of Commerce that a subsidy is being provided, whichever is longer.

Finding: If the ITC's determination is affirmative, the Secretary of Commerce issues a countervailing duty order. (For further information, see sec. 701 et seq. of the Tariff Act of 1930, 19 U.S.C. 1671 et seq.)

Section 733(a), Tariff Act of 1930 (Preliminary Antidumping Investigations), Imports Marketed at Less Than Fair Value

When: The ITC, after the simultaneous filing of a proper petition with it and the Department of Commerce, conducts investigations to determine, on the basis of the best information available to it at the time of the determination, whether there is a reasonable indication that an industry is materially injured, or is threatened with material injury, or the establishment of an industry is materially retarded, by reason of imports of the allegedly dumped merchandise that is the subject of investigation by Commerce.

Duration: The investigation must be completed within 45 days of receipt of the petition.

Finding: If the ITC's determination is affirmative, Commerce continues its investigation.

Section 735(b), Tariff Act of 1930 (Final Antidumping Investigations), Imports Marketed at Less Than Fair Value

When: The ITC, after a preliminary determination by the Secretary of Commerce that imported products are being, or are likely to be, sold at less than fair value, conducts investigations to determine whether any industry in the United States is materially injured, or is threatened with material injury, or the establishment of an industry in the United States is materially retarded, by reason of imports of the dumped merchandise.

Duration: The investigation must usually be completed within 120 days after an affirmative preliminary determination by the Secretary of Commerce that the imported products are being, or are likely to be, sold at less than fair value.

Finding: If both the Commerce Department's and ITC's determinations are affirmative, the Secretary of Commerce issues a countervailing duty order. (For further information, see sec.

Other Areas of Involvement by Statute

731 et seq. of the Tariff Act of 1930, 19 U.S.C. 1673 et seq.)

Section 332, Tariff Act of 1930, General Factfinding Investigations

When: Upon official request (from the President, the Congress, or the USTR) or upon its own motion, the ITC initiates a factfinding investigation on any matter involving tariffs and international trade. This broad provision allows the ITC to investigate trade matters of immediate concern to the Government and the public.

Duration: Unless otherwise directed, the ITC establishes an administrative deadline.

Finding: Unless the President or the Congress directs otherwise, the ITC's final reports are made available to all interested parties, the general public, the President and executive departments, and the Congress. (For further information, see sec. 332 of the Tariff Act of 1930, 19 U.S.C. 1332.)

Section 22, Agricultural Adjustment Act, Import Interference With Agricultural Programs

When: The ITC conducts investigations at the direction of the President to determine whether any products are being, or are practically certain to be, imported into the United States under such conditions and in such quantities as to render or tend to render ineffective, or materially interfere with, any loan, purchase, or other program or operation of the Department of Agriculture, including price-support programs for agricultural commodities or products thereof, or to reduce substantially the amounts of any product processed in the United States from such commodities or products. The ITC makes findings and recommendations to the President.

Finding: The President may restrict the imports in question by imposition of either quotas or import fees (not to exceed 50 percent of the imported product's value). (For further information, see sec. 22 of the Agricultural Adjustment Act, 7 U.S.C. 624.)

Countervailing Duty Investigations Under Section 303 of the Tariff Act of 1930

In the case of countervailing duty investigations not covered by section 701 of the Tariff Act of 1930 that involve articles that enter free of duty, the ITC determines, with respect to any article on which the Secretary of Commerce has determined that a bounty or grant is being paid, whether an industry in the United States is materially injured or threatened with material injury, or the establishment of an industry in the United States is materially retarded, by reason of the importation of such article. (For further information, see sec. 303, Tariff Act of 1930, 19 U.S.C. 1303.)

Caribbean Basin Economic Recovery Act

The ITC submits annual reports to the Congress and the President on the economic impact on U.S. industries and consumers of the Caribbean Basin Economic Recovery Program. (For further information, see 19 U.S.C. 2704.)

Uniform Statistical Data

The ITC, in cooperation with the Secretary of the Treasury and the Secretary of Commerce, establishes for statistical purposes an enumeration of articles imported into the United States and exported from the United States, and seeks to establish comparability of such statistics with statistical programs for domestic production. (For further information, see sec. 484(e), Tariff Act of 1930, 19 U.S.C. 1484(e).)

Harmonized Tariff Schedule of the United States and Tariff Schedules of the United States Annotated

The ITC issues a publication containing U.S. tariff schedules and related material and considers questions concerning the arrangement of such schedules and the classification of articles. (For further information, see sec. 201, Tariff Classification Act of 1962, 76 Stat. 74 and secs. 332(a) and 484(e), Tariff Act of 1930, 19 U.S.C. 1332(a) and 19 U.S.C. 1484(e).)

Annual Report on the U.S. Trade Agreements Program

The ITC prepares for the Congress and the interested public a "factual report on the operation of the trade agreements program." The report contains information on U.S. participation in multilateral trade negotiations and agreements, as well as related material on foreign economic and trade developments and the administration of U.S. trade laws. (For further information, see sec. 163(b), Trade Act of 1974, 19 U.S.C. 2213.)

Advice Concerning Trade Negotiations

The ITC advises the President as to the probable economic effect on domestic industries and consumers of modification of duties and other barriers to trade that may be considered for inclusion in any proposed trade agreement with foreign countries. (For further information, see sec. 131, Trade Act of 1974, 19 U.S.C. 2151.)

Generalized System of Preferences

With respect to articles that may be considered for duty-free treatment when imported from designated developing countries, the ITC advises the President as to the probable economic effect of the removal of duty on the domestic industry and on consumers. (For further information, see secs. 131 and 503, Trade Act of 1974, 19 U.S.C. 2151, 2163.)

East-West Trade-Monitoring System

The ITC monitors imports into the United States from nonmarket economy countries and makes a report not less frequently than once each calendar quarter on the effect of such imports on the production of like or directly competitive articles in the United States and on employment within the industry. (For further information, see sec. 410, Trade Act of 1974, 19 U.S.C. 2440.)

Trade With Communist Countries

The ITC investigates to determine whether imports of an article produced in a Communist country cause market disruption in the United States. In general, if the ITC's determination is in the affirmative, the President may take the same action as in a case involving injury to an industry under section 201 of the Trade Act of 1974, except that the action would apply only to imports of the product from the Communist country. (For further information, see sec. 406, Trade Act of 1974, 19 U.S.C. 2436.)

Appendix C
Reports Submitted
to Congress on
Proposed
Legislation,
Fiscal Year 1988

Reports Submitted
to the House on
Proposed Legislation

1. H.R. 2453 (Mr. Pickle)—To suspend the duty on triallate pesticides until January 1, 1991. October 18, 1987.
2. H.R. 2917 (Mr. Carper)—To suspend for a five-year period the duty on bendiocarb. October 28, 1987.
3. H.R. 2947 (Mr. Brown)—To suspend for a three-year period the duty on carfentanil citrate. May 23, 1988.
4. H.R. 3139 (Mr. Crane)—To extend for three years the existing suspension of duty on certain brussels sprouts. January 28, 1988.
5. H.R. 3271 (Mr. Rose)—To suspend for a three-year period the duty on thiothiamine hydrochloride. February 1, 1988.
6. H.R. 3306 (Miss Schneider)—To extend the temporary suspension of duty on a certain chemical. November 30, 1987.
7. H.R. 3426 (Mr. Clinger)—To temporarily suspend the duty on N-methylaniline and m-chloroaniline. February 2, 1988.
8. H.R. 3475 (Mr. Inhofe)—To suspend until January 1, 1991, the duty on acetophenone. January 11, 1988.
9. H.R. 3513 (Mr. Ford)—To suspend until January 1, 1991, the duty on N,N'-bis(2,3-dihydroxypropyl)-5-[N-(2,3-dihydroxypropyl)acetamido]-2,4,6-triiodoisophthalamide. March 28, 1988.
10. H.R. 3522 (Mr. Crane)—To extend duty-free treatment to railway car bolsters and frames. February 18, 1988.
11. H.R. 3527 (Mr. Smith)—To suspend temporarily the duty on calcium carbaspirin. February 18, 1988.
12. H.R. 3538 (Mr. Levine)—To suspend temporarily the duty on certain electronic connector contact parts. April 18, 1988.
13. H.R. 3626 (Mr. Bilbray)—To provide duty-free treatment for three-dimensional cameras. May 10, 1988.
14. H.R. 3637 (Mr. Pease)—To suspend temporarily the duty on certain imported fluorspar. February 2, 1988.
15. H.R. 3645 (Mr. Wyden)—To provide relief to Columbia Sportswear Co. with respect to the tariff classification of certain wearing apparel, and for other purposes. March 30, 1988.
16. H.R. 3773 (Mrs. Patterson)—To suspend temporarily the duty on MDBS and HPBA. March 2, 1988.
17. H.R. 3789 (Mr. Rose)—To suspend until December 31, 1991, the duty on a herbicide intermediate. May 17, 1988.
18. H.R. 3946 (Mr. Moody)—To suspend temporarily the duty on piperonyl butoxide. April 18, 1988.
19. H.R. 3992 (Mr. Bustamante)—To provide for a separate tariff classification for opal borosilicate glassware and to suspend temporarily the duty on glassware of that kind. May 5, 1988.
20. H.R. 4092 (Mr. Smith)—To continue until January 1, 1990, a reduced rate of duty on ceramic statues, statuettes, and handmade flowers. May 23, 1988.
21. H.R. 4103 (Mr. Coble)—To suspend for a five-year period the duty on disperse yellow 27 dye. May 10, 1988.
22. H.R. 4167 (Mr. Green)—To provide for permanent duty-free treatment on imports of certain tartaric chemicals. June 3, 1988.
23. H.R. 4240 (Mrs. Martin)—To suspend temporarily the duty on certain glass bulbs until January 1, 1993. May 24, 1988.
24. H.R. 4244 (Mr. Vander Jagt)—To suspend for three years the duty on bentazon. June 3, 1988.
25. H.R. 4266 (Mr. Stokes)—To temporarily suspend the duty on mixed ortho/para-toluenesulfonamide. June 17, 1988.
26. H.R. 4269 (Mr. Andrews)—To suspend temporarily the duty on furniture of unspun fibrous vegetable materials. July 14, 1988.
27. H.R. 4294 (Mr. Buechner)—To suspend until January 1, 1991, the duty on N-(2-hydroxyethyl)-2,4,6-triiodo-5-[2-(2,4,6-triiodo-3-(N-methylacetamido)-5-(methylcarbamoyl)-benzamidoacetamido]isophthalamide. June 16, 1988.

28. H.R. 4295 (Mr. Clinger)—To suspend temporarily the duty on 3-ethyl-8-hydroxyquinoline. June 8, 1988.
29. H.R. 4296 (Mr. Clinger)—To suspend temporarily the duty on naphthalic acid anhydride. June 8, 1988.
30. H.R. 4303 (Mr. Goodling)—Regarding the rates of duty on bone chinaware. June 16, 1988.
31. H.R. 4313 (Mr. McEwen)—To amend the appendix to the Tariff Schedules of the United States to suspend the duties on certain bicycle parts. July 14, 1988.
32. H.R. 4316 (Mr. Nagle)—To suspend until the close of December 31, 1990, the duty on sulfachloropyridazine (technical). July 13, 1988.
33. H.R. 4347 (Mr. Shaw)—For the relief of the State of Florida. June 24, 1988.
34. H.R. 4350 (Mr. Vander Jagt)—To alter the tariff treatment of certain printed advertisements. June 24, 1988.
35. H.R. 4395 (Mr. Wylie)—To continue the suspension of duties on m-xylenediamine and 1,3-bis(amino-methyl)cyclohexane. July 14, 1988.
36. H.R. 4411 (Mr. Roe)—To reduce the duty on certain fabrics for use in making fire-protective garments for firefighters. July 14, 1988.
37. H.R. 4415 (Mr. Thomas)—To extend until January 1, 1994, the existing suspension of duty on certain yttrium ores, materials, and compounds. July 11, 1988.
38. H.R. 4500 (Mr. Mollohan)—To suspend temporarily the duty on octadecyl isocyanate. June 24, 1988.
39. H.R. 4504 (Mr. Frenzel)—Relating to the temporary tariff treatment of impact line printers. September 28, 1988.
40. H.R. 4553 (Mr. Brennan)—To enhance the enforcement of the laws relating to the conservation of the American lobster. August 10, 1988.
41. H.R. 4679 (Mr. Skaggs)—To amend the appendix to the Tariff Schedules of the United States to suspend the duties on certain infant nursery monitors and intercoms. September 28, 1988.
42. H.R. 4683 (Mr. Guarini)—To suspend for three years the duty on ADC-6. September 22, 1988.
43. H.R. 4684 (Mr. Guarini)—To suspend for three years the duty on diflunisal. September 9, 1988.
44. H.R. 4696 (Mr. Dwyer)—To suspend for three years the duty on norfloxacin. August 9, 1988.
45. H.R. 4697 (Mr. Dwyer)—To suspend for three years the duty on amiloride hydrochloride crude. August 3, 1988.
46. H.R. 4698 (Mr. Dwyer)—To suspend for three years the duty on D-carboxamide. August 9, 1988.
9. S. 1650 (Mr. Cranston)—Entitled the "Democracy in Panama Act of 1987." November 17, 1987.
10. S. 1669 (Mr. Shelby)—To provide temporary duty-free treatment to 2,6-HNA. October 20, 1987.
11. S. 1807 (Mr. Helms)—To temporarily suspend the duty on thiothiamine hydrochloride. February 1, 1988.
12. S. 1810 (Mr. Pell)—To extend until October 1, 1988, the existing suspension of duty on p-hydroxybenzoic acid. January 26, 1988.
13. S. 1845 (Mr. Hatfield)—To provide relief to Columbia Sportswear Co. with respect to the tariff classification of certain wearing apparel, and for other purposes. April 20, 1988.
14. S. 1866 (Mr. Hecht)—To provide duty-free treatment for three-dimensional cameras. January 26, 1988.
15. S. 1880 (Mr. Chafee)—To temporarily suspend the duty on theobromine. March 4, 1988.
16. S. 1881 (Mr. Chafee)—To temporarily suspend the duty on chlorhexanone. April 1, 1988.
17. S. 1895 (Mr. Bradley)—To temporarily suspend the duty on methyl and ethyl parathion. March 11, 1988.
18. S. 1900 (Mr. Thurmond)—To temporarily suspend the duty on dimethylbenzylidene sorbitol and 4,'-isopropylidenedicyclohexanol. March 1, 1988.
19. S. 1948 (Mr. Bradley)—To amend the Tariff Schedules of the United States to modify the quota on the importation of sugar. April 6, 1988.
20. S. 2052 (Mr. Glenn)—To continue the suspension of duties on m-xylenediamine and 1,3-bis(amino-methyl)cyclohexane. April 20, 1988.
21. S. 2053 (Mr. Glenn)—To temporarily suspend the duty on 8-hydroxyquinoline. April 26, 1988.
22. S. 2081 (Mr. Graham)—To suspend temporarily the duty on calcium carbaspirin. May 17, 1988. ⁴³

**Reports Submitted to
the Senate on
Proposed Legislation**

1. S. 379 (Mr. Thurmond)—To amend the Tariff Schedules of the United States with respect to extracorporeal shock wave lithotripters. October 8, 1987.
2. S. 1221 (Mr. Lautenberg)—To provide a three-year suspension of the duty on silk yarn. October 15, 1987.
3. S. 1306 (Mr. Cochran)—To amend the Tariff Schedules of the United States to make the temporary modification of the tariff treatment on certain disposable surgical gowns and drapes permanent. March 16, 1988.
4. S. 1310 (Mr. Rockefeller)—Relating to the tariff treatment of tin plate and tin-coated sheets. March 2, 1988.
5. S. 1496 (Mr. Lugar)—To continue the suspension of duty on certain antibiotic intermediates. October 28, 1987.
6. S. 1497 (Mr. Lugar)—To temporarily suspend the duty on certain antibiotic intermediates. October 28, 1987.
7. S. 1594 (Mr. Graham)—To improve the operation of the Caribbean Basin Economic Recovery Act. May 28, 1988.
8. S. 1644 (Mr. Pell)—To extend the temporary suspension of duty on a certain chemical. November 2, 1987.

23. S. 2087 (Mr. Bradley)—To suspend until January 1, 1991, the duty on iohexol. April 13, 1988.
24. S. 2164 (Mr. Rockefeller)—To temporarily suspend the duty on octadecyl isocyanate. May 10, 1988.
25. S. 2252 (Mr. Bradley)—To encourage economic development in Central America, and to increase the sugar import quota. July 8, 1988.
26. S. 2262 (Mr. Helms)—To suspend for a five-year period the duty on disperse yellow 27 dye. September 22, 1988.
27. S. 2265 (Mr. Danforth)—To provide for a temporary suspension of duty on demetallized laminated plastic film and demetallized plastic laminated to paper for use in microwave applications. June 24, 1988.
28. S. 2266 (Mr. Danforth)—To extend the duty arrangement on certain unwrought lead for a period of four years. June 21, 1988.
29. S. 2290 (Mr. Simon)—To temporarily suspend the duty on piperonyl butoxide. June 16, 1988.
30. S. 2387 (Mr. Heinz)—To suspend temporarily the duty on 3-ethyl-8-hydroxyquinoline. July 13, 1988.
31. S. 2388 (Mr. Heinz)—To suspend temporarily the duty on naphthalic acid anhydride. September 22, 1988.
32. S. 2398 (Mr. Armstrong)—To amend the appendix to the Tariff Schedules of the United States to suspend the duties on certain infant nursery monitors and intercoms. September 28, 1988.
33. S. 2399 (Mr. Armstrong)—To extend until December 31, 1993, the existing suspension of duty on certain yttrium ores, materials, and compounds. August 10, 1988.
34. S. 2407 (Mr. Grassley)—To temporarily suspend the duty on sulfachloropyridazine. July 13, 1988.
35. S. 2489 (Mr. Glenn)—To temporarily suspend the duty on mixed ortho/para-toluenesulfonamide. August 12, 1988.
36. S. 2504 (Mr. Bradley)—To provide for the temporary suspension of duty on tamoxifen citrate for a three-year period. September 19, 1988.
37. S. 2505 (Mr. Bradley)—To temporarily reduce the duty on certain fabrics used in making fire-protective garments for firefighters. August 10, 1988.
38. S. 2548 (Mr. Dixon)—To suspend temporarily the duty on certain glass bulbs until January 1, 1993. July 25, 1988.
39. S. 2567 (Mr. Bentsen)—To suspend temporarily the duty on furniture of unspun fibrous vegetable materials. August 10, 1988.
40. S. 2615 (Mr. Glenn)—To continue until January 1, 1991, the existing suspension of duty on m-aminophenol. August 12, 1988.
41. S. 2616 (Mr. Glenn)—To continue until January 1, 1991, the existing suspension of duty on trichlorosalicylic acid. August 12, 1988.
42. S. 2625 (Mr. Boschwitz)—To temporarily reduce the duties imposed on certain impact line printers. September 28, 1988.

Appendix D
Litigation in
Fiscal Year 1988
Completed Litigation

**Appeals Arising From Antidumping
and Countervailing Duty Investigations**

Alberta Pork Producers' Marketing Board v. United States
Court No. 85-09-01257 (Court of International Trade)

This decision affirmed the ITC's final affirmative determination following remand in *Live Swine and Pork From Canada* (701-TA-224). An earlier decision upheld the ITC's determination on material injury and some elements of the causation determination but remanded to the Commission its analysis of price effects as relying on price elasticities in a manner inconsistent with its determination that pork and swine constituted separate like products. After remand, the court affirmed the ITC's determination, holding that the ITC acted reasonably in relying on an analysis that eliminated the bias in price elasticities that had been derived from data on both pork and swine pricing. The court held that published pricing data coupled with the reconstructed elasticity estimates support the ITC's finding of a significant price-depressing effect.

American Permac, Inc. v. United States
Appeal No. 87-1159 (Court of Appeals for the Federal Circuit)

The Court of Appeals for the Federal Circuit sustained the Court of International Trade's decision, which had upheld the ITC's determination that an industry in the United States would be materially injured if the outstanding antidumping order against *Drycleaning Machinery From the Federal Republic of Germany* (751-TA-9) were revoked or modified. The Federal circuit sustained the ITC's analytic approach to reviews under section 751 of prior injury determinations, which assumes that dumping will resume if the existing antidumping order were revoked. It also upheld the ITC's two-stage analysis in such cases under which the ITC first forecasts the likely behavior of importers in the event of revocation or modification and then analyzes the likely impact of the imports on the domestic industry in view of that behavior.

Avesta AB v. United States
Court No. 85-10-01497 (Court of International Trade)

The court affirmed the ITC's determination to dismiss a request for a review under section 751(b) of the antidumping determination in *Stainless Steel Plate From Sweden* (AA1921-114). In particular, the court held (1) that the standard governing the determination of what are sufficient changed circumstances for purposes of the conduct of a section 751 review of an existing determination is different from the "reasonable indication" standard applicable in preliminary determinations under 19 U.S.C. 1673b(a), (2) that Commission Rule 207.45(b)(2) was a reasonable means for determining the existence of changed circumstances sufficient to warrant review, and (3) that a hearing was not required at that stage of a section 751(b) proceeding.

BMT Commodity Corp. et al. v. United States
Appeal No. 88-1188 (Court of Appeals for the Federal Circuit)

The Court of Appeals for the Federal Circuit adopted the ITC's final affirmative determination in *Certain Dried Salted Codfish From Canada* (731-TA-199), sustaining the Court of International Trade's decision in *BMT Commodity Corp. et al. v. United States*, 667 F.Supp. 880 (1987). The court in particular upheld the ITC's framework for analyzing the viability of a nascent enterprise in deciding whether a domestic industry has suffered material retardation by reason of the subject imports.

Copperweld Corp. v. United States
Court No. 86-03-00338 (Court of International Trade)

The court sustained the ITC's final negative determination in *Heavy-Walled Rectangular Welded Carbon Steel Pipes and Tubes From Canada* (731-TA-254), holding inter alia that the statute did not prohibit use of dumping margins as a factor in determining injury, that the ITC was not required to factor into

its analysis the value of freight absorption and other services offered in connection with imports, and that the ITC need not conduct a company-by-company analysis of injury to the domestic industry.

Empire Plow Co., Inc. v. United States
Court No. 85-11-01620 (Court of International Trade)

The court sustained the ITC's final negative determination in *Agricultural Tillage Tools From Brazil* (701-TA-223) with respect to nondisc tillage tools, upholding as reasonable the ITC's approach to whether a domestic producer is a party related to a foreign producer that should be excluded from the domestic industry.

Hercules, Inc. v. United States
Court Nos. 83-07-00951, 83-07-01075, 83-09-01324, and 83-09-01325
(Court of International Trade)

The court affirmed the ITC's final affirmative determination in *Nitrocellulose From France* (731-TA-196 and 701-TA-190), reiterating that title VII does not state a standard of investigative thoroughness and upholding the ITC's determination despite plaintiff's arguments that additional cost data from one firm should be gathered.

NTN Bearing Manufacturing Corp. of America v. United States
Court No. 88-01-00053 (Court of International Trade)

The Court of International Trade granted the ITC's motion to dismiss this action, the second of two appeals filed by NTN challenging the ITC's affirmative final injury determination in *Tapered Roller Bearings and Parts Thereof and Certain Housings Incorporating Tapered Rollers From Japan* (731-TA-343), holding that a new period for appeal for review of an ITC determination does not begin to run from an amendment of the Department of Commerce's antidumping order.

National Association of Mirror Manufacturers v. United States
Consolidated Court No. 87-04-00592
(Court of International Trade)

The court upheld the ITC's final negative determination in its investigation of *Certain Unfinished Mirrors* from several countries (731-TA-320 through 325), specifically reiterating that the ITC need not decide whether an industry is not suffering material injury on a disaggregated basis.

Wells Manufacturing Co. v. United States
Court No. 84-02-00193 (Court of International Trade)

The court affirmed the ITC's preliminary negative determination in *Iron Bars From Brazil* (701-TA-208), holding inter alia that the ITC acted reasonably in considering trade-restrictive practices of the domestic industry among other factors in determining that the lack of a causal nexus between the subject imports and the condition of the domestic industry established that there was no reasonable indication of material injury.

Yuasa-General Battery Corp. v. United States
Court No. 85-04-00483 (Court of International Trade)

The court reversed the ITC's preliminary negative determination in *12-Volt Motorcycle Batteries From Taiwan* (731-TA-238), holding that the ITC had abused its discretion by failing to follow its own standard for preliminary determinations, in particular by evaluating the strength of evidence tending toward an affirmative determination rather than whether the negative evidence was clear and convincing.

Appeals Arising From Investigations Under Section 337 of the Tariff Act of 1930

Allied Corp. v. U.S. International Trade Commission
Appeals Nos. 87-1455 and 87-1616
(Court of Appeals for the Federal Circuit)

The Federal circuit affirmed the ITC's Modified Exclusion Order in *In the Matter of Certain Amorphous Metals and Amorphous Metal Articles* (337-TA-143), and it dismissed the appeal of the advisory opinions resulting from the same investigations.

The court held that advisory opinions are not appealable under section 337(c) because they do not constitute final determinations, whereas decisions to modify existing exclusion orders are appealable. The court also held that, in the ITC's determination finding that the subject processes do not infringe complainant's process patents, under the doctrine of equivalence, the ITC employed a proper analysis and its findings were supported by substantial evidence.

Beloit Corp. v. U.S. International Trade Commission
Appeal No. 87-1230 (Court of Appeals for the Federal Circuit)

The decision in this case affirmed the ITC's negative determination in *Certain Papermaking Machine Forming Sections* (337-TA-147). The court upheld the ITC's determinations that the subject patent was invalid on the grounds of anticipation and obviousness.

Bioscan v. U.S. International Trade Commission
Appeal No. 87-1599 (Court of Appeals for the Federal Circuit)

The Federal circuit affirmed the ITC's determination of no violation in *Certain Chromatogram Analyzers* (337-TA-251). The court upheld the ITC on all three of the issues on appeal, i.e., patent infringement, patent validity, and domestic industry.

Fischer & Porter Co. v. U.S. International Trade Commission
Appeal No. 87-1166 (Court of Appeals for the Federal Circuit)

In this appeal, the court upheld the ITC's negative determination in *In the Matter of Certain Unitary Electromag-*

netic Flowmeters (337-TA-230). The court sustained the ITC's determination that the complainant failed to carry its burden of proof under the Administrative Procedure Act to show that respondent's infringement had the effect or tendency to substantially injure. The court held that the ITC appropriately found complainant's evidence insufficiently probative and specifically noted that the expense of putting the evidence in usable form would afford complainant no excuse.

Lenox, Inc. v. U.S. International Trade Commission
Appeal No. 87-1370 (Court of Appeals for the Federal Circuit)

The court on December 24, 1987, affirmed the ITC's negative determination in *Certain Luggage Products* (337-TA-243), upholding the ITC's finding in general and specifically the ITC's finding that the failure of petitioner's witnesses to be able to identify the features of the claimed product configuration trademark support the inference that the mark was weak.

Rotron, Inc. v. U.S. International Trade Commission
Appeal No. 87-1099 (Court of Appeals for the Federal Circuit)

The court reversed the ITC's negative determination on the basis of patent claim invalidity in *Fans With Brushless DC Motors* (337-TA-228), holding that certain references were not properly regarded as prior art, that the ITC improperly found commercial success of the patented devices unrelated to the claimed invention, and that expert testimony in the investigation did not substantiate a finding of obviousness of the claimed invention.

Tandon Corp. v. U.S. International Trade Commission
Appeal No. 86-1077 (Court of Appeals for the Federal Circuit)

The court affirmed the ITC's final negative determination in *Double-Sided Floppy Disk Drives and Components Thereof* (337-TA-215), upholding the

ITC's findings of noninfringement and reiterating that appellate treatment of ITC decisions does not estop fresh consideration of issues by other tribunals.

Union Manufacturing Co., Inc. v. U.S. International Trade Commission
Appeal No. 85-2473 (Court of Appeals for the Federal Circuit)

The court affirmed the ITC's negative determination in *Certain Vacuum Bottles and Components Thereof* (337-TA-108), sustaining the ITC's finding that complainant's evidence on its marketing failed to establish secondary meaning in its product's appearance. The court also upheld the ITC's decision to deny a motion for reconsideration as improperly filed under its Rule 19 CFR 211.57 and to deny a request for a new investigation as failing to set forth sufficient evidence of a substantial buyer group's identification of the claimed mark with a single source.

Litigation Terminated

In addition to the cases discussed above, a number of cases were terminated during fiscal year 1988 without decisions on their merits, by court dismissal, voluntary dismissal by the plaintiff, or failure by the plaintiff to file a complaint after the service of a summons. Those cases are listed below.

Aunyx Corp. v. U.S. International Trade Commission
Appeal No. 88-1360 (Court of Appeals for the Federal Circuit)

Batts, Inc. v. U.S. International Trade Commission
Appeal No. 88-1015 (Court of Appeals for the Federal Circuit)

China National Metals & Minerals Import & Export Corp. v. United States
Court No. 86-06-00782 (Court of International Trade)

LSI Computer Systems, Inc. v. U.S. International Trade Commission
Appeal No. 87-1179 (Court of Appeals for the Federal Circuit)

Maverick Tube Corp. v. United States
Court No. 87-04-00636 (Court of International Trade)

NTN Bearing Manufacturing Corp. of America v. United States
Court No. 88-01-00053 (Court of International Trade)

Price v. Briggs
Civil Action No. 2:87-1484 (U.S. District Court for the Southern District of West Virginia)

Pending Litigation at the End of Fiscal Year 1988

| | |
|--|----|
| Cases arising from antidumping and countervailing duty investigations ¹ | 51 |
| Cases arising from section 337 determinations | 12 |
| Other litigation | 1 |
| Total | 64 |

¹ All cases filed by different parties that challenge the same ITC determination or that have been consolidated by the court are counted only as a single piece of litigation. Thus, the actual number of complaints filed is greater than the number given above.

By comparison, at the end of fiscal year 1987, there were 58 pending cases arising from antidumping and countervailing duty investigations, 16 arising from section 337 determinations, and 3 arising from other subjects, for a total of 77.

