



CPSC Staff Statement on SEA, Ltd. Report “Dynamic Occupant Protection Performance Tests for Recreational Off-Highway Vehicles (ROVs)”¹

March 2016

The report titled, “Dynamic Occupant Protection Performance Tests for Recreational Off-Highway Vehicles (ROVs),” presents results from dynamic occupant protection performance tests conducted by SEA, Ltd. (“SEA”) on the SEA Roll Simulator. SEA tested six model year 2014-2015 ROVs under contract CPSC-D-11-0003, Task Orders 005 and 006. The six vehicles are a subset of vehicles previously tested for CPSC to evaluate their handling and stability characteristics and tilt table ratios.^{2,3} The vehicle code notations used in this report are the same as for the previous reports.

This report also presents results from tests conducted to evaluate occupant side retention devices. The specific tests performed are proposed voluntary standards in the canvass draft of American National Standard ANSI/OPEI B71.9-2016, American National Standard for Multipurpose Off-Highway Utility Vehicles (Section 8.10). These tests will be referred to as Probe tests. The Probe tests were conducted on 11 of the 2014-2015 model ROVs.

This report contains two main sections: one describing the Roll Simulator testing and one describing the Probe testing. This report also has four appendices:

- Appendix A contains Roll Simulator test results,
- Appendix B contains photos of the restraint system of each vehicle,
- Appendix C contains Probe test results, and
- Appendix D describes the video processing procedure.

¹ This statement was prepared by the CPSC staff, and the attached report was produced by SEA for CPSC staff. The statement and report have not been reviewed or approved by, and do not necessarily represent the views of, the Commission.

² *Tilt Table Measurements on Twenty-Two Recreational Off-Highway Vehicles*, CPSC Contract CPSC-D-11-0003, SEA, Ltd. Report to CPSC, September 2015. <http://www.cpsc.gov/Global/Research-and-Statistics/Injury-Statistics/Sports-and-Recreation/ATVs/SEAREportTiltTableResults22ROVsSept2015.pdf>

³ *Vehicle Characteristics Measurements of Recreational Off-Highway Vehicles, Results from Tests on Thirteen 2014-2015 Model Year Vehicles*, CPSC Contract CPSC-D-11-0003, SEA, Ltd. Report to CPSC, September 2015.

<http://www.cpsc.gov/Global/Research-and-Statistics/Injury-Statistics/Sports-and-Recreation/ATVs/SEAREportVehicleCharacteristicsMeasurementsROVResultsTests%20Thirteen20142015ModelYearVehicles.pdf>

*Dynamic Occupant Protection
Performance Tests for
Recreational Off-Highway Vehicles
(ROVs)*

Results for 2014-2015 Model Year Vehicles

for:
The Consumer Product Safety Commission

March 2016



Vehicle Dynamics Division
7349 Worthington-Galena Road
Columbus, Ohio 43085

*Dynamic Occupant Protection
Performance Tests for
Recreational Off-Highway Vehicles
(ROVs)*

Results for 2014-2015 Model Year Vehicles

for:
The Consumer Product Safety Commission

“These comments are those of S-E-A, Ltd. staff and they have not been reviewed or approved by, and may not necessarily reflect the views of, the Commission.”

Report prepared by:
Scott Zagorski, Ph.D., P.E. and Anmol Sidhu, Ph.D.



Vehicle Dynamics Division
7349 Worthington-Galena Road
Columbus, Ohio 43085

TABLE OF CONTENTS

1. INTRODUCTION.....	2
2. ROLL SIMULATOR TESTING.....	3
2.1 Overview.....	3
2.2 Input Parameters.....	3
2.3 Test Protocols.....	7
2.4 Standard Test Results.....	9
2.5 Additional Test Results	15
3. PROBE TESTS	34
Appendix A: Roll Simulator - Standard Test Results	38
Appendix B: Vehicle Photos and Restraint Systems	63
Appendix C: Probe Test Results	71
Appendix D: Video Processing Procedure	94

1. INTRODUCTION

This is a report of a series of tests conducted by S-E-A, Ltd. (S-E-A), for the Consumer Product Safety Commission (CPSC) under contract number CPSC-D-11-0003. This report presents the results from dynamic occupant protection performance tests conducted on the S-E-A Roll Simulator. The Roll Simulator testing is a follow-up to a study conducted for CPSC on seven model year 2008-2011 ROVs¹.

For the current Roll Simulator study, six 2014-2015 model year ROVs were tested. The six vehicles are a subset of vehicles previously tested for CPSC to evaluate their handling and stability characteristics² and tilt table ratios³. The vehicle code notations used in this report are the same as for the previous reports.

This report also presents results from tests conducted to evaluate occupant side retention devices. The specific tests performed are proposed voluntary standards in the canvass draft of American National Standard ANSI/OPEI B71.9-2016, American National Standard for Multipurpose Off Highway Utility Vehicles (Section 8.10). For the remainder of this report, these tests will be referred to as Probe tests. The Probe tests were conducted on 11 of the 2014-2015 model ROVs.

This report contains two main sections after this overview, one describing the Roll Simulator testing and one describing the Probe testing. This report also has four appendices, one containing Roll Simulator test results, one containing Probe test results, one containing photos and restraint systems for the vehicles tested on the Roll Simulator and one describing the video processing procedure.

¹ *Test and Evaluation of Recreational Off-Highway Vehicles (ROVs), Dynamic Occupant Protection Performance Tests*, CPSC Contract CPSC-D-11-0003, SEA, Ltd. Report to CPSC, September 2012. <http://www.cpsc.gov/Global/Research-and-Statistics/Technical-Reports/Sports-and-Recreation/ATV-ROV/ROVOccupantProtectionPerformanceTests.pdf>

² *Vehicle Characteristics Measurements of Recreational Off-Highway Vehicles, Results from Tests on Thirteen 2014-2015 Model Year Vehicles*, CPSC Contract CPSC-D-11-0003, SEA, Ltd. Report to CPSC, September 2015. <http://www.cpsc.gov/Global/Research-and-Statistics/Injury-Statistics/Sports-and-Recreation/ATVs/SEAreportVehicleCharacteristicsMeasurementsROVResultsTests%20Thirteen20142015ModelYearVehicles.pdf>

³ *Tilt Table Measurements on Twenty-Two Recreational Off-Highway Vehicles*, CPSC Contract CPSC-D-11-0003, SEA, Ltd. Report to CPSC, September 2015. <http://www.cpsc.gov/Global/Research-and-Statistics/Injury-Statistics/Sports-and-Recreation/ATVs/SEAreportTiltTableResults22ROVsSept2015.pdf>

2. ROLL SIMULATOR TESTING

2.1 Overview

For the Roll Simulator tests, occupant kinematics data during a 90-degree rollover event were analyzed. Both minimum energy (threshold) and higher energy (tripped) rollover events were studied. The kinematics of a belted Hybrid III 50th percentile male anthropomorphic test device (ATD) were recorded and the measured ATD head motion is presented in the Appendix A.

The Roll Simulator can be used to simulate 90-degree rollover events of ROVs. The device has been validated through vehicle dynamics testing of vehicles within this vehicle class. The roll simulator has been shown to reproduce lateral accelerations, roll rates, and roll angles experienced by ROVs during field-testing. For the subject testing protocol the roll simulator incorporated one Hybrid III 50th percentile male ATD for evaluation of occupant protection devices. Please refer to the following publications for additional information and validation details of the S-E-A Roll Simulator:

- “Modeling and Validation of a Roll Simulator for Recreational Off-Highway Vehicles,” Zagorski, et al., American Society of Mechanical Engineers, Paper Number: IMECE2011-62603, 2011.
- “Control Strategies for a Roll Simulator for Recreational Off-Highway Vehicles,” Zagorski, et al., American Society of Mechanical Engineers, Paper Number: IMECE2011-62601, 2011.
- “Validation of a Roll Simulator for Recreational Off-Highway Vehicles,” Zagorski, et al., Society of Automotive Engineers, Paper Number: SAE 2012-01-0241, 2012.

2.2 Input Parameters

Input parameters for the roll simulator testing were determined through vehicle dynamics testing of representative vehicles within the subject vehicle class, as well as review of published literature¹.

The profiles shown in Figures 1 and 2 were used as target inputs for the roll simulation and were developed based on the mean response profiles as discussed in previous studies². The levels in Tables 1 and 2 outline the specific ranges shown in Figures 1 and 2, respectively. For the threshold rollover event (Figure 1 and Table 1), a peak body-fixed lateral acceleration in the range of 0.6-1.0 g is used. The *Time to 90 deg Roll* was established to be in the range of 0.9-1.1 sec, where *Time = 0 sec* is defined as the time when the lateral acceleration enters the beginning of the Acceleration Peak range (0.6 g).

¹ *Test and Evaluation of Recreational Off-Highway Vehicles (ROVs), Dynamic Occupant Protection Performance Tests*, CPSC Contract CPSC-D-11-0003, SEA, Ltd. Report to CPSC, September 2012. <http://www.cpsc.gov/Global/Research-and-Statistics/Technical-Reports/Sports-and-Recreation/ATV-ROV/ROVOccupantProtectionPerformanceTests.pdf>

² Ibid

For the tripped rollover events (Figure 2 and Table 2), the maneuver can be split-up into two segments:

- 1) Pre-trip event: Range where a brief period of build-up in lateral acceleration (deceleration) occurs. This simulates the vehicle decelerating laterally, prior to hitting a tripping feature or hazard (e.g., soil furrow, curb or tree root). For this, a deceleration in the range of 0.4-0.8 g is used.
- 2) Tripped event: Range where a peak body-fixed lateral acceleration in the range of 2.5-3.5 g is used. The duration of the lateral acceleration pulse in the tripped rollover is much shorter than the lateral acceleration profile used during the threshold event and is in the range of 0.2-0.3 sec. Consequently, the *Time to 90 deg Roll* is much shorter, in the range of 0.5-0.7 sec, where *Time = 0 sec* is defined as the time when the tripped event begins.

It should be noted that prior to conducting this suite of tests on the 2014-2015 model year vehicles, an upgrade to the tripping mechanism of the Roll Simulator was made. The previous studies¹ used a mechanical brake which relied on the frictional force generated between two metal surfaces when the sled made contact with them. The tuning of this system was cumbersome and it was difficult to achieve a high degree of repeatability. The new mechanism uses two hydraulic cylinders that are mounted to the floor. When the sled makes contact with the extended cylinders, they close and the fluid flows back to the reservoir. A servo-valve between the cylinders and reservoir dictates the peak pressure and rate of build up. The initial valve position and rate-of-close are adjustable and aide in the tuning and achieving a desired tripped event. This hydraulic control system was found to be more efficient in producing repeatable runs. For this study, no change was made to the threshold braking mechanism.

For all data presented in this report, the standard SAE vehicle dynamics (SAE J670) coordinate system is used.

¹ Ibid

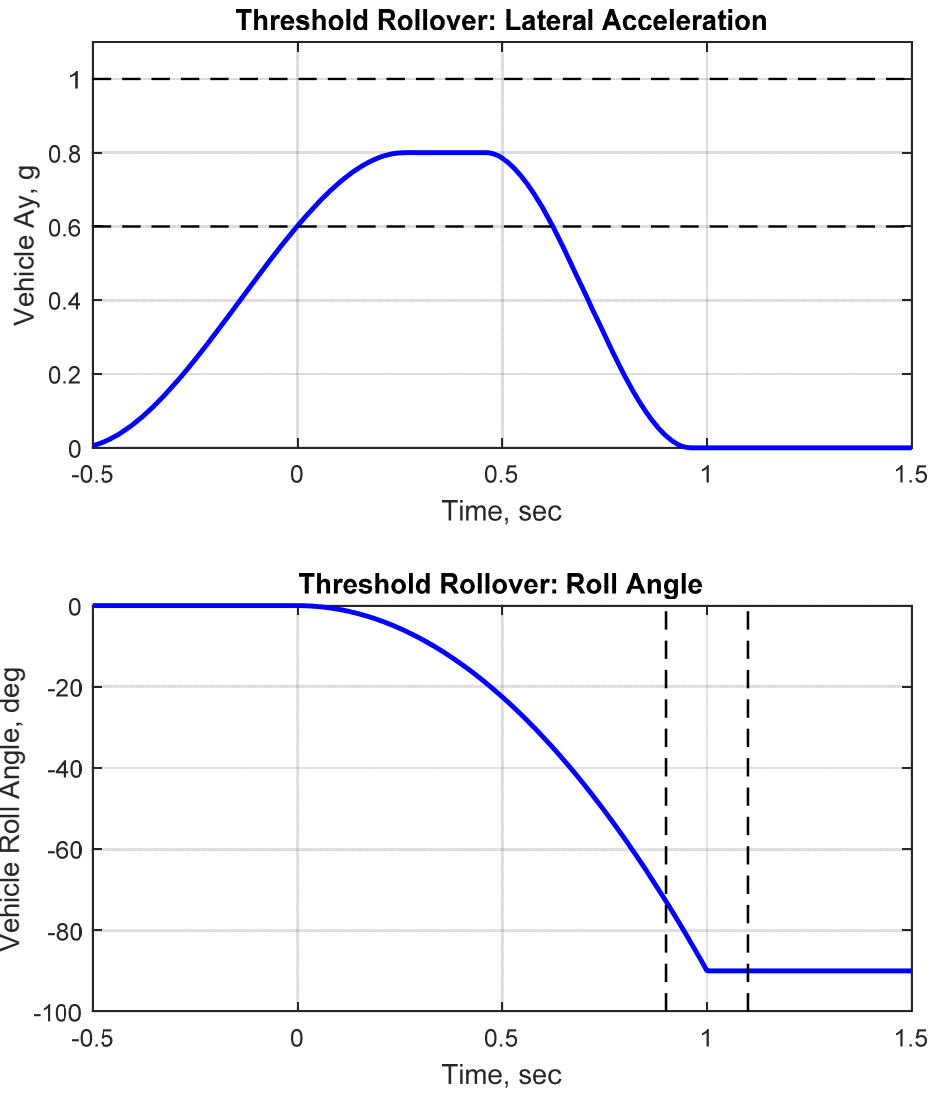

Figure 1: Roll Simulator Nominal Response Profiles with Test Parameters - Threshold Event

Table 1: Roll Simulator Test Parameters for Threshold Event			
Variable	Name	Units	Range
AY	Acceleration Peak	g	0.6 – 1.0
T ₉₀	Time to 90 Deg Roll (and End Accel.)	sec	0.9 – 1.1

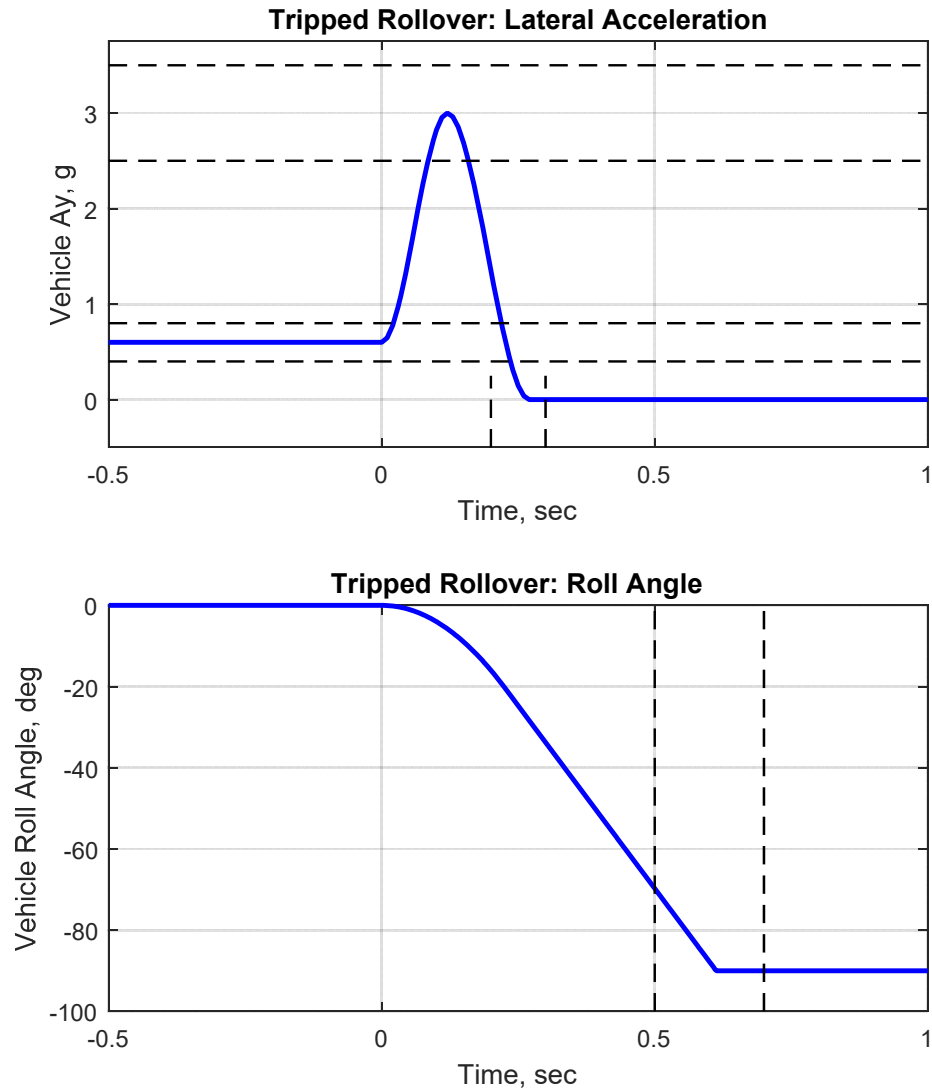

Figure 2: Roll Simulator Nominal Response Profiles with Test Parameters for Tripped Event

Table 2: Roll Simulator Test Parameters for Tripped Event			
Variable	Name	Units	Range
AY_{peak}	Acceleration Pulse Amplitude	g	2.5 – 3.5
AY_{init}	Initial Acceleration	g	0.4 – 0.8
T_{pulse}	Acceleration Pulse Width	sec	0.20 – 0.30
T_{90}	Time to 90 Deg Roll	sec	0.50 – 0.70

2.3 Test Protocols

For each of the six vehicles tested, a set of standard tests were performed: three threshold tests and three tripped tests, each with a belted and instrumented Hybrid III 50th percentile male ATD in the driver's seat. For these standard tests all occupant restraint components including doors and nets were used (Table 3). All roll events were driver's side leading; thus, the ATD was a belted nearside occupant.

For Vehicles L15 and J15, three additional threshold tests were performed where the driver's side net was removed. For Vehicle J15, two more tests were performed: one tripped test with the net removed and one threshold where the net and door were removed. Table 3 summarizes the tests performed.

For Vehicle M15, with the net removed, only two threshold tests were performed. Also, for Vehicle M15, 11 additional tests were performed where the ATD was varied and/or the vehicle's restraint system was modified (Table 4). The tests were:

1. 50th percentile male: two tests without the hip bar and two tests without the hip bar and without net
2. 95th percentile male: three tests with net and with hip bar
3. 5th percentile female: three tests with net and with hip bar and one test without net and without belt

Table 3: Test Protocol					
Vehicle	Net		No Net		Additional Tests
	Threshold	Tripped	Threshold	Tripped	
C15	3	3	-	-	n/a
E15	3	3	-	-	n/a
H15	3	3	-	-	n/a
J15	3	3	3	1	1 Test No Net + No Door (Threshold)
L15	3	3	3	-	n/a
M15	3	3	2	-	See Table 4

ATD	With Net + With Hip Bar	No Hip Bar	No Net + No Hip Bar	No Net + No Belt
50th Percentile Male	3	2	2	-
95th Percentile Male	3	-	-	-
5th Percentile Female	3	-	-	1

The ATD positioning and documentation protocol used here was based upon methods established in the previous study¹. The ATD joints were set at 1 g, and prior to each test, the ATD was positioned within the occupant compartment. His hands were placed on his lap, the right foot was placed on the gas pedal and the left knee was bent 90 degrees. Measurements of the ATD's position relative to the occupant compartment and the on-board cameras were recorded. These pre-test measurements were used to determine the position of the outboard ROPS plane (x-z plane) and the ATD initial y and z-positions relative to this plane for each test. The initial ATD Head Y position was set as close as possible to the lateral center of the seat (this is where Y displacement is zero). The ROPS geometries are shown in the results in Appendix A as thick solid lines in the y-z plane. Pre-test and post-test photographs were taken to document each test.

Table 5 lists the instrumentation used to measure the vehicles' motions. The accelerometer and gyroscope were rigidly mounted to the bed of the vehicle. The measurements were displaced to the center of gravity of the vehicle.

Unit	Manufacturer	Model No.	Range
Tri-Axial Accelerometer	Crossbow	CXL04GP3-R-AL	4 g
Uni-Axial Gyroscope	Spectrum Sensors and Control	11206AC	300 deg/sec

Occupant motion was recorded with two on-board, high-speed video cameras (250 fps). In addition to the on-board camera, two off-board video cameras were used to document each test: a high-speed at 300 fps and a high-definition at 60 fps. These off-board cameras captured the vehicle and occupant motion isometrically from the side of the vehicle during the actual roll phase for the threshold tests and in front for the tripped tests. Synchronization of the on-board video with the vehicle and ATD data was accomplished through an electrical signal. ATD head and chest accelerations were also recorded for each test that used the 50th percentile male ATD. All vehicle and ATD data was recorded at 5000 Hz. The vehicle data was low-pass filtered during post-processing using a digital Butterworth filter with a cut-off frequency of 10 Hz.

¹ Ibid

2.4 Standard Test Results

Appendix A contains results of the standard tests for each belted occupant test (3 threshold and 3 tripped with all occupant restraint components used). For each of the six vehicles tested, Appendix A contains two pages of graphs for both the threshold tests and the tripped tests. These graphs include plots of ATD Head Y (lateral) displacement and ATD Head Z (vertical) displacement. The ATD head displacements are calculated in three dimensions through analysis of the high-speed video data from the two on-board cameras. The procedure for calculating these displacements is outlined in detail in Appendix D.

Appendix B includes photos of each vehicle as tested on the Roll Simulator. Also in this section is a table of the restraint systems for the vehicles tested (Table B-1). Five of the six vehicles tested had some form of net system. The same five vehicles also had a bar installed (hip, shoulder or arm). Three of the vehicles were equipped with some form of door. All vehicles had seat belts that were webbing sensitive (retractor locks when seat belt undergoes sudden movement) and all vehicles, except for vehicles H15 and C15, had vehicle sensitive locking retractors (inertial locking, where the belt locks when a vehicle reaches a certain roll angle or ground plane acceleration level). Vehicle H15 did not have a net or a bar installed and only had a webbing sensitive seat belt, but did have a full door, that typically covered the shoulder and arm.

Samples of the two pages provided for a single vehicle (Vehicle J15) during a threshold event are shown here as Figures 3 and 4. The states presented in the time domain plots of Figure 3 are vehicle body-fixed lateral acceleration at the vehicle center of gravity, vehicle roll angle, and ATD Head Y and Z displacements. ATD Head Y and Z displacements are also plotted as a function of Roll Angle.

In the time-based plot of vehicle roll angle (top right), the *Time to 90 deg Roll* limits are co-plotted and shown as dashed black lines. Also included is the point at which vehicle roll angle reaches 90 degrees, shown as a solid circle. For this sample, a threshold event, *Time = 0 sec* is defined as the moment where the lateral acceleration enters the beginning of the Acceleration Peak range (0.6 g).

ATD Head Y and Z displacements are the displacements of the marker attached to the ATD's forehead. For the Head Y displacements, zero displacement represents the initial position of the ATD head determined during ATD set-up; positive displacement represents inboard motion; and negative displacement represents outboard motion. For the Head Z displacements, zero displacement represents the horizontal position of the ROPS above the ATD's head, with positive displacements indicting the Z-direction distance from the ROPS to the marker on the ATD's forehead.

The initial phase of motion of the Roll Simulator involves accelerating the vehicle to a specified speed and then maintaining this speed prior to initiating any roll motion. During this initial phase, the ATD leans inboard and then, during the constant speed phase, the ATD reaches a quasi-static position near its original position prior to roll initiation. Quantitative analysis of ATD head kinematics was only completed during the roll event,

starting at roll angle equal to 0 degrees. The ATD Head Y displacement at the beginning of the motion analysis is sometimes positive because the ATD has returned to its zero position before the video processing was started.

Figure 4 shows a sample cross plot of the ATD Head Z displacement versus Head Y displacement. Co-plotted on all of the Head Z versus Head Y plots are a vertical projection of the ROPS plane (indicated by two thick solid black lines) as sectioned through the ATD head initial longitudinal position, as shown on Figure 5. Figure 5 also shows a ROPS Bounds Plane that was used to create the ROPS line (on the Head Z versus Head Y plots) at the outside edge of each vehicle. The ROPS Bounds Plane is a triangle with one side defined by the line of the rear ROPS upright and the other two sides defined by lines connecting two points on the rear ROPS upright to a point on the front upright at the ATD head initial height. The horizontal ROPS line represents the height of the ROPS structure in a vertical plane sectioned through the ATD head initial longitudinal position. For reference, the ROPS (indicated by a thick solid black line) is also co-plotted on all Head Y versus time and Head Y versus roll angle plots (see Figure 3). The ROPS at 0 degrees of roll angle is used for these plots. For each vehicle, the dimensions of the ROPS structures were measured using a 3D Faro scanner.

The blue line on the Head Z versus Head Y plot (Figure 4) shows the trajectory of the marker located on the forehead of the ATD. If the blue head trajectory line exceeds the ROPS plane (to the right and/or above), it would indicate that the ATD has traveled outside the ROPS boundary. Also shown in these plots are the ATD head positions at discrete instances of vehicle roll angle at 0, 15, 45 and 90 degrees.

The plots contained in Figures 3 and 4 are shown in Appendix A for each vehicle for all standard threshold and tripped tests conducted.

Table 6 contains a summary of all of the threshold and tripped tests. The maximum Head Y displacement and the maximum Head Z displacement are shown for each test. Also, the Head Y and Head Z average displacements for the three runs for each test configuration are included. For the Y-axis displacements, the data is referenced to the initial position of the ATD head. For the Z-axis, for this calculation only, the data is referenced to the position of the ATD head at a roll angle equal to 0 degrees. A positive head displacement in the Z-axis would indicate the ATD moved away from the ROPS; whereas, a negative head displacement would indicate the ATD moved toward and closer to the ROPS. The data in Table 6 illustrates that for all the standard tests the ATD moved closer to ROPS in the Z-axis.

In the standard test conditions, for the threshold maneuvers, all vehicles except for C15, the ATD's head stayed within the ROPS for the entire maneuver. It's noted that Vehicle C15 only had a webbing sensitive seat belt and a small hip bar and foot net. For the tripped tests, the ATD's head stayed within the ROPS for all vehicles except for vehicle L15, where for two of the three runs the ATD moved outside the ROPS for a portion of the vehicle motion.

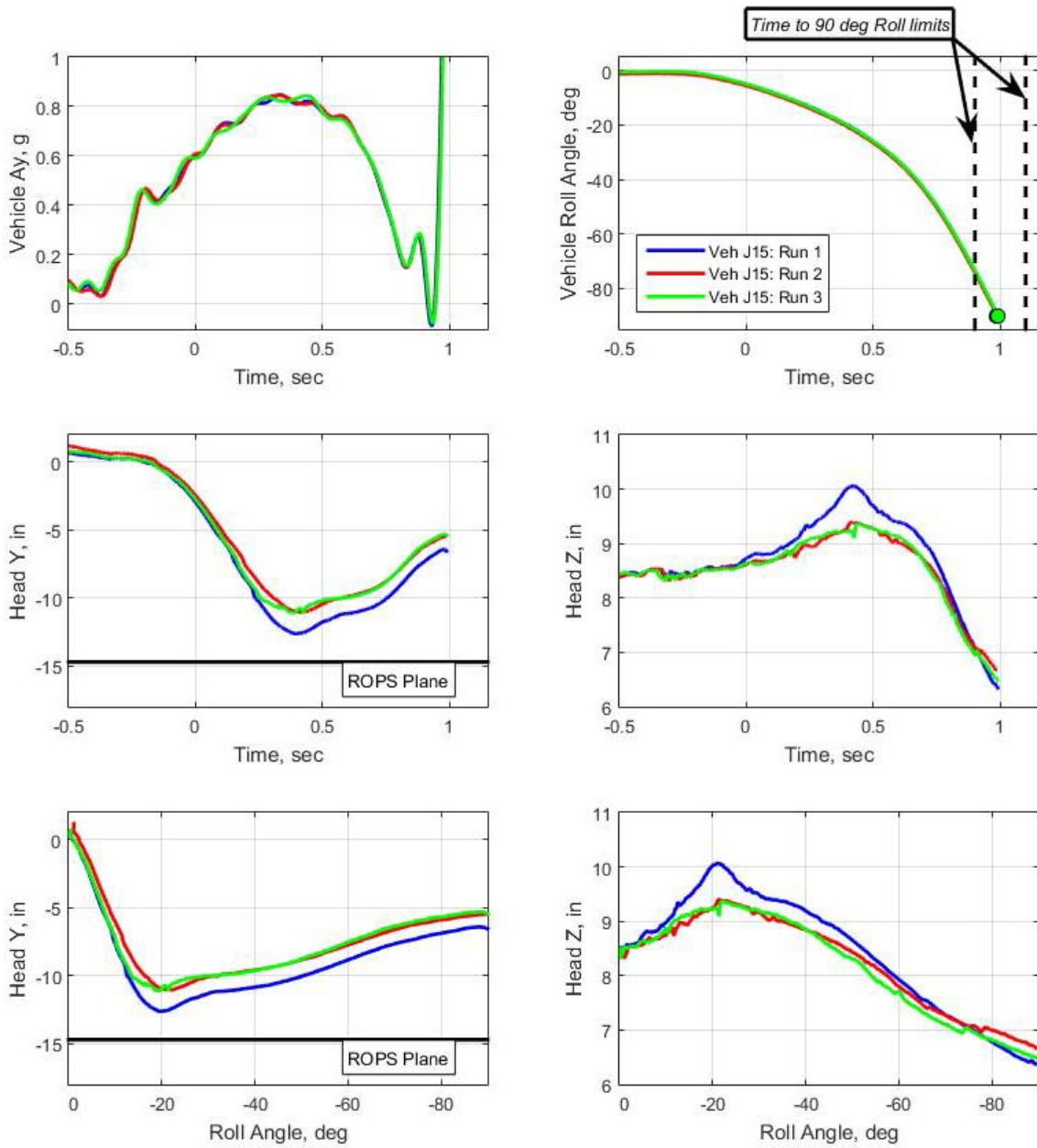

Figure 3: Sample Roll Simulator Results for Threshold Event - Vehicle Response and ATD Head Displacement

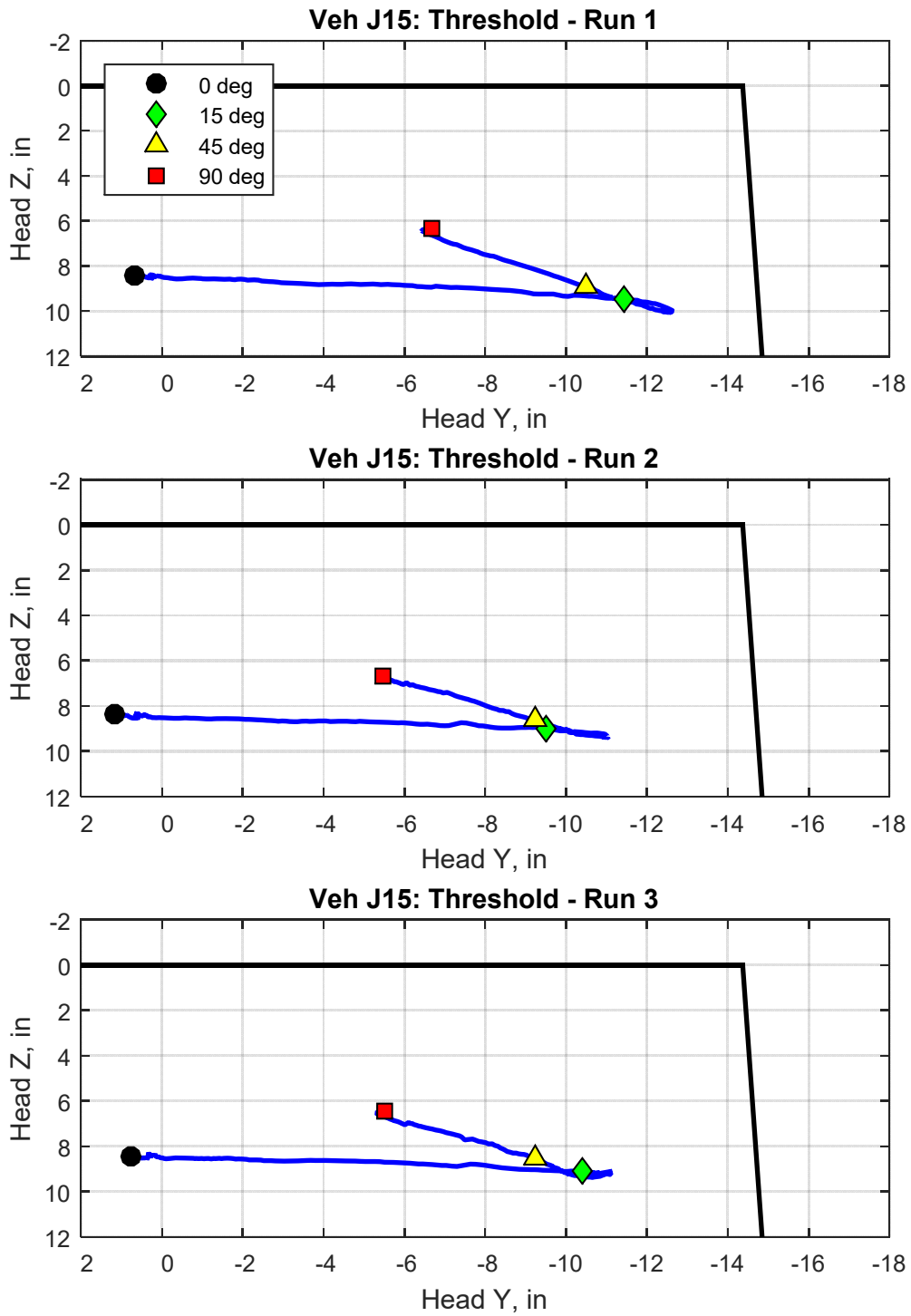

Figure 4: Sample ATD Head Displacement for Threshold Event - Head Z vs. Head Y

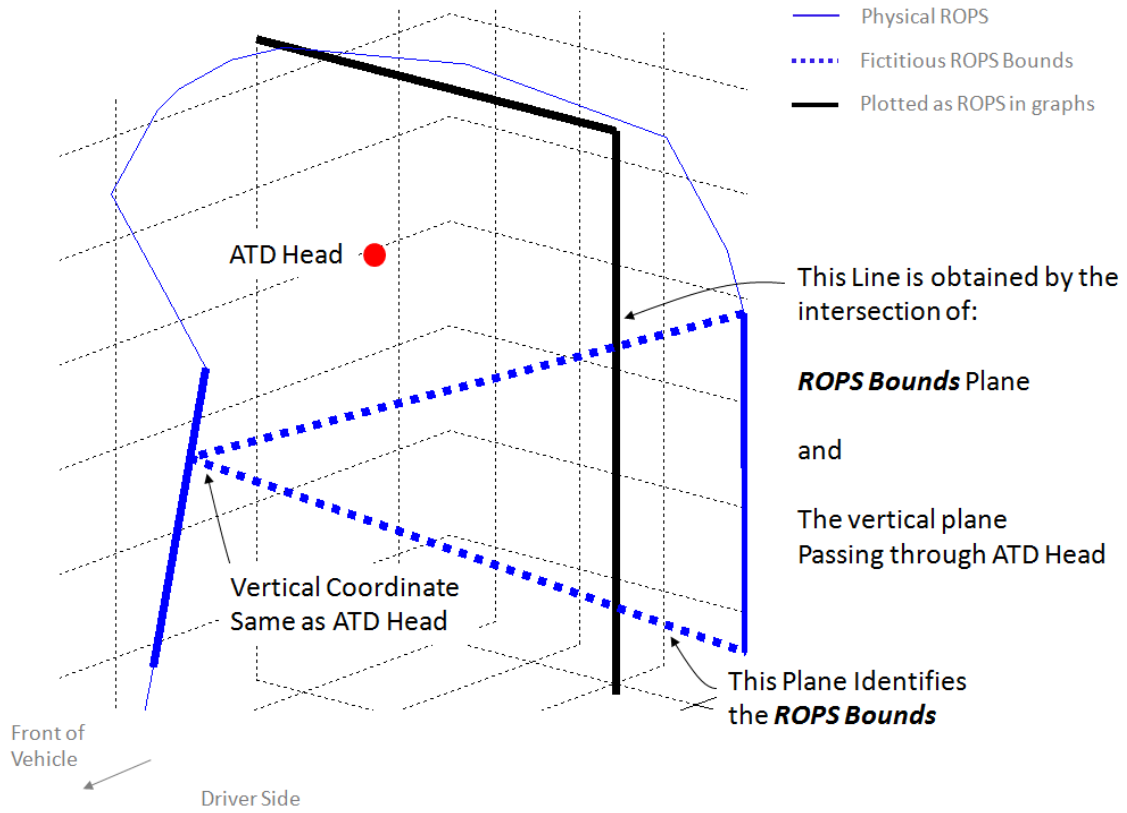

Figure 5: ROPS Plane Definition

Table 6: Individual Maximum and Average Maximum Head Displacement Levels for Standard Tests - Threshold and Tripped Events

Vehicle	Test No.	Threshold		Tripped	
		Head Y (in)	Head Z (in)	Head Y (in)	Head Z (in)
C15	Run 1 Max	-20.4	-3.8	-11.3	-2.7
	Run 2 Max	-16.3	-3.2	-11.1	-2.8
	Run 3 Max	-16.6	-2.4	-10.9	-2.0
	Average Max	-17.8	-3.1	-11.1	-2.5
E15	Run 1 Max	-3.3	-2.0	-4.0	-2.3
	Run 2 Max	-2.6	-2.2	-5.1	-2.3
	Run 3 Max	-3.2	-1.8	-3.5	-2.3
	Average Max	-3.0	-2.0	-4.2	-2.3
H15	Run 1 Max	-6.6	-1.4	-8.6	-2.3
	Run 2 Max	-6.8	-1.3	-8.2	-2.3
	Run 3 Max	-6.2	-1.3	-9.8	-2.4
	Average Max	-6.5	-1.3	-8.9	-2.3
J15	Run 1 Max	-12.6	-2.3	-11.1	-1.9
	Run 2 Max	-11.0	-2.0	-10.5	-1.9
	Run 3 Max	-11.1	-2.2	-9.8	-2.0
	Average Max	-11.6	-2.1	-10.5	-2.0
L15	Run 1 Max	-11.5	-2.9	-13.1	-2.9
	Run 2 Max	-10.4	-2.4	-12.1	-3.6
	Run 3 Max	-12.0	-3.0	-12.6	-2.6
	Average Max	-11.3	-2.8	-12.6	-3.0
M15	Run 1 Max	-4.7	-1.9	-6.6	-1.1
	Run 2 Max	-5.5	-1.6	-6.2	-1.6
	Run 3 Max	-5.0	-1.2	-7.4	-1.7
	Average Max	-5.1	-1.6	-6.8	-1.5

2.5 Additional Test Results

In this section, data is presented from the additional tests performed for Vehicles J15, L15 and M15 as outlined in Tables 3 and 4. As indicated in these tables, some of the additional tests had multiple runs. For brevity, only one representative test run for each variation is shown below. The first set of tests was for Vehicle J15. Figure 6 shows the restraint system (net and door) for the standard test conditions and Figure 7 shows the vehicle with the net removed. Data in Figures 8-11 shows tests where the driver-side restraint system is varied. Figures 8 and 9 show data from threshold events, where the variations were: 1) Standard (full occupant restraint system); 2) Net Removed; and 3) Net and Door Removed. Data in Figures 10 and 11 show tripped tests where the variations were: 1) Standard; and 2) Net Removed. For all variations, the ATD was belted and the hip guard (bar) was attached. The plots illustrate for both events and all variations, the ATD was contained within the vehicle. Minor differences were exhibited with the Net removed or with the Net and Door removed. For this vehicle, the passive restraints of the belt and hip guard were sufficient to prevent the ATD from moving outside the ROPS.

For Vehicle L15 the restraint system was varied and is shown Figures 12 and 13. Figure 12 shows the vehicle with the standard restraint system. Data in Figures 14 and 15 display results where only threshold events were performed. The variations for this vehicle were: 1) Standard; and 2) Net Removed. Comparison of the two conditions indicates that without the net, the ATD moves further from its initial position than the standard and exceeds the ROPS boundary. In fact, for this test run, the ATD is outside the ROPS for the majority of vehicle motion, between approximately 15 and 80 degrees of roll. Further investigation of the standard condition shows that even though the ATD head is contained with the ROPS boundary for the entire range of motion, the ATD is within 1-inch of the ROPS at 15 degrees of roll angle.

Photographs of the last vehicle, Vehicle M15, where additional tests were performed are shown in Figures 16-21. The first set of tests for this vehicle were with the Hybrid III 50th percentile ATD and the restraint system varied. The variations were: 1) Standard; 2) Net Removed; 3) Bar Removed; and 4) Net and Bar Removed. Results from these test conditions are shown in Figures 22 and 23. Comparison of the four restraint conditions show that with the exception of the condition where the Net and Bar are removed, the ATD head stays within the ROPS boundary. Removing the Bar had greater influence on the ATD head displacement than simply removing the Net. Moreover, removing the Bar allowed the ATD to travel closer to the ROPS boundary, but still stayed within the ROPS. Only when removing the Bar and Net did the ATD travel beyond the ROPS. For the configuration with the Bar and Net removed, the data in Figure 22 shows a flat line between 0.25 and 0.8 seconds (15-55 degrees of vehicle roll). This is due to the marker on the ATD out of view from one or both of the cameras; and consequently, the actual displacement during this time cannot be captured. Thus, the trajectory shown in Figure 23 (bottom subplot) is not indicative of the maximum displacement of the ATD head, it was actually more than indicated on the plot.

The second set of tests for Vehicle M15 was with variation in the ATD size using the standard restraint components. Comparison of Figure 16 with Figures 20 and 21 illustrate the differences in ATD size. The trajectory data in Figures 24 and 25 indicates that there appears to be a correlation between ATD size and displacement. For this vehicle, the larger the ATD, the less displacement there is from the initial position. That is, the 5th percentile female moves the most, where the 95th percentile male moves the least. All three of the ATD heads stayed within the vehicle compartment and did not move beyond the ROPS. However, the excursion of the head of the 5th percentile ATD is much greater than the 50th and 95th percentile male ATDs.

The final set of tests for this vehicle was with the 5th percentile female. Two conditions were performed: 1) Standard; and 2) Net and Belt Removed. Figures 25 and 26 compare these two conditions. As previously shown in Figure 25, the data illustrates that with the fully restrained ATD it stays within the ROPS boundary. As expected, with the ATD unbelted and the net removed, it exhibits significantly more movement. Furthermore, the ATD moves out of view of both cameras at 0.6 seconds (35 degrees of vehicle roll) and never comes back into view for the remainder of vehicle motion. For this unbelted test, the ATD head is far outside of the ROPS boundary.



Figure 6: Vehicle J15 on the Roll Simulator - Standard Tests



Figure 7: Vehicle J15 on the Roll Simulator - Additional Tests, Net Removed

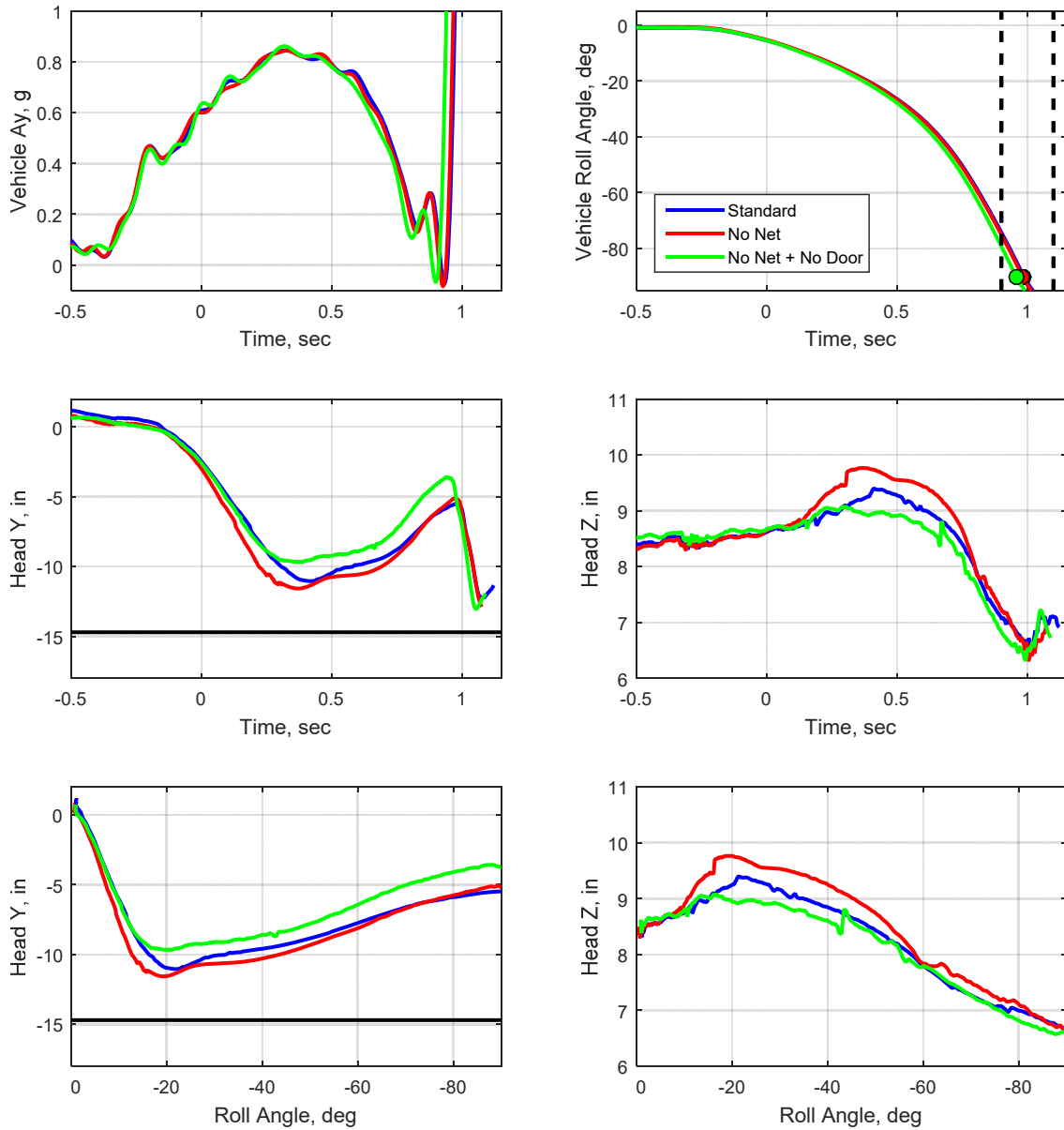

Figure 8: Roll Simulator Threshold Event - Additional Tests - Vehicle J15 - Vehicle Response and ATD Head Displacement

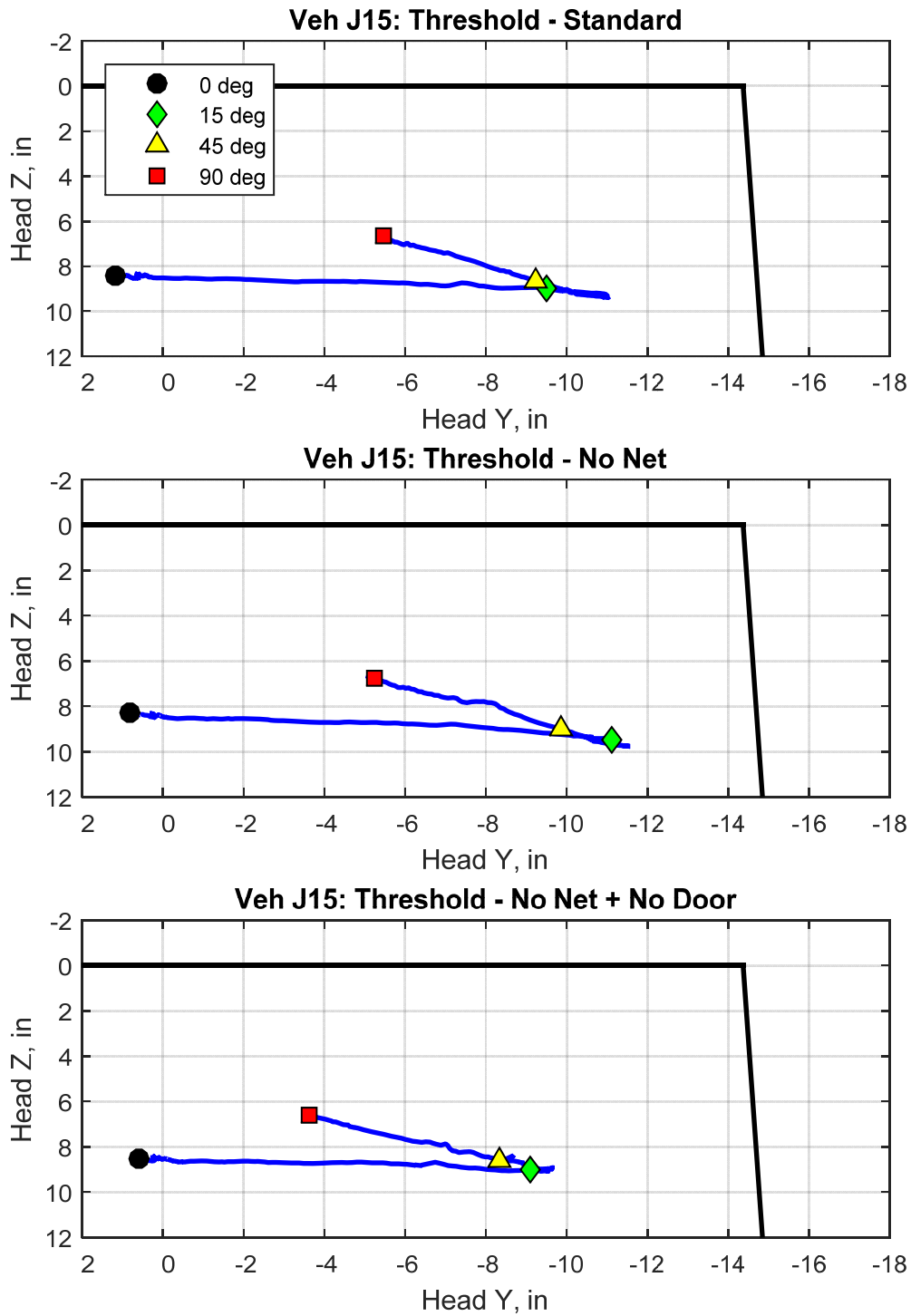

Figure 9: Roll Simulator Threshold Event - Additional Tests - Vehicle J15 - ATD Head Displacement - Head Z vs. Head Y

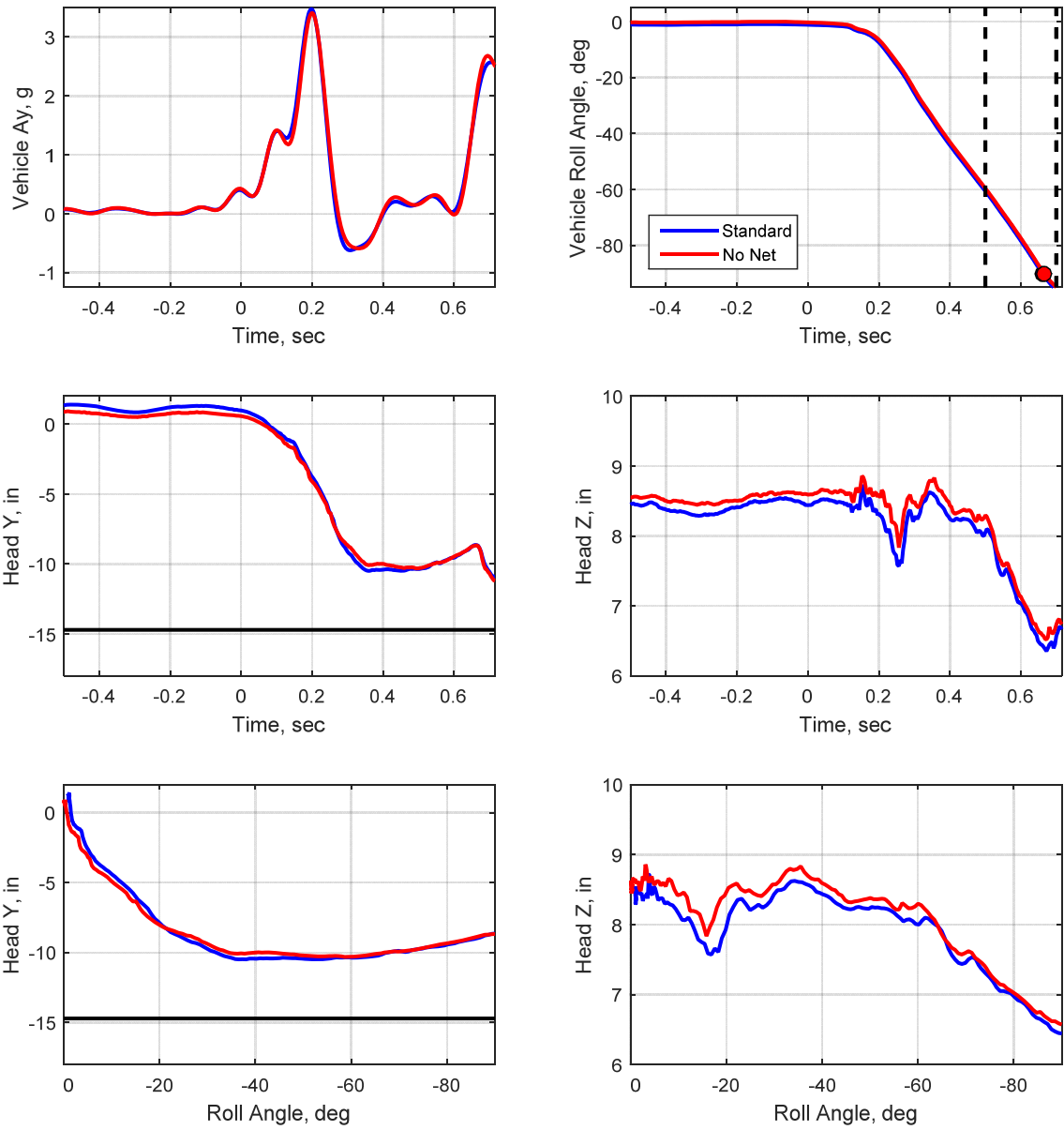

Figure 10: Roll Simulator Tripped Event - Additional Tests - Vehicle J15 - Vehicle Response and ATD Head Displacement

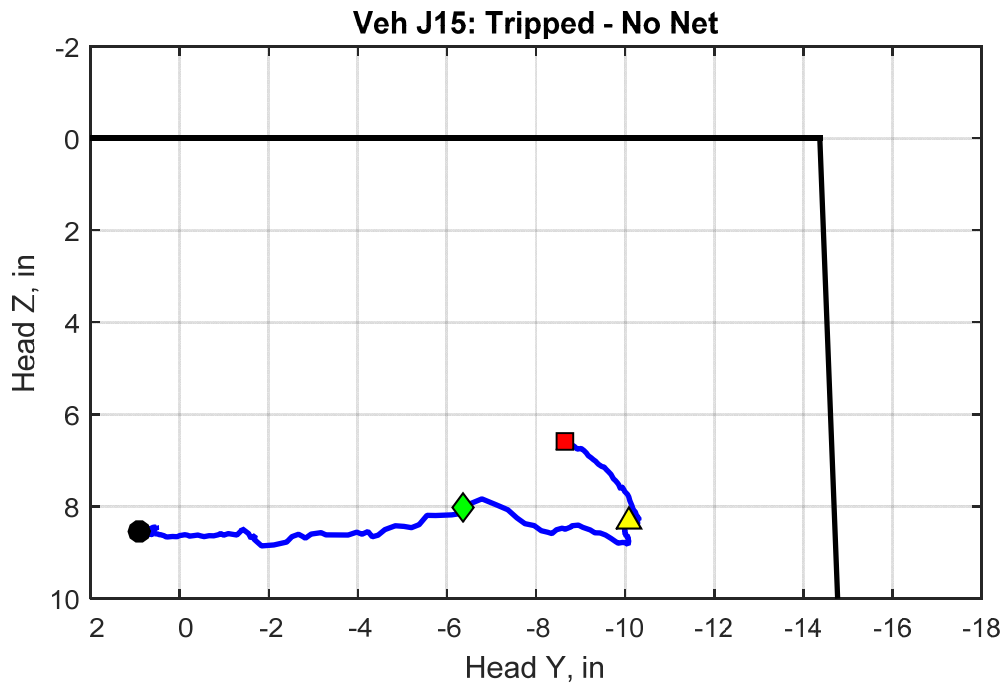
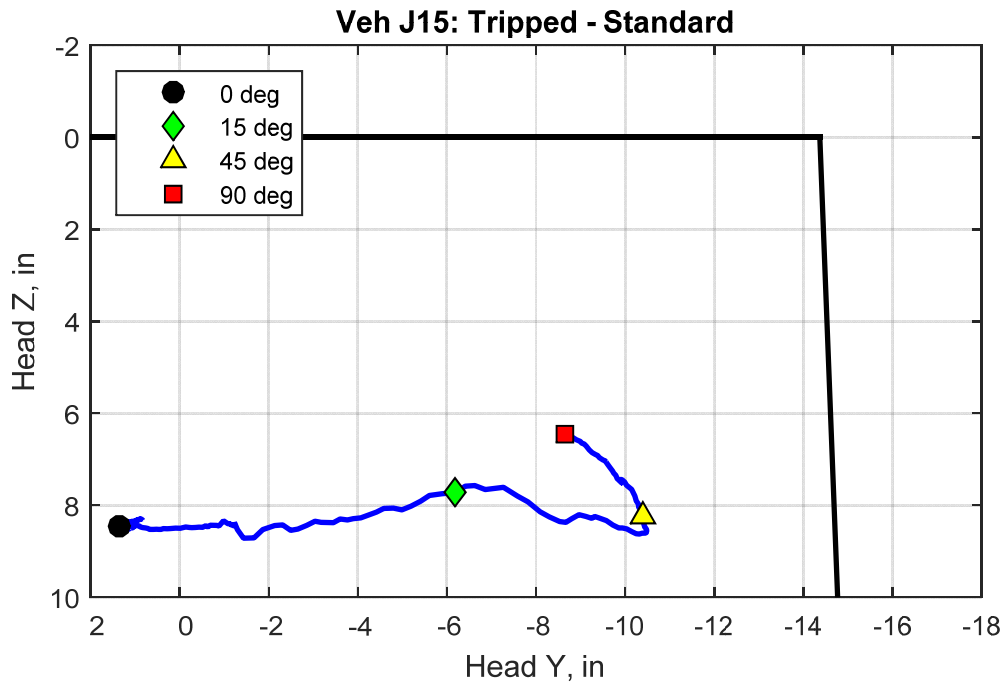

Figure 11: Roll Simulator Tripped Event - Additional Tests - Vehicle J15 - ATD Head Displacement - Head Z vs. Head Y



Figure 12: Vehicle L15 on the Roll Simulator - Standard Tests



Figure 13: Vehicle L15 on the Roll Simulator - Additional Tests, Net Removed

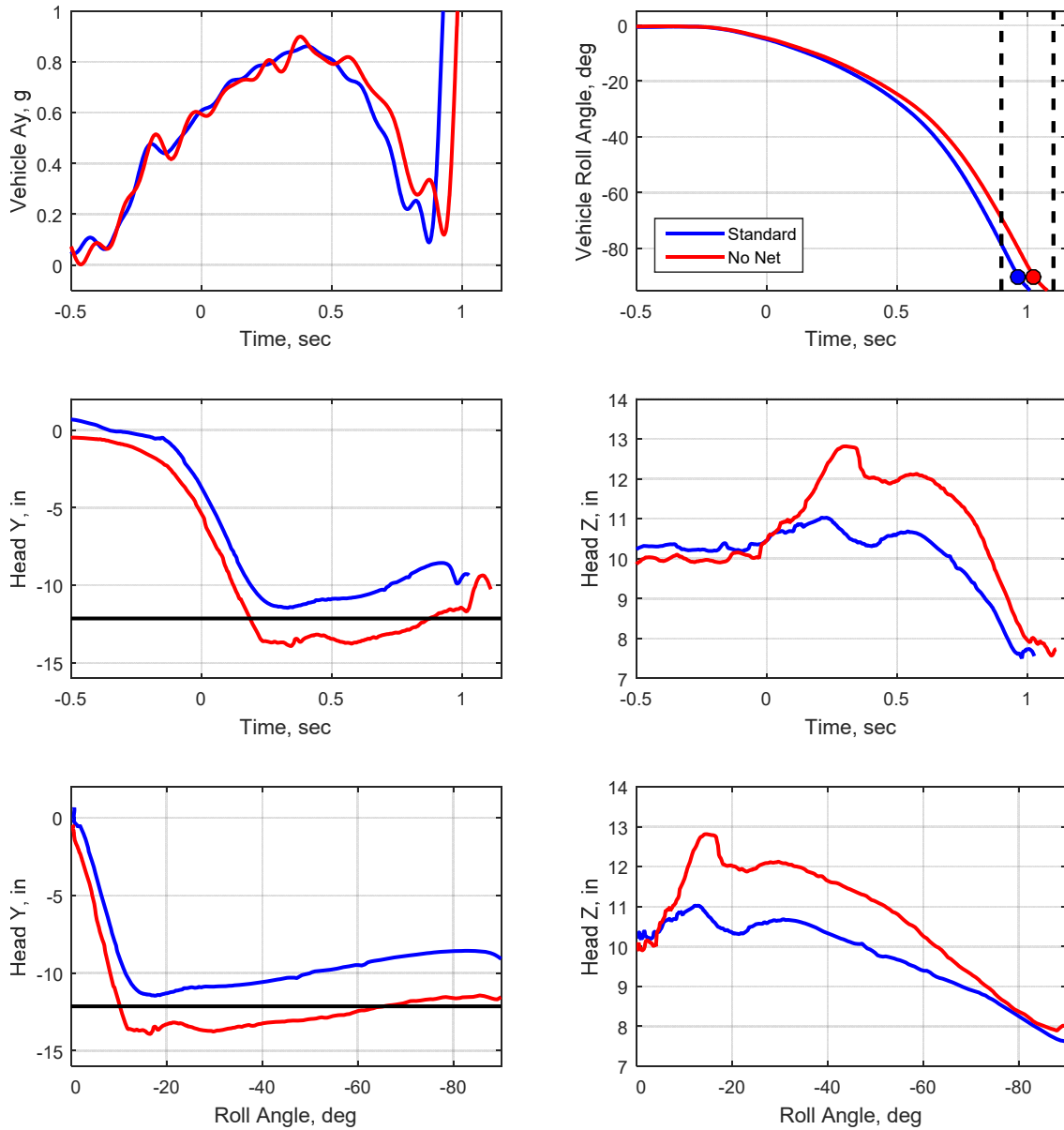

Figure 14: Roll Simulator Threshold Event - Additional Tests - Vehicle L15 - Vehicle Response and ATD Head Displacement

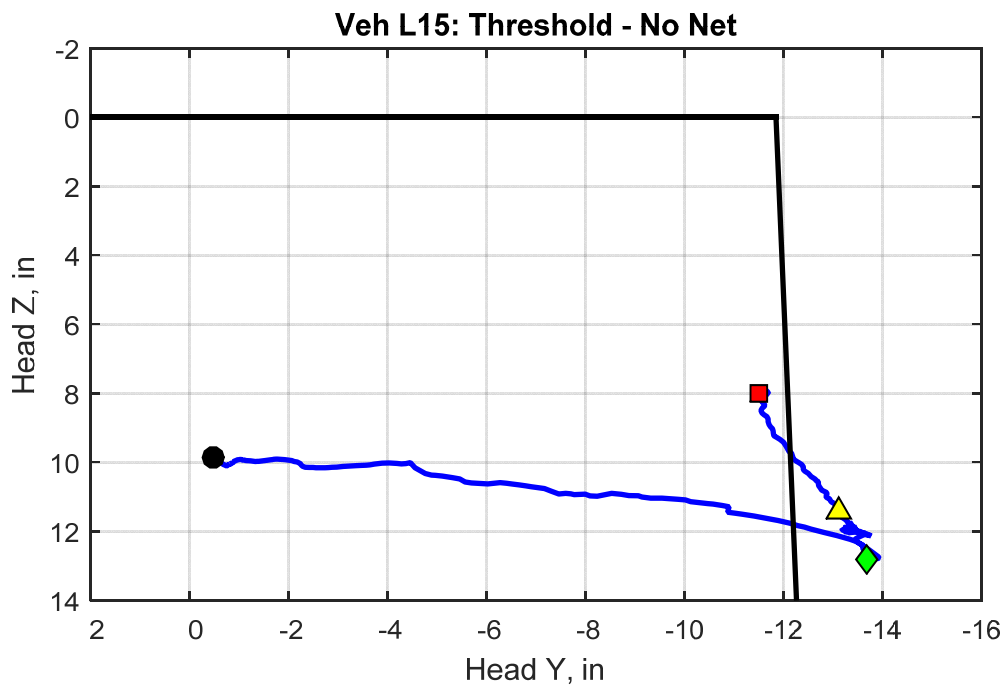
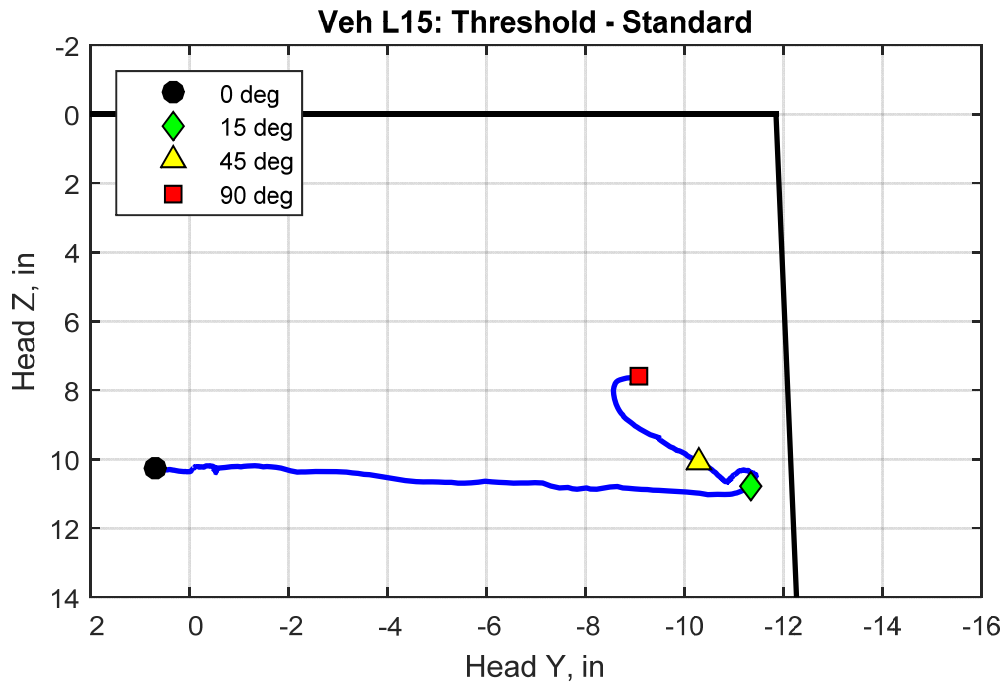

Figure 15: Roll Simulator Threshold Event - Additional Tests - Vehicle L15 - ATD Head Displacement - Head Z vs. Head Y



Figure 16: Vehicle M15 on the Roll Simulator - Additional Tests, Full Restraint System, Hybrid III 50th Percentile Male



Figure 17: Vehicle M15 on the Roll Simulator - Additional Tests, No Net, Hybrid III 50th Percentile Male



Figure 18: Vehicle M15 on the Roll Simulator - Additional Tests, No Bar, Hybrid III 50th Percentile Male



Figure 19: Vehicle M15 on the Roll Simulator - Additional Tests, No Net + No Bar, Hybrid III 50th Percentile Male



Figure 20: Vehicle M15 on the Roll Simulator - Additional Tests, Full Restraint System, 95th Percentile Male



Figure 21: Vehicle M15 on the Roll Simulator - Additional Tests, Full Restraint System, 5th Percentile Male

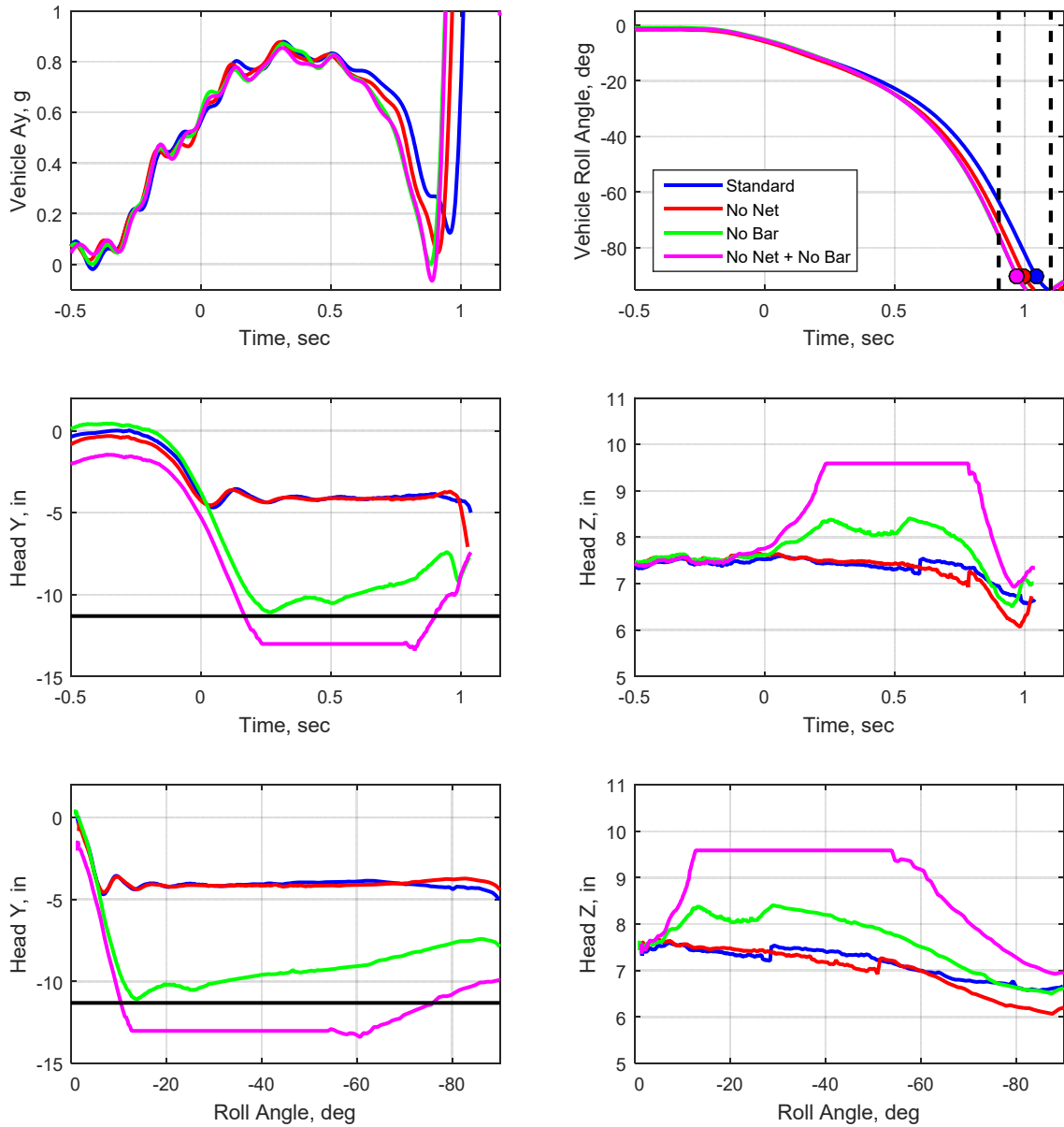

Figure 22: Roll Simulator Threshold Event - Additional Tests, Restraint Variation - Vehicle M15 - Vehicle Response and ATD Head Displacement

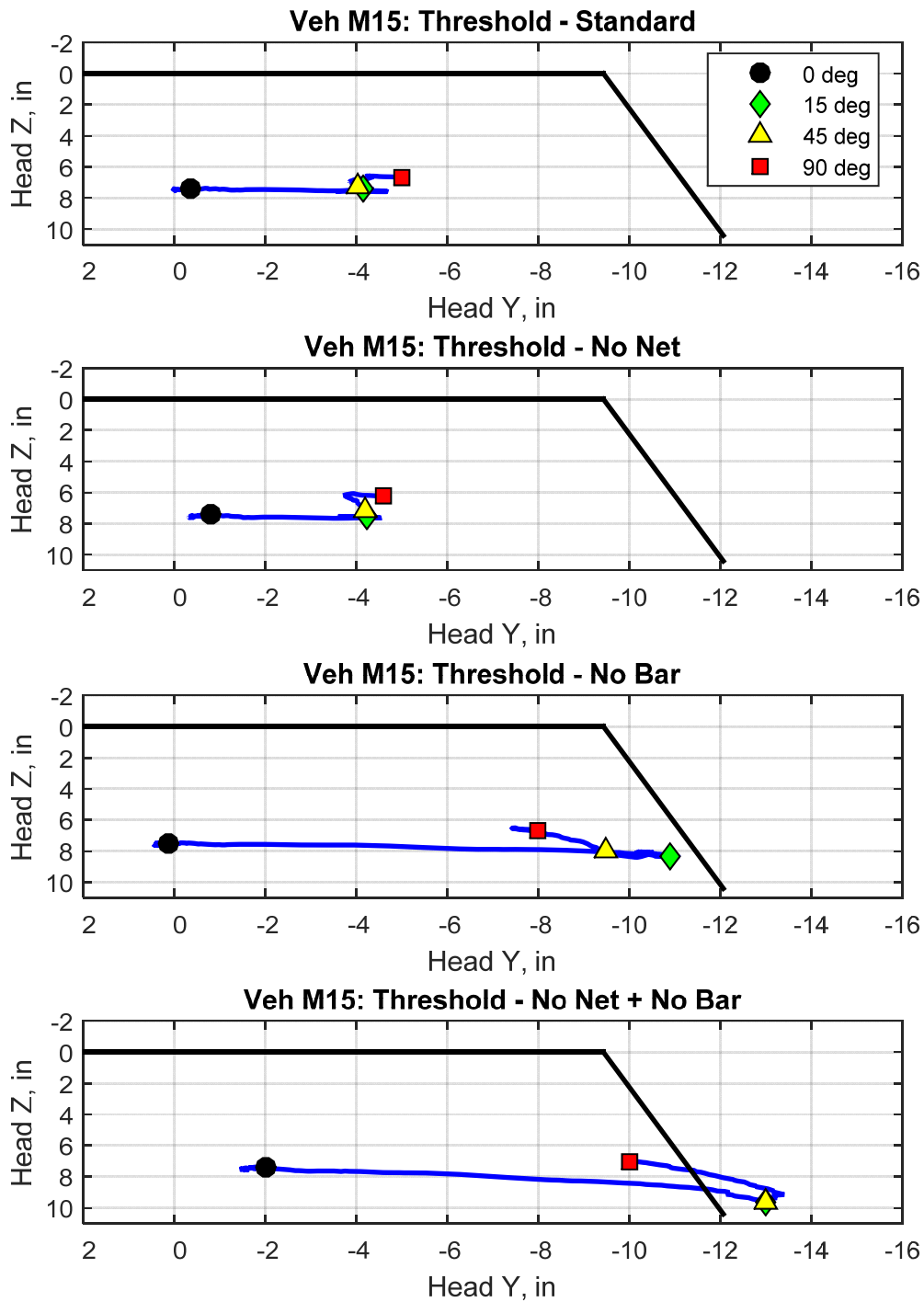

Figure 23: Roll Simulator Threshold Event - Additional Tests, Restraint Variation - Vehicle M15 - ATD Head Displacement - Head Z vs. Head Y

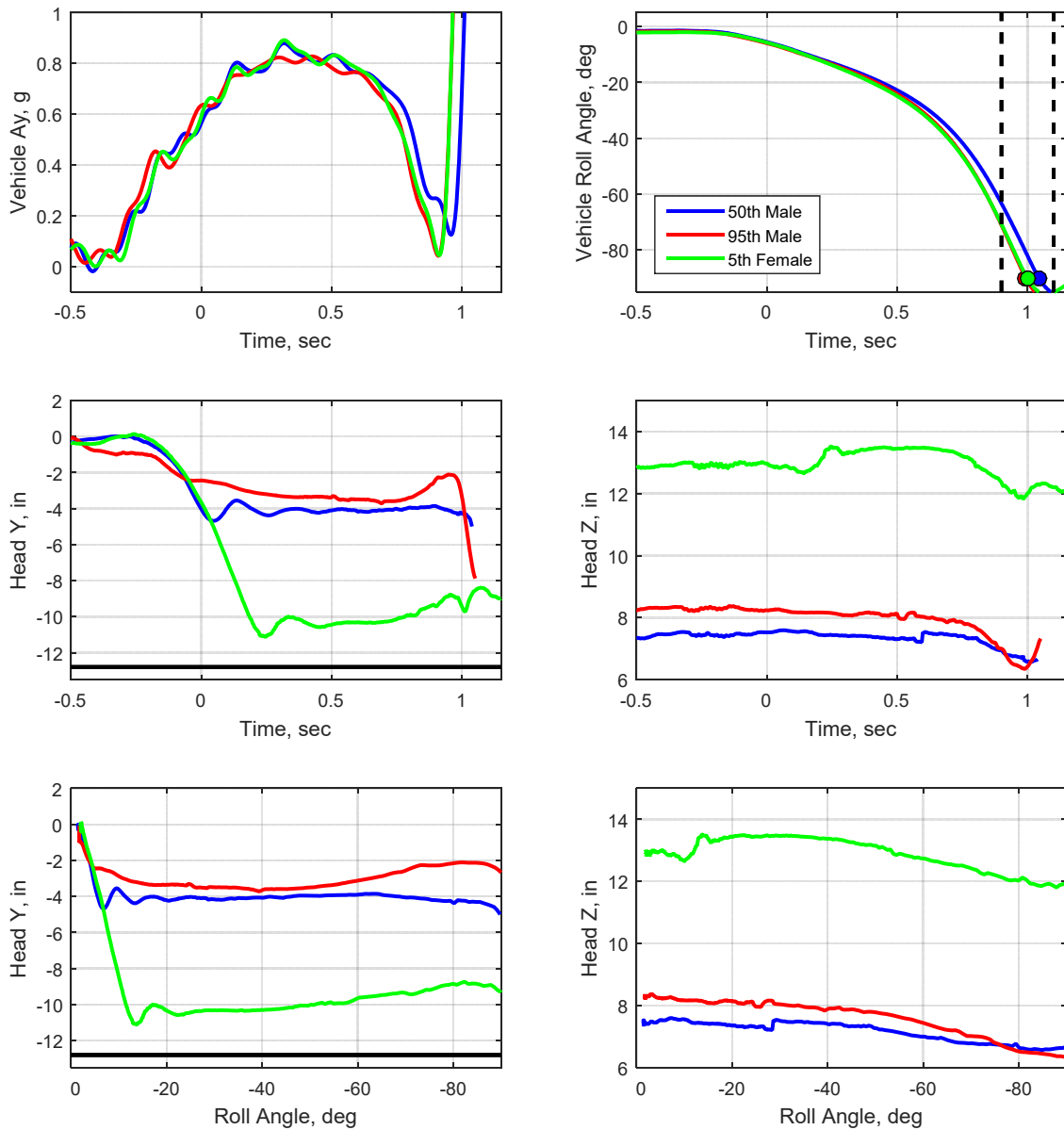

Figure 24: Roll Simulator Threshold Event - Additional Tests, ATD Variation - Vehicle M15 - Vehicle Response and ATD Head Displacement

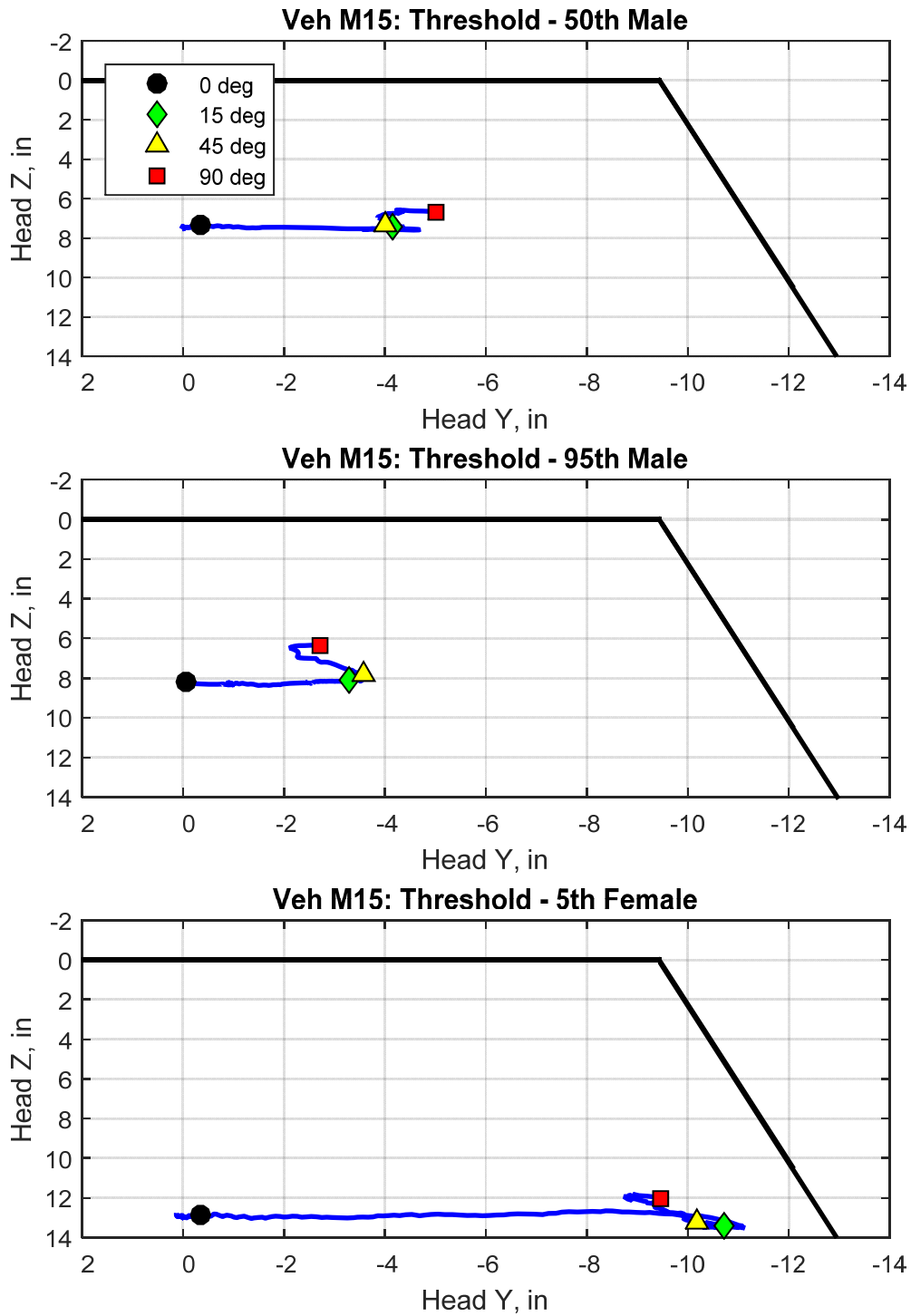

Figure 25: Roll Simulator Threshold Event - Additional Tests, ATD Variation - Vehicle M15 - ATD Head Displacement - Head Z vs. Head Y

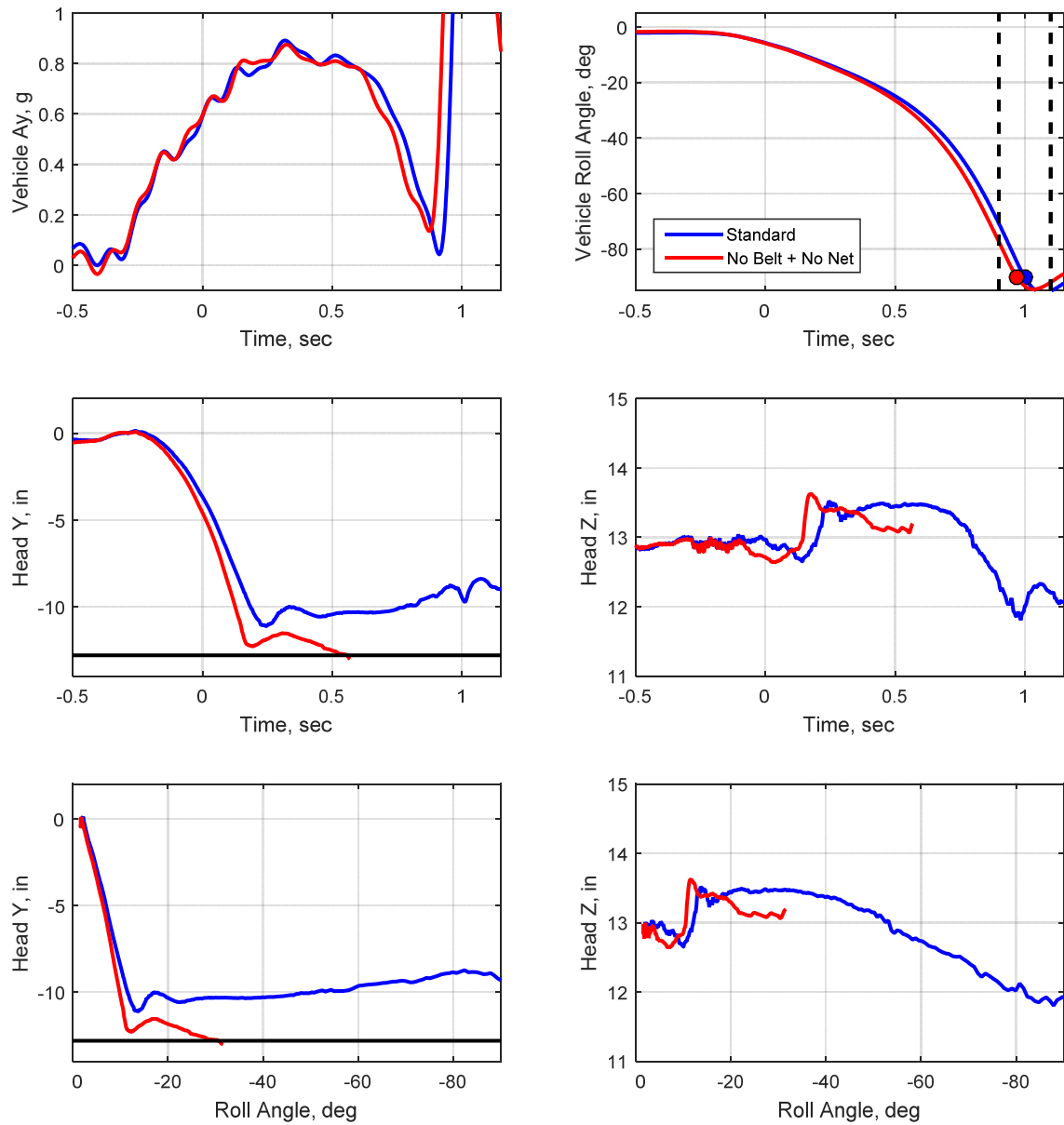

Figure 26: Roll Simulator Threshold Event - Additional Tests, 5th Female, Belt, No Belt - Vehicle M15 - Vehicle Response and ATD Head Displacement

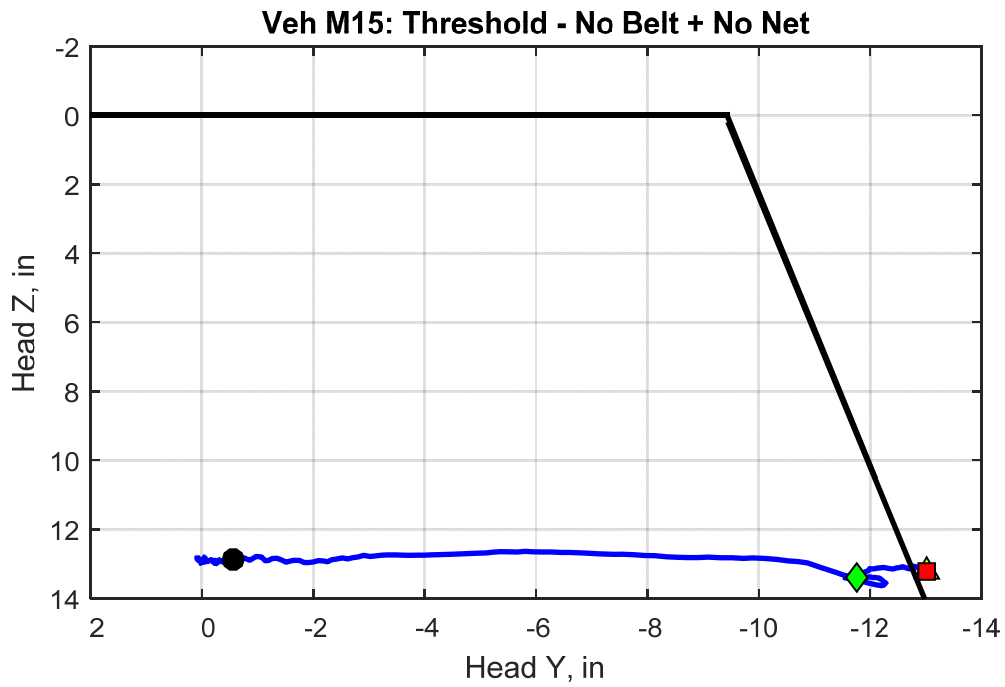
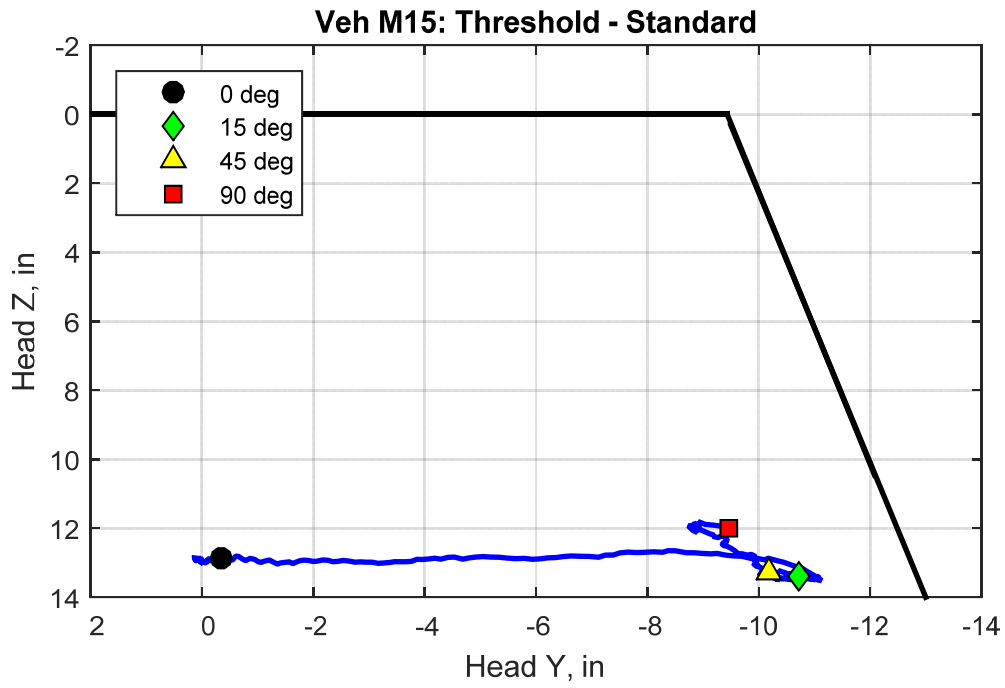

Figure 27: Roll Simulator Threshold Event - Additional Tests, 5th Female, Belt, No Belt - Vehicle M15 - ATD Head Displacement - Head Z vs. Head Y

3. PROBE TESTING

Probe tests were performed on 11 vehicles. These tests were conducted to evaluate the proposed voluntary standards outlined in the canvass draft American National Standard ANSI/OPEI B71.9-2016. Specific details of the test procedure are discussed in Section 8.10, Occupant Side Retention Devices, of this document. Vehicle C15 was not tested because it had no net, door or restraint system bars in the region of the R-point, where the probe would have applied the force (so this vehicle would fail the proposed test). Also, Vehicle G15, a single passenger vehicle, was not tested.

To apply the 163 lb (725 N) force, an air cylinder with a 10 inch stroke was used. The air cylinder was mounted securely to the ROPS, body and/or frame of each vehicle using a selection of 80/20 T-slotted aluminum framing and assorted fasteners. Figure 28 shows the probe test set-up for Vehicle A15. The horizontal, lateral line of action of the probe is 17 inches above the seat bottom and 6 inches fore of the seat back. The applied load and probe displacement were measured using a load cell and potentiometer, respectively, listed in Table 7. For these tests, two test probes were used to apply the load to the R-point: a 3-inch diameter probe (as outlined in the standard) and a 6-inch diameter probe. The 6-inch probe was included to determine if the size of the probe would influence the outcome of the tests.

The proposed test protocol allows for letting the probe's flat test surface swivel to accommodate design characteristics as well as elastic deflection. An articulated probe end, which allowed the probe's flat test surface to swivel up to 15 degrees, was used on the first three vehicles tested. In some cases the articulation feature allowed for forces to develop out of the line of action of the cylinder, so the cylinder support system had to be reinforced. Fixed probe ends were used on the other eight vehicles tested, and the fixed probe ends seemed to mitigate force application misalignment issues.

Figure 29 contains results from a probe test done on Vehicle A15 using the 3" diameter fixed probe. The photographs show the probe in the "In" position (the position of the probe under zero force, prior to applying air pressure to cylinder) and in the "Out" position (the position of the probe after enough air pressure was supplied to the cylinder to develop at least 163 lb on the probe). For each vehicle, a white string was used to indicate a position at the outside edge (i.e. vehicle width) of each vehicle (the performance requirement of the proposed standard that the occupant side retention device shall not deflect more than 4 inches past the vehicle width). The white string can be seen in the photographs. The "In" positions of the probe were set to convenient positions on each vehicle, but close enough to the occupant side retention device to assure that the probe could reach a position that was at least 4 inches past the vehicle width.

There are three plots shown in Figure 29, and these are the same plots shown in Appendix B for all probe tests conducted. The top plot shows the applied load versus time, showing that an applied force of at least 163 lb was applied and held for at least 10 seconds. The

middle shows probe displacement (blue line) versus time. For each vehicle, the probe displacement measurement was zeroed so that zero distance would indicate the outside edge of the vehicle (black line), and a distance of four inches would indicate a position four inches outside of the edge of the vehicle width (red line). The photographs and plots on Figure 29 show that for this test the probe face started a little more than two inches from the outside edge of the vehicle and moved to a position about one inch from the outside edge of the vehicle after a force of at least 163 lb was applied for at least ten seconds. The bottom plot of Figure 29 is a plot of applied load versus distance. The portions of these plots where the force is increasing could be used to assess the stiffness of the restraint feature.

Table 8 contains a summary of the probe test results, and the photographs and plots for all the individual probe tests are included in Appendix B.

Table 7: Probe Test Instrumentation			
Unit	Manufacturer	Model No.	Range
Load Cell	Interface	1210AF-1K	1000 lb _f
Potentiometer	UniMeasure	LX-PA-20	20 inch

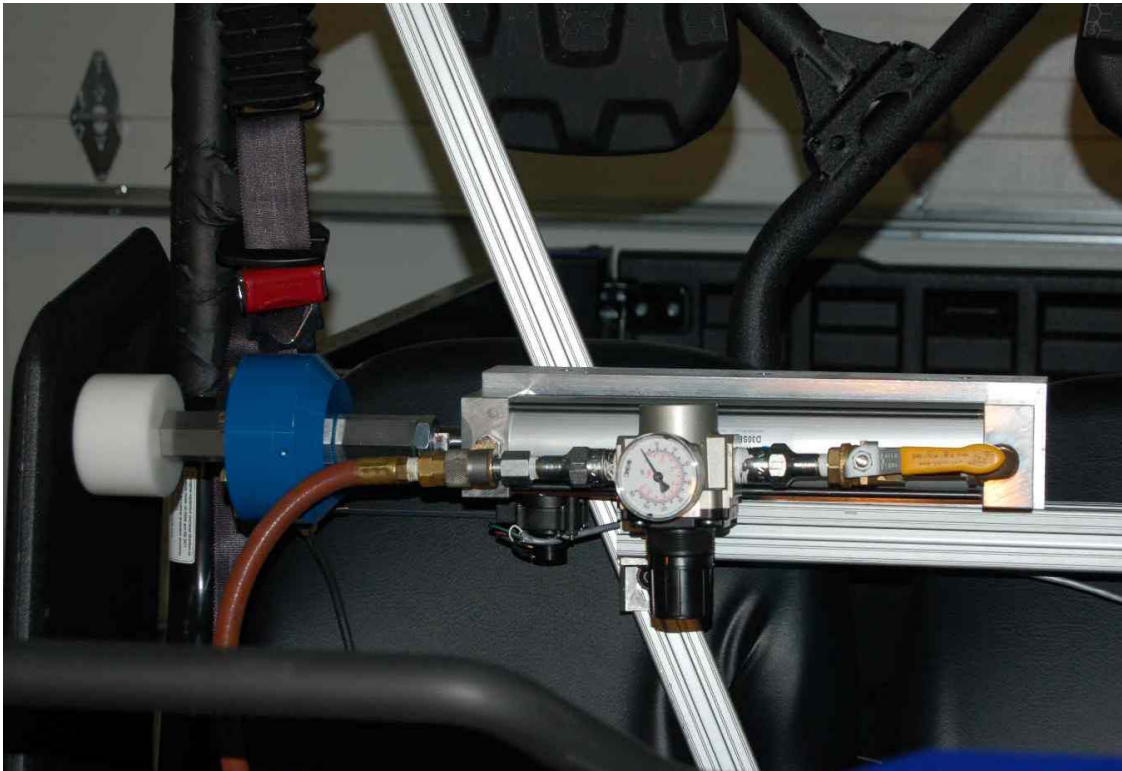
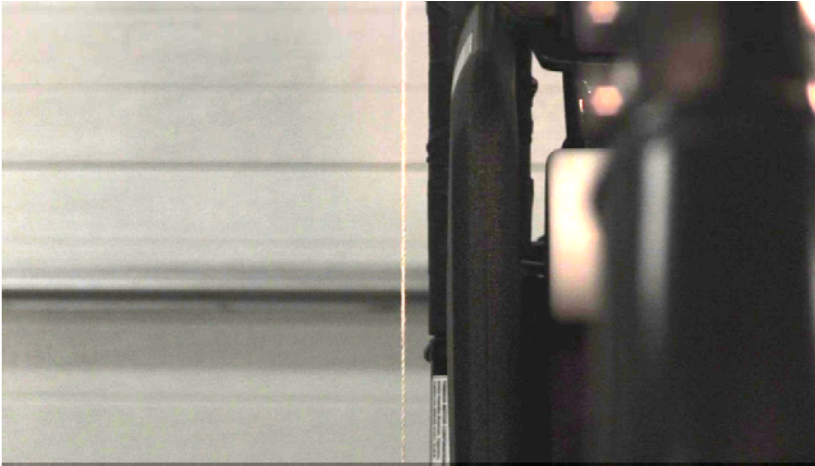

Figure 28: Test Set-up on Vehicle A15



Sample Test Apparatus 3" Fixed Probe – In



Sample Test Apparatus 3" Fixed Probe - Out

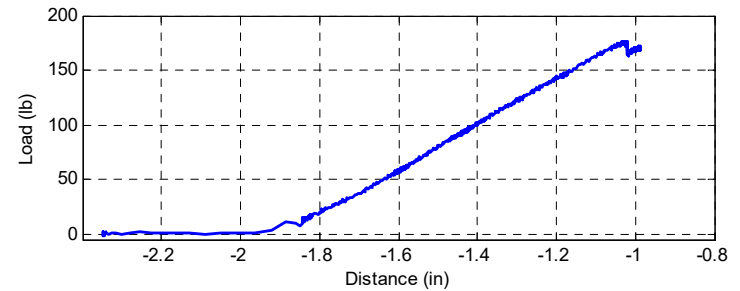
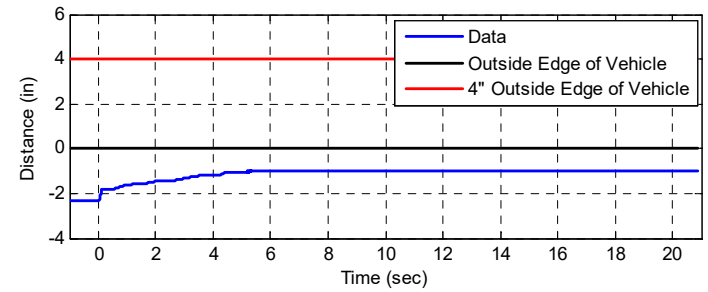
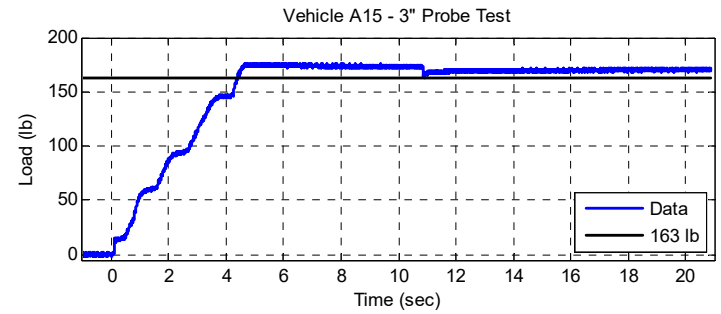

Sample Probe Test - Load and Distance Data

Figure 29: Vehicle A15: 3" Fixed Probe

Table 8: Summary of Probe Test Results			
Vehicle	Probe Connection	Outcome of Test Using 3" Probe	Outcome of Test Using 6" Probe
Vehicle A15	Fixed	Pass	Pass
Vehicle B15	Fixed	Pass	Pass
Vehicle C15	NA	Fail	Fail
Vehicle D15	Articulated	Pass	Pass
Vehicle E15	Fixed	Pass	Pass
Vehicle F15	Fixed	Pass	Pass
Vehicle H15	Fixed	Pass	Pass
Vehicle I15	Articulated	Pass	Pass
Vehicle J15	Articulated	Fail	Fail
Vehicle K15	Fixed	Pass	Pass
Vehicle L15	Fixed	Fail	Fail
Vehicle M15	Fixed	Pass	Pass

APPENDIX A - Roll Simulator Results - Standard Tests

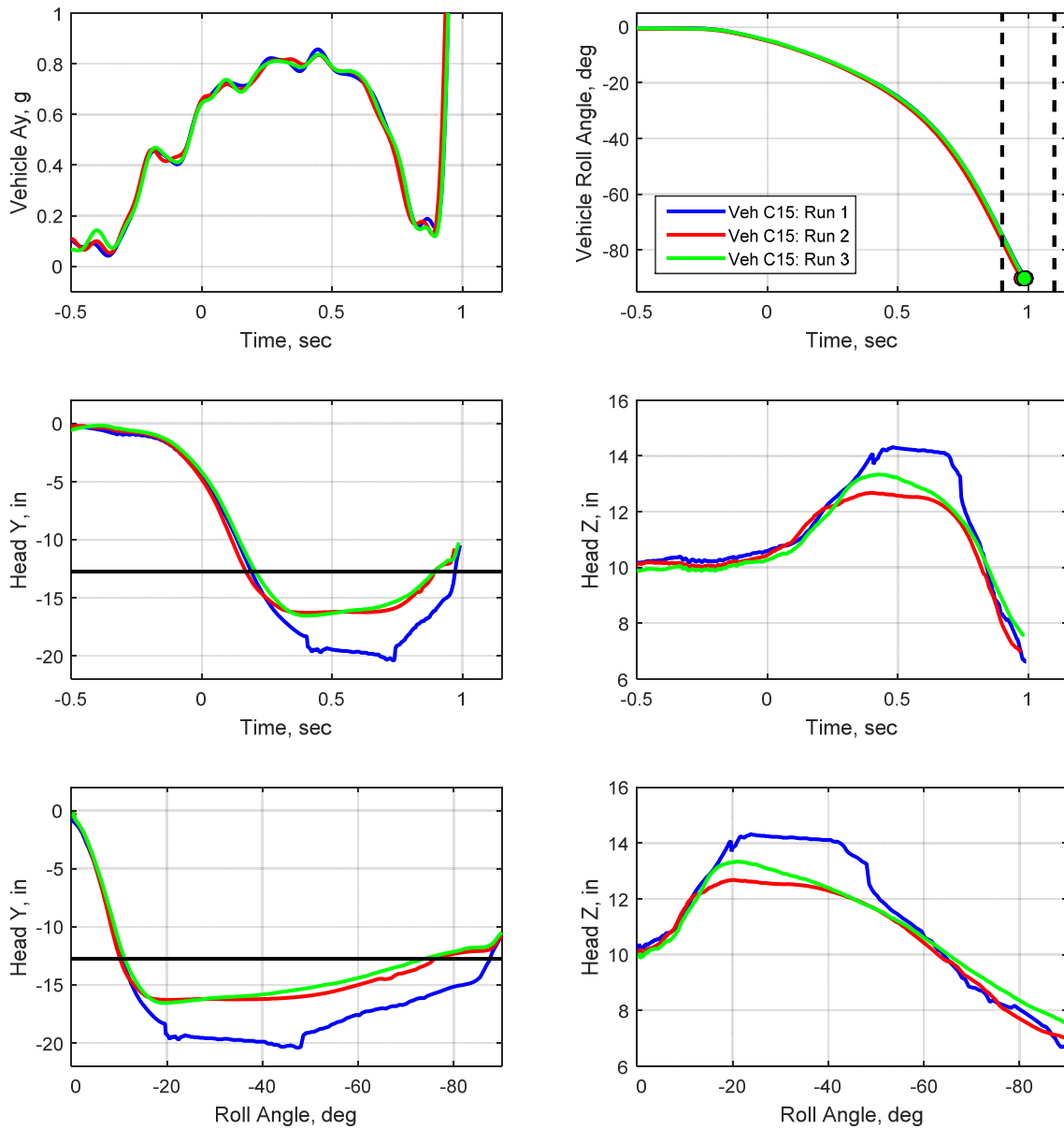

Figure A-1: Roll Simulator Threshold Event - Vehicle C15 - Vehicle Response and ATD Head Displacement

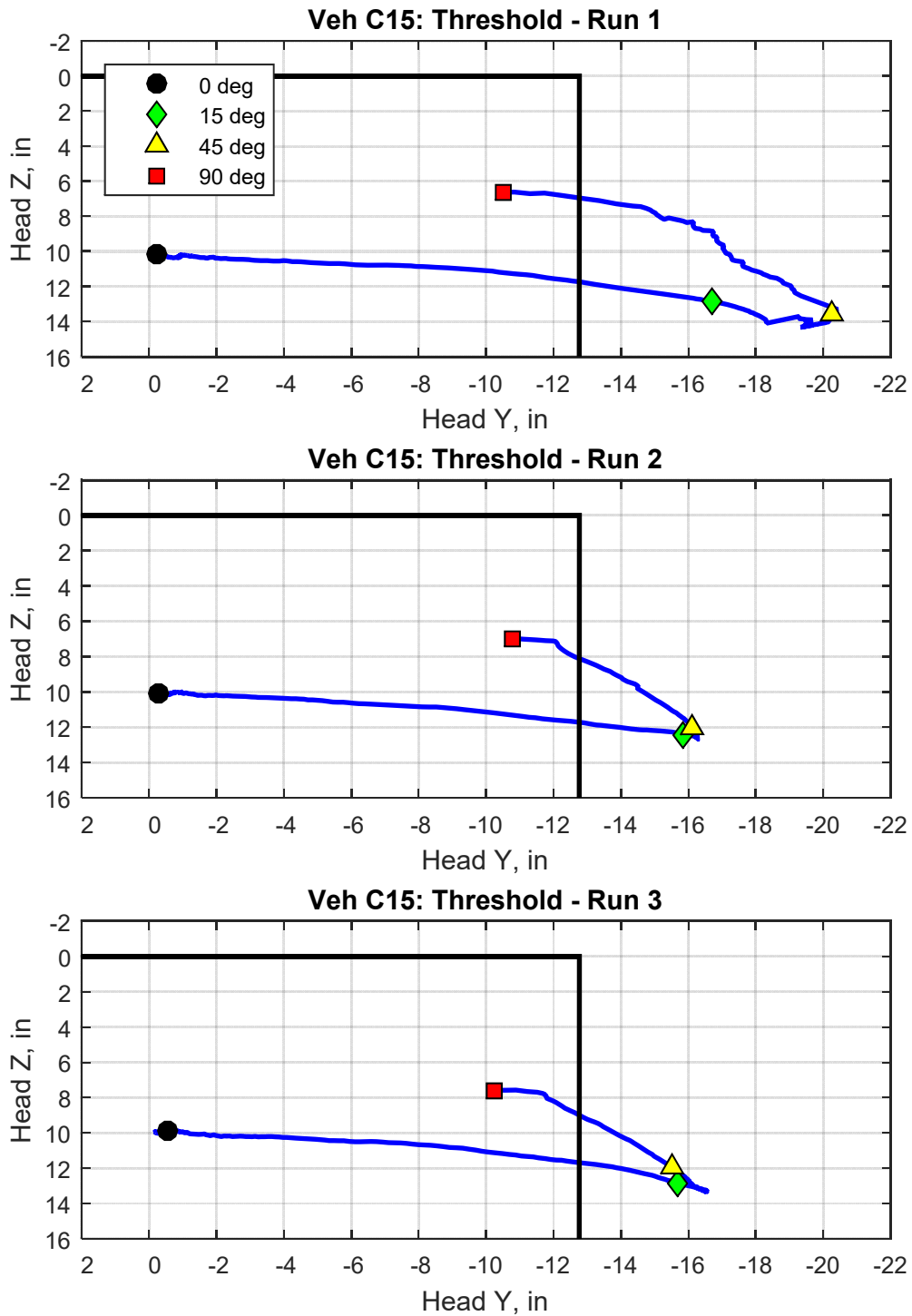

Figure A-2: Roll Simulator Threshold Event - Vehicle C15 - ATD Head Displacement - Head Z vs. Head Y

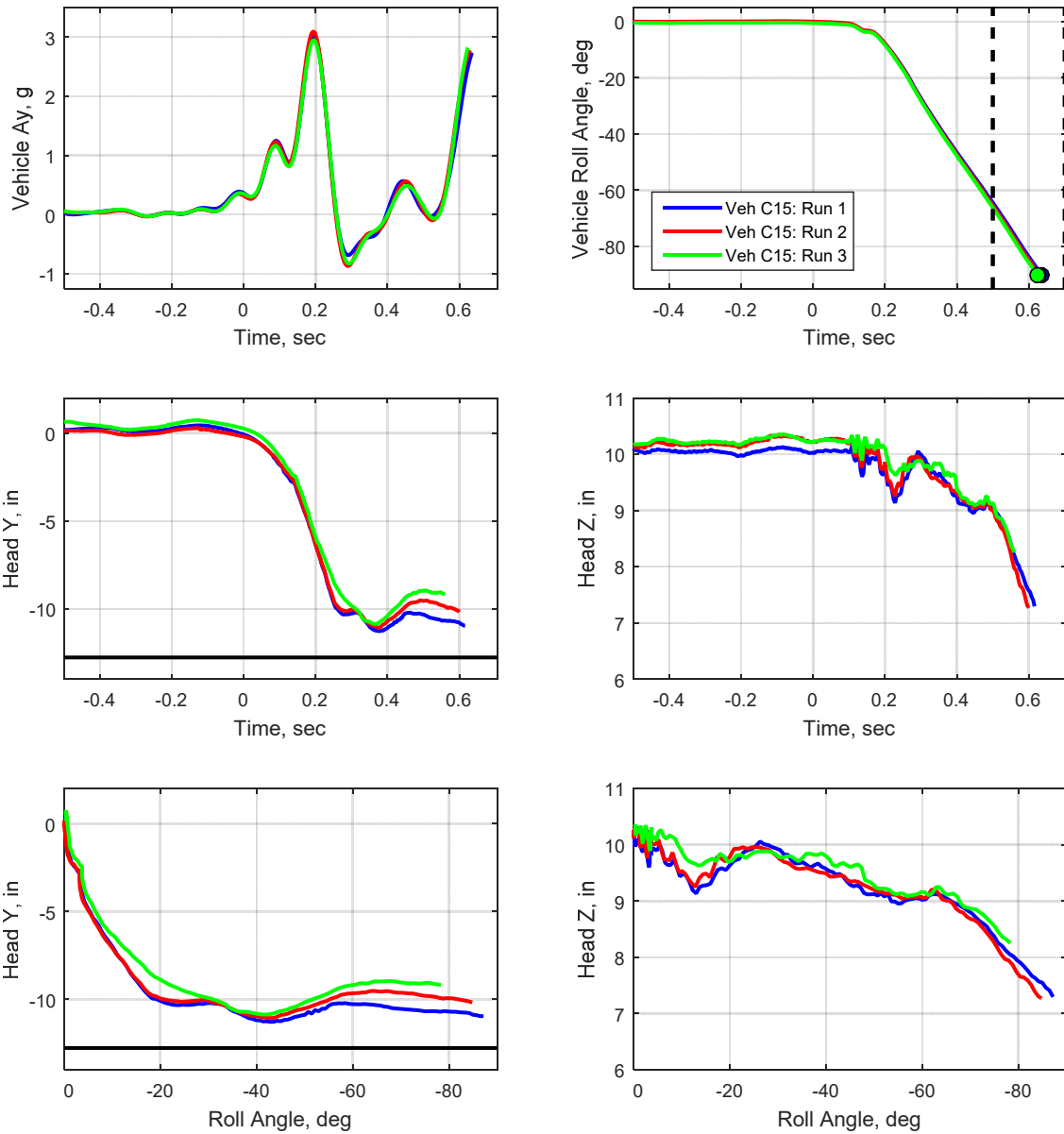

Figure A-3: Roll Simulator Tripped Event - Vehicle C15 - Vehicle Response and ATD Head Displacement

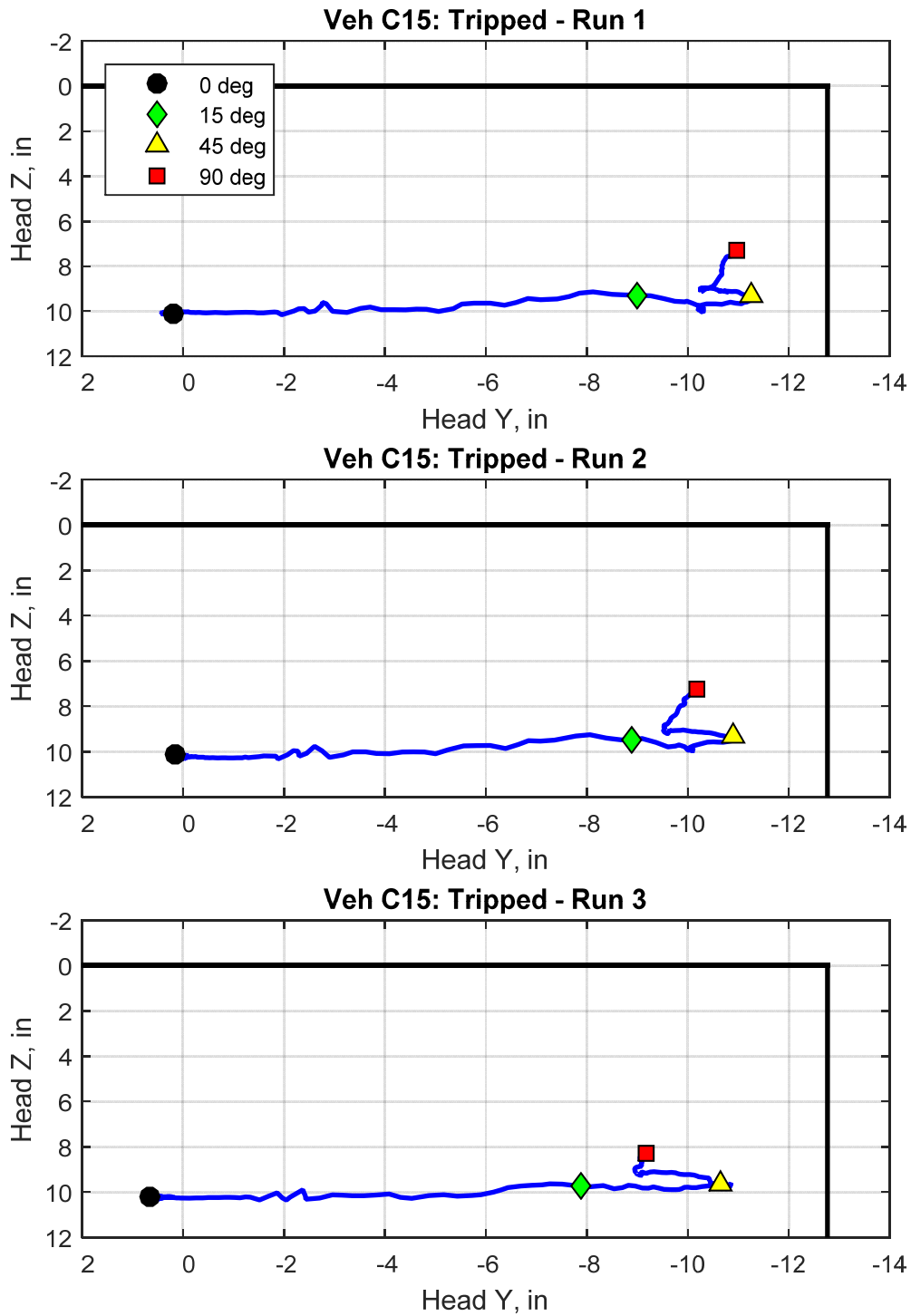

Figure A-4: Roll Simulator Tripped Event - Vehicle C15 - ATD Head Displacement - Head Z vs. Head Y

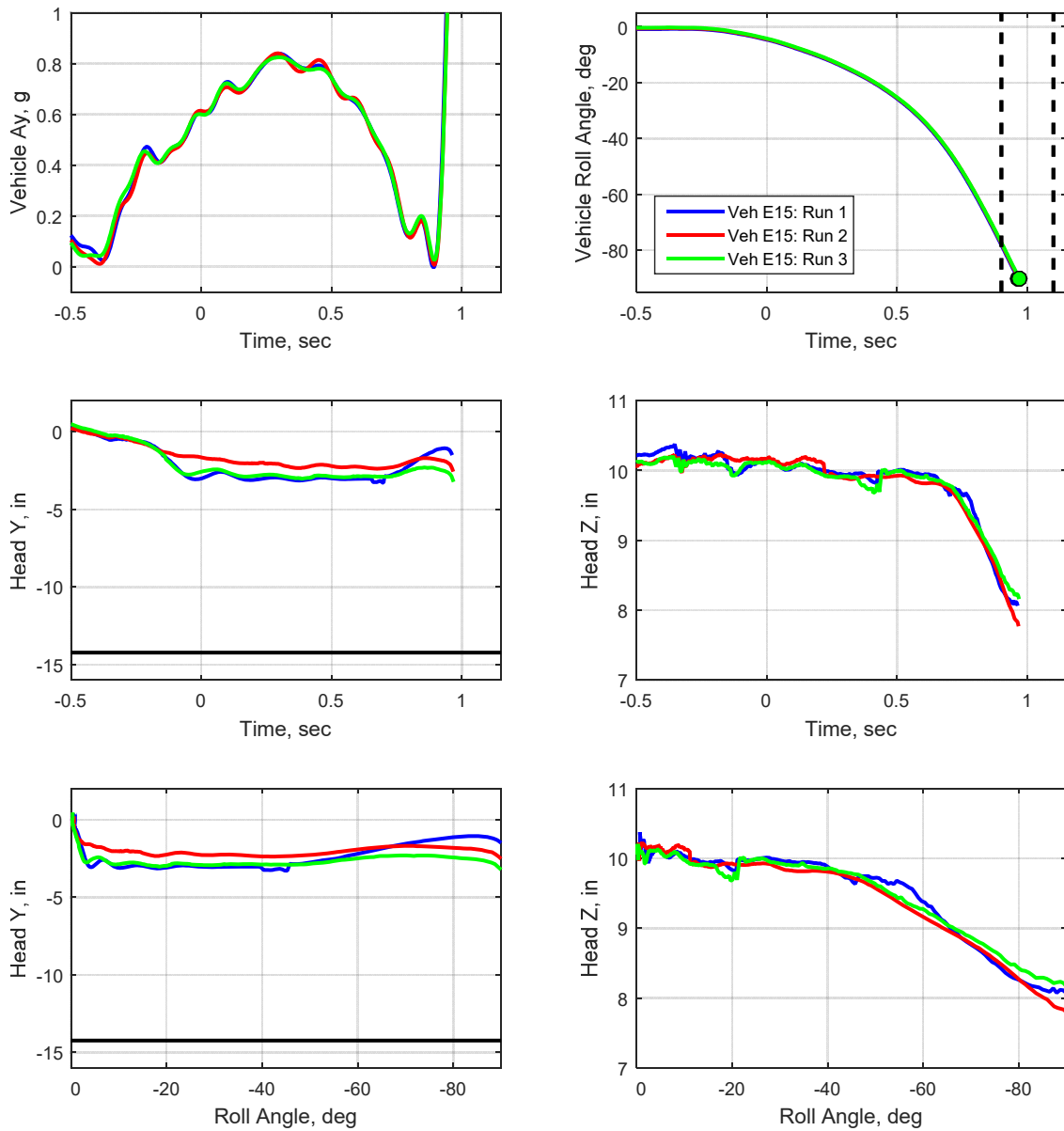

Figure A-5: Roll Simulator Threshold Event - Vehicle E15 - Vehicle Response and ATD Head Displacement

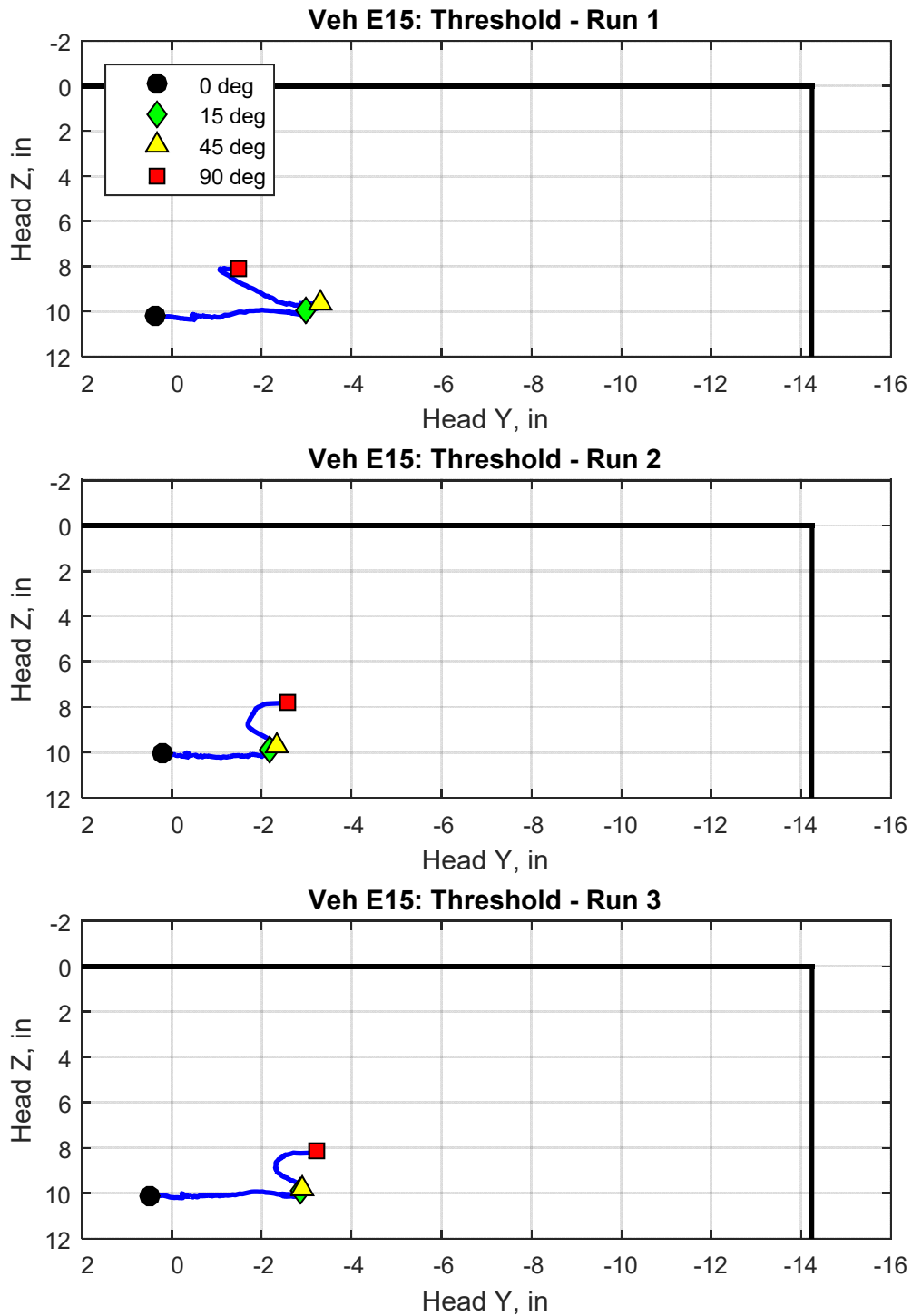

Figure A-6: Roll Simulator Threshold Event - Vehicle E15 - ATD Head Displacement - Head Z vs. Head Y

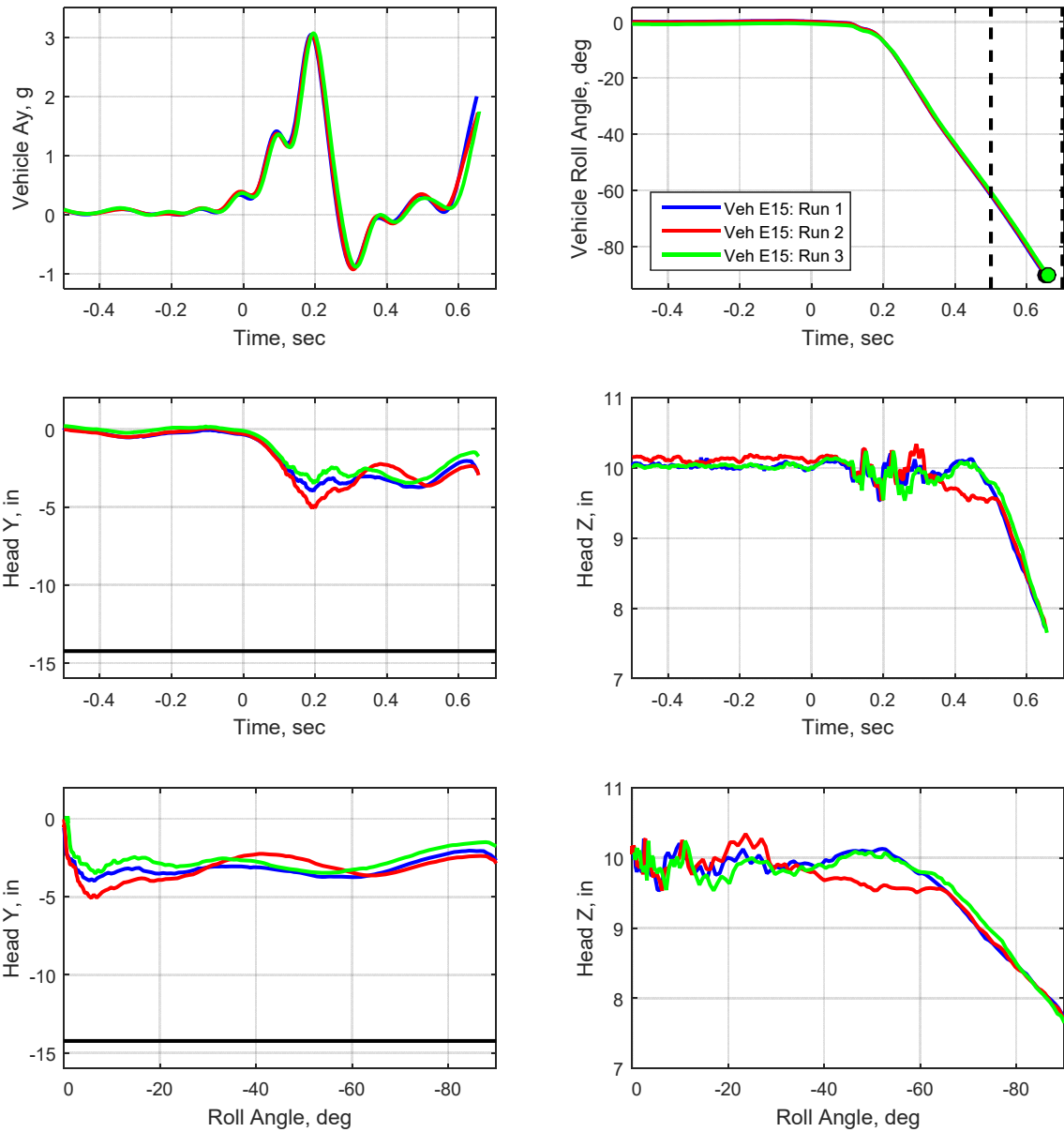

Figure A-7: Roll Simulator Tripped Event - Vehicle E15 - Vehicle Response and ATD Head Displacement

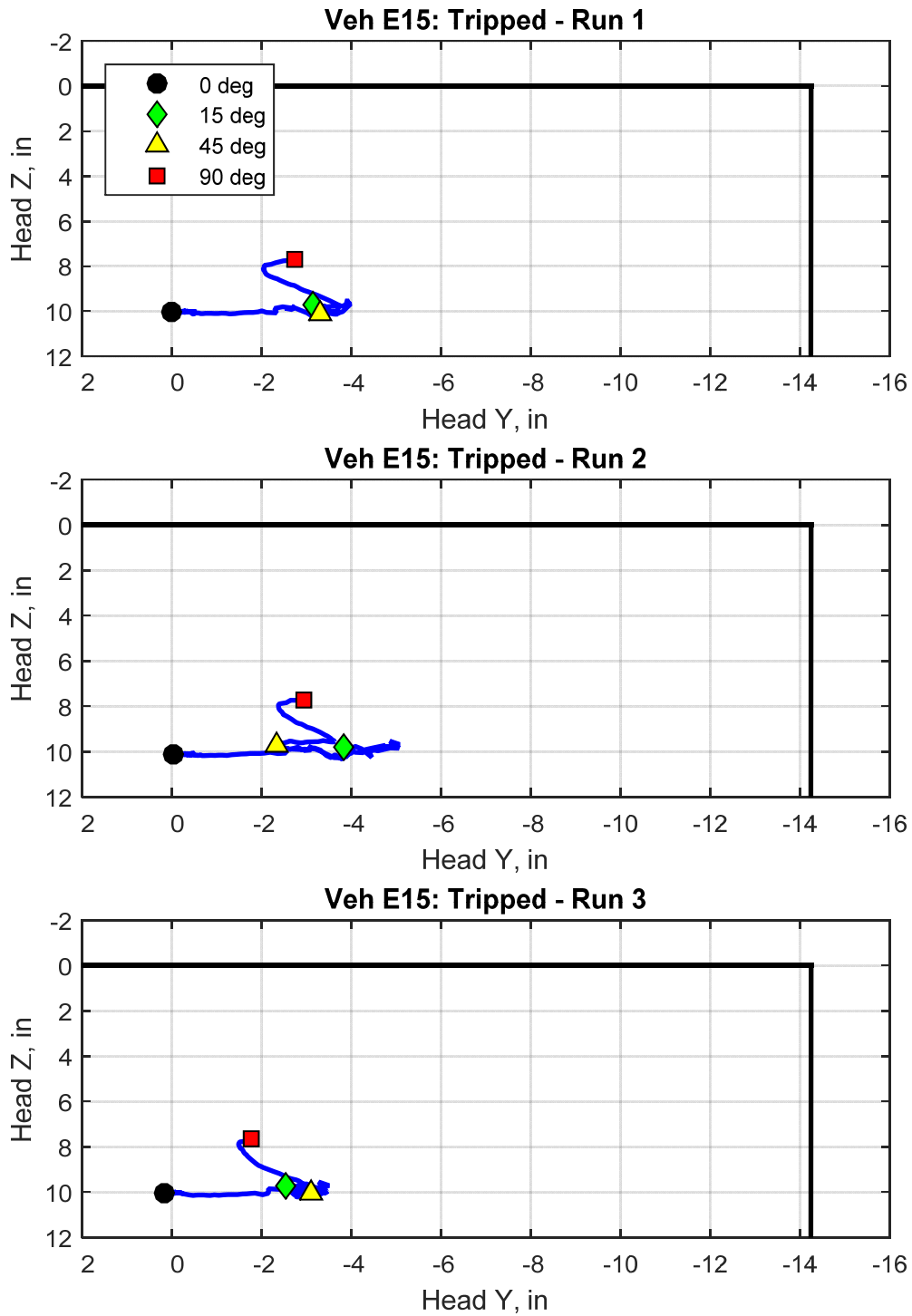

Figure A-8: Roll Simulator Tripped Event - Vehicle E15 - ATD Head Displacement - Head Z vs. Head Y

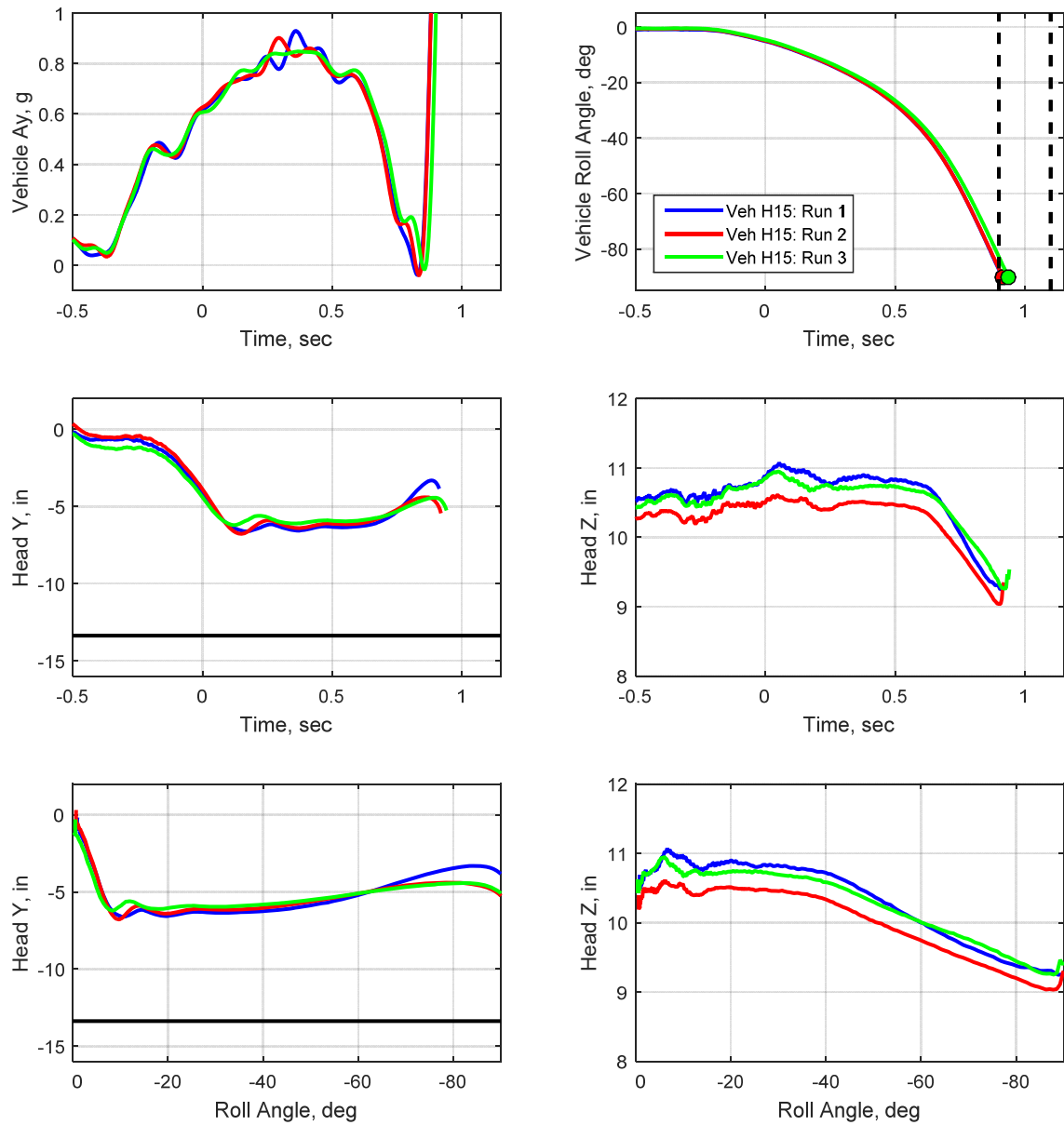

Figure A-9: Roll Simulator Threshold Event - Vehicle H15 - Vehicle Response and ATD Head Displacement

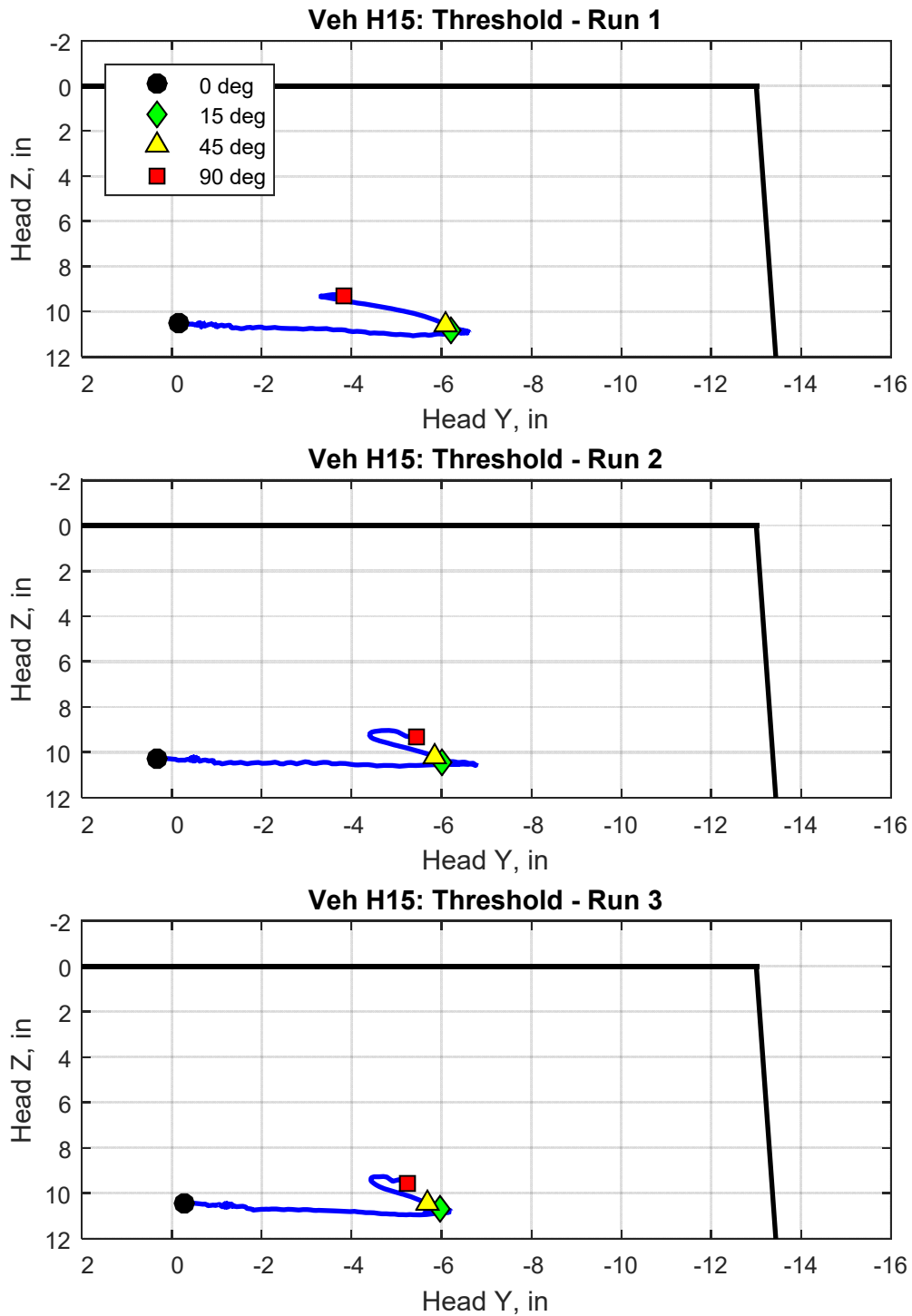

Figure A-10: Roll Simulator Threshold Event - Vehicle H15 - ATD Head Displacement - Head Z vs. Head Y

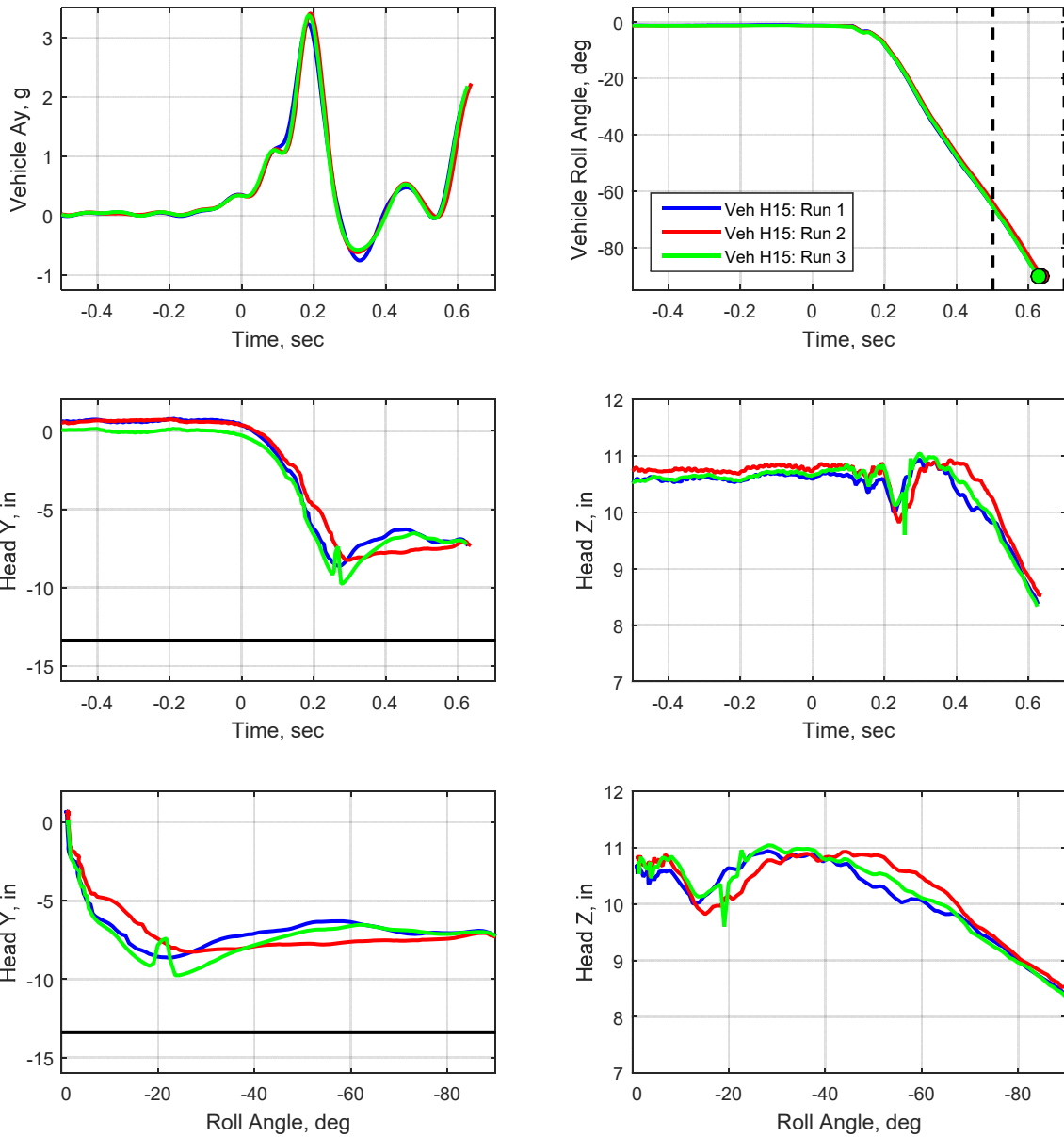

Figure A-11: Roll Simulator Tripped Event - Vehicle H15 - Vehicle Response and ATD Head Displacement

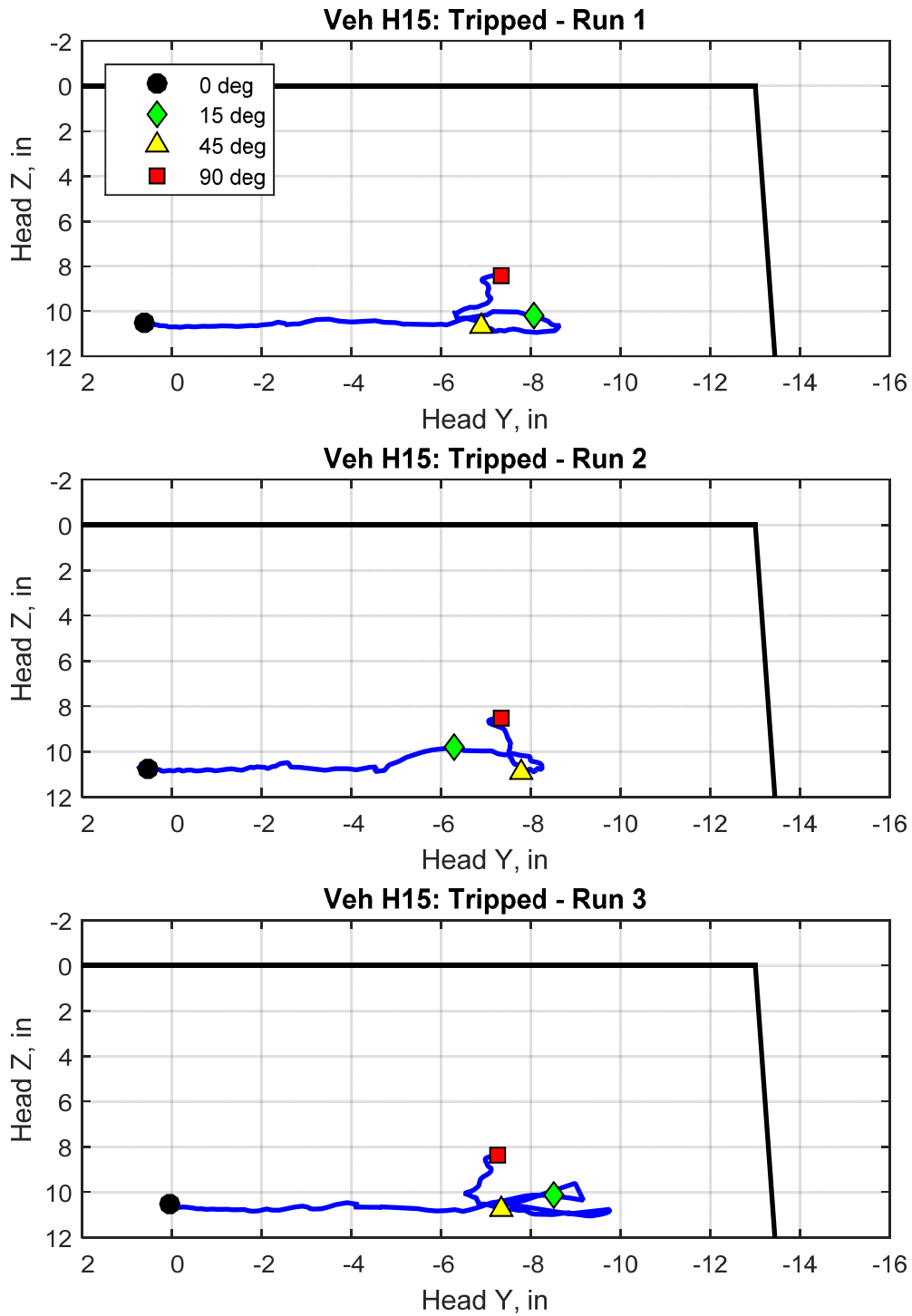

Figure A-12: Roll Simulator Tripped Event - Vehicle H15 - ATD Head Displacement - Head Z vs. Head Y

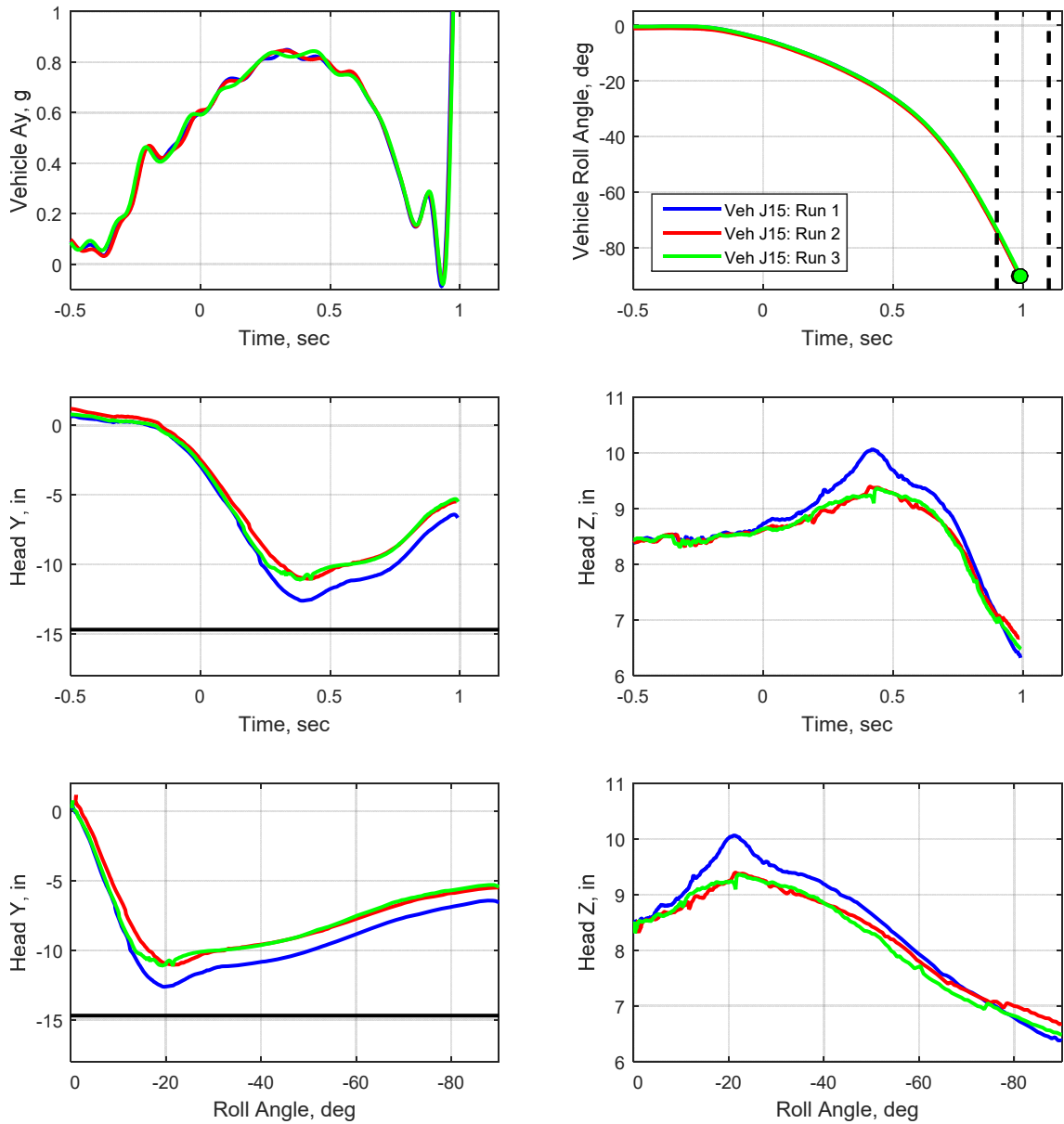

Figure A-13: Roll Simulator Threshold Event - Vehicle J15 - Vehicle Response and ATD Head Displacement

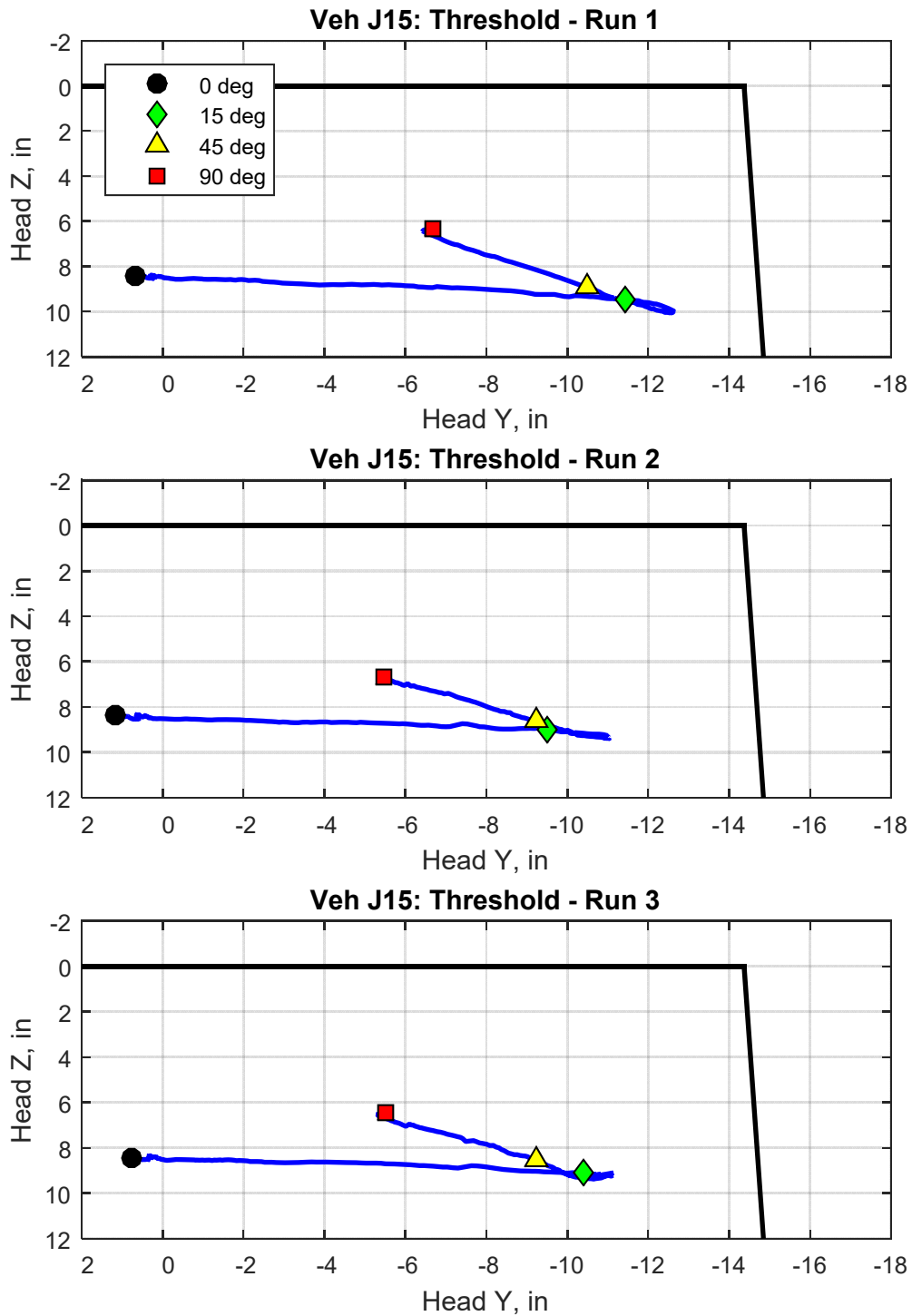

Figure A-14: Roll Simulator Threshold Event - Vehicle J15 - ATD Head Displacement - Head Z vs. Head Y

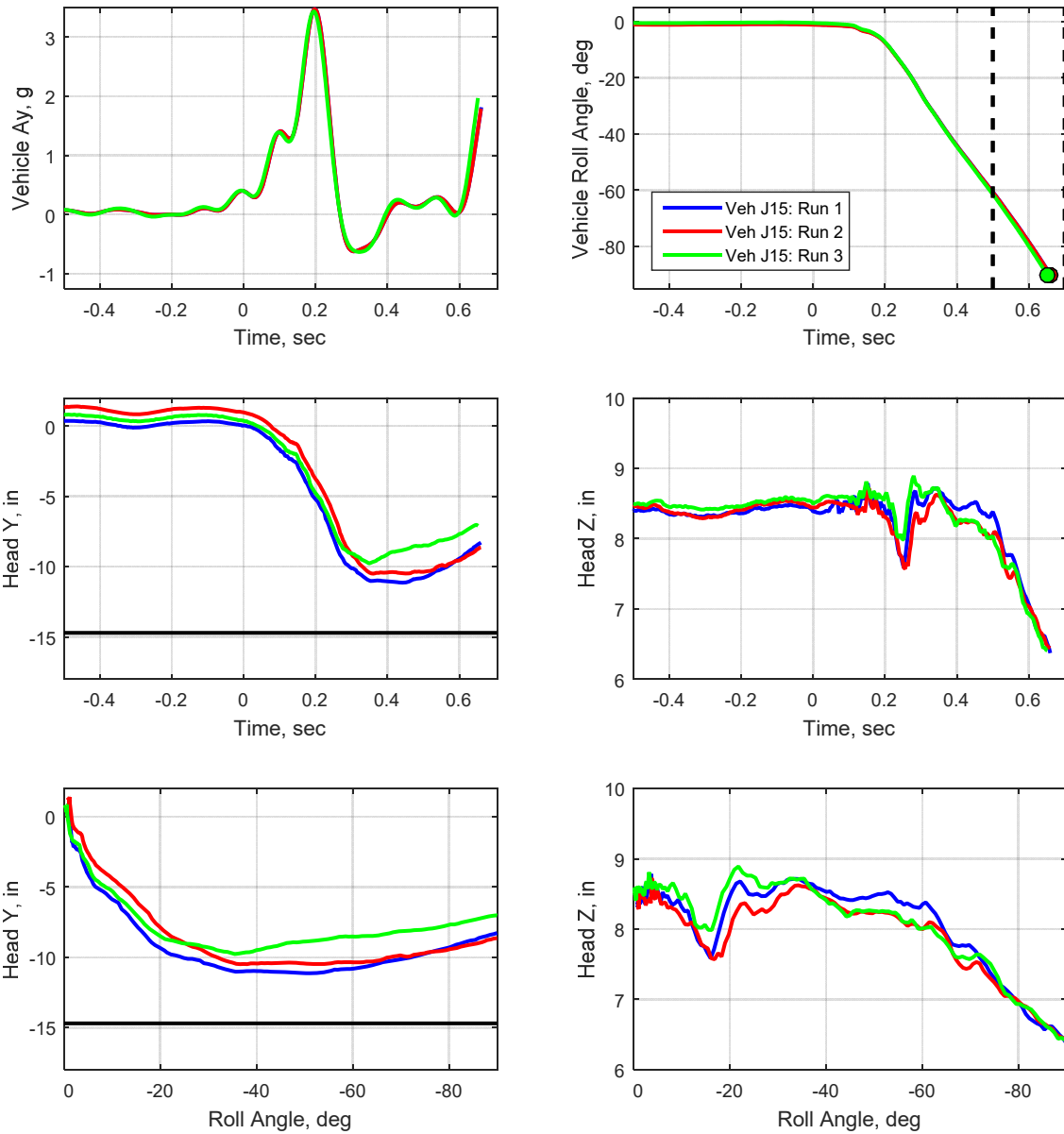

Figure A-15: Roll Simulator Tripped Event - Vehicle J15 - Vehicle Response and ATD Head Displacement

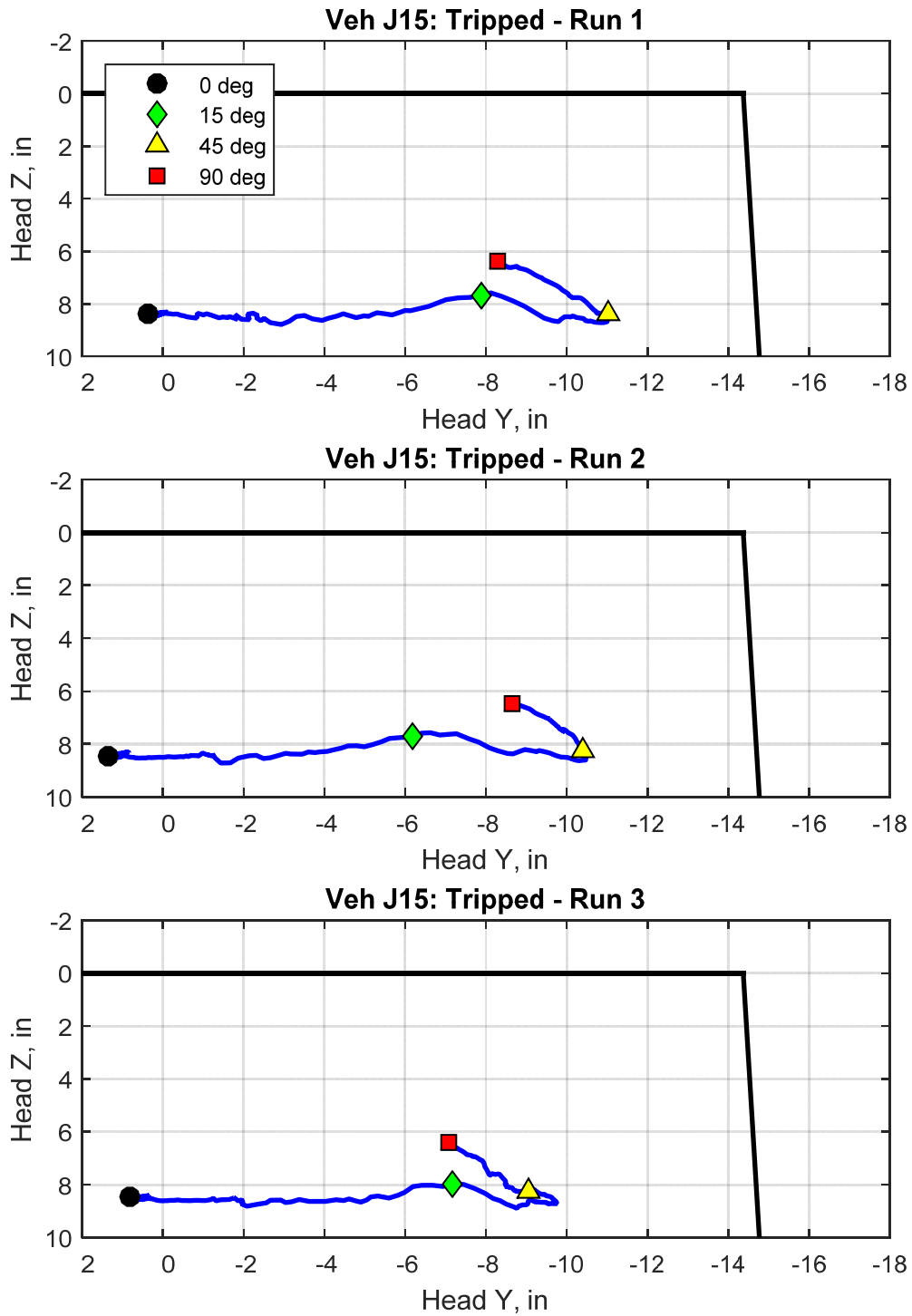

Figure A-16: Roll Simulator Tripped Event - Vehicle J15 - ATD Head Displacement - Head Z vs. Head Y

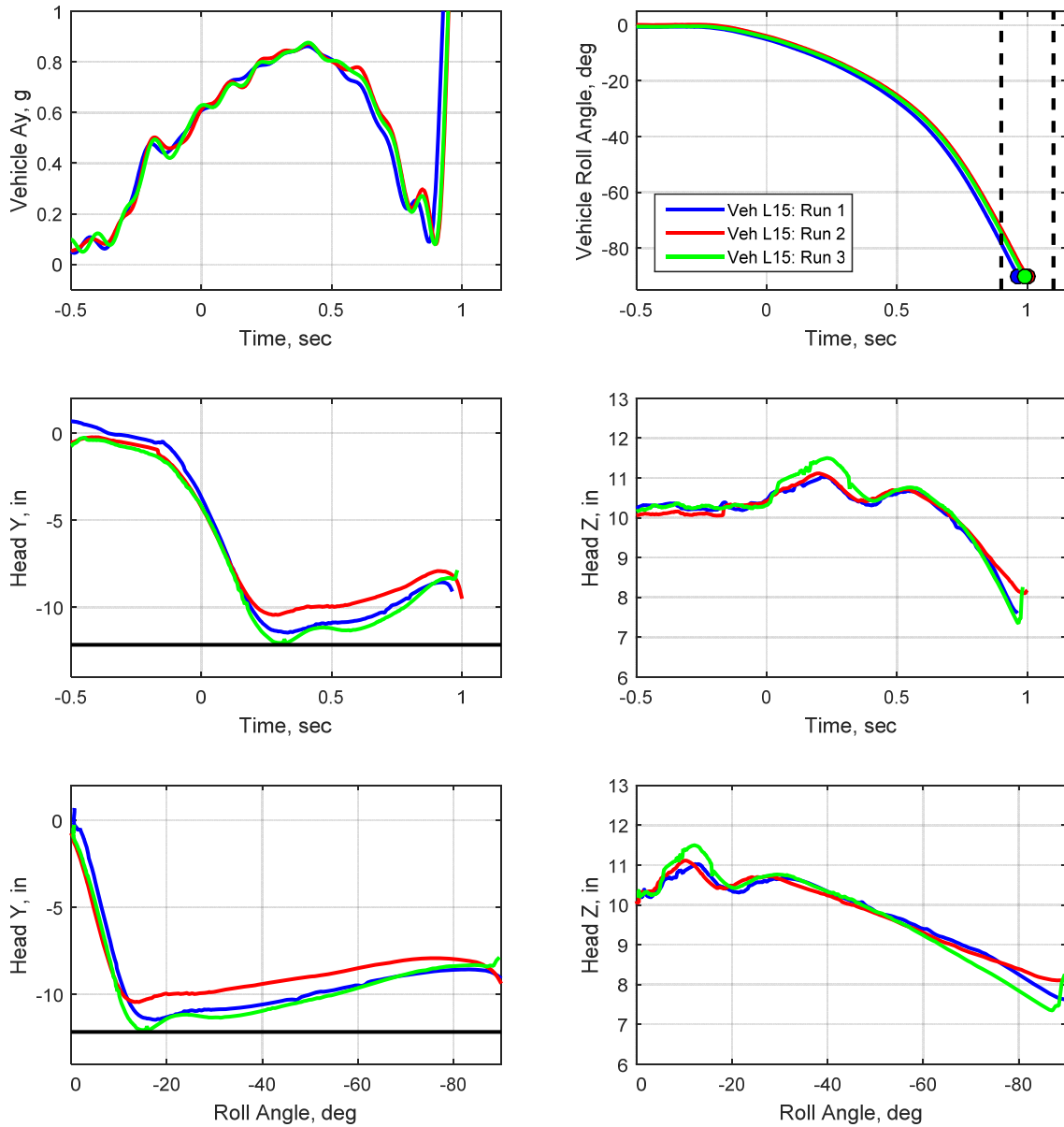

Figure A-17: Roll Simulator Threshold Event - Vehicle L15 - Vehicle Response and ATD Head Displacement

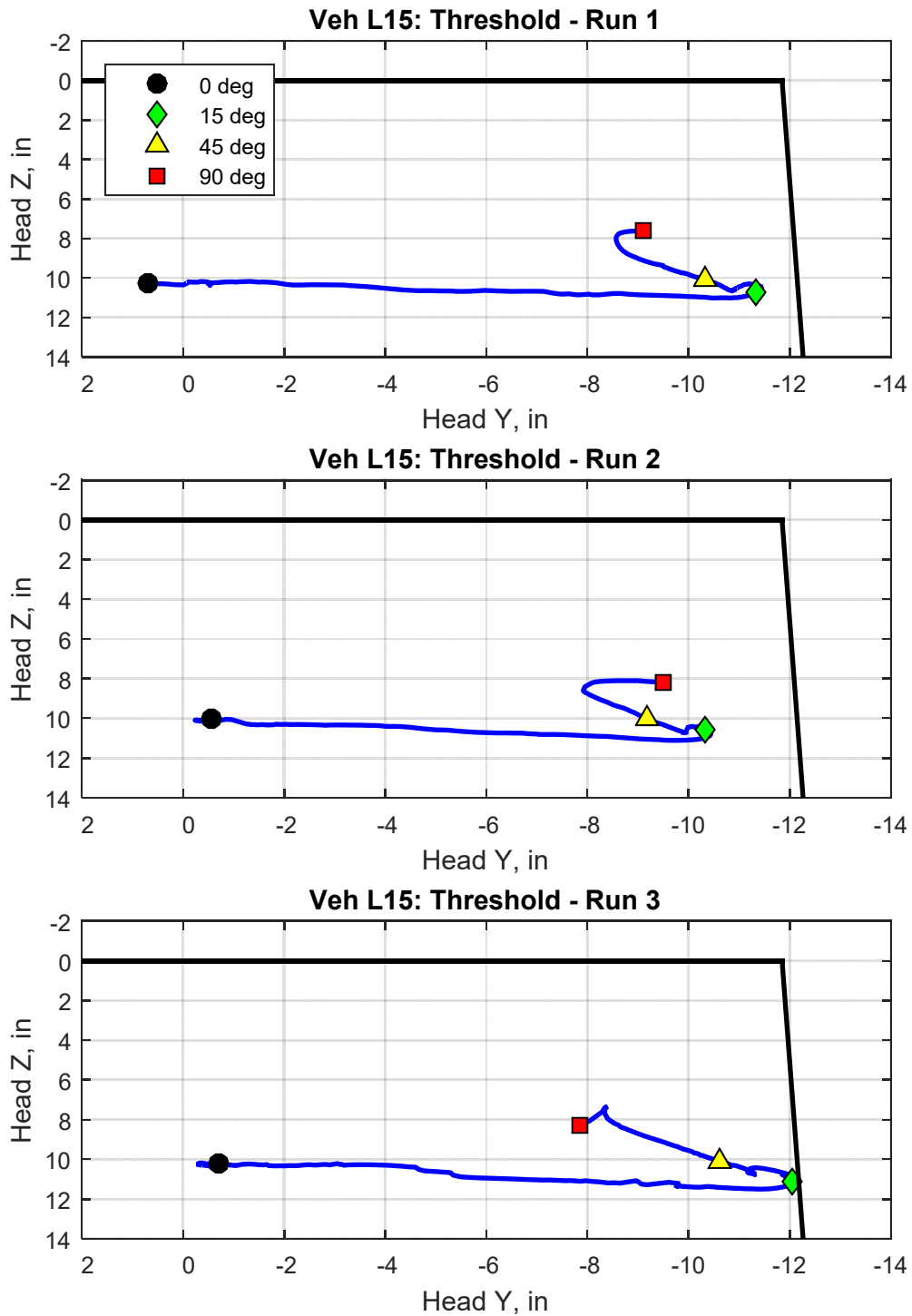

Figure A-18: Roll Simulator Threshold Event - Vehicle L15 - ATD Head Displacement - Head Z vs. Head Y

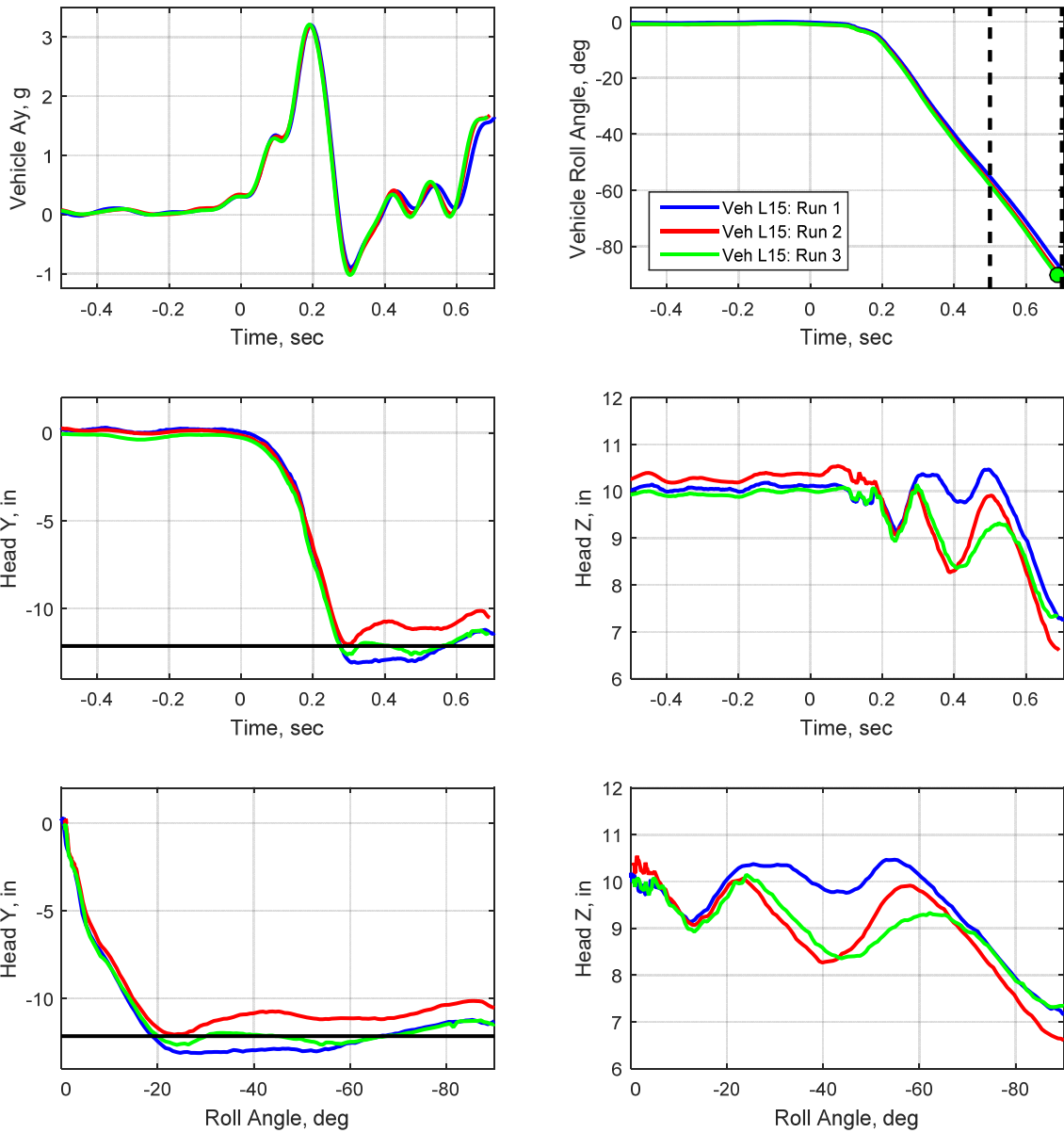

Figure A-19: Roll Simulator Tripped Event - Vehicle L15 - Vehicle Response and ATD Head Displacement

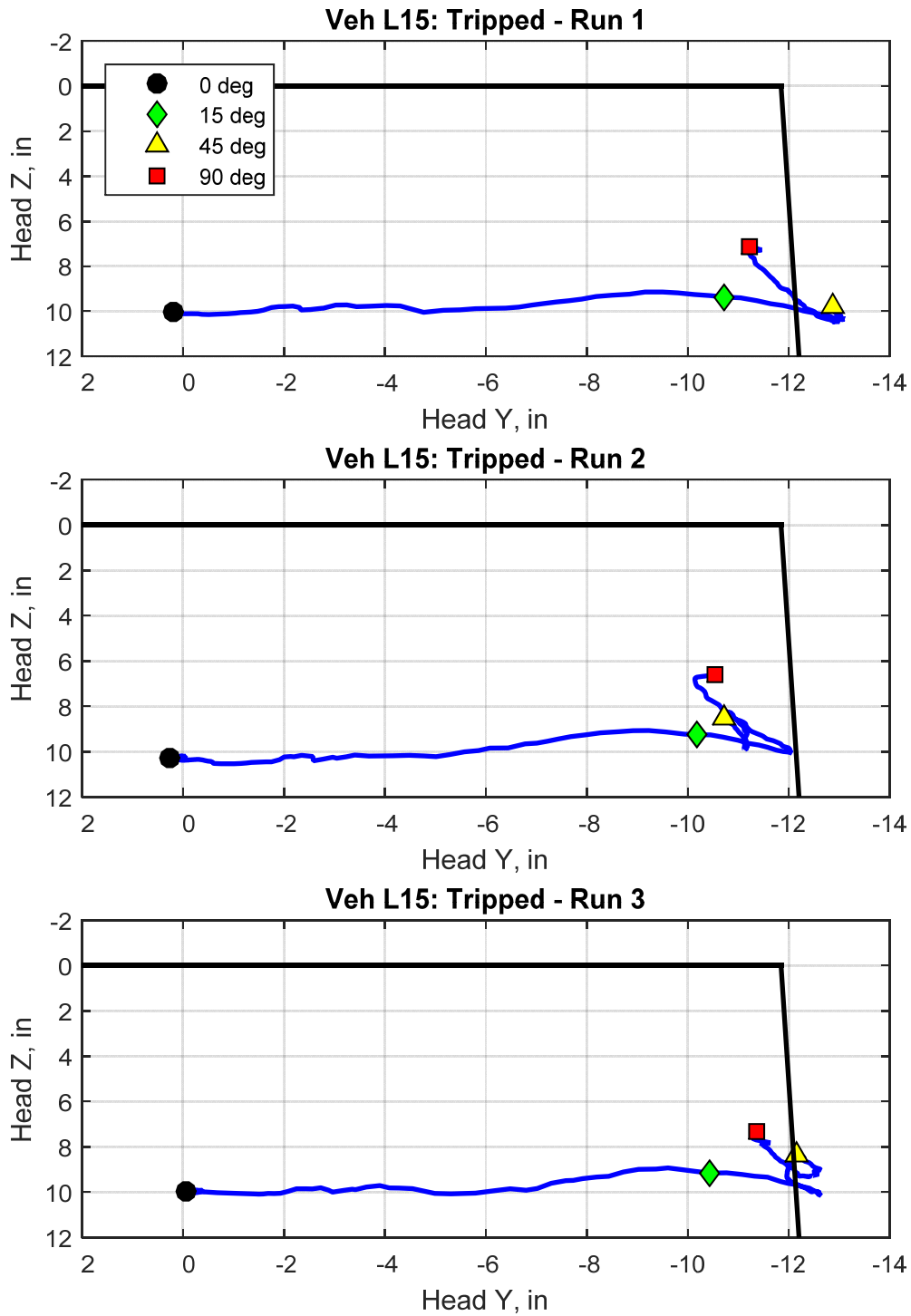

Figure A-20: Roll Simulator Tripped Event - Vehicle L15 - ATD Head Displacement - Head Z vs. Head Y

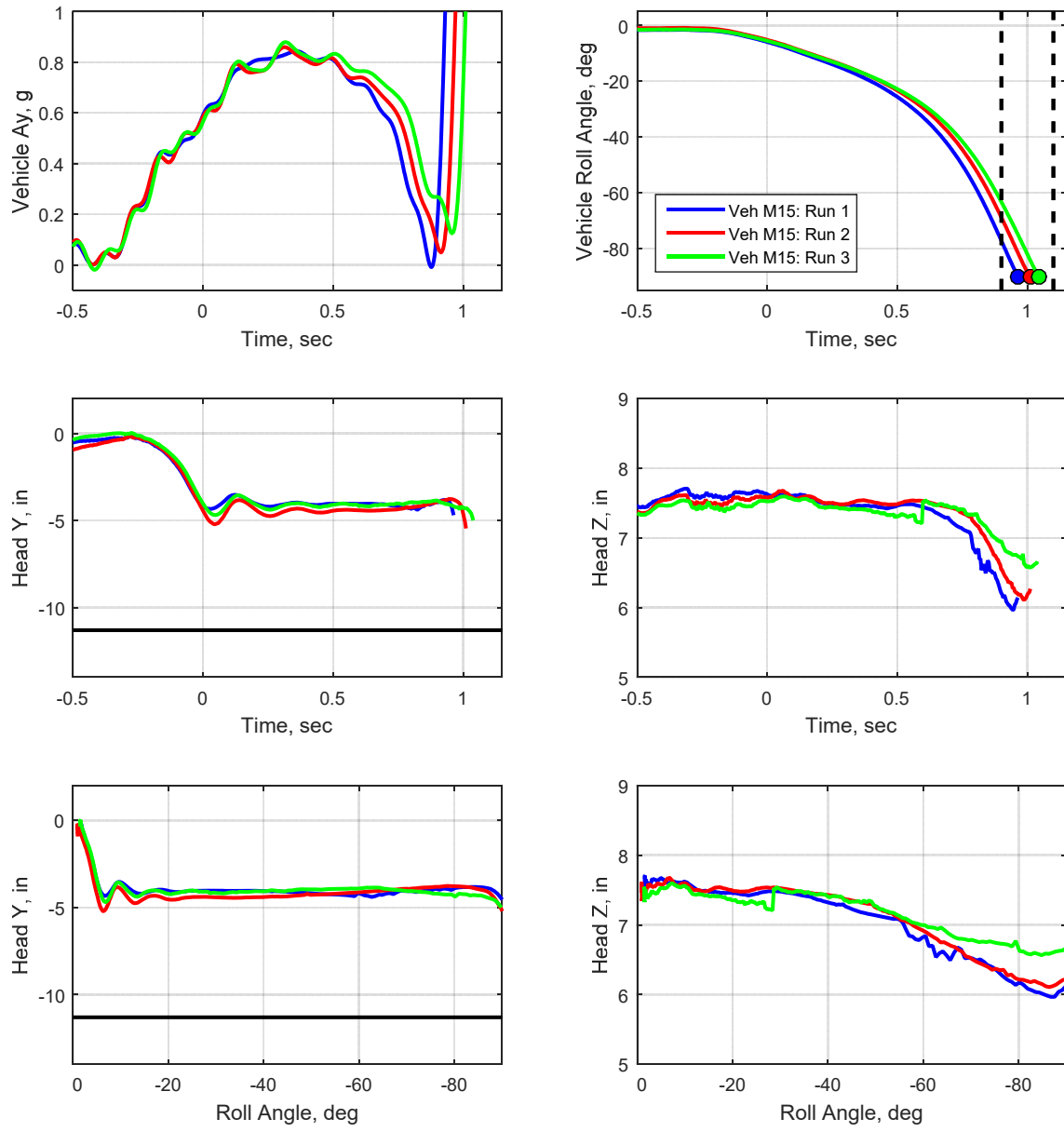

Figure A-21: Roll Simulator Threshold Event - Vehicle M15 - Vehicle Response and ATD Head Displacement

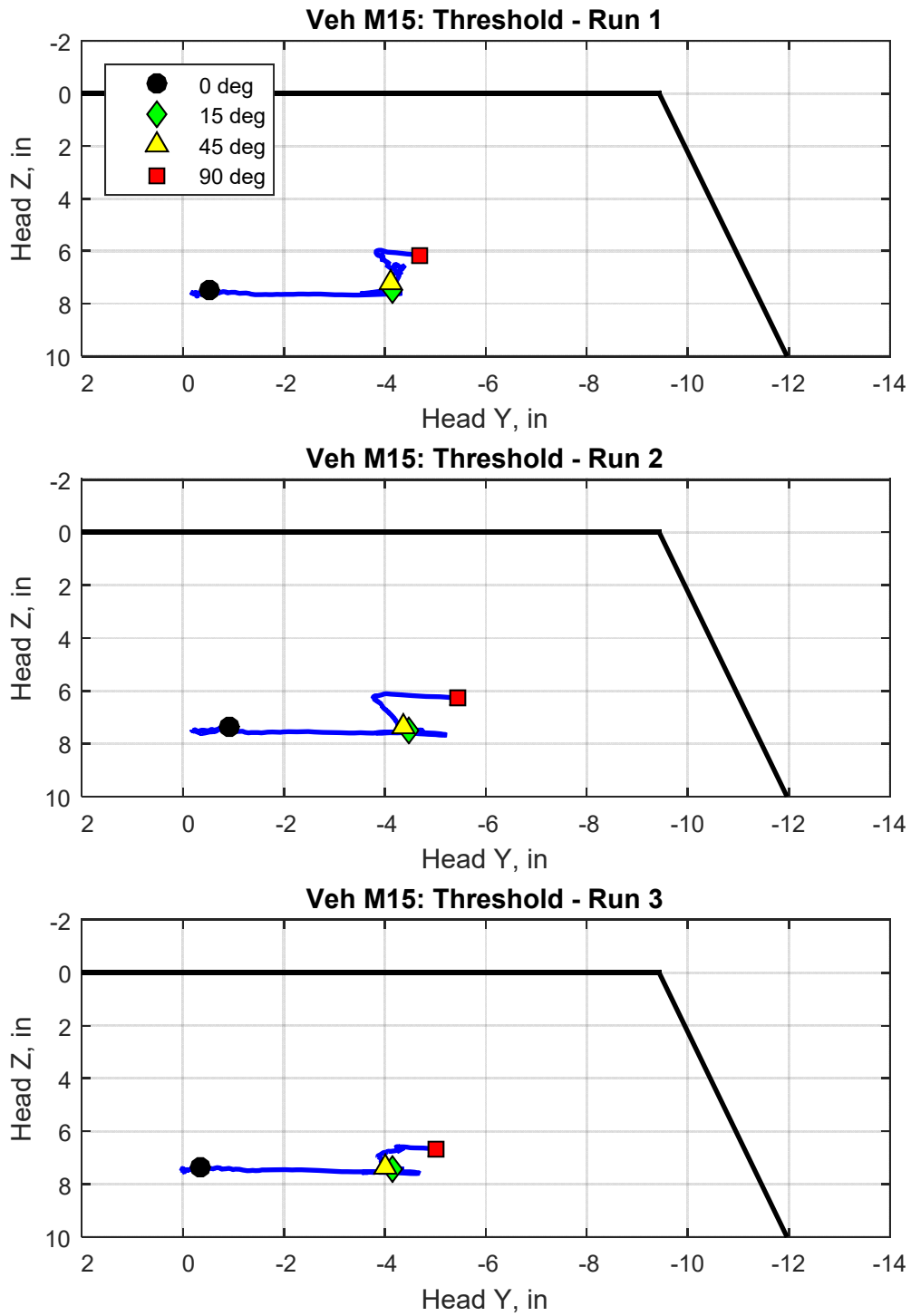

Figure A-22: Roll Simulator Threshold Event - Vehicle M15 - ATD Head Displacement - Head Z vs. Head Y

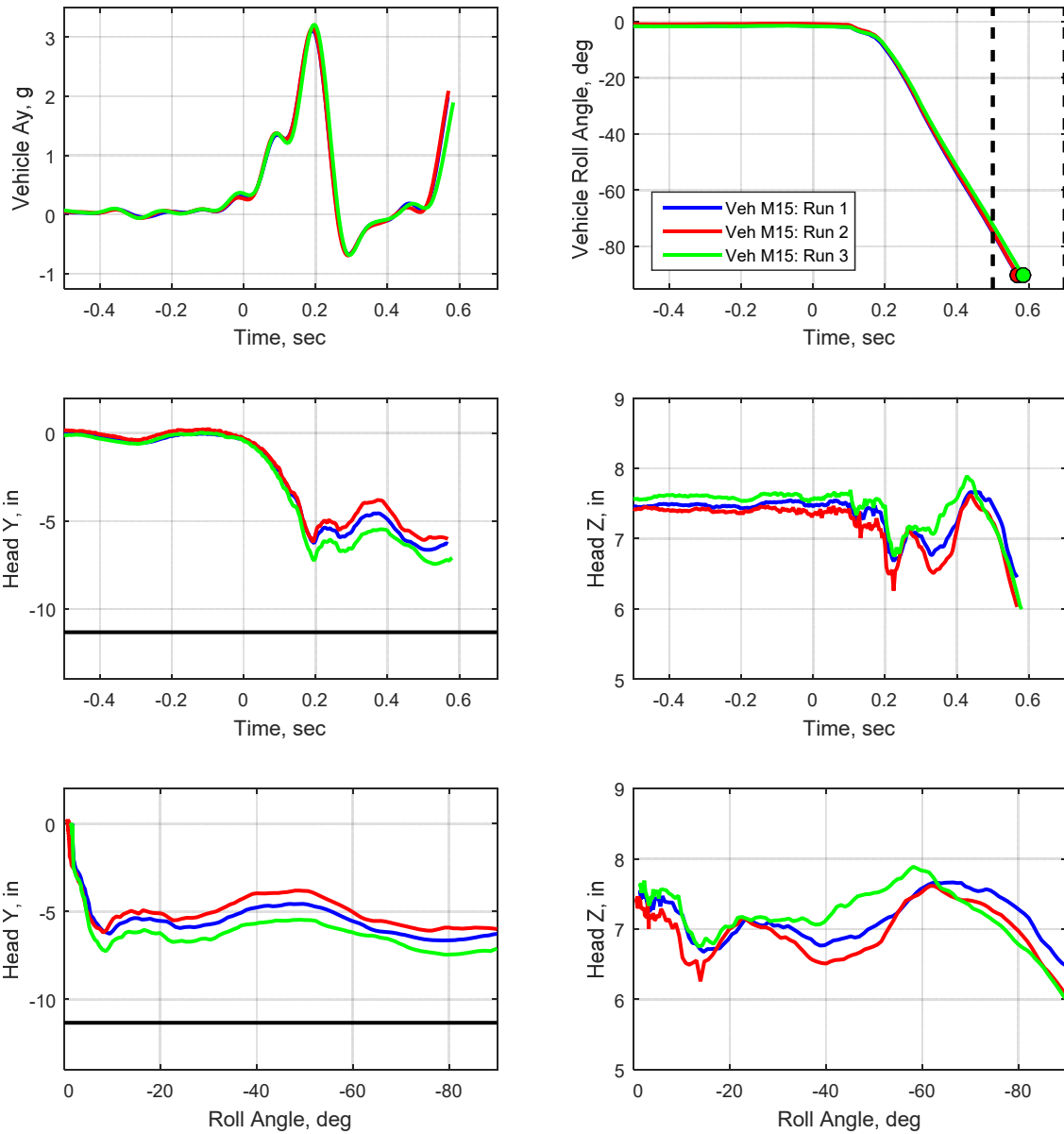

Figure A-23: Roll Simulator Tripped Event - Vehicle M15 - Vehicle Response and ATD Head Displacement

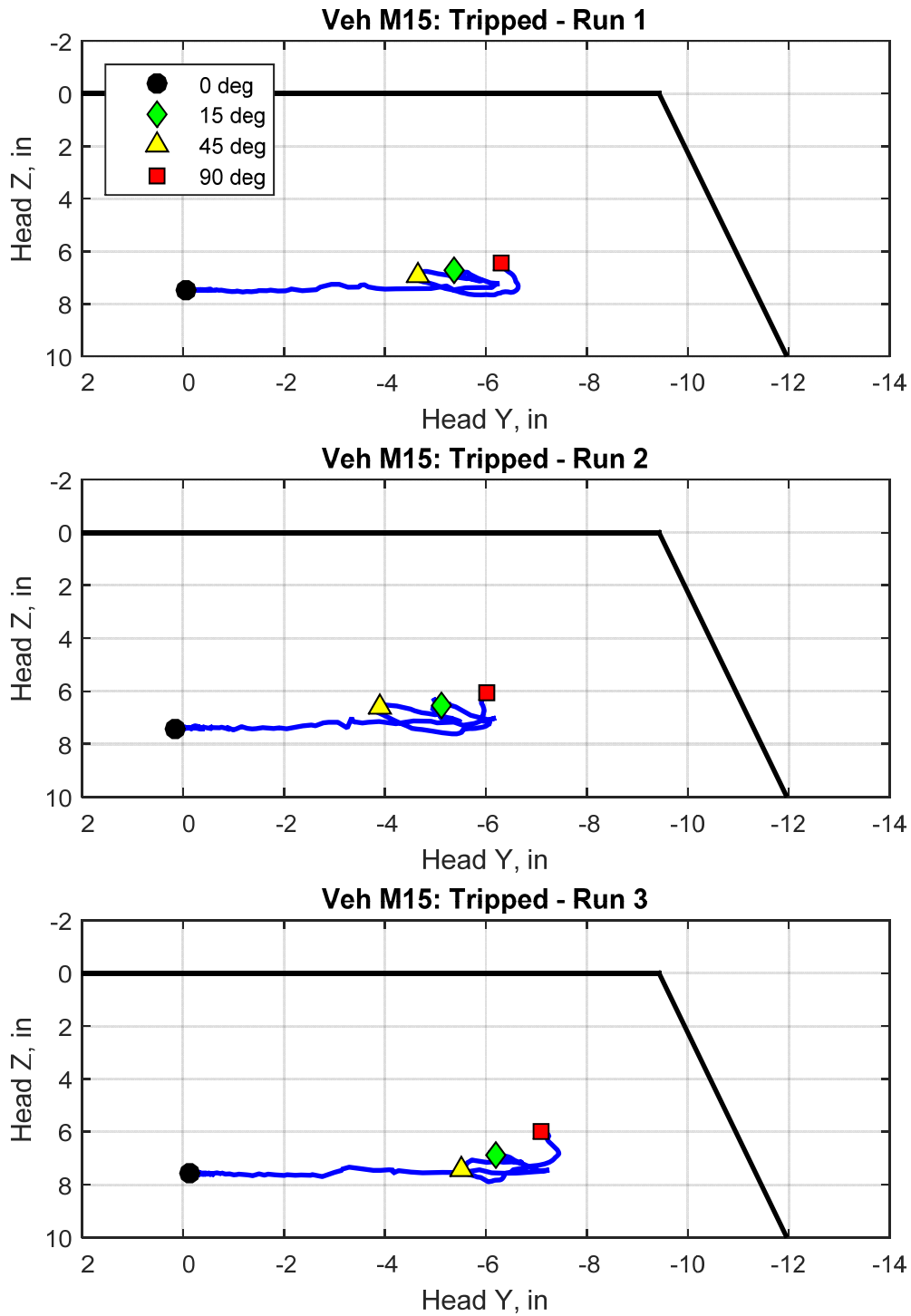

Figure A-24: Roll Simulator Tripped Event - Vehicle M15 - ATD Head Displacement - Head Z vs. Head Y

APPENDIX B - Vehicle Photos and Restraint Systems



Figure B-1: Vehicle C15 on the Roll Simulator - Standard Tests



Figure B-2: Vehicle E15 on the Roll Simulator - Standard Tests



Figure B-3: Vehicle H15 on the Roll Simulator - Standard Tests



Figure B-4: Vehicle J15 on the Roll Simulator - Standard Tests



Figure B-5: Vehicle L15 on the Roll Simulator - Standard Tests



Figure B-6: Vehicle M15 on the Roll Simulator - Standard Tests

Table B-1: Vehicle Restraint Systems				
Vehicle	Net	Door	Occupant Protection Shoulder Area	
			Bar	Seat Belt
C15	Foot Net	None	Hip Bar	Webbing Sensitive
E15	Arm Net	None	Hip Bar + Shoulder Pad	Webbing Sensitive + Vehicle Sensitive
H15	None	Full Door (Shoulder/Arms/Legs)	None	Webbing Sensitive
J15	Full Net (Upper Body)	Half Door (Legs)	Hip Bar	Webbing Sensitive + Vehicle Sensitive
L15	Full Net (Arms + Legs)	None	Hip + Lower Arm Bar	Webbing Sensitive + Vehicle Sensitive
M15	Full Net (Arms + Legs)	Passive Shoulder	Hip + Shoulder Bar	Webbing Sensitive + Vehicle Sensitive

APPENDIX C - Probe Test Results



Vehicle A15 – 3” Fixed Probe – In



Vehicle A15 – 3” Fixed Probe – Out

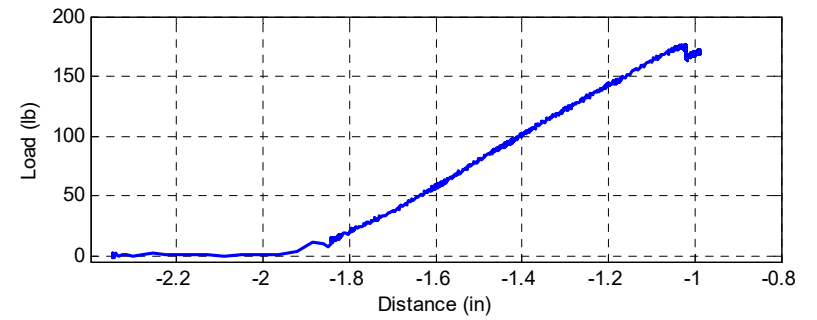
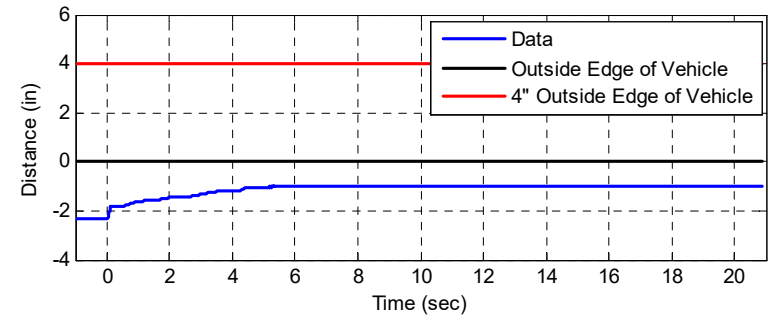
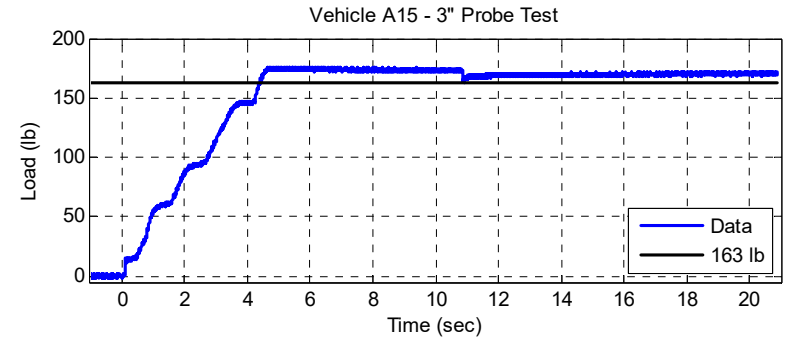

Load and Distance Data

Vehicle A15 - 3" Fixed Probe



Vehicle A15 – 6” Fixed Probe – In



Vehicle A15 – 6” Fixed Probe – Out

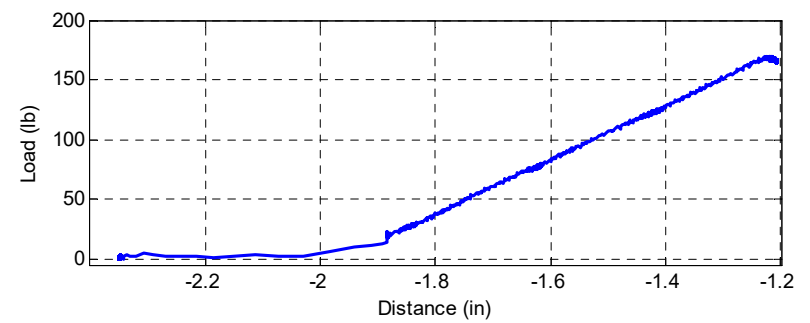
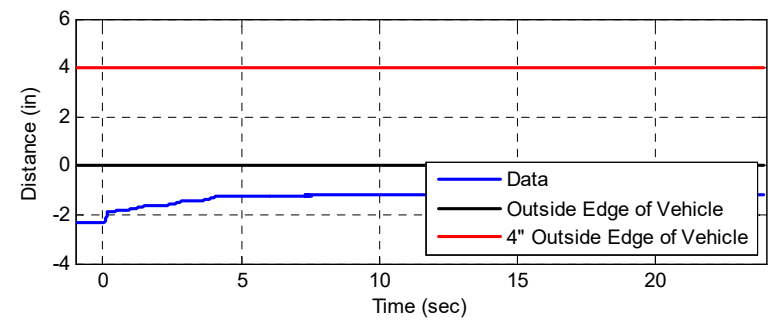
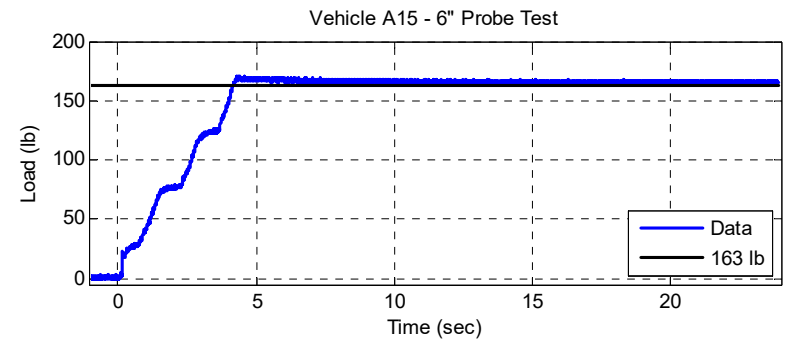

Load and Distance Data

Vehicle A15 - 6" Fixed Probe



Vehicle B15 – 3” Fixed Probe – In



Vehicle B15 – 3” Fixed Probe – Out

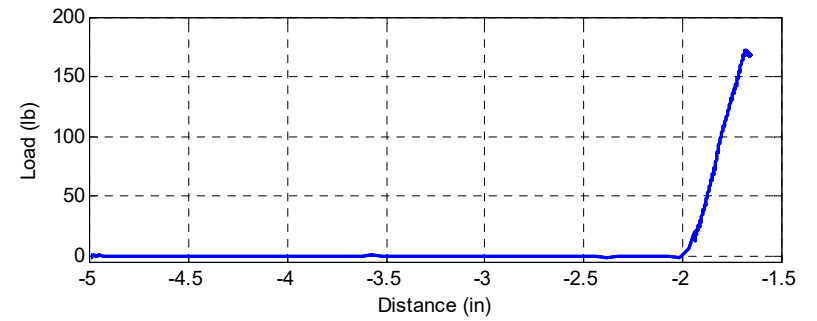
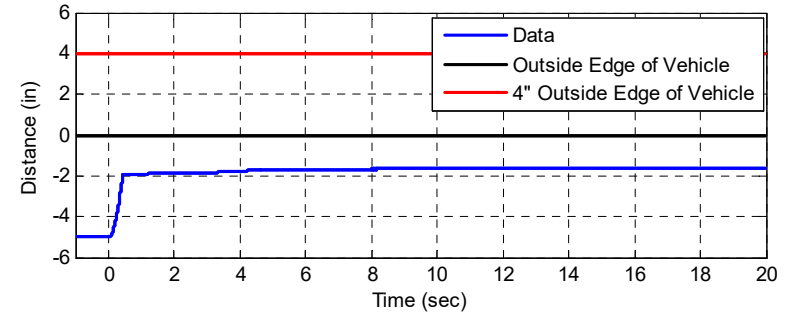
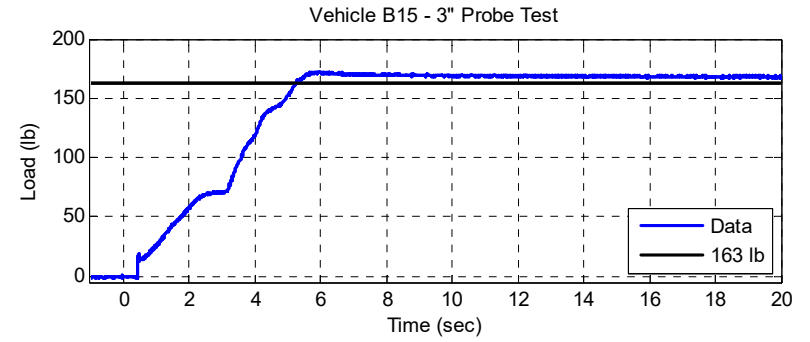

Load and Distance Data

Vehicle B15 - 3" Fixed Probe



Vehicle B15 – 6" Fixed Probe – In



Vehicle B15 – 6" Fixed Probe – Out

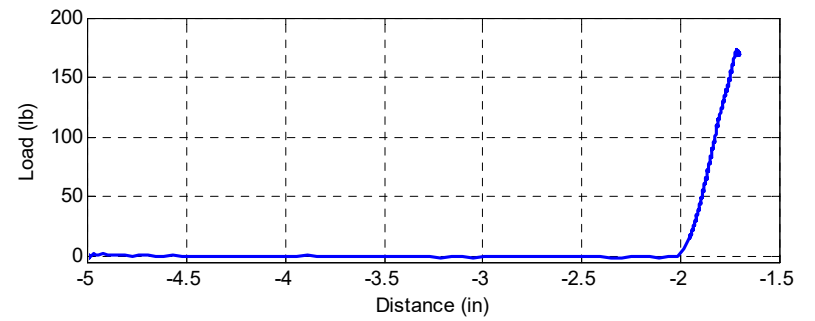
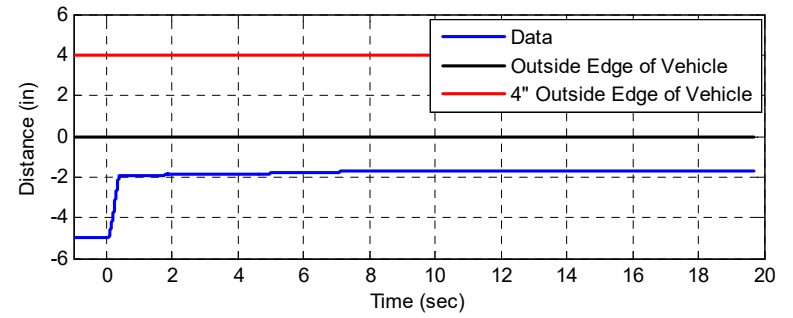
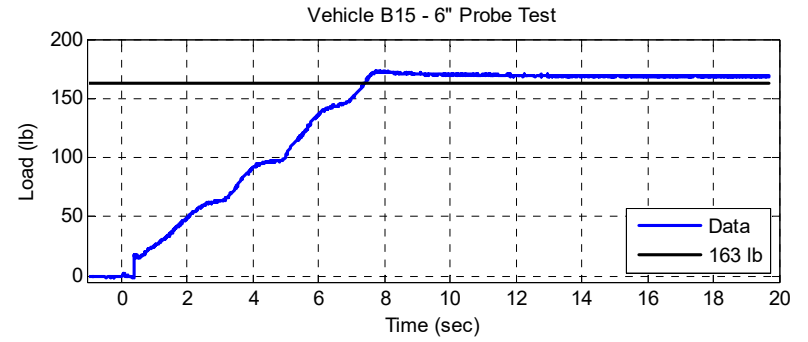

Load and Distance Data

Vehicle B15 - 6" Fixed Probe



Vehicle D15 – 3" Articulated Probe – In

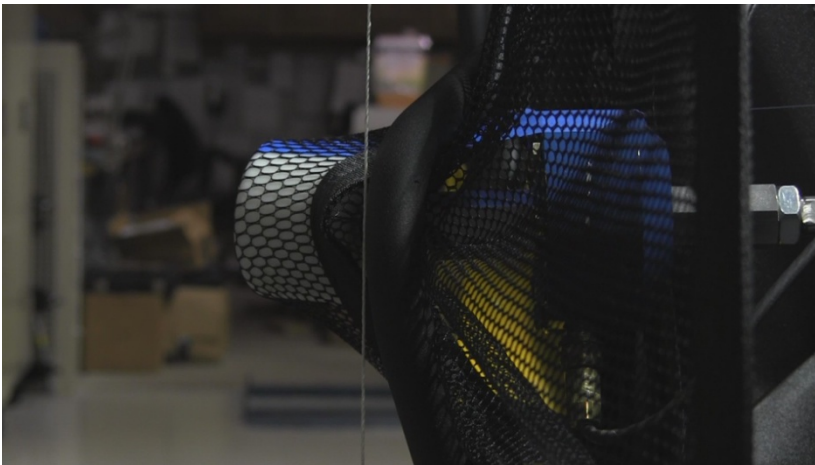

Vehicle D15 – 3" Articulated Probe – Out

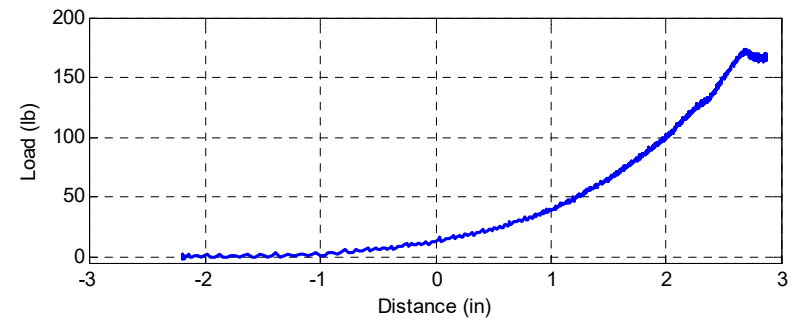
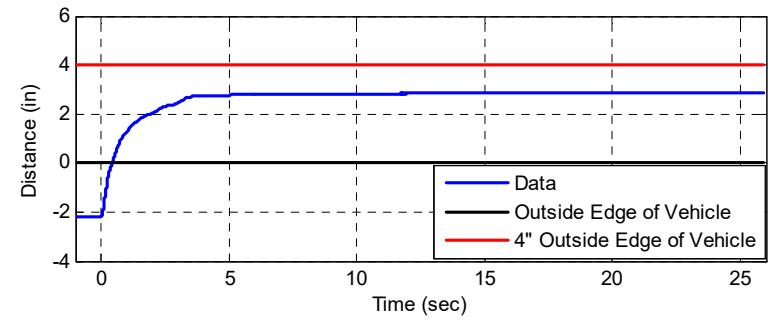
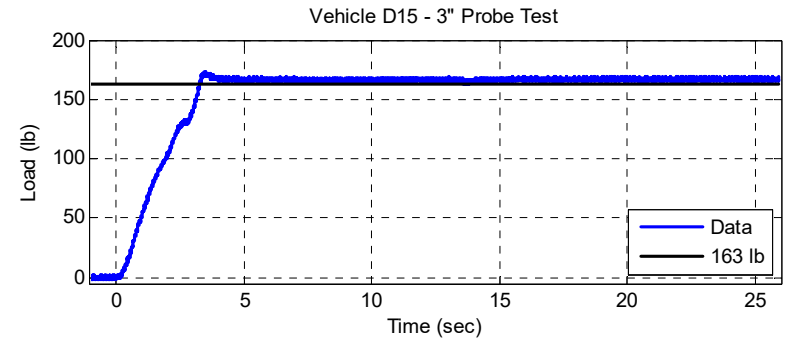

Load and Distance Data

Vehicle D15 - 3" Articulated Probe



Vehicle D15 – 6" Articulated Probe – In

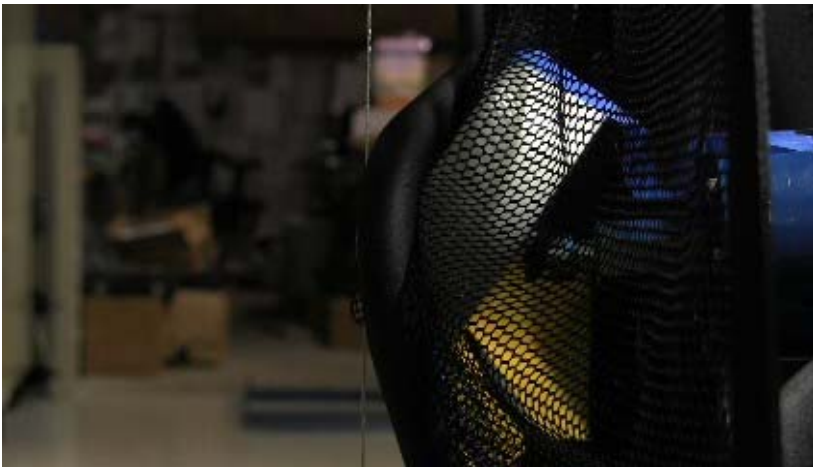

Vehicle D15 – 6" Articulated Probe – Out

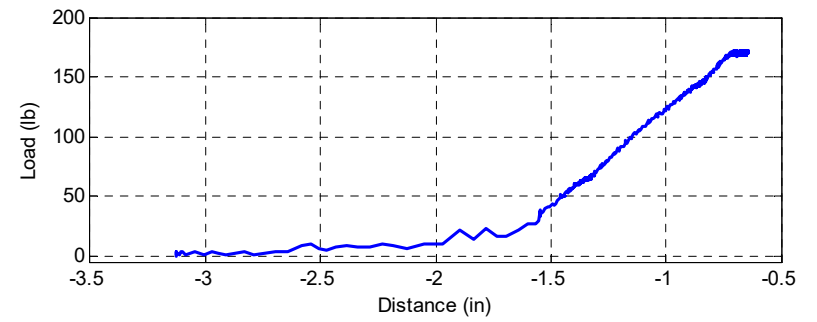
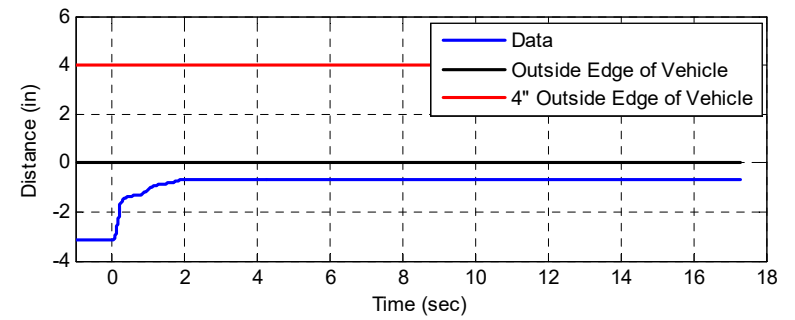
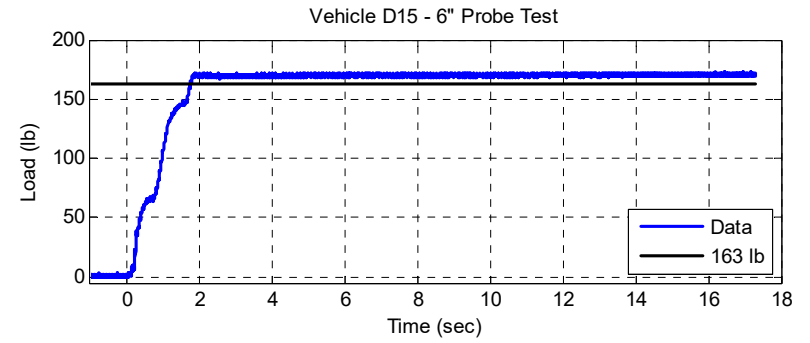

Load and Distance Data

Vehicle D15 - 6" Articulated Probe



Vehicle E15 – 3” Fixed Probe – In



Vehicle E15 – 3” Fixed Probe – Out

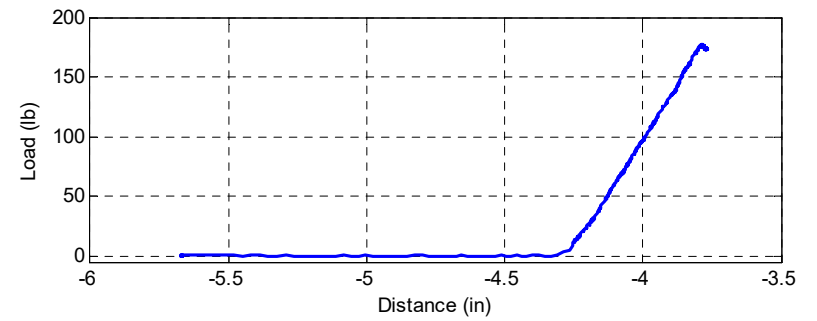
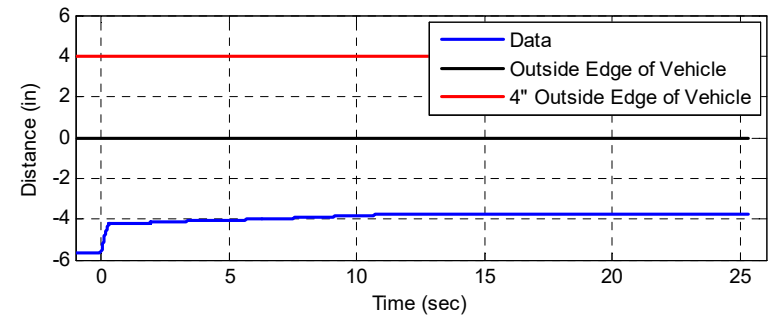
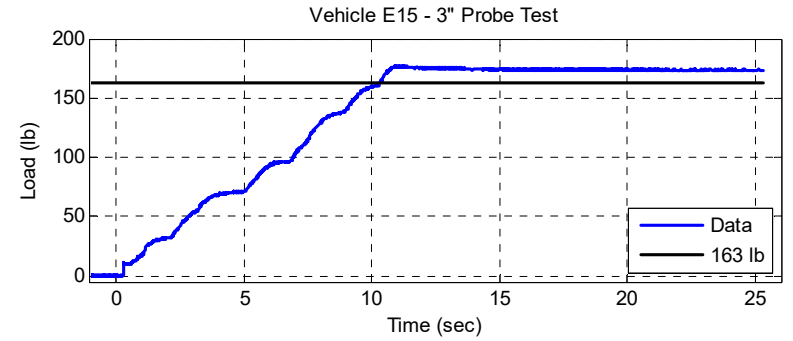

Load and Distance Data

Vehicle E15 - 3" Fixed Probe



Vehicle E15 – 6” Fixed Probe – In



Vehicle E15 – 6” Fixed Probe – Out

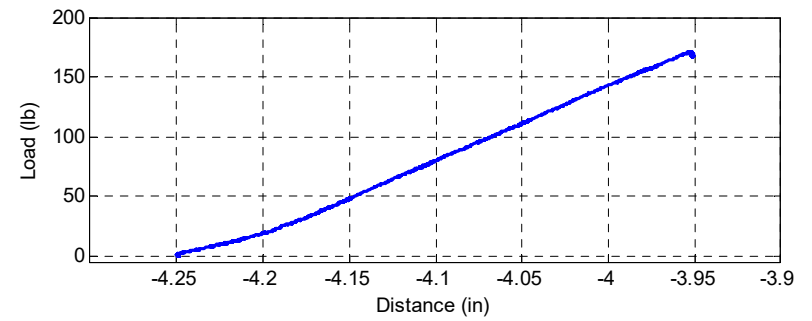
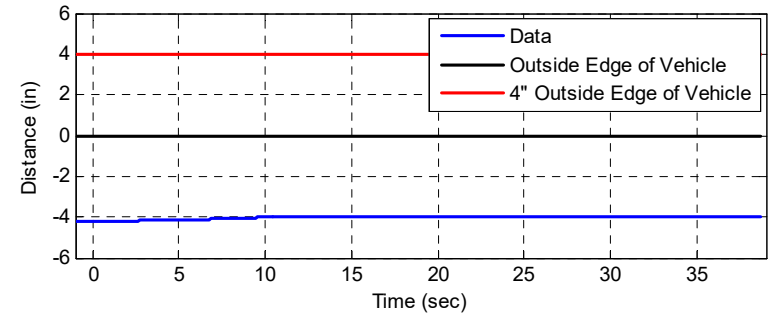
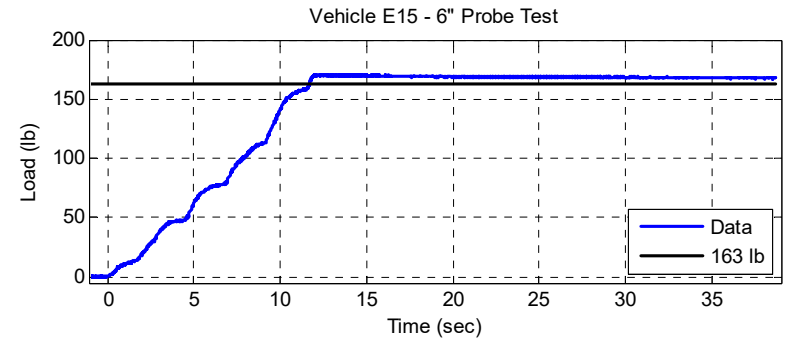

Load and Distance Data

Vehicle E15 - 6" Fixed Probe



Vehicle F15 – 3" Fixed Probe – In

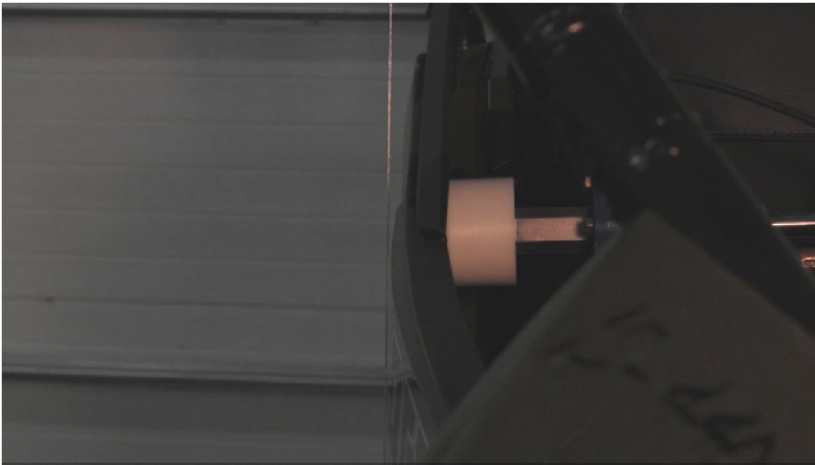

Vehicle F15 – 3" Fixed Probe – Out

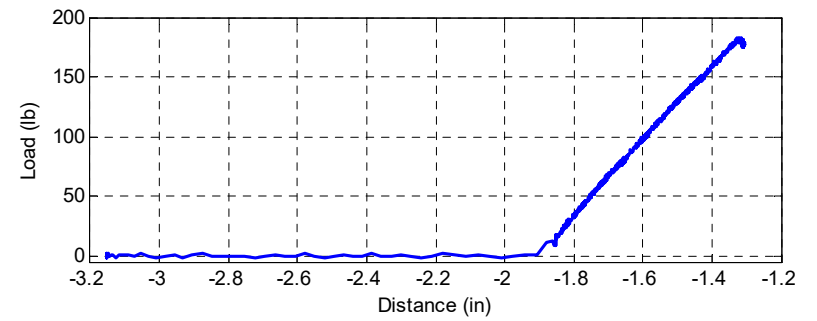
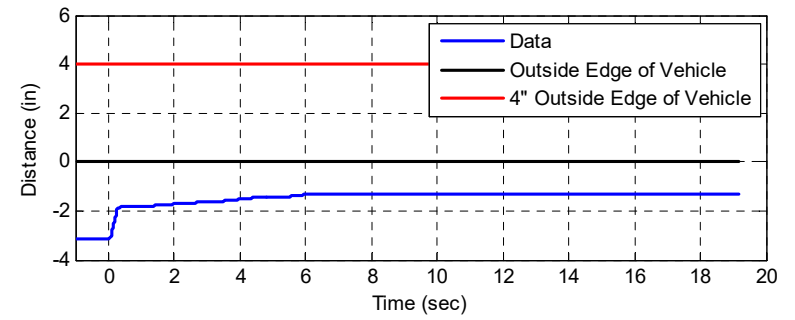
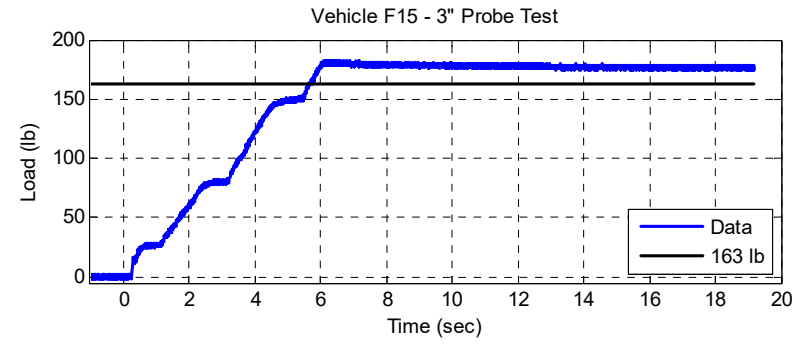

Load and Distance Data

Vehicle F15 - 3" Fixed Probe



Vehicle F15 – 6” Fixed Probe – In



Vehicle F15 – 6” Fixed Probe – Out

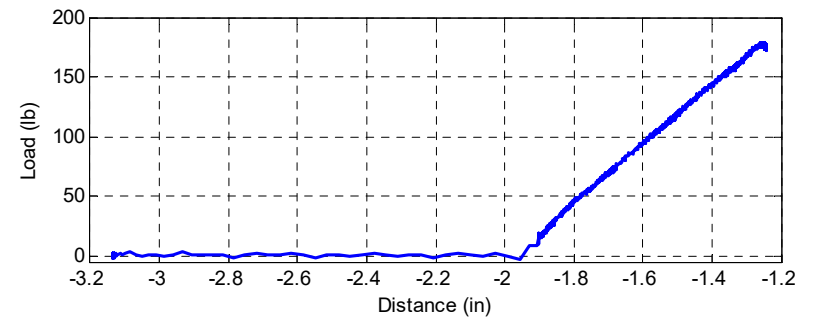
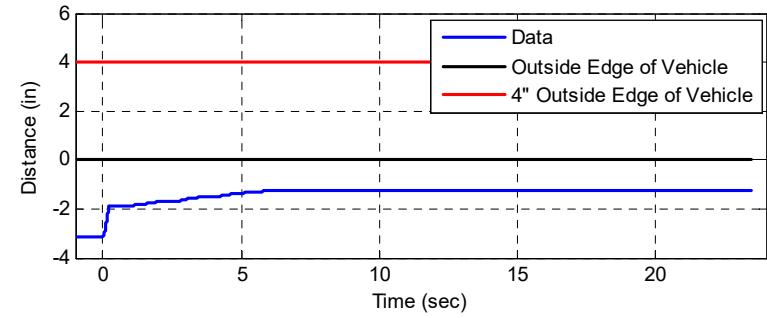
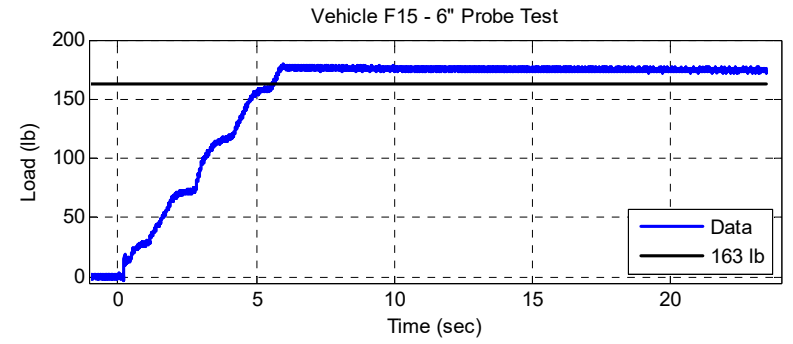

Load and Distance Data

Vehicle F15 - 6" Fixed Probe



Vehicle H15 – 3” Fixed Probe – In



Vehicle H15 – 3” Fixed Probe – Out

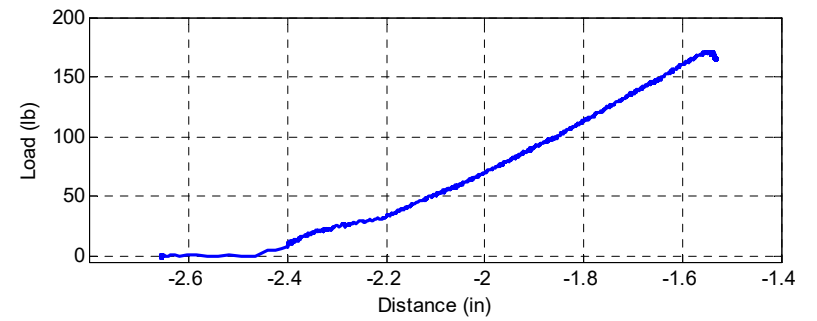
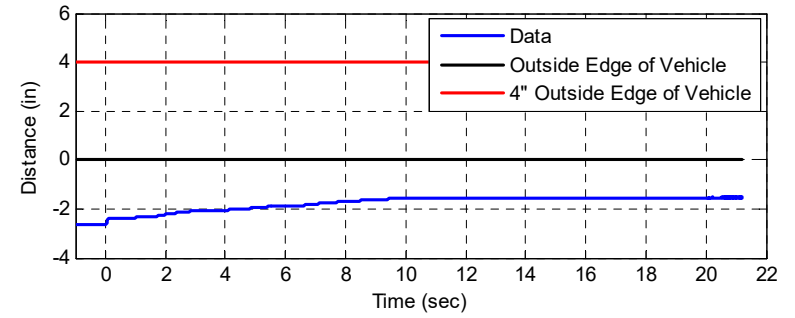
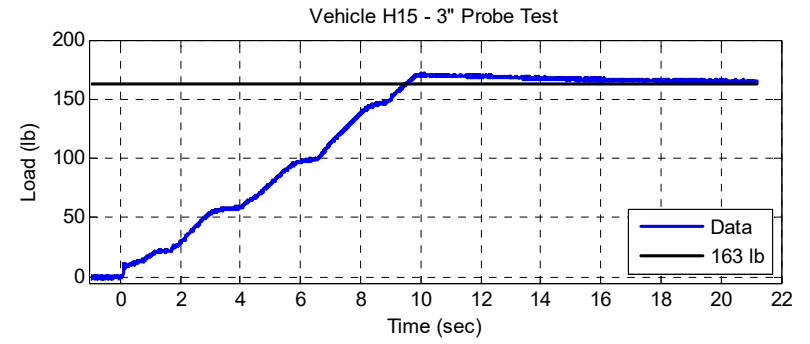

Load and Distance Data

Vehicle H15 - 3" Fixed Probe



Vehicle H15 – 6" Fixed Probe – In



Vehicle H15 – 6" Fixed Probe – Out

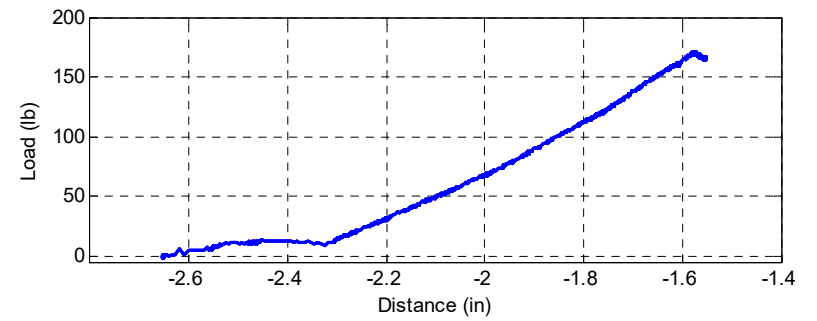
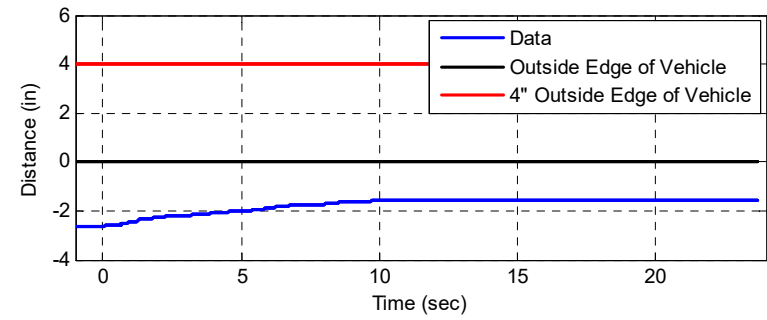
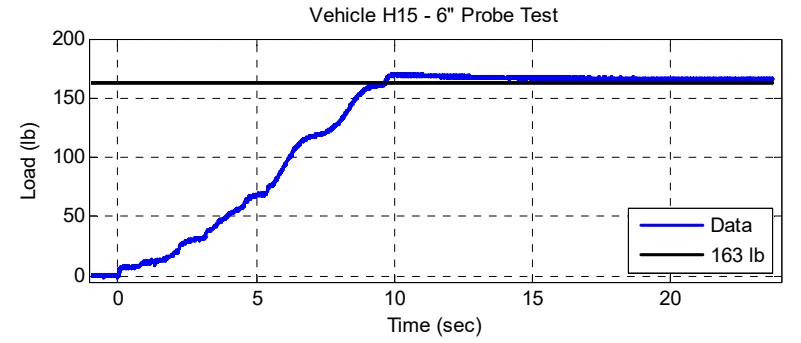

Load and Distance Data

Vehicle H15 - 6" Fixed Probe



Vehicle I15 – 3” Articulated Probe – In

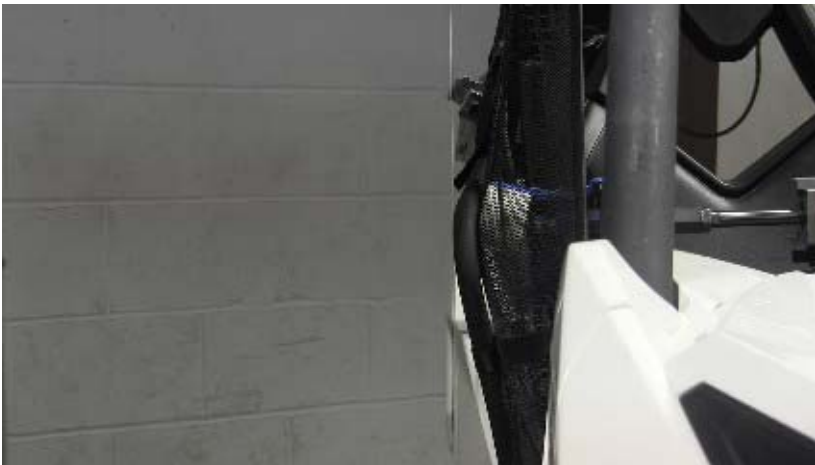

Vehicle I15 – 3” Articulated Probe – Out

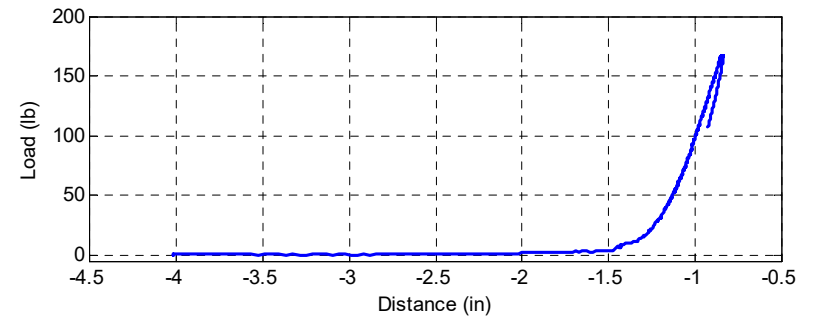
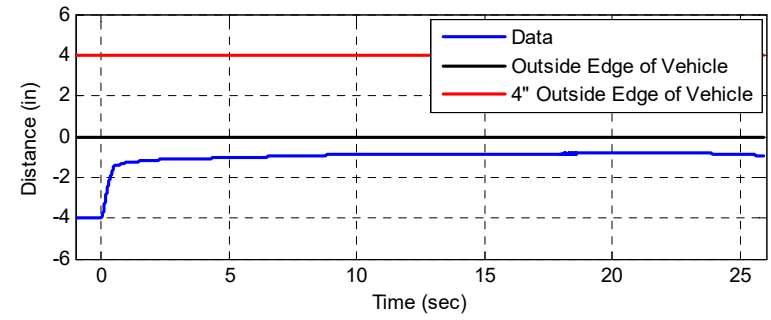
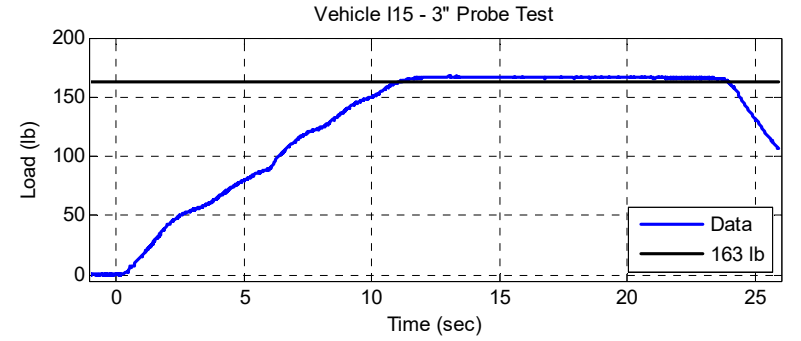

Load and Distance Data

Vehicle I15 - 3" Articulated Probe



Vehicle I15 - 6" Articulated Probe - In



Vehicle I15 - 6" Articulated Probe - Out

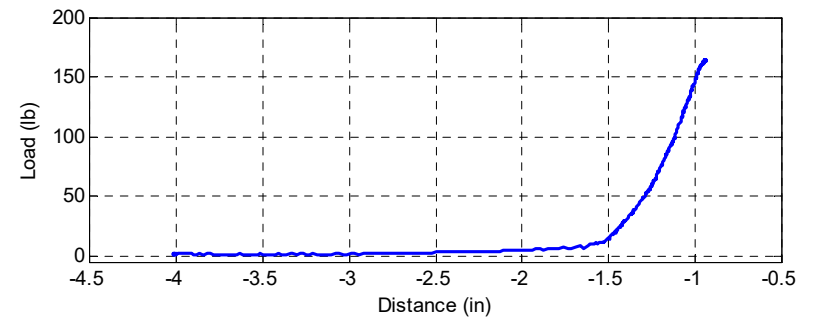
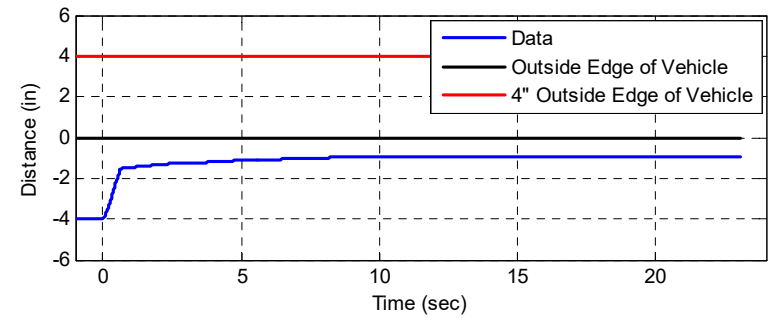
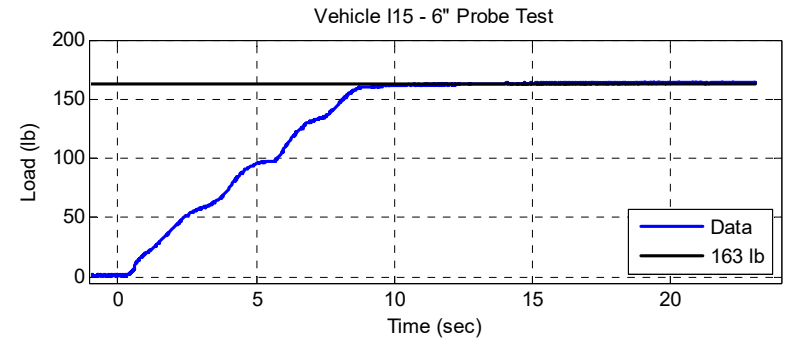

Load and Distance Data

Vehicle I15 - 6" Articulated Probe



Vehicle J15 – 3” Articulated Probe – In

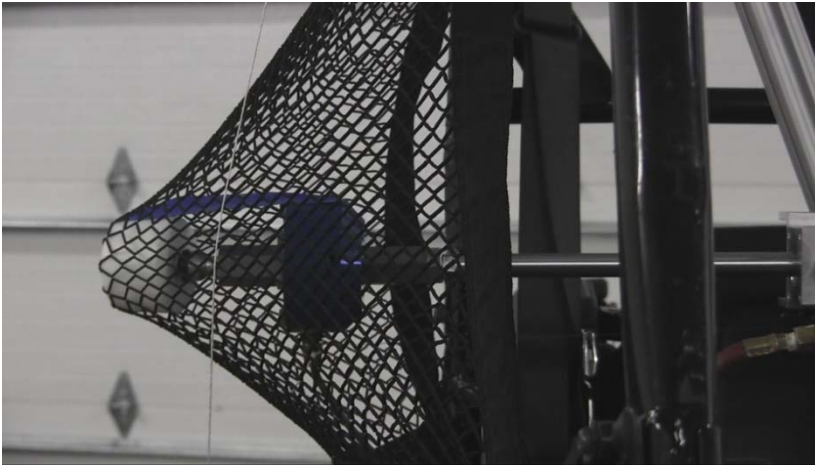

Vehicle J15 – 3” Articulated Probe – Out

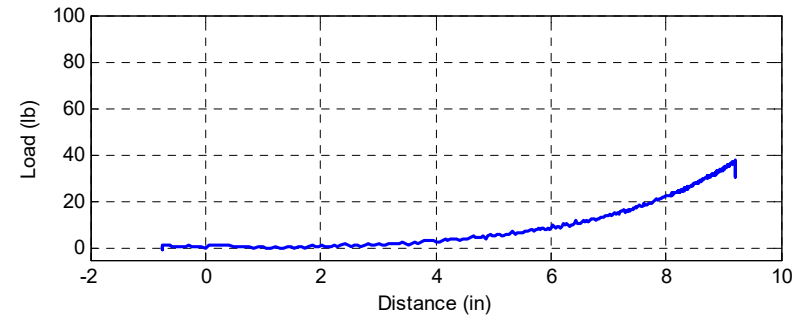
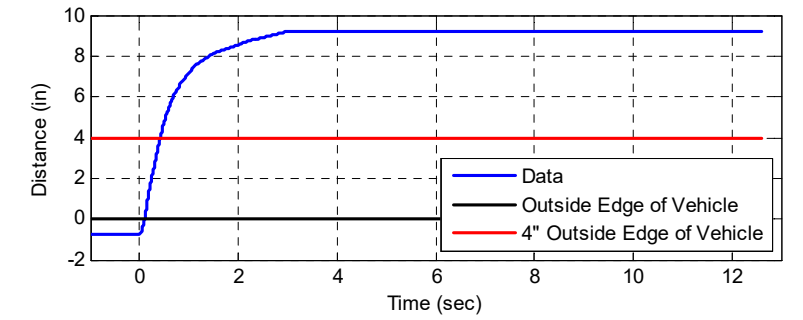
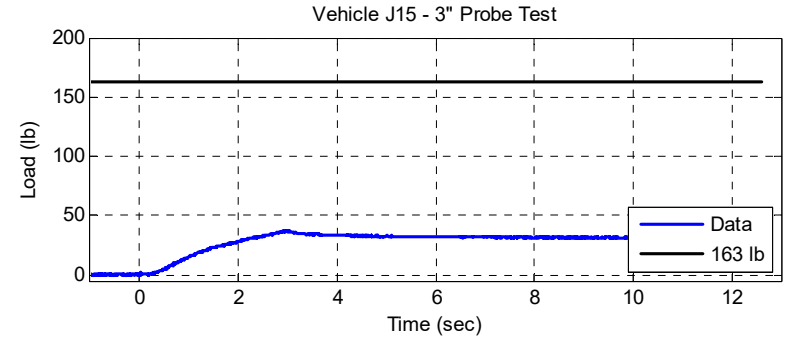

Load and Distance Data

Vehicle J15 - 3" Articulated Probe



Vehicle J15 – 6" Articulated Probe – In



Vehicle J15 – 6" Articulated Probe – Out

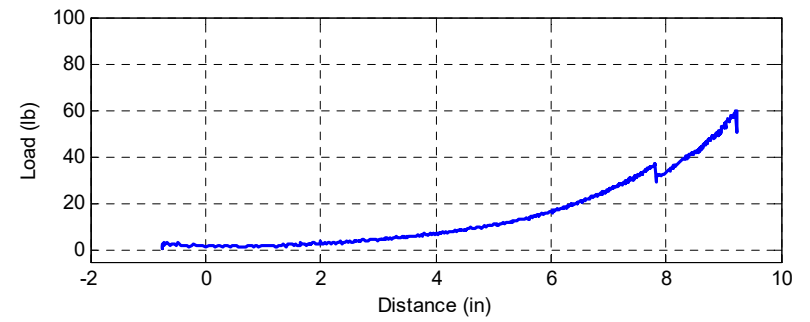
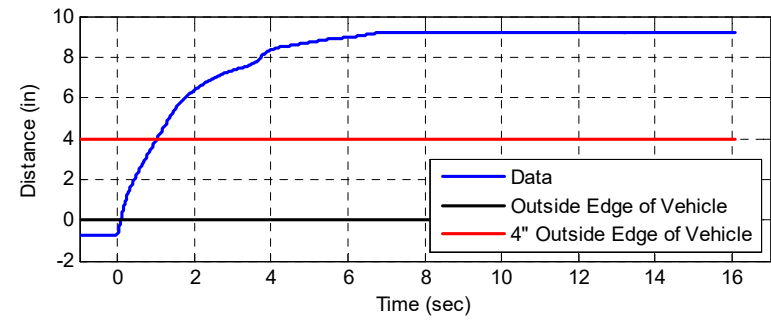
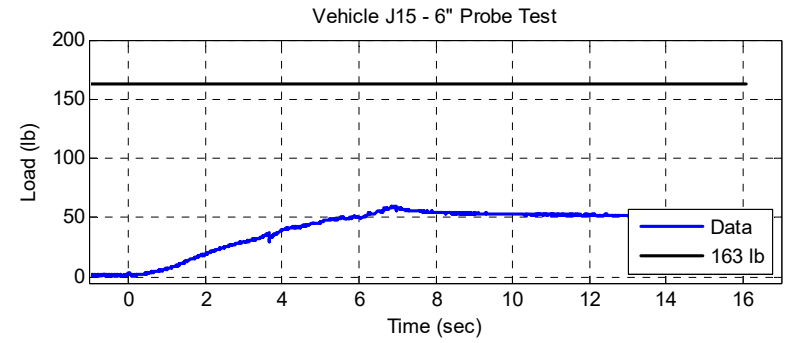

Load and Distance Data

Vehicle J15 - 6" Articulated Probe



Vehicle K15 – 3” Fixed Probe – In



Vehicle K15 – 3” Fixed Probe – Out

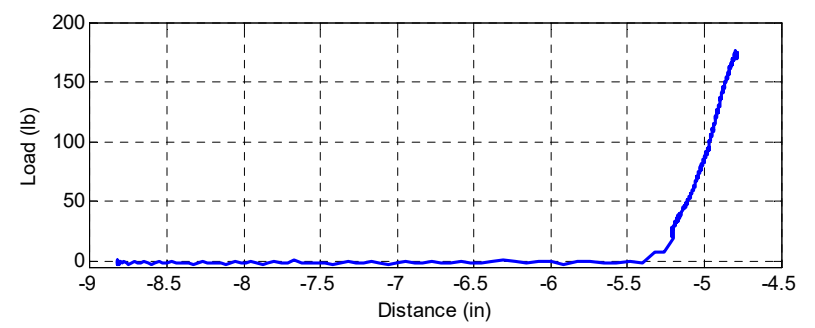
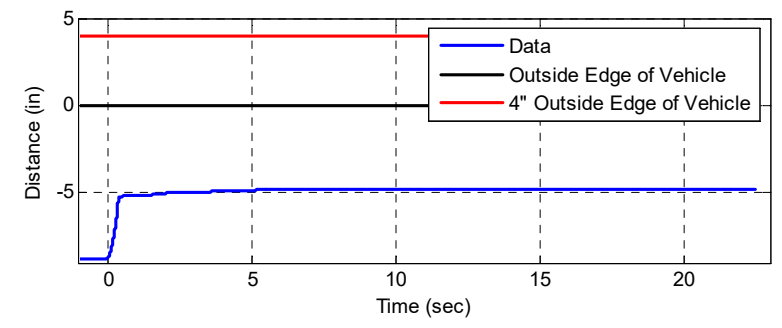
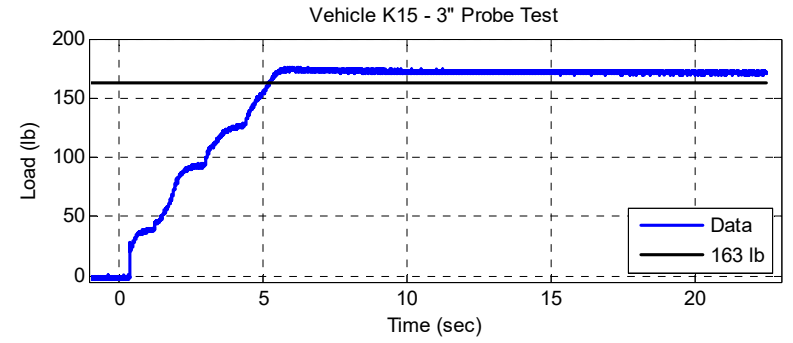

Load and Distance Data

Vehicle K15 - 3" Fixed Probe



Vehicle K15 – 6” Fixed Probe – In



Vehicle K15 – 6” Fixed Probe – Out

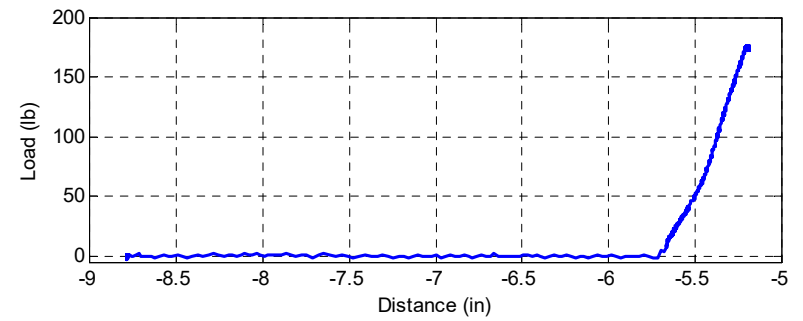
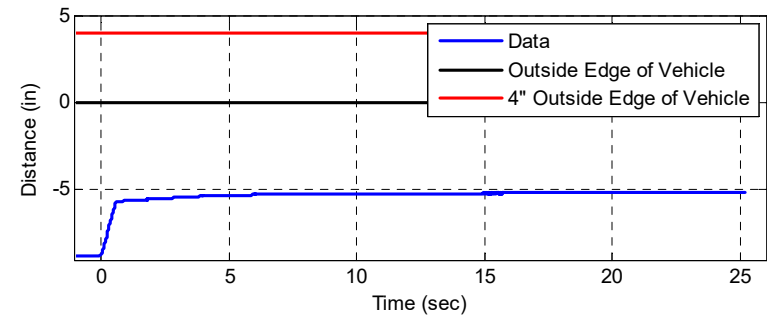
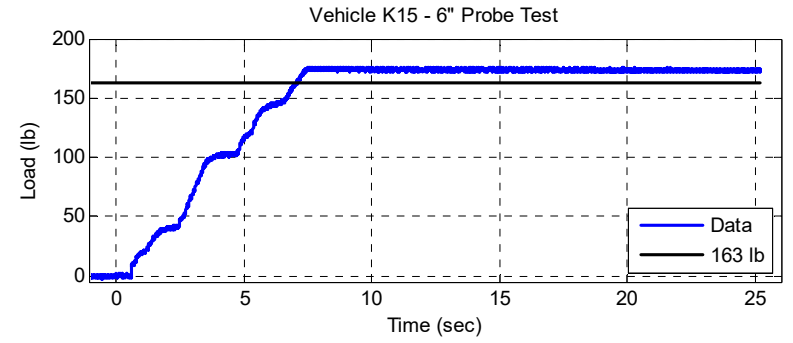

Load and Distance Data

Vehicle K15 - 6" Fixed Probe

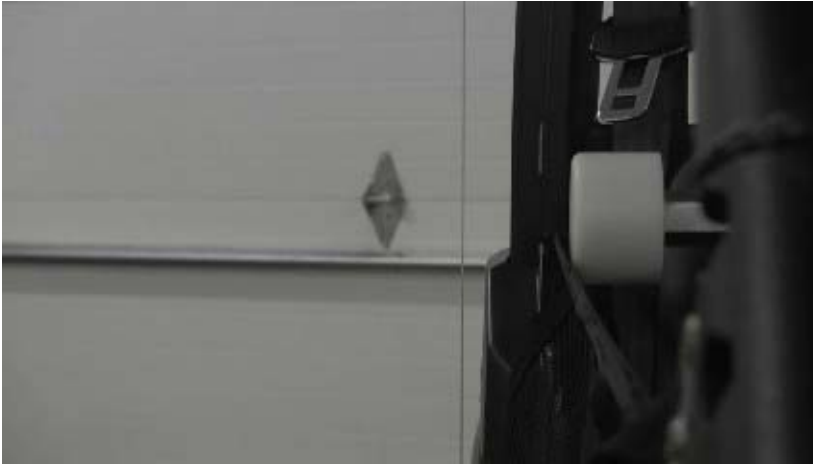

Vehicle L15 – 3” Fixed Probe – In

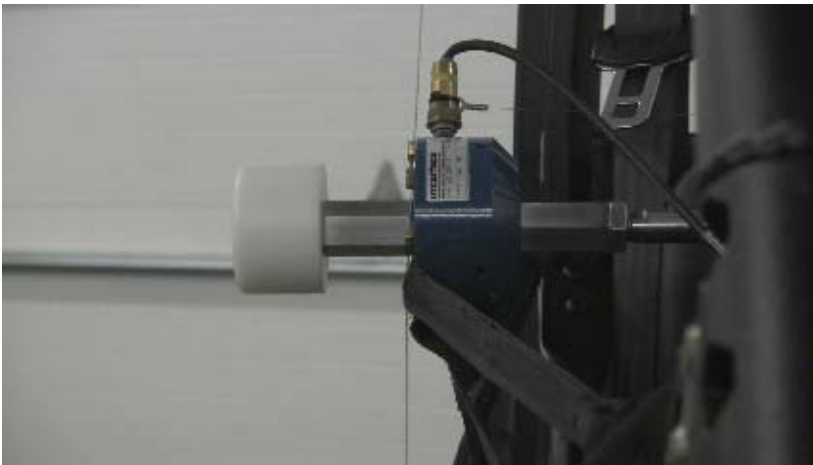

Vehicle L15 – 3” Fixed Probe – Out

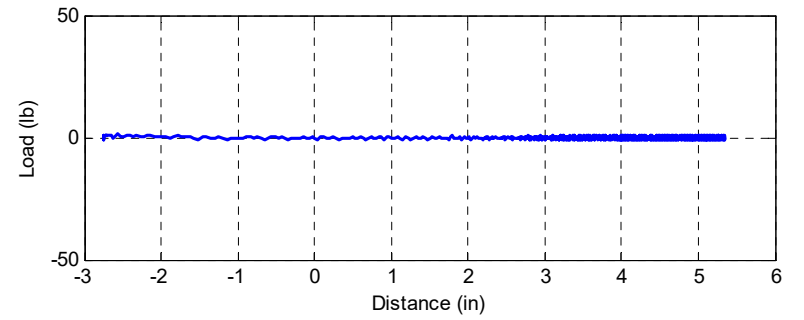
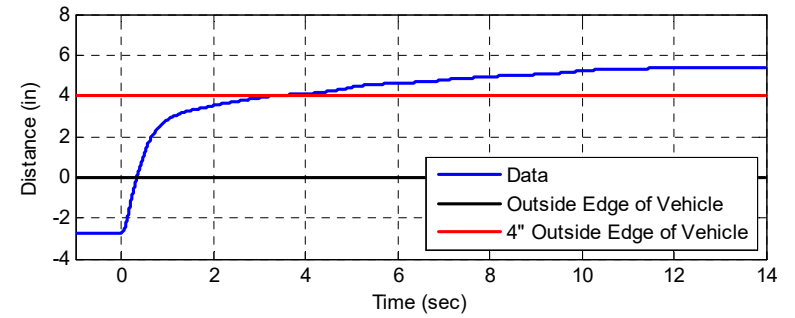
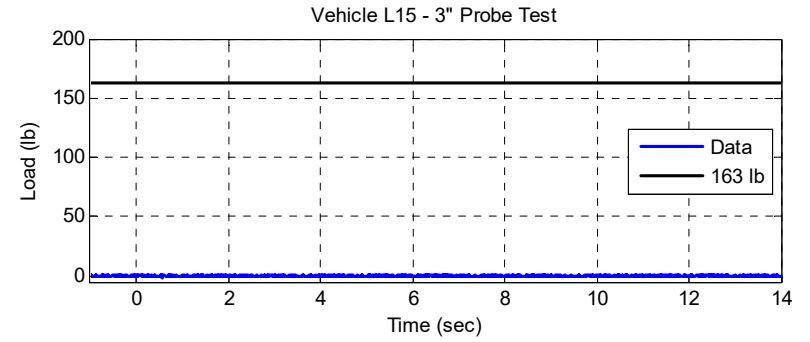

Load and Distance Data

Vehicle L15 - 3" Fixed Probe

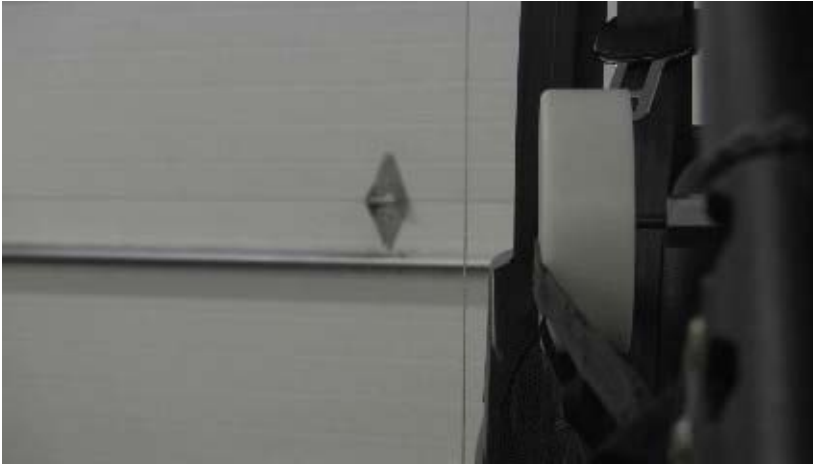

Vehicle L15 - 6" Fixed Probe - In

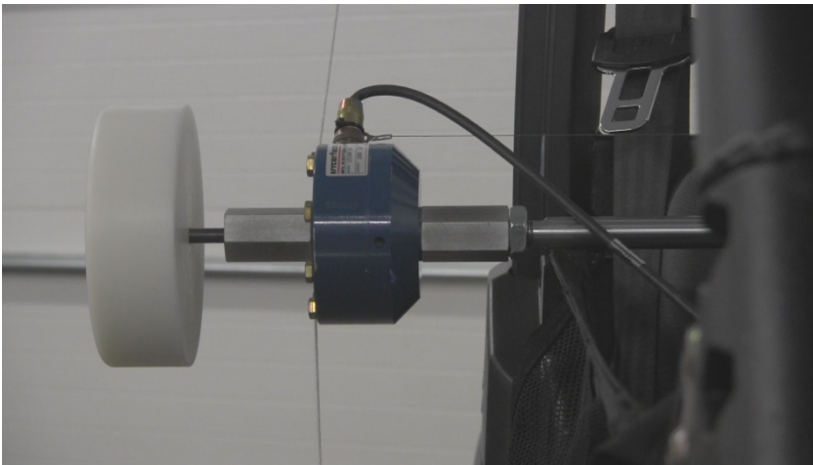

Vehicle L15 - 6" Fixed Probe - Out

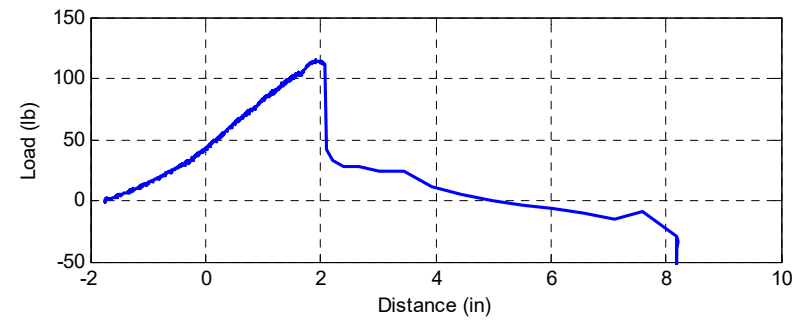
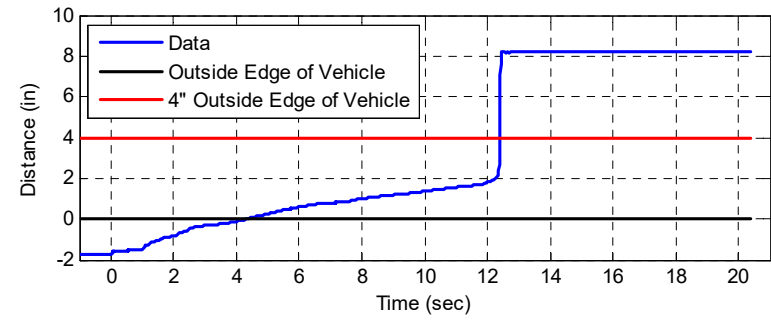
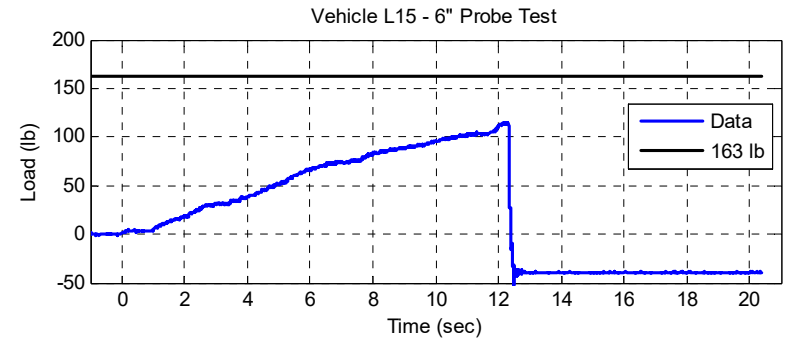

Load and Distance Data

Vehicle L15 - 6" Fixed Probe

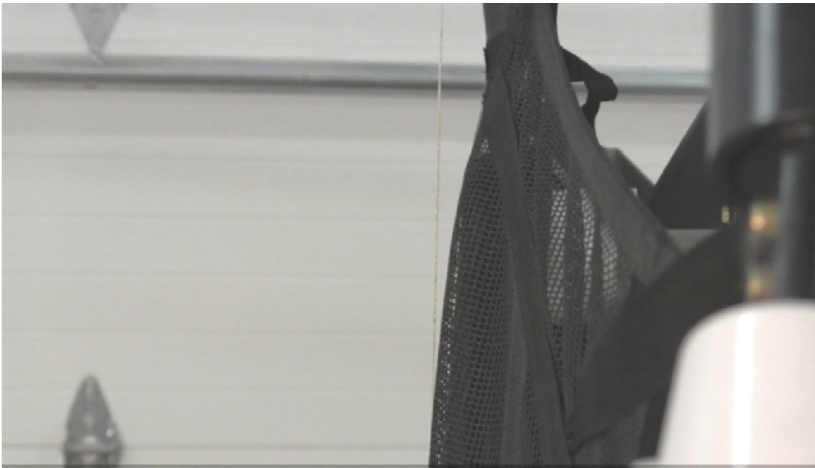

Vehicle M15 – 3” Fixed Probe – In



Vehicle M15 – 3” Fixed Probe – Out

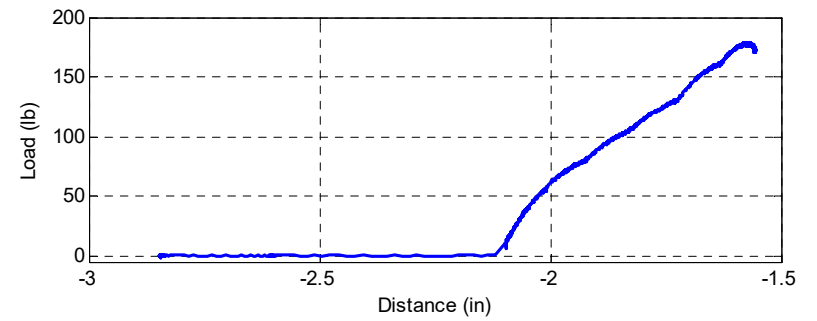
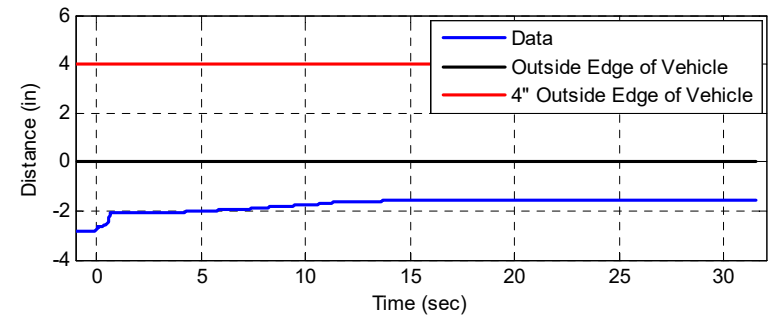
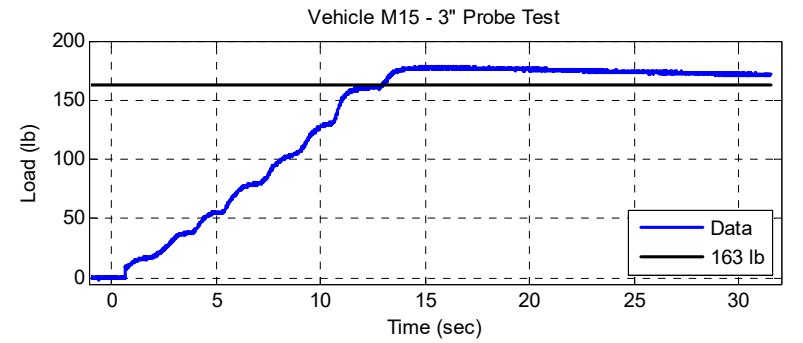

Load and Distance Data

Vehicle M15 - 3" Fixed Probe



Vehicle M15 – 6” Fixed Probe – In



Vehicle M15 – 6” Fixed Probe – Out

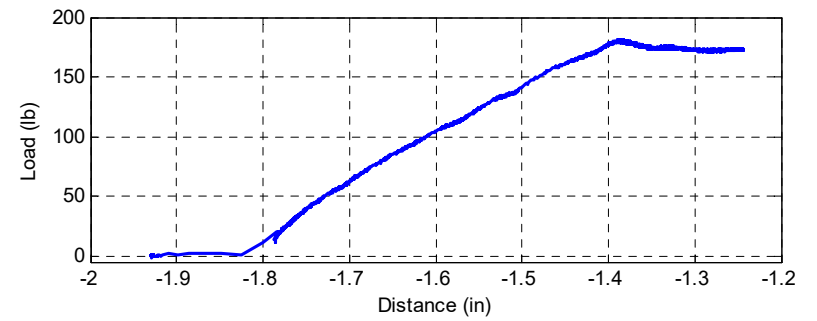
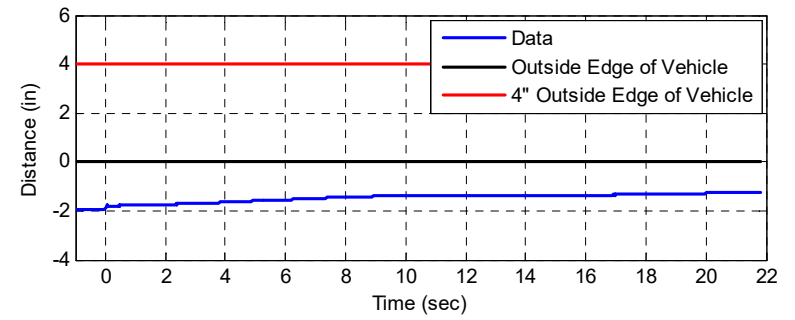
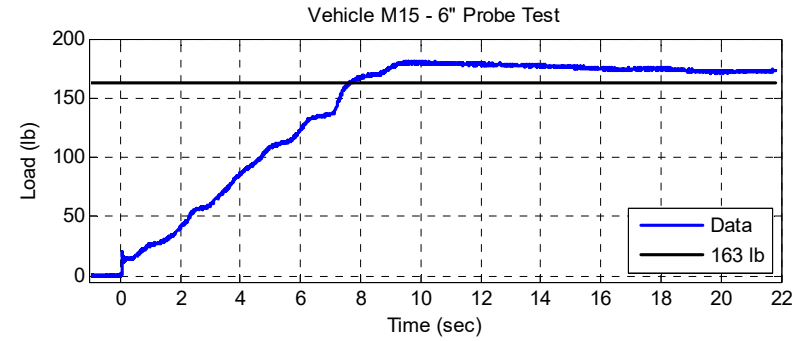

Load and Distance Data

Vehicle M15 - 6" Fixed Probe

APPENDIX D - Video Processing Procedure

The position of a marker placed on the ATD head was measured in three dimensions using stereo vision processing of images from two high-speed cameras mounted on the ROPS.

Computation of 3D coordinates (XYZ) from cameras is a two step process as shown in Figure D-1.

1. Camera calibration: This step involves obtaining camera calibration matrices from 2D image, coordinates 3D space coordinates of the known calibration points in space. SVD decomposition is used to solve over-determined homogenous equations for this step.
2. Measurement of 3D space coordinates: This step involves computing the 3D coordinates of the point of interest (ATD Head Marker) from 2D image coordinates and camera calibration matrices.

A fixture with marker tape was temporarily mounted on the ROPS and images were captured by both cameras. The fixture served as the known 3D space coordinates for camera calibration as shown in Table D-1.

With the camera calibration matrices known, the two cameras can be used to compute the 3D space coordinates of the ATD Head Marker, as shown in Table D-2.

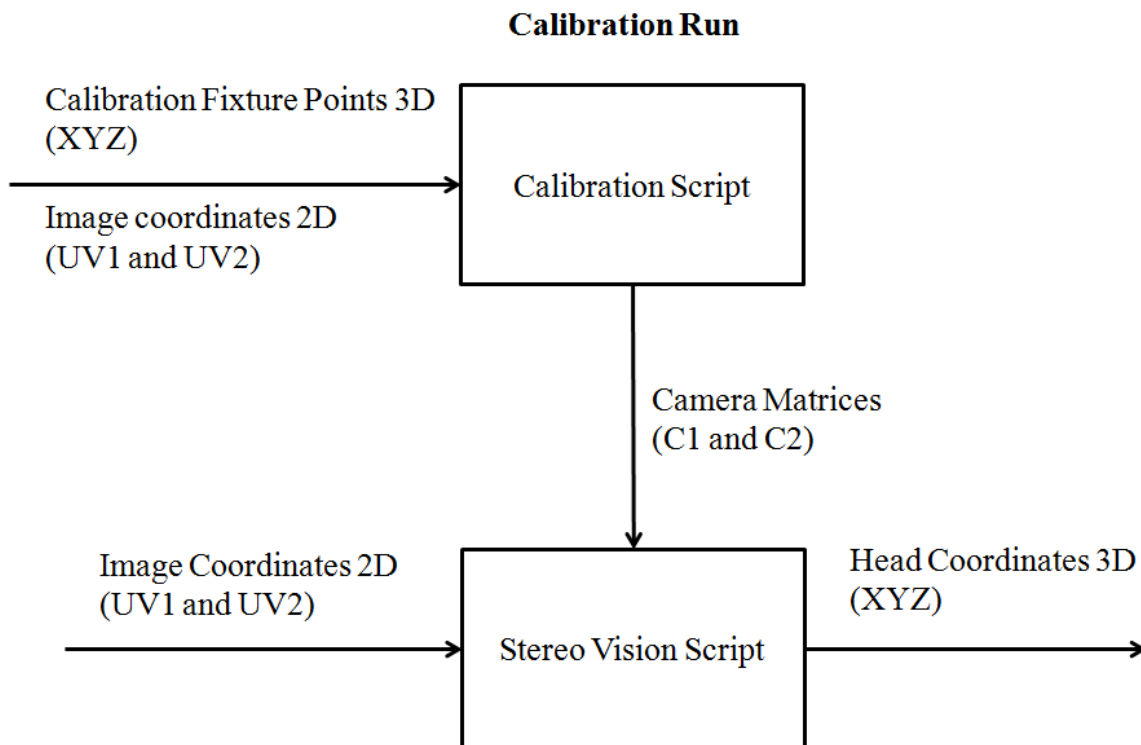

Figure D-1: Procedure to Compute XYZ Coordinates of ATD

Table D-1: Camera Calibration Run and Output of Calibration Matrices





Calibration Run	
Inputs	Outputs
1. Measured three dimensional coordinates (XYZ) of the tape markers (tape measure)	Camera calibration matrices (C1 and C2)
2. Two sets of measured two dimensional image coordinates (UV1 and UV2) from two cameras (manually picked in MATAB).	
	
Calibration Fixture in Camera 1	Calibration Fixture in Camera 2

Table D-2: Measurement Run - Stereo Vision

Measurement Run (Stereo Vision)

Inputs	Outputs
1. Two sets of measured two dimensional image coordinates (UV1 and UV2) from two cameras (automated marker detection using image processing algorithms in MATAB).	Three dimensional coordinates (XYZ) of the ATD Head Marker
2. Camera calibration matrices (C1 and C2)	
 <p>Head Marker in Camera 1</p>	 <p>Head Marker in Camera 2</p>