

146

November 16, 1994

STUDY OF DETERIORATION OF SEPARABLE ELECTRICAL CONTACTS IN SMOKE DETECTORS

Contract No. CPSC-C-93-1139

IITRI Project No. A06393

Final Report

Prepared for:

**Julie I. Shapiro
U.S. Consumer Product Safety Commission
10901 Darnestown Road
Gaithersburg, MD 20878-2611**

Prepared by:

**John P. Farrell
George Ebel
IIT Research Institute
201 Mill Street
Rome, NY 13440-6916**



since 1936



CPSA 6 (b)(1) Cleared

[Handwritten signature]
Privileged
Date: 11/16/94
via

November 16, 1994

**STUDY OF DETERIORATION OF SEPARABLE ELECTRICAL CONTACTS IN
SMOKE DETECTORS**

Contract No. CPSC-C-93-1139

IITRI Project No. A06393

Final Report

Prepared for:

Julie I. Shapiro
U.S. Consumer Product Safety Commission
10901 Darnestown Road
Gaithersburg, MD 20878-2611

Prepared by:

John P. Farrell
George Ebel
IIT Research Institute
201 Mill Street
Rome, NY 13440-6916

ACKNOWLEDGMENT

The authors are grateful for the support of Ms. Julie I. Shapiro, the Consumer Product Safety Commission (CPSC) Program Manager, for her many contributions, including the project background section of this report and support of the program. They also thank subcontractors Mr. Paul Patty of Underwriters Laboratories, Inc. (UL), and Mr. Todd Castello of Oneida Research Services, Inc. (ORS), for their testing contributions to this effort.

EXECUTIVE SUMMARY

This report describes the tests and evaluations performed to determine the cause of the deterioration of separable contacts in smoke detectors that had previously failed. This effort confirmed that smoke detector horn separable contact deterioration can cause horn malfunction. The cause of failure is a function of contact materials, operating environment and contact interface motion. The failure mechanism is fretting corrosion, which is an accelerated atmospheric oxidation that forms at metal contact interfaces. Fretting action can promote fast changes in resistance through minute amplitude cyclic motion.

Physical testing (e.g., Scanning Electronic Microscope, Auger) was used to identify the contaminants carbon, oxygen, chlorine and sulphur in the contact areas of horns that were aged in the field and reported as failures. Measurements made on horn contacts aged by exposure to the standard UL 217 corrosion testing indicated differences varying from no sulphur to lower levels of chlorine when compared to the field aged devices. Additionally, horn contact resistances measured on the UL 217 aged horns were less than those recorded on field aged devices. These results show that UL 217 corrosion tests do not simulate field results.

Failures were found to be intermittent and tunneling was identified as the predominant conduction mechanism. Smoke detectors were also submitted to accelerated temperature cycling to provide the contact motion required for fretting corrosion. This testing generated contact opens and increasing and decreasing contact resistances, again simulating fretting corrosion action. Because of the high impedance circuits involved with the piezoelectric horns, large increases in interface contact resistance are required to cause horn failures. Therefore, even though horn failures (resistance increases) were induced, the probability of a horn failure in the field is not high due to this based on the limited number of field and test failures.

UL 217, "Standard for Single and Multiple Station Smoke Detectors," was reviewed based on the information developed during the program.

In summary, the above results and the accelerated testing statistical analysis indicate that no life limiting mechanism exists. Overall smoke detector reliability is considered good. Changes to UL 217, including the performance of flowing mixed gas testing, the evaluation of the effect of contact motion and additional horn reliability requirements are recommended.

TABLE OF CONTENTS

	<u>Page</u>
1.0 INTRODUCTION	1
1.1 General.....	1
1.2 Program Objective.....	1
1.3 Project Background.....	2
1.4 Organization of Report.....	4
2.0 STUDY.....	5
2.1 Task I: Analysis of Malfunctioning Smoke Detectors and Development of Test Protocol.....	5
2.1.1 Smoke Detector Examination.....	7
2.1.2 Test Protocol Development.....	13
2.2 Task II: Test Protocol Implementation	16
2.2.1 Verification Testing	16
2.2.2 Selection of Units for Cross-Section and Surface Analyses.....	16
2.2.3 Optical Inspection and Photographic Documentation.....	16
2.2.4 SEM Inspection of Contacts.....	17
2.2.5 Encapsulating and Cross-Sectioning of the Horns.....	22
2.2.6 Documentation of Contact Area Materials.....	22
2.2.7 Optical Ultraviolet (UV) Test for Organics and Sample Preparation.....	22
2.2.8 Auger (AES) Surface Analyses and Depth Profiles	22
2.2.9 Fourier Transform Infrared (FTIR) Tests.....	24
2.2.10 Separable Connector Failure Root Cause Hypothesis	25
2.2.11 Accelerating Testing.....	25
2.2.12 Extended Temperature Cycling	31
2.2.13 UL 217 Corrosion Tests.....	32
2.3 Task III: Review and Evaluation of UL 217	45
2.3.1 Aerosol Smoke Detector Tester Evaluation.....	46
2.4 Task IV: Development of UL 217 Recommendations.....	47
2.4.1 Alternate Contact Methodology.....	49
2.5 Accelerated Testing Data Analysis.....	49
2.5.1 Methodology 1.....	50
2.5.2 Methodology 2.....	52
2.5.3 Data Analysis Conclusions.....	52
3.0 SUMMARY OF FINDINGS.....	54
3.1 Separable Contact Failure Mechanism	54
3.2 Contact Area Contamination.....	54
3.3 UL 217 Corrosion Testing.....	55
3.4 Horn Construction.....	55
3.5 Failure Modes/Corrective Action.....	55
3.6 Corrosion Mechanism Analysis.....	56
3.6.1 Contaminants.....	56
3.6.2 Relative Motion.....	57
3.7 Aerosol Smoke Detector Tester.....	57
4.0 CONCLUSIONS	58

TABLE OF CONTENTS (Cont'd)

	<u>Page</u>
APPENDIX A: TASK II REPORT	A-1
APPENDIX B: TASK III & IV REPORT	B-1
APPENDIX C: BIBLIOGRAPHY.....	C-1
APPENDIX D: GLOSSARY OF TERMS.....	D-1

LIST OF FIGURES

FIGURE 1: VOLTAGE/CURRENT CHARACTERISTICS OF SEPARABLE CONTACTS.....	6
FIGURE 2: CONCEPTUAL CROSS-SECTION OF HORN DISK AND CONTACTS.....	8
FIGURE 3: HORN V/I CHARACTERISTICS.....	13
FIGURE 4: TEST PROTOCOL FLOW CHART	15
FIGURE 5: SEPARABLE CONTACTS ON A SMOKE DETECTOR HORN	17
FIGURE 6: BIFURCATED CONTACT B.....	18
FIGURE 7: DIMPLED CONTACT F ON NEW HORNS.....	18
FIGURE 8: SEM PHOTOGRAPH OF A BIFURCATED CONTACT.....	19
FIGURE 9: SEM PHOTOGRAPH OF A DIMPLED CONTACT.....	19
FIGURE 10: NON-LINEAR V/I CHARACTERISTICS OF A SMOKE DETECTOR HORN CONTACT	21
FIGURE 11: TEMPERATURE CYCLE PROFILE FOR ACCELERATED SMOKE DETECTOR HORN TESTS.....	26
FIGURE 12: TOP VIEW TYPE A HORN.....	29
FIGURE 13: BOTTOM VIEW TYPE A HORN.....	29
FIGURE 14: TOP VIEW TYPE B HORN	30
FIGURE 15: BOTTOM VIEW TYPE B HORN	30
FIGURE 16: BEFORE CORROSION TEST - SO ₂	33
FIGURE 17: BEFORE CORROSION TEST - H ₂ S.....	34
FIGURE 18: BEFORE CORROSION TEST - H ₂ S/SO ₂	35
FIGURE 19: AFTER CORROSION TEST - SO ₂	37
FIGURE 20: AFTER CORROSION TEST - H ₂ S.....	38
FIGURE 21: AFTER CORROSION TEST - H ₂ S/SO ₂	39
FIGURE 22: AFTER CORROSION TEST - H ₂ S/SO ₂	40
FIGURE 23: AUGER ELEMENTAL SURVEY OF SAMPLE X, TERMINAL S.....	42
FIGURE 24: AUGER DEPTH PROFILE OF SAMPLE X, TERMINAL S.....	43
FIGURE 25: AUGER ELEMENTAL SURVEY AFTER PROFILE OF SAMPLE X, TERMINAL S.....	44
FIGURE 26: WEIBULL PLOT OF PREDICTED CYCLES TO FAILURE.....	52
FIGURE 27: WEIBULL PLOT (WITH LOWER 95% CONFIDENCE LEVEL).....	53

LIST OF TABLES

	<u>Page</u>
TABLE 1: RESISTANCE OF HORN CONTACTS ON UNITS 14, 18 AND 45...	8
TABLE 2: SMOKE DETECTOR DATA SHEET.....	10
TABLE 3: TEST RESULTS ON 15 SELECTED UNITS.....	12
TABLE 4: SMOKE DETECTOR HORN CURVE TRACER TESTS.....	12
TABLE 5: RESULTS OF EDAX SURFACE ANALYSES.....	20
TABLE 6: SUMMARY OF MATERIALS ON SMOKE DETECTOR HORNS.....	22
TABLE 7: RESULTS OF AES SURFACE ANALYSES.....	23
TABLE 8: AES DEPTH PROFILE SUMMARY.....	24
TABLE 9: CONTACT RESISTANCE TEST RESULTS.....	27
TABLE 10: CONTACT RESISTANCE VALUES VERSUS TEMPERATURE CYCLES.....	31
TABLE 11: SMOKE DETECTORS FOR UL CORROSION TESTS.....	32
TABLE 12: CONTACT RESISTANCE AFTER UL CORROSION TEST.....	36
TABLE 13: SUMMARY OF SULPHUR LAYERS ON HORNS RUN IN THE UL CORROSION TESTS.....	41
TABLE 14: FMG ENVIRONMENTS BY COMPOSITION.....	48
TABLE 15: RESISTANCE REGRESSION ANALYSIS RESULTS.....	51

1.0 INTRODUCTION

1.1 General

In September of 1993, IIT Research Institute (IITRI), Rome, NY, was awarded a contract by the US Consumer Product Safety Commission (CPSC) to test and evaluate smoke detectors that had been collected after failure in the field. The effort's findings will be used to propose change(s) to UL 217 "Standard for Single and Multiple Station Smoke Detectors" to improve smoke detector field performance and to recommend design practices and procedures to manufacturers.

IITRI's technical staff was complemented through subcontracts with Oneida Research Services, Inc. (ORS) and Underwriters Laboratories, Inc. (UL). ORS, a testing organization, provided the surface analysis tools (i.e., Scanning Electronic Microscope (SEM), Auger Electronic Spectroscopy (AES)) and test expertise to evaluate the separable contact surfaces. The UL provided testing services to perform the required UL 217 corrosion testing. All evaluation of the smoke detectors and analysis of test results was performed by IITRI personnel. Mr. John P. Farrell was program manager, Mr. George Ebel was the principal investigator, Mr. William Denson performed the reliability analysis of the separable contacts. Ms. Susan Swiss and Ms. Jeanne Crowell typed and formatted all reports.

1.2 Program Objective

This program was initiated to determine the cause(s) of deterioration of separable electrical contacts used in residential smoke detectors and to develop recommendations for revisions and/or additions to the voluntary standards which will ensure that contact deterioration will not compromise the operability of such detectors.

Four tasks were defined to accomplish this objective:

Task I: Examine smoke detectors provided by the CPSC which appear to be malfunctioning because of deterioration of separable contacts. Based upon this preliminary examination, develop a detailed testing protocol to be used in Task II. This protocol shall describe the test(s) to which each sample will be subjected.

STUDY OF DETERIORATION OF SEPARABLE ELECTRICAL CONTACTS IN SMOKE DETECTORS

- Task II: Using the CPSC approved testing protocol, analyze the contact surfaces of the separable contacts in the smoke detectors identified in Task I and provide a draft report of findings. Perform UL 217 corrosion testing (para. 62.1.2 and 62.1.3) on a maximum of six samples, provided by CPSC, to compare the corrosion and deterioration of naturally aged smoke detectors with UL 217 accelerated aged smoke detectors.
- Task III: Review and evaluate UL 217 in light of the information developed during Task I and II. Identify those weaknesses which permit separable contacts prone to deterioration in service to meet the requirements of UL 217.
- Task IV: Based upon the information developed during Tasks I, II and III, develop recommendations for additions and/or revisions to UL 217 intended to address the issue of deterioration of separable contacts.

1.3 Project Background (Paragraph C.1 of CPSC-P-93-1139 Statement of Work)

a. Origin of Project

- (1) The Smoke Detector Project, a priority project in FY 1992-1993, began in late 1990 with the purpose of reducing the number of fire deaths in the United States by increasing the number of working detectors in residences.
- (2) The Consumer Product Safety Commission's (CPSC's) priority project work encompasses three primary tasks: (1) the implementation of two smoke detector operability studies, (2) consumer awareness activities, and (3) the overall management and direction of the cooperative National Smoke Detector Project. The National Smoke Detector Project is co-sponsored by the CPSC, the National Fire Protection Association (NFPA), the US Fire Administration (USFA), and the Congressional Fire Services Institute (CFSI).

b. Collection of Malfunctioning Detectors During the Operability Studies

- (1) A major element of each of the operability studies involved in situ testing of smoke detectors in order to identify units which appeared to be malfunctioning. The detectors were tested by exposing them to bursts of artificial smoke (Underwriters Laboratories, Inc., listed aerosol smoke detector tester), and if they responded by use of the test button (if so equipped). Detectors which did not respond to the first test were retested after they were equipped with a fresh battery or had their branch circuit supply wiring energized if they were AC powered. Detectors which still did not respond were collected and sent to the CPSC for analysis after ensuring that their power supply was adequate. Some

STUDY OF DETERIORATION OF SEPARABLE ELECTRICAL CONTACTS IN SMOKE DETECTORS

detectors were collected for additional reasons, such as the occupant's complaint that the detector was prone to frequent "nuisance alarms."

c. Preliminary Analysis of the Malfunctioning Detectors Collected During the Operability Studies

- (1) Upon arrival at the CPSC laboratory, the malfunctioning smoke detectors were equipped with fresh batteries or connected to a source of AC power, as appropriate. The samples were then exposed to a large but uncontrolled quantity of smoke (Gross Smoke Test). The detectors which alarmed when exposed to the uncontrolled smoke were then tested in the "Smoke Box" described in Underwriters Laboratories, Inc., Standard UL 217, Single and Multiple Station Smoke Detectors, in order to determine their sensitivities. Other tests, such as an attempt to determine if a battery powered detector's low battery alert circuitry was functioning properly, were also conducted.
- (2) The analysis of the malfunctioning smoke detectors revealed the existence of a potential design weakness which may be common to all current production of residential quality smoke detectors. The design weakness involves the use of separable contacts at various locations in the detector circuitry - primarily, between the circuitry and the piezo crystal element in the integral horn assembly. The separable contacts are used to facilitate assembly of the detectors and otherwise serve no purpose in the designs which CPSC has examined. These electrical contacts appear to suffer deterioration of their performance due to a number of factors including corrosion, contamination, and wear-through of contact surfaces. Depending upon the nature and degree of contact deterioration, a smoke detector suffering such deterioration may perform erratically or not at all.
- (3) The contact deterioration problem is insidious in that it can be temporarily corrected by relative motion between the contact surfaces. Such motion can be unintentionally caused by attempting to test the detector with its integral test button. Many smoke detectors require the application of sustained and substantial force to their test buttons in order to make sufficient contact to cause the detector to alarm. That force is transmitted directly to the printed wiring board which is typically secured only by snapping into notched towers molded integrally with the thermoplastic enclosure of the unit. Consequently, an attempt to test the smoke detector with its test button can result in flexing of the printed wiring board and/or of the board relative to other parts of the unit's enclosure which may hold the horn components. This externally induced mechanical motion of the separable contact surfaces may permit the unit to function normally. The CPSC operability study in situ test protocol anticipated this possibility and addressed it by using exposure to artificial smoke as the first test to be conducted on a smoke detector.

- (4) The operability studies collected samples of smoke detectors providing clear evidence of the ability of the deterioration of electrical contacts to cause malfunctions of the detectors. A total of 73 detectors which failed to respond to the in situ test with artificial smoke were examined by CPSC. Six units were found to have visually obvious deterioration of their horn contacts. These smoke detectors were able to function normally when their horns were replaced. Forty of the units appeared to work properly when tested upon their arrival at the CPSC's laboratory. Given the training provided to the field investigators in the conduct of the in situ test protocol and the constant emphasis on the quality of the work performed, it is unlikely that such a large number of detectors could have been identified as malfunctioning because of in situ test errors. CPSC believes that shipping and handling of the detectors prior to their receipt at the CPSC laboratory resulted in temporarily "correcting" an electrical contact problem in those units. The remaining 26 units were found to have other deficiencies which precluded their responding to either an in situ or laboratory test.

1.4 Organization of Report

This report is presented in two general parts. The first part is a discussion of the overall program and includes pertinent testing, analysis, findings and conclusions. The organization is such that major program phases are covered within the major subsections.

The second part is appendices containing program task reports which support the findings discussed and the conclusions. Also included as appendices are a bibliography and a glossary of terms (Appendix C and D, respectively).

2.0 STUDY

2.1 Task I: Analysis of Malfunctioning Smoke Detectors and Development of Test Protocol

To form the basis for the analysis of smoke detector separable electrical contacts, the electrical conduction mechanism and a technique for its measurement were evaluated using a physics of failure approach and semiconductor measurement techniques to trace electronic failures to the root cause.

The physics of electrical conduction through the interface of two separable metal contacts is complicated and not well understood. Also, the number of variables that affect the interface is too large for the universal testing of each individual set of materials, contaminants and environments without a detailed and costly design of experiments. Therefore, the method used to evaluate the malfunctioning smoke detectors focused on the physical nature of the interface resistance, not just on the statistical analysis of a limited dataset.

The conduction mechanism through the deleterious films in the interface between two separable metal contacts can be explained using quantum or semiconductor physics. Because of this, much was learned about the specific conduction mechanisms by studying the voltage/current (V/I) characteristics of the contact interface layers. The V/I plots evaluated were obtained using a Tektronix Model 576 curve tracer that was designed to look at semiconductor junctions. Polaroid pictures and a video camera were used to record the cathode ray tube display on the curve tracer for comparative purposes.

Figure 1 shows the V/I characteristics of a separable contact interface. Curve (a) is the typical, expected, purely resistive interface. Curve (b) results when there are localized hot spots caused by only a very small area of purely metal contact that creates non-linear characteristics. Curve (c) illustrates the effect of instabilities that are caused by electron tunneling through a thin oxide, sulfide or polymer layer formed by corrosion at the contact interface. The curve tracer characteristics, as would be expected with this conduction mechanism, are highly unstable. They vary between curve (c) and an open circuit (a horizontal trace) and take on a snake-like appearance.

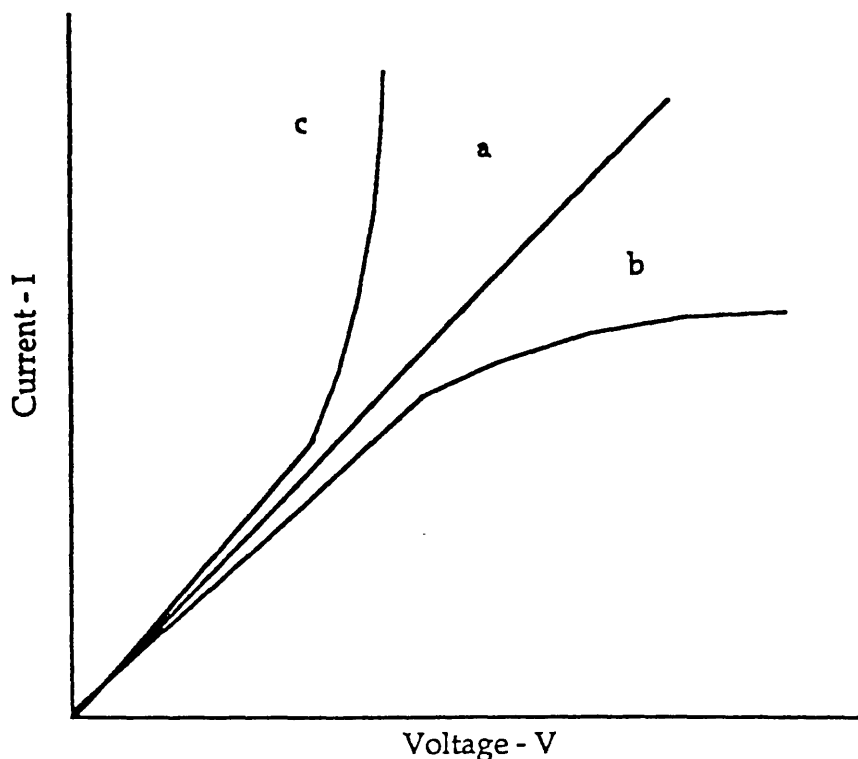

FIGURE 1: VOLTAGE/CURRENT CHARACTERISTICS OF SEPARABLE CONTACTS

Two major issues concerning the contact resistance of the separable contacts were addressed in the analysis of malfunctioning smoke detectors. The first was to explain the physics of the malfunctioning interface [1]. The contact resistance is made up of two parts. The first, which is always present, is the constriction resistance - limited areas of contact at the interface cause current to flow through relatively small spots of actual contact. The second, and more complex part of the contact resistance, is the interfacial film resistance which falls within the realm of semiconductor physics and, therefore, is readily susceptible to analysis by a curve tracer. The contact resistance, because of the two different methods of conduction through the film, is observed as a complex nonlinear function on a V/I plot on the curve tracer. When a unit appears to be functioning properly, analysis of a V/I difference or a change in two curves taken at different times on the same contact can be used as a precursor to a smoke detector failure. Because a high contact resistance is needed for horn failure, the nonlinear V/I characteristics can be used to show that films are present before horn failure. Contact resistance change is one of the best methods for evaluating the condition of the contact interface [2]. Resistance changes

of only a few milliohms or subtle changes in the low current area of the V/I curves can identify when a large percentage of the constriction resistance has been changed, and actual area of contact has been reduced [3]. The V/I curves were used to distinguish between current tunneling and thermionic emission through thin films.

2.1.1 Smoke Detector Examination

Each CPSC-provided detector was carefully evaluated in a logical testing sequence so that all nondestructive testing was accomplished before the start of destructive testing. All steps were documented, with photographs when applicable, to allow for retracing an investigation to determine exactly when and where critical changes occurred. For clarity and consistency, the number which has been assigned to each smoke detector in the CPSC Smoke Detector Evaluation Databook also identifies the same smoke detector in this effort.

Because mechanical shock and vibration from handling and shipping of the smoke detectors can affect the contact resistance, extreme care was exercised to preclude losing vital information through physical mishandling.

The initial examination of smoke detectors provided information concerning the physics and statistics of the interface resistance. This examination was accomplished through the use of two primary nondestructive tools: the optical microscope (primarily for corrosion and configuration documentation) and a curve tracer. The curve tracer, which has a high series resistance, provides nondestructive testing and is the key to understanding the physics of interfaces.

Major emphasis in this phase of the program was placed on isolating horns that exhibited high contact resistance. As a starting point three units (14, 18 and 45) were selected from the 50 smoke detectors provided by CPSC for examination. The three units had been reported as failures in the field but functioned properly at CPSC, and contained visible corrosion or damage based on information in the CPSC Smoke Detector Evaluation data book. The horn configuration includes separable contacts B, F and S identified in a conceptual cross section drawing (Figure 2). In Figure 2 only one contact is illustrated because the S and F contacts are identical. All three units functioned properly when the units were energized and the test buttons were activated. The horns from all three units were removed and visually checked.

STUDY OF DETERIORATION OF SEPARABLE ELECTRICAL CONTACTS IN SMOKE DETECTORS

Then all contacts were tested on the curve tracer at the lowest voltage and current setting. All nine contacts showed very low resistance in both voltage polarities without any abnormalities. Previous failure or visible contact corrosion does not indicate that a contact will exhibit resistive abnormalities. Resistance measurements made on each of the nine contacts are shown in Table 1.

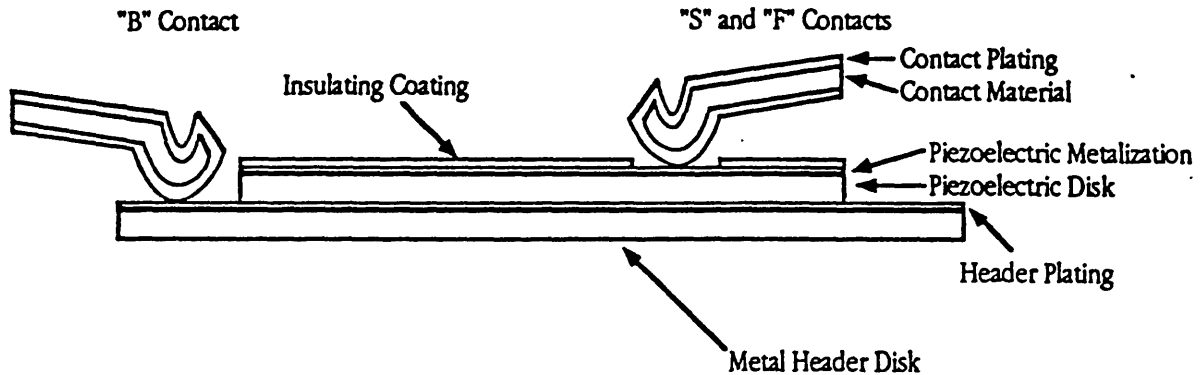

FIGURE 2: CONCEPTUAL CROSS-SECTION OF HORN DISK AND CONTACTS

TABLE 1: RESISTANCE OF HORN CONTACTS ON UNITS 14, 18 AND 45

Horn	B(Ω)	S(Ω)	F(Ω)
14	.38	.25	.38
18	.45	.46	.46
45	1.85	.37	.49

To determine what horn contact resistance would be needed to cause a malfunction, unit 18 was set up as a test bed. The evaluation procedure used was to open each test lead (one at a time) to determine the effect of open (infinite resistance) contacts on horn operation. When either contact lead F or S was opened a faint audible signal still emanated from the horn. However, when contact lead B was opened the horn ceased operating. Next a 500K ohm potentiometer was inserted in lead B. The series resistance was increased to 180K when the horn no longer sounded. Various combinations of resistance in series with the horn leads were tried to determine their effect on horn performance. It was determined that large contact resistances, approximately 2500 Ω s, are required for a horn malfunction. A malfunction is considered to be significantly lower than the sound specification limit for the horn.

To identify all possible malfunctioning horns, a spreadsheet was generated from the CPSC data book. Table 2 contains this information, along with a key for failure codes, comments and test results. Failure codes are based on the reported field discrepancies. Twelve of the 50 units had comment and test results coded 2. Units coded 2 were those that required a change in horns to make the unit function properly. Each of the 12 units, and the three units previously selected, were powered and tested for functionality using the test button. Only 5 of the 15 units failed the test button operation. The results of the testing appear in Table 3.

All 15 units were tested to determine the waveshape, peak to peak amplitude, frequency and DC component of the electrical signal at each of the horn terminals to assure that the proper voltage characteristics were present at the circuit board horn terminals. This testing verified that the horns in Units 16, 17, 32, 36 and 39 were bad because measurements at the horn terminals did not exhibit a sine wave. Presence of a sine wave is characteristic of a good horn.

The next step was to remove the horns carefully from the 15 smoke detectors selected for evaluation, plus horns from Units 49 and 50 (new units for control). These horns were then tested using the Tektronix 576 curve tracer to establish the quality of each horn connection. Table 4 summarizes the V/I test results using the curve tracer and indicates the operating status of each horn. To assure adequate current limiting (that is, to prevent a large current flowing through faulty contacts or significantly altering the interface impedance) a 56K ohm resistor was used in series with the measurement probe. The curve tracer data agreed very well with the voltage characteristics measured at the horn terminals. The data summarized in Table 4 indicates that the units 16, 17, 32, 35, 36 and 39 had questionable horn contacts. All of these units exhibited evidence of one or more degraded horn contacts. No other horn had defective contacts. However, the following major difference was observed in the horn from Unit 35. Originally, it had an open contact at terminal S when measured on the curve tracer and did not exhibit a sine wave voltage characteristic, but functioned properly when the test button was activated. Additionally, after completion of the curve tracer test, this horn was retested in a smoke detector using the test button. The alarm did not sound when the test button was operated continuously for 30 seconds. This confirmed the fact that the contact at terminal S had opened between the voltage characteristics tests and the curve tracer tests.

STUDY OF DETERIORATION OF SEPARABLE ELECTRICAL CONTACTS IN SMOKE DETECTORS

TABLE 2: SMOKE DETECTOR DATA SHEET

Smoke Detector No.	Battery or AC	Ion or Photo Electronic	Failure Code (s)	Comments	Test Results	Horn Type	Source
1	B	I	1,2	1	1	A	Lodi, OH
2	B	I	1,2	1	1	A	Lodi, OH
3	B	I	3	1	1	A	Chickasha, OK
4	B	I	1,2	1	1	A	Lodi, OH
5	B	I	3	1	1	A	Sycamore, IL
6	B	I	1,2	2	2	A	Sycamore, IL
7	B	I	1,2	1	1	A	Knoxville, TN
8	B	I	1,2	1	1	A	Knoxville, TN
9	B	I	1,2	1	1	A	Knoxville, TN
10	B	I	1,2	1	1	A	Knoxville, TN
11	B	I	1,2	1	1	A	Telluride, CO
12	B	I	1,2	1	1	A	Knoxville, TN
13	B	I	1,2	1	1	A	Knoxville, TN
14	B	I	1,2	3	1	A	Lamar, MO
15	B	I	1,2,3	1	1	A	Lamar, MO
16	B	I	1,2	4	3	A	Edison, NJ
17	B	I	1,2	2	2	A	Lamar, MO
18	B	I	1,2	1	1	A	Telluride, CO
19	B	I	1,2	1	1	A	Chickasha, OK
20	B	I	1,2,3	1	1	A	Atlanta, GA
21	B	I	1,2	2	2	A	Dickson City, PA
22	B	I	1,2	5	1	B	Medford, NY
23	B	I	4	6	1	A	Memphis, TN
24	B	I	4	6	1	C	Memphis, TN
25	B	I	4,3	6	1	B	Memphis, TN
26	B	I	4	2	4	A	Fort Worth, TX
27	B	I	1,2,4	7	1	A	Memphis, TN
28	B	I	1,2,4	1	1	A	Memphis, TN
29	B	I	4	2	2	A	Portland, OR
30	B	I	4	7	5	A	Memphis, TN
31	B	I	1,2,4	7	1	A	Oklahoma City, OK
32	B	I	4	2	2	A	Memphis, TN
33	B	I	4	1	1	A	Memphis, TN
34	B	I	4	2	2	A	Seattle, WA
35	B	I	4	2	2	A	Seattle, WA
36	B	I	4	2	2	A	Memphis, TN
37	B	I	4	2	2	A	Corpus City, TX
38	B	I	1,2,3,4	1	1	A	Portland, OR
39	B	I	1,2,4	2	2	A	Portland, OR

STUDY OF DETERIORATION OF SEPARABLE ELECTRICAL CONTACTS IN SMOKE DETECTORS

TABLE 2: SMOKE DETECTOR DATA SHEET (CONT'D)

Smoke Detector No.	Battery or AC	Ion or Photo Electronic	Failure Code (s)	Comments	Test Results	Horn Type	Source
40	AC	I	4	1	1	D	Miami, FL
41	B	I	1,2	8	3	A	Reyers, MA
42	B	I	1,2	1	1	A	Medford, NY
43	B	I	1,2,3	1	1	A	Medford, NY
44	B	I	1,2	1	1	A	Panama City, FL
45	B	I	1,2,4	1	1	A	Portland, OR
46	B	I	1,2,4	9	1	A	Miami, FL
47	B	I	1,2	1	1	A	Dolton, IL
*48	B	I	*			B	
*49	B	I	*			A	
*50	B	I	*			A	

*New smoke detectors - no failure history

Key:

Failure Codes	Comments	Test Results
1 - Push button	1 - Worked on arrival	1 - Passed all
2 - Smoke test	2 - Replaced horn to make it work	2 - Passed with new horn
3 - Nuisance Alarm	3 - Horn clicks when exposed to smoke/button	3 - Did not test
4 - No alarm in fire	4 - Questionnaire inconsistent	4 - Failed tests
	5 - Bad horn contacts, fixed by repositioning	5 - Failed sound test
	6 - Failed after passing all tests	
	7 - Worked after some testing	
	8 - Continuous Alarm, Suspect IC	
	9 - Worked after cleaning horn	

STUDY OF DETERIORATION OF SEPARABLE ELECTRICAL CONTACTS IN SMOKE DETECTORS

TABLE 3: TEST RESULTS ON 15 SELECTED UNITS

Unit	Results
6	Horn sounded with test button
14	Horn sounded with test button
16	Horn did not sound with test button
17	Horn did not sound with test button (faint buzz)
18	Horn sounded with test button
21	Horn sounded with test button*
26	Short delay with test button then horn sounded
29	Short delay with test button then horn sounded
32	Horn did not sound with test button
34	Short delay with test button then horn sounded
35	Short delay with test button then horn sounded
36	Horn did not sound with test button (faint buzz)
37	Short delay with test button then horn sounded
39	Horn did not sound with test button (faint buzz)
45	Horn sounded with test button

*Unit 21 did not function on first test, but once battery terminals were cleaned unit functioned properly.

TABLE 4: SMOKE DETECTOR HORN CURVE TRACER TESTS

Unit	Terminal			Remarks
	B	S	F	
6	S	S	S	Appears to be properly functioning horn
14	S	S	S	Appears to be properly functioning horn
16	I	S	S	Terminal B contact did not conduct until ± 1.5 volts was applied
17	S	S	I	Terminal F contact did not conduct until ± 5 volts was applied
18	S	S	S	Appears to be properly functioning horn
21	S	S	S	Appears to be properly functioning horn
26	S	S	S	Appears to be properly functioning horn
29	S	S	S	Appears to be properly functioning horn
32	O	O	S	Terminals B and S contacts were open
34	S	S	S	Appears to be properly functioning horn
35	S	O	S	Terminal S contact was open
36	S	I	I	Terminal S did not conduct until + 1.5 volts and - 1.0 volts Terminal F did not conduct until + 2.5 volts and - 2.0 volts
37	S	S	S	Appears to be properly functioning horn
39	S	O	I	Terminal S contact was open Terminal F contact did not conduct until $\pm .4$ volts
45	S	S	S	Appears to be properly functioning horn
49	S	S	S	Appears to be properly functioning horn
50	S	S	S	Appears to be properly functioning horn

Key: S = Short (vertical line on curve tracer)
 I = Intermittent/nonlinear (diode characteristics on curve tracer)
 O = Open (horizontal line on curve tracer up to ± 5 volts)

Note: Outside terminal on horn always positive

Horns were then selected for additional curve tracer testing to further document photographically the non-linear contact characteristics of these horns that indicate the tunneling mechanism is predominant. A typical result appears in Figure 3.

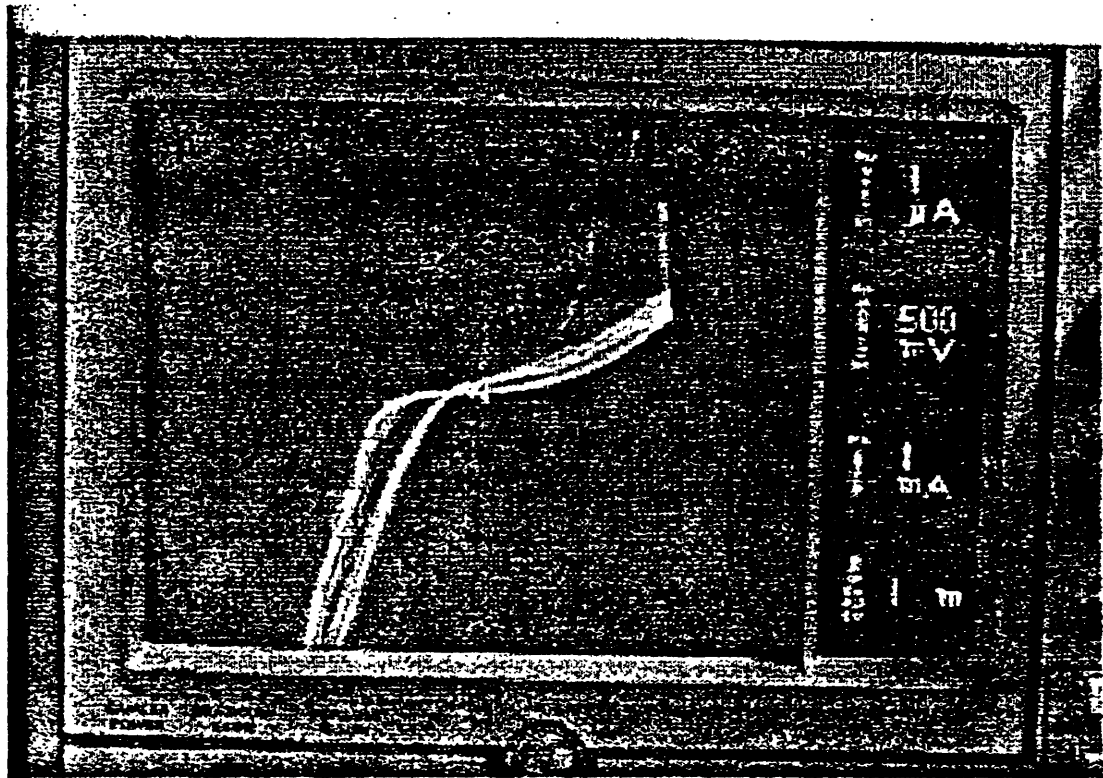

FIGURE 3: HORN V/I CHARACTERISTICS

2.1.2 Test Protocol Development

The approach used in the development of the test protocol was to identify the type of corrosion causing the separable contact problem and the mechanisms and environments that lead to contact failure.

The test protocol was designed to isolate the specific corrosion mechanisms responsible for the failures. Some of the mechanisms addressed were:

1. Oxide Corrosion
2. Sulfide Corrosion
3. Hydroxychloride Corrosion
4. Fretting Corrosion
5. Polymeric Outgassing Film Corrosion
6. Silicone Creep Corrosion

The first step in developing the test protocol was to analyze the data on the fifty smoke detectors in the CPSC data book. Forty seven of the units supplied had failed in the field, with twenty exposed to fire situations. Three new units were provided for control samples. Test protocol sample selection was made up of units that failed in the field and two control units. The IITRI analysis performed during the smoke detector examination phase, which identified the normal, non-linear and open contact conduction categories of fielded units, was used for test protocol sample selection.

The video process was used to record contact behavior, especially those that were erratic. Contacts that were nonlinear for a very short interval before becoming "good" were recorded.

A sample from each category was selected for destructive testing of the contact surfaces of the separable connectors using the following surface analysis tools:

1. Optical - Standard optical microscopes with magnification from about 7x to 500x were used. Special ultraviolet (UV) techniques were used to isolate organic compounds that exhibit florescence in the UV spectrum.
2. Scanning Electron Microscope (SEM) - The SEM has become commonplace in industry and is literally the starting point of all materials-related analyses. The SEM yields photomicrographs illustrating high resolution surface topography at magnifications up to 200,000x. The SEM was used primarily to document high magnification observations.
3. AES - Auger Electronic Spectroscopy (AES) was used to characterize the elemental composition of surfaces and interfaces at a penetration depth of 10 angstroms or less. The Auger was used for elemental analysis and depth profiling of the interface films.
4. Fourier Transform - Infrared Analysis (FTIR) - This technique was used to analyze contact surfaces to determine if organic films were present.
5. Energy Dispersive Analysis by X-Ray (EDAX) - This attachment to the SEM provides an x-ray diffraction mode that is used for the elemental chemical analysis.

The test protocol defining the test methodology, analysis to be performed and the analytical tools to be used in this effort was then completed. The CPSC-approved test protocol is shown in Figure 4.

STUDY OF DETERIORATION OF SEPARABLE ELECTRICAL CONTACTS IN SMOKE DETECTORS

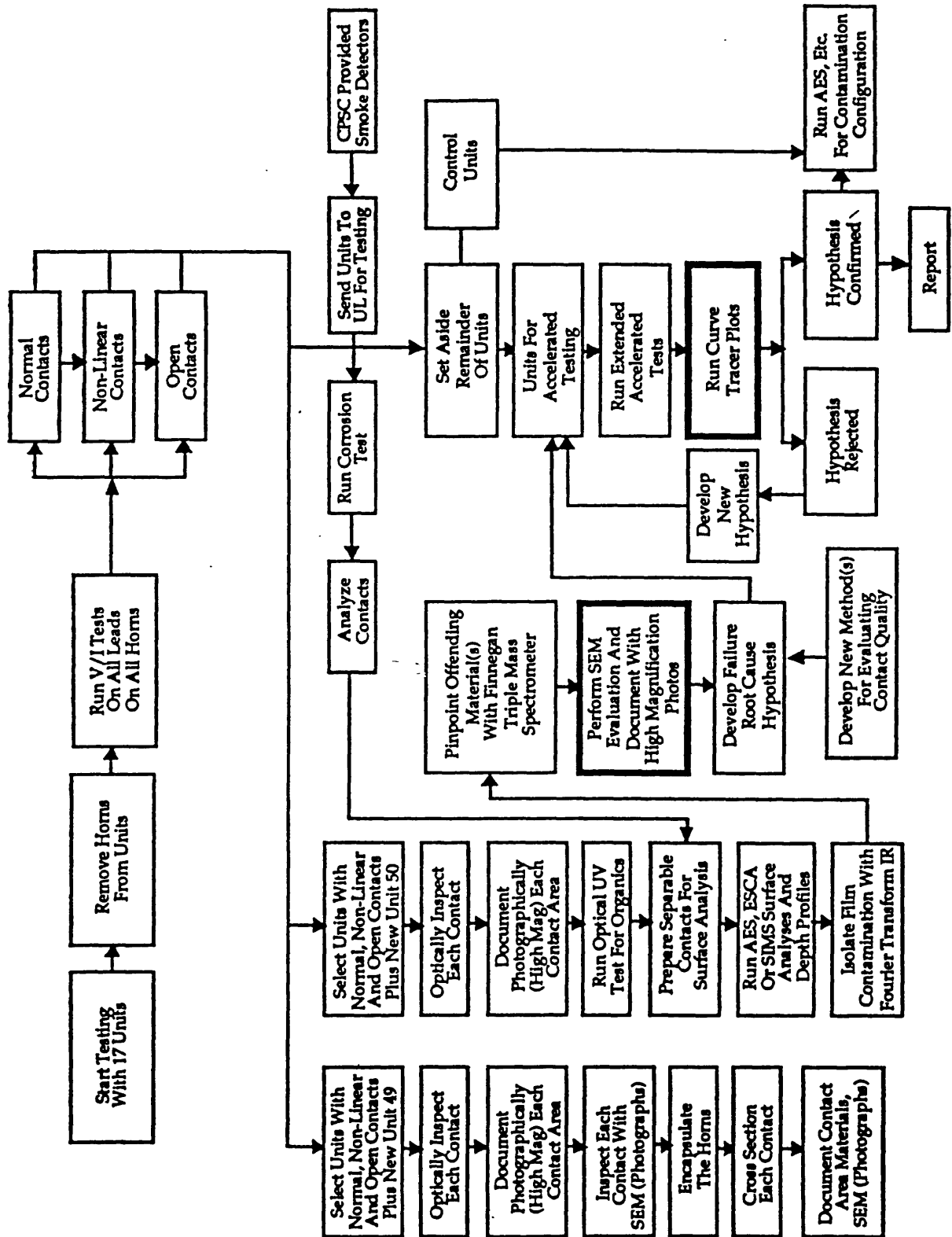

FIGURE 4: TEST PROTOCOL FLOW CHART

2.2 Task II: Test Protocol Implementation

Using the CPSC-approved test protocol developed in Task I, IITRI implemented the detailed investigation of the smoke detector separable contacts. The test protocol flow chart (Figure 4) lists the complete sequence of events that occurred during testing and analysis by IITRI, and testing performed by ORS and the UL. The detailed description and results of the test protocol testing are included in Appendix B, Task II "Test Protocol Implementation Report."

2.2.1 Verification Testing

Protocol testing started with seventeen smoke detectors selected from the fifty smoke detectors supplied to IITRI by the CPSC for test and evaluation. Fifteen of the units were those that had failed in the field and two were new units to be used as control samples.

Testing of all units for functionality per the protocol was started at IITRI, with twelve units passing the test (normal contacts) and five units failing (open or non-linear contacts). Electrical signals (voltage, waveshape, frequency) at each of the three terminals on every horn were also measured using an oscilloscope. These measurements confirmed that, for the five failed units, the proper electrical signals were present to operate a good horn. Throughout all of the IITRI smoke detector investigation, the only failures detected have been due to the separable connectors on the horn elements.

2.2.2 Selection of Units for Cross-Section and Surface Analyses

Eight of the seventeen horns tested on the curve tracer were selected for analysis. These were units 6, 14, 32, 33, 36, 39, 49 and 50. The remaining nine horns were set aside for possible testing later in the protocol. All of the eight horns selected for testing were optically inspected and each contact area photographically documented.

2.2.3 Optical Inspection and Photographic Documentation

Figure 5 shows the separable contacts on a typical smoke detector horn. The three contacts B, S and F are indicated on the photograph. The six smoke detectors

in this phase of the test protocol had bifurcated contacts. Figure 6 shows a close up of a bifurcated horn contact B. Figure 7 shows a close up of the dimpled horn contact F used in the new control sample units 49 and 50. New signifies that the units had not been exposed to field use conditions. To perform the auger (AES) surface analysis, the contacts were removed from the horns.

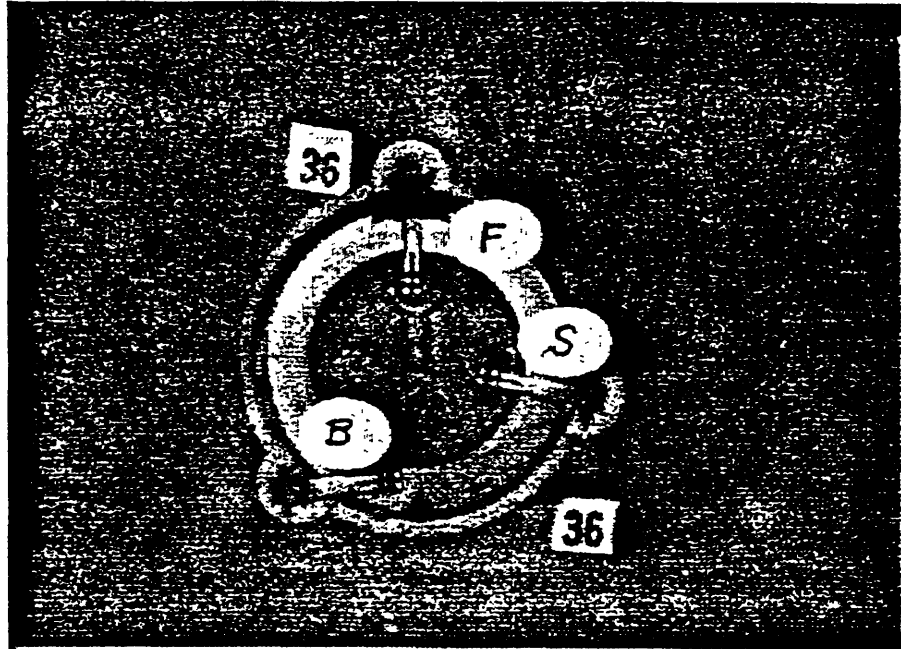

FIGURE 5: SEPARABLE CONTACTS ON A SMOKE DETECTOR HORN (1.25X)

2.2.4 SEM Inspection of Contacts

Before the four horns used to document contact area materials were encapsulated for cross-sectioning, scanning electron microscope (SEM) photographs were taken of each contact area. Representative pictures of bifurcated and dimpled contacts appear in Figures 8 and 9, respectively. Energy Dispersive Analysis by X-Rays (EDAX) surface analyses were made on each of the four horns prior to encapsulation. Table 5 summarizes the results of these analyses. Because of the relatively high beam voltages used by the SEM, the depth of the surface analyses was about 1 micron. Even with this sensitivity, both sulphur and chlorine are prominent on the units collected in the study. Sulphur was also present on the new control sample units.

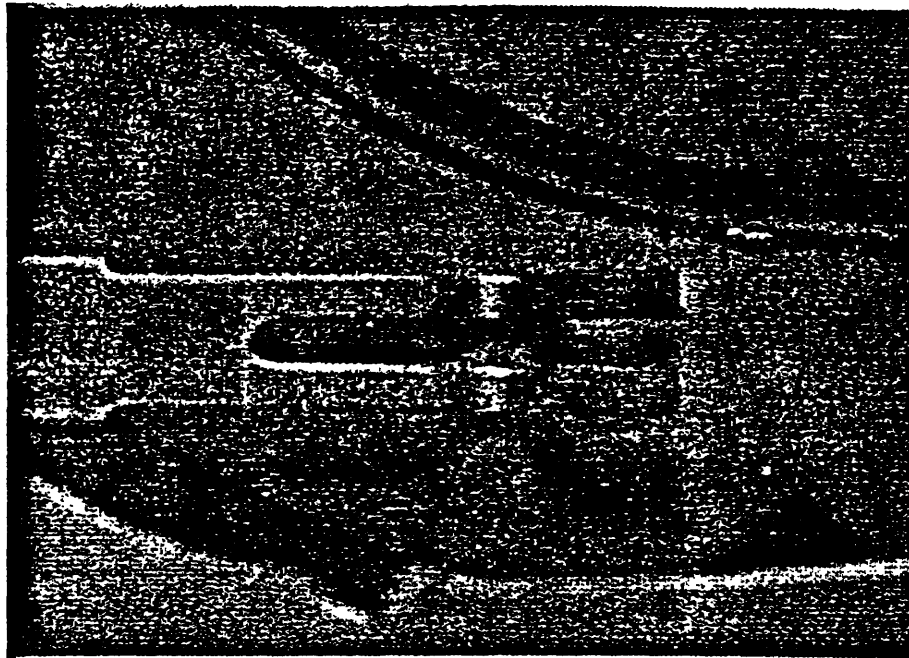

FIGURE 6: BIFURCATED CONTACT B (12X)

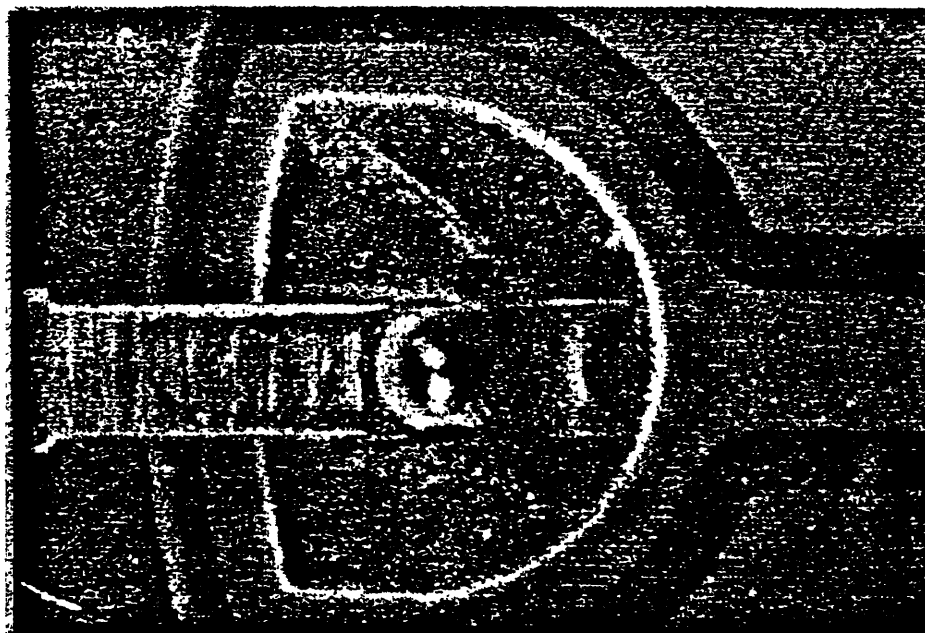

FIGURE 7: DIMPLED CONTACT F ON NEW HORNS (12X)

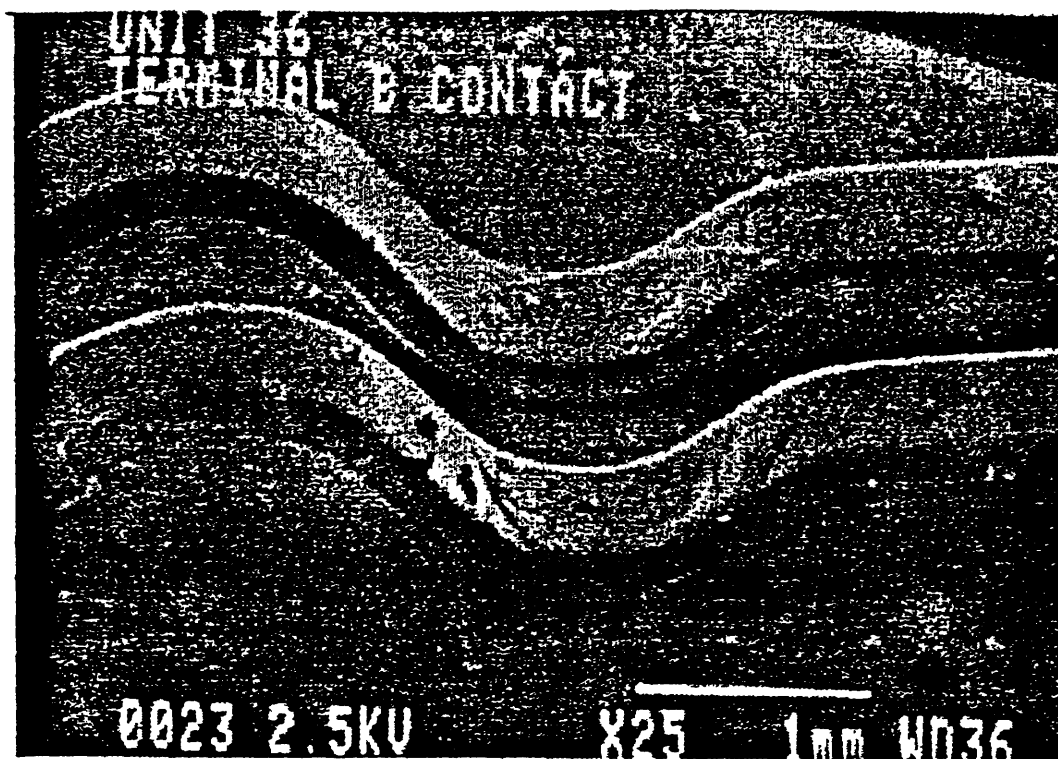

FIGURE 8: SEM PHOTOGRAPH OF A BIFURCATED CONTACT

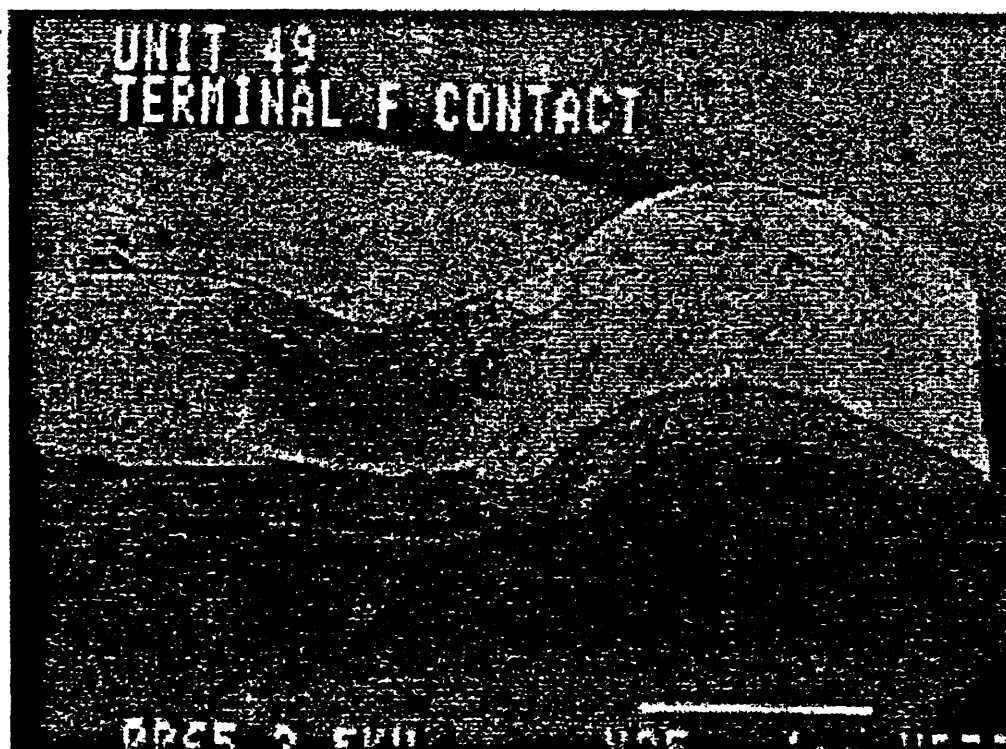

FIGURE 9: SEM PHOTOGRAPH OF A DIMPLED CONTACT

STUDY OF DETERIORATION OF SEPARABLE ELECTRICAL CONTACTS IN SMOKE DETECTORS

TABLE 5: RESULTS OF EDAX SURFACE ANALYSES

S/N	Location	C	O	Si	S	Ca	Cr	Fe	Ni	Cl	Ag	Al	K	N	SN	Pb
6	B Contact Pad	•	X	X	X	•	X	X	X							
6	S Contact Pad		•	•	X					X	X					
6	S Contact	•	X	X	X	•	X	X	•			•	•			
6	F Contact Pad	•	•	•	X					X	X					
32	B Contact Pad	X	X					X	•			X				
32	S Contact Pad	X	X	X	X				X	X	X					
32	F Contact Pad	X	X	•	X				X	X	X					
36	B Contact Pad	•	X	•		•		X	•	•		X				
36	S Contact Pad	•	•	X	X					•	X	•				
36	F Contact Pad	•	X	X	X					X	X	•				
49	B Contact Pad													•	X	
49	S Contact Pad				X						X					
49	S Contact														X	X
49	F Contact Pad				X						X					

Key X = Significant Level

• = Detectable Level

The horns were then removed from all seventeen smoke detectors and tested in a horn test platform for failure verification. The same five horns that failed prior to removal failed at this time. All of the remaining twelve horns tested good.

V/I testing was performed using a curve tracer to determine if the contacts had normal, open or non-linear characteristics.

Semiconductor physics is used to explain the conduction mechanism of the deleterious film(s) that forms in the interface between two separable metal contacts. Because of this relationship, identification of specific conduction mechanisms can be made by studying the V/I characteristics of the films.

Normal contacts appear as a vertical trace on the curve tracer and are indicative of a good contact. Open contacts appear as horizontal traces on the curve tracer. This indicates that an insulating layer was present in the contact interface that would not conduct at a five volt level (the horn would malfunction).

The non-linear V/I contact characteristics are those that can be identified through curve tracer testing. A non-linear V/I characteristic indicates that a thin

STUDY OF DETERIORATION OF SEPARABLE ELECTRICAL CONTACTS IN SMOKE DETECTORS

non-conductive layer has formed in the contact interface. Figure 10 is a photograph of a non-linear V/I characteristic exhibited by a horn contact. In this case the forward diode breaks down at about 1.75 volts and the reverse breakdown is at about 1 volt. As the voltage is increased by ± 5 volts, very little current (less than $.1\mu\text{A}$) flows through the contact in either polarity. Through tunneling [4, 5] and film rupture, the current increases rapidly. Figure 10 also shows the instability in the contact interface. If the current is increased, the film will rupture and the V/I characteristic will return to a linear characteristic. As a result, when the voltage across a non-linear contact in a horn circuit is not large enough to cause rupture of the film, the horn will malfunction. Units 16, 17, 36 and 39 had one or more non-linear contacts. Units 32, 35 and 39 had one or more open contacts. The remaining units 6, 14, 18, 21, 26, 29, 34, 37, 45, 49 and 50 had normal contacts.

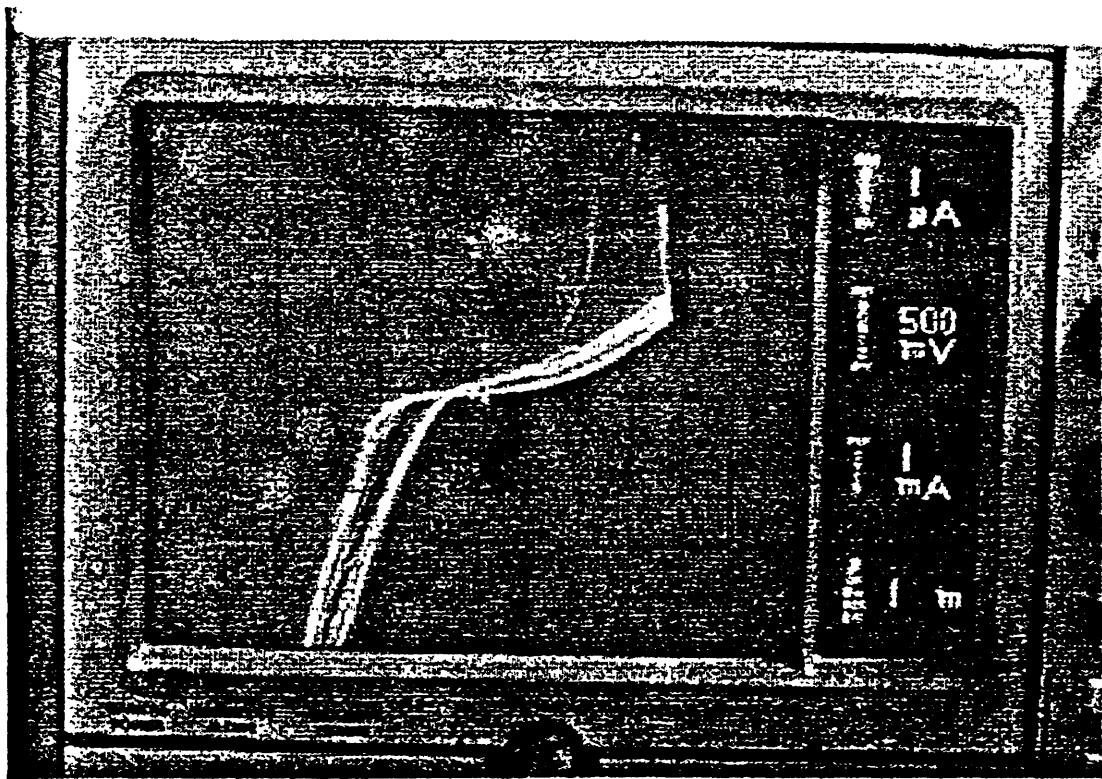

FIGURE 10: NON-LINEAR V/I CHARACTERISTICS OF A SMOKE DETECTOR HORN CONTACT

2.2.5 Encapsulating and Cross-Sectioning of the Horns

A technique similar to that used for encapsulating (potting) semiconductor die for cross-sectioning was developed. The four horns from units 6, 32, 36 and 49 were then encapsulated and cross-sectioned.

2.2.6 Documentation of Contact Area Materials

After the four horns were cross-sectioned, each of the materials shown in Figure 2 (the conceptual cross-section of the horn disk and contacts) were analyzed using EDAX. Table 6 lists the results of this EDAX investigation for each horn. This completed the preliminary investigation using the SEM.

TABLE 6: SUMMARY OF MATERIALS USED ON SMOKE DETECTOR HORNS

	S/N 6	S/N 32	S/N 36	S/ 49
Contact Material	Fe, Cr, Ni,	Fe, Cr, Ni	Fe, Cr, Ni	Fe, Cr, Ni
Contact Plating	None	None	None	SN, Pb
Piezoelectric Disk	Pb, Zr, Ti, O	Pb, Zr, Ti, O	Pb, Zr, Ti, O	Pb, Zr, Ti, O
Piezoelectric Metallization	Ag*	Ag*	Ag*	Ag
Insulating Coating	None	Si, Mg, C, O, Cl	Si, C, O, Cl	Si, Mg, C, O, Cl
Metal Header Disk	Fe, Cr, Ni	Fe, Cr, Ni	Fe, Cr, Ni	Fe, Cr, Ni
Header Plating	None	None	None	SN

*A surface film was detected on the piezoelectric disk metallization. EDAX identified the layer to contain sulphur and silver.

2.2.7 Optical Ultraviolet (UV) Test for Organics and Sample Preparation

Horns on the four units (14, 35, 39, 50) scheduled for auger analyses were then disassembled to reveal the terminal pad and the contact mating areas to allow performance of an optical UV test for organics. No organics were found as a result of this testing. Also, at this time, the samples to be surface analyzed were prepared.

2.2.8 Auger (AES) Surface Analyses and Depth Profiles

AES measurements were taken at 24 locations on the four contacts and terminal pads of the 4 horns selected for surface analysis. A summary of these analyses are shown in Table 7. Both sulphur and chlorine are present in all four samples. AES is more sensitive to the presence of surface contamination than the EDAX, which explains why chlorine was found even in the control smoke detectors.

STUDY OF DETERIORATION OF SEPARABLE ELECTRICAL CONTACTS IN SMOKE DETECTORS

TABLE 7: RESULTS OF AES SURFACE ANALYSES

Location	Terminal	Unit	Elements Detected on Surface													Remarks	
			Si	Pb	S	Cl	K	C	Ag	N	SN	O	Fe	Ni	Na		Al
C	B	14	X		•	•	•	X	•	•	•	X	X	•	X		NIF
T	B	14	•		•	•	•	X		•		X	X	•	X		NIF
BT	B	14			•			X				X				X	NIF
C	S	14	X	•	X			X	•	•	•	X	X	•			NIF
BC	S	14	X		X		•	X		•		X	X		X		NIF
C	F	14	•	•	X	•		X	X	•		X	X	•	X		NIF
T	F	14			X	•		X	X			X					NIF
BT	F	14			X	X		X	X			X					NIF
C	B	35				X		X		•		X	X	•	•		IF
T	B	35	•	•		X		X		•		X	X	•		•	IF
C	S	35	•		•	X		X	X	•		X	X	X	•		IF, OC
T	S	35	X	•		X		X	•	•		X	•	X			IF, OC
BC	S	35	•			X		X	•	•		X	X		•		IF, OC
C	F	35	•			X		X	•	•		X	X	•	•		IF
T	F	35	•		X	X		X	X			X	X	X			IF
C	B	39	•		•	X		X		•		X	X	•	•		IF, HFD
T	B	39	X			X		X		X		X	•		•		IF, HFD
C	S	39	•		•	X		X		X		X	X	•	•		IF, OC, HFD
BC	S	39	•		X	•		X	X	X		X	•		•		IF, OC, HFD
C	F	39	•		•	X		X		X		X	X		•		IF, NLC, HFD
C	B	50	X	X	•	X		X			X	X		•			N
C	S	50	•	X	X	X		X			X	X		•			N
BC	S	50	•	X	X	X		X			X	X		•			N
C	F	50	X	X	X	X		X			X	X					N

Location Keys: C = Contact area under spring loaded half of contact
 T = Terminal area on ceramic disc or metal rim under spring loaded contact
 BT = Background reading near T but not in contact area
 BC = Background reading near C but not in contact area

Element Key: X = Significant peak • = Detectable peak

Remark Keys: NIF = Not in fire N = New unit
 OC = Open contact NLC = Non-linear contact
 HFD = Heavy fire damage
 IF = In fire

STUDY OF DETERIORATION OF SEPARABLE ELECTRICAL CONTACTS IN SMOKE DETECTORS

After the surface analyses were finished, depth profiles were run at seventeen locations. The results of the depth profiling appears in Table 8. The surface material was sputtered away at a known rate while elemental measurements were being made. As each element dropped in intensity, the thickness of the layer containing that element could be determined. Following the depth profiles, another AES scan was run. The residual non-base material elements found after profiling are recorded in the last column of Table 8.

TABLE 8: AES DEPTH PROFILE SUMMARY

Unit	Location	Element Depth, Å Units							Profile Depth	Residual Non-Base Material Elements After Profile
		O	C	S	Cl	Si	K	Na		
14	Contact B	300	40	25	-	25	25	25	450Å	C, O
14	Terminal B	100	40	70	-	30	30	30	450Å	C
14	Contact S	300	300	300	-	-	-	-	550Å	C, O, S, Ag
35	Contact B	2000	2000	-	2000	-	-	-	2000Å	C, O, Cl
35	Contact S	1500	2000	1400	2000	-	-	-	2400Å	O, Cl
35	Terminal S	-	1300	-	1000	-	-	-	2250Å	O, Cl, Si, Ni
35	Terminal F	30	100	-	-	-	-	-	450Å	O, S, Cl, Si
39	Contact B	700	1200	-	700	-	-	-	1300Å	C
39	Contact S	200	1000	-	300	-	-	-	1300Å	C, N
39	Terminal S	-	2000	-	2000	-	-	-	3450Å	O, S, Cl, Si
39	Contact F	350	700	-	-	-	-	-	777Å	C
39	Terminal F	-	200	200	200	-	-	-	300Å	S, Cl, Si
50	Contact B	600	30	-	60	-	-	-	450Å	O, Cl
50	Terminal B	400	30	-	80	-	-	-	450Å	O, Cl
50	Contact S	900	25	-	-	-	-	-	370Å	O, Cl
50	Contact F	600	30	-	300	-	-	-	600Å	O, Cl
50	Terminal F	400	30	-	-	-	-	-	450Å	O

2.2.9 Fourier Transform Infrared (FTIR) Tests

FTIR tests were run on some of the horn contacts to determine if the visible films were organic in nature. No organic films were detected. The absence of organic films on contacts of fielded horns means that outgassing of polymeric materials used in smoke detector construction can be ruled out as a source of detrimental films on smoke detectors. It also means that Finnegan Triple Mass Spectrometer testing will not be required for organic film identification.

2.2.10 Separable Connector Failure Root Cause Hypothesis

Based on the data collected in the first half of the test protocol, a root cause hypothesis was developed. Fretting corrosion [6, 7, 8] in the presence of sulphur and/or chlorine was selected as the cause of contact failure. Non-noble metal contacts which easily oxidize are subject to resistance changes through fretting corrosion.

Fretting corrosion is an oxidation of interconnect metal surfaces subjected to small physical movements in the presence of contaminants. Because non-noble metal contacts form thin oxides, conduction usually occurs at a point contact of metal to metal due to surface roughness [3]. At these points, the metal has broken through the oxide and established electrical contact. When displacement of the contacting surfaces occurs, the original point contact erodes and oxidizes. Electrical conduction stops and new point contacts are made. The process continues until a thick insulating layer is formed in the contact interface, resulting in an open contact. There are ample contaminants present such as carbon, oxygen, sulphur and chlorine to form resistive-layers in the contact area. This hypothesis is further verified by the V/I non-linear contact analysis that identified the tunneling conduction mechanism.

In the case of the smoke detector separable contact, the movement of the test button or other handling can cause greater displacement than normal to disrupt the surface, which will re-establish an electrical contact.

To test this theory, aged horns were subjected to temperature cycling in the presence of evaporating water. An accelerated test to provide contact motion was designed to run for a total of 2,000 cycles over a temperature range higher than normal smoke detector operating conditions. The thermal cycle profile shown in Figure 11 allows for 500 thermal cycles, varying from 50-80°C, in 10 days and 10 hours.

2.2.11 Accelerated Testing

Horns from 20 smoke detectors were selected from the 50 supplied by CPSC. These 20 horns (60 contacts) were measured on the curve tracer to obtain V/I curves. All horns were functionally tested using the test button on the smoke detector test platform. All horns except serial number 16 functioned properly. A total of 2000 thermal cycles were performed on the 20 horns. Resistance measurements were made initially and after 500, 1000 and 2000 cycles. The results are included in Table 9.

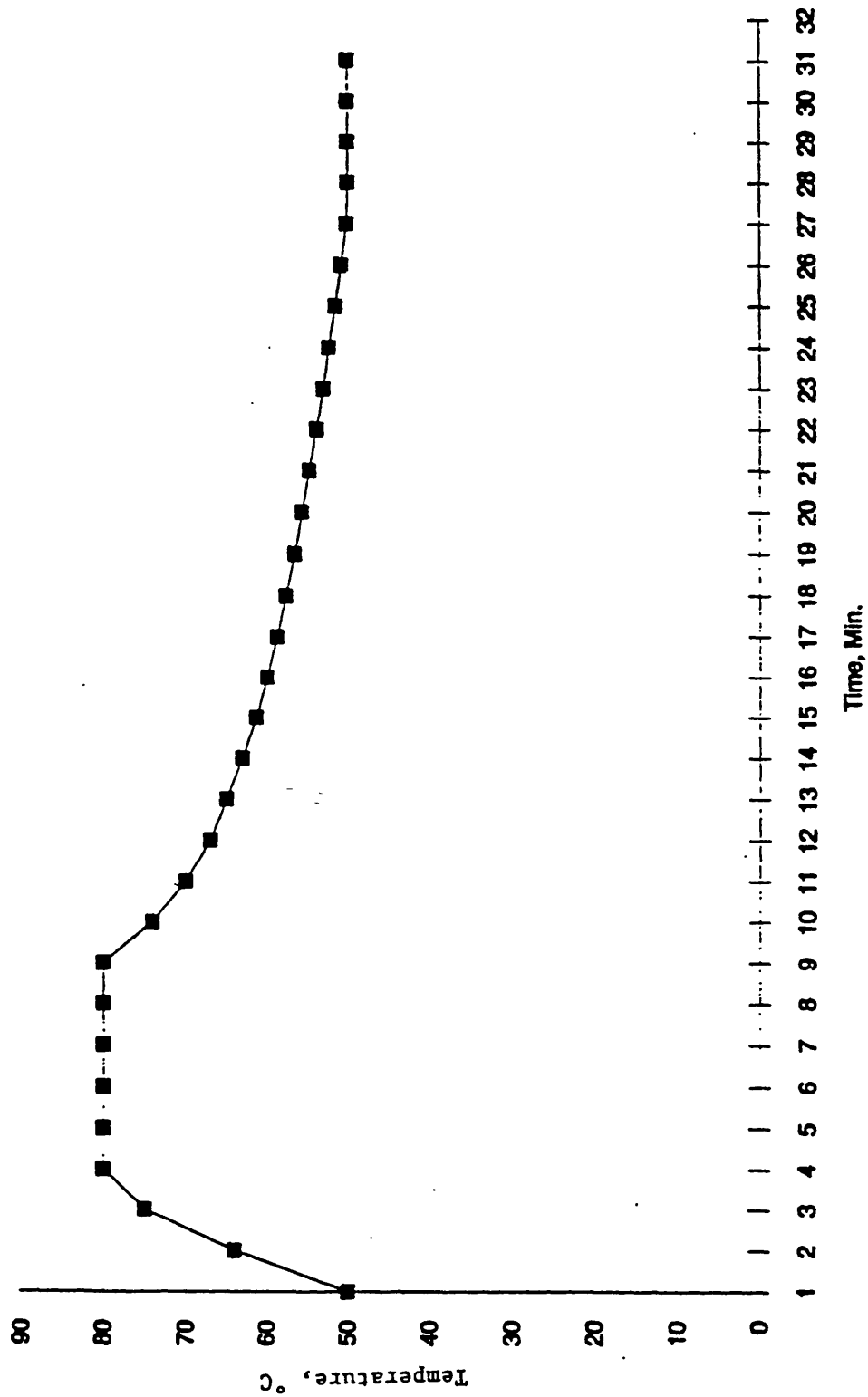

FIGURE 11: TEMPERATURE CYCLE PROFILE FOR ACCELERATED SMOKE DETECTOR HORN TESTS

STUDY OF DETERIORATION OF SEPARABLE ELECTRICAL CONTACTS IN SMOKE DETECTORS

TABLE 9: CONTACT RESISTANCE TEST RESULTS

Unit	Contact	Initial Resistance	Resistance (in ohms) After		
			500 Cycles	1000 Cycles	2000 Cycles
2	B	.18	.75	870	81
	S	.68	.98	1.02	348
	F	.30	2.26	7.16	11.2
7	B	3.5	226	1196	522
	S	.33	.97	3.75	2.09
	F	4.14	28.4	4.01	38.6
8	B	1.07	122	434	284
	S	55.0	38.7	192	87.6
	F	6.55	43.1	15.9	12.4
11	B	3.18	2.68	3.03	11.8
	S	.83	.91	2.93	5.5
	F	.11	.21	.41	2.98
12	B	.69	1.43	250	1200
	S	.58	3.87	7.3	3.1
	F	4.72	7.21	12.3	4.3
15	B	.29	4.68	28.6	105
	S	.37	1.08	1.08	1.62
	F	.61	.62	1.66	1.8
16	B	∞	∞	∞	∞
	S	.03	.08	.28	.36
	F	.08	.09	.22	.41
18	B	5.62	197	1.83	2.1
	S	.15	.34	.48	1.14
	F	.28	.77	2.30	6.7
21	B	.42	10.23	275	336
	S	.55	1.96	4.75	230
	F	30.2	21.1	88	25
26	B	2.81	446	303	58
	S	1.11	2.35	4.14	35
	F	39.4	141	192	14
28	B	2.80	13.1	178	4.0
	S	260	822	193	680
	F	2300	63,000	83,000	760
29	B	.17	20.6	108	20
	S	8.32	11.2	85	17
	F	7.12	4.17	5.80	38
34	B	.79	435	3,200	540
	S	1.87	1.02	.80	1.9
	F	.91	1.68	2.12	6.3
37	B	122	322	322	450
	S	.10	1.06	.54	5.5
	F	.10	.43	.31	11
41	B	500	∞	∞	∞
	S	.20	.08	.25	.20
	F	.21	.08	.23	.26
42	B	.65	6.48	108	500
	S	.15	.09	∞	∞
	F	.17	.12	.27	.21

TABLE 9: CONTACT RESISTANCE TEST RESULTS (CONT'D)

Unit	Contact	Initial Resistance	Resistance (in ohms) After		
			500 Cycles	1000 Cycles	2000 Cycles
43	B	.65	4.26	10.2	8.3
	S	.40	.84	.47	4.3
	F	.21	4.31	3.31	1.1
44	B	.33	75.5	10.1	43
	S	.26	3.38	3.74	10.3
	F	.63	16.5	29.2	42.6
45	B	2.75	9.65	76.4	
	S	.36	.14	.34	
	F	.36	.47	.78	
47	B	.85	30.2	202	
	S	.27	.16	1.09	
	F	.24	.78	1.38	

Seventeen of the 20 horns undergoing the accelerated testing of 2000 thermal cycles are of the type shown in Figures 12 and 13. They are ruggedly constructed and must be unsoldered to reveal the contacts. Also, if the detector is disassembled the horn will probably be destroyed. For future discussion this style of horn will be referred to as Type A. Three of the 20 horns were of the type shown in Figures 14 and 15. This is basically a three-piece horn which can be easily disassembled and reassembled without a soldering operation. For future discussion this style of horn will be referred to as Type B.

The 20 horns were then placed in the oven and thermal cycling was started. After the 500 cycles, the V/I curves, resistance measurements (Table 9) and functional tests were run.

At this time, horns 16 and 41 malfunctioned. The contact resistances for the remaining horns generally went up, although 10 of the 60 contacts actually had lower contact resistances. This is the type of behavior that would be expected for fretting corrosion. As fretting takes place the film surface changes, lowering some resistances, but the additional corrosion on formerly exposed areas tends to raise resistances. This erratic behavior raises the mean resistance of the population and eventually causes contacts to remain open.

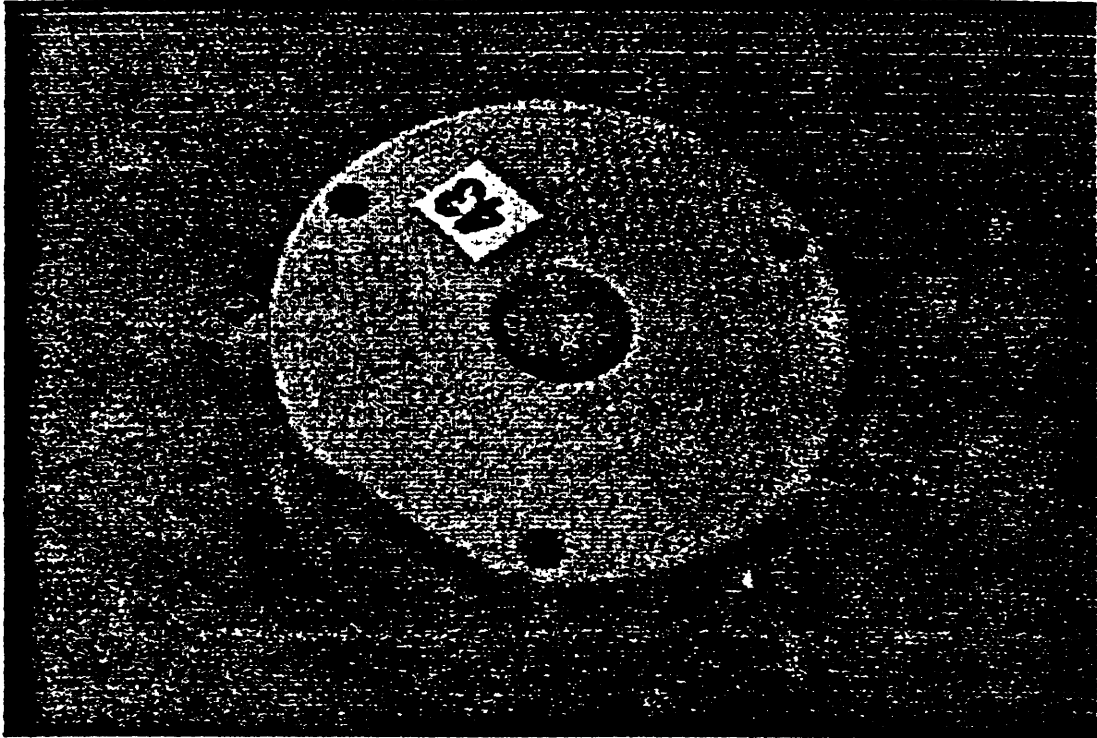

FIGURE 12: TOP VIEW TYPE A HORN

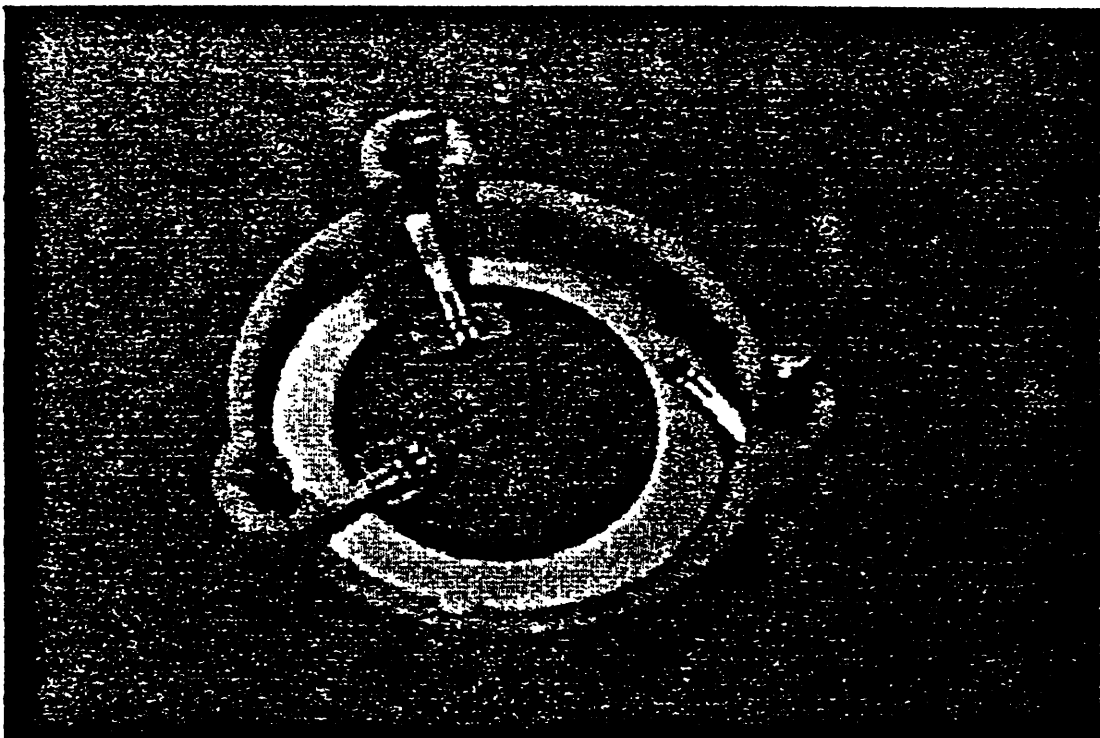

FIGURE 13: BOTTOM VIEW TYPE A HORN

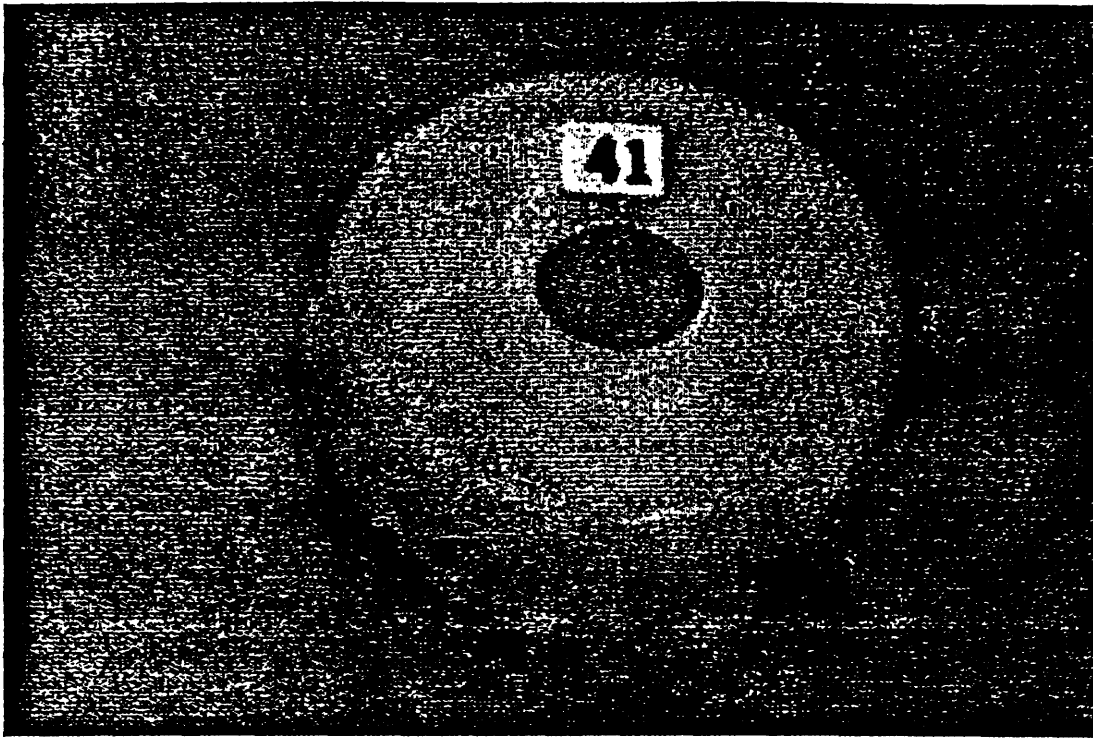

FIGURE 14: TOP VIEW TYPE B HORN

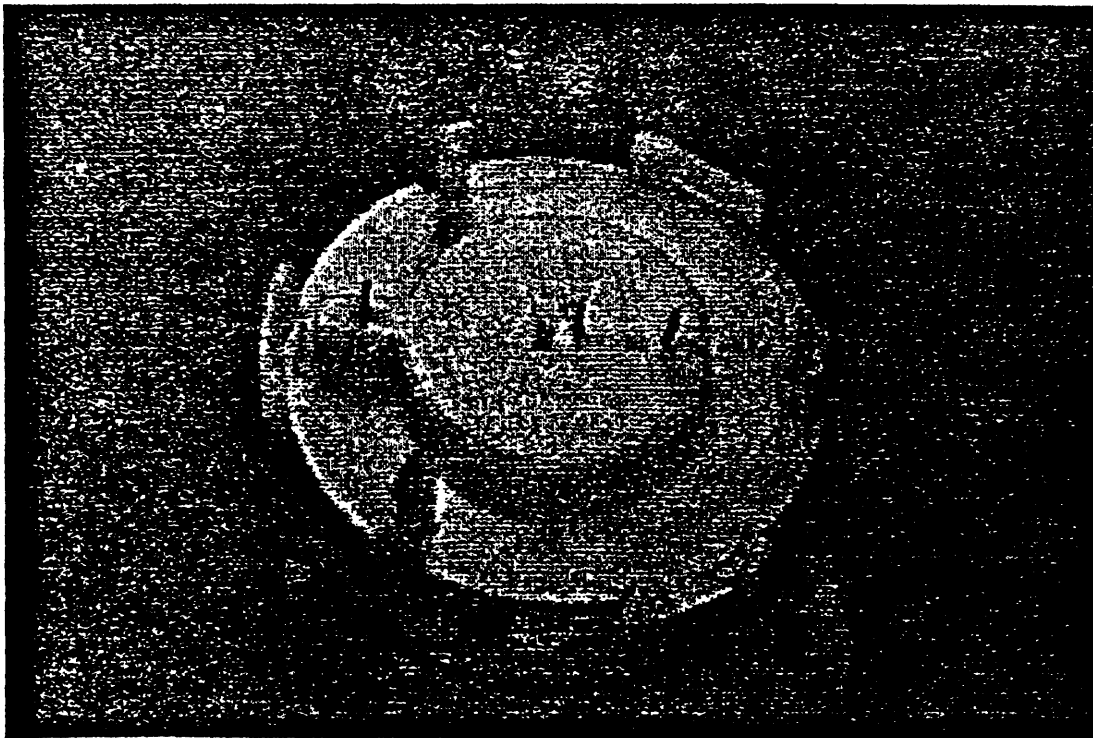

FIGURE 15: BOTTOM VIEW TYPE B HORN

A second series of 500 thermal cycles was run on the same 20 horns. Horn 42 malfunctioned as well as horns 16 and 41. Again, the general population of measured contact resistances (Table 9) were higher than the readings taken after 500 cycles, and 9 out of the 60 contact resistances actually dropped. However, only 5 of the 60 contact resistances were lower after 1000 cycles than in the initial condition.

2.2.12 Extended Temperature Cycling

Eighteen of the 20 horns (two horns were used for contact lubricant tests) that had undergone 1000 temperature cycles were run for an additional 1000 cycles, making a total of 2000 cycles. The results of this testing are listed in Table 9. Table 10 summarizes the population shift of contact resistance versus the number of temperature cycles. This shows a continuous increase of contact resistance with increasing temperature cycling. When the tests started, over 50 percent of the population had less than 1 ohm resistance. After 2000 cycles less than 10 percent of the contacts were less than 1 ohm and over 50 percent of the population was over 10 ohms.

TABLE 10: CONTACT RESISTANCE VALUES VERSUS TEMPERATURE CYCLES

Number of Cycles	Percentage of Resistances by Decades						Open Contacts %
	0-1 Ohm	1-10 Ohms	10-100 Ohms	100-1000 Ohms	1000-10,000 Ohms	10,000-100,000 Ohms	
0	63.3	23.3	5.0	5.0	1.7	0.0	1.7
500	31.7	30.0	20.0	13.3	0	1.7	3.3
1000	21.7	31.7	13.3	21.7	3.3	1.7	5.0
2000	9.6	31.5	31.5	20.4	1.9	0	5.6

In order to determine what contamination might have been added to the horns during the accelerated testing, a strip of clean aluminum foil was placed in the tray holding the horns. The only material present in the surface analysis results of the aluminum foil was aluminum. Therefore, the only contaminants involved in the accelerated testing were those present on the horns at the start of the test.

The accelerated testing has established two criteria. First and foremost, that it is possible to induce horn failures by thermal cycling, and second, that thermal cycling increases the contact resistance of the horns. This substantiates the theory that failures are caused by fretting corrosion.

Additionally, based on the 2000 cycle test, the Type B horns appear less reliable than the Type A horns. None of the Type A horns failed after 2000 thermal cycles, while all three Type B horns failed.

2.2.13 UL 217 Corrosion Tests

Six new smoke detectors were supplied by CPSC to IITRI for standard corrosion testing as specified in UL 217 (para 62.1.2 and 62.1.3). Three of the units were designated A, B and C, and were tested to assure functionality using the test button. These units had their horns removed and were tested at ORS using the SEM. The remaining three units designated X, Y and Z were only tested functionally, using the test button, to assure that they were operating properly before the start of test. Smoke detectors A, B, C, X and Y contain type A horns (described earlier in the report). However, the horn from smoke detector Z is neither type A or B and, for future reference, will be called a type C horn. The intent of this design is to have a sharp point contacting the horn element. Figures 16, 17 and 18 are EDAX plots for contact S (Unit A), contact F (Unit B) and contact B (Unit C), respectively. A slight amount of sulphur was detected at contacts F and S (the silver plated pads), while none was detected at contact B. This is expected since sulphur and silver have an affinity for each other. These EDAX results were compared to the results after the UL testing.

After the testing at ORS, the horns were reinstalled in the smoke detectors. All six smoke detectors were checked for functionality using the test buttons prior to shipment to UL for corrosion testing. During corrosion testing, two smoke detectors were exposed to sulphur dioxide (SO₂), two were exposed to hydrogen sulfide (H₂S) and two were exposed to a mixture of SO₂ and H₂S. Table 11 identifies each unit and the test gas to which it was subjected.

TABLE 11: SMOKE DETECTORS FOR UL CORROSION TESTS

Unit Identification	Test Gas	Pre-Test Function Test
A	SO ₂	Passed
B	H ₂ S	Passed
C	SO ₂ /H ₂ S	Passed
D	SO ₂ /H ₂ S	Passed
E	H ₂ S	Passed
F	SO ₂	Passed

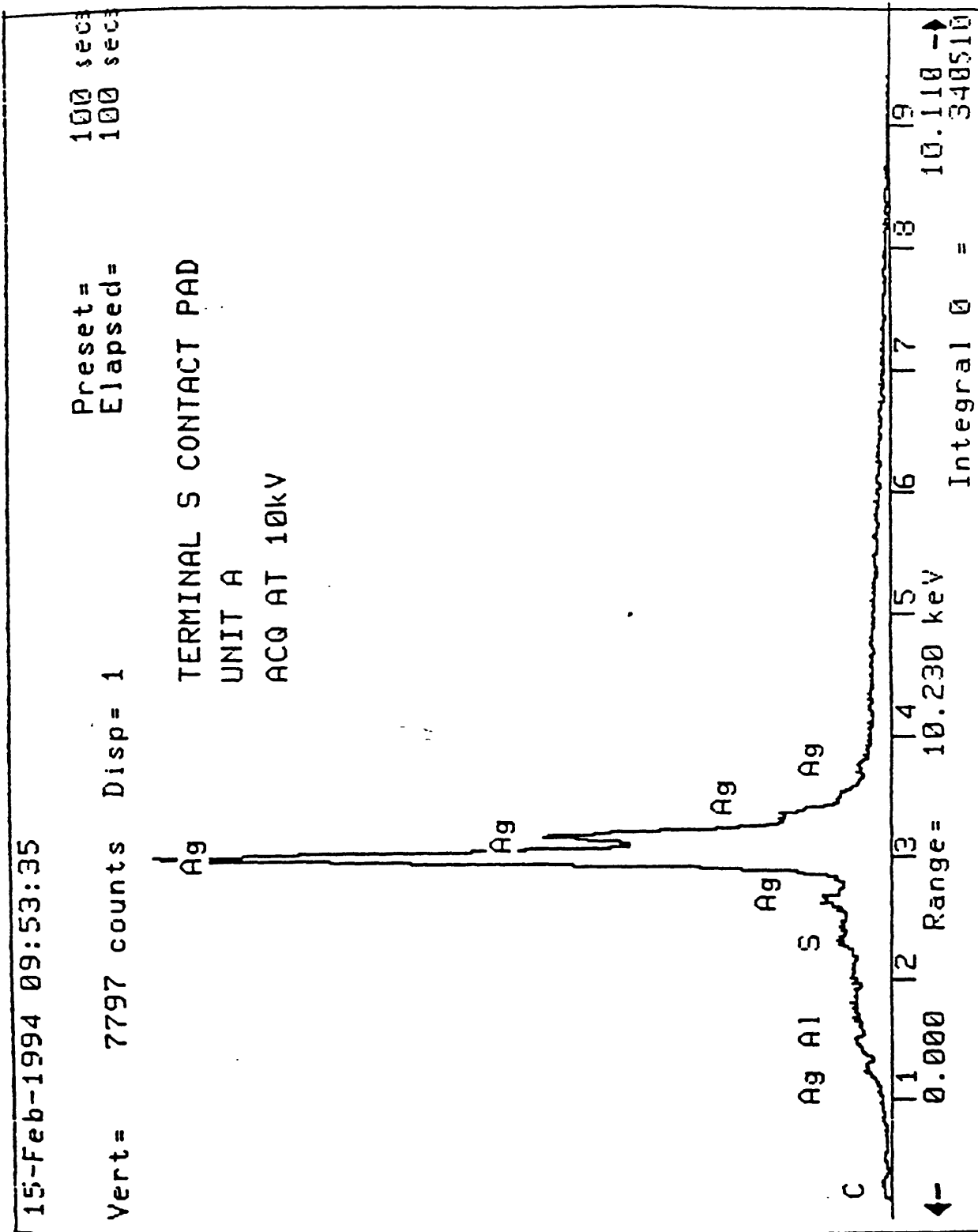

FIGURE 16: BEFORE CORROSION TEST - SO₂

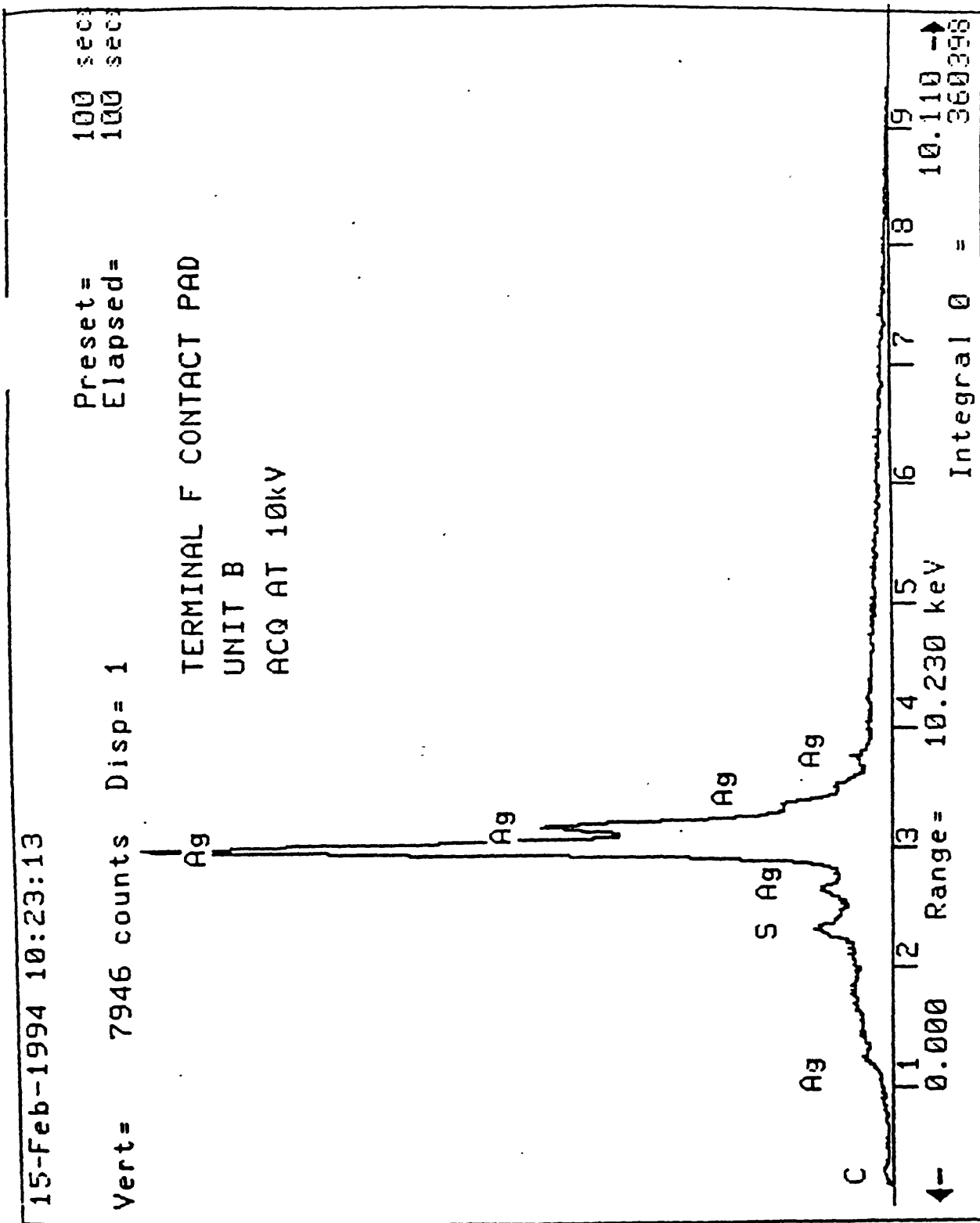

FIGURE 17: BEFORE CORROSION TEST - H₂S

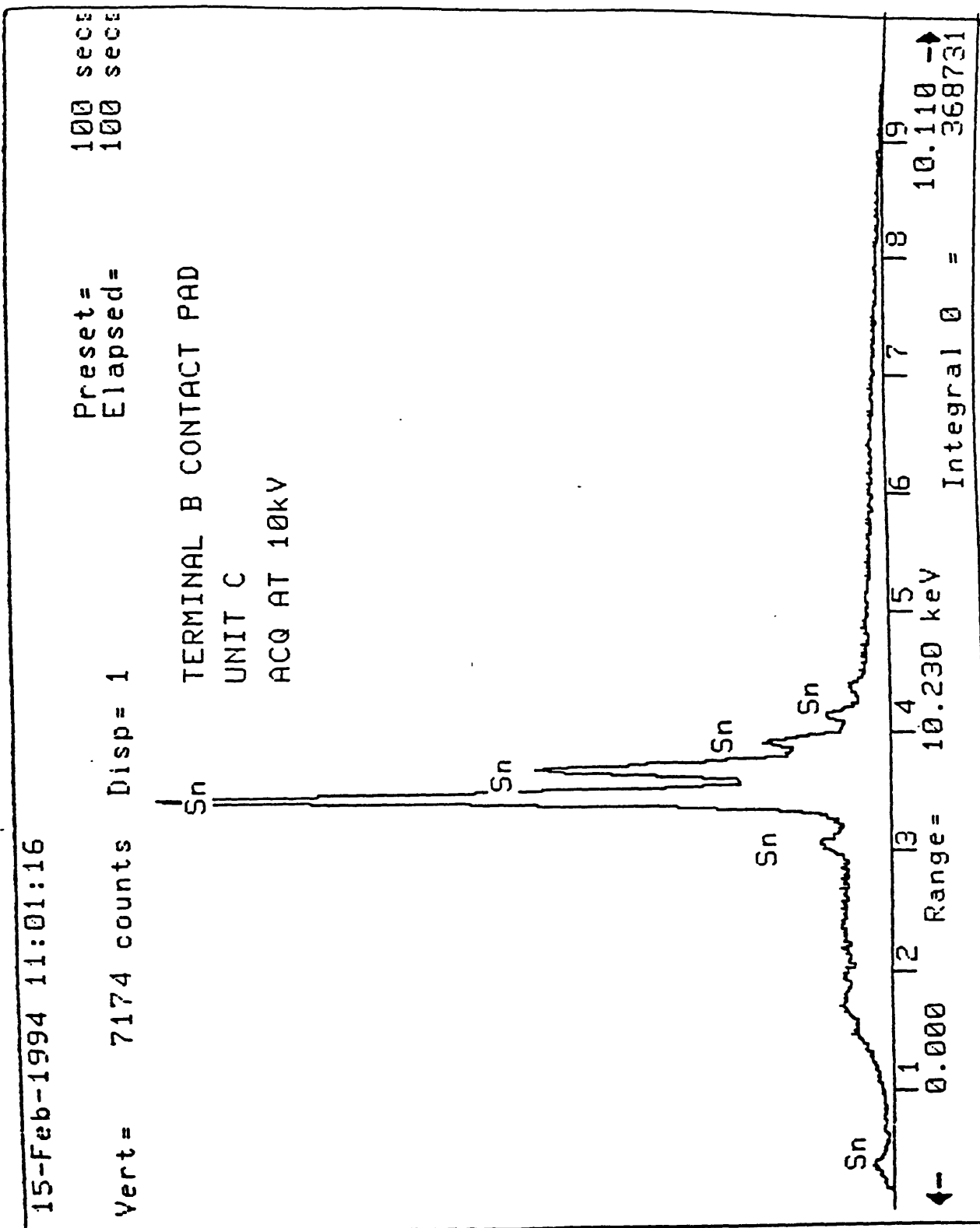

FIGURE 18: BEFORE CORROSION TEST - H₂S/SO₂

After the smoke detectors were returned by UL, all six were tested using the test buttons and functioned properly. The horns were then removed and contact resistance measurements were made. Measurement results are shown in Table 12. These low contact resistances are a strong indication that the UL 217 corrosion tests do not accelerate horn contact degradation.

TABLE 12: CONTACT RESISTANCE AFTER UL CORROSION TEST

Unit Identification	Test Gas	Contact Resistance in Ohms		
		B	S	F
A	SO ₂	.47	.26	.20
B	H ₂ S	.25	.23	.29
C	H ₂ S/SO ₂	.19	.35	.26
X	H ₂ S/SO ₂	.20	.49	.24
Y	H ₂ S	.16	.27	.23
Z	SO ₂	.64	*	*

*Because of the horn construction, no test could be made

Each horn was then documented photographically and delivered to ORS for surface analyses. The horns subjected to SO₂ had less film deposits than the H₂S testing, while those exposed to the combination of H₂S and SO₂ had the most deposits.

Units A, B and C were investigated with SEM and EDAX before and after the corrosion testing. No noticeable visual difference could be found for any unit. However, the EDAX testing showed some differences. Figures 16 and 19 show the before and after tests of Unit A, Terminal S. The only difference is the increase in sulphur. Figures 17 and 20 show the before and after tests of Unit B, Terminal F. Again, the only difference was an increase in the sulphur. Figures 18 and 21 show the before and after tests of Unit C, Terminal B. In this case there was no difference between the before and after plots. This testing again shows how benign the corrosion tests are concerning the horn contacts. The silver, which has an affinity for sulphur, did show an increase in sulphur, but the tin plated area did not show any significant amount of sulphur either before or after testing. A post corrosion EDAX test was run on the silver pad at contact F for Unit C. This plot (Figure 22) showed that the sulphur level was similar to the post corrosion EDAX tests on Units A and B.

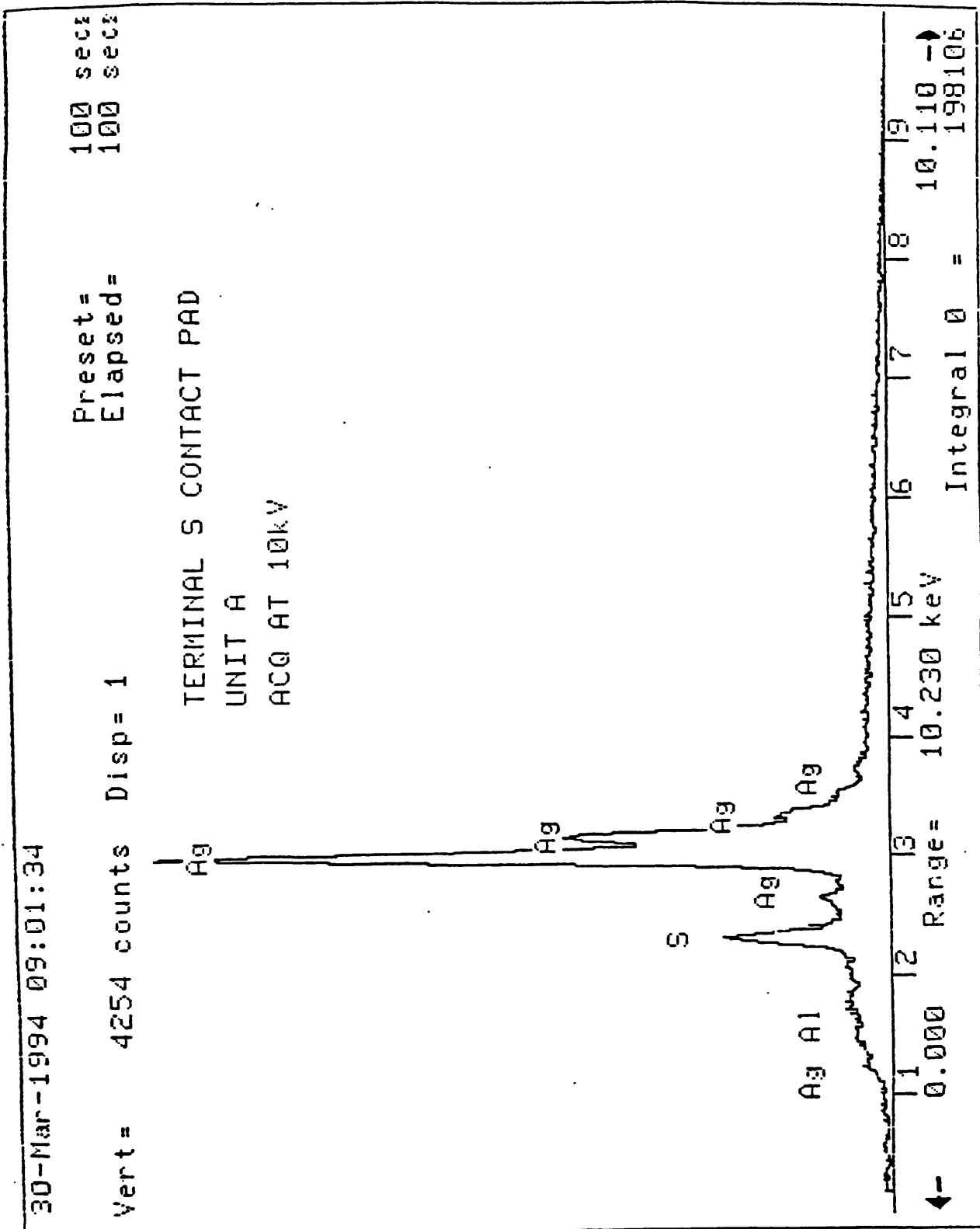

FIGURE 19: AFTER CORROSION TEST - SO₂

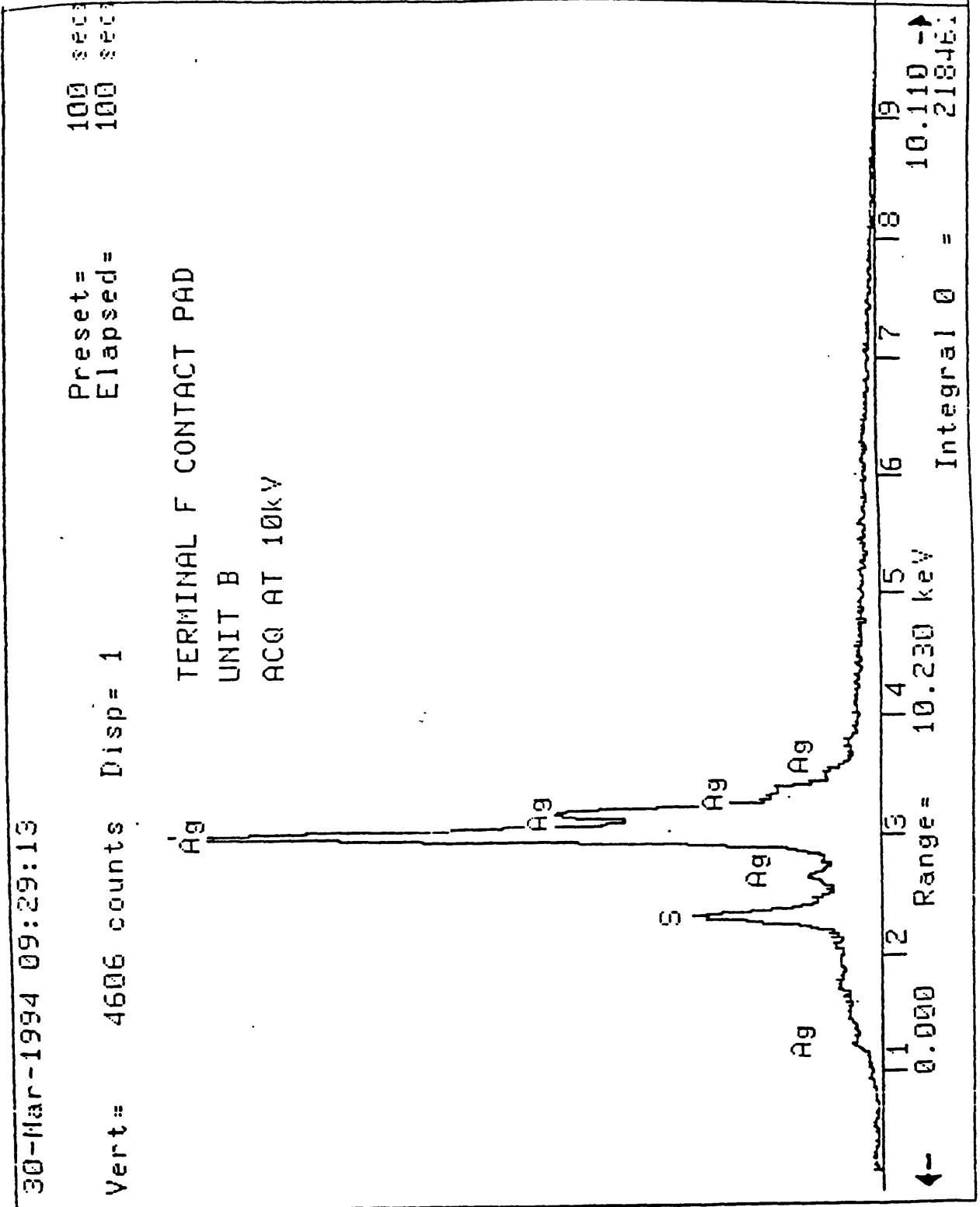

FIGURE 20: AFTER CORROSION TEST - H₂S

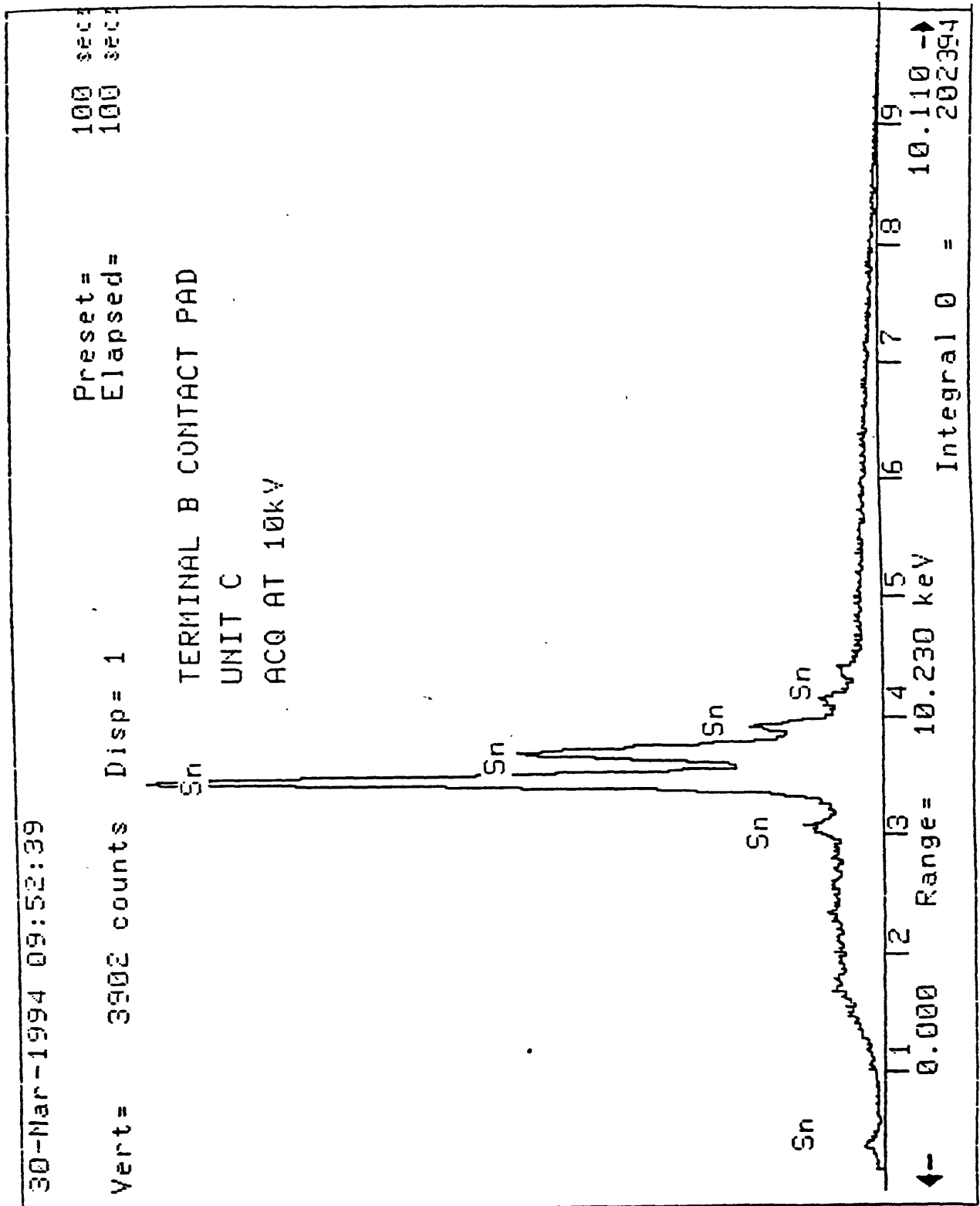

FIGURE 21: AFTER CORROSION TEST - H₂S/SO₂

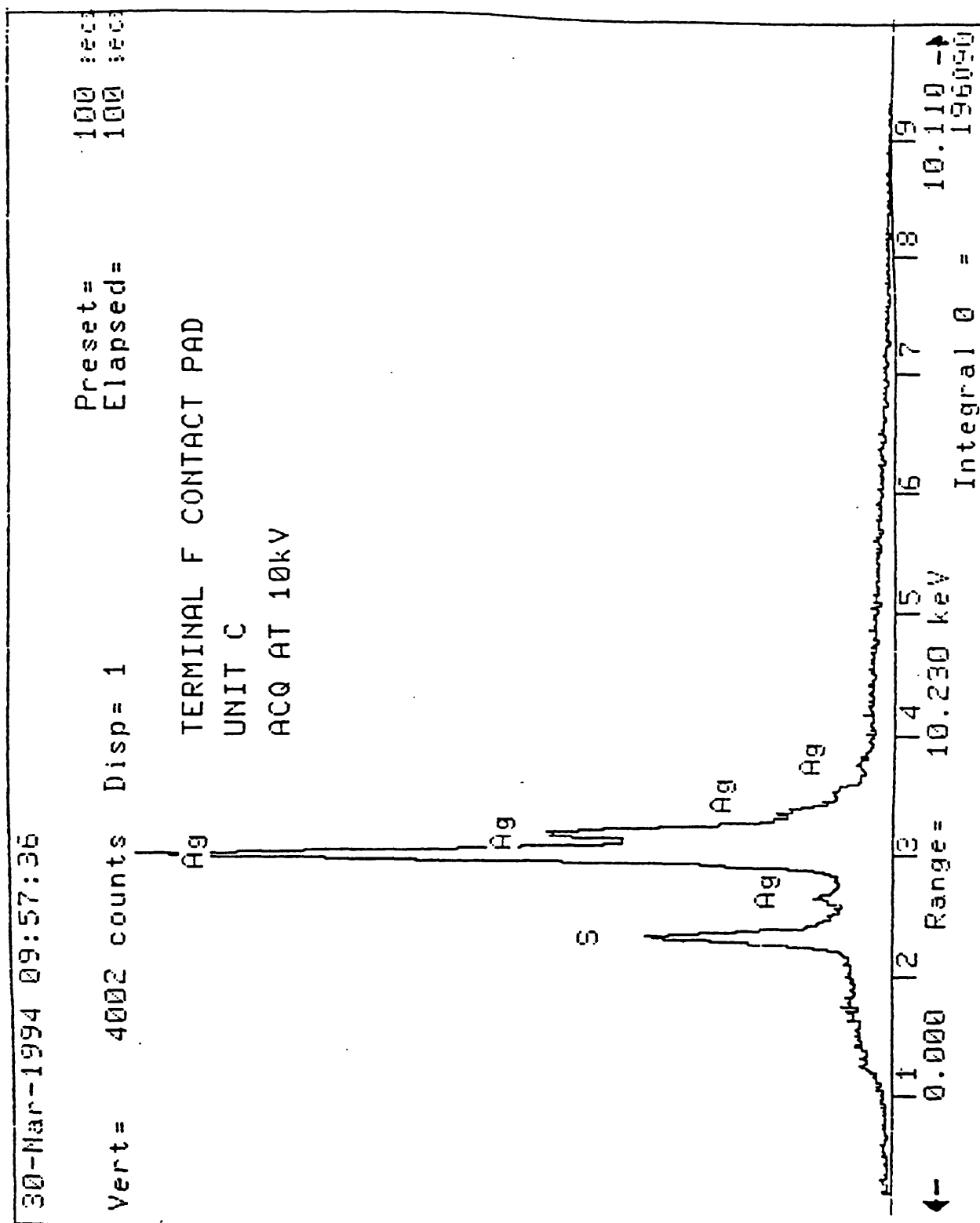

FIGURE 22: AFTER CORROSION TEST - H₂S/SO₂

Horns X, Y and Z were prepared for auger surface analyses and depth profiling. For each sample a surface analysis was run on terminal S, plus terminal B on sample X. Each sample was then depth profiled, followed by another surface analysis.

Figures 23, 24, and 25 are typical pre- and post-sputter surface analyses, and the depth profiles for the four samples tested, respectively.

Note that the surface analyses on the silver "S" contacts show what appears to be a thick carbon layer. Due to an overlap of the silver and carbon peaks between 260 and 280 eV, this is an artifact due to the presence of silver and not carbon.

Sulphur was the only significant contaminant noted in the auger testing. Table 13 summarizes the depth level of the sulphur layer for each sample.

TABLE 13: SUMMARY OF SULPHUR LAYERS ON HORNS RUN IN THE UL CORROSION TESTS

Sample	Contact	Test Gas	Thickness of the Sulphur Layer
X	S	H ₂ S/SO ₂	400Å
X	B	H ₂ S/SO ₂	0Å
Y	S	H ₂ S	180Å
Z	S	SO ₂	80Å

As shown in Figure 23, the pre-sputtering surface analysis on terminal S of horn X shows only a slight trace of sulphur. Both silicon and chlorine have higher levels than the sulphur. Horn X which was exposed to both gases was selected for this testing because it should have had the thickest layer of contamination and to confirm the EDAX surface analysis on horn C (Figure 21). Comparison of this data with the Table 5 EDAX test results of field units, which identified significant levels of sulphur, shows that the UL 217 test environment does not represent field conditions.

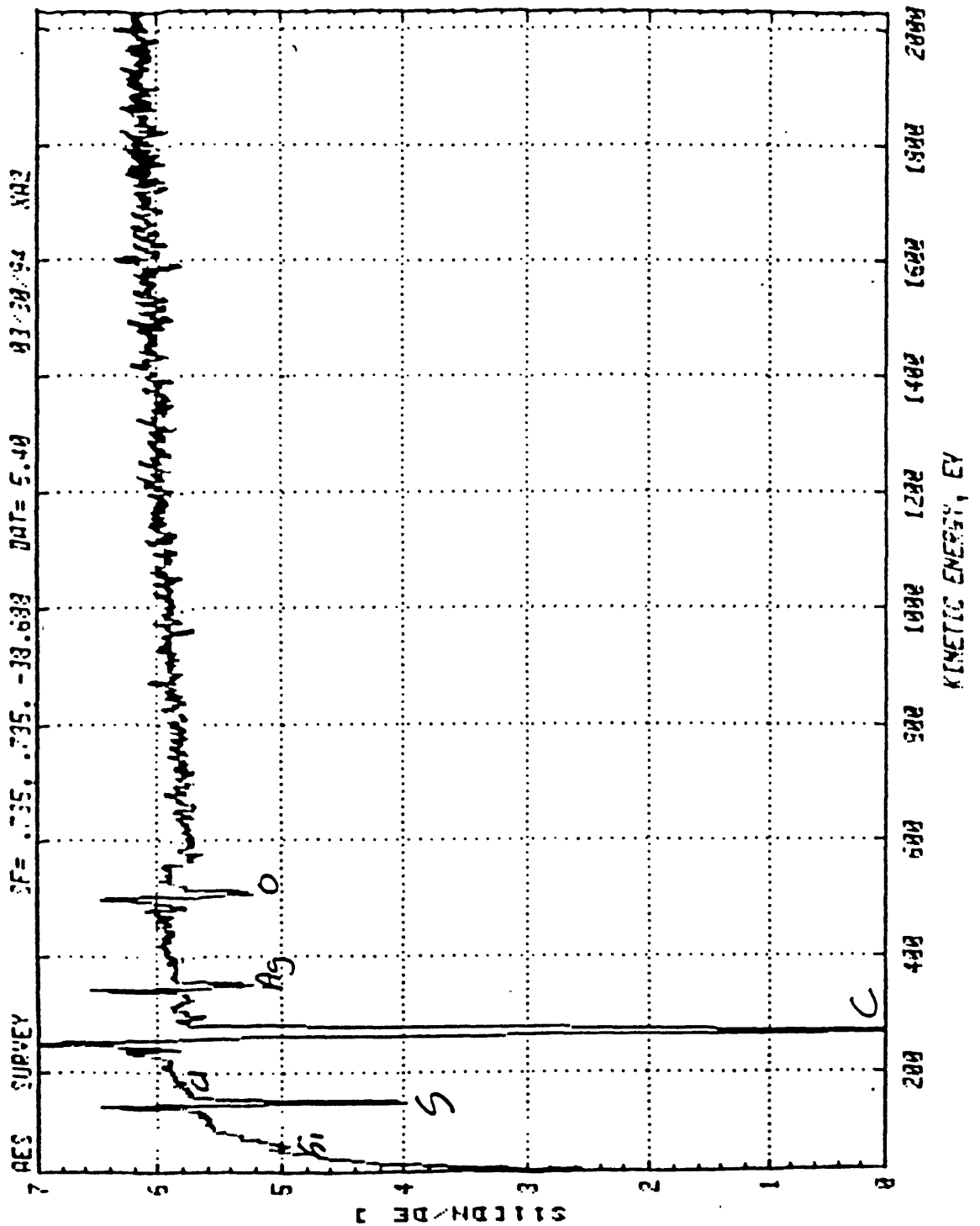

FIGURE 23: AUGER ELEMENTAL SURVEY OF SAMPLE X, TERMINAL S

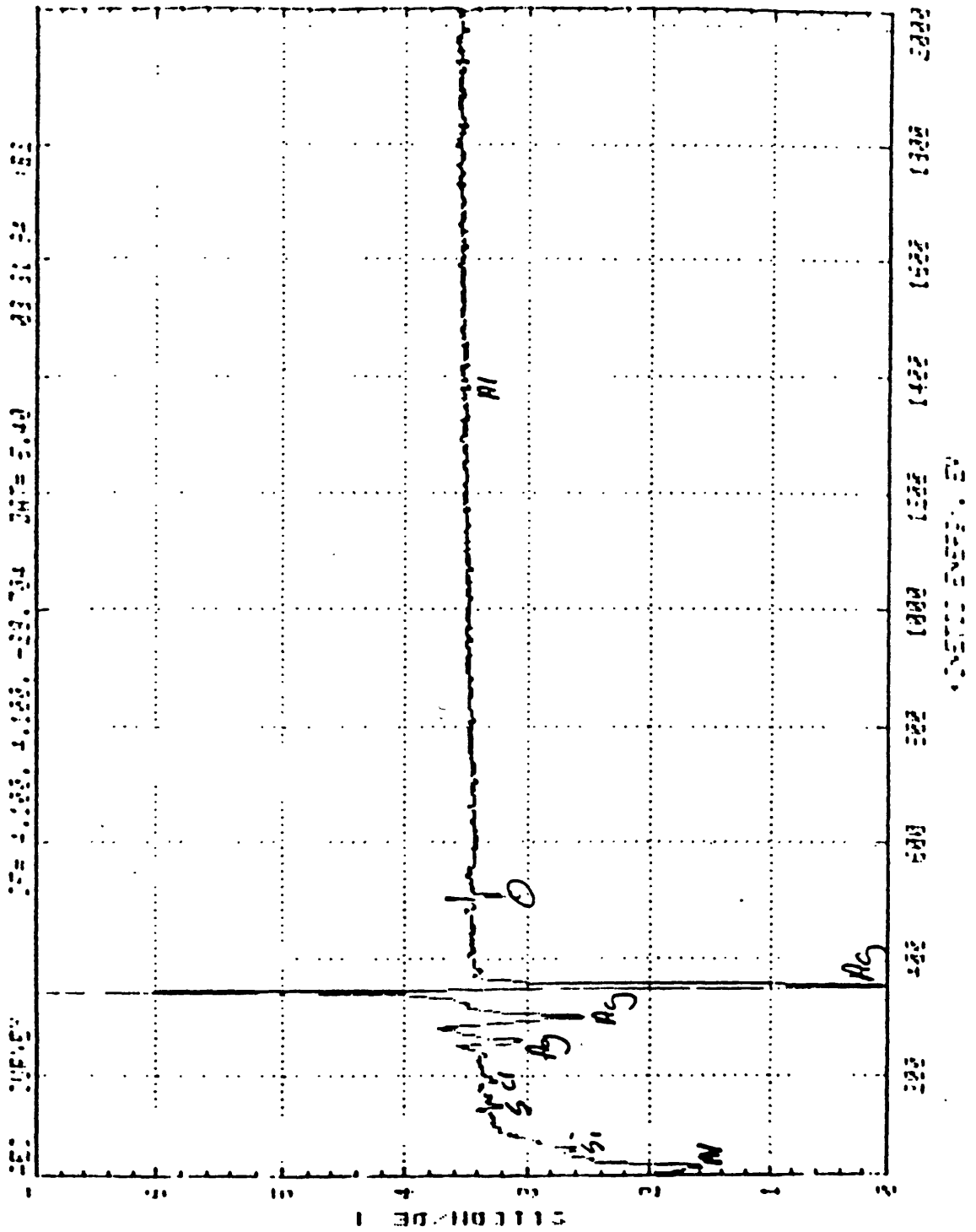

FIGURE 24: AUGER DEPTH PROFILE OF SAMPLE X, TERMINAL S

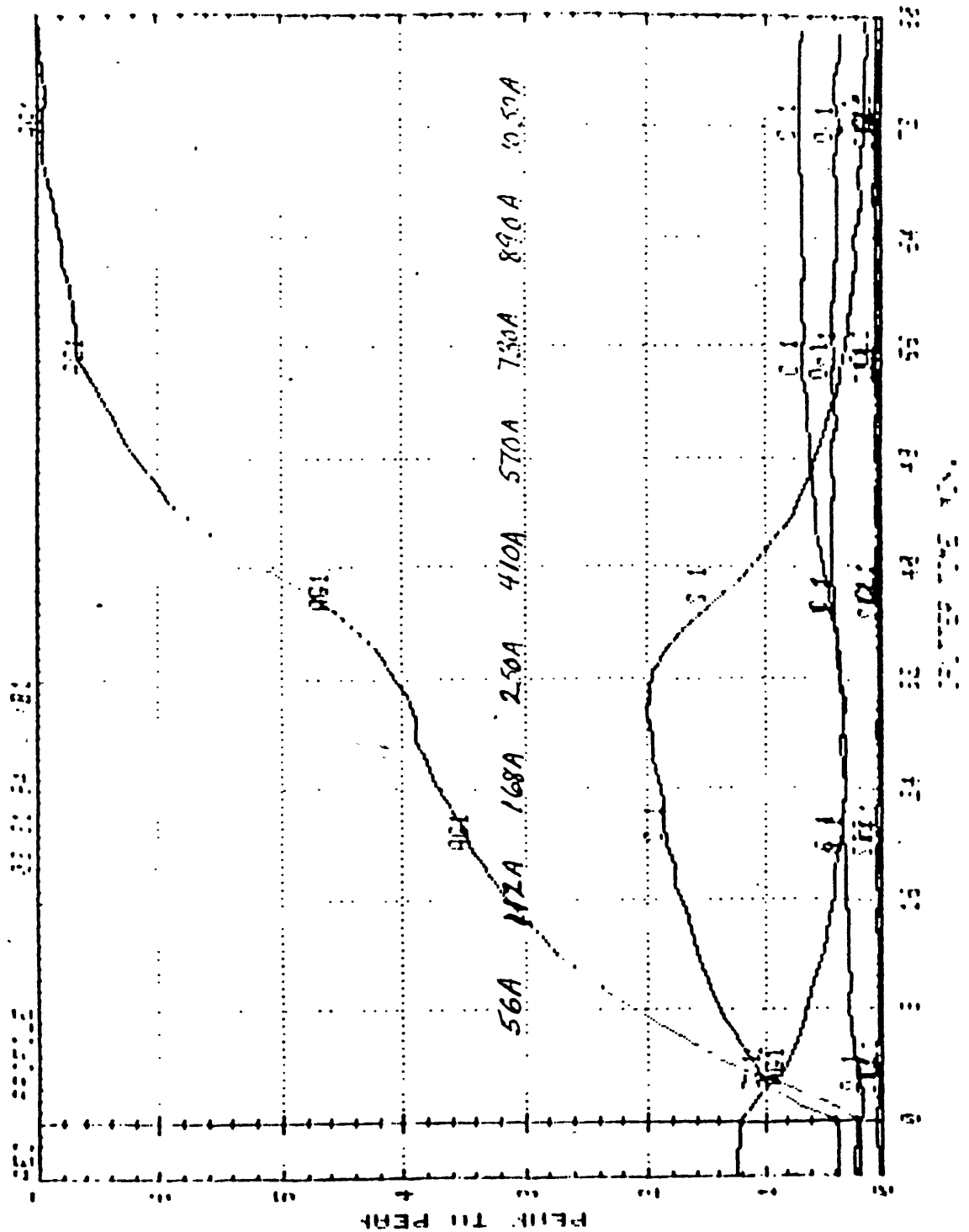

FIGURE 25: AUGER ELEMENTAL SURVEY AFTER PROFILE OF SAMPLE X, TERMINAL S

2.3 Task III: Review and Evaluation of UL 217

UL 217, the "Standard for Single and Multiple Station Smoke Detectors," was reviewed by IITRI to identify inadequacies in required testing, test conditions and acceptance criteria that allow time- and contamination-dependent failure mechanisms to escape detection during specified testing, yet occur under field use conditions. The review was based on the results of Tasks I and II; discussion with CPSC personnel; previous IITRI experience concerning environmental and reliability testing; contact failure modes and mechanisms; and other industry related efforts.

Required corrosion testing is described in paragraph 62, Corrosion Test of the UL Standard. The smoke detectors are tested for sensitivity before and after exposure to the corrosive atmospheres. Exposure to the corrosive atmospheres is performed in two steps. The procedure does not require the same devices to go through each step. Paragraph 62.1.2 states that two samples are to be exposed to a moist hydrogen sulfide - air mixture. Paragraph 62.1.3 states two samples are to be exposed to a moist carbon dioxide - sulphur dioxide air moisture.

A literature search [9, 10, 11, 12, 13] identified that accelerated corrosion testing of electrical contacts currently performed use flowing mixed gases (FMG) that simulate operating environments. A typical mixture consists of H₂S, nitrogen dioxide (NO₂) and chlorine (Cl₂) in a humid environment at 30°C. The proper simulation of the sulfide-chloride interaction to approximate the field environment is necessary for realistic testing. It has also been shown that SO₂, though widely used in the past, does not enhance the corrosion testing of most metals. Flowing mixed gas environments are defined to closely simulate various field environments.

Testing of powered electrical contacts using FMG, although increasing the rate of corrosion over that of unpowered testing, is not applicable to smoke detector contacts which are unpowered until the alarm is triggered [14].

Temperature cycling or vibration, which can cause mechanical motion within the separable connector interface, is also necessary to simulate field conditions. This action, which is necessary for fretting corrosion, can be attributable to the displacement caused by material temperature coefficient of expansion (TCE)

differences. Comparison of the contact contamination analysis resulting from smoke detector field use and UL 217 corrosion testing provided different results. The UL 217 testing does not simulate the smoke detector field environment. Discussions with Paul Patty of UL revealed that Battelle is presently using FMG to test carbon monoxide detectors for UL. These carbon monoxide detectors use the same type of horns used in smoke detectors.

The development of proposed changes to UL 217 corrosion testing will be predicated on the following:

- Flowing mixed gas testing
- Combination of necessary test gases
- Relative humidity and temperature test requirements
- Vibration or temperature cycling during FMG testing

Several inconsistencies were also identified during UL 217 review concerning smoke detector reliability and reliability prediction. These are:

- Latest version of MIL-HDBK-217 is not required for reliability predictions
- Horn reliability contribution is specifically omitted from the reliability prediction
- Horn reliability testing requirements are not included

2.3.1 Aerosol Smoke Detector Tester Evaluation

The aerosol smoke detector tester used to field test the units furnished to IITRI for evaluation was analyzed to determine what contaminants it contained. The material supplied to IITRI by CPSC was applied to clean aluminum foil and analyzed using SEM and EDAX. The materials detected in the spray by these tests were carbon and oxygen. This is what would be expected of a phthalate material, which is the main ingredient listed on the vendor-furnished safety information data sheet. No chlorine, sulphur or other detrimental material was detected.

An FTIR test was also run on a sample of the smoke detector tester material. This test confirmed that the smoke detector tester forms an organic film. The closest match found was dioctylphthalate.

2.4 Task IV: Development of UL 217 Recommendations

Tasks I, II and III results were reviewed to assist in the preparation of practical, technically sound and cost effective recommendations for inclusion in UL 217, either as additions or changes to address life limiting separable contact deficiencies. Additionally, testing and evaluation studies relating to electrical contacts [1, 3, 5, 6, 15] were reviewed for applicability to this effort.

As stated earlier, the approach to determine the reliability or life limiting characteristics of a component is to first identify the failure mechanisms attributable to the particular (separable) component, then to effectively develop or modify test procedures and conditions to eliminate a defect. Understanding the variables that contribute to the defect is necessary. This study has shown that the reliability of a separable contact is a function of contact materials, use environment and contact interface motion. If all three of these items are not considered when the test procedure is developed, higher field failure rates than what were determined during testing and analysis will result.

It was established as part of this effort's testing that fretting corrosion was the major failure mechanism causing the deterioration of smoke detector horn separable contacts. Fretting corrosion is one of several corrosion mechanisms (i.e., pore corrosion, corrosion product creep) that can occur at connector interfaces. The generation of fretting corrosion products requires two conditions. The presence of contaminants and relative motion between the two halves of the contact. Temperature cycling is the major cause of relative motion between the separable contact halves because the horns are constructed of materials (plastics, metals, ceramics) that have different thermal coefficients of expansion.

The summarization of this effort's testing results also leads to the conclusion that the UL 217 accelerated corrosion testing does not simulate the field environment that smoke detectors are exposed to. The UL 217 corrosion testing employs single gases (either H₂O or SO₂) sequentially, not in combination. Analysis of these test results, in general, have not been correlated with field results. Additionally, contact resistances measured after the UL 217 corrosion testing were much lower than the measurements taken on contacts from smoke detectors that failed in the field. The Battelle Flowing Mixed Gas (FMG) corrosion testing

procedure simulates the degradation mechanisms that exist in indoor areas. Battelle studies indicate that the films generated by mixed gas testing appear to have similar chemistries and electrical effects to those from field experience [12]. Table 14 illustrates the various environments defined for FMG testing. The majority of the data collected has been from results using test/class III. The gas moisture for test/class III consists of 100ppb of H₂S, 20ppb of Cl₂ and 200ppb of NO₂. The test is run at 70% relative humidity with an operating temperature of 30°C. The purpose of using flowing mixed gases is to take advantage of their interaction to accelerate film growth over single gas testing [19]. NO₂, in particular, acts as a catalyst in the film growing process.

TABLE 14: FMG ENVIRONMENTS BY COMPOSITION

Test/Class	Gas Concentration, ppb			% RH	T, °C
	H ₂ S	Cl ₂	NO ₂		
I	-	-	-	-	-
II	10	10	200	70	30
III	100	20	200	70	30
IV	200	50	200	75	50

Additionally, the CPSC in-house evaluation and this effort identified that failures were intermittent. That is, in some cases, a high resistance (bad) contact reverted to a low resistance (good) contact and back again. This agrees with the point conduction mechanism theory, where fretting corrosion causes resistance change through motion within the interface. Therefore, an environmental stress (e.g., temperature cycling, vibration) to impose mechanical displacement must be included as part of the FMG test. Several references have recently stated the importance of this motion [6, 15].

Many types of separable connectors use insertion of one element into the other to make the connection. Pressure is created during the insertion and good mechanical, as well as electrical, contact is made. However, the smoke detector connector is a static contact that mates two surfaces using spring pressure. This arrangement could allow easy displacement, thereby promoting changes in contact resistance.

2.4.1 Alternate Contact Methodology

Self-wiping contacts and contact lubricants are techniques for improving contact reliability. Self-wiping connectors rely on the physical force of mating, unmating and remating periodically to establish good contact. The present smoke detector separable contact design is not of the self-wiping type, nor is the detector designed to be periodically disassembled and reassembled. Redesign of the evaluated smoke detectors would be necessary to gain a benefit from a self-wiping contact. However it has also been demonstrated that disengagement and reengagement can cause the resistance of a contact to decrease or increase [16]. The use of self-wiping contacts to improve connector reliability should be made on a case-by-case basis. Laboratory/field test data are needed to demonstrate effectiveness before acceptance.

Another technique for improving connector reliability is the use of lubricants [7]. Preliminary testing of two samples performed by IITRI indicated significant decrease in contact resistance. However, a review of the literature indicates that little effort has been performed on evaluating stationary contacts. Lubricant testing must be performed for each material considered for use in stationary contacts to determine the following:

- Fretting inhibitor - provide an atmospheric barrier during contact motion
- Contamination effects
 - Long term protection
 - Non-reactive with contact material
 - Low creep

Of the two alternate connector technologies, the use of lubricants is considered the most promising. Lubricants have widespread use in the semiconductor industry, especially in zero force connectors.

2.5 Accelerated Testing Data Analysis

Two different methodologies were used to analyze the data summarized in Table 9. The first utilized regression analysis to identify trends in the contact resistance change, predict the number of temperature cycles-to-failure based on the regression model, and analyze the predicted cycles-to-failure data with Weibull analysis. The second methodology also used a Weibull analysis, but used only the

actual, observed failures (of which there were five) and treated all others as survivals.

2.5.1 Methodology 1

The objective of this methodology was to model the resistance change of each contact as a function of the number of temperature cycles and to use these models to predict a number of cycles to failure. Several model forms were considered. The first was a third order polynomial. While this form could very accurately fit the data between 0 and 2000 cycles, it is of very limited value when extrapolating the observed resistance values to the resistance required for failure as a function of the number of temperature cycles. This limitation is due to the fact that the higher order terms in the model will dominate beyond the 2000 cycles tested to the point where unrealistic estimates are predicted. Therefore, the following model form was chosen:

$$R = R_1 (NC)^x$$

where:

- R = Contact resistance
- R₁ = Initial contact resistance before cycling
- NC = Number of cycles
- x = Constant fit to the data

Although this model was determined to be superior, its basic premise is that the resistance value changes monotonically. Since only 22 contacts exhibited monotonically increasing resistance, models were derived for only those 22. The remainder of the contacts were treated as survival data, since their resistance value was decreasing at the end of the test and, therefore, any prediction would indicate an infinite life. Table 15 presents the results for the contacts exhibiting monotonically increasing resistances. It must be noted that two contacts (11B and 15F) had a predicted number of cycles-to-failure high enough to be considered survivals. Therefore, there were only twenty devices analyzed. Listed are the contact, R₁, the exponent constant, and the predicted number of cycles until failure.

TABLE 15: RESISTANCE REGRESSION ANALYSIS RESULTS

Contact	R_1	x	Number of Cycles to Failure
11B	2.77	.08	2.8×10^{36} *
12B	.39	.79	65,900
15B	.23	.68	862,000
21B	.33	.83	47,200
37B	120.6	.16	1.7×10^8
42B	.47	.74	1.1×10^5
2S	.40	.44	4.2×10^8
11S	.71	.19	4.6×10^{18}
15S	.36	.18	2.2×10^{21}
16S	.03	.27	1.7×10^{18}
18S	.14	.21	1.7×10^{20}
21S	.37	.53	1.7×10^7
26S	.88	.31	1.4×10^{11}
44S	.25	.44	1.2×10^9
2F	.27	.44	1.0×10^9
11F	.09	.30	6.5×10^{14}
15F	.56	.12	2.6×10^{30} *
16F	.07	.16	2.8×10^{28}
18F	.24	.34	6.6×10^{11}
34F	.82	.18	2.3×10^{19}
37F	.08	.40	1.7×10^{11}
44F	.62	.55	3.6×10^6

* Numbers large enough to be considered survivals.

These times to failure were then plotted on Weibull paper to determine the characteristic life (η) and the shape parameter (β). Figure 26 presents the Weibull plot for this data with the addition of the five actual failures, and indicates $\eta = 2.7 \times 10^{14}$ and $\beta = .097$.

This methodology extrapolated the observed resistance change over the 2000 cycle test to a number of cycles that might be expected to cause contact failure. This extrapolation distance, however, is very large and thus there is little confidence that the predicted cycles to failure is accurate. This is especially true given the highly variable behavior of the contact resistances. It is interesting to note, however, that for the 22 contacts exhibiting monotonically increasing resistance values, the exponents (x) were all less than one. This indicates that the rate of increase in contact resistance decreases with an increasing number of cycles.

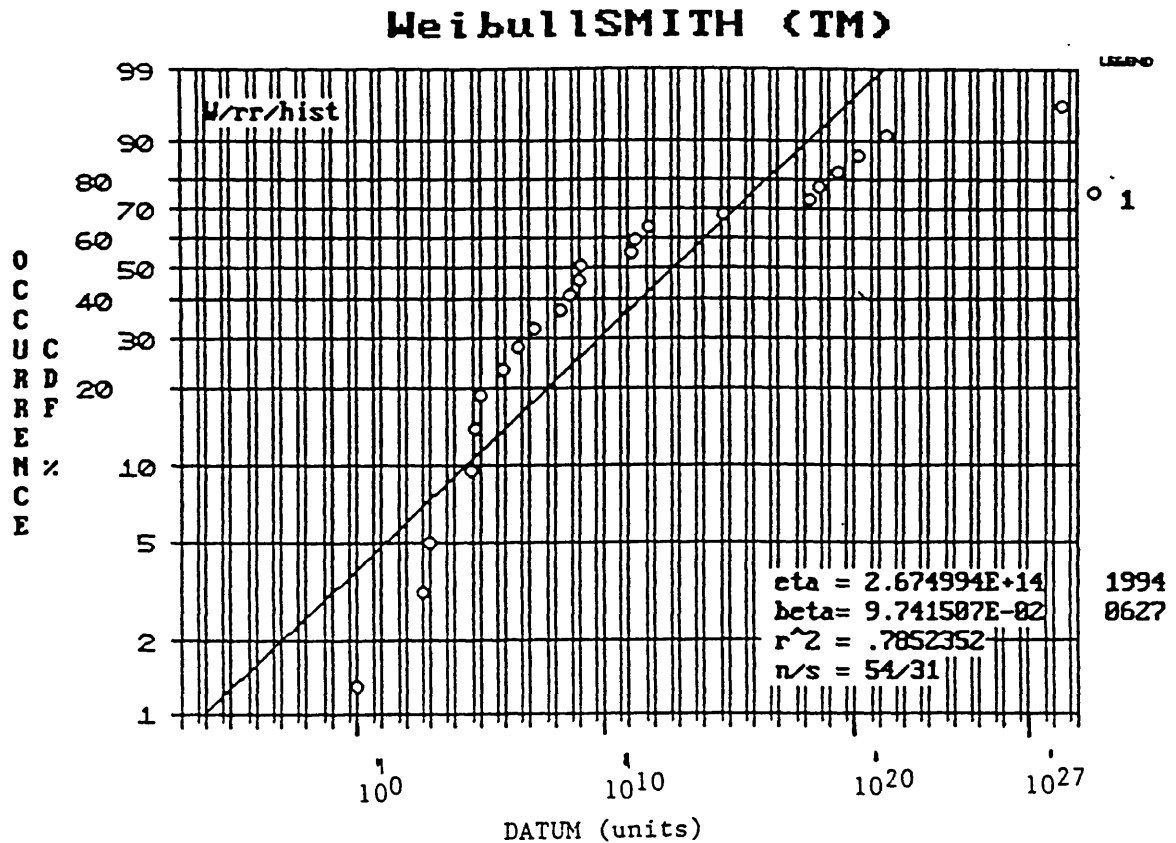

FIGURE 26: WEIBULL PLOT OF PREDICTED CYCLES TO FAILURE

2.5.2 Methodology 2

The second methodology also utilized Weibull Analysis, but only considered the three infinite resistance contacts (16B, 41B and 42S) and the two contacts greater than 2500 ohms (28F, 34B) as true failures. All other contacts were considered survivals after 2000 cycles. The three infinite resistance failures were observed at 0, 500 and 1000 cycles and the two greater than 2500 ohms were at 500 and 1000 cycles. Figure 27 is a Weibull plot of this data with the lower 95% confidence level.

2.5.3 Data Analysis Conclusions

There is no obvious trend in the behavior of the contact resistance as a function of temperature cycling. Of the 54 contacts analyzed, 22 exhibited monotonically increasing resistances. It is interesting to note, however, that the exponent fit by the regression analysis that describes the rate of resistance change for the 22 contacts

analyzed was between 0 and 1. This indicates that the rate of resistance change slows as the number of cycles is increased. The remaining 36 contacts exhibited randomly fluctuating or decreasing resistance values. One of the objectives of this analysis was to determine if wearout characteristics were evident based on the limited data taken. From the analysis, there is no evidence of wearout based on the very low beta values observed. Values greater than one indicate wearout characteristics (failure rate increasing in time) and values less than one indicate infant mortality characteristics (failure rate decreasing in time). All of these observations are consistent with fretting corrosion.

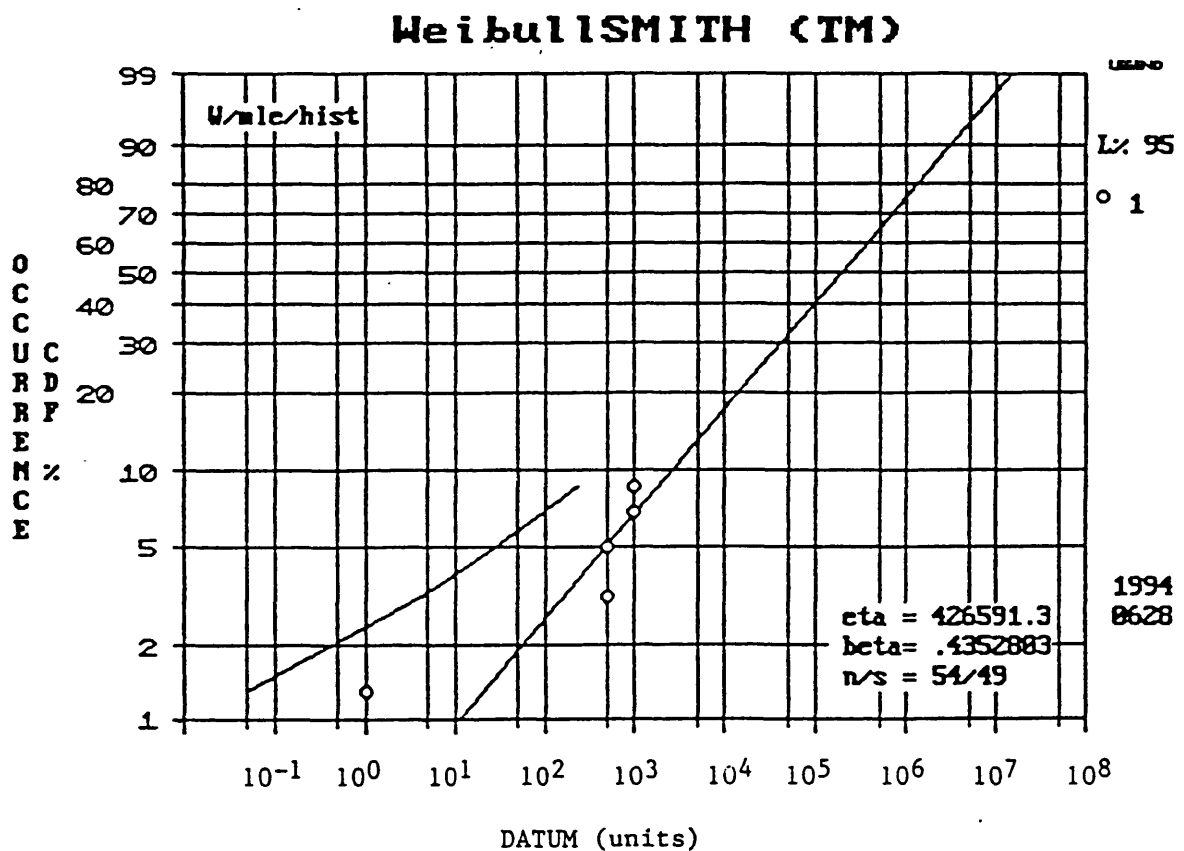

FIGURE 27: WEIBULL PLOT (WITH LOWER 95% CONFIDENCE LEVEL)

It must also be noted that the change in temperature of 50°C to 80°C does not necessarily correlate to field use conditions. Therefore, correlating these test results to actual conditions of use would require an accurate acceleration factor as a function of temperature cycling extremes.

3.0 SUMMARY OF FINDINGS

The major goals of this study were to identify the failure mechanism(s) causing the deterioration of residential smoke detector separable electrical contacts and to develop recommendations to improve UL 217, the Standard for Single and Multiple Station Smoke Detectors, to ensure that contact degradation will not compromise smoke detector operability. The following major items were investigated to achieve these goals.

3.1 Separable Contact Failure Mechanism

It has been established that the separable horn contacts used for smoke detectors can fail in an open condition with extended exposure to contaminants (i.e., chlorine, sulphur) and contact motion.

Accelerated temperature cycling was performed to simulate contact motion and confirmed that fretting corrosion is the failure mechanism. Because fretting corrosion depends on relative motion between the two separate halves of the contact, the resistance buildup at the contact is slow and irregular and includes both a lowering and raising of contact resistance with time. The fretting process is one of alternating increases and decreases in contact resistance. This process, on a statistical basis, is one that slowly builds up contact resistance until the contact becomes open. Relative motion on a high resistance contact breaks down the corrosion film and can cause the contact to conduct again. This explains why most of the reported field failures that were collected by CPSC and sent to IITRI for evaluation functioned properly when initially tested at CPSC and IITRI.

3.2 Contact Area Contamination

Surface analyses showed that both chlorine and sulphur were present in the contact areas of all horns tested that were reported as failures in the field. Film thicknesses up to 2000^oA were measured on the contact areas.

STUDY OF DETERIORATION OF SEPARABLE ELECTRICAL CONTACTS IN SMOKE DETECTORS

Fourier Transform Infra Red (FTIR) testing and ultraviolet microscopy confirmed that there were no organic films in the contact areas.

3.3 UL 217 Corrosion Testing

The results of the UL smoke detector testing using the UL 217 corrosion test showed this to be an ineffective procedure. This was especially true for non-silver contact areas. Specifically, the test-generated contact contamination differed from contamination occurring on contacts returned from the field. Additionally, contact resistance measurements were lower than those measured on the collected malfunctioning field units.

3.4 Horn Construction

Three basic horn constructions were involved in Task II testing and are referred to in this report as Types A, B and C. The type A horn uses essentially a monolithic construction, meaning any attempt to disassemble it will most likely destroy the horn. Also, the type A horn contacts are protected from accidental damage because they have to be unsoldered to reveal their contacts. On the other hand, the type B and C horns can be easily disassembled, thereby allowing critical contacts to be destroyed. There is also the possibility that the piezoelectric discs in the B and C horns could be replaced upside-down, causing the horn to become inoperative.

To preclude owners from rendering their smoke detectors inoperative during cleaning/disassembly, consideration should be given to indicate "Do Not Disassemble Horn" on the smoke detector housing.

3.5 Failure Modes/Corrective Action

The only failure mechanism identified in the smoke detector effort was associated with the horn separable contacts. However, horn reliability characteristics are not included in the UL 217 reliability prediction procedure, and component level testing to ensure reliability are not defined. Because of these omissions, the effect of good or poor quality horns is usually unknown until smoke detectors are used. The

improvement of separable contact reliability would be a significant advance in the reliability of smoke detectors and result in longer lifetimes for smoke detectors. This can be accomplished through the following corrective actions:

- Model smoke detector horn reliability characteristics and add appropriate factors to UL 217 reliability prediction procedures
- Develop a procedure to determine horn acceptability prior to use in a smoke detector

3.6 Corrosion Mechanism Analysis

Fretting corrosion has been identified as the major failure mechanism involved with the separable contacts of smoke detector horns. Occurrence of this mechanism requires the presence of contaminants, relative humidity, temperature and relative motion between the two halves of the separable contact. Analyses of these conditions were completed to assist in developing corrosion test requirements.

3.6.1 Contaminants

The major contaminants affecting separable contacts come from common gases such as SO₂, H₂S, Cl₂ and NO₂. Most current work evaluating film formation on contacts employs the flowing mixed gas technique. The majority of the data collected has been from testing using 100ppb of H₂S, 20ppb of CL₂ and 200ppb of NO₂. The test is run at 70% relative humidity with an operating temperature of 30°C. The purpose of using mixed flowing gases is to take advantage of their interaction to accelerate film growth over single gas testing. NO₂, in particular, acts as a catalyst in the film growing process.

More recently [17, 18], it has been demonstrated that amorphous SiO₂ can be formed on contact interfaces in the presence of silicone vapors, causing the growth of a glass non-conductive film. Since silicone vapors are common by-products of the decomposition of oils, rubbers, etc., and since silicon and oxygen were present on many of the surface analyses, this mechanism cannot be ruled out at this time.

3.6.2 Relative Motion

Temperature cycling is considered the major cause of relative motion between contact halves. Because the horns are constructed of materials (plastics, metals, ceramics) that have different thermal coefficients of expansion, horn temperature changes will cause displacement of the contact halves.

To simulate and/or accelerate field usage conditions, separable contact testing can be performed in the presence of mixed flowing gases during temperature cycling or vibration. Another important factor in relative motion and fretting corrosion is the contact forces. The effect of contact forces on fretting corrosion needs to be investigated to determine benefits to be gained.

3.7 Aerosol Smoke Detector Tester

Early testing of the CPSC-provided smoke detectors included the use of an aerosol smoke detector. This material was analyzed using SEM, EDAX and an FTIR to determine what contaminants were included. No chlorine, sulphur or other detrimental material was detected.

4.0 CONCLUSIONS

A major finding of this effort is the confirmation that the deterioration of separable contacts in smoke detector horns can cause horn malfunction during a fire situation. The cause of failure is a function of contact materials, operating environment and contact interface motion. The failure mechanism that deteriorates the separable contacts is fretting corrosion, which is an accelerated atmospheric oxidation that forms at metal contact interfaces. Fretting action can promote fast changes in resistance through minute amplitude cyclic motion.

The contaminants carbon, oxygen, chlorine and sulphur were identified in the contact areas of all tested horns that were aged in the field and reported as failures. Lower levels of sulphur were found in the silver contact areas of the horns aged by exposure to the standard UL 217 corrosion testing. The non-silver contact areas did not contain sulphur. Chlorine was found in small quantities on some contact surfaces. Horn contact resistances measured on the UL 217 aged horns were less than those recorded on fielded units. These results show that UL 217 corrosion tests do not simulate field results.

Accelerated temperature cycling performed to simulate fretting corrosion induced open horn contacts and increased the average contact interface resistance. Because of the high impedance circuits involved with the piezoelectric horns, large increases in interface contact resistance are required to cause horn failures. Therefore, even though horn failures (resistance increases) were induced, the probability of a horn failure in the field is not high due to the limited number of field and test failures. However, considering the possible consequence of a malfunctioning horn in a fire situation, any effort to eliminate or reduce this failure mechanism would be worthwhile.

It is recommended that the existing UL 217 corrosion testing be replaced with the Battelle Flowing Mixed Gas (FMG) testing procedure using a Class III environment [12]. Additionally, it is recommended that the effect of contact motion be evaluated and added to the FMG testing procedures, so that testing will accurately define separable contact performance in the field (see Appendix B).

STUDY OF DETERIORATION OF SEPARABLE ELECTRICAL CONTACTS IN SMOKE DETECTORS

The horn separable contacts evaluated in this study rely on spring pressure to create and sustain a good contact. The majority of the contacts were bifurcated, with a few dimpled and point contact types. Another important factor to be considered in fretting corrosion, separable connector motion and contact geometries [19] is contact force. The impact of contact forces and geometries on fretting corrosion problems should be evaluated in order to minimize the effects of this failure mechanism.

Lastly, it is recommended that greater emphasis be placed on assuring horn reliability and quality by implementing the following:

- Develop a horn qualification/screening procedure for inclusion in UL 217 (see Appendix B)
- Include horn reliability characteristics in smoke detector reliability predictions (see Appendix B)
- Develop a design of experiments program to determine minimum acceptable contact force

In summary, the implementation of the above recommendations will enhance smoke detector field performance through improved smoke detector testing, increased horn reliability and accurate reliability assessment.

APPENDIX A
TASK II REPORT

**STUDY OF DETERIORATION OF
SEPARABLE ELECTRICAL CONTACTS
IN SMOKE DETECTORS**

**Contract No. CPSC-C-93-1139
IITRI Project No. A06393**

TASK II TEST PROTOCOL IMPLEMENTATION REPORT

Prepared for:

**U.S. Consumer Product Safety Commission
Attn: Julie I. Shapiro/USCPSC
10901 Darnestown Road
Gaithersburg, MD 20878-2611**

Prepared by:

**John P. Farrell
IIT Research Institute
201 Mill Street
Rome, NY 13440-6916**

TABLE OF CONTENTS

	<u>Page</u>
1.0 INTRODUCTION	1
2.0 TEST PROTOCOL RESULTS	1
2.1 Start Testing	1
2.2 Horn Removal	1
2.3 Run V/I Tests	2
2.3.1 Normal Contacts	2
2.3.2 Non-Linear Contacts	2
2.3.3 Open Contacts	3
2.4 Selection of Units for Cross-Section and Surface Analyses	3
2.4.1 Optical Inspection and Photographic Documentation	3
2.4.2 SEM Inspection of Contacts	3
2.5 Potting and Cross-Sectioning of the Horns	4
2.6 Documentation of Contact Area Materials	4
2.6.1 Optical UV Test for Organics and Sample Preparation	5
2.6.2 Auger (AES) Surface Analyses and Depth Profiles	5
2.6.3 Fourier Transform Infra Red (FTIR) Tests	5
2.7 Develop Failure Root Cause Hypothesis	5
2.8 Accelerated Testing	7
2.9 UL 217 Corrosion Tests	12
3.0 SUMMARY	15
3.1 Open Contact Failure Mechanism	15
3.2 Films Found in Contact Areas	15
3.3 UL 217 Corrosion Testing	16
3.4 Horn Construction	16
3.5 Failure Modes	16
3.6 Corrosion Mechanism Analysis	17
3.6.1 Contaminants	17
3.6.2 Relative Motion	17

LIST OF FIGURES

	<u>Page</u>
FIGURE 1: TEST PROTOCOL FLOW CHART	18
FIGURE 2: NON-LINEAR V/I CHARACTERISTICS OF A SMOKE DETECTOR HORN CONTACT.....	19
FIGURE 3: SEPARABLE CONTACTS ON A SMOKE DETECTOR HORN.....	19
FIGURE 4: CONCEPTUAL CROSS-SECTION OF HORN DISK AND CONTACTS.....	20
FIGURE 5: BIFURCATED CONTACT F ON OLDER HORNS.....	20
FIGURE 6: DIMPLED CONTACT F ON NEWER HORNS.....	21
FIGURE 7: BIFURCATED CONTACT B	21
FIGURE 8: BIFURCATED CONTACT SEPARATED FROM HORN.....	22
FIGURE 9: DIMPLED CONTACT SEPARATED FROM HORN	22
FIGURE 10: SEM PHOTOGRAPH OF A BIFURCATED CONTACT.....	23
FIGURE 11: SEM PHOTOGRAPH OF A DIMPLED CONTACT.....	23
FIGURE 12: TEMPERATURE CYCLE PROFILE FOR ACCELERATED SMOKE DETECTOR HORN TESTS	24
FIGURE 13a: TOP VIEW TYPE A HORN	25
FIGURE 13b: BOTTOM VIEW TYPE A HORN	25
FIGURE 14a: TOP VIEW TYPE B HORN.....	26
FIGURE 14b: BOTTOM VIEW TYPE B HORN.....	26
FIGURE 15: TERMINAL S CONTACT PAD UNIT A BEFORE CORROSION TEST - SO ₂	27
FIGURE 16: TERMINAL F CONTACT PAD UNIT B BEFORE CORROSION TEST - H ₂ S	28
FIGURE 17: TERMINAL B CONTACT PAD UNIT C BEFORE CORROSION TEST - H ₂ S/SO ₂	29
FIGURE 18: TERMINAL S CONTACT PAD UNIT A AFTER CORROSION TEST - SO ₂	30
FIGURE 19: TERMINAL F CONTACT PAD UNIT B AFTER CORROSION TEST - H ₂ S	31
FIGURE 20: TERMINAL B CONTACT PAD UNIT C AFTER CORROSION TEST - H ₂ S/SO ₂	32
FIGURE 21: TERMINAL F CONTACT PAD UNIT C AFTER CORROSION TEST - H ₂ S/SO ₂	33

1.0 INTRODUCTION

This report summarizes the results of testing that was performed during the completion of the smoke detector test protocol. The detailed back-up information for this report appears in the monthly status reports.

Fifty smoke detectors were supplied by the Consumer Product Safety Commission (CPSC) to IIT Research Institute (IITRI) for test and evaluation. Forty-seven of these smoke detectors were identified as having failed in the field and twenty of these had been in fire situations. Three new units were provided for control samples.

Fifteen horns were selected from those that had been reported as failed in the field and two new horns to be used as control units were selected for preliminary testing based on information supplied by CPSC. This information detailed the results of the CPSC evaluation of the 50 smoke detectors.

All units were tested at IITRI for functionality using the test button with twelve units passing the test and five units failing. Electrical signals (voltage, waveshape, frequency) at each of the three terminals on every horn were also measured using an oscilloscope. These measurements confirmed that, for the five failed units, the proper electrical signals were present to operate a good horn. Throughout all of the IITRI smoke detector investigation to date the only failures detected have been due to the separable connectors on the horn elements.

2.0 TEST PROTOCOL RESULTS

Figure 1 shows the approved test protocol flow chart. The following sections describe the results of all test and evaluations.

2.1 Start Testing

Testing per the protocol was started with the preselected seventeen units discussed in the introduction. Six of these were units that had previously failed operational tests in the field but had not been in a fire situation. Nine units had previously failed operational testing and had been in a fire situation. The remaining two units were new and will be used as controls.

2.2 Horn Removal

The horns were removed from all seventeen smoke detectors and tested in a horn test platform for failure verification. The same five horns that failed prior to removal failed at this time. Three of these had been in a fire situation and two had not. All of the remaining twelve horns tested good.

2.3 Run V/I Tests

The conduction mechanism of the deleterious film(s) that builds up in the interface between two separable metal contacts can be explained using quantum or semiconductor physics. Because of this relationship, a great deal can be learned about specific conduction mechanisms by studying the V/I (voltage current) characteristics of the interface layers. The V/I plots generated in this study were obtained using a Tektronix curve tracer that is designed to look at semiconductor junctions. Photographs and a video recorder tape were used to document the V/I characteristics. The V/I characteristics are identified in three contact categories: normal, non-linear and open.

2.3.1 Normal Contacts

Normal contacts appear as a vertical trace on the curve tracer. Because high current can clear or open marginal contacts, the current through the contacts during curve tracer measurements was limited to $\pm 5 \mu\text{A}$. At this current level contact resistances of about 1000 ohms would still appear as vertical traces on the curve tracer even at 100 mV per division on the voltage axis. The main purpose of the V/I testing was to determine if the contacts had linear conducting V/I characteristics, non-linear conducting characteristics or non-conducting characteristics. Forty-two of the fifty-one horn contacts tested on the curve tracer had "normal" contact characteristics. That is, none of these contacts should have caused a horn to malfunction. In fact, all of the horns that had normal contact characteristics on all three contacts functioned properly.

2.3.2 Non-Linear Contacts

The non-linear V/I contact characteristics are those that can be identified through curve tracer testing. A non-linear V/I characteristic indicates that a thin non-conductive layer has formed in the contact interface. Figure 2 is a photograph of a non-linear V/I characteristic exhibited by a horn contact. In this case the forward diode breaks down at about 1.75 volts and the reverse breakdown is at about 1 volt. As the voltage is increased by ± 5 volts then very little current (less than $.1 \mu\text{A}$) flows through the contact in either polarity. Through tunneling and film breakdown the current increases rapidly. Figure 2 also shows the instability in the contact interface. If the current is increased the film will break down and the V/I characteristic will return to a linear characteristic. As a result in a horn circuit when the voltage across a non-linear contact is not large enough to cause breakdown of the film, the horn will malfunction. Five of the fifty-one horn contacts that were tested displayed non-linear V/I characteristics and were in malfunctioning horns. Two of these contacts had not been in fire situations while three of them (two on one horn) had been involved with a fire environment.