



UNITED STATES
CONSUMER PRODUCT SAFETY COMMISSION
BETHESDA, MD 20814

Memorandum

Date: May 9, 2012

TO : Dale R. Ray, Project Manager, Upholstered Furniture Project

THROUGH: George A. Borlase
Associate Executive Director, Directorate for Engineering Sciences

Patricia K. Adair
Director, Division of Combustion and Fire Sciences

FROM : Shivani Mehta
Fire Protection Engineer, Division of Combustion and Fire Sciences

SUBJECT : Upholstered Furniture Full Scale Chair Tests – Open Flame Ignition Results and Analysis.

1 BACKGROUND

The U.S. Consumer Product Safety Commission (CPSC) proposed a flammability standard for residential upholstered furniture under the Flammable Fabrics Act (FFA).¹ The proposed standard establishes performance requirements to reduce the likelihood of smoldering-induced ignition of upholstered furniture. Manufacturers of upholstered furniture could choose one of two possible methods for compliance: (1) use cover materials that are sufficiently smolder resistant to meet the specified cigarette ignition performance test, *i.e.*, “Type I” furniture; or (2) incorporate fire barriers between the cover fabric and interior filling materials that meet smoldering and small open-flame resistance tests, *i.e.*, “Type II” furniture. The proposed standard also details labeling requirements for upholstered furniture. The proposed rule would require manufacturers of upholstered furniture to certify compliance with the standard and to comply with certain record-keeping requirements.

In developing the proposed flammability standard to address smoldering ignition of residential upholstered furniture, CPSC staff considered the available hazard information and existing standards development research, together with the latest CPSC test results and technical information developed by other organizations. Economic, health, and environmental factors were also considered.

The proposed standard addresses resistance to smoldering ignition and limited fire growth by means of bench-scale performance tests for cover fabrics or, alternatively, for fire barriers. Cover fabrics must meet smoldering ignition-resistance requirements. If fire barriers are chosen as the means of compliance, they must meet both small open-flame and smoldering ignition-resistance requirements. The proposal adapts elements and variations

¹ 73 F.R. 11702. “16 CFR Part 1634, Standard for the Flammability of Residential Upholstered Furniture; Proposed Rule” March 4, 2008.

of existing standards, including California Technical Bulletin 117,² ASTM E-1353³ (tests from the Upholstered Furniture Action Council (UFAC) industry-consensus voluntary guidelines), and United Kingdom regulations (based on British Standard BS-5852⁴).

CPSC staff is performing bench-scale and full-scale tests to assess the potential effectiveness and benefits of the proposed standard. Testing will include an evaluation of Type I (smolder-resistance of cover fabrics) and Type II (smolder- and small open-flame resistance of fire barriers) compliant upholstered furniture. This report presents staff's evaluation of open-flame ignition resistance of full-scale, Type II upholstered chairs.

The proposed standard does not require full-scale tests for compliance of any materials. The objective of conducting full-scale tests was to characterize the performance of proposed bench-scale tests as a reliable predictor of full-scale furniture fire performance. Specifically, the purpose of the testing is to evaluate the effectiveness of the fire barrier for chairs of different fabrics and foams, as measured by the peak heat release rate and the time to reach the peak heat release.

2 TEST DESCRIPTION

Flammability performance of full-scale furniture constructed with Type II barriers was compared with flammability performance of furniture constructed without fire barriers. Since there are no standard test procedures or pass/fail criteria for fire barriers in full-scale furniture, the CPSC tasked the National Institute of Standards and Technology (NIST) to aid in developing a test protocol and to perform the tests at the NIST Large Fire Laboratory (LFL).

2.1 Test Room

An ISO 9705-⁵compliant room, as shown in Figure 1, was constructed and instrumented. An ISO 9705-size room is typically used when evaluating the heat release rate (HRR) of upholstered furniture.

- The wood-stud constructed walls were covered with two layers of Type C gypsum wallboard on the interior surface. The wallboard paper covering was burned off before testing because the burning paper could generate a sharp HRR spike that would interfere with the test furniture heat release data.
- A piece of Durock^{®6} was placed in a catch pan under the test specimen to collect any debris during testing.
- A heat flux gauge was placed in the middle of the room at floor level, pointing up toward the ceiling.

² CA TB 117, Test Procedures and Apparatus for Testing the Flame Retardance of Resilient Filling Materials Used in Upholstered Furniture. 2000.

³ ASTM E1353, Standard Test Methods for Cigarette Ignition Resistance of Components of Upholstered Furniture.

⁴ BS-5852, Methods of test for assessment of the ignitability of upholstered seating by smouldering and flaming ignition sources. 1990.

⁵ ISO 9705:1993, Fire tests - Full-Scale Room Test for Surface Products.

⁶ Durock[®] is a cement board.

- Two thermocouple (TC) trees were placed in the room to measure the vertical temperature gradients at two different locations. Each tree consisted of eight thermocouples positioned at eight heights, including one inch from the ceiling and at seven, 1-foot intervals from the ceiling. One tree was located near the chair and the other in the front of the room, near the doorway.
- Carbon monoxide (CO) and carbon dioxide (CO₂) sensors were located directly outside the room at door height and were used to measure CO and CO₂ levels in the upper gas layer in the room.
- Two paper signs were located at 48 and 72 inches above the floor, one at standing height and one at seated height, to note the rate of smoke layer growth in the room by observing loss of visibility of the paper signs when viewed from the doorway.
- Video cameras were placed at four locations: two cameras were focused on the chair seat, one on a side arm and one under the chair.

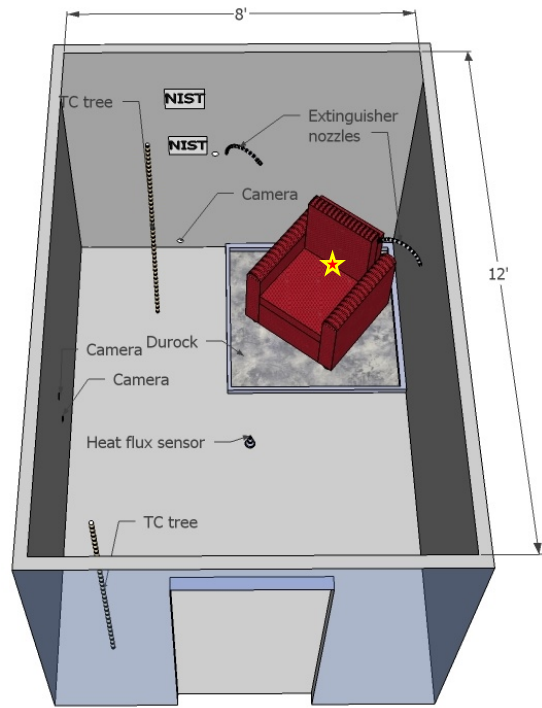

Figure 1. Schematic of ISO Room

2.2 Test Procedure

The sample chairs were conditioned at $21^{\circ} \pm 3^{\circ}\text{C}$ ($70^{\circ} \pm 5^{\circ}\text{F}$) and at a relative humidity of between 50 percent and 66 percent for at least 48 hours at the NIST LFL. After conditioning and within 10 minutes of ignition start time, a sample chair was placed on the Durock® board in the far right corner of the ISO 9705 room for the tests, as shown in Figure 1.

A 240 mm butane flame⁷ was applied at in the center of the crevice of the seat and back cushion for 70 ± 1 seconds (see star on Figure 1). The heat release rate data were observed in real time on an overhead monitor. The test was allowed to continue until the peak heat release rate (PHRR) was observed. Time to melt dripping,⁸ smoke obscuration, and full sample involvement in the fire were visually observed and annotated while tests were being conducted.

Sixty-four chairs were tested in this evaluation. The chairs were constructed with different combinations of a fire barrier, foams, and cover fabrics to characterize their flammability performance, in accordance with a statistical plan developed by the CPSC Directorate for Epidemiology staff. A description of the materials and combinations is detailed in the next section of this report.

⁷ This is the same ignition source specified in the proposed standard to test mock-ups with barriers.

⁸ In this report, melt dripping refers to the melted foam dripping as a liquid.

3 DESCRIPTION OF TEST SAMPLES

The chairs used in this evaluation were made to order based on CPSC staff specifications for fabrics, foams, and a fire-barrier installed on a basic wooden frame. The materials, chosen on the basis of previous bench-scale testing by CPSC Directorate for Laboratory Sciences (LS), were all commercially available and were purchased by the furniture manufacturer.

3.1 Test Samples

CPSC contracted with a residential furniture manufacturer to procure materials for and assemble 64 chairs in 16 combinations. The materials that make up the 16 combinations are listed in Table 1. A schematic of the chairs is shown in Figure 2, and a partially upholstered chair is shown in Figure 3. The chair manufacturer obtained the materials as specified above. The chairs were assembled with either nonfire-retardant (SPUF) or fire-retardant (FR) foam, covered with either a fire barrier or typical polyester batting, and the specified cover fabric.

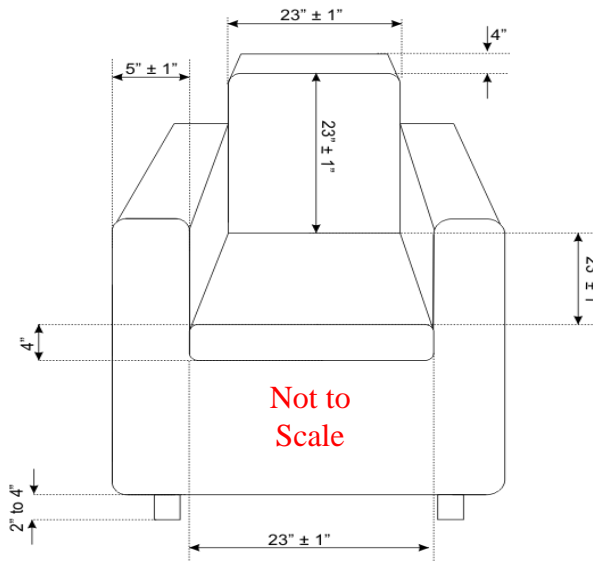

Figure 2. Schematic of Sample Chair



Figure 3. Prototype of Partially Upholstered Chair

Table 1. Chair Material Combinations for Full-Scale, Open-Flame Testing

Combination	Foam	Polyester batting	Barrier	Cover Fabric	Number of chairs
1	SPUF		✓	1a	4
2	SPUF	✓		1a	4
3	FR		✓	1a	4
4	FR	✓		1a	4
5	SPUF		✓	1b	4
6	SPUF	✓		1b	4
7	FR		✓	1b	4
8	FR	✓		1b	4
9	SPUF		✓	2a	4
10	SPUF	✓		2a	4
11	FR		✓	2a	4
12	FR	✓		2a	4
13	SPUF		✓	2b	4
14	SPUF	✓		2b	4
15	FR		✓	2b	4
16	FR	✓		2b	4

3.2 Cover fabrics

Four groups of 16 test chairs were constructed with four different cover fabrics as described in Table 2. Fabrics 1a and 1b were shown to be highly smolder prone, while Fabrics 2a and 2b were shown to exhibit inconsistent smolder resistance, as determined in prior testing conducted at the CPSC Laboratory.⁹ The fabrics were selected because of these smoldering characteristics.

Table 2. Cover Fabrics for Full-Scale Tests

Fabric Code	Fiber	Weight (oz/yd ²)	Weave
1a	100% cotton	8	Twill
1b	100% cotton	20	twill (denim)
2a	100% cotton	7	Jacquard
2b	100% cotton	8	Matelasse

3.3 Foam

Full-scale chairs were constructed with commercially available foams, including SPUF and FR foam to observe any difference in flammability behavior when a barrier was used. The

⁹ In the bench-scale tests, these fabrics were neither always smoldering nor never smoldering when exposed to a burning cigarette.

batch of foam used in this test series was not tested in mock-ups prior to the tests. The foams were specified from the foam manufacturer as follows:

Non-FR SPUF Foam:

- Density: 1.8 ± 0.1 lb/ft³;
- Indentation Load Deflection (ILD): 25% to 30%;
- Air Permeability: Greater than 4.0 ft³/min; and
- No flame-retardant chemical treatment, as determined by post production chemical analysis.

FR foam was specified as foam that meets California Technical Bulletin 117 (TB 117) requirements.

3.4 Fire-Barrier System

The purpose of the open-flame tests is to evaluate the performance of fire barriers. A series of tests conducted by CPSC Directorate for Laboratory Sciences staff identified a fire-barrier system consisting of a combination of polyester batting over a commercially available fire barrier, which met the requirements for the proposed Type II tests. **Error! Bookmark not defined.** This fire-barrier system was used for the full-scale testing.

- The fire barrier was a needle-punched sheet barrier containing 47 percent fiberglass, 50 percent modacrylic and 3 percent polyester fibers.
- The 100% polyester batting was nominally 4 oz/yd², 0.375" thick, nonwoven construction.

3.5 Polyester Batting

The chair design was intended to represent conventional residential furniture as found in the market. CPSC staff has been advised by manufacturers that it is common practice to place a thin layer of polyester batting between the foam cushion and cover fabric. The 100% polyester batting was nominally 7 oz/yd², 0.75 inch thick, nonwoven.

4 DATA AND OBSERVATIONS

During the tests, specific events in each test were observed and noted. Heat flux was measured in the center of the room, and CO and CO₂ levels were recorded from the effluent gases in the exhaust hood. Additionally, flame spread across the cushions, melt dripping, pool fires, smoke layer, and full involvement of the chair were observed during the tests. Thermocouple trees located in the room measured temperature, and HRR was also measured via oxygen consumption calorimetry in the hood.

4.1 Heat Release Rate Data

Heat release rate (HRR) is used to describe quantitatively the size of a fire. It is the rate at which the combustion process produces heat and is a driving force in the spread of fire. The peak HRR (PHRR) indicates the point at which the fire produces the most heat (*i.e.*, the instantaneous largest size of the fire). The time to the PHRR indicates how fast the fire has grown and is considered an important parameter of fire growth characterization.

The HRR was measured in the effluent from the room, using oxygen consumption calorimetry. Plots of all HRR data from all 64 tests are detailed in Appendix A. An example of an HRR progression is shown in Figure 4. As seen in the Figure 4 plot, the burn sequence featured two peaks in the heat release profile. The first peak occurred when the soft materials (cushions, fabric, and batting on arms) were burning intensely. The second peak was observed once the wood frame was fully involved in the fire and much of the upholstery materials were consumed. The proposed standard addresses the performance of the soft materials only; the contribution of upholstery materials has little effect on the second peak. Thus, the first PHRR value and time to this PHRR will be examined as the principal measures of effectiveness of the proposed standard and will be closely examined in this report

Figure 5 shows the value of the first PHRR for each of the fires involving the 64 chair samples. Figure 6 shows the time at which these PHRR occurred for each of the 64 chairs. In some cases, the first peak was not well defined; so an average was taken in the area of the peak in the data to account for uncertainty in the exact PHRR. The fires were suppressed with water after the second peak was reached, which caused the heat released to drop quickly within the test room.

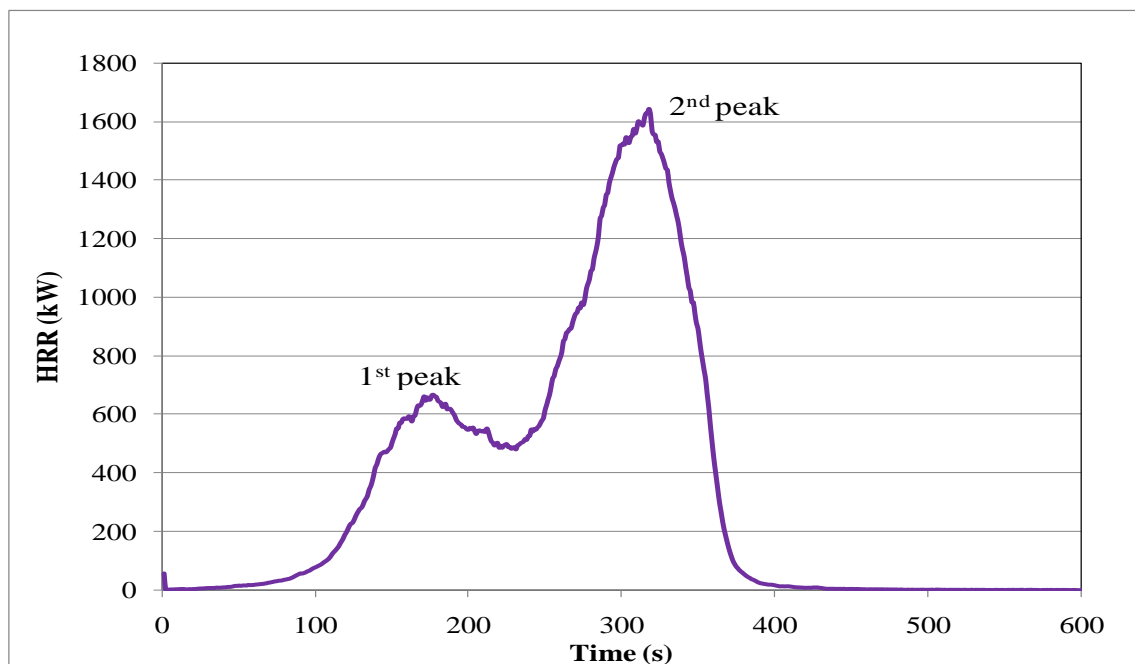

Figure 4. Heat Release Rate Curve Demonstrating Two “Peaks”

In this test series, temperatures were recorded near the door and near the chair, at eight heights. As expected, the thermocouple tree data shows a vertical temperature gradient, as illustrated by the typical profiles depicted in Figures 7 and 8. High temperature smoke was produced, which rose to form a hot upper layer and a cool lower layer from which fresh air was entrained to feed the fire. The upper layer temperatures followed the same profile with respect to time as the HRR; there was a sharp rise, followed by a dip, and then another sharp rise.

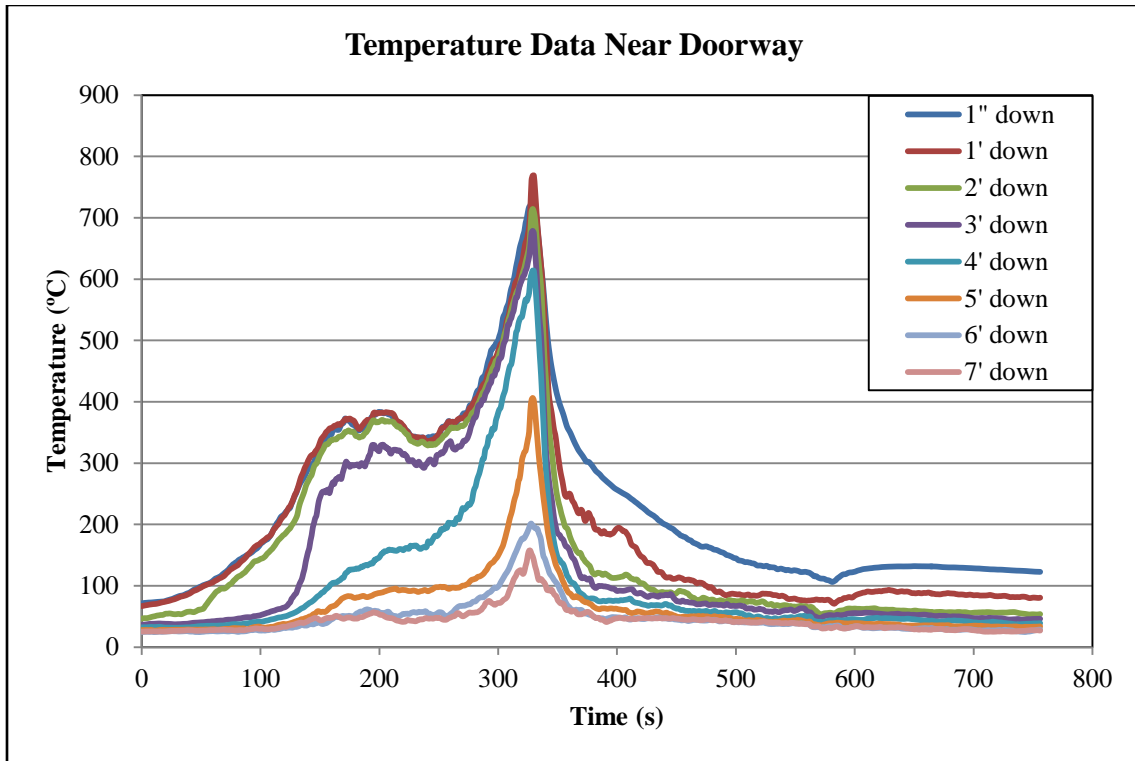

Figure 7. Typical temperature profile near doorway, measured down from the ceiling

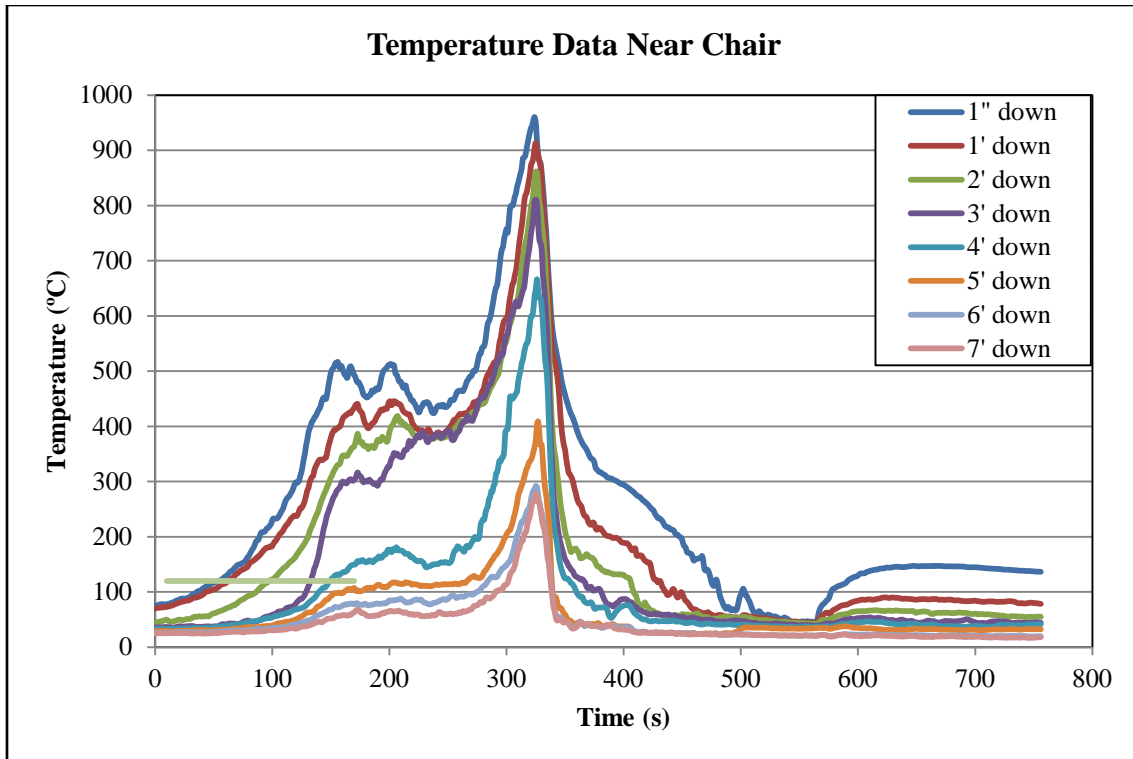

Figure 8. Typical temperature gradient near chair, measured down from ceiling

4.3 Observations

In addition to recording the HRR of the test samples, visual observations during all 64 tests provided qualitative differences in the burning behaviors of the chair samples.

4.3.1 Flame Spread

The propagation of flames on the chairs was observed to be similar in all the tests of this series. Photographs 3a through 3h included in Table 3 show an example using a chair with a fire barrier. As the ignition source flame was applied (flame application time = 70s), the cover fabrics formed a thin char layer (3a). The char then split open and allowed the heat from the flames to reach the layers of material below the cover fabric (3b). As the flames progressed along the back/seat cushion crevice, the flames also spread up and across the back cushion (3c). The seat cushion started to show some charring and flames as the materials in the back/seat cushion crevice burned more intensely (3d). Once the flames spread to the edges of the back/seat cushion crevice, the arms of the chair became involved (3e). When the flames spread to the edges of the back cushion, the flames traveled around the cushion (3f). This flame progression provided heat to the back frame of the chairs and eventually involved the fabric and wood from that part of the chair (3g). As flames moved around the back cushion, flames also progressed down the seat cushion toward the front of the chair (3h). The flame front on the seat cushion moved slower than on the back cushion, involving the chair arms as it progressed toward the front edge of the chair. In many of the chairs that contained a fire barrier, the back cushion fell forward onto the seat, presumably because the support provided by the seat cushion burned away, causing a faster rate of burning for the remainder of the chair.

The major difference between the fire-barrier and nonfire-barrier chairs was the rate of flame propagation, as evidenced by the times to peak HRR (shown earlier in Figure 6). The fire barrier slowed down the progression of flames on the faces of the cushions. However, once the flames started to wrap around the back cushion and came into contact with the chair back, the flames grew in magnitude; there was no fire-barrier material on the chair frame in any of the chairs. Another difference between the fire-barrier and nonfire-barrier chairs was that at the end of the test, the chairs with a fire barrier kept the general shape of the cushion with the interior foam burned, while the chairs without a fire barrier lost the entire cushion.

Table 3. Propagation of Burning on a Chair with a Fire Barrier

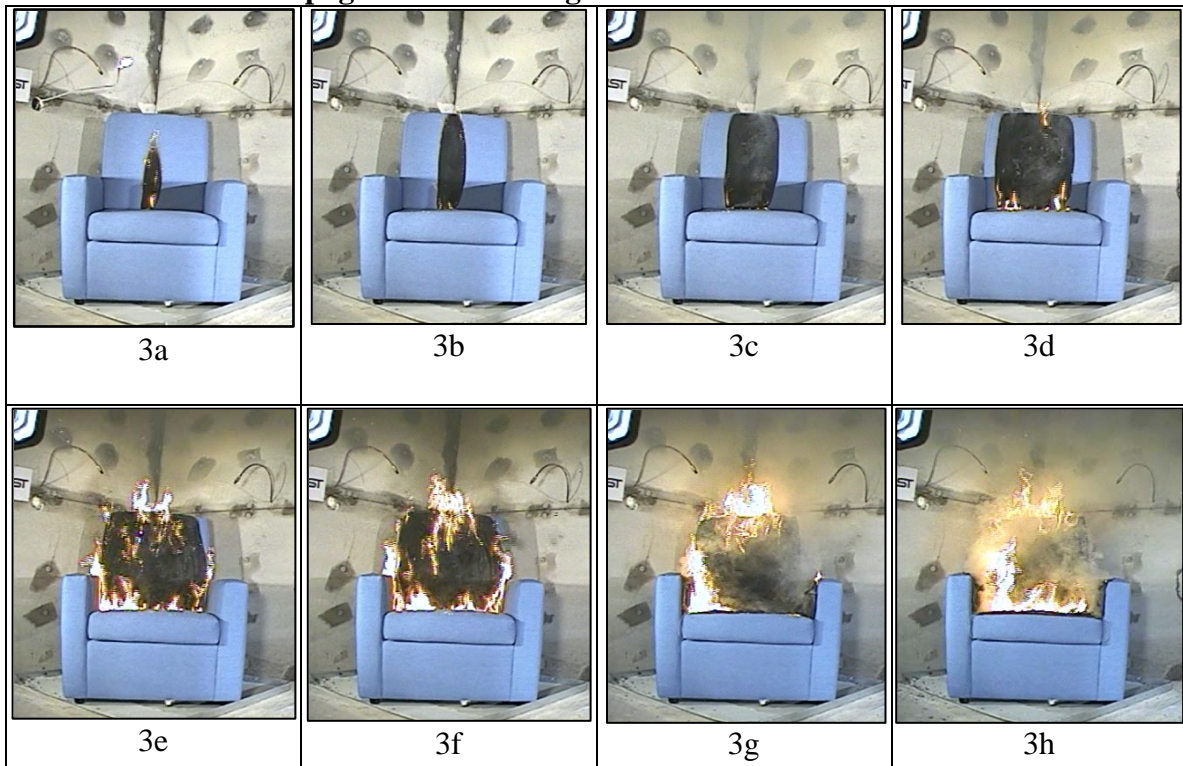

4.3.2 Melt Dripping

For most samples, melt dripping was observed during the tests. The melt drippings are created by liquefied foam that falls under and around a burning chair. As the flames get closer to the bottom of the chair, the melt drippings form a pool. The vapors from the pool are heated by the surrounding fire, causing a pool fire. The pool fire then also provides heat from below the chair and increases fire growth. An example of a pool fire observed in this test series is shown in Figure 9. Pool fires occurred in tests regardless of chair material combinations but occurred earlier in tests involving nonfire-barrier chairs than in tests with fire-barrier chairs. It is unclear whether this is because the foam took longer to melt or the barrier was able to contain the melted foam longer without dripping.

















Figure 9. Example of a Pool Fire

4.3.3 Fire Growth

As mentioned earlier, the heat release data indicate that the chairs with fire barriers were associated with lower peak heat release rates and slower fire growth. Enhanced fire resistance of chairs with fire barriers was also evident during observations of the tests. Photographs taken during the tests demonstrated the differences in fire growth times between the chairs with and without fire barriers. A snapshot of the test chairs four minutes after ignition for the 16 fabric/foam/fire-barrier combinations tested are shown in Table 4. Additionally, the photographs illustrate the slower progression of flames in fabric 1b, which was more than twice the weight of the other three fabrics (1a, 2a, and 2b).

Table 4. Photographs of Chair Samples Four Minutes After Ignition. Each photograph shows a sample of one of 16 fabric/foam/fire-barrier combinations.

Fabric	Nonfire Barrier, SPUF	Nonfire Barrier, FR	Fire Barrier, SPUF	Fire Barrier, FR
1a	 Combination 2	 Combination 4	 Combination 1	 Combination 3
1b	 Combination 6	 Combination 8	 Combination 5	 Combination 7

Fabric	Nonfire Barrier, SPUF	Nonfire Barrier, FR	Fire Barrier, SPUF	Fire Barrier, FR
2a	 <p data-bbox="394 776 604 808">Combination 10</p>	 <p data-bbox="800 776 1010 808">Combination 12</p>	 <p data-bbox="1213 776 1423 808">Combination 9</p>	 <p data-bbox="1619 776 1829 808">Combination 11</p>
2b	 <p data-bbox="394 1279 604 1312">Combination 14</p>	 <p data-bbox="800 1279 1010 1312">Combination 16</p>	 <p data-bbox="1209 1279 1419 1312">Combination 13</p>	 <p data-bbox="1619 1279 1829 1312">Combination 15</p>

5 ANALYSIS AND DISCUSSION

The three components evaluated in this study were the fabrics, the foams, and the fire barrier. Determining the effect of the fire barrier on the flammability performance is the primary goal of this evaluation and is discussed below. Interactions among the components of the chairs can also have effects on the flaming behavior; they are also examined for the following combinations: cover fabric and foam, fire-barrier and foam, and fire-barrier and fabric. Each interaction contributed in varying levels to the heat release rates and temperatures. These interactions are further discussed below. It is important to note that results of this test series using selected combinations of components cannot be generalized over the entire market of materials that may be incorporated into furniture

5.1 Fire-Barrier Effect

Since the proposed standard only requires open-flame tests to evaluate the fire barrier, this test series was designed primarily to assess the behavior of the fire barriers. Examining the PHRR data for all 64 tests using the fire barrier as the discriminating factor demonstrates the effect of the fire barrier. There is a clear difference in the PHRR and the time to PHRR, as shown in Figures 10 and 11. The fire barriers work to increase the time to PHRR while decreasing the actual size of the fire. The Directorate for Epidemiology (EPI) estimates that a fire barrier in the chair results in a time to PHRR that is 3.323 times longer than for the chairs without fire barriers.¹⁰ The effect of the fire barrier as an interaction with the other components is detailed below.

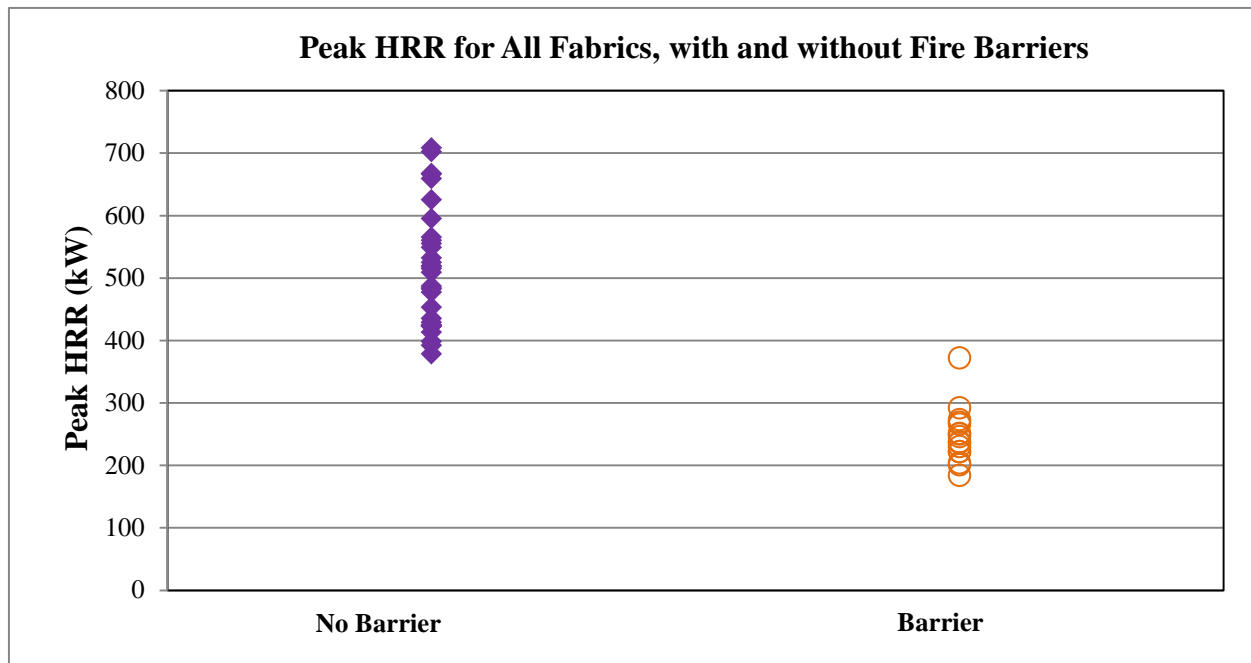

Figure 10. PHRRs for All 64 Tests, Separated by Fire Barrier Use

¹⁰ "Analysis of Chair Open- Flame Data" Memo to Dale Ray, Project Manager, from David Miller, Directorate for Epidemiology, Division of Hazard Analysis. September 16, 2010.

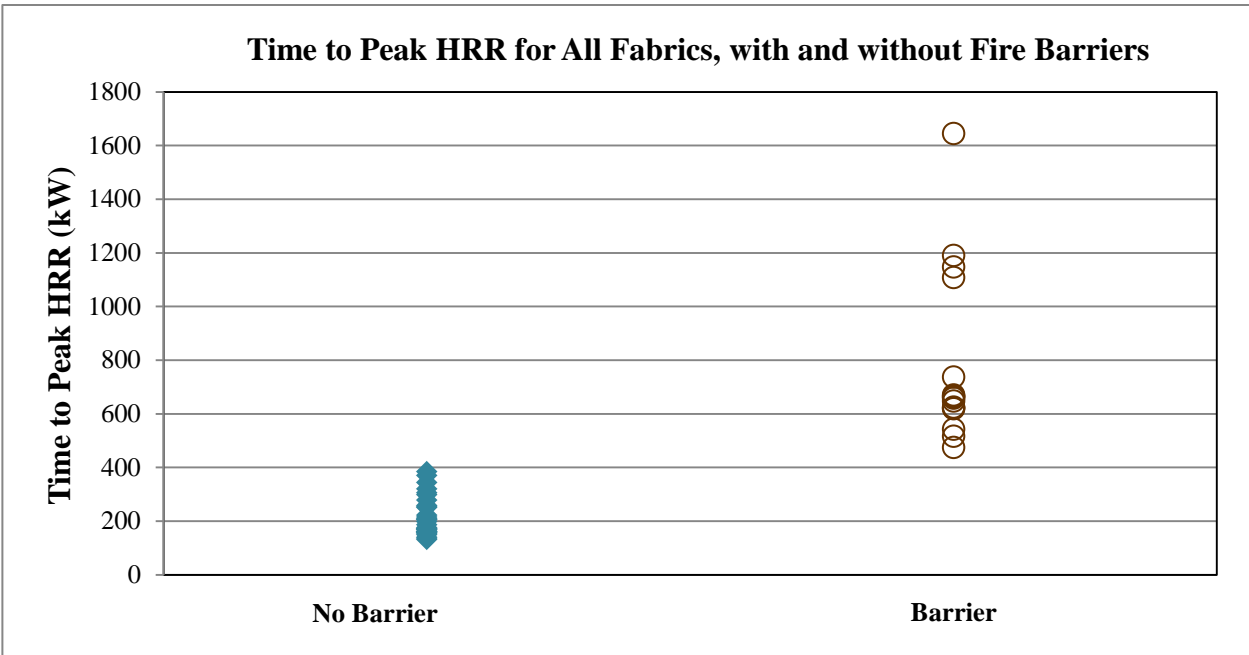

Figure 11. Time to PHRR for All 64 Tests, Separated by Fire Barrier Use

5.2 Foam and Fire Barrier Interaction

To determine whether there is an interaction between the fire barrier and the type of foam used, the data for all the tests without the fabric identifier were examined. All of the PHRR data are shown in Figure 12 to demonstrate the relationship between barriers and foam type. In both cases (*i.e.*, chairs constructed with fire barriers and chairs constructed without fire barriers), there is no clear distinction between the PHRR values for the two types of foam. Additionally, statistical testing of the data shows a 7 percent mathematical difference. The graphs and statistical testing indicate that for open-flame ignitions, the type of foam does not have a practically significant effect on barrier performance as measured by PHRR.

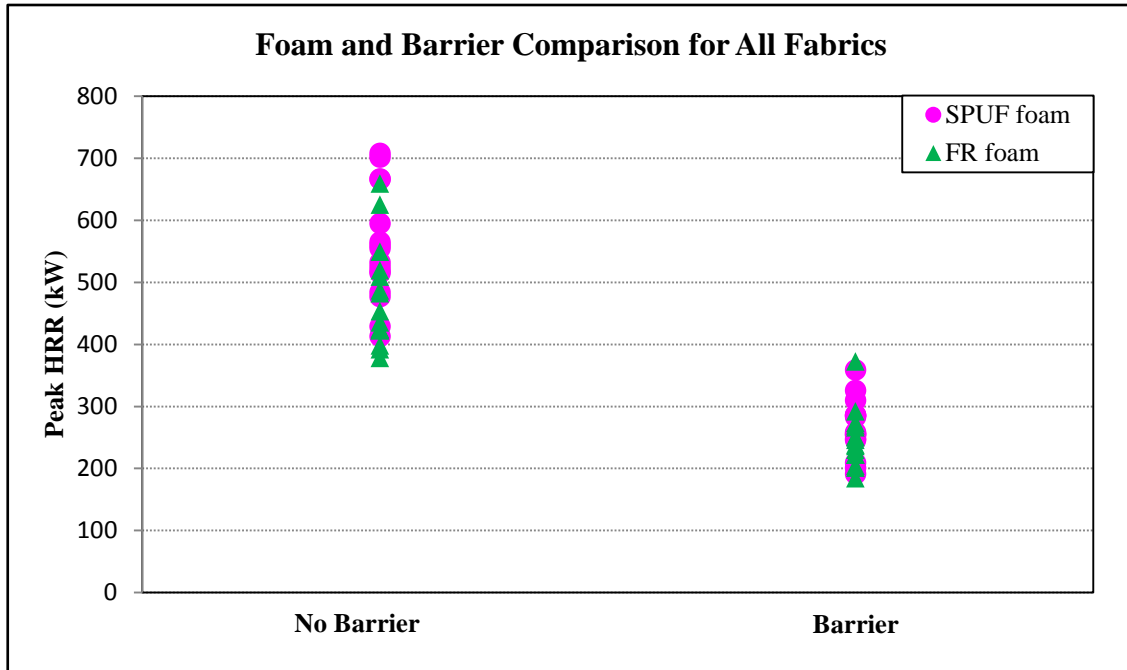

Figure 12. Peak HRR for All Tests

5.3 Fabric and Foam Interaction

As detailed earlier, four fabrics (1a, 1b, 2a, and 2b) that previously demonstrated a range of smolder propensity were included in this study. Two commercially available foams were used in this study—one FR and one non-FR (SPUF)—as found in the marketplace.

The test data for chairs with the fire barrier were reviewed to observe the interaction between fabrics and foams, with the fire barrier as a parameter in the behavior. The HRRs for chairs constructed with fabric 1a and with either SPUF or FR foam are shown in Figure 13. The first peaks in the heat release rate for the chairs with SPUF and with the FR occur in the same region. The values of the peaks are not significantly different and overlap in some cases.

The same observations were made for the chairs with the fire barriers in place, as shown in Figure 14. Figures 5 and 6 are compilations of the values and times of the first peaks for all the fabrics. There are no distinct separations for the data between the types of foams, indicating a similar performance for all the fabrics. This observation is further confirmed by the analysis provided by EPI,¹⁰ in which a statistically significant interaction was not found between the fabrics and foams and their effect on the PHRR of the chairs.

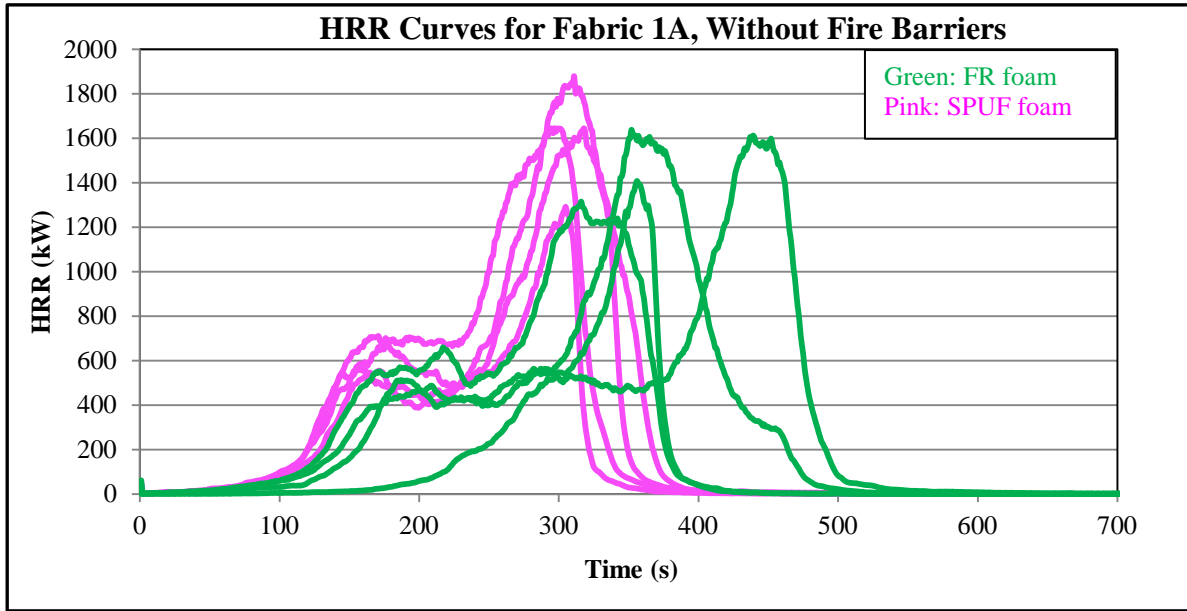

Figure 13. Heat Release Rate Curves for Fabric 1a Without Fire Barriers for SPUF and FR Foam

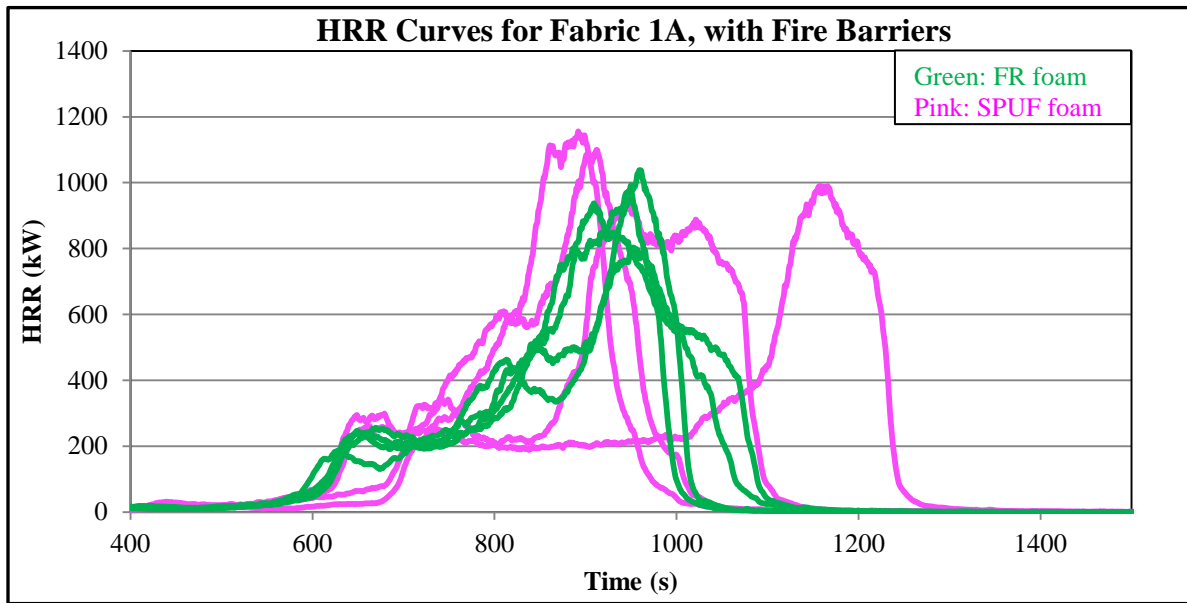

Figure 14. Heat Release Rate Curves for Fabric 1a with Fire Barriers for SPUF and FR foam

5.4 Fabric and Fire Barrier Interaction

The fabrics used in the test chair samples were fabrics that either have a high propensity to smolder, (fabrics 1a and 1b, consistent smolder behavior), or have a moderate propensity to smolder, fabrics 2a and 2b (inconsistent smolder behavior). Staff expects that under the proposed standard these fabrics would require a fire barrier.

Between the highly smolder-prone fabrics (1a and 1b), fabric 1b was the better performing fabric when no fire barrier was present; the tests resulted in the lowest PHRRs and the highest times to PHRR (as shown in Figures 5 and 6). However, adding a fire barrier did not significantly change the results for fabric 1b as it did for fabric 1a. The PHRR values for fabric 1b are very close for the chairs with and without fire barriers, as shown in Figure 13. Fabric 1a showed a considerable decrease in PHRR and increase in time to PHRR when a fire barrier was present.

The moderately smolder-prone fabrics (2a and 2b) demonstrated similar flammability behavior in the open-flame ignition tests. Chairs with both cover fabrics and the fire barrier showed a lower value of PHRR and substantial increase in time to PHRR—indicating a slower growing, smaller fire—than chairs without fire-barriers. While the addition of a fire barrier affected the fire behavior of the chairs, the magnitude of the difference varied. Three of the four fabrics—1a, 2a and 2b—demonstrated a sizeable change in the value of PHRR and the time to PHRR. These three fabrics had similar area densities, while fabric 1b was more than twice the weight. The results suggest that the area density of the cover fabric has a beneficial influence on the effect that the fire barrier has on the flammability behavior of the chairs.

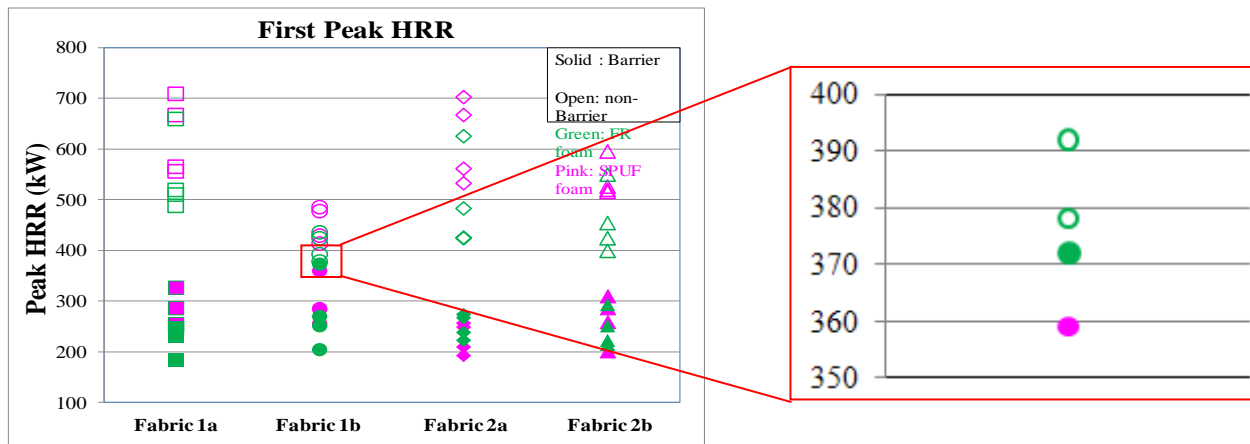

Figure 15. Close-Up of Fabric 1b Data

5.5 Effect on Life Safety

The life safety hazards associated with a fire may include: heat (heat flux and temperature), toxic gases, and smoked obscuration (loss of visibility for quick egress). In these experiments, quantitative measures of heat release rates and temperature were made; and qualitative measures of visibility were made by test operators.

5.5.1 Temperature and Heat Flux

Heat is transferred from the source to surrounding objects by conduction, convection, and radiation, either singularly, or in combination. Frequently, the hazard from the fire to a person is simplified as an exposure temperature for a prescribed duration. In the room of origin, an occupant will be exposed to heat primarily through convection and radiation, quantified by temperature and heat flux.¹¹ It is generally estimated that the tenability limit

¹¹ Heat flux is defined by heat release rate over an area (kW/m²).

due to convected heat near the occupant is 120°C (248°F) or to radiant heat fluxes above 2.5kW/m².¹² Above this limit, the onset of pain is rapid, and burns can develop within a few minutes or less, as temperatures increase above this threshold. These limits are affected by factors that influence the rate at which the skin temperature itself is elevated, such as clothing, fit of clothing, humidity, air flow, and skin thickness, which can mitigate or exacerbate the impact of the heat transfer to the victim’s skin for a given heat level and exposure time. Therefore, the numerical values of temperature (120°C) and heat flux (2.5kW/m²) are used as a basis for discussion rather than as absolute limits.

Comparisons of the effects of the various chair constructions on tenability are made by examining the temperatures at approximately five feet above the floor, two feet above the floor, and the heat flux at the floor, in the center of the room. The 5-foot elevation can be considered the face height of a typical, standing person, the lower elevations depicting a crawling person. Figures 16 and 17 show the time at which the tenability limit of 120°C occurs near the chair and near the door, respectively, at two different heights. Figure 18 shows the time at which the tenability limit of 2.5 kW/m² occurs at the center of the room, at floor level.

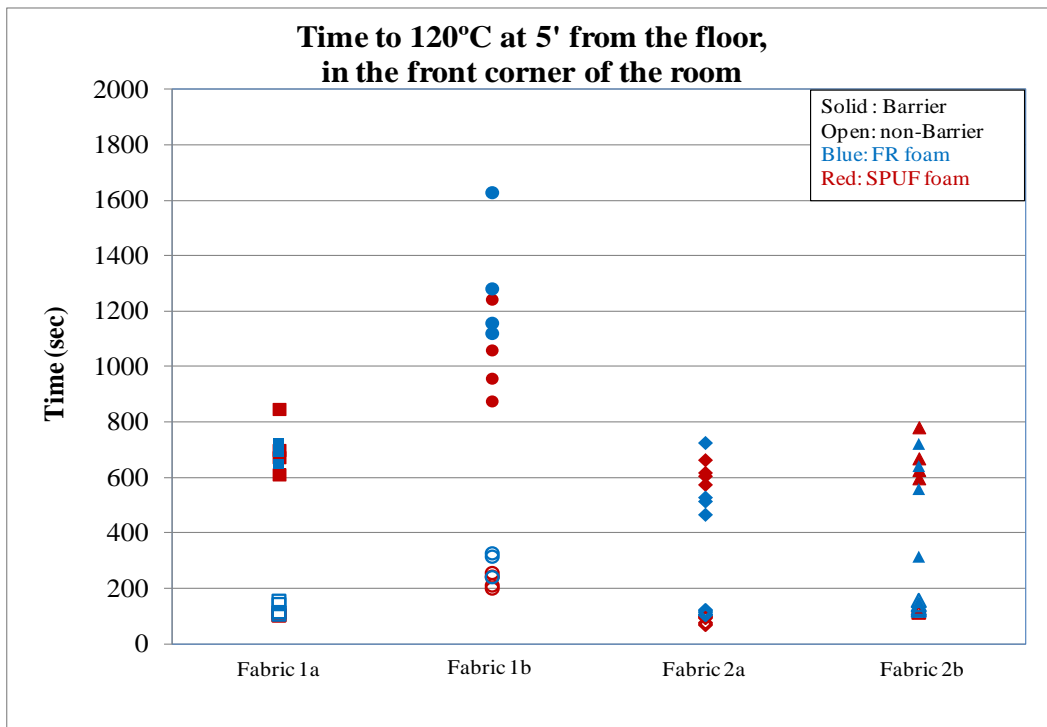

Figure 16 a. Time to 120°C for All 64 tests, Taken at Five Feet from Floor, Near Door

¹² Purser, D.A., “Assessment of Hazards to Occupants from Smoke, Toxic Gases, and Heat” The SFPE Handbook of Fire Protection Engineering. 4th Ed, 2008. Pp 2-141-142.

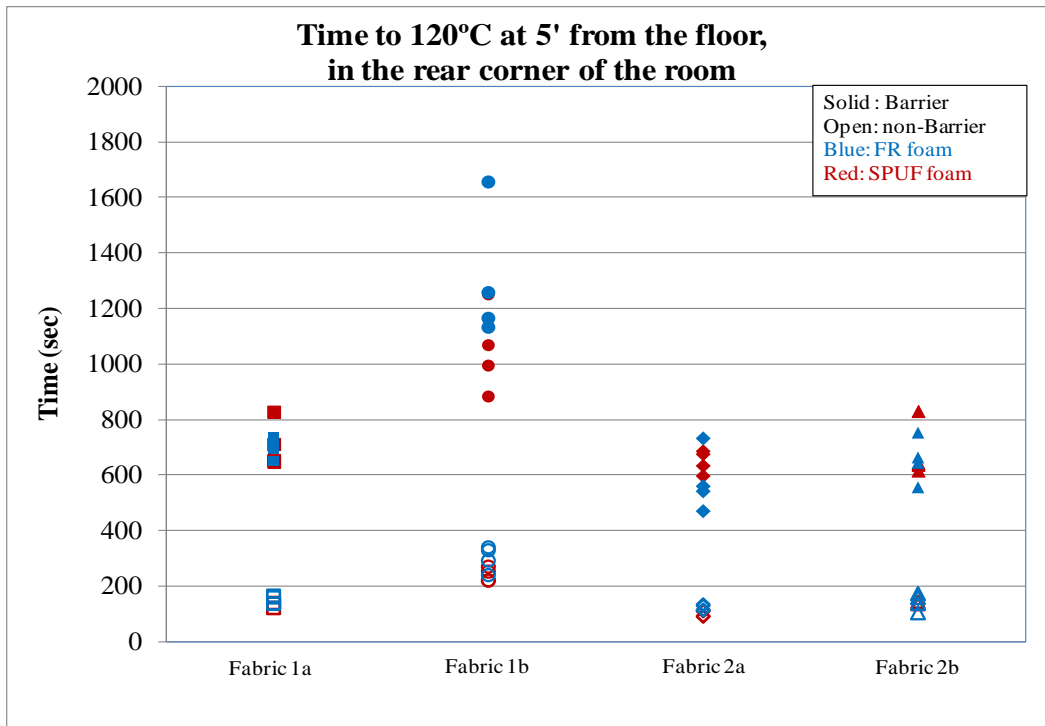

Figure 16 b. Time to 120°C for All 64 Tests, Taken Five Feet from the Floor, Near Chair

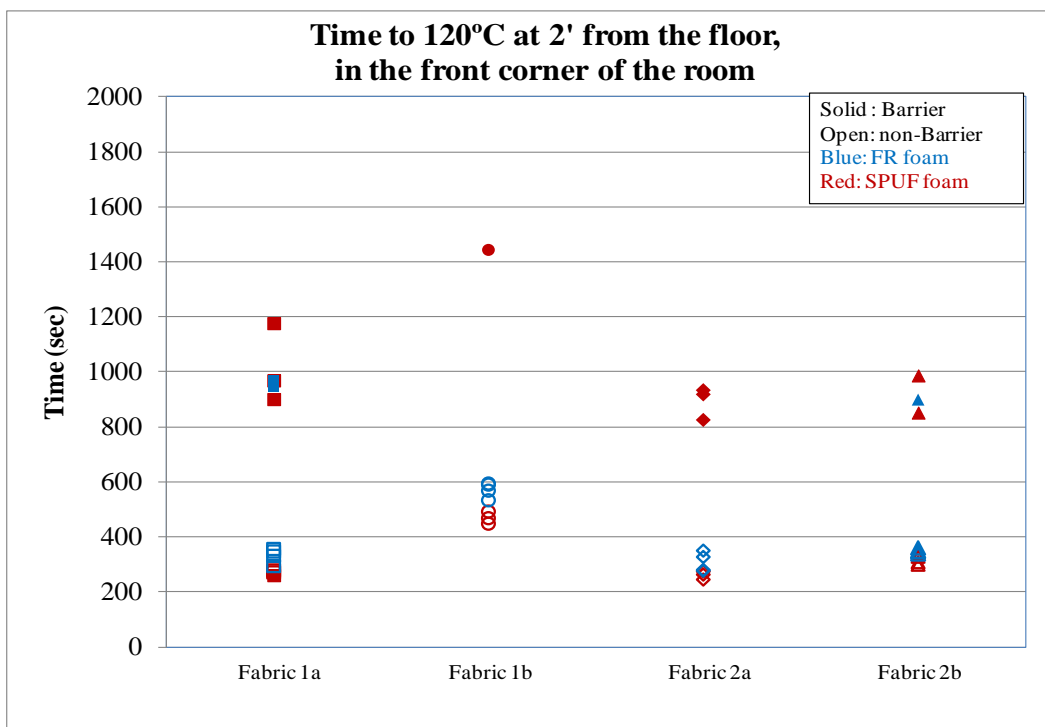

Figure 17 a. Time to 120°C for All 64 Tests, Taken at Two Feet from the Floor, Near Door

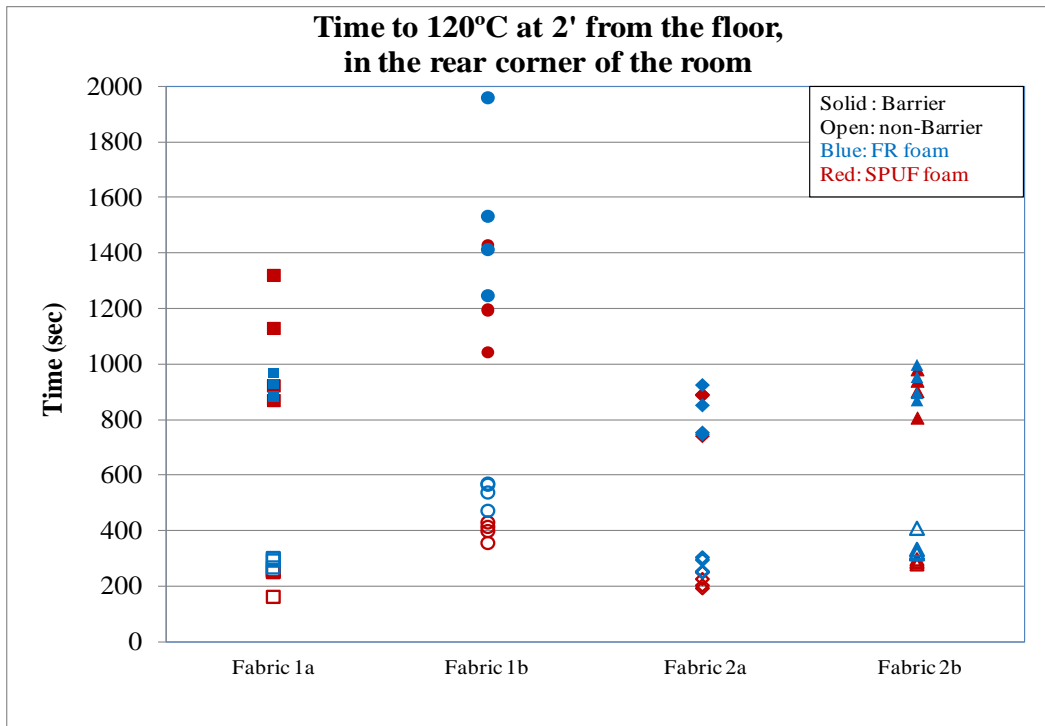

Figure 17 b. Time to 120°C for All 65 Tests, Taken at Two Feet from the Floor, Near Chair

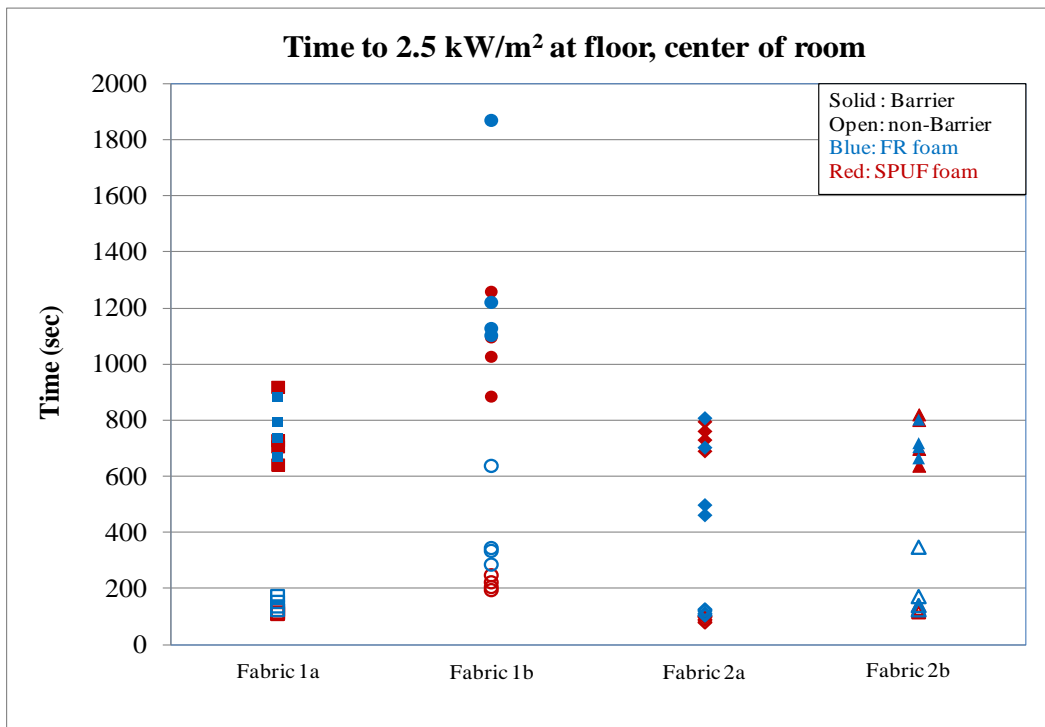

Figure 18. Time to 2.5kW/m² for All 64 Tests, Taken at the Floor

Although the absolute times for which the limits occur differ, the distribution of the data is similar to the time to PHRR, indicating that the chairs with fire barriers markedly improve tenability time, regardless of metric used.

5.5.2 Visibility Measurements

Qualitative visibility measurements were taken during each test. A paper sign with “NIST” printed on it was placed on the far wall of the room at four feet from the floor. Since only one of the test operators noted when he could no longer see “NIST,” the observation was made from the same height each time. In this test series, obscuration of the sign was not consistently indicative of the tenability conditions in the room. Either thick white or black smoke obscured the sign. When the fire was growing quickly and the smoke was full of thick black soot, the sign could often be seen until the time of flashover, whereas in slow growing fires, the sign was obscured early in the fire. These measurements do not aid in examining the effect of the fire barriers in the chairs on egress time improvement.

5.5.3 Carbon Monoxide Measurements

Often, carbon monoxide (CO) measurements are also used in determining tenability of a space during a fire. In this test series, the data were taken outside the room, under the hood. The data were extremely noisy and did not provide any insight into the behavior of CO generation from the chairs.

6 CONCLUSIONS

This test series examined the results of open-flame ignition tests conducted with upholstered furniture chairs. Specifically, the aim of the study was to determine the effect that the selected fire barrier had on the flammability characteristics of the chairs. Sixteen combinations of materials were chosen from materials previously tested by CPSC staff. The cover fabrics used in this series would likely require the use of a fire barrier under the proposed rule. The foams were chosen to represent both an FR and non-FR-treated (SPUF) foam. The data presented in this report are valid only for the materials used in this series; other fabrics, foams, and fire barriers may behave differently. The fabrics chosen for this series, however, represent differing levels of smolder propensity, and thus, they can be expected to illustrate different levels of fire performance with the fire barriers.

The four fabrics were categorized into two types: very smolder prone and moderately smolder prone. The very smolder-prone fabrics exhibited different burning behaviors from each other with respect to fire size and growth time. Conversely, the moderately smolder-prone fabrics performed similarly to each other and to one of the very smolder-prone fabrics (fabric 1a). This tends to support the widely held view that fabric smolder propensity is not necessarily a good indication of open-flame ignition performance.

Overall, the results demonstrated that the addition of a fire barrier markedly increased the fire safety of the furniture. The data indicated that the fire sizes were smaller and the time to reach the peak fire size was slower with fire barriers, regardless of the fabric or foams used. Among the other effects examined, a relative difference was noticed in the foams, but the fire-retardant foams did not offer a practically significantly greater level of open-flame safety than did the untreated foams.

7 APPENDICES

- Appendix A. HRR Curves for Tests, by Fabric and Foam Combinations
- Appendix B. Temperature Curves for Tests by Fabric and Foam Combinations.
- Appendix C. Heat flux curves for the Tests by Fabric and Foam Combinations.
- Appendix D. Test Plan

Appendix A. HRR Curves for Tests, by Fabric and Foam Combination

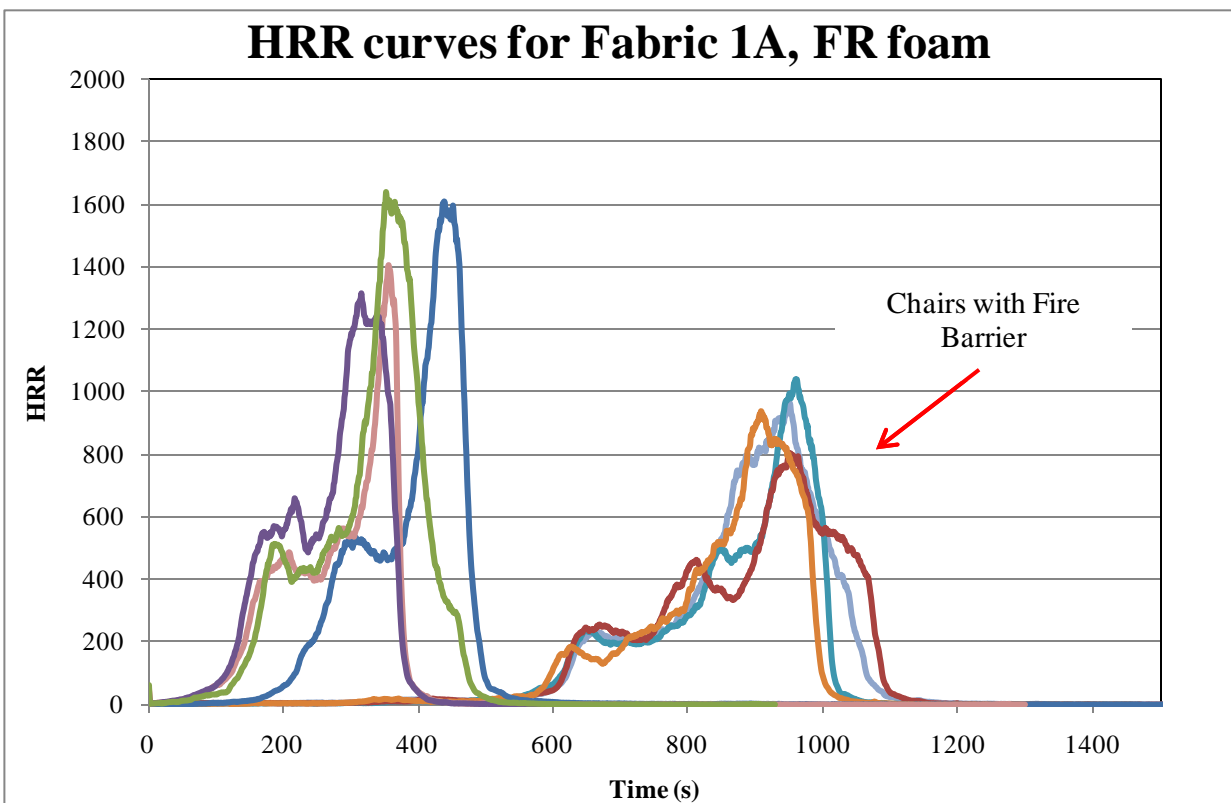
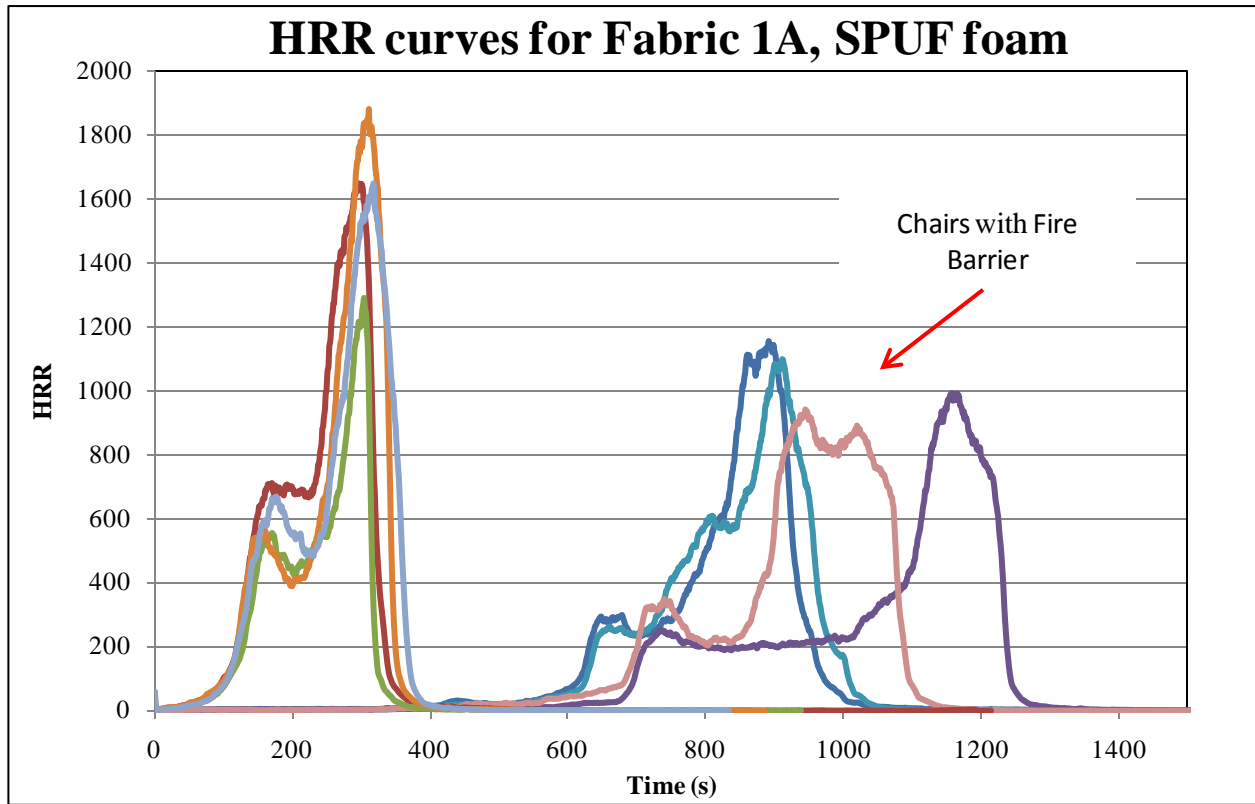

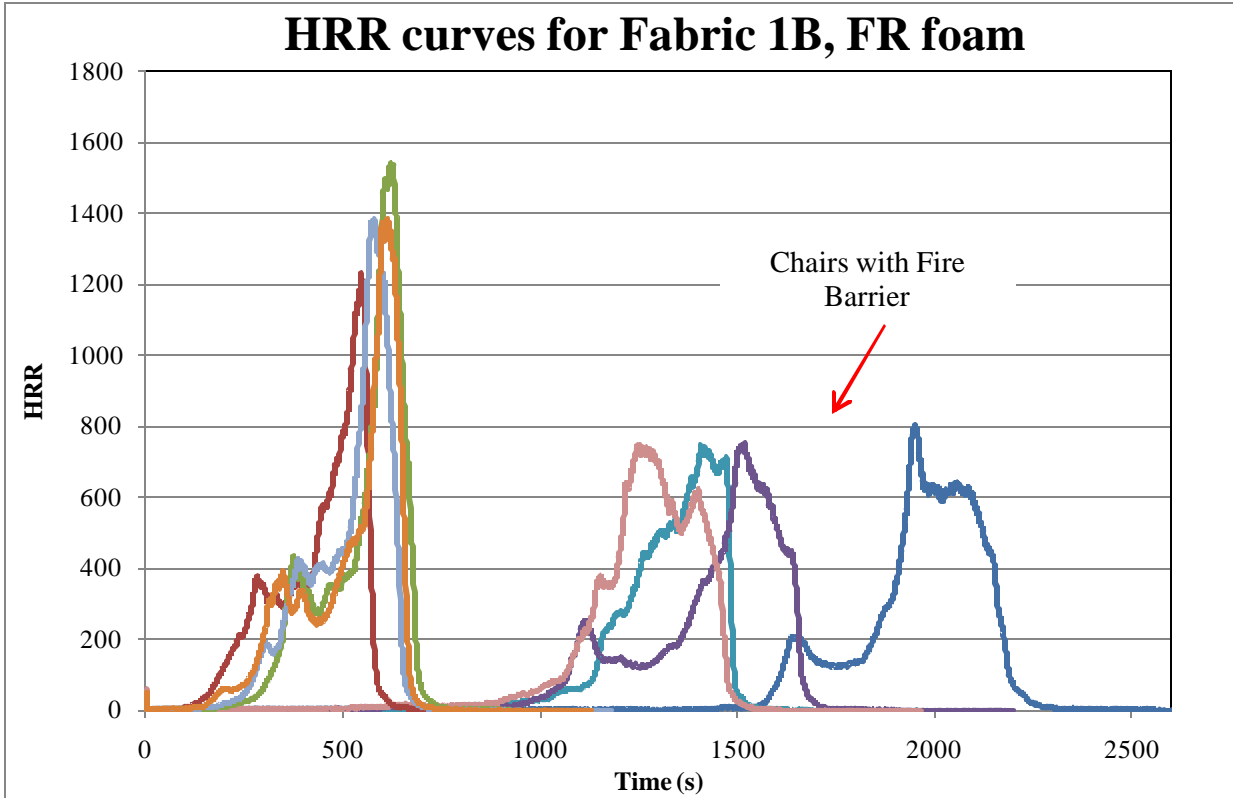
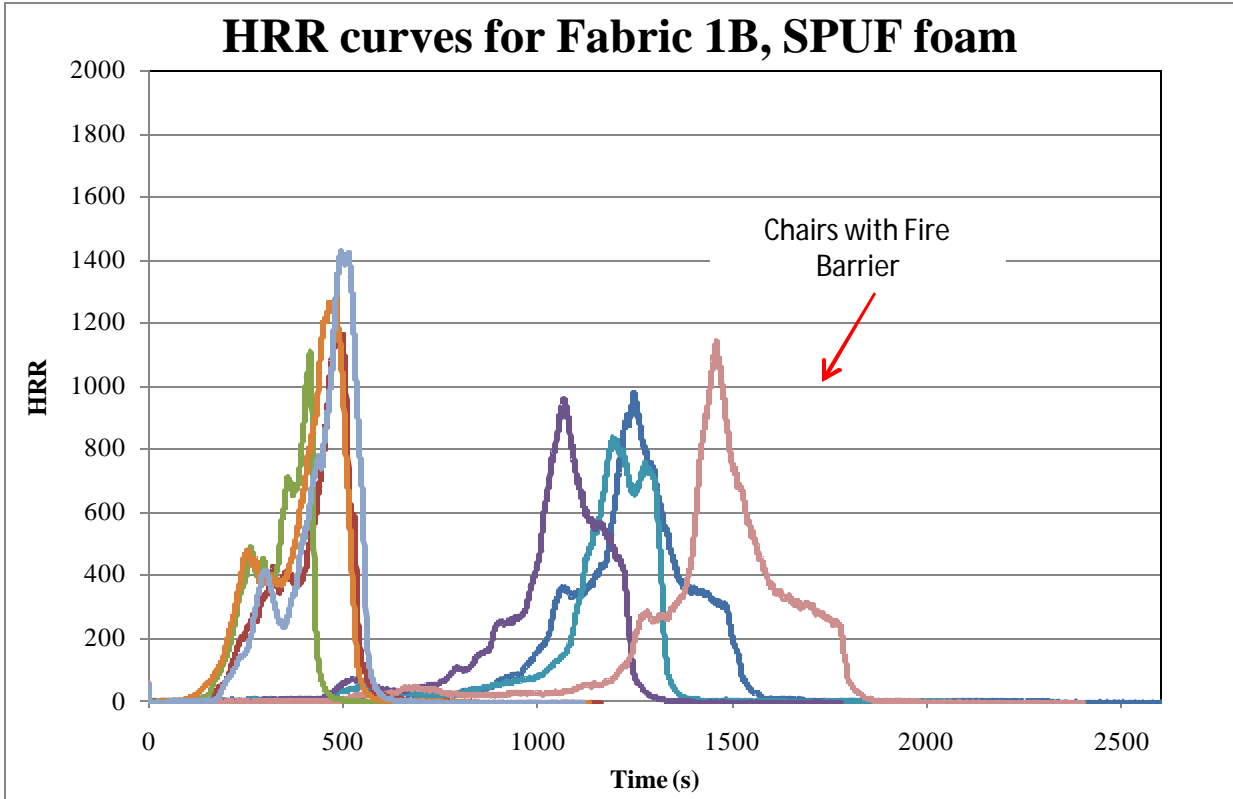

HRR curves for Fabric 2A, SPUF foam

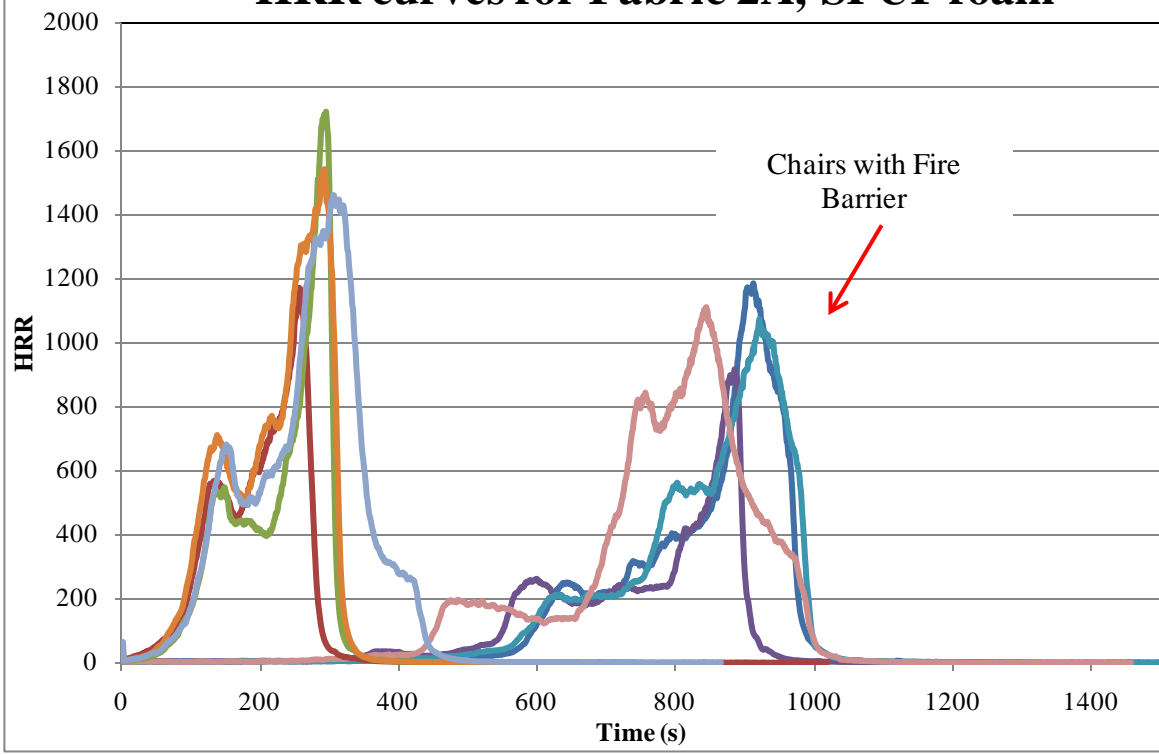

HRR curves for Fabric 2A, FR foam

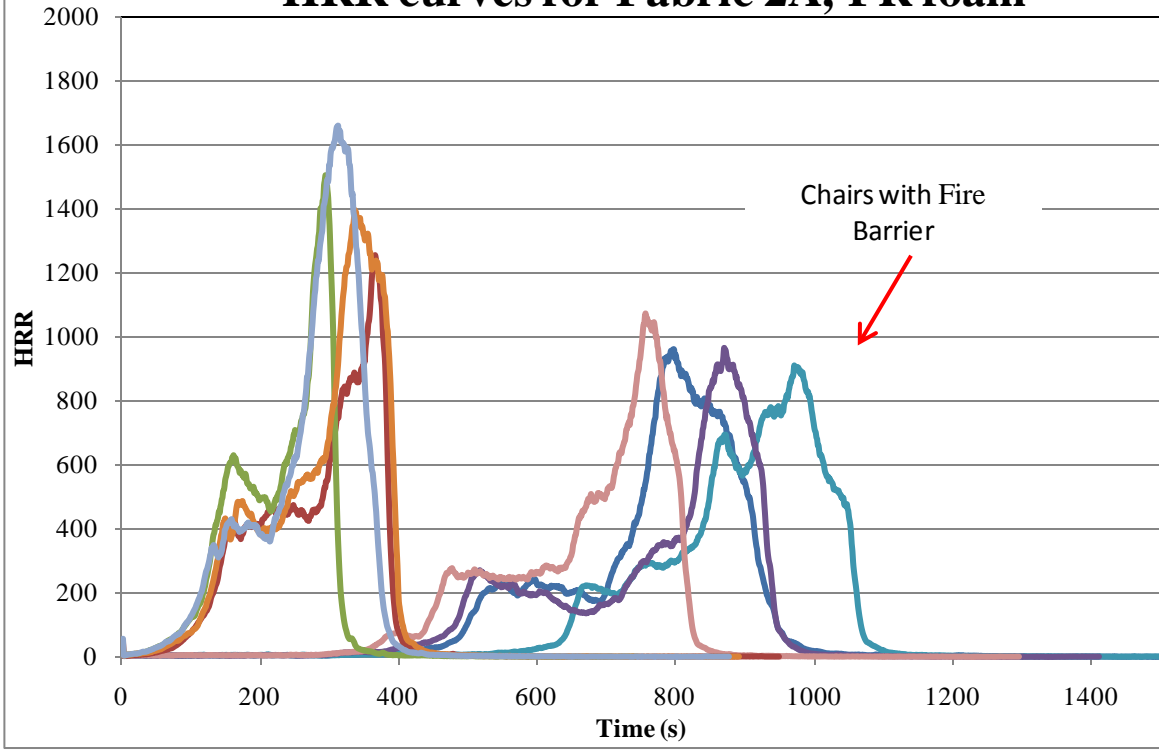

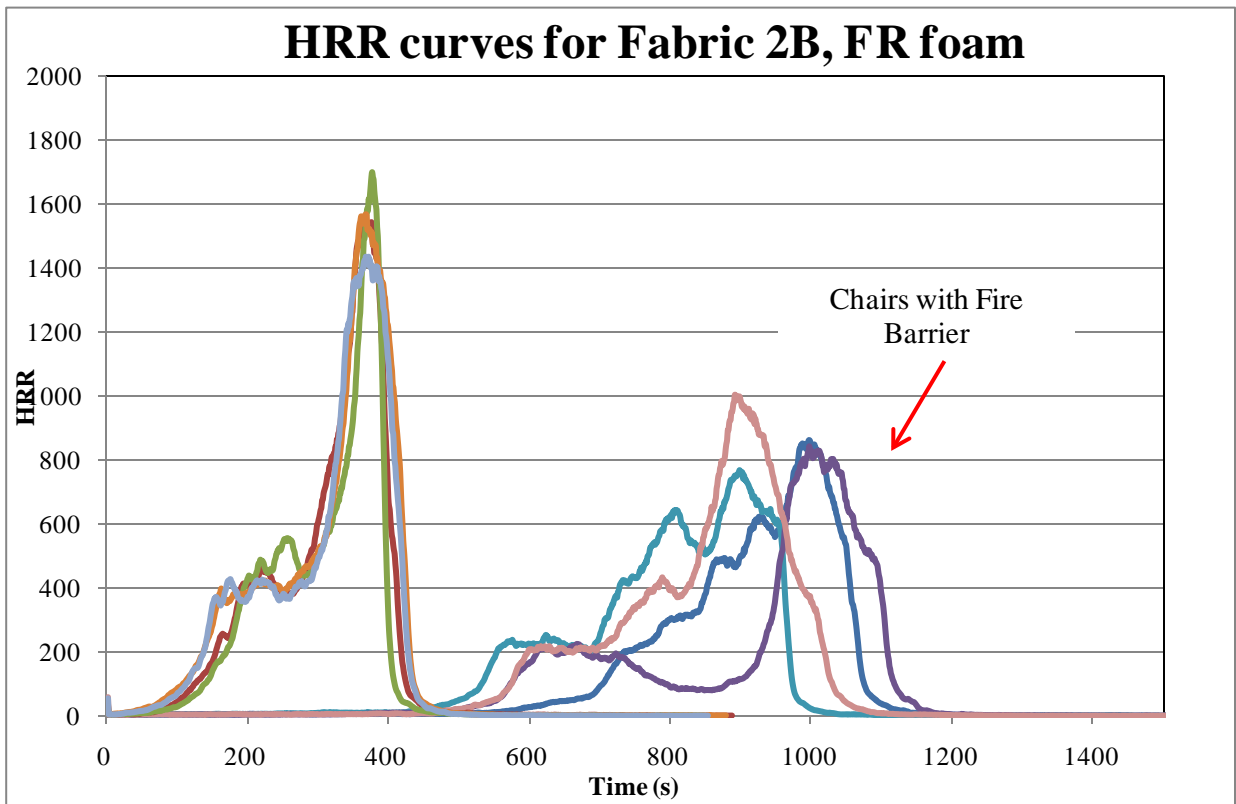
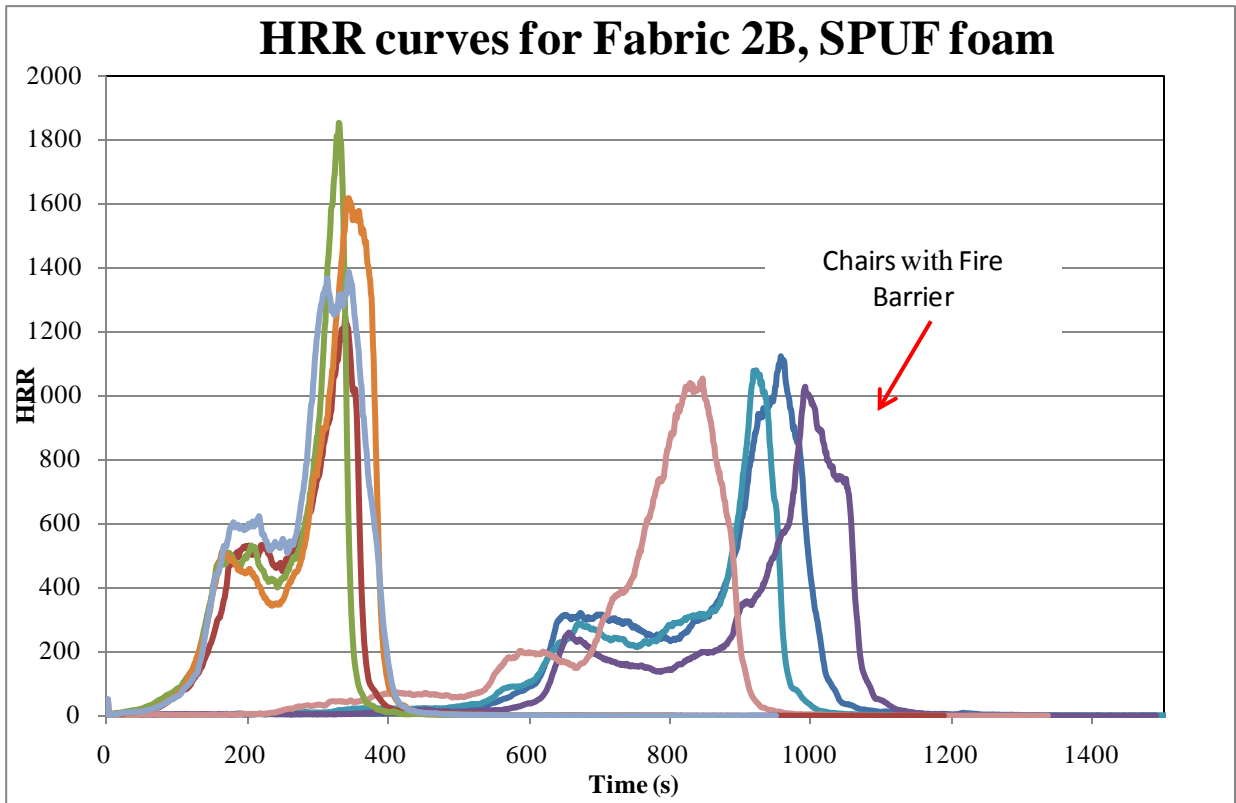

Appendix B. Temperature Curves for Tests by Fabric and Foam Combinations

**Temperature Curves for Fabric 1A, SPUF foam,
5' from floor, near door**

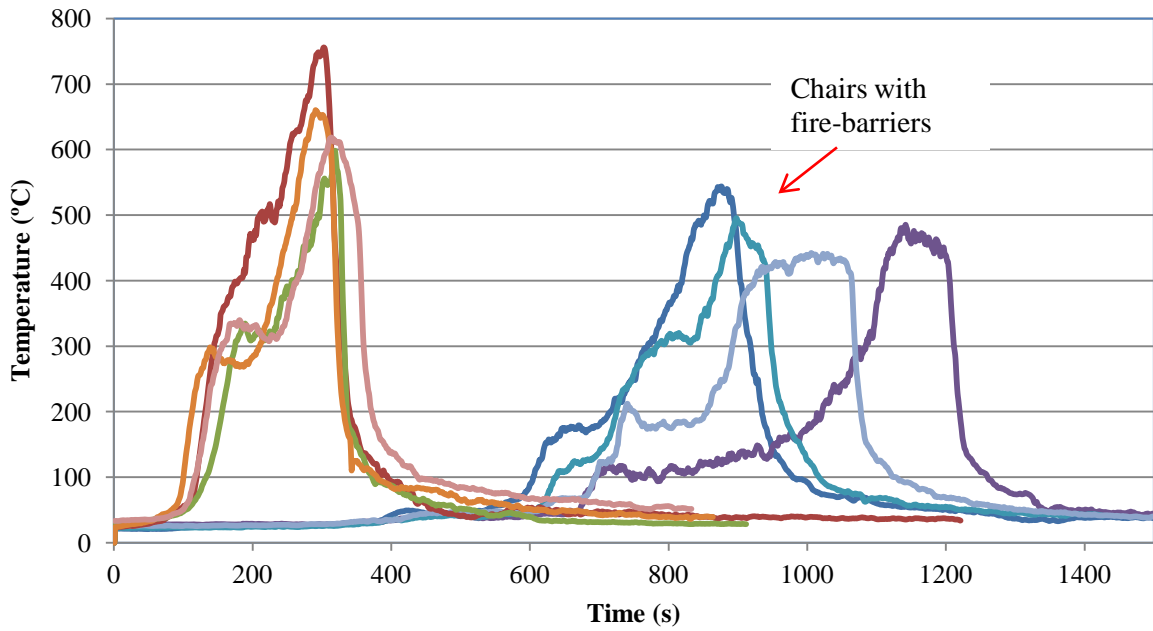

**Temperature Curves for Fabric 1A, FR foam,
5' from floor, near door**

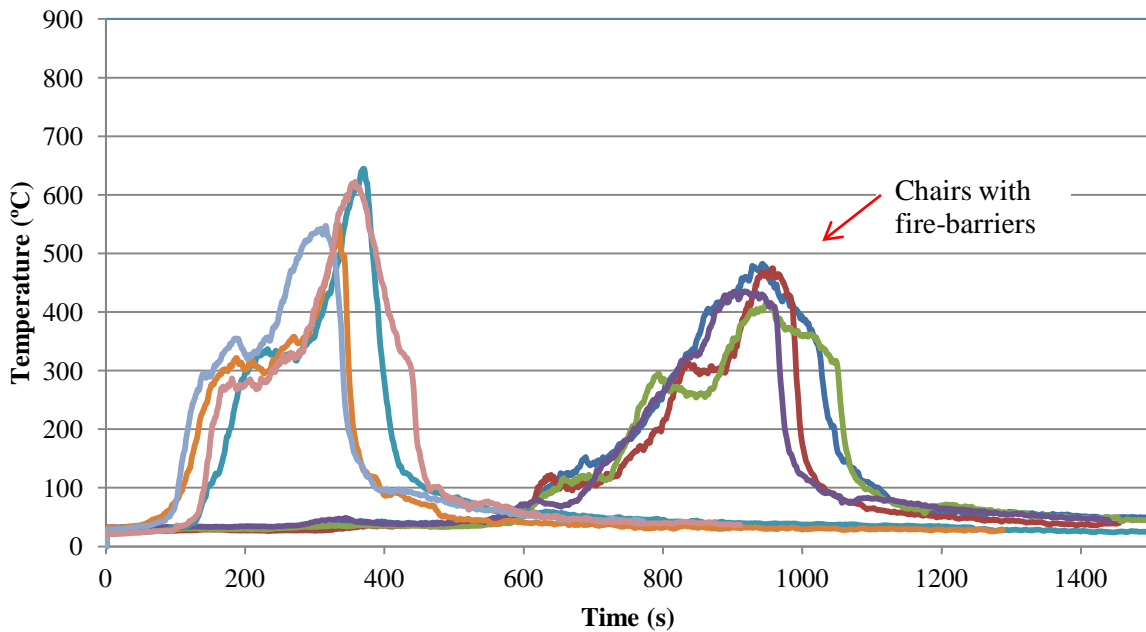

Temperature Curves for Fabric 1B, SPUF foam, 5' from floor, near door

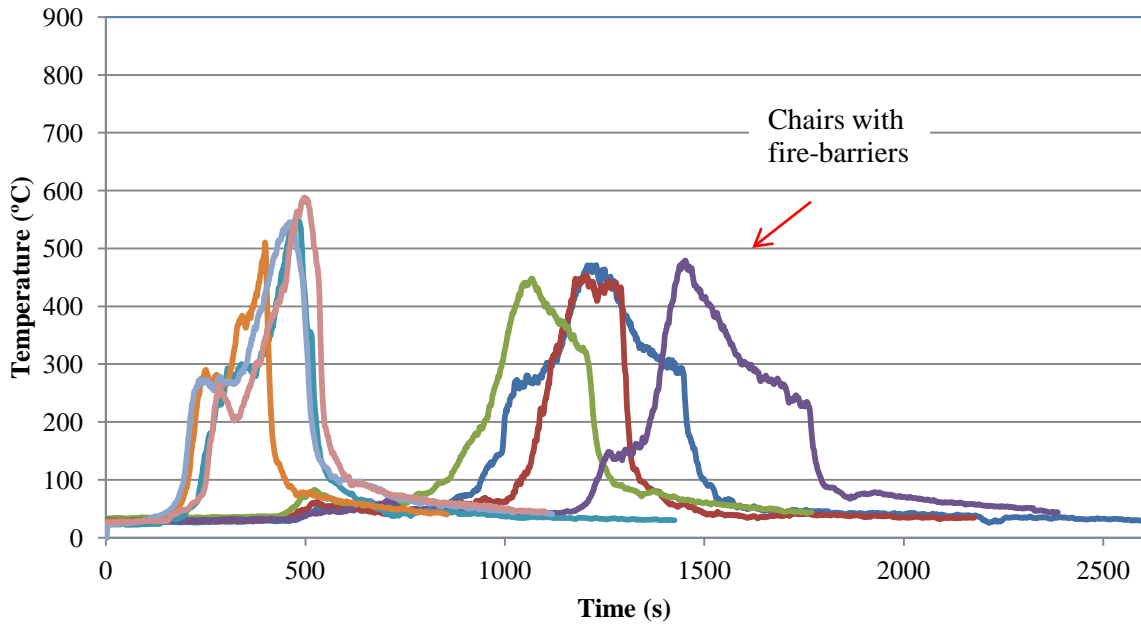

Temperature Curves for Fabric 1B, FR foam, 5' from floor, near door

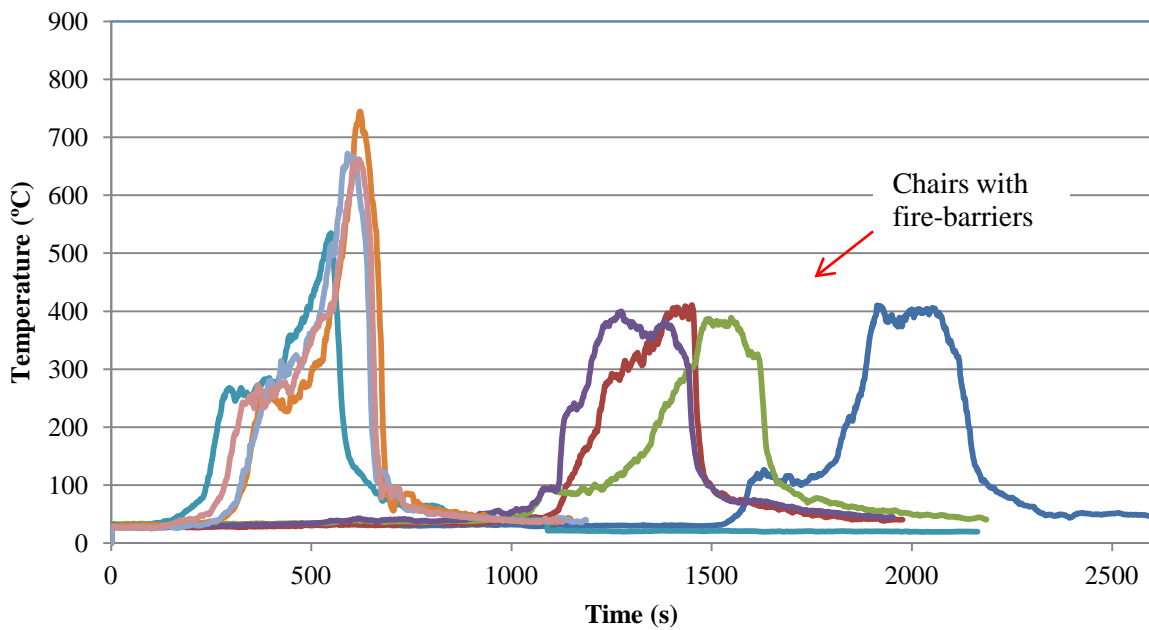

**Temperature Curves for Fabric 2A, SPUF foam,
5' from floor, near door**

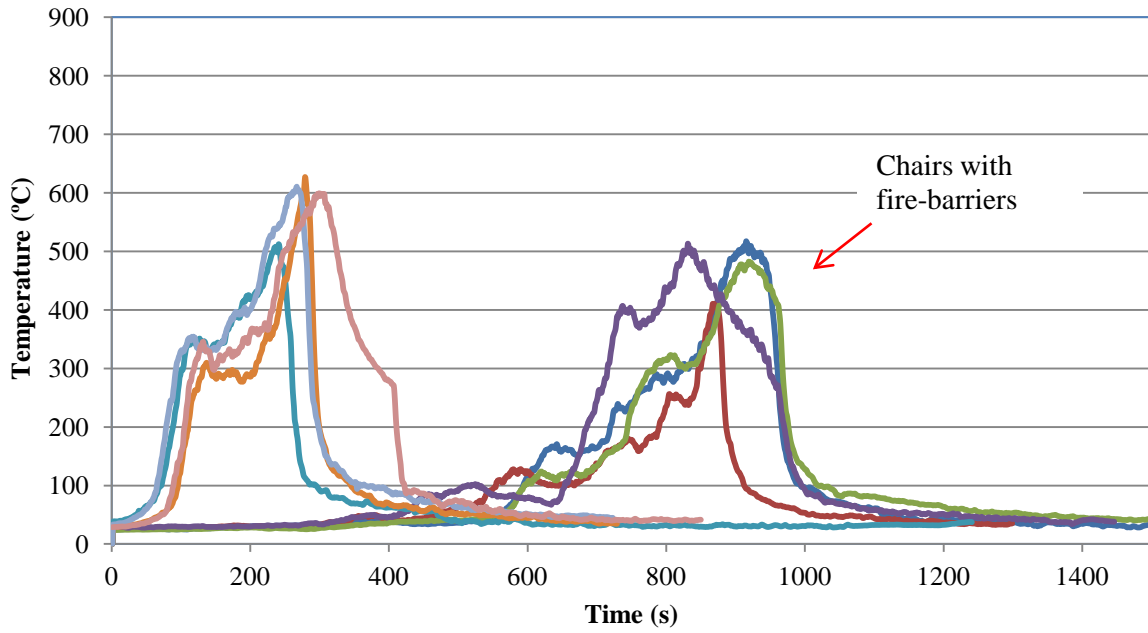

**Temperature Curves for Fabric 2A, FR foam,
5' from floor, near door**

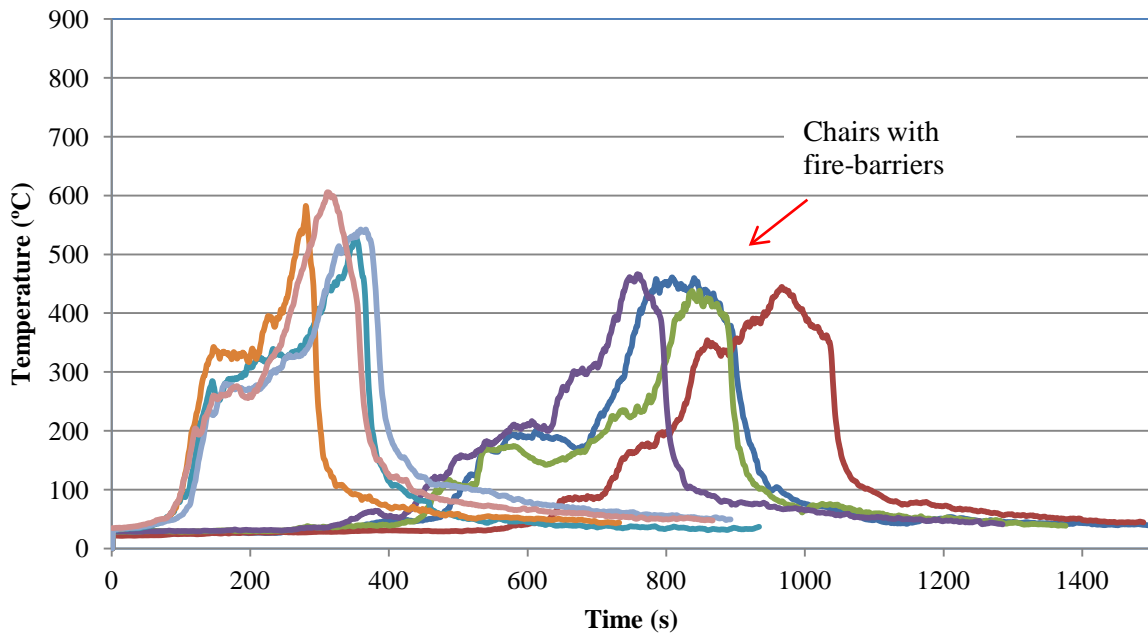

**Temperature Curves for Fabric 2B, SPUF foam,
5' from floor, near door**

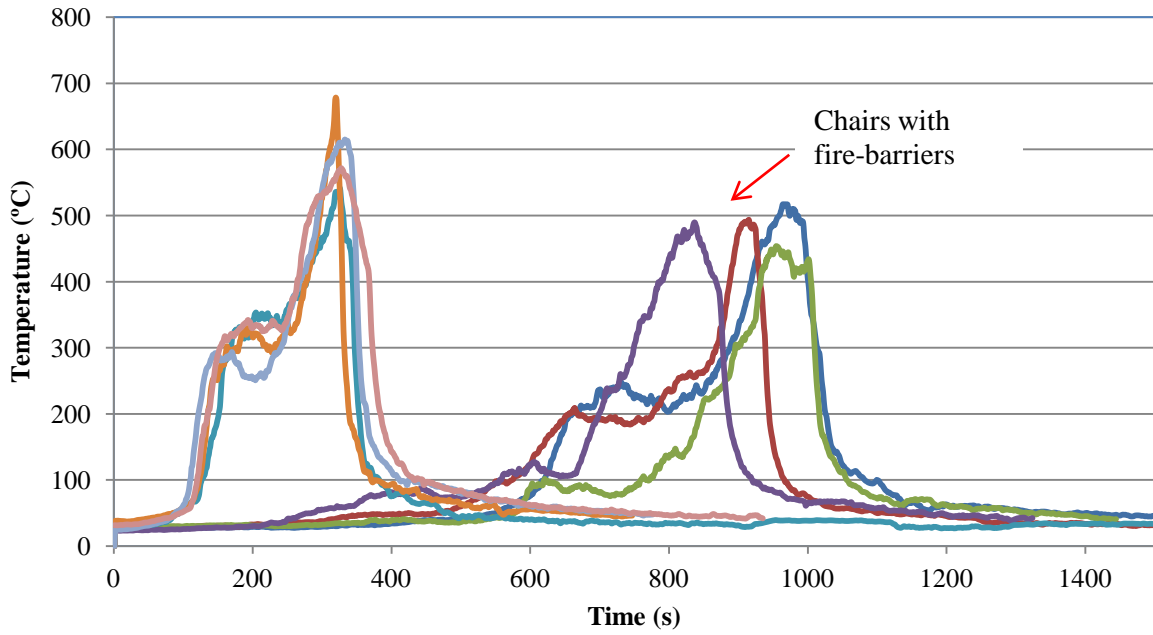

**Temperature Curves for Fabric 2B, FR foam,
5' from floor, near door**

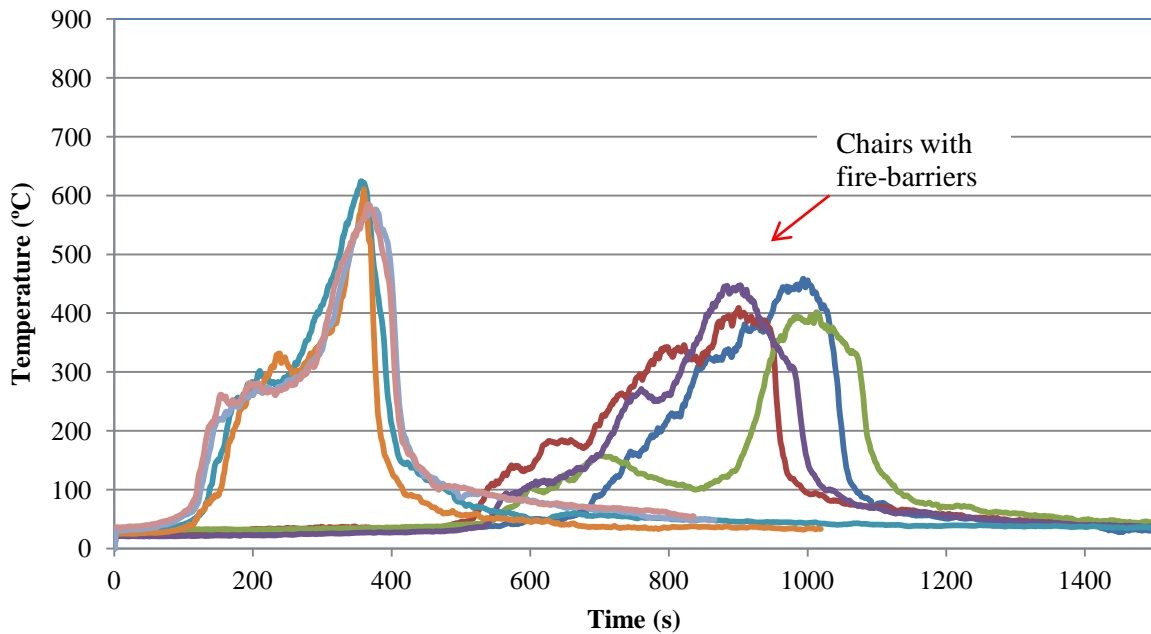

**Temperature Curves for Fabric 1A, SPUF foam,
5' from floor, near chair**

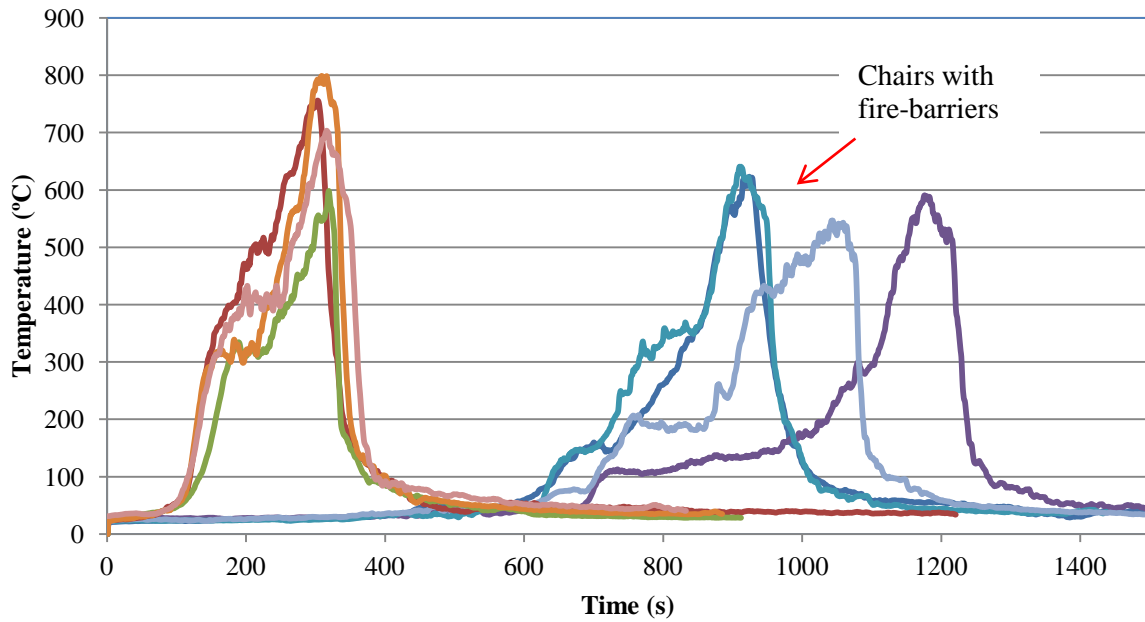

**Temperature Curves for Fabric 1A, FR foam,
5' from floor, near chair**

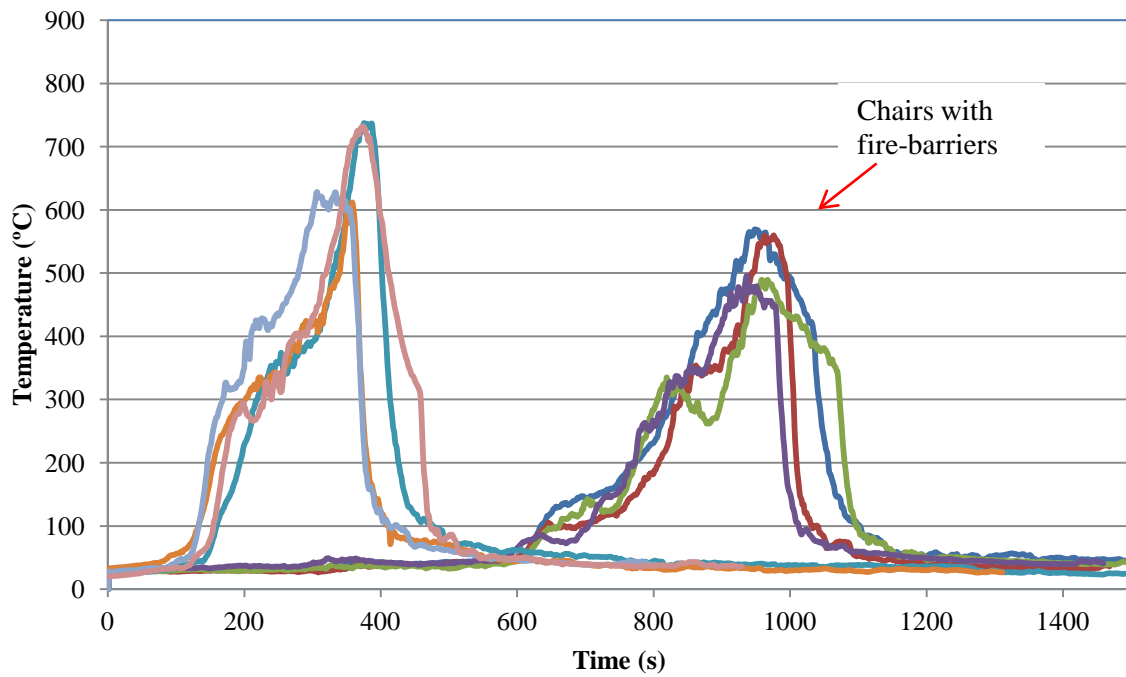

**Temperature Curves for Fabric 1B, SPUF foam,
5' from floor, near chair**

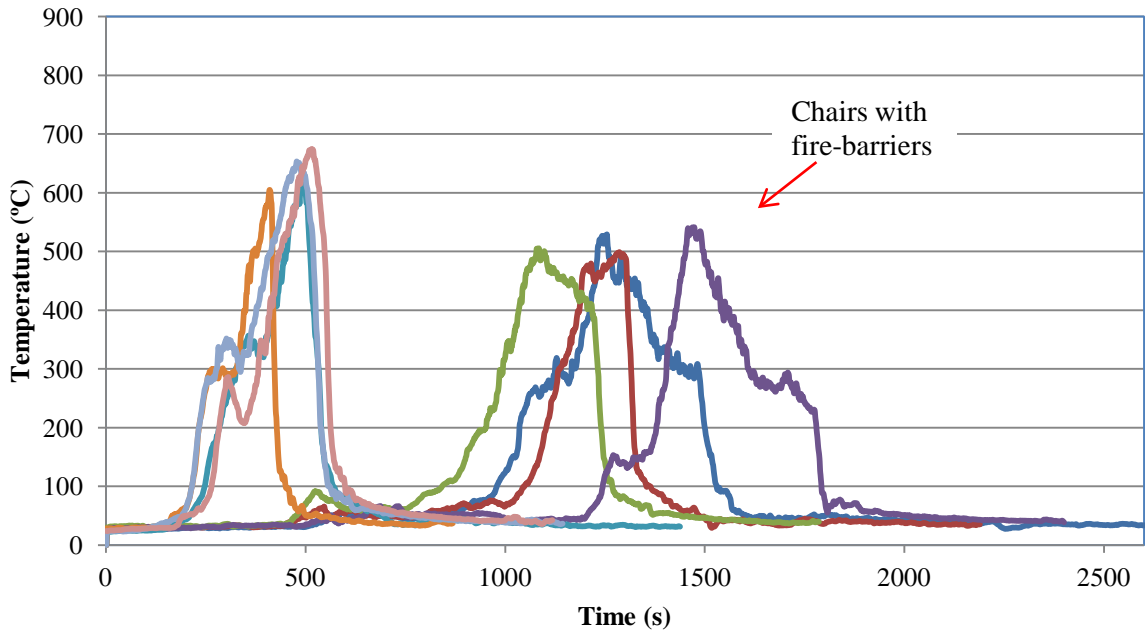

**Temperature Curves for Fabric 1B, FR foam,
5' from floor, near chair**

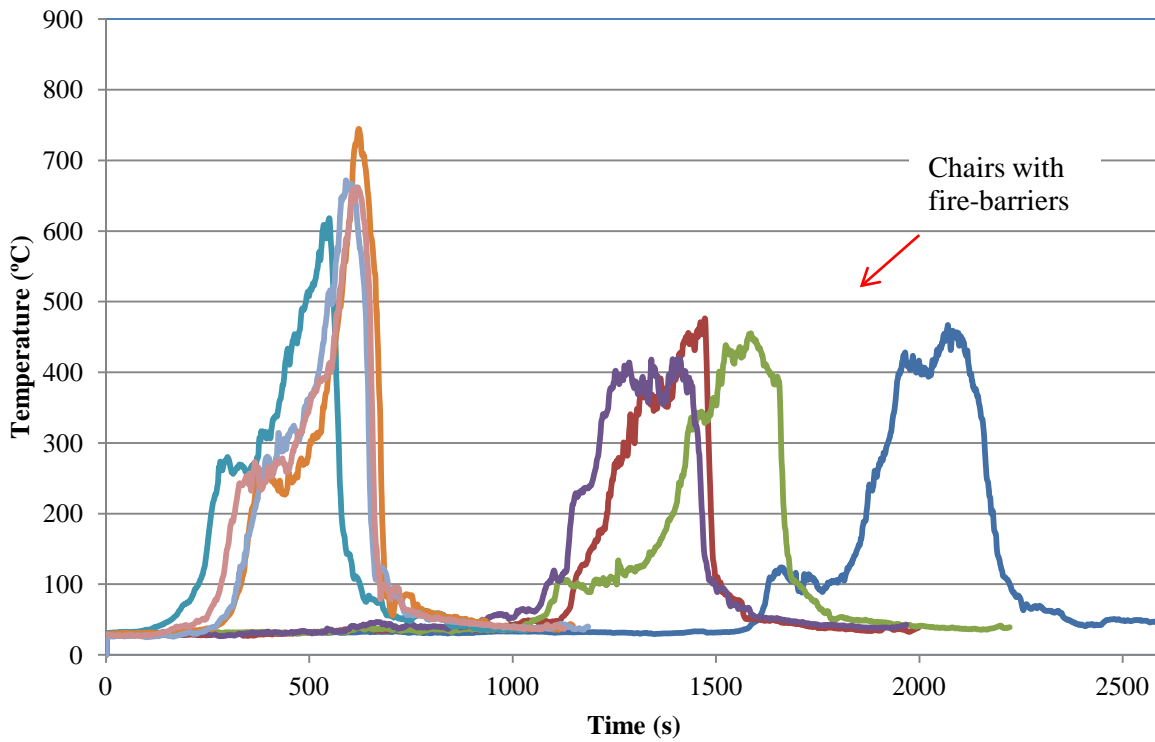

**Temperature Curves for Fabric 2A, SPUF foam,
5' from floor, near chair**

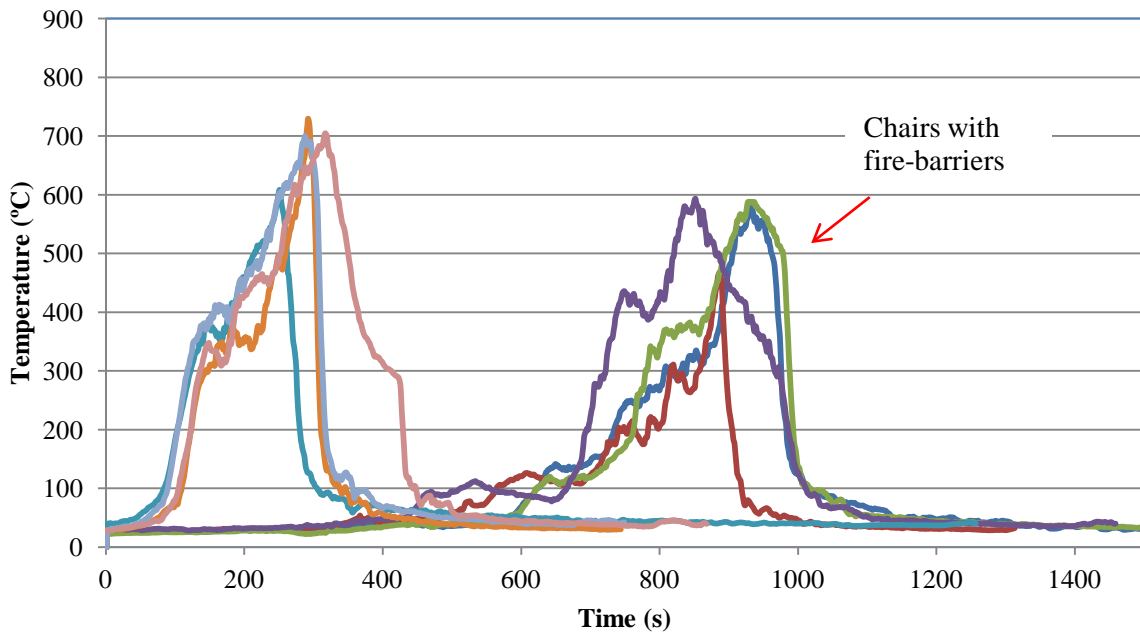

**Temperature Curves for Fabric 2A, FR foam,
5' from floor, near chair**

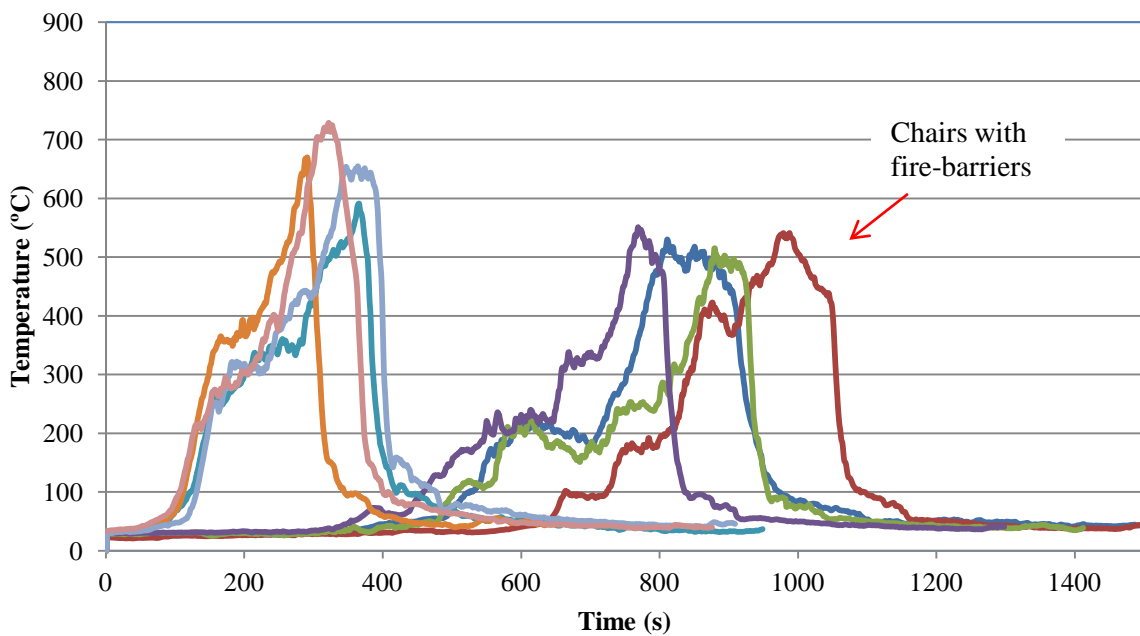

**Temperature Curves for Fabric 2B, SPUF foam,
5' from floor, near chair**

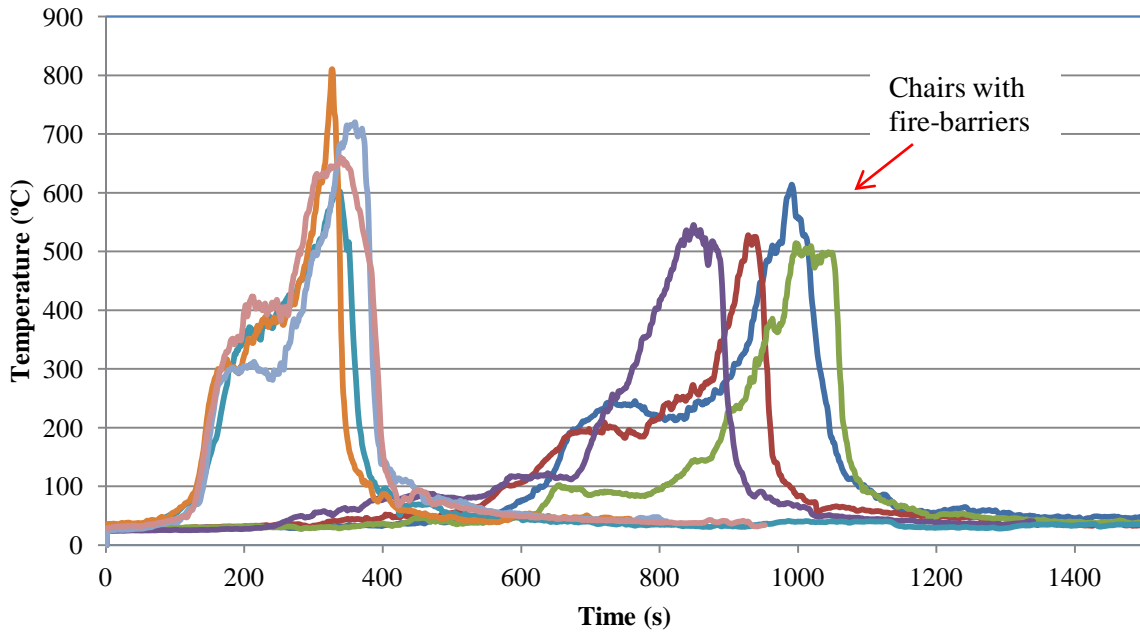

**Temperature Curves for Fabric 2B, FR foam,
5' from floor, near chair**

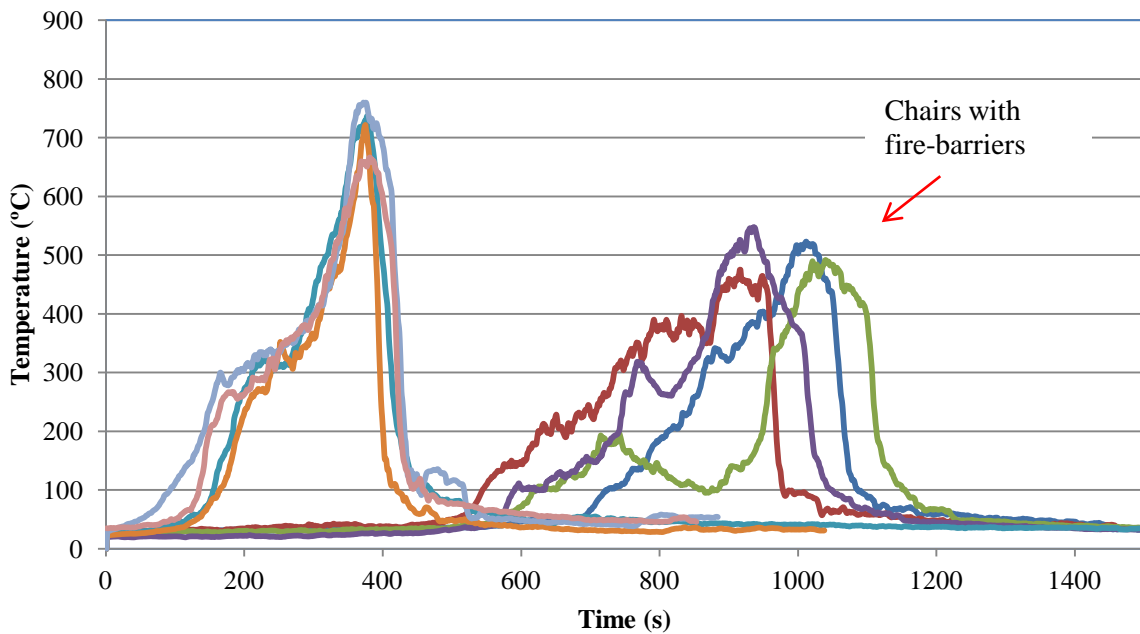

**Temperature Curves for Fabric 1A, SPUF foam,
2' from floor, near door**

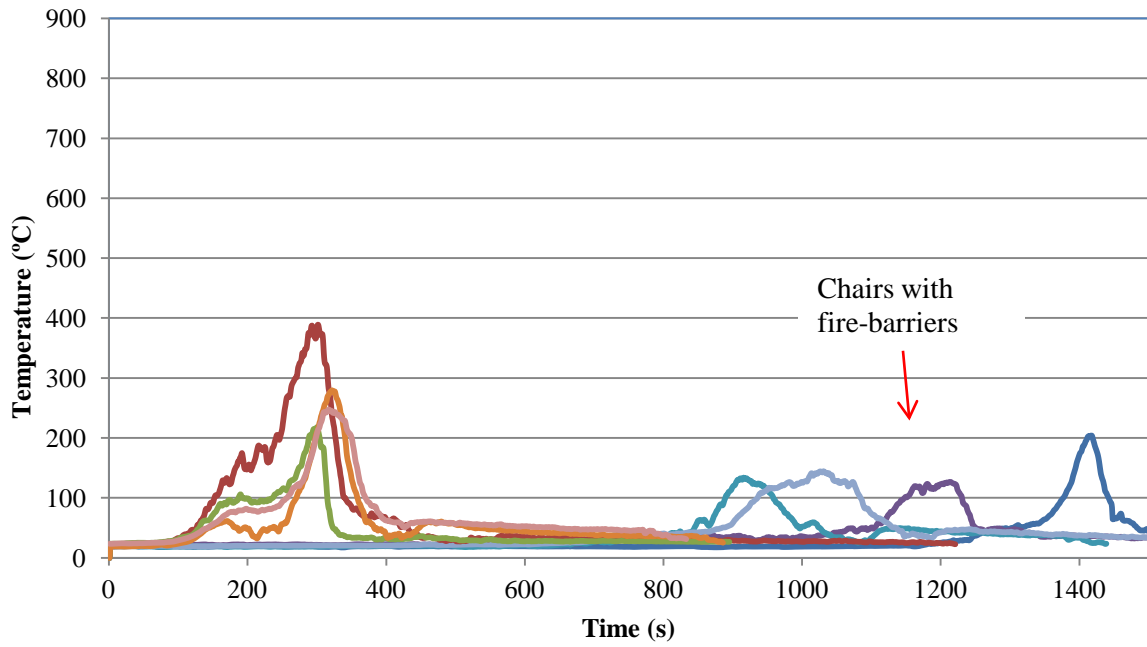

**Temperature Curves for Fabric 1A, FR foam,
2' from floor, near door**

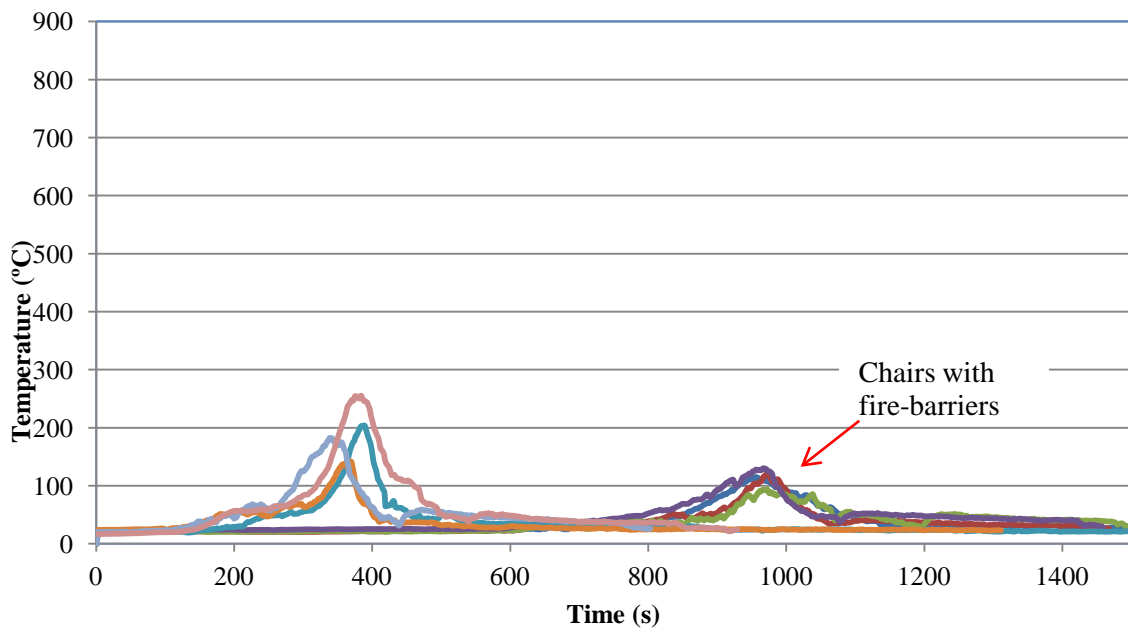

**Temperature Curves for Fabric 1B, SPUF foam,
2' from floor, near door**

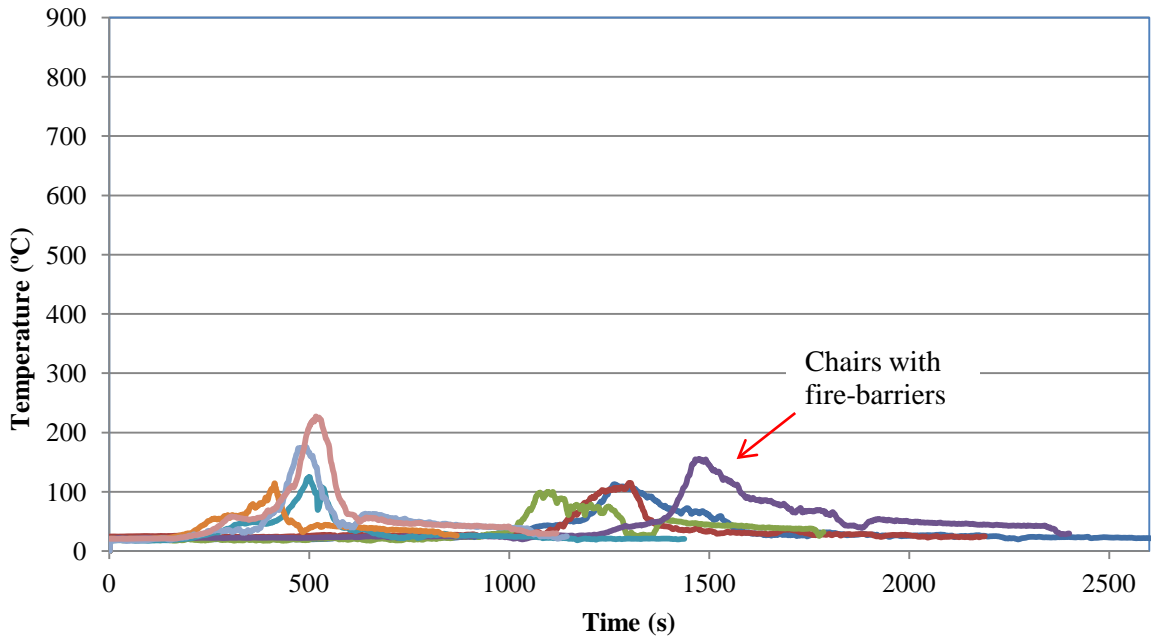

**Temperature Curves for Fabric 1B, FR foam,
2' from floor, near door**

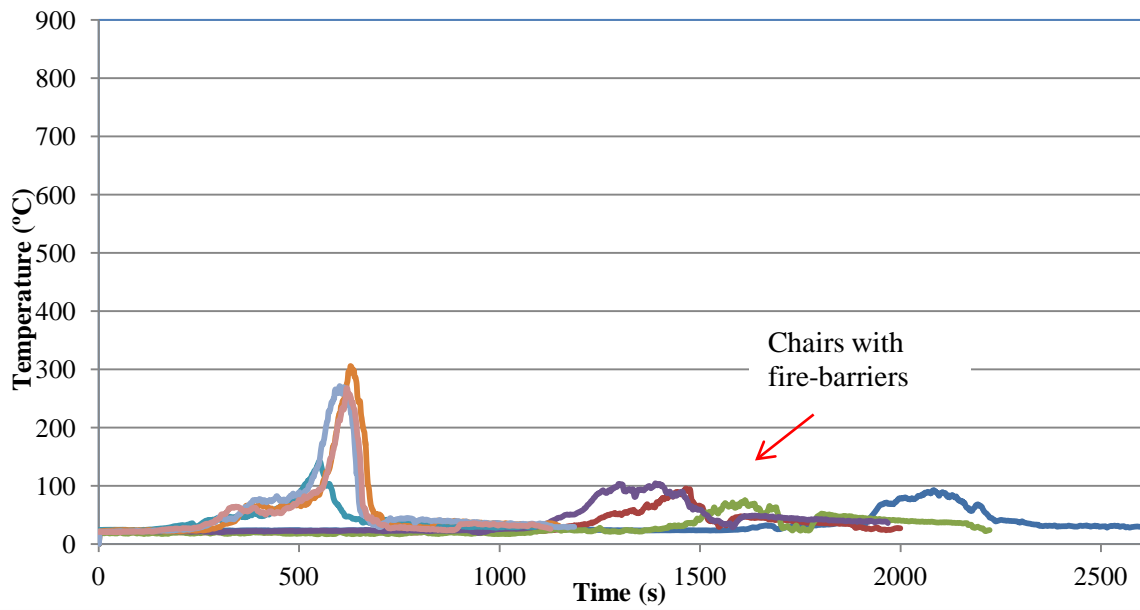

**Temperature Curves for Fabric 2A, SPUF foam,
2' from floor, near door**

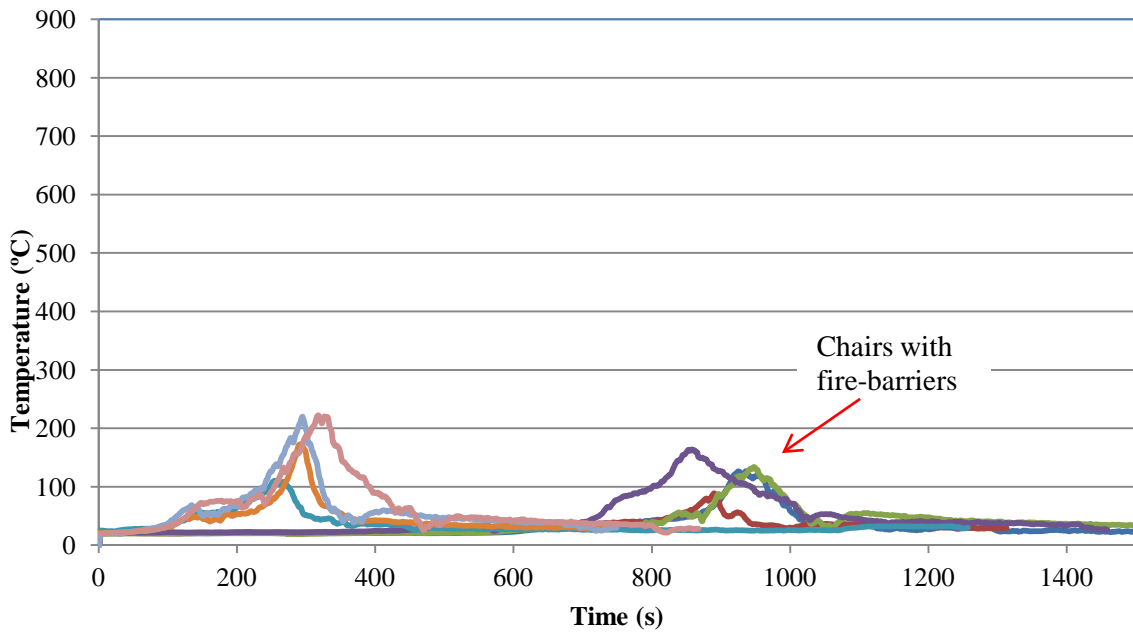

**Temperature Curves for Fabric 2A, FR foam,
2' from floor, near door**

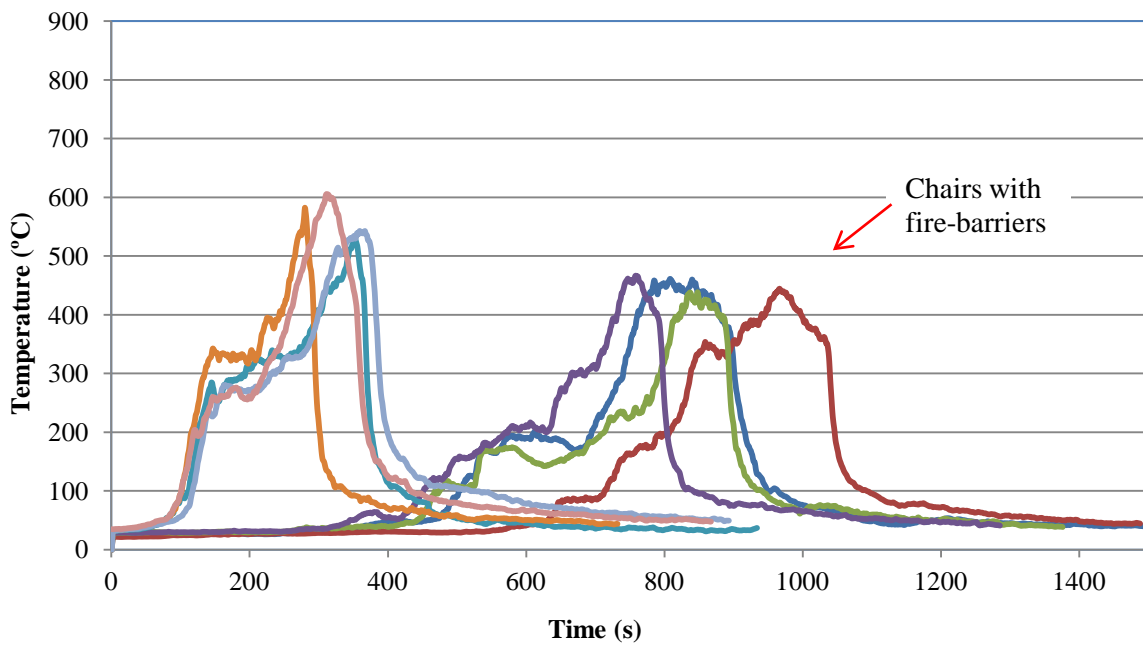

**Temperature Curves for Fabric 2B, SPUF foam,
2' from floor, near door**

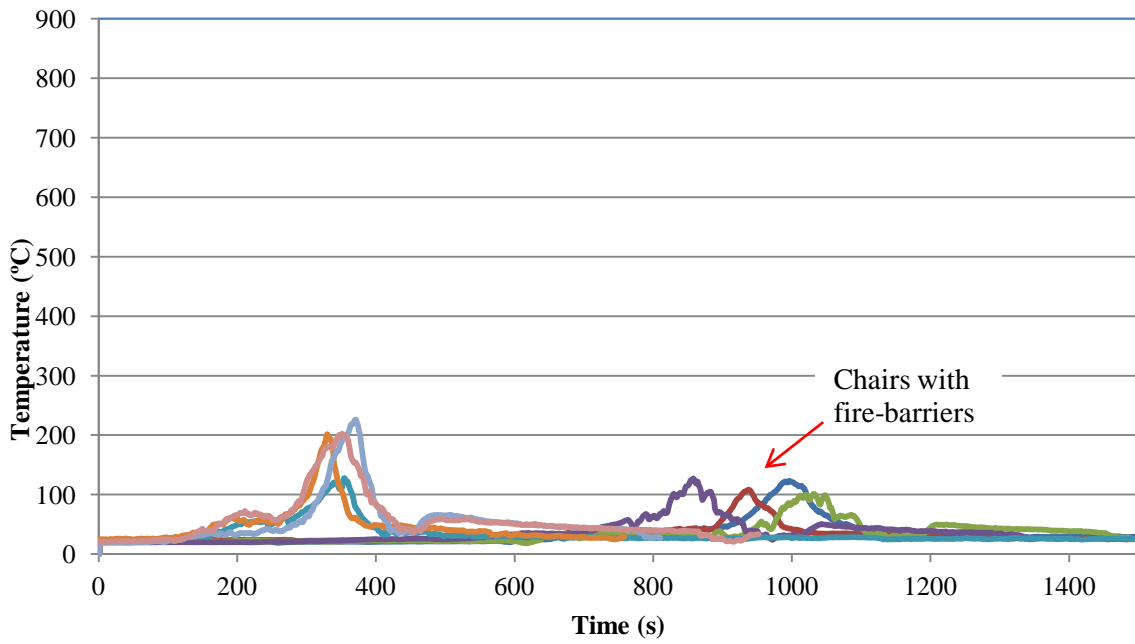

**Temperature Curves for Fabric 2B, FR foam,
2' from floor, near door**

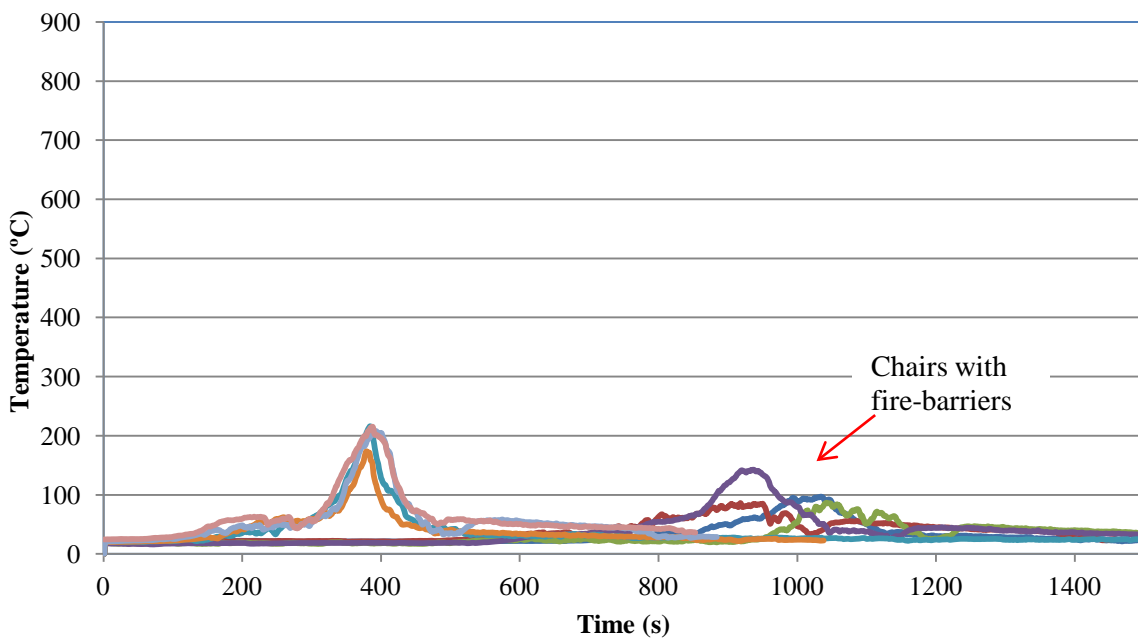

**Temperature Curves for Fabric 1A, SPUF foam,
2' from floor, near chair**

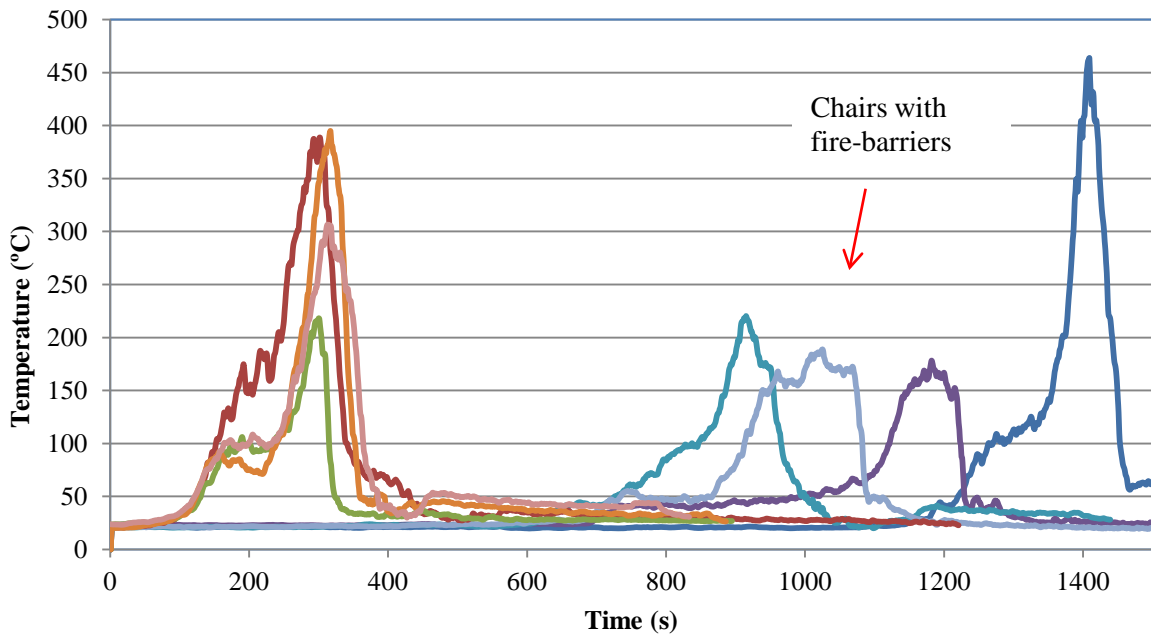

**Temperature Curves for Fabric 1A, FR foam,
2' from floor, near chair**

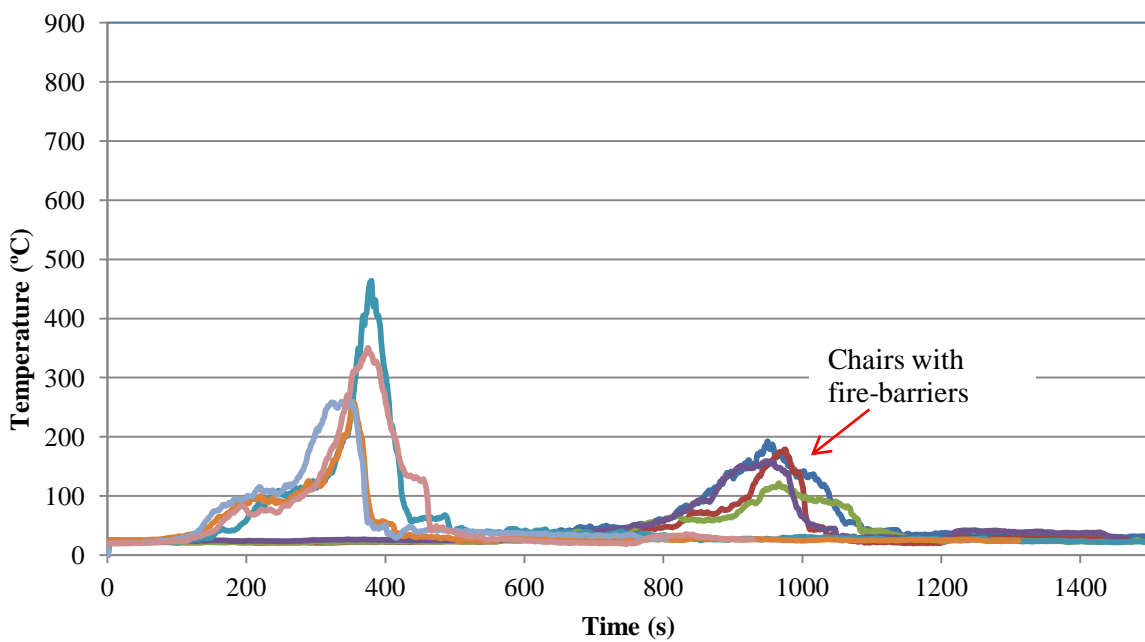

**Temperature Curves for Fabric 1B, SPUF foam,
2' from floor, near chair**

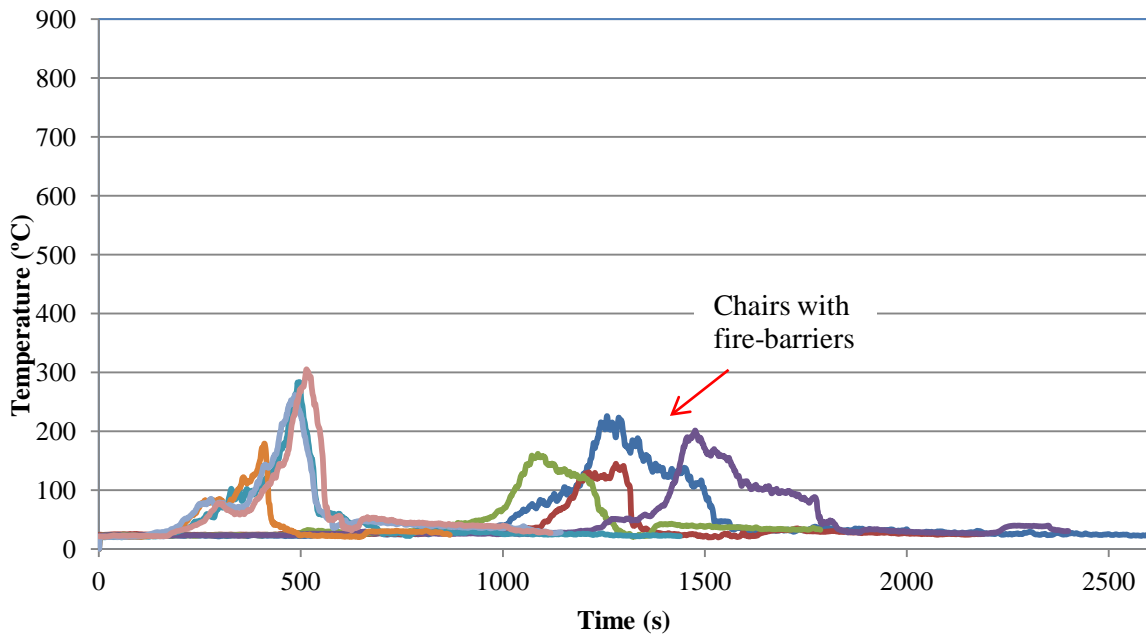

**Temperature Curves for Fabric 1B, FR foam,
2' from floor, near chair**

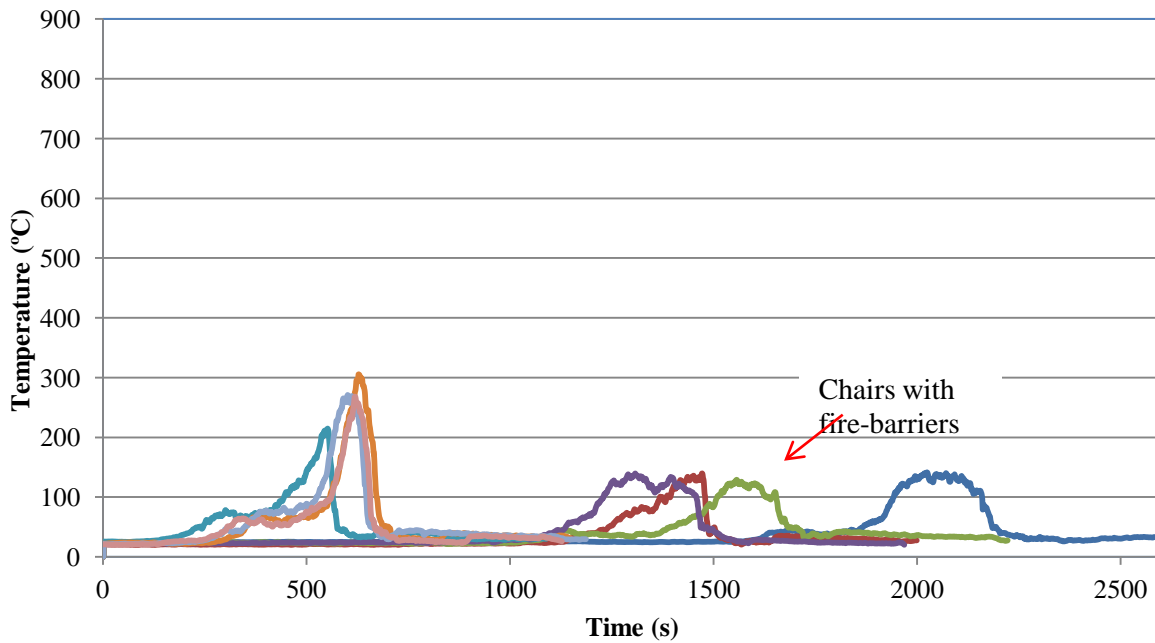

**Temperature Curves for Fabric 2A, SPUF foam,
2' from floor, near chair**

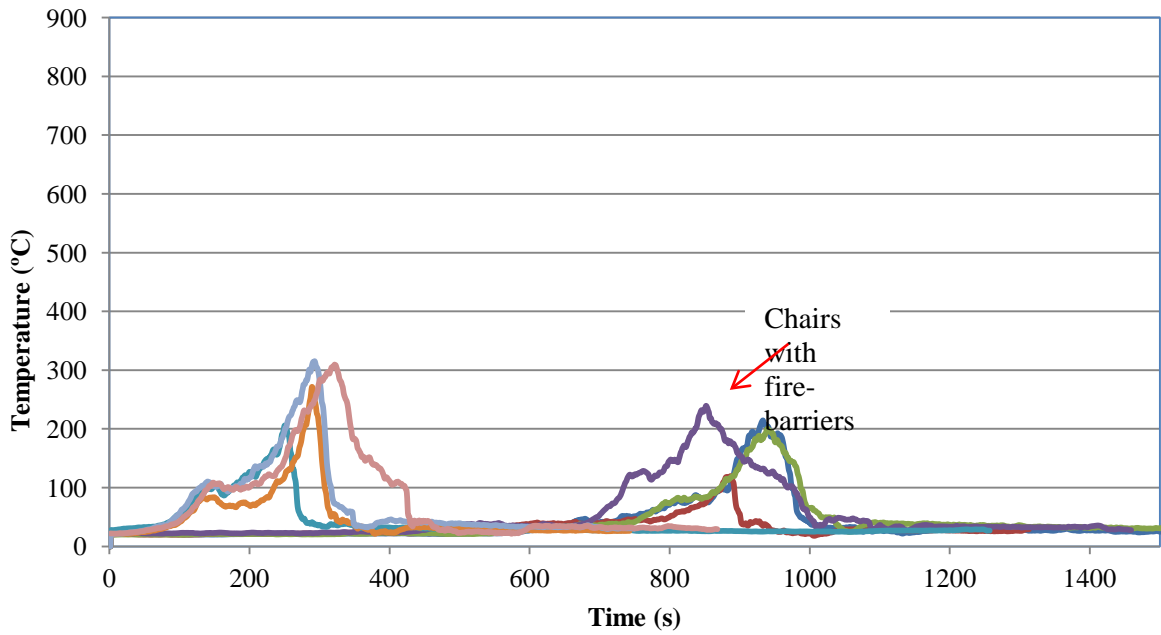

**Temperature Curves for Fabric 2A, FR foam,
2' from floor, near chair**

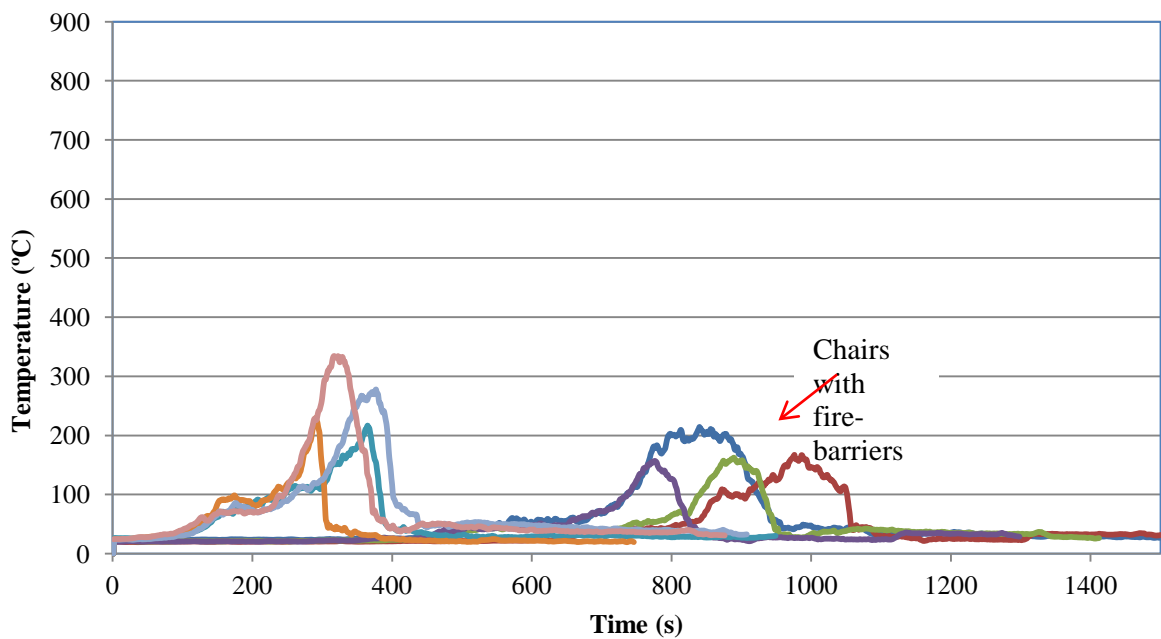

**Temperature Curves for Fabric 2B, SPUF foam,
2' from floor, near chair**

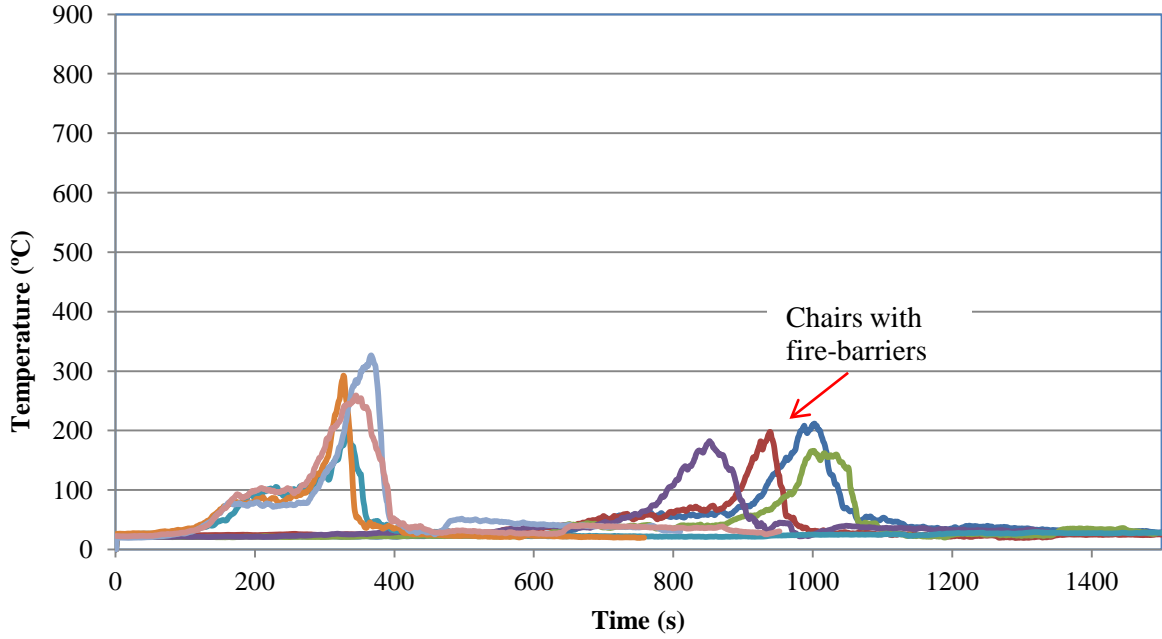

**Temperature Curves for Fabric 2B, FR foam,
2' from floor, near chair**

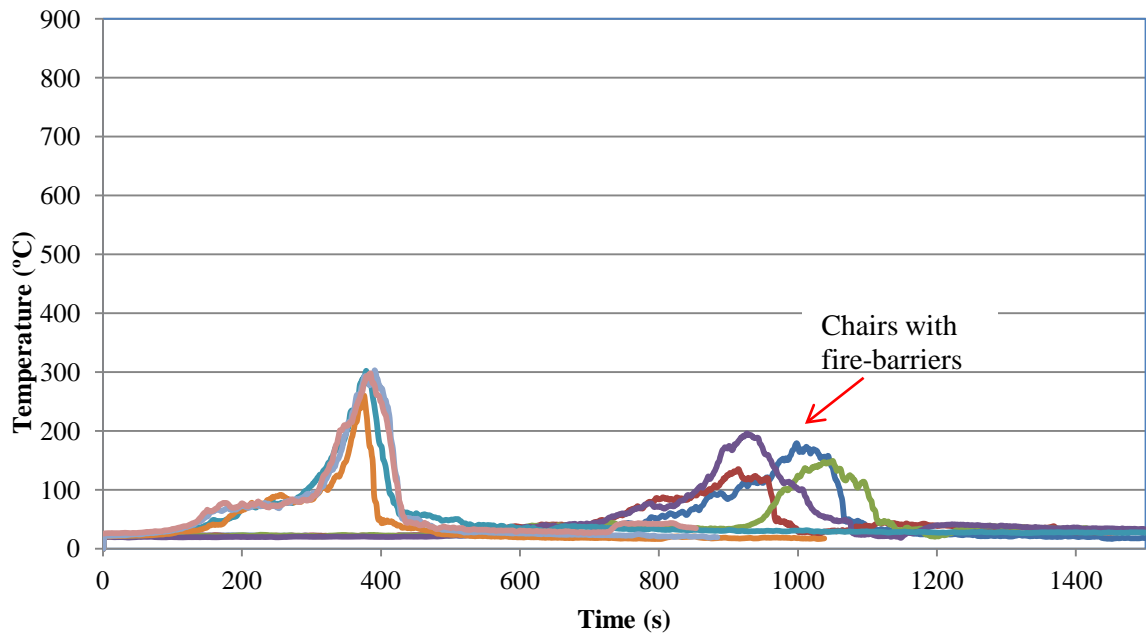

Appendix C. Heat Flux Curves for Tests by Fabric and Foam Combinations

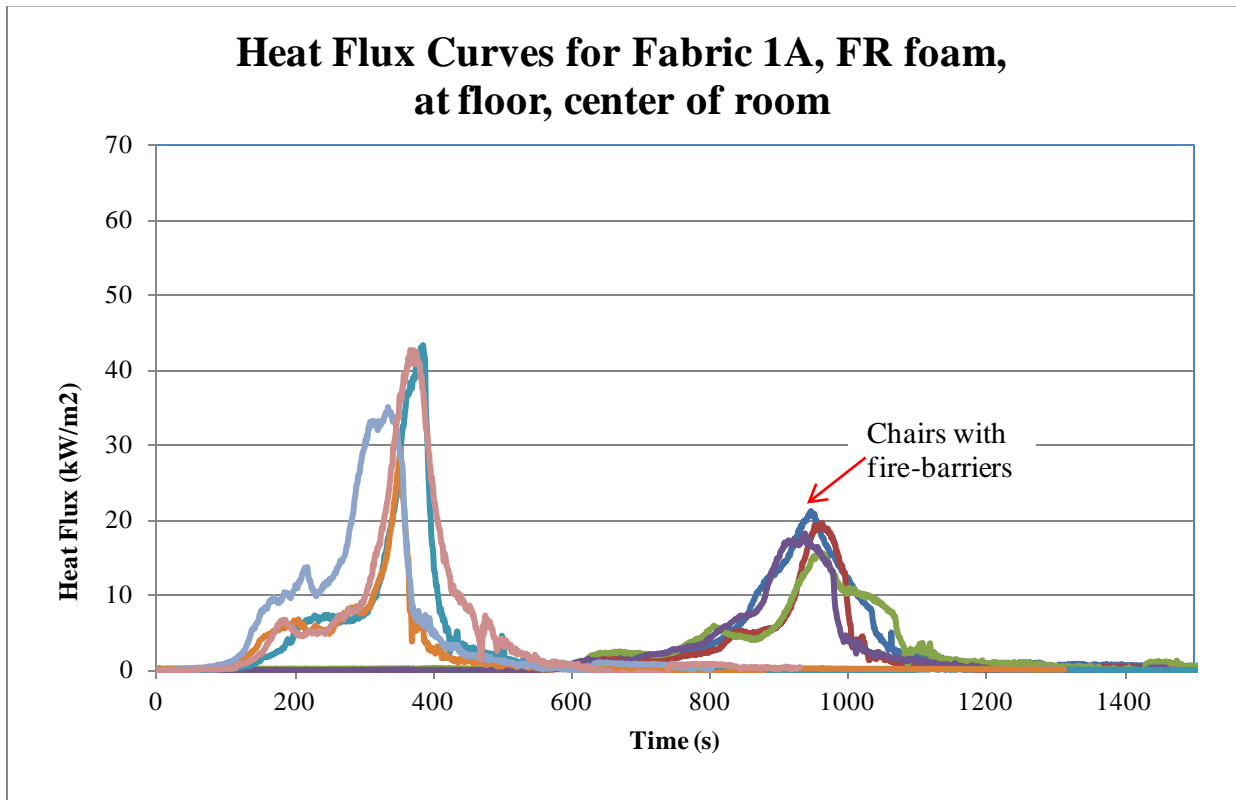
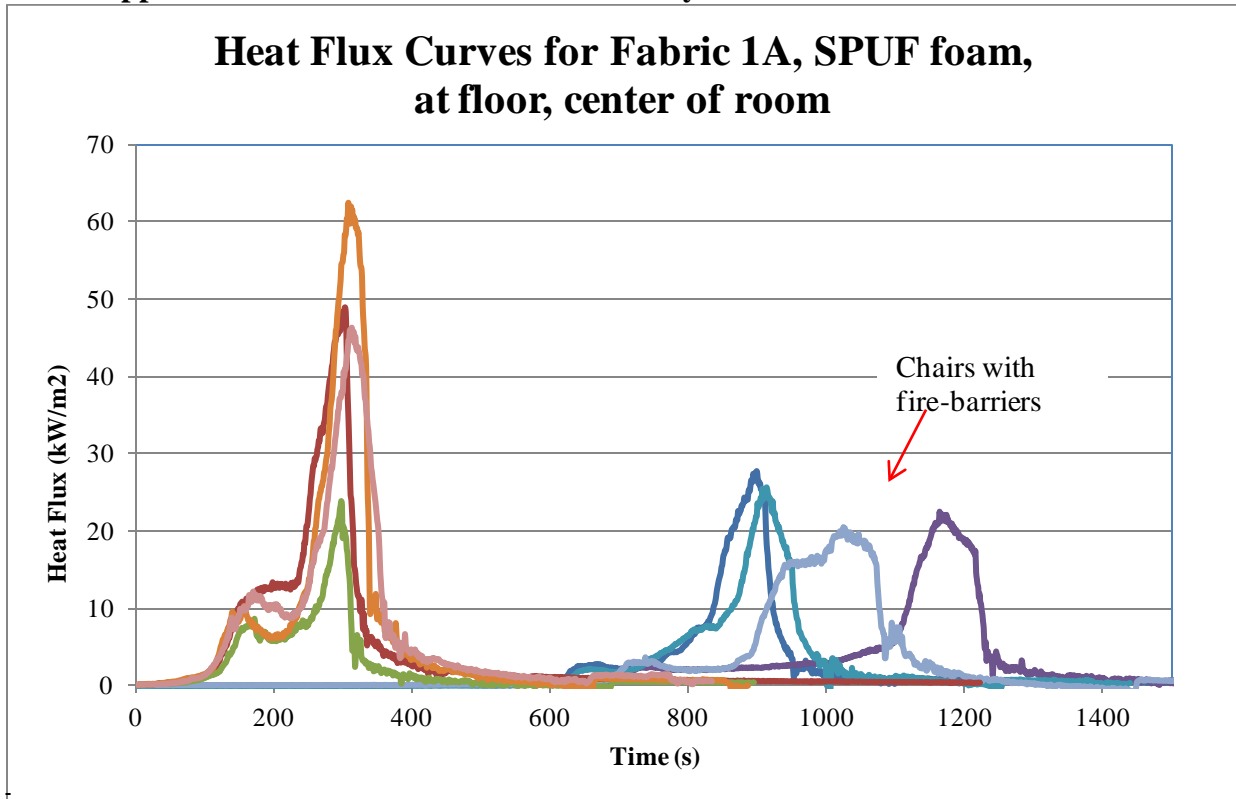

Heat Flux Curves for Fabric 1B, SPUF foam, at floor, center of room

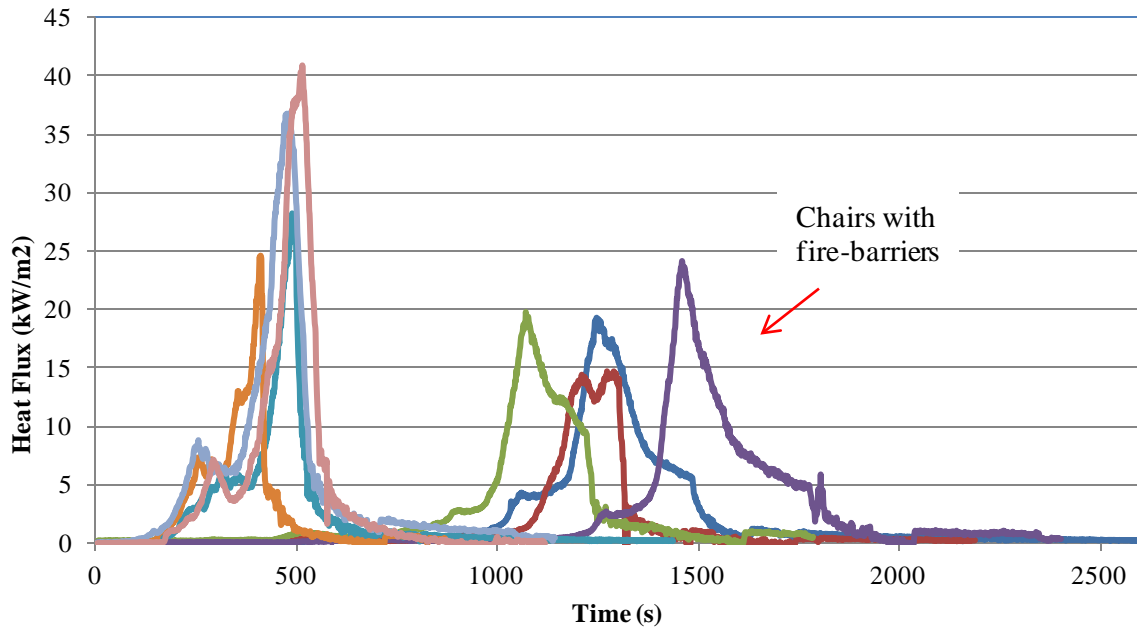

Heat Flux Curves for Fabric 1B, FR foam, at floor, center of room

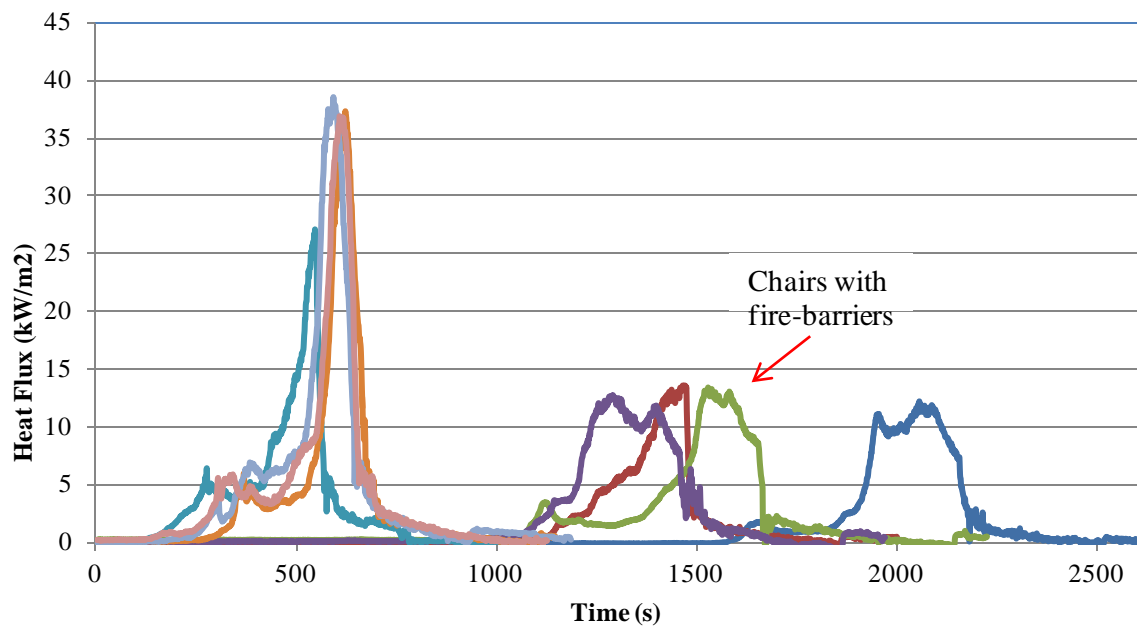

**Heat Flux Curves for Fabric 2A, SPUF foam,
at floor, center of room**

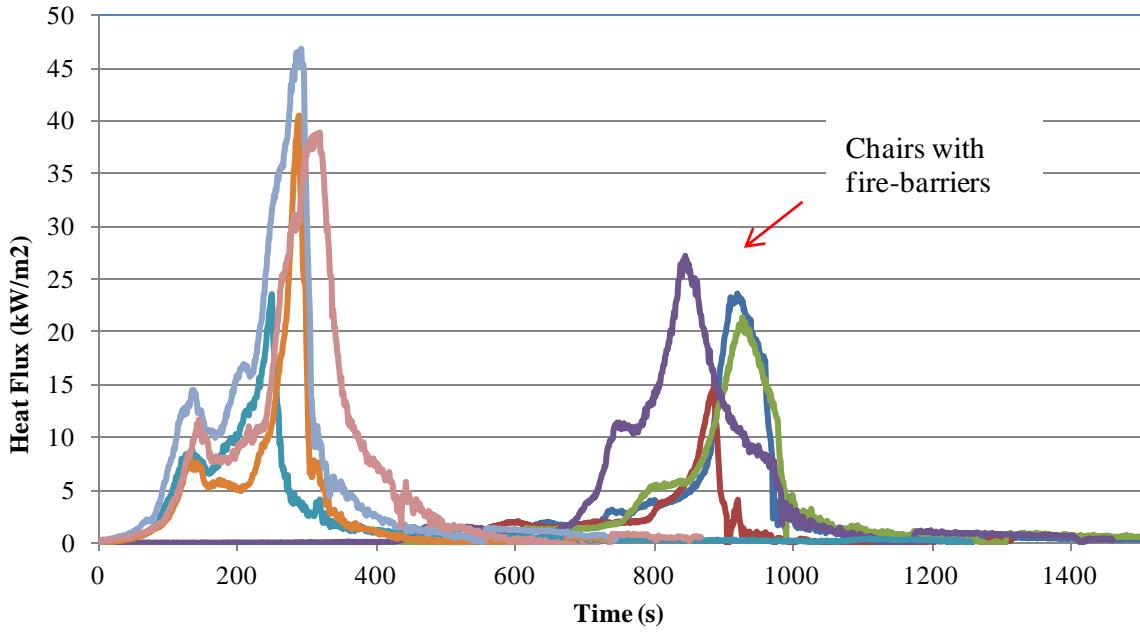

**Heat Flux Curves for Fabric 2A, FR foam,
at floor, center of room**

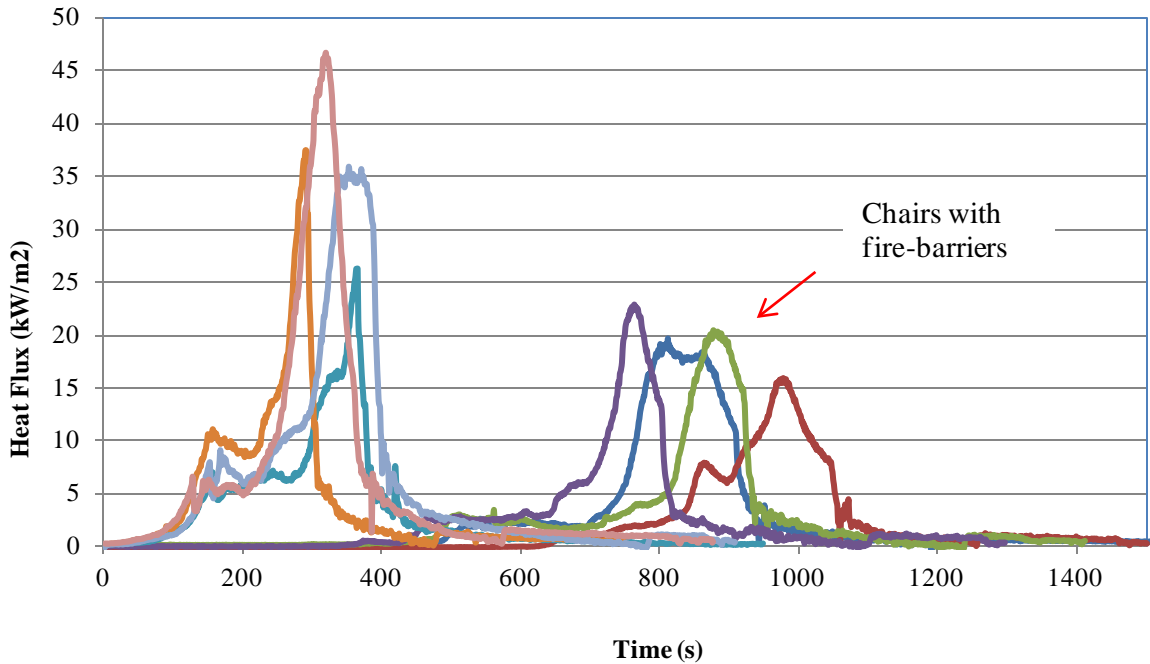

**Heat Flux for Fabric 2B, SPUF foam,
at floor, center of room**

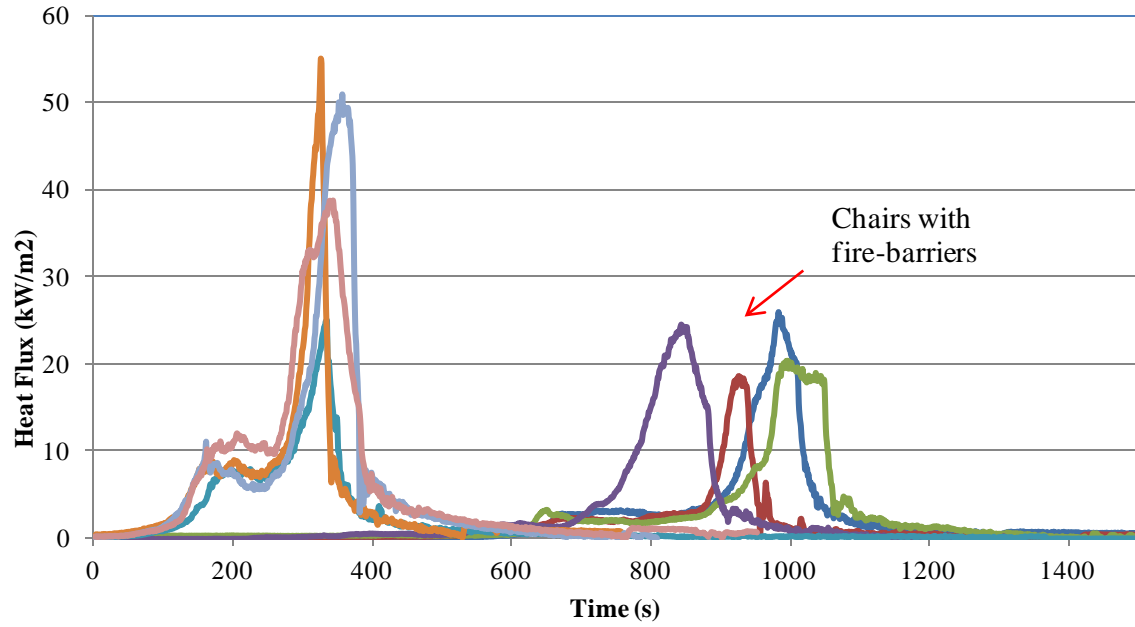

**Heat flux for Fabric 2B, FR foam,
at floor, center of room**

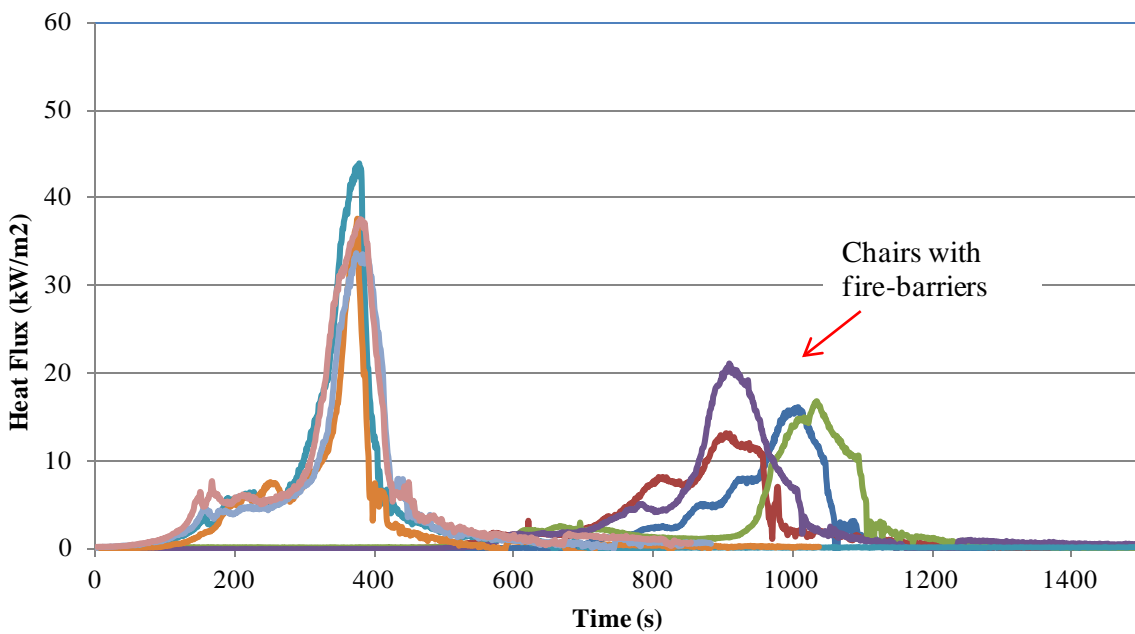

Appendix D. Upholstered Furniture Full-Scale Project Plan

Type II (Fire Barrier) Open-Flame Testing at NIST

TABLE OF CONTENTS

1 TEST PLAN INTRODUCTION 2

1.1 Background 2

1.2 Goal and Objectives 3

2 PRODUCT DESCRIPTION AND SUBCOMPONENTS BEING TESTED..... 3

2.1 Full-Scale Upholstered Chair Sample Description 3

2.2 Text Matrix..... 5

3 Type II Open-Flame Testing 5

3.1 Test Facilities and Instrumentation Setup 5

3.2 Test Procedure..... 7

3.3 Data Collection..... 8

3.4 Test Setup..... 8

4 Roles and Responsibilities..... 8

4.1 CPSC 9

4.2 NIST..... 9

5 CONTACT INFORMATION 10

Appendix D1 – Test Protocol 11

Appendix D2 – Full-Scale Chair Testing Data Sheet 13

Appendix D3 – Testing Sequence..... 14

1 TEST PLAN INTRODUCTION

1.1 Background

The U.S. Consumer Product Safety Commission (“CPSC”) has proposed flammability standards for residential upholstered furniture under the Flammable Fabrics Act (“FFA”).^{*} The proposal would establish: (1) performance requirements to reduce the likelihood of smoldering-induced ignition and (2) certification and labeling requirements for upholstered furniture. Manufacturers of specific types of upholstered furniture would choose one of two possible methods for compliance: They could use cover materials that are sufficiently smolder resistant to meet a cigarette-ignition performance test (*i.e.*, “Type I” furniture); or they could place fire barriers that meet smoldering- and small open-flame resistance tests between the cover fabric and interior filling materials (*i.e.*, “Type II” furniture). Manufacturers of upholstered furniture would be required to certify compliance with the standard and comply with certain record-keeping requirements, as specified in the proposal.

In developing the proposed flammability standard to address ignitions of specific types of residential upholstered furniture, the Commission considered the available hazard information, and existing standards development research, together with the latest CPSC laboratory data and technical information developed by other organizations. Economic, health, and environmental factors were also considered.

The proposed standard addresses resistance to smoldering ignition and limited fire growth by means of bench-scale performance tests for cover fabrics, and alternatively, for barriers. The performance requirements of the proposed standard are intended to reduce the risk of fire from smoldering ignition. If barriers are chosen as the means of compliance, they must meet both small open-flame and smoldering-resistance requirements. The proposal adapts elements and variations of existing standards, including California Technical Bulletin 117, ASTM E-1353 (tests from the UFAC voluntary industry guidelines) and United Kingdom regulations (based on British Standard BS-5852)[†].

CPSC staff is planning to conduct full-scale upholstered furniture chair testing to assess qualitatively the potential effectiveness/ benefits of the proposal. This will include an evaluation of Type I (smolder resistance of cover fabrics) and Type II- (smolder and small open-flame resistance of fire barriers) compliant upholstered furniture. In addition to collecting data on full-scale furniture fire performance, the response of smoke and carbon monoxide alarms will be

^{*} Federal Register, March 4, 2008. Consumer Product Safety Commission, 16 CFR Part 1634, Standard for the Flammability of Residential Upholstered Furniture; Proposed Rule.

[†] BS-5852, Methods of test for assessment of the ignitability of upholstered seating by smouldering and flaming ignition sources. 1990.

examined in this study. This test plan covers the assessment of Type II open-flame examination of fire barriers that will be conducted at National Institute of Standard and Technology (NIST).

1.2 Goal and Objectives

The goal of this phase of full-scale testing is to develop test data on Type II upholstered furniture to demonstrate the potential effectiveness of the CPSC-proposed upholstered furniture flammability standard.

The objectives of this full-scale testing program are to:

- Obtain data on full-scale fire performance of upholstered furniture;
- Determine the extent to which the proposed bench-scale testing performance requirements can predict full-scale furniture fire performance;
- Incorporate knowledge gained from this test program to revise the proposed rule, if necessary; and
- Examine response characteristics of smoke and carbon monoxide alarms during large-scale testing.

2 PRODUCT DESCRIPTION AND SUBCOMPONENTS BEING TESTED

2.1 Full-Scale Upholstered Chair Sample Description

In FY 2008, CPSC staff issued a contract for the construction of full-scale upholstered furniture to conduct full-scale fire testing. CPSC staff specified information on upholstery and filling materials necessary to establish controls for the test procedures. The contractor purchased directly from specified manufacturers, the materials needed for the construction of the chairs and constructed furniture.

CPSC is providing NIST 64 chairs for Type II open-flame ignition testing. NIST is providing 7 weeks of time in the Large Fire Laboratory to complete testing of as many of the 64 chairs as possible. The chairs are upholstered, single-seat, “club chairs” (see Figures 1 and 2), with a contiguous seat, upholstered back and arms, and the chairs are constructed with a combination of fabric and filling materials.

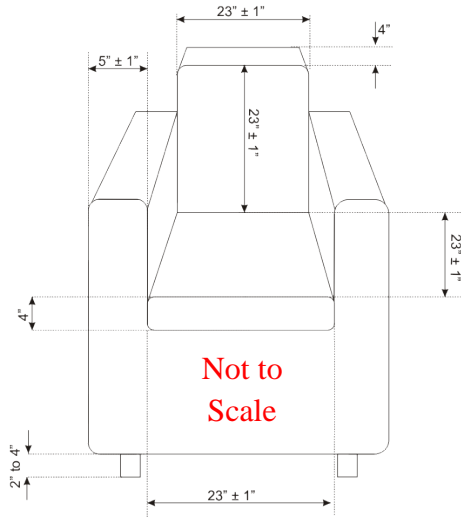

Figure 1. Schematic of Sample



Figure 2. Prototype

2.2 Text Matrix

The following is the chair test matrix, showing the various combinations of upholstery cover fabrics, filling materials (*e.g.*, polyurethane foam, batting), and interior fire-barrier materials.

Combination Number	Foam	Poly Wrap	Barrier ⁺	Fabric	Number of Chairs
1	SPUF	none	B1	1a	4
2	SPUF	P1	none	1a	4
3	FR	none	B1	1a	4
4	FR	P1	none	1a	4
5	SPUF	none	B1	1b	4
6	SPUF	P1	none	1b	4
7	FR	none	B1	1b	4
8	FR	P1	none	1b	4
9	SPUF	none	B1	2a	4
10	SPUF	P1	none	2a	4
11	FR	none	B1	2a	4
12	FR	P1	none	2a	4
13	SPUF	none	B1	2b	4
14	SPUF	P1	none	2b	4
15	FR	none	B1	2b	4
16	FR	P1	none	2b	4
Total					64

⁺ Barrier B1 is a combination of nominal 4 oz. polyester batting over a fire-blocking barrier.

3 TYPE II OPEN-FLAME TESTING

CPSC will provide NIST with the testing details (Test Setup, Test Protocol, and Data Collection). CPSC may change any or all of the testing details at any time before or during testing. NIST will take necessary steps to comply with any and all changes to the test details. If NIST and/or CPSC believe the changes cannot be accommodated within a reasonable timeframe, NIST and CPSC Primary Investigators (PI) will determine the path forward. No immediate written record of changes is required. CPSC staff's report will describe any such changes.

3.1 Test Facilities and Instrumentation Setup

This section contains the necessary information to construct the testing environment; *i.e.*, type and location of instrumentation and room design. During testing, the PIs can change the test setup conditions, such as placement of smoke alarms; however, it is the initial assumption that the information contained in this section will not be a variable in this testing study. The role and

responsibilities for the activities in this section are explained in section 4, “Roles and Responsibilities”:

- Tests are to be conducted in a NIST/ISO 9705-compliant room, instrumented as detailed in this section. If the fire substantially damages the room structure, then the instrumentation and drywall will be removed to allow for the required room reconstruction prior to reinstrumenting for the next test. The room layout is shown in Figure 3.
 - The walls will be two layers of Type C Gypsum board. Only the inner layer will be sealed. The outer layer will have joints offset from the inner layer to minimize loss of combustion products through the walls.
 - The paper will be burned off before testing because the paper can generate a sharp HRR spike.
 - The catch pan will contain Durock®; Kaowool® may be added to insulate the catch pan better and prevent warping, as needed.
 - The room air temperature must be below 50 °C before clean up. Room “cool down” will be accelerated using fans, but this could also increase the failure rate of the drywall, requiring more frequent rebuilds. The most efficient process will be determined during testing.
- Two thermocouple trees will be used to measure upper layer temperature and depth. The location of the thermocouple trees will be determined at the time of room construction.
- CO and CO₂ sensors will be used to measure CO and CO₂ levels in the upper layer. The sensors will be placed so as to measure at the top of the door opening. The exact location of the sensor will be determined on day 1 of testing.
- A heat flux gauge will be placed in the middle of the room, pointing through the floor directly toward the ceiling.
- Smoke obscuration will be measured as follows: A word will be written in the middle of the back wall about 4 feet above the floor. An observer will call out when the word is no longer visible.
- Heat Release Rate (HRR) will be measured.
- Two to three video cameras will be used to record each test. The exact location of the cameras is TBD.
- Six smoke and X CO alarm locations are TBD. The location and the frequency of using these alarms will be the responsibility of the CPSC.
- The door to the NIST/ISO 9705-compliant room will be open completely during testing.
- The ignition source and fuel are to be provided by the CPSC.
- The chair will be placed in the corner of the room with the front of the chair facing the door.

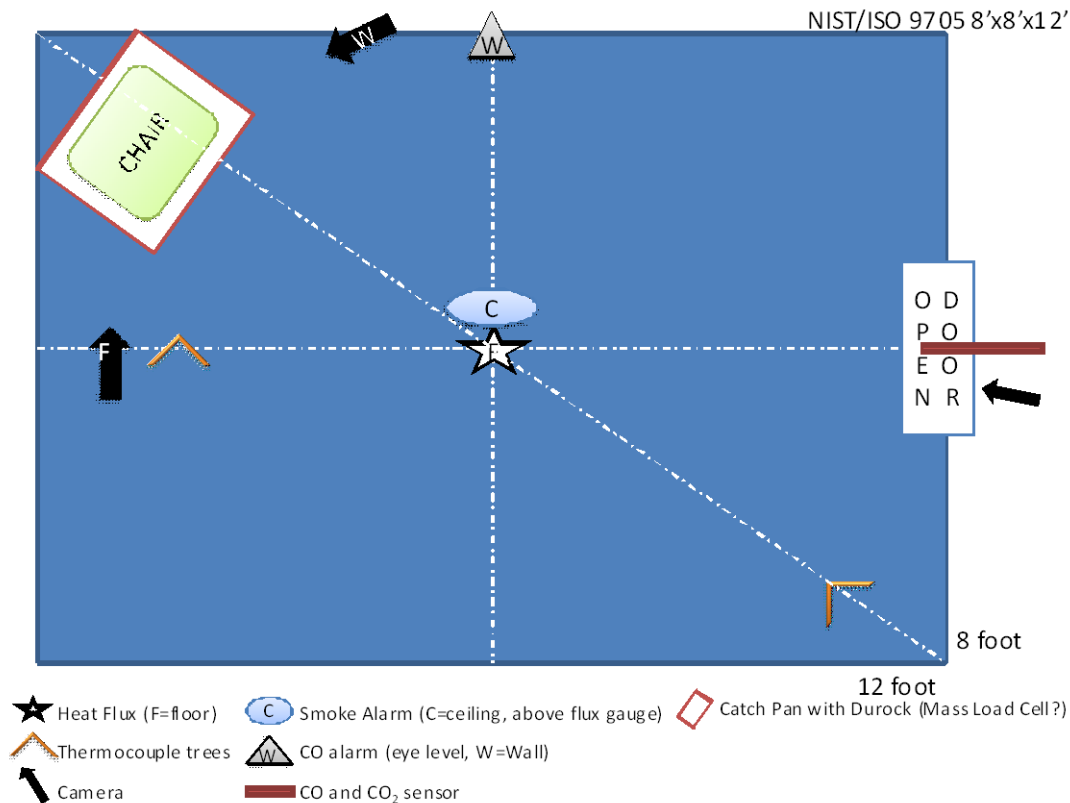

Figure 3. Schematic of Test Room, with Dimensions and Placement of Sample, Devices and Sensors Note: Not to Scale.

3.2 Test Procedure

The details of the testing protocol are in Appendix D1 of this document and include the following factors: NIST activities under the protocol are explained in section 4, “Roles and Responsibilities”:

- Ignition sequence
- Testing sequence (randomization scheme, Appendix D3)
- Duration and termination parameters
- Data collection specifics, such as beginning and ending measurements, and sampling frequency
- If the room is damaged during testing, room reconstruction and reinstrumenting cannot occur until the room cools down to a level that the supervisor determines to be safe to perform these activities. The baseline assumption is that the nonbarrier chairs will release at least/approximately 500–600 kW of heat, which may require the room to be rebuilt after two to three tests; suppression activities will have a big impact on if and when the room will need to be rebuilt. Room reconstruction and reinstrumenting will take approximately half a day. NIST has suggested a testing rate of three chairs/day (barrier) and two chairs/day (non-barrier). However, NIST is not guaranteeing a testing rate or a total number of tests because there are a lot of unknowns (heat flux generated by

a chair). NIST will provide 7 weeks of LFL testing time and will do everything possible to complete as many of the 64 chairs, as long as “everything” falls within NIST’s safety policies.

3.3 Data Collection

The data collected will include:

- Heat release rate vs. time. Within this measurement is data collection for CO, CO₂ and O₂ in the fire effluent.
- CO concentration vs. time. The location of the CO sensor in the room is TBD. It is expected to be placed at approximately eye level inside the test room. CO is also measured in the effluent stream of the hood.
- Time to smoke detector activation. Two brands of three types of hard-wired smoke detectors will be used: photoelectric, ionization, and combination. They will be located on the ceiling directly above the chair specimen with signal data capture.
- CO alarm performance.
- Heat flux meter data.
- Peak heat release rate.
- Time to peak heat release.
- Total energy release, as needed.
- Temperature of the test room vs. time. Thermocouple locations are TBD.
- Smoke obscuration, noted by a visual cue in the room.

3.4 Test Setup

Open-flame ignition testing of upholstered furniture will be conducted in a NIST/ISO 9705 room. This room will be built and instrumented as follows:

- Two thermocouple trees to measure upper layer temperature and depth;
- CO and CO₂ levels in the upper layer (as measured at the top of the door opening);
- Heat flux meter at center of room, pointed up at the ceiling;
- Smoke obscuration indication (*e.g.*, painted mark 4 ft. above the floor);
- Heat release rate;
- At least two video cameras;
- Smoke alarms and CO alarms; and
- The door of the room will be open to help the room size accentuate the build-up of heat and toxic gases.

4 ROLES AND RESPONSIBILITIES

Unless otherwise indicated, the CPSC and NIST will have the following responsibilities. The ownership of these responsibilities is subject to change, depending upon factors, such as equipment and personnel availability. Such deviation from the original assignment of activities

described in this test plan document requires only verbal approval by the PIs of CPSC (Rik Khanna) and NIST (Rick Davis) or other designees. No written or documented approval is required.

Safety

Safety conditions are the first and highest priority during every stage of this study. Every person involved has the right to express their safety concerns. The PIs are responsible for performing necessary safety risk assessments and ensuring all activities are being performed safely.

Matthew Bundy (Building 205 supervisor) will also be responsible in safety discussions for all activities that involve Building 205. Because Dr. Bundy is the expert in Building 205, he will have absolute and final decision-making authority when it comes to safety conditions in Building 205.

4.1 CPSC

The upholstered furniture fire performance testing detailed in this document will be performed in Building 205 of NIST by CPSC personnel. CPSC will also be responsible for the following:

- a. Complying with all NIST and Large Fire Laboratory safety guidelines
- b. Providing and transporting to NIST, 64 upholstered furniture chairs for testing.
- c. Providing a test plan that details a specific test protocol and randomization scheme.
- d. Providing smoke and carbon monoxide (CO) alarms that are prewired to interface directly with NIST's data collection system. The location in the room and which tests will or will not use alarms will be determined by CPSC before testing but can be changed at any point in the test series with only verbal communication to the NIST PI (Rick Davis) and NIST staff.
- e. As long as CPSC staff and the type of activity are in compliance with NIST's safety policies and practices, CPSC will provide personnel to help NIST with activities, such as, but not limited to, test set up, test performance, and cleanup activities,

4.2 NIST

NIST will provide technical expertise in conducting large-scale fire testing to assist CPSC staff. NIST will specifically be responsible for the following:

- Providing all scientists and visitors with appropriate safety training before testing begins.
- Supplying personnel and facilities for all NIST responsible activities.
- Furnishing up to 1 week of short-term storage of the upholstered furniture samples.
- Providing all instrumentation and materials necessary for performing these tests, except for smoke and CO alarms.
- Collecting and reporting all data as indicated in the Data Collection section.
- Set up, clean up, and operation of each fire performance test, as indicated in the Test Protocol section, with assistance from CPSC staff.

- Building and, if necessary, rebuilding with the assistance of CPSC staff, a NIST/ISO 9705 room with the following characteristics:
 - 8 ft x 12 ft x 8 ft (L x W x H). The framing will be wood, and the walls will be type C Gypsum Board. The room will have a standard interior door located at the middle of the 8 ft wall. The door must be operational and will remain open during testing.
- Collecting and reporting video, temperatures, CO, CO₂, heat flux, and heat release rate measurements, as instructed in the Test Setup, Test Protocol, and Data Collection sections.
- Providing and setting up two thermocouple trees, CO and CO₂ sensors, two heat flux gauges, and two video cameras. The set up of the all sensors, devices, and samples can be seen in Figure 3.
 - Submitting a data report to the CPSC by the end of the contract, or at a date to be agreed upon by the PIs. Note: analysis of the data by NIST is not required; analysis will be performed by CPSC staff.

5 CONTACT INFORMATION

Dr. Rick Davis

Material Research Engineer

Materials Flammability Group, NIST

Building and Fire Research Laboratory

100 Bureau Drive MS-8665

Gaithersburg, MD 20878

Office: (301) 975-5901

Mobile: (240) 246-5698

Rick.Davis@NIST.gov

Rik Khanna

U.S. Consumer Product Safety Commission

4330 East West Highway

Bethesda, MD 20814

(301) 504-7546

rkhanna@cpsc.gov

Shivani Mehta

U.S. Consumer Product Safety Commission

4330 East West Highway

Bethesda, MD 20814

(301) 504-6995

smehta@cpsc.gov

APPENDIX D1 – TEST PROTOCOL

Note: Have a means for extinguishing the sample. The exact chemical content of the FR foams is not known, so prepare appropriately.

A. Pretest–

1. Sample to be tested is determined by the Randomization Scheme in Appendix D3 of the Test Plan.
2. Record time that the sample was taken out of conditioning room.
3. Record the initial total mass of the sample.
4. Place sample chair in NIST/ISO room at a 45° angle in corner of the room so that the seat and back cushions face the doorway.
5. Ensure Test ID is visible on placard and within the viewing frame of the video cameras.
6. Record temperature and RH% inside the room.
7. Clear all personnel from the room/under the hood.
8. Turn on data acquisition system (including all sensors). Ensure appropriate readings. Begin background measurements.
 - The data should be taken in 1-second intervals.
9. Start all video cameras.
10. Photograph the sample in place.

B. Lighting the igniter flame–

1. Open the butane tank slowly, and light the end of the burner tube. Adjust the gas flow to the appropriate rate to achieve a 240 mm flame. Allow the flame to stabilize for at least 2 minutes.

C. Performing the test–

1. Apply the flame for 70 ± 1 seconds at the center of seat/back crevice of the sample, using the bent burner tube; then immediately remove ignition source from the sample.
 - This is the test “Start Time.” Note in data acquisition system.
2. Upon leaving room, operator shall leave door open.
3. Once Peak HRR has been observed, the operator will decide how much longer to continue test. Also, there may be multiple peaks in HRR; the PI will determine the length of test (Note: If the instantaneous HRR of a sample under test is high and the fire is observed to be growing, the test may be terminated for safety reasons.
4. Observe the sample combustion behavior for X minutes after a Peak HRR has been reached.
(Note: If the instantaneous HRR of a sample under test is X, and the fire is observed to be growing, the test may be terminated for safety reasons. To be determined by the PIs and LFL safety officer)
5. Record time of Smoke Alarm Activation, as seen in data.
6. Record time of CO Alarm Activation, as seen in data.

7. Record time at which smoke obscuration mark is no longer visible.

D. Post-Test–

1. Stop all measurements and video cameras.
2. Collect “drift measurements.”

APPENDIX D2 – FULL-SCALE CHAIR TESTING DATA SHEET

Date:	_____	Temp (°C):	_____
Sample # :	_____	RH %:	_____
Fabric (circle one)	1A 1B 2A 2B	Sample retrieval time:	_____
Foam:	SPUF FR		
Barrier:	Yes No		
Initial Mass (kg):	_____	End Mass (kg):	_____
Test Start Time:	_____	Test End Time:	_____
Time to visual smoke obscuration	_____	Obscuration observed by:	_____
Smoke Alarm activation:	_____	CO Alarm Activation:	_____

Time	Observation

APPENDIX D3 – TESTING SEQUENCE

Note: Chairs with no barriers have polyester batting between the fabric and foam.

Test #	Fabric	Foam	Barrier	Replicate	Combination #
1	1A	FR	No	1	4
2	1A	SPUF	Yes	1	1
3	1B	FR	No	1	8
4	1B	SPUF	No	1	6
5	1A	SPUF	No	1	2
6	1B	SPUF	Yes	1	5
7	2A	FR	Yes	1	11
8	2B	SPUF	Yes	1	13
9	2B	FR	No	1	16
10	1A	FR	Yes	1	3
11	1B	FR	Yes	1	7
12	2B	SPUF	No	1	14
13	2A	FR	No	1	12
14	2A	SPUF	No	1	10
15	2A	SPUF	Yes	1	9
16	2B	FR	Yes	1	15
17	2B	SPUF	Yes	2	13
18	1A	SPUF	No	2	2
19	1A	FR	No	2	4
20	1B	SPUF	Yes	2	5
21	1A	SPUF	Yes	2	1
22	2A	FR	No	2	12
23	2B	SPUF	No	2	14
24	2B	FR	No	2	16
25	1A	FR	Yes	2	3
26	2A	SPUF	No	2	10
27	2A	SPUF	Yes	2	9
28	1B	FR	Yes	2	7
29	1B	SPUF	No	2	6
30	2B	FR	Yes	2	15
31	2A	FR	Yes	2	11
32	1B	FR	No	2	8

Test #	Fabric	Foam	Barrier	Replicate	Combination #
33	2A	SPUF	Yes	3	9
34	2B	FR	No	3	16
35	1A	SPUF	Yes	3	1
36	1B	FR	No	3	8
37	2B	FR	Yes	3	15
38	1B	SPUF	No	3	6
39	1B	FR	Yes	3	7
40	2A	FR	No	3	12
41	1B	SPUF	Yes	3	5
42	1A	SPUF	No	3	2
43	1A	FR	No	3	4
44	2A	SPUF	No	3	10
45	2A	FR	Yes	3	11
46	2B	SPUF	No	3	14
47	2B	SPUF	Yes	3	13
48	1A	FR	Yes	3	3
49	2B	SPUF	Yes	4	13
50	2A	FR	Yes	4	11
51	1B	FR	No	4	8
52	2B	SPUF	No	4	14
53	1B	SPUF	No	4	6
54	2B	FR	No	4	16
55	1A	FR	Yes	4	3
56	2A	FR	No	4	12
57	1A	SPUF	No	4	2
58	2B	FR	Yes	4	15
59	1A	SPUF	Yes	4	1
60	1B	FR	Yes	4	7
61	1B	SPUF	Yes	4	5
62	1A	FR	No	4	4
63	2A	SPUF	No	4	10
64	2A	SPUF	Yes	4	9