



CPSC Staff Statement on the  
National Institute of Standards and Technology Report,  
“Technical Note 1781: Modeling and Measuring the Effects of Portable Gasoline Powered  
Generator Exhaust on Indoor Carbon Monoxide Level”<sup>\*</sup>  
March 2013

The report titled, “Technical Note 1781: Modeling and Measuring the Effects of Portable Gasoline Powered Generator Exhaust on Indoor Carbon Monoxide Level,” presents the findings of research conducted by the National Institute of Standards and Technology (NIST) under an interagency agreement with the U.S. Consumer Product Safety Commission (CPSC).<sup>†</sup> This research was performed in support of CPSC’s advance notice of proposed rulemaking (ANPR) to address the carbon monoxide (CO) poisoning hazard associated with portable generators.<sup>‡</sup>

Under this agreement with CPSC, NIST performed certain generator testing and modeling studies. The tested generators included both commercial unmodified and low CO-emission prototype configurations. One series of tests characterized indoor CO concentrations resulting from portable generators operating in the attached garage of a single level, single family house (SFH) under various use and environmental conditions. NIST used those empirical test data to validate the ability of NIST’s indoor air quality (IAQ) model CONTAM to predict CO levels in the garage and the house. Another series of tests determined the generators’ CO emission and oxygen consumption rates by testing them in a single-zone enclosed space. These rates were used as inputs to the CONTAM model validation and in simulation analyses to examine the potential performance of the low CO-emission prototype under a wider range of operating conditions than those actually tested with the generator operating in the attached garage of the SFH.

For two different commercially available unmodified generators (*i.e.*, with carbureted engines lacking CO-emission controls) tested in the single-zone enclosed space, CO emissions ranged from a low of around 500 grams per hour (g/h), at near ambient oxygen levels, to a high of nearly 4000 g/h as oxygen decreased to 17 percent. Tests of two modified, prototype generators (commercially available units adapted with closed-loop electronic fuel injection and a small catalyst integrated into the muffler) showed CO emissions reductions of more than 90 percent with most CO emission rates well below 500 g/hr; and no trend toward higher emission rates was seen as the oxygen level dropped. CPSC staff will use this information to develop a potential staff recommendation to the Commission as part of the process initiated with the ANPR described above.

---

<sup>\*</sup> This statement was prepared by CPSC staff, and the attached report was produced by NIST for CPSC staff. The statement and report have not been reviewed or approved by, and do not necessarily represent the views of, the Commission.

<sup>†</sup> CPSC-I-06-0012.

<sup>‡</sup> *Portable Generators; Advance Notice of Proposed Rulemaking; Request for Comments and Information*, Federal Register, 71 FR 74472, December 12, 2006.

NIST Technical Note 1781

Modeling and Measuring the Effects of Portable  
Gasoline Powered Generator Exhaust on Indoor  
Carbon Monoxide Level

Steven J Emmerich

Andrew K Persily

Liangzhu (Leon) Wang

<http://dx.doi.org/10.6028/NIST.TN.1781>

# NIST Technical Note 1781

## Modeling and Measuring the Effects of Portable Gasoline Powered Generator Exhaust on Indoor Carbon Monoxide Level

Steven J Emmerich

Andrew K Persily

*Energy and Environment Division  
Engineering Laboratory*

Liangzhu (Leon) Wang

*Concordia University*

<http://dx.doi.org/10.6028/NIST.TN.1781>

February 2013



U.S. Department of Commerce  
*Rebecca Blank, Acting Secretary*

National Institute of Standards and Technology  
*Patrick D. Gallagher, Under Secretary of Commerce for Standards and Technology and Director*

Certain commercial entities, equipment, or materials may be identified in this document in order to describe an experimental procedure or concept adequately. Such identification is not intended to imply recommendation or endorsement by the National Institute of Standards and Technology, nor is it intended to imply that the entities, materials, or equipment are necessarily the best available for the purpose.

**National Institute of Standards and Technology Technical Note 1781**  
**Natl. Inst. Stand. Technol. Tech. Note 1781, 141 pages (February 2013)**  
**<http://dx.doi.org/10.6028/NIST.TN.1781>**  
**CODEN: NTNOEF**

## Abstract

The U.S. Consumer Product Safety Commission (CPSC) is concerned about the hazard of acute residential carbon monoxide (CO) exposures from portable gasoline powered generators that can result in death or serious and/or lasting adverse health effects in exposed individuals. In an initial approach to characterizing these hazards, CPSC measured the CO emission rates from generators by testing them in a small, laboratory test chamber (Brown 2006). CPSC subsequently contracted with the University of Alabama (UA) to develop a low CO-emission prototype generator by adapting off-the-shelf emission control technologies on a commercially available portable generator and then to construct multiple units for testing. Under an interagency agreement with CPSC, NIST conducted a series of tests to characterize the indoor CO concentrations resulting from portable generators operating in the attached garage of a house under various use and environmental conditions so CPSC staff could analyze the safety implications of operating generators under these conditions. The tested generators include both unmodified and modified low CO emission prototype configurations. NIST used those test data to validate the ability of the CONTAM indoor air quality (IAQ) model to predict CO levels in the garage and the house and to develop an estimate of the uncertainty of these predictions relative to measured values. NIST also conducted tests with the generators operating in a one-zone shed to derive their CO emission and O<sub>2</sub> consumption rates. These rates were used both as inputs to the model validation effort as well as in simulation analyses conducted to examine the potential performance of the low CO-emission prototype under a wider range of operating conditions.

To determine generator CO emission rates under more realistic conditions than those attained in a small, laboratory test chamber, NIST conducted tests on the unmodified and modified generators (*i.e.* without and with CO emission controls) in a single-zone shed. For two different unmodified generators (*i.e.*, without CO emission controls), it was found that CO emissions ranged from a low of around 500 g/h at near ambient O<sub>2</sub> levels to a high of nearly 4000 g/h as O<sub>2</sub> approached 17 %. The rates of CO generation and O<sub>2</sub> consumption in these unmodified generators were affected by multiple parameters, with the O<sub>2</sub> level in the space and the actual electrical output of the generator being two of the most important. Tests performed below 17 % O<sub>2</sub> showed a drop off in CO emissions due to poor engine performance under these conditions. Tests of two modified, prototype generators (*i.e.*, with CO emission controls) showed CO emissions reductions of over 90 % depending on the specific emission controls and operating conditions and no trend toward higher emission rates was seen as O<sub>2</sub> levels dropped to 18 %.

A series of tests were also conducted to measure the emission and transport of CO when operating portable gasoline-powered generators in an attached garage. This series of tests included both unmodified and prototype generators operated in the garage attached to NIST's manufactured test house. Testing was conducted under seven different test house/garage configurations to evaluate their impacts on the buildup of CO in the garage and its transport into different rooms in the house. The configurations studied included two different garage bay door positions (fully closed or open 0.6 m); two connecting door settings between the garage and the family room (fully closed or open 5 cm); and two house central heating, ventilating, and air conditioning (HVAC) fan settings (on or off). CO concentrations varied widely with peak house CO concentrations ranging from under 10 µL/L to over 10,000 µL/L (note that µL/L are equivalent to ppm<sub>v</sub>). As expected, the highest concentrations in the house resulted from operation of the unmodified generator in the garage with the bay door closed and the house access door open 5 cm. The lowest concentrations resulted from

operation of a modified low CO-emission prototype in the garage with the bay door open 0.6 m and the house access door closed. These garage tests documented reductions of 85 % to 98 % in CO concentrations in the house due to emissions from two modified, prototype low CO-emission portable generators compared to a “stock” generator. Note that these results apply to the specific units tested and that other units, modifications and test conditions may produce different results.

An extensive model validation effort using the multizone airflow and IAQ model CONTAM was carried out using the data from the seven tests that were conducted with a generator operating in the attached garage of the test house to compare predicted CO concentrations with measured values. The agreement between the measurements and predictions of the O<sub>2</sub> concentrations in the garage and of the average CO calculated for the house zones was excellent for the collective set of data; all of the calculated statistical values met the ASTM D5157 criteria for comparing IAQ model predictions and measurements. The agreement, however, was somewhat worse for the garage CO concentrations, with some parameters falling slightly outside the ASTM criteria limits. Overall, the average individual house zone and garage CO concentration predictions and measurements were within about 20 % and 30 % respectively when averaged over all cases.

Forty-two simulations were then performed with the NIST CONTAM model to examine the potential performance of the prototype generator under a wider range of conditions than studied during the experiments at the test house. All of the simulations were based on the NIST manufactured test house and the tested low CO emission prototype generator with and without a catalyst integrated in the muffler (referred to as cat muffler and noncat muffler, respectively). Model parameters that were varied included ambient conditions, CO emission rates, source locations and door positions. The highest house CO concentrations were found for the generator with the noncat muffler operated in the utility room of the house, with indoor CO concentrations reaching 2000 µL/L for some cases. Operation of the generator with the cat muffler substantially reduced CO concentrations, however, they still reached levels of 280 µL/L to 600 µL/L for cases with the generator located in the utility room. The lowest indoor CO concentrations resulted from operation of the generator with the cat muffler in the garage, with CO concentrations in the house reaching 10 µL/L to 160 µL/L. Simulations also showed that, as expected, closed bedroom doors resulted in less uniform indoor concentrations and higher peak indoor zone concentrations, though the impact varied greatly from about a 10 % to about a 100 % increase.

## ***Keywords***

Generator; carbon monoxide; CONTAM; exposure; indoor air quality; health; measurements; multizone airflow model; simulation

# Table of Contents

|  |     |
|--|-----|
| Abstract.....                                    | iii |
| Keywords .....                                   | iv  |
| Table of Contents.....                           | v   |
| List of Figures.....                             | vii |
| List of Tables .....                             | x   |
| Nomenclature.....                                | xi  |
| Introduction.....                                | 1   |
| Background.....                                  | 1   |
| Objective.....                                   | 2   |
| Contents of report .....                         | 2   |
| Experimental.....                                | 3   |
| Methods and Equipment .....                      | 3   |
| Instrumentation .....                            | 3   |
| Test House .....                                 | 3   |
| Shed.....  | 4   |
| Generators and Loading.....                      | 5   |
| Shed Test Results.....                           | 8   |
| Analysis Method .....                            | 8   |
| Generator B.....                                 | 9   |
| Generator X.....                                 | 13  |
| Generator SO1 .....                              | 16  |
| Discussion of Shed Tests .....                   | 19  |
| Garage Test Results .....                        | 20  |
| Testing Configurations.....                      | 20  |
| Results.....                                     | 22  |
| Summary of Garage Tests.....                     | 54  |
| Simulation.....                                  | 56  |
| Modeling Method.....                             | 56  |
| Garage Pressurization Tests.....                 | 58  |
| Model Validation .....                           | 61  |
| Statistical Evaluation of Model Predictions..... | 61  |
| Testing Configurations.....                      | 62  |
| RESULTS OF MODEL VALIDATION .....                | 64  |
| Case #1 .....                                    | 64  |
| Case # 2.....                                    | 66  |

|  |    |
|--|----|
| Case # 3 .....   | 67 |
| Case # 4 .....   | 68 |
| Case # 5 .....   | 70 |
| Case # 6 .....   | 72 |
| Case # 7 .....   | 74 |
| Summary .....  | 75 |
| Prototype Generator Performance Simulations .....          | 78 |
| Garage source cases .....                                  | 79 |
| Utility source .....                                       | 82 |
| Closed bedroom door cases .....                            | 84 |
| Discussion of Simulation Results .....                     | 85 |
| Conclusion .....   | 87 |
| Shed Tests .....   | 87 |
| Garage Tests .....   | 87 |
| Simulations .....  | 88 |
| Acknowledgements .....                                     | 89 |
| References .....   | 89 |
| Appendix A Uncertainty Analysis of Shed Measurements ..... | 92 |
| Appendix B Summary of Instrument Calibrations .....        | 98 |
| Appendix C Additional Garage Tests .....                   | 99 |



## **List of Figures**

|            |  |    |
|------------|--|----|
| <b>1</b>   | Aerial view of NIST manufactured test house  | 4  |
| <b>2</b>   | Floorplan of NIST manufactured test house  | 4  |
| <b>3</b>   | Front view of the test shed  | 5  |
| <b>4</b>   | Inside view of the test shed   | 5  |
| <b>5</b>   | Schematic of experimental setup in shed  | 6  |
| <b>6</b>   | Schematic of a generator operating in a single-zone space  | 9  |
| <b>7</b>   | Measured CO and O <sub>2</sub> concentrations of Tests 1 and 13  | 11 |
| <b>8</b>   | Five-minute averaged (a) CO emission rates and (b) O <sub>2</sub> consumption rates at different O <sub>2</sub> levels for Gen B                             | 13 |
| <b>9</b>   | Five-minute averaged (a) CO emission rates and (b) O <sub>2</sub> consumption rates at different O <sub>2</sub> levels for unmodified Generator X            | 14 |
| <b>10</b>  | Five-minute averaged (a) CO emission rates and (b) O <sub>2</sub> consumption rates at different O <sub>2</sub> levels for modified Generator X              | 16 |
| <b>11</b>  | Five-minute averaged (a) CO emission rates and (b) O <sub>2</sub> consumption rates at different O <sub>2</sub> levels for Generator SO1 with CAT muffler    | 17 |
| <b>12</b>  | Five-minute averaged (a) CO emission rates and (b) O <sub>2</sub> consumption rates at different O <sub>2</sub> levels for Generator SO1 with nonCAT muffler | 18 |
| <b>13a</b> | CO and O <sub>2</sub> concentrations in the garage and measured load for Test B (unmod Gen X, Configuration 1)   | 22 |
| <b>13b</b> | CO (ppm range) concentrations in the house for Test B (unmod Gen X, Configuration 1)   | 23 |
| <b>13c</b> | CO (high range) concentrations in the house for Test B (unmod Gen X, Configuration 1)  | 23 |
| <b>14a</b> | CO and O <sub>2</sub> concentrations in the garage and measured load for Test O (mod Gen X, Configuration 1)   | 24 |
| <b>14b</b> | CO concentrations in the house for Test O (mod Gen X, Configuration 1)   | 25 |
| <b>14c</b> | Temperatures and AFR measured in Test O (mod Gen X, Configuration 1)   | 25 |
| <b>15a</b> | CO and O <sub>2</sub> concentrations in the garage and measured load for Test N (Gen SO1, Configuration 1)   | 26 |
| <b>15b</b> | CO concentrations in the house for Test N (Gen SO1, Configuration 1)   | 27 |
| <b>15c</b> | Temperatures and AFR measured on Gen SO1 in Test N (Gen SO1, Configuration 1)  | 28 |
| <b>16a</b> | CO and O <sub>2</sub> concentrations in the garage and measured load for Test F (unmod Gen X, Configuration 2)   | 29 |
| <b>16b</b> | CO concentrations in the house for Test F (unmod Gen X, Configuration 2)   | 30 |
| <b>17a</b> | CO and O <sub>2</sub> concentrations in the garage and measured load for Test R (mod Gen X, Configuration 2)   | 31 |
| <b>17b</b> | CO concentrations in the house for Test R (mod Gen X, Configuration 2)   | 32 |
| <b>17c</b> | Temperatures and AFR measured in Test R (mod Gen X, Configuration 2)   | 32 |
| <b>18a</b> | CO and O <sub>2</sub> concentrations in the garage and measured load for Test T (Gen SO1, Configuration 2)   | 33 |

|  |    |
|--|----|
| <b>18b</b> CO concentrations in the house for Test T (Gen SO1, Configuration 2)  | 34 |
| <b>18c</b> Temperatures and AFR measured in Test T (Gen SO1, Configuration 2)  | 34 |
| <b>19a</b> CO and O <sub>2</sub> concentrations in the garage and measured load for Test I (unmod Gen X, Configuration 3)              | 35 |
| <b>19b</b> CO (ppm range) concentrations in the house for Test I   | 36 |
| <b>19c</b> CO (high range) concentrations in the house for Test I  | 36 |
| <b>20a</b> CO and O <sub>2</sub> concentrations in the garage and measured load for Test Z (Gen SO1 noncat, Configuration 3)           | 37 |
| <b>20b</b> CO concentrations in the house for Test Z (Gen SO1 noncat, Configuration 3)   | 38 |
| <b>20c</b> Temperatures and AFR measured on Gen SO1 in Test Z  | 39 |
| <b>21a</b> CO (high range) and O <sub>2</sub> concentrations in the garage and measured load for Test J (unmod Gen X, Configuration 4) | 40 |
| <b>21b</b> CO concentrations in the house for Test J (unmod Gen X, Configuration 4)  | 40 |
| <b>22a</b> CO and O <sub>2</sub> concentrations in the garage and measured load for Test W (Gen SO1, Configuration 4)                  | 41 |
| <b>22b</b> CO concentrations in the house for Test W (Gen SO1, Configuration 4)  | 42 |
| <b>22c</b> Temperatures and AFR measured in Test W (Gen SO1, Configuration 4)  | 42 |
| <b>23a</b> CO (high range) and O <sub>2</sub> concentrations in the garage and measured load for Test D (unmod Gen X, Configuration 5) | 43 |
| <b>23b</b> CO concentrations in the house for Test D (unmod Gen X, Configuration 5)  | 44 |
| <b>24a</b> CO and O <sub>2</sub> concentrations in the garage and measured load for Test AH (Gen SO1 noncat, Configuration 5)          | 45 |
| <b>24b</b> CO concentrations in the house for Test AH (Gen SO1 noncat, Configuration 5)  | 46 |
| <b>24c</b> Temperatures and AFR measured in Test AH (Gen SO1 noncat, Configuration 5)  | 46 |
| <b>25a</b> CO and O <sub>2</sub> concentrations in the garage and measured load for Test G (unmod Gen X, Configuration 6)              | 47 |
| <b>25b</b> CO concentrations in the house for Test G (unmod Gen X, Configuration 6)  | 48 |
| <b>26a</b> CO and O <sub>2</sub> concentrations in the garage and measured load for Test U (Gen SO1, Configuration 6)                  | 49 |
| <b>26b</b> CO concentrations in the house for Test U (Gen SO1, Configuration 6)  | 50 |
| <b>26c</b> Temperatures and AFR measured in Test U (Gen SO1, Configuration 6)  | 50 |
| <b>27a</b> CO and O <sub>2</sub> concentrations in the garage and measured load for Test K (unmod Gen X Configuration 7)               | 51 |
| <b>27b</b> CO concentrations in the house for Test K (unmod Gen X Configuration 7)   | 51 |
| <b>28a</b> CO and O <sub>2</sub> concentrations in the garage and measured load for Test V (noncat Gen SO1, Configuration 7)           | 52 |
| <b>28b</b> CO concentrations in the house for Test V (noncat Gen SO1, Configuration 7)   | 53 |
| <b>28c</b> Temperatures and AFR measured in Test V (noncat Gen SO1, Configuration 7)   | 54 |
| <b>29</b> CONTAM Sketchpad Representation of Test House  | 56 |
| <b>30</b> Test house and garage fan pressurization configurations  | 59 |
| <b>31</b> Predicted and observed CO and O <sub>2</sub> concentrations for Case #1  | 65 |
| <b>32</b> Predicted and observed CO and O <sub>2</sub> concentrations for Case # 2   | 66 |
| <b>33</b> Predicted and observed CO and O <sub>2</sub> concentrations for Case # 3   | 68 |

|  |    |
|--|----|
| <b>34</b> Predicted and observed CO and O <sub>2</sub> concentrations for Case # 4   | 70 |
| <b>35</b> Predicted and observed CO and O <sub>2</sub> concentrations for Case # 5   | 71 |
| <b>36</b> Predicted and observed CO and O <sub>2</sub> concentrations for Case # 6   | 73 |
| <b>37</b> Predicted and observed CO and O <sub>2</sub> concentrations for Case # 7   | 75 |
| <b>38</b> Comparison of predicted and observed individual house zone average CO concentrations for all cases                         | 77 |
| <b>39</b> Garage source, open bay door, closed house door, cat muffler cases   | 80 |
| <b>40</b> Utility source, closed utility door, cat muffler cases   | 83 |
| <b>41</b> CO concentrations for garage source, closed bay door, open house door, mild weather, cat muffler with closed bedroom doors | 85 |

## **List of Tables**

|  |    |
|--|----|
| <b>1</b> Hourly cyclic load profile  | 7  |
| <b>2</b> Summary of Gen B test results   | 10 |
| <b>3</b> Tests Conducted in Attached Garage  | 21 |
| <b>4</b> Summary of garage test results  | 55 |
| <b>5</b> Air Leakage Values  | 57 |
| <b>6</b> HVAC System Supply Flows  | 58 |
| <b>7</b> Fan Pressurization Test Results   | 60 |
| <b>8</b> Model Validation Tests Conducted  | 63 |
| <b>9</b> Statistical parameters for Case #1  | 65 |
| <b>10</b> Statistical parameters for Case # 2  | 67 |
| <b>11</b> O <sub>2</sub> dependent CO emission rate for Gen B  | 67 |
| <b>12</b> Statistical parameters for Case # 3  | 68 |
| <b>13</b> Hourly cyclic load profile for Gen SO1 cat   | 69 |
| <b>14</b> Statistical parameters for Case # 4  | 70 |
| <b>15</b> Hourly cyclic load profile for Gen SO1 cat   | 71 |
| <b>16</b> Statistical parameters for Case # 5  | 72 |
| <b>17</b> Hourly cyclic load profile for Gen SO1 cat   | 72 |
| <b>18</b> Statistical parameters for Case # 6  | 73 |
| <b>19</b> Hourly cyclic load profile for Gen SO1 noncat  | 74 |
| <b>20</b> Statistical parameters for Case # 7  | 75 |
| <b>21</b> Summary of statistical parameters from comparison of average observed and predicted zone CO concentrations for all cases | 76 |
| <b>22</b> Simulation results for garage source cases   | 81 |
| <b>23</b> Simulation results for utility source cases  | 84 |
| <b>24</b> Simulation results for closed bedroom door cases   | 85 |

## Nomenclature

|                |  |
|----------------|--|
| $A_{in}$       | hourly air change rate of a test space evaluated at the ambient temperature, $h^{-1}$                    |
| $A_{out}$      | hourly air change rate of a test space evaluated at the space temperature, $h^{-1}$                      |
| $C_{CO}$       | CO concentration, $mg/m^3$   |
| $C_{H_2O,t_1}$ | water vapor volumetric concentration at time $t_1$ , $m^3/m^3$   |
| $C_{H_2O,t_2}$ | water vapor volumetric concentration at time $t_2$ , $m^3/m^3$   |
| $C_{O_2}^*$    | non-dimensional $O_2$ concentration  |
| $C_{out}$      | gas volumetric concentration outside the space, $m^3/m^3$  |
| $C_{SF_6,in}$  | $SF_6$ concentration in the intake of the generator, $m^3/m^3$   |
| $C_{SF_6,ex}$  | $SF_6$ concentration in the exhaust of the generator, $m^3/m^3$  |
| $D_{gen}$      | displacement of the generator engine, $m^3$  |
| ELA            | Effective leakage area, $cm^2$ at 4 Pa   |
| $K_{m,\rho}$   | $\rho_{m,out} / \rho_{m,in}$ , ratio of density outside and inside the test space of a gas component “m” |
| $K_{SF_6,d}$   | $SF_6$ decomposition ratio in the generator  |
| $L_o$          | output load of a generator   |
| $L_o^*$        | non-dimensional generator load   |
| $P$            | partial pressure of water vapor, Pa  |
| $P_{sat}$      | saturated water vapor pressure, Pa   |
| $Q_{gen,in}$   | volumetric flow rate through the generator at the intake gas temperature, $m^3/h$                        |
| $Q_{in}$       | volumetric air inflow of a test space, $m^3/h$   |
| $Q_{out}$      | volumetric air outflow of a test space, $m^3/h$  |
| $Q_{gen,ex}$   | volumetric flow rate through the generator at the exhaust gas temperature, $m^3/h$                       |
| RPM            | revolutions per minute of the generator engine, $min^{-1}$   |
| $S_C$          | source emission rate of a gas “C” at the air temperature of the test space, $kg/h$                       |
| $S_{CO}^*$     | non-dimensional CO emission rate   |
| $S_{CO,min}$   | minimum CO emission rate, $g/h$  |
| $S_{CO,max}$   | maximum CO emission rate, $g/h$  |
| $S_{H_2O}$     | water emission rate from the generator, $kg/h$   |
| $S_{gen}$      | mass added from the generator to the test space, $kg/h$  |
| $S_{O_2}^*$    | non-dimensional $O_2$ consumption rate   |
| $T$            | gas temperature, K   |
| $T_{gen,in}$   | temperature of the generator intake gas, K   |
| $T_{gen,ex}$   | temperature of the generator exhaust gas, K  |
| $V_s$          | volume of the test space, $m^3$  |
| $\phi$         | water vapor relative humidity  |
| $\eta_{gen}$   | volumetric efficiency of the generator engine  |
| $\rho_{C,in}$  | density of a gas component inside the test space, $kg/m^3$   |
| $\rho_{C,out}$ | density of a gas component outside the space, $kg/m^3$   |
| $\rho_{in}$    | gas mixture density in the test space, $kg/m^3$  |
| $\rho_{m,out}$ | density of gas mixture ( $= \rho_{air}$ ) outside the test space, $kg/m^3$                               |



# Introduction

## ***Background***

The U.S. Consumer Product Safety Commission (CPSC) is concerned about the hazard of acute residential carbon monoxide (CO) exposures from portable gasoline powered generators that can result in death or serious and/or lasting adverse health effects in exposed individuals. As of April 2012, CPSC databases contain records of at least 755 (695 from generator use alone, 60 from generator use in conjunction with another CO-producing consumer product) deaths from CO poisoning associated with consumer use of generators in the period of 1999 through 2011 (Hnatov 2012). In addition, the percentage of estimated non-fire, consumer product-related CO poisoning deaths specifically associated with generators for CPSC's four most recent years of data are 51 % (2005), 49 % (2006), 38 % (2007), and 49 % (2008) (Hnatov 2011). Typically, these deaths occur when consumers use a generator in an enclosed or partially enclosed space or outdoors near an open door, window or vent, and they often occur after severe weather events such as hurricanes and ice or snow storms. The initial health impact of CO is caused by anoxia: deprivation of oxygen supply. When inhaled, CO preferentially binds with the oxygen carrier in the red blood cells, hemoglobin (Hb), to form carboxyhemoglobin (COHb), which causes the anoxia (Stewart 1975).

Since the possession of household generators in the U.S. has climbed continuously in recent years, from an estimated 9.2 million units in 2002 to 10.6 million units in 2005, CPSC is working to avoid future generator-related CO poisoning incidents, especially those associated with operating a generator indoors (CPSC 2006). Measures have been taken to educate people not to operate generators indoors and to require manufacturers of portable generators to warn consumers of CO hazards with a warning label (CFR 2007). In order to understand the CO exposures associated with such incidents and their potential reduction, the emission characteristics of these generators need to be better characterized.

In an initial approach to characterizing these hazards, CPSC measured the CO emission rates from generators by testing them in a small, laboratory test chamber (Brown 2006). Using those data, CPSC performed preliminary indoor air quality (IAQ) modeling and estimated that a 92 % reduction in the CO emission rate based on these measurements would likely result in a significant delay and reduced severity of the CO exposure in areas of a home remote from the generator location (Inkster 2006). CPSC subsequently worked with the University of Alabama (UA) to develop a low CO-emission prototype generator by adapting off-the-shelf emission control technologies on a commercially-available portable generator. UA then constructed multiple prototype generators by adapting the same emission control strategy onto other units powered by the same model engine. In conjunction with these efforts, CPSC established an interagency agreement with the National Institute of Standards and Technology (NIST) to model indoor time course profiles of CO concentrations throughout a single-family residence resulting from CO emissions from a portable generator operating in the attached garage of a home under various use and environmental conditions to enable CPSC staff to understand the safety implications of operating a portable generator in these conditions. The agreement was later expanded to include a series of tests to provide empirical data to further characterize the hazard by measuring the emission and transport of CO when generators are operated in an actual building, to test them in a one-zone shed to derive their CO emission and O<sub>2</sub> consumption rates, and to provide model validation data.

An interim report by Emmerich (2011) presents data from a series of tests of both unmodified and UA-modified low CO emission prototype generators operated in the garage attached to NIST's manufactured house, a test facility designed for conducting residential indoor air quality (IAQ) studies. This double-wide manufactured house is similar in size to homes commonly involved in fatal consumer incidents (Hnatov 2012). The garage tests described in the interim report documented reductions of 85 % to 98 % in CO concentrations due to emissions from two modified, prototype low CO-emission portable generators compared to an unmodified generator in this house for the scenarios tested.

### ***Objective***

The primary objective of this project was to measure and model CO emission and exposure, and O<sub>2</sub> depletion, resulting from portable generators operating in a home's attached garage under various use and environmental conditions in order to enable CPSC staff to analyze the safety implications of operating a portable generator under these conditions.

### ***Contents of report***

This report contains four main sections. The Experimental section describes the experimental methods and equipment, test house and shed, and generators used in the experimental portion of this project. The Shed Test Results section presents the results of testing three different generators operating in the test shed. The Garage Test Results presents the results of testing three different generators operating in the attached garage of the NIST test house. The Simulation section describes the CONTAM model of the test house, the model validation effort and the simulations used to extend the measurement results to other scenarios. The report also contains three appendices including one describing the uncertainty analysis of the measurements, one on instrument calibrations, and one with additional garage test results beyond those presented in the main body of the report.



# Experimental

## *Methods and Equipment*

### **Instrumentation**

Gas concentrations were measured with two multi-gas engine exhaust analyzers (NOVA Analytics Model 7464), which are combination non-dispersive infrared (NDIR) and electrochemical sensor technologies, referred to as N1 and N2 in the rest of this report. These analyzers measured CO on two channels covering different ranges of 0 % to 1 % and 0 % to 10 %, CO<sub>2</sub> from 0 % to 20 %, hydrocarbons (as hexane) from 0 % to 2 % and O<sub>2</sub> from 0 % to 25 % with a reported accuracy of 1 % of full scale for all five channels. An electrochemical sensor CO analyzer (NOVA Analytics Model 7461), referred to as N3 in this report, measured CO over a range of 0 ppm<sub>v</sub> to 2000 ppm<sub>v</sub> and with a reported accuracy of 1 % of full scale. Two additional NDIR CO analyzers were used, a Thermoelectron Model 48 (referred to as TE) and a Rosemount Model 880A (referred to as RM), both with ranges of 0 ppm<sub>v</sub> to 1000 ppm<sub>v</sub> and reported accuracy of 1 % of full scale. Finally, a portable O<sub>2</sub> analyzer (Sybron Servomex O<sub>2</sub> Analyzer OA 580) was also used. Not all instruments were used during every test. Repeated calibrations during the test periods found that typical measurement uncertainties were consistent with the manufacturers' reported accuracies. See Appendix B for more detail on calibrations. To protect the analyzers from condensed water and/or soot particles, desiccant and high efficiency particulate air (HEPA) filters were used in the sampling system.

Air change rates were measured using tracer gas decay method (ASTM 2011). A pulse of sulfur hexafluoride (SF<sub>6</sub>) was injected and allowed to mix before being measured with a gas chromatograph with an electron capture detector. A local weather station was used to measure ambient conditions. All gas concentration, air temperature, and humidity data were recorded by an automated data acquisition system. Nabinger and Persily (2008) provide more details on the SF<sub>6</sub>, temperature, humidity, and ambient weather condition measurements including uncertainties.

### **Test House**

The test house used in this study was a manufactured house located on the NIST campus, which was erected in 2002 (Nabinger and Persily 2008). An aerial view and floorplan of the house are shown in Figures 1 and 2. The house includes three bedrooms (MBR, BR2, and BR3), a living room (LR), a family room (FAM), a kitchen (KIT), and an attached garage. The house has a floor area of 140 m<sup>2</sup> and a volume of 340 m<sup>3</sup>. The attached garage has a floor area of 36.5 m<sup>2</sup>, a volume of 90 m<sup>3</sup> and was built as an addition to the house in 2007. The interior of the garage, including the ceiling, is finished with painted gypsum board. As part of the garage construction, the underlayment and siding of the exterior west wall of the house were removed and replaced with ¾ inch gypsum board on studs with fibrous glass batt insulation in the wall cavity.



**Figure 1** Aerial view of NIST manufactured test house



**Figure 2** Floorplan of NIST manufactured test house

Measurements of gas concentrations were made at various points throughout the house using sample lines suspended 1.5 m above the floor in the center of each of the three bedrooms, the living room, the kitchen, and the family room, as well as five sample lines located near the four corners and center of the garage. The six individual living space locations were measured for one minute each in a repeating six minute cycle. The garage sample locations were measured separately, as well as a single mixed sample, the latter of which is reported here. Indoor air temperature and humidity were measured with sensors in each room of the house and on two opposite walls of the garage. The outdoor temperature and wind speed were measured at a weather station located about 6 m behind the house for tests conducted in 2008. For tests in 2010, wind speed data were collected from a weather station located on the roof of Building 226 on the NIST campus (about a mile from the test house), however, wind direction data were still collected at the local weather station.

### Shed

Experiments were also conducted in a shed, with dimensions of 4.88 m (L) × 3.05 m (W) × 2.90 m (H), as shown in Figures 3 and 4, for the purpose of measuring the CO emission rate and O<sub>2</sub> consumption rate of the generators. The shed was used because it allowed better control of conditions than the garage and enabled a simplified single-zone analysis of the measurement results (see Shed Test Results section for description of analysis method). An explosion-proof

exhaust fan was installed in the wall opposite the door for shed ventilation at the end of a test and for quick exhaust during an emergency. This fan was also used in selected tests to create a high air change rate to obtain CO emission rates at near ambient conditions. The shed also had two operable windows at both sidewalls, which were adjusted to vary the air change rate.



**Figure 3** Front view of the test shed



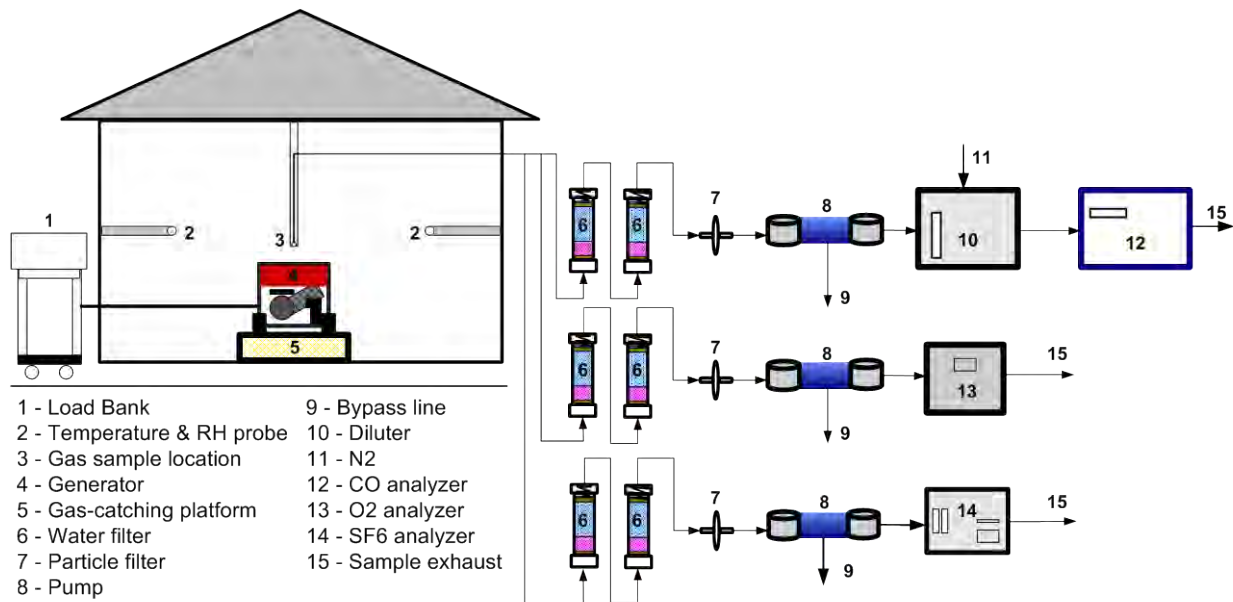
**Figure 4** Inside view of the test shed

Separate sample lines were placed mid-height in the center of the shed (midway between the walls) for CO, O<sub>2</sub>, and SF<sub>6</sub>. Non-dispersive infrared and electrochemical sensor CO analyzers (N1, N2 and N3 described in the Instrumentation section) and a portable O<sub>2</sub> analyzer were used to measure CO and O<sub>2</sub> respectively. A gas divider/diluter was also used to dilute the sampled CO for the CO analyzer for some tests. The air temperature and humidity in the shed were measured at two locations near two sidewalls.

### **Generators and Loading**

Generators were selected with electrical power output ratings in the size range most commonly involved in fatal consumer incidents, which is 5.0 kilowatts (kW) to 6.5 kW (Hnatov 2012). Tests were conducted with three different generators that were configured in multiple ways. Two unmodified ‘stock’ (*i.e.*, in their as-purchased condition) generators were tested. The first generator (referred to here as Gen B) has a full-load power rating of 5.5 kW with a 7.5 kW (10 horsepower, hp) carbureted, single-cylinder gasoline engine and no specific CO emission control

technology. This same generator was also tested by CPSC in a small chamber as reported on by Brown (2006).



**Figure 5** Schematic of experimental setup in shed

The second generator is powered by a carbureted 8.2 kW (11 hp) single-cylinder gasoline engine made by a different manufacturer than Gen B and has an advertised full-load electric power rating of 5.0 kW. This generator was tested in both unmodified condition (referred to as unmod Gen X) and as a modified low-CO emission prototype (referred to as mod Gen X). The unmodified generator operates at air-fuel ratios (AFR, ratio of mass of air to mass of fuel) in the range of 10 to 13 AFR depending on the load, which is common for small, air-cooled carbureted engines. The modifications were made by the University of Alabama (UA) and included adding an engine management system (EMS) with associated sensors and actuators for electronic fuel injection (replacing the carburetor) and a muffler with a small catalyst integrated in it. The function of the EMS is to control ignition timing and fuel delivery through an engine control unit (ECU) microcomputer that receives input from a variety of system sensors. UA calibrated the ECU on the modified prototype to operate around a 14.6 AFR over the full range of loads. This AFR fuel control strategy is the primary means by which the prototype aims to achieve its reduction in CO emissions. The catalyst primarily targets reduction of oxides of nitrogen (NO<sub>x</sub>) and has relatively low catalytic activity because the EMS significantly reduces the available oxidation constituents in the exhaust stream.

For the third generator (referred to as Gen SO1), a model similar to Gen X was obtained which had the same model engine but with an alternator with an output rating of 7 kW. It was tested after UA modified it using the same fuel control strategy and largely the same emission control hardware that was used in mod Gen X. One difference is that Gen SO1 had a different model ECU than that used on mod Gen X. Another difference noted during the testing is that its manufacturer included programming to maintain rich AFR operation until the oil temperature rose above approximately 60 °C, resulting in an initial “spike” of CO when the engine was started cold. This ECU also includes an algorithm developed by UA that can be switched on or off by the test operator for testing purposes. The algorithm was intended to sense when the

generator was operating in an enclosed space, based on engine operation parameters and when enabled, was intended to shut off the engine before a life-threatening CO hazard develops. All the tests with Gen SO1 that are reported in the main body of this report were performed with the algorithm disabled. Gen SO1 was also tested in a configuration with a muffler that did not contain a catalytic converter (referred to as the noncat muffler). The purpose of testing with the two different muffler versions was to measure the CO emissions produced in the engine due to the fuel control strategy alone (from tests with the noncat muffler) as well as get an indication of the catalyst's performance in further lowering those emissions (from the tests with the cat muffler). A full description of the prototype configuration of both mod Gen X and Gen SO1 is provided in greater detail in UA's report to CPSC (CPSC 2012).

To monitor prototype engine operation, generators mod GenX and Gen SO1 were outfitted with thermocouples and a Lambda sensor to measure AFR (ECM Model Lambda 5220, with an AFR range of 6 to 364 and reported accuracy of 0.2 for  $12 < \text{AFR} < 18$ ). The Lambda sensor and a thermocouple for measuring engine-out exhaust temperature were mounted through ports that UA provided on the exhaust manifold pipe between the engine and muffler. Cylinder head temperature was measured with a ring thermocouple mounted under the spark plug. Engine oil temperature was measured with a thermocouple inserted into the sump. For some of the tests, muffler and shroud temperatures were also measured, using thermocouples mounted directly on their surfaces at the hottest locations previously identified by UA with infrared cameras during their prototype tests.

The generators were operated using reformulated gasoline with 10 % ethanol obtained from the NIST motor pool, which is purchased to the same specification year-round. The generators were placed on a spill-catching platform in the middle of the garage (or shed) with the exhaust pipe pointing towards the garage wall adjoining the house.

A portable alternating current (AC) resistive load bank connected to the generator's 240-volt receptacle was used to draw electrical power and thereby act as a surrogate for consumer appliance loads. The load bank has manual switches in 250 W increments with a maximum setting of 10 kW. Some tests involved a constant load while others followed a cyclic load profile (see Table 1). This profile is similar to the load profile used by UA during the durability and emission testing of their low CO emission prototype generator. It was derived from a test cycle developed by industry to replicate typical in-use operation of small utility engines when used in all types of engine-driven products (CPSC 2012). Because the actual delivered power did not always match the load bank settings, particularly when oxygen depletion was occurring, the delivered power was measured and recorded during all tests.

**Table 1 Hourly cyclic load profile**

| <b>Load bank setting (W)</b> | <b>Duration (min)</b> |
|------------------------------|-----------------------|
| no load                      | 3                     |
| 500                          | 4                     |
| 1500                         | 18                    |
| 3000                         | 17.5                  |
| 4500                         | 12                    |
| 5500                         | 5.5                   |

## Shed Test Results

Few studies have been conducted directly on CO emission and O<sub>2</sub> consumption rates associated with gasoline-powered generators running indoors. Brown (2006) studied the CO emission rates from four different commercially-available generators in an enclosed experimental chamber, where air temperature and air change rate were controlled to provide different operating conditions. Also, the air change rates during these chamber tests were generally quite high compared with typical residences. Steady-state CO concentrations were found to be more than 7400 µL/L and O<sub>2</sub> levels as low as 18.5 %. CO emission and O<sub>2</sub> consumption rates at steady state were also calculated, and were found to be affected by O<sub>2</sub> level, generator loading, and/or chamber air temperature.

While generator tests conducted in laboratory chambers offer a high degree of control, they do not allow consideration of the real-world impacts of varying outdoor weather or the lower and variable air change rates that occur in residential structures. Alternatively, operating a generator in an enclosed space such as a garage or a storage shed, as opposed to a laboratory chamber, will be subject to uncontrolled temperatures and to lower ventilation rates determined by ambient weather conditions. To study generator CO emission rates under more realistic conditions including emission controls, tests were conducted in a single-zone space. This section reports on the measurement of CO emission rates from generators, operating in the unmodified carbureted configuration as well as in the low CO emission prototype configuration, (*i.e.* without and with CO emission controls) in a test shed located outdoors. The CO emission rates and O<sub>2</sub> consumption rates are used for the prediction of CO emission, migration and exposure in simulations.

### Analysis Method

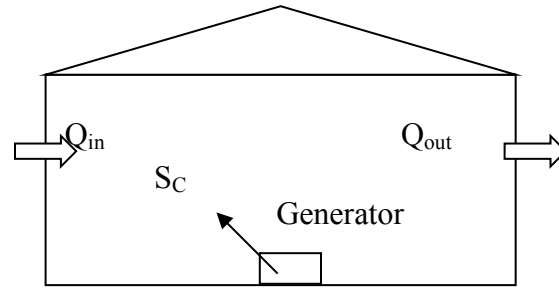
To model a generator running inside an enclosed single-zone space, a theoretical model was constructed based on Figure 6. This model was used to calculate CO emission and O<sub>2</sub> consumption rates from the concentrations measured during the tests. Assuming a gas component,  $C$ , is either generated ( $S_C > 0$ ) or consumed ( $S_C < 0$ ) in the zone, a differential mass balance equation for  $C$  during a period of  $\Delta t = t_2 - t_1$  can be expressed as

$$\rho_{C,in} V_s \frac{dC}{dt} = S_C - \rho_{C,in} C Q_{out} + \rho_{C,out} C_{out} Q_{in} \quad (1)$$

by assuming the following:

- the gas component,  $C$ , is an ideal gas,
- the concentration of  $C$  is uniform in the zone,
- $\rho_C$ ,  $S_C$ , and  $Q$  are constant during  $\Delta t$ , and
- the mass of fuel added from the generator to the zone air is neglected.

Note: See the Nomenclature list for all terms in the equations.



**Figure 6** Schematic of a generator operating in a single-zone space

The density of  $C$  in Eq. (1) can be obtained by the ideal gas law.  $S_C$  is positive when referred to as  $S_{CO}$ , the emission rate of CO, and negative for  $S_{O_2}$ , the consumption rate of  $O_2$ . In the experiments presented in this report, the concentration of a gas component,  $C$ , was measured by a gas analyzer, as described above. The air change rate,  $Q$ , was determined by using the tracer gas decay method using  $SF_6$ . Given that  $SF_6$  may decompose at temperatures above 200 °C (Air Products 2006), the potential consumption of  $SF_6$  in the generator engine,  $S_{SF_6}$  ( $<0$ ), was examined but was found to be insignificant (Wang and Emmerich 2010).

After determining the air change rate of the space from the decay rate of the  $SF_6$  (see Wang and Emmerich 2010 for details),  $S_{CO}$  and  $S_{O_2}$  can be solved from Eq. (1) for the time period of  $t_1$  to  $t_2$

$$S_{CO} = \rho_{CO,in} A_{out} V_s \frac{C_{CO,t2} - C_{CO,t1} e^{-A_{out}\Delta t}}{1 - e^{-A_{out}\Delta t}} \quad (2)$$

$$S_{O_2} = \rho_{O_2,in} A_{out} V_s \frac{C_{O_2,t2} - C_{O_2,t1} e^{-A_{out}\Delta t}}{1 - e^{-A_{out}\Delta t}} - \frac{\rho_{O_2,out} A_{out} V_s}{K_{m,\rho}} C_{O_2,out} \quad (3)$$

In addition, several gas concentration uniformity tests were conducted by collecting samples at five different locations in the shed. It was found that the thermal plume, which was driven by the heat from the running generator, mixed the shed very well throughout testing. The variations among the five sample locations were less than 5 % for  $SF_6$ , which met the uniformity requirement of 10 % in the ASTM standard (ASTM-E741-00 2006).

## **Generator B**

Using the same generator (B), Brown (2006) found that CO emission rate was closely related to generator load and  $O_2$  level in small chamber tests. In the current study, 13 tests of Gen B were conducted for load settings of 2.5 kW (half of the maximum load of the generator) and 5.0 kW (full load) for different air change rates (which result in different  $O_2$  levels) and air temperature as shown in Table 2. Different air change rates were achieved by adjusting the shed windows to be opened with a 0.05 m  $\times$  0.2 m crack (OW) or completely closed (CW). Each test was also conducted at least twice to confirm the validity of the measurement data. Each test in Table 2 is named by its load setting, window adjustment and repetition, for example, 2.5kW-OW-1 indicates the first test running under a 2.5 kW load setting and with open windows. Note that Tests 6, 11, and 12 were conducted after the generator engine was serviced (S = serviced), which entailed changing the oil and cleaning the air filter. For Test 13, the shed was tightened to achieve a low air change rate (LA).

**Table 2 Summary of Gen B Shed Test Results**

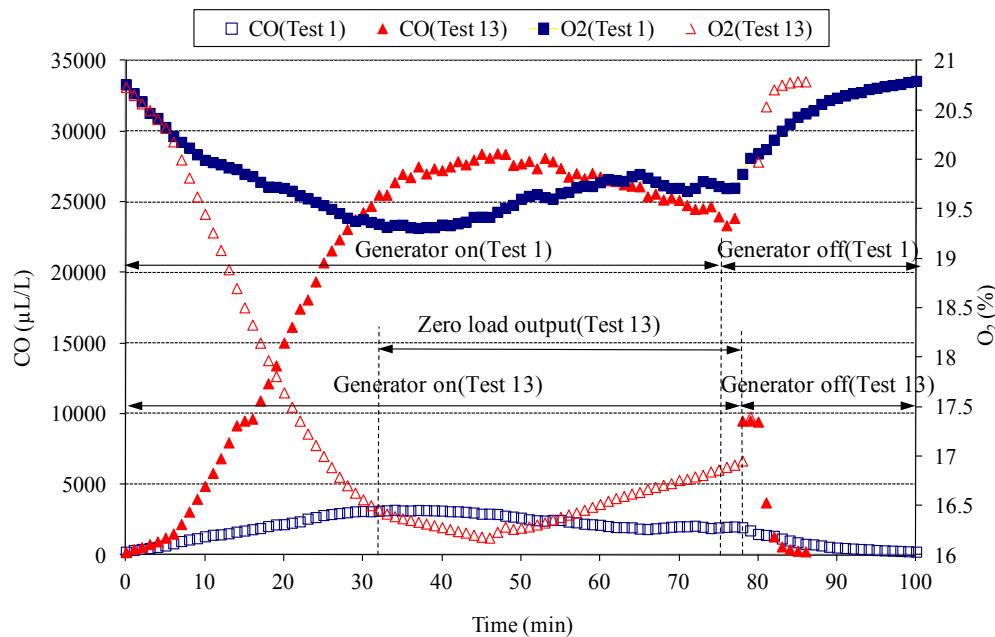
| Load setting (kW) | Test | Name        | Run Time min | Max CO ( $\mu\text{L/L}$ ) | Min O <sub>2</sub> (%) | CO Emission rates (g/h) | O <sub>2</sub> Consumption rates (g/h) | Air change rate ( $\text{h}^{-1}$ ) |
|-------------------|------|-------------|--------------|----------------------------|------------------------|-------------------------|--|-------------------------------------|
| 2.5               | 1    | 2.5kW-OW-1  | 80           | 3190                       | 19.3                   | 340 to 900              | 3300 to 4800                           | 6.5                                 |
|                   | 2    | 2.5kw-OW-2  | 63           | 5290                       | 18.9                   | 40 to 900               | 3300 to 4000                           | 3.7                                 |
|                   | 3    | 2.5kw-CW-1  | 86           | 23950                      | 16.9                   | 1100 to 3100            | 4600 to 5900                           | 2.6                                 |
|                   | 4    | 2.5kw-CW-2  | 101          | 23270                      | 16.8                   | 1000 to 3000            | 4200 to 5700                           | 3.1                                 |
|                   | 5    | 2.5kw-CW-3  | 80           | 20090                      | 17.1                   | 880 to 2600             | 4100 to 5100                           | 2.9                                 |
|                   | 6    | 2.5kw-CW-S1 | 106          | 8160                       | 18.2                   | 500 to 1400             | 4200 to 5100                           | 3.6                                 |
| 5.0               | 7    | 5.0kw-OW-1  | 90           | 18210                      | 17.9                   | 120 to 3700             | 5700 to 7100                           | 4.7                                 |
|                   | 8    | 5.0kw-OW-2  | 81           | 8420                       | 19.1                   | 1500 to 2600            | 4100 to 6500                           | 7.6                                 |
|                   | 9    | 5.0kw-CW-1  | 62           | 21320                      | 17.4                   | 1100 to 3600            | 5600 to 6700                           | 3.7                                 |
|                   | 10   | 5.0kw-CW-2  | 74           | 21200                      | 17.1                   | 1700 to 3000            | 4700 to 6400                           | 2.9                                 |
|                   | 11   | 5.0kw-CW-S1 | 65           | 22470                      | 16.9                   | 1600 to 3500            | 5800 to 7600                           | 3.0                                 |
|                   | 12   | 5.0kw-CW-S2 | 66           | 22280                      | 17.0                   | 70 to 3800              | 1400 to 7100                           | 3.6                                 |
|                   | 13   | 5.0kw-CW-LA | 86           | 25500                      | 16.2                   | 2000 to 3400            | 3900 to 6200                           | 0.7                                 |

Table 2 shows large variations in CO and O<sub>2</sub> levels between tests with Gen B under the different constant load settings and window positions. The CO level reached only 3190  $\mu\text{L/L}$  (note that  $\mu\text{L/L}$  are equivalent to the commonly used unit ppm<sub>v</sub>) within 80 min in Test 1 when the generator was at half-load with the shed windows opened, but reached a maximum of 25500  $\mu\text{L/L}$  for an 86-min run-time under full load in Test 13 when the shed was tightened. The shed O<sub>2</sub> concentration dropped significantly below ambient levels when operating the generator in this enclosed space. The largest decline occurred for Test 13, when the O<sub>2</sub> level was 16.2 % with the low air change rate and full loading. Table 2 also provides the measured air change rates and time-averaged weather conditions. When the shed was tightened in Test 13, the air change rate reached its lowest value, 0.7  $\text{h}^{-1}$ , which explains it reaching the highest CO level and lowest O<sub>2</sub> level. For the rest of the tests, the shed window positions played an important role. The air change rates of open-window cases were all as high as or higher than those with closed windows. As a result, the opened window tests always had higher O<sub>2</sub> levels than those with closed windows for the same load. The CO levels in opened-window tests were generally lower than closed-window cases. Note also that the weather conditions during these tests varied significantly. The ambient temperature ranged from 4.0 °C to 17.2 °C and the wind speed from 1.1 m/s to 6.8 m/s. The variations of weather provided realistic generator operating conditions for these experiments as compared to controlled chamber experiments. Note that the CO and O<sub>2</sub>



levels in Table 2 are only provided to indicate the range of test conditions, as these tests were primarily performed to determine CO emission and O<sub>2</sub> consumption rates for use in the simulation effort described later in this report.

As an illustration of individual shed tests, Figure 7 shows the CO and O<sub>2</sub> measured for Tests 1 and 13 from Table 2. The patterns of CO concentration in both tests are almost an inverse to that of the O<sub>2</sub> level for this unmodified generator. The CO level is low at the beginning of generator startup and increases steadily as the O<sub>2</sub> level drops. As the O<sub>2</sub> drops further and causes a very rich fuel mixture in the engine, CO reaches a maximum level. Test 13 in Figure 7 shows an extreme case in which the generator eventually produces a zero electrical load when the O<sub>2</sub> drops to around 16.4 %, although it was set at a full load and the engine crankshaft was still rotating.



**Figure 7** Measured CO and O<sub>2</sub> concentrations of Tests 1 and 13.

Figure 7 also shows that steady state was never reached for either test. A relatively stable period occurred at about 40 min for Test 1 and 45 min for Test 13, but they only held for a few minutes. These results differed from chamber experiments, where CO concentrations becomes constant after a period of time as complete steady state can be achieved under the controlled environment and higher air change rate. While these chambers tests are useful, the results from the shed confirm the importance of studying CO emission as a transient process under real weather conditions and more realistic air change rates to better understand generator performance in the field.

In order to generalize these test results to other conditions beyond this particular test facility, it is important to convert the results into CO emission and O<sub>2</sub> consumption rates. As seen in these tests, many factors can affect these rates directly or indirectly: space ventilation conditions, combustion conditions in the engine, O<sub>2</sub> level in the space, load setting, and the time over which the generator has been running.

Figures 8(a) and 8(b) illustrate how 5-min average CO emission rates and O<sub>2</sub> consumption rates ( $\Delta t = 5$  min in Eqs. (7) and (8)) change with O<sub>2</sub> levels in the thirteen shed tests. Figure 8(a) shows that for both full and half load settings CO emission rates increase with decreasing O<sub>2</sub>, reach maximum values when O<sub>2</sub> drop to about 17 % to 18 %, and then decline at lower O<sub>2</sub> levels. Under the extreme case of Test 13 (5.0kw-CW-LA), the CO rate decreases dramatically as the O<sub>2</sub> level reaches around 16.4 % with an electrical output of zero. Figure 8(b) shows an opposite trend of O<sub>2</sub> consumption rate compared to CO. The O<sub>2</sub> consumption rate decreases notably near 16.4 %, corresponding to the zero electrical output caused by O<sub>2</sub> deficiency. Given that the engine crankshaft was still rotating, the O<sub>2</sub> consumption rate was not quite zero, which explains the continual drop of O<sub>2</sub> in Test 13 of Figure 7, although the electrical output is zero.

The solid points in Figure 8 are data points for a half-load setting (2.5 kW) and the hollow ones for a full load setting (5.0 kW). As seen in previous small chamber test results in Brown (2006), a higher load setting generally results in more CO generated and O<sub>2</sub> consumed until the O<sub>2</sub> level reaches about 17 %, where data for full and half loads come together. This overlap corresponds to the drop in electrical output with the decrease of O<sub>2</sub>. Note that Figure 8 also shows the calculated uncertainty for each data point of CO emission and O<sub>2</sub> consumption rates, which was mostly less than 20 % with a confidence level of 95 %. Appendix A discusses the uncertainty analysis in detail.

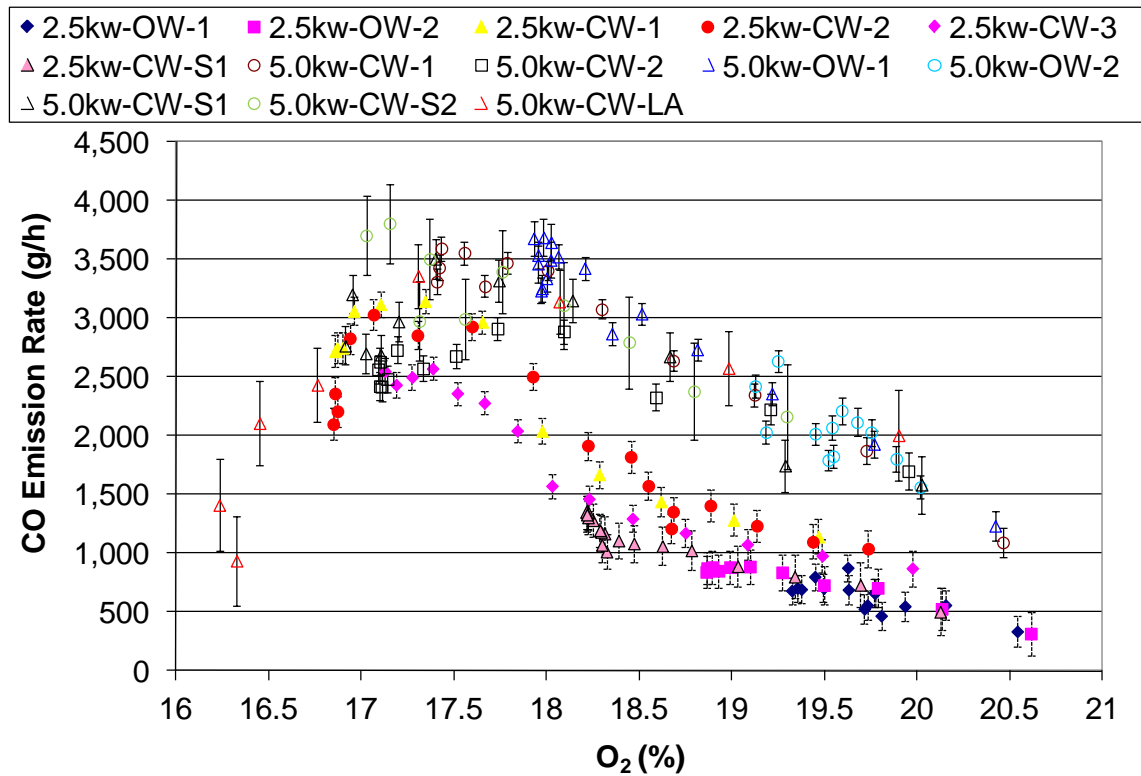


Figure 8(a)

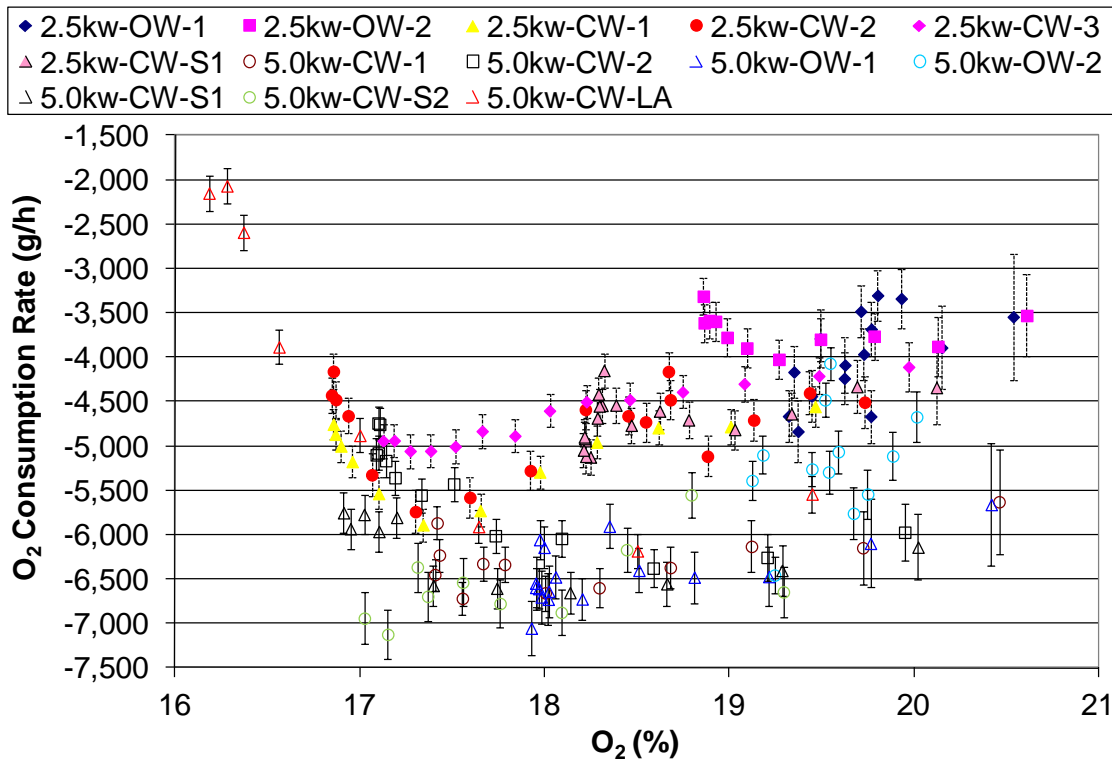


Figure 8(b)

**Figure 8** Five-minute averaged (a) CO emission rates and (b) O<sub>2</sub> consumption rates at different O<sub>2</sub> levels for Gen B

### Generator X

Generator X was tested in both unmodified and modified (low CO emission) prototype configurations. The primary difference between the tests with Gen X and Gen B was the generator loading. Gen X was tested at load points selected to approximately match the points of the load profile used by UA (See Table 1) during the durability and emission testing of their low CO emission prototype generator.

Figures 9(a) and 9(b) present the CO emission rates and O<sub>2</sub> consumption rates as a function of O<sub>2</sub> levels for unmodified Generator X. Although the tests of Gen X and Gen B were not identical, Figure 9(a) show similar results in that the CO emission rates range from a low of around 500 g/h at near ambient conditions to a high of nearly 4000 g/h as O<sub>2</sub> approaches 17 %. Unlike Gen B, however, the emission rate is only clearly load-dependent when the O<sub>2</sub> drops below about 19 %. Fewer tests were performed on Generator X below 17 % O<sub>2</sub> but the results indicate a similar drop off in CO emissions due to poor engine performance under these conditions.

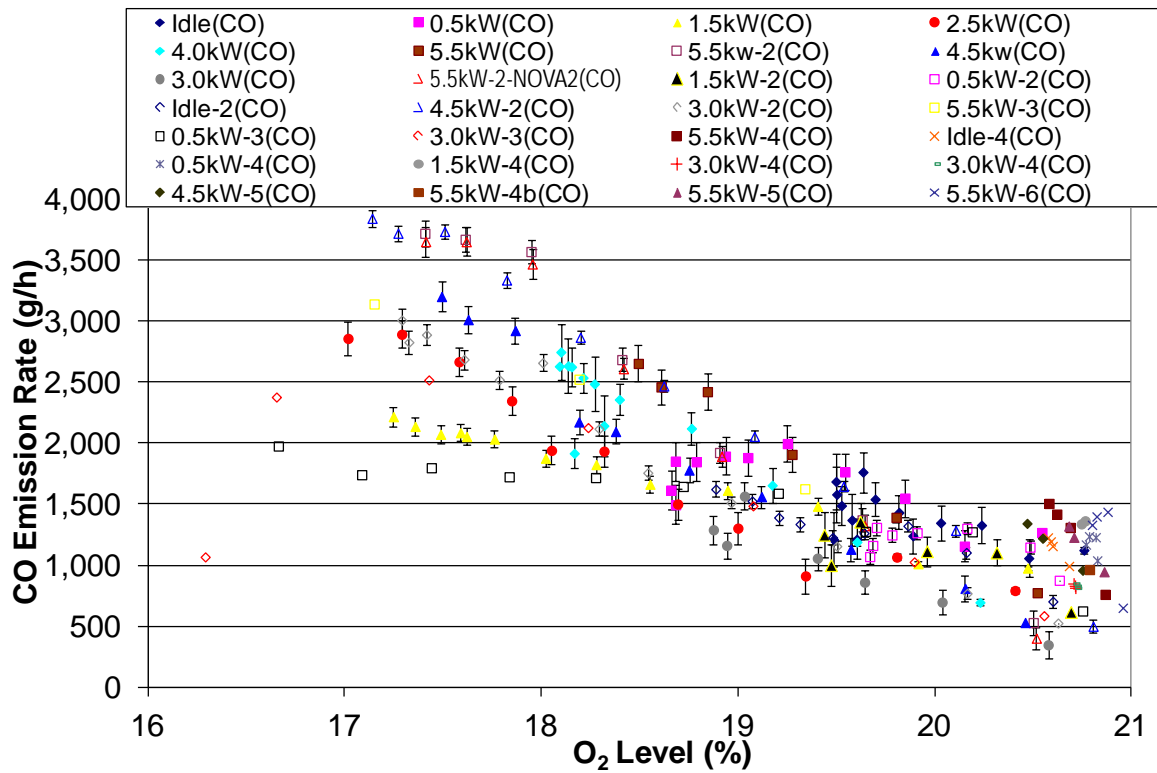


Figure 9(a)

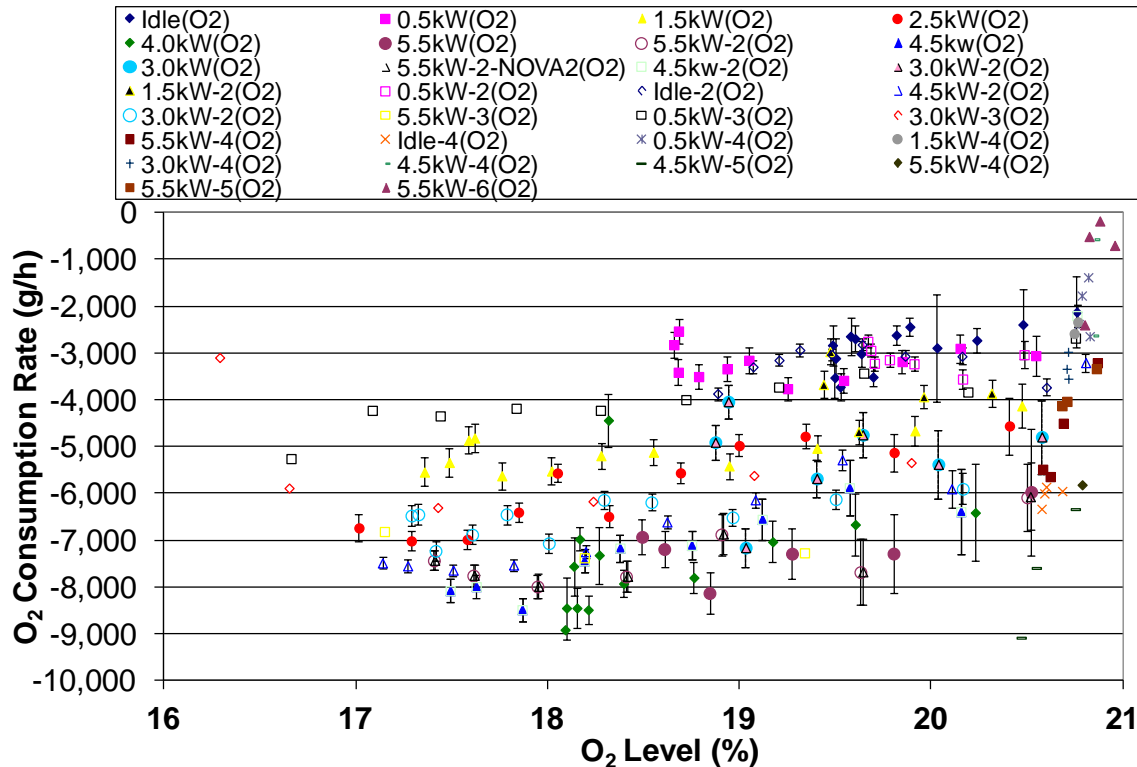


Figure 9(b)

**Figure 9** Five-minute averaged (a) CO emission rates and (b) O<sub>2</sub> consumption rates at different O<sub>2</sub> levels for unmodified Generator X

Figures 10(a) and 10(b) present the CO emission rates and O<sub>2</sub> consumption rates as a function of O<sub>2</sub> levels for modified Generator X. Although modified Gen X was not tested as many times as unmodified Gen X, comparing Figure 10(a) to Figure 9(a) shows the dramatic reduction in CO emission rates due to the low CO emission modifications included on the prototype. Most of the modified Gen X CO emission rates were well below 500 g/h. Although not enough low O<sub>2</sub> tests were performed to be conclusive, the CO emission rates at the highest loads did tend to increase as O<sub>2</sub> dropped.

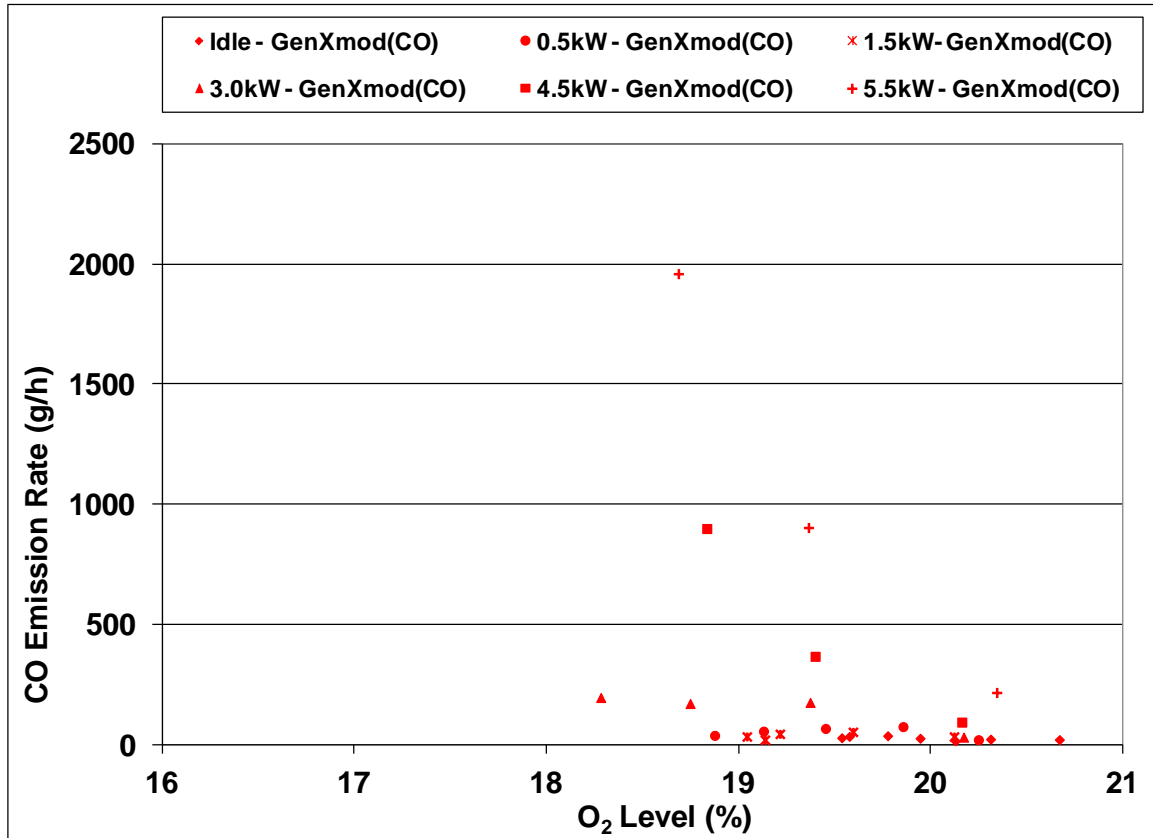


Figure 10(a)

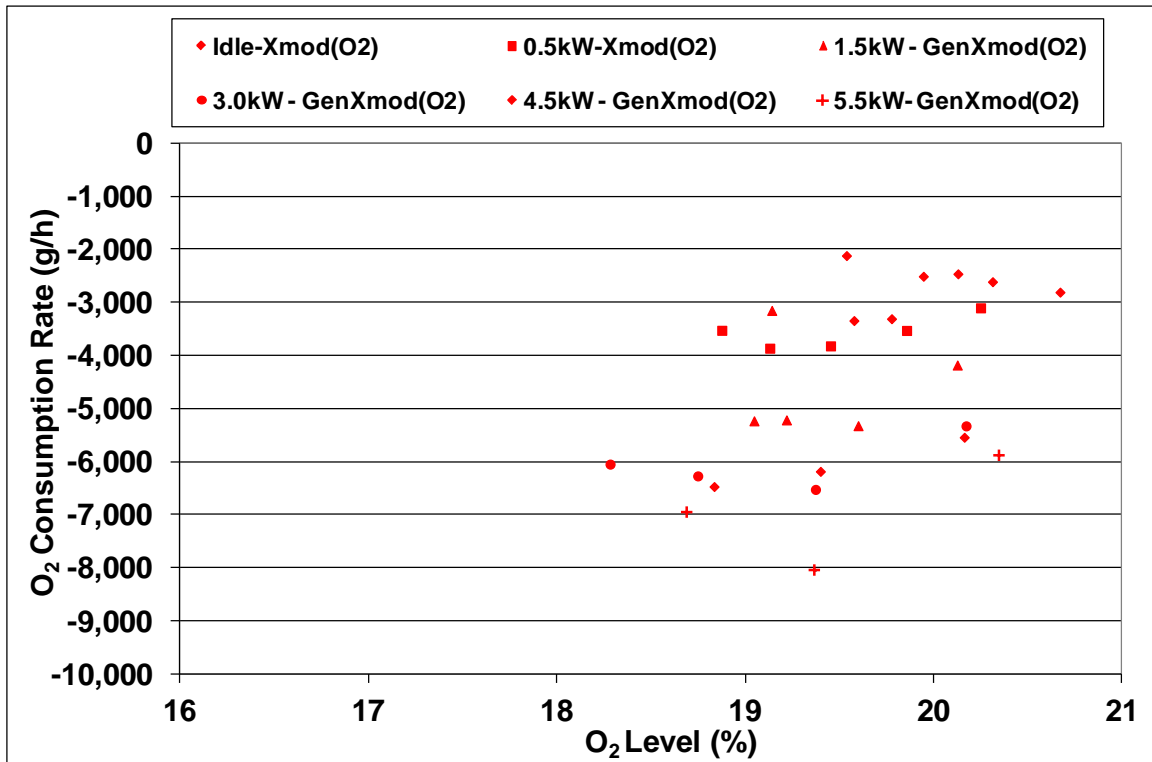


Figure 10(b)

**Figure 10** Five-minute averaged (a) CO emission rates and (b) O<sub>2</sub> consumption rates at different O<sub>2</sub> levels for modified Generator X

### Generator SO1

Generator SO1 was tested at the same load points as Generator X but was not tested in an unmodified configuration. Instead, it was tested in two modified configurations – with and without a catalyst integrated in the muffler (referred to as cat muffler and noncat muffler, respectively). Figure 11(a) and 11(b) present the CO emission rates and O<sub>2</sub> consumption rates as a function of O<sub>2</sub> levels for Generator SO1 with the cat muffler (referred to as Gen SO1 cat). Comparing Figure 11(a) to Figure 10(a) shows that Gen SO1 cat performed somewhat better than modified Gen X. All measured CO emission rates for Gen SO1 cat were well below 500 g/h, and no trend toward higher emission rates was seen as O<sub>2</sub> levels dropped to 18 %. However, as with Gen X, no tests were performed at levels as low as 17 %.



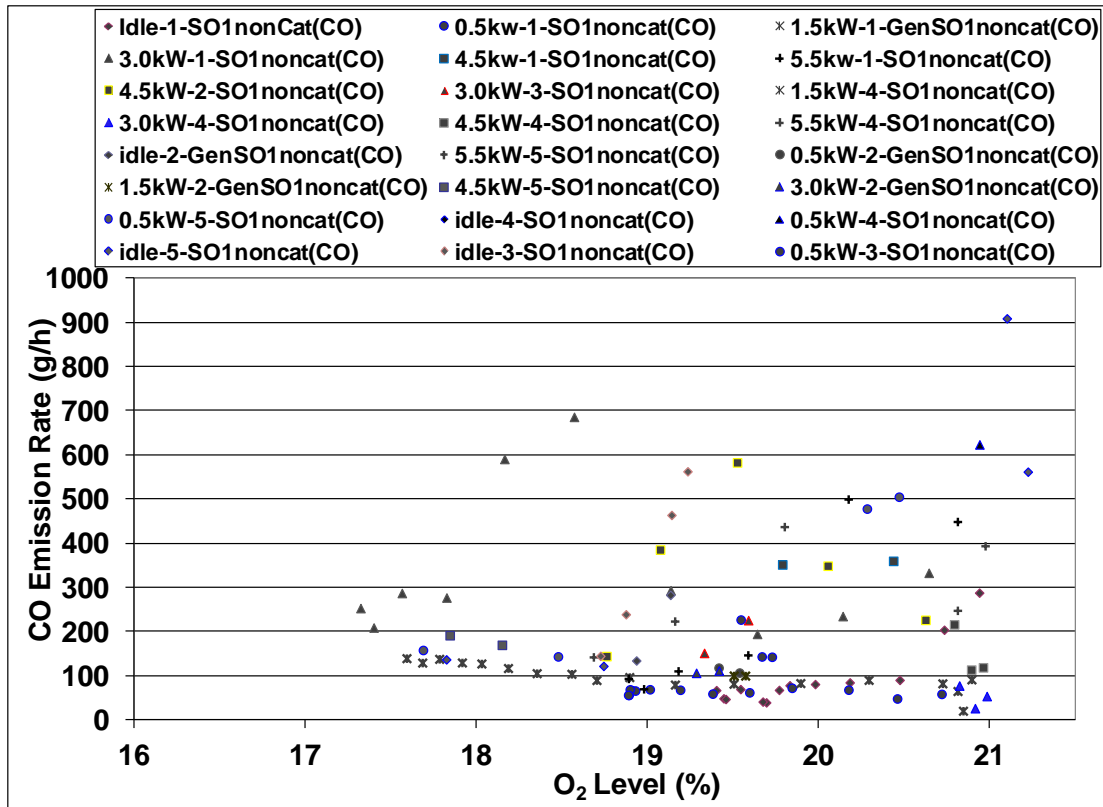


Figure 12(a)

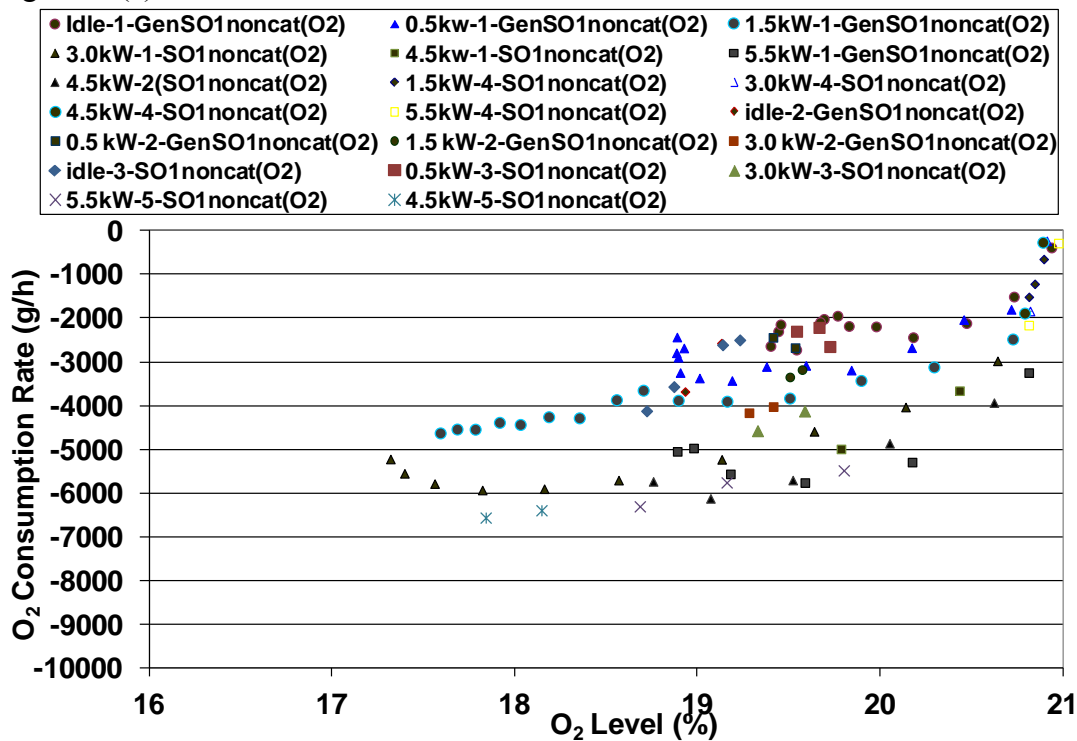


Figure 12(b)

**Figure 12** Five-minute averaged (a) CO emission rates and (b) O<sub>2</sub> consumption rates at different O<sub>2</sub> levels for Generator SO<sub>1</sub> with noncat muffer



Figures 12(a) and 12(b) present the CO emission rates and O<sub>2</sub> consumption rates as a function of O<sub>2</sub> levels for Generator SO1 with the noncat muffler (referred to as Gen SO1 noncat). Comparing Figure 12(a) to Figure 11(a) shows that Gen SO1 noncat had higher CO emission rates than Gen SO1 cat. However, the measured CO emission rates for Gen SO1 noncat were still substantially lower than the emission rates of the unmodified generators, and no trend toward higher emission rates was seen as O<sub>2</sub> levels dropped close to 17 %.

### ***Discussion of Shed Tests***

A series of experiments were conducted to measure CO emission and O<sub>2</sub> consumption rates of portable, spark-ignited, gasoline-powered electric generators (in both unmodified carbureted configuration and prototype low CO emission configuration) operated in a single-zone shed. These tests were used to derive the CO emission and O<sub>2</sub> consumption rates to be used as inputs to a model validation effort, as well as for the simulation analyses conducted to examine the potential performance of the low CO-emission prototype under a wider range of operating conditions. For two different unmodified generators (*i.e.*, without CO emission controls), it was found that CO emission ranged from a low of around 500 g/h at near ambient O<sub>2</sub> levels, to a high of nearly 4000 g/h as O<sub>2</sub> approached 17 %. The rates of CO generation and O<sub>2</sub> consumption were affected by multiple parameters, with the O<sub>2</sub> level and the actual electrical output of the generator being two of the most important. Tests performed below 17 % O<sub>2</sub> showed a drop off in CO emissions due to poor engine performance under these conditions. Tests of two modified prototype low CO emission generators (*i.e.*, with CO emission controls) showed reductions of CO emissions of over 90 % depending on the specific emission controls and operating conditions.

## Garage Test Results

NIST also conducted a series of tests to provide empirical data to characterize the emission and transport of CO due to operating portable gasoline-powered generators in an attached garage. This section of this report presents data from these tests of both unmodified and UA-modified prototype generators operated in the garage attached to NIST's manufactured test house. Note that these results apply to the specific units tested and that other units, modifications, houses and test conditions may produce different results.

### *Testing Configurations*

Testing was conducted under seven different test house configurations to evaluate their impacts on the buildup of CO in the garage and its transport into the different rooms in the house. These configurations included two different garage bay door positions (fully closed or open nominally 0.6 m), two connecting door settings between the garage and the family room (fully closed or open nominally 5 cm), and two house central heating, ventilating, and air conditioning (HVAC) fan settings (on or off). All internal house doors were kept open throughout all tests.

There were multiple purposes in conducting tests under these different configurations. The garage-house door positions directly affect the rate of engine exhaust transfer from the garage into the house. The status of the HVAC fan, which circulates the interior air throughout the rooms of the house, affects the CO distribution within the house. The fan operation also affects the house air change rate due to air distribution duct leakage within the crawl space (Nabinger and Persily 2008). It is also relevant to consider the fan status, even when there is a power outage, because the consumer may use the generator to provide power to the home's central heating system, which includes providing power to the HVAC fan. Another reason for testing under different garage door and garage-house door positions is that, with the generator operating in the garage, it is possible that the engine will consume the oxygen in the garage at a faster rate than the rate at which natural air change replenishes oxygen. The degree of either door's opening will impact whether or not the garage's oxygen level can be maintained at ambient level and, if not, how low it will drop. Testing with different door positions enabled observations of the effects of different oxygen levels on generator engine performance. Variations in house configuration can be found in CPSC's investigation reports of fatal CO poisonings involving generators (Hnatov 2010). These reports include cases in which consumers were aware of the CO poisoning hazard but attempted to provide what they considered "proper ventilation" by operating the generator in a partially-open garage. A bay door opening of 0.6 m was selected in part based on it being within the range of openings that can be modeled using the multizone airflow and IAQ model CONTAM. The house door opening of 5 cm was selected because it is a reasonable opening to allow the passage of an extension cord from the generator into the house.

Table 3 includes a summary of the tests conducted including information on the generator tested, the test house configuration (defined by door positions and fan status), a test identification code, the date the test was conducted, the average ambient temperature and wind speed, and the CO analyzers used. As described in the Instrumentation Section, several different analyzers were used during the tests to span the full range of CO concentrations, but data is presented only from the analyzer considered most appropriate for the CO concentration range in each test. All tests listed in Table 3 were "cold start" tests. Additional garage tests are reported in Appendix C.

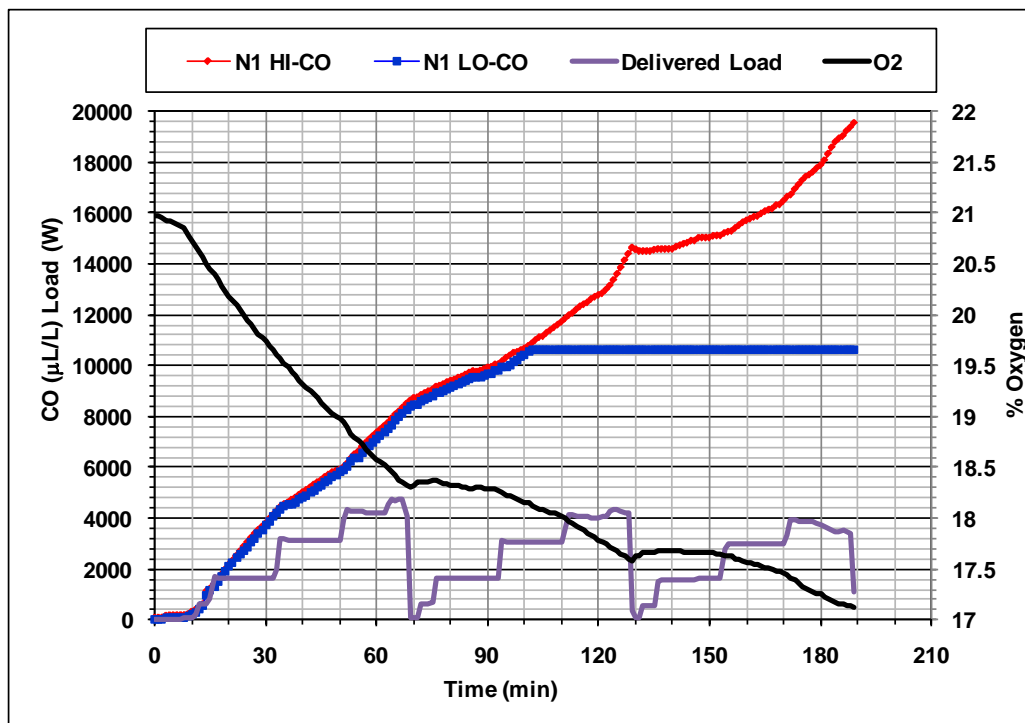
**Table 3 Tests Conducted in Attached Garage**

| <b>Generator</b>               | <b>House Configuration</b> | <b>Garage bay door</b> | <b>Garage to house door</b> | <b>HVAC fan</b> | <b>Test ID</b> | <b>Date</b> | <b>Outdoor Temp (°C)</b> | <b>Wind speed (m/s)</b> | <b>CO analyzers in garage</b> | <b>CO analyzers in house</b> |
|--------------------------------|----------------------------|------------------------|-----------------------------|-----------------|----------------|-------------|--------------------------|-------------------------|-------------------------------|------------------------------|
| <b>unmod GenX</b>              | 1                          | Closed                 | Open                        | OFF             | B              | 04/22/08    | 20.1                     | 6.5                     | N1                            | N2, N3                       |
| <b>modGenX</b>                 | 1                          | Closed                 | Open                        | OFF             | O              | 04/02/10    | 22.0                     | 6.5                     | N2, N3                        | N1, R1                       |
| <b>SO1</b>                     | 1                          | Closed                 | Open                        | OFF             | N              | 04/01/10    | 19.9                     | 6.3                     | N2, N3                        | N1, R1                       |
| <b>unmod GenX</b>              | 2                          | Open                   | Closed                      | OFF             | F              | 05/06/08    | 22.8                     | 7.7                     | N1                            | N2, N3                       |
| <b>modGenX</b>                 | 2                          | Open                   | Closed                      | OFF             | R              | 04/12/10    | 19.9                     | 6.7                     | N2, N3                        | N1, R1                       |
| <b>SO1</b>                     | 2                          | Open                   | Closed                      | OFF             | T              | 04/14/10    | 13.4                     | 6.9                     | N2, N3                        | N1, R1                       |
| <b>unmod GenX</b>              | 3                          | Closed                 | Open                        | ON              | I              | 05/15/08    | 22.8                     | 7.4                     | N1                            | N2, N3                       |
| <b>SO1 with noncat muffler</b> | 3                          | Closed                 | Open                        | ON              | Z              | 05/05/10    | 28.3                     | 6.7                     | N2, N3                        | N1, R1                       |
| <b>unmod GenX</b>              | 4                          | Closed                 | Closed                      | ON              | J              | 05/21/08    | 18.2                     | 9.6                     | N1                            | N2, N3                       |
| <b>SO1</b>                     | 4                          | Closed                 | Closed                      | ON              | W              | 04/29/10    | 17.8                     | 9.5                     | N2, N3                        | N1, R1                       |
| <b>unmod GenX</b>              | 5                          | Closed                 | Closed                      | OFF             | D              | 04/30/08    | 12.2                     | 8.2                     | N1                            | N2, N3                       |
| <b>SO1 with noncat muffler</b> | 5                          | Closed                 | Closed                      | OFF             | AH             | 05/13/10    | 15.6                     | 6.5                     | N2, N3                        | N1, R1                       |
| <b>unmod GenX</b>              | 6                          | Open                   | Open                        | ON              | G              | 05/07/08    | 25.1                     | 7.0                     | N1                            | N2, N3                       |
| <b>SO1</b>                     | 6                          | Open                   | Open                        | ON              | U              | 04/22/10    | 20.4                     | 7.8                     | N2, N3                        | N1, R1                       |
| <b>unmod GenX</b>              | 7                          | Open                   | Open                        | OFF             | K              | 05/23/08    | 13.84                    | 7.0                     | N1, T1                        | N2, N3                       |
| <b>SO1 with noncat muffler</b> | 7                          | Open                   | Open                        | OFF             | V              | 04/23/10    | 15.8                     | 6.5                     | N2, N3                        | N1, R1                       |

## Results

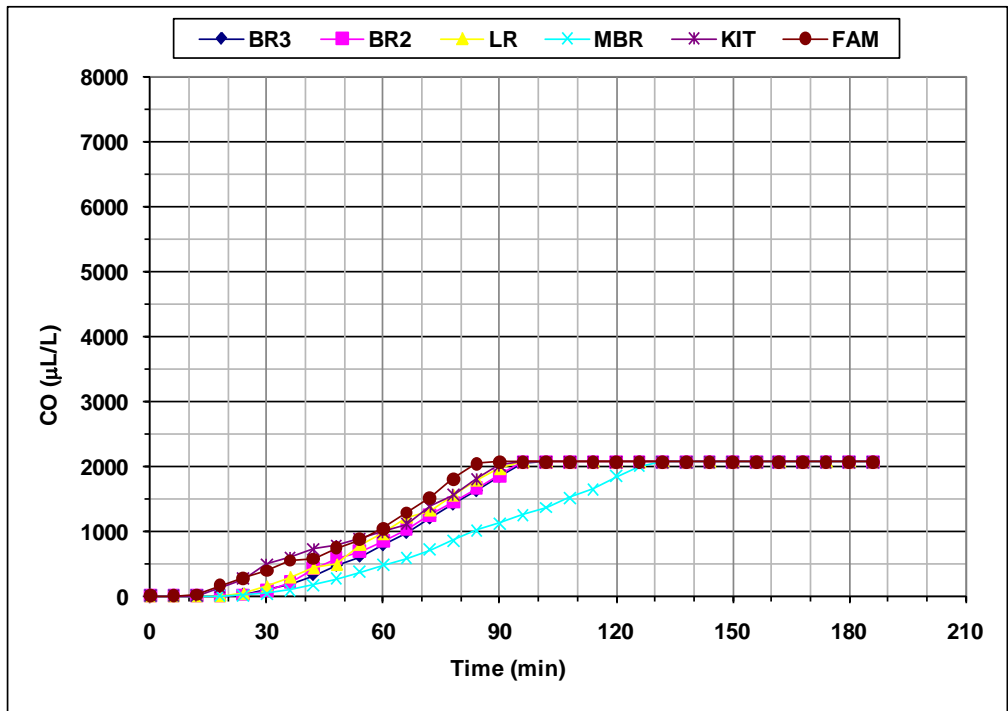
Figures 13 through 28 show the measurement results for all 16 tests listed in Table 3, including CO concentration in the house and garage, O<sub>2</sub> concentration in the garage, and the measured electric load supplied by the generator. In all tests, the generator was started at time 0 and was manually shut off by the test operator using a wireless switch that interrupted the engine's ignition. The data in the figures are plotted up until the time mechanical venting was initiated, which typically immediately followed generator shut-off. In some tests, where time and circumstances permitted, natural decay was allowed to occur after the generator was stopped, before mechanical venting was initiated. In those tests, the natural decay is plotted.

Figures 13a, 13b, and 13c show the results for Test B, which was a three hour test of unmod Gen X in Configuration 1 (garage bay door closed, garage access door to house open nominally 5 cm, and the house central HVAC fan off). Since it was a three hour test, the hourly cyclic load profile in Table 1 was repeated three times. At the end of the third cycle, the generator was stopped, and the garage was mechanically vented.

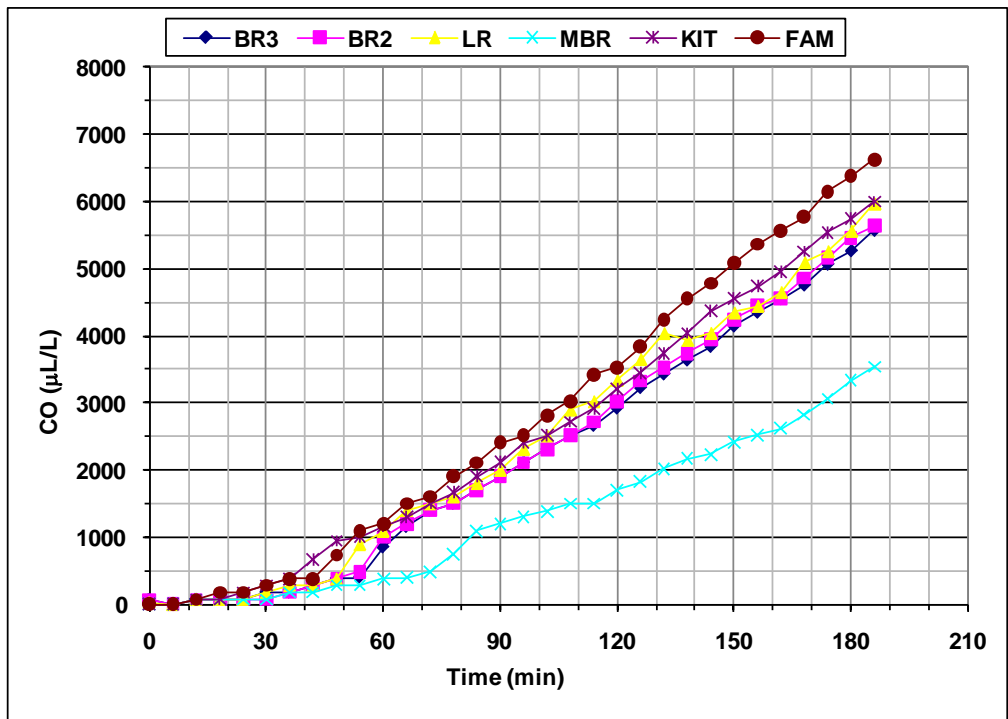


**Figure 13a** CO and O<sub>2</sub> concentrations in the garage and measured load for Test B (unmod Gen X, Configuration 1)

Figure 13a shows the concentration of CO in the garage reached a peak of over 19,500 µL/L and the volume fraction of O<sub>2</sub> in the garage dropped by 3.8 % to nearly 17 % when the generator was stopped. It also shows that in the first load cycle, the delivered electrical output was less than the load bank settings for the two highest loads in the load cycle, 4500 W and 5500 W, which were applied when the oxygen was already below 19 %. As the oxygen continued to drop in the subsequent load cycles, the delivered power for these load points decreased further.



**Figure 13b** CO (ppm range) concentrations in the house for Test B (unmod Gen X, Configuration 1)

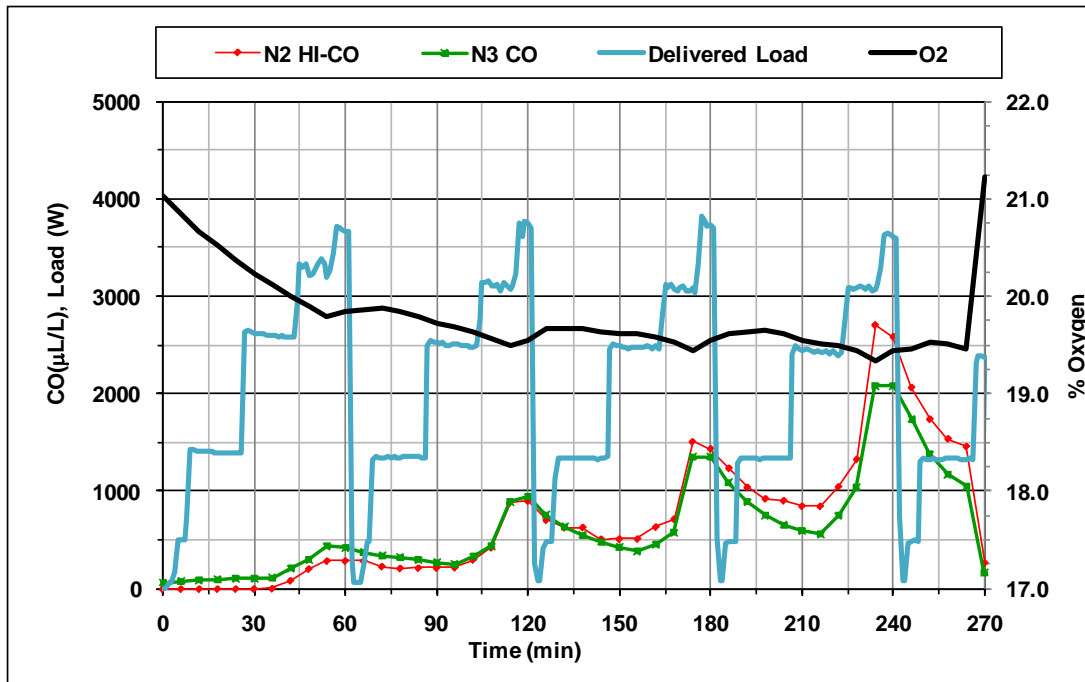


**Figure 13c** CO (high range) concentrations in the house for Test B (unmod Gen X, Configuration 1)

Figures 13b and 13c show the CO concentration in six rooms of the test house (see Figure 2 for room locations) as measured with the N3 ‘ppm range’ (where the CO concentration plot plateaus at the instrument’s 2000 µL/L limit) and N2 ‘high range’ CO instruments, respectively. The CO

reached a peak concentration of over 6500  $\mu\text{L/L}$  in the family room, with peak concentrations in the other rooms ranging from about 3500  $\mu\text{L/L}$  to 6000  $\mu\text{L/L}$ . As described in the Instrumentation section, samples were taken for one minute at each location on a rotating six minute cycle.

Figures 14a, 14b, and 14c show the results for Test O, which was a four and a half hour test of mod Gen X with the same test house configuration (Configuraiton 1) as used in Test B of unmod Gen X (shown in Figure 13). After the generator was stopped, the garage and house were mechanically ventilated.

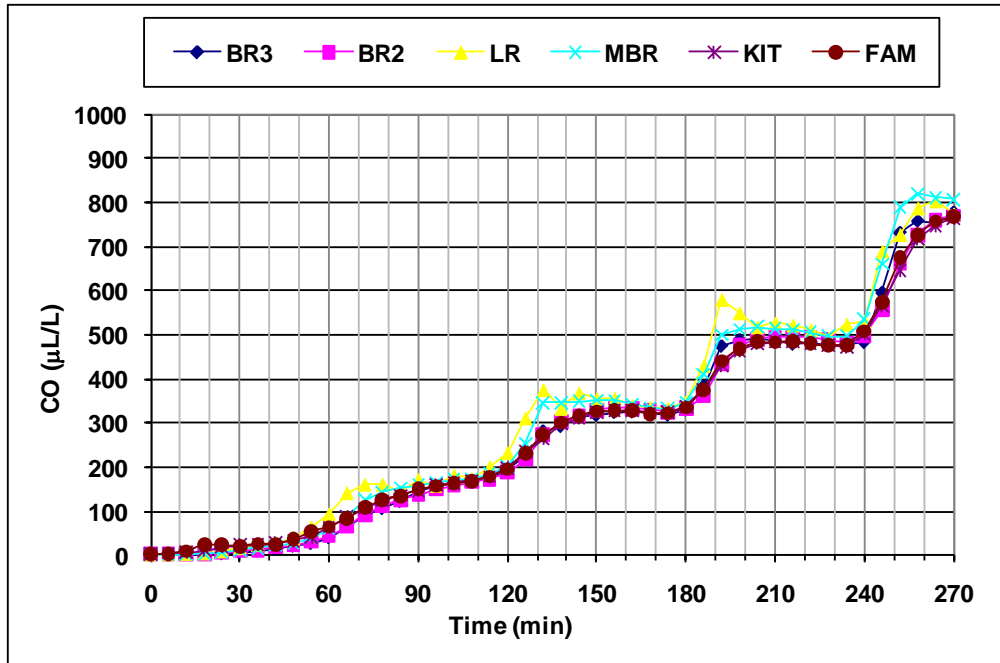


**Figure 14a** CO and O<sub>2</sub> concentrations in the garage and measured load for Test O (mod Gen X, Configuration 1)

As shown in Figure 14a, the garage CO concentration reached a peak of nearly 3000  $\mu\text{L/L}$  while the garage O<sub>2</sub> concentration dropped by 1.7 % to 19.5 % after completing the fourth cycle of the load profile. Note that the ppm instrument (N3) briefly topped out at this time, about 230 min into the test. Also, the initial O<sub>2</sub> concentration is shown as slightly above 20.9 % for this and some other tests due to the limitations in instrument accuracy. The generator was intentionally stopped midway through the fifth load cycle.

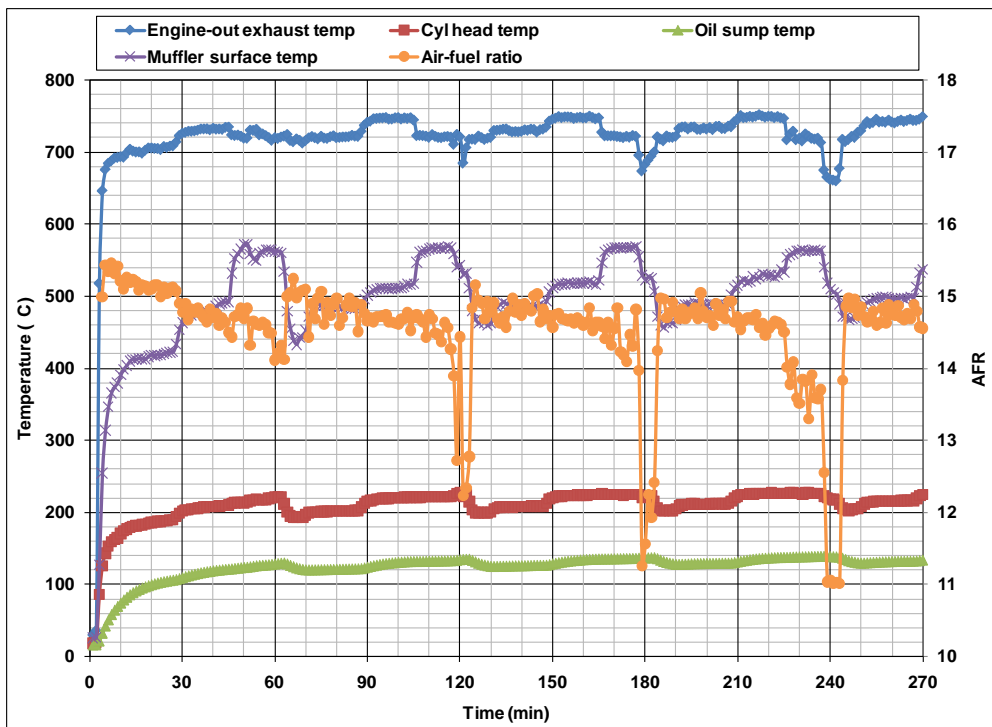
At three hours into this test, the garage CO concentration was approximately 1400  $\mu\text{L/L}$ . Under fairly similar ambient conditions between this test and Test B, this CO concentration is a 93 % reduction compared to that measured with unmod Gen X in Test B. In that case, the garage CO was over 19,500  $\mu\text{L/L}$  at the same time during the test.

In the first load cycle, as the oxygen dropped, the delivered electrical output was less than the load bank settings for the three highest loads in the load cycle, 3000 W, 4500 W, and 5500 W. While the electrical output stayed near constant for the four cycles, the CO levels increased progressively and the oxygen decreased slightly with each additional cycle.



**Figure 14b** CO concentrations in the house for Test O (mod Gen X, Configuration 1)

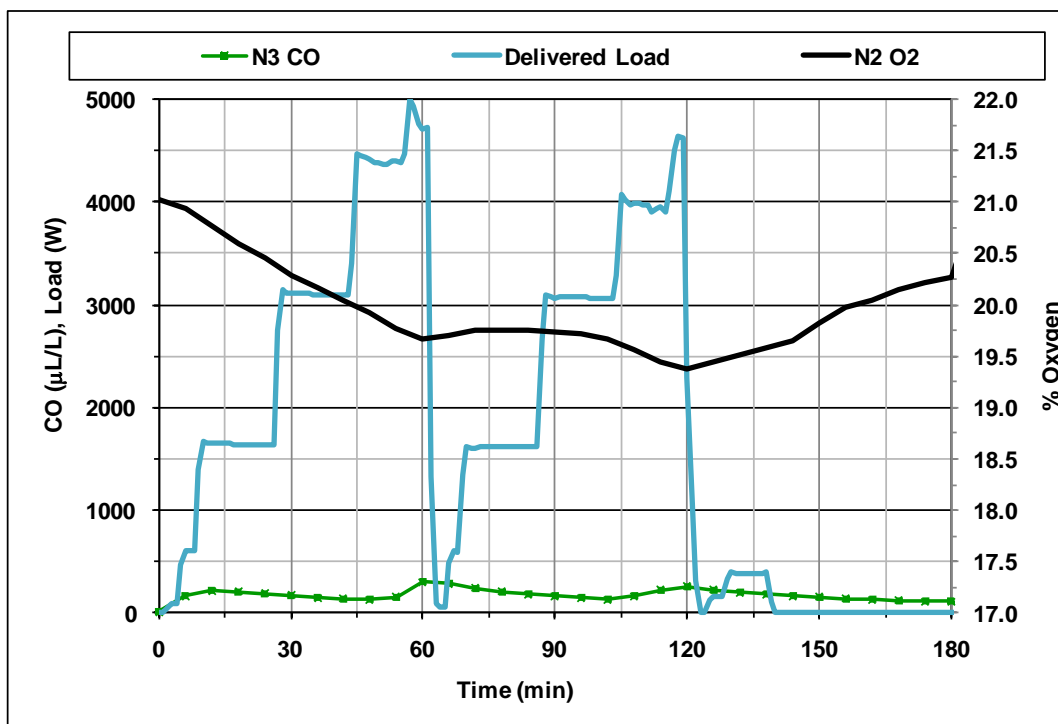
As seen in Figure 14b, the peak CO concentration throughout the house was about 800  $\mu\text{L/L}$ , with a relatively uniform distribution in all the rooms despite the HVAC fan being off. By comparison, unmod Gen X in Test B produced a peak concentration of over 6500  $\mu\text{L/L}$  in the family room.



**Figure 14c** Temperatures and AFR measured in Test O (mod Gen X, Configuration 1)

The AFR (provided as a general indicator of the prototype engine’s performance for this and other tests) and temperatures measured on modGen X during Test O are shown in Figure 14c. During this test, the engine performed off design with AFR largely ranging from around 14 to around 15.4 during each load cycle and reducing to rich operation when transitioning between the load cycles as well as during the high loads.

Figures 15a, 15b, and 15c show the results for Test N, which was a two hour test of Gen SO1 with the same test house configuration used in Test B of unmod Gen X and Test O of mod GenX (Configuration 1). This test was terminated earlier than planned after a fuse blew on the load bank after 114 min of operation, dropping half the load. The generator was turned off 138 min after it was started. A natural decay period of 45 min was included after the generator was stopped, followed by mechanical venting.

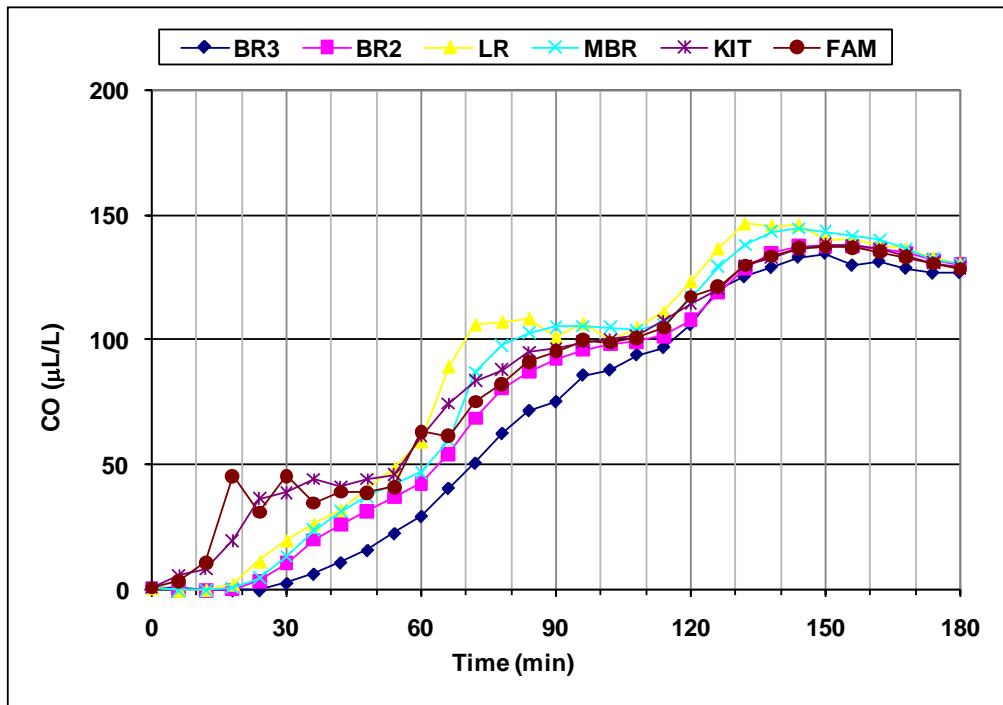


**Figure 15a** CO and O<sub>2</sub> concentrations in the garage and measured load for Test N (Gen SO1, Configuration 1)

As shown in Figure 15a, there was an initial increase of CO to almost 220 µL/L in the first 12 min after the generator was started. This rise is due to the rich operation upon cold engine start until the oil warms and the ECU transitions to the calibrated AFR fuel control. This initial increase is observed at the start of each of the tests with Gen SO1. The garage CO concentration reached a peak of around 300 µL/L, and the garage O<sub>2</sub> concentration dropped by 1.6 % to 19.4 % before the generator was stopped. The garage CO concentration after two hours is about 98 % lower than the concentration at two hours with unmod Gen X in Test B, which was about 13,000 µL/L. In the first load cycle, as the oxygen dropped, the delivered electrical output was less than the load bank setting for the highest load in the load cycle, 5500 W. This difference increased in the subsequent load cycle as the oxygen level decreased. Comparing the performance of mod Gen X (Figure 14a) and Gen SO1 (Figure 15a) shows that, under similar

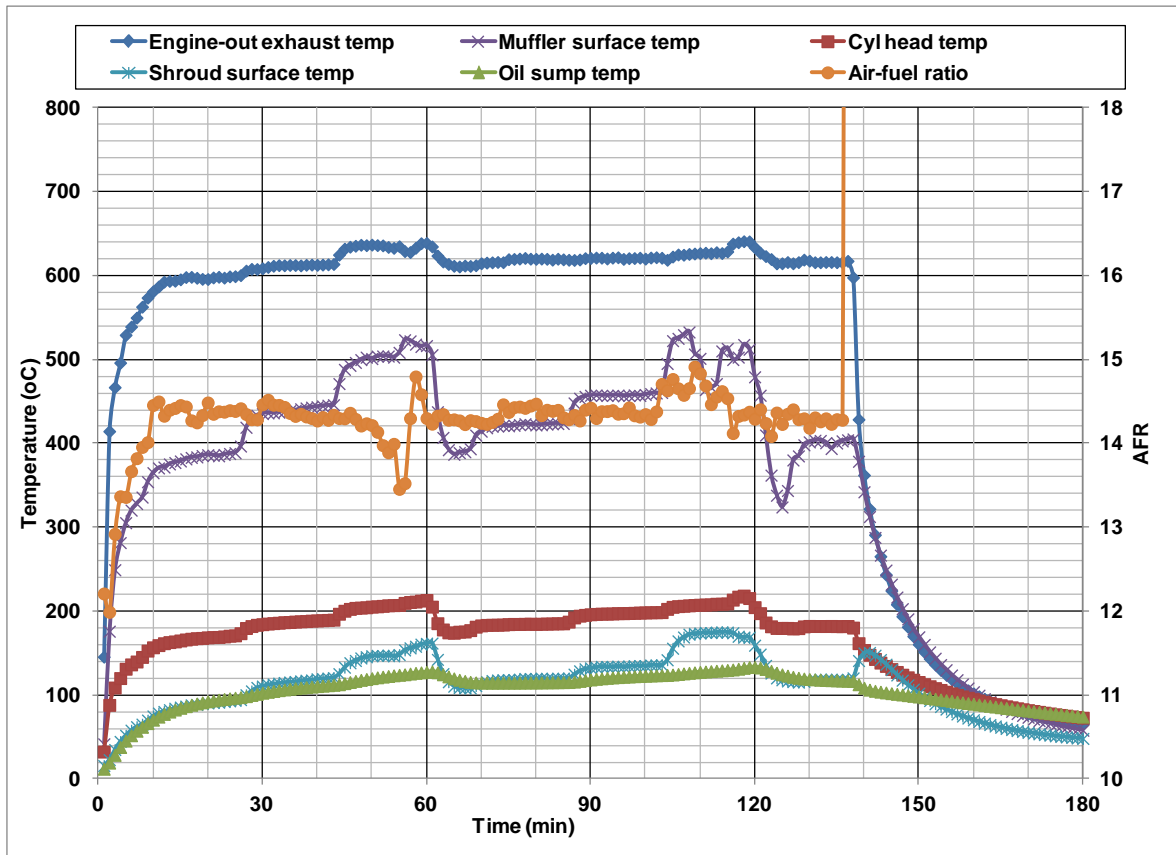


conditions (Configuration 1), Gen SO1 resulted in significantly lower CO concentrations at the 2 h mark.



**Figure 15b** CO concentrations in the house for Test N (Gen SO1, Configuration 1)

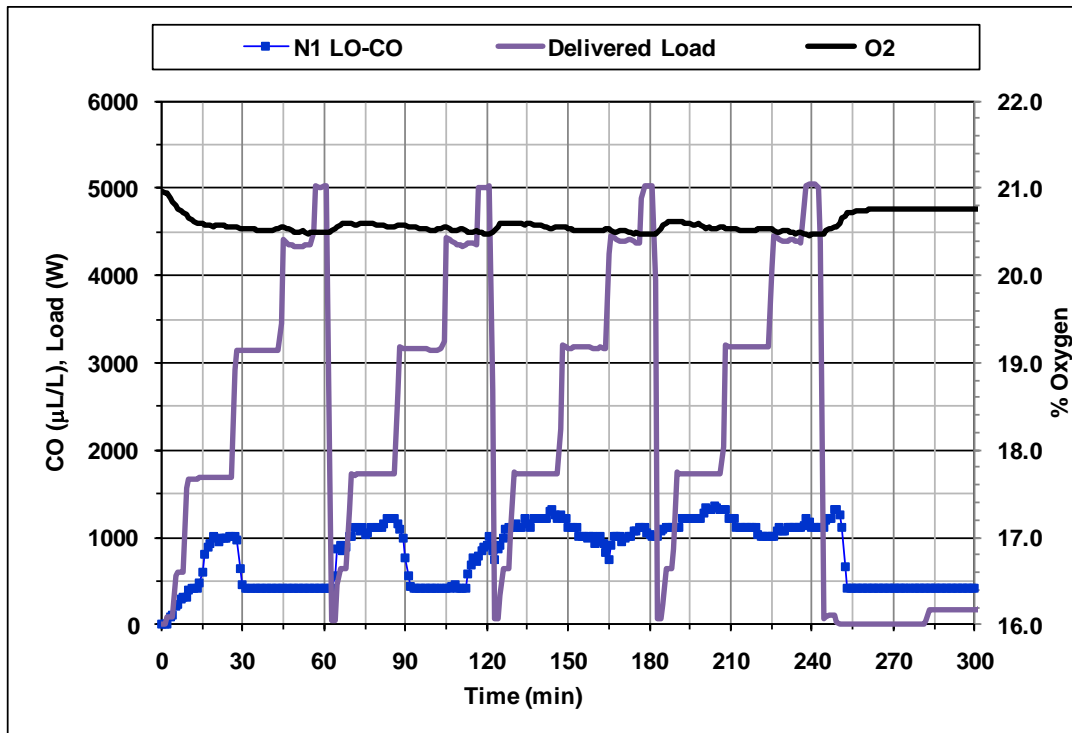
As shown in Figure 15b, the concentration throughout the house was about 130  $\mu\text{L/L}$  when the generator was stopped after 114 min. There is a relatively even CO distribution among the rooms in spite of the HVAC fan being off. For the following 45 min in which the exhaust was allowed to naturally decay, CO continued to infiltrate from the garage into to the house, slightly increasing the house concentration to about 140  $\mu\text{L/L}$  before the concentration began dropping. By comparison, unmod Gen X in Test B produced a peak concentration of over 3500  $\mu\text{L/L}$  in the family room after 2 h.



**Figure 15c** Temperatures and AFR measured on Gen SO1 in Test N (Gen SO1, Configuration 1)

The AFR and temperatures measured on Gen SO1 during Test N are shown in Figure 15c. With the exception of two periods of AFR excursion after the engine warmed up (*i.e.*, after approximately 10 min), the engine operated at the calibrated AFR of 14.5 as the oxygen level dropped. The spike in AFR at the end of the test occurred when the engine was turned off.

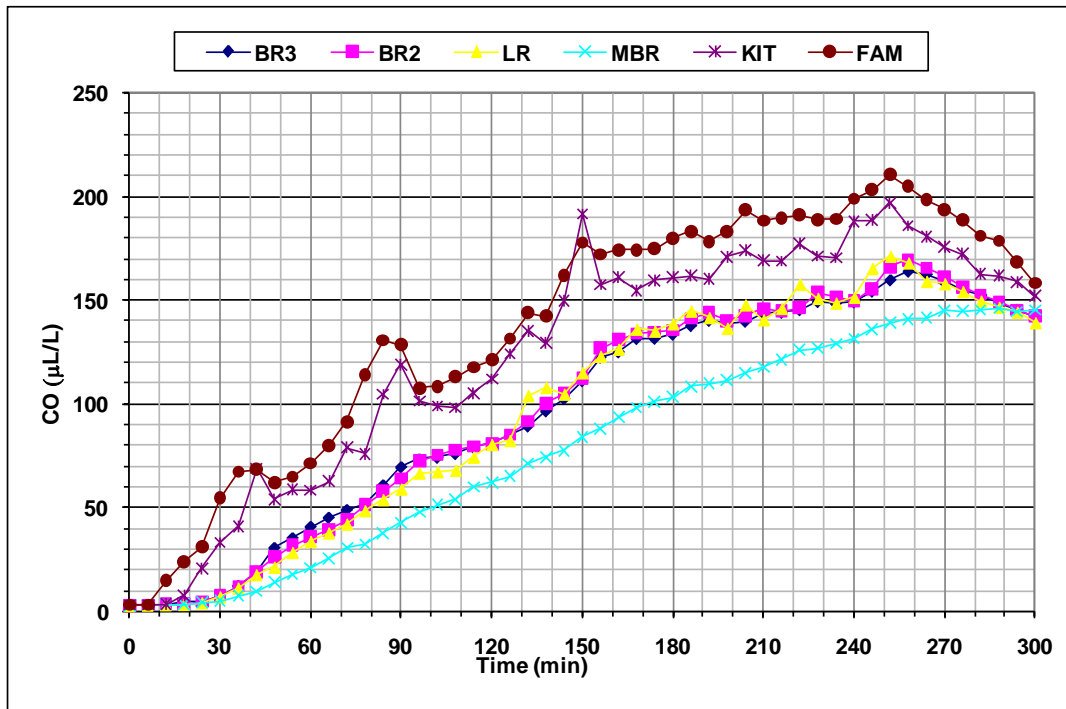
Figures 16a and 16b show the results for Test F, which was a four hour test of unmod Gen X with Configuration 2 (garage bay door open, garage access door to house closed, and house central HVAC fan off). After the generator was stopped, the garage concentration was allowed to naturally decay for one hour before the garage and house were mechanically vented.



**Figure 16a** CO and O<sub>2</sub> concentrations in the garage and measured load for Test F (unmod Gen X, Configuration 2)

The garage CO concentration peaked during each load cycle during the 1500 W load bank setting. The peak concentration rose slightly in each load cycle, reaching a maximum concentration somewhat under 1500 µL/L in the fourth load cycle. For this test, the garage was not instrumented with a low concentration CO analyzer, and the instrument uncertainty is large relative to measured concentrations below 500 µL/L.

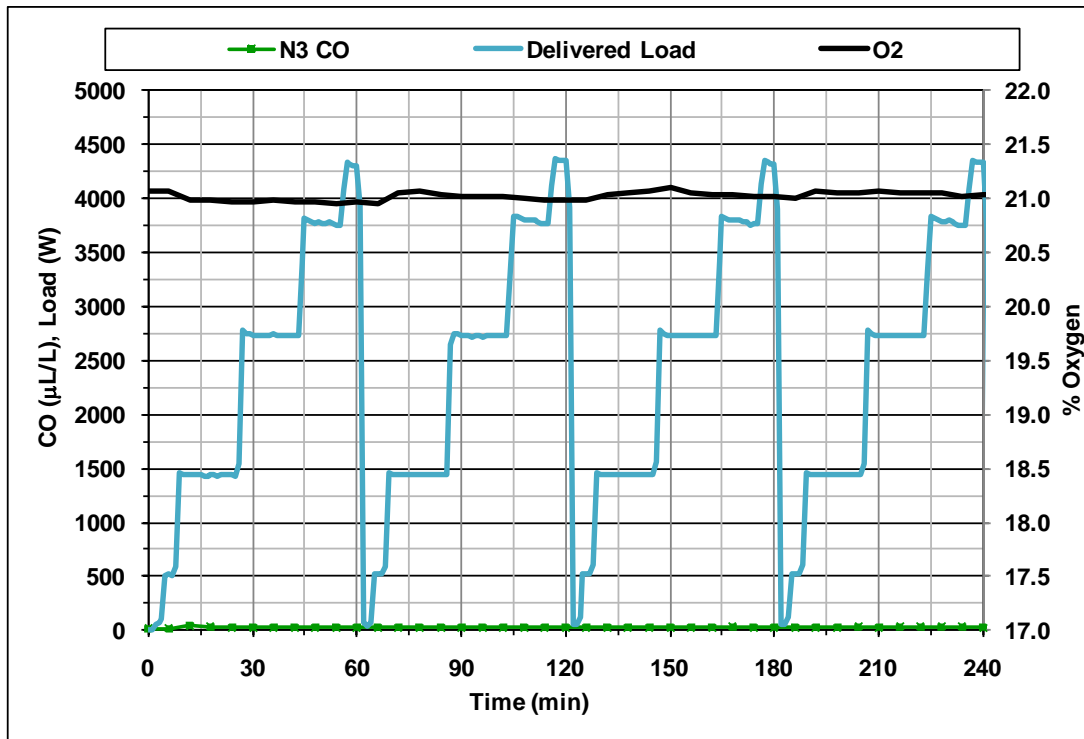
During this test, with the garage bay door open, the garage oxygen level decreased only slightly, down by 0.5 % to 20.5 %, and the delivered electrical output was consistent during each cycle, largely meeting the load bank setting with the exception of the 5500 W setting.



**Figure 16b** CO concentrations in the house for Test F (unmod Gen X, Configuration 2)

As shown in Figure 16b, the maximum house CO concentration was measured in the family room at just over 200  $\mu\text{L/L}$  about 15 min after the generator was stopped after a 4 h runtime. The master bedroom had the lowest peak concentration among all the rooms, reaching just over 150  $\mu\text{L/L}$  about 30 min after the generator was stopped.

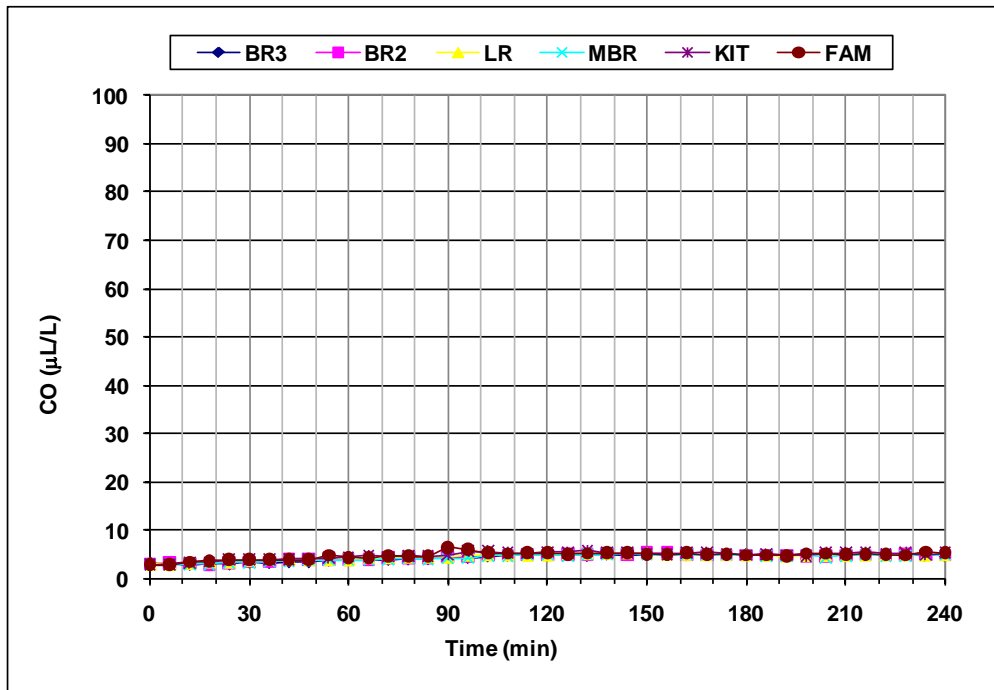
Figures 17a, 17b, and 17c show the results for Test R, which was a four hour test of mod Gen X with the same test house configuration as used in Test F of unmod Gen X (Configuration 2). Mechanical venting was initiated right after the generator was stopped.



**Figure 17a** CO and O<sub>2</sub> concentrations in the garage and measured load for Test R (mod Gen X, Configuration 2)

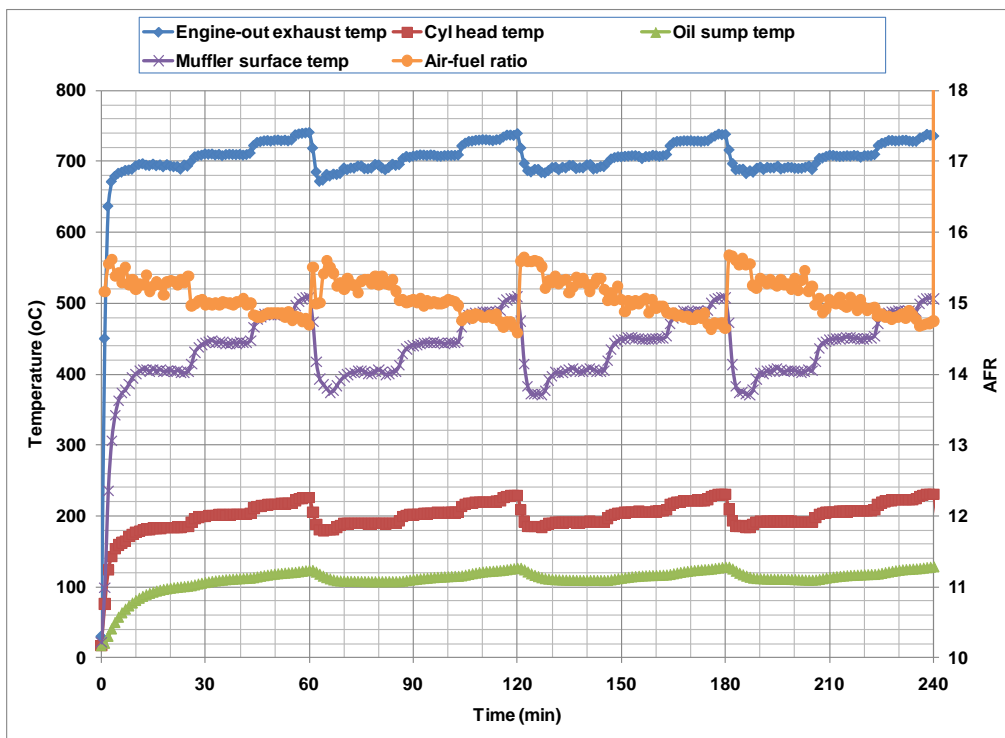
As seen in Figure 17a, the garage CO concentration was nominally steady at 30 µL/L (though the uncertainty of the instrument is large relative to this level), and the oxygen stayed nominally at ambient throughout the test. This is about a 98 % reduction in CO compared to the nearly 1500 µL/L measured with unmod Gen X in Test F.

The delivered electrical output was less than the load bank settings for the three highest loads in the load cycle, which occurred with no significant oxygen depletion. After this test, the unit was thoroughly inspected, including the wiring between the generator head and the 240-volt receptacle, but no anomalies were found. During UA’s development of this prototype, they observed on several occasions that these wires and associated connector melted.



**Figure 17b** CO concentrations in the house for Test R (mod Gen X, Configuration 2)

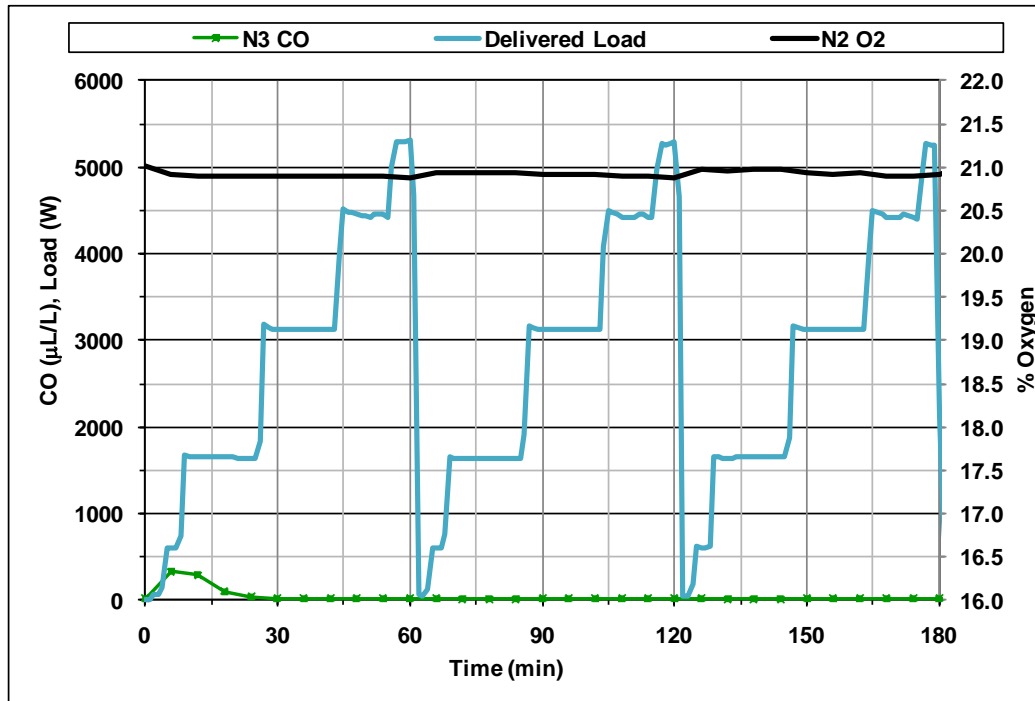
The CO concentration throughout the house was nominally steady at 5  $\mu\text{L/L}$  in all rooms throughout the test (though the instrument uncertainty is large relative to this concentration). By comparison, unmod Gen X in Test F produced a maximum CO concentration in the family room at just over 200  $\mu\text{L/L}$ , corresponding to a reduction of around 98 % in Test R.



**Figure 17c** Temperatures and AFR measured in Test R (mod Gen X, Configuration 2)

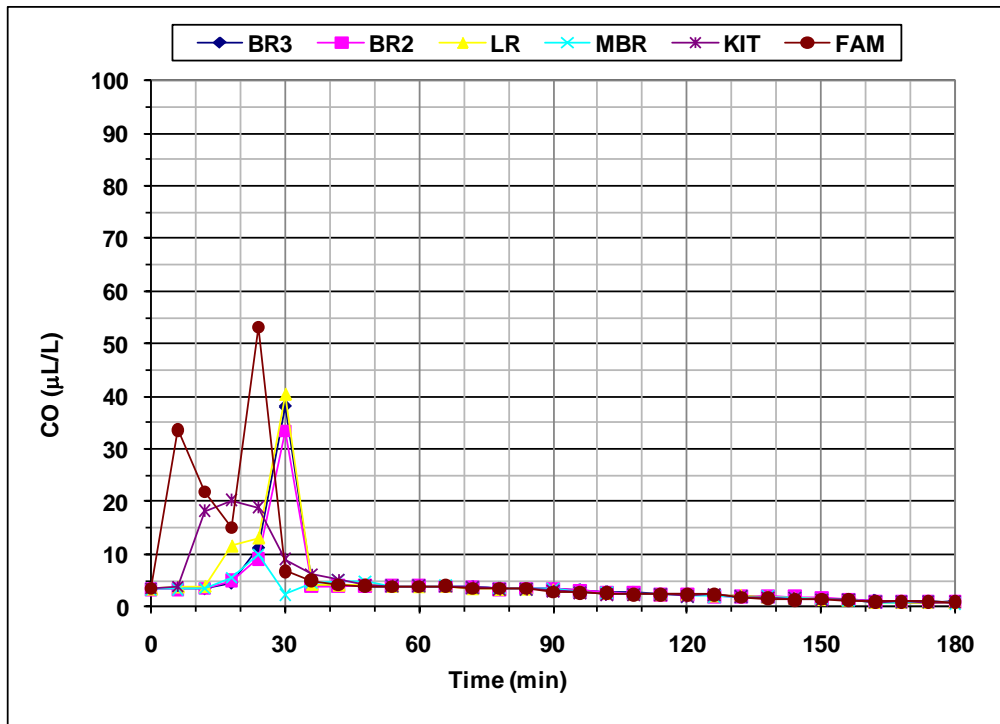
The AFR and temperatures measured on modGen X during Test R are shown in Figure 17c. During each load cycle, the engine primarily ran lean, with the AFR ranging from about 14.5 to 15.6. The spike in AFR at the end of the test corresponds to when the engine was turned off.

Figures 18a, 18b, and 18c show the results for Test T, which was a three hour test of Gen SO1 with the same test house configuration as used in Test F and Test R of unmod Gen X and modGenX respectively (Configuration 2). The generator was stopped when a circuit breaker on the 240-volt receptacle tripped. Mechanical venting was initiated right after the generator was stopped.



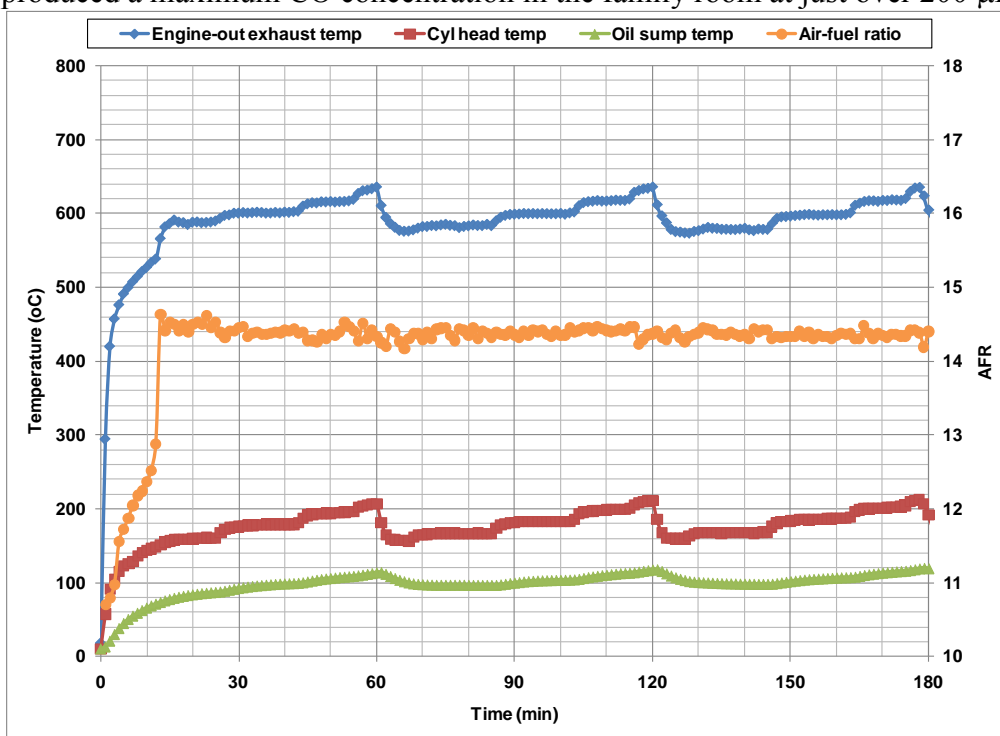
**Figure 18a** CO and O<sub>2</sub> concentrations in the garage and measured load for Test T (Gen SO1, Configuration 2)

As shown in Figure 18a, there was an initial spike of CO in the garage of over 300 µL/L when the engine was started and as the oil warmed before operation transitioned to the calibrated AFR. The CO concentration then dropped and maintained a level of about 20 µL/L throughout the test (though the uncertainty of the instrument is large relative to this level). With the garage bay door open, the garage oxygen level stayed nominally at ambient. With the exception of the early peak, this CO concentration is over a 98 % reduction compared to the peak garage CO measured with unmod Gen X in Test F. Throughout the test, the delivered electrical output was consistent during each cycle, largely meeting the load bank setting with the exception of the 5500 W setting. Comparing the performance of mod Gen X (Figure 17a) and Gen SO1 (Figure 18a) shows that, for Configuration 2, both generators resulted in similar low CO concentrations after the initial spike in Test T.



**Figure 18b** CO concentrations in the house for Test T (Gen SO1, Configuration 2)

As shown in Figure 18b, an initial spike of CO exceeding  $50 \mu\text{L/L}$  was measured in the family room about 25 min after the generator was started, but 5 min after that it dropped below  $10 \mu\text{L/L}$  and continued to drop for the remainder of the test. By comparison, unmod Gen X in Test F produced a maximum CO concentration in the family room at just over  $200 \mu\text{L/L}$ .



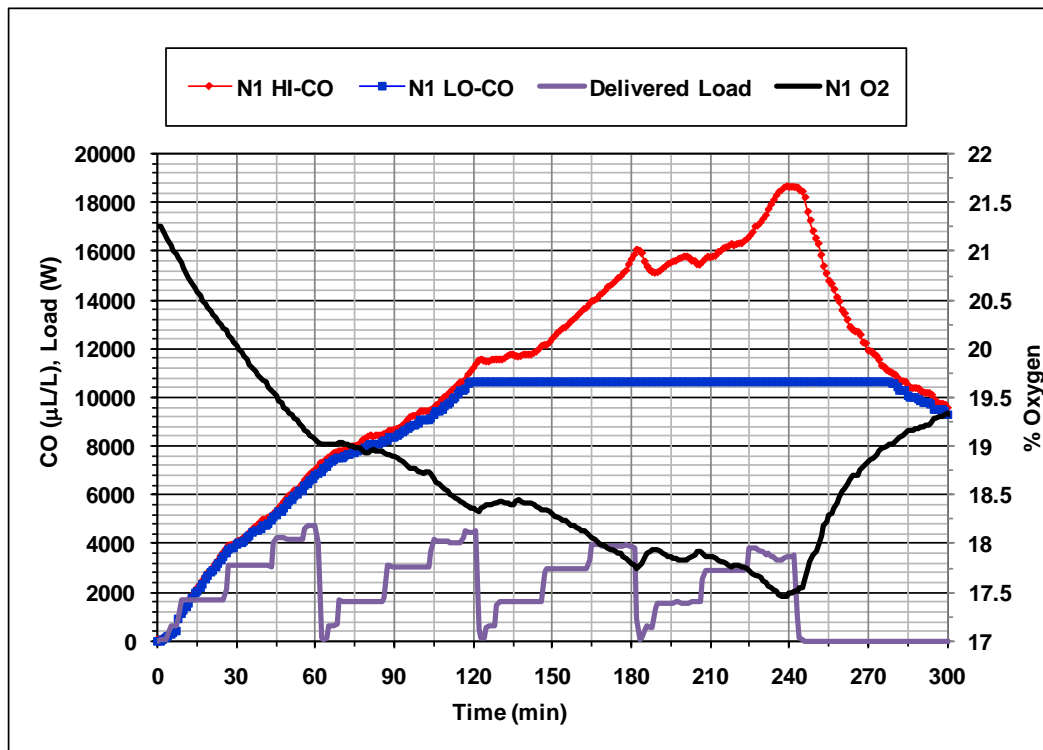
**Figure 18c** Temperatures and AFR measured in Test T (Gen SO1, Configuration 2)



The AFR and temperatures measured on Gen SO1 during Test T are shown in Figure 18c. The engine operated at the calibrated AFR after the engine oil temperature warmed to about 70 °C.

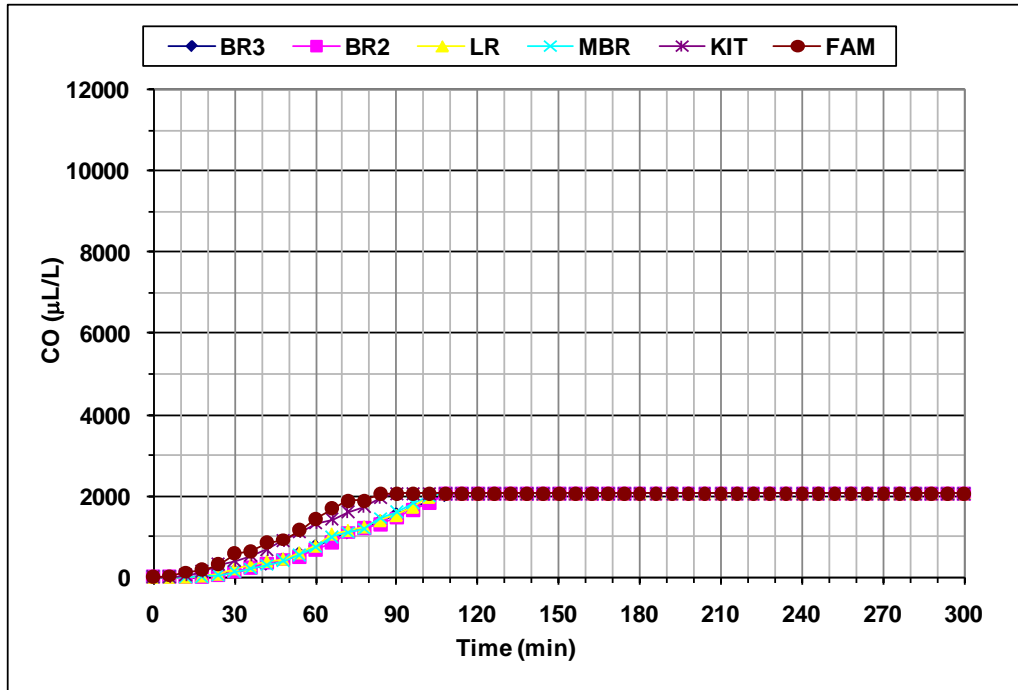
After this series of tests was conducted, due to limitations in the test program resources that would not support continued testing of both prototypes, a decision was made to continue the testing only the newer prototype Gen SO1 for drawing comparisons between performance of the prototype and stock generator.

Figures 19a, 19b, and 19c show the results for Test I, which was a four hour test of unmod Gen X in Configuration 3 (garage bay door closed, garage access door to house open 5 cm, and the house central HVAC fan on). These conditions are similar to the three hour Test B with unmod Gen X under Configuration 1 except for the HVAC fan status. Since the operation of HVAC fan primarily affects the airflow between rooms in the house and is not expected to significantly impact the airflow between the house and garage, this allows a comparison between the garage CO and oxygen levels in Tests I and B. After the generator was stopped, the building naturally decayed for one hour before the garage and house were mechanically vented.

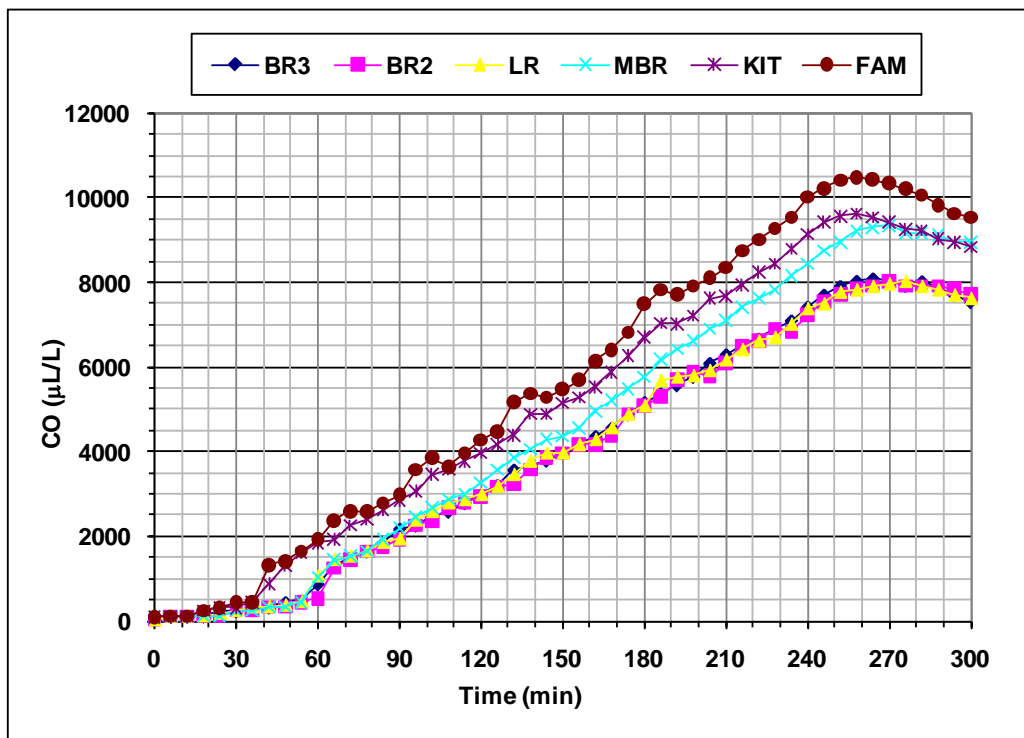


**Figure 19a** CO and O<sub>2</sub> concentrations in the garage and measured load for Test I (unmod Gen X, Configuration 3)

Figure 19a shows that the concentration of CO in the garage reached a peak of about 18,600 µL/L and the concentration of O<sub>2</sub> in the garage had dropped by 3.7 % to 17.5 % when the generator was stopped. It also shows that in the first load cycle the delivered electrical output was less than the load bank settings for the two highest loads in the load cycle, 4500 W and 5500 W, which were applied as the oxygen was approaching 19 %. As the oxygen continued to drop in the subsequent load cycles, the delivered power for these load points decreased further. These results are fairly similar to those in Test B.



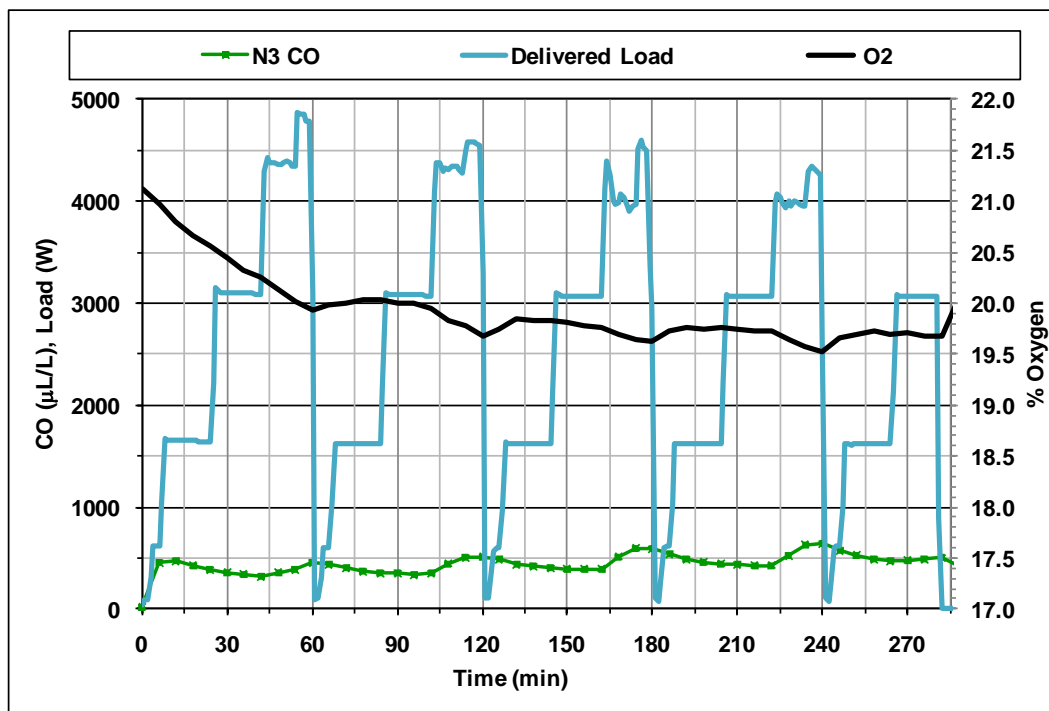
**Figure 19b** CO (ppm range) concentrations in the house for Test I (unmod Gen X, Configuration 3)



**Figure 19c** CO (high range) concentrations in the house for Test I (unmod Gen X, Configuration 3)

Figures 19b and 19c show the CO concentration in the rooms of the test house, as measured in the ‘ppm range’ (where the CO concentration plot plateaus at the instrument’s 2000  $\mu\text{L/L}$  limit) and with the ‘high range’ CO instruments, respectively. The CO reached a peak concentration of around 10,500  $\mu\text{L/L}$  in the family room, with peak concentrations in the other rooms ranging from about 8,000  $\mu\text{L/L}$  to 10,000  $\mu\text{L/L}$ . With the HVAC fan on in this test, there is a relatively more uniform distribution of CO compared to Test B in which the HVAC fan was off.

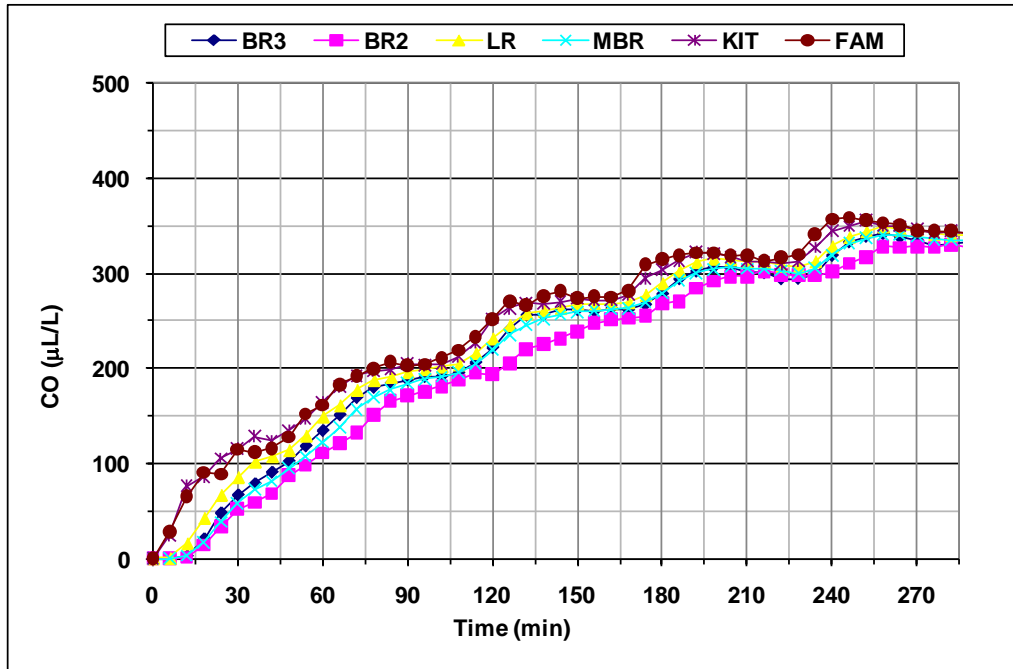
Figures 20a, 20b, and 20c show the results for Test Z, which was a 4.75 h test of Gen SO1 with the noncat muffler (Configuration 3). The test ended when the generator ran out of fuel. (Note: this run time does not indicate a limit on potential run-time as the tank was not full at the beginning of the test.) The test house configuration conditions are the same as that in the 4 h Test I with unmod Gen X. They are also the same as that used in the 2 h Test N with Gen SO1 except that the HVAC fan was off in Test N and Gen SO1 had the catalyst-installed muffler (referred to as cat muffler) in Test N. Since the operation of the HVAC fan is not expected to significantly impact the airflow between the house and garage, the effect of the catalytic and non-catalytic muffler on the resulting garage CO and oxygen levels between Tests Z and N (Configuration 3 and 1, respectively) up to the 2 h point can be seen. After the generator was stopped, the garage and house were mechanically vented.



**Figure 20a** CO and O<sub>2</sub> concentrations in the garage and measured load for Test Z (Gen SO1 noncat, Configuration 3)

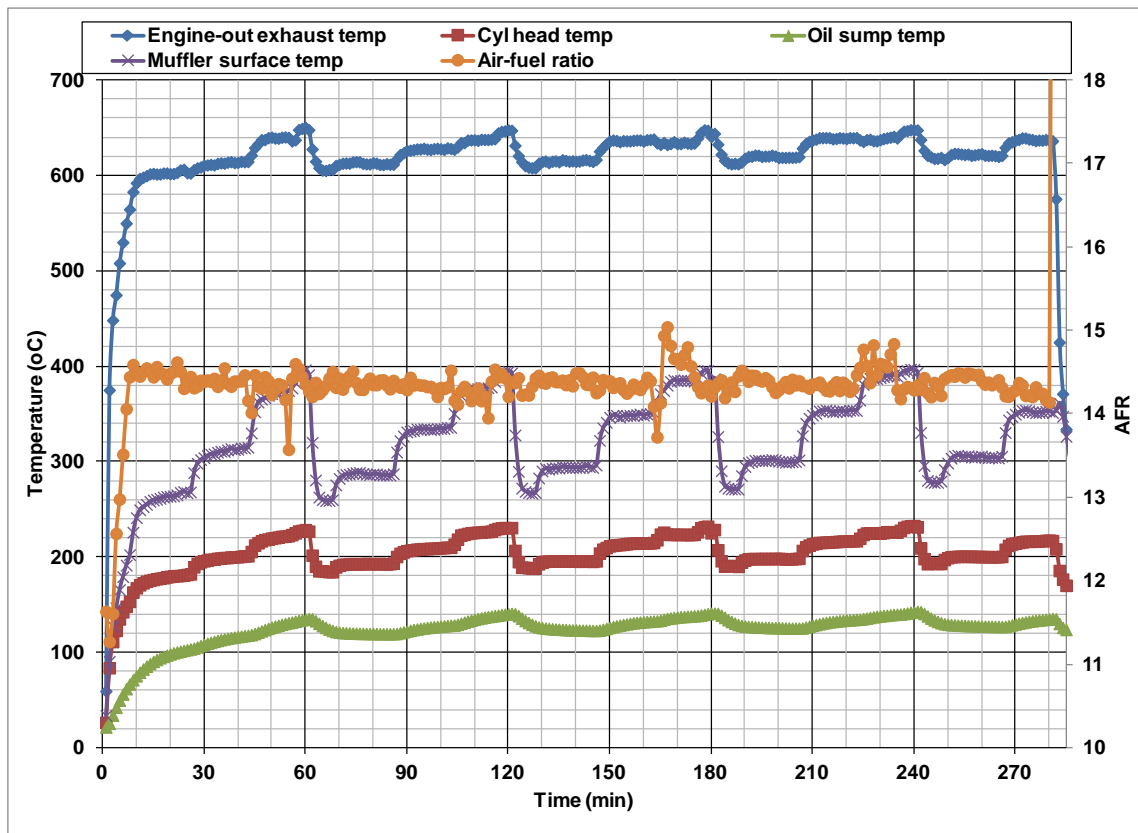
As shown in Figure 20a, the CO concentration in the garage initially rose to about 470  $\mu\text{L/L}$  upon start, then lowered after the engine warmed up. It further increased and decreased cyclically with each successive load cycle. By the end of the fourth load cycle, it had reached a nominal peak of 630  $\mu\text{L/L}$  and the oxygen dropped 1.6 % to 19.5%. This peak CO concentration is a 97 % reduction compared to that measured with unmod Gen X in Test I in which the garage CO reached about 18,600  $\mu\text{L/L}$  at the end of the fourth load cycle.

Figure 20a also shows that the delivered electrical output was progressively less than the load bank settings for the two highest loads in the load cycle as the oxygen dropped throughout the test.



**Figure 20b** CO concentrations in the house for Test Z (Gen SO1 noncat, Configuration 3)

As shown in Figure 20b, the CO concentration reached a peak of nominally 360 µL/L at 4 h in the family room. There is a relatively even distribution, with all the rooms reaching at least 300 µL/L, as would be expected with the HVAC fan on. By comparison, unmod Gen X in Test I produced a peak CO concentration of around 10,600 µL/L in the family room, with peak concentrations in the other rooms ranging from about 8,000 µL/L to 10,000 µL/L.

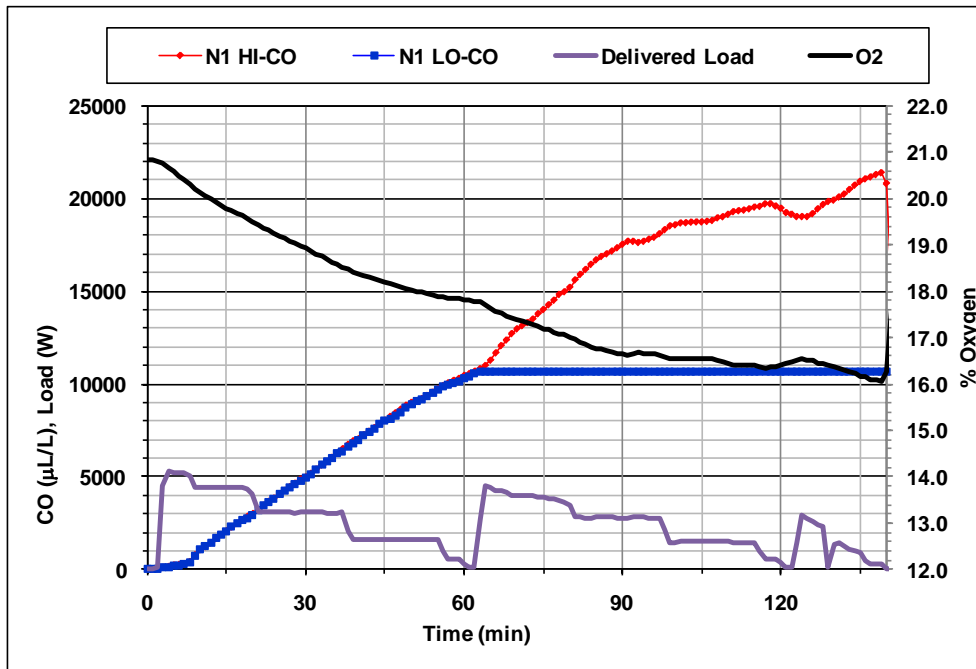


**Figure 20c** Temperatures and AFR measured on Gen SO1 in Test Z (Gen SO1 noncat, Configuration 3)

The AFR and temperatures measured on Gen SO1 during Test Z are shown in Figure 20c. With the exception of a few short periods of AFR excursion after the engine warmed up, the engine operated at the calibrated AFR of about 14.5. The spike in AFR at the end of the test corresponds to when the engine was turned off.

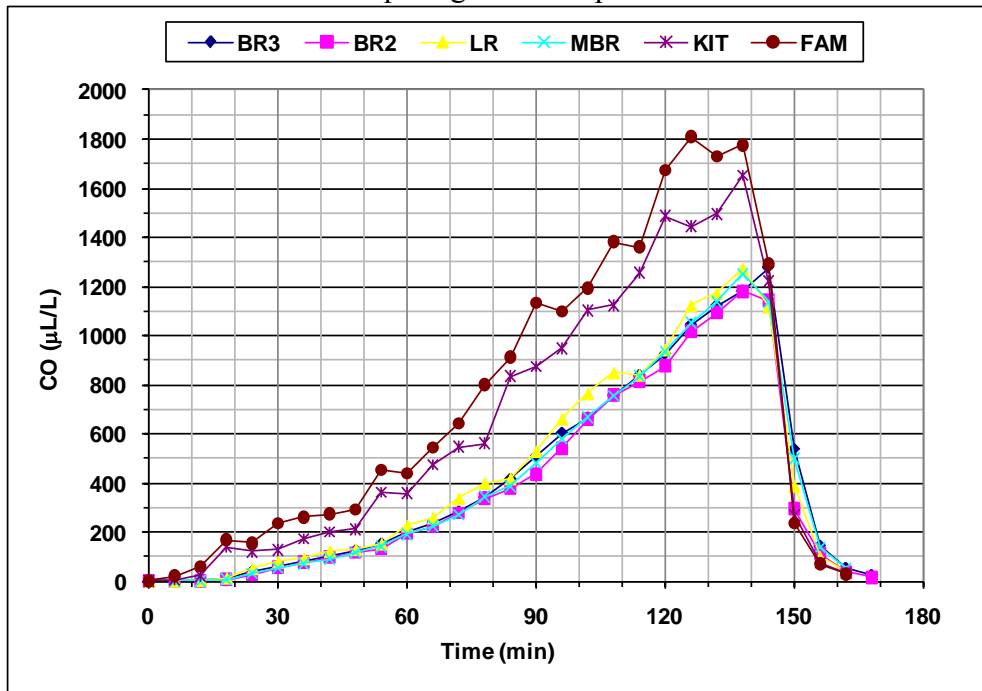
Engine operation was, by and large, comparable between Test Z and Test N, which were with Gen SO1 and the cat muffler respectively. Therefore, the garage CO concentrations at the same time in each test can be compared to get an indication of the catalyst's performance in further lowering the CO emissions. At 2 h into Test Z, the garage CO concentration was 500  $\mu\text{L/L}$  and the oxygen was 19.7 %. By comparison, at the end of the 2 h Test N, the garage CO concentration reached a peak of around 300  $\mu\text{L/L}$  and the garage  $\text{O}_2$  concentration dropped to 19.4 %. Therefore, the CO concentrations were approximately 40 % lower for Test Z with the catalyst than for Test N with the EMS alone. An unknown portion of the difference may be due to differences in ambient or other test conditions.

Figures 21a and 21b show the results for the two and a quarter hour test of unmod Gen X, Test J, in Configuration 4 (garage bay door closed, garage access door to house closed, and the house central HVAC fan on). After the generator was stopped, the garage was mechanically vented. For this test, the load cycle was applied in reverse order to that shown in Table 1.



**Figure 21a** CO (high range) and O<sub>2</sub> concentrations in the garage and measured load for Test J (unmod Gen X, Configuration 4)

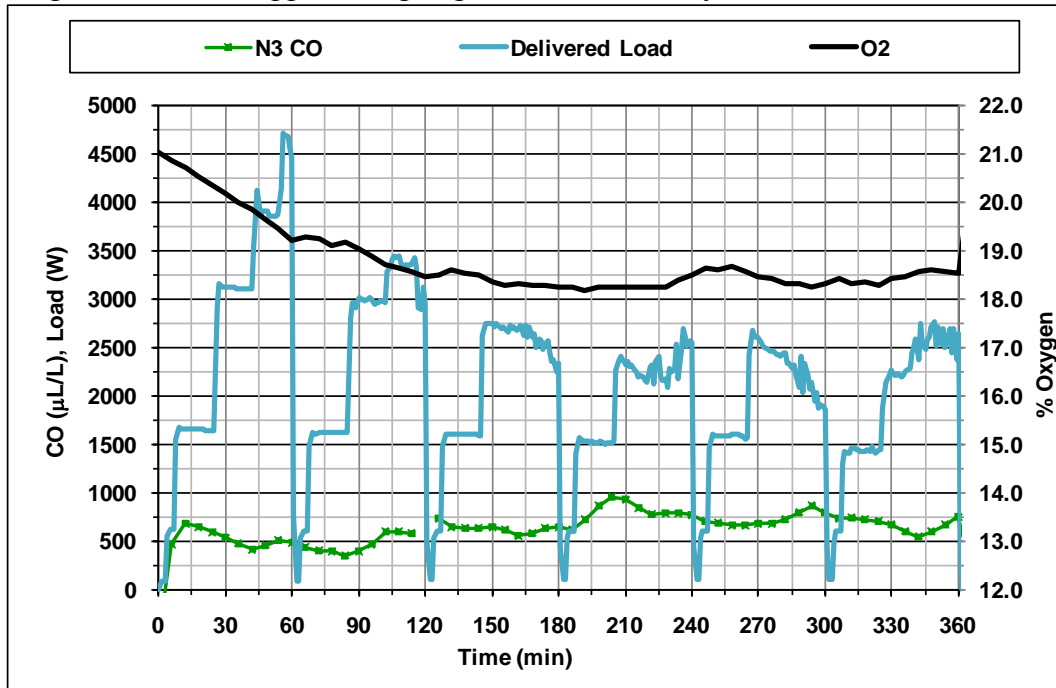
As shown in Figure 21a, at the time the generator was stopped, the garage CO concentration reached a peak of over 21,300 µL/L and the oxygen dropped by 4.7 % to about 16 %. It also shows that in the first load cycle, the delivered electrical output matched the load bank settings with the exception of the 5500 W setting. However, during the third load cycle, as the oxygen level dropped significantly, the generator’s ability to meet the load was severely compromised and the test was ended due to poor generator operation.



**Figure 21b** CO concentrations in the house for Test J (unmod Gen X, Configuration 4)

As shown in Figure 21b, the CO reached a peak concentration of about 1,800  $\mu\text{L/L}$  in the family room, with peak concentrations in the other rooms ranging from about 1,200  $\mu\text{L/L}$  to 1,650  $\mu\text{L/L}$ .

Figures 22a, 22b, and 22c show the results for a six hour test of Gen SO1, Test W, with the same test house configuration as used in Test J of unmod Gen X (Configuration 4). The load cycle was applied with the same profile as that in Table 1, with the load going from low to high. After the generator was stopped, the garage was mechanically vented.

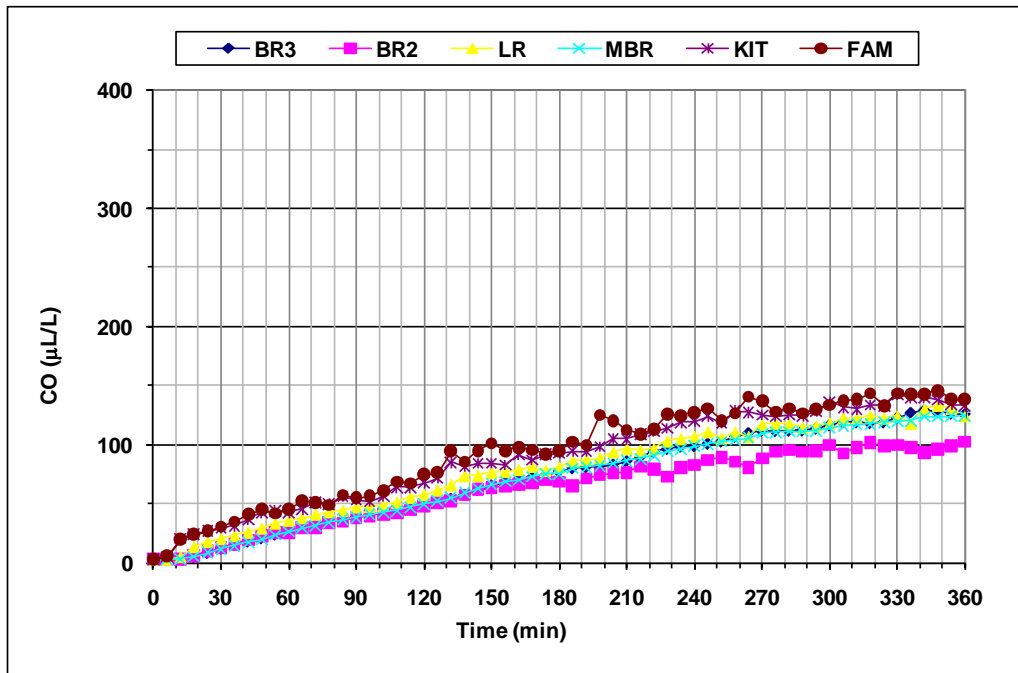


**Figure 22a** CO and O<sub>2</sub> concentrations in the garage and measured load for Test W (Gen SO1, Configuration 4)

As shown in Figure 22a, the CO concentration in the garage initially rose to 680  $\mu\text{L/L}$ , and then decreased after the engine warmed up. In the fourth load cycle, it reached a peak of about 960  $\mu\text{L/L}$  and the oxygen lowered by 2.8 % to 18.2 %.

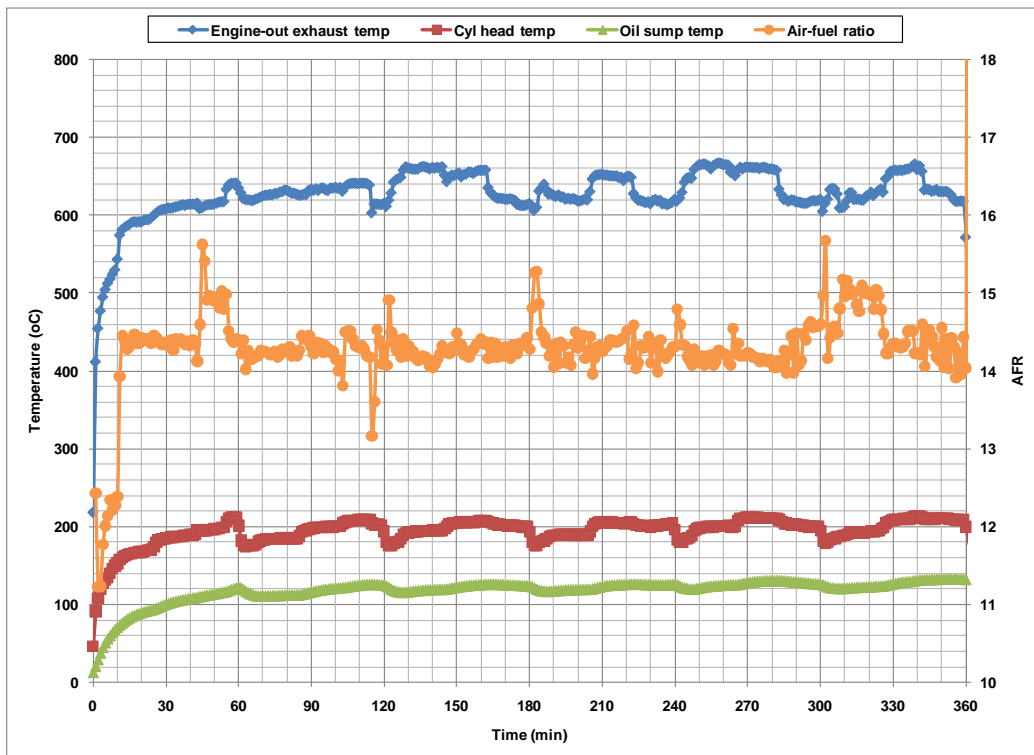
At two and one quarter hours into this test, the garage CO concentration was nominally 640  $\mu\text{L/L}$ . Although the tests are not entirely comparable due to the opposite loading pattern, this CO concentration is a 97 % reduction compared to that measured with unmod Gen X in Test J in which the garage CO was over 21,300  $\mu\text{L/L}$  at the same time during the test.

In the first load cycle, the delivered electrical output exceeded the load bank settings except for the two highest loads. In the subsequent load cycles, as the oxygen level dropped, the delivered load was less than the load bank settings for the three highest loads in the cycle.



**Figure 22b** CO concentrations in the house for Test W (Gen SO1, Configuration 4)

As shown in Figure 22b, the CO reached a peak concentration of about 145  $\mu\text{L/L}$  in the family room, with peak concentrations in the other rooms relatively evenly distributed just below that, down to 100  $\mu\text{L/L}$ . By comparison, unmod Gen X in Test J produced a peak CO concentration of over 1,800  $\mu\text{L/L}$  in the family room after 2 h of operation.

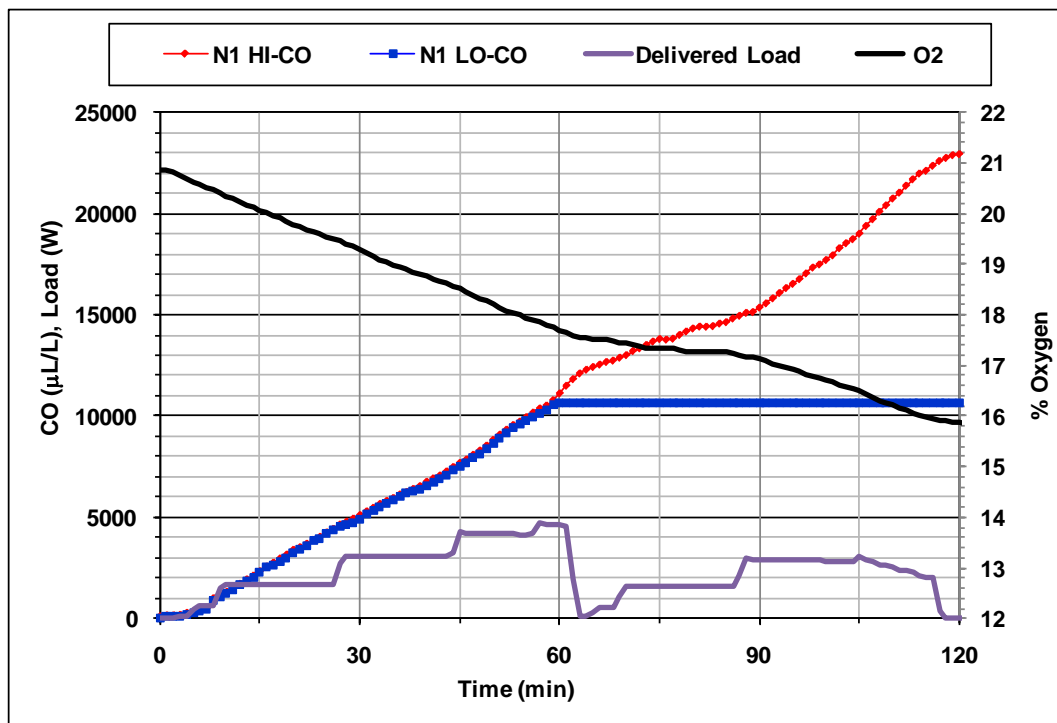


**Figure 22c** Temperatures and AFR measured in Test W (Gen SO1, Configuration 4)



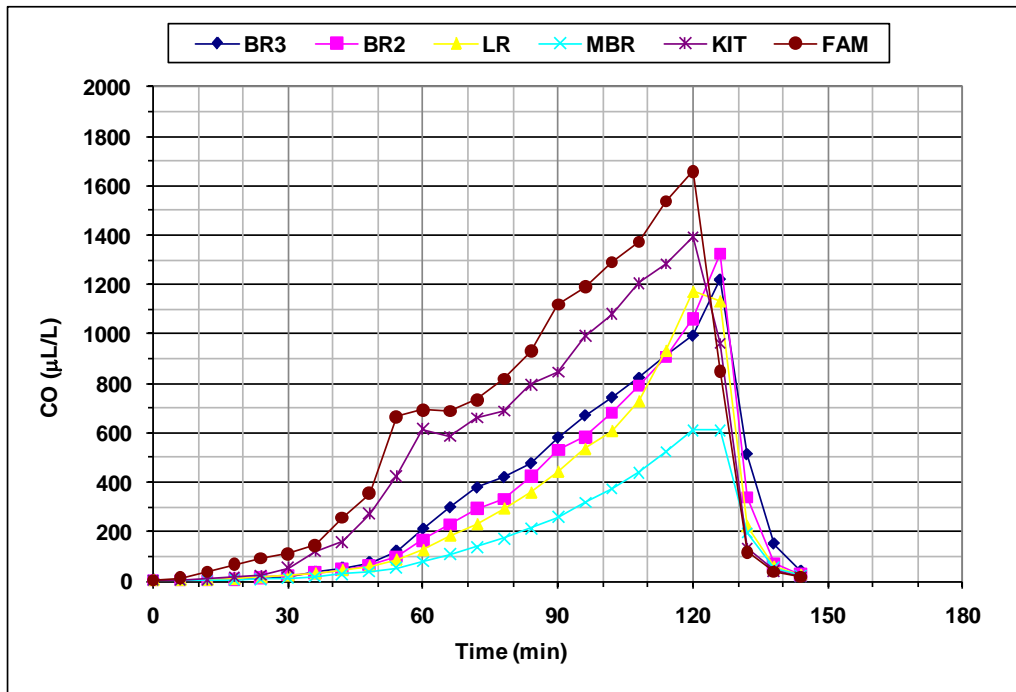
The AFR and temperatures measured on Gen SO1 during Test W are shown in Figure 22c. After the engine warmed up, the engine operated at the calibrated AFR for the next 30 min. There were then occasional periods of lean as well as rich operation, with most of them occurring during the transition between the load cycles when the load bank was switched from 5500 W to no load. The spike in AFR at the end of the test corresponds to when the engine was turned off.

Figures 23a and 23b show the results for the two hour test of unmod Gen X, Test D, in Configuration 5 (garage bay door closed, garage access door to house closed, and the house central HVAC fan off). These conditions are the same as the two and a quarter hour Test J with unmod Gen X except in that test the HVAC fan was on. Since the operation of the HVAC fan is not expected to significantly impact the airflow between the house and garage, especially with the house door closed, this allows some degree of comparison to be made for the resulting garage CO and oxygen levels between Tests D and J. After the generator was stopped, the garage was mechanically vented.



**Figure 23a** CO (high range) and O<sub>2</sub> concentrations in the garage and measured load for Test D (unmod Gen X, Configuration 5)

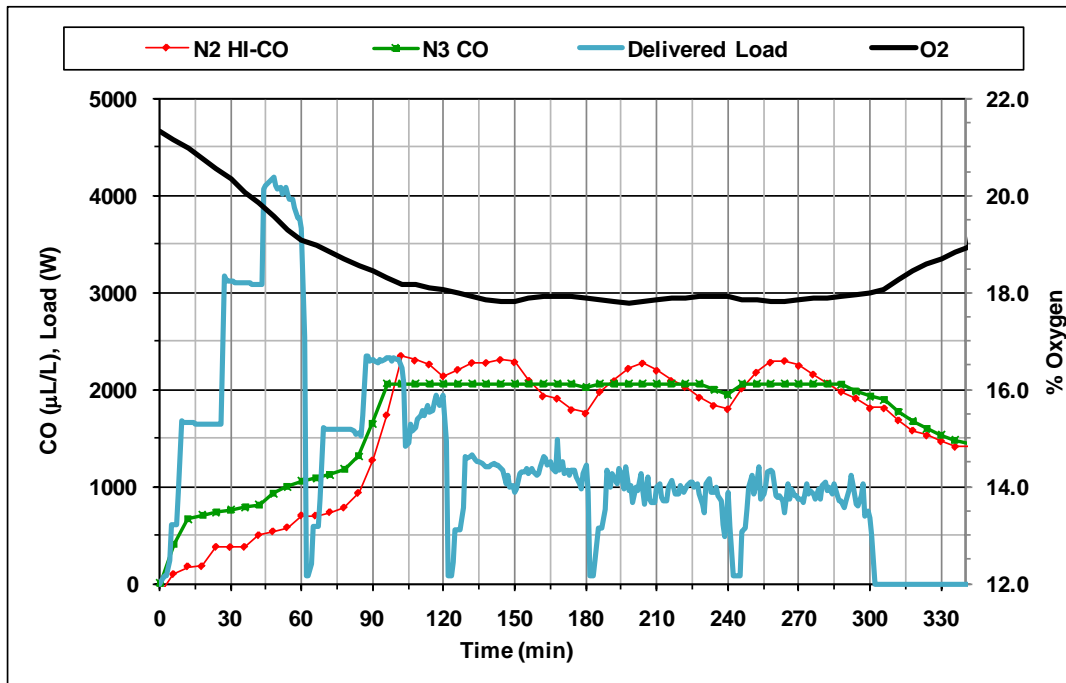
Figure 23a shows the concentration of CO in the garage reached a peak of almost 23,000 µL/L, and the concentration of O<sub>2</sub> in the garage dropped by 5.0 % to below 16 % when the generator was stopped. It also shows that in the first load cycle the delivered electrical output was less than the load bank settings for the two highest loads in the load cycle, 4500 W and 5500 W, which were applied as the oxygen was approaching 18 %. As the oxygen continued to drop in the subsequent load cycle, the delivered power for these load points decreased further. The results are similar to those in Test J despite the reversal of the load cycled pattern in Test J.



**Figure 23b** CO concentrations in the house for Test D (unmod Gen X, Configuration 5)

Figure 23b shows the CO reached a peak concentration of almost 1660  $\mu\text{L/L}$  in the family room with peak concentrations in the other rooms ranging from about 600  $\mu\text{L/L}$  to 1400  $\mu\text{L/L}$ . This is a comparable peak CO concentration to the 1670  $\mu\text{L/L}$  measured in the family room at the 2 h point in Test J. When comparing the other room time course profiles with those at the 2 h point in Test J, it can be observed that the mixing due to the operation of the HVAC fan made the most difference in the master bedroom. This effect is not consistent during all tests as other factors affecting mixing (such as temperature) differ from test to test.

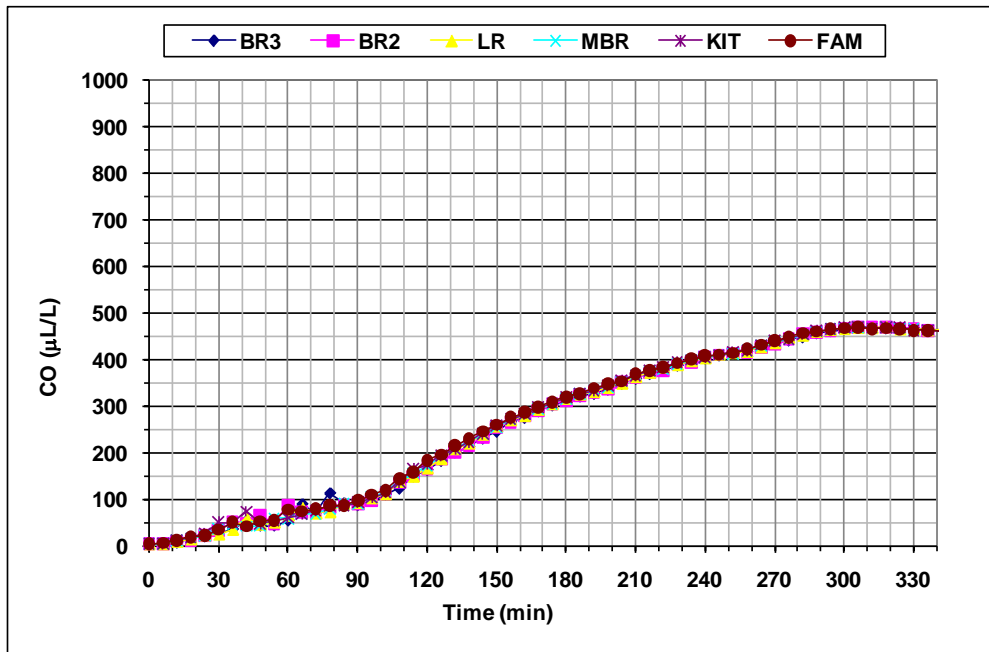
Figures 24a, 24b, and 24c show the results for Test AH, which was a five hour test of Gen SO1 with the noncat muffler and the same conditions of the test house as used in the 2 h Test D with unmod Gen X (Configuration 5). These conditions are also the same as that used in the 6 h Test W with Gen SO1 except that in Test W Gen SO1 had the cat muffler and the HVAC fan was on. Since the operation of the HVAC fan is not expected to significantly impact the airflow between the house and garage, this allows some degree of comparison to be made for the resulting garage CO and oxygen levels between Tests AH and W. After the generator was stopped, the exhaust decayed naturally for 45 min and then the garage and house were mechanically vented.



**Figure 24a** CO and O<sub>2</sub> concentrations in the garage and measured load for Test AH (Gen SO1 noncat, Configuration 5)

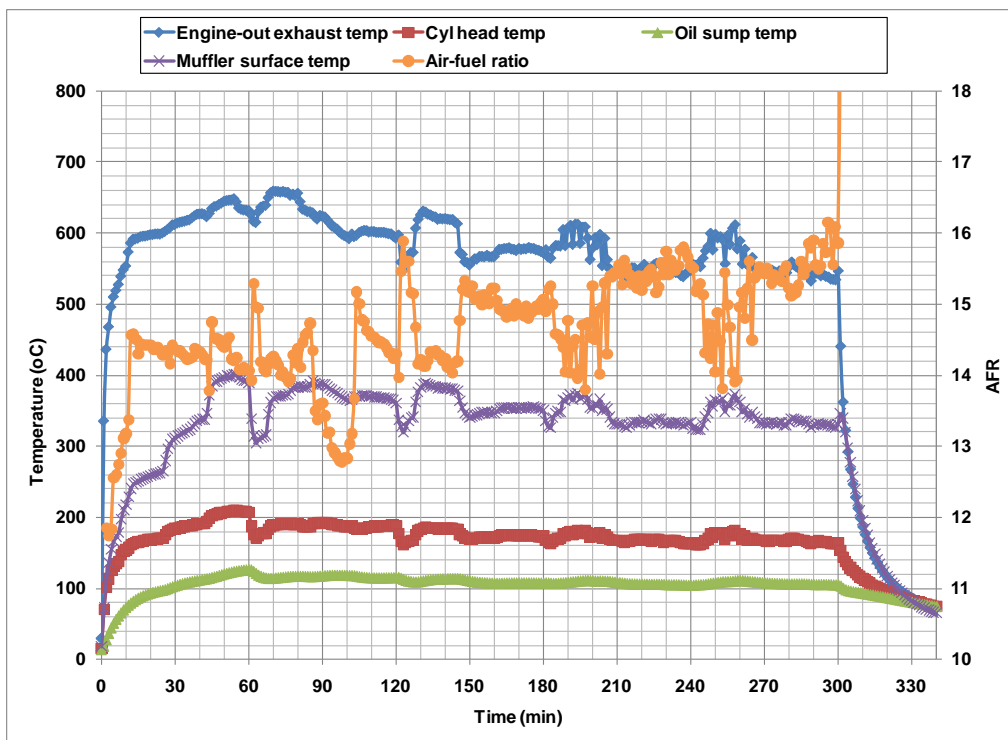
As shown in Figure 24a, the CO concentration in the garage initially rose to nominally 670 µL/L upon start, then continued to climb until it reached a nominal peak of 2300 µL/L and oxygen lowered 3.5 % to 17.8 % in the garage during the second load cycle. This CO concentration is a 90 % reduction compared to that measured with unmod Gen X in Test D in which the CO in the garage at the end of the second load cycle was almost 23,000 µL/L.

Figure 24a also shows that in the first load cycle the delivered electrical output was less than the load bank settings for the two highest loads in the load cycle. During the subsequent load cycles the delivered power degraded even further as the garage oxygen approached and then dropped below 18 %.



**Figure 24b** CO concentrations in the house for Test AH (Gen SO1 noncat, Configuration 5)

As shown in Figure 24b, the CO reached a peak concentration of about 470  $\mu\text{L/L}$  throughout the house, with even distribution among the rooms even though the HVAC fan was off. At 2 h into this test, the CO in the house was about 180  $\mu\text{L/L}$ . By comparison, the 2 h operation of unmod Gen X in Test D produced a peak CO concentration of almost 1660  $\mu\text{L/L}$  in the family room, with peak concentrations in the other rooms ranging from about 600  $\mu\text{L/L}$  to 1400  $\mu\text{L/L}$ .

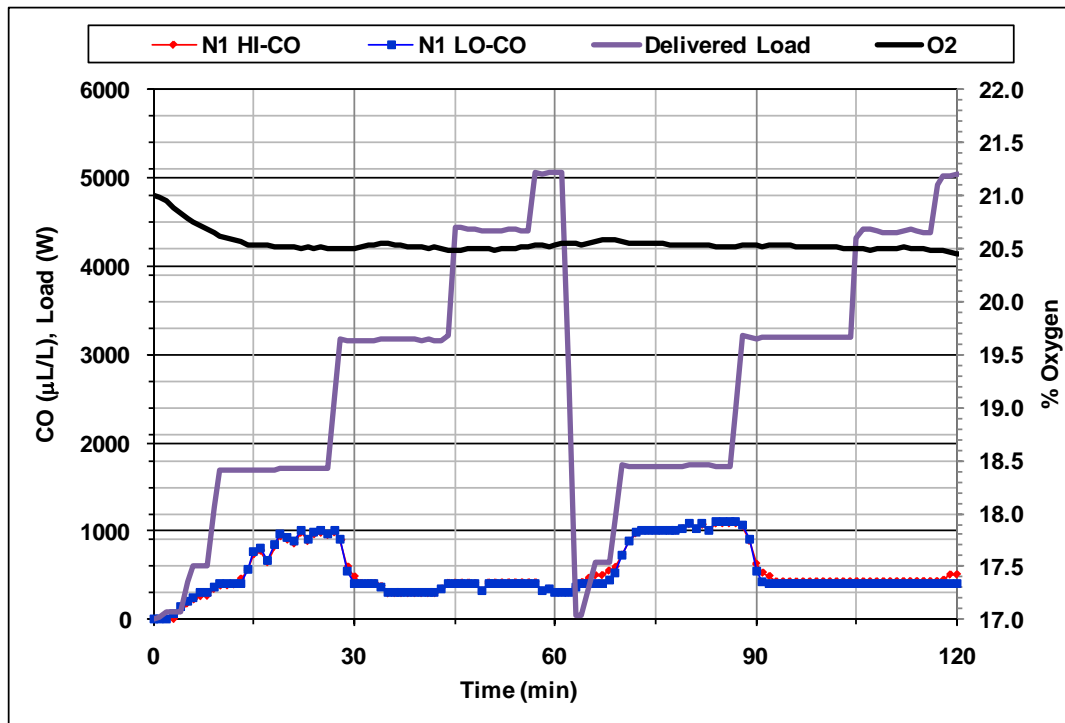


**Figure 24c** Temperatures and AFR measured in Test AH (Gen SO1 noncat, Configuration 5)

The AFR and temperatures measured on noncat Gen SO1 during Test AH are shown in Figure 24c. After the engine warmed up, it operated at the calibrated AFR for the next 30 min, but then had periods of off-design operation throughout the remainder of the test. The spike in AFR at the end of the test corresponds to when the engine was turned off.

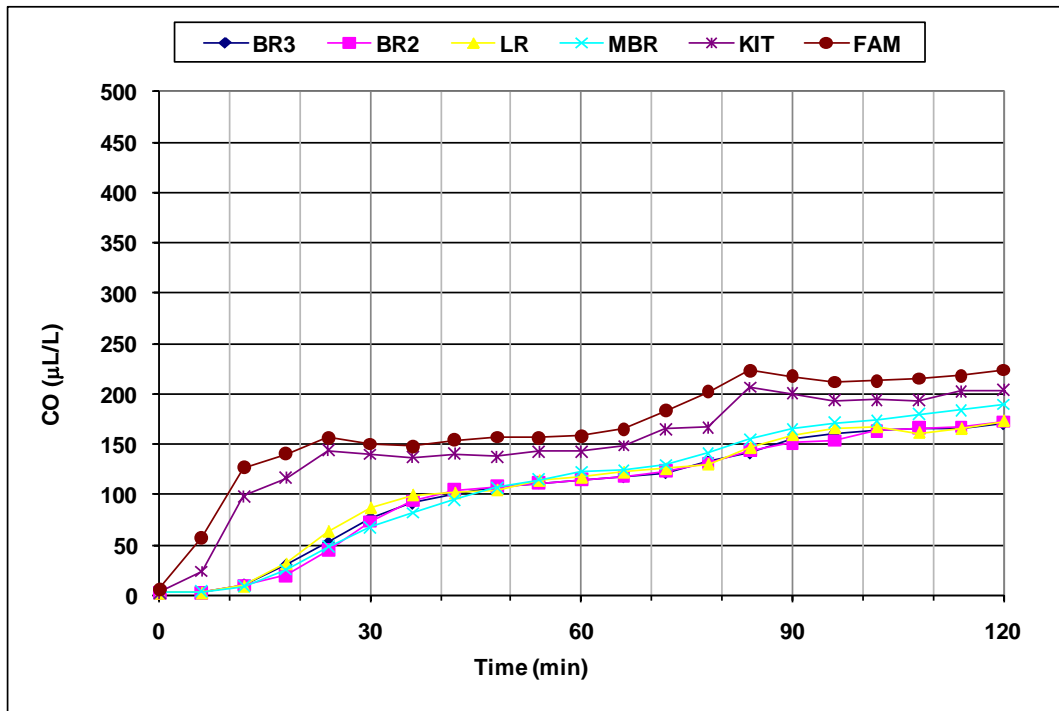
Since engine performance during the first 40 min in Test AH was similar to that in Test W with Gen SO1 and the cat muffler, a comparison of each test’s garage CO concentration at that point in time suggests the prototype’s catalyst is providing about a 50 % reduction in the CO emissions compared with that provided by the EMS alone. At 40 min, the garage CO concentrations were about 410  $\mu\text{L/L}$  and 820  $\mu\text{L/L}$  in Tests W and AH, respectively. This reduction is somewhat larger than the 40 % reduction observed when comparing the garage CO concentrations in Tests Z and N.

Figures 25a and 25b show the results for Test G, a 2 h test of unmod Gen X in Configuration 6 (garage bay door open, garage access door to house open 5 cm, and the house central HVAC fan on). After the generator was stopped, the garage was mechanically vented.



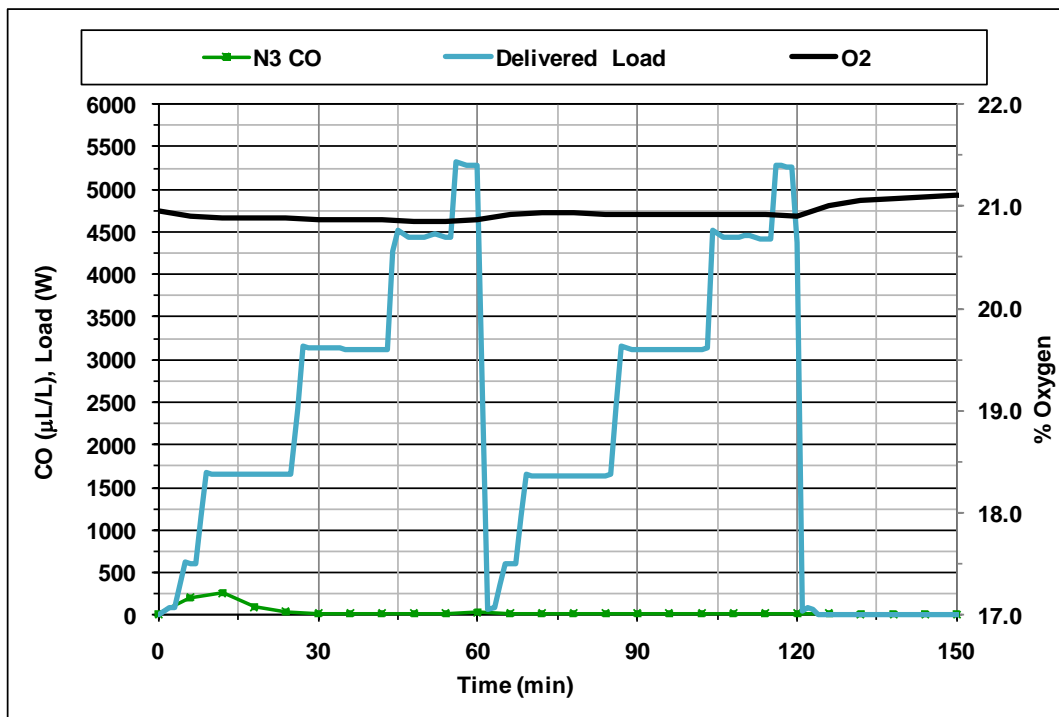
**Figure 25a** CO and O<sub>2</sub> concentrations in the garage and measured load for Test G (unmod Gen X, Configuration 6)

As shown in Figure 25a, the CO in the garage peaked at around 1100  $\mu\text{L/L}$  during the second load cycle (though the instrument uncertainty is large relative to the concentrations). With the garage bay door open, the oxygen level decreased 0.5 % to about 20.5 %. Throughout the test, the delivered electrical output met or exceeded the load bank settings.



**Figure 25b** CO (ppm range) concentrations in the house for Test G (unmod Gen X, Configuration 6)

Figure 25b shows the CO reached a peak concentration of about 220 µL/L in the family room, with slightly lower peak concentrations in the other rooms of around 190 µL/L to 200 µL/L.

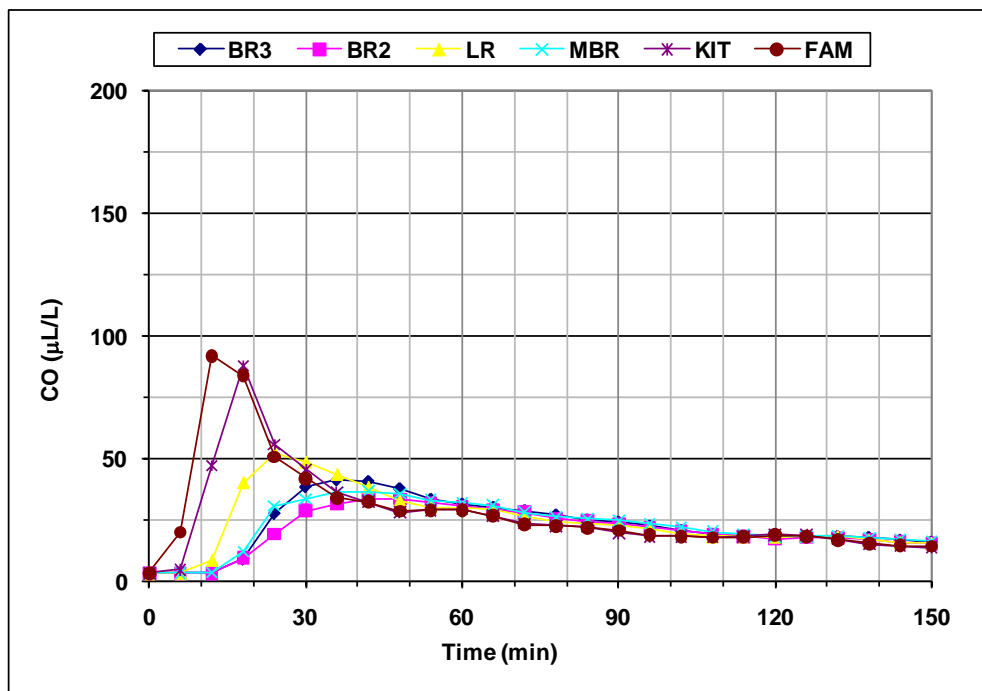


**Figure 26a** CO and O<sub>2</sub> concentrations in the garage and measured load for Test U (Gen SO1, Configuration 6)

Figures 26a, 26b, and 26c show the results for Test U, which was a 2 h test of Gen SO1 with the same conditions of the test house as used in the 2 h Test G with unmod Gen X (Configuration 6). After the generator was stopped, the exhaust decayed naturally for 30 min and then the garage and house were mechanically vented.

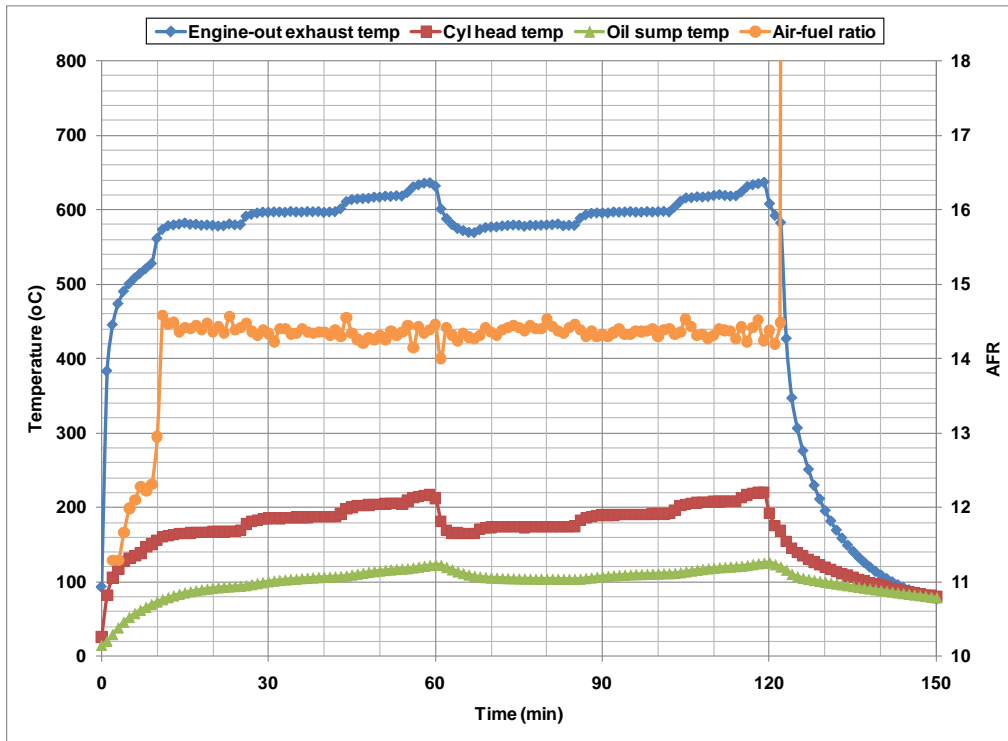
As shown in Figure 26a, after an initial spike to nominally 260  $\mu\text{L/L}$  of CO in the garage shortly after the generator was started, it dropped and maintained a level below 30  $\mu\text{L/L}$  throughout the test. After the initial spike, this CO concentration reflects about a 97 % reduction compared to that measured with unmod Gen X in Test G in which the CO in the garage ranged from around 300  $\mu\text{L/L}$  to 1100  $\mu\text{L/L}$  for portions of the second load cycle. With the garage bay door open, the oxygen level stayed nominally at ambient.

Throughout the test, the delivered electrical output met or exceeded the load bank settings with the exception of the highest load setting.



**Figure 26b** CO concentrations in the house for Test U (Gen SO1, Configuration 6)

As shown in Figure 26b, the CO concentration in the family room initially spiked to about 90  $\mu\text{L/L}$  and then dropped to an even distribution in all rooms of the house around 30  $\mu\text{L/L}$  with a continual decline to below 20  $\mu\text{L/L}$  before mechanical venting was initiated. By comparison, unmod Gen X in Test G produced a nominal peak CO concentration of 220  $\mu\text{L/L}$  in the family room with a minimum peak concentration in the other rooms just below 190  $\mu\text{L/L}$ .

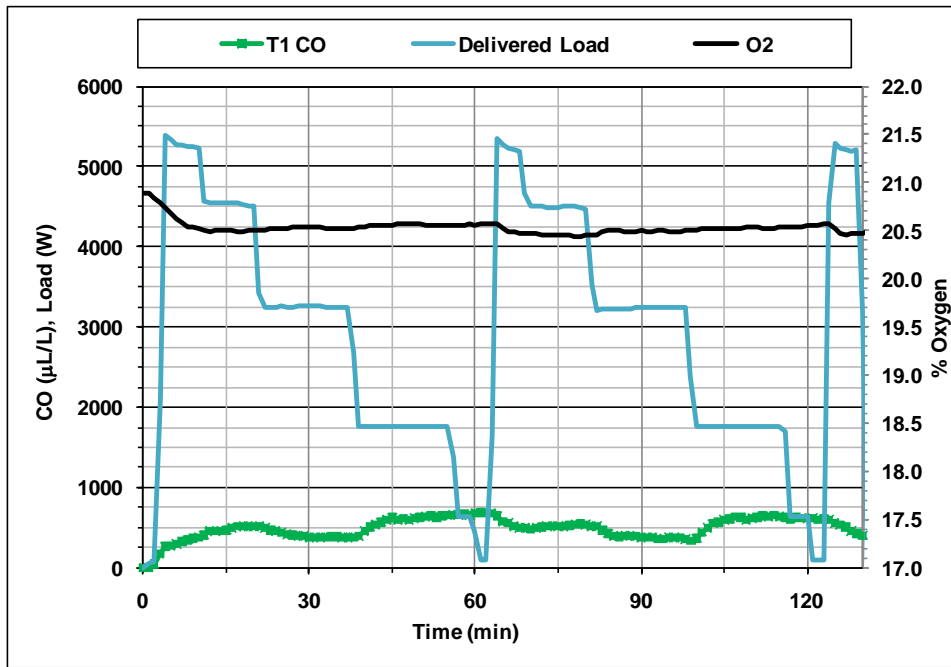


**Figure 26c** Temperatures and AFR measured in Test U (Gen SO1, Configuration 6)

The AFR and temperatures measured on Gen SO1 during Test U are shown in Figure 26c. The engine operated at the calibrated AFR after the engine oil temperature warmed to nominally 70 °C. The spike in AFR at the end of the test corresponds to when the engine was turned off.

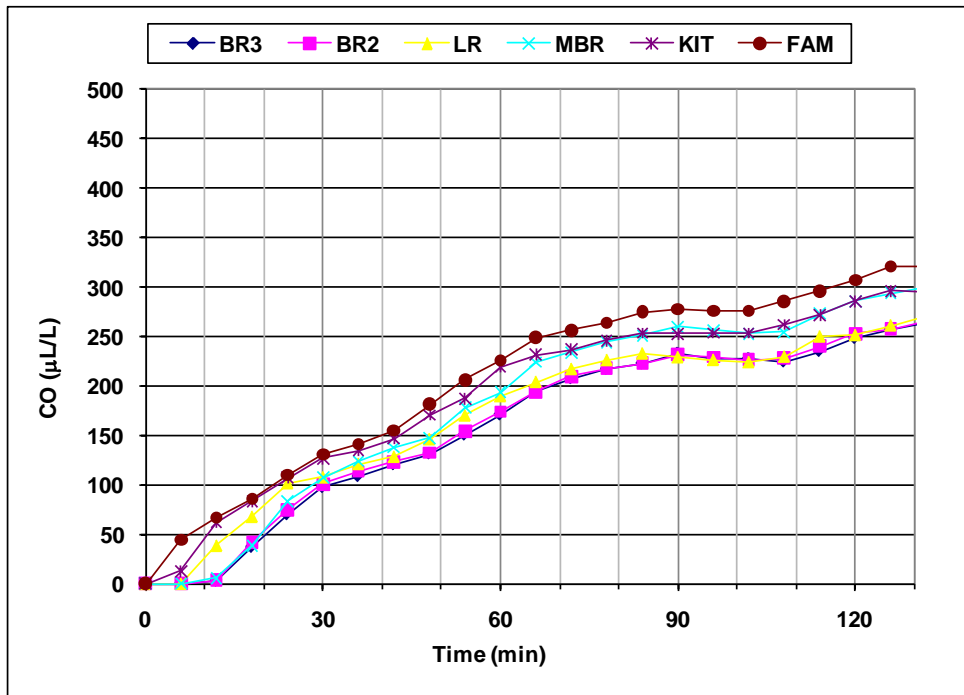
Figures 27a and 27b show the results for Test K, which was a 2 h 10 min test of unmod Gen X in Configuration 7 (garage bay door and garage access door to house open, and house central HVAC fan off). For this test, the load cycle was applied in reverse order to that shown in Table 1. The test house conditions for this test are similar to the 2 h Test G with unmod Gen X except in that test the HVAC fan was on. Since the operation of the HVAC fan is not expected to have a significant impact on the airflow between the house and garage, this allows some degree of comparison to be made for the resulting garage CO and oxygen levels between Tests K and G. After the generator was manually stopped, the garage and house were mechanically vented.





**Figure 27a** CO and O<sub>2</sub> concentrations in the garage and measured load for Test K (unmod Gen X Configuration 7)

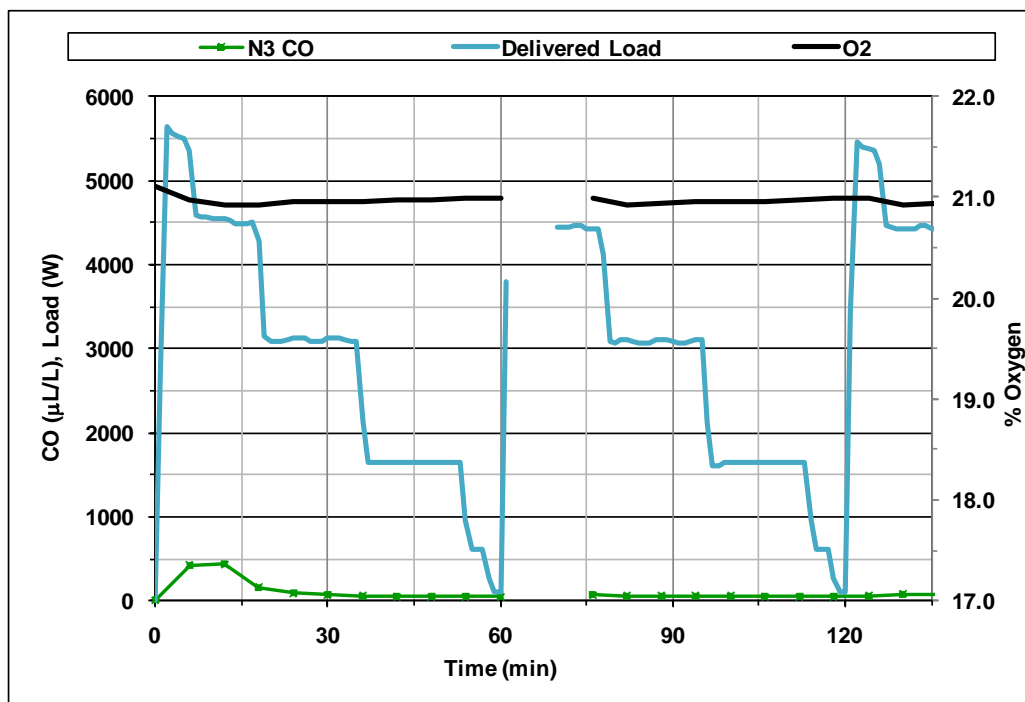
As shown in Figure 27a, the CO in the garage peaked at about 680 µL/L. This compares to the 1100 µL/L reported in Test G with unmod Gen X that was measured with a high range CO analyzer. With the garage bay door open, the garage oxygen level decreased to about 20.4 %. Throughout the test, the delivered electrical output exceeded the load bank settings with the exception of the highest load setting.



**Figure 27b** CO concentrations in the house for Test K (unmod Gen X Configuration 7)

Figure 27b shows the CO reached a peak concentration of 320  $\mu\text{L/L}$  in the family room with peak concentrations in the other rooms just below that value, nominally 260  $\mu\text{L/L}$  when mechanical venting was initiated.

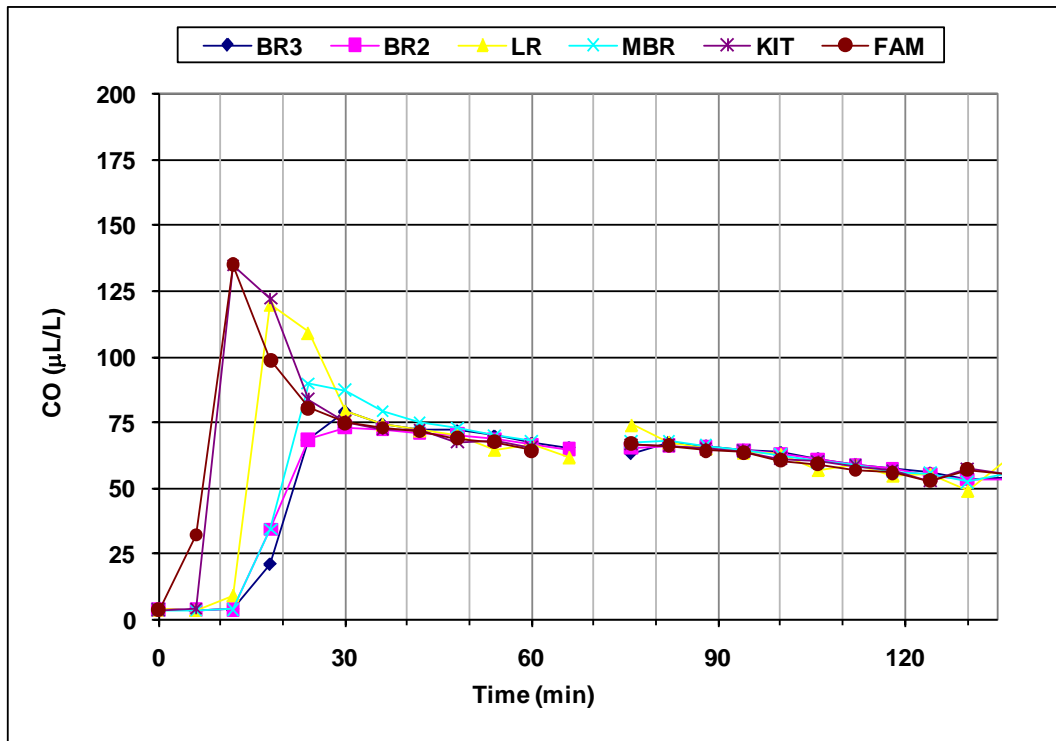
Figures 28a, 28b, and 28c show the results for Test V, which was a 2 h 15 min test of Gen SO1 with the noncat muffler and the same test house configuration as used in the 2 h Test K with unmod Gen X (Configuration 7). To match the reverse order load profile used Test K, the load cycle for this test was also applied in reverse order to that shown in Table 1. The test house conditions for this test are also the same as that used in the 2 h Test U with Gen SO1 except that in Test U Gen SO1 had the cat muffler and the house central HVAC fan was on. After the generator was stopped, the garage and house were mechanically vented. Due to a software error, about 15 min of data were not recorded approximately 1 h into the test.



**Figure 28a** CO and O<sub>2</sub> concentrations in the garage and measured load for Test V (noncat Gen SO1, Configuration 7)

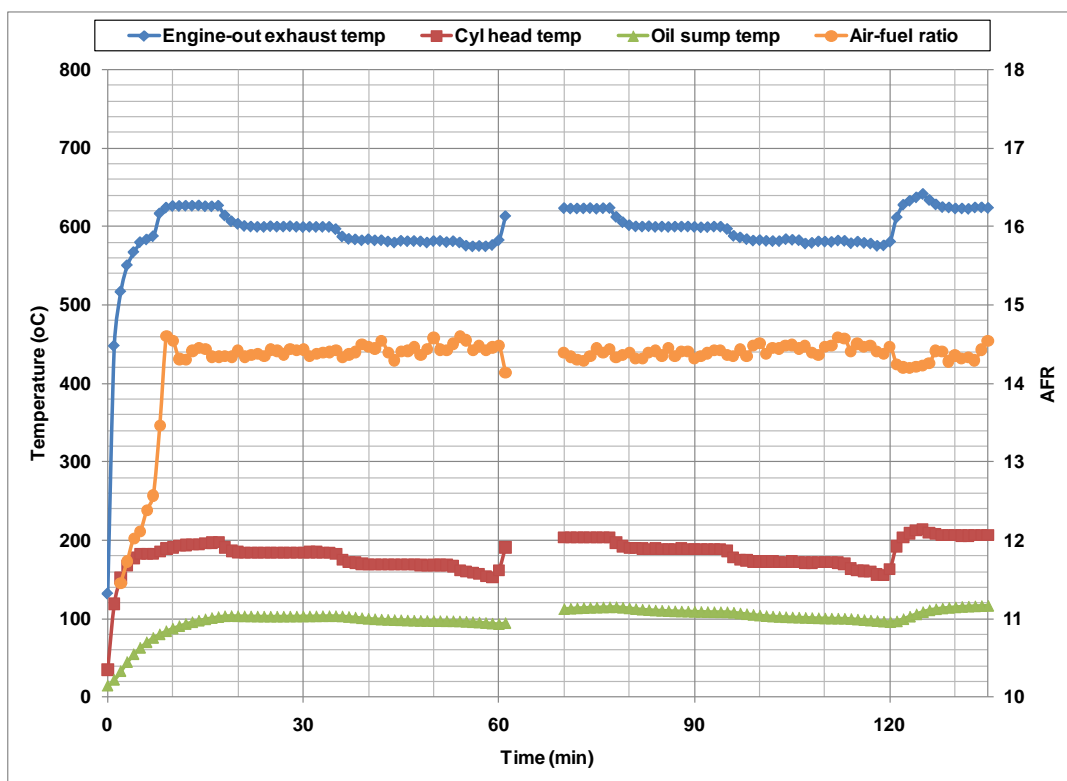
As shown in Figure 28a, after an initial spike to nominally 430  $\mu\text{L/L}$  of CO in the garage shortly after the generator was started, it dropped to a level near 50  $\mu\text{L/L}$  before rising to about 80  $\mu\text{L/L}$  during the brief third load cycle. Note that the missing data included the high load portion of the second load cycle and a peak during this time cannot be ruled out. Excluding the initial peak of Test V, this is a reduction of 85 % to 88 % compared to that measured with unmod Gen X in Test K, in which the CO in the garage ranged from 350  $\mu\text{L/L}$  to 650  $\mu\text{L/L}$ .

With the garage bay door open, the garage oxygen level stayed nominally at ambient. Throughout the test, the delivered electrical output met or exceeded the load bank settings, with the exception of a slight drop at the highest setting during the third load cycle.



**Figure 28b** CO concentrations in the house for Test V (noncat Gen SO1, Configuration 7)

As shown in Figure 28b, the CO concentration in the family room initially spiked to 135  $\mu\text{L/L}$  and then dropped to a uniform concentration throughout the house of around 75  $\mu\text{L/L}$ , with a continual decline to 50  $\mu\text{L/L}$ , at which point the mechanical venting was initiated. With the exception of the first 25 min of the test, the distribution was very uniform despite the HVAC fan being off. By comparison, unmod Gen X in Test K produced a less uniform house distribution, with a peak CO concentration of nominally 320  $\mu\text{L/L}$  in the family room and concentrations in the other rooms just below that, down to 260  $\mu\text{L/L}$ .



**Figure 28c** Temperatures and AFR measured in Test V (noncat Gen SO1, Configuration 7)

The AFR and temperatures measured on Gen SO1 during Test V are shown in Figure 28c. The engine operated at the calibrated AFR after the engine oil temperature warmed to about 70 °C.

Engine performance in this test was similar to that in Test U with Gen SO1 and the cat muffler, with the caveats that the loads were applied in opposite order and some data were missed in Test V. A comparison of the 50 µL/L garage CO concentration in this test with the 20 µL/L in Test U indicates the prototype's catalyst is providing about up to a 60 % reduction in CO emissions from that provided by the EMS alone. This somewhat larger difference than found when comparing Tests Z to N and Tests AH to W could be due to changes in infiltration rates or other factors.

### **Summary of Garage Tests**

A series of tests were conducted in which portable gasoline-powered electric generators were operated in the attached garage of the NIST manufactured test house. The data include CO emission and O<sub>2</sub> depletion in the garage, CO migration into the test house and engine operation parameters. A summary of the test results is provided in Table 4. These tests document reductions of 85 % to 98 % in CO concentrations due to emissions from two modified, prototype low CO-emission portable generators compared to an unmodified generator. The second prototype (Gen SO1) resulted in lower CO concentrations during similar tests with the garage bay door closed while both prototypes resulted in low CO concentrations during tests with the garage bay door open. Note that these results apply to the specific units tested and that other units, modifications, and test conditions may produce different results.

**Table 4 Summary of Garage Test Results**

| <b>Generator</b>               | <b>Test ID</b> | <b>Garage bay door, house door, HVAC</b> | <b>Test Duration (h)</b> | <b>Peak Garage CO Concentration (µL/L)</b> | <b>% Reduction in peak garage CO relative to unmod GenX</b> | <b>Peak CO concentration in house (µL/L)</b> |
|--------------------------------|----------------|--|--------------------------|--|---|--|
| <b>unmod GenX</b>              | B              | Closed, open, off                        | 3                        | 19,500<br>(12,800 at 2 h)                  | NA  | 6500   |
| <b>modGenX</b>                 | O              | Closed, open, off                        | 4.5                      | 3000<br>(1,400 at 3 h)                     | 93  | 800  |
| <b>SO1</b>                     | N              | Closed, open, off                        | 2                        | 300  | 98  | 140  |
| <b>unmod GenX</b>              | F              | Open, closed, off                        | 4                        | 1,500                                      | NA  | 200  |
| <b>modGenX</b>                 | R              | Open, closed, off                        | 4                        | 30   | 98  | 5  |
| <b>SO1</b>                     | T              | Open, closed, off                        | 3                        | 300<br>(20 after initial spike)            | 98  | 50   |
| <b>unmod GenX</b>              | I              | Closed, open, on                         | 4                        | 18,600                                     | NA  | 10,600                                       |
| <b>SO1 with noncat muffler</b> | Z              | Closed, open, on                         | 4.75                     | 630  | 97  | 360  |
| <b>unmod GenX</b>              | J              | Closed, closed, on                       | 2.25                     | 21,300                                     | NA  | 1,800  |
| <b>SO1</b>                     | W              | Closed, closed, on                       | 6                        | 960<br>(640 at 2.25 h)                     | 97  | 145  |
| <b>unmod GenX</b>              | D              | Closed, closed, off                      | 2                        | 23,000                                     | NA  | 1660   |
| <b>SO1 with noncat muffler</b> | AH             | Closed, closed, off                      | 5                        | 2,300                                      | 90  | 470  |
| <b>unmod GenX</b>              | G              | Open, open, on                           | 2                        | 1,100                                      | NA  | 220  |
| <b>SO1</b>                     | U              | Open, open, on                           | 2                        | 260<br>(< 30 after initial spike)          | 97  | 90   |
| <b>unmod GenX</b>              | K              | Open, open, off                          | >2                       | 680  | NA  | 320  |
| <b>SO1 with noncat muffler</b> | V              | Open, open, off                          | >2                       | 430<br>(50 to 80 after initial spike)      | 85 to 88  | 135  |

Notes:

Unmod Gen X is an unmodified (stock) generator with a carbureted engine.

Mod Gen X is a modified (prototype) generator with electronic fuel injection, an engine control unit and a catalytic converter.

Gen SO1 is a modified (prototype) generator with electronic fuel injection, an engine control unit (different than mod Gen X), and a catalytic converter (not used in 'noncat' configuration).

% reduction in peak garage CO concentration excludes initial spike.

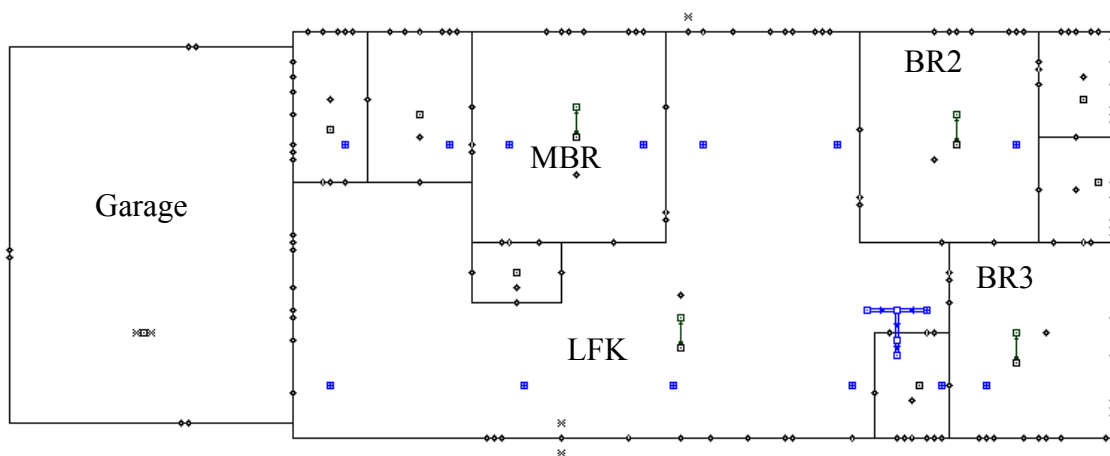
## Simulation

This section of the report describes the CONTAM model of the test house used to extend the measurement results to other scenarios, (*e.g.* weather conditions and house configuration). The primary objective of these modeling efforts was to examine the potential performance of the prototype generators under a wider range of conditions than studied during the experiments at the test house. This section starts with a detailed description of the CONTAM model of the test house, then describes a number of model validation cases, and finally presents simulation results for a broad range of cases. The purpose of the model validation effort was to establish the ability of the CONTAM model to predict CO levels in the garage and the house and to develop an estimate of the uncertainty of these predictions relative to the measured values.

### Modeling Method

The simulations in this study used CONTAM (Walton and Dols 2010), a multizone IAQ and ventilation model developed in the Engineering Laboratory (EL) at NIST. The multizone approach is implemented by constructing a building model as a network of elements describing the flow paths (*e.g.* HVAC ducts, doors, windows, cracks, etc.) between the zones (primarily rooms) of a building. The network nodes represent the zones, which are modeled with a hydrostatically varying pressure, and uniform temperature and pollutant concentration within each zone. After calculating the airflow between zones and the outdoors, zone pollutant concentrations are calculated by applying mass balance equations to the zones. CONTAM has frequently been used to study a variety of residential IAQ issues in past simulation studies (Emmerich and Persily 1996, Emmerich et al. 2005). For more detail on the CONTAM model, see the user's manual which is available online along with the latest version of the CONTAM program ([www.bfrl.nist.gov/IAQanalysis](http://www.bfrl.nist.gov/IAQanalysis)).

The graphical representation of the main floor of the test house as it appears in CONTAM is shown in Figure 29. The test house crawlspace and attic were included in the model but are not shown. The layout of the test house within CONTAM and the division of the zones were defined to represent the actual floorplan of the test house as seen in Figure 2, therefore each zone typically represents one room although the kitchen, living, dining and family room spaces are combined into a single CONTAM zone, referred to as zone LFK, due to the lack of any partitions separating them.



**Figure 29** CONTAM Sketchpad Representation of Test House

Nabinger and Persily (2008) and Nabinger et al. (2010) describe a study of ventilation rates and energy consumption in the test house before and after a retrofit effort to improve the tightness of both the building envelope and air distribution systems. That study included fan pressurization tests of both the envelope and air distribution systems, measurements of HVAC system air flows and tracer gas decay tests of air change rates. A CONTAM airflow model of the building was created and the predicted infiltration rates agreed well with the measured values over a range of weather and system operation conditions. Tables 5 and 6 list the air leakage values (in terms of the effective leakage area (ELA) at a reference pressure difference of 4 Pa) and HVAC system airflows from Nabinger et al. (2010). The CONTAM model used a detailed duct model for the HVAC system and, as such, the modeled flow values varied somewhat from the measured values in Table 6. Also, a duct leak of about 30 L/s was included in the belly. The belly, which is located between the floor of the living space and the crawlspace, contains the supply duct work within an insulated membrane.

**Table 5 Air Leakage Values**

|                              | <b>Airflow path</b>           | <b>ELA at 4 Pa</b>                   |                                   |
|------------------------------|-------------------------------|--------------------------------------|-----------------------------------|
|                              |                               | <b>Post-retrofit</b>                 |                                   |
| <b>Living space envelope</b> | Exterior wall                 | 0.13 cm <sup>2</sup> /m <sup>2</sup> |                                   |
|                              | Ceiling wall interface        | 0.73 cm <sup>2</sup> /m              |                                   |
|                              | Floor wall interface          | 1.12 cm <sup>2</sup> /m              |                                   |
|                              | Window #1                     | 5.00 cm <sup>2</sup>                 |                                   |
|                              | Window #2                     | 1.94 cm <sup>2</sup>                 |                                   |
|                              | Corner interface              | 0.73 cm <sup>2</sup> /m              |                                   |
|                              | Exterior doors                | 18.7 cm <sup>2</sup>                 |                                   |
|                              | Living space to belly         | 1.43 cm <sup>2</sup> /m <sup>2</sup> |                                   |
|                              | <b>Interior airflow paths</b> | Interior walls                       | 2 cm <sup>2</sup> /m <sup>2</sup> |
|                              |                               | Bedroom doorframe                    | 410 cm <sup>2</sup>               |
| Open interior doors          |                               | 2 m x 0.9 m                          |                                   |
| Bathroom doorframe           |                               | 330 cm <sup>2</sup>                  |                                   |
| Interior doorframe           |                               | 250 cm <sup>2</sup>                  |                                   |
| Closet doorframe             |                               | 4.6 cm <sup>2</sup>                  |                                   |
| <b>Attic</b>                 |                               | Attic floor                          | 2 cm <sup>2</sup> /m <sup>2</sup> |
|                              | Roof vents                    | 0.135 m <sup>2</sup> /each           |                                   |
|                              | Eave vents                    | 296 cm <sup>2</sup> /m               |                                   |
| <b>Crawl space and belly</b> | Exterior walls of crawl space | 25 cm <sup>2</sup> /m <sup>2</sup>   |                                   |
|                              | Rear crawl space vents        | 323 cm <sup>2</sup>                  |                                   |
|                              | Front crawl space vents       | 465 cm <sup>2</sup>                  |                                   |
|                              | Crawl space access door       | 206 cm <sup>2</sup>                  |                                   |
|                              | Crawl space to "belly"        | 181 cm <sup>2</sup>                  |                                   |
|                              | Duct leak into belly          | 58 cm <sup>2</sup>                   |                                   |

**Table 6 HVAC System Supply Flows**

|              |          | Airflow rate L/s |
|--------------|----------|------------------|
| Room         | Vent No. | Post-retrofit    |
| Family       | 1        | 54               |
| Family       | 2        | 44               |
| Kitchen      | 3        | 39               |
| Dining       | 4        | 41               |
| Bath2        | 5        | 40               |
| Bed3         | 6        | 62               |
| Bed2         | 7        | 21               |
| Living       | 8        | 27               |
| Living       | 9        | 28               |
| Bed1         | 10       | 29               |
| Bed1         | 11       | 25               |
| Bath1        | 12       | 17               |
| Utility      | 13       | 24               |
| <b>Total</b> |          | <b>450</b>       |

The CONTAM airflow model described by Nabinger et al. 2010 was modified to add the attached garage, including leakage paths from the garage to ambient and to the house. The modeled garage leakage was based on fan pressurizations tests conducted in April, July and August 2008 with analysis following the methods described by Emmerich et al. 2003.

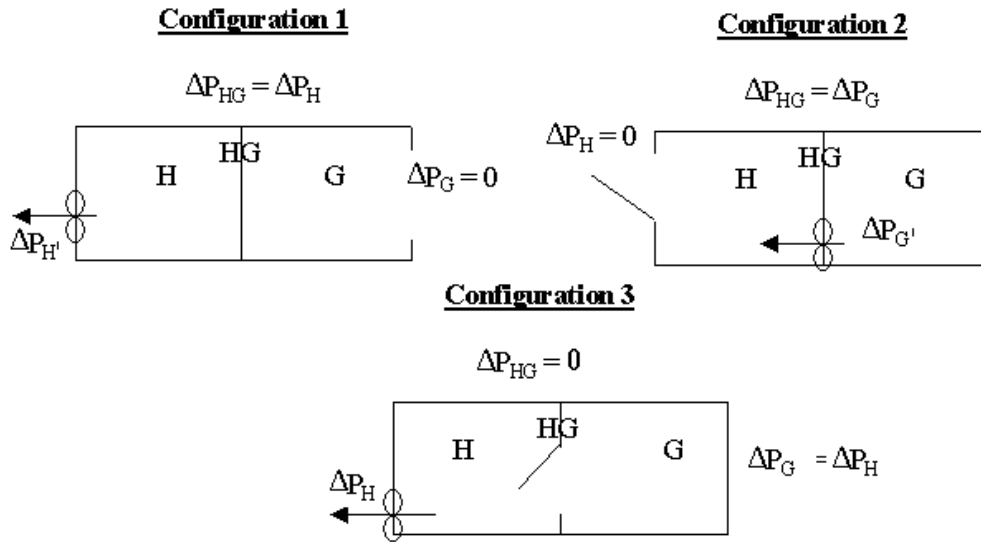
### Garage Pressurization Tests

Additional pressurization tests were conducted on the house to measure the leakage of the house, garage, and the house-garage (HG) interface. The pressurization tests were generally conducted according to ASTM Standard E 779-10 (ASTM 2010). Three configurations were used on the test house as shown in Figure 30:

1. Blower door (or pressurization fan) in the living space with the garage door open.
2. Blower door in the garage access door with the living space doors open.
3. Blower door in the living space with the HG interface door open.

In the figure and the analysis, each building is represented as two zones; a house zone (H) and a garage (G) zone separated by the house-garage interface. Arrows indicate the location of the blower door for each test and the direction of the airflow from the blower door fan. The pressure difference,  $\Delta P_{HG}$ , is the pressure difference across the house-garage interface. The pressure differences across the living space exterior envelope for each test configuration are designated as  $\Delta P_H$ , while  $\Delta P_G$  designates the pressure differences across the garage exterior envelope.





**Figure 30** Test house and garage fan pressurization configurations

**Symbol Legend for Figures and Equations in this section**

- H** – exterior envelope of house (living space)
- H'** – house exterior envelope and HG interface combined (H+HG)
- G** – exterior envelope of garage
- G'** – garage exterior envelope and HG interface combined (G+HG)
- HG** – HG interface
- Q<sub># or L</sub>** – Airflow rate from blower door in configuration # or for surface designation (L)
- ΔP<sub># or L</sub>** – Pressure difference across a surface
- C<sub># or L</sub>** – flow coefficient for Q<sub># or L</sub>.

For each blower door test, measured airflows were recorded at multiple pressures ranging from 10 Pa to 70 Pa (not all spaces were pressurized to 70 Pa). The airflows and pressures were then fit to a power law equation:  $Q = C (\Delta P)^n$ . For configuration 1, depressurizing the living space (H), while the garage door is open, effectively changes the garage space to an ambient zone. The house zone is bounded by the exterior envelope surfaces of the living space, H, and the HG interface surface. The reverse is performed for the garage in test 2, in which the garage zone is bounded by the exterior envelope surfaces of the garage, G, and the HG interface surface. Finally, in configuration 3, the combined house and garage spaces are pressurized.

As described in Emmerich et al. 2003, calculations for the test house are based on continuity, effective leakage area, and power law orifice equations. Applying the law of conservation of mass and the power law orifice equation yields a three by three matrix of airflow rates:

$$Q_1 = C_1 \cdot \Delta P^{n_1} = Q_H + Q_{HG} \quad (4)$$

$$Q_2 = C_2 \cdot \Delta P^{n_2} = Q_G + Q_{HG} \quad (5)$$

$$Q_3 = C_3 \cdot \Delta P^{n_3} = Q_G + Q_H \quad (6)$$

Here,  $C_1$  and  $n_1$  are the flow parameters obtained from the curve fit to the data for configuration 1 (tested twice in depressurization mode only),  $C_2$  and  $n_2$  are obtained from the data for configuration 2 (tested 3 times in depressurization mode and once in pressurization mode), and  $C_3$  and  $n_3$  are obtained from the data for configuration 3 (tested twice in depressurization mode only). With three equations and three unknowns, this matrix can be solved for  $Q_H$ ,  $Q_G$ , and  $Q_{HG}$ , all at a specific reference pressure across surfaces H, G, and HG. Using these three airflow rates, the zone envelope and HG interface ELA's are calculated using the effective leakage area equation (ASHRAE 2009):

$$ELA = \frac{Q}{\sqrt{\left(2 \cdot \Delta P / \rho\right)}} \quad (7)$$

**Table 7 Fan Pressurization Test Results**

|                              |      |
|------------------------------|------|
| $C_1$ ( $m^3/h \cdot Pa^n$ ) | 290  |
| $C_2$ ( $m^3/h \cdot Pa^n$ ) | 157  |
| $C_3$ ( $m^3/h \cdot Pa^n$ ) | 296  |
| $n_1$                        | 0.61 |
| $n_2$                        | 0.56 |
| $n_3$                        | 0.65 |
| $ACH_{50,H}$ ( $h^{-1}$ )    | 11.8 |
| $ACH_{50,G}$ ( $h^{-1}$ )    | 15.5 |
| $ELA_{4,H}$ ( $cm^2$ )       | 574  |
| $ELA_{4,G}$ ( $cm^2$ )       | 210  |
| $ELA_{4,HG}$ ( $cm^2$ )      | 157  |

The total leakage from the house to the garage ( $ELA_{4,HG}$ ) of  $157 \text{ cm}^2$  was equal to the average total leakage from the house to the garage for the five houses tested by Emmerich et al. (2003). The effective leakage areas for G and HG from Table 7 were distributed vertically along the walls of the garage and on the ceiling in the CONTAM model.

Temperatures were measured in most of the individual rooms, garage, crawlspace and attic of the test house during the tests and used as input to the model. Temperatures in the LFK zone were based on an average of the living room, family room, and kitchen measurements. Both BR2 and BR3 temperatures were based on measured BR3 temperatures as there was no measurement available for BR2. Temperatures in the Utility zone were based on the adjacent family room temperature except when the door to the garage was open in which case they were based on an average of the temperature in the LFK zone and the garage. Temperatures in other zones without measurements such as bathrooms were based on an average of all room (*i.e.*, not including garage, crawlspace or attic) measurements.

## **Model Validation**

This section describes the model validation efforts that were carried out to establish the ability of the CONTAM model to predict CO levels in the garage and the house and to develop an estimate of its uncertainty of these predictions relative to the measured values. A number of past studies (e.g., Emmerich and Nabinger (2001) and Emmerich et al. (2004)) have also examined the issue of multizone IAQ model validation as reviewed in Emmerich (2001).

## **Statistical Evaluation of Model Predictions**

As part of this validation effort, predicted CO concentrations were compared with measured values from a series of experiments in the test house. The predictions and measurements were compared using ASTM D5157 Standard Guide for Statistical Evaluation of Indoor Air Quality Models, which provides quantitative and qualitative tools for evaluation of IAQ models (ASTM 2008). It provides guidance in choosing data sets for model evaluation and focuses on evaluating the accuracy of indoor concentrations predicted by a model. As part of the comparison of CONTAM predictions to measurements of CO and O<sub>2</sub> concentrations, the ASTM D5157 suggested criteria were applied. The data sets collected during this study meet the ASTM D5157 criteria for model evaluation, as they are entirely independent of the data used to develop the model and to estimate model inputs. Also, the data are of sufficient detail to evaluate the CONTAM predictions of individual zonal CO concentrations.

ASTM D5157 provides three statistical tools for evaluating the accuracy of IAQ model predictions and two additional statistical tools for assessing bias. Values for these statistical criteria are provided to indicate whether the model performance is adequate. The tools for assessing agreement between predictions and measurements, and the criteria for model evaluation, include:

- 1) The correlation coefficient of predictions and measurements should be 0.9 or greater.
- 2) The line of regression between the predictions and measurements should have a slope between 0.75 and 1.25 and an intercept less than 25 % of the average measured concentration.
- 3) The normalized mean square error (NMSE) should be less than 0.25. The NMSE is calculated as:

$$NMSE = \sum_{i=1}^N (C_{pi} - C_{oi})^2 / 2\bar{C}_o \bar{C}_p \quad (8)$$

where  $C_p$  is the predicted concentration and  $C_o$  is the observed concentration, and the over-bar represents an average over the N data points during the test period for each test case.

ASTM D5157 also provides two statistical measures of bias with values for judging adequate model performance. These measures of bias include:

- 1) Normalized fractional bias (FB) of the mean concentrations. Fractional bias should be 0.25 or lower and is calculated as:

$$FB = 2(\bar{C}_p - \bar{C}_o) / (\bar{C}_p + \bar{C}_o) \quad (9)$$

- 2) Fractional bias based on the variance (FS) which should be 0.5 or lower. FS is calculated as:

$$FS = 2(\sigma_p^2 - \sigma_o^2) / (\sigma_p^2 + \sigma_o^2) \quad (10)$$

where  $\sigma_p$  is the standard deviation of the predicted concentrations and  $\sigma_o$  is the standard deviation of the observed concentrations.

## Testing Configurations

As previously discussed in the Garage Test Results section and as part of the model validation effort, testing was conducted under seven different test house configurations to evaluate their impacts on the ability to predict the build-up of CO in the garage and its transport into the different rooms in the house. These configurations included two different garage bay door positions (fully closed or open nominally 0.6 m), two connecting door positions between the garage and the house (fully closed or open nominally 5 cm), and two house central heating, ventilating, and air conditioning (HVAC) fan settings (on or off). When the garage bay door was open, there was also a vertical opening of approximately 0.15 m at the top of the bay door. All internal house doors were kept open throughout all validation tests and model analyses.

Table 8 includes a summary of the validation tests conducted including information on the generator tested, the test house configuration (door positions and fan status), a test identification code, the date the test was conducted, the average ambient temperature and wind speed, and the CO analyzers used. The validation tests in Table 8 with Gen SO1 were included in the garage test results section, but those with Gen B were used exclusively for model validation.

**Table 8 Model Validation Tests Conducted**

| <b>Generator</b>               | <b>Garage bay door</b> | <b>Garage to house entry door</b> | <b>HVAC fan</b> | <b>Date</b>   | <b>Outdoor Temp (°C)</b> | <b>Wind speed (m/s)</b> | <b>Load</b> | <b>CO analyzers in garage</b> | <b>CO analyzers in house</b> |
|--------------------------------|------------------------|-----------------------------------|-----------------|---------------|--------------------------|-------------------------|-------------|-------------------------------|------------------------------|
| <b>B</b>                       | Closed                 | Open                              | OFF             | 10/8/08       | 18.4                     | 4.5                     | 2.5 kW      | N1, T1                        | N2, N3                       |
| <b>B</b>                       | Open                   | Open                              | OFF             | 10/23/08 a.m. | 8.8                      | 2.2                     | 5 kW        | N1, T1                        | N2, N3                       |
| <b>B</b>                       | Closed                 | Closed                            | ON              | 10/23/08 p.m. | 13.1                     | 3.8                     | 5 kW        | N1, T1                        | N2, N3                       |
| <b>SO1 cat</b>                 | Closed                 | Open                              | OFF             | 04/01/10      | 19.9                     | 6.3                     | Cyclic      | N2, N3                        | N1, R1                       |
| <b>SO1 cat</b>                 | Open                   | Open                              | ON              | 04/22/10      | 20.4                     | 7.8                     | Cyclic      | N2, N3                        | N1, R1                       |
| <b>SO1 cat</b>                 | Closed                 | Closed                            | ON              | 04/29/10      | 17.8                     | 9.5                     | Cyclic      | N2, N3                        | N1, R1                       |
| <b>SO1 with noncat muffler</b> | Closed                 | Closed                            | OFF             | 05/13/10      | 15.6                     | 6.5                     | Cyclic      | N2, N3                        | N1, R1                       |

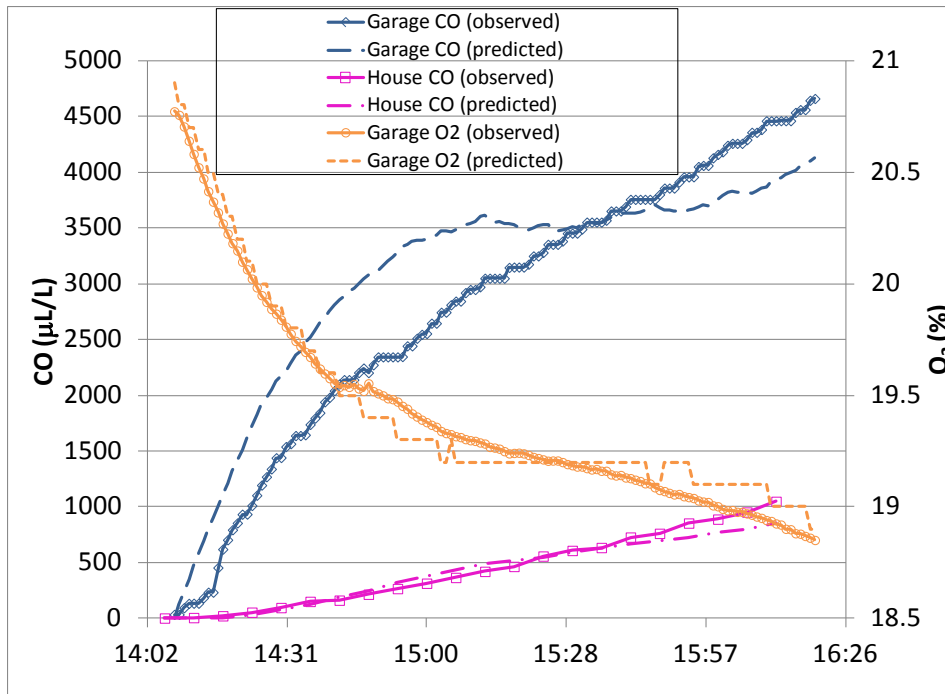
## **RESULTS OF MODEL VALIDATION**

As shown in Table 8, seven validation cases were simulated under a variety of conditions between October 2008 and May 2010. The tests consisted of operating one of the generators in the attached garage and measuring the concentrations in the house and garage for two to six hours.

### **Case #1**

In the first validation case, Gen B was operated with a nominal load of 2.5 kW for 2 h in the garage with the garage bay door closed, house entry door open and the HVAC system off. Based on the shed test results and the fact that the O<sub>2</sub> in the garage did not drop below about 19 % during this test, a constant CO emission rate of 760 g/h and a constant O<sub>2</sub> consumption rate of 4140 g/h were applied in the simulations of this case. These values are based on the average shed test results plotted on Figures 8a and 8b for O<sub>2</sub> at 19 % or above.

The observed and predicted CO and O<sub>2</sub> concentrations for the garage zone and the LFK zone in the house are shown in Figure 31. Table 9 shows average observed and predicted zone CO concentrations and percent differences, along with the ASTM D5157 statistical parameters (described previously) calculated for the zone average concentrations. The suggested ASTM D5157 statistical criteria were evaluated for overall zone average concentrations for the entire testing period for all cases. The columns of Table 9 (and subsequent tables) include the zone average observed concentration ( $C_o$ ), average predicted concentration ( $C_p$ ), standard deviation of observed concentrations ( $\sigma_o$ ), standard deviation of predicted concentrations ( $\sigma_p$ ), correlation coefficient (R), regression slope (m), regression intercept divided by the average observed concentration ( $b/C_o$ ), normalized mean square error (NMSE), fractional bias of the mean concentrations (FB), and fractional bias based on the variance (FS). The average concentration in the bottom row of the tables is a linear average of the five zone concentrations.



**Figure 31** Predicted and observed CO and O<sub>2</sub> concentrations for Case #1 (Notes: Plotted house concentration is from the LFK zone for Figures 31 through 37. The x-axis shows clock time for Figures 31 through 37.)

**Table 9** Statistical parameters for Case #1 (concentrations in units of µL/L)

| Zone                                   | C <sub>o</sub>       | C <sub>p</sub>       | C <sub>o</sub> -C <sub>p</sub> | % diff               |                      |             |             |                                |             |             |             |
|--|----------------------|----------------------|--------------------------------|----------------------|----------------------|-------------|-------------|--------------------------------|-------------|-------------|-------------|
| <b>GAR</b>                             | 2802                 | 3066                 | -265                           | 9                    |                      |             |             |                                |             |             |             |
| <b>LFK</b>                             | 435                  | 414                  | 21                             | -5                   |                      |             |             |                                |             |             |             |
| <b>MBR</b>                             | 307                  | 337                  | -30                            | 10                   |                      |             |             |                                |             |             |             |
| <b>Bed2</b>                            | 308                  | 383                  | -75                            | 24                   |                      |             |             |                                |             |             |             |
| <b>Bed3</b>                            | 289                  | 369                  | -81                            | 28                   |                      |             |             |                                |             |             |             |
| <b>Average<br/> % difference </b>      |                      |                      |                                | <b>15</b>            |                      |             |             |                                |             |             |             |
|  | <b>C<sub>o</sub></b> | <b>C<sub>p</sub></b> |                                | <b>σ<sub>o</sub></b> | <b>σ<sub>p</sub></b> | <b>R</b>    | <b>m</b>    | <b>b/C<sub>o</sub><br/>(%)</b> | <b>NMSE</b> | <b>FB</b>   | <b>FS</b>   |
| <b>Room Average<br/>Concentrations</b> | 828                  | 914                  |                                | 1100                 | 1200                 | <b>1.00</b> | <b>1.09</b> | <b>1.5</b>                     | <b>0.02</b> | <b>0.10</b> | <b>0.27</b> |

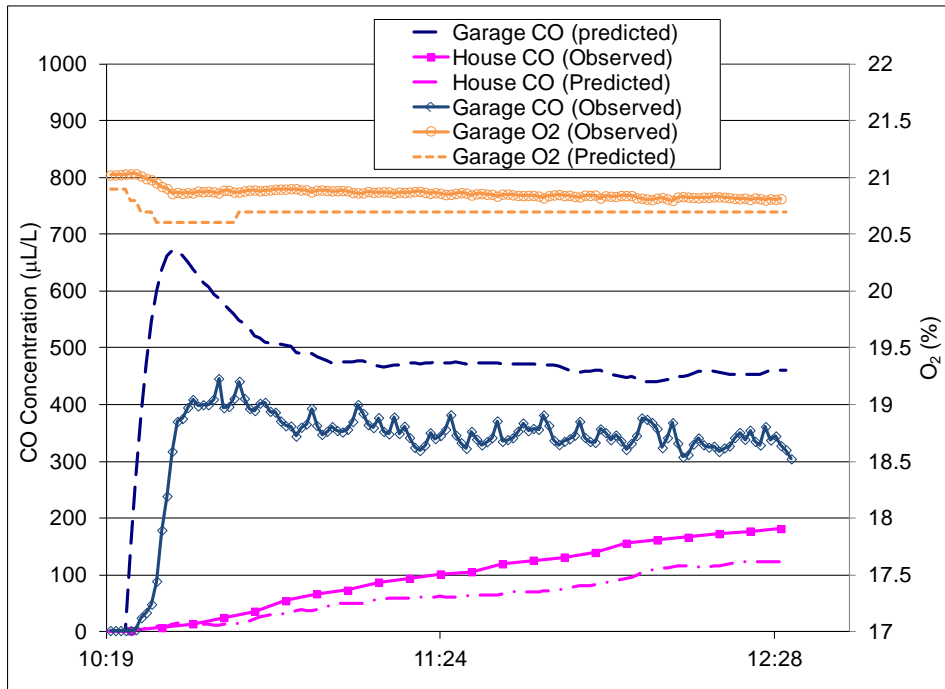
The bold values in Table 9 are those that meet the ASTM suggested criteria. Based on the statistical parameters, this case exhibits excellent agreement between measurements and predictions. Specifically, the values for R, m, b/Co, NMSE, FS and FB calculated for the average zone concentrations all meet the ASTM D5157 suggested limits. Additionally,

the average of the absolute percent differences between the zone values of  $C_o$  and  $C_p$  was 15 %.

### Case # 2

Case # 2 involved operation of Gen B in the garage with the bay door open, the house entry door open and the HVAC system fan off. A constant nominal load of 5 kW was applied for this case. Based on the shed test results and the fact that the  $O_2$  in the garage did not drop below 20.8 % during this test, a constant CO emission rate of 1090 g/h (corresponding to the highest  $O_2$  point during the shed testing [see Fig 6a]) and a constant  $O_2$  consumption rate of 5640 g/h (see Fig 6b) were applied to the simulations.

The observed and predicted concentrations for garage zone and the LFK zone in the house are shown in Figure 32, and the calculated D5157 statistical parameters are shown in Table 10. Based on the statistical parameters, the agreement between measurements and predictions was not as good as for Case #1. Specifically, only the values for R and FB calculated for the average zone concentrations meet the ASTM D5157 suggested limits while m, b/ $C_o$ , NMSE, and FS fall outside the limits. Also, the average of the absolute percent differences between the zone values of  $C_o$  and  $C_p$ , *i.e.*, 24 %, was worse than Case 1. This larger average value was driven primarily by a large difference in the garage zone, though smaller differences are seen in the house zones. One possible reason for poorer agreement is the lack of shed test data for an  $O_2$  level above 20.5 % (see Figure 8a).



**Figure 32** Predicted and observed CO and  $O_2$  concentrations for Case # 2



**Table 10 Statistical parameters for Case # 2 (concentrations in units of  $\mu\text{L/L}$ )**

| Zone                               | $C_o$ | $C_p$ | $C_o - C_p$ | % diff     |            |             |          |                               |             |             |           |
|------------------------------------|-------|-------|-------------|------------|------------|-------------|----------|-------------------------------|-------------|-------------|-----------|
| <b>GAR</b>                         | 329   | 470   | -142        | 43         |            |             |          |                               |             |             |           |
| <b>LFK</b>                         | 96    | 61    | 34          | -36        |            |             |          |                               |             |             |           |
| <b>MBR</b>                         | 55    | 49    | 6           | -11        |            |             |          |                               |             |             |           |
| <b>Bed2</b>                        | 73    | 52    | 21          | -28        |            |             |          |                               |             |             |           |
| <b>Bed3</b>                        | 50    | 51    | -1          | 2          |            |             |          |                               |             |             |           |
| <b>Average<br/> % difference </b>  |       |       |             | <b>24</b>  |            |             |          |                               |             |             |           |
|                                    |       |       |             |            |            |             |          |                               |             |             |           |
|                                    | $C_o$ | $C_p$ |             | $\sigma_o$ | $\sigma_p$ | <b>R</b>    | <b>m</b> | <b>b/<math>C_o</math> (%)</b> | <b>NMSE</b> | <b>FB</b>   | <b>FS</b> |
| <b>Room Average Concentrations</b> | 120   | 137   |             | 118        | 186        | <b>0.99</b> | 1.57     | -43                           | 0.26        | <b>0.19</b> | 1.0       |

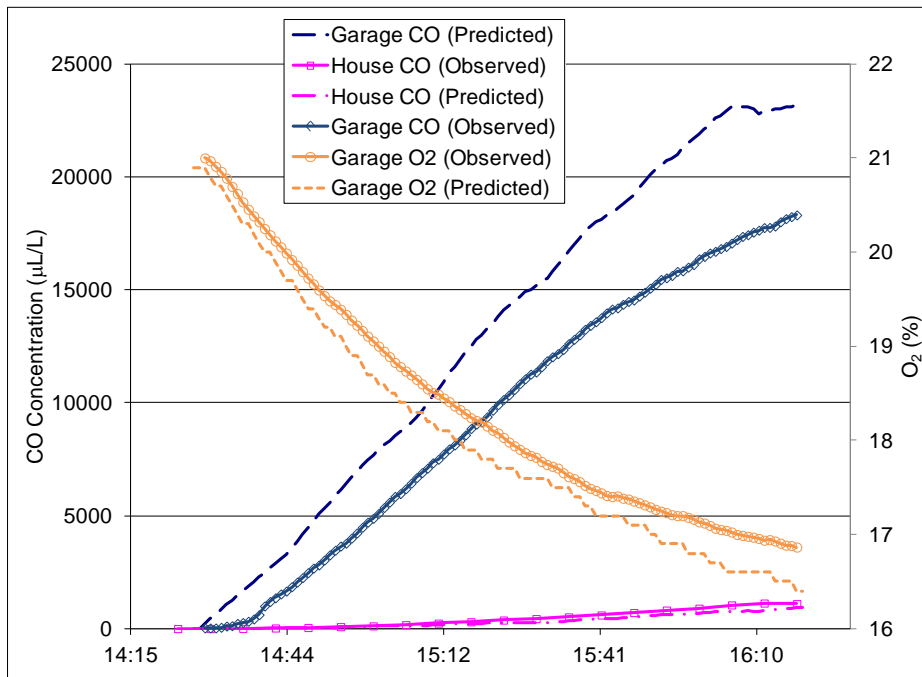
### Case # 3

Case # 3 involved operation of Gen B in the garage with the bay door closed, the house entry door closed and the HVAC system fan on. A constant nominal load of 5 kW was applied for this case. Based on average values from the shed test results in Figure 8, a constant  $O_2$  consumption rate of 5940 g/h was applied and the CO emission rate was dependent on the predicted  $O_2$  level per the relationship in Table 11.

**Table 11  $O_2$  dependent CO emission rate for Gen B**

| $O_2$ level (%) | CO emission (g/h) |
|-----------------|-------------------|
| $O_2 > 20$      | 1370              |
| $19 < O_2 < 20$ | 2070              |
| $18 < O_2 < 19$ | 3000              |
| $17 < O_2 < 18$ | 3150              |
| $O_2 < 17$      | 2140              |

The observed and predicted transient concentrations for the garage zone and the LFK zone in the house are shown in Figure 33, and the D5157 statistical parameters calculated for the zone average concentrations are shown in Table 12. Based on the statistical parameters, this case resulted in agreement between measurements and predictions similar to that seen in Case 2. Specifically, the values for R and b/ $C_o$  calculated for the comparison of average zone concentrations meet the ASTM D5157 suggested limits while those for m, NMSE, FB, and FS fall outside the limits. However, the average of the absolute percent differences between  $C_o$  and  $C_p$ , *i.e.*, 16 %, was better than Case 2. Again, there are large differences in the garage zone concentrations, but differences in the house zones are smaller.



**Figure 33** Predicted and observed CO and O<sub>2</sub> concentrations for Case # 3

**Table 12** Statistical parameters for Case # 3 (concentrations in units of µL/L)

| Zone                                      | C <sub>o</sub> | C <sub>p</sub> | C <sub>o</sub> -C <sub>p</sub> | % diff         |                |             |      |                         |          |      |      |
|---|----------------|----------------|--------------------------------|----------------|----------------|-------------|------|-------------------------|----------|------|------|
| <b>GAR</b>                                | 9542           | 12978          | -3436                          | 36             |                |             |      |                         |          |      |      |
| <b>LFK</b>                                | 434            | 322            | 111                            | -26            |                |             |      |                         |          |      |      |
| <b>MBR</b>                                | 275            | 254            | 20                             | -7             |                |             |      |                         |          |      |      |
| <b>Bed2</b>                               | 289            | 289            | 0                              | 0              |                |             |      |                         |          |      |      |
| <b>Bed3</b>                               | 262            | 289            | -27                            | 10             |                |             |      |                         |          |      |      |
| <b>Average<br/> % difference </b>         |                |                |                                | <b>16</b>      |                |             |      |                         |          |      |      |
|   |                |                |                                |                |                |             |      |                         |          |      |      |
|   | C <sub>o</sub> | C <sub>p</sub> |                                | σ <sub>o</sub> | σ <sub>p</sub> | R           | m    | b/C <sub>o</sub><br>(%) | NMS<br>E | FB   | FS   |
| <b>Room<br/>Average<br/>Concentration</b> | 2160           | 2827           |                                | 4130           | 5580           | <b>1.00</b> | 1.37 | <b>-6.6</b>             | 0.39     | 0.27 | 0.85 |

### Case # 4

Case # 4 involved operation of Gen SO1 with the CAT muffler in the garage with the bay door closed, the house entry door open, the HVAC system fan off and a cyclic electrical

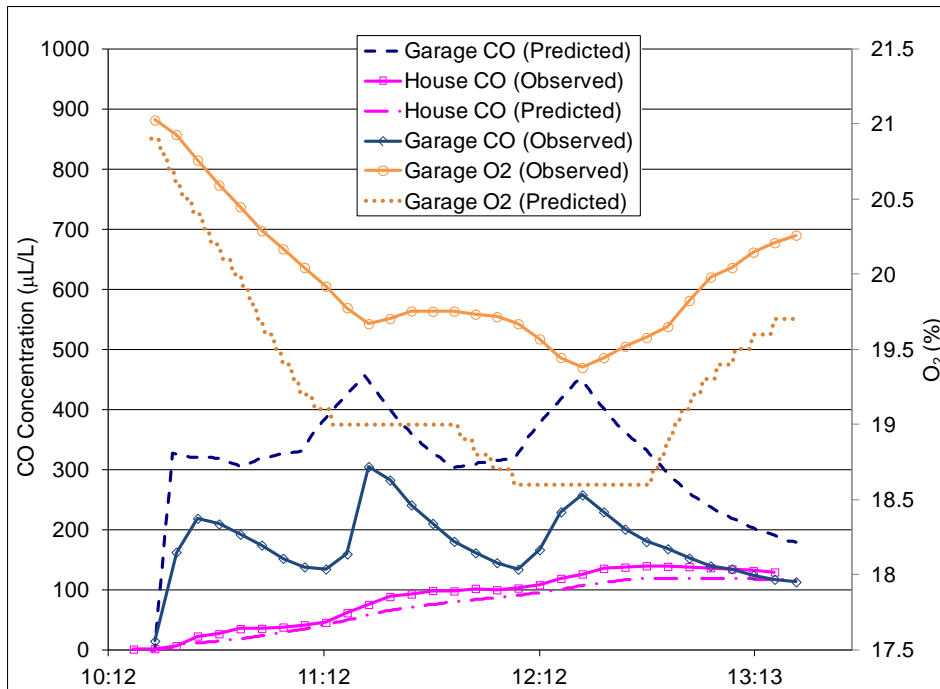
load. During the test, a load bank fuse failed and the load dropped in half for a few minutes before the fuse was replaced and the test continued. Also, this test includes a natural decay period of about 40 min (included in plots and analysis below) following generator shut-off.

Based on average values from the shed test results shown in Figure 11, load-dependent O<sub>2</sub> consumption and CO emission rates were used for this case (see Table 13), with both rates dependent on the electrical load. In addition, past measurement of Gen SO1 operation in both the shed and garage showed that an initial spike of CO is consistently observed immediately following a cold start (note the ECU algorithm is programmed to operate rich upon start-up). Based on analysis of cold start-up data following the method described previously for shed testing, a 430 g/h source of CO was included in the model at start-up in place of the Table 13 value until the measured AFR exceeded 13.5 (the first five minutes of operation for this case).

**Table 13 Hourly cyclic load profile for Gen SO1 cat**

| <b>Load bank setting<br/>(W)</b> | <b>Duration<br/>(min)</b> | <b>CO emission<br/>(g/h)</b> | <b>O<sub>2</sub> consumption<br/>(g/h)</b> |
|----------------------------------|---------------------------|------------------------------|--|
| no load                          | 3                         | 20                           | 2620                                       |
| 500                              | 4                         | 15                           | 3880                                       |
| 1500                             | 18                        | 17                           | 3080                                       |
| 3000                             | 17.5                      | 47                           | 4820                                       |
| 4500                             | 12                        | 96                           | 4370                                       |
| 5500                             | 5.5                       | 102                          | 3710                                       |

The observed and predicted transient concentrations for the garage zone and LFK zone in the house are shown in Figure 34, and the D5157 statistical parameters calculated for the zone average concentrations are shown in Table 14. Based on the statistical parameters, this case resulted in agreement between average concentration measurements and predictions similar to Case #2. Specifically, only the value for R and FB calculated for the comparison of average zone concentrations met the ASTM D5157 suggested limits while m, b/Co, NMSE, and FS fall outside the limits. Additionally, the average of the absolute percent differences between zone values of C<sub>o</sub> and C<sub>p</sub> was 26 %, which was driven by a large difference in the garage zone but much smaller differences in the LFK zone.



**Figure 34** Predicted and observed CO and O<sub>2</sub> concentrations for Case # 4

**Table 14** Statistical parameters for Case # 4 (concentrations in units of µL/L)

| Zone                               | C <sub>o</sub>       | C <sub>p</sub>       | C <sub>o</sub> -C <sub>p</sub> | % diff               |                      |             |          |                            |             |             |           |
|------------------------------------|----------------------|----------------------|--------------------------------|----------------------|----------------------|-------------|----------|----------------------------|-------------|-------------|-----------|
| <b>GAR</b>                         | 175                  | 326                  | -151                           | 86                   |                      |             |          |                            |             |             |           |
| <b>LFK</b>                         | 85                   | 73                   | 12                             | -14                  |                      |             |          |                            |             |             |           |
| <b>MBR</b>                         | 83                   | 69                   | 14                             | -17                  |                      |             |          |                            |             |             |           |
| <b>Bed2</b>                        | 77                   | 69                   | 7                              | -10                  |                      |             |          |                            |             |             |           |
| <b>Bed3</b>                        | 69                   | 70                   | 0                              | 1                    |                      |             |          |                            |             |             |           |
| <b>Average<br/> % difference </b>  |                      |                      |                                | <b>26</b>            |                      |             |          |                            |             |             |           |
|                                    |                      |                      |                                |                      |                      |             |          |                            |             |             |           |
|                                    | <b>C<sub>o</sub></b> | <b>C<sub>p</sub></b> |                                | <b>σ<sub>o</sub></b> | <b>σ<sub>p</sub></b> | <b>R</b>    | <b>m</b> | <b>b/C<sub>o</sub> (%)</b> | <b>NMSE</b> | <b>FB</b>   | <b>FS</b> |
| <b>Room Average Concentrations</b> | 98                   | 121                  |                                | 43                   | 114                  | <b>0.99</b> | 2.6      | -135                       | 0.39        | <b>0.21</b> | 1.6       |

### Case # 5

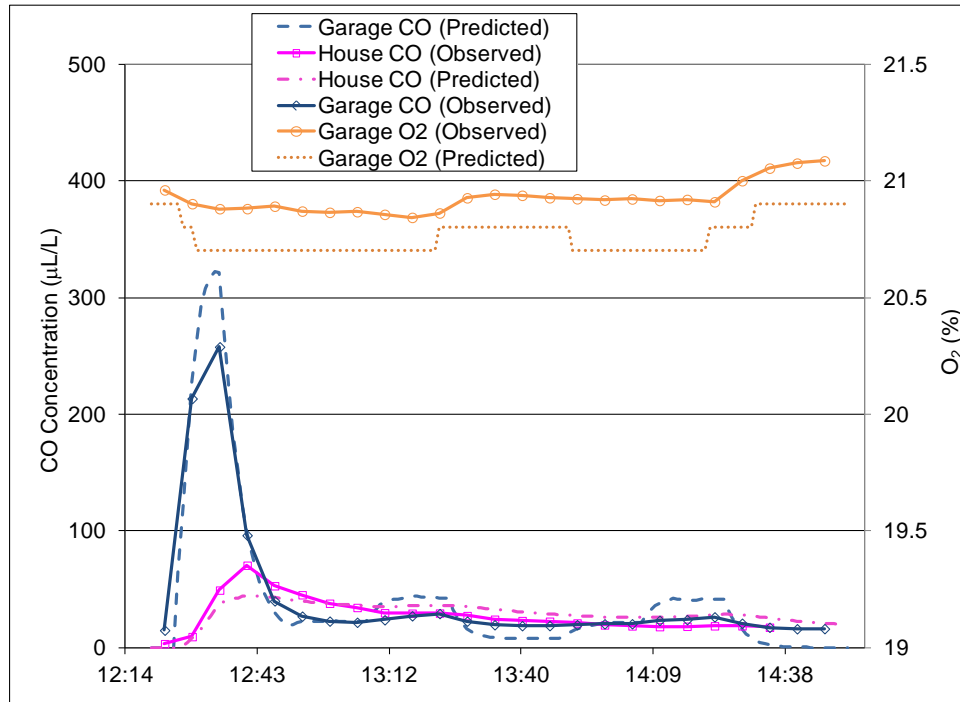
Case # 5 involved operation of Gen SO1 with CAT muffler in the garage with the bay door open, the house entry door open and the HVAC system fan on. A cyclic load was applied for this case. Also, this test includes a natural decay period of about 25 min following generator shut-off. Based on average values from the shed test results shown in Figure 11, load-dependent O<sub>2</sub> consumption and CO emission rates were used for this case

(see Table 15) along with a 430 g/h source of CO at start-up in place of the Table 15 emission until the measured AFR exceeded 13.5 (ten minutes for this case).

**Table 15 Hourly cyclic load profile for Gen SO1 cat**

| Load bank setting (W) | Duration (min) | CO emission (g/h) | O <sub>2</sub> consumption (g/h) |
|-----------------------|----------------|-------------------|----------------------------------|
| no load               | 3              | 20                | 2620                             |
| 500                   | 4              | 15                | 3880                             |
| 1500                  | 18             | 17                | 3080                             |
| 3000                  | 17.5           | 47                | 4820                             |
| 4500                  | 12             | 96                | 4370                             |
| 5500                  | 5.5            | 102               | 3710                             |

The observed and predicted transient concentrations for the garage zone and the LFK zone in the house are shown in Figure 35, and the D5157 statistical parameters calculated for the zone average concentrations are shown in Table 16. Based on the statistical parameters, this case resulted in good agreement between measurements and predictions. The average absolute value of the percent differences between the zone measurements and predictions was 20 %, and the absolute difference was less than 10 µL/L for all zones. Additionally, the values for R, NMSE, and FB calculated for the comparison of average zone concentrations meet the ASTM D5157 suggested limits, while m, b/Co, and FS fall somewhat outside the limits.



**Figure 35** Predicted and observed CO and O<sub>2</sub> concentrations for Case # 5

**Table 16 Statistical parameters for Case # 5 (concentrations in units of  $\mu\text{L/L}$ )**

| Zone                        | $C_o$ | $C_p$ | $C_o - C_p$ | % diff     |            |      |      |              |      |      |       |
|-----------------------------|-------|-------|-------------|------------|------------|------|------|--------------|------|------|-------|
| GAR                         | 41    | 41.9  | -0.5        | 1          |            |      |      |              |      |      |       |
| LFK                         | 26    | 29.2  | -2.8        | 11         |            |      |      |              |      |      |       |
| MBR                         | 23    | 28.4  | -5.8        | 25         |            |      |      |              |      |      |       |
| Bed2                        | 21    | 28.5  | -7.5        | 36         |            |      |      |              |      |      |       |
| Bed3                        | 23    | 28.7  | -5.9        | 26         |            |      |      |              |      |      |       |
| Average<br> % difference    |       |       |             | 20         |            |      |      |              |      |      |       |
|                             |       |       |             |            |            |      |      |              |      |      |       |
|                             | $C_o$ | $C_p$ |             | $\sigma_o$ | $\sigma_p$ | R    | m    | b/ $C_o$ (%) | NMSE | FB   | FS    |
| Room Average Concentrations | 27    | 31    |             | 8.4        | 5.9        | 0.98 | 0.69 | 48           | 0.03 | 0.15 | -0.54 |

### Case # 6

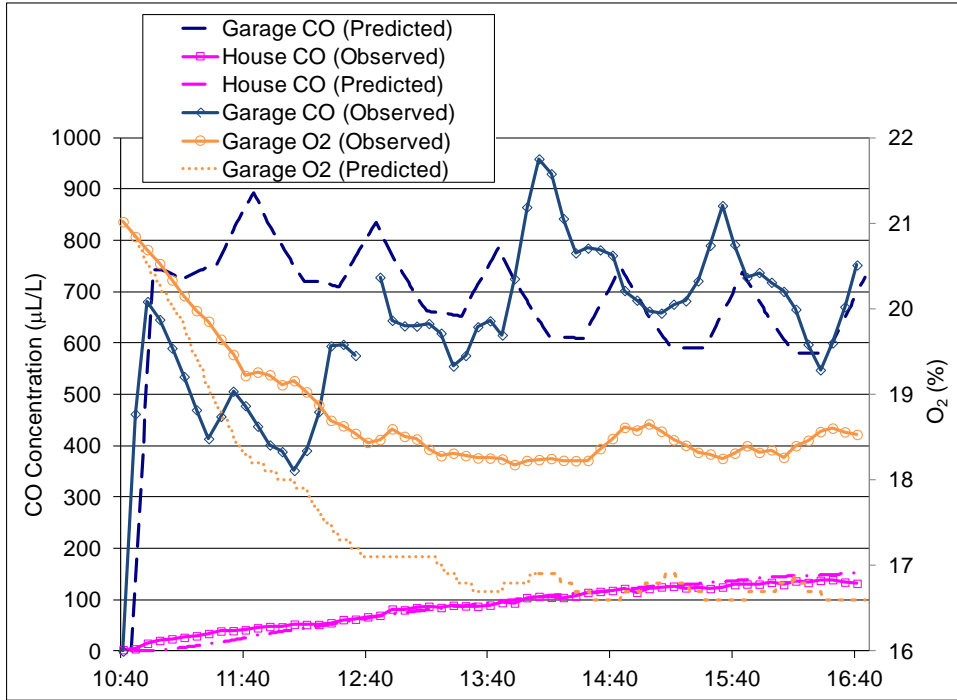
Case # 6 involved operation of Gen SO1 with CAT muffler in the garage with the bay door closed, the house entry door closed and the HVAC system fan on. A cyclic load was applied for this case. Based on the average values from the shed test results shown in Figure 11, load-dependent  $O_2$  consumption and CO emission rates were used for this case (see Table 17) along with a 430 g/h source of CO at start-up in place of the Table 17 emission until the measured AFR reached 13.5 (ten minutes for this case). There was a problem with the Family room temperature measurement for this case so the utility room temperature was set equal to the kitchen temperature.

**Table 17 Hourly cyclic load profile for Gen SO1 cat**

| Load bank setting (W) | Duration (min) | CO emission (g/h) | $O_2$ consumption (g/h) |
|-----------------------|----------------|-------------------|-------------------------|
| no load               | 3              | 20                | 2620                    |
| 500                   | 4              | 15                | 3880                    |
| 1500                  | 18             | 17                | 3080                    |
| 3000                  | 17.5           | 47                | 4820                    |
| 4500                  | 12             | 96                | 4370                    |
| 5500                  | 5.5            | 102               | 3710                    |

The observed and predicted transient concentrations for the garage zone and the LFK zone in the house are shown in Figure 36, and the D5157 statistical parameters calculated for the zone average concentrations are shown in Table 18. The average absolute value of the percent differences between the zone measurements and predictions was 16 %. Based on the statistical parameters, this case resulted in excellent agreement between measurements and predictions. Specifically, the values for R, m, b/ $C_o$ , NMSE, FB and

FS calculated for the comparison of average zone concentrations all meet the ASTM D5157 suggested limits.



**Figure 36** Predicted and observed CO and O<sub>2</sub> concentrations for Case # 6

**Table 18** Statistical parameters for Case # 6 (concentrations in units of µL/L)

| Zone                               | C <sub>o</sub>       | C <sub>p</sub>       | C <sub>o</sub> -C <sub>p</sub> | % diff               |                      |             |             |                            |             |             |             |
|------------------------------------|----------------------|----------------------|--------------------------------|----------------------|----------------------|-------------|-------------|----------------------------|-------------|-------------|-------------|
| <b>GAR</b>                         | 631                  | 686                  | -55                            | 9                    |                      |             |             |                            |             |             |             |
| <b>LFK</b>                         | 87                   | 88                   | 0                              | 0                    |                      |             |             |                            |             |             |             |
| <b>MBR</b>                         | 72                   | 84                   | -12                            | 17                   |                      |             |             |                            |             |             |             |
| <b>Bed2</b>                        | 63                   | 84                   | -22                            | 34                   |                      |             |             |                            |             |             |             |
| <b>Bed3</b>                        | 72                   | 86                   | -13                            | 19                   |                      |             |             |                            |             |             |             |
| <b>Average<br/> % difference </b>  |                      |                      |                                | <b>16</b>            |                      |             |             |                            |             |             |             |
|                                    |                      |                      |                                |                      |                      |             |             |                            |             |             |             |
|                                    | <b>C<sub>o</sub></b> | <b>C<sub>p</sub></b> |                                | <b>σ<sub>o</sub></b> | <b>σ<sub>p</sub></b> | <b>R</b>    | <b>m</b>    | <b>b/C<sub>o</sub> (%)</b> | <b>NMSE</b> | <b>FB</b>   | <b>FS</b>   |
| <b>Room Average Concentrations</b> | 185                  | 206                  |                                | 250                  | 269                  | <b>1.00</b> | <b>1.07</b> | <b>3.5</b>                 | <b>0.02</b> | <b>0.10</b> | <b>0.25</b> |

## Case # 7

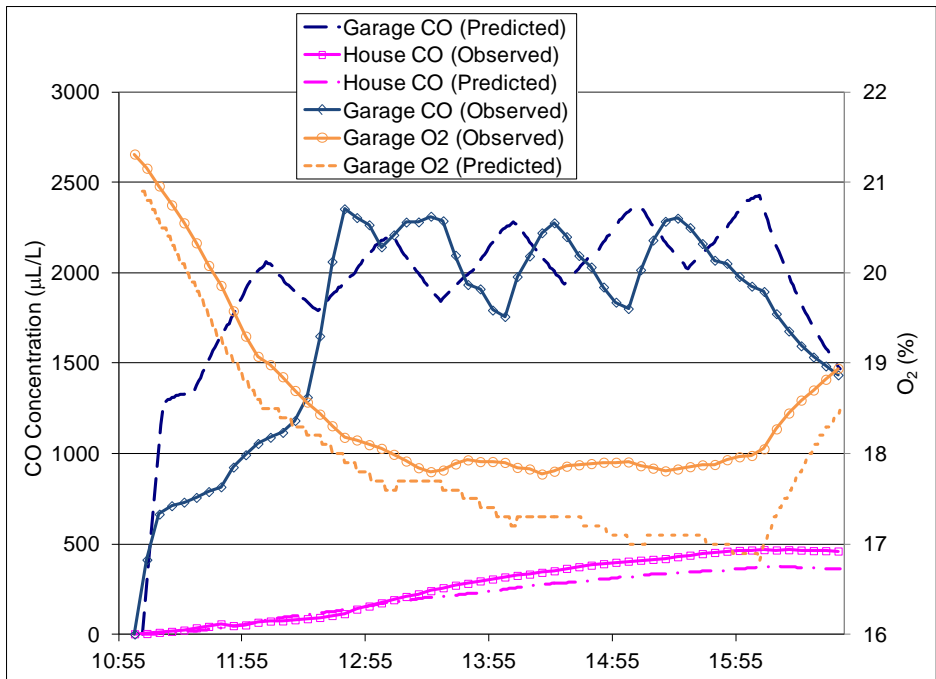
Case # 7 involved operation of Gen SO1 with nonCAT muffler in the garage with the bay door closed, the house entry door closed and the HVAC system fan off. A cyclic load was applied for this case. This case included a natural decay for about 45 min after generator shut-off (included in plots and analysis below). Based on average values of the shed test results shown in Figure 12, load-dependent O<sub>2</sub> consumption and CO emission rates were used for this case (see Table 19) along with an 840 g/h source of CO at start-up in place of the Table 19 emission until the AFR reached 13.5 (the first ten minutes of operation for this case).

**Table 19 Hourly cyclic load profile for Gen SO1 noncat**

| Load bank setting (W) | Duration (min) | CO emission (g/h) | O <sub>2</sub> consumption (g/h) |
|-----------------------|----------------|-------------------|----------------------------------|
| no load               | 3              | 150               | 2580                             |
| 500                   | 4              | 88                | 2780                             |
| 1500                  | 18             | 97                | 3450                             |
| 3000                  | 17.5           | 236               | 4110                             |
| 4500                  | 12             | 271               | 4190                             |
| 5500                  | 5.5            | 236               | 4440                             |

The observed and predicted transient concentrations for the garage zone and the LFK zone in the house are shown in Figure 37, and the D5157 statistical parameters calculated for the zone average concentrations are shown in Table 20. The average absolute value of the percent differences between the zone measurements and predictions was 17 %. Based on the statistical parameters, this case resulted in excellent agreement between measurements and predictions. Specifically, the values for R, m, b/Co, NMSE, FB and FS calculated for the comparison of average zone concentrations all meet the ASTM D5157 suggested limits.





**Figure 37** Predicted and observed CO and O<sub>2</sub> concentrations for Case # 7

**Table 20** Statistical parameters for Case # 7 (concentrations in units of µL/L)

| Zone                        | C <sub>o</sub> | C <sub>p</sub> | C <sub>o</sub> -C <sub>p</sub> | % diff         |                |      |      |                      |      |      |      |
|-----------------------------|----------------|----------------|--------------------------------|----------------|----------------|------|------|----------------------|------|------|------|
| GAR                         | 1712           | 1944           | -232                           | 14             |                |      |      |                      |      |      |      |
| LFK                         | 266            | 223            | 42                             | -16            |                |      |      |                      |      |      |      |
| MBR                         | 264            | 212            | 52                             | -20            |                |      |      |                      |      |      |      |
| Bed2                        | 263            | 216            | 47                             | -18            |                |      |      |                      |      |      |      |
| Bed3                        | 261            | 216            | 46                             | -18            |                |      |      |                      |      |      |      |
| Average<br> % difference    |                |                |                                | 17             |                |      |      |                      |      |      |      |
|                             |                |                |                                |                |                |      |      |                      |      |      |      |
|                             | C <sub>o</sub> | C <sub>p</sub> |                                | σ <sub>o</sub> | σ <sub>p</sub> | R    | m    | b/C <sub>o</sub> (%) | NMSE | FB   | FS   |
| Room Average Concentrations | 553            | 562            |                                | 648            | 772            | 1.00 | 1.19 | -18                  | 0.04 | 0.02 | 0.36 |

## Summary

Table 21 summarizes the statistical parameters calculated for all the cases based on the average zone concentrations. The bold values in Table 21 are those that meet the ASTM suggested criteria. As seen in the table, statistical agreement varies for the individual cases. The agreement was generally better for the cases with both the bay and house entry

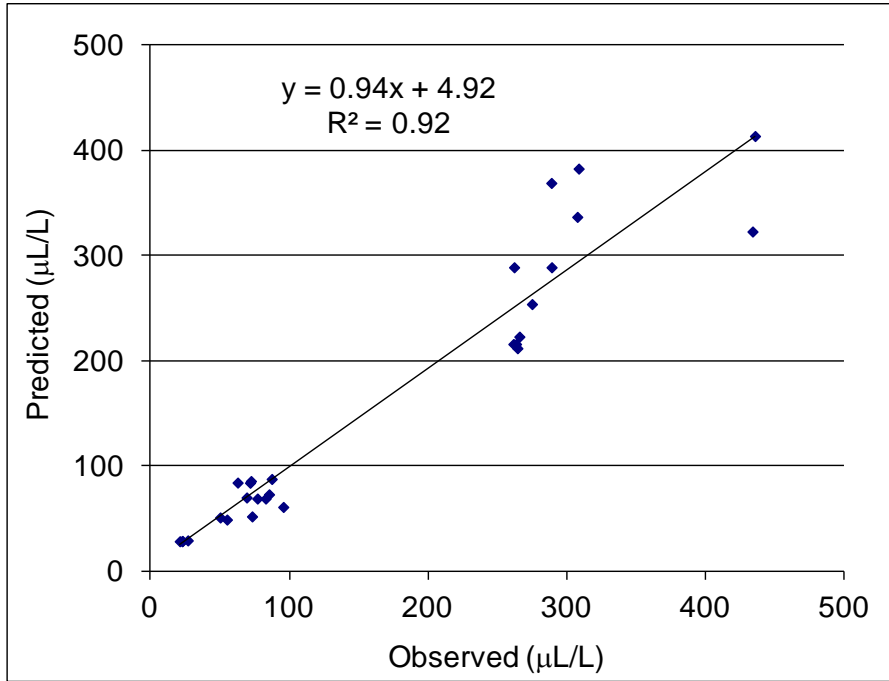
doors closed (3, 6, and 7). This improved agreement is not a surprise, as the cases with better agreement rely primarily on CONTAM’s ability to model airflow through smaller leaks. While CONTAM includes elements to model flow through larger openings (used for the open bay and entry doors of Cases 1, 2, 4 and 5), those flow predictions are thought to be less reliable given the physical theory on which CONTAM is based. Table 21 shows that the statistical agreement was generally somewhat worse for those cases.

**Table 21 Summary of statistical parameters from comparison of average observed and predicted zone CO concentrations for all cases**

| Case  | C <sub>o</sub> | C <sub>p</sub> | Avg<br>[%diff] | σ <sub>o</sub> | σ <sub>p</sub> | R           | m           | b/C <sub>o</sub><br>(%) | NMSE         | FB           | FS           |
|---|----------------|----------------|----------------|----------------|----------------|-------------|-------------|-------------------------|--------------|--------------|--------------|
| 1   | 828            | 914            | 15             | 1100           | 1200           | <b>1.00</b> | <b>1.09</b> | <b>1.5</b>              | <b>0.02</b>  | <b>0.10</b>  | <b>0.27</b>  |
| 2   | 120            | 137            | 24             | 118            | 186            | <b>0.99</b> | 1.57        | -43                     | 0.26         | <b>0.19</b>  | 1.0          |
| 3   | 2160           | 2827           | 16             | 4130           | 5580           | <b>1.00</b> | 1.37        | <b>-6.6</b>             | 0.39         | 0.27         | 0.85         |
| 4   | 98             | 121            | 26             | 43             | 114            | <b>0.99</b> | 2.6         | -135                    | 0.39         | <b>0.21</b>  | 1.6          |
| 5   | 27             | 31             | 20             | 8.4            | 5.9            | <b>0.98</b> | 0.69        | 48                      | <b>0.03</b>  | <b>0.15</b>  | -            |
| 6   | 185            | 206            | 16             | 250            | 269            | <b>1.00</b> | <b>1.07</b> | <b>3.5</b>              | <b>0.02</b>  | <b>0.10</b>  | <b>0.25</b>  |
| 7   | 553            | 562            | 17             | 648            | 772            | <b>1.00</b> | <b>1.19</b> | <b>-18</b>              | <b>0.04</b>  | <b>0.02</b>  | <b>0.36</b>  |
| <i>Overall summary statistics for all tests</i> |                |                |                |                |                |             |             |                         |              |              |              |
| Garage CO                                       | 2180           | 2790           | 28             | 3400           | 4620           | <b>1.00</b> | 1.36        | <b>-7.6</b>             | 0.28         | <b>0.25</b>  | 0.81         |
| Garage O <sub>2</sub>                           | 19.5           | 19.1           | 2.5            | 1.1            | 1.3            | <b>0.94</b> | <b>1.18</b> | <b>-20</b>              | <b>0.001</b> | <b>-0.02</b> | <b>0.41</b>  |
| House zones<br>CO                               | 165            | 160            | 17             | 130            | 128            | <b>0.96</b> | <b>0.94</b> | <b>3.0</b>              | <b>0.05</b>  | <b>-0.03</b> | <b>-0.08</b> |

While the statistical evaluation of the individual cases is useful to understand strengths and weaknesses of the model, a more important statistical evaluation is the comparison of the entire set of cases. This overall evaluation indicates the model’s ability to predict the relative outcome when individual parameters are changed (e.g., door open vs. closed, or one type of generator vs. another). The last three rows of Table 21 include summary statistics for the average CO and O<sub>2</sub> concentrations in the garage and for the average CO calculated for the house zones. The agreement between the measurements and predictions for this entire set of cases was excellent for both the garage O<sub>2</sub> concentrations and the house CO concentrations. All of these statistical values met the D5157 criteria. The agreement, however, was somewhat worse for the garage CO concentrations, with some parameters falling slightly outside the ASTM criteria limits. The average concentrations for individual house zones (*i.e.*, LFK, MBR, BR2 and BR3) from all cases are plotted in Figure 38 to show the comparison of predictions and measurements. To summarize, average individual house zone and garage CO concentration predictions and

measurements were within about 20 % and 30 % respectively when averaged over all cases.



**Figure 38** Comparison of predicted and observed individual house zone average CO concentrations for all cases

As discussed previously (Emmerich 2001), absolute validation of a complex model, such as CONTAM, is impossible as there are infinite possible building models that can be created by a user. However, the primary objective of this experimental validation is to evaluate the accuracy of the CONTAM model predictions for this specific application, to identify large sources of error, and to determine the level of confidence that we may have in the predictions for the other cases simulated. For the cases modeled in this effort, no significant errors in the CONTAM model were identified. Additionally, some of the discrepancies between model predictions and experimental measurements may be due to measurement limitations instead of model deficiencies. For example, this effort involved a fairly rich data set in terms of number of variables monitored and spatial and temporal detail. Still, there are additional measurements that would have been helpful for the simulations. Specifically, the utility room provided the primary pathway for contaminant transport from the garage into the house; however, temperatures and concentrations were not measured in this zone. Also, uncertainties in experimental measurements include more than simply the instrument accuracy. Many of the reported measurements are a single point that was used to represent an average room concentration. The ability of this single point measurement to represent the room may be questionable at times.

## ***Prototype Generator Performance Simulations***

As previously mentioned, a primary objective of these simulations was to examine the potential performance of the prototype generator under a wider range of conditions than studied during the experiments at the test house, such as a longer period of generator operation and operation in a house location other than the garage. These additional simulations were performed to allow analyses of the safety implications of operating a portable generator in these conditions. All of these simulations, a total of 42, were based on the NIST manufactured test house model and the tested generators, which were extensively validated as described above.

Model parameters that were varied included ambient conditions, CO emission rates, source locations (location of the operating generator) and door positions. All simulations used steady state weather with three ambient temperatures (mild, 15 °C; cold, 0 °C; and hot 30 °C) and one wind condition (2 m/s blowing towards the garage bay door).

Since the garage measurements reported above clearly establish the danger of operating the unmodified generators in an attached garage, it was decided to focus the simulations on the potential performance of the reduced CO emission prototype. Therefore, the CO emission rates in the simulation were based on operation of Gen SO1 (both with and without cat muffler) under the cyclic load profile for 18 hours followed by 6 hours with the generator off. The 18 hour period of operation is a conservative estimate based on the fuel consumption rate at a low load and a 5 gallon gas tank capacity; the actual run time would likely be shorter under real operation but using 18 hours provides a more conservative estimate of the CO levels and exposure. Based on the shed test results, the previously-validated load-dependent CO emission rates of Table 13 were used for Gen SO1 with cat muffler along with a constant 430 g/h of CO at start-up in place of the Table 13 emission for the first 10 minutes of operation (typical time to reach an AFR of 13.5 for the model validation cases). Similarly, the previously-validated, load-dependent CO emission rates of Table 19 were used for Gen SO1 with noncat muffler along with a constant 840 g/h of CO at start-up for the first 10 minutes of operation.

The simulations included the generator located in either the attached garage or in the utility room of a modified test house model with the garage removed. For garage source cases, 4 door position combinations were considered: bay door (closed or 0.6 m open) and garage/utility access door positions (closed or 5 cm open). For the utility source cases, two positions of the utility/family room connecting door were modeled (closed and 5 cm open). The temperature, source strength, location and door factors resulted in a matrix of 36 cases. See Tables 22 and 23 for lists of the garage and utility source cases, respectively.

The HVAC system fan was modeled as off for all cases. Typically all other interior house doors were modeled as open but, for a set of 6 additional cases, the bedroom doors were modeled as closed (See Table 24 for closed bedroom door cases). Interior zone temperatures were set at 23 °C except for source zones and zones adjacent to source zones. Source zones were initially 23 °C, then experienced a linear increase over 2 h to 40 °C, which was held constant until the generator stopped operating, followed by a

linear decrease over the final 6 h back to 23 °C. Zones adjacent to the source zone experienced a linear increase over 2 h to 30 °C until the generator stops operating and a linear decrease over the final 6 h to 23 °C.

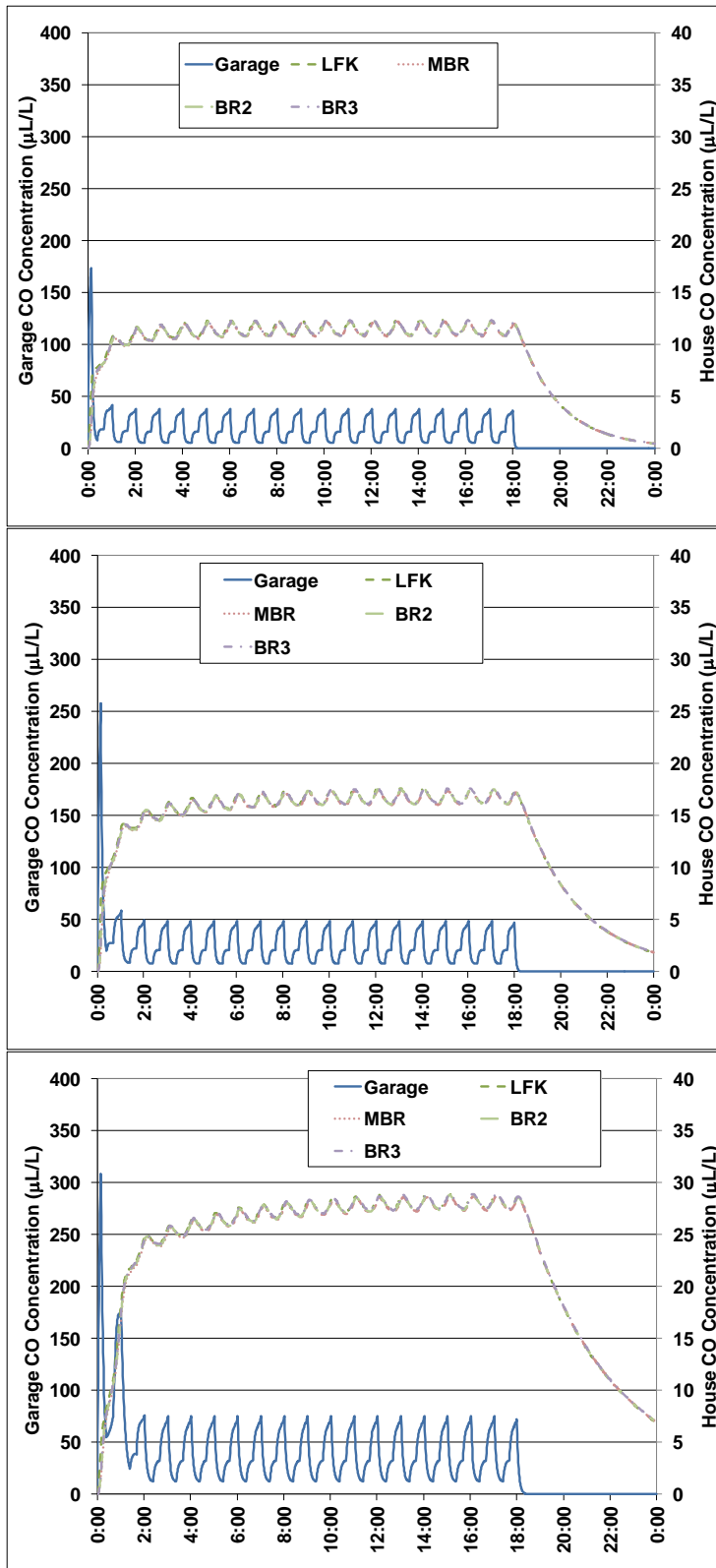
### **Garage source cases**

Figure 39 presents the simulation results for the cold, mild and hot ambient temperature cases with Gen SO1 with cat muffler in the garage with the bay door open and the house door closed. For these cases, the CO concentration in the garage spikes to around 200 µL/L to 300 µL/L, but then drops and remains well below 100 µL/L and does not exceed 30 µL/L in the house. It can also be seen in Figure 39 that the temperature difference between the rooms of the house with the open doors resulted in very uniform concentrations regardless of ambient temperature. The other garage source cases have mostly similar patterns with the primary difference among all the cases with different door positions being the peak garage and house concentrations reached.

Table 22 presents the peak CO concentrations in the house (not including utility room) and garage for all of the garage source cases. In general, for a specific set of door positions, increasing the ambient temperature from cold to mild to hot resulted in higher garage and house CO concentrations with the impact of a change from cold to hot being as large as a factor of 3. The results for cases 4 through 6 show that adding the open house door increased the peak house CO concentration, but the concentrations were still at or below 50 µL/L in the house.

As expected, the results for cases 7 through 9 with the garage source, closed bay door, closed house door and cat muffler show that with the garage bay door closed the CO concentration reaches much higher peak concentrations in both the garage (850 µL/L to 1300 µL/L) and house (30 µL/L to 100 µL/L) compared to the garage bay door open cases. As shown for cases 10 through 12, opening the house door results in slightly lower garage CO (710 µL/L to 810 µL/L) but higher house CO (70 µL/L to 160 µL/L) compared to cases 7 through 9 as more CO migrates to the house from the garage through the open door.

The larger CO source for the prototype with noncat muffler (cases 13 through 24 in Table 22) resulted in peak garage CO concentrations approximately 2 to 3 times higher than for the equivalent case with cat muffler. The increase in peak house CO concentrations due to the noncat muffler source ranged from a factor of 3 to 4. The noncat muffler source results also display the same impacts due to door opening/closing and ambient temperature as the cat muffler source cases. The highest peak garage CO concentrations were for the noncat source with closed bay door and closed house door at 4300 µL/L while the highest peak house CO concentration was for the noncat source with closed bay door and open house door at 530 µL/L.



**Figure 39** Garage source, open bay door, closed house door, cat muffler cases (a) cold ( $0^{\circ}\text{C}$ ), (b) mild ( $15^{\circ}\text{C}$ ), (c) hot ( $30^{\circ}\text{C}$ ) ambient temperature

**Table 22 Simulation results for garage source cases**

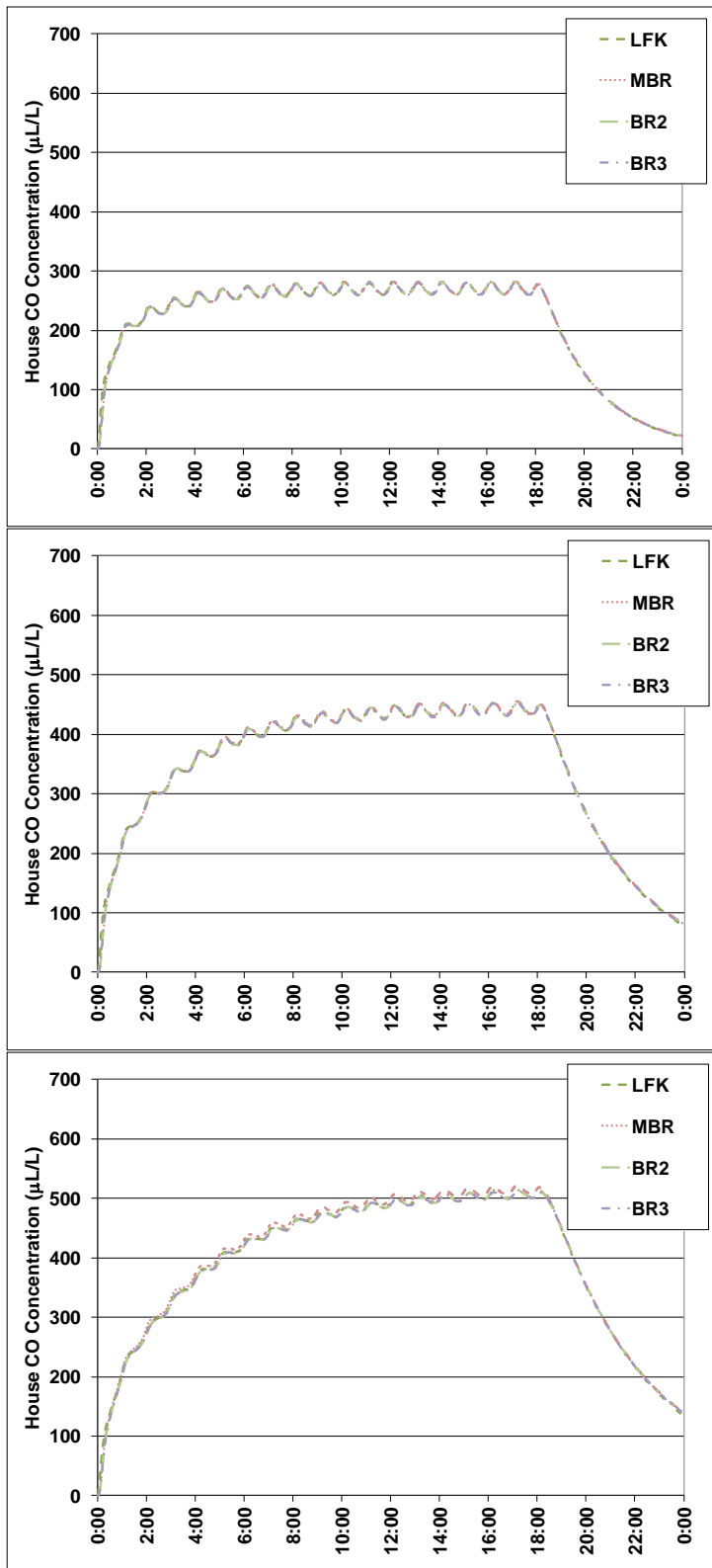
| <b>Sim ID</b> | <b>Source location</b> | <b>Generator</b> | <b>Bay door</b> | <b>House Door</b> | <b>Weather</b> | <b>Garage Peak CO Concentration (µL/L)</b> | <b>House Peak CO Concentration, (Excluding Utility Room) (µL/L)</b> |
|---------------|------------------------|------------------|-----------------|-------------------|----------------|--|---|
| 1             | garage                 | SO1 cat          | open            | closed            | cold           | 170  | 10  |
| 2             | garage                 | SO1 cat          | open            | closed            | mild           | 260  | 20  |
| 3             | garage                 | SO1 cat          | open            | closed            | hot            | 300  | 30  |
| 4             | garage                 | SO1 cat          | open            | open              | cold           | 170  | 20  |
| 5             | garage                 | SO1 cat          | open            | open              | mild           | 240  | 30  |
| 6             | garage                 | SO1 cat          | open            | open              | hot            | 300  | 50  |
| 7             | garage                 | SO1 cat          | closed          | closed            | cold           | 850  | 30  |
| 8             | garage                 | SO1 cat          | closed          | closed            | mild           | 1000                                       | 60  |
| 9             | garage                 | SO1 cat          | closed          | closed            | hot            | 1300                                       | 100   |
| 10            | garage                 | SO1 cat          | closed          | open              | cold           | 710  | 70  |
| 11            | garage                 | SO1 cat          | closed          | open              | mild           | 770  | 110   |
| 12            | garage                 | SO1 cat          | closed          | open              | hot            | 810  | 160   |
| 13            | garage                 | SO1 noncat       | open            | closed            | cold           | 330  | 40  |
| 14            | garage                 | SO1 noncat       | open            | closed            | mild           | 500  | 60  |
| 15            | garage                 | SO1 noncat       | open            | closed            | hot            | 600  | 100   |
| 16            | garage                 | SO1 noncat       | open            | open              | cold           | 310  | 70  |
| 17            | garage                 | SO1 noncat       | open            | open              | mild           | 470  | 90  |
| 18            | garage                 | SO1 noncat       | open            | open              | hot            | 600  | 150   |
| 19            | garage                 | SO1 noncat       | closed          | closed            | cold           | 2700                                       | 100   |
| 20            | garage                 | SO1 noncat       | closed          | closed            | mild           | 3300                                       | 190   |
| 21            | garage                 | SO1 noncat       | closed          | closed            | hot            | 4300                                       | 350   |
| 22            | garage                 | SO1 noncat       | closed          | open              | cold           | 2000                                       | 250   |
| 23            | garage                 | SO1 noncat       | closed          | open              | mild           | 2300                                       | 380   |
| 24            | garage                 | SO1 noncat       | closed          | open              | hot            | 2600                                       | 530   |

## Utility source

Simulations were also performed with the generator operating in the living space of the house as opposed to the garage. Figure 40 presents the simulation results for the cold, mild and hot ambient temperature cases with Gen SO1 operating in the utility room with the door closed. For these cases, the CO concentration in the house (not including the utility room in which the peak concentration exceeds 5000  $\mu\text{L/L}$ ) reaches a peak of 280  $\mu\text{L/L}$  to 520  $\mu\text{L/L}$ . The variation on the house peak CO concentration due to variations in the ambient temperature was close to a factor of two, with higher concentration associated with higher temperature. The other utility room source cases (listed in Table 23) showed a similar effect of ambient temperature. However, there was no notable effect on the CO distribution among the different rooms in the house.

Table 23 presents the peak CO concentrations in the house (not including utility room) and in the utility room (not including the initial concentration spike) for all of the utility source cases. The results for cases 28 through 30 show that adding the open utility door increased the peak house CO concentrations by up to 20 % compared to the closed utility door cases. As seen in Table 23 for cases 31 through 36, the larger CO source for the prototype with noncat muffler results in the peak CO concentration in the house (not including the utility room) increasing by a factor of 3 to 4 times the equivalent cat muffler cases. The worst case is the prototype with noncat muffler in the utility room with the door open and hot weather which results in a peak house CO concentration of about 2000  $\mu\text{L/L}$ .





**Figure 40** Utility source, closed utility door, cat muffler cases (a) cold (0°C), (b) mild (15°C), (c) hot (30°C) ambient temperature

**Table 23 Simulation results for utility source cases**

| Sim ID | Source location | Generator  | Utility door | Weather | Utility Room Peak CO Concentration (excluding initial spike) ( $\mu\text{L/L}$ ) | House Peak CO Concentration, (excluding utility room) ( $\mu\text{L/L}$ ) |
|--------|-----------------|------------|--------------|---------|--|---|
| 25     | utility         | SO1 cat    | closed       | cold    | 2200   | 280   |
| 26     | utility         | SO1 cat    | closed       | mild    | 2500   | 460   |
| 27     | utility         | SO1 cat    | closed       | hot     | 3500   | 520   |
| 28     | utility         | SO1 cat    | open         | cold    | 1200   | 330   |
| 29     | utility         | SO1 cat    | open         | mild    | 1400   | 490   |
| 30     | utility         | SO1 cat    | open         | hot     | 1500   | 600   |
| 31     | utility         | SO1 noncat | closed       | cold    | 6000   | 950   |
| 32     | utility         | SO1 noncat | closed       | mild    | 6600   | 1500  |
| 33     | utility         | SO1 noncat | closed       | hot     | 7500   | 1900  |
| 34     | utility         | SO1 noncat | open         | cold    | 3500   | 1100  |
| 35     | utility         | SO1 noncat | open         | mild    | 3700   | 1600  |
| 36     | utility         | SO1 noncat | open         | hot     | 4100   | 2000  |

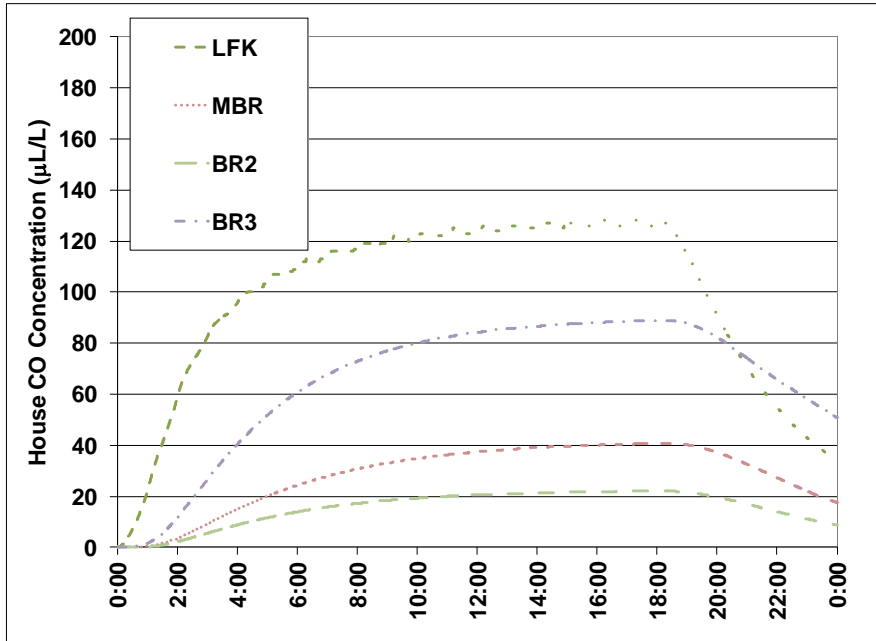
**Closed bedroom door cases**

The cases presented in Tables 22 and 23 all included open bedroom doors, which results in significant mixing between house zones. Selected cases were also simulated with closed bedroom doors to examine the impact of this factor, in part to understand the CO exposure for cases in which occupants sleep with their bedroom doors closed.

Figure 41 presents the simulation results for mild ambient temperature case with Gen SO1 with cat muffler operating in the garage with closed bay door, open house door, and closed bedroom doors. As expected, this case results in far less uniform house zone concentrations than the open bedroom door cases, which range from a peak of 20  $\mu\text{L/L}$  in the BR2 zone to 130  $\mu\text{L/L}$  in the LFK zone.

Table 24 presents the peak house CO concentration for all 6 closed bedroom door cases which show an increase in peak concentration of up to about 30 % in the LFK zone

compared to the equivalent cases with open bedroom doors; however, the bedrooms had generally lower concentrations, with the impact ranging from about an 80 % decrease to about a 2 % increase.



**Figure 41** CO concentrations for garage source, closed bay door, open house door, mild ambient temperature, cat muffler with closed bedroom doors

**Table 24 Simulation results for closed bedroom door cases**

| Sim ID | Source location | Generator  | Bay or Utility door | House door | Weather | House Peak CO Concentration (excluding utility room) (µL/L) |
|--------|-----------------|------------|---------------------|------------|---------|---|
| 37     | garage          | SO1 cat    | closed              | open       | mild    | 130   |
| 38     | garage          | SO1 cat    | closed              | closed     | cold    | 40  |
| 39     | garage          | SO1 noncat | open                | open       | hot     | 160   |
| 40     | garage          | SO1 noncat | closed              | open       | mild    | 450   |
| 41     | utility         | SO1 cat    | open                | NA         | mild    | 490   |
| 42     | utility         | SO1 noncat | closed              | NA         | cold    | 1000  |

### **Discussion of Simulation Results**

A set of 42 simulations were performed to examine the potential performance of the prototype generator with and without the catalyst in the muffler under a wider range of

conditions than studied during the experiments at the test house. All of the simulations were based on the NIST manufactured test house model and the reduced CO emission prototype generator, which was extensively validated as described above. Model parameters that were varied included ambient conditions, CO emission rates, source locations and door positions.

As expected the highest house CO concentrations were found for the generator with noncat muffler operated in the utility room of the house, with indoor CO concentrations reaching 2000  $\mu\text{L/L}$  for one case. Operation of the generator with cat muffler in the utility room substantially reduced CO concentrations, however, they still reached high levels of 280  $\mu\text{L/L}$  to 600  $\mu\text{L/L}$ . The lowest indoor CO concentrations resulted from operation of the cat muffler generator in the garage with peak house CO concentrations as low as 10  $\mu\text{L/L}$  (after an initial spike on start-up). Simulations also showed that, as expected, closed bedroom doors resulted in less uniform indoor concentrations and higher peak concentrations in the LFK zone (up to a 30 % increase) and typically lower peak concentrations in the bedrooms (up to an 80 % decrease).

## Conclusion

Under an interagency agreement with CPSC, NIST conducted a series of tests to characterize the indoor time course profiles of CO concentrations resulting from portable generators. These tests include both unmodified as well as modified low CO emission prototype configurations, operating in the attached garage of a home under various use and environmental conditions, and were conducted so CPSC staff could analyze the safety implications of operating the generators under these conditions. NIST used those test data to validate the ability of the CONTAM model to predict CO levels in the garage and the house and to develop an estimate of the uncertainty of its predictions relative to the measured values. NIST also conducted tests with the generators operating in a one-zone shed to derive their CO emission and O<sub>2</sub> consumption rates, to be used as input to their model validation effort as well as for simulations conducted to examine the potential performance of the low CO-emission prototype under a wider range of operating conditions.

### Shed Tests

Very limited study has been conducted directly on CO emission and O<sub>2</sub> consumption rates associated with gasoline-powered generators running indoors. Brown (2006) studied the CO emission rates from four different commercially-available generators in an enclosed experimental chamber, where air temperature and air change rate were controlled to provide different operating conditions. However, the air change rates were generally quite high compared with typical residences. Operating a generator in an enclosed space such as a garage or a storage shed, as opposed to a laboratory chamber, will be subject to uncontrolled temperatures and to lower ventilation rates determined by ambient weather conditions. To determine generator CO emission rates, tests were conducted in a single-zone shed on generators operating in the unmodified carbureted configuration as well as in the low CO emission prototype configuration. A literature search did not reveal previous studies on CO emission from generators in real conditions, where O<sub>2</sub> levels can become significantly lower than ambient, and thereby impact CO emission.

For two different unmodified generators (*i.e.*, without CO emission controls), it was found that CO emissions ranged from a low of around 500 g/h at near ambient O<sub>2</sub> levels to a high of nearly 4000 g/h as O<sub>2</sub> approach 17 %. The rates of CO generation and O<sub>2</sub> consumption in these unmodified generators were affected by multiple parameters, with the O<sub>2</sub> level in the space and the actual electrical output of the generator being two of the most important. Tests performed below 17 % O<sub>2</sub> showed a drop off in CO emissions due to poor engine performance under these conditions. Tests of two modified low CO emission prototype generators (*i.e.*, with CO emission controls) showed reductions of CO emissions of over 90 % depending on the specific emission controls and operating conditions and no trend toward higher emission rates was seen as O<sub>2</sub> levels dropped to 18 %.

### Garage Tests

A series of tests were also conducted to measure the emission and transport of CO due to operating portable gasoline-powered generators in an attached garage. This series of tests

included both unmodified and UA-modified prototype generators operated in the garage attached to NIST's manufactured test house. Testing was conducted under seven different test house/garage configurations to evaluate their impacts on the buildup of CO in the garage and its transport into the different rooms in the house. These configurations included two different garage bay door positions (fully closed or open 0.6 m), two connecting door settings between the garage and the family room (fully closed or open 5 cm), and two house central heating, ventilating, and air conditioning (HVAC) fan settings (on or off). CO concentrations varied widely with peak house CO concentrations ranging from under 10  $\mu\text{L/L}$  to over 10,000  $\mu\text{L/L}$ . As expected, the highest concentrations resulted from operation of the unmodified generator in the garage with the bay door closed and the house access door open. The lowest concentrations resulted from operation of a reduced-emission prototype in the garage with the bay door open and the house access door closed.

These garage tests documented reductions of 85 % to 98 % in CO concentrations due to emissions from two modified, prototype low CO-emission portable generators compared to a "stock" unmodified generator. Note that these results apply to the specific units tested and that other units, modifications and test conditions may produce different results.

## **Simulations**

A set of 42 simulations were performed with the NIST CONTAM model to examine the potential performance of the prototype generators under a wider range of conditions than studied during the experiments at the test house. All of the simulations were based on the NIST manufactured test house model and the tested reduced CO emission prototype generator. Model parameters that were varied included ambient conditions, CO emission rates, source locations and door positions.

An extensive model validation effort was first carried out using results from seven garage tests to establish the ability of the CONTAM model to predict CO levels in the garage and the house and to develop an estimate of its uncertainty of these predictions relative to the measured values. An absolute validation of a complex model, such as CONTAM, is impossible as there are infinite possible building models that can be created by a user. For the cases modeled in this effort, no significant errors in the CONTAM model were identified. The agreement between the measurements and predictions of the  $\text{O}_2$  concentrations in the garage and of the average CO calculated for the house zones for the collective set of data was excellent. All of the calculated statistical values met the ASTM D5157 criteria. The agreement, however, was somewhat worse for the garage CO concentrations, with some parameters falling slightly outside the ASTM criteria limits. Overall, the average individual house zone and garage CO concentration predictions and measurements were within about 20 % and 30 % respectively when averaged over all cases.

As expected, the highest house CO concentrations were found for the generator with noncat muffler operated in the utility room of the house, with indoor CO concentrations exceeding 2000  $\mu\text{L/L}$  for some cases. Operation of the generator with cat muffler

substantially reduced CO concentrations; however, they still reached levels of 280  $\mu\text{L/L}$  to 600  $\mu\text{L/L}$ . The lowest indoor CO concentrations resulted from operation of the generator with cat muffler in the garage with CO concentrations in the house reaching 10  $\mu\text{L/L}$  to 160  $\mu\text{L/L}$ . Simulations also showed that, as expected, closed bedroom doors resulted in less uniform indoor concentrations and higher peak concentrations in the LFK zone (up to a 30 % increase) and typically lower peak concentrations in the bedrooms (up to an 80 % decrease).

## Acknowledgements

This research was supported by the U.S. Consumer Product Safety Commission (CPSC) under interagency agreement CPSC-I-06-0012. The authors would like to acknowledge the contributions of Donald W. Switzer, Janet Buyer, Christopher J. Brown, Sandy Inkster, Han Lim and Susan Bathalon from CPSC, and Gregory T. Linteris and Steven J. Nabinger from NIST.

## References

- Air Products. 2006. Material Safety Data Sheet (MSDS) for Sulfur Hexafluoride.
- ASHRAE. 2009. *Handbook of Fundamentals Chapter 16*. ASHRAE.
- ASTM. 2008. *Standard Guide for Statistical Evaluation of Indoor Air Quality Models*. D5157-08 American Society for Testing and Materials.
- ASTM. 2006. *Standard test method for determining air change in a single zone by means of a tracer gas dilution*. E741-06 American Society for Testing and Materials.
- ASTM. 2010. *Standard Test Method for Determining Air Leakage Rate by Fan Pressurization*. E779-10 American Society for Testing and Materials.
- Bassett, M. Infiltration and Leakage Paths in Single Family Houses - a Multizone Infiltration Case Study. (1990) AIVC Technical Note 27, Air Infiltration and Ventilation Centre.
- Brown, C. J. 2006. Engine-drive Tools, Phase 1 Test Report for Portable Electric Generators; U.S. Consumer Product Safety Commission: Bethesda, MD.
- CFR. 2007. 16 CFR part 1407, *Portable Generators; Final Rule; Labeling Requirements*, Federal Register, 72 FR 1443, January 12, 2007 and January 18, 2007.
- CPSC. Portable Generators: Legal Memorandum and staff briefing package for advance notice of proposed rulemaking (ANPR); U.S. Consumer Product Safety Commission: Bethesda, MD, 2006; p 295.

CPSC. Performance and accountability report; U.S. Consumer Product Safety Commission: Bethesda, MD, November, 2007; p 140.

CPSC. Technology Demonstration of a Prototype Low Carbon Monoxide Emission Portable Generator; U.S. Consumer Product Safety Commission: Bethesda, MD, August, 2012; p 413.

Dols WS and Walton GN. *CONTAM User Guide and Program Documentation* (2008) NISTIR 7251, National Institute of Standards and Technology.

Emmerich SJ and Nabinger SJ. *Measurement and Simulation of the IAQ Impact of Particle Air Cleaners in a Single-Zone Building*. (2001) International Journal of HVAC&R Research Vol. 1, No. 7, ASHRAE.

Emmerich SJ. “Validation of Multizone IAQ Modeling of Residential-scale Buildings: A Review” (2001) ASHRAE Transactions Vol. 107.2. 49.

Emmerich, S.J., Gorfain, J.E., Howard-Reed, C., Air and Pollutant Transport from Attached Garages to Residential Living Spaces-Literature Review and Field Test (2003) International Journal of Ventilation, Vol., 2 (3).

Emmerich, S. J., & Persily, A. K. (1996). Multizone modeling of three residential indoor air quality control options. *Building Simulation '95*.

Emmerich, S. J., Persily, A., & Nabinger, S. 2002. Modeling moisture in residential buildings with a multizone IAQ program. *Proceedings of Indoor Air 2002*.

Emmerich, S. J., Reed, C. H., & Gupta, A. (2005). *Modeling the IAQ impact of HHI interventions in inner-city housing*. NISTIR 5212, National Institute of Standards and Technology.

Emmerich, S.J., Howard-Reed, C., Nabinger, S.J., Validation of Multizone IAQ Model Predictions for Tracer Gas in a Townhouse (2004) *Building Services Engineering Research and Technology*, Vol. 25 (4).

Emmerich, S. and Wang, L. 2011. Measured CO Concentrations at NIST IAQ Test House from Operation of Portable Electric Generators in Attached Garage – Interim Report to U.S. Consumer Products Commission.

Hnatov, M. V. 2012. Incidents, Deaths, and In-Depth Investigations Associated with Non-Fire Carbon Monoxide from Engine-Driven Generators and Other Engine-Driven Tools, 1999-2011; U.S. Consumer Product Safety Commission: Bethesda, MD.



Hnatov, M.V. 2011. Non-Fire Carbon Monoxide Deaths Associated with the Use of Consumer Products, 2008 Annual Estimates, U.S. Consumer Product Safety Commission, Bethesda, MD.

Luce, C., Heiser, B., Siemer, M., and B. Smith. 2006. Redesign of the mud buggy to reduce emissions by conversion to propane fuel. In Multi-disciplinary engineering design conference, Rochester, NY.

Nabinger, SJ, AK Persily, and WS Dols. 2010. Impacts of Airtightening Retrofits on Ventilation Rates and Energy Consumption in a Manufactured Home. NIST Technical Note 1673.

Nabinger, SJ and AK Persily. 2008. *Airtightness, Ventilation and Energy Consumption in a Manufactured House: Pre-Retrofit Results*. NISTIR 7478.

Proctor, C. L.; Berger, M. C.; Fournier, D. L.; and S. Roychoudhury. 1987. Sulfur hexafluoride as a tracer for the verification of waste-destruction levels in an incineration process. Florida University.

Stewart, R. D. 1975. The effect of carbon monoxide on humans. Annual review of pharmacology . 15, 409-23.

Taylor, B. N., C. E. Kuyatt and T. National Institute of Standards and. 1994. Guidelines for evaluating and expressing the uncertainty of NIST measurement results. Gaithersburg, MD: U.S. Dept. of Commerce, Technology Administration, National Institute of Standards and Technology.

Wang, L., and Emmerich, S.J. 2010. In situ Experimental Study of Carbon Monoxide Generation by Gasoline-Powered Electric Generator in an Enclosed Space. Journal of the Air & Waste Management Association, Vol 60(12).

Wang, L., Emmerich, S.J., Persily A.K. and C-C Lin. 2012. Carbon Monoxide Generation, Dispersion and Exposure from Indoor Operation of Gasoline-powered Electric Generators under Actual Weather Conditions. Building and Environment 56: 283-290.

## Appendix A Uncertainty Analysis of Shed Measurements

This Appendix presents the uncertainty analysis method for calculation of the CO emission and O<sub>2</sub> consumption rates determined from testing the generators in the test shed. Sample calculations are presented in detail.

The uncertainty of A<sub>out</sub> can be expressed as:

$$A_{out} = \frac{(\ln C_{SF_6,t1} - \ln C_{SF_6,t2})}{t2 - t1} + \frac{Q_{gen,in}}{V_s} K_{SF_6,d} = A1 + A2$$

So the propagation of uncertainty for A<sub>out</sub>

$$u_c^2(A_{out}) = u^2(A1) + u^2(A2) + 2u(A1, A2)$$

u(A1) is calculated from

$$u(A1) = A1 / \frac{\tan(\arccos(r(\ln C, t)))}{(N - 2)^{1/2}}$$

r(lnC, t) is the correlation coefficient of lnC and t.

From our pretests of checking SF<sub>6</sub> decomposition, the covariance of A1 and A2

$$u(A1, A2) = -0.07341\%$$

$$u^2(A2) = \left(\frac{K_{SF_6,d}}{V_s}\right)^2 u^2(Q_{gen,in}) + \left(\frac{Q_{gen,in}}{V_s}\right)^2 u^2(K_{SF_6,d}) + \frac{2K_{SF_6,d}Q_{gen,in}}{V_s^2} u(Q_{gen,in}, K_{SF_6,d})$$

K<sub>SF<sub>6,d</sub></sub> = -4 %, which were obtained from our pretests of the SF<sub>6</sub> decomposition.

To get the uncertainty of Q<sub>gen,in</sub>, we can look at the uncertainty propagation of Eq. (6)

$$u(Q_{gen,in}) = \sqrt{\left(D_{gen} \frac{RPM}{2}\right)^2 u^2(\eta_{gen})}$$

η<sub>gen</sub> is 85 % ± 5 % (Luce et al. 2006) so based on Eq. (A-7) of NIST uncertainty guidance (Taylor et al. 1994), we have

$$u(\eta_{gen}) = \frac{5\%}{\sqrt{3}} = 2.89\%$$

Then u(Q<sub>gen,in</sub>) = 0.99 m<sup>3</sup>/h. If we assume u(Q<sub>gen,in</sub>, K<sub>SF<sub>6,d</sub></sub>) = 0, then

$$A2 = \frac{Q_{gen,in}}{V_s} K_{SF_6,d} = -0.0301$$

$$u^2(A2) = \left(\frac{K_{SF_6,d}}{V_s}\right)^2 u^2(Q_{gen,in}) + \left(\frac{Q_{gen,in}}{V_s}\right)^2 u^2(K_{SF_6,d})$$

$$u(A2) = 0.0131$$

### Example of $A_{out}$ Uncertainty Calculation

To calculate the uncertainty of air change rate in Test 1 of Table 2:

$$u(A1) = 0.18$$

$$u(A1, A2) = -0.07341\%$$

$$u(A2) = 0.0131$$

So  $u_c(A_{out}) = \sqrt{u^2(A1) + u^2(A2) + 2u(A1, A2)} = 0.2$ . For a confidence level of 95%, select  $k = 2$ , then  $k \cdot u_c(A_{out}) = 0.4$ ,  $A_{out} = 6.5 \pm 0.4 \text{ hr}^{-1}$

### Uncertainty of CO Emission Rate

$$S_{CO} = \rho_{CO,in} A_{out} V_s \frac{C_{CO,t2} - C_{CO,t1} e^{A_{out}(t1-t2)}}{1 - e^{A_{out}(t1-t2)}} = f(\rho_{CO,in}, A_{out}, C_{CO,t2}, C_{CO,t1})$$

The uncertainty propagation for  $S_{CO}$  was estimated as

$$u_c^2(S_{CO}) = \left(\frac{\partial f}{\partial \rho_{CO,in}}\right)^2 u^2(\rho_{CO,in}) + \left(\frac{\partial f}{\partial A_{out}}\right)^2 u^2(A_{out}) + \left(\frac{\partial f}{\partial C_{CO,t2}}\right)^2 u^2(C_{CO,t2}) + \left(\frac{\partial f}{\partial C_{CO,t1}}\right)^2 u^2(C_{CO,t1})$$

where

$$\frac{\partial f}{\partial \rho_{CO,in}} = A_{out} V_s \frac{C_{CO,t2} - C_{CO,t1} e^{A_{out}(t1-t2)}}{1 - e^{A_{out}(t1-t2)}} = \frac{S_{CO}}{\rho_{CO,in}}$$

$$\begin{aligned} \frac{\partial f}{\partial A_{out}} &= \frac{S_{CO}}{A_{out}} + \rho_{CO,in} A_{out} V_s \left[ \frac{(-C_{CO,t1})(t1-t2)e^{A_{out}(t1-t2)}}{1 - e^{A_{out}(t1-t2)}} \right. \\ &\quad \left. + \frac{(t1-t2)e^{A_{out}(t1-t2)}(C_{CO,t2} - C_{CO,t1}e^{A_{out}(t1-t2)})}{(1 - e^{A_{out}(t1-t2)})^2} \right] \end{aligned}$$

$$\frac{\partial f}{\partial C_{CO,t2}} = \rho_{CO,in} A_{out} V_s \frac{1}{1 - e^{A_{out}(t1-t2)}}$$

$$\frac{\partial f}{\partial C_{CO,t1}} = -\rho_{CO,in} A_{out} V_s \frac{e^{A_{out}(t1-t2)}}{1 - e^{A_{out}(t1-t2)}}$$

To account for the uncertainty of using averaged density during  $\Delta t$

$$u(\rho_{CO,in}) = \left[ \frac{1}{N(N-1)} \sum_{i=1}^N (\rho_{CO,in,i} - \overline{\rho_{CO,in}})^2 \right]^{1/2}$$

$u(C_{CO,t2})$  and  $u(C_{CO,t1})$  were obtained from calibration curves of the CO analyzer as follows.

Suppose the regression function from a calibration curve is

$$Y = B1 + B2 \cdot X$$

where  $X$  is the expected value, for example, a known concentration of a gas cylinder, and  $Y$  is the measured value during calibration.

During a formal test, if  $Y$  is the measured raw data

$$X_c = (Y - B1) / B2$$

Where  $X_c$  is the corrected data by using the calibration curve, whose uncertainty can be determined from:

$$u(X_c) = \sqrt{C_Y^2 u^2(Y) + C_{B1}^2 u^2(B1) + C_{B2}^2 u^2(B2) + 2C_{B1}C_{B2}u(B1, B2)}$$

where

$$C_Y = \frac{\partial X_c}{\partial Y} = \frac{1}{B2}$$

$$C_{B1} = \frac{\partial X_c}{\partial B1} = -\frac{1}{B2}$$

$$C_{B2} = \frac{\partial X_c}{\partial B2} = -\frac{(Y - B1)}{B2^2}$$

$u(Y) = \frac{a}{\sqrt{3}}$ , which can be either determined as a Type B uncertainty from  $a$ , the accuracy of the analyzer, or as a standard deviation for a Type A uncertainty if multiple observations of  $Y$  are available.

$$u(B1, B2) = -\bar{X}u^2(B2)$$

where  $\bar{X}$  is the averaged  $X$  of the expected value during a calibration.

#### An Example of CO Emission Rate Uncertainty Calculation

The maximum CO emission rate of Test 1 in Table 2 is 900 g/h.  $\frac{\partial f}{\partial \rho_{CO,in}} = 0.81$ ;  $\frac{\partial f}{\partial A_{out}} = 0.10$ ;  $\frac{\partial f}{\partial C_{CO,t2}} = 531.14$ ;  $\frac{\partial f}{\partial C_{CO,t1}} = -337.59$ ;  $u(\rho_{CO,in}) = 0.001$

From a calibration curve of the CO analyzer for this test,  $u(C_{CO,t1}) = 91.03 \text{ mg/m}^3$ ;  $u(C_{CO,t2}) = 88.09 \text{ mg/m}^3$ ; So the uncertainty of  $S_{CO}$  when  $S_{CO} = 878 \text{ g/h}$  is

$$u_c(S_{CO}) = \sqrt{\left(\frac{\partial f}{\partial \rho_{CO,in}}\right)^2 u^2(\rho_{CO,in}) + \left(\frac{\partial f}{\partial A_{out}}\right)^2 u^2(A_{out}) + \left(\frac{\partial f}{\partial C_{CO,t2}}\right)^2 u^2(C_{CO,t2}) + \left(\frac{\partial f}{\partial C_{CO,t1}}\right)^2 u^2(C_{CO,t1})}$$

$\approx 60 \text{ g/hr}$

For a confidence level of 95 % and  $k = 2$ ,  $S_{CO} = 900 \pm 120 \text{ g/h}$

#### Uncertainty of O<sub>2</sub> Consumption Rate

$$S_{O_2} = \rho_{O_2,in} A_{out} V_s \frac{C_{O_2,t2} - C_{O_2,t1} e^{A_{out}(t1-t2)}}{1 - e^{A_{out}(t1-t2)}} - \frac{\rho_{O_2,out} A_{out} V_s}{K_{m,\rho}} C_{O_2,out} = f(\rho_{O_2,in}, A_{out}, C_{O_2,t2}, C_{O_2,t1}, K_{m,\rho})$$

The uncertainty propagation for  $S_{O_2}$  was

$$u_c^2(S_{O_2}) = \left(\frac{\partial f}{\partial \rho_{O_2,in}}\right)^2 u^2(\rho_{O_2,in}) + \left(\frac{\partial f}{\partial A_{out}}\right)^2 u^2(A_{out}) + \left(\frac{\partial f}{\partial C_{O_2,t2}}\right)^2 u^2(C_{O_2,t2}) + \left(\frac{\partial f}{\partial C_{O_2,t1}}\right)^2 u^2(C_{O_2,t1})$$

$$+ \left(\frac{\partial f}{\partial K_{m,\rho}}\right)^2 u^2(K_{m,\rho}) + \left(\frac{\partial f}{\partial S_{gen}}\right)^2 u^2(S_{gen})$$

where

$$\frac{\partial f}{\partial \rho_{O_2,in}} = A_{out} V_s \frac{C_{O_2,t2} - C_{O_2,t1} e^{A_{out}(t1-t2)}}{1 - e^{A_{out}(t1-t2)}}$$

$$\frac{\partial f}{\partial A_{out}} = \rho_{O_2,in} V_s \frac{C_{O_2,t2} - C_{O_2,t1} e^{A_{out}(t1-t2)}}{1 - e^{A_{out}(t1-t2)}} + \rho_{O_2,in} A_{out} V_s \left[ \frac{(-C_{O_2,t1})(t1-t2)e^{A_{out}(t1-t2)}}{1 - e^{A_{out}(t1-t2)}} \right. \\ \left. + \frac{(t1-t2)e^{A_{out}(t1-t2)}(C_{O_2,t2} - C_{O_2,t1} e^{A_{out}(t1-t2)})}{(1 - e^{A_{out}(t1-t2)})^2} \right] - \frac{\rho_{O_2,out} V_s C_{O_2,out}}{K_{m,\rho}}$$

$$\frac{\partial f}{\partial C_{O_2,t2}} = \rho_{O_2,in} A_{out} V_s \frac{1}{1 - e^{A_{out}(t1-t2)}}$$

$$\frac{\partial f}{\partial C_{O_2,t1}} = -\rho_{O_2,in} A_{out} V_s \frac{e^{A_{out}(t1-t2)}}{1 - e^{A_{out}(t1-t2)}}$$

$$\frac{\partial f}{\partial K_{m,\rho}} = \frac{\rho_{O_2,out} A_{out} V_s}{K_{m,\rho}^2} C_{O_2,out}$$

$$u(\rho_{O_2,in}) = \left[ \frac{1}{N(N-1)} \sum_{i=1}^N (\rho_{O_2,in,i} - \overline{\rho_{O_2,in}})^2 \right]^{1/2}$$

$$u(A_{out}) = [u^2(A1) + u^2(A2) + 2u(A1, A2)]^{1/2}$$

$u(C_{O_2,t2})$  and  $u(C_{O_2,t1})$  can be obtained using the same method as  $u(C_{CO_2,t2})$  and  $u(C_{CO_2,t1})$ .

$$K_{m,\rho} = \frac{\rho_{air,out}}{\rho_{m,in}}$$

$$u(K_{m,\rho}) = \left[ \frac{1}{N(N-1)} \sum_{i=1}^N (K_{m,\rho,i} - \overline{K_{m,\rho}})^2 \right]^{1/2}$$

### Example of O<sub>2</sub> Consumption Rate Uncertainty Calculation

The maximum O<sub>2</sub> consumption rate of Test 1 in Table 2 is 4800 g/hr.  $\frac{\partial f}{\partial \rho_{O_2,in}} = 55.79$ ;

$$\frac{\partial f}{\partial A_{out}} = -0.69; \quad \frac{\partial f}{\partial C_{O_2,t2}} = 743.30; \quad \frac{\partial f}{\partial C_{O_2,t1}} = -395.40; \quad \frac{\partial f}{\partial K_{m,\rho}} = 65.41; \quad u(\rho_{O_2,in}) = \\ 4.6 \times 10^{-4}; \quad u(C_{O_2,t2}) = u(C_{O_2,t1}) = 0.01\%$$

When neglecting the added fuel from the generator to the shed,  $S_{gen} = 0$

$$u_c^2(S_{O_2}) = \left(\frac{\partial f}{\partial \rho_{O_2, in}}\right)^2 u^2(\rho_{O_2, in}) + \left(\frac{\partial f}{\partial A_{out}}\right)^2 u^2(A_{out}) + \left(\frac{\partial f}{\partial C_{O_2, t2}}\right)^2 u^2(C_{O_2, t2}) + \left(\frac{\partial f}{\partial C_{O_2, t1}}\right)^2 u^2(C_{O_2, t1})$$

$$+ \left(\frac{\partial f}{\partial K_{m, \rho}}\right)^2 u^2(K_{m, \rho})$$

$u_c(S_{O_2}) \approx 170$  g/h. For a confidence level of 95% and  $k = 2$ ,  $S_{O_2} = 4800 \pm 340$  g/h

## Appendix B Summary of Instrument Calibrations

This table summarizes the calibrations of the CO and O<sub>2</sub> analyzers covering the testing periods included in this report. The table includes the date of the calibrations, the standard error for each instrument channel for each calibration, and the average standard error and the average standard error relative to the full scale for each device based on all of the calibrations. Not all analyzer channels were calibrated on each date due to instrument failure or other issues. Table 3 in the report describes which instrument was used for each test, and the instruments are described in the Instrumentation section of the main body. For comparison, the manufacturer's stated accuracy for all of these analyzers is 1 % of full scale.

|                                    | N2             | N1             | N2            | N2            | N1            | N1            | Nova3           | TE              | RM              |
|------------------------------------|----------------|----------------|---------------|---------------|---------------|---------------|-----------------|-----------------|-----------------|
| Date                               | O <sub>2</sub> | O <sub>2</sub> | hi CO         | lo CO         | hi CO         | lo CO         | CO              | CO              | CO              |
|                                    | std error (%)  | std error (%)  | std error (%) | std error (%) | std error (%) | std error (%) | std error (ppm) | std error (ppm) | std error (ppm) |
| 3/17/2008                          | 0.0105         | 0.0191         | 0.0160        | 0.0036        | 0.0096        | 0.0056        | NA              | NA              |                 |
| 4/17/2008                          | 0.0203         | 0.0243         | NA            | NA            | NA            | 0.0094        | 26.3            | NA              |                 |
| 4/21/2008                          | 0.482          | 0.0290         | 0.0107        | 0.0033        | 0.0033        | 0.0072        | 23.4            | NA              | NA              |
| 4/29/2008                          | 0.0317         | 0.0299         | 0.0090        | 0.0035        | 0.0026        | 0.0031        | 18.1            | NA              | NA              |
| 5/5/2008                           | 0.0210         | 0.0344         | 0.0052        | 0.0035        | 0.0028        | 0.0056        | 18.1            | NA              | NA              |
| 5/13/2008                          | 0.0255         | 0.0794         | 0.0397        | 0.0229        | 0.0074        | 0.0094        | 10.8            | 23.0            | NA              |
| 5/21/2008                          | 0.0192         | 0.0305         | 0.0026        | 0.0059        | 0.0062        | 0.0094        | 26.0            | 18.0            | NA              |
| 6/2/2008                           | 0.0551         | 0.0225         | 0.0108        | 0.0074        | 0.0065        | 0.0035        | NA              | NA              | NA              |
| 6/10/2008                          | 0.0140         | 0.0298         | 0.0086        | 0.0108        | 0.0081        | 0.0155        | 44.4            | NA              | NA              |
| 3/17/2010                          | 0.239          | NA             | 0.0090        | NA            | 0.0070        | 0.0045        | 14.4            | NA              | NA              |
| 4/9/2010                           | 0.0543         | NA             | 0.0029        | 0.0065        | 0.0091        | 0.0067        | 13.8            | NA              | 0.387           |
| 4/28/2010                          | 0.0625         | NA             | 0.0056        | 0.0004        | 0.0028        | 0.0003        | 11.0            | NA              | NA              |
| 5/12/2010                          | 0.0798         | NA             | 0.0088        | 0.0253        | 0.0028        | 0.0057        | 6.87            | NA              | 3.22            |
| 5/27/2010                          | 0.0745         | NA             | 0.0144        | 0.0215        | 0.0076        | 0.0225        | 11.6            | NA              | 4.62            |
| 7/1/2010                           | 0.0443         | NA             | 0.0086        | 0.0123        | 0.0447        | 0.0056        | 15.9            | NA              | 6.36            |
|                                    |                |                |               |               |               |               |                 |                 |                 |
| <i>Average of all calibrations</i> | 0.0822         | 0.0332         | 0.0108        | 0.0098        | 0.0086        | 0.0076        | 18.5            | 20.5            | 3.65            |
| <i>Percent of full scale</i>       | 0.33           | 0.13           | 0.36          | 1.08          | 0.29          | 0.85          | 1.03            | 2.27            | 0.41            |



## **Appendix C Additional Garage Tests**

Table C1 provides a complete listing of all tests of the portable generators conducted in the test house garage. The results of these tests were not included in the interim report (Emmerich and Wang 2011), but are provided here to support additional analysis of the results. Plots of the test results that were not included in the main body of this report are included in Figures C1 through C27. The tests are grouped by test house configuration (see Table C2 for description of test house configurations).

**Table C1 Additional Tests Conducted in Attached Garage**

| Generator   | Test ID | Date    | Load Profile   | Test house Config | Outdoor Temp (°C) | Wind speed (m/s) | Approx. Run Time (h) | Garage Peak CO Concentration (µL/L) | Lowest Garage O <sub>2</sub> Concentration (%) | Automatic shut-off activated | Notes                                |
|---|---------|---------|----------------|-------------------|-------------------|------------------|----------------------|-------------------------------------|--|------------------------------|--------------------------------------|
| <b>unmod GenX</b>                                 | B       | 4/22/08 | cyclic profile | 1                 | 20.1              | 6.5              | 3                    | 19,500                              | 17.1   | NA                           | Figure 13                            |
| <b>unmod GenX</b>                                 | E       | 5/1/08  | cyclic profile | 1                 | 13.3              | 1.8              | 2                    | 13,100                              | 17.5   | NA                           | Figure C1                            |
| <b>modGenX with cat</b>                           | O       | 4/2/10  | cyclic profile | 1                 | 22                | 6.5              | 4.5                  | 3000                                | 19.4   | NA                           | Figure 14                            |
| <b>SO1 with catmuffler and algorithm disabled</b> | N       | 4/1/10  | cyclic profile | 1                 | 19.9              | 6.3              | 2                    | 300                                 | 19.4   | NA                           | Figure 15                            |
| <b>SO1 with catmuffler and algorithm enabled</b>  | L       | 3/25/10 | cyclic profile | 1                 | 21.3              | 8.4              | 0.5                  | 420                                 | 20.5   | Yes                          | Not plotted due to instrument error. |
| <b>SO1 with catmuffler and algorithm enabled</b>  | M       | 3/31/10 | cyclic profile | 1                 | 15.1              | 10.0             | 0.8                  | 370                                 | 20.3   | Yes                          | Figure C2                            |
| <b>Gen B</b>                                      | P       | 4/6/10  | cyclic profile | 1                 | 34.0              | 9.0              | 2                    | 5500                                | 19.8   | NA                           | Figure C3                            |
| <b>Gen B</b>                                      | AU      | 7/9/10  | cyclic profile | 1                 | 32.0              | 6.5              | 1                    | 3200                                | 20.0   | NA                           | Figure C4                            |
| <b>Gen B</b>                                      | AG      | 5/10/10 | 500 W          | 1                 | 17.5              | 8.6              | 2                    | 5100                                | 20.0   | NA                           | Figure C5                            |

| Generator   | Test ID | Date    | Load Profile | Test house Config | Outdoor Temp (°C) | Wind speed (m/s) | Approx. Run Time (h)       | Garage Peak CO Concentration (µL/L) | Lowest Garage O <sub>2</sub> Concentration (%) | Automatic shut-off activated | Notes      |
|---|---------|---------|--------------|-------------------|-------------------|------------------|----------------------------|-------------------------------------|--|------------------------------|------------|
| <b>SO1 with noncat muffler and algorithm enabled</b>  | AP      | 5/21/10 | 500 W        | 1                 | 23.7              | 6.9              | 0.2                        | 270                                 | 20.9   | Y                            | Figure C6  |
| <b>SO1 with noncat muffler and algorithm enabled</b>  | AV      | 7/9/10  | 500 W        | 1                 | 35.1              | 6.3              | 2<br>(manually shut off)   | 270                                 | 20.3   | No                           | Figure C7  |
| <b>Gen B</b>  | AI      | 5/14/10 | 5500 W       | 1                 | 20.8              | 7.5              | 1.1                        | 5500                                | 19.6   | NA                           | Figure C8  |
| <b>SO1 with noncat muffler and algorithm disabled</b> | AR      | 5/21/10 | 5500 W       | 1                 | 32.8              | 6.7              | 4                          | 920                                 | 19.0   | NA                           | Figure C9  |
| <b>SO1 with noncat muffler and algorithm disabled</b> | AS      | 6/10/10 | 5500 W       | 1                 | 27.6              | 8.5              | 4                          | 890                                 | 19.0   | NA                           | Figure C10 |
| <b>SO1 with noncat muffler</b>                        | AL      | 5/19/10 | 5500 W       | 1                 | 16.9              | 7.9              | 0.7<br>(manually shut off) | 810                                 | 20.1   | No                           | Figure C11 |

| Generator  | Test ID | Date    | Load Profile   | Test house Config | Outdoor Temp (°C) | Wind speed (m/s) | Approx. Run Time (h) | Garage Peak CO Concentration (µL/L) | Lowest Garage O <sub>2</sub> Concentration (%) | Automatic shut-off activated | Notes      |
|--|---------|---------|----------------|-------------------|-------------------|------------------|----------------------|-------------------------------------|--|------------------------------|------------|
| <b>and algorithm enabled</b>                         |         |         |                |                   |                   |                  |                      |                                     |  |                              |            |
| <b>SO1 with noncat muffler and algorithm enabled</b> | AM      | 5/20/10 | 5500 W         | 1                 | 24.0              | 7.7              | 7 min                | 720                                 | 21.0   | Y                            | Figure C12 |
| <b>SO1 with noncat muffler and algorithm enabled</b> | AN      | 5/20/10 | 2500 W         | 1                 | 28.5              | 6.6              | 13 min               | 400                                 | 21.1   | Y                            | Figure C13 |
| <b>unmod GenX</b>                                    | F       | 5/6/08  | cyclic profile | 2                 | 22.8              | 7.7              | 4                    | 1,500                               | 20.5   | NA                           | Figure 16  |
| <b>unmod GenX</b>                                    | H       | 5/14/08 | cyclic profile | 2                 | 23.2              | 4.0              | 4                    | 1,200                               | 20.8   | NA                           | Figure C14 |
| <b>modGenX</b>                                       | R       | 4/12/10 | cyclic profile | 2                 | 19.9              | 6.7              | 4                    | 30                                  | 20.7   | NA                           | Figure 17  |
| <b>SO1 with catmuffler and algorithm disabled</b>    | T       | 4/14/10 | cyclic profile | 2                 | 12.7              | 6.9              | 3                    | 300                                 | 20.7   | NA                           | Figure 18  |
| <b>SO1 with catmuffler and</b>                       | S       | 4/13/10 | cyclic profile | 2                 | 10.5              | 6.4              | 0.9                  | 210                                 | 21.0   | Y                            | Figure C15 |

| Generator   | Test ID | Date    | Load Profile   | Test house Config | Outdoor Temp (°C) | Wind speed (m/s) | Approx. Run Time (h) | Garage Peak CO Concentration (µL/L) | Lowest Garage O <sub>2</sub> Concentration (%) | Automatic shut-off activated | Notes      |
|---|---------|---------|----------------|-------------------|-------------------|------------------|----------------------|-------------------------------------|--|------------------------------|------------|
| <b>algorithm enabled</b>                              |         |         |                |                   |                   |                  |                      |                                     |  |                              |            |
| <b>Gen B</b>  | Q       | 4/7/10  | cyclic profile | 2                 | 30.0              | 7.7              | 4                    | 480                                 | 21.0   | NA                           | Figure C16 |
| <b>unmod GenX</b>                                     | I       | 5/15/08 | cyclic profile | 3                 | 22.8              | 7.4              | 4                    | 18,600                              | 17.5   | NA                           | Figure 19  |
| <b>unmod GenX</b>                                     | A       | 4/18/08 | cyclic profile | 3                 | 24.5              | 2.5              | 1.5                  | 9,200                               | 18.6   | NA                           | Figure C17 |
| <b>unmod GenX</b>                                     | C       | 4/24/08 | cyclic profile | 3                 | 22.2              | 2.9              | 4                    | 21,000                              | 17.0   | NA                           | Figure C18 |
| <b>SO1 with noncat muffler and algorithm disabled</b> | Z       | 5/5/10  | cyclic profile | 3                 | 28.3              | 6.7              | 4.75                 | 630                                 | 19.5   | NA                           | Figure 20  |
| <b>SO1 with noncat muffler and algorithm enabled</b>  | AA      | 5/6/10  | cyclic profile | 3                 | 27.6              | 9.0              | 1.6                  | 1000                                | 20.0   | Y                            | Figure C19 |
| <b>unmod GenX</b>                                     | J       | 5/21/08 | cyclic profile | 4                 | 18.2              | 9.6              | 2.25                 | 21,300                              | 16.0   | NA                           | Figure 21  |
| <b>SO1 with catmuffler and algorithm disabled</b>     | W       | 4/29/10 | cyclic profile | 4                 | 17.8              | 9.5              | 6                    | 960                                 | 18.2   | NA                           | Figure 22  |

| Generator                                      | Test ID | Date    | Load Profile   | Test house Config | Outdoor Temp (°C) | Wind speed (m/s) | Approx. Run Time (h) | Garage Peak CO Concentration (µL/L) | Lowest Garage O <sub>2</sub> Concentration (%) | Automatic shut-off activated | Notes      |
|--|---------|---------|----------------|-------------------|-------------------|------------------|----------------------|-------------------------------------|--|------------------------------|------------|
| SO1 with catmuffler and algorithm enabled      | X       | 4/30/10 | cyclic profile | 4                 | 24.7              | 7.1              | 0.6                  | 730                                 | 19.8   | Y                            | Figure C20 |
| unmod GenX                                     | D       | 4/30/08 | cyclic profile | 5                 | 12.2              | 8.2              | 2                    | 23,000                              | below 16                                       | NA                           | Figure 23  |
| SO1 with noncat muffler and algorithm disabled | AH      | 5/13/10 | cyclic profile | 5                 | 15.6              | 6.5              | 5                    | 2,300                               | 17.8   | NA                           | Figure 24  |
| SO1 with noncat muffler and algorithm enabled  | AB      | 5/7/10  | cyclic profile | 5                 | 21.6              | 6.6              | 1                    | 1500                                | 19.2   | Y                            | Figure C21 |
| SO1 with noncat muffler and algorithm enabled  | AQ      | 5/21/10 | cyclic profile | 5                 | 27.7              | 6.7              | 0.8                  | 660                                 | 19.4   | Y                            | Figure C22 |
| unmod GenX                                     | G       | 5/7/08  | cyclic profile | 6                 | 25.1              | 7                | 2                    | 1,100                               | 20.5   | NA                           | Figure 25  |
| SO1 with catmuffler                            | U       | 4/22/10 | cyclic profile | 6                 | 20.4              | 7.8              | 2                    | 260                                 | 20.9   | NA                           | Figure 26  |

| Generator   | Test ID | Date    | Load Profile                 | Test house Config | Outdoor Temp (°C) | Wind speed (m/s) | Approx. Run Time (h) | Garage Peak CO Concentration (µL/L) | Lowest Garage O <sub>2</sub> Concentration (%) | Automatic shut-off activated                | Notes                               |
|---|---------|---------|------------------------------|-------------------|-------------------|------------------|----------------------|-------------------------------------|--|---|-------------------------------------|
| <b>and algorithm disabled</b>                         |         |         |                              |                   |                   |                  |                      |                                     |  |   |                                     |
| <b>SO1 with catmuffler and algorithm enabled</b>      | Y       | 4/30/10 | cyclic profile               | 6                 | 28.3              | 7.8              | 0.5                  | 250                                 | 21   | Y   | Figure C23                          |
| <b>unmod GenX</b>                                     | K       | 5/23/08 | cyclic profile (high to low) | 7                 | 13.8              | 7                | >2                   | 680                                 | 20.4   | NA  | Figure 27                           |
| <b>SO1 with noncat muffler and algorithm disabled</b> | V       | 4/23/10 | cyclic profile (high to low) | 7                 | 15.8              | 6.5              | >2                   | 430                                 | 20.9   | NA  | Figure 28                           |
| <b>SO1 with noncat muffler and algorithm enabled</b>  | AC      | 5/7/10  | cyclic profile               | 7                 | 24.6              | 6.5              | 10 min               | 520                                 | 21   | Y (but not confirmed that it was algorithm) | Not plotted as test was only 10 min |
| <b>SO1 with noncat muffler and algorithm</b>          | AD      | 5/7/10  | cyclic profile               | 7                 | 24.1              | 7.1              | 6 min                | 340                                 | 21   | Y   | Not plotted as test was only 6 min  |

| Generator  | Test ID | Date    | Load Profile         | Test house Config | Outdoor Temp (°C) | Wind speed (m/s) | Approx. Run Time (h) | Garage Peak CO Concentration (µL/L) | Lowest Garage O <sub>2</sub> Concentration (%) | Automatic shut-off activated | Notes      |
|--|---------|---------|----------------------|-------------------|-------------------|------------------|----------------------|-------------------------------------|--|------------------------------|------------|
| <b>enabled</b>                                       |         |         |                      |                   |                   |                  |                      |                                     |  |                              |            |
| <b>SO1 with noncat muffler and algorithm enabled</b> | AW      | 7/9/10  | cyclic (high to low) | 7                 | 29.3              | 6.3              | 1                    | 290                                 | 21.1   | Y                            | Figure C27 |
| <b>SO1 with noncat muffler and algorithm enabled</b> | AO      | 5/20/10 | cyclic profile       | 7                 | 30.6              | 6.4              | 1.1                  | 110                                 | 20.9   | Y                            | Figure C25 |
| <b>Gen B</b>   | AJ      | 5/19/10 | 5.5 kW               | 8                 | 15.8              | 7.1              | 3                    | 190                                 | 21.1   | NA                           | Figure C26 |
| <b>SO1 with noncat muffler and algorithm enabled</b> | AK      | 5/19/10 | 5.5 kW               | 8                 | 16.9              | 8.2              | 1.4                  | 200                                 | 21.1   | Y                            | Figure C27 |



**Table C2 House Configurations**

| Test house Configuration | Garage bay door | Garage to house entry door | HVAC fan |
|--------------------------|-----------------|----------------------------|----------|
| 1                        | Closed          | Open 5 cm                  | OFF      |
| 2                        | Open 0.6 m      | Closed                     | Off      |
| 3                        | Closed          | Open 5 cm                  | On       |
| 4                        | Closed          | Closed                     | On       |
| 5                        | Closed          | Closed                     | Off      |
| 6                        | Open 0.6 m      | Open 5 cm                  | On       |
| 7                        | Open 0.6 m      | Open 5 cm                  | Off      |
| 8                        | Fully Open      | Open 5 cm                  | Off      |

Figures C1a, C1b, and C1c show the results for Test E, which was a 2 h test of unmod Gen X in Configuration 1 (garage bay door closed, garage access door to house open nominally 5 cm, and the house central HVAC fan off) with the cyclic load profile (see Table 1 in the body of the report). Since it was a two hour test, the hourly cyclic load profile in Table 1 was repeated two times. At the end of the second cycle, the generator was stopped, and the garage was mechanically vented.

**Figure C1a** CO and O<sub>2</sub> concentrations in the garage and measured load for Test E (unmod Gen X, Configuration 1)

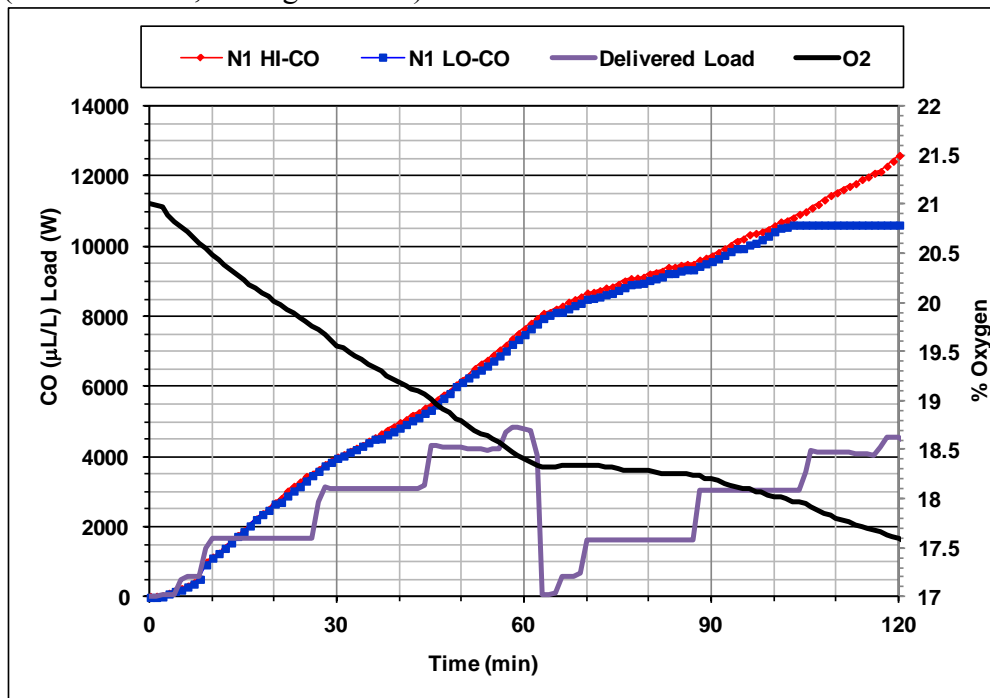
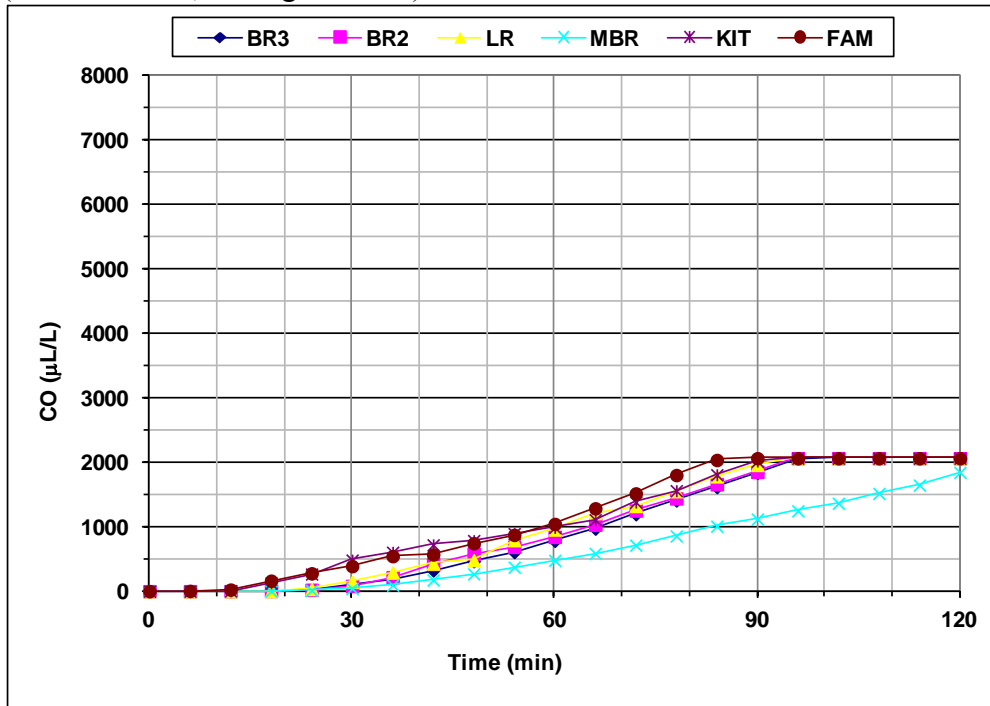


Figure C1a shows the concentration of CO in the garage reached a peak of over 13,000 µL/L (note that µL/L are equivalent to the commonly used unit for CO concentration of ppm<sub>v</sub>) and the volume fraction of O<sub>2</sub> dropped by 3.5 % to nearly 17.5 % when the generator was stopped. It also shows that in the first load cycle, the delivered electrical load was less than the load bank settings for the two highest loads in the cycle, 4500 W and 5500 W, which were applied when the oxygen was below 19 %. As the

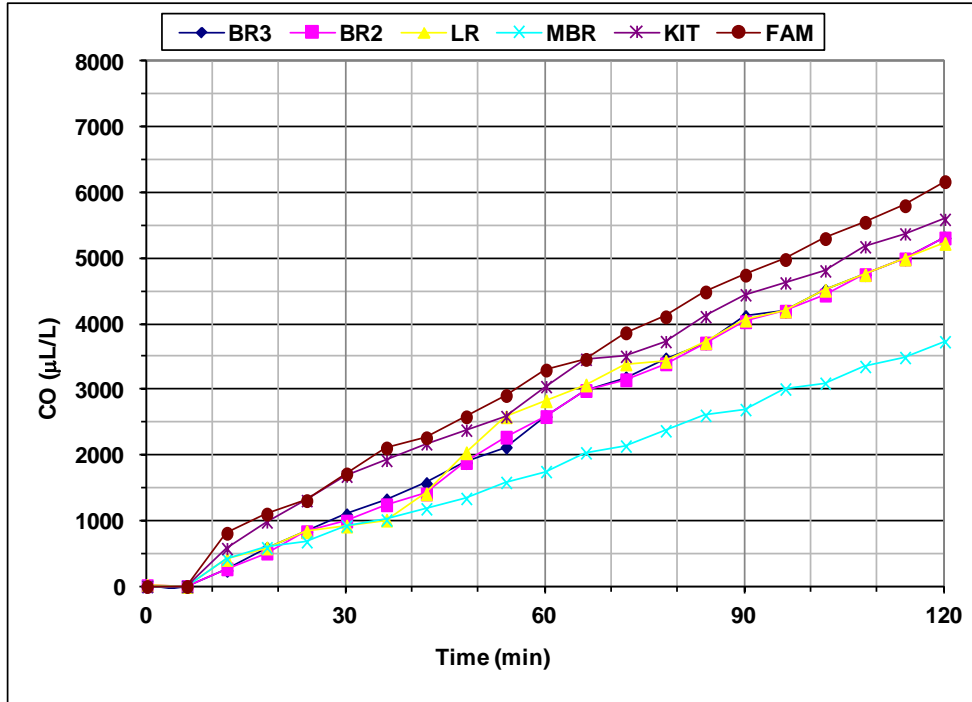
oxygen continued to drop in the subsequent load cycles, the delivered power for these load points decreased further.

Figures C1b and C1c show the CO concentration in six rooms of the test house (see Figure 2 for room locations) as measured on the ‘ppm range’ (where the CO concentration plot plateaus at the instrument’s 2000  $\mu\text{L/L}$  limit) and ‘high range’ CO instruments, respectively. The CO reached a peak concentration of over 6000  $\mu\text{L/L}$  in the family room, with peak concentrations in the other rooms ranging from about 4000  $\mu\text{L/L}$  to 6000  $\mu\text{L/L}$ . The results of Test E were similar to those of Test B, described in the body of the report, which was the same generator under the same house configuration.

**Figure C1b** CO (ppm range) concentrations in the house for Test E (unmod Gen X, Configuration 1)

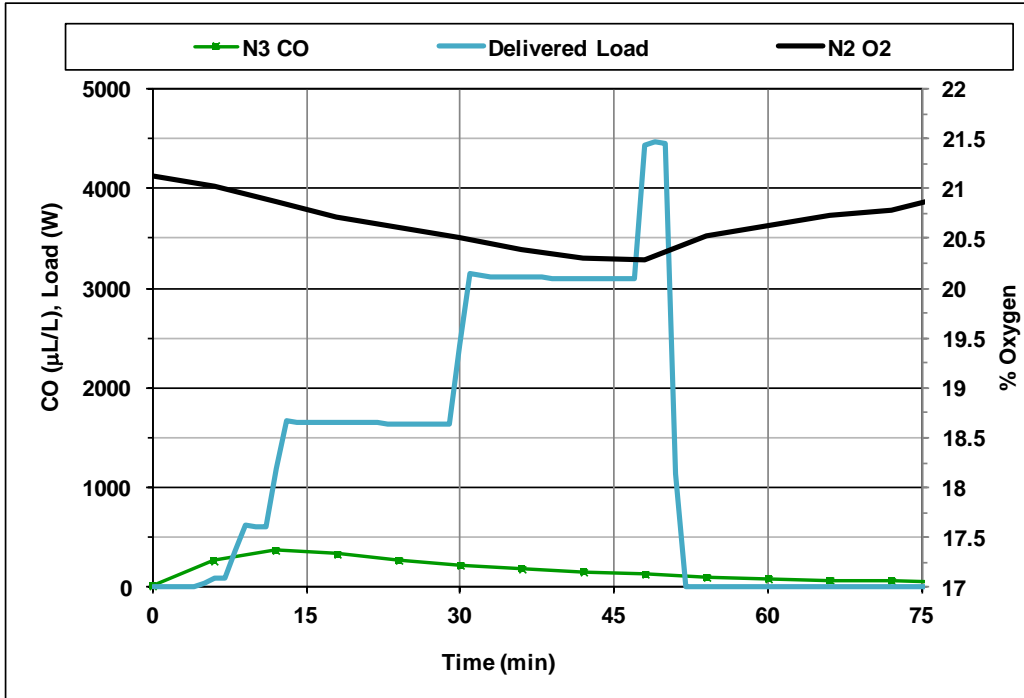


**Figure C1c** CO (high range) concentrations in the house for Test E (unmod Gen X, Configuration 1)

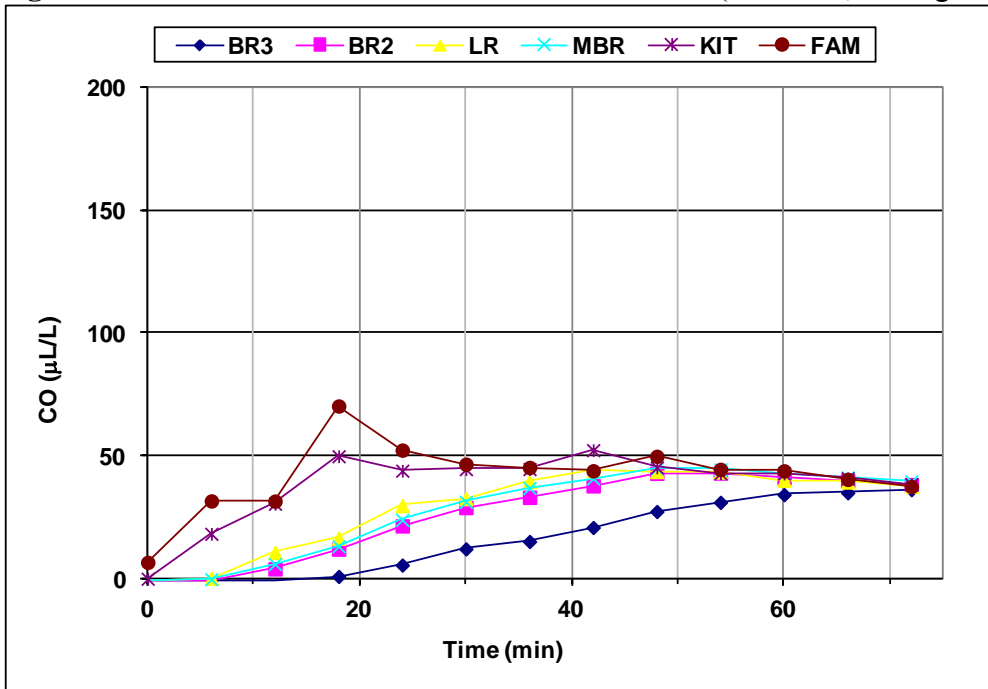


Figures C2a and C2b show the results for Test M, which was a shut-off test of Gen SO1 with the shutoff algorithm enabled under test house configuration 1 and the cyclic load. The algorithm shut off the generator after approximately 0.8 h. A natural decay period of about 0.5 h was included after the generator was stopped, followed by mechanical venting. The results shown in Figures C2a and C2b for Test M, prior to generator shut-off, are similar to those in Figure 15 for Test N in the body of the report (a test of the same generator and house configuration but without the shut-off activated).

**Figure C2a** CO and O<sub>2</sub> concentrations in the garage and measured load for Test M (Gen SO1, Configuration 1)



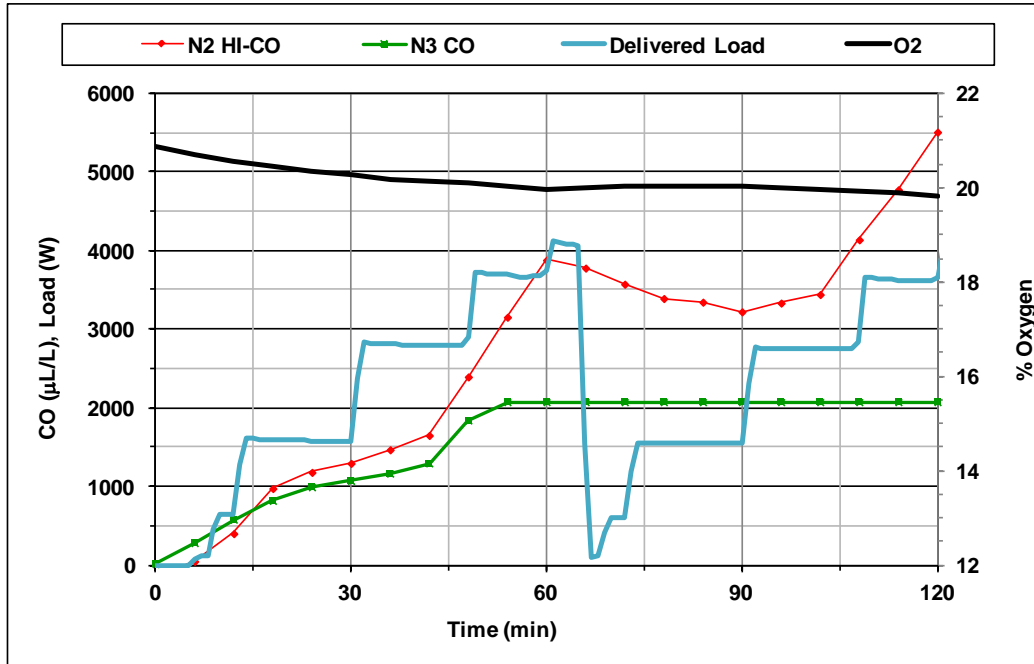
**Figure C2b** CO concentrations in the house for Test M (Gen SO1, Configuration 1)



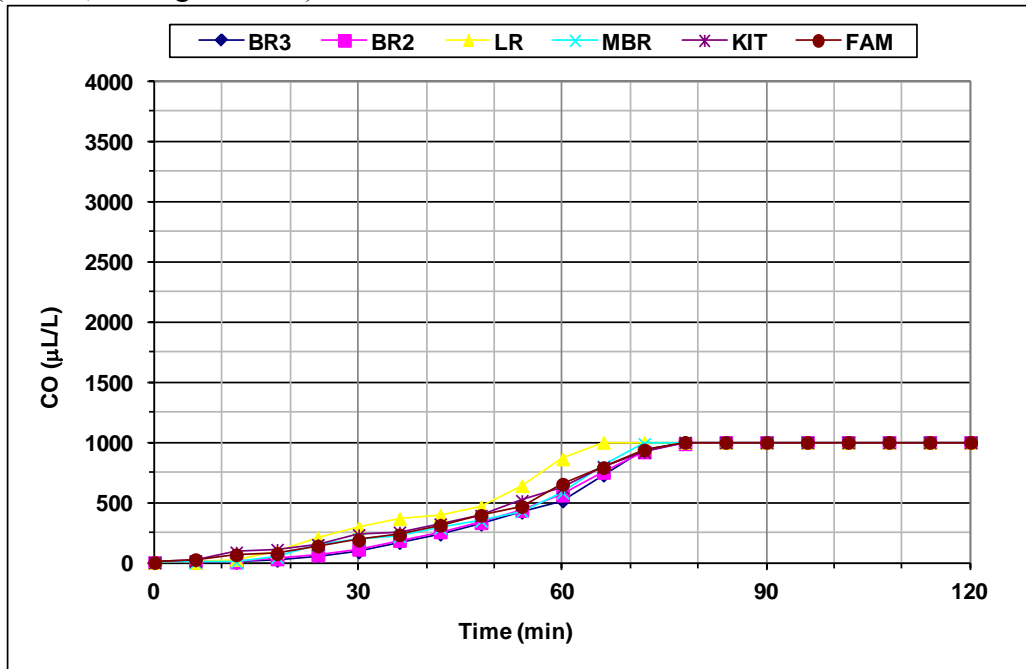
Figures C3a, C3b (the CO concentration exceeded the limit of the ppm range instrument), and C3c show the results for Test P, which was a two hour test of Gen B in Configuration 1 with the cyclic load. Figure C3a shows the concentration of CO in the garage reached a

peak of over 5500  $\mu\text{L/L}$  and the volume fraction of  $\text{O}_2$  in the garage dropped to about 19.8 % when the generator was stopped.

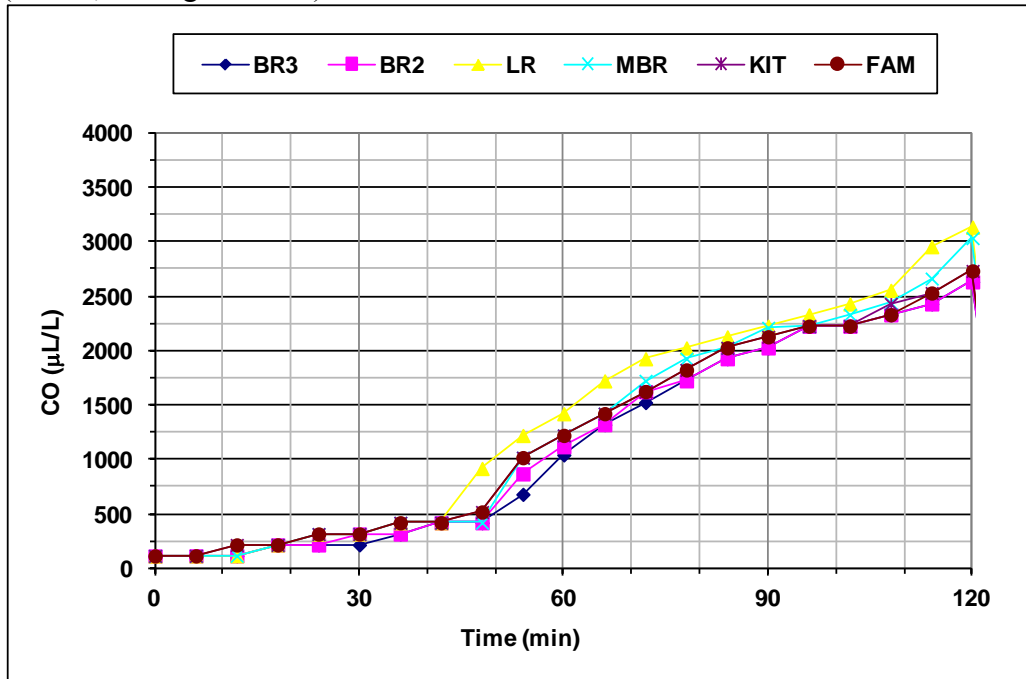
**Figure C3a** CO and  $\text{O}_2$  concentrations in the garage and measured load for Test P (Gen B, Configuration 1)



**Figure C3b** CO (ppm range) concentrations in the house for Test P (Gen B, Configuration 1)

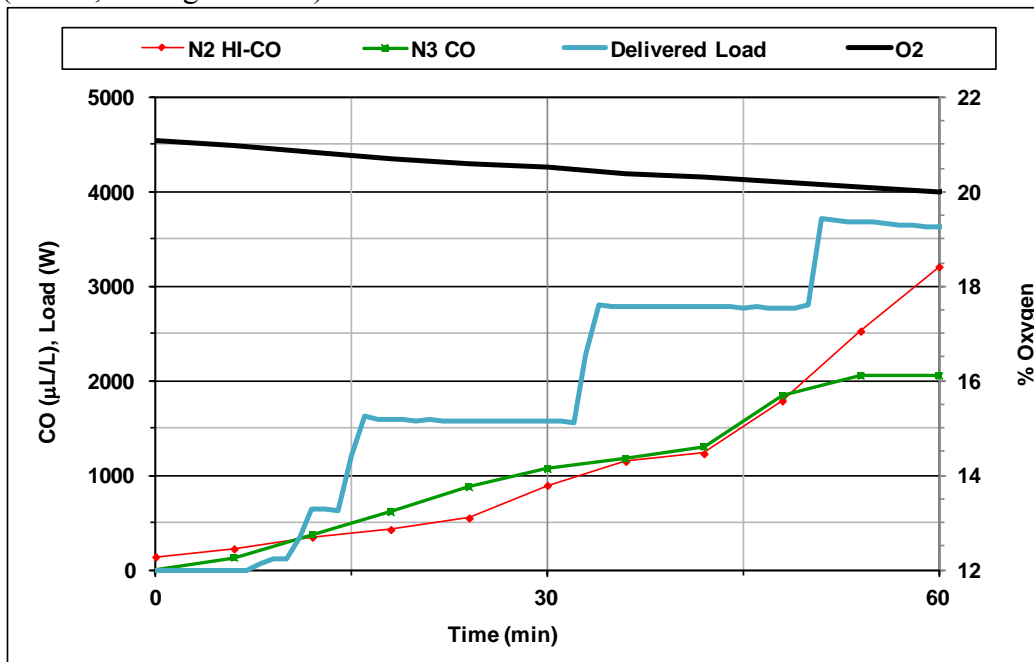


**Figure C3c** CO (high range) concentrations in the house for Test P (Gen B, Configuration 1)

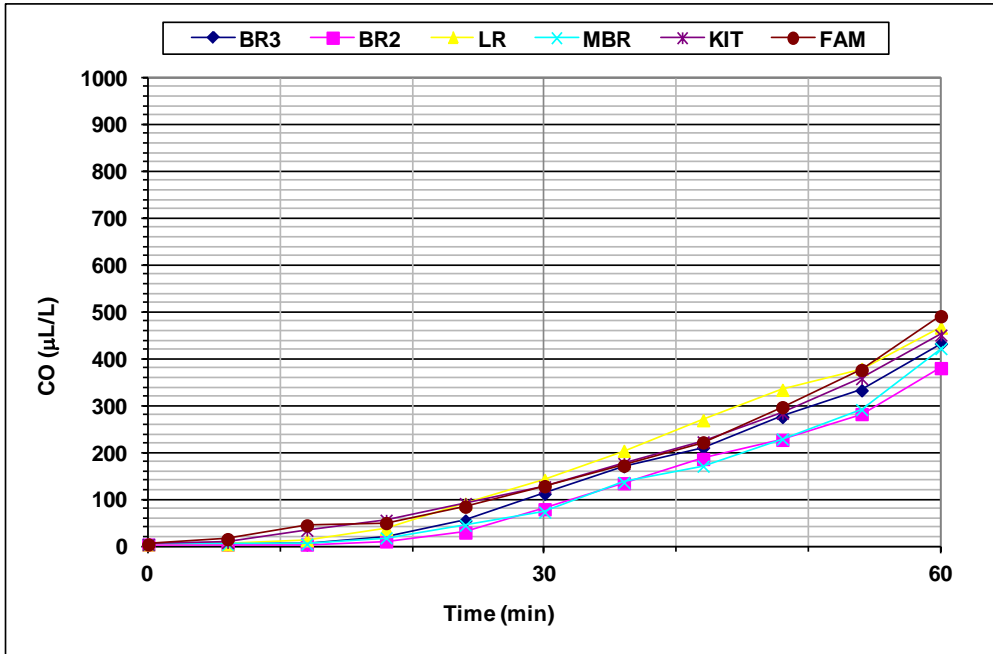


Figures C4a and C4b show the results for Test AU, which was a one hour test of Gen B in Configuration 1 with the cyclic load. Figure C4a shows the concentration of CO in the garage reached a peak of over 3000  $\mu\text{L/L}$  and the volume fraction of  $\text{O}_2$  in the garage dropped to about 20 % when the generator was stopped.

**Figure C4a** CO and  $\text{O}_2$  concentrations in the garage and measured load for Test AU (Gen B, Configuration 1)

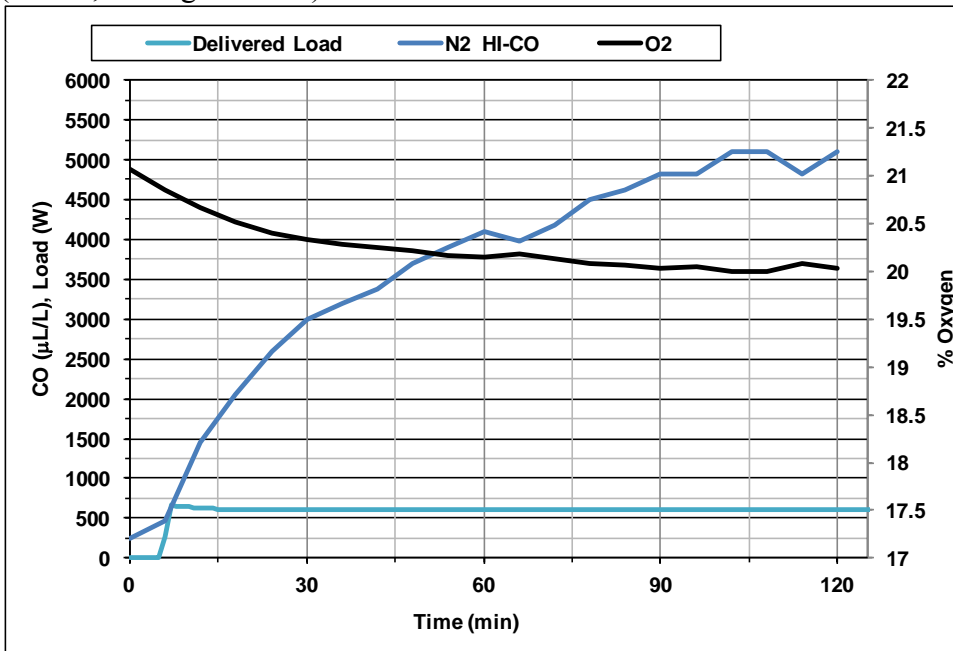


**Figure C4b** CO (ppm range) concentrations in the house for Test AU (Gen B, Configuration 1)

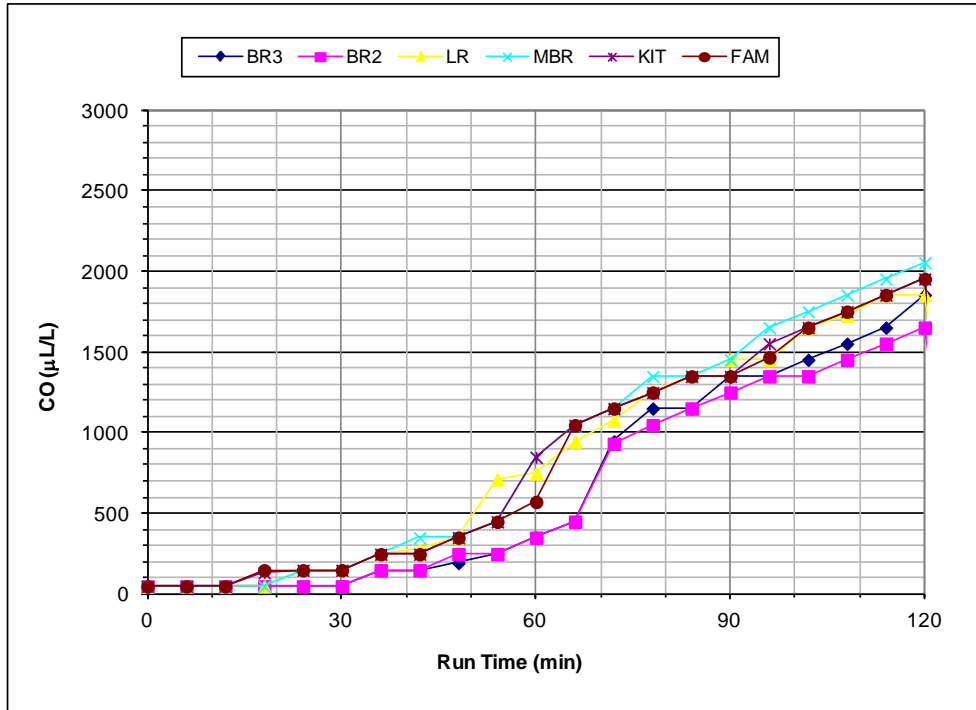


Figures C5a and C5b show the results for Test AG, which was a 2 h test of Gen B in Configuration 1 with a constant 500 W load. The concentration of CO in the garage reached a peak of over 5000  $\mu\text{L/L}$  and the volume fraction of  $\text{O}_2$  in the garage dropped to about 20 % when the generator was stopped.

**Figure C5a** CO and  $\text{O}_2$  concentrations in the garage and measured load for Test AG (Gen B, Configuration 1)



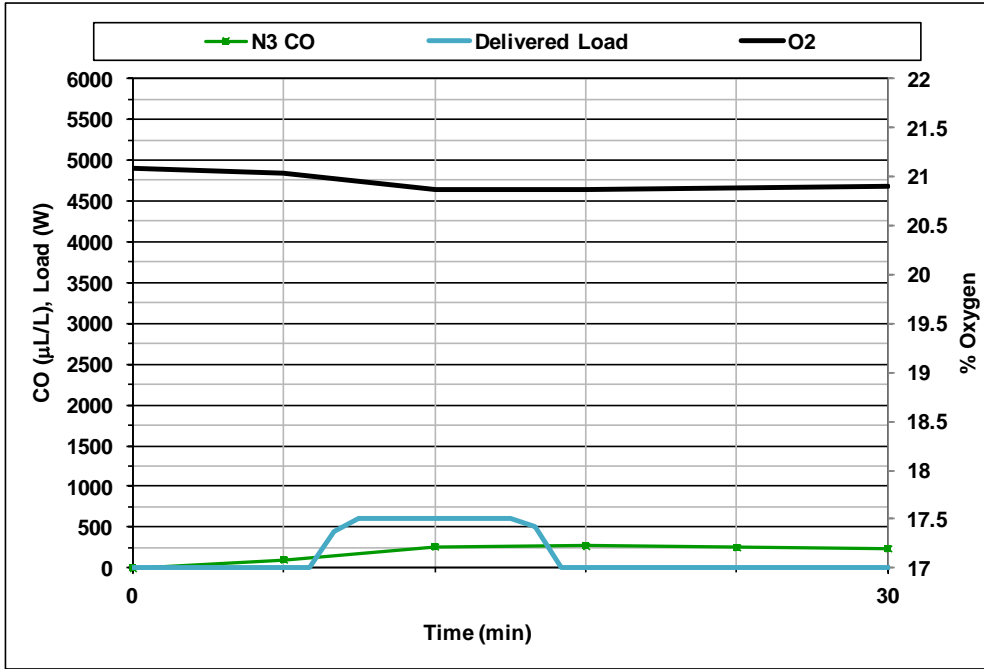
**Figure C5b** CO concentrations in the house for Test AG  
(Gen B, Configuration 1)



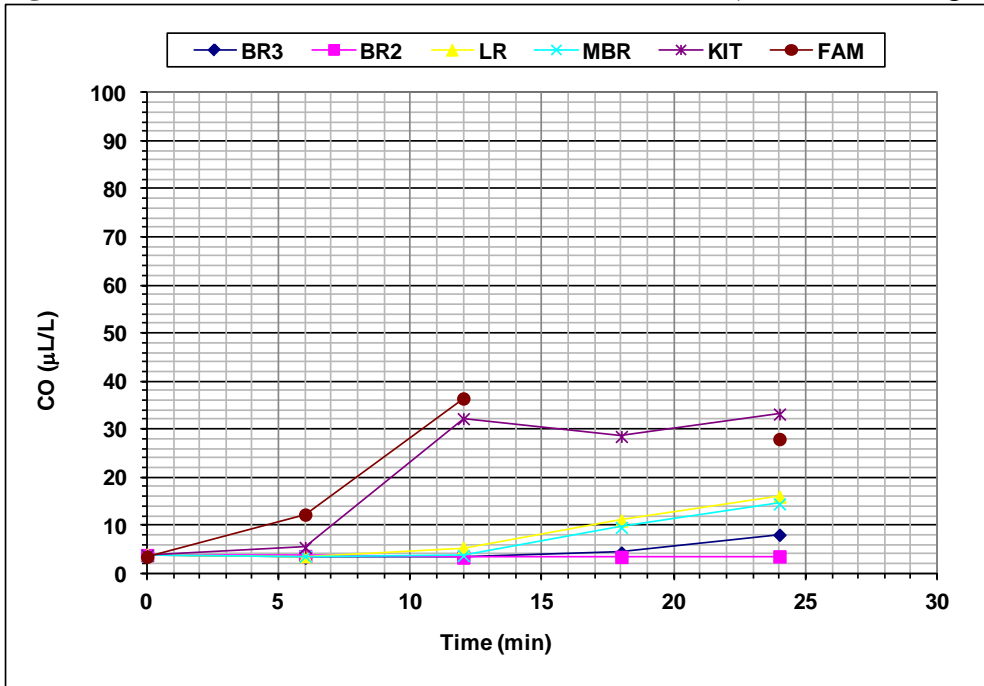
Figures C6a and C6b show the results for Test AP, which was a shut-off test of Gen SO1 with the shutoff algorithm enabled under test house configuration 1 and a constant 500 W load. The algorithm shut off the generator after approximately 10 min. A natural decay period of about 20 min was included after the generator was stopped, followed by mechanical venting.



**Figure C6a** CO and O<sub>2</sub> concentrations in the garage and measured load for Test AP (Gen SO1, Configuration 1)

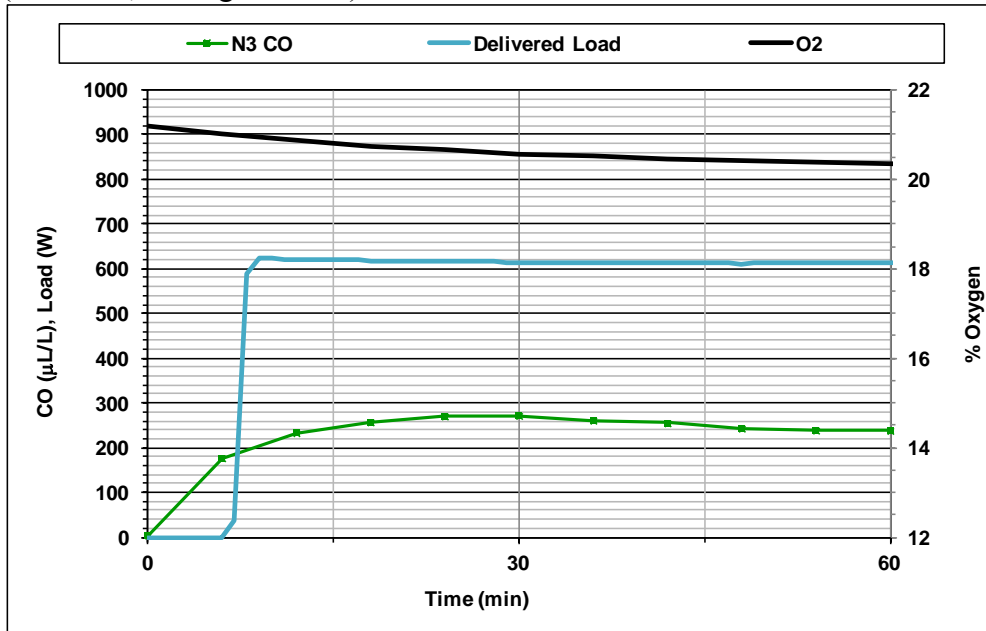


**Figure C6b** CO concentrations in the house for Test AP (Gen SO1, Configuration 1)

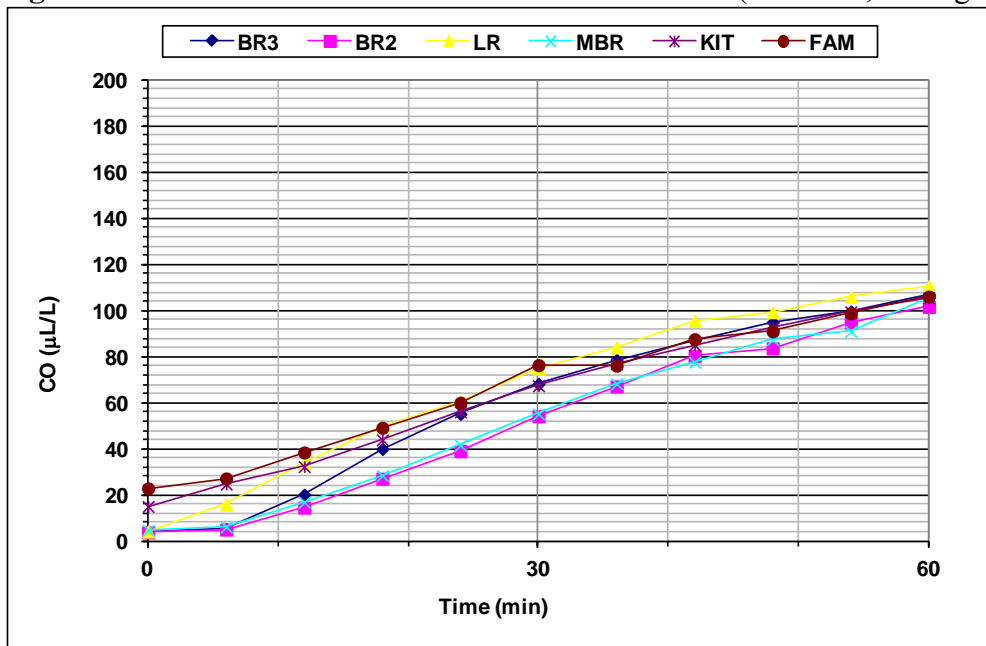


Figures C7a and C7b show the results for Test AV, which was also a shut-off test of Gen SO1 with the shut-off algorithm enabled under test house configuration 1 and a constant 500 W load. The algorithm did not shut off the generator so it was stopped manually after 2 h.

**Figure C7a** CO and O<sub>2</sub> concentrations in the garage and measured load for Test AV (Gen SO1, Configuration 1)

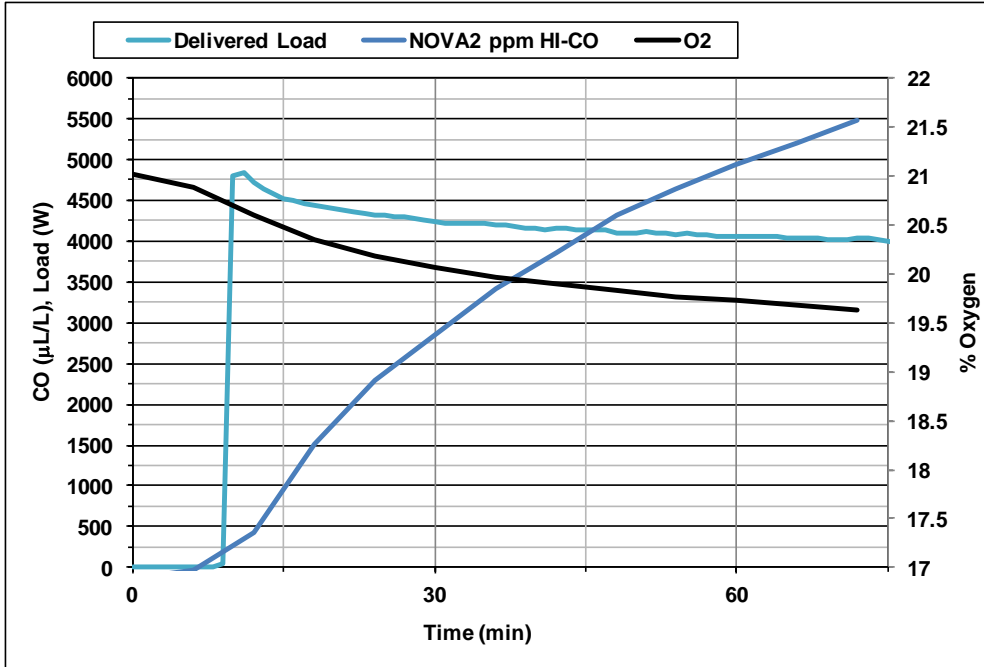


**Figure C7b** CO concentrations in the house for Test AV (Gen SO1, Configuration 1)

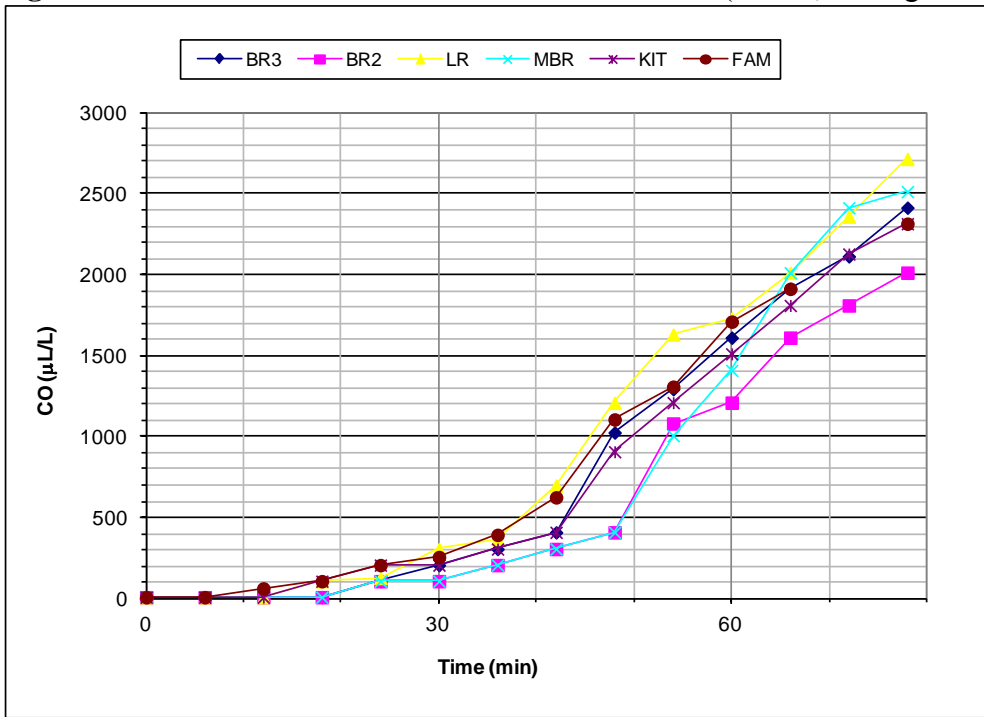


Figures C8a and C8b show the results for Test AI, which was a 1.1 h test of Gen B in Configuration 1 with a constant 5500 W load. The concentration of CO in the garage reached a peak of about 5500 µL/L and the volume fraction of O<sub>2</sub> in the garage dropped to about 19.6 % when the generator was stopped.

**Figure C8a** CO and O<sub>2</sub> concentrations in the garage and measured load for Test AI (Gen B, Configuration 1)

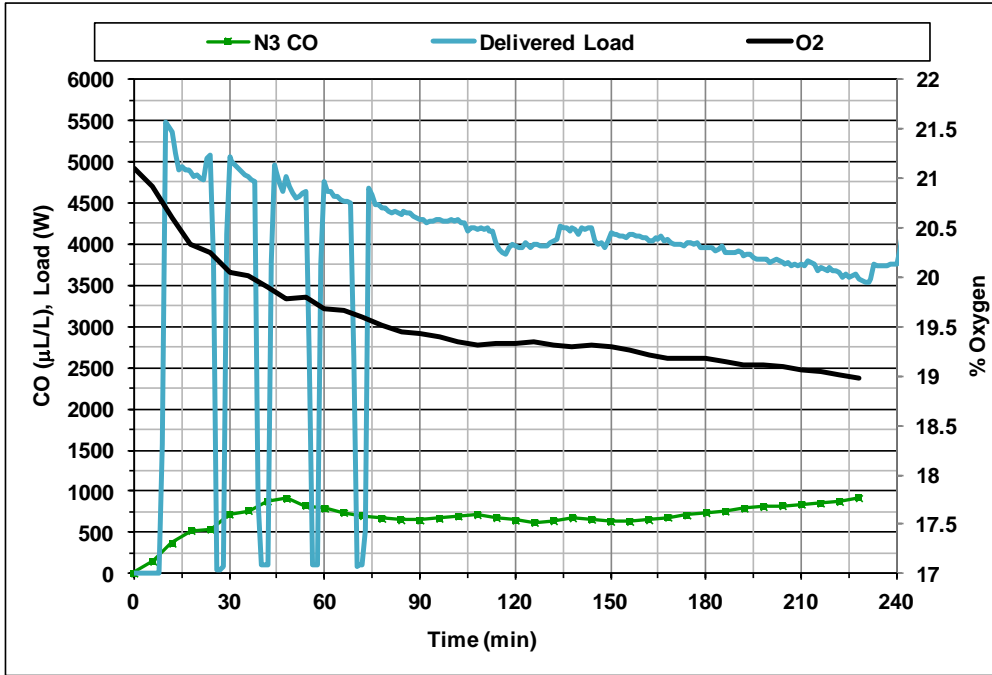


**Figure C8b** CO concentrations in the house for Test AI (Gen B, Configuration 1)

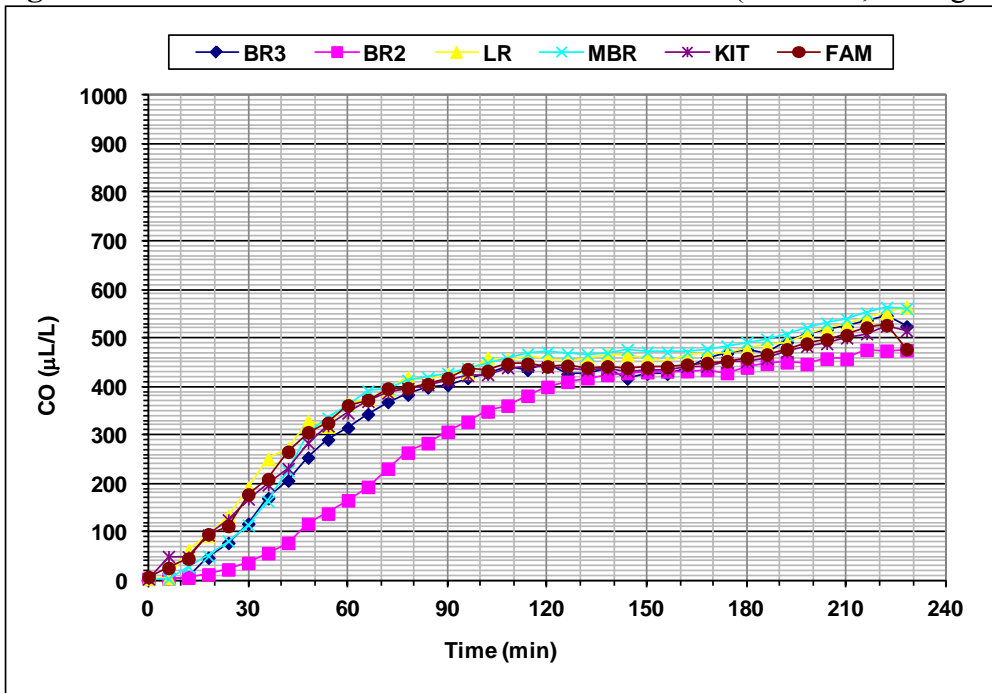


Figures C9a and C9b show the results for Test AR, which was a 4 h test of Gen SO1 with test house configuration 1 and a constant 5500 W load. During this test, the load bank overheated multiple times (resulting in the temporary sharp drops in load seen in Figure 9a) and, following the test, the exhaust manifold was found to be loose, which may have impacted the test results.

**Figure C9a** CO and O<sub>2</sub> concentrations in the garage and measured load for Test AR (Gen SO1, Configuration 1)

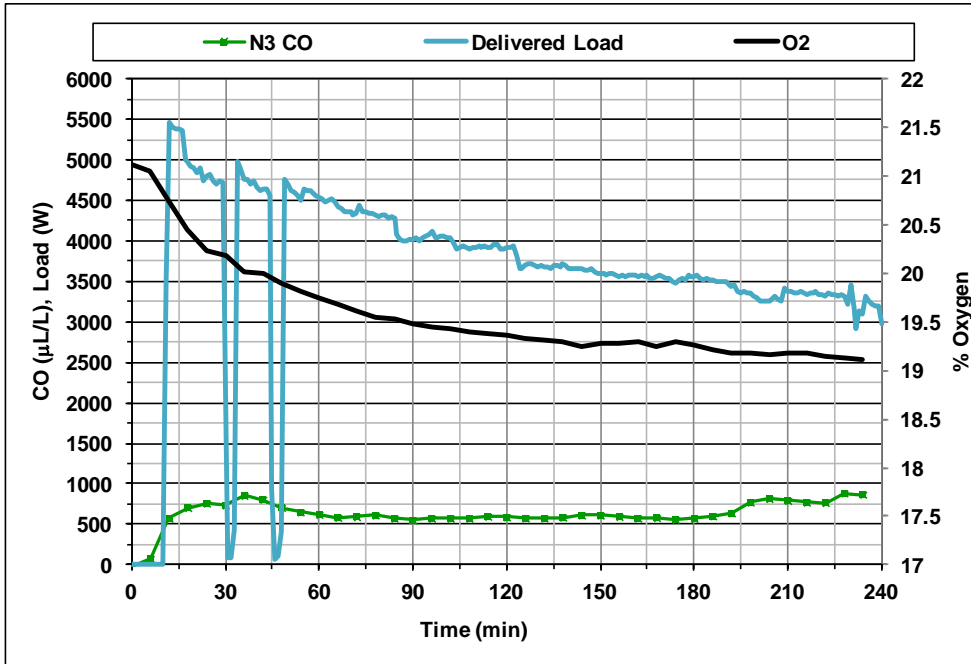


**Figure C9b** CO concentrations in the house for Test AR (Gen SO1, Configuration 1)

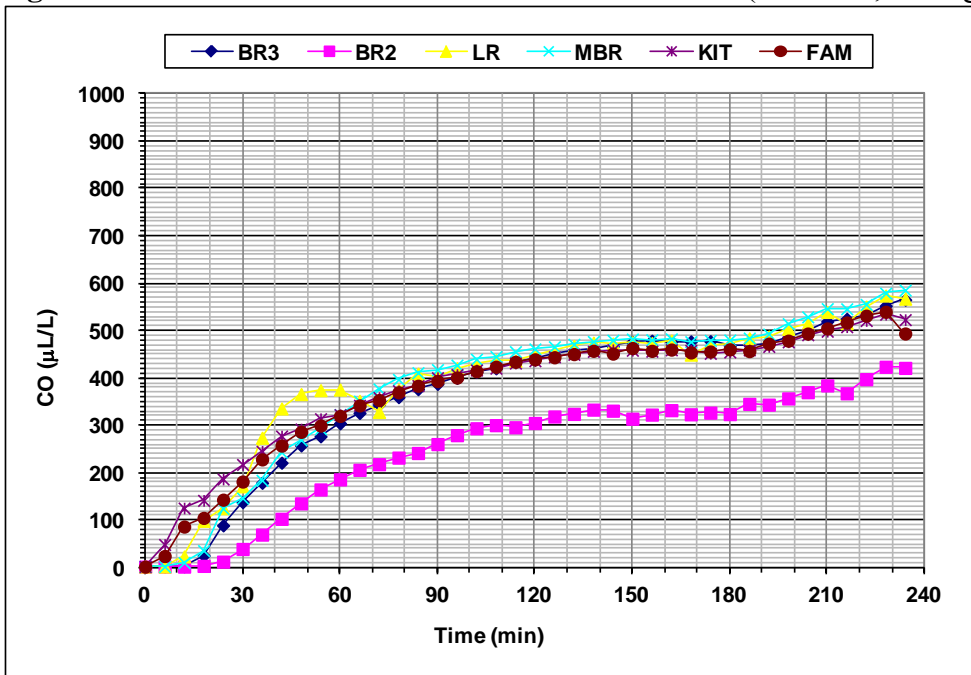


Figures C10a and C10b show the results for Test AS, which was also a 4 h test of Gen SO1 with test house configuration 1 and a constant 5500 W load. As with Test AR, the load bank overheated multiple times during this test. The results of Test AR were very similar to those of Test AS.

**Figure C10a** CO and O<sub>2</sub> concentrations in the garage and measured load for Test AS (Gen SO1, Configuration 1)

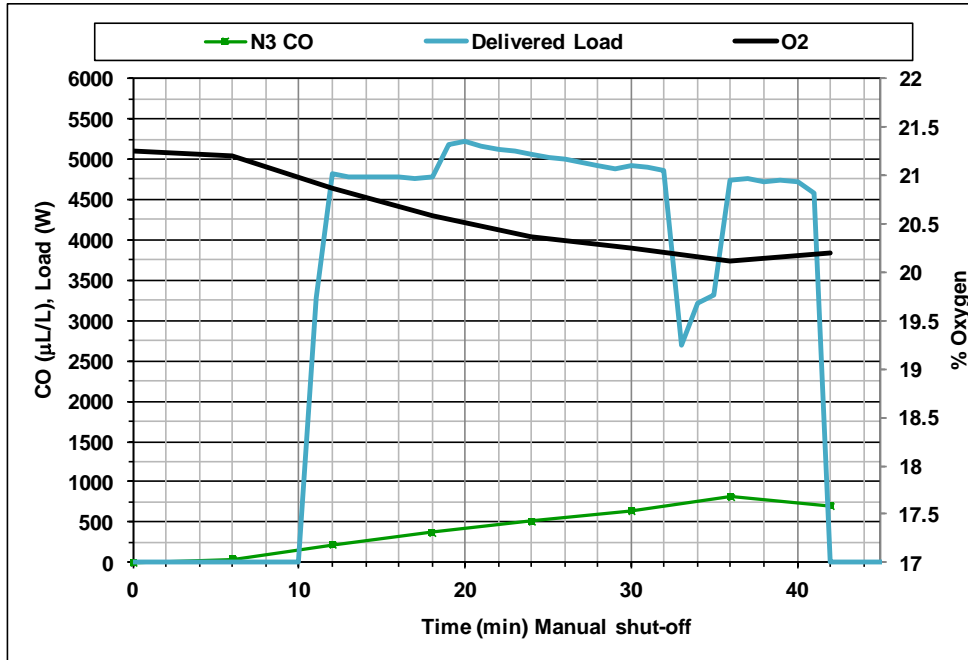


**Figure C10b** CO concentrations in the house for Test AS (Gen SO1, Configuration 1)

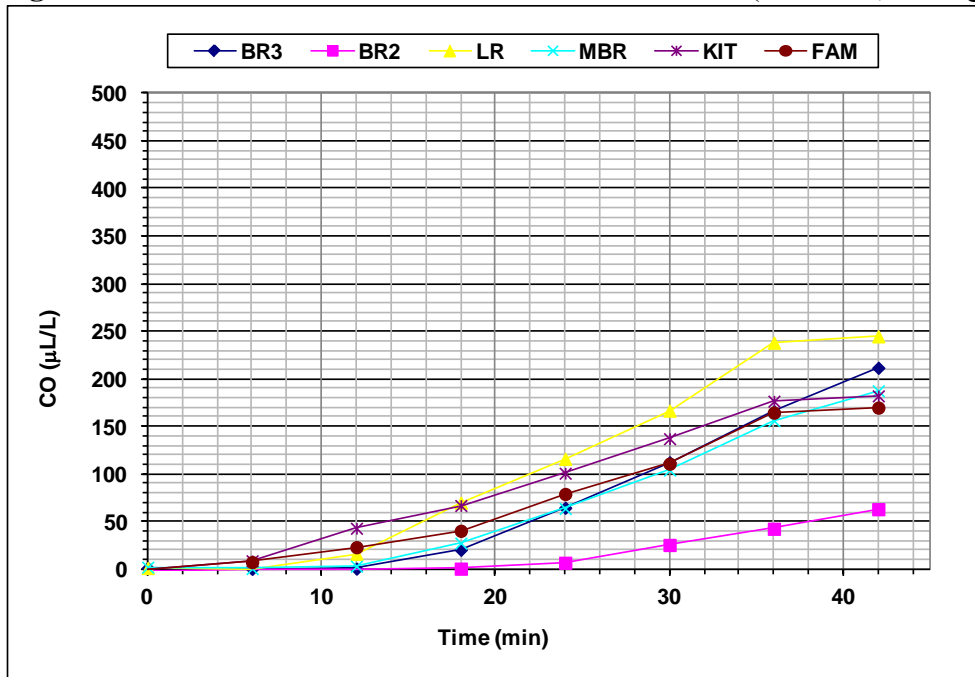


Figures C11a and C11b show the results for Test AL, which was a test of Gen SO1 with the shutoff algorithm enabled with test house configuration 1 and a constant 5500 W load. The algorithm did not shut off the generator before it was manually stopped and the test terminated after about 40 min when a generator circuit breaker tripped.

**Figure C11a** CO and O<sub>2</sub> concentrations in the garage and measured load for Test AL (Gen SO1, Configuration 1)

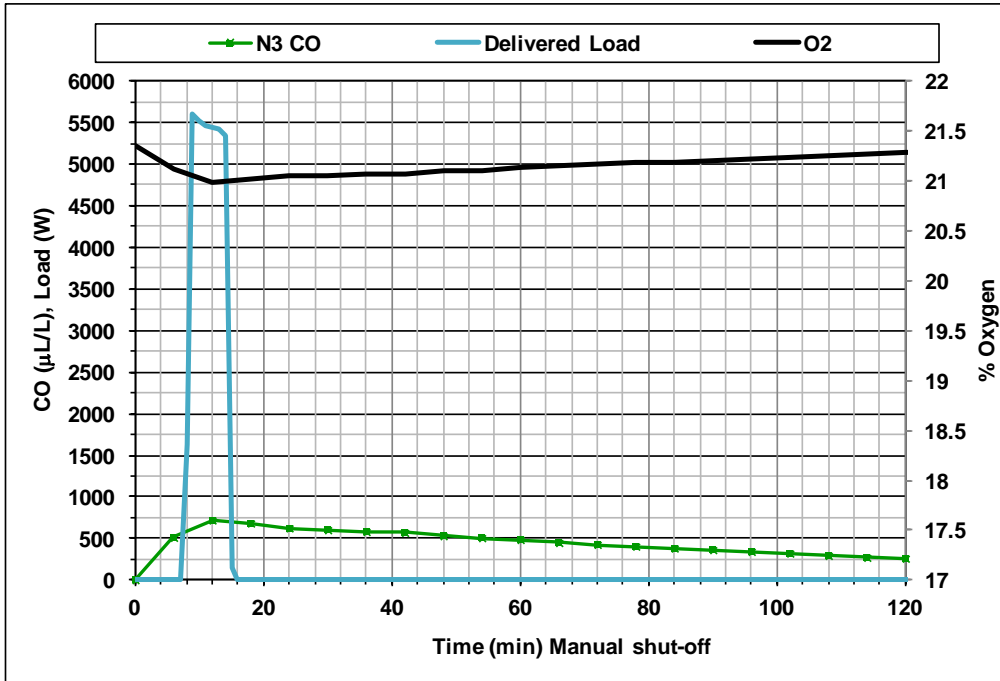


**Figure C11b** CO concentrations in the house for Test AL (Gen SO1, Configuration 1)

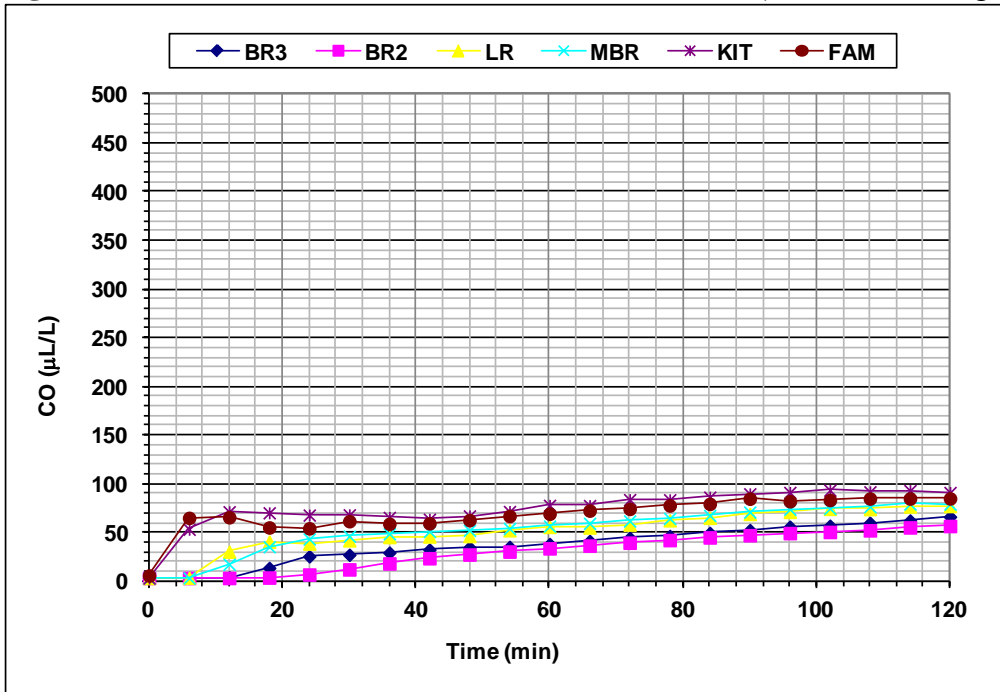


Figures C12a and C12b show the results for Test AM, which was also a test of Gen SO1 with the shutoff algorithm enabled under test house configuration 1 and a constant 5500 W load. The algorithm shut off the generator after about 7 min, which was followed by a 2 h natural decay period before mechanical venting of the house.

**Figure C12a** CO and O<sub>2</sub> concentrations in the garage and measured load for Test AM (Gen SO1, Configuration 1)



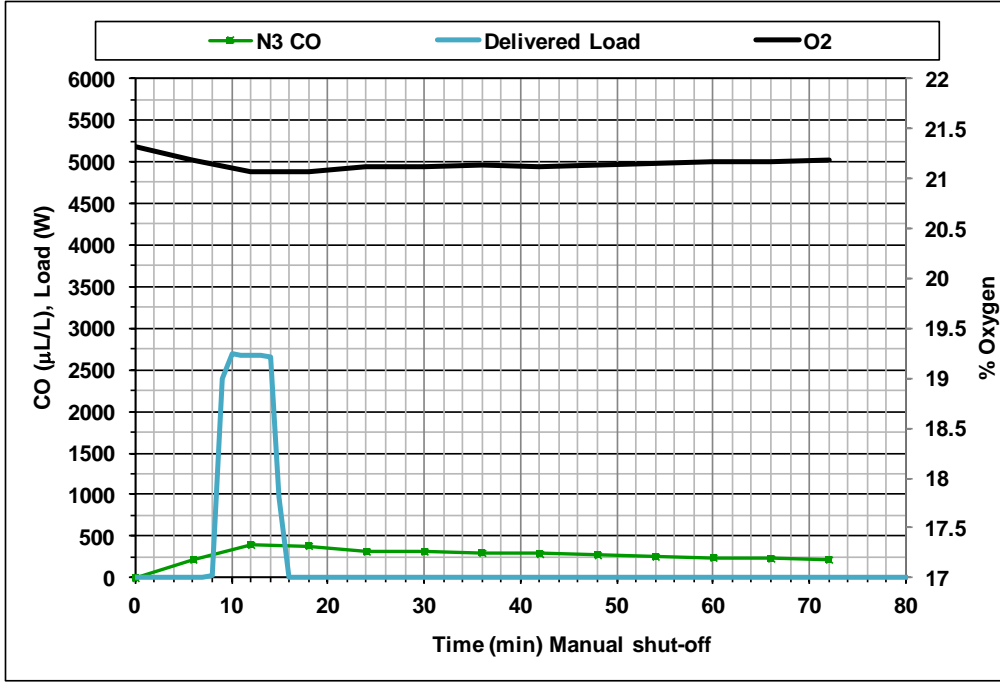
**Figure C12b** CO concentrations in the house for Test AM (Gen SO1, Configuration 1)



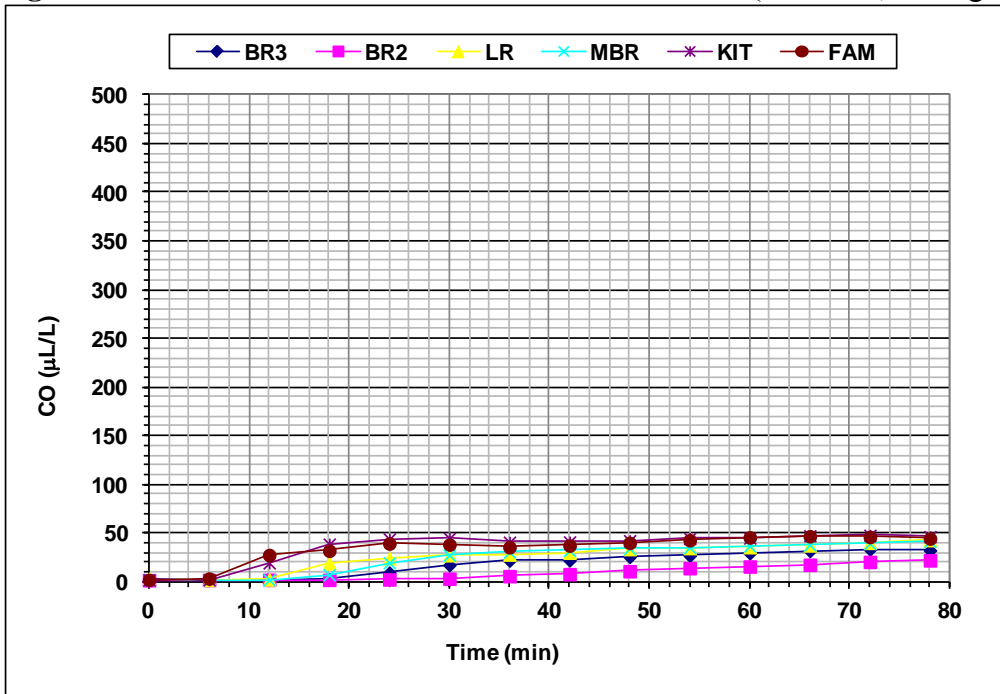
Figures C13a and C13b show the results for Test AN, which was a test of Gen SO1 with the shutoff algorithm enabled under test house configuration 1 and a constant 2500 W

load. The algorithm shut off the generator after about 13 min which was followed by a 1 h natural decay period before mechanical venting of the house.

**Figure C13a** CO and O<sub>2</sub> concentrations in the garage and measured load for Test AN (Gen SO1, Configuration 1)



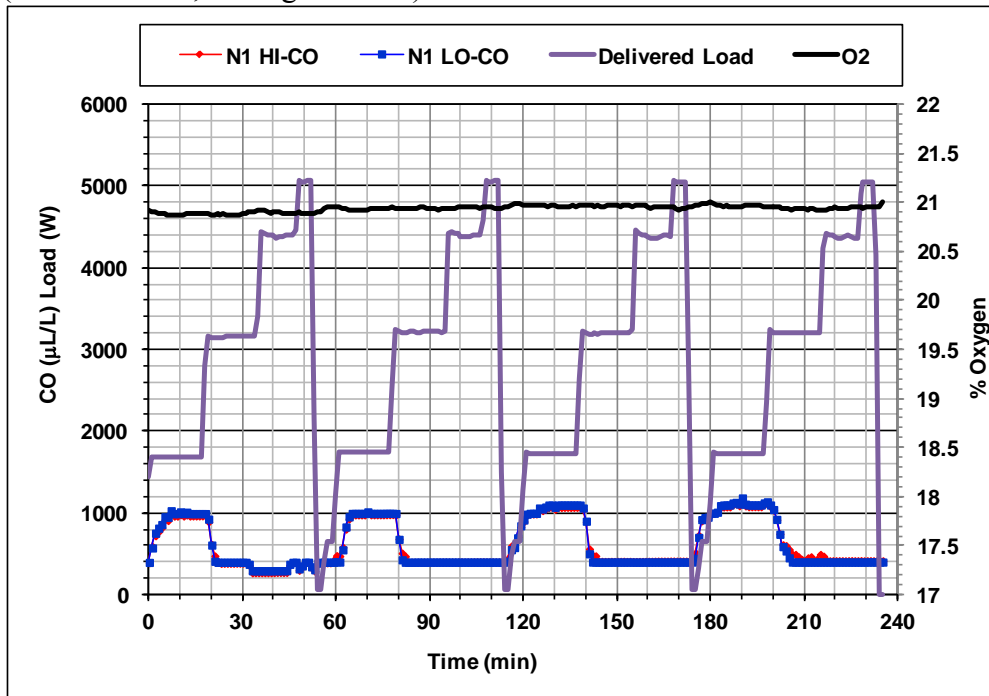
**Figure C13b** CO concentrations in the house for Test AN (Gen SO1, Configuration 1)



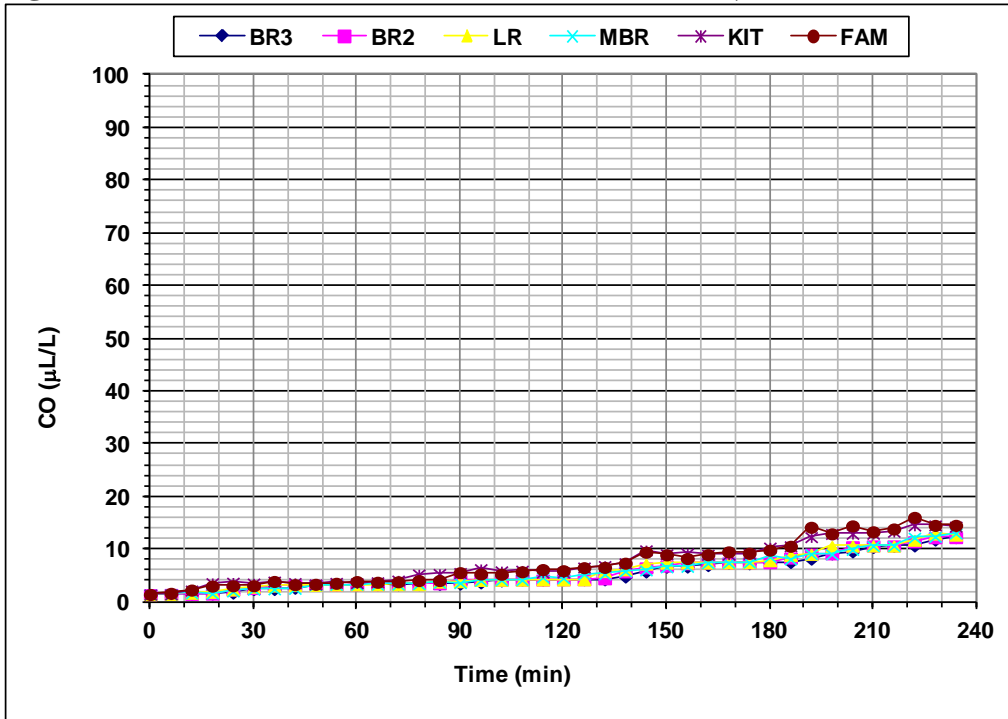


Figures C14a and C14b show the results for Test H, which was a 4 h test of unmod Gen X with Configuration 2 (garage bay door open, garage access door to house closed, and the house central HVAC fan off). The results of Test H were similar to those for Test F which was the same generator and house configuration. The peak concentration occurred during the 1500 W setting and rose slightly in each load cycle, reaching a maximum concentration near 1200  $\mu\text{L/L}$  in the fourth load cycle. For this test, the garage was not instrumented with a low concentration CO analyzer, and the instrument uncertainty is large relative to measured concentrations below 500  $\mu\text{L/L}$ . During the course of this test, with the garage bay door open, the oxygen level dipped only slightly, and the delivered electrical output was consistent during each cycle, largely meeting the load bank setting with the exception of the 5500 W setting.

**Figure C14a** CO and O<sub>2</sub> concentrations in the garage and measured load for Test H (unmod Gen X, Configuration 2)

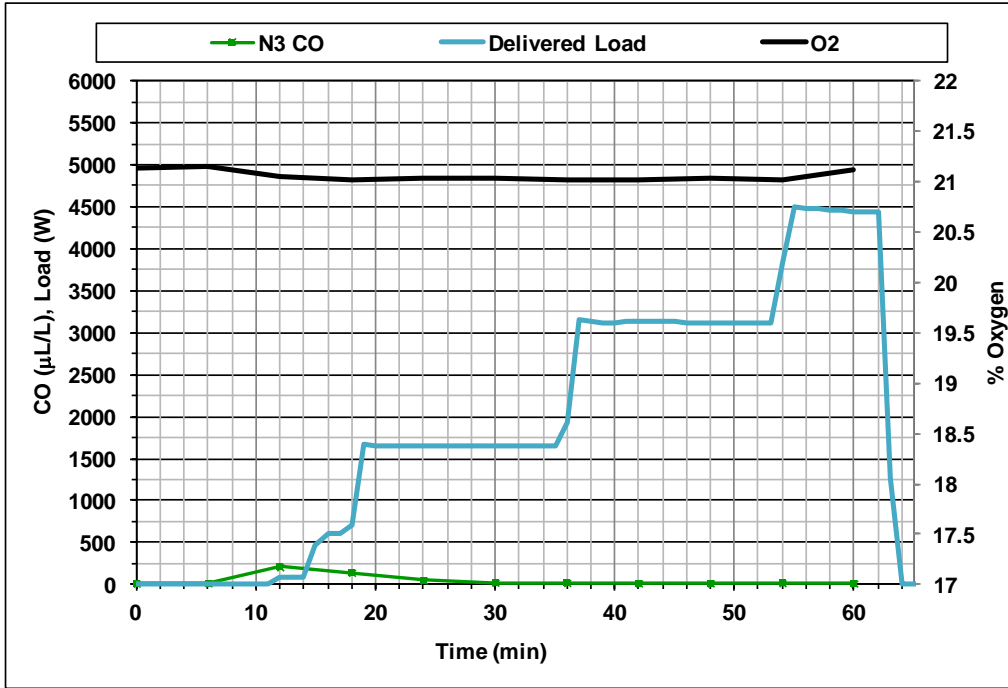


**Figure C14b** CO concentrations in the house for Test H (unmod Gen X, Configuration 2)

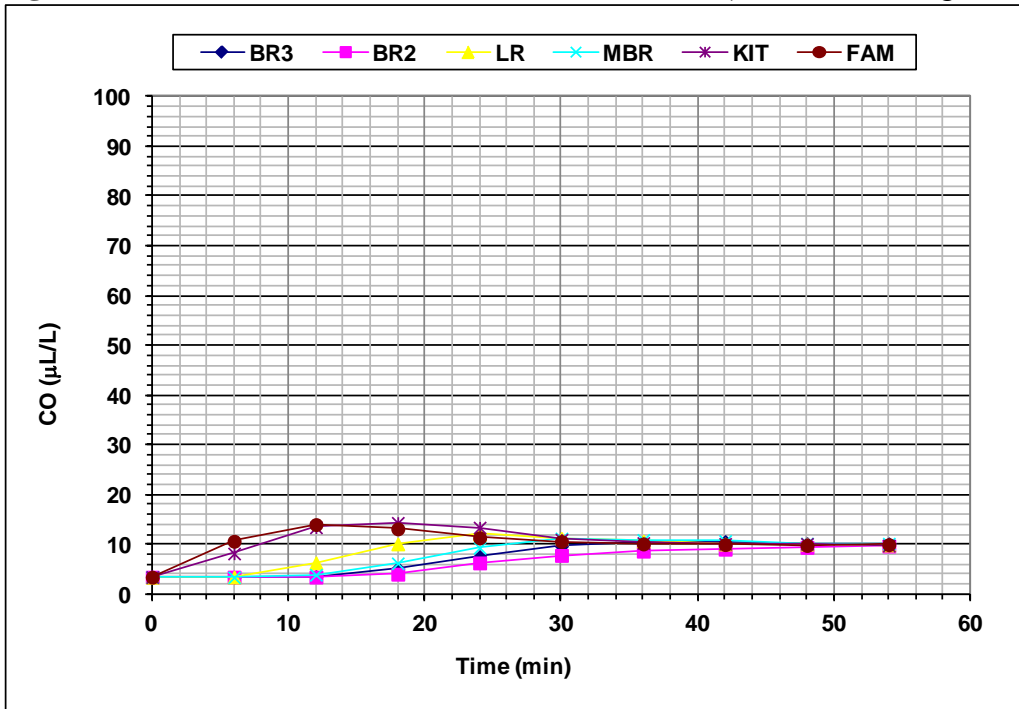


Figures C15a and C15b show the results for Test S, which was a shut-off test of Gen SO1 with the shutoff algorithm enabled under test house configuration 2 and the cyclic load. The algorithm shut off the generator after approximately 0.9 h. The results shown in Figure C15 for Test S, prior to generator shut-off, are similar to those in Figure 18 in the body of the report for Test T (a test of the same generator and house configuration but without the shut-off activated).

**Figure C15a** CO and O<sub>2</sub> concentrations in the garage and measured load for Test S (Gen SO1, Configuration 2)



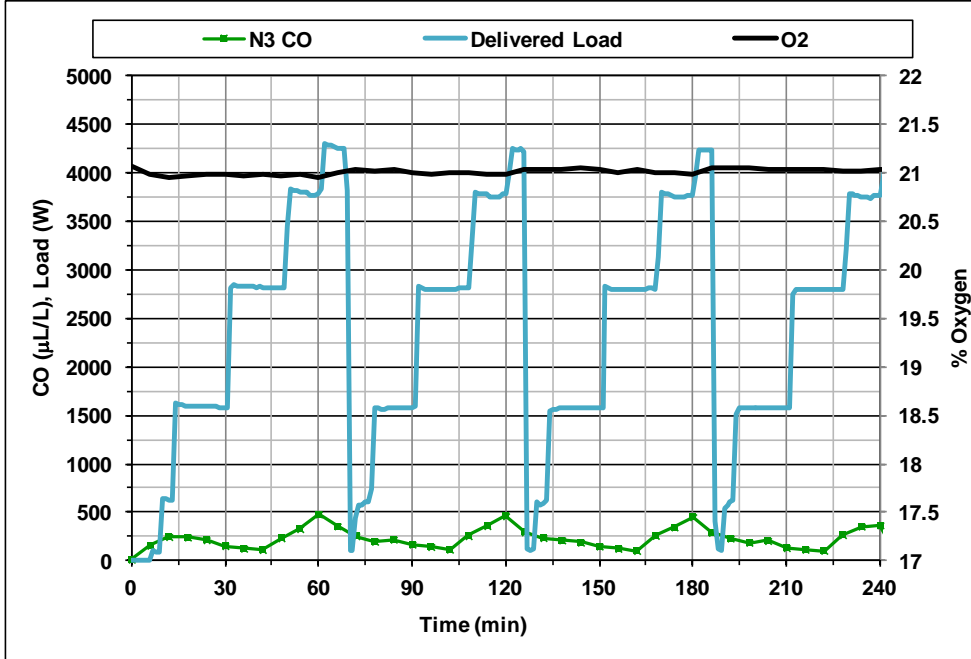
**Figure C15b** CO concentrations in the house for Test S (Gen SO1, Configuration 2)



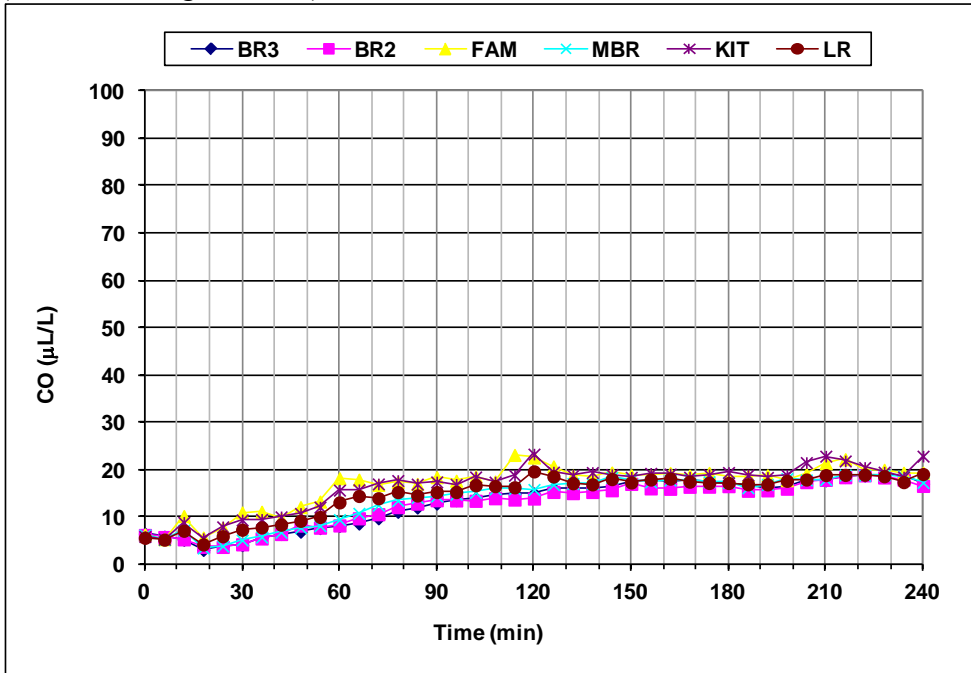
Figures C16a and C16b show the results for Test Q, which was a 4 h test of Gen B with the house in Configuration 2 under the cyclic load. Figure C16a shows the concentration

of CO in the garage reached a peak of near 500  $\mu\text{L/L}$  and the volume fraction of  $\text{O}_2$  in the garage did not measurably change when the generator was stopped.

**Figure C16a** CO and  $\text{O}_2$  concentrations in the garage and measured load for Test Q (Gen B, Configuration 2)

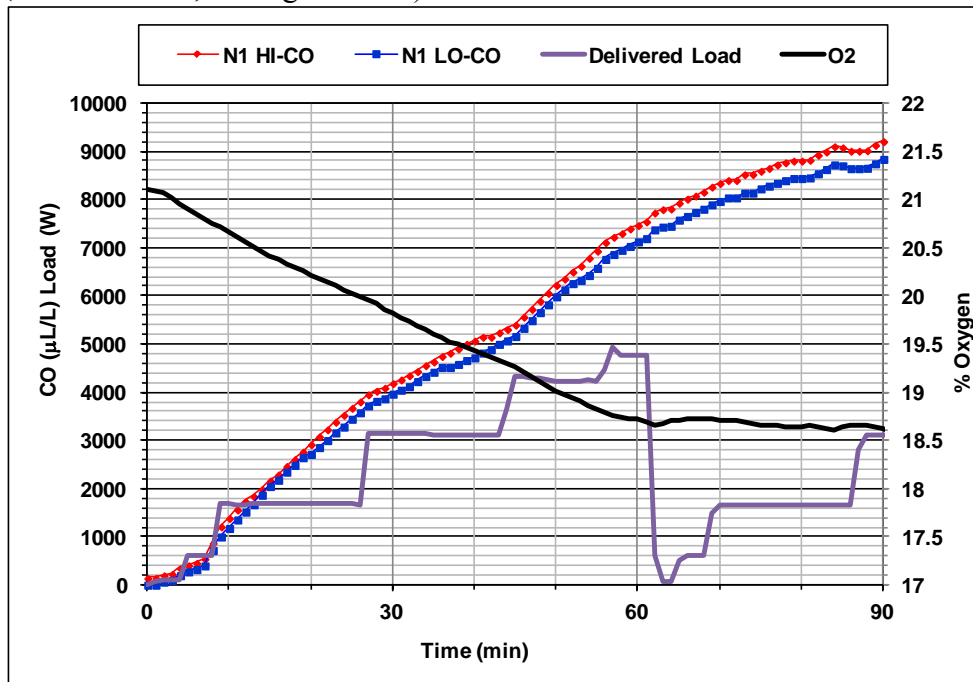


**Figure C16b** CO (ppm range) concentrations in the house for Test Q (Gen B, Configuration 2)

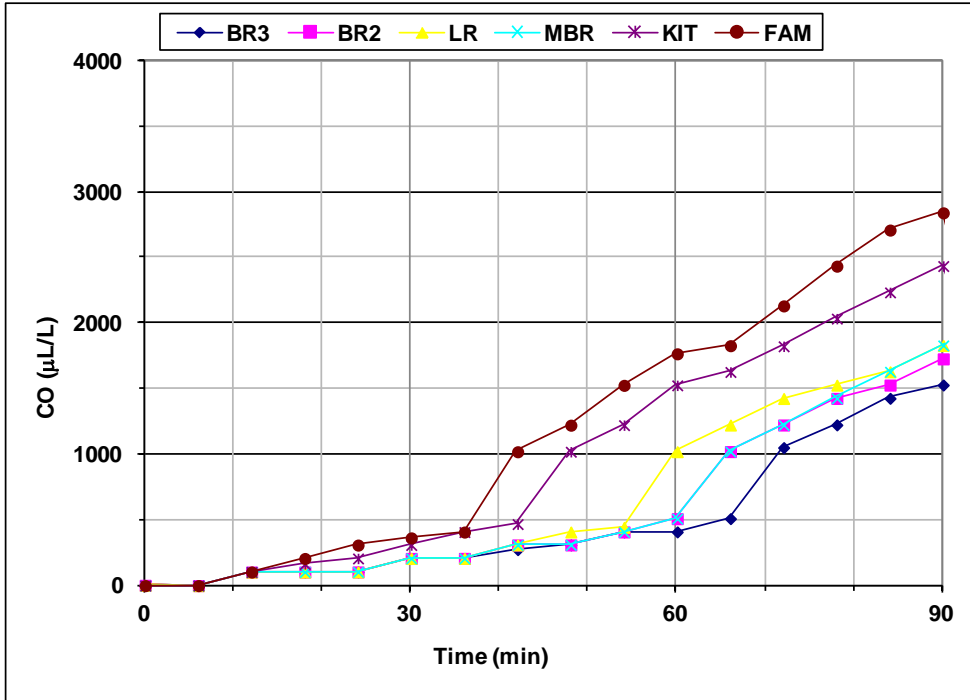


Figures C17a and C17b show the results for Test A, which was a 1.5 h test of unmod Gen X in Configuration 3 (garage bay door closed, garage access door to house open two inches, and the house central HVAC fan on). These conditions are the same as Test I and the results of Test A were similar to the first 1.5 h of Test I (see Figure 19 in the body of the report). After the generator was manually stopped, the garage and house were mechanically vented. Figure C17a shows that the concentration of CO in the garage reached a peak of about 9200  $\mu\text{L/L}$  and the concentration of  $\text{O}_2$  in the garage dropped to 18.6% when the generator was stopped. It also shows that in the first load cycle the delivered electrical output was less than the load bank settings for the two highest loads in the load cycle, 4500 W and 5500 W, which were applied as the oxygen was approaching 19%.

**Figure C17a** CO and  $\text{O}_2$  concentrations in the garage and measured load for Test A (unmod Gen X, Configuration 3)

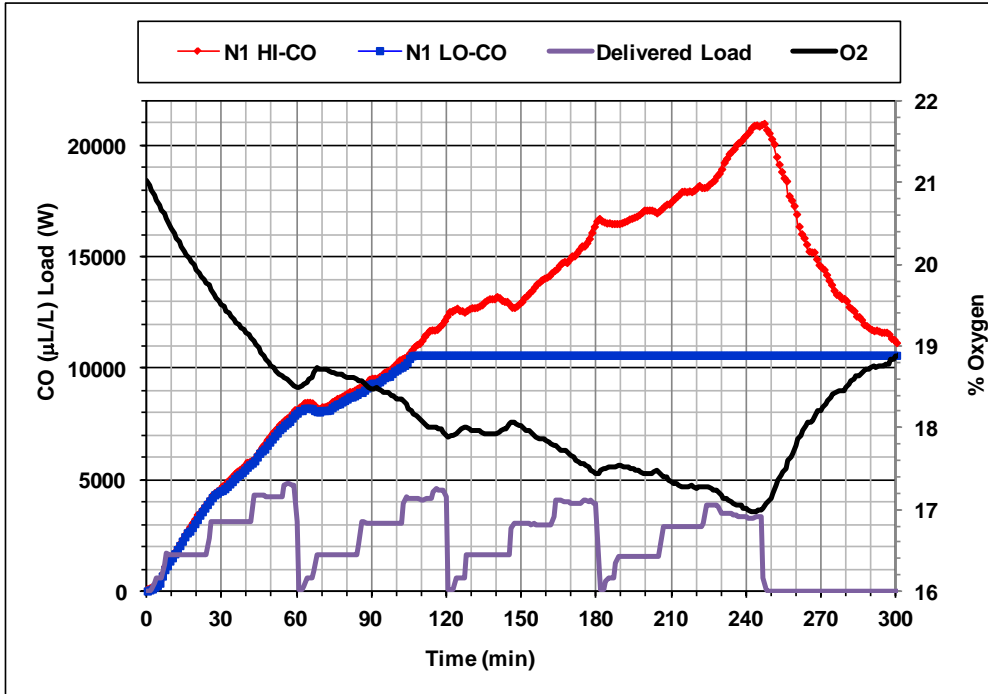


**Figure C17b** CO (high range) concentrations in the house for Test A (unmod Gen X, Configuration 3)

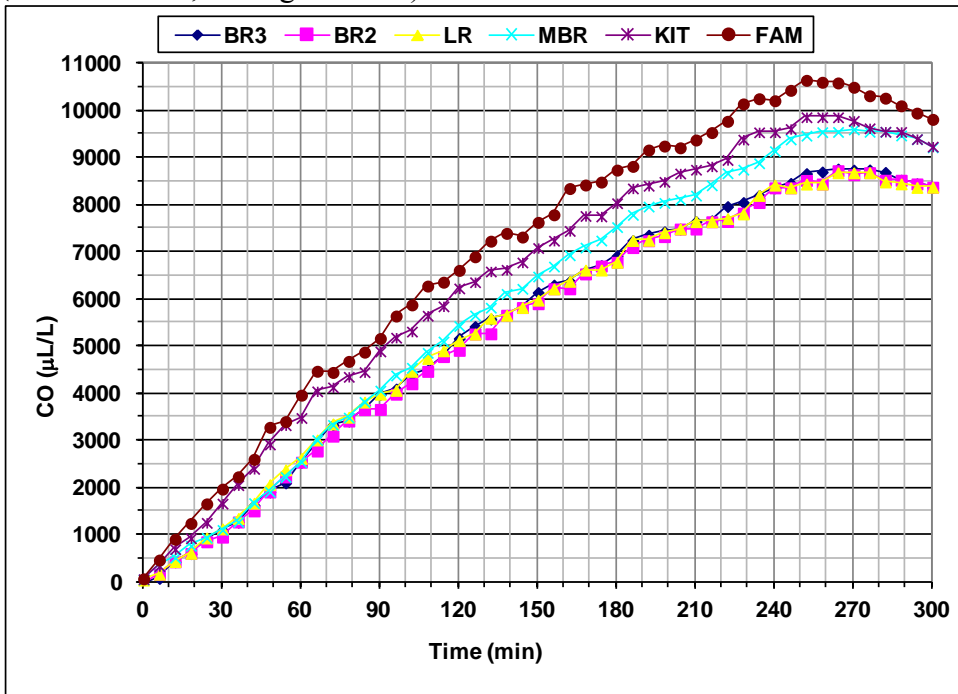


Figures C18a and C18b show the results for Test C, which was a 4 h test of unmod Gen X in Configuration 3 followed by a 1 h natural decay. These conditions are the same as Test I and the results of Test C were similar to those of Test I (see Figure 19 in the body of the report). Figure C18a shows that the concentration of CO in the garage reached a peak of about 21,000  $\mu\text{L/L}$  and the concentration of  $\text{O}_2$  in the garage dropped to 17.0 % when the generator was stopped. It also shows that during the first load cycle the delivered electrical output was less than the load bank settings for the two highest loads in the cycle, 4500 W and 5500 W, which were applied as the oxygen was around 19 %. As the oxygen continued to drop in the subsequent load cycles, the delivered power for these two load points decreased further.

**Figure C18a** CO and O<sub>2</sub> concentrations in the garage and measured load for Test C (unmod Gen X, Configuration 3)



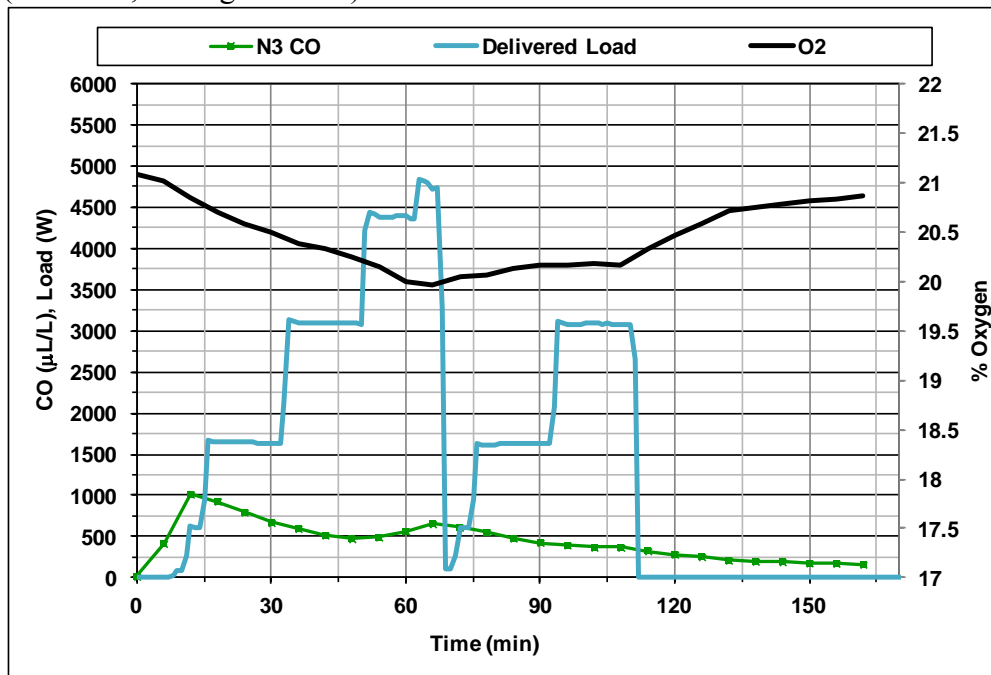
**Figure C18b** CO (high range) concentrations in the house for Test C (unmod Gen X, Configuration 3)



Figures C19a and C19b show the results for Test AA, which was a shut-off test of Gen SO1 with the shutoff algorithm enabled with test house configuration 3 and the cyclic

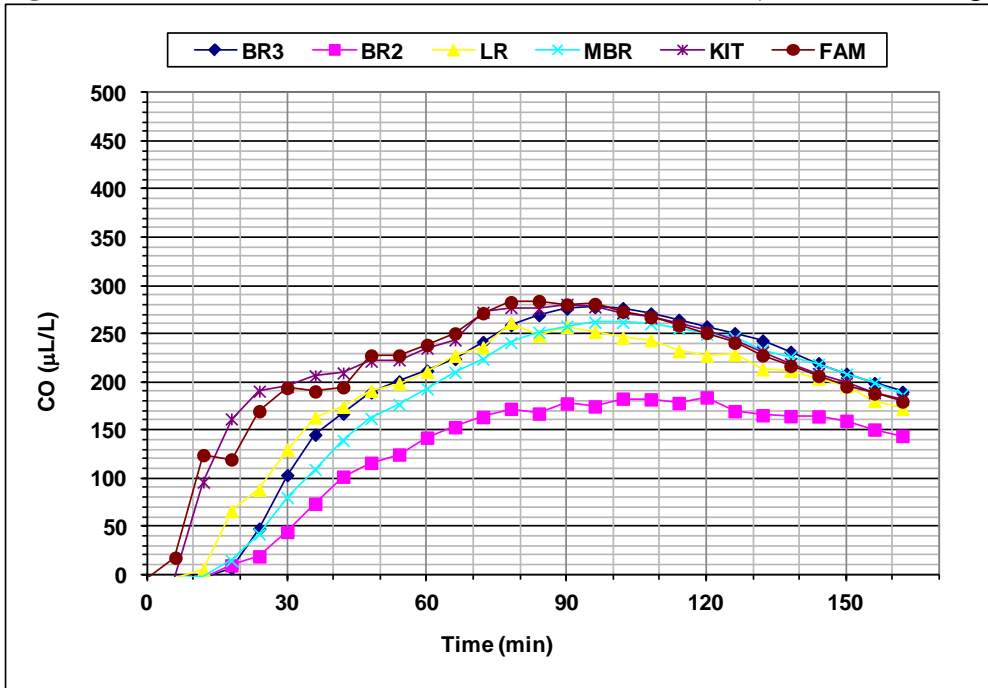
load. The algorithm shut off the generator after approximately 1.6 h. A natural decay period of about 1 h was included after the generator was stopped, followed by mechanical venting. The results shown in Figure C19 for Test AA, prior to generator shut-off, are similar to those in Figure 20 (in the body of the report) for Test Z (a test of the same generator and house configuration but without the shut-off activated) although the CO concentration reached a higher level during the initial spike for Test AA.

**Figure C19a** CO and O<sub>2</sub> concentrations in the garage and measured load for Test AA (Gen SO1, Configuration 3)



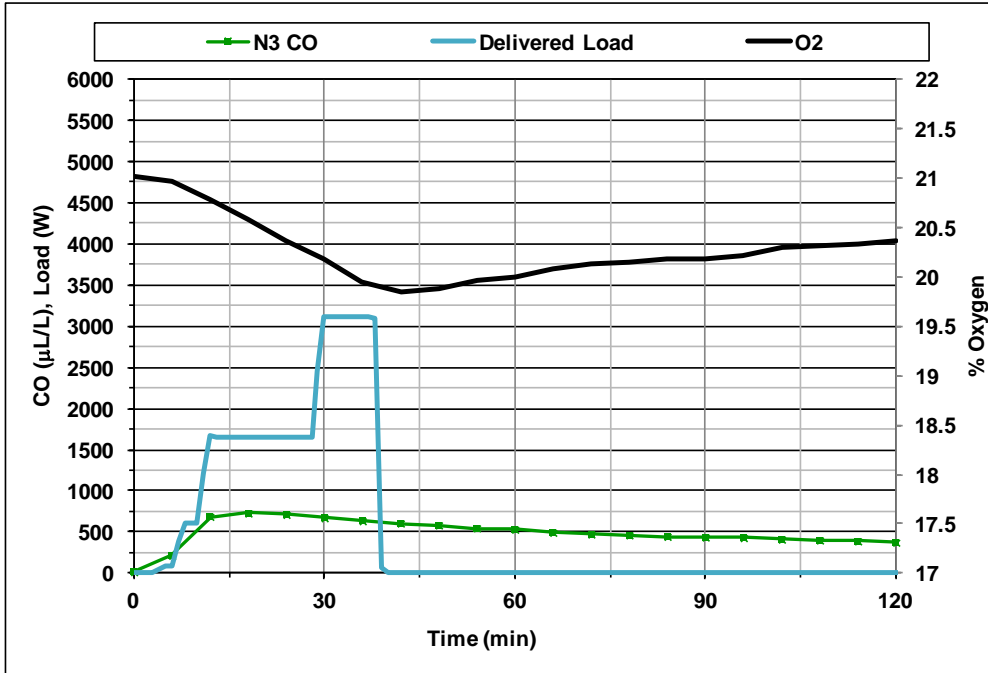


**Figure C19b** CO concentrations in the house for Test AA (Gen SO1, Configuration 3)

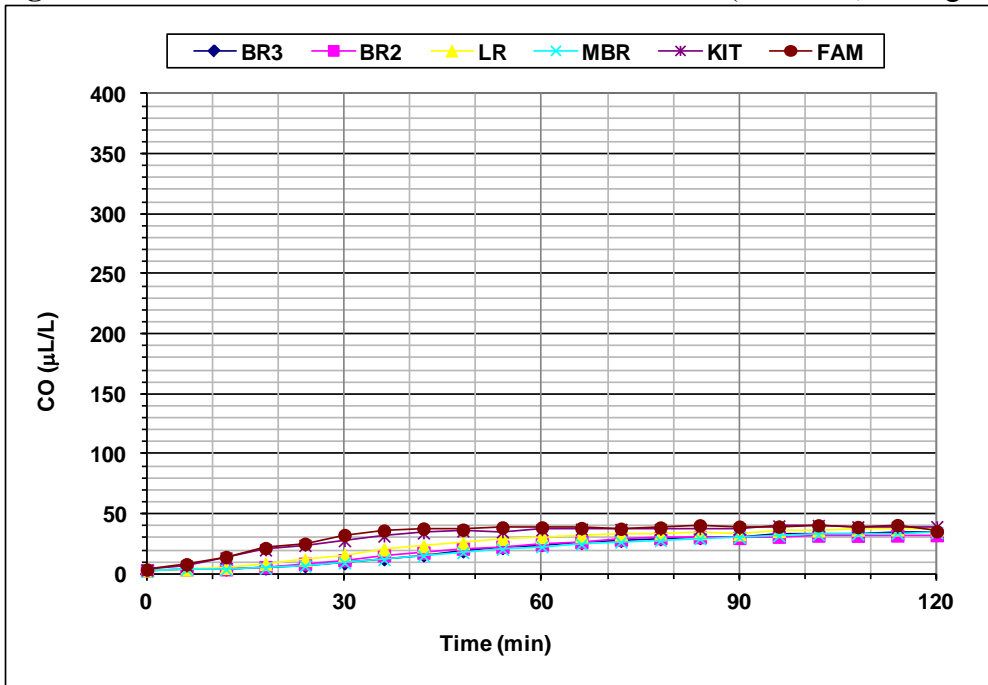


Figures C20a and C20b show the results for Test X, which was a shut-off test of Gen SO1 with the shut-off algorithm enabled under test house configuration 4 and the cyclic load. The algorithm shut off the generator after approximately 0.8 h. A natural decay period of about 1.2 h was included after the generator was stopped, followed by mechanical venting. The results shown in Figure C20 for Test X, prior to generator shut-off, are similar to those in Figure 20 for Test Z (a test of the same generator and house configuration but without the shut-off activated).

**Figure C20a** CO and O<sub>2</sub> concentrations in the garage and measured load for Test X (Gen SO1, Configuration 4)



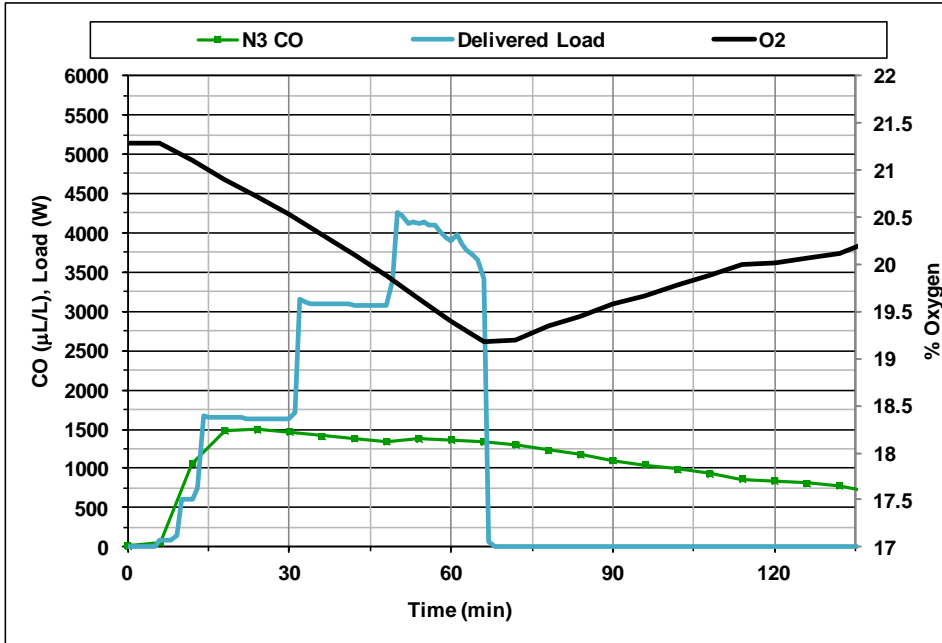
**Figure C20b** CO concentrations in the house for Test X (Gen SO1, Configuration 4)



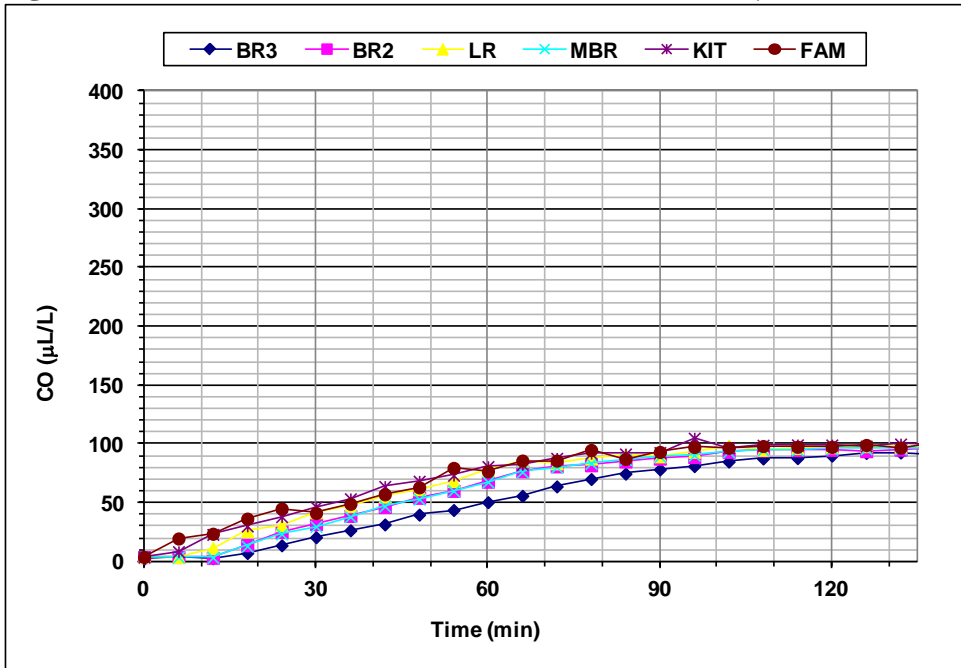
Figures C21a and C21b show the results for Test AB, which was a shut-off test of Gen SO1 with the shut-off algorithm enabled under test house configuration 5 and the cyclic load. The algorithm shut off the generator after approximately 1 h. A natural decay period of about 1.1 h was included after the generator was stopped, followed by mechanical

venting. The results shown in Figure C21 for Test AB, prior to generator shut-off, are similar to those in Figure 24 (in the body of the report) for Test AH (a test of the same generator and house configuration but without the shut-off activated) although the initial spike in CO concentration in the garage was larger for Test AB.

**Figure C21a** CO and O<sub>2</sub> concentrations in the garage and measured load for Test AB (Gen SO1, Configuration 5)

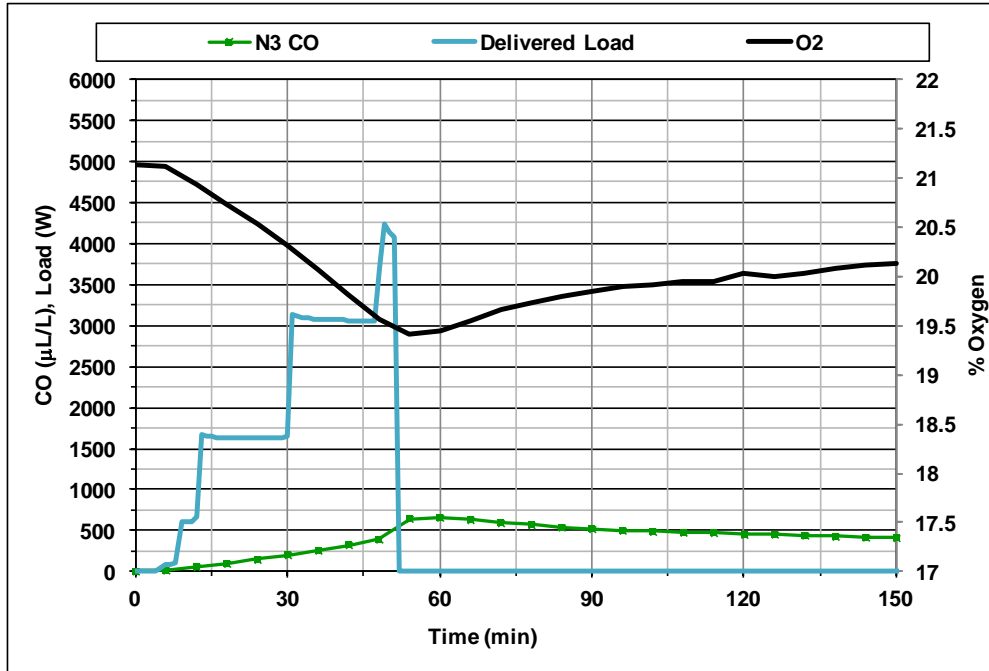


**Figure C21b** CO concentrations in the house for Test AB (Gen SO1, Configuration 5)

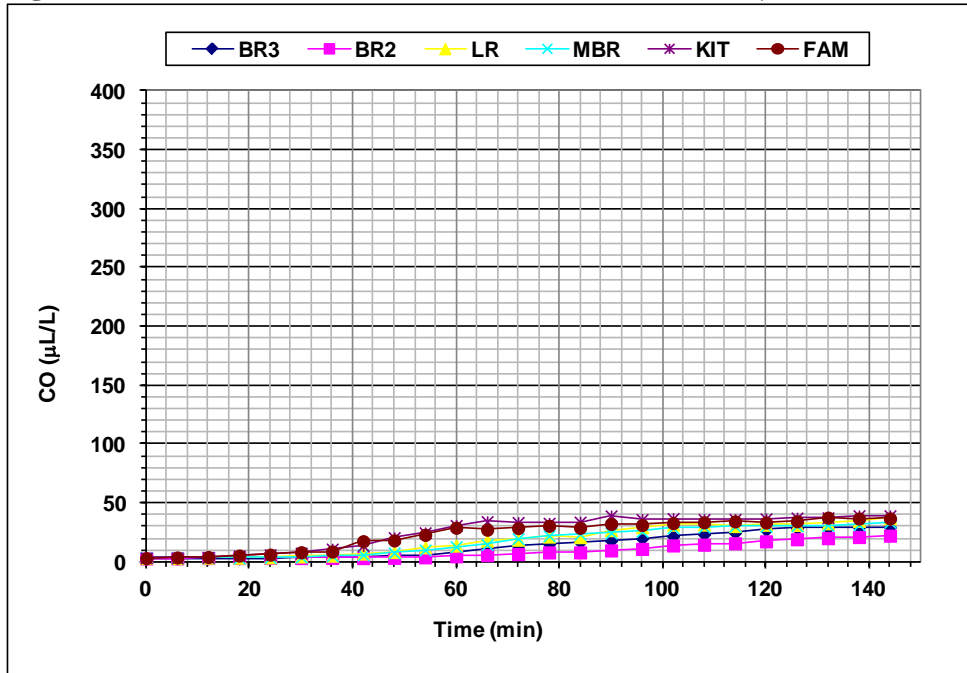


Figures C22a and C22b show the results for Test AQ, which was also a shut-off test of Gen SO1 with the shutoff algorithm enabled under test house configuration 5 and the cyclic load. The algorithm shut off the generator after approximately 0.8 h. A natural decay period of about 1.5 h was included after the generator was stopped, followed by mechanical venting. Figure C22a shows no initial spike in CO concentration in the garage for Test AQ because Test AQ was a warm start while Test AB was a cold start.

**Figure C22a** CO and O<sub>2</sub> concentrations in the garage and measured load for Test AQ (Gen SO1, Configuration 5)

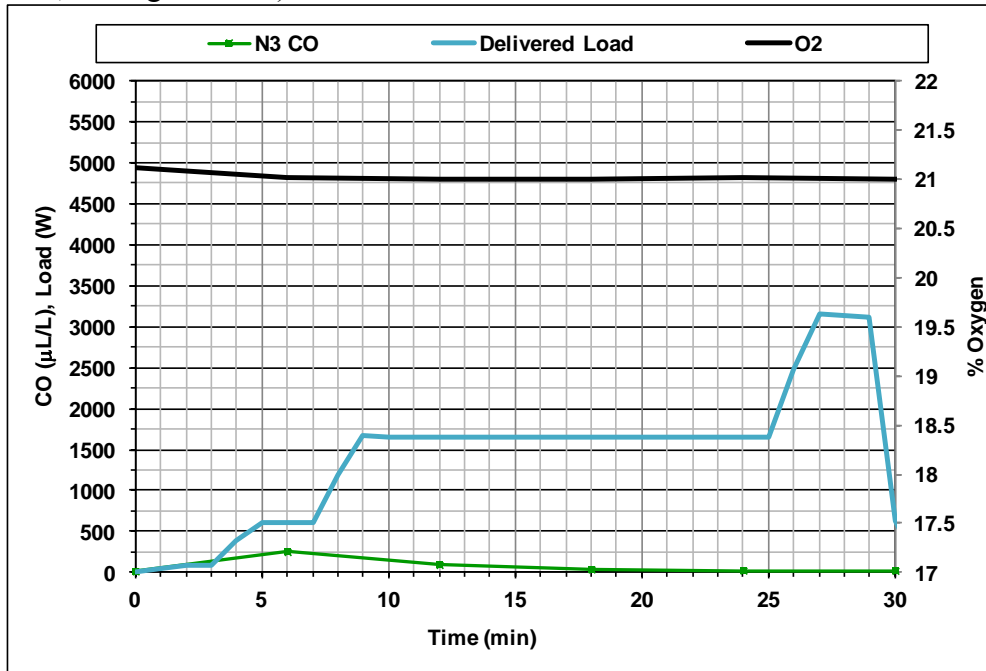


**Figure C22b** CO concentrations in the house for Test AQ (Gen SO1, Configuration 5)

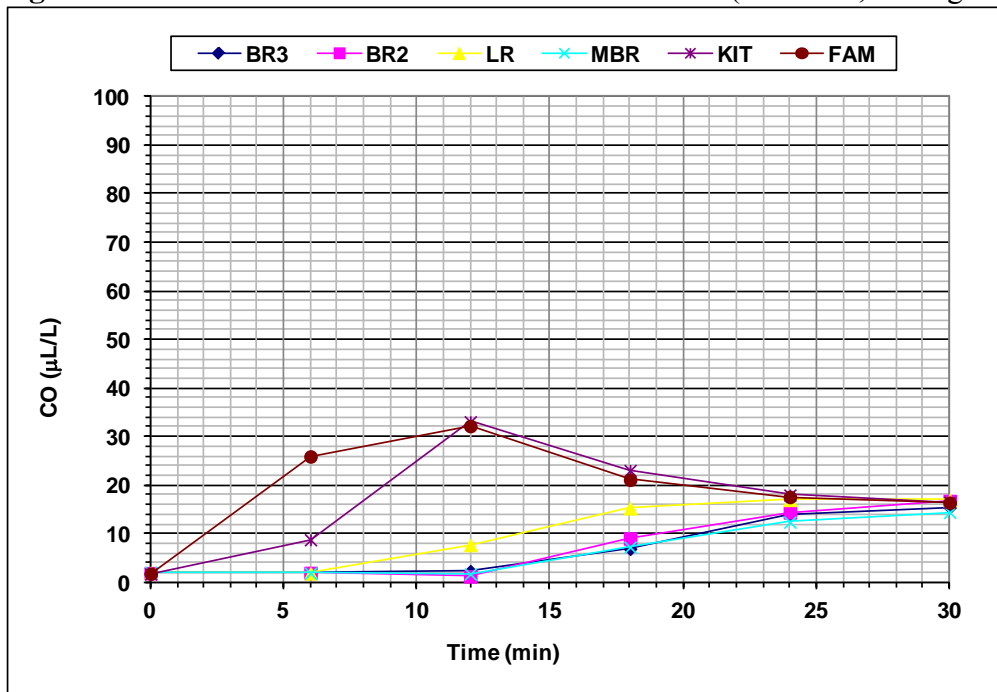


Figures C23a and C23b show the results for Test Y, which was a shut-off test of Gen SO1 with the shutoff algorithm enabled under test house configuration 6 and the cyclic load. The algorithm shut off the generator after approximately 0.5 h, followed by mechanical venting. The results shown in Figure C23 for Test Y, prior to generator shut-off, are very similar to those in Figure 26 (in the body of the report) for Test U (a test of the same generator and house configuration but without the shut-off activated).

**Figure C23a** CO and O<sub>2</sub> concentrations in the garage and measured load for Test Y (Gen SO1, Configuration 6)



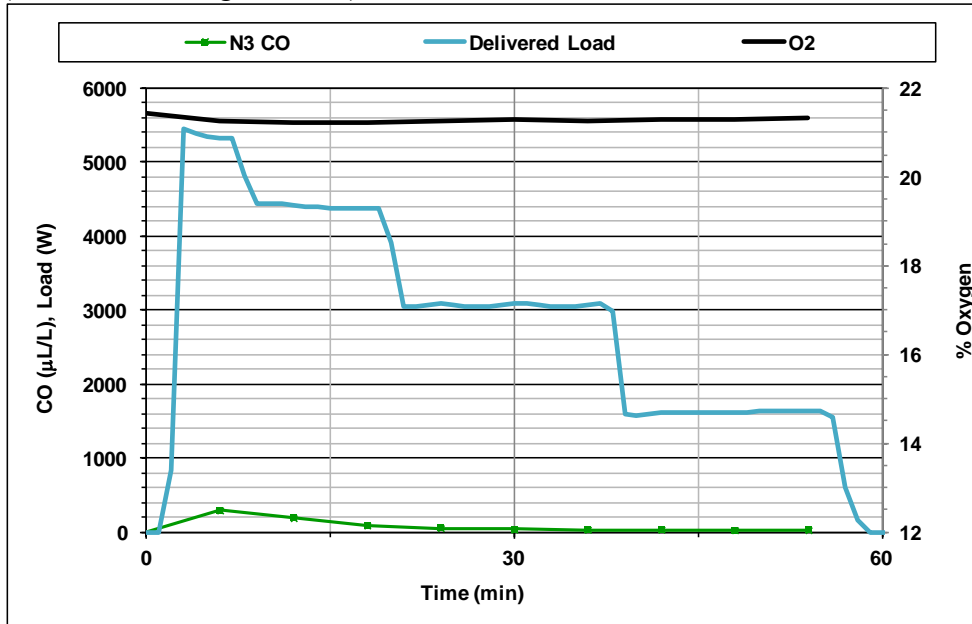
**Figure C23b** CO concentrations in the house for Test Y (Gen SO1, Configuration 6)



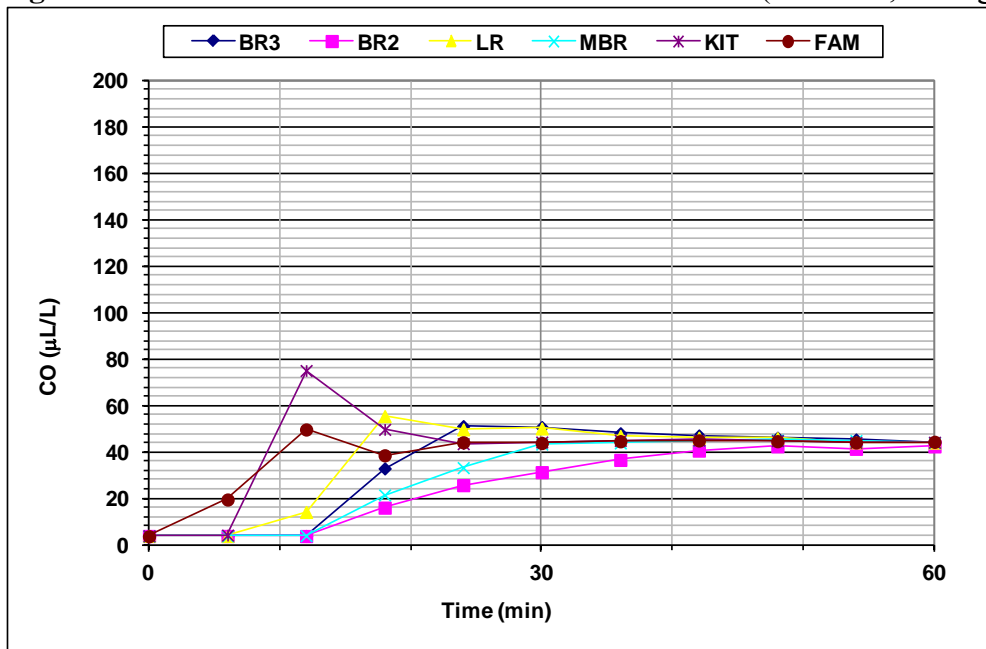
Figures C24a and C24b show the results for Test AO, which was a shut-off test of Gen SO1 with the shutoff algorithm enabled under test house configuration 7 and the cyclic load. The algorithm shut off the generator after approximately 1.1 h, followed by mechanical venting. The results shown in Figure C24 for Test AO do not show an initial

spike in garage CO concentration like that in Figure 28 (in the body of the report) for Test V (a test of the same generator and house configuration but without the shut-off activated) but with a somewhat smaller initial spike in concentration.

**Figure C24a** CO and O<sub>2</sub> concentrations in the garage and measured load for Test AW (Gen SO1, Configuration 7)



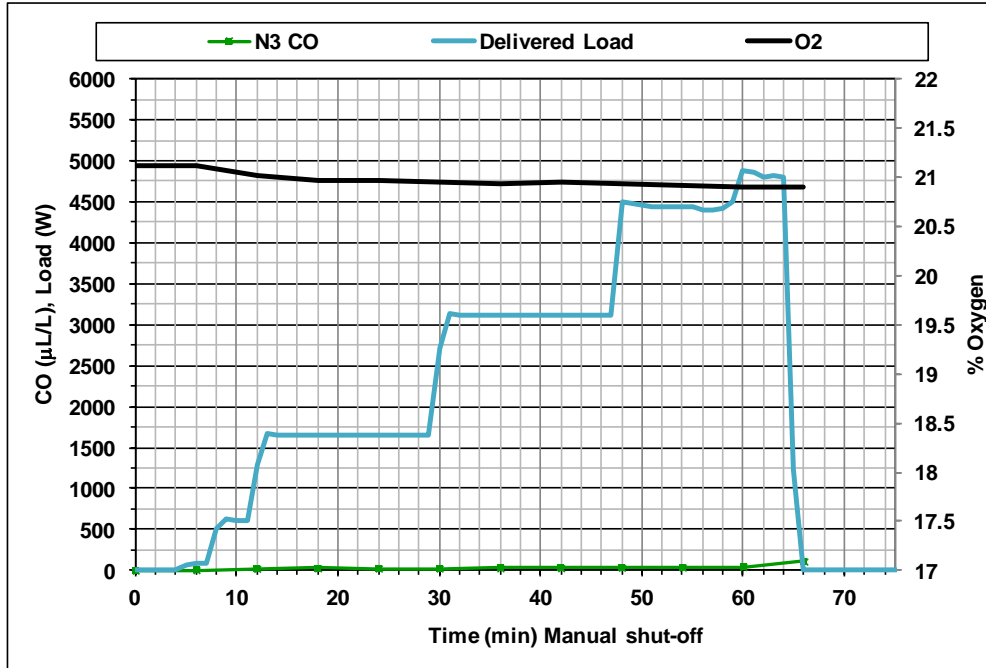
**Figure C24b** CO concentrations in the house for Test AW (Gen SO1, Configuration 7)



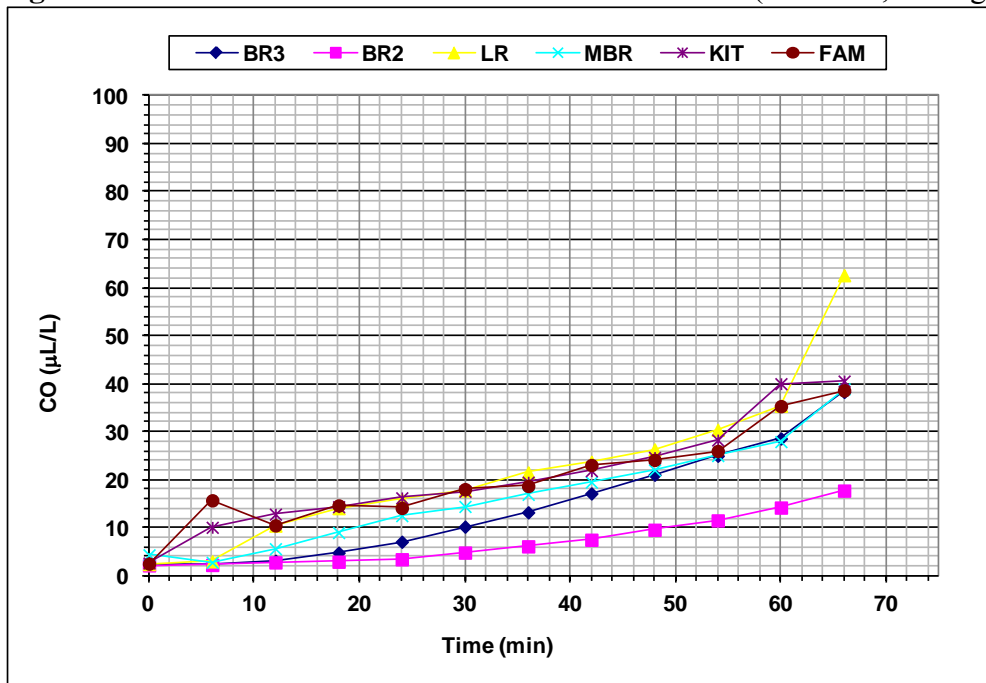
Figures C25a and C25b show the results for Test AO, which was a shut-off test of Gen SO1 with the shutoff algorithm enabled under test house configuration 7 and the cyclic load. The algorithm shut off the generator after approximately 1.1 h, followed by

mechanical venting. The results shown in Figure C25 for Test AO do not show an initial spike in garage CO concentration like that in Figure C24 for Test AW (a test of the same generator and house configuration but loaded in a high to low cyclic pattern), likely because Test AO was a warm start.

**Figure C25a** CO and O<sub>2</sub> concentrations in the garage and measured load for Test AO (Gen SO1, Configuration 7)



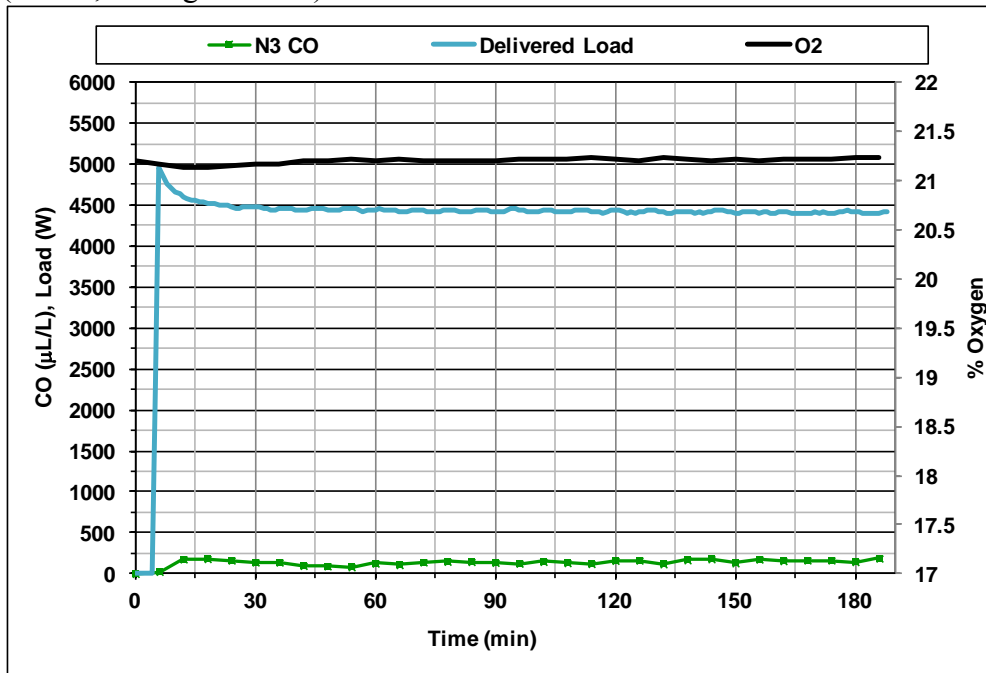
**Figure C25b** CO concentrations in the house for Test AO (Gen SO1, Configuration 7)



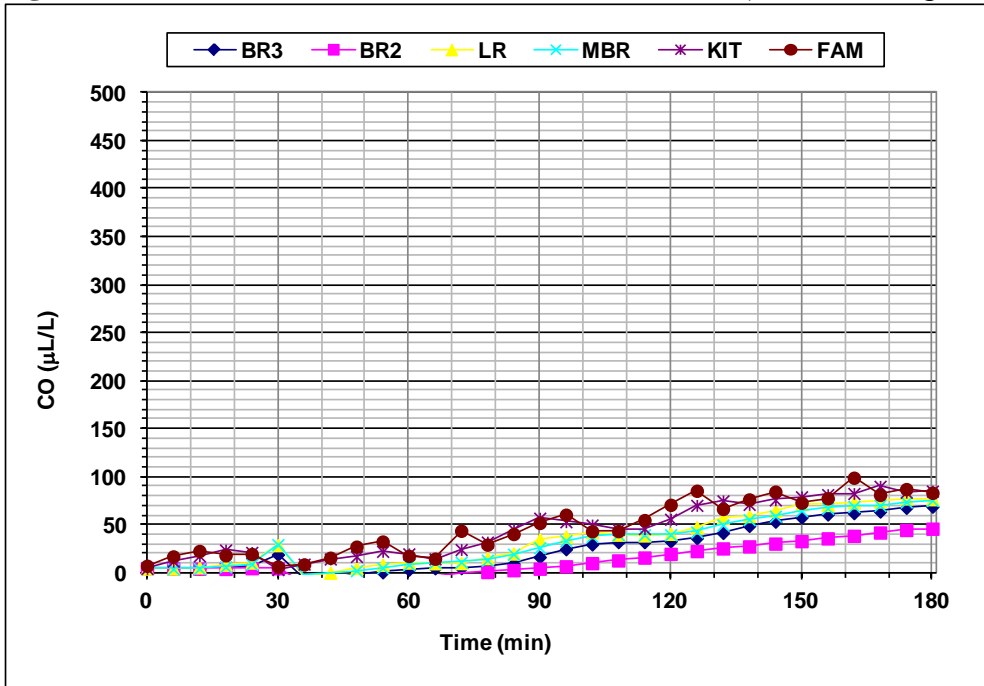


Figures C26a and C26b show the results for Test AJ, which was a 3 h test of Gen B with the house in Configuration 8 with a 5500 W load. Figure C26a shows the concentration of CO in the garage reached a peak near 200  $\mu\text{L}/\text{L}$  and the volume fraction of  $\text{O}_2$  in the garage did not measurably change during the test.

**Figure C26a** CO and  $\text{O}_2$  concentrations in the garage and measured load for Test AJ (Gen B, Configuration 8)

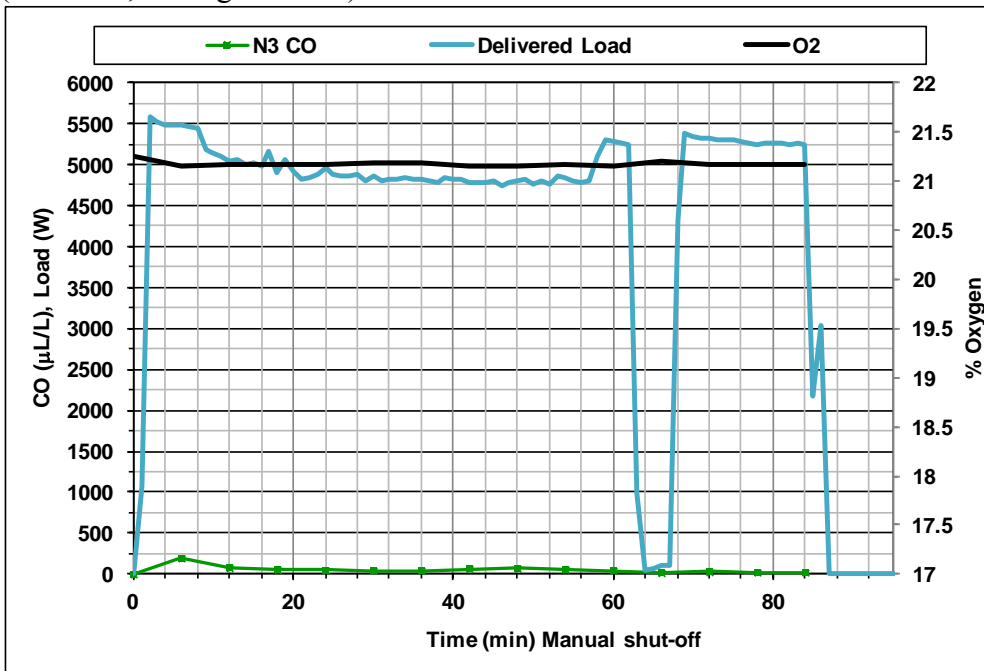


**Figure C26b** CO concentrations in the house for Test AJ (Gen B, Configuration 8)



Figures C27a and C27b show the results for Test AK, which was a shut-off test of Gen SO1 with the shut-off algorithm enabled under test house configuration 8 and a 5500 W load. The algorithm shut off the generator after approximately 1.4 h, followed by mechanical venting.

**Figure C27a** CO and O<sub>2</sub> concentrations in the garage and measured load for Test AK (Gen SO1, Configuration 8)



**Figure C27b** CO concentrations in the house for Test AK (Gen SO1, Configuration 8)

