

RANGE TIPOVERS: AN EVALUATION OF RANGE STABILITY

May 2011



U.S. CONSUMER PRODUCT SAFETY COMMISSION
4330 EAST WEST HIGHWAY
BETHESDA, MD 20814

The views expressed in this report are those of the CPSC staff and have not been reviewed or approved by, and may not necessarily reflect the views of, the Commission.

No Text on This Page

U.S. CONSUMER PRODUCT SAFETY COMMISSION
Directorate for Engineering Sciences



RANGE TIPOVERS:
AN EVALUATION OF RANGE STABILITY

May 2011

Arthur Lee
Division of Electrical Engineering
Directorate for Engineering Sciences

Danny Pineda, Intern
Division of Electrical Engineering
Directorate for Engineering Sciences

ACKNOWLEDGEMENTS

The authors wish to thank the parents and their children who volunteered for this evaluation. Special thanks go to CPSC staff members Dave Miller, Mathematical Statistician, Directorate for Epidemiology, and Tongele Tongele and John Murphy, Mechanical Engineers, Directorate for Engineering Sciences. Without their help, this work would not have been possible.

The authors also would like to thank the CPSC's Human Subjects Committee Institutional Review Board for their guidance and support throughout this study.

EXECUTIVE SUMMARY

The U.S. Consumer Product Safety Commission (CPSC) staff estimates that there are 1,700 appliance-related,¹ emergency department (ED)-treated injuries involving appliance instability and tipover annually. In addition, from 2000 to 2008, CPSC staff has reports of 13 fatalities associated with instability and tipover of appliances. The majority of the fatalities involved children younger than 10 years old.²

The voluntary safety standard for electric ranges is Underwriters Laboratories Inc. (UL) *Standard for Household Electric Ranges* (UL 858), and the standard for gas ranges is American National Standards Institute (ANSI) *Standard for Household Indoor Cooking Gas Appliances* (ANSI Z21.1) (Underwriters Laboratories, 2005) (American National Standards Institute, 2000). The standards include identical performance requirements to address stability under normal use and abnormal use conditions. To comply with the requirements under abnormal use conditions, most manufacturers include an anti-tipping bracket to secure the range to the floor or adjacent wall or cabinets when the unit is installed. There have been recent efforts by the UL 858 Standards Technical Panel to address range tipover incidents by improving labeling for installers and users to encourage use of anti-tip hardware. CPSC staff believes that more stringent performance requirements for free-standing ranges should be developed to address range tipovers.

CPSC staff reviewed 33 reports of incidents involving range tipovers occurring from 1980 to 2006. Two main commonalities in the incidents reviewed were that the ranges were unsecured to an adjacent wall, floor, or cabinet, and sufficient weight was applied to the open oven door to cause the range to tip forward. The available incident data for the past 25 years show that incidents involve two distinct groups—children between the ages of 15 months and 5 years—and older adults.

The circumstances surrounding the events resulting in range tipover varied depending on the victim's age group (*i.e.*, young versus elderly). The incidents involving the elderly occurred when the victims used the open oven door as support. With the range unsecured by anti-tip hardware, the weight of the adult on the open oven door caused the range to tip forward. The events leading up to incidents involving children are sketchy because typically there were no adult eyewitnesses, but the descriptions of the incidents where children were injured are similar. The incidents typically involved a child trapped under the tipped range, when the children were unsupervised in the kitchen or near the range. If multiple children were in the household, usually the younger sibling was the victim who was entrapped under the tipped over range.

In 2009 and 2010, CPSC staff conducted an evaluation of freestanding ranges. Testing included static load tests on each of four sample ranges to determine the loads required for the ranges to reach tipover conditions. The data from these tests were used to identify a threshold line (force versus distance from edge of open oven door) at which tipover would occur.

CPSC staff also conducted testing to determine the forces that could be applied to an open oven door by children. Dynamic forces of children actively climbing and standing on a test fixture/platform,

¹ The appliance category includes: ranges, clothes washers, clothes dryers, refrigerators, and freezers. See Table 10, Potential Appliance Product Codes Associated with Instability or Tipover, for a full list of products included in the appliance category (Gipson, March 2011).

² The deaths are from 2000 through 2008 (2007 and 2008 may be incomplete because of ongoing reporting). Appendix A of the report, Gipson, February 2011, gives the methodology.

which simulated a range with an open oven door, were measured. Thirteen children within the age range of 15 months to 5 years old participated in the staff's testing.

Based on a threshold line corresponding to UL's current requirement to address stability under normal conditions (*i.e.*, a test in which a static weight of 75 pounds is placed on the geometric center of an open oven door) and using the data collected in the CPSC staff's dynamic tests, 26 percent of the events involving up to two children climbing onto an open oven door of an unsecured range would have resulted in range tipover. Using a threshold line corresponding to a static test at 100 pounds on the geometric center of an open oven door and using the data collected in the staff's tests, the percentage of expected tipping events was reduced to approximately 1.5 percent. The weight of two older children (around 5 years old) or more than two children on an oven door still could cause an unsecured range to tip over.

CPSC staff believes that locking an oven door in the open position could address crushing deaths caused by range tipovers and would be effective for both vulnerable populations—children and older adults. In this report, CPSC staff describes two conceptual methods that potentially could be incorporated into the hinge of an oven door to lock it into the open position once the range has started to tip forward. These methods may not be effective in reducing scald injuries³ associated with hot liquids/food spilling onto a child when a range does tip forward.

Based on CPSC staff's evaluation, the following conclusions may be drawn:

- Increasing the stability of an unsecured range by requiring that the range not tip forward with a 100 pound static weight placed on the geometric center of an open oven door could reduce the incidence of range tipover and, therefore, reduce injuries and deaths resulting from scalding and asphyxiation, respectively.
- Locking the oven door into the open position when an unsecured range begins to tip forward may reduce deaths to children and older adults caused by entrapment under a range; however, this may not be effective in reducing scald injuries associated with hot liquids or food spilling onto a person when a range does tip forward.
- CPSC staff is aware of five incidents where adult victims were trapped for an extended period of time under a tipped over range while the oven's heating elements were turned on, resulting in thermal burns each time the oven cycled on. Automatically shutting off the heating source of a range/oven when it has tipped may reduce the severity of thermal burns.

Based on CPSC staff tests, additional research in the following areas may be beneficial:

- Investigation of the effectiveness of locking the oven door into the open position.
- Investigation of the development of an anti-tipping device that must be installed for the oven to operate.

³ In a March 28, 2007 CPSC staff memorandum, *Incident reports involving freestanding kitchen range tipover (1980 to 2006)*, 15 out of 107 incidents involved children who suffered burns or scalding injuries involving the ranges. The majority of these injuries, regardless of age, were burns suffered from hot liquids spilled from the pots or pans that tipped when the range tilted.

Table of Contents

EXECUTIVE SUMMARY	v
1.0 INTRODUCTION	1
2.0 VOLUNTARY STANDARDS REQUIREMENTS.....	1
2.1 “Normal” Stability Test.....	2
2.2 Recent Changes to Improved Consumer Awareness and Installation Practices	3
3.0 INCIDENT DATA	3
3.1 Injuries and Fatalities from Ranges.....	3
3.2 Selected Incidents.....	7
3.2.1 An 18-month-old male – November 2010.....	7
3.2.2 A 23-month-old male–August 2009	8
3.2.4 An 18-month-old male October 2006	8
4.0 RANGE STABILITY–ELECTRIC AND GAS RANGES	9
4.1 Forces to Tip a Range Forward	9
4.2 Inclination Angle to Cause Pot to Slide	13
5.0 CHILD INTERACTION WITH SIMULATED OPEN OVEN DOOR.....	14
5.1 Study Participants.....	15
5.2 Results of Testing.....	19
5.2.1 Analysis of test data for all sessions	19
5.2.2 Sessions 1 and 2 (21-month-old twins).....	20
5.2.3 Session 3 (59- and 16-month old siblings).....	23
5.2.4 Session 4 (59-, 52-, and 16-month olds).....	25
5.2.5 Session 5 (43- and 23-month-old siblings).....	29
5.2.6 Session 6 (56- and 25-month-old siblings).....	31
5.2.7 Session 7 (60- and 32-month-old siblings).....	33
5.2.8 Session 8 (41 and 24 months old).....	35
6.0 ANALYSIS OF TEST DATA.....	37
6.1 Analysis by Maximum Leverage	38
6.2 Analysis by Force and Position	46
7.0 CONCEPTUAL SAFETY FEATURES.....	48
8.0 SUMMARY.....	53
9.0 CONCLUSIONS	54
10.0 REFERENCES	55
Bibliography	55
APPENDIX A – TEST FIXTURE AND SETUP DETAILS	A-1
A1. Simulated Range/Oven Details.....	A-1
A2. Test Structure Stability	A-2
A3. Test Setup.....	A-2
APPENDIX B – CONSENT FORM AND HUMAN SUBJECTS APPROVAL LETTER.....	B-1
APPENDIX C – ADDITIONAL CHARTS FOR INDIVIDUAL TEST SESSIONS	C-1

C1. Session 1 (Participants 1 and 2).....	C-1
C2. Session 2 (Participants 1 and 2).....	C-2
C3. Session 3 (Participants 3 and 4).....	C-4
C4. Session 4 (Participants 3, 4, and 5).....	C-5
C5. Session 5 (Participants 6 and 7).....	C-7
C6. Session 6 (Participants 8 and 9).....	C-8
C7. Session 7 (Participants 10 and 11).....	C-10
C8. Session 8 (Participants 12 and 13).....	C-11

List of Figures

Figure 1. Illustration of a Freestanding Range.....	1
Figure 2. Measuring Force to Cause Tipping	10
Figure 3. Tipover Forces.....	10
Figure 4. Tipover Force Curves	11
Figure 5. Calculated Tipover Threshold Line.....	12
Figure 6. Force to Tip a Sagging Oven Door.....	12
Figure 7. Range Angle of Inclination to Cause Pots to Slide.....	14
Figure 8. Picture of Test Setup.....	15
Figure 9. Test Setup Orientation and Features.....	15
Figure 10. Sessions 1 through 8, Center of Gravity (CG) Plot.....	19
Figure 11. Sessions 1 through 8, CG Plot (Expanded View of Figure 10).....	20
Figure 12. Session 1, CG Plot.....	21
Figure 13. Session 2, CG Plot and Tipover Threshold Line	21
Figure 14. Session 2, Snapshot of Data Point S2-a.....	22
Figure 15. Session 2, 3D Scatter Plot of the Data Points.....	22
Figure 16. Session 3, CG Plot and Tipover Threshold Line	23
Figure 17. Session 3, Snapshots of Data Points S3-a and S3-b	24
Figure 18. Session 3, 3D Scatter Plot of the Data Points.....	25
Figure 19. Session 4, CG Plot (Limited to 2 Participants at a Time).....	26
Figure 20. Session 4, CG Plot (Expanded View of Figure 19).....	26
Figure 21. Session 4, Snapshot of Data Point S4-a.....	27
Figure 22. Session 4, Snapshots of Data Points S4-b and S4-c	27
Figure 23. Session 4, Snapshots of Data Points S4-d, S4-e, S4-f, and S4-g.....	28
Figure 24. Session 4, 3D Scatter Plot of the Data Points (Limited to 2 Participants at a Time).....	29
Figure 25. Session 5, CG Plot.....	30
Figure 26. Session 5, Snapshots of Data Points S5-a and S5-b	30
Figure 27. Session 5, 3D Scatter Plot of the Data Points.....	31
Figure 28. Session 6, CG Plot.....	32
Figure 29. Session 6, Snapshots of Data Points S6-a, S6-b, and S6-c.....	32
Figure 30. Session 6, 3D Scatter Plot of the Data Points.....	33
Figure 31. Session 7, CG Plot.....	34
Figure 32. Session 7, Snapshots of Data Points S7-a and S7-b	34
Figure 33. Session 7, 3D Scatter Plot of the Data Points.....	35
Figure 34. Session 8, CG plot.....	36
Figure 35. Session 8 Snapshot of Data Point S8-a.....	36
Figure 36. Session 8, 3D Scatter Plot of the Data Points.....	37
Figure 37. Sample Timeline of Events.....	38
Figure 38. Frequency of Maximum Leverage per Event	39
Figure 39. Normalized Frequency of Maximum Leverage per Event	40

Figure 40. Normal Probability Plot for Maximum Leverage.....	41
Figure 41. Tipover and Non-Tipover Count Plot Using Generic Static 75 Lb Tipover Threshold.....	42
Figure 42. 75 Lb and 100 Lb Tipover Threshold Lines.....	43
Figure 43. CG Data Points, 75 Lb and 100 Lb Tipover Threshold Lines.....	43
Figure 44. CG Data Points, 75 Lb and 100 Lb Tipover Threshold Lines.....	44
Figure 45. Tip and No Tip Count Plot Using Generic Static 75 Lb and 100 Lb Tipover Threshold Lines .	45
Figure 46. Maximum Leverage, Actual Count Data, and Threshold Count Lines.....	46
Figure 47. Tips and No Tips using 75 pounds, Crossover Line at 75 lbs.....	47
Figure 48. Tips and No Tips using 100 pounds, Crossover Lines at 75 pounds and 100 pounds.....	48
Figure 49. Illustration of Range and Oven Door “Clamming” on Victim Due to Range Tipover.....	48
Figure 50. Illustration of Oven Door Locking in the Open Position After Tipover.....	49
Figure 51. Illustration of an Oven Door Hinge (Illustrated Without the Spring Attached).....	50
Figure 52. Illustration of a Plunger and Cable System.....	50
Figure 53a. Illustration of a Cam and Roller System.....	51
Figure 53b. Illustration of a Cam and Roller System, Guide Wheel Rides Oven Bracket.....	51
Figure 53c. Illustration of a Cam and Roller System, Guide Wheel Drops into Locking Position.....	52
Figure 53d. Illustration of a Cam and Roller System, Locking Cam is Positioned over Locking Wheel ..	52
Figure 53e. Illustration of a Cam and Roller System, Oven Door Locks in the Open Position.....	52
Figure A1. Simulated Range/Oven.....	A-1
Figure A2. Forces to Tipover the Test Structure.....	A-2
Figure A3. Overhead View of Test Setup with Safety Mats and Spotters.....	A-3
Figure C1. Session 1, Timeline.....	C-1
Figure C2. Session 1, CG Plot.....	C-1
Figure C3. Session 1, Force Bin Count.....	C-2
Figure C4. Session 2, Timeline.....	C-2
Figure C5. Session 2, CG Plot.....	C-3
Figure C6. Session 2, Force Bin Count.....	C-3
Figure C7. Session 3, Timeline.....	C-4
Figure C8. Session 3, CG Plot.....	C-4
Figure C9. Session 3, Force Bin Count.....	C-5
Figure C10. Session 4, Timeline.....	C-5
Figure C11. Session 4, CG Plot.....	C-6
Figure C12. Session 4, Force Bin Count.....	C-6
Figure C13. Session 5, Timeline.....	C-7
Figure C14. Session 5, CG Plot.....	C-7
Figure C15. Session 4, Force Bin Count.....	C-8
Figure C16. Session 6, Timeline.....	C-8
Figure C17. Session 6, CG Plot.....	C-9
Figure C18. Session 6, Force Bin Count.....	C-9
Figure C19. Session 7, Timeline.....	C-10
Figure C20. Session 7, CG Plot.....	C-10
Figure C21. Session 7, Force Bin Count.....	C-11
Figure C22. Session 8, Timeline.....	C-11
Figure C23. Session 8, CG Plot.....	C-12
Figure C24. Session 8, Force Bin Count.....	C-12

List of Tables

Table 1. Fatalities from 1980 to 2006.....	4
Table 2. In-Depth Investigation Reports from January 1, 2000 through September 30, 2008	5
Table 3. Incidents Involving a Victim Trapped Under a Tipped Range While the Oven Was Energized....	6
Table 4. Range Samples.....	9
Table 5. Weight of Pots Empty and Filled.....	13
Table 6. Study Participants	17
Table 7. Moments	40
Table 8. Results of Goodness-of-Fit Tests for Normal Distribution.....	40

1.0 INTRODUCTION

The U.S. Consumer Product Safety Commission (CPSC) staff estimates that in 2006, there were 1,700 appliance-related,⁴ emergency department (ED)-treated injuries involving instability and tipover. In addition, from 2000 to 2006, CPSC staff has reports of 13 fatalities and one injury associated with instability and tipover of stoves, ovens, and ranges. The majority of the fatalities involved children younger than 10 years old (Gipson, March 2011).

Ranges that are associated with tipover fatalities and injuries are freestanding or slide-in ranges, which contain oven doors that swing downward, as illustrated in Figure 1.



Figure 1. Illustration of a Freestanding Range

Beginning in 2009, CPSC staff began an evaluation of different models of freestanding ranges to assess the adequacy of the voluntary standards in addressing deaths and injuries associated with range tipovers.

2.0 VOLUNTARY STANDARDS REQUIREMENTS

The voluntary safety standard for electric ranges is Underwriters Laboratories Inc. (UL) *Standard for Household Electric Ranges* (UL 858), and the standard for gas ranges is American National Standards Institute (ANSI) *Standard for Household Indoor Cooking Gas Appliances* (ANSI Z21.1) (Underwriters Laboratories, 2005) (American National Standards Institute, 2000). The standards include identical performance requirements for stability under normal and abnormal use conditions.

Under normal use conditions, stability is determined by the placement of a 75-pound static weight in the middle of the open oven door of a range with the range not secured to surrounding structures (*e.g.*, floor, wall, or cabinetry).⁵ The range meets the performance requirement if the range does not tip forward or move from the horizontal position.

On June 3, 1991, UL adopted a more comprehensive range stability test than the normal stability test of 75 pounds to address abnormal use conditions (Public Citizen, No date). The abnormal test for range stability consists of placing a 250-pound static weight on the geometric center of the open oven door. The range passes if a 4.6 pound weight in a 9-inch pan placed on top of the range does not slide off.

⁴ See Table 10, Potential Appliance Product Codes Associated with Instability or Tipover, for a list of products included in the appliance category (Gipson, March 2011).

⁵ Ranges designed with an opened oven door located less than 36 inches from the floor (Underwriters Laboratories, 2005).

To comply with this requirement, most manufacturers provide an anti-tipping bracket to be used at the time of installation to secure the range to the floor or adjacent wall or cabinets.

2.1 “Normal” Stability Test

Prior to the current stability test for normal use conditions (75 pound weight), the stability test involved placing a static load of 50 pounds or 75 pounds, depending upon the door hinge height on the center of the open oven door of an unsecured range. It is unclear how the test weights were selected, but it appears to have been first discussed at a June 22, 1971, UL Industry Advisory Conference (IAC) meeting (IACs were committees that preceded the UL Standards Technical Panels (STPs) used today) (Musso, 2009). The original proposal in the announcement/agenda for this 1971 meeting recommended a weight of 50 pounds in the center of a fully open door; but based on the meeting discussion, as documented in the meeting report, the proposal was revised to include wording similar to what is in the UL standard today—with both the 50 pound and 75 pound weights, depending upon door hinge height.

As early as 1969, a major appliance manufacturer implemented an internal design standard for its ranges in which a range should withstand a static load of 50 pounds placed on the leading edge of the open oven door (White, 2000). A 50-pound load at the edge of an oven door translates to about a 75-pound load at the center of the oven door that is designed with an opened oven door located less than 36 inches from the floor. The tipping weight was designed to address tipping of the range if a small child’s weight was on an open oven door (Hohn&Scheuerle, 2005).

Below are excerpts from the current UL 858, Section 35 *Stability*.

35 Stability

35.1 General

35.1.1 An appliance provided with casters shall be tested in accordance with 35.2 and 35.3. For each test, the casters are to be in the most unstable position, either locked or unlocked.

35.2 Normal use

35.2.1 When subjected to this test, a floor-supported, cabinet-supported (cabinet below) or counter-supported (counter-hung) appliance shall not tip or move from the horizontal position. The reference to a cabinet-supported appliance here is not intended to include a wall-mounted appliance as specified in 1.5. For this test, the appliance is to be completely assembled, except the broiler pan is to be removed. It is to be installed as intended, but it is not to be connected to the power supply and a floor-supported appliance is not to be secured to any adjacent structure. The appliance is to be mounted on a level surface. For a floor-supported appliance with adjustable feet, the appliance is to be level with the feet set at their most unfavorable position. The appliance is to be loaded as described in 34.4.

34.4 A load is to be uniformly applied, without impact, for 5 min to the fully open oven door. The load is to be 50 lb (22.7 kg) for a door located more than 36 in (914 mm) above the floor, and 75 lb (34 kg) for a door located 36 in or less above the floor. For a side-hinged door, the load is to be applied to the top of the door midway between the vertical edges. For a bottom-hinged door, the load is to be distributed along the center line (midway between the front and back edges) of the door. For an appliance with two or more doors, the test is to be conducted on one door at a time. For a slide-in door (a door that slides into the appliance), the load is to be hung from the top center edge of the door.

35.2.2 An appliance with plug-in modules is to be tested with the combination of modules that will result in the most unfavorable condition. Any optional accessories (e.g., a rotating spit or backguard) are to be removed or placed in the most severe normal operating position, whichever is worse, for the test.

2.2 Recent Changes to Improved Consumer Awareness and Installation Practices

In 2009, a UL Range Stability Task Group reviewed and discussed information regarding range stability requirements and concluded that the current stability for ranges test requirements in UL 858 were still appropriate (Underwriters Laboratories Inc., 2010). The task group, which included a CPSC staff representative, identified consumer awareness and installation practices as possible areas for improvement for potentially reducing incidents. The task group also developed proposals for the Standards Technical Panel (STP) for the Standard for Household Electric Ranges, UL 858 to consider. To address consumer awareness, the proposal included the following:

- (a) An additional anti-tip warning on the front of the range that is visible after installation when an oven door is opened;
- (b) An additional peel-off label, removable by the consumer, specifying how to check installation of the stability device; and
- (c) An anti-tip warning on the first page of the user's guide and the installation instructions.

To address improve installation practices, the proposals included the following:

- (a) Design the anti-tip device to allow two or more possible methods for securing the appliance or provide two different types of stability devices to secure the appliance; and
- (b) Package the anti-tip device hardware with the installation instruction sheet so it is apparent to the installer.

These additional changes to UL 858 to improve consumer awareness and installation practices were adopted by the STP as modifications to the 15th edition of UL 858, *Household Electric Ranges* (Underwriters Laboratories, 2005). The effective date for these changes is scheduled for February 18, 2012.

3.0 INCIDENT DATA

The circumstances surrounding the events resulting in range tipover incidents were different, depending on the victim's age group (*i.e.*, young versus elderly). The incidents involving the elderly occurred when the victims used the open oven door as support when they lost their balance while bending over to take out or put something into the oven, leaned on the door to stand upright, or leaned on the oven door when cleaning inside the oven cavity. With the range unsecured by anti-tip hardware, the weight of the adult on the open oven door caused the range to tip forward onto the victim. The weight of the range—and possibly the frailty of the adult victim—contributed to the victim being trapped under the range and, in some cases, at a time when the oven was in the on position.

The events leading up to incidents involving children were sketchy because there were no adult eyewitnesses, but the descriptions of the incidents were similar. Typically, the incidents involved children between 15 months and 5 years old, who were unsupervised in the kitchen or near the range, and were found trapped under the tipped range. If multiple children were in the household, usually the younger sibling was the victim trapped under the tipped over range.

3.1 Injuries and Fatalities from Ranges

Injuries due to range tipover can be serious, with death a possible outcome. The type and extent of trauma sustained from a tipped range may depend on the weight of the range; the length of time the victim is trapped under the range; the status of the operation of the oven (*i.e.*, heating elements on or off); items cooking on the range top; the part of the victim's body trapped when the range tips over; and the age and physical well-being of the victim.

As of March 2007,⁶ CPSC staff was aware of 143 incidents associated with range tipover that occurred between January 1, 1980 and December 31, 2006 (Stralka, Incident reports involving freestanding kitchen range tipovers, 2007). Contained in the 143 reports are accounts of 107 incidents, which provide enough details to categorize the incident. For these 107 incidents, 15 involved injuries to more than one individual. The majority of these incidents involved burns or scalds suffered by more than one child when the range tipped forward, causing the contents of pots on the stove to spill.

During this 27-year period, CPSC staff has reports of 33 fatalities, as detailed in Table 1. All 33 fatalities involved victims who were trapped under a range when it tipped over. Fifty-eight percent (19 out of 33) of the reported fatalities involved children 5 years old or younger, with some victims as young as 15 months old. Forty-seven percent (9 out of 19) of the child fatalities were victims younger than 2 years old.

Table 1. Fatalities from 1980 to 2006

Year	Reported Fatalities	Age of Decedents
1980	2	18 months, 49 years
1981	2	3 years, 3 years
1982	1	71 years
1983	1	2 years
1984	3	51 years, 38 years, 39 years
1985	2	39 years, adult male
1986	0	--
1987	0	--
1988	1	15 months
1989	0	--
1990	3	60 years, 65 years, 79 years
1991	2	15 months, 18 months
1992	1	2 years
1993	5	20 months, 2 years, 2 years, 60 years, 60 years
1994	0	--
1995	0	--
1996	0	--
1997	2	3 years, adult male
1998	0	--
1999	0	--
2000	0	--
2001	2	23 months, 5 years
2002	1	3 years
2003	2	2 years, elderly female
2004	0	--
2005	1	22 months
2006	2	18 months, 18 months
1980 - 2006	33	Age range 15 months to 79 years old

Source: CPSC staff memo, *Incident reports involving freestanding kitchen range tipovers (1980–2006)*, dated March 28, 2007.

⁶ The search for incident reports was conducted in early 2007. It should be noted that, at that time, fatality reporting was not considered complete for 2003 through 2006. Therefore, the number of fatalities may change.

In October 2008, CPSC staff conducted a search of the CPSC’s In-Depth Investigation epidemiological database⁷ for incidents involving range tipover that were investigated by CPSC staff. From January 1, 2000 to September 30, 2008, CPSC staff identified nine In-Depth Investigation (IDI) reports involving 13 fatalities and one injury associated with instability and tipover ranges. (Stralka, Internal memo, Stove Tipover Completed Investigations of Incidents from 1/1/2000 to 9/30/2008, 2008). All of the incidents involved ranges for which anti-tip hardware was not installed or for which the hardware was not properly installed/engaged.

Of the nine range tipover incidents, three involved scald burns. These three incidents were scenarios that involved two children in the kitchen when the incident occurred. Scalding incidents can occur if the child is tall enough to reach cookware on a stove or when the range tips forward and causes cookware on the range top to slide off and spill its contents onto the child.

At least eight of the nine investigated incidents involved scenarios in which at least two children were in the kitchen unsupervised, and five of these involved fatalities. Table 2 summarizes these incidents (ages of children, disposition, and narrative). The IDIs listed in Table 2 reported that there were no adult witnesses when the incidents occurred, but in some instances, there were uninjured siblings in the home at the time of the incident. It is unclear whether the uninjured siblings played a role in causing the ranges to tip over; but for some incidents, only the weight of the trapped child should not have been sufficient to tip over the range. One IDI involved a 21-month-old tipping over the range while left unsupervised at home with his 6-month-old sibling and pets; but it was unclear whether the 6-month-old or the dogs were involved in the incident. In this incident, the 21-month-old child died from mechanical asphyxia when the range tipped over.

Table 2. In-Depth Investigation Reports from January 1, 2000 through September 30, 2008

No.	In-Depth Investigation Report No.	Age of Child 1 (Disposition)	Age of Child 2 (Disposition)	Conjecture Narratives from the IDIs (unwitnessed accounts of the incident)
1	021217HCC2223	3 years (Death)	3 years (Uninjured)	A 3-year-old died when he climbed on the open oven door of an electric range and the range tipped over and landed on top of him. His twin brother was home at the time.
2	040518HCC1689	2 years (Death)	2 years (Uninjured)	A 2-year-old opened the oven door of the electric range and climbed on the oven door. Subsequently, the entire range tipped over on him. His twin brother was in the room at the time of the incident.
3	070419HWE5860	21 months (Death)	6 months (Uninjured)	A 21-month-old male was compressed under a stove after he opened the door and climbed onto the door, causing it to fall forward. He was home alone with his 6-month-old sister, a dog, and two puppies.
4	070419HWE5861	4 years (Burns)	1 year (Burns)	A 4-year-old and 1-year-old were playing around a range and leaning on the open oven door when it tipped over causing burns.
5	070419HWE5862	2 years (Burns)	4 years (Burns)	A 2-year-old and 4-year-old received scald burns after a stove tipped over.
6	061025CNE1576	18 months (Death)	3 years (Uninjured)	An 18-month-old and his 3-year-old brother attempted to reach some cookies that were on top of the stove, causing the stove to tip over.
7	070419HNE2248	18 months (Burns)	2 years (Uninjured)	An 18-month-old sustained pattern burns from hot food heating on the burners of an electric range, which spilled onto her after she opened the oven door and climbed onto it, tipping the range over.

⁷ In-Depth Investigation (INDP) database.

8	070419HNE2249	18 months (Death)	2 years (Uninjured)	An 18-month-old and her 2-year-old sister opened the range door and stood on it, causing the range to tip over.
9	070213HEP9007	3 years (Broken wrist)	2 years (Uninjured)	A 3-year-old and his 2-year-old brother opened the range door and climbed onto the door. The combined weight of the children caused the range to tip over.

In the 11-year period from 1980 to 1990 (before the requirements to address range stability under abnormal use conditions became effective), CPSC staff is aware of 46 tipover incidents resulting in 15 fatalities and 38 injuries. In the 11-year period from 1991 to 2001, CPSC staff is aware of 36 incidents that resulted in 12 fatalities and 24 reported injuries (Stralka, Incident reports involving freestanding kitchen range tipovers, 2007) (Stralka, Incident reports involving freestanding kitchen range tipovers, 2007) (Stralka, Incident reports involving freestanding kitchen range tipovers, 2007). However, the incidents that occurred from 1991 to 2001 may have involved ranges that were installed prior to the time that anti-tip hardware was required. The average product life of a range is estimated to be 13 and 15 years for electric and gas ranges, respectively (Seinders, et al., 2007). As a result, it might be as late as 2006, before most of the freestanding ranges in consumers' homes were expected to have been provided with anti-tip hardware. Therefore, a review of range tipover incidents that occurred after 2006 may provide a better indication of whether anti-tip hardware is being installed and is effective in reducing the number of incidents.⁸

CPSC staff is aware of at least five incidents where the oven was still on when an adult victim was trapped under the range, as listed in Table 3. These five incidents, in which the victim became dizzy and lost their balance when the oven door was in the open position, occurred within the senior population. In losing their balance, the victim fell onto the oven door, which caused the range to topple forward and onto the victim.

Table 3. Incidents Involving a Victim Trapped Under a Tipped Range While the Oven Was Energized

No.	In-Depth Investigation Report No.	Narratives from the IDIs (unwitnessed accounts of the incident)
1	X8576265A	An electric range tilted forward, hitting a senior citizen. The victim was unconscious for 17 hours. Her hand was caught in the energized oven, requiring amputation of her arm due to the extensive thermal injury.
2	X9083873A	A 60-year-old female died from burns when she fainted and fell on an open oven door. Her body weight pulled the electric oven on top of her, trapping her in the oven. The oven was energized.
3	X9365667A	A 60-year-old female died when the electric oven tipped over on her. At the time, she was cooking on top of the stove and using the oven. When the oven door was opened, the victim became dizzy and fell across the oven door, causing the oven to tip over. The oven trapped her left arm inside the appliance, which was still in the "on" position.
4	X9751739A	A male victim was found with an electric range tipped over and resting on his legs. The oven door was open, and the oven control was set on "broiler." His right foot

⁸ CPSC staff's Instability and Tipover of Appliance, Furniture, and Television: Estimated Injuries and Reported Fatalities, 2010 Report does not report complete death numbers for 2007 and 2008 because of ongoing reporting for these years.

		was amputated because of severe burns.
5	C0325008A	An elderly woman died when her electric range tipped over on top of her after she fell onto the oven door. She was trapped, burned, and suffocated.

3.2 Selected Incidents

3.2.1 An 18-month-old male – November 2010

On November 14, 2010, a newspaper article reported an incident involving the death of an 18-month-old boy due to an electric range tipping over. (8Newsnow.com, 2010) The article stated that “An 18-month-old was killed Sunday afternoon after an oven range tipped over and fell on top of the child, according to Las Vegas police.”

To gather more information on the circumstances surrounding the incident, a CPSC field investigator conducted an In-Depth-Investigation (IDI). A summary of the IDI report follows.

In-Depth Investigation (IDI 101116HWE2402)

The CPSC field investigator used information from the coroner’s report, fire department’s report, a brief interview with the investigating detective, and an interview of the apartment manager for the IDI report. The victim, an 18-month-old male, lived with his twin brother and parents in an apartment complex. The victim was 35-inches tall and weighed about 32 pounds.

The father was preparing to transport the children to their grandparent’s residence when he stepped out of the apartment. The victim and his brother were left unattended in the apartment for about three minutes while the father loaded his vehicle. When the father returned to the apartment, he saw the victim on the kitchen floor with the stove/oven resting on his upper chest, torso, and legs. The father removed the stove from on top of the victim, carried him to the front door, and called for help. The father administered CPR, and the victim reportedly vomited during the chest compressions. The paramedics were called, and the victim arrived at the hospital, where he was pronounced dead.

The CPSC field investigator attempted to collect the sample. However, after the incident, attorneys for the family and apartment complex took possession of the range and would not allow movement of the range or access to the apartment. It could not be confirmed whether the range involved in the incident was listed to UL 858 or whether it would have satisfied the stability performance requirements in UL 858.

During the on-site investigation on December 16, 2010, the attorneys and engineers for the apartment complex, the manufacturer, and the victim’s family were present. At that time, one of the engineers took readings with a force gauge to see how much force/weight was necessary to tip the oven forward. He took three readings from two locations on the open oven door. The readings from the center of the door read 78.8 pounds, 80.9 pounds, and 86.6 pounds. The readings from the front edge of the open door read 44.9 pounds, 44.2 pounds, and 44.1 pounds. The CPSC investigator noted that the oven was not equipped with anti-tipping or stability features. The apartment manager stated that the oven was “built” sometime between 1970 and 1987 and was purchased used and installed by their maintenance manager.

3.2.2 A 23-month-old male–August 2009

On August 12, 2009, a newspaper article reported an incident involving the death of a 23-month-old boy from an electric range tipover (Ahumada, 2009). The article stated: “The boy climbed onto the oven door to use it as a step to get on top of the stove. The weight on the oven door caused the stove to tip over and fall on the boy.”

To gather more information on the circumstance surrounding the incident, a CPSC field investigator conducted an In-Depth-Investigation (IDI). A summary of the IDI report follows.

In-Depth Investigation (IDI 090817HCC3881)

The CPSC field investigator used information from the police and coroner reports for the IDI report. The victim, a 23-month-old male, lived with his 22-year-old mother in a single-family home. The victim was 33-inches tall and weighed about 29 pounds.

At the time of the incident, there were two adults and six children present in the home. On August 12, 2009, at about 9:00 a.m., all six children were in the living room watching television. No one in the home witnessed the victim opening the oven door and climbing onto it, but the police report states that the victim reportedly left the living room and wandered into the kitchen. There was a freestanding stove at the end of the kitchen countertop. Based on how the victim was found, it is assumed that he opened the oven door, and he pushed down on the door in order to climb on it. The stove then tipped over and landed on him.

A friend of the mother was asleep in one of the bedrooms. When he heard the noise in the kitchen, he got up and went into the kitchen. The mother was in another room when she heard the crash and ran into the kitchen. They saw the victim halfway inside the oven. According to family members, the victim was head first inside the oven, with his feet outside the oven. The stove was resting facing down on the floor with the front of the oven door touching the floor. Family members lifted the stove back to the upright position and called 911. The police report indicated that the freestanding stove was not secured to the kitchen wall at the time of the incident.

Paramedics arrived at the scene and transported the victim to the hospital, where he was pronounced dead at 9:38 a.m. The coroner’s report indicated the cause of death as traumatic asphyxia. Autopsy findings were: (1) Petechial hemorrhage of the left eye and around both eyes, (2) contusion of both lungs, (3) pulmonary edema, and (4) cerebral edema.

The CPSC field investigator attempted to collect the sample. However, after the incident, the family removed the stove from the house. It could not be confirmed whether the range involved in the incident was listed to UL 858 or whether it would have satisfied the stability performance requirements in UL 858.

3.2.4 An 18-month-old male October 2006

This investigation originated with a news report of an 18-month-old male who died when a four-burner gas range tipped over and landed on top of him. To gather more information on the circumstances surrounding the incident, a CPSC field investigator conducted an IDI. A summary of the IDI report follows.

In-Depth Investigation (IDI 061025CNE1576)

The victim’s mother stated that the victim and her 3-year-old son had tried to reach some cookies located on top of the stove. The mother stated to the detective that she was in the bedroom of their apartment when she heard a thud. She went into the living room, looked into the kitchen, and saw her 3-year-old son standing next to the stove, which had toppled over onto her 18-month-old son. She saw that her son’s head and a portion of his upper body were inside the oven, and the oven was on. The detective believes that the children opened the oven door and attempted to climb up onto it to reach the cookies. The detective stated that the weight of one or both of the children could have caused the unit to tip over. The range was not anchored in any fashion prior to the incident, according to the detective.

The victim was an 18-month-old male who weighed approximately 29 pounds (30.8 pounds per coroner’s report). The 3-year-old brother’s weight was estimated around 37 pounds. The combined weight was approximately 66 pounds. The detective tested the incident stove using two sand bags, one weighing 29 pounds and the other weighing 36.5 pounds to simulate the children’s weights. An uncertified bathroom scale was used to measure the weights of the sand bags. Upon placing each bag separately onto the stove door, neither caused the stove to tip over. Each bag was dropped from about 4 to 5 inches above the stove door, and neither bag of sand caused the stove to tip over. Upon placing both bags on the stove door, the combined weight caused the stove to tip over. The stove weighed approximately 150 pounds.

The CPSC field investigator attempted to collect the sample; however, after the incident, the stove had been disposed of by the police department. It could not be confirmed whether the incident range was listed to ANSI Z21.1 or whether it would have satisfied the stability performance requirements in ANSI Z21.1.

4.0 RANGE STABILITY–ELECTRIC AND GAS RANGES

Understanding the dynamics involved in a range tipping forward can be simple and complex. Creating more leverage by placing a static weight further from a fulcrum is a simple physics concept; but incorporating the actions of multiple forces, such as children climbing onto an oven door, creates a more complex scenario. The easiest way to understand and gather data on the properties that can cause a range to tip forward is to apply various static weights at different locations on the open oven door.

4.1 Forces to Tip a Range Forward

CPSC staff tested four standard 30-inch freestanding ranges (three electric ranges and one gas range), as listed in Table 4. All of the ranges tested were UL- or ANSI-listed. The static forces required to tip the unsecured ranges (*i.e.*, no anti-tip hardware used) were measured. The maximum tipping force was recorded when the range’s rear feet began to lift off the floor. The samples were tested with the range leveled and the feet extended to their maximum length.

Table 4. Range Samples

Manufacturer	Fuel Type	Cooking Surface	Tipover weight at midpoint (static, force gauge)
A	Electric	Electric coils	75 lbs, 73 lbs
B	Gas	Grate	85 lbs, 82 lbs
C	Electric	Electric coils	76 lbs, 80 lbs
D	Electric	Smooth top	74 lbs, 76 lbs

The tipover loads at different locations on an oven door were measured by two different methods. The first method involved using static loads. The loads were applied geometrically at the midpoint and every 2 inches outward and inward (maximum 6 inches) on the oven door, as shown in Figure 2. The first method had an accuracy of ± 1 lb. To achieve a higher resolution, a second method used a force gauge and a winch. A continuous load was applied at the geometric midpoint of the oven door and at 2 inch increments outward from the midpoint on the door, as shown in the figure. The second method had a resolution of 1/10 lb. Plots of the results for both methods are shown in Figure 3. As expected, testing the four samples showed that, as the weight was moved closer to the front edge of the open oven door, the load needed to tip the oven forward was reduced. This is simple physics of a lever in action, also referred to as mechanical advantage or leverage. A static weight of between 40 to 50 pounds at the edge of the oven door was enough to start all of the ranges tested to tip forward. Figure 3 shows the plotted loads that caused the ranges to tip forward. Figure 3 shows the force required to tip the gas range was slightly greater than the force required to tip electric ranges. This was most likely caused by the slightly heavier gas range, and/or the center of gravity shifted further back because of the heavier components used in a gas range.

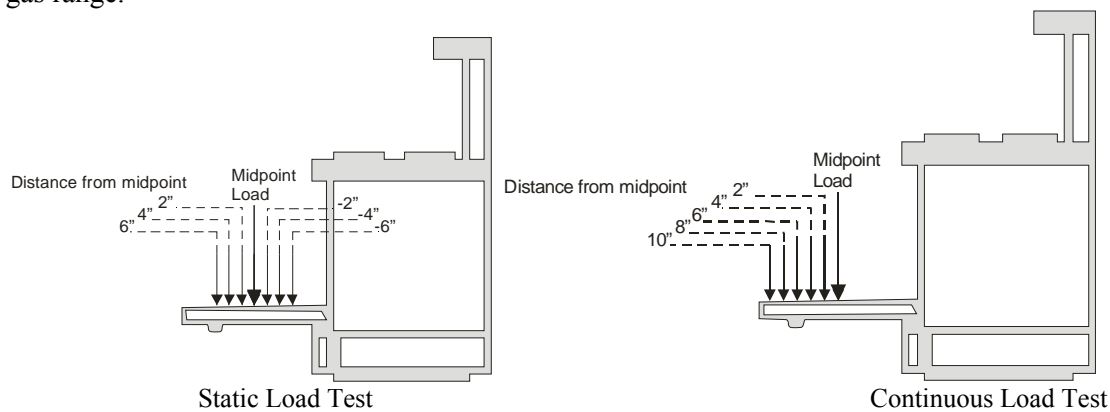

Figure 2. Measuring Force to Cause Tipping

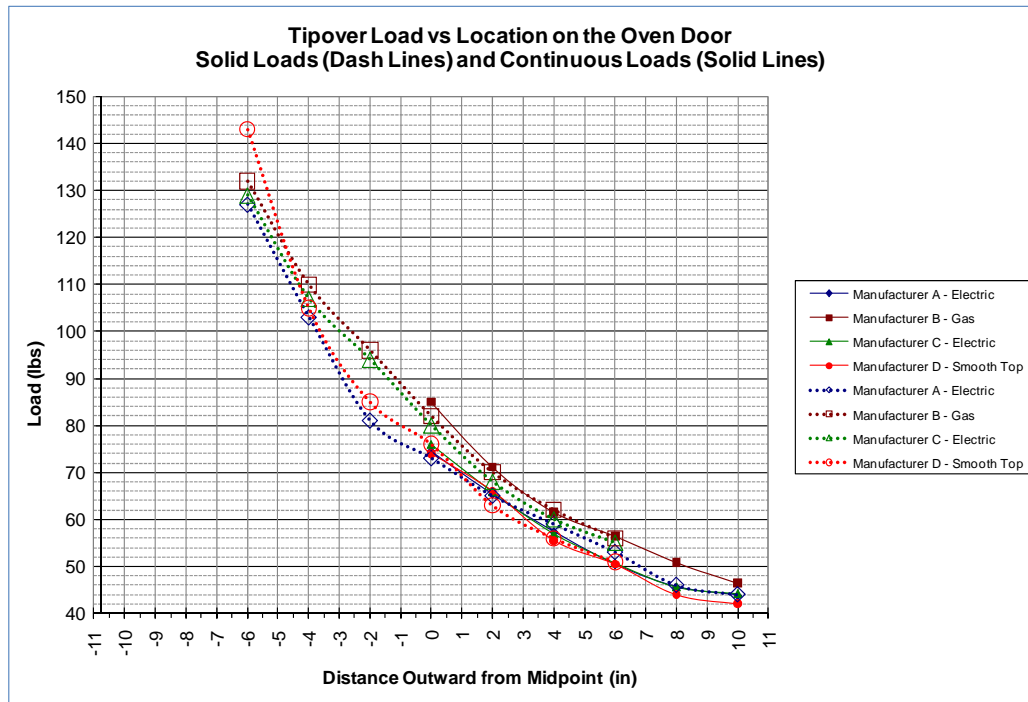

Figure 3. Tipover Forces

To create a generic tipover threshold line, the data for the static load tests for each of the four ranges to reach tipover conditions (as well as the average of the static data for the four ranges) were averaged, as shown in Figure 4. Because the population of electric and gas ranges are disproportional, the data were averaged, using a weighting factor for electric and gas ranges to compensate for the estimated percentage of electric and gas ranges in U.S. homes. The percentages of electric and gas ranges are estimated at 60 and 40 percent, respectively (Appliance, 2009). A worst case scenario threshold line would require using the minimum force at each tested location.

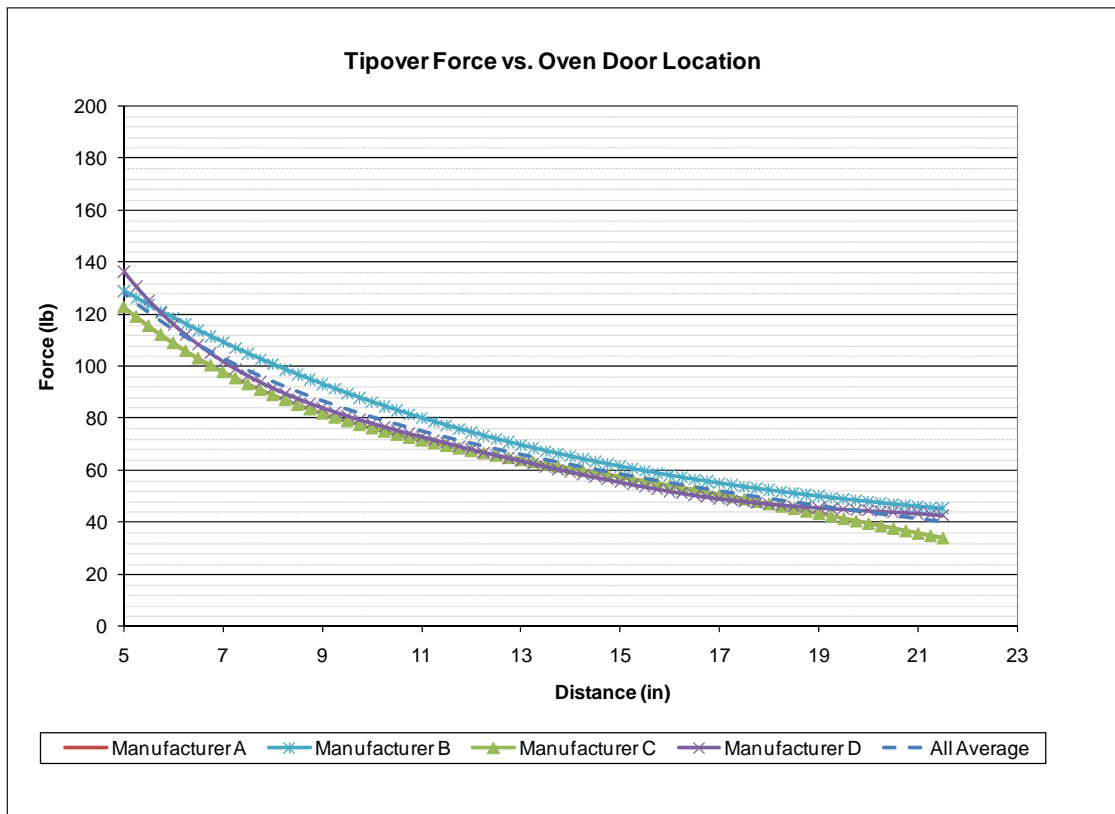

Figure 4. Tipover Force Curves

Using Microsoft Excel, a fifth order polynomial was fitted to the averaged static tipping data. The fitted curve produced the following equation, as shown in Figure 5:

$$y = -0.0001x^5 + 0.0083x^4 - 0.2752x^3 + 4.7232x^2 - 45.724x + 267.99$$

where x = distance outward on the oven door (inches) $5 \leq x \leq 21.5$
and y = tipping force threshold line (lbs)

In Figure 5, data points on or above the threshold line represent adequate force or weight to tip a range forward at specific distances outward on an open oven door. Data points below the threshold line represent forces or weights that are less than the required force to tip a range forward. This graph will be used throughout the report as a reference for the tipover threshold. The tipover threshold does not take into account any torque, twisting, or sagging of the oven door over time. Obviously, a slight shift upward or downward in the tipping threshold line would produce different results in the human subjects testing.

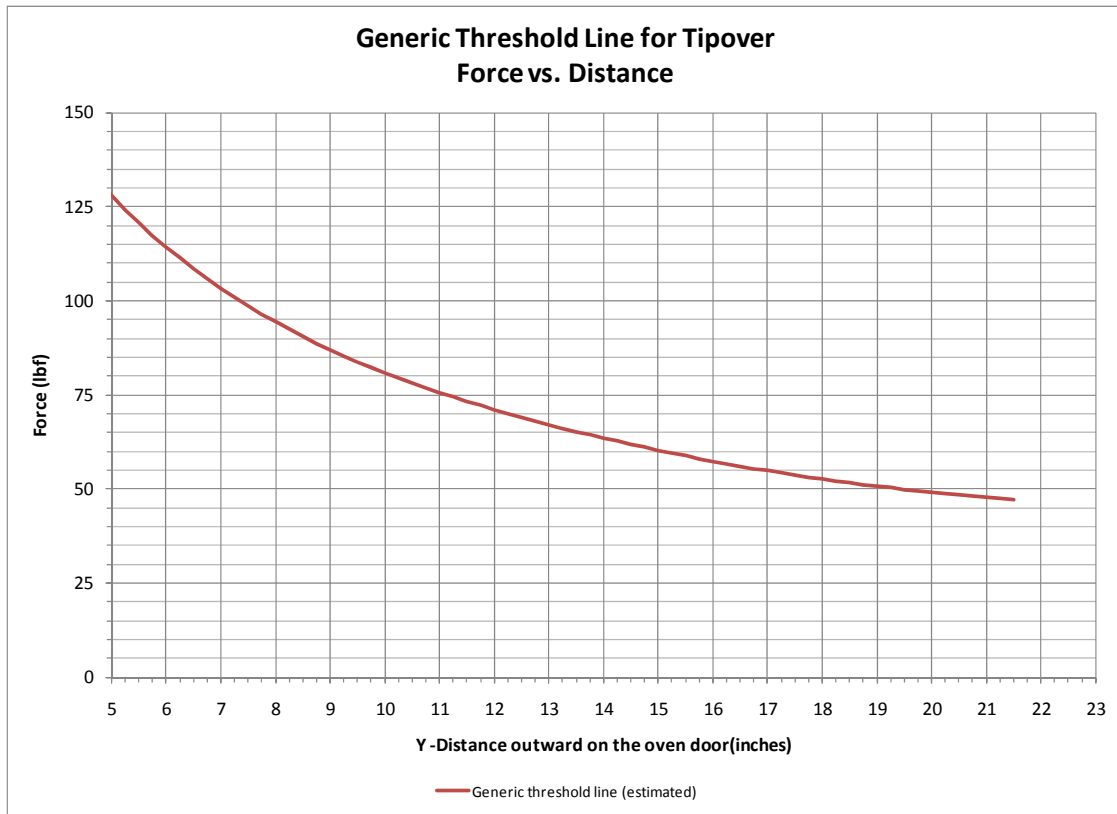

Figure 5. Calculated Tipover Threshold Line

If an oven door begins to sag over time, the amount of force required to tip the range lessens. Figure 6 illustrates that the force required to cause tipover, which is the force perpendicular to the oven door, lessens as the door sags downward. Case 1 shows that the tipping moment on the open oven door, which is perpendicular to the front of the range, requires 75 pounds. Case 2 shows an exaggerated sagging open oven door that is not perpendicular to the front of the range. The z component of the 75-pound force causes the moment. Using the Pythagorean equation shows that z, the component that exerts the moment on the oven door, is less than 75 pounds.

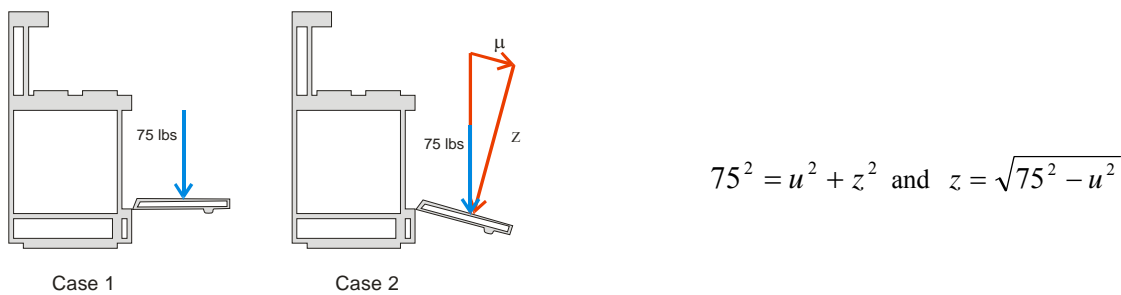

Figure 6. Force to Tip a Sagging Oven Door

4.2 Inclination Angle to Cause Pot to Slide

In this evaluation, for the four samples tested, staff collected data on the inclination angle that the ranges required before various weighted pots began to slide on the range top (burner). Four pot sizes—1, 1.5, 2.0, and 5.5 quarts—were used. The pots were constructed of aluminum bases capped with stainless steel bottoms. The pots were approximately three-fourths filled with water. Table 5 lists the weights of the empty and three-fourths-filled pots.

Table 5. Weight of Pots Empty and Filled

Pot Size (quarts)	Weight (empty)	Weight (approximately 3/4 filled with water)
1.0	1.025 lbs	3.225 lbs
1.5	1.370 lbs	4.135 lbs
2.0	1.505 lbs	5.260 lbs
5.5	2.530 lbs	12.350 lbs

Figure 7 shows the inclination angles of the ranges at which the various filled pots began to slide. The inclination angle of the gas range (B) was the most consistent among pot sizes and, of the ranges tested, required the smallest inclination angle to cause the pots to slide. The enamel coating on the grates provided a smooth, low friction surface, which allowed the pots to slide easier on the gas range than on the other ranges.

It was expected that the smooth ceramic glass top range (D) would also provide a very low friction surface, but the top contained a nonslip coating at the burner locations that helped counter pot slippage. The figure shows that the inclination angle required to cause the pots to slide decreased as the size/weight of the pot increased from 1 to 2 quarts; but the inclination angle increased when tested with the 5-quart pot. Staff believes that this was related to the burner size used for the testing; the 1- to 2-quart pots were tested on a small-size burner, but the 5-quart pot was tested on a larger burner (which also had a larger nonslip area).

The ranges with the electric coils (C and A) allowed the greatest inclination angles before the pots began to slide. There was also a wide variance in the inclination angles of the ranges, depending on pot size/weight. The rough surface of the electric coils provided a high friction surface that prevented the pots from sliding easily. The inclination angles at which pot sliding occurred ranged from 12.5 degrees to 20.5 degrees.

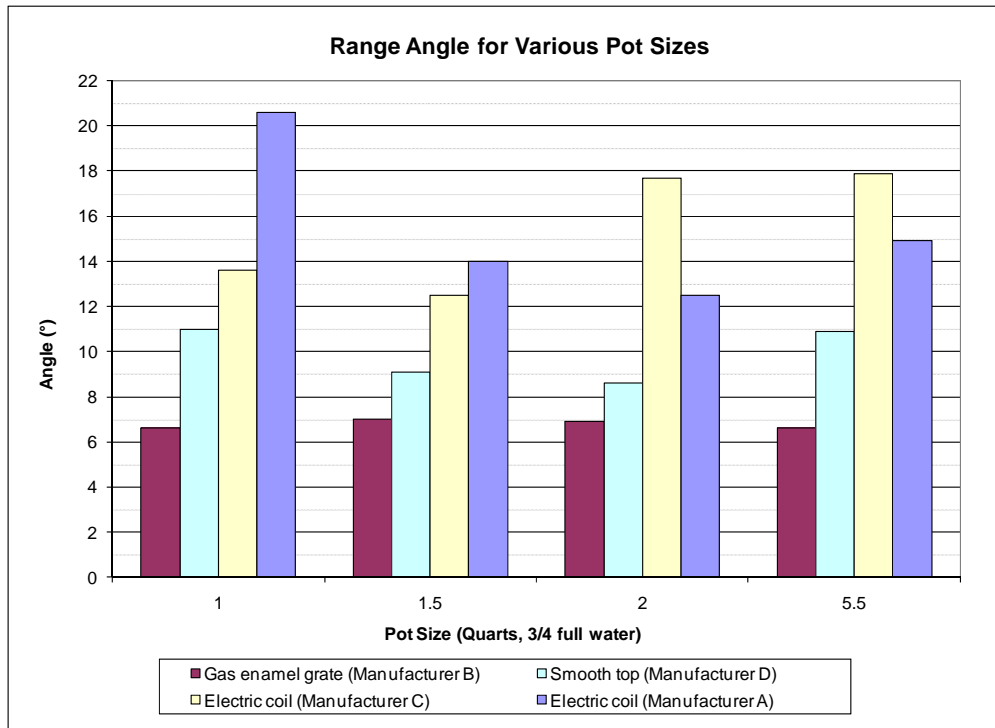

Figure 7. Range Angle of Inclination to Cause Pots to Slide

5.0 CHILD INTERACTION WITH SIMULATED OPEN OVEN DOOR

The staff's evaluation included collecting data on dynamic forces (magnitude and location) applied to a platform, which simulated a range with an open oven door. Dynamic forces were measured by allowing children to actively climb and stand on the platform. Thirteen children within the age range of 15 months to 5 years old were used in staff's testing.

The test fixture (simulated range with open oven door) was designed to not resemble visually a real range with an open oven door in order to prevent fostering the behavior of playing on an open oven door by the study participants. The study and procedures were reviewed and approved by the CPSC's Human Subjects Committee Institutional Review Board. Drawings of the test fixture are contained in Appendix A.

The test fixture was constructed of wood to minimize potential hazards (*e.g.*, laceration injuries from sheet metal, and tipping or tripping hazards associated with the use of a real oven). The platform/simulated a typical oven with the door in the open position and used dimensions similar to an actual 30-inch oven, considering oven door dimensions and the height from the floor. The platform measured 29.5 inches wide x 21.5 inches deep. The platform was approximately 11.5 inches above the floor. The rear of the fixture simulated a range but with reduced depth. The height of the simulated range was 36 inches from the floor and 25 inches from the top of the platform. The width and depth were 29.5 and 10 inches, respectively. Figure 8 shows a photograph of the test fixture, surrounded by safety mats for the protection of study participants in the event of a fall from the platform.

During testing, staff recorded the location of the forces applied by the children as they pressed on or stepped onto the platform. Subjects were allowed to approach, touch, and climb on the test platform. If a subject did not appear interested, the parents were allowed to place an object, such as a favorite toy or

food item, on the test platform to motivate the child. The test subjects were not allowed to climb on the upper portion of the test fixture.



Figure 8. Picture of Test Setup

Four load cells were mounted under the platform, one at each corner. The load cells measured the applied loads on the top of the platform and were last calibrated in September 2008. The platform had less than 1/16 inch of free movement. Each load cell was connected to a laptop via a USB hub. The laptop recorded the load on each individual load cell and the total load on the platform. Each load cell had a sample rate of 150 samples per second. Since every 20 samples are averaged, the load cells had approximately 7 data points per second available for recording. The data recorder was set to record every second. Figure 9 shows the origin reference and the coordinate directions that are used in the discussion of the data.

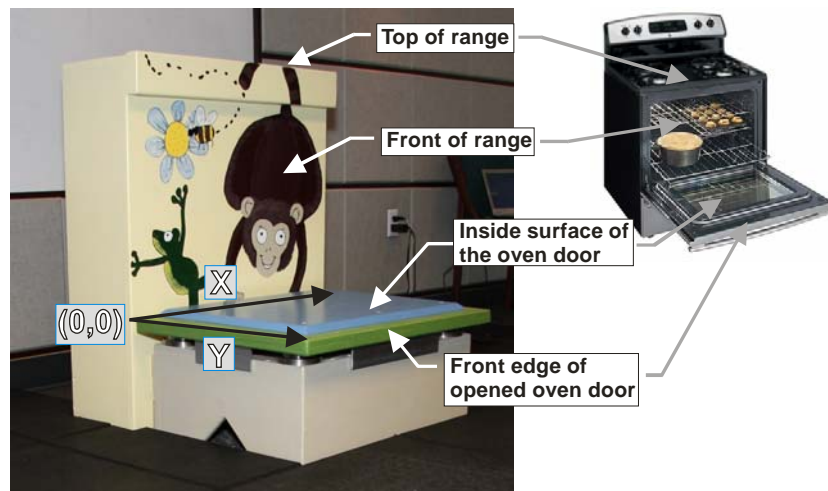

Figure 9. Test Setup Orientation and Features

5.1 Study Participants

Eight test sessions were conducted and included 13 participants, as listed in Table 6. All test sessions used two participants, except for one test session, which consisted of three participants, but only two subjects were on the platform at any time. Thirteen healthy children (*i.e.*, with no physical disability that would affect motor ability) within the age range of 15 months to 5 years old were recruited by

invitation to parents or guardians. The test procedures and protocol were reviewed by the CPSC's Institutional Review Board (IRB). The approval letter by the review board and consent form are in Appendix B.

The table lists the test subjects' respective percentile values for weight for age, height for age, and weight for height, as calculated by the Centers for Disease Control and Prevention growth charts (Centers for Disease Control and Prevention, 2000). The CDC report contains the most recent and comprehensive national data on body measurements and weights of U.S. children.

Table 6. Study Participants

Test Session	Session Time (mm:ss)	Participant Number	Sibling Relationship	Age	Gender	Weight (lbs)	Height (inches)	Weight for Age Percentile*	Height for Age Percentile*	Weight for Height Percentile*
1	07:31	1	1,2 twins	20 months	M	24	32.5	10 th – 25 th	25 th – 50 th	25 th – 50 th
		2	1,2 twins	20 months	F	22	34	10 th – 25 th	75 th – 90 th	<3 rd
2	07:25	1	1,2 twins	20 months	M	24	32.5	10 th – 25 th	25 th – 50 th	25 th – 50 th
		2	1,2 twins	20 months	F	22	34	10 th – 25 th	75 th – 90 th	<3 rd
3	16:03	3	3,4	4 yrs 11 months	F	53	44	95 th – 97 th	75 th – 90 th	95 th – 97 th
		4	3,4	16 months	M	31	35	>97 th	>97 th	75 th – 90 th
4	16:45	3	3,4	4 yrs 11 months	F	53	44	95 th – 97 th	75 th – 90 th	95 th – 97 th
		4	3,4	16 months	M	31	35	>97 th	>97 th	75 th – 90 th
		5	None	4 yrs 4 months	F	48	43	95 th – 97 th	75 th – 90 th	90 th – 95 th
5	18:39	6	6,7	23 months	M	25	33.5	10 th – 25 th	25 th – 50 th	25 th – 50 th
		7	6,7	3 yrs 7 months	F	29	38	10 th – 25 th	25 th – 50 th	5 th – 10 th
6	27:03	8	8,9	2 yrs 1 month	F	32	37	90 th – 95 th	>97 th	75 th – 90 th
		9	8,9	4 yrs 8 months	F	45	44	75 th – 90 th	75 th – 90 th	50 th – 75 th
7	14:48	10	10,11	2 yrs 8 months	M	31	34.5	50 th – 75 th	5 th – 10 th	90 th – 95 th
		11	10,11	5 yrs	F	38	41	25 th – 50 th	10 th – 25 th	50 th – 75 th
8	17:28	12	None	3 yrs 5 months	F	31	38.5	25 th – 50 th	50 th – 75 th	10 th – 25 th
		13	None	24 months	F	27	33	50 th – 75 th	25 th – 50 th	75 th – 90 th

* Source: Centers for Disease Control and Prevention, National Center for Health Statistics. CDC growth charts: United States.

<http://www.cdc.gov/growthcharts/> May 30, 2000.

No Text on This Page

5.2 Results of Testing

Section 5.2.1 presents all the data collected for the eight test sessions. The data for individual test sessions are analyzed in subsequent sections, and additional charts for the individual test sessions are included in Appendix C.

5.2.1 Analysis of test data for all sessions

Figure 10 shows all the data points from test sessions 1 through 8. The center of gravity (CG) was calculated for each 1 second measurement. CGs less than 2 pounds were filtered from the data set to eliminate erroneous non-zeroing data from the load cells. Figure 10 shows each 1 second CG data point greater than 2 pounds. The x-axis is the distance measured outward on the platform (or the y distance as shown in Figure 9). The y-axis is the CG force in pounds. The colored groups of data points represent the combined or individual weights of the study participants for a particular session. The blue line is the calculated tipover threshold that was presented in Figure 5. The majority of the data points fall below the threshold line (calculated for a range that meets UL 858 or ANSI Z21.1 normal stability requirements); but there are data points that are above the threshold line, and these points are examined more closely in the individual session analyses.

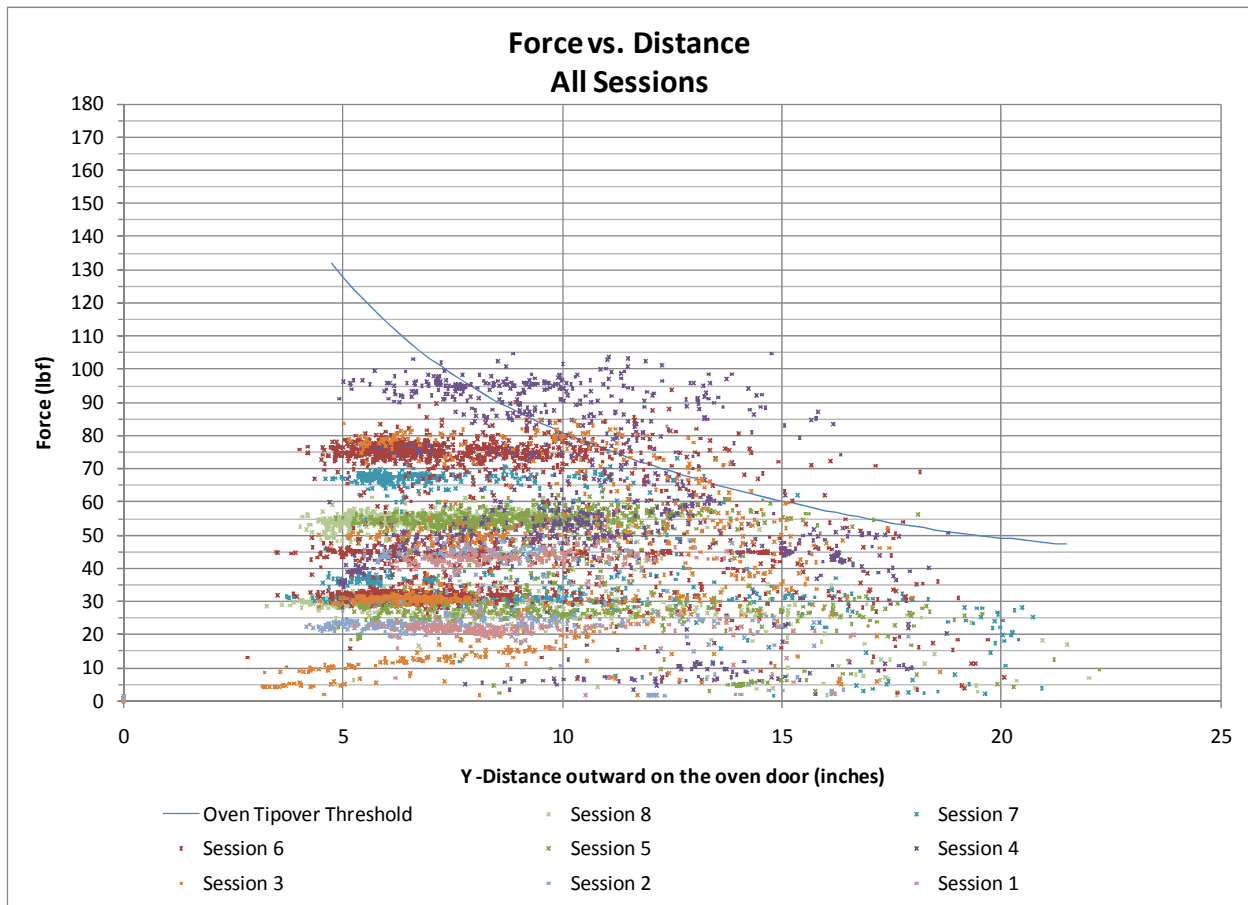

Figure 10. Sessions 1 through 8, Center of Gravity (CG) Plot

Figure 11 shows an expanded view of the same graph presented in Figure 10. The figure shows points straddling the tipover threshold line. A slight shift of the threshold line upward or downward would alter the percentage of tipovers versus non-tipovers.

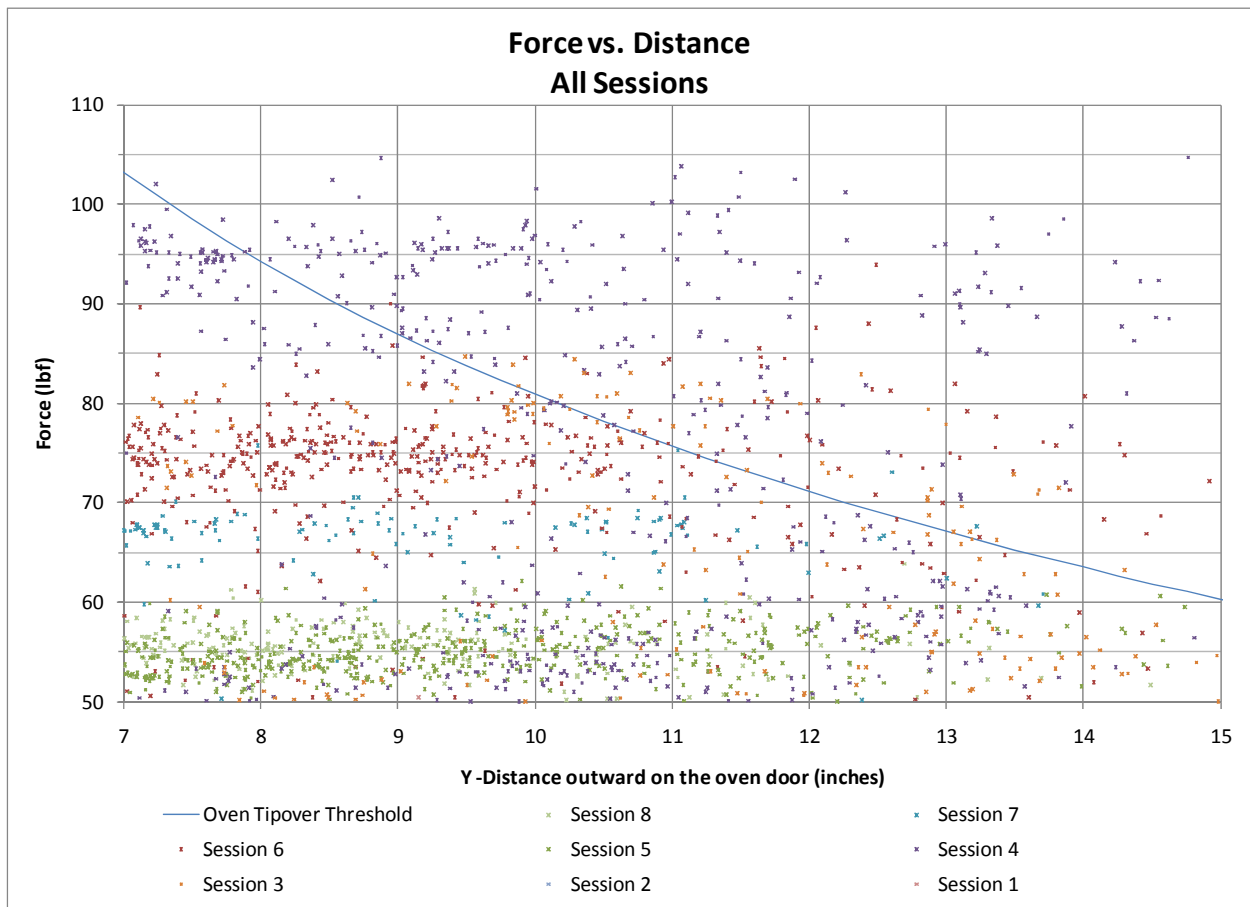

Figure 11. Sessions 1 through 8, CG Plot (Expanded View of Figure 10)

5.2.2 Sessions 1 and 2 (21-month-old twins)

The participants for sessions 1 and 2 were siblings (twins). The twins were 21 months old and weighed 24 and 22 pounds, respectively, at the time of the testing; their combined static weight was 46 pounds. The load cells under the platform measured a maximum of approximately 50 pounds during sessions 1 and 2 testing. The 4-pound difference represents an approximate 8.7 percent increase in dynamic weight compared to the expected maximum static weight. Their combined static weight was about 1.25 pounds less than the weight required to exceed the tipover threshold line if they both were standing along the outer edge of the oven door. When both children were on the platform, the CG typically was near the midpoint or inward on the platform, as shown in Figures 12 and 13.

Figure 13 shows the CG data point in Session 2 that was closest to the threshold line for (S2-a). The data point was approximately 47.5 pounds at almost 6.5 inches from the outer edge. The tipover threshold line at 6.5 inches from the outer edge of the platform is about 64 pounds.

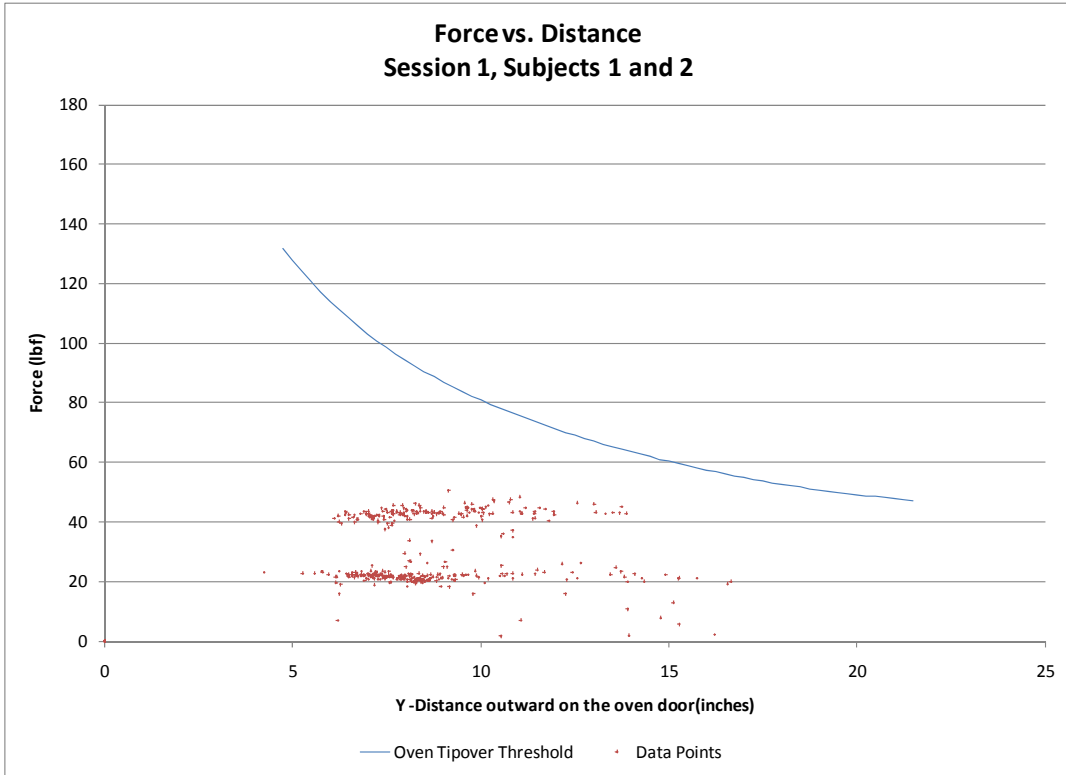

Figure 12. Session 1, CG Plot

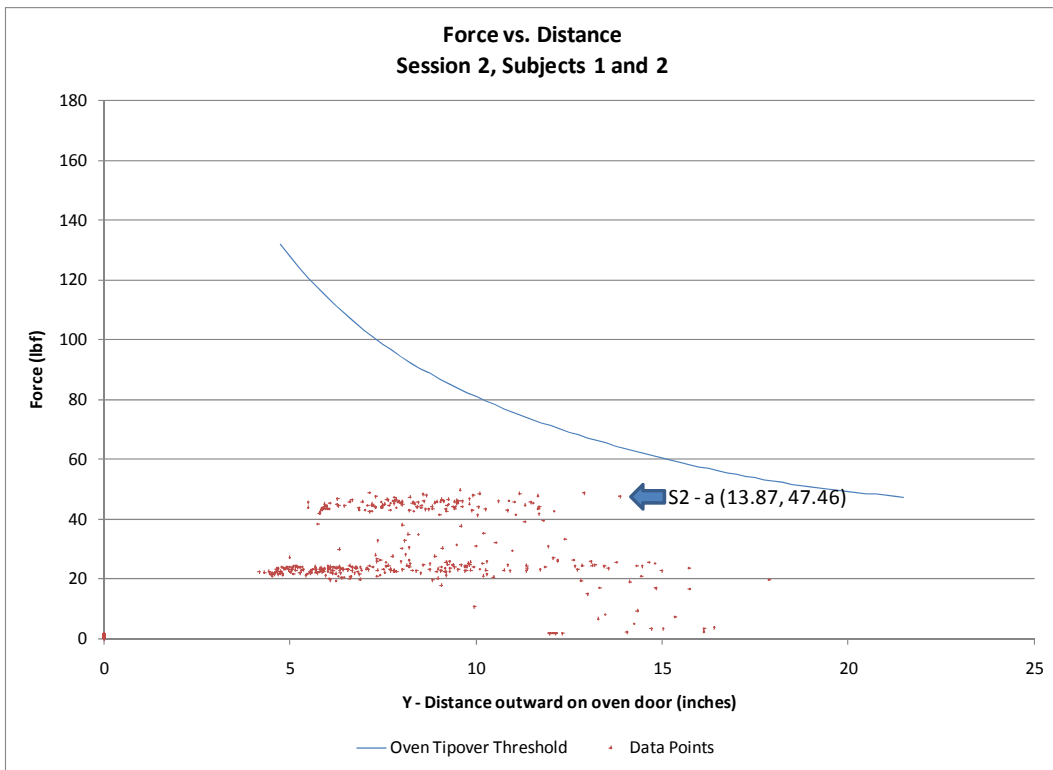

Figure 13. Session 2, CG Plot and Tipover Threshold Line

The snapshot in Figure 14 shows that for data point S2-a (marked in Figure 13), both subjects had just climbed onto the platform. Once they were fully standing, their weight was shifted closer inward, which would have required a higher weight to cause tipover.



S2-a (CG 13.87 inches, total mass 47.45 lbs, no tip)
 Figure 14. Session 2, Snapshot of Data Point S2-a

Figure 15 shows three dimensional (3D) scatter plots of Sessions 1 and 2. The bubbles in the plot represent each data point of the CG location on the platform, as shown in Figures 12 and 13. Each bubble color represents a test session. The width of a bubble represents the pounds recorded at that location. The grey half-bubbles on the left side of the plot represent the tipover threshold for the given distance along the platform. The x and y axes represent the dimensions of the platform, as shown in the picture insert. The CG data points were clustered mainly around the center of the platform.

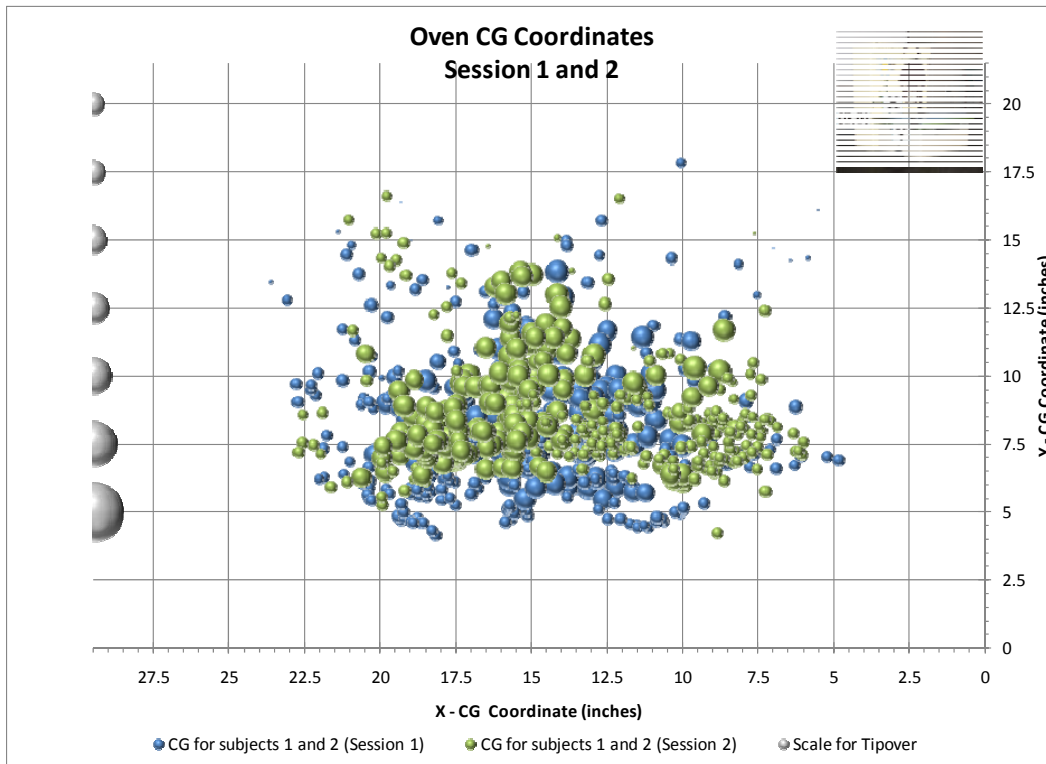

Figure 15. Session 2, 3D Scatter Plot of the Data Points

5.2.3 Session 3 (59- and 16-month old siblings)

Session 3 participants were siblings (male and female). The female subject was 4 years, 11 months old, and weighed 53 pounds at the time of the testing. The male subject was 16 months old, and weighed 31 pounds at the time of the testing. The combined static weight was 84 pounds. The load cells under the platform measured a maximum of approximately 84 pounds during Session 3 testing, unexpectedly showing no apparent difference between static and dynamic weights applied to the platform by both children. The combined static weight was sufficient to exceed the tipover threshold if the CG was located within 12.25 inches of the outer edge of the platform.

During Session 3, which lasted about 16 minutes, there were 41 one-second recorded leverages (in-lbs) that exceeded the tipover threshold, as shown in Figure 16. A recorded data point of 52.04 pounds at 4.1 inches (21.5-17.4) from the outer edge was about 2 pounds less than the weight required to exceed the tipover threshold.

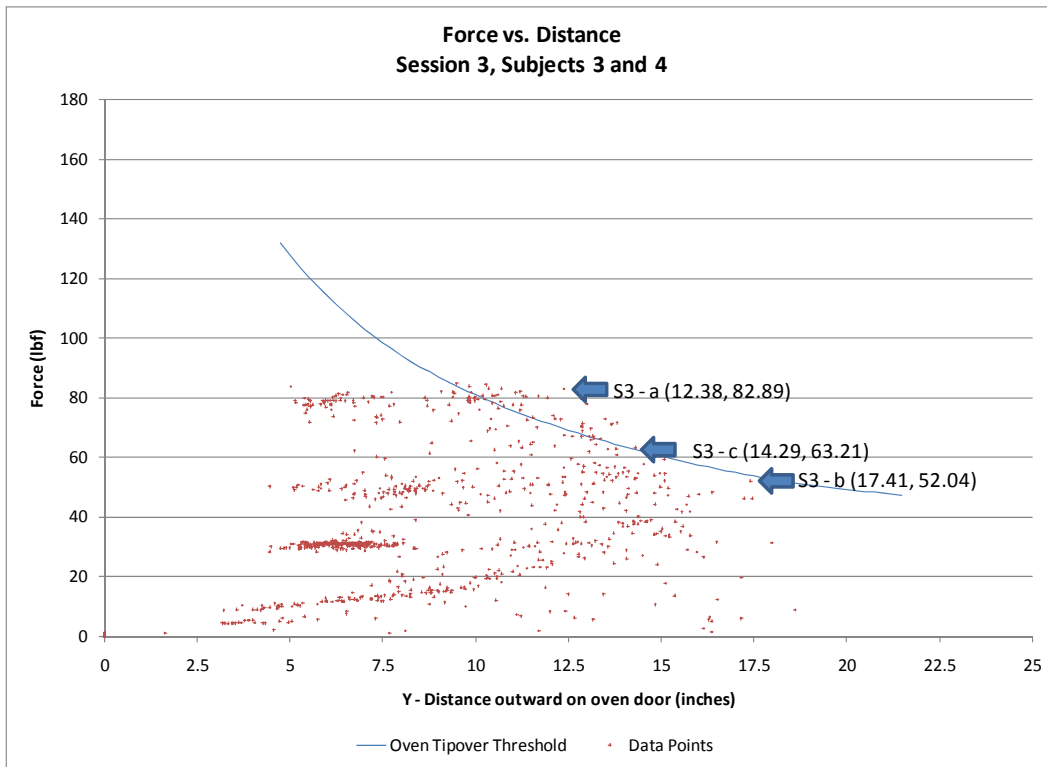

Figure 16. Session 3, CG Plot and Tipover Threshold Line

Figure 17 shows the snapshots of the participants during three selected data points from Figure 16. Figure 17 (S3-a) shows the snapshot of the data point S3-a, where the leverage was the greatest when compared to the tipover threshold line. In this instance, both children were near the center of the platform. Figure 17 (S3-b) shows the snapshot of data point S3-b, where the weight of 52.04 pounds was slightly less than the weight required to cause tipover. In this instance, the older child was standing near the outer edge of the platform. Any additional downward force, such as jumping off, or the weight of the second child, may have been sufficient to exceed the tipover threshold. Figure 17 (S3-c) shows the snapshot of data point S3-c, where the weight of 63.21 lbs (greater than her static weight of 53 lbs.) was slightly more than the weight required to cause tipover. In this instance, only the older child was

standing on the platform. When the child moved her left foot from in front of her to behind her, it shifted her weight enough to exceed the tipover threshold.



S3-a (CG 12.38 inches, total mass 82.89 lbs, tip)



S3-b (CG 17.41 inches, total mass 52.04 lbs, no tip)



S3-c (CG 14.3 inches, total mass 63.21 lbs, tip)

Figure 17. Session 3, Snapshots of Data Points S3-a and S3-b

Figure 18 shows a 3D scatter plot of Session 3. The blue bubbles in the plot represent each data point of the CG location on the platform that did not exceed the tipover threshold line. The width of a bubble represents the pounds recorded at that location. The grey half-bubbles on the left side of the plot represent the tipover threshold for the given distance along the platform. The X and Y axes represent the dimensions of the platform, as shown in the picture insert. In the plot, the CG data points were clustered mainly along the center of the Y axis of the platform. The sizes of some of the bubbles in the scatter plot do not appear to be significantly different from the red bubbles that exceeded the tipover threshold, indicating that the red bubbles/tipover data points are close to the tipover threshold line, which is also represented in Figure 16.

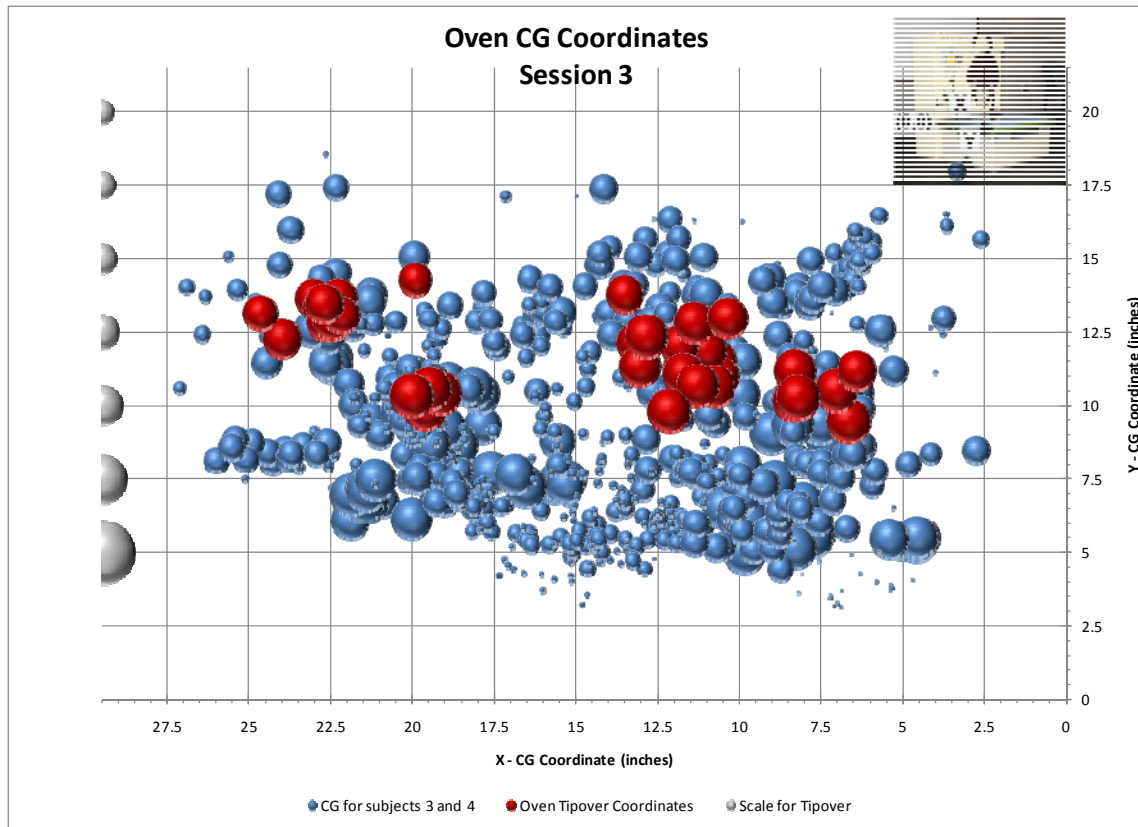

Figure 18. Session 3, 3D Scatter Plot of the Data Points

5.2.4 Session 4 (59-, 52-, and 16-month olds)

Three children participated in Session 4, but only two subjects were on the platform at any time. Two of the children were the siblings from Session 3 tests. Session 4 included an additional female participant, who was 4 years, 4 months old and weighed 48 pounds at the time of the testing. The possible combined static weights of any two subjects were 79, 84, and 101 pounds. The load cells under the platform measured a maximum of 106 pounds during Session 4 testing. The 5-pound difference represents an approximate 4.95 percent increase in dynamic weight compared to the expected maximum static weight. Figure 19 shows the CG plot with up to two test participants on the platform at a time. Any combination of two of the three subjects available may be represented in the plot. Figure 20 shows an enlarged area of Figure 19.

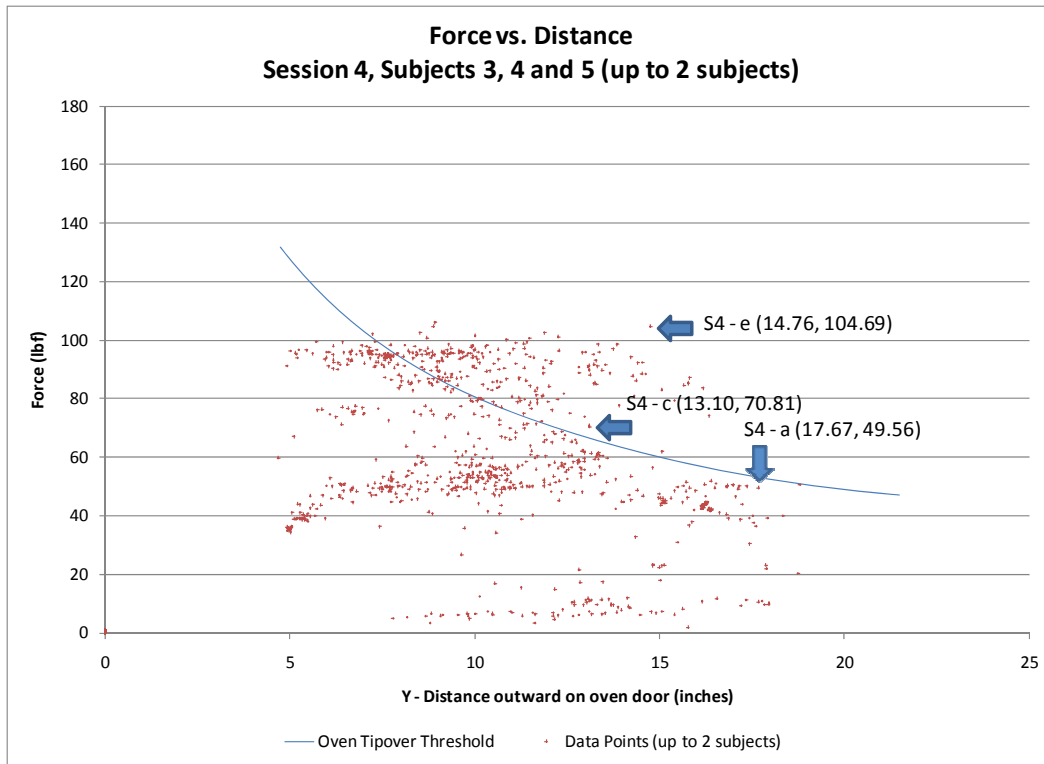

Figure 19. Session 4, CG Plot (Limited to 2 Participants at a Time)

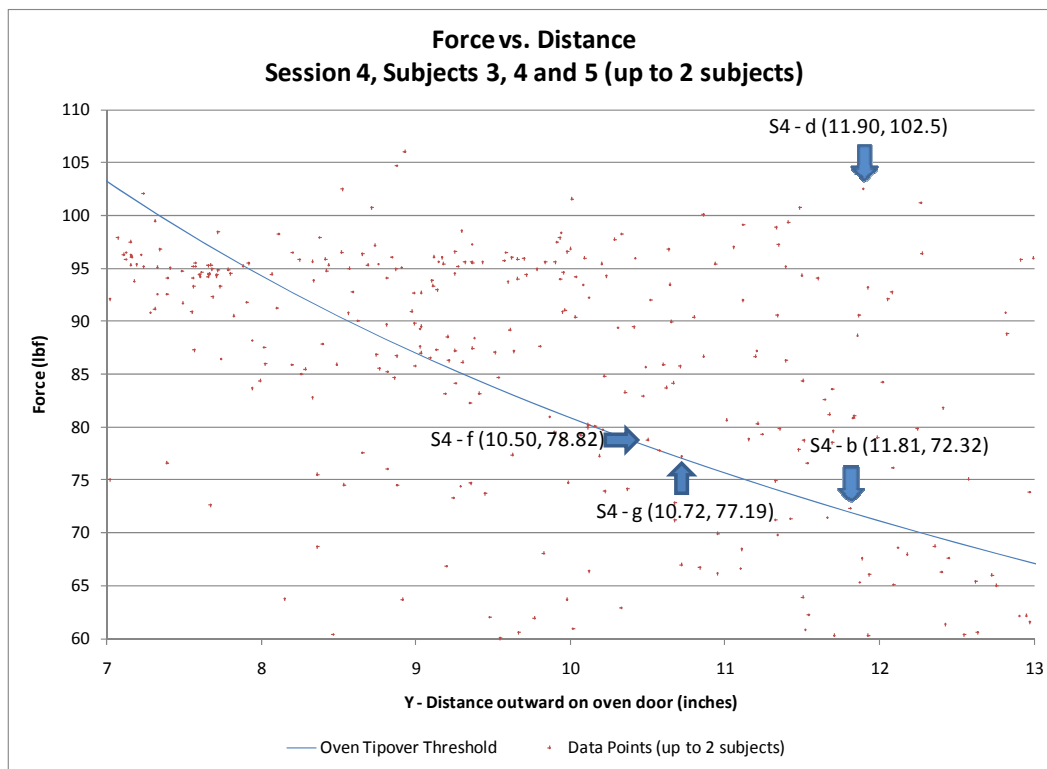

Figure 20. Session 4, CG Plot (Expanded View of Figure 19)

Figure 21 shows a snapshot of the participant for a selected data point from Figure 19. Figure 21 (S4-a) shows the snapshot of the data point S4-a, representing a weight of 49.56 pounds, which was about

3.78 pounds less than the tipover threshold. In this instance, only one of the older test subjects was standing at the very outer edge of the platform. The weight was less than the tipover threshold for that specific location but may have exceeded the threshold if the subject had jumped off the platform. During this session, there were no data points that exceeded the tipping threshold for only a single child.



S4-a (CG 17.67 inches, total mass 49.56 lbs, no tip)
Figure 21. Session 4, Snapshot of Data Point S4-a

Figure 22 shows the live action photographs for two selected tipover data points from Figures 19 and 20. Figure 22 (S4-b) shows the snapshot of data point S4-b, with a CG weight of 72.32 pounds. In this instance, one of the older test subjects was standing on the platform, while the younger male subject was climbing off the platform. Figure 22 (S4-c) shows the snapshot of data point S4-c, with a CG weight of 70.81 pounds. In this instance, one of the older test subjects was standing on the platform, while the younger male subject was sitting on the platform.



S4-b (CG 11.81 inches, total mass 72.32 lbs, tip)



S4-c (CG 13.10 inches, total mass 70.81 lbs, tip)

Figure 22. Session 4, Snapshots of Data Points S4-b and S4-c

Figure 23 shows the snapshot associated with four selected tipover data points from Figures 19 and 20, which involved the pair of older children. Figure 23 (S4-d) shows the snapshot of data point, with a CG weight of 102.5 pounds. In this instance, one of the older test subjects was standing on the platform, while the other older test subject was stepping off the platform. Figure 23 (S4-e) shows the snapshot of data point with a CG weight 104.69 pounds. Similar to the previous instance, one of the older test subjects was standing on the platform, while the other older test subject was stepping off the platform. Figure 23 (S4-f) shows the snapshot of data point with a CG weight of 78.82 pounds. In this instance, both older test subjects were sitting on the platform. Figure 23 (S4-g) shows the snapshot of

data point with a CG weight of 77.19 pounds. In this instance, one of the older test subjects was standing on the platform, while the other older test subject was stepping on the platform.



S4-d (CG 11.90 inches, total mass 102.5 lbs, tip)



S4-e (CG 14.76 inches, total mass 104.69 lbs, tip)



S4-f (CG 10.50 inches, total mass 78.82 lbs, tip)



S4-g (CG 10.72 inches, total mass 77.19 lbs, tip)

Figure 23. Session 4, Snapshots of Data Points S4-d, S4-e, S4-f, and S4-g

Figure 24 shows 3D scatter plots of Session 4 (which was limited to two test participants on the platform at one time). The bubbles in the plot represent each data point of the CG location on the platform. The width of a bubble represents the pounds recorded at that location. The grey half-bubbles on the left of the plot represent the tipover threshold for that given distance along the platform. The X and Y axes represent the dimensions of the platform as shown in the picture insert. In the plot, the CG data points were clustered mainly along the center of the Y axis of the platform. Because of the combined weight of the older test subjects and/or the high percentile weight of the 16-month-old along with one of the older test subjects, there were a large number of data points that exceeded the tipover threshold line.

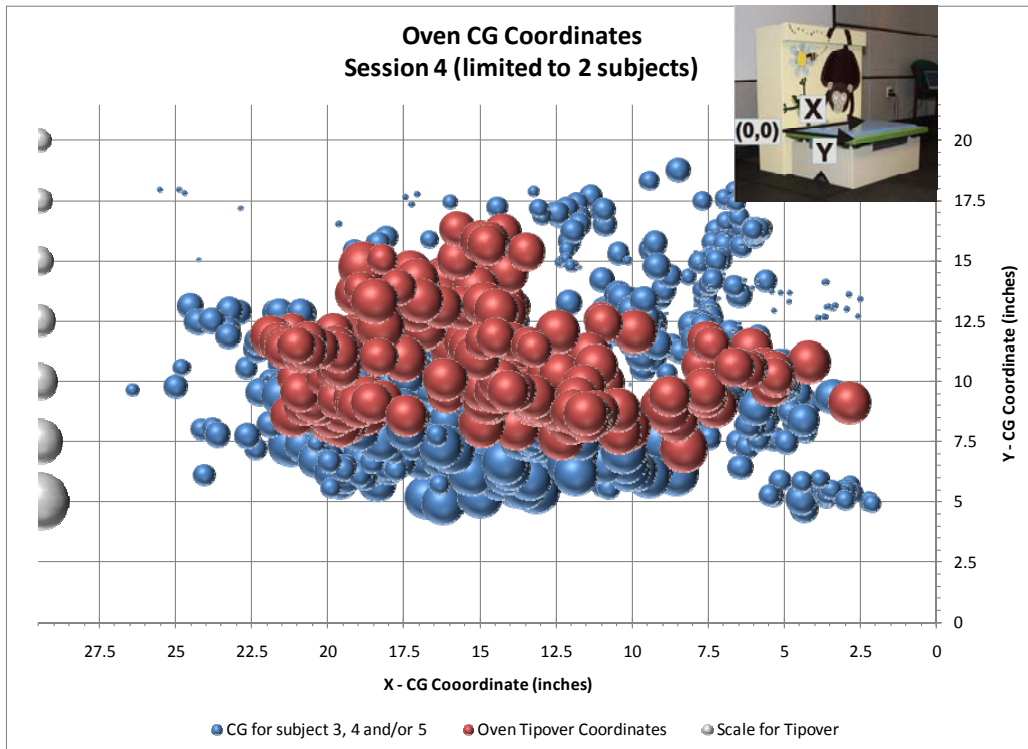

Figure 24. Session 4, 3D Scatter Plot of the Data Points (Limited to 2 Participants at a Time)

5.2.5 Session 5 (43- and 23-month-old siblings)

Session 5 participants were siblings (male and female). The female subject was 3 years, 7 months old and weighed 29 pounds at the time of the testing. The male subject was 23 months old and weighed 25 pounds at the time of the testing. Their combined static weight was 54 pounds. The load cells under the platform measured a maximum of 62 pounds during Session 5 testing. The 8-pound difference represents an approximate 14.8 percent increase in dynamic weight compared to the expected maximum static weight. The combined static weight was sufficient to exceed the tipover threshold if the CG was located 4.25 inches from the outer edge of the platform.

During the session test period, which lasted almost 19 minutes, there were two 1-second recorded leverages (in lbs) that exceeded the tipover threshold, as shown in Figure 25. The figure shows clustering around 55 pounds and 27 pounds. These are the combined weights of the test subjects and the individual weight of one test subject. During this test session, there were no data points that exceeded the tipping threshold line for only a single child.

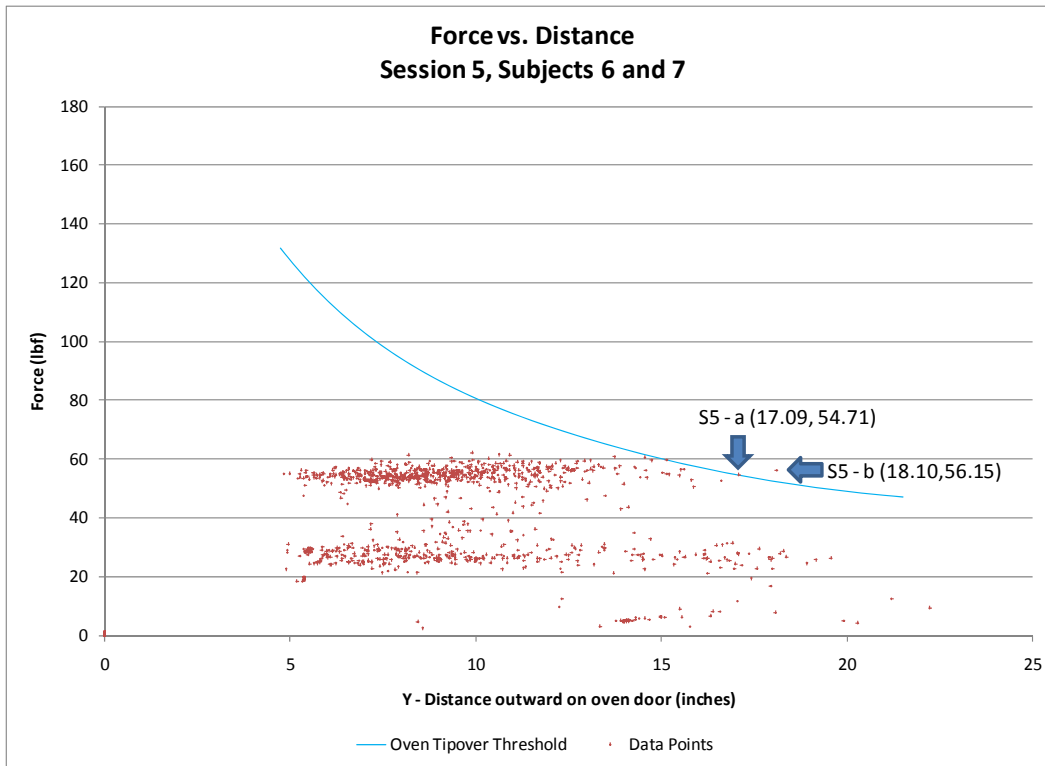

Figure 25. Session 5, CG Plot

Figure 26 shows snapshots associated with two selected data points from Figure 25, where the weight measured exceeded the tipover threshold. Figure 26 (S5-a) shows the data point of 54.7 pounds at about 3 inches from the outer edge of the platform. In this instance, the 23-month-old was standing on the platform, while the older subject was getting off the platform. Figure 26 (S5-b) shows the snapshot of data point (S5-b), representing a force of 56.15 pounds and a CG of 18.1 inches. In this instance, both subjects were getting off the platform at the same time.



S5-a (CG 17.09 inches, total mass 54.71 lbs, tip)



S5-b (CG 18.10 inches, total mass 56.15 lbs, tip)

Figure 26. Session 5, Snapshots of Data Points S5-a and S5-b

Figure 27 shows a 3D scatter plot of Session 5. The bubbles in the plot represent each data point of the CG location on the platform. The width of a bubble represents the pounds recorded at that location. The grey half-bubbles on the left of the plot represent the tipover threshold for that given distance along the platform. The X and Y axes represent the dimensions of the platform, as shown in the picture insert. This plot shows the two tipover points, one at slightly more than 15 inches and the other below 12.5 inches from the outer edge of the platform.

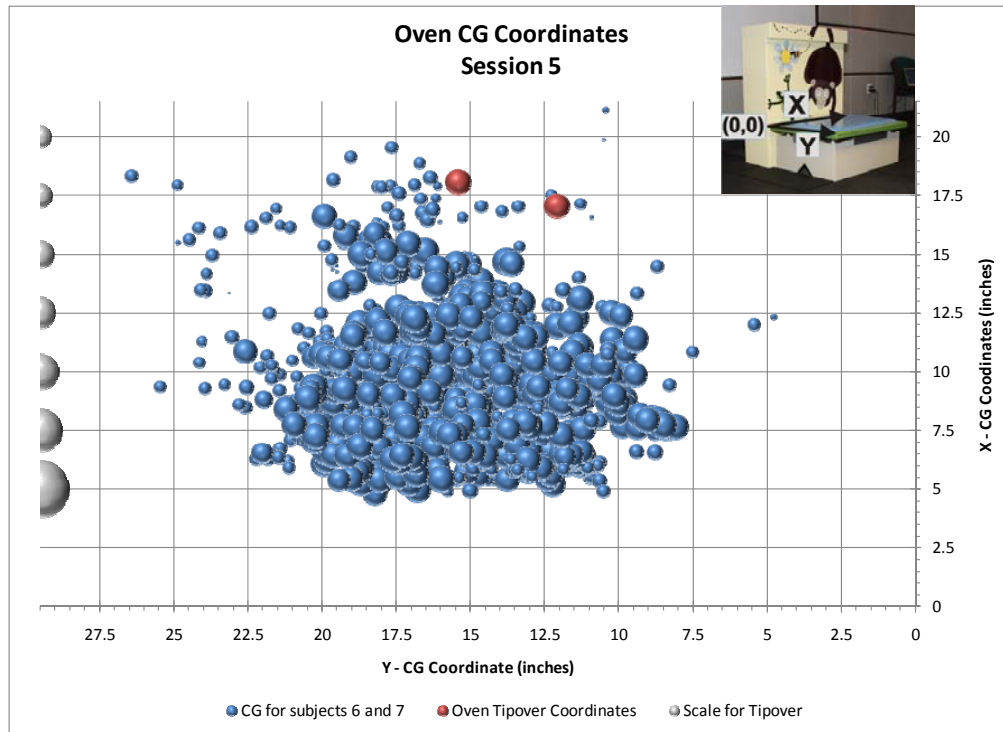

Figure 27. Session 5, 3D Scatter Plot of the Data Points

5.2.6 Session 6 (56- and 25-month-old siblings)

Session 6 participants were siblings (both female). The older subject was 4 years 8 months old and weighed 45 pounds at the time of the testing. The younger subject was 2 years 1 month old and weighed 32 pounds at the time of the testing. The combined static weight was 77 pounds. The load cells under the platform measured a maximum of 93.9 pounds during Session 6 testing. The 16-pound difference represents an approximate 21.9 percent increase in dynamic weight compared to the expected maximum static weight. The combined static weight was sufficient to exceed the tipover threshold if the CG was located within 10.75 inches from the outer edge of the platform.

During the test session, which lasted 27.03 minutes, there were 50 1-second recorded leverages (in-lbs) that would have resulted in a tipover, as shown in Figure 28. The figure shows three clusters around 75, 45, and 30 lbs. These are the combined weights of the test subjects and each of the individual weights of the test subjects. During this test session, there were no data points that exceeded the tipping threshold for only a single child.

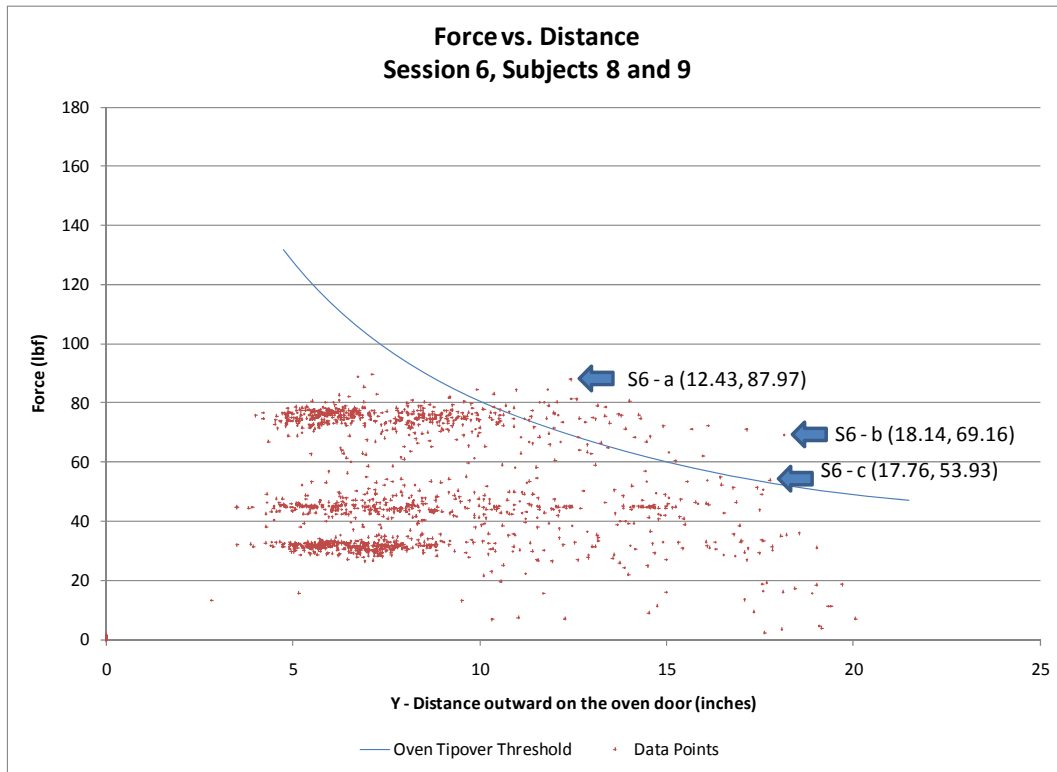

Figure 28. Session 6, CG Plot

Figure 29 shows the snapshots associated with three selected data points where the weight exceeded the tipover threshold. Figure 29 (S6-a) shows the CG data point of 87.97 pounds at about 9 inches from the outer edge of the platform. In this instance, the older sibling was standing on the platform, while the younger sibling was standing at the edge of the platform. Figure 29 (S6-b) shows the snapshot of data point S6-b, representing a force of 69.2 pounds and a moment arm of 3.4 inches. In this instance, both subjects were towards the edge of the platform at the same time, with the older sibling in the process of stepping off. Figure 29 (S6-c) shows the data point where the minimum CG weight of 53.9 pounds exceeded the tipover threshold by less than 1 pound. In this instance, the younger sibling was partially on the platform, while the older sibling was standing at the edge of the platform.

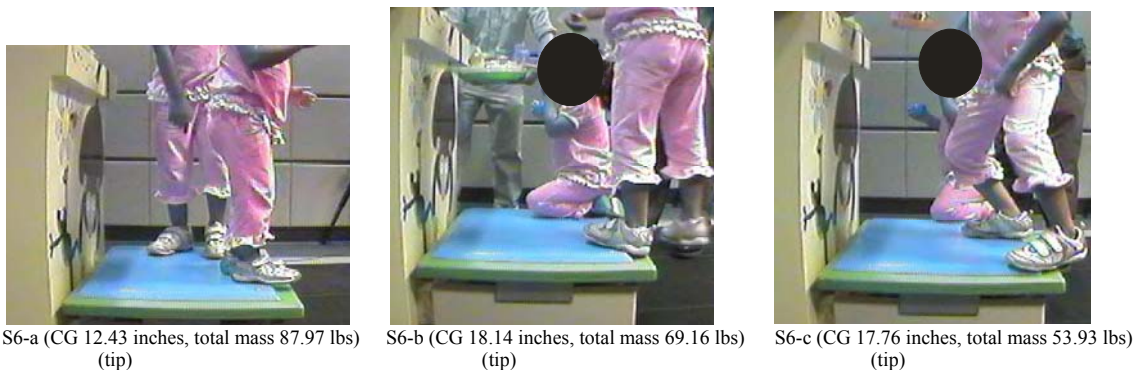

Figure 29. Session 6, Snapshots of Data Points S6-a, S6-b, and S6-c

Figure 30 shows 3D scatter plots of Session 6. The bubbles in the plot represent each data point of the CG location on the platform. The width of a bubble represents the pounds recorded at that location. The grey half-bubbles on the left of the plot represent the tipover threshold for that given distance along

the platform. The X and Y axes represent the dimensions of the platform, as shown in the picture insert. In the plot, the CG tipover data points were scattered between the midpoint and outward along the Y axis.

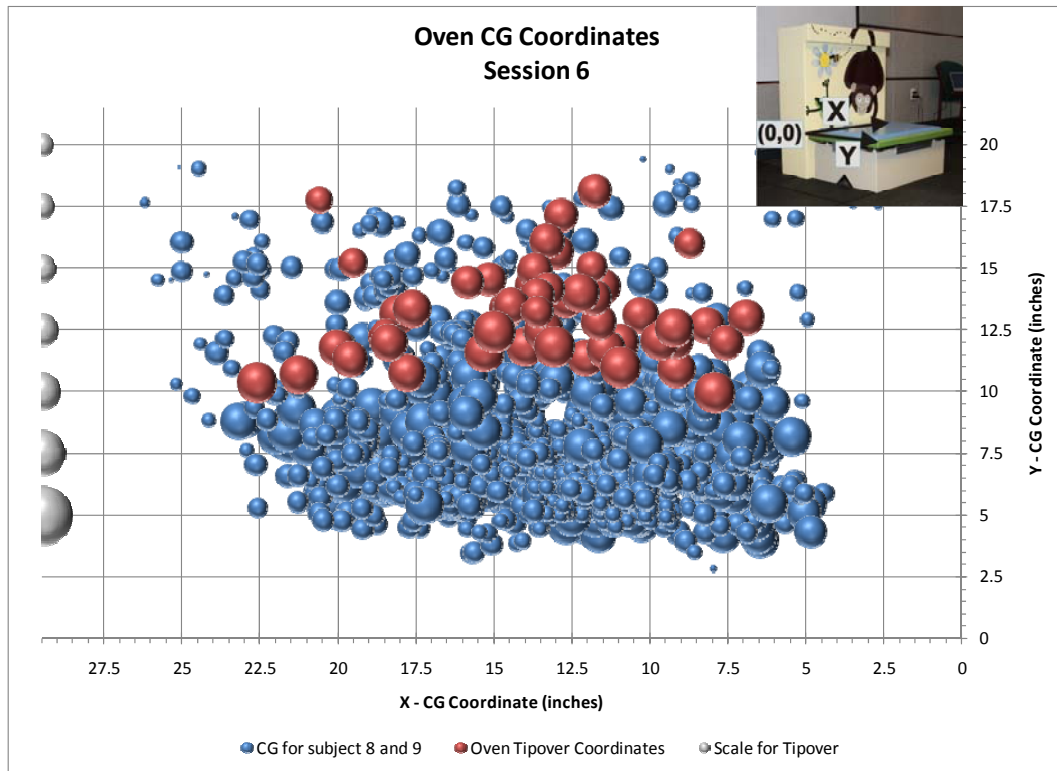

Figure 30. Session 6, 3D Scatter Plot of the Data Points

5.2.7 Session 7 (60- and 32-month-old siblings)

Session 7 participants were siblings (male and female). The female subject was 5 years old and weighed 38 pounds at the time of the testing. The male subject was 2 years 8 months old and weighed 31 pounds at the time of the testing. The combined static weight was 69 pounds. The load cells under the platform measured a maximum of 75.7 pounds during Session 7 testing. The 6.7 pound difference represents an approximate 9.7 percent increase in dynamic weight compared to the expected maximum static weight. The combined static weight was sufficient to exceed the tipover threshold if the CG was located within 9 inches of the outer edge of the platform.

During the session test period, which lasted 26 minutes, there were three 1-second recorded leverages (in-lbs) that would have resulted in tipover, as shown in Figure 31. The minimum recorded weight to cause a tipover was 62.1 pounds at a distance of 6.1 inches (21.5-15.4) from the outer edge. The figure shows three clusters around 70, 35, and 31 pounds. These are the combined weights of the participants and each of the individual weights of the participants. During the test session, there were no data points that exceeded the tipping threshold for a single child.

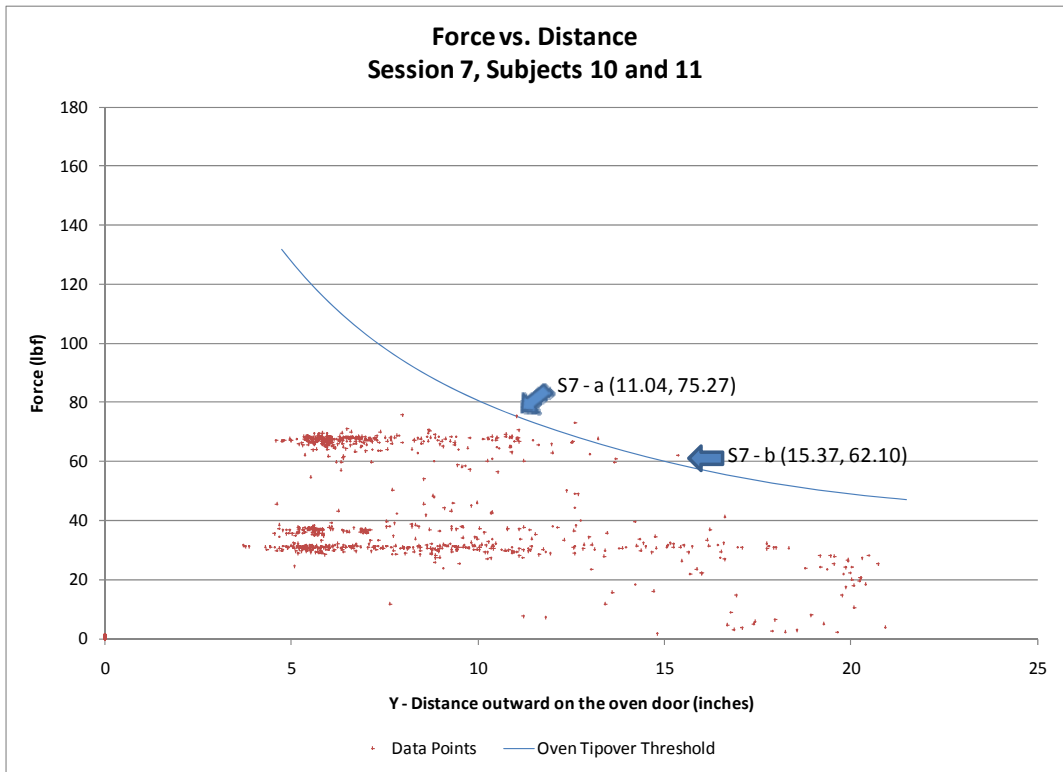

Figure 31. Session 7, CG Plot

Figure 32 shows the snapshots associated with two selected data points from Figure 31. Figure 32 (S7-a) shows the data point of 75.27 pounds at about 10.5 inches from the outer edge of the platform. The weight was only about one-fourth pound less than the 75.46 pounds required to exceed the tipover threshold. In this instance, both subjects were on the platform, with the younger subject standing further inward on the platform, and the older subject standing near the middle of the platform. Figure 32 (S7-b) shows a snapshot of data point S7-b, where the weight of 62.1 pounds exceeded the tipover threshold. In this instance, both subjects were getting off the platform at the same time. The older test subject was jumping off the platform, while the younger test subject was sliding off the platform.



S7-a (CG 11.04 inches, total mass 75.27 lbs, no tip) S7-b (CG 15.37 inches, total mass 62.10 lbs, tip)

Figure 32. Session 7, Snapshots of Data Points S7-a and S7-b

Figure 33 shows 3D scatter plots of Session 7. The bubbles in the plot represent each data point of the CG location on the platform. The width of a bubble represents the pounds recorded at that location. The grey half-bubbles on the left of the plot represent the tipover threshold for that given distance along the platform. The X and Y axes represent the dimensions of the platform as shown in the picture insert. In the plot, there were only a handful of CG tipover data points, which were concentrated near the center of the platform.

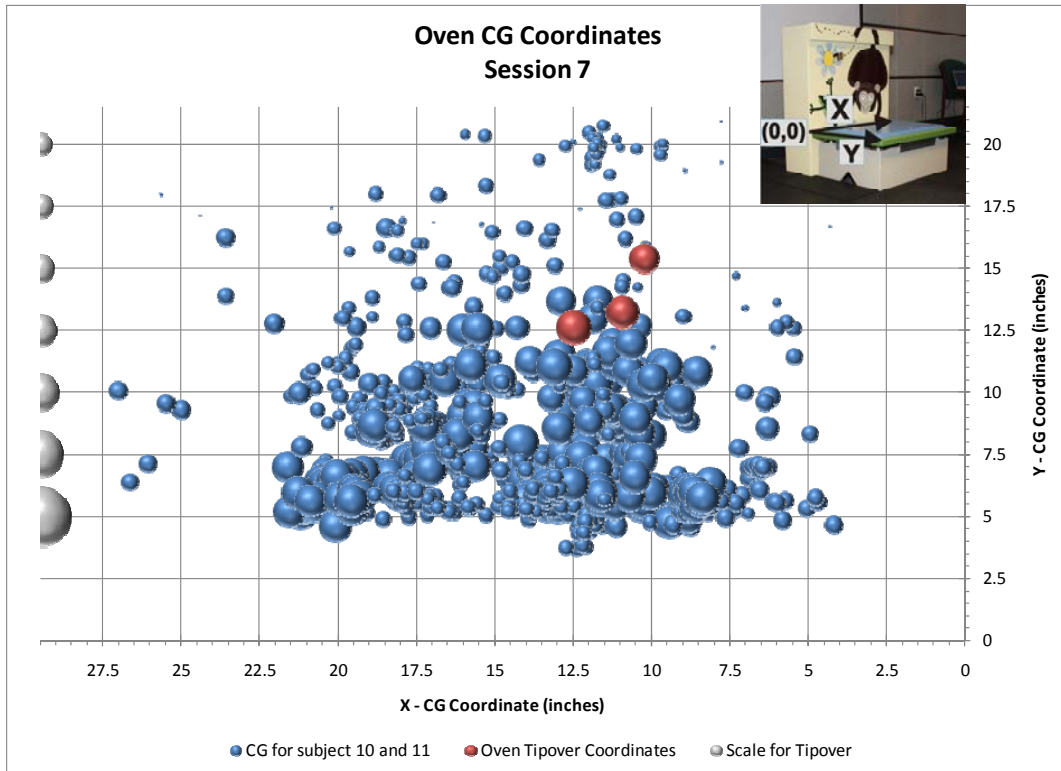

Figure 33. Session 7, 3D Scatter Plot of the Data Points

5.2.8 Session 8 (41 and 24 months old)

Session 8 had two female subjects who were not siblings. The older subject was 3 years 5 months old and weighed 31 pounds at the time of the testing. The younger subject was 24 months old and weighed 27 pounds at the time of the testing. The platform measured a maximum of approximately 63.8 pounds during session 8 testing. The 5.8 pound difference represents an approximate 10 percent increase in dynamic weight compared to the expected maximum static weight. The subject's combined static weight at about 58 pounds is sufficient to exceed the tipover threshold if the CG was located up to 5.75 inches from the outer edge of the platform.

During the test session, which lasted almost 17.5 minutes, there were no recorded leverages (in-lbs) that exceeded the tipover threshold, as shown in Figure 34. The maximum force measured was 63.85 pounds at a distance of 8.8 inches (21.5-12.7) from the outer edge. The figure shows two clusters around 55 and 30 pounds. These are the combined weights of the test subjects and each of the individual weights of the test subjects.

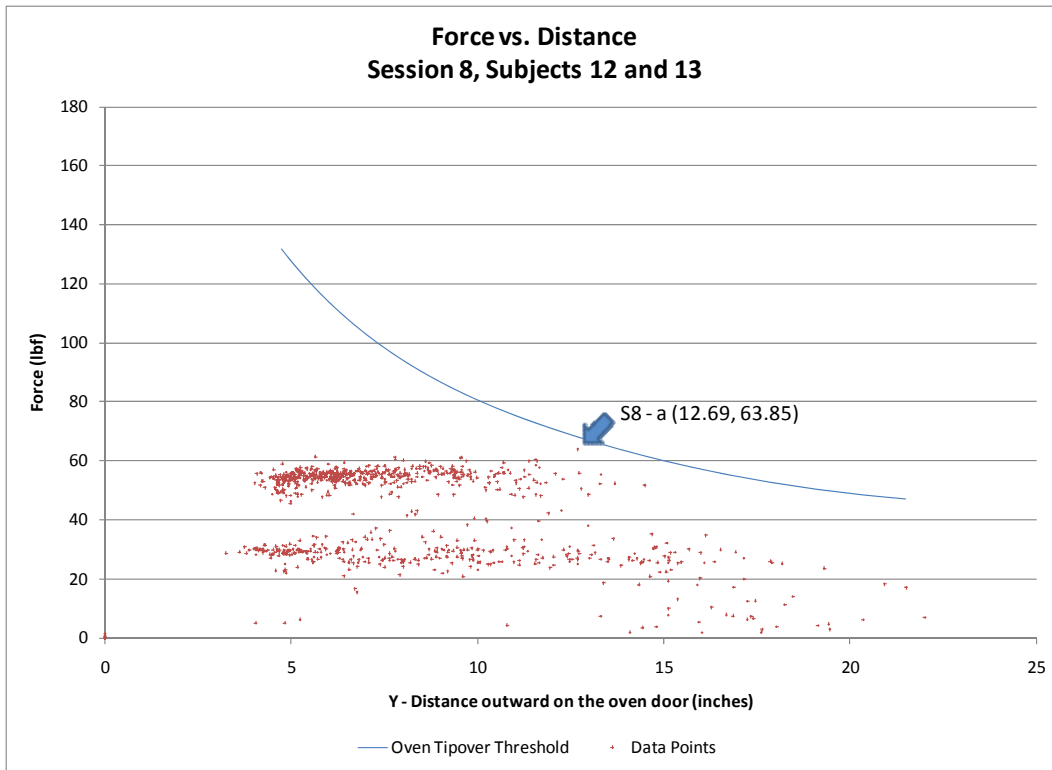

Figure 34. Session 8, CG plot

Figure 35 shows a snapshot of the selected data point from Figure 34. Figure 35 (S8-a) shows the snapshot of data point S8-a representing a weight of 63.85 pounds at about 9 inches from the outer edge of the platform. This data point was about 4.5 pounds less than the 68.3 pounds required to exceed the tipover threshold. In this instance, the 23-month-old was standing on the platform, while the older subject was jumping off the platform.



(CG 12.69 inches, total mass 63.85 lbs, no tip)

Figure 35. Session 8 Snapshot of Data Point S8-a

Figure 36 shows a 3D scatter plot of Session 8. The bubbles in the plot represent each data point of the CG location on the platform. The width of a bubble represents the pounds recorded at that location. The grey half-bubbles on the left of the plot represent the tipover threshold for that given distance along

the platform. The X and Y axes represent the dimensions of the platform as shown in the picture insert. In the plot, there are no CG tipover data points.

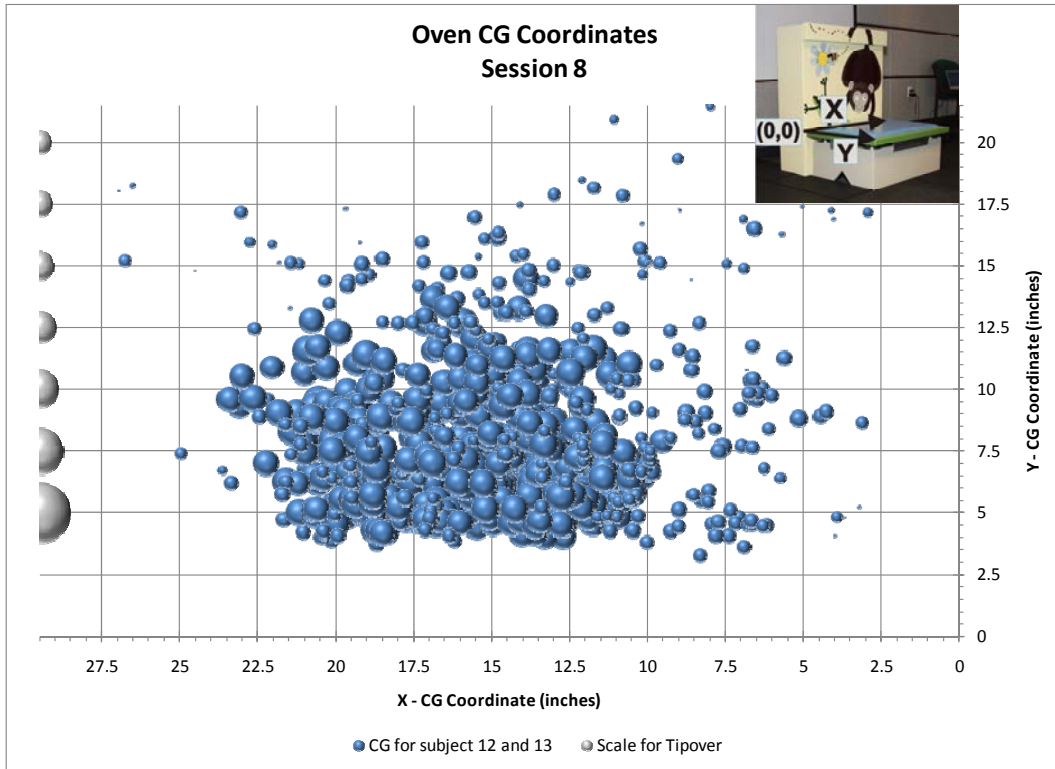

Figure 36. Session 8, 3D Scatter Plot of the Data Points

6.0 ANALYSIS OF TEST DATA

The data were analyzed to examine the maximum leverage for an event. An event was defined as the time when study participants were on the platform. Preceding and following an event required that there be no weight (*i.e.*, no subjects) on the platform, as illustrated in the sample timeline of Figure 37. In the figure, the length of time of an event varied greatly. Event X+2 shows a much longer event, with one of the subjects getting on and off the platform repeatedly; the event does not end until both subjects are off the platform. For each specific event, only the maximum leverage (weight lbs x moment inches) was used as a data point within the specific event timeframe.

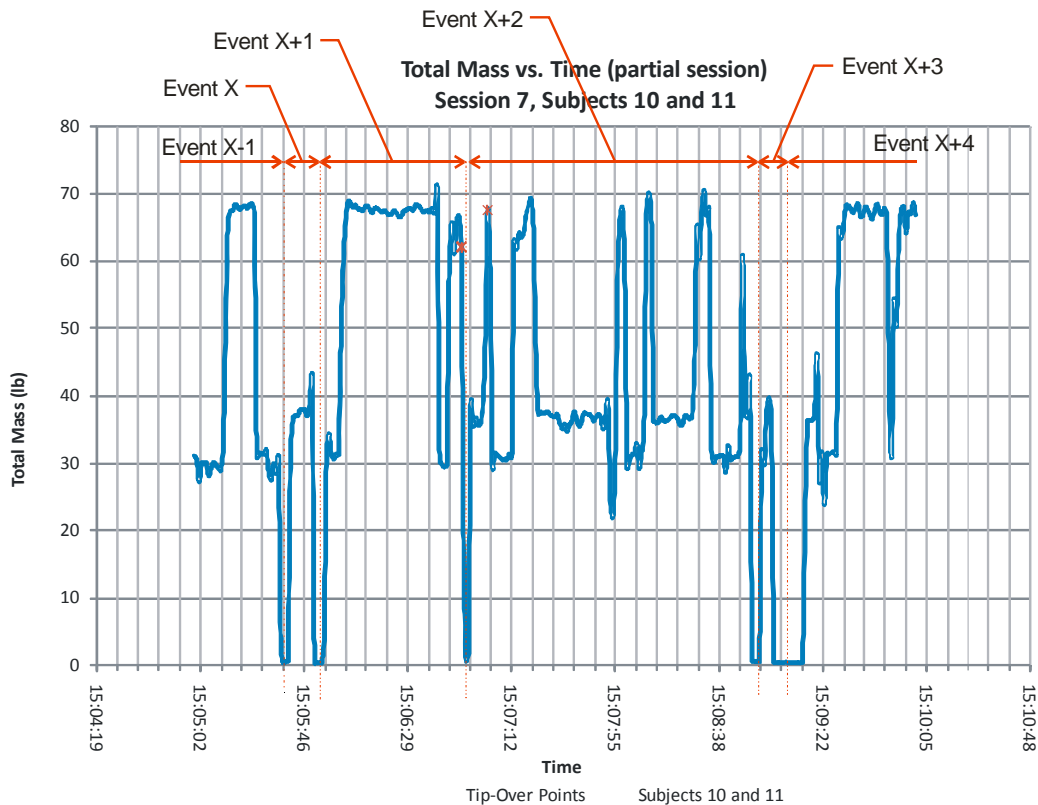

Figure 37. Sample Timeline of Events

6.1 Analysis by Maximum Leverage

For the eight sessions, there were 97 events recorded. The maximum leverage (distance, inches x force, lbs) for each event was calculated and plotted in a frequency chart, as shown in Figure 38. Figure 38 shows the 97 events, which consisted of both tipover events and non-tipover events.

Since the test time was not necessarily the same for each session, comparing the data between sessions may be skewed. For example, in some sessions the children were more interested in the activities than in other sessions in which they lost interest early. This may show an unbalance in comparing the data sets.⁹ To normalize the data between sessions, only the first 15 minutes of a test session were used, and any data points that exceeded the first 15 minutes of a session were truncated, which reduced the number of events from 96 to 72.

⁹ A session of more active test subjects may produce more events than a session of less active test subjects, but the level of activity may be related to age. In other words, older children who have an easier time getting on and off the platform may cause more events. Likewise, younger children who have to put more effort into climbing onto and off the platform may produce fewer events.

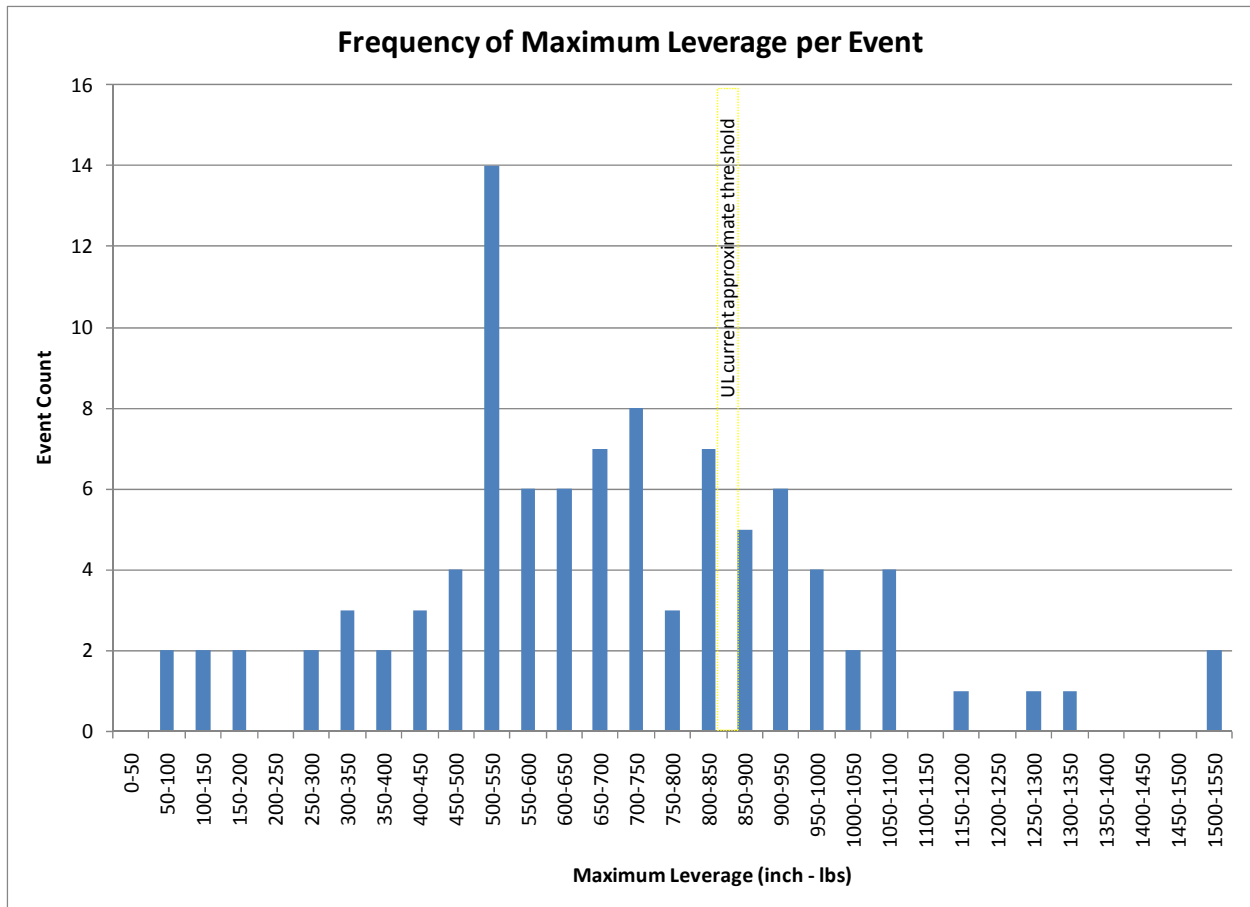

Figure 38. Frequency of Maximum Leverage per Event

Figure 39 shows the normalized and filtered data. In general, the normalized frequency distribution is similar in shape to the unnormalized frequency. The outlier data point in the 1500–1550 bin was point 154.57. This data point was associated with two subjects (both 4.5 years old) on the platform, with one of the subjects jumping off the platform. In this graph, the blue bars represent maximum leverage data points that did not exceed the tipover threshold line, and the red bars represent maximum leverage data points that did exceed the tipover threshold line.

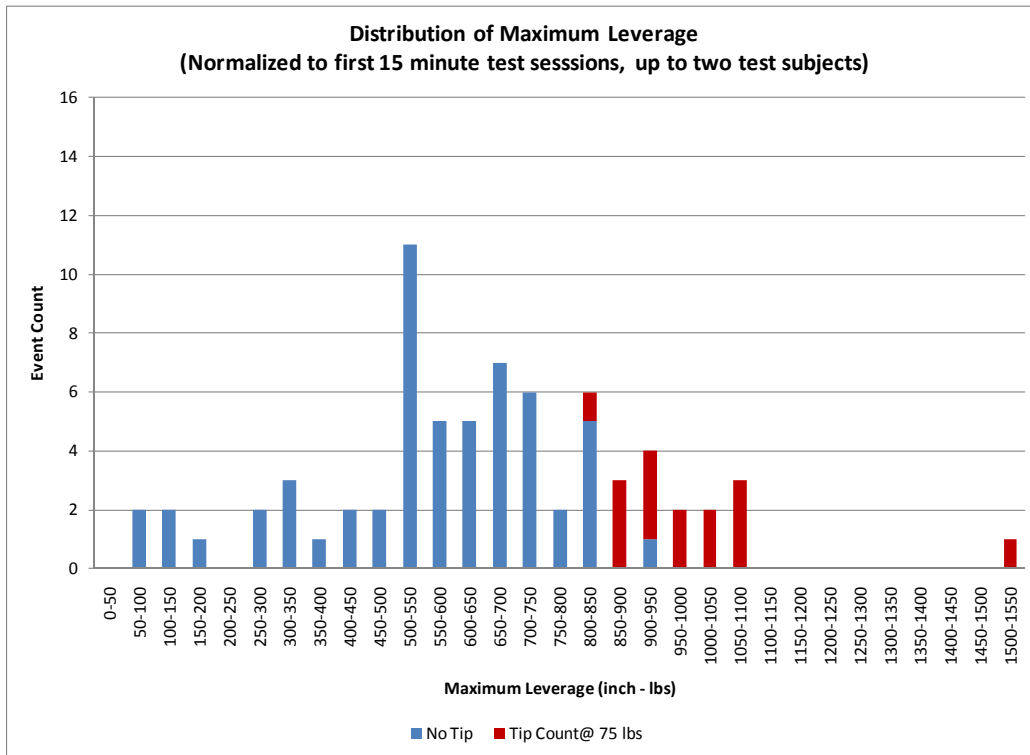

Figure 39. Normalized Frequency of Maximum Leverage per Event

The 72 normalized data points were analyzed using SAS,¹⁰ which produced the following statistical moments, as listed in Table 7:

Table 7. Moments

N	72	Sum Weights	72
Mean	636.407973	Sum Observations	47094.19
Std Deviation	264.113304	Variance	69755.8376
Skewness	0.26593703	Kurtosis	1.03073958
Uncorrected SS	35063294.1	Corrected SS	5092176.14
Coeff Variation	41.5006278	Std Error Mean	30.702548

The data were evaluated for normality by applying Goodness-of-Fit tests. The three test methods, the Kolmogorov-Smirnov, Cramer-von Mises, and Anderson-Darling were applied. Table 8 lists the results of the Goodness-of-Fit test.

Table 8. Results of Goodness-of-Fit Tests for Normal Distribution

Test	Statistic		p Value ¹¹	
Kolmogorov-Smirnov	D	0.06990632	Pr > D	>0.150
Cramer-von Mises	W-Sq	0.04146425	Pr > W-Sq	>0.250
Anderson-Darling	A-Sq	0.30282274	Pr > A-Sq	>0.250

¹⁰ SAS statistical software.

¹¹ Based on the high p-values, CPSC staff failed to reject the null hypothesis that these data are normally distributed.

Figure 40 shows the normal probability plot. The plot represents normality testing by displaying the data set against a theoretical normal distribution that forms a straight line. If the data set departs from the theoretical straight line, it would indicate a departure from normality. The figure shows that the data set follows closely to a normal distribution. The ends of the data set depart slightly from the line.

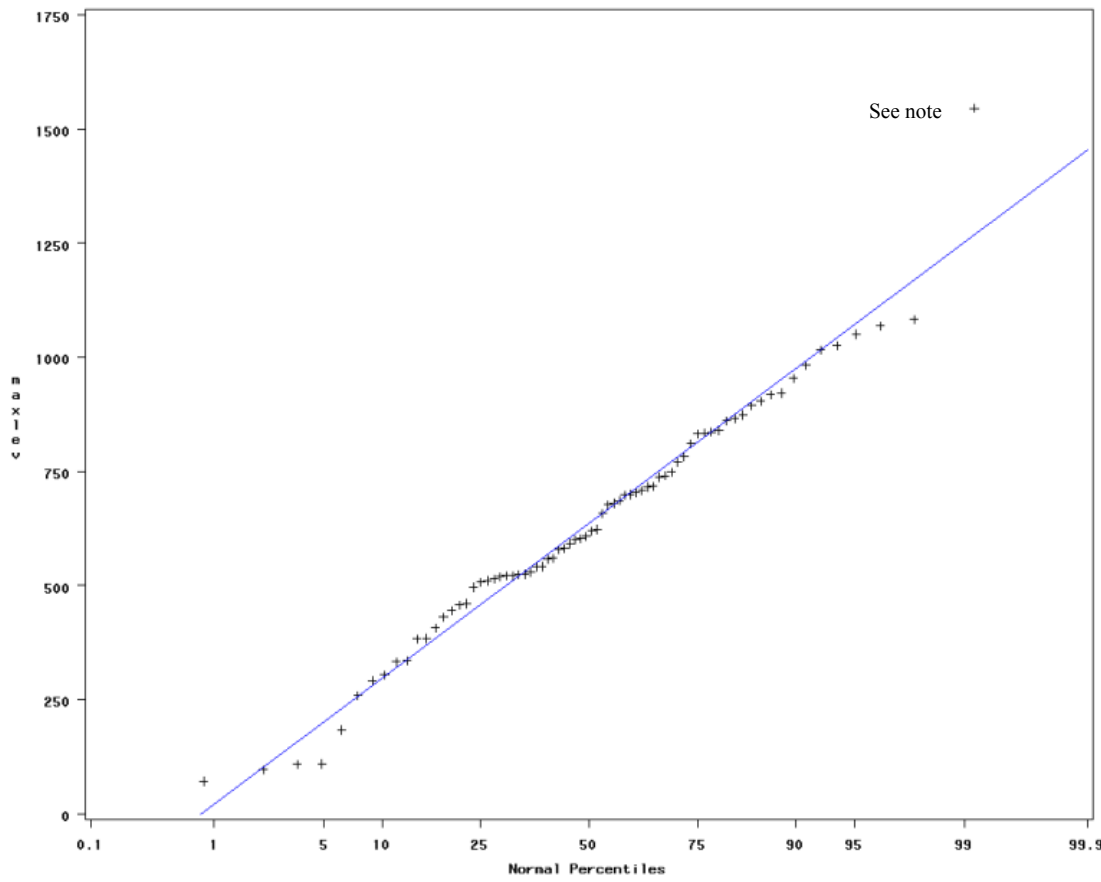

Note - Outlier data point of 154.57 lbs

Figure 40. Normal Probability Plot for Maximum Leverage

From the data presented in Figures 38 and 39, there appears to be a range or bin where both non-tipover and tipover data points can occur. The leverage threshold line uncertainty appears to be between 800 and 950 inch-pounds because these data bars contain both tipovers and non-tipovers. This uncertainty is caused by the established tipover threshold line used for this report and the leverage at various distances and loads.

A plot of the counts of tipovers and non-tipovers in a moment matrix using the distance outward on the oven door (4.75 to 21.5 inches) and an applied force (1 to 132 lbs) is shown in Figure 41. The figure shows that there are moments that fall within 600 to 1000 inch-pound bins that may vary between a tipover or non-tipover event. The crossover between the two curves at approximately 849 inch-pounds represents a 50/50 probability that a moment combination will result in a tipover or non-tipover. To the right of the crossover, the percentage of tipovers versus non-tipovers increases until the moment exceeds 1000 inch-pounds, where all the points become tipovers. To the left of the crossover, the percentage of non-tipovers versus tipovers increases until the moment is below 600 inch-pounds, where all the points become non-tipovers.

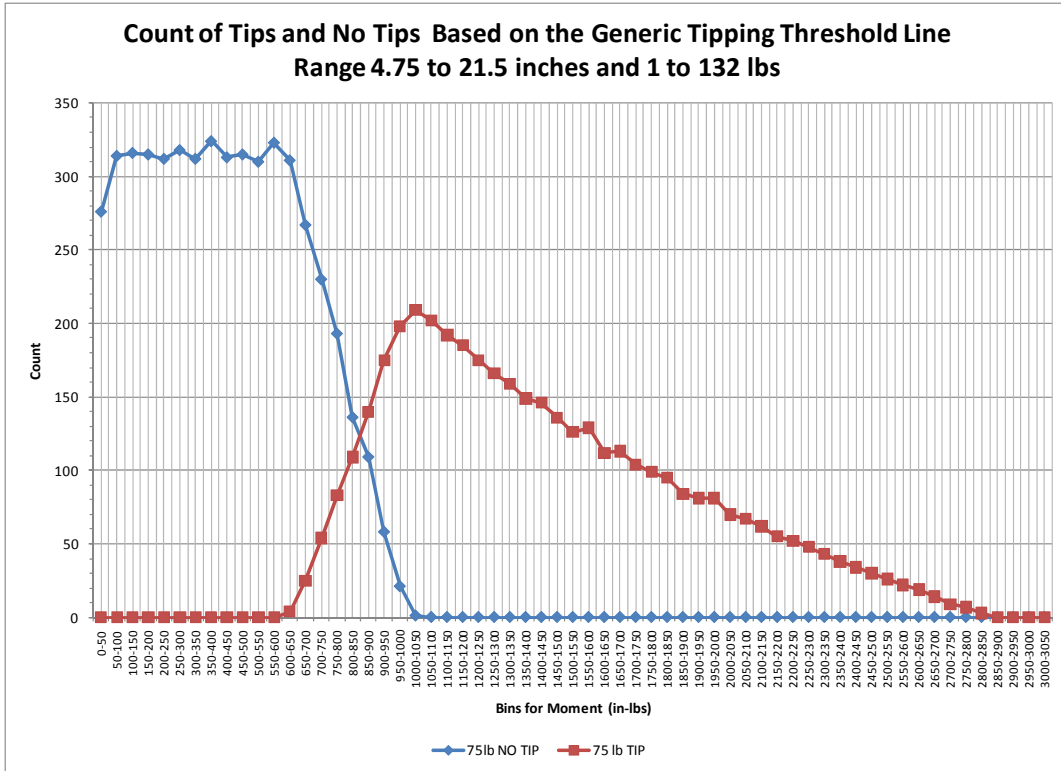

Figure 41. Tipover and Non-Tipover Count Plot Using Generic Static 75 Lb Tipover Threshold

Hypothetically, if the 75-pound static weight test was increased to some greater weight to establish a new threshold line, the non-tipover and tipover boundary would shift and decrease the number of tipovers observed in the staff tests. For example, if the 75-pound static weight test was increased to 100 pounds (an increase of 25 pounds), the threshold line would shift upward, as shown in Figure 42.

By overlaying the 100-pound threshold line onto the data presented in Figure 10 (the CG plot from Sessions 1 through 8), more of the data points that were identified as tipovers would become non-tipovers, as shown in Figure 43.

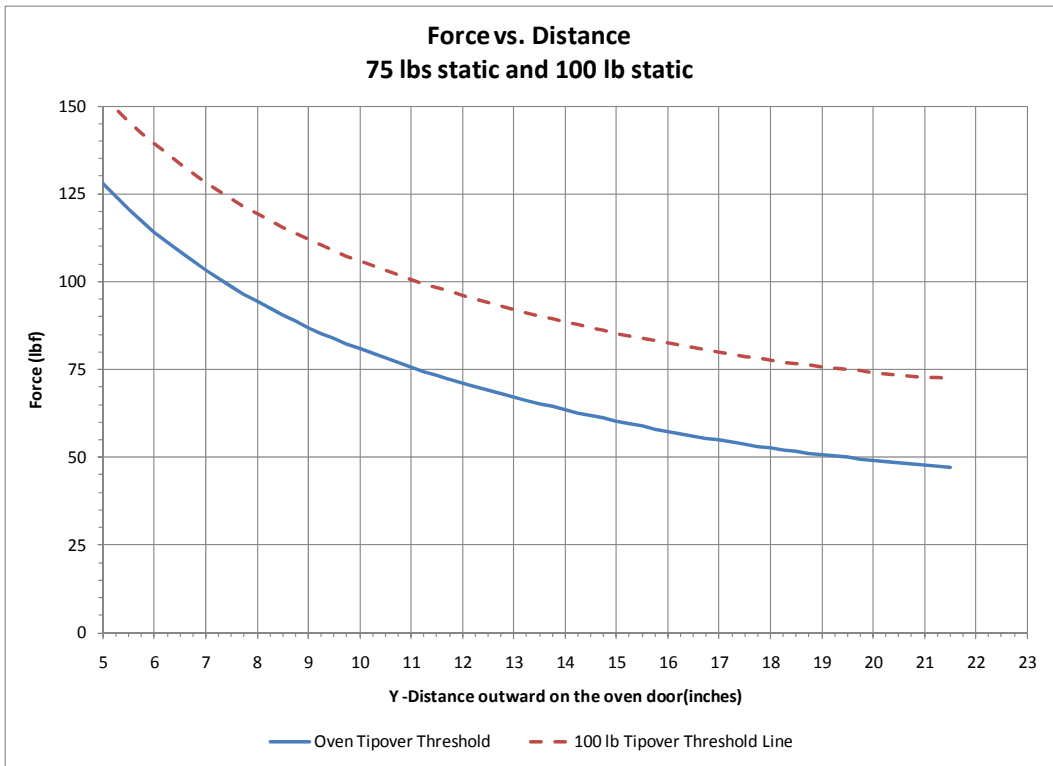

Figure 42. 75 Lb and 100 Lb Tipover Threshold Lines

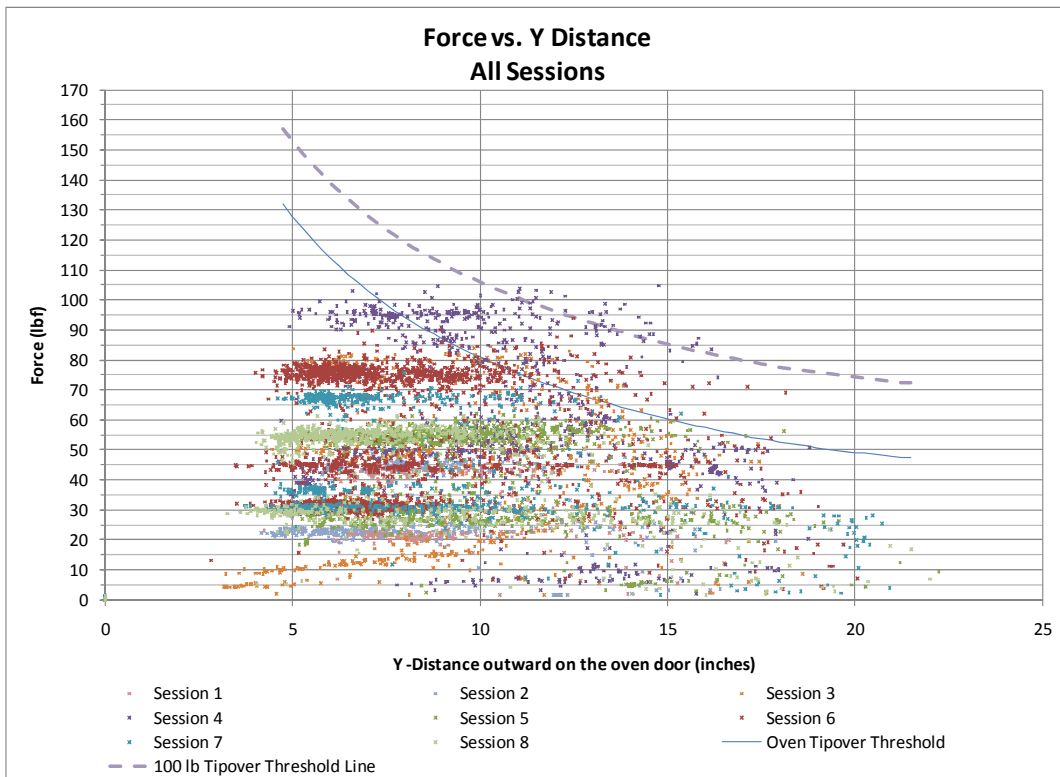

Figure 43. CG Data Points, 75 Lb and 100 Lb Tipover Threshold Lines

A 100-pound threshold line was applied to the normalized frequency event data set. As mentioned earlier, to normalize the data between sessions, only the first 15 minutes of the test session were used. Figure 44 shows the normalized data using the 100-pound threshold. In the figure, the counts in blue are non-tipovers; the counts in green are non-tipovers that were previously tipovers (using the 75-pound tipover threshold line); and the counts in red are still tipovers, regardless of which threshold line is used (75 pounds or 100 pounds). This one tipover event was from Session 4 and involved two 4 ½ year olds. In that instance, both participants were on the platform, while one of the test subjects was jumping off the platform.

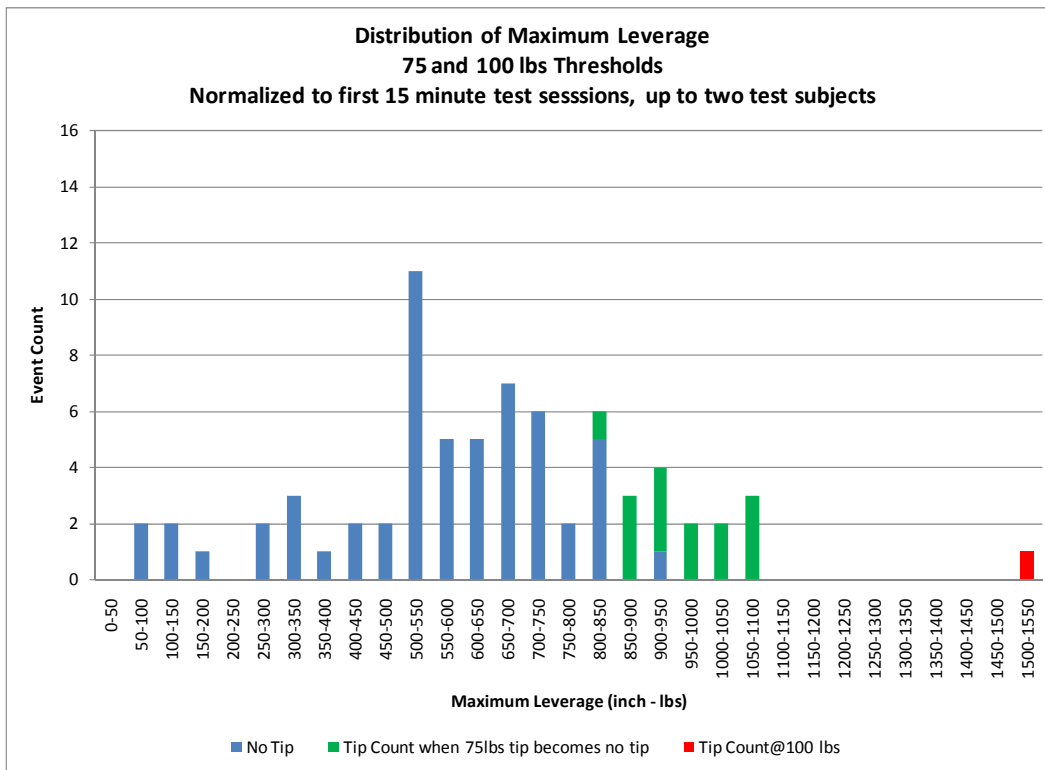

Figure 44. CG Data Points, 75 Lb and 100 Lb Tipover Threshold Lines

Adding 25 pounds to the threshold (from 75 pounds to 100 pounds) shifts the 50/50 crossover in the count plot to the right, as shown in Figure 45. This figure shows that the moment bins that may result in either a tipover or non-tipover event are shifted from 600 to 1000 inch-pounds (as shown in Figure 40) to 900 to 1,550 inch-pounds. The crossover point for the two curves is also shifted, from approximately 849 to 1,263 inch-pounds. To the right of the crossover, the percentage of tipovers versus non-tipovers increases until the moment exceeds 1500 inch-pounds, where all the points become tipovers. To the left of the crossover, the percentage of non-tipovers versus tipovers increases until the moment is below 850 inch-pounds, where all the points become non-tipovers.

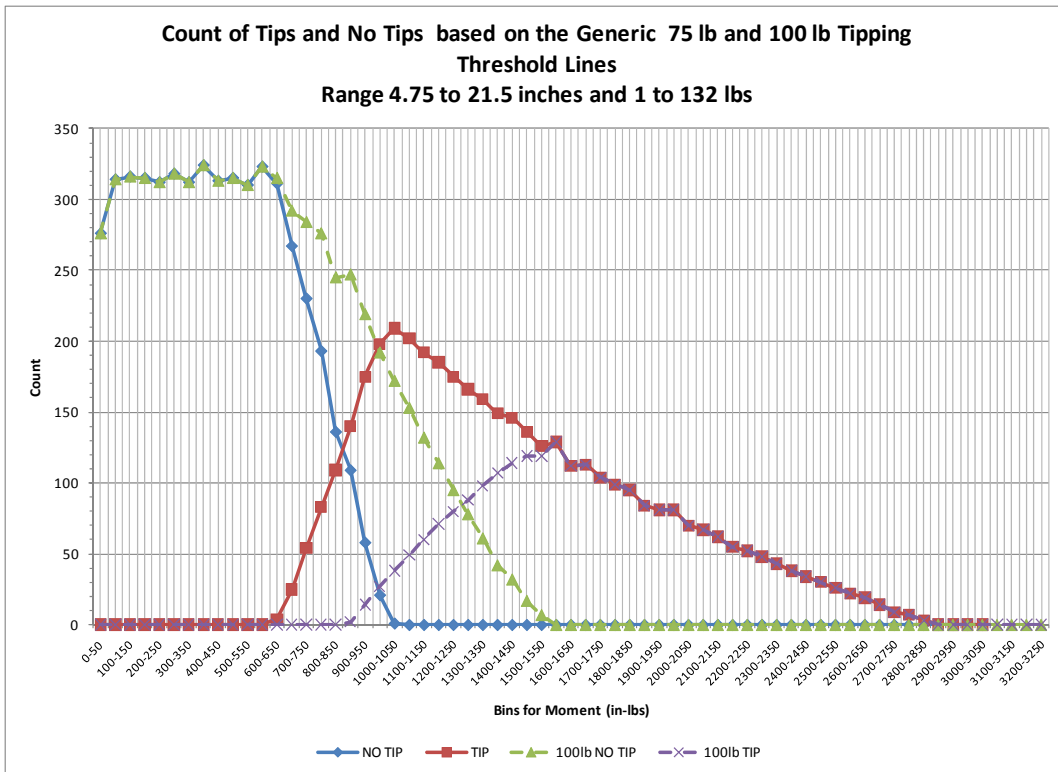

Figure 45. Tip and No Tip Count Plot Using Generic Static 75 Lb and 100 Lb Tipover Threshold Lines

UL’s current requirement for a static test at 75 pounds on the geometric center of an open oven door produces tipover and non-tipover crossover leverages at around 849 inch-pounds. In other words, at leverages of about 849 inch-pounds, 50 percent of the points will result in tipovers and 50 percent will result in non-tipovers. Based on the data collected in CPSC staff tests, 79.2 percent (57/72) of the events involving up to two children climbing onto an open oven door would fall to the left of the crossover point, and 21.8 percent (15/72) of the events would fall to the right of the crossover.

As shown in Figure 46, if UL’s requirement for a static test was increased to 100 lbs on the geometric center of an open oven door, the tipover and non-tipover crossover point would increase to 1,263 inch-pounds. Based on the data collected in CPSC staff tests, 98.6 percent (71/72) of the events involving up to two children climbing onto an open oven door would fall to the left of the crossover point (*i.e.*, the majority would result in non-tipovers) and 1.4 percent (1/72) of the events would fall to the right of the cross over (*i.e.*, a small number would result in tipovers). Under these conditions, 93.3 percent (14/15) of the data points that previously would have resulted in tipovers would now result in non-tipovers.

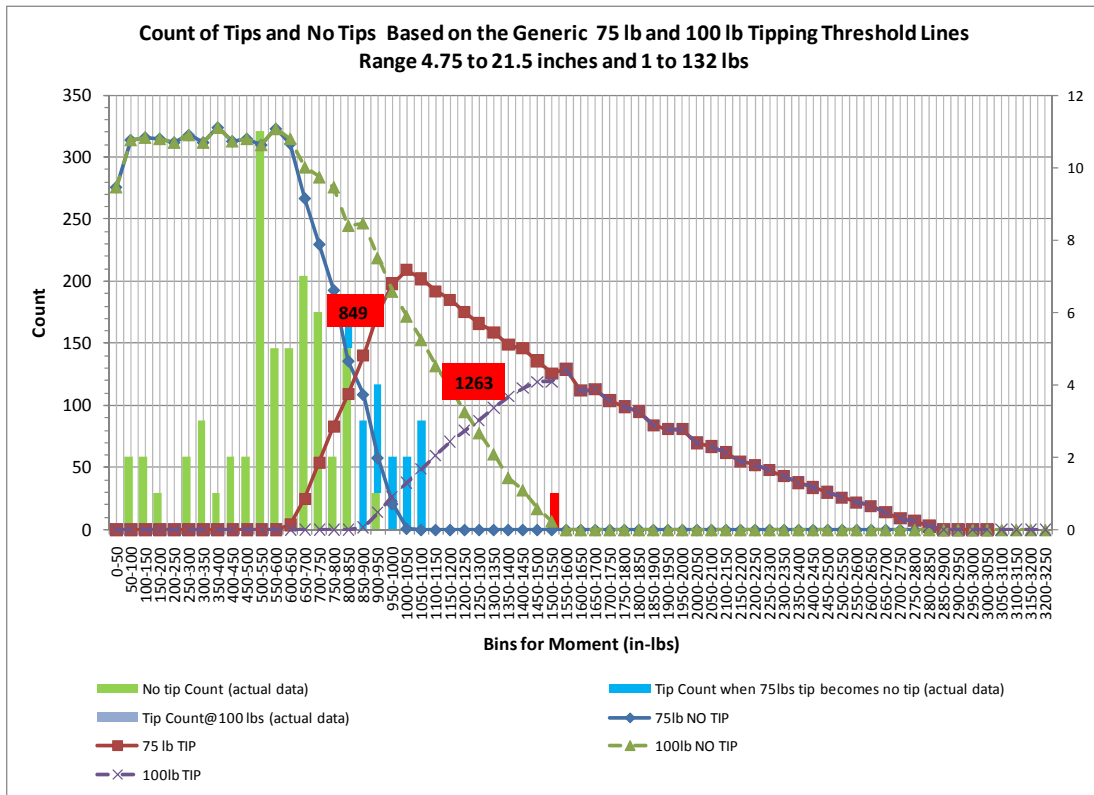

Figure 46. Maximum Leverage, Actual Count Data, and Threshold Count Lines

6.2 Analysis by Force and Position

Regardless of the method of analysis, the number of events within the first 15 minutes for the eight sessions will remain the same. As before, there were 97 events recorded for the eight sessions, and when normalized, the number of events drops from 96 to 72.

To use the fifth order polynomial (threshold line (1)) as the equation for plotting the tipping, non-tipping events, and threshold line, the equation was reordered as shown below:

$$(1) y = -0.0001x^5 + 0.0083x^4 - 0.2752x^3 + 4.7232x^2 - 45.724x + 267.99$$

where x = distance outward on the oven door, and y = tipping force threshold line

$$(2) y + 0.0001x^5 - 0.0083x^4 + 0.2752x^3 - 4.7232x^2 + 45.724x = 267.99$$

where x = CG distance outward on the oven door, and y = recorded force

Equation (2) represents the plotting equation where the recorded force (y) and CG distance (x) for a given event exceeds 267.99. Because the constant is 267.99, the tip and no tip threshold line occurs between 268 and 269; but for plotting purposes, 268.5 will be used.

A plot of the counts of tipovers and non-tipovers per event, using the distance outward on the oven door and the applied force, is shown in Figure 47. The figure shows a distinct separation between the tipping and non-tipping events. To the left of the crossover (268.5), the event counts are non-tips. To the right of the crossover (268.5), the event counts are tipovers.

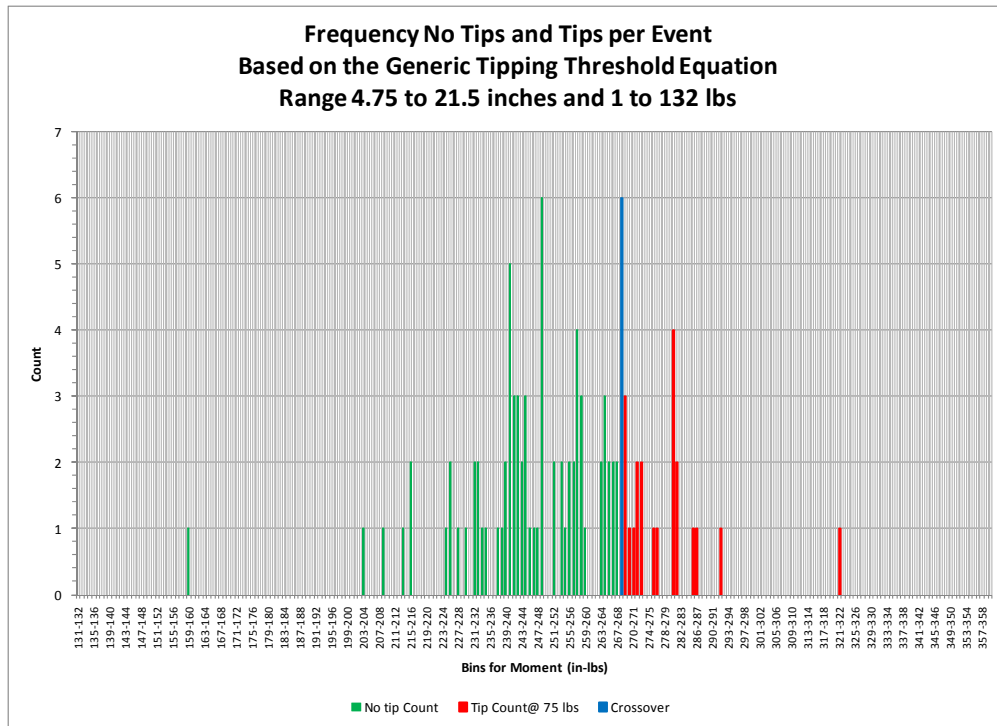

Figure 47. Tips and No Tips using 75 pounds, Crossover Line at 75 lbs

If the threshold line is adjusted to 100 pounds, the crossover shifts to right by 25 to 293.5. Figure 48 shows the normalized data using the 100-pound crossover threshold. In the figure, the counts in green are non-tipovers; the counts in black are non-tipovers that were previously tipovers (using the previous 75-pound crossover tipover threshold line 268.5); and the counts in red are still tipovers, regardless of which crossover threshold line is used (75 pounds or 100 pounds). Similar to the maximum leverage analysis, there is still the one tipover event, which was from Session 4 and involved two 4 ½ year olds. In that instance, both participants were on the platform, while one of the test subjects was jumping off the platform.

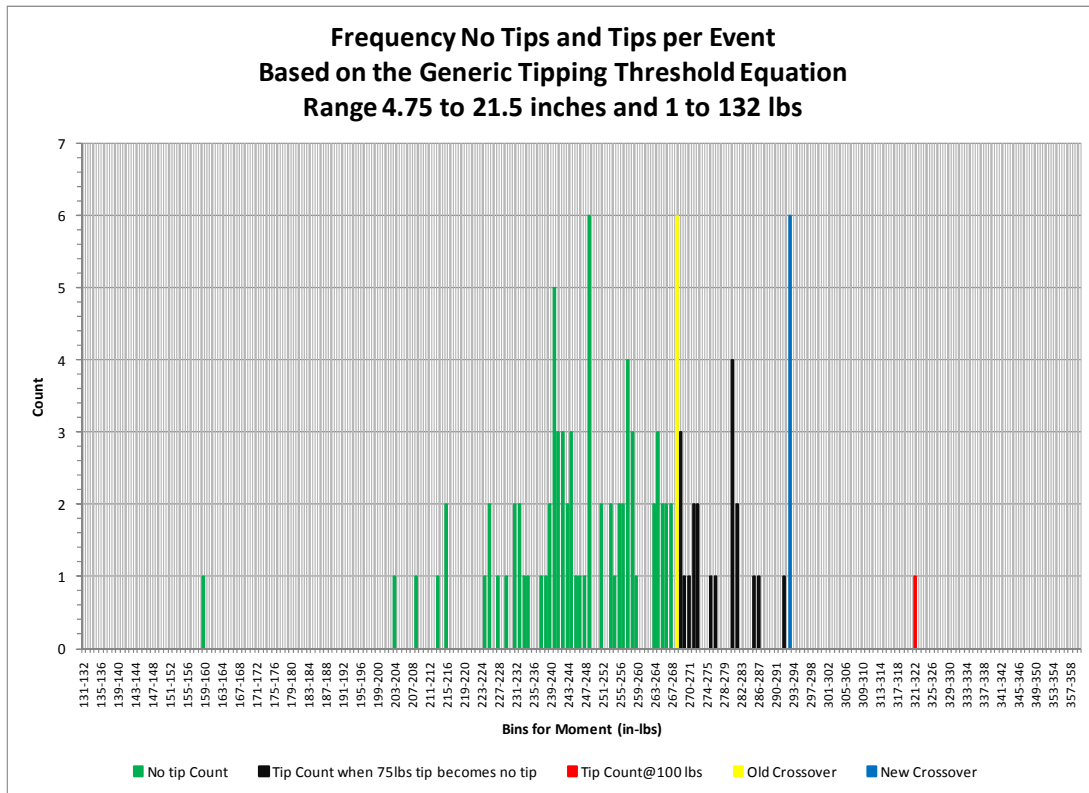

Figure 48. Tips and No Tips using 100 pounds, Crossover Lines at 75 pounds and 100 pounds

7.0 CONCEPTUAL SAFETY FEATURES

Many of the deaths that occur from a range tipping forward are the result of the range weight compressing the victim’s body. Essentially the range and oven door close or “clam” on the victim, as illustrated in Figure 49. The weight of the range prevents the victim from escaping and may cause positional or mechanical asphyxiation.

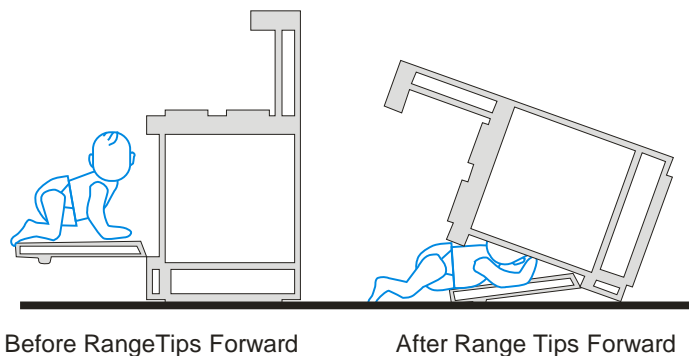
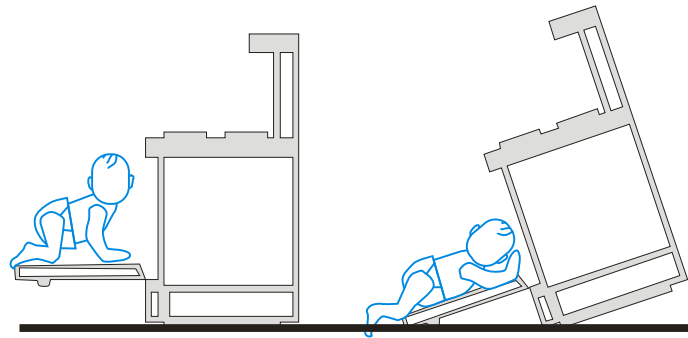

Figure 49. Illustration of Range and Oven Door “Clamming” on Victim Due to Range Tipover

One method to prevent the “clamming” effect is to have the oven door lock in the open position when the range has tipped forward. The oven door would act as a “supporting leg” to prevent the range and oven door from closing onto the victim, as illustrated in Figure 50.



Before Range Tips Forward After Range Tips Forward
 Figure 50. Illustration of Oven Door Locking in the Open Position After Tipover

If the range tilts forward, the oven door would contact the floor when the range has tilted about 28 degrees, but this depends upon door size and distance from the floor. A locking mechanism could engage when the range has tipped forward approximately 15 degrees. This method potentially may prevent deaths, but injuries from scalding liquids sliding off the rangetop and onto the victim are still a potential hazard. CPSC staff conducted tests to determine the inclination angle of a range that would cause various size pots to slide off a burner (see Section 5.2 of this report). The previous testing of inclination and various pot sizes shows sliding when the cooktop tilted between 6.5 and 20.5 degrees from horizontal, all less than the 28-degree angle of the range, if it has tilted such that the oven door contacts the floor.

CPSC engineering staff brainstormed different methods that potentially could be incorporated into a range to lock the oven door in the open position when it has tilted forward. The following criteria were used to design a locking mechanism:

- The locking mechanism must withstand the dynamic forces of the range falling forward.
- The mechanism must not engage unless the door is in the open position and the back supporting feet are not touching the floor.
- The locking mechanism must engage when the range has tilted a specified number of degrees, such as 15 degrees.
- The oven door must be unlocked or must unlock from the locking position when the range is in the upright position.
- The locking mechanism does not require electrical power.

An oven door typically contains a hinge that allows the oven door to be in one of three positions, as illustrated in Figure 51. A spring is attached to the hinge mechanism and acts as a counterbalance to both prevent the heavy oven door from “free falling” when opened and assist a user when lifting/closing the oven door. When the oven door is in the closed position, the hinge contains a natural resting position that, with the assistance of the spring, prevents the oven door from falling forward. A notch in the hinge mechanism allows the oven door to rest in the “ajar” (or slightly open) position. For the fully open position, the hinge is engaged completely, with a stop preventing the door from opening any further.

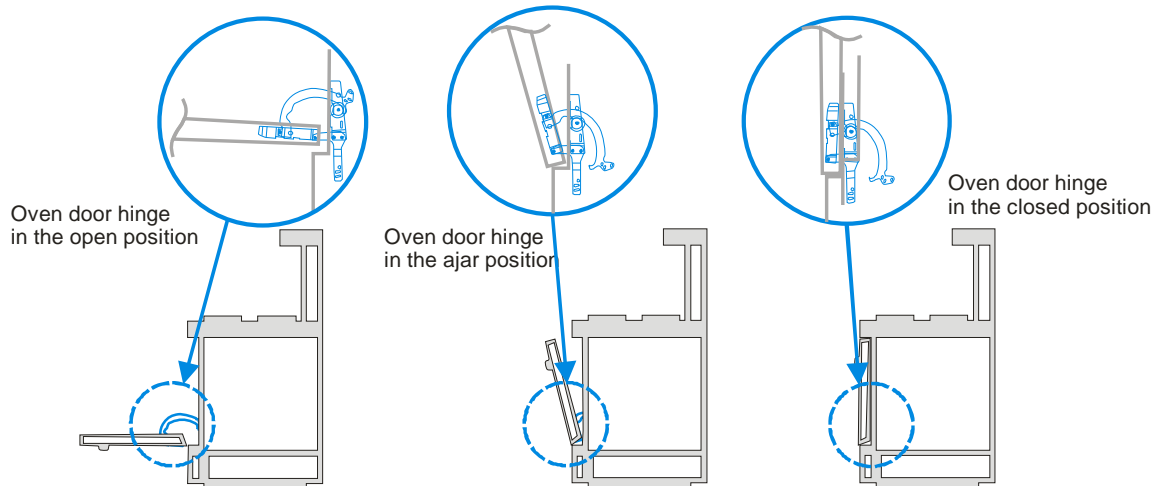

Figure 51. Illustration of an Oven Door Hinge (Illustrated Without the Spring Attached)

Staff identified two conceptual methods that potentially could be incorporated into a range to prevent an oven door from closing when it has tilted forward.

Method 1 – Plunger and cable system

The first method uses a spring-loaded plunger and cable system. When the range begins tilting forward, weight is taken off the plunger at the bottom rear of the range. This action allows the plunger to activate a cable that engages a locking pin in the oven door hinge, preventing the hinge/oven door from closing. This method may require using a plunger that has an adjustable length to allow for irregular flooring. Figure 52 illustrates the plunger and cable method.

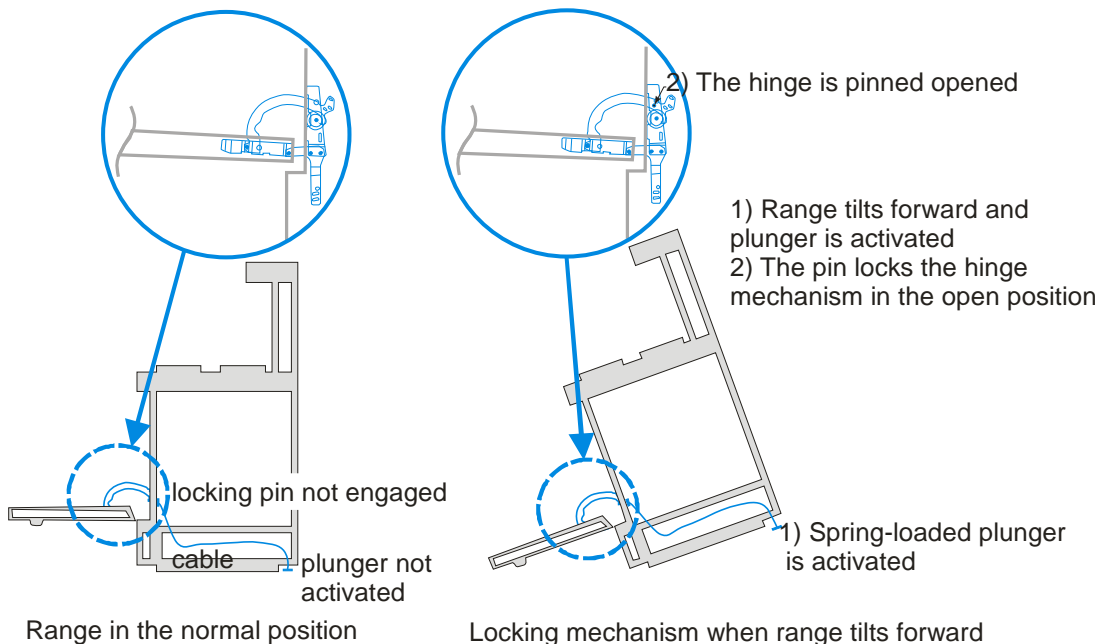
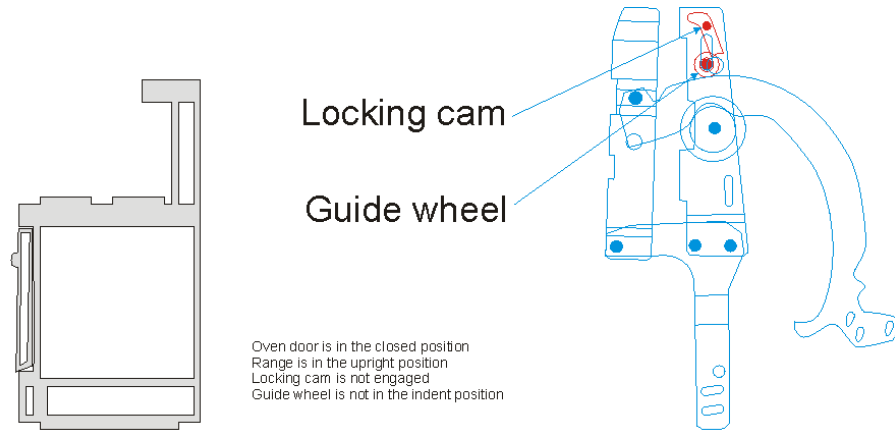

Figure 52. Illustration of a Plunger and Cable System

Method 2 – Cam and roller method

The second method uses a weighted cam that engages against a roller when the range has tilted forward 15 degrees. This method relies on gravity to align the cam with the roller, causing the hinge to stay in the open position. When the oven door is in the open position, the roller wheel rides into an indentation in the hinge mechanism, causing the hinge to jam if force is applied on the hinge. If the range tilts forward, the weighted cam engages against the roller wheel, preventing it from moving. This causes the roller wheel to essentially “jam” the hinge and oven door in the open position. Figure 53 illustrates the cam and roller method.



Position of the range

Oven door bracket

Figure 53a. Illustration of a Cam and Roller System

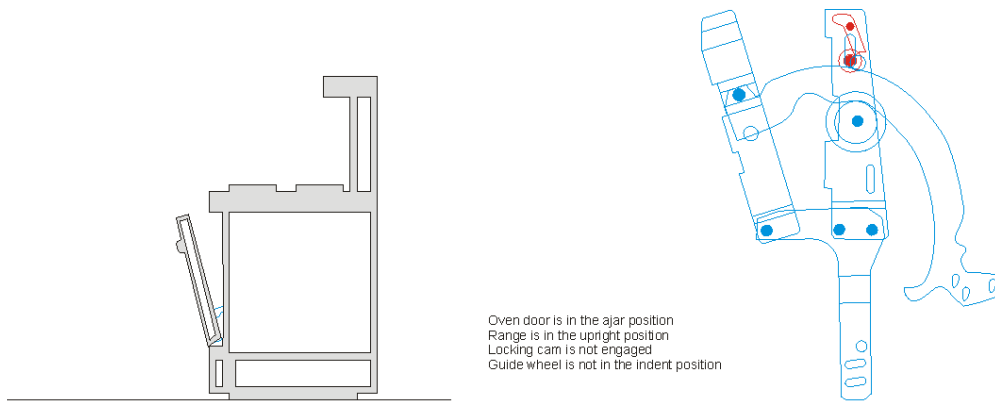

Position of the range

Oven door bracket

Figure 53b. Illustration of a Cam and Roller System, Guide Wheel Rides Oven Bracket

8.0 SUMMARY

CPSC staff reviewed 33 reports of incidents involving range tipovers from 1980 to 2006. Two main commonalities in the reviewed incidents were that the ranges were unsecured to an adjacent wall, floor, or cabinet; and sufficient weight was applied to the open oven door to cause the range to tip forward. The incident data for the past 25 years show that incidents involve two distinct groups—children between the ages of 15 months and 5 years—and older adults.

The circumstances surrounding the events resulting in range tipover were different, depending upon the victim's age group (*i.e.*, young versus elderly). The incidents involving the elderly occurred when the victims used the open oven door as support. With the range unsecured by anti-tip hardware, the weight of the adult on the open oven door caused the range to tip forward. The events leading up to incidents involving children are sketchy because, typically there were no adult eyewitnesses, but the descriptions of the incidents are similar. Typically, the incidents involved one child trapped under the tipped range and occurred when the children were unsupervised in the kitchen or near the range. If multiple children were in the household, usually the younger sibling was the victim trapped under the tipped over range.

Age appears to be related directly to the injuries associated with range tipovers. Interpolating anthropometric data indicates that a 15-month-old child may be tall enough to climb onto an oven door that is 11.5 inches from the floor. This was calculated from the anthropometric measurements of children in *Physical Characteristics of Children* (May 31, 1975). The anthropometric study did not collect data on crotch height for 15-month-olds, but crotch height can be estimated using the stature and sitting height measurements for 15-month-olds. The stature and sitting heights for a 95th percentile 13- to 18-month-old are 32 inches and 20.5 inches, respectively (Snyder, Spencer, Owings, & Schneider, 1975). Subtracting the sitting height from stature height would provide an estimated crotch height of approximately 11.5 inches (32–20.5 inches). This is similar to the height of an open oven door; thus, it is possible for a child as young as 15 months old to swing one of their legs onto an open oven door and climb up.

CPSC staff conducted static load tests on each of four sample ranges to determine the loads required for the ranges to reach tipover conditions. The data from these tests (magnitude of force versus location on an open oven door) were used to derive a threshold line¹² at which tipover would occur.

CPSC staff conducted testing to determine the dynamic forces that could be applied to an open oven door by children. Dynamic forces of children actively climbing and standing on a test fixture/platform, which simulated a range with an open oven door, were measured. Thirteen children within the age range of 15 months to 5 years old participated in staff's testing. Ninety-seven events were recorded during these tests. The data were normalized (data were truncated after 15 minutes), which reduced the data set to 72 events.

Based on a threshold line corresponding to UL's current requirement to address stability under normal conditions (*i.e.*, a test in which a static weight of 75 pounds is placed on the geometric center of an open oven door), 20.8 percent (15/72) of the events in CPSC staff's testing—which involved up to two children climbing onto a fixture that simulated a range with an open oven door—would have resulted in range tipover events. If the threshold line was changed, such that it corresponded to an unsecured

¹² The sample ranges met the current UL performance requirements for stability under normal use conditions (*i.e.*, placement of a 75-lb static weight in the middle of the open oven door of a range with the range not secured to surrounding structures).

freestanding range that was designed not to tip with a static load of 100 pounds on the geometric center of an open oven door, the percentage of tipover events involving up to two children climbing onto an open oven door would be reduced to approximately 1.4 percent (1/72). The weight of two older children (around 5 years old) or more than two children on an oven door still could cause an unsecured range to tip over.

CPSC staff believes that locking an oven door in the open position could address deaths caused by range tipovers and would be effective for both vulnerable populations—children and older adults. CPSC staff described two conceptual methods that potentially could be incorporated into the hinge of an oven door to lock it into the open position once the range has started to tip forward. However, these methods may not be effective in reducing scald injuries associated with hot liquids/food spilling onto a child when a range does tip forward.

9.0 CONCLUSIONS

In all the incident reports involving range tipovers that were reviewed by CPSC staff, it appears that anti-tipping devices were not installed on the ranges at the time of the incidents. No conclusions regarding the reasons why the anti-tipping devices were not installed could be determined from the available information.

Based on CPSC staff's evaluation and testing, the following conclusions may be drawn:

- Increasing the stability of an unsecured range by requiring that the range not tip forward with a 100-pound static weight placed on the geometric center of an open oven door could reduce the incidence of range tipover and, therefore, reduce injuries and deaths resulting from scalding and asphyxiation, respectively.
- Locking the oven door into the open position when an unsecured range begins to tip forward may reduce deaths to children and older adults caused by entrapment under a range; however, this may not be effective in reducing scald injuries associated with the spilling of hot liquids or food onto a child when a range does tip forward.
- CPSC staff is aware of five incidents in which adult victims (primarily older adults) were trapped for extended periods of time under a tipped over range while the oven's heating elements were turned on, resulting in thermal burns every time the oven cycled on. Automatically shutting off the heating elements of a range/oven when it has tipped may reduce the severity of thermal burns.

Based on CPSC staff's evaluation and testing, additional research on the effectiveness of locking the oven door in the open position and research into the development of an anti-tipping device that must be installed for the oven to operate (a safety interlock) may be beneficial in reducing injuries and deaths from range tipovers.

10.0 REFERENCES

Bibliography

- 8Newsnow.com. (2010, November 14). Toddler Killed After Oven Falls on Him. Las Vegas, Nevada.
- Ahumada, R. (2009, August 13). *Modesto toddler is killed in stove accident*. Retrieved August 21, 2009, from Modesto Bee Web Site: <http://modbee.com>
- American National Standards Institute. (2000). *Household Cooking Gas Appliances. ANSI Z21.1 2000 Household Cooking GAs Appliances*, 27. Cleveland, Ohio, USA: CSA America, Inc.
- Appliance. (2009, August). *Statistics for the month of April 2009 - U.S. Appliance Unit Shipment*. (Canon Communications LLC) Retrieved November 17, 2009, from www.appliancemagazine.com: <http://www.appliancemagazine.com>
- Centers for Disease Control and Prevention. (2000, May 30). *CDC Growth Charts*. Retrieved November 11, 2009, from CDC Web Site: <http://cdc.gov/growthcharts/>
- Gipson, K. (March 2011). *Instability and Tipover of Appliances, Furniture and Televisions: Estimated Injuries and Reported Fatalities, 2010 Report*. Directorate for Epidemiology, Division of Hazard Analysis. Bethesda: U.S. Consumer Product Safety Commission.
- Hohn&Scheuerle. (2005, September 30). FOI request S-2005100006. Philadelphia, PA.
- Musso, J. (2009, September 17). E-mail correspondence. IL.
- Public Citizen. (No date). *Consumer Product Safety Commission Knowledge of Range Tip-Over Problem*. Retrieved November 5, 2009, from Public Citizen: www.citizen.org
- Seinders, D., Ahluwalia, G., Melman, S., Quint, R., Chaluvadi, A., Liang, M., et al. (2007). *Study of Life Expectancy of Home Components*. Washington DC: National Association of Home Builders/Bank of America.
- Snyder, R., Spencer, M., Owings, C., & Schneider, L. (1975). *Physical Characteristics of Children, As related to death and injury for consumer product design and use*. Highway Safety Research Institute, Department of Anthropology. Ann Arbor: The University of Michigan.
- Stralka, K. (2007). *Incident reports involving freestanding kitchen range tipovers*. Division of Hazard Analysis. Bethesda: U.S. Consumer Product Safety Commission.
- Stralka, K. (2008, October). Internal memo, Stove Tipover Completed Investigations of Incidents from 1/1/2000 to 9/30/2008. Bethesda, Maryland, USA: US Consumer Product Safety Commission.
- Underwriters Laboratories. (2005, April 12). *Household Electric Ranges. UL 858 Household Electric Ranges, Fifteenth Edition*, 15. Northbrook, IL, USA: Underwriters Laboratories.
- Underwriters Laboratories Inc. (2010, March 19). Subject 858, 1. Proposed Requirements to Improve Consumer Awareness and Installation Practices. Northbrook, IL.
- White, M. S. (2000, November 1). Hidden Hazards of Defective Ranges. *Trial*, 11.

No Text on This Page

APPENDIX A – TEST FIXTURE AND SETUP DETAILS

A1. Simulated Range/Oven Details

To simulate an oven door in the open position, a wooden platform was designed to reduce potential laceration injuries from sheet metal, tipping, or tripping hazards associated with the use of a real oven. The dimensions of typical 30-inch ranges/ovens were measured and a platform was designed, as shown in Figure A1. The platform measured 29.5 inches wide x 21.5 inches deep. The platform was approximately 11.5 inches above the floor. The rear of the fixture was the simulated range but with a reduced depth. The height of the simulated range was 36 inches from the floor and 25 inches from the top of the platform. The width and depth were 29.5 and 10 inches, respectively. The test fixture/platform was designed to not visually resemble a real range/oven so that participating in the testing would not foster a behavior in the participants of playing on a real range.

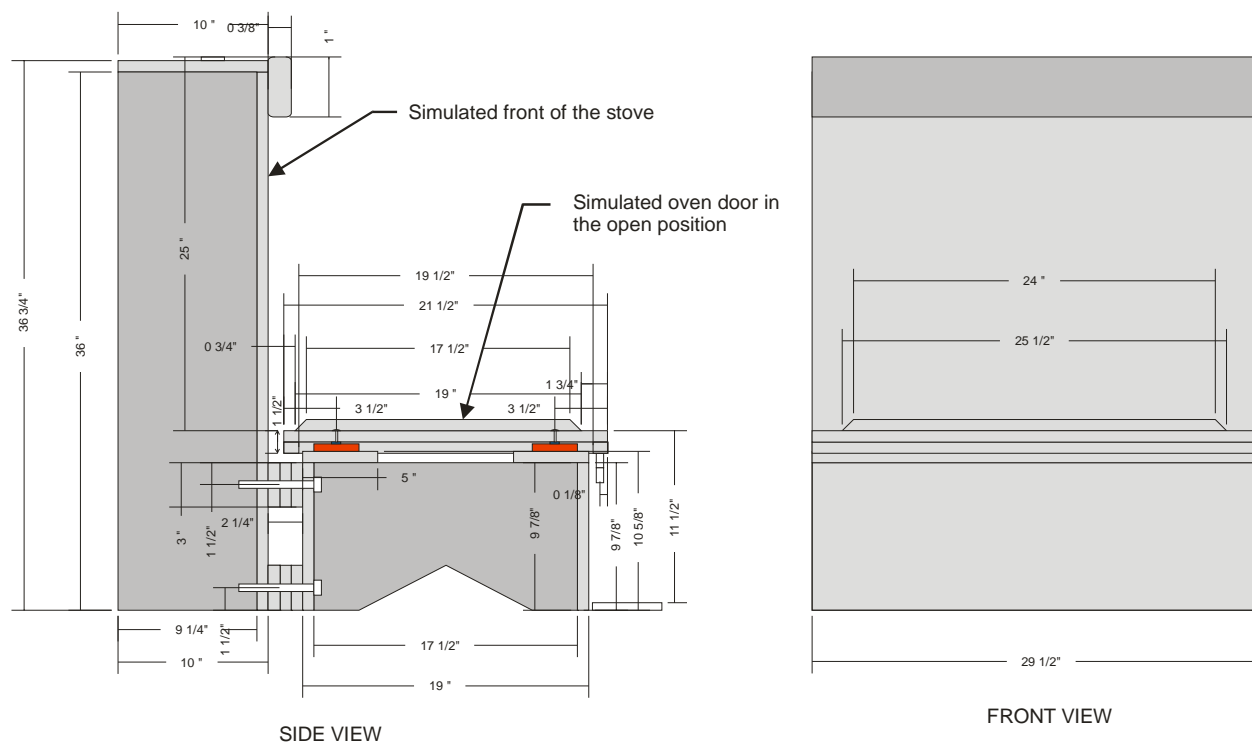

Figure A1. Simulated Range/Oven

The simulated range/oven was constructed of $\frac{3}{4}$ inch hardwood laminated plywood. The panels in the assembly were glued and screwed. The surfaces were sanded smooth and painted with nontoxic indoor paint. All edges and corners were rounded to prevent sharp edges. A handhold was placed at the top of the simulated range/oven front for a child to grasp. The child was allowed to stand only on the simulated oven door/platform, which was 11.5 inches above the floor surface.

Four load cells were mounted under the platform, one at each corner. The load cells measured the applied loads on the top of the platform and were last calibrated in September 2008. The platform had less than 1/16 inch of free movement. Each load cell was connected to a laptop via a USB hub. The laptop recorded the load on each individual load cell and the total load on the platform. Each load cell had a sample rate of 150 samples per second. Because every 20 samples were averaged, the load cells had approximately 7 data points per second available for recording. The data recorder was set to record

every second. The platform was calibrated before the testing began, and the tare was set to zero. The load cell specifications are as follows:

Combined Accuracy

0.15 percent of Full Scale Output (FS) – Standard

Environmental

Compensated Temperature Range -10°C to +40°C (with tare)

Operating Temperature Range -10°C to +70°C, non-condensing

Long-term Drift 0.025 percent of FS per 20 minutes

A2. Test Structure Stability

The test structure was tested for stability. Figure A2 shows the required loads to tip over the test structure at various points on the test structure. The required force to tip over the structure was much greater than the forces a child could apply to the fixture.

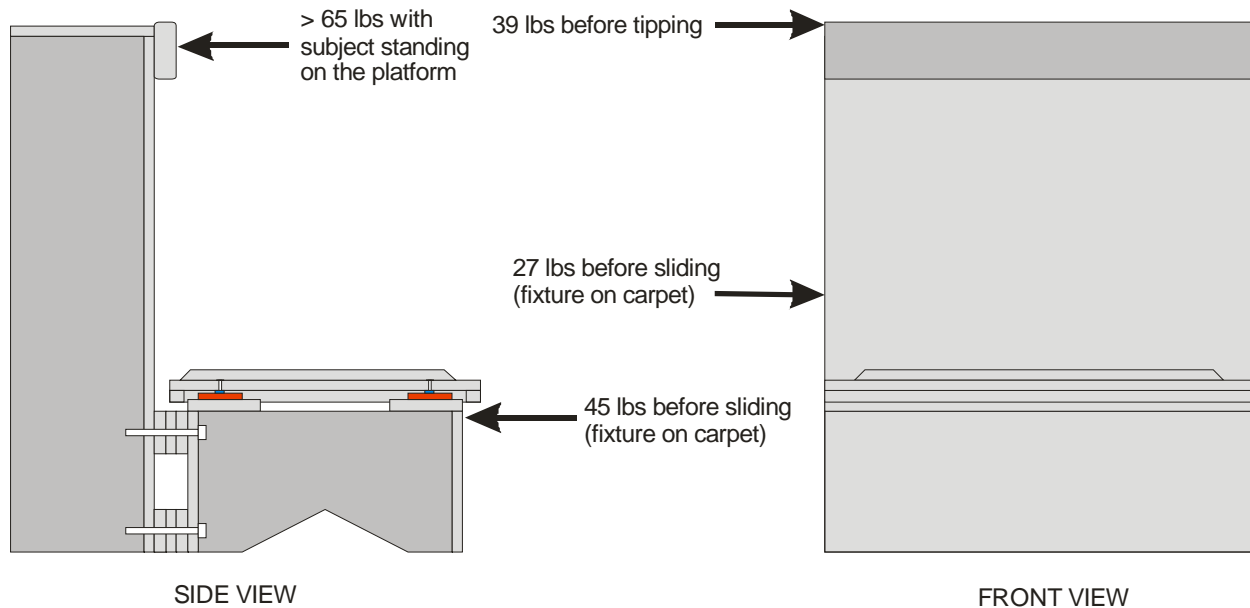

Figure A2. Forces to Tipover the Test Structure.

A3. Test Setup

Every effort was made to prevent injuries to test participants. Two spotters were used to monitor a child and assist if the child lost balance. The spotters were placed within reach of a test subject on each side of the test setup. The floor around the platform was covered with safety mats, as shown in Figure A3. The mats had transition edges to prevent tripping when stepping from the floor to the mats. The mats met the requirements of ASTM 1292-99, testing for head impact attenuation and were rated for falls up to 2 feet.

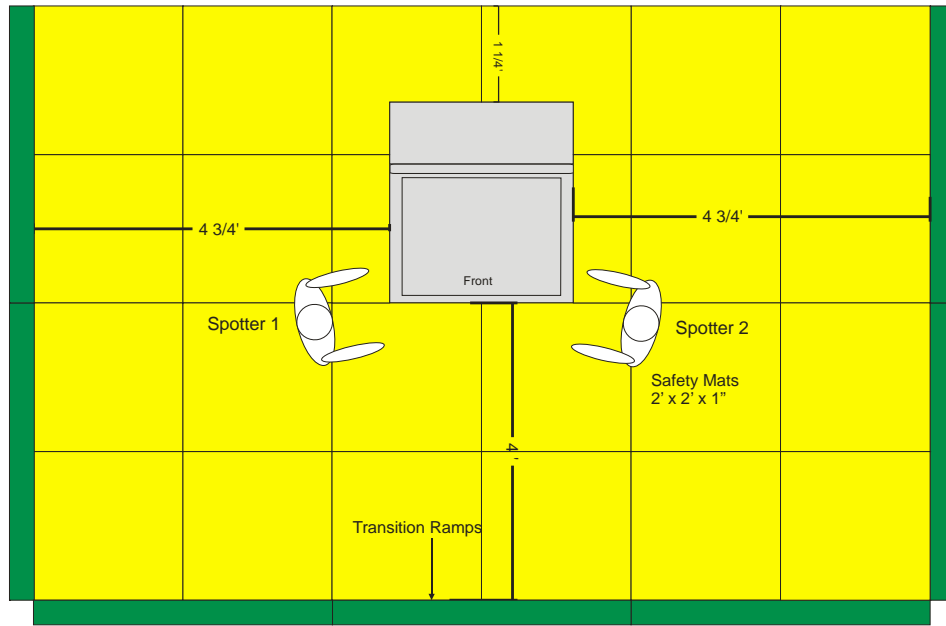

Figure A3. Overhead View of Test Setup with Safety Mats and Spotters

No Text on This Page

APPENDIX B – CONSENT FORM AND HUMAN SUBJECTS APPROVAL LETTER



US Consumer Product Safety Commission

Name: Arthur Lee
Directorate: Engineering Sciences
Address: 4330 East West Hwy
Bethesda, Maryland, 20814

Title of Research Project: Stability of Free-Standing Ovens/Stoves

CONSENT TO PARTICIPATE IN RESEARCH

Dear Parent/Guardian:

Your child is invited to take part in a research study conducted by Engineering Sciences, US Consumer Product Safety Commission. Before you decide whether or not your child may participate, this form will be reviewed with you by CPSC staff. Any questions from you or your child that are not clear or understood will be answered before signing the form.

You and your child are under no obligation to participate. Whether or not your child participates will have no effect on your benefits or employment at CPSC.

Description of the project: The purpose of the study is to record the forces generated when a child plays on a simulated oven door in the open position.

What your child will do: If you agree to allow your child to participate, your child will be allowed to free play, such as climbing, standing, holding, on the simulated oven door, which is actually a wooden platform. Your child may be one of two children that will participate at the same time. The platform is instrumented to record the forces applied onto it.

Time required: Participation will not exceed 30 minutes.

Risks or discomfort: The only anticipated risk in this study is the potential of minor injuries (contusions, abrasions, etc.) if the child may lose balance while playing on or near the platform. The CPSC will provide a first aid kit on site during the testing, and if additional medical care is warranted as requested by the parent(s), an ambulance would be called to transport the child to the nearest emergency room.

Every effort will be made to prevent the child from injury. The floor around the platform will be covered with 1 inch mats. Two spotters will be used to monitor the child and assist if the child loses balance. You may participate as a spotter if you desire.

Unusual circumstances or injury will be reported to the Chair of the CPSC Institutional Review Board (IRB), Jacqueline Ferrante, Ph.D., 301 504-7259.

Benefits of this study: Although there will be no direct benefit to your child for taking part in this study, the researcher may learn more about the forces required for a child to cause a free-standing oven to tip.

Please sign both copies of this form, keeping one copy for yourself.

Assigned Designator _____

Compensation (If applicable): You and your child will not receive compensation for participating in this study.

Confidentiality: The information that is collected in the study will be handled confidentially.

With your permission, I would like to videotape your child during the activity. The recordings made from this study will be downloaded onto a DVD and stored in a locked cabinet. The original recording the digital video recorder (DVR) will be erased once downloaded. The results of the study, including any data, may be published for scientific purposes, but any information that could identify your child will not be released. It is possible that the study information could be reviewed by the CPSC staff or by another government agency that requests the information. If this occurs, there is a legal obligation to keep anything that would identify your child from being released to the public. If the digital recordings are viewed, used, or published by individuals or organizations outside of CPSC or their direct contractors, your child's face will be obscured to protect their identity.

Health Conditions: Your child must not have any physical or mental conditions (e.g. epilepsy) that may make participation more hazardous. Your child must not have taken or is on medications that may make participation more hazardous.

Decision to quit at any time: If you decide to allow your child to participate, you are free to withdraw your child at any time. Your child may also refuse to participate or discontinue participation at any time. The decision to take part in this study is completely voluntary. Whatever you decide will in no way affect your status at the agency.

Questions, Rights and Complaints: If you have questions about this research, please contact Arthur Lee, 301-504-7539, alee@cpsc.gov. You may also contact the agency supervising this work: Andrew Trotta, 301-504-7578.

Signatures:

Signing this document means that you understand the information given to you in this form and that you and your child voluntarily agrees to participate in the research described above.

I would like to participate as a spotter

I give my permission for the testing to be videotaped

I DO NOT give my permission for the testing to be videotaped.

Assigned Designator _____

Child's Name(s) _____

Signature of Participant's Parent or Guardian Date

Signature of Participant's Parent or Guardian Date

Typed/printed Name of Parent or Guardian

Typed/printed Name of Parent or Guardian

Signature of CPSC staff Date

Typed/printed Name of CPSC staff and Division

Please sign both copies of this form, keeping one copy for yourself.

Assigned Designator _____



United States

CONSUMER PRODUCT SAFETY COMMISSION
4330 East West Highway, Bethesda, MD 20814

Date: May 5, 2009

MEMORANDUM

To: Arthur Lee, Electrical Engineer, Directorate for Engineering Sciences

From: Jacqueline Ferrante, Ph.D., Chair, Human Subjects Committee

Subject: Approval for Human Subjects Testing – Forces Applied by Children on a Simulated Oven Door

By a majority vote, the Human Subjects Committee approved the latest version of your proposed study to quantify the dynamic loads applied onto a simulated oven door. According to the protocol, at least eight healthy children of CPSC employees, ranging in age from 15 months to five years old, will be tested in pairs. Generally, committee members agreed that the test protocol meets the definition of a minimal risk¹ and that any risk would be mitigated by the specified safety measures (*i.e.*, two spotters within close proximity of the children, one inch mats around the platform, etc).

As part of the approval, adequate provisions must be made for soliciting the assent of the children and the permission of their parents or guardians 16 CFR 1028.109(b). The parental consent form is approved with the following revisions:

- Include language (appropriate for the age, maturity, and experience level of the child) that will be used to describe the study, its purpose, any possible discomforts (e.g., falling off the platform), and to ask the child directly if they would like to participate. Note that failure of the child to object does not imply assent.
- Add a statement confirming that the child does NOT have an existing health condition (e.g., epilepsy) that could increase the risks or compromise safety.

¹ *Minimal risk* means that the probability and magnitude of harm or discomfort anticipated in the research are not greater in and of themselves than those ordinarily encountered in daily life or during the performance of routine physical or psychological examinations or tests. 16 CFR 1028.102 (i)

You must obtain a signed parental consent form from the parents or guardians of each test subject. To avoid the appearance of undue influence, it is important that at least the non-CPSC parent or guardian sign it. Upon completion of the study, the form with the original signatures must be submitted to the Committee Chair to be kept on file. It is recommended that you keep a copy of these forms for your files. Also, as part of its continuing review, the Committee asks that you report any aberration in the study or injuries sustained during its performance CFR 1028.103(b).

cc: Dr. Richard Thomas, National Naval Medical Center
David Miller, EPHA
Sarah Brown, ES
John Murphy, ES
Alice O'Brien, OGC
Dr. Mary Ann Danello, HS
Lori Saltzman, HS

APPENDIX C – ADDITIONAL CHARTS FOR INDIVIDUAL TEST SESSIONS

C1. Session 1 (Participants 1 and 2)

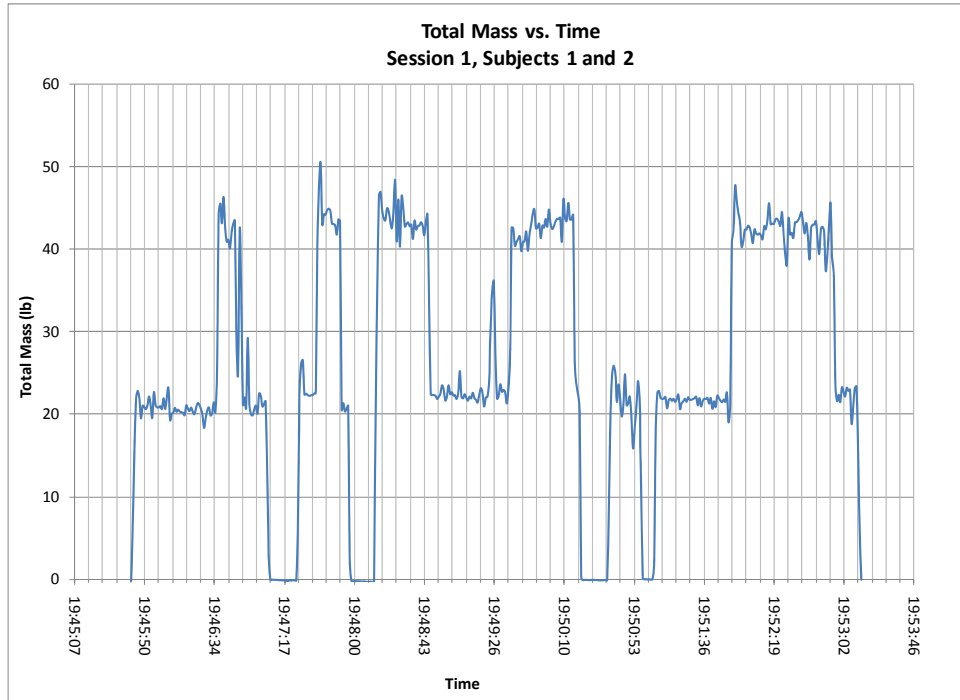

Figure C1. Session 1, Timeline

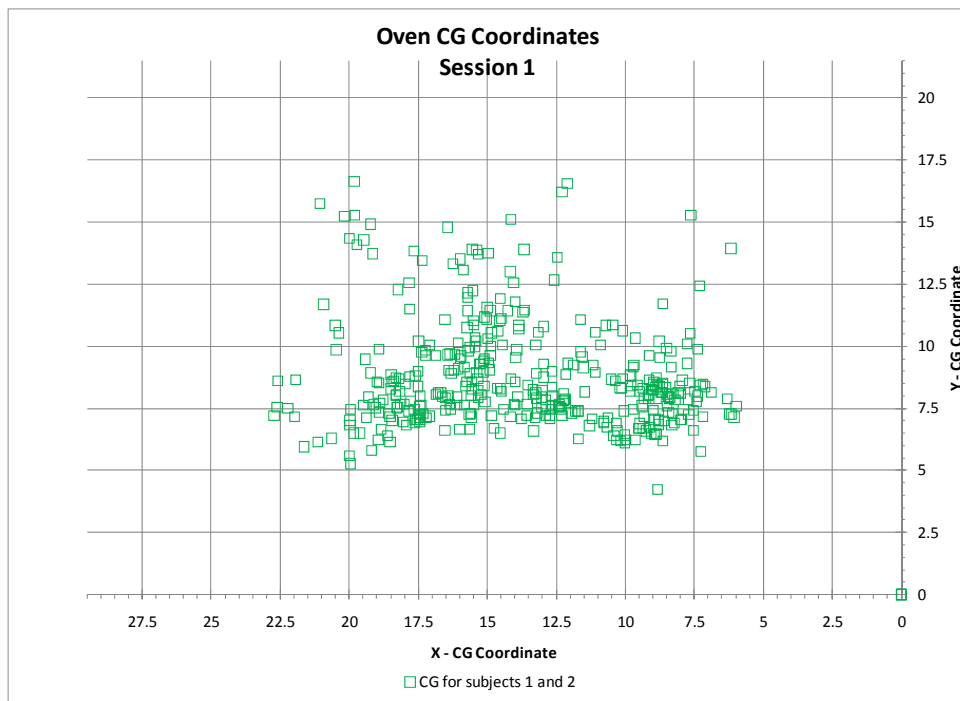

Figure C2. Session 1, CG Plot

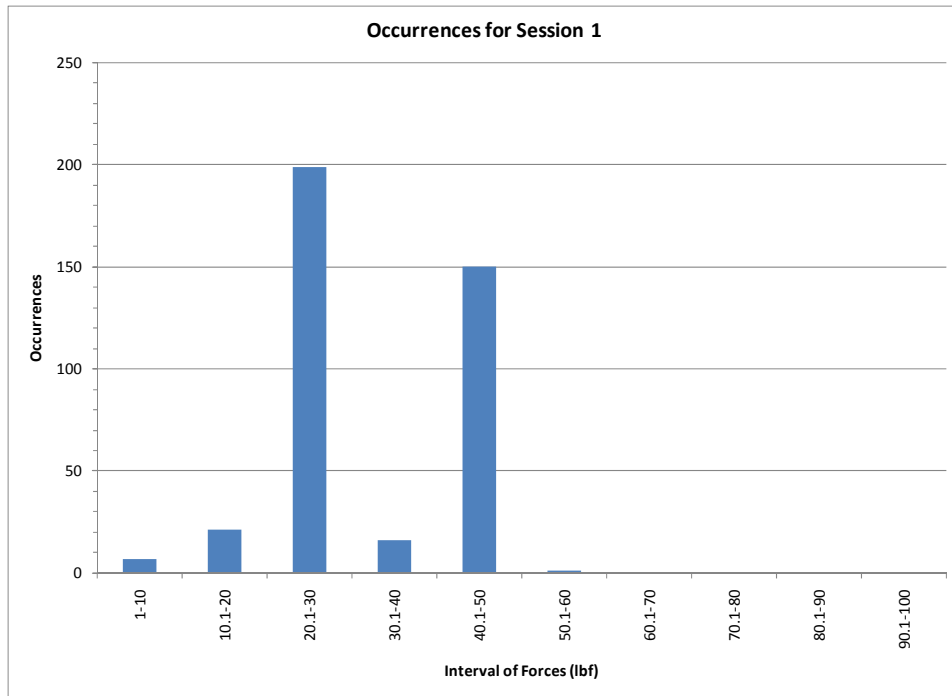

Figure C3. Session 1, Force Bin Count

C2. Session 2 (Participants 1 and 2)

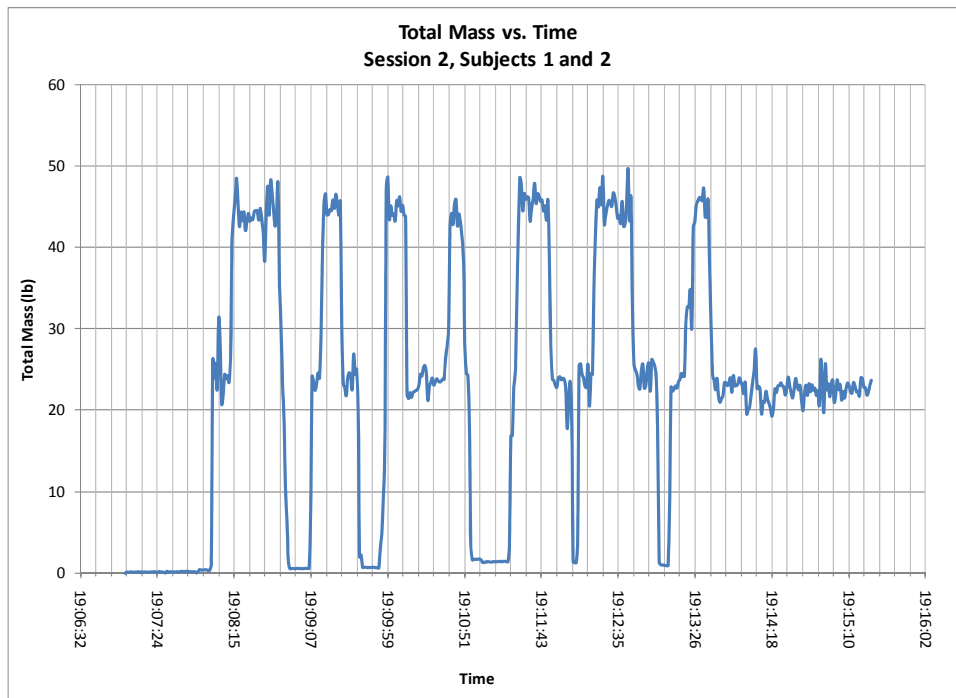

Figure C4. Session 2, Timeline

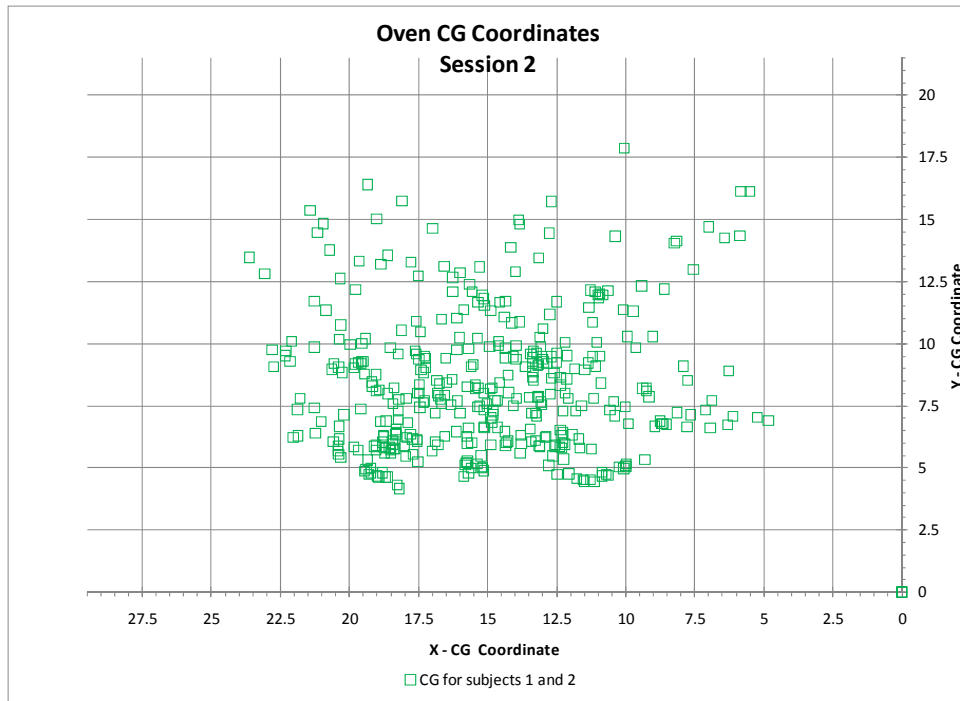

Figure C5. Session 2, CG Plot

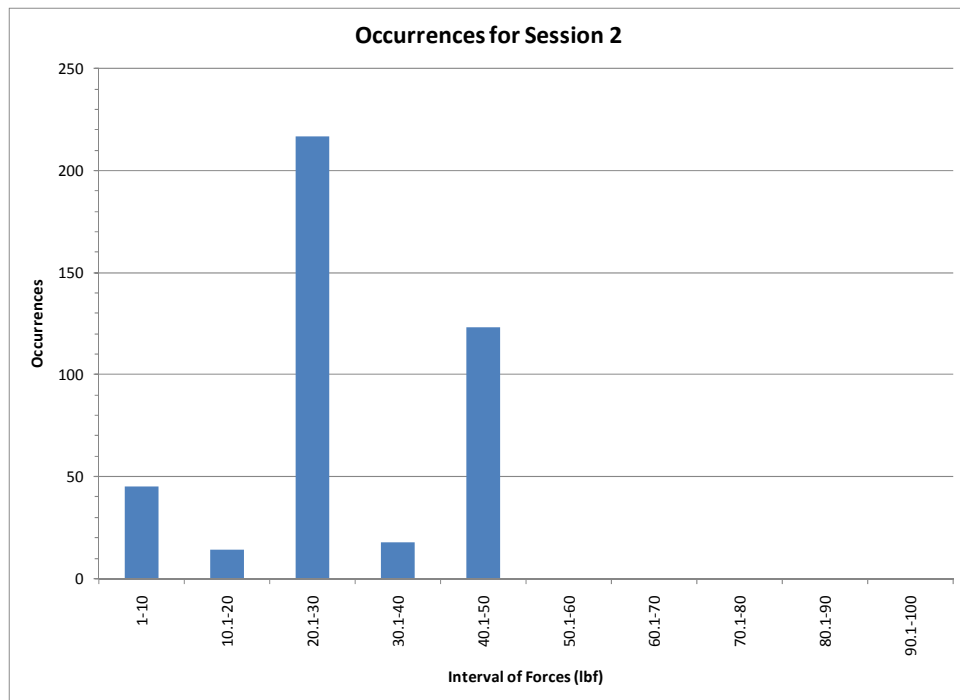

Figure C6. Session 2, Force Bin Count

C3. Session 3 (Participants 3 and 4)

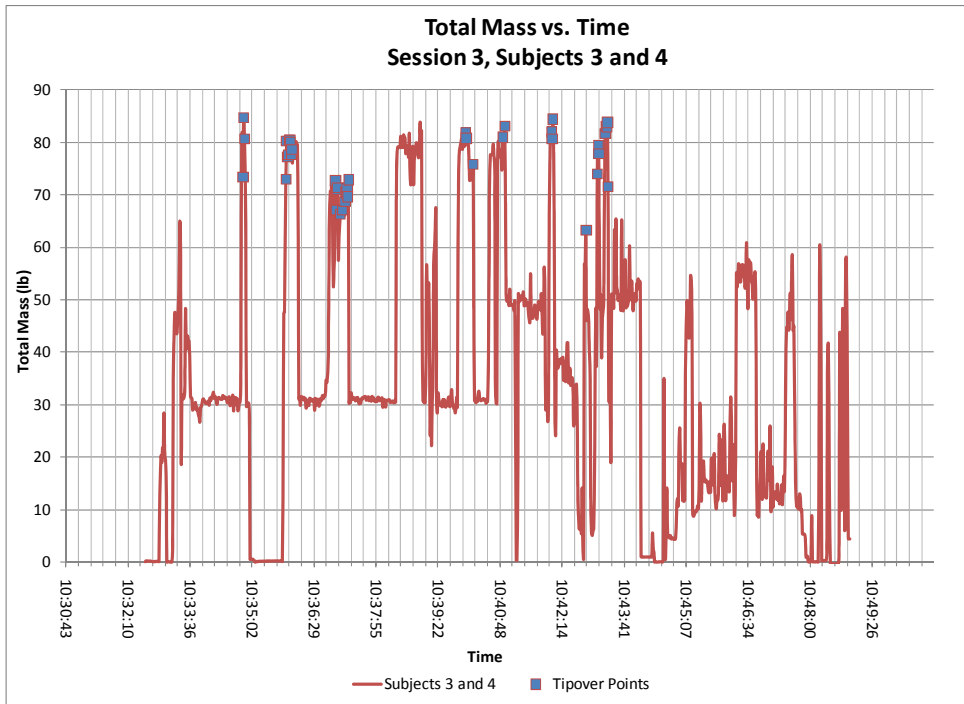

Figure C7. Session 3, Timeline

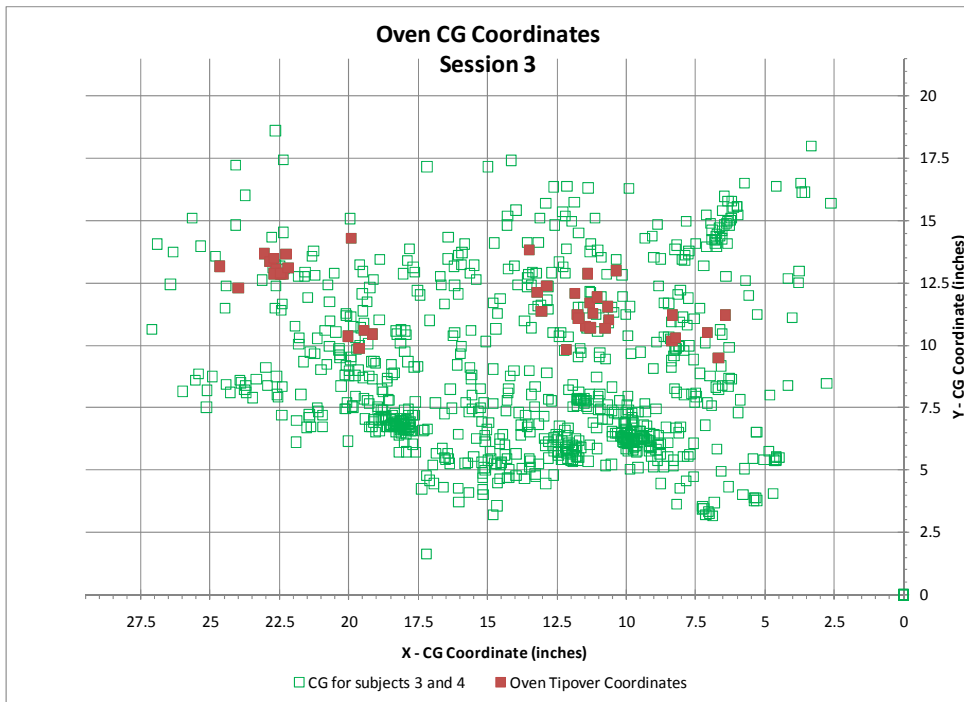

Figure C8. Session 3, CG Plot

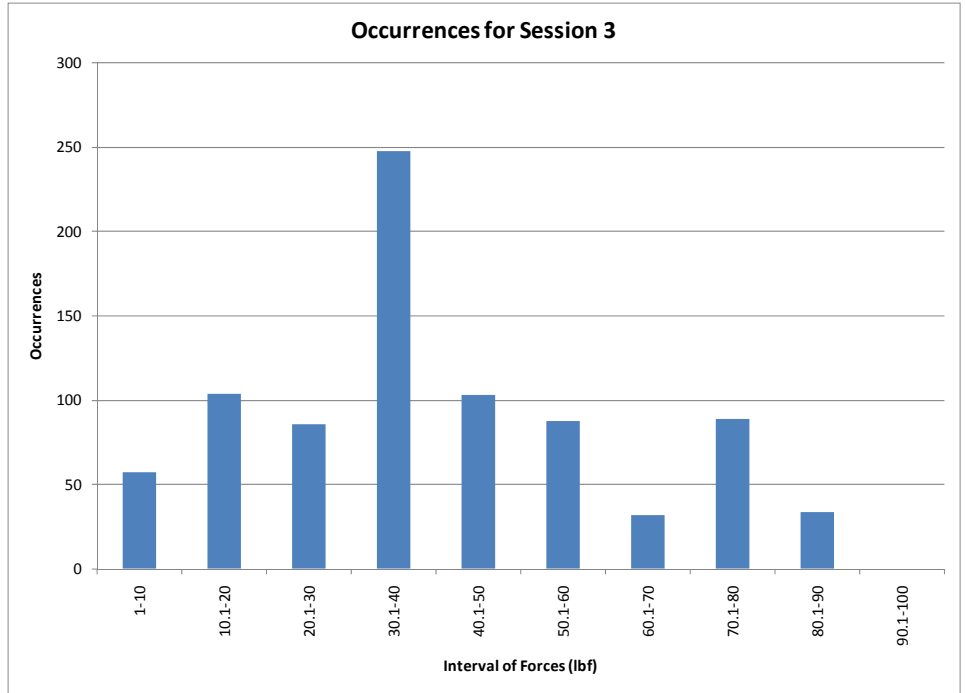

Figure C9. Session 3, Force Bin Count

C4. Session 4 (Participants 3, 4, and 5)

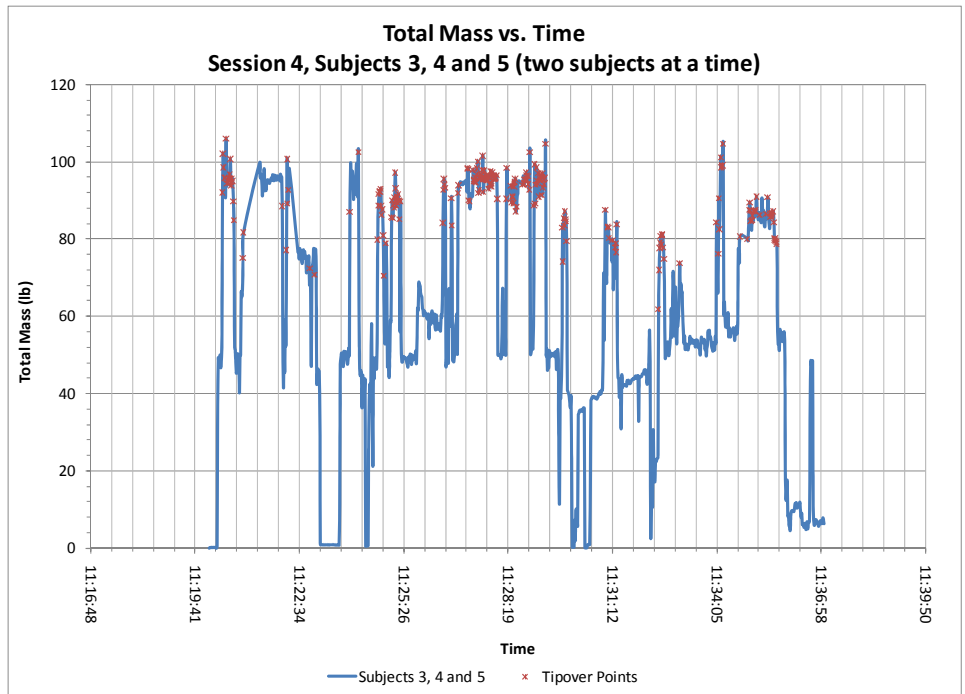

Figure C10. Session 4, Timeline

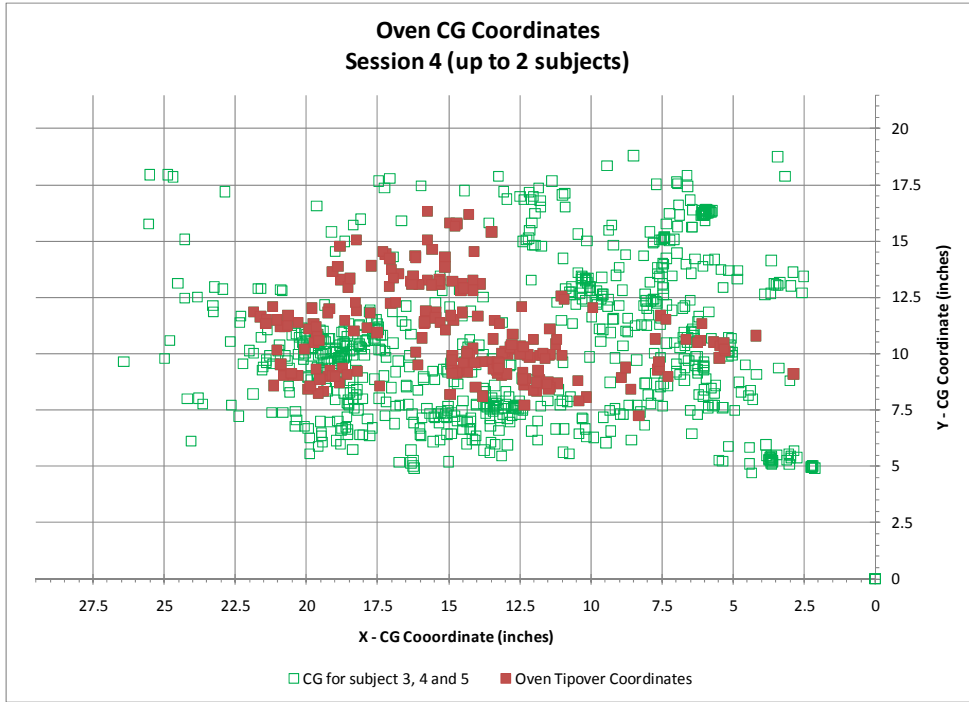

Figure C11. Session 4, CG Plot

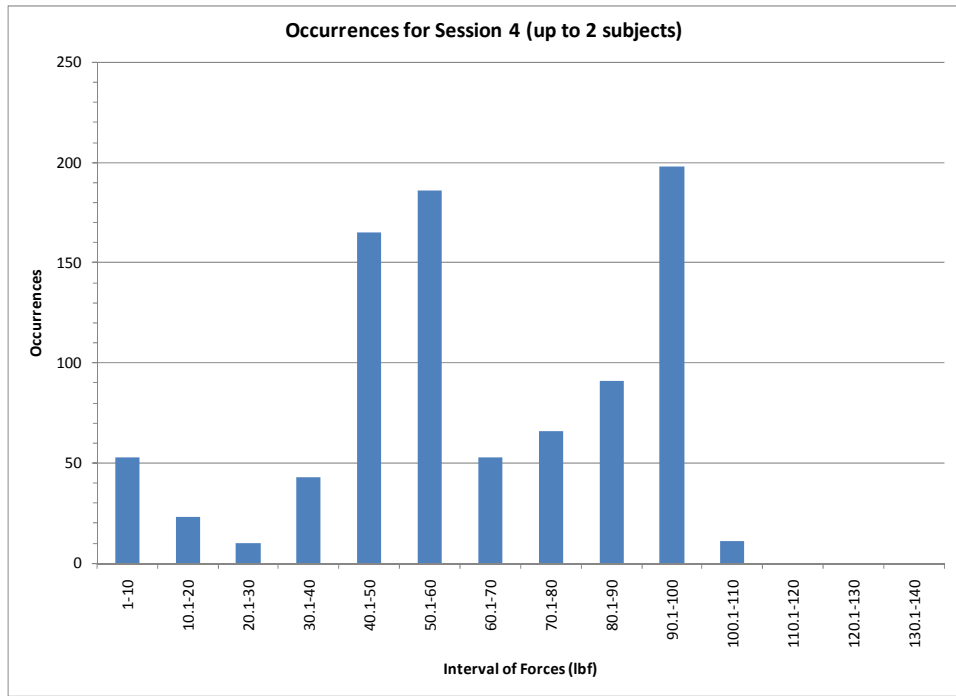

Figure C12. Session 4, Force Bin Count

C5. Session 5 (Participants 6 and 7)

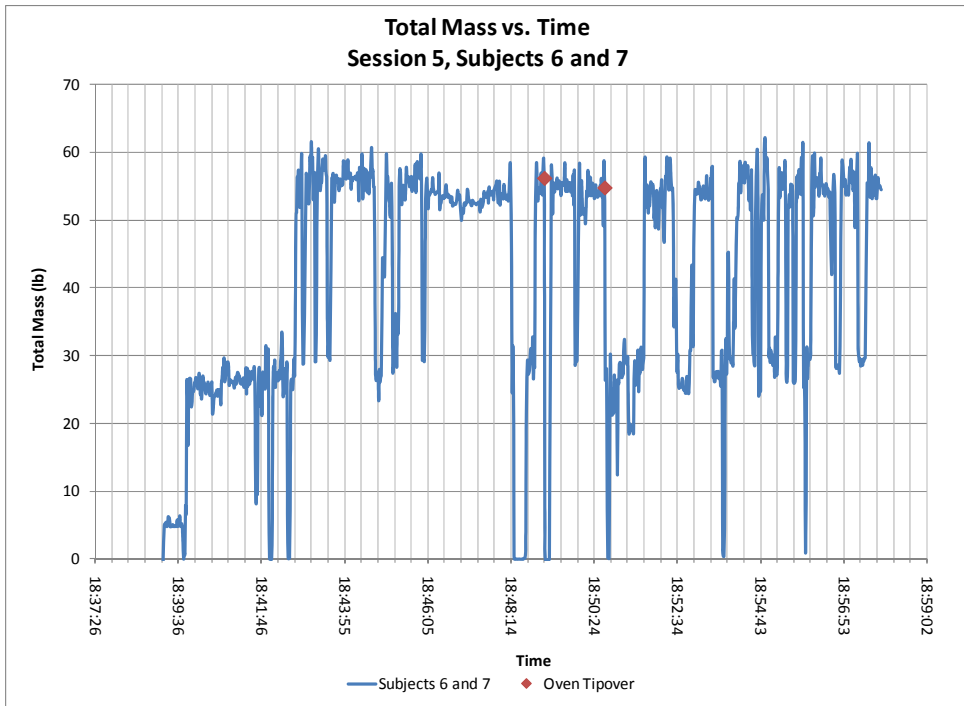

Figure C13. Session 5, Timeline

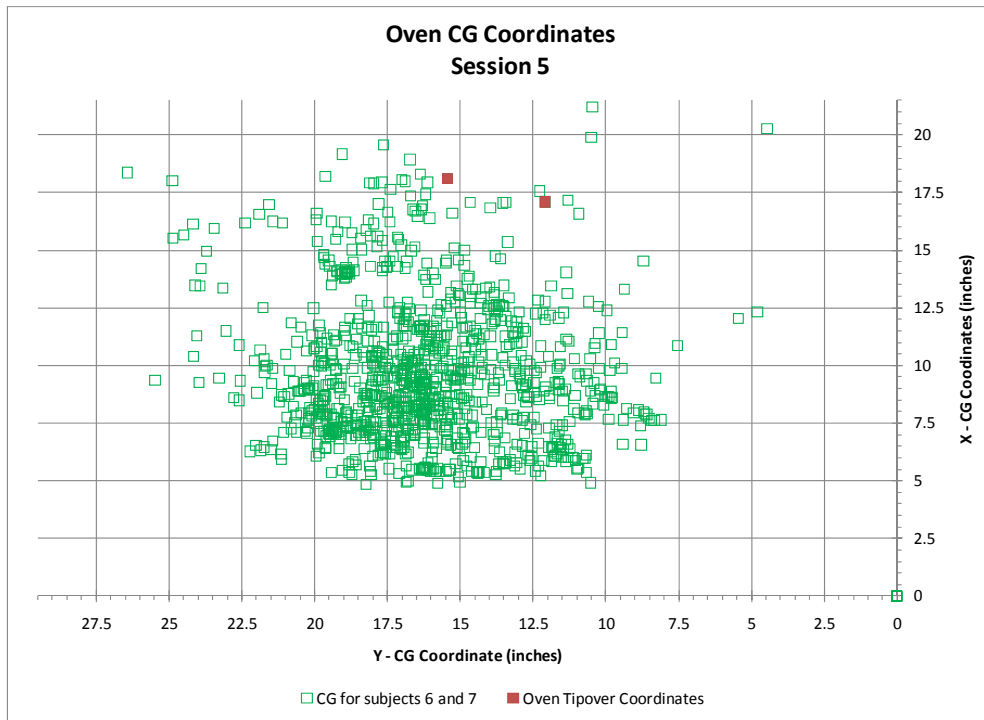

Figure C14. Session 5, CG Plot

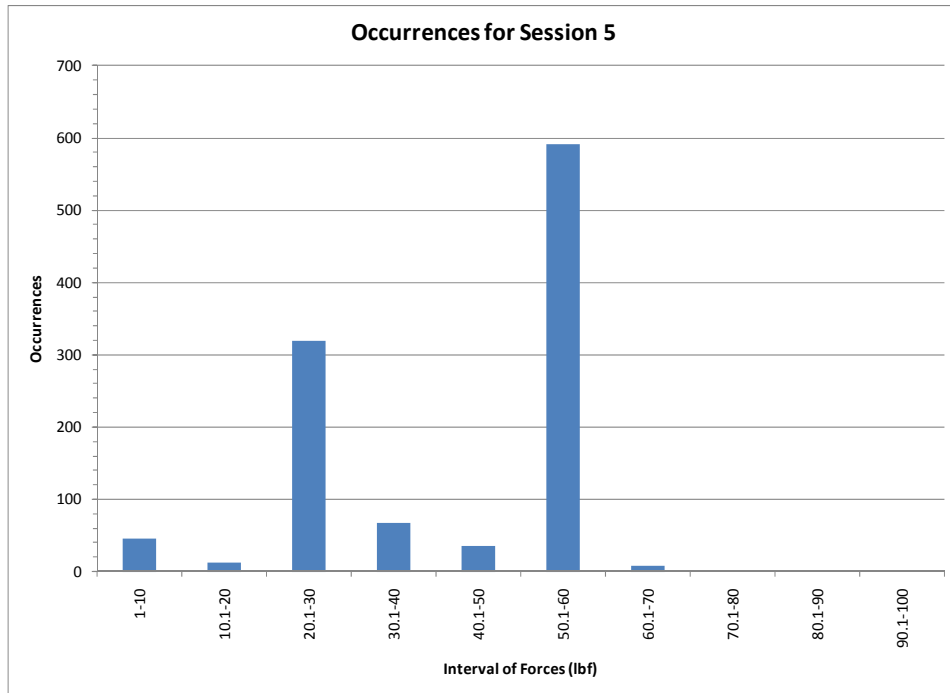

Figure C15. Session 4, Force Bin Count

C6. Session 6 (Participants 8 and 9)

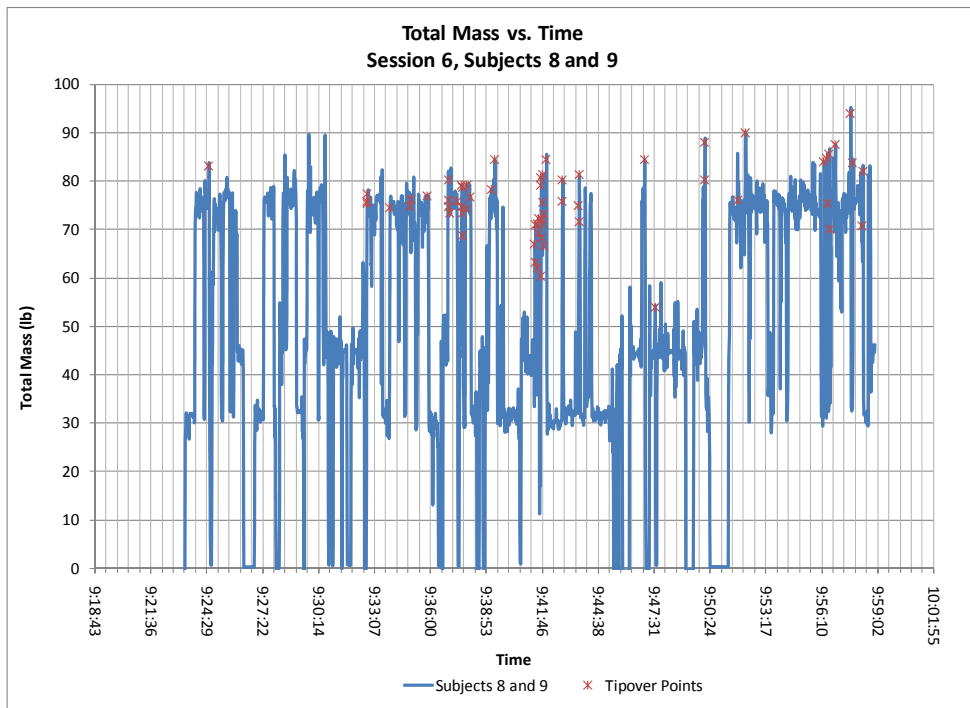

Figure C16. Session 6, Timeline

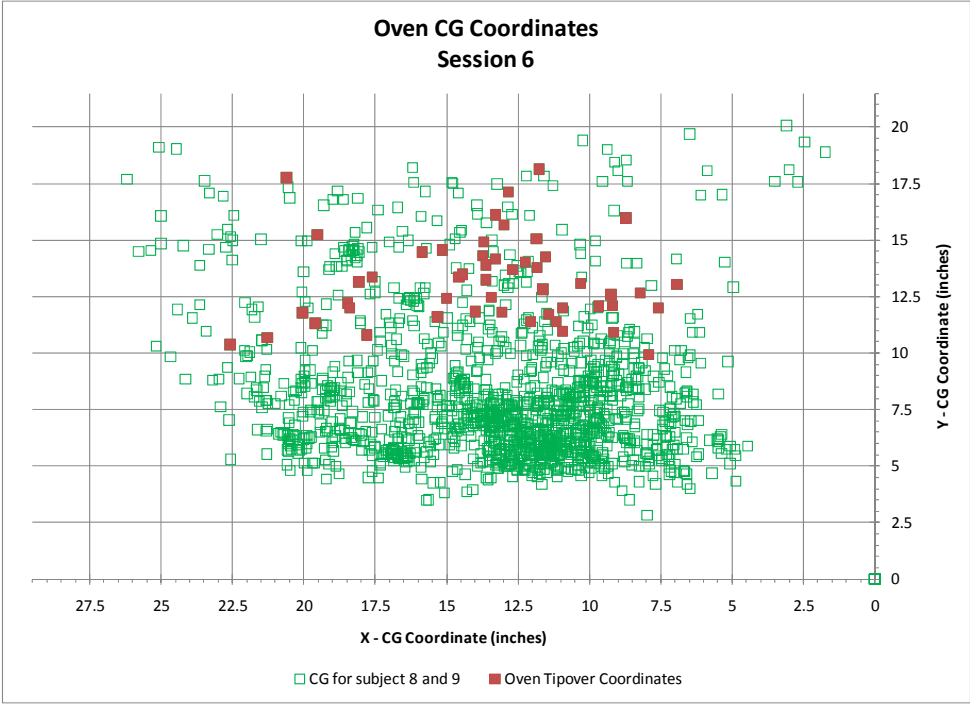

Figure C17. Session 6, CG Plot

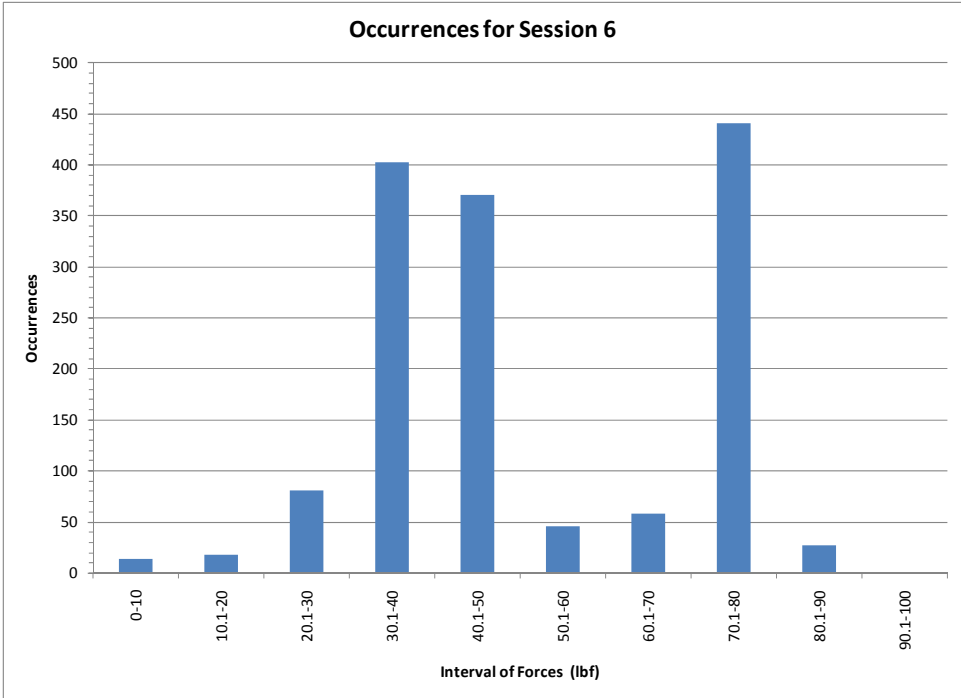

Figure C18. Session 6, Force Bin Count

C7. Session 7 (Participants 10 and 11)

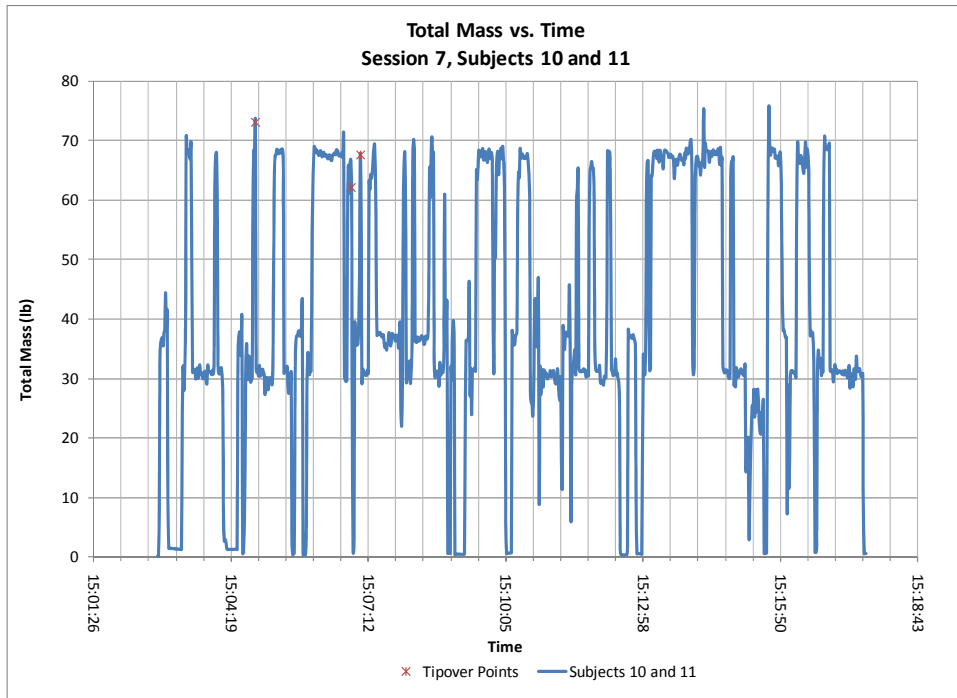

Figure C19. Session 7, Timeline

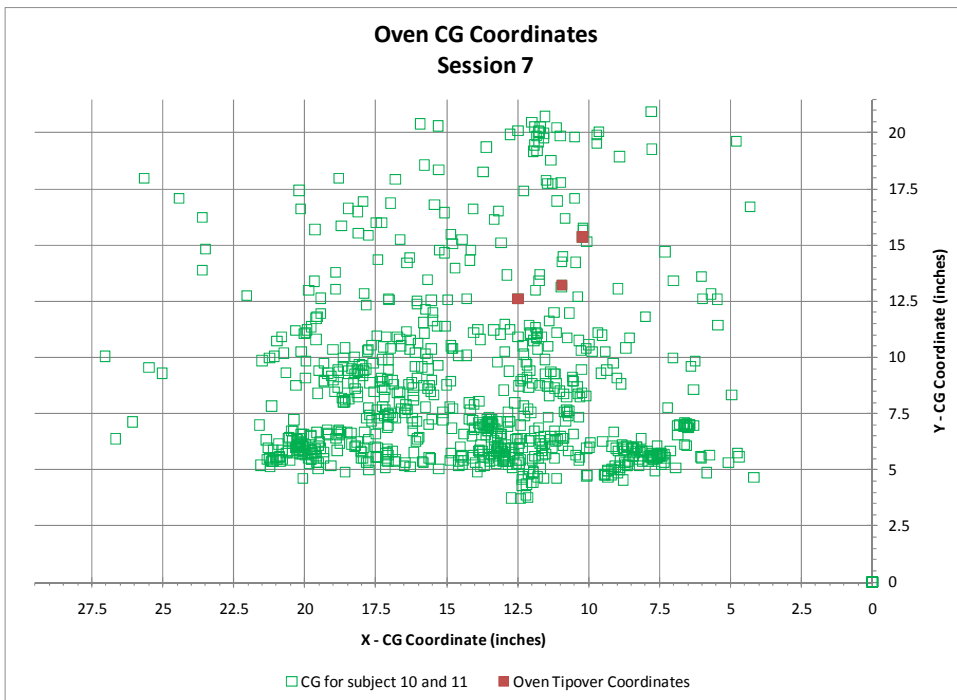

Figure C20. Session 7, CG Plot

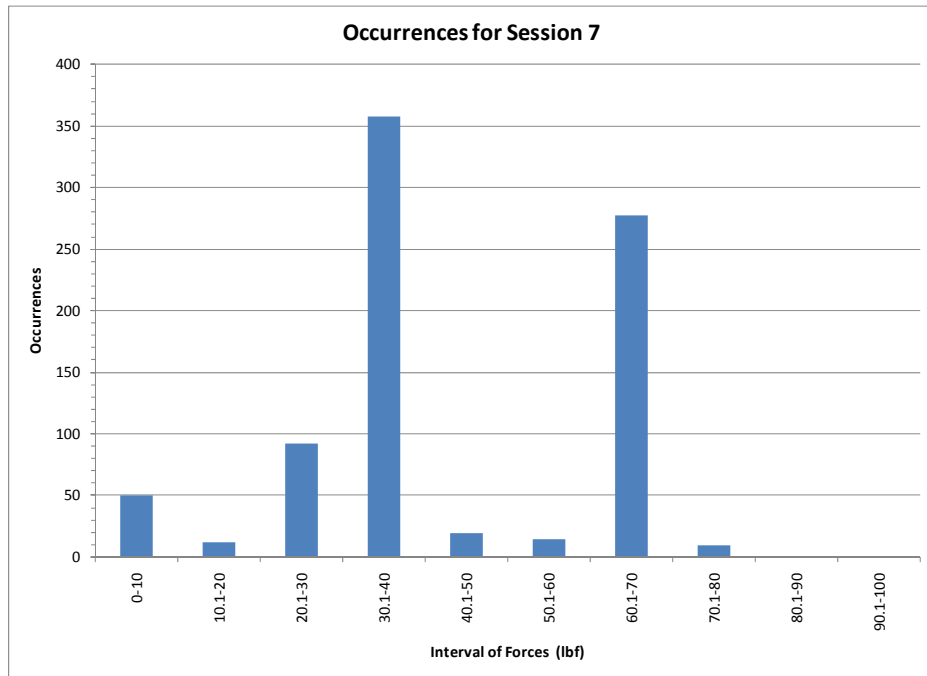

Figure C21. Session 7, Force Bin Count

C8. Session 8 (Participants 12 and 13)

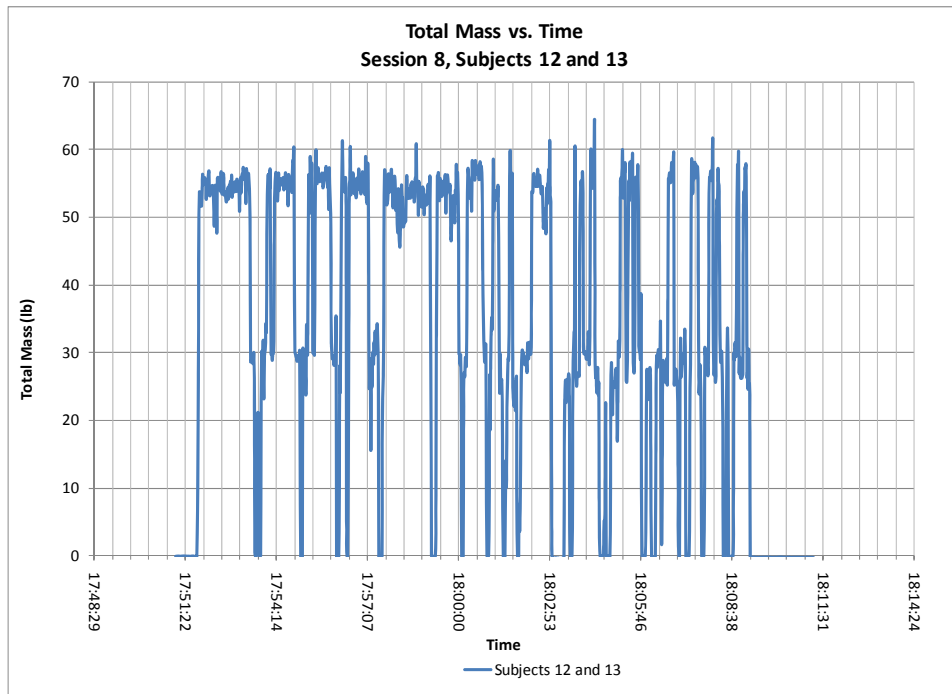

Figure C22. Session 8, Timeline

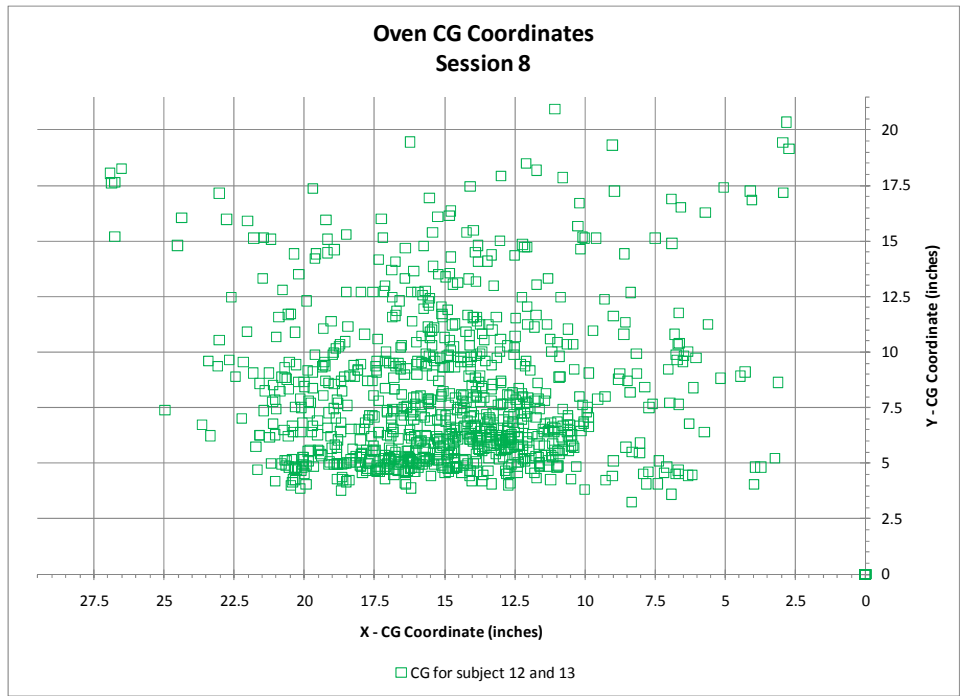

Figure C23. Session 8, CG Plot

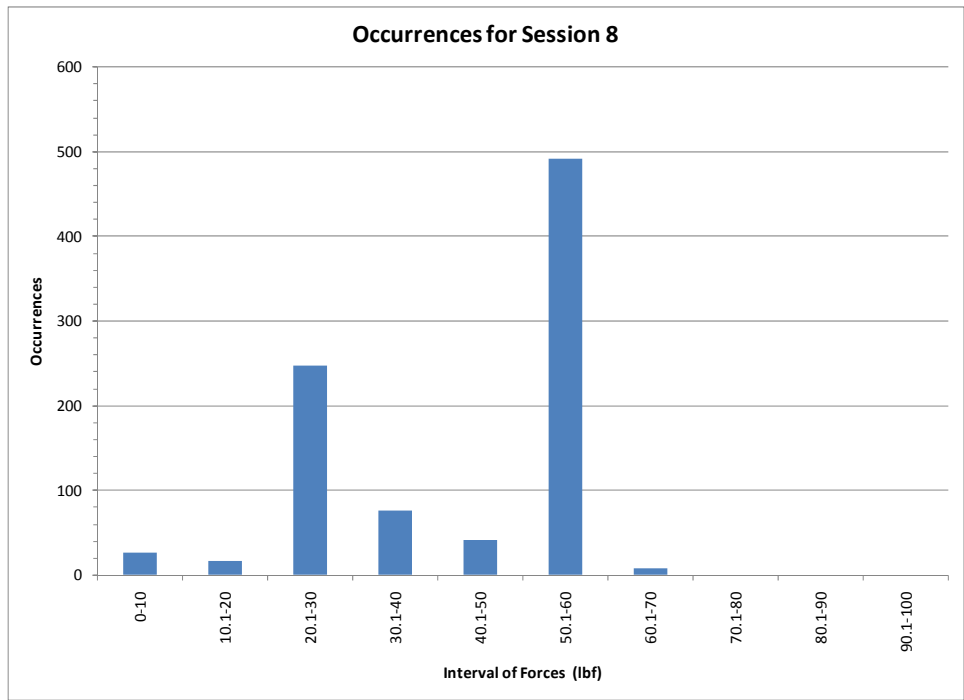

Figure C24. Session 8, Force Bin Count