

**NBSIR 78-1586**

# **Fire Safety Guidelines for Vehicles in a Downtown People Mover System**

---

Richard D. Peacock

Center for Fire Research  
National Engineering Laboratory  
National Bureau of Standards  
Washington, D.C. 20234

January 1979

Final Report

Prepared for:  
**Urban Mass Transportation Administration  
U.S. Department of Transportation  
Washington, D.C. 20591**



NBSIR 78-1586

**FIRE SAFETY GUIDELINES FOR  
VEHICLES IN A DOWNTOWN PEOPLE  
MOVER SYSTEM**

---

Richard D. Peacock

Center for Fire Research  
National Engineering Laboratory  
National Bureau of Standards  
Washington, D.C. 20234

January 1979

Final Report

Prepared for:  
Urban Mass Transportation Administration  
U.S. Department of Transportation  
Washington, D.C. 20591



---

**U.S. DEPARTMENT OF COMMERCE, *Juanita M. Kreps, Secretary***

***Jordan J. Baruch, Assistant Secretary for Science and Technology***

**NATIONAL BUREAU OF STANDARDS, *Ernest Ambler, Director***



TABLE OF CONTENTS

	Page
LIST OF FIGURES . . . . .	v
LIST OF TABLES . . . . .	v
EXECUTIVE SUMMARY . . . . .	vi
Abstract . . . . .	1
1. INTRODUCTION . . . . .	1
2. EXISTING PEOPLE MOVER SYSTEMS . . . . .	2
2.1 The Morgantown System . . . . .	3
2.2 The AIRTRANS System . . . . .	3
2.3 Materials of Construction . . . . .	4
2.3.1 Interior Vehicle Design . . . . .	4
2.3.2 Exterior Vehicle Design . . . . .	4
2.4 Fire Detection/Suppression Provisions . . . . .	5
2.5 Emergency Egress from Vehicles . . . . .	5
2.6 Vehicle Voice Communications . . . . .	6
3. PROPOSED DPM SYSTEMS . . . . .	7
3.1 Proposed DPM System, Houston, Texas . . . . .	7
3.2 Proposed DPM System, Los Angeles, California . . . . .	7
3.3 Proposed DPM System, St. Paul, Minnesota . . . . .	8
4. PROPOSED DPM VEHICLES . . . . .	8
4.1 Otis Elevator Company, Duke University Type Vehicle . . . . .	9
4.1.1 Basic Vehicle Design . . . . .	9
4.1.2 Fire Detection/Suppression Provisions . . . . .	10
4.1.3 Emergency Egress . . . . .	11
4.1.4 Voice Communications . . . . .	11
4.2 DEMAG + MBB Cabintaxi Vehicle . . . . .	11
4.2.1 Fire Detection/Suppression Provisions . . . . .	11
4.2.2 Emergency Egress . . . . .	11
4.2.3 Voice Communications . . . . .	12
5. THE FIRE SAFE DPM VEHICLE . . . . .	12
5.1 Fire Scenarios in a DPM Vehicle . . . . .	12
5.1.1 Interior Ignitions . . . . .	12
5.1.2 Exterior Ignitions . . . . .	15
5.2 Vehicle Design to Minimize Fire Hazard . . . . .	16
5.2.1 Interior Vehicle Design . . . . .	16
5.2.2 Exterior Vehicle Design . . . . .	17
5.2.3 Emergency Egress . . . . .	18
5.2.4 Voice Communications System . . . . .	18
6. EVALUATION . . . . .	19
6.1 Important Areas of Consideration . . . . .	19
6.2 Test Methods for the Flammability of Materials Used in DPM Systems . . . . .	20
6.3 Fire Penetration Test . . . . .	21
6.4 Ignition Resistance Tests . . . . .	21
6.4.1 Motor Vehicle Safety Standard No. 302 . . . . .	21
6.4.2 Federal Aviation Regulation FAR-25.853 . . . . .	21
6.4.3 ASTM D 635 . . . . .	22
6.4.4 ASTM D 1692 . . . . .	22

TABLE OF CONTENTS (Cont'd)

	Page
6.4.5 Carpeting Tests . . . . .	22
6.4.5.1 DOC FF 1-70 Pill Test . . . . .	22
6.4.5.2 NFPA 253-78 . . . . .	23
6.5 Smoke Density Test . . . . .	23
6.6 Rate of Heat Release Tests . . . . .	23
6.7 Flame Spread Tests . . . . .	24
6.7.1 Radiant Panel Test, ASTM E 162 . . . . .	24
6.7.2 ASTM E 84 Tunnel Test . . . . .	24
7. PROPOSED GUIDELINES . . . . .	25
7.1 Materials Flammability . . . . .	25
7.1.1 Ignition Resistance/Flame Spread Test . . . . .	25
7.1.1.1 Interior and Exterior Materials . . . . .	25
7.1.1.2 Floor Covering Flammability Test . . . . .	26
7.1.1.3 Seating Assemblies . . . . .	26
7.1.2 Smoke Generation Test . . . . .	26
7.1.3 Penetration Test . . . . .	27
7.1.4 Rate of Heat Release Test . . . . .	27
7.1.5 Combustion Products Toxicity . . . . .	27
7.2 Fire Detection . . . . .	28
7.2.1 System for Vehicle Interior . . . . .	28
7.2.2 System for Vehicle Electrical and Mechanical Equipment Bays . . . . .	28
7.3 Fire Suppression . . . . .	29
7.3.1 Portable Fire Extinguishers . . . . .	29
7.3.2 Automatic Fire Suppression . . . . .	29
7.4 Emergency Egress . . . . .	30
7.5 Voice Communications . . . . .	30
7.6 Vehicle Construction . . . . .	30
7.6.1 Heating and Air Conditioning System . . . . .	30
7.6.2 Electrical Fire Safety . . . . .	30
7.7 Guidelines for Testing Protocol . . . . .	31
8. SUMMARY AND CONCLUSIONS . . . . .	31
9. REFERENCES . . . . .	32

LIST OF FIGURES

	Page
Figure 1. Morgantown passenger vehicle construction . . . . .	40
Figure 2. AIRTRANS passenger vehicle construction . . . . .	41
Figure 3. Morgantown emergency egress provisions . . . . .	42
Figure 4. AIRTRANS emergency egress provisions . . . . .	43
Figure 5. Otis passenger vehicle interior construction . . . . .	44
Figure 6. Probable location of ignition sources in a DPM vehicle . .	45
Figure 7. Comparison of ignition source characteristics and minimum ignition energies for various seat assemblies . .	46
Figure 8. Vehicle interior design features . . . . .	47
Figure 9. Vehicle exterior design features . . . . .	48
Figure 10. Vehicle flammability guidelines . . . . .	49

LIST OF TABLES

	Page
Table 1. Worst case evacuation times from people mover vehicles . . .	36
Table 2. Potential for ignition of various seat assemblies by some ignition sources . . . . .	37
Table 3. Summary of selected small-scale test results on transit vehicle components . . . . .	38
Table 4. Recommended acceptance criteria test method ASTM E 162 . . .	39

## EXECUTIVE SUMMARY

The fire safety aspects of vehicles used in Downtown People Mover systems has not been previously studied and considered in depth. This report, prepared by the Center for Fire Research, National Bureau of Standards, presents the results of a limited study to evaluate fire problems and to recommend fire safety provisions for automated vehicles used for the movement of people in a congested urban area.

This study was sponsored by the Urban Mass Transportation Administration (UMTA) to provide reasonable fire safety guidelines to be required for the systems to be deployed under the "Downtown People Mover" (DPM) program and to update existing UMTA guidelines. The specific objectives of the project were to:

- Review the Morgantown and AIRTRANS systems and any fire experience with these systems.
- Review the vehicle design features and materials that are used by the various system manufacturers and those which may be proposed for use in the DPM program.
- Propose criteria for acceptable levels of flammability, smoke generation, and toxic gas generation for vehicle interior materials and vehicle construction materials involved in fires.
- Recommend preferred materials and methods of vehicle construction to minimize fire risk for the different types of DPM systems.
- Recommend fire and smoke detection and suppression methods as appropriate.

By the review of existing vehicles similar to those expected to be used in the DPM program, and by a review of systems that have been proposed by several cities, a series of fire scenarios were developed for potential interior and exterior ignition sources. In addition, a variety of fire protection measures proposed by system manufacturers ranging from simple hand-held fire extinguishers to completely automatic Halon 1301 extinguishment systems were identified.

This report presents guidelines that are recommended for use in the design of downtown people mover vehicles. Methods and criteria, based on established test procedures, are proposed for material flammability and smoke generation.



Specific limits are established with the intent to control ignition/fire spread, smoke, and toxic gas generation with the following types of test methods:

- 1) A fire penetration test to determine the likelihood of an undercar fire penetrating to the vehicle interior.
- 2) An ignition resistance test for nonmetallic materials.
- 3) A smoke density test to limit smoke build-up in the vehicle interior.
- 4) A rate of heat release test to measure fire growth in the event of an ignition.
- 5) A test to screen out materials that generate highly toxic combustion products.

Recommendations for fire and smoke detection equipment for the vehicle interior and undercarriage and automatic fire suppression equipment for the vehicle undercarriage are discussed.

Emergency egress provisions must also be considered in the design of a DPM system. Sufficient emergency exits, recognizing the special needs of the handicapped, should be included in the vehicle design along with provisions to insure the safe evacuation of passengers to the guideway.

Requirements for emergency communications between vehicles and a system's central control facility are also proposed.



FIRE SAFETY GUIDELINES FOR VEHICLES IN A DOWNTOWN  
PEOPLE MOVER SYSTEM

Richard D. Peacock

Abstract

The results of a study to formulate fire safety guidelines to be required for vehicles used in Downtown People Mover (DPM) systems for the movement of people in a congested urban area are presented. Through a review of the design features of existing people mover vehicles and systems, and a review of proposed new systems, fire scenarios are developed and guidelines suggested to minimize the fire risk to passengers.

Methods and criteria, based on established test procedures, are proposed for assessing the flammability and smoke generation of interior finish and furnishing materials. Fire and smoke detection and suppression equipment are recommended, along with proposed guidelines for emergency evacuation provisions and emergency communication requirements.

An extensive bibliography of flammability in fixed guideway transit systems is included.

Key words: Emergency communications; emergency evacuation; fire detection; fire safety, fire suppression; mass transportation; material flammability; people movers; smoke.

1. INTRODUCTION

The fire safety aspects of vehicles used in fixed guideway transportation systems have not been rigorously studied and considered. At the request of the Urban Mass Transportation Administration (UMTA), the Center for Fire Research at the National Bureau of Standard has conducted a limited study to explore and formulate fire safety guidelines to be recommended for automated vehicles used for the movement of people in congested urban areas. The results of this investigation are needed to set reasonable requirements for the systems to be deployed under the "Downtown People Mover" (DPM)

program sponsored by UMTA, to replace existing guidelines, and to insure an acceptable level of fire safety [1]<sup>1</sup>.

As in any transportation system, a complete fire safety analysis would include consideration of station design and placement, trackways, vehicle storage and maintenance areas, as well as surrounding environmental factors that may affect the system's performance. In this study, consideration is limited to the vehicle used in a fixed guideway transit system and to the trackway that may be used for emergency evacuation of passengers. The elevated guideways and automated unmanned vehicles present unique problems in fire safety. This report presents guidelines that are recommended for the design of vehicles to be used in DPM systems. In order to obtain appropriate criteria, based on available established test methods that would provide an acceptable level of fire safety for DPM vehicles, a review is included of two existing systems, of proposals presented to UMTA by cities selected for initial DPM system deployment, and of proposed new vehicle designs from potential DPM system manufacturers.

## 2. EXISTING PEOPLE MOVER SYSTEMS

Automated people mover systems consist of driverless vehicles of varying sizes, capable of carrying from 20 to 200 passengers, that operate on exclusive, fixed-path guideways. A vehicle is comprised of two major components: the chassis usually containing the vehicle control, power collection, propulsion, and heating/air conditioning systems and the body comprised of the exterior shell and vehicle interior [2,3].

There are approximately twenty installations of people mover systems currently in use. Of these twenty systems, more than half are located in recreational parks. Several are also located in airport complexes, plus at least one system operating in a downtown university campus [2]. In the analysis of existing systems, the description will concentrate on two operating systems - one located on the campus of the University of West Virginia at Morgantown (the Morgantown system) and one located at the Dallas/Fort Worth Regional Airport (the AIRTRANS system). These two systems are typical of the people mover systems in use today and provide detailed information on typical vehicle and guideway construction. Other systems in use are described in references [4-9].

---

<sup>1</sup>Numbers in brackets refer to the literature references listed at the end of this report.

## 2.1 The Morgantown System

The people mover system at Morgantown, West Virginia serves the campuses of the University of West Virginia with a maximum of 45 vehicles operating over 3.9 km (2.4 mi) of reinforced concrete guideway. About half of the vehicles are in normal service at any one time [10]. Design specifications, according to Boeing design criteria, require that the system conform to "pertinent provisions of the National Electrical Safety Code, applicable specifications and standards of the National Fire Protection Association," applicable Motor Vehicle Safety Standards promulgated by the National Highway Safety Administration (notably Motor Vehicle Safety Standard No. 302 - Flammability of Interior Materials), and such other local, state and Federal safety codes and standards applicable to the design of system elements. Vehicle floor covering is required to be "self-extinguishing" although no test method is specified. In addition, a hand-held fire extinguisher is required in each vehicle passenger compartment for use by passengers [11,12].

Only a few minor fire incidents have been noted in the operation of the Morgantown system. There have been no incidents of fire on board the vehicles used in the system. Deicing of the guideway with an ethylene-glycol solution combined with salt splashed from an adjacent roadway has caused arcing of the power rails and ignition of plastic power rail insulation on several occasions during severe winter weather. Fires were reported either by passengers or system personnel and extinguished [13].

## 2.2 The AIRTRANS System

With 21 km (13 mi) of guideway, 53 stations, and 68 vehicles, the AIRTRANS system at the Dallas/Fort Worth airport is the largest operating people mover system in the world to date. The system is designed to transport airline passengers, as well as airport personnel, baggage, supplies, mail, and trash at the airport. In considering the flammability characteristics of materials used in the AIRTRANS vehicles, manufacturers were required to meet flammability specifications developed by the system designer, Vought Corporation [14].

The specification for the AIRTRANS system required the following:

- Vehicle insulation must be self-extinguishing and fire-resistant.
- Vehicle flooring must be fire-resistant with a flame spread rating of less than 75 using ASTM E 84-68.

- Each vehicle must have a fire extinguisher.
- Each vehicle must have two emergency exits in addition to the normal entrance/exit doors.

In the twelve million vehicle miles covered in the past 3 1/2 years of operation, the AIRTRANS system has been relatively free of problems associated with fire. In one incident, a burning tire, caused by spinning on a slick guideway, necessitated the removal of passengers from a vehicle because of smoke entering through the air conditioning system. However, there have been no reported cases of fire propagating on board a vehicle [15].

## 2.3 Materials of Construction

### 2.3.1 Interior Vehicle Design

Morgantown vehicles are constructed of steel frames with rigid urethane foam insulation sandwiched between inner and outer shells of molded flame retarded glass fiber laminates. Seats and air conditioning ducting are molded integrally with the inner shell. The polyester resin used is reported to have a flame spread classification of 20 and a smoke density of 250, as determined by test method ASTM E 84. Nylon carpeting used as floor covering in the vehicles is reported to have an ASTM E 84 flame spread rating of less than 75 but does not meet Motor Vehicle Safety Standard No. 302, Flammability of Interior Materials [16]. Figure 1 illustrates the construction of a Morgantown vehicle.

Passenger vehicles used in the AIRTRANS system are constructed of reinforced, vacuum-formed acrylic sheet interior panels, acrylic-coated glass fiber exterior panels with rigid polyurethane foam in between. The seats are upholstered and carpeting is provided on the floors over a base of plywood treated for moisture resistance. No details of tests performed on any of the materials was available and no detailed verification testing was performed [14].

### 2.3.2 Exterior Vehicle Design

The outer shell of flame-retardant glass reinforced polyester on the Morgantown vehicles is supported on a steel frame. The vehicle is designed so that all electrical systems except interior car lighting and vehicle communications are located underneath the shell that forms the interior of the vehicle. The major components that are located beneath the vehicle interior shell include: (a) the vehicle propulsion and braking systems including motor, motor controller, and four-wheel vehicle brakes, (b) the

heating and air conditioning systems, (c) the vehicle steering/guidance system, (d) the vehicle power-pickup shoe (575 VAC, three phase), and (e) the vehicle communications and control systems. Vehicle window material in the Morgantown system is 0.6 cm (1/4 in) tempered glass.

Passenger vehicles used in the AIRTRANS transit system are constructed as illustrated in figure 2. Exterior panels are acrylic-coated glass fiber reinforced plastic with colors impregnated in the acrylic. Propulsion is provided by a 60-hp (continuous rating) DC motor connected to the differential by an automotive drive shaft. The 480 volt AC power is rectified and controlled by the motor controller. The propulsion system is mounted on the chassis, as are the emergency storage batteries. The alternator that charges the batteries and an air compressor for the suspension system, door operator, brakes, and vehicle dock leveling system are suspended below the chassis. Two heating and air conditioning units are also suspended below the chassis, one on either side. Power collection is performed by articulated brushes, a set on each corner of the vehicle, with two sets in normal use and two for redundancy [14].

#### 2.4 Fire Detection/Suppression Provisions

Vehicle on-board fire fighting equipment on both the Morgantown and the AIRTRANS systems consists of manually operated fire extinguishers. No automatic fire detection or suppression system is provided for either system. However, several of the following excess-temperature sensors are included in each system [14,16].

Brake temperature sensor.

Propulsion motor temperature sensor.

Propulsion transformer temperature sensor.

Propulsion armature temperature sensor.

Hydraulic fluid temperature sensor.

Vehicle communications and control system air temperature sensor  
(proposed for Morgantown system).

These sensors are linked to the central control console of the system for further action at the discretion of the system operator.

#### 2.5 Emergency Egress from Vehicles

Emergency egress procedures for both the Morgantown and the AIRTRANS system require passengers to exit through emergency exits provided onto the

vehicle guideway. An estimate of passenger evacuation time was made for the Morgantown and AIRTRANS systems assuming maximum vehicle velocity, normal vehicle deceleration, the maximum station dwell time, and maximum station-to-station travel time [2]. This estimated time represents a worst case estimate using the assumptions that the vehicle would use only normal braking rate and would have to travel the entire station-to-station distance in order to allow a safe stop. The estimated evacuation times were 198 seconds and 91 seconds for Morgantown and AIRTRANS, respectively. It should be noted that these estimates are not based on evacuation drills. Rather they have been calculated from vehicle performance data supplied in reference [2].

In Morgantown vehicles, the left-hand door can be operated manually to provide egress onto a fenced walkway, then to the guideway; the rear window of the vehicle opens to provide an additional exit. This walkway egress is illustrated in figure 3. Due to the special conditions that exist at Morgantown, i.e., an elevated guideway without provisions on the right side of the guideway for passengers to safely leave the car, it was decided that an emergency exit on the right side of the vehicle would expose the passengers to additional, unnecessary hazards [16].

AIRTRANS vehicles are provided with emergency escape doors, 0.6 m (2 ft) wide, at each end of the vehicles, and are posted with a sign warning of guideway hazards -- moving vehicles, etc. This provides direct egress onto the guideway as shown in figure 4. In addition, vehicle doors are provided with means for emergency manual opening. In both systems, operation of emergency exits causes emergency braking of the vehicle, if in motion, and notification to Central Control. Guideway power in the vicinity of the disabled vehicle is also cut off in the Morgantown system. For the AIRTRANS system, the system's Central Control operation shuts power off manually to any segment that could be affected by an evacuation.

## 2.6 Vehicle Voice Communications

Two-way communications are provided in both the Morgantown and the AIRTRANS systems to allow communication between Central Control and the passenger vehicles in the system. There is a UHF radio on each Morgantown vehicle which allows any passenger to communicate directly with Central Control by merely pressing a "push-to-talk" button. The Central operator can communicate separately with an individual vehicle or with the entire fleet. Public announcements may be made to the passengers of the AIRTRANS system via a two-way radio. Passengers request individual communication with Central Control by pressing a button on the passenger service panel in the vehicle.



### 3. PROPOSED DPM SYSTEMS

Proposals submitted to UMTA by cities selected as initial sites for the deployment of people mover systems in urban environments, although only preliminary system proposals, contain information about vehicle design. In addition, some design concepts unique to these proposed systems require careful consideration of fire safety. The three systems proposed, St. Paul, Minnesota, Los Angeles, California, and Houston, Texas, present a variety of operating characteristics and environments that may affect fire safety considerations.

#### 3.1 Proposed DPM System, Houston, Texas

The proposed DPM system in Houston, Texas, is a 3.6 km (2.25 mi) route through the city's central business district. The guideway is proposed to be aerial throughout with a double guideway serving most of the route. A total of eight stations, three in the double guideway, three in the single guideway, and two stations interconnecting with Houston's bus system, are planned. These will be an average of 0.33 km (1080 ft) apart [17].

The Houston proposal provides general specifications for the proposed system and vehicle design. Specifications require provisions for passenger egress from stalled vehicles/trains at any point along the guideway, including provisions for handicapped passengers, with assistance from passengers or system personnel. It is proposed that these requirements be met with walkways along the guideway, special service vehicles operating on the guideway, special street vehicles, or a combination of these.

A communications system is proposed for the system that will allow only one-way voice communication to trains on a selected or group basis. Automatic monitoring of fire and smoke detectors in stations is also proposed for the computerized communications subsystem, indicating the recognition of a potential fire problem in such a system.

#### 3.2 Proposed DPM System, Los Angeles, California

The City of Los Angeles, California, has proposed a DPM system consisting of approximately 4.8 km (3 mi) of guideway including 4.2 km (2.6 mi) of elevated guideway and 0.6 km (0.4 mi) of guideway in an underground portion. Ten elevated stations and one subway station are planned, spaced an average of 0.4 km (1395 ft) apart [18]. The unique evacuation problems associated with subway systems has been recognized and should be considered carefully in the overall fire safety analysis of the proposed system [19,20].

Consistent with the UMTA DPM program objectives, the City of Los Angeles proposes vehicles utilizing existing technology with minimum modifications for adaptation for the downtown environment. Recognition of a potential fire hazard is indicated through the requirement of flame-resistant carpeting to be used in DPM vehicles; however, no definition is provided.

Central Control and the DPM vehicles in the proposed system will be linked by a two-way voice communications system. The system will allow Central Control to make public announcements to any combination of vehicles or to communicate with individual vehicles. In addition, a telephone system is proposed for direct communications between fixed locations throughout the DPM system.

### 3.3 Proposed DPM System, St. Paul, Minnesota

A 2.6-mile, two-way aerial small vehicle transit system connecting ten stations is proposed jointly by the Metropolitan Transit Commission and the City of St. Paul, Minnesota. An aerial guideway through the downtown area is to connect with a below-grade guideway that will utilize an existing trolley tunnel, circa 1907, as well as an underground guideway to a planned office complex. Two underground stations are planned. As mentioned above, the importance of the fire safety consideration given to underground tunnels and terminals, although not within the scope of this project, cannot be overstressed.

The proposal includes provisions for hand-held fire extinguishers, readily accessible to passengers, on every vehicle. In the event of fire or an emergency evacuation, all power is to be turned off by the Central Control system. Separate emergency doors, in addition to manual operation of entrance/exit doors, are required.

During an emergency evacuation of a vehicle, the passenger evacuation route is to be designed to "insure against the possibility of passengers falling from the guideway and/or coming in contact with the power system" [21].

All vehicles and stations are to be equipped with two-way communications for emergency use between patrons and Central Control.

## 4. PROPOSED DPM VEHICLES

Perhaps the most critical element in the protection of rapid transit riders from fire is the passenger vehicle used on the system. A number of

potential suppliers of Downtown People Mover systems were contacted for information regarding vehicle design and materials that may be proposed for use in the DPM program. Of the nine system manufacturers, replies were received from six. Of these six, two, Ford Transportation Systems Operations and Rohr Industries indicated they were no longer in the business of designing and producing people mover systems [22,23]. The remaining four manufacturers, however, provided information about the vehicles that may be proposed for use in a DPM system. These four manufacturers were Boeing, Vought, Otis and DEMAG + MBB.

Plans proposed by Boeing Aerospace Company [16] and Vought Corporation [8] for DPM vehicles were not finalized sufficiently to respond. However, detailed information is available on the Morgantown (Boeing) and AIRTRANS (Vought) systems (see section 2). Materials that may be used in DPM vehicles are expected to be similar to those used in these systems.

#### 4.1 Otis Elevator Company, Duke University Type Vehicle [3]

##### 4.1.1 Basic Vehicle Design

The Otis vehicle, like other people mover vehicles, is designed with the major components necessary to operate the vehicle attached to the chassis, below the passenger compartment. Equipment contained in the chassis includes subsystems for:

- Propulsion
- Braking (service and emergency)
- Suspension
- Power collection
- Control
- Lateral guidance

Wireways have been provided for the major wire runs. Other system wiring is routed in open wiring harnesses.

The vehicle body assembly is composed of the following major elements:

- Body shell
- Interior
- Lighting
- Heating, ventilating, and cooling
- Doors, emergency exits, and glazing

The vehicle body shell is constructed of interior and exterior panels of glass fiber reinforced plastic.

Interiors of the Otis, Duke-type vehicles, illustrated in figure 5, are composed almost entirely of glass fiber reinforced plastic with steel supports. A molded reinforced plastic seat shell with reinforced plastic seat and back inserts are provided with package storage under the seats. This open area beneath the seat has been a vulnerable area in other systems, providing an area for intentional ignition of seat assemblies. Enclosure of the under-seat area would minimize the potential for ignition of seat assemblies. Carpeting is provided for the vehicle floors.

Heating, ventilation and air conditioning duct work and outlet is included in the ceiling assembly in the vehicles.

According to Otis personnel [3], several fire protection items have been incorporated in the Otis DPM vehicle system concept. These are summarized and described in further detail below:

- Fire-resistant materials.
- Fire detection.
- Fire suppression (option).
- Fire extinguishers.
- Two-way communications.
- Emergency exits.
- Emergency ventilation.
- Fault isolation and monitoring.
- Automatic power shutdown.

#### 4.1.2 Fire Detection/Suppression Provisions

Each vehicle is to be equipped with two portable, hand-operated fire extinguishers. The removal of an extinguisher will activate an alarm in Central Control. As an option, automatic fire control equipment can be incorporated in the chassis electrical power equipment bays. The chassis equipment bays will be protected from fire by a halogenated gas fire suppression system. High temperature sensors will be used to detect the presence of fire. Excessive temperature will cause the fire control system to release the agent and signal a fire to Central Control. Fire suppressant discharge lines, incorporating separate orifices, are routed to those compartments or equipment bays of the vehicle which contain electrical power equipment [3].

Smoke detectors are installed in two equipment bays in the vehicle chassis and in the command and control equipment compartment in the vehicle body. These smoke detectors are configured into a serial fire bus arrangement that is monitored by the on-board safety system. Dirt and contamination

could lead to false alarm conditions with detectors mounted in undercar areas. This should be recognized in the design.

#### 4.1.3 Emergency Egress

A hinged window in each end of the body serves as an emergency exit. No railings on elevated portions of guideway to allow use of regular entrance/exit doors are proposed. Emergency evacuation of handicapped persons, possibly difficult through end windows, should be considered in the design.

#### 4.1.4 Voice Communications

Two-way voice communications are planned for the Otis vehicles to permit public address/monitor and intercom operation. Passengers will have access to an intercom panel which operates in a push-to-talk mode.

### 4.2 DEMAG + MBB Cabintaxi Vehicle

Two West German engineering firms, DEMAG Fordertechnik and Messerschmitt-Bolkow-Blohm GmbH, have proposed a unique system currently under development and planned for deployment in two German cities [24]. The Cabintaxi vehicles operate on small guideways suspending vehicles below the guideway as well as on the upper surface. This system presents unique problems for the emergency evacuation of passengers. Specific details of construction materials were not available.

#### 4.2.1 Fire Detection/Suppression Provisions

Automatic and manual suppression along with automatic detection methods are proposed by DEMAG + MBB for the Cabintaxi vehicles. Ionization smoke detectors and temperature detectors are proposed, linked to an automatic Halon 1301 extinguishing system and distributed to the cabin interior, heating, electronics, and undercarriage. Hand-held fire extinguishers are also planned [25].

#### 4.2.2 Emergency Egress

As mentioned above, emergency egress from vehicles suspended below the guideway presents a special problem in fire safety. Because of the variety of operating conditions that would exist in this system, different evacuation procedures are proposed. These include:

An emergency walkway along the guideway.  
Inflatable emergency slides for heights up to ten meters.  
Emergency ropes for very short distances from ground.  
A safe walkway directly adjacent to guideway.

Space limitations in a downtown environment, and the increasing pressure to design to accommodate the handicapped, would place limitations on the feasibility of such egress procedures.

#### 4.2.3 Voice Communications

Two-way communications through a radio-telephone link is planned. Automatic monitoring of on-board detectors is also proposed.

### 5. THE FIRE SAFE DPM VEHICLE

It is virtually impossible to completely protect a system against the occurrence and subsequent spread of a fire. However, from previous fire incidents in existing people mover systems and from a knowledge of fire experience in other transit systems, a series of fire scenarios can be developed for DPM type vehicles. These scenarios, representing likely ways in which ignition and subsequent fire spread can occur, suggest critical areas that must be protected in order to reduce the fire risk to passengers. Throughout this analysis, primary consideration has been given to passenger safety, and only secondarily to the protection of the vehicle.

While all portions of a vehicle are considered, two areas seem to be of considerable importance from the standpoint of fire protection: (a) the subfloor area, because it contains the majority of heat-producing electrical components - vehicle propulsion, braking and control systems and (b) the vehicle interior because of the wide variety of potential combustible materials that may be present [26], and the presence of ignition sources associated with human activity such as cigarettes, matches or intentional ignition sources.

#### 5.1 Fire Scenarios in a DPM Vehicle

##### 5.1.1 Interior Ignitions

Consider a DPM vehicle outfitted in a similar manner to those proposed by various companies described earlier. The vehicle interior, usually less than 100 m<sup>3</sup> in volume, may be constructed of various materials. Wall and ceiling panels of aluminum, glass fiber reinforced plastic, FR glass fiber

resin/chopped glass fiber and the like are common. Seating is usually provided for some passengers and the seats may or may not be upholstered. Carpeting is usually provided on the floor.

For a DPM vehicle, there are three primary parameters that need to be defined to permit a determination of the effect of an interior fire:

- 1) The characteristics of the ignition source (the rate of energy release and the total energy released).
- 2) The location of the ignition source.
- 3) The behavior responses of passengers.

Because it was considered outside the scope of the project, no details are given on the third parameter.

Braun [19] developed a series of fire scenarios for vehicles used on the San Francisco California Bay Area Rapid Transit System. The same principles apply to DPM vehicles. The ignition sources characterized by Braun are summarized in table 2.

In a DPM vehicle interior, except for electrical fires, there are three probable locations for an interior ignition source (fig. 6). They are:

- 1) On the floor - in the aisle.
- 2) On the floor - directly adjacent to a wall or seat or beneath a seat.
- 3) On a seat.

In the ignition sequence, the first item ignited would be either the wall, ceiling, or seat assembly. For the ceiling to be the first item ignited, an ignition source in the aisle would have to produce flame heights at least equal to the floor to ceiling distance, about 2 m. Since this would require an inordinately large amount of fuel, it is highly unlikely that this would have a high probability of occurrence. No consideration will be given to this specific scenario. However, intentional ignition of the ceiling panels is possible with a hand-held flame. In this case, flames could spread either to the edges of the ceiling, involving the walls and windows, or burning plastic materials could melt and drip onto the seats, carpet, or walls.

For ignition adjacent to, beneath, or on a seat, probable flame spread paths may be developed. If the ignition source is on the floor, directly adjacent to or beneath a seat assembly, as shown in figure 6, there are two

possible paths for flame spread. One would be along the carpeting and the other along the seat assemblies. Flame spread along the carpeting could travel eventually either to the seat assemblies or to the lower wall lining material, then involving the upper wall liners or window material and the ceiling. However, floor covering material used in other transit system vehicles has been shown to provide sufficient protection to ignition and flame spread in full-scale tests in mass transit vehicles, and in an actual fire incident in a subway car [19,27,28]. Carpeting in these systems complied with either the ASTM E 84 (tunnel test) test method with a flame spread index less than 75 or the proposed Flooring Radiant Panel Test with a critical radiant flux of  $0.5 \text{ W/cm}^2$ . If the first item to ignite were a seat assembly, the fire would probably grow in intensity until the back of the seat, the ceiling, and the upper wall liners became involved. Seats that are upholstered have been shown in full-scale tests and actual fire incidents to be a particularly important link in the fire growth chain [19,27,28]. Seating integrally molded into the interior liner without an open space beneath the seats would prevent intentional placement of an ignition source beneath the seat.

For an ignition source on the floor, near the wall, primary fire growth would again involve either the carpeting or the seat assemblies as above. However, the lower wall liner would ignite at a much earlier stage in the fire development, contributing further to the total evolution of smoke and heat.

For fires originating on a seat, the fire development may be faster than with an ignition source on the floor, since simultaneous involvement of back and seat assemblies could occur. In addition, the wall liner, windows, and ceiling would become involved at a much earlier stage. However, the floor covering, if it would support flame spread, would not become involved until a later stage from either falling or melting material or with sufficient feedback energy from the developing fire to permit ignition of the flooring.

The characteristics of the ignition and the minimum energy necessary for ignition are important in determining whether an ignition will occur. Possible ignition sources, ranging from smoldering cigarettes to flammable liquids, differ in the rate of energy release and in the total energy released. Braun [19] presented the relationship of energy release rate and total energy for various ignition sources, with ignition levels for seating materials indicated. The relationship developed by Braun is shown in figure 7. From this, table 2 presents ignition levels of various seating materials along with energy output of various ignition sources. Proper choice of seating material, if upholstery is to be provided, can provide significant ignition resistance.



Smoke generation in such a small, confined volume also poses a significant threat to life safety. Hill, et al. [29] presented smoke density measurements in full-scale tests on a simulated automated guideway transit vehicle with a variety of ignition sources. Less than one percent light transmission measured at the ceiling of the vehicle was reached in as little as 28 seconds after ignition of a neoprene cushioned seat. Probable evacuation times for people mover systems, shown in table 1, are calculated assuming maximum vehicle velocity, normal vehicle deceleration, and maximum station dwell time based on the estimated maximum time to evacuate passengers from a vehicle [2]. This estimated time represents a worst case estimate using the assumptions that the vehicle would use only a normal braking rate and would be required to travel the entire station-to-station distance in order to allow a safe vehicle stop. Evacuation times ranged from a minimum of 41 seconds to a maximum of 449 seconds.

### 5.1.2 Exterior Ignitions

A majority of the fire incidents in other transit systems have originated below the floor of the vehicles due to overheated brakes, tires, bearings, etc. In addition, the majority of mechanical and electrical equipment in a people mover vehicle is located beneath the floor, providing a prime source for electrical fires. Detection of subfloor fires is also difficult. A number of mechanical and electrical failures can cause a vehicle to stop on the guideway. A stalled vehicle in a subway or tunnel section of guideway presents a particularly dangerous situation. Passenger evacuation and fire suppression in an underground fire require special consideration and present special difficulties to the design and operating personnel. Although subfloor fires can originate from a wide variety of causes, some simple scenarios can be developed describing their consequences. The critical parameters that enter the description are:

- 1) The location of the vehicle at the time of detection - is it at a station, between stations, or underground, etc.
- 2) The condition of the vehicle at the time of the failure - is it operable.
- 3) The intensity of the fire, at the time of detection.

The first two conditions determine the nature of the response that operating personnel must initiate; the third affects the time available for passenger evacuation and suppression of the fire. The vehicle floor and any bulkheads between mechanical and electrical equipment and the vehicle interior must provide penetration resistance and allow a habitable environment

long enough to allow safe passenger evacuation. Duct work through such bulkheads, particularly the air conditioning system, must also be designed to prevent entrainment of smoke, heat, and toxic products into the vehicle interior in the event of a fire.

## 5.2 Vehicle Design to Minimize Fire Hazard

From the fire scenarios developed above, utilizing several design aspects of the various people mover systems already in existence, somewhat simplified design features of a DPM vehicle can be proposed that would reduce the potential risk of fire. These design features, developed primarily from consideration of the fire safety of the vehicle, are not meant to be the only approach, nor necessarily an economic one. In addition, no consideration was given to the actual construction of the vehicle and any difficulties that may be encountered. It is presented merely to point out important areas that must be considered in the fire safe design of a DPM system. The construction details presented here are by no means the only way to achieve an acceptable level of fire safety.

### 5.2.1 Interior Vehicle Design

A possible vehicle interior design is shown in figure 8. Seating is provided along the sides of the vehicle. The space below the seats is enclosed to prevent potential ignition beneath the seats. The interior lining of the vehicle, wall liners, ceiling liners, and seat assemblies would preferably be constructed of aluminum or similar metal. However, the use of metal throughout, in addition to providing a very stark interior and added vehicle weight, would create additional problems with existing DOT guidelines for noise and passenger safety in the event of collision. Fire-retardant glass fiber laminates could possibly be used with the seats molded integrally with the interior shell. No upholstery would be provided on the seats.

A full door emergency exit would be provided on at least one end of the vehicle to allow safe evacuation of passengers, including the handicapped, onto the guideway in the event of an emergency. A push-out window exit on the other end can serve as another exit. Release handles for emergency exits in the interior are placed so that they may be reached from a wheelchair. The opening of any door or emergency exit would lead to activation of an alarm at Central Control. For vehicles to be used in multi-car trains, an emergency door on the side or both ends may be preferable.

Carpeting (similar to that used in the WMATA Metrorail cars) would be provided over flooring of plymetal (a plywood/aluminum sandwich). This plymetal construction is also provided at any bulkhead between mechanical or electrical equipment and the vehicle interior. It has been estimated that this construction would provide about a ten-minute endurance to a given fire load [27]. This time should be ample to allow passenger evacuation.

The air conditioning system could be designed with the return ducts most probably in the ceiling. Smoke detectors, either ionization or photoelectric, are placed in the main airflow stream in the vehicle interior. It could be possible, with such a small interior volume (less than 100 m<sup>3</sup>), to place the detectors in the return air ducts. Activation of the detectors would trigger an alarm in Central Control. Such a system must be fairly insensitive to avoid false alarms.

Hill, et al. [29], concluded that a five percent Halon 1301 system, using an early-warning detection system, can safely extinguish fire in the passenger compartment of a people mover vehicle without producing intolerable levels of toxic decomposition products (notably hydrogen flouride). It was noted, however, that Halon-type systems do produce extremely loud noise levels during discharge. For systems where evacuation is easily accomplished and an early detection system is included, a Halon system would not likely be necessary. However, for systems where evacuation would be difficult, particularly for elevated or suspended systems, such an extinguishment system may be necessary.

Hand-held fire extinguishers would be provided in each vehicle, with an alarm to Central Control to indicate removal.

### 5.2.2 Exterior Vehicle Design

Figure 9 illustrates one possible design for the vehicle exterior. The outer shell could be constructed of aluminum, stainless steel, enameled metal, etc., at least halfway up the vehicle sides and end to prevent, to a large extent, ignition of the outer shell from an undercarriage fire. The upper shell could be constructed of aluminum, reinforced plastic, or the like.

The undercarriage could contain all electrical and mechanical equipment and would also be enclosed, subdivided, and compartmentalized as much as possible. The following detection equipment could be installed as appropriate:

Brake temperature sensor.  
Propulsion motor temperature sensor.  
Propulsion transformer temperature sensor.  
Propulsion armature temperature sensor.  
Hydraulic fluid temperature sensor.  
A/C system temperature sensor.  
Vehicle communication system temperature sensor.  
Vehicle control system temperature sensor.

While smoke detectors could possibly be installed, they may not be practical for this application. These detectors are sensitive to dirt and contamination, potentially a problem beneath the car. Any detectors used would be linked to alarms in Central Control.

Detector operation in the undercarriage could also be linked to an automatic Halon 1301-type extinguishment system for the undercarriage with appropriate plumbing to carry the extinguishing agent to all major subsystems to provide an additional measure of safety for the vehicle. An automatic fire suppression system may be desirable for the undercar area because of the difficulty of early detection and the potential for a fire to penetrate into the interior. The system should be designed so that the detection system used for initiating suppression is desensitized to minimize false alarms.

### 5.2.3 Emergency Egress

For the safe evacuation of passengers, including the handicapped, a full door exiting directly onto the guideway is preferable to emergency window exits or egress through normal entrance/exit doors onto a catwalk. Thus, guideway design should prevent passengers from coming in contact with the vehicle power rails, preferably by turning power off to the section of the guideway affected by the evacuation.

### 5.2.4 Voice Communications System

The communications systems would be designed to allow two-way voice communication between Central Control and the vehicles on the DPM system. Designed to operate even if primary power was disconnected to the vehicle, the system could allow one-way announcements to all vehicles from the Central Control facilities and would allow two-way conversations with individual vehicles.

## 6. EVALUATION

### 6.1 Important Areas of Consideration

Based on the fire scenarios developed, the DPM design and systems proposals reviewed, and the vehicle design exercise described above, several factors were found to be important to the fire safety of a DPM vehicle. These are summarized below.

#### Vehicle Interior

- 1) Vehicle interior wall and ceiling liners should be designed to prevent ignition, flame propagation, and smoke build-up when exposed to an ignition source or fire load from another burning material within the vehicle.
- 2) Vehicle seats and seat assemblies should be designed to prevent ignition flame propagation, and smoke build-up when exposed to an ignition source of fire load from another burning material within the vehicle.
- 3) Carpeting should not ignite from simple ignition sources or support the spread of flames when exposed to an ignition source or fire load from another burning material within the vehicle.
- 4) Window material and glazings, light diffusers, etc. should not increase the rate of fire growth.

The requirements for the vehicle interior are determined by the vehicle design, support, and use. Factors that are important for design are: (a) the ease of exiting, (b) track location (tunnel versus open), and (c) mode of vehicle support (elevated, suspended, or on-grade).

#### Vehicle Exterior

- 1) Flooring and bulkheads that separate the passenger compartment from electrical and mechanical equipment should be designed to prevent penetration of an undercar fire to the interior long enough to insure safe evacuation of passengers from the vehicle.
- 2) The exterior body shell, particularly the lower half, should not ignite or support flame spread from an undercar fire.
- 3) Insulation material used throughout the vehicle should not contribute to fire growth.
- 4) The induction system for the air conditioning/heating system in the vehicle should be located and suitably protected/designed to prevent the ingestion of smoke, heat, and toxic combustion products from the exterior to the interior of the vehicle from fires in the vehicle undercarriage.

## Fire Detection and Suppression

- 1) Smoke detection systems might be installed in the vehicle interior to provide early warning of a developing fire, particularly in an unoccupied car with an alarm indication to Central Control. In an occupied car, the passengers may be assumed to detect a developing fire more quickly than the desensitized smoke detectors.
- 2) High temperature detectors should be incorporated into the vehicle underbody as appropriate to insure early detection of a fire in the undercar area.
- 3) A Halon 1301-type suppression system could be incorporated into the vehicle underbody along with sufficient compartmentalization to insure effectiveness of the system, to further protect the vehicle.
- 4) Hand-held ABC fire extinguishers should be provided on each vehicle, sized properly for different vehicle capacities, and protected from theft and vandalism.
- 5) All fire detection and suppression systems should be linked to alarms in the system's Central Control center and should be designed so that any malfunction in the system triggers an alarm.
- 6) Appropriate detection and suppression systems should be linked, automatically or manually, to stopping of the vehicle.

## Emergency Evacuation

- 1) Emergency exits should be provided to allow safe evacuation of all passengers.

## Communications

- 1) A two-way voice communications system should be provided to allow both P/A announcements to all vehicles and private communication with individual vehicles in the event of an emergency.
- 2) All smoke and fire detection alarms should be linked in a serial alarm bus to indicate to Central Control the alarm situation.

### 6.2 Test Methods for the Flammability of Materials Used in DPM Systems

In order to insure acceptable levels of flammability, smoke, and toxic gas generation, the following types of test methods are required:

- 1) A penetration resistance test for flooring and bulkhead assemblies.
- 2) A self extinguishing/ignition resistance test for nonmetallic materials.
- 3) A smoke density generation test for nonmetallic materials used in the interior of the vehicle.
- 4) A rate of heat release test, and/or a flame spread test for non-metallic materials.
- 5) A test to permit screening materials that generate highly toxic combustion products.

A review of test methods which are currently available for testing of materials, such as those expected to be used in DPM systems, is presented below.

### 6.3 Fire Penetration Test

ASTM test method E 119 is designed to determine the fire endurance of materials and constructions used in buildings [30]. The complete construction is subjected to heating in a furnace with a prescribed temperature-time curve loaded to simulate actual use. The time to the first sign of structural failure or transmission of excessive temperature through the specimen are among the test results.

### 6.4 Ignition Resistance Tests

#### 6.4.1 Motor Vehicle Safety Standard No. 302

Motor Vehicle Safety Standard 302 is a test for horizontal burn rate used to evaluate materials in all passenger motor vehicles sold in the U.S. The standard requires that all materials used in the occupant compartment of automotive vehicles have a horizontal burn rate of less than four inches per minute [31]. Table 3 shows results of materials tested under MVSS-302 in other transit systems [19,27]. Fabrics and foams used for seating materials in the BART subway system and WMATA buses meet this requirement, but have been involved in a number of full-scale fires. These have been a significant link in the fire growth chain [19,27].

#### 6.4.2 Federal Aviation Regulation FAR-25.853

This standard, issued by the Federal Aviation Administration, defines both a test procedure and acceptance criteria for small-scale fire performance of compartment interior materials used in transport category airplanes [32]. The test procedure outlined in this standard is a vertical test with a 3.9 cm

(1.5 in) flame applied either for 12 seconds or for 60 seconds (determined by the end use of the material) to the lower edge of a 5 cm (2 in) wide 30.5 cm (12 in) long specimen. The test records the flame time, burn length, and flaming time of dripping material. The test criteria require that specimens self-extinguish with a burn length not exceeding 15 to 20 cm (6 to 8 in) (depending on the end use), a flame time not exceeding 15 seconds after removal of the burner, and flaming on the floor of the cabinet not to exceed three to five seconds (end use dependent). Table 3 presents results of tests of materials used in other transit systems [28].

#### 6.4.3 ASTM D 635

This test is intended for the measurement of the rate of burning or the extent of burning of self-supporting plastics [33]. A 12.5 cm x 1.25 cm specimen in its end use thickness is clamped with its long dimension in the horizontal direction. A bunsen burner flame is applied to the unclamped end of the specimen for 30 seconds. Average burning rate, average time of burning, and average extent of burning for 10 or 20 samples are reported as test results. No acceptance criteria are provided. Test method ASTM D 635 has been used in the past for the evaluation of materials used in other transit systems [19]. From the fire history of vehicles used in one such system, BART, this test method would be inadequate for DPM vehicles. Seat assemblies that meet the requirements of ASTM D 635 have been involved in a number of fires and have been particularly important in fire growth.

#### 6.4.4 ASTM D 1692

Test method ASTM D 1692, discontinued by ASTM in 1978, has been used to determine the rate of burning or extent of burning for cellular plastics using a horizontal screen to support a 15 x 5 x 1.3 cm specimen [34]. A propane bunsen burner with a flame spreader attached is the ignition source and applied to one end of the specimen for 60 seconds. Average burning rate, average extent of burning, and average time of burning are reported as test results. Table 2 shows results of tests from other transit systems. Again, from the fire history of vehicles in the BART system, this test method would be inadequate for DPM systems.

#### 6.4.5 Carpeting Tests

##### 6.4.5.1 DOC FF 1-70 Pill Test

No carpets and rugs sold in the United States are permitted to spread a flame beyond a radius of 7.6 cm (3 in) when exposed to the flame from a methenamine timed burning pill on its surface [35]. This standard is intended



to eliminate carpets or rugs as a means of flame spread from small ignition sources.

#### 6.4.5.2 NFPA 253-78

This test, the Standard Method of Test for Critical Radiant Flux of Floor Covering Systems Using a Radiant Heat Energy Source, NFPA 253-78, exposes a specimen placed horizontally to a radiant energy source that varies across a one meter length from a maximum of  $1.1 \text{ W/cm}^2$  down to  $0.1 \text{ W/cm}^2$  [36]. The specimen is ignited by a small flame at the high energy end. The distance at which the burning flooring material extinguishes itself defines the critical radiant flux (CRF) necessary to support continued flame propagation. The higher the CRF, the better is the fire safety of the carpeting. Carpeting taken from several large fatal fires, tested according to this method, was found to have CRF's of less than  $0.1 \text{ W/cm}^2$ . A wood floor would have a CRF between  $0.4$  and  $0.5 \text{ W/cm}^2$ , while vinyl floor materials have values greater than  $1.1 \text{ W/cm}^2$ . Results of tests of carpeting taken from other transit vehicles are shown in table 3 [27,28]. Acceptance criteria of  $0.25 \text{ W/cm}^2$  for residential and commercial occupancies and  $0.5 \text{ W/cm}^2$  CRF for institutional occupancies have been suggested [37,38]. The carpeting tested from transit systems meets both of the criteria.

#### 6.5 Smoke Density Test

The smoke density chamber, NFPA 258-76, measures the smoke generation of solid specimens exposed to a radiant flux level of  $2.5 \text{ W/cm}^2$  [39]. The smoke produced by the burning specimen in the chamber is measured by a light source-photometer combination. The maximum attenuation of the light beam by the smoke is a measure of the optical density or "quantity of smoke" that a material will generate under the given conditions of the test. The maximum optical density,  $D_m$ , is useful primarily in ranking relative smoke production of the material used, and in identifying likely sources of severe smoke production in a full-scale fire. Table 3 presents maximum optical density values under flaming exposure conditions of materials used in other transit systems [27,28,40].

#### 6.6 Rate of Heat Release Tests

The rate of heat release for materials provides a measure of a material's contribution to the growth of a fire. If an ignition occurs, then a test method must be provided to insure that other items do not subsequently become involved. Unfortunately, no established test methods exist to measure rate

of heat release. Several tests have been proposed and are in the process of adoption with standards organizations. Smith has proposed one test method that allows measurement of rate of heat, smoke, and toxic gas release of materials. The apparatus measure release rate, in a flow system, of a material exposed to piloted ignition at various heat flux exposures. Release rates are determined by measuring the concentration of heat, smoke, and toxic gases leaving an environmental chamber containing the sample [42]. Smith has also proposed criteria and methodology for testing of materials used in transit systems [43].

## 6.7 Flame Spread Tests

### 6.7.1 Radiant Panel Test, ASTM E 162

This method measures flame spread and rate of energy release under a varying radiant flux ranging from 4. to 0.3 W/cm<sup>2</sup> [44]. The flame spread factor,  $F_s$ , calculated from the flame spread velocity, and the heat evolution factor of the burning sample,  $Q$ , are combined to yield a flammability index,  $I_s$ , defined as

$$I_s = F_s \cdot Q$$

The higher the index, the greater is the flammability. An  $I_s$  value of less than 75 is considered acceptable for the walls and ceilings of corridors in commercial buildings, but a value of less than 25 is commonly required for corridor linings in institutional buildings. There is, however, no generally accepted level of performance based on this test method since it is not a prescriptive standard. Table 3 also presents results of tests by this method for materials used in other transit systems [27,28,45,46].

### 6.7.2 ASTM E 84 Tunnel Test

The purpose of this test is to determine the surface burning characteristics of various building materials [47,48]. A specimen 51 cm wide by 7.3 m long (20 in x 25 ft) is mounted and supported on the ceiling of a long test chamber. Two gas burners pointing up at one end of the chamber impinge flame on the exposed surface of the specimen. The test evaluates a material's flame spread, fuel contribution, and smoke development. Results of tests on materials used in other transit systems are presented in table 3 [16,19].

## 7. PROPOSED GUIDELINES

The following guidelines are proposed for use in the design specifications for vehicles to be used in Downtown People Mover systems. Specific test methods are proposed as guidelines for material flammability specifications. In addition, general guidelines are presented as recommendations for fire detection and suppression, emergency passenger evacuation, and vehicle communications. Different vehicle and system designs will require different levels of protection in the vehicle design. A number of trade-offs exist for different system types. For elevated or suspended systems, safe passenger evacuation may be a problem. If passengers cannot evacuate a vehicle in an emergency, then the floor and all panels that provide separation between the vehicle interior and electrical or mechanical equipment must be fire-hardened to provide resistance to penetration of an undercar fire. For such a system, consideration should also be given to the inclusion of automatic detection and suppression systems to provide further protection. On the other hand, for systems where egress during an emergency is easily accomplished, the fire penetration resistance of the floor, etc. becomes less important and automatic detection and suppression provisions may not be needed. These provisions are included in the recommended requirements below.

### 7.1 Materials Flammability

The test methods reviewed in section 6 have been used to test materials in other transit systems. Some of these tests, however, have not been adequate based on the fire experience of the systems. The test methods outlined below, with recommended acceptance criteria, were chosen based on the review. These are recommended as guidelines for design specifications for DPM system vehicles.

#### 7.1.1 Ignition Resistance/Flame Spread Test

##### 7.1.1.1 Interior and Exterior Materials

Materials made into interior and exterior components as described below should be tested in accordance with test method ASTM E 162 or ASTM D 3675. The recommended acceptance criteria are included for the materials and presented in table 4.

- Wall and ceiling lining, including partitions, door linings, etc.
- Hard-molded seats.
- Cushioned seats, including upholstered or self-skinned cushions.
- Seat cushion coverings.

- Window glazings.
- Thermal and acoustical insulation.
- Exterior vehicle shell.
- Air conditioning duct work with outlets into the vehicle interior.

#### 7.1.1.2 Floor Covering Flammability Test

Carpeting or other material used as a floor covering over the structural floor should be capable of passing test method NFPA 253-78 [36] with a minimum critical radiant flux of  $\geq 0.25$  W/cm<sup>2</sup>. Flooring should be tested together with any underlay that may be used.

#### 7.1.1.3 Seating Assemblies

Seating assemblies should be evaluated using a full-scale mockup of the finished seat constructed utilizing the same upholstery materials, assembled in the order used in the finished seating product. No established test methods are available to evaluate seating in the end-use configuration. Test methods are currently being developed for adoption as standard test methods [49]. If these tests become available, they should be adopted with appropriate acceptance criteria to prevent the ignition and contribution to fire growth of seating assemblies.

#### 7.1.2 Smoke Generation Test

Interior finish materials and exterior materials which may, when ignited, generate smoke which could be ingested by the heating/air conditioning system and carried into the vehicle interior should be tested in accordance with test method NFPA 258-76. The maximum optical density when testing in the flaming mode should not exceed 300. Materials made into the following components should be tested:

- Wall and ceiling lining, including partitions, door linings, etc.
- Hard-molded seats.
- Seat cushions.
- Seat cushion coverings.
- Window glazings.
- Thermal and acoustical insulation.
- Air conditioning duct work with outlets directly into the vehicle interior.
- The exterior vehicle shell if smoke can be entrained by the air conditioning system and carried to the vehicle interior.

However, the hazard of a particular material in its end-use configuration may not be predicted by a single test method. The amount of smoke generated by a material in actual use and the hazard presented by the smoke depends on a number of properties, such as the amount of material present, the rate of smoke generation, the ventilation characteristics of the vehicle, and the potential for egress from the vehicle.

#### 7.1.3 Penetration Test

The structural flooring and all panels that provide separation between the vehicle interior and any electrical or mechanical equipment other than communication panels, light switches, destination switches, etc., should be designed to have sufficient resistance to prevent the penetration of fire to the interior of the vehicle for a period of time to allow safe evacuation of passengers from a vehicle. A fire endurance test such as the fire exposure test in ASTM E 119 is recommended. The recommended fire test exposure duration should be at least two times the period of time necessary for a vehicle to come to a complete, safe stop from maximum velocity, plus the time necessary to evacuate all passengers from the vehicle to a safe area. This duration may be shortened if automatic fire detection and suppression equipment is included in the vehicle. A minimum of ten minutes protection is recommended. While test method ASTM E 119 may not be appropriate for extremely short evacuation times, no appropriate alternate exists for such short times. One should be adopted if it becomes available.

#### 7.1.4 Rate of Heat Release Test

A rate of heat release test is recommended for the evaluation of all nonmetallic materials used in DPM vehicles, particularly vehicle interior wall and ceiling panels, seats, and seat upholstery. No established test methods are available to evaluate a material's rate of heat release. Test methods are currently under consideration for adoption as standard test methods. When these tests become available, they should be adopted with appropriate acceptance criteria to prevent the excessive contribution of materials to fire within a vehicle.

#### 7.1.5 Combustion Products Toxicity

No accepted protocol has been established to evaluate materials that may produce highly toxic combustion products. If test protocols become available, they should be adopted for all nonmetallic materials used in the interior of the vehicle to eliminate the use of materials that produce highly toxic products of combustion. The toxicity of the combustion products generated

by a burning material in its end-use configuration depends on a number of properties including the amount of material involved, the rate of toxic product generation, the rate of flame spread, and the ventilation characteristics of the vehicle. Actual acceptance criteria of a prospective test method would vary depending on these properties and the particular test method in question.

## 7.2 Fire Detection

### 7.2.1 System for Vehicle Interior

An automatic smoke detection system could be included in the vehicle interior to allow detection of a fire in the early stage of development. Two problems, however, are encountered in the use of fire detectors: what type of detector to use and where to install the detectors.

The type of detector to be installed is dictated by the environment in which it will be used and its tolerance for false alarms. The location of the detector in the vehicle is also critical to the proper operation of the system. An investigation of the flow patterns in a vehicle must be made in order to properly determine correct placement of the detectors. This is necessary to insure that the detectors are placed in the main air stream - not in an area of stagnant air, and to preclude placement of the detectors adjacent to a fresh air inlet within the vehicle.

The detectors should be connected via communication lines to an alarm in Central Control.

References [50] through [54] provide information on detector siting and studies on the effects of room geometry, ceiling configuration, fire type, and detector spacing in dwellings, mobile homes, and commercial establishments. While the environment within the interior of a DPM vehicle is obviously different from those in dwellings, important parameters necessary for study are presented. The National Fire Protection Association also provides guidelines for detector installation [55,56]. Fire detection equipment should be installed and maintained in accordance with NFPA Standard 72 E-1975.

### 7.2.2 System for Vehicle Electrical and Mechanical Equipment Bays

Major vehicle electrical and mechanical equipment bays should be protected by an automatic fire detection system. The following detection equipment should be installed as appropriate.

Brake over-temperature detectors.  
Propulsion motor over-temperature detector.  
Propulsion transformer over-temperature detector.  
Propulsion armature over-temperature detector.  
Hydraulic fluid over-temperature detectors.  
Air conditioning compressor over-temperature detector.  
Air conditioning fan motor over-temperature detector.  
Vehicle communications electronics over-temperature detector.  
Vehicle control electronics over-temperature detector.

In addition, fixed temperature heat detectors should be included in major equipment bays, and the possibility of the installation of smoke detectors in major equipment bays should be investigated.

All detectors in the vehicle electrical and mechanical equipment bays should also be connected via communications lines to alarms in the Central Control facility of the system. Consideration should also be given to provisions designed to automatically stop the vehicle and open emergency exits if detectors indicate that a risk to life safety exists. Fire detection equipment should be installed and maintained in accordance with NFPA Standard 72 E, [56]. The undercar area should be compartmentalized as appropriate to insure the effectiveness of the system.

### 7.3 Fire Suppression

#### 7.3.1 Portable Fire Extinguishers

Every vehicle should be equipped with at least one approved multipurpose (ABC) fire extinguisher accessible to system rescue personnel. The extinguisher can be mounted in a cabinet located on the outside of the vehicle to be accessible only to rescue personnel. If the authority having jurisdiction deems it necessary for passengers to have access to the extinguishers, they can be located within the vehicle and provided with appropriate theft protection to prevent loss of the extinguishers. References [57] and [58] provide recommendations on sizing, installation, and maintenance of extinguishers.

#### 7.3.2 Automatic Fire Suppression

The fire detection system in vehicle equipment bays could be linked to an automatic fire suppression system for all vehicle equipment and mechanical bays. The system, if included, should be designed to provide automatic suppression of fires in the undercarriage to prevent the penetration of undercar

fires to the vehicle interior. Release of the extinguishing agent should be indicated to the Central Control center. Sufficient compartmentalization of the undercar area must be included to insure the effectiveness of the system.

#### 7.4 Emergency Egress

Provisions for the safe emergency evacuation of all passengers from a vehicle must be included in the system design. Federal Vehicle Safety Standard 217, Bus Window Retention and Release, contains requirements detailing minimum number, type, and area of exits that are applicable for DPM vehicles [59]. The safe evacuation of handicapped passengers must also be considered. For the safe emergency egress of handicapped passengers, a full door exiting directly onto the guideway is preferable to emergency window exits or egress through normal entrance/exit doors onto a catwalk. Guideway design should also prevent passengers from coming in contact with guideway power rails and vehicle electrical pickups.

Emergency exits should be clearly marked both on the inside and outside of the vehicle.

#### 7.5 Voice Communications

The voice communications system should be designed to allow two-way voice communications between Central Control and the vehicles in the DPM system. The voice communications system should be designed to allow one-way announcements to all vehicles from Central Control and to allow two-way communications between Central Control and individual vehicles in the system.

#### 7.6 Vehicle Construction

##### 7.6.1 Heating and Air Conditioning System

Duct work in the heating and air conditioning system should be designed to prevent the ingestion of heat, smoke, and toxic combustion products and the conveying of these products to the vehicle interior. The fresh air makeup inlet from the vehicle exterior should be placed to minimize ingestion of products from undercar fires.

##### 7.6.2 Electrical Fire Safety

All electrical systems and wiring should be designed in accordance with applicable Federal, state, and local electrical codes. It is important to provide fire stops for electrical cabling that penetrates to the interior from electrical equipment bays to protect passengers from an undercar fire.



## 7.7 Guidelines for Testing Protocol

The guidelines presented above for material fire properties, fire detection and suppression, emergency egress, and vehicle communications provide for a number of trade-offs between detection and suppression provisions and material flammability requirements. In order to provide a realistic testing protocol both for system specification and system designers, figure 10 describes a logical sequence that should be followed for the design specification and acceptance of material design for flammability of DPM vehicle materials. The logic analysis provides a step-by-step procedure for the design of materials to be used in DPM systems.

## 8. SUMMARY AND CONCLUSIONS

Based upon a review of existing people mover systems, proposed DPM vehicles, and DPM systems proposed by several cities, a series of possible fire scenarios for DPM vehicles has been developed. The small enclosed volume of a DPM vehicle and likelihood that elevated guideways will be used presents a unique problem in the potential rapid development of hazardous conditions within and around vehicles. Thus, the fire safety design of DPM vehicles is a particularly important aspect in the design of a DPM system.

Guidelines are presented that are recommended for use in the design of vehicles and systems to be deployed under the Downtown People Mover program. Test methods for seating assemblies, rate of heat release, and toxicity of materials as recommended in this report should also be adopted as they become available.

The test methods and criteria presented are based on a review of the design, construction, and operation of typical DPM systems. Additional testing of actual vehicles and materials would, of course, be needed to provide support and validation for the recommended tests and criteria. In addition, a study of methods to reduce the false alarms of smoke detectors in such a hostile environment should be initiated.

## 9. REFERENCES

- [1] Downtown People Mover Project Implementation Guidelines, Appendix C, Section 3.4.5, U.S. Urban Mass Transportation Administration UTD Document 77-10, Revision 01 (March 1977).
- [2] People Mover Profile, Urban Mass Transportation Administration, Transportation Systems Center, 1976.
- [3] Donlon, R. H., Otis Elevator Company, Transportation Technology Division, letter to R. D. Peacock (October 26, 1977).
- [4] Yen, A. M., et al, Assessment of the UMI Type II Tourister AGT System at King's Dominion, Urban Mass Transportation Administration, Report No. UMTA-IT-06-0135-77-6 (December 1977).
- [5] Yen, A. M., et al, Assessment of the Tunnel Train System at the Houston Intercontinental Airport, UMTA, Report UMTA-IT-06-0135-77-3 (December 1977).
- [6] Yen, A. M., et al, Assessment of the Automatically Controlled Transportation (ACT) System at Fairlane Town Center, UMTA-IT-06-0135-77-2 (December 1977).
- [7] Yen, A. M., et al, Assessment of the Satellite Transit System (STS) at the Seattle-Tacoma International Airport, UMTA-IT-06-0135-77-1 (December 1977).
- [8] Yen, A. M., et al, Assessment of the Passenger Shuttle System (PSS) at Tampa International Airport, UMTA-IT-06-0135-77-4 (December 1977).
- [9] Yen, A. M., et al, Assessment of the WEDway Peoplemover System at Walt Disney World, UMTA-IT-06-0135-77-5 (December 1977).
- [10] Demoro, H. W., People Movers, Mass Transit, Vol. IV, 52-58 (July/August 1977).
- [11] Performance/Design and Qualification for the Phase II Morgantown Operational Personal Rapid Transit System, General Specification for (Boeing Document WVBOR-TD-001), Boeing Aerospace Company, Seattle (January 1977).
- [12] Morgantown Personal Rapid Transit Final Report, (Boeing Document D191-60016-1), Boeing Aerospace Company, Seattle.
- [13] Morgantown, WVU PRT personnel, personal communication.
- [14] Kangas, R., et al, Assessment of Operation Automated Guideway Systems - AIRTRANS (Phase 1), Transportation System Center, Report No. UMTA-MA-06-0069-1, (1976).
- [15] Corbin, A., AIRTRANS Program Manager, Vought Corporation, letter to R. D. Peacock (October 31, 1977).
- [16] Davidson, T. M., Automated Transportation Systems, Boeing Aerospace Company, letter to R. D. Peacock (November 14, 1977).
- [17] Houston Downtown People Mover, A proposal to the Urban Mass Transportation Administration, submitted by the City of Houston (1976).

- [18] Downtown People Mover Element of the Circulation Distribution System. A proposal to the Urban Mass Transportation Administration, submitted by the City of Los Angeles (1976).
- [19] Braun, E., Fire hazard evaluation of BART vehicles, Nat. Bur. Stand. (U.S.), NBSIR 78-1421 (March 1978).
- [20] Troy, J. J., Fire Protection for Rapid Transit Systems, Fire International, Vol. 5, No. 55 (March 1977).
- [21] Proposal to the Urban Mass Transportation Administration for a Downtown People Mover System, St. Paul, Minnesota, Metropolitan Transit Commission and the City of St. Paul, Minnesota, Report No. 76-08 (1976).
- [22] Esmer, G. P., Transportation Systems Operations, Ford Motor Company, letter to R. D. Peacock (September 9, 1977).
- [23] Tantlinger, K. W., Rohr Industries, letter to R. D. Peacock (October 12, 1977).
- [24] Germany's Automated People Mover, Civil Engineering, ASCE (July 1977).
- [25] Arbeitsgemeinschaft Cabaientaxi DEMAG+MBB personnel, personal communication.
- [26] National Academy of Sciences (U.S.), Fire Safety and Fire Hazards Related to Polymeric Materials in Cars of Washington Metropolitan Area Transit Authority (1975).
- [27] Braun, E., Report of fire test on an AM General Metro Bus, Nat. Bur. Stand. (U.S.), NBSIR 75-718 (1975).
- [28] Braun, E., A fire hazard evaluation of the interior of WMATA Metrorail cars, Nat. Bur. Stand. (U.S.), NBSIR 75-971 (1975).
- [29] Hill, R. G., et al, Fire Detection, Extinguishment, and Material Tests for an Automated Guideway Transit Vehicle, National Aviation Facilities Experimental Center (U.S.), Report No. FAA-NA-76-52 (1977).
- [30] Fire Tests of Building Construction and Materials, E 119, American Society for Testing and Materials, Philadelphia (1974).
- [31] Motor Vehicle Safety Standard - 302, National Highway Traffic Safety Administration, Federal Register, Vol. 36, No. 5, 70 (1972).
- [32] Federal Aviation Regulation - FAA Crash Worthiness Standard, Part 25, Section 25.853, Federal Register, Vol. 34, p. 130 (August 12, 1969).
- [33] Test for Flammability of Self Supporting Plastics, D 635, American Society for Testing and Materials, Philadelphia (1974).
- [34] Test for Rate of Burning or Extent of Burning of Cellular Plastics Using a Supported Specimen by a Horizontal Screen, D 1692, American Society for Testing and Materials, Philadelphia (1974).
- [35] Standard for the Surface Flammability of Carpets and Rugs, FF-1-70, Federal Register, Vol. 35, No. 74, 6211-6212 (April 16, 1970).
- [36] Hartzell, L. G. Development of a radiant panel test for flooring materials, Nat. Bur. Stand. (U.S.), NBSIR 74-495 (May 1974).

- [37] Benjamin, I. A., and Adams, C. H., The Flooring Radiant Panel Test and Proposed Criteria, Fire Journal (March 1976).
- [38] Benjamin, I. A. and Adams, C. H., Proposed criteria for use of the critical radiant flux test method, Nat. Bur. Stand. (U.S.), NBSIR 75-950 (1975).
- [39] Standard Test Method for Measuring The Smoke Generated by Solid Materials, NFPA 258-1976, National Fire Codes, Vol. 10, National Fire Protection Association, Boston (1977).
- [40] Lee, T. G., The smoke density chamber method for evaluation of the potential smoke generation of building materials, Nat. Bur. Stand. (U.S.), NBS Tech. Note 757 (1973).
- [41] Smith, E. E., Heat Release Rate of Building Materials, Symposium on Ignition, Heat Release, and Noncombustibility of Materials, ASTM STP 502, American Society for Testing and Materials, Philadelphia, Pa. (1972).
- [42] Smith, E. E., Measuring Rate of Heat, Smoke and Toxic Gas Release, Fire Technology, Vol. 8, No. 3 (August 1972).
- [43] Smith, E. E., Transit Vehicle Material Specification Using Release Rate Tests for Flammability and Smoke, Phase I Report, prepared for Transit Development Corporation, Washington, D.C., unpublished (Oct. 1976).
- [44] Surface Flammability of Materials Using a Radiant Heat Energy Source, E 162, American Society for Testing and Materials, Philadelphia (1977).
- [45] Robertson, A. F., Surface Flammability Measurements by the Radiant Panel Method, ASTM Symposium on Fire Test Methods, Special Technical Publications, 344-1962 (1962).
- [46] Rose, A., Comparison of Flame-Spread Ratings by Radiant Panel, Tunnel Furnace, and Pittsburgh Corning Apparatus, National Research Council of Canada, NRC 10788 (1969).
- [47] Test for Surface Burning Characteristics of Building Materials, E 84, American Society for Testing and Materials, Philadelphia (1977).
- [48] Lee, T. G., and Huggett, C., Interlaboratory Evaluation of ASTM E 84-70 Tunnel Test Applied to Flooring, Journal of Testing and Evaluation, Vol. 3, No. 1 (1975).
- [49] Draft for Development, Tests for the Ignitability of Upholstered Seating, BSI No. DD58:1978, British Standards Institution (May 1978).
- [50] Gawin, W. M. and Bright, R. G., Mobile home smoke detector siting study, Nat. Bur. Stand. (U.S.), NBSIR 76-1016 (May 1976).
- [51] Bukowski, R. W., Christian, W. J., and Waterman, T. E., Detector sensitivity and siting requirements for dwellings, Nat. Bur. Stand. (U.S.), NBS-GCR 75-51 (August 1975).
- [52] Harpe, S. W., Waterman, T. E., and Christian, W. J., Detector sensitivity and siting requirements for dwellings, Phase 2, Nat. Bur. Stand. (U.S.), NBS-GCR-77-82 (February 1977).

- [53] Heskestad, G. and Delichatsios, M. A., Environments of fire detectors - Phase 1: Effect of fire size, ceiling height and material, Vol. 1, Measurements, Nat. Bur. Stand. (U.S.), NBS-GCR-77-86 (May 1977).
- [54] Heskestad, G. and Delichatsios, M. A., Environments of fire detectors - Phase 1: Effect of fire size, ceiling, height and material, Vol. 2, Analysis, Nat. Bur. Stand. (U.S.), NBS-GCR-77-95 (July 1977).
- [55] Standard for the Installation, Maintenance and Use of Local Protective Signaling Systems for Watchmen, Fire Alarm and Supervisory Service, NFPA 72C-1975, National Fire Codes, Vol. 7, National Fire Protection Association, Boston (1977).
- [56] Standard on Automatic Fire Detectors, NFPA 72E-1974, National Fire Codes, Vol. 7, National Fire Protection Association, Boston (1977).
- [57] Fire Protection Handbook, 14th Edition, Section 16, National Fire Protection Association, Boston (1977).
- [58] Standard for Portable Fire Extinguishers, NFPA 10-1975, National Fire Code, Vol. 1, National Fire Protection Association, Boston (1977).
- [59] Federal Vehicle Safety Standard 217, Bus Window Retention and Release, National Highway Safety Bureau, Department of Transportation (U.S.).

Table 1. Worst case evacuation times from people mover vehicles<sup>1</sup>

People mover system	Stopping times from maximum velocity (sec) normal deceleration	Station dwell time and travel time (sec)	Total evacuation time <sup>2</sup> (sec)	Total evacuation time for equal station spacing of 1.0 mi. (sec)
Morgantown	22	176	198	162
DEMAG+MBB	16	63	79	145
Ford	23	70-130	93-153	153-213
Rohr	4	37- 74	41- 78	324-344
Universal Mobility	9	55-440	64-449	224-248
AIRTRANS	8.2	82	91	216
Disney	10	-	-	287
Westinghouse	15	44- 80	59- 95	155

<sup>1</sup>Velocity and station dwell times taken from reference [1].

<sup>2</sup>Based on normal deceleration, station dwell time, and maximum inter-station travel time.

Table 2. Potential for ignition of various seat assemblies by some ignition sources<sup>1</sup>

Seat material	Estimated potential for ignition by an ignition source				
	Cigarette 30 W-sec	Match 20 W-sec	Trash bag 40 W-sec	Newspaper 60 W-sec	Gasoline 60 W-sec
Vinyl Neoprene	no	no	no	no	yes
Self-skin Urethane, 30% FR	no	no	no	yes	yes
Self-skin Urethane, 10% FR	no	no	yes	yes	yes
Nylon/Urethane	no	yes	yes	yes	yes

<sup>1</sup>Based on data presented in figure 6

Table 3. Summary of selected small-scale test results on transit vehicle components

Material	FAR		ASTM		ASTM E 162 I <sub>g</sub>	ASTM E 84	Flooring Test (FRPT) (W/cm <sup>2</sup> )	NFPA 258 D <sub>m</sub>	Source <sup>3</sup>
	MVSS 302 (cm/min)	25.853	D 1692	D 1692					
Floor Carpet	DNI	6.4	3.5		8.1	<75	0.66 >1.1	319 694	WMATA-bus WMATA-subway Morgantown
Wall Carpet	DNI				181				WMATA-bus
Ceiling Carpet	DNI				51			211	WMATA-bus
Seat Cushions									
-Fabric	9.5							67	WMATA-bus
-Foam	3.0								BART
Urethane	3.4							83	WMATA-bus
Vinyl/Neoprene		3.3	9	11.2	3.2			632	WMATA-subway
Urethane		7.6	0	S.E.	S.E.			678	WMATA-subway BART
Seat Back									
-Fabric	9.0								WMATA-bus
-Foam 11	4.9							111	WMATA-bus
-Foam 21	6.6							204	WMATA-bus
Signs <sup>2</sup>	20.5								
Wheel Housing	5.6							600	WMATA-bus
Head Pad	2.44							374	WMATA-bus
Inferior Wall									
PVC-acrylic		6.4	0		51			710	WMATA-subway Morgantown
Glass fiber - FR resin								20	Morgantown
Sound Insulation								<75	BART
								<25	Morgantown

<sup>1</sup>Mixture of different types of foam

<sup>2</sup>Styrene/butadiene coated with Ethylene-ethylacrylate copolymer

<sup>3</sup>Tests on WMATA bus and subway materials were performed by NBS; tests on BART materials were from reference [19]; tests on Morgantown materials reported by [16].



Table 4. Recommended acceptance criteria test method ASTM E 162

---

<u>Material</u>	<u>Acceptance Criteria</u>
Interior:	
Wall and ceiling linings	35
Window glazings	35
Thermal and acoustical insulation	35
Air conditioning duct work	35
Seats:	
Hard-molded seats	25
Cushioned seats	
Cushion coverings	35 <sup>1</sup>
Padding	25 <sup>2</sup>
Exterior:	
Exterior vehicle shell	35

---

<sup>1</sup> Seat cushion coverings should be tested in conjunction with seat cushions. Acceptance criteria is for composite assembly.

<sup>2</sup> ASTM D 3675-78, a variant of ASTM E 162, has been developed specifically for flexible cellular materials.

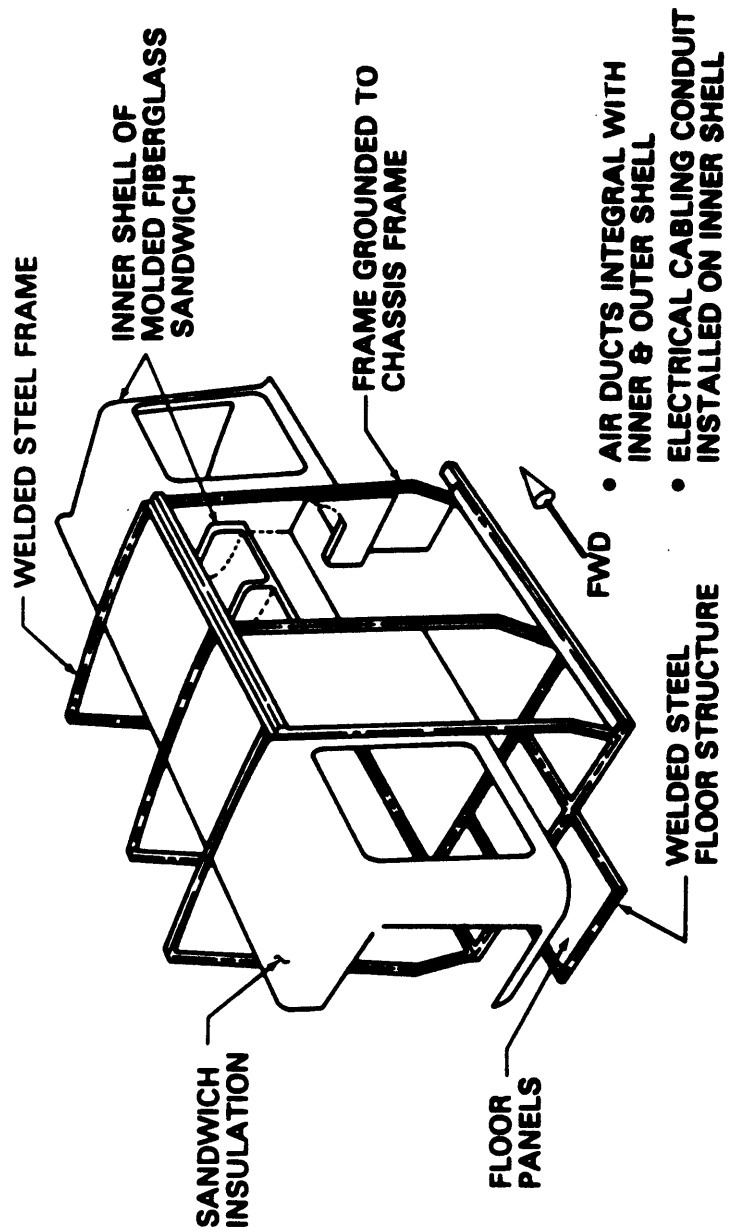


Figure 1. Morgantown passenger vehicle construction

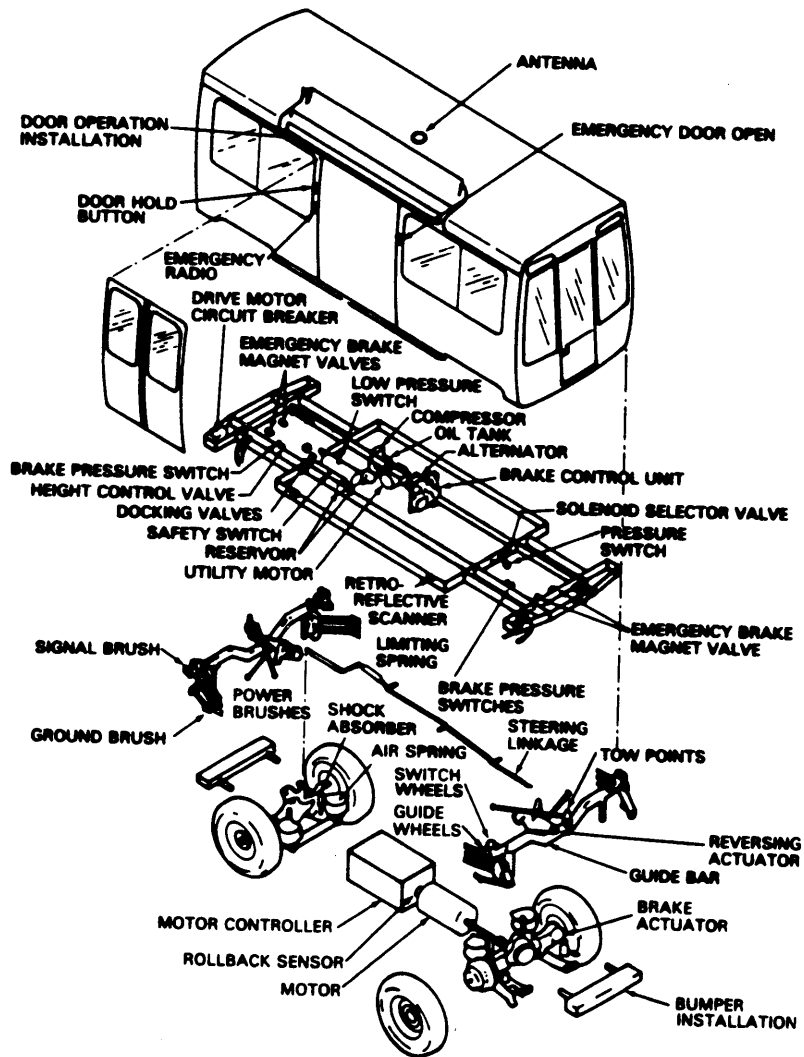


Figure 2. AIRTRANS passenger vehicle construction

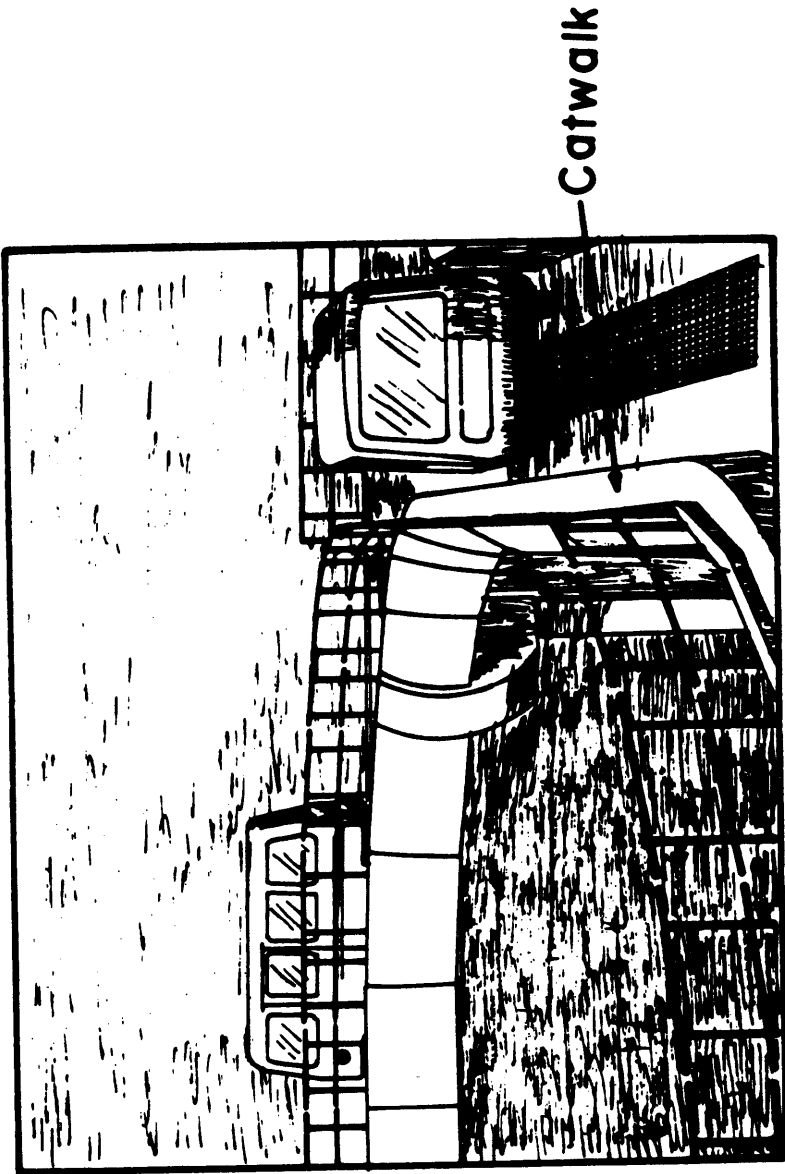


Figure 3. Morgantown emergency egress provisions

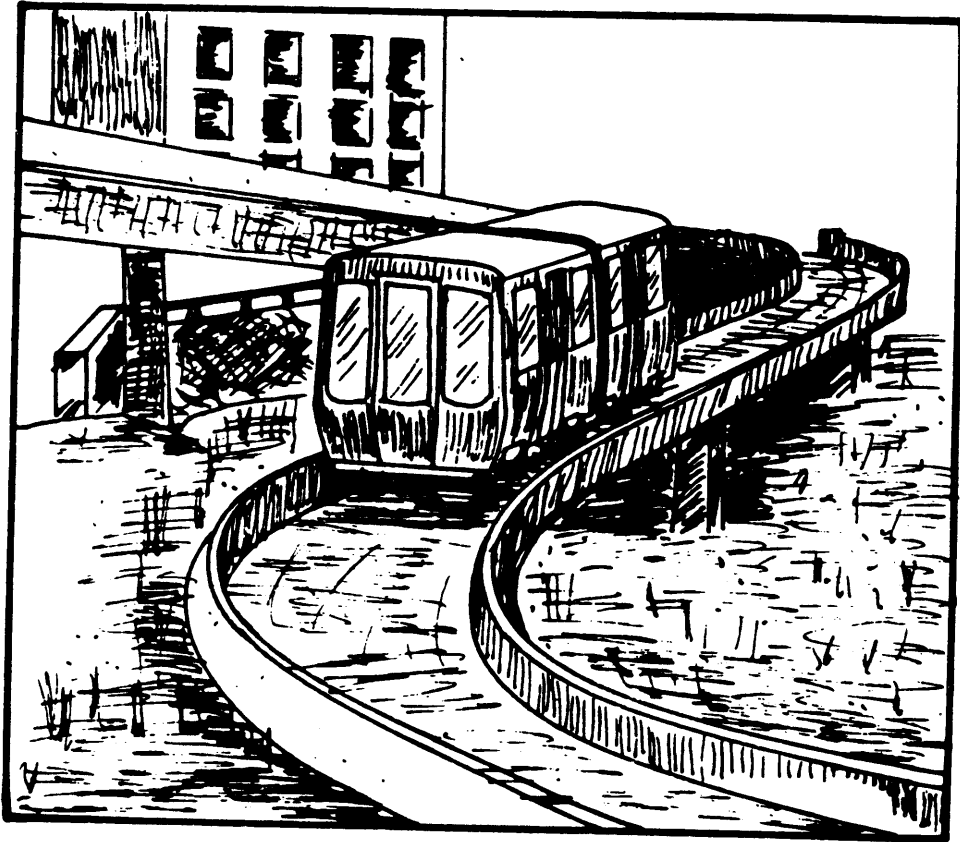


Figure 4. AIRTRANS emergency egress provisions

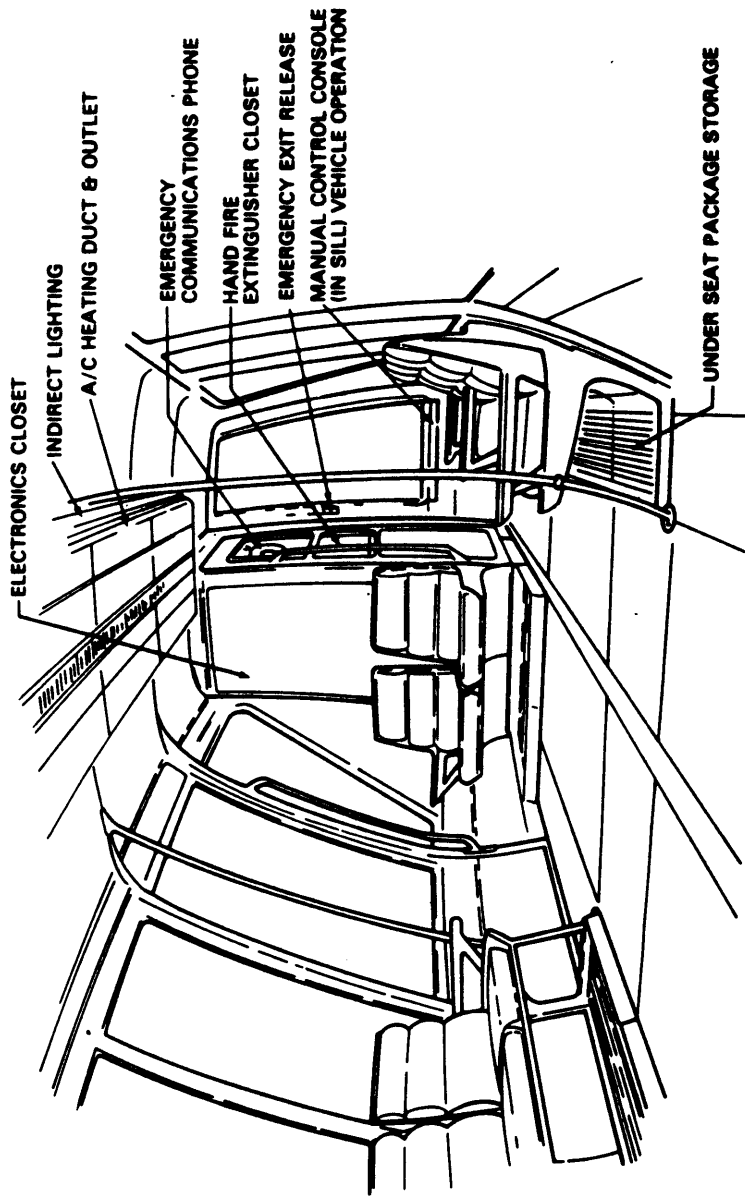


Figure 5. Otis passenger vehicle interior construction

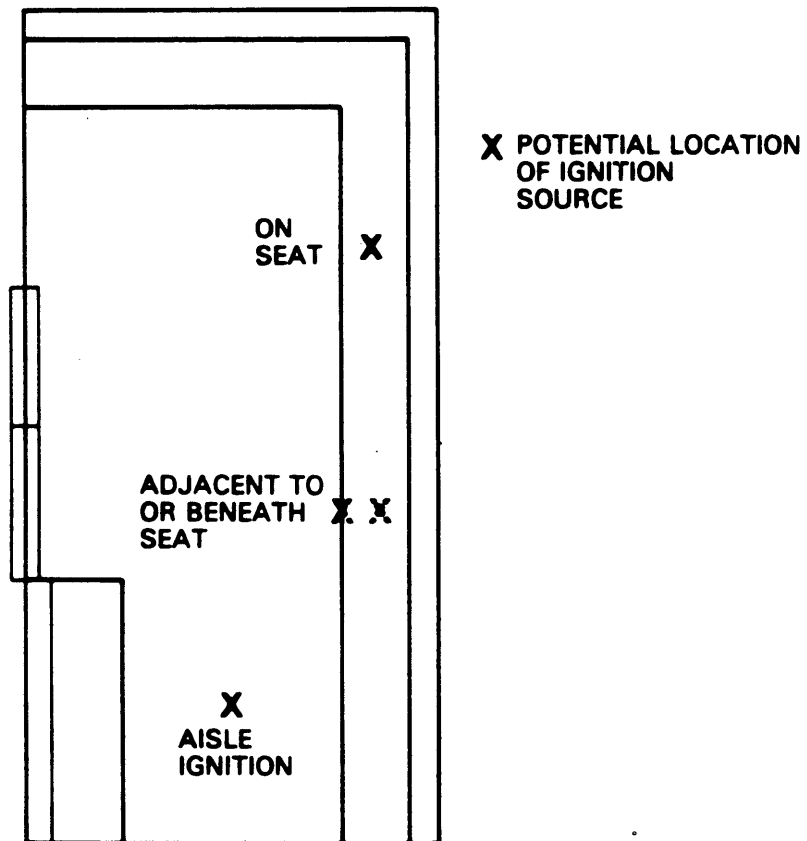


Figure 6. Probable location of ignition sources in a DPM vehicle

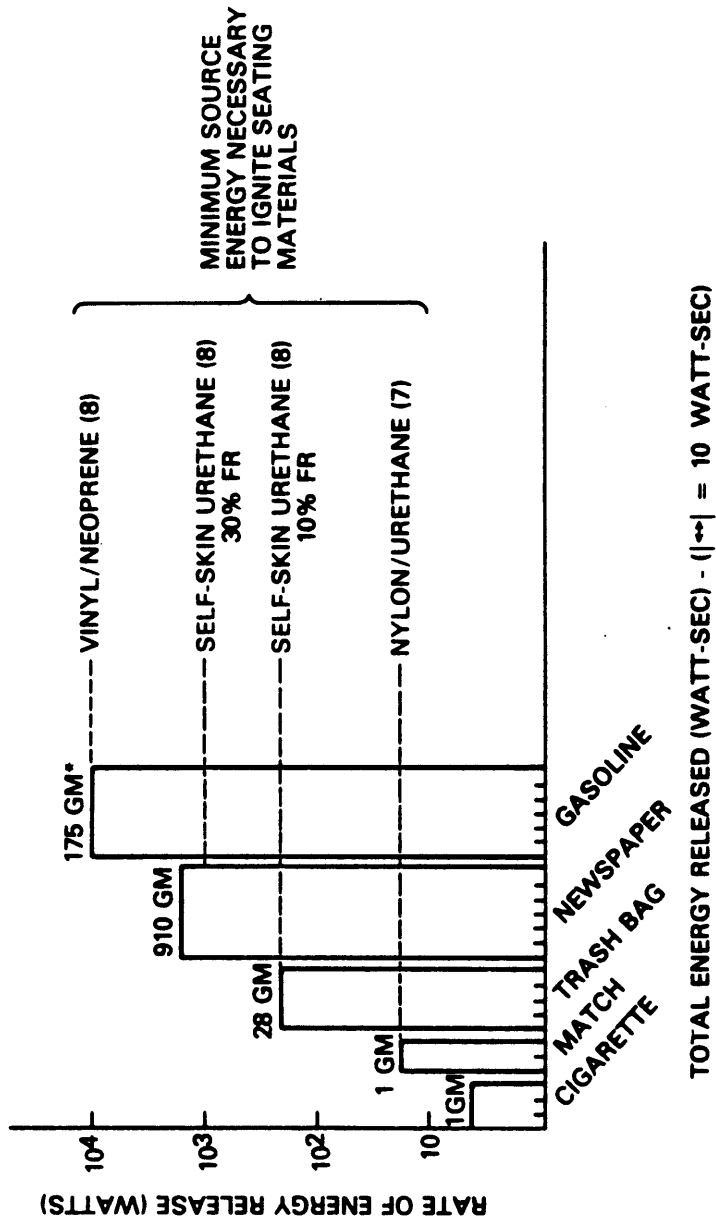


Figure 7. Comparison of ignition source characteristics and minimum ignition energies for various seat assemblies



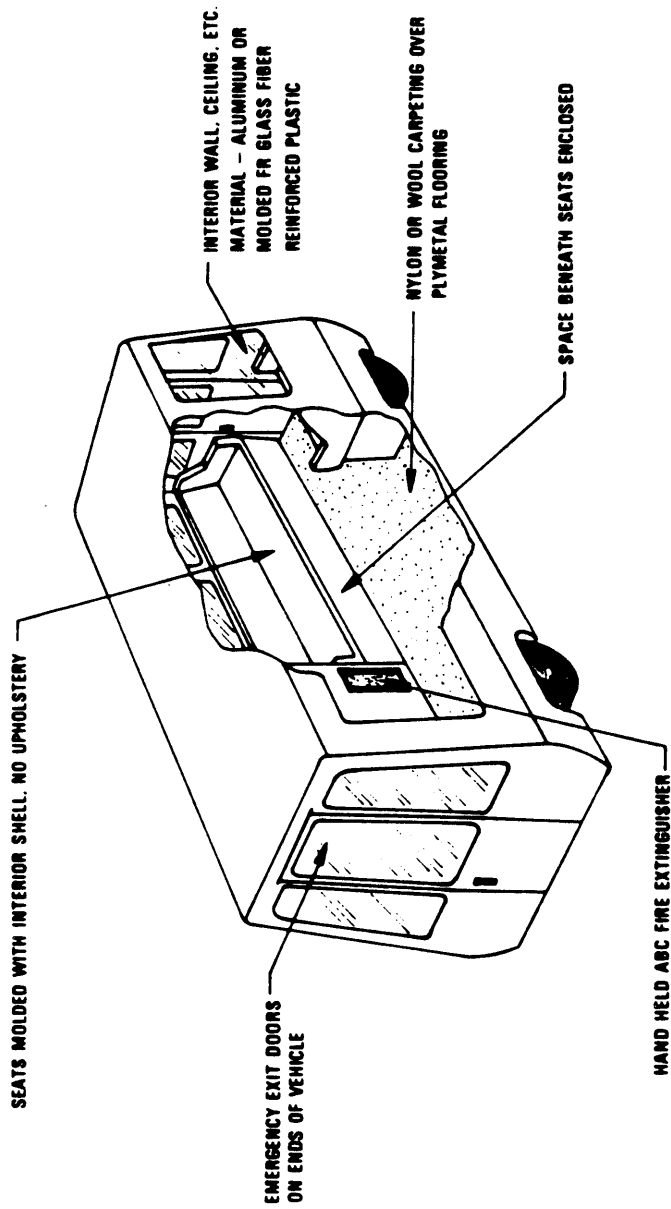


Figure 8. Vehicle interior design features

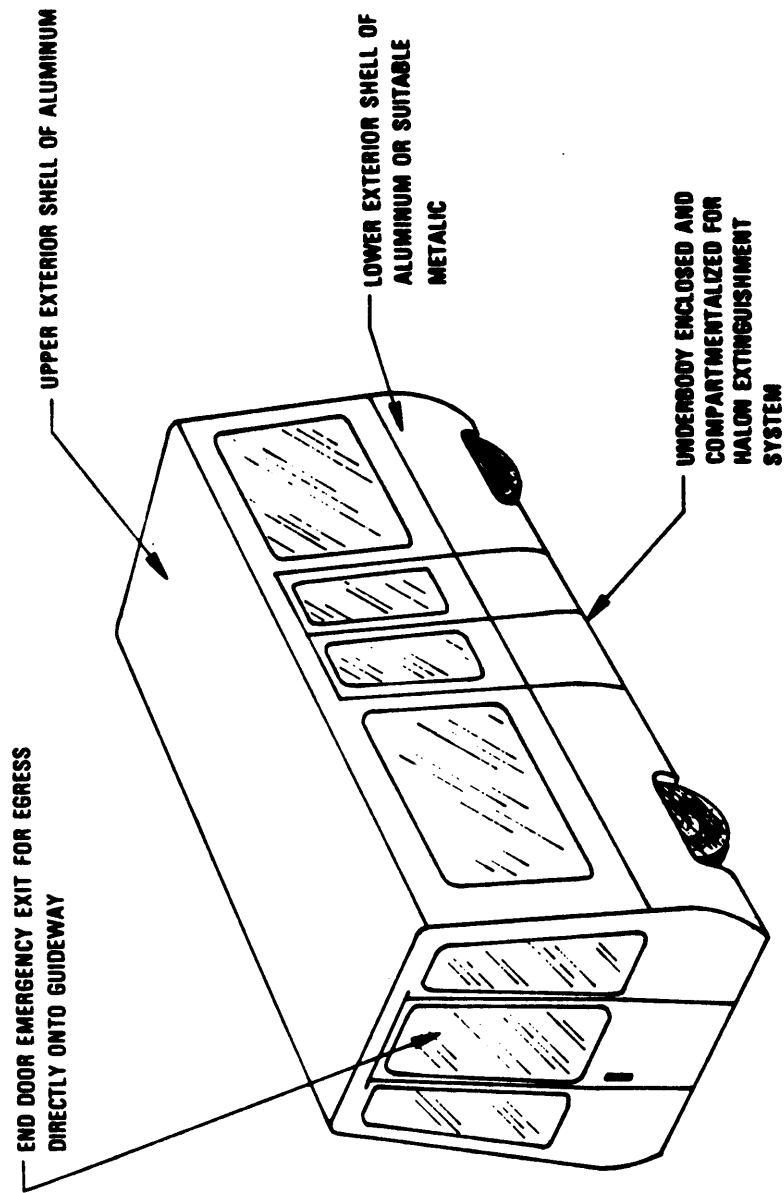
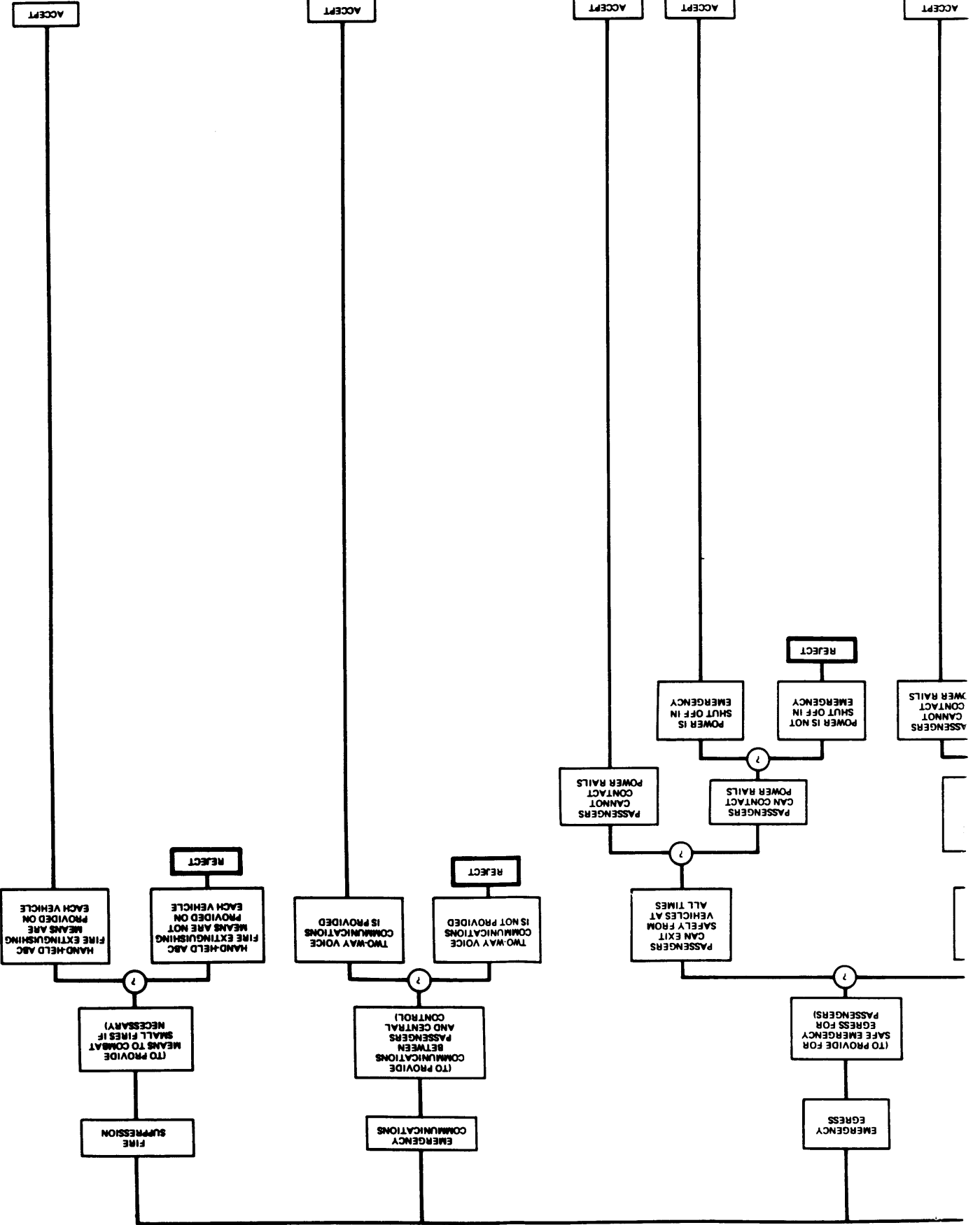
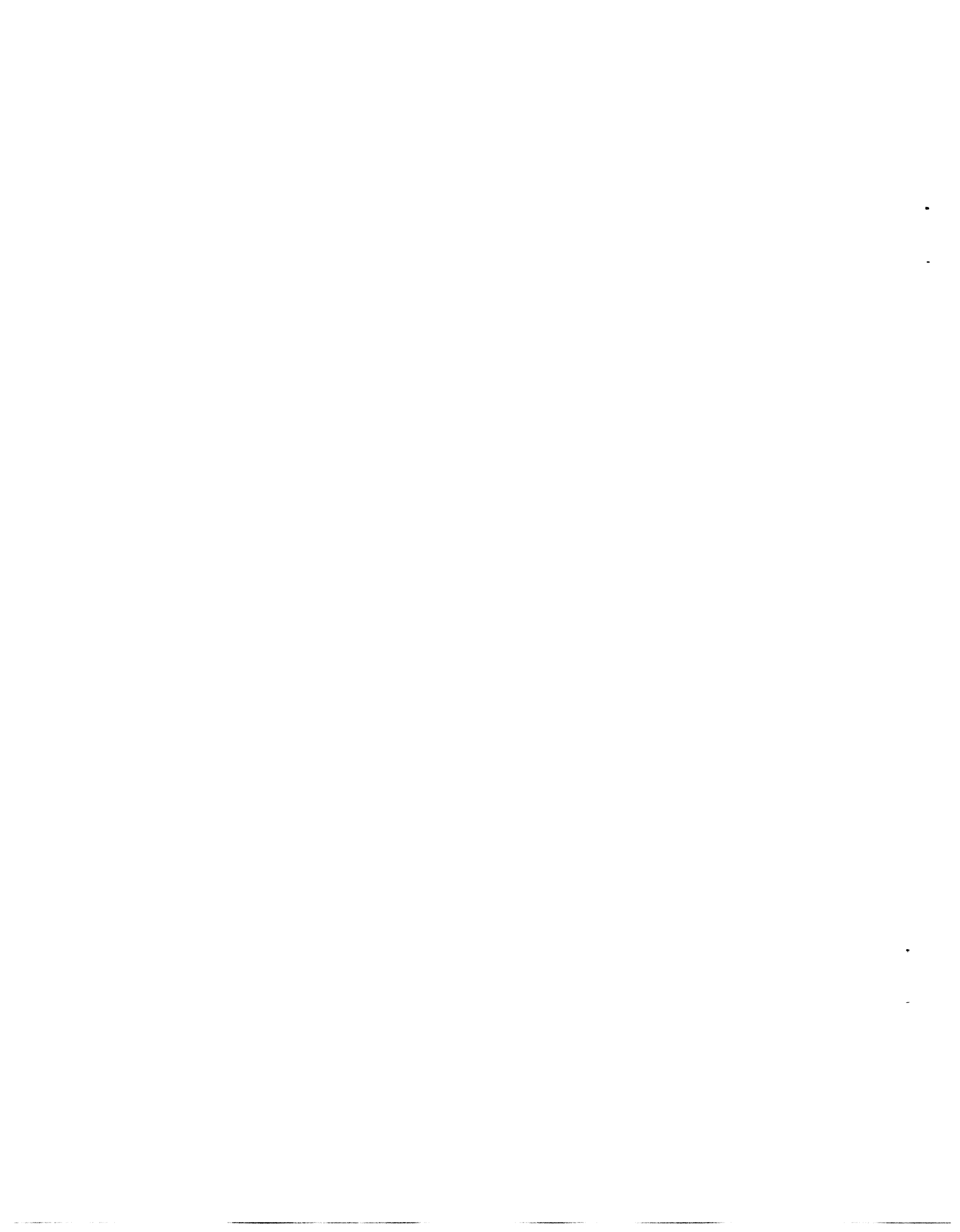


Figure 9. Vehicle exterior design features



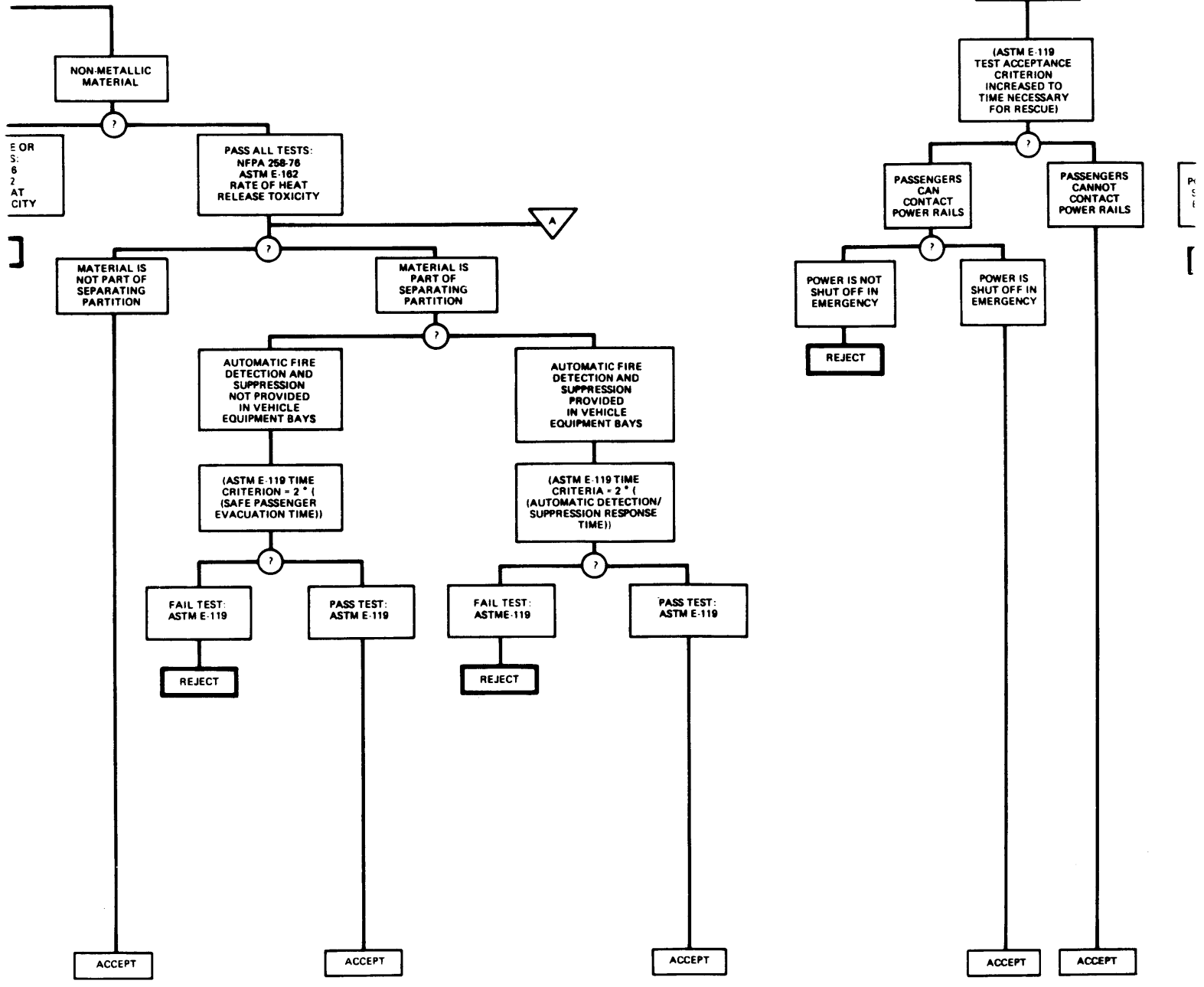


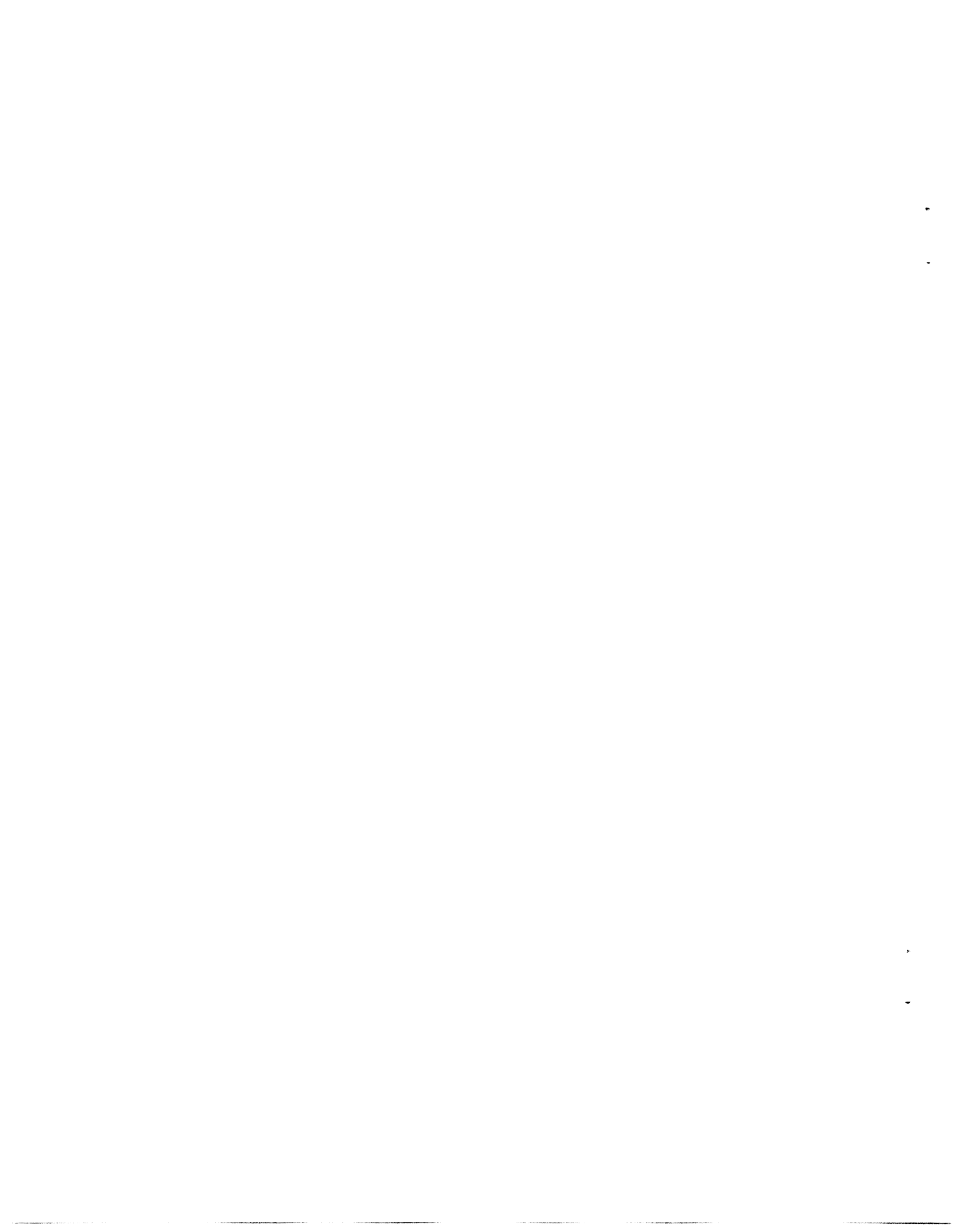
VEHICLE  
FLAMMABILITY  
GUIDELINES

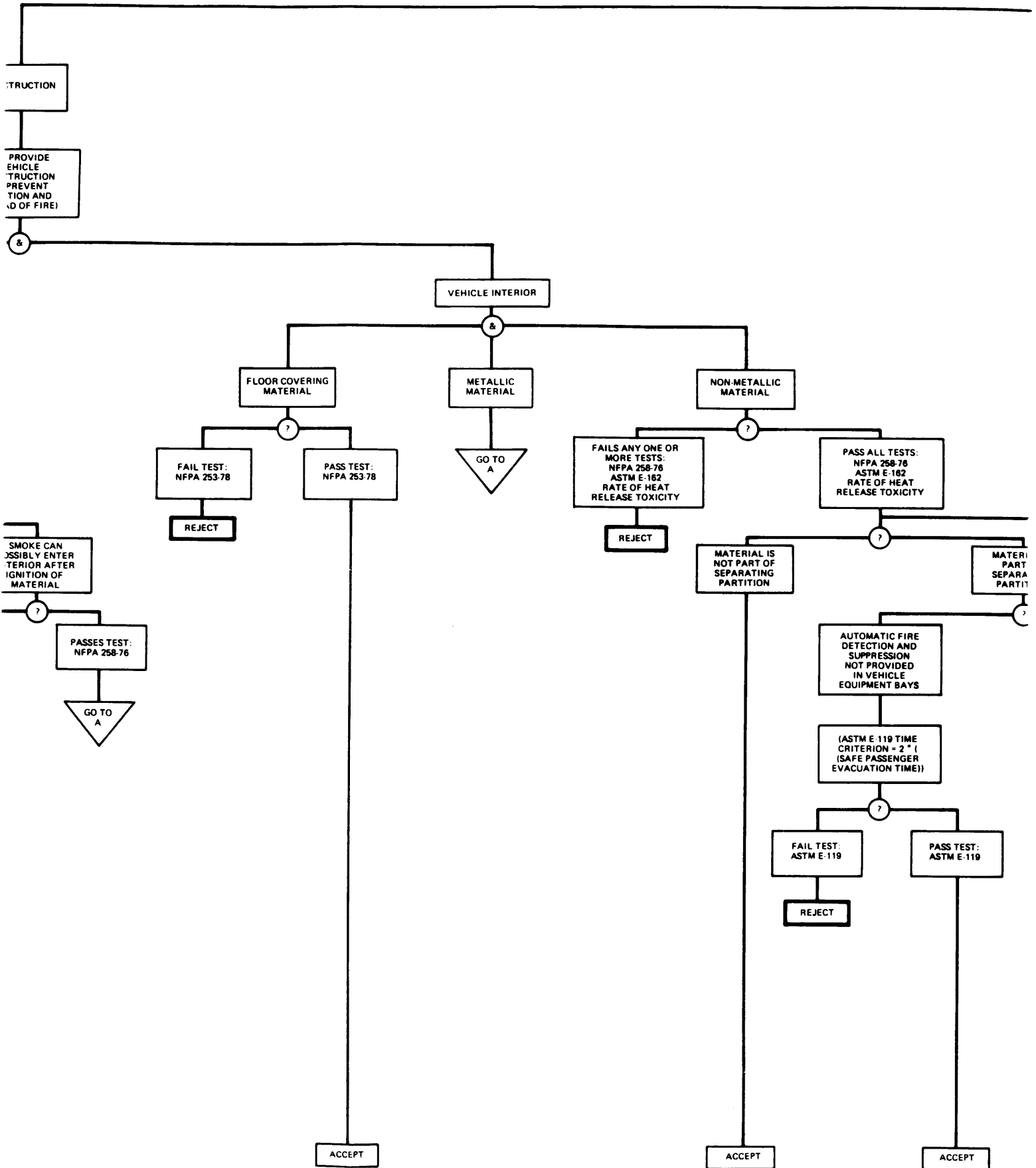
&

EMER  
EG

(TO PRO  
SAFE EM  
EGRE  
PASSE

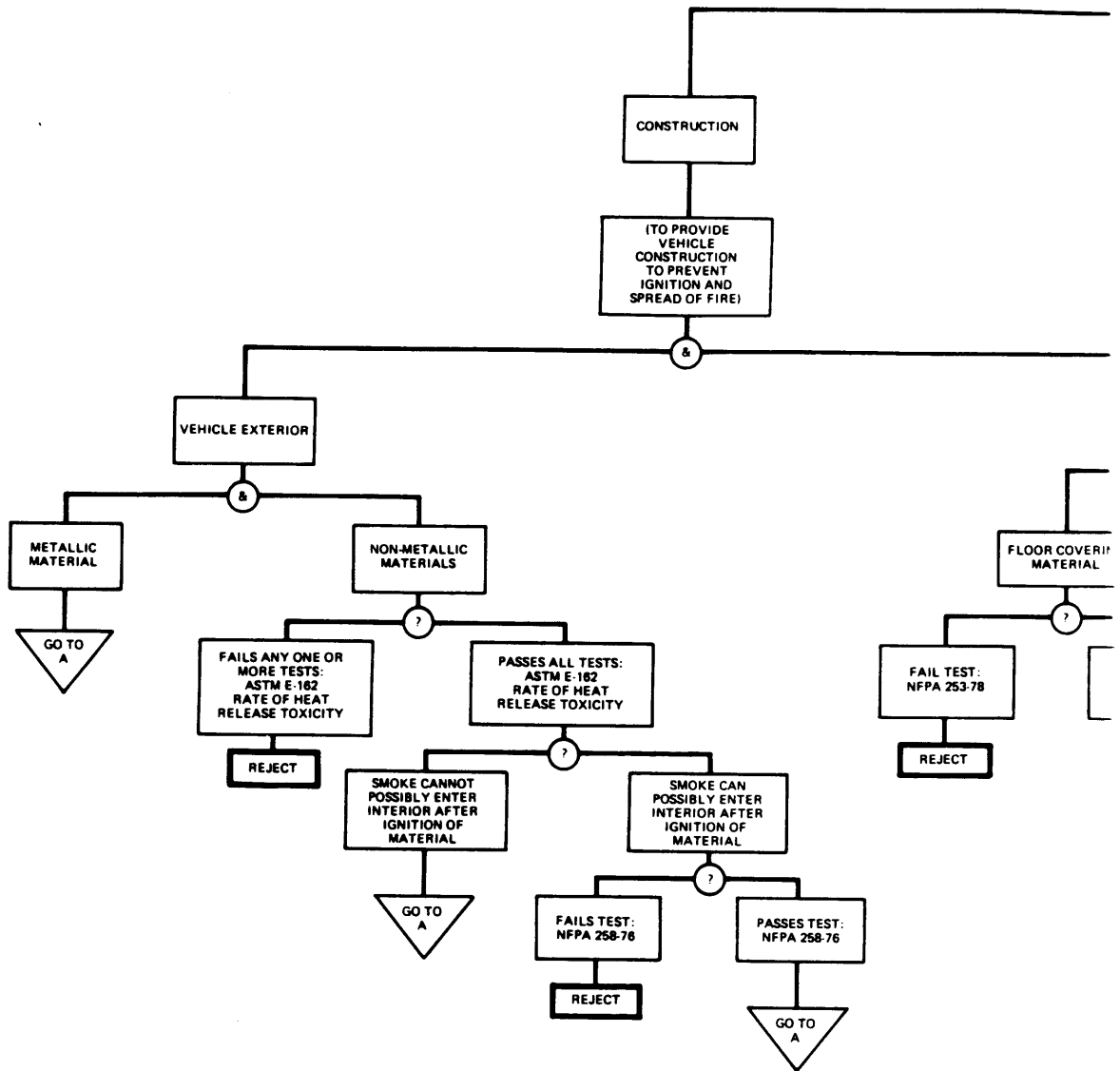












**FIGURE 10: VEHICLE FLAMMABILITY GUIDELINES**

- ⊗ - AND BRANCH - ALL ROUTES FOLLOWING BRANCH MUST BE EVALUATED.
- ⊙ - DECISION BRANCH - ROUTE TAKEN DEPENDS ON DECISION IN BOXES FOLLOWING POINT.
- ▽ - ENTRY POINT.



U.S. DEPT. OF COMM. BIBLIOGRAPHIC DATA SHEET	1. PUBLICATION OR REPORT NO. NBSIR 78-1586	2. Govt. Accession No.	3. Recipient's Accession No.
4. TITLE AND SUBTITLE FIRE SAFETY GUIDELINES FOR VEHICLES IN A DOWNTOWN PEOPLE MOVER SYSTEM		5. Publication Date January 1979	6. Performing Organization Code
7. AUTHOR(S) Richard D. Peacock	8. Performing Organ. Report No.		
9. PERFORMING ORGANIZATION NAME AND ADDRESS NATIONAL BUREAU OF STANDARDS DEPARTMENT OF COMMERCE WASHINGTON, DC 20234		10. Project/Task/Work Unit No.	11. Contract/Grant No.
12. SPONSORING ORGANIZATION NAME AND COMPLETE ADDRESS (Street, City, State, ZIP) Urban Mass Transportation Administration U.S. Department of Transportation Washington, D.C. 20591		13. Type of Report & Period Covered Final Report	
15. SUPPLEMENTARY NOTES  <input type="checkbox"/> Document describes a computer program; SF-185, FIPS Software Summary, is attached.		14. Sponsoring Agency Code	
16. ABSTRACT (A 200-word or less factual summary of most significant information. If document includes a significant bibliography or literature survey, mention it here.)  The results of a study to formulate fire safety guidelines to be required for vehicles used in Downtown People Mover (DPM) systems for the movement of people in a congested urban area are presented. Through a review of the design features of existing people mover vehicles and systems, and a review of proposed new systems, fire scenarios are developed and guidelines suggested to minimize the fire risk to passengers.  Methods and criteria, based on established test procedures, are proposed for assessing the flammability and smoke generation of interior finish and furnishing materials. Fire and smoke detection and suppression equipment are recommended, along with proposed guidelines for emergency evacuation provisions and emergency communication requirements.  An extensive bibliography of flammability in fixed guideway transit systems is included.			
17. KEY WORDS (six to twelve entries; alphabetical order; capitalize only the first letter of the first key word unless a proper name; separated by semicolons) Emergency communications; emergency evacuation; fire detection; fire safety; fire suppression; mass transportation; material flammability; people movers; smoke.			
18. AVAILABILITY <input checked="" type="checkbox"/> Unlimited  <input type="checkbox"/> For Official Distribution. Do Not Release to NTIS  <input type="checkbox"/> Order From Sup. of Doc., U.S. Government Printing Office, Washington, DC 20402, SD Stock No. SN003-003-  <input checked="" type="checkbox"/> Order From National Technical Information Service (NTIS), Springfield, VA. 22161		19. SECURITY CLASS (THIS REPORT) UNCLASSIFIED	21. NO. OF PRINTED PAGES
		20. SECURITY CLASS (THIS PAGE) UNCLASSIFIED	22. Price

