

CGSC

PAM 28-1

**Welfare, Recreation, and Morale
DINING-IN**

COMMAND & GENERAL STAFF COLLEGE

MARCH 1985

DEPARTMENT OF THE ARMY
 U.S. ARMY COMMAND AND GENERAL STAFF COLLEGE
 Fort Leavenworth, Kansas 66027-6900

PAMPHLET
 NO. 28-1

15 March 1985

Welfare, Recreation, and Morale

DINING-IN

	Page
INTRODUCTION	iii
CHAPTER 1. THE CUSTOMS AND TRADITIONS OF THE BRITISH REGIMENTAL MESS	1
2. THE CUSTOMS AND TRADITIONS OF THE UNITED STATES ARMY REGIMENTAL MESS	5
3. PLANNING AND CONDUCTING THE DINING-IN	9
Rationale Behind the Dining-In	9
Planning the Dining-In	10
Dining Room Arrangements	12
Mess Arrangements.	14
Program Planning	16
Protocol	20
Conducting the Dining-In	22
4. ETIQUETTE	25
Guests	25
Invitations.	26
Place Settings	27
Table Manners.	29

	Page
Appendix A. BASIC DUTIES CHECKLISTS FOR DINING-IN COMMITTEES . . .	A-1
B. SEATING AND TABLE ARRANGEMENTS	B-1
C. DIAGRAM OF THE TABLE SETTING	C-1
D. PUNCH CEREMONY	D-1
E. MENUS	E-1
F. SAMPLE MENU/PROGRAM	F-1
G. WINE CHART	G-1
H. SEQUENCE OF EVENTS FORMAT	H-1
I. VIOLATIONS OF THE MESS	I-1
J. RECEIVING LINE SKETCH	J-1
K. SKETCH OF WINE GLASSES	K-1
L. NOTES	L-1
M. BIBLIOGRAPHY	M-1

INTRODUCTION

The exact origin of the Dining-In is not known. It is believed, however, that the practice dates back to an old Viking tradition of holding formal ceremonies to celebrate great battles and feats of heroism. These ceremonies usually included a dinner of fine foods, drinks, and fellowship. Later this custom spread to the monasteries, universities, and, eventually, to the military officers' mess.¹

During the early eighteenth century, the British Army incorporated the practice of formal dining into their regimental mess system. Customs and rules of the mess were soon institutionalized in the Queen's Regulations that governed the actions and conduct of the British Army. The mess was a home for the bachelor officers, a club for all officers, and the center of social life at the military garrison.² An important feature of the mess was mess night. Usually held once a week, it was a formal mandatory gathering of the officers of the regiment. The purpose of the dinner was to bring the officers together in a fraternal atmosphere and to make them aware of the luxuries of life.³ The mess night or Dining-In became a tradition in all British regiments.

The close association between the British and American armies during the world wars led the United States Army to adopt the Dining-In as a part of its social program.⁴ The practice flourished during World War II and became a regular social function. Unfortunately, it is difficult to create a tradition, and the Dining-In lost favor among U.S. Army units in the postwar period. Moreover, the rapid turnover of officers in the American Army made it difficult, if not impossible, to establish loyal ties to a unit and its traditions. These facts added to the decline of the Dining-In.⁵

Today, the Dining-In appears to be making a comeback in many Army units and organizations. Senior commanders are again recognizing the value of the Dining-In for building professionalism and esprit de corps among the young officers. They recognize that the Dining-In is an ideal forum in which to strengthen and perpetuate the spirit, professionalism, and soul of the Army.

The purpose of this reference book is to assist those who would help spark a comeback for the Dining-In in the United States Army. It is intended as a source document for officers planning a Dining-In or Dining-Out in their units. It provides a brief history of the British and American regimental messes, a detailed explanation of the standards and procedures for conducting a Dining-In, and a short sketch of service etiquette as it applies to formal dining. There are many other books and pamphlets on the customs and traditions of the Army and service etiquette available to reinforce the information contained in this booklet. The most important sources are in the bibliography at the back of this book.

CHAPTER 1

THE CUSTOMS AND TRADITIONS OF THE BRITISH ARMY REGIMENTAL MESS

1-1. To understand the evolution of the Dining-In, one must examine the origin and procedures of the British regimental mess system. It developed and established several lasting customs and traditions that British and American military units still practice today in their formal dining programs.

1-2. In the early eighteenth century, there were no barracks for the British soldiers. Upon entering a town, the officers and men were quartered wherever lodging was available. They posted the unit colors at the officers' billet, which became the central meeting place for all officers awaiting orders from their commanders. The fraternal atmosphere that developed from these meetings fostered esprit de corps and camaraderie. The billet became known as the officers' mess.¹

1-3. During the latter decades of the eighteenth century, some regiments did not have their own mess. Consequently, many British officers turned to taverns as their source of communal life. It was not until the nineteenth century that the mess proper became an established part of the British Army.²

1-4. The regimental mess served many important functions. It was not only a practical method of dining in large units, but it provided an opportunity for the officers to become better acquainted, and it developed a sense of cohesion among the officers of the command. It was also an educational experience for the younger officers. They received training that enabled them to serve as hosts of formal gatherings when they became senior officers. Besides entertaining guests, the formal mess nights served to impress upon the officers the luxuries of life and gentlemanly behavior.³

1-5. Not all the advice given to the junior officers, however, recommended civil, gentlemanly conduct. Francis Grose, an adjutant of the militia, provides a recommendation for different behavior in his Advice to Officers of the British Army, written in 1782:

If you belong to a mess, eat with it as seldom as possible, to let folks see you want neither money nor credit. And when you do, in order to show that you are used to good living, find fault with every dish that is set on the table, damn the wine, and throw the plates at the mess-man's head . . . if you have pewter plates, spin them on the point of your fork, or do some other mischief, to punish the fellow for making you wait.⁴

Subsequent events occurring in the regimental messes indicated that many British officers heeded Grose's advice.

1-6. Despite its official purposes, the mess was a constant source of satire and upheaval among the officers of the regiment. Jealousy and bickering often animated the mess.⁵ This volatile environment led to practical jokes, horseplay, and, on occasions, duels.⁶

1-7. An incident that occurred in the 85th Light Infantry mess in the early nineteenth century demonstrates just how turbulent affairs could be among the British officers. The atmosphere among the officers of the regiment became so charged with jealousy and bickering that bitter quarrels, challenges, and fights erupted. Court-martials became the order of the day. To alleviate what soon became an uncontrollable situation, all the regiment's officers were reassigned to other units. The new officers assigned to the 85th Light Infantry became known as the "elegant extracts," a title that later became the regiment's nickname.⁷

1-8. Duelling, the ultimate arbitration among gentlemen, was perpetuated by the mess. There were several instances whereby otherwise mild-mannered officers were impelled into a duel by their fellow officers of the mess. Although the regimental commander tried to keep duelling down, he could not police every incident.⁸ Occasionally, even he was forced into this gentlemanly code of chivalry. One such incident, involving the 10th Hussars, occurred in 1824. The regiment's colonel, the marquis of Londonderry, ordered a young officer, Cornet Battier, out of the mess for behavior unbecoming an officer. A heated altercation ensued, and the colonel met Battier with pistols. Battier's pistol misfired, and his opponent offered him another chance. Battier declined and left the field of honor. He was later horsewhipped by Sir Henry Hardinge, the marquis's second.⁹

1-9. With the repression of duelling in the 1850s, a period of practical joking and horseplay evolved in the British Army. This new form of entertainment soon became an integral part of the regimental mess system. Because cohesion and brotherhood were considered virtues in the British officers corps, the misfit or nonconformist was quickly identified and became the target of practical jokes. Officers felt duty bound to torment this unfortunate soul with every kind of practical joke imaginable. Common practices included forcing open the door to the victim's quarters, breaking his windows, damaging his furniture, and placing all kinds of strange objects in his bed. In the field, his tent cords were loosened in stormy weather. The poor chap was either driven into conformity or out of the regiment.¹⁰

1-10. At Sandhurst similar practices were believed to be an educational process necessary for developing an iron will in the timorous officer. The "curriculum," administered by noble classmates, included shovelling, a process highlighted by placing the student on a table and striking him with shovels; "ventilating," a procedure whereby the victim was tied to a ventilator and struck with forks; and blanket-tossing. Another instructional technique included kidnapping the student, stripping him naked, and leaving him on the parade field. It was believed that the

educational value of this latter practice would reap great benefits in later life. The theory was that anyone who could walk naked into a guardhouse was certainly unlikely to be embarrassed by any future social mishap.¹¹

1-11. The Sandhurst graduates carried their levity and buffoonery with them into the British Army. Of course, it found its way into the regimental mess. To maintain a certain degree of propriety, yet still allow for some fun, most regiments set aside certain nights for joking, horseplay, and general mayhem. The activities included cockfighting, where two officers were tied together and had to overthrow each other; high cockalorum, where one set of players leaped astride the arched backs of another set in an attempt to overthrow them; wrestling; wall-scaling; and roof-climbing.¹² Other notable events on the mess night agenda included such feats of derring-do as drinking a glass of water while standing on one's head and a version of "Simon Says" where the penalty for failing to follow instructions was the immediate consumption of a glass of liquor.¹³ As a matter of honor, the senior officers present felt compelled to join in the revelry.

1-12. Although the behavior of the officers in the British regimental mess seems wild enough, it was exceedingly tame when compared with the acts practiced by the czar's officers in St. Petersburg. There, two officers with loaded pistols were locked away in a dark room. As the officers roamed cautiously about the room, they took turns crying out "Coo Coo," while the other fired in the direction of the sound.¹⁴ It is not known how many Russian pigeons were bagged playing this dangerous game.

1-13. Not all events surrounding the regimental mess were lighthearted or dangerous. There were occasions of solemn formality when all officers were expected to act in a highly mature and dignified manner. A breach of such behavior could result in rebuke, challenge, and even court-martial. An example of the severe consequences of inappropriate behavior is an incident that occurred in the regimental mess of the 11th Light Dragoons, later Hussars, in 1840. The inspector-general of cavalry visited the regiment and was invited, along with other foreign guests, to dine in the mess. Although the occasion called for champagne, Capt. John Reynolds, at the request of a guest, ordered a bottle of Moselle and placed it corked on the table. The regimental commander, believing the bottle contained ale, was outraged. To him, such an act was an unpardonable sin. Captain Reynolds was reminded by the regimental commander that "the mess should be conducted like a gentleman's table and not like a tavern or pothouse."¹⁵ Eventually, Reynolds was ordered out of the regiment. His banishment, however, did not terminate the issue. The officers of the regiment received an official reprimand from the commander in chief of the British Army which stated in part that "the rules and regulations of the service require strictly from all officers that they should conduct themselves as ought gentlemen in every situation in which they may be placed."¹⁶

1-14. Although the preceding incidents and events are amusing, the real legacy of the British regimental mess was its perpetuation of customs and traditions. Many of them are still very much a part of the formal mess procedures in the British and American Armies. Several incidents involving the proposing and drinking of toasts are worthy of a short explanation.

1-15. Some British regiments do not drink a toast to the king. This custom arose because "they so distinguished themselves in battle that the king excused them from the symbolic proof of loyalty represented by drinking to his health."¹⁷ In short, they are "above suspicion."¹⁸

1-16. The Royal Navy is allowed to remain seated while toasting the king. This unorthodox procedure resulted from the excruciating pain experienced by the prince of Wales when he struck his head on the low beam of a ship while standing for a toast. Reportedly, he remarked, "When I'm king, there'll be no such foolishness." When he became king, he made good his promise.¹⁹

1-17. Another interesting British tradition stems from the exploits of the 14th Light Dragoons, later the 14th Hussars. After defeating the French at Vittoria in the Peninsular War, the regiment captured Joseph Bonaparte's personal coach. The most prized treasure taken from the vehicle was the emperor's silver chamberpot, which is still in the regiment's mess. On special occasions, the "unholy grail" is filled with champagne and passed around the dinner table.²⁰

1-18. In conclusion, the rich tradition of the regimental mess is still alive in the British Army. All regiments hold a mess night regularly; it is comparable to our Dining-In. The Queen's Regulations require all bachelor and unaccompanied officers to attend, unless duly authorized to be absent. Although the regimental commander may specify the dress for the occasion, it is usually the formal dress uniform. The president of the mess committee presides over the mess with the colors, standards, and guidons displayed behind him. Regimental trophies, relics, and souvenirs are displayed on a table nearby. Although events are somewhat more civil than those in the past, the evening is still a combination of solemn formality and light-hearted camaraderie.

1-19. It is recognized that some of the hazing and games may have been counter productive in the installation of good leadership principles and respect for individual dignity and thus have been mitigated. The gathering of the officers for exchange of banter, professional discussion with quest speakers, and a bonding of the unit leadership should be retained.

CHAPTER 2

THE CUSTOMS AND TRADITIONS OF THE UNITED STATES ARMY REGIMENTAL MESS

2-1. The United States Army regimental mess was not an established institution as were those of the European armies. Consequently, our mess procedures lacked uniformity. Today, there are only a few customs and traditions associated with our early regimental messes.¹ This scarcity is attributed to the divergent customs and sociological paradoxes prevalent in this vast land of ours. For example, in the eastern United States, formal dinners were popular among the more social regular and militia units stationed around Boston, New York, Philadelphia, and Washington. Along the isolated posts of the western frontier, however, formal dining was not stylish among Army officers. Dining-In seemed incongruous in a primitive land of buffaloes and Indians.²

2-2. It was not until the beginning of the twentieth century that the officers' mess began to flourish. Even then, they were officers' clubs and not permanent messes comparable to those of the British Army.³ It was during this period, however, that the United States Army began to establish rigid rules for formal dining. Special attention was given to proper dress, etiquette, and other social customs. For example, if an officer arrived late, he was expected to submit a formal apology to the mess members before taking his seat. Moreover, the formal dinner was strictly a male affair. If women were present, they were accommodated only in an emergency and served in a room away from the formal dining area.⁴

2-3. Following World War I, the custom of formal dinners in the United States Army declined in popularity. Fortunately, some units continued the practice on special occasions. Their source of inspiration and guidance was Lieutenant Colonel James A. Moss's Officer's Manual, published in 1917. Recognizing the need for instructions on formal dining procedures in the Army, Moss produced an informative guide based primarily on European rules taken from a consensus of American officers who attended regimental messes at home and abroad.⁵ His book outlined the proper procedures for the conduct of the mess.

2-4. The primary purpose of the regimental mess was "to promote cordiality, comradeship, and esprit de corps."⁶ It was not only a place where the bachelor officers dined, but also the regimental hearthstone where, at certain intervals, all the regiment's officers were required to dine together.⁷ Capt. Charles Miller, addressing the 2d Provisional Officers'

Battalion of the Army Service Schools at Fort Leavenworth in April 1917, described the mess as follows:

It should be the place where the colonel and lieutenant meet in the social equality of gentlemen in that camaraderie and good-fellowship which teaches the youngster respect and affection for his seniors, and the elders, kindness and consideration for the juniors; it should be the place where are forged the links that bind the regimental front unbroken to the outside world . . . ; it should be the place where dwells the spirit and the soul of the principles that have made the regiment and that have preserved intact its prestige, its honor, and its tradition.⁸

In short, the regimental mess became the single, most important means of building esprit de corps and professionalism among the officers.

2-5. Although the mess was primarily social, the meals, especially dinner, were semiofficial. The colonel, or senior officer, presided over the dinner. The officers of the mess assembled and, upon his arrival, followed him into the mess and took their seats after he had taken his. He was seated at the head of the table with the lieutenant colonel, or next ranking officer, to his right and the adjutant to his left. The other officers were seated according to rank on both sides of the table. Dinner was a formal affair with everyone wearing the dress uniform.⁹

2-6. To provide the proper atmosphere for the occasion, it was the custom to display the regiment's souvenirs in the mess.¹⁰ This tradition, of course, came from the British Army. For example, the 8th Horse, later 7th Dragoon Guards, of the British Army displayed a set of French kettledrums in its mess. These trophies were captured by the regiment at the battle of Dettingen in 1743.¹¹

2-7. Regimental dinners were usually conducted in two parts; the formal dinner and the informal, after-dinner smoker. The formal part terminated with a procedure known as "removing the cloth," also a British custom. The "cloth" was officially removed when the senior officer received his cup of coffee. No officer could leave the table before the changeover without being excused by the presiding officer. Moreover, at important dinner functions no officer was allowed to leave before the departure of the presiding officer.¹²

2-8. If the regimental chaplain or some other "man of the cloth" was present at the dinner, he was invited to say grace before dinner. This was done by a mere inclination of the presiding officer's head. Additionally, guests were introduced to the presiding officer before the meal began.¹³

2-9. The regimental mess was the appropriate setting to teach the new officers the importance of proper dress, social grace, and genteel living. The newly commissioned officer was encouraged to use his pay and allowances

to "live with the quiet dignity becoming his station."¹⁴ Also, he was instructed that he owed it to the service to "dress and live, though simply, yet always like a gentleman."¹⁵

2-10. In conclusion, the practice of Dining-In was never a consistent part of the social life of the American army officer; at best, it was an intermittent affair. This important tradition, however, was kept alive in the Army by a few dedicated and farsighted commanders who understood its value in building esprit de corps among the officers. Although the United States Army was influenced by the British, many of the customs and traditions of its Dining-Ins are uniquely American.

CHAPTER 3

PLANNING AND CONDUCTING THE DINING-IN

3-1. This chapter is a guide for officers who plan, conduct, or participate in a military Dining-In. For clarity, it is divided into three primary sections that explain the rationale behind the Dining-In, procedures for planning the agenda, and methods for conducting the program. Subparagraphs in these sections further explain in detail the important considerations, tasks, and procedures for accomplishing each activity.

3-2. Although this chapter is intended as a comprehensive guide, local resources, unit traditions, and command desires may require additions, deletions, or changes to the procedures listed herein.

Rationale Behind the Dining-In

3-3. The Dining-In is a formal dinner held by a military unit or organization.

The rationale prompting the event may vary. The dinner may be held to welcome new arrivals or to say farewell to departing personnel; to recognize the achievements of an officer, a dignitary, or a unit; to build and maintain esprit de corps among the officers of the command; or to take advantage of the availability of a distinguished guest to speak.¹

3-4. With the addition of female officers, the Dining-In has changed from being a stag affair. Moreover, some units occasionally invite spouses. This is an excellent opportunity to introduce the spouses to the Army's history, customs, and traditions, and their attendance often stimulates greater interest and participation in the event. When spouses are included, the dinner is referred to as a Dining-Out or "Stepping Out."

3-5. The motivation for attending the Dining-In should be a sincere desire on the part of the unit's officers for camaraderie and perpetuation of a tradition; not the coercion of a command performance.² The real benefit of the dinner comes from wanting to attend, not having to attend. When invited, however, each officer of the command should consider his attendance as obligatory. Absence should occur only for valid reasons and with the approval of the commanding officer.

3-6. Dining-Ins are often held on special occasions such as the birthday or some other significant event in a branch of the Army or a unit. Regardless of the occasion, the Dining-In should be held frequently if it is to accomplish its intended purpose of improving morale within the command. Anything more frequent than two or three times a year, however, tends to lessen the desire for celebration and imposes a financial burden on the junior officers.

Planning the Dining-In

3-7. The reason for the Dining-In and the kinds of guests invited will influence the overall planning process and the conduct of the affair. For example, if a foreign dignitary is to be welcomed at the dinner, special attention must be given to specific points of protocol: a flag of the dignitary's country must be acquired for display; and an appropriate toast must be planned for the head of state of the guest's country. If spouses are invited, their attendance must be considered in the formation of the receiving line, the arrangement of tables and chairs, and the selection of entertainment and games.

3-8. Regardless of the reason for the Dining-In, the key to a successful execution of the program is proper organization and meticulous planning, which can only be accomplished by organizing committees and assigning tasks early in the planning process.

3-9. Organization and Responsibilities of the Dining-In Officials and Committees. Two officers are responsible for the successful execution of the Dining-In. They are the President of the Mess and Mr. Vice. The President is normally the commanding officer of the unit or organization holding the Dining-In. He presides over the dinner or appoints his second in command as the ex officio presiding officer. The President of the Mess or his presiding officer appoints Mr. Vice. In the selection process, the appointing authority should seek a junior officer with keen wit and a fine sense of repartee who can stimulate table conversation.³

3-10. Duties of the President of the Mess or his Presiding Officer. The President of the Mess or his presiding officer oversees the entire organization and operation of the Dining-In. For the purpose of continuity and clarity, the term "President" will be used throughout the remainder of this chapter to denote the person responsible for planning and presiding over the Dining-In.

a. In addition to appointing Mr. Vice, the President sets the date and place of the Dining-In, obtains the speaker, designates a host, and appoints persons or committees to handle the arrangements, food, and protocol for the event.

b. During the Dining-In, the President greets all guests before dinner, opens and closes the mess, presides over the mess throughout the evening, introduces the guest speaker and honored guests to the mess, and calls upon Mr. Vice to perform any duty deemed appropriate for the conduct of the affair.

3-11. Duties of Mr. Vice. Mr. Vice plays a key role in planning the event and assists the President of the Mess in ensuring the success of the Dining-In.

a. Before the event, he monitors the activities of the planning committees to keep himself abreast of the progress of the preparations phase. Moreover, he performs specific duties as assigned to him by the President. He may be called upon to handle reservations, plan the entertainment, select the menu, and supervise the cleaning of the unit silver. He also ensures that the unit trophies and souvenirs are ready for display and that all colors and standards are available and in good order.⁴

b. During the Dining-In, Mr. Vice assembles the members of the mess at the specified time by sounding the dinner chimes. He makes the appropriate toasts and provides poems, witticisms, and limericks relating to personalities present at the dinner. These recitations will be done in good taste so as not to embarrass the persons to whom they are directed. Mr. Vice tests the meat course before it is served to the other members of the mess and announces whether or not it is fit for human consumption.⁵ Moreover, he is the only member of the mess who may address items of interest to the mess members without the President's permission.⁶ He is the first to arrive and the last to leave the mess.⁷ Mr. Vice is seated at the end of the banquet hall facing the President of the Mess. If possible, he should be provided his own table.

3-12. Appointment of Planning Committees and Hosts. As required, committees are appointed by the President to assist in the planning and execution of the Dining-In.

a. The most important committees are those for dining room arrangements, mess arrangements, program, and protocol. The duties of each of these committees are explained in the appropriate subheadings below. Also, a checklist for each committee is at appendix A. The President designates a chairman for each committee and assigns the number of officers to each committee to perform the tasks. The committee chairmen report to the President periodically on the progress of their committees.

b. The President assigns hosts or escorts to contact the invited guests before the Dining-In to inform them of the mess customs, dress, agenda, and other requirements as appropriate. If required, they arrange for transportation and quarters for the guests.⁸

3-13. Selecting a Date and Location for the Dining-In. Before the planning gets under way, a suitable date and location must be selected for the Dining-In. The best time for a formal dinner is Friday or Saturday night, and the best place at a military post is the local officers' open mess. Military mess personnel are more experienced with Dining-In procedures and familiar with military customs and traditions. Also, care must be taken to ensure that the Dining-In does not conflict with some other social event scheduled at the club at the same time. A second event might detract from the ability of mess personnel to support the Dining-In effectively.⁹

Dining Room Arrangements

3-14. Table Arrangement and Seating. The table arrangement for the Dining-In depends upon the facilities available and on the number of attendees. The tables may be round, square, or oblong and positioned in one of several configurations depending upon the layout of the dining area. The head table, however, should be a long single table, and no one should be seated across from the persons at the head table. So that all members of the mess have sufficient elbow room, tables should not be crowded.¹⁰ Moreover, sufficient space should be left between tables to allow waiters to carry out their duties. Several basic table arrangements are shown at appendix B.

a. Regardless of the table arrangement, special attention must be given to the layout and seating of the head table to preclude embarrassment to the command. The President sits in the center with the most distinguished guest at his right. The next most distinguished guest is at his left and so on alternately across the head table until all are accounted for in order of relative rank or importance.¹¹ If the President is not the commanding officer of the unit, he still sits in the center with the most distinguished guest at his right and the commander to his left. The other guests are alternated to the President's left and right in order of rank. It is customary for all guests to sit at one table. Appropriate seating arrangements for the head table are also shown at appendix B.

b. Protocol for seating civilian or foreign guests dictates governmental, ecclesiastical, and diplomatic precedence. Some key points to consider are as follows:

(1) A younger official takes precedence over an older one when the younger occupies a higher echelon.

(2) Military officers and noncommissioned officers are positioned by grade or rank.

(3) The guest of honor might not be seated in the ranking position unless his rank justifies it or unless the highest ranking guest concedes his position.

(4) When guests with no official rank are present, their places are determined by age, prominence, linguistic ability (when foreign persons are present), and congeniality. Nonranking guests may be placed between those of official rank in the most congenial way for all concerned.

c. Special attention must also be given to seating members of the other military services who are in attendance. If the officers all belong to the same service, they are seated by rank. If they are from different services, they are seated by rank in order of precedence of the service. For example, a colonel of the Army takes precedent over a colonel of the Air Force. If

there are guests of honor from the services of Allied nations, they are seated in the guest positions by rank; they are not considered in the overall seating by rank.¹²

d. Although military protocol recommends that the other members of the mess be seated according to seniority, it is a good practice to seat by organization. Each unit should be assigned its own table with the unit commander responsible for deciding the seating arrangements for his table. Using a modified "E" configuration with the tables perpendicular to the head table, all units will have some members adjacent to the head table. This procedure also allows the subordinate commanders to sit with their units, and their presence enhances control during the event.

e. Mr. Vice should be seated at the foot of the other tables of the mess, preferably at his own table.¹³

f. When spouses are present at the Dining-In, the guest of honor's spouse is seated to the right of the President; the second ranking spouse is to his left. The President's spouse is seated to the right of the guest of honor.¹⁴ The spouses of the members of the mess are seated to their right.

g. To prevent confusion and wandering about in the dining area, a diagram depicting the location of tables and names of persons seated at each table should be promptly displayed near the entrance to the dining room. The seating chart should be neatly prepared and easily understood. Moreover, place cards should be prepared and positioned at each table setting.

3-15. Table Settings. The formal table is set with sterling silver, a damask cloth, fine china, and crystal glassware. There should be a centerpiece of flowers flanked by silver candlesticks or candelabra. A diagram depicting the appropriate table place setting is at appendix C.

3-16. Flag Displays. At the Dining-In, all flags are initially displayed to the rear of the receiving line. The flag line is arranged in order of precedence with the flag of the United States at the right of the receiving line, the observer's left, regardless of the order or location of persons in the line.¹⁵

a. In the dining room, the national colors and distinguishing flags are displayed in the flag line arranged in a centered position behind the head table.¹⁶

b. The colors and flags are normally displayed in a row, arranged in order of precedence, with the colors of the United States at the left of the line (as seen by observers). If the colors and flags are grouped and displayed from a radial stand, the colors of the United States will be in the center and at the highest point of the group. The colors of the United

States will always be displayed when foreign national flags, state flags, the United States Army flag, and other organizational colors are displayed.¹⁷

c. The order of precedence of national colors and distinguishing flags are as follows:

- (1) The colors of the United States.
- (2) Foreign national colors (displayed in English alphabetical order).
- (3) The flag of the President of the United States.
- (4) State flags displayed in the order that the state was admitted to the Union.
- (5) Military organization colors in order of precedence or echelon. When more than one service color is represented, the order of service creation is used. The order is Army, Marine Corps, Navy, and Air Force.
- (6) Personal flags in order of rank. Only one general officer star flag per grade is displayed regardless of the number of general officers present in that grade. When more than one service is represented, star flags from each service are displayed with the flag of the senior officer(s) preceding the others.¹⁸

Mess Arrangements

3-17. Cocktails. A predinner cocktail period provides an excellent forum for fellowship and allows the President the opportunity to circulate among the guests. The period is for lighthearted conversation and entertainment. Conducted in an area separate from the dining room, it should not exceed 30 minutes.¹⁹

a. During the cocktail period, it is customary for each member of the mess to greet the President. Although it is the specific responsibility of the President to greet each official guest as he arrives, it is also the duty of all members to introduce themselves and extend their amenities to each of the guests.²⁰

b. During the cocktail period, conversation should be short and light. Each mess member should attempt to talk with as many comrades and guests as possible.²¹

c. Some organizations serve a special punch or alcoholic beverage during the cocktail period. For example, field artillery units often incorporate additional ceremony into the Dining-In by concocting their

elaborate Artillery Punch and serving it to the assembled members of the mess. It must be remembered, however, that the beverage should be of appropriate alcoholic strength to allow moderate consumption while maintaining the solemnity of the occasion throughout the formal dinner. Also, an alternative, nonalcoholic drink should be available for those who desire it. The description of a Punch Ceremony is at appendix D.

d. At the conclusion of the cocktail period, Mr. Vice signals for the commencement of the dinner. The mess members, except those seated at the head table, retire immediately to the mess and stand behind their chairs. Drinks, cigarettes, cigars, and pipes will not be carried into the dining room.

e. When the members of the mess are assembled, the President, with the honored guest on his right, leads the other members of the head table into the mess. When they are in position, Mr. Vice reports to the President that the members of the mess are assembled. The President then orders the appropriate customs such as posting of the colors, toasts, and other formalities that initiate the program.²²

3-18. Menu. Although the Dining-In is a formal occasion, it is not a cold and formidable affair. The food served at the function should be of the best quality, be expertly prepared, and be served in an efficient and timely manner.

a. The dinner may consist of from three to seven courses depending on the facilities available and the expenses deemed appropriate. Customarily, four or five courses are served.²³ Examples of three-, four-, five-, and seven-course menus with appropriate wines are shown at appendix E.

b. A written menu should be prepared and placed at each table setting. The menu should contain the name of the organization giving the Dining-In; the date, time, and location of the Dining-In; and the food to be served.²⁴ A suggested format for the Dining-In menu is at appendix F.

3-19. Wines. Light wines are served with light dishes and heavy wines with heavy dishes. For example, a white Rhine is appropriate for hors d'oeuvres, fish, and white meats; a red Burgundy should be served with dark meats, game, and cheeses.²⁵

a. There are several generally accepted customs for serving wines. Dry wines should be served before sweet wines; white wines served before red ones; and light wines served before heavier ones. With few exceptions, wines are served at 45 to 60 degrees.²⁶

b. Champagne or a medium dry sherry is appropriate to serve with all foods throughout the dinner. Champagne is always served cold at 35 to 40 degrees. It should be cooled gradually in a refrigerator and placed in ice shortly before being used.²⁷

c. Wine should be served in clear, uncolored glasses of thin, plain design. The glass should never be poured more than two-thirds full. If a person does not want wine, he should express his desires in that regard or position his place card over the glass. He should not turn his wine glass upside down.²⁸

d. Cordials and liqueurs provide a perfect ending to a delicious dinner. They are served with after-dinner coffee in tiny glasses, for they are strong and stimulating. Normally, a choice of two liqueurs is offered. Some people often prefer brandy or cognac.²⁹

e. A wine chart showing the proper wine for each course of the meal and its recommended serving temperature is at appendix G.

Program Planning

3-20. Sequence of Events. Although there is no strict format for conducting the Dining-In, the evening's activities are usually divided into three distinct parts: assembly, dinner, and social activities.³⁰

a. During the assembly part, cocktails should be served, the receiving line formed, and any traditional unit ceremonies carried out. The ceremonies may include the mixing of a special punch or the installation of a unit trophy, insignia, or emblem in a special place of honor.³¹

b. The dinner part includes serving the meal, toasts, after dinner remarks, and any scheduled or impromptu events initiated by Mr. Vice or the members of the mess. The beginning and end of the dinner portion of the Dining-In are marked by the invocation and benediction as well as the posting and retiring of the colors.³²

c. The social activities part includes serving liqueurs, playing games, or any other scheduled activities. It may continue as long as interest, participation, and good sense warrant.³³

d. If the Dining-In is to be a matter of tradition, careful consideration must be given to planning the sequence of events. As little change as possible should be introduced into future Dining-In programs in order that tradition may be maintained and perpetuated. An outline of an accepted sequence of events for Dining-In in the United States Army is at appendix H.

3-21. Ceremonial Toasts. While no longer spontaneous, the offering of ceremonial toasts is a traditional Army custom at the Dining-In. Although unit traditions and the desires of the commander dictate the procedures used, there are three general guidelines to be followed. First, the order and subject of each toast should be decided upon in advance and the President and guests should be advised of actions required of them. Second, toasts are usually offered at the conclusion of the meal, but they may be given before sitting down for the meal. When preliminary toasts are

offered, they are made with the wine appropriate for the first course.³⁴ Third, a toast is only offered to an office or institution, never to an individual.

a. The most frequent toasts offered at the Dining-In are to the President of the United States, United States Army, division, regiment, and unit, and to the spouses and sweethearts, regardless of whether they are present. These toasts are given in descending order of rank or importance. It is customary for the junior officer present to offer the traditional toast to the United States Army.

b. If a foreign guest is present, his head of state is toasted after the President of the United States. When more than one country is represented, the President of the Mess proposes a collective toast to the heads of their several states, naming them in order of the seniority of the representatives present. To this collective toast, the highest ranking foreign officer present will respond on behalf of all guests by proposing a toast to the health of the host's head of state. Toasts are an important and often ambassadorial part of the Dining-In. Consequently, they must be meticulously planned before the event to preclude error.³⁵

c. During the toast, each officer stands with raised glass. Because several toasts are offered in succession, the member should not empty his glass when toasting. There are two exceptions to this policy. The final traditional toast to the Army and the toast to national sovereigns such as the President of the United States are drained in one drink.³⁶

d. Traditionally, the practice of using "gunners" is followed in some messes to ensure the wine flasks are kept full and all the mess members' glasses are continually charged, for it is improper to toast with an uncharged glass. Usually, this duty is assigned to the junior person at each table. This practice, however, is not used during the formal passing of the port for toasting.³⁷

3-22. Entertainment. Entertainment may be included in the formal and informal portions of the Dining-In.

a. Entertainment for the formal part of the Dining-In usually includes a speech by the guest of honor, background music, and a few limericks and ditties by members of the mess. Policing violations of the mess during the dinner and assessing penalties for those violations may also serve as a source of entertainment.

b. If entertainment is to be a part of the informal portion, there should be a distinct break between the formal and informal parts of the program. Following the formal part, the mess should be adjourned to the lounge or bar to allow the dining room to be cleared and prepared for the informal ceremonies. Each time the mess is adjourned and reassembled, the members allow the persons at the head table to depart and return before them.³⁸

3-23. Music. Background music during the dinner is encouraged because it tends to make the meal more enjoyable. Regimental airs, traditional military tunes, and dinner music are considered appropriate. Music may also serve as entertainment during the informal part of the program.³⁹

3-24. Limericks and Ditties. Certain messes include the tradition of chiding or poking good-natured fun at fellow members of the mess through limericks and ditties. This is a form of self-generated entertainment during the dinner hour and serves to enhance camaraderie and unit esprit while remembering the formality of the occasion. If they are used, limericks and ditties should be written in advance.

a. The procedure normally followed is for the member who wishes to propose a limerick to first secure permission from Mr. Vice and then present his limerick. If the humor in the limerick or ditty is not readily apparent to all members and guests of the mess, a brief explanation, but not to divulge the humor, should be offered so all present can share in the wit. Upon receiving a limerick, a group or a person is bound by honor to refute the remark before the close of the dinner hour, lest all present believe the remark to be true.⁴⁰

b. An example of a ditty to a person on orders to Ranger School and slightly overweight might be: "Rangers have to dart, so why have you made eating an art?" Another possibility for an information officer who has been unable to get his unit's news published in the local paper is:

It has been told
By a man of old
That your efforts at news
Have been void
In the Post Tabloid.

c. Limericks or ditties can be posed by a member of the mess to another regardless of rank. Items of personal or unit sensitivity, those which might cause embarrassment, and, of course, those detrimental to the officer's career are never proposed. It is imperative that all members of the mess remember the formality of the evening and the purpose behind limericks. Personal vendettas and attacks upon notable or sacred institutions, politics, and women are never in good taste. Remember, a limerick should be witty to all, elicit a response from the person being attacked, be in good fun and taste, and not cause the person making it or the recipient undue embarrassment.⁴¹

3-25. Games. Games are an important part of the Dining-In tradition. If well planned and properly conducted, they tend to develop camaraderie and teamwork among the officers. Certain games require the units to select teams and conduct rehearsals before the Dining-In. This stimulates additional interest in the event and encourages officers to attend.

a. Imagination, common sense, and good judgment should govern the planning of games. Games that show irresponsibility and lack of self-discipline should be avoided. Also, when planning games, it should be kept in mind that some activities that are normally safe may be dangerous after the participants have indulged in alcoholic beverages. Remember, it is not necessary to be destructive or to have fun at the expense of others for the affair to be a success.⁴²

b. If games are a part of the Dining-In, awards should be given to the winners. It is important that the awards be tangible objects such as plaques or certificates. Many recipients will cherish these mementos and display them proudly for years to come. They will serve as a reminder of the esprit de corps of the unit and help perpetuate the tradition of the Dining-In.

3-26. Rules of the Mess and Their Enforcement. During the dinner, the members of the mess are expected to conduct themselves with proper decorum and good taste. Any violations of the rules of the mess, breaches of etiquette, or anything else for that matter observed by other mess members will be subject to challenge. Any member of the mess wishing to challenge any other member for a violation of the rules or any other impropriety must first be recognized by Mr. Vice. Upon being recognized, the challenger stands, faces the President, and states his challenge. A typical exchange between a member of the mess and Mr. Vice might be:

Member of the Mess: "Mr. Vice, I request permission to address the President of the Mess."

Mr. Vice: "Granted, Sir" or "Denied, Sir." (If permission is granted, Mr. Vice says, "What is the nature of your inquiry?")

Member: "I wish to challenge Major Jones and ask that a penalty or fine be levied against him for toasting with an uncharged glass."

Mr. Vice: "Granted" or "So noted."
"Major Jones may rebut."

After the officer has presented his rebuttal, the President will rule on the validity of the transgression and, if appropriate, assess a penalty or fine.

a. Although many units levy fines for mess violations, it is recommended that some other form of penalty be used. Collecting money may lead to criticism of the person directing it and does not really punish the violator. Instead of imposing a fine, it is recommended that the violator be required to perform some feat of physical prowess or demonstrate his knowledge of some military topic within a very stringent time limitation. A penalty of this sort will deter further violations of the mess and serve as an added source of entertainment.

- b. A list of common mess violations is shown at appendix I.

3-27. Color Guard Support. The posting of the colors is an important traditional ceremony associated with the Dining-In. Great care should be taken in selecting and training the Color Guard personnel.

- a. The Color Guard should be recommended by the unit's command sergeant major. It should comprise a noncommissioned officer in charge, a bugler, a drummer, a flutist, three color bearers, and two color guards. To present the most favorable impression, all members of the Color Guard should be approximately the same height.⁴³

- b. The organization of the Color Guard from right to left is as follows: 1st guard, colors of the United States, flag of the United States Army, organizational colors, and the 2d guard. The drummer and flutist play "To the Colors" as the colors are being presented. The bugler should be used to sound "Mess Call."⁴⁴

- c. The formality of the Dining-In should be maintained for the support personnel. The noncommissioned officer-in-charge should wear the Army blue or green Uniform with white shirt and black bow tie. Members of the Color Guard should wear the green uniforms with helmet liners appropriate for ceremony, branch scarves, and stripped pistol belts.⁴⁵

- d. The key to a successful performance by the Color Guard is critical selection of the guard personnel, dedicated training, and many rehearsals.

Protocol

3-28. Guests and Invitations. Because the Dining-In is closed to all persons except the members of the command, the attendance of guests merits special attention. There are two types of guests.

- a. Official and personal guests. Official guests are those guests who are invited by the President and hosted by the command. An example of an official guest is the guest of honor, who may be a distinguished civilian, a prominent foreign national, a senior official of the United States Government, or any other person whom the President wishes to honor. Officers of other armed services and the armed services of foreign nations are often invited as official guests. The expenses of the official guest(s) are shared by all the members of the mess.⁴⁶

- b. Personal guests are invited only with the permission of the President of the Mess. Examples of personal guests are key noncommissioned officers and Department of the Army civilians of the command. If personal guests are permitted, their expenses are paid by the persons who invited them.⁴⁷

c. It is important that the senior noncommissioned officers, the command sergeant major, the staff sergeant majors, and first sergeant are occasionally invited to the Dining-In. As the link between the officer and enlisted ranks, these noncommissioned officers help forge the bond that binds the unit together toward a common goal. The feeling of camaraderie and esprit de corps that these noncommissioned officers gain from participating in the Dining-In will find its way to the soldiers of the command.

d. If the command does not have an assigned chaplain, the post chaplain should be invited by the President. If a foreign dignitary is invited as the guest of honor, his interpreter or a person who speaks his language should also be invited.

e. Invitations should be formally extended to the members of the command about two weeks before the event. This will allow them sufficient time to plan for the event on their social calendars, but not so far in advance as to preclude their knowing whether they can attend. The R.S.V.P. date of the invitation should be at least one week before the Dining-In. Guests should respond to the invitation within 72 hours of its receipt.⁴⁸

3-29. Uniform and Dress. Because the Dining-In is a formal occasion, black tie is the appropriate dress. It is the designation used on invitations. Military personnel wear the black bow tie with one of four appropriate uniforms: Army blue, Army blue mess, Army white, or Army white mess. The "black tie" designation also implies the wearing of miniature medals on the Army blue mess or Army white mess uniforms and the wearing of ribbons and miniature or regular medals on the Army blue or white uniforms.⁴⁹ Civilian men wear a tuxedo or dark civilian suit; civilian women wear an evening dress or a dinner dress.

3-30. The Receiving Line. The Dining-In may be embellished by a receiving line immediately before the cocktail period. If a large organization is conducting a Dining-In, its members may be directed to proceed through the receiving line at staggered intervals. In a smaller unit, the members may proceed through the line upon arrival.⁵⁰

a. Although a receiving line may be formed from the right or left, the preferred method is from right to left. It is formed in order of rank with the President of the Mess at the right of the line with the guest or guests of honor immediately to his left. The adjutant is positioned to the right of the President.⁵¹ A sketch of a receiving line is at appendix J.

b. As the mess members proceed through the receiving line, they announce their names to the adjutant, but do not shake hands with him. The mess members should never assume that the adjutant will automatically remember their names, even though they may consider themselves to be friends. The adjutant will in turn introduce each mess member to the President; handshakes and greetings are exchanged. The President then

introduces the mess member to the person on his left and the procedure is repeated throughout the receiving line. If the mess member's name is forgotten during the process, he should repeat it to the person being greeted. As they proceed through the line, mess members should always face the person being greeted and move promptly to the next person. Conversation with the members of the receiving line should only be engaged in when progress through the line is delayed.⁵²

Conducting the Dining-In

3-31. After meticulous planning for the Dining-In is completed, the final key to a successful event is rigid adherence to the agenda. The sequence of events format at appendix H basically explains how the formal program should be conducted. This section provides further explanation of the main events of the Dining-In program.

3-32. Forming the Mess. Mr. Vice sounds the chimes to begin the formal portion of the Dining-In. The members of the mess move immediately into the dining room and stand behind their chairs. The President leads the guests to their respective table assignments. The President then calls the mess to order, raps the gavel once, and announces, "Post the colors."

3-33. Posting the Colors. Before the President's command, the noncommissioned officer in charge (NCOIC) places the Color Guard in a rank formation, the colors at the carry (slings), and the guards at right shoulder arms. Upon the signal of the President of the Mess to post the colors and with the role of the drum and sound of the flute, the column advances at half step to the front of the head table. The NCOIC then commands "Mark time," "Halt!!" when the Color Guard is aligned. He then reports to the President, "Sir, the colors are formed." The President acknowledges his salute and replies, "Post the colors!" The NCOIC salutes, and the President acknowledges the salute. The NCOIC then marches the Color Guard to the stands, halts them, and faces them toward the flag stands. He then commands "Present arms!" and orders the color bearers to "Post the colors!" The colors are posted by the Color Guard in the following order: United States colors, United States Army flag, and organizational colors. After the colors are posted, the NCOIC commands, "Port arms!" then "Left face!" He then commands "Right shoulder arms!" and marches the Color Guard to the nearest exit.⁵³ Note: All commands by the NCOIC should be at a low tone and directly to the members of the Color Guard. If there is limited overhead space in the dining area, the colors and weapons should be carried at port arms.

3-34. Invocation. After the colors are posted, the President calls on the chaplain or other appropriate person to give the invocation. The invocation is optional and may be omitted or tailored so as not to prove offensive to persons of other sects or religions.⁵⁴

3-35. Toasts. Toasts are offered in accordance with the instructions stated earlier in this chapter. As a reminder, all toasts should have been decided on in advance of the program.

3-36. Welcoming Remarks by the President and Introduction of Distinguished Guests. After the initial toasts, the President seats the mess, remains standing, and proceeds with his welcoming remarks. His remarks should set the tone for the formal part of the ceremony. He then introduces the distinguished guests at the head table. The guests rise when they are introduced and then take their seats. If there is a group of foreign dignitaries at the head table, the ranking official rises and introduces the other foreign guests, who stand when announced and then take their seats.⁵⁵

a. After the guests have been introduced, Mr. Vice rises and proposes a toast: "To our guests!" All members of the mess rise, hold up their glasses, respond, "Hear, Hear!" and drink the toast.

b. The President then announces, "Please be seated for dinner!" All members of the mess take their seats.

3-37. Actions During Dinner. At a large Dining-In, it is customary for the members of the mess to begin eating immediately after being served. This procedure results in part of the mess finishing its main course while the remainder is still eating. Often, this leads to excessive conversation among the mess members and other activities that may cause the dinner to degenerate into a loud, confusing affair. To prevent this from happening and to maintain better control over the tempo of the dinner, the President should announce that no one will start eating until he starts. Efficient mess personnel can accomplish this technique without letting the food of those being served first to become cold. Regardless of the procedure used to control the dinner, the key concern is to ensure that the food is still warm when the mess members eat it.

a. During the dinner, a member of the mess may wish to be recognized for some appropriate reason. If so, the member will stand and ask to be recognized by saying, "Mr. Vice, I have a point of order." Mr. Vice responds by calling the person's rank and name, at which time the member states his point of order in a polite and forthright manner. Mr. Vice may then solicit the recommendation or action of the President or take appropriate action on his own.⁵⁶

b. Smoking is not permitted during the dinner. After dinner, it is authorized only after the President orders the smoking lamp to be lit. The smoking lamp is a single candelabra with new white candles or a clear glass kerosene lamp. It should be placed on a lone table visible to the entire mess. If Mr. Vice is seated at a separate table in view of the entire mess, the smoking lamp is positioned on his table. He lights and extinguishes the smoking lamp as directed by the President.

3-38. Introduction of the Guest Speaker and the Speech. The President introduces the guest speaker. The guest of honor's speech should be a short presentation on a subject entertaining or of professional interest to the members of the mess. It is delivered as the last item on the formal agenda of the mess and is normally the highlight of the evening.⁵⁷

3-39. Toast to the Guest Speaker. Formality dictates that Mr. Vice propose a toast "To our distinguished speaker!" at the end of the speech. Upon his proposal, all members of the mess rise, hold up their glasses, respond "Hear! Hear!" drink the toast, and sit down.

3-40. Retiring the Colors. Upon command of the President of the Mess, the NCOIC moves the Color Guard in reverse order to the front of the head table. The President commands, "Retire the colors!" Salutes are exchanged, and the NCOIC moves the Color Guard to secure the colors. He halts the detail and commands "Present arms!" The appropriate color guards secure the colors. The NCOIC commands "Port arms!" then "Right shoulder arms!" and marches the Color Guard at the half step to the nearest exit with the 1st color guard leading, followed by the colors of the United States. After the color guard clears the dining area, the colors are cased.⁵⁸

33-41. Adjourning and Departing the Mess. After the colors are retired, the President provides the appropriate closing remarks and adjourns the mess with two raps of the gavel. After the mess is adjourned, members should remain until the guest of honor and the President have departed. If there is to be an extensive delay in their departure, the President may allow members to leave at their discretion. Mr. Vice should be the last member to leave.

3-42. Informal Entertainment. A period of entertainment may be scheduled following the formal dinner. If so, the games and events should have been planned by an entertainment committee in accordance with the information provided earlier in this chapter.

CHAPTER 4

ETIQUETTE

4-1. What is etiquette? Webster's dictionary defines etiquette as "the forms required by good breeding, social conventions, or prescribed by authority, to be observed in social or official life; the rules of decorum."

a. Etiquette is important in the official and social functions of the armed services. As representatives of the United States Government, Army officers are judged not only by their professional abilities but also by their manners in social and official life.¹

b. Although several tools of etiquette were discussed in the previous chapter of this reference book, there are some other important rules to be considered by persons participating in the formal Dining-In. These include the preparation of the guest list; the selection of the proper place setting for the table, glasses, and other eating utensils; and the use of socially approved table manners. This chapter highlights the most important of these rules as they pertain to the Dining-In.

Guests

4-2. The selection of the guest list is an important function in the planning process for the Dining-In. It is prepared in accordance with the desires of the commander of the unit hosting the function. If the list includes dignitaries, coordination should be made with the appropriate protocol office to insure that the proper rules of etiquette and protocol are adhered to.² Some of these are as follows:³

a. If the guest of honor is staying in a private home during his visit, it is courteous to include his host in the guest list.

b. If a foreign guest is invited to the Dining-In, it is appropriate to invite persons who have visited or have a special interest in the guest's country.

c. Language must be considered. If a foreign guest does not speak fluent English, it is important to have someone who speaks his language seated nearby to act as an interpreter or table companion.

d. The personality and interests of the guests should be considered in the seating arrangements. A person or persons with similar interests should be seated next to the guests.

e. Protocol requires that guests at the Dining-In be seated according to rank.

Invitations

4.3. Invitations to the formal Dining-In may be fully engraved, partially engraved, thermographed, or handwritten on the first page of folded white or cream-colored note paper. The paper should be six by seven or five by eight inches in size. Popular letterings are script and shaded antique Roman. The unit crest or insignia may be engraved on the paper.⁴ The invitations should be written in the third person and issued two or three weeks before the social occasion.⁵

4-4. Wording of Formal Invitations. The following general rules apply to the wording of formal invitations:⁶

a. Abbreviations and initials are to be avoided in the preparation of formal invitations. Exceptions are: "Mr.," "Mrs.," "Ms.," and "R.S.V.P." In those cases where an initial is always used in place of a first middle name, that initial may be used. For example, Lieutenant H. Perry Jones.

b. The date and hour should always be spelled out, but only the day and month are capitalized: Saturday, sixth of August. The year designation is never used in an invitation. The time on an invitation should be shown using standard time, not the 24-hour clock system, (that is, seven o'clock--not nineteen hundred hours).

c. Ranks, titles, and names are written in full: "Major General," "Lieutenant Colonel," etc. The exception to this rule is that "Second" and "First Lieutenant" are designated "Lieutenant."

d. The person or persons issuing or acknowledging invitations should refer to themselves by their full names: "Captain and Mrs. Paul Smith, Junior." (When the name is very long, "Jr." is correct). Guests or hosts, however, are designated by their last names only: "Major and Mr. Brown" or "Major and Captain Ulin."

e. "Black Tie," engraved in the lower right-hand corner of the invitation, means the dinner dress uniform or tuxedo.

f. R.S.V.P. means a reply is mandatory.

g. "Regrets only" means that only those who cannot attend the function need reply. When many guests are invited, this keeps correspondence to a minimum. When a telephone number appears on the invitation, you may answer by phone.

4-5. Replies to Formal Invitations. Follow these general rules when replying to a formal invitation:⁷

a. Replies should be written within 48 hours, preferably 24 hours after receipt of the dinner invitation.

b. Replies are handwritten in the third person on the first page of folded white or cream-colored note paper.

c. An acceptance should include your own full title and name; the title and surname of the host; and the date, time, and place of the social event.

d. A regret should include the same information as listed in subparagraph 3 above, except it should make no reference to the time or place of the event.

e. After accepting a formal invitation, you are committed to the event over all other invitations.

Place Settings

4-6. The formal place setting for the Dining-In is shown at appendix C. Remember, however, that this sketch is but one type of formal table setting. You may find fewer pieces before you, depending on the number of courses and the wines to be served. Some important tips related to the table setting and the use of the utensils found there are as follows:⁸

a. It is customary for the waiters to remove each set of knives and forks, used or unused, and each glass as the course for which they were set is finished.

b. A service plate will be part of the table setting, but it is not intended for use.

c. The table setting for a formal dinner has no butter plate. If bread is served, it should be placed on the table near the upper left edge of the plate.

d. A finger bowl is usually served before the last course on the plate intended for that course. Often a lace doily is under the finger bowl. The finger bowl and doily should be removed, and the bowl should be placed upon the doily to the upper left of the plate. The fork and spoon should be removed from the plate and placed to the left and right of the plate, respectively. Finger bowls will normally be served after any course that requires the use of the hands.

4-7. Forks. No more than three forks, not counting the oyster fork, and three knives are placed on the table when it is set. Butter knives and plates are never a part of the formal table setting.⁹

4.8. Wine Glasses. The types of wine glasses used depend upon the menu. Arrangement will always be according to size so that small ones are not hidden behind larger ones.

a. The water goblet is directly above the knives or to the right of the plate; at a slight distance to the right is the champagne glass; in front of and between these two glasses is the red wine glass or white wine glass; then further to the right is the sherry glass. Instead of grouping the glasses on the table, some mess personnel place them in a straight row slanting downward from the goblet at the upper left to the sherry glass at the lower right.¹⁰

b. The shape of the wine glass should be considered in the place setting. Generally, champagne is served in a wide-brimmed glass such as that shown in figure 1 below. Some connoisseurs, however, prefer the glass shown in figure 2. It is believed that this shape of glass tends to prolong the life of the bubbles and thus contributes much to the enjoyment of the wine. Wine glasses should be picked up by the stem rather than the bowl. This helps to keep chilled wines cool and enables one to appreciate the colors of the wine.¹¹

Other types of wine glasses are shown at appendix K.

4-9. Serving. The waiter will always serve the dishes from the diner's left and the beverages from the right. After the table is completely cleared, dessert will be served. At the end of the dinner, coffee and liqueurs may be served.¹²

Table Manners

4-10. Mastery of correct table manners is each person's responsibility. Some important tips are outlined below, but they are certainly not all inclusive. If in doubt as to a certain aspect of table etiquette, consult one of the many excellent etiquette sources, two of which are Emily Post's Etiquette and Oretha D. Swartz's Service Etiquette.

4-11. When to Start Eating. To ensure better control of the dinner, the President of the Mess should announce when he desires for the members to start eating. If this procedure is not in effect, it is appropriate to begin eating when those around you have been served.¹³

4-12. Selection of Silver. Silver is arranged to allow for the use of utensils farthest from the plate first, so take the next item in order with each succeeding course.¹⁴

4-13. Use of the Knife. The knife is always held in the right hand, with the handle in the palm and the index finger along the back of the blade. After the knife is used, it should never be placed on the table. Instead, the knife should be placed across the upper half of the plate or on the right side of the plate, with the blade facing in.¹⁵

4-14. Use of the Fork. The fork is held in the left hand while being used with the knife to cut food. The handle of the fork will rest in the palm, with the index finger extending along the back. At all other times, the fork is preferably held in the right hand, tines up, with the handle controlled by the thumb and first two fingers. The end of the handle should extend out between the thumb and index finger.¹⁶ After the fork is used, it should be placed on the plate below the knife or at the left and parallel to the knife with the handle at the right and the tines up.¹⁷

4-15. Use of the Spoon. When used to eat soup, the spoon should be dipped away from the diner, and then the side of the spoon placed to the diner's lip. When finished with the soup course, the diner should place the spoon in the soup plate with the bowl up, handle resting on the right rim of the plate. The spoon should not be placed on the under plate unless a light soup or consommé has been served in a cup or bowl at which time the spoon bowl is placed up on the right side of the under plate. When a spoon is used with coffee or tea, it should be placed with the bowl up on the right side of the saucer.¹⁸

4-16. Napkins. Napkins are placed on the place plate at formal dinners. After the invocation has been said, the diner should place the napkin, half unfolded, in his lap. To place the napkin smoothly, it should be picked up

by the right top corners and spread in one motion across the lap. At the end of the meal, the diner should place the napkin unfolded at the right of the plate.

4-17. How to Eat Chicken and Other Fowl. Broiled or fried chicken should be held with the fork in the plate while the meat is stripped off the bones with the knife. If the chicken is not greasy, the diner may hold it in his left hand against the plate while he strips the meat off with the fork.²⁰

4-18. Salad. Salad is cut and eaten with a fork. When iceberg lettuce is served, it may be cut with a knife and fork, then eaten with the fork.²¹

4-19. Ice Cream. Ice cream is served with a fork and/or spoon. The fork is for the solid part, the spoon for the softer part. It is always eaten with a spoon when served in a sherbet glass.²²

4-20. Finger Bowl. Finger bowls are frequently offered at formal meals after the serving of any food that is greasy or that must be handled. It is filled three quarters full with warm water. Only the fingertips, one hand at a time, are dipped into the bowl. The hands may be dried on the napkin.²³

4-21. Handling Wine Glasses. Long-stemmed water goblets or wine glasses should be held with the thumb and first two fingers at the base of the bowl. Small-stemmed glasses are held by the stems, and tumblers are held near the base. A brandy snifter is held in the palms of both hands to warm the liquor.²⁴

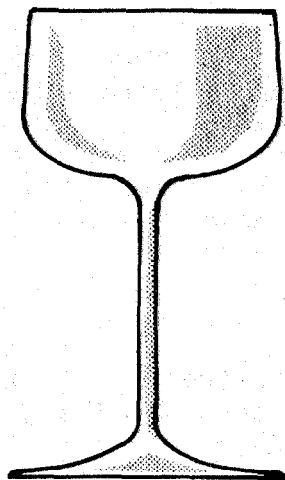

Figure 1

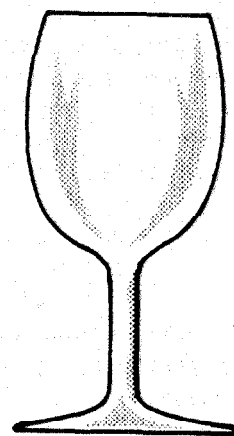

Figure 2

Other types of wine glasses are shown at appendix 11.

APPENDIX A

Basic Duties Checklist for Dining-In Committees

A-1. Program Committee

- a. Plan the sequence of events.
- b. Prepare and publish a detailed agenda for conduct of the Dining-In.
- c. In coordination with the Protocol Committee, prepare the appropriate toasts for the Dining-In.
- d. Plan the entertainment. This includes games, music, or any other activities decided upon.
- e. Obtain awards to be presented to the winners of the games.
- f. Arrange for public affairs coverage. This includes a photographer.
- g. Prepare a script for the President.
- h. Prepare reminder cards for the President and other key personnel who are scheduled to propose a toast.

A-2. Dining Room Committee

- a. Coordinate with the club for the appropriate table and seating arrangements.
- b. Prepare place cards. The cards should be prepared so that the lettering is readable from the standing position. Only the person's grade and last name are printed on the card.
- c. Prepare centerpieces for the tables.
- d. When appropriate, check and clean the unit's silver, crystal, and china.
- e. Request a podium with lights and microphones. The microphones should be conveniently located for the President, Mr. Vice, and the guest speaker.
- f. Arrange for two red carpets for the receiving line. They are to be arranged in the shape of an "L."
- g. Arrange for the appropriate flags and colors with stands.

- h. Ensure that the unit trophies, relics, and souvenirs are present and in good order.
- i. Obtain a gavel and board to be positioned at the President's table.
- j. Obtain a set of dinner chimes for Mr. Vice's table.
- k. Obtain a candelabrum or kerosene lamp to serve as a smoking lamp.

A-3. Mess Committee

- a. Reserve the dining facility for the appropriate date and time.
- b. Coordinate with the club on the selection of the menu and wines.
- c. Arrange for the cocktail lounge with bartenders.
- d. Coordinate with the club manager for the time and method of serving the food courses.
- e. In coordination with the Program Committee, prepare the menu card and program.
- f. If a Punch Ceremony is part of the predinner activities, order the required liquors and other beverages through the club.
- g. Order cigars for the after-dinner period. They should be quality cigars and can be ordered through the club.
- h. Establish a system for collecting funds from the attendees and payment of the mess charges.

A-4. Protocol Committee

- a. Coordinate with the commanding officer or President of the Mess in preparation of the guest list.
- b. Prepare and mail invitations to the guests at least sixty days before the Dining-In. These invitations will be signed by the commander or, when appropriate, the President.
- c. Distribute invitations to the members of the command at least fourteen days before the Dining-In.
- d. Advise the Dining Room Committee on the seating arrangements.
- e. Prepare the seating chart and post it in the lobby of the mess on the afternoon of the Dining-In.
- f. Prepare a biographical sketch of the guest speaker and other guests as required.

- g. Brief the President on protocol matters as required.
- h. Plan for and establish the receiving line.
- i. Prepare "thank-you" letters for the commander's signature and mail them to the guests following the Dining-In.
- j. Coordinate with and assist the Program Committee in the preparation of toasts.
- k. Coordinate with and assist the Dining Room Committee in the establishment of the flag line.

APPENDIX B

Seating and Table Arrangements

Example 1: Modified "E"

Flag Stand



Head Table



Trophy Table

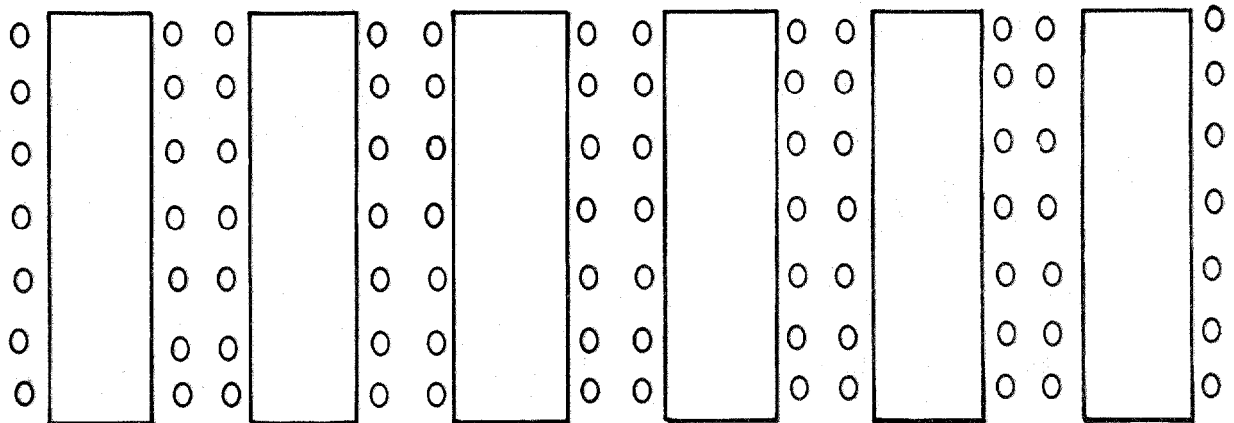

Legend

- President of the Mess
- 1. Guest of Honor
- 2. Commander



- 3.-7. Guests in order of Rank
- 8. Chaplain
- Mr. Vice
- Members of the Mess

NOTE: For large units, arrange the tables in a vertical fashion so that all units have some members near the headtable and no unit is totally at the back of the room.

Example 2: Long Head Table, any style membership tables

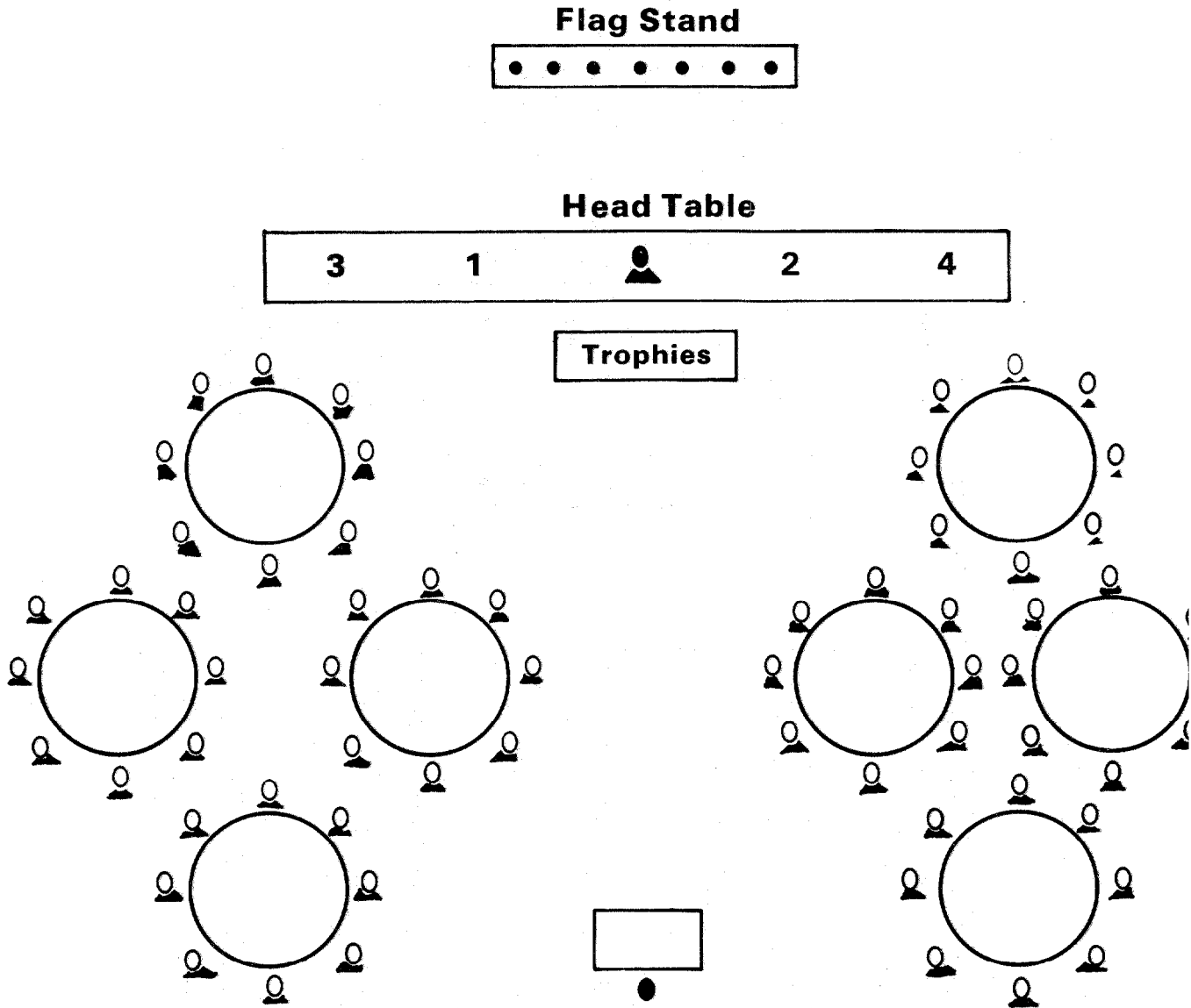

Legend

- = President
- 1** = Guest of Honor
- 2** = Commander
- 3** = Interpreter, if necessary
- 4** = Chaplain
- = Mr. Vice
- = Mess Members

32

Example 3: "U" or "Horseshoe" Table

Flag Stand

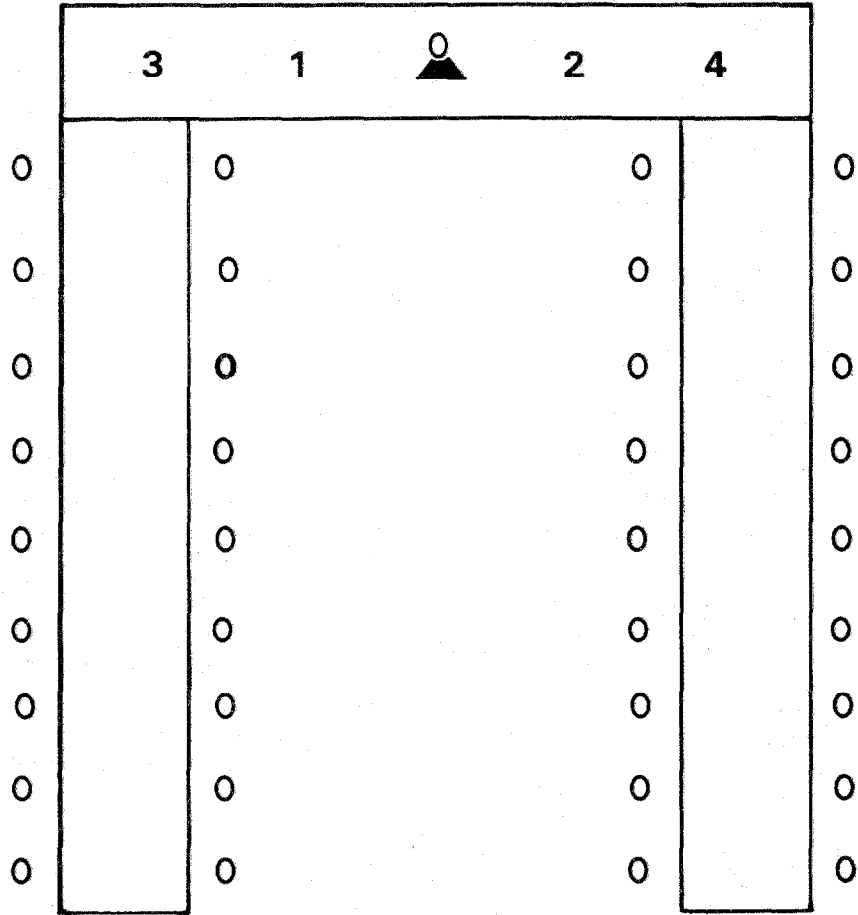

Legend

-  = President (Commander)
- 1 = Guest of Honor
- 2 = Guest (Order of Rank)
- 3 = Guest (Order of Rank)
- 4 = Chaplain
- = Mr. Vice
- 0 = Mess Members

37

APPENDIX C

Diagram of the Table Setting

1. The Menu Card
2. Fish Fork
3. Meat Fork
4. Salad Fork
5. Plate
6. Napkin and Place Card
7. Salad Knife
8. Meat Knife
9. Fish Knife
10. Soup Spoon
11. Oyster Fork
12. Champagne Glass
13. White Wine Glass
14. Sherry Glass
15. Red Wine Glass
16. Water Goblet

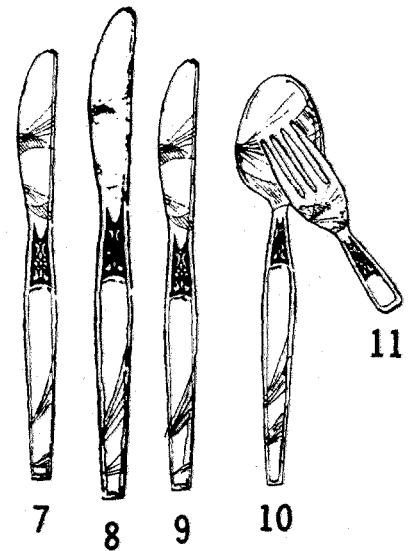
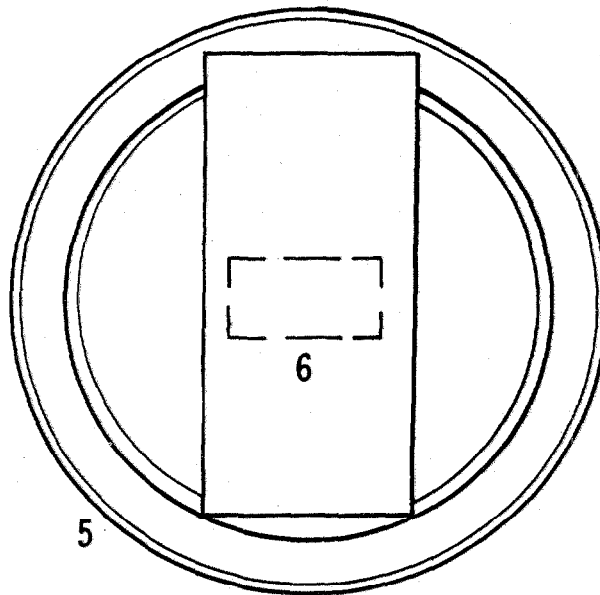
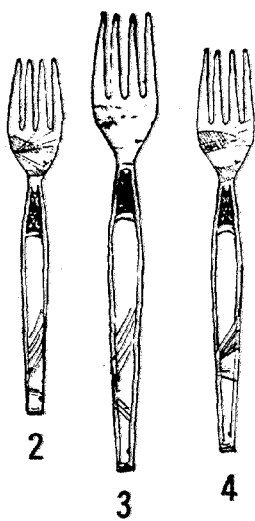
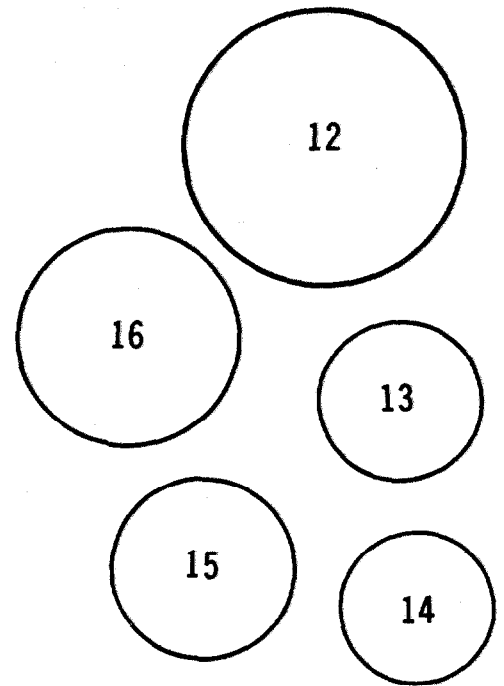

Note: Each glass is removed with the course it accompanies. The dessert wine glass, however, stays throughout the serving of the demitasse. The salad and fish knives may not be needed, and only two wines, sherry and champagne, may be served.

39

APPENDIX D

Punch Ceremony

D-1. GENERAL

The Punch Ceremony is held before the dinner in an area adjacent to the dining room. The purpose is to provide a proper forum for reading the unit lineage and concocting a mixture that embodies the experiences of the unit's past. The procedure requires a Master of Ceremonies, a Master of Punch, a mixer(s), and assistants. The basic duties of each are as follows:

a. The Master of Ceremonies serves as the narrator during the ceremony. He reads the lineage, explains the punch-mixing procedures, and oversees the functioning of the ceremony.

b. The Master of Punch oversees the mixing process to ensure that the proper ingredients are added in the required amounts at the appropriate times. He presents each bottle of spirits, or suitable substitute, to the presiding officer for approval before mixing, and he presents the first cup of the punch to the presiding officer after the punch is fully mixed. Some units prefer to have the junior officer, Mr. Vice, determine the fitness of the punch before offering it to the presiding officer.

c. The mixer pours the contents into the punch bowl in accordance with the directions given by the Master of Punch. If auxiliary punch bowls are used at a large gathering, additional mixers must be assigned. They mix the punch in accordance with the Master of Punch's instruction and follow the lead of the mixer at the main punch bowl.

d. A sufficient number of assistants should be detailed to serve a glass of punch to each VIP and official guest. They should also assist in serving the mess members as they file past the punch bowls.

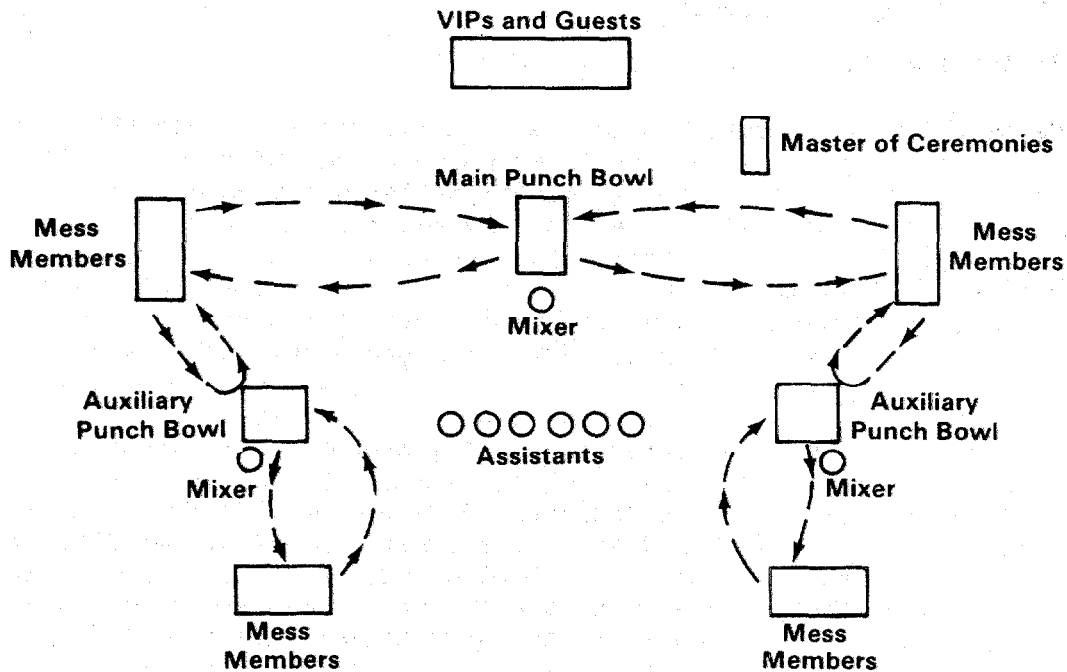

Figure D-1. Punch Ceremony Formation for a Large Dining-In.

D-2. Ceremony Procedures (Example of a Field Artillery punch ceremony):

a. The Master of Ceremonies normally reads a witty narrative describing the ingredients of the punch and their significance to the officers of the field artillery branch. This narrative varies from unit to unit and may include a short history of the artillery or a sketch of the life of Saint Barbara, the patron saint of field artillerymen. Some units hold a more serious ceremony by reading the lineage of the unit. Regardless of the narrative, the Master of Ceremonies must call out each ingredient of the punch sometime during his reading. As each beverage is named, the Master of Punch takes the bottle to the presiding officer for approval. After approval is obtained, the Master of Punch returns to the main punch bowl and pours the contents into the bowl. When auxiliary punch bowls are used, the other mixers follow suit. As soon as the punch is prepared and deemed acceptable, the Master of Punch presents the first cup to the presiding officer for his approval. Upon approval, the assistants give each member of the official party a cup of the punch. The other members of the mess file past the punch bowls in equal lines and each fills his cup half full of punch. The arrangement of the mess members into equal groups or sections and the designation as to which punch bowls they are to use should be

30

planned in advance by the Mess Committee. After all members have filled their cups and returned to their places in formation, the presiding officer proposes: "A toast to our heritage and comrades who have gone before us: May we serve our country and our unit in honor." Response by the mess members is: "To (unit designation)!"

b. Script for the Mixing of Artillery Punch:

Master of Ceremonies: "It is time for the Master of the Punch to come forward to prepare the punch in the centuries old tradition begun by stone hurlers and fusiliers."

Master of Ceremonies: "Artillery Punch has a long and glorious tradition and has been enjoyed by artillerymen wherever they gather: At socials such as this, during the heat of battle as a source of courage, or at any time a true artilleryman feels the need."

"Artillery Punch is a substantive brew of proven medical value. It will cure what ails you, or it will ensure that you don't care. We wean our children on it and carry it in our thermos jugs to ward off the winter's chill. In a pinch, it is an effective bore cleaner for the cannon, lubricant for the breech, or propellant for the missile."

Master of Ceremonies: "True artillerymen maintain a base for the punch in their homes at all times and enjoy it at their leisure. In preparation for our gathering, I took a quantity of my private stock, sealed it in a flippy, and buried it beneath a pig sty. There it has been aging and as tradition requires, on a moonless night last week, we dug it up and will now lay it down as a base for our punch."

(Master of Punch takes the flippy, brushes off the mud, and pours its content into the container in the punch bowl.)

Master of Ceremonies: "The base, ladies and gentlemen, traces its heritage to the Mecca of all field artillery men--Block House, Signal Mountain--and ensures that the base charge for our punch is correct and proper."

"Charge 2 is champagne, which signifies the quality of the artillery, the king of battle. As is well known, we artillerymen lend dignity by our mere presence."

"Charge 3 is good corn squeezins. These squeezins remind us of our earliest American heritage, our heritage of citizen soldiers who served honorably and well at a moment's notice and are in tribute to our contemporaries in the reserve components."

"Charge 4, a quality scotch, represents our British heritage, our noble allies with whom we have fought many rounds and with whom we, with our other allies, guard freedom today."

Master of Ceremonies: "Charge 5, a cognac, represents the French, who contributed so much to the winning of our national freedom and who have provided many fine artillery pieces for our Army."

"Charge 6 is a blended bourbon to serve as the catalyst to tie our punch together. It represents all the services of all men of arms of all nations and serves to remind us of our common bond and that no one arm can do it all: We must have a combined arms team on the field of battle."

"The final Charge is couth: Red, representing the color of artillery and reminding us of the blood shed by so many in pursuit of freedom."

Master of Ceremonies: (Takes a large spoon and stirs the punch, takes a small sip). "This punch is not quite right--something is missing. What have you forgotten, gentlemen?"

Designated Mess
Member:

(Holds up a sock) "This sock represents the basic soldier without whom we could do nothing, and these (waves women's nose) represent the ladies who make all things worth doing."

Designated Mess

Member:

(Holds up oil and primer). "This oil represents those iron monsters, the artillery pieces we have learned to love, and this primer is the needed item to get all things started--including our punch." (Mess member places items in the center bowl)

Master of Ceremonies: "I believe that did it. Now, I will have the most expendable member of the mess provide us an expert opinion as to the suitability of the punch. Mr. Vice, would you please come forward and taste the punch." (Master of Punch pours a cup of the punch and hands it to Mr. Vice, who drinks it and pronounces it fit to drink.)

Master of Ceremonies: (After the punch has been pronounced fit to drink by Mr. Vice). "(Name of the presiding officer or distinguished guest), would you please do the honor of tasting our punch?" (Master of Punch pours a cup of the punch and hands it to the (presiding officer or distinguished guest).

Presiding Officer or
Distinguished Guest:

(Drinks the punch and announces) "This is a fine fettle of a punch--suitable for all present."

The assistants then serve punch to the official party, and the other mess members file past the punch bowls, get a cup of punch, and return to their designated positions. Once everyone is in position, the presiding officer proposes the appropriate toasts. This concludes the Punch Ceremony.

c. Shortly after the conclusion of the Punch Ceremony, Mr. Vice signals for the mess to assemble. All mess members leave their punch glasses in the cocktail room, enter the dining room, and stand behind their chairs awaiting the entrance of the official party.

APPENDIX E

Menus

<u>Course Number</u>	<u>Course</u>	<u>Wine</u>
<u>E-1. Seven-Course Menu</u>		
1	Shrimp cocktail, oysters, clams on the halfshell	Chablis
2	Soup (usually clear)	Sherry
3	Fish (hot or cold)	Rhine
4	Main course of meat (usually beef) and vegetables	Claret
	or	
	Main course of game and vegetables	Burgundy
5	Salad	Claret/Burgundy
6	Dessert (ice cream, sherbet)	Champagne
7	Fruit (pears, grapes)	Champagne
<u>E-2. Five-Course Menu</u>		
1	Shrimp Cocktail	Chablis
2	Soup (usually clear)	Sherry
3	Main course of meat (beef) and vegetables	Claret
	or	
	Main course of game and vegetables	Burgundy
4	Salad	Claret/Burgundy
5	Dessert (ice cream, sherbet)	Champagne

<u>Course Number</u>	<u>Course</u>	<u>Wine</u>
<u>E-3. Four-Course Menu</u>		
1	Soup (clear)	Sherry
2	Main course of meat (beef) and vegetables	Claret
	or	
	Main course of game and vegetables	Burgundy
3	Salad	Claret/Burgundy
4	Dessert (ice cream, sherbet)	Champagne
<u>E-4. Three-Course Menu</u>		
1	Soup (clear)	Sherry
2	Main course of meat (beef) and vegetables	Burgundy
	or	
	Dessert (ice cream, sherbet)	Champagne
Notes: 1. Rolls, condiments, and after-dinner coffee are always served. Cigars are frequently served with the coffee, as is a port wine.		
2. These sample menus are reproduced from appendix A (Menu) to club management director booklet titled <u>Guide to Military Dining</u> .		

APPENDIX F

Sample Menu/Program

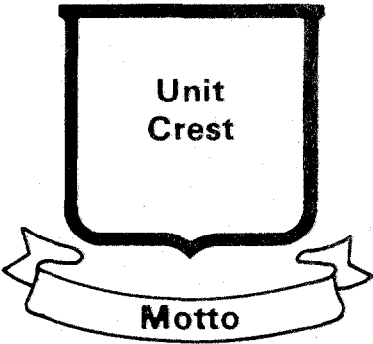
Back	Cover
<p data-bbox="508 495 707 527">Unit History</p> <hr/> <hr/> <hr/> <hr/> <hr/> <hr/> <hr/> <hr/> <hr/> <hr/>	<p data-bbox="1033 489 1318 521">Name of the Unit</p> <div data-bbox="992 576 1365 917"><p data-bbox="1135 651 1229 719">Unit Crest</p><p data-bbox="1130 874 1234 906">Motto</p></div>
Inside Cover	Inside Back
<p data-bbox="570 1253 664 1285">Menu</p> <hr/> <hr/> <hr/> <hr/> <hr/> <hr/> <hr/> <hr/> <hr/> <hr/>	<p data-bbox="978 1240 1381 1308">Notes appropriate to the program or evening</p> <hr/> <hr/> <hr/> <hr/> <hr/> <hr/> <hr/> <hr/> <hr/> <hr/> <p data-bbox="1161 1657 1408 1761">Signature of the President or Commander</p>

APPENDIX G

Wine Chart

<u>COURSE</u>	<u>WINE</u>	<u>HOW TO SERVE</u>
Shellfish or Hors d'oeuvre	Chablis	Cold-40 to 45 degrees
	Graves	"
	Rhine	"
	Moselle	"
Soup	Sauterne	Cold-40 to 45 degrees
	Dry Sherry	Room Temperature
	Madeira	Cool-50 degrees
Fish	White Bordeaux	Cool-50 degrees
	White Burgundy	Cool-50 degrees
	Rhine	Cool-50 degrees
	Moselle	
Roasts Red Meats	Fine Claret	Room Temperature
	Red Burgundy	Room Temperature
	Sparkling Burgundy	Cold-40 to 45 degrees
Roasts White Meats	White Bordeaux	Cold-40 to 45 degrees
	White Burgundy	Cool-50 degrees
	Champagne	
Fowl or Game	Fine Claret	Room Temperature
	Red Burgundy	"
	Rhone	"
Cheese	Fine Claret	"
	Red Burgundy	"
	Port	"
	Old Sherry	"
	Full-bodied Madeira	"
Dessert	Madeira	"
	Rich Old Sherry	"
Coffee	Cognac	"
	Port	"
	Old Sherry	"
	Madeira	"
	Liqueur	"

APPENDIX H

Sequence of Events Format

<u>Times</u>	<u>Events</u>	<u>Remarks</u>
1900	Members and guests arrive.	Upon arrival, the members proceed through the receiving line.
1900	Cocktails.	After the members go through the receiving line, they proceed to the cocktail area.
1940	Announcement by Mr. Vice for the personnel to take their places in the mess.	The members take their places behind their chairs. The smoking lamp is out.
1945	The President calls the mess to order.	One rap of the gavel.
1946	The President orders the posting of the colors.	Color Guard posts the colors.
1951	Invocation by the chaplain.	
1952	Toasts.	At this time, toasts are usually presented to the United States, the President, the Army, and the unit.
1955	The President announces: "Take your seats!"	
1956	Welcoming remarks by the President.	
1958	The President introduces the guests at the head table.	Applause is held as an appropriate toast will be proposed by Mr. Vice.
2000	The President seats the mess and dinner is served.	The members start eating only when authorized by the President and after Mr. Vice has announced that the food is fit for human consumption.

<u>Times</u>	<u>Events</u>	<u>Remarks</u>
2045	The President calls for a break with two raps of the gavel.	Members adjourn to the lounge or bar.
2100	Members return to the mess and remain standing until seated by the President with one rap of the gavel.	Dessert is served.
2115	Smoking lamp is lit by Mr. Vice.	Upon direction of the President.
2116	The President introduces the distinguished speaker.	
2117	Speech.	
2140	After conclusion of the speech, Mr. Vice proposes a toast to the distinguished speaker: "To our distinguished speaker."	Everyone rises and responds: "Hear! Hear!"
2141	Benediction by the chaplain.	
2142	The President calls for the retiring of the colors.	Color Guard retires the colors.
2146	The President gives the closing remarks.	
2147	The President adjourns the mess with two raps of the gavel.	Members of the mess remain standing behind their chairs until the guests have left.
2200	After-dinner entertainment commences.	As planned.

Note: These times merely illustrate the approximate duration of each of the events.

APPENDIX I

Violations of the Mess

-
- I-1. Untimely arrival at proceedings.
 - I-2. Smoking at the table before the lighting of the smoking lamp.
 - I-3. Haggling over date of rank.
 - I-4. Inverted cummerbund.
 - I-5. Loud and obtrusive remarks in a foreign language.
 - I-6. Improper toasting procedure.
 - I-7. Leaving the dining room without permission from the President of the Mess.
 - I-8. Carrying cocktails into the dining area before the conclusion of dinner.
 - I-9. Foul language.
 - I-10. Toasting with an uncharged glass.
 - I-11. Wearing a clip-on bow tie at an obvious list.
 - I-12. Rising to applaud particularly witty, succinct, sarcastic, or relevant toasts, unless following the example of the President.
 - I-13. Haggling over penalties or fines imposed.

APPENDIX J

Receiving Line Sketch

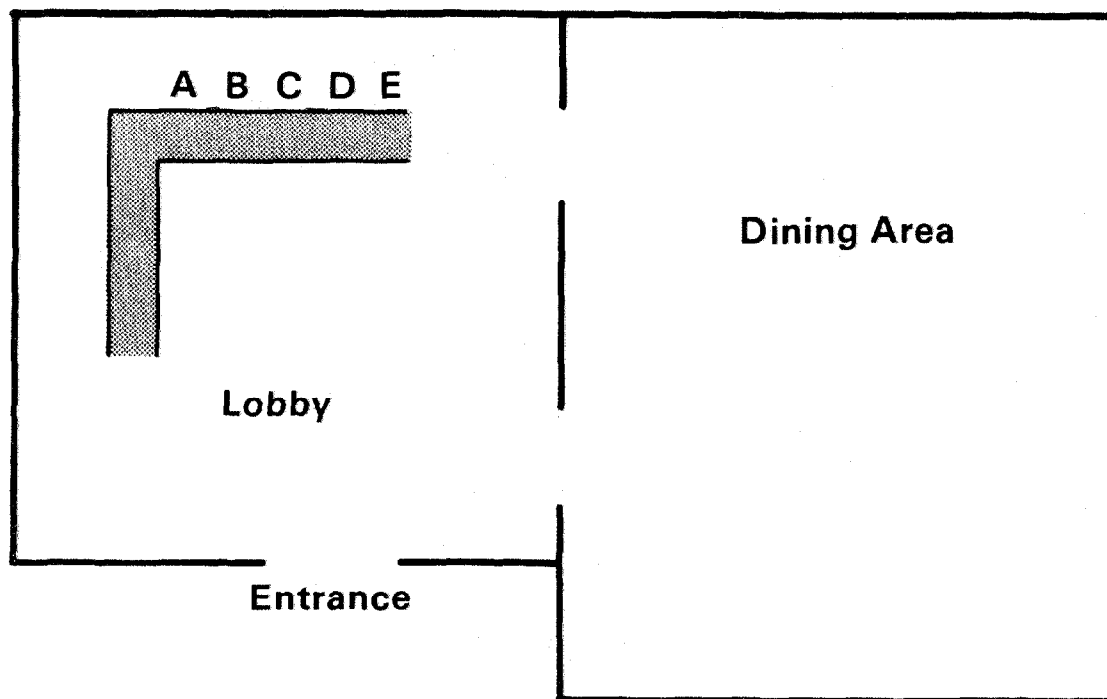

A = Adjutant
B = Presiding Officer
C = Honored Guest

D = Honored Guest
E = Commander

NOTES:

1. After all the VIPs have arrived, the announcement to take positions for the receiving line should be made after coordination with the Presiding Officer.
2. There should be no more than five persons in the receiving line. It should include the guests, the Presiding Officer, the Commander, and others as determined by the Presiding Officer.
3. Drinks will not be carried through the receiving line.
4. There will be no smoking in the receiving line.
5. Guests escorts should link-up with their guests immediately following the receiving line.

APPENDIX K

Sketch of Wine Glasses

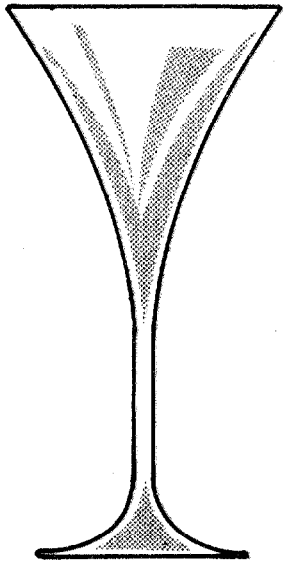

Flute Sherry

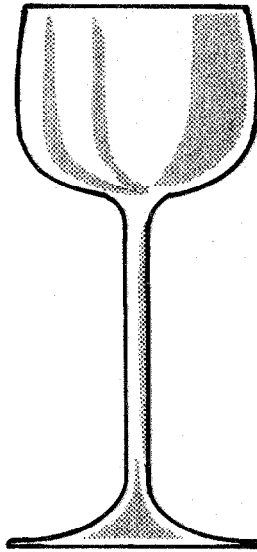

German

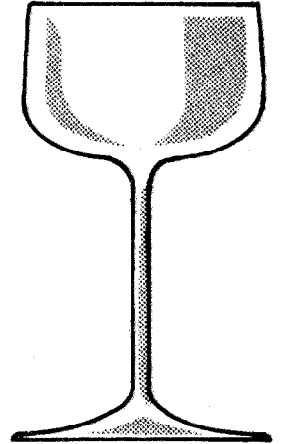

Alsace

White Wine

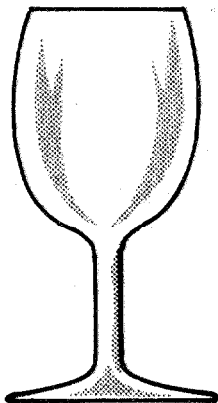

Bordeaux

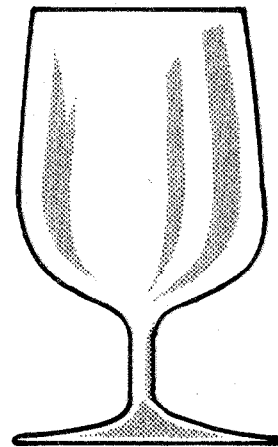

Burgundy

Red Wine

APPENDIX L

Notes

L-1. INTRODUCTION

1. Oretha D. Swartz, Service Etiquette (Annapolis: Naval Institute Press, 1977), p. 497.
2. Mark M. Boatner, Military Customs and Traditions (New York: David McKay Co., 1956), p. 150.
3. United States Army John F. Kennedy Center for Military Assistance, Dining-In Guide (Fort Bragg, NC, n.d.), p. 8 (hereafter cited as Dining-In Guide).
4. United States Army Club Management Directorate, This One Is for the Manager: Guide to Military Dining-In (Washington, DC: The Adjutant General Center, n.d.), p. 1 (hereafter cited as Guide to Military Dining-In).
5. Dining-In Guide, p. 3.

L-2. CHAPTER 1

1. Dining-In Guide, p. 8.
2. E. S. Turner, Gallant Gentlemen: A Portrait of the British Officer, 1600-1956 (London: Michael Joseph, 1956), p. 84.
3. Dining-In Guide, p. 8.
4. Turner, Gallant Gentlemen, pp. 82-83.
5. U.S. Army Training Center, 3d Brigade, Dining-Out Guide (Fort Leonard Wood, MD, n.d.), p. 3.
6. U.S. Army, Sergeants Major Academy, Formal Dining-In Handbook (Fort Bliss, TX, n.d.), pp. 2-3 (hereafter cited as Formal Dining-In Handbook).
7. Turner, Gallant Gentlemen, p. 165.
8. Ibid., pp. 176-77.
9. Ibid., pp. 168-70.
10. Ibid., pp. 213-14.

CGSC PAM 28-1

11. Ibid., p. 215.
12. Ibid., pp. 240-41.
13. Ibid., p. 241.
14. Ibid., pp. 241-42.
15. Ibid., p. 172.
16. Ibid., p. 173.
17. Boatner, Military Customs and Traditions, p. 137.
18. Ibid.
19. Ibid.
20. R. Money Barnes, A History of the Regiments and Uniforms of the British Army (London: Seeley Service and Co., 1950), pp. 93-94.

L-3. CHAPTER 2

1. Charles Miller, The Customs of the Service, Also Some Suggestions and Advice (Fort Leavenworth, KS: Army Service Schools Press, 1917), p. 16.
2. Dining-In Guide, p. 4.
3. Boatner, Military Customs and Traditions, p. 150.
4. Dining-In Guide, p. 4.
5. Ibid., p. 5.
6. Miller, The Customs of the Service, p. 16.
7. Ibid.
8. Ibid., pp. 16-17.
9. James A. Moss, Officers' Manual (Menasha, WI: George Banta Publishing Co., 1929), pp. 108-9.
10. Ibid., p. 108.
11. Barnes, A History of the Regiments and Uniforms of the British Army, p. 35.
12. Moss, Officers' Manual, pp. 108-9.

13. Ibid.
14. Ibid., p. 9.
15. Ibid.

L-4. CHAPTER 3

1. Swartz, Service Etiquette, p. 497.
2. Guide to Military Dining-In, p. 1.
3. Dining-In Guide, p. 10.
4. Swartz, Service Etiquette, p. 498.
5. Formal Dining-In Handbook, p. 9.
6. Dining-In Guide, p. 10.
7. Swartz, Service Etiquette, p. 498.
8. Ibid.
9. Guide to Military Dining-In, p. 1.
10. Swartz, Service Etiquette, p. 499.
11. The Officer's Guide: A Ready Reference on Customs and Correct Procedures Which Pertain to Commissioned Officers of the United States Army (Harrisburg, PA: The Stackpole Company, Military Service Division, 1961), p. 222.
12. Dining-In Guide, p. 20.
13. Swartz, Service Etiquette, p. 499.
14. Ibid.
15. Formal Dining-In Handbook, p. 13.
16. U.S. Department of the Army, Army Protocol and Social Usage: A Department of the Army Pamphlet Prepared to Assist Personnel in the Planning and Conduct of Official Entertainment (Washington, DC, 1968), p. 26.
17. Ibid., pp. 26-27.
18. Ibid.

19. Guide to Military Dining-In, p. 3.
20. Dining-In Guide, p. 11.
21. U.S. Army, Infantry School, Etiquette (Fort Benning, GA, 1969), p. 3 (hereafter cited as Etiquette).
22. Dining-In Guide, p. 11.
23. Guide to Military Dining-In, p. 2.
24. Dining-In Guide, p. 14.
25. Ibid., p. 21.
26. Ibid.
27. Ibid.
28. Ibid.
29. Ibid., pp 21-22.
30. U.S. Army, Infantry School, School Brigade, 1st Battalion, Formal Dining-In (Fort Benning, GA, 1974), p. 1-2 (hereafter cited as Formal Dining-In).
31. Ibid.
32. Ibid.
33. Ibid.
35. Formal Dining-In Handbook, p. 17.
34. U.S. Army, Infantry School, The Officers' Code, Customs, and Courtesies (Fort Benning, GA, 1969), pp. 12, 13 (hereafter cited as The Officers' Code).
36. Swartz, Service Etiquette, p. 501.
37. Formal Dining-In Handbook, p. 18.
38. Ibid.
39. Dining-In Guide, p. 15.
40. Formal Dining-In Handbook, pp. 15-16.
41. Ibid., p. 16.

42. Ibid., p. 12.
43. Ibid.
44. Ibid.
45. Ibid.
46. Dining-In Guide, p. 10.
47. Ibid.
48. Guide to Military Dining In, p. 2.
49. The Officers' Code, p. 34.
50. Etiquette, p. 17.
51. Ibid.
52. Ibid., p. 18.
53. Formal Dining-In, p. 1-5.
54. Guide to Military Dining In, p. 3.
55. Ibid., p. 4.
56. Formal Dining-In Handbook, p. 15.
57. Ibid., p. 18.
58. Formal Dining-In, p. 1-5.

L-5. CHAPTER 4

1. Swartz, Service Etiquette, pp. xiii-xiv.
2. Formal Dining-In Handbook, p. 20.
3. Mary Jane McCaffree and Pauline Innis, Protocol: The Complete Handbook of Diplomatic, Official, and Social Usage (Englewood Cliffs, NJ: Prentice-Hall, 1977), p. 214.
4. Swartz, Service Etiquette, p. 175.
5. Ibid.
6. Ibid., p. 176.

7. Ibid., pp. 176-77.
8. Etiquette, pp. 22-23.
9. Elizabeth L. Post, Emily Post's Etiquette (New York: Funk and Wagnalls, 1969), pp. 174-75.
10. Ibid., p. 175.
11. Ibid., pp. 180-81.
12. Etiquette, p. 23.
13. Ibid., p. 28.
14. Ibid.
15. Swartz, Service Etiquette, p. 263.
16. Ibid.
17. Ibid.
18. Etiquette, p. 29.
19. Swartz, Service Etiquette, p. 266.
20. Ibid., p. 267.
21. Ibid., p. 268.
22. Ibid.
23. Etiquette, p. 30.
24. Swartz, Service Etiquette, p. 266.

APPENDIX M

Bibliography

M-1. BOOKS

- Barnes, R. Money. A History of the Regiments and Uniforms of the British Army. London: Seeley Service and Co., 1950.
- Boatner, Mark M. Military Customs and Traditions. New York: David McKay Co., 1956.
- McCaffree, Mary Jane, and Innis, Pauline. Protocol: The Complete Handbook of Diplomatic, Official, and Social Usage. Englewood Cliffs, NJ: Prentice-Hall, 1977.
- Miller, Charles. The Customs of the Service, Also Some Suggestions and Advice. Fort Leavenworth, KS: Army Service Schools Press, 1917.
- Moss, James A. Officers' Manual. Menaska, WI: George Banta Publishing Co., 1929.
- Post, Elizabeth L. Emily Post's Etiquette. New York: Funk and Wagnalls, 1969.
- Stradling, A. H. Customs of the Services. Aldershot, NH: Gale and Polden, 1962.
- Swartz, Oretta D. Service Etiquette. Annapolis, MD: Naval Institute Press, 1977.
- The Officer's Guide: A Ready Reference on Customs and Correct Procedures Which Pertain to Commissioned Officers of the United States Army. Harrisburg, PA: The Stackpole Company, Military Service Division, 1961.
- Turner, E. S. Gallant Gentlemen: A Portrait of the British Officer, 1600-1956. London: Michael Joseph, 1956.

M-2. OTHER SOURCES

- U.S. Army. Infantry School. School Brigade. 1st Battalion. Formal Dining-In. Fort Benning, GA, 1974.
- U.S. Army. Club Management Directorate. This One Is for the Manager: Guide to Military Dining-In. Washington, DC: The Adjutant Center, n.d.
- U.S. Army. Infantry School. Etiquette. Fort Benning, GA, 1969.

CGSC PAM 28-1

U.S. Army. Infantry School. The Officers' Code, Customs, and Courtesies.
Fort Benning, GA, 1969.

U.S. Army. John F. Kennedy Center for Military Assistance. Dining-In
Guide. Fort Bragg, NC, n.d.

U.S. Army. Sergeants Major Academy. Formal Dining-In Handbook.
Fort Bliss, TX, n.d.

U.S. Army Training Center. 3d Brigade. Dining-Out Guide. Fort Leonard
Wood, MO, n.d.

U.S. Department of the Army. Army Protocol and Social Usage: A Department
of the Army Pamphlet Prepared to Assist Personnel in the Planning and
Conduct of Official Entertainment. Washington, DC, 1968.

The proponent agency of this pamphlet is the Combat Studies
Institute. Users are invited to send comments and suggested
improvements to the Director, Combat Studies Institute, U.S. Army
Command and General Staff College, ATTN: ATZL-SWI-A, Fort
Leavenworth, KS 66027-6900.

FOR THE COMMANDANT:

OFFICIAL

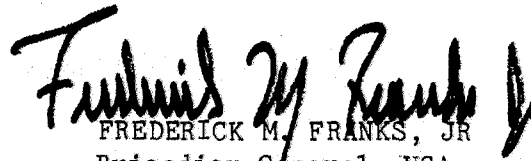
FREDERICK M. FRANKS, JR
Brigadier General, USA
Deputy Commandant

STEWART R. KIDD
Colonel, Armor
Secretary

DISTRIBUTION:
Special