

In Memory of
the Quiet Professionals
who have Paid
the Ultimate Price.

FOREWORD



Marshall Billingslea
Principal Deputy
Assistant Secretary of Defense
(Special Operations/Low-Intensity Conflict)



General Charles R. Holland
Commander
U.S. Special Operations Command

Two critical challenges face our nation's Special Operations Forces (SOF). The first is fighting a global, long-term war against terrorism; SOF are the tip of the spear in that effort. The second related challenge confronting SOF is the need to “transform” their forces. SOF must improve their speed, precision, lethality, stealth, survivability, and sustainability to meet the needs of the future. SOF must be able to fight in unpredicted places, at unpredicted times.

The phenomenon of global terrorism is far different today than in the past. We face today an international terrorist network that has global reach and significant operational resources. The attacks of September 11, 2001 clearly demonstrated that determined terrorists will go to any lengths to inflict catastrophic losses on Americans, be they civilians, or military personnel. Moreover these terrorists desire chemical, biological, nuclear, radiological, and high-yield explosive (CBRNE) weapons to kill as many Americans as possible and undermine our nation's interests around the world. **SOF are playing a vital role in addressing global terrorism, by disrupting terrorist organizations and bringing their members and supporters to justice—or taking justice directly to them.**

SOF are peerless for a number of reasons. Their capabilities are diverse and they provide critical options to policy makers to deter conflict, dissuade potential adversaries, assure friends and allies, and swiftly defeat adversaries of the United States. Furthermore, SOF are transforming their forces to meet the challenges of current and future wars. The impetus for SOF change is the pressing requirement for a full range of capabilities to deal with the new spectrum of threats confronting the nation. The overarching priority for SOF will be the capability to deal with numerous terrorism and CBRNE threats on a global scale before they threaten the Homeland. In supporting this new strategic requirement SOF will prevail. The stakes are high. USSOCOM, as the supported combatant command responsible for waging the war on terrorism, is up to the job.

USSOCOM MISSION

USSOCOM plans, directs and executes special operations in the conduct of the War on Terrorism in order to disrupt, defeat, and destroy terrorist networks that threaten the United States, its citizens and interests worldwide. USSOCOM organizes, trains, and equips Special Operations Forces provided to Geographic Combatant Commanders, American Ambassadors and their Country Teams.

CONTENTS

FOREWORD	3
INTRODUCTION	
History	7
Title 10 Responsibilities	9
Major Force Program 11	10
SOF ORGANIZATIONAL DESCRIPTION	
United States Special Operations Command	11
United States Army Special Operations Command	14
Naval Special Warfare Command	19
United States Air Force Special Operations Command	23
Joint Special Operations Command	25
STRATEGY	
New Challenges	27
Supporting A New Defense Strategy	27
Operational Priorities for Special Operations Forces	29
Enduring Truths	30
Answering the Call	31
TAILOR TO TASK	
Special Operation Forces	33
Nine SOF Core Tasks	36

SOF OPERATIONS AROUND THE WORLD

Current Operations	39
Unified Commands and Theater Special Operations Commands	40
United States Central Command and Special Operations Command, Central	42
United States European Command and Special Operations Command, Europe	45
United States Pacific Command and Special Operations Command, Pacific	48
United States Southern Command and Special Operations Command, South	52
United States Joint Forces Command and Special Operations Command, Joint Forces Command	56
The Korean Theater of Operations and Special Operations Command, Korea	59

TRANSFORMING SPECIAL OPERATIONS

Introduction	63
Vectors of Transformation	64
SOF Vision	65
The SOF Warrior	65
SOF Attributes	66
USSOCOM's Transformation Roadmap	69
Transforming to 2020	70
Managing the Risks Associated with Transformation	70
A Path to the Future	72

SOF PROGRAM SYSTEMS

Mobility, Combat Equipment, Munitions & Armament	73
Intelligence & Information Systems	81
Mission Support	88

SOF BUDGET & MANPOWER

Resource Overview	89
SOF Funding Profile	90
Research, Development, Testing & Evaluation	96

APPENDICES

A - HQ USSOCOM Center Organizational Charts and Descriptions	101
B - Glossary	109

INTRODUCTION

Special operations are operations conducted in hostile, denied, or politically sensitive environments to achieve military, diplomatic, informational, and/or economic objectives employing military capabilities for which there is no broad conventional force requirement. These operations often require covert, clandestine, or discreet capabilities. Special operations are applicable across the range of military operations. They can be conducted independently or in conjunction with operations of conventional forces or other government agencies and may include operations by, with, or through indigenous or surrogate forces. Special operations differ from conventional military actions in the following ways:

- Greater degree of physical and political risk
- Unique operational techniques, mode of employment, and independence from friendly support
- Detailed operational intelligence and indigenous assets

The task, however, does not define the force. SOF are more than just what they do. SOF are comprised of specially selected, trained, and organized special operations soldiers, sailors, and airmen from the Armed Services. Their training, education, maturity, initiative, and experience set them apart from all others in the Department of Defense. SOF personnel form the core of our nation's ability to combat terrorism, counter proliferation of weapons of mass destruction, and conduct unconventional warfare.

The business of managing more than 49,000 active duty and Reserve Component SOF personnel is the responsibility of the United States Special Operations Command (USSOCOM), which is headquartered in Tampa, Florida. USSOCOM has been a leading agency in the fight against terrorism for almost a quarter of a century.

Despite their demonstrated capability and recent successes in Afghanistan and Iraq, SOF face significant challenges in the years ahead. SOF must develop capabilities to defend the U.S. Homeland from terrorism and CBRNE threats wherever they occur, as well as prepare to meet the uncertain challenges of the future. Transforming the force from one designed to combat specific threats to one with capabilities that can address a broad range of contingencies will not be easy, but it must be done. As the American public learned on September 11, some groups and rogue states are willing to attack them directly. Given the stakes associated with future attacks involving CBRNE weapons, SOF cannot fail. They must be prepared to wage war “everywhere, all the time.”

History

Until 1986, the United States had a practice of creating and using SOF on an *ad hoc* basis. Frequently, SOF were used to the point of exhaustion, and then disbanded once the crisis had passed. There was also a tendency to use SOF for missions for which they were not suited, such as sustained theater combat operations. Indeed, the *ad hoc* nature of SOF led to an unfamiliarity by policy makers over what SOF could, and could not do, and how best to employ them. As a result, SOF had little “institutional memory” that informed policy makers and conventional force commanders not only of their unique value, but their limitations as well.

The tendency to form SOF for limited periods can be traced back to the early colonial period, when officers such as Captain Benjamin Church and Major Robert Rogers established “Ranger” companies to fight against irregular foes. In other cases, such as the partisan forces of Francis “the Swamp Fox” Marion and Confederate

“Destructionists,” SOF were designed to offset the superior numbers and technology of their adversary. Although the immediate cost to disband SOF in all these cases was marginal, the long-term implications were significant and lasting. As warfare has grown in scale and complexity, the time it takes to build competent SOF has increased dramatically. The example of the unsuccessful Iran hostage rescue attempt in 1980 clearly demonstrates this point.

The rescue attempt, code-named Operation EAGLE CLAW, was conducted when many American military and political leaders believed that unconventional forces such as SOF were a distraction at best. The Soviet threat in Central Europe, as well as the outcome of the Vietnam War, drove this belief. The United States honed superb special operations capabilities during the Vietnam War but most SOF units were either

disbanded or downsized after 1975. The drastic cuts to SOF units within the Services meant that the nation lost its ability to execute special operations of any significant value. For example, active duty Army Special Forces Groups were reduced from seven to three, all Air Force gunships were slated for deactivation, and the Navy Sea, Air, and Land (SEAL) units were at half of their wartime strength.

The net result was that when the nation most needed a joint special operations capability for a challenging mission, the capability simply did not exist. In 1979 Iranian students stormed the United States Embassy in Tehran and took over fifty Americans hostage. President Jimmy Carter ordered a rescue operation and an ad hoc multi-service rescue force was formed. One significant shortcoming of the rescue force, which



Desert One



Desert One Showed the Need for a Dedicated, Well - Resourced and Trained SOF Capability.

had tragic consequences, was the lack of a complete and combined mission rehearsal with all elements. In addition, the plan for the rescue was a complicated one. Several groups would infiltrate into Iran separately and meet at a remote location in the Iranian desert. Once there, the raiders would regroup and transport the assault force close to the Iranian capital to free the hostages.

Although the rescue force made a clandestine entry into Iran, the ground commander aborted the mission at the rendezvous point (Desert One). His decision was based on the mechanical failure of several helicopters that significantly increased the odds of mission failure. After the abort order was issued, a helicopter and an EC-130 airplane collided killing eight members of the rescue force. After the withdrawal of the rescue force, the Iranian government broadcast images of the destroyed and abandoned military equipment, reinforcing perceptions of American military weakness. This propaganda victory highlights another aspect of special operations: missions that promise a high political and/or military return based on substantial risk exact a high price should they fail.

Various panels and investigations, including the Holloway Commission, studied Operation EAGLE CLAW and determined that a standing joint capability was needed to conduct special operations. Although the reports derived from these studies were useful in pointing out the shortfalls in joint SOF capabilities, meaningful change only occurred in the face of continued operational problems in using SOF. In 1983, Operation URGENT FURY in Grenada may have been a success, but it nevertheless highlighted continuing interoperability problems both between the services and in the integration of SOF into joint operations. Concerns about these shortcomings triggered Congress to pass the 1986 Goldwater-Nichols Defense Reorganization Act, which reorganized parts of the Defense Department. An amendment to the Act established USSOCOM and transformed SOF in the process.

Title 10 Responsibilities

Compounding these developments was an overall lack of emphasis perceived by Congress in the Department of Defense on Low Intensity Conflict and counterterrorism. In 1985, the Senate Armed Services Committee published the results of a two-year defense review which led to the Goldwater-Nichols Defense Reorganization Act of 1986 establishing the unified command structure in use today. Also, Senators Sam Nunn and William Cohen saw the need for a joint military organization to oversee SOF and for a civilian policy and oversight element within the Department of Defense. The resulting legislation, the Cohen-Nunn Amendment to the DOD Authorization Act of 1987, established USSOCOM and the Office of the Assistant Secretary of Defense for Special Operations and Low Intensity Conflict (SO/LIC). The objectives of this amendment were:

- 1) Provide close civilian oversight for special operations and low-intensity conflict activities
- 2) Ensure that genuine expertise and a diversity of views are available to the President and Secretary of Defense regarding possible responses to special operations requirements and low-intensity conflict threats
- 3) Improve interagency planning and coordination for special operations and low-intensity conflict
- 4) Bolster U.S. special operations capabilities in a number of areas to include joint doctrine and training, intelligence support, command and control, budgetary authority, personnel management, and mission planning

With the passage of the Cohen-Nunn Act, USSOCOM's responsibilities were codified into U.S. law as part of the Title 10 U.S. Code, Section 167. This law mandated a unified command with "service-like" responsibilities to oversee all SOF. These designated responsibilities include resource allocation and budget management separate from the eight unified commands and services. The law also mandated that, when directed by the President or Secretary of Defense, the commander USSOCOM shall exercise command of a selected special operation mission.

USSOCOM Responsibilities, Title 10 (Sec 167)

1. Develop Strategy, Doctrine & Tactics
2. Train assigned forces
3. Conduct specialized courses of instruction for commissioned and noncommissioned officers
4. Validate and establish priorities for requirements
5. Ensure the interoperability of equipment and forces
6. Ensure combat readiness of forces assigned to USSOCOM
7. Monitor the preparedness of special operations to carry out assigned missions of SOF assigned to unified combatant commands other than USSOCOM
8. Formulate and submit requirements for intelligence support
9. Prepare and submit to Secretary of Defense program recommendations and budget proposals for special operations and other forces assigned to USSOCOM
10. Exercise authority, direction, and control over the expenditure of funds for forces assigned to USSOCOM and for special operations forces assigned to unified combatant commands other than the USSOCOM
11. Prioritize requirements
12. Ensure interoperability of equipment
13. Monitor the promotions, assignments, retention, training, and professional military development of all special operations force officers
14. Internally audit and inspect purchase and contract actions
15. Develop and acquire special operations-peculiar equipment
16. Acquire special operations-peculiar material, supplies, and services

Major Force Program 11

The creation of MFP-11 was important for USSOCOM. Although the Cohen-Nunn Amendment had created MFP-11 to reform SOF funding, the wording of the law permitted varying interpretations, and some Department of Defense officials argued that the new command should not submit its own Program Objective Memorandum (POM). In September 1988, Senators Nunn and Cohen clarified Congressional intent, saying the sponsors of the law “fully intended that the commander of USSOCOM would have sole responsibility for the preparation of the POM.” Congress enacted Public Law 100-456 that same month, directing the commander to submit a POM directly to the Secretary of Defense. For the first and only time, a combatant commander was granted authority for a budget and a POM.

Conclusion

USSOCOM manages and oversees all CONUS-based SOF: the Air Force Special Operations Command, the Naval Special Warfare Command, the US Army Special Operations Command, and the Joint Special Operations Command. USSOCOM also develops SOF-specific tactics, techniques, procedures, and doctrine, and conducts research, development, and acquisition of SOF-peculiar equipment. USSOCOM ensures its forces are trained and “joint-ready” to respond to the call from the President, Secretary of Defense and the other eight combatant commanders as necessary.

SOF ORGANIZATIONAL DESCRIPTION

United States Special Operations Command (USSOCOM)

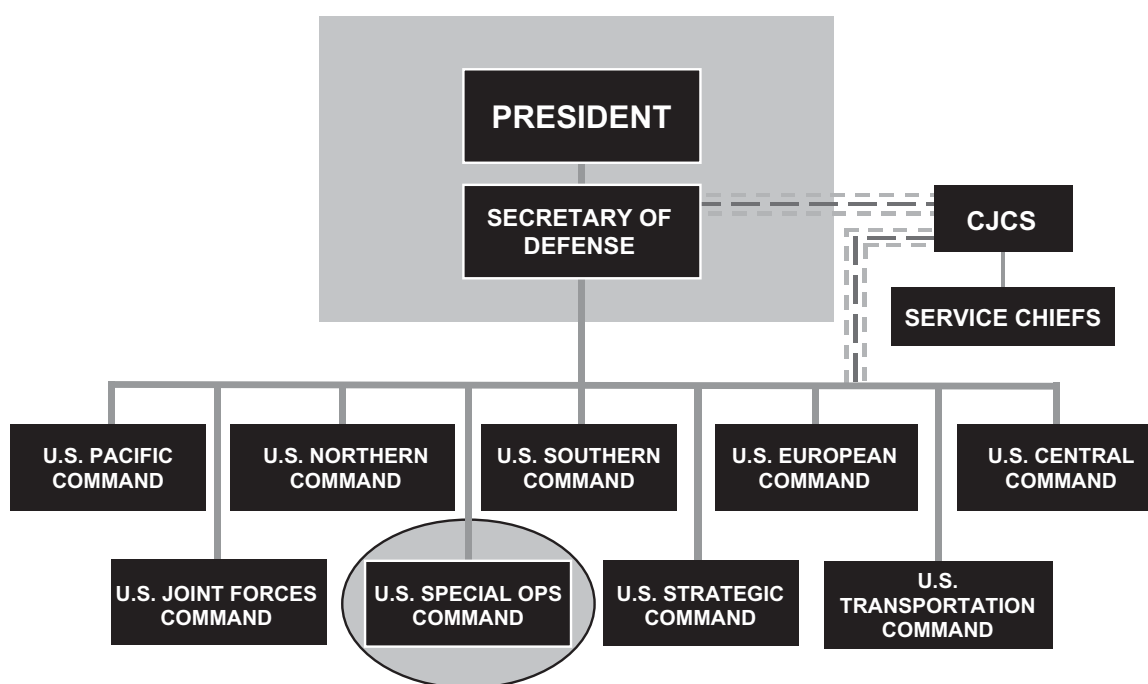

USSOCOM is one of nine combatant commanders directly responsible to the President and Secretary of Defense. As a functional combatant command, USSOCOM has been given lead responsibility for waging war on terrorism. Its duties in connection with this responsibility include planning, directing, and executing special operations in the conduct of the war on terrorism. USSOCOM also provides special operations forces (SOF) to support the Geographic Combatant Commander's theater security cooperation plans. The designation of Special Operations as a Major Force Program

makes USSOCOM unique among the nine combatant commands in that it has service-like responsibilities to organize, train, and equip its forces for special operations missions.

The People. The men and women of U.S. Special Operations Command number approximately 49,000. They are active duty and Reserve Component forces organized into a variety of land, sea and aerospace units. Although the acronym SOF is used to describe this community of world-class organizations, no one joins "SOF" *per se*. Instead



The SOF Family

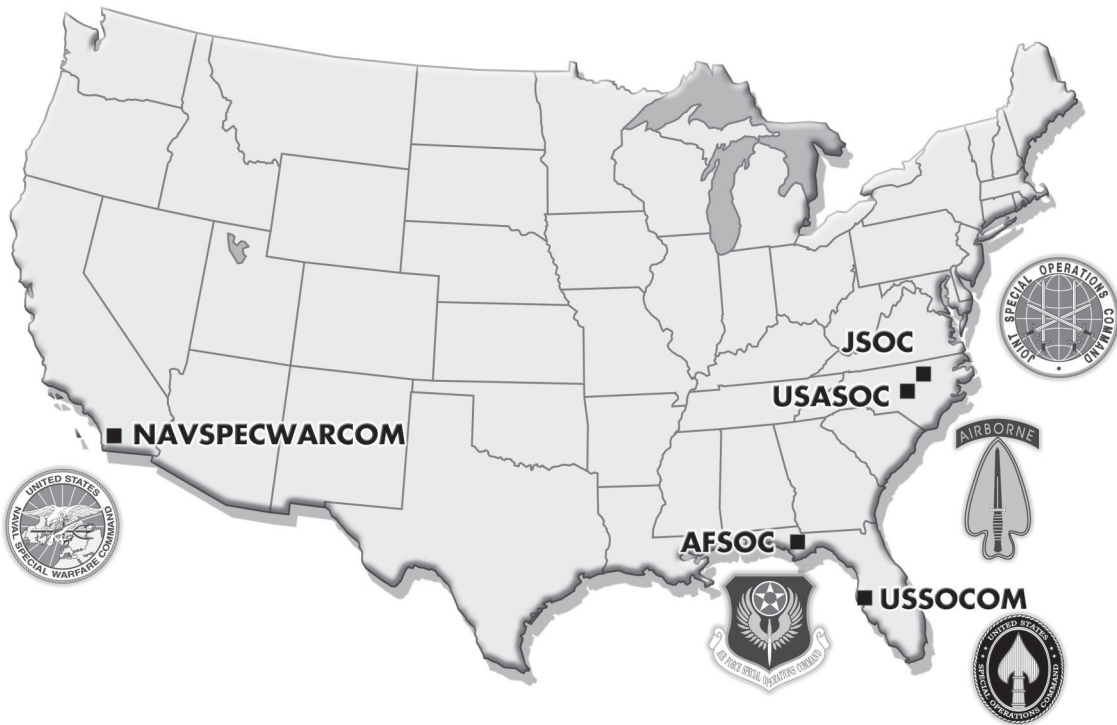

they join a unit, unique in its history, culture, and contribution to the joint SOF team. Our nation is better served as a result of this diversity.

Components. USSOCOM has three component commands and one sub-unified command:

U.S. Army Special Operations Command or USASOC is located at Ft. Bragg, North Carolina. The mission of USASOC is to organize, train, man, equip, educate, maintain combat readiness, and deploy assigned active duty and Reserve Components of the Army Special Operations Force. Their mission is to accomplish special operations, psychological operations, and civil affairs operations as assigned by the Commander, USSOCOM and/or Geographic Combatant Commanders employing SOF. Their forces include the United States Army Civil Affairs and Psychological Operations Command (Airborne), United States Special Forces Command (Airborne),

John F. Kennedy Special Warfare Center and School, and the Special Operations Support Command located at Fort Bragg, North Carolina, the 75th Ranger Regiment located at Fort Benning, Georgia, and the 160th Special Operations Aviation Regiment located at Fort Campbell, Kentucky.

Naval Special Warfare Command or NAVSPECWARCOM is located at Naval Amphibious Base, Coronado, CA. The mission of NAVSPECWARCOM is to organize, train, man, equip, educate, maintain combat readiness, and deploy assigned forces in support of joint and fleet operations worldwide. Naval Special Warfare (NSW) forces include Naval Special Warfare Group ONE and THREE in California; Naval Special Warfare Group TWO and FOUR in Virginia; and Naval Special Warfare Reserve units located throughout the United States. Their mission is to accomplish special operations as

assigned by Commander, USSOCOM and the Geographic Combatant Commanders employing SOF.

Air Force Special Operations Command or AFSOC is located at Hurlburt Field, Florida. AFSOC is America's specialized air power. It is a step ahead in a changing world, delivering special operations combat power anytime, anywhere. The command is committed to continual improvement to provide Air Force Special Operations Forces for worldwide deployment and assignment to geographic unified commands, conducting the full spectrum of special operations core tasks. AFSOC active duty forces are the 16th Special Operations Wing, 720th

Special Tactics Group, and 18th Flight Test Squadron, 352nd Special Operations Group, and 353rd Special Operations Group. Reserve Component forces are the 193rd Special Operations Wing (Air National Guard), 280th Combat Communications Squadron (Air National Guard), 123rd Special Tactics Squadron (Air National Guard), and the 919th Special Operations Wing (Air Force Reserve).

Joint Special Operations Command or JSOC is a sub-unified command of USSOCOM. JSOC provides a joint headquarters to study special operations requirements, ensures interoperability and equipment standardization, develops joint special operations plans and tactics, and conducts joint special operations exercises and training.

United States Army Special Operations Command (USASOC)

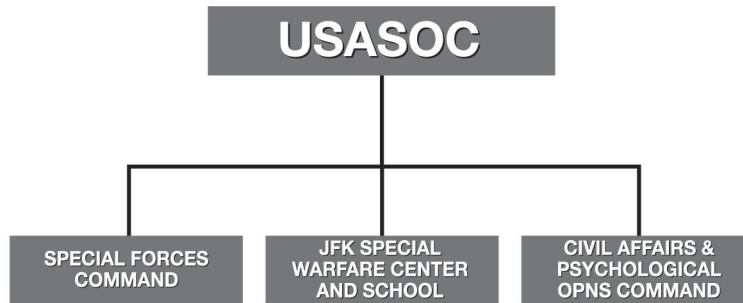

OPERATIONAL UNITS

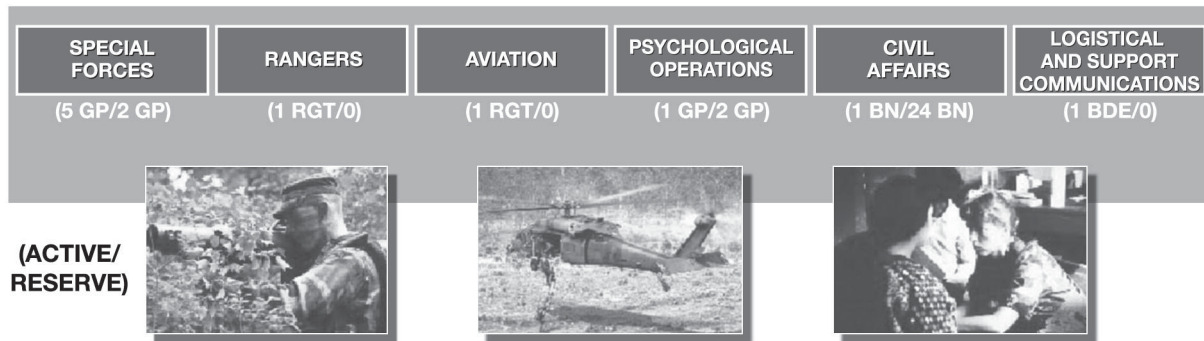

United States Army Special Operations Command – *Sine Pare*. On December 1, 1989 the Department of the Army established the U.S. Army Special Operations Command at Fort Bragg, North Carolina, as a major Army command to enhance the readiness of Army SOF.

USASOC is a component of USSOCOM and commands both the Army’s active duty and Reserve Component SOF. It also provides oversight of Army National Guard SOF readiness, organization, training, and employment in coordination with the National Guard Bureau and State Adjutants General. USASOC’s major subordinate commands include:

- U.S. Army Special Forces Command (Airborne)
- U.S. Army Civil Affairs and Psychological Operations Command (Airborne)
- U.S. Army John F. Kennedy Special Warfare Center and School

Major subordinate units include:

- 75th Ranger Regiment
- 160th Special Operations Aviation Regiment (Airborne)
- Special Operations Support Command (Airborne)

Major Subordinate Commands

U.S. Army Special Forces Command (Airborne) (USASFC (A)) – *De Oppresso Liber*. U.S. Army 1st Special Operations Command was redesignated the U.S. Army Special Forces Command (Airborne) on November 27, 1990. The mission of USASFC (A) is to train, validate and prepare special forces (SF) units to deploy and execute operational requirements for the U.S. military's Geographic Combatant Commanders throughout the world. In addition to USASFC (A), there are five active duty SF groups and two U.S. Army National Guard SF groups. Each group has three battalions consisting of three operational companies, a group support company and a headquarters company. The operational companies have six Operational Detachment Alphas (ODA), or A-teams, assigned to them. The ODA is the heart and soul of SF operations.

SF units perform five doctrinal missions: foreign internal defense, unconventional warfare, special reconnaissance, direct action, and counterterrorism. These missions make SF unique in the U.S. military, because it is employed throughout the three stages of the operational continuum: peacetime, conflict, and war.

On a daily basis, soldiers of the U.S. Army Special Forces Command (Airborne) are deployed around the world, living up to their motto – *De Oppresso Liber*, “To Free the Oppressed.”

Chemical Reconnaissance Detachments (CRD) are assigned to Special Forces Command and are allocated one per Special Forces Group. The CRD is a 14-man detachment consisting of airborne qualified Chemical Corps soldiers led by a captain and a master sergeant. The CRD supports special reconnaissance, unconventional warfare, foreign internal defense and direct action missions with chemical, biological, and nuclear defense and mitigation expertise.

U.S. Army Civil Affairs and Psychological Operations Command (Airborne) USACAPOC (A) – *By Sword, Deed, and Word*. All CONUS-based Army Civil Affairs and Psychological Operations units belong to USACAPOC (A). About 96 percent of USACAPOC (A)'s approximately 10,000 soldiers are in the U.S. Army Reserve and are located in 25 states. The active duty units consist of one Psychological Operations Group of six battalions and one Civil Affairs Battalion. The Army Reserve Component includes four Brigadier General-commanded Civil Affairs Commands, with subordinate brigades and battalions and two Psychological Operations Groups with subordinate battalions and companies.

Civil Affairs (CA) – *Secure the Victory*. CA units support military commanders by working to minimize the effect of civilians in the battlespace and by coordinating with civil authorities and civilian populations in the commander's area of operations to lessen the impact of military operations on them during peace, contingency operations, and declared war. Civil Affairs forces support activities of both conventional and SOF, and are capable of assisting and supporting the civil administration in their area of operations. Long after the guns have fallen silent, the men and women of Civil Affairs continue to provide assistance to foreign governments, and to stabilize regions in turmoil.

Psychological Operations (PSYOP) – *Persuade, Change, Influence*. PSYOP are a vital part of the broad range of U.S. political, military, economic, and ideological activities used by the U.S. government to secure national objectives. PSYOP disseminate truthful information to foreign audiences in support of U.S. policy and national objectives. Used during peacetime, contingency operations, and declared war, these activities are not a form of force, but are force multipliers that use nonviolent means in often violent environments. Persuading rather than

compelling physically, they rely on logic, fear, desire or other mental factors to promote specific emotions, attitudes or behaviors. The ultimate objective of U.S. military psychological operations is to convince target audiences to take action favorable to the United States and its allies. The importance and effectiveness of psychological operations has been underscored during OPERATIONS ENDURING FREEDOM and IRAQI FREEDOM.

The U.S. Army John F. Kennedy Special Warfare Center and School – *Truth and Liberty*.

The mission of the USAJFKSWCS is to develop doctrine and all related individual and collective training material; develop and maintain the proponent training programs/systems; provide entry-level and advanced individual training and education; establish leader development policy and standards of grade authorization for both active duty and Reserve Component's Army SF, CA, and PSYOP forces, and act as the specified proponent for Army Rangers and Army Special Operations Aviation.

Major Subordinate Units

75th Ranger Regiment – *Rangers Lead the Way*. The Ranger Regiment is the premier light-infantry unit of the United States Army. Their mission is to plan and conduct joint special military operations in support of U.S. policy and objectives.

The Army maintains the Regiment at a high level of readiness. Each battalion can deploy anywhere in the world. Because of the importance the Army places on the 75th Ranger Regiment, it must possess a number of capabilities. These capabilities include: infiltration and exfiltration by land, sea, and air; direct action operations; raids; recovery of personnel and special equipment; and conventional or special light-infantry operations.

To maintain readiness, Rangers train constantly.

Their training encompasses arctic, jungle, desert, and mountain operations, as well as amphibious instruction. The training philosophy of the 75th Ranger Regiment dictates the unit's high state of readiness. The philosophy includes performance-oriented training emphasizing tough standards and a focus on realism and live-fire exercises, while concentrating on the basic capabilities of physical training, marksmanship, medical proficiency, and small unit tactics. Training at night, during adverse weather, or on difficult terrain enhances the benefits of training events. Throughout training, Rangers are taught to expect the unexpected.

The 160th Special Operations Aviation Regiment (160th SOAR) (Airborne) – *Night Stalkers Don't Quit*.

What began as an emergency deployment from Fort Campbell, KY in 1980 has become what is now the finest aviation capability in existence. The 160th SOAR(A) is the Army's premier special operations aviation unit specifically manned, equipped, and trained to provide no-notice, focused and precision aviation support to SOF worldwide under any operational and threat environment.

To accomplish its mission, the 160th SOAR(A) employs a unique combination of highly sophisticated and combat proven aircraft. These aircraft, coupled with the Regiment's stringently selected and highly trained aircrew members, provide the SOF community with an ever-expanding array of reliable aviation capabilities including:

- Precision rotary wing operations in complex urban areas
- Long range infiltrations/exfiltrations under high threat, adverse weather and all terrain/environmental conditions
- Long range precision attack and close air support to ground SOF in contact
- Rotary wing foreign internal defense
- Personnel recovery

For over two decades, the 160th SOAR(A) has demonstrated leading edge capabilities under some of the most arduous and unforgiving conditions found in combat. Their extraordinary operational history includes URGENT FURY in Grenada, PRIME CHANCE in the Persian Gulf, JUST CAUSE in Panama, DESERT SHIELD/DESERT STORM in Iraq, TASK FORCE RANGER in Somalia, UPHOLD/RESTORE DEMOCRACY in Haiti, ENDURING FREEDOM in Afghanistan and the Philippines, and IRAQI FREEDOM in Iraq. Such unmatched accomplishments have earned the Night Stalkers the trust and respect of their ground SOF counterparts.

Special Operations Support Command (Airborne) (SOSCOM (A)) – Assured Support. A stand-alone unique organization, the SOSCOM (A) provides C2 of its organic elements to accomplish its mission of planning and coordinating

dedicated combat service support and level I health service support to ARSOF and special operations signal support to SOF units supporting the Geographic Combatant Commander. The SOSCOM (A) consists of a Material Management Center providing centralized logistics management and visibility to all USASOC active duty and reserve units. The SOSCOM (A) operates the Army component of the SOCOM “Storefront” initiative to support SOF unique logistics support requirements for ARSOF units. The SOSCOM (A) has 5 geographically oriented forward deployed Special Operations Theater Support Elements. These planning, coordinating, and facilitating staff elements serve as ARSOF liaisons embedded in the theater armies for matters pertaining to logistics, medical and signal needs. The SOSCOM (A) provides forward-deployed Special Operations Signal Detachments in each of the regionally aligned Special Operations Commands giving them immediate communications capabilities. The SOSCOM (A) executes its mission by providing robust tailorable, deployable, dependable modular logistical and signal support packages wherever and whenever needed.

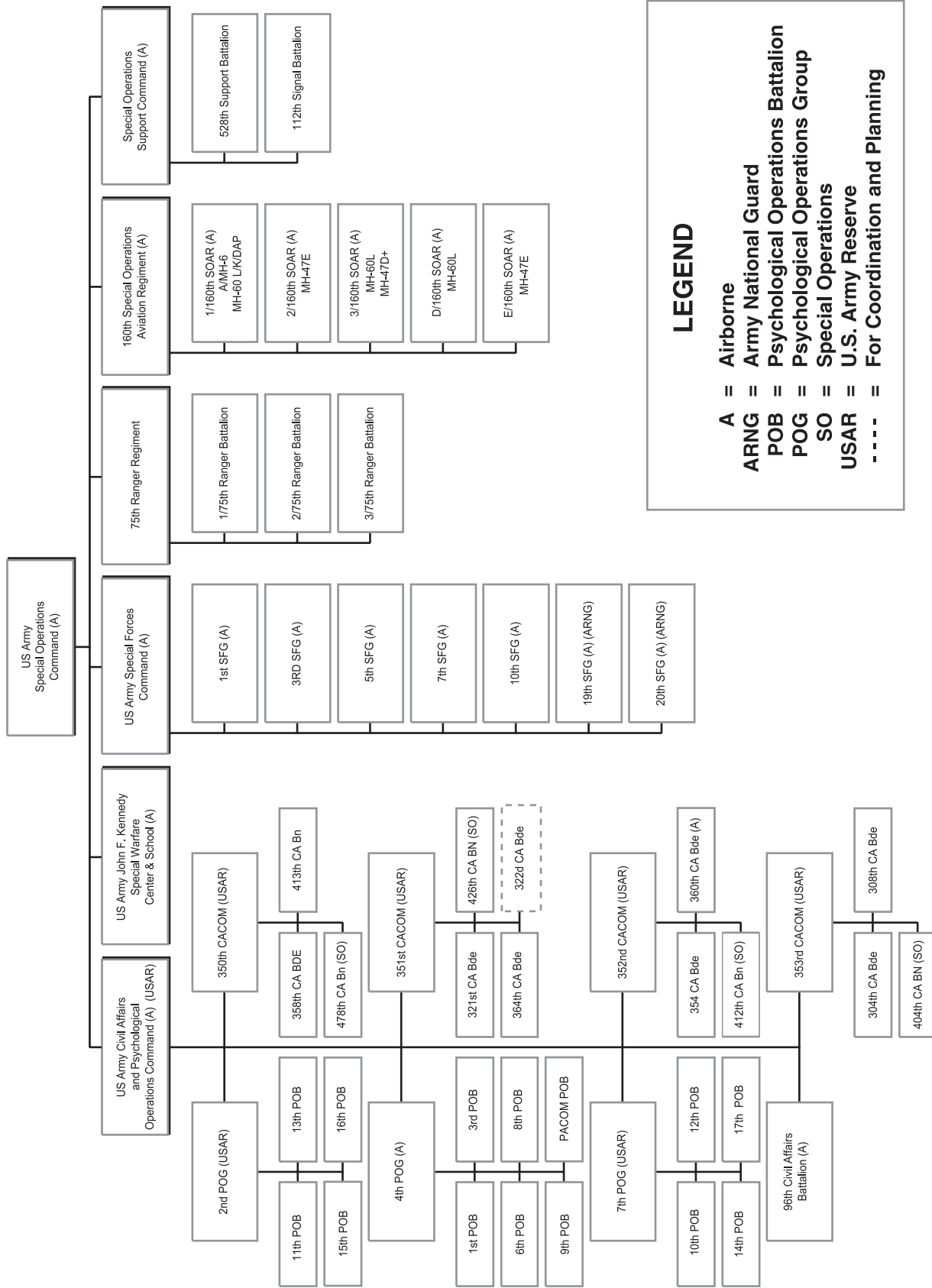

LEGEND

- A = Airborne
- ARNG = Army National Guard
- POB = Psychological Operations Battalion
- POG = Psychological Operations Group
- SO = Special Operations
- USAR = U.S. Army Reserve
- - - - = For Coordination and Planning

Naval Special Warfare Command (NAVSPECWARCOM)



Naval Special Warfare Command (NAVSPECWARCOM) is the Navy component of USSOCOM. Established at Naval Amphibious Base, Coronado, California in April 1987, NAVSPECWARCOM oversees the organization, training, equipping and readiness of all active duty and reserve Navy SOF.

A recent force realignment, commonly referred to as “Naval Special Warfare 21” (NSW 21), was undertaken to create the optimal Naval Special Warfare (NSW) organization for the 21st century. It included the following initiatives:

- Developing the NSW Squadron
- Restructuring the Force
- Realigning Training
- Optimizing Command and Control Relationships Forward
- Creating the C4ISR Backbone

These initiatives provide the Geographic Combatant Commanders with a more capable, tailorable and focused war fighting force led by more senior and operationally experienced NSW leadership.

Major Operational Commands

- Naval Special Warfare Group ONE, Coronado, California
- Naval Special Warfare Group TWO, Little Creek, Virginia
- Naval Special Warfare Group THREE, Coronado, California
- Naval Special Warfare Group FOUR, Little Creek, Virginia

These commands train, equip, and deploy components of Naval Special Warfare Squadrons to meet the training, exercise, contingency, and wartime requirements of the Geographic Combatant Commanders, Theater Special Operations Commands and numbered fleets located around the world. Under NSW 21, the squadron is built around the entire SEa, Air and Land (SEAL) Team deploying and includes its senior leadership, SEAL Vehicle Delivery Teams and Special Boat Teams, as well as personnel detachments such as mobile communications teams, tactical cryptologic support and explosive ordnance disposal. Additionally, they receive support from five permanently deployed NSW units overseas.

NSW forces can operate independently or in conjunction with other U.S. Special Operations Forces or within U.S. Navy Carrier Battle Groups and Amphibious Ready Groups. There are approximately 5,000 total active duty personnel.

At the heart of the NSW realignment is the NSW Squadrons and a new 2-year, 4-phase deployment cycle. The deployment schedule is facilitated by the establishment of new SEAL Teams created from the restructuring of current continental U.S.-based forces. Following a year of individual and unit level training, the Squadron receives six months of interoperability training prior to its six-month deployment. The NSW Squadron provides the same tactical forces and assets, but they arrive in theatre more completely trained and integrated with enhanced command and control forward. This greatly increases the Squadron's ability to task organize NSW forces to meet specific requirements.

Consolidating the SEAL Teams' administrative and support functions under the Logistics Support Units and shifting the training functions from the Teams to training detachments assigned to the Groups has created a more efficient organization. This consolidation allows NSW operators to maintain a strong operational focus.

Due to an increased focus on complex maritime/undersea weapon systems, Special Boat Squadrons transitioned in FY03 to become part of Commander, Naval Special Warfare Groups (CNSWG). Each CNSWG retains operational control (OPCON) of current forces previously assigned to the Special Boat Squadrons and gains OPCON of SEAL Delivery Vehicle Teams and Communications Equipment Support Element units. This transition provides unity of command for these systems and optimal support to the operational commanders.

Major Component Command

Naval Special Warfare Center (NSWC) provides basic and advanced instruction and training in maritime special operations to U.S. military and government personnel and members of other allied armed forces. Efforts are underway at the Center to take on all courses leading to individual qualifications or certifications, including some training previously conducted at the SEAL Team or platoon level. Additionally, standards are being redefined and courses will be validated to ensure operators reach consistently high skill levels.

Major Subordinate Commands

SEAL Teams are maritime, multipurpose combat forces organized, trained and equipped to conduct a variety of special missions in all operational environments and threat conditions. They infiltrate their objective areas by fixed and rotary-winged aircraft, Navy surface ships, combatant craft and submarines. Operating in small numbers, SEALs' ability to conduct clandestine, high-risk missions and provide real time intelligence and eyes on target, offer decision-makers immediate and virtually unlimited options in the face of rapidly changing wartime situations. SEAL special mission areas include unconventional warfare, direct action, counterterrorism,

special reconnaissance, foreign internal defense, information warfare, security assistance, counter-drug operations, personnel recovery, and hydrographic reconnaissance.

Warrior Diplomats. SEALs maintain a forward presence, regional orientation, language skills, and cultural awareness as they conduct operations throughout the world.

Global Access. With half the world's industry and population located within one mile of an ocean or navigable river and 144 of 170 sovereign nations accessible from sea or river systems, Naval Special Warfare's unique maritime capabilities make it a proven force for the future.

Systems Integration. By integrating a number of significant systems (Secret Internet Protocol Routing Network, Mission Support Center, and Special Operations Mission Planning Environment) NSW has decreased its footprint forward. At the same time, it continues to provide its land, ship, and submarine-based forces the ability to conduct worldwide collaborative joint mission planning. The NSW Mission Support Center employs "reach back technology," providing forces with the operational picture and continuous battle space awareness. It also enables deployed forces to connect to resources required to rapidly plan and conduct successful special operations missions.

SEAL Delivery Vehicle (SDV) Teams are specially trained SEALs and support personnel who operate and maintain SDVs, Dry Deck Shelters (DDS), and the Advanced SEAL Delivery System (ASDS) when it becomes operational in late FY03 . The ASDS is a dry-submersible vessel that can be launched from a Navy submarine. SDVs are wet submersibles which, along with the ASDS, provide clandestine reconnaissance, direct actions and passenger delivery capability in maritime environments. DDS deliver SDVs and specially trained forces from modified submarines. When teamed with their host submarines, the ASDS, SDV and DDS platforms provide the most clandestine maritime delivery capability in the world.

Special Boat Teams. NSW platforms include the Rigid Inflatable Boats, MK-V Special Operations Craft and riverine craft. Special Warfare Combatant-craft Crewmen (SWCC) operate and maintain these state-of-the-art, high performance boats used to conduct coastal patrol and interdiction and support special operations missions. Focusing on infiltration and exfiltration of SEALs and other SOF, SWCC provide dedicated rapid mobility in shallow water areas where larger ships cannot operate.

NSW Command Relationships

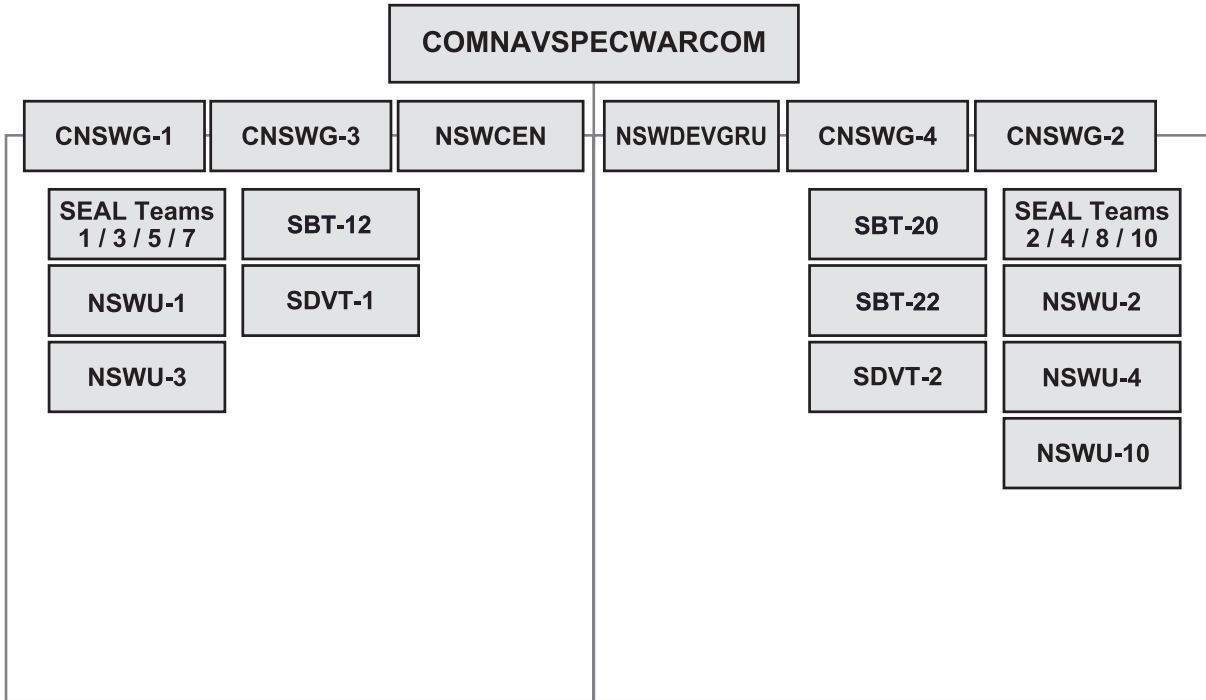

United States Air Force Special Operations Command (AFSOC)

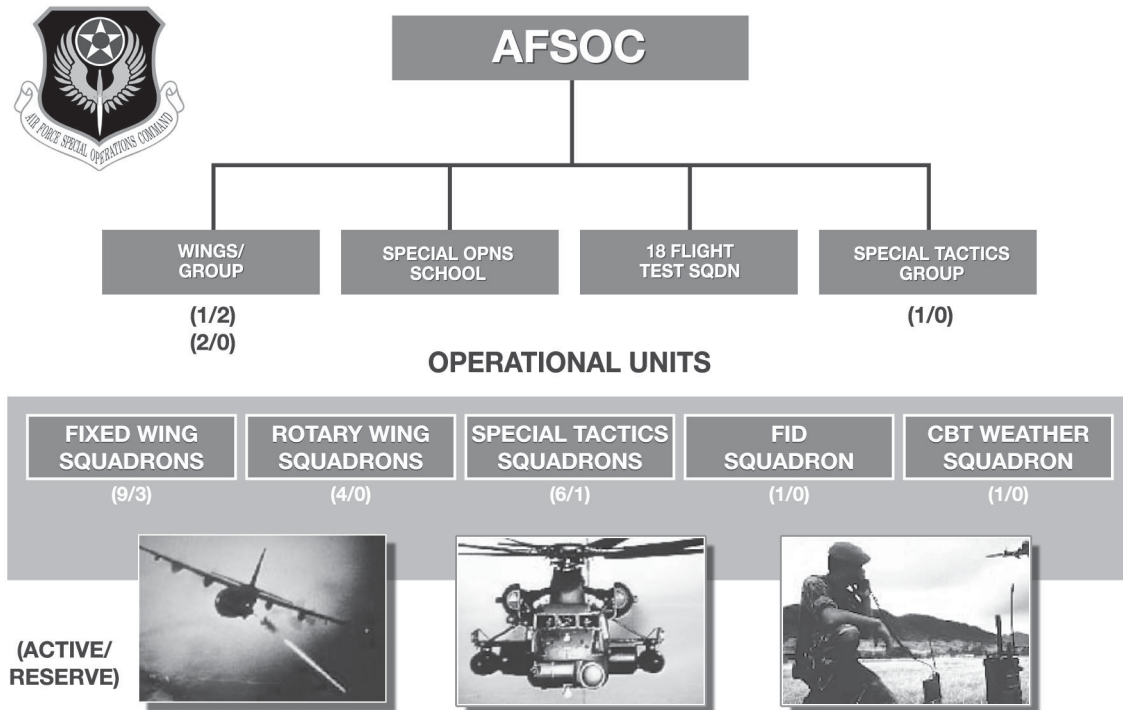

United States Air Force Special Operations Command (AFSOC). Air Force Special Operations Forces are comprised of highly trained, rapidly deployable airman who are equipped with highly specialized, fixed and rotary wing aircraft. Air Force Special Operations Command, located at Hurlburt Field, Florida, is responsible to USSOCOM for the readiness of active duty, Air Force Reserve, and Air National Guard SOF for worldwide deployment. Three special operations wings, two special operations groups, and one special tactics group are assigned to AFSOC. AFSOC's quiet professionals deliver the nation's specialized air power to provide SOF mobility, forward presence and engagement, precision employment/strike, and information operations. The command has the following active duty, Air National Guard, and Air Force Reserve units assigned:

- One active duty special operations wing with eight special operations squadrons, including five fixed-wing, one rotary-wing, a combat aviation advisory unit, and a fixed-wing training squadron
- Two active duty overseas-based special operations groups; Pacific Theater Group is comprised of fixed-wing special operations squadrons and a special tactics squadron and the European Theater Group is comprised of fixed-wing and one rotary-wing special operations squadrons and a special tactics squadron
- One Air Force Reserve Special Operations Wing with two fixed-wing special operations squadrons
- One Air National Guard Special Operations Wing with one fixed-wing special operations squadron

- One active duty special tactics group with four active special tactics squadrons, one Air National Guard special tactics squadron, and an active combat weather squadron
- One active duty flight test squadron
- The Air Force Special Operations School

“Anytime, Anywhere” epitomizes AFSOC’s commitment to stay a step ahead in a changing world. AFSOC’s unique active duty, Air National Guard and Air Force Reserve units provide a global ability to conduct special operations missions ranging from precision application of fire-power, to infiltration, exfiltration, resupply, and refueling of SOF operational elements. Unique capabilities include airborne radio and television broadcast for psychological operations, as well as combat aviation advisors to provide other governments military expertise for their internal development. Special tactics squadrons combine combat control, weather, and pararescue personnel to

ensure air power is integrated and operable with special operations and conventional forces.

USAF Special Operations School “Unconventional thought for an uncertain world”

As an element of the Joint Special Operations University, the USAF Special Operations School (USAFSOS) mission is to educate U.S. military and other government personnel in the art and science of special operations. The school has four academic departments (Asymmetric Warfare, Regional Studies, Joint Special Operations, and Professional Studies), that focus on their respective aspect of special operations. Courses range from three days to two weeks in length and vary in style from large orientation courses to small interactive seminars. USAFSOS faculty also accomplishes advanced academic research in support of the SOF community.

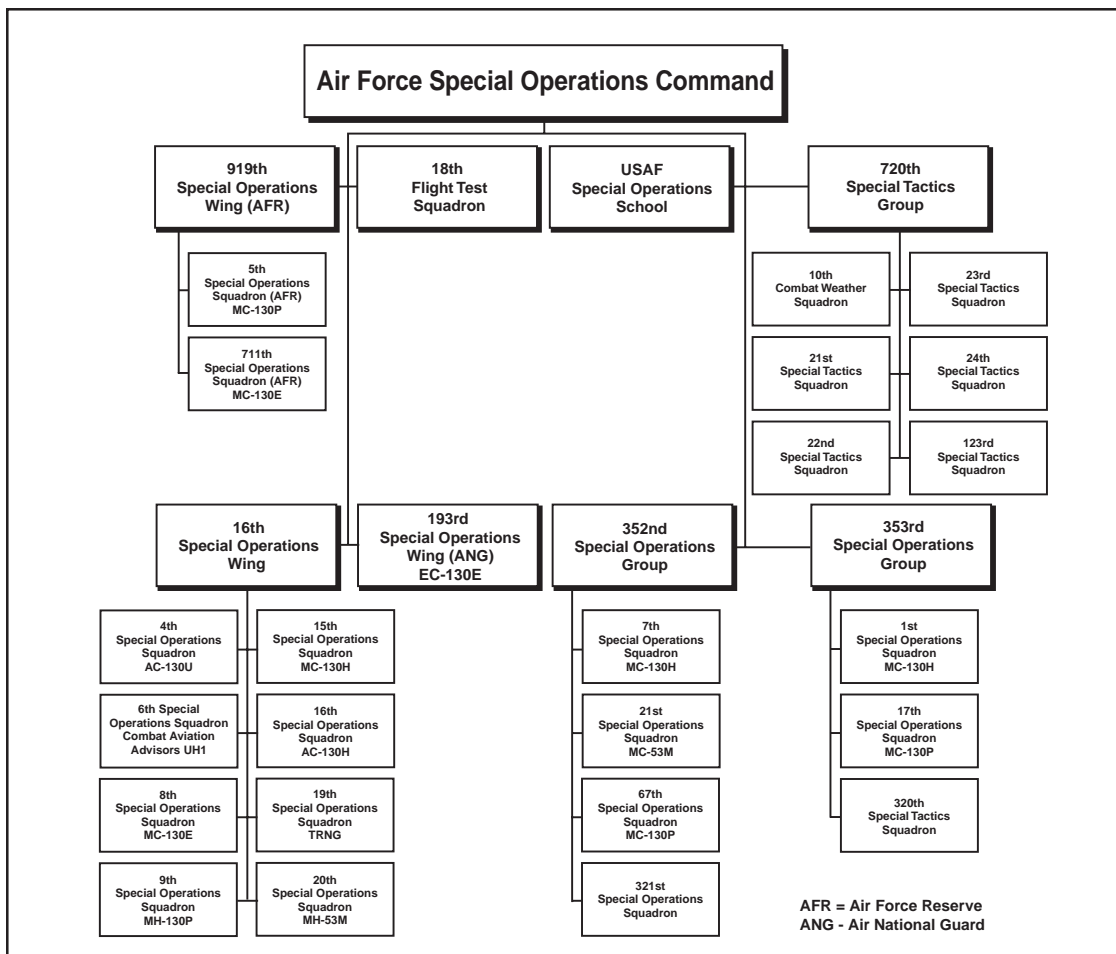

Joint Special Operations Command (JSOC)



Established in 1980, the Joint Special Operations Command is a sub-unified command of USSOCOM. JSOC provides a standing joint headquarters to study special operations requirements, ensures interoperability and equipment

standardization, develops joint special operations plans and tactics, and conducts joint special operations exercises and training.

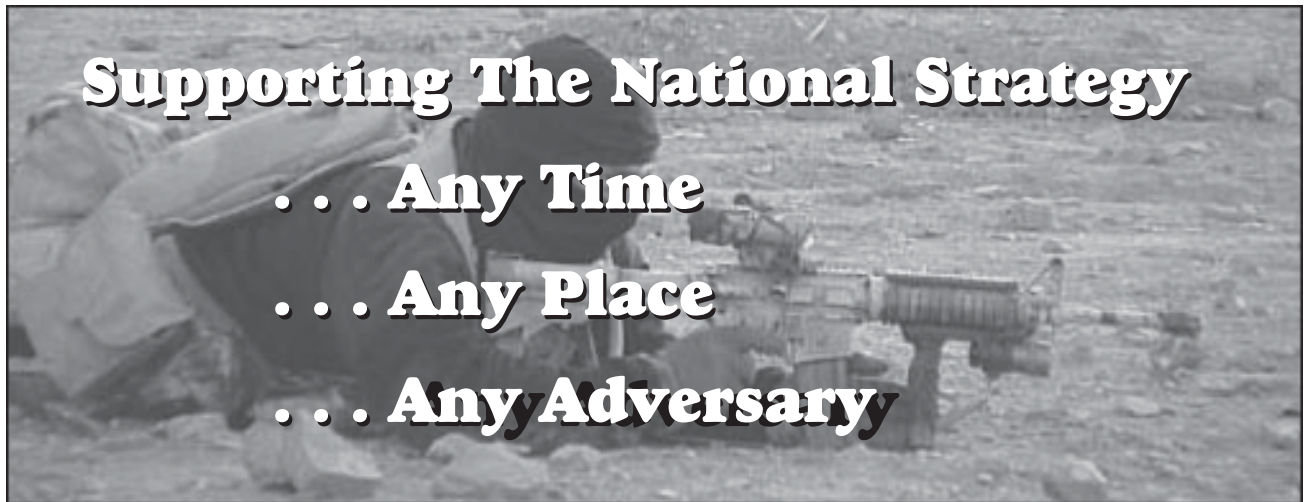

New Challenges

Our nation is at war, but this war is unlike any we have ever fought. It is a war fought without formal declaration, without concrete resolution, and against adversaries willing and able to circumvent our military forces by striking directly against the U.S. Homeland. It is a long-term conflict against adversaries determined to use weapons designed to cause catastrophic injury to our people and our way of life.

U.S. Special Operations Forces (SOF) are playing a critical role in this war, by bringing terrorists, their supporters, and their state facilitators to justice, or by taking justice to them.

But winning this war will require new capabilities, sustainable increases in capacity, and significant improvements in the global reach and response time of our forces. To meet the demands of the new environment, SOF must ensure that their capabilities are well-tuned to meet emerging needs. This section articulates some of the more important contributions that SOF can make to support the goals of the new U.S. Defense Strategy.

Supporting A New Defense Strategy

Throughout the history of the United States, decision makers have relied upon warriors with unique capabilities who venture to foreign lands and perform military tasks that could not be performed by more conventional military units. SOF continue to play this role maintaining competencies to execute a wide variety of important and highly specialized missions. For the future, capabilities to counter terrorist threats and Chemical, Biological, Radiological, Nuclear and high-yield Explosive (CBRNE) threats, levy the most pressing requirements on SOF.

Although counterterrorism has long been a core task of SOF, the events of September 11, 2001 focused national interest on several urgent national priorities:

- Destroying al'Qaida and other parts of the international terrorist network
- Speeding transformation of the military
- Counter the proliferation of weapons of mass destruction and associated delivery systems
- Strengthening intelligence collection and dissemination

In order to prepare the military to address 21st Century threats while maintaining capabilities to meet current challenges, the Secretary of Defense developed a new defense strategy in the 2001 Defense Planning Guidance that would promote these new national priorities. This strategy focuses on four defense policy goals:

- Assuring Allies and Friends
- Dissuading Adversaries
- Deterring Aggression and Coercion
- Decisively Defeating Any Adversary

The unique capabilities of SOF allow them to make a number of important contributions to the U.S. defense strategy. Although SOF are not well suited for addressing every problem, SOF can provide policymakers with an expanded set of options for rapidly resolving strategic problems with relatively limited resources, fanfare, and risk. The ongoing Afghan and Iraqi operations graphically demonstrates this point.

SOF's ubiquitous presence as "Global Scouts" serves to *assure* allies and friends of U.S. government resolve. SOF's participation in Theater Security Cooperation Plans, Joint Combined Exchange Training, Humanitarian Demining, Counterdrug and Foreign Internal Defense programs provides tangible training benefits while building rapport with our friends and allies.

SOF's presence and unique capabilities *dissuade* potential adversaries by complicating their planning and providing the President and Secretary of Defense a wider array of options for dealing with potential adversaries. By operating "in the seam" between peace and war, SOF can address transnational and asymmetric threats through direct military means or concerted action with conventional military forces and/or other government agencies. SOF can shape the pre-conflict environment to set conditions favorable to the U.S. and can also provide a strategic economy

SOF Core Tasks

Counterterrorism (CT)
Counter Proliferation (CP)
Special Reconnaissance (SR)
Direct Action (DA)
Unconventional Warfare (UW)
Information Operations (IO)
Psychological Operations (PSYOP)
Foreign Internal Defense (FID)
Civil Affairs Operations (CAO)

of force in areas of the world left uncovered by the commitment of conventional forces to other priorities.

SOF *deter* threats and counter coercion through the deployment and employment of specialized forces tailored to counter adversaries' capabilities with both direct and surrogate means. Global SOF presence sends a tangible signal to potential adversaries of U.S. resolve and commitment to its friends and allies. Forces organized, trained, and equipped to execute the SOF core tasks of counterterrorism and counter-proliferation of weapons of mass destruction also provide an important deterrent against adversaries that might contemplate producing or employing these weapons against the United States or its allies.

Finally, SOF, operating in conjunction with conventional forces, provide important capabilities to decisively *defeat* aggressors of all types. Through their ability to operate with coalition forces, regional allies and unconventional warfare forces, SOF serve as a valuable source of intelligence, as well as a force multiplier for conventional warfighting capabilities.

Although SOF provide the President and the Secretary of Defense with important operational capabilities, careful effort must be given to developing operational priorities both to maximize return on the national investment in

special operations capabilities and to minimize the expenditure of effort on operations that provide relatively little strategic return. Today, there are five priority requirements for SOF that flow from the broader strategic guidance.

Operational Priorities for Special Operations Forces

SOF are a strategic asset—one that expands the range of military options available to the President, the Secretary of Defense and other key decision makers.

The priorities listed below are designed to give SOF the direction that they need to become an even more relevant and capable instrument for meeting the national security challenges of the 21st Century.

Priority One—Preempting Global Terrorist and CBRNE Threats

The most critical priority for SOF for the foreseeable future will be to expand and enhance existing capabilities for dealing with adversaries abroad that pose mortal threats to our people, our nation and our way of life.



Priority Two—Enhancing Homeland Security

The second critical priority for SOF is to support the needs of conventional forces and other government agencies as they perform their primary mission of defending the U.S. Homeland.

Priority Three—Performing Unconventional Warfare and Serving as a Conventional Force Multiplier in Conflict against State Adversaries

The third critical priority for SOF is to facilitate the development of indigenous capabilities to fight against terrorists and rogue regimes. Robust unconventional warfare capabilities greatly expand the set of options available to policy makers for defeating rogue regimes and for developing viable indigenous alternatives to them.

SOF must also maintain and improve capabilities to support conventional forces. Although technology will become an increasingly important facet of target recognition and battle damage assessment, it is not likely that unmanned vehicles will fully replace the need for “brains on target.” Putting men on-site will remain a critically important core competency for SOF for the foreseeable future.

Priority Four—Conducting Proactive Stability Operations

The fourth priority for SOF will be the provision of support to friendly governments trying to defeat insurgent or other criminal movements within their borders.

Priority Five—Executing Small-Scale Contingencies

Finally, the fifth key priority for SOF will be to provide robust capabilities to support small-scale contingencies. These operations, whether they be personnel recovery, non-combatant evacuation or other small-scale contingency operations, will rely on the ability of SOF to organize quickly and deploy rapid-response packages that are tailored carefully to meet the operational requirement.

These strategic priorities provide a practical framework for focusing the employment and resource development of SOF. Although the current limitations of SOF cannot be addressed in this document, it should be clear that areas in which SOF are not adequately prepared to

support the above priorities represent critical areas for capability expansion or enhancement. That said, SOF should not be expanded without a deeper consideration of the fundamental constraints associated with the development of special operations capabilities. The most critical of these constraints are addressed in the next section of this document.

Enduring Truths

SOF provide unique capabilities not found in other elements of the Armed Forces. While other U.S. military units can conduct certain types of special operations, and other nations may have special operations capabilities, no other force in the world has the range of capabilities possessed by the U.S. SOF.

Four truths remain the cornerstone shaping the development of our nation's special operations capabilities:

1) *Humans are more important than hardware.*

The special operations soldier, sailor, or airman is the most critical component of any special operations capability.

2) *Quality is better than quantity.*

A small number of people, carefully selected, well trained, and well led, are preferable to larger numbers of troops, some of whom may not be up to the task.

3) *SOF cannot be mass-produced.*

There is no easy formula for creating special operations personnel. Experience—a key element of special operations capability—can only be produced over time.

4) *Competent SOF cannot be created after emergencies occur.*

Time is perhaps the most critical element involved in the creation of competent SOF: time to select, assess, train and educate personnel; and time to gain the experience necessary to perform operations with a reasonable assurance of success. Since competent forces cannot be created instantly, decision-makers must plan ahead to create forces that are sufficient in size, capability and speed of response.

SOF provide capabilities that expand the options available to the employing commander, however they are not the ideal solution to all problems requiring a military response. Usually the best means of employing SOF is to do so in conjunction with conventional forces where each force fulfills the roles that they are optimally designed to accomplish.

Answering the Call

The strategy outlined provides a framework for improving special operations capabilities drawn from the goals of the new defense strategy articulated in the 2001 Quadrennial Defense Review. The strategy functions from the premise that SOF should seek to build upon the strong foundation set down by special operations warriors throughout history. At this critical time in our nation's history the need for capable SOF has never been more acute. Given the immense risks to our nation, it is increasingly clear that for many of tomorrow's special operations, neither failure nor the perception of failure is an acceptable result. SOF must prepare now to meet this pressing need.



TAILOR TO TASK

Special Operations Forces. SOF are designated by the Secretary of Defense, comprised of active duty and Reserve Component forces specifically organized, trained, and equipped to conduct special operations. A simple way to remember the difference between SOF and conventional forces is that SOF's unique training, capabilities, and skills that allow them to conduct high risk operations in hostile, denied, and politically sensitive areas. All SOF candidates undergo a rigorous selection process and mission-specific training far beyond that required by conventional military. SOF are regionally oriented, trained in language and cross-cultural communications skills. SOF personnel spend many years immersed in their respective foreign cultures becoming intimately familiar with

the areas in which they specialize and operate. As a result, SOF are often in the first echelon of any commitment of U.S. forces overseas.

Education. USSOCOM meets this requirement through the continued adaptation and growth of its education and training capability. Each SOF service component has a school to train its personnel in their combat specialties. These schools are: John F. Kennedy Special Warfare Center and School, U.S. Army Special Operations Command, Ft Bragg, North Carolina; Naval Special Warfare Center, Naval Special Warfare Command, Naval Amphibious Base, Coronado, California; and the Air Force Special Operations School, Air Force Special Operations Command, Hurlburt Field,



Our SOF Schools



Joint Special Operations University and the Air Force Special Operations School



JFK Special Warfare Center & School



Naval Special Warfare Center

Florida. USSOCOM also established the Joint Special Operations University, co-located with the Air Force Special Operations School at Hurlburt Field, Florida. The University is comprised of the following principal elements: Air Force Special Operations School; Naval Post-graduate School, Special Operations Program, Monterey, California; and the Distributed Learning College for Joint Special Operations Studies. The University focuses on educating SOF senior and intermediate leaders and national and international decision-makers, both military and civilian, in the art of joint special operations. This type of education is critical to ensure leaders at all levels understand the unique capabilities and requirements, across the spectrum of conflict, of the SOF warrior.

Flexible Adaptable Response. SOF are inherently flexible and rapidly adaptable to a broad and constantly varying range of tasks and conditions. This organizational agility allows

SOF to quickly concentrate synergistic effects from widely dispersed locations and assist joint force commanders in achieving decisive results without the need for time-consuming and risky massing of people and equipment. Even under austere conditions, SOF can conduct 24-hour, multi-dimensional operations to penetrate denied or sensitive areas and resolve terrorist activity, preempt the threat posed by weapons of mass destruction, and strike key targets with precision and discrimination. Although a potent military force, SOF can often accomplish their mission without resorting to the use of force. SOF training skills combined with language proficiency, cultural awareness, regional orientation, and an understanding of the political context of their missions make SOF unique in the U.S. military—true “warrior diplomats.” SOF’s ability to help mold the international environment, rather than merely responding to it, is our most important day-to-day contribution to national security and represents our “steady state” for the future.



Versatile Warriors

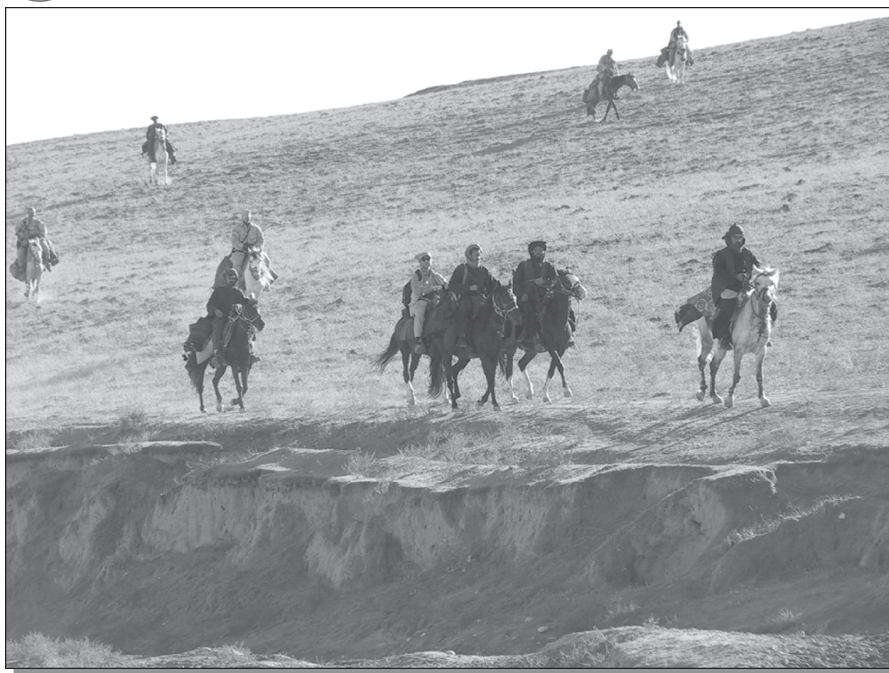

Moreover, this broad array of versatile capabilities allows SOF to “tailor to task” and operate effectively in any situation or environment.

SOF have a virtually ubiquitous presence throughout the world. They therefore serve the nation as global scouts with regard to tracking and reporting political and social developments within the regions in which they operate.

Additionally, technological developments now give SOF unprecedented global reach and increasingly sophisticated means of insertion, support, and extraction of small units to penetrate and successfully return from hostile, denied, or politically sensitive areas. Consequently, SOF provide the President and Secretary of Defense with a broad range of capabilities and flexible options when considering appropriate responses to crises.

The People. Like the Services, the strength of SOF resides in its people. Our philosophical approach is to equip the warrior, not man the equipment. This concept permeates our thinking and frames our attitude to developing our capabilities.

Characteristics of the SOF War Fighter

- Specialized skills, equipment and tactics
- Regional focus
- Language skills
- Political and cultural sensitivity
- Small flexible, joint-force

The ranks of SOF require mature, selectively recruited personnel. Trained for certainty and educated for uncertainty, they are equally adept at using sophisticated equipment or low-tech solutions to accomplish their mission.

Core Values. SOF teams are specifically trained to function in small isolated units within culturally and politically sensitive environments. Because difficult decisions must often be made in these isolated environments, standards of behavior are critical. Our standards of behavior are our unchanging core values: absolute integrity in all we do, courage and competence when we do it, and creativity to accomplish our mission in any circumstances using whatever tools are at hand.

Core Values

- Integrity
- Courage
- Competence
- Creativity

Mission. As has been discussed previously, the United States of America has always had SOF, but only activated such units on an ad hoc basis, and often dismantled the unit once the crisis had passed. A new era began for the special operations community on 16 April 1987 with the activation of the United States Special Operations Command (USSOCOM). Under the leadership of USSOCOM, SOF components, and Theater Special Operations Commands, special operations missions are vetted, planned, and fully integrated into the commander’s collective security plans and contingency operations. All SOF missions are conducted in a joint environment.

Operational SOF Mission Criteria

- Is it an appropriate SOF Mission?
- Does it support commander’s Campaign Plan?
- Are required resources available to execute?
- Does expected outcome justify the risk?

Nine SOF Core Tasks

SOF relevance is its people and it's the people who are organized, trained and equipped to assist our American Ambassadors and the Geographic Combatant Commander in their directed missions. Through the capabilities to conduct their nine core tasks, SOF provides the President and Secretary of Defense expanded options and a strategic economy of force.

Counterterrorism (CT) – is our number one mission. CT produces effective protective measures to reduce the probability of a successful terrorist attack against U.S. interests. This task involves offensive measures taken to prevent, deter, preempt, and respond to terrorism. SOF are specifically organized, trained, and equipped to conduct covert, clandestine, or discreet CT missions in hostile, denied, or politically sensitive environments. These missions include, but are not limited to intelligence operations, attacks against terrorist networks and infrastructures, hostage rescue, recovery of sensitive material from terrorist organizations, and non-kinetic activities aimed at the ideologies or motivations that spawn terrorism.

Counterproliferation (CP) of Weapons of Mass Destruction (WMD) – refers to actions taken to support DOD and other governmental agencies to prevent, limit, and/or minimize the development, possession, and employment of weapons of mass destruction, new advanced weapons, and advanced-weapon-capable technologies. The major objectives of DOD policy are to prevent acquisition of WMD and missile capabilities (i.e., preventive defense), roll back proliferation where it has occurred, deter the use of WMD and their delivery systems, and adapt U.S. military forces and planning to operate against the threats posed by WMD and their delivery systems. SOF provide unique capabilities to monitor and support DOD policy.

Special Reconnaissance (SR) – reconnaissance and surveillance actions conducted as special operations in hostile, denied or politically sensitive environments to collect or verify information of

strategic or operational significance, employing military capabilities not normally found in conventional forces. These actions provide an additive capability for commanders and may supplement other intelligence collection when conventional reconnaissance and surveillance actions are limited by weather, terrain, or adversary countermeasures.

Direct Action (DA) – the conduct of short-duration strikes and other small-scale offensive actions conducted as a special operation in hostile, denied, or politically sensitive environments to seize, destroy, capture, exploit, recover, or damage designated targets of strategic or operational significance, employing specialized military capabilities. Direct action differs from conventional offensive actions in the level of physical and political risk, operational techniques, and the use of discriminating force to achieve specific objectives.

Unconventional Warfare (UW) – a broad spectrum of military and paramilitary operations, normally of a long duration. UW is predominantly conducted by, with, or through indigenous or surrogate forces who are organized, trained, equipped, supported, and directed in varying degrees by an external source. UW includes guerrilla warfare and other direct offensive, low-visibility, covert, or clandestine operations, as well as the indirect activities of subversion, sabotage, intelligence activities, and unconventional assisted recovery.

Information Operations (IO) – actions taken to influence, affect or defend information, information systems and decision-making.

Psychological Operations (PSYOP) – planned operations to convey truthful information and indicators to foreign audiences to influence their emotions, motives, objective reasoning, and ultimately, the behavior of foreign governments, organizations, groups, and individuals. The purpose of PSYOP is to induce or reinforce foreign attitudes and behaviors favorable to the originator's objectives.



SOF Core Tasks Across the Range of Military Operations (Across the Spectrum of Conflict)

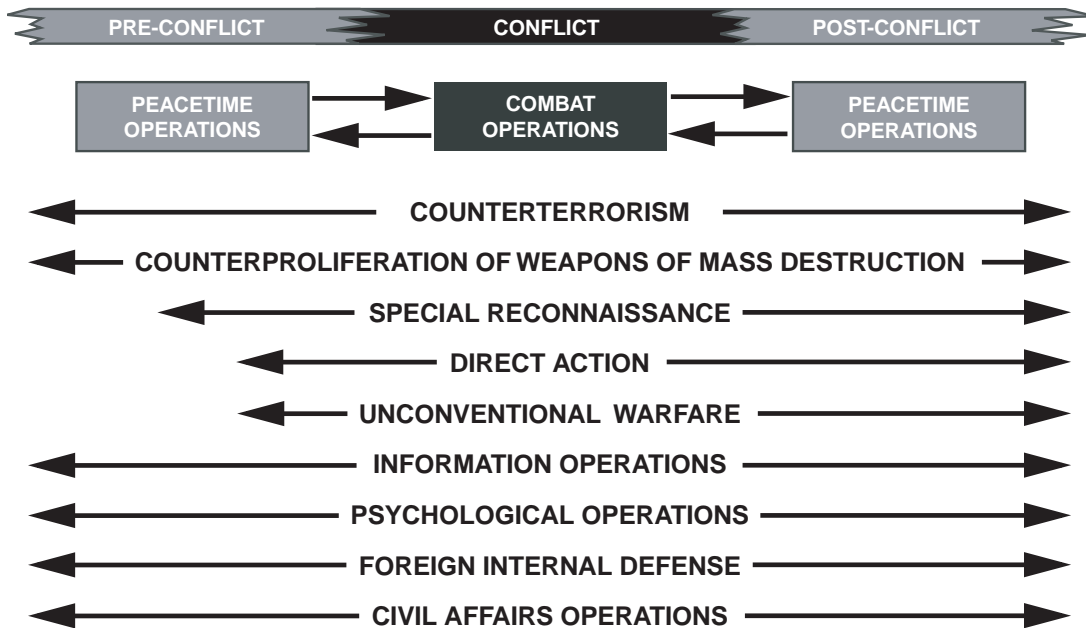

Foreign Internal Defense (FID) – participation by civilian or military agencies of a government in any of the action programs taken by another government or other designated organization to free their society from subversion, lawlessness, and insurgency. SOF’s primary contribution to this interagency activity is to organize, train, advise, and assist host-nation (HN) military and paramilitary forces. The goal is to enable these forces to maintain the HN’s internal stability, to counter subversion and violence in their country, and to address the causes of instability.

Civil Affairs Operations (CAO) – operations consisting of civil affairs (CA) activities and specialized support provided to commanders responsible for conducting civil military operations (CMO). CA activities involve establishing and conducting military government or civil administration until civilian authority or government can be restored or transitioned to other appropriate authorities. CA supports CMO by focusing efforts to minimize civilian interference with military operations and limit the adverse impact of military operations on civilian populations and resources.

SOF OPERATIONS AROUND THE WORLD

Current Operations

U.S. SOF are conducting more missions, in more places, and under a broader range of conditions than ever before. SOF, working with U.S. combat aviation and precision guided delivery systems, were crucial components of both Operations ENDURING FREEDOM and IRAQI FREEDOM: successful efforts to dismantle two terrorist regimes and to destroy al'Qaida and other terrorist groups who sought sanctuaries and safehavens in Afghani-

stan and Iraq. In FY02, SOF units deployed to 148 countries and territories. In any given week, over 4,900 SOF operators are deployed in numerous countries worldwide. Operations and numerous joint/combined exercises in the United States and overseas, continue to reinforce two key principles. First, SOF provide complementary capabilities that, when used in conjunction with conventional forces, expand the military options of a joint force

Commanders' Areas of Responsibility

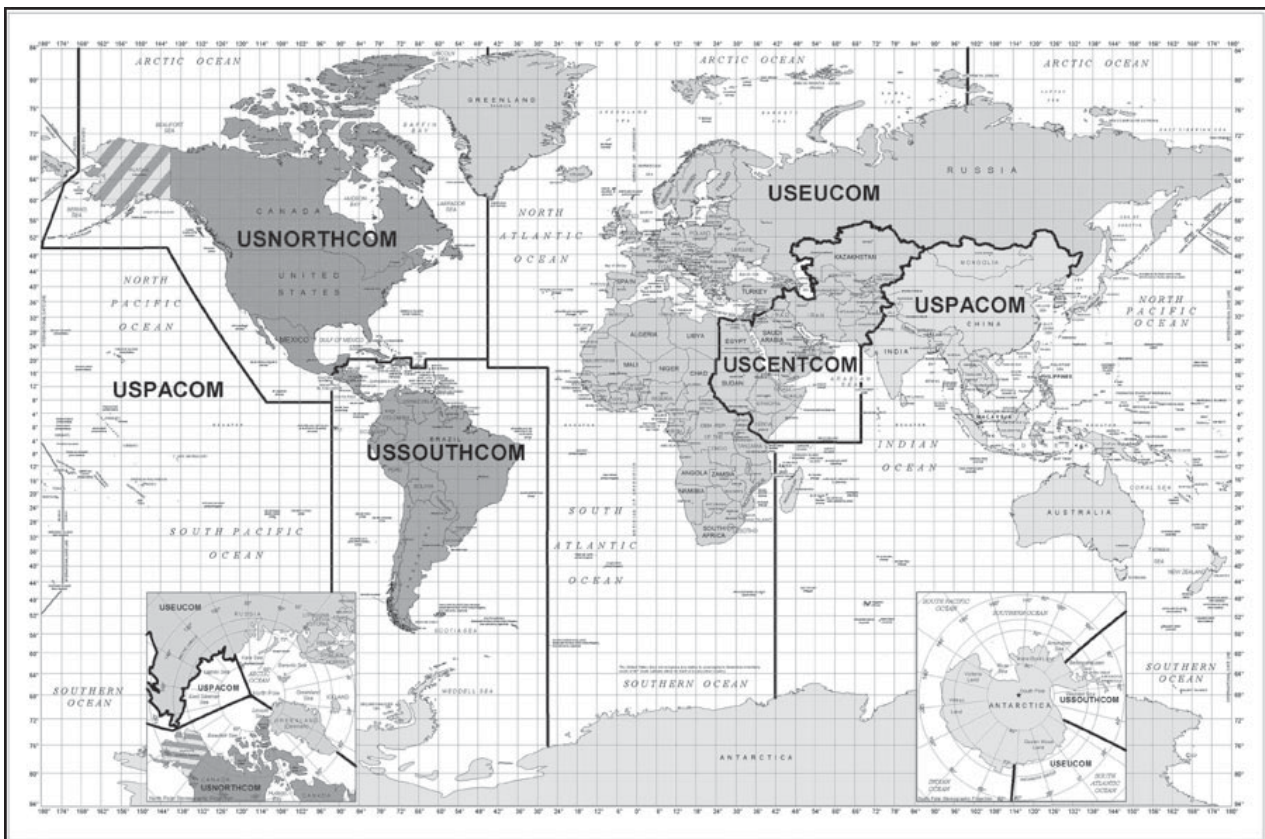



Unified Commands and Theater Special Operations Commands (SOCs)

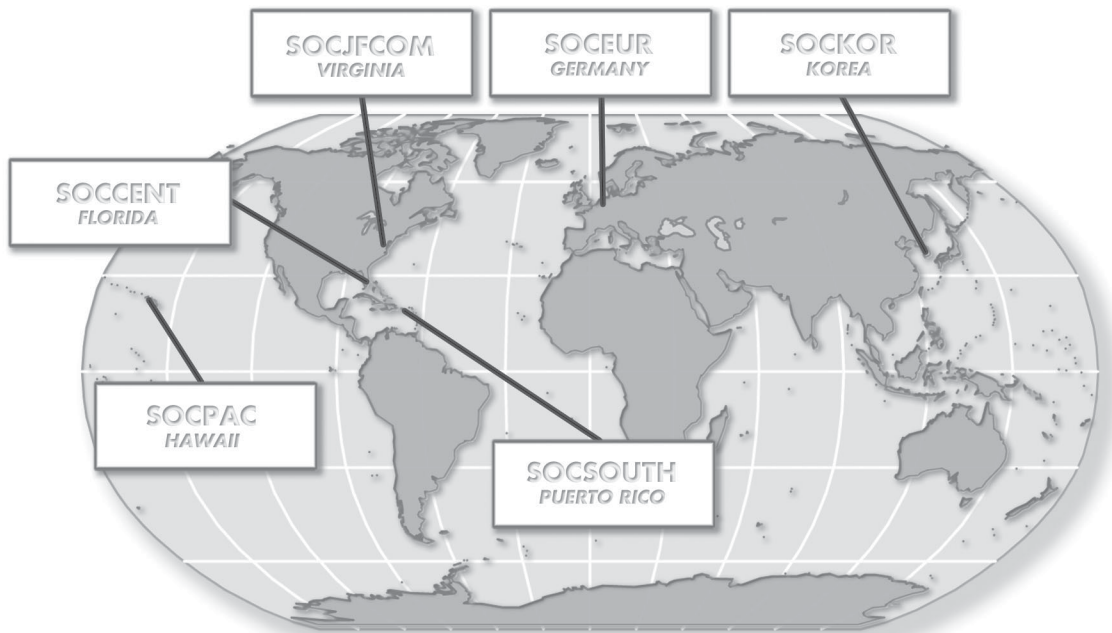

commander (JFC). Second, SOF are most effective when they are fully integrated into a JFC's campaign plan. The theater SOCs, highlighted in this section, ensure that SOF capabilities are considered throughout the entire planning process and fully integrated into both peacetime and wartime plans.

Theater Special Operations Commands (SOC) are sub-unified commands established within each geographic unified command. The function of the SOC is to ensure that SOF are fully integrated into the Geographic Combatant Commander's collective security plans and contingency operations. The SOC commander plans and conducts joint special operations, ensuring that SOF capabilities are matched to mission requirements while advising component commanders in theater on the proper employment of SOF. Additionally,

SOCs provide the core element for establishing a joint special operations task force (JSOTF)—a quick reaction command and control element that can respond immediately to regional emergencies. As a result, JSOTFs are usually the first U.S. military elements to deploy to areas affected by an emergency situation. One of the major roles of USSOCOM is to support geographic commands by providing certain types of funding to the SOCs for SOF-unique activities and personnel. Among the common support activities SOCs provide are:

Counter-Narcoterrorism – Support to interagency and host-nation measures taken to detect, interdict, disrupt, or curtail any action that is reasonably related to illegal narcotics activity. Among other support provided, SEALs, Special Boat Team

personnel, Air Force SOF, and Army Special Forces teams are continuously training host nation counter-narcotics forces in a wide range of skills applicable to drug interdiction.

Demining – In coordination with host nations and U.S. government agencies, the SOCs design and manage training programs to improve mine awareness, detection and recovery, as well as the treatment of casualties.

Integrated Survey Program – SOF teams conduct surveys of U.S. facilities, including embassies and consulates supporting State Department Emergency Actions Plans and Non-Combatant Evacuation Operations. These teams also frequently

deploy in emergency situations to support U.S. Ambassadors in their efforts to assess the impact on host nations of such events as natural disasters or civil unrest.

Joint Combined Exchange Training (JCET) Exercises – Training activities with host nation forces that provide SOF with immersion training in the customs and language of foreign nations, while exercising a spectrum of SOF military skills. In addition to improving SOF skills, JCETs provide an effective means to cultivate relationships that frequently open diplomatic doors for other forms of nation-to-nation cooperation.

Humanitarian Relief – Humanitarian relief efforts include hurricane rescue and earthquake and flood relief.



Theater Special Operations Commands

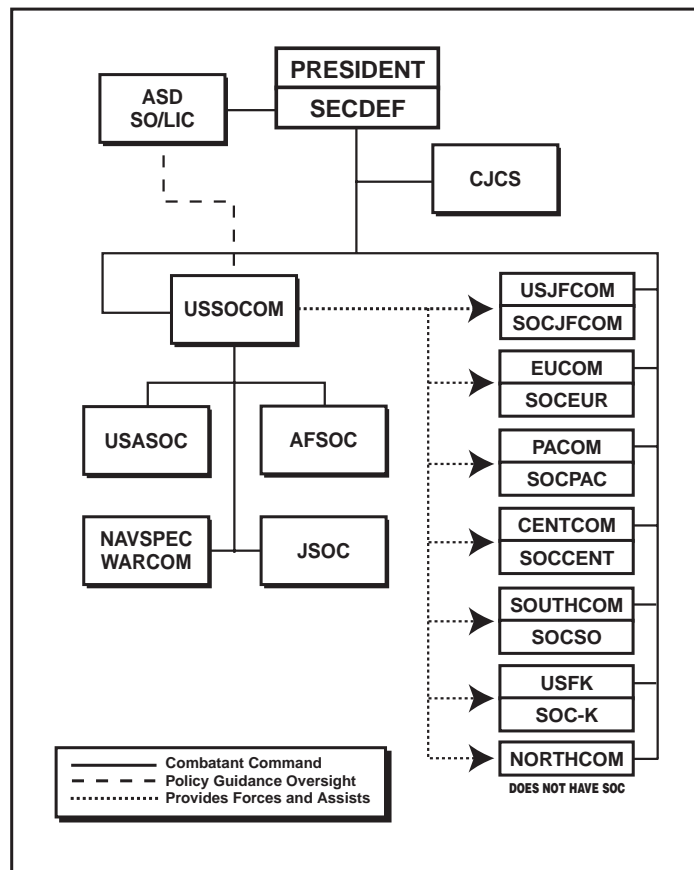



United States Central Command and Special Operations Command, Central (SOCCENT)



United States Central Command's (USCENTCOM) area of responsibility is one of the most dynamic and diverse areas of the world. It is an area that has been, and will continue to be, vitally important to the United States. Operations ENDURING FREEDOM and IRAQI FREEDOM, currently focused on the CENTCOM region, underscores the importance of continued and expanded cooperation throughout the range of SOF activities. The Central Region is the birth place of three of the world's major religions; has a population of over 428 million people; and consists of 17 different ethnic groups, six major languages, hundreds of dialects, varied

forms of government, and a wide range of per capita incomes. CENTCOM's strategy of "Shaping the Central Region for the 21st Century" seeks to integrate the efforts of U.S. Central Command with those of other U.S. government agencies, non-governmental/private volunteer organizations, and our partners in the region to obtain the shared goal of a peaceful, stable, and prosperous Central Region. Implementing this strategy involves the full spectrum of security cooperation, including warfighting and contingency planning, combined and bilateral exercises, and monitoring, security assistance, and demining operations.

Special Operations Command Central (SOCCENT) implements the command's theater strategy through numerous initiatives and programs. SOCCENT's culturally sensitive forces provide a direct link to host-nation counterparts and work to formalize coalition operations procedures, agreements, and doctrine for coalition warfare. SOCCENT has several forward-positioned command and control elements.

Headquarters Structure. Located in Florida. The command is organized similar to other joint commands with responsibilities divided among six directorates: personnel, operations, plans, intelligence, logistics, and communications. Command manning is heavily reliant upon individual mobilization augmentees.

Recent Operations. SOCCENT is committed to support the CENTCOM's regional strategy through a variety of initiatives that also support the U.S. defense policy goals of assure allies and friends, dissuade future military competition, deter threats and coercion against U.S. interests, and decisively defeat the adversary. Some recent operations and initiatives conducted by SOCCENT forces are described below.

Operations ENDURING FREEDOM and IRAQI FREEDOM. In September 2001, SOCCENT was thrust into the world spotlight as the main effort in the War on Terrorism. SOCCENT went to wartime conditions and is currently executing CENTCOM's war plan. The headquarters deployed in support of Operation ENDURING FREEDOM and IRAQI FREEDOM and will continue to be engaged in Afghanistan and Iraq for the foreseeable future.

Maritime Interception Operations (MIO). SOCCENT supported UN sanctions enforcement through MIO conducted in support of UN Security Council Resolution 687 that imposed international trade and economic sanctions against Iraq. Supporting Enduring Freedom, SOCCENT has coordinated a large increase in the number of MIO operations.



Maritime intercept operations

Operation DESERT SPRING. SOCCENT continues Operation DESERT SPRING with increased emphasis in the Operation ENDURING FREEDOM and IRAQI FREEDOM environments. The original purpose of the exercise remains the same: to provide combat support units for terminal guidance of close air support. Operation DESERT SPRING has expanded to include SF teams and a special operations command and control element.



Demining training

Demining. SOCCENT forces plan, establish, and conduct humanitarian demining operations to provide a self-sustaining, indigenous capability. Training is performed to locate, identify, and create databases for mine locations; eliminate the threat of land mines and unexploded ordnance; reduce the risk to life and property; return land to productive use; and train and maintain indigenous forces in demining techniques. Demining operations have been conducted in Yemen, Jordan, Djibouti, Oman, and Afghanistan. The partnership established through the demining program has become the prototype for all other demining programs throughout the world.

Counter-Narcoterrorism. SOCCENT supports host-nation measures taken to detect, interdict, disrupt, or curtail any action that is reasonably related to illegal narcotics activity.



Live fire training for Uzbek forces

Integrated Survey Program (ISP). SOCCENT forces conduct surveys of U.S. facilities, including embassies and consulates, within the AOR on a recurring basis. These surveys support State Department emergency action plans for each post. In addition, surveys provide planning information for Non-Combatant Evacuation Operations.

Central Asian States. USCENTCOM has responsibility for all military activities for the countries in the Central Asian Region. SOCCENT's inherently small footprint and culturally sensitive forces play a critical role in nurturing CENTCOM's relationships in this region.

JCS and JCET Exercises. SOCCENT's Joint Chief's of Staff and Joint Combined Exchange Training exercise programs are vital security cooperation tools that support the theater strategy. Two primary goals of these programs are to enhance SOF's warfighting capability through maintaining combat readiness and to maintain access and presence in the area of responsibility. These exercises also provide the principal means by which to improve coalition warfighting capabilities while simultaneously building strong military-to-military relationships.

Conclusion. SOCCENT stands at the forefront of the War on Terror employing special operations in a rapidly changing AOR. From the east African nations to Kazakhstan, SOCCENT's deployed forces are engaged in an extensive series of operations and training exercises aimed at professionalizing selected national military forces. SOCCENT's pivotal role in Operations ENDURING FREEDOM and IRAQ FREEDOM, combined with their inherently small footprint and culturally sensitive forces, will continue to play a role in stabilizing this area.



United States European Command and Special Operations Command, Europe (SOCEUR)



United States European Command (USEUCOM) is the second largest geographic area of responsibility in the unified combatant command structure. Spanning three continents and encompassing 91 countries, it extends over 13 million square miles and is home to more than one billion people of extremely diverse backgrounds, race, and cultures. Europe is a key trading partner with America. Europe and the United States produce almost half of all the global goods and services; more than 60 percent of total U.S. investment abroad is in Europe; commerce between the two partners exceeds \$1 billion per day. Apart from commercial interests, U.S. interests in the

USEUCOM area of responsibility also stem from the deeply rooted historical, cultural, and racial ties the American population has with the peoples of Europe and Africa. U.S. goals in the region include fostering a European community that is integrated, democratic, prosperous, and at peace.

With regard to Africa, USEUCOM activities are focused on supporting concerted efforts to transform the U.S. relationship with Africa through regional initiatives. These are initiatives designed to enhance the independence of states and promote interstate cooperation in dealing with regional security challenges.

Special Operations Command, Europe (SOCEUR) is a deployable headquarters and employs the personnel and special-capability platforms of Army Special Forces, Naval Special Warfare (SEALs and Special Warfare Combatant-craft Crewmen), Air Force Special Operations Forces, Civil Affairs, and Psychological Operations to accomplish its assigned tasks. The forces include SOCEUR units based in Europe and select augmentation from continental U.S.-based organizations.



Special operations aircraft conduct aerial refueling

The distinctive capabilities of SOCEUR's component commands, manned by highly trained, mature, and resourceful people, offer USEUCOM a wide range of special operations capabilities. SOCEUR stands ready to promote peace and stability and to defeat adversaries throughout the AOR as directed, and in support of USEUCOM strategies. To accomplish these theater objectives, USEUCOM relies on SOCEUR to provide unconventional military options.

Current Activities. After the events of September 11th, SOCEUR rapidly transitioned to a campaign supporting the War on Terrorism, while continuing numerous operations and activities in Europe and Africa. SOCEUR provided critical sustainment for Special Operations Command Central (SOCCENT) to conduct offensive combat operations in Afghanistan and Iraq. SOCEUR's efforts in coordination with U.S. Army Europe and U.S. Air Forces Europe contributed to their overall mission success. Since 1999, SOCEUR has provided joint SOF support to the Kosovo Peacekeeping Force (KFOR). SOCEUR

also supported Operation NORTHERN WATCH, while maintaining the ability to conduct the full range of contingency operations.

In addition to supporting ongoing operations and maintaining readiness for contingency operations, SOCEUR has provided training that has significantly enhanced the combat capabilities of numerous countries in the AOR. Most notably, SOCEUR concluded Operation FOCUS RELIEF, a 14-month mission that provided training and equipment to seven battalions from the countries of Nigeria, Ghana, and Senegal. SOCEUR also trained over 8,500 soldiers from eight African countries in Peacekeeping Operations (PKO) under the African Crisis Response Initiative, which produced trained units capable of conducting PKO in the region.

SOCEUR also conducts a wide range of security cooperation activities throughout the AOR. These activities include Joint Combined Exchange Training events, Joint Contact Team Program training, security assistance activities, humanitarian demining operations, and Civil Affairs training. The events include U.S. SOF and host nation elements in activities ranging from combined small unit tactical training to briefings at the Ministry of Defense level. These activities enhance cooperation, add to the safety and stability of the region, and maintain a SOF presence in priority countries.



Special Forces coordinate combined operations with Russian soldiers in Kosovo



SEALs conduct heliborne visit board search and seizure training

Conclusion. SOCEUR maintains its readiness to conduct contingency operations, to respond to the full range of conflict, and to continue security cooperation assistance. These efforts have shown the importance of SOF in the theater. Support to Operations ENDURING FREEDOM and IRAQI FREEDOM demonstrated the unique capabilities and tenacity of SOF warriors who tirelessly accom-

plish the mission. Support to the Stabilization Force demonstrates SOF ability to adapt and meet unexpected challenges. Support to KFOR demonstrates SOF's flexibility and expertise. Finally, Operation NORTHERN WATCH has shown the indispensable value of SOF.

These operations reveal that SOF has the capability to meet the challenges of the dynamic and unpredictable environment. SOCEUR continues to maximize its forward presence, and achieve success employing our high value, low-density forces. Readiness to respond to crises is SOCEUR's highest priority, reflected by its motto—*Semper Parate* (Always Prepared). SOCEUR provides the “point of the spear” for operations throughout the theater—to thwart terrorism, to stem the proliferation of weapons of mass destruction, to prevent conflict through security cooperation, and to respond to crises with precision and strength.



United States Pacific Command and Special Operations Command, Pacific (SOCPAC)

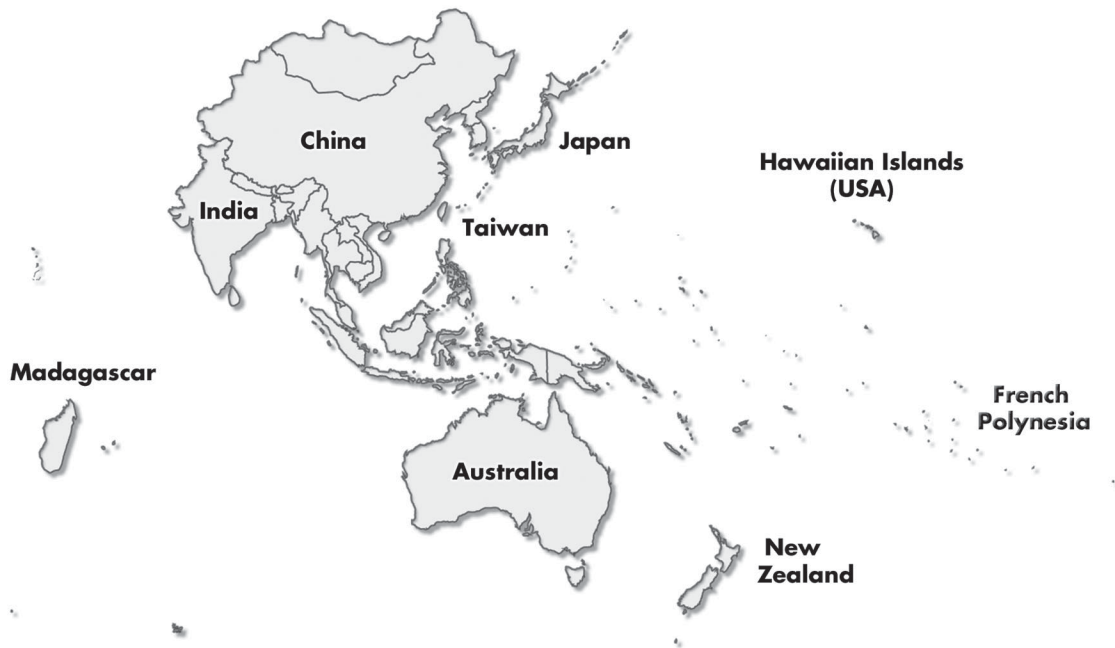

United States Pacific Command's (USPACOM) area of responsibility represents the largest geographic area of the unified commands. The area covers over half of the earth's surface with over 105 million square miles and nearly 60 percent of the world's population. Distance, diversity, and change characterize the PACOM AOR. Although the Asian-Pacific Rim has experienced an economic slowdown, over the last decade Asia's economic growth rate was twice that of the world as a whole. This growth has increased competition for both natural resources and markets. Thirty-six percent of U.S. merchandise trade is within the region and over three million American jobs are linked to Asian export markets. Sovereignty claims to areas such as the Spratly Islands have become important due to

the resource potential of the surrounding seas. Economic growth has fueled an expansion of military technologies and capabilities. The six largest armed forces in the world operate in the Pacific AOR. Military capabilities in the region are increasingly modern due to technical development and economic growth. This enhanced military capability has resulted in several nations possessing the capability to build and deliver weapons of mass destruction (WMD). Other regional nations also have the economic and technical sophistication to develop WMD capabilities on short notice, should they believe a threat exists. USPACOM stands ready to protect vital U.S. interests in the Asian-Pacific area, while simultaneously fostering regional peace, prosperity, and security.

The political challenges in the region are also changing. Asian-Pacific nations are proud of their cultures and sensitive about issues of independence and sovereignty. These nations are strikingly diverse in size, population, culture, and history. The 43 nations, 20 territories, and ten U.S. territories represent 75 official languages and over 20 distinct religions. Security concerns and threats, such as the Korean peninsula, Peoples Republic of China aggression against Taiwan, Indo-Pakistani border, and Indonesia, remain concerns. Local insurrection, territorial disputes, religious and ethnic conflicts, and illegal drug trafficking have economic, political, and military implications for the commander and all theater service components. The commander's strategy harmonizes employment of military resources through activities that promote peace and stability with the other elements of national power. This strategy recognizes contributions made, both directly and indirectly, by military forces supporting the new defense policy goals. This strategy focuses on continued military presence in the region demonstrating U.S. commitment, developing trust, and deterring aggressors.

Special Operations Command Pacific (SOCPAC), located in Hawaii, is a sub-unified command and serves as the SOF component command for the U.S. Pacific Command area of responsibility. It supports theater strategy principally through crisis response and through numerous initiatives and programs aimed at both assisting nations and developing close working relationships with counterpart forces.

SOCPAC supports PACOM's collective security plan through demining training activities, counter-drug training, bilateral/multilateral exercises, Joint Combined Exchange Training (JCET), Pacific Situation Assessment Teams (PSAT) and the annual Pacific Area Special Operations Conference. Theater Security Cooperation seeks to:

- Demonstrate continued American intent and capability
- Reassure allies and friends
- Promote regional stability, cooperation and trust
- Deter potential regional aggressors; build force interoperability
- Maintain access to host-nation support and facilities

Responding to Crises. SOCPAC provides PACOM with a highly capable crisis response force. Crisis response is provided by a rapidly deployable Joint Task Force (JTF). With SOCPAC as the nucleus, JTF is specifically structured for, and capable of, timely response to special contingencies, humanitarian assistance, disaster relief, noncombatant evacuation operations, and other crises. With a secure, mission-tailored, highly mobile, reliable communications package, JTF is usually the first to deploy in real-world crises and in each major exercise.

Demining. Landmines continue to inflict hundreds of civilian casualties per month. Additionally, the mine threat removes arable land from production and reduces the flow of commerce. Various factions laid these mines over the last 40 years. SOF, in cooperation with the host nation and U.S. government agencies, have designed and managed a training program to improve mine awareness, detection and recovery, and the treatment of casualties. Other countries plagued by landmines are looking at ways to participate in the program.

Counter-Narcoterrorism. Southeast Asia remains one of the world's largest drug-producing areas. SOF assist host nations in improving their capability to deal with this significant problem. Specifically, SOF conduct training to improve planning,

expertise, and small-unit tactics of host-nation military and law enforcement agencies to increase their ability to battle narco-terrorists. SOCPAC forces were instrumental in training the Thai Task Force to help curb the flow of drugs from Burma into Thailand. This training benefits the host nation's environment through activities that promote peace and stability. The strategy focuses on continued military presence in the region—demonstrating U.S. commitment, developing trust, and deterring aggressors.

Joint Combined Exchange Training (JCET).

One of the cornerstones supporting the new defense policy goals is the SOCPAC-managed JCET program. This program fulfills SOF training requirements and allows the sharing of skills between SOF elements and their host-nation counterparts. These activities include airborne and air mobile patrolling, lifesaving, reconnaissance, and small-unit tactics. JCET activities improve SOF and host nation capabilities, and also demonstrate the PACOM commander's commitment to constructive cooperation. In addition, humanitarian and civic action projects, done in conjunction with JCET events, provide tangible benefits for the host-nation civilian population. Participants include in-theater and CONUS units from both the active duty and Reserve Component force. The commander uses this cornerstone program for initial military-to-military contact, annually demonstrated through presence in some of the smaller countries, and as part of an ongoing military program in many of the larger nations.

Pacific Situation Assessment Team (PSAT).

PSAT enhances coordination between the PACOM commander and the U.S. Chief of Mission's country team by providing on-site advice regarding the suitability and feasibility of the application of military forces and resources in support of U.S. government responses to crisis situations. The annual Pacific Area Special Operations Conference (PASOC) is another forum that supports theater security cooperation. This weeklong conference, comprising over 140

delegates—including 20 flag officers—from 24 countries and over 250 attendees, provides the commanders with an “azimuth check” for U.S. peacetime cooperation. In addition, PASOC provides a unique opportunity to develop, in a multilateral setting, senior foreign military contacts that will facilitate the conduct of future exercises, crisis response, and other operations within the area of responsibility.



SF soldier teaches shooting skills to AFP soldiers

Security Assistance. In FY02 U.S. Special Forces conducted security assistance to develop the Armed Forces Philippines (AFP) Counterterrorist (CT) unit. The purpose of this operation was to develop the CT capabilities of the AFP, Southern Command while enhancing and supporting peacetime theater security cooperation in the Pacific area of responsibility. The eight phase training focused on small-scale recovery operations and the collective execution of close quarter battle. In the end, the AFP CT unit was capable of unilaterally planning and executing CT operations in urban and rural environments.



Live fire drill in the Republic of the Philippines

Conclusion. SOCPAC serves as the SOF focal point for the most expansive and diverse geographic area of the world. In an AOR that is characterized by distance, diversity and change, SOCPAC fulfills a key role in harmonizing the use of military resources in the region with other elements of national power. The presence of this command and its deployed service members serves to demonstrate U.S. commitment, develop trust among pacific nations, and deter aggression throughout the region.



United States Southern Command and Special Operations Command, South (SOCSOUTH)



United States Southern Command's (USSOUTHCOM) area of responsibility encompasses the land mass and surrounding waters of Latin America south of Mexico and South America. This area is approximately 10 million square miles or approximately one-sixth of the world's entire land area. Every country conducts national elections and employs a democratic form of government. Economically, the region is vital to our Nation's continued prosperity.

Over 30 percent of U.S. trade originates from this AOR. Brazil is the world's ninth largest economy, larger than Canada's. Over 300 million people of the area speak eight official languages: English, Spanish, Dutch, Portuguese, French, Guarani, Quechua, and Aymara. Extreme differences in geography, topography, prosperity, stability, and ethnicity characterize the theater.



SEALs conduct joint training with Special Operations Aviation Regiment.

Special Operations Command South (SOCSOUTH), forward based in Puerto Rico, is USSOUTHCOM's subordinate unified command for special operations. It is responsible for all SOF in the theater, to include Civil Affairs and Psychological Operations forces.

SOCSOUTH is a joint headquarters. U.S. Special Operations Command, SOFs primary force provider, augments SOCSOUTH with U.S.-based SOF forces to respond to the full spectrum of crises, from transnational threats, through the myriad forms of smaller-scale contingencies, to full-scale war.

Challenges. Many of the region's democracies remain fragile, their basis undermined by widespread economic, sociological, and political problems. They face security problems that are multidimensional and localized. Latin America has the most uneven distribution of income and wealth, where the poorest 40 percent of the population receive only 10 percent of the income. Poverty is widespread. Rapid population growth, proliferating transnational threats, international drug trafficking, organized crime, terrorism, environmental exploitation, illegal migration, the proliferation of land mines, and

illegal paramilitary forces challenge the well-being and moral fiber of every country in the Western Hemisphere. Regional domestic crime threatens U.S. economic interests and the security of our citizens abroad—over 3,000 kidnappings per year occur in Colombia, one-half of the world's abductions. The region's porous borders, the expanding influence of insurgent organizations, and the symbiotic relationship between the illicit drug industry and insurgencies combine to make the region the most complex in the world.

Regional security considerations now include threats to the domestic order that challenge a state's ability to hold the country together and to govern. Today, many regional militaries focus on issues that garner the support of the people for the government. This includes responding to natural disasters and their aftermath; domestic threats; and dealing with non-state actors including terrorists, organized crime, and paramilitary groups.



U.S. trained Colombian counter-narcotics soldiers conduct a training raid on a drug lab.

To assist in the U.S. effort to meet these challenges, SOCSOUTH provides a flexible means of accomplishing a wide-range of missions. As the theater's only rapid response force, SOCSOUTH is commonly called upon to handle emergencies requiring immediate military assistance.

Strategy. SOCSOUTH supports the USSOUTHCOM Strategy by applying SOF capabilities to expand and strengthen alliances and security relationships. This application of SOF assures our regional allies and friends of U.S. national resolve to support, defend, and advance common interests within the Americas.

- Assisting U.S. agencies in training host-nation forces to combat terrorist groups and to target drug production and trafficking, as well as and support interagency efforts to interdict the flow of drugs and related materials in the transit zone
- Enhancing regional stability by assisting friendly nations in coping with internal and external threats to their security, while fostering professionalism and respect for human rights
- Building military-to-military contacts that generate mutual trust, improve collective military capabilities, and promote democratic ideals
- Staying ready to conduct special operations during periods of conflict and peace in support of U.S. interests

Counter-Narcoterrorism support is a major area of focus for USSOUTHCOM. Deployed on a continuous basis throughout the source and transit zones, SOF supports interagency and host-nation measures taken to detect, interdict, disrupt, or curtail any action that is reasonably related to illegal narcotics activity. Counter-Narcoterrorism denies the revenue generated by drugs to terrorist organizations such as the FARC. SEAL and Special Boat Team personnel are constantly engaged in training missions to assist participating nations in controlling their coastlines and waterways. U.S.

Air Force SOF provide critical training that help host-nations develop counterdrug aviation capabilities and support infrastructures. Army Special Forces (SF) detachments continuously train host-nation forces in a wide range of relevant skills. Through the precise application of these highly trained SOF, SOCSOUTH directly contributes to the accomplishment of theater objectives.

Combined Training. To assure our regional partners of U.S. resolve while dissuading potential adversaries, SOCSOUTH manages over 450 total deployments annually, averaging 42 missions in 18 countries at any given time. Combined training is a primary means of interaction with participating nation's military forces and provides the link for USSOUTHCOM's counter-narcoterrorism strategy.



Host nation soldiers receive 81mm mortar training from a Special Forces soldier during a combined training deployment.

The U.S.'s largest foreign policy effort, has helped the Colombian Government make substantial inroads in neutralizing those organizations responsible for illicit drug activities and terrorism in its country. As USSOUTHCOM's major implementer for this U.S. national strategic effort, in accordance with NSPD-18, SOCSOUTH has directly overseen the training and fielding of three Colombian Army Counterdrug Battalions and a Counterdrug Brigade Headquarters. This brigade is a force

that is capable of day/night operations in all weather and terrain; a highly professional force that operates within the rule of law and respects and promotes universal human rights. Currently, SOCSOUTH is ensuring the sustainment and continued operational capabilities of this newly formed Counterdrug Brigade through a robust sustainment-training program.

Combined Exercises. The USSOUTHCOM combined exercise program supports security cooperation in the AOR by providing tailored opportunities to sustain positive trends in the development of both appropriate roles and missions, and cooperative, interoperable capabilities to respond to shared challenges.

SOCSOUTH hosts the annual SOF Combating Terrorism Symposium. This activity brings security forces from throughout the region together in friendship to exchange ideas and foster dialogue on the common issue of combating terrorism. Additionally, SOCSOUTH deploys forces on numerous occasions to improve force protection for U.S. units and enhance the safety of U.S. citizens and interests during periods of internal strife.

SOCSOUTH is dedicated to providing SOF expertise to the USSOUTHCOM exercise program, serving as executive agent for two Joint Chief of Staff exercises. One exercise is a joint and combined field training exercise with South American countries that focus on peacekeeping operations skills. This exercise serves to promote regional stability. Another exercise is an annual contingency response event that provides superb training in operational planning and warfighting skills to U.S. SOF. Additionally, SOCSOUTH participates in a variety of other exercises designed to enhance U.S. joint interoperability.



Special Forces soldiers conduct assault training in support of USSOUTHCOM contingency operations

Humanitarian Demining. The residual effects of previous regional conflicts and the proliferation of land mines pose a significant threat to several of the region's countries. SOCSOUTH averages four humanitarian demining deployments within five Central and South American countries per year. This program continues to save hundreds of lives each year and provides a stabilizing influence throughout the region. These operations fully support the Organization of American States and the Inter-American Defense Board by providing training and technical advice and assistance.



Special Forces soldiers conduct assault training in support of USSOUTHCOM contingency operations.



Host Nation soldiers receive demining training

Conclusion. SOCSOUTH remains USSOUTHCOM's force of choice in supporting theater and national strategy. SOCSOUTH continues to maintain a ubiquitous theater presence with tailored SOF which poses a wide range of unique capabilities. SOCSOUTH leads the way in assuring our theater friends and allies, that if required, it remains prepared to deter and defeat aggression at a moment's notice.



United States Joint Forces Command and Special Operations Command Joint Forces Command (SOCJFCOM)



U.S. Joint Forces Command (USJFCOM), headquartered in Virginia, is one of nine unified commands in the Department of Defense. The commander of USJFCOM oversees the command's roles in transformation, experimentation, joint training, interoperability, and force provision as outlined in the Department of Defense's Unified Command Plan. The Command has four essential tasks:

- Discover promising alternatives through joint concept development and experimentation
- Define enhancements to joint warfighting requirements
- Develop joint warfighting capabilities through joint training and solutions
- Deliver joint forces and capabilities to warfighting commanders

The Department of Defense appointed U.S. Joint Forces Command as the "transformation laboratory" of the United States military that serves to enhance the unified commanders' capabilities to implement transformation strategy. USJFCOM develops concepts, tests these concepts through rigorous experimentation, educates joint leaders, trains joint forces, and makes recommendations on how the Army, Navy, Air Force, and Marines can better integrate their warfighting capabilities. USJFCOM develops future concepts for joint warfighting. Such work must include and strengthen service efforts, draw on the best of industry, and follow the will of the citizens as expressed through Congress.

Special Operations Command, United States Joint Forces Command (SOCJFCOM) has the mission to train both conventional and special operations joint commanders and staffs in employment considerations for SOF. Located in Virginia

near the USJFCOM Joint Warfighting Center (JWFC) and Joint Experimentation Center, SOCJFCOM is well situated to assist in enhancing both the current and future readiness of SOF – and conventional forces. SOCJFCOM is fully integrated into the joint training and experimentation world to ensure that key insights are shared between the SOF and conventional communities. SOCJFCOM support the training of the Geographic Combatant Commands, Joint Task Forces (JTF), Theater Special Operations Commands (SOC), and joint special operations task forces (JSOTFs). SOCJFCOM supports these commands and staffs by providing academic seminars on SOF capabilities, limitations, and employment considerations. They also provide SOF observer – trainers which impart additional training and feedback during the exercises or operations. SOCJFCOM also collects and shares gained insights in tactics, techniques, and procedures and incorporates emerging insights into joint concept development and experimentation.

Working with the JWFC, SOCJFCOM supports approximately 15 joint exercises per year worldwide within the priorities established by the respective Geographic Combatant Commanders. Also, they are called to support real world opera-

tions. By working together with the JWFC, SOCJFCOM is able to assist many of the prospective JTF headquarters (such as XVIII Airborne Corps, 6th Fleet, III Marine Expeditionary Force, and US Air Forces, US Central Command).

Sharpening the edge on SOF joint training methodologies. Theater Special Operations Commands recognize the importance of their role as the special operations advisor to their Geographic Combatant Commander, as well as commanding SOF throughout the AOR. SOCJFCOM assists the SOCs to train their operational headquarters by providing external training support. The SOCs, with USSOCOM and USSOCOM's service components' concurrence, increasingly task O-6 commands to form the core of JSOTFs performing at the operational and tactical level. Below are some examples of training assistance over the past two years:

- Supported SOCPAC's crawl, walk, run training in FY01 and FY02, and SOCPAC's full up participation in the JCS exercise Tandem Thrust (all occurring just prior to Operation ENDURING FREEDOM and their operations in the Philippines)

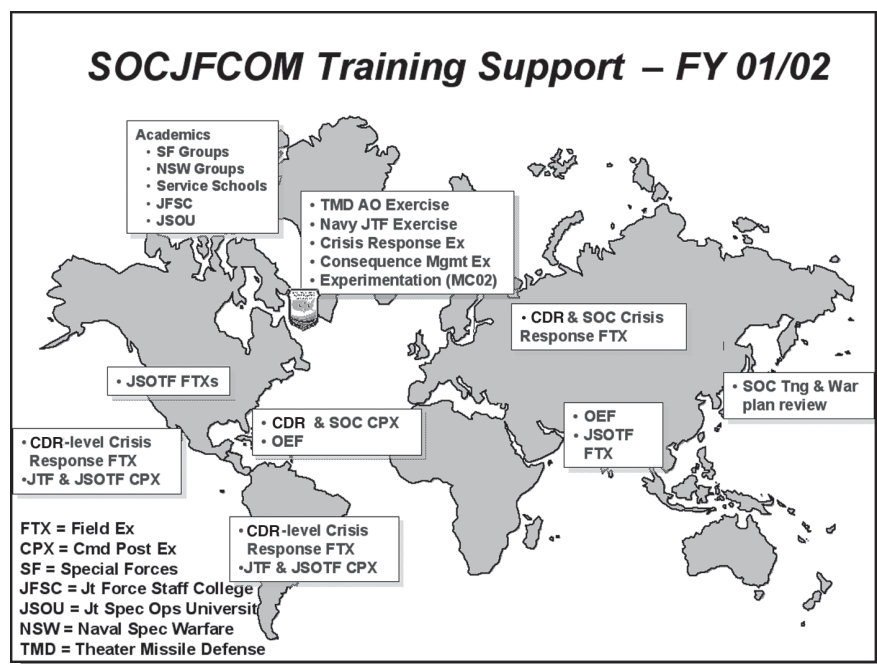

- Assisted SOCCENT in preparation for INTERNAL LOOK 03
- Assisted SOCSOUTH with their training prior to and during the JFCOM computer assisted simulation exercise, UNIFIED ENDEAVOR
- Supported SOCEUR's training of one of their functional concept plans with subsequent planned participation in a EUCOM JCS exercise
- After SOCJFCOM training support, SOCKOR reviewed and modified their standard operating procedures, and subsequent exercise of its warfighting competencies in ULCHI FOCUS LENS

USSOCOM is taking the next step in increasing SOF's joint warfighting capabilities, developing a long-term training strategy that incorporates the crawl, walk, run methodology. This strategy consists of going beyond the 'walk (partially trained)' level of training that SOCJFCOM, by itself, can support. It extends to the incorporation of all of the worldwide training opportunities and resources to increase warfighting proficiency to a 'fully trained' level. The strategy starts with clearly defined Joint Mission Essential Task List and identification of those headquarters that may be tasked as a JSOTF.

USSOCOM deliberately schedules operational units with SOCJFCOM for 'crawl' and 'walk' training. This training is integrated with 'run' training as part of OCONUS JCS exercises and USJFCOM joint exercises in CONUS.

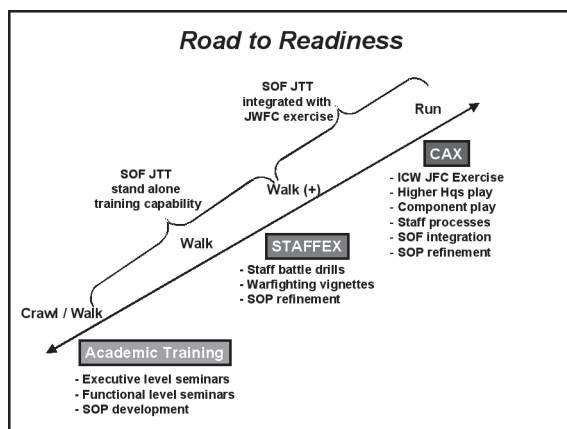

SOF Joint Training Teams (SOF JTTs).

SOCJFCOM provides stand-alone 'crawl and walk' level training support using 'observer-trainers (O/T)' – officers and noncommissioned officers who have gained subject matter expertise through self study, schooling, and experience gained from involvement in exercises and real world operations. The O/Ts deploy to the training unit as part of SOCJFCOM tailored SOF Joint Training Teams (SOF JTTs). The SOF JTTs provide executive and functional level seminars and vignette style staff exercises, utilizing after action reports, and commander's summary reports to support the commander's training objectives. The SOF JTT can also support the training audience in 'run' training by supporting the planning and execution of JCS and JFCOM exercises.

Supporting joint concept development and experimentation and integration. SOCJFCOM assists both USJFCOM and USSOCOM in their concept development and experimentation programs and interoperability with the Services. SOCJFCOM reviews all USJFCOM conceptual documents, has a working knowledge of their ongoing experimentation program, and supports experiments such as the MILLENNIUM CHALLENGE and PINNACLE PATHWAY series. SOCJFCOM maintains visibility of current command and control systems and procedures used by SOF. Uniquely postured during these training and operational activities, SOCJFCOM observes and notes interoperability challenges. These challenges are then shared with USSOCOM and USJFCOM for vetting, assessment, and potential action.

Conclusion. The men and women within SOCJFCOM, working with the Theater SOCs and the USJFCOM Joint Warfighting Center, assist today's warfighter while supporting the transformation of SOF.



The Korean Theater of Operations and Special Operations Command, Korea (SOCKOR)



The Korean Theater of Operations.

The Korean peninsula remains under the terms of an armistice agreement signed by the opposing military forces. Republic of Korea (ROK) and U.S. Military forces on the Korean peninsula work together to maintain peace through vigilance. The Korean area of operations (AO) has a complex web of command relationships and is comprised of five military components, all commanded by Commander United States Forces Korea (COMUSKOREA). The Korean AO is unique because COMUSKOREA is a sub-unified commander under United States Pacific Command (USPACOM).

COMUSKOREA wears three hats. As commander, United Nations Command, he is the international commander responsible for maintaining the armistice that has existed in Korea since 1953. As commander, ROK/U.S. Combined Forces Command, he is a bi-national commander who supports Korea by deterring North Korean aggression and, if necessary, defeating a North Korean attack. Finally, he is the subordinate unified commander responsible for providing U.S. forces to commander, United Nations Command.

Special Operations Command Korea (SOCKOR) is the theater SOC responsible for special operations on the Korean peninsula and, when deterrence fails, the Korean Theater of Operations (KTO). During armistice, SOCKOR is responsible



Combat Shadow aircraft airdrops SOCKOR personnel at a drop zone in the Republic of Korea.

to the Geographic Combatant Commander for SOF war planning, targeting, training, and participation in exercises and contingency operations on the Korean peninsula. During armistice, contingencies, and hostilities, SOCKOR exercises operational control of the U.S. Army Special Forces Detachment, Korea (SFD-K), which is the longest continuously serving SF unit in Asia. This organization is key to ensuring inter-operability between ROK Army Special Warfare Command (SWC) Brigades, Special Missions Group, Battalions and U.S. SOF. The SF NCOs of SFD-K live, train, and work with the ROK Special Forces Brigades on a daily basis, and thus play a critical role in the shaping of ROK and U.S. SOF operations.

Deterrence and Readiness. Because of the unique command relationships in Korea, SOCKOR is the only theater SOC that is not a subordinate unified command. Established in 1988 as a functional component command of USFK, SOCKOR is the principal organization responsible for the integration of U.S. SOF in Korea. Its' primary mission focus is simple: be ready to employ U.S. SOF and win, should war resume in Korea.

Warfighting. Should deterrence fail in Korea, SOCKOR will combine with the Republic of Korea Army SWC to establish the Combined Unconventional Warfare Task Force (CUWTF). As the special operations component of Combined Forces Command, the CUWTF will plan and conduct combined and joint special operations throughout the then established Korean Theater of Operations, exercising operational control of all assigned and attached ROK and U.S. SOF. Additionally, SOCKOR will function as the United Nations Command Special Operations Component Command, integrating all third country SOF.

Cooperation. SOF long-term deployments help develop the strategic environment by contributing directly to deterrence efforts. Through the integration of ROK and U.S. SOF in combined exercises, SOCKOR assists in expanding Korean SOF capabilities to respond to the spectrum of threats as well as to ensure that there is post-reunification relevance for ROK SOF.



U.S. Special Forces Group and ROK Special Warfare Command soldiers conduct advanced small arms marksmanship with 9mm pistols during Joint Combined Exchange Training (JCET).

Contingencies. To add to the challenge posed by a return to hostilities, there are a number of other scenarios that may occur. They include North Korean terrorist actions, direct military confrontations, threats of the use of Weapons of Mass Destruction (WMD), missile launches, and other forms of provocation to gain political and economic concessions from the international community. Other potential crises include massive refugee flow, natural or man-made disasters, transfer of or loss of control of WMD, the outbreak of civil war within North Korea, and collapse of the North Korean regime. Therefore, as ROK and U.S. SOF train for war, they must also prepare for the uncertainty and complexity of post-hostilities and a wide range of potential crises requiring swift and skilled military intervention. This is a uniquely human endeavor and while advanced technology will have important applications in these scenarios, it is the human element which is key to success. The cultural awareness and language abilities of SOF units will play a critical role in influencing the North Korean population and assisting allied forces in the transition to a reunified Korean Peninsula.



MK-V from a Special Boat Team carries U.S. and ROK Navy SEALs off the Korean coast during a ROK/U.S. JCS exercise.

Conclusion. ROK and U.S. SOF have an important role to play as force multipliers in supporting the commander's campaign plan. It is highly likely that the entire range of special operations missions will be conducted in some form should hostilities resume or other crisis occur. Therefore, SOCKOR and U.S. SOF must remain focused on their ability to execute the full spectrum of special operations in Korea.

TRANSFORMING SPECIAL OPERATIONS

Throughout history, success by a small force against a strategic or operational objective has frequently required units with combinations of special people with specialized training, experience and equipment that employ tactics not found in conventional units. These attributes have allowed such units to be employed in unconventional ways, for which the enemy often was unprepared. In general, tasks that require “special” operating forces include those that:

- Have potential strategic impact and require judgment and discretion by the individual operator
- Require a small group that presents a minimal footprint – when clandestine operation is desired, or where presence is denied to conventional forces
- Require the application of techniques, intelligence, and/or technology beyond the training of conventional forces
- Require strategic decision-making under stress
- Involve the creative application of force outside conventional doctrine
- Require perseverance beyond the sustainability of conventional forces, or operation in difficult environments
- Require human observation, interaction, and initiative at the point of contact
- Require presence prior to, during and continuing after an action

SOF Essence. SOF perform, accomplish, and sustain missions strategic in nature and impact. SOF are viable across the full spectrum (peacetime engagement to high-intensity combat) of integrated operations. SOF utilize extraordinary means and possess unique capabilities that are not found

in other elements of the general-purpose U.S. Armed Forces or those forces of other nations. SOF achieve unique levels of relevance by exploiting peculiar organizations, training, and equipment while maintaining distinctive personnel.

USSOCOM faces a strategic environment characterized by geopolitical shifts, rapid technological changes, evolving threats, constrained resources, and evolving roles. These factors require innovative thinking and new ways to shape change if we are to provide the widest array of options for protecting America’s interests. A primary objective of transformation is to increase the margin of our advantage over potential adversaries in all facets of warfare. These facets of warfare include: projecting power to any location on the globe at a time of our own choosing; dominating the information space while preventing adversaries from affecting our information operations; and defeating our enemies decisively with unparalleled speed and precision. This transformation objective must be accomplished while reducing the human and fiscal costs associated with the planning, preparation and conduct of warfare.

The 21st century SOF Warrior—selectively recruited and assessed, mature, superbly trained and led—will remain the key to success in special operations. These warriors must be capable of conducting strategic operations in all tactical environments—combining a warrior ethos with language proficiency, cultural awareness, political sensitivity, and the ability to maximize Information Age technology. SOF must also have the intellectual agility to conceptualize creative, useful solutions to ambiguous problems, and provide a coherent set of choices to the Combatant Commanders or Joint Force Commander.

Vectors of Transformation

Vectors for transformation include combined operations, experimentation, validation, SOF-specific elements, and interagency integration. There are a number of additional non-material factors that drive SOF transformation. Foremost among these factors is a change in mindset. Although the new policy priorities for SOF described earlier in this document provide inspiration for change, it is important for those within and outside of the special operations community to understand that the United States will be at war for the foreseeable future. In this long and costly war, SOF will play an instrumental role. This fact should color every facet of special operations planning. Not only must SOF be prepared to support sensitive high-risk operations at any time; Special Operations leaders should plan now for the losses that inevitably will occur.

To meet the requirements of the future, SOF will rely upon quality personnel. Given the complexity and sensitivity of tomorrow's special operations,

SOF will need to apply innovative approaches to attract and retain those distinctive personnel who can become the capable and efficient SOF Warrior.

Although people will always remain a more important component of SOF capability than hardware, future SOF will leverage maturing technologies more effectively than any other force today. Technology improvements will allow commanders to track and communicate discretely with SOF anywhere in the field. Improvements in unmanned vehicle technology will provide better: precision fire, force protection, personnel recovery, and logistics support. SOF will also need to develop new competencies and enhance existing ones in support of critical national requirements, including the ability to locate, tag, and track mobile targets and support strategic influence operations.

Most importantly, the improvement of SOF training, education, and experience contributes to the development of SOF capability. Doctrine, organization, and materiel factors have additive value to the force — leadership and personnel factors, however, exponentially multiply invest-



ments in doctrine, organization, and materiel. As training, education, and experience influence the quality and effectiveness of leadership, they also have the greatest long-term effect on SOF capability. Indeed, SOF operational, training, and education experiences set SOF personnel apart from their conventional counterparts. In order to maintain strategic flexibility and maximize the likelihood of operational success, SOF will increase their commitment to “training for certainty, educating for uncertainty”.

SOF Vision

The United States Special Operations Command’s (USSOCOM) vision is to develop “the most capable special operations force, relevant to the needs of our nation ...any time ...any place ...any adversary.” Whether combating terrorism or helping rebuild a government, SOF must be ready any time, to go any place, to quickly and successfully accomplish the assigned mission. Relevancy means SOF personnel are highly skilled with capabilities matched against whatever the nation needs them to do across the spectrum of peace and war. Leadership must constantly anticipate and evaluate the future to determine the capabilities SOF must possess to keep pace with the ever-changing needs of our nation. The Command must constantly strive to keep the “special” in special operations. Areas of operation change; mission priorities change; SOF endures!

Any future special operations force will be:

- Sized, trained, and equipped to engage in any threat environment against any adversary
- Culturally, linguistically, politically, and regionally focused
- Rapidly deployable
- Capable of conducting exceptionally-precise discriminate strikes against specific targets
- Able to achieve operational and tactical superiority through surprise, speed, violence of action, and through the ability to facilitate the precise application of massive conventional firepower

- Flexible, tactically, operationally, and strategically agile joint forces that can develop and execute unconventional, audacious, and high pay-off courses of action

Given these basic parameters, it is clear that SOF of the future will be called upon to employ unorthodox approaches, at any time, in any place, against any adversary, toward the end of achieving lasting strategic effects that are beneficial to the United States.

The SOF Warrior

The central, defining quality of SOF has always been the distinctive personnel – **the SOF Warrior**. It is through the warrior that the **SOF Truths** are realized. Through the character traits of selflessness, tenacity, patriotism, and striving for excellence, the SOF Warrior provides this nation and its leaders with the means to accomplish strategic missions effectively and efficiently. The competent and capable SOF Warrior provides the means to implement and realize the attributes of SOF and ensures relevance in the future. Highly specialized skill sets are required, including mastery of technology (spanning the spectrum from no-tech to high-tech), cultural and regional awareness and expertise. To accomplish this level of proficiency and guarantee SOF and ensure relevance in the future, attention must be placed on all four phases in the life of a SOF Warrior.

Recruitment. A rigorous program designed to acquire SOF Warrior candidates who possess the required personal traits proven to enable success in future SOF role and mission areas. SOF recruitment objectives must include exposing the largest possible audience to the SOF career option.

Accession. A demanding selection program or series of programs designed to test potential candidates. Candidates experience physical, mental, and emotional evaluation geared to ensure their ability to perform the tasks, roles, and functions required

by combat and combat support specialities. Only those who satisfactorily complete the program become SOF Warriors.

Development. SOF personnel are developed through professional training and education programs designed to enhance the SOF Warrior's natural abilities and performance while producing mature and competent professionals. Development includes education and training within SOF as well as appropriate civilian and interagency external training that result in enhanced situational awareness and superior decision-making abilities. Development is continuous and focused on the required skill sets for the duty position. Development of SOF personnel is designed to increase tolerance and endurance, as well as enhance performance, sustainment and alertness. When coupled with experience gained in duty assignments, the SOF Warrior achieves a high level of maturity and proficiency. Through this process the SOF Warrior evolves to embody the **SOF Core Values**.

Retention. SOF Warriors progress in their careers based on their professional and personal development as well as their experiences. All levels of experience are valuable and effort is placed on retaining the services of the individual through an active duty career and beyond.

SOF Attributes

Seven attributes describe what SOF will need to develop, preserve or enhance in order to fulfill the SOF vision and mission of the future. Although these attributes are not necessarily unique to SOF, but as a set they describe a competent and professional force accomplishing assigned missions and responsibilities in an effective and efficient manner. Everything the force is and does revolves around the SOF Warrior. The graphic on page 69 shows the Warrior, built on the SOF Truths, the Core Values and utilizing Distinctive Personnel, at the center of a globe. The attributes are displayed surrounding the globe.

Precision Strike and Effects. SOF are able to perform precision strikes and achieve scaleable lethal or non-lethal effects by rapidly characterizing and tracking targets and exploiting organic, national and international systems and networks, as well as employing any other means or methods available. SOF achieve this capability through the utilization of human and material assets designed to perform precision reconnaissance and surveillance and the use of a wide variety of weapons and methods including advanced technologies. In the popular press, the term "precision strike" has become synonymous with the employment of guided munitions such as Tomahawk cruise missiles. While the employment of those weapons is certainly precise, it is in reality a restrictive subset of what is meant by the term. Precision interventions are not limited to physically or destructively attacking targets, but also include unconventional methods to achieve effects, acquire information and intelligence, and influence enemy capabilities.

Tailored and Integrated Operations. SOF units and individuals must adapt quickly to changing mission requirements, objectives and operating environments. They can rapidly and effectively combine competencies and modify organizations to accomplish a variety of missions with autonomy. SOF transform and reshape organizational design and force structure to ensure effective collaboration in joint, interagency, and combined operational environments, to include work with indigenous forces, non-governmental and international organizations and local civilian entities. SOF operate as an enabling force, across the spectrum between war and peace and synchronize activities between military and non-military participants. Reserve Component forces are ready, quickly accessible and integrated into SOF missions as appropriate. SOF elements exercise flexibility at the strategic, operational and tactical levels, as well as agility in terms of operational time and space considerations, the types of missions, and the method of accomplishment. SOF forces are responsive – physically and mentally capable of quickly adapting to changing mission requirements across the spectrum of conflict. SOF exercise

innovative execution, including the creative application of tactics, techniques and procedures, and are capable of performing a variety of missions in challenging and austere environments. SOF adapts readily to a broad and constantly varying range of tasks and conditions. This organizational agility allows SOF to quickly concentrate synergistic effects from widely dispersed locations and to assist Joint Force Commanders in achieving decisive results without the need for time-consuming and risky massing of people and equipment. Even under the most austere conditions, SOF can conduct multi-dimensional operations to: penetrate denied or sensitive areas and resolve terrorist activity; preempt the threat posed by weapons of mass destruction; or strike key targets with precision and discrimination.

Ubiquitous Access. SOF have access to and can potentially influence events or conduct overt or clandestine operations on demand. SOF conduct operations in all environments; land, air, sea, subsurface, space, and in areas denied to conventional forces because of political or threat conditions. Access includes an appropriate forward presence, as well as the ability to mobilize and project quickly from CONUS or OCONUS basing. SOF maintain a global engagement, molding the international environment rather than responding to it, allowing a quick transition to contingency response or war. SOF possess or have access to the latest in emerging and leap-ahead mobility assets to enter, operate in, and be exfiltrated from the designated area of operations overtly or clandestinely. SOF achieve the best mix of global access capabilities by capitalizing on existing technologies, incorporating selective improvements based on leap-ahead changes, and ensuring conventional military platforms are designed to incorporate SOF requirements.

Regional Expertise, Presence and Influence. SOF conduct and influence operations anywhere, with minimal restrictions, through an extensive personal understanding and a network of relationships throughout the region. SOF are regionally focused, possessing extensive linguistic skills and cultural

understanding. The SOF Warrior is also a diplomat, and as such utilizes recurring deployments to increase language skills, cultural awareness, and to build the military and political contacts that contribute to future operations and activities. Healthy working relationships are maintained with potential joint, interagency, coalition and non-state partners. The effective presence and embedded interagency integration produced by these relationships provides SOF a footing from which to influence events. Through recurring interaction with current and potential coalition partners, SOF are able to favorably influence situations toward U.S. national interests. SOF presence and influence serve multiple roles in peacetime and before, during, and after conflict. SOF forward presence and regional expertise allow for “first response” abilities when required and, permit a full range of unconventional military options against a targeted entity. SOF are immediately ready upon arrival to occupy and influence the area of operations as prescribed by the mission and possess the flexibility to be tailored to task.

C4ISR Dominance. Dominance in the realm of Command and Control, Communications, Computers, Intelligence, Surveillance and Reconnaissance (C4ISR) is vital to the success of SOF operations. Exploiting superiority in this area allows the SOF Warrior to access, develop and operate effectively in any situation, taking decisive action that shapes the desired results without effective opposition. Achieving dominance requires emphasis in each of the following focus areas:

Collection. Employing advanced organic sensor systems and effectively leveraging national-or-theater-level assets gives the SOF Warrior the best possible picture of the operating environment. Electronic and non-electronic collection efforts serve to continuously update the SOF Warrior’s situational awareness through reliable sources. C4ISR systems and networks provide access to topically relevant and timely information about friendly and hostile forces, neutral elements and the area of operations.

Decision Support. Information collected from all sources is processed and fused into working knowledge that can be tailored to fit the needs of operators at all levels. Superior analysis products, modeling and simulation, and decision making algorithms all support this effort.

Communications / Data Exchange. SOF utilize secure C4ISR and sensor systems and networks that provide seamless integrated and unhindered information exchange. Additionally, SOF personnel share data in all environments (e.g., with real-time imagery, simultaneous full spectral, secure, wireless, and undetectable lightweight, miniaturized global and space-based systems through a world-wide information transport and processing grid). SOF systems and networks provide complete integration and compatibility with joint, interagency, national, and as the situation requires, international systems and networks.

Disruption and Denial. SOF can reduce and selectively deny an adversary's ability to use information and information systems with capabilities ranging from passive defense, to psychological operations, to precision strike against key informational nodes. The SOF Warrior can create friction in the enemy, sow confusion, contribute to relative knowledge superiority of SOF elements, and isolate and degrade the enemy's capabilities.

Agile and Unconventional Logistics. SOF are provided with logistical support necessary to conduct operations or employ conventional or unconventional means to acquire their own logistical support. Logistics are focused so as to obtain and provide exactly what is required in an effective and efficient manner. Flexible logistics ensure rapid and uninterrupted acquisition and delivery regardless of changes in the mission, operation, or environment, with accountability, but without the bureaucratic restrictions of conventional forces. SOF are as self-sufficient as possible, but are rapidly and effectively provided with replenishment of materials, utilizing both service-common and SOF-unique supplies and materials as the situation requires. Superior technology and advanced equipment are utilized to

ensure logistical support is consistently provided to deployed SOF elements. A seamless, near real-time network is utilized to rapidly procure and tailor agile and responsive materials and logistics forces to support full spectrum operations and reduce the logistic footprint to SOF units.

Force Protection and Survivability. SOF personnel enhance physical survivability through education, training and experience. SOF elements employ stealth, speed, and counter-measures to ensure survivability. Anti-access measures are defeated to retain freedom of mobility and maneuver. SOF personnel employ signature management measures and technology, equipment (including weapons), electronic and C2 systems and networks that possess features that ensure survivability regardless of the operating environment and conditions. To the maximum extent possible, SOF personnel are protected from the effects of enemy offensive systems and extreme environmental conditions. SOF personnel are also protected from threats of airborne, surface, and space assets by a variety of methods, including advanced technologies.

USSOCOM's Transformation Roadmap

USSOCOM's Transformation Roadmap provides the command and its components a framework for developing the capacity for full-spectrum, global engagement. Achieving this goal is not an end-state, but a process that continually adapts to exploit new technologies or meet new challenges.

Currently Capstone Concepts and portions of the Requirements Generation Process, Joint Requirements Oversight Council, Joint War-fighting Capability Assessment process, and acquisition technology initiatives focus the methods or ways the Command can achieve transformational goals and capabilities. Strong advocacy of Service programs and joint concepts that support SOF transformation are constant elements of USSOCOM's transformation strategy. The estab-



lished joint processes are the path to attaining the SOF Attributes, Capability-Based Program Lists, and Unresourced Priority Lists used to build the Program Objective Memorandum.

Technology Development. USSOCOM’s technology development programs are separate and independent from specific acquisition programs described elsewhere. They bridge the gaps that exist between specific SOF requirements, new warfighting systems, and emerging technologies. New capabilities can be developed in a variety of ways: rapid acquisition programs; normal acquisition programs; insertion into existing system upgrades; or in conjunction with Preplanned Product Improvements. Leveraging commercial and/or Service technologies plays an important role in the pursuit of USSOCOM operational requirements. The scope of total R&D funding for partnering and leveraged projects greatly exceeds the funding in the Special Operations Advanced Technology Development , Special Operations Advanced Special Technology and National

System Support to SOF programs. The five major program categories are Special Operations Technology Development, Special Operations Special Technology (SOTO), SOF Medical Technology Development, Small Business Innovation Research and National System Support to SOF. The SOTOs enhance and guide USSOCOM’s Science and Technology investment, but they are not intended to prioritize technology areas. The primary value of SOTOs is that they allow USSOCOM to benefit from technology advancements earlier in the acquisition process than would happen normally. In addition, SOTOs provide the DOD R&D communities, academia, industry, and allies with a USSOCOM perspective on emerging technologies.

The SOTOs act as the foundation for developing technological “thrust areas.” Thrust areas offer USSOCOM the greatest opportunity for future payoff that also address significant technological gaps within the special operations environment. The nine thrust areas, in no

particular order of priority, are Signature Reduction; High Bandwidth/Reachback Communications; Underwater Communications; Unmanned Systems; Batteries/Fuel Cells; Remote Sensing; Advanced Training Systems; Bioengineering; and Directed Energy Weapons.

USSOCOM also leverages technologies developed by the Services under the Advanced Concept Technology Demonstration (ACTD) program to address SOF shortfalls. The DOD ACTD program expedites the transition of maturing technologies from developer to user, thereby assisting the DOD acquisition process in adapting to today's economic and threat environments. This process emphasizes technology assessment and integration rather than technology development. The goal is to provide a prototype capability to the warfighter and to support him in the evaluation of that capability. ACTDs provide the SOF community an avenue to develop and refine concepts of operations to fully exploit the capability under evaluation, develop interoperability with joint structures, to evolve operational requirements and make assessments of the military utility of proposed capabilities before investing MFP-11 funds.

Transforming to 2020

USSOCOM has been, is and will continue to be a catalytic agent that influences the transformation of conventional force, as well as SOF capabilities. SOF capabilities will continue to improve, but the fundamental character of SOF, its values and truths will not change over the next quarter century. While SOF missions remain constant, the context of how and the manner in which they are executed may change significantly. Transformation across the entire DOD (Services and Defense Agencies) augurs an increasing integration of current conventional and special operational capabilities. This realization demands SOF to remain flexible and dynamic and to inculcate innovation as a core

competency. USSOCOM will meet its legislated authorities and lead the DOD in its transformation effort, working closely with Joint Forces Command and all other DOD components.

Managing the Risks Associated with Transformation

Managing risk has always been an important component of military planning. In the past, the U.S. Special Operations Command has focused primarily on managing operational risk. The Defense Planning Guidance for 2003-2007 established the requirement to manage risk in four dimensions. These dimensions, clarified and given additional detail in the 2001 quadrennial defense review, were identified as operational; force management; institutional; and, future challenges risk. Each dimension is defined below and followed by an outline of the associated SOF-specific issues.

Operational Risk

Operational risk refers to the uncertainty of a force's ability to achieve military objectives in conflict or other contingency. Like the Services, SOF have sought to mitigate operational risk by maximizing current readiness. SOF will require significant capability, capacity and speed of response enhancements to meet the all of the priorities outlined in this report. SOF will have to weigh an increased operational risk in some areas against the potential future payoff of developing new programs.

Key Issues Associated with Operational Risk

- Sizing the force to conduct effective preemptive operations
- Optimizing basing to support strategic objectives
- Improving SOF strike and mobility capabilities

Force Management Risk

Force management risk refers to the uncertainty in the ability to recruit, train and retain quality personnel in sufficient numbers to sustain the force as currently equipped while accomplishing its operational tasks. In many respects, force management issues are the most critical problems facing SOF. The special operations community must retain its personnel to gain a significant return on the investments that it makes in assessing, selecting, training, educating and retaining quality personnel.

Key Issues Associated with Force Management Risk

- Retention of mid-grade and senior-grade personnel
- Growing the force to meet current requirements
- Growing the force to meet new operational requirements

Institutional Risk

Institutional risk refers to the uncertainty in the management practices and controls that promote efficient use of resources and effective operation of the Defense establishment. SOF because of their joint nature, suffer from the collective inefficiencies of the Military Departments, such as legacy approaches for dealing with resource, manpower, and base operations support issues.

Key Issues Associated with Institutional Risk

- Achieving equitable support from the Military Departments
- Improving logistical and communications support for Theater Special Operations Commands
- Aligning Regional Employment with National Strategy

Future Challenges Risk

Uncertainty about the causes and locations of regional conflicts in which SOF will be asked to operate poses interesting mid- to long-term military challenges. Dealing with future challenges may be overcome by using fundamentally different approaches, tactics, techniques and procedures than those used by today's forces.

Key Issues Associated with Future Challenges Risk

- Improving strategic influence capabilities to support global operations
- Building a linguistically, culturally and ethnically diverse force
- Improving capabilities to operate for extended periods in anti-access environments
- Providing force protection in adverse environments
- Improving ground-directed fire support
- Improving capabilities to operate in urban environments

Managing Opportunities

Given the challenges facing SOF, risk management in all of its forms will be critical to maintaining a force that can meet the needs of tomorrow. Another critical goal will be to manage opportunities. The United States does not have the resources to operate everywhere—our military does not have the wherewithal to perform multiple large-scale operations all over the world. For this reason, SOF must take advantage of opportunities as they arise to conduct preventative operations in areas where our interests are at stake and work closely with indigenous forces in locations all over the world.

Through this process, SOF can be well positioned to take advantage of fleeting opportunities to pursue critical U.S. objectives.

Transformational Means

USSOCOM has identified means in the material, organization, and doctrine categories that will spark transformation within SOF, that include:

- CV-22 Osprey
- Advanced SEAL Delivery System
- SOF Information Enterprise
- MX aircraft
- Pathfinder (ACTD)
- PSYOP(ACTD)
- Naval Special Warfare 21
- Army Special Operations Aviation 21
- Improving theater SOC capability

A Path to the Future

In the future, SOF should be ready to deal equally with the demands of both peacetime and warfighting roles. SOF should be deliberate in its transformation to ensure that it continues to support critical national requirements. Given the range of requirements, it is important for SOF to choose an evolutionary path that is supportive of, but not confined by, the future plans of conventional forces. In other words, SOF should possess capabilities that expand the range of options available to policy makers. Future missions might include operations for psychological effect, low-visibility strike operations, advanced unconventional warfare, special forms of reconnaissance, human and technical collection operations and strategic influence operations. Above all else, because the future is uncertain, SOF will pursue new combinations of concepts, capabilities, people, and organizations to create a force capable of

conducting full spectrum engagement in a joint environment, anytime, anywhere, against any adversary. SOF will lead the DOD transformation, employing tailored Joint Special Operations Task Forces as the vehicle with which experimentation and innovative task organization will provide a dynamic laboratory. SOF will achieve relatively low cost, high value force application as the military and informational elements of national power integrate with political and economic elements to increase national security in a global context throughout the 21st Century.

SOF PROGRAMS & SYSTEMS

USSOCOM's unique responsibilities include providing SOF with specialized equipment to perform their worldwide missions. As a result, the Commander, USSOCOM is the only unified commander charged by law with acquisition responsibilities similar to those of the services to develop, acquire, and field equipment. To accomplish this, USSOCOM has its own

special operations acquisition executive, with responsibilities and authorities equal to service acquisition executives, and a Special Operations Acquisition Center that supports USSOCOM program management and oversight of MFP-11 acquisition funding. The following pages highlight some of the key SOF programs and systems.

AIR MOBILITY

CV-22 Osprey

Mission

Perform long-range, night and all-weather infiltration, exfiltration, and resupply missions; medical evacuation, and selected rescue and recovery missions.



AC-130H/U Spectre Gunship

Mission

The AC-130 mission is to acquire and identify targets predominately at night, coordinate with ground forces and command and control agencies, and deliver surgical firepower in support of both conventional and special operations missions. The gunship is best suited for the close air support mission and has a unique capability to deliver ordnance in extremely close proximity to friendly forces in a troops-in-contact situation. Gunships can also perform interdiction and armed reconnaissance missions, particularly where limited collateral damage is required.



MC-130E/H Combat Talon

Mission

The Combat Talon I and Combat Talon II support activities from crisis response to wartime commitment in special operations missions. The Combat Talon mission is to provide global, day, night, and adverse weather capability to airdrop and airland personnel and equipment in support of U.S. and allied SOF. The Combat Talon conducts infiltration, exfiltration, resupply (using airland and/or airdrop), psychological operations, air refueling of SOF helicopters and aerial reconnaissance in hostile or denied territory. The Combat Talon missions may be accomplished either singleship or in concert with other special operations assets in varying multi-aircraft scenarios.



Combat Talons can airland and airdrop personnel and equipment on austere, marked and unmarked landing zones/drop zones, day or night. Combat Talon missions may require overt, clandestine, or low visibility operations.

MC-130P Combat Shadow

Mission

The mission of the Combat Shadow is clandestine formation/single-ship intrusion of hostile territory to provide air refueling to special operations helicopters and infiltration, exfiltration, and resupply of SOF by airdrop or airland operations. Utilizing night vision goggles the crew of the Combat Shadow primarily flies missions at night to reduce probability of visual acquisition and intercept by airborne threats. Secondary mission capabilities may include airdrop of small special operations teams, small bundles, and combat rubber raiding craft; as well as NVG takeoff and landing procedures, tactical airborne radar approaches, and in-flight refueling as a receiver. The MC-130P can be employed in a low to medium threat environment. The aircraft was originally modified for combat



search and rescue and maintains most of its rescue capability. High-intensity parachute flares, various smoke-producing pyrotechnics, and sea dye are still carried aboard this aircraft for helicopter overwater escort and rescue.

EC-130E Commando Solo

Mission

Commando Solo conducts psychological operations missions in the standard AM, FM, HF, TV and military communications bands. Missions are flown at maximum altitudes possible to ensure optimum propagation patterns. This system may also be used to support disaster assistance efforts by broadcasting public information and instruction for evacuation operations.



MH-53M Pave Low

Mission

Conduct clandestine infiltrations, exfiltrations, resupply, airdrop, and heavy-lift sling operations over a wide range of environmental conditions. The aircraft can perform a variety of other missions, including shipboard operations, radar vectoring, and search and rescue. The Pave Low can be employed in low to medium threat environments.



MH-60K

Mission

Conduct overt or covert infiltration, exfiltration, and resupply of SOF over a wide range of environmental conditions. The MH-60K is capable of operating from fixed base facilities, remote sites, or oceangoing vessels.



MH-60L

Mission

Conduct infiltration, exfiltration, and resupply of SOF across a wide range of environmental conditions. Additionally, the MH-60L/DAP has the primary mission of escort. Secondary missions of the MH-60L include C2, external load, CSAR, and medical evacuation (MEDEVAC) operations. The MH-60L can operate from fixed-base facilities, remote sites, or oceangoing vessels.



MH-47D/E

Mission

Conduct infiltration, exfiltration, air assault, resupply, and external-sling operations under a wide range of environmental conditions. The aircraft can perform a variety of other missions, including shipboard, platform, urban, water, FARP, mass casualty, and CSAR operations.



AH/MH-6M Mission Enhancement Little Bird

Mission

Conduct and support short-range, infiltration/exfiltration, resupply operations in hostile areas, and selected rescue and recovery missions. Includes shipboard, platform, over water and urban operations.



MARITIME MOBILITY

Advanced SEAL Delivery System (ASDS)

Mission

Provides undersea mobility for SOF personnel and their mission support equipment.

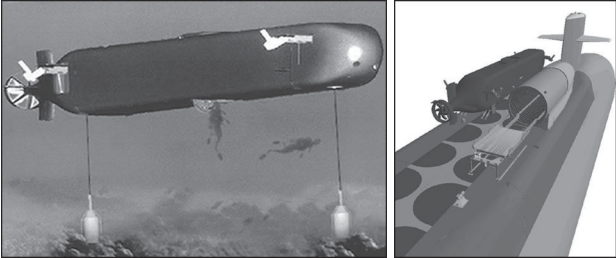

Patrol Boat Light – Counter Drug (PBL-CD)

Mission

The Patrol Boat Light (PBL) is a maritime platform used for training host nation forces in riverine environments.



Rigid Inflatable Boat (RIB)

Mission

Perform short-range infiltration and extraction of SOF and limited coastal patrol and interdiction in “low to medium” threat environments. Naval Special Warfare RIB detachments are also deployed on USN amphibious ships.



Mark V Special Operations Craft

Mission

Perform medium-range, adverse-weather infiltration and exfiltration of SOF and limited coastal patrol and interdiction in low to medium threat environments.



Special Operations Craft Riverine (SOCR)

Mission

Provide short-range insertion and extraction of SOF personnel in a riverine environment.



Swimmer Transport Device Special Operations Craft

Mission

Provide SOF combat swimmers and their mission essential equipment an intermediate transport capability when operating from an insertion/extraction platform to and from target areas at ranges of up to five nautical miles.



GROUND MOBILITY

Internally Transportable Vehicle

Mission

Provide a highly mobile, rugged platform to support the five core tasks (special reconnaissance, direct action, unconventional warfare, foreign internal defense, counterterrorism) and other secondary missions.



Ground Mobility Vehicles (GMV)

Mission

The GMV program modifies the Army provided HMMWV to meet SOF peculiar mobility platform requirements. The GMV gives SOF superior cross-country maneuverability, the capability to travel unassisted over long distances and supports direct action, special reconnaissance, airfield seizure, unconventional warfare, foreign internal defense, and liaison missions.



SOLDIER SYSTEMS

SOF Personal Equipment Advanced Requirements (SPEAR)

Mission

Provide SOF operators with state of the art equipment that improves operator survivability, mobility, lethality, and endurance. SPEAR acquires individual operator equipment in nine functional areas including: lightweight environmental protective (LEP) clothing, body armor/load



LEP



BALCS



MICH

carriage system (BALCS), and modular integrated communications helmet (MICH).

WEAPONS

SOF Machineguns (SMG)

Mission

Provide the SOF operator with reliable, belt fed, man portable systems capable of addressing area targets using existing 5.56 and 7.62mm ammunition.



Special Operations Peculiar Modifications to the M4 Carbine

Mission

Allow SOF operators to configure the M4A1 carbine and M203 Grenade Launcher, based on mission-specific requirements. Kit items increase weapons effectiveness through

improved weapons performance, target acquisition, signature suppression, and fire control in close-quarters battle and out to ranges of 800 meters, both day and night.

DEMOLITIONS

SOF Demolition Kit

Mission

Provides the capabilities to custom build, attach, and waterproof, demolition charges based on specific targets and operational scenarios.



NIGHT VISION / ELECTRO-OPTICS

Night Vision Devices (NVD)

Mission

NVD is a joint funding line that provides for the modernization of USSOCOM's inventory of visual augmentation systems. Approved by USSOCOM in 1996 the funding line now has a detailed modernization roadmap and approved capstone requirements document. These documents and proper funding will allow USSOCOM to break its dependence on image intensification devices and stay ahead of threat capabilities through the procurement of state-of-the-art



technology that ensures 24-hour, all-weather, all-condition capabilities through the pursuit of thermal devices.

INTELLIGENCE & INFORMATION SYSTEMS

Joint Threat Warning System (JTWS) Threat Warning/Situational Awareness System

Mission

Provide threat warning and situational awareness capabilities to SOF utilizing common components and multiple variants to meet air, ground, and maritime mission needs.

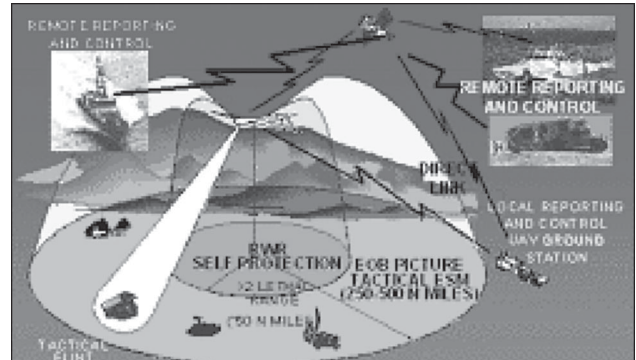

PRIVATEER Threat Warning/ Situational Awareness System

Mission

Provide threat warning and situational awareness aboard NAVSPECWARCOM Mark V Special Operations Craft.

SENTINEL Threat Warning/ Situational Awareness System

Mission

Provide threat warning and situational awareness aboard AFSOC fixed-wing aircraft.



Integrated Survey Program (ISP) Mission Familiarization Virtual Reality (MFVR)

Mission

Supports JCS contingency planning requirements by conducting surveys on OCONUS facilities where U.S. interests may be at risk.

Special Operations Tactical Video System (SOTVS)

Mission

Execute special reconnaissance missions by SOF in support of national and Geographic Combatant Commander war-fighting requirements.

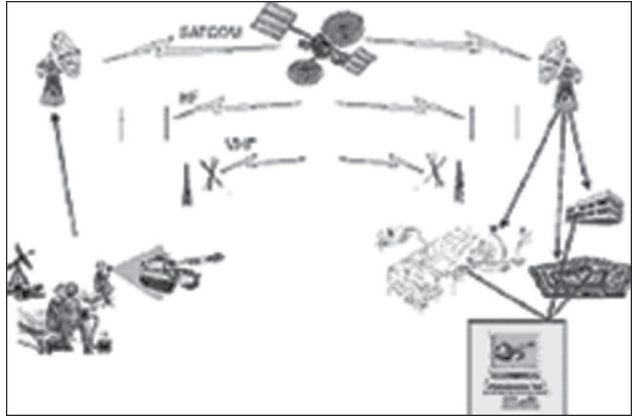

Special Mission Radio System (SMRS)

Mission

Provide reliable, secure, high frequency (HF) C² communications via voice and data over varying distances. Supports strategic recon and general purpose HF missions; required for both manpack and vehicular operations.



Tactical Radio System (TRS)

Mission

Provides a base station for NSW combatant crafts to conduct intra-craft and external C² communications to other SOF base stations, tactical aircraft, and various SOF, conventional forces, and allied platforms.

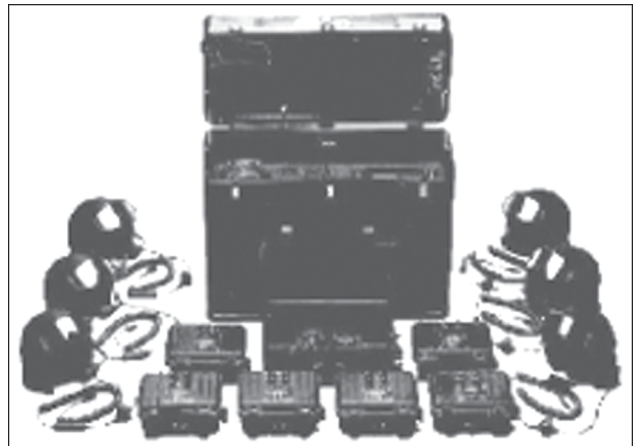

Multi Band Inter/Intra Team Radio (MBITR)

Mission

Provide reliable, voice and data communications on a user-selected frequency using a handheld radio.



Multi-Band, Multi-Mission Radio

Mission

Provide reliable voice and data communication across the VHF and UHF bands with a single manpack radio.



Joint Base Station

Mission

Provide a deployed SOF commander the ability to establish and maintain mobile- and fixed-combat, contingency, training and administrative communications from any level within a theater of operations.

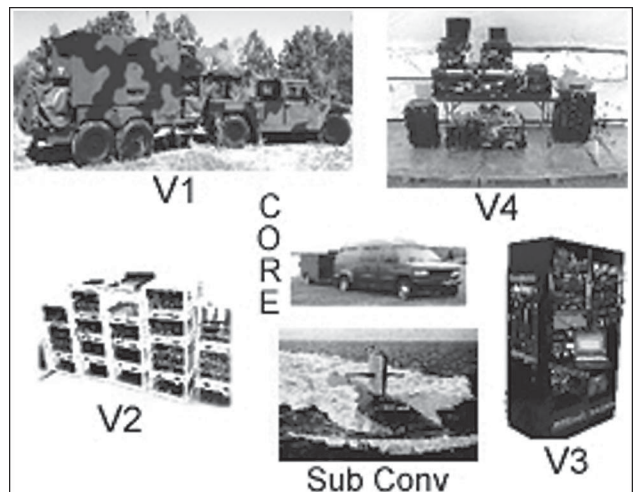

Telecommunications System Mission/ SOF Deployable Node (SDN)

Mission

USSOCOM's primary command and control network. Provides secure voice, data, and VTC to world-wide deployed and strategic SOF locations. SDN is the follow-on system to SCAMPI and provides improved modularity, scalability, and reliability at reduced nodal size and weight. Designed to provide STEP/Teleport interoperability.



Special Operations Forces Tactical Assured Communications System (SOFTACS)—Deployable Multi-Channel SATCOM (DMCS)

Mission

Provides SOF component forces with a lightweight, easily transportable, rapidly deployable tri-band SHF satellite communications terminal, flexible for utilization in peacetime and all threat environments across the entire spectrum of conflict.



Psychological Operations Broadcast System

Mission

Provide strategic, wide-area, multi-media radio and television production, distribution, and dissemination capability in support of Geographic Combatant Commander.



Special Operations Media System B

Mission

Provide enhanced tactical television and radio capabilities to produce, broadcast, record, and transmit programming material in support of PSYOP and CA missions.



Family of Loudspeakers

Mission

Provide a high quality loudspeaker broadcast system to target areas in support of SOF and conventional forces when deployed by mobile PSYOP forces.

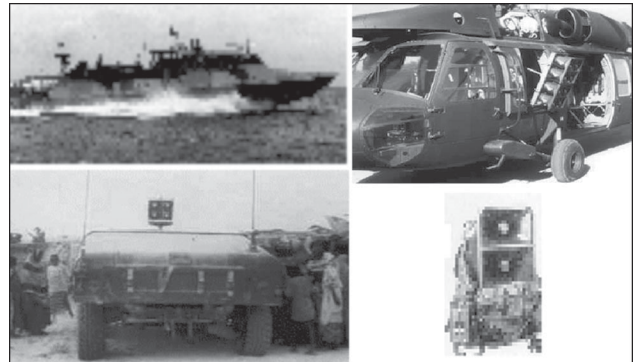

Leaflet Delivery System

Mission

Provide accurate and reliable dissemination of large quantities of PSYOP material across the spectrum of war and during peacetime, in denied areas, at short- and long- standoff ranges.

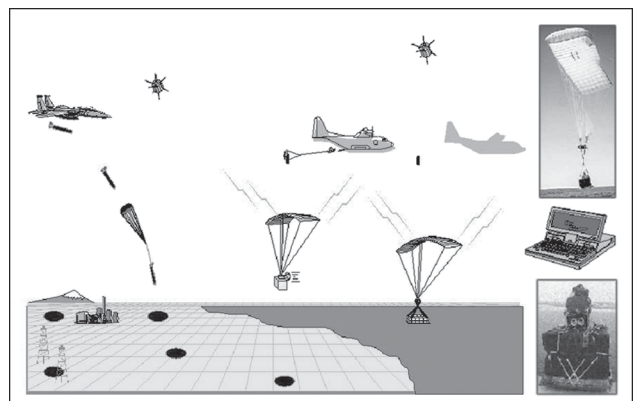

Miniature Multiband Beacon

Mission

Provide a dual-band portable radar transponder beacon that can be hand emplaced.

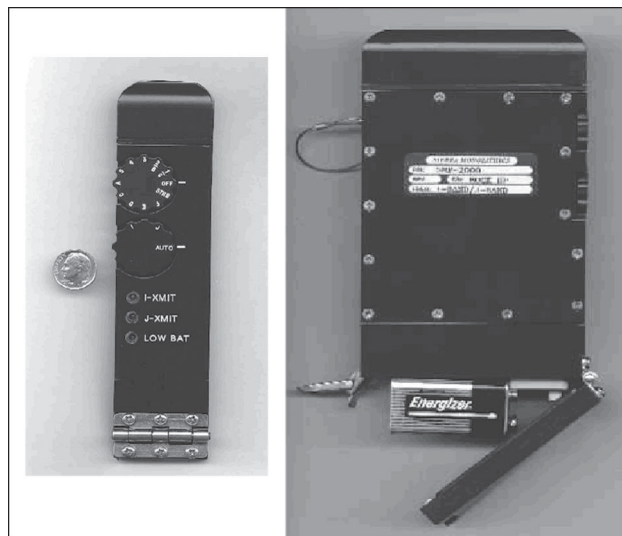

C⁴I Automation Systems

Mission

Provides a wide range of services from C⁴I surveillance and reconnaissance capabilities to office automation tools. Provides the conduit for various systems such as the Global Command and Control System to connect the SOF war-fighter to the global infosphere.



Joint Deployable Intelligence Support System–Special Operations Command Research, Analysis and Threat Evaluation System (JDISS-SOCRATES)

Mission

Provide access to both national and specially focused intelligence products using a wide-area, network-based, multi-functional intelligence system for USSOCOM headquarters, its component commands, and operating forces worldwide.



Tactical Local Area Network (TACLAN)

Mission

TACLAN provides automation connectivity with flexible interfaces to communications, databases, and mission applications that will collectively provide an equivalent of the garrison based architecture to deployed units remote operators. TACLAN includes servers, routers, hubs, and notebook computers (workstations), and field computing devices (FCDs) required to set up one (1) unclassified network (NIPR), one (1) classified network (SIPR) and one (1) SCI network. Provides the data network infrastructure for the SOF Digital Environment (SDE).

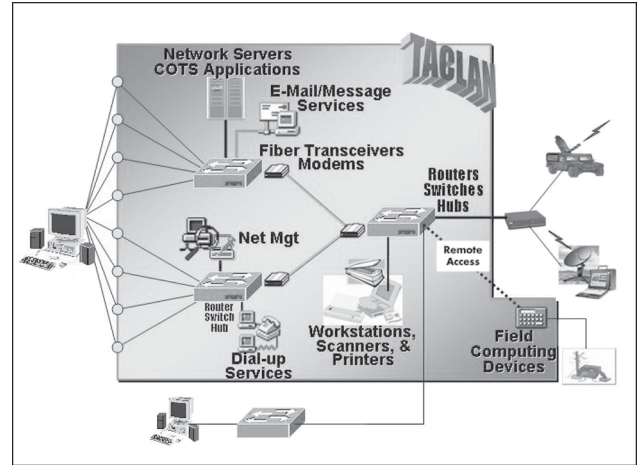

Special Operations Mission Planning Environment (SOMPE) (formerly SOF Planning and Rehearsal System–SOPARS)

Mission

Provide for the consolidation of all operational and tactical mission-planning requirements across the command. SOMPE will be a family of integrated software products and tools providing interoperable and tailorable support for special operations components, commands, units, teams, and aircrews. SOMPE will automate the many aspects of the mission planning and serves as a vital piece of the SOF Digital Environment (SDE).

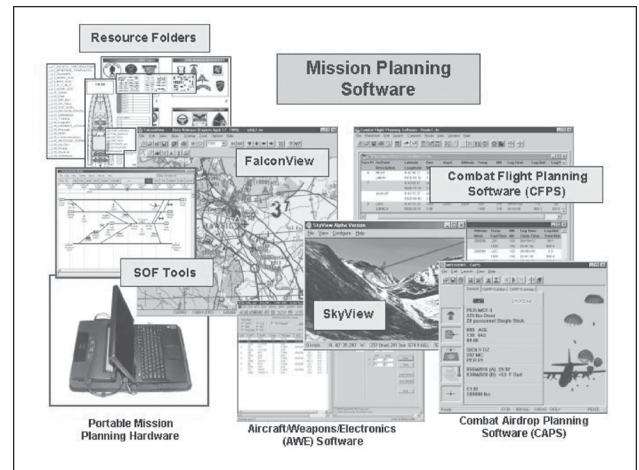

MISSION SUPPORT

Special Operations Forces Support Activity

Mission

Provide Joint SOF with a dedicated logistics support capability world-wide.

- The “cornerstone” for executing USSOCOM’s SO-peculiar logistics responsibilities to joint SOF world-wide
- The Center of Excellence for designated logistics commodities in the areas of SOF support

Joint Operational Stocks

Mission

The Joint Operational Stocks program provides joint SOF with resource constrained mission-critical, mission-essential, and mission-enhancing equipment in order to provide responsive support to worldwide contingency and training missions.

SOF Sustainment, Asset Visibility, and Information Exchange

Mission

The SOF Sustainment, Asset Visibility, and Information Exchange provides on-line responsive logistics materiel support to maximize readiness and sustainability for SOF worldwide.

Munitions Management

Mission

Provide world class munitions replenishment support of Navy, Air Force and Army SOF peacetime, war reserve, and training ammunition as required to sustain SOF readiness worldwide.

SOF BUDGET & MANPOWER

RESOURCE OVERVIEW

Background

The Nunn-Cohen Amendment to the legislation that created USSOCOM gave its commander direct control over many of the fiscal resources necessary to pay, train, equip, and deploy SOF through the establishment of a separate major force program (MFP), MFP-11. This control of SOF fiscal resources provides several significant benefits. First, SOF funding choices may now be assessed on their merits and not submerged or ignored within the military departments' much larger programs. Second, a separate MFP for SOF provides an easy SOF program tracking tool for the Department of Defense (DOD) and a Congress concerned with ensuring appropriate SOF resourcing. Third, informed SOF resourcing decisions are based on analyses of comprehensive, joint SOF data that balance the competing requirements for all SOF. This facilitates the development of and ensures a focus on effective Joint SOF capability for Combatant Commanders, which was nearly impossible when SOF capability was the product of separate disjointed military department efforts.

A Powerful Investment

The Department of Defense has begun a significant "retooling" of USSOCOM to enable the Command to lead the war effort in an even more effective manner. Congress will see that re-engineering effort manifested in the President's Fiscal Year 2004 Budget Request. Perhaps the most profound change is a shift in expectation by the Department that USSOCOM will no longer serve as primarily a supporting command, but rather will plan and execute certain key missions as a supported command. In the President's Budget for Fiscal Year 2004, an increase of about 47 percent

has been proposed for USSOCOM, totaling approximately \$4.5 billion. This increase includes an additional \$391 million for operations and related expenses, and about \$1.1 billion in procurement of critical equipment. These increases facilitate the addition of 2,563 personnel in critical mission areas. Military personnel costs which are included in the budgets of the Military Departments total another \$1.2 billion.

SOF resources constitute only 1.8 percent of the overall defense budget and some 49,000 personnel. Yet these limited SOF resources greatly enhance the effectiveness of conventional military forces by providing essential leveraging capabilities all the while ensuring that "must succeed" special operations are completed with the absolute certainty and professionalism the nation demands. No where has the benefit of this powerful investment been clearer than during operations in Afghanistan, Iraq, and elsewhere in the Global War on Terrorism, however, SOF has been remarkably effective no matter what the nature of the conflict.

A Disciplined Fiscal Process

The USSOCOM Strategic Planning Process drives decision making related to resourcing, acquisition, sustainment, and modernization. It is a continuous process with a biennial cycle that facilitates the shaping of the strategic direction of SOF.

The USSOCOM Strategic Planning Process has four phases: guidance development, capability assessment, program assessment, and integration/resourcing. These phases contain activities related to the creation of guidance, the assessment of capabilities, and the prioritization of an integrated capabilities list to guide the Program Objective Memorandum (POM) development. USSOCOM service component staff, Theater Special Opera-

tions Command, and Office of Assistant Secretary of Defense Special Operations/Low Intensity Conflict participation is significant during all phases of the process. They serve as members of an integrated concept team and provide subject matter expert inputs prior to the completion of each phase of the process. Additionally, component commanders participate throughout the process, as members of the USSOCOM Board of Directors, which is co-chaired by the USSOCOM Commander and the ASD SO/LIC.

The starting point for the biennial cycle may be driven by actual or forecasted changes in the planning environment or by DOD or USSOCOM directive. The cycle ends with the approval of the next POM that includes the approved resource constrained listing of capability-based programs. The POM serves as the basis for the SOF biennial budget development and the annual President’s budget submission.

Military Department Support to SOF

The military departments also have a significant role in the resourcing of SOF. Title 10, Chapter 6, United States Code (U.S.C.), defines and apportions responsibilities between the military departments and the combatant commands, including USSOCOM. Title 10, U.S.C. Section 165, charges the military departments with the responsibility for providing administration and support for forces assigned by the respective military departments to the combatant commands, subject to the authority of the respective commanders.

DOD Directive 5100.1, “Functions of the Department of Defense and its Major Components,” requires the military departments to develop, garrison, supply, equip, and maintain bases and other installations, including lines of communications, and to provide administrative and logistics support for all forces and bases, unless otherwise directed by the Secretary of Defense. DOD Directive 5100.3, “Support of the Headquarters of Unified, Specified, and

Subordinate Joint Commands,” makes clear this broad support responsibility and extends to USSOCOM and its subordinate headquarters.

Additional DOD guidance further defines military department support responsibilities. MFP-11 related programs funded in the appropriations accounts of the military departments (SOF Support Programs), but not identified as MFP-11, will consist of programs that support other users in addition to SOF. Programs in this category, such as, base operating support, standard ammunition, and maintenance of real property, are programmed, budgeted and executed by military departments with input from USSOCOM.

SOF Funding Profile

The SOF budget request for FY04 is approximately \$6.7 billion, including military pay and allowances. The MFP-11 budget supports the SOF primary mission—maintaining the readiness and sustainability of current forces to support the geographic commanders, U.S. Ambassadors and their country teams, and other government agencies.

The following appropriation display of the FY04 president’s budget for MFP-11 illustrates the SOF funding profile. Detailed budget data are contained in following charts and paragraphs.

Appropriation	FY03	FY04
MILPERS*	\$1,970	\$2,211
O&M	1,615	2,006
Procurement	862	1,978
RDT&E	512	440
MILCON	72	99
Totals	\$5,031	\$6,734

* Funded in the MILPERS accounts of the military departments

Military Personnel (MILPERS) includes the basic salaries for all active duty and Reserve Component (RC) military personnel assigned to USSOCOM, as well as the RC SOF military pay necessary for additional schools and training days. MILPERS requirements are programmed and budgeted for by SOF and executed by the military departments. SOF manpower data are displayed in Table 7-1.

Operation and Maintenance (O&M) is the heart of maintaining SOF operational readiness. O&M includes the day-to-day costs of SOF unit mission activities such as civilian pay, travel, airlift, SO-peculiar equipment, equipment maintenance, minor construction, fuel, consumable supplies, spares and repair parts for weapons and equipment, as well as the headquarters functions of USSOCOM and its Service components. Additional information is contained in Table 7-2.

Procurement provides vital modernization and recapitalization in areas such as mobility, weapons and munitions, communications, and intelligence equipment. Detailed information is provided in Table 7-3.

Research, Development, Test, and Evaluation (RDT&E) are a significant request in each budget cycle, since technological advances will continue to provide critical advantages for special operations. Many of the benefits of RDT&E efforts will also ultimately accrue to conventional forces. RDT&E funding is discussed in greater detail in Table 7-9.

Military Construction (MILCON) allows USSOCOM to provide unique facilities necessary for the training, housing, or deployment of SOF.

Special Operations Forces (SOF)—Budget Details

The FY04 budget request for SOF is approximately \$6.8 billion. The SOF budget request by appropriation is shown on the previous page and detailed in the paragraphs that follow.

Manpower

Table 7-1 depicts the manpower end strength data for FY04.

Category	FY04
<i>Active Military</i>	
Officer	5,948
Enlisted	25,548
Total Active	31,496
<i>National Guard</i>	
Officer	714
Enlisted	3,015
Total National Guard	3,729
<i>Reserve</i>	
Officer	3,139
Enlisted	8,108
Total Reserve	11,247
<i>Civilian</i>	
U.S. Direct Hire	3,376
Total Manpower	49,848

As the chart portrays, the SOF total end strength for FY04 is 49,848 with approximately one-third of their military personnel in Reserve Component units. Although the active duty force is largely responsible for meeting the demands of regional crises and conflicts and providing overseas presence, USSOCOM relies on Reserve Component units to augment and reinforce the active force. U.S. Army Reserve SOF personnel, for example, provide a variety of essential skills, particularly in the areas of CA operations and PSYOP. Additionally, approximately 3,000 civilians join SOF active duty and reserve military personnel as partners in defense.

Operation and Maintenance

Table 7-2 details the FY04 funding for O&M budget activity (BA) areas.

Table 7-2
Operation & Maintenance Budget
(\$ in Millions)

Budget Activity	FY03	FY04
Operating Forces	\$1,492	\$1,851
Training	60	93
Administrative	63	62
Total	\$1,615	\$2,006

Operating Forces includes necessary resources for SOF tactical units and organizations, including costs directly associated with unit training, deployments, and participation in contingency operations. Resources support civilian and military manpower, SOF peculiar and support equipment, fielding of SOF equipment, routine operating expenses, and necessary facilities. Budget Activity 1 is divided into two activity groups: special operations operational forces and special operations operational support.

Training includes resources for operation and maintenance costs directly attributable to supporting the component special operations schools. USSOCOM operates the John F. Kennedy Special Warfare Center and School at Fort Bragg, North Carolina; the Naval Special Warfare Center at Coronado, California; and the Air Force Special Operations School and Joint Special Operations University at Hurlburt Field, Florida. The schools and centers provide mobile training teams to support the operational forces as required. SOF aircrew training and training at the Joint Readiness Training Center are directly related to SOF. The SOF medical training center at Fort Bragg, North Carolina provides modularized qualification, advanced enhancement, and limited sustainment medical training for joint SOF.

Administrative provides resources for operation and maintenance costs supporting SOF peculiar acquisition programs being developed or procured. Funding is executed by the Special Operations Acquisition and Logistics (SOAL) Center. Funds acquisition program management support engineering and logistical support for SOF tactical acquisition programs. This includes funding for travel, operational testing and evaluation support, and related supplies and equipment. Funds for civilian program management and general contractor support for SOAL include support equipment, necessary facilities, SOAL civilians, and costs associated with the management of SOAL.

Procurement

The FY04 Procurement Budget allocates funds for mobility, ammunition, communications, intelligence, and miscellaneous programs as shown in Table 7-3.

Table 7-3
Procurement Budget (\$ in Millions)

Program	FY03	FY04
Mobility	\$627.493	\$1,511.182
Ammunition	39.238	58.252
Communication Equipment & Electronics	28.267	56.225
Intelligence	31.572	34.791
Miscellaneous	135.819	317.836
Total	\$862.389	\$1,978.286

Mobility programs, the largest mission area in procurement, include funds for completion of major aircraft and maritime procurement programs.

Ammunition budget will be used primarily to procure munitions for training, operations, and war reserve stocks.

Communications Equipment and Electronics programs will continue to procure lighter, more

reliable communications equipment that will be an improvement over current systems.

Intelligence programs are consolidated into one SOF budget line item. This consolidation emphasizes the importance of effective management in an area that is critical and essential to special operations.

Mobility Programs

Table 7-4 depicts the FY04 budget for Mobility Programs.

Program	FY03	FY04
Rotary Wing Upgrades	\$297.206	\$675.063
SOF Training Systems	13.728	56.133
MC-130H Combat		
Talon II	7.991	8.838
CV-22 SOF Modifications	57.404	108.790
AC-130U Gunship		
Acquisition	128.842	390.054
C-130 Modifications	71.768	214.798
Aircraft Support	.099	.295
Advanced SEAL		
Delivery System	27.565	31.924
MK8 MOD1 Seal		
Delivery System	10.673	10.100
SOF Combatant		
Craft Systems	12.218	9.981
Internally Transportable		
Vehicle	0	5.206
Total Mobility	\$627.494	\$1,511.182

Rotary-Wing Upgrades and Sustainment

funding provides for a variety of critical improvements to the A/MH-6, MH-60/L/K, MH-53J, TH-53A and MH-47D/E aircraft. These aircraft must be capable of operating at extended ranges under adverse weather conditions to infiltrate, provide logistics for, reinforce, and extract SOF. This program provides ongoing survivability,

reliability, maintainability, and operational upgrades as well as procurement appropriation sustainment costs for fielded rotary wing aircraft and subsystems to include forward basing of MH-47E helicopters.

SOF Training Systems (STS) will be used to procure, modernize, and link SOF Army and Air Force ground based trainers to support initial, refresher, and continuation training. These systems also provide a critical method for mission rehearsal. STS also funds data base generating equipment required for building and maintaining real-world training and mission rehearsal scenarios.

MC-130H Combat Talon II is a production and sustainment program in which a specialized avionics suite has been integrated into a C-130H airframe. Its mission is to conduct night, adverse weather, low-level, long-range operations in hostile, politically denied/sensitive, defended areas to infiltrate, resupply, or exfiltrate SOF and equipment. All MC-130H aircraft have been procured in prior years; ongoing efforts focus on meeting operational requirements in the System Operational Requirements Document by establishing organic intermediate and depot level maintenance capability on the APQ-170 Radar and Nose Radome.

CV-22 SOF Modification program provides for SOF modifications to the V-22 vertical lift, multi-mission aircraft. The Navy is the lead Service for the joint V-22 program and is responsible for managing and funding the development of all V-22 variants, including the CV-22. The Air Force will procure and field 50 CV-22 aircraft and support equipment for USSOCOM, conduct Initial Operational Test and Evaluation, and provide Type I training. USSOCOM funds the procurement of SOF peculiar systems, i.e., terrain following radar, electronic warfare suite, etc. The Air Force will fund 85 percent of the procurement cost for CV-22 training systems; USSOCOM funds 15 percent. The Air Force and Navy will utilize joint training facilities at Marine Corps Air Station, New River, NC, to conduct all maintenance

training and initial V-22 aircrew qualification training. CV-22 SOF peculiar aircrew mission training will be conducted at the Special Operations Mission Qualification Schoolhouse at Kirtland AFB, NM.

AC-130U Gunship program provides funds to modify C-130H2 aircrafts to AC-130Us. Program funding also supports the ongoing process of transitioning prior AC-130U acquisitions to normal sustainment.

C-130 Modification program provides for numerous modifications to various models of the C-130 aircraft. The FY03 program includes: environmental control unit, special mission equipment obsolescence, part task trainer, and wide-band satellite for the EC-130.

Aircraft Support program funds SOF-peculiar support equipment for 16th SOW aircraft.

Advanced SEAL Delivery System (ASDS) provides spares, government furnished equipment, a trainer, and ASDS alterations. The ASDS is a manned combatant mini-submarine used for the delivery of SEAL personnel and weapons and will provide the requisite range, endurance, payload, and other capabilities for operations in a full range of threat environments.

MK8 MOD1 Seal Delivery Vehicle (SDV) program procures two SDVs. The mission of the SDV is to provide infiltration/exfiltration of SEAL combat swimmers into hostile/denied shore areas and harbor/port facilities for the conduct of special operations.

SOF Combatant Craft Systems program provides a short-range surface mobility platform for SOF insertion and extraction. The program supports the procurement of craft, trailers, prime movers, deployment packages, contractor logistics, and engineering support.

Ammunition Programs

Table 7-5 presents the FY04 Ammunition budget request.

**Table 7-5
Ammunition Programs
(\$ in Millions)**

Program	FY03	FY04
Ordnance Replenishment	\$28.072	\$35.746
Ordnance Acquisition	11.166	22.506
Total Ammunition	\$39.238	\$58.252

Ordnance Replenishment provides replenishment munitions to support SOF peacetime expenditures, combat reserve quantities.

Ordnance Acquisition program includes funds to meet the inventory objectives for war reserve and training on a variety of items developed and modified for SOF. This includes SOF demolition kits (SOFDK), IMP 105, multi-purpose anti-armor/anti-personnel weapons system (MAAWS), and foreign weapons and ammunitions.

Communications Programs

**Table 7-6
Communications
Equipment and Electronics
(\$ in Millions)**

Program	FY03	FY04
SOFTACS	\$0	16.853
NSW Tactical Radio	2.451	0
MBMMR	4.441	2.525
Miniature Multiband Beacon	0	1.131
Joint Base Station	3.165	0
SOF C4IAS	9.379	10.435
SCAMPI	7.494	2.727
VTC	.542	.341
HQ C4I Systems	.375	0
TACLAN	.420	22.213
Total Comm Equip & Electronics	\$28.267	\$56.225

The Communications Equipment and Electronics program provides for communication systems to support the SOF mission mandate that SOF systems remain technologically superior to any threat and to provide a maximum degree of survivability. SOF units require communication equipment that will improve their war-fighting capability without degrading their mobility. Therefore, the SOF Communications Equipment & Electronics program is a continuing effort to procure lightweight and efficient SOF Command, Control, Communications, and Computer (C⁴) capabilities. USSOCOM has developed an overall strategy to ensure that C⁴ systems continue to provide SOF with the required capabilities well into the 21st Century. The integrated network of systems provide positive command and control and the timely exchange of intelligence and threat warning to all organizational echelons. The C⁴ systems that support this new architecture will employ the latest standards and technology by transitioning from separate systems to full integration with the infosphere (a multitude of existing and projected national assets that will allow SOF elements to operate with any force combination in multiple environments).

Intelligence Programs

USSOCOM consolidates Intelligence programs in one budget line item to emphasize the importance of effective management in an area that is critical and essential to special operations. Table 7-7 shows the distribution of funds for these programs.

Program	FY03	FY04
TACLAN	4.877	.591
SOJICC	1.450	3.110
JTWS	4.806	3.631
JDISS/SOCRATES	2.189	5.711
JMIP	18.240	18.269
MATT	0	3.479
Total Intelligence	\$31.632	\$34.971

Funding for the Special Operations Joint Interagency Collaboration Center (SOJICC), an initiative program designed to support information operations, counterterrorism, and counterproliferation operational requirements, will provide hardware and software designed for data-mining, data analysis, data visualization, and interoperability. The Joint Threat Warning System (JTWS) funding will provide interim gap-filling capabilities to a program designed to provide force protection, threat warning, and enhanced situational awareness information to SOF via signals intelligence intercept and direction finding. The Joint Deployable Intelligence Support System/SOC Research, Analysis, and Threat Evaluation System (JDISS/SOCRATES) program will provide enhancements to intelligence preparation of the battlespace, joint intelligence fusion, collection asset management, automated language translation, and meteorological and oceanographic system capabilities, upgraded access to national databases, and enhanced messaging capabilities. Replacement equipment includes next generation hardware and software purchase for the special operations intelligence system network. The TACLAN program procures tactical LAN suites, laptops, and miscellaneous ADP equipment.

Miscellaneous Programs

The FY04 budget for Miscellaneous Programs is displayed in Table 7-8.

Program	FY03	FY04
Small Arms/Weapons	\$20.356	\$16.003
Maritime Equipment MODS	2.587	1.316
Spares/Repair Parts	5.223	7.995
SOF Maritime Equipment	2.530	1.990
Miscellaneous Equipment	5.634	11.207
SOPARS	.294	.292
Op Force Enhancements	93.653	260.769
PSYOP Equipment	5.532	18.264
Total Miscellaneous	\$135.819	\$317.836

Small Arms and Weapons provides small arms and combat equipment in support of SOF and procures a variety of weapons and equipment to include: advanced lightweight grenade launchers, night vision devices, improved night/day observation/fire control devices, Special Operations advanced tactical parachute systems, and 5.56 and 7.62mm lightweight machine guns to meet inventory objectives.

Maritime Equipment Modifications provide for the MK-V SOC maritime modifications. The FY03 program provides for pre-planned product improvements for procurement and integration of stabilized weapon mounts on the MK-V SOC.

Spares/Repair Parts program finances both initial weapon system and aircraft modification spares for SOF fixed and rotary wing aircraft. Initial weapon system spares include new production spares, peculiar support equipment spares, and upgrades to existing spares required to support initial operations of new aircraft and increases in the inventory of additional end items. Aircraft modification spares include new spare parts required during the initial operation of modified airborne systems. These funds reimburse the Air Force Stock fund for SOF initial spares provisioned with Air Force Stock fund obligation authority. The FY03 funding provides for the projected deliveries of initial spares for the AC-130U/H, MC-130E/H, and MH-53J aircraft.

SOF Maritime Equipment provides SOF peculiar equipment and related production support necessary for the Naval Special Warfare Command to execute special operations and fleet support missions as the Naval Component of USSOCOM. Funding for FY03 provides for procurement/integration of pre-planned product improvement efforts for the semi-autonomous hydrographic reconnaissance vehicle, procurement of hardware that is installed on the dry deck shelter as field changes, and procurement of an alternative fuels engine.

Miscellaneous Equipment provides for various types of low cost procurement equipment that do not reasonably fit in other USSOCOM procurement line categories. Examples include: joint operational stocks, a USSOCOM managed stock of materiel designed to provide joint SOF access to immediately available equipment in support of real world, contingency and training missions; procurement of collateral equipment for military construction projects; Naval Civil Engineering support equipment; and investment sustainment items for components and subordinate commands.

SOF Planning and Rehearsal System (SOFPARS) is an integrated family of mission planning systems supported by intelligence databases and imagery that will be used by planners within the SOF command structure worldwide to plan and preview SOF missions. FY03 procurement is a continuation effort of the peripheral equipment and data transfer devices for air, ground, and maritime mission planners.

Operational Force Enhancements provides funding for classified SOF projects.

Psychological Operations (PSYOP) Equipment procures equipment to meet emergent requirements of operational forces. The purpose of PSYOP is to induce or reinforce foreign or hostile attitudes and behavior favorable to U.S. national objectives. The FY03 program will acquire two Fly-Away Broadcast Systems, two PSYOP distribution systems, initial spares, and legacy equipment upgrades.

Research, Development, Test & Evaluation (RDT&E)

Modern technology provides the essential advantage for many special operations. Consequently, resources are requested for SOF RDT&E each year. Most funds

requested for FY04 will be used to improve current systems, components, and subsystems. Table 7-9 shows how RDT&E funds will be budgeted for FY04.

**Table 7-9
RDT&E (\$ in Millions)**

Program	FY03	FY04
Small Business Innovative Research	\$12.620	TBD
Tech Base Development	18.006	9.715
Adv Tech Development	79.550	67.017
Intelligence Systems	4.648	16.726
Medical Technology	3.339	1.961
SOF Operational Enhancements	83.860	64.430
Tactical Sys Development	287.621	255.981
Special Applications for Contingencies	22.817	24.587
Total	\$512.461	\$440.417

Small Business Innovative Research (SBIR) program element consists of a highly competitive three-phase award system which provides qualified small business concerns with the opportunity to propose high quality innovative ideas that meet specific research and development needs of USSOCOM.

Technology Base Development program conducts studies and develops laboratory prototypes for applied research and advanced technology development, as well as leverages other organizations' technology projects that may not otherwise be affordable within MFP-11. This program provides an investment strategy for USSOCOM to link non-systems technology opportunities to USSOCOM deficiencies, capability objectives, and technology development objectives and mission area analyses.

Advanced Technology Development program conducts rapid prototyping and Advanced Technology Demonstrations (ATD). It provides a means for demonstrating and evaluating the utility of emerging/advanced technologies in as realistic an operational environment as possible by SOF users. The FY03 plan is to participate in SOF C⁴I, Mobility, Weapons, and Sustainment ATDs; manage the Advanced Tactical Laser Advanced Concept Technology Demonstration (ACTD); and continue the AC-X Analysis of Alternatives.

Intelligence Systems Development program funds are used to develop and test selected special operations equipment that provides timely intelligence support to deployed forces. The FY03 plan is to participate in JCS and theater ACTDs that: evaluate national technical support to amphibious operations, overall interoperability and support of combined SOF and conventional operations; continue to assess technology and operational utility of national systems; and continue the Special Operations Joint Interagency Collaboration Center (SOJICC) program.

Medical Technology program provides studies, non-system exploratory ATDs and evaluations focused on medical technologies and centered on physiologic, psychologic, and ergonomic factors affecting the ability of SOF to perform their missions. Funds will be used in the seven following areas of investigation: combat casualty management; decompression procedures for SOF diving operations; exercise-related injuries; inhaled gas toxicology; medical sustainment training techniques; mission-related physiology; and thermal protection.

SOF Enhancements program provides funding for classified SOF projects as directed by the Secretary of Defense and/or the Joint Staff.

Tactical Systems Development program develops and tests selected specialized equipment to meet SOF-unique requirements. Table 7-10 details use of funds for these programs.

Special Applications for Contingencies (SAFC) program element develops and deploys special capabilities to perform intelligence surveillance and reconnaissance for deployed Special Operations Forces using non-traditional means.

**Table 7-10
Tactical Systems (\$ Millions)**

Program	FY03	FY04
Aircraft Defensive System	\$69.018	\$53.615
AC-130 U	28.969	1.228
PSYOP	0.475	2.273
SOF Aviation	36.450	46.094
Underwater System		
Adv Development	31.305	16.254
SOF Surface Craft		
Adv Systems	0.950	0.471
SOFPARS	1.704	2.603
Wpns/Spt System		
Adv Development	3.568	3.840
SOF Training System	0.0	10.326
Comm Adv Development	2.095	0.00
Munitions Adv		
Development	3.690	0.216
Aviation Sys Adv		
Development	48.150	82.605
CV-22	59.820	36.456
SO Misc Equip		
Adv Development	1.427	0.00
Totals	\$287.621	\$255.981

Aircraft Defensive Systems project identifies hardware, and software enhancements, for each SOF aircraft that will reduce detection, vulnerability, and threat engagement from threat radars. The FY04 program will continue to support laboratory efforts to maintain SOF aircraft

defensive systems and continued non-recurring engineering for towed decoy, as well as development and test of aircraft integration.

AC-130U Gunship program for FY03 began development of modifications to C-130H's including: weight and drag reduction designs, revised survivability studies, and a common electro-optical sensor system. This program continues efforts with Air Force laboratories to analyze and demonstrate gunship-related emerging electro-optical sensor technologies; continuing ground and flight test operations for ongoing AC-130 modifications; and technical studies and reliability/maintainability studies.

PSYOP Advanced Development Program begins environmental and operational testing of the PSYOP Distribution System, and Fly-Away Broadcast System variants, and completes developmental and operational test and evaluation of the Theater Media Production Center.

ARSOF Aviation continues MH-47/MH-60 and A/MH-6 projects. The FY 2004 plan: completes prototype testing of the G Cal 50 machine gun for the A/MH-6; continues non-recurring engineering for the MH-47 SLEP; begins an effort to develop a replacement radar altimeter that is less detectable; begins development and testing of panoramic night vision goggles, a rotary wing terrain following/terrain avoidance navigation system, and an obstacle avoidance/cable warning system for all platforms.

Underwater Systems Advanced Development project funds the development of Naval Special Warfare support items used during hydrographic/inland reconnaissance, beach obstacle clearance, underwater ship attack, and other direct action missions. Sub-projects include the ASDS, NSW very shallow water mine countermeasures, SEAL delivery vehicle electronic equipment, and non-gasoline burning outboard engine.

Special Operations Forces Planning and Rehearsal System (SOFPARS) is an automated mission planning capability to support SOF and consists of the SOF version of the Air Force mission support system and the SOF portable computer flight planning system. The FY03 program provides continued development of software architecture interfaces to ensure system compatibility with service/component mission planning, rehearsal, and execution systems and continues test and evaluation on core software, installable software modules, aircraft weapons/electronics, and flight performance models.

Weapons and Support Systems Advanced Development Program provides development and testing of specialized, lightweight individual weapons, fire control/surveillance devices, and combat equipment to meet the unique requirements of SOF. FY03 funding is being used to develop Enhanced Combat Optical Sights.

Munitions Advanced Development projects include specialized munitions and equipment for unique SOF requirements. The FY03 program supports the SOF Demolition Kit, updating MS C package, and preparing for material release.

Aviation Advanced Systems Development project investigates the applicability of current and maturing technologies that have great potential for direct application to the development and procurement of specialized equipment to meet SOF-unique aviation requirements. The FY03 program: continues terrain following/terrain avoidance and enhanced situational awareness (ESA) development under the U.S. Air Force AMP contract; initiates development of below line-of-sight ESA; completes engineering & manufacturing development activities for the MC-130H air refueling system; and continues AC-130U pre-planned product improvements.

CV-22 project provides capabilities necessary to meet Special Operations Forces operational requirements. The CV-22 acquisition program delayed the incorporation of some operational capabilities until the completion of a block 10 (formerly Pre-Planned Product Improvement) CV-22 program. This strategy was based on a developmental funding cap agreed to by the Department of the Navy and the USSOCOM Acquisition Executive and concerns over the technical maturity of parallel acquisition programs. The FY04 program continues the development/integration/testing of the block 10 program.

HQ USSOCOM CENTER ORGANIZATIONAL CHARTS AND DESCRIPTIONS

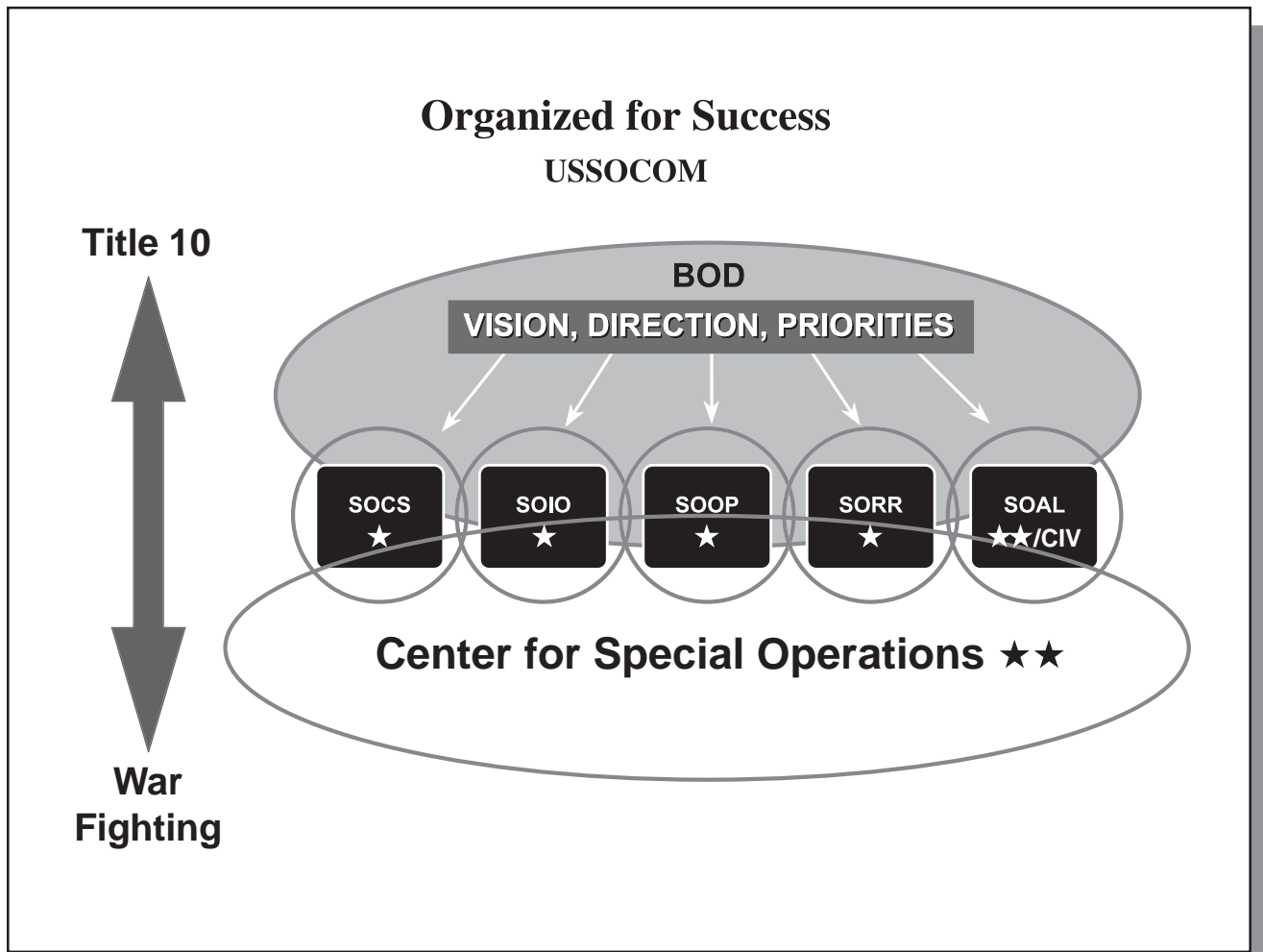

SOCS Organizational Chart

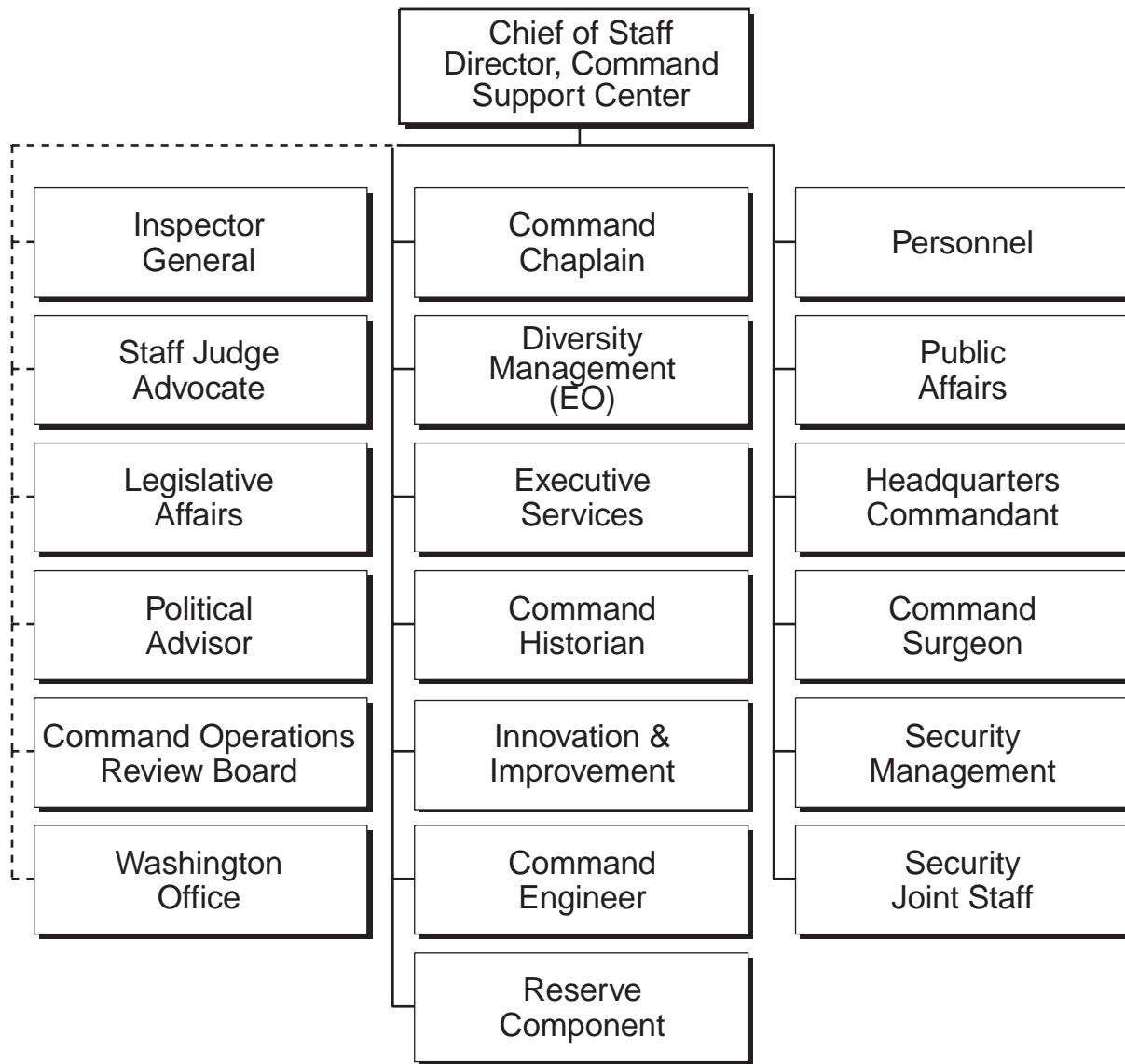

Center for Command Support (SOCS)

SOCS Mission

A special and support staff providing advice and assistance on a broad range of issues to the HQ USSOCOM, Components, and SOCs enhancing command mission accomplishment.

SOCS Title 10 Responsibilities

- Monitor the promotions, assignments, retention, training, and professional military development of all SOF officers
- Internally audit and inspect purchase and contract actions

Center for Acquisition and Logistics (SOAL)

SOAL Mission

1) Directly manage selected SO-peculiar development and procurement programs; 2) maintain insight into MFP-11 funded programs managed by the Services; 3) conduct total life cycle management for SOF; 4) serve as command focal point for SOF acquisition and logistics policies, procedures, activities, programs, projects, and

information; and 5) serve as USSOCOM interface with DOD and national labs, components, Services, joint staff, Congress, and industry on RD&A matters.

SOAL Title 10 Responsibilities

- Acquire special operations-peculiar material, supplies, and services
- Develop and acquire special operations-peculiar equipment

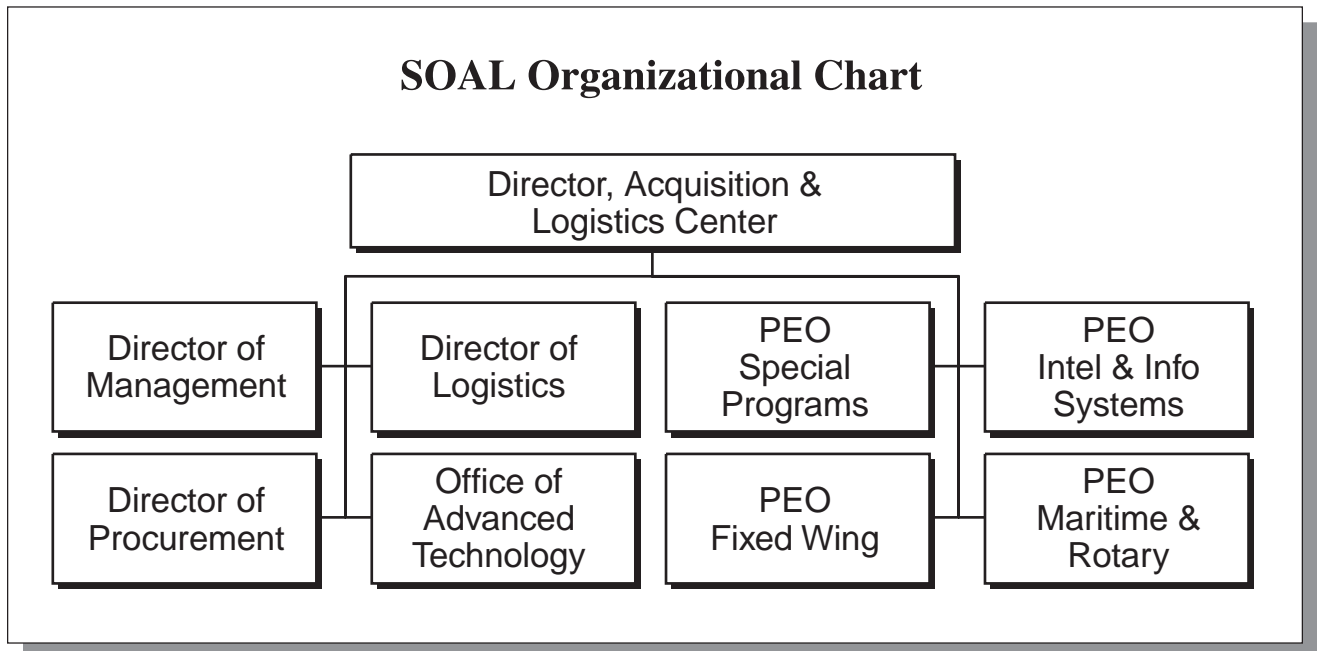

SORR Organizational Chart

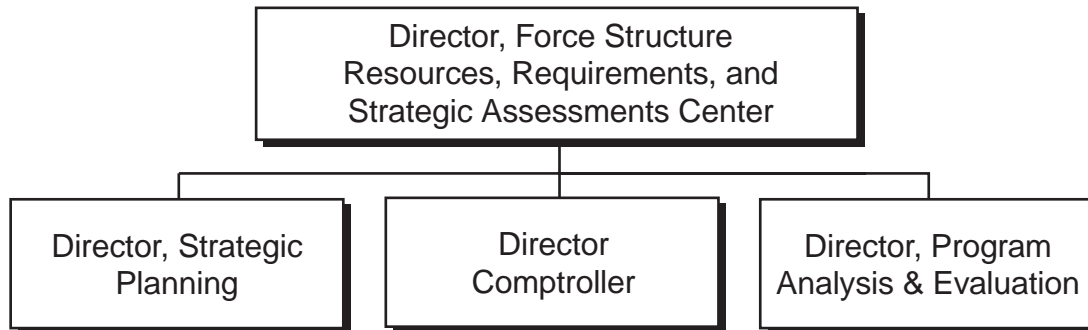

Center for Requirements and Resources (SORR)

SORR Mission

Support SOF through the development of resourcing, operational mission and force structure analysis, and strategic assessments to support our component commands and customers.

SORR Title 10 Responsibilities

- Prepare and submit to Secretary of Defense program recommendations and budget proposals for special operations and other forces assigned to USSOCOM
- Exercise authority, direction, and control over the expenditure of funds for forces assigned to USSOCOM and for SOF assigned to unified combatant commands other than the USSOCOM
- Prioritize requirements
- Ensure interoperability of equipment

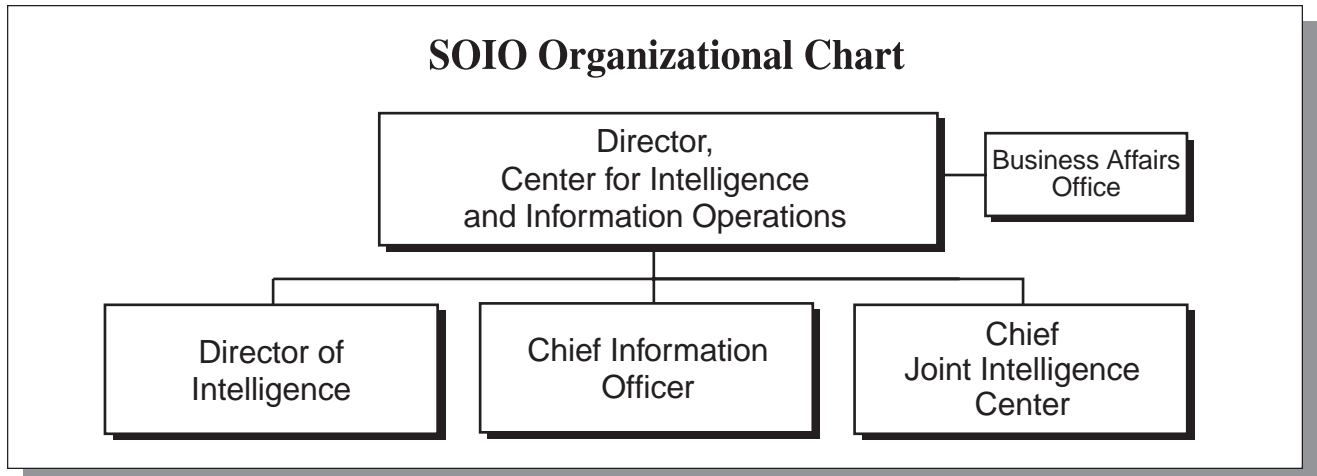

Center for Intelligence and Information Operations (SOIO)

SOIO Mission

The mission of SOIO is to ensure full spectrum information dominance for Special Operations Forces through intelligence, communications, and information operations; develop strategy, formulate policy and provide oversight of intelligence, communications, and information operations to support the successful accomplishment of SOF missions worldwide.

SOIO Title 10 Responsibilities

- Formulate and submit requirements for intelligence support
- Assist other Centers in executing their responsibilities for intelligence- and communications-related aspects of Title 10 responsibilities such as acquiring SO-peculiar equipment, prioritizing requirements, and ensuring interoperability of equipment and forces

Center for Policy, Training, & Readiness (SOOP)

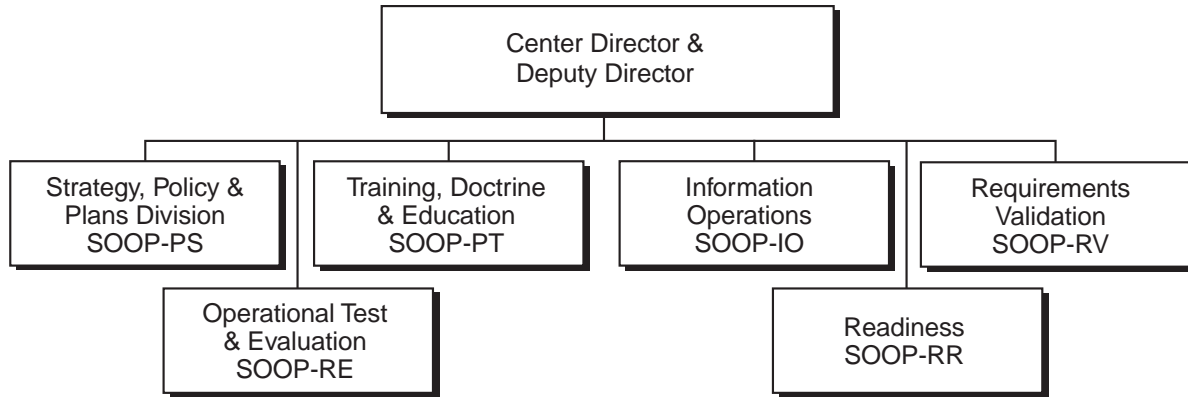

Center for Policy, Training, and Readiness (SOOP)

SOOP Mission

Ensure all special operations deployments and plans supporting the President and Secretary of Defense, Geographic Combatant Commanders and Ambassadors are tailored to mission requirements, reflect current force capabilities, and are consistent with USSOCOM Title 10 responsibilities and core tasks. In support of these objectives, oversee: SOF doctrine, education, tempo, remediation as well as the training and exercise programs in order to optimize force readiness and SOF relevance.

SOOP Title 10 Responsibilities

- Develop Strategy, Doctrine, and Tactics
- Train assigned forces
- Conduct specialized courses of instruction for commissioned and noncommissioned officers
- Validate and establish priorities for requirements
- Ensure the interoperability of equipment and forces
- Ensure combat readiness of forces assigned to USSOCOM
- Monitor the preparedness of special operations to carry out assigned missions of SOF assigned to unified combatant commands other than USSOCOM

Center for Special Operations

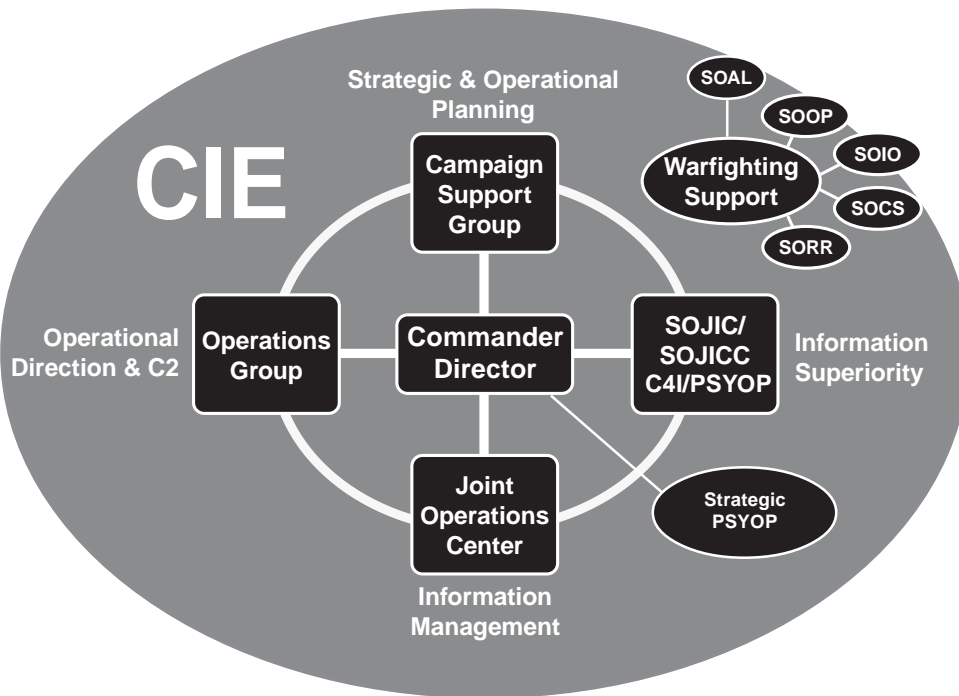

CIE = Collaborative Information Environment

Center for Special Operations (CSO)

CSO Mission

Responsible to the Commander, USSOCOM for planning, directing, and executing special operations in the conduct of the War on Terrorism in order to disrupt, defeat, and destroy terrorist networks that threaten the United States, its citizens, and interests worldwide.

APPENDIX B

GLOSSARY

Air Force special operations forces (AFSOF) – Those active duty and Reserve Component Air Force forces designated by the Secretary of Defense that are specifically organized, trained, and equipped to conduct and support special operations. (Joint Pub 1-02)

antiterrorism (AT) – Defensive measures used to reduce the vulnerability of individuals and property to terrorist acts, to include limited response and containment by local military forces. (Joint Pub 1-02)

area oriented – Personnel or units whose organizations, mission, training, and equipping are based on projected operational deployment to a specific geographic or demographic area. (Joint Pub 1-02)

armed reconnaissance – A mission with the primary purpose of locating and attacking targets of opportunity (i.e., enemy materiel, personnel, and facilities, in assigned general areas or along assigned ground communications routes) and not for the purpose of attacking specific briefed targets. (Joint Pub 1-02)

Army special operations forces (ARSOF) – Those active duty and Reserve Component Army forces designated by the Secretary of Defense that are specifically organized, trained, and equipped to conduct and support special operations. (Joint Pub 1-02)

campaign plan – A plan for a series of related military operations aimed at accomplishing a strategic or operational objective within a given time and space. (Joint Pub 1-02)

civil administration – An administration established by a foreign government in (1) friendly territory, under an agreement with the government of the area concerned, to exercise certain authority normally the function of the local government, or (2) hostile territory, occupied by U.S. forces, where a foreign government exercises executive, legislative, and judicial authority until an indigenous civil government can be established. (Joint Pub 1-02)

civil affairs activities – Activities performed or supported by civil affairs that (1) enhance the relationship between military forces and civil authorities in areas where military forces are present; and (2) involve application of civil affairs functional speciality skills, in areas normally the responsibility of civil government, to enhance conduct of civil-military operations. (Joint Pub 1-02)

civil affairs (CA) forces – Military units, detachments, or other military organizations that are designated as “civil affairs” organizations and are mission oriented and trained to plan, direct, and conduct civil affairs activities; also includes personnel who are trained and qualified in civil affairs and meet the qualifications of civil affairs as determined by their Service. (Joint Pub 3-57)

civil-military operations (CMO) – The activities of a commander that establish, maintain, influence, or exploit relations between military forces, governmental and non-governmental civilian organizations and authorities, and the civilian populace in a friendly, neutral, or hostile operational area in order to facilitate military operations, to consolidate and achieve U.S. objectives.

Civil-military operations may include performance by military forces of activities and functions normally the responsibility of local, regional, or national government. These activities may occur prior to, during, or subsequent to other military actions. They may also occur, if directed, in the absence of other military operations. Civil-military operations may be performed by designated CA, by other military forces, or a combination of CA and other forces. (Joint Pub 1-02)

civil-military operations center (CMOC) – An ad hoc organization, normally established by the geographic combatant commander or subordinate joint force commander to assist in the coordination of activities of engaged military forces, and other U.S. Government agencies, non-governmental organizations, and regional and international organizations. There is no established structure, and its size and composition are situation dependent. (Joint Pub 1-02)

clandestine operations – An operation sponsored or conducted by governmental departments or agencies in such a way as to assure secrecy or concealment. A clandestine operation differs from a covert operation in that emphasis is placed on concealment of the operation rather than on concealment of the identity of the sponsor. In special operations, an activity may be both covert and clandestine and may focus equally on operational considerations and intelligence-related activities. (Joint Pub 1-02)

combat control team (CCT) – A small task organized team of Air Force parachute and combat diver qualified personnel trained and equipped to rapidly establish and control drop, landing, and extraction zone air traffic in austere or hostile conditions. They survey and establish terminal airheads as well as provide guidance to aircraft for airlift operations. They provide command and control, and conduct reconnaissance, surveillance, and survey assessments of potential objective airfields or assault zones. They also can perform limited weather observations and removal of obstacles or unexploded ordnance with demolitions. (Joint Pub 3-17)

combat search and rescue (CSAR) – A specific task performed by rescue forces to effect the recovery of distressed personnel during war or military operations other than war. (Joint Pub 1-02)

combat weathermen – Air Force personnel who provide specialized meteorological, environmental, and oceanographic services for worldwide employment of joint SOF. As an ancillary mission, combat weathermen also have the capability to deploy forward to provide meteorological and oceanographic data in data-denied areas. (Joint Pub 3-59)

combating terrorism (CBT) – All actions, including *antiterrorism* (defensive measures taken to reduce vulnerability to terrorist acts), *counterterrorism* (offensive measures taken to prevent, deter, and respond to terrorism) taken to oppose terrorism throughout the entire threat spectrum, to include terrorist use of WMD and/or high explosives. (Joint Pub 1-02)

command and control warfare (C2W) – The integrated use of operations security, military deception, psychological operations, electronic warfare, and physical destruction, mutually supported by intelligence, to deny information to, influence, degrade, or destroy adversary command and control capabilities, while protecting friendly command and control capabilities against such actions. Command and control warfare is an application of information warfare in military operations and is a subset of information warfare. Command and control warfare applies across the range of military operations and all levels of conflict. (Joint Pub 1-02)

contingency – An emergency involving military forces caused by natural disasters, terrorists, subversives, or by required military operations. Due to the uncertainty of the situation, contingencies require plans, rapid response, and special procedures to ensure the safety and readiness of personnel, installations, and equipment. (Joint Pub 1-02)

counterdrug (CD) – Those active measures taken to detect, monitor, and counter the production, trafficking, and use of illegal drugs. (Joint Pub 1-02)

countermine operation – In land mine warfare, an operation to reduce or eliminate the effects of mines or minefields. (Joint Pub 1-02)

counterproliferation (CP) – The activities of the Department of Defense across the full range of U.S. government efforts to combat proliferation of nuclear, biological, and chemical weapons, including the application of military power to protect U.S. forces and interests; intelligence collection and analysis; and support of diplomacy, arms control, and export controls. Accomplishment of these activities may require coordination with other U.S. government agencies.

counterterrorism (CT) – Offensive measures taken to prevent, deter, and respond to terrorism. (Joint Pub 1-02)

covert operation – An operation that is so planned and executed as to conceal the identity of or permit plausible denial by the sponsor. A covert operation differs from a clandestine operation in that emphasis is placed on the concealment of the identity of the sponsor rather than on concealment of the operation. (Joint Pub 1-02)

deployment – The relocation of forces and materiel to desired areas of operation. Deployment encompasses all activities from origin or home station through destination, specifically including intra-continental U.S., inter-theater, and intra-theater movement legs, staging, and holding areas. (Joint Pub 1-02)

direct action (DA) – Short-duration strikes and other small-scale offensive actions by special operations forces to seize, destroy, capture, recover, or inflict damage on designated personnel or materiel. In the conduct of these operations, SOF may employ raid, ambush, or direct assault tactics; emplace mines and other munitions; conduct standoff attacks by fire from air, ground, or mari-

time platforms; provide terminal guidance for precision-guided munitions; conduct independent sabotage; conduct anti-ship operations. (Joint Pub 1-02)

dry deck shelter (DDS) – A shelter module that attaches to the hull of a specially configured submarine to provide the submarine with the capability to launch and recover special operations personnel, vehicles, and equipment while submerged. The dry deck shelter provides a working environment at one atmosphere for the special operations element during transit and has structural integrity to the collapse depth of the host submarine. (Joint Pub 1-02)

employment – The strategic, operational, or tactical use of forces. (Joint Pub 1-02)

force multiplier – A capability that, when added to and employed by a combat force, significantly increases the combat potential of that force and thus enhances the probability of successful mission accomplishment. (Joint Pub 1-02)

foreign internal defense (FID) – Participation by civilian and military agencies of a government in any of the action programs taken by another government to free and protect its society from subversion, lawlessness, and insurgency. (Joint Pub 1-02)

guerrilla warfare (GW) – Military and paramilitary operations conducted in enemy-held or hostile territory by irregular, predominantly indigenous forces. (Joint Pub 1-02)

host nation (HN) – A nation which receives the forces and/or supplies of allied nations and/or NATO organizations to be located on, to operate in, or to transit through its territory. (Joint Pub 1-02)

humanitarian assistance (HA) – Programs conducted to relieve or reduce the results of natural or manmade disasters or other endemic conditions, such as human pain, disease, hunger, or privation, that might present a serious loss

of life or that can result in great damage or loss of property. Humanitarian assistance provided by U.S. forces is limited in scope and duration. The assistance is designed to supplement or complement the efforts of the host-nation civil authorities or agencies that may have the primary responsibility for providing humanitarian assistance. (Joint Pub 1-02)

humanitarian demining (HD) – A humanitarian and civic assistance mission aimed at assisting host nations to reduce or eliminate landmines. HD includes activities related to furnishing of education, training, and technical assistance with respect to the detection and clearance of landmines. (10 USC §401(e)(5))

infiltration – 1) The movement through or into an area or territory occupied by either friendly or enemy troops or organizations. The movement is made, either by small groups or by individuals, at extended or irregular intervals when used in connection with the enemy, it infers that contact is avoided. 2) In intelligence usage, placing an agent or other person in a target area in hostile territory. Usually involves crossing a frontier or other guarded line. Methods of infiltration are black (clandestine); grey (through legal crossing point but under false documentation); and white (legal). (Joint Pub 1-02)

information operations (IO) – Actions taken to affect adversary information and information systems while defending one's own information and information systems. (Joint Pub 1-02)

information superiority – That degree of dominance in the information domain which permits the conduct of operations without effective opposition. (Joint Pub 1-02)

information warfare (IW) – Information operations conducted during time of crisis or conflict to achieve or promote specific objectives over a specific adversary or adversaries. (Joint Pub 1-02)

insurgency – An organized movement aimed at the overthrow of a constituted government

through the use of subversion and armed conflict. (Joint Pub 1-02)

joint force commander (JFC) – A general term applied to a combatant commander, subunified commander, or joint task force commander authorized to exercise combatant command (command authority) or operational control over a joint force. (Joint Pub 1-02)

joint force special operations component commander (JFSOCC) – The commander within a unified command, subordinate unified command, or joint task force responsible to the establishing commander for making recommendations on the proper employment of special operations forces and assets, planning and coordinating special operations, or accomplishing such operational missions as may be assigned. The JFSOCC is given the authority necessary to accomplish missions and tasks assigned by the establishing commander. The joint force special operations component commander will normally be the commander with the preponderance of SOF and the requisite command and control capabilities. (Joint Pub 1-02)

joint special operations air component commander (JSOACC) – The commander within the joint force special operations command responsible for planning and executing joint special air operations and for coordinating and deconflicting such operations with conventional nonspecial operations air activities. The JSOACC will normally be the commander with the preponderance of assets and/or greatest ability to plan, coordinate, allocate, task, control, and support the assigned joint special operations aviation assets. The JSOACC may be directly subordinate to the joint force special operations component commander or to any nonspecial operations component or joint force commander as directed. (Joint Pub 1-02)

joint special operations task force (JSOTF) – A joint task force composed of special operations units from more than one Service, formed to carry out a specific special operation or prosecute special operations in support of a theater campaign or other operations. The JSOTF may have conven-

tional nonspecial operations units assigned or attached to support the conduct of specific missions. (Joint Pub 1-02)

joint task force (JTF) – A joint force that is constituted and so designated by the Secretary of Defense, a combatant commander, a sub-unified commander, or an existing joint task force commander. (Joint Pub 1-02)

low-intensity conflict (LIC) – Political-military confrontation between contending states or groups below conventional war and above the routine, peaceful competition among states; frequently involves protracted struggles of competing principles and ideologies. Low-intensity conflict ranges from subversion to the use of armed force. It is waged by a combination of means employing political, economic, informational, and military instruments. Low-intensity conflicts are often localized but contain regional and global security implications.

military operations other than war (MOOTW) – Operations that encompass the use of military capabilities across the range of military operations short of war. These military actions can be applied to complement any combination of the other instruments of national power and occur before, during, and after war. (Joint Pub 1-02)

mine warfare (MIW) – The strategic, operational, and tactical use of mines and mine countermeasures. Mine warfare is divided into two basic subdivisions: the laying of mines to degrade the enemy's capabilities to wage land, air, and maritime warfare; and the countering of enemy-laid mines to permit friendly maneuver or use of selected land or sea areas. (Joint Pub 1-02)

mobile training team (MTT) – A team consisting of one or more U.S. military or civilian personnel sent on temporary duty, often to a foreign nation, to give instruction. The mission of the team is to train indigenous personnel to operate, maintain, and employ weapons and support systems, or to develop a self-training capability in a particular skill. The President or Secretary

of Defense may direct a team to train either military or civilian indigenous personnel, depending upon host nation requests. (Joint Pub 1-02)

naval special warfare (NSW) – A designated naval warfare specialty that conducts operations in the coastal, riverine, and maritime environments. Naval special warfare emphasizes small, flexible, mobile units operating under, on, and from the sea. These operations are characterized by stealth, speed, and precise, violent application of force. (Joint Pub 1-02)

naval special warfare forces (NSW or NAVSOF) – those active and Reserve Component Navy forces designated by the Secretary of Defense that are specifically organized, trained, and equipped to conduct and support special operations. (Joint Pub 1-02)

naval special warfare group (NSWG) – A permanent Navy echelon III major command to which many naval special warfare forces are assigned for some operational and all administrative purposes. It consists of a group headquarters with command and control, communications, and support staff; sea-air-land teams; and sea-air-land delivery vehicle teams. (Joint Pub 1-02)

naval special warfare unit (NSWU) – A permanent Navy organization forward based to control and support attached naval special warfare forces. (Joint Pub 1-02)

overt operation – An operation conducted openly without concealment. (Joint Pub 1-02)

paramilitary forces – Forces or groups distinct from the regular armed forces of any country, but resembling them in organization, equipment, training, or mission. (Joint Pub 1-02)

pararescue team (PRT) – Specially trained personnel qualified to penetrate to the site of an incident by land or parachute, render medical aid, accomplish survival methods, and rescue survivors. (Joint Pub 1-02)

poststrike reconnaissance – Missions undertaken for the purpose of gathering information used to measure results of a strike. (Joint Pub 1-02)

psychological operations (PSYOP) – Planned operations to convey selected information and indicators to foreign audiences to influence their emotions, motives, objective reasoning, and ultimately the behavior of foreign governments, organizations, groups, and individuals. The purpose of PSYOP is to induce or reinforce foreign attitudes and behaviors favorable to the originator's objectives. (Joint Pub 1-02)

raid – An operation, usually small scale, involving a swift penetration of hostile territory to secure information, confuse the enemy, or to destroy installations. It ends with a planned withdrawal upon completion of the assigned mission. (Joint Pub 1-02)

Rangers – Rapidly deployable, airborne light infantry personnel organized and trained to conduct highly complex joint direct action operations in coordination with or in support of other special operations units of all Services. Rangers can also execute direct action operations in support of conventional, nonspecial operations missions conducted by a combatant commander and can operate as conventional light infantry when properly augmented with other elements of combined arms. (Joint Pub 1-02)

recovery operations – Operations conducted to search for, locate, identify, rescue, and return personnel, sensitive equipment, or items critical to national security. (Joint Pub 1-02)

sabotage – An act or acts with intent to injure, interfere with, or obstruct the national defense of a country by willfully injuring or destroying, or attempting to injure or destroy, any national defense or war materiel, premises, or utilities, to include human or natural resources. (Joint Pub 1-02)

sea-air-land team (SEAL team) – A naval force specially organized, trained, and equipped to

conduct special operations in maritime, littoral, and riverine environments. (Joint Pub 1-02)

security assistance – Group of programs authorized by the Foreign Assistance Act of 1961, as amended, and the Arms Export Control Act of 1976, as amended, or related statutes by which the U.S. provides defense articles, military training, and other defense-related services by grant, loan, credit, or cash sales in furtherance of national policies and objectives. (Joint Pub 1-02)

special activities – Activities conducted in support of national foreign policy objectives that are planned and executed so that the role of the U.S. Government is not apparent or acknowledged publicly. They are also functions in support of such activities, but are not intended to influence U.S. political processes, public opinion, policies, or media and do not include diplomatic activities or the collection and production of intelligence or related support functions. (Joint Pub 1-02)

special boat teams (SBT) – Those U.S. Navy forces organized, trained, and equipped to conduct or support naval special warfare, riverine warfare, coastal patrol and interdiction, and joint special operations with patrol boats or other combatant craft designed primarily for special operations support.

special forces (SF) – U.S. Army forces organized, trained, and equipped specifically to conduct special operations. Special forces have five primary missions: unconventional warfare, foreign internal defense, direct action, special reconnaissance, and counterterrorism. Counterterrorism is a special mission for specially organized, trained, and equipped special forces units designated in theater contingency plans. (Joint Pub 1-02)

special forces group (SFG) — A combat arms organization capable of planning, conducting, and supporting special operations activities in all operational environments in peace, conflict, and war. It consists of a group headquarters and headquarters company, a support company, and special

forces battalions. The group can operate as a single unit, but normally the battalions plan and conduct operations from widely separated locations. The group provides general operational direction and synchronizes the activities of subordinate battalions. Although principally structured for unconventional warfare, special forces group units are capable of task-organizing to meet specific requirements. (Joint Pub 3-05)

special operations (SO) — Operations conducted by specially organized, trained, and equipped military and paramilitary forces to achieve military, political, economic, or informational objectives by unconventional military means in hostile, denied, or politically sensitive areas. These operations are conducted across the full range of military operations, independently or in coordination with operations of conventional, non-special operations forces. Political-military considerations frequently shape special operations, requiring clandestine, covert, or low visibility techniques and oversight at the national level. Special operations differ from conventional operations in degree of physical and political risk, operational techniques, mode of employment, independence from friendly support, and dependence on detailed operational intelligence and indigenous assets. (JP 3-05)

special operations command (SOC) — A subordinate unified or other joint command established by a joint force commander to plan, coordinate, conduct, and support joint special operations within the joint force commander's assigned operational area. (JP 3-05)

special operations forces (SOF) — Those active duty and Reserve Component forces of the Military Services designated by the Secretary of Defense and specifically organized, trained, and equipped to conduct and support special operations. (Joint Pub 3-05.3)

special operations liaison element (SOLE) — A special operations liaison team provided by the joint force special operations component commander to the joint force air component commander (if designated) to coordinate, deconflict,

and integrate special operations air and surface operations with conventional air operations. (Joint Pub 1-02)

special operations-peculiar (SO-peculiar) — Equipment, material, supplies, and services required for special operations mission support for which there is no broad conventional force requirement. This includes standard items used by other Department of Defense (DOD) forces but modified for special operations forces (SOF); items initially designed for, or used by, SOF until adapted for use as Service-common by other DOD forces; and items approved by the Commander, US Special Operations Command (CDRUSSOCOM) as critically urgent for the immediate accomplishment of a special operations mission but not normally procured by CDRUSSOCOM. (Joint Pub 3-05)

special operations wing (SOW) — An Air Force special operations wing. (Joint Pub 3-05.5)

special reconnaissance (SR) — Reconnaissance and surveillance actions conducted by special operations forces to obtain or verify, by visual observation or other collection methods, information concerning the capabilities, intentions, and activities of an actual or potential enemy or to secure data concerning the meteorological, hydrographic, or geographic characteristics of a particular area. It includes target acquisition, area assessment, and post-strike reconnaissance. (Joint Pub 3-05.5)

special tactics team (STT) — U.S. Air Force special operations task organized element that may include combat control, pararescue, and combat weather personnel who are organized, trained, and equipped to establish and control the air-ground interface at an airhead in the objective area. Functions include assault zone reconnaissance and surveillance, establishment, and terminal control; combat search and rescue; combat casualty care and evacuation staging; special operations terminal attack control; and tactical weather observations and forecasting. (Joint Pub 3-05.1)

subordinate unified command – A command established by commanders of unified commands, when so authorized through the Chairman of the Joint Chiefs of Staff, to conduct operations on a continuing basis in accordance with the criteria set forth for unified commands. A subordinate unified command may be established on an area or functional basis. Commanders of subordinate unified commands have functions and responsibilities similar to those of the commanders of unified commands and exercise operational control of assigned commands and forces within the assigned joint operations area. Also called sub-unified command. (Joint Pub 1-02)

subversion – Action designed to undermine the military, economic, psychological, or political strength or morale of a regime. (Joint Pub 1-02)

unconventional warfare (UW) – A broad spectrum of military and paramilitary operations, normally of long duration, predominately conducted by indigenous or surrogate forces who are organized, trained, equipped, supported, and directed in varying degrees by an external source. It includes guerrilla warfare and other direct offen-

sive, low visibility, covert, or clandestine operations, as well as the indirect activities of subversion, sabotage, intelligence activities, and evasion and escape. (Joint Pub 1-02)

unified command – A command with a broad continuing mission under a single commander and composed of significant assigned components of two or more Military Departments, that is established and so designated by the President, through the Secretary of Defense, with the advice and assistance of the Chairman of the Joint Chiefs of Staff. (Joint Pub 1-02)

weapons of mass destruction (WMD) – Weapons that are capable of a high order of destruction and/or of being used in such a manner as to destroy large numbers of people. WMD can be high explosive, nuclear, chemical, biological, and radiological weapons, but excludes the means of transporting or propelling the weapon where such means is a separable and divisible part of the weapon. (Joint Pub 1-02)



Special Tactics Operators in Operation Enduring Freedom

ACKNOWLEDGMENTS

With special appreciation to Colleen Wiatt, Protean Gibril, Ray Chapman, Jim Kiras and Matt Johnson whose efforts made this document possible.

World Wide Web Information Access

The Special Operations Forces Posture Statement
may be accessed on the Defense LINK at
<http://www.defenselink.mil/policy/solic>