



U.S. Department of Transportation
Federal Highway Administration
ITS Joint Program Office

Intelligent Transportation Systems Benefits: 1999 Update



28 May 1999

Notice

This document is disseminated under the sponsorship of the Department of Transportation in the interest of information exchange. The United States Government assumes no liability for its contents or use thereof.

1. Report No. FHWA-OP-99-012	2. Government Accession No.	3. Recipient's Catalog No.	
4. Title and Subtitle ITS Benefits: 1999 Update		5. Report Date 28 May 1999	
		6. Performing Organization Code	
7. Author(s) Allen T. Proper		8. Performing Organization Report No.	
9. Performing Organization Name and Address Mitretek Systems, Inc. Intelligent Transportation Systems 600 Maryland Ave, SW, Suite 755 Washington, D.C. 20025		10. Work Unit No. (TRAI5)	
		11. Contract or Grant No. DTFH61-95-C00040	
12. Sponsoring Agency Name and Address Department of Transportation FHWA Intelligent Transportation Systems Joint Program Office 400 Seventh Street, SW - Room 3422 Washington, D.C. 20590		13. Type of Report and Period Covered	
		14. Sponsoring Agency Code HVH-1	
15. Supplementary Notes Joe Peters			
16. Abstract This report continues the emphasis in documenting evaluation results of ITS user services and the benefits these services provide to the surface transportation system. The organization of this report differs from that of the previous ITS Benefits reports. Referenced data are classified into a structure that reflects individual ITS program areas. These program areas include the metropolitan and rural infrastructure, ITS for Commercial Vehicle Operations (ITS/CVO) and Intelligent Vehicle user services. Data within the report reflect empirical results from field operations of deployed systems, supplemented with benefits information based upon modeling studies and statistical studies. This report is intended to be a reference report. It highlights benefits identified by other authors and refers the reader to information sources. The interested reader is encouraged to obtain source documents to appreciate the assumptions and constraints placed upon interpretation of results. It is the intent of the ITS Joint Program Office to update this report periodically.			
Key Words Intelligent Transportation Systems (ITS), ITS Benefits, Benefits to Cost Analysis		18. Distribution Statement No restrictions. This document is available to the public	
19. Security Classif. (of this report) Unclassified	20. Security Classif. (of this page) Unclassified	21. No of Pages 95	22. Price NA

Intelligent Transportation Systems Benefits: 1999 Update

Prepared by
Mitretek Systems Inc.
600 Maryland Avenue SW, Suite 755
Washington, D.C., 20024

Under Contract to the Federal Highway Administration
United States Department of Transportation
Washington, D.C.

28 May 1999



Center for Telecommunications
and Advanced Technology
McLean, Virginia

PREFACE

The Federal Intelligent Transportation Systems (ITS) program came into being as a result of the Intermodal Surface Transportation Efficiency Act of 1991. In the years since, the ITS field has developed from a collection of ideas and isolated applications of technology into an interrelated program with initial projects yielding benefits for the nation's surface transportation system. On 9 June 1998, the Transportation Equity Act for the 21st Century was signed into law. Known as TEA-21, this new legislation succeeded the 1991 act and authorized \$1.3 billion, enabling the continued investment in ITS.

Since December of 1994, the United States Department of Transportation's (U.S. DOT's) ITS Joint Program Office (JPO) has been actively collecting information regarding the impact of ITS projects on the operation of the surface transportation network. This report is a compendium of reported impacts of ITS collected for this effort. Its purpose is to provide the JPO with a tool to transmit existing knowledge of ITS benefits to the transportation professional who may not be well versed in ITS products and services. Also, this report is intended to provide the research community with information on ITS areas where further analysis is required.

This report is intended to be a reference report. It highlights benefits identified by other authors and refers the reader to information sources. The interested reader is encouraged to obtain source documents to appreciate the assumptions and constraints placed upon interpretation of results.

To aid the distribution of the information in this report, this document will be placed in the U.S. DOT's ITS Electronic Document Library at www.its.dot.gov/cyberdocs/welcome.htm as document number 8323.

Many ITS efforts initiated by states, local governments, and private enterprise do not have their benefits or cost documented in this report. Readers who are aware of important ITS benefits and cost information from these and other sources are encouraged to send reference documents to:

Joseph I. Peters, Ph.D.
ITS Program Assessment Coordinator
ITS Joint Program Office
Federal Highway Administration (HOIT-1)
400 7th Street, SW
Washington, D.C. 20590

TABLE OF CONTENTS

PREFACE i
 TABLE OF CONTENTS iii
 EXECUTIVE SUMMARY vii

1.0 INTRODUCTION 1
 1.1 GOALS OF THE ITS BENEFITS REPORT 1
 1.2 ORGANIZATION OF THIS REPORT 2
 1.3 A FEW GOOD MEASURES 4
 1.4 POSITIVE AND NEGATIVE IMPACTS OF ITS 5

2.0 BENEFITS OF METROPOLITAN ITS INFRASTRUCTURE 7
 2.1 ARTERIAL MANAGEMENT SYSTEMS 9
 2.1.1 Summary of Arterial Management Systems Data 14
 2.2 FREEWAY MANAGEMENT SYSTEMS 16
 2.2.1 Summary of Freeway Management Systems 20
 2.3 TRANSIT MANAGEMENT SYSTEMS 21
 2.3.1 Summary of Transit Management Systems 23
 2.4 INCIDENT MANAGEMENT SYSTEMS 24
 2.4.1 Summary of Incident Management 27
 2.5 EMERGENCY MANAGEMENT 28
 2.6 ELECTRONIC TOLL COLLECTION 30
 2.6.1 Summary of Electronic Toll Collection 31
 2.7 ELECTRONIC FARE PAYMENT PROGRAMS 32
 2.8 HIGHWAY-RAIL INTERSECTIONS 33
 2.9 REGIONAL MULTI-MODAL TRAVELER INFORMATION 34
 2.10 BENEFITS OF INTEGRATED METROPOLITAN ITS 38

3.0 BENEFITS OF RURAL ITS INFRASTRUCTURE 41
 3.1 TRAVELER SAFETY AND SECURITY 42
 3.2 EMERGENCY SERVICES 43
 3.3 TOURISM AND TRAVEL INFORMATION 44
 3.4 PUBLIC TRAVEL AND MOBILITY SERVICES 44
 3.5 INFRASTRUCTURE OPERATION AND MAINTENANCE 46
 3.6 FLEET OPERATION AND MAINTENANCE 47

4.0 BENEFITS OF ITS FOR COMMERCIAL VEHICLE OPERATIONS	49
4.1 SAFETY ASSURANCE	50
4.2 CREDENTIALS ADMINISTRATION	51
4.3 ELECTRONIC SCREENING	51
4.4 CARRIER OPERATIONS	53
5.0 BENEFITS OF INTELLIGENT VEHICLES	57
5.1 DRIVER ASSISTANCE	57
5.2 COLLISION AVOIDANCE / WARNING	60
6.0 SUMMARY	63
APPENDIX 1: REFERENCE LIST	67
APPENDIX 2: LISTING OF ACRONYMS	75

LISTING OF TABLES

Table ES-1: Summary of References Discussed in This Report.....	viii
Table ES-2: Summary of Available Data by Benefit Measure	ix
Table 2-1: Summary of Incident Management Results	28
Table 6-1: Number of Point Data Summarized in This Report	65
Table 6-2: Summary of Available Data by Benefit Measure	66

LISTING OF FIGURES

Figure ES-1: Summary of Reported ITS Benefits Data From Traffic Signal Control.....	xi
Figure ES-2: Summary of Ramp Metering Impacts	xii
Figure ES-3: Operational Cost Savings for Electronic Toll Collection	xii
Figure 1a: Intelligent Infrastructure Taxonomy for Reporting ITS Benefits	3
Figure 1b: Intelligent Vehicles Taxonomy for Reporting ITS Benefits	3
Figure 2-0: Metropolitan ITS Program Areas	8
Figure 2-1: A Possible Set of Integration Links	8
Figure 2-2: Taxonomy of Arterial Management Systems.....	10
Percent Reduction In Stops Due To Adaptive Control	14
Percent Reduction In Travel Time Due To Adaptive Control	15
Percent Delay Reduction Due To Adaptive Control.....	15
Figure 2-3: Taxonomy of Freeway Management Systems	16
Percent Accident Reduction Due To Ramp Metering	20
Percent Increase in Speed Due To Ramp Metering	20

Figure 2-4: Taxonomy of Transit Management Systems	21
Figure 2-5: Taxonomy for Incident Management Systems.	24
Figure 2-6: Taxonomy of Emergency Management	28
Figure 2-7: Taxonomy of Electronic Toll Collection	30
Estimated Annual Operating Cost Savings for ETC	31
Figure 2-8: Taxonomy of Electronic Fare Payment	32
Figure 2-9: Taxonomy for Highway-Rail Intersections	34
Figure 2-10: Taxonomy for Regional Multimodal Traveler Information	34
Figure 3-0: Rural ITS Program Areas	41
Figure 3-1: Taxonomy for Traveler Safety and Security	42
Figure 3-2: Taxonomy for Emergency Services	43
Figure 3-3: Taxonomy of Tourism and Travel Information	44
Figure 3-4: Taxonomy of Public Travel and Mobility Services	45
Figure 3-5: Taxonomy for Infrastructure Operation and Maintenance	46
Figure 3-6: Taxonomy for Fleet Operation and Maintenance	47
Figure 4-0: ITS/CVO Program Areas	49
Figure 4-1: Taxonomy for Safety Assurance	50
Figure 4-2: Taxonomy for Credentials Administration	51
Figure 4-3: Taxonomy for Electronic Screening	52
Figure 4-4: Taxonomy for Carrier Operations	53
Figure 5-1: Taxonomy for Driver Assistance	57
Figure 5-2: Taxonomy for Collision Avoidance / Warning	60

EXECUTIVE SUMMARY

Since December of 1994, the United States Department of Transportation's (U.S. DOT) ITS Joint Program Office (JPO) has been actively collecting information on the impacts that ITS and related projects have on the operation and management of the nation's surface transportation system. The evaluation of ITS and precursor systems is an ongoing process. Significant knowledge is available for many ITS services, but gaps in knowledge also exist.

The purpose of this report is to provide the JPO with a tool to transmit existing knowledge of ITS benefits to the transportation professional who may not be well versed in ITS products and services. Also, this report is intended to provide the research community with information about where further analysis is required in the ITS program. Intended to be a reference report, it highlights benefits identified by other authors and refers the reader to information sources. This report summarizes much of the available quantifiable data and benefits of ITS impacts collected by the JPO. It demonstrates that in general all ITS services have shown some positive benefit and that negative impacts are usually outweighed by other positive results. For example, higher speeds and improved traffic flow result in increases in Nitrous Oxides, while other emission measures, fuel consumption, travel time, and delay, are reduced.

Table ES-1 presents the number of references that contain information about measured and predicted impacts of ITS services. These references represent data sources that are discussed in this report. Table ES-2 presents these data for each ITS service by measure of effectiveness. Each source may contain data for more than one measure or ITS user service. The authors acknowledge that this is not an exhaustive report of ITS impacts and continue to seek available impacts data. Using these two tables, conclusions can then be drawn as to where gaps in knowledge of ITS benefits are located.

Most of the data collected to date are concentrated within the metropolitan areas, while rural applications have few data points available. This may be due to the fact that the metropolitan program has been in existence longer and is much more developed than rural or CVO. The heaviest concentrations of data in the metropolitan area are for safety and delay savings in traffic signal control, freeway management, and incident management. Although there are several operational tests currently underway for the program area of highway/rail intersections, it is the newest program area of metropolitan infrastructure and no data have been reported as of this date.

Currently, few benefits data have been collected regarding rural ITS. Several state and national parks are now examining the possibilities of providing improved tourism and travel information, and several rural areas are implementing public travel services. Also, many states are now examining the benefits of incorporating ITS, specifically weather information, into the operation and maintenance of facilities and equipment. Over the next several years and as this program matures, more data will become available.

Infrastructure	User Service	Benefit Area	Number of References	
			Measured	Predicted
Metropolitan	Arterial Management Systems	Safety	9	
		Time	12	3
		Throughput	1	
		Customer Satisfaction	2	
		Emissions/Fuel Savings	5	
	Freeway Management Systems	Safety	5	
		Time	2	
		Throughput	4	
		Other	2	
	Transit Management Systems	Time	3	
		Cost	2	
		Customer Satisfaction	1	
	Incident Management Systems	Safety	4	
		Time	10	1
		Cost	6	
		Emissions/Fuel Savings	2	1
	Emergency Management	Time	1	
		Customer Satisfaction	1	
		Other	1	
	Electronic Toll Collection	Time	1	
Throughput		1		
Cost		1		
Emissions/Fuel Savings		1		
Electronic Fare Payment	Time	1		
	Cost	5		
Regional Multi modal information	Cost	1		
	Customer Satisfaction	6		
	Emissions/Fuel Savings	1		
	Other	5		
Integrated systems	Time	4		
	Cost	3		
	Customer Satisfaction	2		
Rural	Traveler Safety and Security	Safety	1	
	Emergency Services	Safety	1	
		Time	1	
	Public Travel and Mobility	Cost	2	
		Other	1	
Infrastructure Operation	Cost	2		
ITS/CVO	Safety Assurance	Cost	1	
	Credentials Administration	Time	1	
	Electronic Screening	Time		1
		Cost	4	
	Carrier Operations	Time	5	
		Cost	7	
Other		4		
Intelligent Veh.	Driver Assistance	Safety		4
		Time	3	
		Throughput		1
		Cost		1
	Platform Specific	Customer Satisfaction	2	
		Safety		1
		Throughput		1
Total			144	14

Table ES-1 Summary of References Discussed in This Report

Key:
 Number of References
 0 : ○
 1 to 3 : ◐
 4 to 6 : ◑
 7 to 10 : ◒
 > 10 : ◓

		Safety	Time & Delay	Effective Capacity	Cost	Customer Satisfaction	Emissions/Fuel Saving	Other
Metropolitan	Arterial Management Systems	◑	◓	◑	○	◑	◑	◑
	Freeway Management	◑	◐	◑	○	○	○	◑
	Transit Management	○	◐	○	◑	◑	○	○
	Incident Management	◑	◓	○	◑	○	◑	○
	Emergency Management	○	◐	○	○	◑	○	◑
	Electronic Toll Collection	○	◐	◑	◑	○	◑	○
	Electronic Fare Payment	○	◐	○	◑	○	○	○
	Highway/Rail Intersection	○	○	○	○	○	○	○
	Regional Mutimodal Travel Information	○	○	○	◑	◑	◑	◑
	Integrated Systems	○	◑	○	◑	◑	○	○
Rural	Traveler Safety and Security	◐	○	○	○	○	○	○
	Emergency Services	◐	◐	○	○	○	○	○
	Tourism and Travel Information	○	○	○	○	○	○	○
	Public Travel and Mobility Services	○	○	○	◑	○	○	◑
	Infrastructure Operation and Maintenance	○	○	○	◑	○	○	○
	Fleet Operation and Maintenance	○	○	○	○	○	○	○
ITS/CVO	Safety Assurance	○	○	○	◑	○	○	○
	Credentials Administration	○	◐	○	○	○	○	○
	Electronic Screening	○	◐	○	◑	○	○	○
	Carrier Operations	○	◑	○	◑	○	○	◑
I.V.	Driver Assistance	◑	◐	◑	◑	◑	○	○
	Platform Specific	◐	○	◑	○	○	○	○

Table ES-2: Summary of Available Data by Benefit Measure

ITS for Commercial Vehicle Operations (ITS/CVO) continues to provide benefits to both carriers and state agencies. ITS/CVO program areas usually report benefits data from directly measurable effects. Therefore, it might be expected that these data are accurate and only a few data points would be necessary to convince carriers, states, and local authorities of the possible benefits of implementing these systems. To date, most of the data collected for ITS/CVO are for cost, travel time, and delay savings for carrier operations.

ITS program areas and user services associated with driver assistance and specific vehicle classes are still being developed and planned. Although a few of these services are available in the marketplace, much of the data currently associated with these services are predicted or projected based on how systems are expected to perform. As market penetrations increase and improved systems are developed, there will be ample opportunity to measure and report more accurate data.

As shown in Table ES-2, ITS benefits data are available across all measures of effectiveness categories. The heaviest concentration of data available for particular measures is for time/delay and cost savings. Much less data are available on effective capacity, emissions, and customer satisfaction at this point in time.

General conclusions and results are developed throughout the main body of the report. It should be mentioned that due to the nature of the data, it is often difficult to compare data from one project to another. This is due to the fact that there are several different variables involved between different implementations of ITS user services. Thus, statistical analysis of the data is not done across data points. In several cases, ranges of reported impacts are presented and general trends can be discussed. These cases include traffic signal systems, ramp metering, and electronic toll collection.

Traffic Signal Systems

The charts in figure ES-1 contain the reported values for traffic signal system data presented in this report, arranged from the lowest to the highest values. As a general observation, one might assume that for adaptive control signal systems, the number of stops could be reduced a minimum of 20%. Likewise, the reduction in travel times range between 8% and 20%, and delay reductions can be expected to be around 15% or better. Video enforcement of traffic signal compliance has shown the potential to reduce between 20 and 43% of crashes occurring at intersections. Impacts of emission reductions appear to be favorable, with the exception of emissions of Nitrous-oxides. This is expected because improved flows and increases in speed lead to increased production of Nitrous-oxides while decreasing other emission measures.

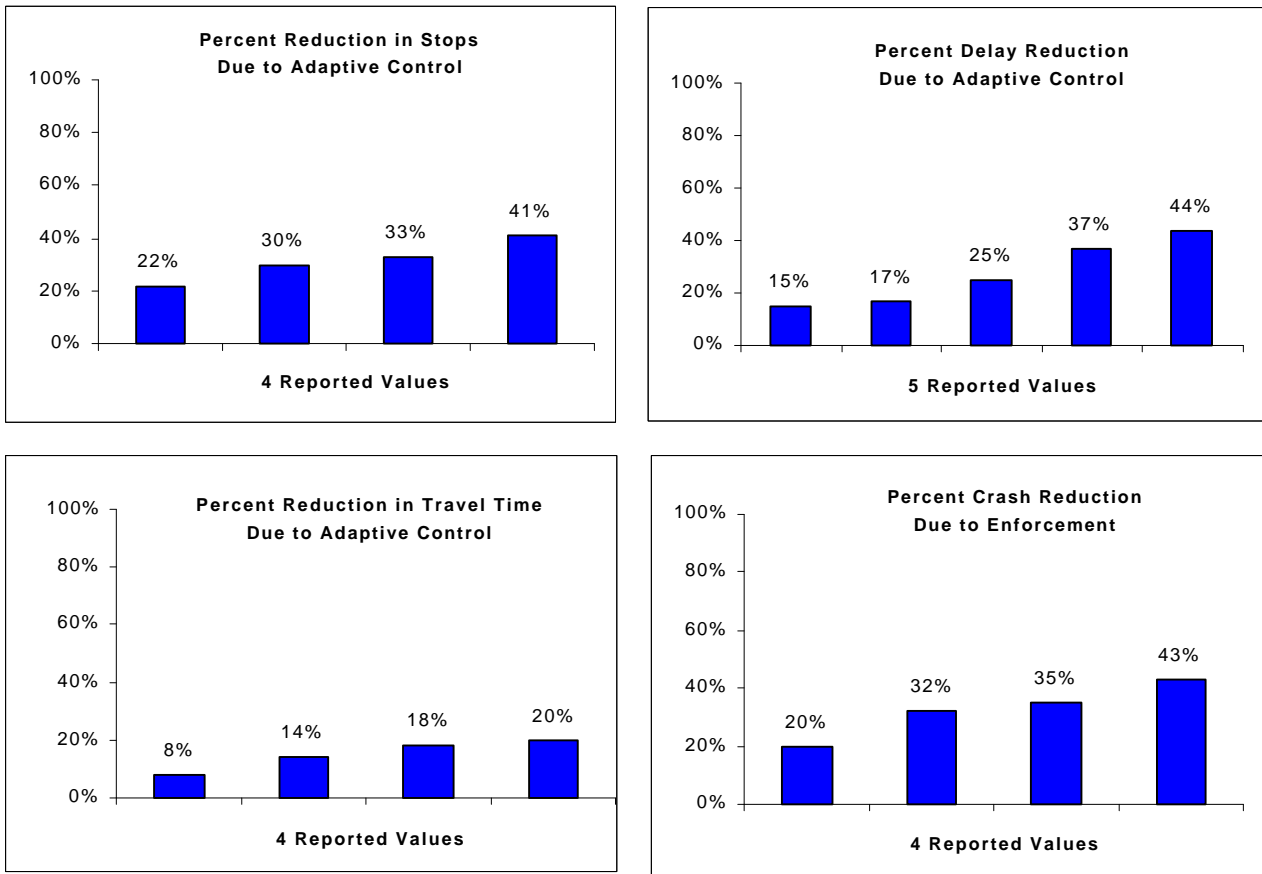

Figure ES-1: Summary of Reported ITS Benefits Data From Traffic Signal Control

Ramp Metering

Figure ES-2 summarizes the impacts on accidents and speed reported for ramp metering. Ramp metering can reduce crashes by reducing the probability of side swipes in merge areas. Also reduced are rear end collisions that occur as vehicles slow to allow others to merge, or because they cannot merge. These reductions occur on both mainline lanes as well as on ramps. The range of accident reduction due to ramp metering for the reported data is from 15% to 50%.

The range of speed increase due to ramp metering for the reported data is from 8% to 60%. The large range of values for ramp metering may be due to the differences in flow rates, geometric configurations of the freeway, number of meters, ramp spacing, or the length of freeway being measured.

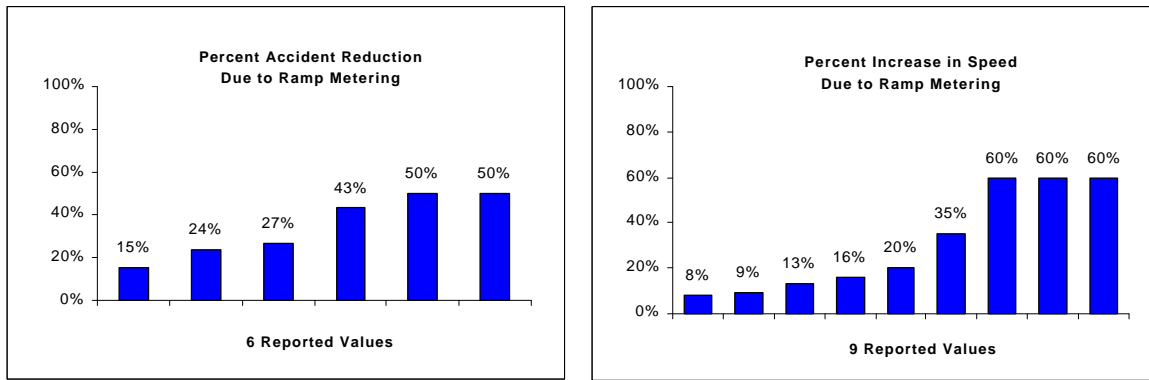

Figure ES-2: Summary of Ramp Metering Impacts

Electronic Toll Collection

Electronic Toll Collection has been shown to reduce emissions, decrease delay, improve throughput, and save on the operating costs at toll plazas. Figure ES-3 is a summary of estimated data for reducing operational costs by using Electronic Toll Collection over conventional manual lanes. It is estimated that the number of people required to operate toll collection booths can be reduced 43%. Roadway and building maintenance cost can be reduced approximately 14% and 2%, respectively.

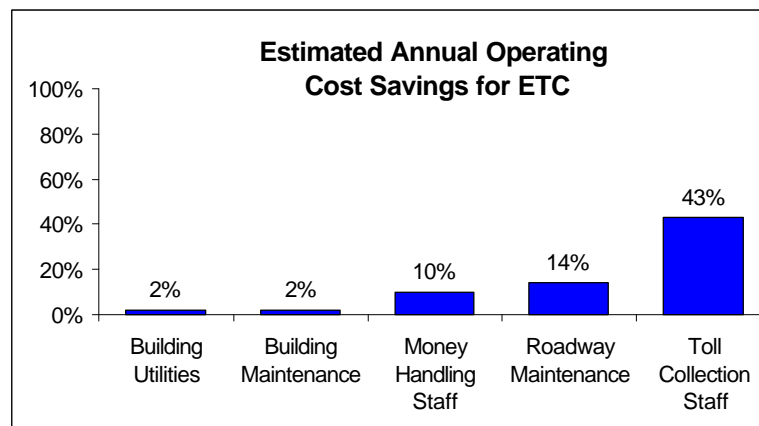

Figure ES-3: Operational Cost Savings for Electronic Toll Collection

Outlook

As market penetrations increase and improved systems are developed, there will be ample opportunity to measure, analyze, and report more accurate data. As these data become available, it may be possible to perform more detailed analyses for particular program areas or benefits measures. These analyses are expected to assist in improving the estimated ranges of impacts, and the level of confidence in those ranges.

1.0 INTRODUCTION

The transportation system of the United States consists of more than 6.3 million kilometers of highways and roads, and 503 public transit operators. More than 258 million people, 6 million businesses, and 86 thousand federal, state, and local government agencies produce more than 6.3 trillion kilometers of travel and 4.8 trillion ton kilometers of domestic freight each year. In 1995, Congress designated the near 260,000 kilometer National Highway System. Although this system includes all of the interstates and many other highways, and carries almost half the total highway traffic and most truck and tourist traffic, it consists of less than 4% of the roadway system in the nation. More than 30% of the roads on the interstate system are rated either “poor” or “mediocre,” and more than 125,000 bridges nationwide are near the end of their useful lives¹.

Over the next decade, travel demand in the U.S. is expected to increase by about 30%. In order to simply maintain congestion at current levels, the United States would need to add (in 50 major urban areas) more than 7,100 new lane kilometers of roadway every year. Currently, roads are being built at about two-thirds this rate.

Another option is to develop alternatives that increase effective capacity by improving the efficiency of the transportation system. This option focuses on building fewer lane-kilometers while investing in Intelligent Transportation Systems (ITS) infrastructure. A twenty-year life-cycle cost analysis for 50 major urban areas for the two options, indicated that “Buying smarter by deploying ITS reduces the need for new roads while saving taxpayers 35% of the required investment in urban highways².” In addition to other effects, ITS can also positively impact environmental and societal concerns. This analysis demonstrates that ITS can be an important factor in addressing the needs of our growing transportation system.

1.1 GOALS OF THE ITS BENEFITS REPORT

Since December of 1994, the United States Department of Transportation’s (USDOT) ITS Joint Program Office (JPO) has been actively collecting information regarding the impacts that ITS and related projects have on the operation and management of the nation’s transportation system. This periodically updated report is a compendium of reported impacts of ITS that have been collected from a number of sources. Its purpose is to provide the JPO with a tool to transmit existing knowledge of ITS benefits to the transportation professionals who may not be well versed in ITS products and services. Also, this report is intended to provide the research community with information about where further analysis is required in the ITS program. Although a concentrated effort was made to include and highlight recent data, this report also contains data included in previous versions and is considered to be cumulative. Intended to be a reference report, it highlights benefits identified by other authors and refers the reader to information sources.

¹“*Transportation: Driving a Thriving Economy*,” American Association of State Highway and Transportation Officials and the National Governors’s Association, May 1997.

²Peters, J, McGurrin, M. F., Shank, D. E., and Cheslow, M., “*An Estimate of Transportation Cost Savings from Using Intelligent Transportation System (ITS) Infrastructure*,” ITE Journal, November 1997.

1.2 ORGANIZATION OF THIS REPORT

The previous benefit reports were organized according to measures of effectiveness such as safety, delay savings, and customer satisfaction. Although that format worked well for those interested in the results of a particular benefit measure, it did not easily provide references to data related to a particular ITS program area or service. Also, it did not represent a convenient way to express information to decision makers or the research community in determining areas of ITS that need further investigation.

Therefore, a more useful taxonomy for classifying ITS benefits data has been developed for this report. This effort is based on the observation that there are several different view points in examining the structure of ITS across the nation. The ITS taxonomy used in this report groups benefits data into two major components: Intelligent Infrastructure and Intelligent Vehicles. These components are then divided into program areas and specific ITS application areas. While this taxonomy was not intended to reflect the official structure of the ITS program, it has proven useful in promoting discussion within the ITS community and has been used to demonstrate the breadth of the ITS program. An overview of this taxonomy is represented in Figure 1.

This report follows this taxonomy for reporting ITS benefits. Sections within chapters discuss each program area for which benefit data are available. Each section begins with a brief description of the ITS application and the current state of knowledge. Following this are summaries of benefits data collected. Finally, when possible, an overview of the data is presented for those sections with enough data that may support some general conclusions.

It is realized that many of the program areas highlighted in the taxonomy can be dependent or heavily influenced by other areas. It is also understood that many ITS program areas share information and operate in a cooperative fashion. For example, incident management systems can directly influence emergency response by providing timely and accurate information on incident location and severity. Additionally, in-vehicle systems, such as route guidance, require a cooperative infrastructure that can provide routing and/or travel time information to the vehicle. This report attempts to account for these influences and cooperative aspects of ITS. Most data are classified by the specific program area and infrastructure that the data most directly support. This classification of data types was based on geographic setting (metropolitan, rural) or functionality (ITS/CVO) of the ITS services referenced in the source documentation. In some cases, source documentation did not provide enough detailed information to classify referenced data. When this occurred, the author used judgement to determine how these data should be classified.

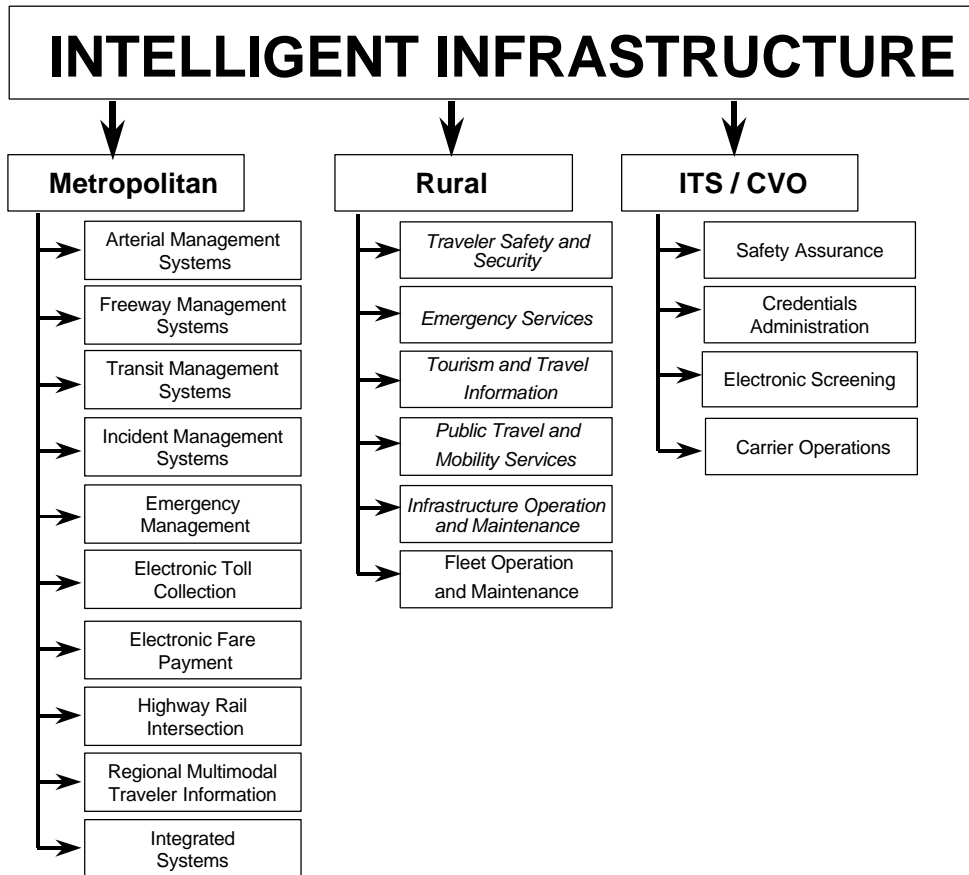

Figure 1a: Intelligent Infrastructure Taxonomy for Reporting ITS Benefits

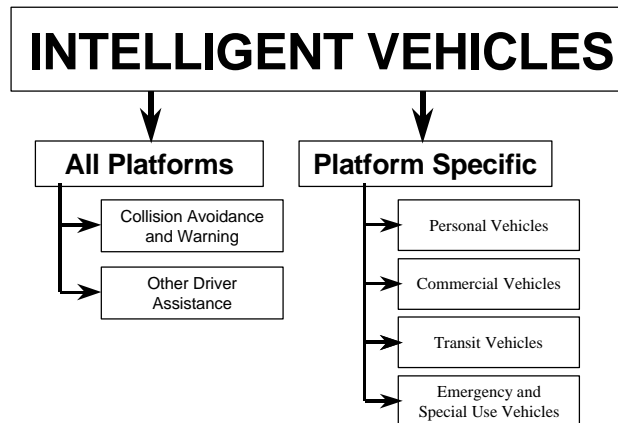
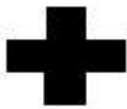

Figure 1b: Intelligent Vehicles Taxonomy for Reporting ITS Benefits

1.3 A FEW GOOD MEASURES

As mentioned in section 1.2, previous versions of this report were organized based on a few measures of effectiveness. Termed “A Few Good Measures,” the JPO has identified these as the measures that are used to track progress toward meeting ITS program goals. Because of this emphasis, the collection of these measures is a standard in the reporting of much of the ITS benefits data currently available. Throughout the document, icons are placed next to each source to reflect the measure that is reported. Benefits that are not included in the set of a few good measures are also included; however, they are not referenced by icons. The Few Good Measures include safety improvements (crashes and fatalities), delay reduction, cost savings, effective capacity improvements, customer satisfaction, and energy and other environmental impacts.



Safety

An explicit objective of the transportation system is to improve the safety of travel. Although undesirable, crashes and fatalities are an inevitable occurrence of the transportation system. ITS helps to minimize the risk of accident occurrence. This measure focuses on reducing the number of crashes, and lessening the probability of a fatality should a crash occur.



Delay

Delay reduction and travel time savings is a major goal of many ITS services. In 1996, the Secretary of Transportation termed an ITS initiative of the US DOT, “Operation TimeSaver.” Benefits of this measure also include reducing the variability of time in transit and increasing the reliability of destination arrival time.



Cost

ITS implementation frequently reduces operating costs and allows productivity improvements. In addition, ITS options may have lower acquisition costs compared to traditional transportation improvement options. While ITS services may have higher recurring operational and maintenance cost, they may also have lower life-cycle costs. This measure examines the cost savings impacts of ITS services.



Effective Capacity

Many ITS services seek to optimize use of existing facilities and rights-of-way so that mobility and commerce needs can be met while reducing the need to construct new facilities or expand rights-of-way. This is accomplished by increasing the effective capacity of the transportation system. Effective capacity is the maximum potential rate at which persons or vehicles may traverse a network under a representative composite of roadway conditions. Increases in throughput are sometimes realizations of increases in effective capacity. Throughput is typically measured in terms of people or vehicles per unit time traversing a segment of roadway. Throughput is more easily measurable than effective capacity and therefore is used as a surrogate measure.



Customer Satisfaction

Customer satisfaction indicates the degree to which transportation consumers are accommodated by ITS service offerings. Although satisfaction is difficult to measure directly, measures related to satisfaction can be observed including the amount of travel in various modes, mode options, and the quality of service as well as the volume of complaints and/or compliments. Customer satisfaction is often measured by using surveys, questionnaires, or focus groups.



Energy and Environment

In most cases, environmental benefits from a given project can only be estimated by analysis and simulation. The problems related to regional measurement include the small impact of individual projects and large numbers of exogenous variables including weather, contributions from non-mobile sources or other regions, and the time evolving nature of ozone pollution. Small-scale studies, so far, generally show positive impacts for ITS on the environment. These result from smoother and more efficient flows in the traffic system. However, the environmental impact of travelers reacting to large-scale deployment in the long term are not well understood.

1.4 POSITIVE AND NEGATIVE IMPACTS OF ITS

The majority of available references demonstrate positive benefits for ITS. This is true both for actual deployments and for analytical studies predicting future benefits. The number of cases reporting negative results has been very small. However, most of the systems that produce negative impacts are carried out primarily to obtain broader societal benefits, or contain other benefits or intangible effects that may not be measurable. It is also recognized that negative impacts may be under-reported in the literature. This report includes both the positive and negative impacts reported in the literature.

2.0 BENEFITS OF METROPOLITAN ITS INFRASTRUCTURE



Metropolitan ITS consist of those program areas that are primarily implemented in urban and suburban geographic locations. This does not imply that these systems are not implemented in or do not impact other geographic settings. However, they are more often associated with urban areas.

In 1996, the Secretary of Transportation announced a program called Operation TimeSaver. Operation TimeSaver included a metropolitan ITS infrastructure deployment goal that focused on 75 of the nation's largest metropolitan areas and established a commitment to track the progress

toward this goal at these sites. Four of the areas were selected to participate in the metropolitan model deployment initiative (MDI) program which includes the evaluation of several ITS user services and their integration. When results from MDI evaluations are available, this section will be updated to include impacts of ITS at these sites.

Metropolitan ITS infrastructure is made up of nine major components. These components include: Arterial Management Systems, Freeway Management Systems, Transit Management Systems, Incident Management Systems, Emergency Management, Electronic Toll Collection, Electronic Fare Payment, Highway-Rail Intersections, and Regional Multi-Modal Traveler Information Systems. Figure 2-0 summarizes the components associated with Metropolitan ITS.

Also, several metropolitan areas are implementing ITS services that are very highly integrated. Because the interaction between services may affect the resulting system benefits, these "Integrated Systems" are shown as a separate box under the metropolitan program areas. Integration is accomplished by creating a number of "links" between services or program areas. These links are used to share operational information and allow for sharing of infrastructure between ITS services or components. Figure 2-1 demonstrates one possible set of links that may be used. Each link is referenced by a number to refer to the specific linkage made. For example, link number 2 represents the sharing of arterial traffic condition information originating from a traffic signal system with the freeway management system. Impacts from these types of deployments are captured in section 2.10 of this report.

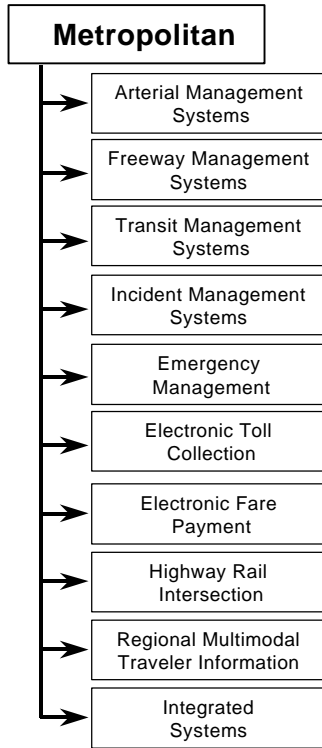

Figure 2-0: Metropolitan ITS Components

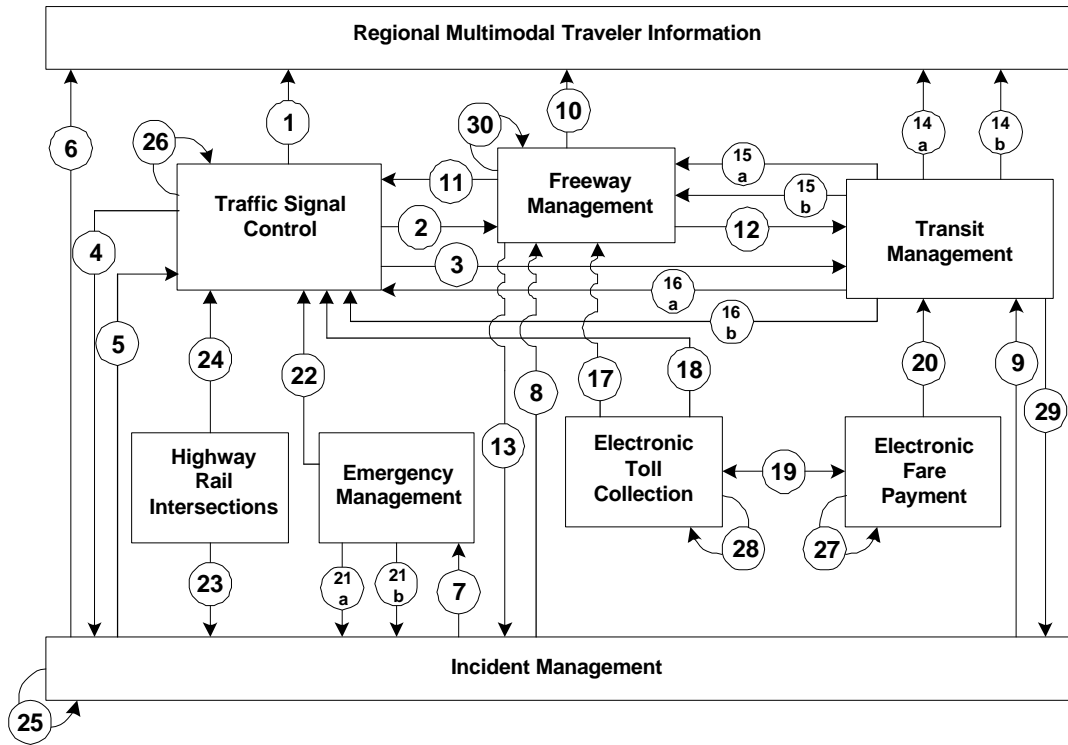
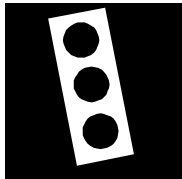

Figure 2-1: A possible set of Integration Linkages

For a more complete understanding of these components and how they can be interpreted, the reader is referred to the following documents. Both documents are electronically available on the FHWA electronic document library at www.its.fhwa.dot.gov/cyberdocs/welcome.htm.

- “Tracking the Deployment of Integrated Metropolitan Intelligent Transportation Systems Infrastructure in the USA: FY 1997 Results,” Document Number 5883, September 1998.
- “Measuring ITS Deployment and Integration,” Document Number 4372, January 1999.



2.1 ARTERIAL MANAGEMENT SYSTEMS

Arterial management systems are used to manage traffic and the control of arterial roadways. Included in this program area are arterial traffic management systems that provide surveillance and signal control, and systems that provide travelers with information on arterial street travel conditions through audio or visual displays.

Signal control systems are upgraded for a number of reasons, primarily to improve traffic flow and system maintenance. Arterial traffic signal systems provide coordinated control across metropolitan areas. Traffic information may be shared between jurisdictional boundaries and with other metropolitan infrastructure components. Traffic signal control systems include adaptive and transit or emergency priority control.



Figure 2-2 shows the format for the classification of benefits used in the taxonomy for arterial management systems. For this report, video enforcement of signal compliance is also included because of its potential to improve safety at intersections.



The Institute of Transportation Engineers (ITE) estimates that reduction in travel time from traffic signal improvements range from 8% to 25%³. Improvements in flow and reducing delays also have a generally positive environmental impact by reducing emissions and fuel consumption.

³Meyer, M., ed., A Toolbox for Alleviating Traffic Congestion, Institute of Transportation Engineers, Publication No. IR-054B, Washington DC, 1997.

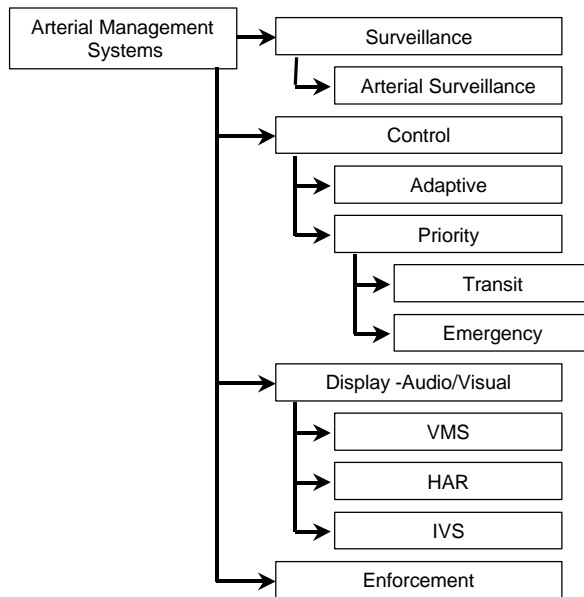

Figure 2-2: Taxonomy of Arterial Management Systems



Along with a neighboring county, Oakland County, Michigan shares the strain of having the highest percentage of single-occupancy-vehicle use in the nation. Developed for Oakland County, FAST-TRAC's mission is to integrate an Advanced Transportation Management System (ATMS) and an Advanced Traveler Information System (ATIS) together and to provide synergistic benefits to travelers in the county. The program includes the Sydney Coordinated Adaptive Traffic System (SCATS) for signal control, which became operational in Troy, Michigan on June 2, 1992. FAST-TRAC helps to relieve some of the problems experienced by the county, including improving safety, reducing delay, and improved operational efficiency. By controlling traffic signals, the program has improved safety by reducing accidents (particularly those resulting in severe injuries). Preliminary floating car studies showed a decrease of 33% in the number of stops in system corridors, as well as increased average speeds, particularly during off-peak periods⁴. Seventy two percent of the surveyed drivers said they are better off for having FAST-TRAC⁵. Other benefits appear to have been gained in the areas of governmental relations and public/private cooperation.



An adaptive traffic signal control system developed by the British Columbia Ministry of Transportation and Highways in Canada has cut traffic delays significantly. Since mid 1995, urban corridor traffic signal systems on the provincial highways have produced an average savings of more than 25% in traffic delays. In April 1996, the first dynamic system was implemented on the Trans-Canada Highway in Duncan,

⁴Barbaresso, James C., "Preliminary Findings and Lessons Learned From The Fast-Trac IVHS Program," Road Commission for Oakland County, Beverly Hills, MI, 1994.

⁵"Fast-Trac's Signal System Clear Winner for County Commuters," in ITS America News, May 1997.

British Columbia, Canada. Initial analysis shows that an additional reduction of 15% in traffic delays has been achieved during the peak traffic periods over that of the previous static control⁶.



The SURF-2000 (Systeme Urbain de Regulation des Feux) traffic control system in Paris France has brought extremely positive results. Among these include a 20% savings in travel times, a 30% reduction in number of stops, reduction of pollution, and 10% reduction in fuel consumption⁷.



The Automated Traffic Surveillance and Control Program in Los Angeles, California consists of a computerized signal control system that has been in operation since 1984. As of 1994 it included 1,170 intersections and 4509 detectors for signal timing optimization. It has reported a 13% decrease in fuel consumption, 14% decrease in emissions, 41% reduction in vehicle stops, 18% reduction in travel time, a 16% increase in average speed, and a 44% decrease in delay⁸.



Toronto, Canada evaluated the performance of the SCOOT adaptive traffic signal control system on 75 signals within the metropolitan area. When compared to a best effort fixed timing plan the evaluation showed an 8% decrease in travel time, 22% decrease in vehicle stops and a 17% decrease in vehicle delay. Additional results included a 5.7% decrease in fuel consumption, 3.7% decrease hydrocarbons and 5.0% decrease carbon monoxide⁹.



Simulation and analysis have predicted that adaptive traffic signal controls could further reduce delays and emissions compared to the currently implemented systems under certain conditions. In simulations performed for the National ITS Architecture Program using non-proprietary adaptive algorithms, more than a 20% delay reduction was observed when traffic patterns deviated from predicted levels¹⁰.



Simulation of a network based on the Detroit Commercial Business District indicated that adaptive signal control for detours around an incident reduced delay by 60% to 70% for affected paths. Additionally, when simulating the effects of providing

⁶Zhou, Wei-Wu, et al, “*Fuzzy Flows*,” ITS: intelligent transportation systems, May/June 1997.

⁷Beteille, J. and Briet, G., “*Making Wave in Traffic Control*,” Traffic Technology International, Annual 1997.

⁸City of Los Angeles Department of Transportation, “*Automated Traffic Surveillance and Control (ATSAC) Evaluation Study*,” June 1994.

⁹“*SCOOT in Toronto*,” Siemens Automotive, USA, in Traffic Technology International, Spring 1995.

¹⁰Glassco, R, et al, “*Studies of Potential Intelligent Transportation System Benefits Using Traffic Simulation Modeling*,” Mitretek Systems, MP96W0000101, June 1996.

alternative routing information, 52% of vehicles that used an alternative rather than the detour benefitted. Using the same network under non-incident conditions, it was demonstrated that a synchronized, actuated signal control system reduced travel times between 25% and 41%. The highest savings occurred for high traffic volume paths. Over all paths, 91% had some benefit and 65% benefitted more than 20%¹¹.



Delays at traffic signals can represent a significant proportion of transit travel time. European experience with transit priority control systems reveals average reductions in signal delay of 10 seconds per intersection, with a potential reduction in delays ranging from 40% to 80%. England and France have experienced reductions in transit travel times of 6% to 42%. Based on European experience, the impact of these traffic control systems on automobile travel time has been small, ranging from a 0.3 to 2.5% increase. The payback period for installation of transit priority systems is estimated to be 1 to 2 years¹².



The Transit Way at the University of Minnesota is a bus-only facility with intersections with other roadways. In response to an accident rate 30 percent higher than the state average, a transit priority signal control system was installed at the intersections along the Transit Way. Since the Transit Way was first used in 1992, there had been 32 accidents involving buses, other vehicles and one in-line skater. The system consists of a series of fiberoptic loop detectors and cameras that send information to the traffic signals. University buses traveling the route trigger the system that changes the intersection signal. Since the signals were put into use in the fall of 1997, there have been no accidents. Some drivers feel the new system makes drivers more aware of the stop lights and buses¹³.



In April 1996, Sapporo city, Japan started operation of a Public Transportation Priority System along a 5.7 km section of Route 36. An evaluation on the effectiveness of the system on weekdays was conducted during the month of May 1996 for the time period between 7:30 and 9:00. Bus travel times in the section were reduced by 6.1%, while ridership increased 9.9%. Also reported was a 7.1% reduction in the number of stops busses made at signals which resulted in a 20.8% reduction in stopped time¹⁴.

¹¹Glassco, R, et al., “*Studies of Potential Intelligent Transportation System Benefits Using Traffic Simulation Modeling: Volume 2*,” Mitretek Systems, MTR 1997-31, June 1997.

¹²“*Traffic Control Systems Give Transit a Break*,” Newslite, TRB, December 1995.

¹³Fors, Heather, “*Transit Safety is Up Due to Timed Lights*,” The Minnesota Daily, February 2, 1998.

¹⁴“*ITS developed by Japanese Police*,” Japan Traffic Management Technology Association, Institute of Urban Traffic Research, Undated.



Portland, Oregon has integrated a bus priority system with the traffic signal system on a major arterial. By allowing buses to either extend green time or shorten red time by only a few seconds, the bus travel time was reduced by between 5% and 8%. In addition to the travel time savings, this approach allows the use of fewer vehicles to serve that route¹⁵.

Using intersection-mounted cameras to reduce violations has been shown to improve safety at intersections by reducing the number of crashes. Research has determined that noncompliance with intersection controls accounts for 22% of all urban crashes. The costs associated with these crashes are estimated to exceed \$7 billion annually¹⁶.



Fairfax City, Virginia has been using automated cameras to record intersection violations and ticket violators. City police report that the program is responsible for decreasing the number of accidents throughout the city. In November 1997, 28 accidents occurred at intersections with traffic lights compared with 43 accidents in November of 1996 before the devices were installed (approximately a 35% accident reduction)¹⁷.



A three-year federally-funded project to implement red-light running (RLR) cameras has shown to reduce red-light running crashes by as much as 43%. Completed reports for Howard County, MD and Los Angeles, CA show success with the technology and reduction of RLR crashes¹⁸.



Initial indications from London show that camera enforcement equipment has been instrumental in saving lives through speed reduction and by limiting red-light running. Reductions in injury accidents range between 20% and 80% when using the cameras. Also, the installations in London show¹⁹:

- Speed has been reduced by about 10%
- All casualties have been reduced by about 20%
- Fatal and serious casualties have been reduced by about 50%

¹⁵Kloos, W., et al., “*Bus Priority at Traffic Signals in Portland: The Powell Boulevard Pilot Project*,” ITE Compendium of Technical Papers, July 1994.

¹⁶“*Battle Lines Drawn in California Legislature Over Red Light Running Cameras*,” The Urban Transportation Monitor, May 22, 1998.

¹⁷Melillo, Wendy, “*Traffic Enforcement By Remote Camera Catching On in Area*,” The Washington Post, March 16, 1998, p B08.

¹⁸“*Battle Lines Drawn in California Legislature Over Red Light Running Cameras*,” The Urban Transportation Monitor, May 22, 1998.

¹⁹Harris, John & Sands, Mary, “*Life-Saving Speed Camera Technology*,” Traffic Technology, 1995.



Australia and the Netherlands have also experimented with red light cameras. They have reported that the technology can reduce right-angle accidents by 32 percent²⁰.

2.1.1 Summary of Arterial Management Systems Data

Based on the results from referenced reports, it appears that, in general, advanced traffic signal systems (i.e. those providing traffic adaptive control) provide a significant positive benefit. However, it is difficult to generalize an expected benefit for these services. Benefits for an individual area depend on a number of operational variables that are unique in each implementation. These variables may include, the number of intersections or signals in a corridor, spacing of intersections, size of study area, corridor lengths, vehicle demand patterns, etc. However, it is possible to make some general conclusions based on reported results that may be useful to decision makers.

The chart at the left presents the measured values for percent reduction in the number of stops due to adaptive signal control presented in this section. As one would expect,

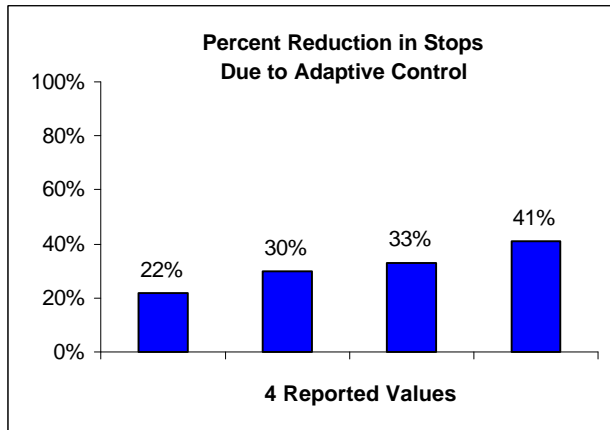

if the flow of green bands in a corridor can be maintained as traffic patterns change, the number of stops can be reduced. Although no statistical analysis was done given the small amount of data presented, one might conclude that a reduction of at least 20% in the number of stops for corridors using adaptive control could be expected. This assumes that benefit results are compared to fixed timing plans and that significant variations exist in traffic patterns in the study corridors.

²⁰Coleman, Janet A. et al “FHWA Study tour for Speed Management and Enforcement Technology,” Federal Highway Administration, Publication No. FHWA-PL-96-006, February 1996.

The figures at the right present the measured values due to adaptive signal control for the percent reduction in travel time and delay discussed in this section. As expected, the reductions of travel time appear to be far less than that reported for delay saved. Furthermore, there is an apparent large range of possible values for each measure. A likely contributing factor to this range is that individual studies may define or measure travel time and delay differently. Travel time may be defined as the time required to complete an entire trip or the time required to traverse a corridor or fraction of the trip. Delay may be defined as stopped time due to signals only or as the time exceeding a predetermined base travel time. Depending on the definitions used, and other operational conditions, estimated values of time saved appear to range between 8% and 20%. Likewise, reductions in delay due to adaptive control may range between 15% and 44%.

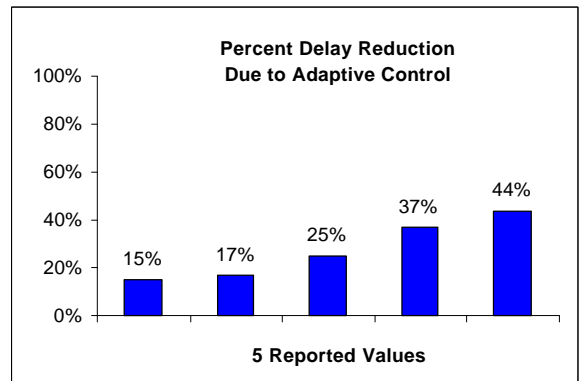
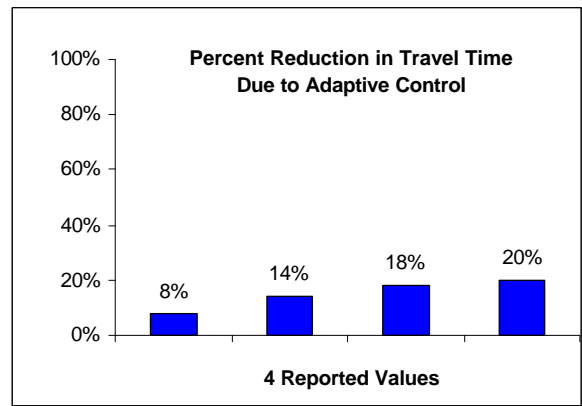

The number of reports depicting emission reductions and benefits of transit priority signal control have been small. Therefore, no overall conclusions can yet be determined. However, their impact appears to be positive, with the exception of emissions of Nitrous-oxides. This is expected because improved flows and increases in speed lead to increased production of Nitrous-oxides while decreasing other emission measures.



2.2 FREEWAY MANAGEMENT SYSTEMS

There are three major ITS functions that make up Freeway Management Systems. Two of these are the monitoring and control of freeway operations. Monitoring and surveillance can be used to implement control and management strategies such as ramp metering rates and variable speed limits based on observed freeway conditions. The third function consists of displaying or providing that information to the motorist. Motorists may receive this information in several ways, including Variable Message Signs (VMS), Highway Advisory Radio (HAR), In-vehicle Signing (IVS), or specialized information can be transmitted to only a specific set of vehicles. Enforcement is also included when it can be shown to improve safety.

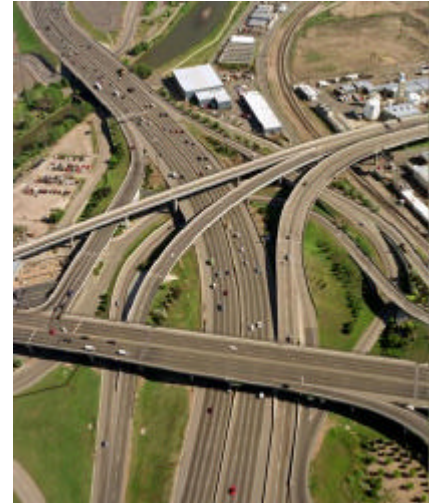

Figure 2-3 shows the classification of benefits data for freeway management systems.

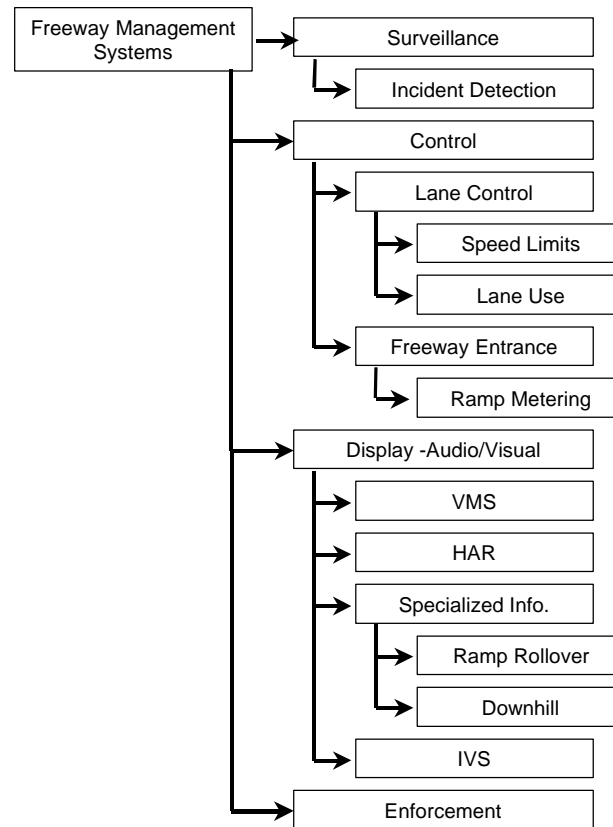

Figure 2-3: Taxonomy of Freeway Management Systems

Ramp Meters can be used to help improve flow rates and reduce travel time on freeways. Also, ramp meters have been shown to improve safety by reducing accidents in merge areas.



A longitudinal study of the ramp metering/freeway management system in the Seattle, Washington area over a six year period shows that accident rates have fallen to 62% of the rates reported during the base period. According to the study, freeways in the area show a growth in traffic volume of 10% to 100% along various segments of I-5 while speeds have remained steady or increased up to 20%. The improvements have occurred while average delays caused by ramp meters have remained at or below three minutes ²¹.



The Integrated Corridor Traffic Management-Ramp Metering System in use by Minnesota State DOT has been implemented in the Minneapolis-St. Paul region. The system turns off ramp meters when not needed and automatically balances queues at the ramps. Ramps can also be prioritized using the system. The ramp metering system is also used in conjunction with the SCATS arterial signal control system to assist in optimizing traffic flow. The system has reported a 30% increase in throughput, and an increase in freeway speeds (I-494) from 30 mph to almost 50 mph, a 60% increase while peak period demand increased between 2.9 and 7.2%. Also, the net results indicate a vehicle delay reduction of between 11 and 93.1 vehicle hours during peak periods for the 7 ramp meters included in the study ^{22, 23}.



Studies comparing 1987 to 1990 flow rates of the Long Island, New York's Information For Motorist (INFORM) system were used to determine the benefits from ramp metering in combination with motorist information. The results showed freeway speeds increased 13% despite an increase of 5% in Vehicle Miles Traveled (VMT) for the PM peak. The number of detectors showing speeds of less than 30 mph decreased 50% for the AM peak. Average queue lengths at ramp meters ranged from 1.2 to 3.4 vehicles, representing 0.1% of vehicle hours traveled ²⁴.

²¹Henry, K. and Meyhan, O., "6 Year Flow Evaluation", Washington State DOT, District 1, January 1989.

²²"Ramp up the Volume," in ITS International, Nov/Dec 1997.

²³"Partners in Motion, 494 Transportation Corridor: ICTM Project, Interim Report #1," Prepared for ICTM Evaluation Committee by HNTB Corporation, undated.

²⁴Smith, S. and Perez, C., "Evaluation of INFORM - Lessons Learned and Application to Other Systems," Conference Paper Presented at 71st TRB, January 1992.



A national survey of traffic management centers using ramp metering reported speed increases between 16% and 62%, travel time improvements of up to 48%, and increases in peak throughput between 8% and 22% while demand increased 17%–25%. Accidents were reduced between 15% and 50%. While some other freeway improvements were implemented during the study periods, the combination of geometric, vehicle, and operational procedures resulted in significant reduction of accident rates²⁵. The results from individual studies in the survey are summarized below:

- Portland, Oregon: 58 ramp meters, 43% accident reduction, 39% travel time reduction, 25% demand increase, 60% increase in speed.
- Minneapolis/St. Paul, MN: 6 ramp meters, 8 km of freeway, 24% accident reduction, 38% accident rate reduction, 16% increase in speed.
- Minneapolis, MN: 39 ramp meters, 27 km of freeway, 27% accident reduction, 38% demand increase, 35% increase in speed, 32% increase in demand.
- Seattle, WA: 22 ramp meters, 52% decrease in travel time, 39% decrease in accident rate, 86% increase in demand.
- Denver, CO: 5 ramp meters, 50% accident reduction, 18.5% demand increase
- Detroit, MI: 28 ramp meters, 50% accident reduction, 8% increase in speed, 12.5% increase in demand.
- Austin, TX: 3 ramp meters, 4.2 km of freeway, 60% increase in speed, 7.9% increase in demand.
- Long Island, NY: 70 ramp meters, 207 km of freeway, 15% accident reduction, 9% increase in speed.

²⁵Robinson, J. and Piotrowicz, G., “Ramp Metering Status in North America, 1995 Update,” federal Highway Administration, June 1995.



The Department of Transport in the United Kingdom has implemented variable speed limits on the M25, one of the most congested freeways in England. Loop detectors measuring traffic density and speed are used to lower speed limits as congestion increases. Speed limits are then displayed on variable message signs, and are enforced using photographic cameras. During an 18 month study, results showed that traffic accidents had decreased by 28%. Motorists were more inclined to keep to their lane when there no longer was a “faster lane.” They were also more inclined to keep to the inside lane and to keep proper distances between successive vehicles. This resulted in smoother traffic flow which actually increased average travel times of traffic²⁶.



A 12 kilometer section of the A4 in Strasbourg, France is experimenting with another variable speed limit system. The system sets up an “advised speed” of 50, 70, 90, or 110 kph depending on traffic density. The results to date indicate a 5% increase in effective capacity during peak hours²⁷.



The safety potential for a specialized roadside information systems that warn vehicles of a potentially dangerous highway situation are currently being installed in several location across the U.S. Two of these systems have reported quantifiable benefits. Over the past decade, the Washington, DC, Capitol Beltway area has experienced several accidents involving truck rollovers at exit and entry ramps. As a result, three sites around the capitol region were selected as ITS operational test sites for a Ramp Rollover Warning System (RRWS). The sites are located at both the Maryland and Virginia Capitol Beltway (I-495) and I-95 Interchanges, and the interchange between the Capitol Beltway and Virginia state route 123. The system consists of a weigh-in-motion scale, height detection, and a processor to calculate the rollover threshold speed for trucks on the ramp. The critical safe threshold speed is based on the maximum curvature of the ramp. The system is used to alert drivers to slow down by activating a VMS when the maximum safe speed is exceeded. Before the implementation of RRWS there were ten reported rollover truck accidents at the three sites between 1985 and 1990. Between implementation in 1993 and 1997, there were no rollover accidents at any of the sites and average truck speed has been reduced by 11kph²⁸.

²⁶Borough, Peter, “*Variable Speed Limits Reduce Accidents Significantly in the U.K.*,” The Urban Transportation Monitor, March 14, 1997.

²⁷“*Speed Modulation Experimentation*,” SANEF, eastern and Norther Highways Concessionary Company - France, October, 1998.

²⁸ Taylor, B. and Bergan, A., “*Words of Warning*” in ITS: intelligent transport systems, Issue No 10, May/June 1997.



Operating similarly to the RRWS, the Down Grade Warning System (DGWS) in Colorado advises truck drivers of safe descent speed prior to a mountain grade. The system was installed on I-70 in 1993 and has resulted in an overall decrease in use of truck runaway ramps by 24% and a 13% drop in accidents resulting from excessive truck speed²⁹.

2.2.1 Summary of Freeway Management Systems

The benefits of freeway management, as shown in this section, have included improvements to safety, reductions in travel time and delay, increased throughput, and flow improvements. Although each of these measures do contain data points, the two measures with enough point data for meaningful comparisons or analysis are accident

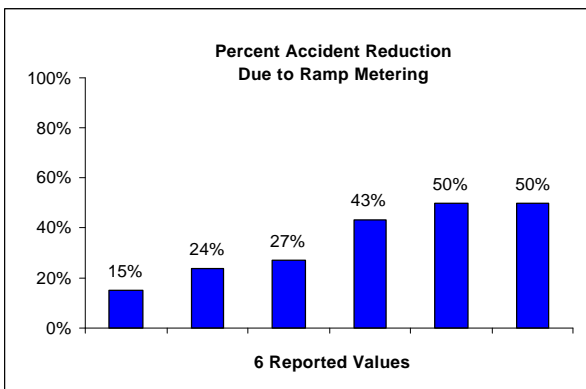

reduction and improvements in speed. The figure to the left summarizes the measured values for the percent reduction in accidents due to ramp metering of freeways highlighted in this section. Ramp metering can reduce crashes by reducing the probability of side swipes in merge areas. Also reduced are rear end collisions that occur as vehicles slow to allow others to merge, or because they can not merge. These reductions occur on both mainline lanes as well as on ramps. The range of accident reduction due to ramp metering for the reported data is from 15% to 50%.

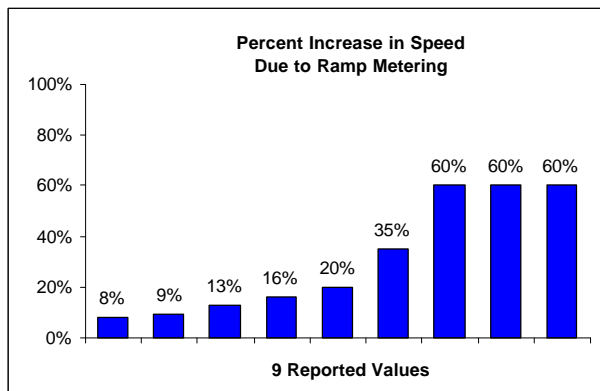

The figure to the left summarizes the values for the percent increase in speed due to ramp metering of freeways discussed in this section. The range of speed increase due to ramp metering for the reported data is from 8% to 60%. This large range may be due to the differences in flow rates, geometric design of the freeway, number of meters, ramp spacing, or the length of freeway being measured. Note that the data tend to be grouped around a low (8-20%) and high (60%) thresholds, with only one value in between (35%).

²⁹Taylor, B. and Bergan, A., "Words of Warning" in ITS: intelligent transport systems, Issue No 10, May/June 1997.

2.3 TRANSIT MANAGEMENT SYSTEMS

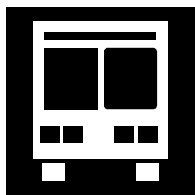

Advanced Public Transportation Systems (APTS) help to provide additional safety and security to passengers by allowing remote monitoring of transit vehicle status and passenger activity. Transit ITS services also assist operators in maintaining fleets of vehicles. Vehicle self-diagnostics can alert mechanics of potential problems or when they are nearing scheduled maintenance. Transit operators can also use automated vehicle location (AVL) and Computer Aided Dispatch (CAD) devices to improve scheduling activities and maintain schedule adherence. Figure 2-4 shows the taxonomy of Transit Management Systems used for this section. Electronic Fare Payment, which is discussed in section 2.7, also provides significant benefits to transit operations.



Analysis of benefits accruing to the transit industry from APTS technologies predicts that current and planned deployments at US transit properties will yield benefits totaling between \$3.8 billion and \$7.4 billion in discounted 1996 dollars over the next several years. In approximate terms, 44% of the total results are from transit management systems, 34% are from electronic fare payment systems, 21% are from advanced traveler information systems, and 1% of the total benefit is from computer-aided dispatching in demand-responsive transit applications³⁰.

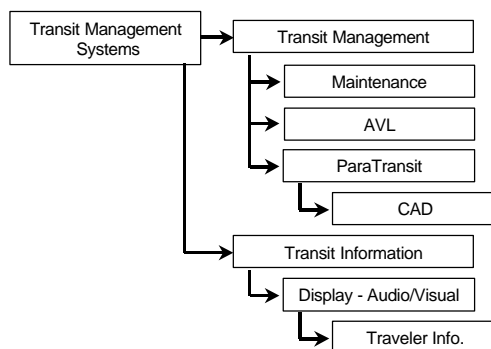

Figure 2-4: Taxonomy of Transit Management Systems

³⁰Goeddel, D., “Benefits Assessment of Advanced Public Transportation Systems (APTS)”, prepared for Federal Transit Administration by Volpe National Transportation Systems Center, July 1996.

For nearly a decade, transit properties have been installing and using automatic vehicle location (AVL) systems based on signpost, triangulation, LORAN, and GPS technologies³¹. Transit agencies have also utilized Computer Aided Dispatch (CAD) systems to improve efficiency and service. The most direct improvement enabled by transit management systems relates to schedule adherence. Fleet management systems with vehicle location capability are producing benefits in productivity, security, and travel time. In addition, several operators have reported incidents where AVL information assisted in resolving disputes with employees and patrons. A 1996 study found 22 U.S. transit systems operating more than 7,000 vehicles under AVL supervision and another 47 in various stages of procurement. The new procurements represent a tripling of the number of deployed systems, with most new systems using a GPS-based location process. Five Canadian operators are using AVL on fleets totaling 3700 buses, including a 2300-vehicle fleet in Toronto³².



The Transit Authority in Winston-Salem, North Carolina, evaluated the effects of a computer-aided dispatch and scheduling system on the operation of a 17 bus fleet. During a 6-month period, the client list grew from 1,000 to 2,000 and vehicle miles per passenger-trip grew 5%. At the same time, operating expenses dropped 2% per passenger trip and 9% per vehicle mile. These productivity improvements occurred at the same time that other service improvements were incorporated. As a result, it is difficult to isolate the effects of the CAD system. These improvements included the institution of same day reservations, which grew to account for 10% of trips. Also noted was a decrease in passenger wait time of over 50%³³.



After an extended analysis of travel times, Kansas City, Missouri, was able to reduce up to 10% of the equipment required for some bus routes using an AVL/CAD system. The system allows fewer buses to serve those routes with no reduction in customer service. The result is a savings in both operating expense and capital expense by actually removing these buses from service and not replacing them. The productivity gain of eliminating seven buses out of a 200 bus system allowed Kansas City to recover their investment in AVL in two years. Other transit systems have reported reductions

³¹ Jones, W., “*ITS Technologies in Public Transit: Deployment and Benefits*”, USDOT ITS Joint Program Office, November 1995.

³² Casey, R. et. al., “*Advanced Public Transportation Systems: The State of the Art - Update '96*,” USDOT Federal Transit Administration, January 1996.

³³ Stone, J., “*Winston-Salem Mobility Management: An Example of APTS Benefits*,” NC State University, 1995.

in fleet size of 4% to 9% due to efficiencies of bus utilization³⁴. The Kansas City Area Transportation Authority in and around Kansas City, Missouri, improved on-time performance by 12% in the first year of operation using AVL, compared to a 7% improvement as the result of a coordinated effort to improve on-time performance between 1986 and 1989³⁵.

Preliminary results from Milwaukee, Wisconsin, indicate a 28% decrease in the number of buses more than one minute behind schedule. The Mass Transit Administration in Baltimore, Maryland, reported a 23% improvement in on-time performance by AVL-equipped buses³⁶.

2.3.1 Summary of Transit Management Systems

Transit management systems have demonstrated that they are capable of reducing travel time both by improving the operation of the vehicles and the overall operation of the transportation network. Transit management systems improve schedule adherence resulting in a reduction in passenger wait time and improvement in transfer coordination. Also, the application of advanced transit systems reduce the cost of operations and improve staff productivity and the utilization of facilities and equipment.

Due to the wide range of measures of effectiveness and different conditions each system is implemented under, impact measures of transit management systems reported in this section appear to be uncomparable between implementations. Therefore, it is difficult to predict the expected benefits from these systems. However, it does appear that those systems utilizing AVL and CAD have significant benefits. There are currently several operational tests underway examining different methods and implementations of transit management. Over the next few years, it is expected that these programs will mature and publish evaluation reports.

³⁴ Jones, W., “*ITS Technologies in Public Transit: Deployment and Benefits*,” USDOT ITS Joint Program Office, November 1995.

³⁵ Giugno, M., Milwaukee County Transit System, July 1995 Status Report.

³⁶ Ibid

2.4 INCIDENT MANAGEMENT SYSTEMS



It is projected that by the year 2005, incident related congestion will cost the U.S. public over \$75 billion in lost productivity and will result in over 8.4 billion gallons of wasted fuel³⁷. Incident management systems can reduce these effects by decreasing the time to detect incidents, reducing the time for responding vehicles to arrive and by decreasing the time required to return the facility to normal conditions. Freeway service patrols, which began prior to the emergence of ITS technologies, but are being incorporated into traffic management centers, significantly reduce the time to clear incidents, especially minor incidents. It is generally understood that incident management systems are implemented concurrently with freeway management systems, but is important to keep in mind that arterials can be included in incident management programs as well. The classification of benefits data for incident management systems is summarized in figure 2-5.

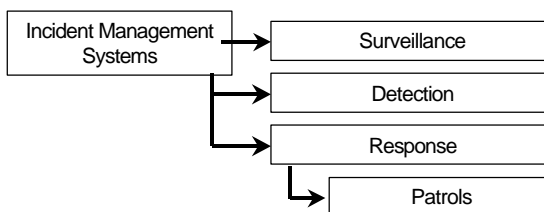

Figure 2-5: Taxonomy for Incident Management Systems



The Gowanus Expressway/Prospect Expressway rehabilitation project in Brooklyn, NY, has one of the most advanced incident detection systems presently deployed in the US. The system consists of an automated incident detection system and 20 closed-circuit television (CCTV) cameras with pan, tilt, and zoom capabilities. Other technologies in place include highway advisory radio, variable message signs and a construction information hotline. Processors analyze the data from the CCTVs and determine speed, occupancy, and volume of the vehicles. An alarm sounds if an incident is detected, altering the traffic control center operators. Before the system was introduced, it took an average of 1.5 hours to clear any type of incident. Since implementation of the system, the time it takes to aid a motorist whose vehicle has

³⁷“Incident Management: Detection, Verification, and Traffic Management,” Field Operational Test Cross-Cutting Study, Boos Allen & Hamilton, September 1998.

broken down has been reduced to 19 minutes. The average time to clear all types of incidents has been reduced to 31 minutes (a 66% reduction)³⁸.



The Philadelphia, Pennsylvania, Traffic and Incident Management System (TIMS) is helping traffic avoid highway incidents and emergencies on I-95. TIMS reroutes vehicles immediately after an incident is detected, thus diluting traffic flow and decreasing the risk of secondary incidents. The system has helped decrease freeway incidents by 40%, cut freeway closure time by up to 55%, and reduce incident-severity rate by 8%³⁹.



The first phase of the TransGuide System became operational July 26, 1995, and includes 26 miles of freeway in downtown San Antonio. The incident management system includes a digital communications network, variable message signs, lane control signals, loop detectors, and freeway surveillance cameras. A 35% reduction in total accidents, 30% reduction in secondary accidents, 40% reduction in accidents during inclement weather, and 41% reduction in overall accident rate were found, as well as significant improvements in driver confidence. Review of video surveillance data indicated an average reduction in response time of 20%. From results of CORFLO freeway simulations using those reductions, an average delay savings of 700 vehicle-hours and reduction in fuel consumption of 2600 gallons per major incident were indicated. Based upon accident frequency rates for freeways, these figures translate to an annual savings of \$1.65 million⁴⁰.



TV cameras were installed at the Awaza curve on the Hanshin Expressway in Japan. The purpose is to automatically detect disabled vehicles and those involved in accidents by using image processing. The detection system shortened the time required to provide information to trailing vehicles from 8 minutes to 2 seconds. As a result, the rate of secondary accidents decreased by 50%⁴¹.



Funded under the Federal-aid Congestion Mitigation and Air Quality Improvement Program, the San Francisco, freeway service patrol has been in operation since August 1992. As of January 1997, the program has assisted more than 90,000 drivers. It has



³⁸Samartin, Kevin, "Under Detection," ITS: intelligent transport systems, May/June 1997.

³⁹Taylor, Steven T., feature article, ITS World, Jan/Feb 1997.

⁴⁰Henk, Russell H. et al, "Before-and-After analysis of the San Antonio TransGuide System," Texas Transportation Institute, Third World Congress on Intelligent Transportation Systems, July 1996.

⁴¹Intelligent Transport Systems Handbook in Japan, Highway Industry Development Organization, Ministry of Construction.

decreased air pollution and reduced fuel consumption by helping to reduce the effects of incident-caused congestion, start-and-stop travel and vehicle idling. Estimates indicate a reduction in 32 kg/day of hydrocarbons, 322 kg/day of CO emissions, and NOx is reduced by 798 kg/day⁴².

 The incident management program of the Houston TranStar system covers 127 miles of the Houston Texas freeway network. An analysis for freeway incidents within the TranStar system estimated an annual delay savings of 572,095 vehicle-hours with an economic value of \$8.4 million. The ramp metering program on the I-10 Katy Freeway of the TranStar system reports daily savings of 2,875 vehicle hours resulting in a  \$37,030 benefit to Houston commuters. In 1996, there were seven occurrences where  video surveillance was used to determine if HOV restrictions could be lifted. It was estimated that 12,910 vehicles were able to save between 13.5 to 27 minutes over those vehicles remaining in the queue for a total estimated cost savings of \$42,500 to \$85,100⁴³. As a result of reducing incident detection and response time, the TranStar Management Center helps to reduce hydrocarbons by 91 kg/day⁴⁴.

 The six month pilot Courtesy Patrol Program in Denver, Colorado is estimated to have reduced the cost of traffic delay by \$0.8–\$1.0 million for the morning period, and by \$0.90–\$0.95 million in the evening. This assumes a time value of \$10 per hour. Program costs varied between the tow truck operators from \$29 to \$38 per truck-hour, which results in a benefit to cost ratio of 10.5:1 to 16.9:1⁴⁵.

 In preparation for the 1996 Olympic Games, Atlanta Georgia added several ITS capabilities to assist in moving visitors and vehicles in an extremely crowded area. Improved interagency coordination was developed based on the capabilities of a regional ATMS program. The mean time between the first report of an incident and incident verification was reduced from 4.2 minutes to 1.1 minutes, a reduction of 74%. Mean time between incident verification and automated generation of incident response

⁴²“*Innovations in Transportation and Air Quality: Twelve Exemplary Projects*,” US department of Transportation, Publication number FHWA-PD-96-016, 1996.

⁴³“*Estimation of Benefits of Houston TranStar*,” Prepared by Parsons Transportation Group in cooperation with the Texas Transportation Institute, February 7, 1997.

⁴⁴“*Innovations in Transportation and Air Quality: Twelve Exemplary Projects*,” US department of Transportation, Publication number FHWA-PD-96-016, 1996.

⁴⁵Cuciti P., and B Janson., “*Incident Management via Courtesy Patrol: Evaluation of a Pilot Program in Colorado*,” 74th annual Meeting of the Transportation Research Board, Washington DC, Transportation Research Record, 1995.

was reduced from 9.5 minutes to 4.7 minutes (50%). The mean time between incident verification and clearance of traffic lanes was reduced from 40.5 minutes to 24.9 minutes (38%). The maximum time between incident verification and clearance of traffic lanes was reduced from 6 hours 15 minutes to 1 hour 28 minutes, a 76% reduction⁴⁶.



The Maryland CHART program is in the process of expanding to more automated surveillance with lane sensors and video cameras. The evaluation of the initial operation of the program shows a benefit/cost ratio of 5.6:1, with most of the benefits resulting from a 5% (2 million vehicle-hours per year) decrease in delay associated with non-recurrent congestion⁴⁷.



The Minnesota Highway Helper Program⁴⁸ reduces the duration of a stall (the most frequent type of incident, representing 84% of service calls) by 8 minutes. Based upon representative numbers, annual benefits through reduced delay total \$1.4 million for a program that costs \$600,000 to operate.

2.4.1 Summary of Incident Management

Table 2-1 summarizes the data presented in this section. Incident management programs have shown the potential to reduce both the number of accidents and the time required to detect and clear incidents. These programs show a significant savings in the cost of congestion and have been shown to be cost effective. In addition, the public response to these programs has been positive.

⁴⁶Booz Allen & Hamilton,"1996 *Olympic and Paralympic Event Study*," Final Report, May 1997.

⁴⁷COMSIS Corporation, "*CHART Incident Response Evaluation Final Report*," Silver Spring, MD, May 1996.

⁴⁸Minnesota Department of Transportation, "*Highway Helper Summary Report - Twin Cities Metro Area*," Report # TMC 07450-0394, July 1994.

Table 2-1: Summary of Incident Management Data

Location	Reduced Incident Clearance Time	Reduced Response Time	Accident Reduction	Secondary Accident Reduction	Reduced Accident Rates	Cost Savings/yr. (\$ millions)	Delay Savings (hrs/yr.)
	Brooklyn, NY	66.0%					
Philadelphia, PA			40.0%				
San Antonio, TX		20.0%	35.0%	30.0%	41.0%	1.65	255,500
Japan				50.0%			
Houston, TX						8.40	572,095
Denver, CO						0.95	95,000
Atlanta, GA							2,000,000
Minnesota						1.40	

2.5 EMERGENCY MANAGEMENT

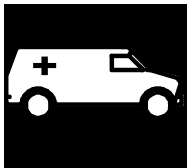

The benefits of emergency management are sometimes highly dependent on the related implementations of Incident Management systems. Benefits related to the notification, dispatch, and guidance of emergency or other response equipment are included in this report, as shown in figure 2-6.

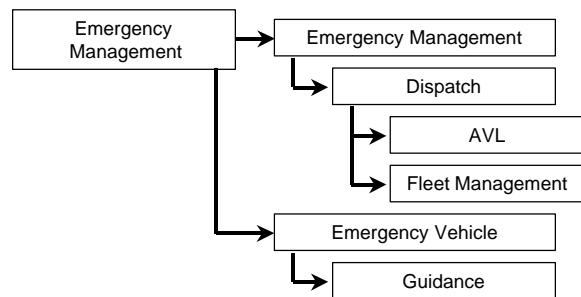

Figure 2-6: Taxonomy of Emergency Management

Emergency Response Saves a Life:

Heading home for supper, ambulance 706 of the Dallas Fire Department had just left the hospital, when its mobile data terminal alarm sounded. Two blocks away, inside the jurisdiction of Ambulance 703, a major auto accident had occurred. Arriving on scene in 43 seconds Ambulance 706 found a patient with chest trauma caused by hitting the steering wheel and was having severe breathing difficulty. Paramedics rapidly removed the patient from the vehicle and transported him to the hospital. The patient survived the incident without complications.

Patients with trauma to the chest usually only have a few minutes before the onset of traumatic asphyxia, which leads to brain damage and death. Without the AVL system, the dispatcher would have sent Ambulance 703 to the accident. It would have taken approximately 5 minutes for 703 to reach the scene. Rescuers are convinced that the patient survived because the AVL system identified the closest unit.

FROM: Steffy, Christina, "ITS to the Rescue," ITS World, July/August 1997.

Albuquerque, New Mexico uses a map-based computer-aided dispatch system in its ambulance fleet. The system allows the dispatch center to send ambulances to the exact location of an emergency and provide guidance on how to get there. As a result, the company's efficiency has increased by 10 to 15 percent⁴⁹.

Palm Beach County, Florida is installing the Priority One traffic system, connecting the Global Positioning System (GPS) to its emergency vehicles, that could cut 20% from the response time, depending on the intersection and time of day (as found by two Illinois towns currently using the system). As the vehicle approaches a traffic light, it transmits a signal interrupting the normal cycle, which allows the emergency vehicle to go through it without stopping. The GPS system will also allow dispatchers to figure out who is closer to an emergency. The cost is about \$4000 per intersection and \$2000 per vehicle⁵⁰.



The Puget Sound Help Me (PuSHMe) Mayday System allowed a driver to immediately send a response center a notification and location of incidents along with the need for any assistance. The system includes 2-way pagers and cellular telephones that transmit vehicle location, nature of the problem, and a priority level of the problem to a response center. The devices may also send automated signals when the driver may be incapable of manually initiating a signal. Of those drivers equipped with voice communications, 95% felt more secure while 70% of those with only data communications said that they were more secure with the system installed⁵¹.

⁴⁹Taylor, Steven T., "Helping Americans," feature article in ITS World, Jan/Feb 1997.

⁵⁰Shifrel, Scott, "Satellites Around Globe May Save Lives Right Here," The Palm Beach Post, June 1, 1997.

⁵¹Haselkorn, M., et al., "Evaluation of PuSHMe Mayday System," Final Report, June 19, 1997.

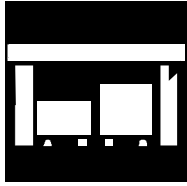

2.6 ELECTRONIC TOLL COLLECTION

Electronic Toll Collection (ETC) is one of the ITS program areas where little new benefits information is required. Benefits due to impacts on the cost of toll administration, management and collection have been demonstrated. Vehicle delay reduction and throughput at toll plazas have been proven to be very high.



Therefore, many of the recent reports for applications of ETC have concentrated on the accuracy and improvements in vehicle identification. Technologies are now capable of identifying vehicles at mainline speeds and at a high rate of accuracy. As a result, throughput is maximized, and delay that would occur at toll plazas is substantially reduced.

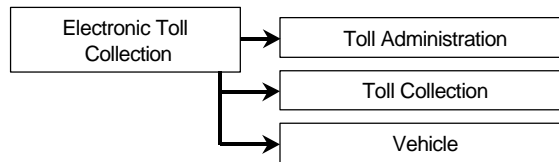

Figure 2-7: Taxonomy of Electronic Toll Collection



Japan initiated a test operation of ETC at the Odawara Toll Gate on March 31, 1997 to confirm that safe and smooth traffic operation can be secured at actual toll gates.

Where conventional toll collection takes 14 seconds per car in Japan on average, ETC takes only about 3 seconds per car⁵².



The Pike Pass ETC program on the Oklahoma Turnpike started operation on the first of January 1991. As of June 1994, 250,000 passes had been issued, of which over 90% (226,000) were still active, accounting for 35% of the turnpike association's revenue⁵³.



A protocol, prepared by the Northeast States for Coordinated Air Use Management, is used to estimate toll booth emissions at three locations. The locations are the

⁵²“Intelligent Transport Systems Handbook in Japan,” Highway Industry Development Organization, Ministry of Construction, October 1997.

⁵³Clean Air Action Corp., “Proposed General Protocol for Determination of Emission Reduction Credits Created by Implementing an Electronic Pike Pass System on a Tollway,” Study for the Northeast States for Coordinated Air Use management, December, 1993.

Muskogee Turnpike in Oklahoma, the Asbury Plaza on the Garden State Parkway in New Jersey, and the Western Plaza on the Massachusetts Turnpike. The protocol is based on dynamometer tests and toll road observation. The Clean Air Action Corp. report uses the experiences gained with the Pike Pass project and applies them to the other two freeways. It projects significant reduction in tons of pollutants for the 260 day commuter case. The overall percent change is dependent upon the frequency of toll plazas. The average emissions reductions are 72% for carbon monoxide, 83% for hydrocarbons, and 45% for oxides of nitrogen per mile of impacted operation⁵⁴.



As stated earlier, ETC can greatly improve throughput on a per-lane basis compared with manual toll collection techniques. On the Tappan Zee Bridge toll plaza, a manual toll lane can accommodate 400–450 vehicles per hour while an electronic lane peaks at 1000 vehicles per hour⁵⁵.

2.6.1 Summary of Electronic Toll Collection

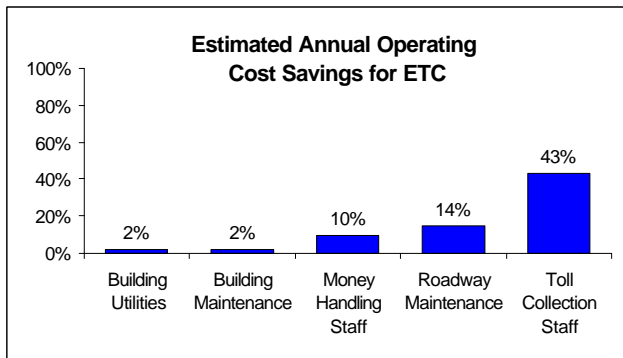

Deployment of ETC is occurring throughout the United States at a rapid pace and is being driven by cost savings to the operator. A recent study has shown that ETC can reduce the cost of staffing toll booths by 43.1%, money handling by 9.6%, and roadway maintenance by 14.4%. The figure on the left summarizes these estimated savings⁵⁶.

⁵⁴Clean Air Action Corp., “Proposed General Protocol for Determination of Emission Reduction Credits Created by Implementing an Electronic Pike Pass System on a Tollway,” Study for the Northeast States for Coordinated Air Use management, December, 1993.

⁵⁵Lennon L., “Tappan Zee Bridge E-Z Pass System Traffic and Environmental Studies,” Compendium of Technical Papers, 64th ITE Annual Meeting, Institute of Transportation Engineers, 1994.

⁵⁶Philip, Davy & Walter Schramm, “Cashless tolls mean money saved,” Reprinted from Traffic Technology International 1997 for Hughes Transportation Management Systems, Canada.



2.7 ELECTRONIC FARE PAYMENT PROGRAMS

Electronic Fare Payment is another one of the ITS program areas where little new benefits information has been required to justify implementation. Electronic fare payment tests are ongoing in both bus and rail systems which address customer convenience and security.

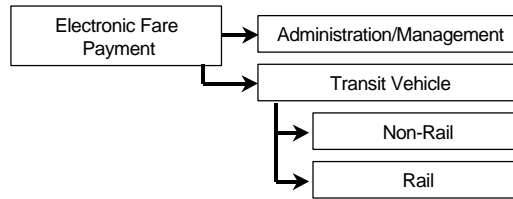

Figure 2-8: Taxonomy of Electronic Fare Payment

In California, tests comparing various card technologies have found RF proximity cards to be high in reliability. A test in the Marseilles, France, metropolitan area is comparing RF and IR technologies that would allow each patron to use a card of his or her choice (credit card, debit card, monthly pass, etc.) for transportation payment, while processing a transaction in less than a second⁵⁷.



The Phoenix transit operators have used electronic fare payment techniques since 1991. Maricopa County, the county encompassing Phoenix, passed a travel reduction ordinance that required each employer in the Phoenix area with over 100 employees to reduce single-occupancy commuting trips by 5% in two years. This ordinance was passed to help the county comply with the Arizona state legislatures' air quality bill passed in the late 1980's. To assist in the data collection needed for this program as well as to reduce operational problems, the City of Phoenix Public Transport System led the development of the Bus Card Plus system to read magnetically encoded plastic passes. Employers were then billed monthly for transit use by their employees. As of 1996, 190 companies participate in the Arizona system with a total of 35,000 cards in use. Express routes report 90% of fares are paid by bus pass cards. Since employers

⁵⁷Mathieu, J., "Multiservices/Multiproviders Remote Ticketing on the Marseille Metropolitan Area," Proceedings of the Second World Congress on Intelligent Transport Systems, November 1995.

are billed only for transit usage rather than purchasing monthly passes, costs to them are decreasing by up to one third. Starting in May of 1995, VISA and MasterCard have also been accepted. During the four months between May and September 1995, processing fees totaled under 7% of revenue generated and there were no major problems⁵⁸.



While much of the literature regarding electronic fare payment discusses technical capability and patron convenience, some indications of benefits to the transit property are accumulating. Reductions in data collection costs range from an estimated \$1.5 million in Manchester, UK to a predicted \$5 million in Ventura, California, in addition to improved data accuracy⁵⁹. New York estimates the increase in ridership due to electronic fare payment to be worth \$49 million. New Jersey Transit estimates annual cost reduction of \$2.7 million in cash handling, while Atlanta estimates \$2 million in savings⁶⁰.



2.8 HIGHWAY-RAIL INTERSECTIONS

The need for improvements at highway-railway intersections (HRI) is indicated by the number of accidents that occur on a yearly basis. Additionally, the occasional spectacular accident including school children or hazardous materials attracts national attention. However, the number of accidents occurring at HRIs has continued to decline over the last several years. Statistics as of November, 1998 show that from January to August 1998 2,297 HRI incidents were reported. This number is down 11.7% over that of the same period in 1997. The number of fatalities were also reduced 5.6% over the same period⁶¹. It should be noted that these reductions are not related to ITS implementations.



⁵⁸Schwenk, J., "Using Credit Cards To Pay Bus Fares in Phoenix," The Volpe Center, DOT-TSC-FTA-96-01, 1996.

⁵⁹Dinning, M., "Benefits of Smart Cards in Transit," The Volpe Center September 1995.

⁶⁰Jones, W., "ITS Technologies in Public Transit: Deployment and Benefits," USDOT ITS Joint Program Office, November 1995.

⁶¹Federal Railroad Administration, Office of Safety Analysis

Several operational tests involving coordinating traffic signals and notifying vehicles of approaching trains at intersections are currently being developed and implemented. A few pilot projects are now in progress to test new technologies but have yet to produce quantitative data on benefits. Figure 2-9 illustrates the classification of benefits data for highway-rail intersections.

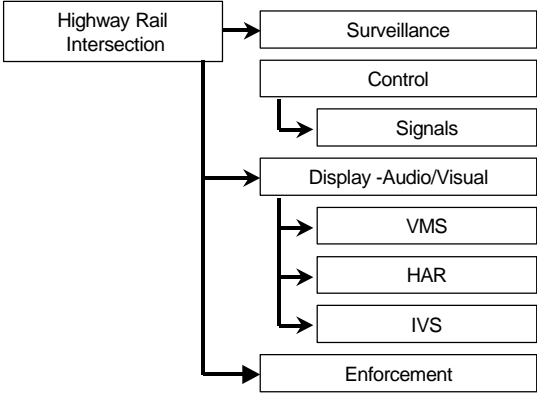
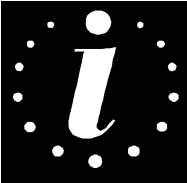

Figure 2-9: Taxonomy for Highway-Rail Intersections



2.9 REGIONAL MULTI-MODAL TRAVELER INFORMATION

Providing traveler information over several modes of travel can be beneficial to both the traveler and service providers. Several transit agencies have started using traveler information kiosks and web sites to provide schedules, expected arrival times, expected trip times, and route planning services to patrons. Also, several traffic management centers are providing current traffic conditions and expected travel times using similar approaches. These services allow users to make a more informed decision for trip departures, routes, and mode of travel. They have been shown to increase transit usage, and may help to reduce congestion when travelers choose to defer or postpone trips, or to select alternate routes.

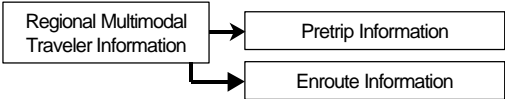

Figure 2-10: Taxonomy for Regional Multimodal Traveler Information



Rail, Omnibus, Underground Travel Enquiry System (ROUTES), is a computerized route planning system in use by London Transport. The system is used to provide callers with information about the transit system and to assist in route selection, and trip planning. Studies indicate that 80% of those using the system make the journey they ask for information about. It is also estimated that 38% of callers change their route based on information received from the call. An additional 13% of callers decide to travel by transit for trips they would not normally use public transit for. The 13% increase is estimated to generate £1.3 million of revenue for bus companies, £1.2 million for the underground, and £1 million for the railways. Furthermore, societal benefits could be as much as £11 million⁶².



Surveys performed in the Seattle, Washington area and Boston, Massachusetts areas indicate that when provided with traveler information, 50% of travelers change route of travel and 45% will change time of travel. Additionally 5%–10% of travelers will change travel mode based on traveler information. Assuming that 30% of the 96,000 daily callers projected for 1999 change travel plans according to this breakdown, the impact of SmarTraveler in Boston on emissions has been estimated using the MOBILE5a model. On a daily basis, this adjustment of travel behavior nets an estimated reduction of 498 kg of volatile organic compounds, 25kg of NO_x, and 5032 kg of CO representing reductions of 25%, 1.5%, and 33% respectively of these pollutants from travelers changing travel plans. While this represents significant reductions for participating travelers, only 28,800 daily trips are expected to be affected in a metropolitan area with 2.9 million registered drivers⁶³.

⁶²“Survey Finds London Transit Info changes Behavior, Creates Revenue,” Inside ITS, March 9, 1998, p8.

⁶³Tech Environmental, Inc., “Air Quality Benefit Study of the SmarTraveler Advanced Traveler Information Service,” July 1993.

An automated transit information system implemented by the Rochester-Genesee Regional Transportation Authority resulted in an increase in calling volume of 80%⁶⁴, while a system installed by New Jersey Transit reduced caller wait time from an average of 85 seconds to 27 seconds and reduced caller hang-up rate from 10% to 3% while increasing the total number of callers⁶⁵.

The Automated Network Travel Time System (ANTTS) collects travel time data from vehicles traveling routes around the traffic network in Sydney, Australia. Used on the airport express bus service, travel time predictions are expressed as arrival times for bus travelers. Singapore's land transport authority (LTA) is developing similar pilot bus arrival and information systems. The predicted arrival time information is displayed at the bus stop. LTA studies indicate a high 85% accuracy in reporting travel time to within one minute⁶⁶.

Pre-trip traveler information is also popular for travelers. The Los Angeles Smart Traveler project has deployed a small number of information kiosks in locations such as office lobbies and shopping plazas. The number of daily accesses range from 20 to 100 in a 20-hour day, with the lowest volume in offices and the greatest in busy pedestrian areas. The most frequent request was for a freeway map with 83% of users requesting this information. Over half of the accesses included requests for MTA bus and train information⁶⁷.

The TravLink test in the Minneapolis area distributed PC and video text terminals to 315 users and made available transit route and schedule information, including schedule adherence information, as well as traffic incidents and construction information. For the month of July 1995, users logged on to the system a total of 1660 times, an average of slightly more than one access per participant per week. One third of the accesses to the system requested bus schedule adherence; another 31% examined bus schedules. Additionally, three downtown kiosks offering similar information averaged a total of 71 accesses per weekday between January and July of 1995; real-time traffic data were more frequently requested than bus schedule adherence information⁶⁸.

⁶⁴USDOT, Federal Transit Administration, APTS Benefits, November 1995.

⁶⁵"NJ Transit's Customer Information Speeded Up by New System," Passenger Transport, January 24, 1994.

⁶⁶Kirkham, Rob, "Making the most of SCATS," Traffic Technology International, Annual 1997, p 32-34.

⁶⁷Giuliano, G., et al., "Los Angeles Smart Traveler Information Kiosks: A Preliminary Report," 74th Transportation Research Board Annual Meeting, Transportation Research Record 1516, January 1995.

⁶⁸Remer, M., Atherton, T., and Gardner, W., "ITS Benefits, Evaluation and Costs: Results and Lessons from the Minnesota Guidestar Travlink Operational Test," Draft, November 1995.



The Genesis project in Minneapolis delivered incident information via alphanumeric pagers. A majority of Genesis users (65%) reported using the service daily and 88% reported using the service once or more per week. Of users who participated in the test, only 2% dropped out of the project during operation due to dissatisfaction with the service. An additional indication that users found the service valuable is that users discovered over half of the incidents affecting their travel via Genesis compared to discovering 15% of incidents via radio and TV. When users became aware of incidents via Genesis, they chose alternate routes for travel in 42% of the situations⁶⁹.



Completed in June of 1995, the Pathfinder operational test consisted of an in-vehicle navigation system with real time traffic information. The test was implemented on the Santa Monica Freeway and neighboring arterials in the City of Los Angeles, California. The test was designed to examine the benefits of using vehicles to provide information regarding traffic conditions and to evaluate a computer-assisted method of collecting and combining travel information from several different sources. In addition, the test evaluated drivers' responses to the real time traffic information provided. Users perceived that their trips were less stressful and that they were saving time, even in situations where the time savings were insignificant. Drivers were also more comfortable in diverting with Pathfinder, as indicated by a 40% increase in diversion⁷⁰.



The availability of navigational information may help to reduce travel stress, particularly for the unfamiliar driver. The TravTek test consisted of an in-vehicle navigation and dynamic route guidance system with real time traffic information. The test was conducted in the Orlando Florida area between March 1992 and March 1993, in which several rental car users were equipped with the system. Of rental users of TravTek, 38% found the device helpful in finding specific destinations in unfamiliar territory as did 63% of local drivers⁷¹.

⁶⁹Wetherby, B., et al., "*System Effectiveness Test*," final report, June 10, 1997.

⁷⁰Pathfinder Evaluation Report, Prepared for California Department of Transportation, JHK & Associates, Pasadena, CA, February 1993.

⁷¹Inman, V., et. al., "*TravTek Evaluation: Rental and Local User Study*," FHWA-RD-96-028, Federal Highway Administration, March 1996.

2.10 BENEFITS OF INTEGRATED METROPOLITAN ITS

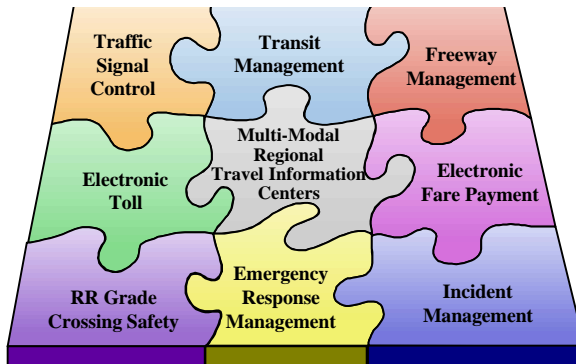

Due to institutional and technical problems, implementing integrated systems can be much more difficult than isolated ITS user services. It is most likely that integrated systems will be implemented in stages that build upon or tie together initial or isolated services. These stages may consist of the sharing of resources, the sharing of information, and the coordination of control between ITS program areas, user services, and across other ITS geographic or political boundaries.



Houston TranStar is responsible for the planning, design, operations, and maintenance of transportation operations and emergency management operations in the Houston Texas area. Along with other intelligent transportation systems programs, TranStar integrated a freeway management system, a freeway and arterial street incident management program, a traffic signal control system, and an emergency management program. A few of the components include ramp meters, closed circuit television, variable message signs, a HOV lane system, a regional computerized traffic signal system, emergency management operations, and a motorist assistance program. A conservative estimate of average freeway incident time savings as a result of the system is 5 minutes, but analysis has shown that a savings of 30 minutes is possible for major freeway incidents. Total annual delay savings is estimated at 572,095 vehicle-hours, resulting in about \$8.4 million in savings per year. Integrating the HOV lanes with other ITS infrastructure can be used to help reduce congestion during incident conditions. During 1996, there were 7 instances where the occupancy requirements for HOV lanes have been lifted due to an incident on the mainline. As a result of lifting restrictions, Texas Transportation Institute estimated that 12,910 vehicles were able to avoid the incident delay and save 13.5 to 27 minutes. Annual vehicle delay savings were estimated at \$42,500 to \$85,100 for the seven incidents. TranStar flow signal (i.e. ramp meter) benefits were an estimated travel time savings of 2,875 vehicle-hours daily, or \$37,030 per day. Due to inclement weather, incidents and other events, these savings could be expected for about 150 days each year, for a yearly user delay savings of over \$5.5 million. The Motorist Assistance Program (in place since 1989) has a benefit-to-cost ratio as high as 23.3 to 1 with a positive impact on incident delay reduction. ATMS implemented in the Astrodome area is estimated to have resulted in reducing area street congestion time by 46%⁷².

⁷²"Estimation of Benefits of Houston TranStar," Prepared by Parsons Transportation Group in cooperation with the Texas Transportation Institute, February 7, 1997.



Before and after surveys of the San Antonio TransGuide system were used to capture the effects of the system on travelers. Surveys taken before and after the installation indicated an improvement from 40% to 86% of travelers that believe methods for notifying motorists and managing congestion are efficient. Surveys also showed an improvement from 45% to 71% of people using alternative routes during incident conditions believed they saved time due to accurate information. There is also evidence of improved driver confidence in the system. Before studies showed 33% of travelers who received instructions followed them during incident conditions. After the implementation of the system, 80% of travelers receiving instructions follow them. Also, 88% of travelers surveyed feel messages are “very easy” to understand⁷³.



The Information for Motorists (INFORM) program is an integrated corridor management system on Long Island, New York. INFORM consists of an incident and freeway management program, traffic signal controls, and some inter-jurisdictional coordination. It provides information via variable message signs (VMS), control using ramp meters serving parallel expressways, and some signal coordination on arterials. The program stretches back to concept studies in the early 1970’s and a major feasibility study performed from 1975 to 1977. The implementation progressed in phases starting with VMS’s, followed by ramp meters in 1986 and 1987 and completed implementation by early 1990. Estimates of delay savings due to motorist information⁷⁴ reach as high as 1900 vehicle-hours for a peak period incident and 300,000 vehicle-hours in incident-related delay annually.

⁷³Henk, R. H. “*Before-and-After Analysis of the San Antonio TransGuide System Phase I,*” 76th Annual Meeting, Transportation Research Board, Washington DC, January 1997.

⁷⁴Smith, S. and Perez, C., “*Evaluation of INFORM - Lessons Learned and Application to Other Systems,*” Conference Paper Presented at 71st TRB, January 1992.

3.0 BENEFITS OF RURAL ITS INFRASTRUCTURE



Although rural areas account for a small portion of our nation’s population, they contain a major portion of the transportation system. Eighty percent of the total US road mileage is in rural areas generating 40% of the vehicle miles traveled. Unlike urban areas, the rural environment has a different set of priorities and needs that reflect longer distances, lower traffic volumes, drivers that are unfamiliar with the surroundings, and longer emergency response times. Many of the ITS services provided in metropolitan areas can also be implemented in the rural environment. However, these services are sometimes required to cover much broader areas, or may become much more specialized in what they provide to the traveler.

The rural initiative is a relatively new program, with increasing activity and funding levels over the last few years. Many rural operational tests are currently underway. Some of these tests are starting to report impacts and benefits, while most are still undergoing development, implementation, or evaluation.

Rural ITS infrastructure is classified into six major program areas. These areas include: Traveler Safety and Security, Emergency Services, Tourism and Travel Information, Public Travel and Mobility Services, Infrastructure Operation and Maintenance, and Fleet Operation and Maintenance. Figure 3-0 summarizes these six major program areas for Rural ITS.

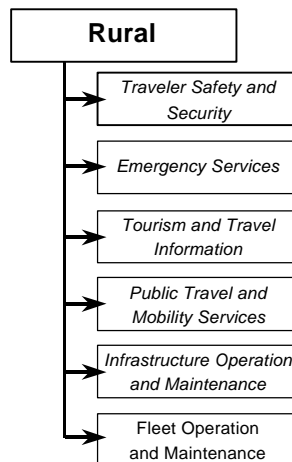

Figure 3-0: Rural ITS Program Areas

3.1 TRAVELER SAFETY AND SECURITY



One of the major goals of Rural ITS is to improve safety and security. Many of these services are highly related to emergency response while other services provide hazardous conditions or site-specific safety related information, as discussed in this section. This type of information could assist in evacuation and disaster management plans, where timely information is critical. Also included are services such as remote surveillance and monitoring. These services could be implemented at park-and-ride lots, rest areas, etc. Information

from these services can be used to implement roadway control strategies, such as emergency road closings or variable speed limits. Figure 3-1 demonstrates the classification of benefits related to traveler safety and security.

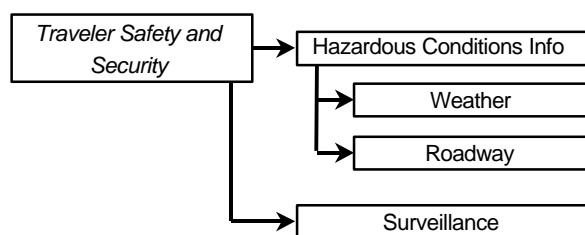

Figure 3-1: Taxonomy for Traveler Safety and Security

To promote safer driving behavior during fog conditions, an automatic fog-signaling system was implemented on the A16 Motorway in the Netherlands. The system uses 20 sensors along the 12 km stretch to measure visibility. Based upon the visibility distance calculated, a speed limit is set for the roadway. With visibility greater than 140 meters, no speed limit is displayed. When visibility is reduced to between 70 and 140 meters, an 80 kph limit is posted. When less than 70 meters, the speed limit is displayed as 60 kph. The system was found to result in an additional decrease of speed of about 8 to 10 kph and a slight reduction in the standard deviation of the speed. However, in extremely low visibility conditions (< 35 m), the system is reported to have an adverse effect. Average speed under these conditions is around 60 kph, the posted limit, while without the signs the average speed had been 29 kph⁷⁵. Implementing speed limits below 60kph under extremely low visibility may have reduced the adverse effect.

⁷⁵Hogema, Jeroen H., and Richard van der Horst, "Evaluation of the A16 Motorway Fog-Signaling System with Respect to Driving Behavior," TNO Human Factors Research Institute.

3.2 EMERGENCY SERVICES

Emergency services address the response to incidents and widespread events such as natural disasters. For rural areas, the longer response time for Emergency Medical Services contributes to much more severe consequences than would occur with a rapid response. Data related to incident notification and the mobilization and response due to emergencies in rural areas are classified in the taxonomy as shown in figure 3-2.

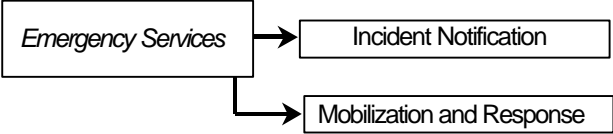

Figure 3-2: Taxonomy for Emergency Services

Field tests conducted on the Ford Lincoln Continental RESCU (Remote Emergency Satellite Cellular Unit) security system showed that it took under one minute for a driver to make voice contact with a response center operator. On average, it took under 11 minutes from the punch of a button until emergency vehicles arrived⁷⁶.

⁷⁶Meyer, Harvey, “*Safer Cars Make Safer Roads,*” GEICO Direct, Fall 1997, p 24-27.

3.3 TOURISM AND TRAVEL INFORMATION



Tourism and Travel Information focus on the needs of the travelers who may be unfamiliar with the area they are traveling through. These services address the issues of mobility and convenience of the traveler, and may also improve the economy and productivity of rural and tourist areas.

Most of these services are still in the development stages, and few data regarding benefits for these services are available. Several National parks are examining the possible impacts of these services. Information services could include electronic yellow pages, transit, and parking availability. Mobility services such as a pre-trip route selection or en-route navigation are also included. Figure 3-3 summarizes the classification for benefits of tourism and travel information.

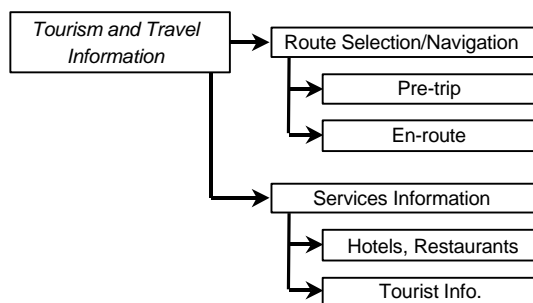

Figure 3-3: Taxonomy of Tourism and Travel Information

3.4 PUBLIC TRAVEL AND MOBILITY SERVICES



The need for public transportation in rural areas is highlighted by the fact that 38% of the nation's rural residents have no access to public transit services and another 28% live in areas in which the level of transit service is negligible. Providing these services in an efficient and effective manner can be difficult and result in high operating costs. Coordination between various providers can prove useful when trips consist of many different origins and uncommon destinations over wide areas.

Advanced transit with AVL-assisted dispatching and routing along with fare payment strategies can also be used. Advanced ride sharing with improved parking information is also considered under this group of rural services. Data associated with public travel and mobility services are classified as shown in figure 3-4.

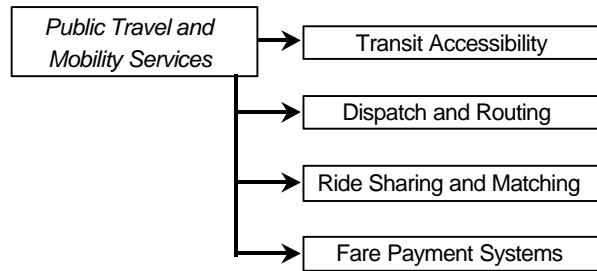

Figure 3-4: Taxonomy of Public Travel and Mobility Services



The Potomac and Rappahannock Transportation Commission operates demand-responsive transit to serve transit needs and commuter rail stations in the suburban fringe of the Washington, DC, metropolitan area. The service also meets requirements of the Americans with Disabilities Act. Compared to a fixed route service and complementary paratransit service, the demand-responsive system is estimated to produce a 40% reduction in total cost⁷⁷. Use of coordinated paratransit with a dispatch system including AVL, which can coordinate trips among up to five agencies, has the potential to reduce fraud in Medicaid transportation by \$11 million annually in the State of Florida⁷⁸.



Public transportation providers in rural areas can produce cost efficiencies by increasing ridership. The computer-assisted dispatching system in Sweetwater County, Wyoming, which allows same-day ride requests to be accepted, has contributed to an increase in ridership from 5,000 passengers monthly to 9,000 monthly without increasing the dispatch staff and a reduction of operational expense of 50% over a 5-year period on a per passenger-mile basis⁷⁹.

⁷⁷Farwell, R., “*Evaluation of OmniLink Demand Driven Transit Operations: Flex-Route Services*,” SG Associates, Annandale, Virginia, presented at the European Transport Forum, 1996.

⁷⁸Ride Solutions, “*Operational Strategies for Rural Transportation*,” Florida Coordinated Transportation System, undated

⁷⁹Casey, R., “*The Benefits of ITS Technologies for Rural Transit*,” The Volpe Center, presented at the Rural ITS Conference, September 1996.

3.5 INFRASTRUCTURE OPERATION AND MAINTENANCE



Operating and maintaining rural transportation systems can be costly. Managing traffic and monitoring roadway conditions in rural areas is often difficult due to distance, isolation, and the number of road miles. The safety of work zones and construction areas is often cited as requiring improvement. Many state DOTs are implementing ITS to optimize winter weather maintenance. Figure 3-5 summarizes how benefits data are classified into infrastructure operation and maintenance.

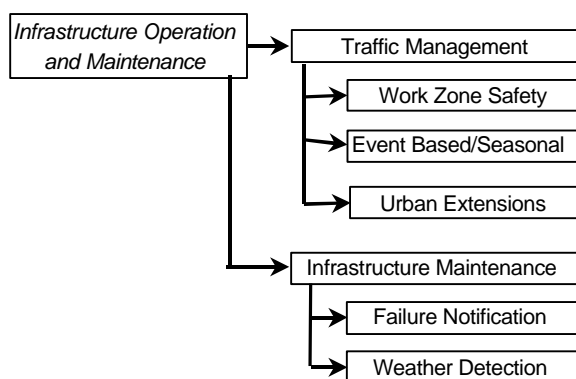

Figure 3-5: Taxonomy for Infrastructure Operation and Maintenance



The Finnish National Road Administration has developed a road weather service system to improve the monitoring of road weather conditions so that winter maintenance can be carried out systematically and at the right time. The system is an automated information system that sends both actual and predicted weather and road surface conditions to road maintenance personnel. The network of transmitters is made of up 11 central stations, about 200 workstations, and approximately 150 observation stations. For de-icing activities, it is estimated that the system saves about 23 minutes per activity. Converting estimated benefits to monetary amounts results in an annual \$900,000 savings due to accident reductions, \$60,000 for time costs, and \$20,000 for vehicle operations. The cost-to-benefits ratio of the program is estimated at 1 to 5⁸⁰.

⁸⁰Pilli-Sihvola, Yrjo, Kimmo Toivonen, and Jouko Kanton, "Road Weather Service System in Finland and Savings in Driving Costs," Finnish National Road Administration.



The Indiana state DOT has implemented the Computer Aided System for Planning Efficient Routes (CASPER) for districts in the state. The software is used to assist with the design of routes needed to service the roadway network. Developers claim that the equipment and operating cost for winter maintenance has been reduced from between \$11 and \$14 million. Additionally, they have reported an increased service level and an 8 to 10 percent reduction in the number of routes needed to service the network⁸¹.

3.6 FLEET OPERATION AND MAINTENANCE

Similar to Transit Operations discussed in section 2.3, the operation and maintenance of state owned vehicles can be improved. Vehicle self-diagnostics can alert mechanics of potential problems. Fleet operators can also use automated vehicle location devices to improve the scheduling of maintenance activities. Although a few of these services have been deployed, benefits data are not yet available from these implementations. The taxonomy for classifying benefits data into fleet operation and maintenance is summarized in figure 3-6.

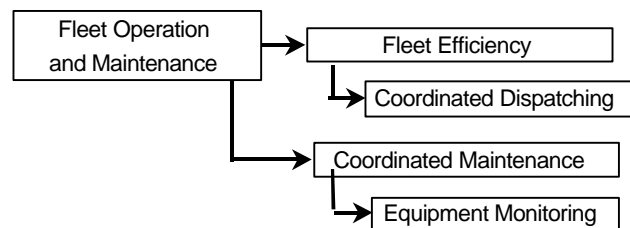

Figure 3-6: Taxonomy for Fleet Operation and Maintenance

⁸¹Deeter, D., and Bland, C.E. “*Technology in Rural Transportation ‘Simple Solutions’*,” Federal Highway Administration, Publication No. FHWA-RD-97-108, October 1997.

4.0 BENEFITS OF ITS FOR COMMERCIAL VEHICLE OPERATIONS



Commercial vehicle regulators will also experience financial benefits due to implementation of ITS. Improvements in administrative efficiency, avoidance of infrastructure investment, and improvements in highway data collection will improve safety and reduce operating costs. Also, ITS may result in benefits through operational and administrative improvements. Currently, ITS for Commercial Vehicle Operations (ITS/CVO) has three areas of state motor carrier regulation: safety assurance, credentials administration, and electronic clearance. Also

included in ITS/CVO are those services that help to improve carrier operations. Currently, many individual companies are equipping their own fleets with custom systems that provide them with a competitive advantage, but may or may not fit with eventual standards.

ITS/CVO is made up of four major program areas. These areas include: Safety Assurance, Credentials Administration, Electronic Screening, And Carrier Operations. Figure 4-0 summarizes the four ITS/CVO major program areas.

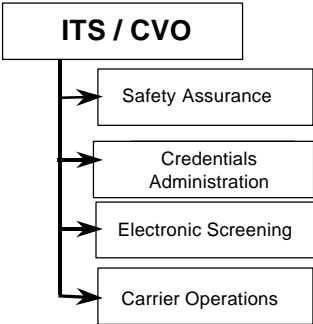

Figure 4-0: ITS/CVO Program Areas



An extensive benefit/cost analysis of the effects of CVO user services on regulatory compliance cost of motor carriers predicted a range of benefits. The study segmented the motor carrier industry into small firms (1–10 power units), medium-sized firms (11–99 power units), and large firms (100 or more power units) and analyzed each user service from the perspective of each market segment. The benefit/cost ratio for commercial vehicle administrative processes range from 19.8:1 to 1.0:1. For electronic screening, the benefit/cost ratio ranges from 6.5:1 to 1.9:1. The benefit/cost ratio for

automated roadside safety inspection ranged from 1.3:1 to 1.4:1. The benefit/cost ratio for on-board safety monitoring ranged from 0.49:1 to 0.02:1. For hazardous materials incident response, the benefit/cost ratio ranged from 2.5:1 to 0.3:1⁸².

4.1 SAFETY ASSURANCE

Improved safety information exchange programs will assist in improving the safe operation of commercial vehicles. By providing inspectors with better access to safety information, the number of unsafe commercial drivers and vehicles removed from the highway can be increased. Onboard monitoring of cargo can alert drivers and carriers of potential unsafe load conditions. Many of these services are beginning to be implemented in the CVO community. It is expected that as these services mature, benefits data will become available. Data associated with the benefits of safety assurance is classified as shown in figure 4-1.

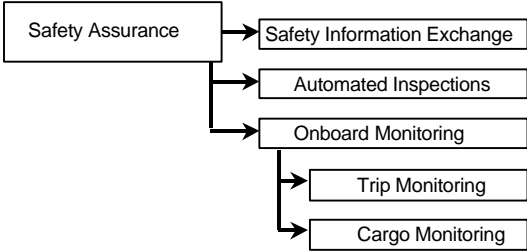

Figure 4-1: Taxonomy for Safety Assurance

⁸²“Assessment of Intelligent Transportation Systems/Commercial Vehicle Operations Users Services: ITS/CVO Qualitative Benefit/Cost Analysis - Executive Summary,” American Trucking Associations Foundation, Inc., Alexandria, VA, 1996.

4.2 CREDENTIALS ADMINISTRATION

Services that support in-house administrative functions can provide savings to state and administrative agencies. Electronic credentialing can improve the time required for states to approve operating permits. Data warehouses can facilitate the exchange of credentials data between agencies and states. The classification of these types of data is summarized in figure 4-2.

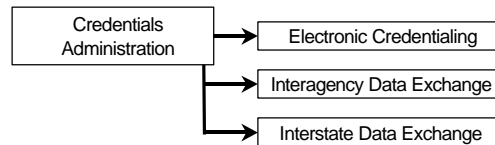
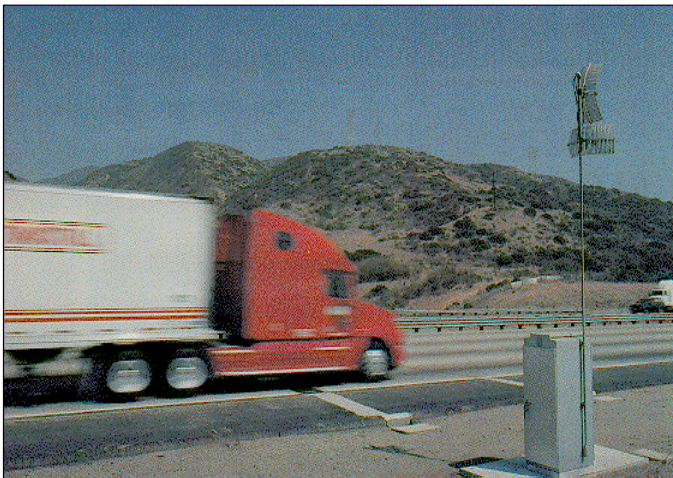

Figure 4-2: Taxonomy for Credentials Administration

Several State DOTs are now implementing automated oversize and overweight permitting and routing systems. The systems allow permit officials to spend less time on paperwork and more time examining routes in more detail. By filling out applications using Internet connections to state DOTs rather than filling them out in person, states have found that the turnaround time for permits has been reduced. Minnesota reports that it has been able to reduce its workforce from more than 20 people across 16 districts and 5 people in a central office to nine personnel managing the entire state⁸³.

4.3 ELECTRONIC SCREENING



Congestion at weigh and inspections stations can be reduced by allowing safe and legal carriers to bypass without stopping. Roadside electronic screening allows authorities to concentrate on greater percentages of potential unsafe vehicles. Benefits data related to electronic screening is classified as shown in figure 4-3.

⁸³ "Software System Eases Truck Permitting" in *Civil Engineering*, July 1998, p 30.

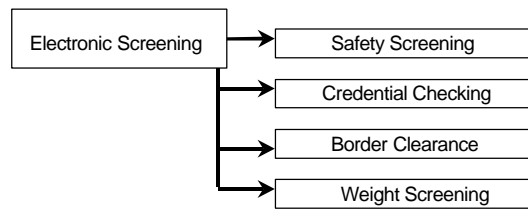

Figure 4-3: Taxonomy for Electronic Screening

The HELP/Crescent Project on the West Coast evaluated the applicability of four technologies for screening transponder-equipped vehicles. The technologies included automatic vehicle identification, weigh-in-motion, automatic vehicle classification, and integrated communications systems and databases. The benefits data are developed as a projection of experience from the project and from other databases rather than direct measurement by the project. Impact of hazardous material incidents could be reduced by \$1.7 million annually per state. Estimates of reductions in tax evasion range from \$0.5 to \$1.8 million annually per state. Overweight loads could be reduced by 5% leading to a savings of \$5.6 million annually. Operating costs of a weigh station could be reduced up to \$169,000, with credentials checking adding \$4.3–\$8.6 million and automated safety inspections adding \$156,000–\$781,000 in savings due to avoided accidents annually per state. A full implementation of services examined in the Crescent project would yield a benefit/cost ratio of 4.8 for a typical state government over a 20-year period. Less complete implementations range in benefit/cost ratio from no benefit up to 12:1 for the government⁸⁴.



The COVE Study estimates a benefit/cost ratio to the government of 7.2 for electronic clearance, 7.9 for one-stop/no-stop shopping, and 5.4 for automated roadside inspections⁸⁵.



A simulation study demonstrated ITS capabilities that could be used to improve the effectiveness of a hypothetical advanced truck weigh station⁸⁶. The study examined the delay effects of increased transponder usage of trucks as arrival rates to the station varied. Trucks equipped with transponders were permitted to bypass the station thereby reducing delay by 100% compared with non-equipped trucks. As transponder usage increased, queue lengths behind the scales decreased, thus also decreasing the delay experienced for non-equipped trucks. Savings for non-equipped trucks varied as



⁸⁴“*The Crescent Project: An Evaluation of an Element of the HELP Program*,” The Crescent Evaluation Team, Executive Summary and Appendix A, February 1994.

⁸⁵Study of Commercial Vehicle Operations and Institutional Barriers, Appendix F, Booz, Allen & Hamilton, McLean, VA, November 1994.

⁸⁶Glassco, R., et al, “*Studies of Potential Intelligent Transportation Systems Benefits Using Traffic Simulation Modeling: Volume 2*,” Mitretek Systems, MTR 1997-31, June 1997.

a function of average inter-arrival time, time required at the scale, and percent of trucks equipped with transponders. For an average inter-arrival time of 20 seconds and a weigh time of 25 seconds, non-equipped vehicles saved approximately 30 seconds for a 20% transponder equipage and an average 8 minutes saved at the station for a 60% transponder equipage.

4.4 CARRIER OPERATIONS

ITS/CVO can improve carrier operations by improving the scheduling of vehicles and reducing the number of empty loads. Administrative compliance costs can be reduced for carriers by participating with automated state credentialing processes. Classification of data related to carrier operations is shown in figure 4-4.

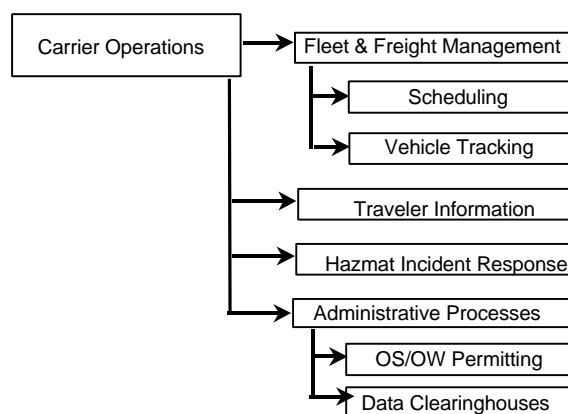



Figure 4-4: Taxonomy for Carrier Operations

To aid in optimization of routing vehicles, Bilspedition Transport & Logistics of Scandinavia is using GPS-based tracking of vehicles in combination with remotely-accessed on-board computers in southern and central Sweden. The company has been using the technology since 1994. Not only has the system reduced wasted mileage and emissions, it has brought a 15% increase in freight carried⁸⁷.

Motor carriers are currently involved with development of additional fleet equipment related to electronic tags, enhanced communications, and emerging CVO standards. A study of real-time diversion of truckload carriers predicted an additional productivity improvement of 6%⁸⁸.

⁸⁷Bunting, Alan, "Tracking Trucks," in ITS: intelligent transport systems, Man/June 1997.

⁸⁸Regan, A., et al., "Improving Efficiency of Commercial Vehicle Operations Using Real-Time Information: Potential Uses and Assignment Strategies," 74th Transportation Research Board Annual Meeting, Transportation Research Record 1493, January 1995.

 Anecdotal evidence that fleet management provides benefits is continuing to accumulate. The Automated Mileage and State line Crossing Operational Test (AMASCOT) has generated significant interest from carriers, manufacturers, and regulators. Although the AMASCOT evaluation did not estimate cost savings during the operational phase, carriers involved in the test estimated a potential to reduce costs by 33% to 50% for International Fuel Tax Agreement (IFTA) and International Registration Plan (IRP) reporting⁸⁹. State processing and audit staffs were receptive to potential changes in processing requirements. These staffs were also optimistic about the ability of such a system to improve accuracy, productivity, and compliance for both carriers and states⁹⁰.

-  Other benefits from carrier operations include the following⁹¹:
- Telesat Canada estimates use of its system will increase loaded mileage 9% to 16% and reduce operating cost \$.12 to \$.20 per truck mile.
 - Schneider of Green Bay, Wisconsin, reports that the elimination of driver check-in telephone calls saves approximately two hours per day resulting in a driver salary increase of \$50 per week.
 - Trans-Western Ltd. of Lerner, Colorado notes that drivers are able to drive 50 to 100 additional miles per day, and driver turn-over has decreased from 100% to 30%.
 - Frederick Transport of Dundas, Ontario, Canada, estimates a reduction of \$30 (from \$150 per month) in telephone charges, a 0.7% greater load factor and a 9% increase in total miles.
 - Best Line of Minneapolis, Minnesota, estimates a \$10,000 per month savings since 300 drivers previously lost about 15 minutes each day waiting to talk with dispatchers.
 - Mets of Indianapolis, Indiana, performed tests that showed vehicle utilization increased by 13%.
 - United Van Lines of Fenton, Missouri, claims that the ability to track and recover stolen vehicles is expected to reduce theft insurance premiums.

⁸⁹Maze, TH., et al., “Automated Mileage and State line Crossing Operation Test Part 1 - Evaluation Summary,” May 1, 1996.

⁹⁰Center for Transportation Research and Education, “Automated Mileage and State line Crossing Operational Test Evaluation Summary,” Final Report, Federal Highway Administration, May 1996.

⁹¹Hallowell, S., and Morlok, E., “Estimating Cost Savings From Advanced Vehicle Monitoring and Telecommunication Systems in Intercity Irregular Route Trucking.,” department of Systems, University of Pennsylvania, Philadelphia, PA, January 1992.

Additional results are provided in an ATA Foundation 1992 survey⁹² of 69 trucking companies operating in an urban area. More than half of the 69 companies surveyed use CAD systems. Productivity gains resulted from an increase in the number of pickups and deliveries per truck per day, ranging from 5% to more than 25%, with most gains being clustered in the 10 - 20% range. The use of two-way text communication systems yielded driver time savings of 30 minutes per day because of the reduced time spent locating and using telephones.

⁹²ATA Foundation, Inc., "A Survey of the Use of Six Computing and Communications Technologies in Urban Trucking Operations," Alexandria, VA, 1992.

5.0 BENEFITS OF INTELLIGENT VEHICLES

ITS services focusing on the vehicle include those functions that assist the driving task or recommend control actions. Although many in-vehicle services are directly effected by non-vehicle infrastructure systems, for purposes of classification this section considers those systems which directly influence the driving task as part of the Intelligent Vehicle Program Area.

Most Intelligent Vehicle services are applicable across all platforms of vehicles. However, a few services have been developed for specific types of vehicles. For example, unlike other types of vehicles, commercial vehicles may have cargo monitoring systems to alert drivers of possible load shifting or hazardous materials leakage. Because there has been little reported benefit data for individual platforms, this report classifies all data related to Intelligent Vehicles into driver assistance and collision avoidance and warning systems.

5.1 DRIVER ASSISTANCE



ITS services that assist in the driving task are beginning to make their way to the market place. In-vehicle vision enhancement may improve safety for driving conditions involving reduced site distance due to night driving, inadequate lighting, fog, snow, or other inclement weather conditions. Navigational systems are also included here as they provide assistance to the driver in unfamiliar surroundings. Figure 5-1 summarizes how benefits data are classified under driver assistance.

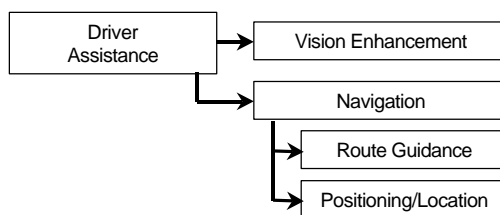

Figure 5-1: Taxonomy for Driver Assistance



The INTEGRATION simulation model was used to estimate the safety impact of the TravTek project. The simulation consisted of a representation of the Orlando roadway network, and performance parameters obtained during the field studies. Analyses were performed to estimate crash risk of motorists using navigation devices compared to

motorists without them. In addition, the safety impacts on the entire traffic network (both equipped and unequipped vehicles) were analyzed. Results indicated an overall reduction in crash risk of up to 4% for motorists using navigation devices, due to improved wrong turn performance and the tendency of the navigation system to route travelers to higher class (normally safer) facilities. Increased safety risks of up to 10% were estimated for the equipped vehicles, while the overall network showed the safety impact to range from neutral to a slight improvement when diversion occurred. The network safety improvements were experienced when diversion from congested roadway reduced the level of congestion for the remaining equipped and non-equipped vehicles and helped to smooth traffic flows on those roads⁹³.



TravTek users perceived that their driving was safer. Based on survey data, users felt less nervous and confused and more confident, attentive, and safe, with local users being significantly more positive than renters. Users also felt that the use of TravTek did not interfere with their driving task. While users were no more likely to be involved in close calls than were nonusers, users who were interacting with TravTek immediately before a “near accident” were more likely to feel that they had contributed to close calls⁹⁴. In-vehicle navigation devices can benefit users in terms of travel time and route finding. Field operational test experience is producing data that suggest system benefits when wider deployment appears. The TravTek test in Orlando found that for unfamiliar drivers, wrong turn probability decreased by about 33% and travel time decreased by 20% relative to using paper maps, while travel planning time decreased by 80%⁹⁵. The TravTek yoked driver study demonstrated a travel time benefit from the use of the system for route planning and route guidance. A time savings of 80% was observed for trip planning⁹⁶. Simulations using data collected during the TravTek test predicted an increase in throughput. Using constant average trip duration as a surrogate for maintaining level of service, a market penetration of 30% for dynamic route guidance results in the ability to handle 10% additional demand⁹⁷.

⁹³Inman, V., et al, “*TravTek Evaluation: Orlando Test Network Study*,” Federal Highway Administration, FHWA-RD-95-162, January 1996.

⁹⁴Inman, V., et. al., “*TravTek Evaluation: Rental and Local User Study*,” FHWA-RD-96-028, Federal Highway Administration, March 1996.

⁹⁵Inman, V. et al., “*TravTek Evaluation Orlando Test Network Study*,” FHWA-RD-95-162, Federal Highway Administration, January 1996.

⁹⁶Inman, V., et al, “*TravTek Evaluation Yoked Driver Study*”, FHWA-RD-94-139, Federal Highway Administration, October 1995.

⁹⁷Van Aerde, M., and Rakha, H., “*TravTek Evaluation: Modeling Study*,” FHWA-RD-95-090, Federal Highway Administration, March 1996.



The ADVANCE project in the Northwest suburbs of Chicago tested the time effects of dynamic route guidance using a yoked vehicle study on an arterial network with limited probe data. The aggregate data set demonstrated that motorists could reduce travel time by 4% under normal or recurring conditions; however, a small sample size and relatively high standard deviation formulated the basis for this result⁹⁸. It did appear that the dynamic route guidance concept, as implemented in ADVANCE, can detect some larger delays and help drivers to avoid them.

The Pathfinder project implemented an in-vehicle navigation and motorist information system including access to real-time traffic information. The project was implemented in the Los Angeles area. The evaluation⁹⁹ stated that the Pathfinder navigation system delivered meaningful user benefits including fewer travelers failing to follow their desired route. Since in-vehicle systems operate in a complex environment, specific results vary with the conditions and options selected.



In preliminary analyses performed for the Automated Highway System Program, throughput increases of 300% for platooned operation and 200% for non-platooned automated control compared to non-automated freeway segments have been predicted.



Analysis based on the Long Island Expressway and the Capital Beltway near Washington DC, predicted that capacity improvements could reduce travel time by 38% to 48%¹⁰⁰.



Beginning operations in the spring of 1994, VICS is considered to be the forefront of ITS in Japan. The system is now covering 4 city areas: Tokyo, Aichi, Osaka and Kyoto, and provides drivers with road condition information and alternative route choices to avoid congestion.



Drivers using the system report that they felt less stressed due to the provided advice. They also indicated that they would like the area of service expanded. Road tests of the system have indicated that the dynamic route guidance provided saves about 15% of travel time¹⁰¹.

⁹⁸Schofer, J. et al., “*Formal Evaluation of the Targeted Deployment*,” Vol. II, Appendix J, Northwestern University Transportation Center, July 1996.

⁹⁹Pathfinder Evaluation Report, Prepared for California Department of Transportation, JHK & Associates, Pasadena, CA, February 1993.

¹⁰⁰Stevens, W. et al., “Summary and Assessment of Findings From the Precursor Analysis of Automated Highway System,” The MITRE Corporation, WN95W0000124, October 1995.

¹⁰¹“VICS reduces travel time by 15%,” ERTICO News, January 1998, p10.

5.2 COLLISION AVOIDANCE / WARNING



Collision avoidance and warning systems are expected to result in safety and effective capacity benefits by reducing the number of incidents. Collision avoidance includes several user services such as Intelligent Cruise Control, Rear-end crash avoidance, and

Road Departure avoidance. Each of these user services may take on three different levels of control. The lowest level warns or suggests to the driver what action to take. The middle level responds to safety-compromising positions by taking limited control of the vehicle. For example, intelligent cruise control could slow a vehicle down if approaching a lead vehicle too quickly. The highest level of control would be when the system overrides the driver and takes complete control of the vehicle. User services associated with collision avoidance and warning systems are classified as shown in figure 5-2.

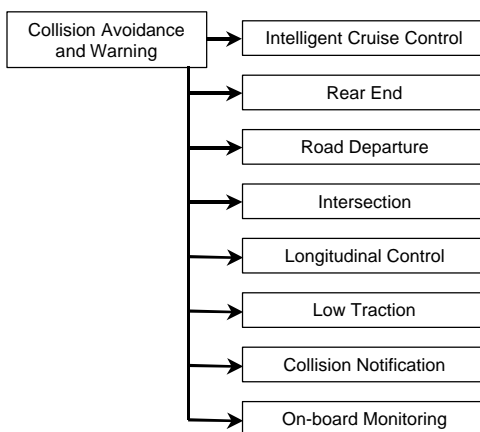

Figure 5-2: Taxonomy for Collision Avoidance / Warning



Less complete implementations, termed evolutionary representative system configurations, with rear-end collision warning or collision avoidance, can show less dramatic capacity increases. Analyses performed on hypothetical data indicates effective capacity increases of 30% with collision warning in uniform vehicles to 60% with collision avoidance in vehicles differing in braking capacity¹⁰².

¹⁰²“Precursor Systems Analyses of Automated Highway Systems: Volume Four - Lateral and Longitudinal Control Final Report,” prepared by University of Southern California Center for Advanced Transportation Technologies under subcontract to Raytheon Company for Federal Highway Administration, February 1995.



A recent NHSTA study estimated the possible effectiveness of several collision avoidance technologies. The effectiveness for rear-end collisions with the lead vehicle decelerating is estimated to be 42%. For prevention of collisions with lead vehicle stopped, the estimate is 75%. The overall effectiveness of rear-end collision is predicted to be 51%. Lane Change or Lane Merge warning systems are estimated to decrease all lane change collisions by 37% or about 90,000 crashes annually. Road-departure countermeasures are estimated to have an effectiveness of 24% resulting in about 287,000 crashes avoided annually. The study also indicates that the economic benefits of the three systems together would be approximately \$25.6 billion (based on the 1994 value of the dollar)¹⁰³.



¹⁰³Kianianthra, Dr. Joseph, and Mertig, A., “*Opportunities for Collision Countermeasures Using Intelligent Technologies*,” National Highway Traffic Safety Administration, 1997.

6.0 SUMMARY

The evaluation of implemented systems and emerging concepts of ITS has been an ongoing process. Significant knowledge is available for many ITS services, but gaps in knowledge also exist. This paper has summarized much of the quantifiable data on ITS impacts collected by the JPO. In general, all ITS services have shown some positive benefit. Negative benefits are usually outweighed by other positive impacts. For example, higher speeds and improved traffic flow result in increases in Nitrous Oxides, however other emission measures, fuel consumption, travel time, and delay, are reduced.

Due to the wide range of different technologies used to implement these services and the difference in variables between implementations, in many cases it is difficult to predict the potential impacts of individual ITS services planned for a particular area. Also, ITS services are beginning to be incorporated into the planning process and are included with the addition of traditional capacity or service. When this occurs, it is very difficult to measure the separate impacts of the additional capacity and the individual ITS services. However, through simulation and comparison with similar services that have been implemented elsewhere, planners and decision makers may be able to estimate the contribution of the ITS services. Furthermore, where measured or predicted data are not available, perceived or anecdotal benefits may be available. This type of data can be determined through interviews or from case studies.

Although further evaluation of ITS services is an ongoing program, the remainder of this section summarizes the availability and depth of known data and points to where gaps in knowledge exist. Table 6-1 presents the number of measured and predicted impacts of ITS services discussed in this report. The table is organized along the taxonomy presented in this report and reflects the various measures that have been reported in each area. These data may be unrelated and referenced reports may contain more than one data point for a particular service. Also, the authors acknowledge that other data may exist which could have been included but has yet to be uncovered in their literature search.

Table 6-2 presents the data in a slightly different format. The table organizes the data by the measures of effectiveness and reflects a scale of the available data. Circles within cells that are blank have no reported data for that particular service area and measure of effectiveness. The various levels of shaded circles then indicate a progressing number of available data points for any given service area and measure of effectiveness. In this table, the number of data points represent the sum of all available measured and predicted data points from table 6-1. The reader who is interested in finding available benefits information on a particular measure of effectiveness can use this table as a cross reference into the report.

It can be seen that most of the data collected to date is concentrated within the metropolitan areas, while rural has very few data points available. This is probably due to the fact that the metropolitan program has been in existence longer and is much more developed than rural or CVO. The heaviest concentrations of data in the metropolitan area are in traffic signal systems, freeway management and

incident management. Most of the available data on traffic signal control systems is from adaptive traffic control. For freeway management, most data is concentrated around benefits related to ramp metering. Although there are several operational test currently underway for the program area of highway/rail intersections, it is the newest area of metropolitan infrastructure and no data has been reported as of this date.

Currently, little benefits data has been collected regarding rural ITS. Several state and national parks are now examining the possibilities of providing better tourism and travel information, and several rural areas are implementing public transit services. Also many, states are now examining the benefits of incorporating ITS into the operation and maintenance of facilities and equipment. Over the next several years and as this program matures more data will become available.

ITS/CVO continues to provide benefits to both carriers and state agencies. Although it appears that little data has been collected for ITS/CVO, the data that has been reported is from measures that are often directly measurable. Therefore, it might be expected that this data is accurate and few data points would be necessary to convince carriers, states and local authorities of the possible benefits of implementing these user services. Also, it may be that few data points are needed to convince local jurisdictions that data sharing, and other integration measures between other jurisdictions could provide for significant cost savings and improved service. To date, the largest percentage of benefit data related to ITS/CVO is from carrier operations and fleet management systems.

ITS programs areas and user services associated with driver assistance and specific vehicle classes are still being developed and planned. Although a few of these services are available in the marketplace, much of the data currently associated with these services is predicted or projected based on how systems are expected to perform. As market penetrations increase and improved systems are developed, there will be ample opportunity to measure and report more accurate data.

Analysis of table 6-2 indicates that ITS benefits data is available across all measures of effectiveness categories. The heaviest concentration of data available for particular measures is for time/delay and cost savings. Much less data is available on emissions and customer satisfaction at this point in time.

Infrastructure	User Service	Benefit Area	Number of References	
			Measured	Predicted
Metropolitan	Arterial Management Systems	Safety	9	
		Time	12	3
		Throughput	1	
		Customer Satisfaction	2	
		Emissions/Fuel Savings	5	
	Freeway Management Systems	Other	4	
		Safety	5	
		Time	2	
		Throughput	4	
	Transit Management Systems	Other	2	
		Time	3	
		Cost	2	
	Incident Management Systems	Customer Satisfaction	1	
		Safety	4	
		Time	10	1
	Emergency Management	Cost	6	
		Emissions/Fuel Savings	2	1
		Time	1	
	Electronic Toll Collection	Customer Satisfaction	1	
		Other	1	
		Time	1	
	Electronic Fare Payment	Throughput	1	
		Cost	1	
Emissions/Fuel Savings		1		
Time		1		
Regional Multi modal information	Cost	5		
	Customer Satisfaction	6		
	Emissions/Fuel Savings	1		
	Other	5		
Integrated systems	Time	4		
	Cost	3		
	Customer Satisfaction	2		
Rural	Traveler Safety and Security	Safety	1	
	Emergency Services	Safety	1	
		Time	1	
	Public Travel and Mobility	Cost	2	
		Other	1	
Infrastructure Operation	Cost	2		
ITS/CVO	Safety Assurance	Cost	1	
	Credentials Administration	Time	1	
	Electronic Screening	Time		1
		Cost	4	
	Carrier Operations	Time	5	
		Cost	7	
Other		4		
Intelligent Veh.	Driver Assistance	Safety		4
		Time	3	
		Throughput		1
		Cost		1
	Platform Specific	Customer Satisfaction	2	
Safety			1	
Total		Throughput		1
			144	14

Table 6-1: Number of References summarized in this report

Key:
 Number of References
 0 : ○
 1 to 3 : ◐
 4 to 6 : ◑
 7 to 10 : ◒
 > 10 : ◓

		Safety	Time & Delay	Effective Capacity	Cost	Customer Satisfaction	Emissions/Fuel Saving	Other
Metropolitan	Arterial Management Systems	◑	◓	◑	○	◑	◑	◑
	Freeway Management	◑	◑	◑	○	○	○	◑
	Transit Management	○	◑	○	◑	◑	○	○
	Incident Management	◑	◓	○	◑	○	◑	○
	Emergency Management	○	◑	○	○	◑	○	◑
	Electronic Toll Collection	○	◑	◑	◑	○	◑	○
	Electronic Fare Payment	○	◑	○	◑	○	○	○
	Highway/Rail Intersection	○	○	○	○	○	○	○
	Regional Multimodal Travel Information	○	○	○	◑	◑	◑	◑
	Integrated Systems	○	◑	○	◑	◑	○	○
Rural	Traveler Safety and Security	◑	○	○	○	○	○	○
	Emergency Services	◑	◑	○	○	○	○	○
	Tourism and Travel Information	○	○	○	○	○	○	○
	Public Travel and Mobility Services	○	○	○	◑	○	○	◑
	Infrastructure Operation and Maintenance	○	○	○	◑	○	○	○
	Fleet Operation and Maintenance	○	○	○	○	○	○	○
ITS/CVO	Safety Assurance	○	○	○	◑	○	○	○
	Credentials Administration	○	◑	○	○	○	○	○
	Electronic Screening	○	◑	○	◑	○	○	○
	Carrier Operations	○	◑	○	◑	○	○	◑
I.V.	Driver Assistance	◑	◑	◑	◑	◑	○	○
	Platform Specific	◑	○	◑	○	○	○	○

Table 6-2: Summary of Available Data by Benefit Measure

APPENDIX 1: REFERENCE LIST

"Assessment of Intelligent Transportation Systems/Commercial Vehicle Operations Users Services: ITS/CVO Qualitative Benefit/Cost Analysis - Executive Summary," American Trucking Associations Foundation, Inc., Alexandria VA, 1996.

"Battle Lines Drawn in California Legislature Over Red Light Running Cameras," The Urban Transportation Monitor, May 22, 1998.

"Estimation of Benefits of Houston TranStar," Prepared by Parsons Transportation Group in cooperation with the Texas Transportation Institute, February 7, 1997.

"Fast-Trac's Signal System Clear Winner for County Commuters," in ITS America News, May 1997.

"Incident Management: Detection, Verification, and Traffic Management," Field Operational Test Cross-Cutting Study, Boos Allen & Hamilton, September 1998.

"Innovations in Transportation and Air Quality: Twelve Exemplary Projects," US department of Transportation, Publication number FHWA-PD-96-016, 1996.

"Intelligent Transport Systems Handbook in Japan," Highway Industry Development Organization, Ministry of Construction, October 1997.

"ITS developed by Japanese Police," Japan Traffic Management Technology Association, Institute of Urban Traffic Research, Undated.

"NJ Transit's Customer Information Speeded Up by New System," Passenger Transport, January 24, 1994.

"Partners in Motion, 494 Transportation Corridor: ICTM Project, Interim Report #1," Prepared for ICTM Evaluation Committee by HNTB Corporation, undated.

"Precursor Systems Analyses of Automated Highway Systems: Volume Four - Lateral and Longitudinal Control Final Report," prepared by University of Southern California Center for Advanced Transportation Technologies under subcontract to Raytheon Company for Federal Highway Administration, February 1995.

"Ramp up the Volume," in ITS International, Nov/Dec 1997.

"SCOOT in Toronto," Siemens Automotive, USA, in Traffic Technology International, Spring 1995.

"Software System Eases Truck Permitting" in Civil Engineering, July 1998, p 30.

"Speed Modulation Experimentation," SANEF, eastern and Northern Highways Concessionary Company - France, October, 1998.

"Survey Finds London Transit Info changes Behavior, Creates Revenue," Inside ITS, March 9, 1998, p8.

"Traffic Control Systems Give Transit a Break," Newslines, TRB, December 1995.

"Transportation: Driving a Thriving Economy," American Association of State Highway and Transportation Officials and the National Governors's Association, May 1997.

"VICS reduces travel time by 15%," ERTICO News, January 1998, p10.

"The Crescent Project: An Evaluation of an Element of the HELP Program," the Crescent Evaluation Team, Executive Summary and Appendix A, February 1994.

Advanced Rural Transportation Systems (ARTS): Strategic Plan, United States Department of Transportation, August 1997.

ATA Foundation, Inc., "A Survey of the Use of Six Computing and Communications Technologies in Urban Trucking Operations," Alexandria, VA, 1992.

Barbaresso, James C., "Preliminary Findings and Lessons Learned From The Fast-Trac IVHS Program," Road Commission for Oakland County, Beverly Hills, MI, 1994.

Beteille, J. and Briet, G., "Making Wave in Traffic Control," Traffic Technology International, Annual 1997.

Booz Allen & Hamilton, "1996 Olympic and Paralympic Event Study," Final Report, May 1997.

Borough, Peter, "Variable Speed Limits Reduce Accidents Significantly in the U.K.," The Urban Transportation Monitor, March 14, 1997.

Bunting, Alan, "Tracking Trucks," in ITS: intelligent transport systems, Man/June 1997.

Casey, R., "The Benefits of ITS Technologies for Rural Transit," The Volpe Center, presented at the Rural ITS Conference, September 1996.

Casey, R. et. al., "Advanced Public Transportation Systems: The State of the Art - Update '96," USDOT Federal Transit Administration, January 1996.

Center for Transportation Research and Education, "Automated Mileage and State line Crossing Operational Test Evaluation Summary," Final Report, Federal Highway Administration, May 1996.

City of Los Angeles Department of Transportation, "Automated Traffic Surveillance and Control (ATSAC) Evaluation Study," June 1994.

Clean Air Action Corp., "Proposed General Protocol for Determination of Emission Reduction Credits Created by Implementing an Electronic Pike Pass System on a Tollway," Study for the Northeast States for Coordinated Air Use management, December, 1993.

Coleman, Janet A. et al "FHWA Study tour for Speed Management and Enforcement Technology," Federal Highway Administration, Publication No. FHWA-PL-96-006, February 1996.

COMSIS Corporation, "CHART Incident Response Evaluation Final Report," Silver Spring, MD, May 1996.

Cuciti P., and B Janson., "Incident Management via Courtesy Patrol: Evaluation of a Pilot Program in Colorado," 74th annual Meeting of the Transportation Research Board, Washington DC, Transportation Research Record, 1995.

Deeter, D., and Bland, C.E. "Technology in Rural Transportation 'Simple Solutions'," Federal Highway Administration, Publication No. FHWA-RD-97-108, October 1997.

Dinning, M., "Benefits of Smart Cards in Transit," The Volpe Center September 1995.

Farwell, R., "Evaluation of OmniLink Demand Driven Transit Operations: Flex-Route Services," SG Associates, Annandale, Virginia, presented at the European Transport Forum, 1996.

Federal Railroad Administration, Office of Safety Analysis

Fors, Heather, "Transit Safety is Up Due to Timed Lights," The Minnesota Daily, February 2, 1998.

Giugno, M., Milwaukee County Transit System, July 1995 Status Report.

Giuliano, G., et al., "Los Angeles Smart Traveler Information Kiosks: A Preliminary Report," 74th Transportation Research Board Annual Meeting, Transportation Research Record 1516, January 1995.

Glassco, R., et al., "Studies of Potential Intelligent Transportation System Benefits Using Traffic Simulation Modeling," Mitretek Systems, MP96W0000101, June 1996.

Glassco, R., et al., "Studies of Potential Intelligent Transportation System Benefits Using Traffic Simulation Modeling: Volume 2," Mitretek Systems, MTR 1997-31, June 1997.

Goeddel, D., "Benefits Assessment of Advanced Public Transportation Systems (APTS)", prepared for Federal Transit Administration by Volpe National Transportation Systems Center, July 1996.

Hallowell, S., and Morlok, E., "Estimating Cost Savings From Advanced Vehicle Monitoring and Telecommunication Systems in Intercity Irregular Route Trucking.," department of Systems, University of Pennsylvania, Philadelphia, PA, January 1992.

Harris, John & Sands, Mary, "Life-Saving Speed Camera Technology," Traffic Technology, 1995.

Haselkorn, M., et al., "Evaluation of PuSHMe Mayday System," Final Report, June 19, 1997.

Henk, Russell H. et al, "Before-and-After analysis of the San Antonio TransGuide System," Texas Transportation Institute, Third World Congress on Intelligent Transportation Systems, July 1996.

Henk, R. H. "Before-and-After Analysis of the San Antonio TransGuide System Phase I," 76th Annual Meeting, Transportation Research Board, Washington DC, January 1997.

Henry, K. and Meyhan, O., "6 Year Flow Evaluation", Washington State DOT, District 1, January 1989.

Hogema, Jeroen H., and Richard van der Horst, "Evaluation of the A16 Motorway Fog-Signaling System with Respect to Driving Behavior," TNO Human Factors Research Institute.

Inman, V., et al, "TravTek Evaluation: Orlando Test Network Study," Federal Highway Administration, FHWA-RD-95-162, January 1996.

Inman, V., et al, "TravTek Evaluation Yoked Driver Study", FHWA-RD-94-139, Federal Highway Administration, October 1995.

Inman, V., et. al., "TravTek Evaluation: Rental and Local User Study," FHWA-RD-96-028, Federal Highway Administration, March 1996.

Intelligent Transport Systems Handbook in Japan, Highway Industry Development Organization, Ministry of Construction.

Jones, W., "ITS Technologies in Public Transit: Deployment and Benefits", USDOT ITS Joint Program Office, November 1995.

Kanianthra, Dr. Joseph, and Mertig, A., "Opportunities for Collision Countermeasures Using Intelligent Technologies," National Highway Traffic Safety Administration, 1997.

Kirkham, Rob, "Making the most of SCATS," Traffic Technology International, Annual 1997, p 32-34.

Kloos, W., et al., "Bus Priority at Traffic Signals in Portland: The Powell Boulevard Pilot Project," ITE Compendium of Technical Papers, July 1994.

Lennon L., "Tappan Zee Bridge E-Z Pass System Traffic and Environmental Studies," Compendium of Technical Papers, 64th ITE Annual Meeting, Institute of Transportation Engineers, 1994.

Mathieu, J., "Multiservices/Multiproviders Remote Ticketing on the Marseille Metropolitan Area," Proceedings of the Second World Congress on Intelligent Transport Systems, November 1995.

Maze, TH., et al., "Automated Mileage and State line Crossing Operation Test Part 1 - Evaluation Summary," May 1, 1996.

Melillo, Wendy, "Traffic Enforcement By Remote Camera Catching On in Area," The Washington Post, March 16, 1998, p B08.

Meyer, Harvey, "Safer Cars Make Safer Roads," GEICO Direct, Fall 1997, p 24-27.

Meyer, M., ed., "A Toolbox for Alleviating Traffic Congestion", Institute of Transportation Engineers, Publication No. IR-054B, Washington DC, 1997.

Minnesota Department of Transportation, "Highway Helper Summary Report - Twin Cities Metro Area," Report # TMC 07450-0394, July 1994.

Orcutt Associates, "Evaluation Study, Buffalo Gap Road, Abilene Signal System," prepared for the City of Abilene, Texas, 1994.

Pathfinder Evaluation Report, Prepared for California Department of Transportation, JHK & Associates, Pasadena, CA, February 1993.

Peters, J. McGurrin, M. J., Shank, D. E., and Cheslow, M., "*An Estimate of Transportation Cost Savings form Using Intelligent Transportation System (ITS) Infrastructure,*" in ITE Journal, November 1997.

Philip, Davy & Walter Schramm, "Cashless tolls mean money saved," Reprinted from Traffic Technology International 1997 for Hughes Transportation Management Systems, Canada.

Pilli-Sihvola, Yrjo, Kimmo Toivonen, and Jouko Kanton, "Road Weather Service System in Finland and Savings in Driving Costs," Finnish National Road Administration.

Regan, A., et al., "Improving Efficiency of Commercial Vehicle Operations Using Real-Time Information: Potential Uses and Assignment Strategies," 74th Transportation Research Board Annual Meeting, Transportation Research Record 1493, January 1995.

Remer, M., Atherton, T., and Gardner, W., "ITS Benefits, Evaluation and Costs: Results and Lessons from the Minnesota Guidestar TravLink Operational Test, "Draft, November 1995.

Ride Solutions, "Operational Strategies for Rural Transportation," Florida Coordinated Transportation System, undated

Robinson, J. and Piotrowicz, G., "Ramp Metering Status in North America, 1995 Update," Federal Highway Administration, June 1995.

Samartin, Kevin, "Under Detection," ITS: intelligent transport systems, May/June 1997.

Schofer, J. et al., "Formal Evaluation of the Targeted Deployment," Vol. II, Appendix J, Northwestern University Transportation Center, July 1996.

Schwenk, J., "Using Credit Cards To Pay Bus Fares in Phoenix," The Volpe Center, DOT-TSC-FTA-96-01, 1996.

Shifrel, Scott, "Satellites Around Globe May Save Lives Right Here," The Palm Beach Post, June 1, 1997.

Smith, S. and Perez, C., "Evaluation of INFORM - Lessons Learned and Application to Other Systems," Conference Paper Presented at 71st TRB, January 1992.

Stevens, W. et al., "Summary and Assessment of Findings From the Precursor Analysis of Automated Highway System," The MITRE Corporation, WN95W0000124, October 1995.

Stone, J., "Winston-Salem Mobility Management: An Example of APTS Benefits," NC State University, 1995.

Study of Commercial Vehicle Operations and Institutional Barriers, Appendix F, Booz, Allen & Hamilton, McLean, VA, November 1994.

Taylor, Steven T., "*Helping Americans*," feature article, ITS World, Jan/Feb 1997.

Taylor, B. and Bergan, A., "Words of Warning" in ITS: intelligent transport systems, Issue No 10, May/June 1997.

Tech Environmental, Inc., "Air Quality Benefit Study of the SmarTraveler Advanced Traveler Information Service," July 1993.

USDOT, Federal Transit Administration, APTS Benefits, November 1995.

Van Aerde, M., and Rakha, H., "TravTek Evaluation: Modeling Study," FHWA-RD-95-090, Federal Highway Administration, March 1996.

Wetherby, B., et al., "System Effectiveness Test," final report, June 10, 1997.

Zhou, Wei-Wu, et al., "Fuzzy Flows," ITS: intelligent transportation systems, May/June 1997.

APPENDIX 2: LISTING OF ACRONYMS

AMASCOT: Automated Mileage and State line Crossing Operational Test

ANTTS: Automated Network Travel Time System

APTS: Advanced Public Transit Systems

ATA: American Trucking Association

ATIS: Advanced Traveler Information Systems

ATMS: Advanced Transportation Management Systems

AVL: Automated Vehicle Location

CAD: Computer Aided Dispatch

CASPER: Computer Aided System for Planning Efficient Routes

CCTV: Closed Circuit Television

CMAQ: Congestion Mitigation and Air Quality Improvement Program

CO: Carbon monoxide

CVO: Commercial Vehicle Operations

DGWS: Down Grade Warning System

DOT: Department of Transportation

ETC: Electronic Toll Collection

FHWA: Federal Highway Administration

GPS: Global Positioning System

HAR: Highway Advisory Radio

HC: Hydro carbons

HOV: High Occupancy Vehicle

HRI: Highway Rail Intersection

IFTA: International Fuel Tax Agreement

INFORM: Information for Motorist

IRP: International Registration Plan

ITE: Institute of Transportation Engineers

ITS: Intelligent Transportation Systems

JPO: ITS Joint Program Office of the U.S. DOT

LTA: Land Transport Authority

MDI: Model Deployment Initiative

NOx: Nitrous Oxide

OS/OW: Oversize and Overweight

PuSHMe: Puget Sound Help Me Mayday System

RESCU: Remote Emergency Satellite Cellular Unit

ROUTES: Rail, Omnibus, Underground Travel Enquiry System

RRWS: Ramp Rollover Warning System

SCATS: Sydney Coordinated Adaptive Traffic Control

SOV: Single Occupancy Vehicle

SURF-2000: Systeme Urbain de Regulation des Feux

TEA-21: Transportation Efficiency Act for the 21st Century

TIMS: Traffic and Incident Management System

U.S. DOT: United States Department of Transportation

VMS: Variable Message Sign

VMT: Vehicle Miles Traveled

**To access an electronic version of this publication
and other ITS related publications visit the**

**ITS Electronic Document Library (EDL):
<http://www.its.fhwa.dot.gov/cyberdocs/welcome.htm>
EDL Document Number 8323**

**Visit Our ITS WEB Site
ITS Joint Program Office: <http://www.its.dot.gov>**

**Publication No. FHWA-OP-99-012
HVH-1/2-98 (200) QE**