

United States
Department of
Agriculture

Forest Service

Forest
Products
Laboratory

Research
Paper
FPL 450

Structural Fire Design: Wood

E.L. Schaffer



Abstract

Analytical procedures to predict the fire endurance of structural wood members have been developed worldwide. This research is reviewed for capability to predict the results of tests in North America and what considerations are necessary to apply the information here. Critical research needs suggested include: (1) Investigation of load levels used in reported tests, and parameters in analyses, for application to North American practice; (2) the effect of lumber grade on wood property response at elevated temperature; and (3) further effort in reliability-based design procedures so that the safety of fire-exposed members and assemblies may be determined.

Keywords: Structural design, structural members, timber/structural, wood, wood laminates, fire resistance, fire protection, structural analysis, connections, joints, beams/structural, columns/structural, structural adhesives, softwoods, hardwoods, heat resistance, high temperature tests, thermal degradation, mechanical properties.

October 1984

Schaffer, E. L. Structural fire design: Wood. Res. Pap. FPL 450. Madison, WI: U.S. Department of Agriculture, Forest Service, Forest Products Laboratory; 1984. 16 p.

A limited number of free copies of this publication are available to the public from the Forest Products Laboratory, P.O. Box 5130, Madison, WI 53705. Laboratory publications are sent to over 1,000 libraries in the United States and elsewhere.

The Laboratory is maintained in cooperation with the University of Wisconsin.

Contents

	Page
Introduction	1
Properties of Wood	3
Charring	3
Temperature and Gradients	4
Strength	5
Modulus of Elasticity (Parallel to Grain)	5
Tensile and Compressive Strength (Parallel to Grain)	5
Duration of Load	6
Other Properties	6
Summary	6
Deformation (Time-Dependent)	6
Fire Endurance Prediction	8
Beams	8
Columns	9
Connections	12
Decking	13
Tension Members	14
Combined Load Members	14
Research Needs	15
References	15

Nomenclature

A	area
b	beam breadth
d	beam depth
v	charring rate
f	correction factor for column load and slenderness
x	distance into section from section surface
ξ	distance into wood from char-wood interface
g, h	functionals
q	heat flux
P	load
S	load-bearing area section modulus
E	modulus of elasticity
MOR	modulus of rupture
M	moment of applied load
r	radius of gyration
κ	ratio of initially applied load to initial critical buckling load
l/r, λ	slenderness ratio
l	span or column length
ε	strain
σ	stress
T	temperature
α	temperature reduction factor
a_T	temperature-time shift factor
k	thermal conductivity
α_q	thermal diffusivity
β	thermal expansion coefficient
t	time
V	volume

Mathematical Symbols

ξ	xi
λ	lambda
ℓ	script l
ε	epsilon
σ	sigma
α	alpha
β	beta
κ	kappa

Subscripts

B	bending
cw	char-wood interface
c	creep
cr	critical
e	effective
q	heat
o	initial or reference condition
r	residual section and strength property
1,2	secondary conditions
s	surface
T	tension

Structural Fire Design: Wood

E. L. Schaffer

Forest Products Laboratory, Madison, Wis.

Introduction

Heavy timber construction was recognized as having firesafe attributes by the Factory Mutual insurance companies in the early 1800's (8).¹ Massive heavy timber construction, which minimizes concealed spaces for hidden fire spread and allows minimal combustible surface area, withstood severe fires without structural failure. With the inception of the fire endurance rating system employing American Society for Testing and Materials (ASTM) E 119 (4) fire exposure tests, heavy timber type construction, of specified minimum dimensions, was considered equivalent to or better than other types of construction having a 1-hour fire endurance. This appeared to be a "grandfather clause" for acceptance of a proven system. With the key issue being the difference between "real" fire and "simulated" fire performance, this allowance was a rational decision.

Fire endurance is defined (3) as a measure of the elapsed time during which a material or assembly continues to exhibit fire resistance under specified conditions of test and performance. As applied to structural elements of buildings in North America, it is measured by the methods and to the criteria of ASTM Standard E 119 (4). The structural members or assemblies are subjected to a standard fire exposure and evaluated for their continued load-carrying ability or effectiveness to act as a heat transmission barrier. Single structural members are only evaluated for their load-carrying ability. The standard specifies that the applied load be the maximum superimposed load allowed by design under nationally recognized structural design criteria. This loading condition is termed "full design load" and would be determined for timber constructions in the United States employing the National Design Specification (39) and the Timber Construction Manual (1). The E 119 standard also allows test under less than "full design load" if such restricted load conditions are reported.

The minimum nominal dimensions required for timber to be accepted for classification as "Heavy Timber" are given in table 1. Though members were once exclusively sawn from large-diameter logs, such sizes are now also available in glued-laminated lumber (glulam) sections having equivalent fire performance. Fire endurance tests of heavy timber members

using the ASTM E 119 standard fire exposure indicate some sizes may not meet the performance requirements of the standard for a 1-hour rating.

This paper will attempt to summarize the data base related to the deterministic prediction and measurement of the fire endurance of heavy timber members. For testing the accuracy of analytical models, the characteristic loading conditions and actual fire endurance times of members are needed. This is done for each member type.

[*Note.* United States-Canadian data cannot be directly compared with Asian-European fire endurance data for members. Though their fire exposure severities (time-temperature curves) are similar to United States-Canadian practice (fig. 1), Asian-European countries compute allowable design stresses for the wood and members in markedly differing ways (18). Hence, for comparison, the Asian-European results must be translated to the United States-Canadian basis. The mean strengths of dry clear wood, \bar{f}_u , are reduced to design stress levels, f_d , by applying a reduction factor for variability, ϕ ; general adjustment factor, F_s , that includes duration of load application effects; grade factor, G_F ; and cross-section size, C_F :

$$f_d = \phi F_s G_F C_F \cdot \bar{f}_u \quad (1)$$

The reduction factor attempts to correct a population to anticipated use of a weak member. In a statistically normal population, these are usually 5 percent and 1 percent exclusion limits of strength (i.e., 95 pct and 99 pct respectively of the wood used is expected to be stronger than this level). These factors are shown in table 2 (18) for several variability levels. The reduction factor for visually graded lumber in the United States is about 0.474 and, for proper comparison, practices in other countries need to be calibrated to this level. The same care must be used in the general adjustment factor, grade factor, and size factor terms, United States-Canadian F_s levels for softwoods are stress type dependent as shown in table 3 (2).]

¹Italicized numbers in parentheses refer to references cited at end of report.

Table 1.—Minimum nominal dimensions for heavy timber construction

Member and use ¹	Inches, nominal
Columns	
Supporting floor loads	8 x 8
Supporting roof and ceiling loads only	6 x 8
Floor framing	
Beams and girders	6 x 10
Arches and trusses	8 x 8
Roof framing	
Arches from grade not supporting floor	6 x 8 (lower half) 6 x 6 (upper half)
Arches, trusses from top of walls, and other roof framing not supporting floor loads	4 x 6
Floors (covered with 1-in. flooring or ½-in. plywood)	
T and G or splined plank	3
Planks set on edge	4
Roofs	
T and G splined plank	2
Planks set on edge	3
T and G plywood (with exterior glue)	1-1/8

¹T and G—tongued and grooved.

Table 2.—Values of reduction factor for 1 percent and 5 percent exclusion limits (normal distribution) (22)

Levels of coefficient of variation (COV)	Reduction factors (Φ)	
	5 percent exclusion limit	1 percent exclusion limit
0.40	0.342	0.068
.35	.424	.185
¹ .32	.474	.254
.30	.507	.301
² .25	.589	.418
.20	.671	.534
³ .16	.737	.627
.15	.753	.651
⁴ .11	.819	.744
⁵ .10	.836	.767
.05	.918	.884

¹Visually graded sawn lumber. (Based on National Forest Products Association estimates of extreme fiber in bending.)

²Visually graded sawn lumber. (Based on 1977 National Design Specification modulus of elasticity.)

³Glued-laminated lumber. (Based on National Forest Products Association estimates of extreme fiber in bending.)

⁴Machine stress-rated sawn lumber. (Based on 1977 National Design Specification modulus of elasticity.)

⁵Glued-laminated timber. (Based on 1977 National Design Specification modulus of elasticity.)

Table 3.—General adjustment factor, F_s, applied to various softwood¹ stress types in the United States and Canada (2)

Property	Factor
Modulus of elasticity	1.00
Bending strength	0.475
Tensile strength	.475
Compressive strength parallel to grain	.526
Shear strength	.244
Compressive strength perpendicular to grain	.667

¹Adjustment factors for hardwoods are generally 10 percent smaller (10).

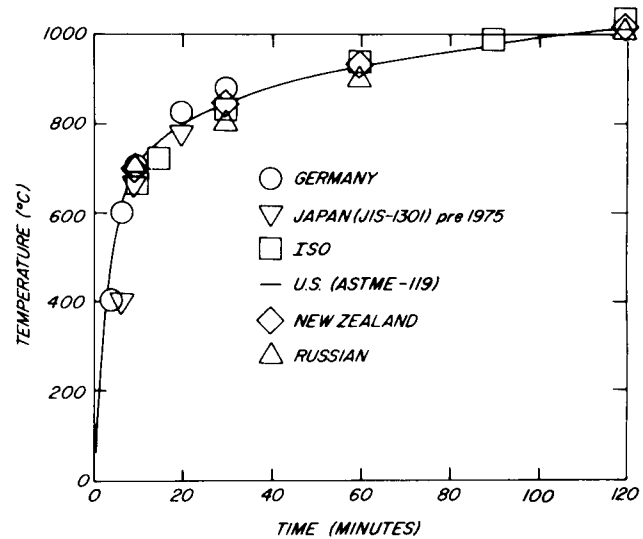

Figure 1.—Standard fire exposure time-temperature curves used around the world. (M149 244)

Properties of Wood

To generate analytical models for estimating fire endurance that are not simply empirical, the models need to include parameters for the charring of the wood, compensation for wood strength or reformation characteristics at elevated temperature, and changing moisture content. Considerable progress has been made in defining these effects in recent years.

Charring

The progressive conversion of the fire-exposed surfaces to ever-deepening char occurs at definable rates. Because of the negligible strength and fissured nature of this char, only uncharred wood is assumed to contribute to load-carrying capability. The interface between charred and noncharred wood is the demarcation plane between black and brown material. Because the temperature gradient through this area is steep, the demarcation is practically characterized by a temperature of 288°C (550°F).

It is relatively well established that the rate of conversion to char decreases with increasing moisture content and density of the wood used (45). Charring rate is also affected by the permeability of the wood to gaseous or vapor flow. Charring normal to the grain of wood is one-half that parallel to the grain (19,22,54). As long as the residual section is large with respect to the depth of char development, the rate is unaffected by the dimension of the section exposed.

The charring rate, v , for vertically exposed surfaces of coast Douglas-fir and southern pine species (commonly used in glulam beams, columns, and decking) and white oak under ASTM E 119 fire exposure (fig. 1) is given in table 4. Other countries cite charring rates comparable to these for species of similar densities. However, German experiments (29) have shown that the bottoms of loaded beams experience a higher charring rate (0.043 in./min) during exposures of up to 50 minutes. Evidently the increased charring is a result of the effect of beam deflection to reduce insulative capacity of the char layer. That is, the char layer develops wider fissures than in the nonloaded case.

Charring rates have been both measured for various species and employed in design by various countries. In general, softwood rates range from 0.024 to 0.033 inch per minute (in./min) and are inversely proportional to density. Based upon these results, a charring rate for all softwoods would conservatively be 0.031 in./min under fire exposure. Hardwood charring rates are less than 0.021 in./min.

Table 4.—Charring rate of vertically fire-exposed sections of coast Douglas-fir, southern pine, and white oak (52)

Species	Dry specific gravity	Charring ¹ rate, v (in./min)	Coefficient of variation
Coast Douglas-fir	0.45	0.0245	9.9
Southern pine	.52	.0300	6.5
White oak	.68	.0207	—

¹At mean species density and moisture content of 12 percent.

The charring rates cited apply to cases where members are either large enough in cross section or durations of fire exposure short enough to minimize heat storage within the uncharred residual volume. A qualitative measure of the onset of heat storage is given by the time at which temperature at the center of a fire-exposed section begins to rise significantly above that initially. A 2- by 4-inch section, for example, could tolerate only a few minutes of fire exposure on four sides, as compared to an 8 by 10, before a significant heat storage effect develops. Such storage of heat will increase the charring rate because less energy is required to raise the material temperature and more can be used in pyrolysis. For a given wood species, the energy stored with time can be rigorously defined as a function of wood density and specific heat capacity, member volume, surface area exposed, and temperature difference between exterior and interior. If all other variables are constant, one may expect the time, t , until heat storage develops significantly to be only a function of the member surface area exposed to fire, A_s , and member volume, V :

$$t \propto \frac{V}{A_s}$$

For a long beam or column, this can be expressed as a function of initial fire-exposed perimeter and cross-section area, A . For a three-sided fire exposure of a beam of breadth, b , and depth, d , the time is:

$$t \propto \frac{A}{(b + 2d)} \quad (2)$$

The relationship of charring rate to this effect has not been qualified.

Temperature and Moisture Gradients

The temperature gradients generated within a fire-exposed wood section are very steep because of the low thermal diffusivity coefficient, α_q , of wood. Char develops in the temperature range of 280° to 320°C (536° to 608°F); 288°C (550°F) has been found to be a convenient temperature level to locate the char-pyrolyzing wood interface through the use of embedded thermocouples. The steep temperature gradient (heat flux) generates movement of moisture within the section. Description of the temperature and moisture gradients within fire-exposed wood sections has received considerable research attention in recent years. Such description is intended to provide the basis for adjusting standard mechanical properties for elevated temperature and moisture content in fire-exposed load-bearing members.

Providing an analysis that predicts either, or both, the temperature gradient and moisture gradient within such sections has not been attained to date (53). Though a finite element analysis does predict the temperature gradient quite well in oven-dry (0 pct moisture content (MC)) wood, the results with moisture present do not. Approximations of the temperature gradient at early and later stages of fire exposure have been found useful. For fire exposure with little char development (up to 5 min), Carslaw and Jaeger (11) provide estimates for constant heat flux, q_0 :

$$T - T_0 = \left(\frac{2q_0}{k}\right) (\alpha_q t)^{1/2} \text{ierfc} \left[\frac{x}{2(\alpha_q t)^{1/2}}\right], \quad (3)$$

where:

$$\text{ierfc}(u) = \frac{2}{\sqrt{\pi}} \int_u^{\infty} (\Phi - u)e^{-\Phi^2} d\Phi. \quad (4)$$

The heat flux, \dot{q}_0 , is about 3 watts/cm² for a standard fire exposure.

A second equation has been used (47) to describe practically the temperature distribution in the uncharred wood below the char-wood interface at a distance, ξ , once a quasi-steady-state charring rate, v has been reached. (This occurs about 15 to 20 min after initiation of fire exposure.) The equation is:

$$\frac{\{T - T_0\}}{\{T_{cw} - T_0\}} = \exp \left[\frac{-v\xi}{\alpha_q} \right], \quad (5)$$

and where:

T_{cw} = char-wood interface temperature of 288° C (550° F), and

T_0 = initial wood temperature.

ξ = depth into wood from char-wood interface

α_q = thermal diffusivity

The temperature distribution for times between 5 and 15 minutes would require interpolation, as no satisfactory solution is available.

Once the center of a section begins to increase in temperature, heat is being stored. In this case, too, no analytical solutions are available to describe the temperature gradient change with time.

Kanury (25) provides estimates for the temperature distribution in solid panels exposed to fire on one side. Improved predictions of temperature and pyrolysis of wood are being sought (e.g., Kansa *et al.* (24)).

The moisture distribution has been measured in sections during and after fire exposure (13,47,53). One notes that the moisture decreases from a peak to zero in a 0.59-inch (1.5-cm) zone in the wood below the char-wood interface. Research (47, 53) has shown that a peak occurs at about 100°C and is about 1.26 to 2.0 times greater than the initial MC. The location of the peak is well correlated ($R = 0.98$) to the location of the char-wood interface. Typical moisture and temperature gradient curves are shown (fig. 2) for a southern pine section of mean dry specific gravity of 0.52 and initial MC of 10.0 percent.

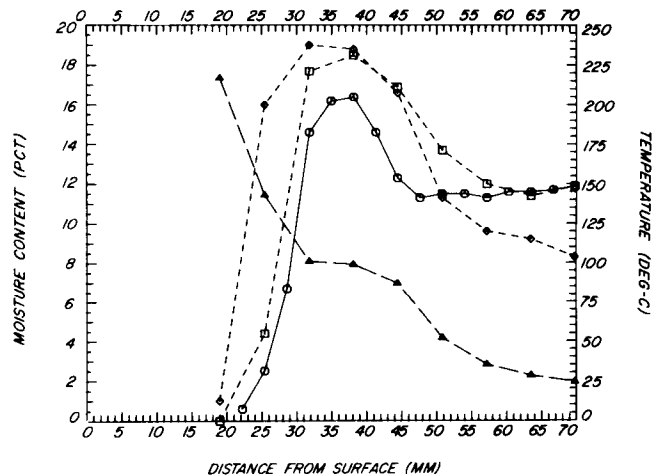

Figure 2.—Experimentally measured temperature and moisture content gradients within slab exposed on one face to furnace temperature of 538° C for about 20 minutes (53).

◇ □ ○ Moisture content results

△ Temperature results

(M148 841)

Strength

This section focuses on how various defect-free wood strengths (tensile, compressive, bending, and shear) and the modulus of elasticity (E) are influenced by a change in temperature and MC. (Considerable recent research indicates that temperature and moisture change response of defect-free wood differs significantly from that of lumber and timbers containing knots, checks, and slope-of-grain defects. Unfortunately there is yet no way to compensate directly for the effect temperature and moisture have on defect-containing lumber. As a result, corrections for temperature and moisture in structural lumber and timbers must be based upon defect-free response estimates.)

Modulus of Elasticity (parallel to grain)

The E of dry (0 pct MC) wood decreases linearly with increasing temperature to about 200°C (fig. 3). Above 200°C, there is some evidence it decreases nonlinearly. For wood at 12 percent MC, a common in-use level, a small linear decrease is observed to about 180°C, and decreases rapidly above this level (fig. 3).

Tensile and Compressive Strength (parallel to grain)

The tensile strength parallel to grain exhibits a small linear decrease to about 200°C; above 200°C the effect becomes greater (fig. 4).

Parallel-to-grain compressive strength of dry wood (0 pct MC) linearly decreases more rapidly with temperature than tensile strength (fig. 5). Limited data for wood at 12 percent MC and temperatures to 70°C show an even greater decrease.

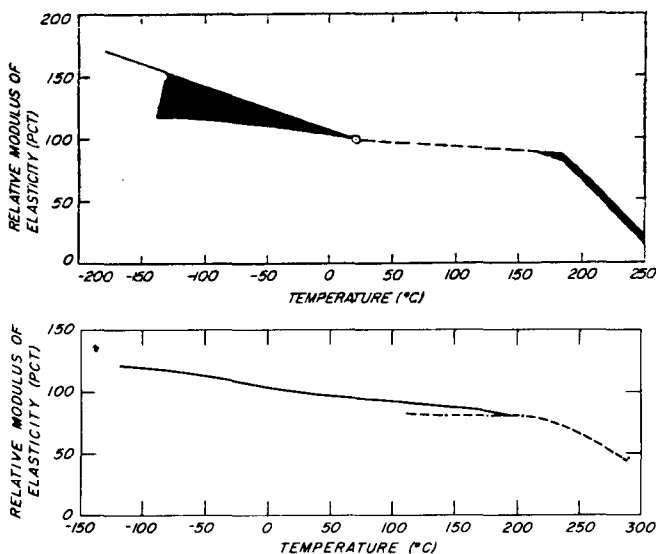

Figure 3.—Effect of temperature on E parallel to grain at near 0 percent MC and at about 12 percent MC. E is 100 percent at 20° C. Banded areas indicate variability in results reported by various researchers (17).
A. Moisture content of 12 percent.
B. Moisture content of 0 percent.
(M148 689) (M149 818)

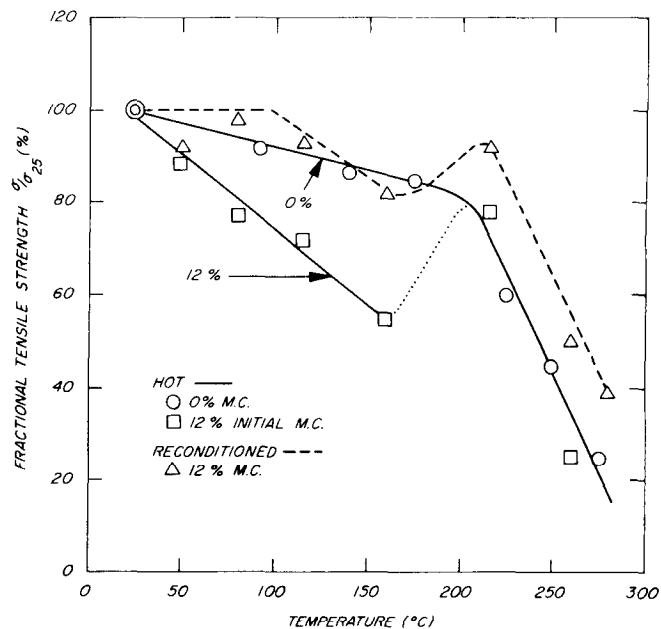

Figure 4.—Tensile strength as function of temperature while hot as well as after cooling (47).
(M145 176)

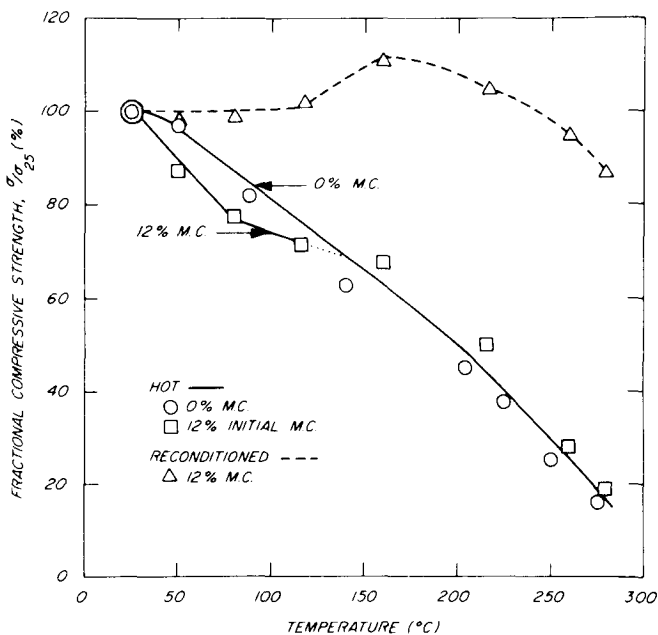

Figure 5.—Compressive strength as function of temperature while hot as well as after cooling (47).
(M145 174)

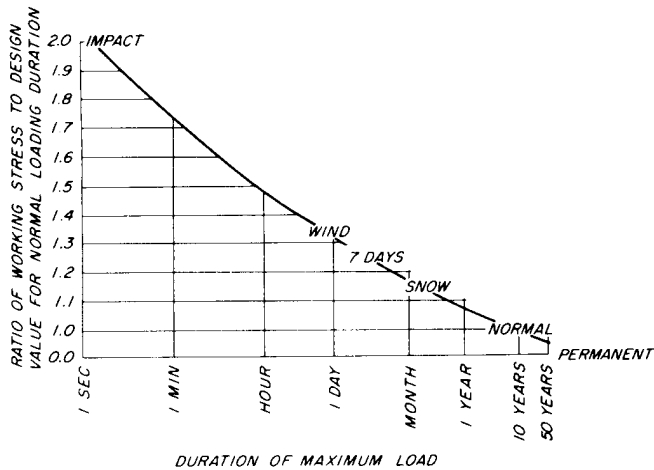

Figure 6.—Adjustment of working stresses for various durations of load application (39). (M149 822)

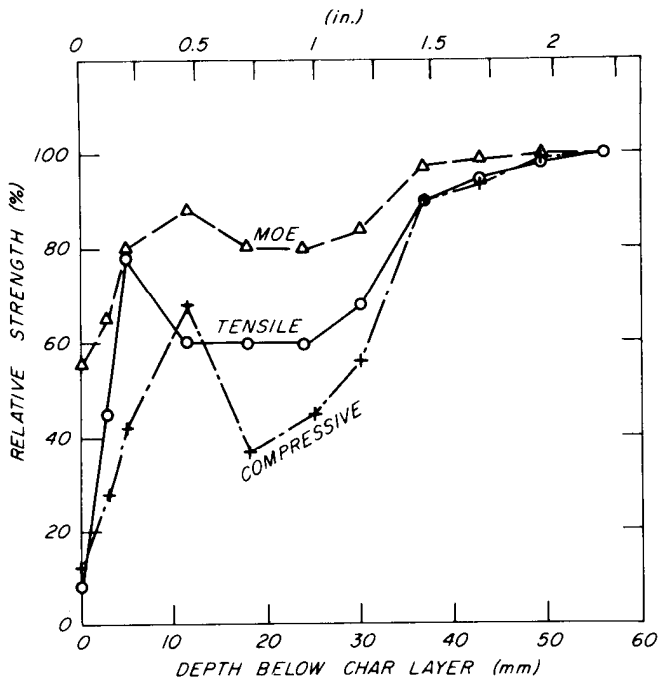

Figure 7.—Relative modulus of elasticity, compressive and tensile strength as function of distance below char layer in softwood section under fire exposure. (Expressed in percent of that at 25° C and initial moisture content of 12 pct.) Duration of fire exposure should be equal to or greater than 20 minutes to apply results of this figure. (M149 821)

Duration of Load

Wood can carry substantially greater maximum loads for short durations than for long durations. As a result the working stresses are compensated for expected periods of load application. The allowable stresses given in the National Design Specification (39) have been adjusted to reflect the effect of 10 continuous or accumulative years of full design load application and is termed normal duration of load. The ratio of other working stress levels to the normal allowable stress levels is shown in figure 6 (39). Note that for a period of load application of full design load for 1 hour, the allowable normal stresses may be increased 47 percent. The duration of load adjustment does not apply to moduli of elasticity or rigidity.

Other Properties

For detailed information on such other mechanical properties as shear strength and tensile strength (normal-to-grain), the reader is directed to a comprehensive survey produced by C. C. Gerhards (17).

Summary

A rise in temperature decreases all mechanical properties and the decrease becomes greater with increasing wood moisture content.

The parallel-to-the-grain strength and stiffness responses may, at this point, be combined with temperature and MC gradient information for large fire-exposed sections. This is illustrated in figure 7 for parallel-to-grain E, and compressive and tensile strength as a function of distance into the wood below the char layer. The results apply to a cross section large enough to minimize temperature rise at the center of the section and after 20 minutes of fire exposure to allow a quasi-steady moisture and temperature gradient to develop. These factors can be applied to adjust the modulus of elasticity and expected tensile-compressive strength for estimating rupture levels under fire exposure. Care should be used in applying any duration of load factor in accomplishing this. To precisely predict the true stress state, or predict failure, a complete analysis including time-dependent stress-strain compatibility is required.

Deformation (Time-Dependent)

The parallel-to-grain time-dependent deformation (creep) of wood is important to fire-exposed structural members.

Though long-duration creep has been examined at temperatures of 25°C and several moisture contents, no similar long-term creep information is available at higher temperature with varying MC. Increasing the exposure temperature results in increasing the rate of creep deformation (5,26,29,43,46). As MC is increased as well, the creep rate is increased proportionately (6). Hence, hot moist conditions are conducive to high creep deflection.

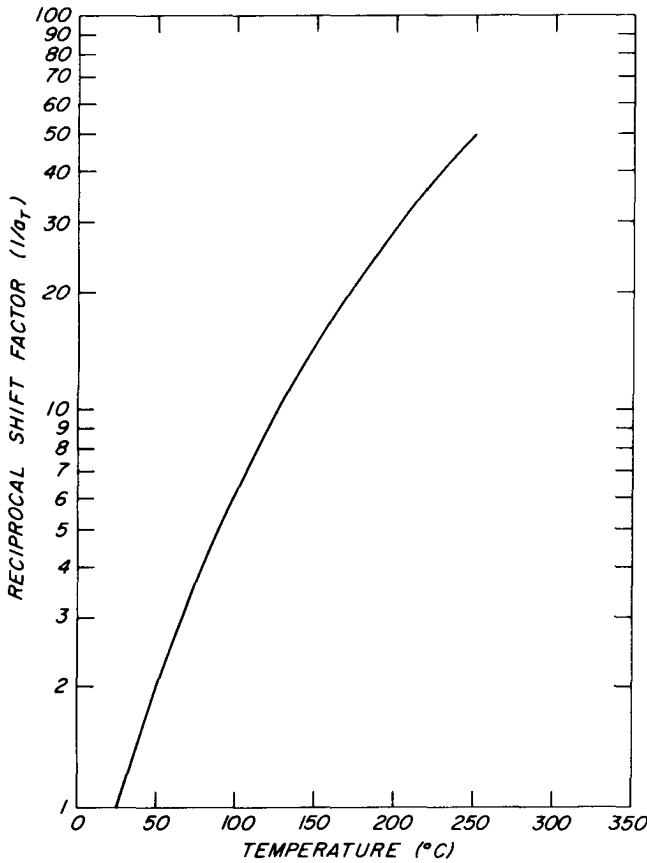

Figure 8.—Reciprocal shift factor ($1/a_T$) for oven-dry Douglas-fir as a function of temperature. (M149 817)

Total creep strain behavior, ϵ_c , can be prescribed as a function of temperature, T , by a single exponential function (5):

$$\epsilon_c = \sigma t^{0.25} \{ (.27 \times 10^{-4}) \exp(.042 T) \} \quad (6)$$

where t is time in minutes, and T , the temperature in $^{\circ}\text{C}$. Such a form has been employed to predict the total deformation with time in a short column loaded parallel to grain, using a finite difference technique (5).

To partition the creep into recoverable and irrecoverable (permanent or plastic) deformation at elevated temperature has proved difficult to fully quantify (48), but it is believed the ideal model has the form:

$$\epsilon_c = g_1(\sigma) \int_{-\infty}^t D_1(\xi - \xi') \frac{dg_2(\sigma)}{d\xi'} d\xi' + \int_{-\infty}^t \beta_1(\xi - \xi') \frac{d\phi_1(\xi)}{d\xi'} d\xi' \quad (7)$$

where

- T = absolute temperature { $^{\circ}\text{K}$ },
- D_1 = creep compliance,
- β_1 = thermal expansion or shrinkage (time dependent),
- Φ_1 = function of the temperature difference, ξ ,
- ξ = $T - T_0$, and
- ξ = $\int_0^t \frac{dt'}{a_T}$, and
- a_T = shift factor = $a_T(T)$,
- $g_1(\sigma)$ and $g_2(\sigma)$: functions of stress, σ .

The effect of elevated temperature on creep response is reflected in the shift factor, a_T . Creep increases dramatically with increasing temperature as shown by the response of reciprocal shift factor with temperature shown in figure 8. Creep is magnified tenfold at 125°C and fiftyfold at 250°C compared to 25°C .

Levels of creep are small at room temperature, but increase with both temperature and MC (6) (fig. 9).

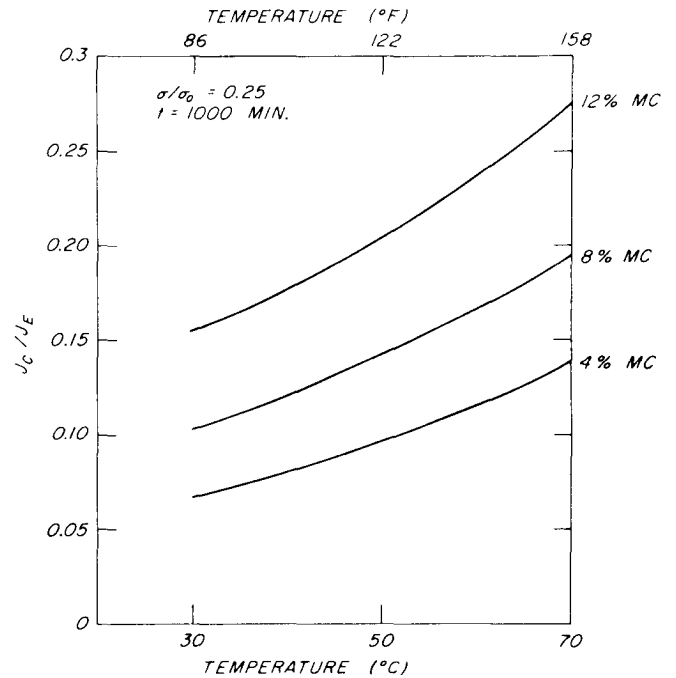

Figure 9.—Ratio of creep compliance to elastic compliance for maple as function of temperature and moisture content (6). (Applied stress is 25 pct of room temperature ultimate. Duration of creep $t = 1,000$ minutes.) (M149 497)

Fire Endurance Prediction

The fire endurance predictive models in Europe and Asia have been developed through modifying simple strength theory for the reduction in cross-section size due to charring. Similar models have not as yet been proposed in the United States and Canada. The models and references to actual fire endurance test data for major structural member types will be briefly discussed in the sections to follow. Negligible effort has been expended in using the thermal and mechanical property characteristics summarized in the preceding section to develop improved models. The analysis to determine the stress or deformation state to predict failure requires the application of time-dependent stress-strain compatibility and solution of heat and mass transfer equations. The models proposed are attractive to users because of their simplicity in application.

Beams

Under fire exposure heavy beams may catastrophically fail due to (1) achieving critical extreme fiber stress, (2) reaching a critical horizontal shear, or (3) reaching a state where the beam becomes unstable if not laterally supported. Excessive deflection or crushing at the supports might be other conditions of interest, but these usually are not as serious as the above three. Available analyses have focused on using the initial three cited.

For bending rupture, the elementary strength of materials formula of

$$\sigma = \frac{M}{S} \quad (8)$$

is used to calculate time under fire exposure to achieve a selected rupture stress level. In this case it takes the form:

$$\sigma_{cr} = \frac{M}{S(t)} \quad (9)$$

where

M = moment of applied load
 σ_{cr} = critical modulus of rupture
S(t) = section modulus for the char-reduced section.

Unprotected rectangular beams are usually exposed to fire on three or four sides, in which case S(t) is:

$$S(t) = \frac{1}{6} [(b_o - 2v_1 t)(h_o - kv_2 t)^2] \quad (10)$$

As before, v_1 and v_2 are charring rates normal to the grain in the width, b_o , and depth, h_o , directions respectively. Here k is a constant, 1 for three-sided fire exposure, and 2 for four-sided.

Such a formulation requires specification of an appropriate critical modulus of rupture, σ_{cr} , and charring rates, v_1 and v_2 , to solve the equation for the time-to-failure, t. Many countries employ this form to either predict the failure of heavy timber beams or set minimum cross-section requirements to achieve 30-, 60-, and 90-minute endurance ratings for various beam grades (9,13,14,19,23,26,29,31,32,34,35,40,41,49, 50). Charring rates, v_1 , and critical strengths, σ_{cr} (given as a fraction of unheated 5 percent (assumed) exclusion limit strength), for several countries are shown in table 5.

Some analyses include the effect of "rounding" at the corners of beams (9,26,35), but most neglect this effect in computing the residual section. The degree of rounding reduces the net section as a function of the breadth to height, b/h, ratio of the section (26). The area lost can be approximated per round as:

$$A = 0.215 (vt)^2 \quad (11)$$

and the center of gravity of the area lost will lie 0.223 vt from either initial surface (9).

A heavy timber deck is assumed to provide sufficient lateral restraint to a beam to prevent lateral buckling during fire exposure (41). If, however, such restraint is not present, analyses are available which include prediction of failure for this state (16,23). The most detailed analysis (16) requires numerical procedures to solve for failure time and as a result expresses the results in dimensionless ratios as a function of char depth, breadth, height, and span for several factors of safety.

Horizontal shear failure can occur during fire exposure of beams having relatively short spans and great depth. It is suggested that the critical span, l , to depth, d, ratio must be 22.2 or less for shear failure to be evidenced during fire exposure (26).

Other limit states are used to predict beam failure in some countries. Austria (7) employs a rate of bending deformation limit {cm/min} of $l^2/8,000d$ and Britain (9) $l/30$.

Table 5.—Critical parameters for fire endurance of softwood beams and columns proposed by various countries

Country	Char rates v_1, v_2	Bending		Compression		Horizontal Shear	Tension	Reference
		σ_c/σ_o^1	Δ	C_c/C_o^1	E_c/E_o	$\tau_c\tau_o$	σ_c/σ_o	
Finland	0.024, .024 ².031, .031	0.75	—	—	0.85	—	—	43
Sweden	.024, .024	.8	—	—	—	—	—	28,49
New Zealand	.025, .025	.5	—	—	—	—	—	66
Russia	.031, .031	.8	—	0.8	—	0.78	0.85	33
Britain	.026, .026	.68	³Span/30	.68	.70-.80	—	—	12,50,53
Germany	.031, .043	—	—	—	—	—	—	42
France	.026, .026	.83	—	—	—	—	—	60

¹ σ_o, C_o : 5% exclusion limit ultimate stress.

²For solid-sawn members.

³Using $E/E_o = 1$.

Table 6.—Minimum dimensions for base/height required for glued-laminated beams of rectangular cross section (42) to resist four levels of stress¹

Level	Stress		For fire endurance class					
			30 min		60 min		90 min	
			Base	Height	Base	Height	Base	Height
	N/mm^2	Psi	mm	mm	mm	mm	mm	mm
3-SIDED FIRE EXPOSURE								
1	≥14	2,030	140	260	280	520	420	780
2	11	1,600	110	200	220	400	330	600
3	7	1,020	80	150	160	300	240	450
4	≤3	435	80	120	140	220	210	330
4-SIDED FIRE EXPOSURE								
1	≥14	2,030	150	310	300	620	450	930
2	11	1,600	120	250	240	500	360	750
3	7	1,020	90	190	180	380	270	570
4	≤3	435	80	160	160	300	240	450

¹Interpolation is permitted between levels.

Of all beam analysts, German engineers (34) have done the most to test the predictive capabilities of the simple reduced section bending strength model. A group of 35 fire endurance test results obtained on glued-laminated beams of varied cross section and subjected to load levels very close to full design load were compared with predictions. Rupture stress was assumed to be about 2.5 times the initial allowable design stress. The equation was found to consistently underestimate time-to-failure by a range of 0 to 30 minutes. As a result, the model has been used to generate conservative fire endurance design curves for three- and four-sided fire exposure of glulam beams (figs. 10 and 11) having at least the breadth, b, and depths, h, as given in table 6 to achieve the respective fire endurance. For example, a three-sided fire exposure of a glulam beam under load generating an applied stress of 14 N/mm² (2,030 lb/in.²) must have not only a section modulus of about 13,000 cm³ (790 in.³) to have an expected fire endurance of 60 minutes, it must also have a minimum breadth of 280 mm (11.0 in.) and depth of 520 mm (20.5 in.) to be acceptable. Figure 12 illustrates the influence applied stress has on predicted fire endurance for a given beam type.

Columns

The analysis of fire endurance of columns is based upon the increasing slenderness ratio for buckling due to decreasing cross section under fire exposure. As a result, column behavior under fire exposure depends upon column length, fixity, residual cross-section geometries and properties, and modulus of elasticity of the wood. The charring rate for fire-exposed columns is believed to be less than that for beams due to the vertical orientation. This rate is about 0.024 to 0.031 in./min (0.6 to 0.8 mm/min) for softwoods (e.g. 20,42,48).

For a short column, failure can occur when compressive stress in the column achieves a level equal to the temperature-reduced compressive strength $\alpha\sigma_{cr}$ of

$$\alpha\sigma_{cr} = \frac{P}{A_r} \tag{12}$$

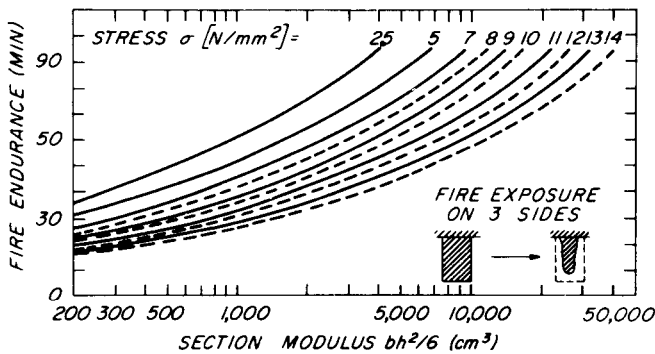

Figure 10.—Fire endurance time of glued-laminated beams exposed to fire on three sides and loaded to various stress levels. Beams of Grade Class II (modified from Meyer-Ottens (34)). (1 N/mm² = 145.04 lb/in.²) (M149 815)

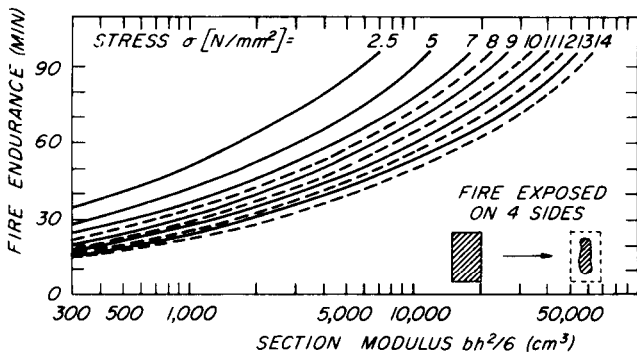

Figure 11.—Fire endurance time of glued-laminated beams exposed to fire on four sides and loaded to various stress levels. Beams of Grade Class II (34). (1 N/mm² = 145.04 lb/in.²) (M149 814)

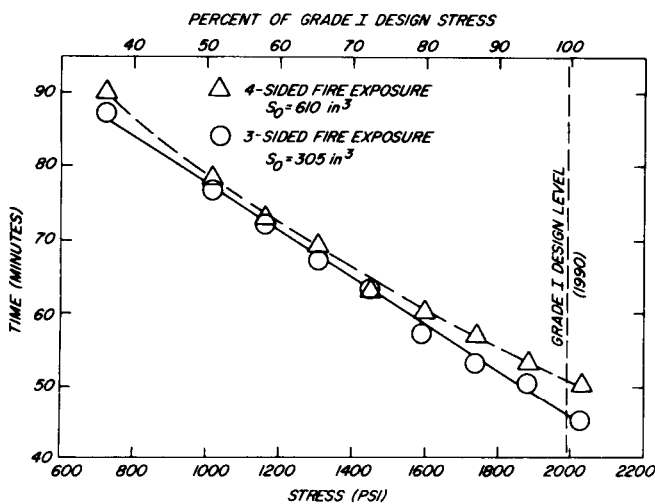

Figure 12.—Influence of applied stress level on fire endurance of glulam beams exposed to fire on three and four sides. (Three-sided beam section modulus = 305 in.³, four-sided beam section modulus = 610 in.³.) (M149 245)

In the case of longer columns, buckling can occur as predicted by Euler's formula:

$$\sigma_{cr} = \frac{\pi^2 E_r}{\lambda^2} \quad (13)$$

where σ_{cr} here is the critical compressive stress at buckling, E_r is modulus of elasticity of the residual section, and A is the slenderness ratio (l_e/r). (The radius of gyration, r , for a rectangular section of breadth, b_o , and depth, d_o , is initially $d_o/\sqrt{12}$ when $d_o < b_o$.)

If one introduces the reduction of cross section due to charring during fire exposure, both cases generate an equation of the form (31):

$$\frac{\frac{b_o}{d_o}}{\frac{d}{d_o} - (1 - \frac{b_o}{d_o})} = \alpha \left(\frac{d}{d_o}\right)^n \quad (14)$$

where $n = 1$ for short columns and $n = 3$ for long columns. For intermediate length columns then $1 \leq n \leq 3$, and n is expected to be 2. By inserting the time-dependent residual depth, d , of:

$$d = d_o - 2vt \quad (15)$$

one may solve for the time-to-failure or critical residual depth, d_{cr} . Lie (31) provides such curves for columns fire exposed on four sides (fig. 13) for various values of initially applied load to critical buckling load, κ . Lie assumes that the other factors are as follows:

$$\alpha = 0.80$$

$$v = .024 \text{ in./min}$$

He further suggests an approximate formula to predict time to achieve failure:

$$t = 33 \left(\frac{d_o}{\kappa}\right) \left[3 - \left(\frac{d_o}{b_o}\right)\right] \quad (16)$$

where dimensions are in meters.

For κ less than 0.2 (or a factor of safety on applied load of greater than 5) the approximate expression overestimates the time predicted by the more exact equation solution.

Lie then compares calculated and experimentally observed fire endurance times of others (8,11,15,33,48). An average value κ of 0.33 and $n = 2$ was assumed. Most predicted times exceeded those observed, but the differences were as high as 50 percent between prediction and observed times. Some improvement in prediction was achieved by correcting for column slenderness and applied loads less than allowable load.

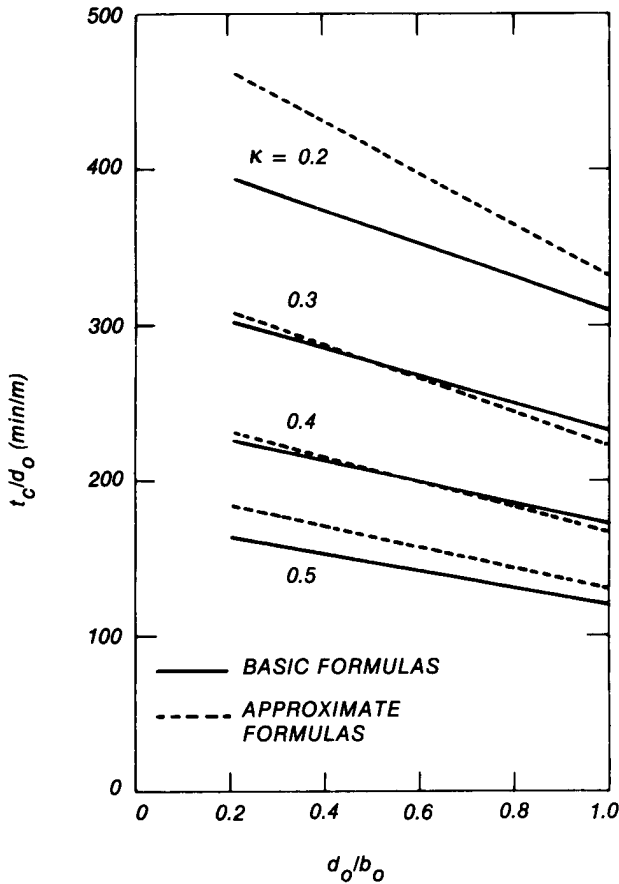

Figure 13.—Fire endurance of columns fire exposed on all four sides as a function of size (m) and load (31). (M149 813)

Table 7.—Load correction factor, f , for fire-exposed columns (38)

Load (as pct of allowable load)	$(t/d_o) > 10$	$(t/d_o) \leq 10$
>75	1.0	1.2
$\leq 75, > 50$	1.1	1.3
≤ 50	1.3	1.5

The resulting approximate formula for four-sided fire exposure was:

$$t_c = 100 f d_o \left[3 - \left(\frac{d_o}{b_o} \right) \right] \quad (17)$$

where f is the correction for load and column slenderness. Values of f for use are as specified in table 7. It is clearly seen that reducing the load increases the fire endurance.

In addition to the above model, and comparison with experimental evidence by Lie, the team of Haksever and Meyer-Ottens (20) proposes the use of solution of the Euler equation using properties of a standard cross section as a base. The standard section is 5.5 in. (14 cm) in depth, d_o , and the "effective" cross-sectional temperature, T , increases with fire exposure time, t , in minutes as follows:

$$T = 20 + 1.67 t \quad \{^\circ\text{C}\} \quad (18)$$

To determine temperature rise, T_m , in other sections, one employs the expression:

$$T_m = T \left(\frac{d}{d_o} \right)^{1.428} \quad (19)$$

where d_r is the residual depth as function of exposure time, t :

$$d_r = d_o - 2vt \quad (20)$$

Incorporated is the effective temperature-time dependence of modulus of elasticity and compressive strength as:

$$\frac{E(t)}{E_o} = g(T_m)$$

$$\frac{\sigma(t)}{\sigma_o} = h(T_m) \quad (21)$$

The charring rate, v , is assumed 0.028 in./min (0.7 mm/min). The compressive stress at buckling, σ_c , is equated to a series' expanded form of a resulting modified Euler equation:

$$\sigma_c = \frac{1}{2} \left[\sigma(t) + \frac{\pi^2 \cdot E(t)}{\lambda^2(t)} (1 + \epsilon) \right] - \quad (22)$$

$$\sqrt{\frac{1}{4} \left[\sigma(t) + \frac{\pi^2 \cdot E(t)}{\lambda^2(t)} (1 + \epsilon) \right]^2 - \frac{\pi^2 \cdot E(t)}{\lambda^2(t)} \cdot \sigma(t)}$$

Here, ϵ , is specified as:

$$\epsilon = 0.1 + \left(\frac{\lambda(t)}{125} \right) \quad (23)$$

Table 8.—Minimum cross-section dimensions (mm) for laminated columns of rectangular shape to satisfy fire endurance classes F 30-B and F 60-B (35)

Column type	Applied compressive stress σ [N/mm ²]	F 30-B								F 60-B							
		Euler-type 2 ¹ $l_e = 1,0l$ ² $l \leq$				Euler-type 3 or 4 ¹ $l_e = 0,7l$ to $0,5l$ ² $l \leq$				Euler-type 2 ¹ $l_e = 1,0l$ ² $l \leq$				Euler-type 3 or 4 ¹ $l_e = 0,7l$ to $0,5l$ ² $l \leq$			
		2.0	3.0	5.0	7.0	2.0	3.0	5.0	7.0	2.0	3.0	5.0	7.0	2.0	3.0	5.0	7.0
1.1	≥ 11	160	168	184	200	150	154	162	170	240	260	300	340	230	240	260	280
1.2	$= 8.5$	145	151	163	175	140	143	149	155	215	231	263	295	210	218	234	250
1.3	≤ 5	120	124	132	140	120	122	126	130	180	190	210	230	180	186	198	210
2.1	≥ 11	140	148	164	180	140	144	152	160	220	238	274	310	210	220	240	260
2.2	$= 8.5$	130	136	148	160	130	133	139	145	200	214	242	270	195	202	216	230
2.3	≤ 5	120	122	126	130	115	116	118	120	170	178	194	210	170	174	182	190

¹ l_e : Effective column length {m}.

² l : Column length {m}.
(1 N/mm² = 145.07 lb/in.²)

One then can seek equivalence of the right-hand and left-hand sides of the above equation numerically by using increments, Δt , of 1 minute. The predicted sizes for a square ($b_0/d_0 = 1$) and rectangular columns having $b_0/d_0 \geq 2$ in order to attain 30- and 60 minute times are given in table 8. Figure 14 illustrates how fire endurance time is influenced by square column dimension, effective length, and applied initial stress. Above a $b_0/d_0 = 2$, they show that fire endurance time no longer is a function of b_0/d_0 but only of minimum dimension.

Experimental results of testing 15 rectangular columns, plus employing the column test results of Stanke (48), are found to lie within the range predicted by the analytical method. (Kordina, Haksever, and Meyer-Ottens (20,28) also provide predicted minimum cross-section dimensions for "I" and "T" shaped laminated columns that will attain 30- and 60-minute fire endurance times.)

Several key differences are found between the results predicted by Lie (31) and that of Haksever and Meyer-Ottens (20). Possibly the greatest difference is generated by the assumed design load condition. The United States-Canadian allowable loads are substantially greater than that in Germany for short columns (fig. 15). At an l/d_0 of 12 (l/r of 42), for example, the allowable load is 26 percent greater in the United States and Canada. Lie partially corrects for this in employing a greater correction factor, f , for columns of ($l/d_0 \leq 10$). However, if results using Lie's approximate formulation are compared to the predicted results of Haksever and Meyer-Ottens given in figure 14 for square columns, Lie predicts consistently earlier failure. The difference at 100 percent design load is about 6-7 minutes and increases to as much as 30 minutes for applied load less than 50 percent of design. This illustrates the need for additional analysis, especially at reduced load levels. (Odeen (40), employing a modified Euler equation, predicts failure times on the order of 5 min less than Lie at 100 pct design load.) Lie also predicts that for increasing b_0/d_0 , fire endurance time increases for a given dimension, d_0 ; whereas Haksever and Meyer-Ottens conclude fire endurance time is insensitive to increasing breadth, b_0 , beyond $b_0/d_0 = 2$.

United States experimental work on columns is limited (36,37). Results on a few timber columns showed the importance of a load-carrying column cap on fire endurance of longleaf southern pine or Douglas-fir columns of 120-in.² cross section. A concrete or protected steel cap was required to achieve a 75-minute fire endurance time under full design load for these 10-foot columns. Haksever and Meyer-Ottens predict a fire endurance of 70 minutes and Lie only 56 minutes for this case. None of the analyses assume the end cap has any effect on fire endurance.

European fire endurance tests of columns are more abundant (12,20,21,27,33,48) and have been used in the discussed analyses. For a discussion of the results of other work, a previous paper can be referred to (47).

Connections

The connections recommended for heavy timber construction in the United States and Canada have changed significantly from the connections employed in early mill-type construction. Earlier connections featured more heavy cast-iron units. Newer connections are composed of steel plates, hangers, and bolts for which the critical load-bearing portions are embedded or concealed within the timber members (38). Typical details are provided in a National Forest Products Association publication (38) and Canadian Wood Council publication (10) and are too extensive to duplicate for use here. European publications also support embedment of critical connectors within wood sections and provide details consistent with United States recommendations (9,19,28). Several typical construction details showing methods meeting this requirement are shown in figure 16 as taken from German reference (19).

Limited information on the performance of timber joints is available in literature (29,30,44,51,52). The German reference (29) also provides the results of investigating the thermal protection afforded bolted and nailed joints by wood plugs or additional thicknesses of wood cover plate. This is shown in figure 16(b). A plug or plate of 0.4-inch (10-mm) thickness can increase the fire endurance of a split-ring bolted or nailed joint under load from 15 to 30 minutes. To achieve an hour, a 1.4-inch (35-mm) thickness is required. The results of tests of nonthermally protected split-ring and bolt-connected joints by Leicester (30) of 11 and 14 minutes compare well with Kordina and Meyer-Ottens (29). Schaffer (44), employed cover plates of 1 inch (25 mm) with 2-1/2-inch (64-mm) split-rings rather than 2-inch- (51 -mm) thick plates and recorded failure in less than 1 minute. Simple lap split-ring joints of nominal 2 by 4 members carried the design load under fire exposure for an average of 2.2 minutes (range 0.-4.1) in Douglas-fir coast wood and 4.0 minutes (range 2.4-5.2 min) in southern pine. Nonjoint members failed at 10.5 and 11.7 minutes respectively for the species under design load in tension.

Nailed joints fare substantially better under load and fire. Unprotected with cover plates, failure occurs in 21 to 33 minutes (29,30).

Recommended critical dimensions and spacings for various joints in order to achieve 30- and 60-minute fire endurance are given in German references (19,28,29).

Decking

To qualify for heavy timber construction (table 1), solid wood decking in the United States is required to be of nominal 2-inch (1.5-in. actual) thickness if tongue and groove (T&G) or splined, and of nominal 3-inch (2.5-in. actual) thickness if consisting of planks set on edge. To satisfy German standards (29), double T&G decking is required to be 50 mm (2.0 in.) thick to meet 30 minute fire endurance under load. This can be reduced to 40 mm (1.6 in.) thick if covered with at least 0.5-inch (12.5-mm) gypsum board or if joints are covered with a 1.2-inch- (30-mm) thick wood batten. At least 2.75-inch- (70-mm) thick T&G decking plus 0.5-inch (12.5-mm) gypsum board are required for a 60-minute fire endurance classification.

A calculation procedure is given by Kordina and Meyer-Ottens (29) to select decking thickness. The procedure calculates the residual uncharred thickness after a given fire endurance period, and computes the residual section modulus and apparent stress under floor load. This resultant stress is compared with five times the near-minimum ultimate stress (or 10 times the allowable bending stress) to determine whether it will perform satisfactorily. Such a procedure assumes the room temperature bending strength is reduced 80 percent (or is 20 pct of room temperature strength) due to the heating. This is highly conservative.

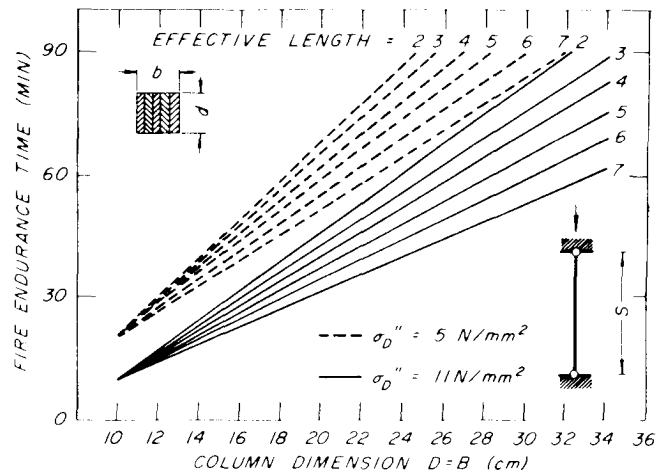

Figure 14.—Square laminated wood column fire endurance time as function of column dimension (modified from Haksever and Meyer-Ottens (20)). (1 N/mm² = 145.04 lb/in.²) (M149 819)

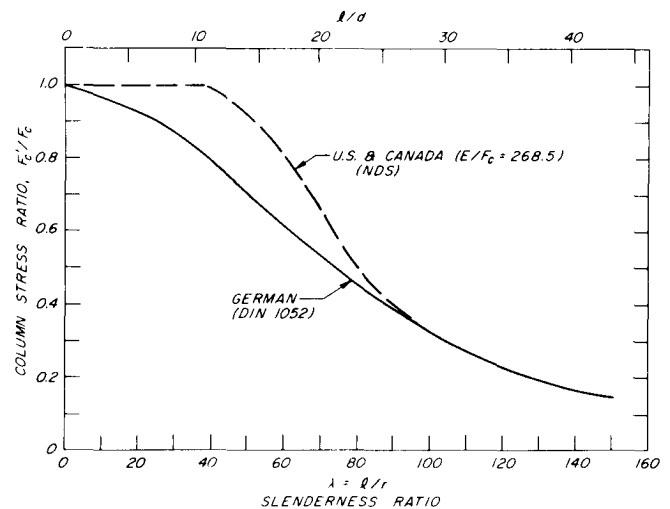

Figure 15.—Column allowable design stress as a function of slenderness ratio (l/r) in Germany and North America. (Curves based upon $E/F_c = 268.5$.) (M149 820)

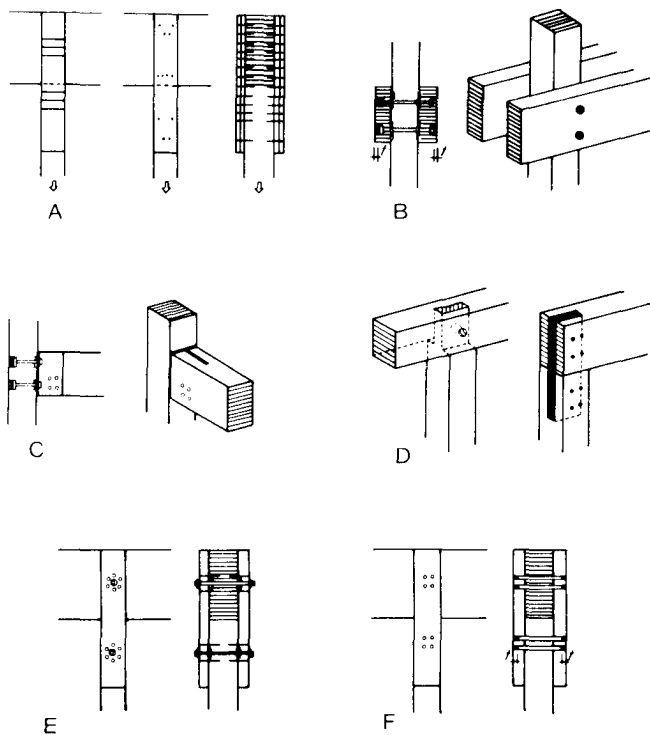

Figure 16.—Typical fire resistive timber connections recommended in Germany (23):
A. Nailed butt-splice joint with sacrificial nailed cover plates. *B.* Split ring and bolted joint with countersunk and wood-capped bolt heads and nuts. *C.* Embedded steel shoe and bolted assembly with countersunk and wood-capped bolt heads. *D.* Simple embedded or wood-doweled connection. *E.* Split-ring connected butt-splice plate joint having exposed bolt head and nut but with cover plates nailed to members. *F.* Butt-splice joint employing embedded steel dowels and wood-capped holes. (M149 802)

Tension Members

A tension member can be treated in the same way as is a short column. That is, the time to failure under load, P , is dictated by the ultimate tensile stress, σ_{cr} , on the residual cross-section, A_r (9,26):

$$\sigma_{cr} = \frac{P}{A_r} \quad (24)$$

However, one reference recommends the charring rate be increased 25 percent in computing the residual section when using charring rates derived from unloaded sections (9). Though not substantiated, it was surmised that charring will be accelerated by the presence of tensile stress. (This is similar to the view that the charring rate along the bottom of fire-exposed beams should be conservatively 40 percent higher than along the sides (29).)

The British (9) also recommend that the ultimate tensile stress in the residual section be assumed 2.0 times the allowable long-term dry stress (as is done in compressive elements).

Only one reference (44) reviewed dealt with the experimental fire endurance of tension members. Though previously unpublished, nominal 2- by 4-inch (1.625- by 3.625-in. actual) Select Structural coast Douglas-fir and southern pine were constantly tension loaded to the allowable design stress during standard fire exposure. The mean times-to-failure and standard deviations (in parentheses) were:

Douglas-fir Min	Southern pine Min
10.5 (2.1)	11.7 (1.1)

Combined Load Members

Russian scientists (26) recommend that an interaction formula be applied to determine when failure will occur under combined tension and bending:

$$\left(\frac{P}{A_r}\right) + \left(\frac{M}{S_r}\right) \leq \sigma_{cr} \quad (25)$$

where σ_{cr} is the failure stress in tension and A_r and S_r are the residual area and residual section modulus respectively. Again, no experimental evidence is provided to indicate this procedure is acceptable. It is not the same as the commonly applied interaction formula of:

$$\frac{\left(\frac{P}{A_r}\right)}{\sigma_{FT}} + \frac{\left(\frac{M}{S_r}\right)}{\sigma_{FB}} \leq 1 \quad (26)$$

where limiting tensile stress, on, and bending stress, σ_{FB} , differ at room temperature.

Research Needs

All of the analytical methods proposed are based upon deterministic models that employ a load-resisting section shrinking under fire exposure. The limit state to predict failure is normally the reaching of a temperature-reduced rupture stress. Moderate success has been achieved in Europe in predicting short-term (less than 1 h) fire endurance using a rupture stress of about 80 percent of initial ultimate low level (5 pct exclusion limit) stress. With the availability of new data on temperature and moisture gradients within large fire-exposed sections, improvements in analysis are possible. The translation of European member and connection test results to what may be expected in North America requires careful attention. For example, it is necessary to define and compensate for the induced initial stress states in Europe as compared to what is prescribed in North America. As indicated earlier, allowable stress levels are determined in varying ways in Europe; the fire endurance of members is quite sensitive to the level of loading. With the current North American practice of conducting fire endurance tests for rating purposes under full design load in order to use the results more universally, the allowable stress level plays a critical role.

The fundamental properties of strength and stiffness as a function of temperature and moisture content have been developed employing "defect-free" wood specimens. There is some concern that the response may not be the same for common structural grades of lumber and timber. Unfortunately, negligible information is available to develop response curves for lower grade material so the response of the defect-free wood will need to be used until better information is available.

The analyses reviewed appear to be on a sound enough basis to be used in design. However, when one is confronted with selecting a given charring rate, rupture stress, and even applied load, normal conservatism means that design is for a "worst case" situation. This approach is traditional in structural design and has been very successful. However, the approach does not allow the "safety" of the structural members to be defined. To assess safety we need to account for variability in fire endurance by including variability in the properties of members (e.g. charring rate, strength, stiffness), variability in anticipated applied load, and variability in fire severity. Reliability-based design and analysis provides such an approach.

References

1. American Institute of Timber Construction. Timber construction manual. John Wiley and Sons. New York; 1974.
2. American Society for Testing and Materials. Standard method for evaluating allowable properties for grades of structural lumber. ASTM Stand. D 2915. American Society for Testing and Materials. Philadelphia, Pa.; 1974.
3. American Society for Testing and Materials. Standard definitions of terms relating to fire tests of building construction and materials. ASTM Stand. E 176. American Society for Testing and Materials. Philadelphia, Pa.; 1979.
4. American Society for Testing and Materials. Standard methods of fire tests of building construction and materials. ASTM Stand. E 119. American Society for Testing and Materials. Philadelphia, Pa.; 1980.
5. Arima, T. Creep in process of temperature change. III Prediction of creep at elevated temperature. J. Jap. Wood Res. Soc. 19(2): 75-79; 1973.
6. Bach, L. Non-linear mechanical behavior of wood in longitudinal tension. Ph.D. Thesis, Syracuse Univ., Syracuse, N.Y.; 1965. (Available from Univ. Michigan Microfilms, Ann Arbor.)
7. Bednar, H. Building regulations concerned with fire safety and their impact on the use of wood products: The situation in Austria. *In: Behavior of wood products in fire.* p. 129-142. Pergammon Press; 1977.
8. Boyd, R. B. Trends in regulation of wood construction and products: an insurance company viewpoint. *Wood and Fiber* 9(1): 33-39; 1977.
9. British Standard Institution. Code of practice for the structural use, part 4. Fire resistance of timber structures, section 4.1, method of calculating fire resistance of timber members. BS 5268, Part 4, Section 4.1: 1978. British Stand. Inst. UK; 1978.
10. Canadian Wood Council. Construction types—Fire Protective Design. CWC Data File FP-2. Ottawa, Canada; 1977.
11. Carslaw, H. S.; Jaeger, J. C. Conduction of heat in solids. Oxford Univ. Press. Oxford, England; 1965.
12. Compin, B. Behavior of wood structures and components (beams and columns) in fire. *In: Behavior of wood products in fire, Semin. U.N. Econ. Comm. Eur.,* p. 85. 1977.
13. Dorn, H.; Egner, K. Fire tests on glued laminated structural timbers (glulam beams). *Holz-Zentralbl.* 28: 435-438; 1961.

14. Dorn, H.; Egner, K. Brandversuche and brett-schichtverleimten Holzträgern unter Biegebeanspruchung. Holz als Roh-und Werkstoff 8; 1967.
15. Fackler, J. P. Essais de resistance au feu. Centre Scientifique et Technique du Batiment, Cahier 415, Paris, France; 1961.
16. Fredlund, B. Structural design of fire exposed rectangular laminated wood beams with respect to lateral buckling. Rep. 79-5, Lund Inst. Tech., Dep. Struct. Mech., Lund, Sweden; 1979.
17. Gerhards, C. C. Effect of moisture content and temperature on mechanical properties of wood: an analysis of immediate effects. Wood and Fiber. 14(1):4-36; 1981.
18. Goodman, J. R.; Kovacs, Z.; Bodig, J. Code comparisons for design of wood members based upon factor design methodology. Presented at annual FPRS meeting. Boston, Mass., July 1980.
19. Götz, K-H; Hoor, D.; Möhler, K.; Natterer, J. Holzbau Atlas. Institut für Internationale Architektur-Dokumentation Gmb H. Muchen, Germany; 1978.
20. Haksever, A.; Meyer-Ottens, C. Brandverhalten von brett-schichtverleimten Holzstützen. Forschungsbeiträge für die Baupraxis. Verlag von Wilhelm Ernst & Sohn. Berlin, Munich, Dusseldorf; 1979.
21. Haksever, A.; Meyer Ottens, C. Fire response of laminated rectangular wood columns with respect to buckling. Institute für Baustoffe, Massivbau und Brandschutz. Technischen Universität Brunschweig. Brunschweig, W. Germany; 1979.
22. Hall, G. S.; Sanders, R.; Allcorn, R.; Jackman, P.; Hickey, M. W.; Fitt, R. Fire performance of timber-literature survey. Timber Res. and Dev. Assoc., High Wycombe, Bucks, UK; 1972.
23. Imaizumi, K. Stability in fire of protected and unprotected glued laminated beams. Norsk. Skogind. 16(4): 140-151; 1963.
24. Kansa, E. J.; Perlee, H. E.; Chaiken, R. F. Mathematical model of wood pyrolysis including internal forced convection. Combust. Flame 29(3): 311-324; 1977.
25. Kanury, A. M. Thermal decomposition kinetics of wood pyrolysis. Combust. Flame 18(1): 75-83; 1972.
26. Kirpichenko, G. M.; Romanenkov, I. G. Basic principles of fire resistance analysis of timber structures. [Presented at US-USSR Conf. on Fire Resist. of Struct., NBS, Gaithersburg, Md.]; 1980.
27. Klement, E.; Rudolphi, R.; Stanke, J. Das Brandverhalten von Holzstützen unter Druckbeanspruchung. Deutschen Gesellschaft für Holzforschung. (DGFH) 6: 318-330; 1972.
28. Kordina, K.; Meyer-Ottens, C. Feuerwiderstandsklassen von Bauteilen aus Holz und Holzwerkstoffen. Tech. Univ. Braunschweig, Inst. für Baustoffkunde und Stahlbetonbau, Braunschweig.
29. Kordina, K.; Meyer-Ottens, C. Fire behavior of wood structures. Tech. Univ. Braunschweig. FRG Inst. Baustoffkunde. Stahlbetonbau Braunschweig; 1977.
30. Leicester, R. H.; Seath, C. A.; Pham, L. The fire resistance of metal connectors. Proc. 19th For. Prod. Res. Conf., 12-16 Nov. 1979, Melbourne, Australia; 1979.
31. Lie, T. T. A method for assessing the fire resistance of laminated timber beams and columns. Natl. Res. Council of Canada, Div. Build. Res., DBR 718; June 1977.
32. Lie, T. T. Calculating resistance to fire. Can. Build. Dig., CBD 204, NRC. Canada; 1979.
33. Malhotra, H. L.; Rogowski, B.F.W. Fire resistance of laminated timber columns. In: Proc. Symp. No. 3, Fire and structural use of timber in buildings. p. 16-51. Minist. Tech. and Fire Off. Comm., Joint Fire Res. Org., HMSO, London; 1970.
34. Meyer-Ottens, C. Feuerwidenstandsdauer unbekleideter hoher Rechteck balken aus Brettschichtholz. Forschungsbeiträge für die Baupraxis. Wilhelm Ernst and Sohn, Berlin; 1979.
35. Monomen, E. Design of timber structures for fire resistance in Finland. In: Behavior of wood products in fire, Semin. U.N. Econ. Comm. Eur.; 1977. p. 103.
36. National Board of Fire Underwriters. Factory Mutual. Natl. Bur. of Stand. In: Fire tests of building columns; 1919.
37. National Bureau of Standards. Fire resistance classifications of building constructions. Rep. BMS 92. NBS Dep. Commer., Washington, D.C.; 1942.
38. National Forest Products Association. Heavy timber construction details. Wood Construction Data No. 5, p. 5.

39. National Forest Products Association. National design specification for wood construction. Washington, D.C.; 1980.
40. Odeën, K. Fire resistance of glued, laminated timber structures. *In: Proc. Symp. No. 3, Fire and structural use of timber in buildings proceedings.* p. 7-15. Minist. Tech. and Fire Off. Comm., Joint Fire Res. Org., HMSO, London; 1970.
41. Ozelton, E. C.; Baird J. A. Timber designers manual. Chapter 22. *In: Structural design for fire resistance.* Crosby, Lockwood, Staples; London, UK; 1976.
42. Rogowski, B.F.W. Charring of timber in fire tests. *In: Proc. Symp. No. 3, Fire and structural use of timber in buildings.* p. 52-59. Minist. Tech. and Fire Off. Comm., Joint Fire Res. Org., HMSO, London; 1967.
43. Sawabe, O. Studies on the thermal softening of wood. III Effects of temperature on the bending creep of dry Hinoki wood. *J. Jap. Wood Res. Soc.* 20(11): 517-522; 1974.
44. Schaffer, E. L. The effects of fire on selected structural timber joints. M.S. Thesis Civil Engineering, University of Wisconsin, Madison, Wis.; 1961.
45. Schaffer, E. L. Charring rate of selected woods—transverse to grain. Res. Pap. FPL 69. Madison, WI: U.S. Department of Agriculture, Forest Service, Forest Products Laboratory, 1967.
46. Schaffer, E. L. Elevated temperature effect on longitudinal mechanical properties of wood. Ph.D. Thesis, College of Engineering, Univ. of Wisconsin. (Available from Univ. Microfilms 71-16901, Univ. Michigan, Ann Arbor, Mich.); 1970.
47. Schaffer, E. L. State of structural timber fire endurance. *Wood and Fiber* 9(2): 145; 1977.
48. Stanke, J. Ein Beitrag zur theoretischen Ermittlung der Feuer widerstands dauer von eiteiligen, brett-schichtverleimten Stutzen uter Druckbeanspruchung (Contribution to the theoretical determination of the fire endurance of single glued-laminated wood columns under compressive stress.) *Zeitschrift fur Forschung und Technik im Brandschutz* 19(2): 67-71; 1970.
49. Syndicat National des Constructeurs de Charpentes en Bois Lamelle-Colle. Laminated wood in face of fire. Paris, France.
50. Tenning, K. Glued laminated timber beams: fire tests and experience in practice. *In: Proc. Symp. No. 3, Fire and structural use of timber in buildings.* p. 1-6. Minist. Tech. and Fire Off. Comm., Joint Fire Res. Org., HMSO, London; 1970.
51. Wardle, T. M. Fire resistance of heavy timber construction. *New Zealand For. Serv. Publ. Inf. Ser. No. 53.* Wellington, N.Z.; 1966.
52. Webster, C. T.; Ashton L. A. Investigations on building fires. Part 4, Fire resistance of timber doors. *Natl. Build. Studies Tech. Paper No. 6,* UK; 1951.
53. White, R. H.; Schaffer, E. L. Transient moisture gradient in fire-exposed wood slab. *Wood and Fiber* 13(1): 17-38; 1981.
54. Wright, R. H.; Hayward, A. M. Kinetics of the thermal decomposition of wood. *Can. J. of Tech.*, 29(12): 503-510; 1951.