

# FLAKEBOARD THICKNESS SWELLING. PART II. FUNDAMENTAL RESPONSE OF BOARD PROPERTIES TO STEAM INJECTION PRESSING

*Robert L. Geimer*

Wood Scientist  
USDA Forest Service  
Forest Products Laboratory<sup>1</sup>  
Madison, WI 53705

and

*Jin Heon Kwon*

Professor  
Department of Wood Science and Technology  
College of Forestry  
Kangwon National University  
Chuncheon 200-701, Korea

(Received September 1997)

## ABSTRACT

The results of this study showed that the same relative reductions in thickness swelling (TS) previously obtained with steam-injection-pressed (SIP) resinless mats are also obtained in boards bonded with 3% isocyanate resin. Reductions in thickness swelling were proportional to steam time and pressure. Thickness swelling of 40% measured in conventionally pressed boards following a vacuum-pressure-soak treatment was reduced to 25% in a board exposed to 20 sec of steam at 600 kPa and to 6% in a board exposed to 40 sec of steam at 1,900 kPa. We believe that the reductions in thickness swelling result from a combination of flake plasticization, "lignin flow," and chemical modification. Bending properties of the SIP boards were substantially lower than that of conventionally pressed boards, which we attribute in part to the very short press times and the relatively fast decompression used to manufacture the SIP boards. Bending properties of SIP boards also suffered from a reduction of the vertical density gradient. However, this characteristic is favorable to shear properties.

**Keywords:** Flakeboard, steam injection, bending, shear, thickness swelling.

## INTRODUCTION

Flakeboard, also known as oriented strand-board (OSB), will soon surpass plywood as the dominant panel in the huge North American sheathing market. A major difference in the performance of these two products is the greater thickness swelling (TS) of flakeboard under severe moisture conditions. This characteristic is a result of the higher pressures

needed to consolidate the flakeboard mat. Previous research showed that injection of steam into a resinless flakeboard mat during pressing can substantially reduce the TS that occurs when the mat is submerged in water (Geimer et al. 1998). Thickness swelling of 350% in conventionally pressed resinless mats can be reduced to 200% with 20 sec of steam at 600 kPa pressure. A tenfold reduction in TS compared to that of conventionally pressed mats can be attained by increasing the steam time to 40 sec and steam pressure to 1,950 kPa. This research showed that a number of factors, including wood plasticization, "lignin flow," and chemical changes, may be responsible for

---

<sup>1</sup>The Forest Products Laboratory is maintained in cooperation with the University of Wisconsin. This article was written and prepared by U.S. Government employees on official time, and it is therefore in the public domain and not subject to copyright.

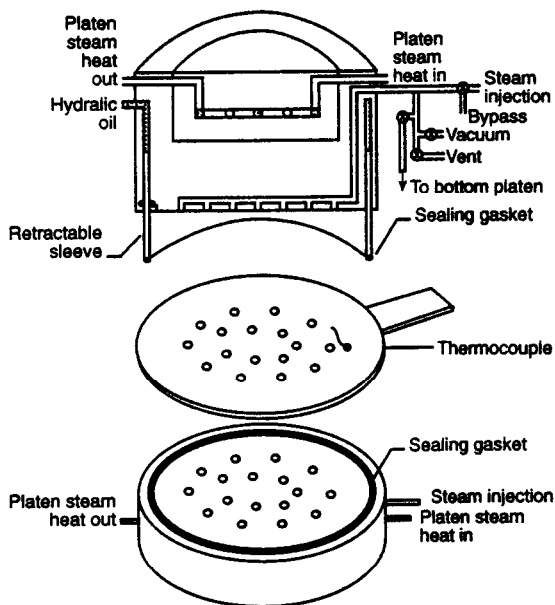

FIG. 1. Schematic for shielded steam injection platens.

the improvement in dimensional stability. As a logical sequel, in the research reported here we studied whether the same mechanisms function in a resin-bonded board and whether they can be related to both mechanical and physical properties.

#### OBJECTIVE

The objective of this study was to determine the influence of steam injection on thickness swelling, bending properties, and shear properties of isocyanate-bonded flakeboard. Steam time and steam pressure treatments were examined.

This report is the second in a series on thickness swelling in flakeboard. Part I covered the steam injection pressing variables that affect thickness swelling in a flakeboard mat. In the future, we intend to document the chemical analysis of steam-treated wood and explore the relationship with TS.

#### PROCEDURE

##### *Board fabrication*

Aspen (*Populus tremuloides*) ring-cut flakes averaging 0.762 mm in thickness were dried



FIG. 2. Flakeboard mats, 152-mm-diameter on circular perforated caul, are inserted between shielded steam injection platens.

to a moisture content (MC) of approximately 4% and screened on a 0.08-cm-mesh screen; 23% of the total material passed through the screen and was eliminated. At any one time, enough flake furnish was blended with 3% isocyanate resin to produce 24 152-mm-diameter boards. All boards were fabricated to a target oven-dry (OD) specific gravity of 0.640, without accounting for the resin, and pressed to a target thickness of 13 mm. Mat MC was 5% when the mats were placed in the press.

#### *Pressing*

Special shielded platens were designed and built to expose mats to high pressure (maximum of 2,000 kPa) steam before, during, or after closure of the press to target thickness (Fig. 1). Circular mats, 152 mm in diameter, are formed on a circular aluminum caul that has perforations matching those in the lower steam injection platen. Screens are usually placed below and on top of the mat. A deep 10-mm-wide circular slot is milled into the top head (surrounding the steam injection ports). This slot contains a piston in the form of a circular sleeve. In practice, the caul, mat, and screens are loaded onto the bottom circular platen with the sleeve in the retracted position (Fig. 2). The sleeve, sometimes referred to as a shield, is then forced to the down position by hydraulic oil pressurized in a nitrogen-

loaded accumulator. The mat chamber is sealed when the o-ring gasket in the end of the sleeve contacts the top surface of the caul plate. A hole, drilled in the edge and exiting out the top surface of the caul, provides the means for inserting a thermocouple into the mat without interfering with the seal. When the press is closed, the sleeve retracts against the pressure of the oil and compressible nitrogen. Release of pressure in the accumulator system, after the chamber has been vented and while the press is closed, permits the sleeve to remain retracted when the press is opened.

Steam can be injected through the top platen or simultaneously through the top and bottom platens at any time during the press cycle. Steam pressure can be released instantly by opening the manifold to atmosphere. The advantage of this closed system is that mats can be exposed to controlled steam pressure for precise times, independent of the press position. The entire pressing operation is computer controlled, including press position and pressure, sleeve operation, steam flow or steam manifold pressure, vacuum application, and steam entry and release.

A general press schedule was used to delineate the effect of specific press variables on TS (Table 1). The range of steam duration was intentionally narrowed with increasing pressures to provide overlapping results between pressure treatments. Press variables recorded for a mat pressed at 1,500 kPa steam pressure for 20 sec are displayed in Fig. 3. Following an initial adjustment period of 2 sec, the press closed at a linear rate of 5 mm/sec. When a position corresponding to a mat height of 50 mm was reached, the press was scheduled to continue closing to 13 mm following a parabolic rate curve at the average rate of 2 mm/sec. When the mat had been compressed to 28 mm, a 1-sec burst of steam was used to purge the manifold. Steam was directed to the top platen and exhausted from the bottom platen for 2 sec to purge the mat of air. Steam was then directed into both the top and bottom platens. Manifold pressure was maintained at 1,500 kPa for 20 sec (Table 1), resulting in an

internal board temperature of 188°C. The manifold was immediately vented to atmosphere following the specified steam period, allowing the board temperature to rapidly decrease to approximately 110°C. It took 9 sec for the press to close to target thickness after the steam purge was initiated. The press was held at this position for 20 sec (Table 1), which allowed 6 sec for exhausting the steam before decompression began. Following decompression at 2 mm/sec to 30 mm, the press opened at a rate of 6 mm/sec.

Six boards were pressed at each combination of steam manifold pressure, and steam time as noted in Table 1. In addition, six "control" boards were made without steam at the platen temperatures used for each steam pressure setting. The control mats were held at target thickness for 4 min to permit core temperature to approach platen temperature.

#### *Board exposure and testing*

Boards were immediately weighed and measured for thickness after removal from the press. For each treatment, two resin-bonded boards were conditioned to equilibrium at 27°C, 65% relative humidity (RH). One 50.8- by 57.1-mm Minnesota shear specimen and one 25.4- by 139.7-mm bending specimen were cut from each board. The shear specimen was tested in accordance with ASTM D1037 (ASTM 1992) procedures. Bending tests using a single-point center load were also performed according to ASTM D1037 procedures, with the exception that the span was 114.4 mm because of sample size limitations.

One board from each treatment was trimmed to 127-mm diameter and measured for TS after progressive equilibrium exposures to the following conditions: (1) initial oven-dry (OD1), (2) 27°C-50% RH, (3) 27°C-90% RH, (4) vacuum pressure soak (VPS), and (5) final oven-dry (OD2). The VPS treatment consisted of submerging boards in a sealed tank of water at ambient temperature while a vacuum of approximately 0.9 bars was applied for 30 min. Approximately 400 kPa water pres-

TABLE 1. *Press and steam injection schedules and variables.*

<i>Press and steam injection schedules<sup>a</sup></i>			
<i>Press schedule</i>	<i>Cumulative time<sup>b</sup></i> (sec)		<i>Steam schedule</i>
Hold at 137 mm for 2 sec	2		
Linear closure rate of 5 mm/sec to 50 mm	19		
Parabolic closure rate of 2 mm/sec to 13 mm	(26)		Steam flow of 350 kg/h; on at 28 mm for 3 sec <sup>c</sup>
	(29)		Steam at pressure (a) for (b) seconds
	37		
Hold at 13 mm for (c) seconds	(29 + b)		
	37 + c		Vent
Decompress at 2 mm/sec to 30 mm	45 + c		
Open at 6 mm/sec to 137 mm	63 + c		
<i>Steam injection variables<sup>a</sup></i>			
<i>Steam manifold pressure (a)</i> (kPa)	<i>Steam time (b, c)</i> (sec)		<i>Platen temperature</i> (°C)
600	20		165
	40		
	80		
	160		
1,050	10		186
	20		
	40		
	80		
1,500	5		201
	10		
	20		
	40		
1,950	5		213
	10		
	20		
	40		

<sup>a</sup> Letters (a), (b), and (c) refer to steam injection variables (steam pressure, steam time, and press hold time, respectively) at target position. See Fig. 3.

<sup>b</sup>Cumulative times (in parentheses) apply to changes in steam injection schedule only.

<sup>c</sup> Steam purges manifold for 1 sec and mat (top to bottom) for 2 sec.

sure was applied for 30 min, and boards were then extracted, drained, weighed, and measured for TS. Thickness was averaged from measurements taken at four predetermined locations 25.4 mm from the edge of the board.

One board from each press condition was

trimmed to a diameter of 127 mm and measured for thickness following equilibration at 27°C-65% RH. Boards were then placed in a horizontal position under water. After 24 h, boards were extracted, drained, weighed, and measured for TS. Thickness swelling was av-

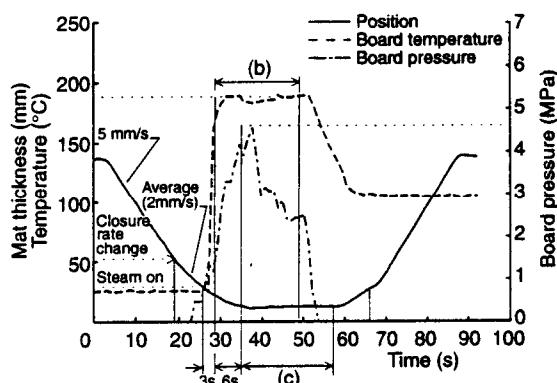

FIG. 3. Press schedule for mats exposed to 1,500 kPa steam (a) for 20 sec (b). Press dwell time was 20 sec (c).

eraged from measurements taken at four predetermined locations 25.4 mm from the edge of the board. The same sample was again measured for thickness after submersion for 48, 168, 336, and 504 h.

Specimens measuring 50.8 by 57.1 mm were cut from each remaining board for each press condition and used to obtain vertical density profiles after conditioning to 27°C-65% RH. These specimens will be used along with the remaining boards to obtain measurements of TS and mechanical properties after 1 year.

## RESULTS AND DISCUSSION

### *Previous exploratory studies*

A lengthy set of exploratory studies indicated that 24-h watersoak TS of a resinless mat decreased with steam treatment during pressing. This reduction was accentuated if the steam was introduced during press closure and continued without interruption until the press had reached target thickness. Applying this sequential SIP pattern, the press schedule and treatment levels given in Table 1 were developed and used to determine the effect of steam pressure and steam duration on out-of-press and 24-h TS of resinless mats (Table 2) (Geimer et al. 1998). At low treatment levels, out-of-press TS (initial springback) of resinless mats was affected by out-of-press MC. As the treatment levels increased, the favorable ef-

TABLE 2. Resinless mat thickness swelling.

Press and steam conditions					Mat conditions		
Steam pressure (kPa)	Steam time (sec)	Platen temp (°C)	Total time (sec)	Max temp (°C)	TS (10.75-mm basis)		
					Out-of-press MC (%)	Out of press (%)	24 h (%)
600	20	175	54	155	19.7	82	205
	40	175	74	163	17.5	60	191
	80	175	114	163	20.4	52	173
	160	175	194	163	23.4	55	158
1,050	10	190	50	173	13.6	30	164
	20	190	57	177	15.4	29	147
	40	190	77	180	17.1	28	129
	80	190	120	181	21.7	20	101
1,500	5	205	44	207	10.4	13	148
	10	205	49	202	13.1	13	118
	20	205	59	190	15.7	13	87
	40	205	79	192	18.4	9	63
1,950	5	220	44	233	13.1	19	114
	10	220	49	234	12.0	5	90
	20	220	59	194	14.7	5	61
	40	220	77	201	15.9	1	32
—	—	175	278	123	3.2	31	351
—	—	190	279	129	2.1	20	352
—	—	205	279	136	1.6	18	361
—	—	220	277	141	1.3	17	338

fects of SIP masked any detrimental effects of increased MC, and both out-of-press and 24-h TS decreased with increasing steam time and pressure. We attribute improvement in out-of-press TS to both plasticization of the wood and "lignin flow." We attribute improvement in 24-h TS to "lignin flow" and chemical changes in the wood.

The term "lignin flow" is qualified because (1) lignin, as used in this report, includes hemicelluloses, free sugars, and extractives, and (2) the flow of these substances can affect TS in a number of ways. What we envision is a softening of the noncrystalline cellular material and its movement to surround, conform to, and perhaps invade the deformed cellular structure. We also extend this in a macroscopic manner to the formation of a coating or partial coating on the exterior surface of the wood particles that comprise the composite furnish.

TABLE 3. Water absorption and thickness swelling for various press and steam conditions, specimen thickness, and specific gravity.

Press and steam conditions														
Steam		Platen temp (°C)	Out of press		Specimen thickness 50% RH (mm)	SG OD (wt) 50% RH (tk)	Water absorption (OD basis)			Thickness swelling (10.75-mm basis)				
Pressure (kPa)	Time (sec)		Thick-ness (mm)	MC (%)			50% RH (%)	90% RH (%)	VPS (%)	OD1 (%)	50% RH (%)	90% RH (%)	VPS (%)	OD2 (%)
600	20	175	12.22	7.6	11.15	0.776	7	14	83	1	4	11	25	38
	40	175	11.95	7.7	11.25	0.775	7	14	81	2	5	11	25	37
	80	175	12.11	9.2	11.31	0.685	7	14	84	2	5	11	22	26
	100	175	11.84	8.4	11.16	0.764	7	13	78	1	4	10	20	24
1,050	10	190	11.69	9.3	10.79	0.759	7	14	88	-3	0	7	22	26
	20	190	11.97	13.1	10.80	0.769	7	13	82	-3	0	6	20	22
	40	190	11.92	12.2	10.92	0.760	7	13	79	-1	2	7	17	19
	80	190	12.01	14.5	10.86	0.760	7	13	78	-2	1	6	16	18
1,500	5	205	12.50	9.1	10.71	0.802	7	13	81	-4	0	6	26	34
	10	205	11.53	8.4	10.42	0.819	7	13	75	-6	-3	2	18	21
	20	205	11.52	10.9	10.59	0.782	6	12	76	-4	-2	3	15	16
	40	205	11.48	10.7	10.62	0.786	6	12	70	-4	-1	3	11	10
1,950	5	220	11.42	4.7	11.11	0.784	6	12	76	0	3	9	24	26
	10	220	10.75	4.5	10.36	0.796	6	12	72	-6	-4	1	13	15
	20	220	11.16	7.5	10.54	0.786	6	12	67	-4	-2	2	10	7
	40	220	11.06	8.9	10.49	0.776	6	11	63	-5	-2	2	6	1
—	—	170	12.36	1.5	12.23	0.659	7	15	112	9	14	27	41	31
—	—	190	12.15	0.8	12.11	0.682	7	15	107	8	13	26	41	31
—	—	205	12.10	0.2	12.09	0.683	6	15	105	8	12	26	40	31
—	—	220	11.84	0	11.92	0.700	6	15	101	7	11	24	38	29

### Thickness swelling

**RH and VPS exposures.**—The response of boards made with 3% resin to changes in RH and VPS treatments is shown in Table 3. It is customary to compensate for board thickness and specific gravity changes resulting from intentional or unintentional changes to board or press variables by adjusting the target press position. These corrections were not made in this study since we were interested in observing the direct effects of steam treatment variables on out-of-press TS. Consequently, board thickness varied with steam treatment (Fig. 4). Thickness of all the resin-bonded boards, including those pressed conventionally, was less than the target 13 mm, suggesting a discrepancy in press control calibration. These errors are usually attributed to initial calibration under low pressure, variation in screen thickness, sensitivity of measurement gages, or overshoot or lag in attaining position as a result of

compromises in the control program. The thinnest boards, averaging 10.75 mm, were produced using 1,950 kPa steam for 10 sec. Therefore, to compare the effect of treatments, TS was calculated throughout this study on a basis of 10.75 mm:

$$TS = (\text{measured thickness (mm)} - 10.75) \times 100/10.75$$

One might think that the thinnest boards would be made with 40 sec of 1,950 kPa steam. A possible explanation might be the higher out-of-press MC of the boards steamed for 40 sec. The same relative moisture differential also appeared in the resinless mats pressed at similar conditions (Table 2). In this case, however, the favorable effects of the extended steam treatment masked the effect of MC, and the resinless mat exposed to 40 sec of steam at 1,950 kPa experienced less out-of-press TS than did the mat made with 10 sec

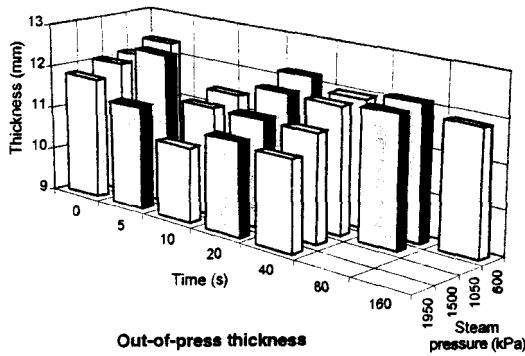

FIG. 4. Out-of-press board thickness.

of steam. The out-of-press MC in the resin-bonded boards was considerably less than that measured in the resinless mats pressed at the same conditions. Use of moisture in the cure of the isocyanate resin and retardation of wood moisture adsorption by the cured resin would contribute to this reduction in MC.

Higher steam-treatment pressures clearly reduced out-of-press thickness (Fig. 4). We attribute this result principally to a reduction in compression-set forces resulting from increased plasticization and to the stabilizing effect of lignin flow. However, increasing steam pressure from 1,050 to 1,950 kPa had an influence on reducing out-of-press board MC (Fig. 5), which in turn reduced out-of-press thickness. Steam duration, on the other hand, had little effect on out-of-press TS. Perhaps in this case, the favorable effects of increased steam duration were offset by increased board MC. This effect was not noted when pressing the resinless mats.

Higher platen temperatures reduced out-of-press thickness in the conventionally pressed (hereafter called "conventional") boards but had no appreciable effect on TS measured after the boards were exposed to 50% RH, 90% RH, or a VPS exposure. Steam treatment affected minor water adsorption changes at the 50% and 90% RH exposure levels. The small differences in water adsorption may have been responsible for TS differences in SIP boards but hardly account for the difference between SIP boards and conventional boards. Differ-

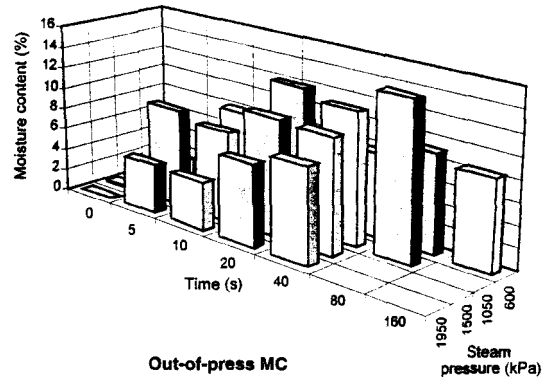

FIG. 5. Out-of-press board moisture content.

ences in water absorption of saturated boards merely reflect the ability of a thicker board to retain more water under these conditions.

All the SIP boards showed less VPS-TS than did the conventional boards (Fig. 6). Reduction in VPS-TS was dependent on increases in both steam pressure and steam time. Compared to the approximate 40% TS in conventional boards, VPS-TS of SIP boards ranged from approximately 25% in those boards exposed to a relatively short duration of steam to a low of 6% in the boards made with 40 sec of steam at 1,950 kPa. Thickness swelling in a resin-bonded board after a VPS exposure was well correlated to TS of a resinless mat after a 24-h soak (Fig. 7). By removing the data from the shortest (5-sec) steam treatments, we obtained a linear regression fit with an  $r^2$  value of 0.99.

Nonrecoverable TS measured after the

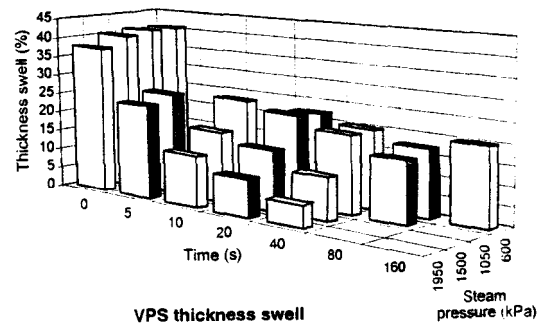

FIG. 6. Vacuum-pressure-soak (VPS) thickness swelling (TS); 10.75-mm basis.

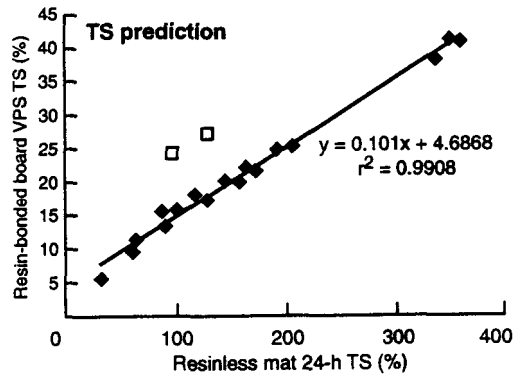

FIG. 7. Relation of board to mat TS. Squares represent omitted data (1,500 kPa—5 sec, 1,950 kPa—5 sec). Outlying data were discarded.

soaked boards were dried for 24 h at 105°C is shown in Table 3 under the heading OD2. The conventional boards and those SIP boards exposed to longer duration of steam at high pressures shrunk in a normal fashion when dried from a saturated condition, while the remaining SIP boards actually increased in thickness.

The most rational explanation for this behavior is that the contraction forces imparted during drying were sufficient to break adhesive bonds. This implies that resin cure was incomplete in those SIP boards pressed with a combination of relatively short press times and low steam pressures. We intentionally excluded any extended press dwell period in the SIP board press schedules so that board properties could be related more closely to steam treatment variations.

#### *Watersoak exposure*

Results of the soak exposure tests are given in Table 4; data for the 24-h soak test are plotted in Fig. 8. Note that the conventional board TS, calculated on a 10.75-mm basis, was already between 11% and 16% at the beginning of the soak exposure. Moisture movement through the faces of the conventional boards during the first 24 h was most likely limited by the densified surface layers, as shown in the vertical density gradient (Fig. 9). Most wa-

TABLE 4. *Thickness swell, 24-h to 504-h soak*

Steam pressure (kPa)	Steam time (sec)	Platen temp (°C)	Specimen thickness 65% RH (mm)	Specific gravity OD—65% RH	Water absorption (65% RH basis)			Thickness swell (10.75-mm basis)			
					24 h (%)	168 h (%)	504 h (%)	0 h (%)	24 h (%)	504 h (%)	OD2 (%)
600	20	175	11.25	0.782	68	86	90	5	40	51	39
	40	175	11.23	0.770	61	83	87	4	33	44	33
	80	175	11.28	0.729	57	83	88	5	29	39	27
	160	175	11.25	0.754	53	81	87	5	27	39	26
1,050	10	190	10.69	0.793	66	85	89	-1	34	44	31
	20	190	11.09	0.781	64	81	85	3	30	39	25
	40	190	11.06	0.758	61	80	84	3	26	35	18
	80	190	10.86	0.767	54	70	74	1	19	26	6
1,500	5	205	11.39	0.753	68	85	90	6	39	47	31
	10	205	10.76	0.801	57	75	80	0	26	37	23
	20	205	10.70	0.796	55	72	77	0	22	32	12
	40	205	10.70	0.772	55	73	78	0	19	28	9
1,950	5	220	10.69	0.796	61	79	83	-1	29	39	22
	10	220	10.17	0.795	57	74	79	-5	17	25	9
	20	220	10.50	0.771	56	71	75	-2	16	23	2
	40	220	10.59	0.790	43	64	68	-2	11	20	0
—	—	170	12.43	0.653	24	73	98	16	31	53	32
—	—	190	12.28	0.674	23	70	95	14	29	51	34
—	—	205	12.13	0.686	22	66	91	13	26	48	29
—	—	220	11.98	0.697	21	63	87	11	23	46	26



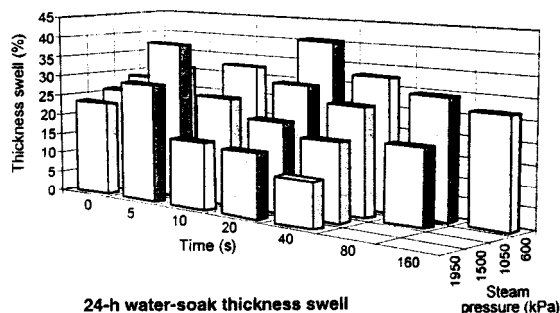

FIG. 8. Twenty-four-h watersoak TS (10.75-mm basis).

ter uptake (approximately 22% based on weight at 65% RH) occurred through board edges and had not progressed to the measuring spots located 2.54 mm from the edge. Consequently, the change in thickness at these measured spots was slight during the first 24 h for the conventional boards (changing from approximately 13% to 26% calculated on a 10.75-mm basis) as compared to the change measured in SIP boards (from approximately 0 to between 11% and 40% depending on steam time and pressure). However, edge swelling of the conventional boards was between 40% and 44% after a 24-h soak.

To track the flow of water and consequent TS over time, both the SIP and conventional boards were re-measured successively after 48, 168, 336, and 504 h of soaking. These times were chosen as a result of periodic monitoring of selective samples. After 48 h, TS of the conventional boards, measured 25.4 mm from the edge, averaged 34% while edge TS was 45%. After 168 h, TS was 45% at 25.4 mm from the edge and 49% at the edge. After 336 h, TS stabilized and remained at approximately 50% at both measurement locations until the end of the test at 504 h. Thickness swelling of SIP boards increased slightly during this period, in a gradual fashion.

Conventional boards did not absorb water as rapidly as did SIP boards in the early stages of soaking. After 168 h, however, MC of conventional boards surpassed that of SIP boards and this difference continued to grow until the end of the test. Deposition of a lignin, hemi-

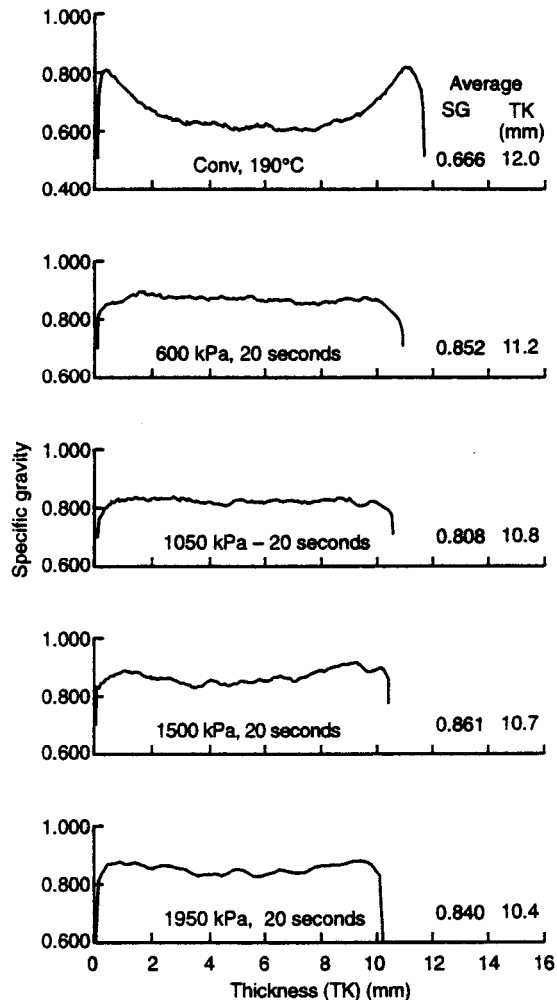

FIG. 9. Vertical density profiles for all steam pressures.

cellulose, extractive, or adhesive glaze on the surface and the presence of a high-density surface layer retard water movement through the faces of conventional board. Reduction of the density gradient, wash-in of deposited surface materials, and opening of micro steam channels, on the other hand, increase the permeability of SIP boards.

After 504 h of soaking, the pattern of TS was similar to that following a 24-h soak with the exception of relatively higher TS in the conventional boards. Thickness swelling decreased with increases in steam time and pressure. However, 504 h of soaking proved to be

more severe than the VPS treatment. Moreover, the 24-h soak was more severe than the VPS treatment for many of the SIP boards. We believe that the moisture gradient within the cell walls of adjacent flakes is more severe and remains for a longer duration in the soak test than in the VPS treatment. This occurs because of the relatively greater difference in moisture changes (90% RH to saturation in VPS treatment compared to 65% RH to saturation in 24-h soak treatment) and the difference in moisture transfer rate between the two exposures.

The difference in VPS-TS and 24-h TS was more pronounced in SIP boards than in conventional boards and may have been influenced by incomplete resin cure in SIP boards. When comparing data from the 504-h soak and VPS, it is interesting that the same OD2 thickness measured in both cases was approached from opposite directions in a number of SIP boards.

#### Density gradient

Changes in platen temperature made only minor differences in the vertical density gradient of conventional boards. Steam injection, however, resulted in large reductions in the vertical density profile (Fig. 9). In general, increasing steam pressure increased the gradient. All boards made at 600 kPa had a rounded profile and all boards made at 1,050 kPa had a square profile. We do not know whether the higher profile observed in boards made at 1,500 and 1,950 kPa with 20 sec of steam developed before or after the press closed to final position. Time does interact with pressure in determining the vertical density profile. The board pressed for 5 sec at 1,500 kPa had a more pronounced density gradient than the board pressed for 5 sec at 1,950 kPa (Fig. 10a). The reverse was true for those boards pressed for 10 sec at 1,500 and 1,950 kPa (Fig. 10b).

#### Mechanical properties

Bending modulus of rupture (MOR) and modulus of elasticity (MOE) and Minnesota

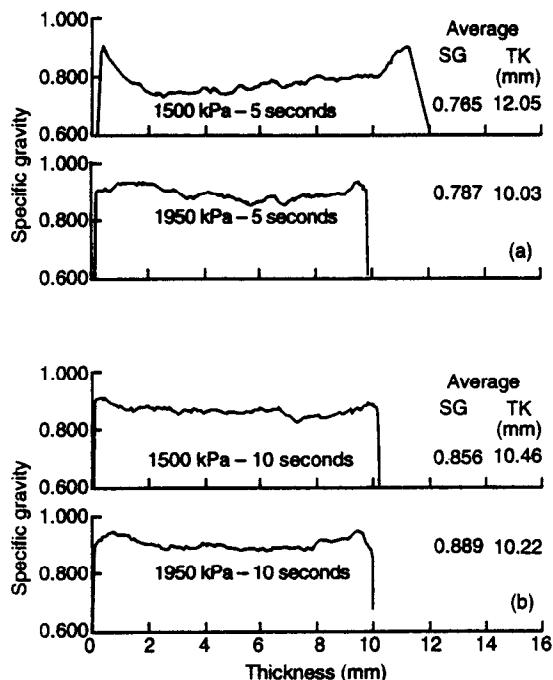

FIG. 10. Vertical density profiles for 1,500-kPa steam pressure: (a) 5-sec steam duration; (b) 10-sec steam duration.

shear properties were adjusted for differences in specimen specific gravity to ascertain the effect of steam variables (Table 5). While it is customary to adjust the mechanical property test values of composite boards to account for small differences in specific gravity related to forming errors, the reader must realize that in this case the adjustments were rather large and were attributed directly to the variables under consideration. We elected to adjust the conventional board data separately from the SIP board data for both bending MOR and MOE. The slopes of the two regression lines were similar for the MOR data (Fig. 11a), but differed substantially for the MOE data (Fig. 11b) (statistical difference in the slopes was questionable, as shown by the relatively low  $r^2$  values). Shear values were adjusted with a single regression line (Fig. 11c). All properties were adjusted to a specific gravity (SG) of 0.640 (OD weight, 65% RH thickness basis) as follows:

TABLE 5. *Bending and shear properties.*

Steam pressure (kPa)	Steam time (sec)	Platen temp (°C)	Specimen thickness 65% RH (mm)	Bending <sup>a</sup>			Shear <sup>a</sup>	
				Specific gravity OD—65% RH	MOR (MPa)	MOE (MPa)	Specific gravity OD—65% RH	Shear (kPa)
600	20	175	11.44	0.784	17.2	759	0.787	5,880
	40	175	11.43	0.777	17.1	1,116	0.788	6,225
	80	175	11.44	0.723	16.7	1,264	0.704	4,702
	160	175	11.37	0.758	15.7	1,045	0.760	5,243
1,050	10	190	11.29	0.759	16.6	880	0.758	4,609
	20	190	11.57	0.720	13.8	1,100	0.723	4,011
	40	190	11.28	0.765	14.2	1,084	0.775	4,613
	80	190	11.19	0.741	11.4	1,299	0.754	4,379
1,500	5	205	11.71	0.747	14.7	1,315	0.752	4,091
	10	205	11.01	0.785	11.6	720	0.797	3,209
	20	205	11.07	0.783	15.5	1,270	0.793	4,662
	40	205	10.87	0.796	17.5	1,451	0.809	4,618
1,950	5	220	11.58	0.760	13.1	955	0.774	4,383
	10	220	10.39	0.825	14.8	1,242	0.798	4,093
	20	220	10.55	0.795	12.0	1,285	0.779	4,080
	40	220	10.62	0.785	10.5	1,235	0.772	4,151
—	—	170	12.64	0.652	26.2	2,713	0.641	4,569
—	—	190	12.59	0.666	23.2	2,748	0.658	4,710
—	—	205	12.40	0.662	27.1	2,874	0.662	4,732
—	—	220	12.12	0.685	26.2	2,852	0.665	4,814

<sup>a</sup> Values adjusted to 0.640 specific gravity.

Adjusted value = measured value + (0.640 - measured SG) × (slope of regression line)

The low span-to-thickness ratio (between 9 and 11) of the bending specimens did not cause any apparent shear failures during the test. All specimens failed in simple tension. Conventional boards had substantially higher bending MOR and MOE properties than those of SIP boards (Figs. 12 and 13). A major reduction in the vertical density profile in all SIP boards could account for some differences between conventional and SIP boards. In addition, bending properties of SIP boards suffered from limited press time, excessive steaming in some cases, and relatively fast decompression. There were no definite patterns in the effect of steam pressure and time on bending properties. Variations in the vertical density profile of SIP boards were not well correlated to the differences in MOR or MOE of these boards. Although no precepts mandate that MOE and

MOR track one another, this is usually the case in a wood composite. In this study, MOE did not always follow MOR. Two examples are the boards made with the shortest steam time at 600 and 1,050 kPa pressure. Within their respective pressure groups, these boards had the highest MOR and the lowest MOE.

Shear properties were not as adversely affected by the short press cycles as were bending properties (Fig. 14). The reduction of face-layer specific gravity, which adversely affected SIP board bending properties, resulted in an increase in core specific gravity and favorably affected shear properties. As with bending properties, there was no distinctive pattern to the effect of steam pressing variations on shear properties.

## CONCLUSIONS

Flakeboard mats bonded with 3% isocyanate were steam-injection-pressed (SIP) using an array of steam times and steam pressures.

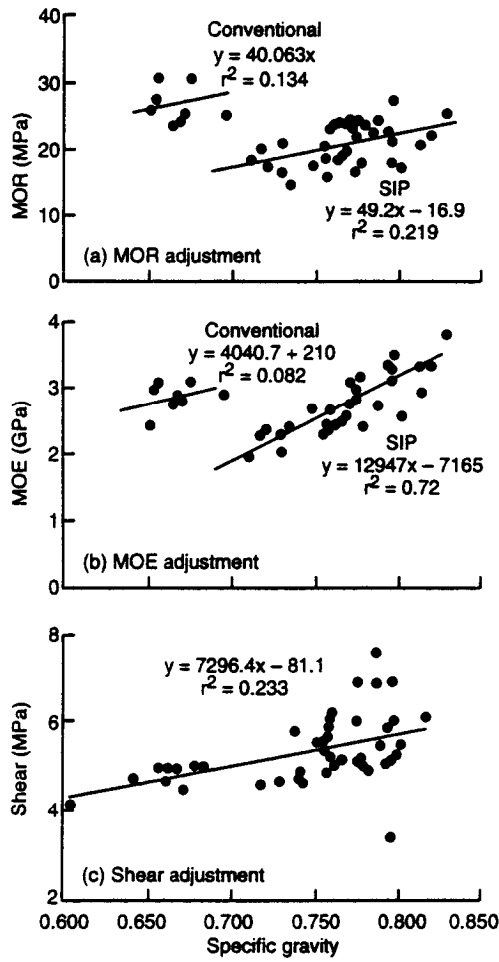

FIG. 11. Bending property adjustments for specific gravity: (a) MOR, (b) MOE, (c) shear.

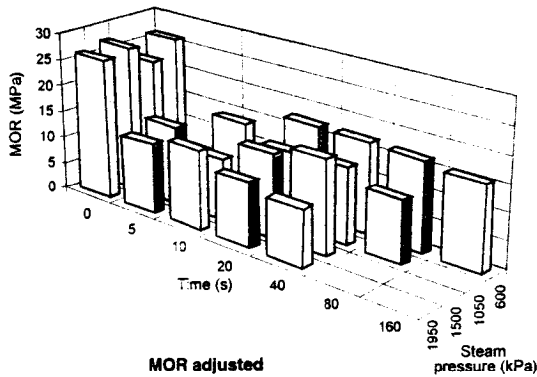

FIG. 12. Adjusted MOR.

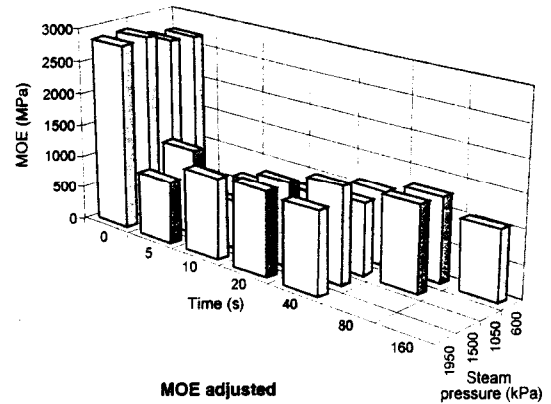

FIG. 13. Adjusted MOE.

The same relative improvements in thickness swelling (TS) observed previously for resinless mats were obtained in the resin-bonded boards. Reductions in TS were proportionate to steam pressure and duration. Thickness swelling of 40% measured in conventionally pressed boards following a vacuum-pressure-soak (VPS) treatment was reduced to 25% in a board exposed to 20 sec of steam at 600 kPa and to 6% in a board exposed to 40 sec of steam at 1,900 kPa. Thickness swelling in boards submerged under water at atmospheric pressure for 24 h was influenced by the vertical density gradient and/or board permeability. The conventionally pressed boards experienced relatively little swelling during this first 24-h period except at their edges. Swelling continued in these boards for 336 h until both center and edge thickness were the same.

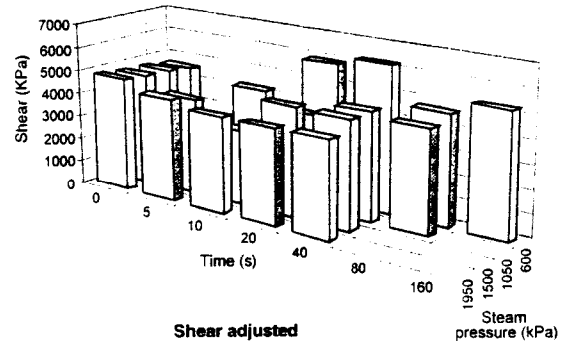

FIG. 14. Adjusted shear

In contrast, 24-h TS in SIP boards approached much closer to the maximum TS measured after 504 h. However, after 504 h of soaking, more TS occurred in conventionally pressed boards than in SIP boards. Reductions of both 24- and 504-h TS in SIP boards were proportionate to steam time and duration. Prolonged soaking under water at atmospheric pressure is a more severe exposure than VPS. This is attributed to the exposure of adjacent flakes to greater moisture content differentials for a longer time in the atmospheric soak test than in the VPS test. Bending properties of SIP boards were considerably lower than those of conventionally pressed boards. This is attributed to the reduction in the vertical density profile of SIP boards and to poor resin cure or bonding associated with the short press time and rapid decompression used in the SIP schedule. Shear properties of SIP boards were in most cases similar to those measured in conventionally pressed boards. Decrease in shear properties resulting from adhesive bond degradation was offset by an increase in core density. Any pattern of board strength associated with changes in the steam treatment variables was apparently disrupted by the interaction of the steam and press variables.

This study and complementary research on resinless mats have shown the tremendous potential of using steam in the pressing process to achieve flakeboard dimensional stability. Work has also been undertaken to determine the range of stability and board strengths that can be attained using an unsealed steam injection system. Optimization studies are necessary to determine how board specific gravity and board strength properties are related to the parameters of press time, steam pressure, and steam duration.

#### ACKNOWLEDGMENTS

We wish to credit Professor Paul Winistorfer, University of Tennessee, for providing the vertical density profiles shown in this and related studies.

#### REFERENCES

- ASTM. 1992. **Standard methods of evaluating the properties of wood-based fiber and particle panel materials.** ASTM D 1037-92. American Society for Testing and Materials, Philadelphia, PA
- GEIMER, R. L., J. H. KWON, AND J. BOLTON. 1988. **Flakeboard thickness swelling. I. Stress relaxation in a flakeboard mat.** *Wood Fiber Sci.* 30(4):326-338.