

United States
Department of
Agriculture

Forest Service

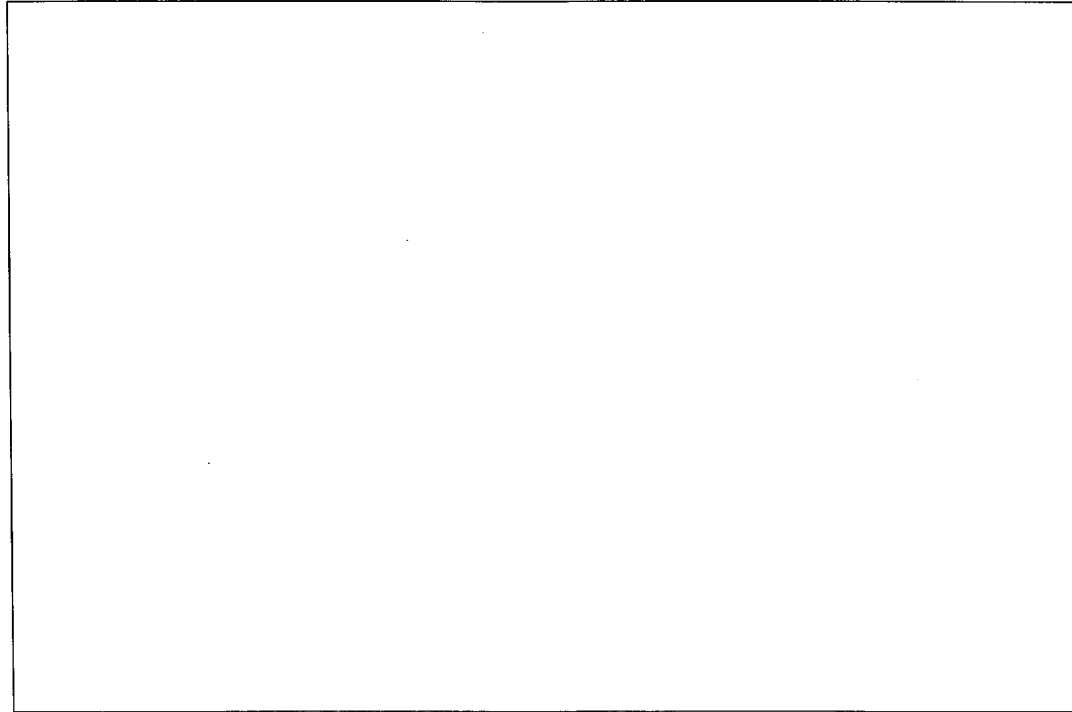
Forest
Products
Laboratory

General
Technical
Report
FPL-GTR-84



Standard Plans for Southern Pine Bridges

Paula D. Hilbrich Lee
Michael A. Ritter
Michael Triche



Abstract

The development of standardized timber bridge plans and specifications is a key element in improving design and construction practices. The bridge plans presented were developed as a cooperative effort between the USDA Forest Service, Forest Products Laboratory (FPL); the University of Alabama; and the Southern Pine Council and are the first step in developing standardized designs for the southern United States where Southern Pine is the primary structural wood species group. This publication contains standardized designs and details for three timber bridge superstructure types, including stress-laminated sawn lumber bridges, stress-laminated glued laminated timber (glulam) bridges, and longitudinal sawn lumber stringer bridges with transverse plank decks. Each set of plans encompasses numerous span length and width combinations, design loadings for AASHTO HS 20-44 and HS 25-44 vehicles, and two options for live-load deflection criteria.

Keywords: Bridge, stress laminated, Southern Pine, stringer, glulam

September 1995

Lee, Paula D. Hilbrich, Ritter, Michael A.; Triche, Michael. 1995. Standard Plans for Southern Pine Bridges. Gen. Tech. Rep. FPL-GTR-84. Madison, WI: U.S. Department of Agriculture, Forest Service, Forest Products Laboratory. 26 p.

A limited number of free copies of this publication are available to the public from the Forest Products Laboratory, One Gifford Pinchot Drive, Madison, WI 53705-2398. Laboratory publications are sent to more than 1,000 libraries in the United States and elsewhere.

The Forest Products Laboratory is maintained in cooperation with the University of Wisconsin.

The United States Department of Agriculture (USDA) prohibits discrimination in its programs on the basis of race, color, national origin, sex, religion, age, disability, political beliefs, and marital or familial status. Persons with disabilities who require alternative means of communication of program information (braille, large print, audiotape, etc.) should contact the USDA Office of Communications at (202) 720-2791. To file a complaint, write the Secretary of Agriculture, U.S. Department of Agriculture, Washington, DC 20250, or call (202) 720-7327 (voice), or (202) 720-1127 (TTD). USDA is an equal employment opportunity employer.

Standard Plans for Southern Pine Bridges

Paula D. Hilbrich Lee, General Engineer
 Michael A. Ritter, Research Engineer
 USDA Forest Service, Forest Products Laboratory

Michael Triche, Associate Professor
 Department of Civil Engineering
 University of Alabama

Introduction

Interest in timber bridges has increased significantly in recent years, primarily as a result of programs implemented through the Timber Bridge Initiative passed by Congress in 1988. During this period, the development of standardized timber bridge plans and specifications has been continually emphasized by bridge designers and builders as a key element for contributing to improved design and construction practices. Additionally, standard plans have been viewed as a beneficial tool for helping engineers address the critical transportation infrastructure needs of state, county, and rural regions. To meet this need, several projects to develop standardized timber bridge plans have been initiated at the Federal and local levels based on modern technology for design, fabrication, and construction.

The bridge plans presented in this publication are the first step in developing standardized designs for the Southern United States where Southern Pine is the primary structural wood species group. The plans were developed as a cooperative effort between the USDA Forest Service, Forest Products Laboratory (FPL), the University of Alabama, and the Southern Pine Council. The plans include standardized designs and details for 3 timber bridge superstructure types including stress-laminated sawn lumber bridges, stress-laminated glued laminated timber (glulam) bridges, and longitudinal sawn lumber stringer bridges with transverse plank decks. The stress-laminated designs were developed at FPL, and the sawn lumber stringer designs were developed at the University of Alabama. The plans are intended to serve as a useful guide to state, county, and local highway departments in the development of practical and economical bridge designs using Southern Pine lumber and glulam. They should be particularly valuable to smaller highway departments with limited engineering staffs.

In the development of these plans, every effort has been made to provide complete information for bridge superstructure design and fabrication for a range of design options. Each set of plans encompasses numerous span length and width combinations, design loadings for AASHTO HS 20-44 and HS 25-44 vehicles, and two options for live load deflection criteria. However, specific site conditions may necessitate modification because plans were developed for right-angle crossings only. In all cases, these designs must be verified by a registered professional engineer prior to construction.

The USDA Forest Service hereby gives notice that the information herein contained shall not create any warranty expressed or implied. The person or organization using this information waives and relinquishes any and all claims against the United States of America, its officers, employees, and project cooperators, for any loss, damage, personal injury, or death incident to, or occurring as a consequence of, the use thereof.

Acknowledgments

We express appreciation to Mr. Marc Lishewski, formerly from the Southern Forest Products Association, and Mr. Mac Lupold, Federal Paperboard Inc., for their assistance in the development and review of these plans. We are also grateful to the many individuals who provided review comments and suggestions during plan development.

Comments

Comments and suggestions for improvement of these drawings are appreciated and should be addressed to the Timber Bridge Team, Forest Products Laboratory, One Gifford Pinchot Drive, Madison, WI, 53705 (FAX 608-231-9303).

Specifications

AASHTO. 1991. Guide Specifications for the Design of Stress-Laminated Wood Decks. Washington, DC: American Association of State Highway and Transportation Officials.

AASHTO. 1992. Standard Specifications for Highway Bridges, 15th edition. Washington, DC: American Association of State Highway and Transportation Officials. (with interims through 1994).

AASHTO. 1990. Standard Specifications for Transportation Materials and Methods of Sampling and Testing. Vol. 1: Specifications. Washington, DC: American Association of State Highway and Transportation Officials.

M111 Zinc (Hot-Dip Galvanized) Coatings on Iron and Steel Products
 M168 Wood Products
 M232 Zinc Coating (Hot-Dip) on Iron and Steel Hardware

ASTM. Annual Book of ASTM Standards. Philadelphia, PA: American Society for Testing and Materials.

ASTM A36-90 Standard Specification for Structural Steel
 ASTM A47-84 Standard Specification for Ferritic Malleable Iron Castings
 ASTM A307-92a Standard Specification for Carbon Steel Bolts and Studs, 60,000 psi Tensile Strength

ASTM A722-90 Standard Specification for Uncoated, High-Strength Steel Bar for Prestressing Concrete

ANSI/ASME B18.2.1-1981, Square and Hex Bolts and Screws (Inch Series), American Society of Mechanical Engineers, New York, NY, 1981.

AWPA. 1994. Standards. Woodstock, MD: American Wood Preservers' Association.

National Design Specification for Wood Construction. 1991. Washington, DC: National Forest Products Association.

National Design Specification Supplement: Design Values for Wood Construction. 1991. Washington, DC: National Forest Products Association.

SAE J412, General Characteristics and Heat Treatment of Steels, Society of Automotive Engineers, Warrendale, PA, 1989.

References

Faller, R.K.; Ritter, M.A.; Holloway, J.C.; Pfeifer, B.G.; Rosson, B.T. 1992. Performance level 1 bridge railings for timber decks. In: Transportation Research Record 1419. Washington, DC: Transportation Research Board, National Research Council.

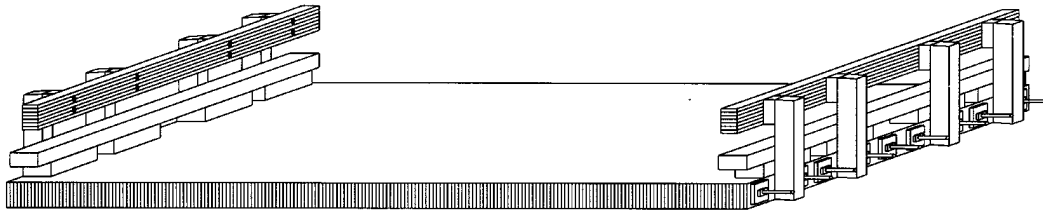
Ritter, M.A. 1990. Timber bridges: design, construction, inspection and maintenance. EM7700-8. Washington, DC: U.S. Department of Agriculture.

Ritter, M.A.; Faller, R.K.; Lee, P.D.H.; Rosson, B.T.; Duwadi, S.R. [In press.] Plans for crash tested bridge railings for longitudinal wood decks. Madison, WI: U.S. Department of Agriculture, Forest Service, Forest Products Laboratory.

Contents

Stress-Laminated Sawn Lumber Decks	Page
Title	2
General Layout and Notes	3
General Details	4
Rail Option Details	5
Fabrication Details	6
Materials and Construction Recommendations	7
Construction Recommendations	8
Design Procedure	9
Design Procedure	10
Stress-Laminated Glued Laminated Timber Decks	
Title	11
General Layout and Notes	12
General Details	13
Rail Option Details	14
Fabrication Details	15
Fabrication Details	16
Materials and Construction Recommendations	17
Construction Recommendations	18
Design Procedure	19
Design Procedure	20
Design Procedure	21
Longitudinal Stringer with Transverse Plank Decks	
Title	22
General Layout	23
Attachment Details	24
Rail Details	25
Notes and Design	26

Stress-Laminated Sawn Lumber Bridge Decks



Drawing Index

1. Title
2. General Layout and Notes
3. General Details
4. Rail Option Details
5. Fabrication Details
6. Materials and Construction Recommendations
7. Construction Recommendations
8. Design Procedure
9. Design Procedure

The bridge superstructures depicted on these drawings were developed under a cooperative research agreement between the USDA Forest Service, Forest Products Laboratory, the University of Alabama and the Southern Forest Products Association.



Standard Plans for Southern Pine Bridges

August 1995

Stress-Laminated Sawn Lumber Decks

Title

Sheet 1 of 9

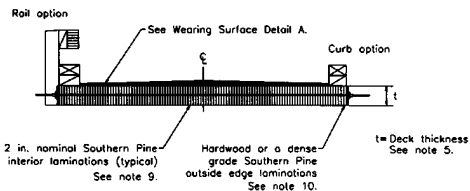
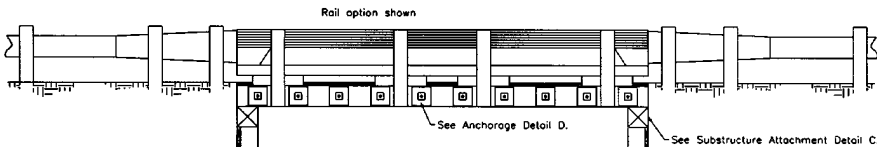
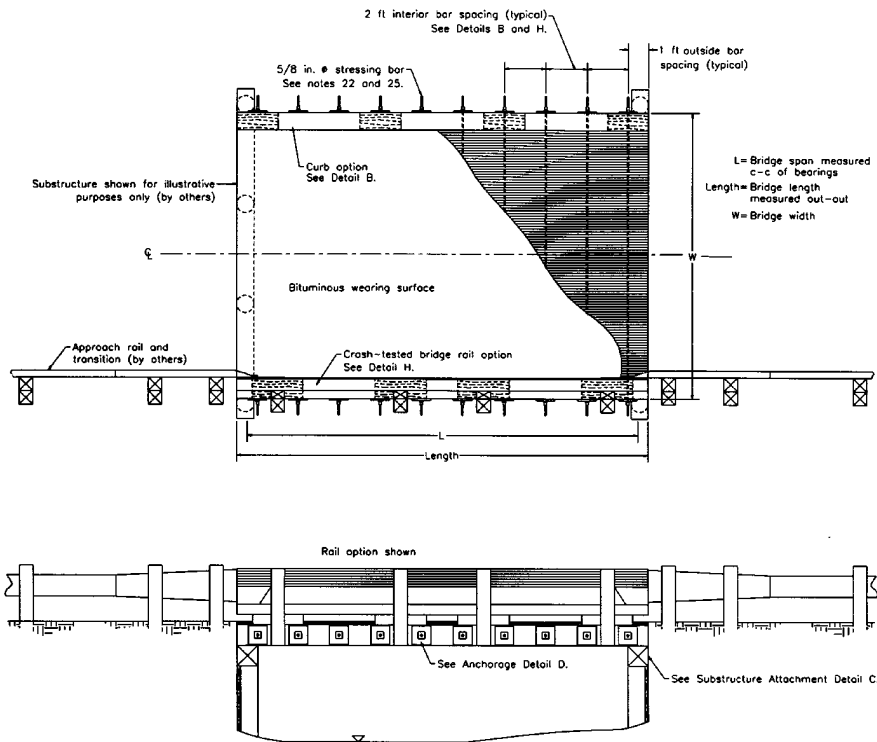


Table 1 - Minimum Required Nominal Deck Thickness (in.¹)

Bridge length (ft)	Bridge span ² (ft, in.)	HS 20-44		HS 25-44	
		L/360 ³	L/500 ³	L/360 ³	L/500 ³
10	9, 2	8	10	10	10
12	11, 2	10	10	10	10
14	13, 2	10	10	10	12
16	15, 2	10	12	12	12
18	17, 2	12	12	12	12
20	19, 2	12	N/A	12	N/A

¹ Minimum deck thickness is controlled by deflection (see Sheets 8-9).
² Bridge span, L, is measured center-to-center of bearings, assuming a minimum 10 in. bearing length at each abutment.
³ Deflection limit as a fraction of the bridge span, L.
 N/A = Deck thickness greater than 12 in. required.

NOTES AND REQUIREMENTS

DESIGN

- These drawings are for stress-laminated sawn lumber timber bridge decks constructed of Southern Pine dimension lumber, 2 in. in nominal thickness and 8 to 12 in. in nominal width. The designs are applicable for single- and double-lane rectangular bridges (no skew) with simple span lengths from 10 to 20 ft in 2 ft increments. Design truck loading is AASHTO HS 20-44 or HS 25-44.
- Unless noted, designs comply with the Standard Specifications for Highway Bridges (15th Edition, 1992) (with interims through 1994) and Guide Specifications for the Design of Stress-Laminated Wood Decks (1991), published by the American Association of State Highway and Transportation Officials. Design criteria and procedures are shown on Sheets 8 and 9.
- Designs are applicable to single-lane and double-lane bridges, 12 to 36 ft wide. Guidelines for determining the required number of laminations, bar lengths, and other material quantities are given on Sheet 6.
- The plans are based upon bearing lengths of 10 in. A longer bearing length will result in a slightly conservative design.
- The controlling design criteria for deck thickness is live load deflection (see Sheets 8 and 9). The required deck thickness for a stated bridge length is determined from Table 1, based on the design loading and live load deflection limits of 1/360 or 1/500 of the bridge span (S), measured center-to-center of bearings.
- Unless noted, plan dimensions for sawn lumber are nominal dimensions. Design calculations and fabrication details are based on actual dimensions for dressed (S4S) lumber.
- These designs are intended for informational purposes only and must be verified by a registered professional engineer prior to construction.

MATERIAL AND FABRICATION

Wood

- Sawn lumber and glued laminated timber shall comply with the requirements of AASHTO M168.
- Unless noted, all lumber shall be dressed (S4S) Southern Pine. Lumber 2 to 4 in. shall be visually graded No. 2 or better. Lumber 5 in. or greater in thickness shall be visually graded No. 1 or better.

- The two exterior laminations along each deck edge shall be Northern Red Oak, Red Maple, or another treatable dense hardwood species, visually graded No. 2 or better, or No. 1 Dense Southern Pine.
- Glued laminated timber rail material shall be Combination No. 48 Southern Pine.
- All interior deck laminations shall be continuous between supports with no butt joints. Butt joints are permitted in hardwood exterior laminations provided that (a) they are placed midway between stressing bars within the center half of the bridge length, and (b) the spacing of butt joints in adjacent laminations is not less than 2 ft (see Detail E, Sheet 3).
- Unless noted, all wood shall be cut, dried, and completely fabricated prior to pressure treatment with preservatives.
- The moisture content of sawn lumber prior to and after treatment shall not exceed 15% for lumber 2 to 4 in. thick, and 19% for lumber thicker than 4 in.
- Fabrication details for wood members are shown on Sheet 5. Each member shall be legibly marked with the designated mark number to aid in construction.

Preservative Treatment

- All sawn lumber shall be treated in accordance with the requirements of AWPA Standard C14 with one of the following preservatives:
 - Cresote conforming to AWPA Standard P1
 - Pentachlorophenol conforming to AWPA Standard P8 in hydrocarbon solvent, Type A, conforming to AWPA Standard P9
 - CCA conforming to AWPA Standard P5
- Glulam shall be treated to the above requirements with cresote or pentachlorophenol.

- Material treated with cresote or pentachlorophenol shall be free of excess preservative on the wood surfaces. The treating process for these preservatives shall include an expansion bath, steaming and/or dripping to ensure that preservative will not bleed.

Steel Fasteners and Hardware

- Preservative treatment shall be inspected and certified in accordance with AWPA Standard M2.
- Steel plates and shapes shall comply with the requirements of ASTM A36.

- Bolts and lag screws shall comply with the requirements of ANSI-ASME Standard B18.2.1 1981, Grade 2.
- Stressing bars shall be 5/8 in. diameter and shall comply with the requirements of ASTM A722. Nuts and couplers for stressing bars shall be provided by the bar manufacturer.
- Split rings shall be manufactured from SAE 1010 hot rolled carbon steel. Shear plates shall be malleable iron manufactured according to Grade 32510 of ASTM A47.
- Washers shall be provided under bolt and lag screw heads and nuts that are in contact with wood. Washers may be omitted under heads of special timber bolts or dome-head bolts when the size and strength of the head is sufficient to develop connection strength without wood crushing.
- All steel components and fasteners shall be galvanized in accordance with AASHTO M111 or AASHTO M232. Galvanizing of stressing bars shall follow the recommendations of the bar manufacturer so as not to adversely affect the mechanical properties of the high-strength steel.
- All nuts for bolts and stressing bars shall be oversized or re-threaded to ensure proper fit after galvanizing.
- When the bridge deck is treated with CCA, stressing bars shall be placed in a protective grease-filled PVC tube that is continuous across the bridge width (See Detail G, Sheet 3).

Miscellaneous

- Geotextile fabric should be an impregnated, non-woven fabric that provides a watertight membrane over the deck surface. Application procedures and compatibility of the fabric with the preservative treatment shall be verified with the manufacturer prior to fabric placement.
- Sealer for wood end grain is typically a commercial roofing cement.

CONSTRUCTION

- All wood and metal components shall be handled and stored carefully so as not to damage the material. If damage does occur, wood shall be field treated in accordance with Note 31. Damage to galvanized surfaces shall be repaired with a cold galvanizing compound or other approved coating.
- When field fabrication of wood is required or if wood is damaged, all cuts, bore holes, and damage shall be immediately field treated with wood preservative in accordance with AWPA Standard M4.

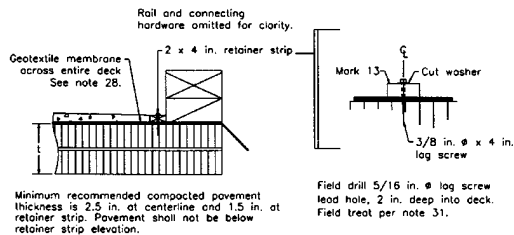
- Stressing bars shall be fully tensioned to the values specified in Table 2, in accordance with the following sequence:
 - Initially, at construction
 - 1 week after the initial tensioning
 - 3-8 weeks after the second tensioning
 In addition, it is recommended that the bars be checked, and retensioned as required, on an annual basis for the first 2 years after construction and at 1 to 3 year intervals thereafter until the bar force stabilizes.

- Refer to Sheets 6 and 7 for recommended bar stressing procedures and considerations.

Table 2 - Bar Stressing Requirements

Nominal Deck Thickness (in.)	Required Bar Tension (lb)
8	17,400
10	22,200
12	27,000

A Wearing Surface



The bridge superstructures depicted on these drawings were developed under a cooperative research agreement between the USDA Forest Service, Forest Products Laboratory, the University of Alabama and the Southern Forest Products Association.



Standard Plans for Southern Pine Bridges

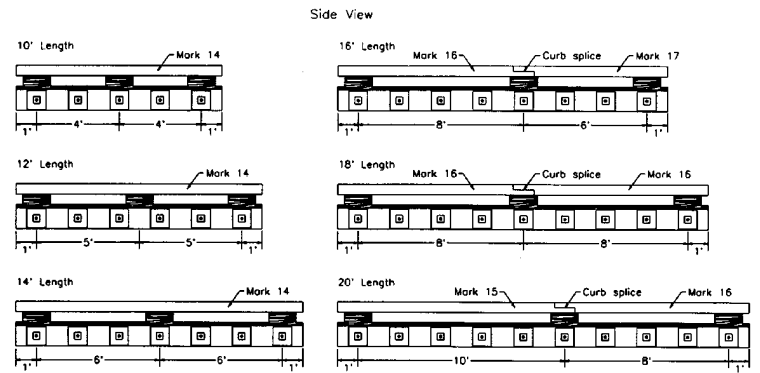
Stress-Laminated Sawn Lumber Decks

General Layout and Notes

August 1995

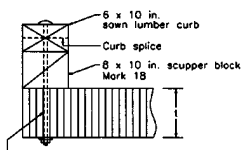
Sheet 2 of 9

B Curb Option Configuration and Scupper Spacing



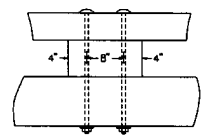
Spliced curbs may be continuous when sawn lumber of sufficient length is available or when glulam timber curbs are used.

Curb Detail End View

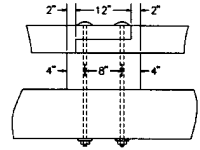


5/8 in. \emptyset dome head bolts (typical)
Field drill 13/16 in. \emptyset holes through deck. Field treat per note 31, Sheet 2.

Curb Detail Side View

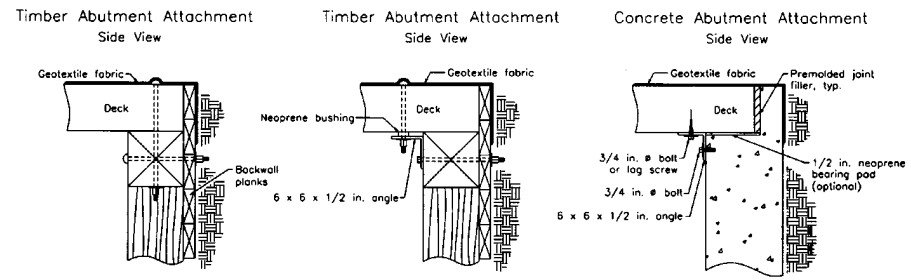


Curb Splice Detail Side View



See fabrication details, Sheet 5.

C Suggested Deck/Substructure Attachment



These details are representative of common substructure attachments and are shown for illustrative purposes only. The attachments must be designed for specific locations. The following recommendations are applicable in most circumstances.

- Attachment bolt spacing shall not exceed 4 ft over the entire bridge width.
- Minimum bearing shall be 10 in. at abutments and 7 in. at bents.
- Geotextile fabric shall wrap over abutment ends a minimum of 2 ft vertically. See note 28, Sheet 2.
- Bolts are 3/4 in. \emptyset . Use dome head bolts in wood contact and hex bolts in steel contact. Field drill deck bolt holes 13/16 in. \emptyset and field treat in accordance with note 31, Sheet 2.
- Log screws for deck attachment are as follows:
 - A. For 8 in. deck, 3/4 in. \emptyset x 6 in.; Prebore 11/16 in. \emptyset lead hole. Counterbore 13/16 in. \emptyset x 2-1/2 in.
 - B. For 10 and 12 in. deck, 3/4 in. \emptyset x 8 in.; Prebore 11/16 in. \emptyset lead hole. Counterbore 13/16 in. \emptyset x 3-1/2 in.
- Apply preservative to all field borings. See note 31, Sheet 2.

D Anchorage Configuration

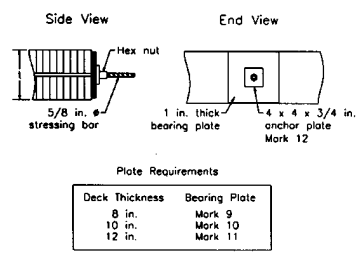
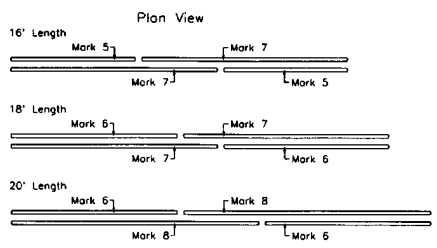


Plate Requirements

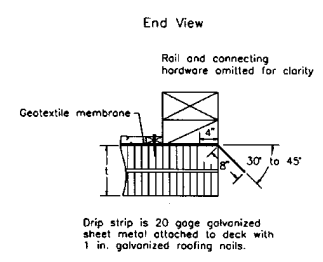
Deck Thickness	Bearing Plate
8 in.	Mark 9
10 in.	Mark 10
12 in.	Mark 11

E Exterior Lamination Layout



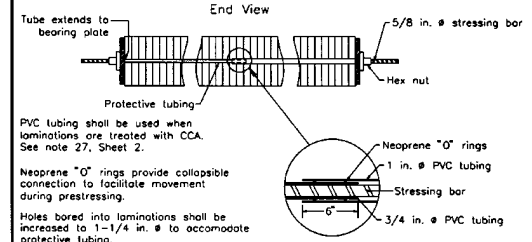
Exterior laminations may be continuous if preferred. See note 10, Sheet 2.

F Drip Strip



Drip strip is 20 gauge galvanized sheet metal attached to deck with 1 in. galvanized roofing nails.

G PVC Tubing



PVC tubing shall be used when laminations are treated with CCA. See note 27, Sheet 2.

Neoprene "O" rings provide collapsible connection to facilitate movement during prestressing.

Holes bored into laminations shall be increased to 1-1/4 in. \emptyset to accommodate protective tubing.

For additional protection, it is recommended the PVC tube be filled with grease after placement.

The bridge superstructures depicted on these drawings were developed under a cooperative research agreement between the USDA Forest Service, Forest Products Laboratory, the University of Alabama and the Southern Forest Products Association.



Standard Plans for Southern Pine Bridges

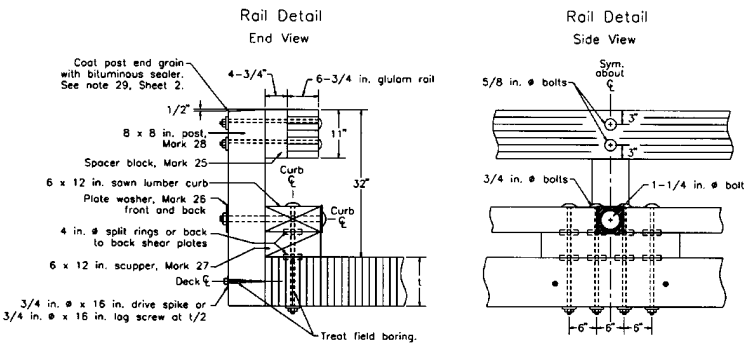
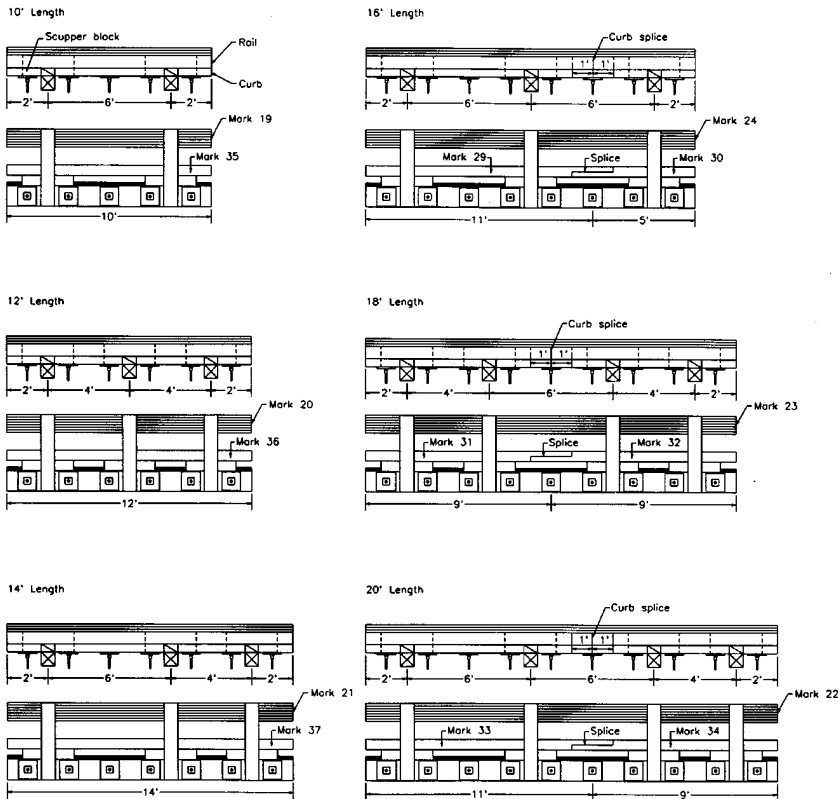
August 1995

Stress-Laminated Sawn Lumber Decks

General Details

Sheet 3 of 9

H Rail Option Configuration and Scupper Spacing

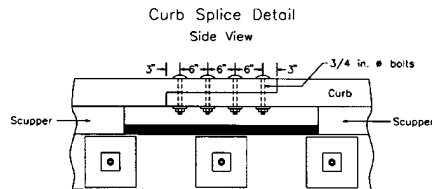


This bridge rail was successfully crash tested to the requirements for Performance Level 1 as outlined in the 1989 AASHTO Guide Specifications for Bridge Railings.

Refer to "Plans for Crash Tested Bridge Railings for Longitudinal Wood Decks" (Ritter and others, in-press) for additional crash tested bridge railings and approach railing transition.

Glulam rails are full span. Refer to fabrication details, Sheet 5.
 Spliced curbs may be continuous when material of sufficient length is available or when glulam timber curbs are used.
 Hardware eliminated for clarity.

See fabrication details, Sheet 5.



The bridge superstructures depicted on these drawings were developed under a cooperative research agreement between the USDA Forest Service, Forest Products Laboratory, the University of Alabama and the Southern Forest Products Association.



Standard Plans for Southern Pine Bridges

August 1995

Stress-Laminated Sawn Lumber Decks

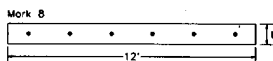
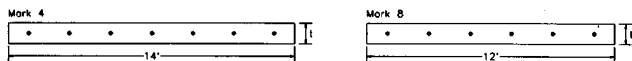
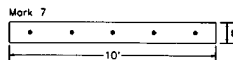
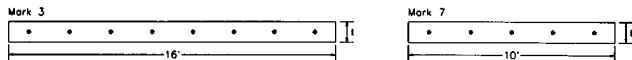
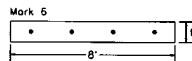
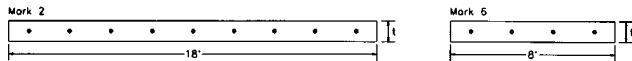
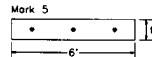
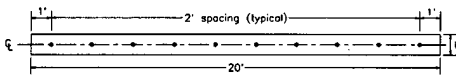
Rail Option Details

Sheet 4 of 9

Bridge Deck

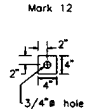
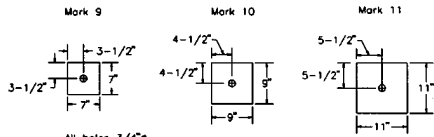
Nominal 2 in. Deck Laminations

Mark 1 Actual lumber dimensions are shown. All holes 1"ø.



Bar Bearing Plate: 1 in. Thick A36 Steel, Galvanized

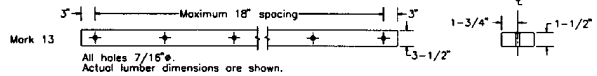
Anchor Plate: 3/4 in. Thick A36 Steel, Galvanized



All holes 3/4"ø.

Wearing Surface Retainer

2 x 4 in. Retainer Strip, No. 2 SP

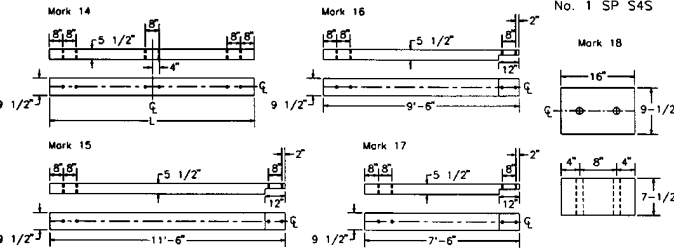


All holes 7/16"ø.
Actual lumber dimensions are shown.

Curb Option

6 x 10 in. Curb; No. 1 SP S4S

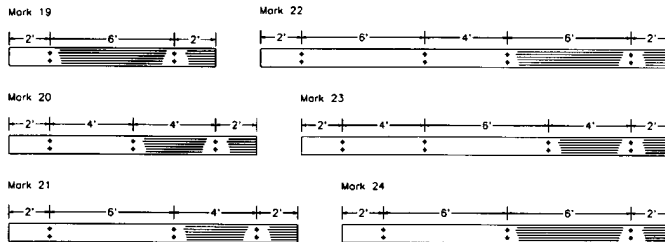
8 x 10 in. Scupper; No. 1 SP S4S



For curb option, actual lumber dimensions are shown and all holes are 7/8"ø.

Rail Option

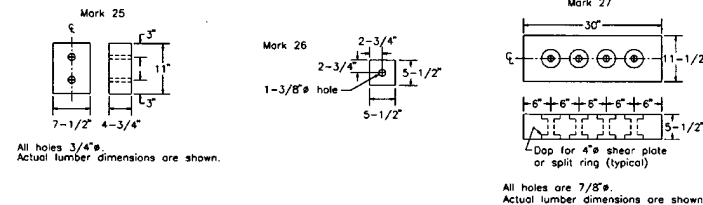
6-3/4 x 11 in. Glulam Rail; SP Comb. No. 48



8 x 4-3/4 in. Spacer Block; No. 1 SP S4S

Plate Washer: 1/4 in. Thick A36 Steel, Galvanized

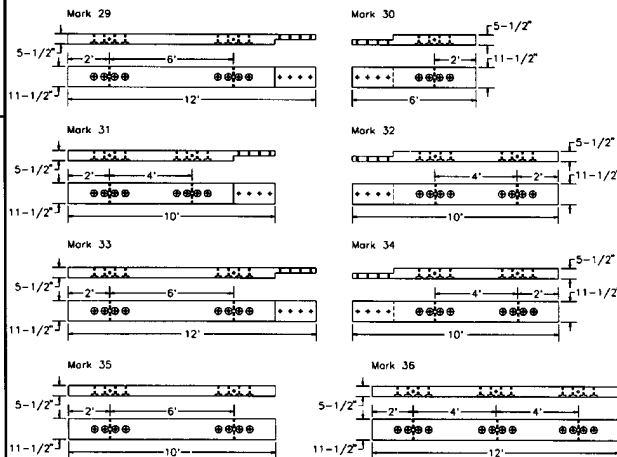
6 x 12 in. Scupper; No. 1 SP S4S



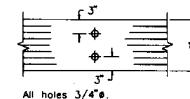
All holes 3/4"ø.
Actual lumber dimensions are shown.

All holes are 7/8"ø.
Actual lumber dimensions are shown.

6 x 12 in. Curb; No. 1 SP S4S

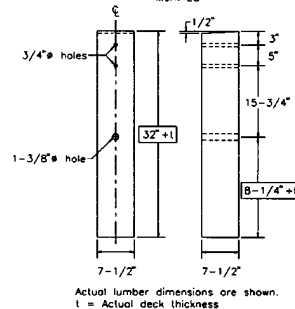


Typical Boring Detail for Rail



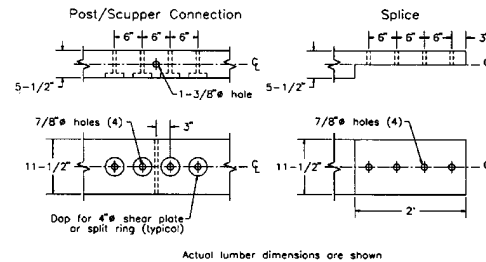
All holes 3/4"ø.

8 x 8 in. Rail Post; No. 1 SP S4S



Actual lumber dimensions are shown.
t = Actual deck thickness

Typical Boring Details for Curb



Actual lumber dimensions are shown

The bridge superstructures depicted on these drawings were developed under a cooperative research agreement between the USDA Forest Service, Forest Products Laboratory, the University of Alabama and the Southern Forest Products Association.



Standard Plans for Southern Pine Bridges

August 1995

Stress-Laminated Sawn Lumber Decks

Fabrication Details

Sheet 5 of 9

Table 3 - Table of Material Quantities

Item	Mark/Size	Bridge Length (ft)					
		10	12	14	16	18	20
Bridge Deck							
Interior deck Laminations	See Note 3						
	Hardwood	MK-7	MK-8	MK-4	MK-3	MK-2	MK-1
Exterior deck Laminations		4@MK-7	4@MK-8	4@MK-4	4@MK-5 4@MK-7	4@MK-6 4@MK-7	4@MK-6 4@MK-8
Exterior deck laminations	Dense SP	4@MK-7	4@MK-8	4@MK-4	4@MK-3	4@MK-2	4@MK-1
Stressing bars	5/8 in. ϕ (see Note 6 for length)	5	6	7	8	9	10
Stressing bar nuts	5/8 in. ϕ	10	12	14	16	18	20
Bar bearing plate	MK-9 through MK-11	10	12	14	16	18	20
Bar anchor plate	MK-12	10	12	14	16	18	20
Wearing Surface							
Geotextile fabric (yd ²)	-----	See Note 4					
Asphalt pavement (yd ³)	-----	See Note 5					
Retainer strip	MK-13	20 lin. ft	24 lin. ft	28 lin. ft	32 lin. ft	36 lin. ft	40 lin. ft
Lag screws	3/8 in. ϕ x 4 in.	20	25	25	30	30	32
Cut washers	3/8 in. ϕ	20	25	25	30	30	32
Curb Option							
Curb ¹	MK-14 through MK-17	2@MK-14	2@MK-14	2@MK-14	2@MK-16 2@MK-17	4@MK-16	2@MK-15 2@MK-16
Scupper block	MK-18	6	6	6	6	6	6
Curb bolts with hex nuts ²	3/4 in. ϕ x 2 1/2 in. for 8 in. deck 3/4 in. ϕ x 2 3/4 in. for 10 in. deck 3/4 in. ϕ x 2 5/8 in. for 12 in. deck	12	12	12	12	12	12
Malleable iron washers	3/4 in. ϕ	12	12	12	12	12	12
Rail Option							
Glulam rail	MK-19 through MK-24	2@MK-19	2@MK-20	2@MK-21	2@MK-24	2@MK-23	2@MK-22
Rail offset block	MK-25	4	6	6	6	8	8
Post	MK-28	4	6	6	6	8	8
Scupper block	MK-27	4	6	6	6	8	8
Curb ³	MK-29 through MK-37	2@MK-35	2@MK-36	2@MK-37	2@MK-29 2@MK-30	2@MK-31 2@MK-32	2@MK-33 2@MK-34
Curb bolt with nut ⁴	3/4 in. ϕ x 2 1/2 in. for 8 in. deck 3/4 in. ϕ x 2 3/4 in. for 10 in. deck 3/4 in. ϕ x 2 5/8 in. for 12 in. deck	16	24	24	24	32	32
Rail bolt with hex nut	5/8 in. ϕ x 2 1 in.	8	12	12	12	16	16
Post bolt with hex nut	1-1/4 in. ϕ x 2 1 in.	4	6	6	6	8	8
Malleable iron washer (rail)	5/8 in. ϕ	8	12	12	12	16	16
Malleable iron washer (curb)	3/4 in. ϕ	16	24	24	24	32	32
Plate washer (post)	MK-26	8	12	12	12	16	16
Split Rings ⁵	4 in. ϕ	32	48	48	48	64	64
Curb Splice Bolts	1-1/8 in. ϕ x G-1/2 in.	0	0	0	8	8	8
Miscellaneous							
Wood preservative (Gal.)	-----	1	1	1	2	2	2
Bituminous sealer (Gal.)	-----	1	2	2	2	2	2

- Material quantities are approximate and do not include quantities for substructure attachment options.
- Refer to Sheet 5 for Mark (MK) numbers and corresponding fabrication details. See Sheet 2 for material specifications.
- The number of laminations depends on the bridge width. For an actual lamination of 1-1/2 in. (standard dressed thickness for 2 in. nominal lumber), the number of laminations is determined from the following equation: # laminations = 1.01 Wx12(in. / ft. / 1.5in.)
- The required quantity of geotextile fabric is based on the following formula: fabric (yd²) = 1 (WxL) / (9 ft²/yd²)
- The volume of compacted asphalt is determined by the following formula: asphalt (yd³) = 1 (D.1875 HWL / (27 ft²/yd²))
- The bar length is determined by the following formula: bar length (ft) = W + 4(ft)
- Full length curbs may be used. See Detail B, Sheet 3.
- Bolt length should be verified based on specified material dimensions.
- Full length curbs may be used. See Detail H, Sheet 4.
- In lieu of split rings, back-to-back shear plates may be used. The quantity is twice that shown for split rings.

For the above equations,
W = Bridge width (ft); L = Out-to-out bridge length (ft).

Construction Recommendations and Procedures

The performance and longevity of any bridge depends on the materials and construction practices. Abbreviated recommendations for proper construction of the stress-laminated bridges depicted in these drawings follow. It is advisable to read and understand all these recommendations prior to beginning construction. For additional information, refer to the drawing notes and *Timber Bridges: Design, Construction, Inspection, and Maintenance* (Ritter 1990).

MATERIALS

The following recommendations should be followed for materials:

- Lumber must be stress graded and properly treated with wood preservatives.
- Laminations should be straight and free of distortion. Laminations with warp, sweep, or cupping will make bar insertion difficult.
- The wide face of the lumber laminations must be surfaced to ensure uniform lamination thickness. Variations in lamination thickness may cause changes in the deck width and may prevent full contact and load distribution between adjacent laminations.
- The moisture content of the laminations should not exceed the value specified. Lumber that is dry will result in better deck performance because shrinkage and associated bar force loss will be minimized. If lumber is placed at a high moisture content, it will eventually dry and shrink, which will result in bar force loss.
- The location and size of holes in the laminations for stressing bars should be verified before bridge erection. Misaligned or undersized holes will make bar insertion difficult and may require field drilling. Oversized holes may reduce the bridge load capacity.
- Nuts for galvanized stressing bars must be oversized to compensate for the galvanizing. Nuts that are not oversized or reamed will not fit on the stressing bars.
- Proper material certification and/or quality assurance certificates should be received and verified for all materials.
- Field cutting and drilling of treated wood members must be minimized. In cases where field fabrication is required, proper field treating is essential.

BRIDGE ASSEMBLY

The stress-laminated bridge deck shown in these plans are typically assembled and stressed on the abutments. Another option is to assemble the bridge adjacent to the bridge site and lift the stressed bridge into place with a crane. Guidelines for bridge assembly using both approaches follow.

Assembly on the Abutments

When the bridge is assembled on the abutments, there are two techniques commonly used for placing the laminations:

- The laminations are placed individually. Using this method, the first 4 to 8 laminations are placed at the deck edge location and nailed together so that they stand unsupported. The remaining laminations are then placed using wood dowels to align holes. When holes are aligned, nails may be used to hold the laminations in place or the stressing bars may be inserted and pushed through the holes as laminations are added. If bars are inserted, it is important that they be supported on the free end and not allowed to bend excessively. Bar bending may damage the bar or the galvanizing coating.
- The laminations are preassembled into panels. In this case, panels 2 to 4 ft wide are assembled by nailing laminations together or banding laminations with metal bands. In both cases, the holes must be aligned so that stressing bars can be easily inserted. If banding is used, corner guards must be provided to prevent damage to the wood when the bands are tightened. After assembly, the panels are lifted onto the abutments and the bars are inserted and tensioned. When lifting panels, use full support across the bottom of the panels so that individual laminations do not move relative to one another.

If bars are difficult to insert through the laminations and gently striking the bar aids assembly, place a wood block over the end of the bar to protect the steel. Do not hammer

directly on the end of the bar. This will cause the steel to "mushroom" and the nut cannot be properly threaded. Also be careful not to bend or otherwise damage the bar. If bars cannot be inserted without excessive hammering, shift the laminations as necessary until the holes align properly.

One method that works well for aiding in bar insertion is to insert PVC pipe through the laminations as the bridge is being assembled (See Detail G, Sheet 3). The pipe is inexpensive and easy to handle in the field. After all laminations are placed, the bars are easily inserted through the pipe. The o-ring joint shown in Detail G allows the PVC pipe to adjust with the bridge as it narrows due to tensioning.

Assembly Adjacent to the Site

Stress-laminated bridges may be completely assembled adjacent to the site and lifted into place with a crane. To accomplish this, a level site is necessary and wood blocking or other supports are needed at the bridge ends to serve as temporary abutments. Laminations may be placed on the supports individually or in panels as previously described. After assembly, the bars must be fully tensioned, as discussed below, before the bridge is lifted. When lifting the assembled bridge, use lifting eyes through the top of the bridge or use spreader beams under the bridge. Do not lift the bridge by the stressing bars as this may cause the bars to bend or laminations to slip.

BAR TENSIONING

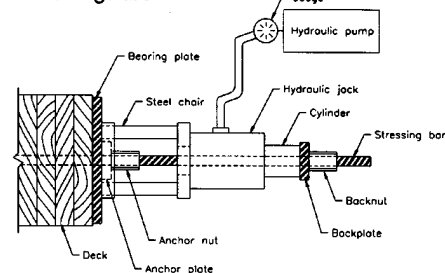
The prestressing system is perhaps the most important part of a stress-laminated bridge because it holds the bridge together and develops the necessary friction between the laminations. Thus, it is important that a sufficient level of uniform, compressive prestress be maintained between the lumber laminations in order for a stress-laminated bridge to perform properly.

Recommendations for bar tensioning using a single hydraulic jack, which is the most economical and commonly used, are given below.

Equipment and Procedures

Stress-laminated bridges are stressed together with a hydraulic jack that applies tension to the prestressing bar by pulling the bar away from the steel anchor plate. After the tension is applied, the nut is tightened against the anchor plate and the tension remains in the bar when jack pressure is released. The typical equipment for bar tensioning consists of a hydraulic hollow-core jack, pump, hose and gauge, a steel tensioning chair, backplate, and backnut (Figure 1). The following should be considered regarding equipment:

Figure 1 - Tensioning Equipment and Configuration



The bridge superstructures depicted on these drawings were developed under a cooperative research agreement between the USDA Forest Service, Forest Products Laboratory, the University of Alabama and the Southern Forest Products Association.



Standard Plans for Southern Pine Bridges

August 1995

Stress-Laminated Sawn Lumber Decks

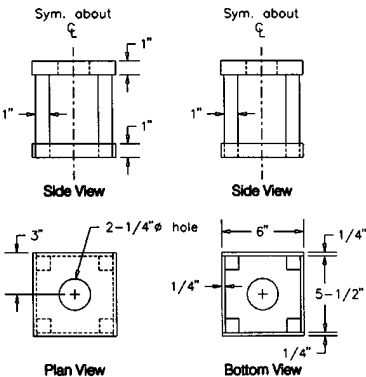
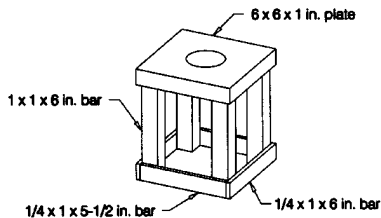
Materials and Construction Recommendations

Sheet 6 of 9

- The capacity of the jack must be sufficient to provide the design tension force.
- The pump may be hand operated or electric. Hand operated pumps are less expensive but slower than electric pumps. Electric pumps also require an on-site power source.
- The scale of the hydraulic gauge attached to the pump may be calibrated in lb/in.² or tons. It is generally easier to work in tons. If the gauge is calibrated in lb/in.², a table which converts lb/in.² values to the jack force must be provided.
- The stressing chair is normally fabricated locally. An example of a typical welded steel stressing chair for the bridges in these plans is shown in Figure 2. It is important that the base of the chair be large enough to fit over the bar anchor plate, but remain on the bearing plate. The chair must not bear directly on the lumber laminations. The height of the chair should be 2-3 times the length of the bar nut plus the anchor plate thickness.
- The backplate is generally the same size as the bar anchor plate.

Figure 2 - Typical Welded Steel Chair

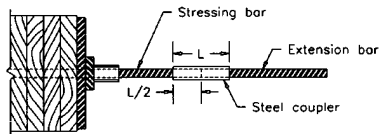
All components A36 steel.



- Several extra backnuts should be kept on-hand during bar tensioning. After repeated tensioning, the backnuts may tend to bind and should be replaced.

To tension the bars properly, there must be sufficient bar length beyond the nut on which to place the tensioning equipment. It is generally beneficial to select one bridge edge and place all bar extension on that edge. On the opposite edge, bars should extend approximately 1 in. beyond the nut. If there is insufficient bar length for the tensioning equipment, a temporary coupler and bar extension may be used (Figure 3). If this is done, it is critical that each bar be threaded fully into half the coupler length. Failure to do so may result in coupler breakage. It is also important to verify that the holes in the hydraulic jack and stressing chair are large enough to fit over the coupler.

Figure 3 - Typical Coupler and Extension Bar Assembly



Coupler is threaded halfway onto stressing bar and halfway onto extension bar.

During all bar tensioning procedures, it is important that personnel not stand in line with the bar, or place hands or other body parts on or near the tensioning equipment. At the high force during tensioning, a broken bar will exit at great speed and force and can cause serious injury or death. It is also important not to lift the jack by the hydraulic hose as this may damage the hose and cause rupture under high oil pressure. To aid in handling, a rope securely tied to the jack may be beneficial.

The following steps outline the typical procedure for bar tensioning.

- Place the chair and jack on the bar. Place the jack so that the cylinder extends away from the bridge. Placing the cylinder against the chair may cause the chair to bend.
- Place the backplate and backnut on the bar. Provide a small gap of approximately 1/4 in. between the backplate and the jack to prevent binding when hydraulic pressure is released.
- Apply hydraulic pressure to the jack until the gauge is at the required reading. It is common to apply approximately 10% greater force to compensate for lockoff losses when the nut is tightened. Ensure that the proper gauge scale is used. Most gauges have several scales for different jacks.

- Tighten the bar nut against the bridge anchor plate; an open-end wrench generally works best. As the nut is tightened, the gauge pressure on the hydraulic pump will drop slightly. On occasion, the nut may bind slightly on the galvanizing. It is important to tighten the nut sufficiently to ensure that it bears tightly against the anchor plate.
- Release the pump hydraulic pressure slowly and remove the tensioning equipment. If the backnut binds, tap it gently along the bar axis to loosen the threads.

Tensioning Sequence

For a stress-laminated bridge to function properly, all bars must be tensioned uniformly to the design force. As the bars are tensioned, the laminations compress and the bridge deck narrows. When using a single hydraulic jack, tensioning one bar compresses the bridge and causes the force in adjacent bars to decrease. This effect is most pronounced when the bridge is initially tensioned and decreases as the force in all bars becomes equal. To compensate for this effect, bars must be sequentially tensioned several times to equalize force. This is generally accomplished by tensioning the first bar on one end of the bridge and sequentially tensioning each successive bar down the bridge length. The process is then repeated several times until all bars are fully tensioned to the design level.

As described in Note 32, Sheet 2, bar tensioning must be completed three times during the construction process:

- at the time of bridge erection
- approximately 1 week after the first tensioning
- 6-8 weeks after the second tensioning

When initially tensioning bars with a single jack, it is important that the tension be applied gradually to prevent distortion along the bridge edges. If bars are initially tensioned to the full design level, the bridge edges may become distorted. For best results, the following procedure is recommended for the first tensioning.

- Starting at one end of the bridge, sequentially tension each bar to approximately 25% of the design level. During this process, a stringline may be used to ensure that the edges of the bridge remain straight.
- Following the same procedure, tension each bar to approximately 50% of the design level. The force level may be varied slightly to ensure that bridge edges remain straight.
- Starting at one end again, sequentially tension each bar to the full design level. Again, the force level may be varied slightly to ensure that bridge edges remain straight.
- Return to the first bar, and repeat step 3.
- Check the force in several bars using the procedures described below. If the force is 10% or more below the design level, retension the bar. Generally, the above steps are sufficient to achieve uniform bar tension; however, in some cases it may be necessary to repeat step 3 one or two more times.

After the above initial tensioning, the bars must be retensioned a second and third time in accordance with the tensioning sequence previously discussed. At the conclusion of each bar tensioning, the force level should be checked to verify that all bars are at the design level. When the last two tensionings are completed, the bar force should stabilize and should not drop below 40% of the design level. However, the decrease in bar force depends on many factors and should be checked periodically after construction. It is recommended that the bar force be checked on an annual basis for the first 2 years after construction and at 1 to 3 year intervals thereafter until the bar force stabilizes. This typically requires little time or equipment and will ensure that the bridge performs properly over the design life.

Checking Bar Force

The force in tensioning bars can be checked quickly with the same equipment used for tensioning. The two methods given below provide acceptable estimates of bar force. The nut turn method is applicable to both the manual and electric pumps and the gauge method is applicable only to hand-operated hydraulic pumps.

Nut Turn Method

To determine the bar force using the nut turn method, a wrench is placed on the bar nut adjacent to the anchor plate and force is slowly applied to the hydraulic jack. During the application of jack force, the wrench is pushed in the direction to loosen the nut. The gauge reading at the point where the nut just begins to turn can be converted to the approximate force in the bar. In some cases, the nut may slightly bind on the bar and may not turn when the bar force is applied. In this case, jack the bar until the nut is pulled away from the plate and turn the nut slightly in both directions to loosen the binding. After turning the nut, be sure to return it to the original position prior to releasing the jack force. After this is accomplished, the procedure to check bar force can be completed using the free-turning nut.

Gauge Method

When the hydraulic jack applies tension to the bar, the gauge needle moves relatively quickly as the load is initially applied. As the force increases, and the full bar becomes tensioned, the needle movement is slower. When the bar force is overcome and the jack begins to apply force to the entire bar, there is a slight pause in the gauge needle rise. This occurs approximately at the point where the force in the jack equals the force in the bar. To check bar force using this method, slowly pump the hydraulic pump and watch the movement of the gauge needle. When the jack is pumped, and the needle stops moving momentarily, note the gauge reading. This reading represents the approximate bar force. At this time, it will also become slightly more difficult to pump the jack. Using this method requires a "feel" for the release point and should be practiced prior to determining the bar force.

Tensioning Considerations

As the bars are tensioned, the laminations compress and the bridge width will narrow slightly. This is most pronounced when the bars are initially tensioned and decreases with subsequent tensioning. It is therefore advisable to delay substructure attachment and curb and rail placement until after the second bar tensioning. It is also advisable to wait until after the second or third bar tensioning to apply the asphalt wearing surface.

After the bars in a bridge have been tensioned, it is important that sufficient bar length remain along one edge to allow future bar force verification and retensioning. If a coupler and extension bar will be used for future tensionings, bars may be cut short, but a minimum of 10 in. of bar should remain beyond the nut. When no coupler and extension bar will be used for future tensionings, the bar length beyond the nut should be 18 to 24 in., depending on the bar length required for the tensioning equipment.



Design Guidelines for Stress-Laminated Bridge Decks Constructed with Visually Graded No. 2 Southern Pine Dimension Lumber

Background

The concept of stress-laminated wood bridges is relatively new in the United States. Although bridges of this type have been built in Canada since 1976, they were not introduced in the U.S. until the late 1980s. In April 1991, the American Association of State Highway and Transportation Officials (AASHTO) published Guide Specifications for the Design of Stress-Laminated Wood Bridges (AASHTO 1991). As a guide specification, the publication represents the recommendations of AASHTO and is open to comment and revision prior to adoption in the AASHTO Standard Specifications for Highway Bridges. It is anticipated that design provisions for stress-laminated wood bridges will be included in the AASHTO within the next several years.

The design criteria for stress-laminated Southern Pine bridge superstructures presented on the preceding sheets are based on design recommendations presented in the following references:

AASHTO. 1991. Guide Specifications for the Design of Stress-Laminated Wood Decks. Washington, DC: American Association of State and Highway Transportation Officials.

AASHTO. 1992. Standard Specifications for Highway Bridges, 15th edition. Washington, DC: American Association of State and Highway Transportation Officials. (with interims through 1994).

Ritter, M.A. 1990. Timber bridges: design, construction, inspection and maintenance. EM7700-8. Washington, DC: U.S. Department of Agriculture.

In general, the criteria follow the recommendations of the AASHTO Guide Specifications for the Design of Stress-Laminated Wood. However, minor modifications have been made to improve performance or simplify the design process.

Design Procedures

The following procedures are for stress-laminated decks constructed of No. 2 visually graded Southern Pine lumber. The lumber is dressed (S4S) with a nominal thickness of 2 in. (1.5 in. actual) and widths of 8, 10, and 12 in. (7.25, 9.25, and 11.25 in. actual, respectively). Design references are included to AASHTO specifications with the notation "AASHTO" signifying the Standard Specifications for Highway Bridges and "AASHTO GS" signifying the Guide Specifications for the Design of Stress-Laminated Wood Decks. Calculations and summary tables are included to illustrate the design methodology and values used for the plans. Numbers noted in the calculations and summaries were rounded for the final solution, but generally were not rounded for intermediate steps. For additional design information, refer to the above references.

1. Define deck geometry and design live load.

Deck Geometry

Definitions and options for deck geometry are as follows:

Width: Bridge width is the total deck width measured out-to-out. The plans include options for single-lane bridge widths of 12 to 18 ft and double-lane bridge widths of 22 to 38 ft

Length: Bridge length is the total deck length, measured end-to-end. The plans include bridge length options of 10 to 20 ft in 2 ft increments. These increments correspond to standard lumber lengths.

Span: Bridge span is the distance measured center-to-center of bearings. The plans are based on a minimum bearing length at each bridge end of 10 in. Thus, the bridge span is 10 in. less than the bridge length. A longer bearing length results in a slightly conservative design.

Design Live Load

Plans include an option for either AASHTO HS20-44 or HS25-44 vehicle live loads (AASHTO 3.7). For both loads, the design is controlled by the truck loads, rather than lane loads.

2. Select a species and grade of lamination and compute allowable design values.

All designs are based on nominal 2 in. thick Southern Pine dimension lumber, visually graded No. 2. The following tabulated design values are obtained from AASHTO Table 13.5.1.A:

Table 1 - Tabulated Values for No. 2 Southern Pine Dimension Lumber

Nominal Lumber Width, (in.)	Tabulated Design Values (lb/in. ²)		
	Bending, F_b	Modulus of Elasticity, E	Compression Perpendicular to Grain, $F_{c\perp}$
8	1,200	1,600,000	565
10	1,050	1,600,000	565
12	975	1,600,000	565

Allowable design values are based on wet service conditions and are computed in accordance with the following equations, for bending, modulus of elasticity, and compression perpendicular to grain:

Bending [AASHTO 13.6.4]:

$$F_b' = F_b C_D C_M C_D C_{LS} \quad (1)$$

where:

- F_b' = allowable bending stress (lb/in.²);
- F_b = tabulated bending stress (lb/in.²);
- C_D = bending size factor = 1.0 (AASHTO 13.6.4.2);
- C_M = wet service factor (AASHTO 13.5.4.1);
- = 1.0 for $F_b C_D \leq 1,150$ lb/in.² ($t = 10$ and 12 in.)
- = 0.85 for $F_b C_D > 1,150$ lb/in.² ($t = 8$ in.);
- C_D = load duration factor = 1.15 (AASHTO 13.5.4.2);
- C_{LS} = load sharing factor = 1.50 (AASHTO GS 13.2.7).

For: 8 in. nominal lumber; $F_b' = (1200)(1.0)(0.85)(1.15)(1.50) = 1,760$ lb/in.².

10 in. nominal lumber; $F_b' = (1050)(1.0)(1.0)(1.15)(1.50) = 1,811$ lb/in.².

12 in. nominal lumber; $F_b' = (975)(1.0)(1.0)(1.15)(1.50) = 1,682$ lb/in.².

Modulus of elasticity [AASHTO 13.6.3]:

$$E' = EC_M \quad (2)$$

where:

- E' = allowable modulus of elasticity (lb/in.²);
- E = tabulated modulus of elasticity (lb/in.²);
- C_M = wet service factor = 0.90 (AASHTO 13.5.4.1).

For 8, 10, and 12 in. nominal lumber;
 $E' = (1600000)(0.90) = 1,440,000$ lb/in.².

Compression perpendicular to grain [AASHTO 13.6.6]

$$F_{c\perp}' = F_{c\perp}(C_M) \quad (3)$$

where:

- $F_{c\perp}'$ = allowable compression perpendicular to grain (lb/in.²);
- $F_{c\perp}$ = tabulated compression perpendicular to grain (lb/in.²);
- C_M = wet service factor = 0.87 (AASHTO 13.5.4.1).

For 8, 10, and 12 in. nominal lumber; $F_{c\perp}' = (565)(0.87) = 379$ lb/in.².

3. Choose a deck thickness and compute the distribution width and effective deck section properties.

The design of stress-laminated decks is based on beam theory and assumes that one wheel line of the design vehicle is supported by a strip of deck width, measured normal to the bridge span, defined as the wheel load distribution width (AASHTO GS 3.25.5.2). The distribution width is a function of the deck thickness and the design vehicle maximum wheel load. Thus, a deck thickness must be estimated for initial distribution width calculations. This estimated thickness may be revised later in the design process if it is found to be insufficient or too conservative.

Values shown in Table 2 are used to estimate deck thickness for No. 2 visually graded Southern Pine laminations, 8, 10 or 12 in. wide. Options are given for loading and deflection limits of L/360 and L/500. Note that in most cases, the same deck thickness is required for both the L/360 and L/500 deflection limits.

Table 2 - Estimated Deck Thickness

Bridge Length (ft)	Bridge Span L (ft)	Estimated deck thickness (in.)			
		HS 20-44 loading		HS 25-44 loading	
		L/360	L/500	L/360	L/500
10	9.17	8	10	10	10
12	11.17	10	10	10	10
14	13.17	10	10	10	12
16	15.17	10	12	12	12
18	17.17	12	12	12	12
20	19.17	12	>12	12	>12

Calculations for distribution width and section properties, as well as subsequent calculations for stresses and deflection, are based on the actual lamination size rather than the nominal size. For nominal 8, 10 and 12 in. laminations, the actual dimensions are 7.25, 9.25, and 11.25 in., respectively (AASHTO Table 13.2.1.A).

The distribution width is computed by the following equations:

$$b_f = \sqrt{0.025P} \quad D_w = b_f - 2t \quad (4)$$

where:

- b_f = wheel load tire width (in.) (AASHTO 3.30);
- = 20.00 in. for HS 20-44
- = 22.36 in. for HS 25-44

- P = maximum wheel load (lb) (AASHTO 3.7);
- = 16,000 lb for the HS 20-44 vehicle
- = 20,000 lb for the HS 25-44 vehicle

- D_w = wheel load distribution width (in.) (AASHTO GS 3.25.5.2);
- t = actual deck thickness (in.).

Section modulus and moment of inertia are computed for a beam with a depth and width equal to the deck thickness and distribution width, respectively:

$$S = \frac{D_w(t)^2}{6} \quad I = \frac{D_w(t)^3}{12} \quad (5)$$

where:

- S = section modulus (in.³);
- I = moment of inertia (in.⁴).

A summary of deck section properties is given in Table 3.

Table 3 - Deck Section Properties

Nominal t (in.)	Actual t (in.)	AASHTO HS 20-44		AASHTO HS25-44	
		D_w (in.)	S (in. ³)	D_w (in.)	S (in. ³)
8	7.25	34.5	302.2	1,095.6	—
10	9.25	38.6	549.0	2,539.3	40.9
12	11.25	42.5	896.5	5,042.7	44.9

4. Compute the deck dead load, dead load moment, and live load moment.

Compute the dead load of the deck and wearing surface in pounds per square foot using unit weights of 50 lb/ft³ for wood, 150 lb/ft³ for asphalt pavement, and 490 lb/ft³ for steel (AASHTO 3.3.6). The dead load of the bridge rail and stressing hardware is normally assumed to be equally distributed across the deck width.

The dead load acting across the distribution width is computed by the following equation:

$$w_{DL} = \frac{DL(D_w)}{12} \quad (6)$$

where:

- w_{DL} = dead load acting over the distribution width (lb/ft);
- DL = deck dead load (lb/ft²).



The maximum dead load moment for a simple span deck with a uniformly distributed load is computed by the following equation:

$$M_{DL} = \frac{w_{DL} L^2}{8} \quad (7)$$

where:

- M_{DL} = maximum dead load moment (ft-lb);
- L = bridge span measured center-to-center of bearings (ft).

A summary of dead load values is given in Table 4.

Table 4 - Dead Load Summary

Length (ft)	L (ft)	Actual t (in.)	DL ¹ (lb/ft ²)	HS 20-44		HS 25-44	
				w _{DL} (lb/ft)	M _{DL} (ft-lb)	w _{DL} (lb/ft)	M _{DL} (ft-lb)
10	9.17	7.25	98	280.9	2,950.5	—	—
10	9.17	9.25	106	340.2	3,573.5	361.1	3,792.6
12	11.17	9.25	106	340.2	5,302.9	361.1	5,628.1
14	13.17	9.25	106	340.2	7,372.5	361.1	7,824.6
14	13.17	11.25	114	—	—	427.6	9,265.7
16	15.17	9.25	106	340.2	9,782.4	—	—
16	15.17	11.25	114	405.1	11,647.4	427.6	12,294.4
18	17.17	11.25	114	405.1	14,921.8	427.6	15,750.6
20	19.17	11.25	114	405.1	18,601.2	427.6	19,634.5

¹ Based on 30 lb/ft² for rail and stressing hardware.

The maximum live load moment, M_{LL} , for one wheel line of the design vehicle on a simple span deck is computed using statics, or by obtaining the maximum moment value from design tables. Values used for preparation of the plans are shown in Table 5.

Table 5 - Maximum Live Load Moment

Length (ft)	L (ft)	Live load moment per wheel line (ft-lb)	
		HS 20-44	HS 25-44
10	9.17	36,670	45,830
12	11.17	44,670	55,830
14	13.17	52,670	65,830
16	15.17	60,670	75,830
18	17.17	68,670	85,830
20	19.17	76,670	95,830

5. Compute maximum deck bending stress.

The maximum applied bending stress is computed by the following equation:

$$f_s = \frac{(M_{DL} + M_{LL}) (12 \text{ in./ft})}{S} \quad (8)$$

The applied bending stress must not exceed the allowable bending stress. If $f_s \leq F_{cs}$, the deck is sufficient in bending. If f_s is substantially less than F_{cs} , a thinner deck may be more economical; however, no changes in deck thickness should be made until after live load deflection is checked. If $f_s > F_{cs}$, the deck is insufficient in bending and the deck thickness must be increased.

A summary of bending stresses is given in Table 6.

Table 6 - Bending Stress

Length (ft)	L (ft)	Actual t (in.)	HS 20-44			HS 25-44		
			F_c (lb/in ²)	f_b (lb/in ²)	f_s/F_{cs}	F_c (lb/in ²)	f_s (lb/in ²)	f_s/F_{cs}
10	9.17	7.25	1,760	1,573	0.89	—	—	—
10	9.17	9.25	1,811	880	0.49	1,811	1,022	0.56
12	11.17	9.25	1,811	1,092	0.60	1,811	1,266	0.70
14	13.17	9.25	1,811	1,312	0.72	1,811	1,517	0.84
14	13.17	11.25	—	—	—	1,682	952	0.57
16	15.17	9.25	1,811	1,540	0.85	—	—	—
16	15.17	11.25	1,682	968	0.58	1,682	1,118	0.66
18	17.17	11.25	1,682	1,119	0.67	1,682	1,288	0.77
20	19.17	11.25	1,682	1,275	0.76	1,682	1,464	0.87

6. Check live load deflection.

Maximum live load deflection is computed for one wheel line of the design vehicle. For deflection only, the wheel load distribution width may be increased by a factor of 1.15 (AASHTO GS 3.25.5.3). Thus, the moment of inertia determined in Equation 5 is multiplied by 1.15. Deflection is computed by statics or by coefficients given in design handbooks. Using a handbook coefficient:

$$\Delta_{LL} = \frac{DC}{E' (1.15)} \quad (9)$$

where:

- Δ_{LL} = vehicle live load deflection (in.);
- DC = live load deflection coefficient (Ritter 1990)(lb-in.³).

If the computed live load deflection exceeds the design limit, deck thickness is unacceptable and must be increased. AASHTO recommends a maximum live load deflection of L/500 (AASHTO GS 13.11.3.1). Since a deflection limit of L/360 is sufficient for most bridges, the plans include both limits. A summary of live load deflections computed by Equation 9 is given in Table 7.

Table 7 - Live Load Deflection

Length (ft)	L (ft)	Actual t (in.)	HS 20-44 loading			HS 25-44 loading		
			DC (lb-in ³)	Δ_{LL} (in.)	L/	DC (lb-in ³)	Δ_{LL} (in.)	L/
10	9.17	7.25	4.44x10 ⁸	0.24	450	—	—	—
10	9.17	9.25	4.44x10 ⁸	0.11	1043	5.55x10 ⁸	0.12	885
12	11.17	9.25	8.02x10 ⁸	0.19	703	1.00x10 ⁹	0.22	597
14	13.17	9.25	1.31x10 ⁹	0.31	505	1.64x10 ⁹	0.37	429
14	13.17	11.25	—	—	—	1.64x10 ⁹	0.19	847
16	15.17	9.25	2.01x10 ⁹	0.48	381	—	—	—
16	15.17	11.25	2.01x10 ⁹	0.24	756	2.51x10 ⁹	0.28	639
18	17.17	11.25	2.91x10 ⁹	0.35	590	3.64x10 ⁹	0.41	499
20	19.17	11.25	4.06x10 ⁹	0.49	474	5.07x10 ⁹	0.58	400

7. Determine the required prestress level.

The level of compressive prestress between the laminations must be sufficient to offset flexural tension caused by transverse bending and vertical slip caused by transverse shear. Different methods for determining the initial prestress level are given in several publications (AASHTO 1991; Ritter 1990). For these designs, an initial prestress of 100 lb/in.² was selected because it has been widely used and has provided good performance for Southern Pine decks.

8. Determine the size and spacing of the prestressing bars and the required prestressing force.

The size and spacing of prestressing bars must satisfy the following equations (AASHTO GS 13.11.2.3):

$$A_p \geq \frac{p_i s t}{f_s} \quad \text{and} \quad \frac{A_p}{s t} \leq 0.0016 \quad (10)$$

where:

- A_p = cross-sectional area of the prestressing bar (in.²);
- p_i = initial prestress = 100 lb/in.²;
- s = prestressing bar spacing (in.);
- f_s = allowable tensile stress for the prestressing bar = 105,000 lb/in.² for ASTM A722 bars (AASHTO 9.15.1).

The required prestressing force, F_{ps} (lb), is computed by the following equation:

$$F_{ps} = p_i s t \quad (11)$$

For all spans and deck thicknesses, 5/8 in. diameter ASTM A722 bars are selected with a 24 in. center-to-center spacing. A summary of prestressing bar information is given in Table 8.

Table 8 - Prestressing Bar Summary

Nominal t (in.)	Actual t (in.)	A_p (in ²)	s (in.)	(p _{st})/f _s (in ²)	A _p /st (in ²)	F _{ps} (lb)
8	7.25	0.28	24	0.166	0.0016	17,400
10	9.25	0.28	24	0.211	0.0013	22,200
12	11.25	0.28	24	0.257	0.0010	27,000

9. Design the prestressing bar anchorage system.

The bar anchorage system consists of a steel bearing plate and a smaller steel anchorage plate that transfer the force of the stressing bars into the wood laminations. They must be designed conservatively to ensure that compressive stress applied to the exterior laminations does not cause wood crushing.

The minimum area of the steel bearing plate in square inches, A_{pb} , is given by Equation 12 (AASHTO GS 13.11.2.4). Minimum bearing plate thickness is computed by Equation 13 (AASHTO GS 13.11.2.4).

$$A_{pb} = \frac{p_i s t}{F_c} \quad (12)$$

$$t_p = \left[\frac{3(f_{bp})(k)^2}{f_s} \right]^{0.5} \quad (13)$$

$$k = \frac{W_p - W_A}{2} \quad \text{or} \quad \frac{L_p - L_A}{2} \quad \text{whichever is greater} \quad (14)$$

where:

- t_p = bearing plate thickness (in.²);
- F_c = actual bearing stress under the bearing plate (lb/in.²);
- k = plate size parameter (in.);
- f_s = allowable bending stress for the steel plate = 20,000 lb/in.² for ASTM A36 steel (AASHTO 10.32.1);
- W_p = width of bearing plate (in.);
- W_A = width of anchorage plate (in.);
- L_p = length of bearing plate (in.);

L_A = length of anchorage plate (in.).

A summary of the anchorage system is given in Table 9.

Table 9 - Prestressing Bar Anchorage Summary

Parameter	Nominal deck thickness, t (in.)		
	8	10	12
Bearing plate size $L_p \times W_p \times 1$ (in.)	7 x 7	9 x 9	11 x 11
Anchor plate size $L_A \times W_A \times 3/4$ (in.)	4 x 4	4 x 4	4 x 4
A_{pb} minimum (in. ²)	46.0	58.6	71.3
A_{pb} actual (in. ²)	49.0	81.0	121.0
f_{cs} (lb/in. ²)	355.1	274.1	223.1
k	1.5	2.5	3.5
t _p minimum (in.)	0.35	0.51	0.64

11. Determine the support configuration and check bearing stress.

Supports for stress-laminated decks must be designed to resist the vertical and lateral forces transmitted from the superstructure to the substructure. The required bearing length is normally controlled by considerations for bearing configuration, rather than compressive strength perpendicular to grain. From a practical standpoint, a minimum bearing length of 10 in. is recommended. Bearing attachments are normally made through the deck to the supporting cap or sill, or from the deck underside. Such attachments are illustrated on Sheet 3.

Bearing stress in compression perpendicular to grain is checked for the maximum reaction at the support due to the bridge dead load and one wheel line of the design vehicle. This load is distributed over an area defined by the distribution width, D_{LL} , and the bearing length, L_b . Bearing stress is computed using the following equation:

$$f_c = \frac{R_{DL} + R_{LL}}{D_{LL}(L_b)} \quad (15)$$

where:

- R_{DL} = dead load reaction (lb);
- R_{LL} = maximum live load reaction for one wheel line of vehicle (lb);
- L_b = deck bearing length at the support (in.).

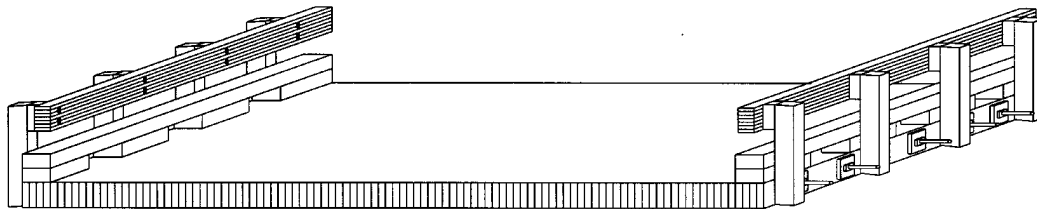
The value of f_c computed by Equation 15 must be less than F_{cs} , which is 379 lb/in.². Bearing information is presented in Table 10.

Table 10 - Bearing Summary

Length (ft)	t (in.)	HS 20-44 loading			HS 25-44 loading		
		R _{DL} (lb)	R _{LL} (lb)	f _c (lb/in. ²)	R _{DL} (lb)	R _{LL} (lb)	f _c (lb/in. ²)
10	7.25	1,405	16,000	50.5	—	—	—
10	9.25	1,701	16,000	46.0	1,805	20,000	53.4
12	9.25	2,041	16,000	46.9	2,167	20,000	54.3
14	9.25	2,382	16,000	47.7	2,528	20,000	55.1
14	11.25	—	—	—	2,993	20,000	51.3
16	9.25	2,722	17,230	51.8	—	—	—
16	11.25	3,241	17,230	48.2	3,421	21,540	55.6
18	11.25	3,646	18,950	53.2	3,848	23,690	61.4
20	11.25	4,051	20,230	57.3	4,275	25,390	66.1



Stress-Laminated Glued Laminated Timber Bridge Decks



Legend

1. Title
2. General Layout and Notes
3. General Details
4. Rail Option Details
5. Fabrication Details
6. Fabrication Details
7. Materials and Construction Recommendations
8. Construction Recommendations
9. Design Procedure
10. Design Procedure
11. Design Procedure

The bridge superstructures depicted on these drawings were developed under a cooperative research agreement between the USDA Forest Service, Forest Products Laboratory, the University of Alabama and the Southern Forest Products Association.



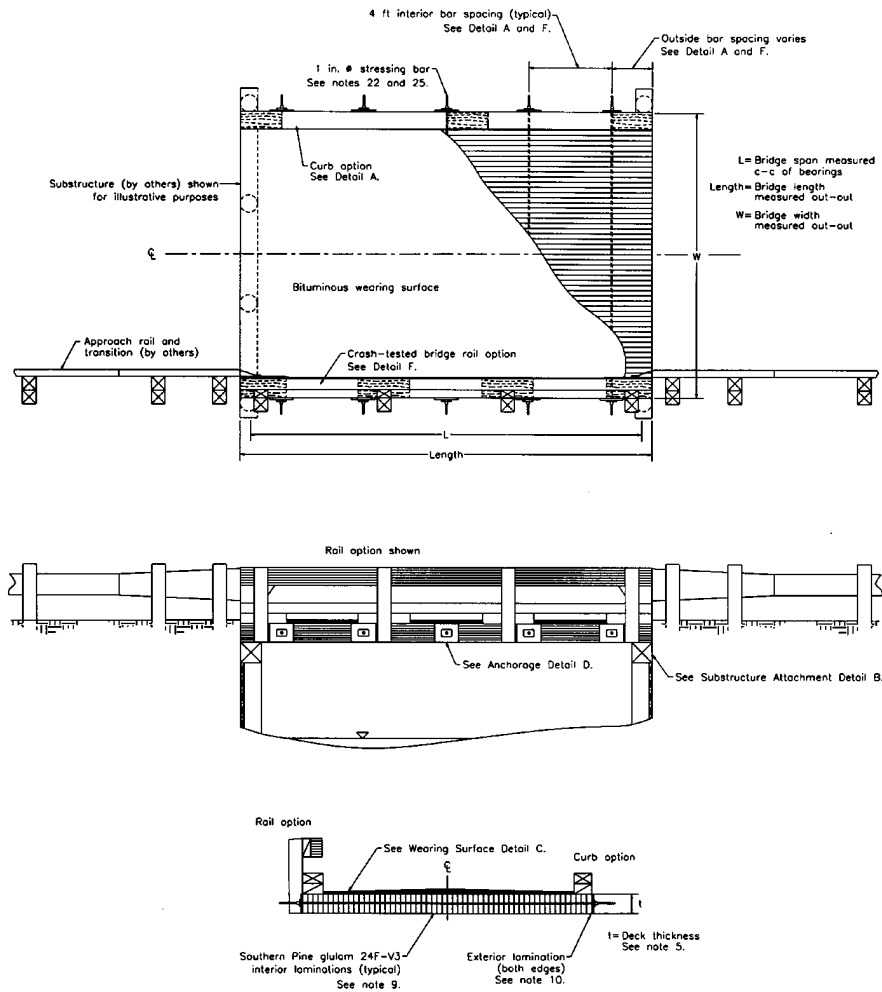
Standard Plans for Southern Pine Bridges

August 1995

Stress-Laminated Glulam Timber Decks

Title

Sheet 1 of 11



NOTES AND REQUIREMENTS

DESIGN

1. These drawings are for stress-laminated timber bridge decks constructed of Southern Pine glued laminated timber. The designs are applicable for single and double-lane rectangular bridges (no skew) with simple span lengths of 20 to 32 ft in 2 ft increments. Design truck loading is AASHTO HS 20-44 or HS 25-44.

2. Unless noted, designs comply with the Standard Specifications for Highway Bridges (15th Edition, 1992) with interims through 1994) and Guide Specifications for the Design of Stress-Laminated Wood Decks (1991), published by the American Association of State Highway and Transportation Officials. Design criteria and procedures are shown on Sheets 9 through 11.

3. Designs are applicable to single-lane and double-lane bridges, 12 to 38 ft wide. Guidelines for determining the required number of laminations, bar lengths, and other material quantities are given on Sheet 7.

4. The plans are based upon bearing lengths of 10 in. A longer bearing length will result in a slightly conservative design.

5. The controlling design criteria for deck thickness is live load deflection (see Sheets 9-11). The required deck thickness for a stated bridge length is determined from Table 1, based on the design loading and live load deflection limits of 1/360 or 1/500 of the bridge span (L), measured center-to-center of bearings.

6. Unless noted, plan dimensions for sawn lumber are nominal dimensions. Dimensions for glulam timber are actual dimensions. Fabrication details and design calculations (Sheet 5-6 and 9-11) are based on actual dimensions.

7. These designs are intended for informational purposes only and must be verified by a registered professional engineer prior to construction.

MATERIAL AND FABRICATION

Wood

8. Sawn lumber and glued laminated timber shall comply with the requirements of AASHTO M16B.

9. Glued laminated timber used as deck laminations shall be Combination 24F-V3 Southern Pine, cambered as specified on Sheet 6. Glued laminated timber rail material shall be Combination No. 48 Southern Pine.

10. The exterior laminations along each deck edge shall be Southern Pine Comb. No. 48 or glulam timber manufactured from Northern Red Oak, Red Maple, or another treatable dense hardwood species.

11. Unless noted, all lumber shall be dressed (S4S) Southern Pine. Lumber 2 to 4 in. shall be visually graded No. 2 or better. Lumber 5 in. or greater in thickness shall be visually graded No. 1 or better.

12. All glulam deck laminations shall be continuous between supports with no butt joints.

13. Unless noted, all wood shall be cut, drilled, and completely fabricated prior to pressure treatment with preservatives.

14. The moisture content of sawn lumber prior to and after treatment shall not exceed 15% for lumber 2 to 4 in. thick, and 19% for lumber thicker than 4 in. Moisture content of glued laminated timber shall not exceed 16%.

15. Fabrication details for wood members are shown on Sheets 5 and 6. Each member shall be legibly marked with the designated mark number to aid in construction.

Preservative Treatment

16. All sawn lumber shall be treated in accordance with the requirements of AWPA Standard C14 with one of the following preservatives:

- a. Creosote conforming to AWPA Standard P1
- b. Pentachlorophenol conforming to AWPA Standard P8 in hydrocarbon solvent, Type A, conforming to AWPA Standard P9
- c. CCA conforming to AWPA Standard P5

17. Glulam shall be treated to the above requirements with creosote or pentachlorophenol.

18. Material treated with creosote or pentachlorophenol shall be free of excess preservative on the wood surface. The treating process for these preservatives shall include an expansion bath, steaming and/or dripping to ensure that preservative will not bleed.

19. Preservative treatment shall be inspected and certified in accordance with AWPA Standard M2.

Steel Fasteners and Hardware

20. Steel plates and shapes shall comply with the requirements of ASTM A36.

21. Bolts and lag screws shall comply with the requirements of ANSI/ASME Standard B18.2.1-1981, Grade 2.

22. Stressing bars shall be 1 in. diameter and shall comply with the requirements of ASTM A722. Nuts and couplers for stressing bars shall be provided by the bar manufacturer.

23. Split rings shall be manufactured from SAE 1010 hot rolled carbon steel. Shear plates shall be malleable iron manufactured according to Grade 32510 of ASTM A47.

24. Washers shall be provided bolt and lag screw heads and under nuts that are in contact with wood. Washers may be omitted under heads of special timber bolts or dome-head bolts when the size and strength of the head is sufficient to develop connection strength without wood crushing.

25. All steel components and fasteners shall be galvanized in accordance with AASHTO M111 or AASHTO M232. Galvanizing of stressing bars shall follow the recommendations of the bar manufacturer so as not to adversely affect the mechanical properties of the high-strength steel.

26. All nuts for bolts and stressing bars shall be oversized or threaded to ensure proper fit after galvanizing.

Miscellaneous

27. Geotextile fabric should be an impregnated, non-woven fabric that provides a watertight membrane over the deck surface. Application procedures and compatibility of the fabric with the preservative treatment shall be verified with the manufacturer prior to fabric placement.

28. Sealer for wood end grain is typically a commercial roofing cement.

CONSTRUCTION

29. All wood and metal components shall be handled and stored carefully so as not to damage the material. If damage does occur, wood shall be field treated in accordance with Note 30. Damage to galvanized surfaces shall be repaired with a cold galvanizing compound or other approved coating.

30. When field fabrication of wood is required or if wood is damaged, all cuts, bore holes, and damage shall be immediately field treated with wood preservative in accordance with AWPA Standard M4.

31. Stressing bars shall be fully tensioned to the values specified in Table 2, in accordance with the following sequence:

1. Initially, at construction
 2. 1 week after the initial stressing
 3. 6-8 weeks after the second stressing
- In addition, it is recommended that the bars be checked, and retensioned as required, 2 years after construction and at approximately 3 year intervals thereafter until the bar force stabilizes.

32. Refer to Sheets 7 and 8 for recommended bar stressing procedures and considerations.

Table 1 - Minimum Required Deck Thickness (in.)¹

Bridge length (ft)	Bridge span ² (ft. in.)	HS 20-44		HS 25-44	
		L/360 ³	L/500 ³	L/360 ³	L/500 ³
20	19, 2	11	12-3/8	11	12-3/8
22	21, 2	11	12-3/8	12-3/8	13-3/4
24	23, 2	12-3/8	13-3/4	13-3/4	13-3/4
26	25, 2	13-3/4	15-1/8	13-3/4	15-1/8
28	27, 2	13-3/4	15-1/8	15-1/8	16-1/2
30	29, 2	15-1/8	16-1/2	15-1/8	N/A
32	31, 2	15-1/8	16-1/2	16-1/2	N/A

1. Minimum deck thickness is controlled by deflection (see Sheets 9-11) and is based on glulam beams manufactured from 1-2/8 in. thick horizontal laminations.
 2. Bridge span, L, is measured center-to-center of bearings, assuming a minimum 10 in. bearing length at each abutment.
 3. Deflection limit as a fraction of bridge span, L.
- N/A = Deck thickness greater than 16-1/2 in. required.

Table 2 - Bar Stressing Requirements

Deck Thickness (in.)	Required Bar Tension (lbs)
11	52,800
12-3/8	59,400
13-3/4	66,000
15-1/8	72,600
16-1/2	79,200

The bridge superstructures depicted on these drawings were developed under a cooperative research agreement between the USDA Forest Service, Forest Products Laboratory, the University of Alabama and the Southern Forest Products Association.



Standard Plans for Southern Pine Bridges

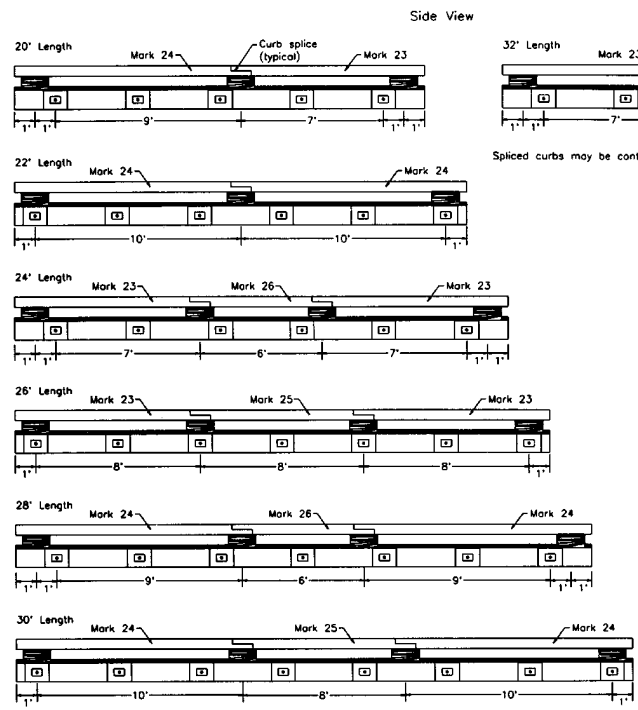
Stress-Laminated Glulam Timber Decks

General Layout and Notes

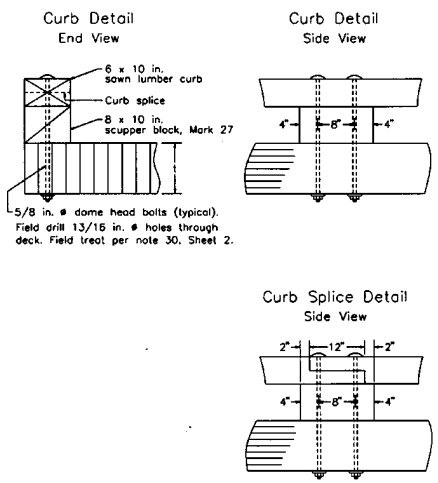
August 1995

Sheet 2 of 11

A Curb Option Configuration and Scupper Spacing

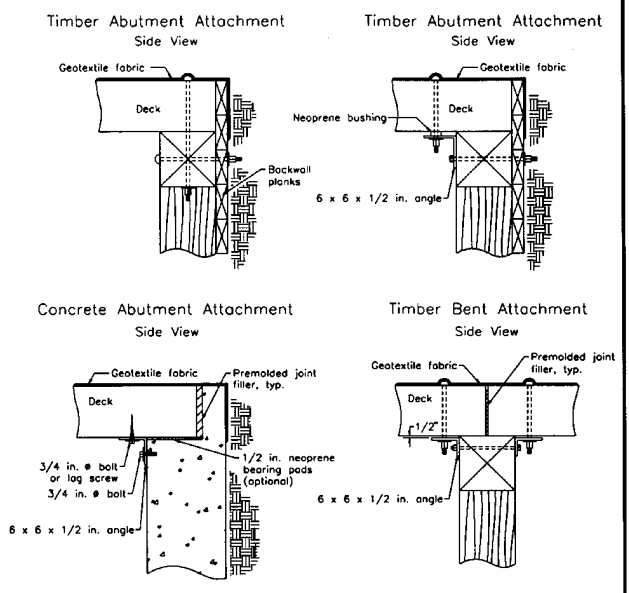


Spliced curbs may be continuous when sawn lumber of sufficient length is available or when glulam timber curbs are used.



See fabrication details, Sheets 5 and 6.

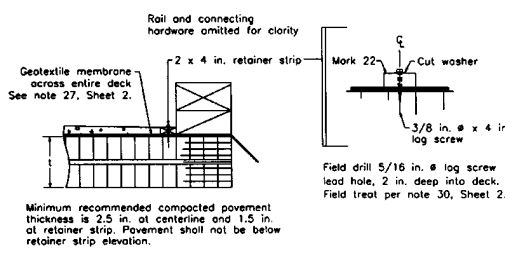
B Suggested Deck/Substructure Attachment



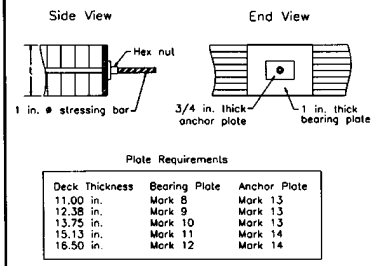
These details are representative of common substructure attachments and are shown for illustrative purposes only. The attachments must be designed for specific locations. The following recommendations are applicable in most circumstances.

- Attachment bolt spacing shall not exceed 4 ft over the entire bridge width.
- Minimum bearing shall be 10 in. at abutments and 7 in. at bents.
- Geotextile fabric shall wrap over abutment ends a minimum of 2 ft vertically. See note 27, Sheet 2.
- Bolts are 3/4 in. \bullet . Use dome head bolts in wood contact and hex bolts in steel contact. Field drill deck bolt holes 13/16 in. \bullet and field treat in accordance with note 30, Sheet 2.
- Log screws for deck attachment are as follows:
 - For 8 in. deck, 3/4 in. \bullet x 6 in.; Prebore 11/16 in. \bullet lead hole. Counterbore 13/16 in. \bullet x 2-1/2 in.
 - For 10 and 12 in. deck, 3/4 in. \bullet x 8 in.; Prebore 11/16 in. \bullet lead hole. Counterbore 13/16 in. \bullet x 3-1/2 in.
- Apply preservative to all field borings. See note 30, Sheet 2.

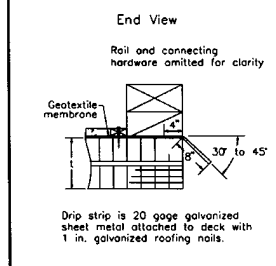
C Wearing Surface



D Anchorage Configuration



E Drip Strip



The bridge superstructures depicted on these drawings were developed under a cooperative research agreement between the USDA Forest Service, Forest Products Laboratory, the University of Alabama and the Southern Forest Products Association.



Standard Plans for Southern Pine Bridges

Stress-Laminated Glulam Timber Decks

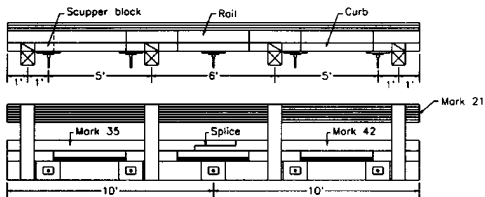
General Details

August 1995

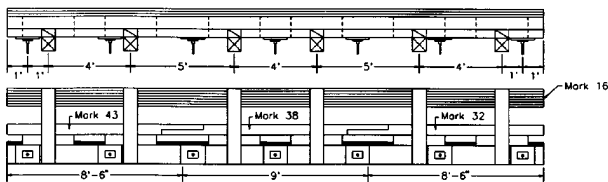
Sheet 3 of 11

F Rail Option Configuration and Scupper Spacing

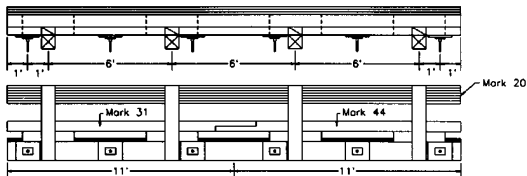
20' Length



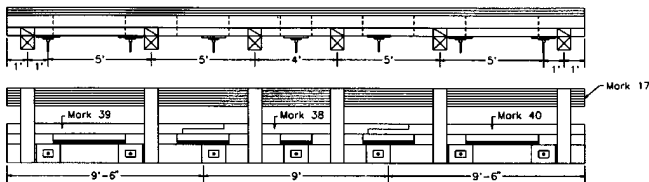
26' Length



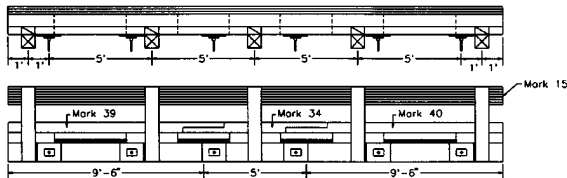
22' Length



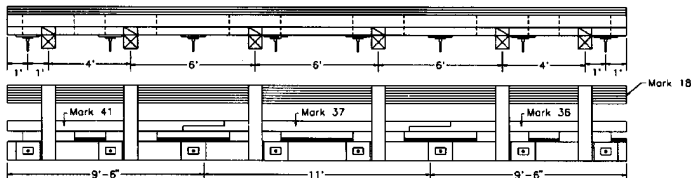
28' Length



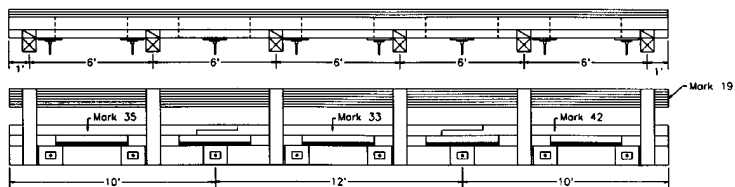
24' Length



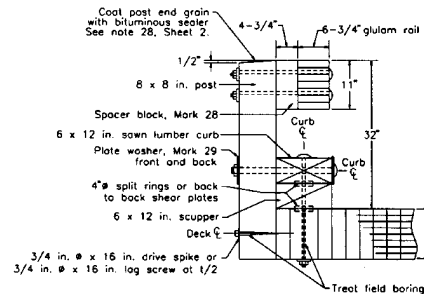
30' Length



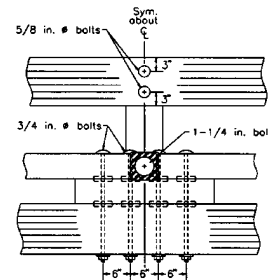
32' Length



Rail Detail
End View

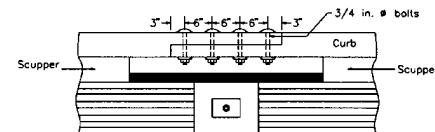


Side View



This bridge rail was successfully crash tested to the requirements for Performance Level 1 as outlined in the 1989 AASHTO Guide Specifications for Bridge Railings. Refer to "Plans for Crash Tested Bridge Railings for Longitudinal Wood Decks" (Ritter and others, in-press) for additional crash tested bridge railings and approach railing transitions.

Curb Splice Detail
Side View



Scupper blocks that but bridge ends for bridge lengths of 20, 24, 28 and 32 ft are Mark 46. See fabrication details, Sheet 6.

Glulam rails are full length. Refer to fabrication details, Sheet 5.

Hardware eliminated for clarity.

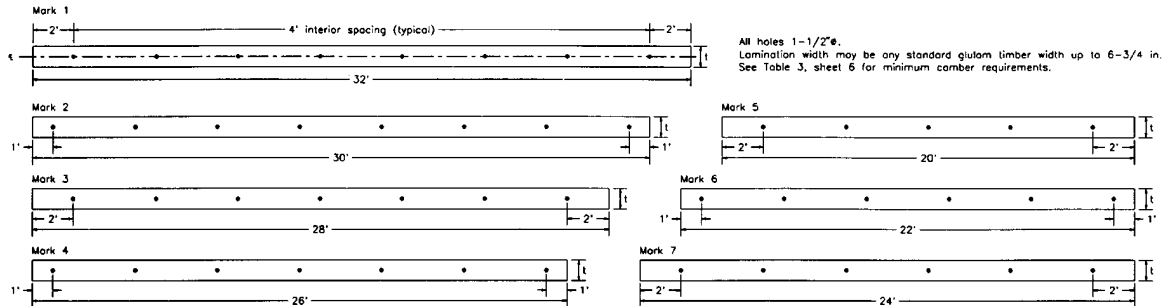
Spliced curbs may be continuous when sawn lumber of sufficient length is available or when glulam timber curbs are used.

Refer to rail fabrication details, Sheet 5 and 6.



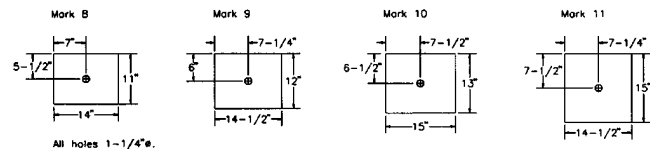
Bridge Deck

Glulam Deck Laminations; SP Comb. 24F-V3
Glulam Deck Edge Laminations; SP Comb. No. 48 or Hardwood (See note 10, Sheet 2)



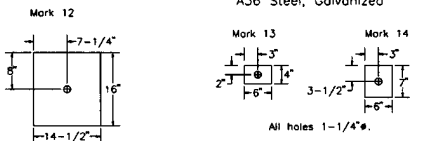
All holes 1-1/2" ø.
Lamination width may be any standard glulam timber width up to 6-3/4 in.
See Table 3, sheet 6 for minimum camber requirements.

Bar Bearing Plate; 1 in. Thick A36 Steel, Galvanized



All holes 1-1/4" ø.

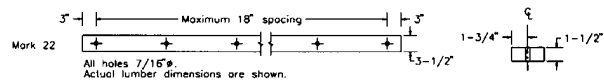
Anchor Plate; 3/4 in. Thick A36 Steel, Galvanized



All holes 1-1/4" ø.

Wearing Surface Retainer

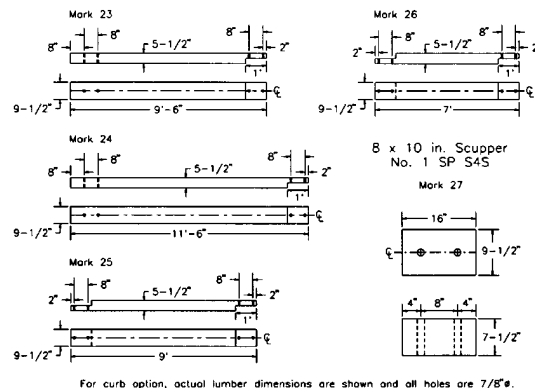
2 x 4 in. Retainer Strip; No. 2 SP



All holes 7/16" ø.
Actual lumber dimensions are shown.

Curb Option

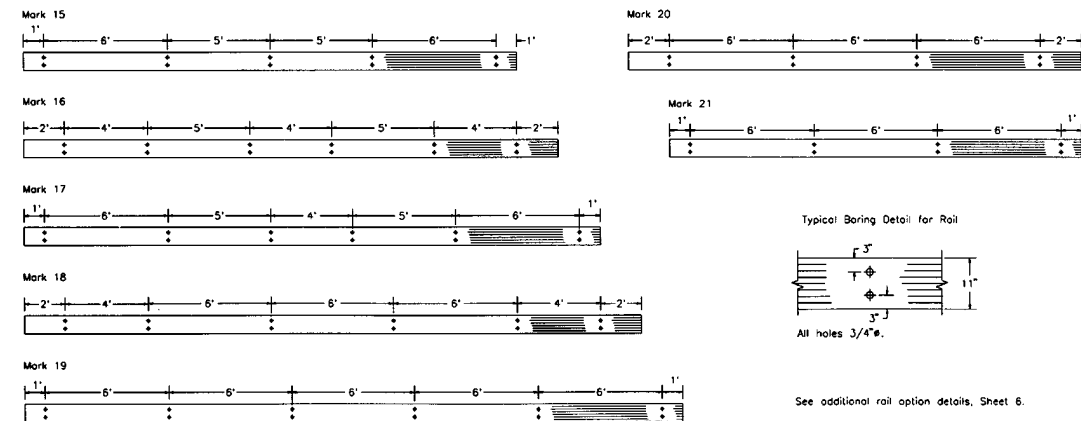
6 x 10 in. Curb; No. 1 SP S4S



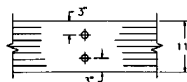
For curb option, actual lumber dimensions are shown and all holes are 7/8" ø.

Rail Option

6-3/4 x 11 in. Glulam Rail; SP Comb. No. 48



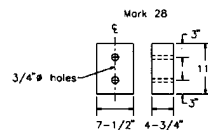
Typical Boring Detail for Rail



All holes 3/4" ø.

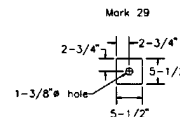
See additional rail option details, Sheet 6.

8 x 4-3/4 in. Spacer Block; No. 1 SP S4S

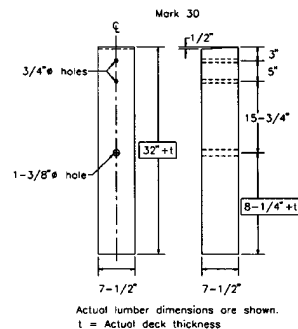


Actual lumber dimensions are shown.

Plate Washer; 1/4 in. Thick A36 Steel, Galvanized



8 x 8 in. Rail Post; No. 1 SP S4S



Actual lumber dimensions are shown.
t = Actual deck thickness

The bridge superstructures depicted on these drawings were developed under a cooperative research agreement between the USDA Forest Service, Forest Products Laboratory, the University of Alabama and the Southern Forest Products Association.



Standard Plans for Southern Pine Bridges

August 1995

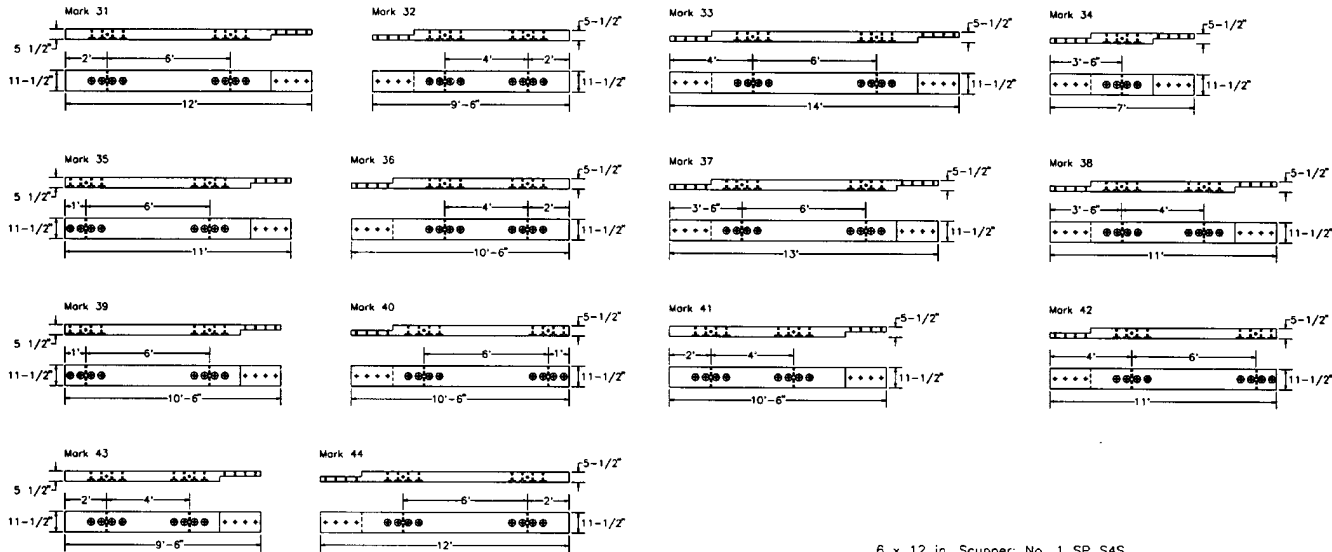
Stress-Laminated Glulam Timber Decks

Fabrication Details

Sheet 5 of 11

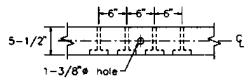
Rail Option

6 x 12 in. Curb; No. 1 SP S4S

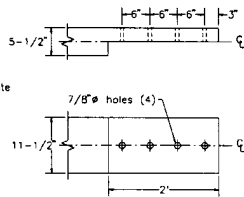


Typical Boring Details for Curb

Post/Scupper Connection

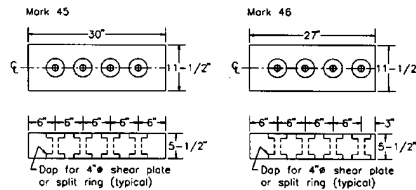


Splice



Actual lumber dimensions are shown

6 x 12 in. Scupper; No. 1 SP S4S



All holes are 7/8".
Actual lumber dimensions are shown.

Bridge Length (ft)	Deck Thickness (in.)	Minimum Camber (in.)
20	11	1/2
	12-3/8	1/2
22	11	3/4
	12-3/8	3/4
	13-3/4	1/2
24	12-3/8	1
	13-3/4	3/4
26	13-3/4	1
	15-1/8	3/4
28	13-3/4	1-1/4
	15-1/8	1
	16-1/2	3/4
30	15-1/8	1-1/4
	16-1/2	1
32	15-1/8	1-3/4
	16-1/2	1-1/2

The bridge superstructures depicted on these drawings were developed under a cooperative research agreement between the USDA Forest Service, Forest Products Laboratory, the University of Alabama and the Southern Forest Products Association.



Standard Plans for Southern Pine Bridges

August 1995

Stress-Laminated Glulam Timber Decks

Fabrication Details

Sheet 6 of 11

Table 4 - Table of Material Quantities

Item	Mark/Size	Bridge Length (ft)						
		20	22	24	26	28	30	32
Bridge Deck								
Deck laminations	See Note 3	MK-5	MK-6	MK-7	MK-4	MK-3	MK-2	MK-1
Stressing bars	1 in. ø (See Note 6 for length)	5	6	6	7	7	8	8
Stressing bar nuts	1 in. ø	10	12	12	14	14	16	16
Bar bearing plate	MK-8 through MK-12	10	12	12	14	14	16	16
Bar anchor plate	MK-13 through MK-14	10	12	12	14	14	16	16
Wearing Surface								
Geotextile fabric (yd ²)	-----	See Note 4						
Asphalt pavement (yd ³)	-----	See Note 5						
Retainer strip	MK-22	40 in. ft	44 in. ft	48 in. ft	52 in. ft	56 in. ft	60 in. ft	64 in. ft
Lag screws	3/8 in. ø x 4 in.	35	35	40	40	45	50	50
Cut washers	3/8 in. ø	35	35	40	40	45	50	50
Curb Option								
Curb ^a	MK-23 through MK-26	2@MK-23 2@MK-24	4@MK-24	4@MK-23 2@MK-26	4@MK-23 2@MK-25	4@MK-24 2@MK-26	4@MK-24 2@MK-25	4@MK-23 2@MK-26
Scupper block	MK-27	6	6	8	8	8	8	10
Curb bolts with hex nuts ^b	3/4 in. ø; bolt length = 1 1/2 in. + deck thickness	12	12	16	16	16	16	20
Malleable iron washers	3/4 in. ø	12	12	16	16	16	16	20
Rail Option								
Glulam rail	MK-15 through MK-21	2@MK-21	2@MK-20	2@MK-15	2@MK-16	2@MK-17	2@MK-18	2@MK-19
Rail offset block	MK-28	8	8	10	12	12	12	12
Post	MK-30	8	8	10	12	12	12	12
Scupper block	MK-45 through MK-46	4@MK-45 4@MK-46	8@MK-45	8@MK-45 4@MK-46	12@MK-45	12@MK-45 4@MK-46	12@MK-45 4@MK-46	8@MK-45 4@MK-46
Curb ^a	MK-31 through MK-44	2@MK-35 2@MK-42	2@MK-31 2@MK-44	2@MK-34 2@MK-39	2@MK-32 2@MK-43	2@MK-38 2@MK-40	2@MK-36 2@MK-37	2@MK-33 2@MK-42
Curb bolt with nut ^c	3/4 in. ø; bolt length = 1 3/4 in. + deck thickness	32	32	40	48	48	48	48
Rail bolt with hex nut	5/8 in. ø x 2 1/2 in.	16	16	20	24	24	24	24
Post bolt with hex nut	1-1/4 in. ø x 2 1/2 in.	8	8	10	12	12	12	12
Malleable iron washer (rail)	5/8 in. ø	16	16	20	24	24	24	24
Malleable iron washer (curb)	3/4 in. ø	32	32	40	48	48	48	48
Plate washer (post)	MK-29	16	16	20	24	24	24	24
Split Rings ¹⁰	4 in. ø	64	64	80	96	96	96	96
Curb Splice Bolts	3/4 in. ø x 6 1/2 in.	8	8	16	16	16	16	16
Miscellaneous								
Wood preservative (Gal.)	-----	1	1	1	2	2	2	2
Bituminous sealer (Gal.)	-----	1	2	2	2	2	2	2

- Material quantities are approximate and do not include quantities for substructure attachment options.
- Refer to Sheets 5 and 6 for Mark (MK) numbers and corresponding fabrication details. See Sheet 7 for material specifications.
- Deck laminations, may be any standard glulam timber width up to 6-3/4 in., or a combination thereof. Therefore, the number of deck laminations depends on both bridge width and lamination width(s). It is recommended the deck width be increased approximately 2% to account for deck narrowing when bar force is applied. Interior lamination material is Southern Pine Combination 24F-V3. For exterior lamination material, see note 10, Sheet 2.
- The required quantity of geotextile fabric is based on the following formula: fabric (yd²) = 1 WL / (9 ft²/yd²)
- The volume of compacted asphalt is determined by the following formula: asphalt (yd³) = 1 / (0.1875 ft³/WL + (27 ft³/yd³))
- The bar length is determined by the following formula: bar length (ft) = W + 4(ft)
- Full length curbs may be used. See Detail A, Sheet 3.
- Bar length should be verified based on specified material dimensions.
- Full length curbs may be used. See Detail F, Sheet 4.
- In lieu of split rings, back-to-back shear plates may be used. The quantity is twice that shown for split rings.

For the above equations,
W = Bridge width (ft); L = Out-to-out bridge length (ft).

Construction Recommendations and Procedures

The performance and longevity of any bridge depends on the materials and construction practices. Abbreviated recommendations for the proper construction of stress-laminated bridges given in these drawings follow. It is advisable to read and understand all these recommendations prior to beginning construction. For additional information, refer to the drawing notes and *Timber Bridges: Design, Construction, Inspection, and Maintenance* (Ritter 1990).

MATERIALS

The following recommendations should be followed for materials:

- Glulam timber must comply with the requirements of ANSI/AITC A190.1 and be properly treated with wood preservatives.
- Glulam is generally manufactured at a moisture content of 10% to 16%. Laminations should be protected from exposure at the job site to maintain this low moisture content prior to construction.
- The location and size of holes in the laminations for stressing bars should be verified before bridge erection. Misaligned or undersized holes will make bar insertion difficult and may require field drilling. Oversized holes may reduce the bridge load capacity.
- Nuts for galvanized stressing bars must be oversized to compensate for the galvanizing. Nuts that are not oversized or reamed will not fit on the stressing bars.
- Proper material certification and/or quality assurance certificates should be received and verified for all materials.
- Field cutting and drilling of treated wood members must be minimized. In cases where field fabrication is required, proper field treating is essential.

BRIDGE ASSEMBLY

The stress-laminated bridge decks shown in these plans are typically assembled and stressed on the abutments. Another option is to assemble the bridge adjacent to the bridge site and lift the stressed bridge into place with a crane. Guidelines for bridge assembly using both approaches follow. In all cases, the laminations must be placed with the camber up.

Assembly on the Abutments

When the bridge is assembled on the abutments, there are two commonly used options for placing the laminations:

- The laminations are placed individually. Using this method, 4 to 8 laminations are placed on the abutments starting at the deck edge location. Wood dowels may be used to align holes. When holes are aligned, stressing bars are inserted and pushed through the holes. Continue to push the bars through the holes as subsequent laminations are added. It is important that the bars be supported on the free end so that they are not allowed to bend excessively. Bar bending may damage the bar or the galvanizing coating.
- The laminations are preassembled into panels. In this case, panels 2 to 4 ft wide are assembled by banding laminations together with metal bands. When placing laminations, corner guards must be provided to prevent damage to the wood when the bands are tightened. The holes must be aligned so that stressing bars can be easily inserted. After assembly, the panels are lifted onto the abutments and the bars are inserted and tensioned. When lifting panels, use full support across the bottom of the panels so that individual laminations do not move relative to one another.

If bars are difficult to insert through the laminations and gently striking the bar aids assembly, place a wood block over the end of the bar to protect the steel. Do not hammer directly on the end of the bar. This will cause the steel to "mushroom" and the nut cannot be properly threaded. Also be careful not to bend or otherwise damage the bar. If bars cannot be inserted without excessive hammering, shift the laminations as necessary until the holes align properly.

Assembly Adjacent to the Site

Stress-laminated bridges may be completely assembled adjacent to the site and lifted into place with a crane. To accomplish this, a level site is necessary and wood blocking or other supports are needed at the bridge ends to serve as temporary abutments. Laminations may be placed on the supports individually or in panels as previously described. After assembly, the bars must be fully tensioned, as discussed below, before the bridge is lifted. When lifting the assembled bridge, use lifting eyes through the top of the bridge or use spreader beams under the bridge. Do not lift the bridge by the stressing bars as this may cause the bars to bend or laminations to slip.

BAR TENSIONING

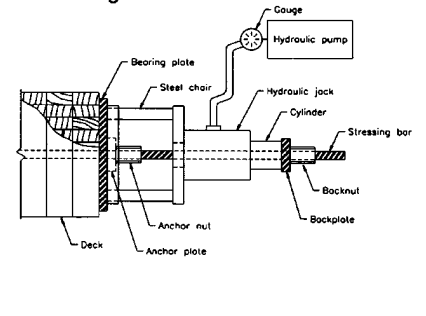
The prestressing system is perhaps the most important part of a stress-laminated bridge because it holds the bridge together and develops the necessary friction between the laminations. Thus, it is important that a sufficient level of uniform, compressive prestress be maintained between the lumber laminations in order for a stress-laminated bridge to perform properly.

Recommendations for bar tensioning using a single hydraulic jack, which is the most economical and commonly used, are given below.

Equipment and Procedures

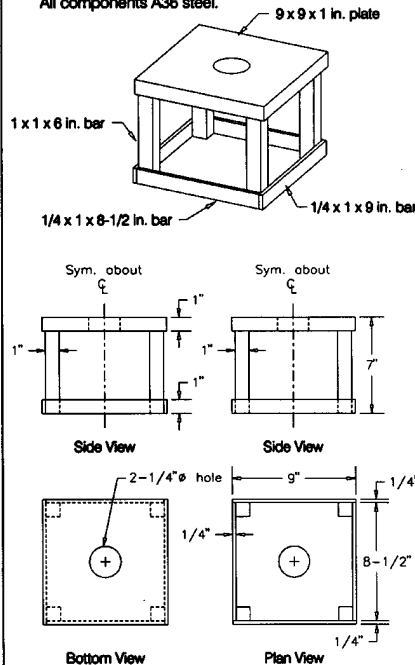
Stress-laminated bridges are stressed together with a hydraulic jack that applies tension to the prestressing bar by pulling the bar away from the steel anchor plate. After the tension is applied, the nut is tightened against the anchor plate and the tension remains in the bar when jack pressure is released. The typical equipment for bar tensioning consists of a hydraulic hollow-core jack, pump, hose and gauge, a steel tensioning chair, backplate, and backnut (Figure 1). The following should be considered regarding equipment:

Figure 1 - Tensioning Equipment and Configuration



- The capacity of the jack must be sufficient to provide the design tension force.
- The pump may be hand operated or electric. Hand operated pumps are less expensive but slower than electric pumps. Electric pumps also require an on-site source of power.
- The scale of the hydraulic gauge attached to the pump may be calibrated in lb/in.² or tons. It is generally easier to work in tons. If the gauge is calibrated in lb/in.², a table which converts lb/in.² values to the jack force must be provided.
- The stressing chair is normally locally fabricated. An example of a typical welded steel stressing chair for the bridges in these plans is shown in Figure 2. It is important that the base of the chair be large enough to fit over the bar anchor plate, but remain on the bearing plate. The chair must not bear directly on the lumber laminations. The height of the chair should be 2 to 3 times the length of the bar nut plus the anchor plate thickness.
- The backplate is generally the same size as the bar anchor plate.

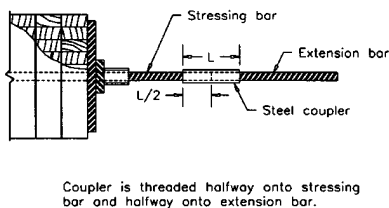
Figure 2 - Typical Welded Steel Chair
All components A36 steel.



- Several extra backnuts should be kept on-hand during bar tensioning. After repeated tensioning, the backnuts may tend to bind and should be replaced.

To tension the bars properly, there must be sufficient bar length beyond the nut on which to place the tensioning equipment. It is generally beneficial to select one bridge edge and place all bar extension on that edge. On the opposite edge, bars should extend approximately 1 in. beyond the nut. If there is insufficient bar length for the tensioning equipment, a temporary coupler and bar extension may be used (Figure 3). If this is done, it is critical that each bar be threaded fully into half the coupler length. Failure to do so may result in coupler breakage. It is also important to verify that the holes in the hydraulic jack and stressing chair are large enough to fit over the coupler.

Figure 3 - Typical Coupler and Extension Bar Assembly



Coupler is threaded halfway onto stressing bar and halfway onto extension bar.

During all bar tensioning procedures, it is important that personnel not stand in front of the bar, or place hands or other body parts on or near the tensioning equipment. At the high force during tensioning, a broken bar will exit at great speed and force and can cause serious injury or death. It is also important not to lift the jack by the hydraulic hose as this may damage the hose and cause rupture under high oil pressure. To aid in handling, a rope securely tied to the jack may be beneficial.

The following steps outline the typical procedure for bar tensioning.

- Place the chair and jack on the bar. Place the jack so that the cylinder extends away from the bridge. Placing the cylinder against the chair may cause the chair to bend.
- Place the backplate and backnut on the bar. Allow a small gap of approximately 1/4 in. between the backplate and the jack to prevent binding.
- Apply hydraulic pressure to the jack until the gauge is at the required reading. It is common to apply approximately 10% greater force to compensate for lockoff losses when the nut is tightened. Ensure that the proper gauge scale is used. Most gauges have several scales for different jacks.
- Tighten the bar nut against the bridge anchor plate; an open-end wrench generally works best. As the nut is tightened, the gauge pressure on the hydraulic pump will drop slightly. On occasion, the nut may bind slightly on the galvanizing. It is important to tighten the nut sufficiently to ensure that it bears tightly against the anchor plate.

- Release the pump and hydraulic pressure slowly and remove the tensioning equipment. If the outside nut binds, tap it gently along the bar axis to loosen the threads.

Tensioning Sequence

For a stress-laminated bridge to function properly, all bars must be tensioned uniformly to the design force. As the bars are tensioned, the laminations compress and the bridge deck narrows. When using a single hydraulic jack, tensioning one bar compresses the bridge and causes the force in adjacent bars to decrease. This effect is most pronounced when the bridge is initially tensioned and decreases as the force in all bars becomes equal. To compensate for this effect, bars must be sequentially tensioned several times to equalize force. This is generally accomplished by tensioning the first bar on one end of the bridge and sequentially tensioning each successive bar down the bridge length. The process is then repeated several times until all bars are fully tensioned to the design level.

As described in Note 31, Sheet 2, the bar tensioning must be completed three times during the construction process.

- at the time of bridge erection
- approximately 1 week after the first tensioning
- 6 to 8 weeks after the second tensioning

When initially tensioning bars with a single jack, it is important that the tension be applied gradually to prevent distortion along the bridge edges. If bars are initially tensioned to the full design level, the bridge edges may become distorted. For best results, the following procedure is recommended for the first tensioning.

- Starting at one end of the bridge, sequentially tension each bar to approximately 25% of the design level. During this process, a stringline may be used to ensure that the edges of the bridge remain straight.
- Following the same procedure, tension each bar to approximately 50% of the design level. The force level may be varied slightly to ensure that bridge edges remain straight.
- Sequentially tension each bar to the full design level. Again, the force level may be varied slightly to ensure that bridge edges remain straight.
- Return to the first bar, and repeat step 3.
- Check the force in several bars using the procedures described below. If the force is 10% or more below the design level, retension the bar. Generally, the above steps are sufficient to achieve uniform bar tension; however, in some cases step 3 will have to be repeated one or two more times.

After the above initial tensioning, the bars must be retensioned a second and third time in accordance with the tensioning sequence previously discussed. At the conclusion of each bar tensioning, the force level should be checked to verify that all bars are at the design level. When the last two tensionings are completed, the bar force should stabilize and should not drop below 40% of the design level. However, the decrease in bar force depends on many factors and should be checked periodically after construction. It is recommended that the bar force be checked 2 years after construction and at approximately 3 year intervals thereafter until the bar force stabilizes. This typically requires little time or equipment and will ensure that the bridge performs properly over the design life.

Checking Bar Force

The force in tensioning bars can be checked quickly with the same equipment used for tensioning. The two methods given below provide acceptable estimates of bar force. The nut turn method is applicable to both the manual and electric pumps and the gauge method is applicable only to hand-operated hydraulic pumps.

Nut Turn Method

To determine the bar force using the nut turn method, a wrench is placed on the bar nut adjacent to the anchor plate and force is slowly applied to the hydraulic jack. During the application of jack force, the wrench is pushed in the direction to loosen the nut. The gauge reading at the point where the nut just begins to turn can be converted to the approximate force in the bar. In some cases, the nut may slightly bind on the bar and may not turn when the bar force is applied. In this case, jack the bar until the nut is pulled away from the plate and turn the nut slightly in both directions to loosen the binding. After turning the nut, be sure to return it to the original position prior to releasing the jack force. After this is accomplished, the procedure to check bar force can be completed using the free-turning nut.

Gauge Method

When the hydraulic jack applies tension to the bar, the gauge needle moves relatively quickly as the load is initially applied. As the force increases, and the full bar becomes tensioned, the needle movement is slower. When the bar force is overcome and the jack begins to apply force to the entire bar, there is a slight pause in the gauge needle rise. This occurs approximately at the point where the force in the jack equals the force in the bar. To check bar force using this method, slowly pump the hydraulic pump and watch the movement of the gauge needle. When the jack is pumped, and the needle stops moving momentarily, note the gauge reading. This reading represents the approximate bar force. At this time, it will also become slightly more difficult to pump the jack. Using this method requires a "feel" for the release point and should be practiced prior to determining the bar force.

Tensioning Considerations

As the bars are tensioned, the laminations compress and the bridge width will narrow slightly. This is most pronounced when the bars are initially tensioned and decreases with subsequent tensioning. It is therefore advisable to delay substructure attachment and curb and rail placement until after the second bar tensioning. It is also advisable to wait until after the second or third bar tensioning to apply the asphalt wearing surface.

After the bars in a bridge have been tensioned, it is important that sufficient bar length remain along one edge to allow retensioning of the bars. If a coupler and extension bar will be used for future tensionings, bars may be cut short, but a minimum of 10 in. of bar should remain beyond the nut. When no coupler and extension bar will be used for future tensionings, the bar length beyond the nut should be 18 to 24 in., depending on the bar length required for the tensioning equipment.

Design Guidelines for Stress-Laminated Bridge Decks Constructed with Combination 24F-V3 Southern Pine Glued Laminated Timber

Background

The concept of stress-laminated wood bridges is relatively new in the United States. Although bridges of this type have been built in Canada since 1976, they were not introduced in the U.S. until the late 1980's. In April 1991, the American Association of State Highway and Transportation Officials (AASHTO) published Guide Specifications for the Design of Stress-Laminated Wood Bridges (AASHTO 1991). As a guide specification, the publication represents the recommendations of AASHTO and is open to comment and revision prior to adoption in the AASHTO Standard Specifications for Highway Bridges. It is anticipated that design provisions for stress-laminated wood bridges will be included in the AASHTO within the next several years.

The design criteria for stress-laminated Southern Pine bridge superstructures presented on the preceding sheets are based on design recommendations presented in the following references:

AASHTO. 1991. Guide Specifications for the Design of Stress-Laminated Wood Decks. Washington, DC: American Association of State and Highway Transportation Officials.

AASHTO. 1992. Standard Specifications for Highway Bridges, 15th edition. Washington, DC: American Association of State and Highway Transportation Officials. (with interims through 1994).

Ritter, M.A. 1990. Timber bridges: design, construction, inspection and maintenance. EM7700-8. Washington, DC: U.S. Department of Agriculture.

In general, the criteria follow the recommendations of the AASHTO Guide Specifications for the Design of Stress-Laminated Wood Decks. However, minor modifications have been made as noted in order to improve performance or simplify the design process.

Design Procedures

The following procedures are for stress-laminated decks constructed of combination 24FV3 Southern Pine glued laminated timber. The laminations have an actual thickness of 6-3/4 in. and actual widths of 11, 12-3/8, 13-3/4, 15-1/8, and 16-1/2 in. Design references to AASHTO specifications are included. The notation "AASHTO" signifies the Standard Specifications for Highway Bridges and "AASHTO GS" signifies the Guide Specifications for the Design of Stress-Laminated Wood Decks. Calculations and summary tables are included to illustrate the design methodology and values used for the plans. Numbers noted in the calculations and summaries were rounded for the final solution, but generally were not rounded for intermediate steps. For additional design information, refer to the references listed above.

1. Define deck geometry and design live load.

Deck Geometry

Definitions and options for deck geometry are as follows:

Width: Bridge width is the total deck width measured out-to-out. The plans include options for single-lane bridge widths of 12 to 18 ft and double-lane bridge widths of 22 to 38 ft

Length: Bridge length is the total deck length, measured end-to-end. The plans include bridge lengths of 20 to 32 ft in 2 ft increments.

Span: Bridge span is the distance measured center-to-center of bearings. The plans are based on a minimum bearing length at each bridge end of 10 in. Thus, the bridge span is 10 in. less than the bridge length. A longer bearing length results in a slightly conservative design.

Design Live Load

Plans include an option for either AASHTO HS 20-44 or HS 25-44 vehicle

live loads (AASHTO 3.7). For both loads, the design is controlled by the truck loads, rather than lane loads.

2. Select a species and grade of glulam and compute allowable design values.

All designs are based on Southern Pine glued laminated timber, combination 24F-V3 with the exception of $F_{c, \perp}$, which is based on a hardwood glulam or SP Comb. No. 48. The following tabulated design values are obtained from AASHTO Table 13.5.3.A:

Table 1 - Tabulated Values for Southern Pine Glulam, Comb. 24F-V3

Bending, F_b	Tabulated Design Values (lb/in. ²)	
	Modulus of Elasticity, E_t	Compression Perpendicular to Grain, $F_{c, \perp}$, $F_{c, \parallel}$
2,400	1,800,000	650

Allowable design values are based on wet service conditions and are computed in accordance with the following equations for bending, modulus of elasticity and compression perpendicular to grain. In computing the volume factor, C_v , a width of 6-3/4 in. is assumed.

Bending (AASHTO 13.6.4):

$$F'_{b, \perp} = F_{b, \perp} C_D C_M C_V \quad (1)$$

where:

- $F_{b, \perp}$ = allowable bending stress (lb/in.²);
- $F_{b, \parallel}$ = tabulated bending stress (lb/in.²);
- C_D = wet service factor (AASHTO 13.5.4.1) = 0.80
- C_M = load duration factor = 1.15 (AASHTO 13.5.4.2);
- C_V = volume factor = $(21/L)^{20} (12/t)^{20} (5.125/b)^{20} \leq 1.0$
where: L = bridge span (ft);
t = actual deck thickness (in.) (AASHTO 13.6.4.3);
b = width of bending member (in.): 6-3/4 in. assumed.

Modulus of elasticity (AASHTO 13.6.3):

$$E'_t = E_t C_M \quad (2)$$

where:

- E'_t = allowable modulus of elasticity (lb/in.²);
- E_t = tabulated modulus of elasticity (lb/in.²);
- C_M = wet service factor = 0.833 (AASHTO 13.5.4.1)

For SP Comb. 24F-V3; $E'_t = (1800000)(0.833) = 1499400$ lb/in.².

Compression perpendicular to grain (AASHTO 13.6.6)

$$F'_{c, \perp} = F'_{c, \perp} (C_M) \quad F'_{c, \parallel} = F'_{c, \parallel} (C_M) \quad (3)$$

where:

- $F'_{c, \perp}$ = allowable compression perpendicular to grain (lb/in.²);
- $F'_{c, \parallel}$ = tabulated compression perpendicular to grain (lb/in.²);
- C_M = wet service factor = 0.53 (AASHTO 13.5.4.1).

$F'_{c, \perp}$ and $F'_{c, \parallel} = (650)(0.53) = 344.5$ lb/in.².

3. Choose a deck thickness and compute the distribution width and effective deck section properties.

The design of stress-laminated decks is based on beam theory and assumes one wheel line of the design vehicle is supported by a strip of deck width, measured normal to the bridge span, defined as the wheel load distribution width (AASHTO GS 3.25.5.2). The distribution width is a function of the deck thickness and the design vehicle maximum wheel

load. Thus, a deck thickness must be estimated for initial distribution width calculations. This estimated thickness may be revised later in the design process if it is found to be insufficient or too conservative.

Values shown in Table 2 are used to estimate deck thickness for Comb. 24F-V3 Southern Pine glulam. Options are given for loading and deflection limits of L/360 and L/500. Note that in most cases, the same deck thickness is required for both the L/360 and L/500 deflection limits.

Table 2 - Estimated Deck Thickness

Bridge Length (ft)	Bridge Span, L (ft)	Estimated deck thickness (in.)			
		HS 20-44 loading		HS 25-44 loading	
		L/360	L/500	L/360	L/500
20	19.17	11	12-3/8	11	12-3/8
22	21.17	11	12-3/8	12-3/8	13-3/4
24	23.17	12-3/8	13-3/4	13-3/4	13-3/4
26	25.17	13-3/4	15-1/8	13-3/4	15-1/8
28	27.17	13-3/4	15-1/8	15-1/8	16-1/2
30	29.17	15-1/8	16-1/2	15-1/8	>16-1/2
32	31.17	15-1/8	16-1/2	16-1/2	>16-1/2

The distribution width is computed by the following equations:

$$b_f = \sqrt{0.025P} \quad D_W = b_f + 2t \quad (4)$$

where:

- b_f = wheel load tire width (in.) (AASHTO 3.30.3);
- P = maximum wheel load (lb) (AASHTO 3.7);
- = 16,000 lb for the HS 20-44 vehicle
- = 20,000 lb for the HS 25-44 vehicle
- D_W = wheel load distribution width (in.) (AASHTO GS 3.25.5.2);
- t = actual deck thickness (in.).

$b_f = 20.00$ in. for HS 20-44 and 22.36 in. for HS 25-44.

Section modulus and moment of inertia are computed for a beam with a depth and width equal to the deck thickness and distribution width respectively:

$$S = \frac{D_W(t)^2}{6} \quad I = \frac{D_W(t)^3}{12} \quad (5)$$

where:

- S = section modulus (in.³);
- I = moment of inertia (in.⁴).

A summary of deck section properties is given in Table 3.

Table 3 - Deck Section Properties

Actual t (in.)	AASHTO HS 20-44			AASHTO HS25-44		
	D_W (in.)	S (in. ³)	I (in. ⁴)	D_W (in.)	S (in. ³)	I (in. ⁴)
11	42.0	847.0	4,658.5	44.4	894.6	4,920.3
12-3/8	44.8	1,142.2	7,067.2	47.1	1,202.4	7,440.1
13-3/4	47.5	1,496.7	10,290.1	49.9	1,571.1	10,801.5
15-1/8	50.3	1,915.9	14,489.1	52.6	2,005.9	15,169.8
16-1/2	53.0	2,404.9	19,840.2	55.4	2,512.0	20,723.9

4. Compute the deck dead load, dead load moment, and live load moment.

Compute the dead load of the deck and wearing surface in pounds per square foot using unit weights of 50 lb/ft³ for wood, 150 lb/ft³ for asphalt pavement, and 490 lb/ft³ for steel (AASHTO 3.3.6). The dead load of the bridge rail and stressing hardware is normally assumed to be equally distributed across the entire deck width.

The dead load acting across the distribution width is computed by the following equation:

$$W_{DL} = \frac{DL(D_W)}{12} \quad (6)$$

where:

- W_{DL} = dead load acting over the distribution width (lb/ft);
- DL = deck dead load (lb/ft²).

The maximum dead load moment for a simple span deck with a uniformly distributed load is computed by the following equation:

$$M_{DL} = \frac{W_{DL} L^2}{8} \quad (7)$$

where:

- M_{DL} = maximum dead load moment (ft-lb);
- L = bridge span measured center-to-center of bearings (ft).

A summary of dead load values is given in Table 4.

Table 4 - Dead Load Summary

Length (ft)	L (ft)	Actual t (in.)	DL ¹ (lb/ft ²)	HS 20-44		HS 25-44	
				W_{DL} (lb/ft)	M_{DL} (ft-lb)	W_{DL} (lb/ft)	M_{DL} (ft-lb)
20	19.17	11	113	396.7	18,215.0	419.0	19,238.8
20	19.17	12-3/8	119	444.0	20,388.7	467.4	21,464.3
22	21.17	11	113	396.7	22,214.7	—	—
22	21.17	12-3/8	119	444.0	24,865.8	467.4	26,177.5
22	21.17	13-3/4	125	—	—	518.5	29,038.7
24	23.17	12-3/8	119	444.0	29,786.8	—	—
24	23.17	13-3/4	125	494.0	33,138.7	518.5	34,785.6
26	25.17	13-3/4	125	494.0	39,107.4	518.5	41,050.0
26	25.17	15-1/8	131	546.6	43,270.9	572.2	45,303.7
28	27.17	13-3/4	125	494.0	45,570.2	—	—
28	27.17	15-1/8	131	546.6	50,421.7	572.2	52,790.4
28	27.17	16-1/2	136	—	—	628.6	57,988.2
30	29.17	15-1/8	131	546.6	58,119.0	572.2	60,849.4
30	29.17	16-1/2	136	601.8	63,990.4	—	—
32	31.17	15-1/8	131	546.6	66,362.9	—	—
32	31.17	16-1/2	136	601.8	73,067.1	628.6	76,321.6

¹ Based on 30 lb/ft² for rail and stressing hardware.

The maximum live load moment, M_{LL} , is computed for one wheel line of the design vehicle using statics, or by obtaining the maximum moment value from design tables. Values used for preparation of the plans are shown in Table 5.

Table 5 - Maximum Live Load Moment

Length (ft)	L (ft)	Live load moment per wheel line (ft-lb)	
		HS 20-44	HS 25-44
20	19.17	76,670	95,830
22	21.17	84,670	105,830
24	23.17	92,670	115,830
26	25.17	104,910	131,140
28	27.17	119,760	149,700
30	29.17	134,770	168,470
32	31.17	149,910	187,390

5. Compute maximum deck bending stress.

The maximum applied bending stress is computed by the following equation:

$$f_b = \frac{(M_{DL} + M_L)}{S} \quad (8)$$

The applied bending stress must not exceed the allowable bending stress. If $f_b \leq F_b$, the deck is sufficient in bending. If f_b is substantially less than F_b , a thinner deck may be more economical; however, no changes in deck thickness should be made until after live load deflection is checked. If $f_b > F_b$, the deck is insufficient in bending and the deck thickness must be increased.

A summary of bending stresses is given in Table 6.

Table 6 - Bending Stress

Length (ft)	L (ft)	Actual t (in.)	HS 20-44			HS 25-44		
			F_{bx} (lb/in. ²)	f_{bx} (lb/in. ²)	f_{bx}/F_{bx}	F_{bx} (lb/in. ²)	f_{bx} (lb/in. ²)	f_{bx}/F_{bx}
20	19.17	11	2,197	1,344	0.61	2,197	1,544	0.70
20	19.17	12-3/8	2,184	1,020	0.47	2,184	1,171	0.54
22	21.17	11	2,186	1,514	0.69	—	—	—
22	21.17	12-3/8	2,174	1,151	0.53	2,174	1,318	0.61
22	21.17	13-3/4	—	—	—	2,162	1,030	0.48
24	23.17	12-3/8	2,164	1,287	0.59	—	—	—
24	23.17	13-3/4	2,152	1,009	0.47	2,152	1,150	0.53
26	25.17	13-3/4	2,144	1,155	0.54	2,144	1,315	0.61
26	25.17	15-1/8	2,133	928	0.44	2,133	1,056	0.50
28	27.17	13-3/4	2,135	1,326	0.62	—	—	—
28	27.17	15-1/8	2,125	1,066	0.50	2,125	1,211	0.57
28	27.17	16-1/2	—	—	—	2,116	992	0.47
30	29.17	15-1/8	2,118	1,208	0.57	2,118	1,372	0.65
30	29.17	16-1/2	2,109	992	0.47	—	—	—
32	31.17	15-1/8	2,111	1,355	0.64	—	—	—
32	31.17	16-1/2	2,102	1,113	0.53	2,102	1,260	0.60

6. Check live load deflection.

Maximum live load deflection is computed for one wheel line of the design vehicle. For deflection only, the wheel load distribution width may be increased by a factor of 1.15 (AASHTO GS 3.2.5.5.3). Thus, the moment of inertia previously determined based on the distribution width and actual deck thickness is multiplied by 1.15. Deflection is computed by statics or by coefficients given in design handbooks. Using a handbook coefficient,

$$\Delta_{LL} = \frac{DC}{E'I(1.15)} \quad (9)$$

where:

Δ_{LL} = vehicle live load deflection (in.);
DC = live load deflection coefficient (Ritter 1990)(lb-in.).

If the computed live load deflection exceeds the design limit, deck thickness is unacceptable and must be increased. AASHTO recommends a maximum live load deflection of L/500 (AASHTO GS 13.11.3.1). Since a deflection limit of L/360 is sufficient for most bridges, the plans include both limits. A summary of live load deflections computed by Equation 9 is given in Table 7.

Table 7 - Live Load Deflection

Length (ft)	L (ft)	Actual t (in.)	HS 20-44 loading			HS 25-44 loading		
			DC (lb-in. ³)	Δ_{LL} (in.)	L/I	DC (lb-in. ³)	Δ_{LL} (in.)	L/I
20	19.17	11	4.06x10 ⁹	0.51	456	5.07x10 ⁹	0.60	385
20	19.17	12-3/8	4.06x10 ⁹	0.33	691	5.07x10 ⁹	0.40	582
22	21.17	11	5.46x10 ⁹	0.68	374	—	—	—
22	21.17	12-3/8	5.46x10 ⁹	0.45	567	6.83x10 ⁹	0.53	477
22	21.17	13-3/4	—	—	—	6.83x10 ⁹	0.37	693
24	23.17	12-3/8	8.06x10 ⁹	0.66	420	—	—	—
24	23.17	13-3/4	8.06x10 ⁹	0.45	612	1.01x10 ¹⁰	0.54	514
26	25.17	13-3/4	1.14x10 ¹⁰	0.64	469	1.43x10 ¹⁰	0.77	394
26	25.17	15-1/8	1.14x10 ¹⁰	0.46	661	1.43x10 ¹⁰	0.55	553
28	27.17	13-3/4	1.55x10 ¹⁰	0.87	374	—	—	—
28	27.17	15-1/8	1.55x10 ¹⁰	0.62	526	1.93x10 ¹⁰	0.74	441
28	27.17	16-1/2	—	—	—	1.93x10 ¹⁰	0.54	602
30	29.17	15-1/8	2.03x10 ¹⁰	0.81	431	2.54x10 ¹⁰	0.97	361
30	29.17	16-1/2	2.03x10 ¹⁰	0.59	590	—	—	—
32	31.17	15-1/8	2.59x10 ¹⁰	1.04	361	—	—	—
32	31.17	16-1/2	2.59x10 ¹⁰	0.76	494	3.24x10 ¹⁰	0.91	413

7. Compute dead load deflection and camber.

For longitudinal stress-laminated glulam timber decks, it is recommended the bridge be cambered to offset sagging caused by creep. The amount of camber depends upon the initial dead load deflection resulting from the uniform dead load deflection resulting from the uniform dead load acting over the distribution width, D_u . For a simple span deck, the dead load deflection is computed by the following equation (AASHTO GS 13.11.3.1):

$$\Delta_{DL} = \frac{5}{384} \frac{W_{DL} \frac{ft}{12in}}{E'I} \left(\frac{L \frac{12in}{ft}}{ft} \right)^4 \quad (10)$$

The glulam deck laminations shall be cambered a minimum of 3 times the computed dead load deflection (AASHTO 13.6.1.5 and AASHTO GS 13.11.3.2). Table 8 includes a summary of the dead load deflection and minimum camber requirements.

Table 8 - Dead Load Deflection and Camber

Length (ft)	L (ft)	Actual t (in.)	HS 20-44 Distribution Width		HS 25-44 Distribution Width	
			Dead Load Deflection (in.)	Camber (in.)	Dead Load Deflection (in.)	Camber (in.)
20	19.17	11	0.17	0.52	0.17	0.52
20	19.17	12-3/8	0.13	0.38	0.13	0.38
22	21.17	11	0.26	0.77	—	—
22	21.17	12-3/8	0.19	0.57	0.19	0.57
22	21.17	13-3/4	—	—	0.14	0.43
24	23.17	12-3/8	0.27	0.82	—	—
24	23.17	13-3/4	0.21	0.62	0.21	0.62
26	25.17	13-3/4	0.29	0.87	0.29	0.87
26	25.17	15-1/8	0.23	0.68	0.23	0.68
28	27.17	13-3/4	0.39	1.18	—	—
28	27.17	15-1/8	0.31	0.93	0.31	0.93
28	27.17	16-1/2	—	—	0.25	0.74
30	29.17	15-1/8	0.41	1.23	0.41	1.23
30	29.17	16-1/2	0.33	0.99	—	—
32	31.17	15-1/8	0.53	1.6	—	—
32	31.17	16-1/2	0.43	1.29	0.43	1.29

8. Determine the required prestress level.

The level of compressive prestress between the laminations must be sufficient to offset flexural tension caused by transverse bending and vertical slip caused by transverse shear. Different methods for determining the initial prestress level are given in several publications (AASHTO 1991; Ritter 1990). For these designs, an initial prestress of 100 lb/in.² was selected because it has been widely used and has provided good performance for Southern Pine decks.

9. Determine the size and spacing of the prestressing bars and the required prestressing force.

The size and spacing of prestressing bars must satisfy the following equations (AASHTO GS 13.11.2.3):

$$A_s \geq \frac{p_t s t}{f_t} \quad \text{and} \quad \frac{A_s}{s t} \leq 0.0016 \quad (11)$$

where:

A_s = cross-sectional area of the prestressing bar (in.²);
 p_t = initial prestress = 100 lb/in.²;
 s = prestressing bar spacing (in.);
 f_t = allowable tensile stress for the prestressing bar = 105,000 lb/in.² for ASTM A772 bars (AASHTO 9.15.11).

The required prestressing force, F_{ps} (lb.), is computed by the following equation:

$$F_{ps} = p_t s t \quad (12)$$

For all spans and deck thicknesses, 1 in. diameter ASTM A772 bars are selected with a 48 in. center-to-center spacing. A summary of prestressing bar information is given in Table 9.

Table 9 - Prestressing Bar Summary

Actual t (in.)	A_s (in. ²)	s (in.)	(p _t s _t)/f _t (in.)	(A _s)/s _t (in. ⁻²)	F _{ps} (lb)
11	0.85	48	0.50	0.0016	52,800
12-3/8	0.85	48	0.57	0.0014	59,400
13-3/4	0.85	48	0.63	0.0013	66,000
15-1/8	0.85	48	0.69	0.0012	72,600
16-1/2	0.85	48	0.75	0.0011	79,200

10. Design the prestressing bar anchorage system.

The bar anchorage system consists of a steel bearing plate and a smaller steel anchorage plate that transfer the force of the stressing bars into the wood laminations. They must be designed conservatively to ensure that compressive stress applied to the exterior laminations does not cause wood crushing.

The minimum area of the steel bearing plate in square inches, A_{ps} , is given by the following equation (AASHTO GS 13.11.2.4):

$$A_{ps} = \frac{p_t s t}{F_{c,1/2}} \quad (13)$$

$F_{c,1/2}$ must be based on the tabulated allowable compression perpendicular to grain of the side face of the exterior lamination material.

Minimum bearing plate thickness is computed by the following equations (AASHTO GS 13.11.2.4):

$$t_p = \left[\frac{3(f_{cp})(k)^2}{f_p} \right]^{0.5} \quad (14)$$

$$k = \frac{W_p - W_A}{2} \quad \text{or} \quad \frac{L_p - L_A}{2} \quad \text{whichever is greater} \quad (15)$$

where:

t_p = bearing plate thickness (in.);
 f_{cp} = actual bearing stress under the bearing plate (lb/in.²);
 k = plate size parameter (in.);
 f_p = allowable bending stress for the steel plate = 20,000 lb/in.² for ASTM A36 steel (AASHTO 10.32.1);
 W_p = width of bearing plate (in.);
 W_A = width of anchorage plate (in.);
 L_p = length of bearing plate (in.);
 L_A = length of anchorage plate (in.).

A summary of the prestressing bar anchorage system is given in Table 10.

Table 10 - Prestressing Bar Anchorage Summary¹

Parameter	Nominal deck thickness, t (in.)				
	11	12-3/8	13-3/4	15-1/8	16-1/2
Bearing plate size $L_p \times W_p \times 1$ (in.)	14 x 11	14-1/2 x 12	15 x 13	14-1/2 x 15	14-1/2 x 16
Anchor plate size $L_a \times W_a \times 3/4$ (in.)	6 x 4	6 x 4	6 x 4	6 x 7	6 x 7
$A_{p, \text{ minimum}}$ (in. ²)	153.3	172.4	191.6	210.7	229.9
$A_{p, \text{ actual}}$ (in. ²)	154.0	174.0	195.0	217.5	232.0
f_{be} (lb/in. ²)	342.9	341.4	338.5	333.8	341.4
k	4.00	4.25	4.50	4.25	4.50
t_p minimum (in.)	0.91	0.96	1.01	0.95	1.02

¹Plate sizing is based on interior bar spacing and corresponding force.

11. Determine the support configuration and check bearing stress.

Supports for stress-laminated decks must be designed to resist the vertical and lateral forces transmitted from the superstructure to the substructure. As with other longitudinal wood superstructures, the required bearing length is normally controlled by considerations for bearing configuration, rather than compressive strength, perpendicular to grain. From a practical standpoint, a minimum bearing length of 10 in. is recommended for stress-laminated decks. Bearing attachments are normally made through the deck to the supporting cap or sill, or from the deck underside. Such attachments are illustrated on Sheet 4.

Bearing stress in compression perpendicular to grain is checked for the maximum reaction at the supports due to the bridge dead load and one wheel line of the design vehicle. This load is distributed over an area defined by the distribution width, D_w , and the bearing length, L_b .

Bearing in compression perpendicular to grain is computed using the following equation:

$$f_{c, \perp} = \frac{R_{DL} + R_{LL}}{D_w(L_b)} \quad (16)$$

where:

R_{DL} = dead load reaction (lb);

R_{LL} = maximum live load reaction for one wheel line of design vehicle (lb);

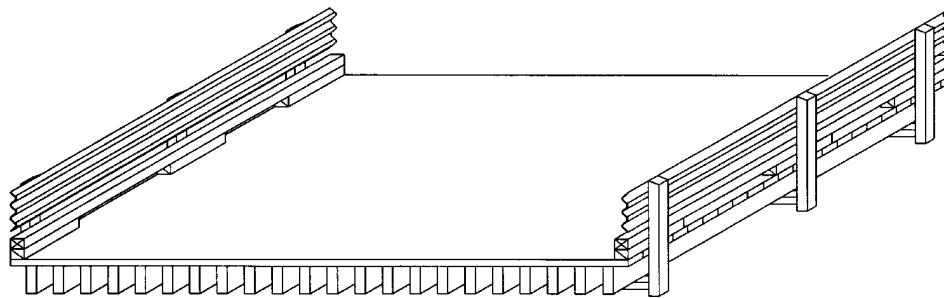
L_b = deck bearing length at the support (in.) = 10 in.

The value of $f_{c, \perp}$ computed by Equation 16 must be less than $F_{c, \perp}$. A summary of bearing information is presented in Table 11.

Table 11 - Bearing Summary

Length (ft)	L (ft)	t (in.)	HS 20-44 loading			HS 25-44 loading		
			R_{DL} (lb)	R_{LL} (lb)	$f_{c, \perp}$ (lb/in. ²)	R_{DL} (lb)	R_{LL} (lb)	$f_{c, \perp}$ (lb/in. ²)
			20	19.17	11	3,967	20,310	57.8
20	19.17	12-3/8	4,440	20,310	55.3	4,674	25,390	63.8
22	21.17	11	4,363	21,420	61.4	—	—	—
22	21.17	12-3/8	4,884	21,420	58.8	5,142	26,770	67.7
22	21.17	13-3/4	—	—	—	5,704	26,770	65.1
24	23.17	12-3/8	5,328	22,330	61.8	—	—	—
24	23.17	13-3/4	5,928	22,330	59.5	6,222	27,910	68.5
26	25.17	13-3/4	6,422	23,100	62.2	6,741	28,870	71.4
26	25.17	15-1/8	7,105	23,100	60.1	7,439	28,870	69.0
28	27.17	13-3/4	6,916	23,750	64.6	—	—	—
28	27.17	15-1/8	7,652	23,750	62.5	8,011	29,690	71.7
28	27.17	16-1/2	—	—	—	8,800	29,690	69.5
30	29.17	15-1/8	8,198	24,480	65.0	8,584	30,600	74.6
30	29.17	16-1/2	9,027	24,480	63.2	—	—	—
32	31.17	15-1/8	8,745	25,220	67.6	—	—	—
32	31.17	16-1/2	9,628	25,220	65.8	10,057	31,520	75.1

Longitudinal Stringer with Transverse Plank Decks



Drawing Index

1. Title
2. General Layout
3. Attachment Details
4. Rail Details
5. Notes and Design

The bridge superstructures depicted on these drawings were developed under a cooperative research agreement between the USDA Forest Service, Forest Products Laboratory, the University of Alabama and the Southern Forest Products Association.



Standard Plans for Southern Pine Bridges

August 1995

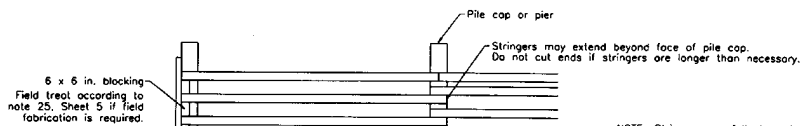
Longitudinal Stringer with Transverse Plank Decks

Title

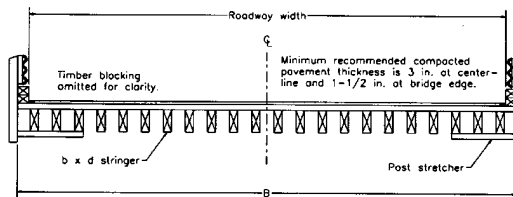
Sheet 1 of 5

Plan View

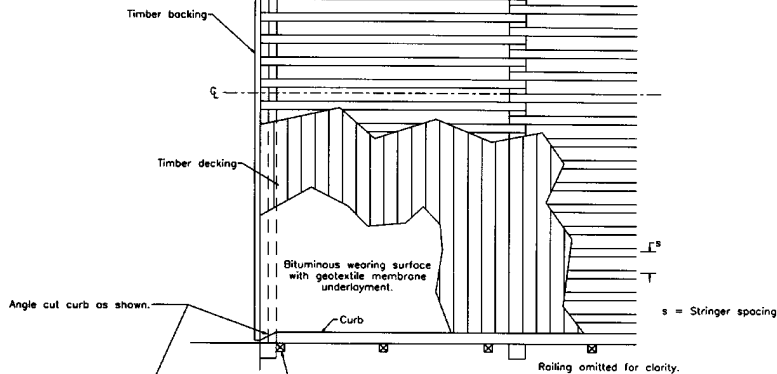
Cross Section



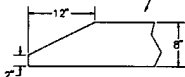
NOTE: Stringers are fully lapped at supports except outside stringers may be butted as shown, provided minimum bearing length is satisfied.



B = Bridge width



Locate railpost so that its attachment does not interfere with stringer attachment hardware.



Elevation

See rail and curb system details on Sheet 4.

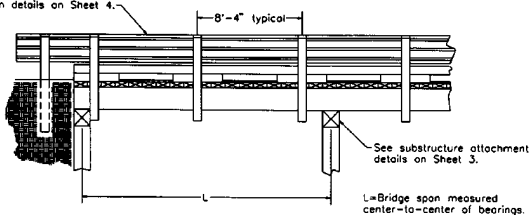
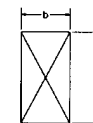


Table 1: Stringer Selection Table

Nominal Stringer Size (in.) (b x d)	Stringer Spacing (in.)	No. 1 Dense			No. 2		
		Maximum Span, L* (ft. in.)		Minimum Bearing Length (in.)	Maximum Span, L* (ft. in.)		Minimum Bearing Length (in.)
		One Lane	Two Lane		One Lane	Two Lane	
6 x 14	12	17, 1	16, 4	8.00	-	-	-
	14	12, 5	7, 0	6.75	-	-	-
6 x 16	12	23, 0	22, 1	9.50	13, 9	13, 1	8.00
	14	20, 6	19, 6	9.00	12, 0	11, 5	8.00
	16	18, 2	17, 4	8.50	9, 10	4, 9	8.00
	18	16, 6	15, 6	8.00	-	-	-
8 x 16	20	10, 6	-	6.75	-	-	-
	16	23, 2	22, 5	7.25	13, 10	13, 2	6.00
	18	21, 2	20, 3	7.00	12, 6	11, 11	6.00
	20	19, 4	18, 5	6.50	11, 5	10, 10	6.00
22	17, 10	17, 0	6.25	10, 5	9, 11	6.00	
	24	16, 7	15, 11	6.00	8, 8	9, 2	6.00

Stringer



b = Stringer width
d = Stringer depth

* Simple span with L measured center-to-center of bearings.

1. Stringer grades: see notes 10-12 on Sheet 5.
2. Analysis for HS20-44 loading includes 3 in. asphalt wearing surface.
3. Designs are applicable to single- and double-lane bridges of any width.

Table 2: Plank Selection Table

Nominal Stringer Size (in.) (b x d)	Stringer Spacing (in.)	Minimum Nominal Plank Size (in.)			
		No. 1 Dense		No. 2	
		Continuous	With Butt Joints	Continuous	With Butt Joints
6 x 14 or 6 x 16	12	3 x 8	3 x 8	3 x 8	3 x 8
	14	3 x 8	3 x 8	3 x 8	3 x 8
	16	3 x 10	3 x 12 or 4 x 8	3 x 10	3 x 12 or 4 x 8
	18	4 x 8	4 x 10	4 x 8	4 x 10
8 x 16	20	4 x 10	4 x 12	4 x 12 or 5 x 8	4 x 12 or 5 x 8
	16	3 x 8	3 x 8	3 x 8	3 x 8
	18	3 x 10	3 x 12 or 4 x 8	3 x 10 or 4 x 8	3 x 12 or 4 x 8
	20	4 x 8	4 x 10	4 x 10 or 5 x 8	4 x 10 or 5 x 8
22	4 x 12 or 5 x 8	4 x 12 or 5 x 8	5 x 10	5 x 10	5 x 10
	24	5 x 10	5 x 10	-	-

* Wider planks of the same thickness may be substituted for the listed sizes.

1. See notes 6-9 on Sheet 5 for plank material specifications.
2. Use column in Table 2 for continuous planks if planks are continuous over entire bridge width.
3. Planks with butt joints must be continuous over at least 5 stringers.
4. See plank deck attachment detail on Sheet 3.

The bridge superstructures depicted on these drawings were developed under a cooperative research agreement between the USDA Forest Service, Forest Products Laboratory, the University of Alabama and the Southern Forest Products Association.



Standard Plans for Southern Pine Bridges

August 1995

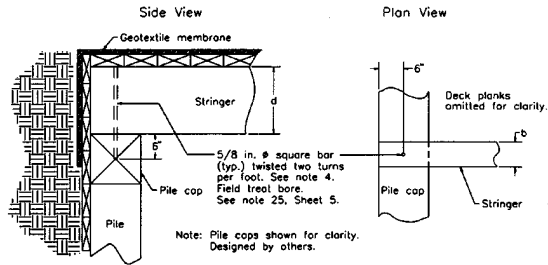
Longitudinal Stringer with Transverse Plank Decks

General Layout

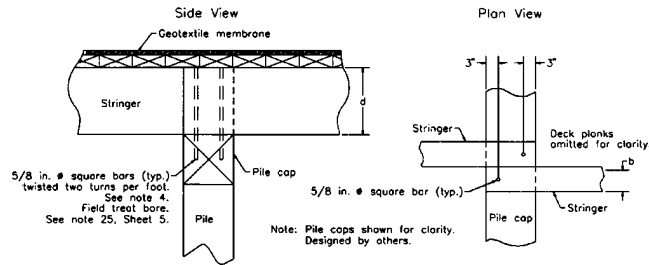
Sheet 2 of 5

Suggested Deck/Substructure Attachment

Timber Abutment Attachment



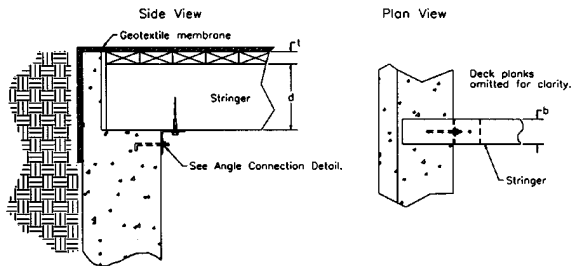
Timber Bent Attachment



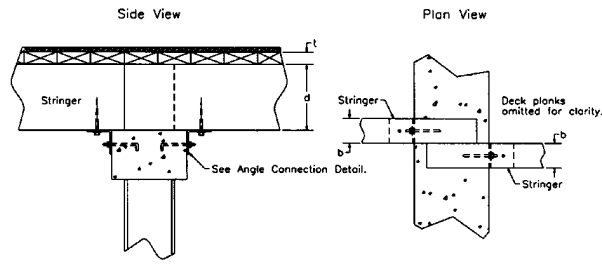
Deck/Substructure Attachment Notes

1. Substructure details are for illustration only and must be designed for specific locations.
2. Geotextile fabric shall wrap over abutment ends a minimum of 2 ft vertically. See note 22, Sheet 5.
3. Stringer attachments shall be designed for specific site conditions. Recommendations given above.
4. For 5/8 in. ϕ square bars, prebore 11/16 in. ϕ lead hole. Counterbore 3/4 in. \times (d-6 in.).

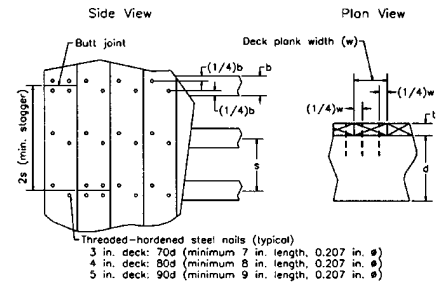
Concrete Abutment Attachment



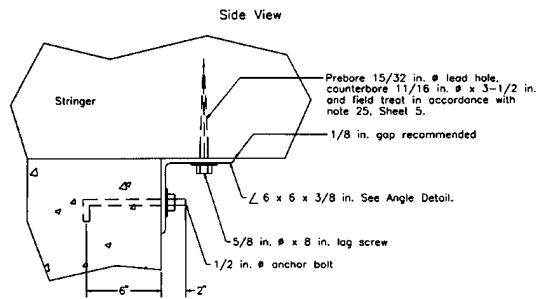
Concrete Bent Attachment



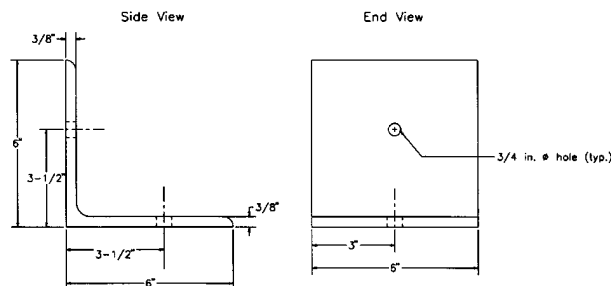
Plank Deck Attachment



Angle Connection Detail



Angle Detail \angle 6 \times 6 \times 3/8 in.; A36 Steel

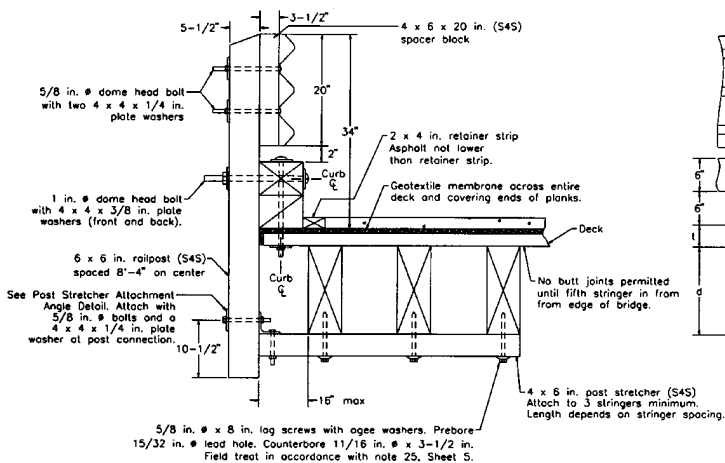


Plank Deck Attachment Notes

1. Edge sawn deck planks are preferable.
2. If flat sawn deck planks are used, orient bark side up.
3. Drive nails at slight angle.
4. Butt joints are centered on stringer with joints for adjacent planks staggered a minimum of two stringer spacings.
5. All planks must be continuous over at least five stringers.

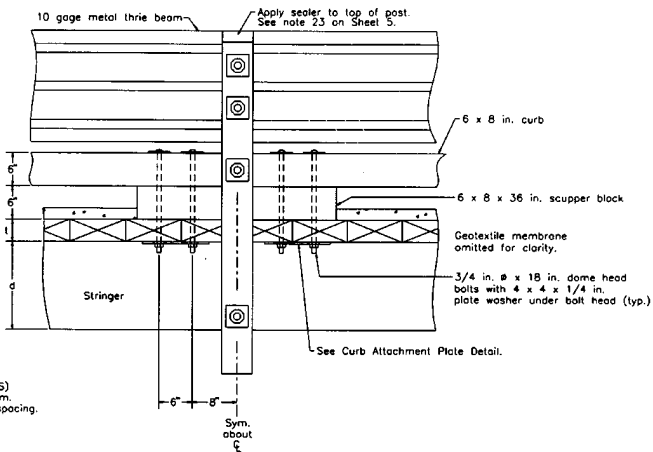
**Rail Detail
End View**

Note: Rail design is not crash tested.

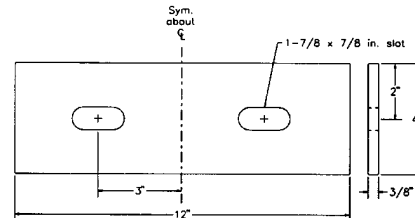


**Rail Detail
Side View**

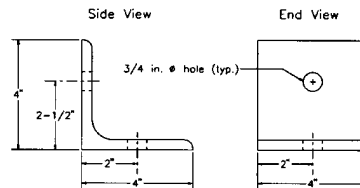
Note: Rail design is not crash tested.



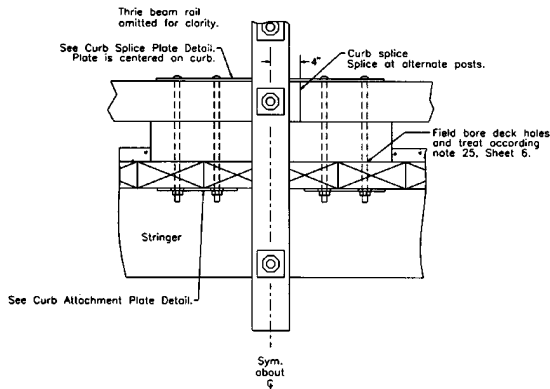
**Curb Attachment Plate
4 x 12 x 3/8 in.; A36 steel**



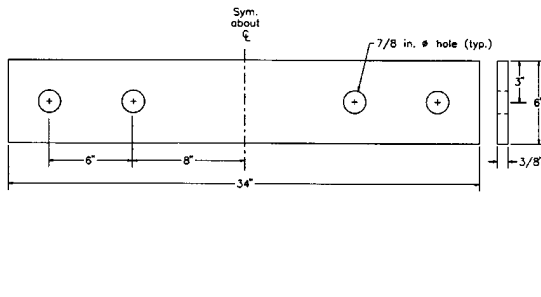
**Post Stretcher Attachment Angle
L 4 x 4 x 3/8 in.; A36 steel**



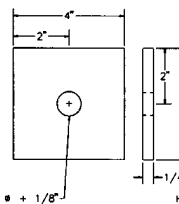
**Curb Splice Detail
Side View**



**Curb Splice Plate
6 x 34 x 3/8 in.; A36 steel**

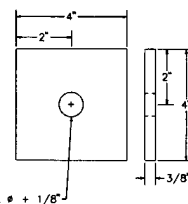


**Plate Washer
4 x 4 x 1/4 in.;
A36 steel**



Hole = Bolt + 1/8"

**Plate Washer
4 x 4 x 1/4 in.;
A36 steel**



Hole = Bolt + 1/8"

The bridge superstructures depicted on these drawings were developed under a cooperative research agreement between the USDA Forest Service, Forest Products Laboratory, the University of Alabama and the Southern Forest Products Association.



Standard Plans for Southern Pine Bridges

Longitudinal Stringer with Transverse Plank Decks

Rail Details

August 1995

Sheet 4 of 5

DESIGN

1. These drawings are for solid sawn longitudinal stringer/transverse deck timber bridges constructed of Southern Pine. The designs are applicable for single- and double-lane rectangular bridges of any width (no skew) with center-to-center spans according to Table 1, Sheet 2. Bridges may be multiple span with any combination of acceptable span lengths.

2. Unless noted, designs comply with the standard specifications for Highway Bridges (15th Edition, 1992), published by the American Association of State Highway and Transportation Officials (AASHTO). Design truck loading is AASHTO HS20-44. Rail detail does not comply with AASHTO static criteria.

3. These designs are intended for informational purposes only and must be verified by a registered professional engineer prior to construction.

MATERIAL AND FABRICATION

Wood

General

4. Sawn lumber shall comply with the requirements of AASHTO M168.

5. Unless noted, all wood shall be cut, drilled, and fabricated prior to pressure treatment with preservatives.

Planks

6. Planks shall be visually graded No. 1 Dense, No. 2, or better Southern Pine dimension lumber or timbers as specified in Table 2, Sheet 2.

7. Planks are rough sawn green, (unseasoned) 3, 4 and 5 in. in nominal thicknesses.

8. Planks shall not be less than minimum sizes listed below.

Minimum Rough Sizes for Planks

Thickness (in.)		Width (in.)	
Nominal	Actual	Nominal	Actual
3	2-11/16	8	7-5/8
4	3-11/16	10	9-5/8
5	4-5/8	12	11-5/8

9. The maximum thickness of a plank shall be no greater than 1/2 in. larger than its nominal thickness. The maximum width along the length of a plank shall not exceed 3/8 in.

Stringers

10. Stringers shall be visually graded No. 1 Dense, No. 2, or better Southern Pine timbers as specified in Table 1, Sheet 2.

11. Stringers are rough sawn (unseasoned) with a minimum size of 3/8 in. less than nominal dimensions.

12. Variation in depth between stringers shall not exceed 3/8 in. so as to provide a flat surface across the width of the bridge to ensure planks have firm contact with all stringers.

Curbs, Scupper Blocks, and Rail Posts

13. Curbs and scupper blocks shall be visually graded No. 2, or better Southern Pine rough sawn timbers with a minimum size of 3/8 in. less than nominal.

14. Rail posts shall be visually graded No. 2, or better nominal 6 x 6 in. surfaced all sides (S4S) with a minimum dressed size of 5-1/2 x 5-1/2 in.

Preservative Treatment

15. All sawn lumber shall be treated in accordance with the requirements of AWP Standard C14 with one of the following preservatives:

- Creosote conforming to AWP Standard P1
- Pentachlorophenol conforming to AWP Standard P8 in hydrocarbon solvent, Type A, conforming to AWP Standard P9

16. Treated material shall be free of excess preservative on the wood surface. The treating process for these preservatives shall include an expansion bath, steaming and/or dripping to ensure that preservative will not bleed.

17. Treated wood shall be inspected and certified in accordance with AWP Standard M2.

Steel Fasteners and Hardware

18. Steel plates and shapes shall comply with the requirements of ASTM A36.

19. Bolts and lag screws shall comply with the requirements of ANSI/ASME Standard B18.2.1-1981, Grade 2.

20. Washers shall be provided under bolt and lag screw heads and nuts that are in contact with wood. Washers may be omitted under heads of special timber bolts or dome-head bolts when the size and strength of the head is sufficient to develop connection strength without wood crushing.

21. All steel connections and fasteners shall be galvanized in accordance with AASHTO M111 or AASHTO M232.

Miscellaneous

22. Geotextile fabric shall be an impregnated, nonwoven fabric which provides a watertight membrane over the deck surface. Application procedures and compatibility of the fabric with the preservative treatment shall be verified with the manufacturer prior to fabric placement.

23. Sealer for wood end grain is typically a commercial roofing cement.

CONSTRUCTION

24. All wood and metal components shall be handled and stored carefully so as not to damage the material. If damage does occur, wood shall be field treated in accordance with note 25. Damage to the galvanized surfaces shall be repaired with a cold galvanizing compound or other approved coating.

25. When field fabrication of wood is required, or if the wood is damaged, all cuts, bore holes, and damage shall be immediately field treated with wood preservative in accordance with AWP Standard M4.

ADDITIONAL DESIGN INFORMATION

This section provides additional bridge design information as an aid to the professional engineer verifying the design prior to construction.

Plank Deck Design

Loading

Live load consists of a 12,000 lb wheel load with the load distributed according to AASHTO 3.25.1.

Dead load consists of a 3-in. asphalt wearing surface and the minimum rough green plank size. Unit weight of asphalt and timber is taken as 150 lb/ft² and 50 lb/ft³, respectively.

Design Values

Allowable design values to determine the plank sizes in Table 2, Sheet 2 are those tabulated in the National Design Specification (NDS) Supplement with applicable adjustment factors applied.

Allowable design values for 3 and 4 in. thick planks are obtained from the NDS supplement Table 4B with wet use service factors applied. The flat use factors are also applied to the NDS tabulated bending values. When the planks are continuous over the full bridge width, a shear stress modification factor of 2 is used to adjust the tabulated shear stress.

Allowable design values for 5 in. thick planks are obtained from the NDS supplement Table 4D with no adjustment except, the shear stress is doubled for continuous plank decks.

Calculation of Internal Forces

All section properties are determined using the minimum rough green sizes.

The span used is as specified in AASHTO 3.25.1.2.

Bending

Maximum moment is calculated as 80% of the maximum simple span moment.

Shear

The maximum shear force is calculated assuming a simple span between stringers, neglecting all loads closer than the plank depth from the face of the stringer. The calculation for shear follows the NDS 3.4.3.

Deflection

Maximum deflection is calculated as 80% of the maximum simple span deflection. Shear distortions are neglected. The calculated deflection is limited to an absolute deflection limit of 0.01 in. to prevent reflective cracking in the wearing surface. However, plank decks designed by this criteria may experience reflective cracking problems.

Stringer Design

Loading

Live load consists of the HS20-44 standard truck loading.

Dead load consists of a 3-in. asphalt wearing surface, the weight of the planks based on a thickness of 1/2 in. greater than nominal, and the weight of the stringer based on minimum rough green sizes.

When two plank sizes are specified in Table 2, Sheet 2 for a given stringer size and spacing, the thicker of the two sizes is used to compute the dead load on the stringer.

Design Values

Allowable design values used to determine the stringer sizes given in Table 1, Sheet 2 are those tabulated in the NDS supplement Table 4D with no adjustment.

Calculation of Internal Forces

All section properties are determined using the minimum rough green sizes. The spans given in Table 1, Sheet 2 are from center-to-center of bearing.

Bending

Maximum moment is determined according to AASHTO 3.23.2.

Shear

The maximum live load shear is calculated according to AASHTO 13.3. Maximum dead load shear is calculated according to NDS 3.4.3.

Deflection

Maximum deflection due to live load is limited to a value equal to span/500.

Compression Perpendicular to Grain

Minimum bearing lengths given in Table 1, Sheet 2 are based on compression perpendicular to grain requirements.

Rail Design

The rail design shown in this set of plans has not been crash tested.

The maximum outward load on the post is calculated to be 4000 lb, which is below the 10,000 lb AASHTO requirement.

For designs using 3-in. deck thicknesses, the expected failure mode is the curb to deck attachment. For thicker decks, the design is limited

