

United States
Department of
Agriculture

Forest Service

Forest
Products
Laboratory

Research
Paper
FPL-RP-515



Field Performance of Timber Bridges

1. Teal River Stress-Laminated Deck Bridge

James P. Wacker
Michael A. Ritter

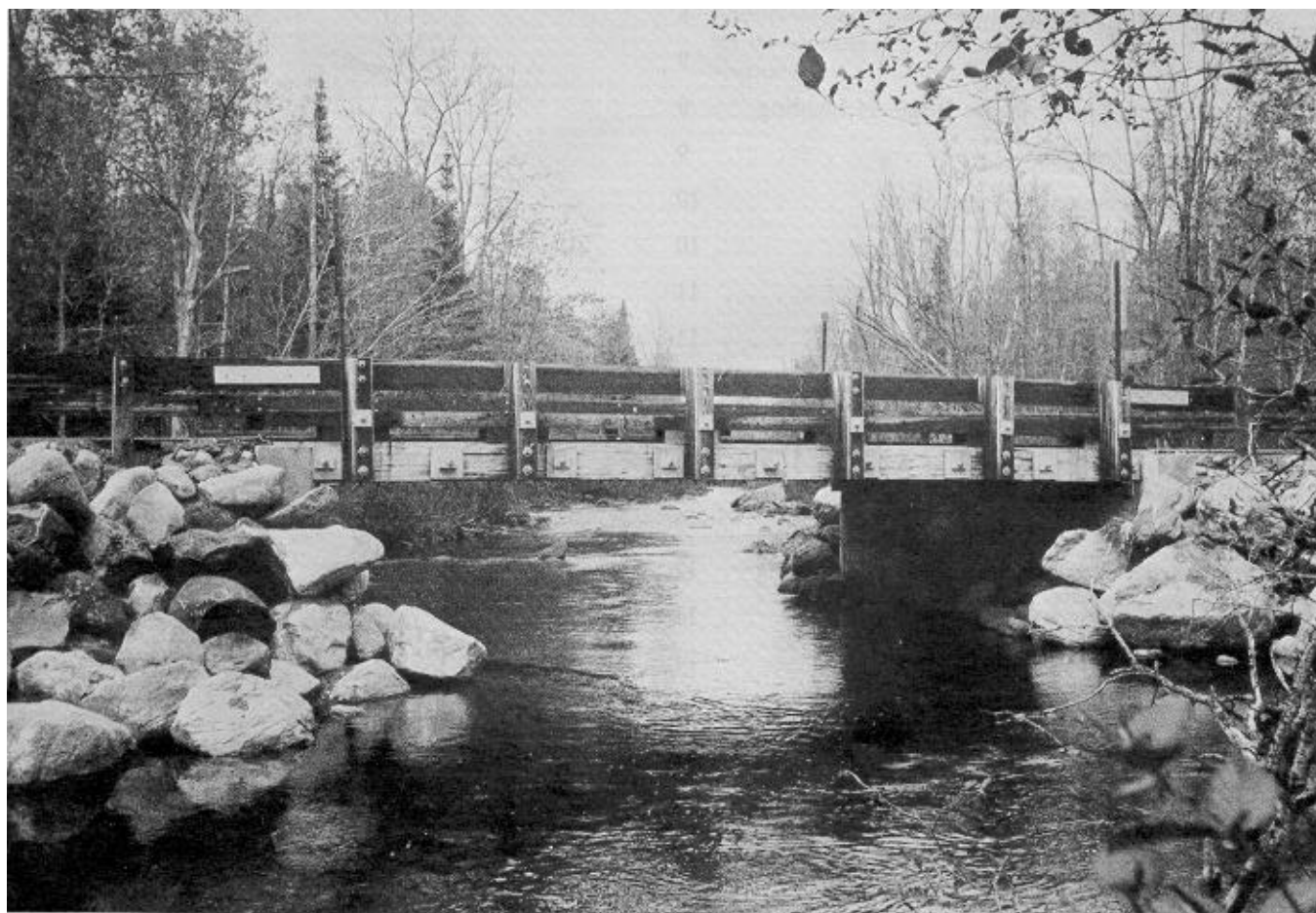

Contents

	<i>Page</i>
Introduction	1
Objective and Scope	2
Background	2
Design, Construction, and Cost	3
Design	3
Construction	4
cost	7
Evaluation Methodology	7
Lamination Stiffness	7
Moisture Content	7
Bar Force	7
Creep	8
Load Test Behavior	8
LoadTest 1	8
LoadTest 2	9
Predicted Behavior Under HS20-44 Loading	9
Condition Assessment	9
Results and Discussion	10
Lamination Stiffness	10
Moisture Content	11
Bar Force	11
Creep	12
Load Test Behavior	12
Load Test 1	12
Load Test 2	12
Predicted Behavior Under HS20-44 Loading	12
Condition Assessment	14
Wood Components	14
Wearing Surface	14
Anchorage System	14
Stressing Bars and Hardware	14
Conclusions	15
References	15
Appendix A	17
Appendix B	19

Abstract

The Teal River bridge was constructed in late 1989 in Sawyer County, Wisconsin, as a part of the demonstration timber bridge program of the USDA Forest Service. The bridge is a stress-laminated deck structure with a 32.5-ft length and a 23.7-ft width. The design is unique in that it is the first known stress-laminated timber bridge in the United States to be constructed of full-span glued-laminated timber beams, rather than the traditionally used sawn lumber laminations. The performance of the bridge was continuously monitored for 2 years, beginning at the time of installation. This performance monitoring involved gathering data relative to the moisture content of the wood deck, the force level of stressing bars, the deck dead-load deflection, and the behavior of the bridge under static-load conditions. In addition, comprehensive visual inspections were conducted to assess the overall condition of the structure. Based on 2 years of field evaluations, the bridge is performing well with no structural or serviceability deficiencies.

Keywords: Timber, bridge, wood, stress laminated, glued-laminated timber

Acknowledgments

We express sincere appreciation to the following who assisted in the structural monitoring of the Teal River Bridge:

Rob Fallon, Art Pond, Ralph Chafer, and Tom Thompson of the Chequamegon National Forest Engineering Department for obtaining field readings and conducting load tests.

Don Ladenthin and Dan Slisz of the Sawyer County (Wisconsin) Highway Department for conducting load tests.

Dave Summy, Regional Bridge Engineer, USDA Forest Service, Eastern Regional Office, for reviewing and interpreting data.

The staff of Sentinel Structures, Inc. (Peshtigo, Wisconsin) for testing glulam timber beams.

Earl Geske and Bob Ross of the Forest Products Laboratory, Engineering Mechanics Laboratory, for developing the instrumentation used for bridge evaluation.

December 1992

Wacker, James P.; Ritter, Michael A. 1992. Field performance of timber bridges: 1. Teal River stress-laminated deck bridge. Res. Pap. FPL-RP-515. Madison, WI: U.S. Department of Agriculture, Forest Service, Forest Products Laboratory. 19 p.

A limited number of free copies of this publication are available to the public from the Forest Products Laboratory, One Gifford Pinchot Drive, Madison, WI 53705-2398. Laboratory publications are sent to more than 1,000 libraries in the United States and elsewhere.

The Forest Products Laboratory is maintained in cooperation with the University of Wisconsin.

Field Performance of Timber Bridges

1. Teal River Stress-Laminated Deck Bridge

James P. Wacker, General Engineer

Michael A. Ritter, Research Engineer

Forest Products Laboratory, Madison, Wisconsin

Introduction

In 1988, the U.S. Congress passed legislation known as the Timber Bridge Initiative. The objective of this legislation was to establish and annually fund a national timber bridge program to provide effective utilization of wood as a structural material for highway bridges. Responsibility for the development, implementation, and administration of the timber bridge program was assigned to the USDA Forest Service. A key element of this program is a demonstration bridge program, which provides matching funds to local governments to demonstrate timber bridge technology through the construction of demonstration bridges (USDA 1991). A primary objective of the demonstration bridge program is to encourage innovation through the use of new or previously underutilized wood products, bridge designs, and design applications. In so doing, bridge designers and users will become more aware of the attributes of wood as a bridge material, and new, economical, structurally efficient timber bridge systems should result. In addition, it is contemplated that timber use in bridges will be expanded to include several abundant but underutilized wood species.

As a national wood utilization research laboratory within the USDA Forest Service, the Forest Products Laboratory (FPL) has taken a lead role in assisting local governments in evaluating the field performance of demonstration bridges, many of which employ design innovations that were not previously evaluated. This has involved the development and implementation of a comprehensive national bridge monitoring program. The objective of this monitoring program is to collect, analyze, and distribute information on the field performance of timber bridges. This

Table 1—Factors for converting English units of measurement to SI units

English unit	Conversion factor	SI unit
inch (in.)	25.4	millimeter (mm)
foot (ft)	0.3048	meter (m)
foot ²	0.09	square meter (m ²)
pound (lb)	0.14	Newton (N)
lb/in ² (stress)	6,894	Pascal (Pa)
lb/ft ² (weight)	4.88	kilogram/meter ² (kg/m ²)

information will provide a basis for validating or revising design criteria and further improving efficiency and economy in bridge design, fabrication, and construction. This report is one in a series documenting field performance of timber bridges built as a part of the Timber Bridge Initiative.

This report describes the development, design, construction, and field performance of the Teal River bridge located in Sawyer County in northwestern Wisconsin. The bridge, built in 1989, is a two-lane, single-span, stress-laminated deck with a length of 32.5 ft. (See Table 1 for metric conversion factors.) The bridge design is unique in that it is the first known U.S. application that utilizes full-span structural glued-laminated (glulam) timber beams in a stress-laminated deck. In 1991, this bridge design was awarded first place in a National Timber Bridge Design Competition in the "Under 40 ft Individual Span Vehicular Bridge" category. An information sheet on the Teal River bridge is provided in Appendix A.

Objective and Scope

The objective of this project was to evaluate the field performance of the Teal River bridge for 2 years, beginning at bridge installation. The project scope included data collection and analysis related to the wood moisture content, stressing bar force, deck creep, bridge behavior under static truck loading, and general structure performance. The results of this project will be used to formulate recommendations for the design and construction of similar bridges in the future.

Background

The Teal River bridge site is located approximately 20 miles east of Hayward, Wisconsin, in Sawyer County (Fig. 1). It is on County Highway S, a two-lane paved road that crosses the Teal River just upstream of where it flows into the Chippewa River. This road is located within the boundary of the Chequamegon National Forest and provides access to several popular recreation areas. The road is on the Chequamegon National Forest transportation network and is a primary route for logging traffic. The estimated average daily traffic over this section of the road is 100 vehicles per day.

The Teal River bridge was originally constructed in 1925 and consisted of steel stringers with a concrete deck supported by concrete abutments. The bridge was 34 ft long, 16 ft wide, and included a rail system constructed of steel angles. In 1988, inspections of the bridge indicated that the concrete deck was in poor condition and the steel girders were badly corroded, although not to a point where restricted load limits were required. In addition, the railing system was substandard, and the narrow bridge width on a two-lane road raised safety concerns. It was apparent to the Sawyer County Highway Department that major rehabilitation or replacement of the structure would be required in the near future.

Subsequent to the bridge inspection, Sawyer County officials determined that the Teal River bridge would be replaced. Through a cooperative effort involving Sawyer County, the North Twenty Resource Conservation and Development Council, and the Chequamegon National Forest, a project proposal was submitted to the USDA Forest Service for partial funding the Teal River bridge replacement as a demonstration bridge under the Timber Bridge Initiative. The proposal included a stress-laminated deck constructed of Red Oak sawn lumber harvested from Wisconsin forests. In 1989, the project was approved as proposed, and matching funds were provided through the USDA Forest Service, Timber Bridge Information Resource Center in Morgantown, West Virginia. In finalizing

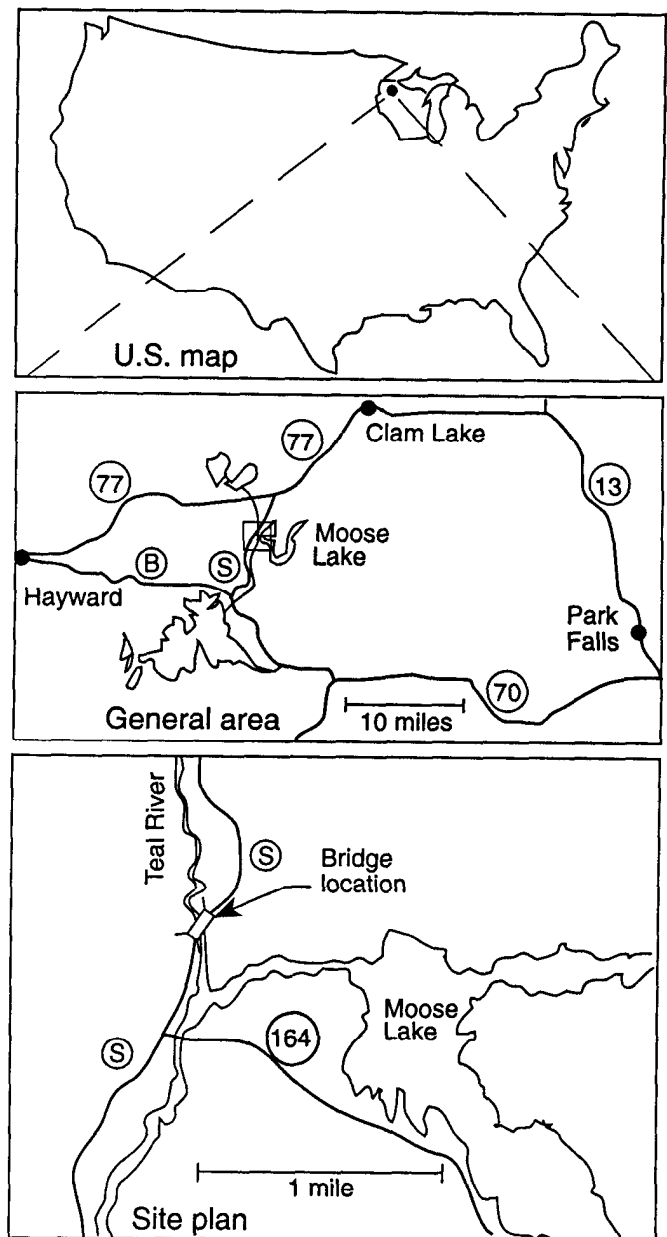

Figure 1—Location of the Teal River bridge.

project plans, it was found that Wisconsin Red Oak lumber of the size required for the bridge was not readily available. As an alternative design, the use of Wisconsin red pine lumber was investigated, but again, the material was not readily available in the required sizes. Consequently, the FPL was contacted for assistance in developing material options for the bridge, where the use of wood products native to Wisconsin was a primary consideration. Preliminary investigations indicated that glulam timber beams presented the most feasible alternative for design. Using this approach, red pine lumber could be laminated with structural waterproof adhesives to form beams of the size required for the bridge laminations.

Design, Construction, and Cost

The design and construction of the Teal River bridge was completed by the Chequamegon National Forest engineering staff in cooperation with the Sawyer County Highway Department officials. Assistance was provided by the bridge design office of the Forest Service Eastern Regional Office and the FPL. An overview of the design, construction, and cost of the bridge superstructure is presented.

Design

Design of the Teal River bridge was a two-part process, involving the development of the glulam timber beams followed by the design of the bridge superstructure. As with most stress-laminated timber bridge decks, it was anticipated that stiffness rather than strength would be the primary design concern. To serve as a basis for designing the glulam timber beams, a preliminary analysis of the Teal River bridge indicated that an acceptable deck depth could be obtained if a minimum design modulus of elasticity of 1.6×10^6 lb/in² could be achieved. The primary objective in developing the glulam timber beams was to meet this stiffness requirement utilizing Wisconsin-grown red pine. Analytical analysis conducted at the FPL indicated that a glulam timber beam manufactured entirely of red pine was potentially feasible. However, little information was available on the properties of red pine lumber, and no information was available on

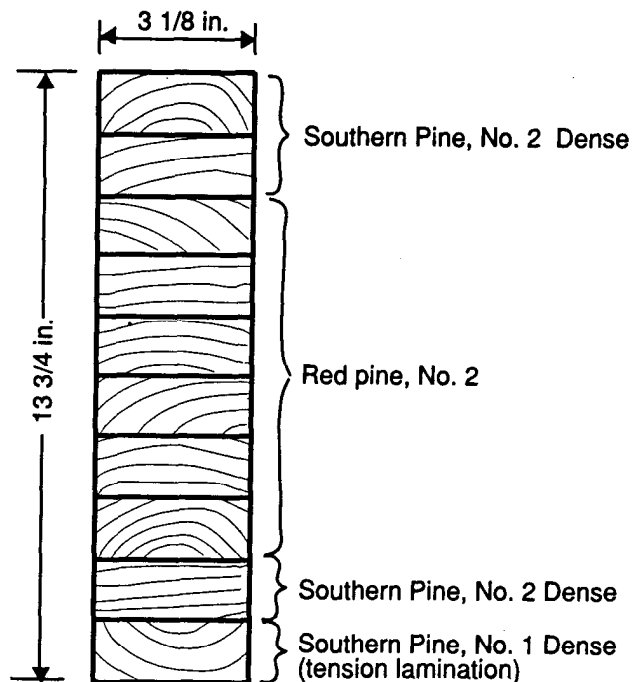

Figure 2—Layout of the Southern Pine-red pine beam laminations used for the Teal River bridge.

red pine glulam timber to confidently establish design values. Given this uncertainty, the FPL engineers proposed that Southern Pine lumber be combined with red pine lumber to provide additional beam stiffness. No design information on Southern Pine-red pine glulam timber beams was available in current American Institute of Timber Construction (AITC) standards (AITC 1987). However, the concept of developing beams using lower stiffness species for the inner lumber laminations and higher stiffness species for the outer lumber laminations had been used for other species in this standard. This same concept was used to develop a proposed beam design with Southern Pine outer laminations and red pine inner laminations (Appendix B). The proposed beam design was subsequently approved by AITC and was used in the Teal River bridge (Fig. 2).

After the glulam timber design values were developed, design of the Teal River bridge was completed by the engineering staff of the Chequamegon National Forest using criteria developed at the University of Wisconsin-Madison and the FPL (Ritter 1990). The design geometry of the deck provided for a 32.5-ft length, a 24-ft width, and a 13.75-in. thickness (Fig. 3). This required the use of 91 Southern Pine-red pine glulam timber beams, each measuring approximately 3.125 in. wide. The outside beam along each deck edge was designed to be Red Oak glulam timber. The Red Oak would provide additional strength in distributing the force in the stressing bars into the deck without damaging the Southern Pine-red pine beams. All glulam beams were used as bridge laminations to form a continuous deck and hereafter are referred to as beam laminations.

All beam laminations were designed to be continuous between supports, without butt joints. The deck was also provided with a curb and bridge rail system to meet American Association of State Highway and Transportation Officials (AASHTO) static-load design requirements. Following fabrication, all wood components were specified to be pressure treated with pentachlorophenol in accordance with American Wood Preservers' Association (AWPA) Standard C14 (AWPA 1991).

The stressing system for the Teal River bridge was designed to provide a uniform compressive stress of 100 lb/in² between the beam laminations. It was assumed that approximately 60 percent of this compression will be lost during the lifetime of the bridge as a result of transverse stress relaxation of the wood laminations. The remaining 40 percent, or 40 lb/in² of compression between the laminations, provides a safety factor greater than 2.0 against relative lamination movement caused by transverse shear or

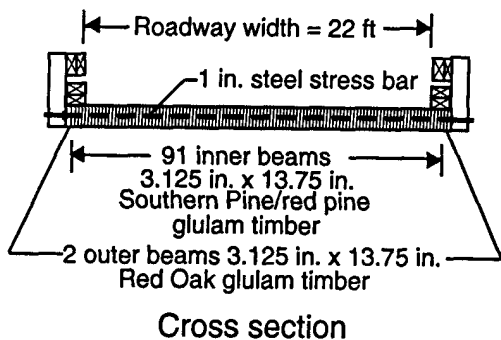
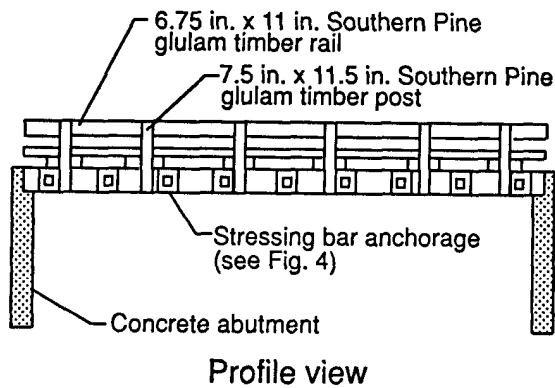
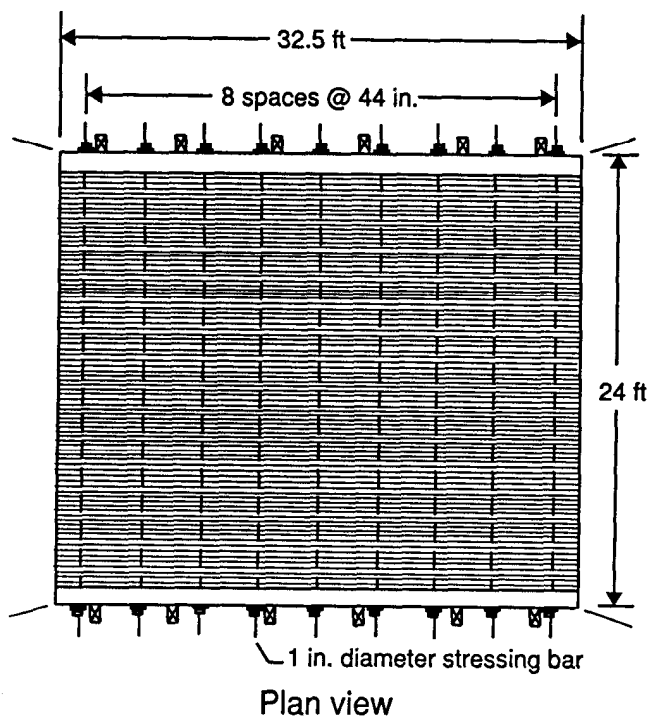

Figure 3—Design configuration of the Teal River bridge.

bending. To provide this interlaminar compression, 1-in.-diameter high-strength stressing bars were spaced 44 in. on center. The bars were specified to comply with the requirements of ASTM A 722 (ASTM 1988) and to provide a minimum ultimate tensile strength of 1.5×10^5 lb/in². The bar anchorage system was the discrete plate anchorage system, consisting of 12- by 12-in. steel-bearing plates with 4 by 6.5-in. steel anchorage plates (Fig. 4). To provide protection from deterioration, all steel components were galvanized, including hardware, stressing bars, and anchorage plates.

Construction

Construction of the Teal River bridge was completed by Sawyer County and Chequamegon National Forest personnel in the fall of 1989. Following work on the approach roadway and widening of the existing concrete abutments, construction of the bridge superstructure began November 14 and was completed November 15. However, several additional days were required for construction of the bridge and approach railing. During this period, the construction site was subjected to inclement weather conditions, including snow and cold temperatures. Although this weather tended to slow the construction, it was completed on schedule with little difficulty.

Construction of the bridge began with the arrival of the beam laminations at the bridge site. The 91 Southern Pine-red pine beam laminations were transported to the site on a flatbed trailer in banded panels consisting of 15 to 16 beam laminations per panel (Fig. 5). Each beam lamination measured 3.125 in. wide by 13.75 in. deep by 32.5 ft long. Panels were placed on the abutments by a crane, bands were removed, and the beam laminations were positioned by the work crew (Fig. 6). After placement of the Southern Pine-red pine beam laminations, a Red Oak beam lamination was placed along each deck edge. During placement, it was

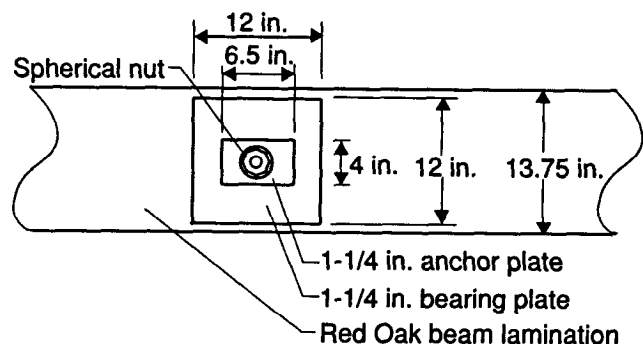

Figure 4—Details of the discrete plate bar anchorage system.

discovered that the abutment configuration restricted the bridge width and would not allow placement of all the beam laminations. Consequently, one Southern Pine-red pine beam lamination was removed, resulting in a finished bridge width of approximately 23.7 ft (design width was 24 ft).

After all beam laminations were in place, steel stressing bars were manually inserted through the predrilled holes in the beam laminations; bearing plates and anchor plates were installed, and nuts were hand tightened. Several stressing bars were then partially tensioned to bring all beam laminations in contact, and the initial deck stressing began. This was accomplished with a hydraulic jacking system, consisting of a hydraulic pump, a single hollow core jack, and a stressing chair (Fig. 7). Using this system, force

applied by the jack is transferred through the stressing chair to the bar bearing plate. The bar is pulled away from the deck until the design force (60,500 lb) is reached. Then, the anchorage nut is tightened with a wrench to lockoff the tension force in the bar. Starting at one bridge end, each stressing bar of the Teal River bridge was tensioned in this manner (Fig. 8). After all bars were tensioned, each was retensioned to insure that the stress level in the deck was uniform and at the required design level.

Following the initial stressing, the timber curb and rail system was installed, and a glulam timber approach rail was constructed. Approximately 1 week after the initial stressing, the bridge was restressed to compensate for anticipated losses in the bar force (Ritter 1990). Approximately 7 weeks after the second deck stressing, the third and final deck stressings were completed. An asphalt wearing surface was subsequently applied in June 1990. The completed bridge is shown in Figure 9.

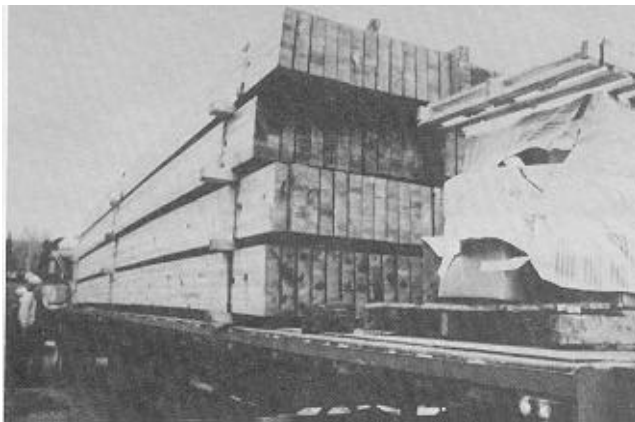

Figure 5—Arrival of beam laminations at bridge site; 15 to 16 beam laminations were banded into panels to facilitate transportation and construction. (M92 0009-3)



Figure 6—Placement of beam laminations on abutments. (M92 0009-4)

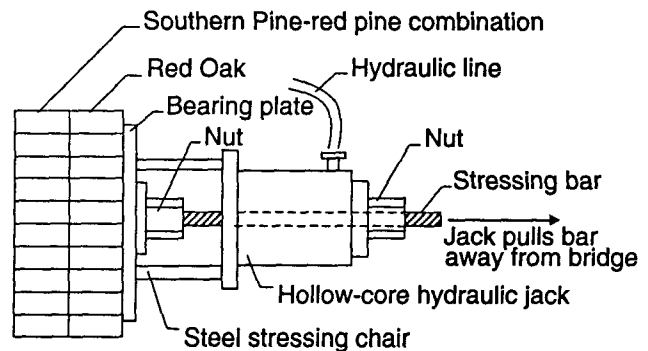

Figure 7—Hydraulic jacking system used to tension bars.

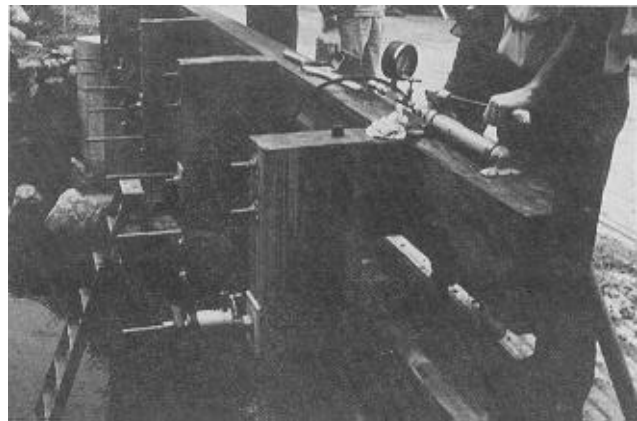

Figure 8—Tensioning bars with hydraulic jacking system. (M92 0009-6)

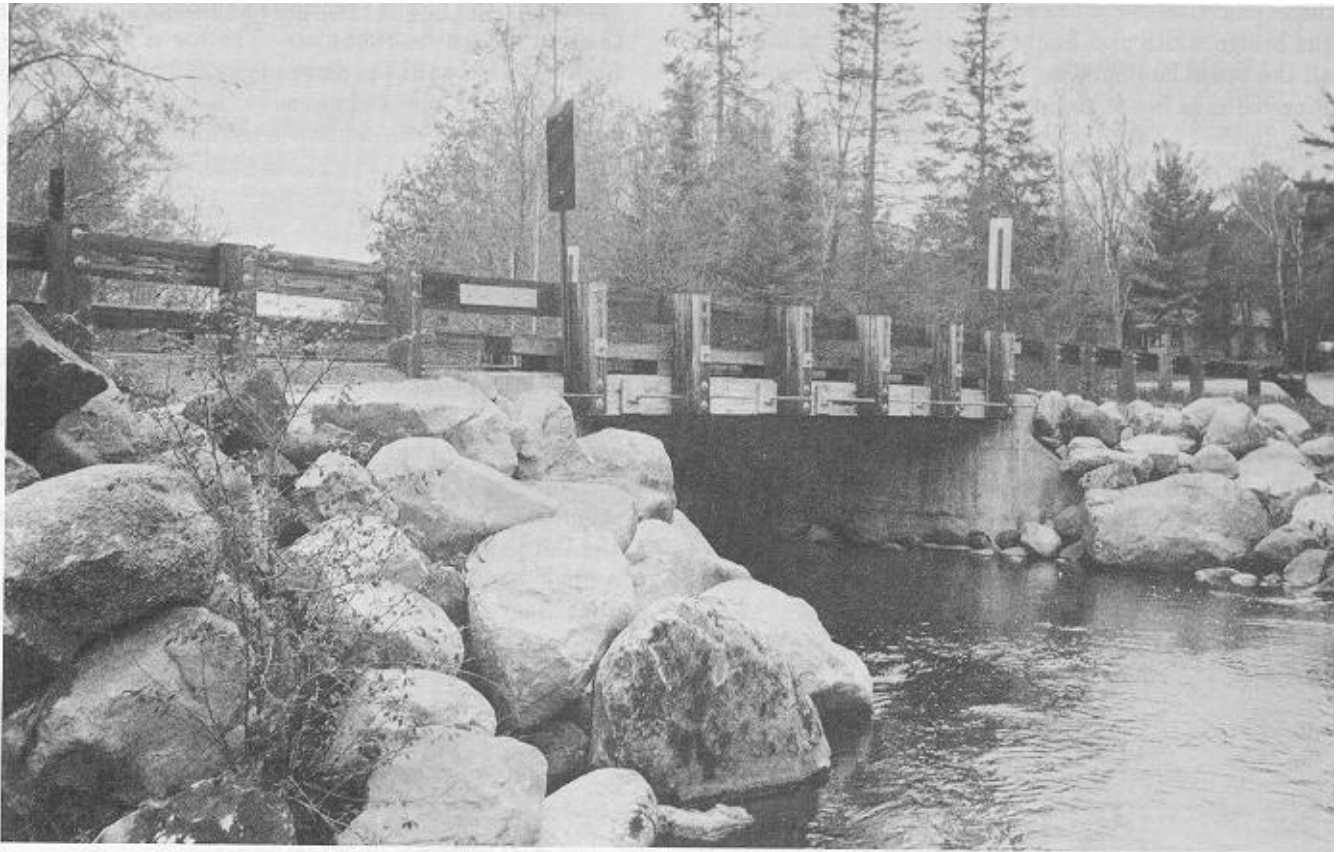

Figure 9—Completed Teal River bridge. (M92 0001-26, M92 0001-24)

Cost

Costs for the design, fabrication, and construction of the Teal River bridge superstructure and rail system were \$4,000 for survey and design, \$26,485 for materials, and \$5,400 for labor and equipment for a total cost of \$35,885. Based on a total deck area of 780 ft², the cost per square foot was approximately \$46.

Evaluation Methodology

To evaluate the structural performance of the Teal River bridge, Sawyer County representatives contacted the FPL for assistance. Through mutual agreement, a bridge monitoring plan was developed by the FPL and implemented as a cooperative research effort with Sawyer County and the Chequamegon National Forest. The plan called for stiffness testing of the beam laminations prior to bridge construction and for performance monitoring of the deck moisture content, bar force in stressing bars, bridge creep, load test behavior, and condition assessments of the structure for the first 2 years in service. The evaluation methodology utilized procedures and equipment previously developed (Ritter and others 1991) and is discussed in the following sections.

Lamination Stiffness

The glulam timber beam developed for the beam laminations of the Teal River bridge was a new combination. Thus, stiffness tests were completed to verify design assumptions. This testing was conducted at both the manufacturing plant and the bridge site.

At the manufacturing plant, modulus of elasticity (MOE) tests were performed on the lumber before gluing and on the completed glulam timber beams prior to preservative treatment. Three different methods were used to determine MOE values (Ross and Pellerin 1991). The first method, known as the static-load method, involved placing a known load at the lumber or beam midspan and measuring the deflection with a dial gauge. The second method, known as the transverse vibration technique, involved impacting the lumber or beam to induce a transverse vibration and measuring the natural frequency with a computer (Ross and others 1991). The third method employed stress-wave technology and involved inducing a longitudinal stress wave in the lumber or beam and measuring the time-of-flight of the wave along the lamination length.

In addition to the MOE testing at the manufacturing plant, tests were also performed at the bridge site after the glued beam laminations were treated with wood



Figure 10—Measurement of the beam lamination MOE at the bridge construction site using the transverse vibration technique. (M92 0009-7)

preservatives. These tests involved a limited number of beam laminations that were previously tested at the manufacturing plant and tagged for identification after treating. The testing methods used in the field were the same as those used at the manufacturing plant and were conducted immediately prior to deck assembly (Fig. 10).

Moisture Content

Changes in the moisture content level of stress-laminated timber decks can significantly affect the performance of the structure. If moisture decreases, the deck can shrink, resulting in a decrease in stressing bar force. Conversely, if moisture increases, swelling of the timber can occur and cause an increase in stressing bar force. Changes in moisture content level can also affect the deck stiffness, creep, and transverse stress relaxation.

To measure the moisture content of the Teal River bridge deck, an electrical-resistance moisture meter with 3-in. pins was used. Measurements were obtained on a monthly basis by driving probe pins into the deck underside at depths of 2 to 3 in., recording the moisture content value from the unit, then adjusting the values for temperature and wood species. At the 3-in. maximum pin penetration depth, measurements were taken in the lower Southern Pine portion of the beam laminations.

Bar Force

For stress-laminated bridges to perform properly, an adequate level of interlaminar compression must be maintained between the bridge laminations. This compression is placed in the bridge by tensioning the

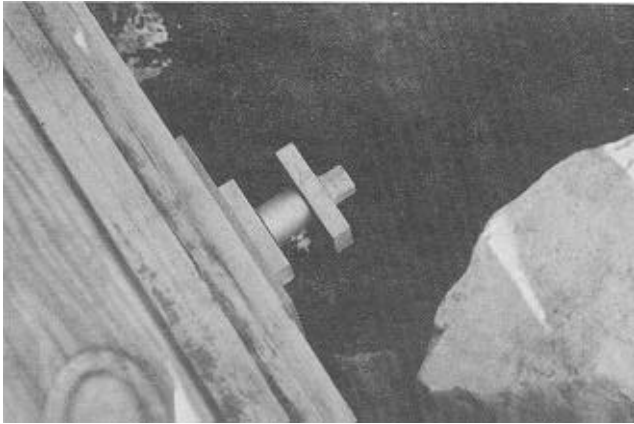

Figure 11—A load cell placed on a stressing bar to measure changes in bar tension. (M92 0009-8)



Figure 12—Reading a load cell with a portable strain indicator. (M92 0001-27A)

stressing bars to high levels and maintaining a portion of this force during the life of the structure. Thus, the force level in the bars provides a direct indication of the interlaminar compression in the bridge. For the Teal River bridge, the initial interlaminar compression of 100 lb/in² required a force in each stressing bar of 60,500 lb. If the force level decreases more than approximately 80 percent (i.e., less than 20 percent remaining), structural and serviceability problems can occur.

To monitor bar force, load cells developed by the FPL were installed on two of the nine stressing bars when the bridge was assembled. These cells consisted of a steel cylinder that was placed between the stressing bar bearing plate and anchorage plate (Fig. 11). Each cell was provided with two 90° strain gage rosettes that measured the strain in the load cell. Strain measurements were then converted to force levels to determine the force remaining in the bar.

Load cell measurements were obtained by connecting a portable strain indicator to a plug on the load cell body (Fig. 12). Measurements were taken on a biweekly basis for the first year and monthly thereafter. Approximately midway through the monitoring period, 1 year after bridge construction, the load cells were unloaded and checked for zero balance shift.

Creep

As a structural material, wood can deform permanently as a result of long-term sustained loads. For stress-laminated bridges, creep caused by structure dead load is an important consideration, because excessive creep can result in a sag in the superstructure (Ritter and others 1990). Creep of the Teal River bridge was measured on a monthly basis with a displacement rule attached to the deck underside at midspan. Vertical movement over time was recorded relative to a stringline attached near the abutments. In addition, a surveying level and rod were used periodically to confirm stringline data.

Load Test Behavior

Static-load testing of stress-laminated bridges is an important part of a comprehensive bridge monitoring program. The information obtained from these tests is used to refine and improve design procedures and evaluate the effects of various design variables on bridge performance. To determine the load test behavior of the Teal River bridge, load tests were conducted at 7 and 17 months after installation. Each test consisted of positioning fully loaded trucks on the bridge deck and measuring the resulting deflections at a series of locations along the bridge centerspan, quarter points, and abutments. Measurements of bridge deflections were taken prior to testing (unloaded), for each load position, and at the conclusion of testing (unloaded).

Load Test 1

For the first load test on June 19, 1990, the vehicle used was a three-axle loaded dump truck with a gross vehicle weight of 79,840 lb (Fig. 13). The vehicle was positioned longitudinally on the bridge so that the centroid of the vehicle aligned with the bridge centerspan for each of three transverse load positions (Fig. 14). For load position 1, the vehicle was positioned facing north in the downstream lane with the center of the outside wheel line 2 ft from the curb face. For load position 2, the vehicle faced south in the upstream lane with the center of the inside wheel line 2 ft from the bridge centerline. Load position 3 was the same as load position 1, except the vehicle faced south in the upstream lane. Measurements of bridge deflections from an unloaded to loaded condition

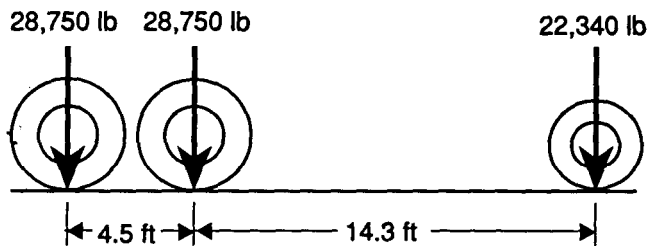

Figure 13—Load Test 1 vehicle configuration and axle loads. The transverse vehicle track width was 6 ft, measured center-to-center of the rear tires.

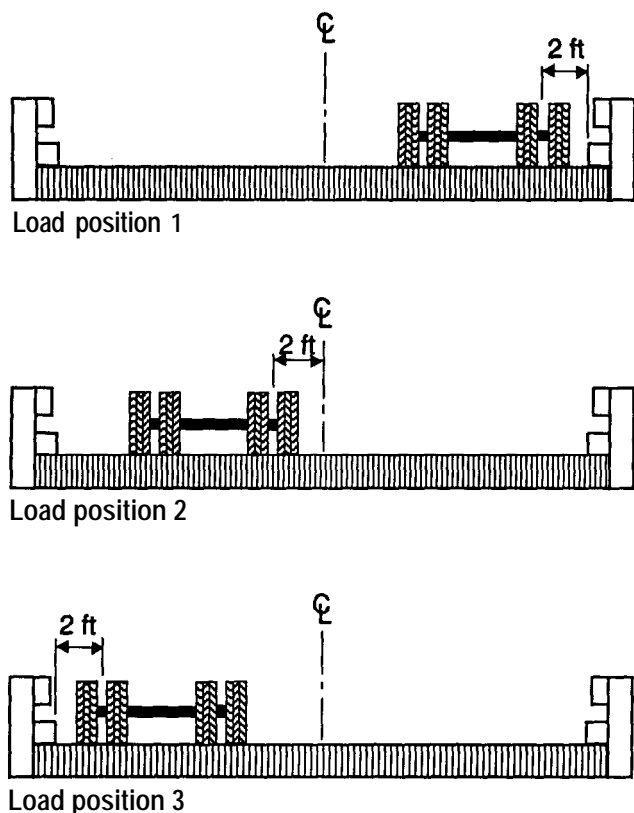

Figure 14 - Transverse load positions used for Load Test 1. Vehicles in the right lane face North, into the page; those in the left lane face South, out of the page. For all load positions, the longitudinal centroid of the vehicle was placed over the bridge centerspan.

were obtained by placing a surveying rod on the deck underside and reading values with a surveyor's level to the nearest 0.005 ft (Fig. 15). The accuracy of this method for repetitive readings is estimated to be ± 0.06 in.

Load Test 2

The second load test on April 26, 1991, involved two test vehicles; Truck 11 with a gross vehicle weight of



Figure 15—Measuring bridge deflection with surveyor's rod. (M92 0009-9)

59,880 lb and Truck 13 with a gross vehicle weight of 59,600 lb (Fig. 16). For this test, the vehicles were positioned longitudinally with the two rear axles centered over the bridge centerspan, and three transverse load positions were used (Fig. 17). For load position 1, Truck 11 was positioned in the downstream lane with the center of the inside wheel line 2 ft from the bridge centerline. Load position 2 involved Truck 13 in the upstream lane, also with the center of the inside wheel line 2 ft from the bridge centerline (Fig. 18). Load position 3 utilized both vehicles placed in the same respective positions used for load positions 1 and 2 (Fig. 19). Measurements of bridge deflections were obtained by suspending calibrated rules from the deck underside and reading values to the nearest 0.06 in. with a surveyor's level. The accuracy of measurements is estimated to be ± 0.03 in.

Predicted Behavior Under HS 20-44 Loading

Previous research showed that stress-laminated decks can be accurately modeled as orthotropic plates (Oliva and others 1990). To further analyze the behavior of the Teal River Bridge, an orthotropic model currently being developed and verified at the FPL was used to predict the deflection of AASHTO HS 20-44 loading and to evaluate changes in bridge stiffness.

Condition Assessment

The general condition of the bridge was assessed on four different occasions during the monitoring period. The first assessment occurred at the time of installation. The second and third assessments took place at the time of load testing. The final assessment occurred during a site visit near the end of the monitoring period. These assessments involved visual inspections, measurements, and photograph

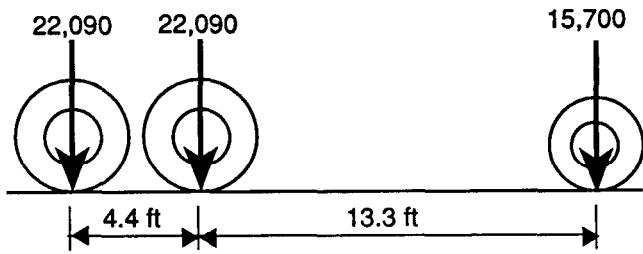

Truck 11

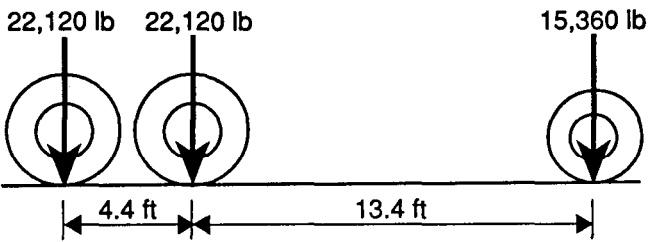

Truck 13

Figure 16—Load Test 2 vehicle configurations and axle loads. The transverse vehicle track width for both vehicles was 6 ft, measured center-to-center of the rear tires.

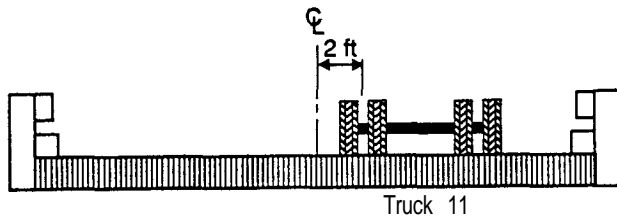

Load position 1

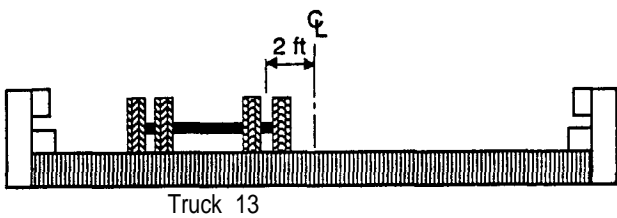

Load position 2

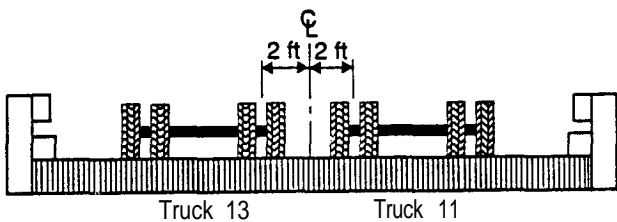

Load position 3

Figure 17—Transverse load positions used for Load Test 2. Vehicles in the right lane face North, into the page; those in the left lane face South, out of the page. For all load positions, the two rear ax/les were centered over the bridge centerspan.



Figure 18—Load position 2 with a single vehicle in the upstream lane. (M92 0009-12)



Figure 19—Load position 3 with both vehicles on the bridge. (M92 0009-13)

documentation of the bridge condition. Items of specific interest included the condition of the timber deck and rail system, asphalt wearing surface, stressing bars, and anchorage systems.

Results and Discussion

The performance monitoring of the Teal River bridge extended from November 1989 through October 1991. The following presents results of the performance data.

Lamination Stiffness

Results of MOE tests on lumber prior to gluing are given in Table 2. For Southern Pine, the measured values were slightly greater than the assumed values given in Appendix B. For red pine, the measured values were approximately 3.5 percent greater than assumed values.

Tests of 30 laminated beams at the manufacturing plant using the transverse vibration technique resulted in an average MOE of 1.78×10^6 lb/in². Additional testing at the plant using the static-load method resulted in an average MOE of 1.77×10^6 lb/in² for 24 laminated beams. Measured MOE values for the five beams tested at both the manufacturing plant and bridge construction site are given in Table 3.

For tests conducted at the manufacturing plant and the bridge site, the stress-wave technique did not provide reliable data and was not used for evaluation.

The average modulus of elasticity of the laminated beams exceeded the target value of 1.6×10^6 lb/in² by approximately 10 percent. This was due primarily because lumber properties for both Southern Pine and red pine exceeded those assumed in the original design.

Moisture Content

The trend of average moisture content changes in the bridge deck is shown in Figure 20. The beam-laminations were initially installed at an average moisture content of less than 10 percent. Since installation, moisture content gradually increased to an average level of approximately 13 percent at the conclusion of the monitoring period. Moisture content fluctuated following seasonal climate changes, with a maximum average moisture content of approximately 15 percent occurring in the fall of 1990 (Fig. 20). These changes will continue to occur over the life of the structure and were generally most apparent in the outer 1 to 3 in. of the deck, where moisture measurements were taken. Moisture changes in the interior portion of the deck were gradual, where the moisture content will continue to increase until an equilibrium level is reached. It is anticipated that the average moisture content of the deck will eventually stabilize at an equilibrium value of 18 to 20 percent (McCutcheon and others 1986), although short-term seasonal changes will continue to occur, primarily in the outer 2 to 3 in. of the deck.

Bar Force

The average trend in bar tension force measured from the average of load cells on two stressing bars is shown in Figure 21. As indicated, the first two stressings were at the design force of 60,500 lb. The final stressing, which occurred about 8 weeks after installation, was approximately 10 percent greater than the design force level. As is typical for stress-laminated decks, the rate of bar force loss as a result of transverse stress relaxation decreased substantially with each restressing (Fig. 21).

Table 2—Results of modulus of elasticity (MOE) measurements on lumber prior to gluing

Species and lumber grade	Pieces tested (number)	Average MOE ($\times 10^6$ lb/in ²)
Southern Pine No. 1 Dense	5	2.07
Southern Pine No. 2 Dense	10	1.93
Red pine No. 2	20	1.49

Table 3—Measured MOE values for five laminated beams tested at the manufacturing plant and the bridge construction site

Beam number	MOE ($\times 10^6$ lb/in ²)				
	Manufacturing plant			Bridge site ^a	
	Transverse vibration ^a	Static load ^a	Static load ^b	Transverse vibration	Static load
6	1.87	1.67	1.75	1.83	1.73
7	1.85	1.73	1.90	1.78	1.66
11	1.80	1.71	1.79	1.78	1.61
12	1.70	1.67	1.76	1.91	1.52
14	1.77	— ^c	— ^c	1.88	1.54

^aPerformed by FPL personnel.

^bPerformed by Sentinel Structures, Inc. personnel.

^c—, no data.

Figure 21 also reflects the minor fluctuations in bar force as a result of moisture changes and stress relaxation in the deck. However, force losses were minimal, and the average bar force was within 10 percent of the design force at the end of the monitoring period. This can be attributed to several factors, the most significant of which was the initial low moisture content level of the beam laminations. As the deck slowly gained moisture in reaching an equilibrium moisture content, the wood swelled slightly, which tended to offset force losses as a result of transverse stress relaxation. Other stress-laminated decks installed at relatively high moisture content levels had bar force losses as much as 80 percent during 2 years (Ritter and others 1990). On a comparative basis, the Teal River bridge vividly illustrates the advantage of low wood moisture content levels at the time of construction in reducing the rate of bar force loss.

Creep

The beam laminations for the Teal River bridge were manufactured with a positive camber of approximately 2 in. After the dead-load deflection of about 0.4 in., measurements indicated that approximately 0.1 in. of vertical creep occurred at centerspan during 2 years. At the conclusion of the monitoring period, approximately 1.5 in. of positive camber remained in the deck at centerspan.

Load Test Behavior

Results for both load tests and the predicted response of the bridge under AASHTO HS20-44 loading are presented. In each case, transverse deflection measurements are given at the bridge centerspan as viewed from the south end (looking north). To aid visual interpretation, deflection values are presented as fourth-order polynomial curve fits to the measured data points. For each load test, no permanent residual deformation was measured at the conclusion of the testing. Additionally, movement at either of the abutments was not detected.

Load Test 1

Transverse deflection values for Load Test 1 are shown in Figure 22. For load position 1 (Fig. 22a), the maximum deflection of 0.84 in. occurred under the outside wheel line, 3 ft from the downstream deck edge. For load position 2 (Fig. 22b), the maximum deflection of 0.85 in. was measured 10 in. from the outside wheel line, toward the upstream deck edge. For load position 3 (Fig. 22c), the maximum deflection of 0.90 in. occurred under the outside wheel line, 3 ft from the upstream deck edge.

In comparing the results for load positions 1 and 3, the symmetry of the load positions should have resulted in the same maximum deflection magnitude and location for both cases, assuming linear elastic deck behavior and uniform deck stiffness. As the load measurement accuracy using a surveyor's rod was within the 0.06 in. difference for the two load cases, it is probable that the maximum deflections for load positions 1 and 3 were approximately equal.

Load Test 2

Transverse deflection values for Load Test 2 are shown in Figure 23. With a single truck on the bridge, both load positions 1 and 2 (Figure 23a,b) produced a maximum deflection of 0.59 in. approximately midway between the truck wheel lines. With both vehicles on the bridge, the maximum deflection for load position 3 (Fig. 23c) was 0.94 in. under the inside wheel line of Truck 11.

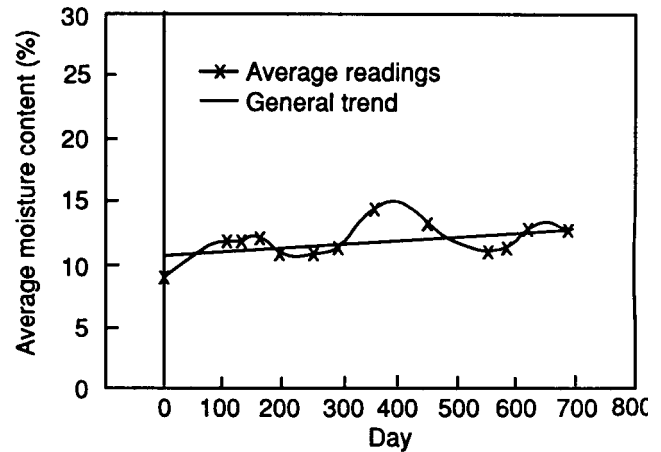

Figure 20—Trend of average moisture content changes in the bridge deck.

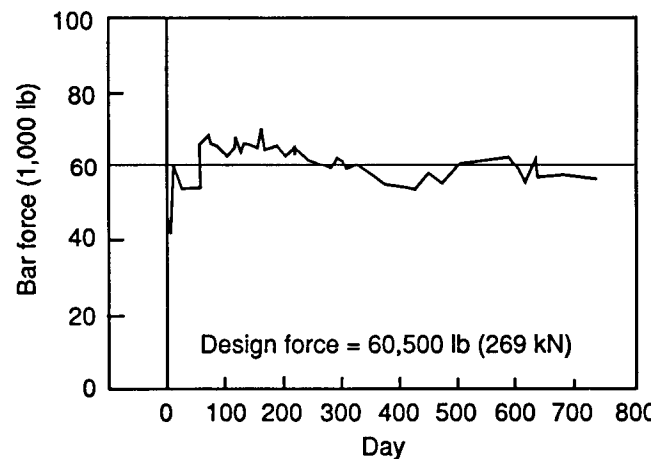
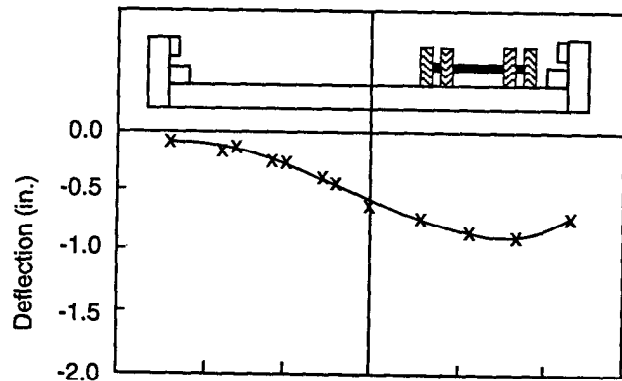

Figure 21—Average trend in bar tension force obtained from load cells installed on two stressing bars.

The measured deflection points for load positions 1 plus 2 compared to a fitted curve for load position 3 are shown in Figure 24. Assuming linear elastic behavior, the deflection resulting from the sum of the two individual truck loads should equal the deflection from both trucks applied simultaneously. As observed in Figure 24, the two curves are similar with only minor variations. These variations are within the accuracy of the measurement methods. From this information, it is concluded that bridge behavior under the applied loads is within the expected linear elastic range.

Predicted Behavior Under HS20-44 Loading

Based on an analysis of both load tests, the maximum deflection of the Teal River bridge subjected to two lanes of HS20-44 loading was estimated at 0.99 in., or where the bridge span is 31 ft measured center-to-center of bearings (Fig. 25). Further orthotropic plate analysis of Load Test 2 compared to Load Test 1



a. Load position 1

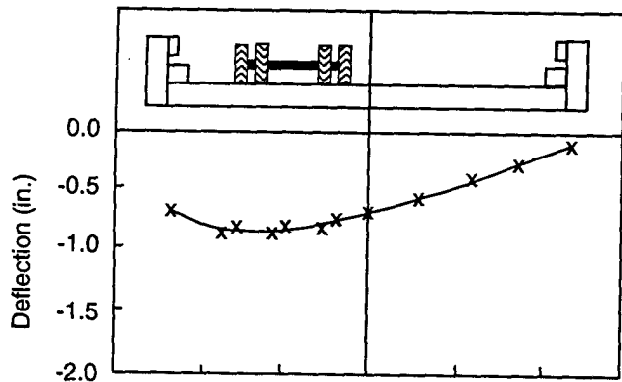

b. Load position 2

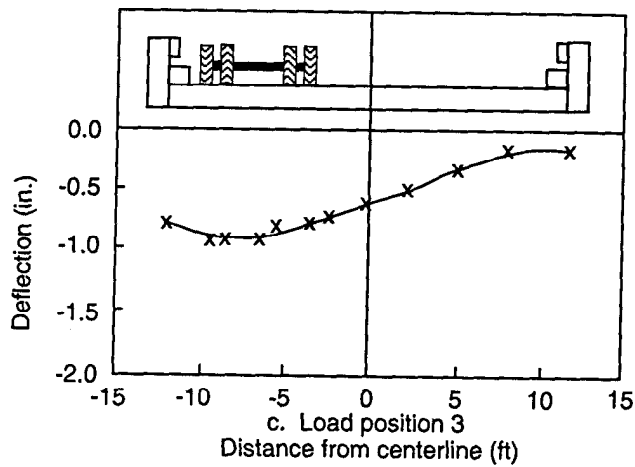

c. Load position 3

Figure 22—Transverse deflection for Load Test 1, measured at the bridge centerspan. Bridge cross-sections and vehicle positions are shown to aid interpretation and are not to scale.

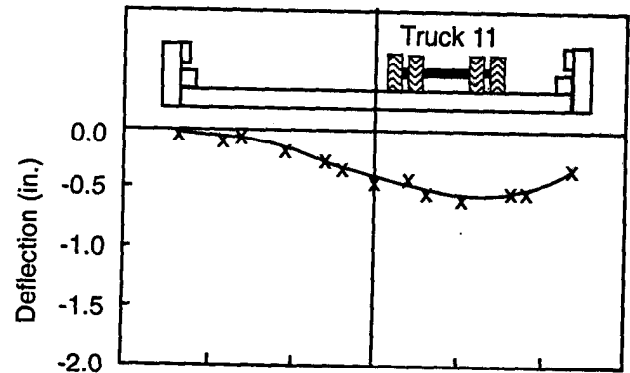

a. Load position 1

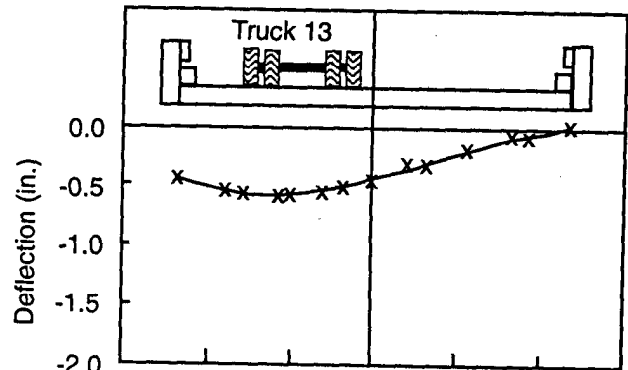

b. Load position 2

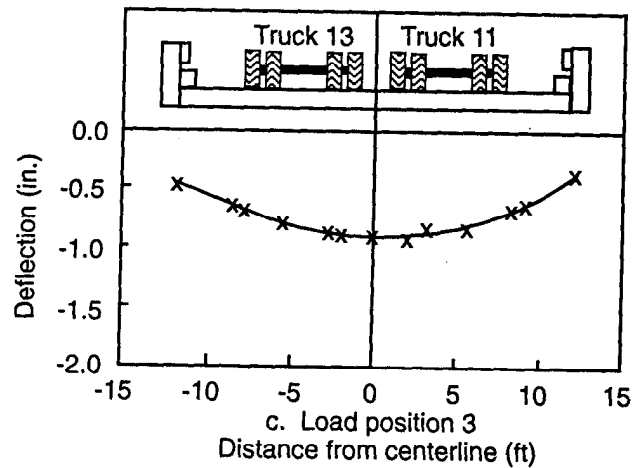

c. Load position 3

Figure 23—Transverse deflection for load Test 2, measured at the bridge centerspan. Bridge cross-sections and vehicle positions are shown to aid interpretation and are not to scale.

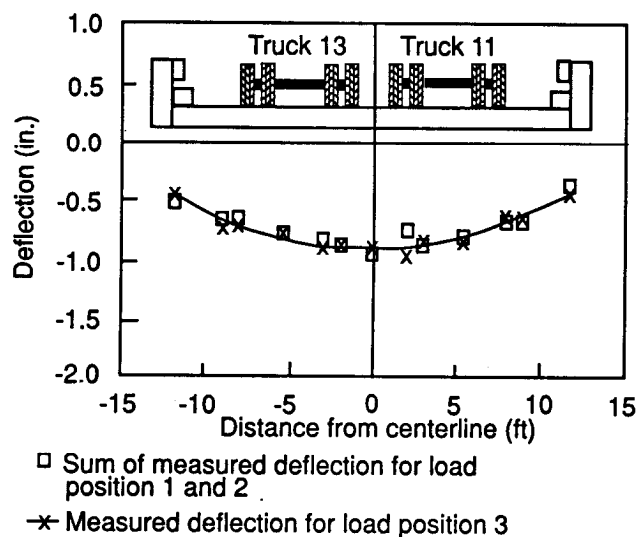

Figure 24—Load Test 2 showing the sum of measured deflections from load positions 1 and 2 compared to a fitted curve of the measured deflections for load position 3.

indicated that for equivalent HS20-44 loading, no significant decrease occurred in bridge stiffness during the monitoring period. This was expected because neither a significant decrease in bar force nor an increase in deck moisture content occurred during the monitoring period.

Condition Assessment

Condition assessments of the Teal River bridge indicated that structural and serviceability performance were good. Inspection results for specific items follow.

Wood Components

Inspection of the wood components of the bridge showed no signs of deterioration, although minor checking was evident on rail members exposed to wet-dry cycles. Checking was most pronounced in the end grain of the Southern Pine glulam timber rail posts. This would have likely been prevented if a bituminous end-grain sealer had been applied at the time of construction. In addition, the top of the bridge rail showed minor checking, but the depth of the checks did not appear to penetrate the preservative treatment envelope of the member. Inspection showed no evidence of wood preservative loss and no preservative or solvent accumulations on the wood surface. The Red Oak edge beams showed a lightening in color from a medium tan to a very light tan as a result of sunlight exposure.

Wearing Surface

Inspection of the asphalt wearing surface indicated minor transverse cracking in a random pattern.

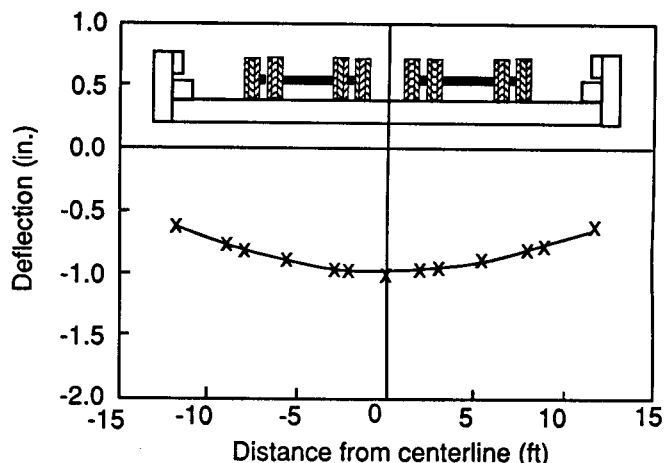

Figure 25—Predicted deflection profile at the bridge centerspan for two HS20-44 trucks, each positioned 2 ft on either side of the bridge longitudinal centerline.

This was attributed to a deficiency in the asphalt mix or application procedures, because the same cracking was observed on both approach roadways, which were paved at the same time as the bridge deck. Aside from the minor cracking, the asphalt was in good condition and showed no other signs of distress.

Anchorage System

The stressing bar anchorage system performed as designed with no significant signs of distress. Inspection indicated no crushing of the discrete plate anchorage into the outside Red Oak beams and no measurable distortion in the bearing plate. A very gradual compression deformation was noted along the deck edge for a distance of several feet on either side of several anchorages. This deformation was difficult to detect visually and was likely the result of transverse stress relaxation in the beam laminations.

Stressing Bars and Hardware

The exposed steel stressing bars and hardware showed no visible signs of corrosion, except at the ends of stressing bars. At bar ends, minor corrosion appeared where the galvanized coating had been stripped from the bar exposing uncoated steel. This occurred because the nuts were not adequately oversized to compensate for galvanizing and were forced on the bars during construction. This problem would not have occurred if nuts had been properly oversized to compensate for galvanizing or if a cold galvanizing compound had been applied to the bar to replace the removed coating.

Conclusions

After 2 years in service, the Teal River bridge is exhibiting excellent performance and should provide many more years of acceptable service. Based on the extensive monitoring conducted since bridge fabrication, the following conclusions are given:

1. It is both feasible and economically practical to manufacture structural glued-laminated (glulam) timber beams for bridge applications using a combination of red pine and Southern Pine lumber. Based on an evaluation of this project, it is probable that beams could be manufactured entirely from red pine, provided appropriate quality control measures are implemented to insure stiffness requirements for the specific design.
2. Stress-laminated decks can be constructed using glulam timber beams for the deck laminations. The ability to manufacture the glulam timber beam laminations as continuous members greatly facilitates transportation and construction because butt joints are not required.
3. The use of Red Oak outside edge laminations facilitates good performance of discrete plate stressing bar anchorages. Red Oak provides sufficient strength to adequately distribute the bar force into the deck without wood crushing or anchor plate deformation.
4. The average trend in deck moisture content indicates that global moisture content changes have been occurring very slowly with an average increase of approximately 3 percent during the 2 years. Cyclic seasonal variations in moisture content have been occurring more rapidly and at greater magnitudes in the outer 2 to 3 in. of the exposed deck.
5. Stressing bar force remained at a relatively high level during the P-year monitoring with less than a 10-percent average decrease in bar force below the initial level. This is attributable primarily to low average moisture content levels of the bridge laminations at installation, which were less than the anticipated equilibrium moisture content for the site. Loss in bar force caused by transverse stress relaxation in the wood has been minimized by dimensional increases in the deck as moisture content increases toward an equilibrium level. The lower moisture content level has also reduced the rate of stress relaxation within the deck and in the vicinity of bar anchorage plates.
6. Creep of the bridge deck has been minimal with approximately 0.10 in. of vertical displacement during the 2 years. A positive camber of approximately 1.5 in. has remained at centerspan.
7. Load testing and analysis indicate that the Teal River bridge is performing as a linear elastic orthotropic plate when subjected to highway loading. The maximum deflection caused by two lanes of AASHTO HS20-44 loading is estimated to be 0.99 in.
8. The deck stiffness has not been appreciably changed. This is attributable to the high level of prestress maintained in the deck during the monitoring period.
9. Wood checking is evident in the exposed end grain of bridge rail posts and other components. It is likely this would not have occurred if a bituminous sealer had been applied to the end grain at the time of construction.
10. The ends of some stressing bars show signs of minor corrosion at locations where the galvanizing was removed during construction. This would not have occurred if the stressing nuts had been oversized to compensate for the thickness of the galvanized coating.

References

- AASHTO.** 1989. *Standard specifications for highway bridges, 14th ed.* Washington, DC: American Association of State Highway and Transportation Officials.
- AITC.** 1987. *AITC 117-87—Design, Standard specifications for structural glued laminated timber of softwood species.* Vancouver, WA: American Institute of Timber Construction. 28 p.
- AITC.** 1988. *AITC 117-88—Manufacturing, Standard specifications for structural glued laminated timber of softwood species.* Vancouver, WA: American Institute of Timber Construction. 55 p.
- ASTM.** 1988. *Standard specification for uncoated high-strength steel bar for prestressing concrete; ASTM A 722-86.* Philadelphia, PA: American Society for Testing and Materials. 3 p.
- ASTM.** 1990a. *Standard methods of static tests of timbers in structural sizes; ASTM D 198-84.* Philadelphia, PA: American Society for Testing and Materials. 19 p.
- ASTM.** 1990b. *Standard test method for establishing stresses for structural glued laminated timber (glulam); ASTM D 3737-89a.* Philadelphia, PA: American Society for Testing and Materials. 16 p.
- AWPA.** 1991. *Standards.* Woodstock, MD: American Wood-Preservers' Association. 200 p.

Green, David W.; Evans, James W. 1987. (U.S. Department of Agriculture, Forest Service, Forest Products Laboratory, Madison, WI) Mechanical properties of visually graded lumber; Volume 1, a summary. 80 p. Available from National Technical Information Service, 5285 Port Royal Road, Springfield, VA 22161.

McCutcheon, W.J.; Gutkowski, R.M.; Moody, R.C. 1986. Performance and rehabilitation of timber bridges. Trans. Res. Rec. 1053. Washington, DC: National Academy of Sciences, National Research Council, Transportation Research Board: 65-69.

NFPA. 1988. Design values for wood construction, a supplement to the 1986 edition of the national design specification. Washington, DC: National Forest Products Association. 40 p.

Oliva, Michael G.; Dimakis, Al G.; Ritter, Michael A.; Tuomi, Roger L. 1990. Stress-laminated wood bridge decks: experimental and analytical evaluations. Res. Pap. FPL-RP-495. Madison, WI: U.S. Department of Agriculture, Forest Service, Forest Products Laboratory. 24 p.

Ritter, Michael A. 1990. Timber bridges: design, construction, inspection, and maintenance. U.S. Department of Agriculture, Forest Service, Engineering Staff, EM 7700-8. 944 p.

Ritter, M.A.; Geske, E.A.; Mason, L.; McCutcheon, W.J.; Moody, R.C.; Wacker, J.P. 1990. Performance of stress-laminated bridges. Wood Design Focus. 1(3): 12-16.

Ritter, M.A.; Geske, E.A.; Mason, L.; McCutcheon, W.J.; Moody, R.C.; Wacker, J.P. 1991. Methods for assessing the field performance of stress-laminated timber bridges. In: Proceedings, 1991 International timber engineering conference; 1991 September; London.

Ross, Robert J.; Pellerin, Roy F. 1991. Nondestructive testing for assessing wood members in structures: A review. Gen. Tech. Rep. FPL-GTR-70. Madison, WI: U.S. Department of Agriculture, Forest Service, Forest Products Laboratory. 27 p.

Ross, Robert J.; Geske, Earl A.; Larson, Gary R.; Murphy, Joseph F. 1991. Transverse vibration nondestructive testing using a personal computer. Res. Pap. FPL-RP-502. Madison, WI: U.S. Department of Agriculture, Forest Service, Forest Products Laboratory. 17 p.

USDA. 1991. The timber bridge initiative, fiscal year 1991 status report. Radnor, PA: USDA Forest Service, State and Private Forestry, Northeastern Area. 12 p.

Appendix A—Information Sheet

General

Name: Teal River Bridge

Location: Along Highway S in the northern part of Sawyer County, Wisconsin

Date of Construction: November 15, 1989

Owner: Sawyer County Highway Department

Design Configuration

Structure Type: Stress-laminated deck consisting of full-span beam laminations (see Table 1 for metric conversion).

Total Length (out-out): 32 ft 6 in.

Skew: None

Number of Spans: 1

Span Lengths (center-to-center bearings): 31 ft 6 in.

Width (out-out): 24 ft 0 in. (23 ft 8 in. as-built)

Width (curb-curb): 22 ft 0 in. (21 ft 8 in. as-built)

Number of Traffic Lanes: 2

Design Loading: HS20-44

Material and Configuration

Timber:

Species: Glulam combination of Southern Pine exterior laminations and red pine interior laminations; Red Oak exterior beams

Size (actual): 13-3/4 in. by 3-1/8 in.

Grade: (Southern Pine) No. 1 and No. 2 Dense, (red pine) No. 2, (Red Oak) No. 1

Moisture Condition: Approximately 10 percent at installation

Preservative Treatment: Pentachlorophenol in oil

Stressing Rods:

Diameter: 1 in.

Number: 9

Design Force: 60,500 lb

Spacing: 44 in.

Type: High strength steel thread bar with course right-hand thread, conforming to ASTM A 722.

Anchorage Type and Configuration:

Steel Plates: 12 in. by 12 in. by 1-1/4 in. Bearing
4 in. by 6-1/2 in. by 1-1/4 in. Anchor

Butt Joint Frequency: None

Wearing Surface Type: Asphalt pavement; 1 to 2 in. thickness.

Appendix B—Glulam Timber Beam Combination

Development of the glulam timber beam combination for the Teal River bridge was based on the procedures outlined in ASTM D 3737 (ASTM 1990b), which were used to develop AITC 117-Manufacturing (AITC 1988). Material property information for Southern Pine was obtained from AITC 117-Manufacturing. Property information for red pine was assumed as follows (see Table 1 for metric conversion).

Modulus of Elasticity: 1.1×10^6 lb/in², which is the average bending MOE found in the In-Grade Testing Program (Green and Evans 1987) for No. 2 red pine and is slightly less than the value presently listed in the National Design Specification (NFPA 1988).

Bending stress index: 1,700 lb/in², as applicable to all softwood species with an assigned MOE more than 1.0×10^6 lb/in² for No. 3 grade.

Knot properties: Same as used in developing AITC 117-Manufacturing for No. 3 grade softwoods.

Values for red pine were believed to represent conservative estimates for use in developing a glulam timber combination. Values used for Southern Pine and red pine are summarized in Table 4.

The beam lamination combination used for the Teal River bridge (Fig. 2) was determined to be adequate for a design bending stress of 2,000 lb/in² and a design MOE of 1.6×10^6 lb/in² if a 302-20 grade tension lamination was used for the outer tension ply (AITC 117-Manufacturing).

In addition to the MOE testing completed at the manufacturing plant and the construction site, one laminated beam was shipped to the FPL and tested in the laboratory using ASTM D198 (ASTM 1990a) techniques. Results indicate a MOE of 1.71×10^6 lb/in² and a MOR of 7,360 lb/in².

Table 4—Information used in developing glulam beam combinations

Species and lumber grade	MOE ($\times 10^6$ lb/in ²)	Knots (percent)		Minimum strength ratio	Bending stress index (lb/in ²)
		Average	Near maximum		
Southern Pine No. 1 Dense	2.00	3.3	35.6	0.710	3,500
Southern Pine No. 2 Dense	1.80	7.9	51.5	0.540	3,500
Red pine No. 2	1.10	20.0	80.0	0.450	1,700