

Determining In-Place Modulus of Elasticity of Stress-Laminated Timber Decks Using NDE

Robert J. Ross, Michael A. Ritter, and Kristin C. Schad
Forest Products Laboratory, USDA Forest Service

Abstract

The objective of this study was to examine use of stress wave nondestructive evaluation (NDE) techniques to evaluate the in-place modulus of elasticity (MOE) of the laminations in stress-laminated timber bridge decks. Prior to bridge deck construction, longitudinal stress wave and transverse vibration NDE techniques were used to determine the MOE of 40 Southern Pine lumber specimens. A strong correlative relationship was found to exist between the MOE values obtained by these two techniques. Then, several bridge decks were constructed from these specimens, and several types of instrumentation were used to measure the MOE of individual specimens within the decks prior to transverse stressing and at maximum transverse stress. Excellent agreement was found between the MOE values prior to bridge deck construction and those observed after deck construction. More importantly, average MOE values obtained from measurements of the individual laminations showed strong agreement with bridge deck MOE.

Keywords: stress wave, nondestructive evaluation, timber bridge

Introduction

Stress-laminated timber bridge decks are constructed by placing lumber laminations on edge and compressing them together with high strength steel bars (Fig. 1).

The compression develops friction and load distribution between the laminations so that they act together as a large orthotropic plate. The concept of stress lamination was first developed in Canada in the mid-1970s and was introduced in the United States in the mid-1980s. Currently, more than 300 stress-laminated decks exist in the United States, many of which were constructed through demonstration timber bridge programs of the USDA Forest Service and Federal Highway Administration (FHWA) (USDA 1995). These bridges are popular for low-volume road applications because they can be constructed using locally available wood species and labor.

With the introduction of stress-laminated timber bridges in the United States, the USDA Forest Service, Forest Products Laboratory (FPL), initiated a program to evaluate the field performance of representative bridges (Ritter and others 1991). A key element of this

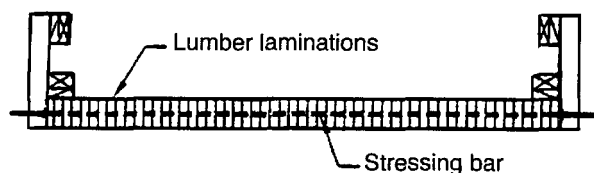

Figure 1—Cross section of a typical stress-laminated timber deck system.

program is testing and analysis of the bridges to evaluate performance and formulate design requirements for vehicle load distribution. Based on data obtained from field testing, an orthotropic plate analysis program was developed that accurately models bridge behavior and load distribution under various field conditions. To verify and further refine the model, accurate information is needed on the bridge configuration, interlaminar compression, and longitudinal modulus of elasticity (MOE) at the time of the load testing. Of these bridge variables, the most difficult to assess is the MOE of the lumber laminations. Because of the variability of published MOE values within a lumber species and grade, field measurement of the actual lamination MOE is considered necessary for accurate modeling.

For several bridges in the FPL performance monitoring program, lamination MOE is measured just prior to bridge construction. This is generally accomplished by using the transverse vibration technique that provides reliable, accurate MOE data (Wacker and Ritter 1992; Ritter and others 1995). However, this type of field measurement proved expensive and difficult to schedule around bridge construction. It was subsequently determined that an in-place nondestructive evaluation (NDE) method was needed for MOE measurement. It was further determined that such a method should also be adaptable to the long-term evaluation of the bridge's stiffness and condition. As a result of these requirements, a cooperative project was initiated between the FPL and FHWA to develop the needed equipment and procedures.

The primary objective of this study was to develop the equipment and procedures required to measure MOE of lumber laminations in stress-laminated timber bridge decks. A secondary objective was to determine if the average MOE obtained from these measurements was affected by transverse stressing, and hence, could be used to estimate the MOE of a deck.

Background

Significant research and development efforts have been devoted to the use of NDE techniques for wood members. A recent review of the literature revealed that these efforts have resulted in a variety of tools for the in-place assessment of wood structural components (Ross and Pellerin 1994). The review also showed that previous and current applications of NDE have been with single members having relatively simple boundary conditions.

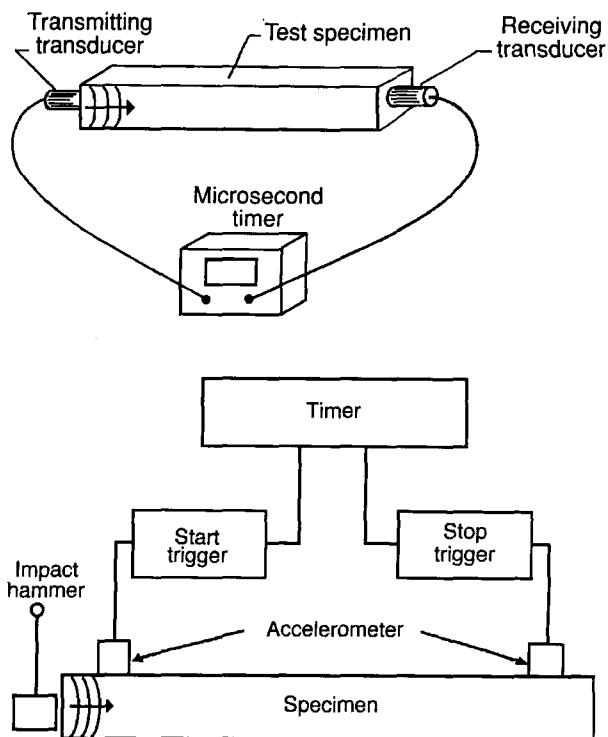

Figure 2—Ultrasonic measurement system used to measure stress-wave transmission time in wood products (top). Measurement system used to measure impact-induced stress wave propagation time in wood products (bottom).

One of the most widely used NDE techniques for in-place assessment is based on transmission characteristics of stress waves in the wood. Several such techniques utilize speed of stress wave transmission through the wood as an indicator of the amount of degradation contained in a particular section. Two commonly used adaptations of this concept are illustrated in Figure 2. Both use simple time-of-flight-type measurement systems to determine speed of wave propagation. In these measurement systems, a mechanical or ultrasonic impact is used to impart a wave into a member. Piezoelectric sensors are placed at two points on the member and used to sense passing of the wave. The time it takes for the wave to travel between sensors is measured and used to compute wave propagation speed. Times in excess of baseline values for wood that has not been degraded by decay fungi or other biological agents are indicative of a weakened member.

Although significant effort has been devoted to the use of NDE technology for locating degraded regions in structural members, no work has been conducted using NDE to determine the MOE of bridge decks.

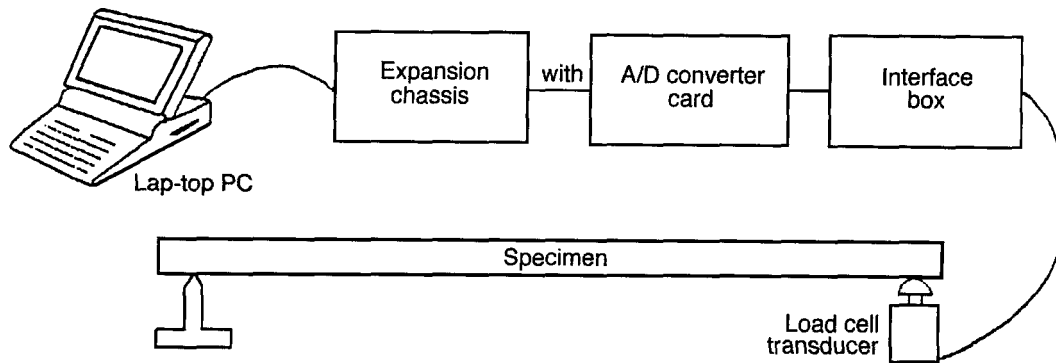

Figure 3—Setup used to measure free vibration characteristics of individual laminations.

Materials and Methods

Forty Southern Pine lumber specimens were obtained from a group of 300 laminations. These specimens were to be used in the construction of several stress-laminated timber bridge deck sections. The deck sections were to be tested to failure in flexure as part of a laboratory study. Prior to construction of the bridge decks, the MOE of each lumber specimen was determined using two nondestructive testing techniques. A transverse vibration NDT technique was used to determine the flatwise MOE of each piece (Fig. 3) (Ross and others 1991).

Speed of stress wave propagation through each lumber specimen was then measured by utilizing an adaptation of the previously described technique (Fig. 4). This adaptation was developed in an attempt to arrive at a measurement technique that could be used in field applications. Note that two types of equipment were used to measure stress wave transmission times: a

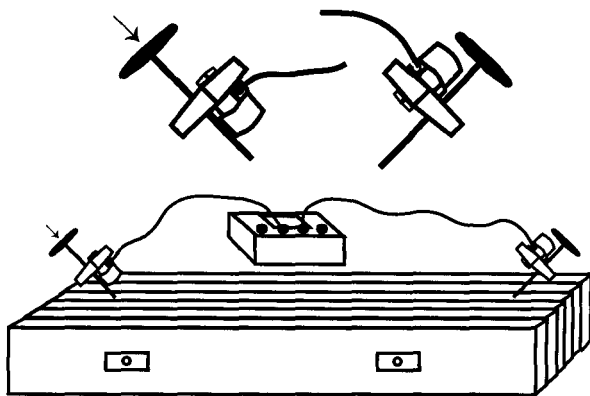

Figure 4—Technique utilized to measure impact-induced stress wave propagation times in individual laminations.

digital storage oscilloscope and a commercially available stress wave timer. An oscilloscope was utilized so that it would be possible to observe the actual magnitude of the stress wave. We anticipated that there would be significant interaction between individual laminations within the deck; hence, we decided it would be beneficial to examine the wave as it traveled in the specimens.

Several bridge decks were then constructed from the lumber specimens. After construction, the MOE of each lamination was measured using stress wave NDE procedures.

Results and Discussion

Prior to Deck Construction

The relationships between transverse vibration and stress wave MOE values, obtained from using both the oscilloscope and stress wave timing unit, for the individual specimens prior to bridge deck construction are shown in Figures 5 and 6. Results of a linear regression analysis comparing individual values are summarized in Table 1. Note that strong relationships were found between the MOE values for the lumber specimens.

After Deck Construction

The relationships between transverse vibration and stress wave MOE values for the laminations after the timber bridge deck construction are illustrated in Figures 7–9. Results of linear regression analyses comparing various MOE values are summarized in Table 2. It is important to note that a poor relationship was found between the stress wave MOE values measured using the commercial timing device and transverse vibration MOE values, whereas a strong relationship was observed when the oscilloscope was

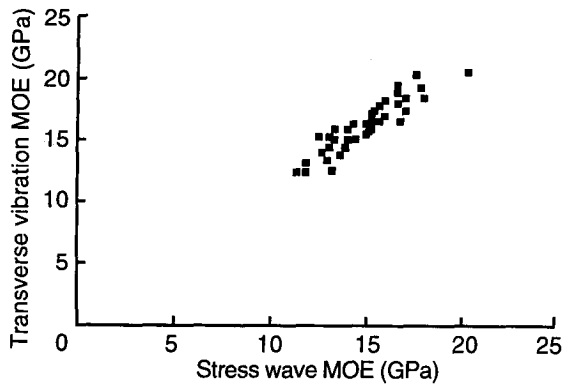

Figure 5—Relationship between stress wave and transverse vibration MOE for individual laminations prior to deck construction. Note that stress wave MOE was determined by using a commercially available stress wave timing device.

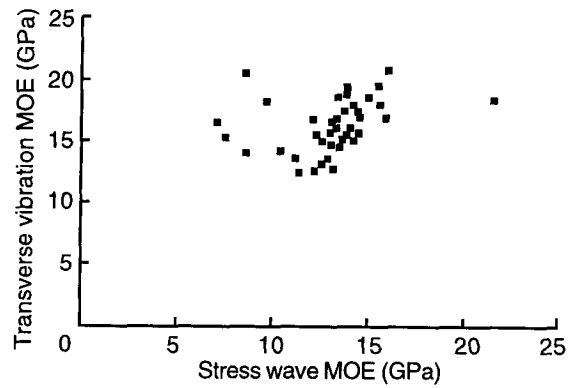

Figure 7—Relationship between stress wave and transverse vibration MOE for individual laminations. Note that the stress wave MOE was determined for the laminations after deck construction by using a commercially available stress wave timing device.

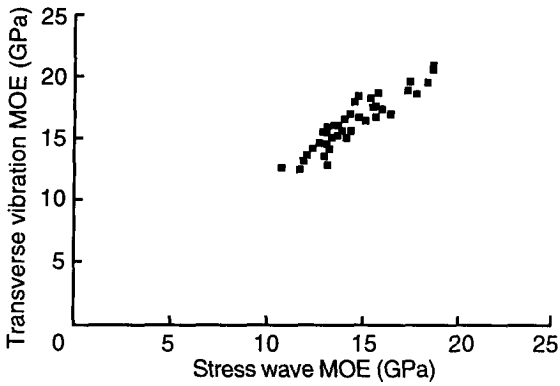

Figure 6—Relationship between stress wave and transverse vibration MOE for individual laminations prior to deck construction. Note that stress wave MOE was determined by an oscilloscope.

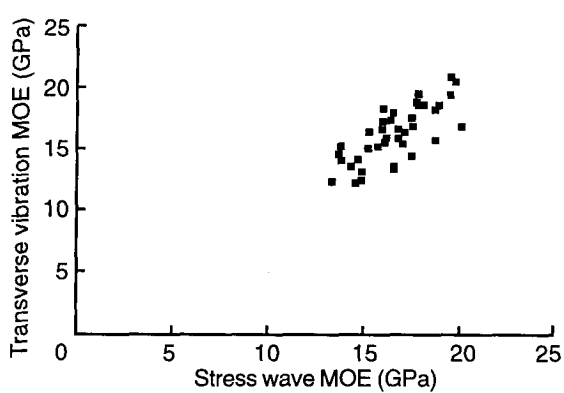

Figure 8—Relationship between stress wave and transverse vibration MOE for individual laminations. Note that the stress wave MOE was determined for the laminations after deck construction by a digital storage oscilloscope.

Table 1—Results of linear regression analysis capacity stress wave (SW) and transverse vibration (TV) MOE values of lumber specimens prior to deck construction.

| Equipment used | Regression equation | Correlation coefficient, R |
|--|--------------------------------------|----------------------------|
| Nicolet Model 310 digital storage oscilloscope | $MOE_{TV} = 1.014(MOE_{SW}) + 1.331$ | 0.93 |
| Metriguard Model 239A stress wave timer | $MOE_{TV} = 1.015(MOE_{SW}) + 1.077$ | 0.93 |

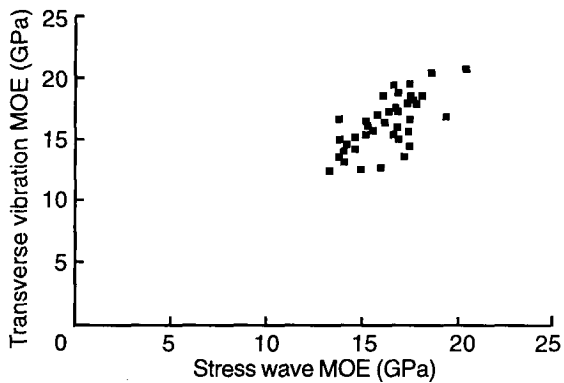

Figure 9—Relationship between stress wave and transverse vibration MOE for individual laminations. Note that the stress wave MOE was determined for the laminations after deck construction (under full transverse stressing) by using a digital storage oscilloscope.

Table 2—Results of linear regression analyses comparing stress wave (SW) and transverse vibration (TV) MOE values of laminations. Stress wave MOE values were determined after deck construction.

| Equipment used | Regression equation | Correlation coefficient, R |
|--|--------------------------------------|----------------------------|
| Metriguard Model 239A stress wave timer | $MOE_{TV} = 0.274(MOE_{SW}) + 12.60$ | 0.33 |
| Nicolet Model 310 digital storage oscilloscope | | |
| Unstressed | $MOE_{TV} = 0.936(MOE_{SW}) + 0.678$ | 0.78 |
| Stressed | $MOE_{TV} = 0.903(MOE_{SW}) + 1.520$ | 0.68 |

Table 3—Average MOE values obtained from the various test setups.

| Deck | Transverse vibration MOE (GPa) | Stress wave MOE (stressed) (GPa) | Stress wave MOE (unstressed) (GPa) | |
|------|--------------------------------|----------------------------------|------------------------------------|-------|
| | | | Oscilloscope | Timer |
| 1 | 16.20 | 16.41 | 16.20 | 13.65 |
| 2 | 16.20 | 16.13 | 17.03 | 11.65 |

utilized. Significant interaction was observed between the individual members when they were placed in the deck section. Although this interaction had little effect on the speed at which the wave propagated in a lamination, it did significantly alter the rate at which the wave lost energy. As a consequence, the signal observed by the stop transducer was lower in amplitude than what was observed in the specimen alone. This would yield longer observed transmission times, because these types of units require that the signal be of a magnitude sufficient to cross a fixed threshold voltage. This would yield a slower transmission speed and MOE value.

Average MOE Values

Average MOE values for the two decks are summarized in Table 3. Note that the average values obtained from the stress wave measurement are nearly identical to those obtained from transverse vibration testing of the individual laminations.

Conclusions

Based on the results of this study, we conclude the following:

- Stress wave MOE values of individual laminations are strongly correlated to those obtained from transverse vibration testing methods.
- Stress wave nondestructive testing techniques can be used to assess the MOE of individual laminations in a stress-laminated deck. However, commonly used stress wave timing devices may yield MOE values that are lower than expected.
- Prestressing has little effect on MOE as measured by using stress wave techniques.
- The average MOE of laminations, as measured in situ, corresponds with the average MOE of a deck.

References

- Ritter, M.A.; Geske, E.A.; McCutcheon, W.J. [and others]. 1991. Methods for assessing the field performance of stress laminated timber bridges. In: Proceedings, 1991 International Timber Engineering Conference, September; London, England.
- Ritter, M.A. Wacker, J.P.; Tice, E.D. 1995. Field performance of timber bridges—1. Cooper Creek stress laminated deck bridge. Res. Pap. FPL–RP–536. Madison, WI: U.S. Department of Agriculture, Forest Service, Forest Products Laboratory. 17 p.
- Ritter, M.A.; Wacker, J.P.; Duwadi, S.R. 1995. Field performance of stress laminated timber bridges on low-volume roads. In: Proceedings, 6th International Conference on Low-Volume roads; 1995 June 25–29; Minneapolis, MN. Washington, DC: National Academy Press: p. 347–356; Vol. 2.
- Ross, R.J.; Pellerin, R.F. 1994. Nondestructive testing for assessing wood members in structures. A review. FPL–GTR–70. Madison, WI: U.S. Department of Agriculture, Forest Service, Forest Products Laboratory. 40 p.
- Ross, R.J.; Geske, E.A.; Larson, G.L.; Murphy, J.F. 1991. Transverse vibration nondestructive testing with a personal computer. Res. Pap. FPL–RP–502. Madison, WI: U.S. Department of Agriculture, Forest Service, Forest Products Laboratory.
- USDA. 1995. The timber bridge initiative, fiscal year 1995 status report. Radnor, PA: U.S. Department of Agriculture, Forest Service, State and Private Forestry, Northeastern Area.
- Wacker, J.P.; Ritter, M.A. 1992. Field performance of timber bridges—Teal River stress laminated deck bridge. Res. Pap. FPL–RP–515. Madison, WI: U.S. Department of Agriculture, Forest Service, Forest Product Laboratory. 19 p.

In: Ritter, M.A.; Duwadi, S.R.; Lee, P.D.H., ed(s). National conference on wood transportation structures; 1996 October 23-25; Madison, WI. Gen. Tech. Rep. FPL- GTR-94. Madison, WI: U.S. Department of Agriculture, Forest Service, Forest Products Laboratory.