

**FMFRP 6-71-7**  
**FM 7-7**

---

# **The Mechanized Infantry Platoon and Squad (APC)**

---



---

**U.S. Marine Corps**

PCN 320 007110 00

## **PREFACE**

The evolution of weaponry establishes a continuing need to develop and refine methods and techniques of employing weapon systems to maximize their potential.

For the next several years, units will be in various stages of transition to Division 86 organizations. This manual updates the tactics, techniques, and operational procedures for the mechanized infantry platoon and squad equipped with the armored personnel carrier M113 but organized under the J-series tables of organization and equipment (TOE). It is also the squad and platoon manual for mechanized infantry operation under the H-series TOE with special considerations. These considerations, arising from the different structures, are highlighted in appendix A. The fundamental tactics, techniques, and operational procedures remain consistent for units operating under either organization.

# THE MECHANIZED INFANTRY PLATOON AND SQUAD (APC)

## CONTENTS

	<b>Page</b>
<b>Preface</b> .....	<b>iii</b>
<b>CHAPTER 1. THE ARMORED PERSONNEL CARRIER</b> .....	<b>1-1</b>
<b>CHAPTER 2. ORGANIZATION OF THE PLATOON AND SQUAD</b> .....	<b>2-1</b>
<b>CHAPTER 3. LEADING THE PLATOON AND SQUAD</b> .....	<b>3-1</b>
<b>CHAPTER 4. MOVEMENT</b> .....	<b>4-1</b>
<b>CHAPTER 5. OFFENSE</b> .....	<b>5-1</b>
<b>CHAPTER 6. DEFENSE</b> .....	<b>6-1</b>
<b>CHAPTER 7. PATROLLING</b> .....	<b>7-1</b>
<b>CHAPTER 8. COMBAT SUPPORT AND COMBAT SERVICE SUPPORT</b> .....	<b>8-1</b>
<b>APPENDIX A. H-SERIES TOE CONSIDERATIONS</b> .....	<b>A-1</b>
<b>APPENDIX B. WEAPONS AND FIGHTING POSITIONS</b> .....	<b>B-1</b>
<b>APPENDIX C. FIRE DISTRIBUTION AND CONTROL</b> .....	<b>C-1</b>
<b>APPENDIX D. SQUAD/PLATOON COMMUNICATIONS</b> .....	<b>D-1</b>
<b>APPENDIX E. FORDING AND SWIMMING OPERATIONS</b> .....	<b>E-1</b>
<b>APPENDIX F. AIR DEFENSE</b> .....	<b>F-1</b>
<b>APPENDIX G. DISMOUNTING THE APC</b> .....	<b>G-1</b>
<b>APPENDIX H. BATTLE DRILL</b> .....	<b>H-1</b>
<b>APPENDIX I. LIMITED VISIBILITY EQUIPMENT AND TECHNIQUES</b> .....	<b>I-1</b>
<b>APPENDIX J. SMOKE</b> .....	<b>J-1</b>
<b>APPENDIX K. EVACUATION OF CASUALTIES FROM AN APC</b> .....	<b>K-1</b>
<b>APPENDIX L. RECOVERY TECHNIQUES</b> .....	<b>L-1</b>
<b>APPENDIX M. NUCLEAR, BIOLOGICAL, AND CHEMICAL OPERATIONS</b> .....	<b>M-1</b>

\*This manual supersedes FM 7-7, 30 September 1977.

<b>APPENDIX N. COMBAT LOADING.....</b>	<b>N-1</b>
<b>APPENDIX O. OPERATIONS SECURITY .....</b>	<b>O-1</b>
<b>APPENDIX P. OBSTACLES .....</b>	<b>P-1</b>
<b>APPENDIX Q. TACTICAL ROAD MARCHES AND ASSEMBLY AREAS .....</b>	<b>Q-1</b>
<b>APPENDIX R. MILITARY OPERATIONS ON URBANIZED TERRAIN .....</b>	<b>R-1</b>
<b>GLOSSARY.....</b>	<b>Glossary-1</b>
<b>REFERENCES .....</b>	<b>References-1</b>
<b>INDEX .....</b>	<b>Index-1</b>

Users of this manual are encouraged to submit recommendations to improve the publication. Comments should be keyed to the page and line(s) of the text where a change is recommended. Reasons should be provided for each comment to insure understanding and complete evaluation. Place comments and recommended changes on DA Form 2028 (Recommended Changes to Publications and Blank Forms) and forward them to the Commandant, US Army Infantry School, ATTN: ATSH-B-ID, Fort Benning, Georgia 31905.

When used in this publication, “he,” “him,” “his,” “man,” and “men” represent both the masculine and feminine genders unless otherwise stated.



CHAPTER 1

**THE ARMORED  
PERSONNEL CARRIER**

**Section I. INTRODUCTION**

**1-1. GENERAL**

The mechanized infantry will often fight in conjunction with armor to form a combined arms team.

The armored personnel carrier (APC) provides the infantry with mobility similar to that of the M60 tank, but the APC has less fire-power and protection.

Mechanized infantry complements tanks by providing a dismount capability that enables the company team to reduce obstacles and to hold ground.

**1-2. FUNDAMENTAL FACTORS**

There will be times when infantrymen can observe the battlefield, fire their weapons, and be protected by the vehicle's armor, but the APC is not invulnerable. The armor does protect against some small arms fire and shell fragments; it does not protect against tanks or antitank guns, missiles, or rockets. This means that the infantry leader must carefully analyze every situation and weigh the advantages and disadvantages of mounted and dismounted combat. The APC is highly vulnerable to the predominant tank and fighting vehicle threat; therefore, many combat tasks can only be performed dismounted.

In the offense, the APC allows the infantrymen to fight mounted as long as possible and to dismount when confronted by close terrain, obstacles that prevent movement, or a strong antiarmor defense that cannot be bypassed or suppressed.

In the defense, the APC allows the infantrymen to fight mounted or dismounted. The decision to fight mounted or dismounted

is dependent upon the situation and the required mobility.

These fundamental factors are synonymous with the five basic rules of combat secure, move, shoot, communicate, and sustain.

**Secure.**

**Use cover and concealment.**

**Establish local security and reconnoiter.**

**Protect the unit.**

**Move.**

**Establish moving element.**

**Get in the best position to shoot.**

**Gain and maintain initiative.**

**Move fast, strike hard, finish rapidly.**

**Shoot.**

**Establish base of fire.**

**Maintain mutual support.**

**Kill or suppress enemy.**

**Communicate.**

**Keep everyone informed.**

**Tell soldiers what is expected and why.**

**Sustain.**

**Keep the fight going.**

**Take care of soldiers.**

CONTENTS	PAGE
Section I. Introduction .....	1-1
II. The APC and Its Characteristics .....	1-2

## Section II. THE APC AND ITS CHARACTERISTICS

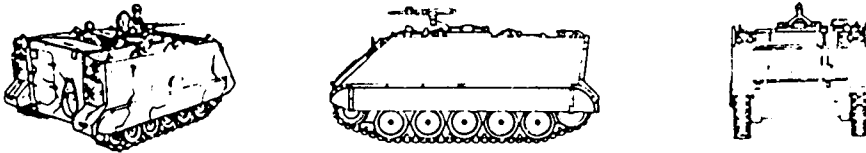
### 1-3. GENERAL

The APC is lightweight aluminum, air-transportable, air-droppable, and amphibious. This section discusses the vehicle's characteristics and gives a brief overview of some of its capabilities.

### 1-4. CHARACTERISTICS

The APC has the following characteristics:

**Figure 1-1. APC CHARACTERISTICS.**



WEIGHT, COMBAT _____	24,986 LBS _____	11,334 KG _____
WEIGHT, NET _____	21,866 LBS _____	9,918 KG _____
LENGTH _____	191.5 IN _____	4.87 M _____
WIDTH _____	105.75 IN _____	2.69 M _____
HEIGHT _____	98.25 IN _____	2.50 M _____
HEIGHT, MIN REDUCIBLE _____	79.5 IN _____	2.03 M _____
MAX SPEED _____	42 MPH _____	67.6 KM/H _____
MAX SPEED WATER _____	3.6 MPH _____	5.8 KM/H _____
RANGE _____	365 MI _____	578 KM _____
GROUND PRESSURE _____	7.9 PSI _____	0.56 KG/DM _____
WIDTH OF TRENCH CROSSING _____	66 IN _____	1.68 M _____
VERTICAL OBSTACLE CROSSING _____	24 IN _____	.61 M _____
SLOPE CAPABILITY _____	60 % _____	60 % _____
SIDE SLOPE CAPABILITY _____	30 % _____	30 % _____
FUEL CAPACITY _____	95 GAL _____	360 L _____
CREW _____	1 _____	1 _____
PASSENGERS _____	12 _____	12 _____

### 1-5. MOBILITY

The mechanized infantry will often fight in conjunction with armor to form a combined arms team.

The maximum road speed of the APC is 42 miles per hour (mph). Under favorable terrain

conditions, it can travel cross country at speeds similar to those of the M60 tank.

### 1-6. APC PROTECTIVE ARMOR

The APC's protective armor does not have the same protective capability as that of the M60 tank, but it will protect the infantry from some small arms fire, hand grenades, and shell fragments.

The APC can minimize the threat of anti-armor weapons by —

- reducing exposure time,**
- suppressing or destroying enemy weapons, and**
- using the cover and concealment offered by the terrain.**

### 1-7. FIREPOWER

The APC's main armament is the caliber .50 heavy machine gun. This weapon provides each vehicle with suppressive firepower and a light-vehicle-killing capability

Each squad is also equipped with a Dragon antiarmor missile, which can be fired from the vehicle or dismounted and fired from a ground position.

The platoon will also have:

- M60 machine guns.**
- M16 rifles.**
- M203 grenade launchers.**
- Squad automatic weapons.**

**NOTE: There are various other munitions available as required, such as light antitank weapons (LAW), grenades, and mines.**

### 1-8. COMMUNICATIONS

The APC's communication system provides the platoon with communication during either mounted or dismounted operations.

All platoon vehicles are equipped with an AN/GRC-160 radio that can be backpacked in an AN/PRC-77 configuration. Additionally the platoon leader's vehicle may be equipped with two AN/GRC-160 radios or with one AN/GRC-46 and one AN/GRC-160.

The platoon leader, platoon sergeant, and each of the three squads are also equipped with an AN/PRC-88.

### 1-9. WATER-CROSSING CAPABILITY

The APC can swim most water obstacles with minimal preparation. The vehicle has a maximum swimming speed of 3.6 mph. The vehicle's trim vane requires about 2 seconds to be extended.

### 1-10. LIMITED VISIBILITY CAPABILITY

The APC carries a variety of limited visibility observation devices. These sophisticated surveillance, target acquisition, and night observation (STANO) devices increase the platoon's ability to accomplish its mission during limited visibility

STANO devices that may be available to the platoon include:

**Binoculars — superior to naked eye daytime or night.**

**AN/PAS-6 metascope — infrared light source used for reading, detecting, or signaling.**

**M19 periscope — infrared periscope used to aid the driver while driving the vehicle.**

**AN/PVS-2 or AN/PVS-4 — mounted on M60, M16, or M203 weapons.**

AN/TVS-2 — mounted on caliber .50 heavy machine guns.

AN/TVS-5 — mounted on caliber .50 heavy machine guns.

AN/PVS-5 night vision goggles — goggles used for performing tasks at

night (map reading, driving, maintenance).

AN/TAS-5 Dragon night vision sight (6x magnification).

CHAPTER 2  
**ORGANIZATION OF THE  
 PLATOON AND SQUAD**

**Section I. THE PLATOON**

**2-1. GENERAL**

The platoon is a basic combat unit capable of maneuvering in the conduct of combat operations. The platoon can fight as part of a pure mechanized infantry company or as part of a company team that is task organized with tank platoons and mechanized infantry platoons. In either case, the platoon can establish a base of fire and then move other elements to seek an advantageous position from which to destroy or dislocate the enemy

On the battlefield, the platoon can expect rapid and frequent movement. It must be prepared to fight in a variety of situations — both mounted and dismounted — while attacking or defending, during movement, and under conditions where nuclear and chemical weapons have been used. The platoon operates in such a way as to make maximum use of its weapons and available firepower.

**Figure 2-1. PLATOON WEAPONS**

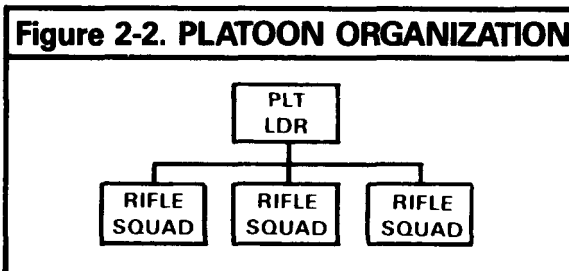
<b>WEAPON</b>	<b>RANGE</b>	<b>PRIMARY TARGET</b>
<b>Caliber .50 machine gun</b>	<b>1,600 meters</b>	<b>Infantry, light vehicles</b>
<b>Dragon LAW</b>	<b>1,000 meters</b>	<b>Tank, BMP</b>
<b>M60 machine gun</b>	<b>1,100 meters</b>	<b>Tank, BMP</b>
<b>Squad automatic weapon</b>	<b>1,000 meters</b>	<b>Infantry, light vehicles</b>
<b>M203 dual-purpose weapon</b>	<b>1,000 meters</b>	<b>Infantry</b>
<b>M16A1 rifle</b>	<b>350 meters</b>	<b>Infantry</b>
	<b>460 meters</b>	<b>Infantry</b>

<b>CONTENTS</b>	<b>PAGE</b>
<b>Section I. The Platoon</b> .....	<b>2-1</b>
<b>II. The Squad</b> .....	<b>2-3</b>
<b>III. Control and Organization for Mounted Operations</b> .....	<b>2-8</b>
<b>IV. Control and Organization for Dismounted Operations</b> .....	<b>2-9</b>

## 2-2. PLATOON ORGANIZATION

The mechanized infantry platoon is equipped with four APCs. It is organized with a platoon headquarters and three rifle squads. The platoon leader and his headquarters are mounted in one APC, and the squads are mounted in the other three.

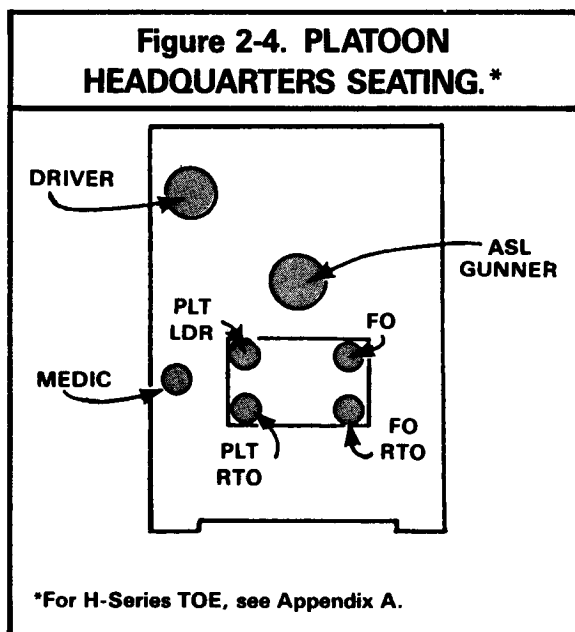
A typical mechanized infantry platoon is organized as shown in illustration.



The platoon headquarters is organized as shown in illustration.



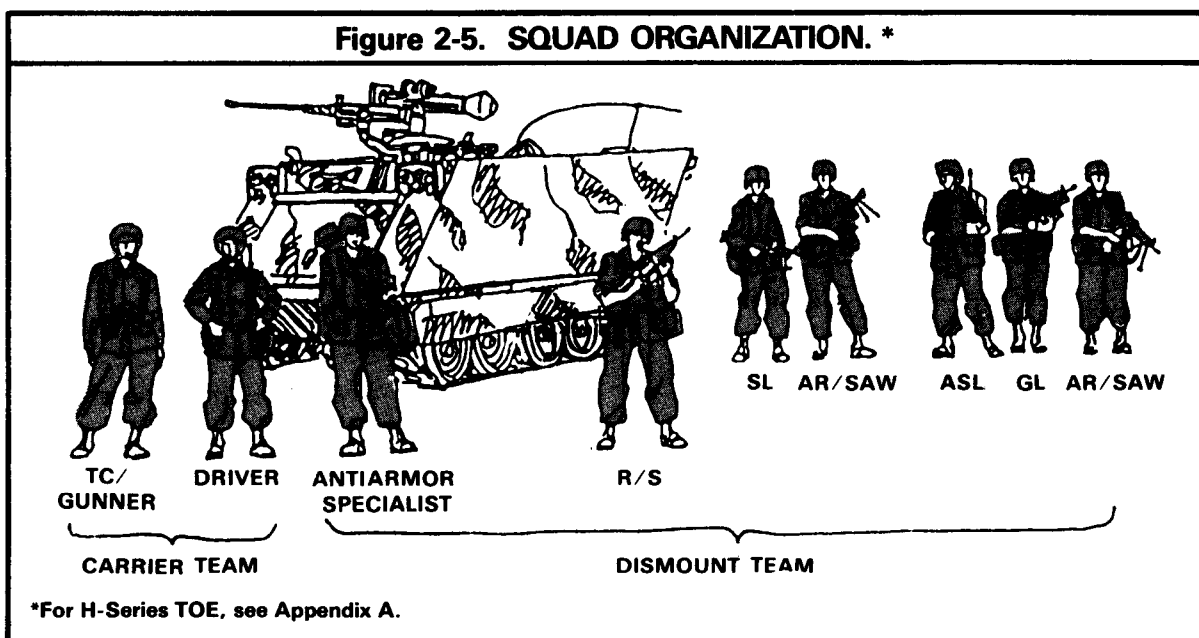
A typical seating arrangement for the platoon headquarters is shown in figure 2-4.



## Section II. THE SQUAD

### 2-3. GENERAL

The squad is composed of the APC and nine men organized into two teams: the carrier team and the dismount team.

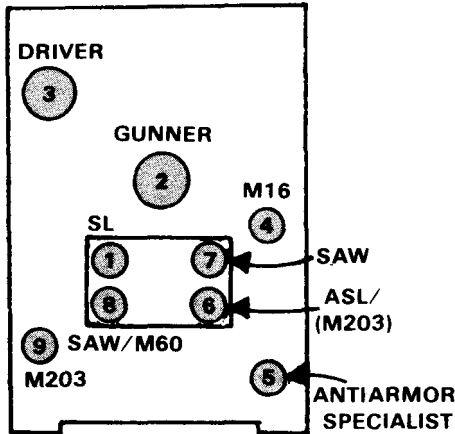


As a minimum, the **carrier team** is normally composed of the team leader/gunner and the driver.

The **dismount team** is made up of all squad members not a part of the carrier team. The platoon leader normally specifies the organization of the dismount team. His decision is usually based on squad strength, mission, enemy terrain, and guidance from the company commander.

A typical seating arrangement for a squad in the APC is shown in illustration.

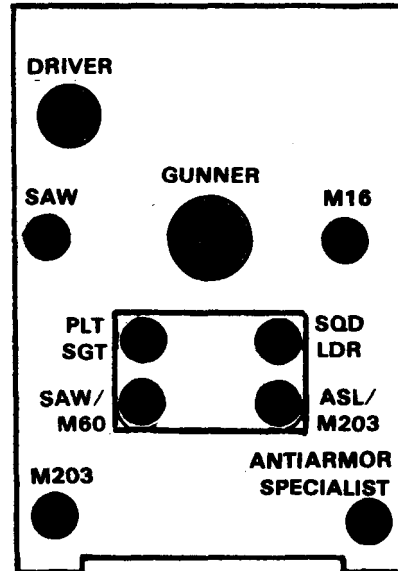
**Figure 2-6. SQUAD SEATING ARRANGEMENT (EXAMPLE). \***



\*For H-Series TOE, see Appendix A.

The squad with the platoon sergeant on board its APC will have a typical seating arrangement as shown in illustration.

**Figure 2-7. SQUAD (WITH PLATOON SERGEANT) SEATING. \***



\*For H-Series TOE, see Appendix A.

## 2-4. SQUAD RESPONSIBILITIES

Each squad is arranged in its vehicle so it can observe in all directions and deliver sustained, effective fire while moving, or rapidly exit the dismount team from the vehicle when required to accomplish dismounted tasks. Each squad member has certain duties and responsibilities based on his duty position in the squad. Each squad member's basic weapon, duties, and responsibilities are outlined below.

### Squad leader, M16A1 rifle:

Has overall responsibility for the squad. While conducting mounted operations, the squad leader designates targets, selects routes of movement, selects vehicle positions, determines weapons to be fired, issues fire commands for all weapons, communicates with the platoon leader, and reacts to the platoon leader's commands. For dismounted operations, the squad leader has the option of remaining with



the vehicle or deploying with the dismount team. The choice is based upon the **platoon leader's desires** or **squad leader's judgment** of the tactical situation.

Is expected to place himself wherever his leadership and experience best influence the most important actions of the squad. The squad leader has to decide how best to utilize the carrier team and the dismount team. Normally, if the dismount team has to dismount, the dismount role is the most important, and the squad leader will dismount and lead it.

**Team leader/grunner, caliber .50 machine gun/M16A1 rifle:**

Observes the battlefield to detect enemy targets and to be aware of location of friendly forces.

Controls the movement of the vehicle under the direction of the squad leader.

Operates the caliber .50 machine gun as directed by the squad leader.

Is responsible for operator maintenance of the caliber .50 machine gun.

Serves as carrier team leader and positions the carrier when the squad leader has dismounted with the dismount team.

**Driver, M16A1 rifle:**

Drives the vehicle under squad leader's/team leader's/gunner's control.

Follows correct terrain-driving procedures and assists in selecting hull-down positions.

Aids in detecting targets and observing rounds fired.

Is primarily responsible for operator maintenance on vehicle. (Other squad members help the driver as directed by the squad leader.)

**M16A1 rifleman/sniper:**

Normally operates as part of the dismount team.

If employed, assists the M60 machine gunner once the machine gun is placed in the ground mount role.

**Antiarmor specialist, Dragon/M16A1 rifle:**

Normally operates as a part of the dismount team.

Is armed with a Dragon antiarmor weapon or, when not firing the Dragon, fights as a rifleman armed with an M16A1 rifle.

**Assistant squad leader, M203 dual-purpose weapon:** Normally operates as part of the dismount team and is one of the team leaders for, the dismount team. He will control the dismount team when the squad leader remains mounted.

**Squad automatic rifleman, squad automatic weapon (SAW):** Normally operates as part of the dismount team.

**Squad automatic rifleman, SAW:** Normally operates as part of the dismount team.

**Grenadier, M203 dual-purpose weapon:** Normally operates as part of the, dismount team.

**Machine gunner:** Although the M60 machine gun does not have a dedicated gunner

assigned, the weapon is available for use by the squad. It may be used in several ways:

In the defense to make use of its heavy firepower in final protective fires when used with a tripod and T&E mechanism and in areas that offer a dismounted avenue of approach into the position.

In the offense when the terrain does not allow a large maneuvering element but does allow a base-of-fire element to place effective fire on the objective area. Frequently, the capacity of the objective area, or the routes leading to it, does not allow the necessary space to employ the optimum number of troops to maneuver against it. The adding of the M60 to the base of fire will partially offset the problem by adding to the overall combat power.

In any situation that offers a significant air threat.

During movement, the M60 machine gun may be affixed to the side of the APC for overwatch purposes and may be left in place, allowing the gunner to deploy, for example, dismounted with a fully loaded SAW.

## **2-5. UNDERSTRENGTH PLATOONS AND SQUADS**

Platoons and squads will not always be at full strength. Even so, the mission (in combat and in training) can still be accomplished if understrength units are organized with these rules in mind:

Keep key leadership positions filled. Always maintain a chain of command — platoon leader, platoon sergeant, and squad leaders.

Man the most potent weapons first. Take full advantage of available firepower. Before each mission, carefully consider how to employ Dragons, machine guns, and automatic rifles.

The platoon must have a plan of organization for use when it does not have all four APCs. Since two full-strength squads cannot ride on

one vehicle, cross-loading of men and equipment, from a disabled or missing APC, among all of the platoon's remaining APCs must be accomplished. Normally, the squad leader of the missing APC rides with the platoon leader. This arrangement has two advantages: the squad leader can follow the operation, and he can get orders from the platoon leader. The platoon leader's APC also serves as the point on which the squad members assemble if the dismount elements deploy from the APCs. Depending on the location and condition of a disabled vehicle and the tactical situation, the platoon leader may choose to leave the driver and gunner with the vehicle to secure it and oversee its recovery and repair. An understrength squad might be organized as shown in illustration.

Squads of five to seven men are common. Before employing such understrength squads, key factors must be considered.

The mission may take longer to accomplish

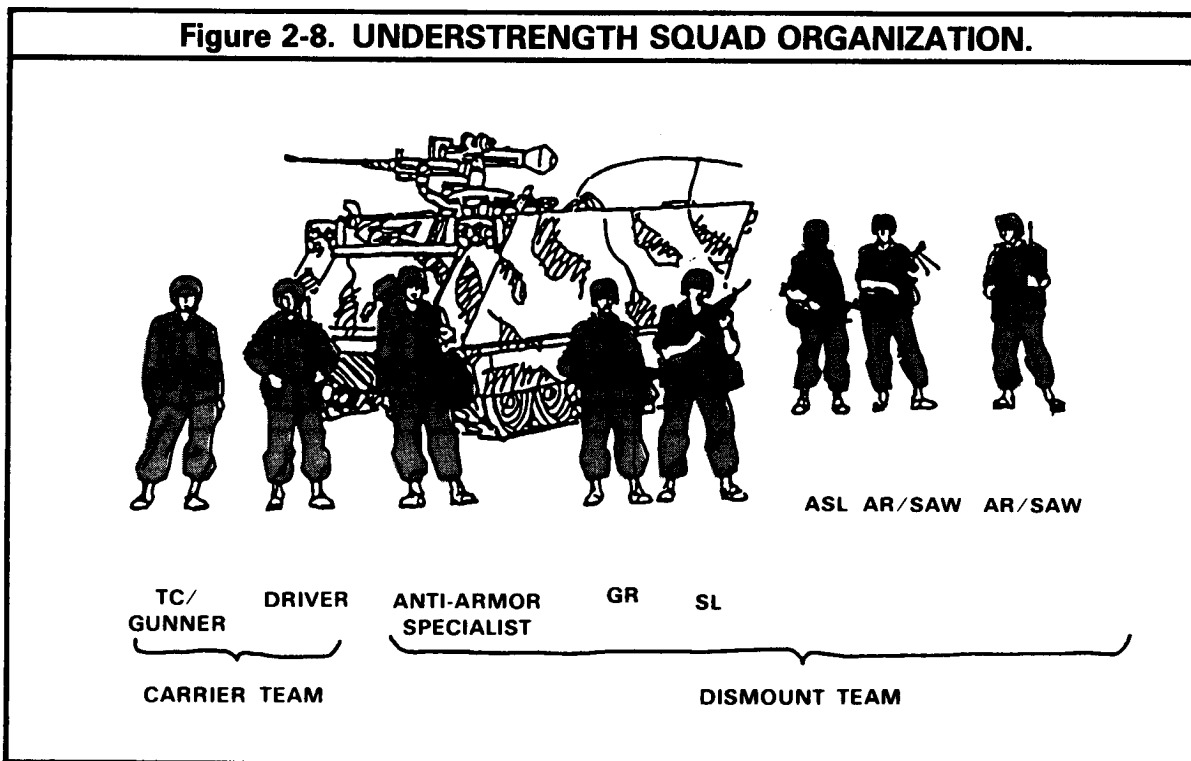
whether tactical, maintenance, or administrative.

The mission may require two squads to accomplish it rather than one.

Extensive individual training needs to be emphasized since all members of the squad must become familiar with all squad weapons.

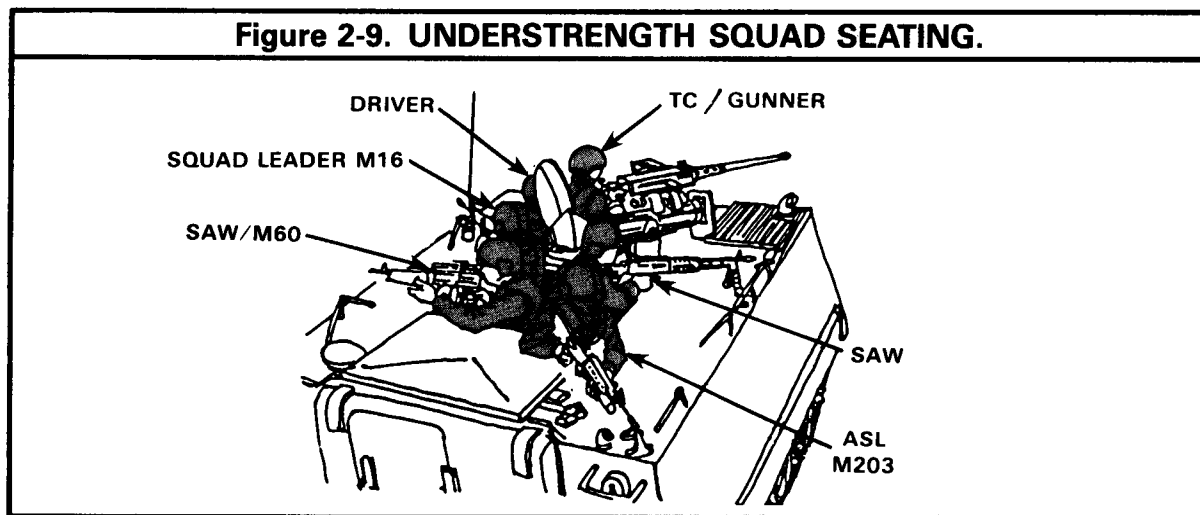
A squad of six men may still man key weapon systems and enable the unit to put sufficient firepower on the enemy to be effective. A five-man squad will have difficulty in manning weapon systems key to the dismount element, and producing the firepower necessary to accomplish the mission. Squad frontages are severely reduced in defensive situations to the point where the combining of squads to produce two nearly full squads may be more beneficial than trying to maintain three understrength squads. In any situation, the factors of mission, enemy terrain, troops available, and time (METT-T) must be carefully weighed to produce the best possible use of understrength squads.

**Figure 2-8. UNDERSTRENGTH SQUAD ORGANIZATION.**



A general priority order in which positions are to be filled (from the most important to the least important) is squad leader, driver, team leader/gunner, Dragon gunner, SAWs, grenadier, rifleman. Depending on the squad/platoon leader's

estimate of the situation, the M60 machine gun may be manned in priority after the Dragon gunner. A typical seating arrangement for a six-man squad is shown in illustration.

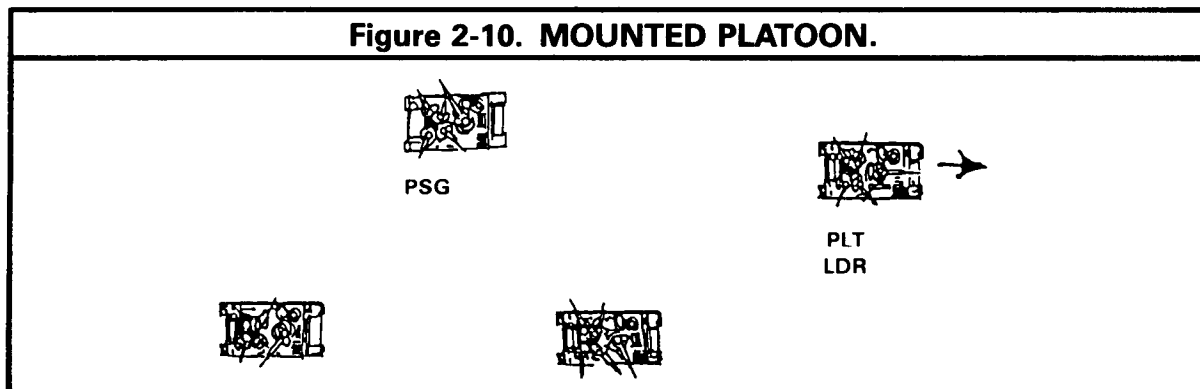


### Section III. CONTROL AND ORGANIZATION FOR MOUNTED OPERATIONS

#### 2-6. GENERAL

The platoon moves and fights mounted whenever possible. When all of the platoon remains mounted, it fights as a single force under the control of the platoon leader. At times, when mounted, the platoon leader may choose to divide the platoon into two sections of two APCs each-for

example, when using bounding overwatch. The platoon sergeant will control one section, while the platoon leader controls the other; however, the platoon leader retains overall control of the platoon. If contact is not likely, the platoon leader may choose to lead the formation.



**2-7. CARRIER MOVEMENT CONTROL**

Each squad leader controls the movement of his vehicle in consonance with the platoon leader's vehicle. The team leader/gunner insures that his vehicle has the correct caliber .50 machine gun

orientation and that the vehicle is properly dispersed in accordance with the formation being used. (Formations and movement techniques are discussed in chapter 4.)

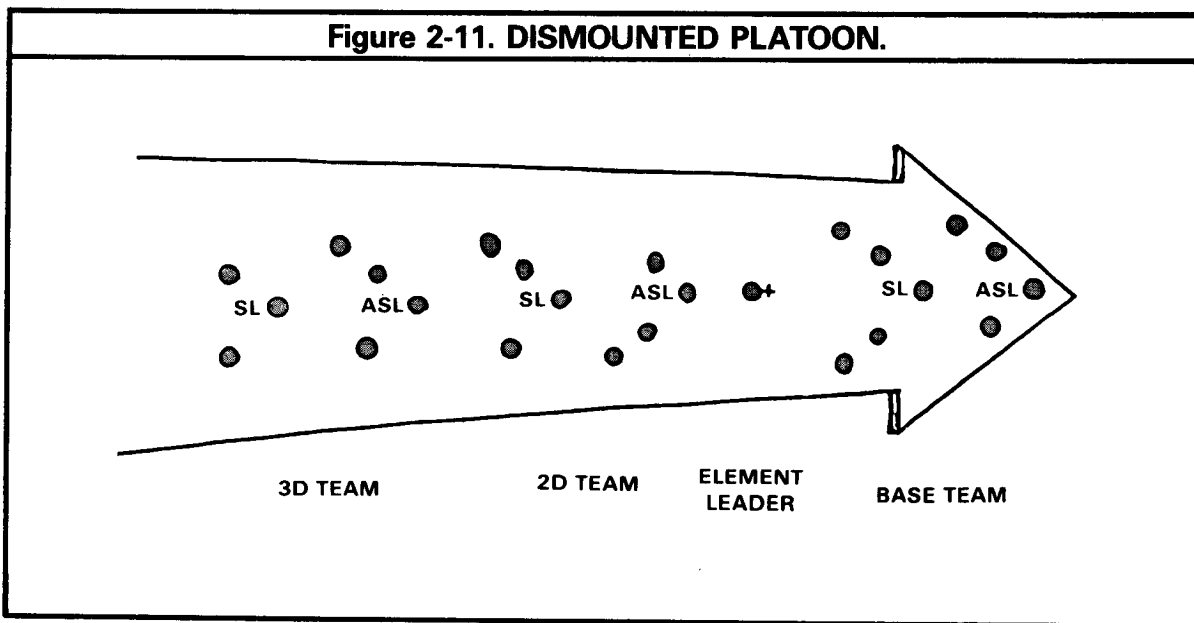
**Section IV. CONTROL AND ORGANIZATION FOR DISMOUNTED OPERATIONS**

**2-8. CONTROL OF THE PLATOON**

Each APC carries a dismount team of infantrymen whose purpose is to fight dismounted. When the dismount teams are deployed, there are methods of maintaining control over the squads and platoon. These two methods have a direct bearing on how the platoon is organized.

In the first method, the carrier team and dismount team remain under the control of their

squad leader. The squad leader directs the movement and fires of both teams. Because this method is a challenge for the squad leader to control, it requires the carrier team to be close to the dismount team. This method may be used when the enemy, visibility, or terrain dictates the use of the dismount team to secure or lead the carrier team.



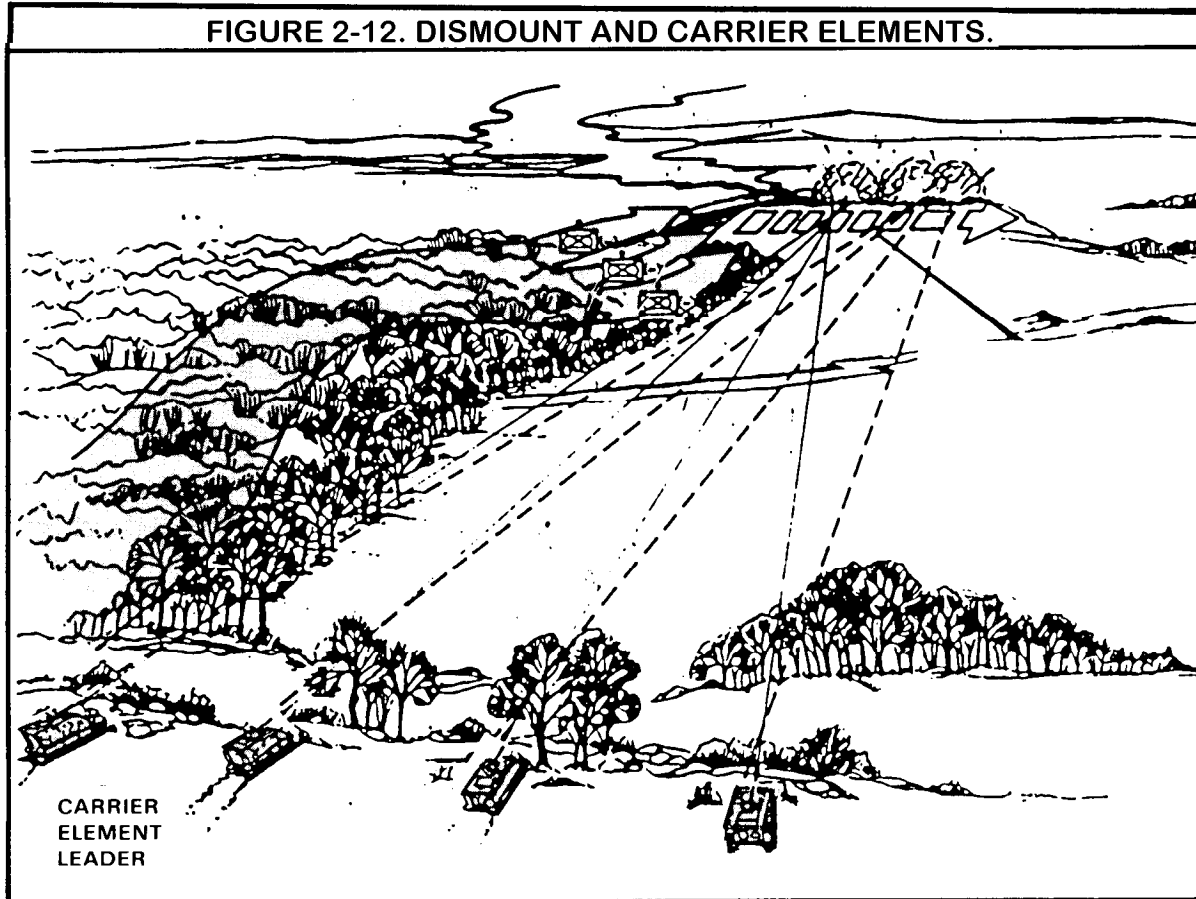
In the second method, the dismount teams and carrier teams are organized into a **dismount element and carrier element**. The three dismount teams compose the dismount element, and the four vehicles (includes headquarters vehicle) compose the carrier element. Thus, the platoon is organized into two ele-

ments. One element is controlled by the platoon leader and the other by the platoon sergeant. This method is commonly used whenever the vehicles and dismounted infantry are separated. For example, the carrier element may be employed at one location to maximize use of its weapons, while the dismount element is in an-

other. These different locations do not have to be far apart in fact it could be a matter of only 50 to 100 meters.

Whichever method is used, the platoon leader retains overall control of the platoon.

FIGURE 2-12. DISMOUNT AND CARRIER ELEMENTS.



## 2-9. OPERATIONS

The platoon leader might order the dismount teams to dismount to:

- Operate in terrain that restricts the movement of APCs, such as in forests or built-up areas.

- Obtain better observation and fires whenever those of the APC are restricted.

- Continue the operation whenever the APC is under effective antiarmor fires.

- Assault or clear an objective.

- Move on a different route while APCs support.

- Defend dismounted.

- Clear an obstacle or danger area.

- Take advantage of the mutual support of squad weapons such as Dragons.

- Provide security.

- Conduct dismounted patrols.

When the dismount team dismounts, the team leader/gunner and driver remain with the

vehicle, while the squad leader normally dismounts.

Before the dismount team dismounts, the squad leader should decide what weapons are to be taken. His decision is based on the tactical situation, that is, is the purpose antiarmor, anti-infantry, or a combination. If the purpose is anti-infantry, there may not be a need to dismount the Dragon/LAWs.

When making the decision to dismount, and in the absence of orders from the platoon leader, the squad leader considers where his presence is required. Specifically, if the situation requires dismounted action, then the squad leader will be dismounted. The squad leader will normally dismount with his dismount team to:

Operate in terrain that restricts the movement of the APC, such as in forests or built-up areas.

Avoid effective antiarmor fires.

Move on a different route while the APC supports.

Clear an obstacle or danger area.

Assault or clear an objective.

Defend dismounted.

Conduct dismounted patrols.

There are other instances in which all or only a portion of the dismount team may dismount. For example, the squad leader may choose not to dismount, but the assistant squad leader would dismount to lead the dismount team to:

Operate whenever the observation and fires of the APCs are restricted by visibility or terrain.

Provide security.

Take advantage of the mutual support of the other squad weapons such as the Dragon.

## CHAPTER 3

# LEADING THE PLATOON AND SQUAD

### Section I. INTRODUCTION

#### 3-1. GENERAL

This chapter discusses troop leading procedures, combat orders, preparing to fight, leading in combat, and standing operating procedures (SOP). The topics discussed pertain to all combat operations. Application of these procedures requires time: the more time, the greater the leader's ability to plan and prepare in depth; the less time, the more reliance the leader must place on SOPs. Leaders must use the procedures outlined, if only in abbreviated form, to insure that their units and soldiers understand and prepare for mission accomplishment.

#### 3-2. TROOP LEADING PROCEDURES

Troop leading is the process a leader goes through to prepare his unit to accomplish a tactical mission. It begins when he is alerted for a mission. It starts all over again when he gets a different mission — it never ends. Listed below are the steps in the troop leading process. Steps 3 through 8 may not follow a rigid sequence, and

at times steps may be accomplished concurrently. In combat, rarely will time be available to go through each step in detail. However, a good leader habitually checks them off in his mind so that he is sure nothing is forgotten.

**Step 1. Receive the mission.**

**Step 2. Issue a warning order.**

**Step 3. Make a tentative plan.**

**Step 4. Start necessary movement.**

**Step 5. Reconnoiter.**

**Step 6. Complete the plan.**

**Step 7. Issue the complete order.**

**Step 8. Supervise.**

CONTENTS		PAGE
Section	I. Introduction . . . . .	3-1
	II. Combat Orders. . . . .	3-4



**Step 1 — Receive the Mission.**

A mission may be received in a warning order, an operation order (OPORD), or a fragmentary order (FRAGO).

As soon as the leader has the order, he analyzes it, taking into account the following

**What is the MISSION?**

**What is known about the ENEMY?**

**How will the TERRAIN affect the operation?**

**What TROOPS are available?**

**How much TIME is available?**

**What SUPPLIES and EQUIPMENT are needed?**

**What SPECIAL TASKS need to be assigned?**

The leader then plans the use of time available. The platoon leader should use no more than one third of the available time, leaving the rest for squad preparation. The unit must be told when to be ready and the things that must be done beforehand. The leader works backward from the time he wants the men to be ready allowing enough time for each task. This is reverse planning. Below is an example of a squad leader's reverse planning.

**1420: Ready time.**

**1415: Check assembly area. (Make sure all Claymores are recovered and that no ammunition, etc., is left behind.)**

**1300: Inspect squad/rehearse.**

**1205: Issue order to squad.**

**1200: Complete squad order.**

**1105: Reconnoiter with platoon leader/receive order.**

**1050: Issue warning order to squad.**

**Step 2 — Issue a Warning Order.**

Initial instructions are usually in a warning order. In it, the leader gives enough information to his unit to start preparing for the operation.

Unit SOPs should prescribe actions to take when a warning order is received — for example, drawing ammunition, rations, water, and communications gear.

The platoon leader issues his unit warning order to the platoon sergeant, squad leaders, and forward observer. The squad leader, in turn, issues a warning order to his squad.

The warning order should state as a minimum:

**The mission (nature of the operation).**

**Who is participating in the operation.**

**Time of the operation.**

**Any special instructions.**

**Time and place for issuance of the complete order.**

**Step 3 — Make a Tentative Plan.**

Based on **mission, enemy, terrain, troops, and time available**, the leader makes a tentative plan. The plan gives him a start point from which to coordinate, reconnoiter, organize, and move.

During his planning, the leader takes into account the following:

What is the platoon's MISSION? (We must attack to seize that objective; or, We must prepare to defend this position by 0400.)

What ENEMY troops oppose us? What size units and where are they? What weapons, artillery or engineer units do they have in support? Will they be mounted, dismounted, or both?

How can we use the TERRAIN to our advantage? To answer this question, the leader examines the observation and fields of fire, cover and concealment, obstacles, key terrain, and avenues of approach (OCOKA).

Observation and fields of fire influence decisions made on placement of carriers, squads, Dragons, and machine guns. In the offense, the fire element must be where it can support the moving element. In the defense, personnel must have observation; weapons must have fields of fire covering avenues of approach. The platoon leader also considers the enemy's point of view as to observation and fields of fire.

Cover and concealment influence the choice of routes, positions, and targets. Terrain is used to provide cover from enemy fires, and to conceal friendly elements from enemy observation.

Obstacles also influence the choice of routes, positions, and targets. In the defense, obstacles are used in conjunction with the terrain to canalize the enemy into kill zones. Obstacles are also used to impede movement and restrict movement to the platoon flanks or other desired areas.

Key terrain is any terrain that affords a marked advantage to the force that seizes or retains it. Key terrain has a bearing on decisions regarding the selection of objectives and routes in offense, and on the choice of positions in defense.

An avenue of approach is an air or ground route that leads an attacking force to its objective or to key terrain in its path. Avenues of approach are considered with all other factors. They influence the choice of routes and the direction of attack in the offense, and they influence the assignment of positions, sectors of fire, and targets in the defense. Enemy avenues of approach or withdrawal are viewed as to how they can affect the platoon's operation.

What effect do TROOPS have on the selection of positions, routes, formations, and the fire plan? How many troops are available to occupy a specific area?

How much TIME is there to prepare positions? How long must a position be defended?

The leader considers each of the factors and compares alternatives. From this analysis, he draws conclusions that form the basis for his plan of action, which, when firm, becomes his order.

**Step 4 — Start Necessary Movement.** During steps 3 through 8, the platoon leader maybe forward completing his plan. If there is a distance between the platoon and where the mission must be started, the platoon sergeant may bring the platoon forward to save time. Such movement may be accomplished under company control, with the company executive officer or first sergeant in charge. This particular step may be omitted, occur in a different sequence, or be done concurrently with some other step(s).

**Step 5 — Reconnoiter.** To make the best use of men and weapons, the leader must look over and evaluate the terrain on which he will fight. This evaluation may be done using the key elements in OCOKA described in step 3. If time is short, the leader, at least, makes a map reconnaissance, which may confirm or cause him to modify his tentative plan.

**Step 6 — Complete the Plan.** Based on the reconnaissance, the leader completes his plan. In a defense, he decides where to put his weapons and how to tie the defense together. In an attack, he decides how to move and how to seize the objective.

**Step 7 — Issue the Complete Order.** Platoon and squad orders are issued orally. For an attack, the platoon leader should give his order from a point where the squad leaders can see the objective. For a defense, he should give the order on the ground his troops will defend. When this is not feasible, the platoon leader should use a

terrain model or a sketch to help explain the order. A squad leader will rarely have a chance to give an attack order from a position where his men see the objective. When feasible, he should make a terrain model for his squad to look at while he gives the order. Like the platoon leader, a squad leader can often give his orders for the defense while his squad is at the defensive position area. Leaders must be sure all their men know the plan of action.

**Step 8 — Supervise.** After the order is issued, leaders direct the preparations to be sure the order is properly carried out.

### 3-3. REHEARSALS

If there is time before an operation, platoon leaders should have squads rehearse combat tasks for the specific mission. This fosters confidence and improves performance. It may also reveal weaknesses in the plan. Some important tasks to rehearse are:

**Fire and movement.**

**Actions upon unexpected enemy contact.**

**Actions at the assault position.**

**Actions in the assault.**

**Breaching a minefield.**

**Assaulting a trench.**

**Breaching wire obstacles.**

**Assaulting a bunker or a building.**

**Using special weapons or demolitions.**

**Test firing of weapons, if situation permits.**

If possible, rehearsals should be on terrain resembling that on which the unit will fight and under the expected light condition.

### 3-4. INSPECTIONS

The last thing done before an operation is to inspect to see if the men and equipment are ready. This may include:

**Rations.**

**Water.**

**Weapons.**

**Ammunition.**

**Individual uniform and equipment.**

**Camouflage.**

**Mission-essential equipment (demolitions, starlight scopes).**

**Knowledge of the mission and responsibilities.**

Once the operation has begun, the leader must see that the plan is followed. He should be ready to change his plan if that is what the situation demands.

## Section II. COMBAT ORDERS

### 3-5. GENERAL

Combat orders are written or oral. Leaders use them to transmit information and instructions to subordinates. The use of combat orders, expressed in standard formats or containing essential elements, insures that a leader conveys his instructions clearly, concisely and completely. The detail of an order varies with the time a leader has to prepare it. SOPs comple-

ment combat orders and allow the leader to refer to them rather than issue the same instructions for tasks and situations that occur often.

There are generally three kinds of combat orders: warning order, operation order, and fragmentary order.

### 3-6. WARNING ORDER

Leaders use warning orders to alert subordinate units of an impending mission and to provide initial instructions so that subordinates have a maximum amount of time to prepare for its execution. Although there is no prescribed format, a warning order contains five MINIMUM essential elements:

**The mission (nature of the operation).**

**Who is participating in the operation.**

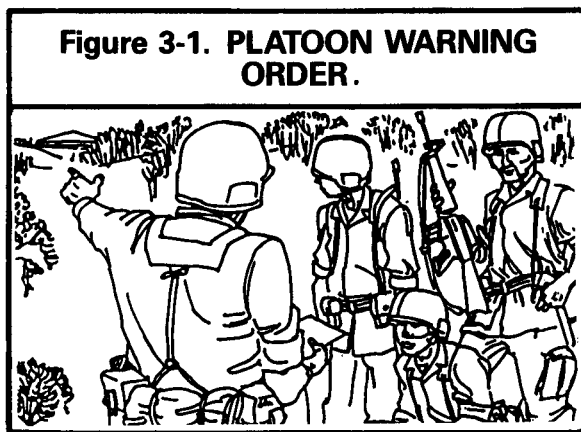
**Time of the operation.**

**Any special instructions.**

**Time and place for issuance of the complete order.**

In addition to these essentials, the leader should also provide any specific instructions not covered by the SOP that are important to the preparation for the mission.

The platoon leader may issue the warning order to his platoon sergeant, forward observer, aidman, and squad leaders, or only to the platoon sergeant if time does not permit the gathering of others.



**“WE ARE GOING TO ATTACK THE VILLAGE OF DASHAWECZ AT 1430 TODAY. IT LOOKS LIKE THE ENEMY HAS PREPARED SOME**

**PRETTY GOOD POSITIONS IN THE BUILDINGS. WE WILL HAVE TO CLEAR HIM OUT. THERE MAY ALSO BE ENEMY TANKS IN THE VILLAGE. DRAW SIX GRENADES AND ONE LAW PER MAN. EACH SQUAD CARRY 10 BLOCKS OF C4, BLASTING CAPS, AND FUSE IGNITORS; AND 50 FEET OF FUSE LINE. THE PLATOON SERGEANT WILL TELL YOU WHERE AND WHEN YOU CAN PICK UP THIS MATERIAL. THE POL TRUCK WILL BE HERE AT 1130 HOURS. TOP OFF EACH CARRIER. LET ME KNOW BY 1145 HOURS IF YOU HAVE ANY MAINTENANCE PROBLEMS THAT YOU CAN’T REPAIR YOURSELVES. MEET ME BACK HERE AT 1200 HOURS. AT THAT TIME, WE WILL MOVE UP THE RIDGE OVERLOOKING THE VILLAGE, AND I WILL TELL YOU EXACTLY HOW WE WILL CAPTURE OUR PART OF THAT VILLAGE.”**

The squad leader normally issues the warning order to all squad members. Preparation for the operation begins immediately based on special instructions and the platoon SOP. The platoon sergeant and team leader keep close watch on the preparations made by the men. They insure that the instructions of the platoon leader and squad leaders are carried out.

**“THE PLATOON LEADER JUST TOLD ME THAT WE ARE GOING TO ATTACK A VILLAGE THIS AFTERNOON AT 1430 HOURS. THE ENEMY IS DUG IN AND PROBABLY HAS TANKS WITH HIM, SO WE HAVE TO BE PREPARED TO CLEAR THE BUILDINGS AND KNOCK OUT THE TANKS. WE WILL CARRY SIX HE GRENADES AND ONE LAW PER MAN IN ADDITION TO OUR STANDARD LOAD FOR RIFLES AND GRENADE LAUNCHERS. SERGEANT THOMAS, YOUR TEAM WILL HANDLE DEMOLITIONS. DRAW 10 BLOCKS OF C4, 10 BLASTING CAPS AND FUSE IGNITORS, AND 50 FEET OF FUSE. MAKE SURE YOU TEST BURN THE FUSE. PRIVATE SMITH, YOU CARRY A CLIMBING ROPE AND A GRAPPLING HOOK. SPECIALIST GEORGE, YOU CARRY THE TA-1 AND DRAW TWO ROLLS OF**

ASSAULT WIRE. THE PLATOON SERGEANT WILL BE HERE IN ABOUT 20 MINUTES TO TELL US WHERE AND WHEN WE CAN PICK UP OUR AMMO AND EQUIPMENT. THE POL TRUCK WILL BE HERE AT 1130 HOURS. SERGEANT JONES, MAKE SURE OUR APC IS TOPPED OFF. IF YOU HAVE ANY MAINTENANCE PROBLEMS, LET ME KNOW BY 1130 HOURS. I'M LEAVING NOW TO GET THE PLATOON ORDER. SERGEANT THOMAS IS IN CHARGE UNTIL I GET BACK. PLAN ON MEETING HERE WHEN I RETURN, AND WE WILL GO OVER THE PLAN IN DETAIL."

**Figure 3-2. SQUAD WARNING ORDER.**



### 3-7. OPERATION ORDER

The OPORD supplies needed information and instructions to subordinates. It outlines what must be done to accomplish a specific mission through coordinated effort. The leader uses the order to tell his subordinates how he intends to fight the battle. It insures that the platoon and squad know everything necessary to accomplish the mission. Consistent use of a standard format allows the leader to refine SOPs and streamline his orders.

The standard OPORD format is used by leaders to organize their thoughts in a logical se-

quence. The operation order format consists of the following elements:

**1. SITUATION.** Paragraph one of the operation order has three subparagraphs: enemy forces, friendly forces, attachments and detachments. Paragraph one also gives an overview of the general situation so subordinate leaders or individuals can gain an understanding of the area of operations. This paragraph provides information only and contains no orders.

**a. Enemy forces.** All available information.

**b. Friendly forces.** Information here contains the verbatim mission statement of the next higher headquarters, and adjacent, supporting, and reinforcing units listed in the following order

(1) Higher unit. (At least the mission of the next higher unit.)

(2) Adjacent units. (Listed in order: left, right, front, and rear.)

(3) Supporting mortar or field artillery units.

**c. Attachments and detachments.** Availability and the time these attachments and detachments are effective.

**2. MISSION.** Paragraph two of the OPORD gives the mission in a clear, concise statement of the tasks to be accomplished. It contains the WHO (unit); WHAT (attack, defend, delay, etc.); WHEN (date-time group); WHY (seize, prevent penetration of positions); and WHERE (generally, grid coordinates).

**3. EXECUTION.** Paragraph three of the OPORD is the execution paragraph. It contains the "HOW TO" information needed to accomplish the mission. It will have the concept of operation, mission for subordinate units, and coordinating instructions.

**a. Concept of operation** states briefly the leader's intent and tactical plan. It describes the scheme of maneuver and plan of fire support. Although brief, it must be detailed enough to insure correct action, and avoid language that

might confuse subordinates. The concept of operation may be broken down into two sub-paragraphs:

**(1) Scheme of maneuver.** The company's ultimate objective, the platoon mission, movement technique, direction, order of march, primary mission for each squad, and position in company order of march.

**(2) Fire support.** Preparation fires/final protective fires; priority of fires.

**b. Missions for subordinate units.** Only units organic or attached are listed. Details of specific missions for each squad (platoon order), or teams or individuals (squad order), are discussed.

**c. Coordinating instructions** is the last subparagraph of paragraph three of the OPORD. It lists tactical instructions and details of coordination (other than signal teams) that apply to two or more elements. When there are no coordinating instructions, this fact will be noted.

**4. SERVICE SUPPORT.** Paragraph four of the OPORD covers administrative instructions and support provided for the operation. It should cover supply (ammunition; petroleum, oil, lubricant [POL]; rations; spare parts), services, (hot food, water), medical evacuation, and handling of prisoners.

**5. COMMAND AND SIGNAL.** Paragraph five of the OPORD covers command and signal.

**a. Command.** Includes the location of the platoon leader and platoon sergeant. May include succession of command if this is not in the SOP

**b. Signal.** Includes any communications or electronics instructions to be used during the operation. At a minimum, it contains call signs and frequencies; it may also contain challenge and password, pyrotechnics, and signal restrictions.

### 3-8. PLATOON OPORD EXAMPLE

#### 1. SITUATION.

**a. Enemy forces.** Elements of the 283 Motorized Rifle Regiment have established squad and

platoon defensive positions in our zone. Their most likely location is vicinity of Hill 301 (NB 782918). They are estimated at 80% strength and their morale is good. They are equipped with BMPs and are capable of employing chemical weapons. They will probably defend in present position.

**b. Friendly forces.** Company C attacks at 090600 Ott to seize Hills 309 (NB 783910) and 301 (NB 782918) to control the road that runs between these two hills. TF 2-76 attacks at the same time to seize Hill 205 (NB 782937), and 1st Platoon attacks at the same time to seize Hill 309 (NB 783910). The heavy mortar platoon will be in the vicinity of Hill 258 (NB 762402). The 1-45 Field Artillery (FA) (155 Self-Propelled [SP]) will support the battalion. Priority of fires to our company

**c. Attachments and detachments.** None.

**2. MISSION:** 2d Platoon will attack at 090600 Ott to seize Hill 301 (NB 782918).

#### 3. EXECUTION

**a. Concept of operation.** The 2d Platoon will attack dismounted crossing the line of departure (LD) at 0600. We will cross the LD in column formation using the traveling overwatch technique. Order of march will be 2d Squad, platoon headquarters, 1st Squad, 3d Squad. The carrier element will provide overmatching fires from Hill 294 (NB 780916). When we reach Catfish Creek, our assault position, we will deploy in line formation with 1st Squad on the left, 2d Squad as the base, squad in the center, and 3d Squad on the right to seize Hill 301, Objective RED. By seizing Objective RED, we will be able to control all movement on the road between Hills 309 (NB 783910) and 301 (NB 782918). If the enemy counterattacks, the company commander thinks they may try to use the road. By seizing Hill 309, Objective BLUE, on our left, 1st Platoon will assist in protecting the battalion's flank against enemy counterattack. The 3d Platoon will be following us during the assault and will be prepared to continue the assault if needed. There will be a 15-minute artillery preparation beginning at 0550. We have priority of fires. The

targets I have chosen are shown on my map. Make sure you mark them on your map before you leave.

**b. Missions for subordinate units:**

- (1) 1st Squad Consolidate from 9 to 11.
- (2) 2d Squad Consolidate from 11 to 1.
- (3) 3d Squad Consolidate from 1 to 3.
- (4) Carrier element:
  - (a) Support assault from Hill 294.
  - (b) Shift fires on order to northeast.
  - (c) Move to objective on order.

**c. Coordinating instructions:**

- (1) 2d Squad is base squad during assault.
- (2) In consolidation, 12 o'clock is east.
- (3) Limit of advance is 100 meters beyond crest of the hill.

**4. SERVICE SUPPORT:**

**a. Supply.** Two C-rations per man. Each squad will carry an additional 600 rounds of 5.56-mm ammo. Top off vehicles at 2000 tonight in your position.

**b. Maintenance.** SOP except logistical release point will be at intersection of Phase Line (PL) Nail and Route ANVIL.

**c. Medical.** SOP.

**5. COMMAND AND SIGNAL:**

**a. Command.** I will be with the dismount element, and the platoon sergeant will be with the carrier element. Succession of command is SOP.

**b. Signal.** Current frequencies and call signs will be in effect. Signal for shifting supporting fires is two green star clusters, or on order. The time is: \_\_\_\_\_

**3-9. SQUAD OPORD EXAMPLE**

Frequently in the interest of time, the squad leader takes only the necessary information from the platoon order and briefs the squad over a terrain table constructed to depict the area of operation:

“THE PLATOON LEADER JUST GAVE US THE OPERATION ORDER. WE’VE GOT ENEMY INFANTRY IN SQUAD AND PLATOON DEFENSIVE POSITIONS WITH BMPs TO OUR FRONT. OUR PLATOON ATTACKS AT 0600 TO SEIZE HILL 301, HERE. TF 2-76 ATTACKS TO OUR LEFT TO SEIZE HILL 205, HERE; 1ST PLATOON ATTACKS TO SEIZE HILL 309, HERE; AND 3D PLATOON FOLLOWS US. THE 1ST SQUAD’S MISSION — OUR MISSION — IS TO ATTACK AND SEIZE THE LEFT PART OF HILL 301. WE ATTACK DISMOUNTED, CROSSING THE LD IN COLUMN FORMATION USING TRAVELING BEHIND 2D SQUAD AND THE PLATOON HEADQUARTERS, WITH 3D SQUAD FOLLOWING US. OUR CARRIER PROVIDES OVERWATCHING FIRES FROM HILL 294, LOCATED HERE. OUR ASSAULT POSITION IS CATFISH CREEK WHERE WE DEPLOY IN LINE FORMATION: OUR SQUAD ON THE LEFT; 2D SQUAD, BASE SQUAD, IN THE CENTER; AND 3D SQUAD ON THE RIGHT TO SEIZE HILL 301, OBJECTIVE RED. AFTER WE SEIZE OBJECTIVE RED, WE HAVE TO WATCH THIS ROAD BETWEEN US AND 1ST PLATOON ON HILL 309 FOR POSSIBLE ENEMY COUNTERATTACK. THE 3D PLATOON MAY COME UP TO PASS THROUGH US TO CONTINUE THE ATTACK. A 15-MINUTE ARTILLERY PREP WILL BE USED BEGINNING AT 0550. WE CONSOLIDATE ON OBJECTIVE RED FROM 9 TO 11 WITH 12 BEING EAST. WE LINK WITH 2D SQUAD AT 11. OUR CARRIER WILL MOVE FORWARD ON ORDER AND JOIN US ON THE OBJECTIVE. NO ONE IS TO ADVANCE MORE THAN 100 METERS BEYOND THE CREST OF THE HILL. WE CARRY TWO C-RATIONS PER MAN AND AN ADDITIONAL 600 ROUNDS OF 5.56-MM AMMO. THE VEHICLE GETS TOPPED OFF AT 2000 HOURS TONIGHT IN POSITION. I WILL BE WITH THE DISMOUNT ELEMENT, AND SUCCESSION OF COMMAND IS SOP. THE TIME IS: — . CURRENT FREQUENCIES AND CALL SIGNS WILL BE IN EFFECT. SIGNAL FOR SHIFTING FIRES IS TWO GREEN STAR CLUSTERS OR ON ORDER. ANY QUESTIONS?”

**Figure 3-3. SQUAD OPERATION ORDER.**



### 3-10. THE OPERATION OVERLAY

An operation overlay is a trace of graphics from an operation map. Its purpose is to reduce the content and insure the understanding of the written or oral order. Normally platoon and squad leaders will not be issued operation overlays. However, in conformance with higher leader's orders, platoon and squad leaders should transfer graphics to their maps. This will allow them to plan their actions, **based on a map reconnaissance, deeper than the terrain may allow them to see.** The overlay or transference should be simple but neatly done. It should include all control measures used during the operation and all other information that can be depicted graphically.

### 3-11. THE FRAGMENTARY ORDER

The fragmentary order is issued to make a change to an existing order. Therefore, FRAGOs address only those items from the OPORD that are changed. Since FRAGOs are normally used

during the conduct of an operation, instructions should be brief and specific. Although there is no standard format for a FRAGO, the following essential items are normally included:

**Situation: Enemy and Friendly** — includes a brief description of the enemy and friendly situation and should indicate the reason for the change in instructions.

**Changes to the organization** — may include the attachment or detachment of the platoon or part of it.

**Orders to Subordinate Units** — should be done by element. To avoid confusion, no element should be left out.

**Fire Support (if applicable)** — indicates any change in priorities or assets.

**Coordinating Instructions** — as in the OPORD, includes all instructions that apply to two or more elements.

### 3-12. THE UNIT STANDING OPERATING PROCEDURE

The unit SOP is a set of instructions having the force of orders. It covers areas which lend themselves to standardization with no loss of effectiveness.

SOPs facilitate and expedite operations by

**Reducing the number, length, and frequency of combat orders.**

**Simplifying the preparation and transmission of combat orders.**

**Simplifying training.**

**Promoting understanding and teamwork between the leaders and troops.**

**Advising new arrivals or newly attached units of procedures followed in the organization.**

**Reducing confusion and errors.**



Contents of higher unit SOPs need not be restated in platoon and squad SOPs unless more detail is needed for actions to be accomplished at platoon and squad level. Virtually any item relating to the platoon can become a matter for the unit SOP. Many SOP items are derived from the personnel and equipment available to the organization. Other SOP items are a function of good tactics and techniques. SOP items can be established by leaders based on how they can operate most efficiently and best prepare their unit for combat. SOPs remain in effect unless modified by an order. If certain items continually need modification, they should not be a part of the SOP.

Battle drills are planned with emphasis on changes in formation and movement to respond to changes in tactical situations. Battle drills are set plays and should be established for mounted and dismounted operations, should become part of the SOP, and should be practiced to perfection. Appendix H provides some specific examples of battle drills.

### 3-13. LEADING IN COMBAT

The **primary** duty of the leader is mission accomplishment. Leadership is the art of influencing and directing men in such a way as to obtain their confidence, respect, obedience, and cooperation in preparing for and executing combat operations and accomplishing the mission. Leadership is based on knowledge of men, equipment, and tactics. The leader is responsible for the discipline, training, welfare, and morale of his men. He must be technically competent in the use of infantry weapons. He must be tactically proficient in their employment. At platoon and squad level, leadership by example is the key. The leader must:

**Set the example.**

**Lead from as far forward as possible.**

**Lead from a position where he can be seen by his men.**

**Lead from where he can control all elements physically or by radio.**

**Move to critical locations to influence the action when necessary.**

**Make sound but quick decisions.**

**Execute decisions forcefully.**

The battlefield is a stressful and fatiguing environment. The first days of battle can be particularly trying as leaders and soldiers adapt to the reality of fighting. The platoon and squad must be prepared to fight at any time 24 hours a day. Leaders must make every effort to minimize the effects of stress and fatigue. Soldiers who are well trained and confident will react better under conditions that produce stress and fatigue. SOPs that are mastered help men and units to endure. Sleep and rest are critical aspects of maintaining individual and unit proficiency. They must be encouraged during lulls in battle.

**Sleep/rest management.** Leaders begin episodes of rest (cat naps or longer) before fatigue becomes debilitating. They should not go longer than 24 hours without sleep, but more important, they should recognize signs of fatigue.

Soldiers should rest or sleep at every opportunity while a buddy remains awake. In tasks requiring attention (surveillance, communication), personnel are rotated.

If possible, after prolonged periods of minimal rest/sleep (2 to 4 days), a long period of uninterrupted sleep (12 to 24 hours) is needed. If awakened ahead of time, a period of reduced responsiveness can be expected.

Special leadership considerations when soldiers are fatigued. If signs of "combat fatigue" appear (following a prolonged period with minimal rest/sleep), then allow uninterrupted sleep if possible.

To lessen mental and physical fatigue, spread the most difficult and dangerous assignments around.

During normal and sustained operations, esprit de corps will be important in coun-

teracting the negative effects of sustained battle.

CHAPTER 4  
**MOVEMENT**

**Section I. INTRODUCTION**

**4-1. GENERAL**

The tempo of mobile warfare and contamination created by nuclear and chemical weapons demand that mechanized infantry units spend a lot of time moving. Although this chapter deals only with how platoons and squads move, rarely do they move alone. They may operate as part of a mechanized infantry company or as part of a company team with one or more tank platoons. The mechanized infantry company also will have support from the battalion's improved TOW vehicles (ITV).

In arriving at a decision about movement, the leader must always consider the mission, enemy, terrain, troops, and time available (METT-T).

**4-2. TERRAIN USE**

Whether moving mounted or dismounted, in contact with the enemy or not, platoons and squads should know the following rules:

**Use the Terrain for Protection.** Terrain offers natural concealment from enemy observation and cover against fire. Using terrain to protect vehicles is difficult, so, terrain driving should become a habit. It must be used when in contact with the enemy and when contact is possible or expected. Follow these terrain-driving rules:

**Use available cover and concealment.**

**Avoid skyining.**

**Do not move directly forward from a hull-down firing position.**

**Cross open areas quickly.**

**Avoid Possible Kill Zones.** Platoons and squads must avoid wide open spaces, especially where high ground dominates, or where terrain can cover and conceal the enemy. They must also avoid obvious avenues of approach into enemy territory. It is better to cross difficult terrain than fight the enemy on his terms. Engineers can work the terrain to improve mobility.

**Take Active Countermeasures.** Platoon leaders should use smoke, direct fire, and indirect fire to suppress known or suspected hostile positions. The enemy should never be allowed an open, unhindered shot at mounted or dismounted friendly elements. This calls for constant alertness and thorough planning and coordination.

CONTENTS		PAGE
Section I.	Introduction .....	4-1
	II. Movement Formations .....	4-2
	III. Movement Techniques.....	4-12
	IV. Maneuver.....	4-23

**Maximize the APC's Capabilities.** The APC has good speed and on the move can quickly change direction or stop. Platoon/team leaders and drivers should use any available depressions and trees when appropriate to avoid enemy antitank guided missile (ATGM) fire.

When necessary to cross an open area, the lead TL/squad leader and the platoon leader check for unfriendly activity, obstacles, and routes across the open space.

For units equipped with them, the smoke-grenade launchers can be used to create an immediate smoke screen around a halted carrier and during disengagement.

The caliber .50 machine gun can be used during movement for suppression.

**Make Contact With the Smallest Force Possible.** During all movement, it is best to

have a small force in the lead and the remainder of the unit ready to react and support. Making contact with the smallest possible force avoids having an entire unit pinned down by enemy fire. Thus, the unit retains flexibility to fire and move.

When not in contact, a lead or bounding force is supported by a trailing or overwatch force. Overwatch means being in position to cover the lead force by firing at an enemy when he appears.

When in contact, one force moves while another force provides fire support or suppression. (This is further explained in section IV.) Suppression is gained by direct and indirect fires or smoke, brought to bear on enemy personnel, weapons, or equipment, thus forestalling effective fire on friendly forces.

## Section II. MOVEMENT FORMATIONS

### 43. GENERAL

Movement formations are an aid to command and control; leaders place themselves where they can best command and control movement. Their placement is also governed by the movement technique being used. It must be clearly understood, however, that movement techniques apply to how a formation moves; they are not, in and of themselves, formations.

### 44. SQUAD MOVEMENT FORMATIONS

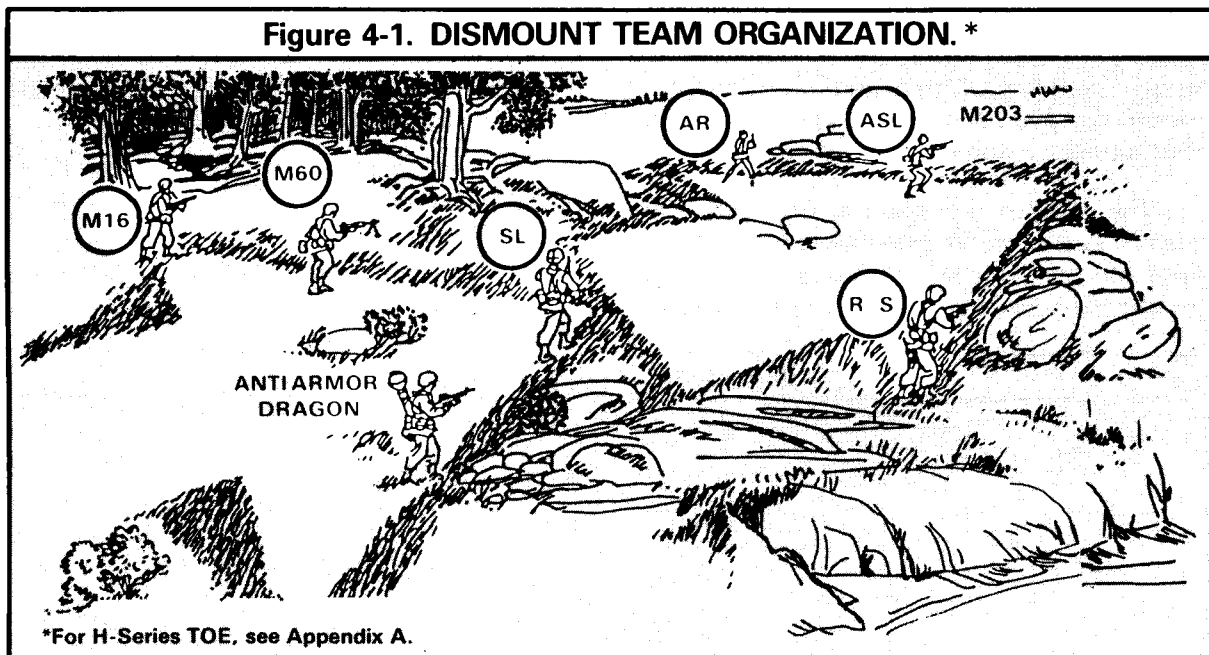
**Entire Squad Mounted.** When mounted, the squad operates as one unit. Thus, it does not have the capability to overwatch itself. It moves mounted as part of the platoon — as the lead squad or as a part of the platoon overwatch force.

**Dismount Team Deployed.** The dismount team moves in two wedges — alone or as part of the platoon dismount element. Its movement is normally overwatched by the platoon's carrier element or by other dismount teams of the platoon dismount element. The squad leader and/or assistant squad leader dismounts to lead the

dismount team. The squad may organize the dismount team into two fire teams with each fire team forming a wedge. In this case, the squad leader leads one fire team while the assistant squad leader leads the other fire team. In this way, the squad can provide its own overwatch element.

Positions within the wedge are based on the mission, enemy situation, terrain, weather, light conditions, weapons carried, and the team's location within the dismount element. Within the wedge, each man is assigned a sector of observation to provide all-round security.

Normal interval between men is about 10 meters, but it may be less if visibility is poor. Terrain may also dictate temporary modification of the wedge formation. For example, the sides of the wedge will have to close into single file when moving along a narrow mountain path, through a minefield, or through heavy undergrowth. But, as soon as conditions permit, the wedge is resumed automatically.



The dismount team leader may lead the lead fire team wedge. He does so whenever speed is essential. For example, the platoon leader may order a squad leader to quickly move his dismount team forward to secure a terrain feature. By dismounting and personally leading, the squad or assistant squad leader can rapidly choose the exact route, set the pace, and reduce reaction time by simply telling his men, "Follow me."

If speed is not important, the position of the squad or assistant squad leader depends on his judgment as to how he can best control the dismount team, maintain visual contact with the platoon dismount element leader, and navigate (if his dismount team is leading). As a rule, however, the dismount team leader will be the lead man in the trailing wedge. He gives instructions to the team leader of the lead fire team, through visual signals — where to go and what to do. During movement, other team members guide on the lead man. If he moves right, they move right. If he stops, they stop. When contact is made, the lead man sets the example for other fire team members to follow.

The few seconds following initial contact often decide team success or failure. Thus, immediate action following contact is critical, and the team leader must act swiftly.

#### 4-5. PLATOON MOVEMENT FORMATIONS

The specific shape of the platoon formation is set primarily by the mission, enemy situation, and terrain. The traveling formation prescribes its form but in a general way only. The APCs will be staggered. The distance between vehicles will vary according to the terrain being crossed. Each vehicle will be guarding and searching a different sector to provide all-round security while on the move. The platoon leader directs the platoon by using arm-and-hand or flag signals. Radios should be used only as a backup means of communicating.

It is critical during movement that the squad members observe their sectors and keep the TL informed of what they see. When buttoned up, the TL must be aware of the limitations of his and his driver's field of view. He must keep the squad informed of the situation.

There are five basic platoon mounted movement formations: column, line, echelon, vee, and wedge. These formations, modified as necessary permit the platoon to react appropriately in most situations and under most conditions.

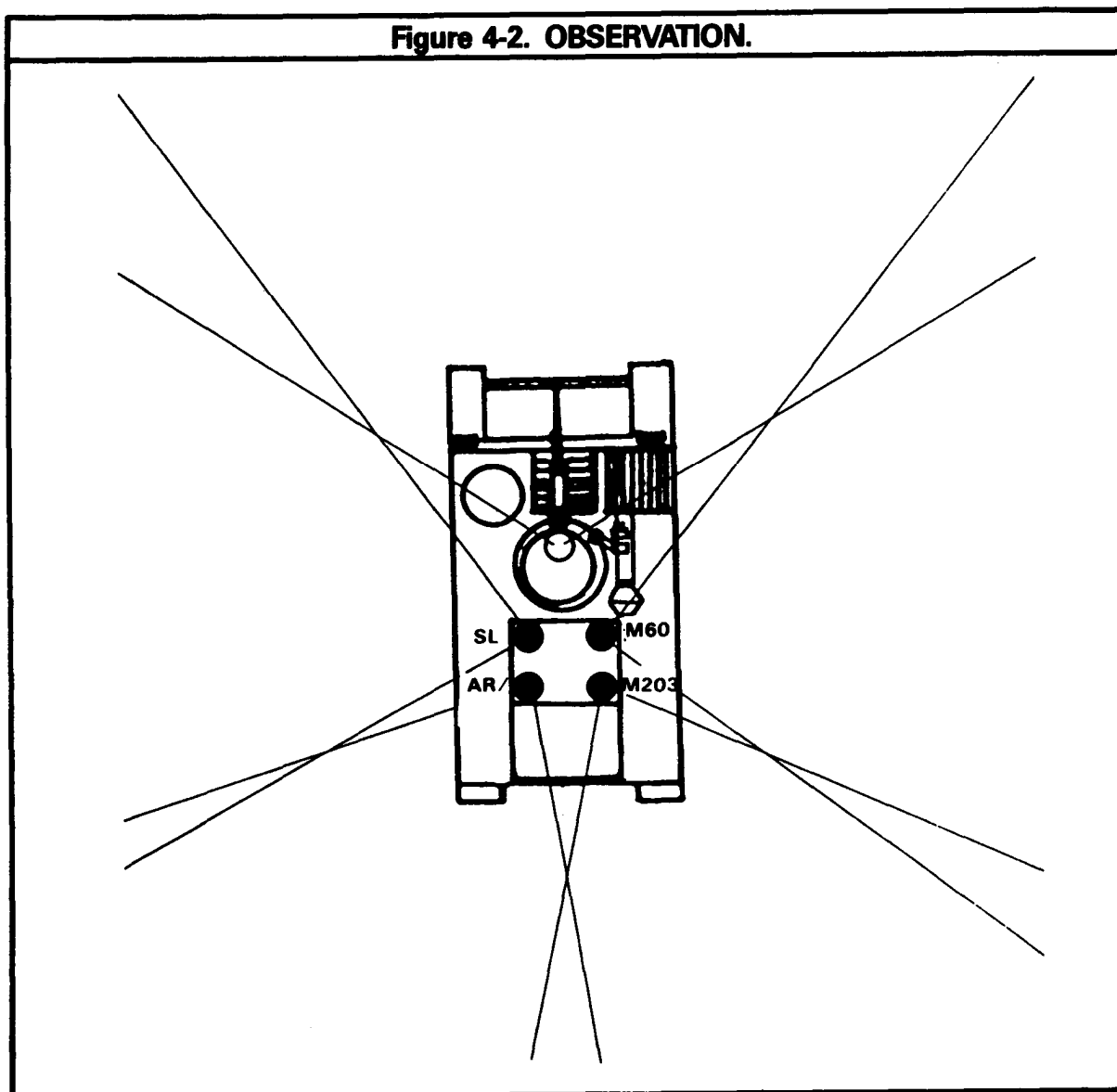
The **column** formation is used most frequently. It is used for road marches, for movement during limited visibility, and when passing through defiles or thick woods. The pla-

toon can deploy rapidly from the column formation into other formations. The column simplifies control, provides good security, and permits maximum firepower to the flanks.

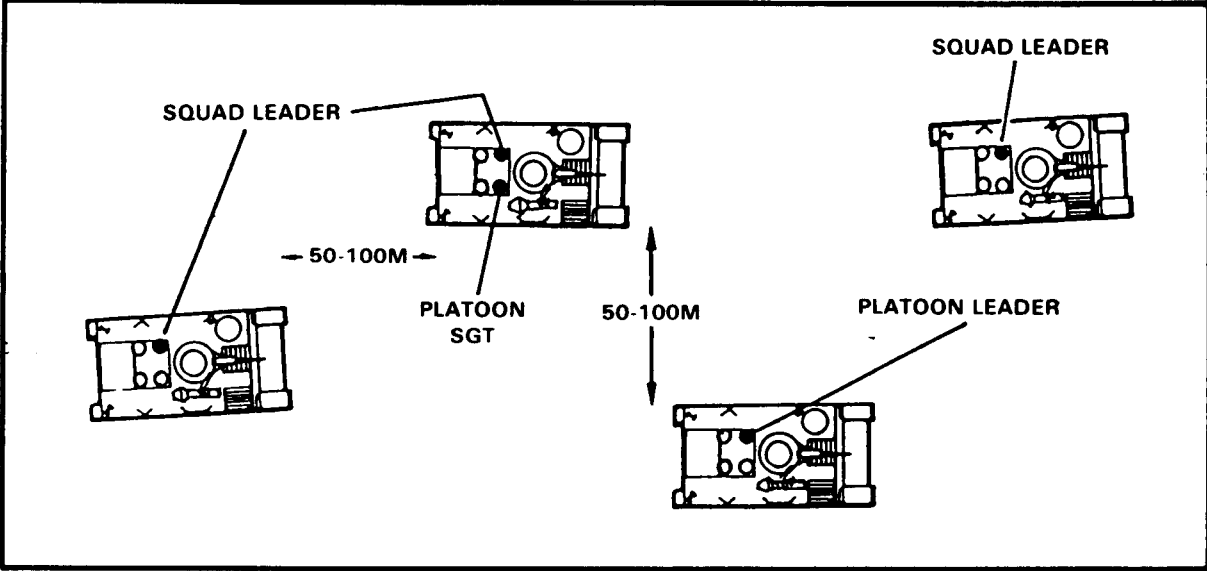
When moving in a column formation, squad members scan their designated areas of observation.

Arm signals are used to change the column's direction of travel.

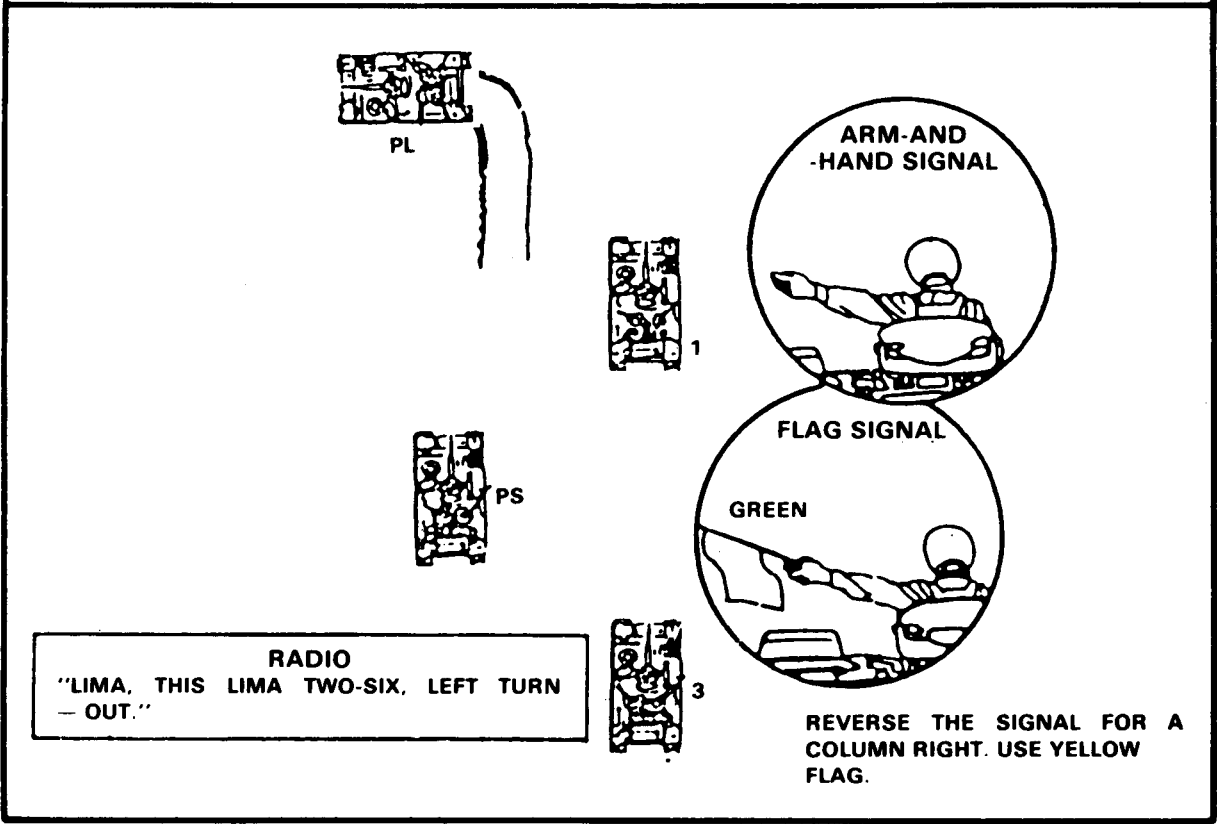
**Figure 4-2. OBSERVATION.**



**Figure 4-3. COLUMN FORMATION.**

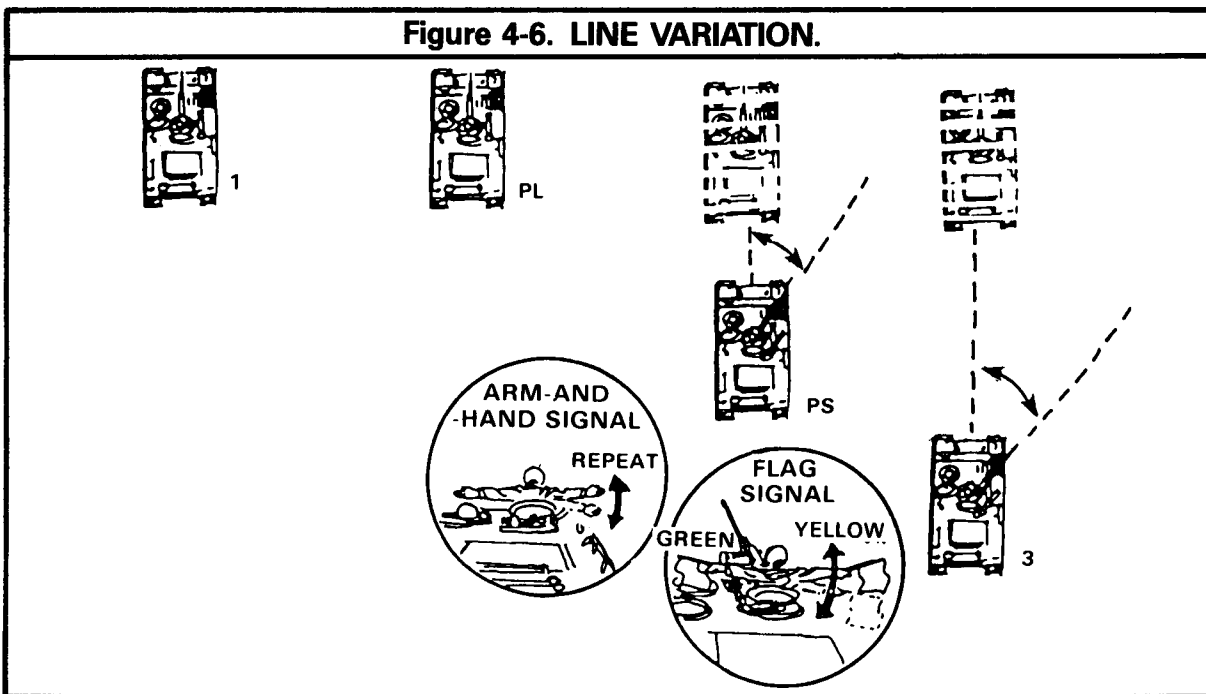
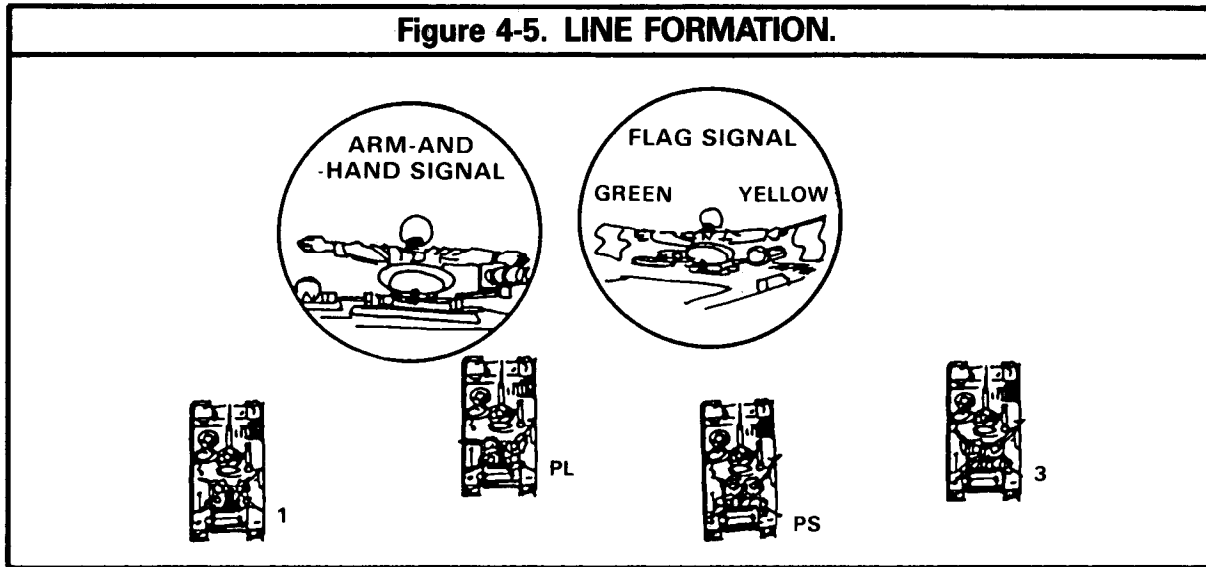


**Figure 4-4. SIGNALS.**



The **line** formation is used when assaulting an objective, crossing open areas, leaving a woodline, or emerging from smoke. This formation lets the platoon cross an objective rapidly with maximum fire to the front. This formation lacks the depth of the column or wedge forma-

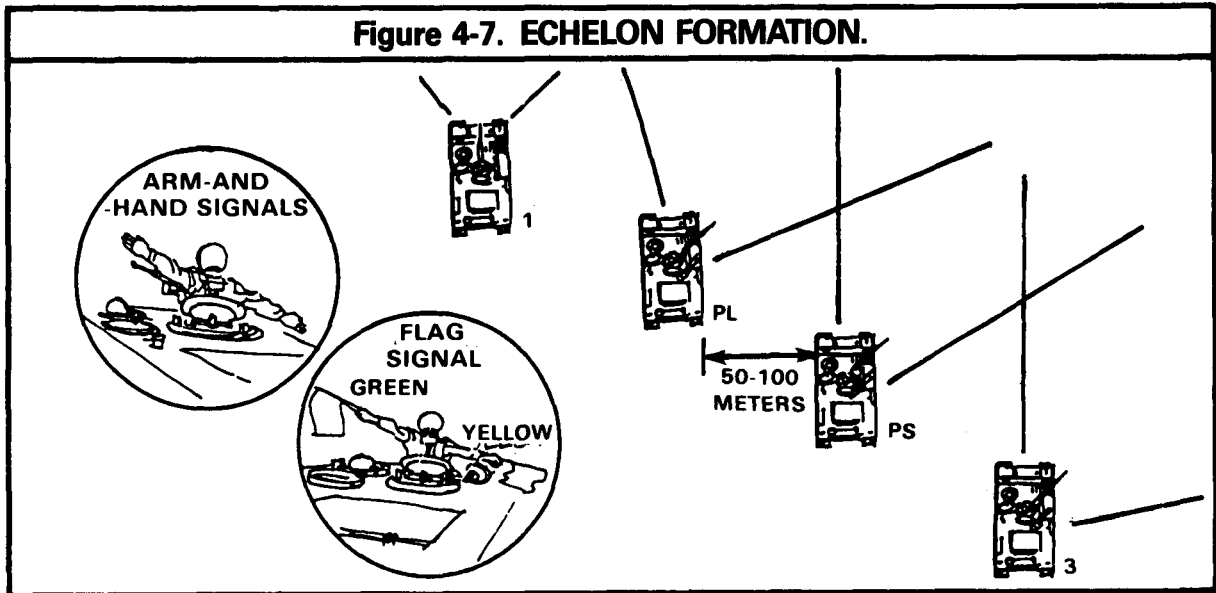
tion. A variation of the line formation is used when the platoon leader desires to protect a flank without changing the entire platoon formation. Two APCs stay on line while two fall back in echelon to guard the desired flank. The distance between elements is terrain dependent.





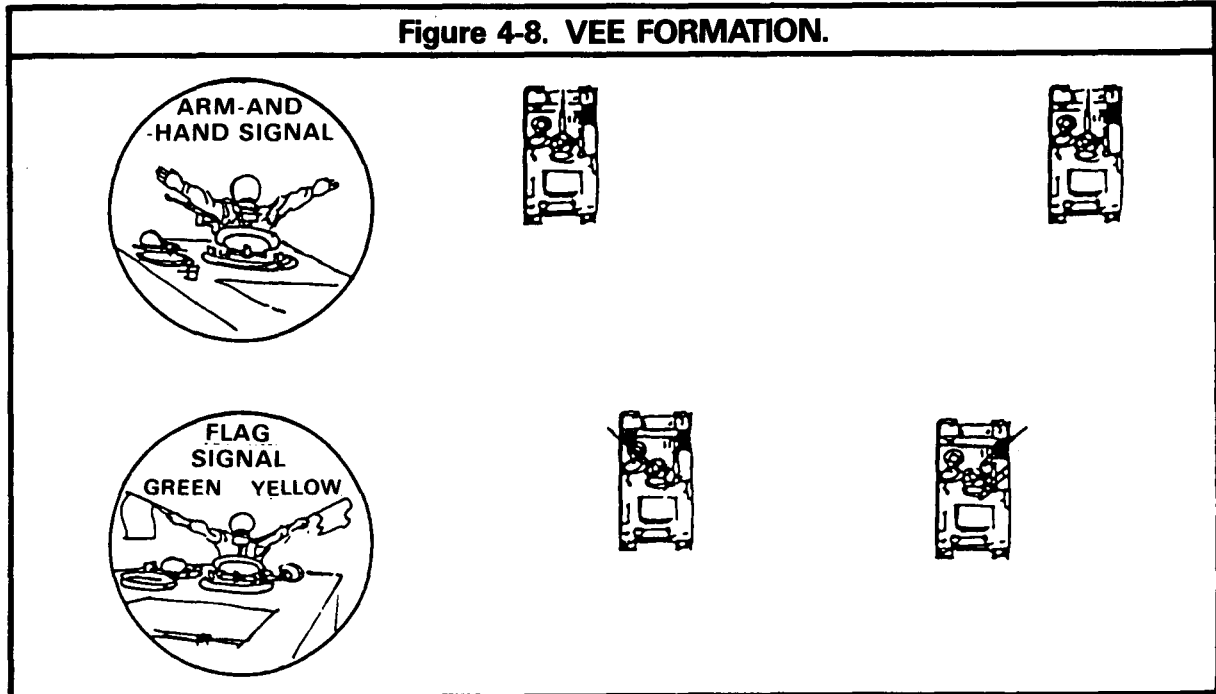
The **echelon** formation permits excellent firepower to the front and to either flank. It is

normally used when a platoon is to cover an exposed flank.



The **vee** formation may be used when the enemy situation is vague and the platoon leader requires firepower to the front and flanks. A

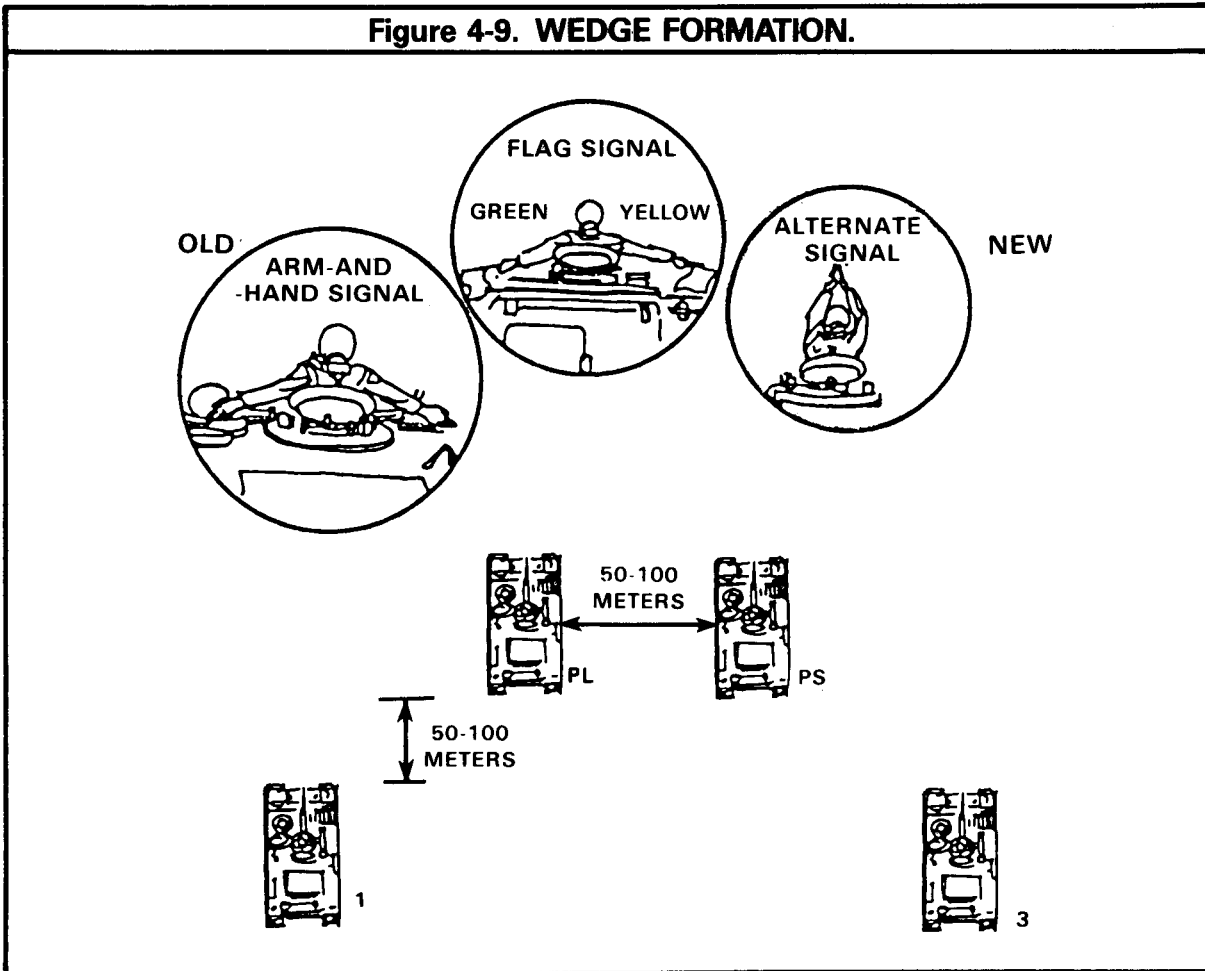
specific use of the vee formation may be when the ridges of a valley are being traversed ahead of the main body of a larger force.



The **wedge** formation permits excellent fire to the front and good fire to each flank. The platoon leader can easily control all vehicles and deploy rapidly into other formations. The wedge formation is often used when the enemy situation is vague.

Although the depicted visual signal conforms to current doctrine, it is not usually suitable. The configuration of the gunner's hatch may make it hard for other TLs to see the signal. An alternative is to extend the arms upward at a 45-degree angle from vertical.

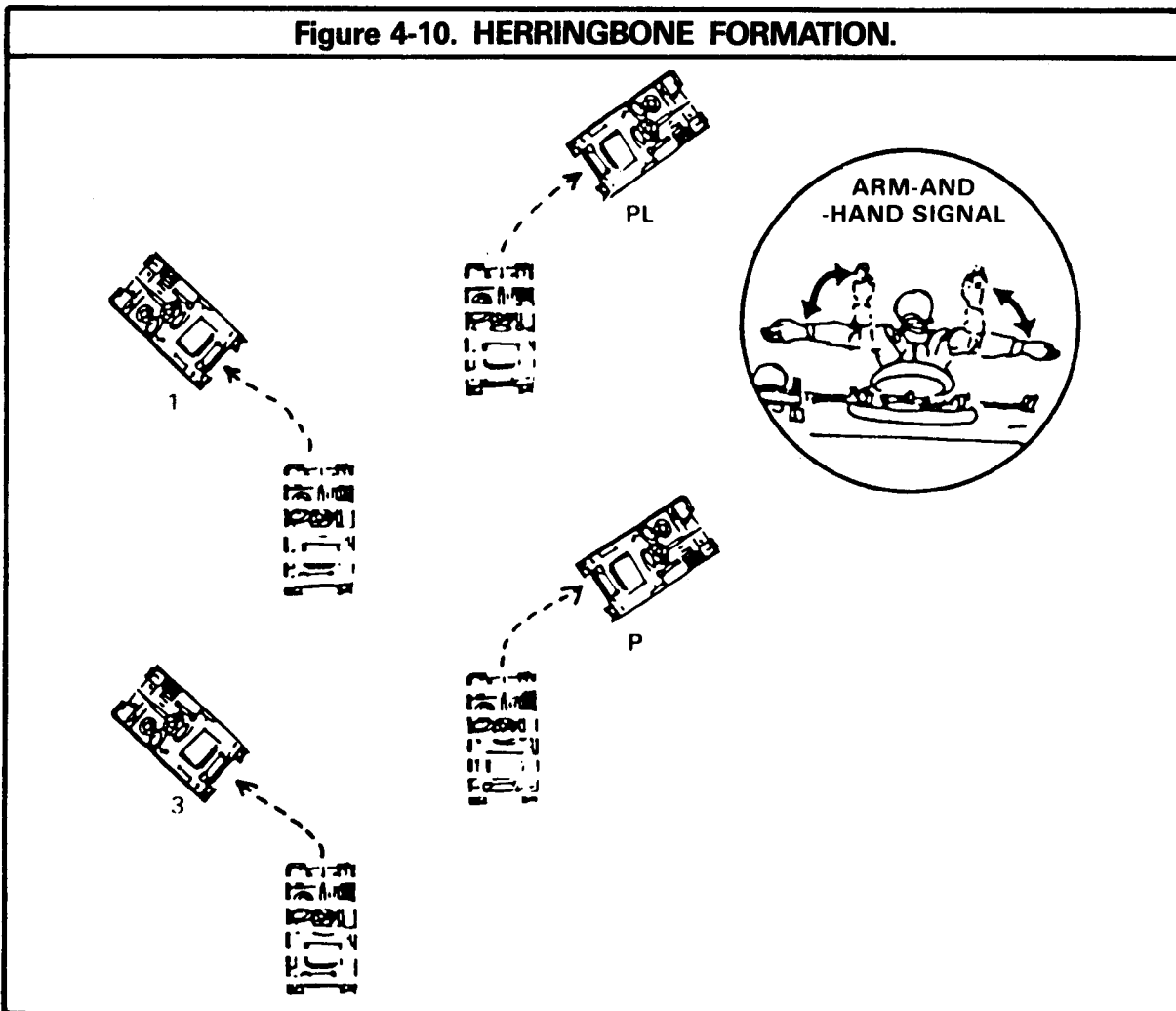
**Figure 4-9. WEDGE FORMATION.**



The wedge can be weighted to the right or left by dropping back one of the lead APCs. The trailing APC (right or left) would then key on the adjacent APC.

The **herringbone** formation is a battle drill formation used to disperse the platoon when traveling in column formation. It is used during air attacks or when the platoon must stop during movement. It lets the platoon move to cov-

ered and concealed positions off a road or from an open area and establish all-round security without detailed instructions being issued. The vehicles are repositioned as necessary and, as time permits, they take advantage of the best cover, concealment, and fields of fire. Dismount teams dismount and establish security during limited visibility or when more than a temporary halt is expected.



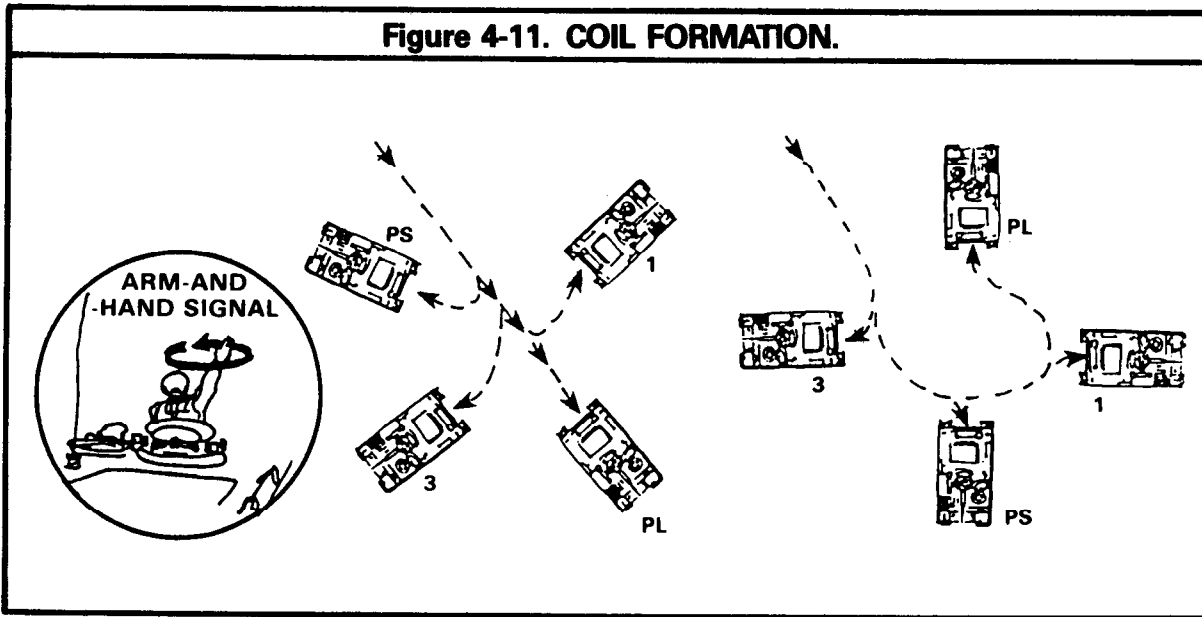
The **coil** is a stationary formation providing all-round security and observation. It is useful for tactical refueling, resupply and issuing platoon orders. Because it presents an easy target, it is not designed to be used for long periods during daylight. Security is posted to include airguards and dismount teams. The caliber .50 machine guns are manned. There are two methods to form a coil:

(1) In the first method, when visibility is limited, it is easier for the platoon leader to form the coil by leading his platoon in a circle. When

the circle is complete, all vehicles stop, turn 90 degrees outward, and post security.

(2) The second method is done by the platoon leader signaling, quickly moving his vehicle into position, and stopping. The other vehicles move directly to their assigned positions, as stated in the platoon SOP, seek cover and concealment, and post security. This technique is used during daylight or whenever speed is essential. When the platoon is operating within a company a company coil will be formed in the same manner. Each platoon is responsible for the security of a designated sector of the company coil.

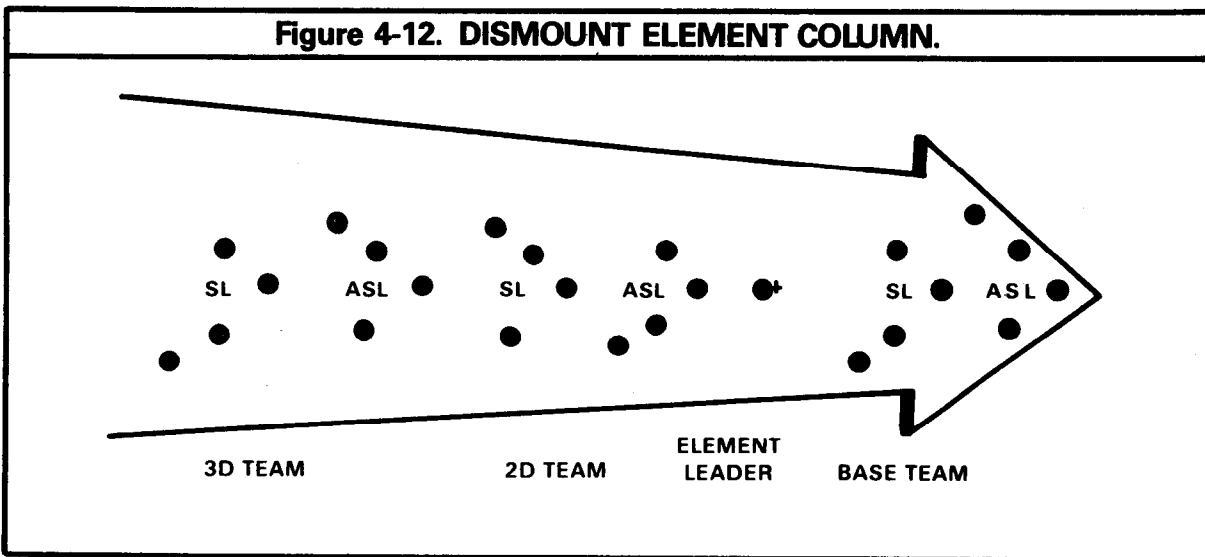
**Figure 4-11. COIL FORMATION.**



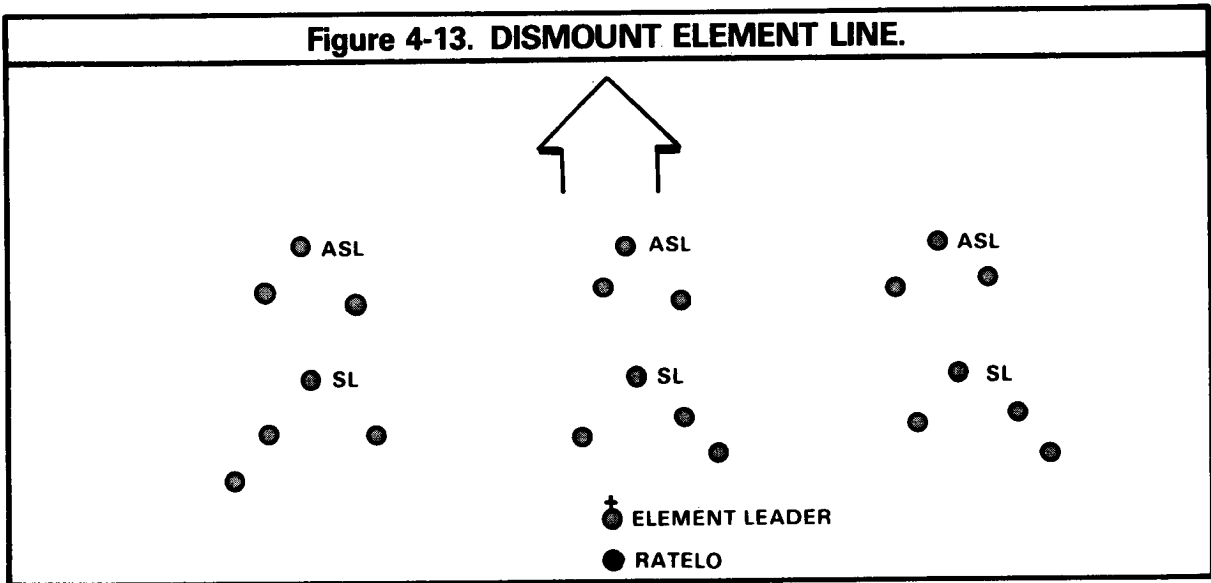
The dismount element is normally organized with three dismount teams and an element leader who is usually the platoon leader or the platoon sergeant. The dismount element uses five basic formations: column, line, echelon, vee, and wedge. No matter which formation is used or the organization of the dismount element, the carrier element, whenever possible, should be in position to support the dismount element.

The dismount element **column** is the primary movement formation. There is good dispersion in depth, and control is eased. This formation can deliver a limited volume of fire to the front and a high volume to the flanks. The base team is the lead team. The other teams guide on the base team.

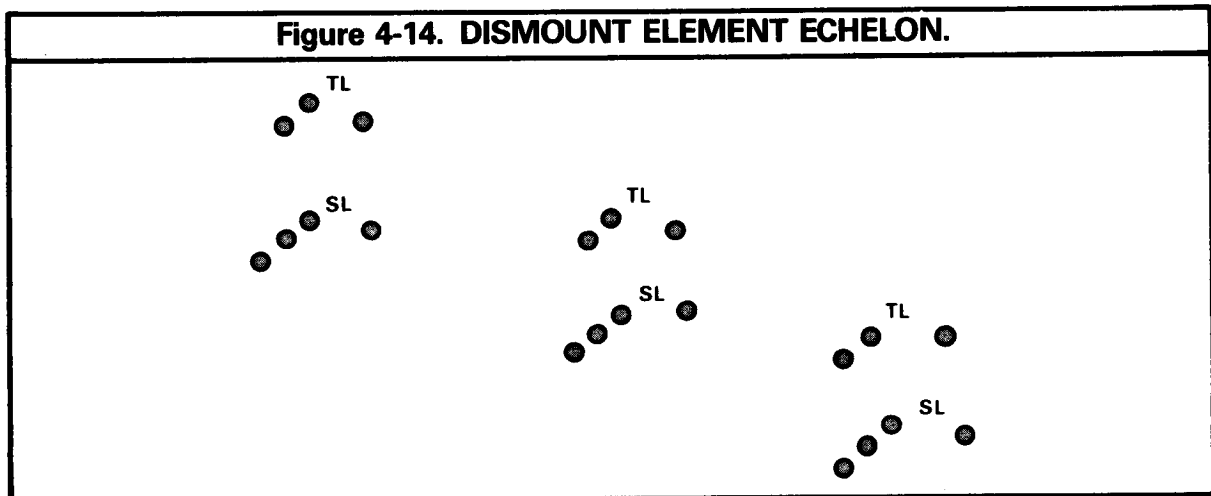
**Figure 4-12. DISMOUNT ELEMENT COLUMN.**



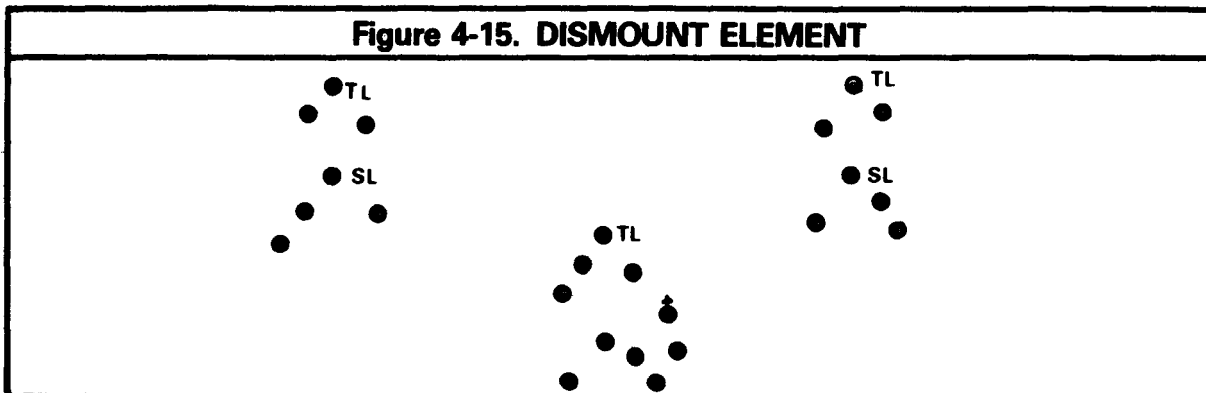
The dismount element **line** is the basic assault formation. It provides good lateral dispersion. In this formation, the dismount element can deliver the greatest amount of fire to the front. The element leader designates a base team that the other teams base their movement on.



The dismount element echelon gives excellent firepower to the front or to the right or left flank. It is normally used when a platoon is covering an exposed flank.

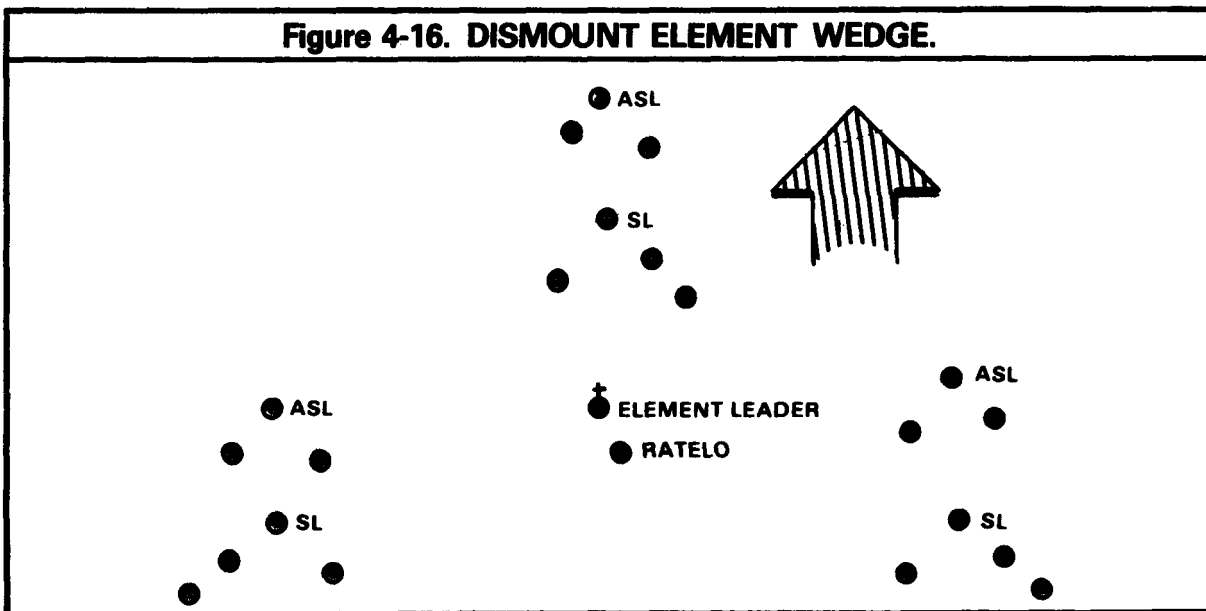


The dismount element **vee** is used when the enemy situation is vague and the platoon leader requires firepower to the front and on the flank.



The dismount element **wedge** is used when the enemy situation is vague. This formation permits a large volume of fire to the front and flanks. It will usually insure that at least one

team will be free to maneuver when contact with the enemy is made. The lead team is normally the ham team.



### Section III. MOVEMENT TECHNIQUES

#### 4-6. GENERAL.

In many cases, a unit moving on the battlefield, when not in contact, encounters the enemy

at a time and place of the enemy's choosing. To offset the enemy's advantage, movement techniques must be used that will cause initial contact to be made with the least number of men and vehicles. This means that the smallest force will be leading. The rest of the unit should be in position to provide suppression or fire and movement in support of the force that makes contact. One APC normally leads the platoon when mounted, and one dismount team leads the dismount element when dismounted.

Because the APC can move rapidly while conserving the infantrymen's strength and reducing their exposure to chemical and radiological contamination, as well as small arms fire and artillery shrapnel, platoons and squads move mounted until one of the following apply:

**It is necessary to dismount in order to accomplish the mission.**

**It would be dangerous to continue mounted movement because of the enemy situation.**

**There is an advantage to be gained by dismounting.**

Likelihood of contact is divided into three categories. From the least chance of contact to the greatest, they are: not likely possible, and expected. The platoon should change its formation and adjust its movement technique to fit the likelihood of contact. For ease of reference, the movement technique used for each likelihood of contact is as indicated:

LIKELIHOOD OF CONTACT	MOVEMENT TECHNIQUE
Not likely	Traveling
Possible	Traveling Overwatch
Expected	Bounding Overwatch

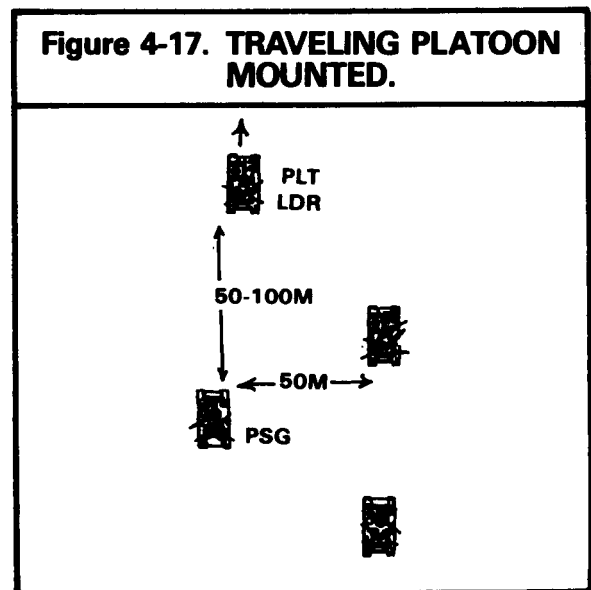
The formations discussed in section II are used with these movement techniques. The formations are not rigid. Distances between dismount teams and carrier teams vary based on terrain and visibility. As terrain becomes more rugged, or as vegetation becomes dense, or if

visibility is reduced, the distances between teams is shortened. Leaders stay in visual contact with the team to their front. The man in the back of the cargo hatch keeps visual contact with the vehicle to his rear and informs the TL if he loses contact. With each team watching its front and rear, the platoon should be able to move using only arm-and-hand signals for control. The platoon should habitually practice orienting their caliber .50 machine guns so as to have all-round security. The lead APC orients to the front, the second to the right, the third to the left, the fourth to the rear. Traveling techniques are used when speed is important and contact with the enemy is not likely.

#### 4-7. TRAVELING TECHNIQUE WITH PLATOON MOUNTED

The platoon moves in a column formation, staggered laterally with intervals of 50 to 100 meters between vehicles. Caliber .50 machine guns are oriented for all-round security. The platoon leader normally leads since contact is not likely and speed is essential. The platoon sergeant's vehicle is where he can see the platoon leader and help control the other two vehicles. The column formation is common to the traveling movement technique.

**Figure 4-17. TRAVELING PLATOON MOUNTED.**

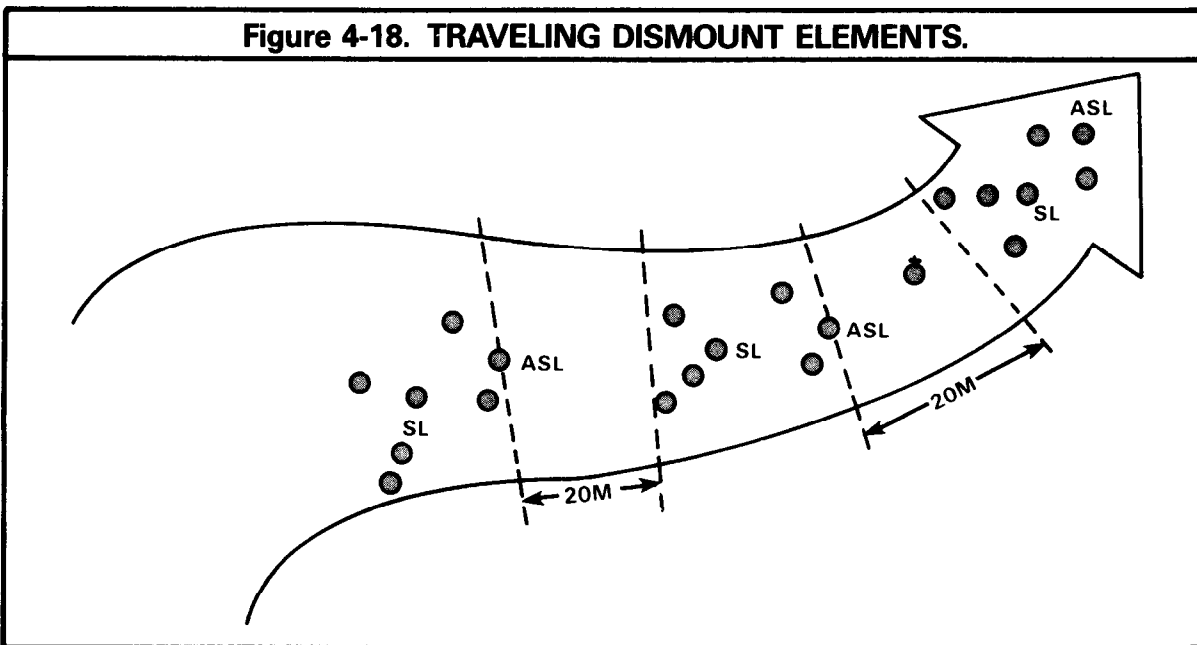


**4-8. TRAVELING TECHNIQUE WITH PLATOON DISMOUNT ELEMENT DEPLOYED**

This technique is not used often since, when contact is not likely the platoon normally remains mounted. Sometimes the platoon has missions that require the dismount element to operate on foot. Since the platoon with its dismount element deployed is harder to control than a mounted platoon, the platoon leader of-

ten will move with the dismount element. The platoon sergeant usually is with the carrier element when the platoon leader is dismounted. If the platoon leader opts to remain mounted, the platoon sergeant dismounts and controls the dismount element.

**Figure 4-18. TRAVELING DISMOUNT ELEMENTS.**



The element's formation is adjusted to fit the situation. Squad leaders normally move near the head of their dismount teams where they have better control and from where they can see the platoon leader or platoon sergeant. When possible, the carrier element should be in position to support the dismount element.

**4-9. TRAVELING OVERWATCH TECHNIQUE**

Traveling overwatch is used when enemy contact is possible but not expected. This technique provides more time and distance in which to react if the lead force makes contact with the enemy.

The distance between the lead force and the

overwatch force varies with terrain. If control can be maintained and the leading force supported, distances should be increased. If the terrain becomes more rugged, or the vegetation becomes dense, or the visibility decreases, then the distance should be decreased and the formation changed as necessary. Although caution is called for, speed is desirable.

**4-10. TRAVELING OVERWATCH TECHNIQUE WITH PLATOON MOUNTED**

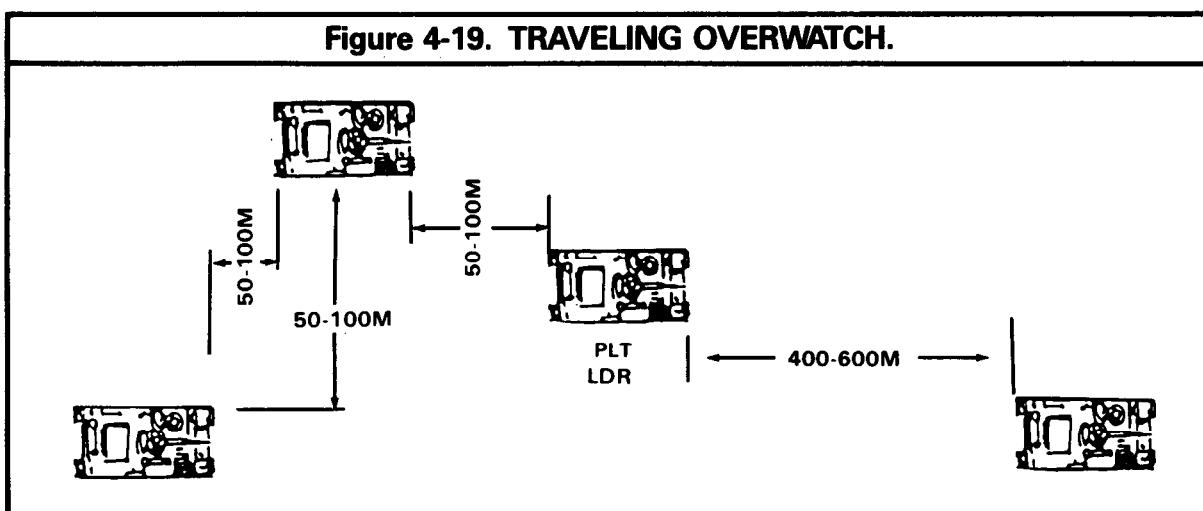
A platoon in traveling overwatch moves in a column, wedge, vee, or echelon formation. With this technique and using the column formation,



the platoon leader takes the second position and sends one vehicle 100 to 400 meters in front of the rest of the platoon. (As noted earlier, the platoon leader may move with two sections — one under his control, the other controlled by the platoon sergeant.) Movement of the whole platoon is continuous, and cover and concealment is used. The trailing or overmatching carriers key their action to the lead carrier or section and vary their rate

of movement as required to maintain the desired interval. Visual contact between the overwatching vehicles and the lead vehicle or section must be maintained. The lead APC or section may have to reduce its speed if the overmatching vehicles cannot keep up. The squad leader in the lead vehicle should be the one to keep the platoon leader in sight and direct the movement of the APC according to the platoon leader's signals.

**Figure 4-19. TRAVELING OVERWATCH.**



#### 4-11. TRAVELING OVERWATCH WITH PLATOON DISMOUNT ELEMENT DEPLOYED

The dismount element normally uses a column or wedge formation. The lead team tries to move at least 50 meters, but preferably 100 meters or more, in front of the rest of the element. The carrier element may be even farther to the rear or to a flank but should be in position to overwatch the dismount element, mainly its lead team.

Dismounted traveling overwatch is rarely used. As stated earlier, when the platoon is not in contact and has to move on the battlefield, it moves mounted unless forced to dismount. In most dismounted situations, more deliberate movement and greater caution are required.

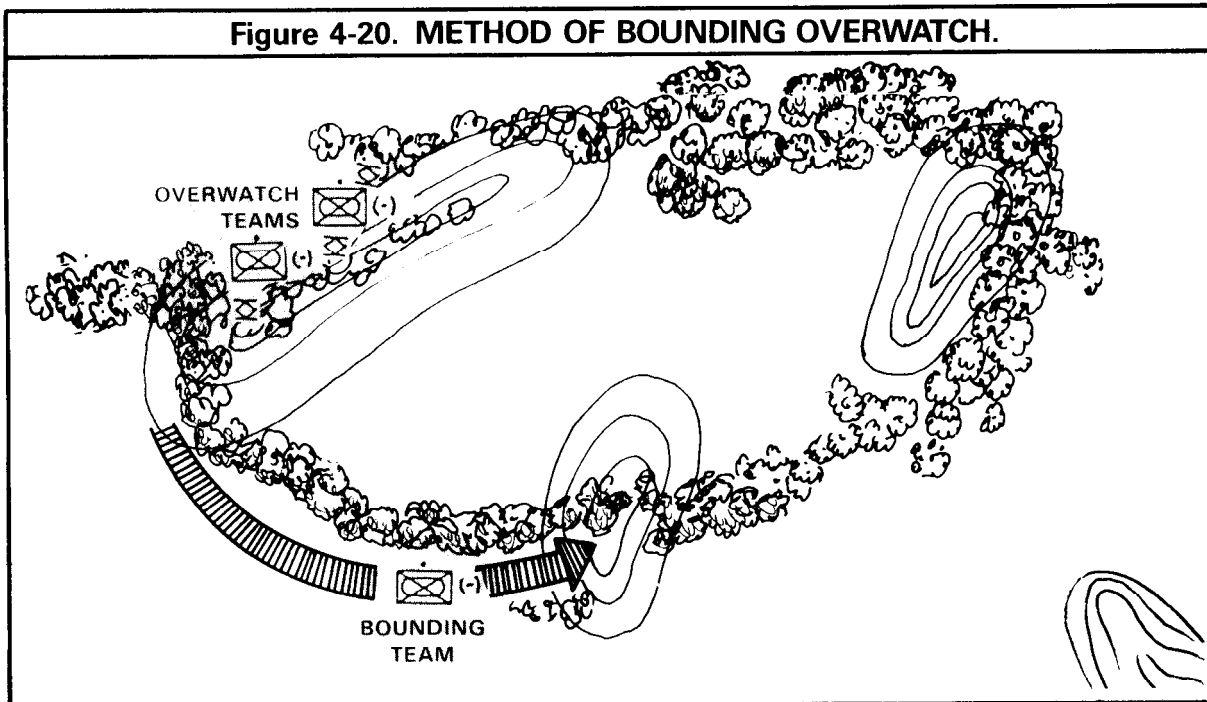
#### 4-12. BOUNDING OVERWATCH

Bounding overwatch is used when contact is expedited. This is the most deliberate and cautious of all movement techniques. (There are two ways to execute bounding overwatch — alternate and successive.) The overwatch force covers the progress of the bounding force from a covered and concealed position which offers good observation and fields of fire against likely enemy positions. If the bounding force makes contact, the overwatch time must be able to render immediate support by providing suppression or fire and movement. The bounding force moves forward to a preselected position while covered by the overwatch force. When it reaches the new position, it secures

the location so that the overwatch force can move forward. The length of each bound is tied closely to the range of weapons, observation, and fields of

fire of the overwatch force. Bounding overwatch will normally lead into maneuver (see section IV).

**Figure 4-20. METHOD OF BOUNDING OVERWATCH.**



The vehicles in the overwatch force should follow the platoon or company SOP for weapons-ready posture. For example, one APC might have its Dragon ready for firing with the other two carriers prepared to fire the caliber .50 machine gun. Each gunner should be prepared for immediate engagement. This arrangement insures that the overwatch force can provide immediate and accurate fire support with the proper weapon and ammunition. This can be adjusted to fit the enemy situation, terrain, and availability of ammunition, and missiles.

All overwatch forces have basically the same tasks:

**Be able to support the bounding force with direct fire using the prescribed weapons-ready posture.**

**Be able to maneuver in support of the bounding force.**

**Have the capability of calling for indirect fire. (It is essential that the platoon leader position his APC so that the forward observer has a good view of the bounding APC or the dismount element.)**

**Cover the flanks and rear as well as the front of the bounding force.**

**Have concealed, protected positions.**

The overwatch force must be controlled by one man (normally the platoon leader), for ease of control and fire distribution. He must have direct communication with the bounding force (in many cases this will be visual).

When the platoon is bounding or when it is overmatching another unit, the platoon leader assigns each squad a sector to cover by observation and, if necessary to cover by fire. Sector identifi-

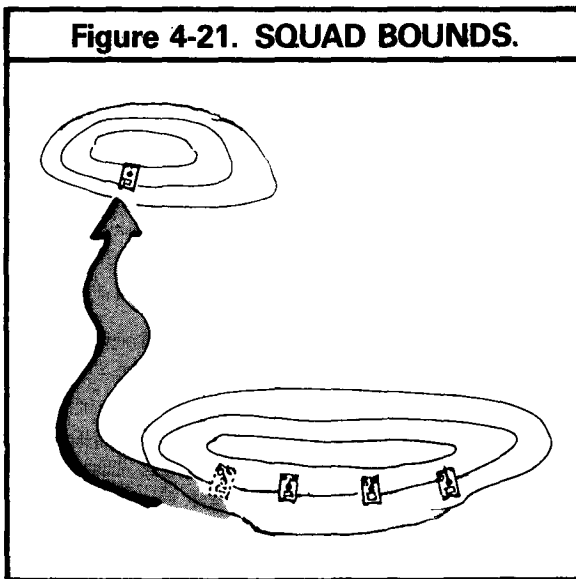
cation may be by specific area, by target reference points, or the platoon may have an SOP (such as the clock system) to denote squad responsibility.

**4-13. BOUNDING OVERWATCH TECHNIQUE WITH PLATOON MOUNTED**

When the platoon uses mounted bounding overwatch, one or two vehicles may bound while the others overwatch from a stationary position in a line or wedge formation. When the new position is reached, the bounding squad(s) may dismount enough men and weapons for local security. If the new position is relatively open, the bounding squad(s) may not need dismounted personnel to secure the position. As soon as the position is secured, the bounding squad(s) covers the rest of the platoon as they move forward. The process is repeated for subsequent moves.

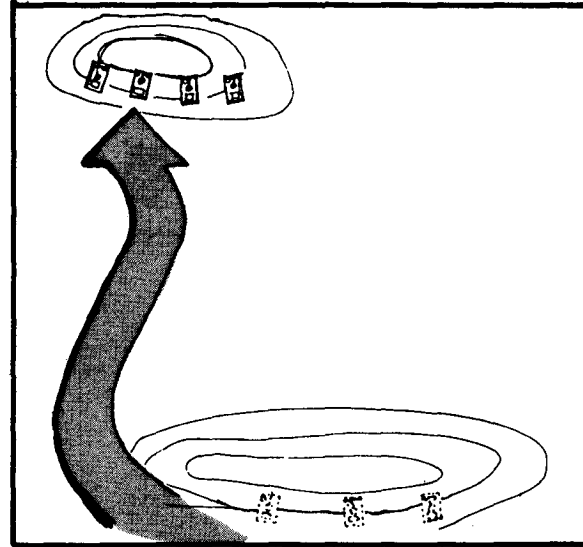
Example of how a platoon might conduct mounted bounding overwatch with one or two squads.

One squad bounds, as platoon overwatches.



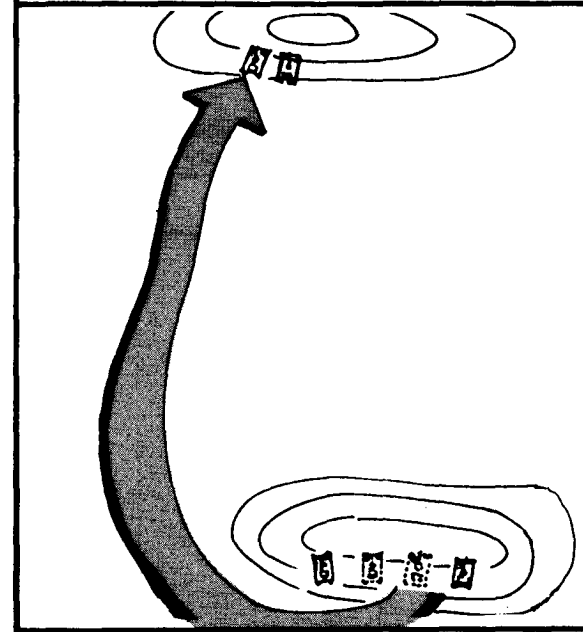
The bounding squad secures the next position and covers the platoon as it moves forward. The platoon leader then issues orders for the next bound.

**Figure 4-22. PLATOON ADVANCES.**

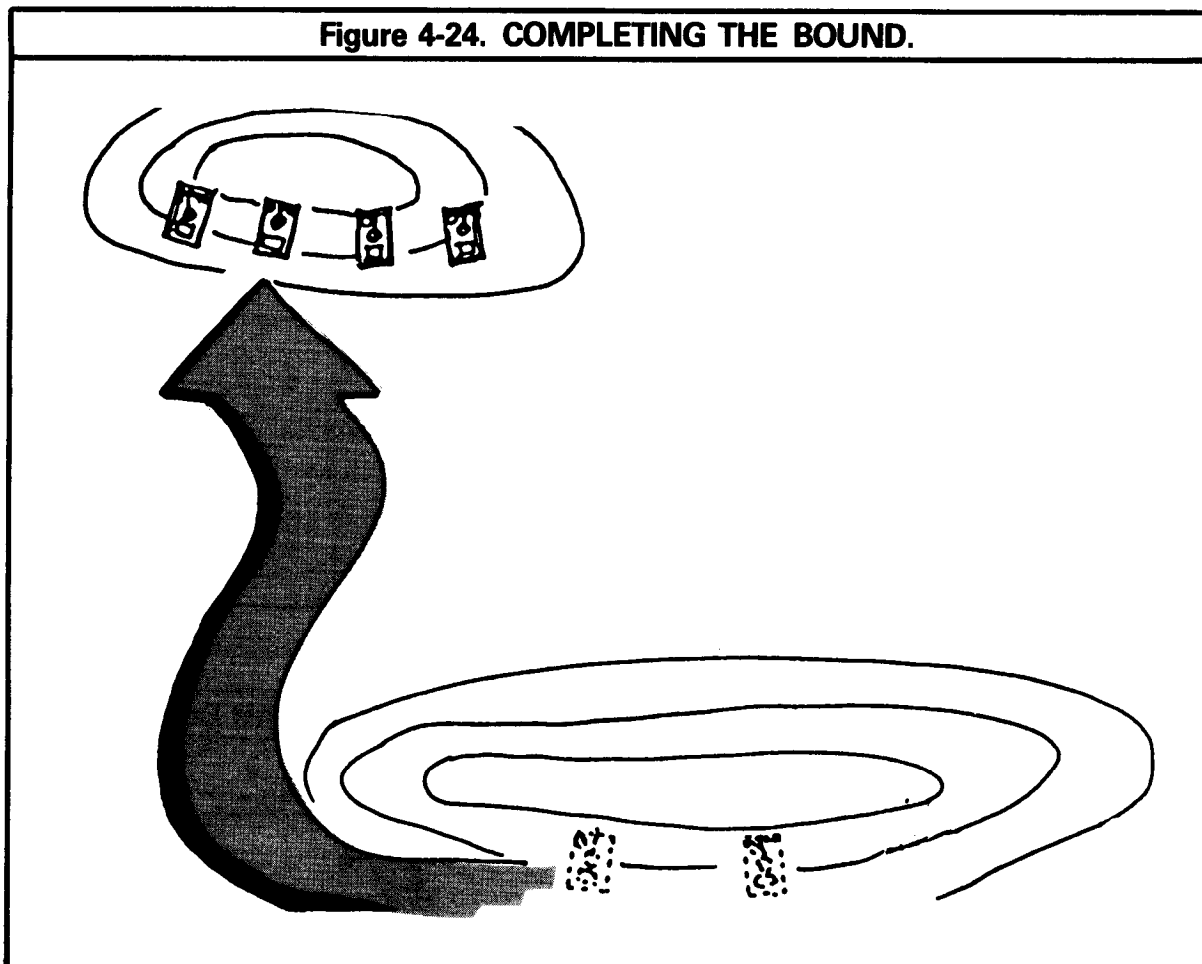


Two squads bound, as platoon overwatches.

**Figure 4-23. SQUAD BOUNDS.**

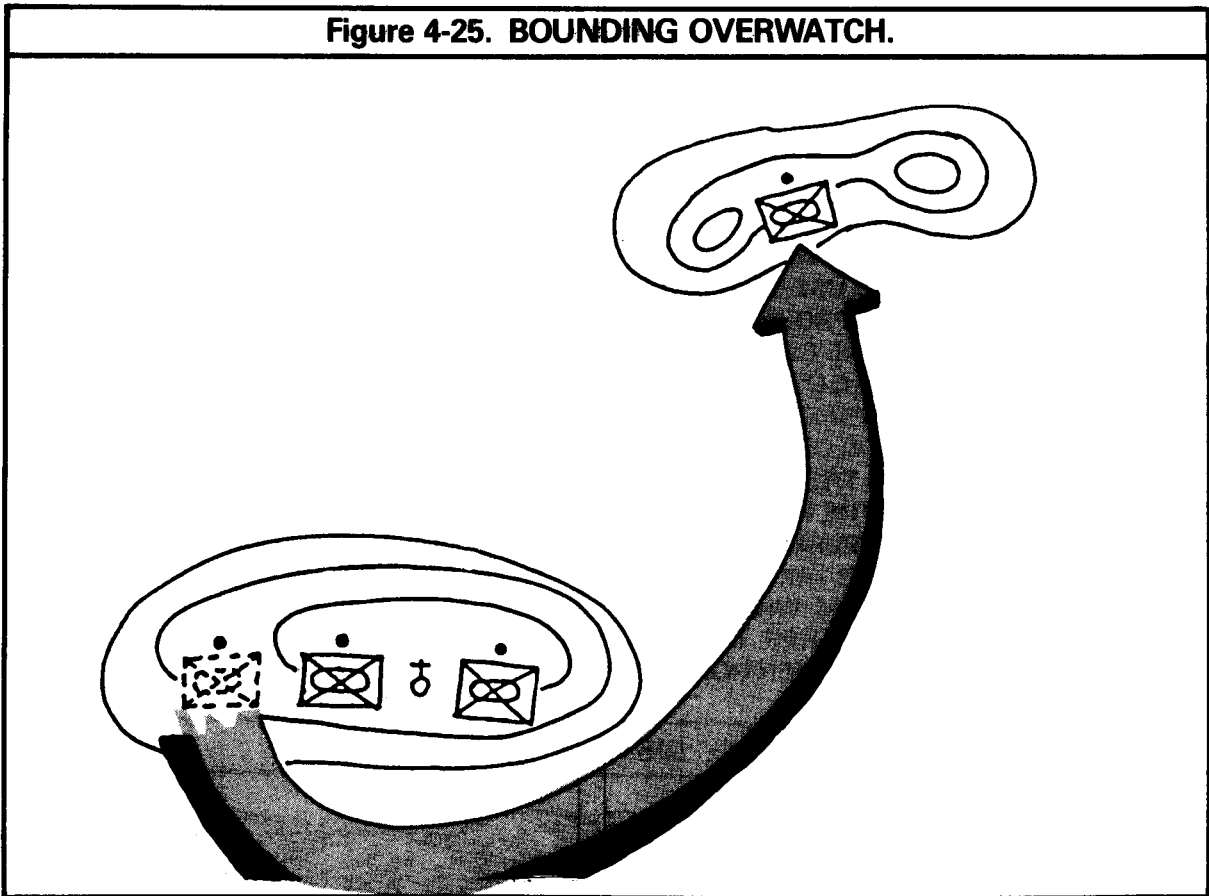


The bounding squads secure the next position and cover the advance of the remaining carriers. Orders are then issued for the next bound.

**Figure 4-24. COMPLETING THE BOUND.**

#### **4-14. BOUNDING OVERWATCH TECHNIQUE WITH PLATOON DISMOUNT ELEMENT DEPLOYED**

When contact is expected and the terrain will not permit mounted movement or when the dismount element is separated from the carrier element, the platoon bounds with the dismount element deployed. This is done like mounted bounding Overwatch except that the length of the bound is reduced because the dismounted weapons have shorter ranges than the APC's mounted weapons and because of the reduced speed of reaction of dismounted troops. The bounding team uses two wedges while the Overwatch teams normally use variations of the line or wedge formation.

**Figure 4-25. BOUNDING OVERWATCH.**

The carrier element should be placed where it can overwatch the dismount element. To do this, the carrier element may have to use some form of bounding overwatch. It normally uses a variation of the line formation to overwatch the bounding APCs.

#### **4-15. ORDERS FOR MOVEMENT**

Regardless of the movement technique to be used, the platoon leader should give the platoon an order which explains what each squad is to do. This becomes more critical as the chance for enemy contact increases.

Before using bounding overwatch (mounted or dismounted), the platoon leader must be sure that the bounding force and the overwatch force know exactly what to do. The platoon leader must give clear and complete orders. When pos-

sible, this is done from the position that he intends to use for the overwatch. He should tell them and show them:

**The enemy situation as he knows or suspects it to be.**

**The next overwatch position (objective for the bounding force).**

**The route of the bounding force to that position.**

**The positions and sectors of responsibility of the overwatch force.**

**What the platoon leader intends to do after the bounding force gets to the next position.**

**Sectors of fire and target reference points.**

Here is an example of a platoon leader's oral order:

"I EXPECT CONTACT IN THIS AREA, SO WE WILL MOVE MOUNTED AND USE BOUNDING OVERWATCH. THE ENEMY PROBABLY HAS ARMORED VEHICLES ON ONE OF THE HILLS TO OUR FRONT. 1ST SQUAD, MOVE MOUNTED THROUGH THE TREELINE TO OUR RIGHT FRONT AND GUIDE ALONG THE LEFT OF THE CREEK. CHECK OUT THE HILL TO OUR FRONT — THE ONE WITH THE FARMHOUSE. IF YOU DO NOT MAKE CONTACT, DEPLOY YOUR DISMOUNT TEAM AND TAKE UP A POSITION ON THAT HILL FROM WHICH YOU CAN COVER THE HILL FARTHER TO OUR FRONT. PAY PARTICULAR ATTENTION TO

THE AREA AROUND THE FARMHOUSE. WE WILL COVER YOU FROM HERE USING A LINE FORMATION UNTIL YOU SECURE YOUR POSITION. AFTER YOU ARE SET UP WE WILL FOLLOW THE SAME ROUTE YOU TOOK AND JOIN YOU. PLATOON SERGEANT WITH THE 2D SQUAD, YOU WILL BE TO MY LEFT. YOU WILL COVER FROM THE FARMHOUSE LEFT TO THE TREELINE. PREPARE TO FIRE THE DRAGON AND WATCH FOR ARMORED VEHICLES ON THE FAR HILL. 3D SQUAD, YOU WILL BE ON MY RIGHT. I WILL BE IN THE CENTER, ABOUT HERE. I WILL COVER THE TREELINE AND CREEK AREA. WHEN WE MOVE FORWARD, I WILL LEAD WITH 2D AND 3D SQUADS FOLLOWING IN THAT ORDER. ARE THERE ANY QUESTIONS? MOVE OUT."

Figure 4-26. DISMOUNT ELEMENTS.



With well-trained platoons and squads, leaders should be able to give almost all orders for

movement techniques by pointing and using arm-and-hand signals.

#### 4-16. MOVEMENT TECHNIQUES AS A PART OF THE COMPANY OR COMPANY TEAM

When the platoon is moving as a part of the company or company team, the entire platoon may be the bounding force. The platoon may also serve as all or part of the company or company team overwatch force.

When the platoon is the company bounding force, it may bound mounted or dismounted. If mounted, the platoon normally uses a combination of traveling overwatch and bounding overwatch techniques within the platoon. If deployed, the dismount element normally uses bounding overwatch. The platoon has more freedom to maneuver than when operating independently because the remainder of the company or company team is in overwatch. When the dismount element is bounding, the company or company team commander may direct the carrier element to remain with the company overwatch force. But, if he does not specify, the platoon leader will position the carrier element to best support the bounding dismount element.

#### 4-17. MOVEMENT WITH TANKS

In a company team, mechanized infantry platoons often operate with tank platoons. Each has weaknesses that the other can compensate for. So, they move together always prepared to support each other.

When terrain and visibility permit mounted movement, tanks normally lead followed or overwatched by infantry.

The dismount element will lead, overwatched by the carrier element and the tanks, when:

Obstacles prevent mounted movement and they cannot be bypassed.

Close terrain (such as an urban area, a forested area, or a defile) cannot be bypassed.

Visibility is limited. (This will often

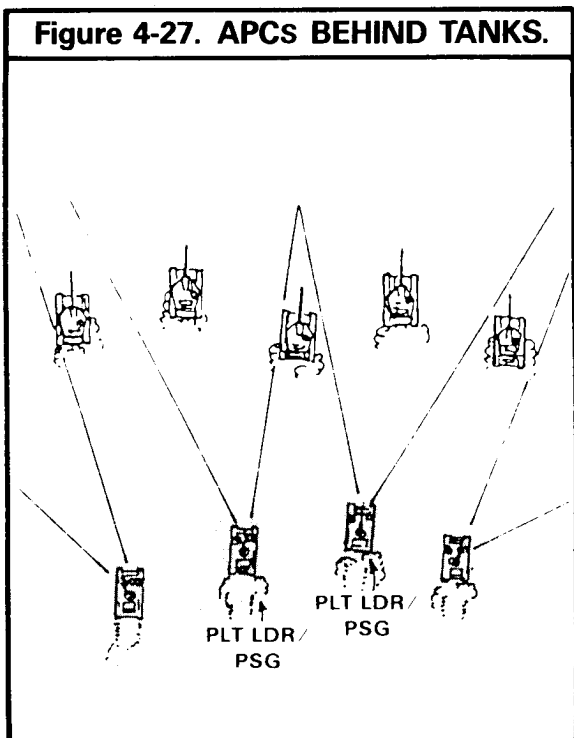
be the case even with the limited visibility devices on both the APC and the tank.)

The infantry usually leads mounted to cross a body of water that the tanks cannot ford. Infantry may also lead mounted when the company team is nearing a heavily wooded area that must be cleared by dismounted infantry before tanks move through it. This is done to facilitate the frequent dismounting necessary to clear the wooded area.

#### 4-18. HOW THE PLATOON MOVES WHEN TANKS LEAD

When the company team is using traveling or traveling overwatch techniques, its commander will tell the platoon where it should move and how far to be behind the tanks. Normally the platoon will use the traveling technique which calls for following the tanks close enough to shoot between them and to their flanks with the caliber .50 machine gun and other squad weapons. The platoon normally moves 200 to 400 meters behind the tanks to avoid fire directed at the tanks. In close terrain, the platoon may have to move closer to the tanks to protect them from enemy infantry and antiarmor weapons.

When the company team is using bounding overwatch a tank platoon is usually the bounding force overwatched by Dragons, APCs, ITVs, and in some cases, by other tanks. When overwatching tank the platoon must observe to the tanks, flanks, and front. Tankers have difficulty seeing behind them, so one of the platoon's primary jobs is to protect the tank's rear and flanks from enemy infantry attack. The platoon must be alert for enemy ATGMs and rocket-propelled grenades (RPG). If a squad sees an ATGM fired, it should immediately fire its caliber .50 machine gun and SAWs at the base of the smoke trail left by the enemy missile. Also, it should send a warning over the radio.

**Figure 4-27. APCs BEHIND TANKS.**

#### 4-19. HOW THE PLATOON MOVES WHEN IT LEADS TANKS

The mounted platoon will seldom lead tanks. Usually the platoon will deploy its dismount element and lead dismounted to overcome obstacles, to move through close terrain, or when visibility is limited.

When an obstacle hinders mounted movement, the dismount element dismounts to clear, breach, or find a way around. To get to the obstacle, it usually moves using bounding overwatch, while the carrier element is positioned to support the dismount element.

When visibility interferes with the company team movement mounted, the dismount element leads, overwatched by the carrier element and tanks. During poor visibility the dismount element may have to use traveling overwatch even though contact is expected. The lead dismount team moves as far forward as it can without breaking visual contact with the dismount element leader.

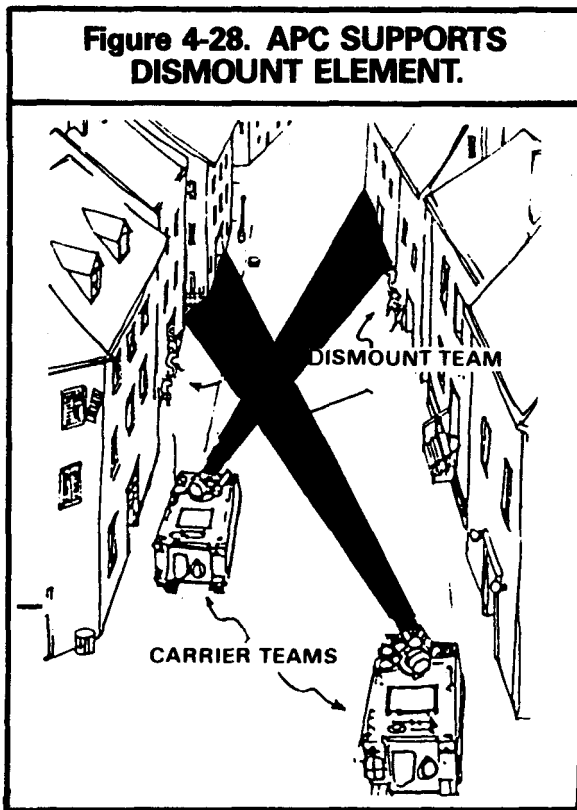
Fire control is difficult while moving during limited visibility. It can be done but only if the platoon has developed well-understood SOPs. Indirect fire illumination should not be relied on. It is slow and not very effective in smoke, fog, snow, dust, or heavy rain. Also, heavy rain reduces thermal sight range capability.

#### CAUTION

**WHEN THE DISMOUNT ELEMENT IS LEADING OVERWATCHED BY TANKS AND APCs, THE PLATOON LEADER MUST BE SURE THAT THE OVERWATCH FORCE KNOWS EXACTLY WHERE THE DISMOUNT ELEMENT IS, SO THAT THE OVERWATCH FORCE DOES NOT FIRE ITS WEAPONS INTO OR DIRECTLY OVER IT. PIECES OF METAL OR PLASTIC FALL OFF ROUNDS FIRED OVER THE DISMOUNT ELEMENT, DISMOUNTED INFANTRYMEN COULD BE ENDANGERED.**

When the infantry dismounts to lead through close terrain or urban areas, it must clear the way so that APCs and tanks can move through safely. The technique is modified to fit the situation. Because vehicle movement through a village or town is generally limited to streets, infantrymen must clear buildings along the way. The infantrymen move down a street in a modified column formation with dismount teams staggered along the street sides. The infantrymen move alongside or through the buildings, clearing each building as they advance. As it moves, each team makes sure that there are no enemy positions left in the buildings on its side of the street. Each team looks for enemy in the upper floors of the buildings on the other side of the street.





When a defile is such that it forces a unit to move single file, the dismount element should always deploy and clear it out beforehand. Common defiles for mechanized units are roads or trails across streams or through swamps and heavy forests. When clearing a defile, each side is cleared far enough from the chokepoint to make sure that there are no ambushes. The surface is checked for mines. This task usually requires the dismount element to move in a modified wedge formation with one dismount team forward and one on each flank. Since contact should be expected at defiles, the leading dismount teams use bounding overwatch.

In each situation where dismounted infantry leads APCs and tanks, the company team commander decides whether tanks or APCs move directly behind the dismount element. Tanks normally are preferred because they can deliver immediate, devastating fire and they have better armor protection than the APCs.

## Section IV. MANEUVER

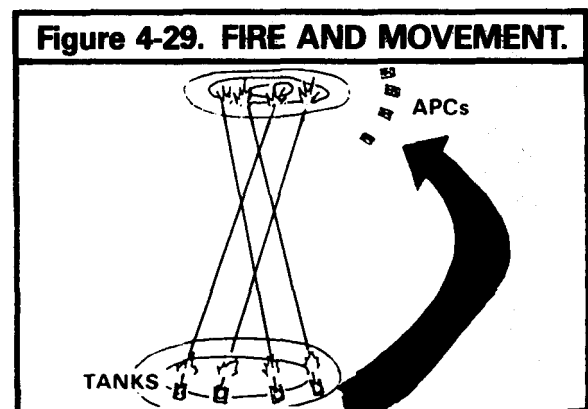
### 4-20. GENERAL

The method for moving when in contact is maneuver. Maneuver is defined as the employment of forces through movement. It is supported by fire to achieve a position of advantage from which to destroy or threaten destruction of the enemy. Maneuver is an immediate change from, and an extension of, the movement techniques described earlier.

### 4-21. HOW MANEUVER WORKS

Maneuver consists of two actions that take place at the same time. A base-of-fire element covers a moving force by firing at the enemy position, and the moving force moves forward to close with the enemy or to reach a better position from which to fire at the enemy. Depending on the distance to the enemy position and the amount of cover and concealment available, the base-of-fire element and the moving force switch roles as needed to continue maneuvering. Before advancing beyond the supporting range of the base-of-fire element, the moving force takes a position from which it can fire on the enemy and the base-of-fire element becomes the moving force. With the APC, the platoon can conduct mounted or dismounted maneuver.

The platoon leader may, when speed is essential, choose mounted maneuver. Tanks add their firepower, mobility and shock effect to the effectiveness of mounted maneuver.



Mechanized infantry platoons and squads will normally employ, or take part in, fire and movement under one of the following conditions:

**When in a company team with tanks leading and the tanks make enemy contact.**

**When in a company team with the platoon leading (mounted or dismounted) and the infantry makes enemy contact.**

**When fighting as part of a company with no tanks attached. (Platoon may be leading or overmatching, mounted or dismounted, when contact is made.)**

In each condition described above, the platoon will be in the company or company team base-of-fire element, or it will be the moving force. When it is the moving force, the platoon may use its squads to carry out fire and movement to advance. If the dismount element is deployed, the platoon leader will normally use the carrier element as the base-of-fire element in support of the moving dismount element. Each dismount team uses fire and movement within the wedges. If the platoon is mounted, it may move by squad or by section (two vehicles). The rest of the platoon serves as the base-of-fire element while the movement force moves.

#### 4-22. TECHNIQUES OF FIRE

The base-of-fire element uses its fire to cover and protect the advance of the moving force. Whenever possible, the base-of-fire element should move undetected into a firing position. A high volume of surprise fire has a greater effect than fire delivered from a known position.

When the base-of-fire element is in position, the following usually takes place:

**A heavy volume of fire is placed on the enemy position to destroy or suppress it.**

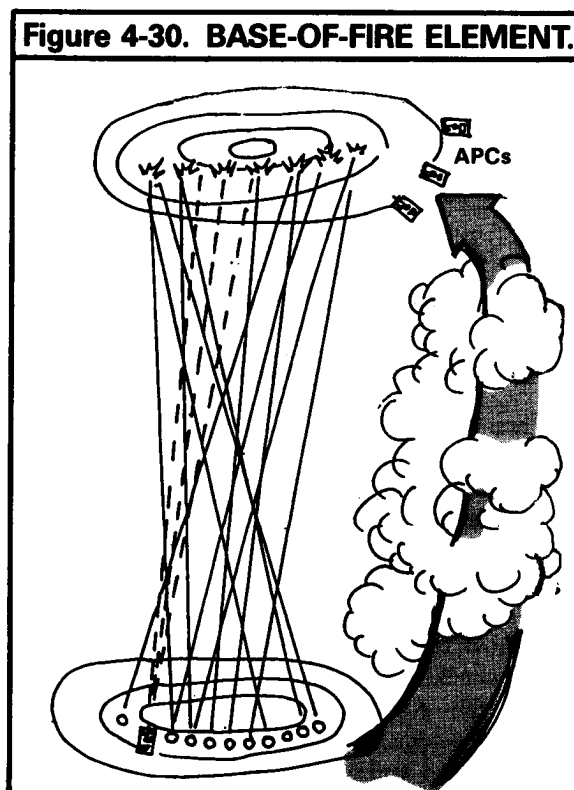
**When the enemy position is sup-**

**pressed, the rate of fire is reduced. However, suppression continues.**

**When the moving force nears its objective, the rate of fire is increased to keep the enemy down. This lets the moving force assault the position before the enemy can react.**

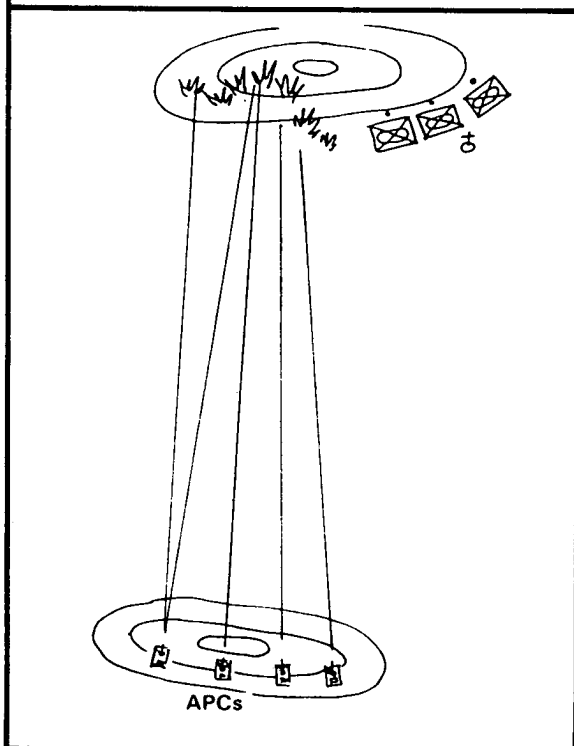
Either on signal or when the assault begins, the base-of-fire element will cease fire, shift its fire to another target area, or, more desirably "walk" its fire across the objective in front of the moving force and then shift or cease its fire.

**Figure 4-30. BASE-OF-FIRE ELEMENT.**



Positions for the base-of-fire element should be selected so that the moving force does not mask the supporting fires. For this reason, selected base-of-fire-element positions are often elevated and to the flank of the moving force. The moving force should neither mask the fire of the base of fire nor move outside its protection.

**Figure 4-31. APC SUPPORTING FIRES.**



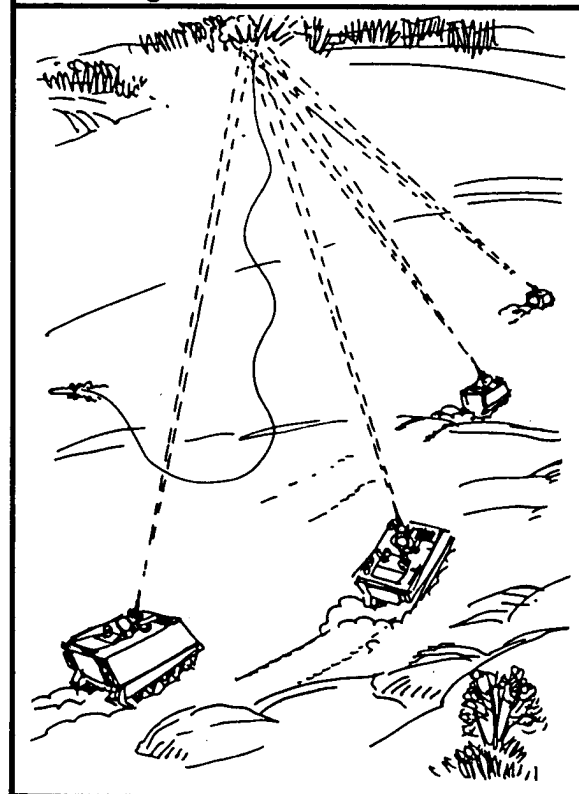
Effective fire on the enemy is the key to forward movement. Suppressive fire is placed on the enemy to keep him from firing at the moving force.

The platoon or squad can concentrate or distribute its fire. In either case, the fire must be controlled. The fire must be directed at the enemy and not endanger the moving force.

The base-of-fire element can deliver two types of fire in support of the moving force.

**Point fire.** Point fire is directed against a specific identified target, such as a machine gun or ATGM position. All weapons are fired at the target. Spreading out the fires of the base-of-fire element aids in point fire because the fire is directed from multiple directions. Point fire is not often used, since the platoon seldom encounters a single, clearly identified enemy weapon.

**Figure 4-32. POINT FIRE.**



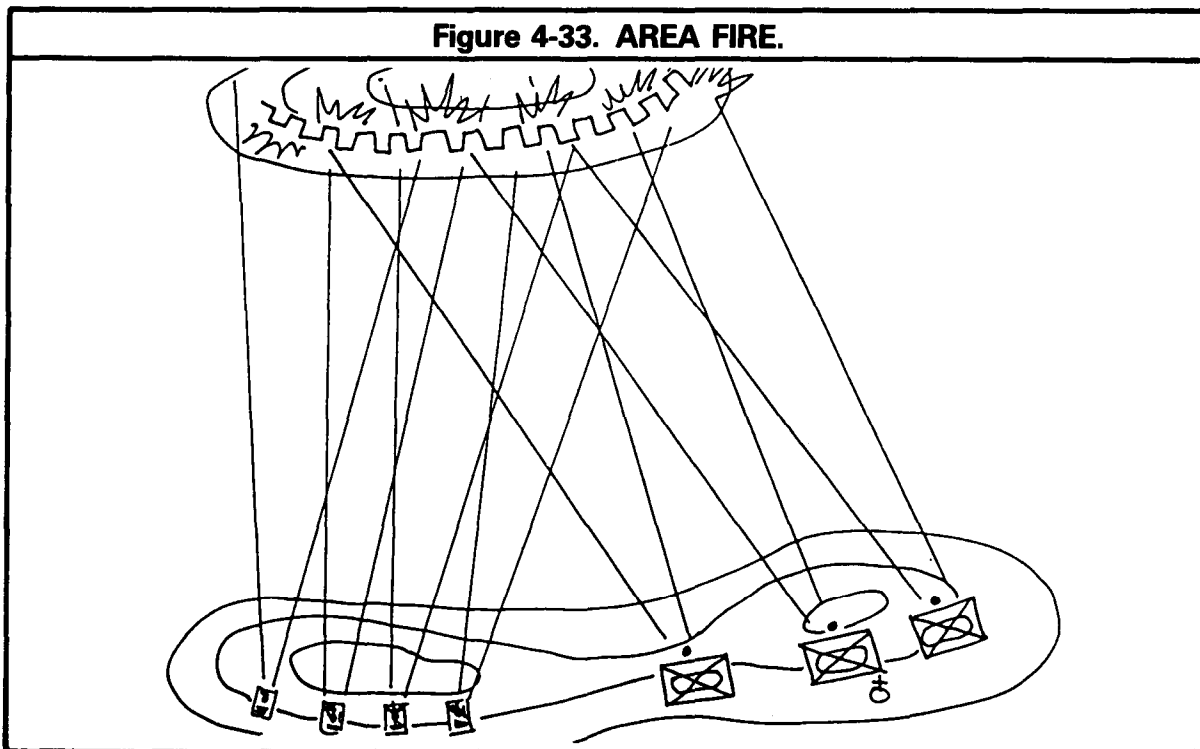
Area fire. Area fire is distributed over an area when enemy positions are more numerous or less obvious. Each weapon in the base-of-fire element is given a specific sector of the target area to fire into. This is done to insure that the entire target area is covered by fire and observation.

When the carrier element is in the base-of-fire element, the element leader will mark or identify the target area by oral order or by tracer fire. Each of the other three carrier teams covers one-third of the target area corresponding to its position in the base-of-fire element — left, middle, or right. The element leader will not cover a specific part of the target area. He will observe and control the fire of the other three vehicles and fire only at targets of opportunity if he can observe the entire objective. However, the terrain may force the carrier element leader to cover a specific part.

Fire is distributed in width and depth to keep all parts of the target under fire. Fire is placed on likely enemy positions rather than into a general area. Each carrier gunner and dismounted infantryman fires his first shot on that part of the target that corresponds to his relative posi-

tion in the base-of-fire element. For example, if he is left of his leader, he fires left of his leader's tracers. He then distributes his remaining shots over that sector of the target assigned several meters to the right and left and front and rear of the first shot.

**Figure 4-33. AREA FIRE.**



When a dismount team or dismount element is a part of the base-of-fire element, each machine gunner should cover his entire team's target. When placing machine gun suppressive fire on the enemy the tendency is to shoot high, so initial bursts should be placed low and then worked up to the target.

Area fire permits the base-of-fire element to rapidly cover an entire target area, even if the enemy cannot be seen. Area fire is the quickest and best way to bring all parts of a target under fire.

#### **4-23. METHODS OF FIRE AND MOVEMENT (MANEUVER)**

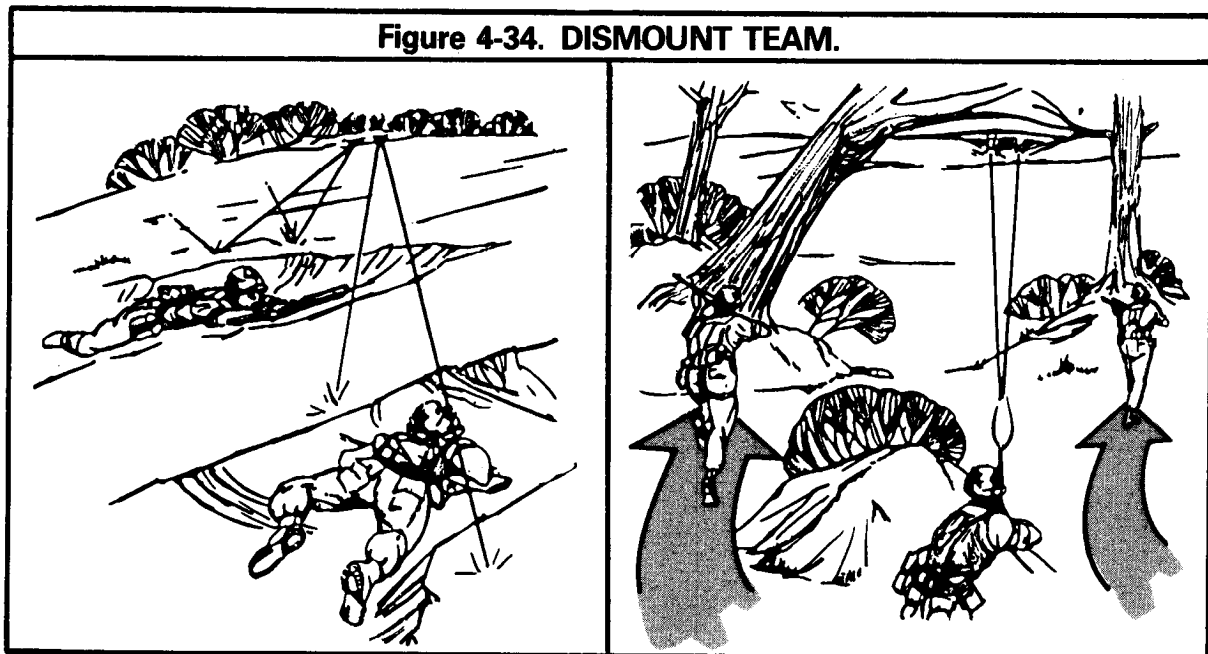
When a Dragon is in the base-of-fire element, the antiarmor specialist stays under the dismount team's direct control. He fires the Dragon at important targets only such as enemy armored vehicles and key weapons. The platoon leader or platoon sergeant may keep one of the squad Dragons under his direct control. In the absence of appropriate Dragon targets, the antiarmor specialists will fire their rifles.

The moving force (mounted or dismounted) advances covered by the base-of-fire element. The method of moving depends chiefly on enemy reactions. When under enemy fire, the moving force moves using fire and movement internally. For example, one man advances while his buddy covers. If it is not receiving direct fire, the mov-

ing force can move using bounding Overwatch or, to be safe, it can maneuver internally.

How members of a dismount team move depends on the intensity of enemy fire. Crawling may be called for when a moving dismount element faces intense enemy fire and there is little cover. Soldiers use the low or high crawl depend-

ing on the situation, the requirement for speed, and the example of their dismount team leader. Progress is slow here, but exposure to enemy observation and fire is reduced. When not moving forward, the individual infantryman delivers suppressive fire to the enemy. If necessary infantrymen may advance all the way into and through enemy positions by crawling.



Short rushes from covered position to covered position may be used when enemy fire allows brief exposure. Dismount teams, fire teams, or individuals may advance by short rushes to avoid accurate enemy fire. Soldiers should not stay up longer than 3 to 5 seconds. Thus, the enemy does not have enough time to "track" with automatic weapon fire. The rule is: Rush from cover to cover, keeping a low silhouette.

The platoon's APCs maneuver using techniques similar to those of the dismount teams. A carrier team may move while the remainder of the carrier element serves as a base-of-fire element. The movement may also be accomplished by section (with two carrier teams in the base-of-fire element), by three carrier teams (with one APC in the base-of-fire element), or by

the entire carrier element moving as a whole. In this last case, the base-of-fire element would normally be another platoon or an ITV section or platoon.

#### 4-24. FIRE AND MOVEMENT (MANEUVER) WITH TANKS

When the mechanized infantry platoon is operating in a company team with one or more tank platoons, the company team commander can make the most of the capabilities of both types of platoons. As in the movement techniques of moving when not in contact, it is better for tanks to lead because of their greater armor protection and firepower.

Tanks can destroy other tanks with their high-velocity main gun and provide suppres-

sion with their caliber .50 machine guns and 7.62-mm coaxial machine guns.

Since the APC and tank have agility and speed, the two types of platoons can alternately perform as the base-of-fire element and the moving force. Additionally the tank platoon can deliver suppressive fire while moving.

The combination of tank and mechanized infantry platoons provides the company team commander with several options:

**Mounted maneuver with tanks.**

**Mounted maneuver with APCs.**

**Mounted maneuver with tanks and APCs.**

**Dismounted maneuver alone.**

**Dismounted maneuver combined with any of the mounted maneuver options.**

CHAPTER 5  
**OFFENSE**

**Section I. INTRODUCTION**

**5-1. GENERAL**

The chief purpose of offensive operations is to destroy the enemy and his will to fight. This destruction is best achieved by breaking through the enemy's defenses and driving violently and rapidly into the rear area to destroy his command posts, logistic bases, and fire support units. At times, offensive operations are conducted for other reasons, such as to seize terrain or determine enemy strength and disposition, or to deceive, divert, or hold the enemy.

**5-2. SCOPE**

Platoons and squads normally conduct offensive operations as part of a company or company team. Mechanized infantry units are well suited for offensive operations because of their firepower, mobility armor protection, agility and the dismount element's ability to close with and destroy the enemy. The primary offensive tasks performed by platoons and squads include:

**In a movement to contact**

**Overwatch tanks or other mechanized infantry units.**

**Lead mounted**

**When no tanks are available.**

**To cross a water obstacle.**

**Lead dismounted:**

**In restrictive terrain.**

**To clear obstacles or possible ambush sites.**

**During limited visibility when the effectiveness of night vision devices is reduced.**

**Conduct actions on contact.**

**In an attack:**

**Attack mounted following tanks or attack mounted without tanks:**

**When enemy resistance is light.**

**When enemy antiarmor fire can be suppressed.**

**When the terrain allows mounted movement.**

**Attack dismounted supported by the carrier element, tanks, and improved TOW vehicles:**

**When the terrain or obstacles prevent mounted movement.**

**When the enemy has strong defensive positions and his antiarmor fire cannot be suppressed.**

**Assault an objective mounted.**

**Assault an objective dismounted.**

**Consolidate and reorganize.**

CONTENTS	PAGE
Section I. Introduction . . . . .	5-1
II. Movement to contact . . . . .	5-2
III. Attack Tactics and Techniques. . .	5-11
IV. Limited Visibility Operations. . .	5-26
V. Other Platoon Offensive Operations . . . . .	5-32

## Section II. MOVEMENT TO CONTACT

### 5-3. GENERAL

When a unit is forward of friendly positions, moving toward but not in contact with the enemy it is conducting a movement to contact. Many offensive operations begin with a movement to contact. Its purpose is to gain or regain enemy contact and to develop the situation to conduct an attack. Movement to contact is usually characterized by limited information about the enemy.

Platoons and squads participate in a movement to contact as part of a company or company team using the movement techniques explained in chapter 4. The lead platoon in the movement to contact has critical missions. These missions are:

**Protecting the company or company team from a surprise attack by providing early warning of enemy positions and obstacles.**

**Assisting the forward movement of the company or company team by removing obstacles or finding routes around them.**

**Defeating enemy forces within the platoon's ability.**

**Developing the situation rapidly once contact is made.**

The remaining platoons within the company or company team are assigned missions and positions within the formation based on the movement techniques being used. Their missions normally include overmatching the lead platoon and reacting with fire and movement once contact is made. These techniques are explained in chapter 4 and other sections of this chapter.

### 5-4. PLANNING A MOVEMENT TO CONTACT

The company or company team commander normally assigns to the lead platoon, in a move-

ment to contact, one or more **march objectives**. A march objective is normally a terrain feature selected at a place which is expected to insure contact with the enemy. The platoon may be instructed to seize the march objective or to bypass it if it is reached without enemy contact. The platoon leader should cover both these situations in his operations order so that further instructions are not required when the platoon nears a march objective.

A platoon is normally assigned an axis of advance to move on. An axis of advance provides the platoon leader flexibility to move as necessary to bypass obstacles or impassable terrain. It directs the platoon to move according to the commander's intention. The exact route selected by the platoon leader must keep the platoon oriented on the march objective and allow the other platoons of the company or company team to follow along with minimum difficulty.

Because the platoon leader does not know when or where he will make contact with the enemy he should select a route that will not restrict vehicle movement. The route should avoid terrain that would restrict mounted movement, such as draws, ravines, narrow trails, or steep slopes.

The line of departure, phase lines, and checkpoints are normally assigned to control and coordinate the forward movement of the company or company team. The lead platoon leader reports crossing all phase lines to the company or company team commander, but the platoon does not stop at a phase line unless told to. If necessary, the platoon leader may designate additional phase lines or checkpoints for internal platoon use to reduce the number and length of orders needed to control movement.

The platoon leader can designate target reference points (TRP) along the axis of advance to control fire and to designate targets. TRPs should be selected on likely enemy locations and



avenues of approach. The platoon leader may assign squad responsibility for covering specific terrain in relation to TRPs. This helps maintain all-round observation and proper caliber .50/ Dragon orientation during movement, and it helps insure that all likely targets are covered by at least one squad.

If the movement to contact is being conducted with two companies or company teams abreast, contact points may be chosen on terrain features between the two companies to insure physical coordination between the two units. The platoon leader must know if his platoon is to make contact with an adjacent company or if contact will be established by a trailing platoon. Contact points are normally designated:

**If a location is critical (for example, a road crossing from one company's axis or zone of action into another's).**

**If face-to-face contact is needed to insure coordinated movement.**

**As a contingency measure in the event a strong enemy force is contacted and it is necessary to establish a defense.**

Once contact is made with the enemy the platoon should not break contact unless ordered to by the company commander.

#### **5-5. TACTICS AND TECHNIQUES FOR A MOVEMENT TO CONTACT**

When conducting a movement to contact, a platoon moves using traveling overwatch or bounding overwatch as discussed in chapter 4. The platoon normally moves mounted to take full advantage of the speed and protection of the APC. At times, when moving through forested areas, towns, or where there is a possibility of an ambush, the platoon may lead with the dismount element. Defiles, bends in roads,

or river crossing sites are all likely ambush locations. Dismount teams or engineers are deployed to breach obstacles, to find a route around impassable terrain, and to provide security. Dismounted operations should be kept to a minimum because they reduce the speed of the company or company team. Continuous friendly forward movement will reduce enemy reaction time and help to keep him off balance.

Platoon alertness is extremely important in a movement to contact. Because information about the enemy is usually limited, the platoon has to be prepared for any contingency. The rapid suppression of enemy antiarmor systems is critical on first contact.

The overwatch force should be prepared to provide immediate suppressive fire, especially with the caliber .50 machine gun. The platoon leader may pick one APC to be prepared to engage point targets, such as tanks or BMPs. This vehicle should be ready to fire the Dragon. This is advisable because it is quicker to change from the Dragon to the caliber .50 than vice versa. The platoon leader must keep in mind that the Dragon is a slow-firing system and speed of engagement is critical on first contact.

One of the major tasks of the lead element in a movement to contact is to protect the company or company team from surprise attack. The platoon must clear possible ambush sites unless otherwise instructed.

If a platoon is given the mission of moving along and clearing a road as part of the movement to contact, it must do this with care. The enemy will often lay weapons, mainly antiarmor weapons, on a bend in the road so that they can ambush lead vehicles without trailing vehicles being able to overwatch. A bend in the road and its shoulder may also be mined. Dismount teams check for mines and look on the far side of a bend in the road before moving around it.

When the platoon approaches a bend in the road that cannot be bypassed, it can clear the area as follows:

- (1) The carrier element gets into an overwatch position where it can cover as much of the bend as possible and any likely enemy positions adjacent to the bend.

Figure 5-1. OVERWATCH FORCE.



- (2) Dismount teams clear the terrain on either side of the bend. High ground adjacent to the bend should be cleared first. The overwatch force must be prepared to support by fire and movement.

Figure 5-2. FIRE AND MOVEMENT SUPPORT.



(3) Once the dismount teams clear the terrain adjacent to the bend, they check the road and shoulders for mines.

Figure 5-3. APPROACHING ROAD BEND.



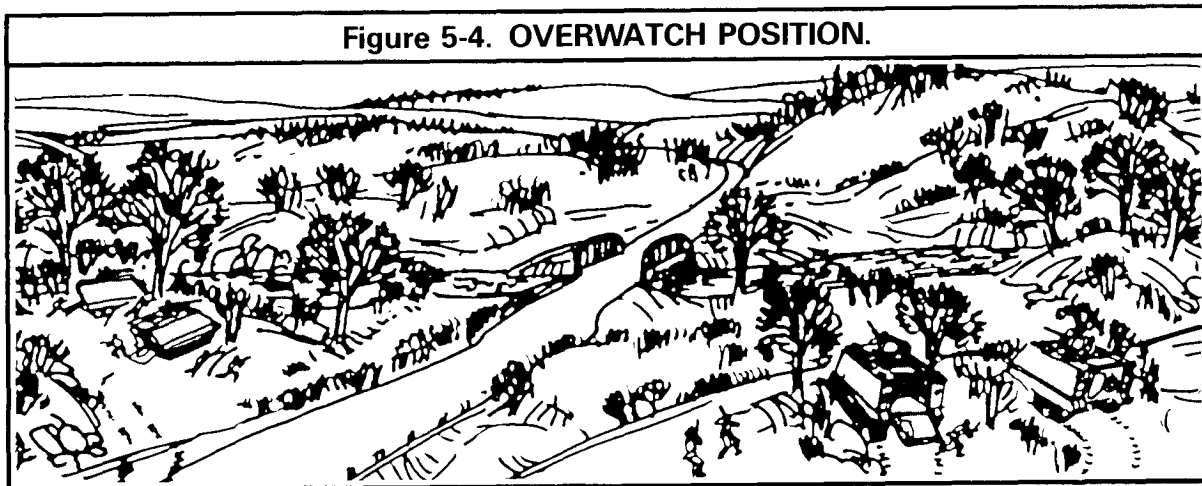
(4) The platoon moves around the bend where it can establish an overwatch force on the route and then continue movement.

A defile is an ideal ambush site because it restricts movement. The platoon checks a defile the same way it checks a bend in the road. Before the platoon moves into a defile, it should clear the terrain on both sides. The dismount teams then check the defile for ambushes, mines, and booby traps.

A bridge must be considered an obstacle or possible ambush site and approached as such. Before it is crossed, it must be cleared.

(1) The carrier element moves into an overwatch position where it can cover the terrain on both flanks of the bridge and the far side. A dismount team then checks the bridge and its approaches. This is best done by engineers, with infantry providing security. The dismount teams also reconnoiter for possible fording sites or bypasses.

Figure 5-4. OVERWATCH POSITION.



(2) If a fording site or bypass is available, the dismount teams cross, secure the

far side of the bridge, and establish observation posts before the bridge is checked.

Figure 5-5. DISMOUNT TEAM FORWARD.

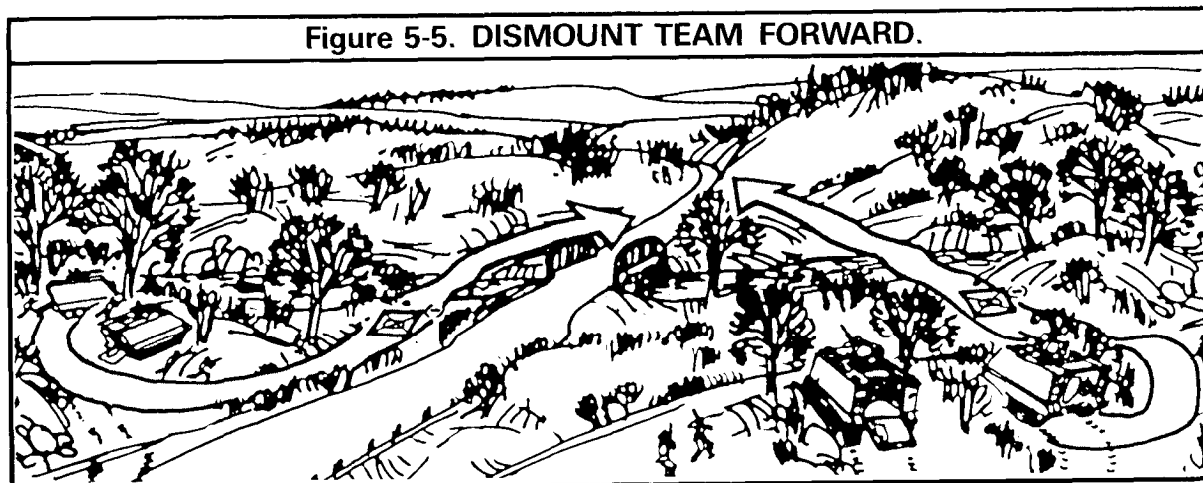
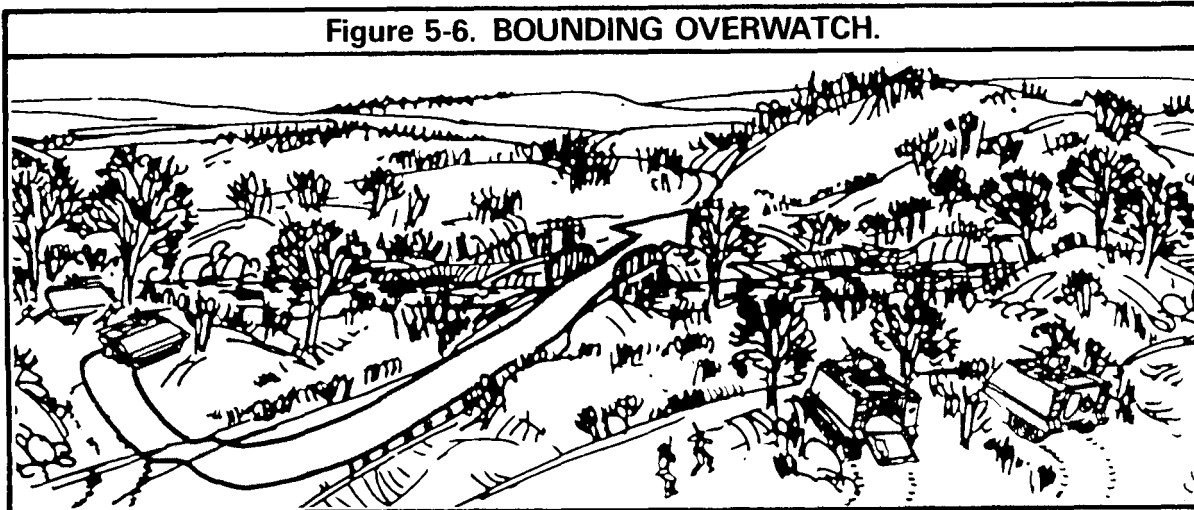


Figure 5-6. BOUNDING OVERWATCH.



(3) This method is the most secure, but it is very slow. If speed is important or a bypass or fording site is not available, the platoon can suppress the far side of the bridge and possible enemy positions on the far side with mortar or artillery smoke and high-explosive (HE) fire. The platoon then uses mounted bounding overwatch to the last covered position short of the bridge. Dismount teams can then move forward using bounding overwatch and check the bridge, while they are overmatched by the carrier element. Armored-vehicle-launched bridge (AVLB) may be used if available.

## 5-6. ACTIONS ON CONTACT

When a platoon makes contact, it must react quickly and aggressively. (Action upon enemy contact is commonly referred to as battle drill.) The platoon's actions in the first few seconds after contact may determine whether a battle is won or lost. Those actions must include several initial moves made almost simultaneously: **suppress, deploy, report**. The platoon leader then must:

**Develop the Situation.** The platoon leader should act quickly to determine the enemy's strength, composition, and disposition. He or his forward observer may call for indirect fire to

suppress, and use fire and movement to close with the enemy force. He should not expose his APCs needlessly. The dismount teams normally remain mounted so that the platoon can move out quickly. The degree of resistance and type of enemy fire influence the platoon leader's recommendation to the company or company team commander on a course of action to be taken.

**Choose a Course of Action.** Based on his observation of the enemy the platoon leader can recommend several actions:

**Conduct a hasty attack.** If the enemy resistance is light, he can recommend a hasty attack to destroy the enemy force. He normally does not move to attack the enemy unless the team commander approves.

**Bypass.** If the enemy does not present a meaningful threat and bypass routes are available, the platoon leader can recommend that the platoon bypass the enemy position. He should not allow light enemy resistance to slow forward movement if bypass routes are available.

**Fix and suppress.** If there is strong enemy resistance and the platoon cannot maneuver, the platoon leader can have the platoon fires fix on and suppress the enemy. This is done to hold the enemy in position while the rest of the company or company team moves to conduct a hasty

attack, uses engineers to breach obstacles, or bypasses.

**Halt in covered position.** When extensive obstacles are encountered that cannot be rapidly breached or bypassed, it may be necessary to halt in covered positions and deploy the dismount element while designated breaching forces reduce the obstacle. The breaching forces should be engineers when available; however, specially equipped and rehearsed members of the dismount elements may perform these missions when engineers are not available. Always reduce obstacles using **suppression, obscurity, security and reduction (SOSR)**.

### Report.

As soon as the platoon leader has reached a protected position, he should tell the company commander all he knows about the enemy. The information that he reports must answer the questions WHO, WHAT, WHERE, and WHEN.

**Size.** The size of the enemy unit is the number of troops seen — for example, 10 enemy infantrymen, not an infantry squad; or three enemy tanks, not an enemy tank platoon.

**Activity.** What the enemy was seen doing — for example, “emplacing antitank mines in the road.”

**Location.** Where the enemy was seen. If a map is available, the coordinates are reported — for example, “GL 874461.” If a map is not available, a key terrain feature is reported in relation to the location — for example, “on the Hann Road 200 meters south of the Ken River Bridge.”

**Unit.** The unit to which an enemy soldier belongs may be difficult to determine. Bumper markings on vehicles are reported. Some countries have particular uniforms, headgear, and colored tabs on uniforms which identify the type unit. The unit’s action may indicate its type, or the kind of equipment observed may be peculiar to a certain type of unit. For example, a light, armored vehicle may indicate a reconnaissance unit.

**Time.** The time when the enemy activity was seen, not the time of the report.

**Equipment.** All of the equipment the enemy was wearing or using is reported. If an item of equipment or a type of vehicle was not recognized, it is sketched and the sketch is submitted with the report.

### Figure 5-7. EXAMPLE OF REPORT.

“BRAVO 11 — THIS IS BRAVO 26 SPOT REPORT — OVER — THREE T64 TANKS AND FOUR BMPs MOVING WEST ON HIGHWAY AT NOVEMBER-BRAVO-TWO-TWO-FOUR-THREE-FIVE-EIGHT AT ONE-THREE-FIVE-ONE HOURS. ENEMY IS WEARING NBC EQUIPMENT. — ENGAGING — OVER.”

Once the platoon leader has developed the situation and decided on a course of action, he updates his earlier report to the commander. In some cases, the commander may change the platoon leader’s plan. Casualties are treated and evacuated as mission permits. Casualty reports are later submitted to update unit manning rosters.

### 5-7. OVERWATCH

When the company or company team is using bounding overwatch, the overwatch force must be ready once contact is made, to suppress enemy weapons which endanger the bounding force.

When a TL or gunner in an overwatch position spots an antitank gun or ATGM fired, or in position to fire, he immediately opens fire on that spot, at the base of the smoke trail, or at the gun flash, and gives the warning over the radio.

When the company or company team is using traveling overwatch, the overwatch platoon quickly fires on the enemy deploys to covered firing positions, and continues to fire. It avoids moving into areas where it may be caught by enemy fire directed at the lead platoon or fire that prevents it from maneuvering toward the enemy. The dismount element remains mounted to reduce vulnerability to enemy indirect fire

and to allow the platoon to move quickly. The platoon continues to suppress the enemy until the lead platoon reaches covered positions. The overwatch platoon then engages only clearly identified targets or areas designated by the company or company team commander.

#### 5-8. CONTACT VEHICLE LEADING MOUNTED

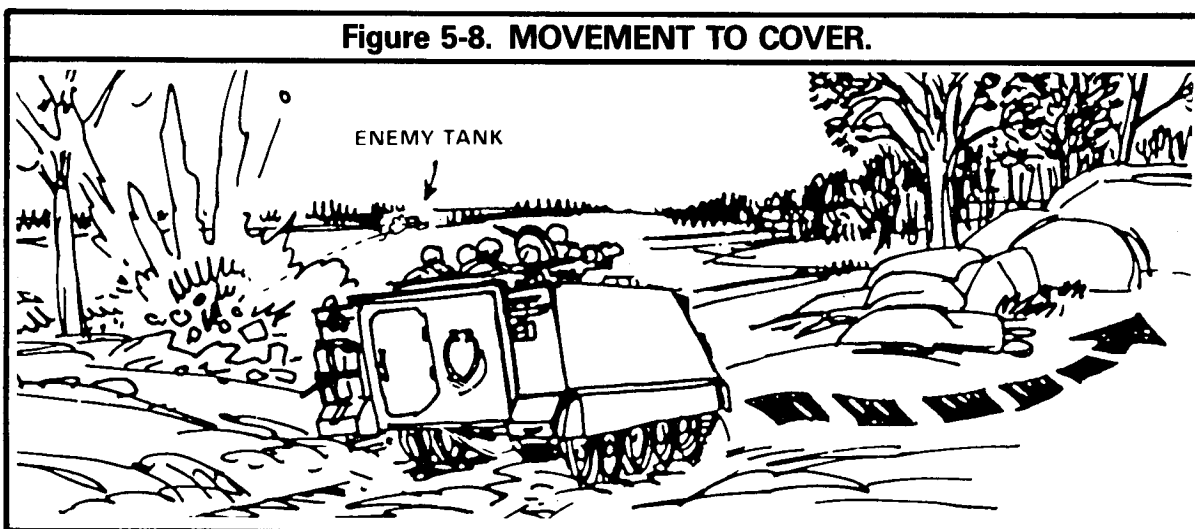
The first action on contact is to deliver a heavy volume of fire with the caliber .50 machine gun and with the 7.62-mm machine gun/

SAW. Other weapons are fired at only clearly identified targets within their range.

The APCs that are exposed to enemy fire move rapidly to hull-down firing positions. Gunners continue to fire while drivers move the carriers.

When receiving enemy antiarmor fire, and if the return fire does not suppress them, squad leaders/TLs may choose to fire the smoke-grenade launchers to hide the vehicles from enemy gunners. Also, drivers must take evasive action.

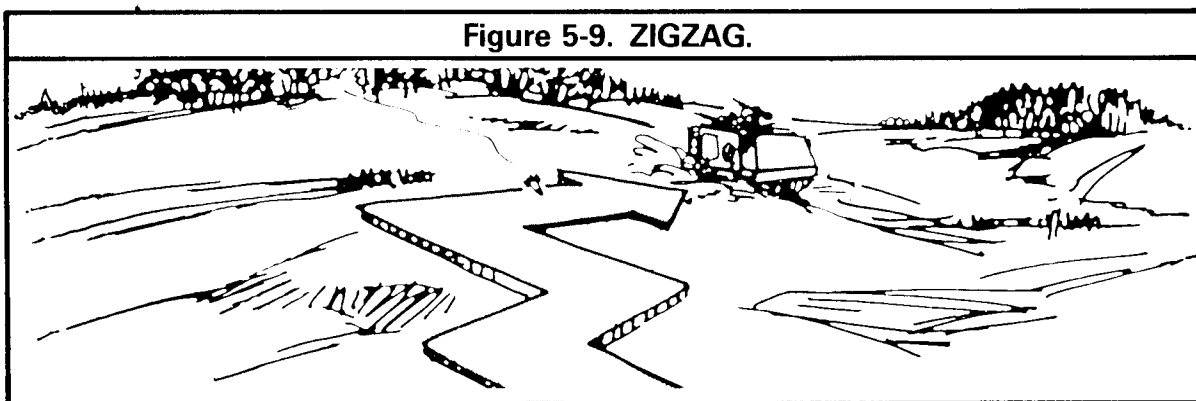
**Figure 5-8. MOVEMENT TO COVER.**



To avoid an ATGM, a driver should drive his APC in an erratic, zigzag path at angles to the ATGM and vary the vehicle speed to make it

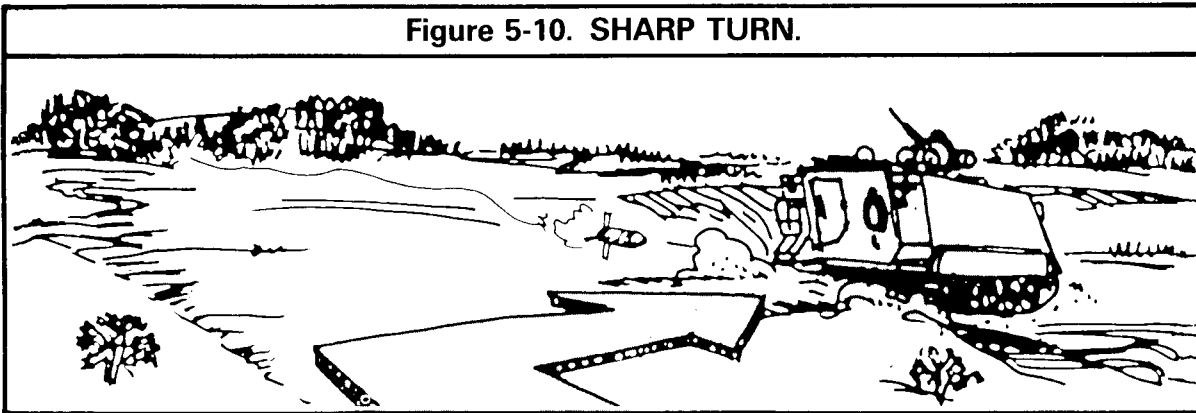
harder for the enemy gunner to keep his crosshairs on the vehicle.

**Figure 5-9. ZIGZAG.**



Another evasive action is to turn quickly to the right or left in the last seconds of the missile's flight.

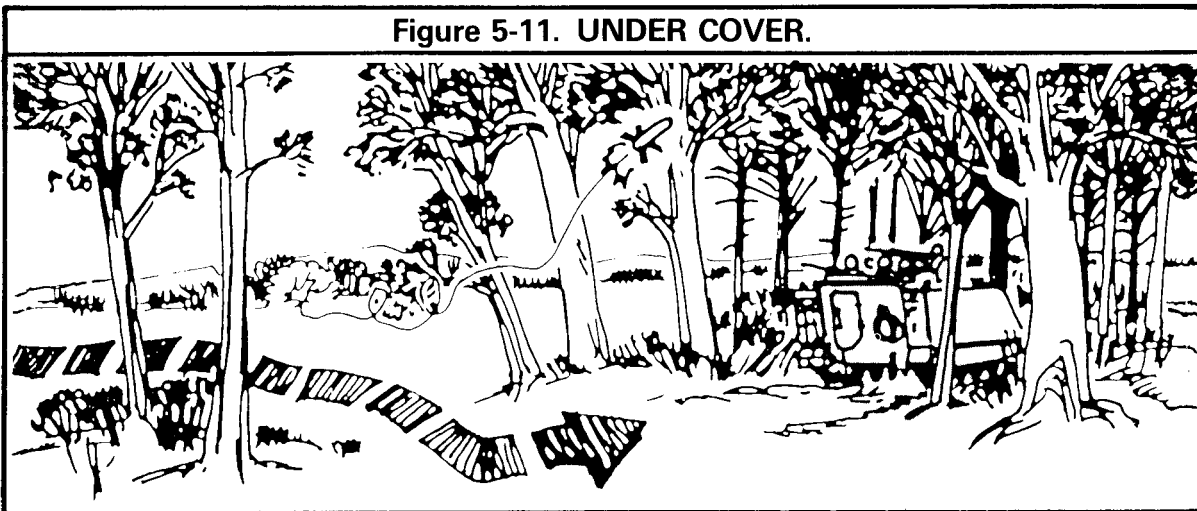
**Figure 5-10. SHARP TURN.**



The driver should also get some type of obstruction, such as trees, telephone poles, or

bushes, between the enemy firing position and the carrier.

**Figure 5-11. UNDER COVER.**



**5-9. CONTACT VEHICLE LEADING DISMOUNTED**

The dismount element may lead to clear an obstacle or likely ambush site, or to lead through a defile or town. In those cases, contact normally will be made at close range.

When fired on, the lead dismount team must return fire at once and take cover and report. The overwatch teams return fire to cover the

leading team and, if possible, designate targets for the carrier element or the tank platoon.

If a dismount team spots an enemy tank or other armored vehicle, it can mark the vehicle for the carrier element or tank platoon using tracer fire from the SAW. Before this mark-by-fire method is used, the dismount element



leader should contact the carrier element to be sure it is prepared to engage the vehicle. The enemy may return fire at the SAW if he is not engaged rapidly by the overmatching APCs, tanks, or ITVs.

If the dismount element sees the enemy

first, it should hold its fire, deploy to covered firing positions, and report the situation to the platoon leader. However, if it is certain that the dismount element can destroy the enemy force with surprise fire, it should engage the enemy without delay.

### Section III. ATTACK TACTICS AND TECHNIQUES

#### 5-10. GENERAL

Attacks are conducted to destroy or capture an enemy force and to secure key terrain. An attack can be either hasty or deliberate. The basic difference between these two types of attack is the amount of time available for planning and preparation.

In an attack, platoons and squads move using fire and movement, taking advantage of all available cover and concealment. When attacking with tanks, the tanks will normally lead unless obstacles or enemy fire prevent mounted movement. Mechanized infantry platoons and squads can attack either mounted or dismounted.

The method of attack is normally determined by the company or company team commander. His decision is based on the mission, enemy, terrain, troops, and time available.

#### 5-11. PLANNING THE ATTACK

The platoon leader begins planning the attack once he receives his commander's OPORD or FRAGO.

The platoon leader's plan, probably oral, should cover as a minimum:

- (1) **Situation.**
  - Enemy.**
  - Friendly.**
- (2) **Mission.**
- (3) **Execution (concept of the operation).**
- (4) **Service support.**

#### (5) **Command and signal.**

Once the platoon leader has plans for the above, he decides on the measures needed to control and coordinate the attack. Some of these measures will be specified in the company or company team commander's order. They usually include as a minimum:

- (1) **Attack position.**
- (2) **Line of departure.**
- (3) **Time of attack.**
- (4) **Axis or direction of attack.**
- (5) **Assault position.**
- (6) **Objectives.**

Phase lines, checkpoints, and visual signals are specified as required.

The attack plan should be prepared in as much detail as time and situation permit. Once the attack has begun and as the tactical situation changes, it may be necessary to alter the plan. Platoons and squad must be able to react to such changes rapidly.

#### 5-12. ATTACKING MOUNTED

Mechanized infantry platoons and squads attack mounted with or without tanks when —

- enemy resistance is light,**
- enemy antitank weapons are destroyed or can be suppressed, and**
- the terrain allows rapid mounted movement to the objective.**

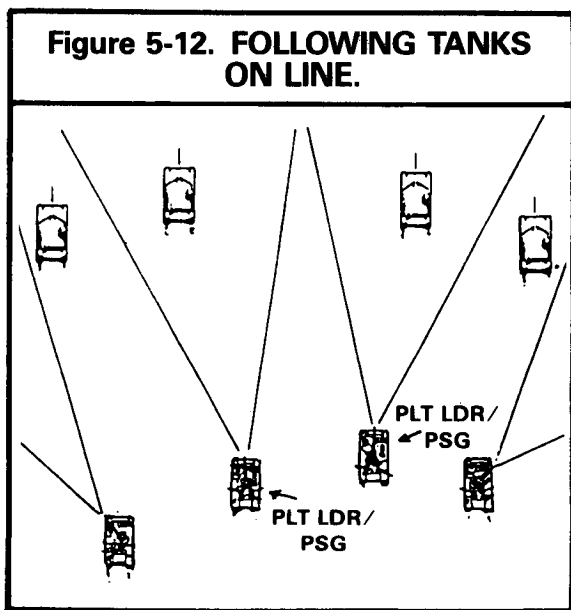
### 5-13. ATTACKING WITH TANKS

Tanks normally lead and place a heavy volume of fire on enemy positions. The APCs follow the tanks and deliver suppressive fire to the flanks and between the tanks with the caliber .50 machine gun, the SAW, and other weapons if not receiving artillery TLs/GUNNERS MUST INSURE THAT THEY DO NOT SHOOT AT OTHER APCs OR FRIENDLY TANKS.

The platoon leader keeps his APCs close enough to protect the tanks against enemy close-in antitank fire, yet far enough behind so that fire directed at the tanks does not hit the APCs. Depending on the terrain, the platoon may move behind the tanks in line, in modified column, or follow the tanks by bounds.

### 5-14. FOLLOWING TANKS ON LINE

Following tanks on line permits the APCs to provide the best all-round protection for the tanks. The carriers are able to suppress targets to the flanks, and rear, and between the tanks.



The platoon leader's APC is the base vehicle. The other APCs guide on it. The platoon leader normally directs each APC to follow a particular tank to control movement left or right.

The flank squads have responsibility for covering the formation flanks. This includes the flanks of their own platoon and the tank platoon flanks. The caliber .50 machine guns normally are oriented to cover the flanks of the leading tanks. The SAWS (or M60 machine gun) and other infantry weapons are used to cover the flanks of their platoon when possible.

The center squads have responsibility for protecting the area between and to the rear of the tanks.

The use of the line formation does not mean that all four vehicles move abreast of one another. Each vehicle, as well as the tanks, must use the terrain and the appropriate movement techniques or fire and movement, as necessary.

Each squad leader/TL controls his APC's movement and directs its fire based on his position in the formation. He watches the platoon leader's APC to determine generally how far to the rear of the tanks he should be. If he loses sight of the platoon leader, the TL keeps his APC close enough to support the tank he is following. When a tank halts to fire or stops for some other reason, the following APC takes up a hull-down position until the tanks resume movement. If the tank is put out of action, the trailing APC either follows another tank or continues forward working from the same general position in the formation.

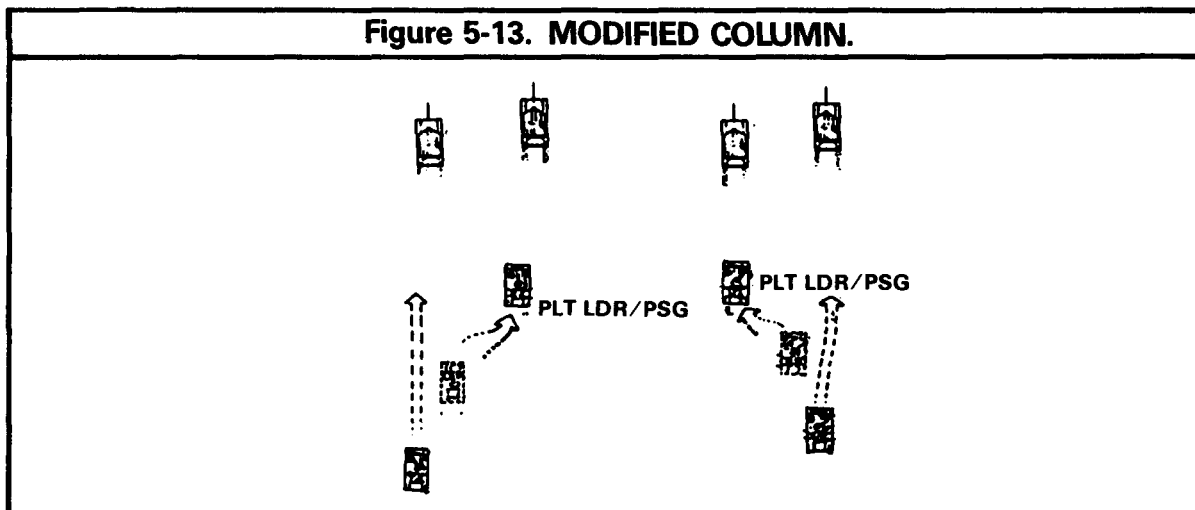
Fire from the SAWS or M60 machine guns and small arms is directed against close-in personnel targets. The caliber .50 machine gun is fired at distant targets and lightly armored vehicles, such as BMPs and BTRs. The platoon leader modifies the platoon's sector of fire based on its position relative to the tanks and the enemy.

### 5-15. FOLLOWING TANKS IN A MODIFIED COLUMN

APCs may follow tanks in a modified column when additional flank security is needed.

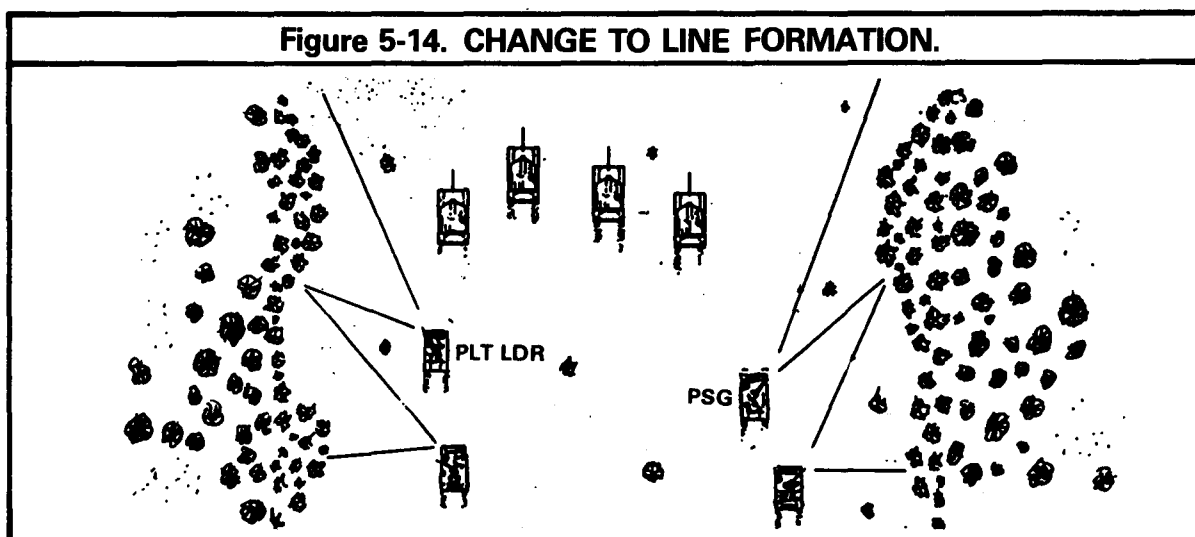
The platoon leader and one squad, in column, follow one flank tank. The platoon sergeant and the other squad follow the tank on the opposite flank. This allows the platoon to secure the

flanks of the team as it attacks and helps the platoon to arrive at the objective with the tanks. Again, the force must use the appropriate movement techniques or fire and movement.



When using this technique, each caliber .50 machine gun is oriented to the front and flank. The soldiers in the cargo hatch facing the inside of the formation must be especially alert because they are providing the only protection to the rear of the tanks.

As soon as the terrain or enemy situation permits, the platoon should switch to the line formation, because it provides all-round tank protection. To switch to the line formation, the platoon leader and platoon sergeant move to the inside of the formation and the trailing squads move forward until they are on line with them.



## 5-16. FOLLOWING TANKS BY BOUNDS

Following by bounds provides more protection for the APCs and allows use of bounding overwatch and fire and movement. The use of this technique is important because the APCs have less armor protection than the tanks. This method, slower than moving with the tanks, is normally used when —

large open areas subject to long-range ATGM fire must be crossed, and

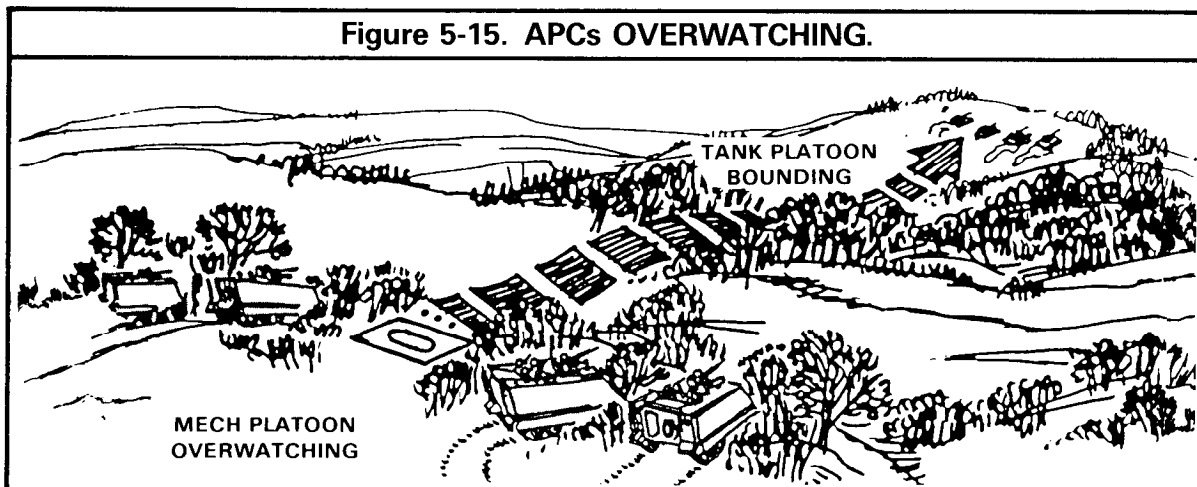
the terrain affords little or no concealment for enemy dismounted infantry that could engage the tanks with close-in antitank fire.

When following tanks by bounds, the platoon occupies a position that has cover and conceal-

ment and lets the platoon cover the tanks all the way to the next position. The caliber .50 machine gun and the Dragon will be the main weapons used to overwatch the tanks. The tank platoon may also bound within itself while advancing in order to add tanks to the overwatch force for security.

Once the tanks reach the next position, the APCs must move quickly forward to join them to maintain the momentum of the attack. This technique is used chiefly for movement between the LD and the objective. Because it does not afford the tanks close-in protection from dismounted enemy infantry, it is not used during the final assault on the objective.

Figure 5-15. APCs OVERWATCHING.



No matter what technique is used, the final movement onto the objective and preparation for the assault may be mounted; or, if the enemy is well dug-in, it may be necessary to halt in covered positions and deploy the dismount element. (The assault is covered later in this section.)

## 5-17. ATTACKING WITHOUT TANKS

A mechanized infantry platoon may attack mounted when there are no tanks attached to the company or when the company team is attacking along two different axes with tanks on one and APCs on the other. The reasons for at-

tacking mounted without tanks are the same as when attacking mounted with tanks, but the effect of the attack will be degraded without armor. Careful analysis of the enemy capability is necessary.

The platoon leader selects the formation best suited to the situation and moves using the appropriate movement techniques. When covered by another unit, the platoon moves as a single maneuver unit to simplify control. It also may move by bounds, as when attacking with tanks. The platoon leader may bound one or two squads

forward while the others lay down heavy suppressive fire. Each bound is made quickly to limit the enemy's time to detect and engage the bounding squads. Short, fast bounds are best.

If ordered to stop, each TL/gunner chooses a covered firing position and continues to engage enemy targets, or he places suppressive fire on the objective. The dismount teams remain mounted for protection from enemy indirect fire, and to eliminate delay if the platoon is ordered to move.

When attacking mounted with APCs, the platoon leader may elect to dismount before moving onto the objective. This may be necessary because the carriers would be vulnerable to close-in antiarmor fire or because of obstacles that restrict movement. **THE DECISION TO DISMOUNT MUST BE MADE PRIOR TO BEING COMMITTED TO THE FINAL ASSAULT.** The platoon leader must not stop APCs in the final assault to dismount in front of an objective if the platoon is exposed to the full force of enemy fire.

The platoon leader tentatively selects a dismount point that will provide cover and concealment for the dismount team while they get out of the APCs. He decides on the composition of the dismount teams, designates who is to control the dismount and carrier elements, and plans how he will assault the objective. Normally the carrier element initially will support the dismount element by fire. When its fire is masked by the dismount element, it moves quickly onto, across, or around the objective.

Attacking mounted depends on the enemy's strength, capability and disposition. This may be when time is critical and the added risk is warranted to accomplish the mission or when supporting fire destroys most of the enemy before the platoon reaches the objective. The platoon leader still should have an alternate plan for dismounted assault.

## 5-18. ATTACKING DISMOUNTED

The company or company team commander may decide to attack dismounted when —

- the enemy has strong defense positions and enemy antiarmor weapons cannot be suppressed, or**
- there are obstacles that prevent mounted movement.**

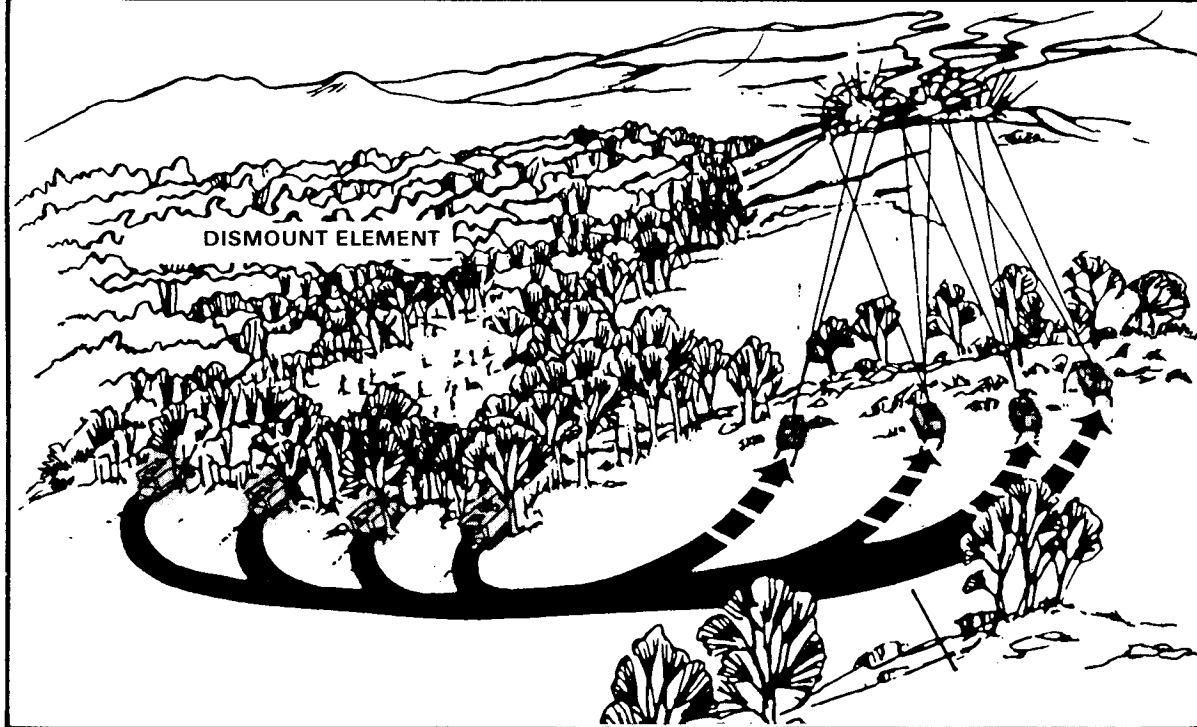
Dismounted attacks can be conducted during any degree of visibility. When illumination is used, the tactics and techniques for a dismounted attack are the same as during good visibility; they are covered in this section. The tactics and techniques used for dismounted attack during darkness, without illumination, or during other periods of limited visibility are covered in section IV.

The platoon leader usually deploys the platoon dismount element based on the orders of the company or company team commander. The dismount point may be on the friendly side of the LD, or on the enemy side if the terrain and enemy situation allow mounted movement forward of the LD.

Tanks, ITVs, and the carrier element normally support the platoon dismount element by fire as it closes with the enemy. The carrier element should not reveal its position until the dismount element has moved away from the vehicles and is out of the probable impact area of enemy fire directed at the carrier element.

The carrier element supports the dismount element from the best terrain available. Its weapons add to the fires of the dismount element by engaging enemy infantry with the M60 machine gun if left behind and manned, engaging lightly armored enemy vehicles with the caliber .50 machine gun and engaging enemy tanks with the Dragon. Company and battalion ITV fire complements and reinforces the antiarmor fires of the Dragons employed by the dismount element.

Figure 5-16. SUPPORT MOVE SUPPORT.



The dismount element should advance on a route that provides cover and concealment and keeps it from masking the carrier element's supporting fires. Each TL/gunner must know the route so that he can follow the movement of the dismount element and fire to support the movement.

Once the dismount element starts forward, the objective should be suppressed by the carrier element and preferably by indirect fire. This allows bold, rapid movement toward the enemy position because friendly fire forces the enemy to keep his head down.

At a designated assault position or when it comes under effective enemy direct fire, the dismount element deploys for the final assault on the objective. The assault position is usually the last covered and concealed location short of the objective. Normally, the platoon will not stop at the assault position but will continue to move as it deploys.

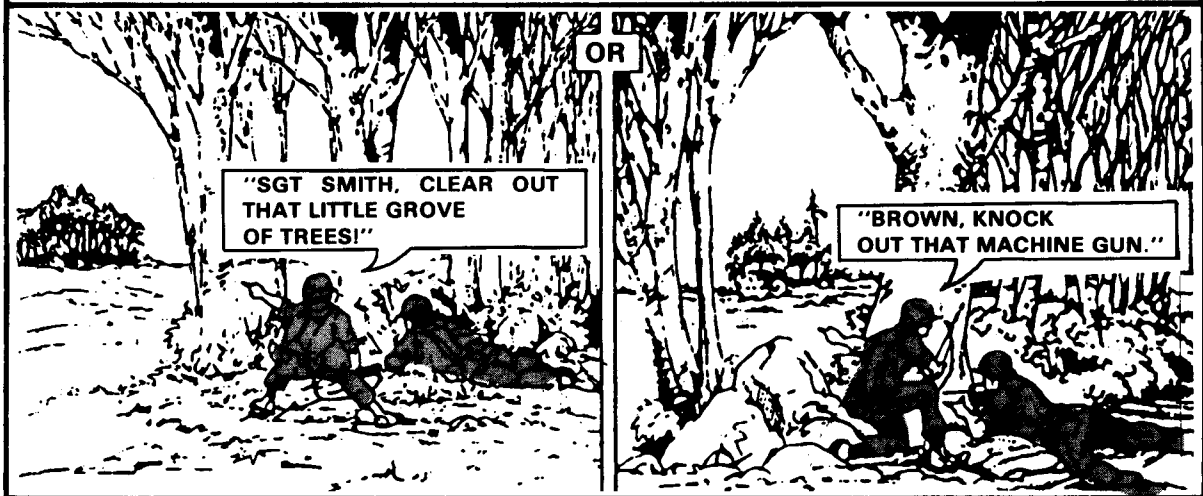
**Figure 5-17. ASSAULT POSITION.**



The platoon leader normally prescribes specific tasks or objectives for each dismount team.

They may be oriented on the enemy the terrain, or both.

**Figure 5-18. ACTION AT ASSAULT POSITION.**



## 5-19. ASSAULTING THE OBJECTIVE

The purpose of the assault is to place violent and intensive firepower on the objective and move rapidly across it to destroy or capture the enemy as soon as possible. The term assault refers only to that phase of an attack when the attacking force actually closes on the enemy position. An assault is not a "charge" against an enemy position. It is a cautious, yet bold and aggressive action using fire and movement even down to buddy-team level and taking advantage of all available cover and concealment.

Mechanized infantry platoons and squads can assault an objective mounted or dismounted.

## 5-20. MOUNTED ASSAULT

The mounted assault is based upon METT-T and conducted most often when the platoon is attacking with tanks.

A mounted assault is best used when the enemy is occupying hasty fighting positions, and when the terrain in the vicinity of the objective allows rapid movement onto and across the objective.

The assault must be carried out rapidly with the tanks leading followed closely by APCs. As the assault force approaches the objective, the APCs should move closer to the tanks for added protection from enemy short-range antiarmor weapons.

The APCs use the caliber .50 machine gun and small arms weapons to suppress or kill enemy infantry dug in on the objective. Enemy soldiers will usually be down in their positions seeking protection from direct fire, so the soldiers manning their weapons from the cargo hatch must be extremely alert. Enemy antitank gunners may wait for the tanks and APCs to pass over or go by their positions, and then pop up and try to hit the vehicles from behind. It is most important that each carrier have all-round observation and fire. Troops should be prepared to throw hand grenades into bypassed positions from the cargo hatch.

Movement across the objective must be fast and continuous. Stabilized turrets allow tanks to continue moving while conducting fire and movement. The tanks and APCs should not stop until they have crossed the objective. The APCs must keep up with the tanks. If they get too far behind, they may not be able to adequately protect the flanks and rear of the tanks.

Once the tanks and APCs reach the far side of the objective, they occupy hull-down positions. Here, they can continue to engage any retreating enemy forces, continue the attack, or defend against a counterattack. If it is necessary to secure the objective, the dismount element is used to clear remaining pockets of enemy resistance and to secure prisoners. If necessary the platoon leader may direct some or all carriers to support the dismount element by fire.

The platoon assaults mounted without tanks in essentially the same way it assaults with them. It moves onto and across the objective as rapidly as possible without halting. Without tanks to cover part of the objective by observation and fire, the platoon leader must insure that his entire portion of the objective is covered. The wedge formation provides the best all-round protection for the platoon. It permits each squad to cover a specific part of the objective. It can be adjusted to allow fire and movement or a single rush. Small arms are used for close-in suppression out to 300 meters. The SAW and caliber .50 and M60 machine guns cover the front and the area beyond 300 meters. In an assault mounted under fire (artillery or small arms), it is critical that indirect fires suppress the objective and stop or shift only when masked by the mounted platoon's arrival.

## 5-21. DISMOUNTED ASSAULT

If the enemy is in well-prepared defensive positions or the terrain restricts vehicle movement onto the objective, the assault is dismounted.



**Figure 5-19. DISMOUNTED ASSAULT.**

If the attack initially is mounted, the infantry should be dismounted in a covered and concealed position that is as close to the objective as " possible. Tanks and indirect fire weapons continue to place a heavy volume of fire on the objective while the dismount teams deploy. This is done to suppress enemy gunners as the dismount teams get out of the APCs. (Dismount procedures are described in appendix G.) The carrier element joins in the suppression when the dismount element has moved away from the vehicles.

Normally the company or company team commander states when and where the platoon is to dismount, and what it is to do once on the ground. The platoon leader should specify in his attack order who will control the dismount teams (squad leader or team leader) and who will control the dismount element (himself or the platoon sergeant).

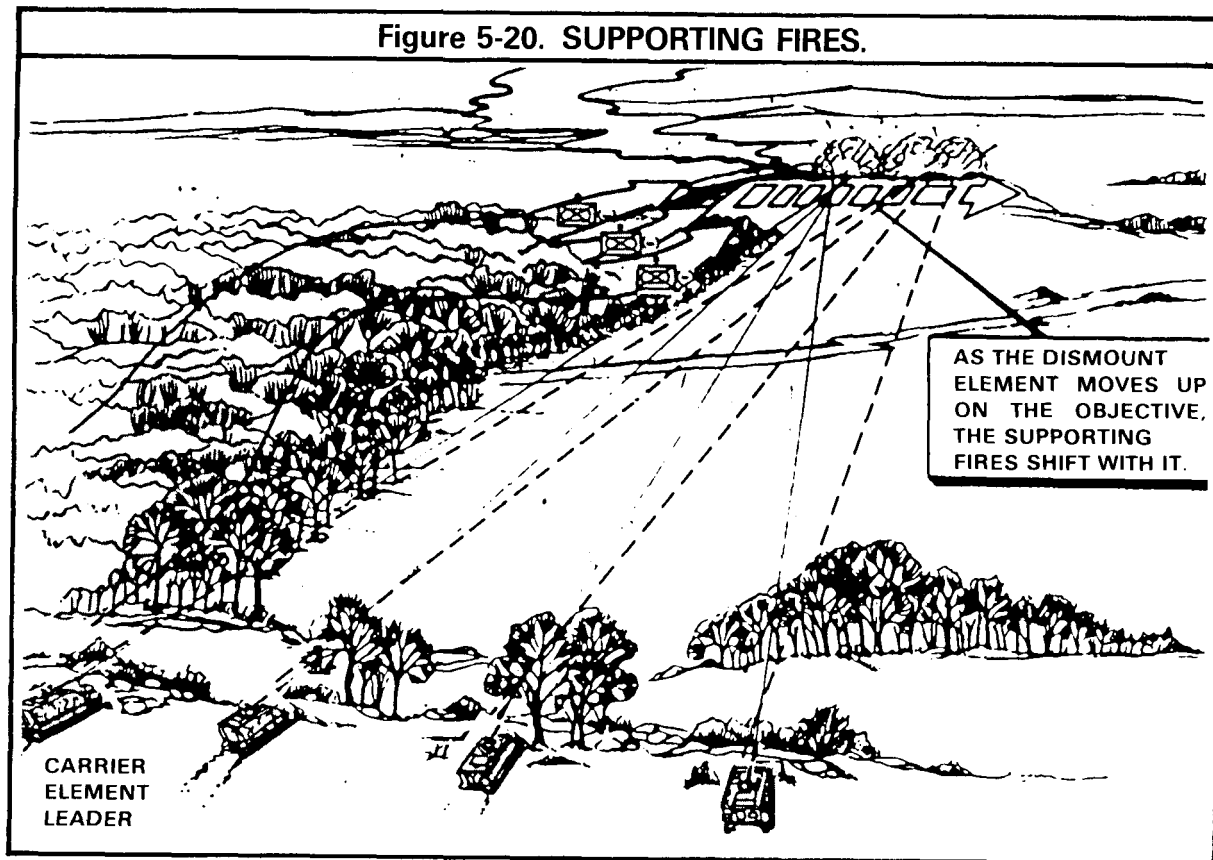
#### **5-22. ACTIONS OF THE CARRIER ELEMENT**

Positive control of the carrier element's fire is absolutely necessary so that the fire does not hit

the dismount element. Within the company team, the commander will issue specific instructions for controlling supporting fires if the assault involves more than one platoon. Many times, though, the carrier element leader must use his own judgment to make fires as effective as possible. Supporting fires need to be near the dismount element to keep the enemy down in their fighting positions. The fires may have to be shifted without command as the dismount element advances.

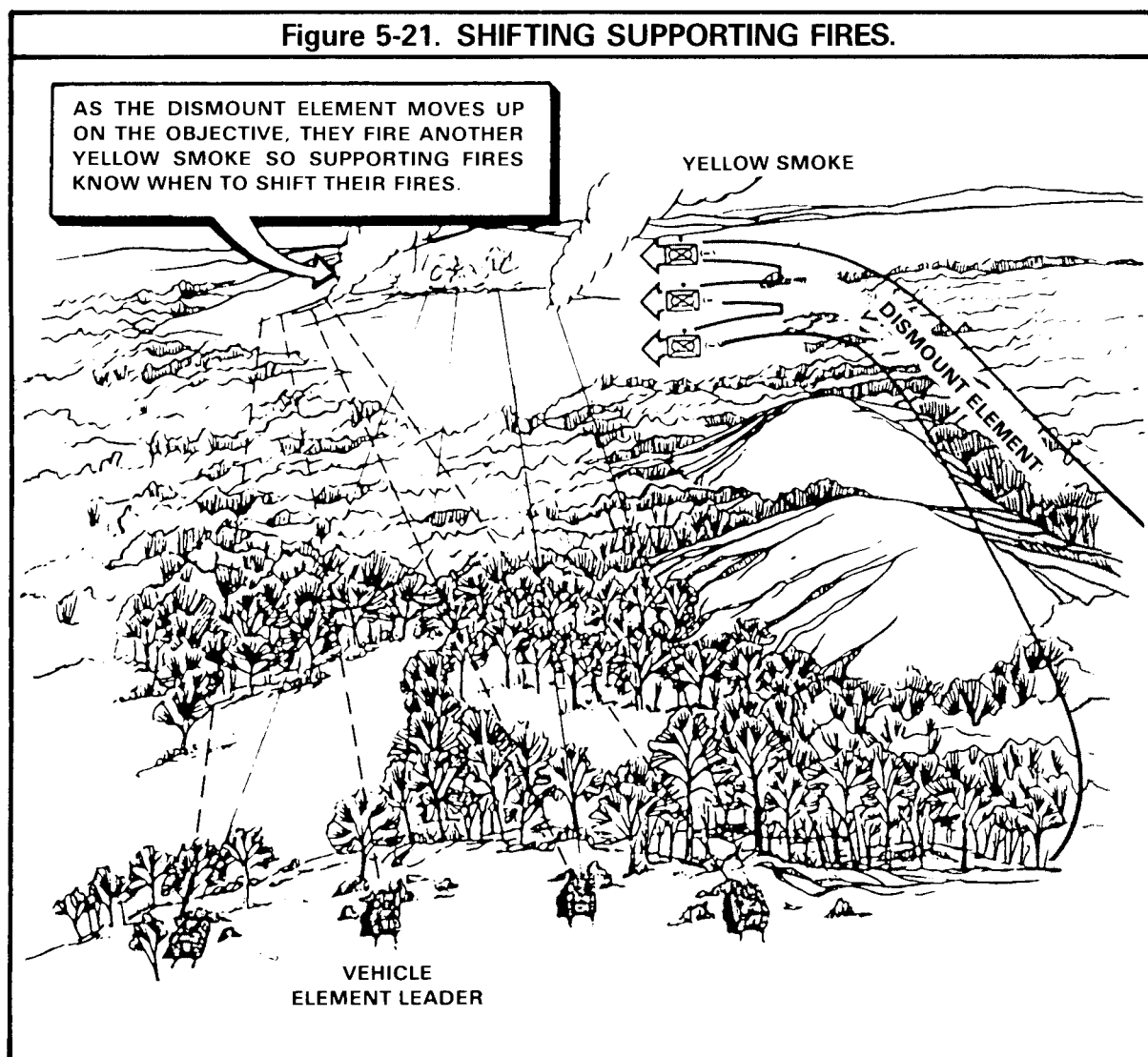
There are several ways to coordinate the fires of the carrier element with the assault of the dismount element. The suppression provided by supporting fire is essential to the success of an assault. The technique used must be simple and effective. The techniques described in subsequent paragraphs also work when the platoon is supported by tanks and ITVs.

The carrier element leader puts his APC on the flank that is closest to the dismount element. He marks the near limit of supporting fire with fire from his caliber .50 machine gun. All other carrier teams distribute their fire toward the other flank.



The dismount element leader will tell the carrier element leader by radio or prearranged visual signal (for example colored smoke or star cluster) when to shift his fires. The carrier element leader will automatically shift supporting fires when he sees that the dismount element is getting too close to the fire.

Figure 5-21. SHIFTING SUPPORTING FIRES.

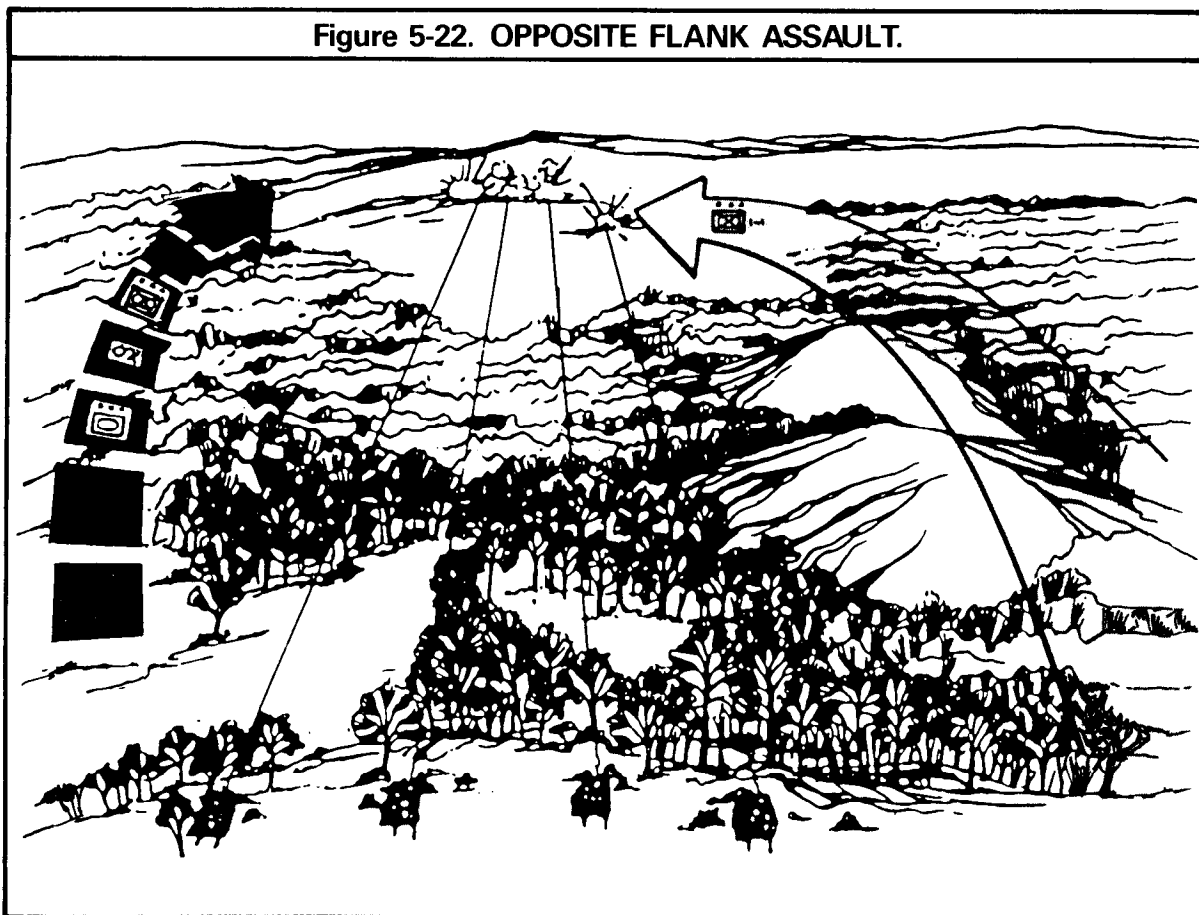


This method can be used when the carrier element leader cannot see the dismount element. The dismount element leader signals the carrier element by using a smoke grenade, smoke streamer, or a star cluster. The pyrotechnic marks the dismount element's flanks. The carrier team leader then adjusts and offsets his fire away from the dismount element's closest flank in the direction of the enemy. The remaining carrier teams distribute their fire away from the dismount team using the carrier team leader's fire as a base.

Regardless of the method used to control fire, the carrier element moves onto the objective, as soon as possible, joining the dismount element. This normally will be when its fire is masked by the dismount element. The APCs should move rapidly to the objective as in a mounted assault and occupy hull-down positions near the dismount element. At this point, the dismount element and the carrier element must support each other. The dismount element should be given the mission of providing flank and rear security for the carrier element.

Once the dismount element begins to assault the objective, the company team commander may order tanks or another platoon to assault around to the opposite flank. This may be done to get around the objective, sealing it off and protecting

Figure 5-22. OPPOSITE FLANK ASSAULT.



against an immediate counterattack or stopping an enemy retreat. Strict fire control measures need to be established to coordinate the assault on the opposite flank.

### 5-23. ACTIONS OF THE DISMOUNT ELEMENT

If an assault position has been designated, the dismount element, if at all possible, deploys for the assault on the move. It should not stop in the assault position. Halting is dangerous and may cause loss of momentum.

When the dismount teams are generally on line, the dismount element leader moves them forward using fire and movement. The final assault is not a stand-up, on-line rush. In the assault, dismount team leaders lead by example because it is hard for oral orders to be understood. "Follow me and do as I do" is the way to lead.

Dismount team leaders must lead on through the enemy positions. They move using the best method for the situation. The soldiers follow that example. The advance may be by crawling or by short rushes from covered position to covered position. It must be aggressively done because the dismount element loses momentum quickly if it stops once it is near the enemy. As it fights its way through the objective (still using fire and movement), the dismount element must avoid exposing itself to fire from enemy forces behind or to the flanks of the objective. Soldiers must not bunch up and make good targets.

Normally the entire dismount element moves forward to assault the enemy, supported by tanks, ITVS, and the carrier element. When their fire is not adequate to support the assault, the dismount element leader may set up a base of fire composed of a dismount squad or a composite of machine guns, grenadiers, and automatic riflemen.

When an armored threat exists, the Dragon is carried by the antiarmor specialist, and it normally is kept under a squad leader's direct control. It is fired only at important point targets,

such as enemy armored vehicles and key weapons. Usually the squad leaders will designate targets to be engaged with Dragon fire. Lacking proper Dragon targets, the antiarmor specialist fires his rifle, which is normally carried across his back. If it is determined that the Dragon would serve no purpose, it is left with the carrier team, and the gunner may deploy with only his M16.

When the dismount element begins to fire and move through the objective, actions by squad leaders are the key to fire distribution. Squad leaders move new the center of their team where their men can see them. Most of the time, they control fire by firing their own weapon into the area where they want their men to fire. They also can use arm-and-hand signals. At times, short, easily understood oral orders can be used, but in many cases orders will be drowned out by battle noises.

Since the squad leader is near the center of his dismount team, he fires his weapon to mark the center of the dismount team's objective. Men on his right and left fire to the sides of the point where his rounds are hitting. The squad leader also can use the grenadier to mark the center of the dismount team's objective with a smoke round. (The platoon leader can assign each squad a different color.) The squad leader too can use tracer ammunition or have the SAW stay with him and mark the objective.

As stated earlier, dismount team objectives during the assault are usually specific terrain features or specific enemy positions. The type of objective influences the kind of fire distribution the leader wants his weapons to have. He may want point fire or area fire (see fire distribution and control, appendix C). Since he may not be able to make his oral orders understood, and all of his men may not be able to see him, the squad should have an SOP for use of point or area fire. For example:

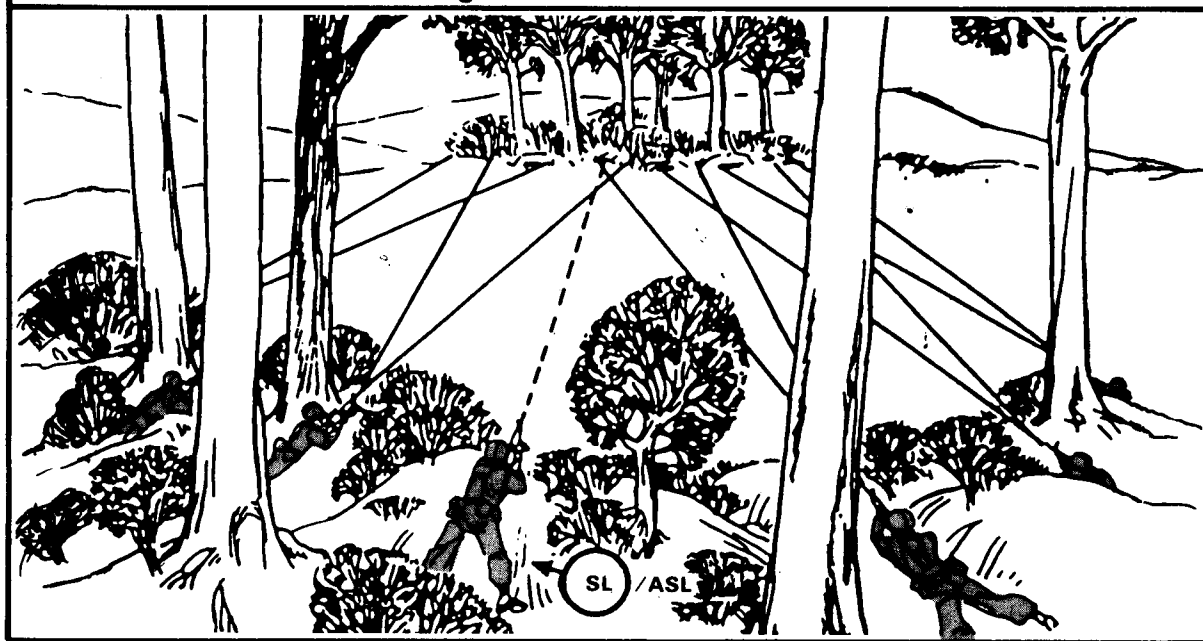
When the leader's marking fire hits a point that can be recognized as a bunker, firing port, or fighting position, then the team uses point fire.

Figure 5-23. POINT FIRE.



When the marking fire hits a point that cannot be identified as an enemy position, the team uses area fire.

Figure 5-24. AREA FIRE.



All leaders must strive to get a heavy volume of accurate fire on the objective, and they must make sure their men move forward aggressively. As the noise and confusion of battle makes control by voice difficult, leaders may move to critical points to make sure that their commands are understood and carried out. They also must see that men do not waste ammunition in the assault by random firing.

Assaulting troops, having closed on the objective, clear the enemy positions and move over the objective far enough to fire at any withdrawing enemy.

When the carrier element joins the dismount element on the objective, the dismount element should be prepared to support by:

**Suppressing any remaining enemy positions as the carrier teams move across the objective.**

**Designating firing positions for the carrier teams on the far side of the objective.**

**Providing flank and rear security for the teams once they are in position.**

The dismount teams and the carrier teams quickly occupy their assigned positions for consolidation to be ready for an enemy counterattack or to remount the APC and resume the attack toward the next objective.

To help coordinate and control the assault of two or more platoon dismount elements, the company commander may designate a base platoon. The dismount element leader in turn designates a base dismount team. Each dismount element guides on the company's base element. Teams guide on their element's base team.

#### **5-24. FIRE SUPPORT**

Fire support includes both direct and indirect fire. The purpose of this fire is to kill as many enemy as possible and to suppress the rest, keeping them from seeing or firing effectively,

while the platoon moves toward or over the objective.

When a dismounted leader wants the carrier element to engage a specific target, such as a bunker, he must be able to direct its fire. Unless being used for some other purpose, a smoke round from a grenade launcher can be used as a prearranged signal. Another way is for the dismounted leader to adjust, by radio, using TRPs or landmarks — for example, “FROM THE BURNING BMP, LEFT 100 METERS, MACHINE GUN BUNKER.”

Most indirect fire is planned by the company commander. But the platoon leader may request additional targets if needed. After receiving the company fire plan, the platoon leader should check to insure that fires are planned on all known or suspected enemy positions in front of, behind, and to the flanks of the platoon objective. If additional targets are needed, the platoon forward observer (FO) coordinates them with the fire support team chief.

An assaulting force should attempt to move with supporting fires as close to them as possible. The closer it is to supporting fires, the safer it is, because the fire will keep enemy troops down. Actually, the platoon leader controls indirect fire through the FO supporting the platoon. The platoon leader probably will not have time to tell the FO each time he wants to call for and adjust fire. So, he should explain to the FO before the assault begins what he wants him to do.

#### **5-25. CONSOLIDATION AND REORGANIZATION**

The platoon should consolidate and reorganize as soon as it takes an objective. This is done so that the platoon is prepared to:

**Repel an enemy counterattack.**

**Continue with the attack.**

An objective is held until the company commander orders other action. At times, especially with mounted assaults, the attack may be continued with little or no hesitation to exploit suc-

cess. In this case, only required reorganization is done, and consolidation is unnecessary.

Consolidation consists of actions taken to secure an objective and prepare to repel an enemy counterattack. In his order, the company or company team commander normally designates platoon positions and actions to be taken. The platoon consolidates an objective by:

**Occupying the position designated in the attack order (APCs are moved into hull-down positions, if available, and assigned specific sectors of fire).**

**Establishing local security and mutual support between squads and adjacent platoons.**

**Eliminating any remaining pockets of enemy resistance and securing prisoners of war (PW).**

**Designating positions for the dismount teams if the commander wants them deployed away from the carrier teams. (This will normally be on a dismounted avenue of approach to the objective. The dismount teams prepare hasty fighting positions as quickly as possible.)**

Reorganization includes all actions taken to prepare to continue fighting. Reorganization should be by SOP.

**The squad leaders:**

**Replace key members who were lost (team leader, driver).**

**Replace gunners of Dragons and SAWs.**

**Redistribute ammunition among dismount team members and get ammunition, as required, from the carrier.**

**Move casualties to a covered position, get medical aid to them, and arrange for their evacuation (as required).**

**Report to the platoon leader the situation, casualties incurred, and status of ammunition.**

**The platoon leader:**

**Replaces key personnel such as the platoon sergeant or squad leaders who were lost.**

**Informs the company or company team commander of the platoon's status.**

**Oversees evacuation of casualties.**

**Requests needed resupply.**

**Sends PWs under guard to the PW collection point.**

## Section IV. LIMITED VISIBILITY OPERATIONS

### 5-26. GENERAL

Mechanized infantry platoons and squads frequently will be required to conduct offensive operations during limited visibility. These operations must not be considered unusual or special. Units must train and operate well under all conditions.

Limited visibility attacks may be conducted to:

**Retain momentum of an operation started in good visibility.**

**Achieve surprise.**

**Exploit success.**

**Rupture strong enemy defenses.**

**Minimize effectiveness of enemy antiarmor fire.**



**Gain a more favorable position to continue the attack when visibility improves.**

### 5-27. EQUIPMENT CAPABILITIES AND LIMITATIONS

Mechanized infantry platoons and squads are better equipped for attack operations during limited visibility than any comparable units in the world (see appendix I).

The driver's infrared periscope allows him to move the APC. Night vision goggles let the squad leader and TL/gunner observe from their opened hatches to control movement and provide close-in security. The Dragon's thermal sight gives the gunner the capability to see and engage targets under almost any visibility condition.

Even though the APC has the capability to operate during limited visibility it has limitations. The driver can see to drive, but the range and fixed field of his viewer scan limits his ability to provide close-in security. Soldiers riding in the opened cargo hatch have difficulty observing, and they can temporarily be blinded by bright flashes of light caused by weapons fire and explosions. This results in security being limited, especially to the rear and flanks.

Because the vehicle is relatively "blind" during darkness, the squad leader and TL/gunner, wearing their night vision goggles, should observe from their opened hatches. The platoon sergeant can use his standard binoculars. In addition, soldiers in the cargo hatch should have starlight scopes mounted on their weapons, and their weapons should be loaded with tracer ammunition for target marking.

Weather, smoke, and dust can lower the effectiveness of the platoon's limited visibility equipment. In some cases, the thermal sight's capability of penetrating fog or smoke exceeds the capability of the missile's guidance system to track and control the missile. This means that the gunner may not be able to hit a target with the Dragon, even though the target is in range and seen through the sight.

The effectiveness of image intensification devices (driver's infrared periscope, night vision goggles, starlight scopes) is reduced by rain, falling snow, fog, and smoke. Since the devices also intensify light from the moon and stars their effectiveness is reduced on dark nights. These visibility limitations dictate slower rates of movement, require tighter formation and limit further the platoon's flank security. The ability of the TL and gunner to detect targets and control fires is reduced, and coordination between the carrier element and the dismount element is difficult.

Leaders should check the effectiveness of their night vision equipment before an operation, to determine the effects of light, weather, and smoke on the equipment. Visibility conditions also can change abruptly during an operation. This requires constant reevaluation of equipment capabilities and limitations.

### 5-28. MOVEMENT DURING LIMITED VISIBILITY

Movement in offensive operations during limited visibility is more difficult than during good visibility. Leaders must consider the likelihood of enemy contact and the difficulty of control when selecting movement techniques and formations. Distances between men or vehicles usually need to be shortened to ease control. Finally leaders must guard against a false sense of security by thinking darkness will conceal them. They also should assume the enemy has night vision devices and they should use cover, concealment, and smoke as they would in daylight.

Navigation is more difficult moving either mounted or dismounted. If possible, routes should be reconnoitered during good visibility. If ground reconnaissance is not possible, a detailed map reconnaissance is a must, keying on terrain features to be crossed and distances involved. Ridges, roads, railroads, creeks, and other identifiable features should be used as a guide. Movement should parallel rather than follow such terrain features, because the enemy often will have them covered by observation and fire. Friendly mortar and artillery fire can also be used to assist navigation.

By planning targets along the route on prominent terrain features, the platoon leader can call for these fires as necessary. These targets are on standard features which the platoon leader would avoid. This will allow him to call for specific target and verify where he is without endangering the platoon.

The element of surprise is the attacker's greatest advantage when moving dismounted. Light and noise discipline must be enforced. When the platoon is moving mounted, the sound of the APCs may alert the enemy. However, he may have difficulty locating the platoon, because it is difficult to pinpoint a moving vehicle by sound only. Lights are a greater danger. Even blackout lights and faltered lights inside the vehicle are visible through the vision blocks and can be detected from great distances with passive night vision devices.

#### **5-29. MOVEMENT FORMATIONS IN LIMITED VISIBILITY**

##### **Mounted.**

The column and wedge formations are the easiest to control. The platoon leader should place his APC as the base vehicle in either formation. In a column, the platoon leader's APC should lead. In a wedge, the platoon leader's vehicle should be in the left front of the formation. Both formations make rapid movement easy by allowing the drivers to guide on the base vehicle with minimal supervision by the squad leaders or TLs/gunners. This frees the squad leaders and TLs to concentrate on detecting and identifying targets.

The line formation is the most difficult to control. When the driver is looking through his inbred periscope to the front, he cannot maintain visual contact with a flank carrier. Therefore, the line formation should only be used to move short distances as when rapidly crossing a danger area or assaulting a position. If the driver is given night vision goggles, he can improve his flank vision and the line formation can be used for greater distances.

**Dismounted.** Many of the same considera-

tions for mounted formations apply to dismounted formations. Dismount teams and elements move closer together for better control. Soldiers should be close enough to see each other. Leaders should place themselves near the front of the formation for movement control.

#### **5-30. MOVEMENT TECHNIQUES IN LIMITED VISIBILITY**

When visibility is limited by darkness only the mechanized infantry platoon should be able to move using any of the movement techniques, making only minor adjustments to formations as previously discussed. When smoke, fog, or falling snow limits visibility the platoon's ability to provide overwatch may be reduced. In all conditions of limited visibility the loss of security to the flanks and rear is a major consideration in movement planning.

When using bounding overwatch, the platoon leader should consider bounding two vehicles instead of one to increase the security of the bounding element. This would allow one vehicle to observe to the left front and the other to the right front, making up for the gunner's limited field of view.

A platoon moving by traveling overwatch keys its movement on the lead APC. The distance between the lead APC and the platoon is based on the ability of the driver and TL of the overwatch vehicles to keep the lead vehicle in sight.

When the traveling technique is used, the lack of flank security becomes an even more important consideration. The platoon, traveling in a staggered column, is vulnerable. This technique would be used only when the chance of enemy contact is slight and speed of movement is necessary.

#### **5-31. ATTACKING DURING LIMITED VISIBILITY**

Attacks during limited visibility require more detailed preparation than attacks during good visibility. In limited visibility objectives are normally smaller and distances to them shorter. Plans must be kept simple but complete

and must be understood by all. If time and the enemy situation permit, leaders should reconnoiter routes and observe the objective area during good visibility. Indirect fire should be planned for suppression, and for illumination during darkness. Whether the attack is mounted or dismounted, every soldier should be rehearsed and questioned on his portion of the plan to insure complete understanding throughout the platoon.

There are several ways the company or company team commander may attack during limited visibility. If the attack is to be done during darkness, he may illuminate the battlefield using indirect fire. If he wishes to take advantage of the limited visibility conditions or cannot adequately illuminate the battlefield, he may attack mounted, dismounting short of the objective as appropriate. He may also decide to attack dismounted and use stealth to gain surprise.

An illuminated night attack is conducted similar to a daylight attack. The techniques discussed in section III of this chapter apply.

Illumination makes control easier and allows rapid movement. It also improves the enemy's ability to detect advancing targets. Illumination fires are planned and called as needed — normally for the final assault. Smoke can be used to cut down the effectiveness of enemy battlefield illumination and some of his night vision devices. Indirect HE fire may be used to hide the sound of the APCs as well as to suppress enemy gunners. Thermal sights work with or without light equally well and should be used by the carrier element using Dragons as they fire into the objective.

The commander may decide to attack mounted to maintain attack momentum against an enemy occupying hastily prepared positions. This allows platoons to close rapidly on the objective, and it conserves the strength of the dismount teams. As during good visibility the platoon moves mounted to the last covered and concealed position short of the objective.

The dismount element may then dismount and assault the objective while the carrier element provides covering fire. During the assault, the carrier element leader must closely control the element's fires to avoid endangering the dismounted soldiers. A signal such as a pyrotechnic device should be prearranged to designate when the carrier element should lift or shift fires from the objective. As soon as the objective is seized, the carrier element should quickly move to the objective area. The platoon should have a prearranged coded signal such as a blinking, filtered flashlight to help the carrier element locate and join with the dismount element. The dismount element leader should select positions on the objective for the carrier teams and require each dismount team to provide a ground guide to simplify the carrier's movement into positions.

Even though a nonilluminated attack is planned, the platoon leader should plan illumination from the LD to the objective so, if needed, it is available. Once the dismount teams start their final assault, illumination on the objective may help them detect targets to fire on and thus rapidly eliminate enemy resistance.

The platoon leader also should plan for the use of smoke during the attack. If the enemy fires illumination, the platoon leader can call for indirect fire smoke or use smoke grenades to screen movement. Smoke also will reduce the effectiveness of some of the enemy's night vision devices.

The main advantage gained by attacking dismounted and using stealth is surprise. Attacks by stealth can be conducted during any condition of reduced visibility. The concept of a dismounted attack using stealth is to get as close as possible to the enemy's position without a fight — then, before he can react, surprise and overwhelm him. The objective will be relatively close to the LD, usually within range of supporting fires from the carrier element.

The mission of the carrier element is to support the dismount element by fire or by fire and

movement. In the company or company team commander's OPORD, the carrier element is normally assigned a firing position, a sector of fire, and a route to the objective. The firing position may be along the LD or to the rear of the LD. The carrier element leader designates a firing position and a sector of fire for each carrier team. He also specifies how he plans to control their fire. He then points out, for the carrier element, the route that the dismount element will move along, and the portion of the objective to be occupied by the carrier element.

The carrier element should move into the overwatch position during good visibility. If the noise of the vehicles will alert the enemy it moves as close as it can to the overwatch position and halts until ordered to occupy it. From there a dismounted observer can be sent forward to observe the sector of fire and assist the carrier teams when they move into the position. The carrier element then supports the dismount element by fire, or by fire and movement, as directed by the company or company team commander. The carrier element normally will not move or shoot until the dismount element begins the assault.

Once the objective is seized, the carrier element moves as quickly as it can to the objective and occupies hull-down positions just as in a daylight attack. The dismount element should provide guides to lead the vehicles across the objective to their positions.

When the company or company team commander plans a nonilluminated attack by stealth, he normally will use the following control measures.

**Attack position.** It should be short of the LD, provide cover and concealment, and permit easy entry and exit. The attack position may be occupied only long enough for the unit to receive final instructions and insure coordination.

**Line of departure (LD).** An LD is designated to coordinate the commitment of attacking units or scouting elements at a specified time of attack.

**Point of departure (PD).** Because it is critical that all movements be closely coordinated, the dismount teams are assigned a specific point to cross over the LD.

**Release points (RP).** Each company commander releases control of his platoons to the platoon leaders at the platoon RPs. RPs are far enough back to let units deploy before they reach the squad RPs and the probable line of deployment. Platoon/squad RPs are used during dismounted attacks.

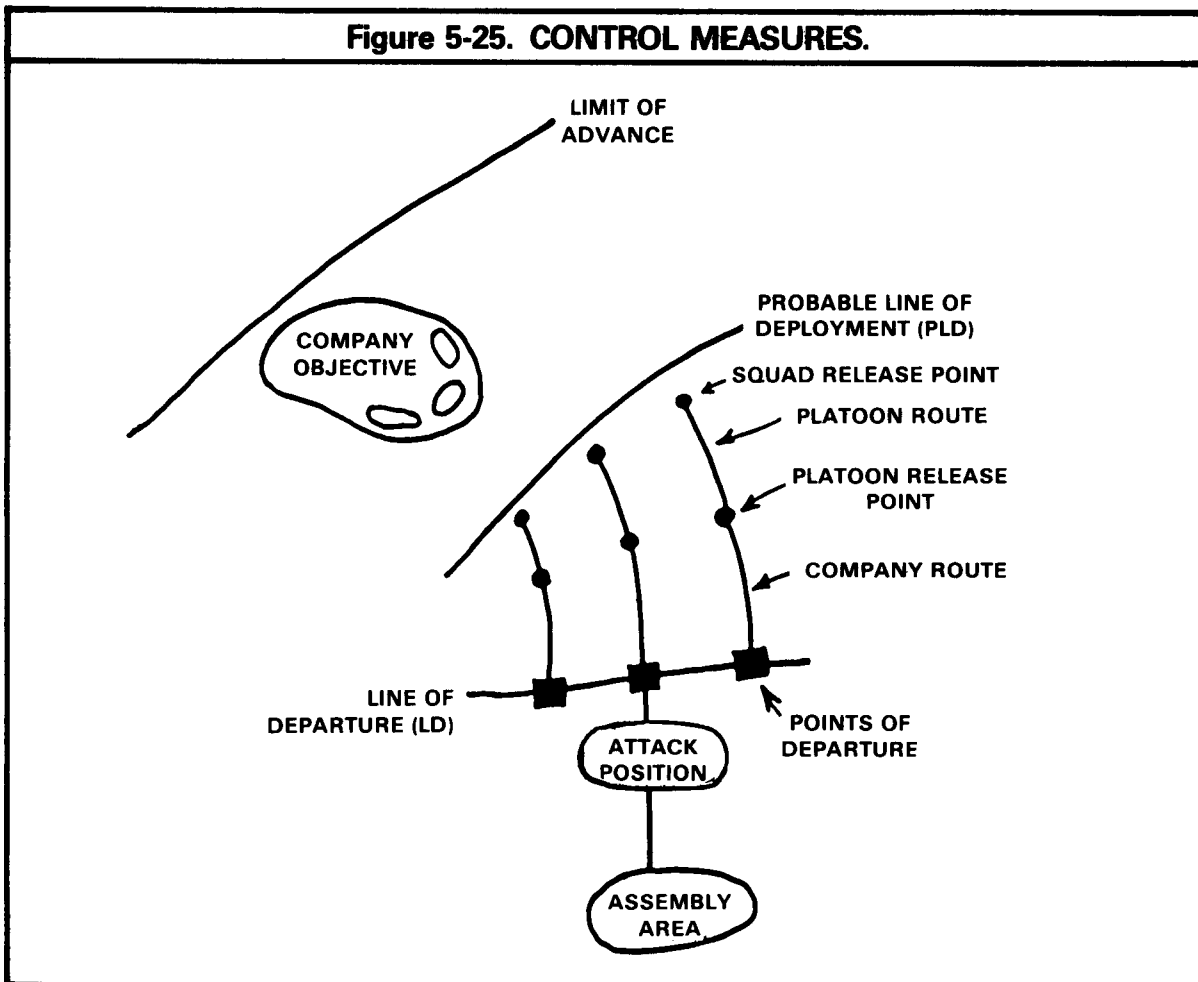
**Route.** The company commander normally picks the route from the company RP to the platoon RP. Platoon leaders pick routes from the platoon RP to the squad RP.

**Probable line of deployment (PLD).** The company commander plans to complete deployment along the PLD before moving forward. If the attack is not yet discovered at the PLD, the unit advances quietly until discovered or ordered to assault. The PLD is generally along an easily identifiable terrain feature perpendicular to the direction of attack.

**Objectives.** The company commander assigns each platoon an objective, which is part of the company objective. These should be easy-to-identify terrain features.

**Limit of advance.** To keep friendly supporting fires from falling on friendly dismounted troops, the company commander may designate a limit of advance. It should be a terrain feature that is easy to recognize even during limited visibility. The assaulting elements must not advance beyond this feature. The limit of advance allows use of supporting fires beyond the objective without endangering friendly troops.

Figure 5-25. CONTROL MEASURES.



The company or company team commander may organize a patrol to guide the dismount elements from the attack position to the point of departure on the line of departure and on to the probable line of deployment. Also, this patrol may, in rare cases, secure the PLD while the dismount elements are moving forward. Patrols are normally composed of two to four men from each dismount element, with the company or company team commander designating the patrol leader.

Except for small objectives, a platoon's dismount element normally attacks dismounted as apart of a company dismounted operation. Each dismount element may have a separate small

objective or a portion of the company objective. The dismount elements move from the assembly area to the attack position as part of the company's attack force, using the formation and movement techniques specified by the company or company team commander. Final coordination is made in the attack position, and then the dismount elements move toward the LD. The commander may move the attack force to the LD along a single route under his control, or for short-distance attacks he may designate separate routes for each dismount element. Once across the LD, movement is continuous, but the rate of advance is slow enough to permit silent movement. The traveling technique with dismount teams in column normally is used to

ease control and maintain stealth. If the attack is discovered during movement, and the element is close enough to the objective to begin the assault, the dismount element leader should immediately deploy his teams on line and begin fire and movement. Scattered enemy fire must not be taken as a loss of surprise and should not be cause to start the assault.

The dismount element should plan on using all of its dismounted night observation equipment to help control movement and to detect enemy positions. This equipment should include the two starlight scopes, the Dragon thermal sight, and perhaps the TL's/gunner's and driver's night vision goggles if they need them.

If enemy flares burst overhead as troops are moving, the troops quickly lie down until the flares burn out. If caught in the light of a ground flare, troops move out of the lighted area quickly and quietly.

If the attack is not discovered before reaching the PLD, the dismount element should deploy

the dismount teams on line and inform the company commander when the teams are fully deployed. On the commander's order, the dismount elements move silently forward, guiding on the base element and using overwatch as much as possible.

The dismount element assaults the objective on order or when the attack is discovered. As in good visibility the assault must be aggressive, using cover-to-cover rushes. The assaulting force must quickly gain fire superiority, by heavy fire, so that it can safely move. Tracers can be used to improve accuracy and to help control fires. Soldiers must not assault past the limit of advance.

As soon as the objective has been seized, the dismount element leader should so inform the carrier element leader. Guides should be posted to meet the vehicles and lead them into position. The rest of the dismount element eliminates remaining pockets of resistance and prepares for a possible enemy counterattack. OPs are posted but not beyond the limit of advance.

## **Section V. OTHER PLATOON OFFENSIVE OPERATIONS**

### **5-32. GENERAL**

Exploitation and pursuit normally follow a successful breakthrough of the enemy's defensive position. By exploiting and pursuing, units seek to keep the enemy off balance, to strike at targets of opportunity and to complete the destruction of the enemy forces or their capability to resist. Platoons participate in exploitation and pursuit operations as part of a larger force.

Both exploitation and pursuit consist of rapid mounted movement over long distances during good and limited visibility. Dismounted action is kept to a minimum. Platoons can expect to conduct frequent mounted bypass and hasty attacks.

During the exploitation and pursuit, brief fragmentary orders are normally used. There is little time for detailed planning. SOPs must be relied on for proper coordination and control.

### **5-33. EXPLOITATION**

The purpose of exploitation is to prevent the enemy from putting together an organized defense or conducting an orderly withdrawal. This is accomplished by rapidly advancing toward the enemy's rear, bypassing small pockets of resistance. Deep objectives are assigned; these normally include key terrain, logistical elements, and command and control centers.

### **5-34. PURSUIT**

The purpose of the pursuit is to complete the destruction of an enemy force that has lost its ability to defend. Objectives assigned are normally the enemy units being pursued. Terrain objectives may be assigned to simplify control. When a terrain objective is assigned, a unit can expect orders to continue the attack shortly after it seizes the objective. Consolidation is seldom carried out and there will be little time for

reorganization. Platoons in the pursuit operate as part of a direct-pressure force or as part of an encircling force.

The direct-pressure force keeps enemy units moving so that they cannot rest, regroup, or re-supply. The force conducts hasty attacks to maintain contact and forward momentum. If contact is lost, units conduct a movement to contact to regain it.

The encircling force attempts to move around the flank of the retreating enemy to block its route of withdrawal. The encircling force moves as fast as possible along the routes available to seize a chokepoint or a major terrain obstacle. The force may set up a defense, or it may be ordered to attack the flank of the enemy force.

## CHAPTER 6 DEFENSE

### Section I. INTRODUCTION

#### 6-1. GENERAL

The purpose of defensive operations is to repel an enemy attack and destroy the attacker. Defensive operations may also be undertaken to hold critical terrain, to gain time, or to wear down the enemy. The platoon defends as part of a company or company team and completes tasks assigned to it by the company or company team commander.

#### 6-2. DEFENSE TASKS

The platoon's defensive tasks include:

**Destroying enemy tanks, BMPs, and BTRs with dismounted or mounted Dragons and LAWs.**

**Suppressing enemy ATGM fires with the caliber .50 machine gun, dismounted machine guns, SAWs, grenade launchers, and rifles.**

**Repelling dismounted enemy attacks.**

**Providing close-in security for tanks and ITVs during limited visibility and in restrictive terrain.**

**Locating the enemy and providing security by manning observation posts and conducting patrols and ambushes.**

**Building obstacles to slow, stop, or canalize the enemy, and providing security for obstacles.**

**Conducting platoon-size counterattacks or counterattacking as part of a larger force.**

In the defense, the company or company team usually is supported by additional ITVs, artillery, mortars, and engineers. Each supporting element is deployed to increase the company or company team's combat power, and to reduce its vulnerabilities. Tanks, if present, are placed to exploit their mobility firepower, and armor protection. ITVs are positioned to exploit their long-range antiarmor fire and pinpoint accuracy. Engineers emplace obstacles, dig defilade positions, and clear routes, to make terrain more favorable for defense.

The defense often involves fast, frequent movement among battle positions and in counterattacks. Platoons and squads must be able to respond to short-notice changes in mission and must be able to fight immediately from a new battle position. Thus, platoons must develop and practice SOPs and, with these, learn to exploit the mobility and firepower of the APC. The order to occupy a position should trigger a series of automatic actions by the entire platoon.

CONTENTS	PAGE
Section I. Introduction . . . . .	6-1
II. Planning the Defense . . . . .	6-2
III. Defensive Tactics and Techniques . . . . .	6-3
IV. Conduct of the Defense . . . . .	6-21
V. Counterattack . . . . .	6-24
VI. Disengagement . . . . .	6-25
VII. Other Platoon Defensive Operations . . . . .	6-32



## Section II. PLANNING THE DEFENSE

### 6-3. GENERAL

When the platoon's mission is to defend, the company or company team commander must explain his defense plan. He does this by issuing an operation order. From the order, the platoon leader learns:

- (1) **The platoon's mission.**
- (2) **The commander's concept of how the defense will be fought.**
- (3) **The position of the platoon in the company or company team defense.**
- (4) **The platoon's sector of fire or engagement area.**
- (5) **The fire support that is available.**
- (6) **The evacuation or destruction procedures for damaged vehicles.**
- (7) **The evacuation procedures for friendly casualties.**
- (8) **The place prisoners of war are to be taken.**
- (9) **The special signals that are to be used.**
- (10) **The on-order missions for the platoon.**
- (11) **Position and mission of units on the flanks and in the rear.**

On receipt of a company operation order, the platoon leader begins his troop leading procedures (discussed in chapter 3). His first step is to plan available time. Once this is done, he can issue a warning order to his key personnel (platoon sergeant, squad leaders, and forward observer). A warning order alerts the platoon personnel to the mission, tells them what preparation they are to complete, and tells them where and when to receive the platoon leader's complete order. This gives the platoon leader

time to reconnoiter and prepare his operation order. He begins this process with an analysis of the mission, enemy, terrain, troops, and time available. The rest of the platoon gets ready for the mission.

Often, the platoon leader will have to issue simple, fragmentary orders and rely heavily on SOPs because the tactical situation requires immediate response. Regardless of the time available, the platoon leader should do as many of the troop leading procedures as possible.

### 6-4. OPERATION ORDER

When the platoon leader has completed his analysis, made his reconnaissance, and developed his plan, he then completes his order. The order should follow the standard five-paragraph operation order format and be issued orally. Where possible, SOPs should be referred to in the order. This helps to shorten the order. When possible, the platoon leader should give his order from a point overlooking (or on) the platoon's defensive position. The order must explain what is to be done, where, how, when, and by whom. The squad leaders then give orders to their squads.

### 6-5. PRIORITY OF TASKS

To help the platoon use available time efficiently, the leader should establish task priorities. Normally these are in the SOP, but they can be modified by the platoon leader or company commander. In most situations, the first five tasks are:

- (1) **Establish security**
- (2) **Position APCs and dismount teams.**
- (3) **Emplace crew-served Weapons and designate sectors of fire and FPLs.**
- (4) **Clear fields of fire.**

### (5) Prepare fighting positions.

Some of these tasks may be done at the same time. Additional tasks can include preparing range cards, emplacing obstacles, preparing alternate and supplementary positions, and laying wire for communications. The order in which these are to be accomplished should be

specified. Coordination with adjacent squads and platoons must be continual throughout the planning and the execution phases. Camouflage netting (radar scattering) should be used whenever possible when the APC is placed in position. The nets greatly add to concealment by breaking up the regular shape of the vehicle and deny ground and aerial observation.

## Section III. DEFENSIVE TACTICS AND TECHNIQUES

### 6-6. GENERAL

The platoon's defense must capitalize on the APC's firepower and mobility the Dragon's thermal vision equipment, **and** the dismounted infantryman's fighting capability.

Carrier teams with Dragons are best used to defend against mounted attacks along open avenues of approach.

Dismount teams are best used to defend against dismounted attacks along avenues that restrict mounted movement.

Seldom is it possible to position the carrier teams where they will not be subject to dismounted attack, or to position the dismount teams where the enemy cannot use his armored vehicles. Thus, it is essential that leaders and commanders carefully position and control carrier teams and dismount teams to make the most of the platoon's total combat power. This is not a simple matter: the APC firing the caliber .50 machine gun or Dragon is chiefly a medium-range weapon system, but the dismounted infantryman is most effective at short ranges. If the two are properly used, they complement and mutually support each other.

### 6-7. CONTROL TECHNIQUES

When the entire platoon is mounted, control is relatively simple. When dismount teams are deployed, control becomes difficult. There are

two ways to control the carrier teams and dismount teams:

**(1.) Squad Control.** The carrier team and dismount team remain under squad leader control only when the two teams are collocated. Because the two teams are together, this method improves control, concentrates firepower, and increases security. The squad leader may remain in the vehicle or dismount, whichever allows him to best control the entire squad and influence the fight.

**(2.) Platoon Control.** When the carrier teams are positioned away from the dismount teams, the teams are formed into a carrier element and a dismount element, each under platoon control. In this situation, the platoon leader must decide which element has the most important mission and from which position he can best control the entire platoon and influence the action. Whichever element the platoon leader decides to be with, he controls the other element through the platoon sergeant.

### 6-8. METHODS OF EMPLOYMENT

There are three methods of employing platoons in defensive operations:

**(1) Carrier teams and dismount teams on the same battle position.**

### 6-9. CARRIER TEAMS AND DISMOUNT TEAMS ON THE SAME BATTLE POSITION

(2) Carrier element and dismount element on separate battle positions.

(3) Platoon mounted on a single battle position.

No matter what the method of employment, the entire platoon and each element and team can be assigned primary alternate, and supplementary defensive positions.

In a **primary position**, a unit or individual can best fight to accomplish the assigned mission.

In an **alternate position**, generally adjacent to the primary position, a unit or individual can perform the original task when the primary position becomes untenable or unsuitable.

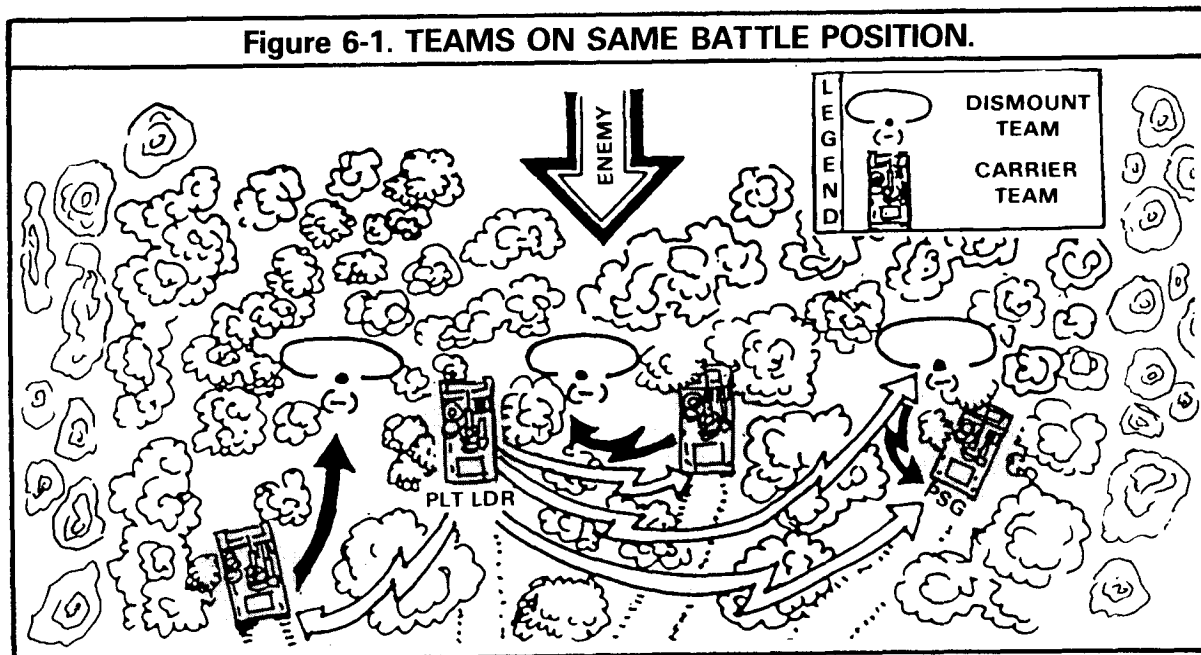
In a **supplementary position**, a unit or individual can accomplish a task that cannot be accomplished from the primary or alternate positions.

When possible, the platoon defends with the carrier teams and the dismount teams on the same battle position. This method takes greatest advantage of the platoon's defensive capability. Using it, the platoon can defend against mounted or dismounted attacks, move rapidly to another battle position, or conduct a counterattack.

Within the battle position, the carrier teams may be positioned with the dismount teams, or they may be forward of, on a flank of, or behind the dismount teams.

The carrier teams remain with the dismount teams when the terrain provides both teams with good observation, fields of fire, and cover and concealment. This is the preferred method because it simplifies control, insures mutual support, and facilitates remounting the vehicles.

Figure 6-1. TEAMS ON SAME BATTLE POSITION.



The platoon leader assigns each squad a primary position and sector of fire, and he may also assign alternate positions and sectors. He gives a general location for each observation post (OP) and designates which squads will man OPs.

The platoon leader supervises the positioning of each APC, insuring that it ties in with the other APCs according to his concept of the defense. Each squad leader positions his dismount team (complemented by the vehicle's fires) to provide security oriented on dismounted avenues of approach.

When using this technique, each squad leader retains control of the dismount team and the carrier team. Each squad leader positions himself where he can observe and control his squad's operations. A squad leader can usually observe the battlefield and control the carrier fires better from the carrier.

Initially, and when it is necessary to gain better observation and fields of fire and thus take better advantage of mounted weapons, the carrier element can be employed forward of the dismount element. In that case, the dismount element is positioned to the rear to avoid unnecessary exposure to enemy fire directed at the APCs. The dismount element should use available time to prepare fighting positions and obstacles. When the enemy attacks, the carrier element normally will engage enemy formations at maximum range and, when endangered, move to alternate positions to the flank or to the rear of the dismount element. The timing of this move is critical. While maximum advantage can often be gained by employing the carrier element forward, the carriers become more vulnerable to enemy fire as the enemy closes.

In most situations, the squad leaders will stay in the same element with the platoon leader. Because the carrier element will be the

first to see and engage the enemy, and because timing of movement to alternate positions is so critical, the platoon leader may decide to stay with the carrier element. The platoon sergeant then would be the dismount element leader. Sometimes, tactical considerations dictate other methods. For example, when the primary fight is expected to be dismounted, it may be wise to leave the squad leaders with the dismount element while the platoon leader stays forward with the carrier element. As the situation develops, the platoon leader may move with the carrier element or dismount in a position where he can better control both elements. This allows the platoon leader to stay abreast of the situation and still provide maximum control where the primary fight is expected.

The platoon leader should assign each carrier team a primary forward position and at least one alternate position. He should also assign positions to be occupied after displacement. Similarly, the platoon leader or platoon sergeant assigns each dismount team a primary and alternate position and a sector of fire, which complement the carrier element's positions once the vehicles have displaced rearward. Carrier element leaders should also plan supplementary positions to maintain security in case one or more vehicles are disabled during the initial engagement.

When the battle position has two avenues of approach, one with long-range and one with short-range fields of fire, the carrier element is positioned on the same battle position but to the flank of the dismount element. This allows good positioning of the carrier element and the dismount element because each is positioned on terrain best suited to its capabilities. Such positioning may allow for a more determined defense, but, in the heat of battle, remounting the carriers by the dismount element may be difficult.

Figure 6-2. CARRIER ELEMENT ON FLANK.



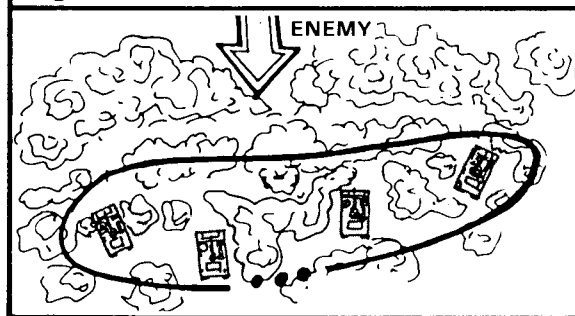
The carrier element and the dismount element should not be separated beyond mutual supporting distance. The platoon leader should personally direct the positioning of each APC, if possible; assign sectors of fire to the dismount team; and assign primary and alternate positions and sectors of fire to crew-served weapons and ground-mounted Dragons. If the platoon leader is called to the company command post on arrival at the battle position, the platoon sergeant lays in the platoons. In that case, the platoon leader has the responsibility of checking the platoon defense on his return.

During reduced visibility, the platoon leader may find he needs to reposition a dismount team — for example, nearer to the carrier element — to provide local security.

When covered positions are available for the dismount element but not for the carrier element, when the terrain is too restrictive for vehicle movement, or when multiple mounted avenues of approach exist, the carrier element is positioned on the same battle position but to the rear of the dismount element. The platoon leader should position the carrier element so that it can overwatch the dismount element. He may decide to keep the carrier element in a centralized hide position.

This allows the carrier element to make a quick move and mass its fires on whichever avenue of approach the enemy uses. (Hide position will be discussed later.)

Figure 6-3. SAME BATTLE POSITION.



This method is best suited to avenues of approach that represent a dismounted threat.

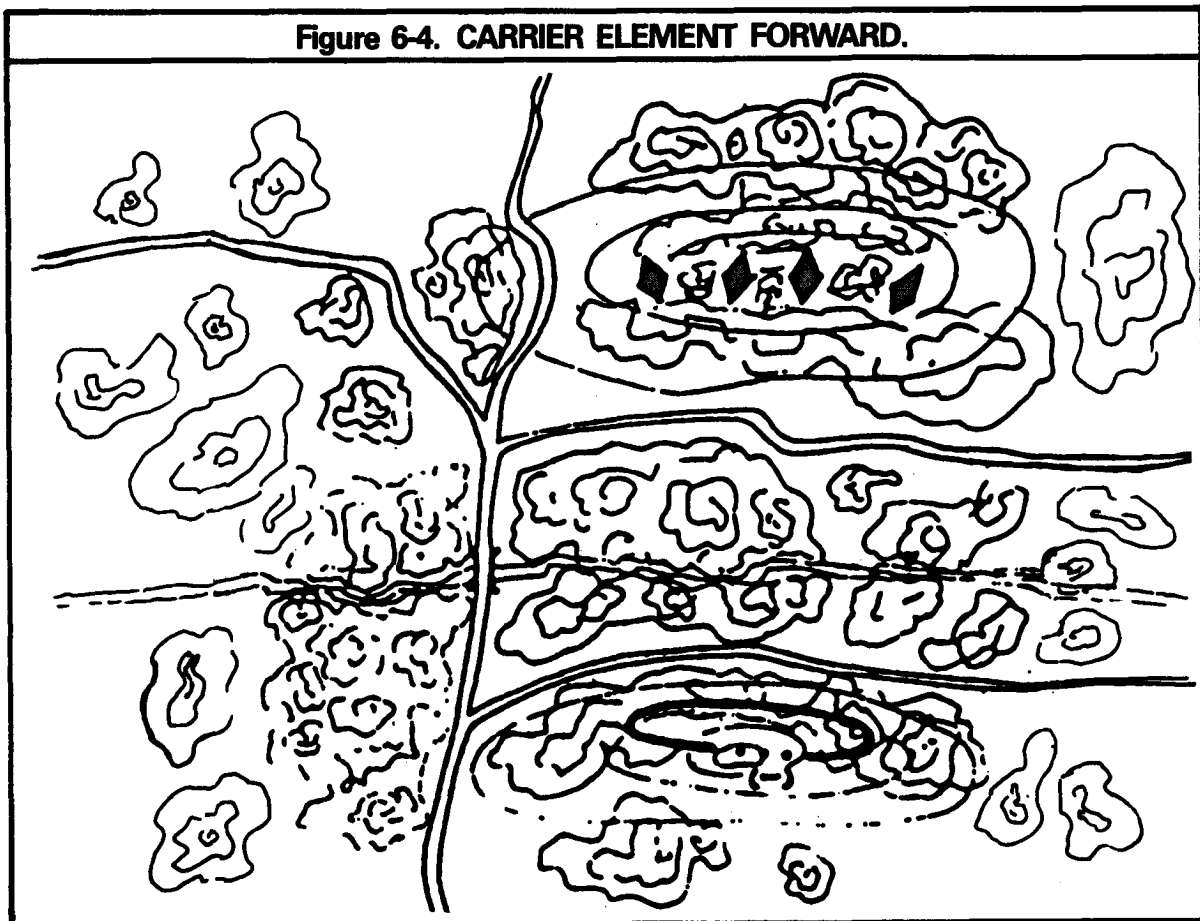
#### 6-10. CARRIER ELEMENT AND DISMOUNT ELEMENT ON SEPARATE BATTLE POSITIONS

The company or company team commander may decide to employ the carrier element and dismount element separately. With this method, the separated elements may be less able to support each other.

Control is difficult when the elements are separated since the two elements will have different missions. The company or company team commander may choose to control both elements directly by having both element leaders on the company or company team command net. If so, the commander will normally tell the platoon leader which element to be with.

Leaders of dismount teams must plan operations that do not need the support of their vehicles. The quantity and type of weapons, ammunition, mines, equipment, and supplies to be with the dismount element must be taken into account. How long the teams will operate separately and how quickly the dismount teams must be able to remount are important planning considerations.

The carrier element may be employed well forward to perform a specific mission. When its mission is completed, the carrier element displaces and rejoins the dismount element. This method may be used when the commander wants to use the APCs for antiarmor engagement well forward of the dismount element's intended positions. In such fights, the carrier element must avoid decisive engagements because the element lacks a dismounted carrier capability. Dismount teams which cannot be used forward appropriately are left in the rear to improve positions and emplace obstacles. Once it has returned to the dismount element's position, the carrier element can fight using any of the methods discussed earlier.



Another variation with the carrier element and dismount element on separate positions is to have the two elements fighting from two **adjacent** battle positions covering the same avenue of approach, and rejoining only to move from those positions.

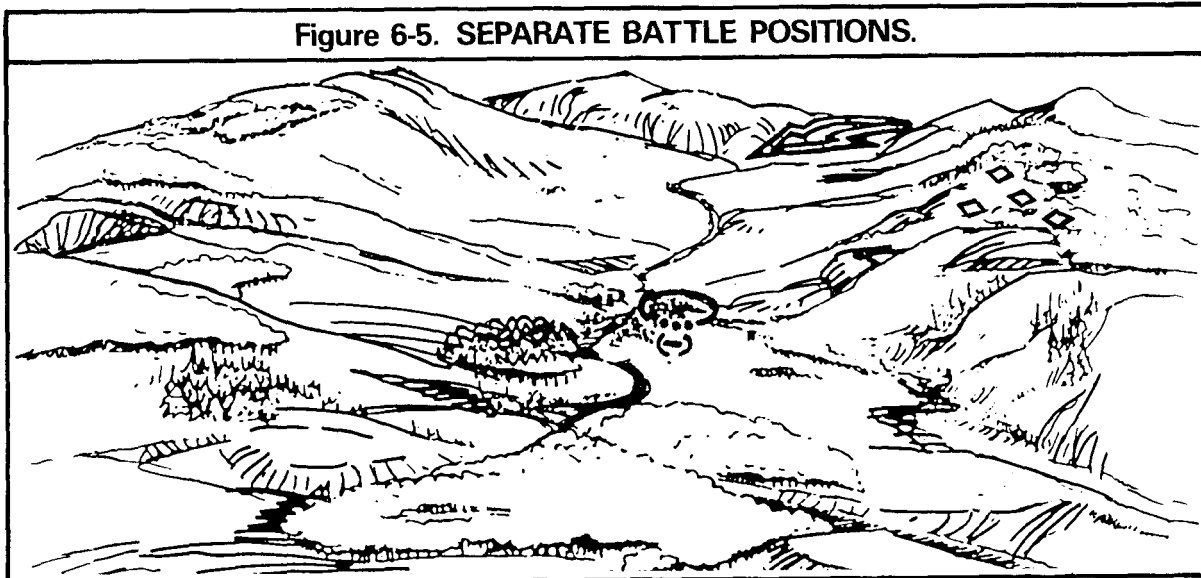
A company or company team commander may use this plan when he needs the dismount element in one location and the carrier element in another, and when both can be employed from separate positions. This situation might arise when:

The primary position for the dismount element does not allow adequate fields of fire for the carrier weapons.

Sufficient forces are not available to cover separate mounted and dismounted avenues of approach.

The dismount element must occupy heavily wooded or rugged terrain that the APCs cannot traverse.

**Figure 6-5. SEPARATE BATTLE POSITIONS.**



When this variation of adjacent position is used, a key consideration is how and where the two elements will link up. Both elements need covered routes to a concealed remount point where the dismount elements can rejoin the carrier element. Because the carrier element can move faster than the dismount element and has more protection against small arms and indirect fires, the platoon remount point should be as close to the dismount element as possible.

During limited visibility the company or company team commander may change his plans to provide additional security for the carrier element. This can be done by moving a dismount

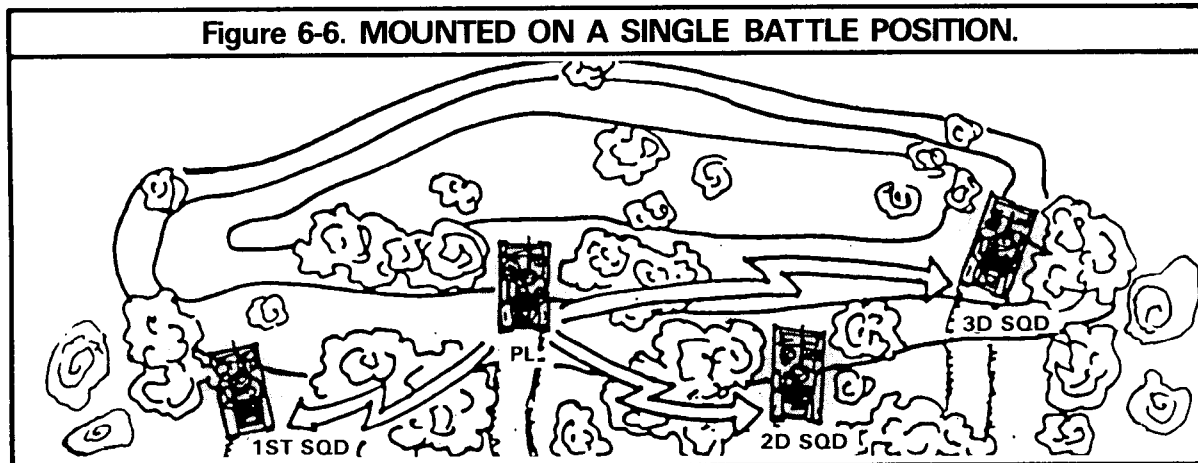
team to the carrier element's position or by rejoining the platoon on a single battle position.

#### **6-11. PLATOON MOUNTED ON A SINGLE BATTLE POSITION**

The platoon defends mounted from a single position if the most advantage can be gained by medium-range antiarmor engagement with mounted Dragon systems and no major gain can be made by deploying a dismount element. This method is used only in a hasty defense when the platoon is going to be in position for only a short time. Staying mounted simplifies the platoon leader's control of the platoon and improves the platoon's ability to react and move quickly. Be-

sides, it reduces troop exposure to indirect fire and provides an excellent posture to exploit an enemy weakness by counterattack. This method may also be used when the platoon must fight immediately upon occupying a position or when

the platoon is alerted to be ready to move to another battle position. It should be remembered, however, that the carrier will draw return fire which will endanger the mounted squad.



Normally staying mounted is the least desirable method of employment. The major disadvantage is that less short-range firepower can be produced, and local observation and security are reduced. The platoon is more vulnerable to an attack by dismounted infantry forces. Each squad, by SOP, should dismount a small force (two or three men) for local security each time it halts. These men are led by the team leader. They use natural cover and concealment. If the enemy does not attack, the remainder of the dismount teams should deploy and prepare fighting positions

### 6-12. BATTLE POSITIONS

A defender has certain natural advantages the attacker does not have. These include a better knowledge of the terrain, ability to better use the terrain for protection and concealment, and a better opportunity to plan the fight. It is essential that platoons and squads select and occupy their positions carefully. If they do not, they lose many of the defender's advantages.

### 6-13. CARRIER TEAM POSITIONS

The firepower of the caliber .50 machine gun and Dragon is one of the platoon's greatest assets.

Hence, the platoon leader first considers where to position the APCs, and then, if the situation allows, builds the platoon defense around them. Ideally each vehicle's position provides:

**Good fields of fire into the most likely avenues of enemy approach.**

**Cover, especially to the front.**

**Concealment from both ground and air observation.**

**Covered and concealed routes to and between positions and to the platoon remount point (if applicable).**

**Mutual support between positions.**

Hull-down positions should be occupied whenever possible. In such positions, mounted weapons are least exposed to enemy fire, and the hull is protected by cover. By camouflaging the weapons, the APC is then difficult to detect, yet the mounted weapons can still be fired. If available, engineer assets can assist the platoon in preparing hull-down positions.



Figure 6-7. APC HULL DOWN.



**NOTE: When first occupying a hull-down position, the caliber .50 machine gun should be fully depressed to insure that close-in targets can be engaged without moving the vehicle.**

Each vehicle should have a primary position and as many alternate positions as needed to cover the entire sector of fire. Supplementary positions may be designated to cover secondary sectors of fire. All mounted weapon systems should be considered when positions are selected and prepared.

**NOTE: The Dragon system positions must offer unobstructed fields of fire and a clear backblast area.**

Dragons can kill tanks out to 1,000 meters. This is within effective range of a tank's main gun (usually between 1,500 and 2,000 meters). This gives the tank a stand-off advantage. To offset the advantage, APCs must have good hull-

down positions, suppress enemy tanks with indirect fire, coordinate TOW and Dragon fires, and insure that tanks fired on are in range.

This kill probability of the Dragon rises if it hits the tank's weaker side armor. Flank engagements are advisable because a tank crew's observation and the tank's main gun are normally oriented to the front. Thus, a side or flank engagement reduces the chances of being detected while it improves the chances of a kill.

In some defensive situations where the emphasis is on the dismount element to hold ground, the carrier element will have to make the best possible use of less than ideal terrain. The use of the mounted carrier must be weighed against its possible loss.

The APC cannot survive against antiarmor missiles, tank fire, or BMP and BTR fire. Thus, the vehicle is subject to being suppressed or destroyed by enemy fire. The best way the vehicle can overcome this disadvantage is to stay concealed and deliver surprise flank fire on enemy tanks or other armored vehicles.

When a carrier has fired on an enemy formation, it probably will attract return enemy fire. This APC should, if possible, pull back into a defilade position and another APC, as yet unseen by the enemy should fire on an enemy vehicle that is firing at the first APC. This is mutual support.

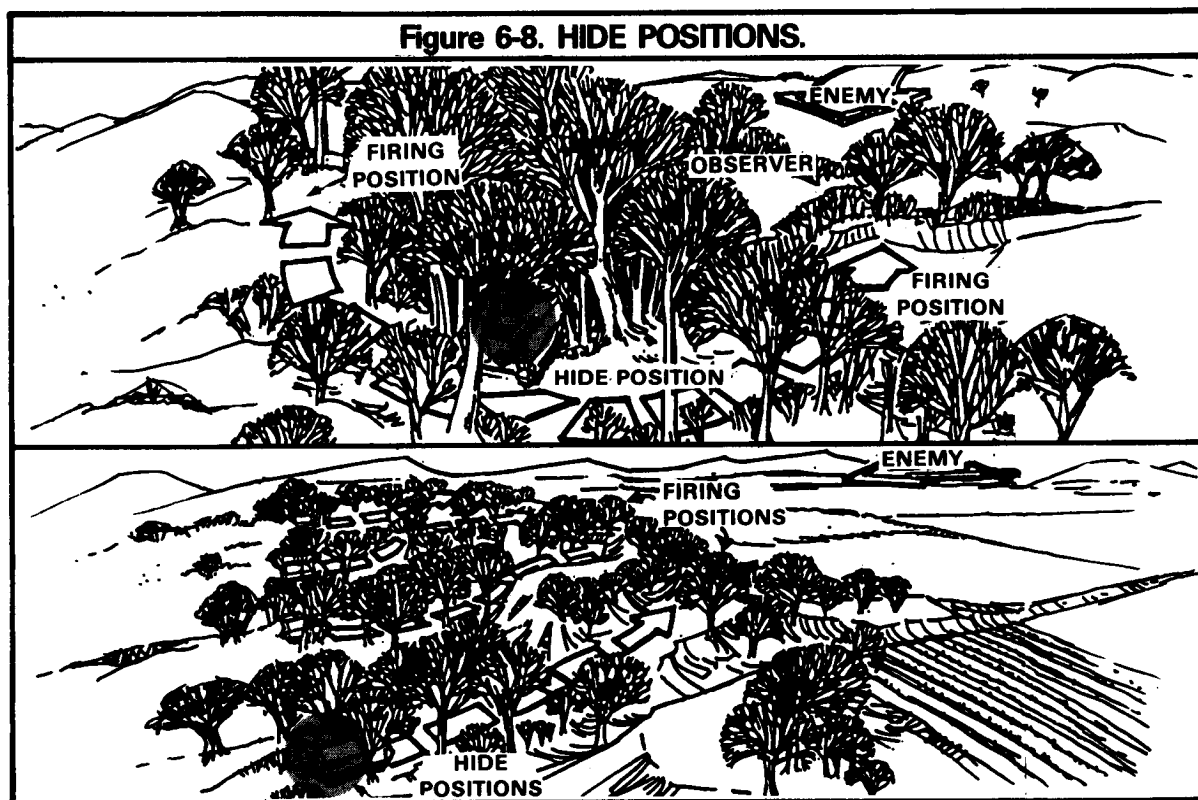
The enemy will attempt to suppress the carrier with direct and indirect fire and smoke. So, the carrier element should be positioned to get as much separation as possible between APCs while still mutually supporting each other. This cuts down the chances of two or more APCs being suppressed by the same enemy fires.

#### 6-14. HIDE POSITIONS

When covered and concealed positions are not available for the APCs initially it may be necessary to hide the vehicles in well-concealed positions to the rear. If the carrier teams are collocated with the dismount teams, the dismounted

infantrymen can observe the sector and call the carrier forward to preselected firing positions when enemy targets are in firing range. The hide-position technique may be used by individual carrier teams or by the entire carrier element. If the elements are separated, the carrier element leader may have to dismount and move forward to observe the sector.

The use of hide positions helps avoid early detection by enemy ground forces. Also, it can help avoid detection by enemy air. Routes from hide positions to firing positions should be concealed so that the vehicles moving forward will not be detected and engaged by the enemy. Communications between the observers and carrier element can be by prearranged visual signals, wire, or radio. By having several firing positions for a single hide position, each APC is able to engage targets with caliber .50 machine gun or Dragon and then move to another firing position before the enemy can effectively return fire.



A variation of hide positions may be used by the entire platoon to gain protection from intense enemy artillery barrages when the platoon has not had time to prepare adequate fighting positions. By staying mounted and moving to covered and concealed positions to the flank or rear of the intended position, the platoon can wait through an enemy barrage and then occupy the position when the barrage ends. The platoon leader must position himself to allow observation of enemy avenues of approach so that he can decide the proper time to move the platoon into position. As discussed earlier, route selection is critical to avoid disclosure of friendly positions. Timing is critical since the enemy only employs barrages if his maneuver forces are in position to exploit them.

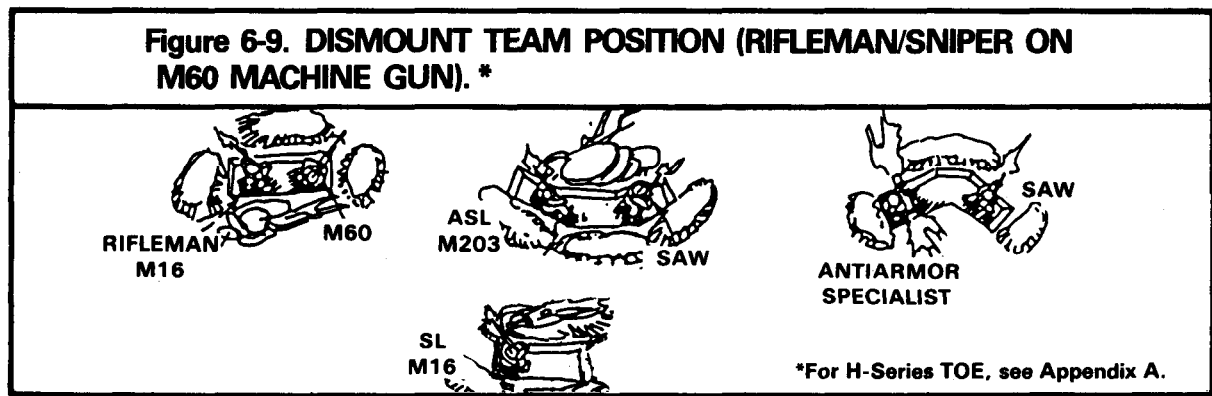
**6-15. DISMOUNT TEAM POSITIONS**

The company or company team commander's concept of the defense normally specifies when the dismount teams are to be deployed and where they are to be positioned. When possible, the platoon's defense is built around the APC and the dismount element's fighting capabilities. The dismount teams are best employed against enemy

dismounted infantry so they should be positioned in areas where the enemy is most likely to fight on foot. Such areas include small towns, rugged terrain, and thick woods.

Seldom is it possible to position the dismount teams in areas that will preclude the enemy's use of armored vehicles; hence, the platoon leader must plan for the dismount teams to fight a mounted and dismounted enemy threat. Restrictive mounted approaches, such as secondary roads, trails, and roads bordered by natural obstacles, are areas well suited for the dismount team's defense against a mounted enemy.

The dismount team members are usually placed in two-man positions. The squad leader should consider whether to remain mounted or to dismount the APC and leave the gunner and driver as the carrier team. If the sector being defended is narrow, then the number of positions may be reduced. If a sector is wide, then it may become necessary to occupy positions with only one man. (Remember to maintain two-man positions on crew-served weapons such as the M60 machine gun if a gunner is designated.) The illustration shows a typical dismount team's position.



Even though it is a small organization, the dismount team has lots of combat power. To fight enemy dismounted attacks, it is armed with one M60 machine gun, three M16A1 rifles (one if the M60 is manned), two M203 grenade launchers (each mounted on an M16A1 rifle), two SAWs, and assorted hand grenades and antipersonnel

mines. Against enemy mounted attacks, the dismount team can employ the Dragon, LAWs, the M203 high explosive dual-purpose (HEDP) round, and antitank mines.

The distance between dismount teams will be determined by enemy capabilities, the terrain,

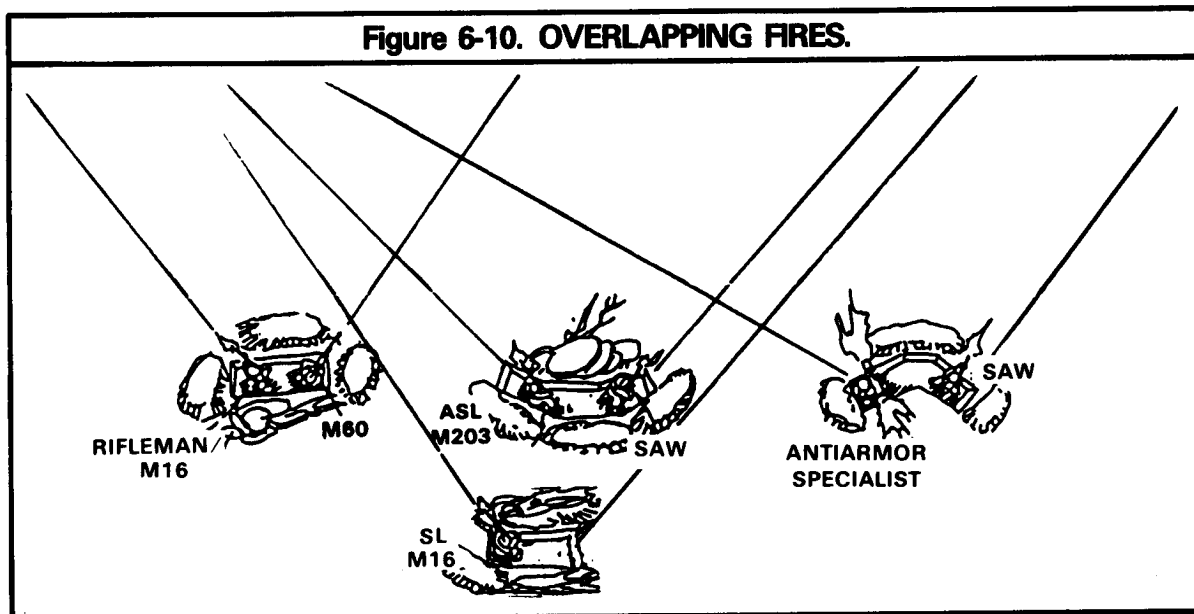
visibility conditions, strength of the dismount teams, and their location with respect to the carrier teams.

If each squad has its dismount team dismounted and collocated with its carrier team, distances between squads can be increased. Still, each squad should tie in its fires with the other squads to provide mutual support.

When the dismount element and carrier element are separated, the teams within each element should be mutually supporting, and should be positioned to render this support.

Where possible, the dismount element's fires reinforce and protect the carrier element. Dismounted infantry should be positioned to maximize the effects of the terrain so that the enemy has limited fields of fire/observation into friendly positions. Friendly artillery and mortar fire should be planned with priority going to support of the dismount element.

When preparing the dismount demerit position, the first thing the element leader does is explain to the dismount team leaders how the carrier teams are to be used. He then assigns each team leader a sector, tells him where to position his machine gun, (if manned), and Dragon (if not mounted), and assigns sectors of fire for each weapon. The dismount element leader insures that key weapons are mutually supporting and that no gaps appear in the element's sector. overlapping sectors of observation and fire between adjacent weapons, fighting positions, and teams provide mutual support within the element's sector. This fire must be enough to stop enemy soldiers from penetrating the position or isolating any part of the dismount element. Obstacles should be planned and emplaced to support the fire plan. Engineer assets, whenever available, should be used to the maximum extent to emplace obstacles and/or to prepare positions.



Protection against enemy indirect fire is a major consideration when preparing dismount team positions. The enemy has the capability to concentrate large amounts of indirect fire. Intense barrages can be expected before any attack.

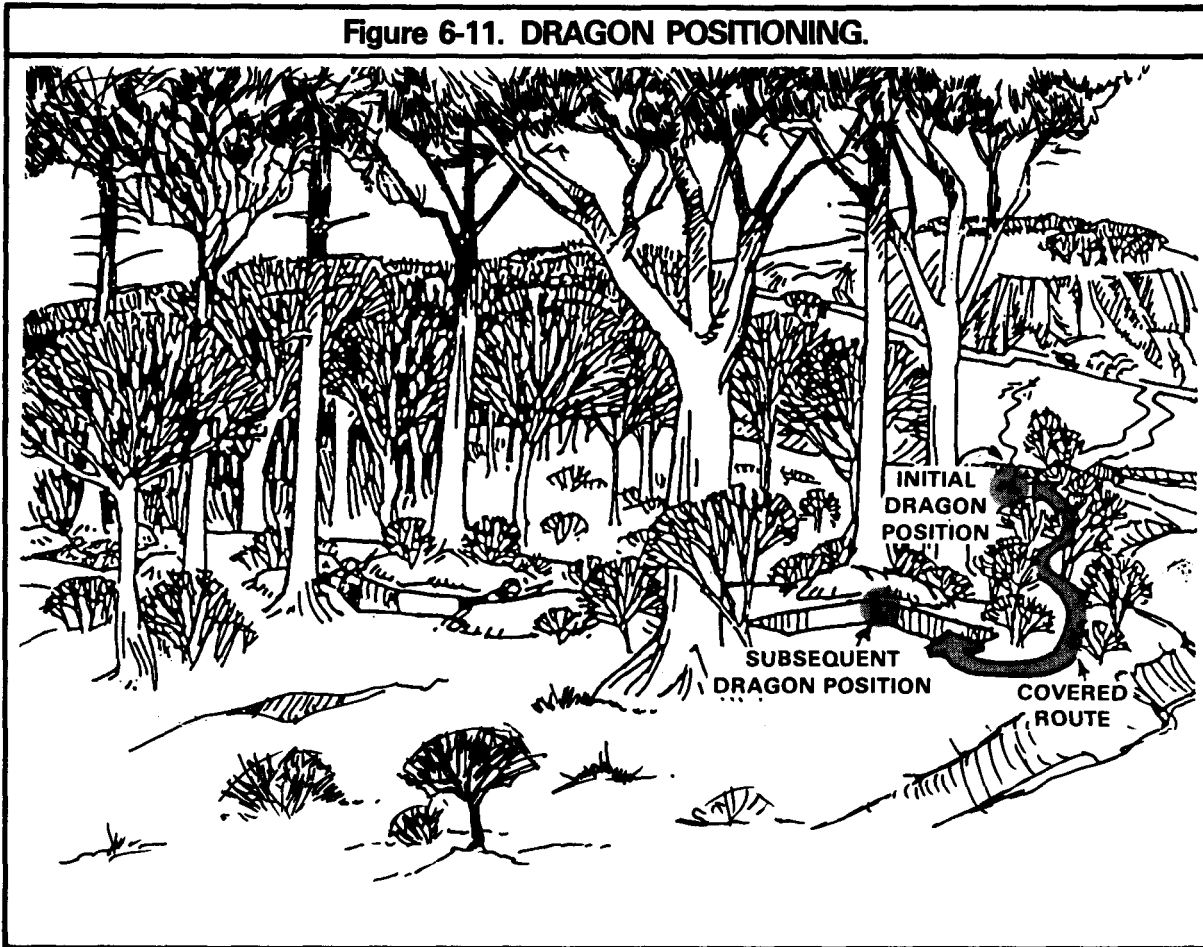
The barrages will continue until the last possible moment before the enemy closes on friendly positions. If dismount teams are deployed, they must be protected. If there is no time to prepare fighting positions with overhead cover, and the APCs

are on the same position, dismount teams should mount their APCs until the indirect fire is shifted past the platoon's position. Then the teams can quickly reoccupy their fighting positions under the APCs' covering fires and prepare for the enemy's dismounted attack.

Since the dismount teams are normally employed in areas that restrict mounted movement,

Dragon positions with suitable engagement ranges may not be available. If this is the case, Dragons initially may be positioned forward or on the flanks of the dismount element to obtain better fields of fire. Dragons should be positioned to obtain flank shots whenever possible. In the absence of Dragon targets or when Dragon missiles have been expended, antiarmor specialists fire their M16A1 rifles.

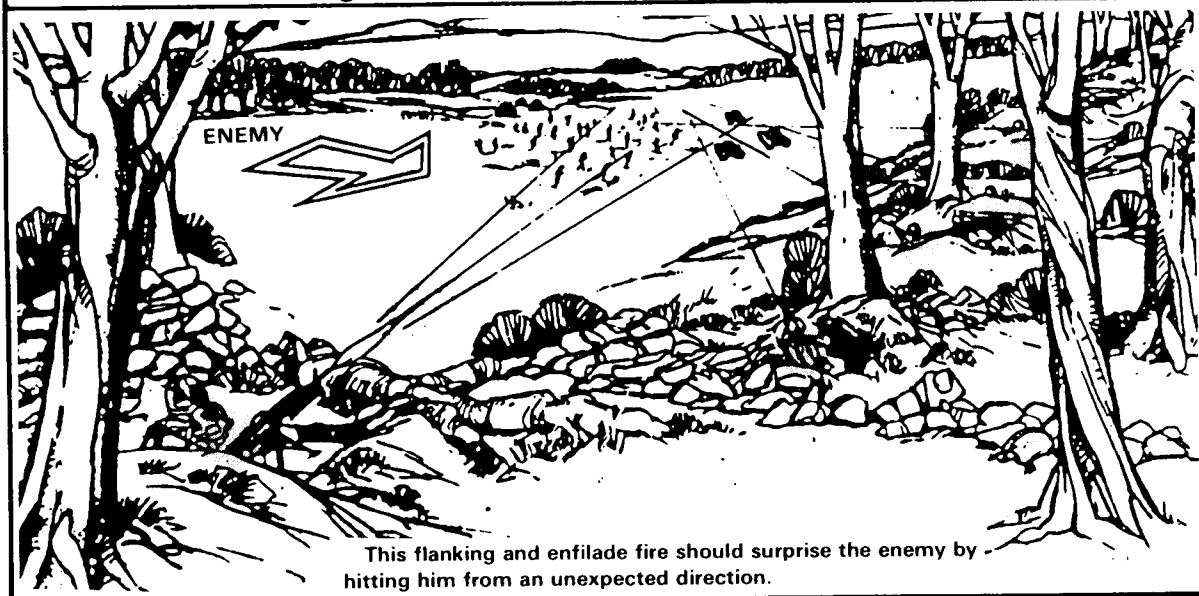
**Figure 6-11. DRAGON POSITIONING.**



Machine guns and SAWs are the dismount element's main weapons to stop infantry attacks. As a rule, all the platoon's machine guns/SAWs are brought to the dismount element's position. The machine guns should be used on tripods with traversing and elevating mechanisms. Their positions should provide sectors of fire across the dis-

mount element's front, interlocking with the carrier element and adjacent platoons, when possible. Machine gun positions should have frontal cover. Machine guns are most effective when delivering enfilade fire down the line of the enemy assault formation.

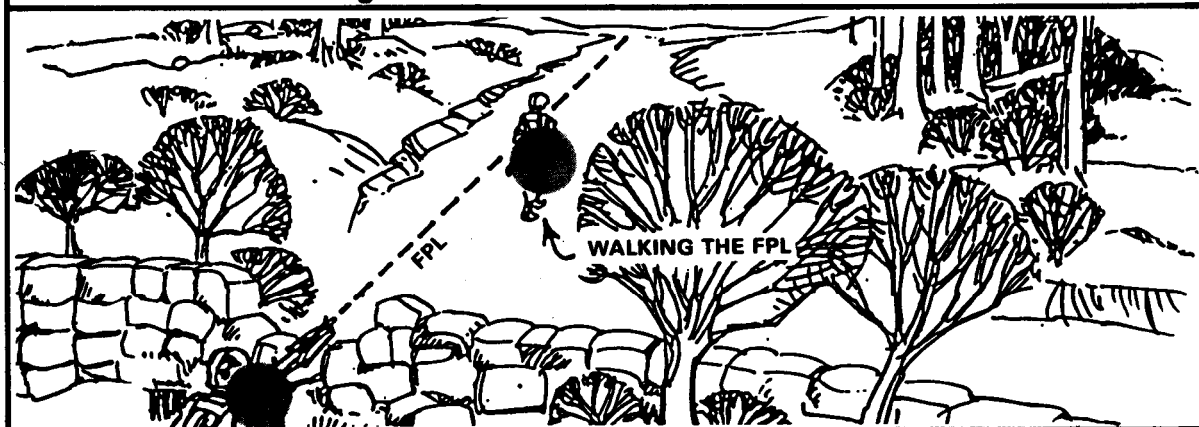
Figure 6-12. MACHINE GUN POSITIONS.



Where it can be done, machine guns are assigned a final protective line (FPL). An FPL is a line where, with interlocking fire and obstacles, the platoon leader plans to stop an enemy dismounted assault. Generally, it is across the front of the battle position. A machine gun FPL should supply as much grazing fire as possible. Grazing fire is to be no more than 1 meter above the ground (about hip high). Dead space is any area along the FPL that cannot be hit with grazing

fire. Dead space is found by having a man walk the FPL. The machine gunner eyes the man walking down the line and records on his range card areas grazing fire does not cover. Dead space should be covered by fires from the grenadiers using the M203. Additionally indirect fire, such as mortars, can be planned on dead space. Where possible, FPLs should overlap so that the lees of a machine gun will not leave a gap.

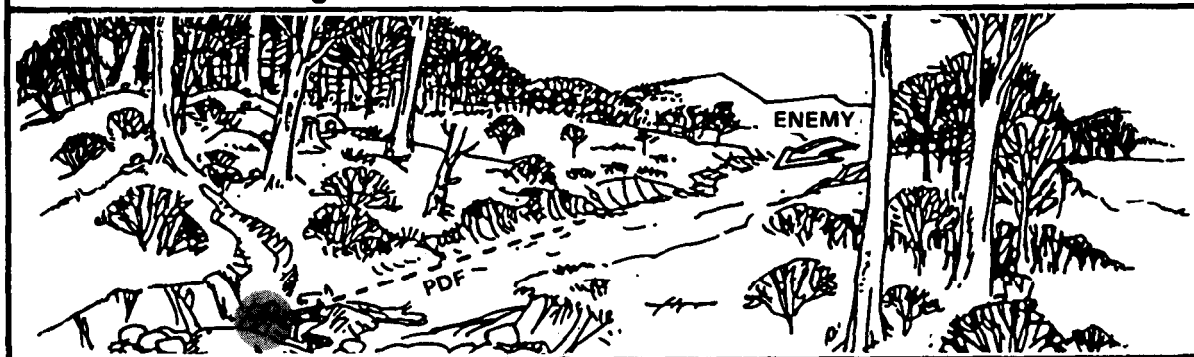
Figure 6-13. CHECKING DEAD SPACE.



Sometimes, a gully or ditch may lead into a position. If so, a machine gun may be positioned to fire directly down the approach rather than

across the team's front. This machine gun will be assigned a principal direction of fire (PDF) down the approach.

**Figure 6-14. PRINCIPAL DIRECTION OF FIRE.**



A machine gun is always laid on its FPL or PDF unless engaging other targets. The FPL machine guns should be fired all at the same time and on signal.

The M60 requires an assistant machine gunner. He should be assigned a sector that helps secure the machine gun position, cover gaps in the machine gun fire, or overlap the machine gun's sector, if no gaps exist. If the gunner becomes a casualty the assistant mans the machine gun. If a mounted enemy attack closes within 400 to 500 meters, the assistant should fire his weapon at any exposed enemy tank commanders on tanks, BMPs, BTRs. This would force them to close their hatches; thus, it would intensify their control problems.

The two SAWs should be positioned to cover gaps in the machine guns' sector. If there are no gaps, SAWs should be assigned sectors that overlap the machine guns' sector. This will insure coverage throughout the team's sector.

The LAWs are the dismount team's primary close-in antiarmor weapon. Each dismount team should have several LAWs in its position. A soldier's sector of fire for the LAW is the same as for his primary weapon.

Enemy approaches into the position should be covered with mines. (Employment of mines re-

quires battalion approval.) To cover dead space that cannot be hit with grenade launchers and to supplement the dismount element's fire, Claymores and other antipersonnel mines can be used. A Claymore must be fired by a soldier who can see its sector of fire. Claymores can be double wired so that they can be fired from either the position they protect or the adjacent position. If more than one Claymore covers the same sector, the dismount team leader should establish a firing sequence. Since there is only 100 feet of wire with the Claymore, care should be taken to insure that soldiers in adjacent positions are not in the Claymore's backblast area.

Antitank mines are used for close-in protection against mounted assaults. It is best to place antitank mines on likely tank routes where they can be covered by LAW and Dragon fire. At least one mine should be emplaced per two-man position; more can be used depending on how vulnerable the dismount team is to armored attack. When mines are used, appropriate reports must be made and locations recorded. All antitank mines should be removed before leaving the position. If this is not possible, such as when a withdrawal is ordered, a report that mines were left in place must be made to proper authority (See appendix P for details of hasty minefield.)

The dismount team leader must concentrate his efforts on controlling the team's fires. He only fires his own weapon to designate targets or in situations where additional firepower is needed.

The dismount element leader and team leaders must be in positions from which they can control their men. The dismount team leader will normally be located toward the center of the team. He may have to occupy a position by himself, or with the Dragon gunner, or near the machine gunner. He should position himself where he can see the entire team and its assigned sector. Ideally, he should be able to see the dismount element leader. The dismount element leader must find a position that lets him overlook the element's entire sector or at least the most critical part of it. When possible, he should have visual contact with the carrier element or a part of it.

**6-16. INDIRECT FIRE**

Most indirect fire planning is done by the company commander and the fire support team (FIST) chief. Based on the platoon leader's guidance, targets are identified by the FO party attached to the platoon. This target list is forwarded to the FIST chief who consolidates the list and incorporates it into the company's target list. A copy of the company target list is given to the platoon leader. The platoon leader and his FO check the target list to insure that fire is planned on all enemy avenues of approach and on known or likely enemy positions in the platoon sector of fire. If more targets are needed, the FO requests them through the FIST chief. The FO normally stays with the same element as the platoon leader. (For details, see chapter 8.)

The company commander may assign a mortar or artillery final protective fire (FPF) — a prearranged barrier of fire — to a platoon area. A platoon leader must plan its location with his FO and the FIST chief. It should cover the most threatening approach with HE quick on dismounted approaches or DPICM on mounted approaches. The FPF is planned close to the

platoon position, but not close enough to endanger friendly troops. When assigned an FPF, the platoon leader will have authority to call for it unless the company commander retains authority. The FPF is essentially fired as a last resort to stop an enemy assault. On signal, it is fired continuously until it is ordered stopped. All other platoon weapons fire while the FPF is being fired. The widths, by weapons, of impact areas of typical FPFs are:

<b>WEAPON</b>	<b>UNIT/NUMBER</b>	<b>WIDTH OF FPF</b>
81-mm mortar	(3 mortars)	100 meters
81-mm mortar	(6 mortars)	200 meters
107-mm mortar	(3 mortars)	150 meters
107-mm mortar	(6 mortars)	300 meters
155-mm howitzer	Battery (6 howitzers)	300 meters
155-mm howitzer	Battery (8 howitzers)	400 meters

**NOTE: The FO will advise the platoon leader on how close to the dismount teams an FPF can be fired with no danger to the troops. This varies with the type of weapon and ammunition fired.**

**6-17. SECURITY**

A platoon leader sets up a security system for his platoon to keep the enemy from observing or surprising the platoon. This system is based on guidance from his company commander, the enemy situation, terrain, and visibility conditions. As a minimum, an OP is established within small arms support range and with communications to provide security for the platoon.

**6-18. COORDINATION BETWEEN ADJACENT PLATOONS/SQUADS/TEAMS**

Platoon leaders coordinate with adjacent platoons. Squad or dismount team leaders coordinate with adjacent squads and teams so that all positions and all units are mutually supporting. Coordination normally is initiated from left to



right. As a minimum, gaps between positions are covered by fire.

Information exchanged includes:

**Locations of primary, alternate, and supplementary positions; and sectors of fire for vehicles, machine guns, and Dragons.**

**Location of dead space between units and how it is to be covered.**

**Location of OPs.**

**Location and types of obstacles and how to cover them.**

**Patrols, to include size, type, time of departure and return, and routes.**

#### **6-19. DEFENSIVE SECTOR SKETCH (TEAM, SQUAD)**

If the carrier teams and dismount teams are under squad control, each squad leader should prepare a sector sketch. (Each antiarmor specialist and 7.62-mm and caliber .50 machine gunners should prepare a range card.) The sketch helps the squad leader plan his defense, control the squad's fires, and aid the platoon leader in preparing the platoon fire plan. If the squad is divided into a dismount team and a carrier team that are separated, the dismount team leader makes a team sector sketch and the carrier team leader prepares a range card.

A sector sketch consists of a rough drawing, as close to scale as possible, showing:

**Main terrain features in the sector and the range to each.**

**Each primary position.**

**Engagement areas or primary and secondary sectors of fire of each position.**

**Dismounted machine gun FPLs or PDFs.**

**Type of weapon in each position.**

Maximum engagement ranges of Dragon and caliber .50 machine guns.

OP and leader positions.

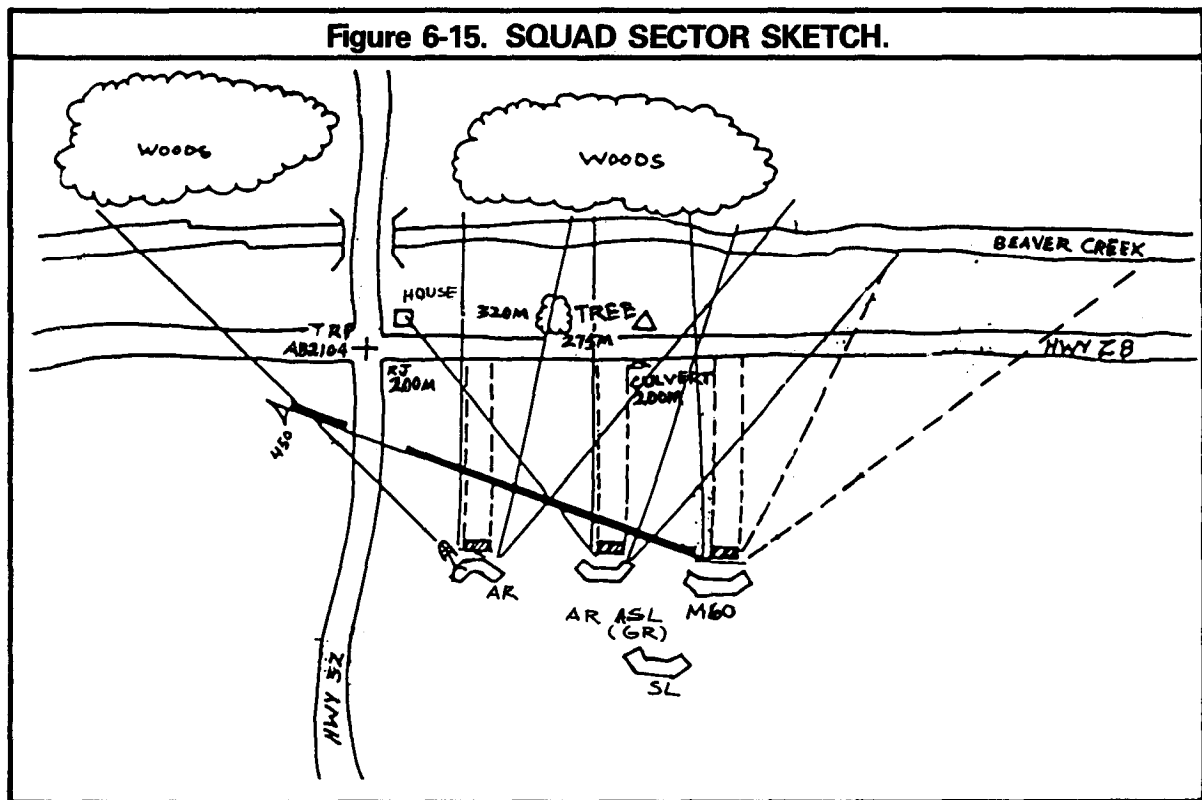
Target reference points in the sector.

Dead space.

Obstacles.

The squad sketch should be prepared based on direct observation of the sector and by using each weapon's range card. (See appendix C for explanation of range card preparation.) Two copies of the squad sketch should be made. One copy goes to the element leader or platoon leader. The other copy remains at the position. The following illustration can be used as a guide in preparing a squad sector sketch.

NOTE: The parts of the squad sector sketch described are the minimum items for a meaningful sketch. The platoon SOP may require more detail.



**6-20. DEFENSIVE SECTOR SKETCH  
(ELEMENT OR PLATOON)**

The platoon defensive sector sketch helps the company or company team commander to inte-

grate his defenses. It also lets the platoon leader shift fires in the platoon sector without moving

to determine which weapon can fire into a certain area. The platoon leader then can direct (by radiotelephone, voice, or signals) which fires are to be shifted to cover the threatened area. He can also instruct all or part of the platoon to move to alternate or supplementary positions, if necessary. If the platoon is organized into a carrier element and a dismount element, each element leader should prepare an element fire plan.

**NOTE:** The parts of the defensive fire plan described below are the minimum necessary items for a meaningful plan. The company SOP or the commander's order may require more detail.

A platoon's defensive sector is drawn as closely to scale as possible, and it includes targets for both direct and indirect fires. The sketch should show:

**Platoon or element sector or engagement area.**

**Squad or team positions (as applicable).**

**APC positions with primary sectors of fire or engagement areas.**

**Dismounted Dragon and machine gun positions with primary sectors of fire for each.**

**Dismounted machine gun FPLs or PDFs.**

**Maximum engagement ranges of mounted Dragons and machine guns.**

**OPs.**

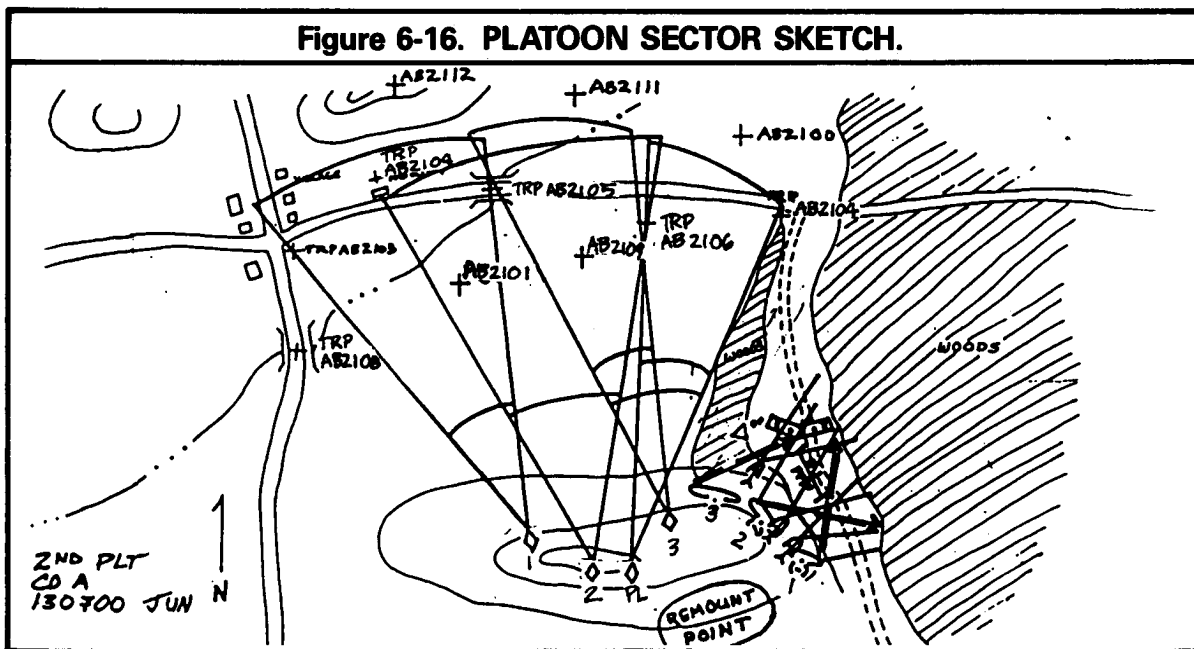
**TRPs.**

**Mines and other obstacles.**

**Indirect fire target locations.**

**The indirect fire FPF location, if allocated.**

**Weapons attached to the company and operating in the platoon area (tanks/ITVs).**



At least two copies of the platoon sector sketch should be prepared, one for the platoon leader and one for the company commander. If time permits, additional copies may be given to each subordinate team or squad.

The platoon sector sketch must be forwarded to the company commander as soon as possible to facilitate company fire planning.

## Section IV. CONDUCT OF THE DEFENSE

### 6-21. GENERAL

When the enemy attacks, all available weapons are brought into play. Beginning at extended ranges, ITVs, attack helicopters, artillery mortars, and tactical air are directed against enemy formations. As the enemy advances, friendly tanks begin to engage enemy tanks. This fire is reinforced by the suppressive fire of caliber .50 machine guns against enemy BMPs and BTRs. When the enemy is within 1,000 meters, Dragons are used against enemy tanks and personnel carriers. At closer ranges, the fires of the dismounted infantry the caliber .50 machine guns, and indirect fires are added to the battle to engage dismounted infantry. If orders are to retain the defensive position, the dismount teams repel the assault. They are supported by the close and continuous fires of the APC. If the mission calls for the platoon to displace before becoming decisively engaged, dismounted elements quickly remount at a remount point to the rear of the fighting position. The platoon then displaces to its new location covered by tanks and the overwatch fires of ITVs.

### 6-22. HOW CARRIER TEAMS DEFEND

Carrier teams must use their mobility, firepower and armor protection to the best advantage in the defense. The carrier team using the Dragon on the viscous mount can defeat armor to ranges of 1,000 meters and using the caliber .50 machine gun can provide suppressive fire to 1,600 meters. Because the carrier team can be organized to fit the situation, the inclusion of an M60 and M203 to the carrier element can increase its security and suppressive fire capability.

The carrier team's antiarmor system is medium range, therefore, they are not used alone except where terrain does not allow longer fields of fire. Generally the carrier element will not be used alone but in conjunction with the ITV and tank element. ITVs begin engaging enemy forces at 3,000 meters to maximize their stand-off advantage. If the enemy draws closer to the 1,500-meter range, ITVs displace to the flanks and rear or to deeper battle positions while tanks and Dragons pick up the fight. If the company team is organized with battle positions in depth, the carrier teams after firing may displace to alternate firing positions or disengage and displace to other battle positions. Tanks generally displace overmatched by ITVs, and other tanks.

The carrier teams must be prepared to move to alternate firing positions to avoid enemy return fire. If effective fire is not received after firing the first missile, a second missile may be fired from the same position. Because the APC's mobility is limited, the timing of the decision to move is critical.

The caliber .50 machine gun is effective in suppressing ATGMs and machine gun positions, defeating thin-skinned vehicles, forcing armored vehicles to button up, and engaging troops riding on the outside of tanks or dismounted. The caliber .50 machine gun should be used whenever possible to conserve use of the Dragon. Whenever terrain does not permit mounted use, the caliber .50 machine gun should be employed ground mounted on a tripod with the traversing and elevating mechanism. This employment is more accurate than

the free gun on the APC in delivering final protective fires. It should be remembered that ground-mounted employment decreases the mobility of the gun and increases redeployment time.

The carrier team leader moves the vehicle to alternate firing positions to get away from effective enemy fire or to gain a better firing position in the desired sector of fire or engagement area.

This movement may be directed by the carrier element leader or may be an automatic action of the team leader. The carrier team must avoid multiple shots from the same firing position when the enemy is effectively returning fire. Movement of individual vehicles must be coordinated so that all vehicles will not be out of firing positions at the same time. Normally when a threat exists in the platoon's secondary sector, movement to supplementary positions is directed by the platoon leader. This movement normally involves all parts of the carrier element moving at the same time, but it may be done by single APCs or by pairs (sections).

If effective enemy fire forces a carrier team to leave its position, grenade launchers (if on board) can be used to conceal the vehicle's movement. (See appendix J.)

If the platoon is ordered to move to another battle position, and if its elements are located together, the carrier element may continue the fight while the dismount teams remount the vehicles. When the elements are separated, the dismount element, as soon as it reaches the remount point, should notify the carrier element. The carrier element then moves to the remount point to pick them up. If either element becomes decisively engaged, then the platoon must disengage. Normally the company or battalion will take action to relieve pressure. (See section VI.)

To avoid decisive engagement, the platoon must move quickly. An enemy force traveling at 20 kilometers per hour (kmph) (12 mph) moves 1 kilometer in only 3 minutes. To slow the en-

emy, the carrier element should increase its rate of fire. The FO should call for indirect fire and smoke. Emplaced obstacles and mines also will slow the enemy attack.

The platoon is especially vulnerable to enemy fire while it is moving. Machine guns and M203s should be oriented to the rear. Techniques of retrograde movement are discussed as part of disengagement (section VI).

## 6-23. HOW DISMOUNT TEAMS DEFEND

**Defending Against a Dismounted Attack.** During an attack, the enemy infantry will advance as far as possible mounted in BTRs and BMPs. When forced to dismount, the infantry will continue the attack on foot supported by indirect fire, tanks, BTRs, and BMPs. Indirect fires should be placed on the enemy's dismounted forces as fast as possible.

The dismount teams should engage the attacking enemy force as soon as it comes within the element's sector of fire. Targets in the primary sector of fire have priority. But, when no targets show in the primary sector, targets in the secondary sectors are engaged. If machine guns are shifted to fire into secondary sectors of fire, assistant gunners should check primary sectors, between bursts, to guard against any enemy movement in the primary sector.

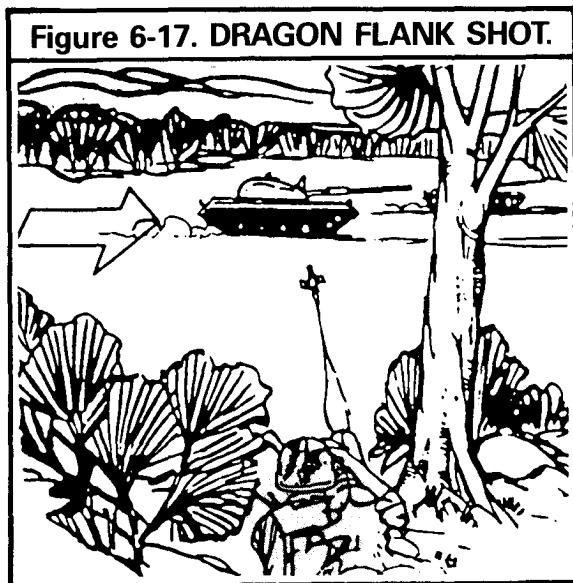
As the enemy begins the assault, the platoon leader requests and employs all FPFs. Machine guns fire on their FPLs or PDFs, and FOs call for mortar and artillery FPFs. A heavy stream of fire is maintained until the enemy assault is halted. The rate of fire is then reduced to save ammunition.

When the enemy assault is repelled, the platoon leader must be ready to counterattack retreating enemy forces. Retreating enemy forces are often disorganized and exposed to fire. While the dismount element's ability to pursue is limited, the element leader should keep calling for indirect fire and be prepared to quickly remount the APCs and counterattack, if ordered to do so.

### Defending Against a Mounted Attack.

The platoon leader should coordinate the employment of indirect fires on enemy infantry riding on tanks, at exposed crew members to force them to close their hatches, and at dismounted infantry moving along with the tanks. Riflemen and automatic riflemen should direct their fires to cause the same effect. If the enemy infantry can be stopped, his tanks become vulnerable to medium and close range antitank weapons.

Dismounted Dragons are used to engage enemy tanks as soon as the tanks enter their sectors of fire. Primary sectors of fire are setup for flank shots. Dragons may be fired at enemy tanks in secondary sectors of fire when no tanks are seen in primary sectors of fire. When engaging targets, antiarmor specialists should make maximum use of the front protection of their positions and try for flank shots at target tanks. All dismounted Dragon engagements should be controlled by the dismount team leaders.



LAWs are fired at enemy armored vehicles that close on the dismount team's position. Dismount team leaders should hold LAW fire until enemy vehicles come into the protective minefield or close enough so that LAW hits can be made on the sides of the target vehicles. A dismount team

leader will normally have better results if his entire team hits one enemy tank with surprise volley or pair fire.

Grenadiers fire dual-purpose ammunition at BTRs and BMPs, preferably from the sides. As with the LAW, they should wait until the targets are close enough so they can make hits.

### 6-24. CONSOLIDATION AND REORGANIZATION - PREPARING FOR THE NEXT ATTACK

When an enemy assault is repelled or when the platoon is moved to a new defensive position, leaders must prepare their men to counterattack, to continue the defense in place, or displace. If the platoon leader is directed to hold his present positions, the platoon must quickly prepare for more enemy attacks. The platoon must:

**Reestablish Security.** If OPs withdrew to the battle position, they are sent back out. If any of the OP personnel did not return or are wounded, they must be accounted for or replaced.

**Replace Key Personnel Who Become Casualties.** If there are casualties among leaders or on critical weapons, they are replaced with other men.

**Redistribute/Resupply Ammunition.** Dismount team leaders inventory and redistribute remaining ammunition. Ammunition from casualties is given to survivors. New belts are placed in machine guns; partial belts are relinked. If the squad vehicle is nearby, the dismount team gets additional ammunition from the vehicle. Ammunition status is reported to the dismount element or platoon leader. Carrier team leaders/gunners make a quick count of remaining ammunition. Ammunition status is reported to the carrier element or platoon leader. The carrier element leader may also redistribute ammunition among the APCs. The platoon leader or platoon sergeant consolidates the entire platoon's ammunition status reports, and then requests resupply from the company or company team commander. If necessary he will send a vehicle to pick up more ammuni-

tion. Barrels on machine guns should be changed if time permits and spare barrels are on hand.

**Evacuate the Dead and Seriously Wounded.** The wounded are treated and, when possible, returned to duty. The seriously wounded are evacuated to the rear, as are the dead. After casualties are evacuated, all sectors of fire must be checked to insure they are still covered. Leaders must insure that positions are readjusted, as needed, to cover any gaps left by casualties or disabled APCs. Casualty reports are submitted and unit rosters are updated to reflect losses.

## Section V. COUNTERATTACK

### 6-25. GENERAL

During the conduct of defensive operations, leaders at all levels must seek opportunities to attack. The counterattack is an excellent way to seize the initiative, to destroy or disrupt the enemy, or to gain key terrain.

### 6-26. PLATOON LEVEL

At the platoon level, counterattacks will resemble a hasty attack. Platoon leaders make an estimate of the situation and react immediately to catch the enemy at a weak point. The preferred method of counterattacking involves repositioning a unit so that effective fire can be placed on the enemy. In this case, the unit moves only to the extent necessary to attack by fire. However, at times it may be necessary to assault the enemy and "kick" him off a piece of terrain. Normally this situation is associated with the enemy overtaking a part or all of your defensive positions. To restore the continuity of the defense, the enemy must be expelled. This requires decisive action to hit the enemy before he has an opportunity to react.

The platoon leader's decision to counterattack must not be a reckless act. It must involve an understanding of the higher (company) commander's intent and the use of good judgment before taking a calculated risk. Knowing the com-

**Replace Camouflage.** When the situation allows, wilted material is removed and replaced with fresh camouflage. A position should not be overcamouflaged.

**Replace Obstacles.** If enemy forces have withdrawn, obstacles, mines, and early warning devices should be replaced. This is a risky task, especially if there are enemy snipers. Troops must be careful; smoke can be used to cover movement. Obstacles may have to be replaced after dark.

**Reestablish Communications.** Repair broken wire lines between positions.

mander's intent alleviates the idea of totally independent action. For example, the company commander may describe the necessity of retaining a specific piece of terrain which is critical to the battalion's defensive plan. If this terrain is lost, but can be regained through the immediate action of a platoon, the platoon leader should seize the initiative and retake the terrain. Where feasible, the platoon leader should take action based upon the commander's direction; however, in the absence of specific orders the platoon leader should have the freedom of action to take the initiative.

Most often, the platoon counterattacks as part of a company, company team, or battalion task force. Some counterattacks are planned in great detail. Others, like hasty attacks, are not planned ahead but are executed rapidly when the right conditions exist. Counterattacking forces must complete their tasks and regain covered positions before any overmatching or following enemy echelons can interfere.

For a particular counterattack, platoons may be detached from one company or company team and attached to another. Platoons must be well-trained to respond to such rapid changes in mission and task organization.

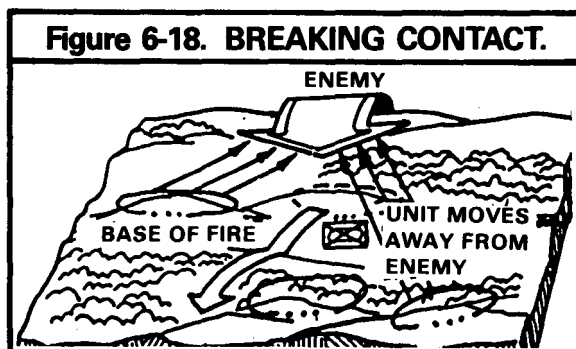
## Section VI. DISENGAGEMENT

### 6-27. GENERAL

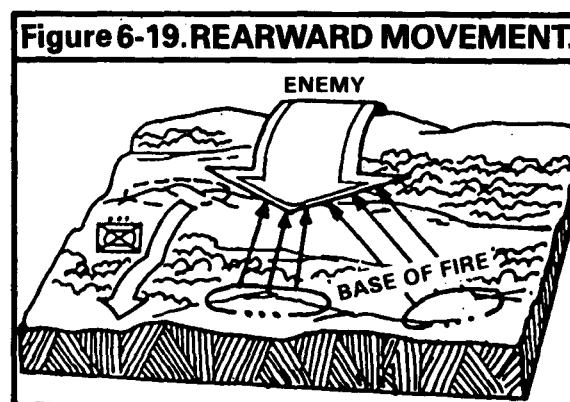
As the enemy closes, and based on orders from the task force commander, the company or company team commander will decide how long to hold defensive positions. The company or company team may be required to remain and fight as long as possible or it may be required to disengage and displace to another position. A platoon, as part of a company or company team, may disengage to defend from another battle position, to prepare for a counterattack, to delay, to withdraw, or to prepare for some other mission.

Fire and movement to the rear is the basic tactic for disengaging. All available fires are used to stop the enemy and allow platoons to move away from the enemy. The company or company team commander may move his platoon and mass fire to stop or slow the enemy advance before beginning the movement away from the enemy. A heavy volume of antiarmor fire will force the enemy to dismount his infantry and thus slow his mounted advance. Artillery and mortar HE fire and smoke, as well as mines (conventional or scatterable), will also add to the enemy's confusion, slow the momentum of his mounted attack, and help conceal the movement of friendly units. Small arms and indirect fire can be used against an attack by dismounted troops.

A base of fire is formed to cover other units moving away from the enemy. One unit acts as the base of fire, holding off the enemy by fire or holding terrain that blocks his advance, while other units move to break contact.



When the moving units get to the next position, they provide a base of fire to cover the rearward movement of the forward unit.



Fire and movement in reverse is repeated until contact with the enemy is broken, until the units pass through a higher level base-of-fire force, or until the units are in the next position to resume their defense.

When facing a mounted enemy attack, antiarmor weapons are the most effective weapons for the base of fire. For that reason, movement of those antiarmor weapons must be closely controlled. Normally ITVs fire and move back first, followed by APCs, then tanks.

In close terrain, when facing a dismounted enemy attack, or with viability limited, the ITVs and tanks may have to move first, covered by the infantry and their APCs.

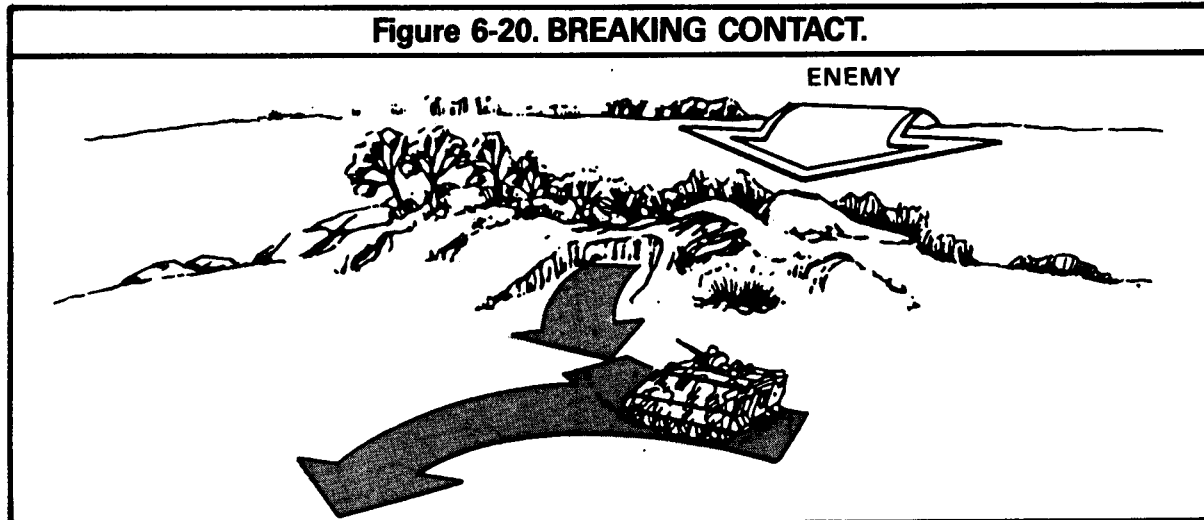
The tactics used by the platoon to disengage from the enemy can differ according to how the platoon is deployed, how the company or company team plans for disengagement, and other factors, but some actions apply in all cases:

Maximum use is made of the carrier team's firepower to cover rearward movement.

APCs should back out of position and move, keeping a terrain feature between the vehicle and the enemy.

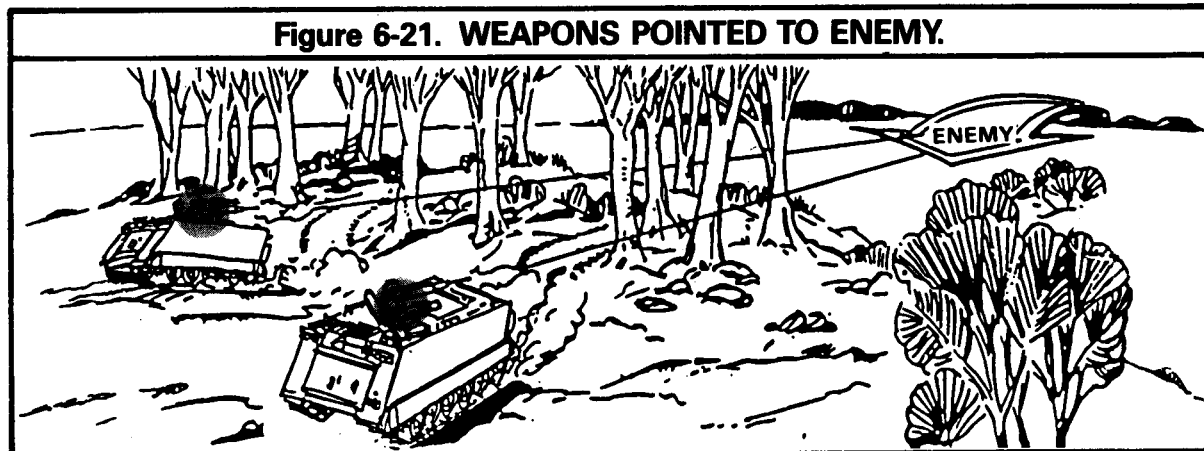


**Figure 6-20. BREAKING CONTACT.**



The vehicle-mounted weapons should remain pointed in the direction of the enemy.

**Figure 6-21. WEAPONS POINTED TO ENEMY.**



Rapid movement and an effective base of fire are the keys to a successful disengagement.

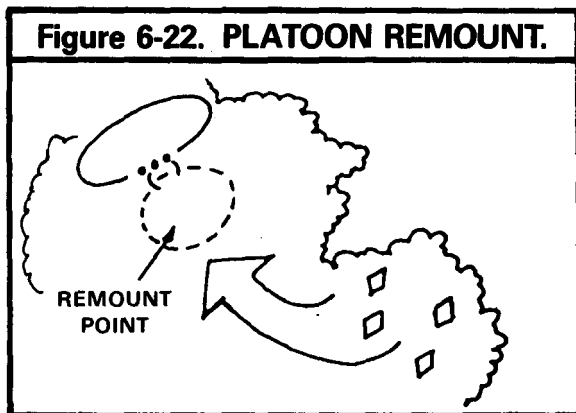
**6-28. PLANS FOR A DISENGAGEMENT**

Plans for a disengagement must be part of any battle position occupation plan. If dismount teams are deployed, a plan for rapid remounting must be made. Keeping the platoon mounted or placing the dismount teams with the carrier teams simplifies this process.

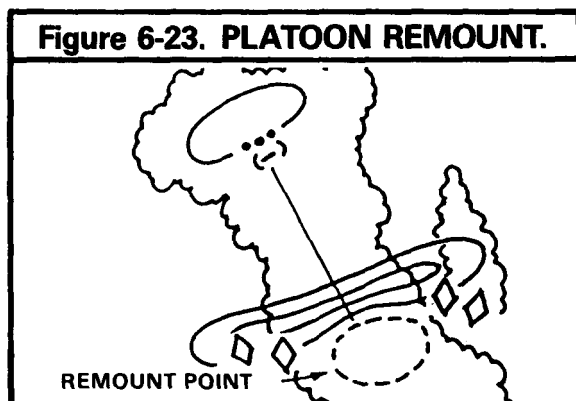
When the platoon employs the carrier and dismount elements on separate positions, platoon

remount points and routes to the remount points must be chosen. The platoon remount point can be:

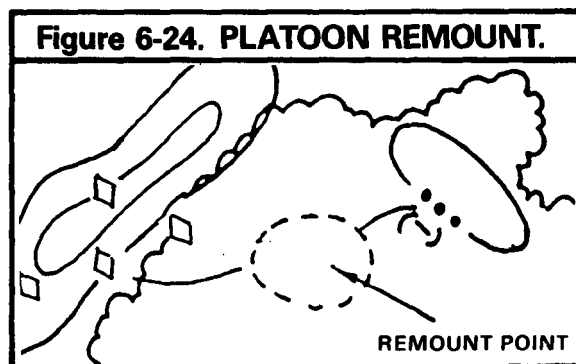
Near the dismount element position.



Near the carrier element position.



Between the two.

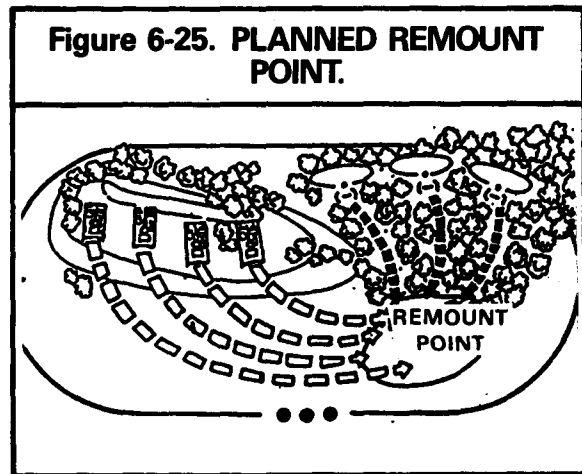


Within the remount point, covered positions for vehicles should be chosen that allow for easy remounting even during limited visibility. Dismount team leaders must be sure their men know the location of the remount point, where the squad carrier is at that point, and routes to the point. Routes to the remount point should be covered and allow speedy movement for both elements. Considerations for planning are:

APCs can move faster and have more protection from enemy small arms fire and artillery fragments than dismounted troops.

The carrier element often will shift from one firing position to another, so routes must be planned from each position to the remount point.

Following routes and finding remount points will be difficult in the heat of battle and even more difficult during limited visibility. As a minimum, routes should be marked and reconnoitered by the carrier element drivers and TLs and by the dismount team leaders.



### 6-29. HOW THE DISMOUNT ELEMENT DISENGAGES

When the dismount and carrier elements are separated, there are three ways the dismount element can disengage. Simultaneous disengagement (moving all teams at the same time) can be used when the element is covered by another force. When the dismount element must cover its

own movement, it disengages by teams or by thinning the lines.

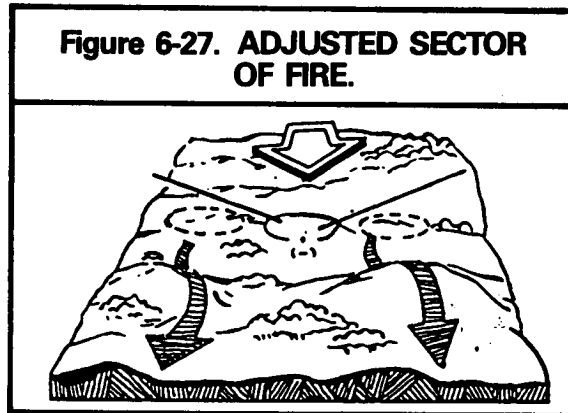
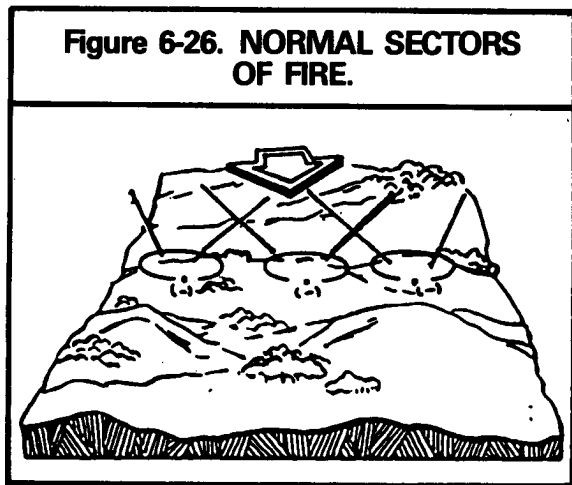
**Simultaneous Disengagement.**

When the dismount teams simultaneously disengage, they assemble and move as one element as fast as possible to the remount point, using movement techniques.

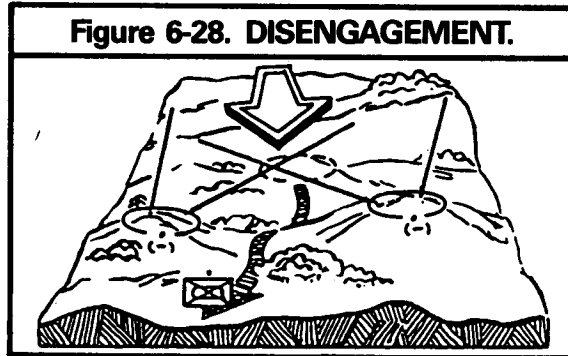
Simultaneous disengagement is favored when rapid movement is critical, the carrier element is adequately covering the disengagement, and the enemy has not closed on the dismount element or cannot fire effectively at it. Simultaneous disengagement can be used when the dismount element can move before the enemy can close on the position because of an obstacle or distance between the dismount element and the enemy. It can also be used when other units of the company company team, or battalion task force are adequately covering the disengagement.

**Disengagement by Dismount Teams.**

When the dismount element must cover its own movement, one or two teams stay in position as a base of fire. The rest of the dismount element moves to the rear. Teams left in position must fire into the entire element's sector to cover the movement of the other dismount teams. Sectors of fire are adjusted as necessary to get better coverage of the element's sector.



The teams left in position disengage when the rest of the element is in position to cover their disengagement.



Movement to the rear by alternating teams is kept up until contact is broken. Once contact with the enemy is broken, the disengagement is complete, and the dismount element moves to the remount point using proper movement techniques.

Disengagement by dismount teams has the advantage of simplicity in that the dismount teams stay together. It is used when one or two teams can effectively cover the entire dismount element's sector.

**Disengagement by Thinning the Lines.**

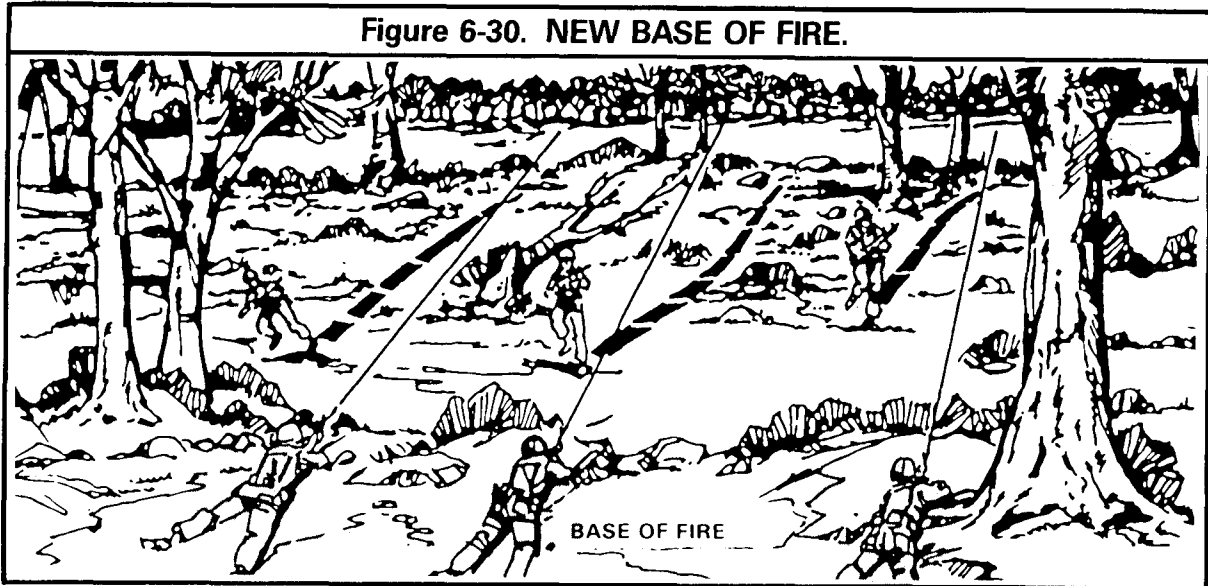
When disengaging by thinning the lines, selected men from each dismount team (often one man from each fighting position) disengage and move to the rear. The men still in position become the base of fire to cover the movement.

Figure 6-29. THINNING THE LINES.



When the rearward-moving men are in position to provide a base of fire, the rest of the element moves to their rear.

Figure 6-30. NEW BASE OF FIRE.



Machine guns may move with either the first or last group, whichever best supports the movement. The Dragon has a 65-meter minimum arming range, so it is usually wise to

move the Dragons first. The elements and squad leaders normally move last. As one group disengages, men remaining in position increase their rate of fire to keep the enemy from overrunning

the position. As with other methods of disengagement, this process is carried on until contact is broken.

Disengagement by thinning the lines allows an even distribution of fire across the dismount element's sector during the disengagement. It is used when no one dismount team can cover the dismount element's sector because of close terrain or limited visibility. But because teams are separated, control is more difficult than when disengaging by teams. If dismount teams are organized into two fire teams, the assistant squad leader moves with the first disengaging team personnel and takes charge of them.

**Disengagement of Dismount Teams When Employed With the Carrier Team.** When the carrier teams and the dismount teams are employed on the same position, the dismount teams normally move to their rear while the APCs provide a base of fire. The carrier teams then quickly move to their rear, link up with the infantry, remount, and move out. The dismount teams can use any of the disengaging techniques discussed earlier. The method selected usually will be dictated by the enemy situation, the terrain, and the carrier teams' ability to serve as a base of fire.

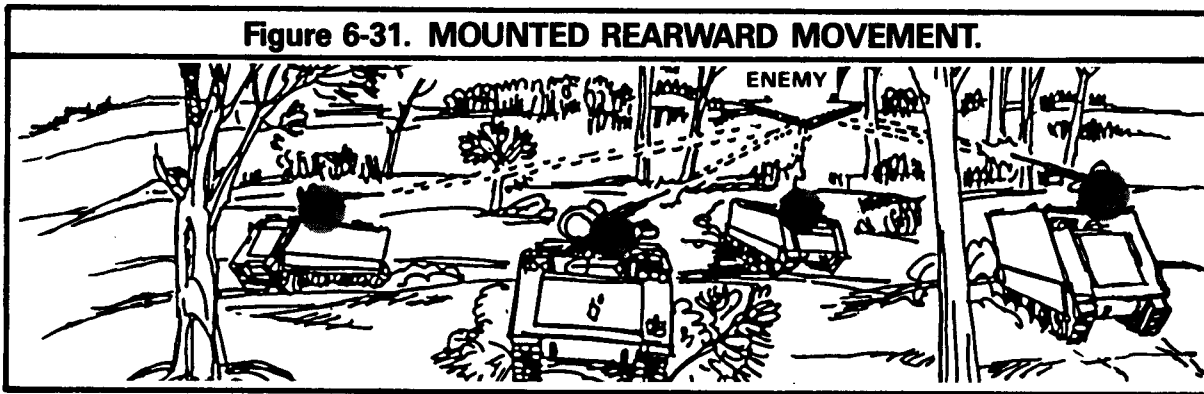
### 6-30. HOW THE CARRIER ELEMENT DISENGAGES

Because of the carrier element's speed and firepower, it is usually best for the dismount

element (when deployed) to disengage first while covered by the carrier element. But, if the carrier element is not in a position to support the dismount element by fire or if the dismount element is heavily engaged, the carrier element may have to disengage first and move to a position to assist the dismount element in disengagement. Whichever method is used, there are two basic ways the carrier element can disengage. If the carrier element is covered by another force, simultaneous disengagement may be used. If the carrier element must cover its own movement, it disengages by teams. These methods are similar in concept to those used by the dismount element.

**Simultaneous Disengagement.** When the teams of the carrier element disengage simultaneously, they move as one unit as quickly as possible. This method is normally used when the carrier element is covered by another force and speed is the most critical factor. If the dismount teams are already mounted, the entire platoon moves, using movement techniques, to a position designated by the company or company team commander. If the dismount teams are deployed, the carrier element moves to the remount point to pick up the dismount teams, or it may have to attack the enemy by fire from a new position to allow the dismount teams to disengage. Once the dismount teams have disengaged, the carrier element again disengages, either by all carrier teams simultaneously or by individual carrier teams, as the situation warrants.

**Figure 6-31. MOUNTED REARWARD MOVEMENT.**



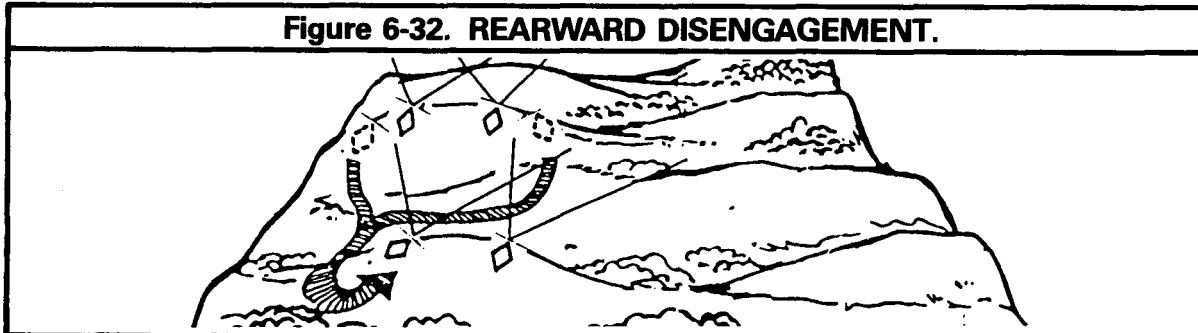
### Disengagement by Carrier Teams.

When the carrier element must cover its own disengagement, one, two, or three vehicles can be left in position as a base of fire while the rest move to the rear. The carrier teams left in position must cover the entire sector until the

moving vehicles reach positions they can use to provide a base of fire.

The number of vehicles left as the base of fire depends on the enemy situation and how quickly the carrier element must disengage.

**Figure 6-32. REARWARD DISENGAGEMENT.**



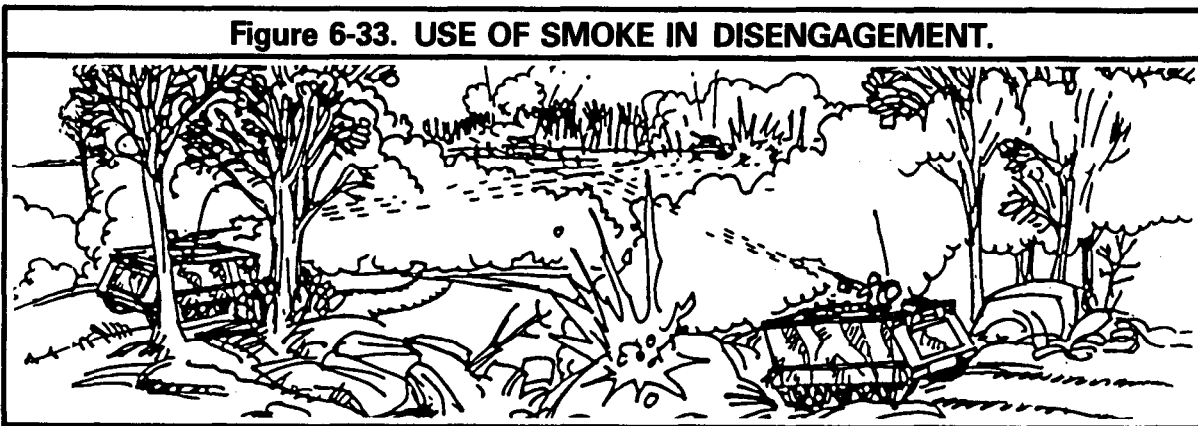
The carrier teams receiving the heaviest tank and ATGM fire are normally disengaged first. It is critical that other carrier teams, ITVs, or tanks be able to cover the sectors of the disengaging APCs. This will prevent the enemy from moving quickly into the friendly positions through the gap left by the rearward moving APCs.

Regardless of the method used, the carrier teams keep up fire and movement to the rear until they disengage or are in position to serve as a base of fire for the dismount teams or for other platoons. Execution must be aggressive and well controlled. Carrier teams told to cover

the rest of the element's disengagement must step up their rates of fire while teams moving to the rear quickly move, taking advantage of covered and concealed routes. Mounted weapons should remain oriented in the direction of the enemy during movement.

To cover the platoon's move, the platoon leader should request indirect fire and smoke through his FO or the company team commander. HE is used against enemy troops and smoke is used to screen exposed routes the platoon must cross. If the vehicles are having difficulty breaking contact, smoke grenade launchers should be used.

**Figure 6-33. USE OF SMOKE IN DISENGAGEMENT.**



If direct fire support is needed to let the platoon disengage, the platoon leader should ask the company or company team commander for assistance. If the covering fire of other elements is not enough to allow it to move, the platoon may have to use a combination of mounted and dismounted fire and movement.

## Section VII. OTHER PLATOON DEFENSIVE OPERATIONS

### 6-31. GENERAL

In addition to the defensive operation discussed earlier, companies, company teams, battalions, and battalion task forces also conduct delays and withdrawals. Platoons do not conduct delays or withdrawals singly but participate in these operations as part of a company or company team.

Platoons and squads use the same fundamental tasks in a delay or a withdrawal that they use in other defensive operations, but these are modified to fit into the company or company team concept of operations.

### 6-32. DELAY

A delay is fought to slow the enemy's advance and to trade space for time. If possible, the delay operation stops the enemy. But should the enemy strength or the risk to friendly forces be too great, the enemy is engaged (destroyed if possible) and at least forced to deploy. Just when the enemy appears ready to mount his assault, the delaying force, at the last possible moment, disengages and withdraws to a new position. The enemy then must begin his time-consuming preparation again. A delaying force may attack, ambush, or raid, or use any other tactic necessary to accomplish the mission.

The platoon takes part in a company company team, or battalion task force delay by performing those tasks given to it by the company or company team commander. Most of these tasks are standard defense missions — emplacing obstacles, defending a position, firing into assigned sectors or engagement areas, providing security, and preparing battle positions in depth.

### 6-32

During a disengagement, the company team commander may direct a platoon to cover the movement of other platoons by occupying battle positions and firing into assigned areas or by holding terrain.

### 6-33. WITHDRAWAL

A withdrawal is an operation in which a force frees itself for a new mission. It may be conducted with or without enemy pressure. When ordered to withdraw, the company or company team disengages (if in contact) and moves to the specified area. It may do this alone or as a part of a battalion or battalion task force.

The method the company or company team commander uses to withdraw depends on enemy pressure. If the enemy is attacking or is expected to attack during the withdrawal, a **withdrawal under pressure** is conducted. If the enemy is not attacking and the commander thinks that by stealth he can withdraw before the enemy can react, he can conduct a **withdrawal not under pressure**.

When withdrawing under pressure, the company or company team normally covers its own disengagement and withdrawal. As described earlier, platoons disengage using fire and movement, massing fires to move away from the enemy.

When withdrawing **not** under pressure, the unit withdraws covered by a detachment left in contact (**DLIC**). The DLIC protects the main body deception, and by resistance when necessary. The makeup of the DLIC is directed by the company or company team commander. It may consist of a squad from each platoon, or one platoon from the company or company team, or another combination of forward elements. The squad or platoon, as part of a DLIC, may shift to cover the sector of the withdrawing forces. Positions should be shifted only when necessary; too much movement may alert the enemy. If they are spread too widely, command and control become difficult.

When a platoon serves as the DLIC for a withdrawing company or company team, the platoon leader normally is the DLIC commander. If a squad remains in the platoon's position while the rest of the platoon withdraws, that squad is a part of the DLIC. It is controlled by one of the platoon leaders or the company executive officer.

The DLIC attempts to deceive the enemy by feigning the company or company team's function. The DLIC must be prepared to detect and repel enemy attacks until the main body has withdrawn safely. This may require that part of the withdrawing force's ammunition be left with the DLIC.

It is best to conduct a withdrawal not under pressure during reduced visibility. The main body dismount teams and carrier teams should have preselected remount areas to the rear of their positions. Team leaders should reconnoiter routes to remount areas so that actual withdrawals can be done quickly, with minimum confusion. Once the dismount teams have mounted their APCs, the platoon(s) should move quickly along a designated route to its next position.

When the DLIC commander directs the DLIC to withdraw, and since the force is relatively exposed, it must quickly withdraw and move along its assigned routes to assemble and move out to its next mission.

### **6-34. RESERVE**

At times, a platoon may be given the mission of being a part of the battalion reserve. The platoon leader must consider the following possible reserve missions

**To reinforce units in the frontline.**

**Where are the positions?**

**How are the units organized?**

**Where is the best avenue of approach?**

**What is the best course of action if the enemy has already reached the defensive positions?**

**What is the recognition plan?**

**To block an enemy penetration.**

**Where are the best enemy avenues of approach?**

**Where is it necessary to have positions for blocking the enemy?**

**What is the best way to reach the blocking positions?**

**How should the platoon organize?**

**Where are existing obstacles, and where should additional obstacles be placed?**

**To conduct a counterattack.**

**Where is the key or advantageous terrain?**

**Where are covered and concealed routes?**

**Where will linkup with friendly forces take place?**

**Where are existing obstacles?**

**Who is participating in the counterattack, and what support is available?**

**How will friendly fires be controlled?**

**What is the recognition plan?**



CHAPTER 7

**PATROLLING**

**Section I. INTRODUCTION**

**7-1. GENERAL**

A patrol is a mission. The unit that has the mission organizes for the conduct of the patrol. When organizing for the patrol, unit integrity is maintained as much as possible; for example, when a squad is tasked to conduct a patrol, the squad leader becomes the leader of the patrol.

Mechanized infantry units are capable of conducting all types of mounted and dismounted combat patrols. While mounted combat patrols are common missions for mechanized infantry platoons, mounted reconnaissance patrols are normally scout platoon missions. However, infantry platoon leaders must be prepared to conduct mounted reconnaissance patrols if the scout platoon is not available.

There are two categories of patrols:

Reconnaissance (area or zone) patrols collect information or confirm or disprove the accuracy of information previously gained.

Combat (ambush, security, or raid) patrols provide security and harass, destroy or capture enemy troops, equipment, and installations. A combat patrol also collects and reports information as part of its mission.

**7-2. ORGANIZING FOR A PATROL**

A patrol generally consists of a headquarters and the elements needed for the mission.

The leader of the patrol must decide what elements and teams are needed, select men for those elements and teams, and decide what

weapons and equipment to provide. He should use his unit's normal organization and chain of command (squad leaders and platoon sergeant) to man the patrol. A combat patrol maybe organized like this: a headquarters; the 1st and 2d Squads as the assault element; the 3d Squad as the security element; and the machine gunners, Dragon gunners, and the platoon sergeant as the support element.

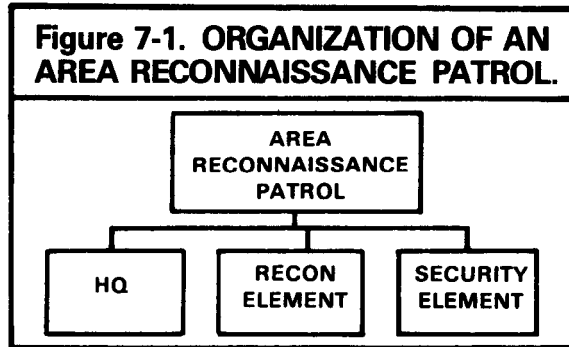
**Headquarters.** The headquarters of a patrol consists of the leader, assistant leader, radiotelephone operators (RATELO), forward observer, and any other troops such as engineers required to control and support the patrol. In a small patrol (three or four men), the leader may be the only man in the headquarters.

**Elements.** Elements are the subordinate organizations in the patrol tailored to the patrol's mission.

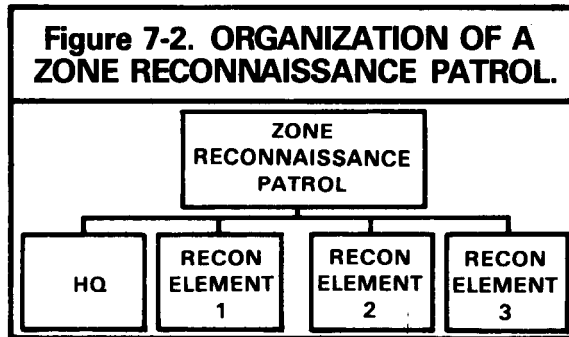
**Reconnaissance patrol.** A two-, three-, or four-man reconnaissance patrol is not organized into elements. Instead, it operates as a single unit providing its own security.

CONTENTS		PAGE
Section	I. Introduction . . . . .	7-1
	II. Preparation for a Patrol . . . . .	7-4
	III. Common Patrolling Tasks . . . . .	7-10
	IV. Reconnaissance Patrol . . . . .	7-16
	V. Combat Patrol . . . . .	7-20
	VI. Patrol Bases . . . . .	7-32
	VII. Mounted Patrol . . . . .	7-38

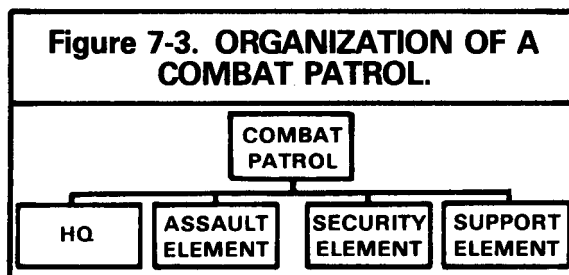
In an area reconnaissance, the patrol is organized into a reconnaissance element and a security element.



In a zone reconnaissance, the patrol is organized into several reconnaissance elements.



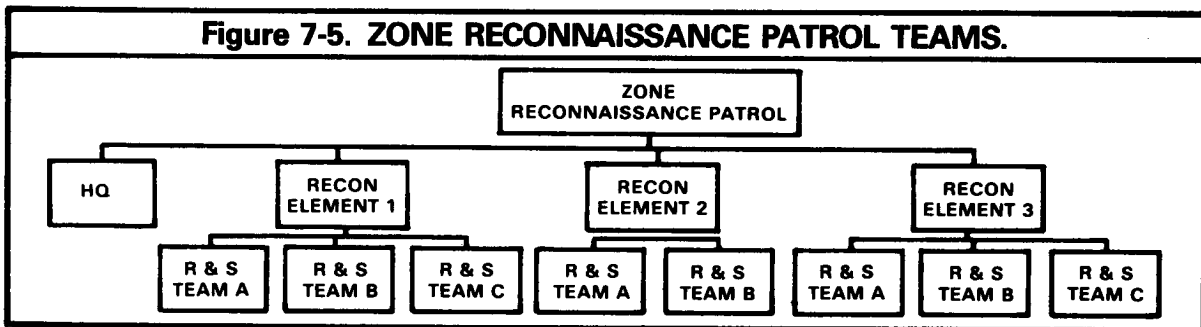
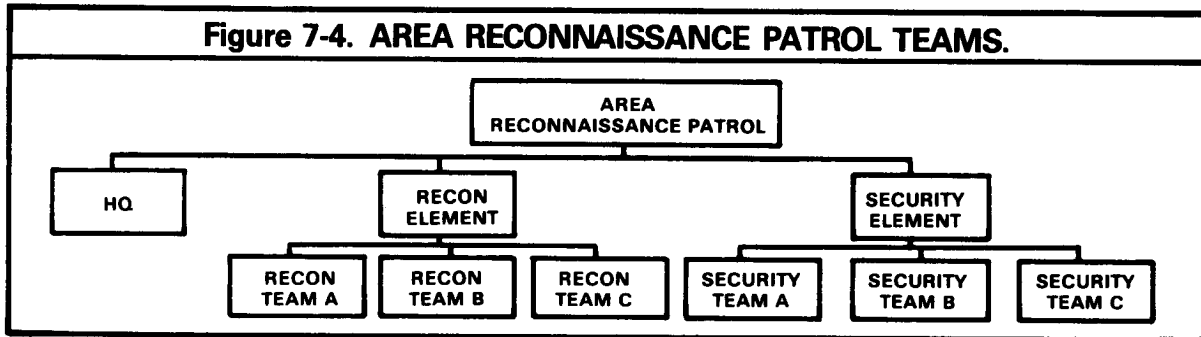
**Combat patrol.** A combat patrol is normally organized into an assault element, a security element, and a support element. At times, the support element may be omitted by keeping automatic weapons in the assault element.



Each element of a patrol may be further organized into the teams needed to perform essential tasks.

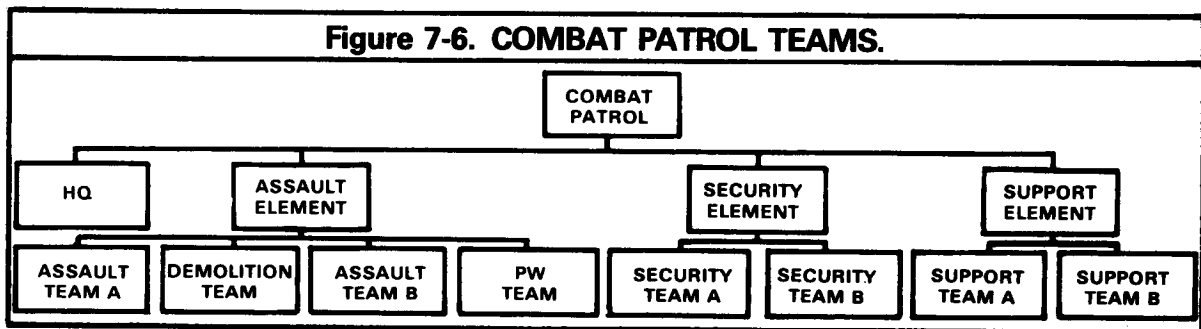
Reconnaissance patrol elements are organized into teams as necessary to accomplish the elements' tasks. Reconnaissance elements may be organized into several reconnaissance teams

for an area reconnaissance or organized into reconnaissance and security teams for a zone reconnaissance. Security teams are organized as required to secure the objective area.



Combat patrol elements are organized into teams as necessary to accomplish the elements' tasks. The internal teams facilitate the execution of the mission with minimum on-the-spot instructions. They may include litter, search, and prisoner teams. Special purpose teams may also be organized and attached to the patrol, such as scout dog and engineer demolition teams.

A team may be designated for either type of patrol. It consists of a compass man who continually checks direction, a point man who follows the directions of the compass man and provides security and a pace man who keeps a running count of his 100-meter pace to verify the distance traveled.



### 7-3. SELECTING MEN, WEAPONS, AND EQUIPMENT

**Men.** Members of the patrol usually come from the leader's platoon or squad, except when—

the headquarters dispatching a patrol provides special troops, such as demolition specialists, engineers, interpreters, guides, scout dog teams, and FOs; and

the leader's company provides aidmen and messengers.

**Weapons.** The weapons and ammunition selected are based on what is needed to do the job. Because of bulk or weight, the difficulty of carrying some weapons when dismounted must be considered. The value of the weapon to the accomplishment of the mission is measured against the difficulty in carrying it.

**Equipment.** In addition to the equipment commonly used by every patrol, the leader selects equipment to aid in control, for routine use in the objective area, and to use en route.

**Aiding in control.** This may include whistles, flares, radios, flashlights, and luminous tape.

**Common use.** This is equipment normally carried on all patrols, or that which is common to all members of the patrol. It may include the uniform to wear and individual equipment to carry. An SOP should prescribe routine uniform and equipment to save time in planning and preparing for a patrol.

**Use in the objective area.** This may include such items as explosives, binoculars, ropes to bind prisoners, and flashlights.

**Use en route.** Equipment to help reach and return from the objective may include maps, binoculars, flashlights, boats, stream-crossing equipment, compasses, and wire cutters.

The leader must determine how much water and food is required. Rations are carried only when needed.

## Section II. PREPARATION FOR A PATROL

### 7-4. GENERAL

When given an order to lead a patrol, the leader starts his troop leading procedure as described in chapter 3.

The warning order is issued to all members of the patrol.

### 7-5. COORDINATION

Coordination is continuous throughout patrol planning and preparation. Even though some coordination is done for the leader of the patrol, the leader should still check to be sure that nothing is overlooked.

Before leaving the place where he gets the OPOD, the leader coordinates what he can. The place will probably be a battalion or com-

pany command post (CP) where communications are better and key personnel are available to help in the coordination.

The leader should prepare a checklist and carry it during his coordination so as not to overlook anything that may be vital to his mission. Some items may need to be coordinated with more than one staff section. The following examples are things which the leader must coordinate.

#### S2.

**Changes in the enemy situation.**

**Special equipment requirements.**

**S3.**

**Changes in the friendly situation.**

**Route selection, landing zone selection.**

**Linkup procedure.**

**Transportation.**

**Resupply (in conjunction with S4).**

**Signal plan — call signs, frequencies, code words, pyrotechnics, and challenges and passwords.**

**Departure and reentry of friendly lines (see below).**

**Other units in the area.**

**Attachment of specialized troops (engineer, demolition team, scout dog team, FOs, interpreters).**

**Rehearsal areas with terrain similar to objective site. Also, security of the rehearsal area; use of blanks, pyrotechnics, and live ammunition; fortifications available, time the area is available, and transportation.**

**PLATOON FO OR COMPANY FIST CHIEF.**

**Fire support on the objective.**

**Fire support along routes to and from the objective (include alternate routes).**

**FRIENDLY FORWARD UNIT.**

**The leader identifies himself and his unit, size of patrol, time(s) of departure and return, and area of the patrol's operation (if it is within the forward unit's area of operation).**

**The forward unit provides information on terrain, known or suspected enemy positions, likely enemy ambush sites, and latest enemy activity. It also furnishes detailed information on friendly positions; obstacle locations; fire plan; and support the unit can furnish, such as fire support, litter teams, guides, communications, and reaction units. The signal plan, to include the signals to be used upon reentry, and the procedure to be used by the patrol and the guide during departure and reentry are also provided by the forward unit. Also, location(s) of dismount point (if used), initial rally point, departure point, and reentry point is furnished.**

**ADJACENT PATROL(S).**

**Identification of the patrol.**

**Mission.**

**Route.**

**Fire plan.**

**Signal plan.**

**Planned times and points for departure and reentry.**

**Any information that either patrol may have about the enemy.**

The leader must make either a map, ground, or aerial reconnaissance before completing his plan.

**7-6. COMPLETE THE PLAN**

After the warning order has been issued and reconnaissance has been made, and while members of the patrol are preparing themselves and their equipment, the leader completes his plan. He first assigns essential tasks to be performed

by elements, teams, and men. He then plans other phases of the unit's mission.

**Tasks in the Objective Area.** Essential tasks in the objective area are assigned. The leader plans how elements, teams, and men are to perform their tasks.

**Other Tasks.** Tasks are assigned and planned which will help the patrol reach the objective and return. These tasks include navigation, security during movement and halts, actions at danger areas, actions on enemy contact, and water crossing.

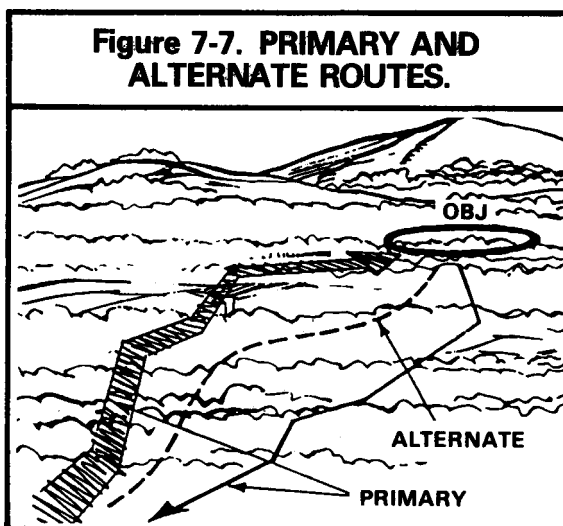
**Times of Departure and Return.** Times of departure and return are based on the amount of time needed to:

**Reach the objective.** This is determined by considering the distance, terrain, anticipated speed of movement, friendly and enemy situation, and (if applicable) the time at or by which the mission must be accomplished.

**Accomplish essential tasks in the objective area.** This includes the leaders' reconnaissance and movement of elements and teams into position, as well as the accomplishment of the unit's mission.

**Return to a friendly area.** This may be difficult to determine because casualties, prisoners, or captured equipment may slow the patrol. The use of a different return route may change the time needed.

**Primary and Alternate Routes.** The leader selects the primary route to and from the objective. The return route should be different from the route to the objective. He also selects an alternate route which may be used either to or from the objective. The alternate route is used when the unit has made contact with the enemy on the primary route. It may also be used when the leader knows or suspects that the patrol has been detected.



**Rally Points.** A rally point is a place where a patrol can reassemble and reorganize if dispersed during movement; or temporarily halt to reorganize and prepare for actions at an objective; or temporarily halt to prepare to depart from friendly lines; or temporarily halt to prepare to reenter friendly lines. The leader should pick rally points either during the patrol or by a map study before the patrol. Those picked from a map are **tentative** and will be so until confirmed on the ground.

The leader should look for places that:

**Are large enough for assembly of the patrol.**

**Are easily recognized.**

**Have cover and concealment.**

**Are defensible for a short time.**

**Are away from normal routes of troop movement.**

He must:

Select an initial rally point (RP) (on the friendly side of a forward unit's lines). An initial rally point is where a patrol rallies if dispersed before departing friendly lines or before reaching an en route rally point. It is located within friendly lines.

Select en route rally points on both the near and far side of danger areas. An en route rally point is where a patrol rallies if dispersed en route to or from its objective. There may be several en route rally points. They are between friendly lines and an objective along a patrol's route.

Select an objective rally point (ORP). An objective rally point is where a patrol halts to prepare for actions at its objective. It is also a point to which a patrol returns after its actions at its objective. It must be near a patrol's objective, but there is no set distance to it from the objective. It should be far enough from the objective so that the patrol's activities will not be detected by the enemy.

Select a reentry rally point on the enemy aide of a forward unit's lines. A reentry rally point is where a patrol halts to prepare to reenter friendly lines. It is short of friendly lines and out of sight and sound of friendly observation posts.

**Rehearsals and Inspections.** These are vital to proper preparation for a patrol. They must be well planned and conducted even though the men are experienced in patrolling. Coordination is made with the commander or S3 for use of a rehearsal area resembling the objective area. Plans must provide for inspections by element and team leaders as well as by the leader of the patrol.

**Signals.** The signals to be used on the patrol must be planned and rehearsed. Signals may be needed to lift or shift supporting fire, to start an assault, to order withdrawal from the objective, to signal "all clear," and to stop and start movement of the patrol. Visual and audible signals such as arm-and-hand signals, flares, voice, whistles, radios and infrared equipment may be used. All signals must be known by all patrol members.

**Communications With Higher Headquarters.** The plan must include radio call signs, primary and alternate frequencies, times to report, and codes.

**Challenge and Password.** The challenge and password from the communications-

electronics operation instructions (CEOI) should not be used beyond the forward edge of the battle area (FEBA). The leader may devise his own challenge and password system to be used beyond the FEBA. An example of this is the odd-number system. Any odd number can be used. If the leader specified 11 as the odd number, the challenge could be any number between 1 and 10. The password would be the number which, when added to the challenge, equals 11 (challenge, 8; password, 3).

**Chain of Command.** Changes to the chain of command given in the warning order are included in the order.

**Location of Leaders.** The location of the leaders of the patrol is planned for all phases of the patrol — during movement, at danger area, and at the objective.

The leader plans to be where he can best control the patrol during each phase.

The assistant leader may be given a special job for each phase of the patrol. He may help the leader control the patrol by being where he can best take command, if required.

Some places the assistant leader may be during actions in the objective area are:

On a raid or ambush, with the support element.

On an area reconnaissance, in the objective rally point.

On a zone reconnaissance, with a reconnaissance element which has been directed to move to and establish the point at which all elements are to link up after reconnoitering.

## 7-7. ISSUE OPERATION ORDER

The operation order is issued in a standard sequence. Terrain models, sketches, or blackboards are used to illustrate the plan. Sketches to show planned actions can be drawn in the sand, dirt, or snow.

Personnel may make notes but should hold questions until the order is completed. This prevents interruption of the leader's train of thought.

**Figure 7-8. OPERATION ORDER FORMAT WITH PATROL CONSIDERATIONS.**

1. **SITUATION.**
  - a. **Enemy forces.**
    - Identification.
    - Location.
    - Activity.
  - b. **Friendly forces.**
    - Mission of next higher unit.
    - Location and planned actions of units on right and left.
    - Mission and routes of other (adjacent) patrols.
    - Fire support available.
  - c. **Attachments and detachments.**
2. **MISSION.**
3. **EXECUTION.**
  - a. **Concept of operation (scheme of maneuver and fire support plan).**
  - b. **Subunit tasks (elements/teams/men).**
  - c. **Coordinating instructions.**
    - (1) **Time of departure and return.**
    - (2) **Movement techniques and order of movement.**
    - (3) **Route (primary and alternate).**
    - (4) **Departure and reentry of lines.**
    - (5) **Rally points and action at rally points.**
    - (6) **Action at danger areas.**
    - (7) **Action on enemy contact.**
    - (8) **Action at the objective.**
    - (9) **Fire support (if not already covered).**



(10) Intelligence requirements.

(11) Other tasks (stream crossings, boat operations, etc.).

**4. SERVICE SUPPORT.**

a. Rations and water.

b. Arms and ammunition.

c. Uniform and equipment.

d. Method of handling wounded, PWs, and captured equipment.

e. Transportation.

**5. COMMAND AND SIGNAL.**

a. Command.

(1) Chain of command.

(2) Location of patrol leader during movement and at the objective.

b. Signal.

(1) Arm-and-hand and other signals, codes, and radio call signs and frequencies to use within the patrol.

(2) Report, codes, and radio frequency(s) and call signs to use with higher headquarters.

(3) Challenge and password.

## 7-8. INSPECT AND REHEARSE

**Inspections** determine the patrol's physical and mental state of readiness. Inspections before rehearsals insure completeness and correctness of uniform and equipment. Men are questioned to see if each one knows —

- the plan;**
- what he is to do and when he is to do it;**
- what others are to do; and**
- challenges and passwords, signals, codes, radio call signs, frequencies, and reporting times.**

**Rehearsals** help insure the proficiency of the patrol. They let the leader check plans and make any changes needed. The suitability of equipment is verified. It is through well-directed rehearsals that men become familiar with what they must do when on patrol.

If the patrol is to be at night, it is advisable to hold both day and night rehearsals. Terrain similar to that over which the patrol will operate should be used. When time permits, all actions are rehearsed. When time is short, only the most critical actions are rehearsed. Actions to take place in the objective area are critical and should always be rehearsed.

A good way to rehearse is to have the leader walk and talk the whole patrol through each action. He describes the actions of elements, teams, and men, and he has them perform these actions. In this dry run, men take their positions in formations at reduced distances to get the "feel" of the patrol. When the different actions are clear to

all concerned, a complete (normal speed) rehearsal is held with the whole patrol. This is a wet run. As many dry runs and wet runs are conducted as deemed necessary to gain proficiency. When possible, element and team leaders rehearse their units separately before the final rehearsal of the entire patrol.

### **Section III. COMMON PATROLLING TASKS**

#### **7-9. GENERAL**

Soldiers who patrol must know a variety of tasks. Although not every patrol requires the same tasks, those discussed here are common to most patrols.

#### **7-10. DEPARTURE FROM FRIENDLY LINES**

The departure of a patrol through another unit's lines can be confusing and dangerous if not well coordinated. The leader must coordinate the departure with the forward unit commander.

When the patrol is ready to conduct the passage, it moves up and halts at the initial rally point.

Before passing through the forward unit, the leader again checks with that unit's commander to learn of recent enemy activity or situation changes that may require adjustment in the patrol plan.

A guide from the forward unit then leads the patrol through his unit and through wire and other obstacles forward of the unit.

The forward unit may have OPs to its front that can help secure the patrol as it moves out. The patrol moves beyond the range of the friendly unit's small area and final protective

fire, and halts briefly to adjust to sights and sounds of the battlefield.

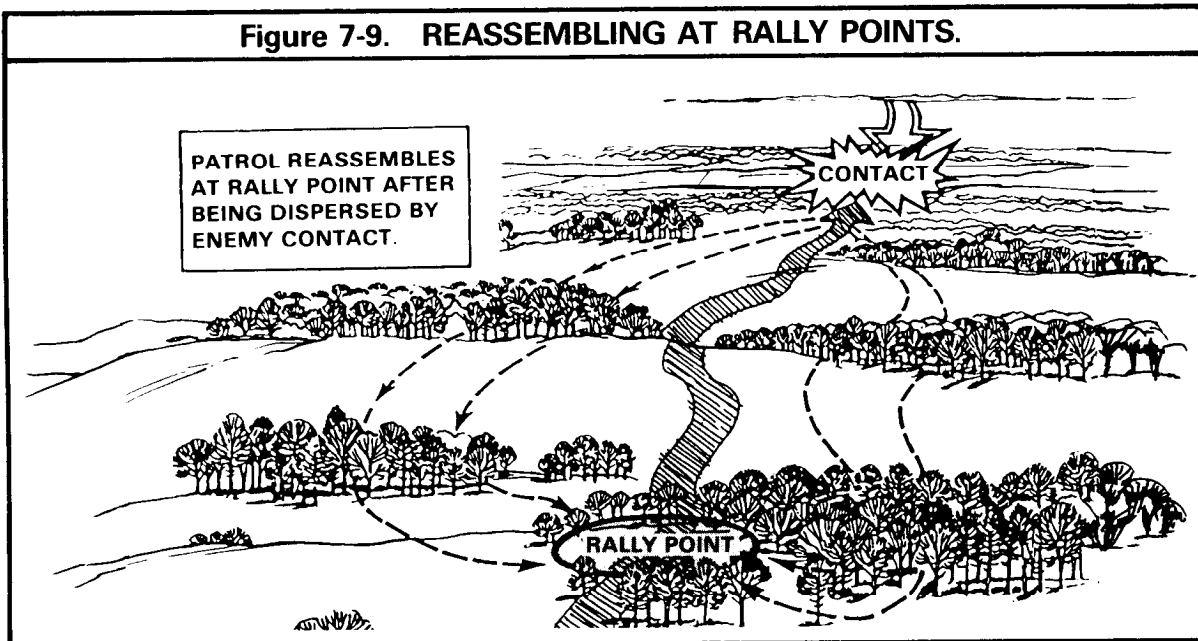
#### **7-11. USE OF RALLY POINTS**

**Rally Points Along the Route.** As the patrol moves along its route, the leader will select and announce rally points, or confirm points that were earlier selected from a map. If dispersed between rally points en route, the patrol rallies at the last rally point it passed. Actions to be taken at rally points must be planned in detail and briefed during the patrol order. The plan must provide for the continuation of the patrol as long as there is a good chance to accomplish the mission. Two examples of plans for actions at rally points are:

Assembled personnel will wait until a set number of men arrive and then go on with the mission under control of the senior man present. This plan is good for a reconnaissance patrol when two or three men may be able to accomplish the mission.

Assembled personnel will wait for a set period, after which the senior man present will decide whether to continue the patrol or not, based on troops and equipment present. This may be the plan when a minimum number of men, or certain items of equipment, or both, are needed to accomplish the mission.

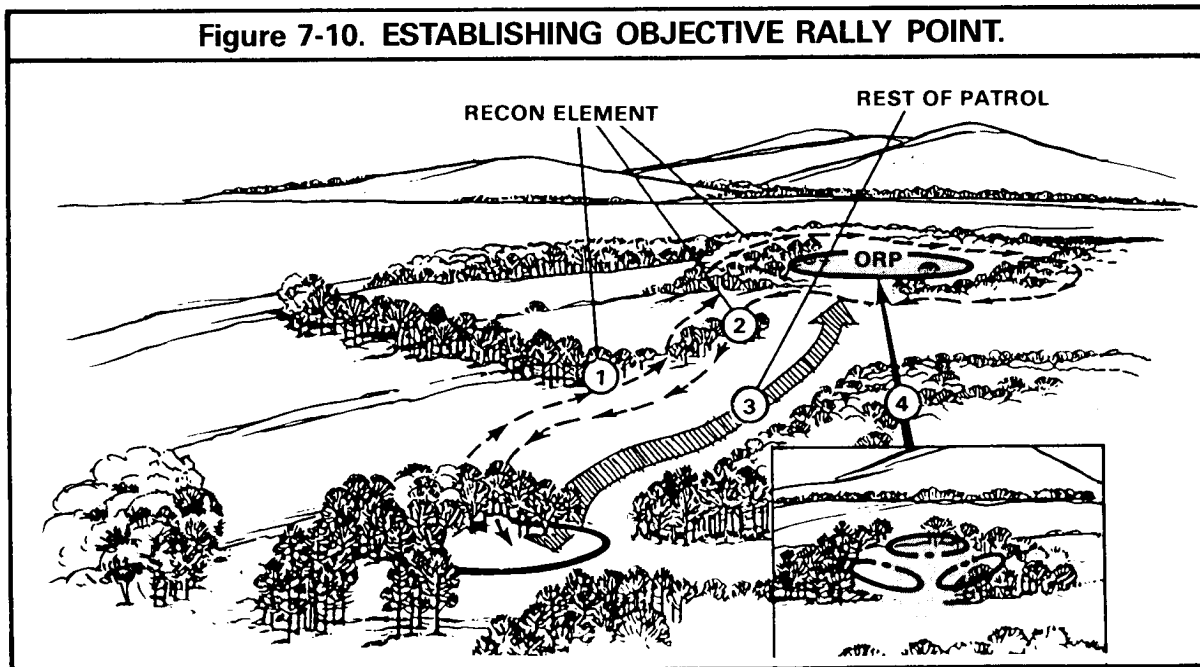
Figure 7-9. REASSEMBLING AT RALLY POINTS.



**Objective Rally Point.** The patrol halts as it nears the tentative ORP, and a reconnaissance element moves forward to see if the point is suitable as an ORP and to see that no enemy troops

are near. When the leader is satisfied, two men are sent back to bring the rest of the patrol into the ORF. The patrol then sets up a perimeter for all-round security.

Figure 7-10. ESTABLISHING OBJECTIVE RALLY POINT.



When the ORP is occupied and secure, the leader of the patrol, compass man, and element leaders go on a leaders' reconnaissance. Before the leader of the patrol goes, he tells the assistant leader:

**Who he is taking with him.**

**How long he will be gone.**

**What to do if he fails to return.**

**What to do if he makes enemy contact.**

**What to do if the assistant leader (in the ORP) makes enemy contact.**

This leader's reconnaissance is done to pinpoint the objective, to pick positions for the patrol's elements, and to get information to confirm or alter the plan. After the leaders' reconnaissance, the leaders return to the ORP to complete plans and disseminate information. While they are doing this, one or more men may stay behind to observe the objective. On a reconnaissance patrol, if the leader gets enough information about the objective during the leaders' reconnaissance, his mission is accomplished and the patrol returns to friendly lines. If he does not get enough information, the patrol reconnoiters as planned until enough information is gained to satisfy the requirement of the mission.

If the patrol is to move out of the ORP as one group, for its action at the objective, its leader may pick a release point where the patrol will separate. Each element then goes on its own route from the release point to its position.

When the mission is accomplished, the patrol assembles in the ORP and disseminates information to all personnel.

## 7-12. DANGER AREAS

Specific plans are made in advance for crossing each known danger area (an area where there is an increased chance of detection or a fight). General plans which can be quickly modified to fit the situation are made for crossing unexpected danger areas.

When moving, the patrol tries to avoid danger areas. Typical danger areas are:

**Known enemy positions.**

**Roads and trails.**

**Streams.**

**Open areas.**

To cross a danger area, a patrol must:

**Designate near and far side rally points.**

**Secure the near side.**

**Secure the far side.**

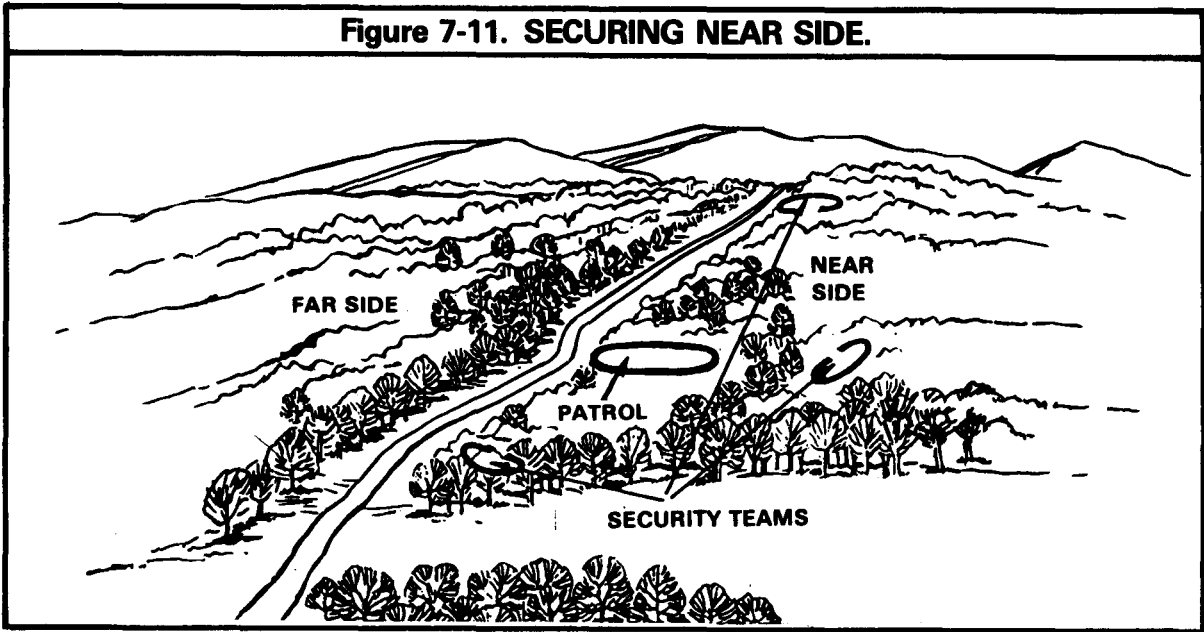
**Cross the danger area.**

The patrol uses bounding overwatch or variations of it to cross a danger area. The leader decides how the patrol will cross based on the time he has, the size of the patrol, the size of the danger area, the fields of fire into the area, and the amount of security he can post. A small patrol may cross all at once, in pairs, or one man at a time.

A large patrol normally crosses its elements one at a time. As each element crosses, it moves to an overwatch position or to the far side rally point until told to continue movement.

Securing the near side may involve nothing more than observing. In other places, it may involve posting security teams far enough out on both flanks and to the rear of the crossing point to give warning of approaching enemy and to overwatch the crossing of the rest of the patrol.

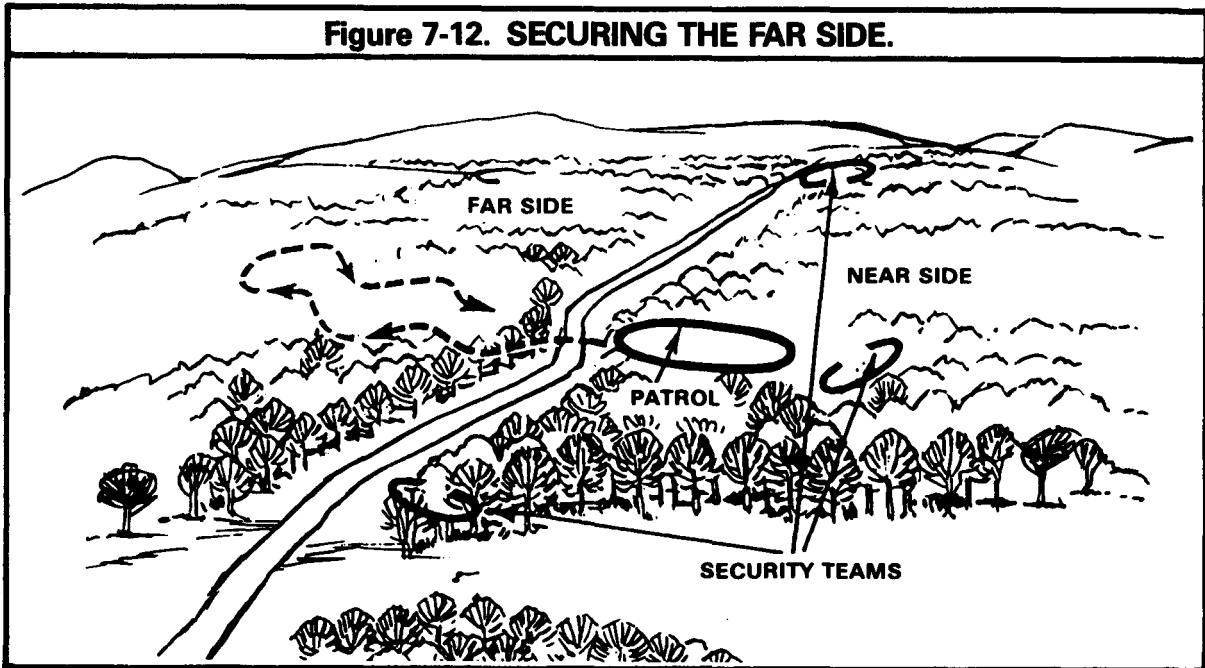
**Figure 7-11. SECURING NEAR SIDE.**



Once flank and rear security is positioned, the danger area is crossed by a team. The team crosses quickly and reconnoiters and secures the far side of the danger area. The area secured on the far side must be large enough for full

patrol deployment. When the team leader is sure the far side is safe, he sends two men back to signal the rest of the patrol to cross. When the patrol has crossed the danger area, the security teams cross and rejoin the patrol.

**Figure 7-12. SECURING THE FAR SIDE.**



### 7-13. ACTIONS ON ENEMY CONTACT

Unless required by the mission, a patrol must strive to avoid enemy contact. If it does make unexpected contact with the enemy, it must quickly break the contact and continue its mission.

**Battle Drills.** Battle drills are well rehearsed plans intended to provide fast reaction to unexpected enemy contacts. Leaders should prepare battle drills for the most common situations. These drills must stress simplicity (every man must be able to understand the plan and be able to carry out his part of it) and speed of execution (as soon as any member of the patrol recognizes a situation requiring an immediate action, he initiates the appropriate drill).

**Air attack.** The first man to see an aircraft shouts, AIRCRAFT, FRONT (RIGHT, LEFT, OR REAR): If the leader sees that the aircraft is making a firing run on the patrol, he hits the ground at once and shoots at the aircraft. All men follow his example.

**Chance contact.**

**“FREEZE.”** This battle drill is used when a patrol, not yet seen by the enemy, sees the enemy and does not have time to take any other action. All men hold still until signaled to continue or to do something else.

**“HASTY AMBUSH.”** This battle drill is used when a patrol, not yet seen by the enemy, sees the enemy approaching and has time to take some action other than to “FREEZE.” When the signal is given to initiate the drill, all men move on line and take concealed firing positions. The leader lets the enemy pass if his patrol is not detected. If the patrol is detected, the ambush is initiated.

**“IMMEDIATE ASSAULT.”** This battle drill is used when a patrol and an enemy element of the same size or smaller see each other at the same time and at such close range that fire and movement is not feasible. The men nearest the enemy open fire and shout, CON-

TACT, FRONT (RIGHT, LEFT, OR REAR). The patrol moves swiftly into the assault. It stops the assault if the enemy withdraws and breaks contact. If the enemy stands and fights, the assault is carried through the enemy and movement is continued until the enemy is destroyed or contact is broken.

**“CLOCK SYSTEM.”** This battle drill is used when a patrol and a larger enemy element see each other at the same time. The patrol must break contact or be destroyed. The direction in which the patrol is moving is always 12 o'clock. When contact is made, the leader shouts a direction and a distance to move — for example, EIGHT O'CLOCK, TWO HUNDRED. This tells the patrol to move in the direction of 8 o'clock for 200 meters. Each man must be sure to move in relation to the patrol's direction of march, not in relation to the direction of the enemy or the direction he is facing at that moment. If contact is broken, the patrol rallies at the designated distance away and continues its mission. If contact is not broken, another direction and distance is given. The process continues until contact is broken.

**Ambush.** If a patrol finds itself in an enemy ambush, it must get out of the kill zone or face destruction. It must take the following battle drill actions:

The men in the kill zone, without order or signal, immediately return fire and quickly move out of the kill zone by the safest way (There is no set way to do this; it must be each man's decision for his situation.) Smoke can help conceal the men in the kill zone.

The men not in the kill zone fire to support the withdrawal of the men in the kill zone.

The patrol breaks contact and reorganizes in the last designated rally point it passed.

**Indirect fire.** If a patrol comes under indirect fire, the leader immediately has the patrol move out of the impact area. The men do not

seek cover. By continuing to move, the patrol is more difficult to hit, and the chance of being pinned down is less.

**Sniper fire.** If a patrol comes under sniper fire, it immediately returns fire in the direction of the sniper. The patrol then conducts fire and movement to break contact with the sniper.

**Handling Casualties and Prisoners.** A patrol should have an SOP for handling casualties and prisoners. The method used must not jeopardize the mission.

Wounded are moved from the immediate area of a firefight before receiving first aid. Giving first aid during a firefight risks even more casualties.

Dead may be handled the same way as seriously wounded, except that no one is left with the body which is concealed for later pickup.

Prisoners are bound and gagged; they may be blindfolded. They may then be taken under guard to a friendly area. They may be evacuated by air, taken with the patrol, or concealed for later pickup. (See chapter 8 for discussion on handling prisoners.)

#### 7-14. REENTRY OF FRIENDLY LINES

The reentry of a patrol through another unit's lines can be confusing and dangerous if not well coordinated. The leader must coordinate the reentry with the friendly unit commander before the patrol leaves on its mission.

When a patrol returns to friendly lines, it stops at the reentry rally point just short of the friendly unit, out of sight and sound of OPs. The leader transmits a radio message (a prearranged code word) to tell the friendly unit that the patrol is ready to reenter. The message must be acknowledged before the patrol moves in. This is done to make sure that men of the friendly unit do not shoot at the returning patrol. If radio communication is not possible, one

patrol member should contact an OP using the challenge and password. Once contact is made, the OP can then relay a message to the unit's commander. The friendly unit then sends a guide to lead the patrol through its position. The leader should pass on to the friendly unit commander anything of tactical value.

If communications are established, and the friendly unit is prepared to guide the patrol through the lines, the patrol moves forward to the reentry point. The guide and leader exchange signals to identify the patrol. Once identified, the patrol moves forward and is led through the lines by the guide. The assistant leader should stay at the reentry point and count the men going through the lines. This will insure that only the members of the patrol reenter friendly lines.

If no communications can be established, or if no OPs can be found, and if a reentry point was coordinated before the patrol's departure, the patrol can still conduct reentry. The leader takes a small security team with him to reconnoiter for the reentry point. He leaves the rest of the patrol outside of small arms range of friendly lines. He avoids probing around wire obstacles. One way to find the reentry point when visibility is poor is to have the guide from the friendly lines turn on an infrared light or a flashlight shielded with a red lens. (This must be coordinated before the patrol departs friendly lines; for example, at a predetermined time and place, the guide from the friendly unit turns on the light source [for 30 seconds] every half hour during a 3-hour period. Note that this method must be used judiciously because of the enemy's capability to detect infrared sources.) Either type light is easy to see with a starlight scope. The leader then makes contact with the guide. He then sends two men to bring the patrol forward. The guide then leads the patrol through the lines. The assistant leader should stay at the reentry point and count the men as they go through the lines.

**Section IV. RECONNAISSANCE PATROL**

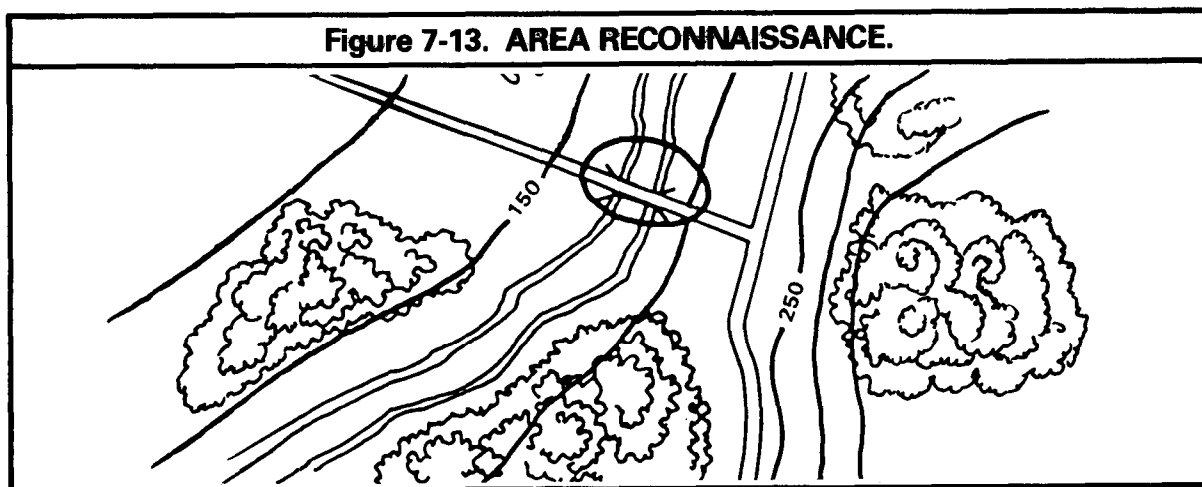
**7-15. GENERAL**

The focus of this section is on dismounted reconnaissance. Scout platoon reconnaissance missions are discussed in FM 71-2 and FM 17-95.

**7-16. TYPES OF RECONNAISSANCE PATROLS**

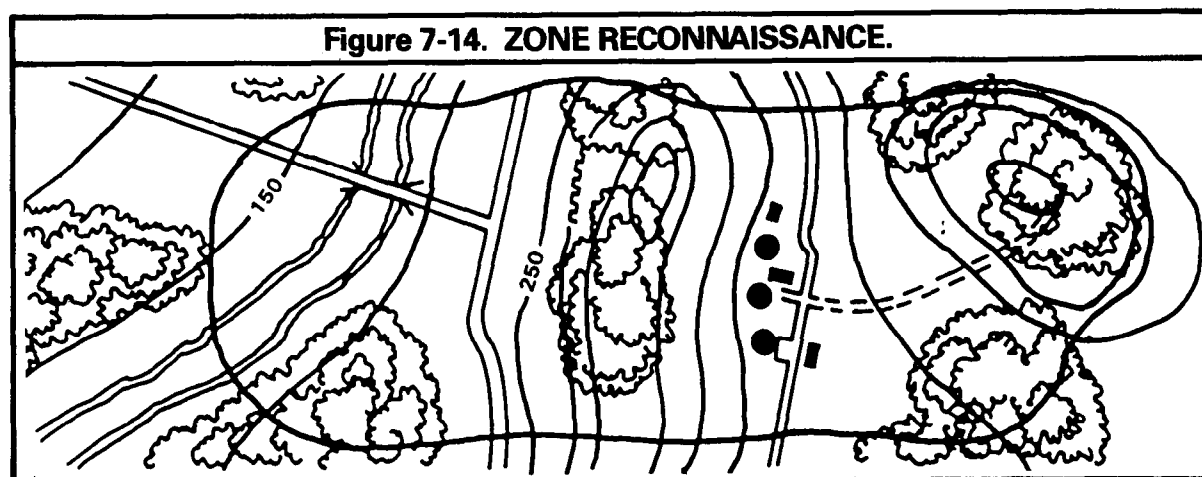
**Area Reconnaissance.** This is a reconnaissance conducted to obtain information concern-

ing a specific location and the area immediately around it (for example, road junction, hill, bridge, enemy position). The location of the objective is designated by either grid coordinates or a map overlay with a boundary line encircling the area.



**Zone Reconnaissance.** This is a reconnaissance conducted to obtain information on all

enemy, terrain, and routes within a specific zone. The zone is defined by boundaries.

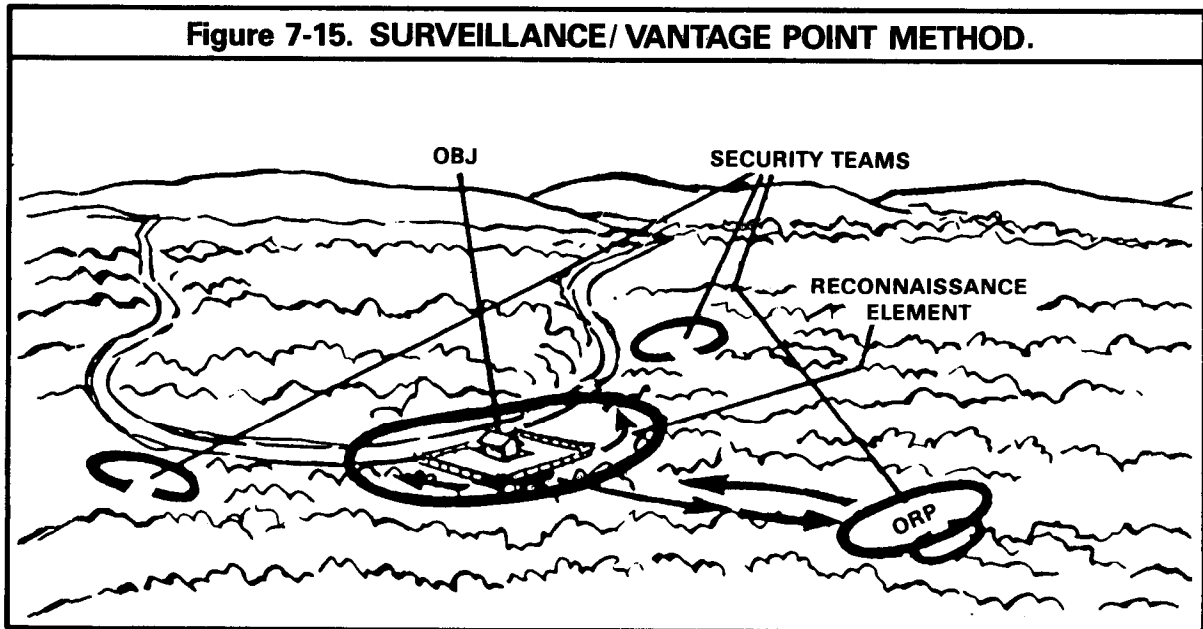




## 7-17. CONDUCT OF AN AREA RECONNAISSANCE

A patrol uses the **surveillance/vantage point method** to conduct an area reconnaissance. The leader uses a series of surveillance

vantage points around the objective from which to observe it and the surrounding area.



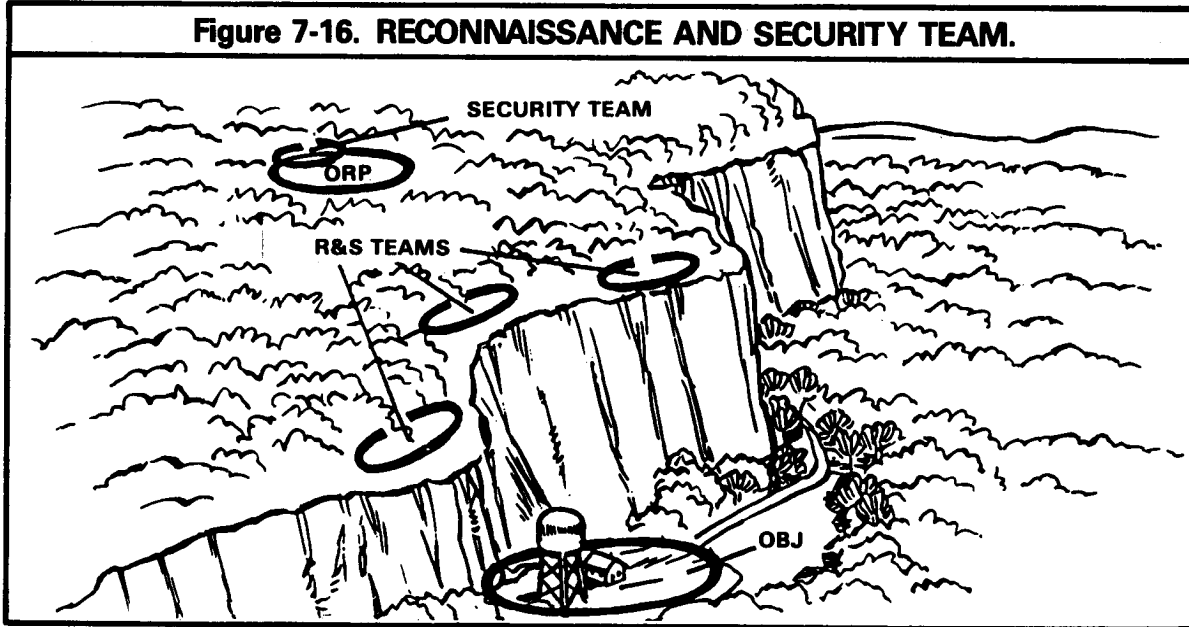
The patrol halts in the ORP and establishes security. The leader confirms the patrol's location. The leaders conduct a leaders' reconnaissance of the objective area to confirm the plan and then return to the ORP. The security element departs the ORP before the reconnaissance element. The security element leader positions security teams at the ORP, and on likely enemy avenues of approach going into the objective area.

Once the security teams are in position, the reconnaissance element departs the ORP. The reconnaissance element moves to several surveillance/vantage points around the objective. The reconnaissance element leader may decide to have a small reconnaissance team move to each surveillance/vantage point instead of

having the entire element move as a unit from point to point. Once the objective has been reconnoitered, the elements return to the ORP and disseminate information. This insures that the information reaches the unit if the patrol is engaged and broken up en route to friendly lines. The patrol then returns to friendly lines.

The terrain may not allow a patrol to secure an objective area. In this case, the leader leaves a security team in the ORP and uses reconnaissance and security teams to reconnoiter the objective. These teams move to different surveillance/vantage points from which they reconnoiter the objective. Once the objective has been reconnoitered, the reconnaissance and security teams return to the ORP and disseminate the information. The patrol then returns to friendly lines.

Figure 7-16. RECONNAISSANCE AND SECURITY TEAM.

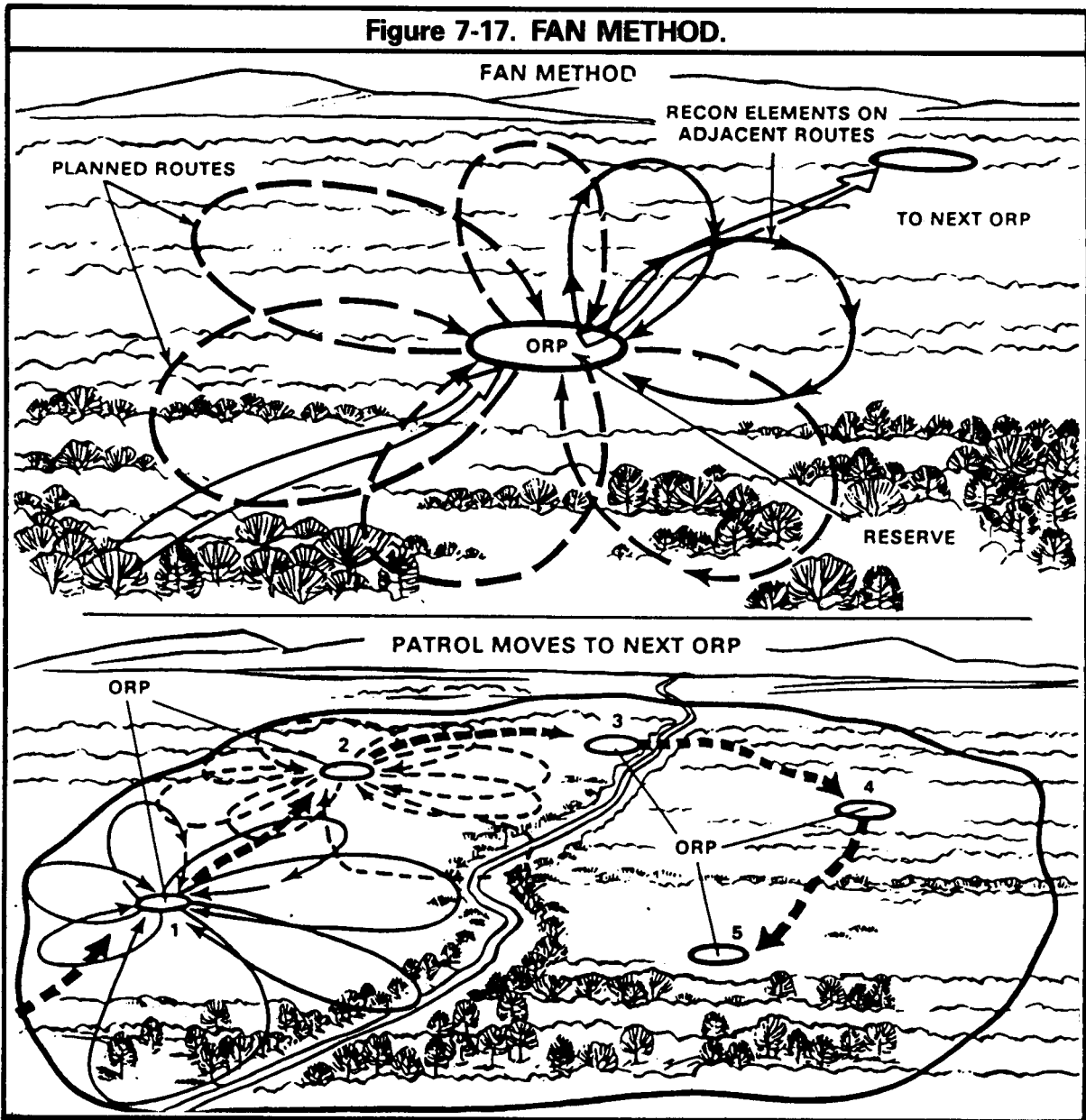


#### 7-18. CONDUCT OF A ZONE RECONNAISSANCE

There are three basic methods of conducting a zone reconnaissance — **fan method**, **converging routes method**, and **successive sector method**.

**Fan Method.** The leader of the patrol first selects a series of ORPs throughout the zone from which to operate. When the patrol arrives at the first ORP, it halts and establishes security. The leader confirms the patrol's location. He then selects reconnaissance routes out from and back to the ORP. (These routes form a fan-shaped pattern around the ORP. The routes must overlap to insure that the entire area has been reconnoitered.) Once the routes have been selected, the leader sends out reconnaissance elements along the routes. He does not send out all of his elements at once. He keeps a security element in the ORP. (For example, if the patrol has three reconnaissance elements, only two are sent out. The other one is kept as a reserve.) Additionally the leader sends the elements out on adjacent routes. This avoids having the patrol make contact in two different directions. After the entire area (fan) has been reconnoi-

tered, the information obtained is disseminated. The patrol then moves to the next ORP. This action is repeated at each successive ORP.

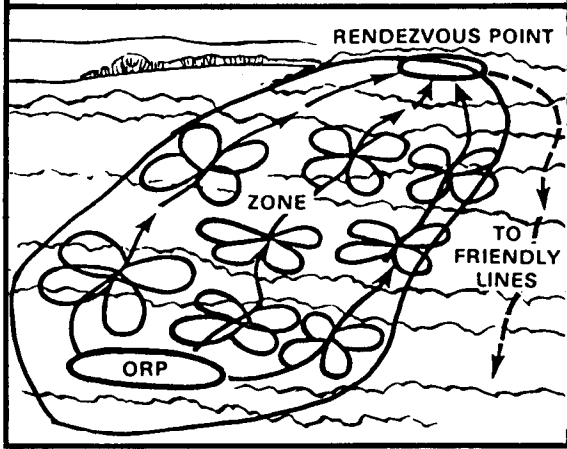


**Converging Routes Method.** The leader of the patrol first selects an ORP, then selects reconnaissance routes through the zone, and then selects a rendezvous point. A reconnaissance

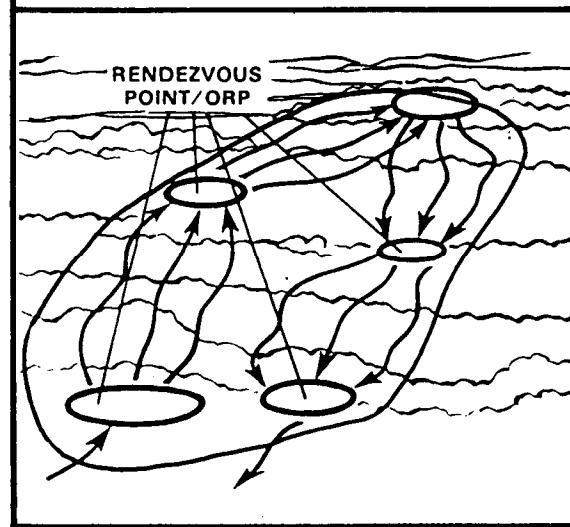
element is sent out on each route where patrol members are to link up after the reconnaissance. The leader normally moves with the center element. The elements normally reconnoiter their routes using the fan method. The entire patrol links up at the rendezvous point at the designated time.

each ORP to each rendezvous point are the same as in the converging routes method. (Each rendezvous point becomes the ORP for the next phase.) When the patrol links up at a rendezvous point, the leader again designates reconnaissance routes, a linkup time, and the next rendezvous point. This action continues until the entire zone has been reconnoitered. Once the reconnaissance is completed, the patrol returns to friendly lines.

**Figure 7-18. CONVERGING ROUTES METHOD.**



**Figure 7-19. SUCCESSIVE SECTOR METHOD.**



**Successive Sector Method.** This method is basically a continuation of the converging routes method. The leader selects an ORP and a series of reconnaissance routes and rendezvous points. The actions of the patrol from

## Section V. COMBAT PATROL

### 7-19. GENERAL

Combat patrols provide security, and harass, destroy, or capture enemy troops, equipment, and installations. There are three types of combat patrols — **ambush**, **security**, and **raid**.

### 7-20. AMBUSH PATROL

An ambush is a surprise attack from a concealed position on a moving or temporarily halted target. It may include an assault to close with and destroy the target, or the attack may be by fire only. It does not require that ground be seized and held. It enables a small unit with

few weapons and little equipment to harass or destroy a larger, better armed unit.

There are two types of ambush: point and area. In a **point ambush**, troops deploy to attack a single kill zone. In an **area ambush**, troops deploy as multiple **related** point ambushes.

Ambushes are categorized as either hasty or deliberate.

A **hasty ambush** is a battle drill, as discussed in section III.

A **deliberate ambush** is planned as a specific action against a specific target. Detailed information of the target is required, such as size, organization, weapons and equipment carried, route and direction of movement, and times the target will reach or pass certain points on its route. Deliberate ambushes are planned when —

reliable information is received on the expected movement of a specific target; and

patrols, convoys, carrying parties, or similar targets establish patterns of size, time, and movement sufficient to permit detailed planning for their ambush.

Ambushes are described in the following terms:

**AMBUSH SITE** — the terrain on which a point ambush is established.

**KILL ZONE** — the part of an ambush site where fire is concentrated to isolate, trap, and destroy the target.

**ASSAULT ELEMENT** — the part of the ambush patrol that fires into and assaults the kill zone.

**SUPPORT ELEMENT** — the part of the ambush patrol that supports the assault element by firing into and around the kill zone.

**SECURITY ELEMENT** — the early warning and security part of an ambush patrol. It secures the ORP, and blocks enemy avenues of approach into and out of the ambush site. It does this to prevent any enemy from getting into or out of the ambush site.

## 7-21. FUNDAMENTALS OF A SUCCESSFUL AMBUSH

**Surprise.** Surprise is a major feature that distinguishes an ambush from other forms of attack. It is surprise that allows the patrol to

seize control of the situation. If **complete** surprise cannot be achieved, it must be so nearly complete that the target does not know of the ambush until too late for **effective** reaction. Surprise is achieved by good planning, preparation, and execution.

**Coordinated Fire.** All weapons, including mines and demolitions, must be positioned, and all fire, including that of supporting artillery and mortars, must be coordinated to achieve —

the isolation of the kill zone to prevent escape or reinforcement; and

the surprise delivery of a large volume of highly concentrated fire into the kill zone. This fire must inflict maximum damage so that the target can be quickly assaulted, when required, and destroyed.

**Control.** Close control must be maintained during movement to, occupation of, and withdrawal from the ambush site. Control is most critical at the time of the target's approach. Control measures must provide for —

early warning of target approach,  
withholding fire until the target has moved into the kill zone,

opening fire at the proper time,  
initiation of proper action if the ambush is prematurely detected,

lifting or shifting of supporting fire when the attack includes assault of the target and

timely and orderly withdrawal of the patrol to the ORP.

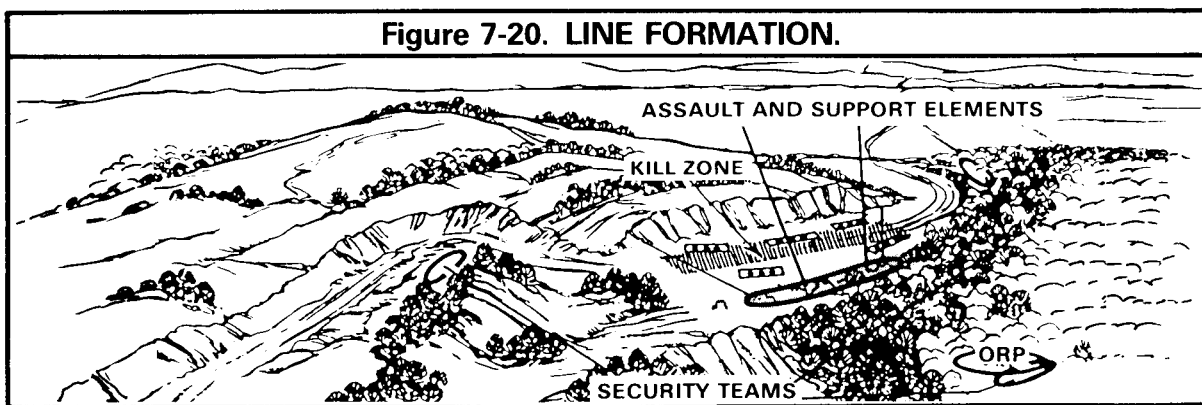
## 7-22. AMBUSH FORMATIONS

**Line.** In an ambush employing a line formation, the assault and support elements are deployed generally parallel to the target's route of movement (road, trail, stream). This positions the assault and support elements parallel to the long axis of the kill zone and subjects the target to **flanking** fire. The size of a target that can be

trapped in the kill zone is limited by the size of the area that the assault and security elements can cover with a great volume of fire. The target is trapped in the kill zone by natural obstacles, mines (Claymore, antitank, antipersonnel), explosives, and direct and indirect fire. A **disadvantage** of the line formation is that its target may be so dispersed that it is larger than the kill zone. The line formation is good in close terrain which restricts the targets movement, and in open terrain where one flank is blocked

by natural obstacles or can be blocked by mines or explosives. Similar obstacles may be put between the assault and support elements and the kill zone to protect the patrol from the target's counterambush actions. When a patrol is deployed this way, access lanes are left through the obstacles so the target can be assaulted. An advantage of the line formation is the relative ease by which it can be controlled under all conditions of visibility.

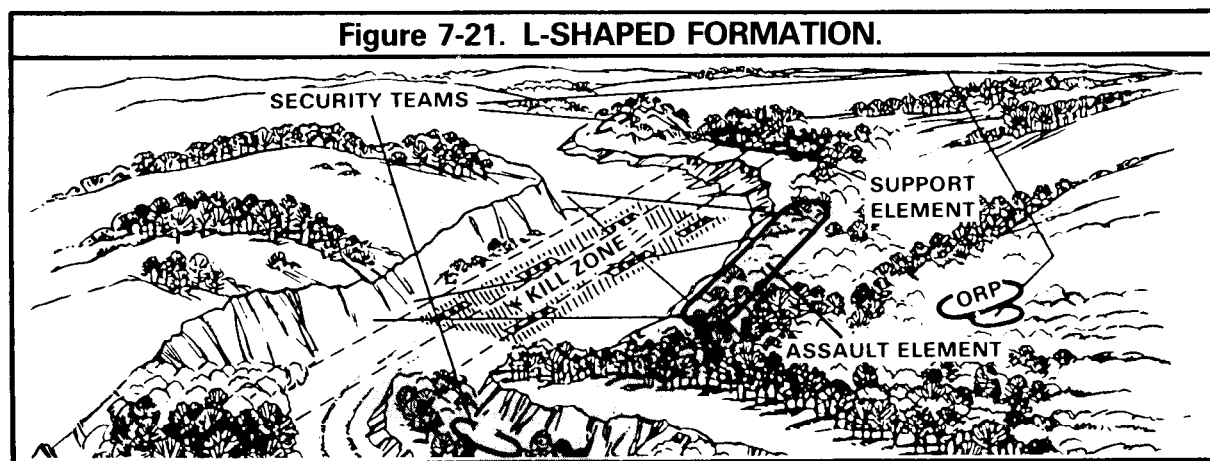
Figure 7-20. LINE FORMATION.



**The L.** The L-shaped formation in an ambush is a variation of the line formation. The long leg of the "L" (assault element) is parallel to the kill zone. This provides **flanking** fire. The short leg (support element) is at the end of, and at a

right angle to, the kill zone. This provides **enfilade** fire which interlocks with fire from the other leg. This formation can be deployed on a straight stretch of a trail, road, or stream, or at a sharp bend in a trail, road, or stream.

Figure 7-21. L-SHAPED FORMATION.



### 7-23. SIGNALS

Audible and visual signals such as whistles and flares must be changed often to avoid setting patterns. Frequent use of the same signals may cause them to become known to the enemy. A target might recognize a signal and react in time to avoid the full effects of an ambush. For example, if a white star cluster is used all the time to signal withdrawal in a night ambush, an alert enemy might fire one and cause premature withdrawal of the ambush patrol.

Normally four signals are needed for the ambush.

**(1) A signal by a security team to alert the leader of the target's approach.**

**(2) A signal to start the ambush, given by the leader or a man he designates. This must be a casualty-producing signal, such as machine gunfire or the detonation of mines or explosives.**

**(3) A signal to shift fire when the target is to be assaulted. Voice, whistles, or flares may be used. All fire must stop or be shifted at once so that the assault can be made before the target can react.**

**(4) A signal to withdraw. This can be by voice, whistle, or flare.**

### 7-24. FIRE DISCIPLINE

Fire discipline is a key part of the ambush. **Fire must be withheld until the signal is given, then delivered at once in the heaviest, most accurate volume possible.** Well-timed and well-aimed fire helps achieve surprise as well as the destruction of the enemy. When the enemy is to be assaulted, the lifting or shifting of fire must also be precise. If it is not, the assault is delayed, and the enemy has a chance to react.

### 7-25. WITHDRAWAL TO THE ORP

Routes of withdrawal to the ORP are reconnoitered. Situation permitting, each man reconnoiters the route he is to use.

On signal, the patrol withdraws to the ORP, reorganizes, and starts its return march. At a set terrain feature or about 1,000 meters from the objective, the patrol will halt and disseminate information.

If the ambush fails and the patrol is pursued, withdrawal may be by bounds. Smoke and indirect fire may be used to assist the patrol in disengagement. Mines set along the withdrawal routes can help stop the pursuit.

### 7-26. CONDUCT OF A POINT AMBUSH

A point ambush, by itself or as part of an area ambush, is positioned on its target's expected route of approach. The ambush formation is important because it determines to a great extent whether a point ambush can deliver the heavy volume of fire necessary to isolate, trap, and destroy the enemy.

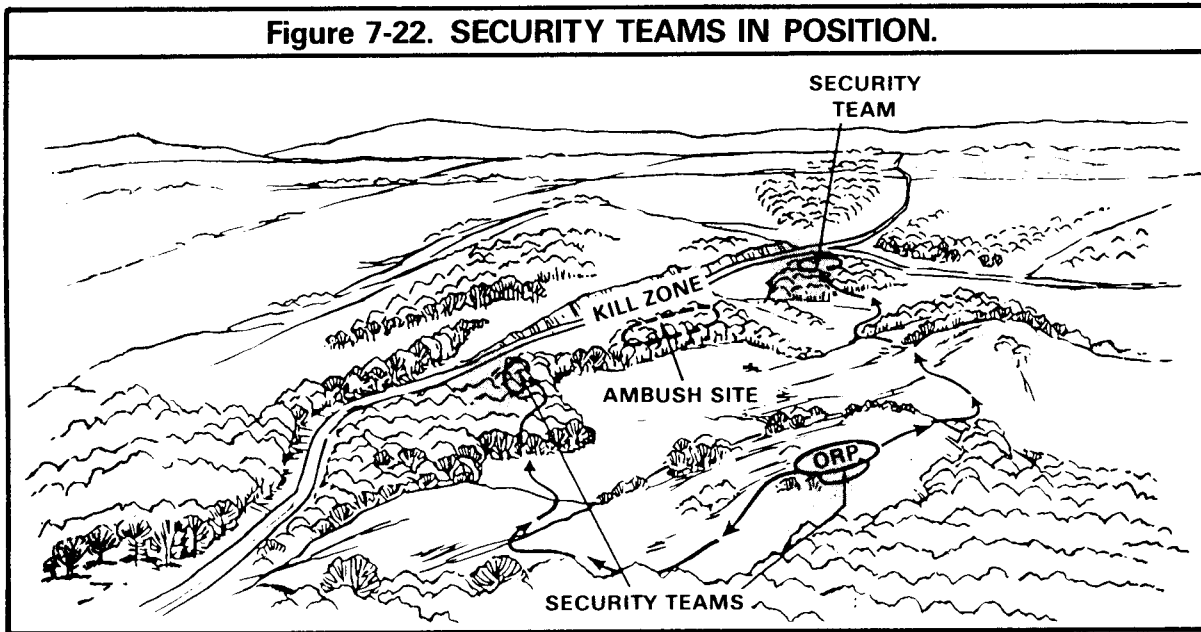
The formation to be used is based on the advantages and disadvantages of each possible formation in relation to the —

**terrain, visibility, troops available, weapons, and equipment  
ease of control;  
enemy force to be attacked, and  
overall combat situation.**

The patrol halts at the ORP and establishes security. The leader confirms the patrol's location. The leader then conducts a reconnaissance of the objective area to confirm the plan.

The security element leaves the ORP first. The teams of the security element move to positions from which they can secure the ORP and the flanks of the ambush site.

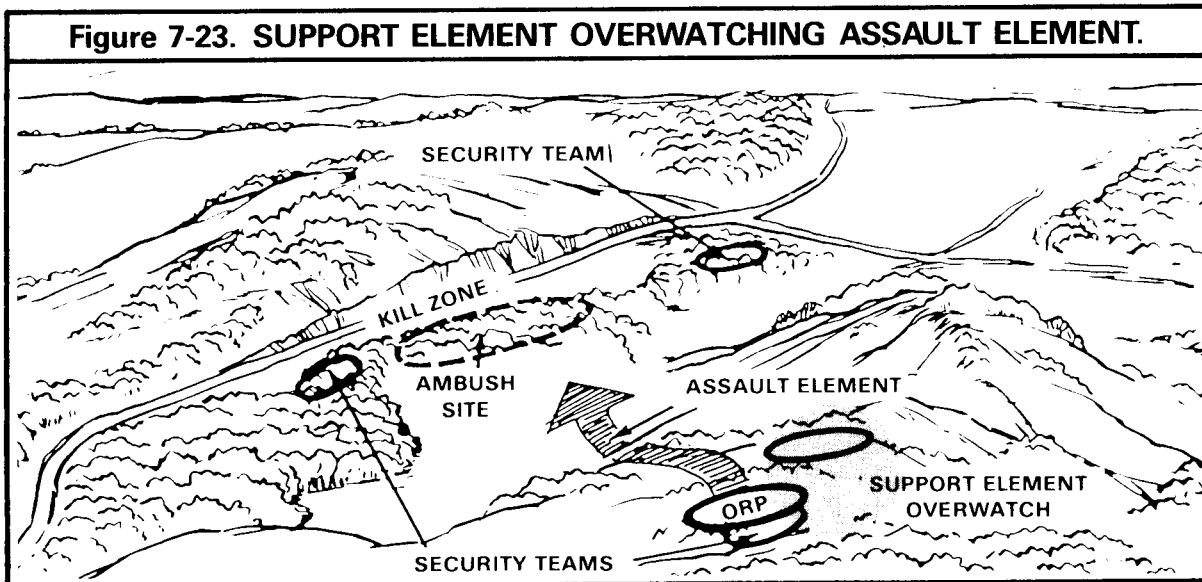
**Figure 7-22. SECURITY TEAMS IN POSITION.**



When the security teams are in position, the support and assault elements leave the ORP and occupy their positions. If there is a suitable position, the leader may have the support element

overwatch the assault element's move to the ambush site. If not, both elements leave the ORP at the same time.

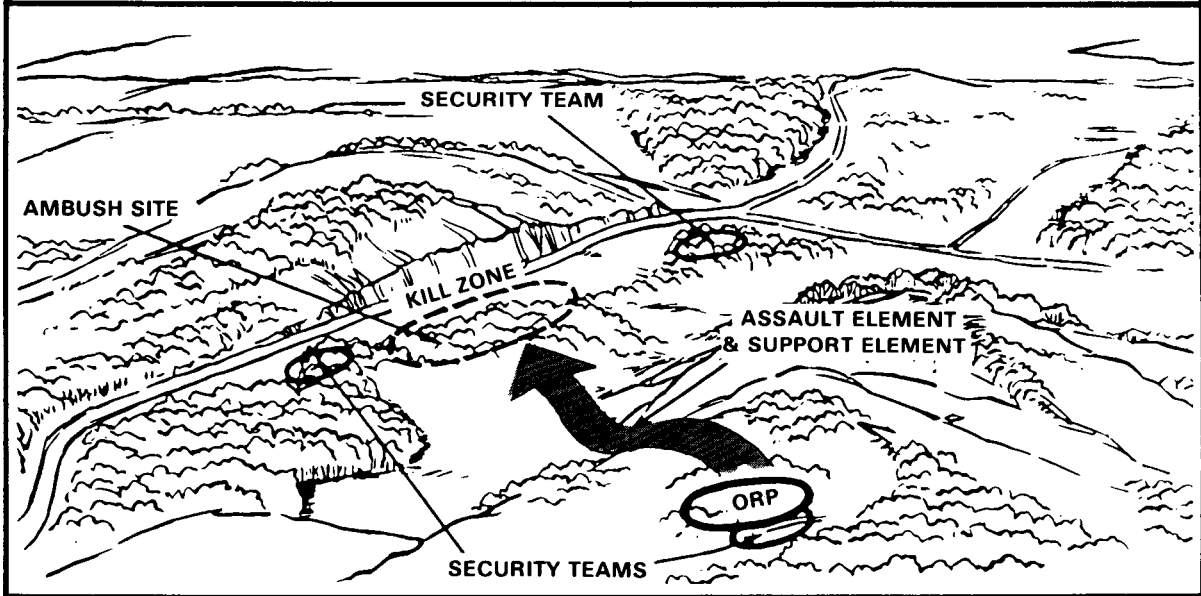
**Figure 7-23. SUPPORT ELEMENT OVERWATCHING ASSAULT ELEMENT.**



Once all elements are in position, the patrol awaits the target. When the target approaches, the security team spotting it alerts the leader of

the patrol. The security team should report the target's direction of movement, size, and any special weapons or equipment.



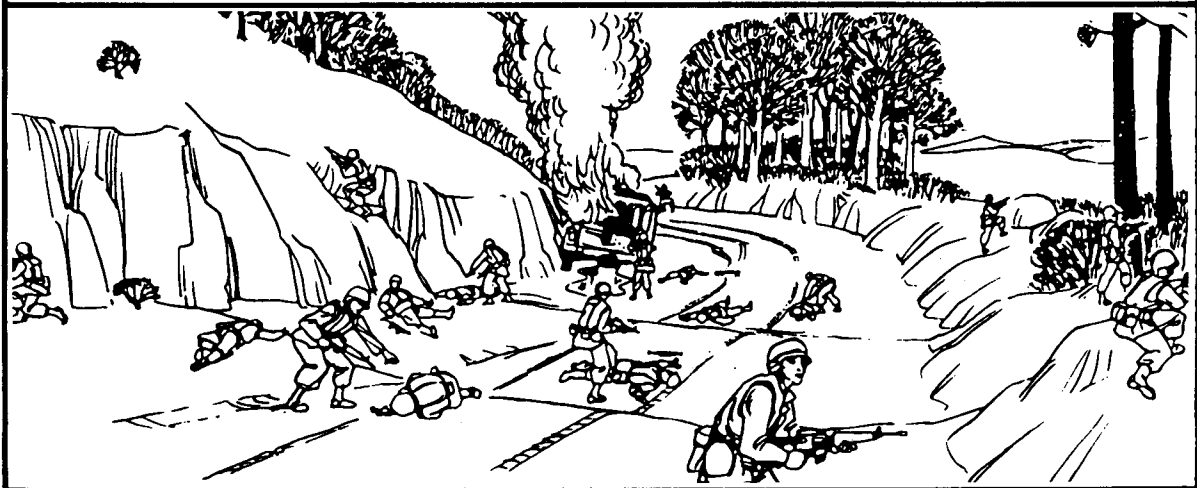
**Figure 7-24. SUPPORT ELEMENT MOVING WITH ASSAULT ELEMENT.**

Upon receipt of the report, the leader alerts the other elements. When the major part of the target is in the kill zone, the leader gives the signal to start the ambush.

When the assault element is required to assault the kill zone, the leader of the patrol gives the signal to lift or shift fire. This is also the signal for the assault to start. When the assault

element has finished its mission in the kill zone, the leader gives the signal to withdraw to the ORP.

When the assault element is not required to assault the kill zone, and when the desired results have been achieved, the leader gives the signal to withdraw to the ORP.

**Figure 7-25. SEARCHING KILL ZONE.**

On the signal to withdraw, all elements move back to the ORP. Equipment and personnel are accounted for, and the patrol moves out to a suitable location to disseminate information. The patrol then returns to friendly lines.

**7-27. CONDUCT OF AN AREA AMBUSH**

An area ambush is not normally conducted by a unit smaller than a platoon. The area ambush works best where enemy movement is largely restricted to trails or streams. The area selected should offer several suitable point ambush sites. The platoon leader must select one central ambush site around which he can organize the outlying ambushes. Squad-size patrols occupy the ambush sites.

Once the central ambush site has been selected, the platoon leader must determine the

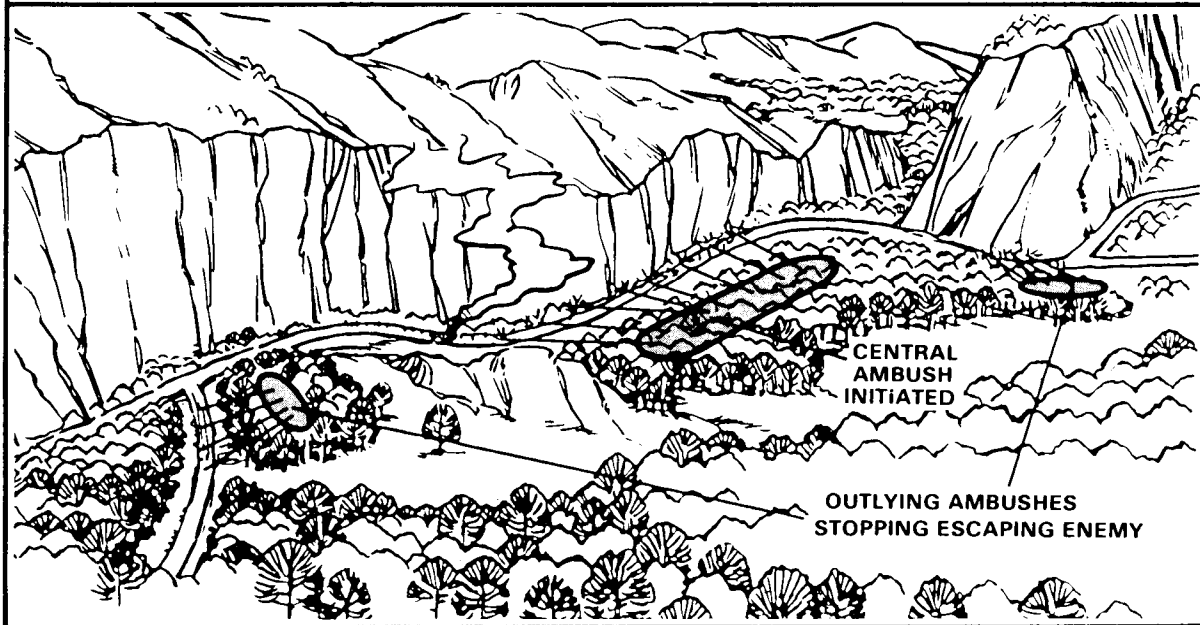
enemy's possible avenues of approach to and escape from this site. He then selects and assigns ambush sites to cover these avenues. The ambush sites are then established as explained for a point ambush.

Once the sites have been established, all enemy traffic going toward or away from the central ambush site is reported to the platoon leader — who is at the central ambush site. The outlying ambushes should allow the enemy to pass through their kill zones until the central ambush has been initiated.

Once the central ambush is initiated, the outlying ambushes prevent any enemy from escaping or entering the area.

The actual conduct of the ambushes is the same as that discussed for the point ambush.

**Figure 7-26. EXECUTING THE AMBUSH.**



**7-28. SQUAD ANTIARMOR AMBUSH**

The purpose of an antiarmor ambush is to destroy armored vehicles.

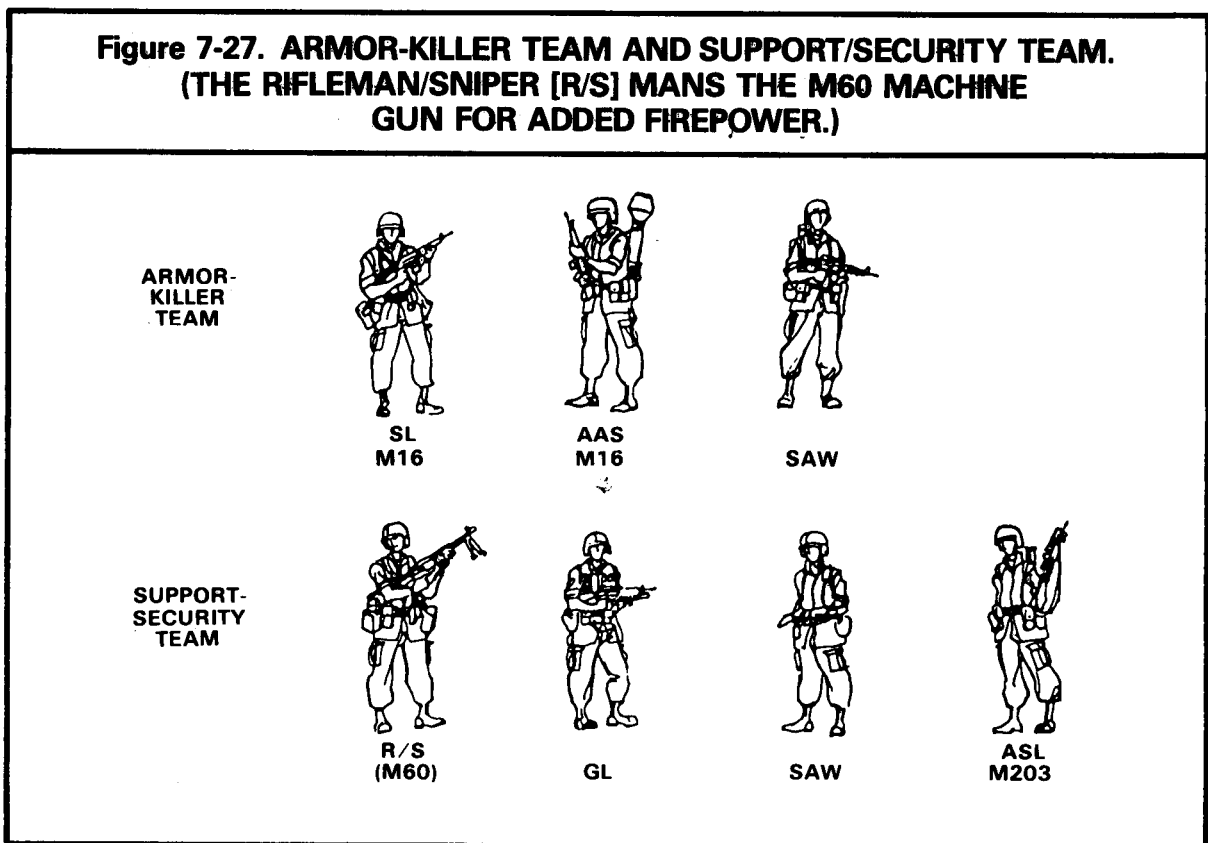
A squad can conduct a dismounted antiarmor ambush.

The leader organizes an **armor-killer team** and a **support/security team**.

The **armor-killer team** fires into the kill zone, augmented by obstacles and mines to pre-

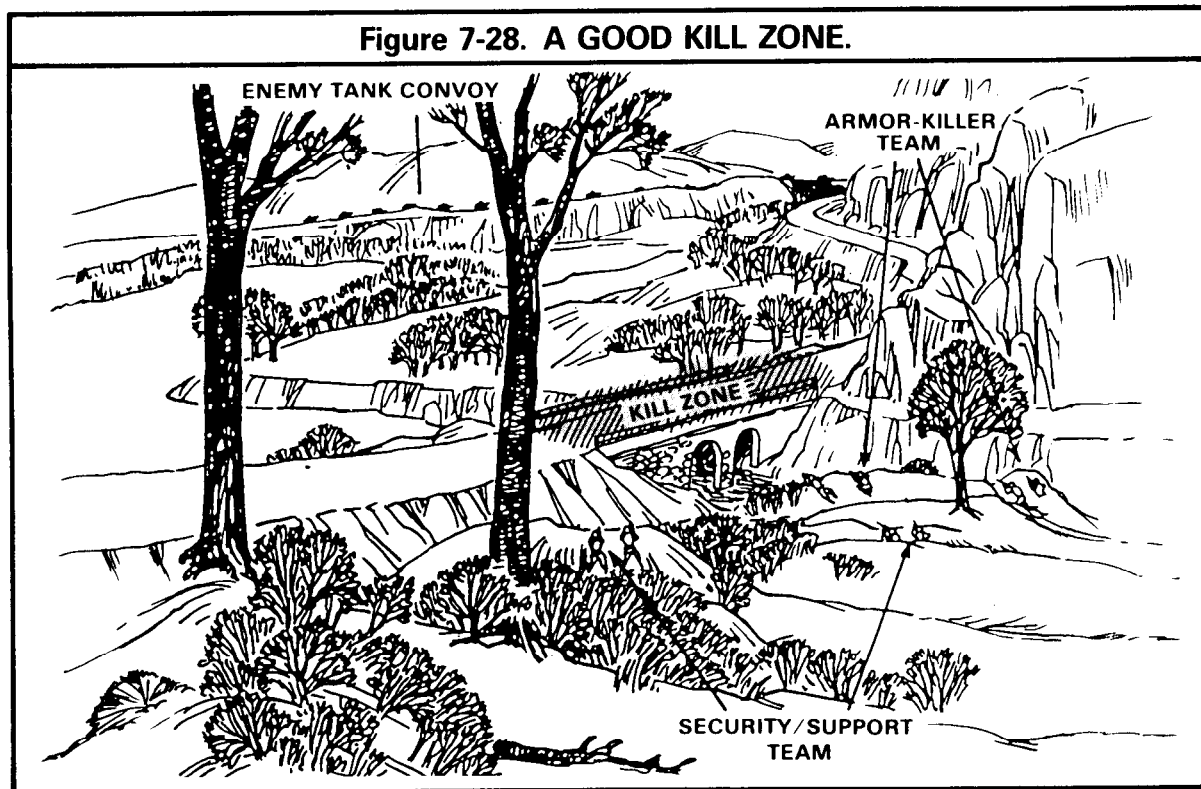
vent enemy maneuver. Normally, the Dragon is the main weapon of this team. LAWs and machine guns/SAWs may be used to supplement its fire. Where fields of fire are less than 100 meters, LAWs may be the main antiarmor weapon. In that case, the armor-killer team must mass LAW fire into the kill zone to make sure the target vehicle is killed.

The **support/security team** provides support and security for the squad and should be positioned where it can cover the withdrawal of the armor-killer team.



The platoon leader will give the general location of the ambush site. The squad leader must pick the best place to put his squad. The squad position is based primarily on the location of the kill zone. When the squad arrives at the ambush site, the leader reconnoiters and picks the kill zone.

Figure 7-28. A GOOD KILL ZONE.



Having selected a kill zone and ambush site, the squad leader picks positions for the teams. Good positions have —

- good fields of fire into the kill zone,**
- cover and concealment,**
- an obstacle between the teams and the kill zone, and**
- covered and concealed withdrawal routes.**

After choosing the kill zone and the team's positions, the squad leader positions his men and equipment.

The support/security team is positioned first. It is important to have security on both flanks. These men may have to be repositioned after the armor-killer team sets up, but when setting up an ambush, the leader must post security first.

As soon as the ambush site is secure, the armor-killer team sets up so that it can cover the kill zone. The squad leader and the Dragon gunner pick the exact firing position. Once the Dragon is in position, the machine gun is positioned where it can cover the kill zone.

The squad leader positions himself where he can best control his men and weapons — normally near the Dragon. When the enemy enters the kill zone, the leader initiates the ambush. A command-detonated antiarmor mine is an excellent means to start the ambush. It must be command-detonated, not "tripped." This precludes initiating an ambush against too large a force or against undesirable targets. The Dragon can be used to initiate the ambush — but remember, it has a slow rate of fire, gives off a signature, and may not hit the target. When possible, the first and last enemy vehicles should be destroyed to keep the other vehicles from escaping.

The rest of the squad opens fire when the Dragon round impacts. Indirect fire should fall in the kill zone as soon as possible after the Dragon impacts. If the kill zone is in range, each man in the squad (except the Dragon gunner and machine gunner) fires a LAW. The machine gunner fires into the kill zone.

If enemy troops on foot precede the armored vehicles into the kill zone, the squad leader must decide if they pose a threat to the ambush. If they can outflank his squad before the enemy armor can be hit, he may decide to withdraw without making contact and to try to set up another ambush somewhere else. If the enemy infantry is an immediate threat to the squad or appears to be ready to find or trip any mechanical devices, the ambush is initiated with machine guns and small arms fire. All action against enemy infantry is just as was planned and rehearsed for action against armor, except that the antiarmor weapons do not fire.

If mounted enemy infantry approach the kill zone, their carriers are treated as light tanks. They should be allowed to get close before being destroyed, one at a time. If mounted infantry is mixed with tanks, the tanks should be the target for the Dragon. After the Dragon is fired, the enemy's carriers are hit with LAWs, grenade launchers (using the HEDP round), and machine guns.

Because of the speed with which other enemy armored vehicles may react, and the responsiveness of enemy artillery the squad must be prepared to move quickly when given the order to withdraw to the ORP.

#### **7-29. PLATOON ANTIARMOR AMBUSH**

The platoon is a good size to conduct a dismounted antiarmor ambush.

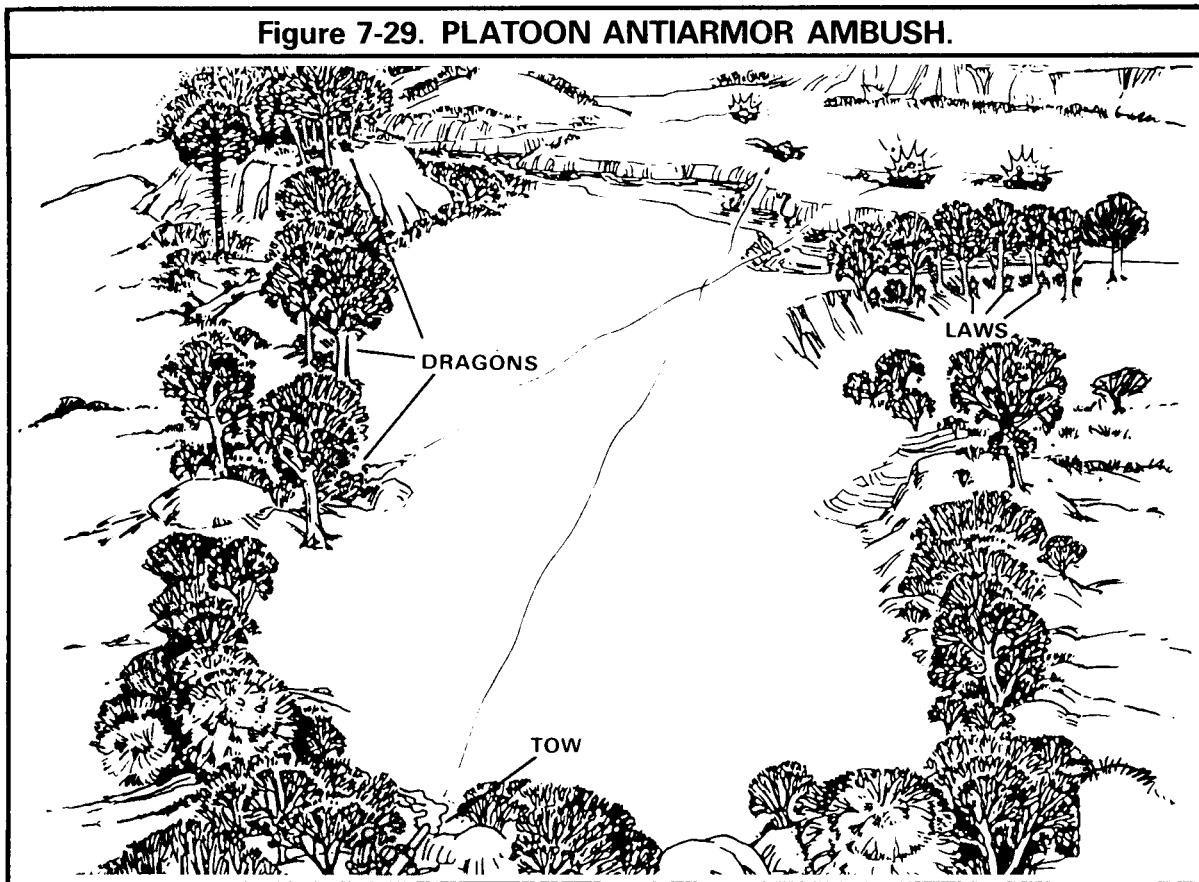
The platoon leader must consider the same criteria for site selection, firing positions, and conduct of the ambush as previously described for the squad leader.

Additionally the platoon leader must organize the ambush into assault, security and support elements.

When the ambush has been completed, the platoon leader gives the order to withdraw to the ORP.

At the ORP, a quick headcount is taken, necessary adjustments in personnel and equipment are made, and the platoon moves out.

**Figure 7-29. PLATOON ANTIARMOR AMBUSH.**



**7-30. MOUNTED ANTIARMOR AMBUSH**

The APC's mobility and firepower allow infantry squads and platoons to conduct mounted antiarmor ambushes.

The squad or platoon leader has several options for conducting the mounted antiarmor ambush.

Carrier teams conduct the ambush with Dragons mounted while the dismount team/element provides security.

Carrier teams conduct the ambush with Dragons dismounted and carrier teams firing caliber .50 machine guns while the dismount team/element provides security.

Both carrier and dismount teams conduct the ambush with one squad providing security.

Dismount teams with Dragon and LAW conduct the ambush while carrier teams provide security and prepare for rapid withdrawal.

The same considerations discussed in the dismounted antiarmor ambush apply for site selection and firing positions.

If the platoon is conducting the ambush, the dismount element can be organized into both an assault and a security element while the carrier element constitutes the support element.

The APCs can be used as a support element and/or overwatch force to assist the dismount element in disengaging.

The ORP must be selected to allow the dismount teams to link up with their vehicles. This may require both elements moving to an ORP. In this case, the ORP should be close to the dismount element.

The ambush is conducted with surprise and violence. Violence is generated by heavy volume fire.

### 7-31. SECURITY PATROL

Some combat patrols provide security. The most common security patrol that the infantry squad or platoon can expect to perform is a screen.

A screen requires a unit to maintain surveillance and provide early warning by maintaining at least visual contact with the enemy. A screening force must impede and harass the enemy by organic and supporting fires and, within its capability must destroy or repel enemy patrols.

Screening patrols prevent surprise attacks on the flank of moving units. They also reconnoiter areas through which units will pass and the routes they will use. They prevent infiltration and surprise attacks on stationary units by screening their front and/or flanks, and by reconnoitering gaps between the units and around their positions.

The leader of the patrol picks a series of OPs overmatching enemy avenues of approach into an area. Mounted or dismounted patrols are used to cover dead space and maintain contact between OPs. If the patrol makes contact, it reports to the

commander and attacks or withdraws according to the commander's instructions.

### 7-32. RAID PATROL

A raid patrol is a combat patrol whose mission is to attack a position or installation for any or all of these purposes:

**(1) Destroy the position or installation.**

**(2) Destroy or capture troops or equipment.**

**(3) Liberate personnel.**

Surprise, firepower, and violent action are the keys to a raid.

Surprise is best achieved by attacking —

**when the enemy may least expect an attack,**

**when visibility is poor, and**

**from an unexpected direction, such as from the rear or through a swamp or other seemingly impassable terrain.**

Fire is concentrated at critical points to suppress the enemy.

Violence is best achieved by gaining surprise, by using massed fire, and by attacking aggressively.

The patrol moves to the ORP as described for a reconnaissance patrol. The ORP is secured, the leaders' reconnaissance is conducted, and plans are confirmed. Elements and teams move to their positions. If possible, their movements are coordinated so that all reach their positions about the same time. This improves the patrol's capability for decisive action if it is detected by the enemy too soon.

**Security element.** The teams of the security element move to positions from which they can secure the ORP, give warning of enemy approach, block avenues of approach into the objective area, prevent enemy escape from the objective

area, or perform any combination of these tasks within their capability.

As the assault and support elements move into position, the security element keeps the leader of the patrol informed of all enemy action. It shoots only if detected or on the leader's order.

Once the assault starts, the security element prevents enemy entry into, or escape from, the objective area.

When the assault is completed, the security element covers the withdrawal of the assault and support elements to the ORP. It withdraws itself on order or on a prearranged signal.

**Support element.** The support element moves into position so that it can suppress the

objective and shift fire when the assault starts. It normally covers the withdrawal of the assault element from the immediate area of the objective. It withdraws itself on oral order or on signal.

**Assault element.** The assault element deploys close enough to the objective to permit immediate assault if detected by the enemy. As supporting fire is lifted or shifted, the assault element assaults, seizes, and secures the objective. It protects demolition teams, search teams, and other teams while they work. On order or signal, the assault element withdraws to the ORP.

At the ORP, the patrol reorganizes and moves about 1,000 meters away to disseminate information. During reorganization, ammunition is distributed, casualties are treated, and status reports are given.

## Section VI. PATROL BASES

### 7-33. GENERAL

A **patrol base** is a position set up when a patrol halts for an extended period in a place not protected by friendly troops.

Having a patrol base is usually part of the patrol plan but it may be an on-the-spot decision.

The time a patrol base may be occupied depends on the need for secrecy. It should not, however, be occupied for more than 24 hours except in an emergency. A patrol base is occupied only as long as necessary for its purpose. A patrol should not use the same patrol base more than once.

Patrol bases are used when there is a need to —

**stop all movement to avoid detection;**

**hide a patrol during a long, detailed reconnaissance of an objective area;**

**eat, clean weapons and equipment, and rest;**

**plan and issue orders;**

**reorganize after a patrol has infiltrated an enemy area; and**

**have a base from which to conduct several consecutive or concurrent operations such as ambush, raid, reconnaissance, or security patrols.**

### 7-34. SELECTION

The site of a patrol base is usually picked from a map or aerial reconnaissance during planning. A patrol base site picked by map or aerial reconnaissance is tentative. Its suitability must be confirmed, and it must be secured before it is occupied.

Plans to establish a patrol base must include selection of an **alternate patrol base site**. The alternate site is used if the initial site is unsuitable or if the patrol is required unexpectedly to evacuate the initial patrol base. It is usually desirable to reconnoiter the alternate site and keep it under watch until occupied or until no longer needed.



### 7-35. CONSIDERATIONS

Planning for a patrol base must include consideration of the mission and security measures, both passive and active.

**Mission.** A patrol base must be located so that it allows the patrol to accomplish its mission.

#### Security Measures.

The leader selects —

**terrain which would probably be considered of little tactical value by the enemy;**

**difficult terrain which would impede foot movement;**

**an area of dense vegetation, preferably bushes and trees that spread close to the ground; and**

**an area near a source of water.**

He plans for —

**OPs;**

**communications with OPs;**

**defense of the patrol base;**

**withdrawal from the patrol base, to include withdrawal routes and a rally point, or rendezvous point, or alternate patrol base;**

**a security system to make sure that necessary troops are awake at all times;**

**enforcement of camouflage, noise, and light discipline; and**

**the conduct of necessary activities with minimum movement and noise.**

He avoids —

**known or suspected enemy positions;**

**built-up areas;**

ridges and hilltops, except as necessary for maintaining communications;

roads, trails, wet areas, steep slopes; and

small valleys.

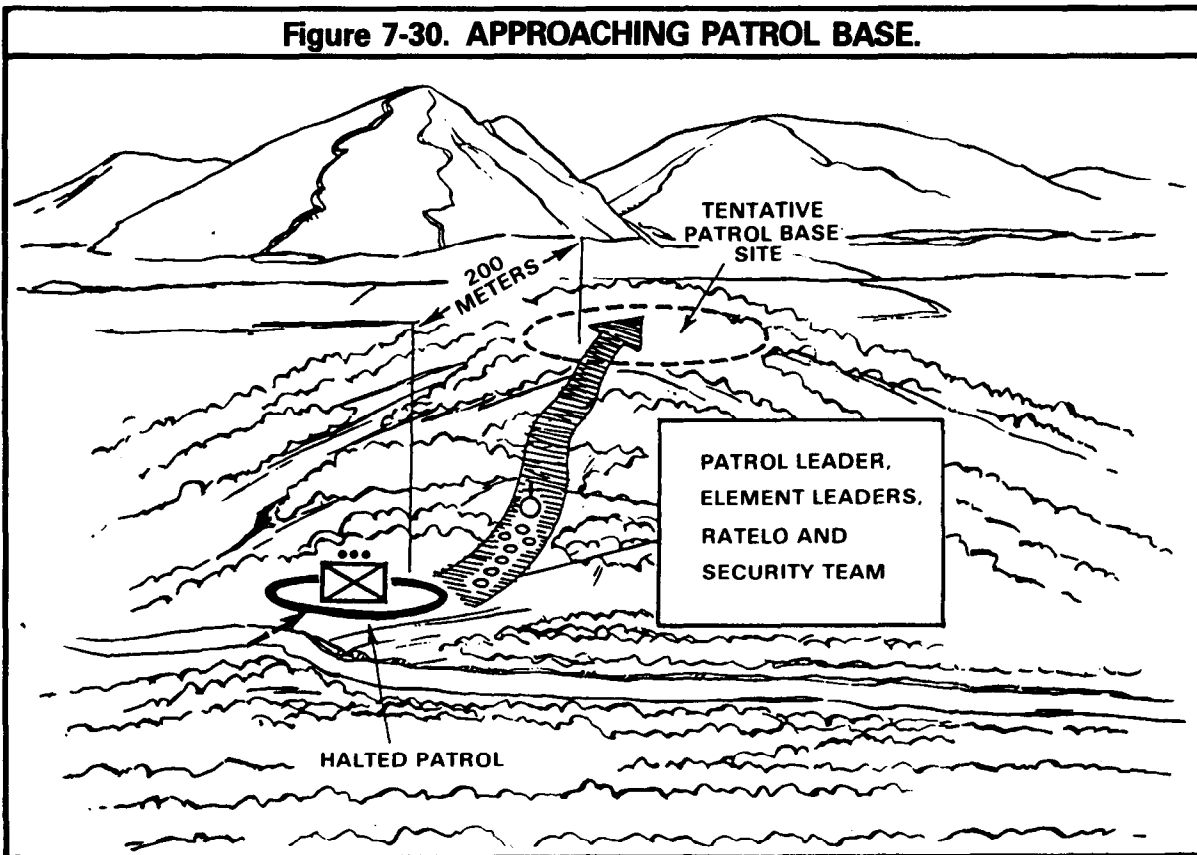
**7-36. OCCUPATION OF A PATROL BASE**

Before moving into a patrol base, the area is reconnoitered and secured. Once secured, a pa-

trol base is occupied by moving to the selected site, deploying into it, and establishing a perimeter defense. The following is an example of a patrol occupying a patrol base.

**Approach.** The patrol halts within 200 meters of the tentative patrol base site. Security is posted. The element leaders, radiotelephone operator, and a security team join the leader of the patrol and move forward to reconnoiter the site.

**Figure 7-30. APPROACHING PATROL BASE.**

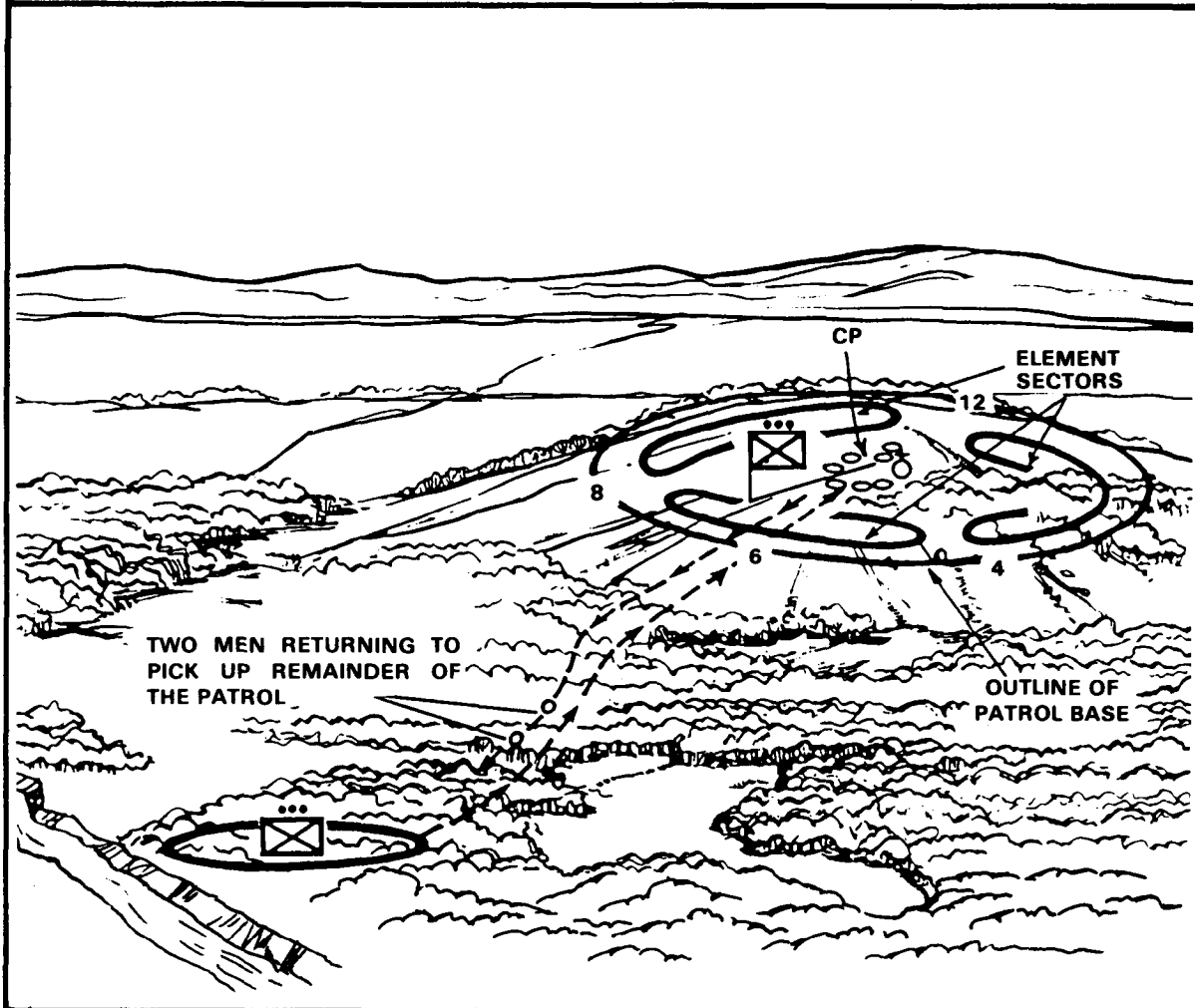


**Reconnaissance.**

The leader designates the point of entry into the patrol base site as 6 o'clock. He moves to and designates the center of the base as the patrol CP.

The element leaders reconnoiter the sectors assigned to them for suitability and then return

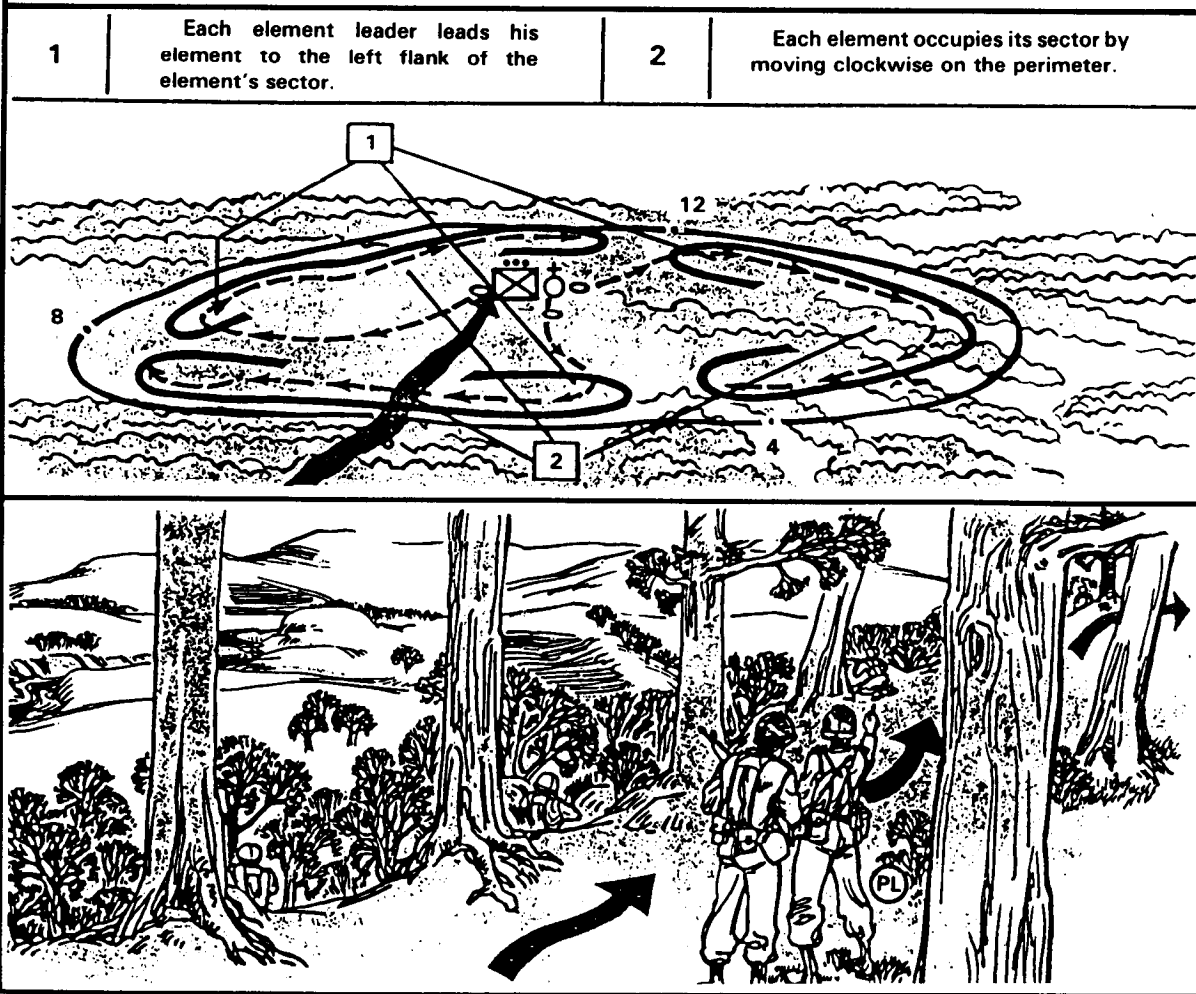
to the CP. The elements would have been given their sectors in the operation order. After the reconnaissance, the leader of the patrol sends two men back to bring the rest of the patrol forward.

**Figure 7-31. RECONNAISSANCE OF PATROL BASE.****Occupation.**

The patrol enters the base in single file. It moves to the center of the base. Designated men remove signs of the patrol's entry into the area.

The leader checks the perimeter by meeting each element leader at the left flank of his respective sector. Together, they move clockwise to the end of that sector, making changes as needed. At the end of the sector, the leader meets the element leader of the next sector and repeats the inspection until he has checked his entire perimeter.

**Figure 7-32. OCCUPYING THE PATROL BASE AND CHECKING THE PERIMETER.**



Each element leader sends out a reconnaissance team to reconnoiter forward of the element's sector. The team moves a set distance out from the left flank of the sector, moves clockwise to the right limit of the sector, and reenters at the right flank of the sector. It reports signs of enemy activity suitable OP locations, possible rally points, and withdrawal routes.

The leader of the patrol designates withdrawal routes and a rally point outside the base for use in case the patrol is dispersed unexpectedly.

Each element puts out an OP and establishes communications with the patrol command post.

**7-37. ACTIONS IN A PATROL BASE**

**Security.**

Security must be a patrol's first priority. Only one point of entry and exit is used. This point is camouflaged and guarded at all times.

Only necessary movement should be permitted, both inside and outside the patrol base.

Noisy work, such as cutting branches, is done only at set times. Such work is done as soon as possible after occupation but never at night or in the quiet periods of early morning and late evening. Noisy work should be done when other noise (sounds of aircraft, artillery or distant battle) will cover it.

A **stand-to** is held both morning and evening to insure that every man adjusts to the changing light and noise conditions, and is dressed, equipped, and ready for action. The stand-to should start before first light in the morning and continue until after light. It should start before dark in the evening and last until dark. The starting and ending times should vary to prevent establishing a pattern, but the stand-to must last long enough to accomplish its purpose.

#### **Defense.**

Defensive measures must be planned, but a patrol base is usually defended only when evacuation is not possible. Complete fighting positions are not built. Camouflage and concealment are stressed.

A fire plan is made. Early warning devices may be put on avenues of approach. The leader must decide whether the probability of the patrol base being detected is high. If it is, and the base definitely must be defended, mines and tripflares should be put on avenues of approach and in places which cannot be covered by fire. If the probability of detection is low, the value of these devices must be weighed against the fact that their discovery could compromise the patrol base.

A withdrawal plan is also made. If the patrol is forced to leave the patrol base, it rallies at either a rally point, a rendezvous point, or an alternate patrol base. Each person must know where to withdraw to.

#### **Communications.**

Communications are established with higher headquarters and OPs, and within the patrol.

Radios are a good means of communication, but they must be closely controlled because of the enemy's ability to monitor the patrol's transmissions and possibly use radio direction finders to find the patrol base.

Wire should be used within the patrol base if its bulk and weight and the time needed to lay and pick it up do not hinder the patrol's ability to accomplish its mission.

Tug or pull wires may be used for signaling. They are quiet and reduce radio or telephone traffic.

**Maintenance.** Weapons and equipment are maintained.

**Sanitation and Personal Hygiene.** In daylight, catholes outside the perimeter are used. The user must be guarded. At night, catholes must be inside the perimeter. Men wash, shave, and brush their teeth on a regular basis. Trash is buried in a concealed site or is carried with the patrol.

**Eating.** Men take turns eating. No more than half of the men should eat at a time, in order to have the other half alert and ready to fight.

**Water.** If details are sent to get water, guards must also be sent to protect them. No more than two trips to the source should be made in a 24-hour period.

**Rest.** Rest and sleep are permitted in special periods only after all work has been done. As in eating, men take turns resting. Security must be maintained.

**Planning.** Leaders should use the time spent in a patrol base to continue to plan and prepare for the mission.

**Departure.** All signs of the patrol's presence are removed or concealed. This may help keep the patrol's presence secret and prevent pursuit.

## Section VII. MOUNTED PATROL

### 7-38. GENERAL

In the METT-T analysis, the factors of troops available, time, and the distance to be traveled have a major impact on the need for mounted patrols. Mounted patrols are especially useful in economy-of-force missions where the unit has a large sector to cover but few troops with which to operate. Mounted patrols can be used to:

**Cover gaps between units in the defense and to provide flank security and coordination;**

**Provide early warning forward of units when operating without a covering force;**

**Provide connecting files and guides for the handover of the battle with a covering force;**

**Prevent or react to the insertion of enemy troops behind friendly lines as part of a rear area protection plan; and**

**Assist in reconnaissance where a large sector must be covered in a relatively short time.**

Since time and distance are critical to the mission of a mounted patrol, security for the patrol is increasingly important and yet more difficult to accomplish. For this reason, a squad is not normally sent out as a mounted patrol since a single APC cannot effectively secure its own movement. Two squads — or if available, the entire platoon — are better suited for mounted patrolling.

### 7-39. ORGANIZATION AND PREPARATION

Depending upon the mission (combat or reconnaissance) of a mounted patrol, the elements, planning considerations, control measures, and techniques for the patrol are the same as previously discussed. The leader of the patrol must analyze the mission, determine

what elements are needed, and decide the appropriate technique to use to accomplish the mission.

The patrol leader must use his coordination checklist and keep in mind that mounted operations will have an impact on route selection, linkup procedures, resupply signal plan, departure and reentry of friendly lines, and other units in the area. Since the speed of execution will significantly be increased, recognition signals must be firmly established to provide early and immediate identification by friendly forces.

Frequently, the area of operation for a mounted patrol will be relatively extensive. The map, ground, or aerial reconnaissance conducted by the leader must take into account the size of the area and the time constraints of the mission measured by the security requirements for the mounted patrol. It is sometimes helpful for the leader to section off the area to be traversed into the separate major cross-compartments offered by the terrain. Once these cross-compartments have been identified, the leader can determine the security measures that must be taken prior to entering each compartment and select the route to address the terrain in the most advantageous manner. In short, know the terrain!

### 7-40. FUNDAMENTALS OF MOVEMENT

Inherent in all mounted patrol operations is the command and control of movement. Good shooting and reconnaissance counts only after units have moved to critical points on the battlefield where they can see and kill. Communications and maintenance are vital because they support movement.

Cross-country movement must be supported by combined arms, competent navigation, and aggressive leadership. Movement techniques (chapter 4) must be understood at all levels of command. An important requirement in

mounted patrolling is for the patrol to see the enemy first and see him farther away than the friendly unit can be seen. To do this, the mounted patrol must —

**Avoid being seen,  
if seen, avoid being hit, and  
if hit, avoid being killed.**

Once the enemy is sighted or contacted, the patrol must move to accomplish whatever the task may be — reconnaissance, security, or attack.

While moving, the patrol must use the terrain for protection. The leader should review the fundamentals of terrain driving (discussed in chapter 4) and maximize the use of cover and concealment. Despite its obvious advantage, terrain will reduce speed and increase control problems. Additionally the possibility of being ambushed by enemy infantry is increased. In most situations, these limitations must be accepted because the accuracy and lethality of long-range weapons have made exposed movement unacceptable. However, the leader must weigh the degree of security allowable against the required speed of execution and accept, but attempt to minimize, risk.

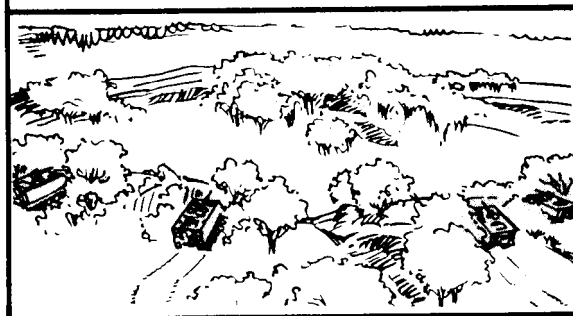
Mounted patrols should never enter a major cross-compartment without first establishing security and visually inspecting the area. Mounted patrols should make maximum use of dominating overwatch positions — in other words, positions that offer good observation and fields of fire into the cross-compartment. Elements occupying overwatch positions must:

**Visually check the security of the position and be prepared to dismount to secure the area.**

**Occupy hull-down positions. This may be accomplished in phases. As the vehicle approaches the position, the observer in the TL**

**hatch should be standing and prepared to observe over the crest of the hill since his vantage point is the highest on the vehicle. If he does not immediately see a threat, the vehicle can move forward until the main weapon system can cover the area. If enemy is seen, however, and if the mounted patrol is a combat mission, the vehicle should back down and move immediately to a hull-down firing position at another location on the overwatch position from which to engage the enemy. This is done to prevent the enemy from engaging first since the observer may have been seen during the initial occupation.**

**Figure 7-33. INITIAL OBSERVATION FROM AN OVERWATCH POSITION.**



**Be assigned areas for observation and fire by the element leader.**

**Orient all weapons on likely or suspected enemy positions. Depending on the leader's initial assessment of the threat, this may be mounted .50 caliber machine guns, Dragons, or a mixture of both. If TOWs are attached, they should always be in the overwatch mode.**

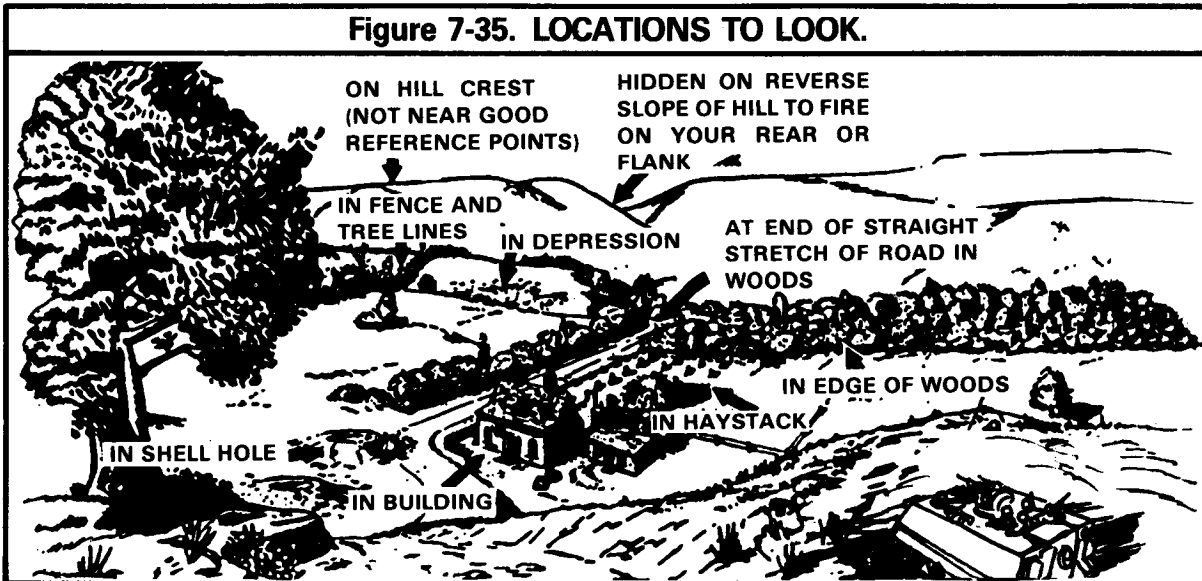
**Search for targets.**

Be alert for enemy activity; do not concentrate on movement of bounding element.

Figure 7-34. SEARCHING HINTS.

WHAT TO LOOK AND LISTEN FOR	WHERE TO LOOK
	<b>TANKS</b>
Engine noise, truck clatter.	0-2,000 meters.
Exhaust smoke.	Near crest, next to buildings, in tree lines.
Dust and shine.	
Firing signature (flash, blast, etc.).	
	<b>ATGMs</b>
Smoke trail of missile in flight.	400-4,000 meters.
Missile controller may be up to 100 meters from launch site.	May be launched from behind crest.
	<b>OTHER AT WEAPONS</b>
Firing signature.	Usually well camouflaged. 360-degree observation to protect against tank ambush teams using hand-held weapons.
Hand-held and crew-served weapons systems.	May be employed on reverse slopes in pairs or more, and protected by mines.
	0-1,000 meters.
	Usually on flank.

Figure 7-35. LOCATIONS TO LOOK.





Before bounding to the next position, the element leader must consider:

- **Where is the next position?**

**Where is the position to be taken on the next bound?**

**Where is the alternate position?**

**If the position is unsuitable on arrival, where to go next?**

- **What is the best route?**

**What is the exact route from here to the next position?**

**Use low ground; take advantage of hedges, trees, and scrubs.**

**Plan an alternate route.**

- **Where is the enemy?**

**Where would the enemy hide in order to observe, fire, and escape?**

**Likely enemy positions should be given special attention during the move.**

**What is the enemy's most likely withdrawal route?**

- **What to do if fired upon?**

**What cover is available on the route chosen?**

**Is the crew fully prepared to return fire immediately?**

**Is the crew fully briefed on the actions expected of them?**

**Who is covering the move; how can they help?**

**Will smoke help; who will deliver it?**

#### 7-41. ACTIONS ON CONTACT

If the enemy does not detect the initial contact, the mounted patrol, depending on the

mission, normally continues observation by **stealth until:**

**Detected.**

**The mission is accomplished.**

**Further development of the situation requires combat action.**

**The need for speed dictates sacrificing stealth.**

Once contact is made during a reconnaissance or security patrol, the mounted patrol executes the following actions:

Deploy and report.

If first contact results in an exchange of fire, overwatch elements lay down a heavy volume of direct suppressive fire and request indirect fires and smoke, as necessary. The bounding elements (normally the first to be engaged) employ smoke devices and return fire while seeking cover. This deployment must be rapidly executed and is based on battle drills.

The patrol leader immediately reports the enemy contact to the commander.

Develop the situation. The patrol takes aggressive measures to determine the location, strength, composition, and disposition of the enemy forces encountered. This may be executed mounted or dismounted, depending on time and the terrain available. The platoon immediately establishes a heavy volume of fire with the leader establishing and designating sectors of fire for the other vehicles. While employing indirect fires, the leader directs the platoon, mounted or dismounted, to continue firing and moving to advantageous positions toward the objective until the enemy has disclosed his composition, size, and intentions.

Choose a course of action. The leader then chooses a course of action that will take care of the immediate situation as well as assist him in the assigned mission. The course of action must be chosen as quickly as the contact will permit.

Recommend a course of action. The leader makes a complete report to his superior. This report includes the enemy situation as it has been developed and the course of action the leader intends to adopt. This may include conducting a:

**Hasty attack.**

**Bypass.**

**Hasty defense.**

Again, the course of action must be favorable to the assigned mission for the patrol.

#### **7-42. THE MOUNTED PATROL IN REAR AREA PROTECTION OPERATIONS**

The mounted patrol may be used in any one of several possible missions as part of the rear area protection plan. The mission may be to:

**Protect lines of communication. The mounted patrol may perform this mission by placing mutually supporting OPs along a route, by conducting mounted patrols over the route, and by escorting noncombat elements using the route.**

**Deny the enemy the use of a drop or landing zone (LZ). The mounted patrol may be sent out to mine or booby-trap potential drop or landing zones or to observe them for a specified period.**

**Protect a specific site or installation by positioning static elements and aggressive mounted patrols.**

**Provide a reaction force. The area in which the patrol is operating should be carefully delineated and subdivided into sectors which are identified by a letter, number, or name to enhance rapid identification and communication of the area of enemy intrusion. The leader must reconnoiter the routes in the area, know the terrain, and develop a plan for reaction to enemy intrusion. The infantry platoon may be**

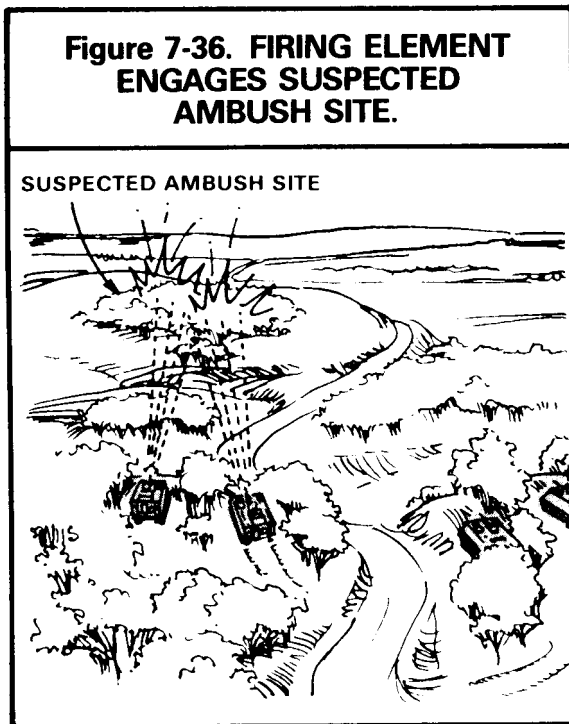
**operating with scout platoons in accomplishing this or any of the above missions.**

#### **7-43. DEPARTURE AND REENTRY OF FRIENDLY LINES**

Given the speed of execution for mounted patrols, timings for departure and reentry of friendly lines, the use of the initial rally point, recognition signals, and the reentry rally point are especially critical. The use of vehicles will increase the size requirement of the rally points significantly. Once the passage has begun, it must continue smoothly to prevent the massing of vehicles at the passage point. Recognition signals, whether panels or smoke during daylight or colored filtered lights at night, must be well disseminated among both the stationary unit and the patrol since the speed of the mission increases the chance for confusion and mistakes during passage. To avoid failure at the passage point, leaders must review the discussion on dismounted patrols with the added consideration of being mounted.

#### **7-44. RECONNAISSANCE BY FIRE**

Reconnaissance by fire is performed by firing on a suspected enemy position in an attempt to cause the enemy to react and thereby disclose his position. Reconnaissance by fire is a technique used when time is critical or the terrain does not favor the employment of dismounted troops. Normally, the platoon given a mounted patrol mission will be told whether the conditions of the mission allow reconnaissance by fire to be used. It is performed at the risk of losing surprise, but it may lessen the probability of moving into a well-concealed enemy position or fire pocket without being aware of its presence. During reconnaissance by fire, the platoon employs a fire element and an overwatch element. The overwatch element must continuously observe with binoculars the positions being reconnoitered, positions being fired upon, and adjacent areas so that any enemy movement or return fire is definitely located.



Reconnaissance by fire can be accomplished by either direct or indirect fire weapons. Some advantages and disadvantages of each technique are:

#### **DIRECT FIRE.**

##### **Advantages.**

**Rapid response.**

**Accuracy.**

**Minimum communications required.**

**Fires can be delivered from different directions.**

##### **Disadvantages.**

**Sacrifices stealth and discloses friendly position.**

**Low volume of fire may telegraph intention.**

**Observation capability reduced.**

**Limited by the availability of ammunition and the maximum effective range of direct fire weapons.**

#### **INDIRECT FIRE.**

##### **Advantages.**

**Security for the mounted patrol that is directing the fire and observing the enemy action.**

**Permits all members of the patrol to observe the effects of the fire.**

**Not restricted by masking.**

**Wider variety of ammunition available for the mission.**

##### **Disadvantages.**

**Slower to deliver initial round.**

**Requires adjustment for accuracy.**

**Increased communications required.**

**Impacts on mortar/artillery supply rate.**

**Will seldom cause the enemy to fire, but may result in movement.**

If the enemy returns fire, the patrol deploys and returns fire in an attempt to make the enemy commit himself to action that will show his composition, size, and intent. The patrol leader must immediately report the contact and actions taken to higher headquarters to obtain guidance to further develop the situation. If the fire is not returned, the unit reconnoiters the position, exercising caution since reconnaissance by fire may fail to cause seasoned troops to react.

CHAPTER 8

**COMBAT SUPPORT AND  
COMBAT SERVICE SUPPORT**

**Section I. COMBAT SUPPORT**

**8-1. GENERAL**

The mechanized infantry platoon as part of the company team may be supported by non-organic elements which provide indirect and direct fire support, military intelligence, and mobility assistance. For fire support, the mechanized infantry platoon is mainly concerned with the supporting fires of mortars, field artillery TOWs, tanks, and to a lesser degree attack helicopters and close air support. Other support is provided by engineer, ground surveillance radar, and air defense elements. The team or higher level commander coordinates most of the combat support.

**8-2. INDIRECT FIRE SUPPORT**

Normally, the most immediate support available to the mechanized infantry platoon is mortar and artillery fire.

The battalion organic mortar platoon mortars may be fired as a platoon or by section. (H-series TOE units may also employ their company organic mortar platoons.)

Artillery fire is provided by a 155-mm how-

itzer battalion that is in direct support of the brigade. Normally the brigade allocates a priority of fire to a maneuver battalion. Each maneuver battalion then establishes fire support priorities for its company teams. Priority of fires is necessary because fire support is limited.

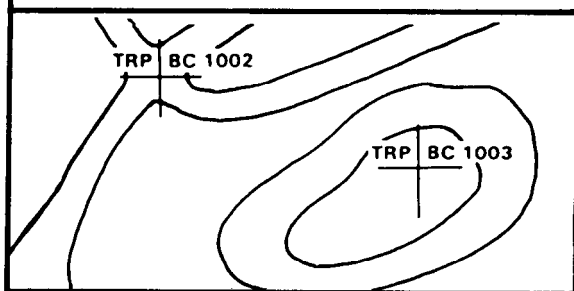
**8-3. PLANNING INDIRECT FIRE**

Each company team has a fire support team attached to it. The FIST helps the company commander plan, call for, and adjust indirect fire. Normally a platoon will have a forward observer party supporting it. This party helps the platoon leader plan and use his supporting fires. The forward observer party moves with the platoon leader, calls for and adjusts fires, and helps in planning and coordinating direct and indirect fires.

CONTENTS	PAGE
SECTION I. Combat Support . . . . .	8-1
II. Combat Service Support . . . . .	8-10

**Figure 8-1. FORWARD OBSERVER PARTY.**

The fire plan should include fire on known, suspected, or likely enemy positions and on prominent terrain features. A planned target can also be a reference point for quickly adjusting fire on targets of opportunity. Except for specific point targets, it is not necessary to plot targets close together. Close plotting complicates the fire plan. Targets are numbered and recorded by the FIST chief. Targets planned for direct fire from such weapons as machine guns, Dragons, tanks, and TOWs are designated as target reference points. They are assigned target numbers by the FIST chief just like other targets.

**Figure 8-2. TARGET REFERENCE POINTS.**

In the offense, to keep the enemy from reinforcing and to protect the unit from counter-attack, the platoon leader and FO plan targets—

**on the approaches short of the objective,**

**on the objective, and**

**beyond and to the flanks of the objective.**

In the defense, withdrawal, or delay the platoon leader and FO plan—

**targets on enemy avenues of approach, on obstacles, and on, behind, and to the flanks of friendly position; and**

**final protective fire where it will break up enemy assaults on friendly positions.**

The platoon leader and FO insure that their fire planning is provided to the company FIST chief. Any duplication of fires between platoons and the company is resolved by the FIST chief. All targets are assigned a number.

Mortars can be used to:

**Destroy infantry in the open, infantry and key weapons in positions without overhead cover (by using variable time [VT] fuzes), and infantry and key weapons in positions with light overhead cover (using delay fuzes).**

**Suppress enemy positions and armored vehicles.**

**Shoot white phosphorus (WP) to destroy enemy positions, to hide (screen) the platoon, or to provide illumination.**

**Hit enemy on reverse slopes and in gullies, ditches, built-up areas, and defilade.**

**Provide continuous battlefield illumination.**

### **Provide smoke screens.**

Field artillery can provide indirect fires to suppress, neutralize, or destroy enemy targets. In addition to the same capabilities as mortars mentioned above, field artillery because of its greater firepower, can:

### **Destroy enemy in field fortifications.**

### **Damage or destroy armored vehicles.**

### **Damage tanks.**

The communication system used by the FO to call for fires depends on the number of fire direction (FD) nets available and the degree of control desired by the company and battalion commanders. Generally there are three FD nets:

### **A company FD net on which the FO and FIST chief operate.**

**A mortar platoon FD net (possibly two if operating as a split section) on which the mortar platoon fire direction center (FDC) operates.**

### **An artillery FD net on which the artillery unit's FDC operates.**

FD nets are assigned in cooperation with the battalion fire support officer. Platoon FOs may be linked to the FIST chief on the company FD net. The FIST chief then takes FO calls for fire and directs them to the mortar or artillery net. The FIST may allow the FOs to work on the mortar net or the artillery net or both. The FIST chief monitors their calls for fire, acts as the net control station, and interrupts them only when the company commander has a priority mission.

If an FO party is not available, the platoon leader may call for and adjust fire. He will normally initiate his call-for-fire support over the company command net which the FIST chief monitors. The platoon leader will receive in-

structions by the company commander or FIST as to which fire direction net to use.

## **8-4. CALL FOR FIRE**

The initial call for fire consists of three basic elements:

**Observer Identification and Warning Order.** The observer identification tells the FDC who is calling. It also clears the net for the rest of the call. The warning order tells the FDC the type of mission and the method of locating the target. The types of missions are:

**Adjust fire.** This type of mission is used when the observer is uncertain of the exact target location. The observer says, "ADJUST FIRE."

**Fire for effect.** The observer should always try for first-round fire for effect. But he should only use a first-round fire for effect if he is sure that his target location is correct. He should also be sure that the rounds of the first volley will have the desired effect on the target so that little or no adjustment will be required. The observer says, "FIRE FOR EFFECT."

**Suppression.** This is used to quickly bring fire on a target. The observer says, "SUPPRESS" (followed by the target identification).

**Immediate suppression.** This is used to quickly bring fire on a planned target or target of opportunity that is firing at a friendly unit or aircraft. The observer says, "IMMEDIATE SUPPRESSION" (followed by the target identification).

**Target Location.** This part of the warning order prepares the FDC for receiving and applying the data sent by the observer to locate the target. The three methods for locating targets are **grid, polar, and shift from a known point.**

If the target is known and has a target number, transmitting the target number is enough to locate the target for the FDC. When using the

grid method, the target location is sent in six- or eight-digit grid coordinates. When the polar method is used, the FDC must first know the observer's location (eight-digit grid) and the observer locates the target by transmitting the range in meters and direction in mils. When using the shift method, the target is located by reference to a known point (previously established target) and directing a left or right shift in meters, and an add or drop, that will bring fire on the new target. The above information is sufficient for the FDC to plot the initial round. The other parts of the call for fire are necessary to attack the target with the right ammunition, fuze, and troop safety in mind.

If adjustment is required, the observer must send the FDC his direction to the target in mils.

**Description of Target, Method of Engagement, and Method of Fire and Control.**

**Description of target. In this part of the call for fire, the observer describes the target to the FDC. The FDC then determines the type and amount of ammunition needed. The target description should be brief yet accurate. It should contain the following:**

**Figure 8-3. TARGET DESCRIPTION.**

(EXAMPLES)		
WHAT THE TARGET IS:	Tanks and dismounted infantry, or truck convoy, or artillery battery.	
WHAT THE TARGET IS DOING:	Attacking, or digging in, or moving on Route 45, or firing.	
STRENGTH OF THE TARGET:	Company of infantry with 10 tanks, or 20 trucks, or 6 guns.	
DEGREE OF PROTECTION:	In open, or dug in, or in bunkers with overhead cover.	
TARGET SHAPE AND SIZE:	Generally used for linear (trenchlines or roads), circular (assembly areas or strongpoints), or rectangular targets. Example:	
	SHAPE	SIZE
	Linear	Grid 186278, Length 800 meters, Attitude 2150 (azimuth of target's long axis). or Grid 186278 to 192284.
	Circular	Radius 200.
	Rectangular	400 by 200, Attitude 3450 (azimuth of target's long axis).

**Method of engagement. In this part of the call for fire, the observer tells how he wants to attack the target (type of ammuni-**

**tion, fuze, nearness to friendly troops). Ammunition type and fuze may be altered by the FDC based on ammunition constraints.**

It is here that the observer would announce "DANGER CLOSE" if proximity of the target to friendly troops is 400 meters or less for mortars and 800 meters or less for 155-mm howitzers. When "DANGER CLOSE" is called, the initial rounds in adjustment should be delay fuze.

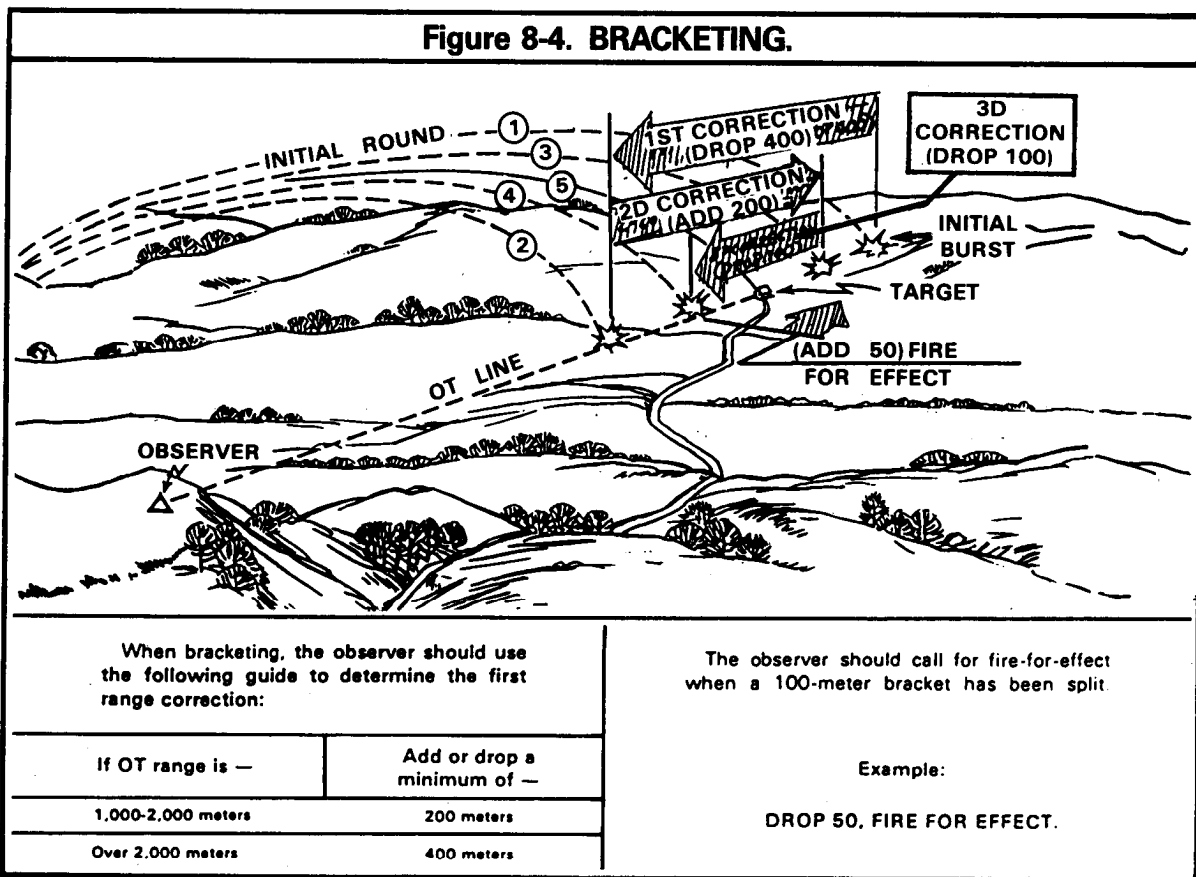
**Method of fire and control.** If the observer wants to control the time of firing, he will say "AT MY COMMAND." The FDC will tell the observer when the unit is ready to fire. At the proper time, the observer will say, "FIRE." If the observer does not say "AT MY COMMAND," the FDC will fire as soon as the platoon/battery is ready.

**8-5. ADJUSTING INDIRECT FIRE**

Once the call for fire has been made, the observer's next concern is to get fire on the target.

If he can accurately locate a target, he will request "FIRE FOR EFFECT" in his call for fire. If for any reason (deceptive terrain, lack of identifiable terrain features, poor visibility or an inaccurate map) the observer cannot accurately locate the target, he must adjust fire onto the target. Usually one artillery piece or mortar is used to adjust fires.

The observer normally uses the bracketing method of adjustment. When using the bracketing method, an initial round is fired, and then the observer attempts to get one round to burst long or short of the target opposite the initial round. By alternating rounds and decreasing distances by half in each adjustment, the target is rapidly bracketed and brought under accurate fire.

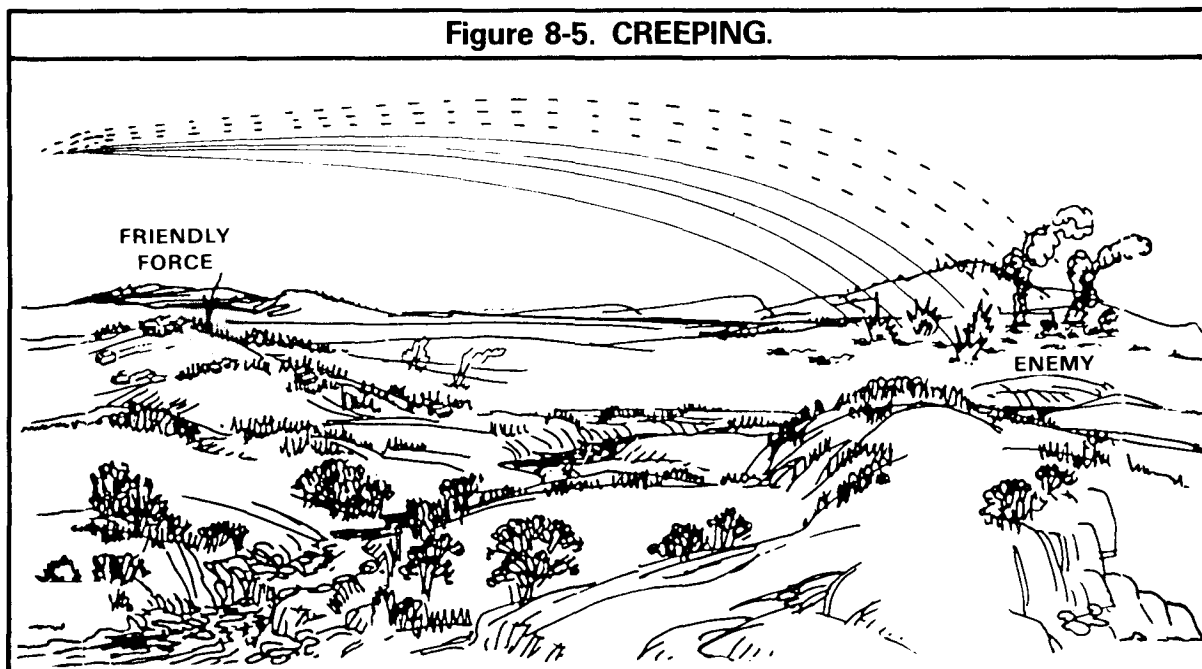




The creeping method of adjustment is used in “DANGER CLOSE” situations. Here, the initial round is fired beyond the target. Adjusting rounds are brought in 50 meters at a time until the target is engaged. This method is slow. It

also tends to use more ammunition; therefore, it should be used only when soldier safety is a major concern. (For a further discussion of adjusting mortar and artillery fire, see FM 6-30 and FM 7-11B1/2.)

Figure 8-5. CREEPING.



## 8-6. DIRECT FIRE SUPPORT

Direct fire support can be provided by tanks and ITVs. The mechanized infantry platoon may operate with these assets; therefore, the platoon personnel must know how they are organized, what they are capable of, and how to coordinate and direct their fires.

**Tank units.** Cross attachment of tank and mechanized infantry companies and platoons is the basic method of organizing a combined arms team. The tank platoon consists of four or five M60 tanks (J or H series TOE). Normally the tank platoon is used as a unit so that tank sections can provide mutual support. Although tank platoons are used as a unit, the requirement remains to tie in fires, coordinate the control measures, avoid target overkill, and make best use of weapon systems. Initial coordination is made between platoon leaders during the is-

suance of orders. Final coordination is made on the ground between platoon/squad leaders.

**ITV units.** ITV sections from the antiarmor platoon may be working with or near the company team. When working with the company team, one or more ITV sections may be attached to, or under operational control (OPCON) of, the company. Attachment and OPCON are command relationships.

When a unit or element is attached, the commander of the unit to which either is attached assigns its missions, and controls its movement, deployment, and fires. The commander is also responsible for logistical support and security.

When a unit or element is under OPCON, the gaining commander's responsibilities are

the same as in attachment except that the headquarters of the unit under OPCON provides the unit its logistical support.

When an antiarmor section is attached to, or under OPCON of, the company team, the antiarmor section leader becomes part of the company team and should be present for the issuance of operation orders.

Antiarmor sections supporting the battalion and controlled by the antiarmor platoon leader may be deployed near mechanized infantry elements. In this situation, initial coordination is done by the company commander and platoon leader. Detailed coordination is made with elements on the ground between squad and platoon leaders to tie in fires, coordinate fire control and distribution measures, avoid target overkill, and make the best use of the TOW, Dragon, and other infantry weapon systems.

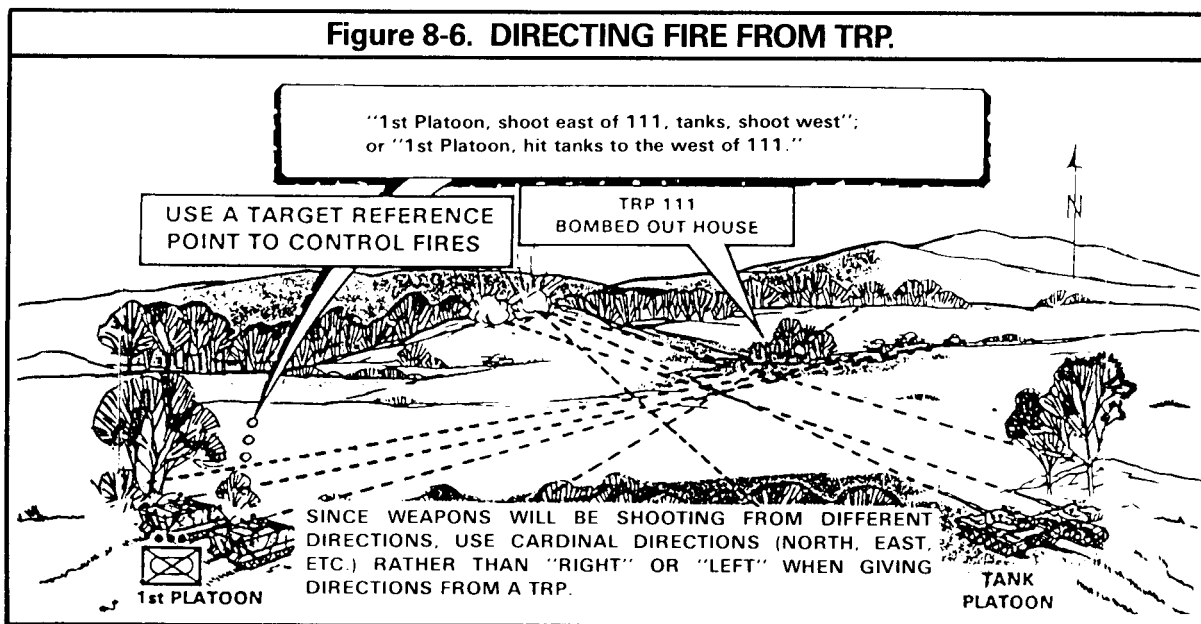
Since mechanized infantry will habitually be working with tanks and ITVs, leaders must be trained to direct the fire of these weapons. There will also be times when tank and ITV crews will need to direct infantry fire. The procedures described below work in both cases. The

objective is to quickly identify the target so that weapon crews can rapidly acquire and engage it.

Fires can be directed by radio, wire, or face to face. Face-to-face communication is the preferred way to direct fires. Fires directed by radio can be transmitted over the company command net or the platoon internal net. The method used will be determined by the company commander's guidance and unit SOP. Wire can be used when the unit is static. When infantry is dismounted and moving with tanks or is stationary the M60 tank has an external telephone which may be used to direct fire.

Prearranged fire control/coordination measures established at the beginning of an operation provide the platoon its sector of fire, engagement areas, and priority of targets. These measures are the parameters within which platoons can fire.

The use of target reference points and other visible terrain features are excellent ways to direct fire. If the infantryman is close to the vehicle, he can direct fire right or left, up or down, from a reference point. If there is any doubt about right or left, a cardinal direction should be used.



If reference points are not used, the gun barrel or launch tube (if visible) can be used as a baseline from which a direction can be given — for example, **“FROM THE TUBE, HALF LEFT, 1,300 METERS.”**

Leaders can direct fire to the target by giving the general target area and then fire tracers at the target. To do this, they will describe the general target area in relation to where the weapon system is located — for example, **“TO THE FRONT, WATCH MY TRACERS.”**

To focus on a target, the leader can narrow the area which the gunner must search by describing the target — for example, **“BMP 600 METERS NORTHEAST OF BRIDGE.”**

If the gunner fails to identify the target or calls the wrong one, corrections are given based on the impact of the first round or another description is given — for example, **“FROM THAT ROUND, RIGHT 200, ADD 100; or TANK, FROM THE POND 600 METERS EAST.”**

## 8-7. AIR SUPPORT

**Attack Helicopters.** The attack helicopter is mainly an antiarmor weapon. Attack helicopter units are maneuver units and are normally not attached to, or operationally controlled by units below brigade or battalion level. They do, however, support the company team in both offensive and defensive operations. Aeroscouts usually arrive ahead of attack aircraft. They establish communication with ground forces and get the situation and mission from the commander on the ground. The aeroscouts identify targets, choose attack positions, and control attack helicopter fire. When aeroscouts are not available or cannot see the enemy attack helicopter assets will need to obtain some targeting information from the ground commander. The commander may also be required to direct attack helicopter fires.

**Close Air Support.** The United States Air Force (USAF) provides close air support (CAS). Close air support strikes can be either pre-

planned (by battalion) or requested on an immediate need basis. Close air support assets are best used as antiarmor weapons against large enemy formations. When close air support is received, forward air controllers (FAC), whether on the ground or in the air, act as a link between the unit and the attacking aircraft. Although the company team commander can provide input into the planning process, CAS planning normally begins at battalion level.

**Marking Friendly Positions.** Friendly positions should always be marked during close air strikes. Be careful that there is no danger of compromising friendly positions to enemy observers. A marker is usually necessary when friendly troops are closer than 300 meters to the target.

The smoke grenade is the most commonly used marker, but it has limitations. Some colors can blend with the background. (Red or white is good with most backgrounds.) Wind may cause smoke to drift above trees.

Flares (rocket or 40-mm) are good attention getters at night and sometimes are usable during the day.

Signal mirrors are probably the best ground-to-air attention devices, if there is sunshine and if the operator is proficient. A pilot can see a mirror flash many miles away. Signal panels (VS-17) are good visual references.

Strobe lights are pocket-size, battery-powered signal lights that produce brilliant white flashes at about one-and-a-half second intervals. The flash is visible at night for 1 to 3 miles.

Vehicle lights, such as an unshielded red taillight, are visible to a pilot at night for several miles.

Chemical glow lights may be used to mark friendly positions.

**Target Location.** When the forward air controller knows where all friendly units are and where the target is, he will tell the USAF fighter

which attack heading he should use. But if the FAC cannot see these elements, the unit will have to make the attack decision. It must be remembered that **FIGHTERS SHOULD NOT ATTACK OVER FRIENDLY POSITIONS**. If a FAC is not available, the company fire support officer or the platoon forward observer can direct attacking aircraft to the target. The platoon leader may be required to locate targets, identify them, and direct the fire to targets by use of a reference point.

Smoke rounds from mortars, artillery and grenade launchers are the principal target marks. White phosphorus is usually best because the smoke cloud blossoms quickly and is highly visible.

Geographical landmarks or terrain features, clearly visible from the air, can help in target identification. Reference to streams, roads, bridges, tree lines, cultivated areas, prominent hills, etc., help narrow the area the pilot has to search.

Friendly positions, when clearly recognizable from the air, may be used as day or night reference points for locating close-in targets.

Ordnance already impacting on the ground may be, or may create, an adequate reference point.

Illumination rounds make good reference points. They can guide strike aircraft to the general target vicinity at night.

Tracer fire can be used to mark a target at night. The target can be marked as being at the intersection of two streams of tracers, or at the impact point of a single stream.

Grass fires or other fires near a target may sometimes be used as night reference points.

## 8-8. AIR DEFENSE ARTILLERY

The mechanized infantry battalion may be supported a division air defense (DIWID) gun platoon or man-portable air defense system (MANPADS) team from the divisional air defense bat-

talion. The battalion commander decides whether to keep the air defense elements in general support of the battalion or to place them in support of specific company teams. These assets require security but it is not normally an assigned mission or task fix an infantry unit. Air defense assets achieve some security by their very presence in friendly troop areas.

Air defense artillery (ADA) fires are controlled using orders and procedures that have been established by higher headquarters. Individual fire unit commanders are responsible for deciding whether an aircraft is hostile. Engagement is governed by the following weapons control status titles:

**“Weapons Free.”** Weapons may fire at aircraft not positively identified as friendly.

**“Weapons Tight.”** Weapons may be fired only at aircraft positively identified as hostile according to announced hostile criteria.

**“Weapons Hold.”** Do not fire except in self-defense.

Because of the signatures of the weapon systems, coordination between leaders should insure that the firing of ADA weapons does not disclose friendly ground positions.

## 8-9. MILITARY INTELLIGENCE

Information-gathering elements from the military intelligence (MI) battalion may be attached down to battalion level or operating in the area. These elements normally consist of ground surveillance radar (GSR) teams, ground-based jamming systems, remote sensor teams. Because GSR teams require a line of sight to their observed area, they will most frequently be located forward and close to friendly troops. As with ADA elements, GSR elements gain security by working in areas occupied by friendly troops. Leaders should coordinate their security activities and they should also coordinate their efforts to gain information of immediate importance to the platoon or company team.

## 8-10. COMBAT ENGINEERS

A combat engineer company normally supports brigade operations, and a combat engineer platoon is allocated to a battalion. Other engineer elements and equipment may be attached or assigned in a support role when additional engineer assistance is required. Brigade and battalion commanders decide how best to employ their engineer assets. Normally engineers are not used in elements smaller than squad or section. Typically engineer units are attached or placed under operational control in the offense; in the defense, they are normally placed in direct support. While in direct support, an engineer unit is kept intact to construct major obstacles.

Combat engineers assist the mechanized infantry in mobility, countermobility, and survivability.

Mobility tasks for engineers include:

**Filling craters and ditches.**

**Removing roadblocks, trees, and rubble.**

**Preparing entrances and exits for fording sites and river crossings.**

**Preparing and maintaining combat routes.**

**Bridging ditches or water obstacles.**

**Marking entrances and exits to minefield breach lanes.**

**Conducting or assisting in breaching minefields.**

Countermobility tasks for engineers include:

**Constructing antiarmor obstacles.**

**Demolishing fords and bridge bypasses.**

**Digging tank ditches.**

**Hauling and emplacing materials to be used for obstacles.**

**Emplacing minefields.**

Survivability tasks for engineers include:

**Digging hull-down positions for ITVs, APCs, and tanks.**

**Preparing defensive positions for command and control.**

**Constructing earth berms for protection.**

**Assisting in preparation of individual and crew-served weapons positions.**

When combat engineers are attached to the company team, the element attached may be an engineer squad or larger unit. The engineer squad normally works for the company team commander. The engineer squad is equipped with an APC and trailer which carries the squad's mechanized basic load of equipment and demolitions. Although the squad's capabilities are limited, these capabilities can be enhanced through the receipt of additional equipment from the engineer platoon/company headquarters elements. When planning obstacles, the company team commander can rely on the engineer squad leader to advise him on construction time and material needed. The commander, however, has to order much of the material through battalion supply channels. During actual construction, and to speed up the process, the engineer squad may need the help of infantrymen.

## Section II. COMBAT SERVICE SUPPORT

### 8-11. GENERAL

The mechanized infantry company executive officer (XO) supervises combat service support (CSS) operations with supply and maintenance

support normally coordinated by the first sergeant.

Combat service support for mechanized infantry platoons consists mainly of maintenance, supply personnel, and medical services required to sustain their fighting capability. Most of this support comes from the company and battalion. The platoon leader is responsible for supervising the platoon's combat service support effort with the platoon sergeant coordinating the effort with the XO/first sergeant. The platoon sergeant and squad leaders supervise the performance of most of the combat service support tasks in the platoon.

At platoon level, combat service support tasks include:

**Insuring that all equipment assigned in accordance with TOE is on hand, accounted for, and safeguarded.**

**Maintaining prescribed levels of ammunition, POL, and rations.**

**Requesting resupply of spent, lost, damaged, or destroyed items.**

**Maintaining all equipment, weapons, and vehicles and evacuating items needing repair.**

**Talking care of the personal needs of soldiers in the platoon.**

Normally procedures for combat service support are specified by unit SOP. The SOP should spell out who the platoon leader contacts to get a service, an item, or technical help. In the company this will usually be the company executive officer, first sergeant, supply sergeant, motor sergeant, or tactical communications chief. If these personnel cannot handle the request, they normally coordinate with the battalion S4 for the support.

## 8-12. MAINTENANCE

Proper maintenance is the key to keeping equipment and materiel in serviceable condition. It includes inspecting, testing, servicing, repairing, requisitioning, recovering, and evac-

uating. Repair and recovery are done as far forward as possible. When equipment cannot be repaired on site, it is moved to the rear, but only as far as necessary for repair.

A platoon leader is responsible for the maintenance of his vehicles. He must be able to perform preventive maintenance himself; know what to do when a maintenance problem arises; know how to inspect and know how to train his operators. Cross-training is critical; the loss of one individual must not adversely affect the combat readiness of the squad or platoon.

The platoon leader has certain maintenance functions that combine to give him three major tasks: executing daily maintenance, executing scheduled maintenance, and executing maintenance training. These functions include:

**Training of operators/crews and squad leaders.**

**Inspecting.**

**Assigning tasks within the unit.**

**Providing adequate time to perform required maintenance.**

**Supervising all maintenance periods.**

**Coordinating support that may be required from higher echelons.**

**Keeping the chain of command informed of major problem areas.**

**Following through on maintenance being performed outside the unit.**

## 8-13. UNIT MAINTENANCE

Unit maintenance is the responsibility of the unit that is assigned the equipment. It is performed by operators/crews and battalion mechanics.

Operator maintenance includes proper care, use, and operation by the driver and other squad

members who perform daily services on the carrier and on all other assigned equipment such as weapons, night vision devices, and nuclear, biological, and chemical gear. These services include inspecting, servicing, tightening, minor lubricating, cleaning, preserving, and adjusting tools and equipment as prescribed by relevant technical manuals. The driver is required to record, on the Equipment Inspection and Maintenance Worksheet, DA Form 2404, all equipment faults he cannot correct. The driver and TL reports are the main way to convey information about equipment faults to the platoon leader and to unit maintenance personnel.

Daily services prescribed for the automotive and weapon systems are divided into three services or checks:

- (1) Before operation.**
- (2) During operation.**
- (3) After operation, to include detailed daily service.**

These services should be conducted as prescribed in the operator's manual.

The driver is not the only person who has maintenance responsibilities. Every member of the squad should be assigned tasks to aid in the maintenance of the vehicle. The gunner, for example, should be responsible for the weapon systems. The driver is responsible for operation of the vehicle and filling out DA Form 2404.

When the operator identifies a problem that is beyond his level of maintenance, the company maintenance team must be notified so the problem can be isolated and corrected. Company maintenance teams have trained mechanics who are authorized to do unit maintenance tasks as prescribed in the APC technical manuals. When the repairs are beyond the capabilities of the company maintenance, battalion maintenance is notified. Battalion maintenance personnel have test equipment that allows them to rapidly diagnose faults in the system. If battalion maintenance is not authorized to make the repair, they will arrange

to have it checked by intermediate forward maintenance.

#### **8-14. INTERMEDIATE FORWARD MAINTENANCE**

Intermediate forward maintenance is performed by the direct support maintenance company which normally supports a brigade. It has repair and/or replacement parts, assemblies, and components. Maintenance support teams from direct support units may be sent forward to make onsite repairs when possible.

#### **8-15. RECOVERY**

Recovery is necessary to repair vehicles, or other items essential to mission accomplishment, that cannot be repaired on site, or to prevent capture or destruction by the enemy. Except for the APC, most damaged equipment can be carried by the platoon until the platoon sergeant coordinates its recovery.

When a vehicle has to be recovered, the platoon leader reports its location and the type and extent of damage or, if known, the repair needed. As a minimum, the driver and gunner should remain with the vehicle to secure it and to aid the recovery. Normally, a recovery vehicle from the company maintenance team will recover the damaged vehicle. (See appendix L for further details on recovery.)

#### **8-16. SUPPLY**

Generally, when the mechanized infantry platoon needs supplies, they are delivered by company or battalion combat service support elements. The platoon leader and the platoon sergeant must plan to keep the platoon supplied. If the platoon leader lets ammunition and other critical supplies get too low before requesting resupply the platoon may run out at a critical point in an operation. Resupply and refueling should be accomplished at every opportunity.

**Ammunition and Missiles.** Mechanized infantry units require many different types and quantities of ammunition and missiles. These can be rapidly expended. Squad leaders must control ammunition use and keep the platoon

leader or platoon sergeant informed on the approximate amounts of ammunition and missiles remaining. This is necessary so accurate and timely requests for resupply can be made. Redistribution of ammunition after contact is critical to maintaining the fighting capability of the platoon.

Resupply of ammunition and missiles is based on a report of expenditures submitted to the company executive officer or first sergeant. Ammunition is sent forward from the battalion trains to release points. There, company personnel take charge and move the supply vehicles to platoon areas.

Wheeled vehicles, armored vehicles, or helicopters can be used for ammunition resupply. The platoon leader should know which type of transportation is to be used. This will affect his selection of location, security requirements, and time required to complete resupply. For example, if resupply is by helicopter, an adequate landing zone must be selected to the rear of the position. It must be secured before the helicopter arrives. Resupply also can require added time because the ammunition might have to be hand-carried off the LZ to avoid exposing the APCs for prolonged periods.

When wheeled vehicles are to be used, the platoon leader must select a location that has routes leading to it suitable for wheeled vehicles.

If armored vehicles are to be used, it may be possible to resupply the platoon in position.

There are several steps that should be taken by an APC crew before being resupplied with ammunition. These include:

**Repositioning the remaining stowed ammunition to leave the easy-to-stow areas open.**

**Filling all empty magazines for M16 rifles.**

**Insuring that adequate tools, such as wire cutters and crowbars,**

**are readily available to open the ammunition boxes.**

**Having a plan as to who provides security, how the ammunition is to be divided, and how the ammunition is to be unloaded and stowed. These actions may be prescribed in the SOP.**

### **Petroleum, Oil, and Lubricants.**

Vehicle fuel tanks should be topped off anytime the tactical situation allows. Normally the platoon sergeant requests POL through the company executive officer or first sergeant. The request should tell how much fuel is needed and where and when to refuel (six-digit grid coordinates).

Generally, refueling is accomplished in one of two ways:

**Fuel is brought to the APCs. This method is used when routes are available and refueling can be done not under direct observation and fire of the enemy. The fuel tanker will move to each vehicle position. The fuel tanker will park as close to the rear of the position as the terrain permits. Any APC that cannot be reached by the fuel tanker's hose may have to be moved to be refueled. If this vehicle's dismount team is deployed, it should stay in position to provide security.**

**The vehicles move to a centrally located refueling point. This method would be used if the platoon is in contact and enemy fire makes it too dangerous for the fuel tanker to close on the position, or if the terrain is too rough for the tanker to traverse. One or two APCs at a time are moved to the refueling point. Because the refueling point may be as far as the next terrain feature to the rear, selected members of the dismount teams, if deployed and not in contact, may remount and stay with their vehicles to provide security during refueling. If in contact, dismount teams remain deployed. If**



**the platoon is required to move, the dismount teams crossload.**

The APC has a 95-gallon fuel capacity. This gives it about a 300-mile cruising range. The platoon leader should keep this in mind when planning to refuel, because the amount of fuel required will directly affect vehicle refueling time. He also must be aware that the cruising range is an approximation, and that terrain and weather influence fuel consumption. It is important to top off fuel tanks whenever the tactical situation permits.

When refueling time is limited, the platoon leader must choose between topping off the vehicles that need the most fuel, or putting a limited amount in each vehicle. If the fuel tanker can move to the vehicle, it is best to put a limited amount in each vehicle. When the APCs have to move to a centrally located refueling point, the APCs requiring the most fuel are moved first and topped off. The other APCs are then topped off at the first opportunity.

At times, the vehicles may have to be topped off using 5-gallon cans. This is slow, so extra time should be allowed. The fastest way to refuel from cans is for each squad to set up a bucket brigade, passing the cans from the fuel-carrying vehicle to the APC.

**Rations and Water.** Each squad carries combat rations and water on its APC. Other than the water carried by each soldier in his canteen, each APC has space for a 5-gallon water container in the rear of the APC. When the situation allows, hot meals prepared by the headquarters company mess teams may be served to the platoon. Rations and water supplied to the platoon are normally based on its personnel strength. The platoon leader or platoon sergeant may submit special requests per unit SOP.

**Repair Parts.**

Repair parts are issued in response to specific requests or by direct exchange. The company maintenance team keeps the company's

prescribed load list (PLL). Requests for repair parts for the vehicle, once verified by a mechanic, are issued from the company's PLL. The parts that are not available are requested through class IX supply channels.

A limited number of armament spare parts are stowed on the vehicle. Included are spare barrels and other parts for the caliber .50 and 7.62-mm machine guns.

There are two track blocks and a drift pin attached to the outside deck of the vehicle. A vehicle tool bag, with tools adequate to perform operator maintenance, is in the driver's compartment. A list of tools in the tool bag is in the vehicle operator's manual.

**Other Supplies.**

Each mechanized infantry platoon has a large amount of equipment, but it requires frequent resupply to accomplish its mission. Periodic checks must be made to insure that all the platoon's equipment is accounted for and ready for use. Low-use items, such as drain plugs, NBC equipment, and certain tools, can get lost or damaged easily. These low-use items should be checked often to insure they are on hand and usable.

Medical supplies are provided by the battalion medical platoon. The medic supporting the platoon assists the platoon sergeant and squad leaders in preparing a consolidated list of required medical supplies. These include not only the medical supplies needed by the medic, but also those used by each soldier, such as first-aid dressings, water purification tablets, and foot powder. The platoon sergeant or the medic passes the list to the company evacuation team. This team takes the list to the battalion medical platoon where the medical supplies are provided.

Tools, TA-50 equipment, batteries, and other expendable are obtained through the company supply sergeant.

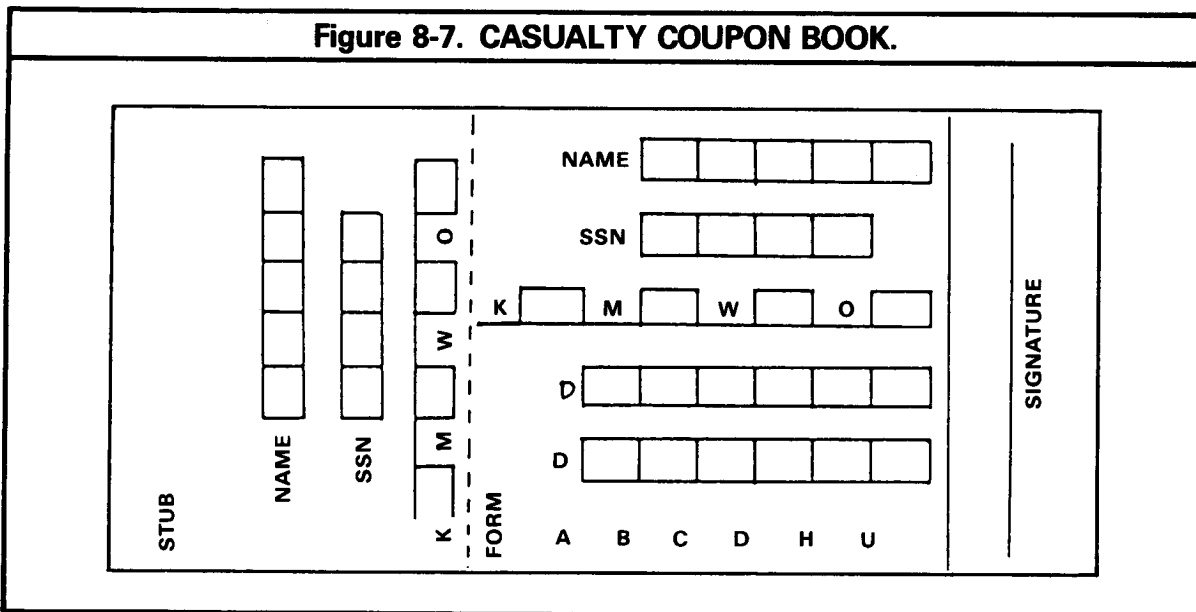
Normally maps are supplied through the company.

**8-17. PERSONNEL SUPPORT AND ADMINISTRATION**

**Personnel Strength.** It is crucial that the platoon leader/platoon sergeant submit accurate strength reports to insure that critical personnel shortages, such as gunners, squad leaders, and team leaders, are replaced quickly and with

qualified persons. Submission of strength reports to the company should be covered in the SOP.

To simplify status reporting, the “stubby pencil” battlefield reporting system is used. Each squad leader keeps a casualty coupon book to report the personnel status of his squad. Each age in the book has a three-line stub, which stays attached, and a five-line form used to record changes in personnel.



When a change in status occurs, the squad leader fills out one of the pages in pencil and gives it to the platoon sergeant. The stub remains in the book as a record of the submission. The platoon sergeant consolidates the pages and gives them to the first sergeant. Instructions for use of the “stubby pencil” system are in the casualty coupon book.

**Services.** Services include awards and decorations, leaves and passes, command information, mail, religious activities, financial matters, legal assistance, welfare, rest and relaxation, and any other service related to the welfare and morale of the soldier. Many services are standard procedure, but the platoon leader has responsibility for insuring that these ser-

vices are available to his platoon, as required. Normally, they are requested through the first sergeant.

**8-18. MEDICAL SUPPORT**

**Medical Services.** The platoon normally has a medical aidman from the supporting battalion medical platoon. His job is to furnish emergency medical treatment, determine which casualties need to be evacuated, and prepare them for evacuation. He also advises the platoon leader on measures to help prevent sickness and injuries that could reduce the platoon’s fighting ability. These include measures to prevent exposure to heat and cold, food poisoning, bad water, field sanitation, etc. Normally the medical aid-

man rides in the platoon leader's vehicle. During exercises, the medical aidman normally attached to the platoon should be present whenever possible to train with the unit.

### **Medical Evacuation.**

The medical aidman should inform the platoon leader when there are casualties that need to be evacuated. The platoon leader decides when to evacuate casualties.

Generally, when the platoon is in contact, casualties awaiting evacuation should be given protection from enemy fire until the fight is over.

The decision to evacuate casualties with serious wounds must be based on the effect of such action on mission accomplishment, and the possibility additional casualties might result.

Casualties should never be deserted.

Weapons of casualties to be evacuated are handled according to unit SOP. **PERSONAL EFFECTS FOUND ON THE BODY OF A DEAD SOLDIER ARE NEVER REMOVED.** Any equipment or personal effects found after a soldier is evacuated should be inventoried and sent to the company supply sergeant.

Casualties are either evacuated by the platoon or by the medical team supporting the company. This team is normally equipped with an armored ambulance for protection against enemy fire.

**Platoon evacuation.** The APC is the quickest and safest way to evacuate casualties. The casualties are transported to the company aid post. If a company aid post has not been set up or the situation does not permit use of an APC, the platoon leader requests help from the company commander. The platoon aidman goes with the casualties if they require immediate care. The aidman fills out a DD Form 1380, US Field Medical Card, and attaches it to the casualty. This card stays with the casualty until evacuation is complete. The information on

the card includes initial diagnosis and medication given.

**Company evacuation.** When the company is to evacuate casualties, the casualties should be moved to a covered and concealed location to the rear of the platoon's position. This location must be reported to the company when the evacuation request is submitted. If enemy indirect fire presents a threat, the casualties are kept in an APC and transferred to the ambulance when it arrives. When this is to be done, the platoon leader may send a couple of men or a dismount team to secure the location and make contact with the ambulance.

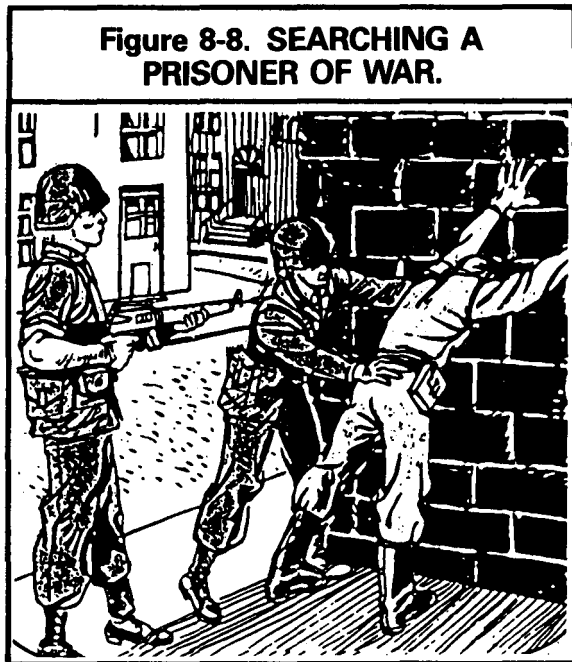
## **8-19. PRISONERS OF WAR AND CAPTURED DOCUMENTS AND EQUIPMENT**

### **Prisoners of War.**

PWs are a good source of combat information. Troops must handle them without violating international law.

PWs must be treated humanely. They must not be physically or mentally abused. The senior officer or noncommissioned officer (NCO) present is responsible for their care. If a platoon cannot evacuate a PW in a reasonable time, he must be given food, water, and first aid. He should not be given comfort items, such as cigarettes and candy. Those PWs who receive favors and those who become mistreated are poor interrogation subjects. In handling PWs, use the five "S's":

**(1) Search PWs** as soon as you capture them. Take their weapons and papers, except identification papers. Give a written receipt for any personal property and documents taken. Tag documents and personal property so that you know which PW had them. Have one man guard while another searches. When searching, do not get between a PW and the guard. To search a PW, have him spread-eagle against a tree or wall, or on the ground in a pushup position with the knees on the ground. Search the PW and all his gear and clothing.



(2) **Segregate PWs** into groups: officers, NCOs, enlisted men, civilians, females, and political figures. This keeps the leaders from promoting escape efforts. Keep groups segregated as they move to the rear.

(3) **Silence PWs.** Do not let them talk to each other. This keeps them from planning escape and from cautioning each other on security. Report anything a PW says to you or tries to say to another PW.

(4) **Speed PWs to the rear.** Platoons turn PWs over to the company where they are assembled and moved to the rear for questioning by the S2.

(5) **Safeguard PWs** when you take them to the rear. Make sure they arrive safely. Watch out for escape attempts. Do not let them bunch up, spread too far out, or start diversions (fist fights, etc.) which create a chance for escape. At the same time, do not let anyone abuse them.

If a PW is wounded and cannot be evacuated through normal channels, he should be treated by an aidman and evacuated through medical channels.

Before evacuating a PW, he should be tagged. The STANAG 2044 (Standardization Agreement) captive and equipment/docu-

ment tag is illustrated below. These tags may be duplicated locally.

**Figure 8-9. PW AND DOCUMENT AND EQUIPMENT TAG.**

<div style="border: 1px solid black; padding: 5px;"> <p style="text-align: center;"><b>ATTACH TO PW</b>      123456</p> <p>DATE OF CAPTURE ( )      <b>A</b></p> <p>NAME ( ) _____</p> <p>SERIAL NUMBER ( ) _____</p> <p>RANK ( ) _____</p> <p>DATE OF BIRTH ( ) _____</p> <p>UNIT ( ) _____</p> <p>LOCATION OF CAPTURE ( ) _____</p> <p>CAPTURING UNIT ( ) _____</p> <p>SPECIAL CIRCUMSTANCES OF CAPTURE ( ) _____</p> <p>WEAPONS / DOCUMENTS ( ) _____</p> <hr/> <p style="text-align: center;"><b>FORWARD TO UNIT</b>      123456      <b>B</b></p> <p>DATE OF CAPTURE ( ) _____</p> <p>NAME ( ) _____</p> <p>SERIAL NUMBER ( ) _____</p> <p>RANK ( ) _____</p> <p>DATE OF BIRTH ( ) _____</p> <p>UNIT ( ) _____</p> <p>LOCATION OF CAPTURE ( ) _____</p> <p>CAPTURING UNIT ( ) _____</p> <p>SPECIAL CIRCUMSTANCES OF CAPTURE ( ) _____</p> <p>WEAPONS / DOCUMENTS ( ) _____</p> <hr/> <p style="text-align: center;"><b>ATTACH TO ITEM</b>      123456      <b>C</b></p> <p>DATE OF CAPTURE ( ) _____</p> <p>NAME ( ) _____</p> <p>SERIAL NUMBER ( ) _____</p> <p>RANK ( ) _____</p> <p>DATE OF BIRTH ( ) _____</p> <p>UNIT ( ) _____</p> <p>LOCATION OF CAPTURE ( ) _____</p> <p>DESCRIPTION OF WEAPONS / DOCUMENTS ( ) _____</p> <p>DOCUMENT AND ( )      WEAPONS CARD ( )</p> <p style="text-align: center;"><b>FRONT</b></p> </div>	<div style="border: 1px solid black; padding: 5px;"> <p style="text-align: center;">PW</p> <p style="text-align: center;">Do not remove this part from PW</p> <hr style="border-top: 1px dashed black;"/> <p>Disarm and Search Thoroughly ( )</p> <p>Tag Correctly ( )</p> <p>Report Immediately ( )</p> <p>Evacuate Rapidly ( )</p> <p>Segregate by Category ( )</p> <p>Safeguard from Danger Escape ( )</p> <p style="text-align: center;">PW</p> <p style="text-align: right;">(in red)</p> <p style="text-align: center;"><b>BACK OF PART A</b></p> </div>
---	--

ONE-UP SERIAL NUMBER

The tag should be perforated into three parts and made of durable material.

The tag should measure approximately 10 x 15 cm **for each part.** (See note 3.)

The tag should be pierced at top and bottom, reinforced, to facilitate attachment.

**NOTES:**

- 1. Main text to be printed in the national language.**
- 2. On the back of the lower part should be written in red letters "ATTACH TO CAPTURED WEAPONS AND/OR DOCUMENTS."**
- 3. Total tag should measure approximately 30 x 15 cm.**

**Captured Documents and Equipment.**

Enemy documents and equipment are good sources of information. Documents may be official (maps, orders, records, photos) or personal (letters, diaries, pay records). If such items are not handled properly the information in them may become lost or outdated. They should be given to the company commander quickly. Each item should be tagged (using the tag discussed above). If an item was found on a PW, his name should be on the tag, and the item should be separated from him.

## APPENDIX A

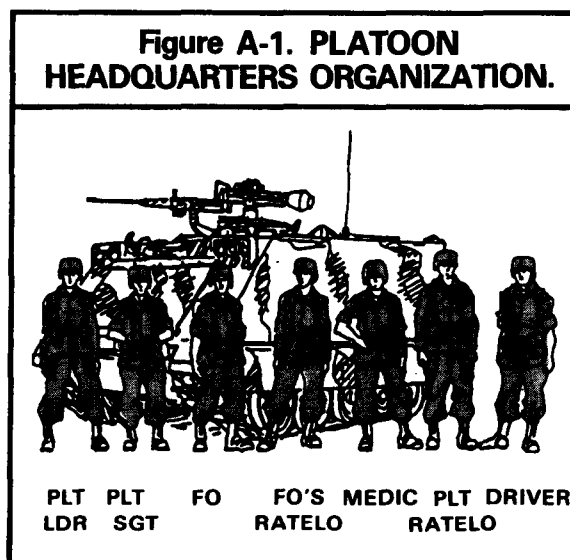
### H-SERIES TOE CONSIDERATIONS

#### A-1. ORGANIZATION

The greatest impact the transition to J-series TOE will have at the squad and platoon level will be the loss of two men per squad and the dedicated M60 machine gunner. This appendix covers the organization and employment of the H-series squad and platoon with the 11-man squad and dedicated M60 machine gunner, and the effect of that organization on operations. The fundamentals of employment for the squad and platoon remain consistent with the tactics and techniques presented in the chapter of this manual for the nine-man squad. Only additional considerations for employing the H-series squad and platoon will be discussed in this appendix.

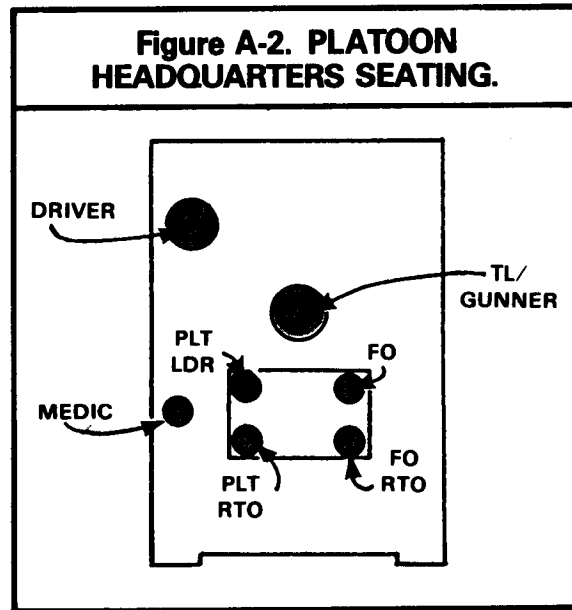
Platoon Headquarters.

The platoon headquarters is organized as shown in illustration. (Fig. A-1.) (The platoon sergeant is a part of the platoon headquarters, but he rides in a squad APC.)



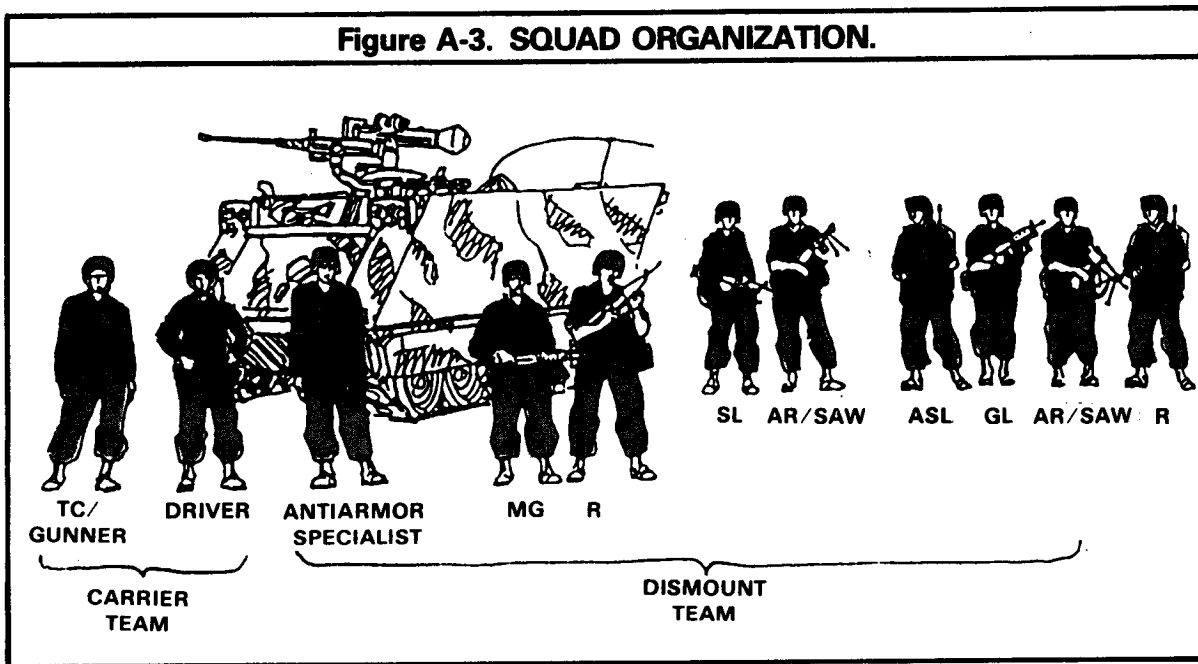
CONTENTS	PAGE
APPENDIX A. H-SERIES TOE CONSIDERATIONS .....	A-1

A typical seating arrangement for the platoon headquarters is shown in illustration.



The Squad.

The squad is composed of the APC and 11 men organized into two teams.

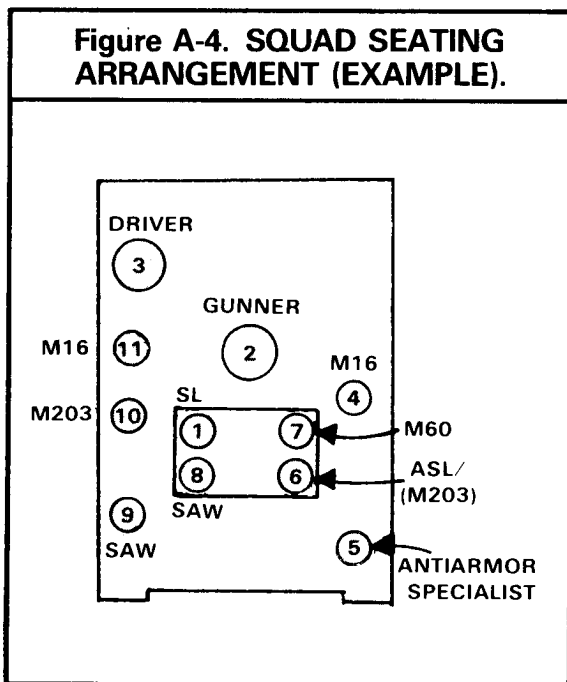




As a minimum, the **carrier team** is normally composed of the team leader/gunner and the driver.

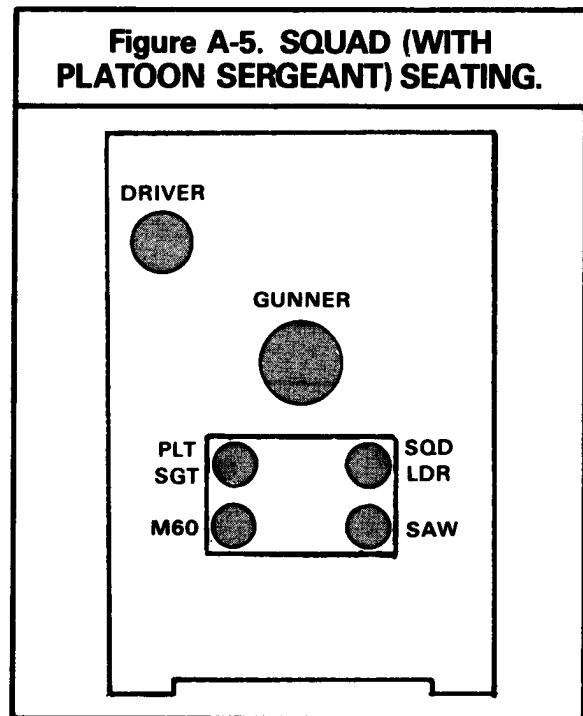
The **dismount team** is made up of all squad members not a part of the carrier team. The platoon leader normally specifies the organization of the dismount team. His decision is usually based on squad strength, mission, enemy terrain, and guidance from the company commander.

A typical seating arrangement for a squad in the APC is shown in illustration.

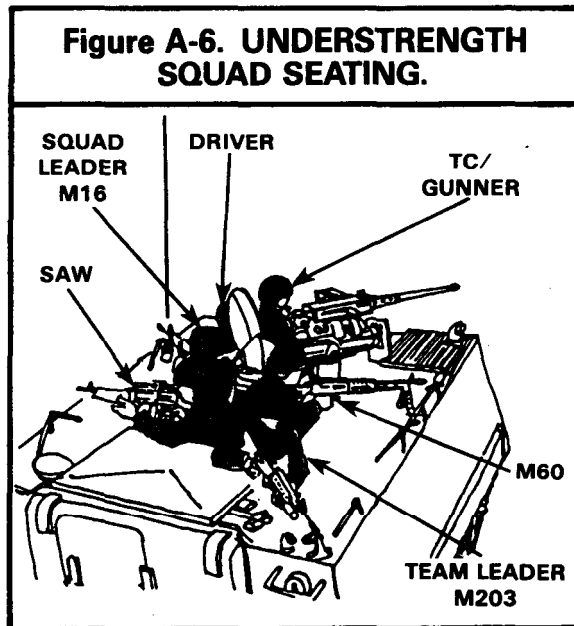


The squad with the platoon sergeant on board its APC will have a typical seating arrangement as shown in illustration. (Fig. A-5.)

Each squad is arranged in its vehicle so it can observe in all directions and deliver sustained, effective fire while moving or rapidly exit the dismount team from the vehicle when required to, accomplish dismounted tasks. Each squad member has certain duties and responsibilities based on his duty position in the squad as discussed in chapter 2.

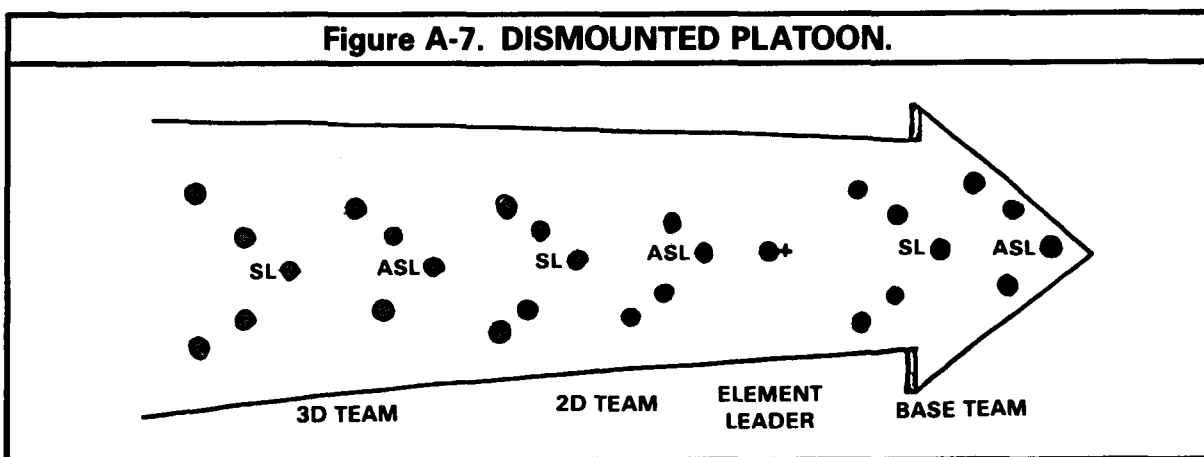


The considerations for employing the under-strength squad, as discussed in chapter 2, remain the same. However, since the H-series TOE dedicates an M60 machine gunner, the M60 is normally considered second in priority of manning after the Dragon.



**A-2. ORGANIZATION FOR DISMOUNTED OPERATIONS**

The dismount element, composed of the dismount teams, for the H-series TOE is shown in illustration.

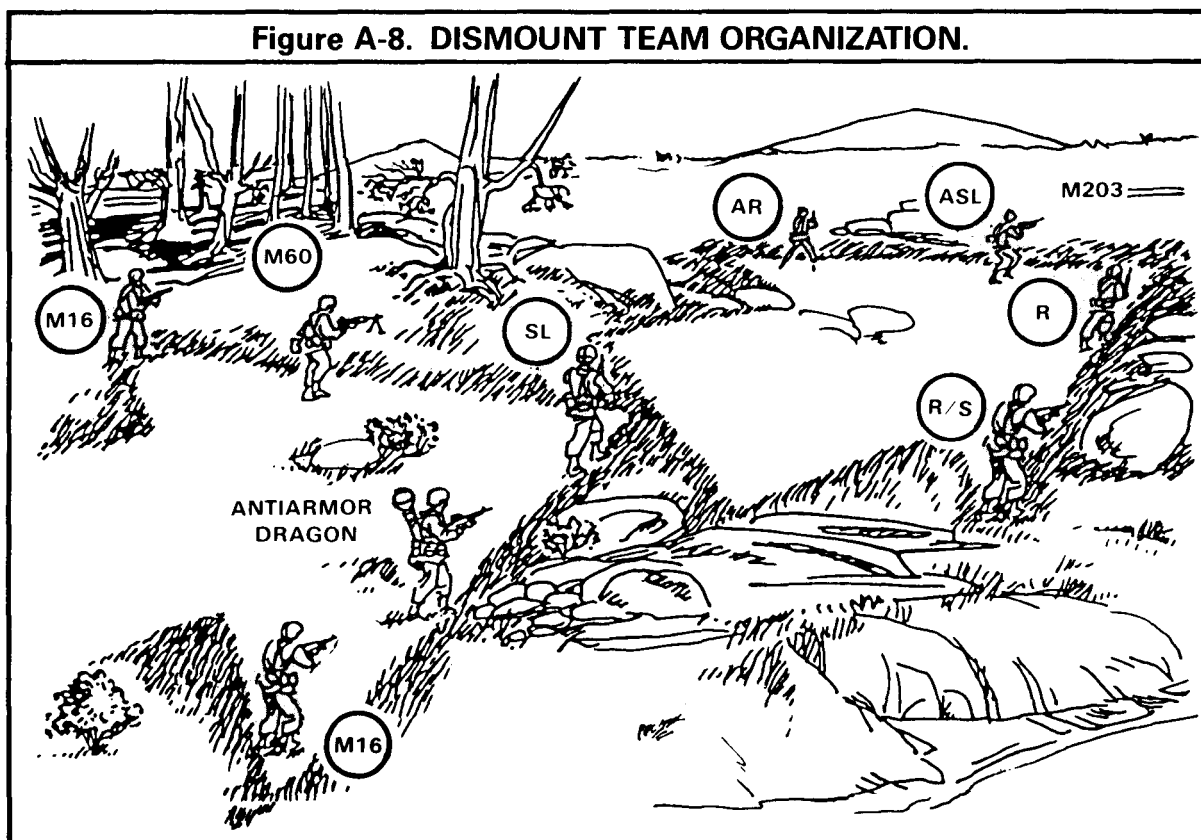


While the methods of control remain the same, the 11-man squad has the extra firepower provided by the M60 machine gunner and a rifleman. Platoon and squad leaders must consider them in their plans for control.

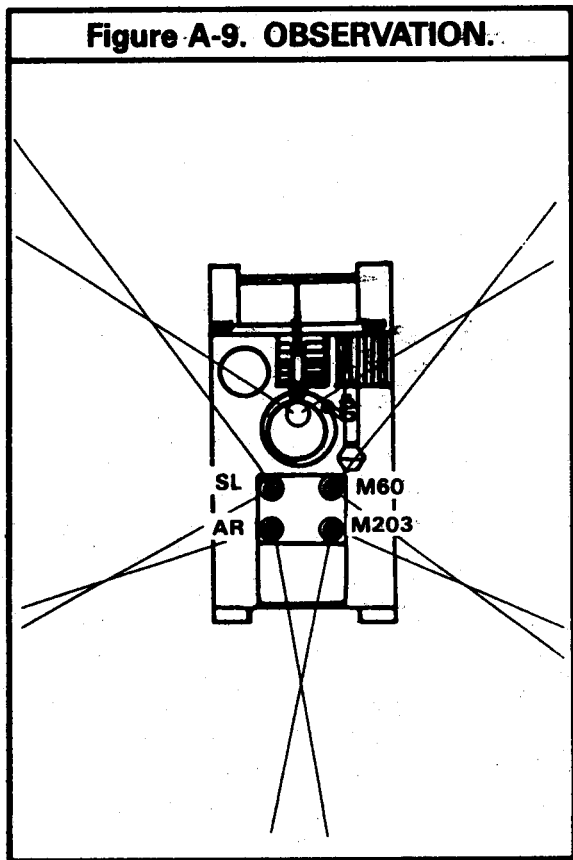
### A-3. MOVEMENT FORMATIONS

As discussed in chapter 4, movement formations are an aid to command and control; leaders place themselves where they can best command and control movement. Their placement also is governed by the movement technique being used. It must be clearly understood, however, that movement techniques apply to how a formation moves; and they are not, in and of themselves, formations.

An example of a dismount team formation for the 11-man squad is shown in illustration.



When mounted, the M60 machine gunner replaces one of the SAWs in the cargo hatch as shown in illustration.



The dismount element movement formations and techniques for the 11-man squad remain the same as discussed in chapter 4. The impact of the additional men is shown in the following six illustrations.

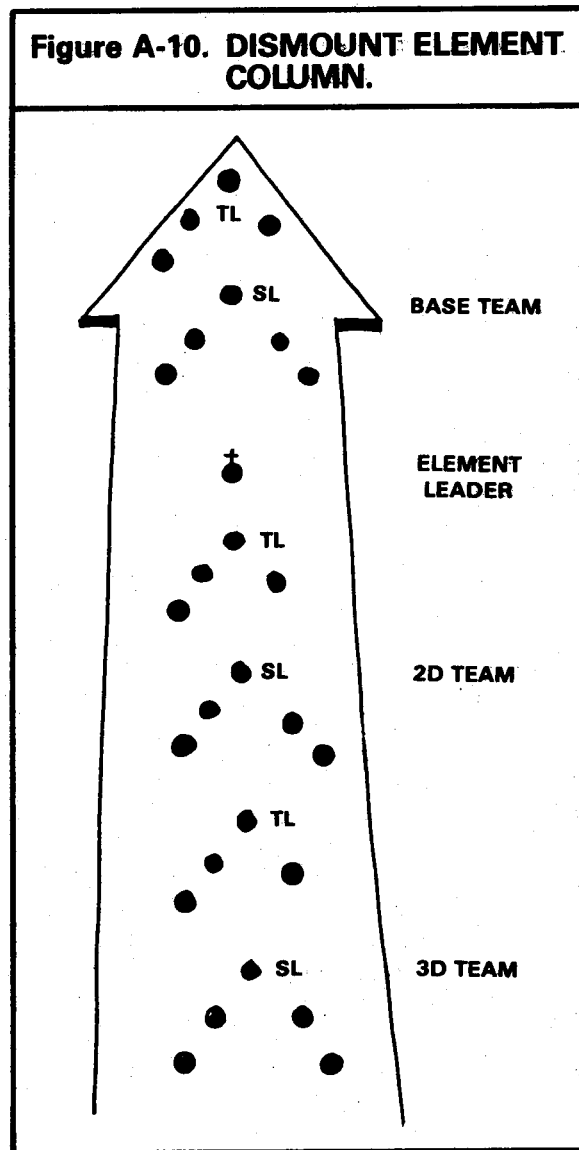
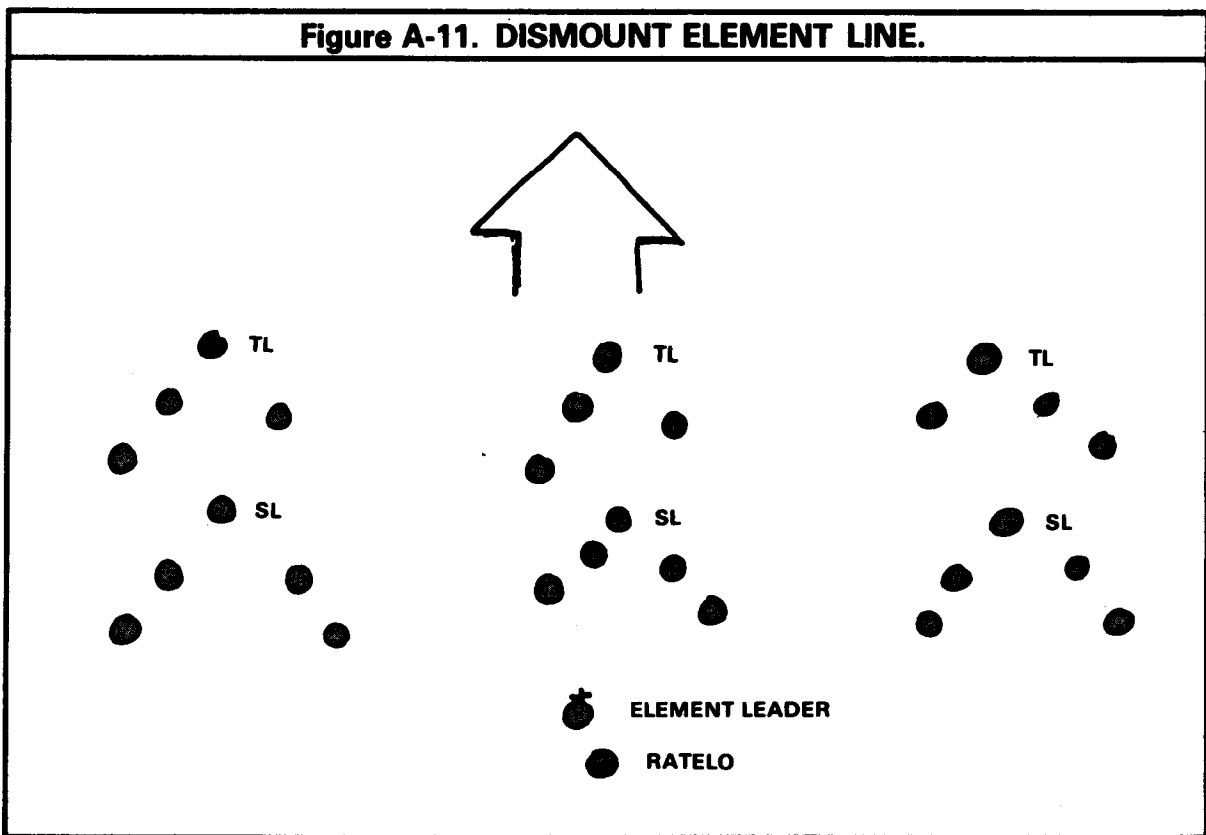
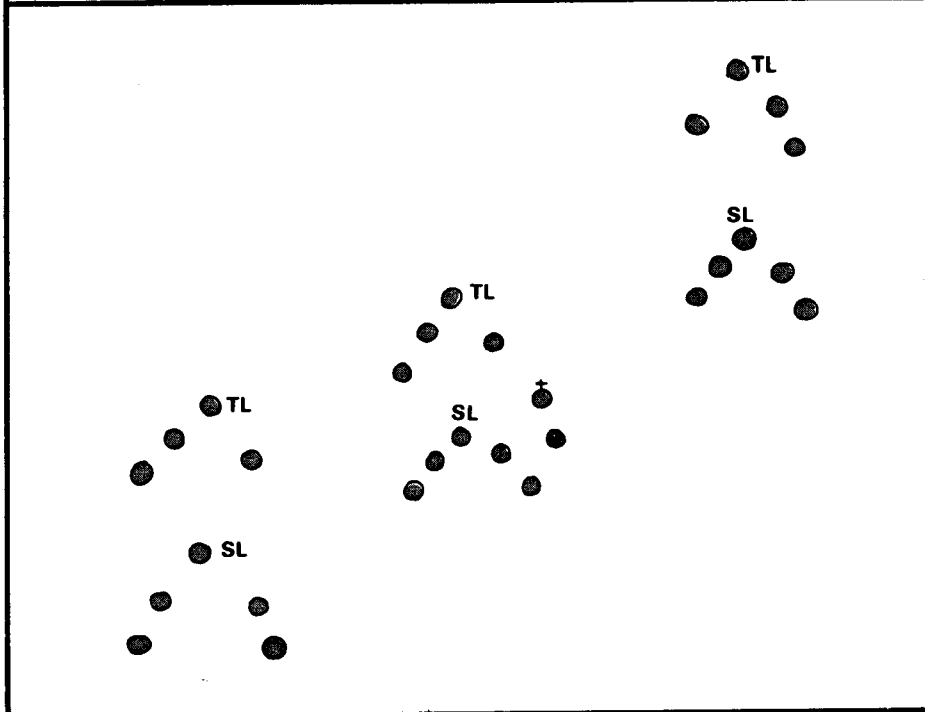


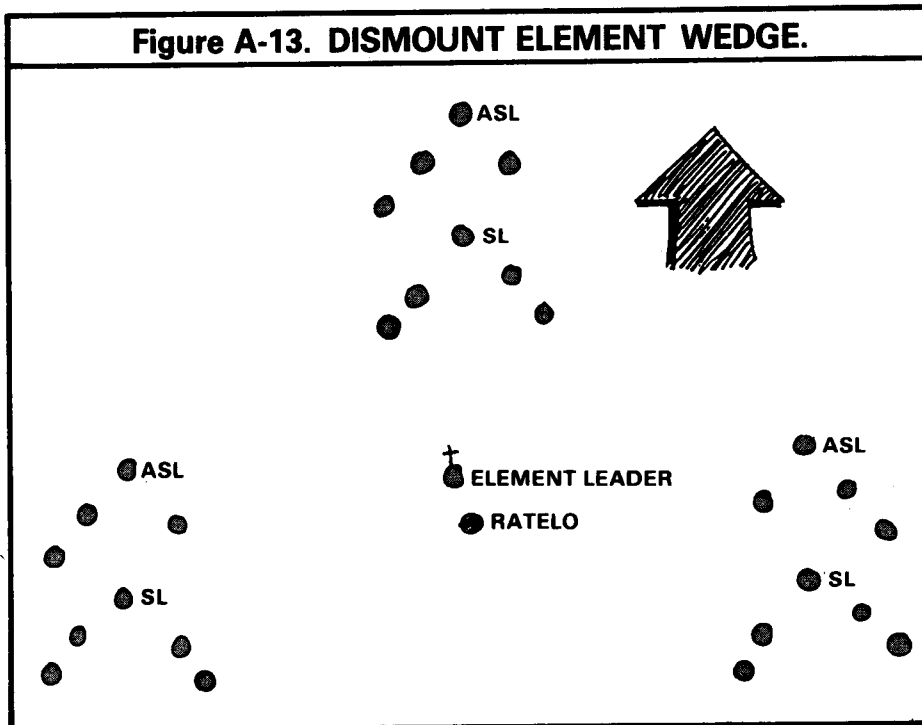
Figure A-11. DISMOUNT ELEMENT LINE.

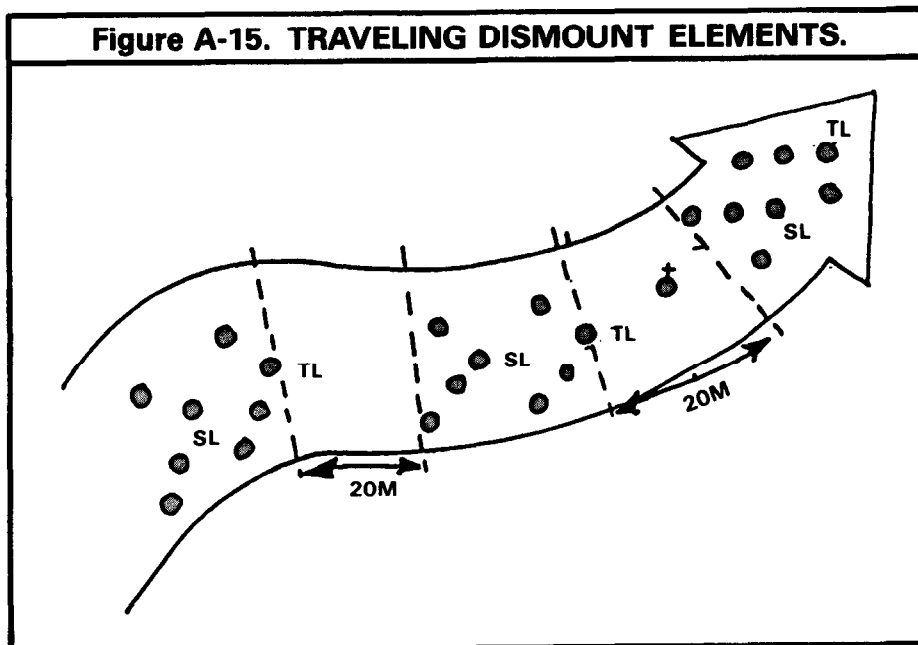
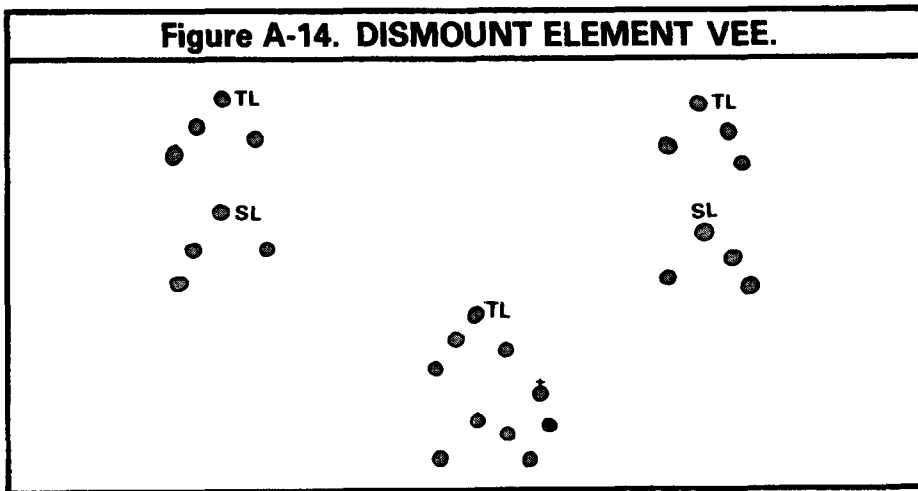


**Figure A-12. DISMOUNT ELEMENT ECHELON.**



**Figure A-13. DISMOUNT ELEMENT WEDGE.**





**A-4. TACTICAL CONSIDERATIONS**

The offensive firepower provided by the dedicated M60 machine gunner is employed to aid the SAWs and caliber .50 in suppression missions:

**During overwatch, against ATGMs.**

**While mounted, against enemy vehicles during initial contact.**

**Combined with other weapons while mounted and following tanks, to secure between and to the flanks of the tank formation.**

**To cover the flanks of the platoon while moving mounted.**

**Against close-in personnel targets.**

**In support of the dismount element when left behind with the carrier element to support by fire.**

**Combined with the SAWs and caliber .50 when assaulting mounted to cover the front and the area beyond 300 meters.**

**To aid in marking the objective for the dismount element through the use of tracer ammunition.**

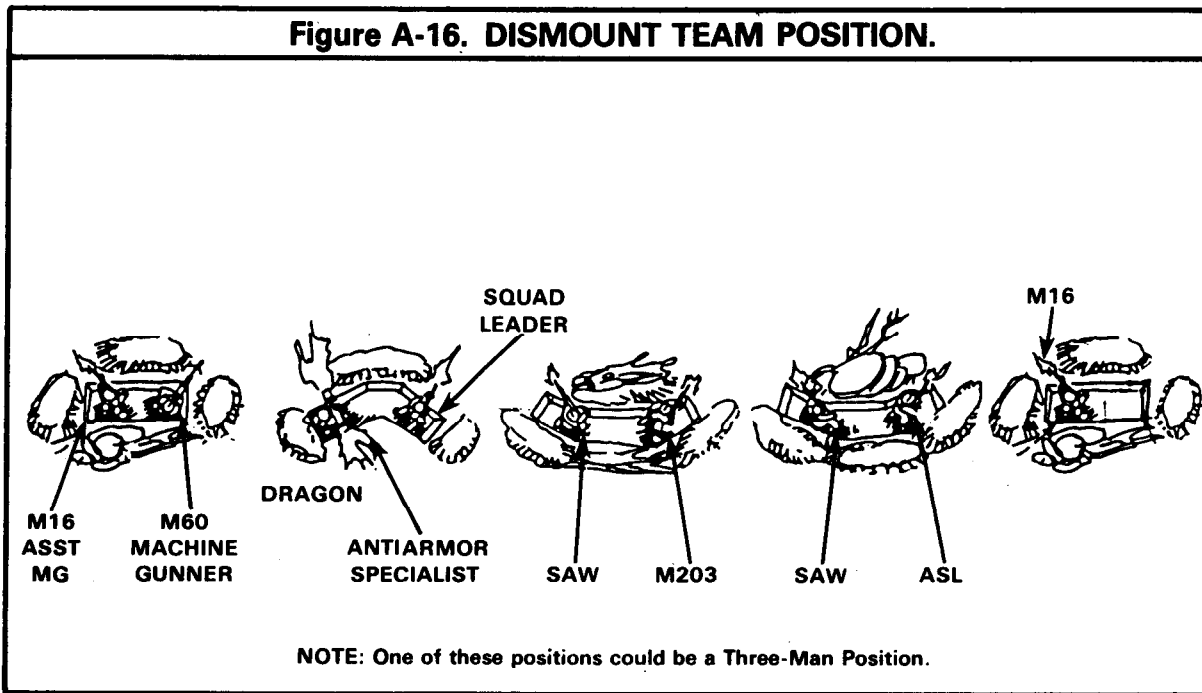
In the defense, the nine dismount team members are usually placed in two-man positions. The squad leader should consider whether to remain mounted or to dismount the APC and leave the gunner and driver as the carrier team. If the sector being defended is narrow, then the number of positions may be reduced. If a sector is wide, then it may become necessary to occupy positions with only one man. (Remember to maintain two-man positions on crew-served weapons such as the M60 machine gun.) The illustration shows a typical dismount team's position.

Even though it is a small organization, the dismount team has lots of combat power. To fight enemy dismounted attacks, it is armed with one M60 machine gun, four M16A1 rifles, two M203 grenade launchers (each mounted on an M16A1 rifle), two SAWs, and assorted hand grenades and antipersonnel mines. Against enemy mounted attacks, the dismount team can employ the Dragon, LAWs, the M203 HEDP round, and antitank mines.

As discussed in chapter 6, the distance between dismount teams will be determined by enemy capabilities, the terrain, visibility conditions, strength of the dismount teams, and their location with respect to the carrier teams.

The dismount element leader insures that key weapons are mutually supporting and that no gaps appear in the element's sector. Overlapping sectors of observation and fire between adjacent weapons, fighting positions, and teams provide mutual support within the element's sector. This fire must be enough to stop enemy soldiers from penetrating the position or isolating any part of the dismount element. Obstacles should

**Figure A-16. DISMOUNT TEAM POSITION.**





be planned and emplaced to support the fire plan. Engineer assets, whenever available, should be used to the maximum extent to emplace obstacles and/or to prepare positions.

**A-5. BATTLE DRILL EXAMPLES — H-SERIES TOE**

This paragraph depicts the changes for the 11-man squad from the standard mechanized battle drills shown in appendix H.

Examples.

**DRILL TITLE:** Dismount the APC.

**TASK:** Squad dismounts left or right.

**CONDITION:** The squad is moving as part of a platoon to make contact with the enemy. Visibility is good.

**STANDARD:** The dismount team immediately exits the vehicle to the left or right and orients to the front of the vehicle.

**INITIATING CUE:** The squad leader directs the dismount team to dismount left or right.

**PERFORMANCE REMINDERS**

The squad leader alerts the dismount team.

The driver looks for a covered and concealed position.

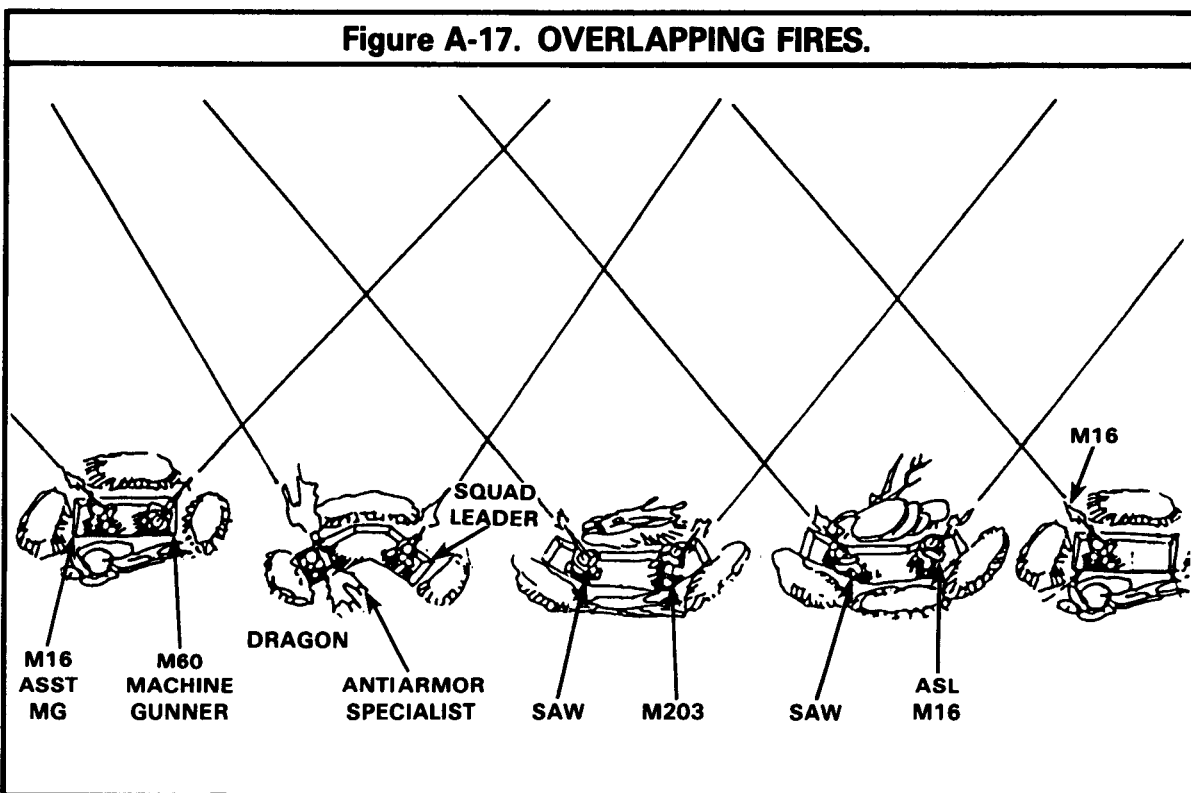
The gunner uses the caliber .50 machine gun to suppress the enemy.

The vehicle is halted in the best available covered and concealed position.

The dismount team dismounts in the following order:

a. No. 5, 9, 8, 7, 1, 10, 6, 4, 11 (dismount right).

b. No. 9, 8, 7, 5, 1, 10, 6, 4, 11 (dismount left).



As the dismount team dismounts, the members orient to the front of the vehicle, which should be facing toward the enemy.

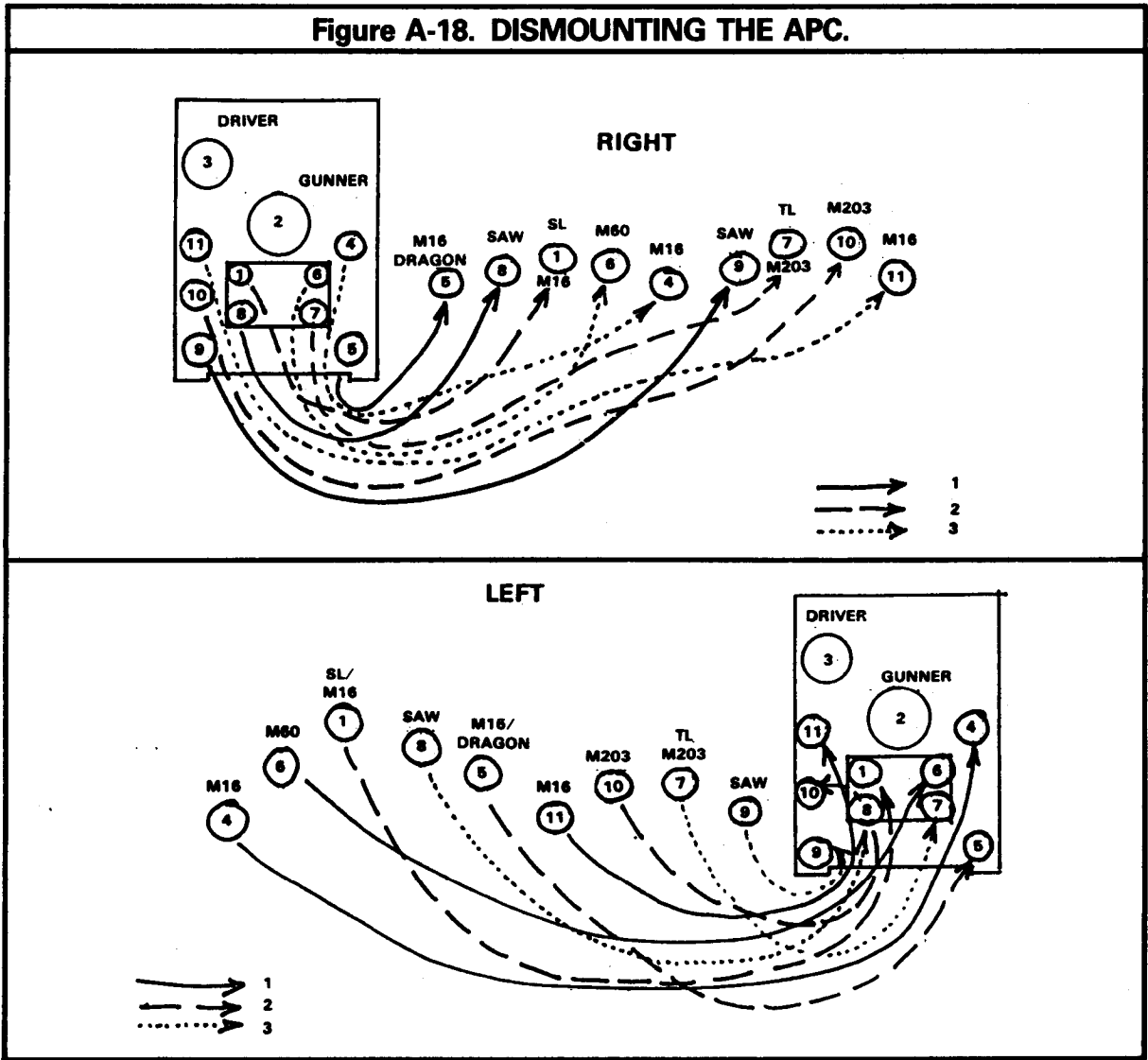
**COUNTERTASK:** The opposing force (OPFOR) engages the APC with antiarmor fire.

**CONDITION:** OPFOR is in a covered concealed fighting position and is armed with ATGM systems.

**STANDARD:** OPFOR suppresses the squad.

**NOTE:** The dismount battle drill terminates when the last man exits the vehicle and orients to the front. The battle drill does not necessarily require the exact dismount sequence shown. The dismount team may not "layout" as depicted but may dismount and move out in a specific direction.

**Figure A-18. DISMOUNTING THE APC.**



**DRILL TITLE:** Mount the APC.

**TASK:** Dismount team mounts the vehicle.

**CONDITION:** The squad is occupying a defensive position as part of the platoon. Visibility is good. Squad's position has become untenable.

**STANDARD:** The dismount team mounts the vehicle.

**INITIATING CUE:** The squad leader, or

dismount team leader, orders the dismount team to mount the vehicle.

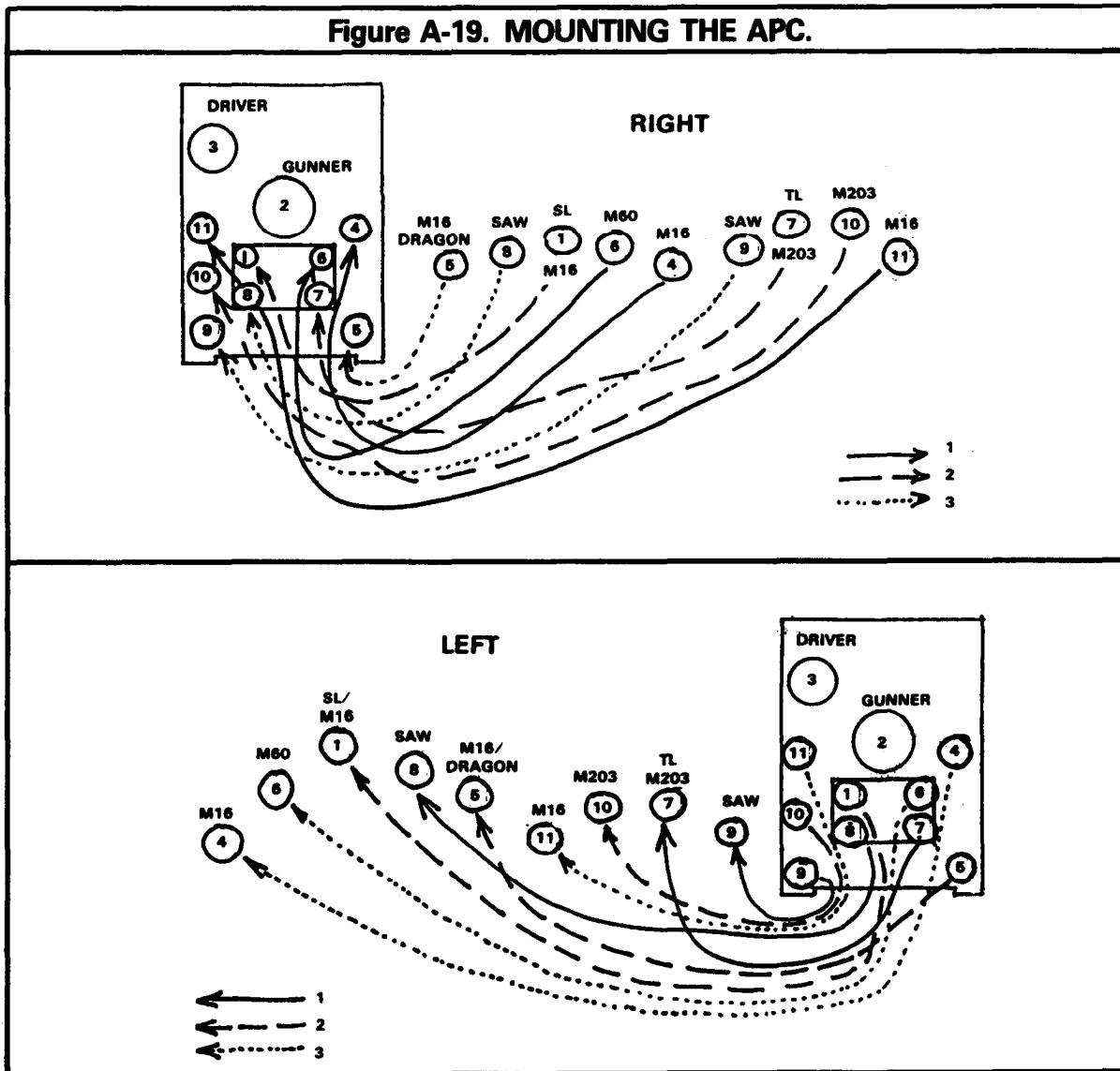
**PERFORMANCE REMINDERS:**

Squad leader or dismount team leader gives warning or signal to prepare to mount.

Squad leader or dismount team leader gives the order to mount.

Soldiers should remount by number in the following order No. 11, 4, 6, 10, 1, 5, 9, 8, 7.

**Figure A-19. MOUNTING THE APC.**



---

First soldiers to mount, cover remaining dismounted team.

Gunner uses the caliber .50 machine gun to suppress the enemy.

Squad leader indicates direction of travel for move out.

**COUNTERTASK:** OPFOR detects the squad occupying a defense position. OPFOR closes with the squad.

**CONDITION:** OPFOR is conducting an attack.

**STANDARD:** OPFOR destroys the squad.

APPENDIX B  
**WEAPONS AND  
 FIGHTING POSITIONS**  
**Section I. WEAPONS**

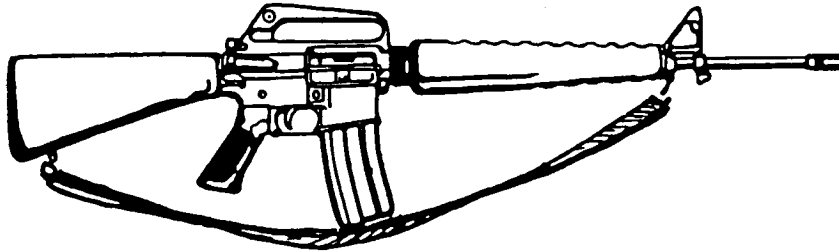
**B-1. GENERAL**

To succeed in combat, soldiers must know the characteristics of their weapons and how to use them. This appendix discusses weapons and fighting positions used by the mechanized infantry platoons.

**B-2. M16A1 RIFLE**

**General.** The M16A1 rifle is 5.56-mm, magazine-fed, and gas-operated. It has a selector lever which allows the rifle to be fired semi-automatic or automatic. The most stable firing positions (those increasing the probability of target hits) are the **prone supported** or **fox-hole supported** for semiautomatic fire and the **prone biped supported** for automatic fire.

CONTENTS	Page
Section I. Weapons . . . . .	B-1
II. Fighting Positions . . . . .	B-14

**Figure B-1. M16A1 RIFLE.****CHARACTERISTICS.****Weight (loaded):**

20-round magazine — 3.5 kilograms (7.6 pounds).

30-round magazine — 3.6 kilograms (7.9 pounds).

Length (w/o bayonet) — 99 centimeters (39 inches).

Ranges at which a 50-50 chance of target hit can be expected:

Moving target — less than 200 meters.

Stationary target — 250 meters.

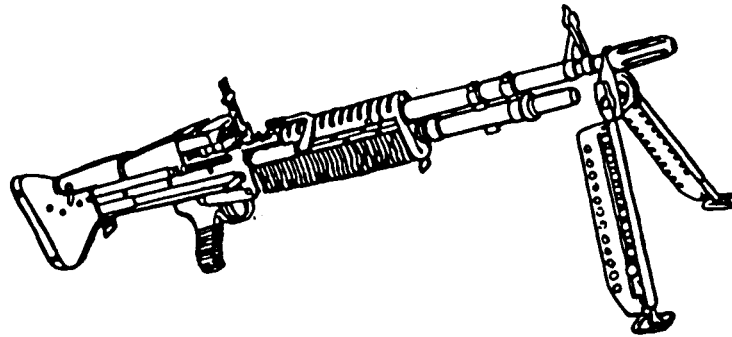
Maximum range of grazing fire: 350 meters.

Maximum range: 2,653 meters.

Rate of fire: Sustained (semiautomatic) — 12 to 15 rounds per minute.

**B-3. M60 MACHINE GUN**

**General.** The M60 machine gun is 7.62-mm, belt-fed, gas-operated, and automatic. It has an attached biped mount and a separate tripod mount. The most accuracy is gained firing from the prone position with the weapon mounted on the M122 tripod. Some vehicular mounts (such as the pedestal mount on the M151 Jeep) are also available for this gun. When the gunner is standing, the gun may be shot from the hip, underarm, or shoulder.

**Figure B-2. M60 MACHINE GUN.**

**Weight (machine gun only): 10.4 kilograms (23 pounds).**

**Tripod with traversing and elevating mechanism — 8.8 kilograms (19.5 pounds)**

**Ammunition: 300 rounds — 9.5 kilograms (21 pounds).**

**Length: 110.5 centimeters (43.5 inches).**

**Maximum range: 3,725 meters.**

**Tracer burnout: 900 meters**

**Maximum range of grazing fire: 600 meters**

**Ranges at which a 50-50 chance of target hit can be expected shooting bursts of six to nine rounds:**

**Moving target — 200 meters (bipod mounted)**

**Point target\* — 600 meters (bipod or tripod mounted).**

**Area target\*\* — 800 meters (bipod mounted)**

**Area target\*\* — 1,100 meters (tripod mounted).**

**Rates of fire:**

**Sustained — 100 rounds per minute.**

**Rapid — 200 rounds per minute.**

**Cyclic — 500 rounds per minute.**

**Types of ammunition:**

**Ball.**

**Tracer.**

**Armor-piercing.**

\* A point target is the size of a standing man.

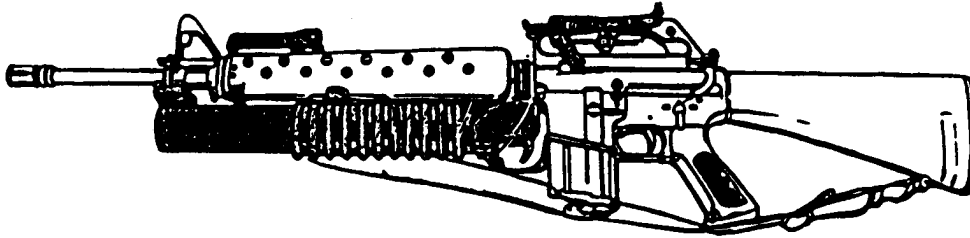
\*\* An area target is approximately the size of an area a fire team would occupy.

#### **B-4. M203 (40-MM GRENADE LAUNCHER)**

**General.** The M203 40-mm grenade launcher is a single-shot, breech-loaded, pump-action weapon. It is attached to an M16A1 rifle. It fires a variety of ammunition. It can suppress targets that are in defilade; suppress or disable armored

vehicles, except tanks; penetrate concrete, timber, or sandbagged weapon positions and some buildings; illuminate and signal. The firing positions with the most stability are the **standing supported** and **prone supported**.

**Figure B-3 GRENADE LAUNCHER, M203.**



**CHARACTERISTICS.**

**Weight (loaded) (rifle and grenade launcher):  
4.98 kilograms (11 pounds).**

**Length: 99 centimeters (39 inches).**

**Ranges at which a 50-50 chance of target hit  
can be expected:**

**Area target (25-meter circle) — 350 meters.**

**Point target:**

**Vehicle, weapon position — 200 meters.**

**Window opening — 125 meters.**

**Bunker aperture — 50 meters.**

**Maximum range: 400 meters.**

**Minimum safe firing ranges (HE and training  
practice [TP]).**

**Training — 80 meters.**

**Combat — 31 meters.**

**Minimum arming range: 14 to 38 meters\*.**

**Basic load for grenadier:**

**40-mm grenades — 36 rounds.**

**5.56-mm ball — 140 rounds.**

---

**\*This must be considered in close-in firing, as in  
towns and jungles, to insure that the round will  
explode.**



**Ammunition.** Types of 40-mm ammunition are:

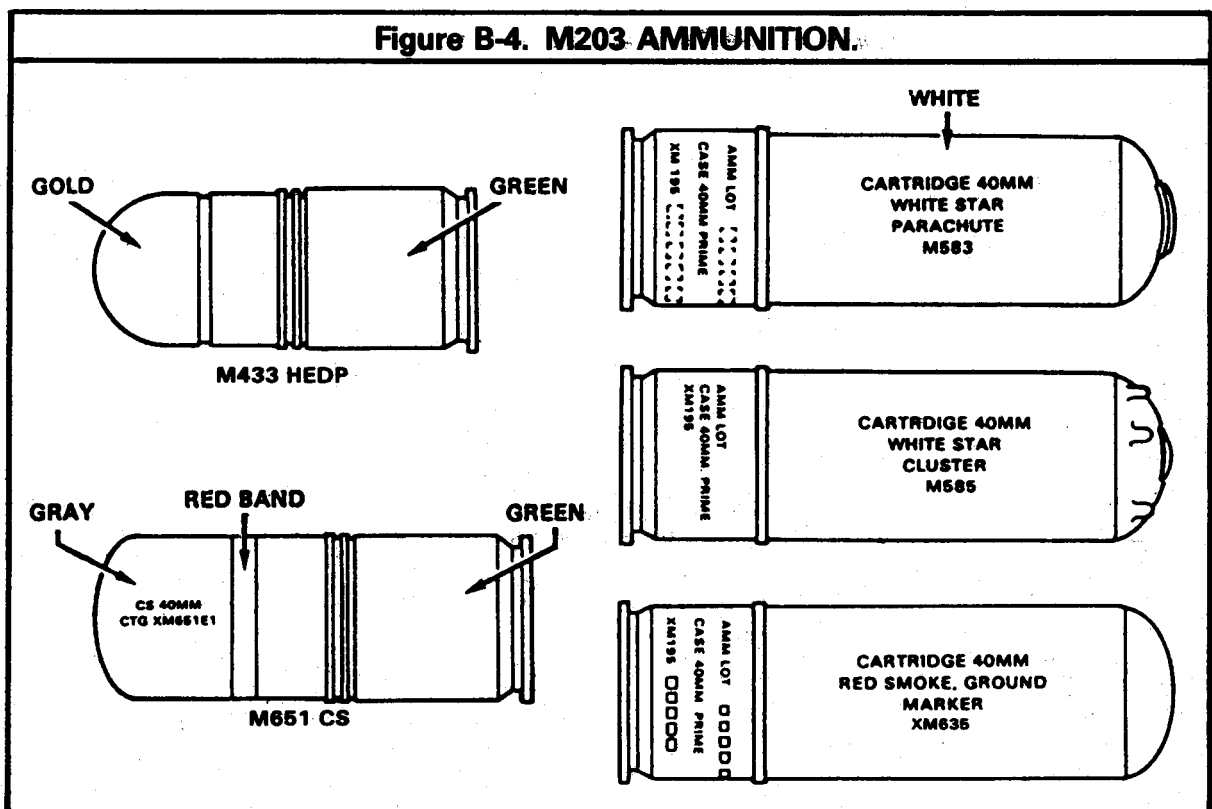
**M433 high explosive dual purpose.** This round can penetrate 5 centimeters (2 inches) of armorplate, 30 centimeters (12 inches) of pine logs, 40 centimeters (16 inches) of concrete blocks, or 50 centimeters (20 inches) of sandbags at a range up to 400 meters. It has a 5-meter casualty radius against exposed troops.

**M651 CS (chemical agent).** This round is used to drive the enemy from bunkers or enclosed positions in built-up areas.

**M583 white star parachute/M661 green star parachute/M662 red star parachute.** This is used to signal and illuminate. It can be placed 300 meters forward of a squad to illuminate an area 200 meters in diameter for 40 seconds.

**M585 white star cluster/M663 green star cluster/M664 red star cluster.** This is used to signal. (The green star cluster may appear white in bright sunlight.)

**XM635 ground smoke.** This is used to spot locations, not for screening. It comes in red, yellow, and green. The burst height is 105 meters (350 feet).



**B-5. M72A2 LIGHT ANTITANK WEAPON**

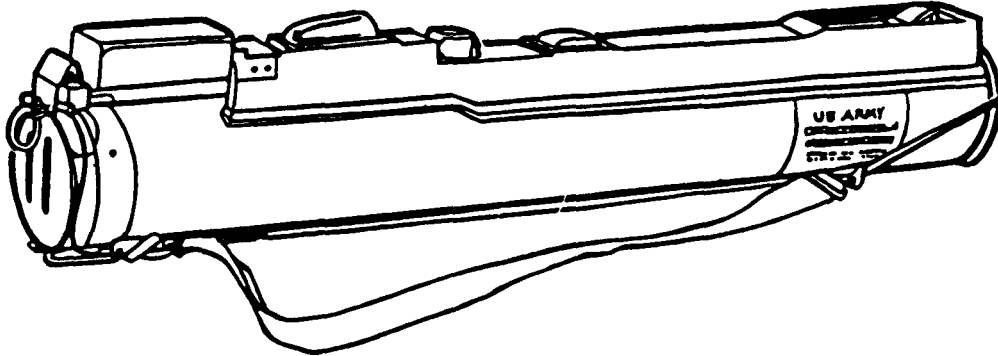
**General.** The M72A2 LAW is a self-contained unit. It consists of a 66-mm high explosive antitank (HEAT) rocket in a disposable fiberglass and aluminum launcher tube. Its

light weight and ability to penetrate more than 30 centimeters (12 inches) of armor make it a weapon that can be used against enemy armor, bunkers, and other hard targets out to a range of

200 meters. The most stable firing positions for the LAW are the **standing supported, prone, and prone supported.**

**Figure B-5. M72A2.**

(CLOSED POSITION)



**CHARACTERISTICS.**

**Length:**

**Closed — 66 centimeters (26 inches).**

**Extended — 89 centimeters (35 inches).**

**Maximum range: 1,000 meters.**

**Ranges at which a 50-50 chance of target hit can be expected:**

**Stationary target — 200 meters.**

**Moving target — 165 meters.**

**Minimum arming range: 10 meters.**

**Methods of Engagement for the LAW.** There are four methods of engagement **single, sequence, pair, and volley firing.**

**Single firing.** One gunner with one LAW shoots at a target. This method is used only at ranges of 50 meters or less. Beyond this range, single firing is ineffective as the chance of a first-round kill is low.

**Sequence firing.** One gunner with two or more LAWs shoots at a target. Before he

shoots, he should extend several launchers. After firing the first LAW, he notes its impact. If he gets a hit, he continues to shoot using the same sight picture until the target is destroyed. If the first round is a miss, he should adjust the range and lead of succeeding rounds until he gets a hit. He then continues to shoot until the target is destroyed.

**Pair firing.** One at a time, two or more gunners with two or more LAWs shoot at a target. Each gunner prepares several LAWs. The gunners swap information when shooting at the target. The first gunner seeing a target identifies it, announces the estimated range and lead he will use (for example, TANK, 150 METERS, FAST TARGET) and shoots. If the first gunner has a miss, the second gunner quickly announces a revised estimate of range and lead (if appropriate) and shoots. The gunners continue exchanging range and lead information until one gets a hit. Once the range and lead have been found, all gunners, on command, shoot at the target until it is destroyed. Pair firing is preferred over sequence firing as it lets gunners get target hits faster; that is, gunners firing the subsequent shots can be ready to shoot as soon as the previous round impacts. In sequence firing, the gunner must get another LAW, establish a sight picture, and shoot. Pair firing also has the advantage of having two or more gunners track the same target.

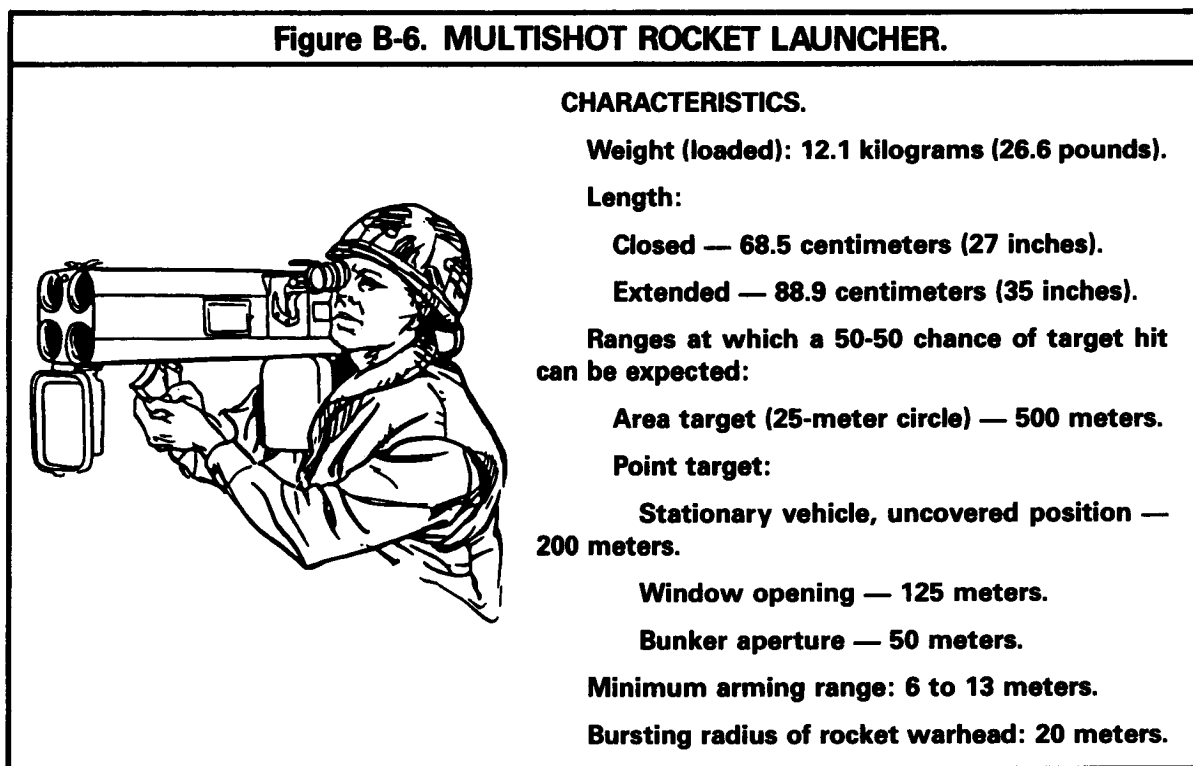
**Volley firing.** Two or more gunners with one or more LAWs shoot at a target at the same time. Shots are fired on command or on signal until the target is destroyed (for example, TANK, 100 METERS, SLOW TARGET, VOLLEY FIRE, READY, AIM, FIRE). Each gunner prepares two or more LAWs. Volley firing is used only when the range to the target and the lead have been determined. Range can be determined by map, by pacing, or from the results of pair firing after a target has been hit. The volley firing method is best because more rounds are shot at a target at one time. This increases the chance of a hit and decreases the chance of being detected.

### B-6. M202A1 MULTISHOT ROCKET LAUNCHER 66-MM

**General.** The M202A1 multishot rocket launcher 66-mm (Flash) is a lightweight, four-tube rocket launcher. It is aimed and shot from the right shoulder in the **standing, kneeling, or prone** position. It can shoot a single rocket or shoot up to four rockets semiautomatically at the rate of one rocket per second. Reloading is done with a new clip of four rockets. The brilliant splash of the bursting incendiary warhead makes it a good weapon to suppress RPGs and Sagers. When it impacts near enemy vehicles,

it will make them button up. The most stable position from which to fire the Flash is the **standing supported** position. When firing from a foxhole, there are two limitations. First, overhead cover can limit the elevation of the rocket launcher and therefore the range. Second, when elevating the launcher, **the gunner must insure that the rear of the launcher is outside the hole so that he is clear of the backblast.**

**Figure B-6. MULTISHOT ROCKET LAUNCHER.**



#### CHARACTERISTICS.

**Weight (loaded): 12.1 kilograms (26.6 pounds).**

**Length:**

**Closed — 68.5 centimeters (27 inches).**

**Extended — 88.9 centimeters (35 inches).**

**Ranges at which a 50-50 chance of target hit can be expected:**

**Area target (25-meter circle) — 500 meters.**

**Point target:**

**Stationary vehicle, uncovered position — 200 meters.**

**Window opening — 125 meters.**

**Bunker aperture — 50 meters.**

**Minimum arming range: 6 to 13 meters.**

**Bursting radius of rocket warhead: 20 meters.**

### B-7. M47 DRAGON MEDIUM ANTITANK WEAPON

**General.** The Dragon is a line-of-sight, wire-guided missile system. It can be man-portable or mounted on the APC. In its lightest configuration, it has two major components, the tracker and the ammunition. The ammunition consists of the launcher with the missile package inside.

The launcher is the handling and carrying container as well as the tube for firing the missile. The tracker is the reusable part of the system. The launcher is destroyed and discarded after firing.

**CHARACTERISTICS.****Weight:**

**Total (day tracker) — 14.5 kilograms (31.9 pounds).**

**Tracker (day) — 3.1 kilograms (6.8 pounds).**

**Tracker (night) — 9.36 kilograms (20.6 pounds).**

**Round — 11.4 kilograms (25.2 pounds).**

**Length: 115.4 centimeters (45.5 inches).**

**Diameter: 29.2 centimeters (11.5 inches).**

**Range:**

**Minimum — 65 meters.**

**Maximum — 1,000 meters.**

**Tracker: electro-optical with 6-power magnification.**

**Firing the Dragon.** To fire the Dragon, the antiarmor specialist looks through the sight and puts the crosshairs on the target. He keeps the crosshairs on the target and fires. By keeping the crosshairs on the target, the missile is guided to the target by the wire link. The tracker detects deviations from the gunner to target, line of sight, and direction of the missile, and sends corrections to the missile system. The missile system responds to corrections by firing jets along its sides to change its direction.

**Firing Configurations.**

**Dismounted bipod.** When used in establishing a hasty defense or when used in dismounted movement, the Dragon may be fired using the bipod attached to the launch tube. Using this method, the Dragon gunner takes a sitting position with the weapon on his shoulder. The tracker crosshairs are kept on target by moving the shoulder and body.

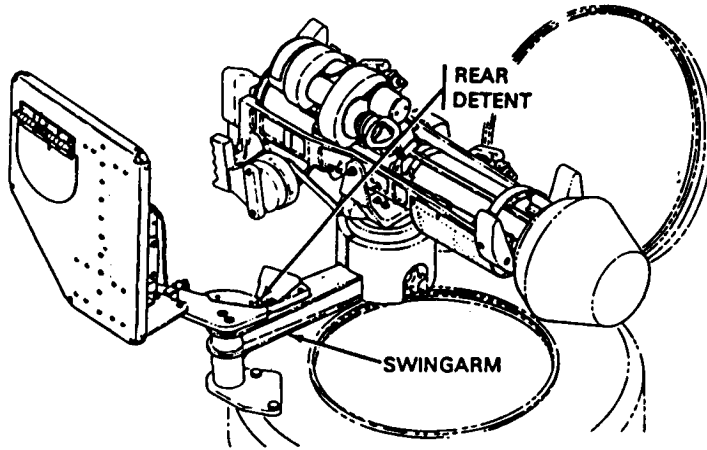
**Figure B-7. DISMOUNTED BIPOD.**



**M175 mount.** The M175 mount is attached to the right side of the gunner's hatch on the APC. The M175 consists of the cradle, firing arm assembly, damper assembly, and shield. When firing mounted, the gunner or antiarmor

specialist locks the launcher and tracker onto the cradle. The target is then tracked and fired at, using the elevation damper assembly handle and the remote firing mechanism handle. The functioning of the missile remains the same.

**Figure B-8. M175 MOUNT.**



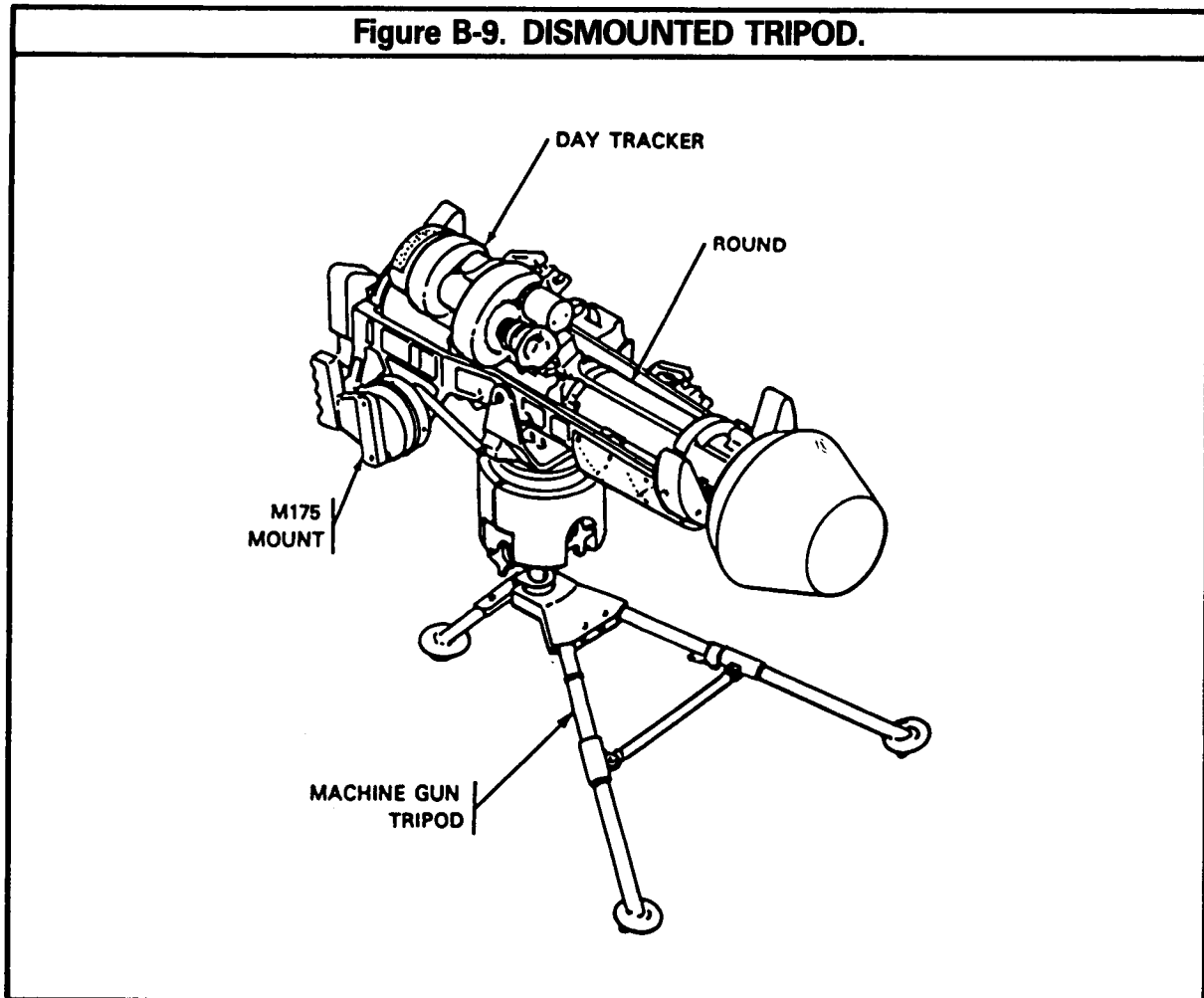
**Dismounted tripod.** When equipped with the M175 mount, the cradle and damper assembly can be installed on an M3 (caliber .50 ma-

chine gun) tripod, or an M122 (M60 machine gun) tripod, by using the tripod adapter. After installing the cradle, the Dragon launcher is

installed and fired the same as from an APC. Using the tripod method provides a more stable

base and smoother tracking for the antiarmor specialist.

**Figure B-9. DISMOUNTED TRIPOD.**

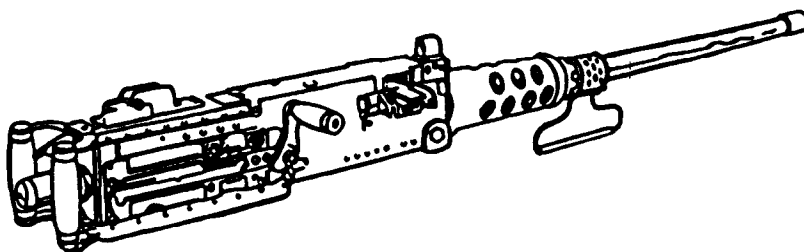


### **B-8. BROWNING CALIBER .50 MACHINE GUN**

**General.** The caliber .50 machine gun is belt-fed, recoil-operated, single shot or automatic. The main infantry vehicular mount is the cupola of the APC. When used in the ground mode, the machine gun is mounted on the M3 tripod mount or the M63 anti-aircraft mount. When shooting at ground targets from a stationary position, the gun is fired in bursts of 9 to 15 rounds. When firing at aircraft, a continuous burst is used rather than several short bursts.

When firing on the move, long bursts of fire are walked into the target. Enemy ATGM gunners, lightly-armored vehicles, and troops can be suppressed with a heavy volume of fire until a force can destroy or bypass the opposition. The AN/TVS-2 night vision device can be mounted on the caliber .50 machine gun. (The AN/TVS-2 should be mounted, boresighted, and zeroed on the gun IAW TM 11-5855-202-12, before employment at night.)

**Figure B-10. CALIBER .50 MACHINE GUN.**



**CHARACTERISTICS:**

**Weight:**

Machine gun — 38 kilograms (84 pounds).

Tripod — 20 kilograms (44 pounds).

Length: 165 centimeters (65 inches).

Maximum range of grazing fire: 800 meters

Tracer burnout: 2,200 meters.

Maximum range: 6,800 meters.

Ranges at which a 50-50 chance of target hit can be expected:

Tripod-mounted, firing bursts of 9 to 15 rounds:

Point target — 700 meters

Vehicle — 1,100 meters

Area target — 1,600 meters.

Cupola-mounted, stationary vehicle, firing bursts of 9 to 15 rounds:

Point target — 500 meters.

Vehicle — 800 meters.

Area target — 1,000 meters.

Cupola-mounted, moving vehicle, firing bursts of 15 to 30 rounds:

Area target — 300 meters.

Squad-size position — 500

meters (probability of hit reduced to 30%).

**Rates of fire:**

Sustained — 40 or less rounds per minute.

Rapid — 40 or more rounds per minute.

Cyclic — 450 to 500 rounds per minute.

Burst of fire for air defense: continuous while target is in range.

**Types of ammunition:**

Ball.

Tracer.

Armor-piercing.

Armor-piercing incendiary.

**FIRING FROM AN APC.**

Use this technique when shooting from an APC:

Hold the weapon tightly to the chest.

Aim (point) slightly low.

Fire and walk the rounds onto the target.

Cease fire when the rounds begin going high, and repeat the process.

The gun does not have a safety, so when you are moving, keep it half-cocked.

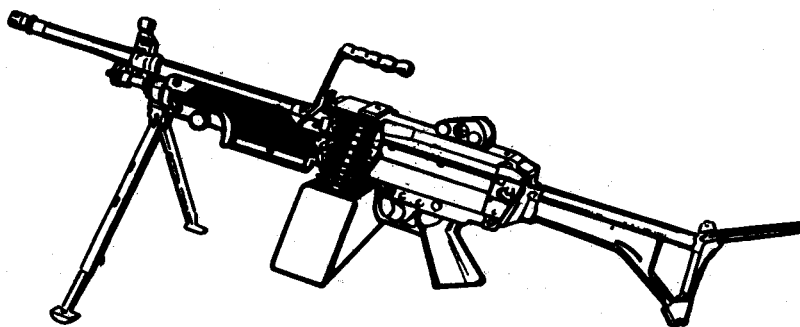


## B-9. SQUAD AUTOMATIC WEAPON (SAW)

**General.** The SAW is 5.56-mm, belt or magazine-fed, gas-operated with two-position regulator, and automatic. It has an attached biped mount and may be fired from the M122 tripod, using the M60 machine gun pintle and adapted

to the traversing and elevating (T&E) mechanism. The most accuracy is gained firing from the prone position on the tripod. When the gunner is standing, the gun may be shot from the hip, underarm, or shoulder.

**Figure B-10.1. SQUAD AUTOMATIC WEAPON.**



### **CHARACTERISTICS.**

**Weight with sling and cleaning kit: 7 kilograms (15.5 pounds).**

**Weight with 200 rounds of ammunition: 9.5 kilograms (21.9 pounds).**

**Length: 105 centimeters (41.4 inches).**

**Ammunition feed: disintegrating links in 200-round assault pack or M16 magazine.**

**Tracer burnout: 900 meters.**

**Maximum range of grazing fire: 600 meters.**

**Cyclic rate of fire: 725 rpm.**

**Types of ammunition:**

**Ball.**

**Tracer.**

**Armor-piercing.**

**Rear sight: adjustable to 1,000 meters.**

**Barrel: chrome-lined bore and 3-second quick change.**

## Section II. FIGHTING POSITIONS

### B-10. GENERAL

Whenever the dismount team dismounts to conduct the defense, it prepares fighting positions. A well-built fighting position gives the defender a marked advantage over the attacker and enhances his weapons' firing capability. Fighting positions must provide cover and concealment against aerial and ground fire and observation, and provide for mutual support among fighting positions' observation and fields of fire.

#### Cover.

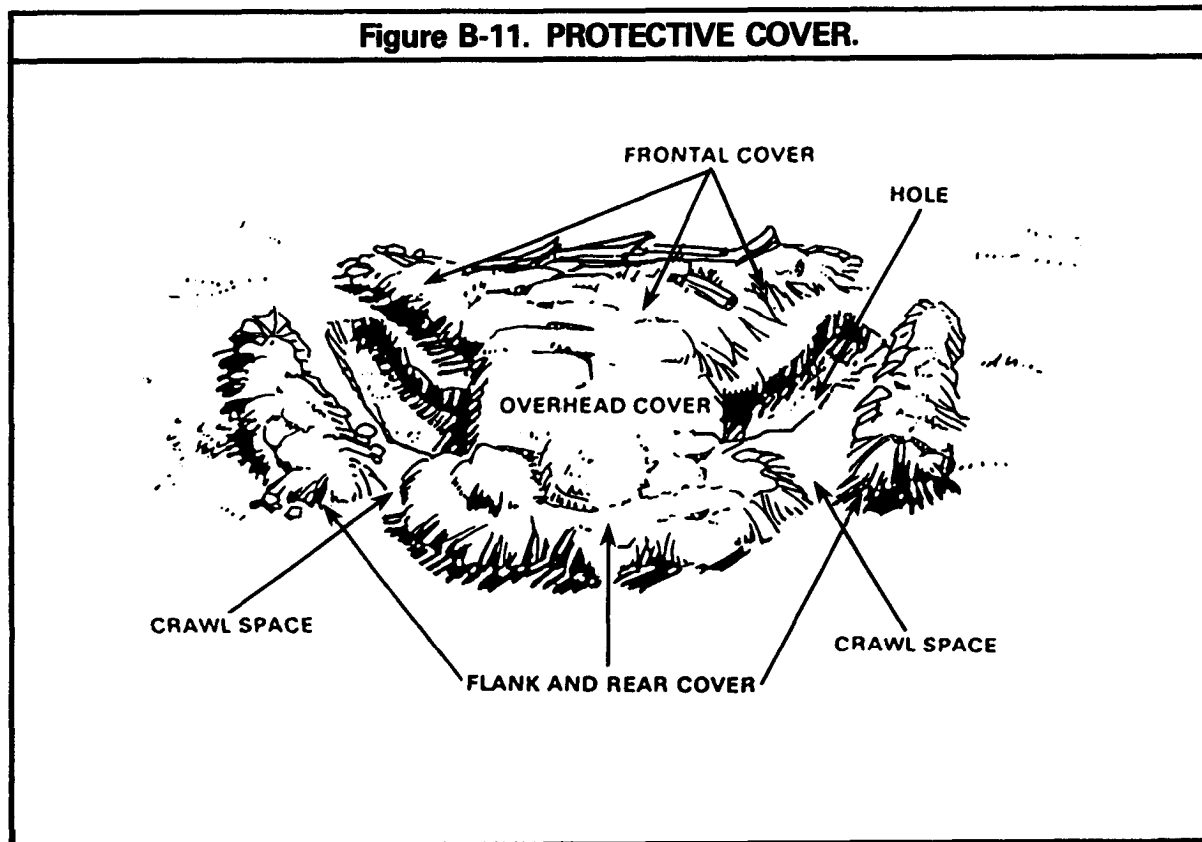
Protection from enemy weapons reduces the chances of casualties. The best way to gain this protection is use of cover.

Frontal cover must be thick enough (at

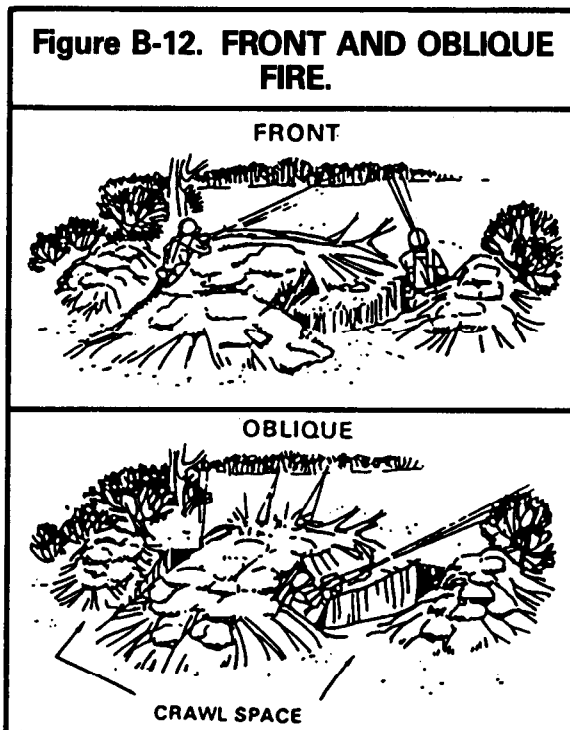
least 46 centimeters [18 inches] of dirt) to stop small arms fire, high enough to cover the heads of the men shooting from it, and far enough in front of the hole to allow room for elbow rests and sector stakes so that the men can fire to the oblique. Oblique shooting requires that the cover be long enough for two men and hide the muzzle blasts of their rifles.

To have complete protection, overhead, flank, and rear cover is required. This protects against indirect fire that bursts overhead, to the flanks, or to the rear of the position. It also protects against the effects of friendly weapons supporting from the rear — for example, small arms fire or discarded sabots from tank gun rounds.

**Figure B-11. PROTECTIVE COVER.**



A position's cover should be such that when the position comes under frontal fire, the troops can move behind the frontal cover and shoot to the oblique.



#### Concealment.

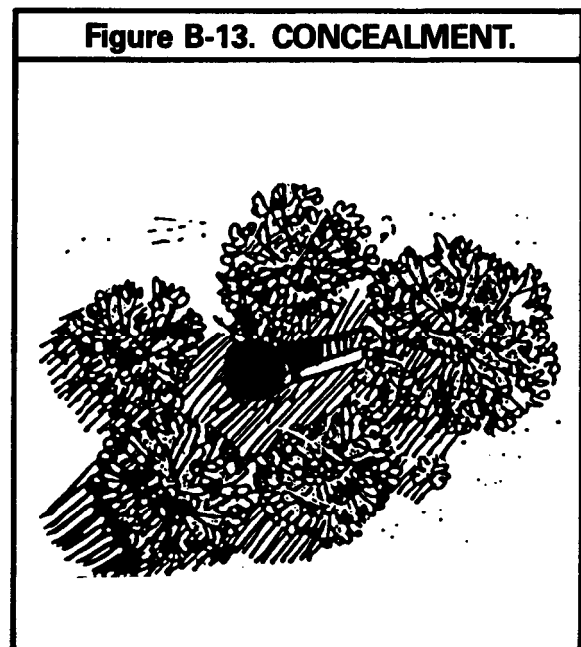
No matter how much protection a position may have, the enemy may be able to defeat the defender if the defender's position is easy to see. Positions must be well hidden so that the enemy will have a hard time seeing them even though he may be in hand-grenade range.

Natural concealment is better than man-made because —

- it is readily available,**
- it is less likely to attract the enemy's attention, and**
- it need not be replaced.**

While digging positions, soldiers should take care not to disturb the natural cover and concealment. The dirt dug out can be used to build cover. Unused dirt is put behind positions and camouflaged.

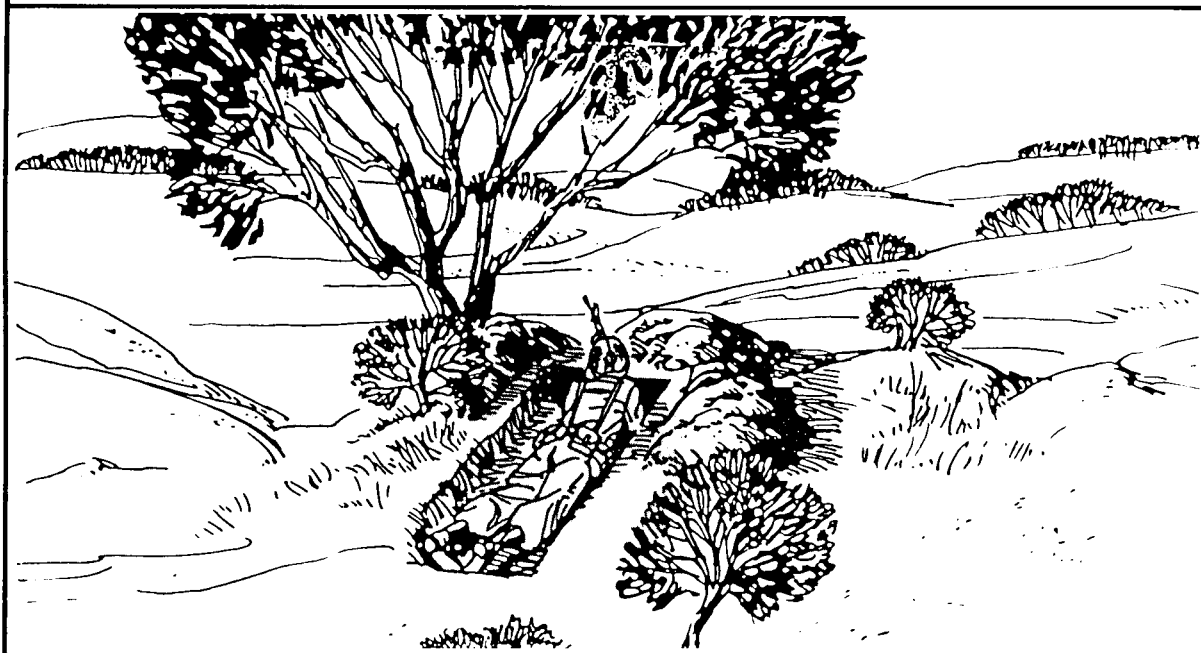
Positions should be concealed from enemy aircraft as well as from ground troops. If positions are under bushes, trees, or in buildings, they are less likely to be seen from above. Leaves, straw, or grass should be placed on the floor of the hole to keep the fresh earth from contrasting with the ground around it. Sticks should not be used, since they may stop grenades from rolling into the grenade sumps.



#### Variations in Fighting Positions.

A hasty fighting position is prepared when there is no time to prepare a deliberate fighting position. It is put behind whatever cover is available. It should give frontal protection from direct fire and still allow shooting to the front and oblique. For protection from indirect fire, a hasty fighting position should be in a small depression or in a hole at least half a meter (18 inches) deep.

**Figure B-14. HASTY FIGHTING POSITION.**



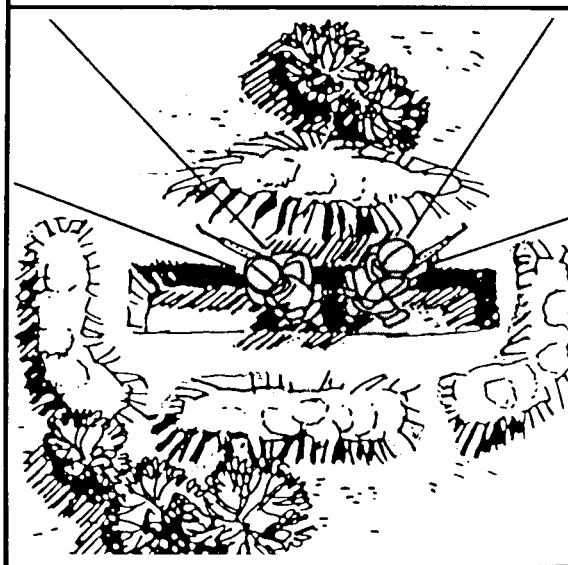
A one-man fighting position allows flexibility in the use of cover because the hole only has to be long enough for one man and his gear. It must let a soldier shoot to the front or to the oblique from behind frontal cover.

A two-man fighting position provides better security than a one-man fighting position. It should give frontal protection from direct fire and allow shooting to the front and oblique.

**Figure B-15. ONE-MAN POSITION.**

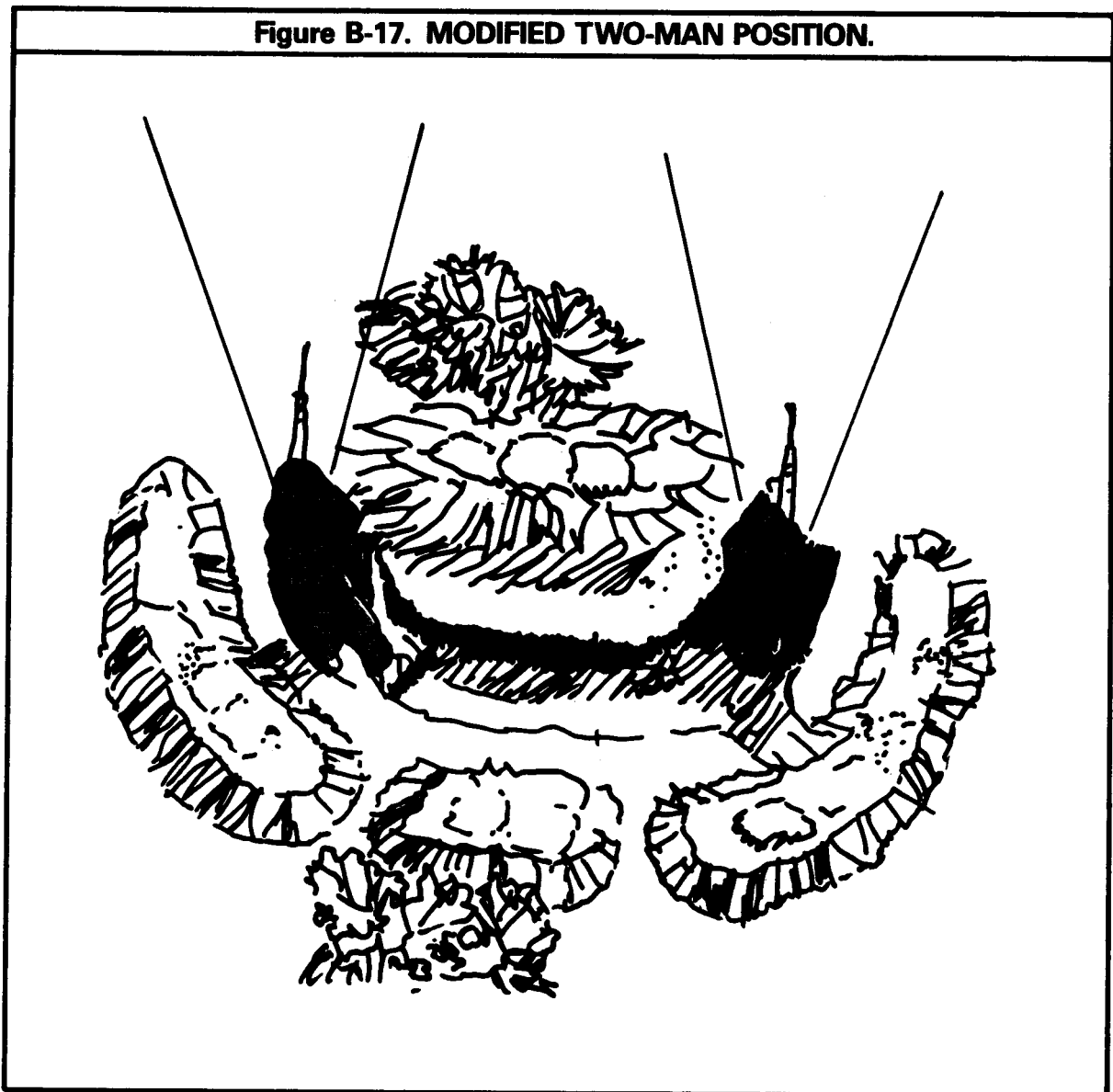


**Figure B-16. TWO-MAN POSITION.**



A modified two-man fighting position may be prepared in close terrain, where grazing fire and mutual support extend no farther than to an adjacent position, or prepared to cover dead

space just in front of the position. This is done by extending one or both ends of the hole around the sides of the frontal cover.



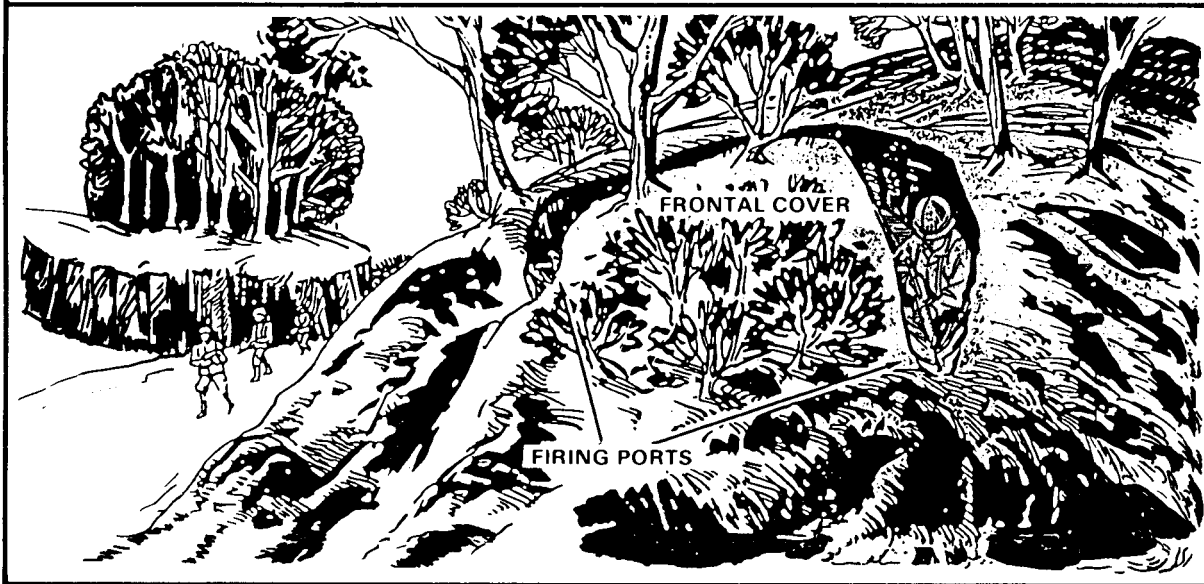
#### Positions on Steep Terrain.

On a steep slope, a soldier in a hole behind frontal cover cannot shoot attackers without standing up and exposing himself too much.

To overcome this, the hole is dug and firing ports are dug out at each end of the hole. The

ground between the firing ports then serves as frontal cover for the position.

**Figure B-18. STEEP TERRAIN POSITION.**



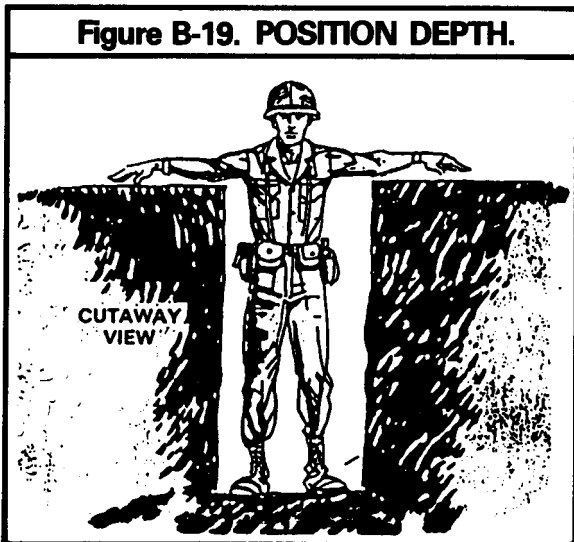
**B-11. PREPARING FIGHTING POSITIONS**

**General.**

Dig a fighting position armpit deep to lower the profile of the occupant(s) and still let him shoot his weapon.

Provide support by having a distance between the hole and the frontal cover that should be enough to let a soldier shoot from a supported position (elbows on the ground).

**Figure B-19. POSITION DEPTH.**



**Figure B-20. WEAPON FIRING SUPPORT.**

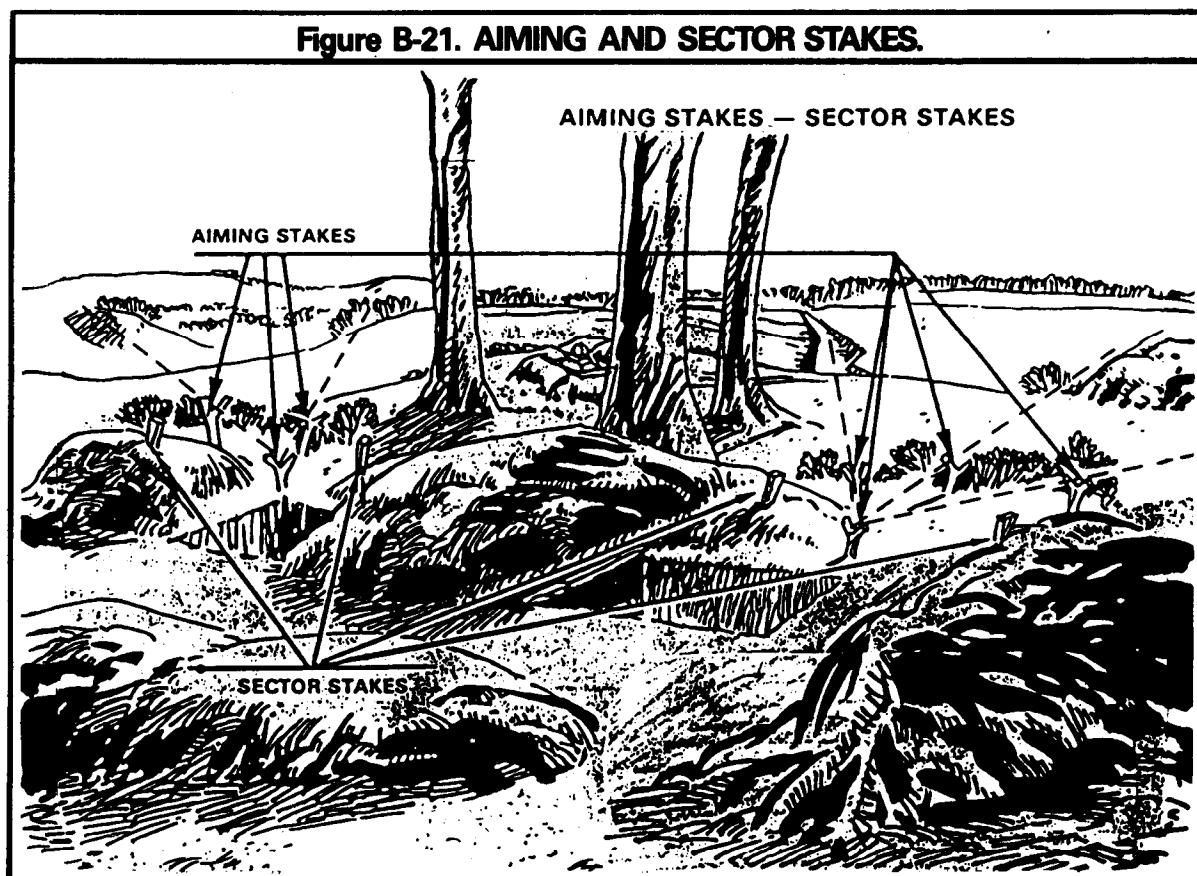


Dig elbow holes that serve to stabilize the shooter's arms and lower his profile.

Dig trenches for the biped legs of an automatic rifle to get it close to ground level.

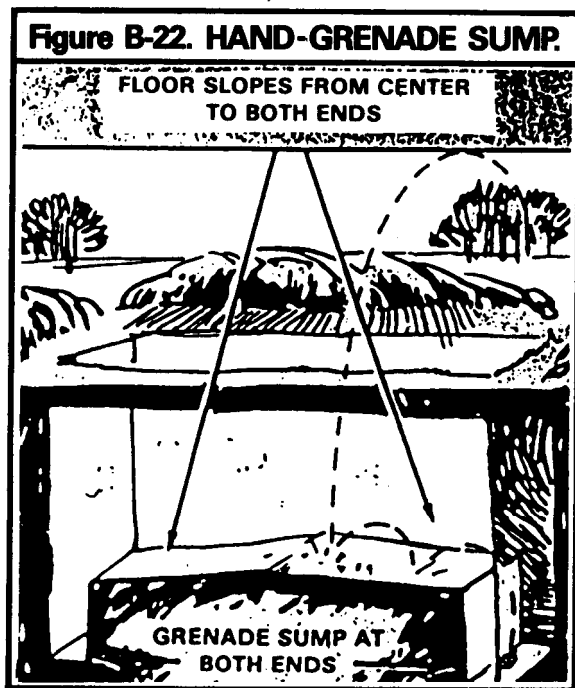
Use aiming stakes to help a soldier fire his rifle on dangerous approaches at night.

Use sector stakes, right and left, to define the sector of fire. They prevent accidental shooting into adjacent positions. A soldier should not let stakes spoil his position's concealment.



Shape the floor of the hole so that it slopes toward the grenade sumps. Water will run into the sumps, and grenades will tend to roll into them.

Dig two trench-shaped hand-grenade sumps at each end of the position. The trenches should be dug as wide as the blade of an intrenching tool, at least as deep as the intrenching tool, and as long as the position is wide. The slope of the floor should channel grenades thrown into the position into one of the sumps.



**Building Overhead Cover.**

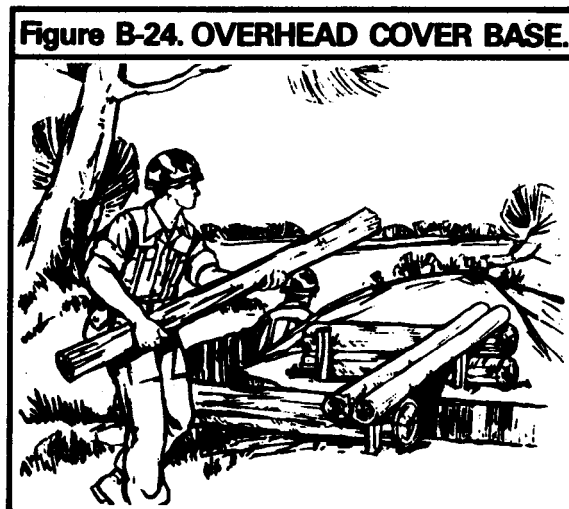
Frontal, flank, and rear cover, as well as the hole, give some protection from shell fragments, but overhead cover should be built to protect from airbursts. A good position has overhead cover that lets a man fire from underneath it.

Support for overhead cover is built by placing logs 10 to 15 centimeters (4 to 6 inches) on top of each other along the entire length of the frontal and rear cover.

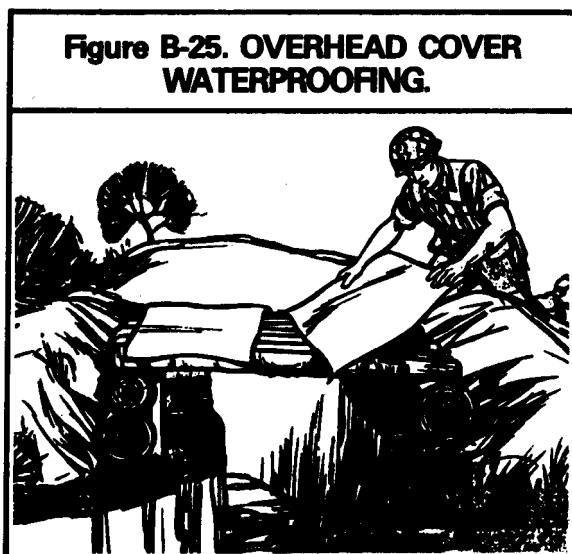


The front supports are high enough so that men can shoot from beneath the overhead cover when it is completed, allowing space for the AN/PVS-4 night vision sight and other devices as necessary.

The base of the overhead cover is made of logs 10 to 15 centimeters (4 to 6 inches) placed side by side across the supports.



A water-repellent layer, such as waterproof packing material from Dragon rounds or C-rations, is then laid over the logs.

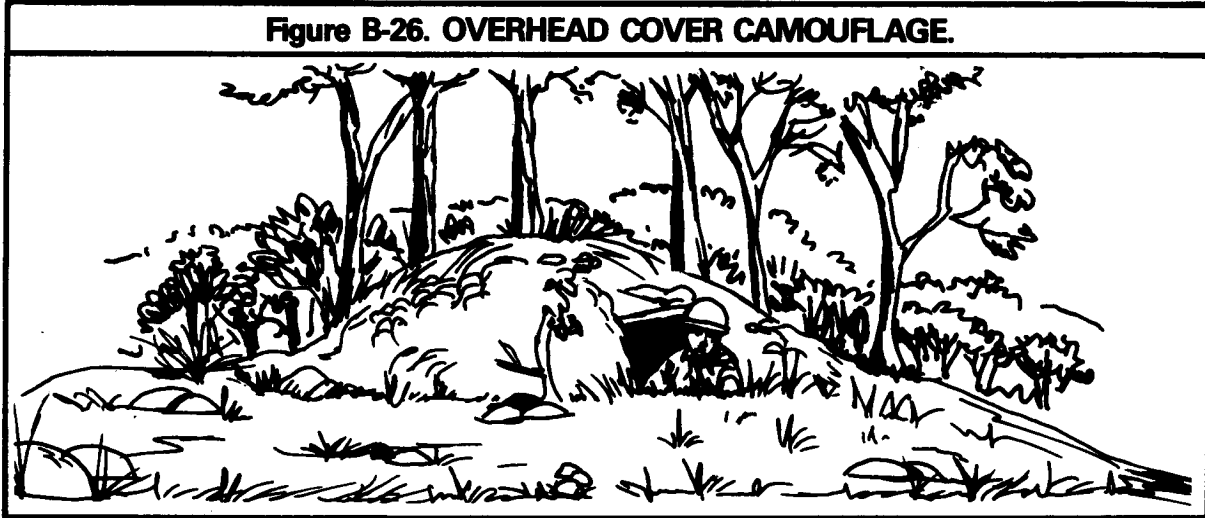




About 15 to 20 centimeters (6 to 8 inch) of dirt is added and molded to blend with the slope of the terrain. And finally, the overhead cover is

camouflage. When it is complete, the man in the position will have protection from shell fragments and still be able to shoot.

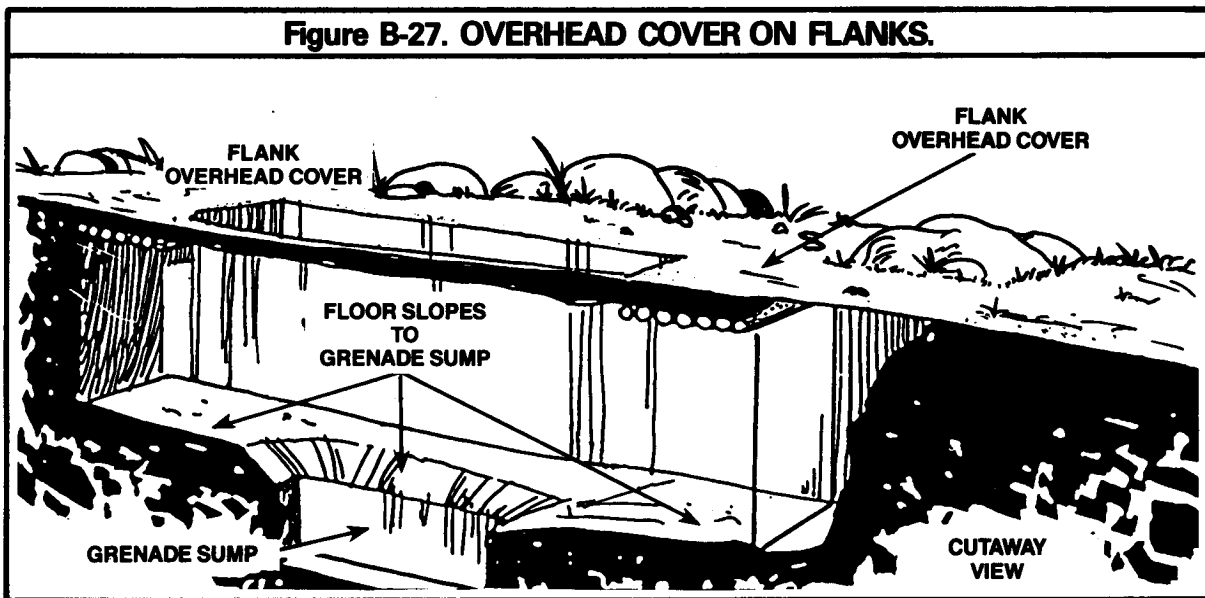
**Figure B-26. OVERHEAD COVER CAMOUFLAGE.**



When overhead cover would make a position easy to see, it can be built off to both flanks. When flank overhead cover is used, only

one grenade sump is dug in the center of the floor against the back wall.

**Figure B-27. OVERHEAD COVER ON FLANKS.**

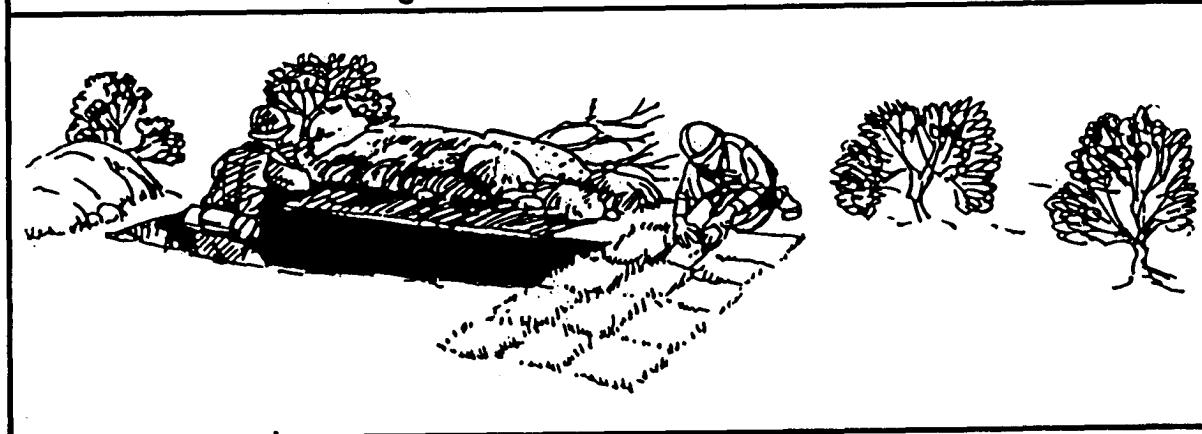


After removing sod and 25 to 35 centimeters (10 to 14 inches) of dirt, 10 to 15 centimeters (4 to 6 inches) of supporting logs or planks are laid

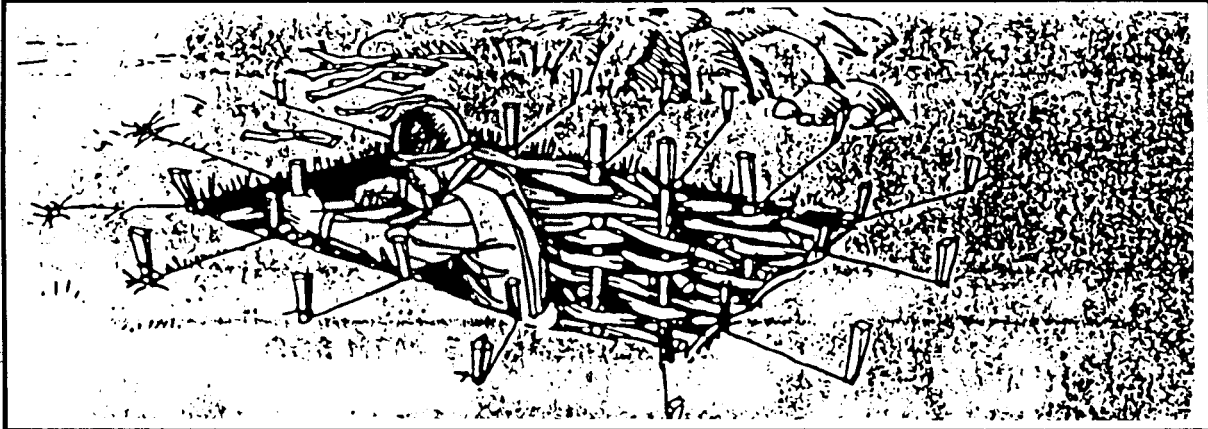
across that place to support the rest of the overhead cover material.

**Figure B-28. OVERHEAD COVER SUPPORT LOGS.**

The logs are covered by piling on them 15 to 20 centimeters (6 to 8 inches) of dirt. Sod is used to camouflage the dirt. It all must look natural.

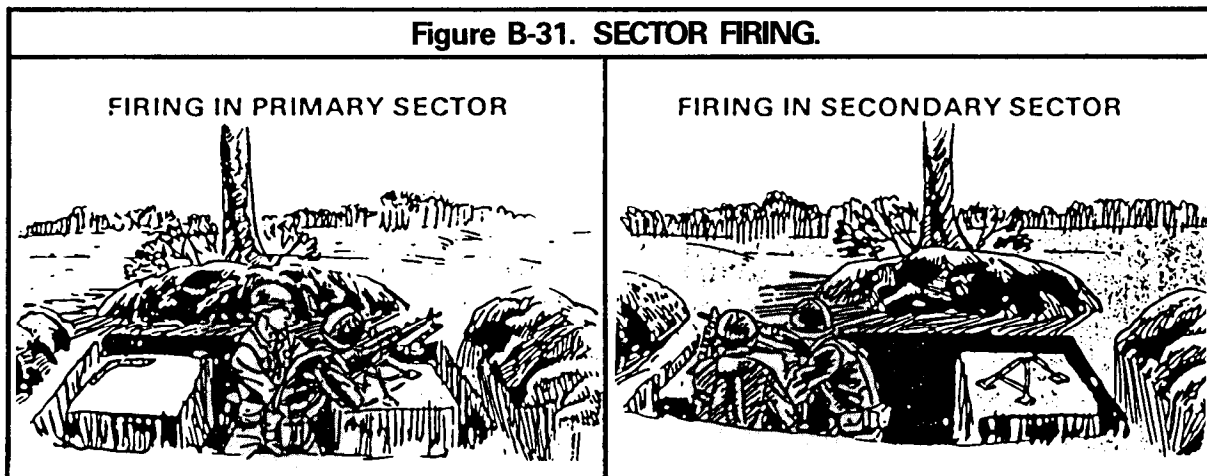
**Figure B-29. SOD CAMOUFLAGE.**

**Revetments.** Revetments are supports put against the sides of a fighting position to keep them from collapsing. Revetting is necessary when positions are dug in loose or wet soil. Anything that will hold in the walls (wire, boards, logs, etc.) can be used to revet as long as it is staked and anchored. After anchor lines are attached, stakes are driven all the way into the ground. That hides them so they will not be mistaken for aiming or sector stakes.

**Figure B-30. REVETMENT.****B-12. MACHINE GUN POSITIONS****General.**

The primary sector of fire is usually to the oblique so that the gun can fire across the platoon's front. The tripod is used on the side with the primary sector of fire, and the bipod legs are

used on the side with the secondary sector. When changing from primary to secondary sectors, the machine gun is moved but the tripod is left in place. The bipod is used in the secondary sector.

**Figure B-31. SECTOR FIRING.**

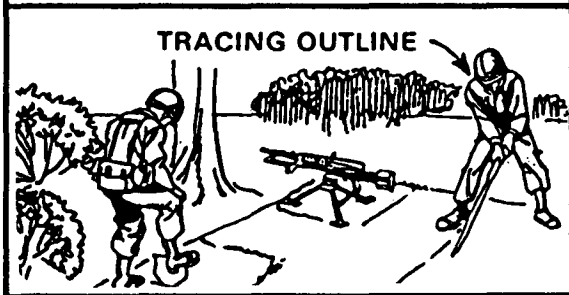
Dig a trench for the machine gun's bipod legs in the secondary sector.

Occasionally a sector of fire is assigned which allows firing directly to the front. This may reduce the amount of frontal cover for the crew when firing to the oblique.

**Preparing a Machine Gun Position.**

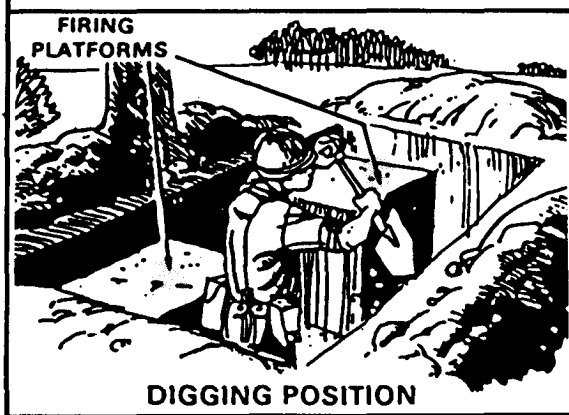
After the platoon leader has positioned a machine gun and has assigned sectors of fire and a PDF or FPL, mark the position of the tripod legs and the limits of the sectors of fire. Then trace the outline of the hole and the frontal cover (if it must be improved).

**Figure B-32. FIRING POSITION PREPARATION.**



The gun is lowered by digging down the firing platforms where the machine gun will be placed. The platforms must not be so low that the gun cannot be traversed across its sectors of fire. Lowering the gun reduces the profile of the gunner when he is shooting and reduces the height of the frontal cover needed. Dig the firing platforms first to the gunner's exposure (in case firing is required before the position is completed). Sandbags may be used to reinforce the platform in soft dirt.

**Figure B-33. MACHINE GUN POSITION PREPARATION.**

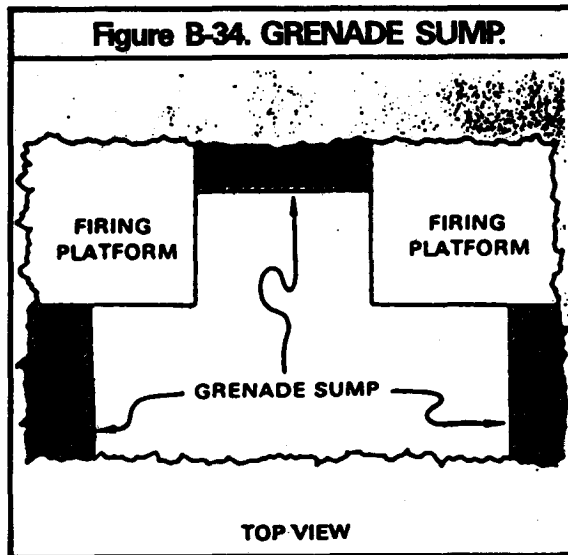


After the firing platforms have been dug down, dig the hole — placing the dirt first where frontal cover is needed. The hole is dug deep enough to provide protection and still let the gunner shoot. This hole is usually about armpit deep. When the frontal cover is high and thick enough,

the rest of the dirt is used to build the flank and rear cover.

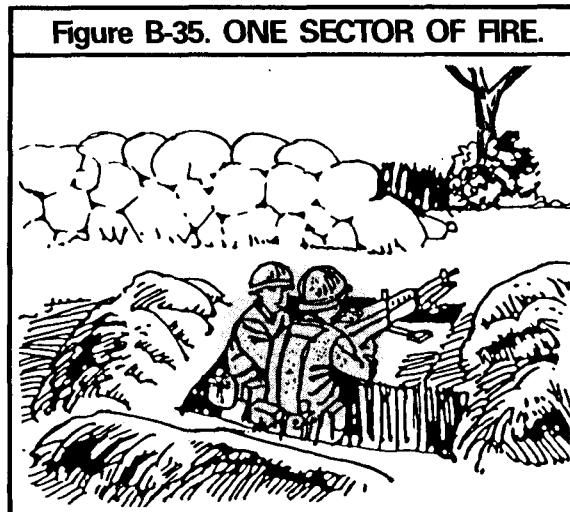
Three trench-shaped grenade sumps are dug at various points so that grenades can be kicked into them.

**Figure B-34. GRENADE SUMP.**

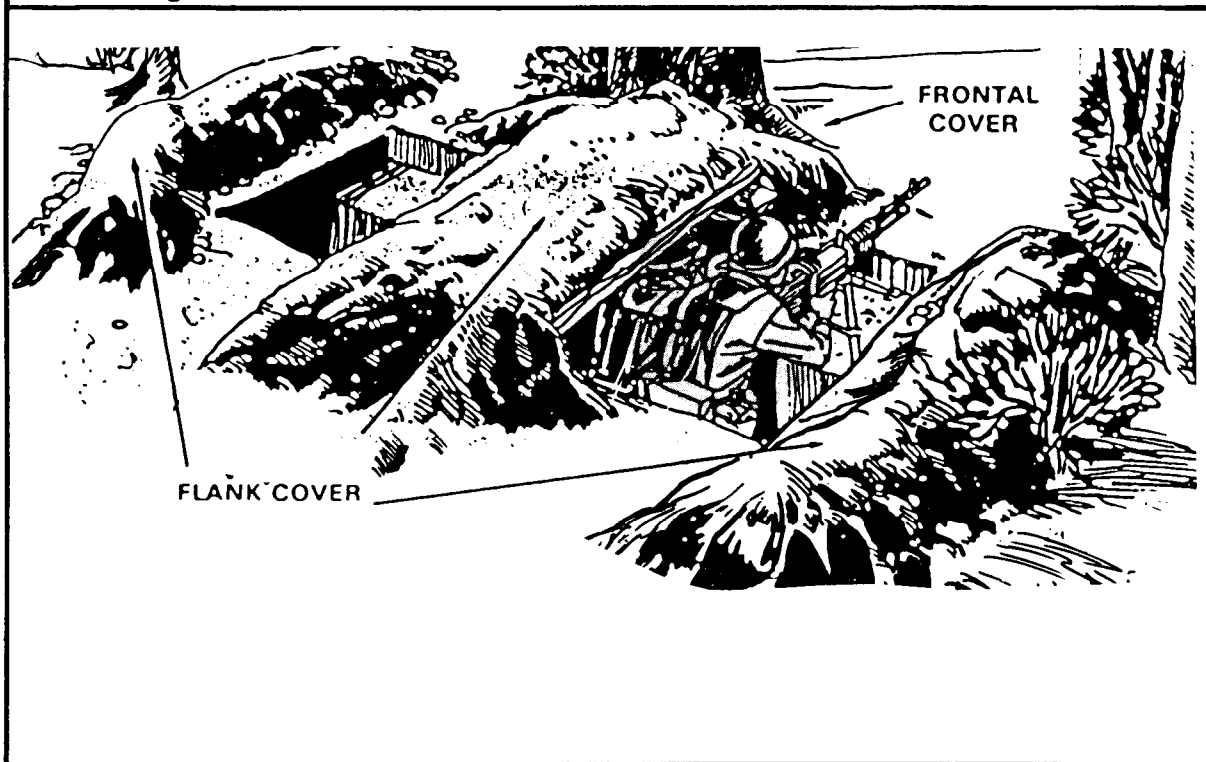


In some positions, a machine gun may not have a secondary sector of fire; so, only half of the position is dug.

**Figure B-35. ONE SECTOR OF FIRE.**



Overhead cover for a machine gun position is built the same as for a two-man position.

**Figure B-36. OVERHEAD COVER FOR A MACHINE GUN POSITION.**

### B-13. DRAGON POSITIONS

#### General.

The Dragon has a primary firing position, and one or more alternate firing positions to cover its primary sector of fire. Additionally, each Dragon may have supplementary firing positions for coverage of other sectors of fire.

The Dragon may be fired from hasty or improved positions. Remember that the backblast and the muzzle blast must be considered when employing the weapon.

When the weapon is fired from an improved position, the muzzle end of the launcher must extend 15 centimeter (6 inches) beyond the front of the hole. The rear of the launcher must extend out over the rear of the hole. As the missile leaves the launcher, the unfolding stabilizing fins require at least 15 centimeters (6 inches) of clearance above the ground.

Figure B-37. DRAGON POSITION.

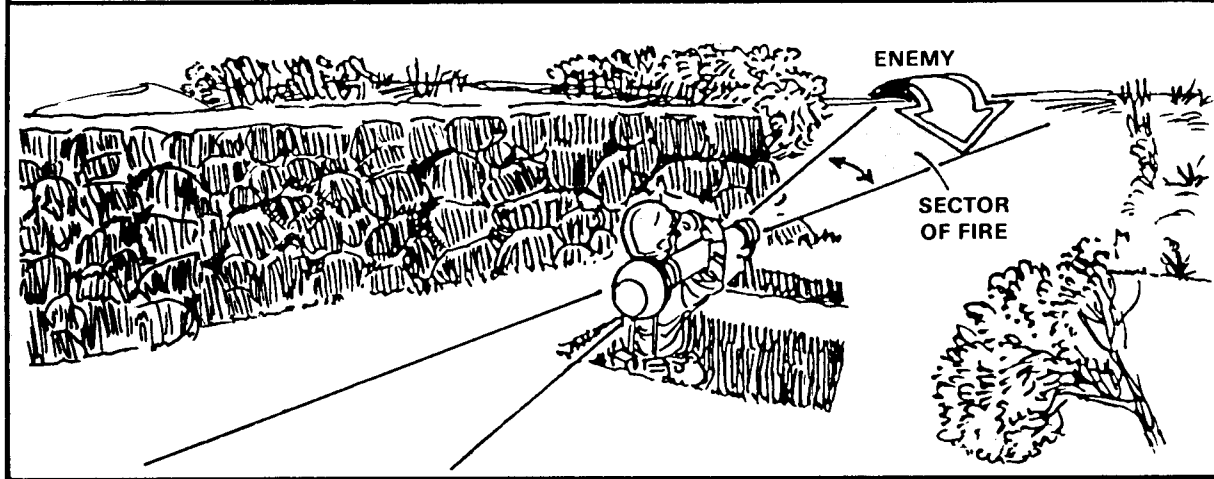


**Preparing a Dragon Fighting Position.**

The position is only waist deep so that the gunner can move while firing. A trench for the bipod is dug 15 centimeters (6 inches) in front of the hole.

The position should be sited and oriented to cover its assigned sector of fire.

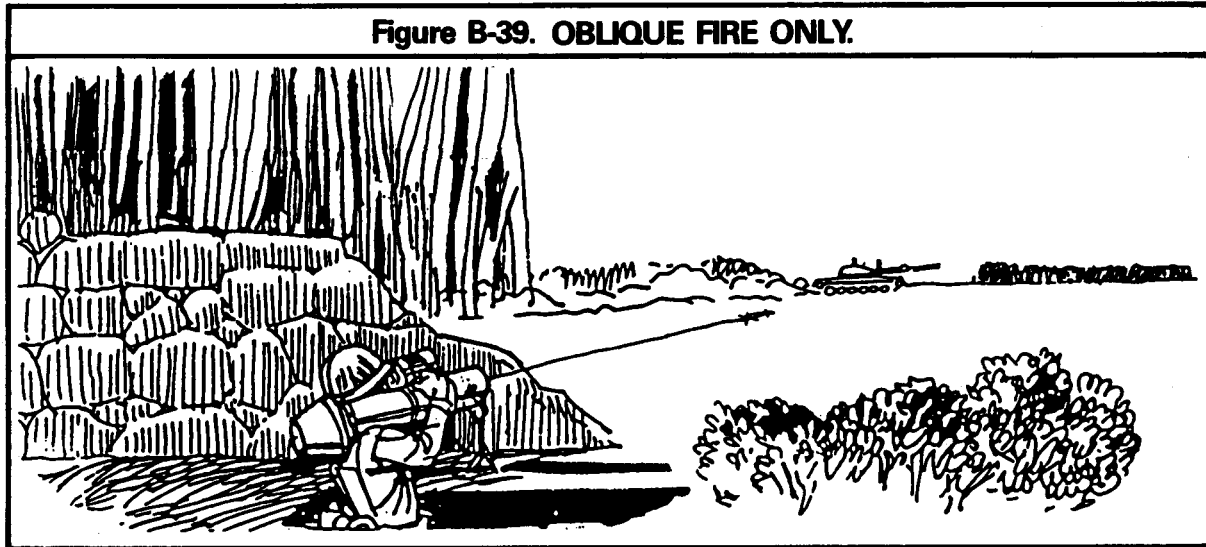
Figure B-38. SINGLE SECTOR OF FIRE (DRAGON).



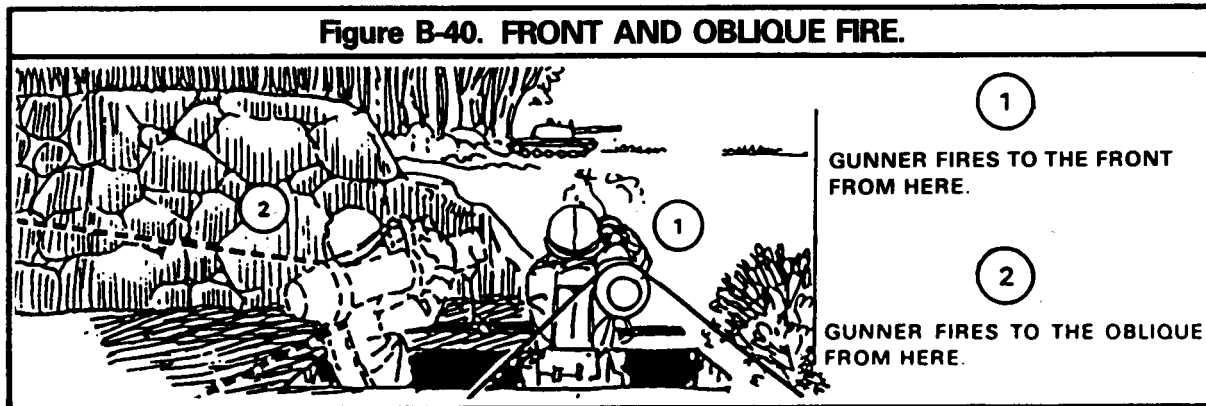
The position should be protected to the front by a parapet, or some natural or man-made cover.

The ground in front of and behind the position should be free of rocks, sand, and debris to prevent a dust cloud (caused by firing) from obscuring the gunner's vision.

When the Dragon is to fire in only one direction, a one-man fighting position is best. The Dragon should be positioned to fire to the oblique so that its position can be protected from frontal fire while the target is being engaged from the flank.



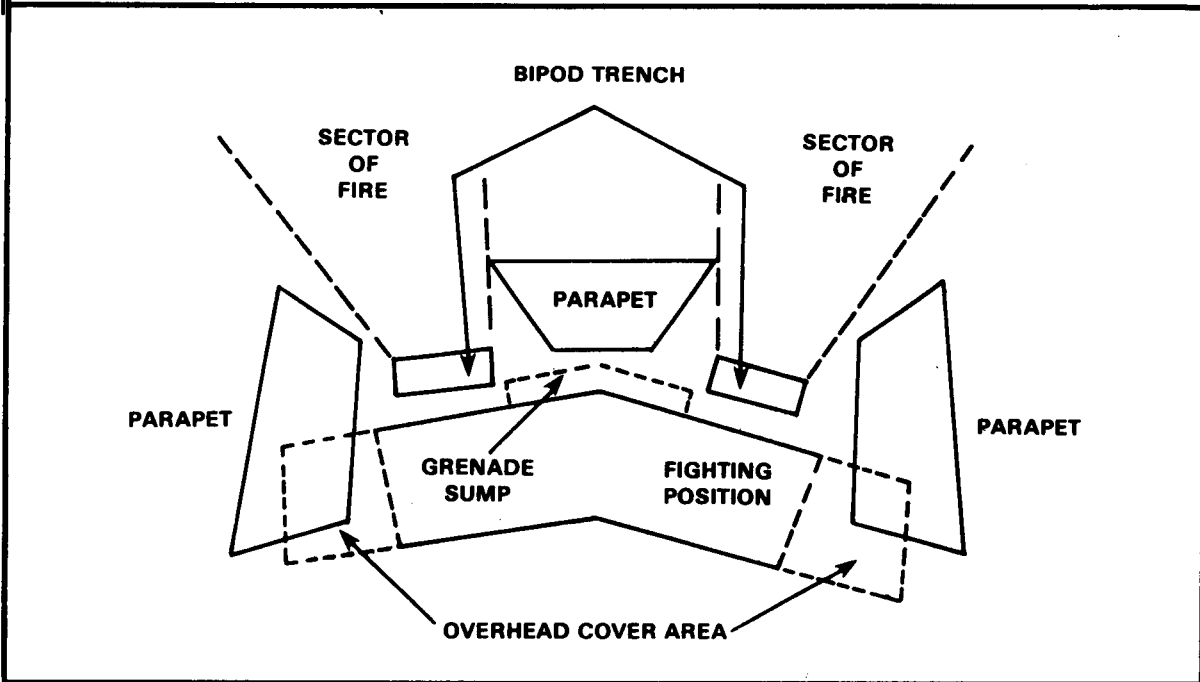
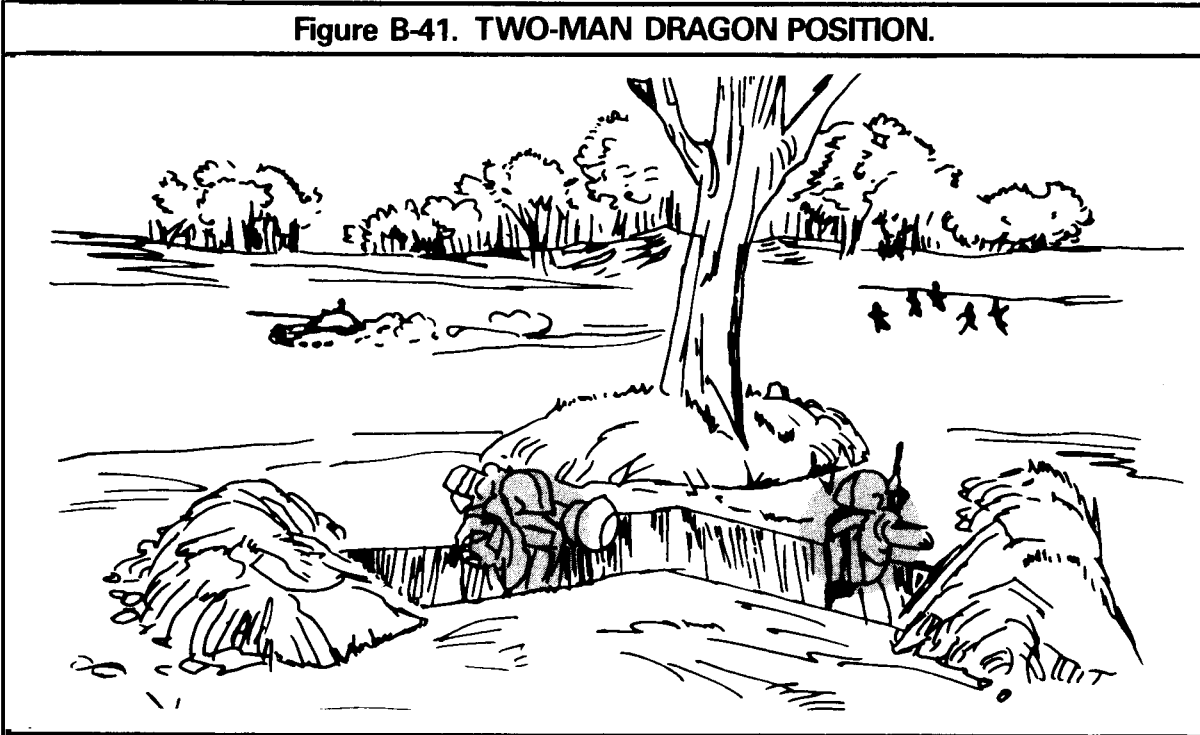
If necessary, the Dragon can fire to the front as well as to the oblique from a one-man position.



**Note:** The one-man firing position is prepared as previously discussed.

The two-man fighting position is wedge-shaped. It is best suited for use when more than one sector of fire can be covered from a single position. The design of the position gives the gunner frontal protection and allows targets to be engaged from the oblique or flank.

Figure B-41. TWO-MAN DRAGON POSITION.



Overhead cover is placed on the flanks of the one- or two-man Dragon position.



APPENDIX C

**FIRE DISTRIBUTION  
AND CONTROL**

**Section I. INTRODUCTION**

**C-1. GENERAL**

Battlefield survival of platoons and squads will often depend on how quickly and effectively they can fire on the enemy. Even when fighting outnumbered, platoons and squads must distribute their fires over an enemy force. To make every shot count, these fires must be controlled. Platoons must develop and use standard procedures for fire distribution and control. These procedures help quicken reaction time and reduce confusion during the first seconds of an engagement. Fire can then be redistributed as needed.

**C-2. PREARRANGED ACTIONS**

There will be times, mainly during defensive operations, when the platoon leader can direct the fires of the entire platoon. In offensive operation this often may not be the case. Prearranged methods will be necessary to rapidly place effective fire on enemy targets as they appear.

Visual control measures often may be used to start and stop engagement, shift fire, and signal prearranged actions. Often, though, the speed of mechanized warfare will require that fires be controlled using the radio. Alerts and command must be clear, accurate, and brief.

CONTENTS	PAGE
Section I. Introduction . . . . .	C-1
II. Fire Distribution Measures . . . . .	C-2
III. Fire Control Measures . . . . .	C-6
IV. Small Arms Fire . . . . .	C-9
V. Platoon Fire Planning . . . . .	C-10
VI. APC Range Card . . . . .	C-11

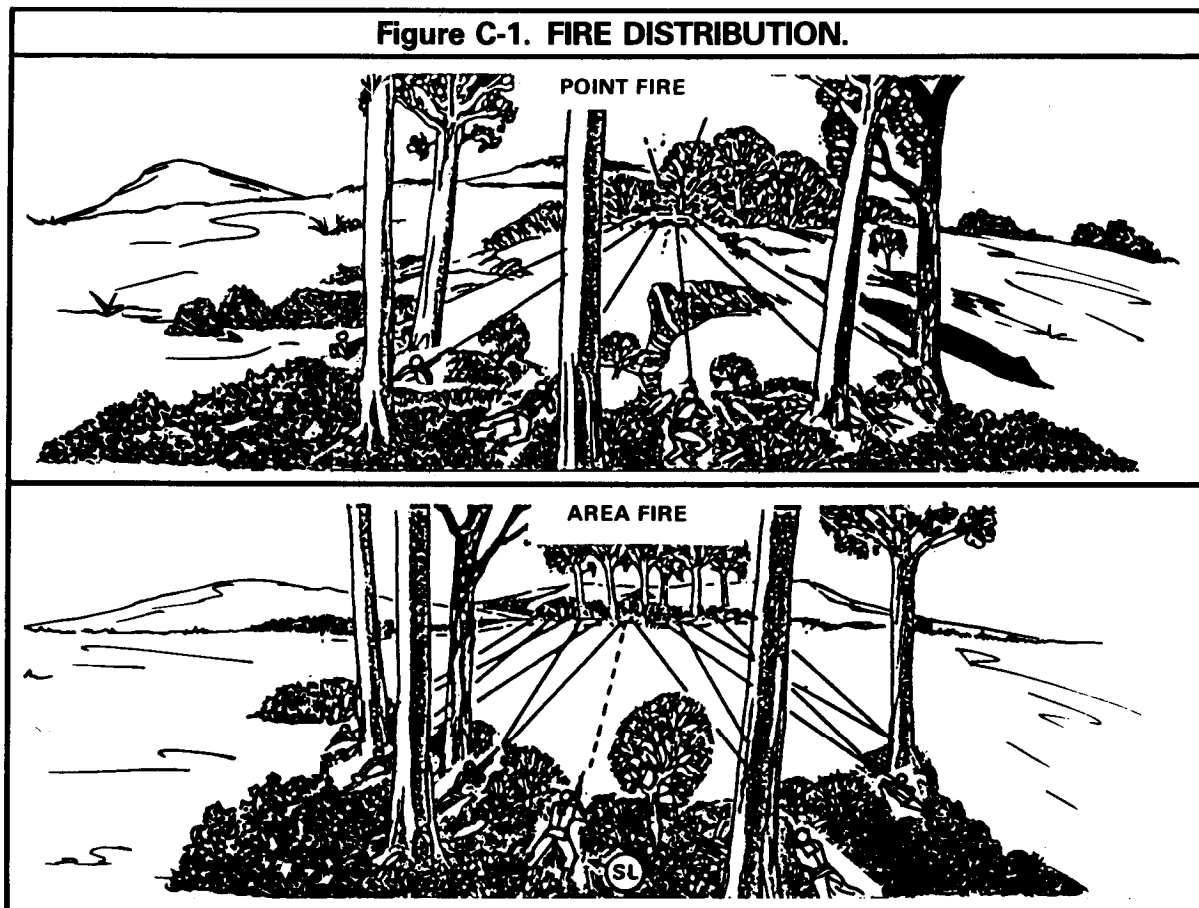
## Section II. FIRE DISTRIBUTION MEASURES

### C-3. GENERAL

Two ways to cover a target with direct fire are point fire and area fire.

**Point fire** is fire directed at one point; for example, an entire fire team or squad shooting at one bunker.

**Area fire** is fire that covers an area laterally and in depth. If a squad leader wants fire on a woodline, tracers may be fired to mark the center of the target. Men to his left fire left of the tracers, and men to his right fire right of the tracers.



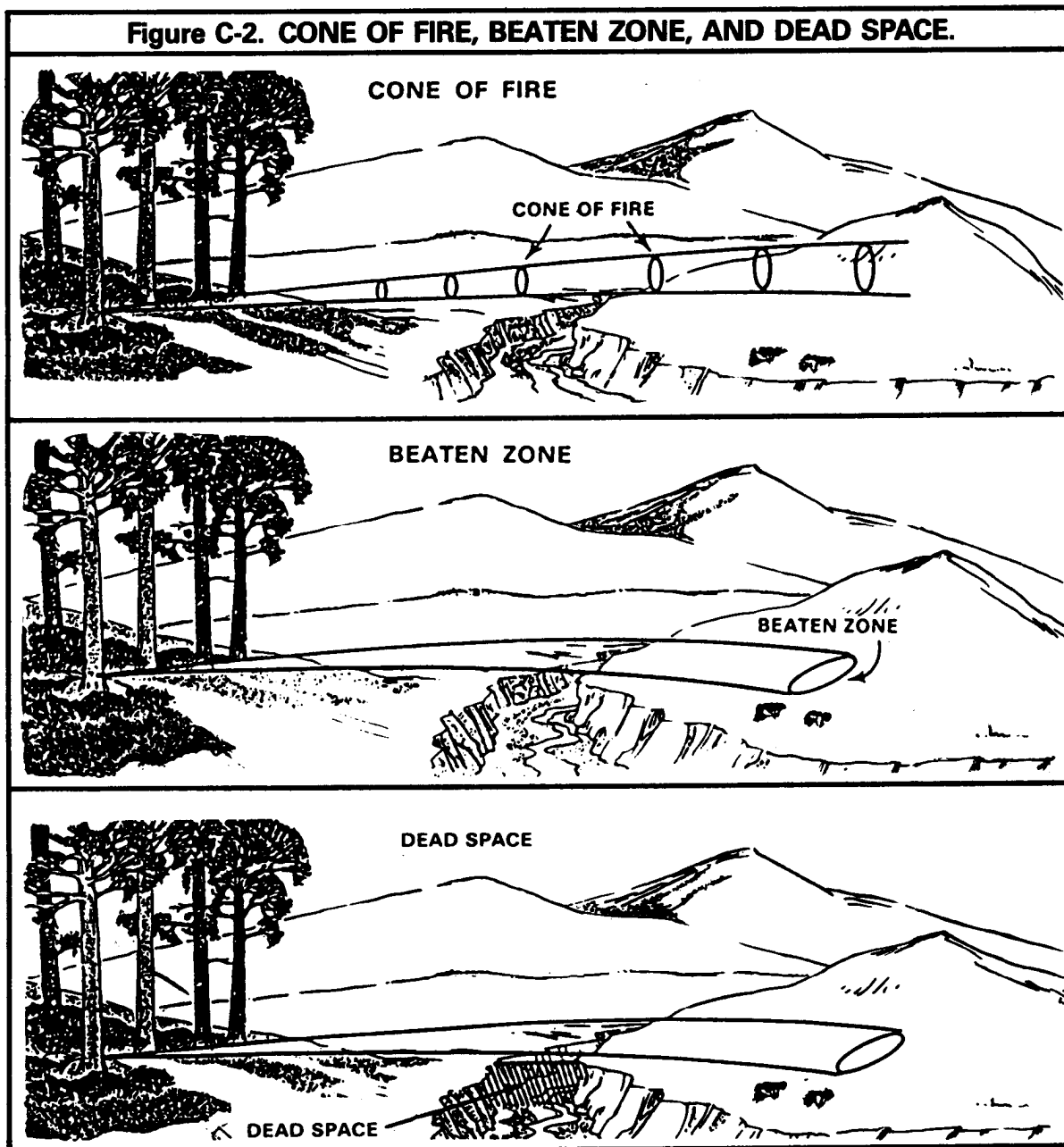
### C-4. DEFINITIONS AND DISCUSSIONS ON FIRE

**Suppressive Fire.** Suppressive fire is fire directed at the enemy to keep him from seeing, tracking, or firing at a target. It can be direct or indirect fire. Suppressive fire can also be smoke, placed on or near the enemy, that keeps him from seeing targets.

**Cone of Fire.** This type of fire is the cone-shaped pattern formed by the paths of rounds in a group or burst of rounds fired from a gun with the same sight setting. The paths differ and form a cone because of vibration, wind changes, variations in ammunition, etc.

**Beaten Zone.** This zone is the pattern on the ground formed by the rounds in the cone of fire as they fall.

**Dead Space.** This is an area, within the sector and range of a weapon, that can neither be hit by fire from that weapon nor seen by its gunner.

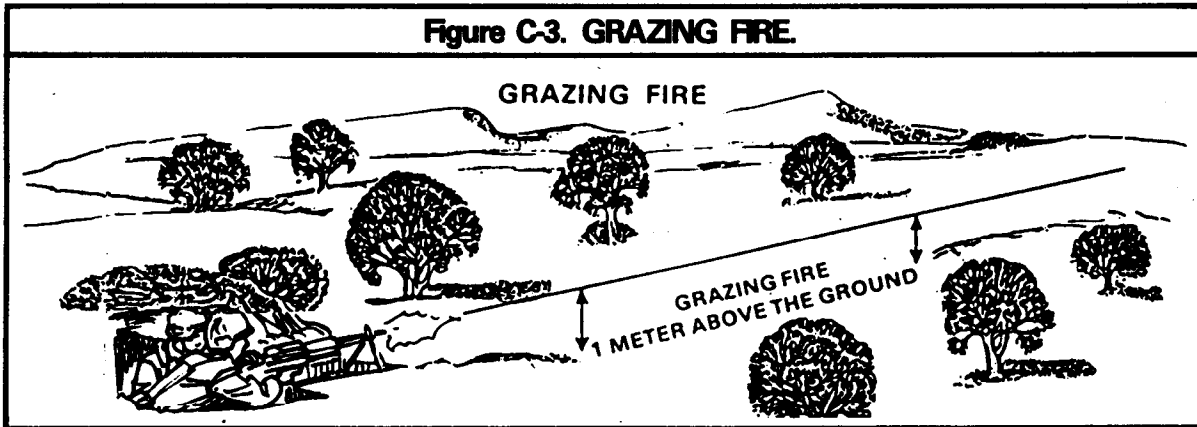


**C-5. CLASSIFICATION OF FIRE**

Rifle and machine gun fire is classified with respect to the ground and with respect to the target.

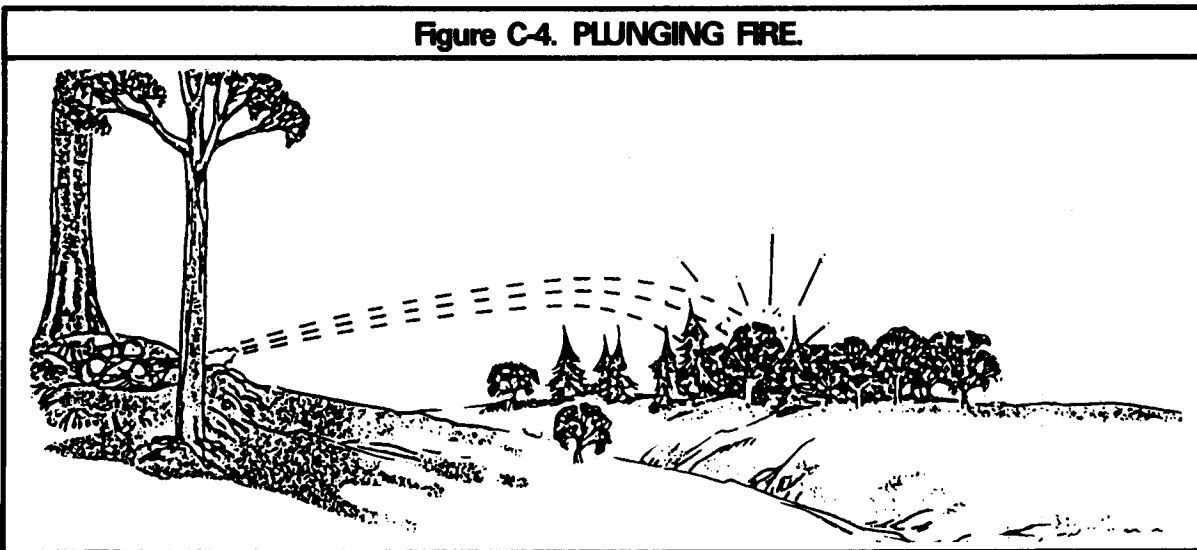
**Fire with Respect to the Ground.**

*Grazing fire* is fire in which most of the rounds do not rise over 1 meter above the ground.



*Plunging fire* is fire in which the path of the rounds is higher than a standing man except in its beaten zone. Plunging fire is at-

tained when firing at long ranges, when firing from high ground to low ground, and when firing into a hillside.



**Fire with Respect to the Target.**

*Frontal fire* is fire shot directly at the front of the target.

*Flanking fire* is fire shot into the flank of the target.

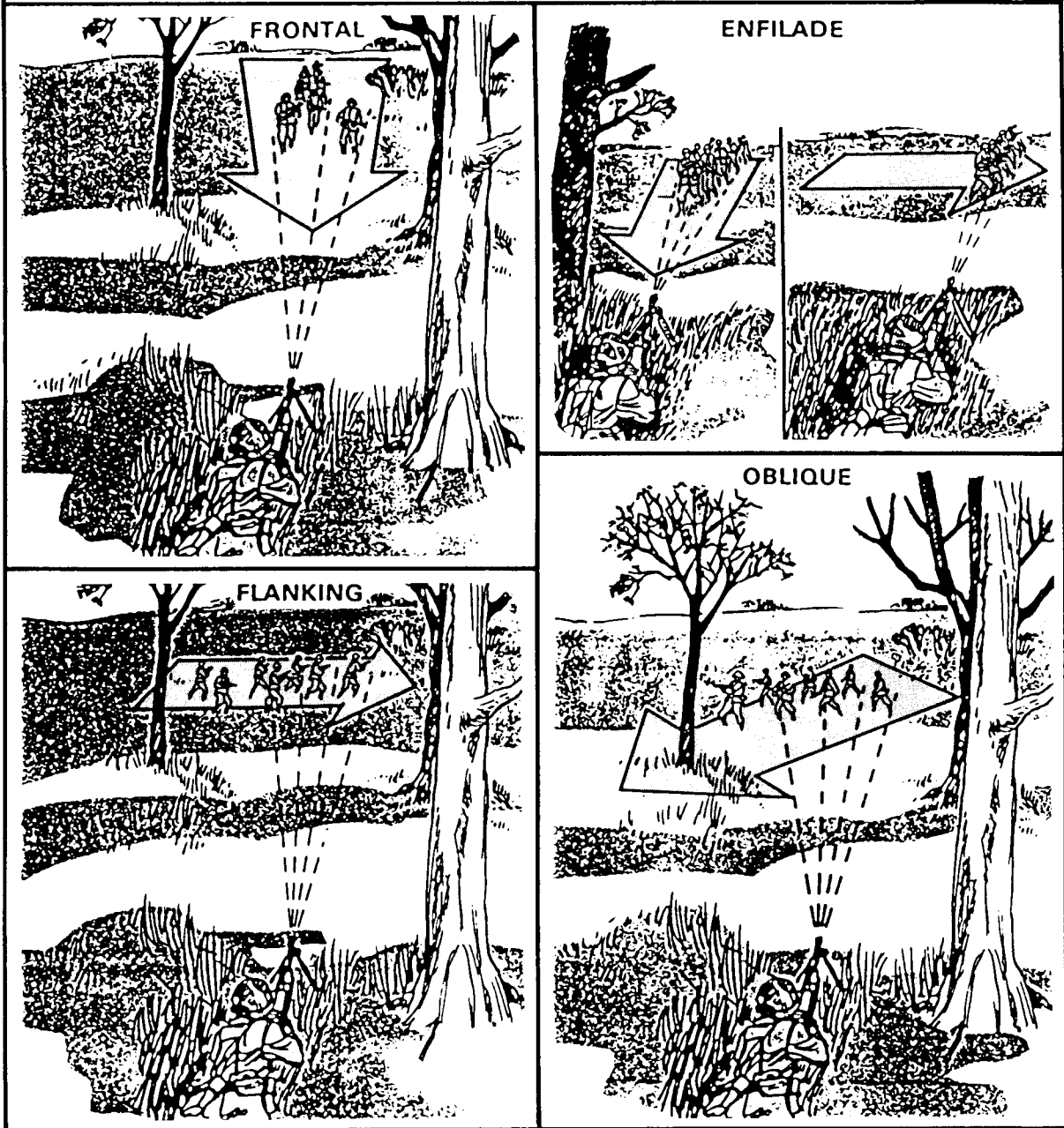
*Oblique fire* is fire where the long axis of the beaten zone is oblique to the long axis of the target.

*Enfilade fire* is fire where the long axis of the beaten zone is the same as the long axis of the

target. This type of fire is frontal, flanking, or oblique. It is the best type of fire with respect to the target because it makes best use of the

beaten zone. An example would be firing at the front of a column of soldiers or at a flank of soldiers on a line.

Figure C-5. FIRE WITH RESPECT TO THE TARGET.



### Section III. FIRE CONTROL MEASURES

#### C-6. GENERAL

In addition to controlling fires, fire control measures for direct- and indirect-fire weapons are used for:

- Massing fire.
- Distributing fire.

These measures are provided by commanders/leaders (battalion/company/platoon) to insure that:

- Targets are covered in depth.
- Fires of direct-fire weapons are integrated.

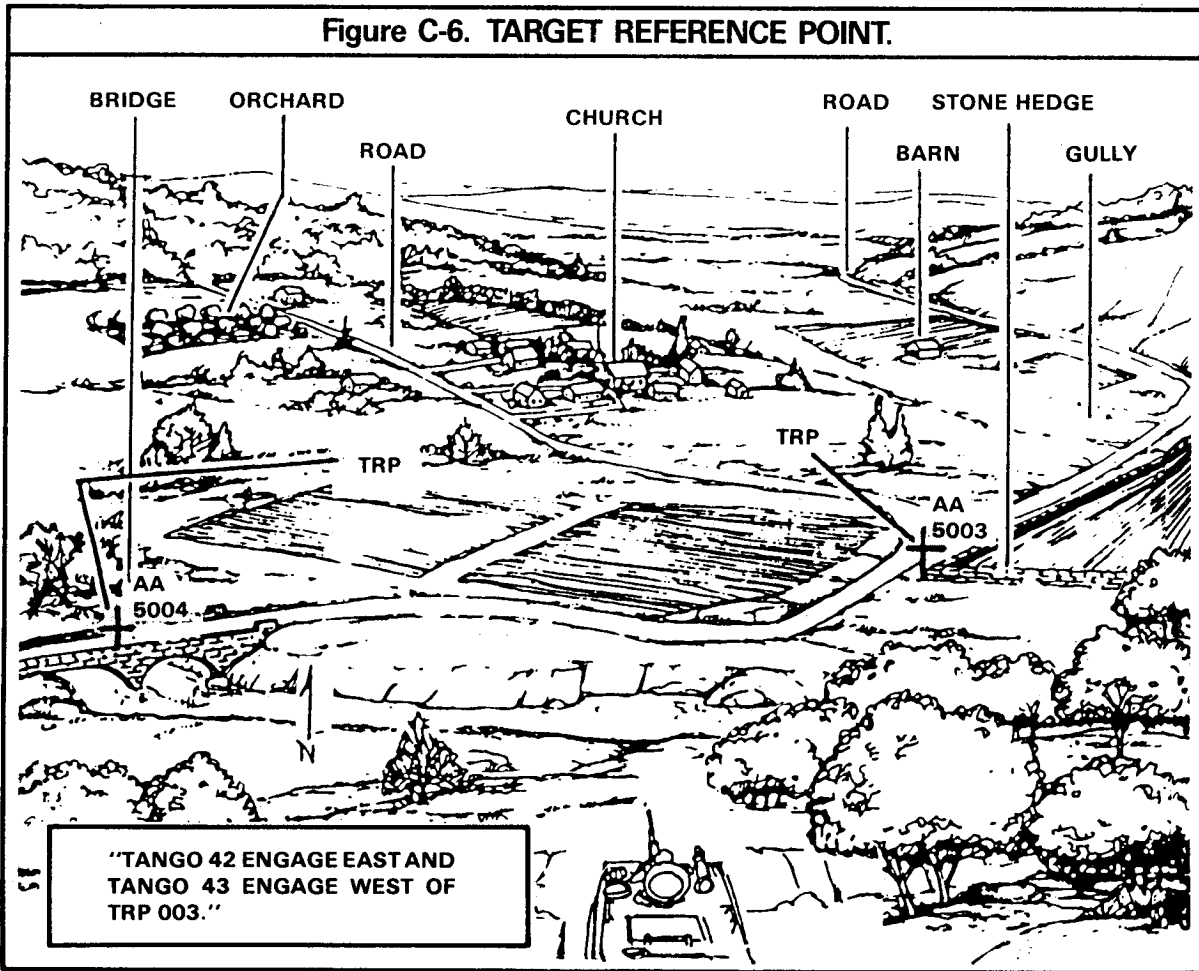
**More than one weapon system does not engage the same target (target overkill).**

Fire control measures must be simple and clearly understood. This section describes fire control measures which can be used by the platoon.

#### C-7. TARGET REFERENCE POINT

A TRP is used for identifying targets or controlling direct-fire weapons.

Figure C-6. TARGET REFERENCE POINT.



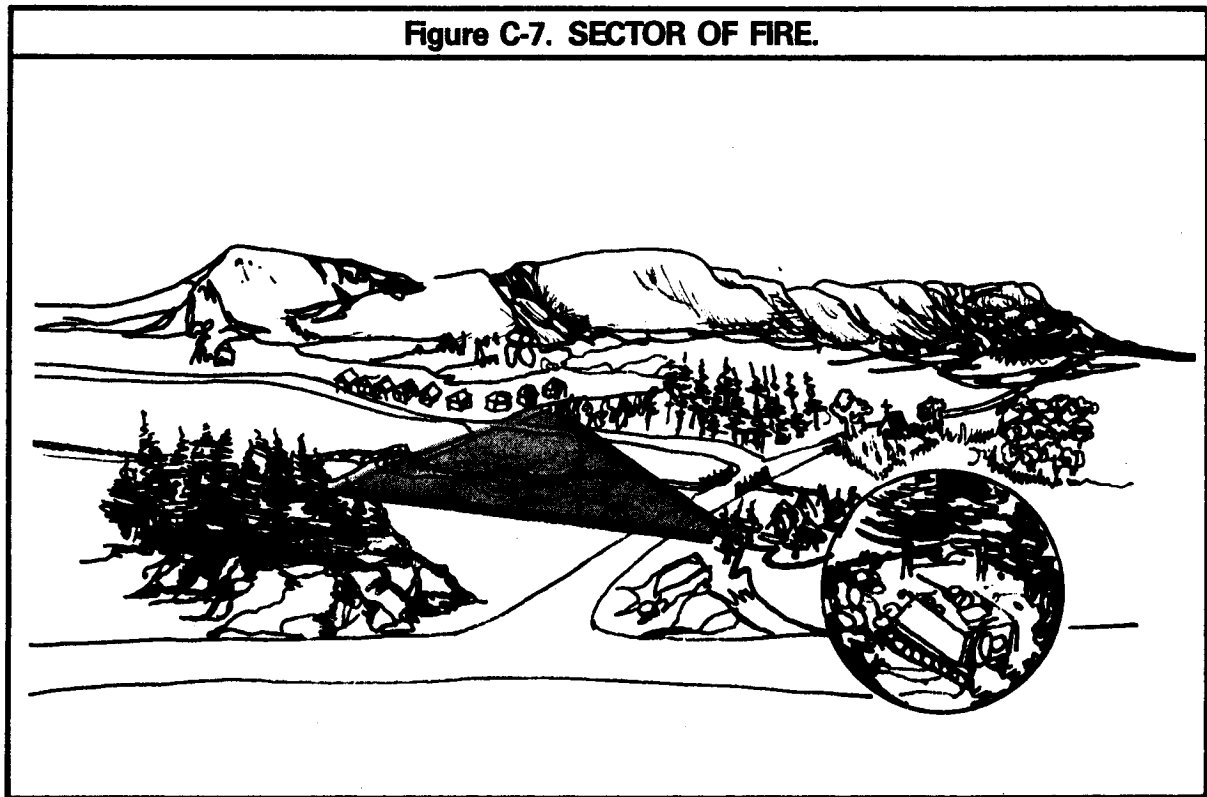
TRPs are usually designated by company commanders or platoon leaders for companies, platoons, squads, or individual weapons.

TRPs are actually indirect fire targets that also control direct fires. Each TRP is given an identification number by the platoon forward observer. The number consists of two letters and four numbers — for example, AB5010. These identification numbers are placed on range cards and sector sketches for easy reference and coordination. To simplify fire commands, TRPs may be referred to by the last three digits. For example, TRP AB5010 may be called TRP 010.

When using a TRP to designate targets or to shift fires, use compass directions (north, south, east, west). Each position may be viewing the TRP from a different direction.

### C-8. SECTOR OF FIRE

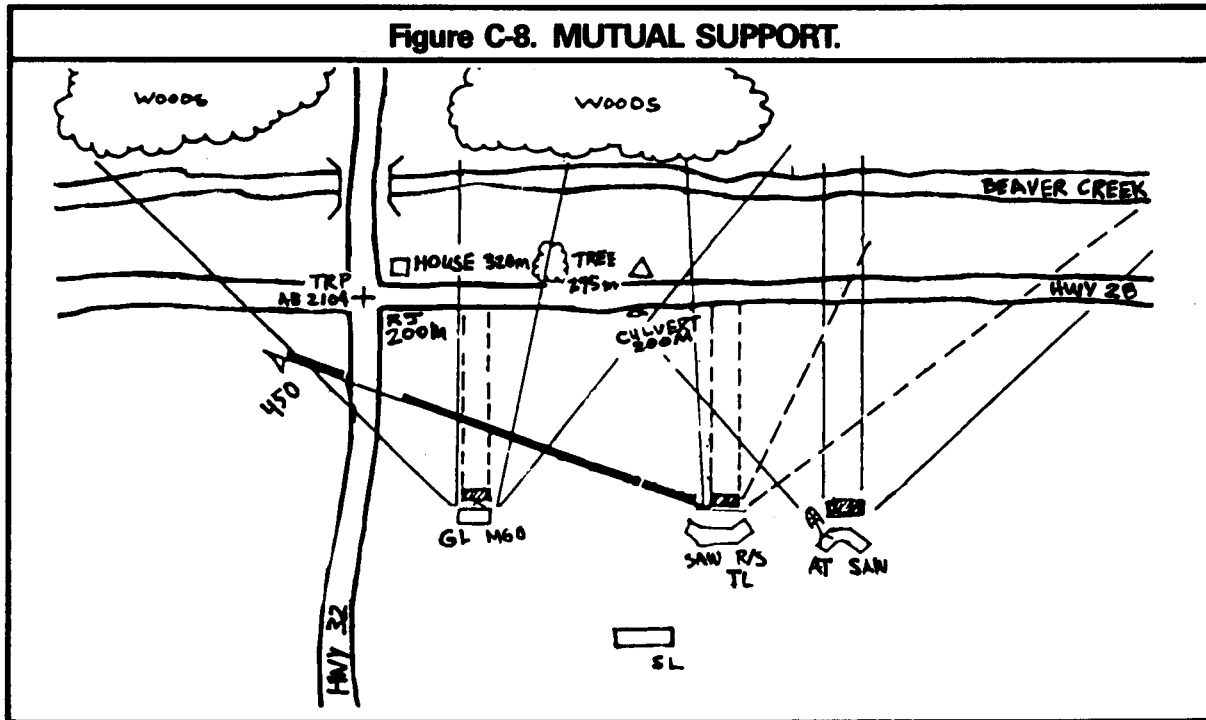
A sector of fire is an area, assigned to a unit (squad, platoon) or a weapon to cover by fire. It is designated by pointing out prominent terrain features (roads, streams, hills, ridgelines) that outline the sector. A sector of fire is assigned to each squad by the platoon leader to insure that the platoon's area is completely covered by fire.



Mutual support is a condition which exists when positions are able to support each other by direct fire. Such support prevents the enemy from attacking one position without being subjected to

direct fire from one or more adjacent positions. In offensive operations, mutual support applies to units in position to maneuver support of another unit.

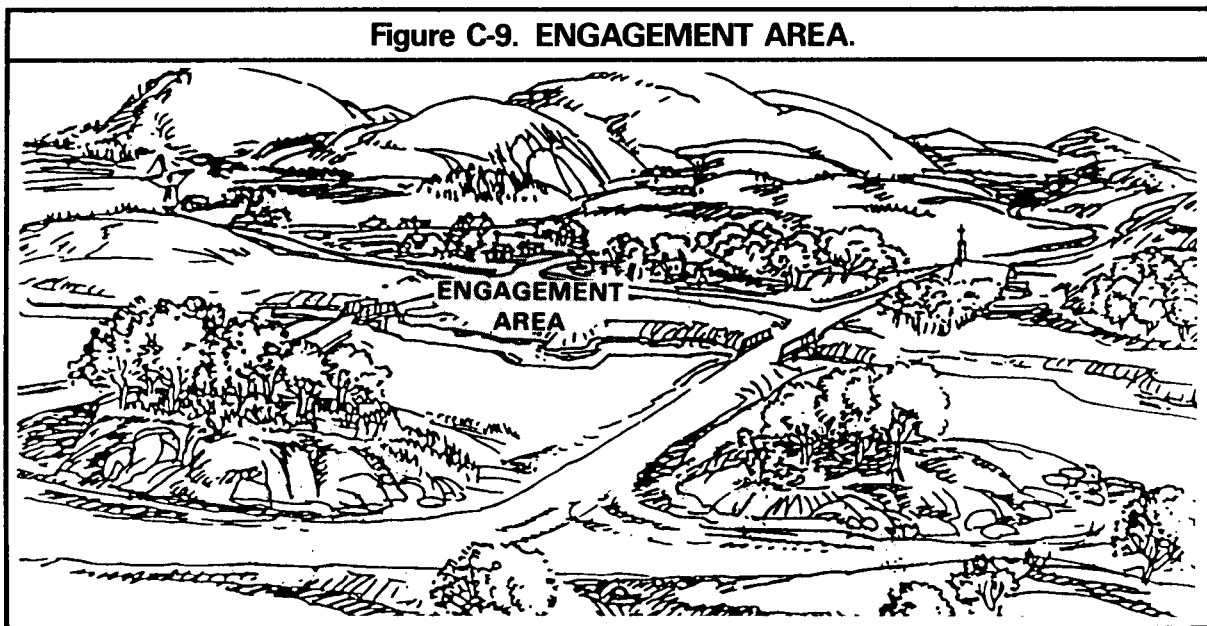
Figure C-8. MUTUAL SUPPORT.



### C-9. ENGAGEMENT AREA

An engagement area is an area clearly defined by natural boundaries.

Figure C-9. ENGAGEMENT AREA.





For an engagement area to be effective, either the enemy must choose to move through the area or he must be forced into the area by friendly action (obstacles, indirect fire, etc.).

Additional control measures are used within an engagement area to distribute fire (TRPs, sector stakes).

## C-10. PRIORITY TARGETS

Priority targets increase responsiveness to specific types of targets within an area or a formation.

They are normally designated by the battalion commander or company commander. When assigning priority targets, consideration is given to targets that present the greatest threat (BMPs with infantry still mounted, ZSU-23-4's if friendly air is available).

## Section IV. SMALL ARMS FIRE

### C-11. GENERAL

The dismount team uses specific techniques of fire for the offense and for the defense.

#### Offense.

During the assault as well as the fire and movement phase, fire distribution and control are critical.

Leaders and riflemen fire on that portion of the objective to their immediate front. If there are no targets to the front, they fire as far to the left and right as necessary to concentrate on enemy positions without endangering friendly forces.

Machine gunners and SAW gunners mainly engage enemy automatic weapons anywhere in the squad's portion of the objective. After destroying the machine guns or if none were available, they concentrate fires on targets within the squad objective.

Grenadiers also engage enemy automatic weapons as a first priority and then other targets throughout the squad objective.

The squad leader does not fire during the assault unless his firepower is more critical to the squad effort than his control of the squad.

All weapons including grenades and bayonets are used to overcome pockets of resistance. Dismount teams or team members who have gained a foothold in enemy positions support the

rest of the platoon by fire, and continue to assault through the objective until reaching the limit of advance.

#### Defense.

Infantry fighting positions are constructed so that individuals can observe and fire to the front as well as to the flanks. Two-man fighting positions work best. If one man becomes a casualty, the second man insures that a gap is not left in the defense. When attack is not imminent, observation to the front by one person is sufficient, allowing the other to rest. When attack is imminent, all squad members observe their assigned sectors of fire, normally to the flank of their positions. When under attack, squad members can concentrate fires on clearly defined targets that present the greatest threat to them; or the squad can distribute its fire throughout its sector of fire when a large number of enemy forces approach or when no single target presents a more critical threat.

Controlling the rate of fire is important because ammunition resupply may be difficult if not impossible during the battle. Fire discipline must be practiced. Only SAW gunners should be allowed to fire in the automatic mode. But even they fire only short bursts. Machine gunners attempt to fire in six-round bursts.

Leaders can use several methods to control fires.

Oral — voice commands provide the most positive control until the noise of battle drowns them out.

Arm-and-hand signals — effective only when squad members can see the leader.

Prearranged signals — visual or sound should be included in SOPs.

Passing orders from man to man — may be effective if fighting positions are close to each other.

Personal contact between squad/team leader and squad members — may be particularly appropriate when the leader desires to maintain control of ground-mounted Dragon or M60 machine gun fire.

## Section V. PLATOON FIRE PLANNING

### C-12. GENERAL

Platoon fire planning, a part of the platoon leader's troop leading procedures, starts as soon as the platoon leader gets a mission. Once begun, fire planning continues until the platoon mission is accomplished. Fire planning's primary goal is to prescribe how fire is to be distributed and controlled to best support the scheme of maneuver. The platoon fire plan furnishes the platoon leader information needed to distribute and control the fire of all available weapons.

### C-13. OFFENSIVE FIRE PLANNING

In offensive fire planning, it is normally not possible to plan fire in the same detail as in defensive fire planning. The platoon leader will have to rely more on fire commands and prearranged SOP signals to rapidly bring effective fire on enemy targets.

Offensive action does, though, require planning. A platoon leader must plan how he will engage known or suspected enemy targets, where suppressive fire may be needed, and how he will control platoon fires against both planned targets and targets of opportunity.

Fire planning should include a thorough analysis of the type of threat expected. This will aid the overwatch element in tailoring the mix of mounted Dragons and caliber .50 machine guns to suit the situation. The analysis will insure that the proper weapon is ready for immediate action.

### C-14. DEFENSIVE FIRE PLANNING

Defensive fire planning is normally deliberate and detailed because more time will be available to consider:

**Individual carrier targets.**

**Platoon targets.**

**Indirect fire targets.**

**Fire distribution and control measures.**

To develop a defensive fire plan, the platoon leader:

Assigns a primary firing position and one or more alternate positions to each squad APC, and assigns each a primary and a secondary sector of fire.

Designates platoon point or area targets and other control measures, such as TRPs, to coordinate the fire when more than one vehicle is firing into the same engagement area or sector.

Receives target information from squad leaders (normally provided on sector sketches and individual weapon range cards). The platoon leader reviews this target information to insure that fire is equally distributed across the entire platoon sector and that sufficient control measures are established.

Completes the platoon fire plan and gives a copy of the platoon sector sketch to the company/company team commander. If time is available, he has each squad leader make a copy of the sector

sketch. If time is short, he may only be able to give the squad leader a quick briefing on the sector sketch.

## Section VI. APC RANGE CARD

### C-15. GENERAL

A range card is a rough sketch of the terrain that a weapon is assigned to cover. It shows possible target areas and terrain features plotted in relation to a firing position. The information is used to plan and control fire, to rapidly detect and engage targets, and to orient replacement personnel or units.

### C-16. PREPARING A RANGE CARD

Each carrier gunner normally prepares range cards for his mounted weapons. He prepares one for each primary alternate, and supplementary position designated in the defense and for any static position when enemy contact is possible, such as a position in an assembly area. Each range card has at least the following information:

**The symbol for the weapon covering the sector.**

**The azimuth (degrees) and distance (meters) of the firing position from an easily recognizable terrain feature. (This serves as an easy reference to locate the firing position.)**

**The boundaries of the area assigned to be covered by observation and fire, to include both primary and secondary sectors.**

**Areas where targets are likely to appear (engagement areas) and the range and azimuth to them from the firing position.**

**Dead space or areas that cannot be observed or covered by fire.**

**Tie in with the weapon system on the right.**

**Identification data:**

**Unit designation (no higher than company).**

**Time and date of preparation.**

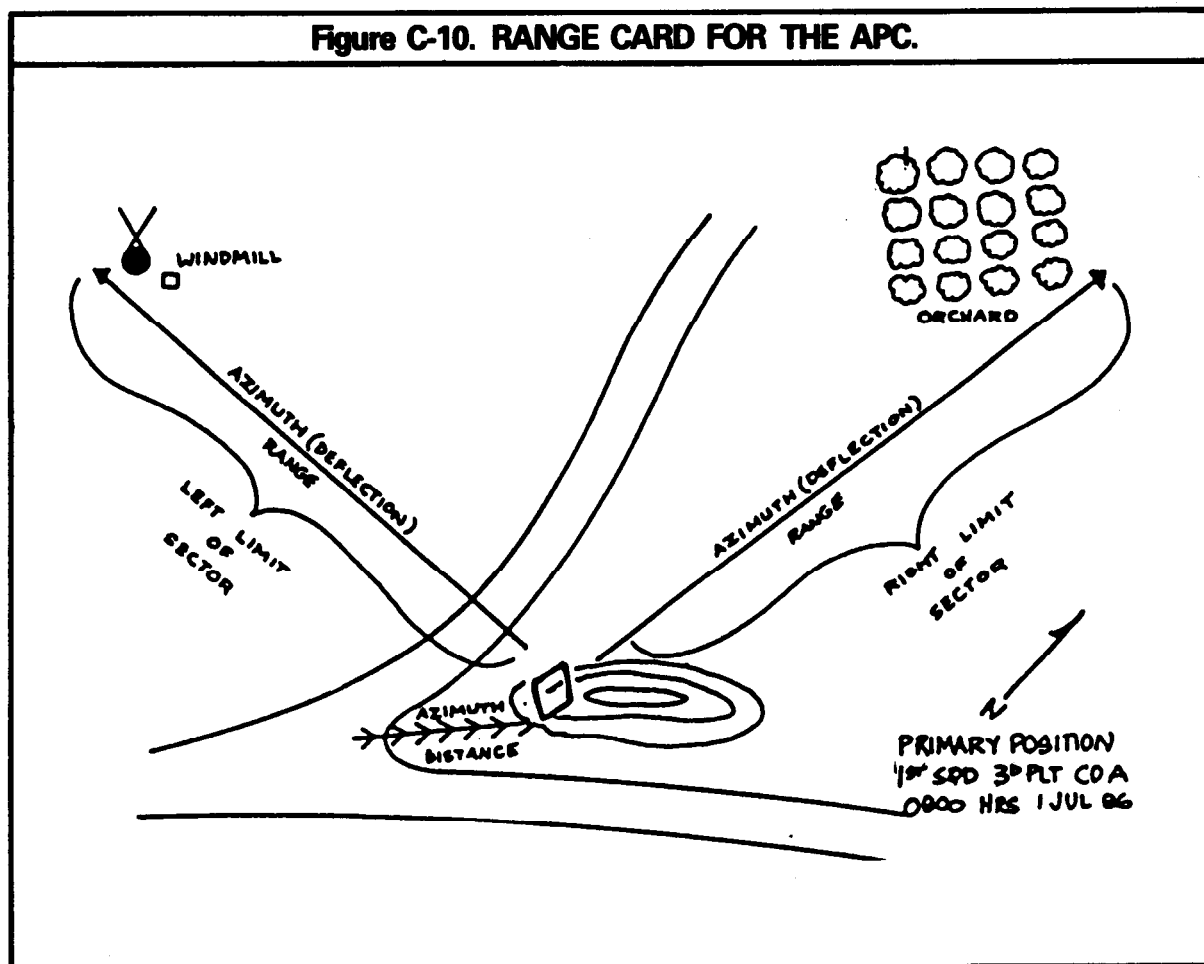
**Firing position (primary, alternate, or supplementary).**

**Magnetic north arrow.**

Depending on the priority of work established, and once the squad leader tells him the sector of fire and other required information, the gunner prepares a range card as soon as possible after moving into a firing position. Two copies must be prepared. One is kept on the carrier, and the other is given to the platoon leader. The platoon leader uses the range cards and squad sector sketches to prepare a platoon sector sketch. A standard preprinted sheet of paper is best for drawing the range card, but anything the gunner can write on, such as notebook paper or a C-ration box, can be used.

The APC map symbol is drawn in the lower center of the range card. A nearby terrain feature is shown and a line is drawn from it to the APC symbol. The magnetic azimuth (degrees) and the distance (meters) from the terrain feature to the firing position are written along the line.

Figure C-10. RANGE CARD FOR THE APC.

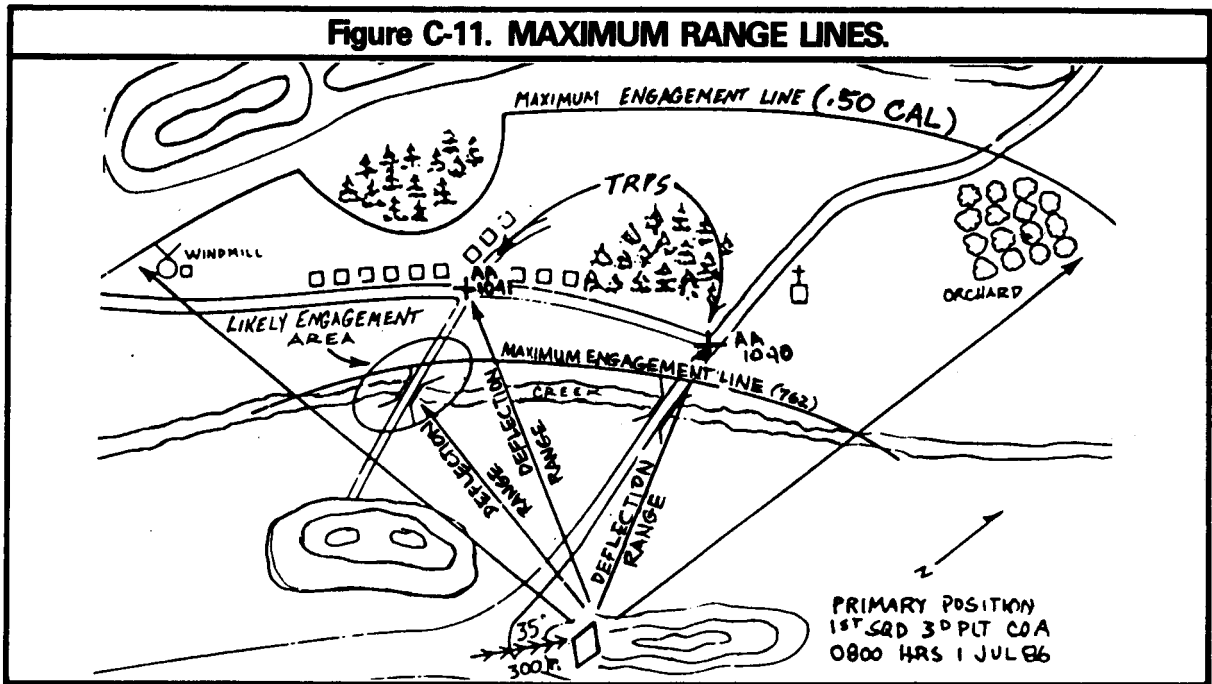


The primary and secondary sectors of fire are shown by drawing solid lines for the primary sector and dashed lines for the secondary sector. These represent the left and right limits of the sectors. Easily recognizable terrain features that can be used to identify the sectors are also sketched on the range card. The magnetic azimuth, deflection, and range to the far limit of the sectors of fire are written along each line. The tie-in with the weapons system on the right is shown by drawing a line to the point of the intersection between the fields of fire and by writing in the type of weapon system.

A sketch of the terrain within the sector of fire is then completed. For easy identification, terrain features are labeled.

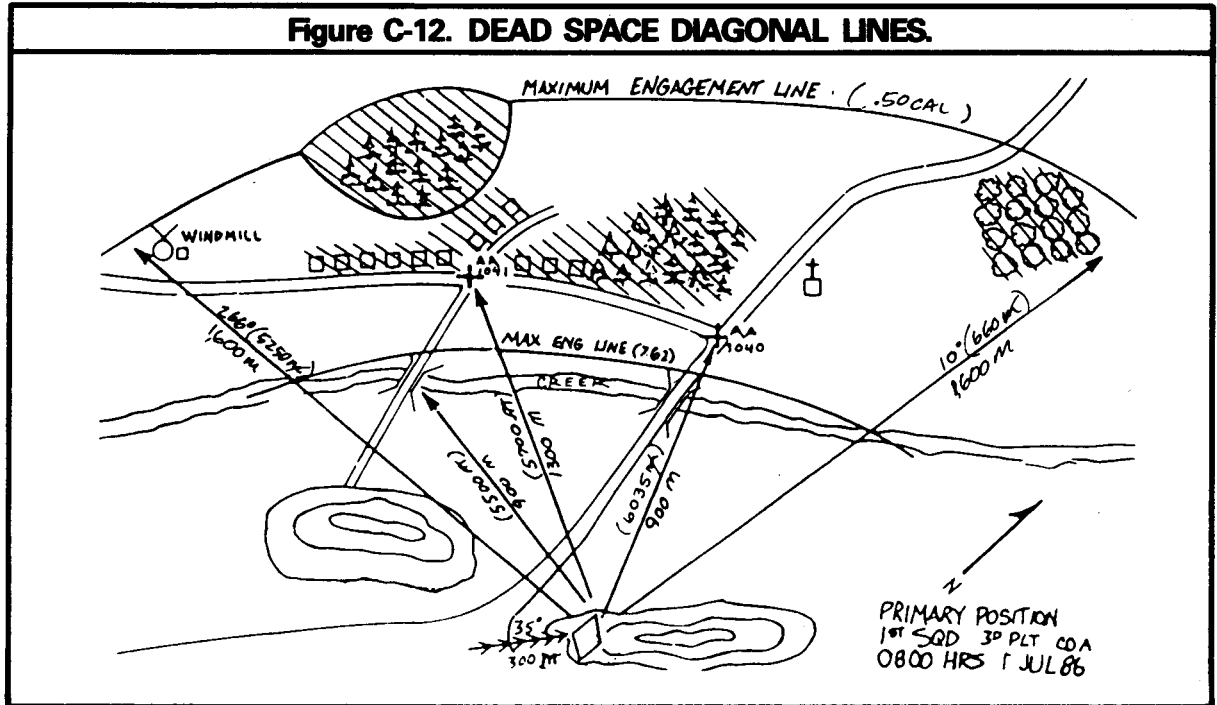
TPRs chosen by the platoon leader are placed on the range card, and other locations where a target would be likely to appear are also marked. A line, with the range and deflection, is drawn to each TRP and every likely target location.

A maximum engagement line is drawn across the sector of fire for the caliber .50 machine gun and Dragon, if mounted. These lines depict the maximum range which targets can be effectively engaged with each of those weapons. If there are no obstructions in the sector, the lines are curved and drawn at the maximum engagement range of each weapon. If there are obstructions that limit the range at which targets can be engaged, that part of the area is shaded to show dead space.



Dead space is shown by drawing diagonal lines across the area or writing the word "dead space."

Deadspace is covered by the M203 and indirect fires.



The last step in preparing the range card is to orient it with the terrain and draw on it a magnetic north arrow. Identification is then added — unit designation, time and date of preparation, and type of position (primary alternate, or supplementary). The information is taken from the sketch and transferred to the data section. Target No. 1 is always the priority target. The deflection is taken from the azimuth indicator pointer and the elevation is taken from the gun elevation pointer.

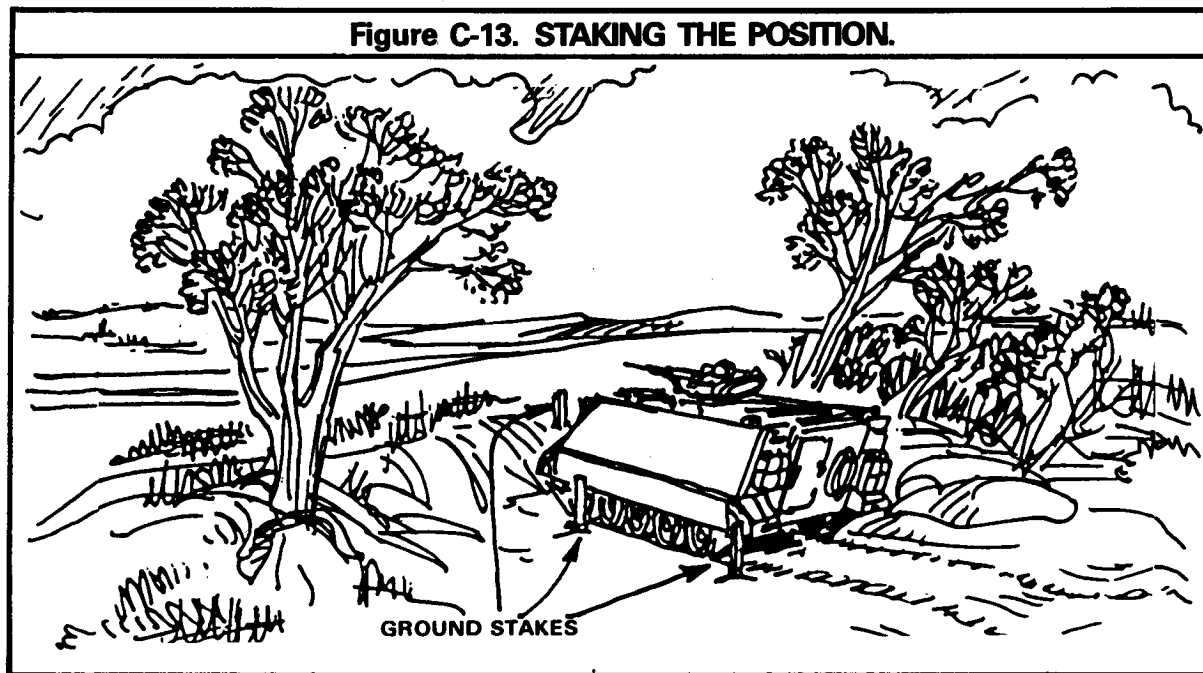
Once the range card is completed, it should be given to the squad leader so that he can check it for accuracy and completeness before it is given to the platoon leader.

## C-17. MARKING A FIRING POSITION

After a firing position range card has been completed, the position should be marked on the ground with stakes. This enables the same APC or an APC from a relief unit to reoccupy the firing position and use the data from the prepared range card for the position.

**Staking the Position.** Once the position range card is completed, the position should be staked before the vehicle is moved to any hide position or to an alternate or supplementary position. Three stakes are needed to mark the position, as shown in the illustration.

**Figure C-13. STAKING THE POSITION.**



One stake, centered on the driver's station and touching the hull, is placed in front of the vehicle. This stake should be long enough so that the driver can see it as he moves into the position. The other two stakes are placed parallel to the left track, one lined up with the front wheel hub and one with the rear road wheels. The stakes should be placed close to the vehicle with only enough

clearance to let a driver move into position without knocking them down.

The stakes should be driven deep enough in the ground so that a strong wind will not knock them down. Engineer tape or luminous tape can be placed on the friendly side of the stakes to make them easier to see during limited visibility.

**Moving into Position.** If the situation permits, a ground guide can be used to help the driver move the vehicle into position.

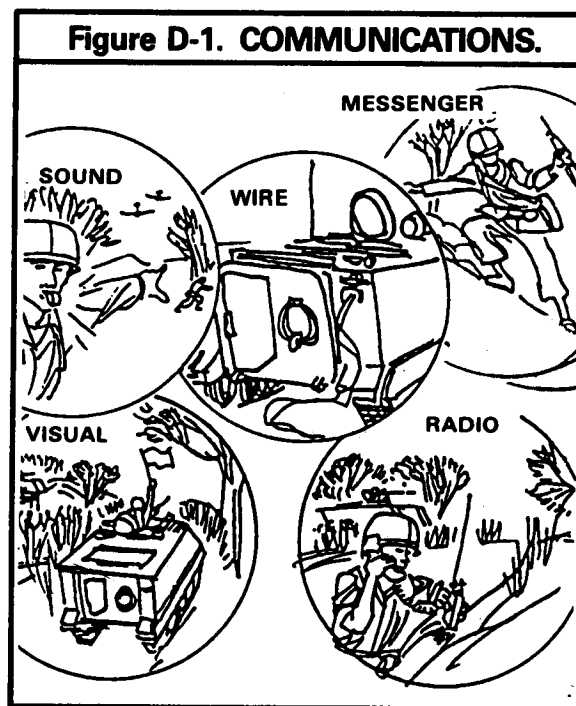
If enemy fire prohibits the use of a ground guide, the driver moves in parallel to the two side stakes with the front stake centered on the driver's station.

Once in position, the gunner should check the range and azimuth for one of the targets on the range card. If the vehicle is correctly positioned, the data from the range card can be used. If not, the gunner should tell the driver which way to move the vehicle to align the target. Only minor adjustments should be necessary.

APPENDIX D

**SQUAD/PLATOON  
COMMUNICATIONS**

**Section I. TYPES OF COMMUNICATIONS**



**D-1. GENERAL**

Squads and platoons must be able to communicate to control and coordinate movement and fires, send and receive instructions, request logistical or fire support, and gather and distribute information.

There are many ways to communicate. Each has its own capabilities and limitations. The primary types of communications available at platoon level are visual, sound messenger, wire, and radio. A backup means of communicating should always be planned in case the primary method fails. The means of communication chosen will depend on the situation.

CONTENTS		PAGE
Section I.	Types of Communications . . . . .	D-1
II.	Radiotelephone Procedures . . . . .	D-11



## D-2. VISUAL

Visual signals are the most common means of communicating in squads and platoons. Arm-and-hand signals, flags, flashlights, and pyrotechnics can be used to rapidly transmit messages and instructions. A disadvantage is that these signals may be seen by the enemy, but using the terrain properly lessens that chance.

Another danger is that visual signals require visual contact between the sender and the receiver, and the signals may be misunderstood. To overcome this disadvantage, every man must be able to send, receive, and understand messages using visual signals. Squads and platoons must continually practice these signals.

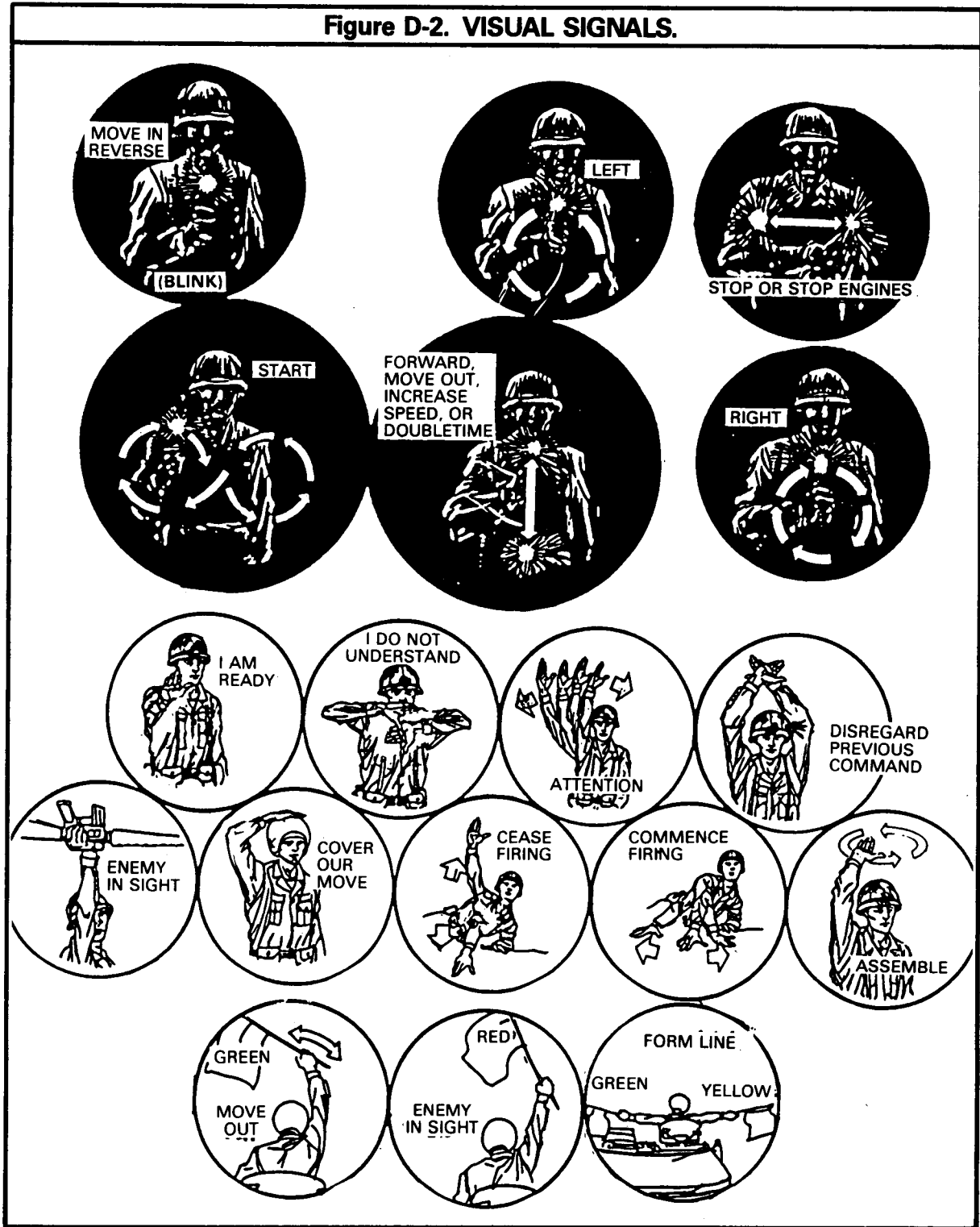
Arm-and-hand signals are the basic way of communicating within squads and platoons when visibility is good. Flag signals are easier to see and understand at greater distances than are arm-and-hand signals. Each APC and each tank has a set of three flags — red, green, and yellow. Flashlight signals are used mainly for communicating during darkness. For identification, each squad or platoon may use a differently colored filter.

Pyrotechnics can be used as signals at any time. In daylight, and in conditions of limited visibility such as fog, rain, or falling snow, they are less effective. Pyrotechnic signals are usually prescribed in the communications-electronics operating instructions. Squads and platoons are not to improvise and use their own pyrotechnic signals. They may conflict with the CEOI and confuse other units. Pyrotechnic messages must be confirmed as soon as possible because the originator cannot be sure that the signal was seen and understood.

**CAUTION**  
**PYROTECHNIC SIGNALS ARE EASY**  
**FOR THE ENEMY TO INTERCEPT**  
**AND IMITATE.**

Mirrors, headlights, and panels are other means of visual communication but are difficult to use on the move. A complete list of each type of visual signal is in FM 21-60.

Figure D-2. VISUAL SIGNALS.



**D-3. SOUND**

Sound communications include such simple devices as whistles, horns, gongs, and explosives. Sound signals are used mainly to attract attention, transmit prearranged messages, and spread alarms. Sound signals work but only for short distances. Battle noises cut down the range and reliability of sound signals. They are also open to enemy interception, so their use may be restricted for security. To avoid any misunderstanding, sound signals must be simple. They are usually prescribed by the unit SOP and the CEOI.

**D-4. MESSENGER**

Messengers are fairly secure means of communicating and usually the best way to send long messages that cannot be delivered personally by a commander. Using a messenger, though, is the slowest means of sending information, and it depends on the messenger not being delayed, captured, or killed.

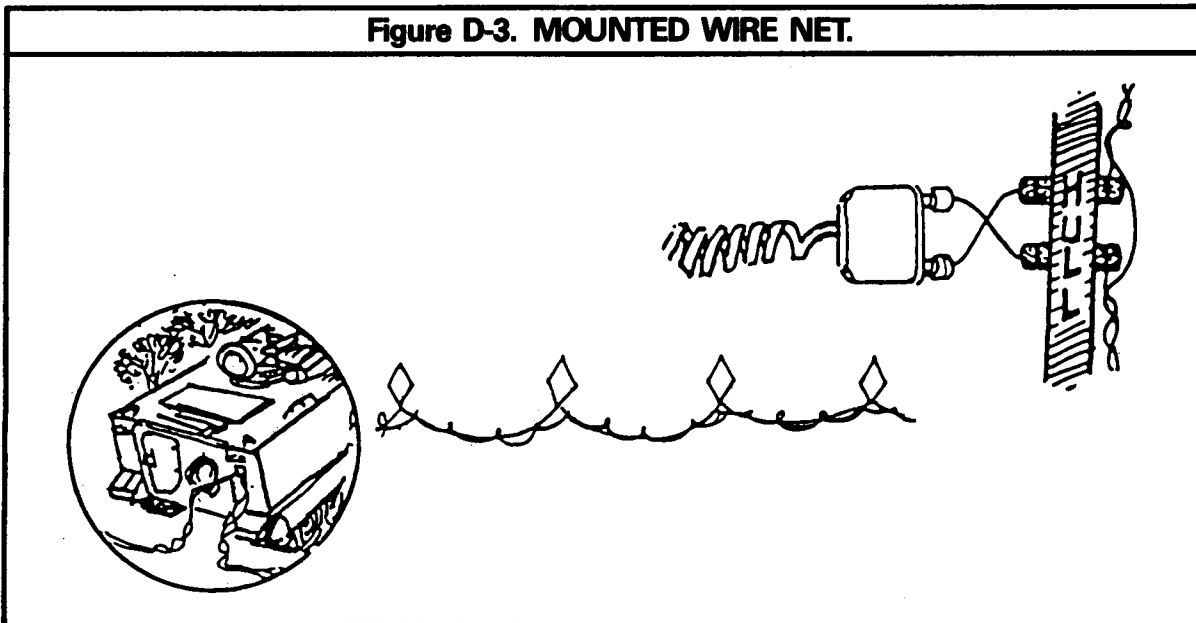
Message sent by messenger should be clear, concise, and complete. No unnecessary words should be used. If there is a chance the messenger might be captured, the message should be in code using the operational code in the CEOI.

**D-5. WIRE**

Wire communications should be used whenever tip platoon expects to stay in one place more than an hour. When possible, the whole platoon is tied together through the use of a wire net. The wire net consists of field wire laid among carrier teams and dismount teams. All field communications wire (WD-1 and combat assault) consists of two independently insulated strands twisted together to form one wire. There are several ways the platoon wire net can be set up, depending on whether the platoon is totally mounted or partially dismounted.

In the **mounted mode**, the wire is laid from vehicle to vehicle and connected to the terminals on the right rear of each vehicle. Because TA-1 telephones (which are sound powered) are being used, one strand of the wire must be cut, the insulation stripped away and the wire ends attached to the wire terminal connectors on the right rear of the APC. The TA-1 is connected to the terminals on the inside of the vehicle by using a short length of wire.

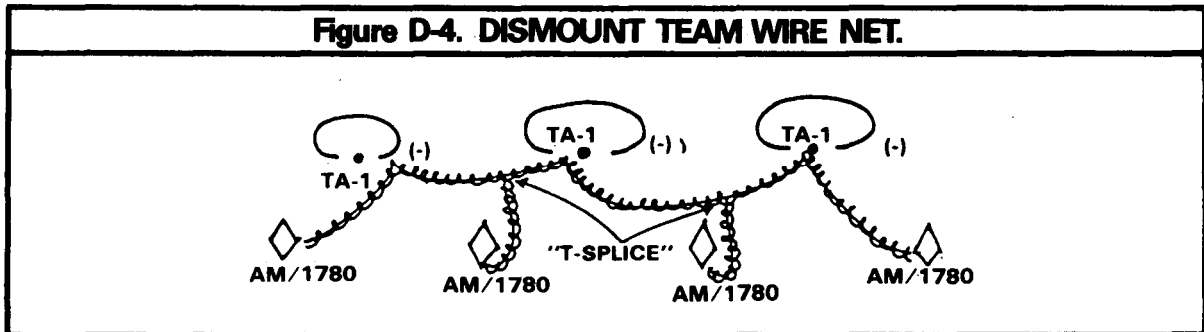
**Figure D-3. MOUNTED WIRE NET.**



In the **dismounted mode**, situations are of two types.

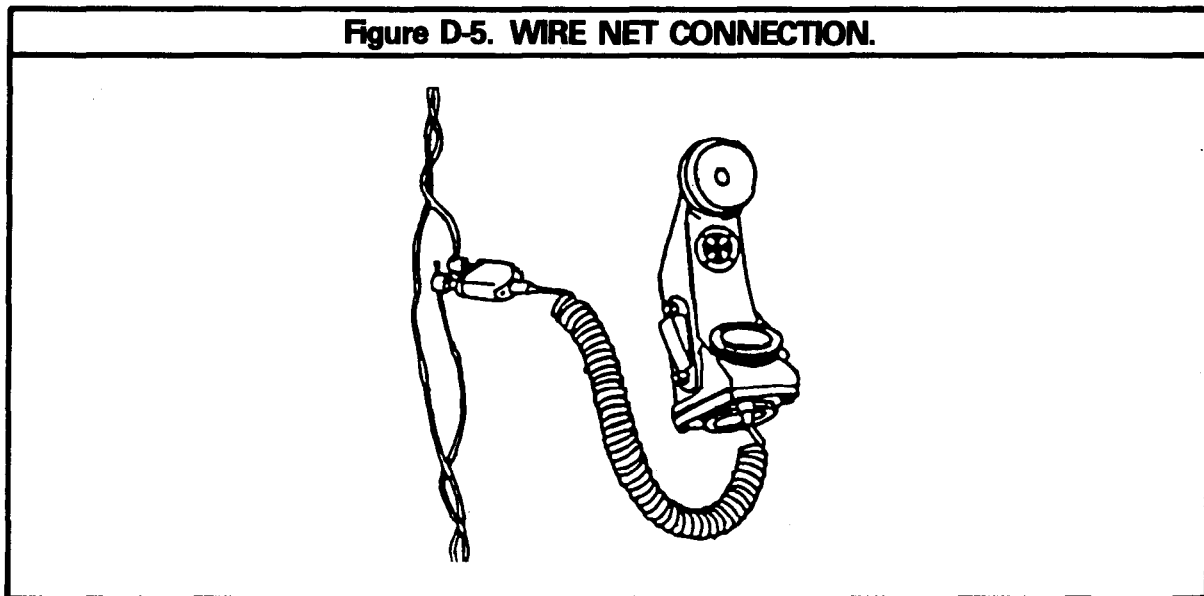
(1) In the first type, the platoon occupies one position with both the carrier element and the

dismount element deployed. The wire net would be made by connecting all the platoon carrier teams and dismount teams together by wire.



Because the dismount teams use TA-1's (as in the mounted mode), one strand of the wire must be cut, the insulation stripped back, and the wires attached to the binding posts of the TA-1 to connect the dismount teams to the wire net. Be-

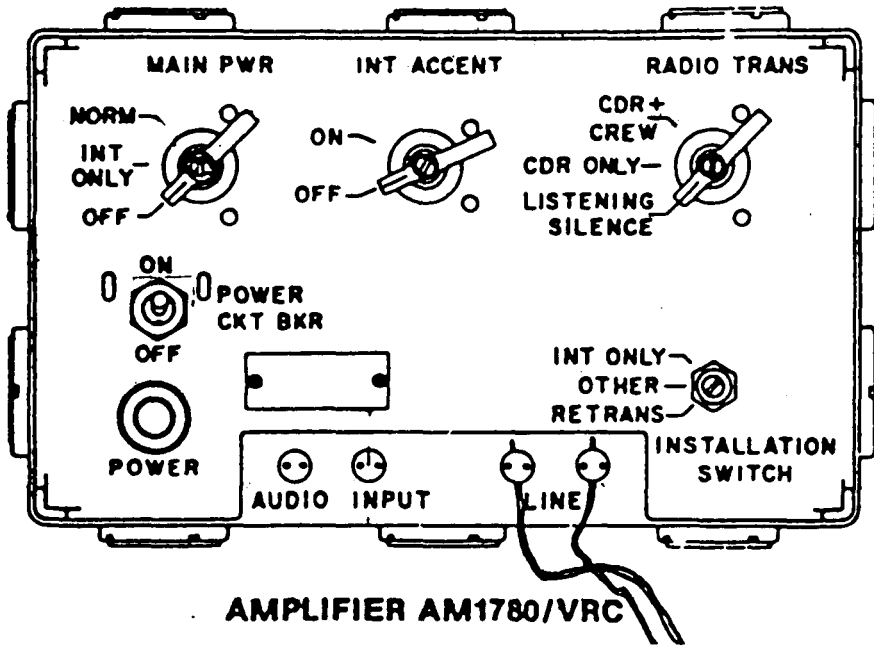
cause one strand of wire must be cut, the wire net is in series, which means that if the wire is broken or disconnected the whole wire net will cease to function.



The carrier teams are connected to the wire net by stripping the insulation from the end of the strands of wire and inserting the wire ends into the binding posts of the AM/1780 audio fre-

quency amplifier. The AM/1780 must be turned on while in the wire net. If it is turned off the wire net will not work.

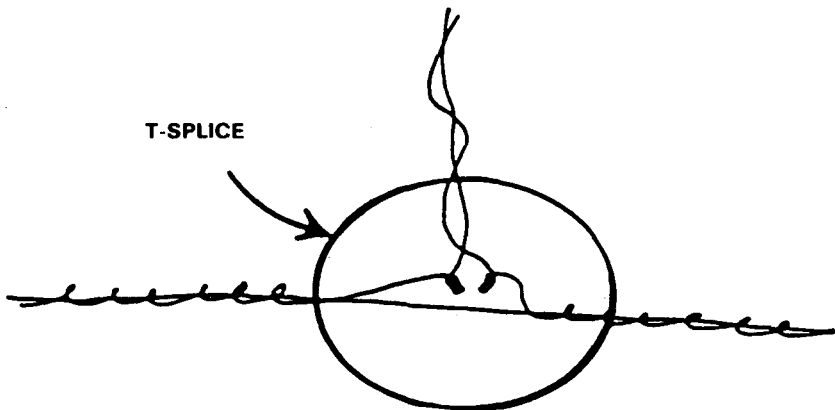
**Figure D-6. AM/1780 AMPLIFIER.**



The T-splice method would be used for vehicles that connect to the wire net between the ends of the wire net. If the wire net starts at an APC, the wire would be connected to the binding posts of the AM/1780. This wire would be

T-spliced into the wire net by cutting one strand of the wire, stripping back the insulation from the ends, and splicing the ends to the wire from the AM/1780.

**Figure D-7. T-SPLICE INTO WIRE NET.**



**NOTE: A communications check must be made to insure that the wire net works. The C-2296 control box must be set in the ALL position. The AM/1780 is set for normal operations. If a carrier team cannot communicate with the rest of the teams, the strands of wire in the AM/1760 binding posts must be reversed and another check made.**

In the second type of dismounted situation, the dismount element is in a position different from that of the carrier element. In this placement, the dismount teams would use their TA-1 telephones to establish a platoon hot loop among themselves. When using the TA-1, one of the wires must be cut and the insulation stripped back to connect the wire to the telephone binding posts. The telephones do not have to be on the same single wire. Only one wire needs to be cut to connect the telephone. The wire net is laid from team to team until all teams are connected to it.

**Figure D-8. TEAM-TO-TEAM CONNECTION.**



Wire can also be laid between the carrier team and the dismount team of the same squad. To do this, the telephone must be with the dismount team. If a second telephone is not available, the wires must be connected directly into the APC's AM/1780.

After the wire has been laid to all the carrier teams, it should be either buried several inches deep or strung overhead. This prevents vehicles damaging the wire or soldiers tripping over it. Before a vehicle moves more than a few feet, the track commander should insure that the telephone wire is disconnected.

When a position is vacated, the wire should be recovered.

#### **D-6. RADIO**

Because Threat forces have an extensive radio intercept capability, radio is used within the platoon only when messages cannot adequately be sent by other means. If a radio transmission is

intercepted, the enemy can usually find out where a unit is and what it is doing.

When radios are used, transmissions must be short and to the point. The sender must know what he wants to say before he transmits. This helps to keep messages short and the radio net open for others to use. Also, it reduces vulnerability to enemy intercept.

Each APC has an AN/GRC-160 radio mounted. The AN/GRC-160 can be configured as an AN/PRC-77. Additionally, the platoon leader's vehicle has either another AN/GRC-160 or an AN/VRC-46 mounted, and the platoon sergeant's vehicle may have an AN/VRC-64. Each squad, the platoon leader, and the platoon sergeant has either the squad radio AN/PRC-88 (transmitter AN/PRT-4 and receiver AN/PRR-9) or the small-unit transceiver (SUT) AN/PRC-68 for dismounted operations. There are five SUTs or AN/PRC-88's per platoon.

**D-7**

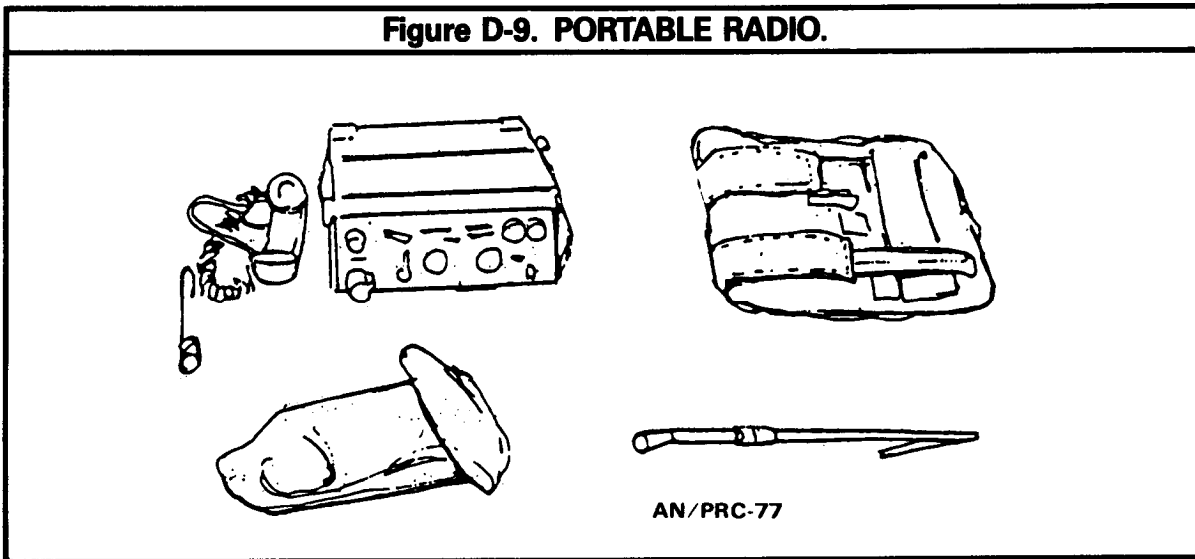
**AN/VRC-46.** The AN/VRC-46 radio is powered by the vehicle's electrical system. Its principal advantage is in its 41-kilometer planning range. If it or any other vehicular radio is operated when the vehicle engine is shut off, the driver must take care that the radio does not drain the batteries.

**AN/GRC-160.** The AN/GRC-160 radio can be mounted in and operated from the vehicle, or it can be dismounted and used as a portable radio

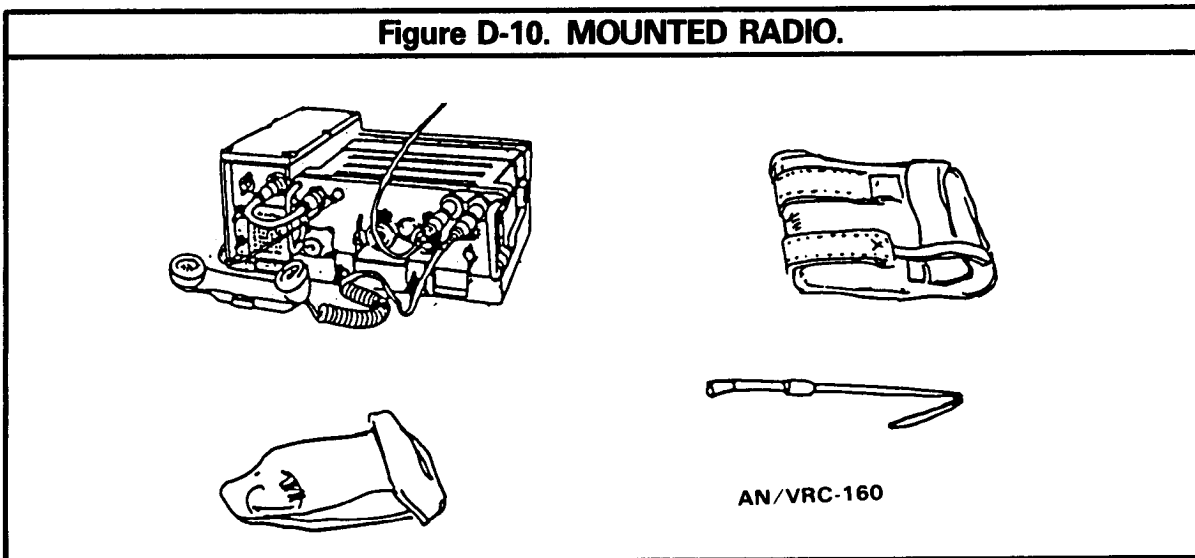
(AN/PRC-77). When mounted, it is powered by the vehicle's electrical system. The planning range mounted is 12 kilometers. When it is dismounted, it is called an AN/PRC-77 and can transmit up to 8 kilometers. It is powered by its own battery (BA-4836).

**AN/VRC-64.** The AN/VRC-64 is similar to the AN/GRC-160 except that it does not come issued with the equipment necessary to make it man-portable.

**Figure D-9. PORTABLE RADIO.**



**Figure D-10. MOUNTED RADIO.**

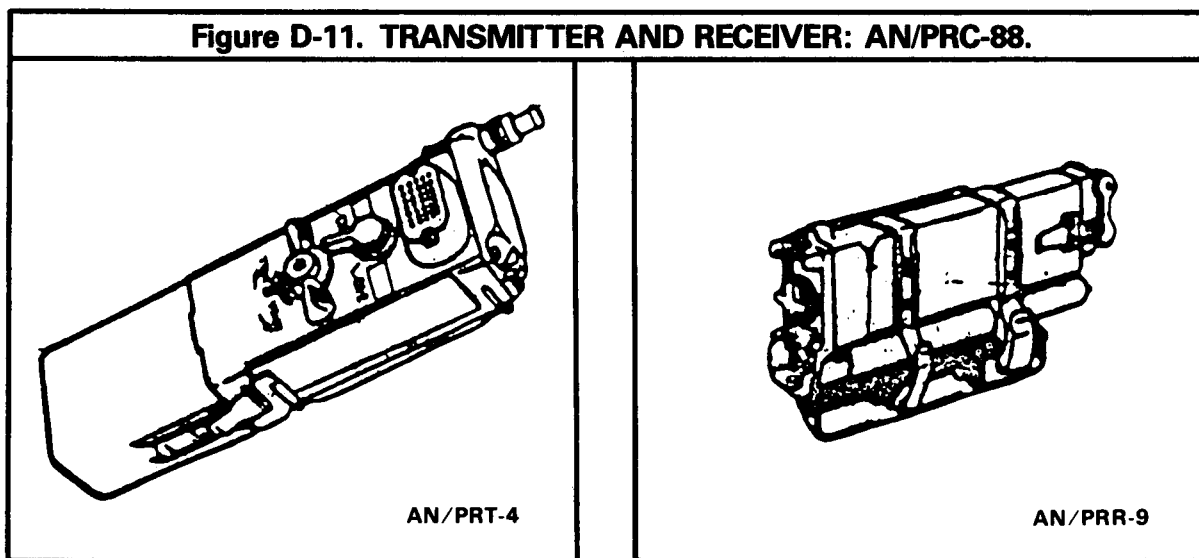


**AN/PRC-88.** Some units may be equipped with the AN/PRC-88 squad radio. The squad radio consists of two pieces of equipment, an AN/PRT-4 transmitter and an AN/PRR-9 receiver. Both the transmitter and receiver have preset crystal-controlled frequencies that can be changed as needed by the battalion communications platoon.

**AN/PRT-4.** The transmitter of the squad radio is battery-powered and has two channels. Channel 1 has a range of 1,600 meters. Channel 2 has a range of 500 meters. The purpose of the

two channels is to give the platoon an alternate frequency. In addition to voice, the AN/PRT-4 can transmit atone. This may be used to send a pre-arranged signal, such as an alert from an observation post. Battery life is about 35 hours for the BA-399.

**AN/PRR-9.** The receiver of the squad radio will receive Channel 1 and Channel 2, one at a time. It is battery-powered. Two types of batteries can be used in the receiver. The dry cell battery (BA-505U) has a life of about 14 hours, and the magnesium battery (BA4505U) has a life of about 28 hours.



When the platoon leader is mounted, he communicates with the company commander using a vehicular radio (AN/VRC-46). He uses the second radio (AN/GRC-160) on the platoon frequency to communicate with the carrier teams and the dismount teams.

When the platoon leader is dismounted, he uses the vehicular radio (AN/GRC-160) in the portable (AN/PRC-77) configuration to communicate with the company commander. He uses the AN/PRC-68 or AN/PRC-88 on the platoon frequency to talk with the dismount teams and the carrier teams.

Squad carrier teams use the vehicular radio (AN/GRC-160). The dismount team uses the AN/

PRC-68, or the AN/PRC-88. When the platoon leader stays mounted and the platoon sergeant dismounts, the platoon sergeant will use his AN/PRC-68 or AN/PRC-88 to communicate with the dismount teams and the platoon leader. He may dismount the AN/GRC-160 as an AN/PRC-77 to monitor the company command net.

#### D-7. INTERCOM SYSTEM

The intercom system in each APC consists of three control boxes and three combat vehicle crew (CVC) helmets. The squad leader, TL/gunner, and driver use the CVC microphones and earphones to communicate over the vehicle intercom and radios. The rest of the men in each vehicle monitor



the radio loudspeaker to stay abreast of the squad's situation.

The AM/1780 amplifier should be kept in the commander-only (CDR ONLY) mode and the control boxes (other than them) in the intercom-only (INT ONLY) mode. This will prevent unauthorized and accidental radio transmissions. This will also prevent accidental "hot mikes" which jam radio nets.

During mounted movement, the crew wear the CVC helmet in place of the soldier's helmet. Before a crew member dismounts, he hangs his CVC helmet on a hook by his intercom system control box. This is done to prevent soldiers tripping over a CVC cord or headset cord or damaging the equipment.

## Section II. RADIOTELEPHONE PROCEDURES

### D-8. GENERAL

Certain commonly used procedural words (prowords) have distinct meanings. They shorten the amount of time used in voice communication and avoid confusion. They are used when talking on the telephone or the radio. The most frequently used prowords include:

**OVER** — "This is the end of my transmission to you and a response is necessary. Go ahead, transmit."

**SAY AGAIN** — "Say again all of your last transmission."

**CORRECTION** — "An error has been made in this transmission (or message indicated). The correct version is..."

**I SAY AGAIN** — "I am repeating transmission, or portion indicated."

**ROGER**— "I have received your last transmission satisfactorily."

**WILCO** — "I have received your message, understand it, and will comply."

**OUT** — "This is the end of my transmission to you and no answer is required or expected."

### D-9. RULES FOR RADIO AND WIRE COMMUNICATIONS

The following are rules for radio and wire communications:

**Listen before transmitting (sending).**

**Make message short and clear.**

**Speak clearly, slowly, in natural phrases; pronounce each word distinctly. If the receiving operator must write, allow him enough time for writing.**

**If jammed (using radio), use the methods listed in the discussion on communication security (below).**

**In all cases of radio and wire traffic, personnel should not waste time. Send the message and get off the net.**

### D-10. COMMUNICATION SECURITY

Communication security (COMSEC) denies or delays unauthorized persons from gaining valuable telecommunications information. It includes:

**Using correct authentication procedures to insure that the other communicating station is a friendly one.**

**Using only approved codes.**

**Restricting the use of radio transmitters, and monitoring radio receivers (radio listening silence).**

**Enforcing net discipline and proper radiotelephone procedures. All stations operating in a net must use authorized call signs and prowords, and they must limit transmissions to official traffic.**

**Selecting radio sites with a hill or other terrain feature between the sites and the enemy.**

**Using directional antennas when it can be done, as discussed in appendix M, FM 24-1.**

**Using low power initially.**

Electronic counter-countermeasures (ECCM) prevent or overcome enemy electronic warfare. ECCM taken by a platoon mainly involve using proper signal security and antijamming techniques.

Radio operators must use antijamming procedures to reduce enemy jamming effects. These procedures include:

**Recognition.** When an operator's radio indicates interference, he first tries to find what is

causing the interference. He should not immediately assume jamming, because jamming signs often are like other types of interference. Removal of the receiver antenna can help to find out if the interference is being produced internally by the receiver. If interference lessens when the antenna is removed, the problem is jamming.

**Continued operations.** Normal radio operations should be continued, once jamming has been identified, so that the enemy cannot determine the jamming effects. The rule is: during jamming, continue operating unless ordered to shut down or shift to an alternate frequency. Do not say "I AM BEING JAMMED" over the radio.

**Reporting.** All operators must report jamming to their next higher headquarters by some other means of communications — for example, wire or messenger. The meaconing, intrusion, jamming, and interference (MIJI) report contains:

**Date and time of jamming.**

**Frequencies affected.**

**Type and strength of jamming signal.**

**Designation of the unit making the report.**

APPENDIX E

**FORDING AND SWIMMING OPERATIONS**

**Section I. FORDING WITH THE APC**

**E-1. GENERAL**

There may be occasions when platoons and squads, moving in the attack or the defense, must cross water obstacles because bridges or ferries are not available. With only minor preparation the APC can ford or swim water obstacles. These capabilities let the mechanized infantry stay on the move.

This appendix explains in general terms how to ford and swim with the APC. (See TM 9-2300-257-10 for more detail.)

Small water obstacles, such as streams, creeks, or ponds may have established fording sites used by local civilians. These are usually shown on military maps. As a rule, the APC can ford at these sites. However, the APC is not limited to established fording sites; it can use any place that has suitable entry and exit points.

**E-2. PREPARING THE APC FOR FORDING**

Platoons and squads should prepare their vehicles for fording before arriving at the ford site so that action is not stopped at a critical point in the

operation. Preparation should be in a covered and concealed location, a short driving distance (1 kilometer or less) from the ford site.

**To prepare the vehicle for fording:**

**Check hull access covers, drain covers, and drain plugs to insure that gaskets are serviceable and that covers and plugs are in place and tight.**

**Secure ramp and ramp door. They should be firmly closed and locked.**

**If the depth of the water is not known or is deep enough to float the vehicle, drop the trim vane.**

**Turn on bilge pumps.**

**Remove M8 chemical-agent alarm and mount it inside the APC.**

CONTENTS		PAGE
Section I.	Fording with the APE . . . . .	E-1
II.	Swimming with the APC . . . . .	E-2
III.	Tactical Considerations . . . . .	E-6

**E-3. FORDING**

The entry and exit sites should be firm ground that is free of rocks, stumps, deep drops, and underwater obstacles. The vehicle driver should ease the carrier into the water to prevent water from rushing back from a bow wave and swamping the hatches. When the vehicle is level, the driver should drive slowly as he would on dry land.

If the vehicle begins to float and loses traction, the driver should continue to drive using the swimming procedures (explained in section II) until the vehicle regains its traction.

As the vehicle nears the exit point, the driver should slow down and exit at a constant speed.

**E-4. AFTER FORDING**

To avoid congestion, the vehicle should be moved away from the exit point to its assigned area or mission. The same after-water operations checks as for swimming the APC are applicable and should be conducted as soon as the tactical situation permits.

**Section II. SWIMMING WITH THE APC**

**E-5. GENERAL**

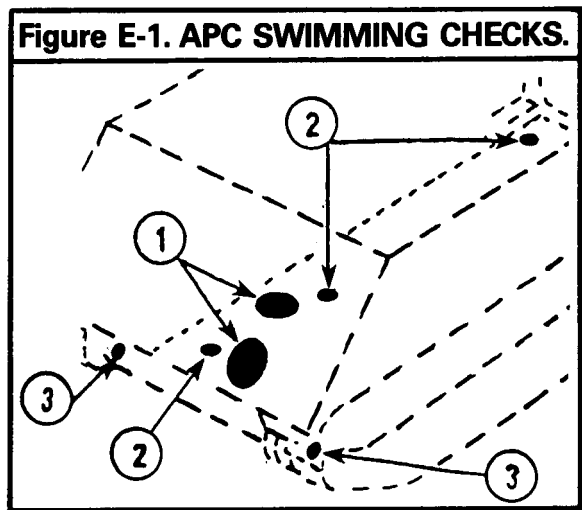
When platoons and squads are required to cross bodies of water that are deeper than APC fording depth, the vehicle must be prepared for swimming. There are three major steps in the swimming process — preparing the vehicle, swimming the water obstacle, and restoring the vehicle to its normal fighting form.

**E-6. PREPARING THE VEHICLE**

Platoons and squads should prepare their vehicles for swimming in a covered and concealed location within a short driving distance to the swim site. The route to the swim site should be free dense underbrush that could damage the trim vane.

To prepare the APC for swimming:

**Check the hull access covers (1) drain covers (2) and final drive recess drain plugs (3). Make sure they are all tight.**



**Check the track shrouds to be sure they are in good condition and correctly installed. Track shrouds are needed to let the tracks drive and steer the carrier while it is in the water.**

**Clean mud and debris from the bilge pump screens. Turn on bilge pumps to insure they work. Just before entering the water, turn bilge pumps on and leave them on until you exit the water.**

Make certain the power plant door is locked down tight and secure. Raise and lock the ramp. Make sure ramp-locking handle goes all the way forward so the ramp is tight and secure against its seal. (See TM 9-2300-257-10 for correct procedure to check seals.)

Extend and lock trim vane. Swing it forward and make certain it locks in place. Check and insure it is locked.

Check and insure all persicopes are securely in place.

Turn on dome lights, if not under blackout conditions.

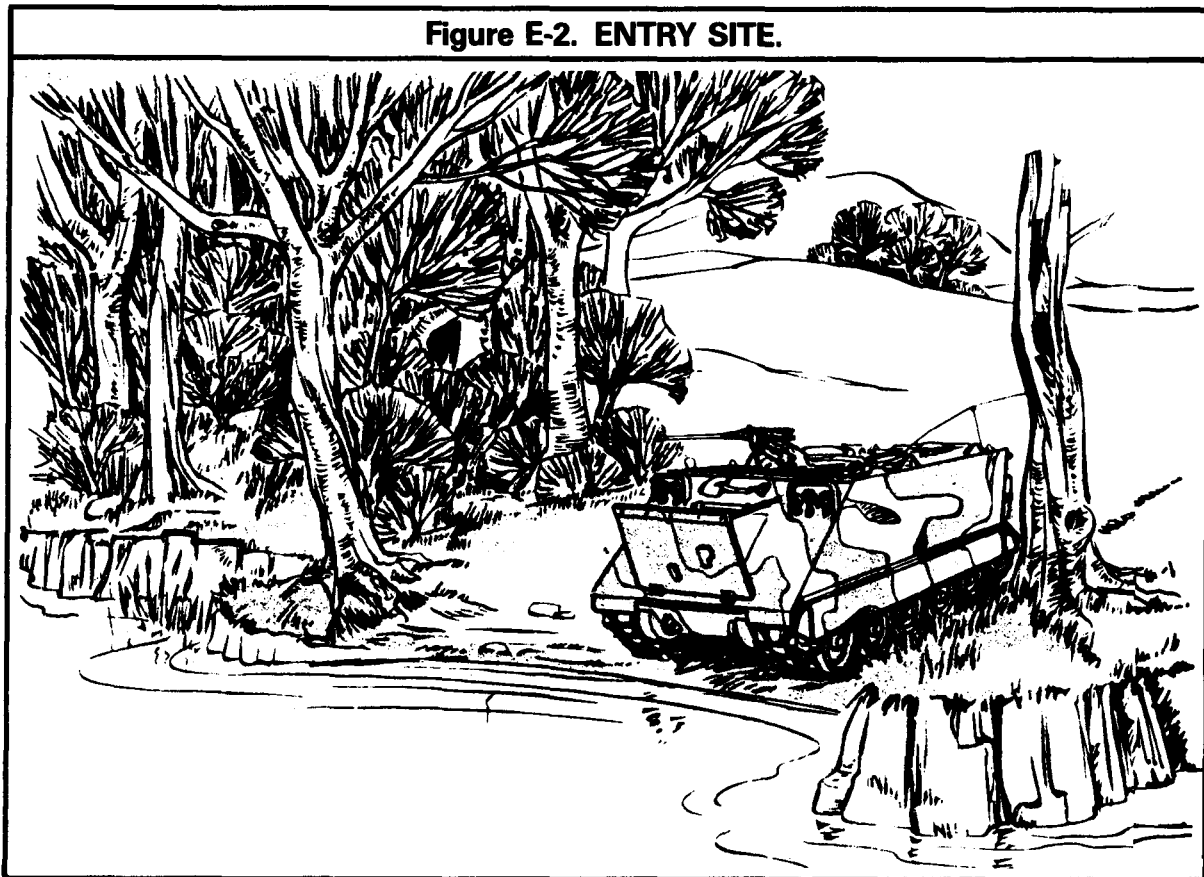
Distribute the load evenly. Movable items are tied down. This helps to

maintain a well-balanced carrier with a slightly elevated front while afloat. Lopsided distribution of cargo or personnel can swamp the carrier. If the front is lower than the rear, water can ship over the carrier.

#### E-7. SWIMMING THE WATER OBSTACLE

The entry site should be firm, and free of rocks, stumps, and deep drops. The driver steers the vehicle so that it enters the water head on, not at an angle. The shift lever is in 1-range, and the vehicle moves no faster than 10 mph. Hatches should be closed initially and opened once the vehicle begins to float. If the vehicle threatens to swamp, the driver backs off if he can; if he cannot, he accelerates to raise the front and get waterborne.

**Figure E-2. ENTRY SITE.**



Once the carrier is floating, the driver shifts to 1-2 range. This range is used for all driving in water except when stopping or backing up.

The vehicle is steered using the pivot steers or the steering and braking levers, but allowance must be made for a much slower response in the water. The driver avoids overshooting turns by releasing the lever a little before the turn is completed. The carrier will swing through and should line up properly.

If the vehicle hits an underwater obstruction, the driver lets up on the accelerator and pulls back on the steering levers to stop the tracks. He then shifts to reverse and backs up. The driver does not try to go through obstacles since they could cause the carrier to roll over or get hung up.

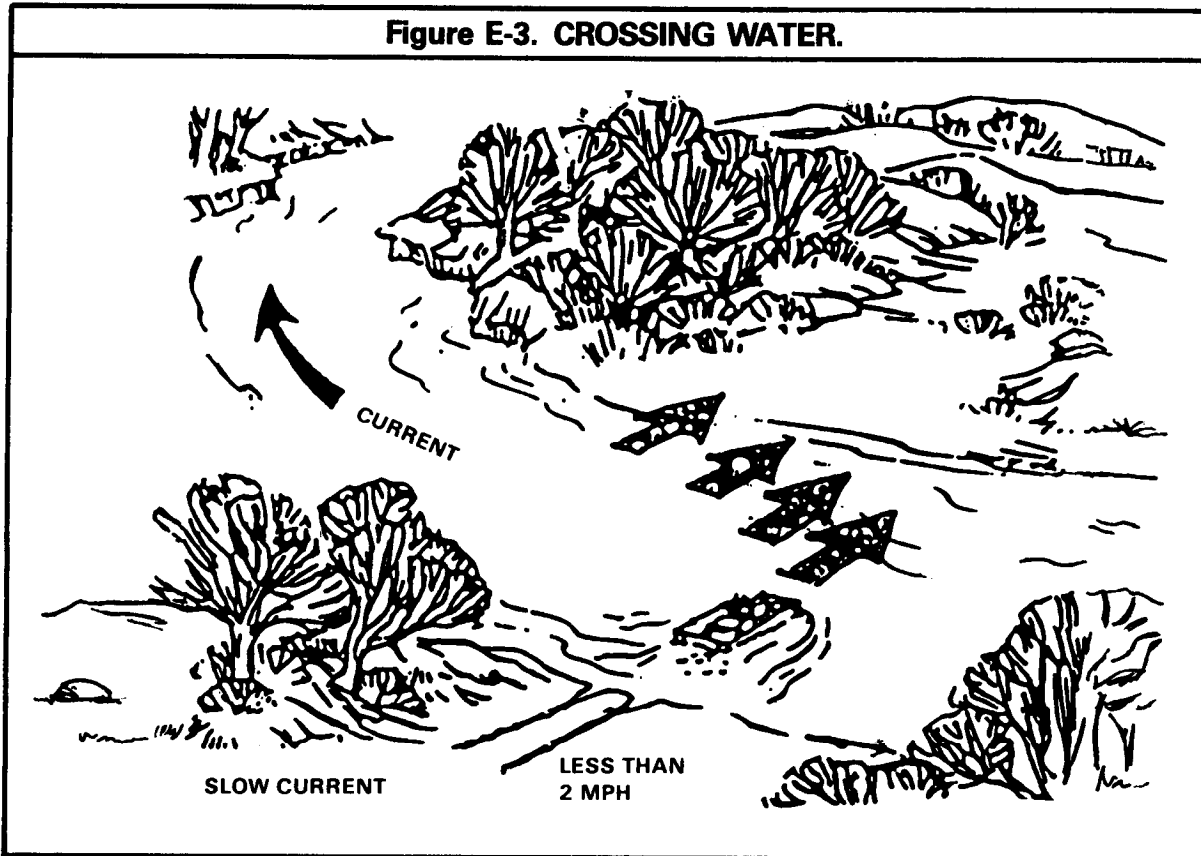
The engine is always maintained at high idle. Low idle is used only to shift and to brake. Even

when in neutral (N), the idle is maintained at about 1200 revolutions per minute (rpm).

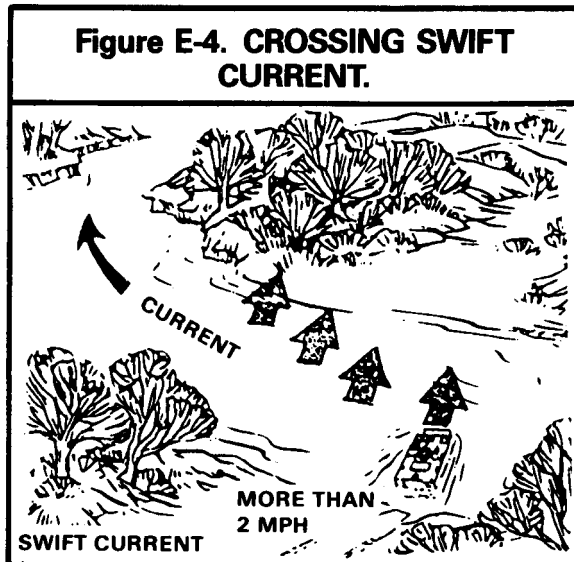
Stops should be anticipated long before the stopping point is reached. The vehicle's momentum must be used. The driver lets up on the accelerator, pulls back on the steering lever, and stops the tracks. When the tracks have stopped, he shifts into reverse, releases the steering levers, and then steps on the accelerator until forward momentum has stopped. Finally the driver releases the accelerator and shifts into neutral.

To cross a slow current, the driver heads straight across and lets the current carry the vehicle downstream until it reaches the other side. If the vehicle must exit directly across from the point of entry, the driver heads upstream and crosses at an angle.

**Figure E-3. CROSSING WATER.**



If swift currents cannot be avoided, the driver crosses by heading the carrier diagonally downstream.

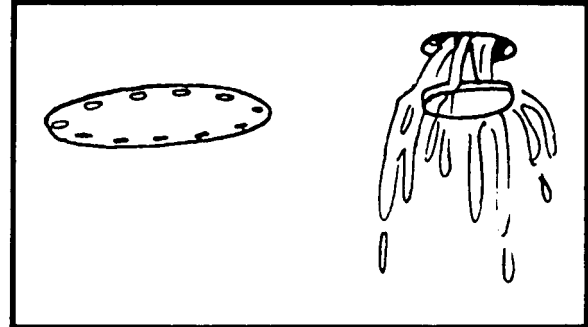


As the vehicle nears the exit bank, the driver and TL should look for firm ground with a gentle slope and free of obstacles. The driver should let up on the accelerator. This is one of the most critical points in swimming. If only one track makes contact, the vehicle can be thrown sharply off course and become swamped if the tracks are moving too fast. The driver should try to touch bottom with both tracks at the same time. When both tracks have hit the bank, he shifts into 1-range. The driver steers the vehicle slowly out of the water to avoid skidding or spinning the tracks.

#### **E-8. RESTORING THE VEHICLE TO ITS NORMAL CONFIGURATION**

Once the vehicle is out of the water, the driver should secure the trim vane. The TL should immediately direct the driver away from the exit site to avoid congestion, to gain dispersion, and to provide security. As the tactical situation permits, the drain plug access covers and the drain plugs should be opened to release any water left in the bilges. When water stops coming out of the bilge pumps, the pumps can be turned off.

**Figure E-5. DRAINING THE HULL.**



Before continuing operations, the peepholes on the road wheels, idler wheels, and roller hubs, and the final drive dipsticks, should be checked for contaminated oil. The oil is contaminated if bubbles appear in it or if it has a milky color. Contaminated oils should be replaced as soon as possible.

#### **E-9. SAFETY CONSIDERATIONS FOR SWIMMING THE APC**

Before swimming the APC in any peacetime operation, and when possible in combat situations, the vehicle should be predipped. This check insures that the vehicle is safe and ready to swim. The vehicle is readied for swimming as explained earlier. A cable from a recovery vehicle should be attached to the APC's tow pintle. The vehicle then enters the water until afloat. Soldiers in the troop compartment should check for leaks. The TL should check to see that the bilge pumps work. If all is well, the vehicle backs out of the water. If it has movement problems, the recovery vehicle will tow it.

Each APC should also be checked before swimming operations to insure that its intercom system and radio work.

Personnel in the vehicle should not wear seat belts while the vehicle is swimming. The belts could hinder emergency exit if the vehicle begins to sink or does sink.

Every man should wear a self-inflating CO<sub>2</sub> life jacket. Life vests are not issued with APCs but are on the vehicle's list of additional authorized items or provided by support elements. THE LIFE

JACKET SHOULD NEVER BE INFLATED INSIDE THE VEHICLE. It should be inflated only when the soldier is free of the vehicle.

Personnel in the vehicle should not wear load carrying equipment, packs, or pistol belts while the vehicle is swimming. Such items may snag in the vehicle as a soldier tries to get out of a sinking vehicle.

Every man in the carrier must know where and how he is to leave the vehicle if it sinks. The gunner and driver leave through their respective hatches. The carrier TL and personnel in the troop compartment may get out through the cargo hatch.

The following emergency escape actions are to be taken if the vehicle begins to sink:

**The carrier TL alerts all personnel of the vehicle's sinking.**

**Personnel begin to leave through their designated hatches as the vehicle sinks. Once free of the vehicle, they inflate their life jackets.**

**If for any reason personnel are unable to get out through the hatches, they can go through the ramp door. They must wait though, until water fills the troop compartment equalizes the water pressure, and allows the ramp door to open.**

### Section III. TACTICAL CONSIDERATIONS

#### E-10. GENERAL

During fording operations, the caliber .50 machine gun and small arms can be fired. The Dragon should not be fired because the vehicle must be halted while the gunner controls the missile from firing to impact. Halting could endanger the vehicle.

#### E-11. CROSSING FORMATIONS

Formations will normally be dictated by the number of usable entry and exit points. When only a few points are available, the crossing may have to be in column formation. This formation is easiest to control, but the crossing requires more time to complete. When many entry and exit points are available, the unit may be able to cross on line. Although crossing on line gets the unit across the obstacle in the least time, it is difficult to control.

#### E-12. SMOKE

While APCs are crossing water obstacles, they are vulnerable to enemy fires. This is because of their slow speed and lack of cover and concealment. Little can be done about slow speed and lack of cover, but concealment may be provided by the use of smoke delivered by the indirect fire method. (see appendix J.)

#### E-13. SUPPRESSION

Before, during, and after the crossing, every effort should be made to suppress and destroy enemy direct from weapons and forward observers who can bring indirect fire on the crossing site.

Tanks, ITVs, and APCs on the near shore should be positioned where they can suppress enemy positions and weapons on the far bank. The firing and swimming APCs can also help suppress with their caliber .50 machine guns.



APPENDIX F

**AIR DEFENSE**

**Section I. INTRODUCTION**

**F-1. GENERAL**

Besides the increase in the number and quality of Threat ground forces, there has been a marked improvement and increase in Threat air forces. Threat air forces will be able to control parts of the battlefield airspace. This appendix discusses methods to defeat Threat high-performance (jet) aircraft and attack helicopters. Since the enemy can be expected to place troops in the battle area by helicopter and parachute, this appendix also discusses engagement of those types of targets.

To effectively defend against air attack, units must make maximum use of cover, concealment, camouflage, dispersion, and early warning. Units must also be proficient in the use of their weapons in an air defense mode. Enemy airmail can attack any ground force whose location has been discovered. The sighting of a few soldiers or vehicles can lead to the disclosure of a whole unit, even if the rest of the unit is well hidden. Concealment is the key to avoid an air attack.

Air attacks will probably be unexpected and swift. To prevent surprise, early warning of a probable attack is necessary so that troops have a chance to take cover. This warning may come

down through normal command channels, or start with track leaders, local observation posts, or air guards. All TLs and OPs should have air-watch instructions, OPs should be positioned so they have a good view of the airspace around them, so a special air guard should be detailed.

**F-2. THREAT TACTICS OF JET AIRCRAFT**

Threat jets usually work together in two teams with two aircraft in each team. Using high speed for surprise and survival, they usually strike along the long axis of the target. This gives them a better chance to hit the target. They try to attack out of the sun to gain surprise. Threat jet aircraft weapons include automatic guns, rockets, and bombs. With guns and rockets, they can fire from a distance, but they must fly over or near the target to accurately deliver conventional bombs.

CONTENTS		PAGE
Section I.	Introduction . . . . .	F-1
II.	Target Acquisition and Engagement . . . . .	F-3
III.	Aircraft Engagement Techniques . . . . .	F-5

A common Threat tactic is to have one team of jet aircraft attack a target, followed by a second team 1 to 3 miles behind. The teams try to surprise the target and divert attention and defensive fire. When the lead team spots a target, it tells the trailing team; then, the lead team pops up in full view of the target. This draws fire to the lead team, while the trailing team, which has not yet been seen, flies in at high speed, for a low-altitude attack. The attack is usually level, under 1,000 feet, with cluster bomb units released along the target's long axis. The lead team then makes a sharp reverse turn to attack the target close-in, firing guns and rockets or divebombing for maximum effect. This tactic has two purposes:

**(1) If the target is surprised by the lead team and does not take evasive**

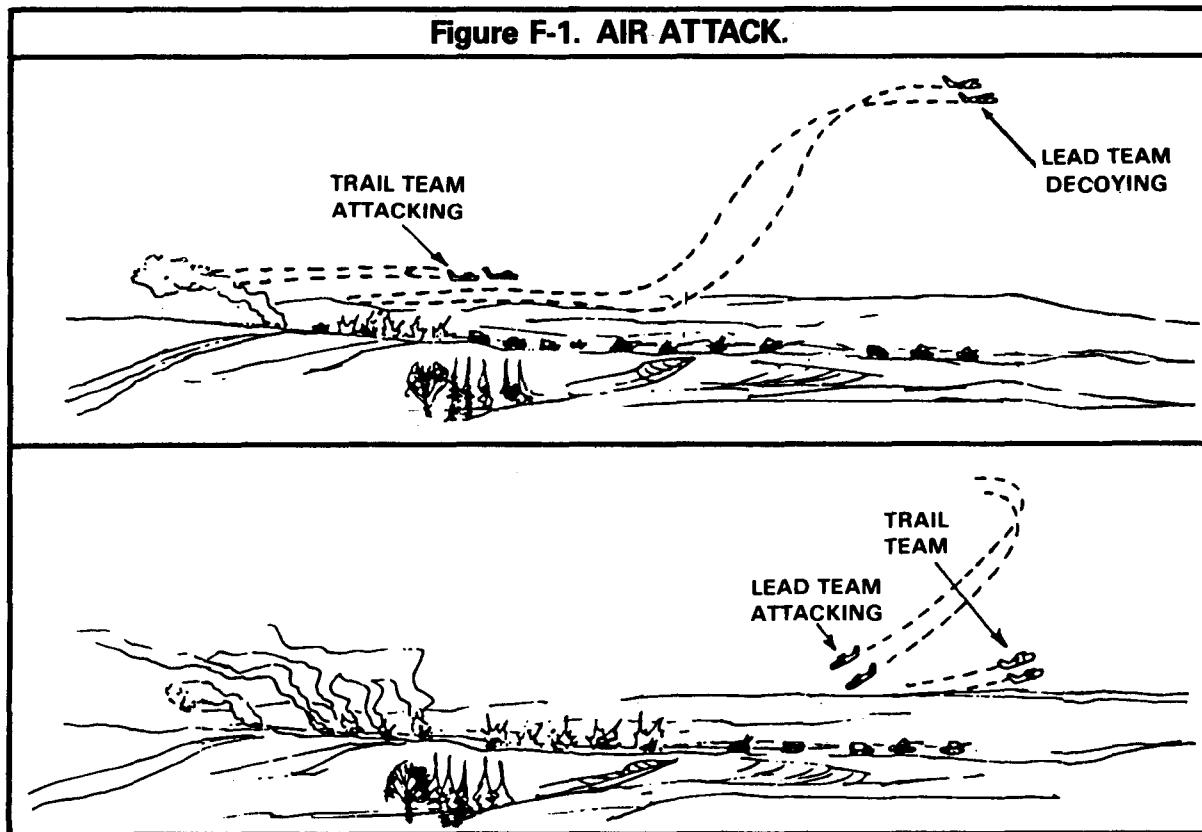
**action, the trailing team will get maximum effect with the cluster bomb units.**

**(2) If the target only evades the first attack and does not concentrate fire on the lead team, this team will get maximum results with rockets and bombs on its return pass.**

The best defense against attacking Threat jet aircraft is to:

**Be familiar with Threat air tactics and not be surprised by the trailing jet team.**

**Immediately concentrate volume fire on any attacking jet, while dispersing and taking evasive action.**



### F-3. THREAT TACTICS OF ATTACK HELICOPTERS

Attack helicopters fight in teams of two or more. They are more agile and maneuverable than jet aircraft and use ground cover and concealment while engaging from stand-off positions. They can employ a variety of weapons in support of this action:

**57-mm free flight aerial rockets (FFAR).**

**Antitank guided missiles.**

**General purpose bombs.**

**12.7-mm machine gun.**

Attack helicopters will be used extensively in forward areas in the following combat roles:

**Close air fire support — aerial fire support for the attacking forces similar to the A-10 support for US forces.**

**Combat air assault — airmobile operations in the friendly rear areas.**

**Antitank fires — ATGM fires (AT-2 Swatter or more advanced systems) similar to US attack helicopters.**

**Air-to-air interdiction — a secondary mission together with one of the other combat roles.**

The combat roles of enemy attack helicopters make contact between friendly forces more likely.

The best defense against attacking Threat helicopters is to:

**Immediately concentrate volume fire on any attacking helicopter within range (1,600 meters).**

**Take evasive action and disperse.**

## Section II. TARGET ACQUISITION AND ENGAGEMENT

### F-4. GENERAL

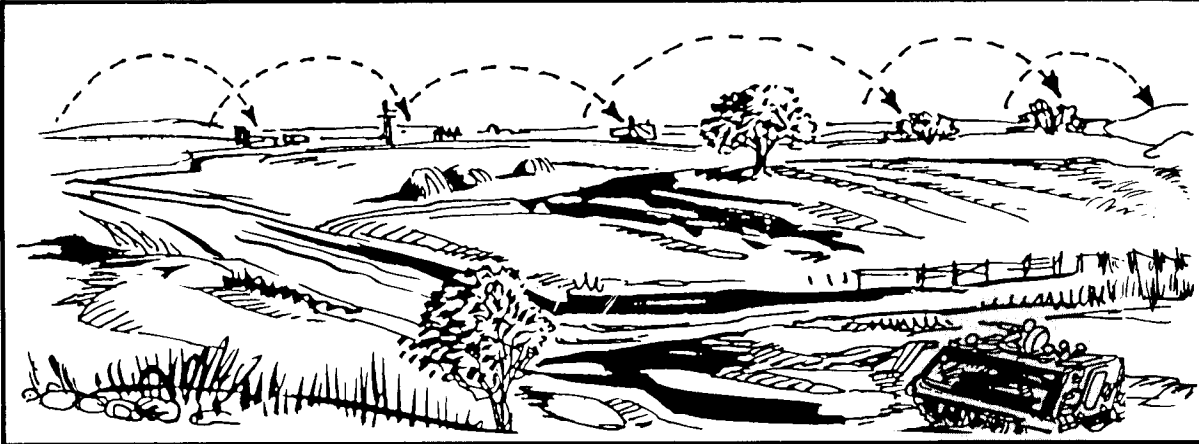
**Where to Look.** A map reconnaissance of the unit's direction of movement or area of operations will help to pinpoint likely areas from which an enemy aircraft might attack. The back of woodlines, ridgelines, and folds in the terrain can be marked out to at least 3,000 meters as a guide to possible attack helicopter positions. Restrictive terrain, defiles, and narrow valleys, where the unit may have to close in, are also areas which should be approached with caution. Moving close together through such areas offers a lucrative target for tactical air attack along the long axis of movement.

**How to Look.** To see attacking aircraft soon

enough for a platoon to react, TLs/gunners (mounted) and individual soldiers (dismounted) must constantly be on the alert for hostile aircraft. Observers may use one of two systematic methods of search to look for aircraft in any type of terrain. Members of the platoon should frequently focus on a distant object, such as a cloud or terrain feature. If this is not done, the eyes tend to relax, and distant objects become blurred.

In the first method, the observer searches the horizon by moving his eyes in short movements across the sky working his way up and across. He continues the scan pattern to below the horizon to detect nap-of-the-earth flying aircraft.

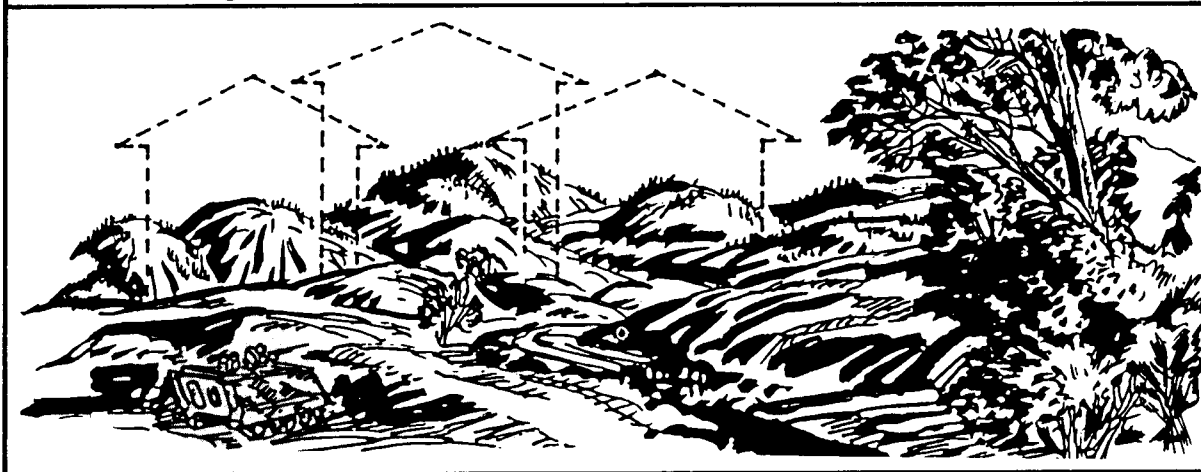
**Figure F-2. SEARCHING ACROSS THE HORIZON.**



In the second method, the observer searches the sky using the horizon as a starting point and prominent terrain features as points of reference. He moves his eyes in short movements up the sky

then back down, continuing the movement across the terrain. He scans in the same pattern below the horizon to detect aircraft flying nap-of-the-earth.

**Figure F-3. SEARCHING UPWARD FROM THE HORIZION.**



Searchers should be alert for:

**Sun reflection from aircraft canopies or cockpit windows.**

**Blade flash from rotating helicopter blades.**

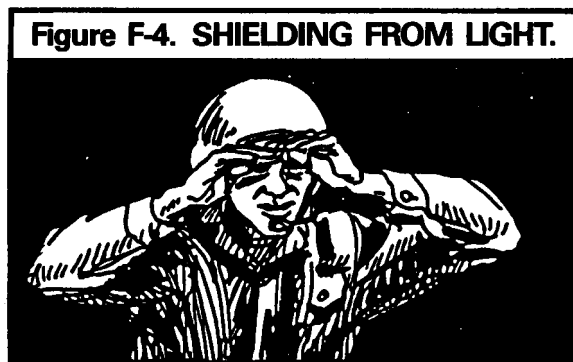
**Smoke or vapor trails from jet aircraft missiles, or rockets.**

**Dust or excessive movement of treetops and bushes in a particular area caused by the downwash of helicopter blades.**

**Noise from helicopter blades, or jets breaking the sound barrier.**

Searching for air targets at night is similar to searching for ground targets at night. How-

ever, the observers may have to rely more on hearing than sight for detecting aircraft. Techniques include short, jerky, abrupt movements of the eyes. Off-center vision (looking slightly to the side of an object) is used to prevent an image from fading. Night vision is aided by cupping the hands around the eyes to shield out distracting light.



Weapons nightsights and binoculars can be used to detect distant targets not visible to the naked eye.

**When to Engage.** Specific rules for engaging aircraft should be in the unit SOP. These rules are based on policies of higher headquarters. Without that guidance, the following is suggested:

**Immediately engage all attacking aircraft.**

**Engage enemy aircraft not attacking your position only when told to do so. Aircraft must not be engaged arbitrarily. To do so may compromise your position.**

**The best defense against enemy aircraft may be passive measures, such as camouflage, cover, and concealment.**

**How to Suppress.** Likely areas where Threat helicopters may be hiding (behind hills and treelines) should be suppressed by fire just as ground target areas are suppressed. This can be done by indirect fire of mortars and artillery

### Section III. AIRCRAFT ENGAGEMENT TECHNIQUES

#### F-5. AIRCRAFT ENGAGEMENT

Enemy aircraft are engaged to:

**Destroy the aircraft, if possible.**

**Force the aircraft away from friendly positions.**

**Force the aircraft to fly higher so that it can be picked up and destroyed by friendly air defense weapons or friendly aircraft.**

**Spoil the hostile aircraft's aim while it is engaging friendly forces.**

Vehicles must take evasive action when engaging or being engaged by hostile aircraft. This lessens the effectiveness of the hostile aircraft's fire. Evasive actions include:

**Seeking cover and concealment.**

**Keeping vehicles dispersed.**

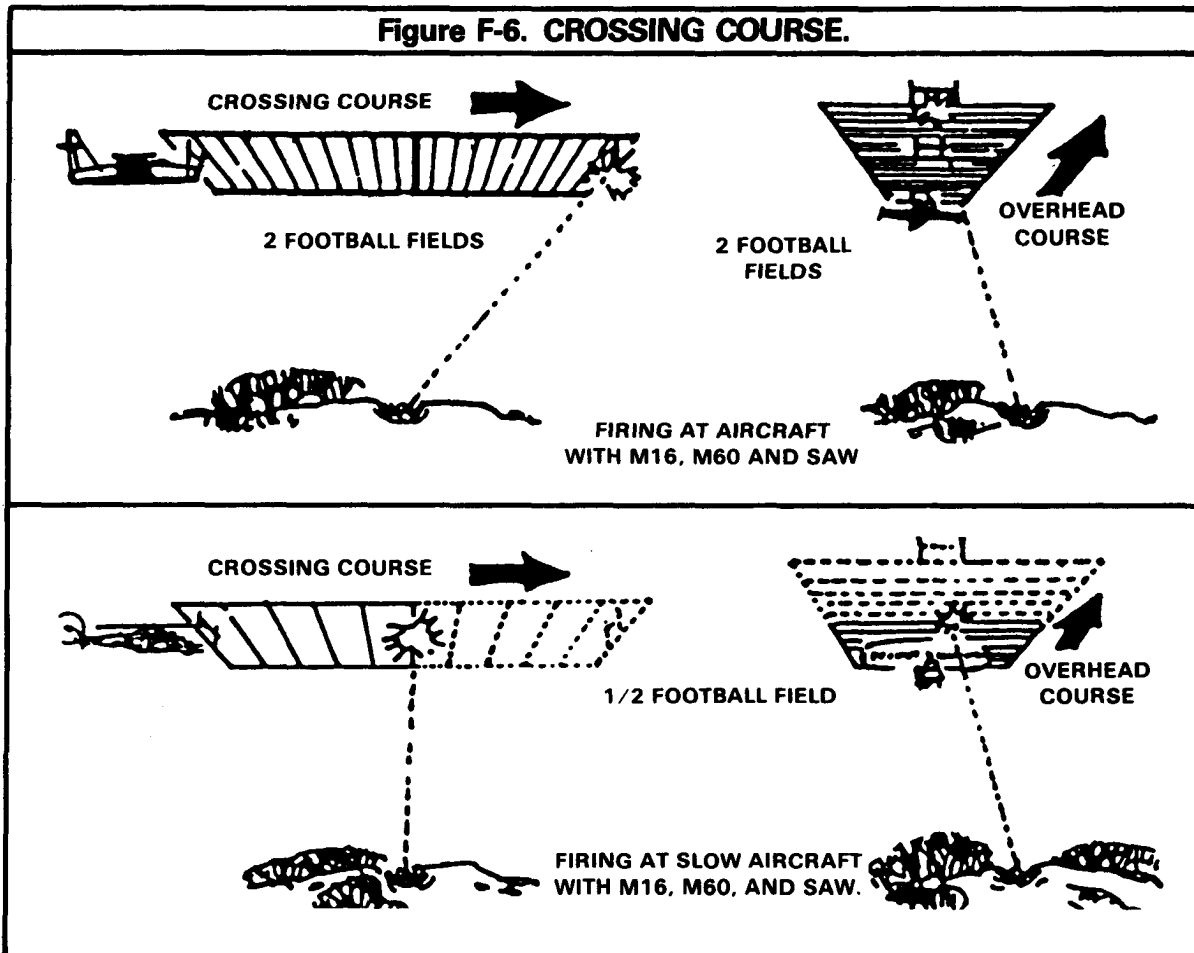
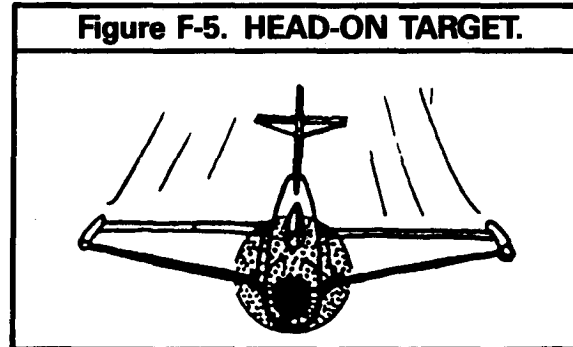
**Moving with frequent changes of speed and direction while turning away from the hostile aircraft's axis of attack.**

**Avoiding use of lights at night.**

**F-6. ENGAGING FAST-MOVING AIRCRAFT**

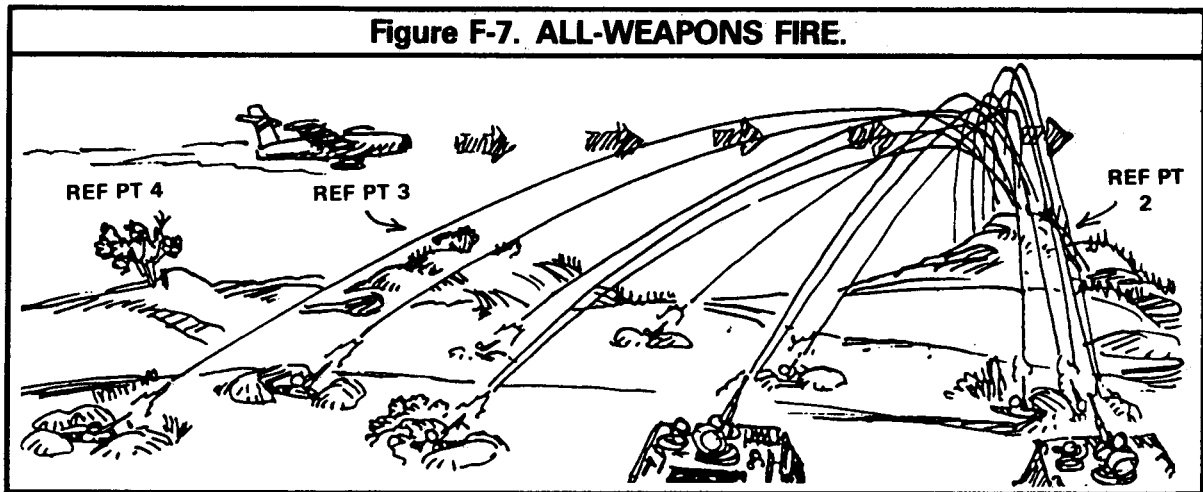
Because of its speed, a jet aircraft can best be engaged by the caliber .50 machine gun in a continuous burst. When the aircraft is flying a crossing course, the gunner uses a lead of 200 meters — two football field lengths. Fire is directed ahead of the aircraft, letting the aircraft fly through the machine gun's cone of fire. The TL should not try to track or traverse with the aircraft. It flies too fast. The dismount element, with its M16A1 rifles, SAWs, and M60 machine guns, uses the same 200-meter lead to engage jet aircraft. For helicopter, a 50-meter (half a football field) lead is used. If the aircraft, either jet or helicopter, is flying directly toward the vehicle,

the TL should aim slightly above the aircraft nose and fire.



A second technique to engage high-speed aircraft is to choose a reference point or a series of reference points. The platoon leader alerts the platoon to get ready. As the aircraft approaches a reference point, he orders, "ENEMY AIR, REF-

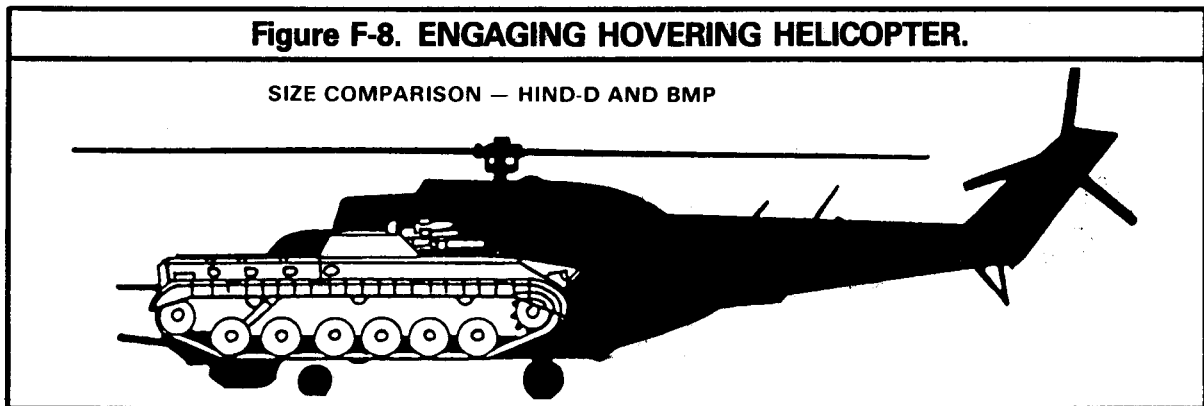
ERENCE POINT 2 — FIRE." All APCs and all dismounted soldiers raise their weapons to a 45-degree angle over the designated reference point and fire.



**F-7. ENGAGING HOVERING HELICOPTER**

If a hovering helicopter is picked up by the TL, the aircraft is engaged with the caliber .50 machine gun. Range to the target is estimated by making a quick check of the map for the target's location and range, using reference points whose range is already known, or estimating the range and adjusting the rounds until they hit the target.

The Threat Hind helicopter is approximately the same height as a BMP when measured from the bottom of the aircraft to the top of the pilot's canopy. The gunner aims slightly above the fuselage. At longer ranges, tracers may appear to be striking the target when they are actually going under it.



**F-8. ENGAGING ENEMY AIRBORNE/ AIRMOBILE FORCES**

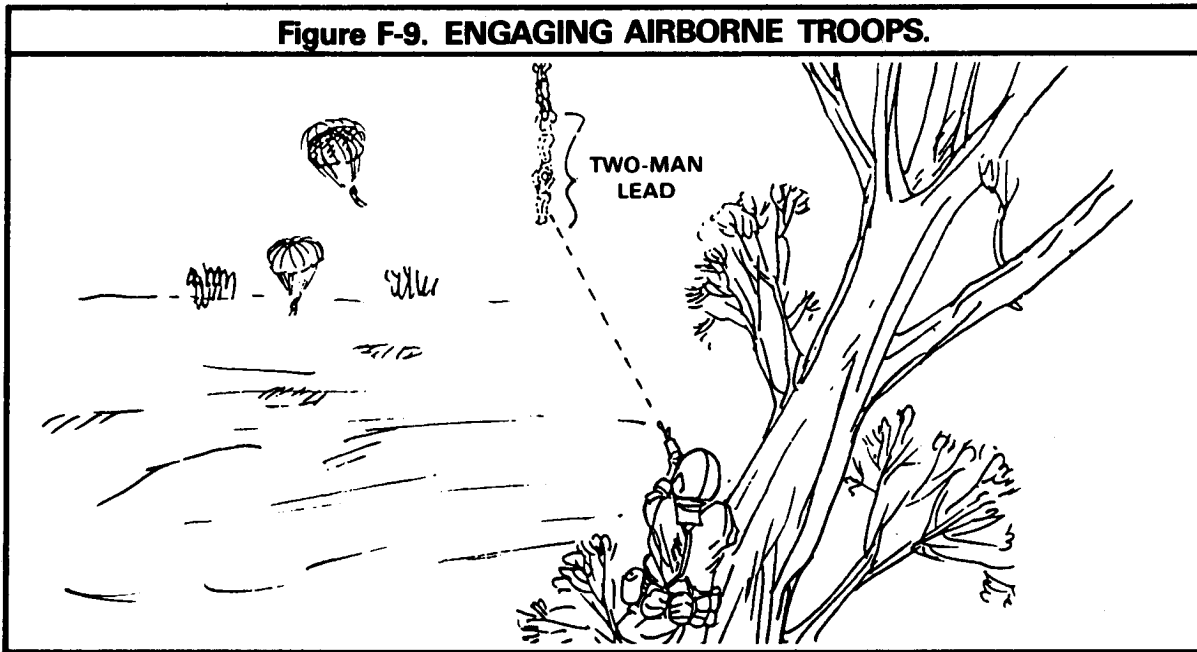
Enemy forces in the attack will frequently try to airdrop or insert troops into the battle area by helicopter or transport aircraft. If landing zones are not available, troops may rappel from their helicopters. If troop-carrying helicopters are sighted, they should be engaged as soon as possible using techniques previously discussed. If rappelling troops are sighted, the helicopter should be engaged, not the troops, because it is a better target.

It is harder to engage airborne soldiers because they are dropped from fast-moving aircraft at

high altitudes and they descend too fast to track effectively. When using the SAW or the M60 machine gun, a lead must be taken to compensate for the airborne soldiers' rate of descent. Use a lead of two man-heights beneath the dropping soldier.

Pilots who have bailed out of disabled aircraft should not be considered as airborne troops. Engaging parachuting pilots violates the covenants of the Geneva Convention.

**Figure F-9. ENGAGING AIRBORNE TROOPS.**



**F-9. SUMMARY**

The platoon must search continually for hostile aircraft as well as ground targets.

Aerial targets can be destroyed or suppressed by mounted and dismounted weapons.

US troops must be familiar with Threat air tactics, both high-performance aircraft and helicopter.

Aircraft engagement rules should be part of the unit SOP.

US troops must take evasive action and engage with all appropriate weapons to destroy attacking aircraft.

Mounted and dismounted weapons are also effective against other aerial targets, such as airborne and airmobile infantry.



APPENDIX G

**DISMOUNTING THE APC**

**Section I. DISMOUNTED OPERATIONS**

**G1. GENERAL**

Squads and platoons move mounted whenever possible. This conserves the infantryman's energy and takes advantage of the APC's mobility and armor protection. When the infantry dismounts, the dismount team must do so rapidly. Both dismount and carrier teams must be able to react with little or no instruction from the squad leader. This appendix explains how to dismount tactically.

Before every operation, each squad and platoon headquarters should establish who is to dismount and with what weapons and equipment, and who is to remain in the carrier team. This should be in the unit SOP and modified as necessary for each situation.

When there are personnel shortages, changes should be made to insure key positions (squad leader or carrier team leader, gunner, assistant squad leader, and driver) are filled and that key dismounted weapons (Dragon, M60 machine gun

if designated, SAWs, and M203 grenade launcher) are manned.

There must also be a clear understanding of who is to be the dismount team leader and who is to be the carrier team leader. Generally, the squad leader dismounts when the whole dismount team dismounts. The TL/caliber .50 gunner takes charge of the carrier team. The dismount team leader takes control of the dismount team. Both team leaders take orders from the squad leader unless the platoon leader tells them otherwise. If the squad leader decides to fight the dismount team as two fire teams, he will be in charge of one of those teams. The squad must have well-practiced procedures for rapidly dismounting the vehicle and organizing on the ground for combat operations.

CONTENTS		PAGE
Section I.	Dismounted Operations . . . . .	G-1
II.	Tactical Considerations. . . . .	G-3

## G-2. SQUAD LEADER'S ALERT FOR DISMOUNT

**Dismount Alert.** Each squad leader must keep all of his squad informed, and alert as to possible dismount situations. As soon as the squad leader knows where and how he wants to dismount, he will give the driver instructions and give the squad members in the troop compartment the dismount alert. The dismount alert should include the following:

Warning — **“Prepare to dismount.”**

Dismount team composition — **“Standard team” or “No Dragon.”**

Dismount team leader — **“I will dismount” or “SGT Jones, dismount.”**

Exit method — **“Ramp” or “Door.”**

Dismount instructions — **“Dismount left.”**

**NOTE:** If the dismount is a result of enemy contact, the alert may include **“action left/right/front”** if the driver is unable to orient the front of the carrier toward the enemy.

**Actions of Soldiers in Troop Compartment.** The squad leader's dismount alert should trigger an automatic reaction among soldiers in the troop compartment:

**Each man secures his weapon and proper ammunition, LAW, or Dragon.**

**Each man places his weapon on SAFE and loads it.**

**The team leader notifies the squad leader when everyone in the troop compartment is ready to dismount.**

**The squad leader keeps his CVC helmet or headset on until he gives the order to dismount or the ramp is lowered. This insures that the squad leader can monitor any last-minute**

**changes he gets from the platoon leader.**

**Actions of Driver and TL/Gunner.** The driver should always be on the alert for covered and concealed positions. When he hears the squad leader's dismount alert, he must respond without delay to the squad leader's orders. Whenever possible, he should stop the vehicle in a covered/concealed position with the vehicle pointed at the enemy. This aids the gunner because the mounted weapons will not have to be traversed. It also puts the carrier directly between the enemy and the dismounting personnel. The TL/gunner directs the driver to the proper dismount point and helps point the vehicle at the enemy.

## G-3. DISMOUNT EXITS AND ORDER

### Dismount Exits.

There are two exits that the dismount team can use to dismount the APC — the ramp and the ramp door. The ramp is the easiest and fastest. If the ramp cannot be used or the squad leader wants to dismount only a few personnel, the ramp door may be used.

Each platoon should have a well-rehearsed SOP sequence for dismounting. Normally this is from the rear to the front. When the ramp is used, the personnel on both sides of the troop compartment can move out at the same time. When the door is used, only one man at a time can get out. (See appendix H.)

**Dismount Order.** When the vehicle is in the right position and correctly oriented, the squad leader gives the order to dismount. If the ramp is used, the dismount order is the driver's signal to lower the ramp. If the ramp door is to be used, the squad leader's dismount order is the signal to open the door. The squad leader removes his CVC helmet, puts on his steel helmet, and dismounts.

#### **G-4. ACTIONS OF THE DISMOUNT TEAM**

The dismount team should move 20 to 30 meters away from the vehicle in the direction specified in the dismount alert (left, right, or rear). The men immediately hit the ground using the best cover and concealment available and face outward toward the enemy. As soon as the dis-

mount team leader accounts for every man and gets oriented, he gives instructions for movement to accomplish the team's mission or to link up with the other dismount teams to form the dismount element.

### **Section II. TACTICAL CONSIDERATIONS**

#### **G-5. GENERAL**

Whether in contact with the enemy or not, the platoon leader makes every effort to dismount in a covered and concealed location. It may be possible to deploy the dismount teams without the enemy detecting the dismount. This adds to the dismount team's security and lessens the chance they will be engaged by surprise fire.

During darkness, only red interior lights should be used in the vehicle if it is necessary to see to get equipment or to look at a map. This helps the infantrymen gain their "night vision" before dismounting. As soon as the dismount team leader lets the squad leader know that everyone in the troop compartment is ready to dismount, the troop compartment red lights should be turned off. This prevents a violation of light discipline when the ramp is lowered or the ramp door is opened.

#### **G-6. SAFETY AND SECURITY**

##### **Safety.**

The carrier team must know the dismount team's location. The gunner should keep the driver oriented so that he does not endanger dismounted infantrymen as the carrier is moved. This is especially critical at night. The gunner must insure that he does not endan-

ger the dismounted infantrymen as mounted weapons are fired.

When possible, the carrier team should wait for the dismount team to move away from the vehicle before carrier weapons are fired. This reduces the chance that enemy fires will be attracted that could endanger the dismount team. However, if suppressive fire is needed, the gunner should not hesitate to provide it.

##### **Security at a Halt.**

Many times when moving mounted, there will be temporary halts. This might be during overwatch, while leaders meet, or while maps are studied. In such cases, platoons and squads should have several men dismount for local security. These men should move far enough away from the carriers so that they can hear battlefield noises above vehicle engine sounds. They should be alert for any sign of enemy activity, on the ground and in the air. They should also watch for movement of other friendly elements.

One person in each vehicle, preferably the squad leader or gunner, must observe these dismounted security elements to relay signals of enemy activity, to provide fire support if needed, and to signal the men when to return.

APPENDIX H

**BATTLE DRILL**

**Section I. INTRODUCTION**

**H-1. GENERAL**

Battle drill is a critical action to be taken in combat in response to an emergency situation. The battlefield requires platoons to move so that they can get the most out of their APC's fire-power, speed, and protection. The precision and ease with which APC's move in response to orders or changing situations attest to the platoon's training level and fighting readiness. Battle drills are preplanned, and they stress changes information and movement in response to changes in the tactical situation. Battle drill is a critical action to be taken in combat in response to an emergency situation.

Battle drills teach team leaders to respond to commands rapidly and by force of habit, without detailed instructions. By order or signal, each APC moves at once to assume a specified position within the platoon formation. Every TL and driver must be skilled in battle drill so that they always know their vehicle's position relative to a base vehicle without further word from the platoon leader.

The platoon leader commands and controls his platoon by using standing operating procedures rather than detailed instructions. This prevents confusion and frees leaders to concentrate on locating and engaging the enemy.

**H-2. BATTLE DRILL TRAINING**

When conducting battle drill training, one thought should be kept in mind: Start with easy-to-do tasks and work progressively up to the complicated, more difficult ones. Classroom work on the blackboard and practice in wheeled vehicles are good ways to start. Drivers and squad leaders can practice dismounted on a parade field if necessary.

Battle drill practice in APCs should begin on the easiest-to-use terrain available — open and relatively flat — and progress to wooded areas where command and control are more difficult.

As the platoon begins to master basic battle drills, the platoon leader can vary his battle drill program. The platoon leader can integrate training in such subjects as communications, air defense, occupation of a battle position, and march security.

Battle drill training never ends. Practice goes on as long as the platoon is in the field. The platoon goal is to move and react quickly, instinctively, and effectively under all conditions.

CONTENTS		PAGE
Section I.	Introduction .....	H-1
II.	Battle Drill Examples .....	H-2

## Section II. BATTLE DRILL EXAMPLES

### H-3. GENERAL

This section illustrates standard mechanized battle drill: dismount the APC; mount the APC; change mechanized mounted formation; react to direct fire; react to indirect fire; execute action right, left, or rear; and establish security at a temporary halt.

The illustrations in this section are only graphical examples and should not be taken as the only way to execute a mechanized battle drill. For example: Dismount the APC shows the dismount team arrayed near the vehicle and in a linear fashion; in combat the dismount team may move away from the vehicle and seek cover, as dictated by the terrain.

### H-4. EXAMPLES

**DRILL TITLE:** Dismount the APC.

**TASK:** Squad dismounts left or right.

**CONDITION:** The squad is moving as part of a platoon to make contact with the enemy. Visibility is good.

**STANDARD:** The dismount team immediately exits the vehicle to the left or right and orients to the front of the vehicle.

**INITIATING CUE:** The squad leader directs the dismount team to dismount left or right.

#### **PERFORMANCE REMINDERS:**

The squad leader alerts the dismount team.

The driver looks for a covered and concealed position.

The gunner uses the caliber .50 machine gun to suppress the enemy.

The vehicle is halted in the best available covered and concealed position.

The dismount team dismounts in the following order: (For H-series TOE, see appendix A.)

**a. No. 5, 9, 8, 6, 1, 7, 4, (dismount right).**

**b. No. 9, 8, 6, 5, 1, 7, 4, (dismount left).**

As the dismount team dismounts, the members orient to the front of the vehicle, which should be facing toward the enemy.

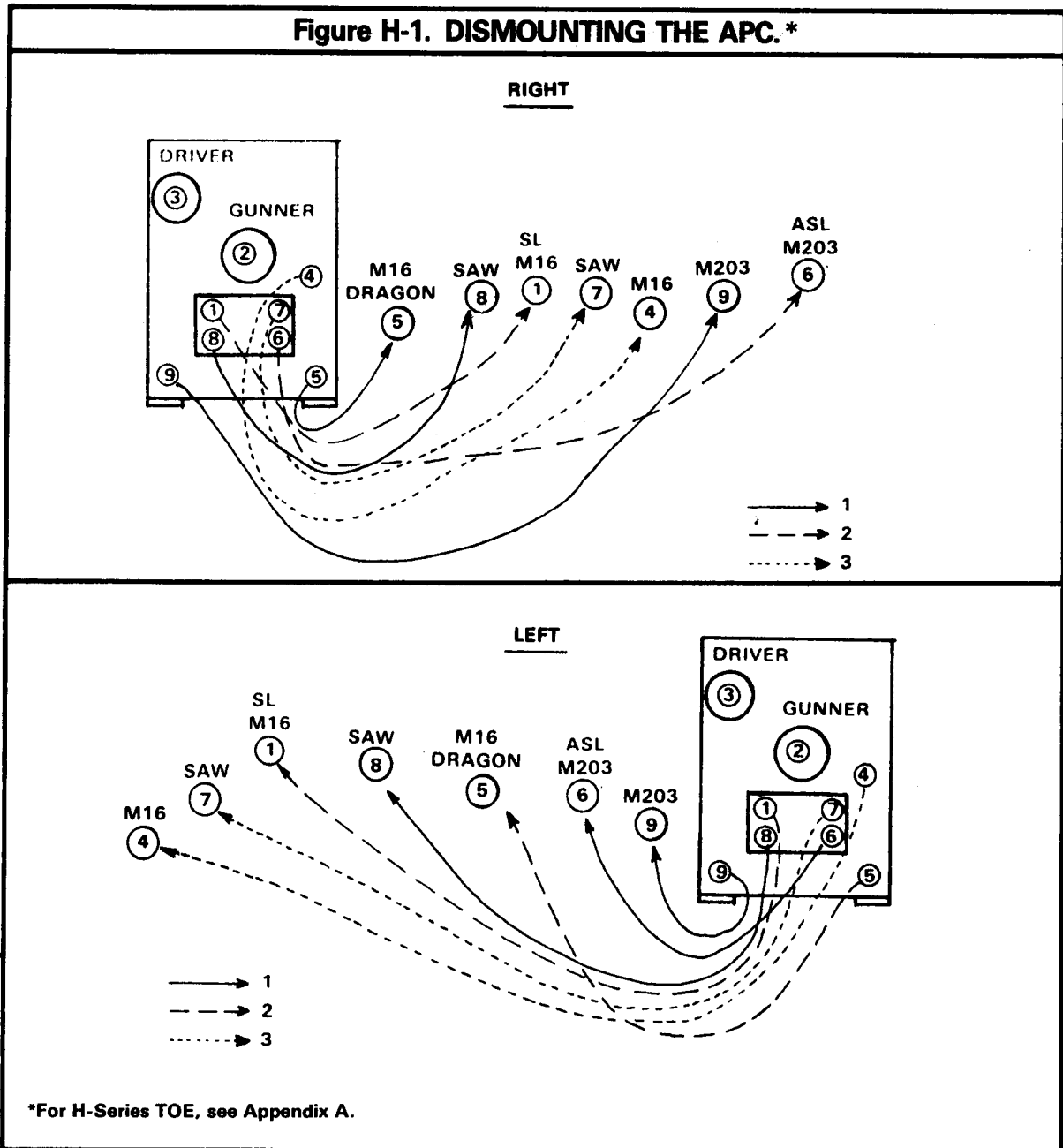
**NOTE: The dismount battle drill terminates when the last man exits the vehicle and orients to the front. The battle drill does not necessarily require the exact dismount sequence shown. The dismount team may not "layout" as depicted but may dismount and move out in a specific direction.**

**COUNTERTASK:** OPFOR engages the APC with antiarmor fires.

**CONDITION:** OPFOR is in a covered/concealed fighting position and is armed with ATGM systems.

**STANDARD:** OPFOR suppresses the squad.

**Figure H-1. DISMOUNTING THE APC.\***



**DRILL TITLE:** Mount the APC.

**TASK:** Dismount team mounts the vehicle.

**CONDITION:** The squad is occupying a defensive position as part of a platoon. Visibility is good. Squad's position has become untenable.

**STANDARD:** The dismount team mounts the vehicle.

**INITIATING CUE:** The squad leader or dismount team leader orders the dismount team to mount the vehicle.

**PERFORMANCE REMINDERS:**

Squad leader or dismount team leader gives warning or signal to prepare to mount.

Squad leader or dismount team leader gives the order to mount.

Soldiers should remount by number in the following order **No. 4, 7, 1, 6, 8, 5, 9.** (For H-series TOE, see appendix A.)

First soldier to mount, cover remaining dismounted team.

Gunner uses the caliber .50 machine gun to suppress the enemy.

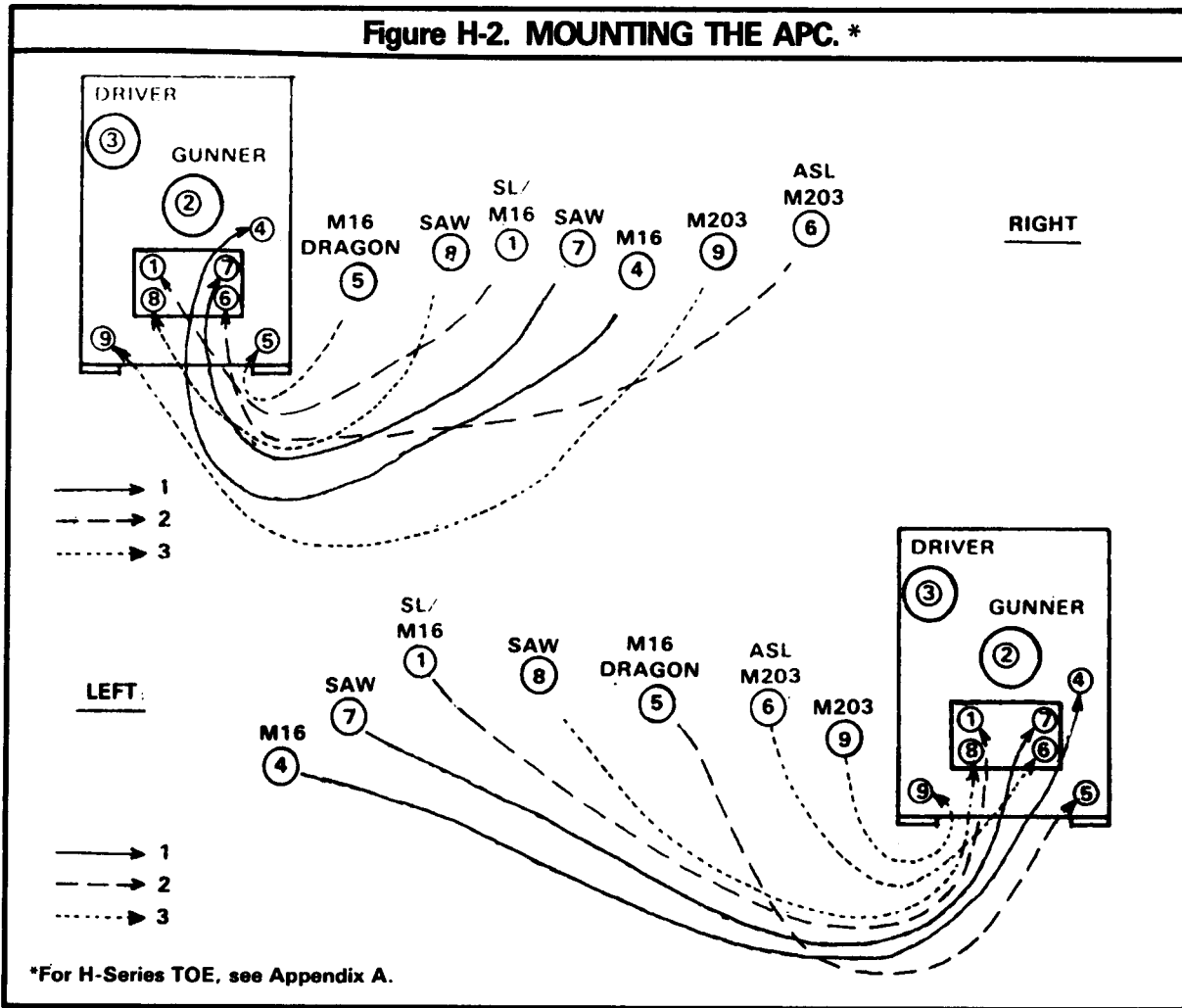
Squad leader indicates direction of travel for move out.

**COUNTERTASK:** OPFOR detects the squad occupying a defensive position. OPFOR closes with and destroys enemy.

**CONDITION:** OPFOR is conducting an attack.

**STANDARD:** OPFOR destroys the squad.

**Figure H-2. MOUNTING THE APC. \***



**DRILL TITLE:** Change mechanized mounted formation.

**TASK:** Change formation while moving mounted.

**CONDITION:** The platoon is moving mounted to make contact. Visibility is good.

**STANDARD:** The platoon changes from any one of five formations to any other as directed.

**INITIATING CUE:** The platoon leader uses arm-and-hand signals, flag signals, or radio to designate desired formation.

**PERFORMANCE REMINDERS:**

The platoon changes formation without delay.

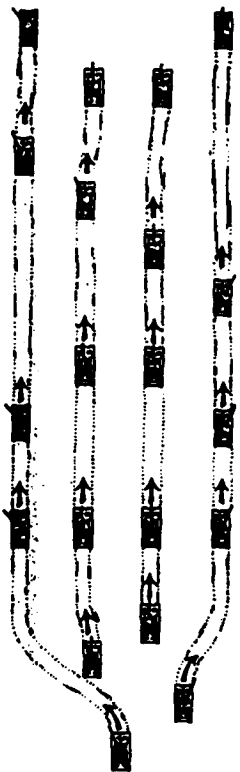

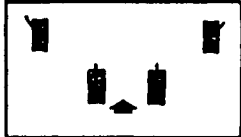

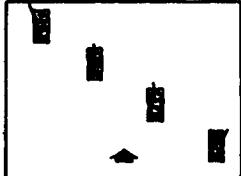


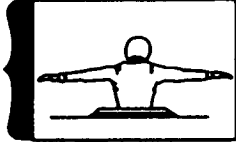

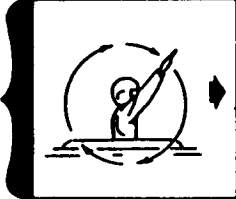
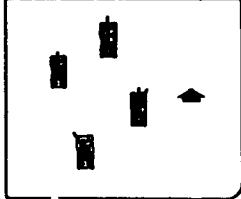
The caliber .50 machine guns are oriented toward likely enemy positions/assigned sectors.

**COUNTERTASK:** Not OPFOR dependent.

**CONDITION:** Not OPFOR dependent.

**SIANDARD:** Not OPFOR dependent.

**Figure H-5. MOVING OUT OF IMPACT AREA.**

THE PLATOON LEADER CHANGES FORMATIONS BY GIVING THE APPROPRIATE ARM AND HAND SIGNALS.	COMMAND	ARM AND HAND SIGNALS	FORMATIONS
	V		
	ECHELON RIGHT (LEFT)		
	WEDGE		
	LINE		
	COLUMN		



**DRILL TITLE:** React to direct fire.

**TASK:** The squad or platoon reacts to direct fire.

**CONDITION:** The unit is moving to make contact with the enemy. Visibility is good.

**STANDARD:** The unit returns fire, moves to nearest cover, and reports.

**INITIATING CUE:** The squad or platoon observes the signature of a weapon or detects rounds impacting against or nearby the vehicle.

**PERFORMANCE REMINDERS:**

Return fire.

Seek cover.

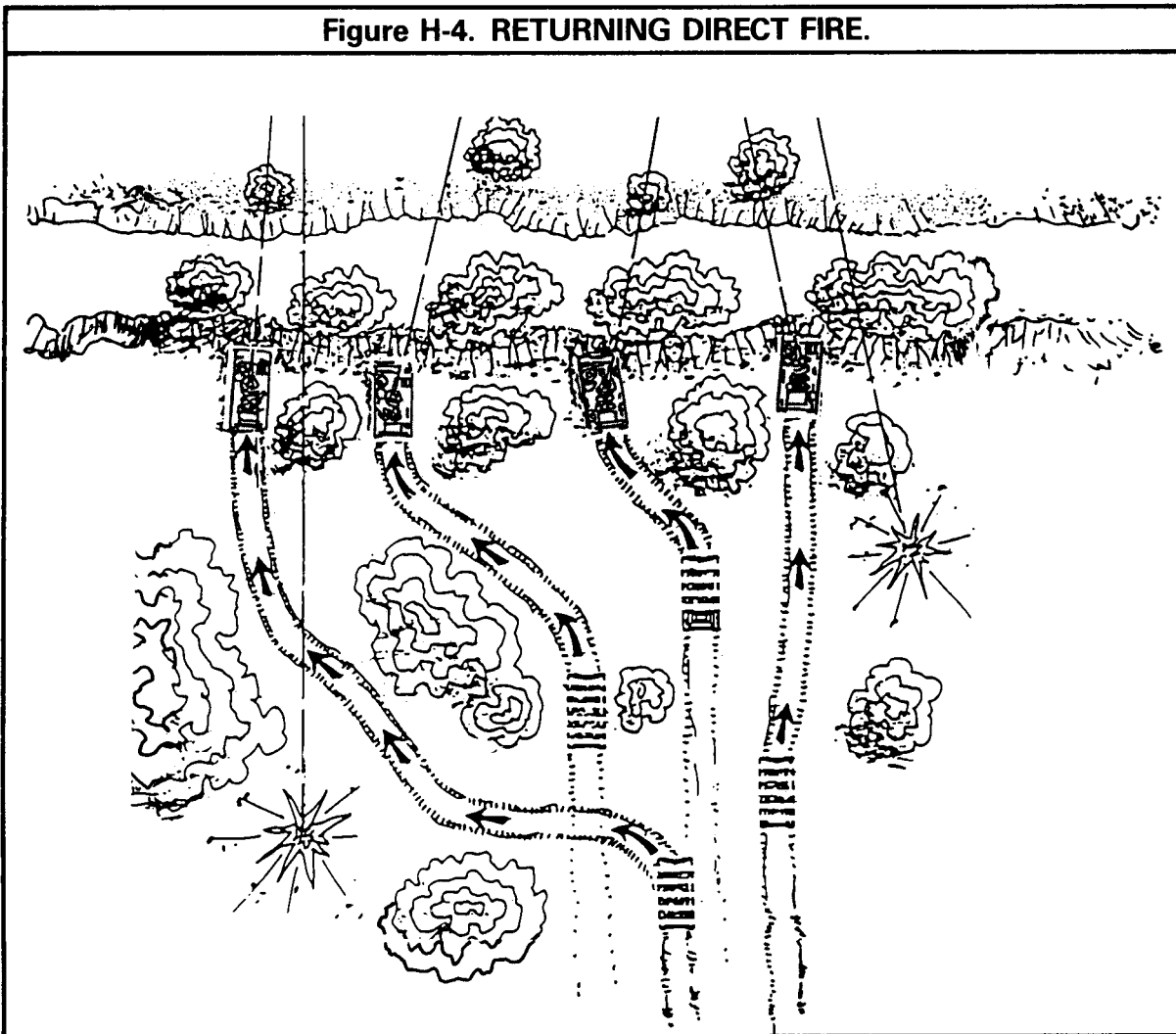
Report to next higher headquarters.

**COUNTERTASK:** OPFOR engages elements of the unit.

**CONDITION:** OPFOR is in a covered, concealed fighting position and is armed with direct fire weapons.

**STANDARD:** OPFOR suppresses the squad or platoon.

**Figure H-4. RETURNING DIRECT FIRE.**



**DRILL TITLE:** React to indirect fire.

**TASK:** The squad or platoon reacts to indirect fire or explosions.

**CONDITION:** The unit is moving to make contact with the enemy. Visibility is good.

**STANDARD:** The unit moves out of the impact area.

**INITIATING CUE:** The squad or platoon hears or sees rounds impacting.

**PERFORMANCE REMINDERS:**

All soldiers immediately don protective masks.

Close all open hatches.

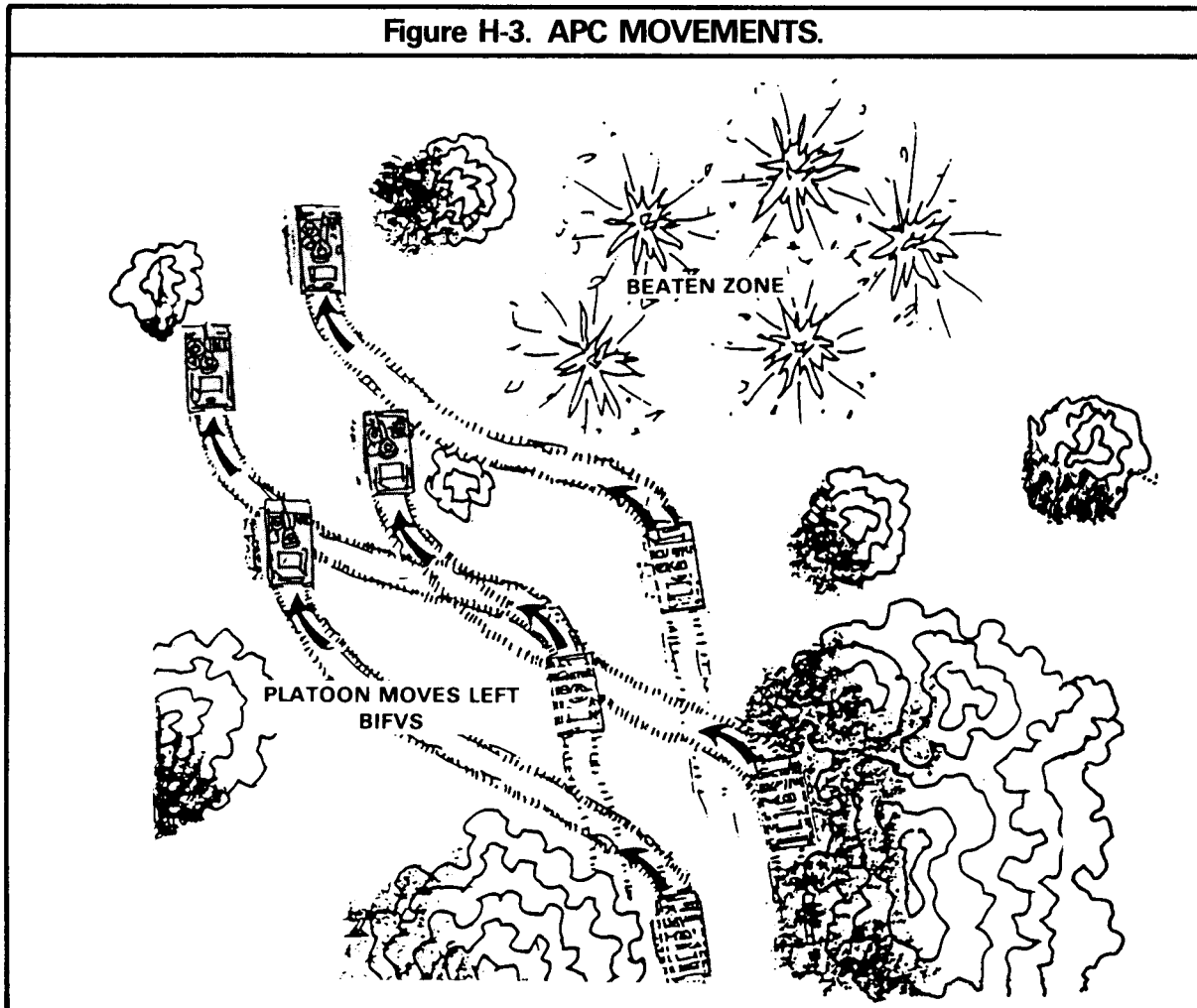
The squad moves out of the impact area.

If the beaten zone is recognized, the platoon avoids it by moving in an appropriate direction.

**COUNTERTASK:** OPFOR calls for indirect fire on the unit's position.

**CONDITION:** OPFOR is defending.

**STANDARD:** OPFOR locates and calls for fire on the unit before it can move out of the impact area.



**DRILL TITLE:** Execute action right, left, or rear.

**TASK:** Execute action right, left, or rear turning movement.

**CONDITION:** The platoon is using the traveling or traveling overwatch technique. Threat is spotted before he can initiate fire.

**STANDARD:** The platoon changes direction without delay

**INITIATING CUE:** Platoon leader's signal.

**PERFORMANCE REMINDERS:**

The platoon leader signals action right, left, or rear.

Each vehicle immediately executes a flanking turn to direction indicated.

Vehicles seek a hull-down firing position.

All caliber .50 machine guns are oriented toward the Threat.

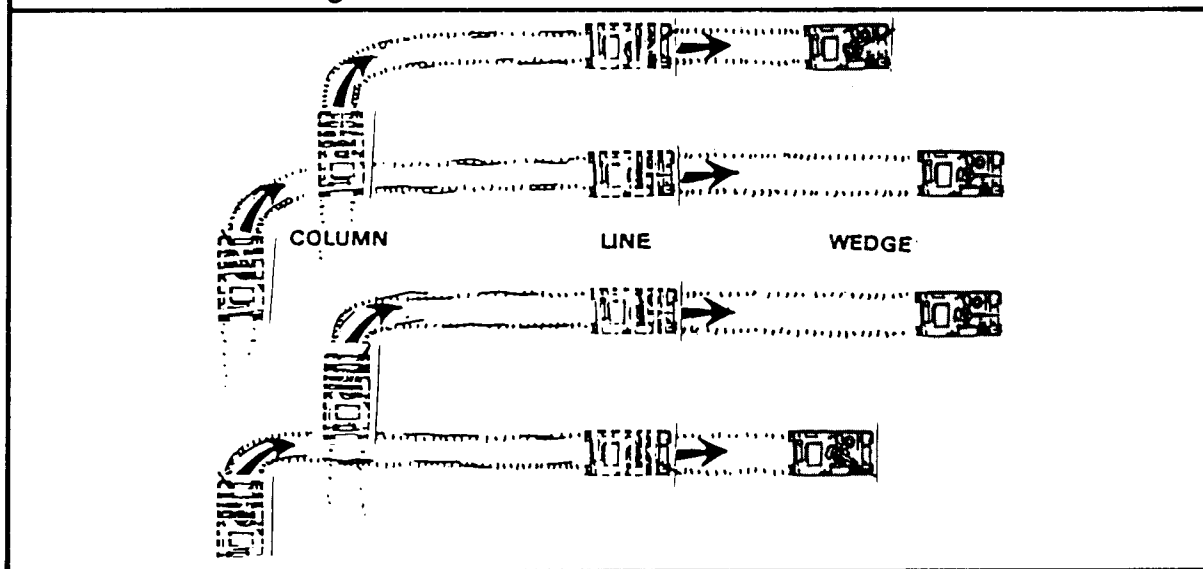
Dismounts as necessary.

**COUNTERTASK:** OPFOR detects the unit's movement.

**CONDITION:** OPFOR is defending.

**STANDARD:** OPFOR locates and reports the unit before being observed and reported.

**Figure H-6. MOVING TO LINE OR WEDGE.**



**DRILL TITLE:** Establish security at a temporary halt.

**TASK:** Establish security during a short halt.

**CONDITION:** The platoon is moving mounted using traveling or traveling overwatch technique.

**STANDARD:** The platoon maintains 360-degree security while halted.

**INITIATING CUE:** The platoon automatically herringbones whenever lead vehicle halts.  
**NOTE:** The platoon leader may give an arm-and-hand signal if he knows he is going to stop.

**PERFORMANCE REMINDERS:**

The platoon vehicles stop in a herringbone formation as a minimum.

The platoon leader may direct vehicles to disperse according to terrain, and find any available covered and concealed positions.

The squads maintain the same areas of responsibility for observation and fire as they had during the march.

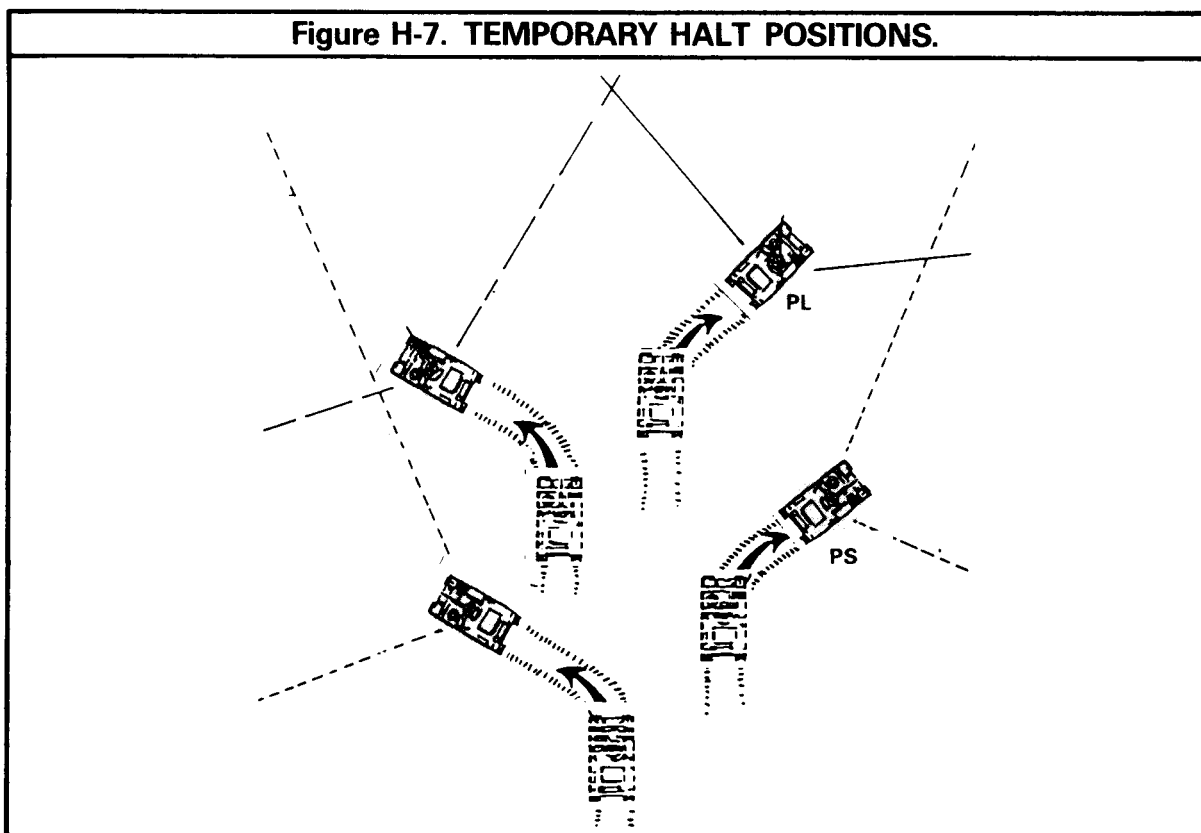
The squad leader may order all or part of the dismount team to dismount.

The squad leader directs which weapons to dismount.

**COUNTERTASK:** Not OPFOR dependent.

**CONDITION:** Not OPFOR dependent.

**STANDARD:** Not OPFOR dependent.



APPENDIX I

**LIMITED VISIBILITY  
EQUIPMENT AND  
TECHNIQUES**

**Section I. INTRODUCTION**

**I-1. GENERAL**

Platoons that have trained long and hard and have mastered the tactical and technical job skills required will fight effectively even when visibility is limited. Darkness limits visibility on the battlefield, but there are also other conditions that limit visibility. They are almost as common as darkness but less predictable and more difficult to deal with. Smoke and suppressive fire, which can severely limit local visibility are used in all armies. Dust and smoke caused by fire and movement of troops in combat, are especially critical to the effective employment of long-range direct fire weapons. Rain, falling snow, and fog also limit visibility. Most current night vision devices and battlefield illumination means are less effective under these conditions.

**I-2. COMMAND AND CONTROL**

The leader's primary task is to coordinate and control the fire and movement of his unit so that

he can mass combat power. This is a demanding task when visibility is good; it becomes even more so when visibility is limited. Poor visibility adds to command and control problems, and leaders must recognize and overcome those problems that make it more difficult to:

**Detect targets.**

**Distinguish between friendly and enemy units.**

**Fire weapons effectively.**

**Navigate.**

CONTENTS		PAGE
Section I.	Introduction .....	I-1
II.	Platoon and Squad Limited Visibility Equipment .....	I-2
III.	Battlefield Illumination .....	I-5
IV.	Control During Limited Visibility .....	I-6

## Section II. PLATOON AND SQUAD LIMITED VISIBILITY EQUIPMENT

### I-3. GENERAL

Technology has produced devices that soldiers and leaders can use to reduce the effects of limited visibility. Several of these devices are organic to the platoon. This section defines the types of devices issued to the platoon and explains how they are employed.

### I-4. SURVEILLANCE, TARGET ACQUISITION, AND NIGHT OBSERVATION EQUIPMENT

Advanced STANO equipment is either active or passive. To be effective, active STANO equipment must project some form of energy. This energy can be detected by the enemy. Passive STANO equipment either detects existing energy emissions or uses available light as a detection means. Use of passive equipment is not detectable by the enemy.

There are two categories of passive STANO equipment — image-intensification devices and thermal-imagery devices.

Image-intensification devices, or starlight scopes, do not project detectable energy. They amplify the existing or ambient light at night to project an image on the scope. Ambient light may be moonlight, starlight, or the glow from cities and towns. Light from flares, searchlights, and laser illumination improves the viewing capability but should not be viewed directly by the device. Image-intensification devices are adversely affected by fog, smoke, heavy rain, and falling snow.

Thermal-imagery devices penetrate fog, smoke, falling snow, camouflage, and light vegetation. The principle of this type of device is that all objects radiate a certain amount of heat, which travels outward as detectable energy. Because of differences in the amount of heat being radiated, the viewer detects each difference as a more intense or less intense image.

Thermal-imagery devices can be used in daylight or darkness.

STANO devices greatly improve a unit's ability to carry out its mission under all conditions of visibility. STANO devices perform three general functions to overcome the effects of limited visibility:

Image-intensification devices and binoculars aid observation and weapons' firing where darkness is the only limiting factor.

Thermal-imagery devices aid observation and weapons' firing through their ability to see through light vegetation, camouflage, darkness, smoke, fog, rain, falling snow, or a combination of these factors.

Image-intensification and thermal-imagery devices aid in detecting enemy active STANO devices, such as infrared equipment.

The platoon is issued the following STANO equipment:

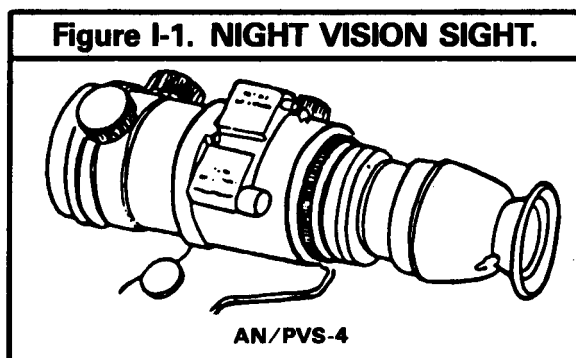
**Binoculars.** The platoon headquarters is issued two sets of 7x 50-mm binoculars. They are used by the platoon leader and the platoon sergeant to acquire long-range targets. At night, binoculars can be used to extend the range of the naked eye by taking advantage of the existing light. Binoculars are less effective through smoke, dust, heavy rain, falling snow, or fog. Additionally each squad is issued one set of 7x 50-mm binoculars.

#### AN/PVS-4 INDIVIDUAL-SERVED WEAPONS NIGHT VISION SIGHT.

The AN/PVS-4 is a small, lightweight image-intensification device used on the M16A1 rifle and the M60 machine gun. It can also be held in the hand. It weighs 3.7 pounds and has a range of 400 meters in starlight and 600 meters in moonlight. It is powered by a 2.7-

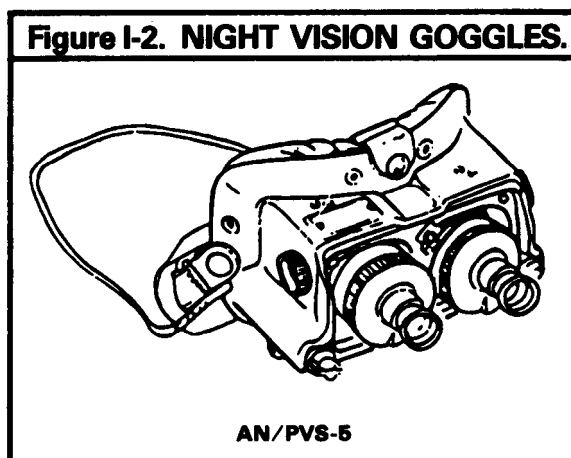
volt battery with a battery life of 10 hours. It is a 3.8x telescopic device used to provide accurately aimed weapons fire at night and to detect, identify and observe friendly and enemy operations. The AN/PVS-4 is issued two per squad and one per platoon headquarters.

Squads can mount one AN/PVS-4 on the M60 machine gun and the other on an M16A1 rifle when in the dismounted role. The squad leader or platoon leader can hold the AN/PVS-4 in the hand, as in an observation post, to provide a night observation capability. Who is to use the device is controlled by the squad leader or platoon leader.



**AN/PVS-5 Night Vision Goggles.** The AN/PVS-5 is a lightweight, battery-powered (2.7-volt), passive or active night vision device worn on the head. The battery life is 10 hours. It weighs 1.9 pounds and has a range of 150 meters in the passive mode. It is issued two per squad and platoon headquarters. By using the AN/PVS-5 while moving, the TL or gunner has the same night vision capability as the driver. The AN/PVS-5 helps the TL/gunner control the movement of the vehicle as it travels at night on roads or cross country. The AN/PVS-5 has a built-in active infrared light source, which can be used to provide added illumination for close-

up viewing within 2 meters. In this mode, it can be used to read maps, overlays, or orders. The area where the active mode is used must be shielded from possible enemy detection. Inside a building, or a vehicle, or under a ponch, there is not a direct line of a sight from the infrared light source to the enemy. The AN/PVS-5 can also be used for vehicle maintenance during darkness, and it can be worn by a ground guide to direct the APC. The dismount element may also use the AN/PVS-5 to aid in dismounted limited visibility operations.



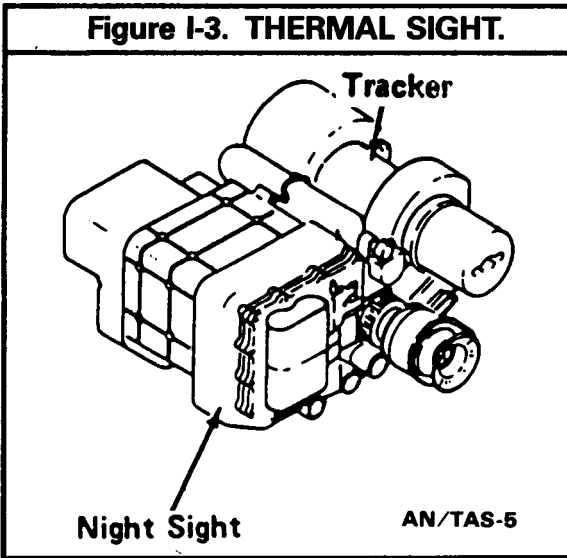
**AN/TAS-5 Dragon Thermal Night Vision Sight.**

The AN/TAS-5 is a battery-powered passive thermal-imagery system. It is issued one per Dragon daysight/tracker (thus three per platoon) for antiarmor specialist use. The AN/TAS-5 will detect, and display on a screen, thermal energy that is emitted by all materials and man-made objects. It weighs 20.6 pounds and has a range out to 1,200 meters. The AN/TAS-5 uses rechargeable batteries and employs small gas cylinders or bottles for cooling the detector electronics. These batteries and cooling bottles

have a life of 2 hours. The AN/TAS-5 should only be used to acquire and engage targets. It should not be used as a surveillance device; other night vision devices are used for that role. When a target is detected, the gunner is alerted and uses the AN/TAS-5 to acquire and engage the target. A cooldown period of 10 to 15 seconds is required to activate the sight before it can be used effectively.

The tracker batteries and cooling bottles are recharged and refilled at the brigade trains. They are placed by direct exchange on a one-for-one basis. Discharged batteries and empty gas bottles should be collected and exchanged whenever the situation permits. Collection and exchange procedures should be in the unit SOP. The platoon sergeant should collect the bottles and give them to the company supply personnel during normal resupply. The bottles should be exchanged during the day, when limited visibility engagements are less frequent.

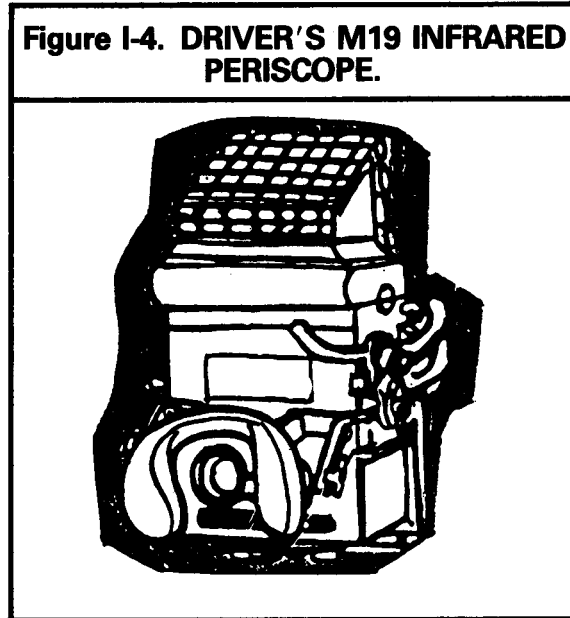
**Figure I-3. THERMAL SIGHT.**



**M19 Infrared Periscope.** The M19 infrared periscope is used by the driver to increase his field of vision during limited visibility operations. It has a 1x optical lens with a 26-degree field of vision and a planning range of 40 meters. This is an active STANO device using the infrared headlights on the car-

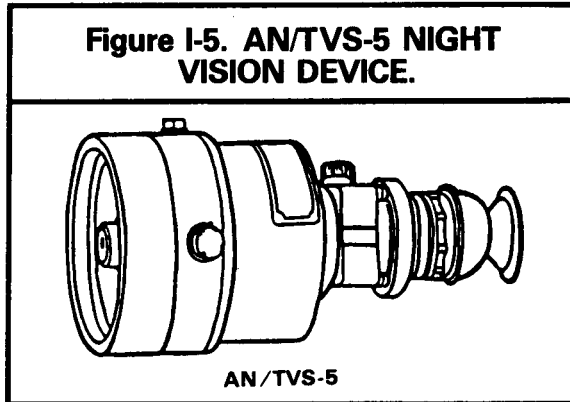
rier as the light source. These lights are easily detectable by the enemy's STANO devices and should be used only when the AN/PVS-5 night vision goggles are not available. (For operation, refer to TM 9-2300 -257-10.)

**Figure I-4. DRIVER'S M19 INFRARED PERISCOPE.**



**AN/TVS-5 Crew-Served Night Vision Device.** The AN/TVS-5 crew-served night vision device can be mounted on the caliber .50 machine gun. It is a lightweight, battery-powered electro-optical telescopic sight. It can detect vehicle-size targets at ranges up to 2,000 meters. It is issued one per squad and one per platoon headquarters.

**Figure I-5. AN/TVS-5 NIGHT VISION DEVICE.**





**AN/TRS-2 Platoon Early Warning System.** The AN/TRS-2 platoon early warning system (PEWS) is a remote sensor system (REMS). Each rifle company has three PEWS. The system has 10 ground-implanted sensors. They transmit a signal (by radio or wire) to a receiving set that indicates movement in the area and which sensor is reporting. PEWS also differenti-

ate between foot and vehicular movement. This device is ideal for monitoring avenues of approach masked by terrain or poor visibility. They should be employed along avenues of approach and in dead spaces or gaps forward of or between units. Each sensor can detect targets up to 15 meters from the sensor location. Its signal can be transmitted up to 1,500 meters.

### Section III. BATTLEFIELD ILLUMINATION

#### I-5. GENERAL

Artificial battlefield lighting is the easiest way to penetrate darkness. The trick is to illuminate or silhouette the enemy without illuminating friendly forces. There is always a chance that artificial lighting may have an adverse effect on friendly troops. The characteristics of available artificial illumination systems, and how they are influenced by darkness, weather, and terrain, are addressed in this section.

#### I-6. CATEGORIES OF ARTIFICIAL LIGHT

There are two types of artificial light — invisible and visible.

Invisible light is emitted by an infrared emitting source and is all but impossible to see with the unaided eye. It offers greater security than visible light because a night observation device is needed to detect it. But, because it is an active device, it is easily detected by active and passive devices.

Visible light, such as flares and searchlights, require no special equipment outside the light source itself. It is the simplest type of illumination. Visible-light sources are used frequently to continue daylight operations into darkness, when troops are untrained, when planning time is limited, or to offset an enemy advantage in night vision devices. The disadvantage of using visible light is that at close ranges it compromises friendly positions.

The platoon uses the following sources of artificial visible light: tripflares, M203 illumina-

tion rounds, indirect fire illumination, and tank searchlights.

Tripflares are mainly for defense and are excellent early warning devices. They can be set to ignite by rigging them either with pull pin or trigger release. Their size and limited burning time make them unsuitable for continuous illumination.

The M203 illumination round can provide fast, close-in illumination when the dismount team is deployed. The round burns for about 40 seconds. It is used the same way and is subject to the same conditions as indirect fire illumination.

Indirect fire illumination from artillery and mortar fire is the most commonly used form of battlefield illumination. Wind direction must be considered when requesting illumination of this type. The height of burst of the shell is set to achieve maximum burning time. Burn time of most rounds is 60 seconds, so to achieve continuous illumination one round should be fired every 30 seconds. Illumination rounds should be fired so that they burn out just before ground contact. Drifting flares may illuminate friendly units, so, the forward observer must adjust the detonation point of the round to keep it from illuminating friendly units. If ground fire is a hazard, the height of burst should be raised to keep the flare from landing while burning. Strong winds may move the burning flares off target; thus, to achieve continuous illumination, increase the rate of fire.

Illumination from artillery or mortar flares is dimmed by fog, dust, smoke, and falling snow. Under these conditions of limited visibility low illumination rounds may be used as a navigation aid, with the flares' light visible enough to act as a beacon, even though it may not furnish usable illumination.

Searchlights are on many types of tanks and in target acquisition batteries of corps artillery. Tank searchlights furnish two types of illumination — white light and infrared light.

Depending on the terrain, enemy situation, and cloud cover, searchlights may be used to provide direct illumination, or reflected illumination off low clouds. They can mark targets, objectives, or boundaries. They can also be used to increase deception by illuminating an area or point outside the intended area of action. When using searchlights, the system employing the light is easily detected and extremely vulnerable. It should be used when no other system is available.

## **Section IV. CONTROL DURING LIMITED VISIBILITY**

### **I-7. GENERAL**

Various techniques must be used by leaders to control units during limited visibility. These include measures to identify friendly forces, to control movement and fire, and to navigate.

During movement, visual contact can be maintained by reducing the intervals between dismounted soldiers or vehicles. Night vision devices (AN/PVS-5 and AN/PVS-4) allow units to retain some dispersion while maintaining visual contact. When vehicles are moving in any area that has friendly dismounted personnel, such as an assembly area or urban terrain, dismounted guides must be used. Leaders should move forward where they can control the direction and speed of the movement.

### **I-8. NAVIGATION**

Whenever possible, guides should be used while moving (mounted or dismounted) over unfamiliar terrain. Compasses, visible landmarks, and night vision devices can be used as navigational aids. Ground surveillance radar and

night vision devices can also be used, to guide dismounted patrols as they depart and when they return to friendly positions. Artillery spotting rounds may help determine location and direction.

### **I-9. FIRES**

Besides the nightsight and other night observation devices, there are several techniques and aids that can be used to control the APC's and dismounted weapons' fires. When the unit is in a stationary position, range cards should be used. Range cards help orient weapons on likely targets and reference points. (See appendix C.) The platoon should make wide use of wire in the defense to establish more reliable and secure communication between the teams, OPs, and platoon headquarters. Tracers can be used to denote targets and to direct fire on targets. Pyrotechnic signals, such as hand-fired flares, can be used to call for the lifting and shifting of fires.

APPENDIX J

**SMOKE**

**Section I. ONBOARD SMOKE PRODUCERS**

**J-1. GENERAL**

Smoke obscures vision and degrades most sighting devices. Both friendly and enemy forces use smoke to reduce their opponent's ability to see, move, and fight. Both forces may use smoke to screen their own movement, and they may place smoke to deceive. Thermal-imagery sights and viewers provide the means to see and shoot through most smoke.

**J-2. SMOKE DEVICES**

The APC may have an onboard smoke device, the M243, and a Dragon thermal-imagery sight to see through the smoke.

The M243 smoke-grenade launcher is used to spread a smoke screen quickly. There are two four-tubed launchers, one on each side of the engine compartment hatch cover. Eight smoke grenades are simultaneously launched electrically from the gunner's position.

More smoke-grenade rounds are stowed in the vehicle. The total number of rounds carried

on the vehicle is 16. This system must be reloaded by hand from outside the vehicle.

The rounds are filled with red phosphorus. Upon activation, a dense cloud of white smoke is created from ground level up to a minimum height of 7 meters by 70 meters wide and between 20 and 50 meters from the vehicle in 2 to 6 seconds. The cloud lasts 1 to 3 minutes depending on wind speed and other weather conditions.

Loading, stowing, reloading, and firing instructions for the grenade launcher are in TM 9-2350-252-10-2.

The M203 has a smoke round but it is used primarily for signaling. (See appendix B.)

CONTENTS		PAGE
Section I.	Onboard Smoke Producers . . . . .	J-1
II.	Tactical Considerations in a Smoke Environment . . . . .	J-2

## Section II. TACTICAL CONSIDERATIONS IN A SMOKE ENVIRONMENT

### J-3. GENERAL

A platoon can use smoke to screen movement between positions; to screen occupation of, withdrawal from, or reoccupation of positions; or to screen a counterattack. The smoke can also cover displacement between delay positions. It can deceive the enemy as to the location and number of vehicles employed on each position, and it can slow the enemy enough to let the platoon occupy new positions.

Because there are only 16 smoke grenades per vehicle, the use of the grenade launcher must be controlled. The limited number of smoke grenades makes it necessary for the platoon to take advantage of all available smoke sources and conserve smoke grenades for self-defense. During movement, a platoon leader might direct a certain squad to launch its smoke grenades to counter antiarmor fires. The 70-meter-wide smoke screen may not screen the entire platoon from the enemy gunners. If not, the platoon leader could then direct another squad to launch its smoke grenades. All vehicles must take evasive action to get full advantage from the smoke screen.

If a smoke screen is needed to cover the crossing of an open area, the smoke-grenade launcher can be used to set up the smoke screen.

### J-4. SMOKE APPLICATION

There are four general applications for smoke on the battlefield: obscuration, screening, marking and signaling, and deception.

**Obscuration Smoke.** Obscuration smoke is placed on or near enemy positions to interfere with his observation and fire. It is usually delivered by indirect fire from artillery and/or mortar shell, and occasionally by aircraft, rockets, or bomb-type dispensers. Employment of obscuration smoke on an attacking armored force may cause reduced speed, an inadvertent change in the direction of the attack, a prema-

ture deployment, or an increase in its radio transmissions.

**Screening Smoke.** Screening smoke is employed within areas of friendly operation, or in areas between friendly and enemy forces, to degrade enemy ground and aerial observation and fire. Screening is primarily intended to conceal friendly forces. Screening smoke usually requires large quantities of smoke for long periods and is normally produced by mechanical smoke generators, smokepots, smoke grenades, and aircraft-delivered dispensing systems. There are three types of screening smoke: smoke blankets, smoke hazes, and smoke curtains.

Smoke blankets are used over friendly areas to hinder enemy aerial observation and long-range ground observation. Smoke blankets may restrict friendly movement and activities within the screen. For example, smoke blankets may be used for river-crossing operations to obscure crossing sites. Smoke blankets are produced by smoke generators.

Smoke hazes are similar to smoke blankets, but the smoke is less dense than in a smoke blanket, thereby allowing better vision within the affected area. Smoke hazes are used to reduce long-range visual observation. A smoke haze hinders aerial and ground observation of friendly areas of operation.

Smoke curtains are normally used in front or to the flank of the forward edge of an area or unit to obscure or restrict enemy ground observation. They are dense, vertical curtains of smoke, with a wall of smoke between friend and foe, which do not restrict aerial observation. Smoke curtains are used to cover withdrawals and movements of attacking troops, and to conceal landing zones or pickup zones in airmobile operations.

**Marking and Signaling Smoke.** These types of smoke are employed to communicate

execution or termination of actions on the battlefield and to mark reference points, targets, or unit locations. They usually consist of colored or WP smoke. Occasionally, WP artillery or mortar rounds may be used to signal such things as the end of an artillery preparation on the target and the beginning of an assault.

**Deception Smoke.** Deception smoke may be used in coordination with other actions to create the illusion that some tactically significant event is occurring, in order to confuse or mislead the enemy. Combat forces which have developed stereotyped patterns of smoke employment might utilize deception smoke in dummy river crossings, withdrawals, or airmobile operations. Generally deception smoke is used in conjunction with other deceptive measures such as sound or electronic deception.

#### J-5. SMOKE EFFECTS

Smoke can affect both the psychological and physiological aspects of troop activities. Therefore, it can also affect unit operations.

**Psychological.** Screening smoke near friendly positions to reduce enemy observation may help maintain morale when personnel are aware of its purpose. However, personnel operating in smoke may develop fear or anxiety due to lack of visibility to detect the enemy see adjacent units, or distinguish terrain features. This can cause orientation difficulties. Smoke tends to isolate individuals, groups, or units, thus degrading their ability to fight. Individuals and units in this situation are vulnerable to deception through other sensory perceptions such as sound. Leaders also at all levels can suffer these effects. Because of the need for constant and detailed command and control, leaders can suffer mental exhaustion in a short time.

**Physiological.** While smoke produced by mechanical generators or munitions may not produce immediate physiological effects, extended

exposure to large concentrations may produce secondary effects such as shortness of breath, inflammation of the respiratory system, dizziness, vertigo, or vomiting. Because of this, the Surgeon General requires that troops be masked whenever they are exposed to smoke. Vertigo may be overcome by leaving the smoke area or, when mounted, dismounting from the vehicle and getting close to the ground. Chemical warfare (CW) agents may also be delivered with smoke; therefore, it is wise to mask and intensify CW detection efforts when smoke is present.

**Operational Factors.** By limiting vision, smoke degrades the ability of soldier and unite to maneuver, fight, and visually communicate. Furthermore, it restricts observation of surrounding terrain and other combat elements on the battlefield. The natural tendency of a vehicle driver when encountering smoke is to avoid it or to slow movement upon entering it.

**Combined Arms Operations.** Smoke adversely affects battlefield systems that must operate in concert, such as tactical aircraft, helicopters, armor, artillery and infantry. Smoke limits scanning ability and prevents the operator/observer from taking timely measures or countermeasures once the enemy is detected.

#### J-6. SMOKE COUNTERMEASURES

Smoke reduces the ability of the attacker and the defender to acquire targets, navigate, and control their forces. The use of smoke must be carefully planned to insure that the intended advantage is gained.

Detailed plans must be made, and everyone must know what actions are to be taken in a smoke environment.

A detailed reconnaissance of the area must be carried out using all available resources (radars, aerial photographs, maps, etc.).

In the defense, and as time permits, routes to subsequent positions should be reconnoitered in depth.

During movement, terrain features, woodlines, riverbeds, and man-made features can be used to guide on.

Use of the thermal-imagery sight to see through smoke must be planned by the platoon

leader. The cooldown period needed before the thermal sight can be used requires that it be turned on before the platoon can shoot through its own or the enemy's smoke.

Smoke is a major factor on the battlefield. Measures should be identified and techniques practiced that allow the platoons and squads to use smoke, both enemy and friendly, to their advantage.

APPENDIX K  
**EVACUATION OF  
 CASUALTIES FROM AN APC**

**Section I. INTRODUCTION**

**K-1. GENERAL**

Mechanized infantry moves and fights mounted whenever possible. If platoon members are wounded or injured while in the APC, they will require evacuation.

To evacuate casualties quickly every man in the platoon must know the evacuation procedures for different vehicle positions, such as vehicle upright, turned on either side, or overturned. This appendix covers the procedures to follow for different situations.

**K-2. STEPS IN CASUALTY EVACUATION**

**Observe for Vehicle Fire.** When an APC is found that has been hit by enemy fire or damaged by a mine, it should be inspected to determine the extent of damage and to find out if there is a danger of fire. The externally fixed fire extinguisher handle should be pulled and a portable fire extinguisher readied, if the threat of fire exists. The handles for the fixed fire extinguisher on the inside are in the driver's compartment and on the top left side of the APC. The fixed fire extinguisher is used to extinguish a fire in the engine compartment. The portable fire extinguisher is used to suppress a fire in the troop compartment. Open hatches and working exit points should be identified to plan the swift evacuation of casualties.

**Move Vehicle to Safe Location.** If the vehi-

cle can move under its own power, it should be moved to a safe place before evacuating casualties. If the driver is wounded and cannot operate the vehicle, he should be removed through the troop compartment, replaced, and the vehicle driven to a safe location.

**Check and Treat Casualty.** Too rapid an evacuation of a casualty may cause further injury. Before a casualty is evacuated, he should be checked thoroughly to discover the full extent of his injuries, and first aid should be administered to those wounds requiring immediate attention. There may be some instances, though, when the casualty should be evacuated immediately. For instance, if the vehicle is burning or when conditions inside the APC do not allow for effective evaluation of injuries.

**Evacuate Casualty.** After giving the necessary first aid, the casualty's CVC helmet should be disconnected or helmet removed and his seat belt released. If the vehicle is on its side or overturned, he must be supported before the seat belt is released, to prevent additional injuries. He is then evacuated.

CONTENTS	PAGE
Section I. Introduction .....	K-1
II. Procedures for Casualty Evacuation .....	K-2

### K-3. SAFETY PRECAUTIONS

Before evacuation, the load-carrying equipment (LCE) should be removed from casualties in the troop compartment so that the equipment does not catch on anything during evacuation.

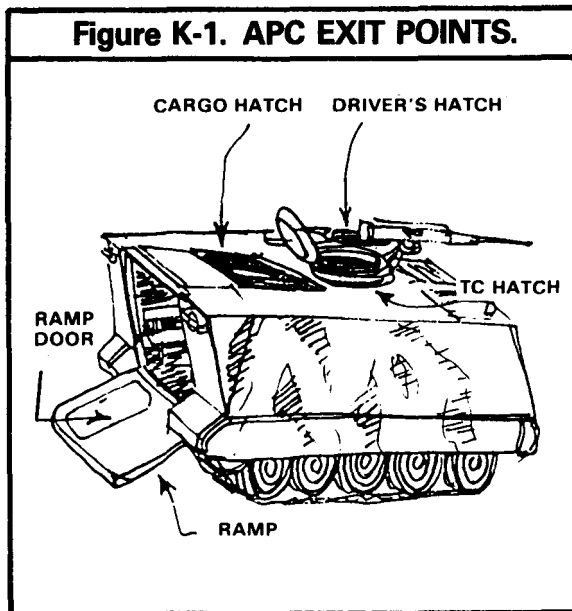
### K-4. EXITS

To evacuate a casualty, individual soldiers must know what exits are available. The APC has five exits: TL/gunner's hatch, driver's hatch, cargo hatch, ramp door, and ramp. Some may be used to evacuate any of the occupants, and others are used to evacuate specific occupants.

When possible, the gunner's hatch and driver's hatch will be the evacuation exit for the gunner and driver. If one or both of these exits is blocked, or if the tactical situation stops their use, casualties from these positions will be evacuated through the troop compartment and out the ramp door or the ramp.

The ramp will be the main exit used to evacuate casualties from the troop compartment. The ramp door will be used if the ramp cannot be

opened. Casualties may also be evacuated through the cargo hatch if the ramp and ramp door do not work.



## Section II. PROCEDURES FOR CASUALTY EVACUATION

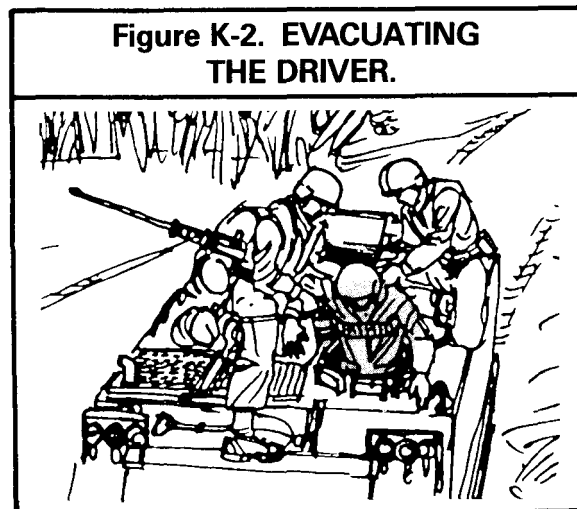
### K-5. GENERAL

The following procedures must be rehearsed so that the squad can effectively evacuate casualties.

### K-6. DRIVER

When the driver's hatch is open and the situation allows, the driver is evacuated through the driver's hatch. The soldiers doing the evacuating will evacuate the driver after opening the hatch fully. One man will then lean head first into the hatch (assisted as necessary) to make sure that the engine is off. If possible, he will raise the seat to the full up position, unbuckle the driver's seat belt, and disconnect his CVC helmet. Depending on the driver's injuries, he will be lifted out, from the top, by two soldiers, helped by another from inside the vehicle. A pistol belt, placed around the driver's chest and under his arms, can be used to pull him out.

Once he is on the top of the vehicle, he will be passed down to personnel on the ground.



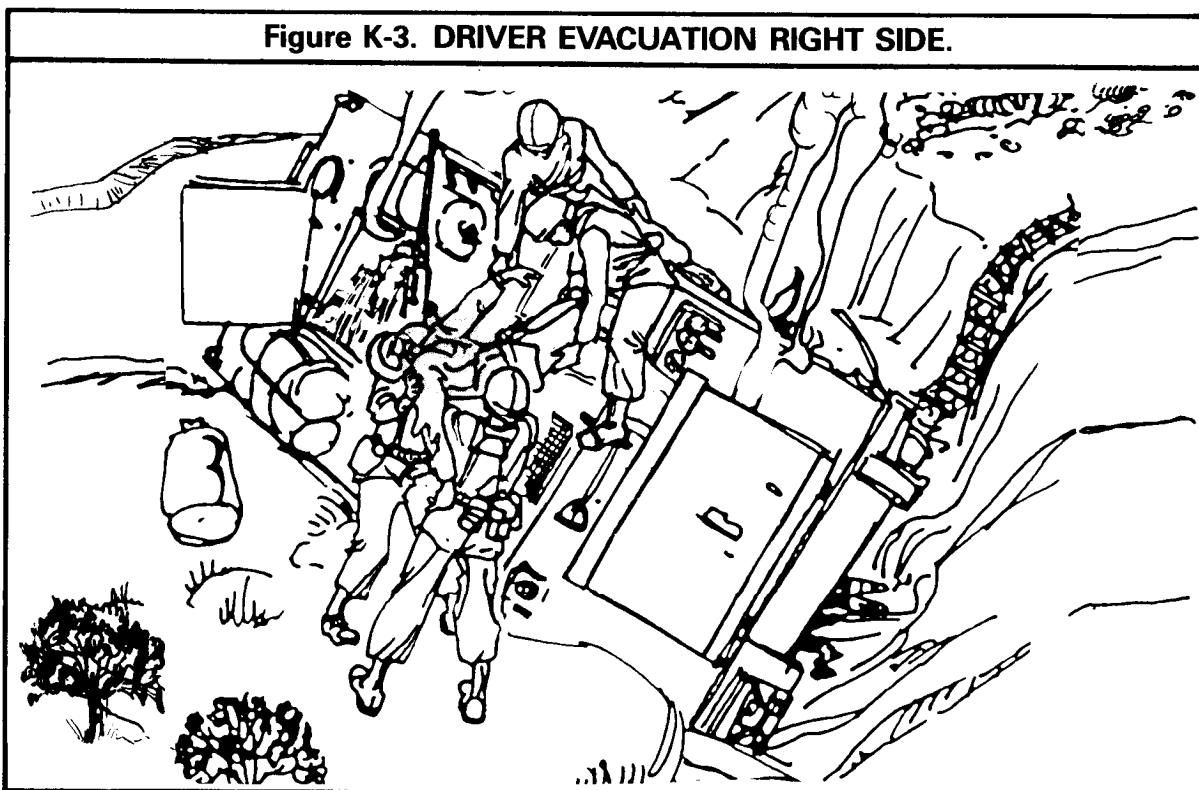


The driver may have to be evacuated through the troop compartment and out the ramp, because his hatch is inoperable or the vehicle is receiving enemy fire, or due to some other tactical condition. The man closest to the driver checks to make sure that the engine is shut off. The driver's seat is lowered and pulled to the rear. The driver's seat belt is unbuckled and his CVC helmet disconnected. The driver is grasped under the arms or in another way, depending on his injuries. He then is pulled into the troop compartment. Care must be taken not to fur-

ther injure the driver because of close quarters or protruding objects. He will be evacuated out the ramp.

If the vehicle is on its side, the driver must be supported while his seat belt is unbuckled, to prevent further injury. If the vehicle is on its left side, it takes two people to pull out the injured driver because the hatch opening will be next to the ground. If the vehicle is on its right side, four people will be needed to pull out the driver and to pass him down from the vehicle.

**Figure K-3. DRIVER EVACUATION RIGHT SIDE.**



#### **K-7. GUNNER**

A soldier injured while occupying the gunner's position is pulled into the troop compartment. The CVC helmet is disconnected and removed and the soldier is then evacuated from the vehicle by the ramp or ramp door.

#### **K-8. PERSONNEL IN TROOP COMPARTMENT**

Injured persons in the troop compartment will be evacuated through the ramp, the ramp door, or the cargo hatch. The casualty's seat belt must be unbuckled before being evacuated through the most convenient exit.

The first steps in evacuating casualties are checking for injury and administering first aid, before evacuating the casualties from the vehicle. Casualties should be moved quickly but safely to the proper medical facility for further

treatment. Prompt, sure action on the part of fellow soldiers to evacuate casualties to the rear, as stated in the unit SOP, will help increase their chances of survival and speed their return to their units.

APPENDIX L  
**RECOVERY TECHNIQUES**

**Section I. INTRODUCTION**

**L-1. GENERAL**

If an APC is disabled, gets stuck, or will not start, the squad must get it moving as quickly as possible. A stationary vehicle is vulnerable to direct, indirect, and air-delivered munitions. This appendix covers towing a disabled APC, starting it by towing or using a slave cable, retrieving it if it is stuck in mud or immobilized on an obstacle, safety considerations for recovery operations, and how to disable the vehicle if it has to be abandoned. For additional techniques, see FM 20-22.

Because the immobilized APC is such a vulnerable target, personnel not involved in the recovery should be in position to provide security. The caliber .50 machine gunner should stay at

his station and be ready to engage targets as required. Squad members picked to provide local security should dismount and be stationed away from the vehicle.

**L-2. REDISTRIBUTION OF MEN AND EQUIPMENT**

If the vehicle cannot be recovered quickly the platoon leader may decide to redistribute men and equipment among the other vehicles. The driver and caliber .50 machine gunner may be left with the disabled vehicle to wait for help, or the vehicle may have to be abandoned if the enemy situation warrants.

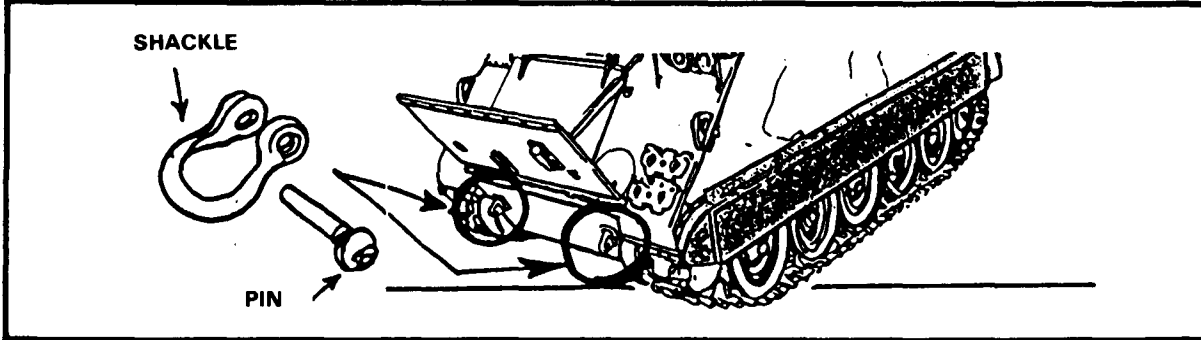
**Section II. TOWING**

**L-3. GENERAL**

The APC may have to be towed when disabled or stuck or to start its engine. The APC is equipped with towing eyes and shackles on the front and a tow pintle in the rear of the vehicle. It also has a tow cable stowed on the outside of the rear ramp.

CONTENTS	PAGE
Section I. Introduction.....	L-1
II. Towing .....	L-1
III. Recovery .....	L-5
IV. Safety .....	L-8
V. Abandoning the APC .....	L-10

**Figure L-1. TOWING EYES AND SHACKLES.**



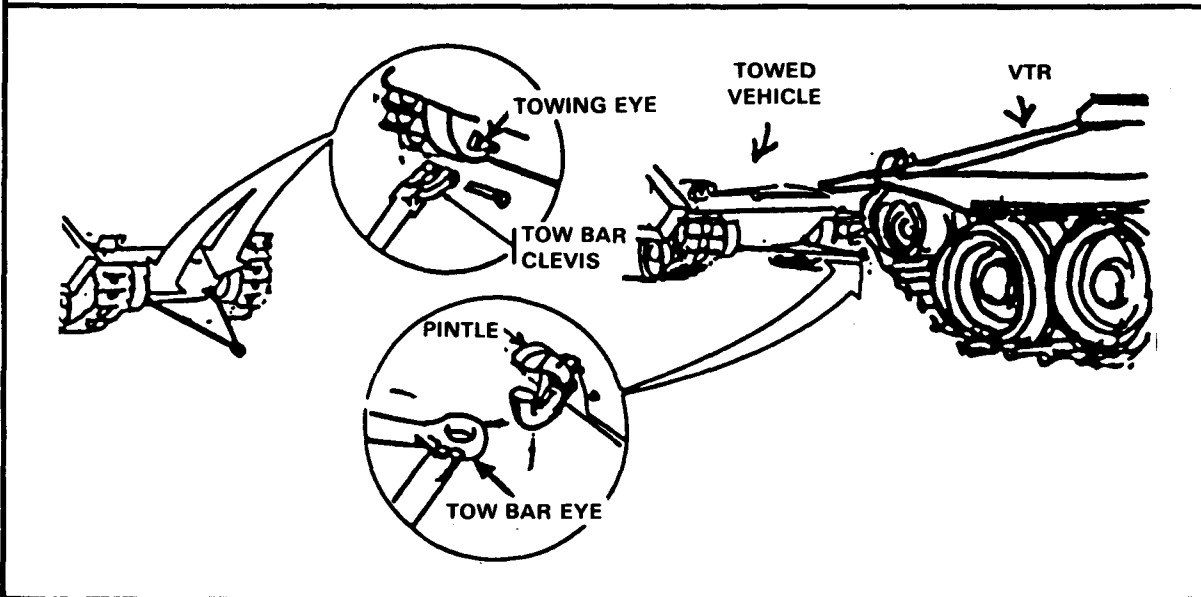
Normally the terrain or enemy situation will dictate the way to tow the APC. When not exposed to enemy fire, either the highway or the cross-country tow may be used. When exposed to enemy fire, the combat tow is used. Before any towing hookup is begun, the master switch should be OFF, the laterals locked, and the range selector placed at N (neutral). Once all connections for towing have been made, the laterals are released.

**L-4. TOWING TECHNIQUES**

**Highway Tow.** When towing an APC on a

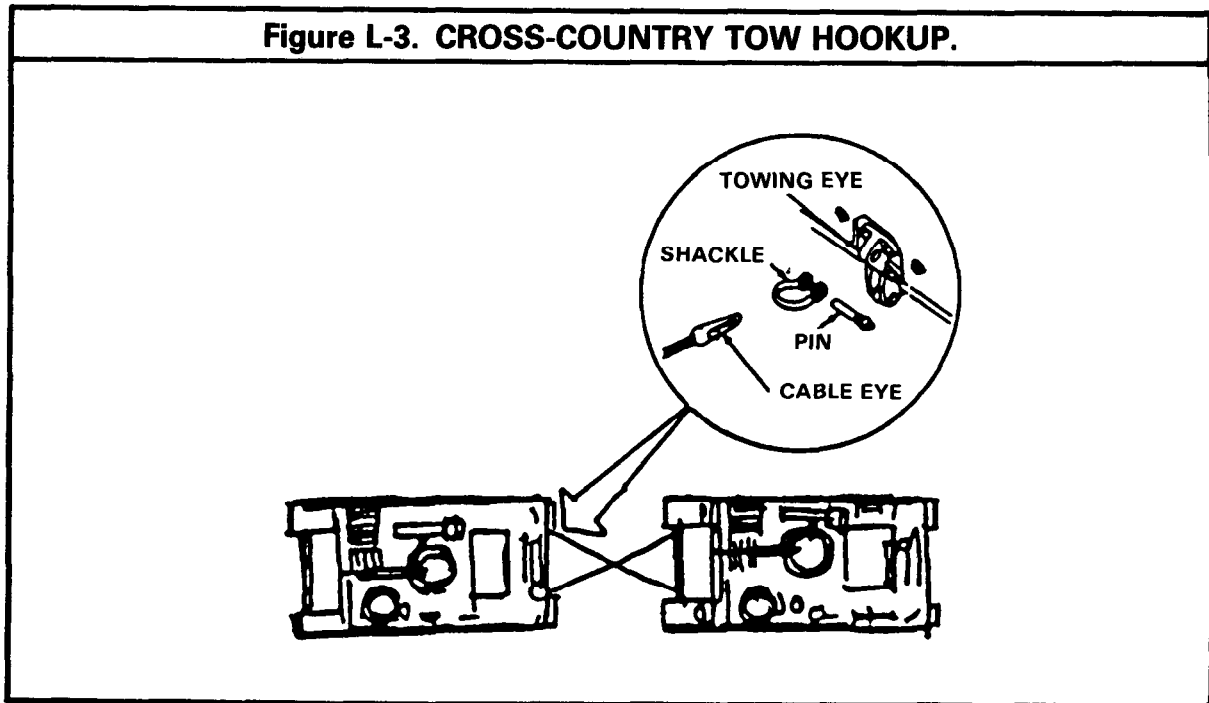
highway it is best to use a recovery vehicle and the recovery vehicle's tow bar. If a recovery vehicle is not available, another APC may be used. The tow bar is attached to the front towing eyes of the disabled vehicle. When a tow bar is used, a driver is not required in the towed vehicle. When recovery is to be at speeds of less than 10 mph and distances are less than 30 miles, the range selector is placed in the N range. When anticipated recovery exceeds 10 mph and 30 miles in distance, the universal joints between final drives and differential must be removed before towing can begin.

**Figure L-2. HIGHWAY TOW HOOKUP.**



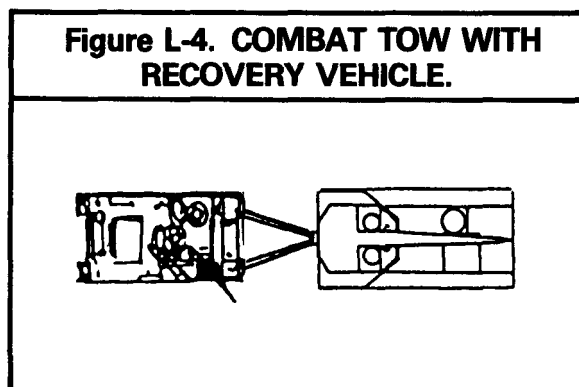
**Cross-Country Tow.** To tow a vehicle cross-country two cables are used. It is best to cross the cables in an X position to keep the two vehicles aligned. To tow the vehicle forward, the cables are attached to the front eyes of the disabled vehicle and the rear eyes of the towing vehicle. The vehicle may also be towed moving back-

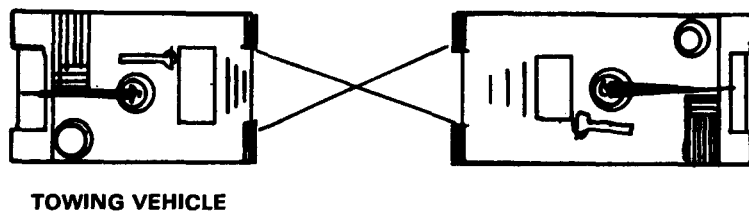
ward. A driver is required in the towed vehicle to apply the brakes to prevent it from overrunning the recovery vehicle on downgrades or when stopping. Never tow an APC with a cable when its universal joint is disconnected; the driver will have no braking or steering ability.



**Combat Tow.** When it is necessary to make a towing connection under fire, the combat tow is used by a recovery vehicle to minimize exposure of personnel. A tow bar or tow cable is attached to the recovery vehicle's tow pintle before the vehicle moves to the disabled vehicle. The recovery vehicle is then moved into the area and backed up as close as possible to the back of the APC, while still allowing the ramp door to open. One soldier then connects the free end of the V-chain or tow cable to the rear tow pintle. (Smoke grenades can be used during the hookup to minimize the exposure of the vehicles and personnel to fire). After hookup, the ramp door is closed, and the recovery vehicle moves out with the disabled APC in tow. This method may be used with either the APC or another recovery

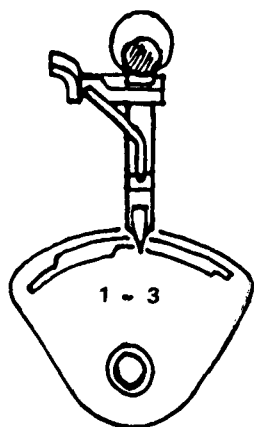
vehicle. As with a cross-country tow, a driver is required to operate the brakes of the towed vehicle. The towed vehicle's range selector must be placed in N.



**Figure L-5. COMBAT TOW WITH ANOTHER APC.**

**Tow Starting.** When an APC cannot be started using a slave cable, it may be started by towing. After securely attaching a tow vehicle to the disabled vehicle and doing all the before-operation preventative maintenance checks and service (TM 9-2300-257-10), the master power switch is on and fuel shut off is pushed in. With

the transmission range selector in N, the APC brake levers are released, and it is towed forward until its speed reaches 20 to 25 mph. The driver then moves the transmission range selector to the 1-3 position and presses the accelerator about halfway.

**Figure L-6. TOW START SETTINGS.**

When the engine starts, the driver moves the transmission range selector to N range. The driver should signal the towing vehicle with his horn or by visual signal so that both vehicles can be brought to a stop. The cables or tow bar are then disconnected.

The vehicle should not be left in any driving range for more than 5 seconds while towing. If the engine does not start, shift back to N for a few seconds before trying again. If the engine will not

start in three tries, notify the maintenance contact team.

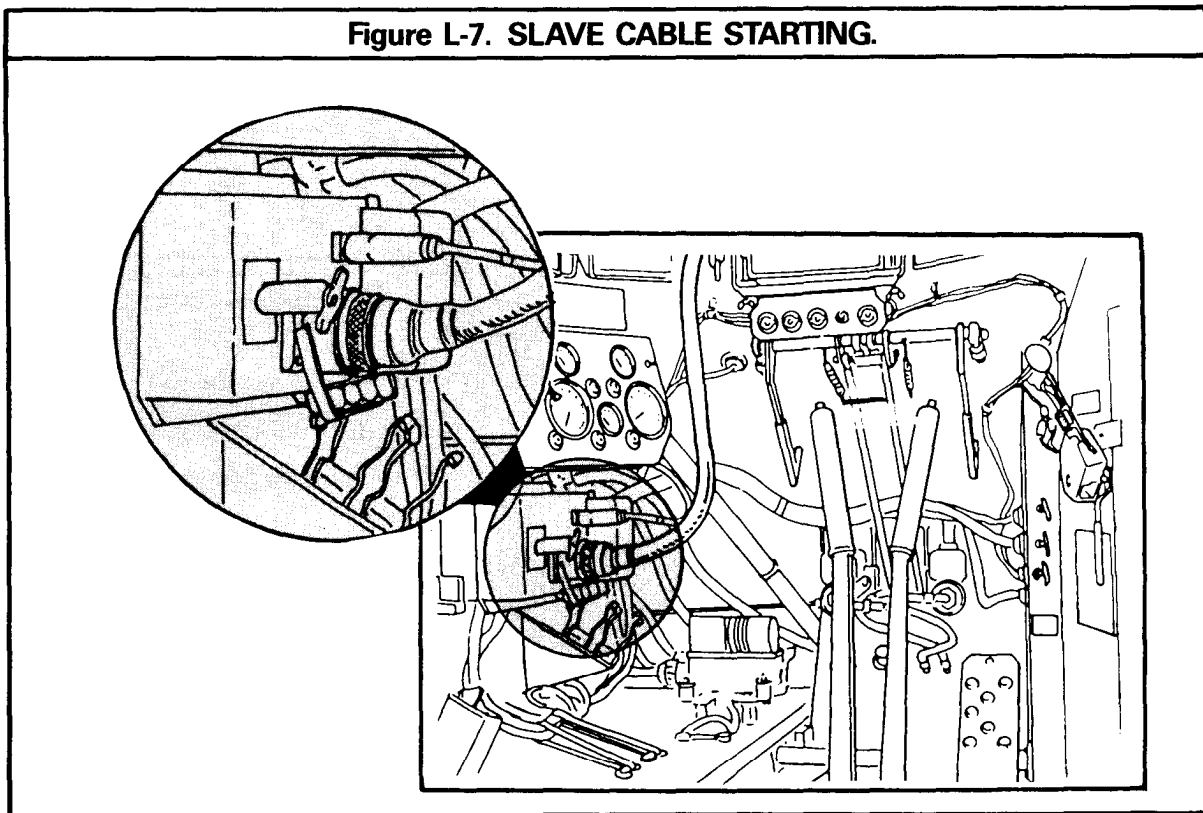
#### **L-5. STARTING VEHICLE WITH SLAVE CABLE**

When the vehicle's battery is dead or missing, the engine can be started using a slave cable connected to any 24-volt DC power source.

Before the slave cable is connected, the master switch on both vehicles must be off. The slave

cable is connected to the slave receptacle in the driver's compartment.

**Figure L-7. SLAVE CABLE STARTING.**



Once the slave cable is connected and both vehicles have turned on the master switches, the engine can then be started in the same way as with its own batteries. When the engine starts, it

should be left running while the slave cable is disconnected. The same process can be used to start another vehicle with the APC as the 24-volt DC outside power source.

### **Section III. RECOVERY**

#### **L-6. GENERAL**

Vehicles often become bellied (high centered) on high stumps, ridges, or mire. In this position, the APC has no traction and is stuck.

#### **L-7. VEHICLE BELLIED IN MIRE**

To recover a vehicle stuck in mire, a log should be obtained that is long enough to span the width of the vehicle and large enough to support the vehicle's weight. Two cables are used to attach the

log to the tracks, one on each track. The log is placed against both tracks. The tow cable is placed so that one end of the cable goes over the log and through one track from the inside. The other end of the tow cable is placed underneath the log. The ends of the cable are connected with a towings shackle and pin. The cable should be connected on the outside of the track for easy disconnecting. The same method is used to attach the log to the track on the other side of the vehicle.

**Figure L-8. MIRED APC RECOVERY.**



By gradually applying power to the tracks, the slack in the cables will be taken up, pulling the log underneath the tracks until it contacts the mire, and anchors the tracks, letting the vehicle move.

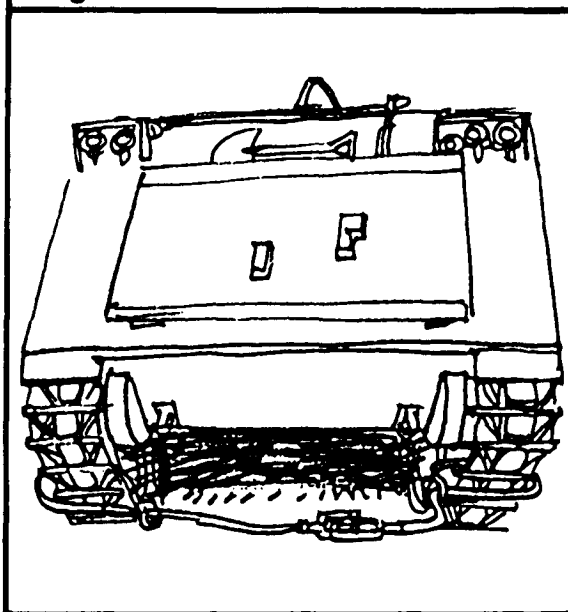
**CAUTION**

**TO PREVENT DAMAGE TO THE TOW CABLES AND TRACKS, STOP THE VEHICLE BEFORE THE LOG REACHES THE FENDERS IN THE FRONT OR REAR OF THE APC.**

**L-8. VEHICLE BELLIED ON HIGH STUMPS, ROCKS, OR RIDGES**

For a bellied disablement other than mire, the tracks can be anchored using just the two tow cables. The tow cables are hooked together and attached to both tracks by passing the ends of the cables through the tracks from the outside and attaching them together in the center with towing shackles and pins.

**Figure L-9. ANCHORING TRACKS.**



When power is applied to the tracks, the cable will contact the obstacle and anchor the tracks. The same caution applies — stop the vehicle before the cables reach the fenders.

**L-9. RECOVERY KITS**

**Capstan Kit.**

A capstan kit NSN 2540-00-933-3570 can be used to ease the APC over steep or slippery banks and through boggy areas. If the APC does not have a kit, one can be ordered using the national stock number. The kit has two adapters permanently bolted to the hub of each drive sprocket, two capstan drums (bolted on each adapter [with a T-bolt]), four 100-foot and two 50-foot lengths of 1-inch nylon rope with shackles, and two marine anchors with recovery cables.

To use the kit:

**Bolt drums with T-bolts to the adapters, making sure that laterals are locked.**

**Thread a length of rope through the outside flange of each drum.**



Make two or three turns over the end of the rope to anchor it, being sure that the rope extends from under the drums.

Set the marine anchors in line with the drums and press them into the ground to give them a good start.

Eliminate all rope slack before attaching the ropes to the anchors.

Apply vehicle power slowly until the tracks are turning equally. Keep a slow, steady, equal pull so that the anchors will dig in evenly.

As the drums winch the ropes, the APC will move out. Use a guide to

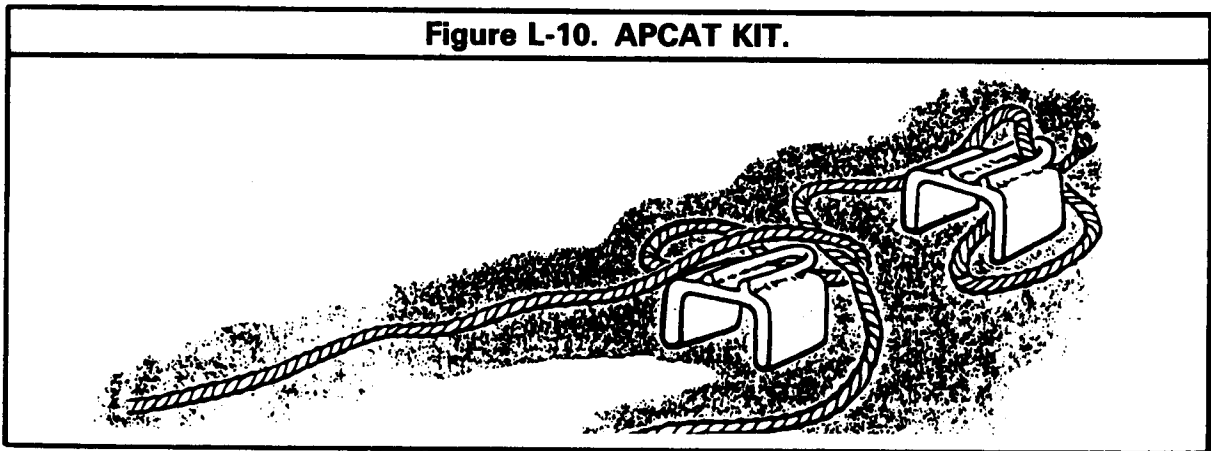
make sure that the rope winds up properly.

The anchors can be used side-by-side or in tandem. Because the anchors may go underground, be sure to attach the recovery cables to them before pulling. Recover the anchors by pulling the recovery cables with the APC.

#### APCAT KIT.

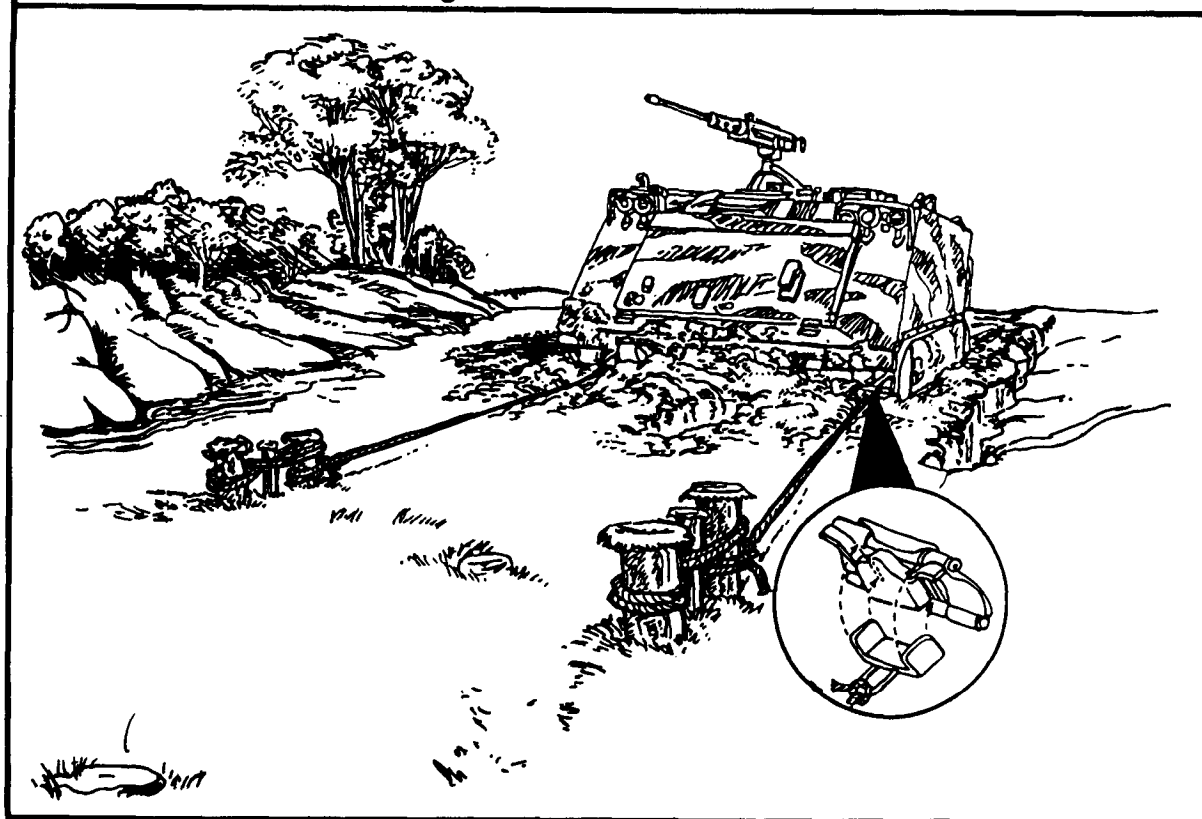
The APCAT (APC anchoring tracks) kit is another handy self-recovery aid. It is locally fabricated and consists of two track anchor blocks and two 100-foot lengths of rope.

**Figure L-10. APCAT KIT.**



To use the kit, attach an anchor block on each track and tie the rope to the loops on the blocks and then to a good anchor.

Figure L-11. ANCHORING.



As the driver applies vehicle power, the tracks anchor themselves to the blocks while the vehicle moves out the length of the track. The blocks can then be retied to the ropes with a half-hitch and the process repeated.

**NOTE:** If all methods listed above fail to free the vehicle, the leader must call for the M578 from the recovery section.

#### Section IV. SAFETY

##### L-10. GENERAL

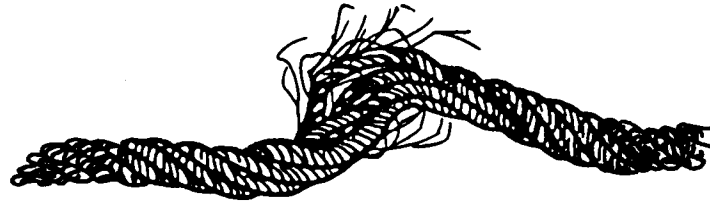
Recovery operations are dangerous. Maximum care must be taken to prevent injury to personnel and damage to the vehicle and equipment. Listed below are general safety precautions to consider before trying any recovery operation.

##### L-11. SAFETY PRECAUTIONS

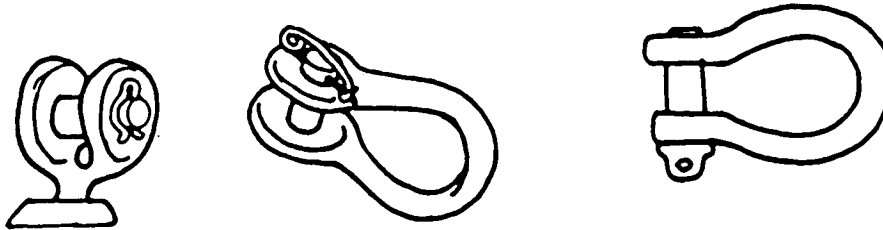
**Handling Cables.** Personnel handling wire ropes or cables should wear heavy leather-palmed gloves to prevent hand injuries or cuts from bro-

ken or frayed wires. A moving cable should never be allowed to slide through the hand, even if gloves are worn.

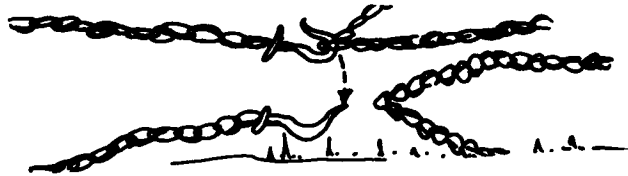
**Care of Cables.** Cables should not be drawn over rocks or around sharp corners. Heavy objects should not be dropped on a cable. They could nick or burr the wires, causing them to break. All loops formed in a cable should be removed before force is applied.

**Figure L-12. FRAYED CABLE.**

**Safety Keys.** All safety keys or pins should be in place before force is applied.

**Figure L-13. SAFETY KEY PINS.**

**Hook positions.** If a hook is used to pull the vehicle, the open part (throat) should point upward. If the hook should straighten out from overload, the rigging will tend to go downward, not upward unrestrained.

**Figure L-14. USE OF HOOKS.**

**Rigging Between Vehicles.** When erecting rigging between vehicles, engines must be off and vehicle brakes applied to prevent possible injury to rigging personnel or damage to vehicles.

**Inspecting Rigged Equipment.** Equipment should be thoroughly inspected before the recovery operation starts. The recovery vehicle operator should be directed to work the winch enough to remove slack from the rigging, then stop the operation and shut off all engines. The rigging can then be inspected without endangering the personnel. Likewise, if a vehicle is being towed, power should be applied slowly until all tow cable slack is taken up. Engines should again be shut off and rigging inspected before going on.

**Operator/Driver Safety.** operators and other personnel, in both the recovery vehicle and disabled vehicle, should keep their hatches closed during a recovery operation and use their periscopes to see hand signals.

**Safe Location of Personnel.** Before a pull starts, all personnel on the ground must be directed to move safely away from rigging before the operators apply power. A taut cable, released by a sudden break, can backlash and cut a man in half. The minimum safe distance is one and a half times the length of the longest line.

**Signalman.** For safe control of a recovery operation, there should be only one signalman. The operators must know the meaning of signals used and must act only on those signals. The signalman must be in a safe place where the operators can observe his signals.

## Section V. ABANDONING THE APC

### L-12. GENERAL

Every effort should be made to recover a disabled APC. If the enemy situation is so critical that the vehicle cannot be recovered, men and equipment may have to be crossloaded on other vehicles and the disabled APC abandoned. An abandoned APC should be of no immediate use to the enemy and yet should be readily repairable by friendly forces.

If the carrier is to be abandoned, secure the weapons, radios, and equipment, and take one of the following actions

**Remove the fuel line from the fuel filter to the engine block.**

**Remove the shaft between the transmission and differential.**

**Break a track and remove at least two shoes.**

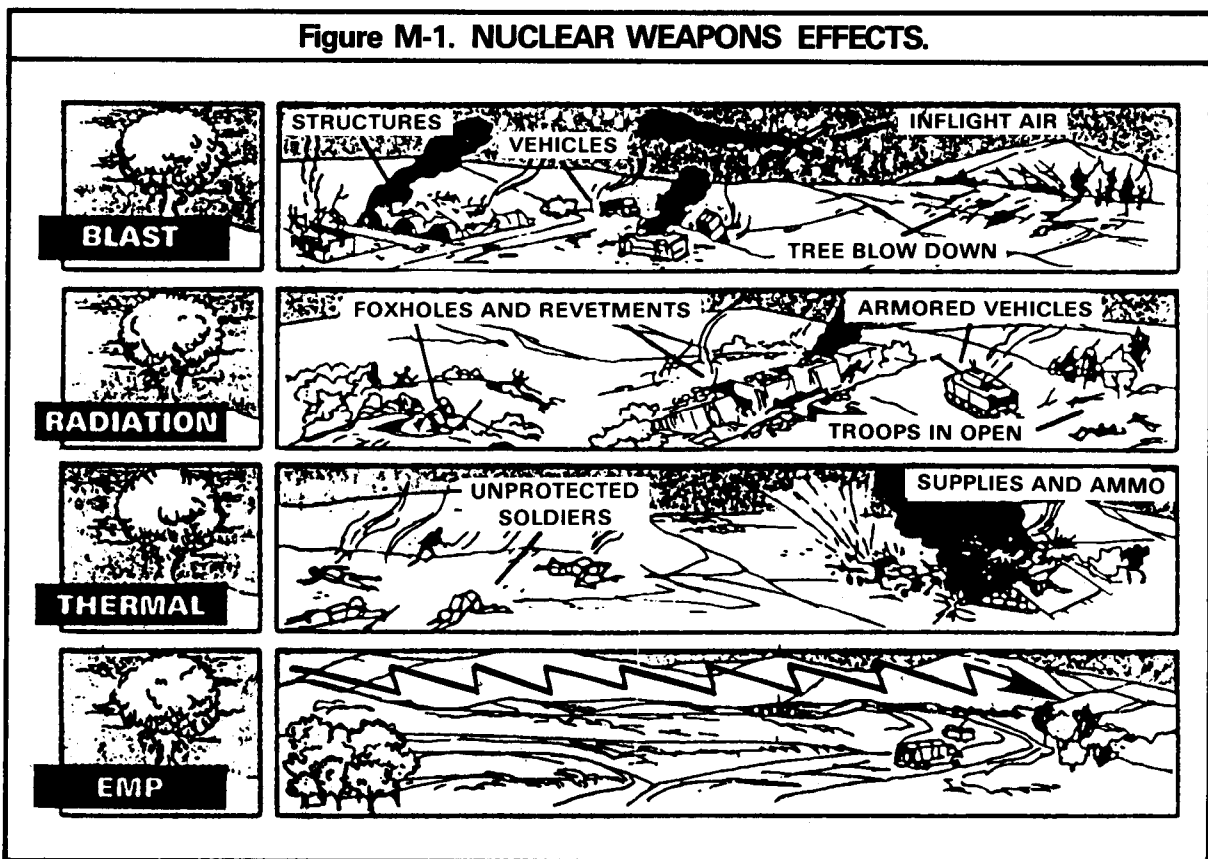
**In an extreme situation, place a thermite grenade on the top of the engine. TM 9-2300-257-20 has detailed information on the destruction of the APC.**

### L-13. DECISION TO ABANDON APC

The decision to abandon a vehicle is the responsibility of the platoon leader or senior man present. The APC should be stripped of all equipment possible and the APC's location reported to the next higher headquarters as covered in the SOP.

APPENDIX M  
**NUCLEAR, BIOLOGICAL AND  
 CHEMICAL OPERATIONS**  
 Section I. NUCLEAR WEAPONS

M-1. GENERAL



Nuclear weapons produce four primary effects: blast, thermal radiation (heat and light), nuclear radiation, and electromagnetic pulse (EMP). The degree of nuclear effect depends on how close a unit is to the detonation and how well soldiers and equipment are protected.

CONTENTS		PAGE
Section I.	Nuclear Weapons .....	M-1
II.	Chemical and Biological Weapons .....	M-9

**Blast.** When a nuclear weapon detonates, it sends out an intense shock wave in all directions at the speed of sound. The shock wave can collapse buildings, blow down trees, and forcefully throw men and equipment about. There are two phases in a blast a positive phase or shock wave, and a negative phase or suction.

**Thermal Radiation.** Thermal radiation produced by a nuclear explosion consists of intense heat and extremely bright light. Unprotected troops exposed to this heat and intense light can be severely burned and blinded. Materials such as wood, plastics, and rubber may melt or burn. The extent of these effects depends on yield of weapon, weather, and terrain. Fog or heavy battlefield smoke can reduce the effects of thermal radiation. On clear nights, the blinding effect is greater, and night vision devices can be damaged.

### **Nuclear Radiation.**

A nuclear weapon produces two forms of nuclear radiation: initial and residual. Both forms of radiation can injure or kill.

Initial radiation occurs during the first minute of the explosion. Since this radiation travels at the speed of light, the only way to lessen the danger is to be protected before the detonation.

Residual radiation remains after the first minute. It is caused by materials being exposed to the initial radiation and retaining the radiation effects. It is found around the site of the nuclear detonation. If radioactive particles are carried aloft, they become fallout, which may spread over a larger area. Fallout is created by dust sucked into the explosion and later scattered by the wind. Dirt, equipment, and buildings become contaminated from exposure to either initial radiation or fallout.

The human body can survive limited exposure to radiation but the effects add up. Each dose a person receives adds to earlier doses. Troop exposure to radiation must be measured and recorded so the amount of radiation absorbed can be monitored. Soldiers should be

taken out of contaminated areas before they are exposed to an overdose of radiation.

**Electromagnetic Pulse.** EMP is a massive surge of electrical power. It is similar to a strong radio signal. It comes from the nuclear explosion and is transmitted through the air in all directions. It occurs immediately when a nuclear device explodes. It can damage electrical components of equipment (radios, radars, and vehicles) and weapon systems (TOW and Dragon) if proper precautions are not taken. EMP does not harm soldiers.

### **M-2. WARNING OF A NUCLEAR EXPLOSION OR HAZARD**

STRIKWARN messages are used to warn units of a friendly nuclear explosion. The NBC 3 nuclear report is used to warn of expected contamination. Normally it is neither necessary nor desirable to transmit the complete STRIKWARN message to companies or platoons. Messages to those units should contain:

**A proword indicating that the message is a nuclear strike warning.**

**A brief message, prearranged by SOP, that directs the unit to observe a specific nuclear defense level, or an order to evacuate the area.**

#### **The expected time of burst.**

Information as to possible enemy use of nuclear weapons will be forwarded to companies and smaller units through the chain of command by the quickest, most secure means possible. It will direct a specific protection posture for these units.

### **M-3. ALARM FOR NUCLEAR HAZARD**

As soon as a soldier using a monitoring device detects a nuclear hazard, he should give the alarm to warn others. The alarm must be passed swiftly throughout the unit. The standard alarm is the yell "FALLOUT." The same warning is used when the platoon moves into an area contaminated by residual radiation.

“ALL CLEAR” is used to indicate that the danger no longer exists. Normally the all-clear signal is first given by the company commander or platoon leader and then repeated by each soldier when he hears it.

**M-4. NUCLEAR PROTECTIVE MEASURES**

**General.**

Many basic infantry skills and tasks contribute to the platoon’s nuclear preparedness. Training and operations must stress:

**Proper positioning of vehicles and soldiers.**

**Proper movement by vehicles and soldiers.**

**Construction of fighting positions with overhead cover.**

The platoon’s ability to fight in a nuclear environment, as in any combat situation, depends largely on how well individual and collective tasks have been learned in training. The unit training program must include cross-training so that the loss of any one man will not seriously lessen the platoon’s combat effectiveness. When the platoon can do all the individual and collective tasks while employing nuclear

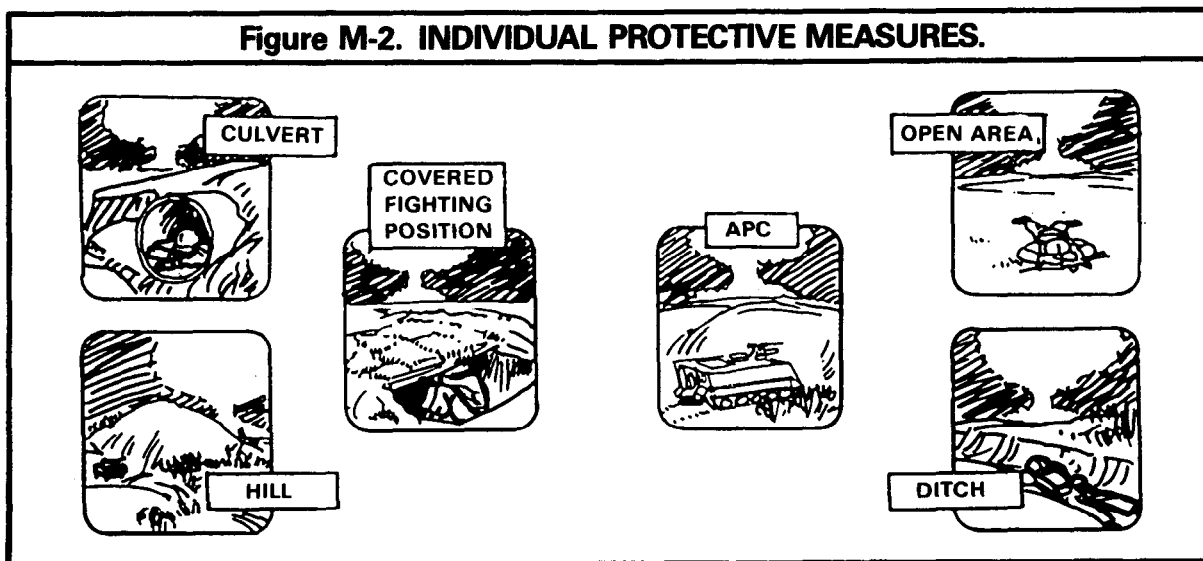
protective measures, its chances of continuing to be combat effective on the integrated battlefield are improved.

A soldier can get protection against many nuclear effects by taking cover in a fighting position, culvert, or ditch; behind a hill; or inside an APC in defilade. In most cases, a fighting position with overhead cover or an APC in defilade offers the best protection.

When a unit, without warning, is subjected to an enemy nuclear attack, the unit should take the following actions immediately:

**When dismounted, exposed troops should immediately close their eyes, fall face down to the ground, and turn their heads away from the blast. They should also cover all exposed skin, place their hands under their bodies, keep their faces down in the dirt, and hunch their shoulders forward to cover the backs of their necks. They should stay down until the blast wave passes and debris stops falling.**

**Personnel exposed in APC hatches should immediately drop down in the vehicle and close the hatches, door, or ramp.**



### Nuclear Defense Levels.

The tremendous destructiveness of nuclear weapons requires that protective measures be taken not only during or after an attack, but before the attack. The table below is an example of how nuclear protective measures can be included in an SOP similar to chemical mission oriented protection posture (MOPP).

<b>Table M-1. NUCLEAR DEFENSE LEVELS.</b>			
<b>NDL</b>	<b>PERSONNEL</b>	<b>RADIOS</b>	<b>EQUIPMENT</b>
<b>A (POSSIBLE)</b>	<b>Offense:</b> Inform personnel, and continue with mission.	<b>Offense:</b> Turn off all nonessential radios. Disconnect antennas and matching unit cables of unused radios One radio per APC will be wrapped in foil and stowed in APC	<b>Offense:</b> Secure all loose equipment Close and latch all hatches not required to be open.
	<b>Defense:</b> Inform personnel. Increase priority of preparation of fighting positions with at least 18 inches of dirt overhead cover. Remain near APC or fighting positions	<b>Defense:</b> Turn off all nonessential radios. Disconnect antennas and matching unit cables of unused radios. One radio per APC will be wrapped in foil and stowed in APC. Use wire, messenger, or SUT whenever possible.	<b>Defense:</b> Secure equipment by tying it down, or placing it inside the APC or fighting position. Close and latch all hatches not required to be open.
<b>B (LIKELY)</b>	<b>Offense:</b> Inform personnel. Restrict movement away from APC except for mission essential tasks. Initiate continuous monitoring of radiacmeter	<b>Offense:</b> Use one radio per APC. Turn off, wrap in foil, and stow all other radios. Remove antennas and disconnect lead-ins, and stow in APC.	<b>Offense:</b> Secure all loose equipment. Close and latch all hatches not required to be open. Move in defilade and avoid urban or forest areas, if possible.
	<b>Defense:</b> Inform personnel. Complete fighting positions with at least 18 inches of dirt overhead cover.	<b>Defense:</b> Use no more than two radios per platoon (platoon leader and platoon sergeant). Use wire, SUT, or messenger whenever possible.	<b>Defense:</b> Secure equipment by tying it down, or placing it inside the APC or fighting position. Move APC to a turret down position.



<b>Table M-1. NUCLEAR DEFENSE LEVELS. (CONT'D)</b>			
<b>NDL</b>	<b>PERSONNEL</b>	<b>RADIOS</b>	<b>EQUIPMENT</b>
	Initiate periodic monitoring of radiacmeter.	Wrap all unused radios in foil and stow in APC or fighting positions.  Remove unused antennas, disconnect lead-ins, and stow in APC.	Close and latch all hatches not required to be open.
<b>C (IMMINENT)</b>	<b>Offense</b> Inform personnel. Place all personnel in APC Reduce observation thru periscopes except for mission essential tasks. Initiate continuous monitoring of radiacmeter. Prepare to cover face with cloth or handkerchief to prevent breathing of fallout (do not use protective mask).	<b>Offense:</b> Use visual signals to control squad and platoon movement. Use one vehicle radio per platoon Wrap all unused radios in foil, and stow in APC. Remove unused antennas, disconnect lead-ins, and stow in APC.	<b>Offense</b> Secure all loose equipment Close and latch all hatches not required to be open. Move in defilade and avoid urban or forest areas, if possible
	<b>Defense:</b> Inform personnel. Have all personnel remain in fighting positions. Place all unprotected personnel in APC Initiate continuous monitoring of radiacmeter. Prepare to cover face with cloth or handkerchief to prevent breathing of fallout (do not use protective mask)	<b>Defense:</b> Turn off all radios, wrap radios in foil, and stow in APC or fighting positions. Use wire communications. Use one SUT in company command net.	<b>Defense:</b> Secure equipment by tying it down, or placing it inside the APC or fighting position. Move APC to a defilade position, avoiding forests or urban areas if possible.

Nuclear defense levels (NDL) involve risk. Leaders must balance the chances of exposing their units to accomplish their missions against the threat of the effects of a nuclear explosion. Some missions cannot be accomplished at NDL C or even NDL B. It may be necessary to accept a higher risk from nuclear effects to accomplish the combat mission. The ideal NDL is the category that provides the highest degree of protection from nuclear effects and still allows mission accomplishment.

**M-5. PROCEDURES FOLLOWING A NUCLEAR DETONATION**

The following actions should be taken automatically and without orders right after the

shock and suction waves of a nuclear detonation pass.

**INDIVIDUAL:**

**Check for injuries and give emergency first aid as necessary**

**Report status to immediate superior.**

**UNITS:**

**Put dismounted radios back into operation and monitor nets.**

**Return the vehicle to a combat-ready status. Connect all antenna lead-ins, return radios to the mounts, replace antennas, and turn radios on.**

Turn on all other necessary equipment in the vehicle. Inspect the vehicle for damage.

Report status of personnel and equipment to next higher headquarters. Casualty reports are submitted and unit rosters are updated to reflect losses.

Start continuous monitoring with the radiacmeters.

Report nuclear effects as required by company SOP.

Platoon leaders should require periodic reports from squad leaders on dosimeter readings and report readings to the company. (The determination of the acceptable radiation level should be made beforehand at company and battalion level and passed to

the platoons and squads.)

Continue mission.

**M-6. NUCLEAR, BIOLOGICAL, AND CHEMICAL REPORTS**

The NBC 4 report is used to report a nuclear hazard or a chemical hazard.

The platoon should continue to monitor radiation levels and report findings to the company commander, using the NBC 4 format. When the accumulated radiation dose of a platoon or squad is determined by the company commander to be unacceptable, the entire platoon or squad should be replaced if possible. The platoon leader should be prepared to receive new squads, integrate them into the platoon, and insure total dose of the squads in the platoon is balanced as much as the tactical situation allows. Squads that have received smaller doses should be considered for missions that probably will result in added exposure to radiation.

**Table M-2. NBC 4 REPORT.**

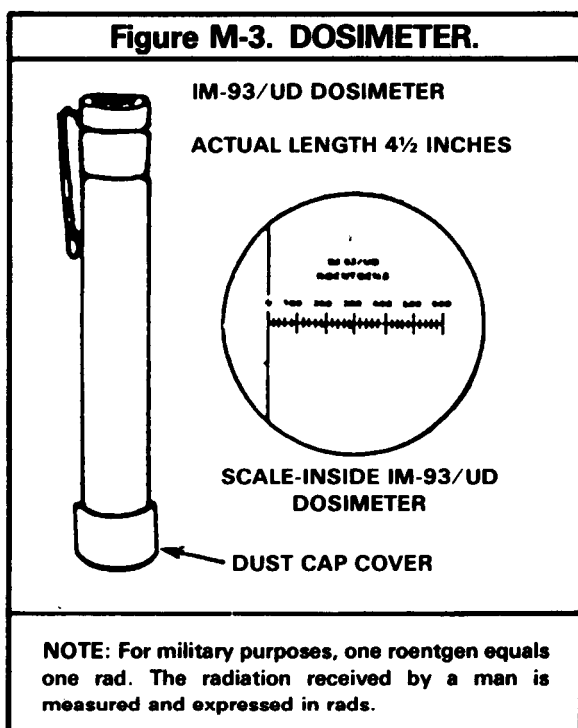
LETTER	MEANING	EXAMPLE
Q	Location of reading (UTM)	Q LB 123987
R	Dose rate (rad hr). The words "initial," "increasing," "peak," or "decreasing," may be added.	R 35 INITIAL
S	Date time of reading (local or ZULU, state which).	S 201735 (local) Q LB 129965 R 60 S 201650 (local) Q LB 146808 R 27 INCREASING S 201710 (local)

## M-7. MONITORING RADIATION LEVELS

### Dosimeter.

One IM-93/UD dosimeter is in the platoon headquarters and one is in each squad. They are used by specified squad members to measure the total amount of radiation exposure (dose) of the squad. (Centigrays [rads] are units of measure for radiation.) The PP-1578/PD charger is used to zero the dosimeter.

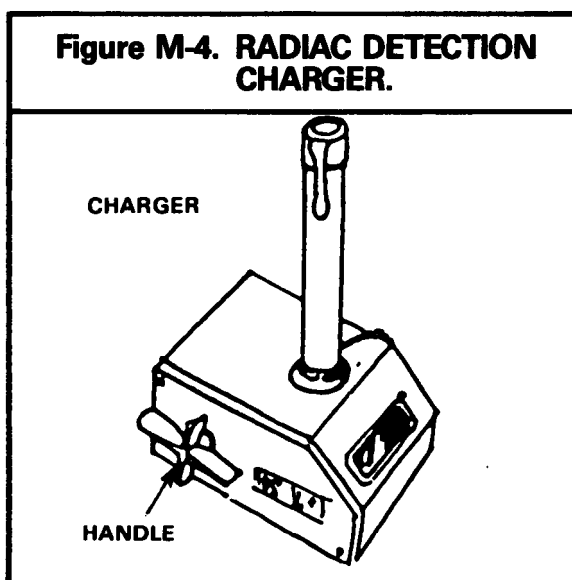
Accurate dose records must be kept to avoid overexposing troops and to keep the total dose relatively equal within a platoon. If a squad is deployed under its leader's control, the dosimeters should be carried and monitored by the dismount team. If the platoon is deployed with a dismount element and a carrier element, a dosimeter should be monitored by each element leader.



To read the dosimeter, remove the dust cover and look at a light source through the dosimeter. An artificial light, such as a flashlight, is needed at night to read the dosimeter.

If the dust cover is lost, a piece of tape can be used to close the open end.

The dosimeter should be zeroed every 24 hours or when the total radiation dose reaches or exceeds 150 centigrays (rads). Before zeroing the dosimeter, the total dose reading must be recorded.



**Radiacmeter.** The radiacmeters issued to units measure the radiation dose rate present at any particular time and location.

The IM-174/PD series radiacmeter is used for area monitoring and surveying. It is used by a survey team designated by the platoon leader.

For each instrument, the platoon leader should assign a primary and an alternate operator. These soldiers must be trained in instrument maintenance and how to use the instruments for radiological monitoring.

### Monitoring.

Monitoring may be periodic or continuous.

During periodic monitoring, the platoon routinely monitors selected points within its

area at least once an hour. The NBC defense annex of the company SOP should prescribe the procedures for periodic monitoring.

All units start continuous monitoring when they get a fallout warning; when a nuclear burst is reported, seen, or heard; when radiation of 1 centigray (rad) per hour is detected by periodic monitoring or when ordered to by the company commander. Continuous monitoring stops on order from higher headquarters or when the dose rate falls below 1 centigray (rad) per hour. Units doing continuous monitoring while moving continue doing it until the move is completed, even if the dose rate falls below 1 centigray (rad) per hour.

When the platoon moves into a new area, the radiation level should be checked before any troops dismount their vehicles. If radiation is detected, the designated radiacmeter operator(s) then conducts a mounted survey of the area, reports radiation levels to the company and waits for further instructions.

When operating in areas with radioactive contamination, rubber overshoes should be worn when outside the vehicle, and then removed before remounting. This cuts down on contamination inside the vehicle. Chemical overboots should not be worn while monitoring for radioactive contamination; the excessive wear will decrease their effectiveness against chemical agents.

#### **M-8. OPERATIONS IN RESIDUAL RADIATION AREAS**

Once nuclear weapons have been employed, units may have to move through areas that are contaminated from radioactive fallout. The following protective measures should be taken to reduce exposure to radiation:

Close all vehicle hatches. In most cases, the APC provides adequate protection from residual radiation. Additional protection can be gained by covering the floor and top of the APC with a layer of sandbags.

Provide for at least a 24-hour supply of uncontaminated food and water for each soldier in the unit. Water and rations should be stowed inside the vehicle, and not externally where they would be exposed to excessive radiation.

Move as rapidly as possible through the area.

Drink and eat only from approved sources.

Avoid swallowing contaminated dust; wear a scarf or handkerchief over the nose and mouth.

Use movement formations, such as a line or wedge, to reduce the amount of dust or mud thrown onto trailing vehicles.

Monitor radiation levels for each squad and try to minimize exposure of troops, especially those who have received higher radiation dose levels.

#### **M-9. RADIOLOGICAL DECONTAMINATION**

Fallout emits radiation that damages body cells and can contaminate equipment. Once fallout has stopped or a unit has left a contaminated area, individuals decontaminate themselves and their equipment in the following manner:

Brush or wash clothing and equipment thoroughly to remove dust particles. This should be done away from the position that the unit will occupy.

Bathe, preferably by showering, and change clothes.

Decontaminate the immediate area around fighting positions or vehicles by turning over soil (down at least 7 inches). (Remember to camouflage.)

Wash APC, individual weapons, and crew-served weapons in a stream, insuring that decontamination is done downstream, or with a hose in a specially designated decontamination area or in an area away from the unit's position.

If there is a great deal of dust in the air, wear a scarf or handkerchief covering the nose and mouth. The handkerchief can be disposed of when it becomes contaminated. DO NOT use

the protective mask for this purpose unless there is a chemical threat. The protective mask will hold the dust in the filters and become contaminated.

## Section II. CHEMICAL AND BIOLOGICAL WEAPONS

### M-10. THE CHEMICAL OR BIOLOGICAL ENVIRONMENT

Threat forces have both chemical and biological weapons that may be used separately together, or with nuclear and conventional weapons. No matter how these weapons might be used, the mechanized infantry platoon and squad must be able to survive and carry on the fight. To insure this, troops must be trained to meet the NBC standards of proficiency prescribed in FM 21-40.

### M-11. CHARACTERISTICS OF CHEMICAL AND BIOLOGICAL AGENTS

Chemical agents can be selected to give a range of effects from lethality to incapacitation. Chemical agents may be delivered as a gas, liquid, or spray. Use of a mixture of agents (such as nerve and choking agents), besides causing casualties, can be used to cause confusion. Artillery mortars, rockets, aircraft spray, bombs, and mines can be used to deliver chemical or biological agents. The characteristics of the chemical agents soldiers can expect on the battlefield are as illustrated. (See figure M-5.)

Biological agents produce diseases. The use of biological agents creates a disease hazard where none exists naturally. These agents may be dispersed by generators, artillery bomblets, rockets, and aircraft. They also may be spread by the release of insects, such as flies, mosquitos, fleas, and ticks.

### M-12. EFFECTS OF CHEMICAL AGENTS

Chemical agents enter the body through the eyes, nose, mouth, or skin. Liquid agents may contaminate equipment, the ground, and foliage. The chemical agent may stay for hours or days, presenting a serious hazard to unprotected troops.

Chemical agents cannot destroy the APC or its equipment. They can, though, restrict equipment use until the equipment is completely decontaminated. At platoon level, soldiers can decontaminate only the mission-essential areas (driver's controls, gunner's controls, and individual weapons). So, all personnel must continue to wear protective masks, overgarments, overboots and gloves, once chemical contamination has occurred. The platoon leader and squad leaders must know what their responsibilities are and be familiar with the techniques for decontamination operations. Each company should have a specially trained decontamination team (FM 21-40, chap 2) with proper equipment (discussed later) to do the job.

Liquid chemical agents can restrict the use of terrain and buildings. Infantry platoons cannot decontaminate terrain. That is usually done naturally by the weather. Contaminated areas may be either bypassed or crossed. They are bypassed whenever possible. When crossing is absolutely necessary, protective equipment is worn. Once across the area, soldiers and equipment should be decontaminated as soon as the situation permits.

**Figure M-5. CHEMICAL-AGENT CHARACTERISTICS.**

	TYPE OF AGENT			
	NERVE	BLISTER	BLOOD	CHOKING
<b>HOW NORMALLY DISSEMINATED</b>	Aerosol or Vapor.  Liquid Droplet.	Liquid Droplet.	Vapor (gas).	Vapor (gas).
<b>SYMPTOMS IN MAN</b>	Difficult breathing, drooling, nausea, vomiting, convulsions, and dim vision.	Mustard, nitrogen mustard, - no early symptoms. Lewisite, mustard lewisite - searing of eyes and stinging of skin. Phosgene Oxine - irritation of eyes and nose.	Convulsions and coma.	Coughing, choking, nausea, headache, and tightness in chest.
<b>EFFECTS ON MAN</b>	Incapacitates, kills if high concentration is inhaled.  Incapacitates; kills if contaminated skin is not decontaminated rapidly.	Blistering skin, is destructive to respiratory tract; can cause temporary blindness. Some agents sting and form wheals on skin.	Incapacitates; kills if high concentration is inhaled.	Damages and floods lungs; may cause death.
<b>INDIVIDUAL FIRST AID</b>	Give nerve agent antidote Mark 1. Artificial respiration may be necessary.	Same as treatment for 2d or 3d degree burns.	Inhale amyl nitrite. Artificial respiration may be necessary.	For severe symptoms, avoid movement and keep warm.
<b>INDIVIDUAL DECONTAMINATION</b>	M258A1.  Flush eyes with water. Decontaminate skin using M258 kit.	Flush eyes with water. Decontaminate skin with M258 kit or wash with soap and water.	None.	None.
<b>PROTECTION REQUIRED</b>	Protective mask and protective clothing.	Protective mask and protective clothing.	Protective mask.	Protective mask.

**M-13. ALARMS FOR CHEMICAL HAZARD OR ATTACK**

When a soldier detects a chemical hazard, he must immediately mask and give the alarm. The alarm should be repeated immediately by every soldier after masking. The standard alarms are:

The vocal alarm, "GAS."

Arm-and-hand signals.

Automatic chemical-agent alarms.

Rapid and continuous beating on any metal or other object that produces a loud noise.

A succession of short blasts on a vehicle horn or other suitable device.

A broken warbling siren sound — for example, 10 seconds on, 10 seconds off, etc.



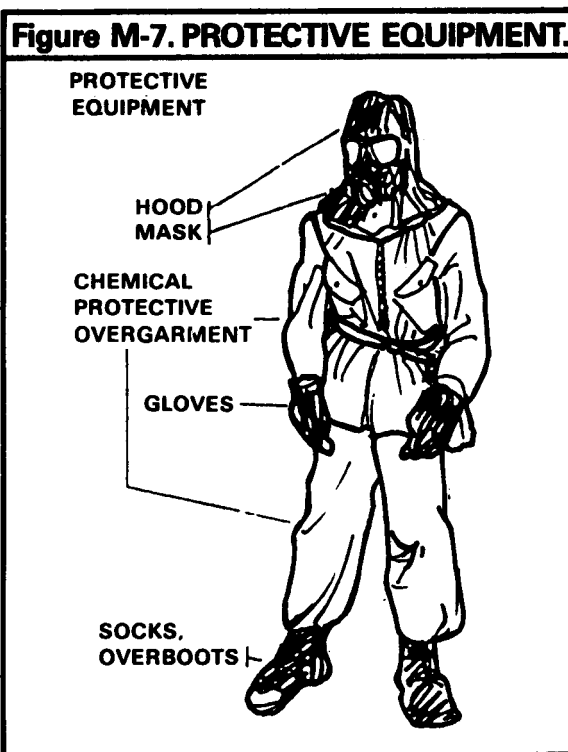
The vocal signal, "ALL CLEAR," is used to indicate that the danger no longer exists. Nor-

really it will be initiated by leaders (company commander or platoon leader) after prescribed unmasking procedures have been completed.

**M-14. PROTECTIVE MEASURES IN CHEMICAL AND BIOLOGICAL WARFARE**

**Chemical Attack.**

A soldier's primary protection against chemical attack is his protective mask. The mask protects against inhalation of chemical agents.



To be fully protected against liquid chemical agents, soldiers must wear the chemical protective overgarments, the mask with hood, overboots, and rubber gloves.

If the commander directs, or the MOPP status dictates, the protective overgarments and masks will be worn rather than carried in the stowed position

Once the chemical hazard is detected, all individuals should immediately mask and put on their protective overgarments if they are not already wearing them. It is difficult for everyone to put on protective overgarments at the same time in the APC. Donning the overgarments is faster when individuals sitting on one side of the APC dress while those on the other side keep up observation. Once the individuals in the first group have their overgarments on, they then take over observation while the rest of the squad dons overgarments. In this way, some security is maintained, and confusion while dressing in the vehicle is kept to a minimum.

**Biological Attack.** Definite information on enemy use of biological agents may come down from higher headquarters. Still, each unit must be alert to the danger and report right away any unusual occurrence of disease. The best local defense against biological warfare is strict enforcement of all preventive medical (prescribed immunizations) and field sanitation measures as well as high standards of personal hygiene. Soldiers should eat and drink only from approved sources.

#### M-15. CONDITIONS REQUIRING MASKING

If an attack is reported to be imminent or if chemical attacks have already been employed by enemy forces, individuals should automatically mask when:

**Chemical alarms or detection kits indicate presence of chemical agents.**

**Any artillery, mortar, rocket, or aircraft attack with other than high explosive munitions occurs on or near their position.**

**Smoke or mist of an unknown source arrives in the area.**

**A chemical attack is suspected for any other reason, such as enemy soldiers seen wearing protective masks and clothing, presence of dead ani-**

**mals or people with no outward sign of injury.**

**The unit must enter an area known to be or suspected of being contaminated by a chemical or biological agent.**

**For obvious reason, soldiers have any of the following symptoms:**

**A runny nose.**

**A feeling of choking or tightness in the chest or throat.**

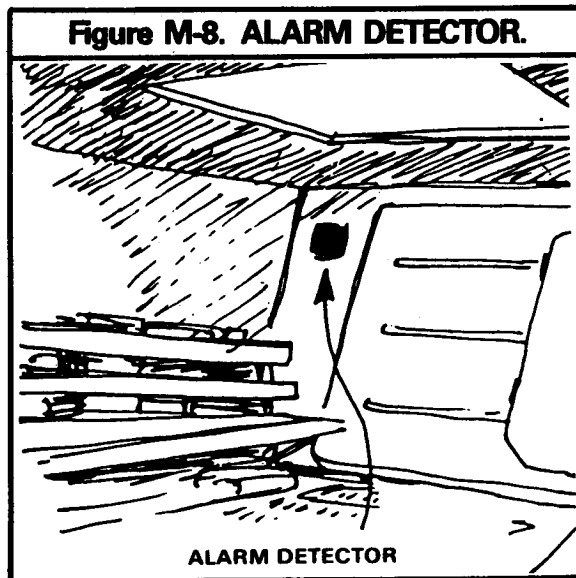
**Blurred vision or difficulty in focusing.**

**Irritation of the eyes, nose, or throat.**

**Difficulty in, or increased rate of, breathing.**

#### M-16. CHEMICAL-DETECTION EQUIPMENT

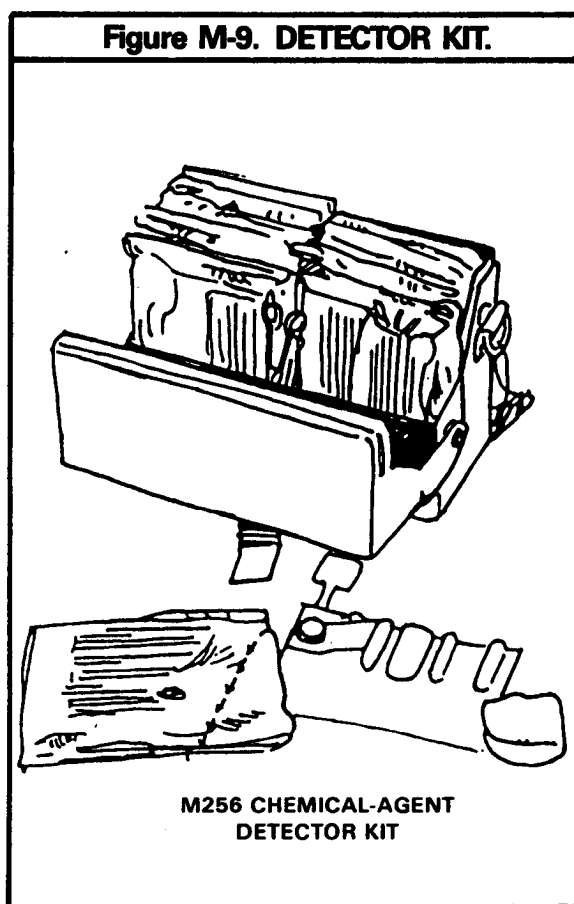
The M8 automatic chemical-agent alarm produces an audible or visual signal when it detects the presence of chemical agents in the air. The M43, the detector of the M8 alarm, will detect





nerve, blood, and choking agents. (The M3A1 detects only nerve agents, but it detects them at lower concentrations than does the M43 detector) It is stowed inside the APC in the back on the right wall. To detect chemical agents, the M8 alarm must be removed from the vehicle, assembled according to TC 3-3 and TM 3-6665-225-12, backpacked, or mounted externally, and placed into operation.

The AN-M256 chemical-agent detector kit is issued one per squad. It is used to detect sublethal vapor concentration of nerve, blister, and blood agents. The kit should be used when a chemical attack is reported to be imminent or when the presence of a chemical agent is suspected. To learn how to use the detector kit correctly, each platoon should select specific soldiers to receive the required training.



ABC-M8 chemical-agent detector paper comes in a 25-sheet booklet. The booklet is a part of the AN-M256 chemical-agent detector kit and is also issued to individuals and kept in the mask carrying case. The paper sheets are treated with chemicals that turn dark green, yellow, or red when in contact with liquid V-type nerve agents, G-type nerve agents, or blister (mustard) agents, respectively. This paper must touch the liquid agent to be sure of a positive test: it does not detect vapor. It is best suited for use on nonporous material, such as metal. The test is not always reliable on porous material (such as wood or rubber) that can absorb the liquid agent. Many substances (including some solvents and decontaminants) can also cause a color change in this paper; hence, it is only reliable as an indicator of the possible presence of a chemical agent. Positive detector paper tests should be verified using the chemical-agent detector kit.

M9 (LAD) chemical agent detector paper is a new item. It is gray-green and has an adhesive back. The adhesive back is protected by a white paper backing until dispensed from the roll. The paper is 2 inches (5.1 centimeters) wide and 30 feet (9.1 meters) long. Each roll is contained in a cardboard dispenser equipped with a cutter edge. The dispenser is packaged in a foil-type shipping bag. A resealable plastic storage bag is included for storing the dispenser after removal from the shipping bag. The detector paper will detect a chemical agent under all types of weather conditions. It is worn by an individual or attached to a vehicle or a piece of equipment. The detector paper indicates the presence of liquid chemical agent. When a liquid chemical agent touches the paper, a pink, red, red-brown, or red-purple spot appears. The spot may be as small as a pin head or large as a dime.

#### **M-17. INDIVIDUAL ACTIONS PRIOR TO A CHEMICAL ATTACK**

If a unit appears to be subject to an imminent chemical attack or downwind vapor hazard,

each individual should take the following precautionary measures:

**Assume MOPP level 2, 3, or 4 (depending on the situation).**

**Attach M8/M9 paper to personnel and vehicles.**

**Cover as much equipment as possible.**

**Place chemical-agent alarm into operation.**

**Insure decontamination equipment is accessible.**

**Be prepared to move from location.**

#### **M-18. INDIVIDUAL ACTIONS DURING A CHEMICAL ATTACK**

Soldiers may be affected by a chemical attack directly on their position or upwind from their position. In either case, when an individual recognizes or is alerted to a chemical attack, he should immediately take the following defensive actions:

- (1) Stop breathing.**
- (2) Put on his protective mask.**
- (3) Clear mask, check for seal.**
- (4) Give the alarm.**
- (5) Don protective clothing if not already on.**
- (6) Continue the mission.**

If the attack is recognized as a chemical spray attack, soldiers should use a protective cover, such as a poncho or shelter half, to further protect themselves from liquid droplets. After the spray has stopped falling, individuals can throw off the cover, taking care to avoid contaminating clothing and equipment.

When friendly forces use chemical agents, the headquarters directing their use will provide the necessary troop safety information to friendly units that may be affected by the mis-

sion. Individuals take the same protective measures they would take against a similar type of enemy chemical attack.

#### **M-19. INDIVIDUAL ACTIONS AFTER A CHEMICAL ATTACK**

Each soldier should remain masked and continue his mission. He should give any needed first aid to any casualties in his immediate vicinity and report the local casualty status to his next higher leader. Contaminated skin must be decontaminated immediately. Clothing and equipment should be decontaminated as soon as possible.

#### **M-20. CONDITIONS FOR UNMASKING**

**AFTER A CHEMICAL ATTACK, TROOPS SHOULD NOT UNMASK UNTIL AUTHORIZED BY THEIR IMMEDIATE COMMANDER.** In the absence of command guidance, the procedures described below are followed by the senior person present.

**Procedures When a Detector Kit is Available.** The chemical-agent detector kit AN-M256 and M8 chemical alarms are used to test for the presence of chemical agents. If there is not any evidence of agents, two individuals unmask for 5 minutes, then remask. They are observed for chemical-agent symptoms for 10 minutes in a shady area. (A shady area is used because bright light will cause contraction of the pupils, which could be wrongly interpreted as a nerve-agent symptom.) If no symptoms appear, the rest of the troops may safely unmask. If available, a medic should be present during unmasking.

**Procedures When No Detector Kit is Available.** The following is an emergency field expedient when friendly elements have been masked for prolonged periods, when there are no remaining signs of chemical agent use, and when the unit has no detector kit. Two soldiers are selected to hold deep breaths, break the seals of their masks, and keep their eyes wide open for 15 seconds. They then clear their masks, reseal them and wait for 10 minutes. If

symptoms do not appear after 10 minutes, the same soldiers again break their seals, take two or three breaths, and clear and reseal their masks. After another 10-minute wait, if symptoms have not developed, the same soldiers unmask for 5 minutes and then remask. After 10 more minutes, if symptoms have not appeared, the rest of the group can safely unmask. They should all remain alert for the appearance of any chemical symptoms.

**M-21. MISSION ORIENTED PROTECTION POSTURE**

Once chemical agents have been employed or while the threat of enemy chemical attack exists, the unit commander decides whether to keep all troops masked and in chemical protective clothing, or only a certain number. This decision is based on the estimated threat of enemy use of chemical weapons, mission of the unit, type of activity required, and temperature. The steps taken are expressed as a MOPP level. Whenever possible, the commander specifies the MOPP level before the mission. He may later direct that the protection be modified, based on his on-the-spot estimate of the situation and operational limitations.

The MOPP level directed by the unit commander will specify what equipment to wear and what precautionary measures are to be employed. Illustrated is the protective clothing and equipment required under the various MOPP conditions. These levels apply to the individuals inside or outside the vehicle in all cases.

The following factors should be considered by the platoon and squad leader when working under any of the MOPP conditions.

**Heat exhaustion.** Soldiers operating at moderate to heavy work rates while in chemical protective gear may experience heat exhaustion (dizziness and fainting) at any time, especially in hot weather. Because of increased sweating, they will need more drinking water than normal.

**Fatigue.** Soldiers in full chemical protective clothing and equipment tend to experience fatigue because of such factors as mask breathing resistance, rise in body temperature from work energy and solar heat, and psychological and physiological stress. This condition of fatigue increases the need for more rest breaks and sleep to maintain individual alertness and efficiency.

**Table M-3. PROTECTIVE EQUIPMENT.**

MOPP				
MOPP	PROTECTIVE EQUIPMENT			
	OVERGARMENT	BOOTIES	MASK/HOOD	GLOVES
1 (POSSIBLE)	Worn, opened or closed based on temperature	Carried	Carried	Carried
2 (POSSIBLE)	Same as MOPP 1	Worn	Carried	Carried
3 (LIKELY)	Same as MOPP 1	Worn	Worn, hood opened or closed based on temperature	Carried
4 (IMMINENT)	Worn, closed	Worn	Worn	Worn

**Senses.** Soldiers who are required to perform duties involving the senses or related functions, such as manning an observation post, tend to operate at lower levels of efficiency while wearing protective equipment. Individual performance levels depend on training and proficiency. Even simple functions, such as talking on the radio and looking through weapon sights, become difficult while wearing the protective mask.

**Personal needs.** Soldiers cannot be in full chemical protection for indefinite periods and still attend to certain personal needs, such as eating, caring for wounds, shaving, and eliminating body wastes. The platoon leader should plan for these needs by:

**Coordination with the company commander for movement to a clean area.**

**Decontamination and regular chemical-agent detection checks of an area designated for personal needs.**

**Keeping the chain of command informed of the effects on the platoon during prolonged operations in a contaminated area.**

### M-22. CHEMICAL REPORT

Once protective measures have been taken after a chemical attack, the platoon leader must send a report to his company headquarters. The format for the report should be prescribed in the unit SOP (NBC 1 report).

### M-23. CHEMICAL DECONTAMINATION

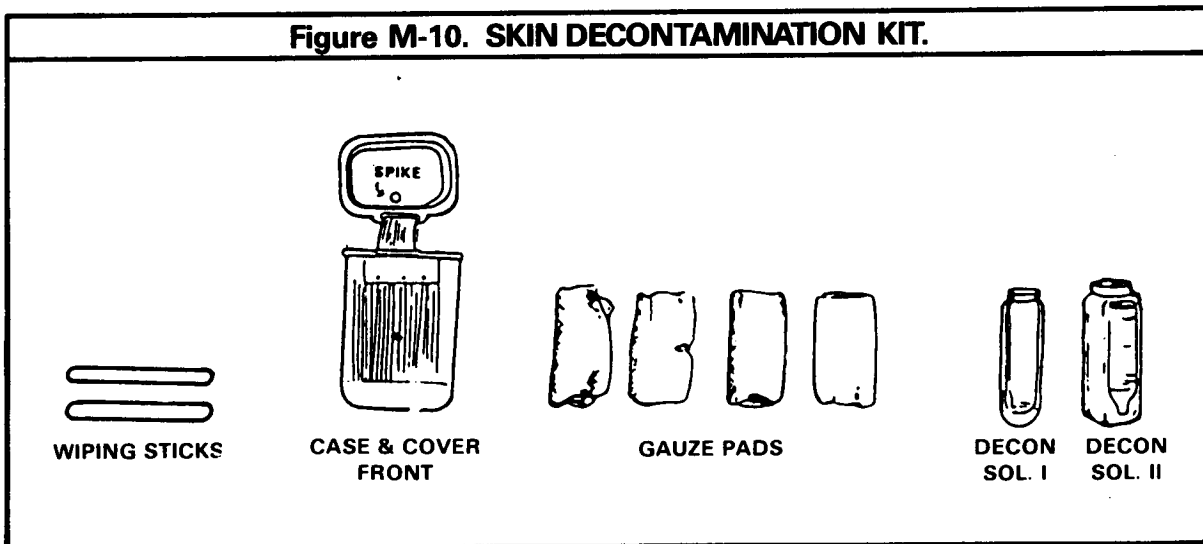
There are three types of decontamination: emergency partial, and complete.

**Emergency Decontamination.** Emergency decontamination consists of an individual removing contamination from his skin. It is done as soon and as quickly as possible after exposure. The M258A1 skin decontamination kit is issued to decontaminate skin. The steps that should be followed for individual decontamination are:

- (1) Obtain overhead cover.
- (2) Flush contaminated eyes with water from canteen.
- (3) Decontaminate skin with the M258A1 decontamination kit.

**Partial Decontamination.** Partial decontamination includes any technique that removes or neutralizes all visible or detectable

**Figure M-10. SKIN DECONTAMINATION KIT.**



contamination from individual clothing and equipment from those surfaces of equipment that operators or crews must touch to perform their mission.

### Individual equipment.

**Protective mask.** Decontaminate the external parts of the mask using the M258A1 kit; decontaminate the interior surface of the mask with the pad from the M258A1 kit.

**Metal equipment.** Decontaminate helmets and entrenching tools with DS-2 or soapy water, and rinse after 30 minutes.

**Weapons.** Decontaminate with cloth from the M258A1 kit. After decontamination, weapons should be disassembled, washed in soapy water, rinsed, dried, oiled to prevent corrosion, and reassembled.

**Web equipment.** If lightly contaminated, decontaminate with soapy water or M258A1 kit. If heavily contaminated, the web equipment must be replaced.

**Crew-served weapons and equipment.** Each vehicle has one M11 decontamination apparatus that contains 1 1/3 quarts of DS-2 decon-

laminating agent and one can of DS-2 replacement fluid. The M11 decontamination apparatus is used to decontaminate vehicle parts that must be touched to operate the vehicle. These areas include the driver's compartment and the hatches. DS-2 must be removed by washing after 30 minutes contact time to prevent corrosive damage to the equipment. MOPP level 4 gear must be worn when using DS-2.

Key weapon systems are decontaminated by using DS-2, soapy water, solvents, or standard tropical bleach (STB) slurry. Ammunition is decontaminated with DS-2 solution. Care must be exercised as DS-2 removes markings. If DS-2 is not available, ammunition should be washed in cool, soapy water, then dried thoroughly.

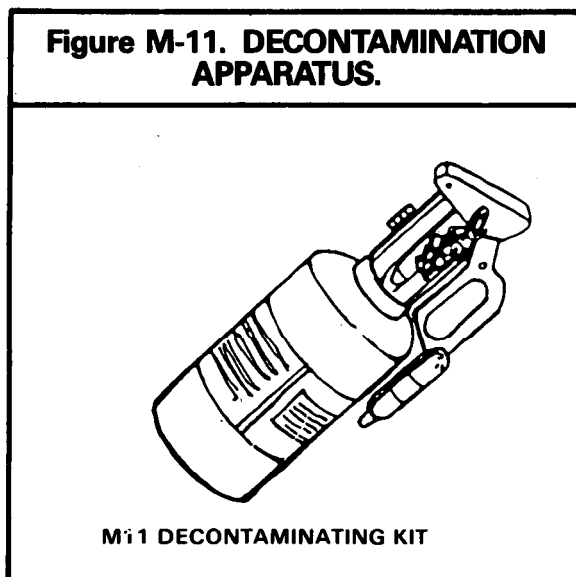
Optical instruments, such as the Dragon tracker and starlight scopes, are decontaminated by blotting with rags, wiping with lens cleaning solvent provided with the sight, and then allowing them to dry.

Communication equipment is decontaminated by airing, weathering, or hot air (if available). The metal parts of field telephones and radios are decontaminated with DS-2 and then wiped with rags.

**Complete Decontamination.** Complete decontamination is anything that reduces all or most of the contamination hazard to a level that permits removal of the protective mask and gloves.

Residual contamination may still remain after decontamination but in insufficient amounts to warrant placing soldiers in full MOPP. A minimum level of protection may be necessary after decontamination. Operators should continue to handle equipment with protective gloves. Equipment should be monitored for contamination for at least 12 hours after cleaning and soldiers should be watched for symptoms of agent poisoning. The goal is to restore combat effectiveness by eliminating the

**Figure M-11. DECONTAMINATION APPARATUS.**



need for soldiers to fight and operate while wearing all of their MOPP gear. To attain this goal, decontamination efforts must reduce residual contamination to negligible risk levels.

Decontamination squads and platoons establish equipment decontamination sites (EDS) as far forward as possible. Because there are limited numbers of personnel in these units, the supported units may be required to assist in the establishment, operation, and supply of these sites. As the tactical situation permits, combat units will undergo overgarment exchange and will be rotated through an EDS to maintain combat effectiveness. (See FM 3-87, chap 4, for details of EDS operations.) Decontamination squads when attached to battalion can assist units in partial decontamination of equipment to make complete decontamination easier, to limit the spread of contamination, and to speed up the partial decontamination process.

#### **M-24. BIOLOGICAL DECONTAMINATION**

The APC can be decontaminated using any of the following methods:

**Apply STB slurry. Leave it on 30 minutes, then remove by washing. (STB is provided to platoons by the company headquarters which gets it from the battalion supply section.)**

**Wash with detergent solution and rinse with high pressure water stream.**

**Steam clean, using a detergent.**

Weapons are decontaminated using household bleach solution, or soap and water. Working parts and surfaces should be dried and lubricated after decontamination. Contaminated clothing is disposed of by burning, burying, or decontaminated by laundering.

FM 3-5 and FM 21-40 contain detailed procedures for decontamination of men, equipment, and vehicles.

APPENDIX N

**COMBAT LOADING**

**Section I. INTRODUCTION**

**N-1. GENERAL**

Combat loading consists of the standard loading and stowing of ammunition, missiles, and equipment in an APC. This helps to insure that all materiel is present and that it is stowed in the proper location, and that it is readily accessible.

commander, a standard combat-loading plan should be developed for each vehicle. The authorized unit equipment may also vary based on unit mission, geographical location, and basic loads of ammunition.

**N-2. STANDARD COMBAT-LOADING PLAN**

Because the equipment carried on an APC will vary slightly depending on whether it is used by a squad or platoon leader, or company

This appendix — which should be used with the operator’s manual — discusses a standard procedure for combat loading of the APC. Based on mission-essential equipment and ammunition, the combat-loading plan should be modified to fit the needs of each unit.

**Section II. INSPECTION OF EQUIPMENT**

**N-3. GENERAL**

The first step in combat loading is to inspect to insure that all items are present and serviceable. The equipment should be laid out in a logical sequence for inspection; that is, weapons, tools, individual equipment, ammunition. These can be arranged in groups, making it easier to account for everything. There will not always be time for a complete inspection, but a complete inspection should be held when time is available.

on a day-to-day basis are carried on the vehicle. Other items, such as cold weather gear and extra sets of clothing (if not needed) are carried in the company trains. The platoon sergeant, based on guidance from the platoon leader or the company SOP, selects what TA-50 equipment stays with the APC.

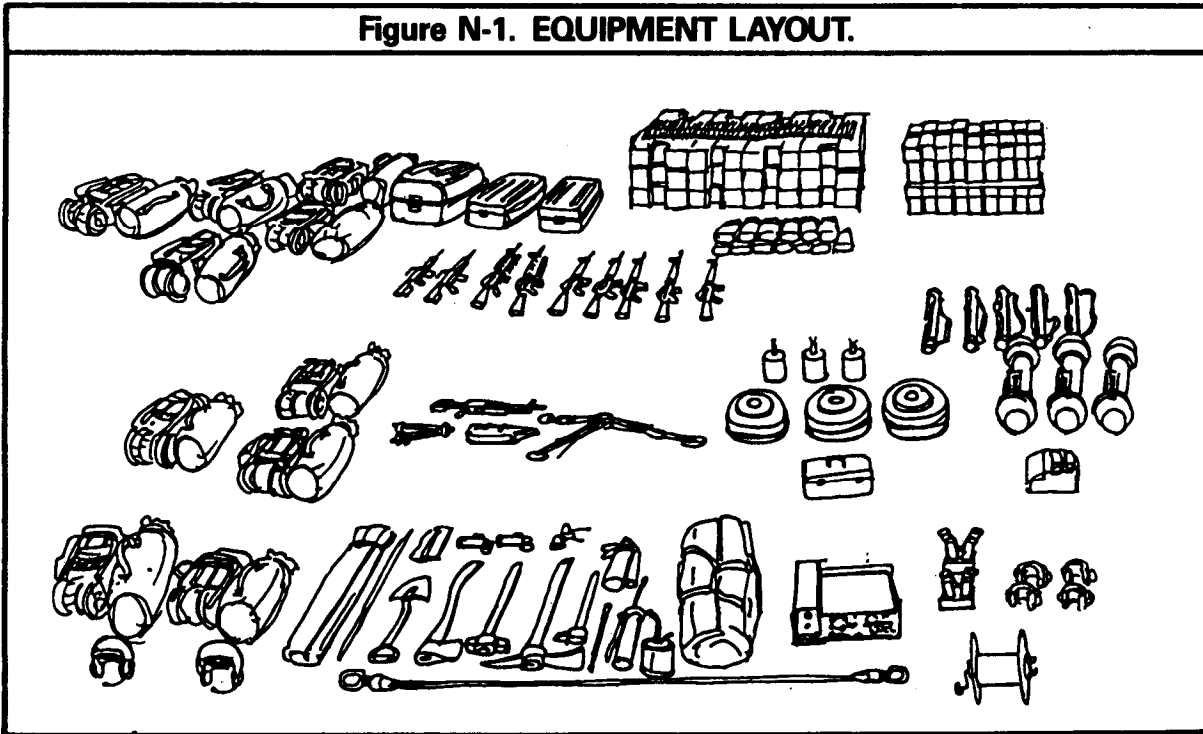
The platoon sergeant should coordinate with company supply personnel for storage of excess TA-50 equipment.

**N-4. APC LOADING**

All the TA-50 equipment issued to each infantry soldier cannot be stowed on the APC. Only those individual items that are required

CONTENTS		PAGE
Section I.	Introduction .....	N-1
II.	Inspection of Equipment .....	N-1
III.	Loading .....	N-2

**Figure N-1. EQUIPMENT LAYOUT.**



**Section III. LOADING**

**N-5. GENERAL**

Loading the APC is best done by dividing the vehicle into loading areas and assigning responsibility for each area to designated squad members. The vehicle can be divided as follows:

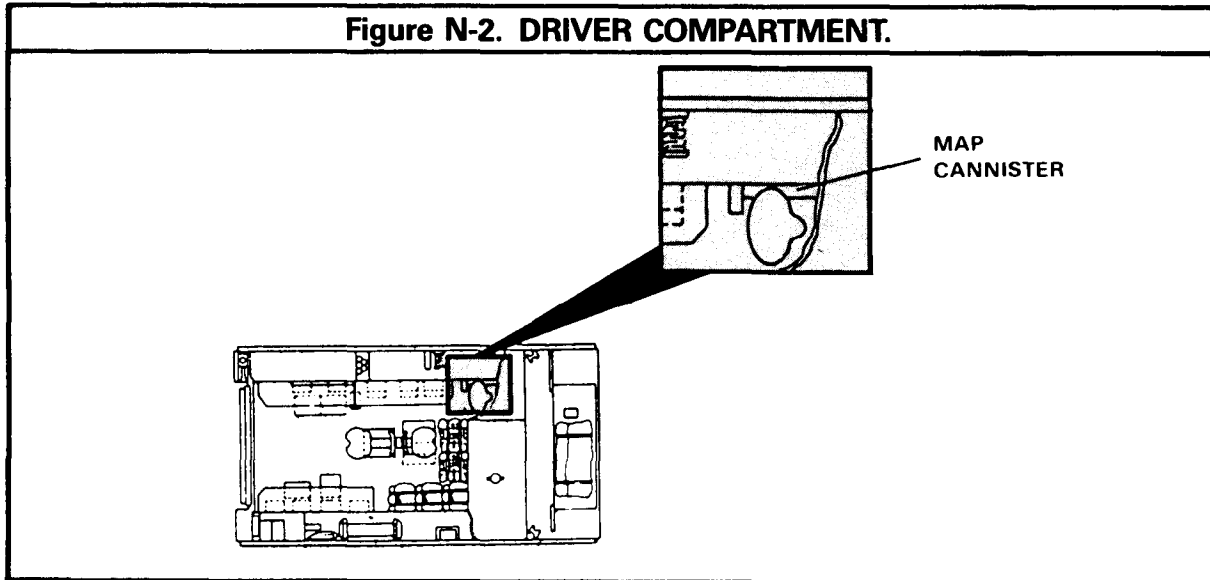
AREA	RESPONSIBLE PERSON
Driver's compartment	Driver
Cupola	Gunner/TL
Troop compartment	Squad leader
Vehicle exterior	Team leader

Every item loaded in the APC must be secured to keep it from being damaged or injuring occupants when the vehicle is moving. Extra equipment, or ammunition for which there is no designated stowage space on the vehicle, must be securely strapped down in the best available place. Equipment or ammunition should never be thrown into the vehicle.

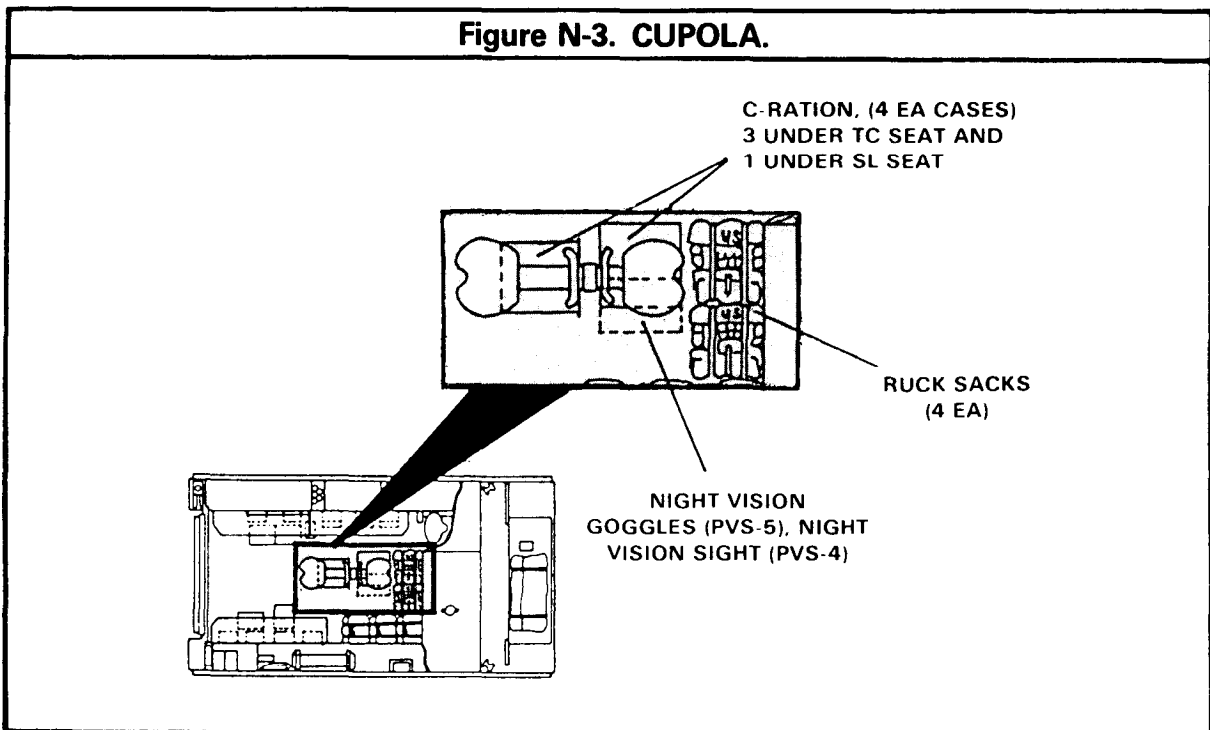


N-6. DRIVER'S COMPARTMENT

Driver's Compartment.

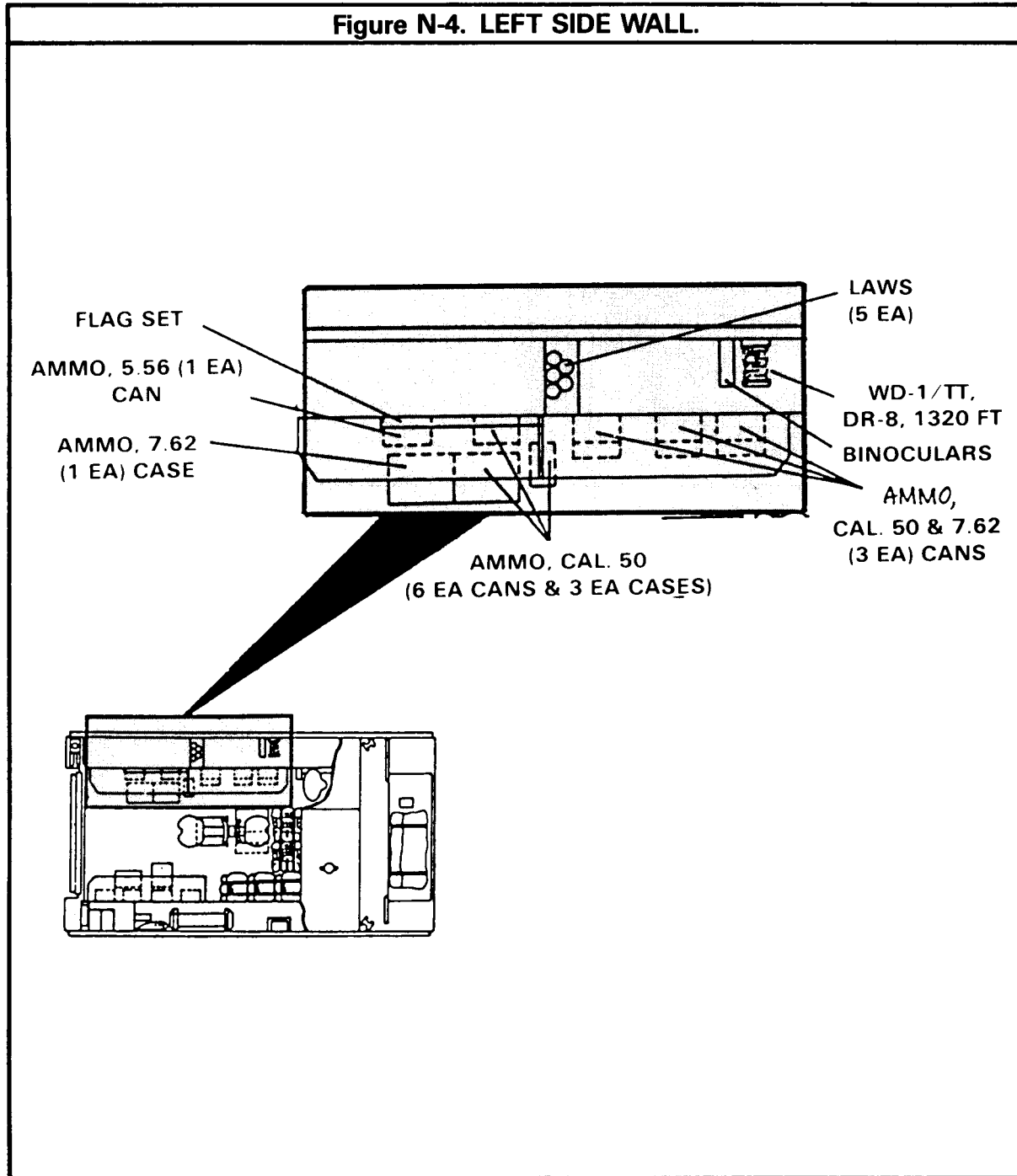


Cupola.

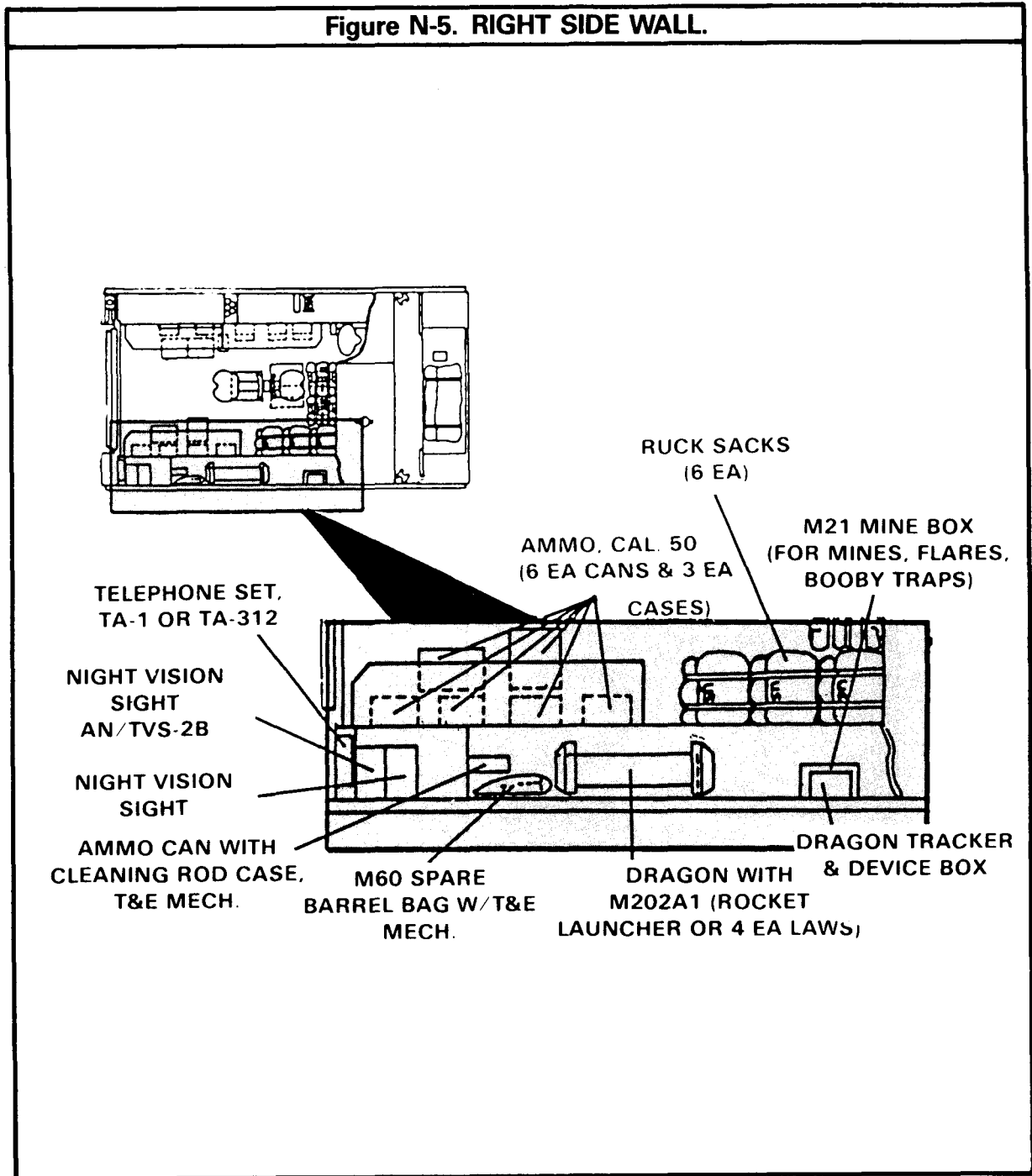


N-7. TROOP COMPARTMENT  
Left Side Wall

Figure N-4. LEFT SIDE WALL.



Right Side Wall.

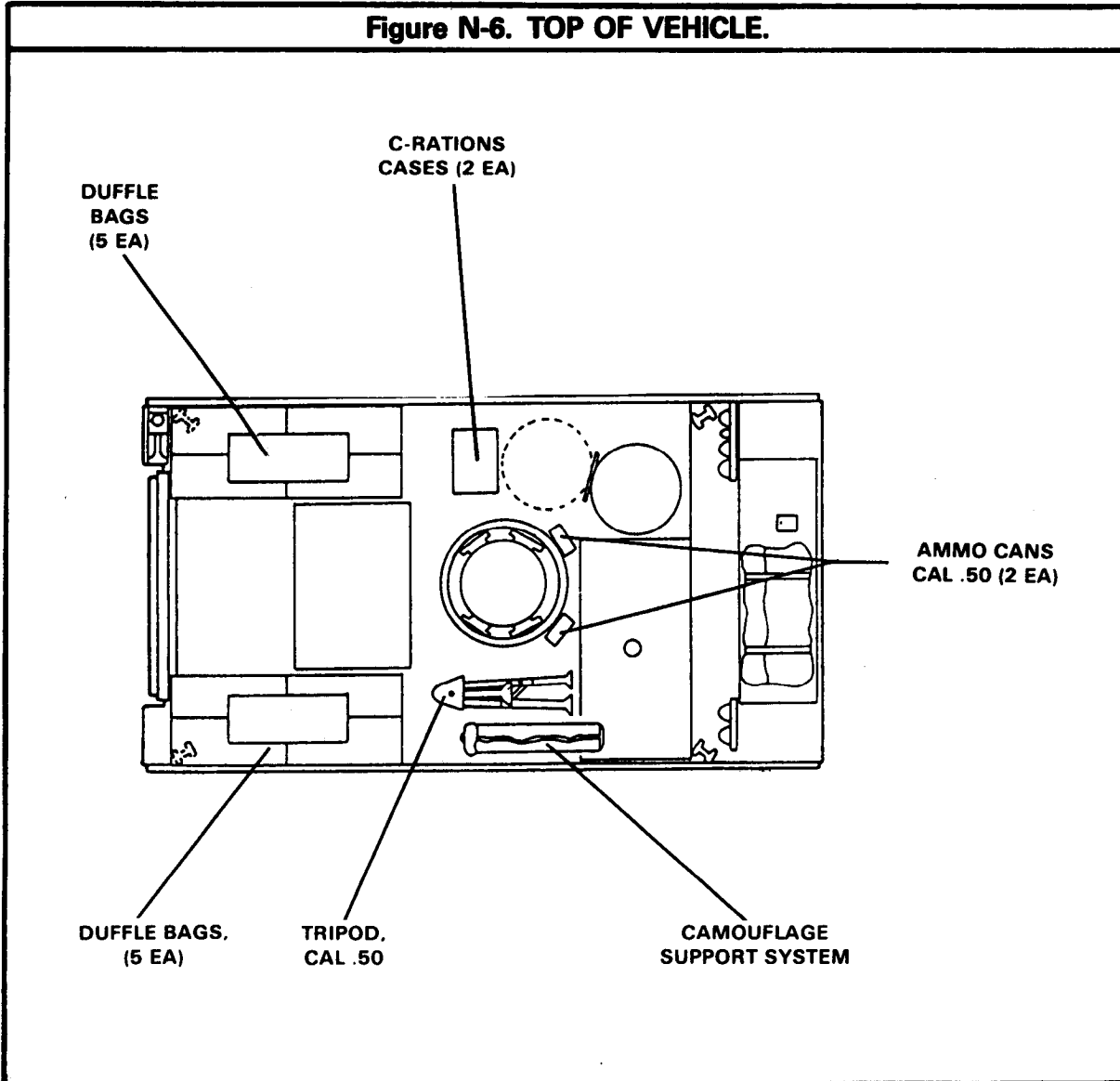


N-8. VEHICLE EXTERIOR

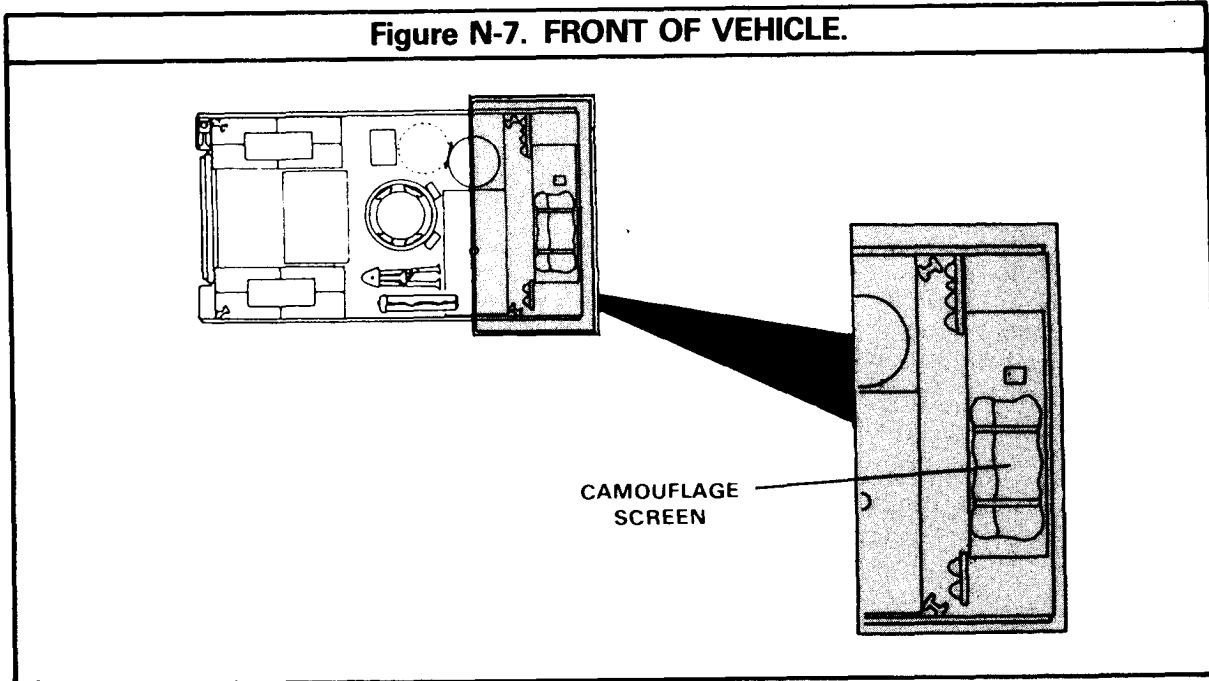
Top of Vehicle.

**NOTE:** The placement of equipment **MUST** not interfere with the operation of the weapons, or the cupola, or the personnel standing in the cargo hatch.

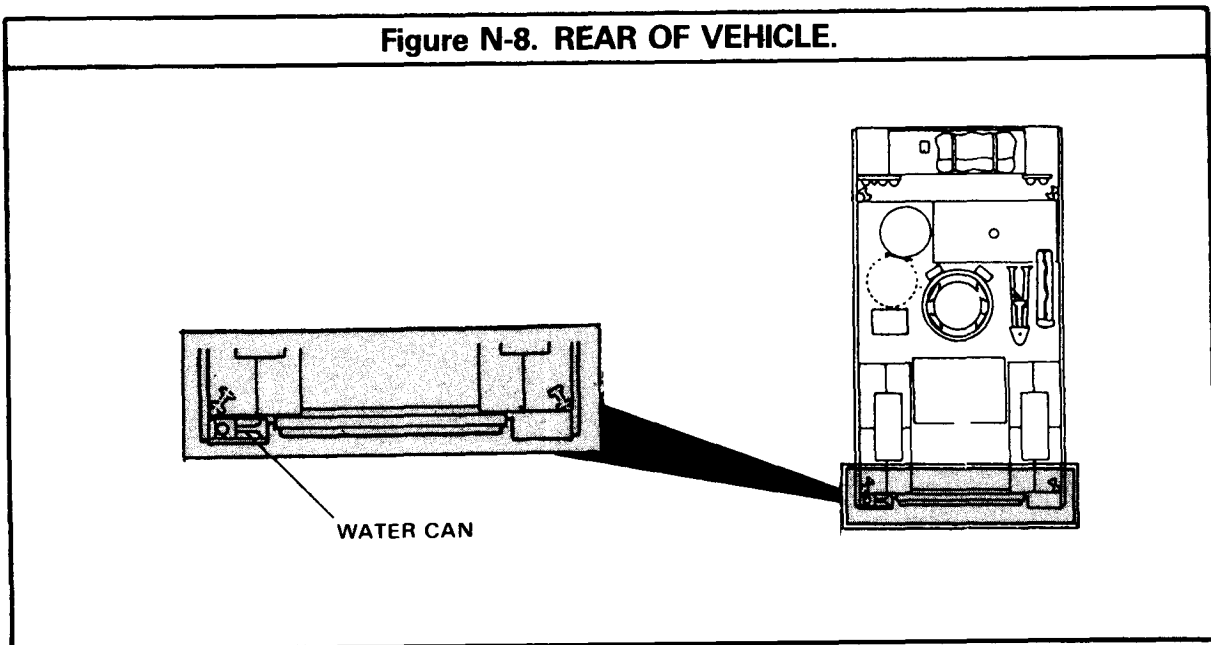
**Figure N-6. TOP OF VEHICLE.**



Front of vehicle.



Rear of Vehicle.



APPENDIX O

**OPERATIONS SECURITY**

**Section I. COUNTERSURVEILLANCE**

**O-1. GENERAL**

Operations security (OPSEC) includes all actions taken to deny the enemy information on planned, ongoing, or completed operations. OPSEC includes measures such as camouflage, physical security noise and light discipline, information security authentication procedures, document security sign and countersign, and terrain masking.

**O-2. CAMOUFLAGE AND CONCEALMENT**

Camouflage is the use of natural and man-made materials to disguise and conceal troops, vehicles, and equipment so they blend with their surroundings. Concealment is the use of available terrain features, both natural and man-made, to hide troops, vehicles, and equipment. Camouflage and concealment make it more difficult for the enemy to detect and engage platoons and squads with accurate fire.

When planning camouflage and concealment, platoons and squads must think about the things the enemy will look for or things that will attract his attention to friendly positions. These include:

**MOVEMENT.** Movement attracts attention, particularly vehicular movement. Even slight movements, such as arm-and-hand signals or a soldier walking, may attract the enemy's attention.

**SHADOWS.** Unusual shadows will attract attention. Since the APC is large and has a distinct shape, its shadow maybe easily seen. Hence, every effort should be made to break up the vehicle's outline and cause its shadow to blend with shadows cast by natural terrain. Shaded areas should be used to the maximum, but shadows move as the position of the sun or moon

changes and this should be taken into account. Vehicles should be repositioned accordingly.

**OBVIOUS POSITIONS.** Hilltops, road junctions, and lone buildings should be avoided. They may be easily seen by the enemy or serve as registration points for enemy indirect fire.

**SHINY OR REFLECTED LIGHT.** In daylight bright or shiny surfaces will reflect sunlight and draw the enemy's attention. At night, an exposed light, even one with a red lens, or the glow of a cigarette can be seen from far away.

**SHAPE.** The shape of a vehicle or even a helmet is easily identified by the enemy. Shape and outline of troops and vehicles must be broken up by camouflage materials.

**COLOR.** Combat uniforms and even the APC are colored to blend with wooded surroundings. Often, though, colors will not blend with the background. For example, if the ground is covered with snow, green camouflage will not blend. Camouflage should be adjusted to fit local conditions

**CONCENTRATION.** Congestion of troops or vehicles will attract the enemy's attention, and probably his fire. Men and vehicles must always be dispersed.

CONTENTS	PAGE
Section I. Countersurveillance .....	O-1
II. Physical Security .....	O-4
III. Signal Security .....	O-5
IV. Information Security .....	O-6

**O-3. POSITIONS**

Since the APC is large, cover is often more important than camouflage. There are two ways to conceal the APC: hull-down position and hide position.

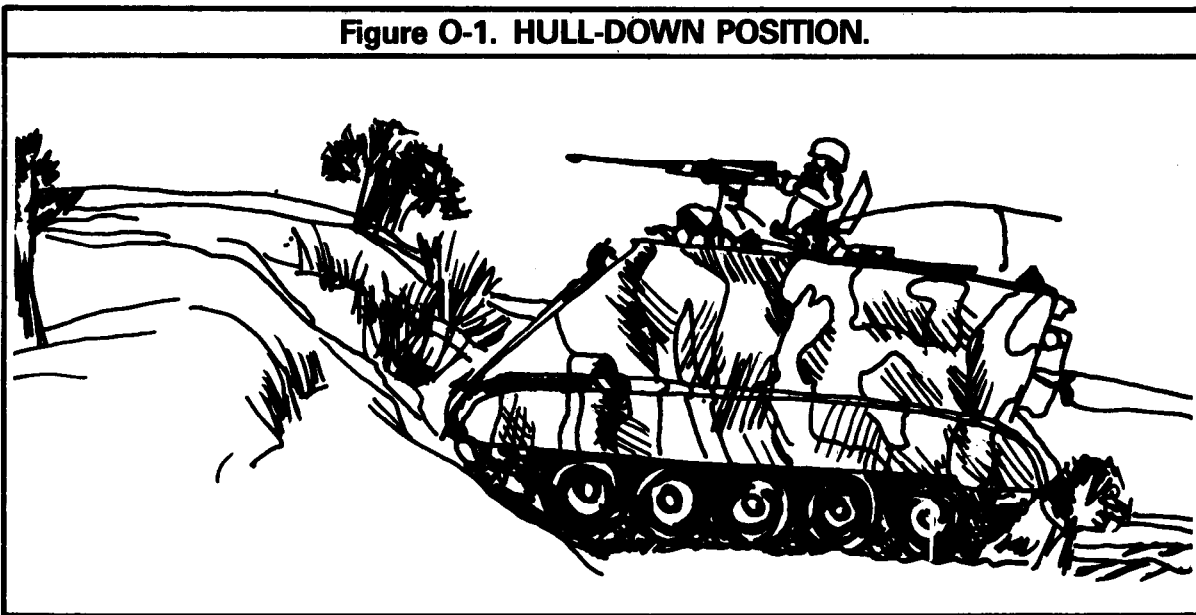
**HULL-DOWN POSITION.**

The most common position, the hull-down position, uses the terrain to protect the hull. This type of position allows the TL/gunner to observe the battlefield and use the mounted weapons.

Camouflage can be attached to the APC by communications wire or string. It should be used to break up the vehicle outline. Camouflage must not interfere with the movement of vehicle weapons or block the gunner's view.

Natural camouflage may include branches, grass, mud, or snow. Man-made camouflage may include wire netting, carpets, boards, or poles. Both natural and man-made items may be used at the same time.

**Figure O-1. HULL-DOWN POSITION.**



Hull-down positions are often found behind undulations, ridges, slopes, road and railroad embankments, and walls. The TL may choose to back into a hull-down position. This allows for more rapid movement out of the position.

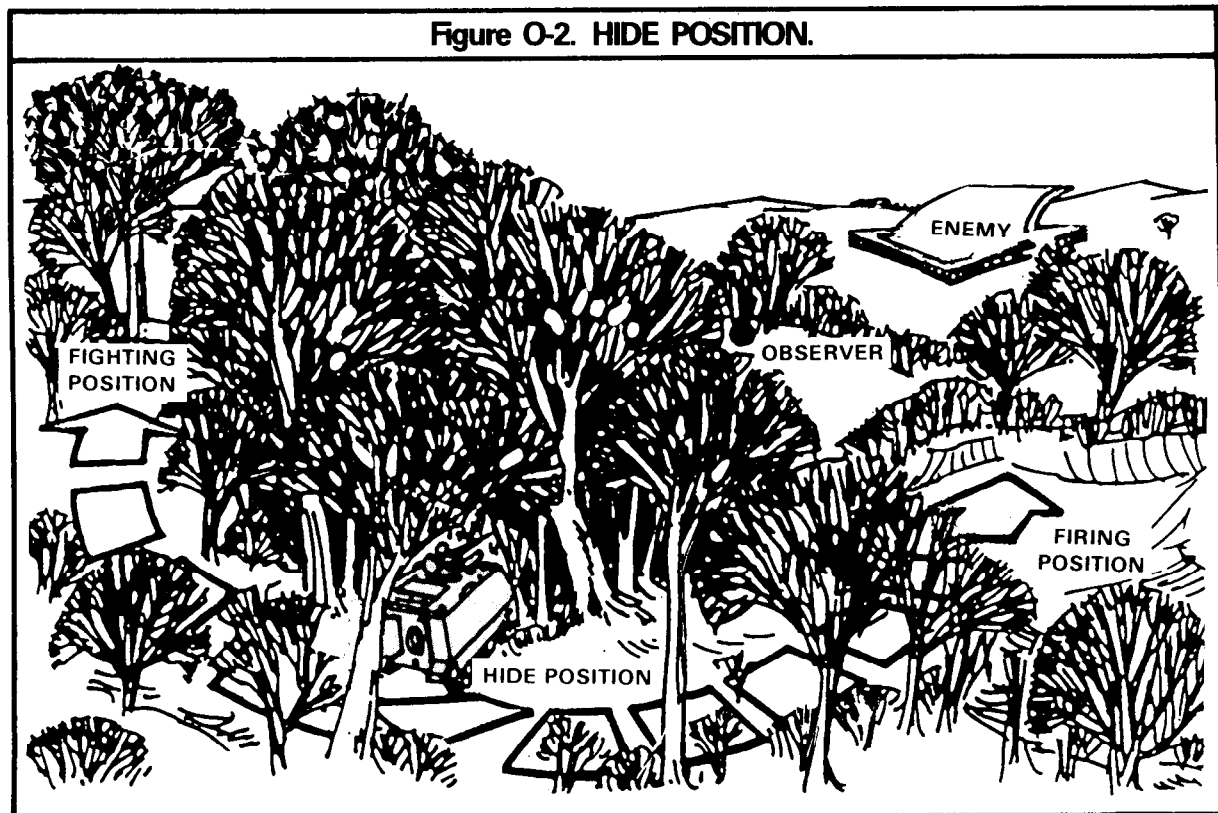
**HIDE POSITION.**

This type of position is used when likely firing positions have little or no cover and concealment. The carriers are placed to the rear of their designated firing positions in a woodline, behind buildings, or in a depression.

When hide positions are used, the dis-

mount teams should be forward to observe the likely engagement areas. They should have a way to signal the carrier teams to alert them to likely targets and to call the vehicles forward at the appropriate time. This can be done by arm-and-hand signals, wire, or radio.

No matter what type of firing position is used, the vehicles should have more than one position. Once the APC engages the enemy it will attract return fire. By having other firing positions, an APC can destroy a target, back down into cover, and move to another position. While this is being done, the other APCs and the dismount element can be firing to divert the enemy's attention.



#### O-4. NOISE AND LIGHT DISCIPLINE

If a unit does not practice noise and light discipline, especially at night, the best operational security measures can be wasted. The most difficult noises to control are those made by the vehicle. These also are the most likely noises to be detected by the enemy. Several techniques can be used to cut down vehicle noises.

When possible, keep night movement to a minimum because the carrier's engine and tracks can be heard at a considerable distance.

Avoid idling engines at high speeds or moving rapidly.

If possible, close ramps and hatches before dark. When closing them after dark, they should not be slammed.

Vehicle light discipline includes:

**Using vision block covers during**

**darkness.**

**Using night vision goggles.**

**Turning off all internal lights.**

**Using blue-green filters on flashlights.**

**When it is dark and preparations have been made, one member of each dismount team should inspect the squad's vehicle from the outside to insure that there is no visible light from the vehicle.**

The dismount teams also must practice noise and light discipline. Noise discipline is simply avoiding loud noises, such as loud talking, laughing, or metal-on-metal sounds. Light discipline involves no smoking or building fires, and controlling use of flashlights.



## Section II. PHYSICAL SECURITY

### O-5. GENERAL

Physical security consists of actions platoons and squads take to insure that the enemy does not close on or infiltrate friendly positions without being detected. These actions include manning observation posts, conducting patrols, conducting stand-to, silent watch, and providing local security to include flank coordination.

### O-6. OBSERVATION POST

Normally a platoon is given the mission to set up and man at least one two-man OP. In turn, the platoon leader will designate a squad to perform OP duties. An OP is designed in the defense to observe to the front or in the gaps between friendly positions. It provides early warning of the enemy's advance. Wire is the primary means of communication between the platoon headquarters and the OP.

A whole squad, including its carrier team, may be given an OP mission. This gives the OP more firepower, armor protection, and better mobility. When this is not feasible, the dismount team will man the OP.

When a platoon leader orders soldiers to man an OP, he must explain to them in detail what he wants them to do, what actions they will take when they detect the enemy and when and how they are to return to the platoon's position. The platoon leader may want to have the forward observer and his radiotelephone operator go with the squad personnel to call for indirect fire on any enemy detected.

### O-7. PATROLS

Normally patrols are conducted to cover unoccupied gaps between defensive positions. On occasion, patrols also may cover the terrain between OPs to the front. Squad dismount teams normally conduct patrols. (See chapter 7 for details on patrolling.)

### O-8. STAND-TO

Platoons and squads will normally be required to conduct stand-to according to unit SOP. A stand-to is a period of maximum preparedness at first light in the morning and at darkness in the evening. This insures that the unit is ready for action and that every man adjusts to the changing light conditions. As a minimum, stand-to is conducted 30 minutes before beginning morning nautical twilight (BMNT) and 30 minutes after end evening nautical twilight (EENT). The SOP should specify the actions to be taken, but as a minimum they should insure that:

**Troops are awake, dressed, and ready for combat.**

**Vehicles are topped off with fuel and stocked with a basic load of ammunition.**

**Weapons are cleaned, serviced, assembled, and ready for action.**

**Radios are turned on and tested (briefly).**

**All vehicles are loaded to the extent possible, less the deployed dismount teams, and are ready for short-notice moves.**

### O-9. SILENT WATCH

During limited visibility and lulls in the battle, it is critical to keep up observation of assigned sectors without exposing friendly positions to enemy view. While doing this, the platoon may use silent watch. Silent watch is a defensive posture that minimizes all sounds that might be detected by the enemy.

### O-10. MOUNTED/DISMOUNTED SECURITY

Local security consists of mounted and dismounted security.

### Mounted security

Mounted security is observing from the APC and preparing the vehicle so it does not represent a security hazard.

The platoon leader should assign each squad an area to watch over. The gunner can best do this because he is elevated and has access to the AN/TVS-5. Dragon tracker and binoculars are used.

During the evening stand-to preparations, noise and light discipline should be enforced, and the vehicle's engine should be run only enough to insure that the batteries are charged.

### Dismounted Security

Dismounted local security is provided by the dismount teams. During daylight, this involves observing in assigned sectors of defensive fires. At night, positions may be moved forward or closer to the vehicle element or to tanks in a company team.

The infantrymen provide security by observing assigned sectors with the naked eye, with binoculars, and with their nightsights. They also listen for the enemy. Tank crews have difficulty listening for the enemy because of vehicle noises and the crew's confined place in the vehicles.

## Section III. SIGNAL SECURITY

### O-11. GENERAL

Signal security (SIGSEC) includes measures taken to deny or counter enemy exploitation of electronic emissions. It includes communications security and electronic security. Communications security measures are discussed in appendix D, paragraph D-10.

At the platoon and squad level, SIGSEC mainly concerns good communication procedures and electronic counter-countermeasures. ECCM, taken to insure friendly use of the electromagnetic spectrum against electronic warfare, includes antijamming, authentication, and radio discipline.

As far as possible, radio should be used as a communications backup for arm-and-hand signals, flag signals, whistles, telephones, flash-light signals, and messengers.

There will be times when the radio must be used. Platoons and squads should assume that the enemy is monitoring every radio transmission and using radio direction finders to locate transmitting radios. They also must assume that the enemy understands English and can

quickly break unauthorized codes. No matter who is transmitting by radio, these rules should be followed:

**Transmit only when necessary.**

**Think the message through and know exactly what needs to be said before keying the transmitter.**

**Keep transmissions short, and use call signs only as necessary.**

**Do not confuse the radio with vehicle intercom systems.**

**Use proper radiotelephone procedures and prowords.**

**Operate radios on low power as much as possible.**

### O-12. ENCODED INFORMATION

In transmissions to the company commander and other platoons, the platoon leader often will have information that needs to be encoded. In these situations, the platoon leader should use

the CEOI for the proper encoding procedures and authentication tables.

Within the platoon, there seldom is occasion to send information that requires code; hence,

transmissions are in the clear. Sensitive information should be passed orally in a face-to-face meeting of leaders or by messenger.

## **Section IV. INFORMATION SECURITY**

### **O-13. GENERAL**

Information security includes measures taken to prevent the enemy from gaining intelligence on friendly units, intentions, or locations. Information security can be associated with physical security in that physical security may be necessary to good information security.

### **O-14. SECURITY MEASURES**

During combat operations, foreign nationals and observers should not be permitted into the area. Specific instructions should be given to platoon members to deny local civilians access into or around their positions. Civilians could be used by the enemy to obtain information about your unit.

Weapons, ammunition, classified documents, and sensitive items should be safeguarded at all times. When not in use, sensitive items should be stored out of sight. Careless equipment security can lead to compromise of your capabilities and limitations. If, for example, you move through a seemingly secure town, with limited visibility devices and ammunition "displayed," enemy infiltrators or sympathizers will obtain information about your capabilities.

Unit vehicle markings should be covered as should individual unit patches. These items may seem insignificant, but they may provide valuable information to the enemy. They allow

the enemy to determine the size and type of unit that opposes them and the unit's capabilities.

Censorship in a war zone is inherent in information security. Soldiers should be briefed on what not to include in their mail. Should they be killed or captured and subsequently searched by the enemy, mail could be a valuable intelligence source. Items that should not be in letters include:

**Unit identification, size, location, or capabilities.**

**Knowledge of future operations.**

**Specific mention of commanders' names.**

**Acknowledgement of heavy losses or poor morale.**

Whenever a unit departs a position, a thorough police of the area should be conducted to insure that items of intelligence value are not left behind. In a laager, ammunition containers should not be left behind since they could provide information as to the types and numbers of systems that a unit has. Food containers could be a dead giveaway as to the unit's size. Discarded radio batteries can disclose communications capabilities. It is essential that unit members police as they go to avoid possible compromise.

APPENDIX P

**OBSTACLES**

**Section I. MINEFIELDS**

**P-1. GENERAL**

Minefields assist in security defensive, retrograde, and offensive operations by reducing the mobility of the enemy. Minefields supplement obstacles and weapons. They also add to the user's combat power without adding more troop strength.

Characteristics and techniques for employment of antipersonnel and antitank mines are shown in illustration. (Fig. P-1.)

**P-2. HASTY PROTECTIVE MINEFIELD**

In the defense, platoons and squads lay hasty protective minefield to supplement weapons, prevent surprise, and give early warning of enemy advance. A platoon can install hasty protective minefield, but only with permission from the company commander. (The company commander must get permission from the battalion commander.)

Hasty protective minefield are reported to the company commander, recorded on DA Form 1355-1, and marked. The leader puts the minefield across likely avenues of approach, within range of his organic weapons and within visual observation from his defensive positions.

The minefield should be recorded before the mines are armed. The leader installing the minefield should warn adjacent platoons and tell the company commander of the minefield's location. When the platoon leaves the area (except when forced to withdraw by the enemy), it must remove the minefield or transfer the re-

sponsibility for the minefield to the relieving platoon leader.

Only metallic mines are used in hasty protective minefields. A metallic mine detector (AN/PSS-11) will help locate them. The mine detectors are in the battalion's supply section. Booby traps are not used in hasty protective minefield; they delay removal of the mines. Time may allow only the placing of mines on the surface of the ground when laying hasty minefield.

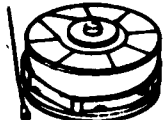





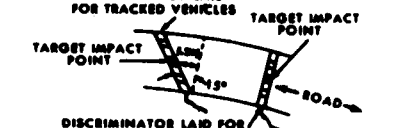






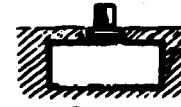




The employing unit must make sure that the minefield can be kept under observation and covered by fire at all times. Continuous observation can keep the enemy from booby-trapping, removing, or easily bypassing the mines.

The following example describes how to lay a hasty protective minefield. Although this is an example for a platoon, a squad follows the same procedure.

The platoon has moved into a battle position and is preparing to defend. Hasty protective minefield are needed to improve the defense. The platoon's basic load contains M21 antitank mines, and M16A1 and M18A1 (Claymore) antipersonnel mines with tripwires.

CONTENTS		PAGE
Section I.	Minefield .....	P-1
II.	Wire and Demolitions .....	P-10
III.	Breaching and Clearing Ostacles .....	P-21

**Figure P-1. ANTIPERSONNEL AND ANTTANK MINES.**

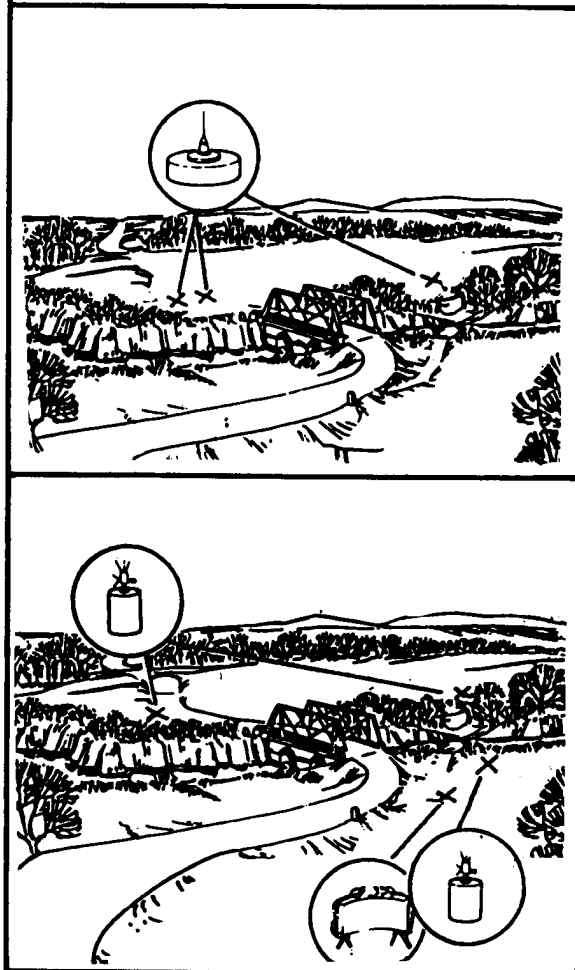
<p><b>M21 METALLIC (KILLER) ANTTANK MINE</b></p>	<p><b>M21 ANTTANK MINE USED WITH M612 FUZE</b></p>	<p><b>M24 OFF-ROUTE ANTTANK MINE</b></p>
		<p><b>INSTALLING AND ARMING</b></p> 
<p>Wt ..... 18 lbs. Explosive ..... 10.5 lbs. Fuze ..... M607 Functioning ..... 290 lbs. (Pressure on pressure ring or 20° deflection of tilt rod)</p>	<p>Has two 2.7m pneumatic leads, safety latch and arming lever.</p>	 <p>Remove above items from accessories pouch. Insert batteries (issued separately) in firing device.</p>
 <p>Remove closing plug, insert M120 booster in bottom, and replace closing plug.</p>	 <p>Remove closing plug, insert M120 booster.</p>	<p><b>DISCRIMINATOR LAID FOR TRACKED VEHICLES</b></p>  <p><b>DISCRIMINATOR LAID FOR WHEELED VEHICLES</b></p> <p>Unreel discriminator starting at far side of road (perpendicular to edge for wheeled vehicles; about 15° from perpendicular for tracked vehicles).</p>
 <p>Remove closure assembly from fuze.</p>	 <p>Remove shipping plug from mine. Screw in fuze.</p>	<p><b>BROWN MARKS</b>      <b>DISCRIMINATOR</b></p>  <p>Attach discriminator wire to DETECTOR of firing device (toggle switch on SAFE). Stand on two brown marks on discriminator nearest firing device. If lamp lights, circuit is good; otherwise, discard system.</p>
 <p>Remove shipping plug from mine and screw in fuze, then screw in tilt rod extension.</p>	 <p>Bury mine. Cross and extend hoses.</p>	<p><b>DISCRIMINATOR</b></p>  <p>Disconnect discriminator wire from firing device. Remove launcher from dispenser pouch and place in position. Remove packing blocks, push rocket forward to safety band, and remove band. Depress ejection pin and push rocket back into launcher until contact ring is exposed at base. Grounding clip must be connected. Remove tagged shorting clip and push rocket back into launcher. Tape plastic covers over ends of launcher.</p>
 <p>Bury mine</p>	 <p>Lift safety latch and turn arming lever to ARMED. Recross hoses.</p>	 <p>Position launcher on bipod assembly or mound of earth. Mount sighting assembly and sight along discriminator to target impact point about 1m above road (soldier's belt buckle.) To aim, move launcher, not sight. Fill poucher with dirt, lay over launcher, recheck sight, remove sight, re-connect discriminator wire to firing device (light out), connect rocket cable to firing device, and push toggle switch to ARM. The system is now armed and will fire when pressure is applied to the discriminator. See TM 9-1345-200.</p>
 <p>Remove safety (pull ring assembly) and complete camouflage.</p>	 <p>Complete camouflage.</p>	
<p>For pressure type mine bury with fuze cap flush with ground surface. Tilt Rod-mines should be seated firmly in snug-fitting hole. Most effective in tall brush or grass.</p> <p><b>TO DISARM:</b> Reverse arming procedure.</p>	<p>Timer provides a 30 ± 5 minute safe separation period. Both leads must be depressed for initiation.</p> <p><b>TO DISARM:</b> Reverse arming procedure.</p>	

After requesting and receiving permission to lay the minefield, the platoon leader and

squad leaders reconnoiter to determine exactly where the mines should be placed.

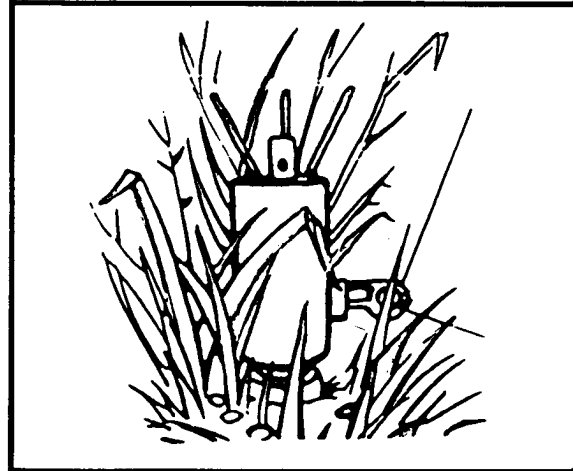
The leaders find a need to use antitank mines to block enemy vehicles at two points — a bridge and a ford (see figure).

**Figure P-2. ANTIPIERSONNEL AND ANTI-TANK MINES IN A HASTY PROTECTIVE MINEFIELD.**



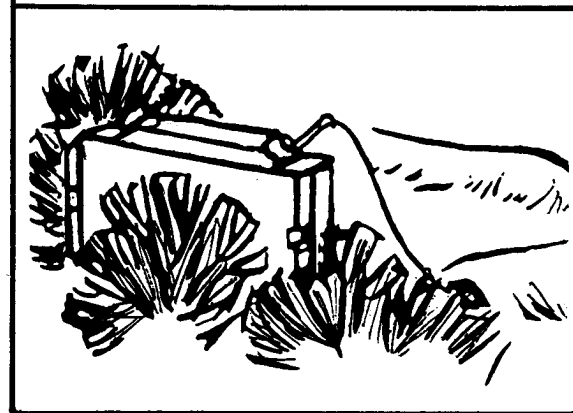
The leaders decide that antipersonnel mines are needed to protect the antitank mines and to cover the likely avenues of approach of enemy infantry. Antipersonnel mines are also needed for the open area in front of the platoon. The M16A1 antipersonnel mines will be buried, time permitting, and the tripwires camouflaged with grass or leaves.

**Figure P-3. TRIPWIRES CAMOUFLAGED.**



The firing wire for the Claymore will be camouflaged using grass or leaves, and it will be buried when possible.

**Figure P-4. CAMOUFLAGED FIRING WIRE.**

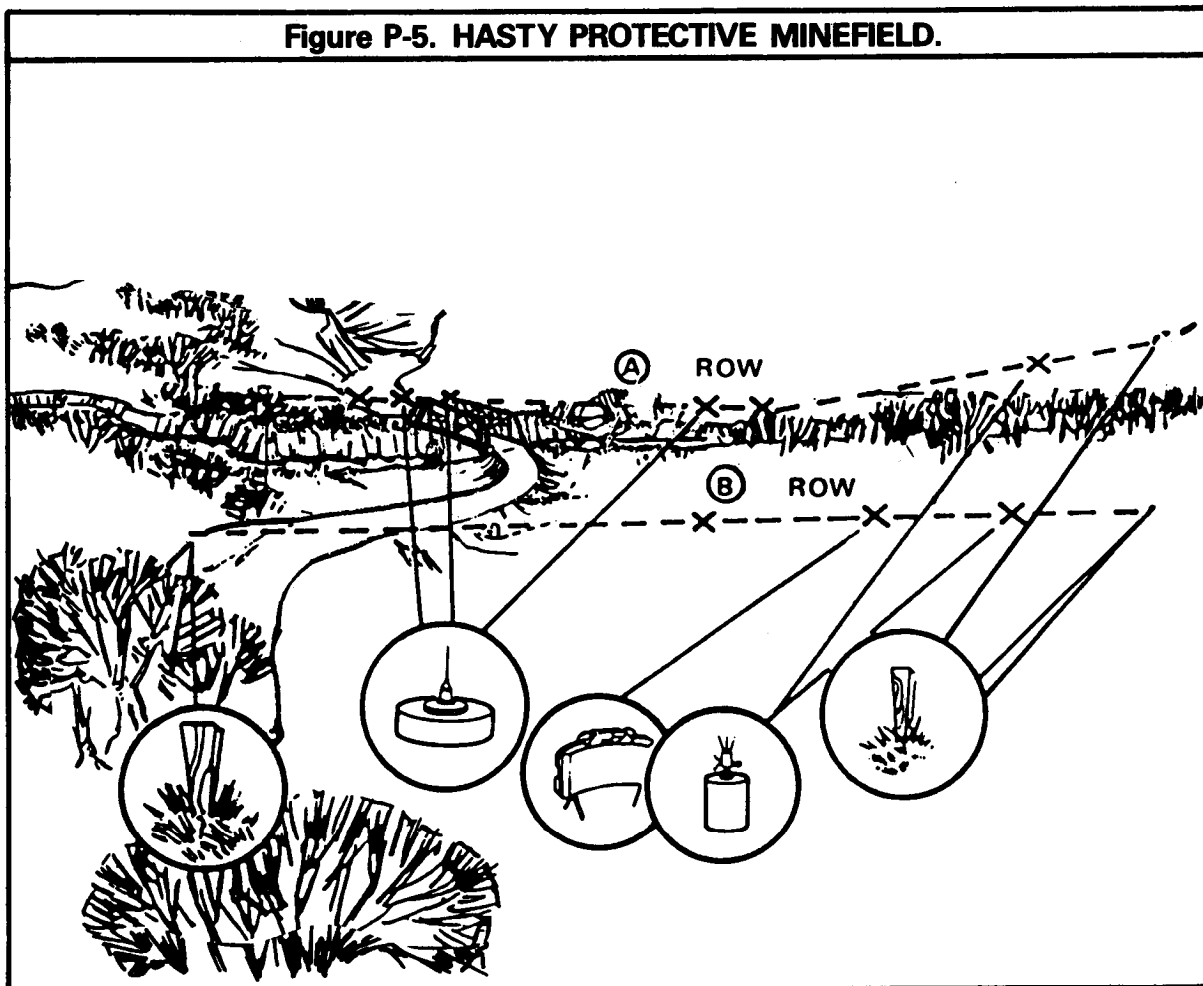


When the leaders have decided exactly where they will lay the mines, and are ready to begin, the platoon leader reports this information to the company commander. This is called an **initiation report**. Next, squad leaders have their men emplace the mines. **THE TROOPS DO NOT ARM OR ATTACH TRIPWIRES TO THE MINES AT THIS TIME.**

While the troops are placing the mines, the platoon leader finds an easily identifiable reference point in front of the platoon's position. In this example, he decides the concrete post to the front is an ideal reference point. The platoon leader now starts to record the minefield.

At the reference point, the platoon leader tries to visualize the minefield running in rows parallel to the defensive position. This will make the recording simpler and will later make retrieval quicker and safer. The row of mines closest to the enemy is designated A and the succeeding rows will be B, C, etc. For this hasty protective minefield, the platoon leader decides that two rows (A and B) will be enough.

**Figure P-5. HASTY PROTECTIVE MINEFIELD.**



The ends of a row are shown by two markers. They are labeled with the letter of the row and the number 1 for the right end of the row and 2 for the left end of the row. The rows are numbered from right to left, facing the enemy. The marker can be a wooden stake or steel picket.

From the concrete post, the platoon leader measures the magnetic azimuth in degrees and paces the distance to a point arbitrarily selected between 15 and 25 paces to the right of the first mine on the friendly side of the minefield. This point is B-1 and marks the beginning of the second row of mines. The platoon leader places a marker at B-1 and records the azimuth and distance from the concrete post to B-1 on DA Form 1355-1-R Fig. P-6.

Next, the platoon leader measures the azimuth and distance to a point 15 to 25 paces from the first mine in row A. He places a marker at this point and records it as A-1. (Fig. P-7.)

The platoon leader then measures the distance and azimuth from A-1 to the first mine in row A and records them. He then measures the distance and azimuth from the first mine to the second, and so on until all mine locations have been recorded, as shown.

The platoon leader gives each mine a number to identify it in the tabular block of DA Form 1355-1-R.

When the last mine location in row A is recorded, the platoon leader measures an azimuth and distance from the last mine to another arbitrary point between 15 and 25 paces beyond the last mine. He places a marker here and calls it A-2. The platoon leader follows this same procedure with row B.

When the platoon leader finishes recording and marking the rows, he measures the distance and azimuth from the reference point to B-2, and from B-2 to A-2, and records them. If the tactical situation requires it, the last mine

in the row can be an antitank mine to facilitate its retrieval. The form now looks like Fig. P-8.

The platoon leader now ties in the reference point with a permanent landmark that he found on the map if available. He measures the distance and azimuth from this landmark to the reference point. The landmark might be used to help others locate the minefield should it be abandoned. Finally he completes the tabular and identification blocks. The completed form looks like Fig. P-9.

**While the platoon leader is tying in the landmark, the troops arm the mines. The troops arm the mines nearest the enemy first (row A). This lets the troops work their way back to the platoon position safely.**

**Now that the field is laid and the paperwork is done, the platoon leader calls the commander and reports that the minefield is completed.**

As long as the unit and the minefield stay in place, the form (DA Form 1355-1-R) stays with the platoon leader. If the minefield is transferred to another platoon, the gaining platoon leader signs and dates the "mines transferred" block and accepts the form from the previous platoon leader. When the minefield is removed, the form is destroyed. If the minefield is left unattended or abandoned unexpectedly, the form must be forwarded to the company commander. The company commander forwards it to battalion to be transferred to more permanent records. In summary the steps for installing a hasty protective minefield are:

**(1) Report intention to lay a hasty protective minefield and get authorization to lay it.**

**(2) Reconnoiter to find the best places for mines based on likely enemy avenues of approach and the platoon's ability to keep the mines under observation.**



Figure P-6. PROTECTIVE MINEFIELD.

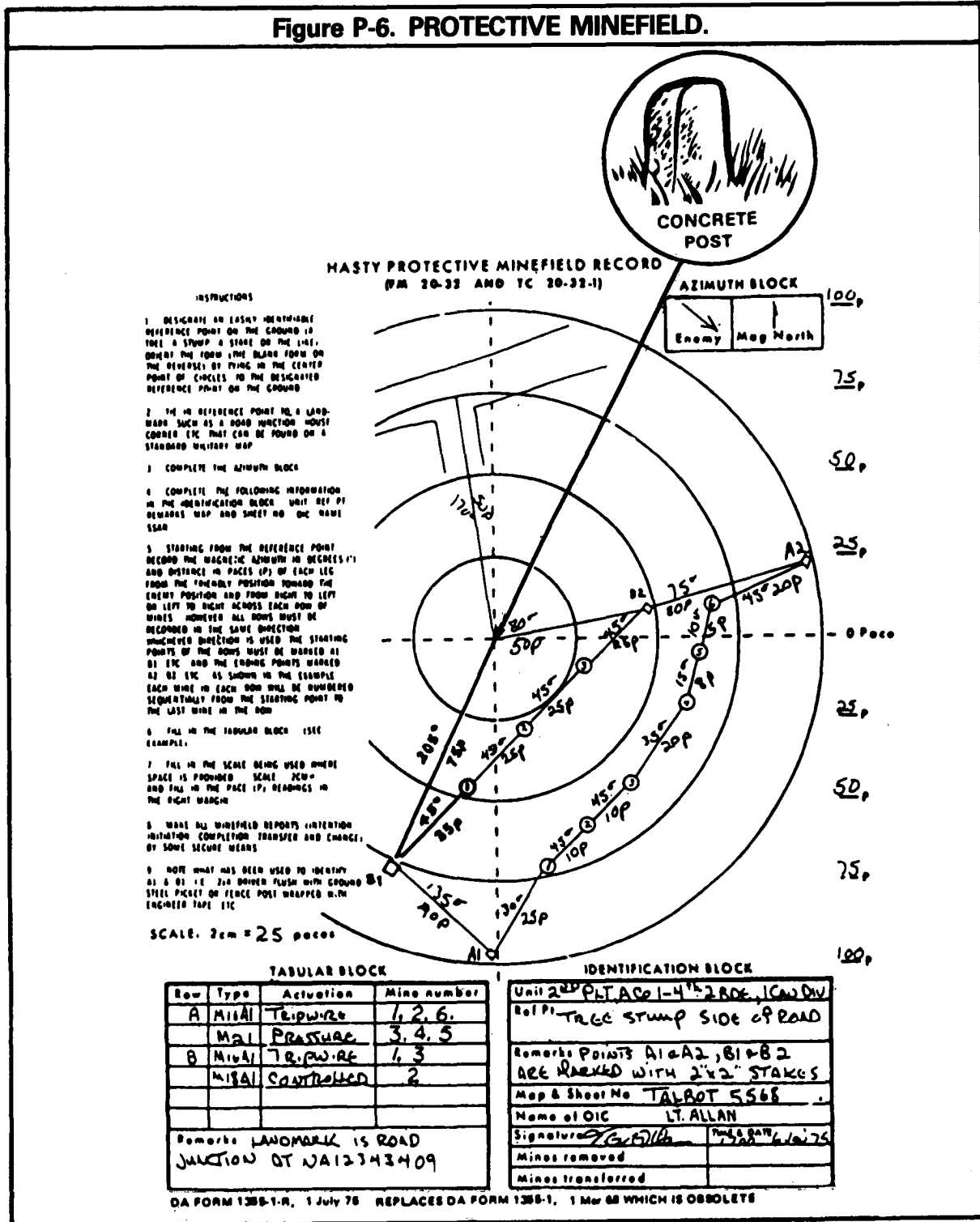


Figure P-7. PROTECTIVE MINEFIELD (CONTINUED).

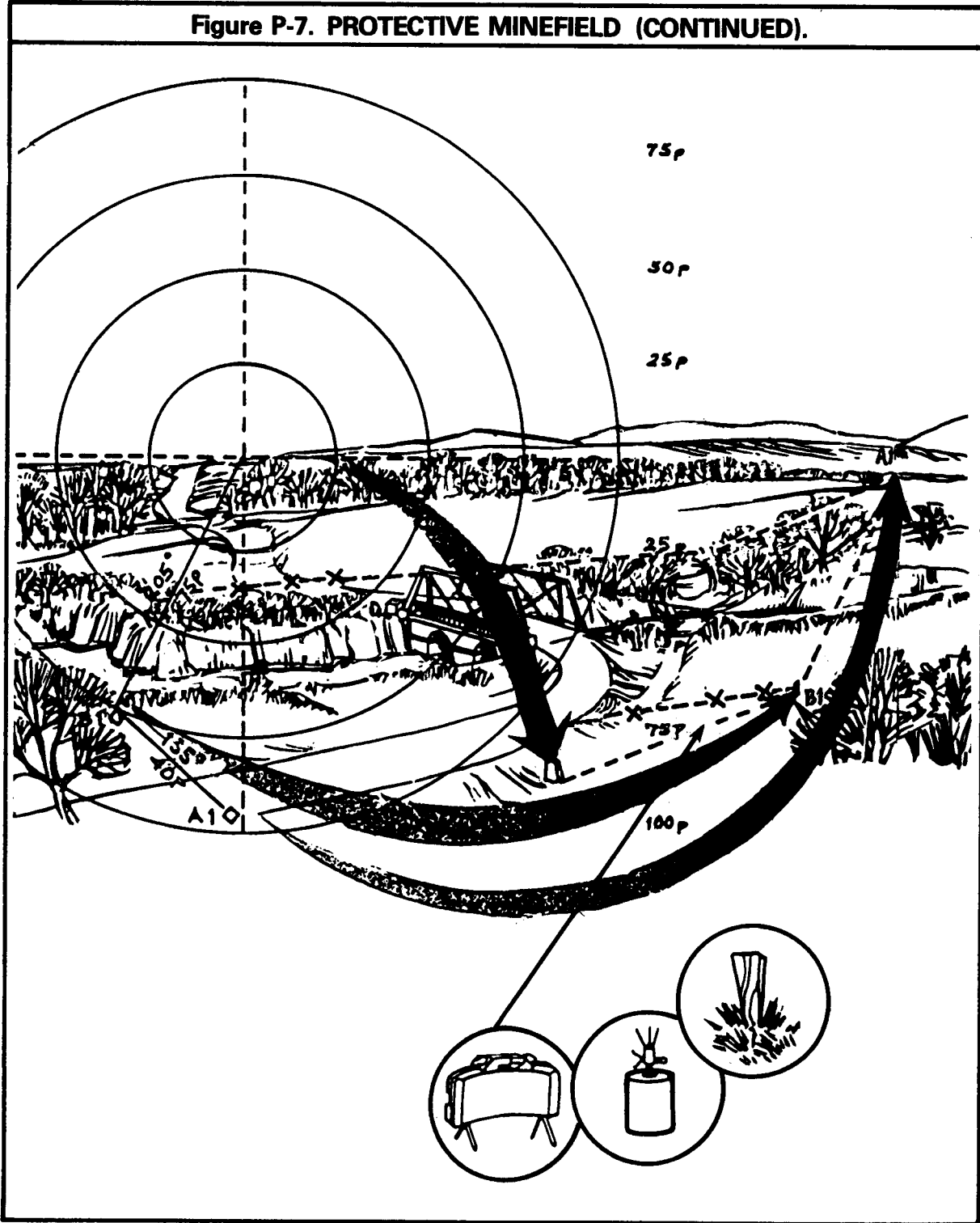
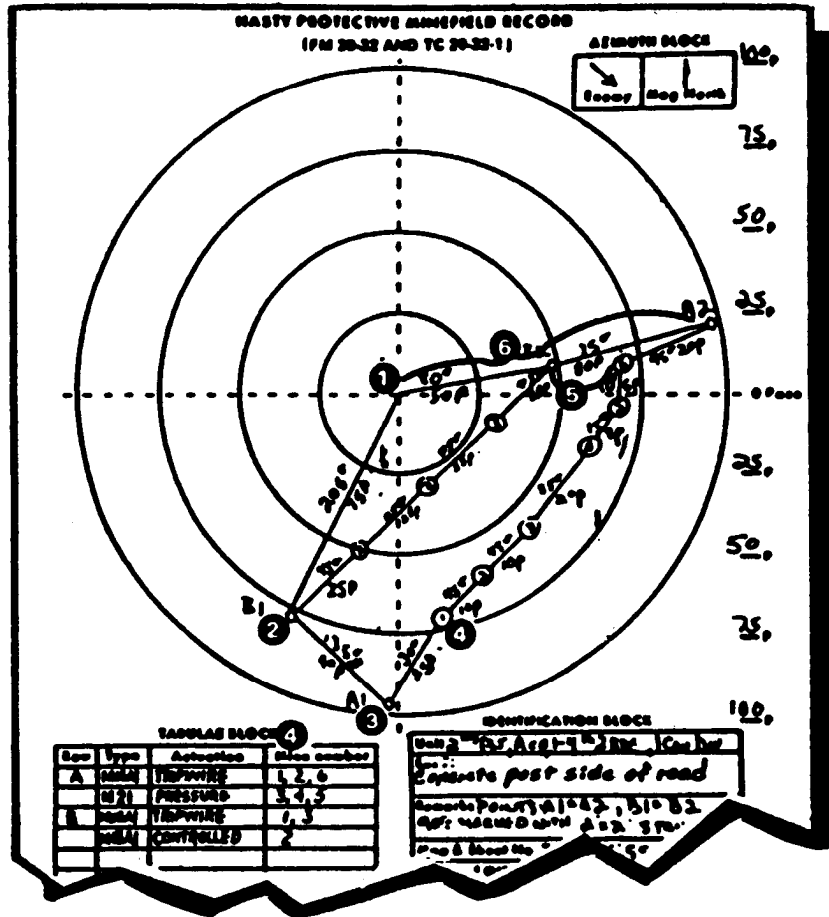
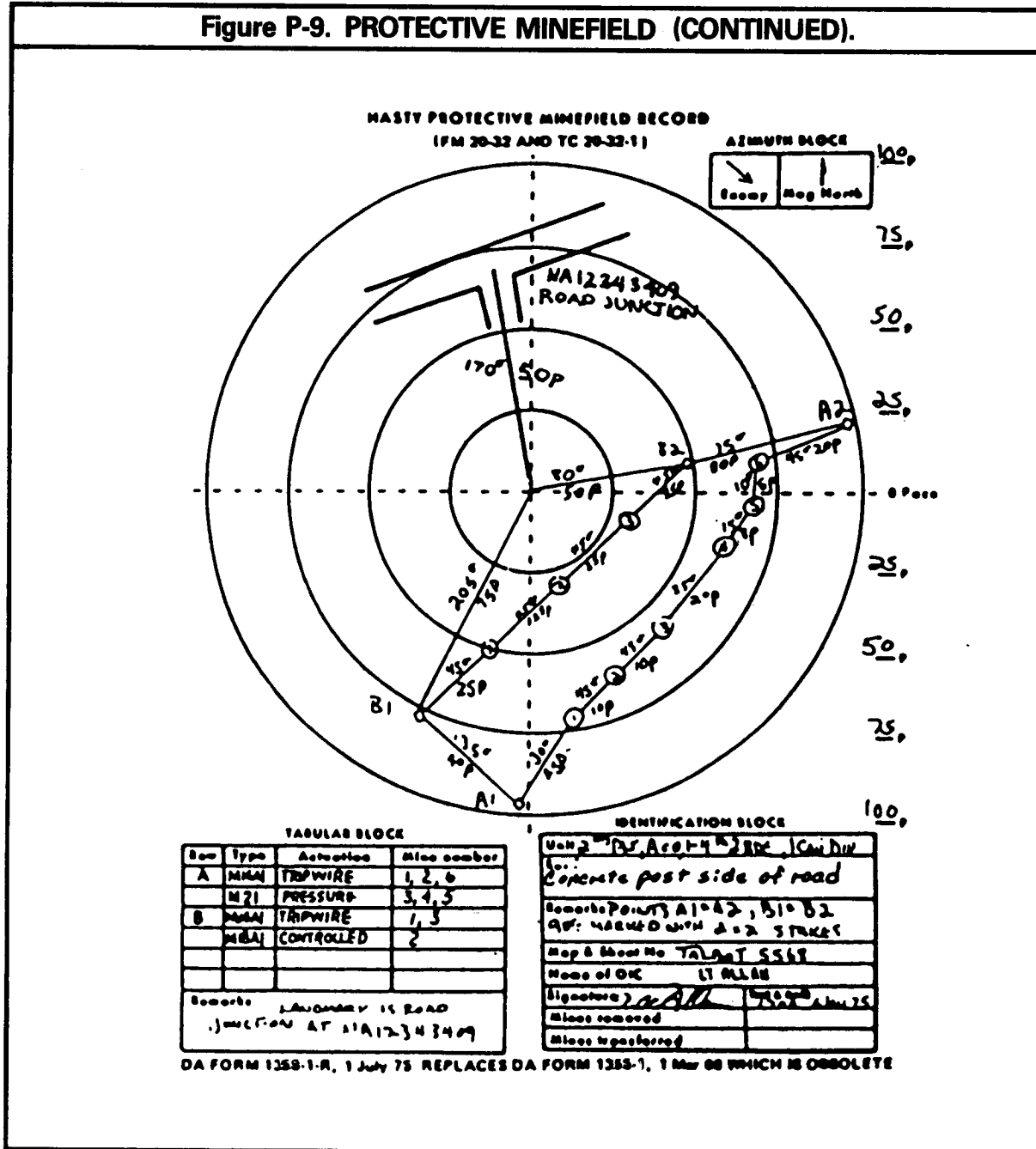


Figure P-8. PROTECTIVE MINEFIELD (CONTINUED).



- ① Find a reference point, i.e., the concrete post.
- ② Find and record the distance and azimuth to an arbitrary point 15 to 25 paces to the right of the first mine. Label it B-1.
- ③ From B-1, find the azimuth and distance to an arbitrary point A-1 15 to 25 paces from the first mine in the "A" row.
- ④ From A-1, measure the azimuth and distance to the first mine in the row; from that mine to the second, etc., until all are recorded. Do the same for "B" row. Record them in the tabular block.
- ⑤ From the last mine in each row find the azimuth and distance to arbitrary points A-2 and B-2.
- ⑥ From the reference point, find the azimuth and distance to B-2; then from B-2 to A-2.

Figure P-9. PROTECTIVE MINEFIELD (CONTINUED).



(3) Report starting of the minefield.

(4) Have the mines placed on the avenues of approach. Do not arm the

mines yet. Use only metallic mines. Do not use booby trap devices.

(5) Record the minefield on DA Form 1355-1-R.

**(6) Arm the mines, working from the enemy side to the friendly side.**

**(7) Report completion of the mine-field.**

**(8) Always integrate mines with other defense plans.**

When retrieving the mines, the troops start at the reference point and move to B-1, using the azimuth and distances as recorded. They

then move from B-1 to the first mine in row B. However, if B-1 is destroyed, they move from the reference point to B-2, using that azimuth and distance. They will now have to shoot the back azimuth from B-2 to the last mine, i.e., add or subtract 180 degrees from the recorded azimuth. The stakes at A-1 and B-1 are required. Stakes at A-2 and B-2 are recommended because it is safer to find a stake when traversing long distances than to find a live mine.

## Section II. WIRE AND DEMOLITIONS

### P-3. GENERAL

Engineers normally have the responsibility and equipment for assisting the infantry in constructing wire and demolition obstacles. The shortage of engineers, however, may require that rifle platoons and squads build these obstacles as best they can. Obstacles should be:

**Under friendly observation and covered by fire.**

**Concealed from enemy observation as much as possible.**

**Erected in an irregular pattern.**

**Employed in depth.**

**Coordinated with existing obstacles.**

**Of no advantage to the enemy.**

### P-4. TRIPLE STANDARD CONCERTINA FENCE

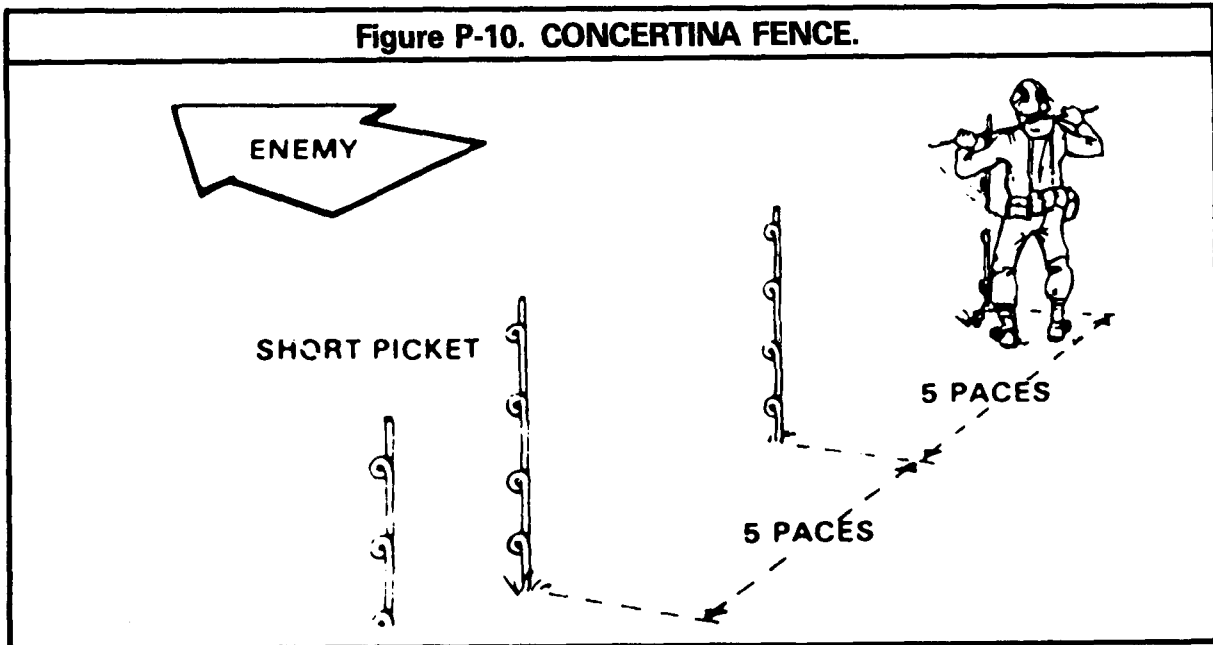
Of the wire barriers a platoon or squad may

build, the most common is the triple standard concertina fence. It is built of either barbed wire concertina or barbed tape concertina. There is no difference in building methods.

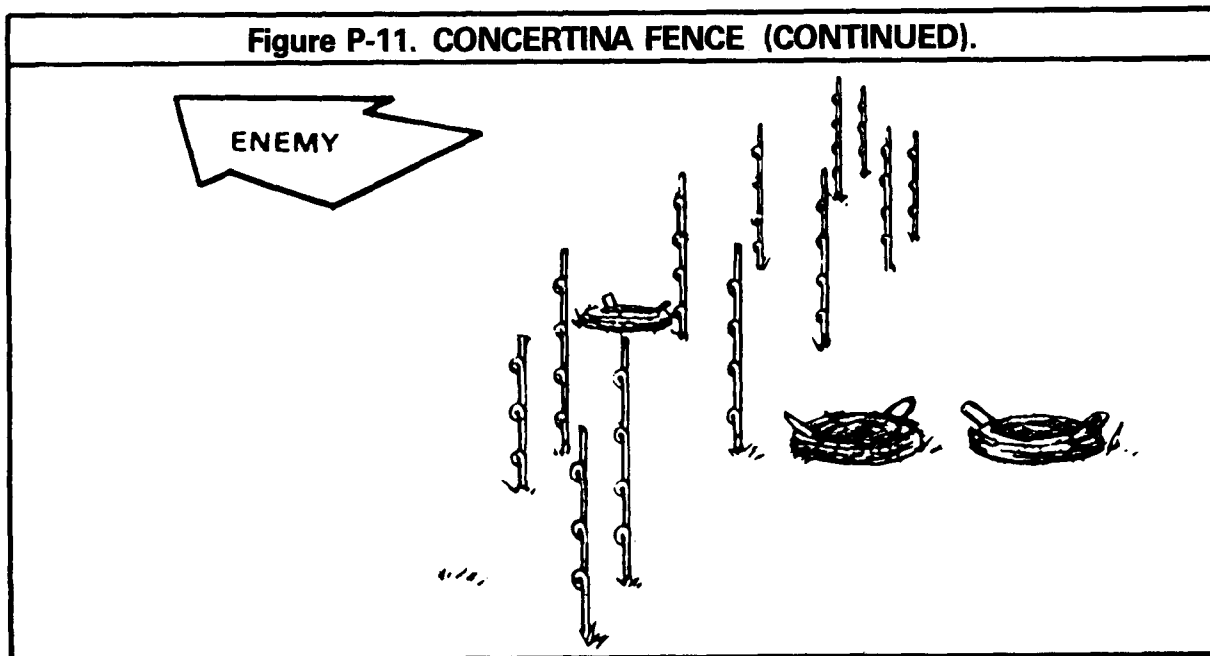
The material and labor requirements for a 300-meter triple standard concertina fence are listed below.

<b>160</b>	<b>long pickets</b>
<b>4</b>	<b>short pickets</b>
<b>3</b>	<b>400-meter reels of barbed wire</b>
<b>59</b>	<b>rolls of concertina</b>
<b>317</b>	<b>staples</b>
<b>30</b>	<b>man-hours to erect</b>

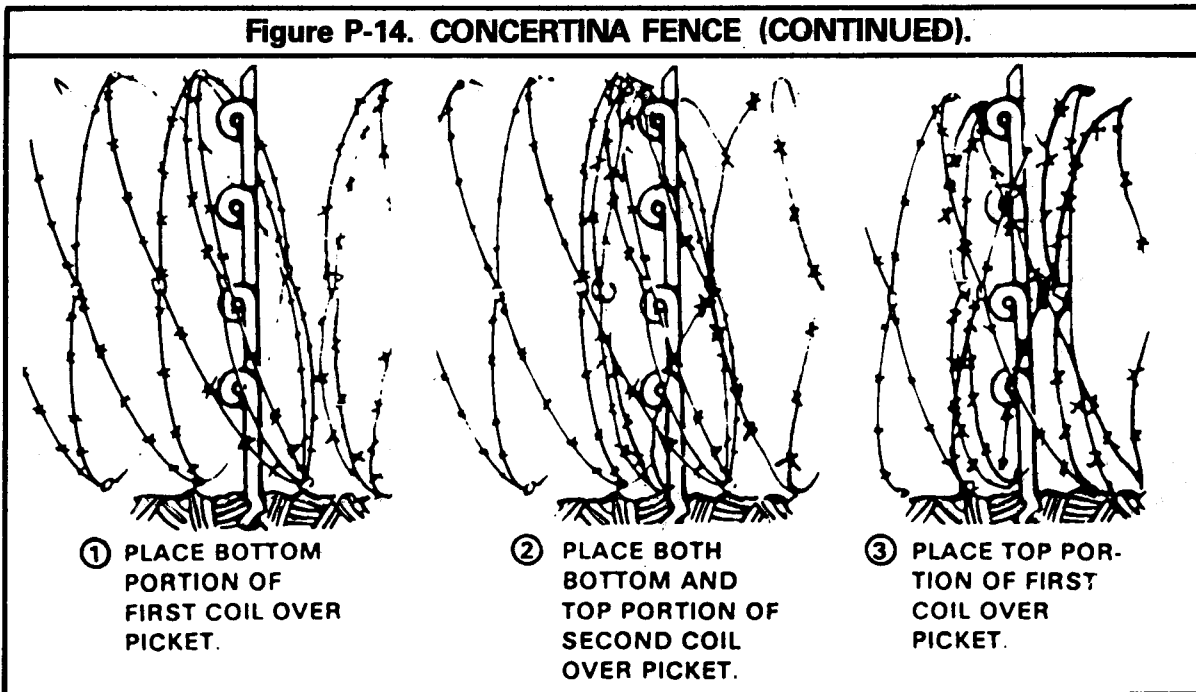
To construct a triple standard concertina fence, first lay out and install all pickets from left to right (as you face the enemy). Put the long pickets five paces apart, and the short (anchor) pickets two paces from the end of the long pickets. The enemy and friendly picket rows are offset and are placed 3 feet apart.



Now lay out all rolls of concertina. Place a roll in front of the third picket on the enemy side, and two rolls to the rear of the third picket on the friendly side. This step is repeated for every fourth picket thereafter.

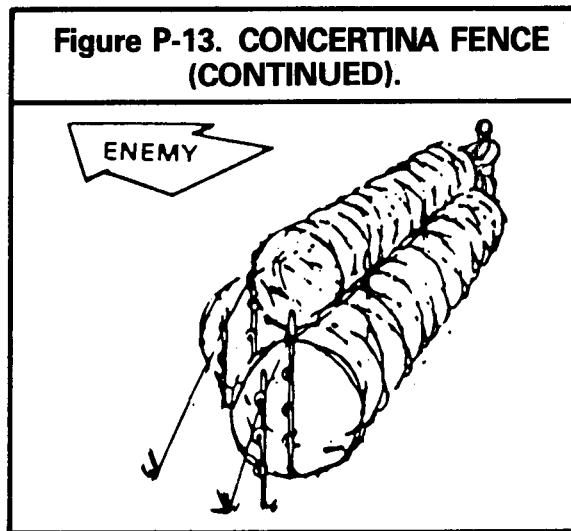
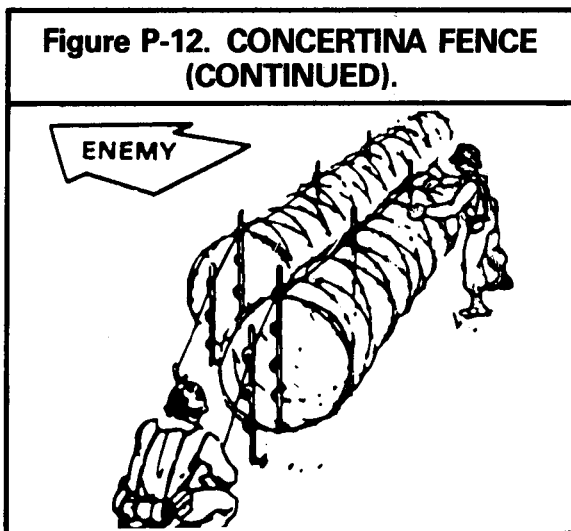


Install the front row concertina and horizontal wire. Place the concertina over the pickets.



Install the rear row of concertina and horizontal wire.

Install the top row concertina and join the rear horizontal wire.

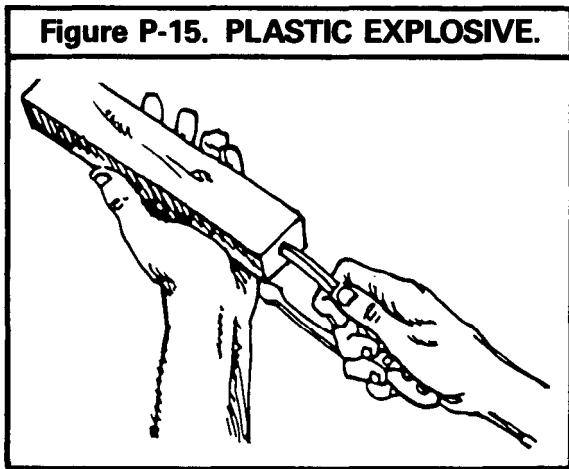


**P-5. DEMOLITION**

The platoon or squad may also perform demolition work. Basic to this is proper preparation of a charge. There are two basic ways to detonate an explosive charge: nonelectrically and electrically.

**Nonelectric.** In the nonelectric way, troops must follow these steps:

- (1) Clear the cap well of a block of TNT or push a hole about the size of a blasting cap (3 centimeters [1 1/3 inches] deep and .65 centimeter [1/4 inch] in diameter) in a block of C4 plastic explosive.

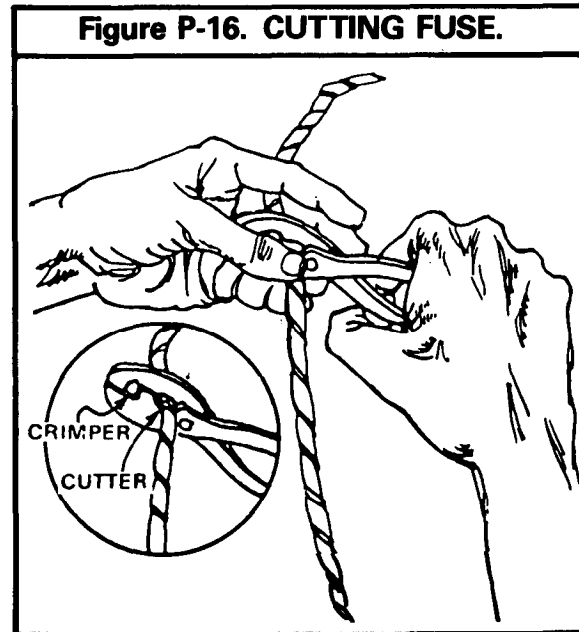


**Figure P-15. PLASTIC EXPLOSIVE.**

- (2) Cut and discard a 15-centimeter (6-inch) length from the free end of the time blasting fuse to prevent a misfire caused by the exposed powder absorbing moisture from the air.

- (3) Compute the burning time of a 91.4-centimeter (3-foot) section of fuse to help determine how much fuse is needed to allow the person detonating the charge to reach a safe distance from the explosion. Divide this burning time by 3 to find the burning time of 30.5 centimeters (1 foot). Now divide the time required to allow the person detonating the charge to reach a safe

distance from the explosion by the burn time of 30.5 centimeters (1 foot). This will give the number of centimeters (feet) of fuse needed.



**Figure P-16. CUTTING FUSE.**

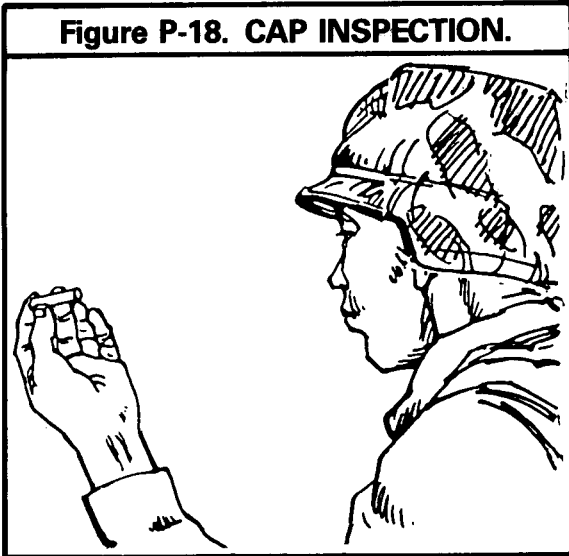


**Figure P-17. BURNING TIME.**



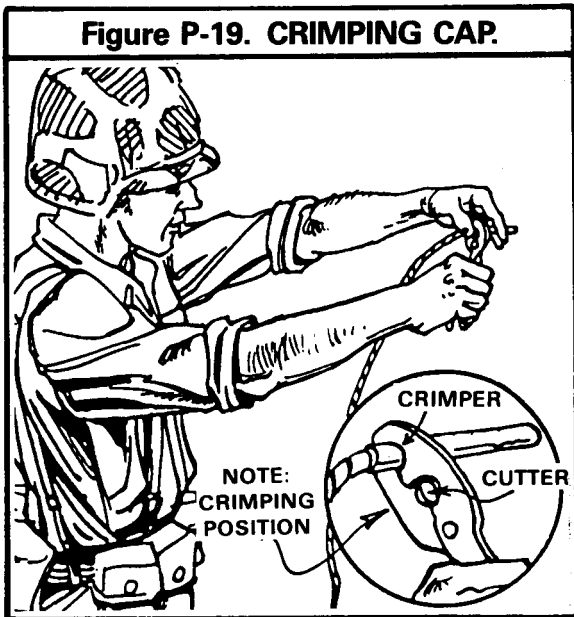
(4) Inspect the nonelectric blasting cap to insure it is clear of foreign matter.

**Figure P-18. CAP INSPECTION.**



(5) Gently slip the blasting cap over the fuse so that the flash charge in the cap is in contact with the end of the time fuse. **DO NOT FORCE IT IN THE CAP.**

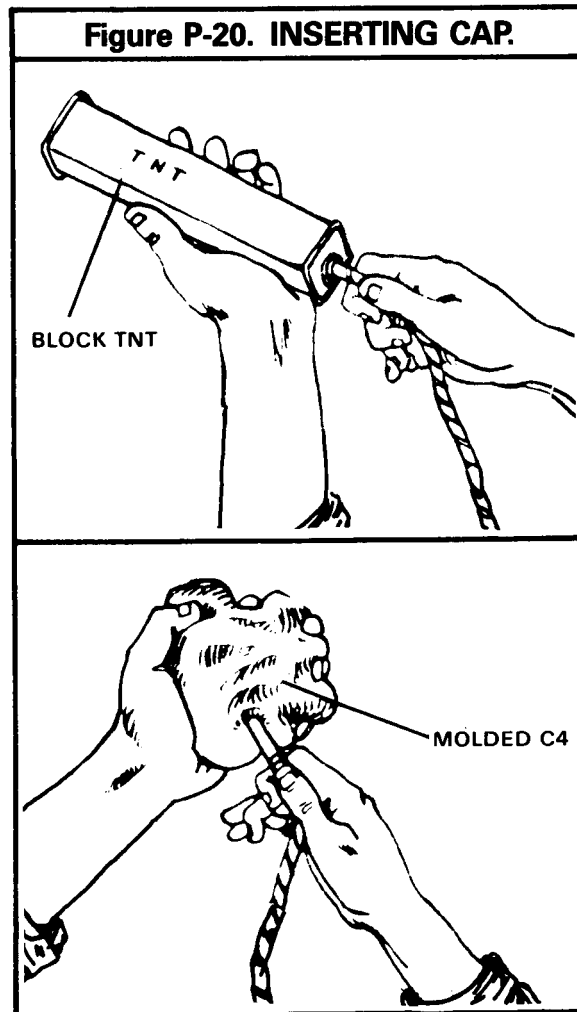
**Figure P-19. CRIMPING CAP.**



(6) After seating the cap, crimp it 1/8 inch from the open end of the cap with a set of M2 cap crimpers. Point the cap out and away from you when crimping.

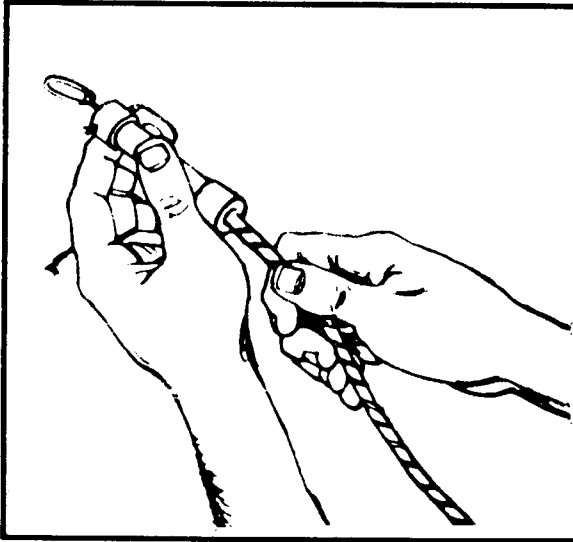
(7) When using TNT, insert the blasting cap into the cap well. When using C4, place the cap into the hole you made in the C4 and mold the C4 around the cap.

**Figure P-20. INSERTING CAP.**



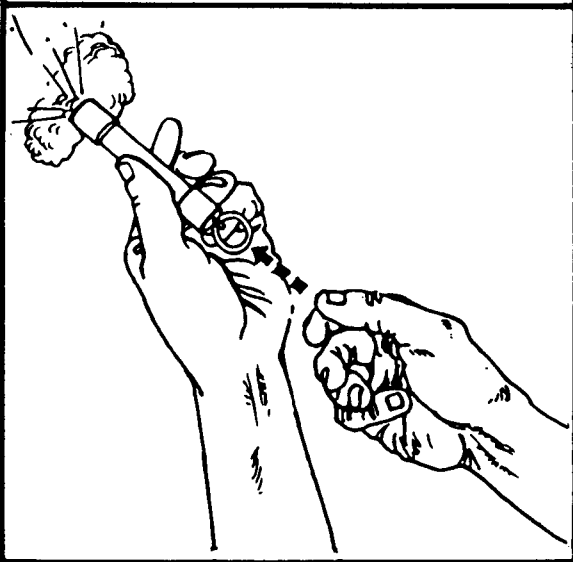
(8) Insert the free end of the fuse into an M60 fuse igniter and secure it in place by tightening the fuse holder cap.

**Figure P-21. FUSE INSERTION.**



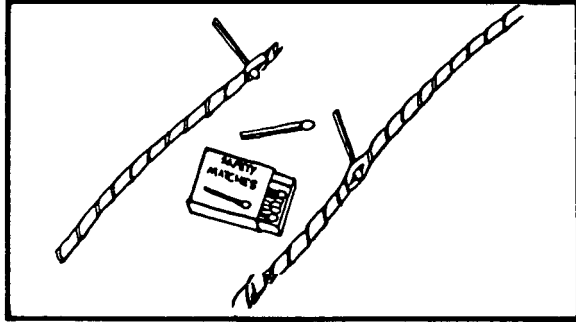
(9) To fire, remove the safety pin, hold the barrel in one hand, and pull on the pull ring with the other, taking up the slack before making the final strong pull. If the fuse igniter misfires, it is reset by pushing the plunger all the way in and trying to fire as before. If it still misfires, replace it.

**Figure P-22. IGNITER.**



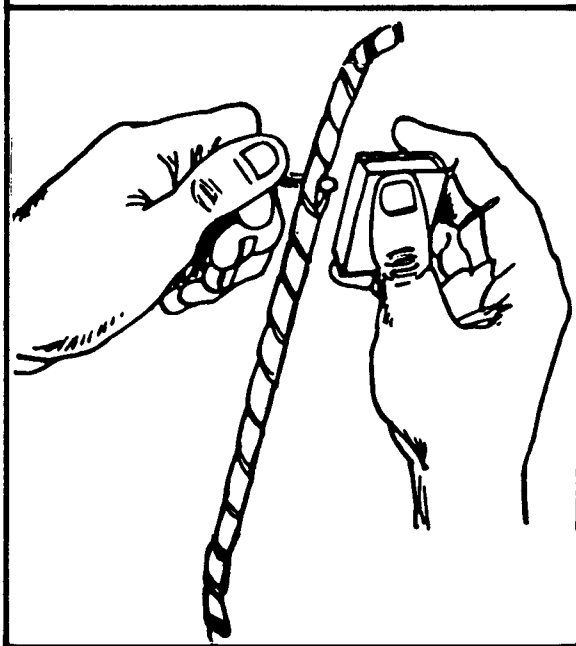
(10) If a fuse igniter is not available, a match can be used to light the fuse. Split the end of the fuse and place the head of an unlighted match in the split (make sure the match head is touching the powder train).

**Figure P-23. MATCH HEAD IGNITER.**



Then light the inserted match head with another flaming match or by striking the inserted match head on a match box.

**Figure P-24. LIGHTING MATCH HEAD.**

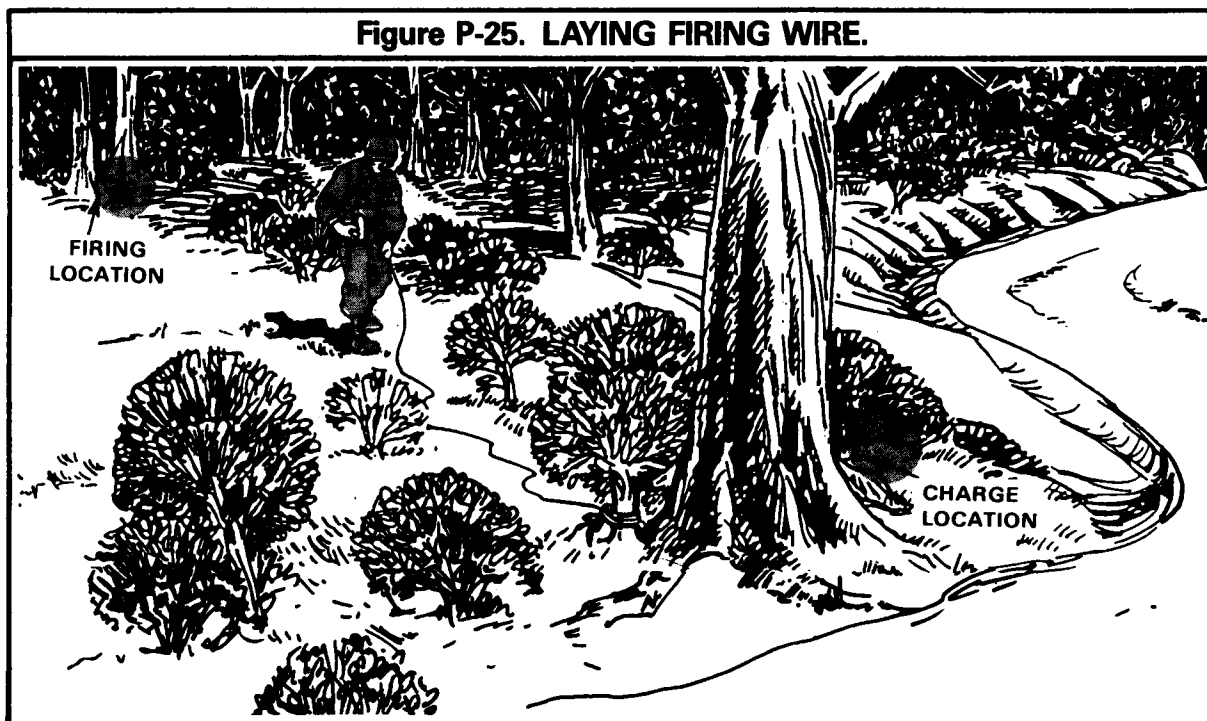


(11) If the fuse burns but the explosive charge does not go off, there is a MISFIRE. When this happens, wait 30 minutes before attempting to clear it. If the misfire charge was not tamped (nothing packed around it), lay a primed charge of at least one block of C-4 or TNT beside it. If it was tamped, place at least two blocks of C-4 or TNT beside it. Do not move the misfire charge. The detonation of the new charge will detonate the misfire charge.

Electric. For the electric method, take the following steps:

(1) After locating a safe firing position, lay out the firing wire from the charge to the firing position. Before leaving the charge area, anchor the wire to something. ALWAYS KEEP THE FIRING DEVICE WITH YOU — DO NOT LEAVE IT AT THE FIRING POSITION.

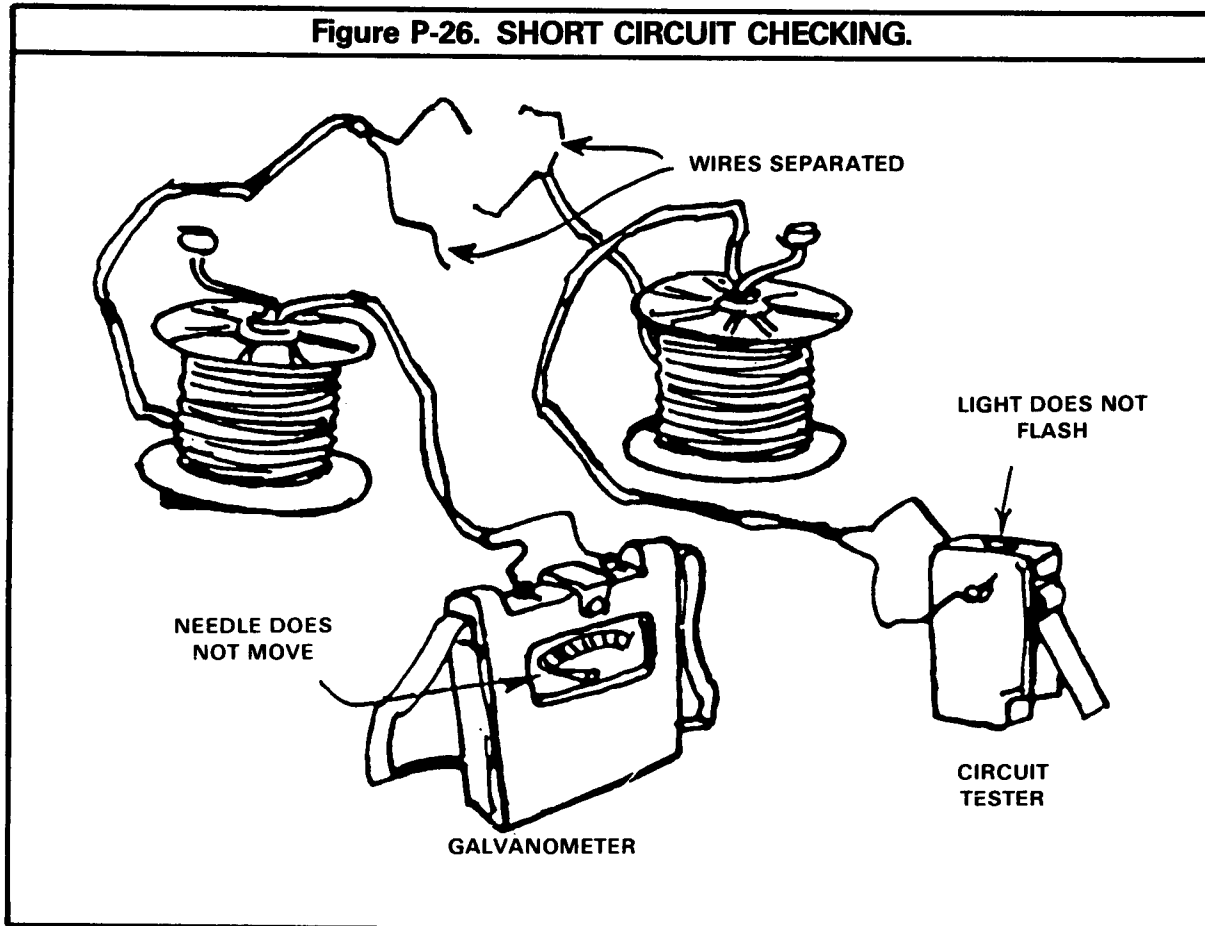
Figure P-25. LAYING FIRING WIRE.



(2) Check the firing wire with a galvanometers or circuit tester to make sure the firing wire does not have a short circuit or a break. Follow these steps:

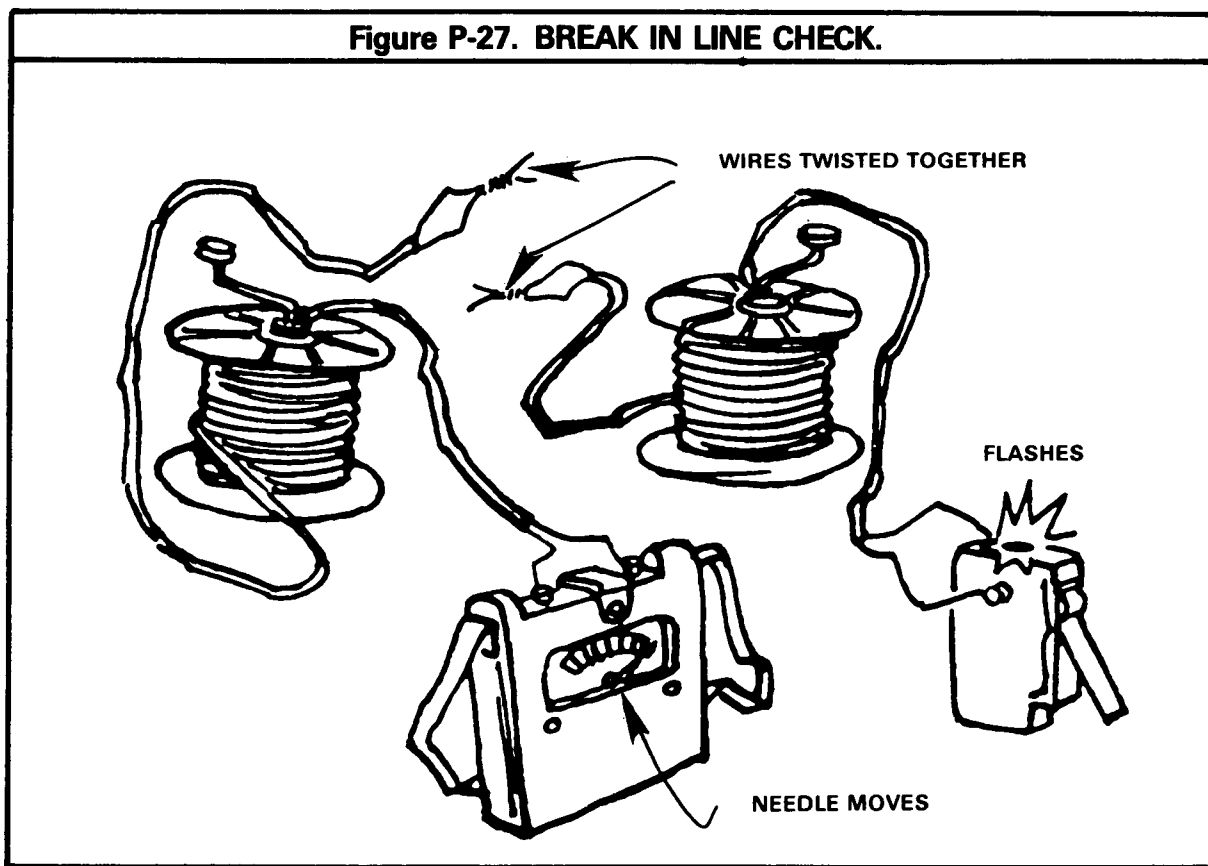
**STEP 1.** Separate the firing wire conductors (bare ends of the wire) at both ends. Touch those at one end to the galvanometer/circuit tester posts. The needle on the galvanometers should not move, or the light on the circuit tester should not come on. If either the light comes on or the needle moves, that firing wire should not be used because the firing wire has a short.

**Figure P-26. SHORT CIRCUIT CHECKING.**



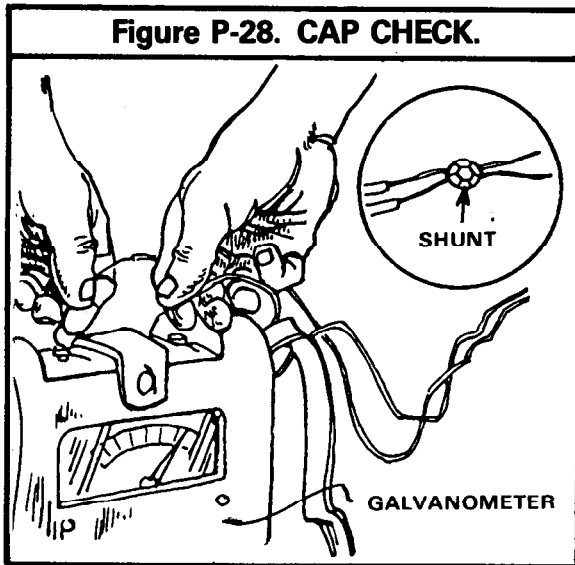
**STEP 2.** Twist the conductors together at one end of the firing wire and touch those at the other end to the galvanometers or M51 blasting cap test set. This should cause a wide deflection of the galvanometers needle or the light to come on in the circuit tester. No movement of the needle in the galvanometers or light on the circuit tester indicates a break in the wire.

**Figure P-27. BREAK IN LINE CHECK.**

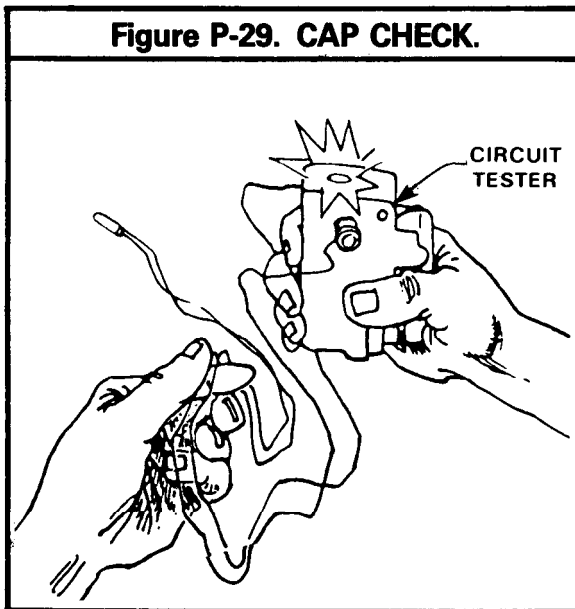


(3) Check the blasting cap with a galvanometers or circuit tester to make sure it does not have a short. Remove the short circuit shunt. Touch one cap lead wire to one post and the other cap lead wire to the other post. When using the galvanometers, the needle

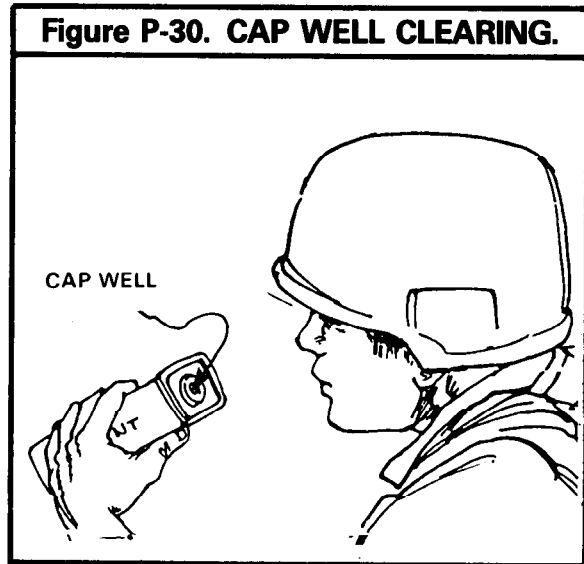
should make a wide deflection. If it does, the cap is good. If the needle fails to move or only makes a slight deflection, the cap should be replaced.



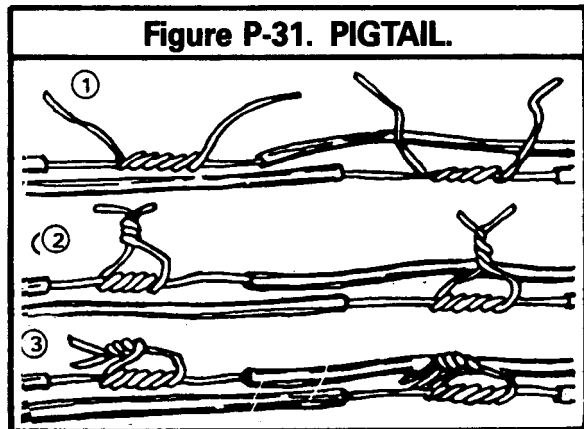
(4) When using the circuit tester, the light should come on when you squeeze the handle. If it does not, the cap should be replaced.



(5) Clear the cap well of a block of TNT or push a hole about the size of a blasting cap in a block of C4 plastic explosive.



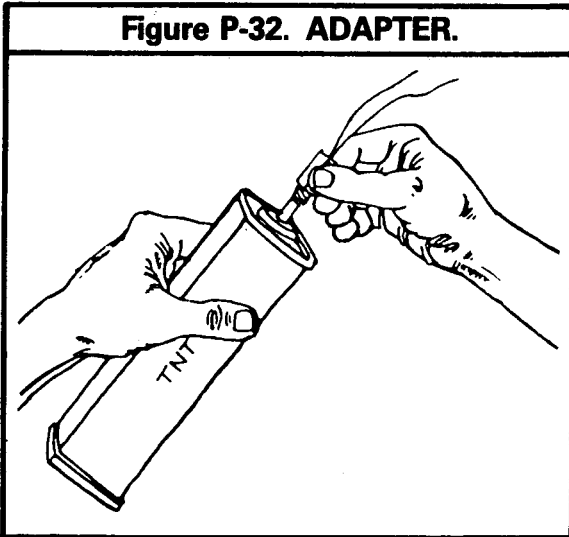
(6) Splice lead wires of cap to firing wires. (Western Union Pigtail.)



**WARNING:**  
 CAP WIRES MUST CONNECT TO THE FIRING CIRCUIT PRIOR TO JOINING THE CAP WITH THE EXPLOSIVE CHARGE.

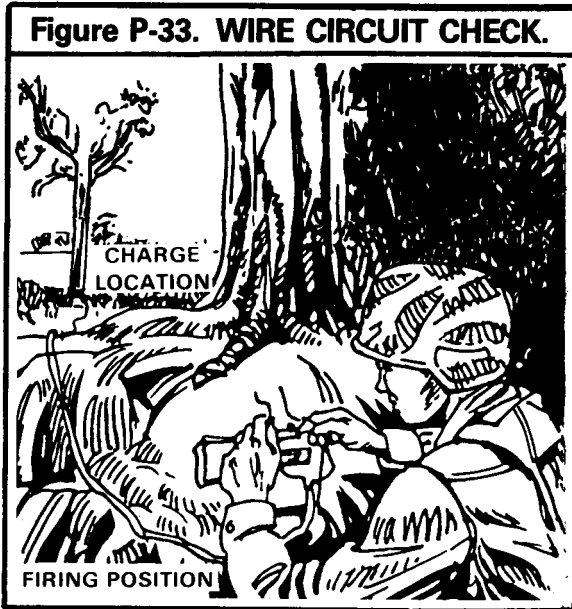
(7) Insert the cap into cap well of the TNT and secure with priming adapter, or insert the cap into the hole you made in the C4 and mold the explosive around the cap.

**Figure P-32. ADAPTER.**



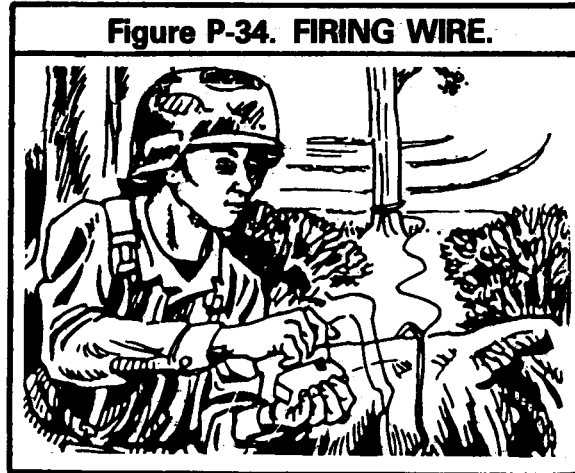
(8) Move to firing position and check the wire circuit with the galvanometers or circuit tester. (Same technique as described previously.)

**Figure P-33. WIRE CIRCUIT CHECK.**



(9) Fasten firing wires to the posts of the blasting machine.

**Figure P-34. FIRING WIRE.**



(10) Operate the blasting machine to fire the charge.

**Figure P-35. FIRING THE CHARGE.**



(11) If the circuit checked out and the blasting machine does not set the charge off, there is a misfire.

(12) If an untamped charge misfires, investigate immediately. If the charge is tamped, wait 30 minutes before investigating. Follow these steps:

(a) Check the firing wire connection to the blasting machine to be sure that the contacts are good.

(b) Make two or three more attempts to fire the charge.

(c) Try to fire again using another blasting machine.

(d) Disconnect the firing wire from the blasting machine and shunt the ends of the wire.

(e) Move to the charge site to investigate.

(f) Check the entire circuit,

including the firing wire, for breaks and short circuits.

(g) Make no attempt to remove the primer or the charge.

(h) Place a new primed charge beside the misfire charge, if the fault has not been found.

(i) Disconnect the old blasting cap wires from the firing wire and shunt the ends of the blasting cap wires.

(j) Finally, attach the new blasting cap wires to the firing circuit, wires before priming the charge with the blasting cap. Prime the charge with the cap and attempt to fire again. The detonation will also dispose of the misfire charge.

### Section III. BREACHING AND CLEARING OBSTACLES

#### P-6. GENERAL

Obstacles are used to halt or slow units, or to cause them to move into an area which has been selected as a kill zone. If the enemy has selected such an area, he will have prepared it so that he can inflict great damage on any opponent moving into it. The enemy will exploit natural obstacles such as defiles, rivers, thick woods, swamps, and cliffs, and reinforce them with man-made obstacles. There are seven basic kinds of reinforcing obstacles: minefield, abatis, log crib, log wall, tank ditch, crater, and wire. Leaders must know the tactics and techniques used to overcome them and the problems which they will present.

Some obstacles may not restrict dismounted elements but will restrict vehicular movement. The platoon may have to clear obstacles to help vehicles go forward. Obstacles are normally covered by enemy direct and indirect fire to keep attacking troops from breaching them. The platoon may not be able to keep the enemy from knowing that it is going to breach, but it should try to keep the enemy from knowing where and when it will try to breach.

SUPPRESS, OBSCURE, SECURE, and REDUCE (SOSR) are key actions in the steps to breach and clear an obstacle.



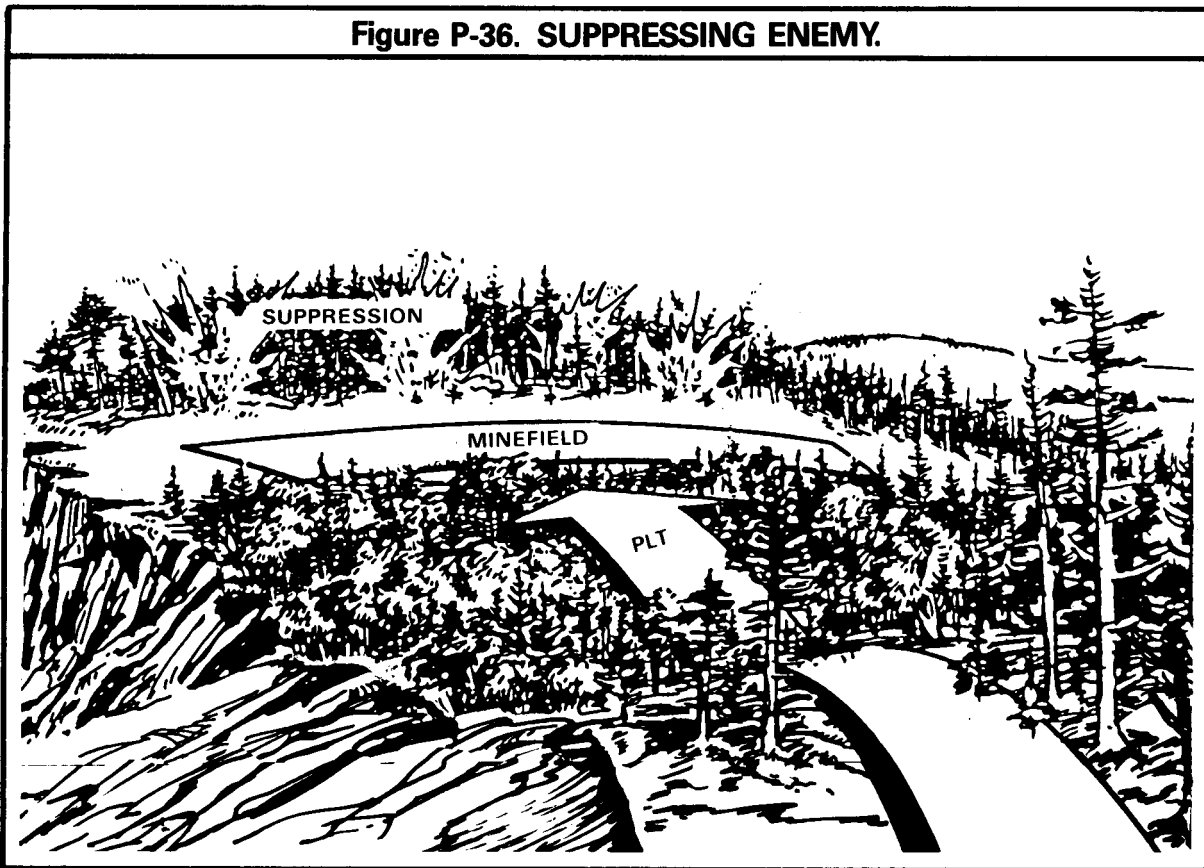
**P-7. MINEFIELDS**

To maintain the momentum of an attack, the platoon must be prepared to breach minefield.

These steps are followed to breach a minefield:

**STEP 1. SUPPRESS the enemy covering the obstacle.** Artillery and mortar fire is used to suppress the enemy. If indirect fire is not available, grenade launchers and machine gun fire are used.

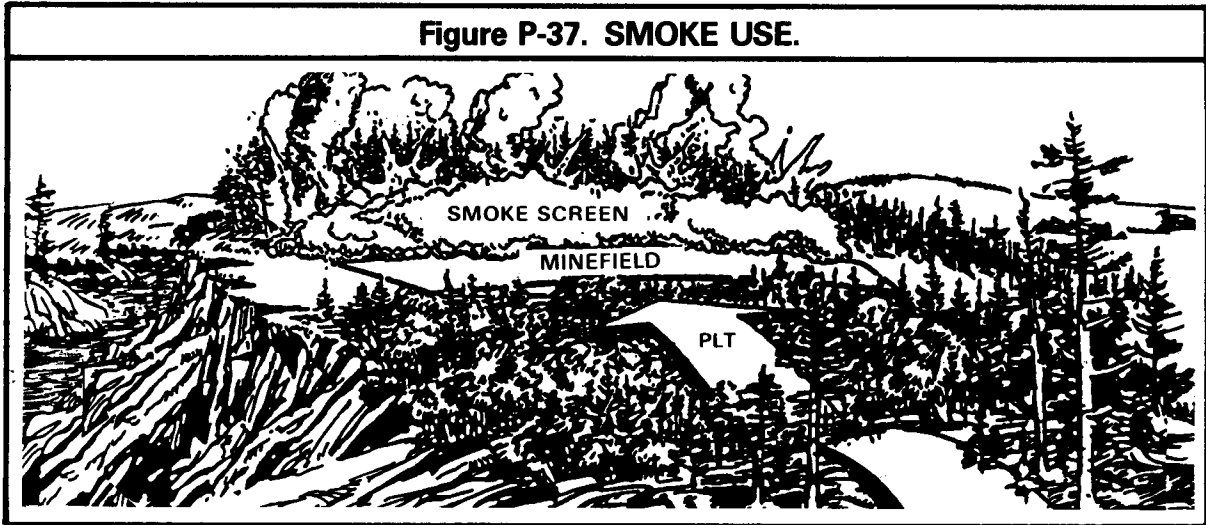
**Figure P-36. SUPPRESSING ENEMY.**



**STEP 2. Request smoke to OBSCURE the obstacle area and conceal friendly troops.**

**STEP 3. SECURE the near side of the obstacle.**

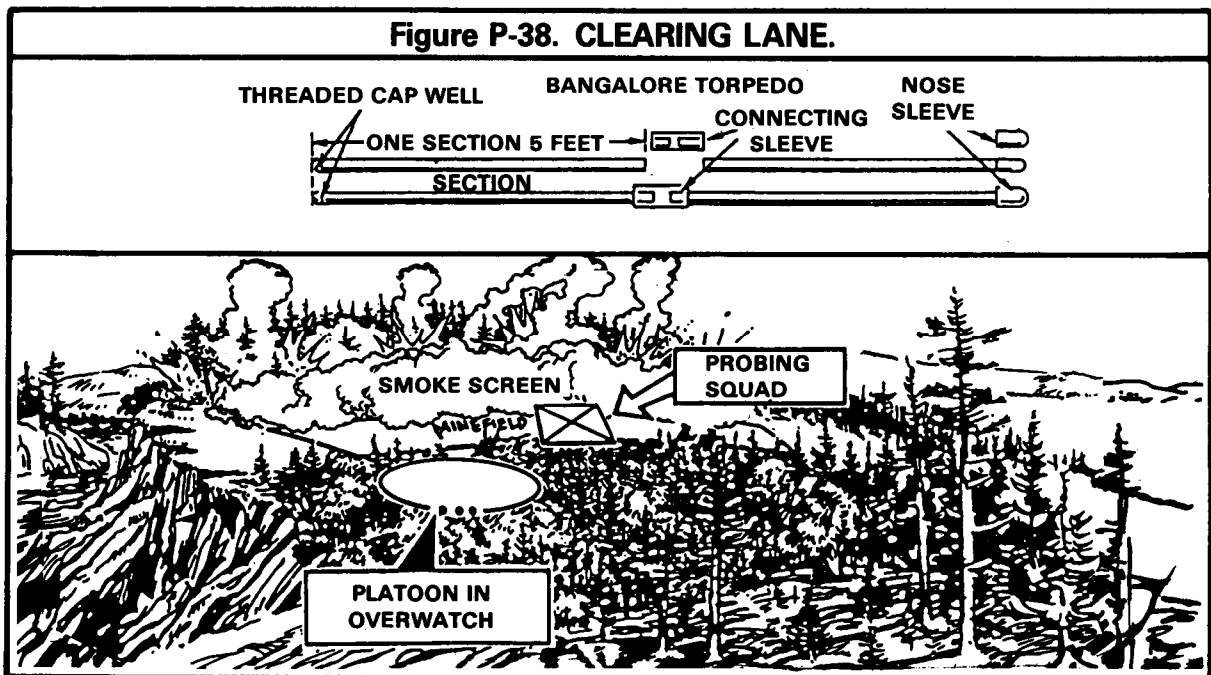
Figure P-37. SMOKE USE.



**STEP 4. REDUCE the obstacle.** Probe a footpath/lane and mark the mines that are found. Lead elements may be accompanied by engineers equipped with specialized mine-clearing equipment. The preferred way to clear a lane through a minefield is to use a rocket-propelled line

charge or bangalore torpedo. The only way to clear a minefield without special equipment is to probe with pointed sticks. Bayonets should not be used; they can detonate antipersonnel mines and other magnetic mines. One squad probes while the platoon (-) overmatches.

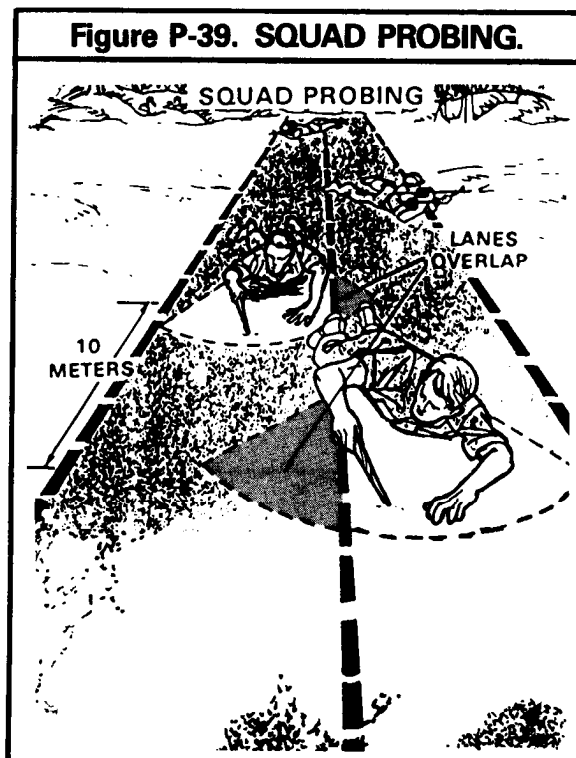
Figure P-38. CLEARING LANE.



The squad probing the footpath/lane through the minefield uses two probers one in front, clearing a lane wide enough to crawl through; and a second one, clearing 10 meters behind the first prober and slightly to one side so that their lanes overlap. The probers should not carry their weapons, field packs, load-carrying equipment, helmets, etc. Their equipment is carried by other squad members. Two other men crawl along behind to secure the probers, to carry additional supplies, or to take a prober's job if one becomes a casualty. The probers should be rotated often to keep them from getting tired and/or careless. The probe will be pushed in at an angle and when a hard object is felt, stop and mark.

**NOTE:** If available, mine detectors should be used to clear the minefield.

**Figure P-39. SQUAD PROBING.**



The probers mark mine locations with sticks, engineer tape, cloth, or toilet tissue. They do not try to remove mines.

**Figure P-40. MARKING A MINE.**



**STEP 5. Secure the far side.** As soon as the probers have cleared a lane, the squad that cleared it moves through the lane, and secures the far side of the minefield.

**Figure P-41. SECURING FAR SIDE.**



**STEP 6.** When time permits, destroy the marked mines with explosives (two 1-pound charges placed within a foot on each side of the mine).

**STEP 7.** Mark the cleared lane.

**STEP 8.** Move the unit through the obstacle.

**Figure P-42. MOVING THE UNIT.**



**STEP 3.** SECURE the far side of the obstacle.

**Figure P-43. ABATIS.**



**STEP 4. REDUCE the obstacle.** Mines and booby traps must first be found and then neutralised by exploding them with C4, or by pulling their tripwires with grappling hooks and long ropes. Use pioneer tools or explosives to cut the trees from their stumps. Tracked and wheeled vehicles can be used to pull the logs out of the road.

**P-8. ABATIS**

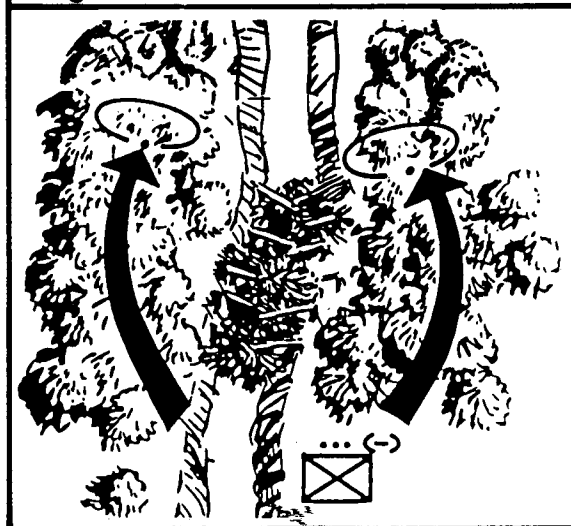
a. An abatis is an obstacle created by cutting down trees so their tops are crisscrossed and pointing toward the expected enemy direction. It is most effective for stopping vehicles in a forest. The trees are left attached to the stumps as high as possible to make removal more difficult. This obstacle may be reinforced with mines and booby traps.

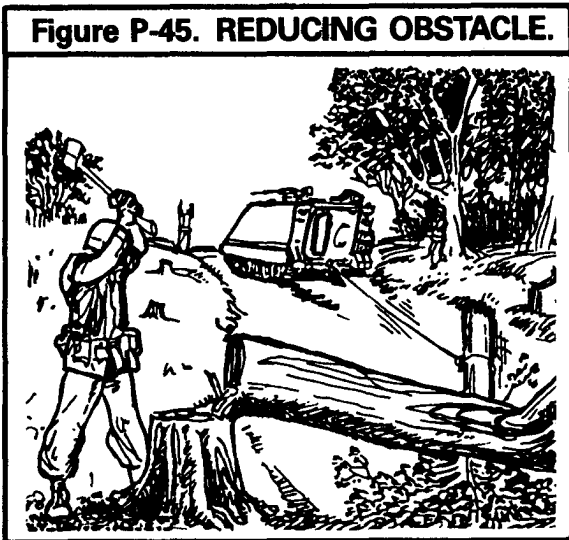
b. These steps are followed to clear an abatis:

**STEP 1. SUPPRESS the enemy covering the obstacle.**

**STEP 2. Request smoke to OBSCURE the obstacle area and conceal friendly troops.**

**Figure P-44. SECURING FAR SIDE.**





**P-9. LOG CRIB**

A log crib is an obstacle constructed of logs, earth, and rocks. The logs are used to make cribs, which are filled with earth and rock. These are used to block narrow roads and defiles.



These steps are followed to clear a log crib:

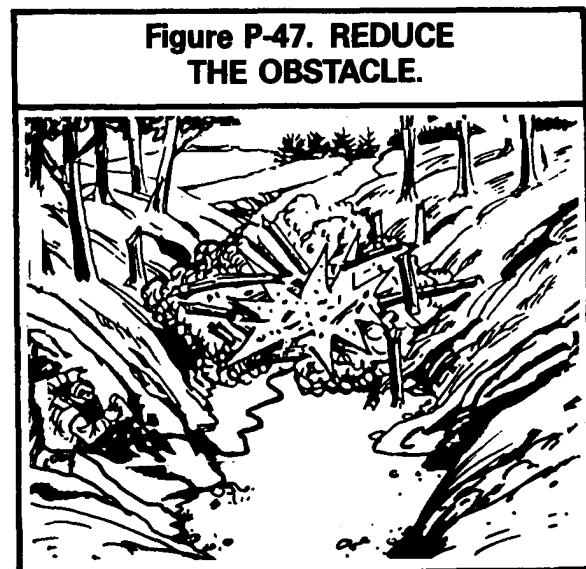
**STEP 1. SUPPRESS the enemy covering the obstacle.**

**STEP 2. Request smoke to OBSCURE the obstacle area and conceal friendly troops.**

**STEP 3. SECURE the far side of the obstacle.**

**STEP 4. REDUCE the obstacle.** Use direct fire weapons (tank/combat engineer vehicle), explosives, pioneer tools, and vehicles to reduce the obstacle.

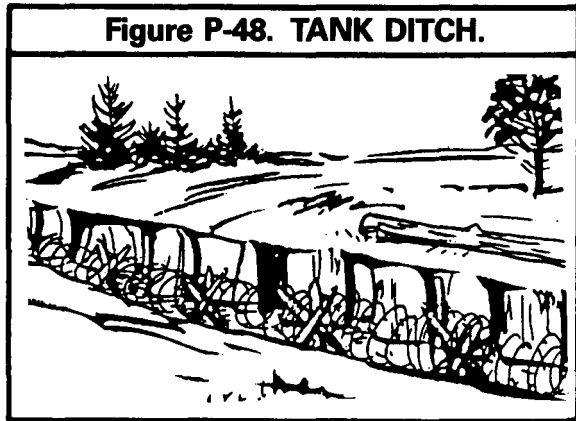
Log wall obstacles are very similar to log cribs and require the same clearing technique.



**P-10. TANK DITCHES**

Tank ditches are usually in open terrain. They are at least 4 meters (13 feet) wide and 1.8 meters (5 feet) deep. The enemy may put barbed wire in them to keep tank crews or infantry from dismounting and using the ditch for shelter. He may prepare the approaches, sides, and bottom of the ditch with antitank and an-

tipersonnel mines or chemicals to make breaching difficult.



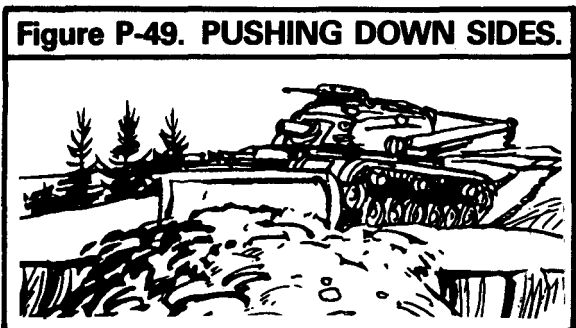
These steps are followed to clear a tank ditch

**STEP 1. SUPPRESS the enemy covering the obstacle.**

**STEP 2. Request smoke to OBSCURE the obstacle area and conceal friendly troops.**

**STEP 3. SECURE the far side of the obstacle.**

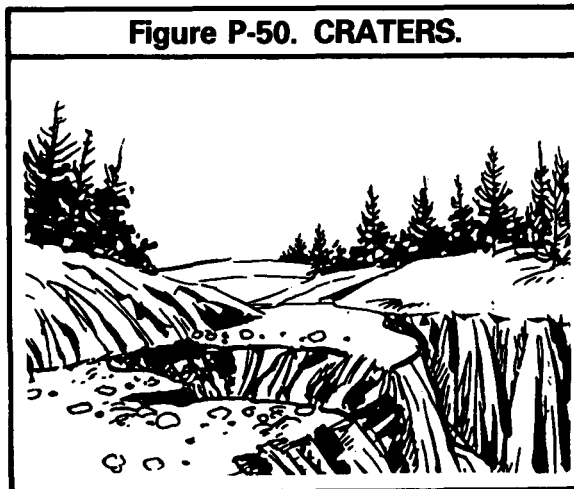
**STEP 4. REDUCE the obstacle.** Use an armored combat earth mover, tank with blade, or combat engineer vehicle to push down the side of the ditch. Explosives may also be used to blow down and slope the sides of the ditch.



## P-11. CRATERS

The enemy uses explosives to create road craters. He will leave the loose spoil around the sides of the crater to make it difficult for a tank to back out.

A crater is cleared using the same steps as with a tank ditch.



## P-12. WIRE

The enemy uses wire obstacles to separate infantry from armor. He also uses them as road-blocks against wheeled vehicles.

These steps are used to breach a wire obstacle:

**STEP 1. SUPPRESS the enemy covering the obstacle.**

**STEP 2. Request smoke to OBSCURE the obstacle area and conceal friendly troops.**

**STEP 3. Secure the near side of the obstacle and clear a lane through the wire.** Use wire cutters, bangalore torpedoes, or explosives to remove the wire. Watch out for antipersonnel mines and booby traps. Mark any mines and booby traps with engineer tape, cloth, or anything recognizable. One squad breaches while the platoon (-) overmatches. Tank fire, combat en-

gineer vehicle fire, and massed indirect and direct fire can help breach the wire.

**STEP 4. SECURE the far side.** As soon as the clearing squad has cleared a lane, the squad moves through the lane and secures the far side.

**STEP 5. Destroy the marked mines with explosives or grappling hooks (REDUCE).**

**STEP 6. Mark cleared lane.**

**STEP 7. Move unit through the obstacle.**



APPENDIX Q

**TACTICAL ROAD MARCHES  
AND ASSEMBLY AREAS**

**Section I. TACTICAL ROAD MARCHES**

**Q-1. GENERAL**

The ground movement of troops can be accomplished by administrative marches, tactical movements, and tactical marches.

Although administrative marches may break up unit integrity they are used in rear areas where speed and best use of transportation assets expedite movement.

Tactical movements, as described in chapter 4, are used when contact with enemy forces is a possibility.

Tactical marches are normally used to move units from rear areas to assembly areas in preparation for the conduct of a mission. Although a company may be required to conduct a tactical march, the platoon and company normally move as part of the battalion.

The tactical march is conducted when speed is essential, unit integrity must be maintained, road nets are available, and enemy contact is limited.

The following definitions apply to tactical road marches and foot marches:

**ARRIVAL TIME.** The time the head of a column reaches a designated point or line.

**CLEARANCE TIME.** The time the tail of a column passes a designated point or line.

**COLUMN (TIME) GAP.** The space between two consecutive ele-

ments calculated in units of length (meters) or units of time (minutes), measured from the rear of one element to the front of the following element.

**COMPLETION TIME.** The time the tail of a column passes the release point.

**CRITICAL POINT.** A selected point along the route of march used for reference in giving instructions; any point along the route where interference with the troop movement may occur.

**MARCH UNIT.** A unit that moves and halts at the command of a single commander — normally one of the smaller troop units such as a platoon or company.

**PACE SETTER (VEHICLE).** A vehicle in the lead element and responsible for regulating speed.

**PASS TIME.** The time between the movement of the first element past a given point and the movement of the last element past the same point.

**RATE OF MARCH.** The average kilometers-per-hour traveled.

CONTENTS		PAGE
Section I.	Tactical Road Marches . . . . .	Q-1
II.	Assembly Areas . . . . .	Q-6

**RELEASE POINT.** A well-defined point on a route at which the elements composing a column return to the authority of their respective commanders.

**SERIAL.** A grouping of march units under a single commander. It is usually a battalion, brigade, or larger unit. For convenience in planning, scheduling, and control, it is given a numerical or alphabetical designation.

**START POINT.** A well-defined point on a route where the elements of the move come under the control of the movement commander. It is at this point that the column is formed by the successive passing of each of the elements in the column.

**VEHICLE DISTANCE.** The space between two consecutive vehicles of an element in the column.

**ORGANIZATION OF A MARCH COLUMN.** Depending on the size and number of units conducting the move, the battalion is normally formed as a serial with companies and elements of headquarters and headquarters company formed into march units. The entire column is organized into an advance party, main body, and trail party. The advance party consists of a reconnaissance element and a quartering party the trail party is made up of maintenance, recovery, and medical elements; and the main body is made up of the rest of the force.

**VEHICLE DISPERSION.** The move can be conducted with vehicles traveling in close column, in open column, or by infiltration. Which method to use is determined by the degree of control required to maintain a cohe-

sive unit, and by the terrain that is being traveled — for example, open terrain requires more dispersion than close terrain.

In close column, vehicles are spaced approximately 25 meters apart during daylight. At night, and during reduced visibility vehicles are spaced so that the driver and TL can see the two lights in the blackout marker of the vehicle ahead, if not the vehicle itself. This method takes maximum advantage of traffic capacity of routes but provides little dispersion. Close column is normally used for marches during darkness, and under blackout conditions, and to move rapidly through urban areas to insure integrity and control of the column.

In open columns, the distance between vehicles is increased to provide greater dispersion. Vehicle distance varies from 50 to 100 meters. The increased distance provides greater protection against air and artillery fires, and ground attack by small enemy forces. It also allows the command vehicle and other vehicles not restricted by march orders to pass the column without disrupting its organization.

During a move by infiltration, vehicles are dispatched individually as small groups, or at irregular intervals at a rate that will keep traffic density down and prevent undue massing of vehicles. Infiltration provides the best possible defense against enemy observation and attack. It is suited for tactical road marches when enough time and road space are available and when maximum security, deception, and dispersion are desired.

When vehicles are farther apart than prescribed in open/closed column, they close up by traveling at a prescribed higher speed. This catch-up speed is normally fast enough to allow the column to close up over a long road distance, thus reducing the accordion effect produced by rapid changes in speed. A fixed catch-up

speed also provides an additional satiety factor for the march.

## **Q-2. CONDUCT OF THE TACTICAL ROAD MARCH**

The movement order issued by the company commander includes information on the enemy and friendly situations, destination, route, rate-of-march, catch-up speed, order of march, start point, location and time, vehicle distances, release points, critical points, combat service support, communications, and location of the commander during the march. Many items of a movement order are SOP. Along with the order, the commander normally issues strip maps of the route. A strip map is a sketch of the route of march and contains as a minimum a start point, a release point, and critical points and distances between them. Strip maps should be issued to each squad leader or TL.

Before starting, each march unit has a designated team reconnoiter its route to the start point and determine the amount of time needed to reach it. The company also forms a quartering party element. It links up with the battalion quartering party before moving to the new assembly area. The company quartering party is normally headed by the executive officer or first sergeant and consists of representatives from platoons, company headquarters, and attached elements as necessary. The platoon sergeant and other designated persons may be assigned this duty. The battalion and company quartering parties move to the new assembly area before the main body moves. The quartering parties normally move by infiltration. Quartering party activities are a matter of SOP but should include:

**Securing the new assembly area.**

**Searching for indications of enemy activity.**

**Looking for mines and booby traps.**

**Selecting routes to platoon locations.**

**Selecting initial vehicle positions.**

**Selecting initial machine gun and Dragon positions.**

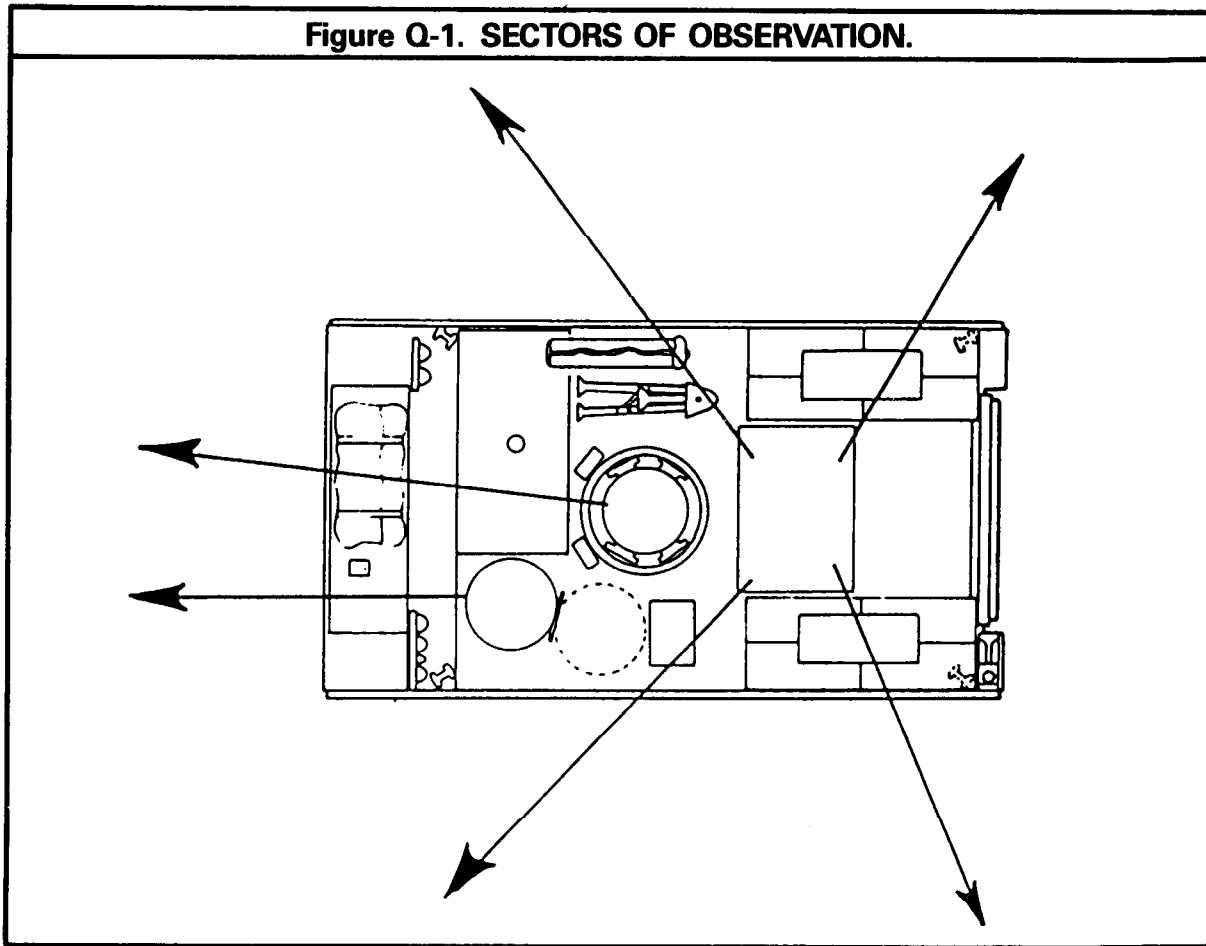
**Meeting platoons at the company release point and guiding vehicles into position.**

Although some movement and lining up may be required before starting the move to the start point, ideally vehicles move from their positions directly into their proper place in the march unit. The march unit should proceed to the start point

without stopping, arrive there on time, and pass through the start point at the proper speed and interval between vehicles.

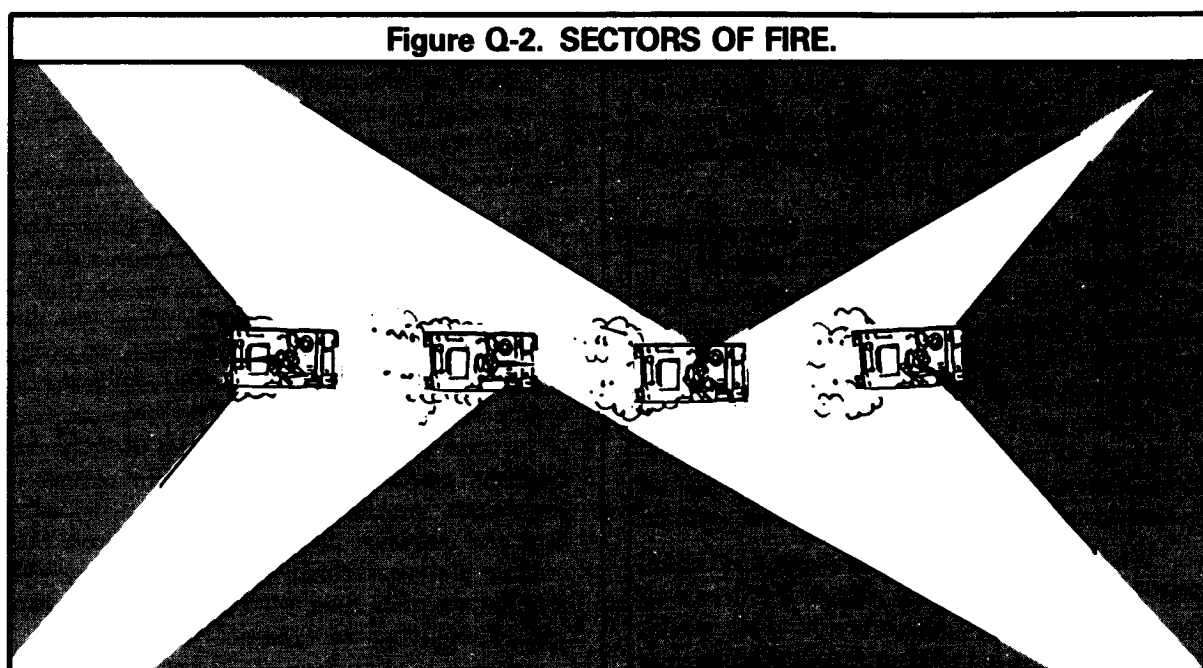
During the move, the crew of each carrier maintains 360-degree observation around the vehicle. The driver observes forward, the squad leader observes to the left of the caliber .50 machine gun, and the gunner observes to the right of the caliber .50 machine gun. Troops inside the cargo hatch observe to the left, right, and rear depending on their location.

**Figure Q-1. SECTORS OF OBSERVATION.**



Within the platoon column, each vehicle is assigned a sector of fire for the move. Each vehicle orients its caliber .50 machine gun and/or Dragon so that they can rapidly fire on targets within

their sector. The assignment of sectors of fire, coupled with the capability of firing from the cargo hatch, provides the platoon with 360-degree security while on the move.



During the move, the platoon must be prepared to take action if attacked by enemy air, artillery, or ground forces. Passive measures against enemy air include:

**Maintaining proper interval between vehicles.**

**Staggering vehicle positions within the column to avoid linear patterns.**

**Camouflaging vehicles.**

**Maintaining air observation.**

If attacked by enemy air, vehicles in the column move from the axis of attack, either occupying covered and concealed positions or continuing to move, maintaining an evasive course. The unit also engages the aircraft with all available weapons.

If the column receives indirect fire during the move, button-up the vehicle, mask, and move rapidly out of the impact area. Masking is necessary because the enemy can use a mix of HE and chemical ammunition to disrupt movement and achieve maximum casualties. After the company team is through the impact area,

the march unit commander will start unmasking procedures.

If engaged by enemy ground forces while on a tactical road march, vehicles attempt to continue movement, or the platoon leader may elect to assault the enemy or fix the enemy for other forces to attack.

Because the primary mission of the unit is to move to a new location in preparation for future operations, additional actions against ground forces depend on the size of the enemy force and instructions from the company team/march unit commanders. If the enemy force consists of snipers or other disruptive forces equipped with small arms, the commander may pass through the force or dispatch a platoon to eliminate it. If the force is larger and presents a danger to the task force as a whole, fragmentary orders may be issued for march unit to leave the route of march, move to covered and concealed positions, and conduct a hasty attack as if conducting a movement to contact.

A march unit can conduct the kinds of halts: scheduled, unscheduled, and vehicle breakdown.

Scheduled halts are planned for maintenance and rest, or to comply with higher level time schedules. At scheduled halts, vehicles pull to the aids of the road but still maintain march distance between vehicles. Dismount teams dismount and establish local security.

Unscheduled halts are caused by unforeseen developments such as obstacles, ambushes, or other enemy activity forward of the platoon which prohibits further movement. If off-road movement is possible, the company team forms a coil for hasty perimeter defense. Platoons occupy a sector of the coil using the clock system. If off-road movement is not possible, the company team forms a herringbone. Dismount teams dismount in heavily wooded areas to improve local security.

When a vehicle becomes disabled and cannot continue the move, the TL directs the driver off the road, so as not to impede traffic. If the vehicle blocks the road, it is towed or pushed away to clear the road. Once the vehicle is clear of the road, the carrier team attempts to repair the vehicle while the dismount team establishes security provides guides, and directs traffic. The platoon to which the disabled vehicle belongs normally continues to move. If the crew gets the vehicle repaired and if the march unit has not passed completely the crew and vehicle rejoin the march unit at the tail end. If the march column has passed, or the crew could not repair the vehicle, the vehicle waits for the serial's trail party. The trail party repairs the vehicle or it tows the vehicle to the battalion assembly area (location of battalion trains). (On occasion, when fighting strength is critical, the platoon will crossload the disabled vehicle's dismount teams and squad leader.)

**NOTE: If the platoon leader's carrier is disabled, the platoon leader moves to another vehicle. If space is available, the FO team should be crossloaded.**

On arrival at the battalion RP, the leader of the company team's quartering party moves from a concealed position and guides the march unit to the company RP. Platoon guides direct the platoon's vehicle to their general locations, where the squad leaders (TLs) assume control and select vehicle positions. Vehicles should not stop on roads or in open fields, but should move directly into concealed positions. Normally the first platoon in the column is guided to positions farthest away from the entrance into the assembly area. Succeeding platoons should move as far as possible into the assembly area, with the last platoon closing and securing the entrance.

If the company team must move into an unprepared assembly area, the clock system can be used to rapidly establish a perimeter defense and road security. Normally direction of movement is 12 o'clock. The lead platoon usually takes up a third of the perimeter in the sector from 10 o'clock to 2 o'clock with succeeding platoons breaking off left and right, according to the company's SOP.

When movement into an assembly area is conducted at night, platoon guides must use easily recognizable visual signals to insure that the vehicles follow the proper guides. Use of different colored flashlight lenses is one method of identifying platoon guides.

## Section II. ASSEMBLY AREAS

### Q-3. GENERAL

An assembly area (AA) is occupied by a unit to prepare for future operations. The mechanized infantry platoon normally occupies a portion of the company team AA. The AA is on defensible ground. It should provide concealment, room for dispersion, and good internal routes, as well as

provide access to routes forward. Even though an AA is not expected to be a battle position, an all-round defense is organized with men and equipment positioned or dug into provide security from ground and air attack. The amount of preparation at an AA depends on the unit's intended stay

Leaders insure that personnel continue to improve positions until the unit moves.

Priority of work at an AA is normally a matter of SOP, but it may be part of the movement or operation order. Although commanders may have differing priorities, the following are normally included, in the order listed:

**(1) Establish local security by dispatching OPs, which should have wire communications with the platoon and be equipped with the M8 chemical-agent alarm. At platoon positions, local security is further achieved by alternating troops from work to watching, thus keeping roughly half the force providing security.**

**(2) Position vehicles and crew-served weapons where they can best be employed. If Dragons cannot be employed because of terrain restrictions, they should not be dismounted.**

**(3) Establish communications within the platoon and to the company CP. The platoon sets up a hot loop, connecting the squads to the platoon leader's vehicle by telephone (TA1). To speed the establishment of telephone communications, the platoon leader can take a member of the platoon headquarters element with him to the company CP. As he returns to the platoon AA, a land telephone line can be reeled out from the company CP back to his vehicle. Also, the platoon leader has a person who knows where the company CP is should a messenger be needed. In the AA, radio use at platoon and squad level should be restricted to radio listening silence.**

**(4) Position remaining squad members. As in the defense, the remaining squad members are positioned to provide security for crew-served weapons, to cover dead space,**

**and to cover avenues of approach. Dismounted troops should prepare hasty fighting positions initially. The following is required:**

**Clear fields of fire.**

**Tie in fires between squads and platoons so that uncovered gaps do not exist in the defense.**

**Prepare range cards for vehicle-mounted weapons and dismounted crew-served weapons. Prepare a platoon sector sketch and forward a copy to the company CP.**

**Camouflage positions by using the appropriate camouflage screens for vehicles and natural material for infantry fighting positions.**

**(5) Once the basics are accomplished, alternate squad rest periods while working to improve the defense. Improve the defense by digging fighting positions and providing overhead cover, setting out remote sensors, and establishing security patrols.**

#### **Q-4. ACTIONS IN ASSEMBLY AREAS**

Assembly areas provide the unit a secure defensible position where the unit can prepare for future operations. During and after the establishment of the defense, the following activities may take place:

**Leaders receive and issue orders.**

**The unit maintains its equipment and weapons.**

**Personnel conduct personal hygiene.**

**Leaders inspect.**

**The unit is resupplied to include distribution of ammunition and refueling of vehicles.**

**The unit rehearses critical aspects of the upcoming operation.**

**Weapon systems are checked and small arms are test fired, if possible.**

**Troops eat and rest.**

**The unit continues to improve its defenses.**



APPENDIX R  
**MILITARY OPERATIONS ON  
 URBANIZED TERRAIN**

**Section I. INTRODUCTION**

**R-1. GENERAL**

Villages and small towns are a common sight in much of the world, particularly in Central Europe. Larger towns, small cities, and major urban centers will often be avoided by mechanized forces. Even so, mechanized infantry units must be ready to fight in urban areas when required. (See FM 90-10-1 for details.) Fighting in urban areas is usually characterized by house-to-house fighting, restricted maneuver space for ground vehicles, and restricted observation and fields of fire. As a result, the dismounted infantry role increases markedly.

Platoons and squads will seldom fight alone in urban combat. Normally they will fight as part of their company or company team. Combat engineers will normally support the infantry.

The rapid rate of expenditure of small arms ammunition, grenades, and demolitions is another characteristic that must be taken into consideration during urban combat.

**R-2. URBAN AREAS**

Streets and alleys make ready-made firing lanes and killing zones. Vehicles, being greatly restricted and canalized, are subject to ambush and short-range attack. Tanks are at a disadvantage because their main guns cannot be depressed enough to fire into basements at close range, nor can they be elevated enough to engage targets on upper floors of tall buildings nearby. The APC has a more flexible capability in this

role. The squad can be organized so that the caliber .50 machine gun as well as other weapons can provide overwatch and suppressive fire to dismounted elements while the APC provides the carrier team with limited armor protection.

Fighting in urban areas will be centered around prepared positions in houses and buildings. These positions should be designed to cover street approaches, and should be protected by mines, obstacles, and booby traps. Hence, bridges, overpasses, and buildings must be inspected and cleared of any mines before they are used. Also, reconnaissance parties must determine the weight-supporting capacity of roads, bridges, and floors to find out if they will support APCs and tanks. Engineers can be used for these tasks.

APCs and tanks should not be employed alone. Dismount teams should be responsible for protecting specific tanks or their carrier teams. Carrier teams should move along the sides of streets, stay close to buildings, and observe and cover the buildings on the opposite side. Carrier team members must remain alert for signals from the dismount teams. Close cooperation between the dismount team and the carrier team in the urban environment is critical.

CONTENTS		PAGE
Section I.	Introduction .....	R-1
II.	Offense .....	R-2
III.	Defense .....	R-7

## Section II. OFFENSE

### R-3. GENERAL

In urban areas, fighting will be mostly dismounted. The carrier teams employed chiefly in a fire support role. Tanks follow and, as needed, move to provide heavy direct fire support from locations secured by the leading infantry.

The attacker has the advantage of maneuver and can isolate a built-up area. Once a built-up area has been isolated, a force can either assault it or conduct a siege until the defender surrenders.

The missions of dismount teams engaged in the attack of a built-up area include:

**Assaulting and reducing enemy positions and clearing buildings under the covering fires of tanks and APCs.**

**Neutralizing and destroying enemy antiarmor weapons.**

**Locating targets for engagement by tank or APC weapons.**

**Protecting tanks and carriers against enemy individual antiarmor measures and surprise.**

**Securing and defending an area once cleared.**

Typical carrier team missions during attacks in urban areas are:

**Destroying enemy positions within a building with the direct fire of the caliber .60 machine gun and the 7.62-mm machine gun (when walls are constructed of light material).**

**Suppressing enemy gunners within buildings and adjacent structures.**

**Figure R-1. SUPPRESSION BY FIRE.**



**Isolating the objective building with direct fire to prevent enemy withdrawal, reinforcement or counterattack.**

**Establishing a roadblock or barricade.**

**Securing cleared parts of the objective.**

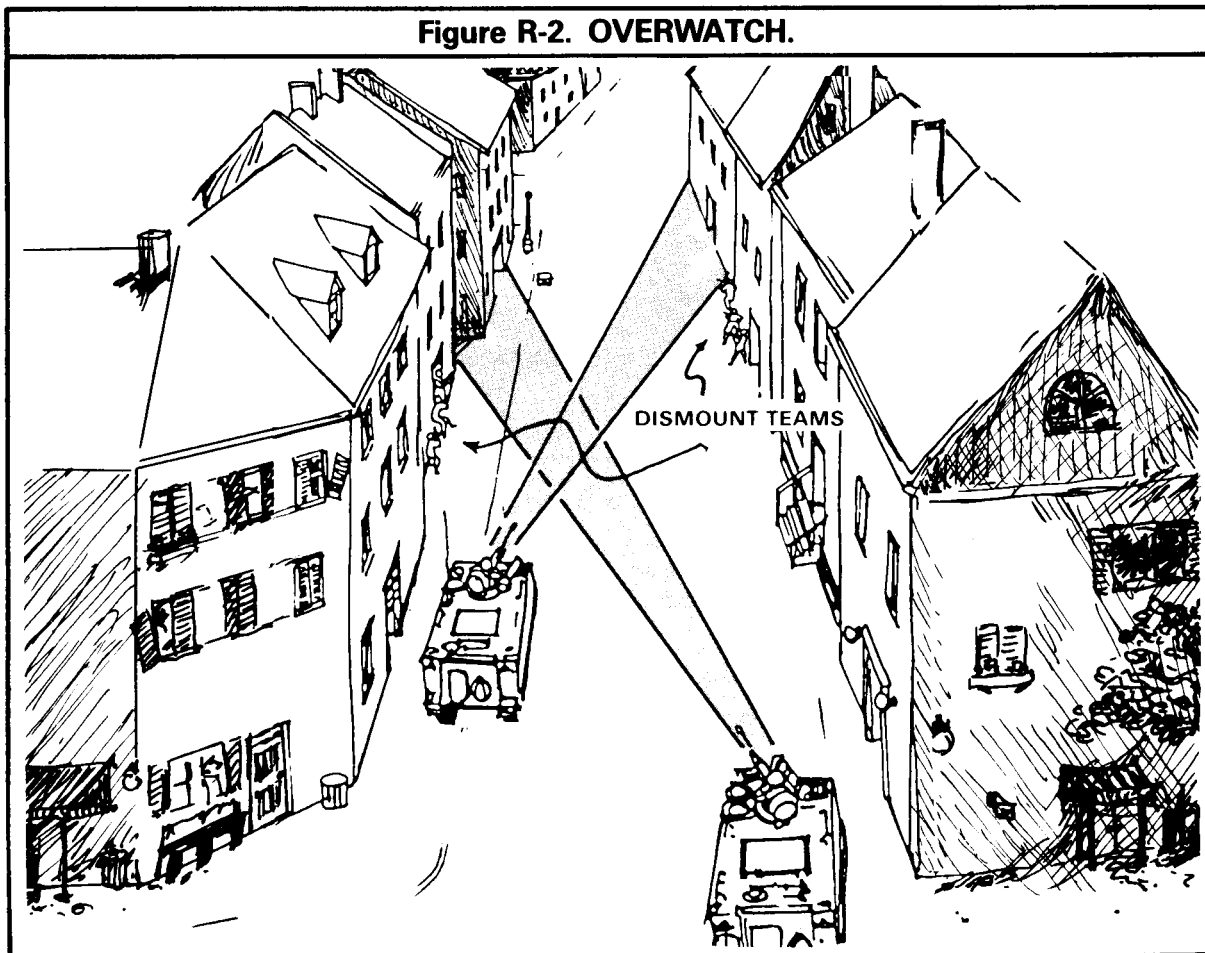
**Obscuring the enemy's view with the APC's smoke-grenade launcher (if vehicle is so equipped).**

**Providing resupply of ammunition and explosives for the assault force.**

**Evacuating casualties from the areas of the fire fight.**

Platoons and squads use the same general movement techniques on urban terrain as on other terrain. When moving toward an urban area and contact is possible, traveling overwatch should be used. Upon entry into the urban area, dismount teams should be deployed, and the platoon should move using bounding

overwatch. Dismount teams should move alongside and through buildings, avoiding open areas when possible. When moving down a street, dismount teams should move staggered on alternate sides of the street. Teams must guard against ground level positions along the street and also should assign two or three men to observe the upper floors of buildings on the opposite side of the street. Carrier teams, overmatching the dismount teams, should travel staggered on alternate sides of the street.

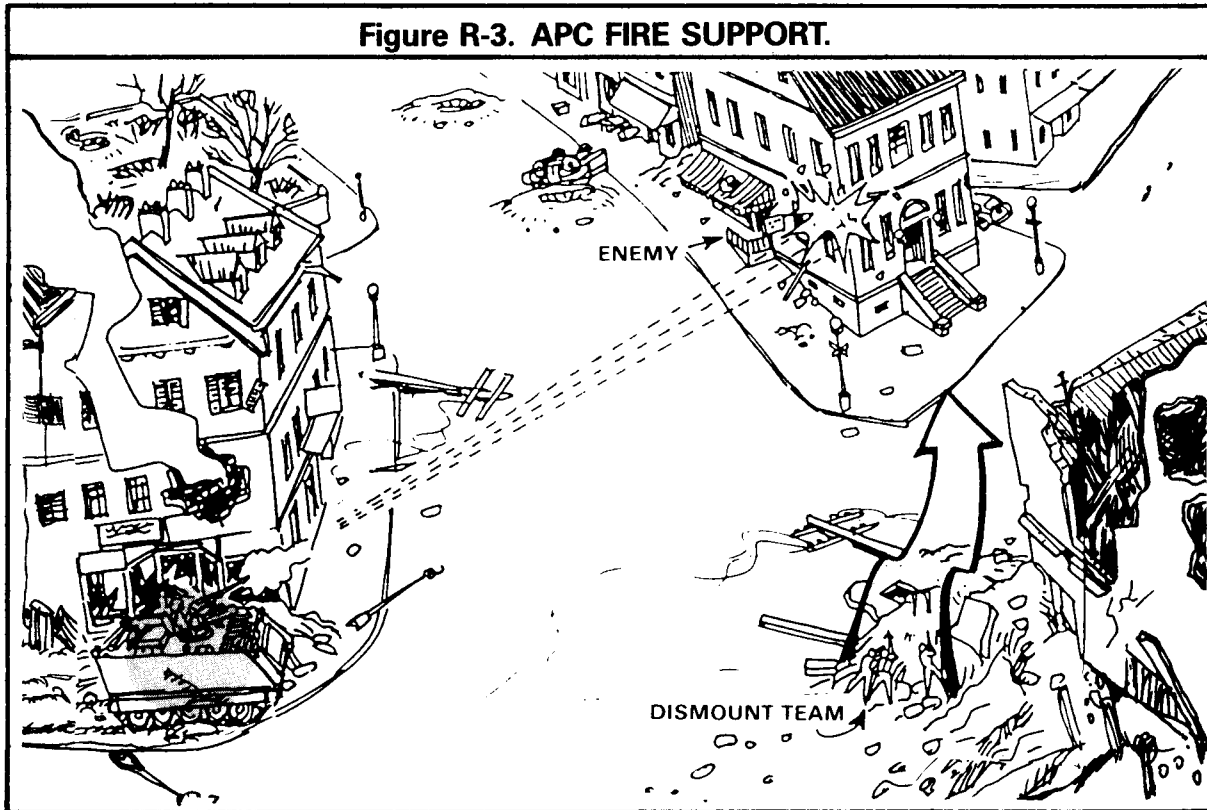


## R-4. APC EMPLOYMENT CONSIDERATIONS

In the offense, the APC is best used to provide direct fire support for the dismount team. The carrier team should move well behind the dis-

mount team and move up when needed to engage targets located by the dismount team.

**Figure R-3. APC FIRE SUPPORT.**



Communications between the dismount element and the carrier element are crucial. Communications can be visual or voice signals, radio or telephone. There is a phone jack on the rear of each APC.

The speed of the APC lets the carrier team rapidly cross streets, open areas, or alleys.

## R-5. HOW TO ATTACK AND CLEAR A BUILDING

When attacking an urban area, the most common mission of the platoon is to clear a building or a group of buildings. The platoon leader designates the composition of the dismount element

and the carrier element. The makeup of these elements can change with the situation. Each dismount team is organized into two- or three-man assault teams. The platoon leader also may designate a part of the dismount element as a demolition team.

The entire dismount element normally is used to attack one building at a time. (Against smaller buildings, the platoon leader may have a single dismount team conduct the attack.) The attack is conducted in three steps:

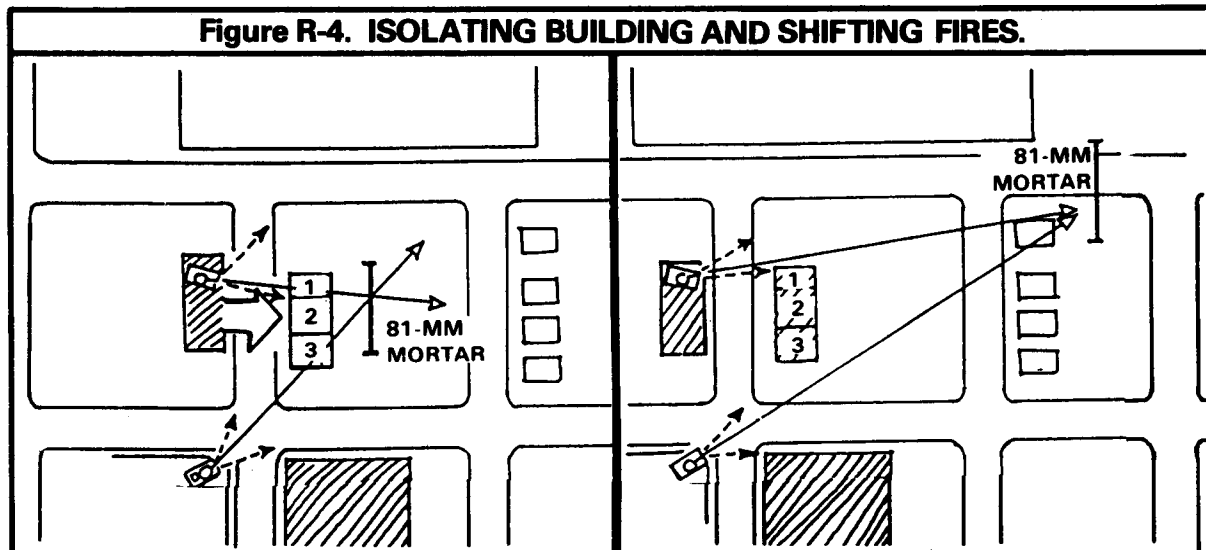
- (1) **The carrier element supported by indirect and direct fire, isolates the building.**

(2) The dismount element enters the building to gain a foothold.

(3) The dismount element clears the building room-by-room.

To isolate a building, the carrier element takes

an overwatch position. It fires the caliber .50 machine gun and the 7.62-mm machine gun to suppress enemy troops, in the building and those in nearby buildings, who can fire at the dismount element.



**NOTE: Targets for Dragons and TOWs in urban areas must be beyond the minimum arming distance of 65 meters.**

The dismount teams move to the building along covered and concealed routes. Smoke grenades and smoke pots can provide additional concealment. The dismount teams enter the building at the highest point they can, because:

**Usually, the ground floor and basement are the enemy's strongest defenses.**

**The roof of a building normally is weaker than the walls.**

**It is easier to fight coming down stairs than going up stairs.**

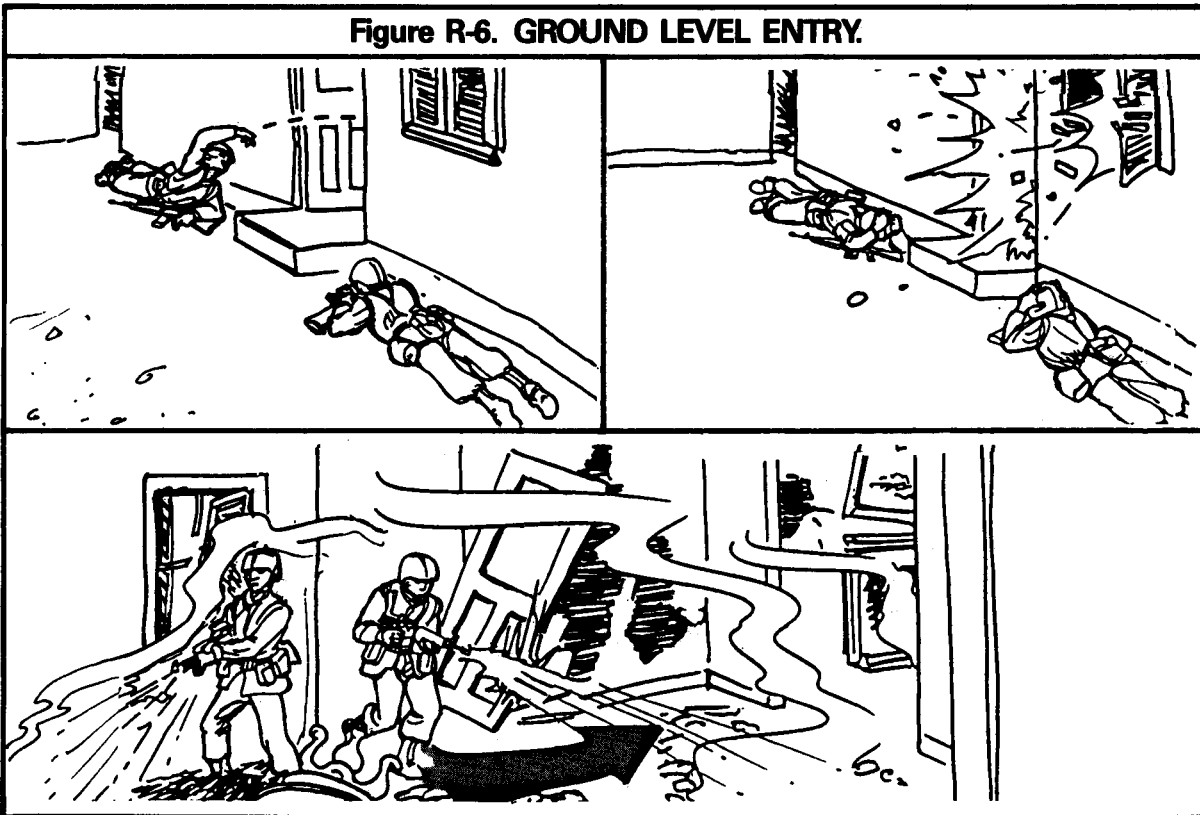
**Figure R-5. GET UP ON ROOF, THEN FIGHT DOWN.**



If there is no covered route to the roof, dismount teams may enter at a lower story or at ground level. In this case, they should seize a

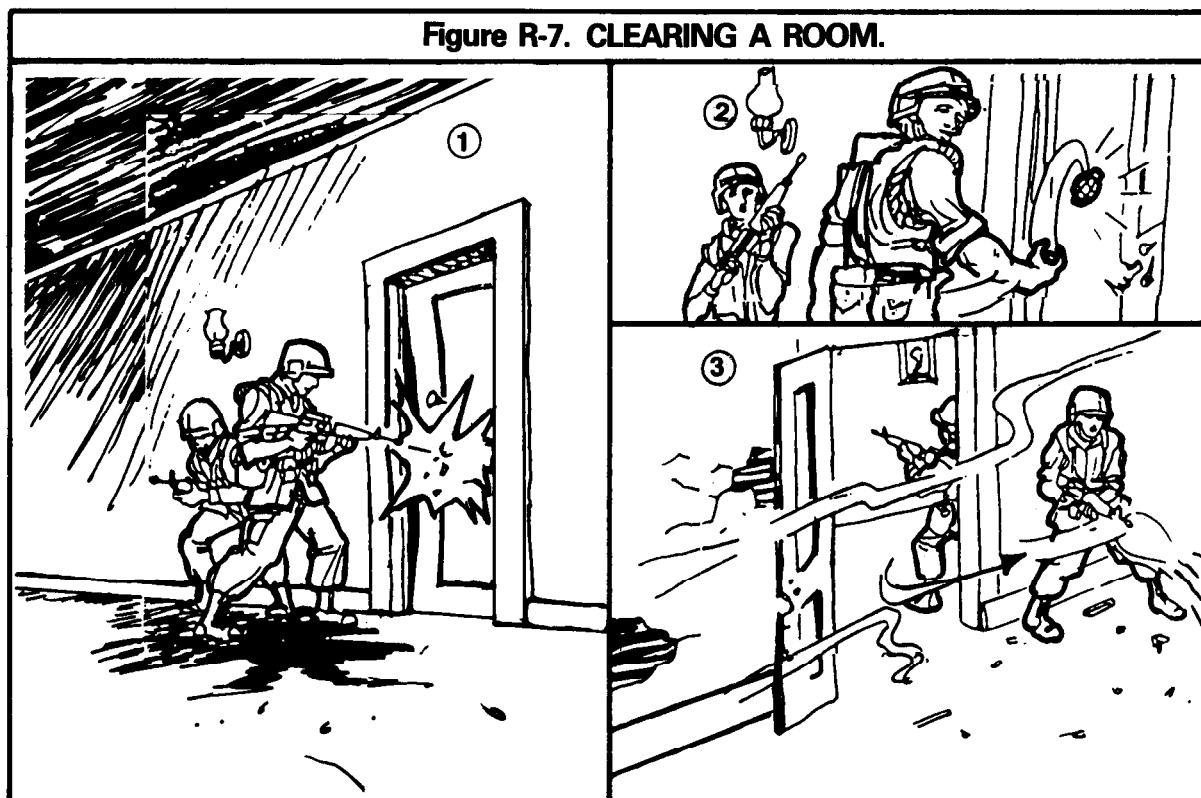
foothold quickly fight to the highest story, and then clear room-by-room, floor-by-floor, from the top down.

**Figure R-6. GROUND LEVEL ENTRY.**



To enter a building, one of the assault teams moves (covered by fire) to the entry point. One soldier throws a grenade into the room. After the explosion, the assault team enters, one man at a time, overmatched by the other men. The

first man rushes in firing his weapon in two- or three-round bursts. He takes a position that gives him coverage of the whole room. The other men enter the room and make a quick but thorough search.



The same procedure is repeated from room to room and floor to floor (to include the basement, if there is one) until the building is cleared of all enemy. It then is considered secured. If it fits in the scheme, the secure building becomes the position from which the assault on the next build-

ing is overwatched. This assault may be made by other dismount teams of the same platoon, or by a dismount element from another platoon. The building should be marked to indicate that it is clear of enemy. (Put white engineer tape or chalk marks over the door.)

### Section III. DEFENSE

#### R-6. GENERAL

As in the attack, most of the fighting in the defense is done by dismount teams. It is harder to build the platoon's defense around the APC in urban areas than in other types of terrain. But the carrier element's role is no less important. A

platoon normally defends from positions in one to three buildings. This depends on the size and strength of the buildings, the arrangement of the buildings, and the size of the platoon.

## R-7. MISSIONS

Typical missions for dismount teams in the defense include:

**Preparing defensive positions (with combat engineer support if required and available).**

**Emplacing demolitions and obstacles with combat engineer support.**

**Observing to provide security and prevent enemy infiltration.**

**Engaging and defeating assaulting enemy forces.**

**Acquiring targets for engagement by tanks.**

**Protecting tanks and APCs from close-in antiarmor weapons.**

Typical missions of carrier teams in the defense include:

**Providing fire support for the dismount teams and mutual support to other APCs.**

**Neutralizing or suppressing enemy positions.**

**Destroying or making enemy footholds indefensible.**

**Providing rapid, protected transport to the dismount teams, as needed.**

**Reinforcing threatened areas by movement through covered and concealed routes to new firing positions.**

**Covering obstacles by fire.**

**Providing smoke screens with the smoke-grenade launcher.**

**Resupplying dismount teams with ammunition and other supplies.**

**Evacuating casualties. (The overall value of the APC to the defense must be weighed against the need to resupply or evacuate casualties.)**

Other aspects of defense in urban terrain that the platoon leader should consider are:

**PROTECTION.** Reinforced concrete and brick buildings provide the best protection. A reinforced cellar is especially good. Wooden buildings should be avoided.

**DISPERSION.** It is better to have positions in two mutually supporting buildings than in one building that can be bypassed.

**CONCEALMENT.** Although buildings provide excellent concealment, positions in buildings that are at the edge of an urban area should be avoided because they are the most likely to receive the heaviest enemy fire. As shadows change with the time of day, vehicles should be moved to compensate.

**FIELDS OF FIRE.** Positions should have good fields of fire in all directions. Wide streets and open areas such as parks may offer excellent fields of fire.

**OBSERVATION.** The buildings selected should permit observation into the adjacent sector. The higher stories may offer the best observation, but they may also invite enemy fire.

**COVERED ROUTES.** Routes that go through or in back of buildings are best.

**FIRE HAZARD.** Buildings that will burn easily should be avoided.

**TIME.** Buildings that need a great amount of preparation are undesirable when time is short.

**STRENGTH.** Buildings in which APCs or tanks are to be placed must be able to holdup under the vehicles'



**weight and withstand the effects of their weapons being fired.**

**R-8. TECHNIQUES**

The APC, after being refueled and uploaded with ammunition, should be integrated into the platoon fire plan. Once placed in position, APCs should not be moved for logistical or administrative functions. Other vehicles should accomplish these functions, when possible.

Once the platoon leader picks the building(s) he will defend, he should position his carrier teams and dismount teams. Dismounted machine guns should be positioned to have grazing fire. Dragons should be positioned on upper stories for longer range and for firing at the tops of tanks. If it can be done, supplementary and alternate positions

should be designated for dismount teams and carrier teams. These positions should permit continuous coverage of the primary sector and allow all-round defense.

It may be advisable in certain instances to move to alternate positions with the onset of darkness to deceive the enemy as to the actual location of the platoon.

When firing the LAW or Dragon from within a room, backblast must be taken into account. In urban combat, the backblast area for these weapons is more dangerous because of rubble and the channeling effect caused by buildings, narrow streets, and alleys. Antitank weapons should not be fired from unvented or closed rooms. By wetting down the floor of the room or building, the signature produced by the backblast may be significantly reduced.

**Figure R-8. BACKBLAST AREA.**

MINIMUM DIMENSIONS				
WEAPON	ROOM SIZE	CEILING HEIGHT	VENT* SIZE	MUZZLE CLEARANCE
TOW	17'x24'	7'	20 SQ. FT.	9 in.
DRAGON/ 90-MM	15'x12'	7'	20 SQ. FT.	6 in.
LAW	4' TO THE BACKWALL	7'	20 SQ. FT.	

\*VENT SIZE - A normal size door, when left open provides adequate venting.

The platoon can use obstacles to hamper enemy mobility and allow longer engagement time for tanks and infantry. Mines and demolitions should be planned for the outside and inside of buildings

to neutralize enemy forces attempting to gain a foothold. Buildings can be selectively rubbled to improve fields of fire and create obstacles.

## GLOSSARY

## ACRONYMS AND ABBREVIATIONS

**AA	assembly area
ADA	air defense artillery
APC	armored personnel carrier
*APCAT	armored personnel carrier anchoring tracks
ATGM	antitank guided missile
AVLB	armored-vehicle-launched bridge
BMNT	beginning morning nautical twilight
*BMP	(Threat fighting vehicle)
*BTR	(Threat vehicle)
CAS	close air support
CEOI	communications-electronics operation instructions
COMSEC	communications security
CP	command post
**CS	(a chemical agent)
CSS	combat service support
*CVC	combat vehicle crew
**CW	chemical warfare
*DIVAD	division air defense
DLIC	detachment left in contact
ECCM	electronic counter-countermeasures
**EDS	equipment decontamination site
**EENT	end evening nautical twilight
EMP	electromagnetic pulse
FA	field artillery
FAC	forward air controller
FD	fire direction
FDC	fire direction center
FEBA	forward edge of the battle area
*FFAR	free flight aerial rockets
**FIST	fire support team
FO	forward observer
*FPF	final protective fire
*FPL	final protective line
*FRAGO	fragmentary order
GSR	ground surveillance radar

HE	high explosive
HEAT	high explosive antitank
*HEDP	high explosive dual-purpose
IRP	initial rally point
*ITV	improved TOW vehicle
kmph	kilometers per hour
LAW	light antitank weapon
*LCE	load-carrying equipment
LD	line of departure
LZ	landing zone
MANPADS	man-portable air defense system
*METT-T	mission, enemy terrain, troops, and time
MI	military intelligence
MIJI	meaconing, intrusion, jamming, and interference
MOPP	mission oriented protection posture
mph	miles per hour
NBC	nuclear, biological, and chemical
NCO	noncommissioned officer
*NDL	nuclear defense level
*OCOKA	observation and fields of fire, cover and concealment, obstacles, key terrain, and avenues of approach
OP	observation post
OPCON	operational control
*OPFOR	opposing force
OPORD	operation order
OPSEC	operations security
*ORP	objective rally point
**PD	point of departure
PDF	principal direction of fire
**PDS	personnel decontamination site
*PEWS	platoon early warning system
PL	phase line
PLD	probable line of deployment
PLL	prescribed load list
POL	petroleum, oils and lubricants
PW	prisoner of war

RATELO	radiotelephone operator
REMS	remote sensor system
RP	release point
*RPG	rocket-propelled grenade
*rpm	revolutions per minute
R/S	rifleman/sniper
*SAW	squad automatic weapon
SIGSEC	signal security
*SLUFAE	surface-launched fuel air explosive
SOP	standing operating procedure
SOSR	suppression, obscuration, security and reduction
SP	self-propelled
STANAG	standardization agreement
STANO	surveillance, target acquisition, and night observation
*STB	standard tropical bleach
*STRIKWARN	strike warning
*SUT	small-unit transceiver
T&E	traversing and elevating
TL	team leader
TOE	table(s) of organization and equipment
TOW	tube-launched, optically-tracked, wire-guided (a missile)
*TP	training practice
*TRP	target reference point
USAF	United States Air Force
*VT	variable time (fuze)
WP	white phosphorus
XO	executive officer

---

\*Not listed in current AR 310-50.

\*\*Listed in current AR 310-50 but does not include this terminology

## REFERENCES

**REQUIRED PUBLICATIONS**

Required publications are sources that users must read in order to understand or to comply with this publication.

**ARMY REGULATIONS (AR)**

- 310-25 Dictionary of United States Army Terms  
 310-50 Authorized Abbreviations and Brevity Codes

**FIELD MANUALS (FM)**

- 21-75 Combat Skills of the Individual Soldier  
 71-1 The Tank/Mechanized Infantry Company Team  
 101-5-1 Operational Terms and Graphics

**TECHNICAL MANUAL (TM)**

- 9-2300-257-10 Operator's Manual for the M1 13 Series Armored Personnel Carrier

**RELATED PUBLICATIONS**

Related publications are sources of additional information. They are not required in order to understand this publication.

**FIELD MANUALS**

- 3-12 Operational Aspects of Radiological Defense  
 3-50 Chemical Smoke Generator Units and Smoke Operations  
 3-87 Nuclear, Biological, and Chemical (NBC) Reconnaissance and Decontamination Operations  
 5-100 Engineer Combat Operations  
 5-101 Mobility  
 5-102 Countermobility  
 7-8 The Infantry Platoon and Squad (Infantry Airborne, Air Assault, Ranger)  
 17-95 Cavalry  
 20-22 Vehicle Recovery Operations  
 20-32 Mine Countermine Operations at the Company Level  
 21-40 NBC Defense  
 21-60 Visual Signals  
 22-9 Soldier Performance in Continuous Operations  
 23-9 M16A1 Rifle and Rifle Marksmanship  
 23-23 Antipersonnel Mine M18A1 and M18 (Claymore)  
 23-30 Grenades and Pyrotechnic Signals  
 23-31 40-mm Grenade Launchers M203 and M79

23-33	66-mm HEAT Rocket, M72A1 and M72A2
23-67	Machinegun 7.62-mm, M60
24-1	Combat Communications
24-18	Field Radio Techniques
71-2	The Tank/Mechanized Infantry Battalion Task Force
90-10-1	An Infantryman's Guide to Urban Combat
90-13	River Crossing Operations
100-5	Operations
101-10-1	Staff Officers Field Manual Organization, Technical, and Logistical Data

**TECHNICAL MANUAL**

3-220	Nuclear, Biological, and Chemical Decontamination
-------	---

**INTERNATIONAL AGREEMENTS**

Certain provisions of this manual are the subject of the international standardization agreements listed below.

	<b>NATO STANAG</b>	<b>CENTO STANAG</b>
Military Symbols	2019	2019
Land Minefield Laying, Recording, Reporting, and Marking Procedures	2036	2036
Standardized Captive and Equipment/Document Log	2044	2044
Reporting Nuclear Detonations, Radioactive Fallout, and Chemical Attacks	2103	2103
Friendly Nuclear Strike Winning to Armed Forces Operating on Land	2104	2104
Infantry and Armored Fighting Vehicles Operations	2146	

INDEX

	Page
abatis .....	P-26
aircraft engagement techniques .....	F-5
air	
artillery .....	8-9
defense .....	F-1
air support .....	8-8
ambush .....	7-20
area .....	7-26
fire discipline .....	7-23
formations .....	7-21
mounted antiarmor .....	7-30
patrol .....	7-20
platoon antiarmor .....	7-29
point .....	7-23
signals .....	7-23
squad antiarmor .....	7-26
ammunition .....	8-12
antiarmor ambush (see ambush)	
area	
ambush .....	7-26
fire .....	4-25
reconnaissance .....	7-17
armored personnel carrier .....	1-1
abandoning during recovery .....	L-10
characteristics .....	1-2
communications .....	1-3
disengagement .....	6-30
dismounting .....	G-1
evacuation of casualties .....	K-1
firepower .....	1-3
fire support .....	R-4
fording preparation .....	E-1
loading .....	N-1
mobility .....	1-2
observation devices .....	1-3
protective armor .....	1-3
range card .....	C-11
swimming with .....	E-2
water-crossing .....	1-3
artificial light, categories .....	I-5
artillery, air defense .....	8-9
assault	
dismounted .....	5-18
mounted .....	5-18
assembly areas .....	Q-6

	Page
attack .....	5-11
dismounted .....	5-15
during limited visibility .....	5-28
mounted, defense .....	5-11,6-23
planning .....	5-11
preparing for .....	6-23
tactics and techniques .....	5-11
with tanks .....	5-12
without tanks .....	5-14
base patrol .....	7-32
battle	
drill .....	H-1
examples .....	H-2
training .....	H-1
positions .....	6-9
battlefield illumination .....	I-5
beaten zone .....	C-3
biological decontamination .....	M-18
bounding overwatch .....	4-15
breaching and clearing obstacles .....	P-21
abatis .....	P-26
log crib .....	P-27
minefields .....	P-22
tank ditches .....	P-27
camouflage and concealment .....	O-1
carrier (see armored personnel carrier)	
carrier teams .....	6-4
in defense .....	6-21
in offense .....	5-19
chemical and biological .....	M-9
alarms .....	M-11
detection equipment .....	M-12
effects .....	M-9
individual actions .....	M-13
masking .....	M-12
mission oriented protection posture .....	M-15
protective measures .....	M-11
unmasking .....	M-14
weapons .....	M-9
chemical attack, individual actions .....	M-13
coil formation .....	4-9
column formation .....	4-4
combat	
engineers .....	8-10
leading .....	3-10



	Page
loading .....	N-1
orders .....	3-4
fragmentary .....	3-9
operation .....	3-6
platoon .....	3-7
squad .....	3-8
warning .....	3-5
patrol .....	7-20
service support .....	8-1, 8-11
support .....	8-1
communications .....	1-3, D-1
radiotelephone .....	D-10
security .....	D-10
squad/platoon .....	D-1
types .....	D-1
messenger .....	D-4
radio .....	D-7
sound .....	D-4
visual .....	D-2
wire .....	D-4
concealment .....	B-15
cone of fire .....	C-2
consolidation .....	5-25, 6-23
counterattack .....	6-24
countersurveillance .....	O-1
camouflage and concealment .....	O-1
noise and light discipline .....	O-3
cover .....	B-14
craters .....	P-28
dead space .....	C-3
decontamination	
biological .....	M-18
chemical .....	M-16
complete .....	M-17
emergency .....	M-16
individual equipment .....	M-17
partial .....	M-17
radiological .....	M-18
defense .....	6-1
against mounted attack .....	6-23
carrier teams .....	6-21
conduct .....	6-21
delay .....	6-32
dismount teams .....	6-22
indirect fire planning .....	6-17

	Page
military operations on urbanized terrain .....	R-7
operation order .....	6-2
planning .....	6-2
reserve .....	6-33
sector sketch .....	6-18, 6-19
tactics and techniques .....	6-3
tasks .....	6-1
withdrawal .....	6-32
defensive fire planning .....	C-10
delay .....	6-32
demolitions .....	P-13
detachment left in contact .....	6-32
disengagement .....	6-25
carrier element .....	6-30
dismount element .....	6-27
dismount teams	
in defense .....	6-22
in offense .....	5-15
dismounted operations .....	G-1
assault .....	5-18
attacking .....	5-15
control .....	2-9
disengagement .....	6-27
organization .....	2-9
dismounting the APC .....	G-1
Dragon, M47 .....	B-8
positions .....	B-25
echelon formation .....	4-7
engagement area .....	C-8
engineers, combat .....	8-10
equipment (see specific type) .....	
evacuation of casualties from APC .....	K-1
exploitation .....	5-32
fighting positions .....	B-14
preparing .....	B-18
fire	
and movement (maneuver) .....	4-23, 4-26
classification .....	C-4
control .....	C-1, C-6
definitions and discussions .....	C-2
discipline .....	7-23
distribution .....	C-2
enfilade .....	C-4
flanking .....	C-4
frontal .....	C-4

	Page
grazing .....	C-4
indirect .....	6-16
methods .....	4-23
oblique .....	C-4
planning, platoon .....	C-10
plunging .....	C-4
reconnaissance by .....	7-42
small arms .....	C-9
support .....	5-25, 8-1
direct .....	8-6
indirect .....	8-1
techniques .....	4-24
with tanks .....	4-27
foraging	
APC, preparation .....	E-1
operations .....	E-2
tactical considerations .....	E-6
formations (see also specific type)	
movement .....	4-2
platoon .....	4-3
squad .....	4-2
fragmentary order .....	3-9
grenade launcher, M203 (40-mm) .....	B-3
herringbone formation .....	4-8
hide formation .....	6-11
H-series TOE .....	A-1
illumination, battlefield .....	I-5
information security .....	O-6
inspection, combat loading .....	N-1
inspections .....	3-4
intercom system, APC .....	D-9
kits	
chemical-agent detector .....	M-13
recovery .....	L-6
leadership .....	3-10
light antitank weapon, M72A2 .....	B-5
limited visibility	
attack during .....	5-28
control during .....	I-6
control measures .....	5-30
equipment capabilities .....	5-27, I-1
movement during .....	5-27
observation devices .....	I-3
operations .....	5-26
techniques .....	I-1

	Page
line formation .....	4-6
loading, combat.....	N-1
log crib .....	P-27
machine gun	
Browning caliber .50 .....	B-11
M60 .....	B-2
positions.....	B-23
maintenance.....	8-11
maneuver.....	4-23
with tanks .....	4-27
masking .....	M-12
medical	
evacuation .....	8-16
supply/support .....	8-13, 8-15
military	
intelligence .....	8-9
operations on urbanized terrain .....	R-1
minefields .....	P-1
missiles.....	8-12
mission oriented protection posture.....	M-15
mounted	
assault .....	5-18
attacking .....	5-11
control.....	2-8
operations .....	2-8
organization .....	2-8
patrol.....	7-38
mounted antiarmor ambush .....	7-30
mount, M175.....	B-10
movement .....	4-1
during limited visibility .....	5-27
formations.....	4-2
methods .....	4-23
orders .....	4-19
platoon .....	4-3
squad.....	4-2
techniques .....	4-12
terrain use.....	4-1
to contact.....	5-2
with tanks .....	4-21
multishot rocket launcher, M202A1 .....	B-8
night observation equipment .....	I-2
noise and light discipline .....	O-3
nuclear, biological, and chemical .....	M-1
monitoring radiation levels .....	M-7

	Page
operations .....	M-1
reports .....	M-6
weapons .....	M-1
objective rally point .....	7-11
obstacles .....	P-1
breaching and clearing .....	P-21
craters .....	P-28
demolition .....	P-13
log crib .....	P-27
minefields .....	P-1
wire and demolitions .....	P-10, P-28
offense (see also specific type and aspect) .....	5-1
offensive fire planning .....	C-10
operation order .....	3-6
defense .....	6-2
patrolling .....	7-7
operation overlay .....	3-9
operations	
defensive .....	6-32
dismounted .....	2-9, G-1
mounted .....	2-8
nuclear, biological, and chemical .....	M-1
on urbanized terrain .....	R-1
security .....	O-1
orders	
combat .....	3-4
fragmentary .....	3-9
operation .....	3-6, 7-7
platoon .....	3-7
squad .....	3-8
warning .....	3-5
organization (see specific type) .....	3-9
overlay, operation .....	5-8
overwatch .....	4-15
bounding .....	4-14
traveling techniques .....	4-14
patrol	
ambush .....	7-20
base .....	7-32
combat .....	7-20
mounted .....	7-38
raid .....	7-31
reconnaissance .....	7-16
security .....	7-31
patrolling .....	7-1

	Page
battle drills .....	7-14
common tasks .....	7-10
danger areas .....	7-12
inspect and rehearse .....	7-9
operation order .....	7-7
organizing .....	7-1
rally points .....	7-10
personnel support and administration .....	8-15
petroleum, oil, and lubricants .....	8-13
physical security .....	O-4
platoon	
antiarmor ambush .....	7-29
communications .....	D-1
dismounted .....	2-9
techniques .....	4-14
fire planning .....	C-10
leading .....	3-1
mounted .....	2-8
OPORD .....	3-7
organization .....	2-1
rehearsals .....	3-4
understrength .....	2-6
point fire .....	4-25
positions	
battle .....	6-9
carrier team .....	6-9
dismount team .....	6-12
Dragon .....	B-25
hide .....	6-11
machine gun .....	B-23
priority targets .....	C-9
prisoners of war .....	8-16
pursuit .....	5-32
radiation levels, monitoring .....	M-7
radio communications .....	D-7
radiological decontamination .....	M-8
radiotelephone .....	D-10
raid patrol .....	7-31
rally points .....	7-10
range card .....	C-11
rations, supply .....	8-14
reconnaissance	
area .....	7-17
by fire .....	7-42
patrol .....	7-16

	Page
zone .....	7-18
recovery .....	8-12, L-1, L-5
abandoning the APC .....	L-10
kits .....	L-6
safety .....	L-8
techniques .....	L-1
rehearsals .....	3-4
reorganization .....	5-25, 6-23
repair parts .....	8-14
reserve missions .....	6-33
revetments .....	B-22
rifle, M16A1 .....	B-1
road marches, tactical .....	Q-1
sector	
defensive .....	6-19
of fire .....	C-7
sketch .....	6-18
security	
information .....	O-6
operations .....	O-1
patrol .....	7-31
physical .....	O-4
signal .....	O-5
signal security .....	O-5
small arms fire .....	C-9
smoke .....	J-1
application .....	J-2
countermeasures .....	J-3
devices .....	J-1
effects .....	J-3
onboard smoke producers .....	J-1
tactical considerations .....	J-2
squad	
antiarmor ambush .....	7-26
communications .....	D-1
OPORD .....	3-8
organization .....	2-1
responsibilities .....	2-4
understrength .....	2-7
squad automatic weapon .....	B-13
standing operating procedure .....	3-9
supply .....	8-12
support	
air .....	8-8
combat service .....	8-1, 8-11

	Page
fire .....	5-25
medical .....	8-15
personnel .....	8-15
security team .....	7-27
surveillance equipment .....	I-2
suppressive fire .....	C-2
swimming	
operations .....	E-1
with APC .....	E-2
tactical	
considerations .....	G-3
dismounting the APC .....	G-3
road marches .....	Q-1
tank ditches, clearing .....	P-27
tanks	
attacking	
with .....	5-12
without .....	5-14
maneuver with .....	4-27
movement with .....	4-21
target	
acquisition and engagement, aerial .....	F-3
equipment .....	I-2
reference point .....	C-6
techniques of fire .....	4-24
terrain use, movement .....	4-1
threat tactics	
attack helicopters .....	F-3
jet aircraft .....	F-1
traveling techniques .....	4-13
overwatch .....	4-14
platoon	
dismounted .....	4-14
mounted .....	4-13
TOE, H-series .....	A-1
towing techniques .....	L-1
troop leading procedures .....	3-1
unmasking, conditions .....	M-14
urban areas	
APC employment .....	R-4
fire support .....	R-4
urbanized terrain	
APC employment .....	R-4
defense .....	R-7



	Page
offense .....	R-2
military operations .....	R-1
vee formation .....	4-7
visibility, limited (see limited visibility)	
warning order .....	3-5
water supply .....	8-14
weapons (see also specific aspect) .....	B-1
chemical and biological .....	M-9
Dragon, M47 .....	B-8
grenade launcher, M203 .....	B-3
light antitank, M72A2 .....	B-5
machine gun	
Browning caliber .50 .....	B-11
M60 .....	B-2
multishot rocket launcher, M202A1 .....	B-8
nuclear .....	K-1
rifle, M16A1 .....	B-1
squad automatic weapon .....	B-13
wedge formation .....	4-8
wire entanglements .....	P-10, P-28
withdrawal .....	6-32
zone reconnaissance .....	7-18

**FM 7-7**  
**15 MARCH 1985**

By Order of the Secretary of the Army:

**JOHN A. WICKHAM, JR.**  
*General, United States Army*  
*Chief of Staff*

Official:

**DONALD J. DELANDRO**  
*Brigadier General, United States Army*  
*The Adjutant General*

**DISTRIBUTION:**

*Active Army, ARNG, and USAR:* To be distributed in accordance with DA Form 12-11A&B Requirements for the Rifle Company, Platoons, and Squads (Qty rqr block no. 78); The infantry Battalions (Qty rqr block no. 79); The Infantry Brigades (Qty rqr block no. 80); Signal Battalion, Armored, Infantry, Infantry (Mechanized) and Airmobile Divisions (Qty rqr block no. 110); Tanks Units, Platoon, Company, and Battalion (Qty rqr block no. 129); Military Police Support Army Division and Separate Brigades (Qty rqr block no. 134); Mechanized Infantry Opns, Pit, Squad (Qty rqr block no. 222); Operations of Army Forces in the Field (Qty rqr block no. 405; and Combat Service Support (Qty rqr block no. 406).

Additional copies may be requisitioned from the US Army Adjutant General Publications Center, 2800 Eastern Boulevard, Baltimore, MD 21220.