



DEPARTMENT OF THE NAVY
HEADQUARTERS UNITED STATES MARINE CORPS
2 NAVY ANNEX
WASHINGTON, DC 20380-1775

MCO P1020.34G
MCUB
31 Mar 03

MARINE CORPS ORDER P1020.34G W/CH 1-4

From: Commandant of the Marine Corps
To: Distribution List

Subj: MARINE CORPS UNIFORM REGULATIONS

Ref: (a) MARCORMAN, par. 2806

Encl: (1) LOCATOR SHEET

1. Purpose. To promulgate current policies and regulations regarding the wear of Marine Corps uniforms per the reference.

2. Cancellation. MCO P1020.34F; White Letter 08-95; ALMAR 144/95; ALMAR 170/95; White Letter 13-95; ALMAR 350/95; ALMAR 351/95; ALMAR 392/95; ALMAR 405/95; ALMAR 06/96; ALMAR 107/96; ALMAR 111/96; ALMAR 123/96; ALMAR 194/96; ALMAR 327/96; ALMAR 352/96; CMC letter to MCUB, dated 6 March 1997; ALMAR 127/97; ALMAR 231/97; ALMAR 299/97; ALMAR 150/98; ALMAR 313/98; MARADMIN 014/99; MARADMIN 155/99; MARADMIN 399/99; MARADMIN 521/99; MARADMIN 380/00; MARADMIN 044/01; MARADMIN 143/01; MARADMIN 198/01; MARADMIN 199/01; MARADMIN 200/01; ALMAR 039/01; ALMAR 059/01; ALMAR 015/02; MARADMIN 142/02; ALMAR 028/02; MARADMIN 318/02; MARADMIN 319/02.

3. Action. Commanders shall ensure that all officers and enlisted personnel of the Marine Corps and the Marine Corps Reserve wear, in the manner prescribed, those articles of uniform and accessories authorized by this Manual.

4. Summary of Revision

a. General. This revision contains substantial changes. Some of the figure numbers have been revised.

b. Chapter 1. States purpose of this Manual and identifies responsibilities for uniform matters. Provides changes to uniform of the day policy. Updates restrictions on tatoos, body

DISTRIBUTION STATEMENT A: Approved for public release; distribution is unlimited.

31 Mar 03

piercing and all forms of body mutilation. Incorporates revised standards of dress. Provides updated regulations on travel uniform policy.

c. Chapter 2. Updates occasions for wearing the various Marine Corps uniforms. Incorporates regulations for wear of the desert and MCO P1020.34G woodland combat utility uniforms in particular and wear of the utility uniform in general off base. Provides guidance the cold weather physical training uniform, blue dress, and blue-white dress uniforms; and the all-season service uniform. Updates the blue white dress uniform as the summer season uniform for SNCOs.

d. Chapter 3. Provides regulations on the wear of the new blue dress and service sweaters with epaulettes, female slacks, necktie length, NCO waistplate, martial arts utility belt, and combat utility uniform.

e. Chapter 4. Lists new regulations for the wear of merrowed edge grade insignia/service stripes, and female cloth chevrons and service/identification badges on female uniforms. Updates wear of insignia on combat utility uniforms. Incorporates wear of diver breast insignia, to include the combatant diver breast insignia.

f. Chapter 5. Updates precedence of awards and regulations for the wear of the Armed Forces Service Medal, Marine Corps Recruiting Ribbon, Drill Instructor Ribbon, Marine Security Guard Ribbon, NATO Medal, U.S. Public Health Achievement Medal, Kuwait Liberation Medal, and the wear of multiple badges on female uniforms; and redefines the regulations regarding the wear of the Hour Glass and "M" devices.

g. Chapter 6. Updates female band member organizational allowance to include the split-dress skirt.

h. Chapter 7. Updates regulations for wear of food service clothing, the campaign (service) hat, military police equipment and the Sam Browne Belt.

i. Chapter 8. Updates regulations for the wear of uniform by Navy personnel.

j. Chapter 9. Updates the male/female officer uniform requirements.

k. Chapter 10. Provides guidance on wear and care of the combat utility uniform, Marine Corps combat boots, and martial arts utility belts.

1. Chapter 11. No changes to the laws and directives applicable to the Marine Corps uniform.

5. Recommendations. Recommendations concerning the contents of the Marine Corps Uniform Regulations are invited, and should be submitted via the appropriate chain of command for endorsement and submission to CMC (MCUB).

6. Reserve Applicability. This manual is applicable to the Marine Corps Total Force.

7. Certification. Reviewed and approved this date.

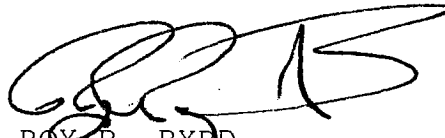

ROY R. BYRD
President, Permanent
Marine Corps Uniform Board

DISTRIBUTION: PCN 10200150000

Copy to: 7000172 (25)
700260/8145005 (2)
7000099, 144/8145001 (1)

C O R R E C T E D A F T E R T R A N S M I S S I O N

MCO P1020.34G CH 1-PROCEEDINGS OF MARINE CORPS UNIFORM BOARD NO. 205
MARADMIN 509/03

««-----»»

Date signed: 11/04/2003 MARADMIN Number: 509/03

R 041030Z NOV 03

FM CMC WASHINGTON DC(uc)

TO AL MARADMIN(uc)

MARADMIN

BT

UNCLASSIFIED

MARADMIN 509/03

MSGID/GENADMIN/CMC WASHINGTON DC MCUB//

SUBJ/MCO P1020.34G CH 1 - PROCEEDINGS OF MARINE CORPS UNIFORM BOARD NO. 205//

REF/A/DOC/CMC/16 JUN 03//

REF/B/MCO P1020.34G//

NARR/REF A IS CMC DECISION MEMORANDUM FOR MCUB NO. 205. REF B IS
THE MARINE CORPS UNIFORM REGULATIONS.//

POC/GS12 M. BOYT/-/MCUB/TEL: (703)432-4607 OR DSN 378-4607//

EMAIL: BOYTMK@MCSC.USMC.MIL//

RMKS/1. SITUATION. ON 28 JUL 2003, CMC DECISIONED UNIFORM BOARD
NO. 205.

2. MISSION. TO ANNOUNCE THE CMC DECISIONS FOR UNIFORM BOARD NO.
205.

3. EXECUTION. PER REF (A) THE BELOW ISSUES FROM UNIFORM BOARD
NO. 205 WERE REVIEWED AND DECISIONED BY CMC:

A. ISSUE: EXTENDED RED PIPING FOR FEMALE DRESS BLUE UNIFORM.

-RECOMMENDATION: DO NOT ADOPT THE EXTENDED RED PIPING
MODIFICATION TO THE ENLISTED FEMALE DRESS BLUE UNIFORM.

-CMC DECISION: CONCUR.

B. ISSUE: WEAR OF WHITE BELT WITH THE ENLISTED FEMALE DRESS BLUE
UNIFORM

-RECOMMENDATION: DO NOT APPROVE THE WEAR OF THE WHITE BELT AND
WAIST PLATE WITH THE ENLISTED FEMALE DRESS BLUE UNIFORM.

-CMC DECISION: CONCUR.

-COMMENT: THE WEAR OF THE WHITE BELT AND WAIST PLATE MAY BE MAN-
DATED FOR CEREMONIAL PURPOSES, BUT MUST BE ISSUED ORGANIZATIONALLY
BY THE COMMAND.

C. ISSUE: MATERNITY JUMPER

-RECOMMENDATION: DECLARE THE MATERNITY JUMPER OBSOLETE AND NO
LONGER AUTHORIZED FOR WEAR.

CMC DECISION: CONCUR.

-COMMENT: WHILE THE MATERNITY JUMPER IS NO LONGER AUTHORIZED FOR
ISSUE/SALE EFFECTIVE IMMEDIATELY, IT MAY CONTINUE TO BE WORN UNTIL
1 DECEMBER 03.

D. ISSUE: RUFFLED FEMALE EVENING DRESS SHIRT

-RECOMMENDATION: DECLARE THE RUFFLED FEMALE EVENING DRESS SHIRT
OBSOLETE AND NO LONGER AUTHORIZED FOR WEAR, AND REPLACE IT WITH
THE PLEATED EVENING DRESS SHIRT.

-CMC DECISION: CONCUR.

-COMMENT: THE PLEATED EVENING DRESS SHIRTS WILL BE AVAILABLE FOR
PURCHASE VIA MCCS, NLT 1 OCTOBER 2004. THE RUFFLED SHIRT MAY
CONTINUE TO BE WORN UNTIL 1 OCTOBER 2005, AT WHICH TIME IT IS
DEEMED OBSOLETE AND MUST BE REPLACED WITH THE PLEATED SHIRT.

DISTRIBUTION STATEMENT A: Approved for public release;
distribution is unlimited

PCN 10200150001

E. ISSUE: IMPROVED COYOTE GREEN GENERAL PURPOSE TRUNKS

-RECOMMENDATION: REPLACE THE CURRENT OLIVE GREEN GENERAL PURPOSE TRUNKS WITH THE IMPROVED GREEN GENERAL PURPOSE TRUNKS.

-CMC DECISION: CMC TABLED THE DECISION PENDING COMPETITION IN THE POM 06 PROCESS.

-COMMENT: IF THE IMPROVED SHORTS ARE APPROVED BY THE POM 06 PROCESS, THE EARLIEST IT WILL BE INTRODUCED VIA INITIAL ISSUE (THE SEABAG) IS 1 OCTOBER 2005 (FY 06). THE RESULTS OF THE POM 06 UNIFORM BOARD ISSUES REVIEW WILL BE RELEASED VIA SEPARATE MARADMIN WITH INTRODUCTION/MANDATORY POSSESSION DATES, IF APPROPRIATE.

F. ISSUE: IMPROVED LONG AND SHORT SLEEVE COYOTE BROWN UNDERSHIRTS

-RECOMMENDATION: REPLACE THE CURRENT ISSUE/REQUIREMENT OF 6 SHORT SLEEVE OLIVE GREEN UNDERSHIRTS WITH A MIX OF IMPROVED LONG SLEEVE (QTY 2) AND SHORT SLEEVE (QTY 4) COYOTE BROWN SHIRTS.

-CMC DECISION: CMC TABLED THE DECISION PENDING COMPETITION IN THE POM 06 PROCESS.

-COMMENT: IF THE IMPROVED SHIRTS ARE APPROVED BY THE POM 06 PROCESS, THE EARLIEST THEY WILL BE INTRODUCED VIA INITIAL ISSUE (THE SEABAG) IS 1 OCTOBER 2005 (FY 06). THE RESULTS OF THE POM 06 UNIFORM BOARD ISSUES REVIEW WILL BE RELEASED VIA SEPARATE MARADMIN WITH INTRODUCTION/MANDATORY POSSESSION DATES, IF APPROPRIATE.

G. ISSUE: IMPROVED COLD WEATHER PT UNIFORM

-RECOMMENDATION: ADD THE IMPROVED COLD WEATHER PT UNIFORM TO THE INITIAL ISSUE (SEABAG) AS A ONE-TIME ISSUE OPTIONAL UNIFORM AUTHORIZED FOR WEAR AS APPROPRIATE CIVILIAN ATTIRE.

-CMC DECISION: NON-CONCUR.

H. THE FOLLOWING ISSUES WERE PENDING FROM OTHER BOARDS THAT HAVE RECENTLY BEEN RESOLVED;

(1) ISSUE: PUBLICATION OF MCO P1020.34G

COMMENT: THE "G" VERSION OF THE UNIFORM REGULATIONS HAS BEEN SIGNED AND PUBLISHED. IT MAY BE VIEWED AT EITHER THE UNIFORM BOARD WEBSITE "WWW.MARCORSYSCOM.USMC.MIL/SITES/MCUB" OR THE PUBLICATIONS HYPERLINK AT "WWW.USMC.MIL." EFFECTIVE IMMEDIATELY, MCO P1020.34F IS CANCELED.

(2) ISSUE: REGULATIONS FOR WEAR OF THE COMBAT FIELD CAP (BOONIE HAT)

- COMMENT: CHANGE THE BOONIE HAT REGULATIONS (PARAGRAPH 3038.4 OF REFERENCE (B)) TO READ:

THE COMBAT UTILITY FIELD CAP MAY BE WORN DURING FIELD TYPE EXERCISES ONLY, AND MAY NOT BE PRESCRIBED FOR PARADES, REVIEWS OR OTHER CEREMONIES. WHEN WORN, THE COMBAT UTILITY FIELD CAP BRIM WILL BE WORN STRAIGHT OR ANGLED SLIGHTLY DOWN.

(3) ISSUE: BRIGADIER GENERAL OFFICER COLLAR INSIGNIA

-COMMENT: CHANGE PARAGRAPH 4005.2.D OF REFERENCE (B) TO READ: D. BRIGADIER GENERAL. ONE SILVER-COLORED STAR (SAME TYPE AS ABOVE). ADDITIONALLY, THE 5/8-INCH INSIGNIA IS AUTHORIZED FOR WEAR AS LONG AS THE SAME SIZE INSIGNIA IS WORN ON BOTH COLLARS.

(4) ISSUE: PER CMC DECISION MEMO 1020 MCUB OF 23 JUN 03, THE WOODLAND MARPAT MATERNITY WORK UNIFORM WAS APPROVED AS A REPLACEMENT UNIFORM FOR THE WOODLAND CAMOUFLAGE MATERNITY WORK UNIFORM.

-COMMENT: THE MARPAT MATERNITY WORK UNIFORM IS AVAILABLE FOR ISSUE NOW. THE CAMOUFLAGE MATERNITY WORK UNIFORM IS NO LONGER AUTHORIZED FOR ISSUE/SALE, BUT MAY CONTINUE TO BE WORN UNTIL 1 OCT 2006, AT WHICH TIME IT WILL BE REPLACED WITH THE MARPAT MATERNITY WORK UNIFORM.

(5) ISSUE: PER CMC DECISION MEMO 1020 MCUB OF 8 DEC 2002, CMC AUTHORIZED THE REMOVAL OF THE FAUX POCKET FROM THE WOMEN'S SERVICE UNIFORM COAT.

-COMMENT: DURING THE SECOND QUARTER FY04 FEMALE SERVICE COATS WILL BEGIN BEING ISSUED/SOLD WITHOUT THE FAUX POCKET. EXISTING COATS WITH THE FAUX POCKET MAY CONTINUE TO BE WORN UNTIL NO LONGER SERVICEABLE. THE FAUX POCKET MAY BE REMOVED FROM EXISTING COATS BY A QUALIFIED TAILOR IF THE REMOVAL DOES NOT RESULT IN A DISCERNABLE DIFFERENCE IN THE COLOR OF THE FABRIC IN THE LOCATION WHERE THE FAUX POCKET WAS LOCATED. ADDITIONALLY, THE FOLLOWING CHANGES TO REFERENCE B ARE REQUIRED:

(A) PARAGRAPH 5301.8, WEARING OF RIBBONS:

ON WOMEN'S KHAKI SHIRTS AND COATS WITHOUT THE FAUX POCKET, RIBBON BARS WILL BE PLACED EVEN WITH OR UP TWO INCHES ABOVE THE FIRST VISIBLE BUTTON

(B) PARAGRAPH 5501.5, REGULATIONS FOR WEAR (SHOOTING BADGES)

ON WOMEN'S KHAKI SHIRTS AND COATS WITHOUT THE FAUX POCKET, BADGES ARE PLACED EVEN WITH OR UP TO TWO INCHES ABOVE THE FIRST VISIBLE BUTTON

(6) ISSUE: IMPROVED BOOT SOCKS (COYOTE COLORED)

COMMENT: DURING FY04 IMPROVED COYOTE BOOT SOCKS WILL BE INTRODUCED TO THE SEABAG. BLACK AND GREEN BOOT SOCKS MAY CONTINUE TO BE WORN UNTIL NO LONGER SERVICEABLE, AT WHICH TIME THEY WILL BE REPLACED BY THE COYOTE SOCKS, IF AVAILABLE. AS SUCH, PARAGRAPH 3029.3 OF REFERENCE (B) IS CHANGED TO READ:
3. COYOTE BROWN CUSHION SOCKS WILL BE STANDARD AS ISSUED GREEN CUSHION AND BLACK CUSHION SOLE SOCKS MAY CONTINUE TO BE WORN UNTIL REPLACEMENT IS REQUIRED.

4. ADMINISTRATION AND LOGISTICS.

A. ADMINISTRATION. THIS ALMAR CONSTITUTES AUTHORITY TO CHANGE REF (B) AS DIRECTED IN PARAGRAPH 3.

B. LOGISTICS. N/A.

5. COMMAND AND SIGNAL.

A. THIS MARADMIN IS APPLICABLE TO THE MARINE CORPS RESERVE.

B. SUBSEQUENT BULLETINS CHANGING, CORRECTING, OR AMPLIFYING THIS OR THE REFERENCES WILL BE PUBLISHED VIA MARADMIN.

C. QUESTIONS MAY BE REFERRED TO GS12 M. BOYT, PROJECT OFFICER, MCUB (EMAIL "BOYTMK@MCSC.USMC.MIL"), AT DSN 378-4607.//

C O R R E C T E D A F T E R T R A N S M I S S I O N

MCO P1020.34G CH 2 TO THE MARINE CORPS UNIFORM REGULATIONS: WEAR OF OPTIONAL
MARINE CORPS COMBAT BOOTS (MCCB)MARADMIN
112/04

««-----»»

Date signed: 03/12/2004 MARADMIN Number: 112/04

R 121200Z MAR 04

FM CMC WASHINGTON DC(uc)

TO AL MARADMIN(uc)

MARADMIN

BT

UNCLASSIFIED

MARADMIN 112/04

MSGID/GENADMIN/CMC WASHINGTON DC MCUB//

SUBJ/MCO P1020.34G CH 2 - TO THE MARINE CORPS UNIFORM REGULATIONS:

/WEAR OF OPTIONAL MARINE CORPS COMBAT BOOTS (MCCB)//

REF/A/DOC/MCO P1020.34G/-//

AMPN/REF A IS THE MARINE CORPS UNIFORM REGULATIONS//

POC/M. BOYT/GS12/CALLSIGN:MCUB/-/EMAIL:BOYTMK@MCSC.USMC.MIL

/TEL: (703) 432-4607 OR DSN 378-4607//

GENTEXT/REMARKS/1. SITUATION. EFFECTIVE 1 OCTOBER 2004, THE

OPTIONAL BLACK/GREEN BOOT PROGRAM IS CANCELLED. THE ONLY

AUTHORIZED BOOT, OTHER THAN SAFETY OR SPECIAL ISSUE BOOTS,

WILL BE THE MCCB. IN ORDER TO CAPITALIZE ON DIFFERENT/NEW SOLE

TECHNOLOGIES, CMC HAS AUTHORIZED A LIMITED OPTIONAL MCCB PROGRAM.

2. MISSION. TO CHANGE THE REFERENCE AS DIRECTED BELOW.

3. EXECUTION. EFFECTIVE IMMEDIATELY, MAKE THE FOLLOWING CHANGES
TO THE REFERENCE.

A. CHANGE PARAGRAPH 3012.2E TO READ:

"E. OPTIONAL BOOTS. OPTIONAL BOOTS (BLACK OR GREEN) ... "

VICE "E. OPTIONAL BOOTS. OPTIONAL BOOTS (BLACK ONLY) ... ".

B. INSERT NEW PARAGRAPH 3012.2F:

"F. OPTIONAL MCCBS. OPTIONAL MCCBS WITH A MARINE CORPS APPROVAL
IDENTIFICATION NUMBER (SEE FIGURE 1-3) AND MARINE CORPS EMBLEM ON
THE OUTSIDE HEEL OF THE BOOT, ARE AUTHORIZED FOR WEAR WITH THE
UTILITY UNIFORM AND WILL MEET THE MINIMUM REQUIREMENT."

4. ADMINISTRATION AND LOGISTICS.

A. ADMINISTRATION. THIS MARADMIN CONSTITUTES AUTHORITY TO CHANGE
THE REF AS DIRECTED IN PARAGRAPH 3.

B. LOGISTICS. N/A.

5. COMMAND AND SIGNAL

A. THIS MARADMIN IS APPLICABLE TO THE TOTAL FORCE MARINE CORPS.

B. SUBSEQUENT CHANGES, CORRECTIONS, OR AMPLIFYING INFORMATION
CONCERNING THIS MATTER OR THE REFERENCE, IF NECESSARY, WILL
BE PUBLISHED VIA MARADMIN.

C. QUESTIONS MAY BE REFERRED TO GS12 M. BOYT, PROJECT OFFICER,
MCUB (EMAIL "BOYTMK@MCSC.USMC.MIL"), AT DSN 378-4607.//

DISTRIBUTION STATEMENT A: Approved for public release;
distribution is unlimited

PCN 10200150002

C O R R E C T E D A F T E R T R A N S M I S S I O N

MCO P1020.34G CH 3 - THE MARINE CORPS UNIFORM REGULATIONS

MARADMIN 199/04

««-----»»

Date signed: 05/03/2004 MARADMIN Number: 199/04 R 030305Z MAY 04

FM CMC WASHINGTON DC(uc)

TO AL MARADMIN(uc)

MARADMIN

BT

UNCLASSIFIED

MARADMIN 199/04

MSGID/GENADMIN/CMC WASHINGTON DC MCUB//

SUBJ/MCO P1020.34G CH 3- THE MARINE CORPS UNIFORM REGULATIONS//

GENTEXT/REMARKS/1. SITUATION. CHANGES TO THE UNIFORM REGULATIONS WERE ERRONEOUSLY OMITTED WHEN THE REFERENCE WAS PUBLISHED. ALSO, MINOR CHANGES HAVE BEEN MADE SINCE ITS PUBLICATION CONCERNING; WEAR OF OFFICER GRADE INSIGNIA ON COMBAT UTILITIES; WEAR REGULATIONS FOR OFFICER GRADE INSIGNIA ON SWEATERS WITH EPAULETTES; WEAR OF THE PRESIDENTIAL SERVICE BADGE/VICE PRESIDENTIAL SERVICE BADGE ON THE RIGHT SIDE OF WOMEN'S COATS; AND WEAR OF THE SERVICE BELT WITH ALL UNIFORMS (COAT OR NO COAT).

2. MISSION. UPDATE THE REFERENCE TO INCLUDE ERRONEOUSLY OMITTED CHANGES AND INCORPORATE NEW CHANGES.

3. EXECUTION. EFFECTIVE IMMEDIATELY, MAKE THE FOLLOWING CHANGES TO THE REFERENCE.

A. ERRONEOUSLY OMITTED CHANGES

(1) ISSUE: ENLISTED GRADE INSIGNIA PLACEMENT ON SWEATERS WITH EPAULETTES (CMC DECISION OF 16 DECEMBER 1999). CHANGE PARAGRAPH 4004.3A(3) TO READ "TANKER JACKET AND SWEATERS WITH EPAULETTES: ..." VICE "TANKER JACKET: ...".

(2) ISSUE: WEAR OF THE PRESIDENTIAL SERVICE BADGE (PSB)/VICE PRESIDENTIAL SERVICE BADGE (VPSB) ON THE WOMEN'S COAT (CMC DECISION OF 14 JANUARY 1999). ADD PARAGRAPH 4007.2B(3): "PLACEMENT OF THE PSB/VPSB. ON WOMEN'S COATS, THE PSB/VPSB WILL BE WORN ON THE RIGHT IN THE MANNER DESCRIBED IN SUBPARAGRAPH 4007.2B(1)."

(3) ISSUE: WEAR OF THE SERVICE BELT (CMC DECISION OF 16 MARCH 2002). NOTE: AS A RESULT OF THIS CHANGE, THE SERVICE BELT MAY BE WORN WITH ALL UNIFORMS, WITH OR WITHOUT COATS. CHANGE PARAGRAPH 7015.1A AS FOLLOWS: DELETE THE FIRST SENTENCE IN ITS ENTIRETY.

B. NEW CHANGES SINCE PUBLICATION OF THE REFERENCE

(1) ISSUE: WEAR OF GREEN UNDERSHIRTS (PMCUB DECISION OF 19 DECEMBER 2003). CHANGE PARAGRAPH 3036.1C AS FOLLOWS: DELETE THE FIRST SENTENCE AND IMMEDIATELY PRECEDING THE REMAINING TWO SENTENCES, ADD THE FOLLOWING: "THE ISSUED UTILITY UNIFORM UNDERSHIRT IS A PLAIN COTTON OLIVE GREEN, SHORT-SLEEVE, CREW-NECK SHIRT. MARINES MAY WEAR OPTIONAL PLAIN, OLIVE GREEN LONG- OR SHORT-SLEEVE UNDERSHIRTS OF ANY MATERIAL, AS LONG AS THE SHIRTS MEET THE COMMAND'S MINIMUM SAFETY STANDARDS AND HAVE A MARINE CORPS APPROVAL IDENTIFICATION NUMBER. OPTIONAL SHIRTS (LONG- OR SHORT-SLEEVE) WILL MEET THE MINIMUM REQUIREMENT, HOWEVER, COMMANDERS MAY DICTATE THE WEAR OF ONLY

DISTRIBUTION STATEMENT A: Approved for public release;
distribution is unlimited

PCN 10200150003

SHORT-SLEEVE SHIRTS WHEN UNIFORMITY IS REQUIRED."

(2) ISSUE: WEAR OF OFFICER GRADE INSIGNIA (COLONEL - COMPANY GRADE) ON COMBAT UTILITIES (PMCUB DECISION OF 19 DECEMBER 2003).

(A) CHANGE PARAGRAPH 4005.3C(2) AS FOLLOWS: ADD THE FOLLOWING AS THE NEW LAST SENTENCE: "ON THE COMBAT UTILITY COAT, THE EAGLE WILL BE WORN WITH THE WINGS PERPENDICULAR TO THE DECK."

(B) CHANGE PARAGRAPH 4005.3C(3) TO READ "FIELD GRADE OAK LEAVES WILL BE WORN WITH THE STEM TOWARD THE BOTTOM OF THE COLLAR AND THE LINE FROM THE TIP TO THE STEM PARALLEL TO THE DECK." VICE " FIELD GRADE OAK LEAVES ... PARALLEL TO THE FRONT COLLAR EDGE."

(C) CHANGE PARAGRAPH 4005.3C(4) TO READ "COMPANY GRADE INSIGNIA WILL BE WORN WITH THE LONG AXIS OF THE BARS PARALLEL TO THE DECK." VICE "COMPANY GRADE ... PARALLEL TO THE FRONT EDGE OF THE COLLAR."

(3) ISSUE: WEAR OF OFFICER GRADE INSIGNIA ON SWEATERS WITH EPAULETTES (CMC DECISION OF 29 MARCH 2004). CHANGE PARAGRAPH 4005.3B TO READ "SHOULDER GRADE INSIGNIA WILL BE PLACED ON EACH SHOULDER STRAP OF DRESS JACKETS, DRESS/SERVICE COATS, THE AWC, THE TANKER JACKET AND FIELD COAT IN THE MANNER DESCRIBED BELOW. SHOULDER GRADE INSIGNIA WILL NOT BE WORN ON THE SERVICE OR DRESS BLUE SWEATER." VICE "SHOULDER GRADE INSIGNIA WILL BE PLACED ON EACH SHOULDER STRAP OF DRESS JACKETS, DRESS/SERVICE COATS, THE AWC, THE TANKER JACKET, THE BLUE DRESS SWEATER, AND FIELD COAT AS FOLLOWS:".

4. ADMINISTRATION AND LOGISTICS

A. ADMINISTRATION. THIS MARADMIN CONSTITUTES AUTHORITY TO CHANGE THE REFERENCE AS DIRECTED IN PARAGRAPH 3.

B. LOGISTICS. N/A.

5. COMMAND AND SIGNAL

A. THIS MARADMIN IS APPLICABLE TO THE MARINE CORPS TOTAL FORCE.

B. SUBSEQUENT CHANGES, CORRECTIONS, OR AMPLIFYING INFORMATION TO THE REFERENCE WILL BE PUBLISHED VIA MARADMIN.

C. QUESTIONS MAY BE REFERRED TO GS12 M. BOYT, PROJECT OFFICER, MCUB (EMAIL: "BOYTMK@MCSC.USMC.MIL"), AT DSN 378-4607.//

C O R R E C T E D A F T E R T R A N S M I S S I O N

MCO P1020.34G CH 4 - PROCEEDINGS OF MARINE CORPS UNIFORM BOARD NO. 206

MARADMIN 250/04

««-----»»

Date signed: 06/07/2004 MARADMIN Number: 250/04 R 071400Z JUN 04

FM CMC WASHINGTON DC(uc)

TO AL MARADMIN(uc)

MARADMIN

BT

UNCLASSIFIED

MARADMIN 250/04

MSGID/GENADMIN/CMC WASHINGTON DC/DMCS//

SUBJ/MCO P1020.34G CH 4 - PROCEEDINGS OF MARINE CORPS UNIFORM BOARD NO.
206//

REF/A/DOC/CMC/31 MAR 04//

REF/B/CMO P1020.34G//

REF/C/MCBUL 10120//

NARR/REF A IS CMC DECISION MEMORANDUM FOR MCUB NO. 206. REF B IS
THE MARINE CORPS UNIFORM REGULATIONS. REF C IS THE INDIVIDUAL
CLOTHING ALLOWANCES.//

POC/GS12 M. BOYT/-/-/-/TEL:(703) 432-4607

/EMAIL: BOYTMK@MCSC.USMC.MIL//

GENTEXT/REMARKS/1. SITUATION. ON 31 MAR 2004, CMC DECISIONED
UNIFORM BOARD

NO. 206.

2. MISSION. TO ANNOUNCE CMC DECISIONS FOR UNIFORM BOARD NO. 206.

3. EXECUTION. PER REF (A), THE BELOW ISSUES FROM UNIFORM BOARD
NO. 206 WERE REVIEWED AND DECISIONED BY CMC:

A. ISSUE: MARINE CORPS JUNIOR RESERVE OFFICER TRAINING CORPS
(MCJROTC) DRESS BLUE INSIGNIA

-RECOMMENDATION: AUTHORIZE MCJROTC CADETS TO WEAR THE GOLD JROTC
PIN-ON SHOULDER GRADE INSIGNIA VICE THE CLOTH SLEEVE INSIGNIA ON
THE DRESS BLUE UNIFORM.

-CMC DECISION: APPROVED, EFFECTIVE IMMEDIATELY. CLOTH SLEEVE GRADE
INSIGNIA MAY CONTINUE TO BE WORN UNTIL 1 JUN 2005, AT WHICH TIME ALL
CADETS WILL WEAR THE PIN-ON SHOULDER GRADE INSIGNIA ON THEIR DRESS
BLUE UNIFORMS.

B. ISSUE: MATERNITY SWEATER

-RECOMMENDATION: AUTHORIZE THE OPTIONAL WEAR OF THE BLACK NAVY
MATERNITY SWEATER (AVAILABLE FOR PURCHASE THROUGH NEXCOM - CARDIGAN
5956 BLACK) WITH THE MARINE CORPS SERVICE MATERNITY UNIFORM.

-REGULATION CHANGE - CHANGE PARAGRAPH 3017.6 OF REF (B) TO READ
"...THE SERVICE SWEATER AND TANKER JACKET ARE NOT AUTHORIZED WITH
THE MATERNITY UNIFORMS. THE BLACK MATERNITY SWEATER (CARDIGAN STYLE
WITH EPAULETTES) IS AUTHORIZED FOR OPTIONAL WEAR WITH THE MATERNITY
SERVICE SWEATER. RANK INSIGNIA WILL BE WORN WITH THE MATERNITY
SWEATER PER THE SWEATER (WITH EPAULETTE) REGULATIONS DETAILED IN
CHAPTER 4 OF THESE REGULATIONS. THE GREEN NECKTAB WILL BE WORN WHEN
THE MATERNITY SWEATER IS WORN. THE SWEATER MAY BE WORN OVER THE
TUNIC AND UNDERNEATH THE ALL-WEATHER COAT, BUT MUST BE BUTTONED AT

DISTRIBUTION STATEMENT A: Approved for public release;
distribution is unlimited

PCN 10200150004

ALL TIMES. THE SWEATER IS AUTHORIZED FOR LEAVE AND LIBERTY AND FOR COMMUTING TO AND FROM WORK."

-CMC DECISION: APPROVED.

C. ISSUE: MATERNITY CAPE FOR U.S MARINE BAND MEMBERS

-RECOMMENDATION: AUTHORIZE PREGNANT MEMBERS OF THE U.S. MARINE BAND TO WEAR AN ORGANIZATIONALLY ISSUED MATERNITY CAPE WITH THE U.S. MARINE BAND UNIFORMS (SPECIAL ISSUE AND CONCERT) PER THE COMMANDER'S DISCRETION.

CMC DECISION: APPROVED.

D. THE FOLLOWING ISSUES WERE APPROVED BY CMC, BUT THEIR IMPLEMENTATION IS HELD IN ABEYANCE PENDING ALLOCATION OF FUNDING. ADDITIONAL GUIDANCE AND FORMAL CHANGES TO REF (C) WILL BE ANNOUNCED WHEN FUNDING IS ALLOCATED.

(1) CMC DECISION: AUTHORIZE ALL ACTIVE DUTY ENLISTED SAILORS SERVING

WITH THE MARINE CORPS THE SPECIAL INITIAL UTILITY UNIFORM ALLOWANCE (SIUUA).

(2) CMC DECISION: AUTHORIZE DRILLING SELECTED NAVAL RESERVISTS (ENLISTED) SERVING WITH THE MARINE CORPS THE SIUUA.

(3) CMC DECISION: APPROVE THE BLOUNT ISLAND COMMAND REQUEST FOR A MEDIUM DRESS BLUE ALLOWANCE (TO BE ISSUED UPON ARRIVAL AT THE COMMAND)

FOR 12 MARINES PROVIDING CEREMONIAL AND COLOR GUARD DUTIES, AS DIRECTED BY THE COMMANDER.

(4) INCREASE THE INITIAL ISSUE TO RECRUITS AND OFFICER CANDIDATES TO TWO (2) COMBAT GARRISON CAPS, WOODLAND MARPAT AND TWO COMBAT GARRISON

CAPS, DESERT MARPAT. NOTE THAT THE MINIMUM REQUIREMENTS LIST WILL REMAIN AT ONE (1) EACH.

4. ADMINISTRATION AND LOGISTICS

A. ADMINISTRATION. THIS MARADMIN CONSTITUTES AUTHORITY TO CHANGE REF (B) AS DIRECTED IN PARAGRAPHS 3A THROUGH 3C ONLY.

B. LOGISTICS. N/A.

5. COMMAND AND SIGNAL

A. THIS MARADMIN IS APPLICABLE TO THE MARINE CORPS TOTAL FORCE

B. SUBSEQUENT BULLETINS CHANGING, CORRECTING, OR AMPLIFYING THIS OR THE REFERENCES WILL BE PUBLISHED VIA MARADMIN.

C. QUESTIONS MAY BE REFERRED TO M. BOYT, PROJECT OFFICER, MCUB (EMAIL "BOYTMK@MCSC.USMC.MIL"), AT DSN 378-4607.//

MCO P1020.34G
31 Mar 03

LOCATOR SHEET

Subj: MARINE CORPS UNIFORM REGULATIONS

Location: _____
(Indicate the location(s) of the copy(ies) of this Manual.)

MARINE CORPS UNIFORM REGULATIONS

RECORD OF CHANGES

Log completed, change action as indicated.

Change Number	Date of Change	Date Entered	Signature of Person Entering the Change

MARINE CORPS UNIFORM REGULATIONS

CONTENTS

CHAPTER

- 1 GENERAL
 - 2 DESIGNATED UNIFORMS AND OCCASIONS FOR THEIR WEAR
 - 3 UNIFORM ITEMS AND REGULATIONS FOR THEIR WEAR
 - 4 INSIGNIA AND REGULATIONS FOR WEAR
 - 5 AWARDS
 - 6 MUSICAL UNITS
 - 7 ORGANIZATIONAL CLOTHING AND EQUIPMENT
 - 8 UNIFORMS FOR NAVY PERSONNEL, RESERVE/RETIRED MARINES,
MCJROTC, AND CIVILIANS
 - 9 UNIFORM REQUIREMENTS
 - 10 CARE AND MARKING OF UNIFORMS
 - 11 LAW AND DIRECTIVES
- INDEX

MARINE CORPS UNIFORM REGULATIONS

CHAPTER 1

GENERAL

	<u>PARAGRAPH</u>	<u>PAGE</u>
GENERAL	1000	1-3
RESPONSIBILITY FOR UNIFORM MATTERS	1001	1-4
UNIFORM OF THE DAY	1002	1-5
RESTRICTIONS ON WEARING UNIFORMS.....	1003	1-5
PERSONAL APPEARANCE	1004	1-5
CIVILIAN ATTIRE	1005	1-10
UNIFORM PROCUREMENT AND MANAGEMENT SYSTEMS	1006	1-12
MATERIALS, FINDINGS, PATTERNS AND SPECIFICATIONS	1007	1-16
ALTERATIONS	1008	1-17

FIGURE

1-1	MALE GROOMING STANDARDS (FRONT VIEW)	1-8
1-2	MALE GROOMING STANDARDS (SIDE VIEW)	1-8
1-3	USMC APPROVAL IDENTIFICATION	1-17

MARINE CORPS UNIFORM REGULATIONS

CHAPTER 1

GENERAL

1000. GENERAL

1. The purpose of this Manual is to define Marine Corps uniform policies and provide regulations for the proper wear of the uniform.
2. Commanders may interpret the provisions of this Manual to address specific concerns whenever necessary. However, authority for local interpretations does not extend to the institution of policies or practices, which are in contradiction to the provisions of this Manual. Exceptions to this Manual are only granted in writing by the Commandant of the Marine Corps (MCUB).
3. The Marine Corps uniform, with appropriate insignia, is designed primarily to show at a glance the branch of service and grade of the individual authorized to wear it. The uniform represents visual evidence of the authority and responsibility vested in the individual by the United States Government.
4. The title "commander," as used in these regulations, includes those Marine officers titled as commanding general, commanding officer, director, officer-in-charge, or inspector-instructor.
5. When official references are made to the uniform by any person in the Marine Corps, or its official publications, the terms in these regulations will be used.
6. Wearing the uniform should be a matter of personal pride to all Marines. Marines are known not just for their battlefield prowess, but for their unparalleled standards of professionalism and uncompromising personal conduct and appearance. It is a Marine's duty and personal obligation to maintain a professional and neat appearance. Any activity, which detracts from the dignified appearance of Marines, is unacceptable. Marines will maintain their uniforms and equipment in a neat and serviceable condition and will, by their appearance, set an example of neatness and strict conformity with these regulations.
7. Components of one uniform will not be worn with components of another except as authorized by these regulations.
8. The commander may authorize Marines participating in athletics, range instructions, field exercises, and similar activities to wear clothing and equipment other than that prescribed in these regulations.
9. Chapter 1 of these regulations is a punitive order. Violation of the specific prohibitions and requirements in chapter 1 by Marine Corps or Marine Corps Reserve personnel and those of other services who wear the Marine Corps uniform may result in prosecution under the Uniform Code of Military Justice (UCMJ).

1001. RESPONSIBILITY FOR UNIFORM MATTERS

1. Permanent Marine Corps Uniform Board (CMC (MCUB)). The President, Permanent Marine Corps Uniform Board acts as the principal advisor to CMC on all uniform matters, coordinates approval of all clothing allowances, and oversees development and coordinates testing of new and redesigned uniform items. The CMC (MCUB) implements the Commandant's guidance or "vision" in regard to uniforms. The Uniform Board functions as advocate for the individual Marine (user) and develops field concerns (as expressed in official correspondence) into decision issues for the Commandant. Also, the PMCUB sponsors this manual, which details uniform policies and prescribes how uniforms are worn.

2. Deputy Commandant for Installations and Logistics, Logistics Capability Center (DC, I&L (LPC)). DC, I&L (LPC) is responsible for individual uniform clothing policy and oversight of the Retail Clothing Outlets (RCOs) and Military Clothing Sales Stores (MCSSs) that stock, manage and sell uniform clothing. DC, I&L LPC sponsors MCO P10120.28, Individual Clothing Regulations, which provides regulations and guidance on the administration of individual clothing. Annually, DC, I&L (LPC) publishes MCBUL 10120, Individual Clothing Allowances, which contains all authorized allowances and minimum requirements lists, as approved by CMC (MCUB).

3. Commanding General, Marine Corps Systems Command (CG, MARCORSYSCOM), Program Manager, Infantry Combat Equipment (PM, ICE). CG, MARCORSYSCOM (PM, ICE) is responsible for research, development and acquisition of both individually retained and organizational items of individual field clothing and equipment as directed by the CMC and PMCUB. It coordinates with the U.S. Army Natick Research, Development and Engineering Center as well as other DoD laboratories on all joint service tests of uniform items. CG, MARCORSYSCOM (PM, ICE) monitors quality control of uniform items through field submission of product quality deficiency reports (PQDRs), and manages the quality control program for optional items. CG, MARCORSYSCOM (PM, ICE) is responsible for preparation and maintenance of detailed specifications and drawings of all authorized uniform items. Also, CG, MARCORSYSCOM (PM, ICE) sponsors TM-10120-15/1, Technical Manual for Fitting and Alteration, which provides detailed guidance on the correct fitting of uniforms.

4. Deputy Commandant for Manpower and Reserve Affairs, (DC, M&RA). The (DC, M&RA (Fiscal Branch (MRF)) administers all Military Clothing Sales Stores (MCSSs) that sell both standard issue and optional items. DC, M&RA (MRF) assists with stock management of supply system items at the MCSSs. The DC, M&RA (Retail Operations Branch (MRX)) administers all uniform shops co-located with Marine Corps Exchanges that sell optional or non-supply system items exclusively. DC, M&RA (MRX) ensures that sufficient quantities of optional uniform items (to include officer uniforms) are procured and stocked at both uniform shops. MCO P1700.27, MWR Policy Manual, details procedures for uniform clothing for all exchange activities. Also, DC, M&RA (MWX) sponsors the Marine Corps Exchange Commercial Sources Manual for Approved Marine Corps Uniform Items, which lists all authorized optional uniform items and accessories with their Marine Corps approval identification serial numbers.

5. Commander, Navy Exchange Service Command (NEXCOM). The Director, Navy Uniform Program is responsible for providing mail-order support to Marine Corps personnel worldwide for system uniform clothing items. The CG, MARCORSYSCOM (PM, ICE) and the Commander, NEXCOM will continually coordinate this program.

6 Army Air Force Exchange Service (AAFES Pacific). AAFES Pacific administers the MCSS in Okinawa and ensures that both standard issue and optional uniforms are procured and stocked in sufficient quantities.

1002. UNIFORM OF THE DAY

1. The uniform of the day will be as prescribed by the commander, per guidance provided in chapter 2 of this manual.

2. In prescribing the uniform of the day, commanders will consider the duty to be performed and the weather conditions.

3. The order prescribing the uniform of the day will be conspicuously posted.

1003. RESTRICTIONS ON WEARING UNIFORMS

1. Members of the Marine Corps and Marine Corps Reserve, including retired Marines, are prohibited from wearing the Marine Corps uniform while engaged in any of the following activities, functions or circumstances unless specifically authorized by the CMC (PA):

a. Soliciting funds for any purpose from the public outside of a military base or establishment.

b. Participating in any type of show or event which is commercially sponsored for advertising purposes, where it could be implied or construed that the Marine Corps "endorses" the product advertised.

c. "Endorsing" commercial products in such ways as to involve the uniform, title, grade or rate, or in any way establish or imply their military affiliation with such products.

d. Appearing or participating in any event in public that would compromise the dignity of the uniform.

2. Whenever any doubt exists as to the propriety of wearing the Marine Corps uniform under circumstances similar to those enumerated above, specific requests should be directed to the CMC (MCUB/PA). For further information on those laws and directives, which govern the authority to wear the uniform, refer to chapter 11.

1004. PERSONAL APPEARANCE

1. Marines will present the best possible image at all times and continue to set the example in military presence. The Marine Corps uniform regulations for standards of personal appearance and grooming are as specific as

practicable in order to establish the parameters with which Marines must comply. Marines are prohibited from:

- (a) mutilation of the body or any body parts in any manner, and;
- (b) attaching, affixing or displaying objects, articles, jewelry or ornamentation to, through or under their skin, tongue or any other body part. Female Marines, however, may wear earrings consistent with paragraph 3009.
- (c) tattoos or brands on the neck and head. In other areas of the body, tattoos or brands that are prejudicial to good order, discipline and morale or are of a nature to bring discredit upon the Marine Corps are also prohibited.
- (d) this regulation does not prohibit necessary medical or surgical procedures conducted by licensed, qualified medical personnel.

2. Marine Corps uniform standards of grooming do not allow eccentric or faddish styles of hair, jewelry, or eyeglasses. Eccentricities in individual appearance detract from uniformity and team identity. Because it is impossible to provide examples of every appropriate or unacceptable style of "conservative" or "eccentric" grooming and attire, the good judgment of Marines at all levels is key to enforcement of Marine Corps standards in this issue, as in other issues.

3. The use of chewing gum, chewing tobacco, cigarettes or the consumption of food while walking in uniform or while in formation, are examples of activities that detract from an appropriate military presence. However, good judgment will govern the application of this policy in the field environment.

4. Articles that are not authorized for wear as a part of a regulation uniform will not be worn exposed with the uniform unless otherwise authorized by the Commandant or higher authority. Examples of such articles include but are not limited to the following: pencils, pens, watch chains, fobs, pins, backpacks/bags, hydration systems, jewelry (except as authorized herein), handkerchiefs, combs, cigarettes, pipes, barrettes, hair ribbons/ornaments, flowers (corsages/boutonnieres, etc.) or other similar items. Except for the authorization contained in paragraph 7000, articles such as cellular phones, pagers, etc. are not authorized for wear on a regulation uniform.

5. Articles that may be worn while in uniform include inconspicuous wristwatches and rings. Sunglasses may be worn on leave, liberty, and in garrison but not in formation with troops, unless the need to wear sunglasses has been certified by medical authorities. When authorized for wear in formations, sunglass lenses will be of standard green or dark green shade or may be the type commonly referred to as "photosensitive." Sunglasses that do not have "photosensitive" lenses will not be worn indoors. Eyeglasses/sunglasses, when worn, will be conservative in appearance. Eccentric or conspicuous eyepieces are prohibited. Chains, bands, or ribbons will not be attached to eyeglasses; however, eyeglass restraints are authorized for safety purposes, but must be of conservative style/design.

6. Subject to temporary revocation due to health, safety, or mission requirements, Marines may wear neat and conservative religious apparel items, as follows:

a. Articles of religious apparel which are not visible or apparent when worn with the uniform.

b. Visible articles of religious apparel with the uniform while attending or conducting divine services or while in a chapel or other house of worship.

c. Visible articles of religious apparel with the uniform which do not interfere with or replace required uniform articles.

7. Grooming Regulations

a. No eccentricities in the manner of wearing head, facial, or body hair will be permitted. If applied, dyes, tints, bleaches and frostings, which result in natural colors, are authorized. The hair color must complement the person's complexion tone. Color changes that detract from a professional image are prohibited. Fingernails will be kept clean and neatly trimmed so as not to interfere with performance of duty, detract from military image or present a safety hazard. Nail polish for male Marines is not allowed. Nail polish as it applies to female Marines will fall under standards in subparagraph 1004.5.c(5).

b. Men will be well groomed at all times and will abide by the following:

(1) Hair will be neat and closely trimmed. The hair may be clipped at the edges of the side and back and will be evenly graduated from zero length at the hairline in the lower portion of the head to the upper portion of the head. Block-style trimming of hair on the back of the head is not authorized. Hair will not be over 3 inches in length fully extended on the upper portion of the head. The back and sides of the head below the hairline may be shaved to remove body hair. Sideburns will not extend below the top of the orifice of the ear, as indicated by the line A-A' in figures 1-1 and 1-2. Sideburns will not be styled to taper or flare. The length of an individual hair of the sideburn will not exceed 1/8 inch when fully extended.

(2) Head hair will be styled so as not to interfere with the proper wear of uniform headgear. Hair, which protrudes from beneath properly worn headgear in an unsightly manner, is considered excessive, regardless of length.

(3) No male Marine will be required to have his hair clipped to the scalp except while he is undergoing recruit training or when such action is prescribed by a medical officer. This does not prohibit a male Marine from having his hair clipped to the scalp if he so desires.

(4) Members of the Selected Marine Corps Reserve will comply with these regulations, except that wigs are authorized for periods of inactive duty for training. If worn, wigs will comply with the above grooming regulations.

MARINE CORPS UNIFORM REGULATIONS

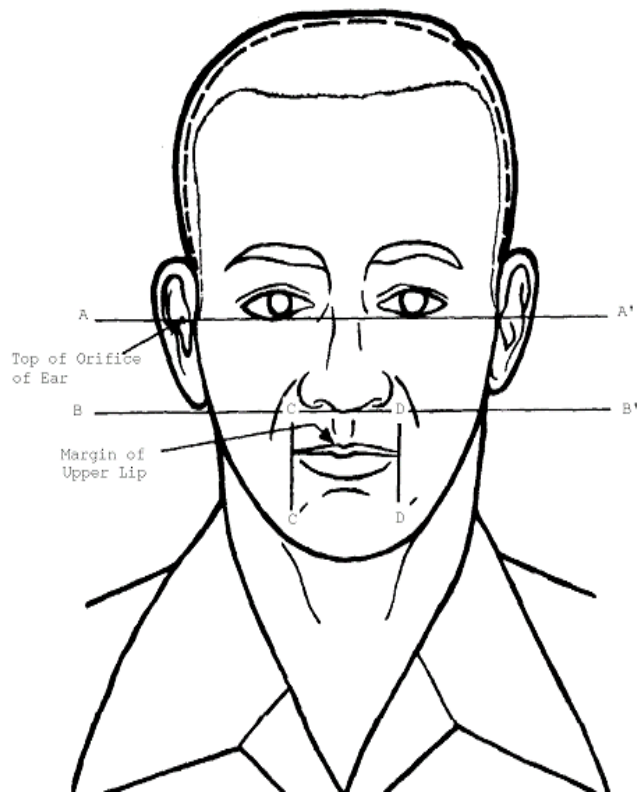

Figure 1-1.--Male Grooming Standards (Front View).

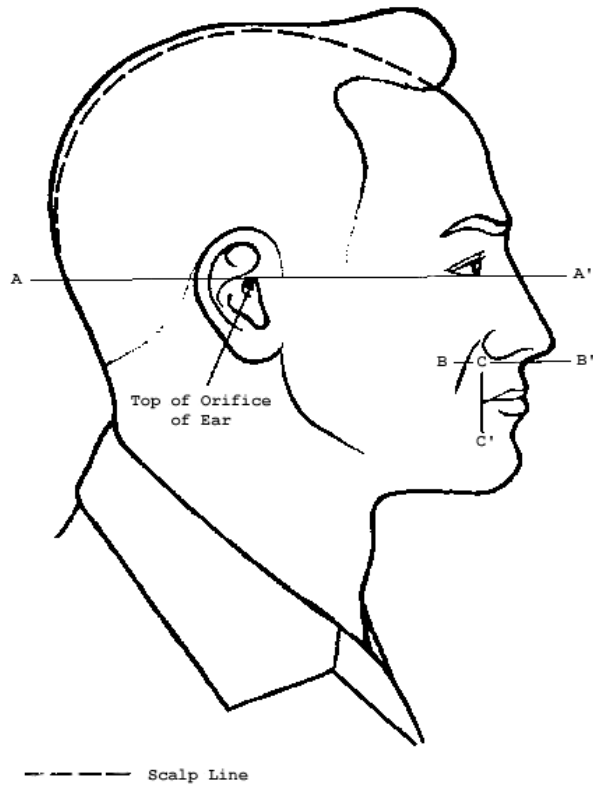

Figure 1-2.--Male Grooming Standards (Side View).

(5) The face will be clean-shaven, except that a mustache may be worn. When worn, the mustache will be neatly trimmed and must be contained within the lines of B-B', C-C', D-D' and the margin area of the upper lip, as shown in figures 1-1 and 1-2. The individual length of a mustache hair fully extended must not exceed 1/2 inch.

(6) Except for a mustache, eyebrows, and eyelashes, hair may be grown on the face only when a medical officer has determined that shaving is temporarily harmful to the individual's health. In these cases, the current edition of MCO 6310.1 applies.

(7) No male Marine will be required to have his chest hair clipped except that which is so long as to protrude in an unsightly manner above the collar of the long sleeve khaki shirt.

c. The requirement for hair regulations is to maintain uniformity within a military population. Women's hairstyles require non-eccentric styles. Female Marines will be well groomed at all times and when in uniform will abide by the following:

(1) Hair may touch the collar, but will not fall below the collar's lower edge. Hair that would fall naturally below the collar's lower edge will be neatly and inconspicuously fastened or pinned. During physical training periods in which physical training clothing is worn, hair will be allowed to fall naturally, without being fastened or pinned. This does not apply when conducting physical training in the utility uniform.

(2) Hair will be styled so as not to interfere with the proper wear of the uniform headgear. All headgear will fit snugly and comfortably around the largest part of the head without distortion or excessive gaps. Hairstyles, which do not allow the headgear to be worn in this manner, are prohibited.

(3) Faddish and exaggerated styles to include shaved portions of the scalp other than the neckline, designs cut in the hair, unsecured ponytails and styles which are distinctly unbalanced or lopsided are prohibited. Multiple braiding is authorized. If hair extensions are used in the braiding of the hair, the extensions must have the same general appearance as the individual's natural hair. Braided hairstyles will be conservative, and conform to other guidelines listed herein.

(4) Barrettes, combs, rubber bands, etc. are authorized, if concealed by the hair. Inconspicuous hair pins and bobby pins, if required, are authorized. Hair nets will not be worn unless authorized for a specific type of duty. Wigs, if worn in uniform, must look natural and conform to the above regulations.

(5) Cosmetics, if worn, will be applied conservatively and will complement the individual's complexion tone. Exaggerated or faddish cosmetic styles are inappropriate with the uniform and will not be worn. If worn, nail polish and non-eccentric in shades of red may be worn with all uniforms. Colored nail polish will not be worn with the utility uniform. Fingernails with multiple colors and decorative ornamentation are prohibited. Nail length will be no longer than 1/4 inch from the tip of the finger.

(6) No female Marine will be required to remove leg hair except where considered unsightly and cannot be covered with appropriate hosiery as described in subparagraph 3027.5.

1005. CIVILIAN ATTIRE

1. Authority

a. The CMC has extended the privilege of wearing civilian clothing to officers and enlisted Marines within the limitations of these regulations.

b. The possession and wearing of civilian clothing by Marines may be prescribed by commanders for military reasons. In prescribing civilian clothing, commanders will be guided by the current edition of MCO P10120.28 and directives of higher authority.

2. Within the United States

a. Marines are associated and identified with the Marine Corps in and out of uniform, and when on or off duty. Therefore, when civilian clothing is worn, Marines will ensure that their dress and personal appearance are conservative and commensurate with the high standards traditionally associated with the Marine Corps. No eccentricities of dress will be permitted.

b. Marines may wear civilian clothing when in an off-duty status, when directed by competent authority, and as otherwise authorized herein. Within the confines of a military base or a DoD installation, civilian clothing will be worn subject to local regulations.

c. When civilian clothing has been authorized by competent authority for wear in a duty status in lieu of a uniform, the civilian clothing will be of the same comparable degree of formality as the uniform prescribed for such duty. Standards of dress and appearance will be conservative and meet the same high standards established for personnel in uniform.

d. The wear of clothing articles not specifically designed to be normally worn as headgear (e.g. bandannas, doo rags) is prohibited.

e. No part of a prescribed uniform, except those items not exclusively military in character, will be worn with civilian clothing.

(1) Items authorized for wear with civilian clothing by men are restricted to the gold cuff links, studs, tie bar, mourning band, footwear, socks, gloves, undergarments, black bow-tie, green wool scarf, general purpose trunks, and crew neck-service sweater, the all-weather coat, tanker jacket, personally owned extreme cold weather jackets (gortex) without grade insignia, watch caps, and cold weather physical training uniforms.

(2) Uniform items authorized for wear with civilian clothing by women are restricted to the white shirt without insignia of grade, footwear, gloves, handbag, clutch purse, mourning band, crew-neck service sweaters, green wool scarf, general purpose trunks, the all-weather coat, extreme cold

weather jacket (gortex) tanker jacket or the dress blue sweater without insignia of grade, watch caps, and cold weather physical training uniforms.

(3) Uniform items that have been declared obsolete may be worn with civilian clothing, when appropriate, provided such items contain no distinctive insignia or buttons.

3. Outside the United States

a. Marines stationed outside the United States will wear the appropriate uniform when on duty unless civilian clothing is required by the laws of a foreign country, prescribed by competent authority, or necessary in performing specialized duties.

b. Personnel on leave and traveling in a foreign country should normally wear civilian clothing. When civilian clothing is worn, it will be in good taste and not in conflict with accepted attire in the country visited. The guidelines in subparagraph 1005.3c apply.

c. In Mexico, official visits will always be made in the appropriate uniform. Unofficial visits to the interior should always be made in civilian clothing. Unofficial visits to border towns may be made in either civilian clothing or the appropriate uniform.

4. Aboard Ship and Aircraft

a. Officers and enlisted Marines are permitted to possess civilian clothing when assigned duty aboard ship. Unless otherwise prescribed by competent authority, such clothing may be worn while leaving or returning to the ship, while awaiting transportation after being given permission to leave the ship, while on authorized leave of absence, liberty, or in any off-duty status ashore.

b. Officers and enlisted Marines will wear appropriate military uniform when traveling as passengers aboard MSC ships. However, all Marines traveling aboard Category B military air charters or government-owned aircraft (including AMC category M) are authorized to wear appropriate civilian attire, unless otherwise directed by the individual's orders or for unit deployment.

c. Civilian clothes will reflect in style and quality the service "C" uniform. Non-inclusive examples of appropriate civilian attire:

- (1) shirt or blouse with a collar,
- (2) trousers/slacks with a belt (if applicable), and
- (3) socks and shoes.

d. Examples of inappropriate civilian attire:

- (1) beach or swim wear,
- (2) gym or sweat gear,

- (3) tank tops,
- (4) short shorts,
- (5) ripped or torn clothing,
- (6) garments designed as underwear,
- (7) clothing with designs of an obscene or suggestive nature, and
- (8) shower shoes/flip-flops.

e. The activity issuing travel orders will refer to the current editions of the USAF Foreign Clearance Guide and MCO 4650.30, to determine whether uniform or civilian attire should be prescribed.

5. Special Assignments/Requirements

a. Marines in special billets whose offices are separate from other naval activities, and whose duties require them to associate principally with civilians, may wear civilian clothing when so stated in their orders or as otherwise authorized by the CMC.

b. Officers under instruction at civilian educational institutions and in civilian industrial establishments may wear civilian clothing for such duty.

6. White House. Civilian attire may not be worn to the White House, except as follows:

a. While attending or participating in conferences, working group sessions, etc., at the Executive Office Building when the President or his senior advisers will not be present.

b. When explicitly called for in an invitation.

c. When an assigned billet requires civilian attire be worn.

d. While visiting the White House as a tourist.

1006. UNIFORM PROCUREMENT AND MANAGEMENT SYSTEMS. There are two distinct categories of uniforms and therefore two separate systems for procurement and management.

1. Department of Defense (DoD) Supply System/Standard Issue Clothing

a. The first category is standard issue or "seabag" clothing items, which constitute minimum required uniforms, and accessories for enlisted Marines. These items are known as "system" items because they are procured and managed by the Defense Supply Center, Philadelphia (DSCP) and are available through the Marine Corps Supply System.

b. The DSCP is responsible for procuring standard uniform items for all services, except those uniform items specifically managed by CG, MARCORSYSCOM (PM, ICE). They use the "best value" concept to evaluate contractor clothing samples in order to make cost-saving multi-year buys. DSCP is responsible to the Secretary of Defense through the Commander, Defense Logistics Agency. The uniform clothing provided by the CG, MARCORSYSCOM (PM, ICE) are managed and distributed through a third party logistics provider.

c. Retail Clothing Outlets (RCOs) and Military Clothing Sales Stores (MCSSs) buy standard issue items from DSCP using normal Marine Corps Supply System procedures per MCO P4400.150. Commands can purchase authorized organizational and/or supplemental clothing using these same procedures.

d. RCOs are managed by the Marine Corps Supply System to sell standard issue uniform items to Marines at cost. MCSSs are managed by the Marine Corps exchange to sell "system" clothing at cost and to sell "non-system" or optional uniform items at cost plus a reasonable retail mark up. Base commanders pay a management fee out of their operating funds to their base MCSS to cover uniform alterations and operation and overhead costs.

e. The procurement and inspection of Marine Corps clothing are matters under the cognizance of the DSCP; therefore, the entry of defective clothing into the Marine Corps Supply System is not recognized until received at the RCO or MCSS. In this instance, commanders will ensure that clothing outlets:

(1) Inspect all uniform clothing prior to issue or sale.

(2) Submit a PQDR in accordance with the current edition of MCO 4855.10 upon receipt of defective clothing that affects the desired appearance and/or functionality. No repairs to defective items are authorized until repair/disposition instructions are received from the CG, MCLB Albany, GA because all uniform items procured are covered by various contractual warranties.

f. All system clothing and accessory items are available to Marines stationed worldwide via a mail order program managed by the NEXCOM. Submit orders by mail to Mail Order Program, 1545 Crossways Blvd., Suite 200, Uniform Support Center, Chesapeake, VA 30320. The following information is required with each order: full name, grade, social security number, sex, telephone number, shipping address, duty station, items desired, size, color, fabric, type, and quantity. Orders may be placed toll free to an operator on duty 24 hours a day, 7 days a week. The telephone number is 1-800-368-4088. Orders may also be placed on the NEXCOM website at <http://www.navy-nex.com>. System items can also be purchased online through the Marine Corps Exchange Uniform Online Store on the Marine Corps Community Services website at <http://www.usmc-mccs.org>.

g. All standard issue or "system" items can be identified as such by the by the Universal Product Code (UPC) barcode label or the national stock number (NSN) on the garment label. Labels will contain the garment's fiber content and proper care and cleaning instructions.

2. Nonsupply System/Optional Clothing. The second category of uniforms is commercial "non-system" or optional clothing items. These items are not

available through the Marine Corps Supply System and therefore must be procured from commercially available sources. Optional uniforms and accessories to include all officer uniform items are procured and managed by the Marine Corps exchange and/or commercial vendors.

a. Exchange-Operated Uniform Shops and MCSSs

(1) The Marine Corps Exchange manages the retail sale of non-supply system clothing through Uniform Shops or MCSSs in a decentralized manner. Each Uniform Shop or MCSS orders and stocks non-supply system clothing as they fit. Retail mark-up on non-supply system items is managed by CMC (MRX) to ensure reasonable and consistent pricing. Base commanders can have a significant impact on their local exchanges management priorities in determining the availability of uniform items.

(2) Items listed as approved for purchase from sources other than the Marine Corps Supply System may be procured from approved commercial vendors. All items purchased must bear the USMC approval identification to indicate that they meet Marine Corps standards (see figure 1-3). Items of hardware must have a USMC approval serial number stamped on the reverse side. The Wool Products Labeling Act and Textile Products Fiber Identification Act require that all clothing manufactured or sold in the U.S. contain a label specifically stating the fiber content of the garment. The military specification for all Marine Corps clothing garments requires this labeling and that proper care and cleaning instructions be included. It is the individual's responsibility to ensure that his or her purchases are properly labeled.

(3) Only those items approved and authorized by the CMC will be sold to personnel through the Marine Corps exchange-operated uniform shops and MCSSs.

(4) Marine Corps exchanges and MCSSs that purchase items of approved, regulation uniforms and/or accessories from a vendor will require, in addition to the approval identification, a certification on the receipt, invoice or statement that the item was manufactured according to approved Marine Corps standards and of Marine Corps approved materials.

(5) Marine Corps exchanges which purchase uniforms or accessories of inferior quality or workmanship from approved manufacturers, distributors, or tailors will immediately notify the Marine Corps Exchange, Retail Operations Branch (MRX) by letter. These reports will specifically detail the nature of the complaint and forward a sample item to the CMC (MRX) for further submission to the CG, MARCORSYSCOM (PM, ICE) for examination and evaluation according to the Quality Control Program. Ensure the following information is contained in the report: name and address of manufacturer, item and date purchased, USMC approval serial number, and detailed description of defects. Articles forwarded should be charged to the Marine Corps Exchange Fund and be accompanied by an invoice showing the description of the article, unit cost price, name of the manufacturer, and of the distributor or tailor if not purchased direct from the manufacturer. After examination and evaluation, the CG, MARCORSYSCOM (PM, ICE) will return and re-invoice the article or direct other disposition.

(6) Marines who purchase defective uniform clothing items from Marine Corps exchanges should report the purchase of defective clothing by letter to the Marine Corps exchange officer at the base where they are stationed, enclosing the defective item. Ensure that the following information is contained in the letter: name and address of the exchange from which item was purchased, description of article, price, date purchased, name of manufacturer, USMC approval serial number, and description of defect.

(7) Marines stationed at bases where there is no Marine Corps exchange in the immediate vicinity and who purchase defective clothing from the Marine Corps Exchanges should report the purchase of the defective item by letter to the CMC (MRX), enclosing the defective item. Ensure that the letter contains all of the information required by subparagraph 1006.2a(6), above.

(8) The Marine Corps exchange operates a mail order program for standard issue and commercial/optional uniform items. The CMC (MRX) publishes and distributes the "Mail Order Catalog for Commercial Uniforms." Mail order service is provided for male and female Marines by the MCCDC Quantico exchange and for male Marines by the exchanges at Marine Corps Bases, Camp Pendleton and Camp Lejeune.

(9) The Marine Corps Exchange (MRX), Quantico, VA maintains a toll-free uniform hotline, which may be accessed internationally, to facilitate the resolution of inquiries/complaints pertaining to the availability and quality of commercial uniforms and uniform items. The number for the hotline is 1-800-386-USMC (8762) or DSN 278-6332. Calls may be placed 24 hours a day, 7 days a week but will be answered by a machine outside of normal working hours and when the office staff is otherwise occupied. When leaving messages include the caller's name, duty station, toll or DSN number along with operator number if available, and time zone or best CONUS time for return calls. Calls should be confined to non-supply system uniform items, which are sold exclusively for officers wear or as optional enlisted items.

b. U.S. Commercial Vendors

(1) Marine Corps activity commanders will prohibit vendors from entering the confines of their activities for the purpose of displaying and/or selling uniform items/accessories without proper identification to indicate that specific uniform items/accessories have been approved by the CMC. All clothing items must be properly labeled to include USMC approval identification, the fiber content of the garment and proper care and cleaning instructions. Instances of nonconformance by an approved source will be reported to the CMC (MRX).

(2) Unless specifically authorized by these regulations, items purchased outside the Marine Corps Supply System and which do not bear approval identification are non-regulation, and wearing such items is prohibited. If an emergency makes it necessary to temporarily wear non-regulation clothing obtained from other sources, such clothing will be procured at the commander's direction and conform as closely as possible to items prescribed herein.

(3) Marines who purchase defective clothing items (containing the USMC approval identification) from authorized commercial vendors, other than the

Marine Corps Supply System and Marine Corps exchange system, are urged to report the purchase of defective clothing directly to the CG, MARCORSYSCOM (PM, ICE). When desirable, forward a sample defective item by registered mail. Ensure the following information is contained in the report: name and address of authorized vendor from which the item was purchased, description of the article, price, date purchased, name of manufacturer, USMC approval serial number, and description of defects. After examination and evaluation, the CG, MARCORSYSCOM (PM, ICE) will return the article via registered mail, annotated with the action taken on behalf of the individual.

c. Purchase Outside the United States

(1) Personnel ordered overseas for a normal tour of duty will possess not less than the minimum required items of uniforms and accessories, unless otherwise prescribed in the individual's orders or in the current edition of MCO P3000.1.

(2) Marines are authorized to purchase uniforms outside the United States, provided such uniforms are manufactured from materials and findings purchased from the CG, MCLB Albany (Fleet Support (586-3)). Under this authority enlisted Marines may purchase only those uniform items listed in paragraphs 9202 and 9203.

(3) Commanders will ensure uniforms purchased conform to Marine Corps specifications and these regulations. An appropriate entry will be made in the individual's service record book.

1007. MATERIALS, FINDINGS, PATTERNS AND SPECIFICATIONS

1. All uniform clothing, equipment, and accessories issued or sold by the DoD Supply System are considered regulation. Non-supply system clothing items are regulation if they contain a USMC approval identification serial number, except as otherwise authorized in these regulations. Non-supply system uniforms must have proper content labeling unless fabricated under the provisions of subparagraph 1006.2(c)(2).



GARMENT MFRD. OF
U.S.M.C. APPROVED
MATERIALS FOR
STYLE, DESIGN &
QUALITY TO LIKE
ITEM APPROVED BY
U.S.M.C.
SERIAL _____

Figure 1-3.--USMC Approval Identification.

2. Figure 1-3 is a sample of the USMC approval identification label that all commercial or non-supply system items must have. The serial number is issued by the MARCORSYSCOM (ICE) to the manufacturer, fabricator or wholesale supplier after an item has been reviewed and approved per the latest edition of MCO 10120.56. The serial number will be unique to the manufacturer/wholesaler and uniform item or material fabricated. Retail

outlets will not normally be issued approval numbers unless they fabricate a uniform item on their own.

3. The term "cloth of adopted standard" refers to the standard sealed samples of fabrics in the custody of the CG, MARCORSYSCOM (PM, ICE). All fabric used in standard issue and optional uniform clothing must be approved by the CMC. DSCP manages the supply support of all issue fabrics. Optional fabric samples submitted to CG, MARCORSYSCOM (PM, ICE) MARCORSYSCOM (ICE) by textile mills and/or distributors must be certified by an independent textile testing agency.

4. The CG, MARCORSYSCOM (PM, ICE) has been delegated the responsibility for the preparation and maintenance of detailed specifications and drawings for all articles of uniform, insignia, and accessories prescribed for wear by Marines. Standard samples of uniforms, fabrics, insignia, and accessories, as approved by the CMC, will be held by the CG, MCLB Albany. Articles procured, manufactured, or issued will conform in every respect to the standard samples, and no change will be permitted without CMC approval.

5. Marine Corps Exchanges and individuals authorized to purchase uniforms from sources other than the DoD Supply System may procure materials and findings upon direct application to the CG, MARCORSYSCOM (PM, ICE). Patterns and specifications may be obtained without cost upon request.

6. Sale of Marine Corps uniform materials for the manufacture of uniforms for enlisted personnel is not authorized, except when enlisted personnel are authorized to wear officer-type uniforms and then therefore are also authorized to procure officer uniform materials, findings, patterns, and specifications.

1008. ALTERATIONS

1. Alterations to uniform clothing to improve fit are authorized; however, such alterations will not change the intended appearance or function of the garment as designed. Wearing improperly altered uniform clothing is prohibited.

2. Alterations to uniform clothing of enlisted personnel will be made at Government expense when authorized by organization supply officers according to instructions in the current edition of TM-10120-15/1, Technical Manual for Uniform Fitting and Alteration.

3. Care should be taken when contracting alteration services from a commercial vendor so that unauthorized or unneeded alteration procedures are not included in the contract. Uniforms are designed so as to minimize alteration costs. Alteration contracts can be reviewed periodically by contacting the CG, MARCORSYSCOM (PM, ICE). Reports of an excessive number of fitting sessions are an indication that there may be problems with the alteration process.

4. Commanders will ensure that all alterations, either at Government expense or at the individual's expense, conform to the spirit and intent of these regulations. Every effort will be made to ensure that proper tailoring facilities are available to all personnel of the command. Personnel will be

advised that alterations performed at other than designated military tailoring establishments will be the individual's responsibility and will conform strictly with these regulations and the current edition of TM-10120-15/1.

MARINE CORPS UNIFORM REGULATIONS

CHAPTER 2

DESIGNATED UNIFORMS AND OCCASIONS FOR WEAR

	<u>PARAGRAPH</u>	<u>PAGE</u>
DESIGNATION OF UNIFORMS	2000	2-5
EVENING DRESS UNIFORMS	2001	2-5
BLUE DRESS UNIFORMS	2002	2-6
BLUE-WHITE DRESS UNIFORMS	2003	2-7
SERVICE UNIFORMS	2004	2-8
UTILITY UNIFORMS	2005	2-9
PHYSICAL TRAINING UNIFORMS	2006	2-11
MATERNITY UNIFORMS	2007	2-11
TYPES AND COMPONENTS OF AUTHORIZED UNIFORMS	2008	2-11

FIGURE

2-1	EVENING DRESS "A" WITH BOATCLOAK (FIELD OFFICER) (MALE)	2-12
2-2	EVENING DRESS "A" (FIELD OFFICER) (FEMALE)	2-12
2-3	EVENING DRESS "B" (GENERAL OFFICER) (MALE)	2-13
2-4	EVENING DRESS "B" (COMPANY OFFICER) (MALE)	2-13
2-5	EVENING DRESS (SNCO) (MALE)	2-14
2-6	EVENING DRESS (SNCO) (FEMALE)	2-14
2-7	BLUE DRESS "A" (FIELD OFFICER) (MALE)	2-15
2-8	BLUE DRESS "A" (FIELD OFFICER) (FEMALE)	2-15
2-9	BLUE DRESS "A" (SNCO) (MALE)	2-16
2-10	BLUE DRESS "B" (COMPANY OFFICER) (MALE)	2-16
2-11	BLUE DRESS "B" (NCO) (FEMALE)	2-17

	FIGURE	<u>PAGE</u>
2-12	BLUE DRESS "B" (ENLISTED) (MALE)	2-17
2-13	BLUE DRESS "C" (COMPANY OFFICER) (FEMALE)	2-18
2-14	BLUE DRESS "C" (NCO) (MALE)	2-18
2-15	BLUE DRESS "D" (COMPANY OFFICER) (MALE)	2-19
2-16	BLUE DRESS "D" (NCO) (FEMALE)	2-19
2-17	BLUE-WHITE DRESS "A" (COMPANY OFFICER) (MALE) ...	2-20
2-18	BLUE-WHITE DRESS "A" (ENLISTED) (MALE)	2-20
2-19	SERVICE "A" (COMPANY OFFICER) (FEMALE)	2-21
2-20	SERVICE "A" (NCO) (MALE)	2-21
2-21	SERVICE UNIFORM WITH SERVICE SWEATER (NCO) (FEMALE)	2-22
2-22	SERVICE UNIFORM WITH SERVICE SWEATER (COMPANY OFFICER) (MALE)	2-22
2-23	SERVICE "B" (NCO) (FEMALE)	2-23
2-24	SERVICE "B" (NCO) (MALE)	2-23
2-25	SERVICE "C" (FIELD OFFICER) (FEMALE)	2-24
2-26	SERVICE "C" (SNCO) (MALE)	2-24
2-27	SERVICE UNIFORM WITH ALL-WEATHER COAT (COMPANY OFFICER) (MALE)	2-25
2-28	SERVICE UNIFORM WITH ALL-WEATHER COAT (NCO) (FEMALE)	2-25
2-29	MATERNITY SERVICE UNIFORM (NCO)	2-26
2-30	MATERNITY SERVICE UNIFORM (COMPANY OFFICER)	2-26
2-31	CAMOUFLAGE UTILITY UNIFORM WITH SERVICE SWEATER (ENLISTED) (FEMALE)	2-27
2-32	WOODLAND COMBAT UTILITY UNIFORM WITH SERVICE SWEATER (SNCO) (FEMALE)	2-27
2-33	DESERT UTILITY UNIFORM (FIELD OFFICER) (MALE) ..	2-28
2-34	WOODLAND COMBAT UTILITY UNIFORM WITH FIELD EQUIPMENT (MALE)	2-29

TABLE		
2-1	UNIFORM EXPLANATION CHART	2-29
2-2	TYPES AND COMPONENTS OF AUTHORIZED UNIFORMS FOR MALE OFFICERS	2-30
2-3	TYPES AND COMPONENTS OF AUTHORIZED UNIFORMS FOR FEMALE OFFICERS	2-31
2-4	TYPES AND COMPONENTS OF AUTHORIZED UNIFORMS FOR ENLISTED MALE	2-32
2-5	TYPES AND COMPONENTS OF AUTHORIZED UNIFORMS FOR ENLISTED FEMALE	2-33

CHAPTER 2

DESIGNATED UNIFORMS AND OCCASIONS FOR WEAR

2000. DESIGNATION OF UNIFORMS

1. Designated uniforms will be worn only as authorized by this chapter. Commanders may prescribe as the uniform of the day only those uniforms listed in male and female minimum requirements lists, as provided by annual edition of MCBUL 10120 for enlisted and chapter 9 of this manual for officers. Commanders authorized supplementary allowances per MCBUL 10120 may prescribe uniforms provided by the allowance.
2. Authorized uniforms for Marine officers are designated as evening dress, blue dress, blue-white dress, service, and utility uniforms.
3. Authorized uniforms for enlisted Marines are designated as blue dress, service, and utility. The evening dress and blue-white dress uniforms are authorized for wear by staff noncommissioned officers (SNCOs).
4. The blue dress and blue-white dress uniforms, except blue dress "A" and blue-white dress "A", and service uniforms may be prescribed for leave and liberty within the United States.

2001. EVENING DRESS UNIFORMS (See figs. 2-1 through 2-6.)

1. The officers' evening dress "A" uniform will be prescribed for official formal evening functions at which civilians would normally wear evening clothes or "white tie" during both winter and summer. The evening dress "A" uniform with white waistcoat for male officers and long skirt for female officers is appropriate for the following "white tie" occasions:
 - a. State occasions at the White House, or at foreign Embassies/Legations.
 - b. Inaugural receptions and dinners.
 - c. Formal dinners.
2. The officers' evening dress "B" uniform with scarlet waistcoat (general officers only) or scarlet cummerbund (all other officers) will be prescribed for official social functions at which civilians would normally wear dinner dress or "black tie" during both winter and summer. Females may wear the long or short skirt, depending on the degree of formality of the function. The evening dress "B" uniform is appropriate for the following "black tie" occasions:
 - a. Club affairs.
 - b. Dinner parties.
 - c. Dinner dances.

d. Evening celebrations in honor of the Marine Corps Birthday.

3. Officers not required and who do not possess evening dress who attend functions at which evening dress is prescribed will wear the blue dress "A" or blue-white dress "A" uniform as appropriate for the occasion/season.

4. SNCOs may optionally wear the SNCO evening dress uniform in lieu of the blue dress uniform for social functions at which civilians would normally wear white or black tie during winter and summer.

2002. BLUE DRESS UNIFORMS (See figs. 2-7 through 2-16.)

1. The blue dress "A" uniform may be worn for parades, ceremonies and formal or semiformal social functions, for NCOs and below throughout the year and for officers and SNCOs as appropriate to the season or those occasions requiring uniformity with NCOs and below. The blue dress "A" uniform will be is worn for the following official military/social occasions:

a. Parades, ceremonies, reviews, solemnities, and entertainments when the commander/senior officer present desires to pay special honors to the occasion.

b. Official visits of, or to, United States civil officials, officers of the United States Armed Forces, and officials/officers of foreign governments, according to chapter 12, U.S. Navy Regulations.

c. Receptions given by, or in honor of, officials/officers listed in chapter 12, U.S. Navy Regulations.

d. At daytime formal or semiformal occasions.

2. The dress "B" uniforms consist of the same items as the corresponding dress "A" uniforms, except that ribbons are worn in lieu of medals. Shooting badges may be prescribed. The blue dress "B" uniform may be worn for parades, ceremonies, informal social functions, for NCOs and below throughout the year and for officers and SNCOs as appropriate to the season or those occasions requiring uniformity with NCOs and below; and as the uniform of the day for those commands that receive the appropriate clothing allowance. The blue dress "A" uniform will be is worn for the following official military/social occasions:

a. Official visits of, or to, United States civil officials, officers of the United States Armed Forces, and officials/officers of foreign governments, according to chapter 12, U.S. Navy Regulations.

b. At informal daytime receptions to which a Marine is invited in an official capacity.

3. Blue dress uniforms are designated as follows:

a. The blue dress "A" uniform includes the blue dress coat with large medals. This uniform will not be worn for leave or liberty.

b. The blue dress "B" uniform consists of the same items as blue dress "A" except that ribbons are worn in lieu of medals.

c. The blue dress uniform with long sleeve khaki shirt (without coat), and tie for male Marines and tab for female Marines, is designated as blue dress "C." Commanders may prescribe blue dress "C" as the uniform of the day for specified occasions or duties. Commanders may prescribe this uniform for honors, parades, and ceremonies on and off the military activity. This uniform is authorized for leave and liberty. The blue dress sweater may be worn as part of the blue dress "C" uniform at the option of the individual except on those occasions when the wear of the blue coat would be more appropriate. The sweater may be worn as part of the duty uniform both on and off the military installation and for commuting to and from work. The sweater may be worn as the uniform of the day and on leave and liberty but will not be worn for inspections, ceremonial formations, or parades.

d. The blue dress uniform with short sleeve khaki shirt (without coat) is designated as blue dress "D." Commanders may prescribe blue dress "D" as the uniform of the day for specified occasions or duties. During the winter uniform period, commanders may, at their discretion when the weather requires, authorize blue dress "D" as the uniform of the day. Commanders may prescribe this uniform for honors, parades, and ceremonies where climatic conditions preclude the comfortable wear of the blue dress "A" or "B" uniforms. This uniform is authorized for leave or liberty.

4. Female Marines may wear slacks as part of the blue dress uniforms per paragraph 3026.

5. Individuals may wear either the all-season polyester/wool gabardine uniform or the all-wool blue uniforms on a year-round basis on all occasions for which the blue dress uniforms are prescribed or authorized.

6. Male field grade officers and below may continue to wear blue coats with blue trousers of different fabrics; however, the future purchase/sale of blue dress uniforms with coats and trousers of different fabrics is prohibited. For female Marines, the coat and skirt must be of the same material; however, if the coat is worn with slacks, the coat and slacks may be of different materials.

2003. BLUE-WHITE DRESS UNIFORMS (See figs. 2-17 and 2-18.)

1. The blue-white dress uniform is worn by officers and SNCOs during the summer season and for the same types of official military/social occasions for which the equivalent blue dress uniform is prescribed. Sergeants and below may wear the blue-white dress uniform for official military and social occasions if provided by the command, but not on leave or liberty. Officers and SNCOs will not wear the blue-white dress uniform with enlisted Marines not provided the blue-white dress uniform during performance of military ceremonies that require uniformity. On such occasions, officers and SNCOs will wear the uniform prescribed for enlisted personnel.

2. The blue-white dress "A" uniform consists of the same items as the blue dress "A" except the trousers/skirt/slacks will be white. This uniform may only be prescribed for official command ceremonies, formal/semiformal social

occasions, and may be worn on leave or liberty. Female officers and SNCOs will wear the following according to whether white slacks or white trousers are worn:

a. With White Slacks.

(1) Black, pumps, black oxfords or black dress flats per guidance at paragraph 3010.4.

(2) Either dark hose or black socks.

(3) Gold or pearl earrings (optional).

(4) White shirt with black necktab.

b. With White Skirt.

(1) Black, pumps, black oxfords or black dress flats per guidance at paragraph 3010.4.

(2) Skin-tone nylon hose.

(3) Gold or pearl earrings (optional).

(4) White shirt with red necktab for officers or black necktab for SNCOs.

c. Only those female officers in assignments requiring the wear of blue slacks will be required to possess white slacks. Trousers, skirts, and slacks for enlisted Marines or white slacks for female officers and SNCOs will be procured from commercial sources utilizing specifications, patterns, and materials obtained from CG, MARCORSSYSCOM (PM,ICE), per paragraph 1007.

3. The blue-white dress "B" uniform consists of the same items as the blue-white dress "A" uniform, except that ribbons are worn in lieu of medals (shooting badges may be prescribed). This uniform will be worn by officers and SNCOs for the occasions as the blue dress "B" uniform. This uniform can be worn on leave and liberty.

2004. SERVICE UNIFORMS (See figs. 2-19 through 2-28.)

1. The service "A" uniform may be prescribed for parades, ceremonies, social events, and as the uniform of the day. It will normally be worn when reporting for duty, unless otherwise prescribed by the commander. The service "A" uniform will be prescribed for the following official military occasions:

a. When assigned as a member of courts-martial or courts of inquiry.

b. Official visits and calls of, or to, United States civil officials, officers of the United States Armed Forces, and officials/officers of foreign governments per chapter 12, U.S. Navy Regulations.

c. When visiting the White House and the temporary White Houses at all times, except in a tourist capacity or when an individual is specifically invited either on a social or official occasion for which another uniform is indicated on the invitation.

2. Service uniforms are designated as follows:

a. The service "A" uniform includes the service coat. When the service "A" uniform is prescribed as the uniform of the day, it is appropriate to remove the coat in office buildings within the confines of a military activity or establishment. Females may wear either the long or short sleeve khaki shirt and green neck tab with this uniform. The service "A" uniform is authorized for leave and liberty.

b. The service "B" uniform is the same as the service "A" uniform except that the service coat is not worn. This uniform may be worn as the uniform of the day and for leave and liberty, unless otherwise prescribed by the commander, and may be prescribed for formations at parades or ceremonies on and off the military activity. This uniform will not be worn for formal or semi-formal social events.

c. The short-sleeve khaki shirt with appropriate service trousers or skirt/slacks is designated as the service "C" uniform. During the winter season, commanders may, at their discretion when the weather requires, authorize the service "C" uniform. This uniform may be worn as a uniform of the day and for leave or liberty, unless otherwise prescribed by the commander, and may be prescribed for formations at parades or ceremonies on and off the military activity. This uniform will not be worn for formal or semiformal social events.

3. The service sweater may be worn at the individual's option as a component of the service "B"/"C" uniforms when worn as the uniform of the day, unless the commander determines that the service "A" uniform is more appropriate. Commanders may prescribe the service uniform with sweater for inspections; however, this uniform will not be worn for ceremonial formations or parades on or off the military installation. The service uniform with sweater may be worn on leave or liberty. Service sweaters with or without epaulettes may be worn per paragraph 30XX.

4. Individuals may wear either the all-season polyester/wool gabardine service uniform or the phase-out summer weight service uniform on a year-round basis for all formations, inspections, and for duty, leave, or liberty. Individuals electing to wear the phase-out summer weight uniform will replace it with the all-season gabardine service uniform when it becomes unserviceable. Individuals may wear the phase-out winter weight service uniform on leave, liberty, and for duty when uniformity is not required.

2005. UTILITY UNIFORMS (See figs. 2-32 through 2-34.)

1. Commanders may prescribe the utility uniform as the uniform of the day, in accordance with the below guidance. The uniform is authorized for parades, reviews or other ceremonies, and informal social functions. The utility coat may be removed only for physical training and work details.

2. The utility uniform is a working uniform. Wear of the utility uniform is authorized while commuting to and from work to include all travel aboard DOD-owned/controlled aircraft. The utility uniform may also be worn for brief and appropriate stops off-base during duty hours or while commuting. In addition to emergency/maintenance stops, Marines are allowed to make brief, essential stops off-base during duty hours and while commuting to and from their place of duty, such as:

- a. when dropping off/picking up children from daycare centers or school;
- b. obtaining gas or other essential driving aids (wiper blades, snow chains, fluids, lights, etc.);
- c. picking up/dropping off dry-cleaning;
- d. off-base financial institutions; to include automatic teller machines; (ALMAR 107/96)
- e. picking up vehicles at repair shops or gas stations;
- f. at drive-thru windows where exiting the vehicle is not required; and,
- g. at a convenience store or drug store solely for the purchase of emergency childcare or health products (milk, diapers, medicine, etc.).

3. Marines are prohibited from wearing the utility uniform as a liberty uniform off-base or during inappropriate circumstances such as:

- a. at restaurants, pizza parlors, bars, lounges, etc.;
- b. when dealing with public officials (police, courthouse, attorneys);
- c. while attending classes or activities, or conducting business at education facilities;
- d. at commercial airports/bus stations for travel or entering pick/drop off passengers;
- e. at retail/rental stores, shopping malls, and shops for shopping or paying bills;
- f. at grocery stores/supermarkets;
- g. at movie theaters, mini-golf, or other similar entertainment/recreational or sporting activities.

4. Regulations for wearing combat utility uniforms are detailed in paragraph 3038. Commanders will, as much as practicable, exercise a balanced rotation of wear between desert and woodland combat utility uniforms.

5. Regulations for wearing utility uniforms are detailed in paragraph 3037.

6. Commanders will prescribe utility uniforms according to the following:

- a. Woodland combat utility uniforms may be prescribed after 1 October 03.
- b. Desert combat utility uniforms may be prescribed after 1 October 04.
- c. Camouflage utility uniforms may be prescribed for Marines that received the uniforms as initial issue until 1 Oct 06, on which date it will be considered obsolete.

2006. PHYSICAL TRAINING UNIFORMS

1. The standard physical training (PT) uniform consists of the green general purpose trunks and the standard olive green undershirt. Footwear or headgear with PT uniforms will be as prescribed by the commander.
2. The cold weather PT uniform consists of an olive green sweat shirt and olive green sweat pants, with "USMC" lettering and Marine Corps emblem on the left breast of the shirt and upper left leg of the pants per paragraph 3030. This uniform may be prescribed for unit physical training when the weather requires.
3. The standard or cold weather PT uniform will be prescribed for all command PT activities except on those specific occasions when the commander determines that the wear of shirts with unit distinct markings, or when the modified wear of another uniform or other clothing is more appropriate to the respective unit's physical training objective.

2007. MATERNITY UNIFORMS (See figs. 2-30 and 2-31). The appropriate maternity uniform will be worn as the uniform of the day by pregnant females per paragraph 3016.

2008. TYPES AND COMPONENTS OF AUTHORIZED UNIFORMS. Table 2-1 summarizes the currently authorized uniform combinations and appropriate occasions for the wear of each uniform. This table is designed and intended for local reproduction, posting and distribution as desired by local commanders. See tables 2-2 through 2-5 for more detailed information on the types and components of authorized uniforms. In using these tables, it is important to note that wherever a uniform choice or option is indicated, reference paragraphs should be referred to for complete regulations.

MARINE CORPS UNIFORM REGULATIONS



Figure 2-1.--Evening Dress "A"
With Boatcloak
(Field Officer) (Male).



Figure 2-2.--Evening Dress "A"
(Field Officer) (Female).

MARINE CORPS UNIFORM REGULATIONS



Figure 2-3.--Evening Dress "B"
(General Officer) (Male).



Figure 2-4.--Evening Dress "B"
(Company Officer) (Male).

MARINE CORPS UNIFORM REGULATIONS



Figure 2-5.--Evening Dress
(SNCO) (Male).



Figure 2-6.--Evening Dress
(SNCO) (Female).

MARINE CORPS UNIFORM REGULATIONS



Figure 2-7.--Blue Dress "A"
(Field Officer) (Male).



Figure 2-8.--Blue Dress "B"
(Field Officer) (Female).

MARINE CORPS UNIFORM REGULATIONS



Figure 2-9.--Blue Dress "A"
(SNCO) (Male).



Figure 2-10.--Blue Dress "B"
(Company Officer) (Male).

MARINE CORPS UNIFORM REGULATIONS



Figure 2-11.—Blue Dress "B"
(NCO) (Female).



Figure 2-12.—Blue Dress "B"
(Enlisted) (Male).

MARINE CORPS UNIFORM REGULATIONS



Figure 2-13.--Blue Dress "C"
(Company Officer) (Female).



Figure 2-14.--Blue Dress "C"
(NCO) (Male).

MARINE CORPS UNIFORM REGULATIONS



Figure 2-15.--Blue Dress "D"
(Company Officer) (Male).



Figure 2-16.--Blue Dress "D"
(NCO) (Female).

MARINE CORPS UNIFORM REGULATIONS



Figure 2-17.--Blue-White Dress "A"
(Company Officer) (Male).



Figure 2-18.--Blue-White Dress "A"
(Enlisted) (Male).

MARINE CORPS UNIFORM REGULATIONS



Figure 2-19.--Service "A"
(Company Officer) (Female).



Figure 2-20.--Service "A"
(NCO) (Male).

MARINE CORPS UNIFORM REGULATIONS



Figure 2-21.--Service Uniform
with Service Sweater
(NCO) (Female).



Figure 2-22.--Service Uniform
with Service Sweater
(Company Officer) (Male).

MARINE CORPS UNIFORM REGULATIONS



Figure 2-23.--Service "B"
(NCO) (Female).



Figure 2-24.--Service "B"
(NCO) (Male).

MARINE CORPS UNIFORM REGULATIONS



Figure 2-25.--Service "C"
(Field Officer) (Female).

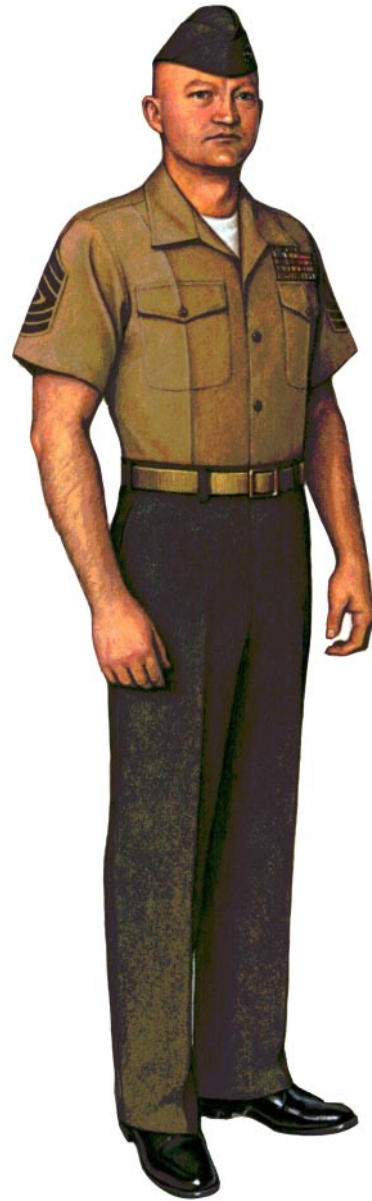

Figure 2-26.--Service "C"
(SNCO) (Male).

MARINE CORPS UNIFORM REGULATIONS



Figure 2-27.--Service Uniform
With All Weather Coat
(Company Officer) (Male).



Figure 2-28.--Service Uniform
with All-Weather Coat
(NCO) (Female).

MARINE CORPS UNIFORM REGULATIONS



Figure 2-29.--Maternity Service Uniform
(NCO) (Female).



Figure 2-30.--Maternity
Service Uniform
(Company Officer) (Female).

MARINE CORPS UNIFORM REGULATIONS



Figure 2-31.--Camouflage Utility Uniform with Service Sweater (Enlisted) (Female).



Figure 2-32.--Woodland Combat Utility Uniform with Service Sweater (SNCO) (Female).

MARINE CORPS UNIFORM REGULATIONS



Figure 2-33.--Desert Utility Uniform (Field Officer) (Male).



Figure 2-34.--Woodland Combat Utility Uniform with Field Equipment (Male).

Table 2-1. Uniform Explanation Chart

<u>UNIFORM COMBINATION</u>	<u>DESCRIPTION</u>	<u>OCCASIONS FOR WEAR</u>	<u>LEAVE/ LIBERTY</u>
Evening Dress ("A"/"B")	Dark blue w/black or dark blue trousers/skirt	Year-round for white tie/black tie social functions	No
Blue Dress "A" or "B"	Blue coat and blue trousers/skirt/slacks w/medals ("A") or ribbons ("B")	Parades, ceremonies, formal or semiformal social functions (winter season only unless uniformity required)	"A" No "B" Yes
Blue-White Dress "A" or "B"	Blue coat and white trousers/skirt/slacks w/medals ("A") or ribbons ("B")	Parades, ceremonies, formal or semiformal social functions (summer season only)	"A" No "B" Yes
Blue Dress "C"	Khaki long-sleeve shirt and tie w/blue trousers/skirt/slacks	Parades, ceremonies, and uniform of the day	Yes
Blue Dress "C" with Blue Sweater	Blue sweater and khaki long-sleeve shirt and tie w/blue trousers/skirt/slacks	Uniform of the day	Yes
Blue Dress "D"	Khaki short-sleeve shirt w/blue trousers/skirt/slacks	Parades, ceremonies, and uniform of the day	Yes
Service "A"	Green coat and trousers/skirt/slacks w/ribbons (badges optional)	Parades, ceremonies, social events and uniform of the day	Yes
Service "B"	Khaki long-sleeve shirt w/green trousers/skirt/slacks (badges optional)	Parades, ceremonies, and uniform of the day	Yes
Service "C"	Khaki short-sleeve shirt w/green trousers/skirt/slacks (badges optional)	Parades, ceremonies, and uniform of the day	Yes
Service with Sweater	Green sweater and khaki long-sleeve or short-sleeve shirt w/green trousers/skirt/slacks	Uniform of the Day	Yes
Utility Uniform	Camouflage coat and trousers (sweater or sweatshirt may be worn underneath)	Working uniform only	No

Accessory/Optional Uniform Items: All-Weather Coat (AWC) may be worn/prescribed for wear with all uniforms. Occasions for wear and liberty are the same as for the basic uniform with which it is worn. Black gloves always worn or carried with the AWC in winter. The tanker jacket may be worn with the blue dress "C"/"D," service "B"/"C," or blue dress and service with sweater. When worn, occasions for wear and leave/liberty are the same as for the basic uniform with which it is worn. The jacket will be worn zipped up to at least the top of the side slash pockets. Green wool scarf and black gloves may be worn with service or utility uniforms during the winter uniform period. The AWC and tanker jacket may be worn, without insignia, with civilian clothing.

Organizational Equipment: Field jackets may be issued/prescribed for wear with utilities. Unless otherwise prescribed, the ECWCS parka may be worn with utilities at the individual's option, or as designated when issued for wear. Sam Browne belts may be issued/prescribed to officers only for wear with blue dress "A"/"B," blue-white "A"/"B," and service "A." Service Belts may be issued/prescribed for wear with the service "B"/"C," blue dress "D" and AWC for officers and with the service uniforms and AWC for SNCO's and NCO's. Both belts are worn only for parades, ceremonies and reviews when the sword is prescribed, or at such times as are deemed appropriate by the local commander.

TABLE 2-2.--Types and Components of Authorized Uniforms for Male Officers.

FIG. NO.	DESIGNATION	REF PARA	CAP	COAT OR JACKET	SHIRT	NECKTIE	TROUSER/ BELT	GLOVES	FOOTWEAR	OUTER COAT (a)	INSIGNIA BOFS	MEDALS/RIBBONS	BADGES	SWORD
			3005	3001/3006/3016	3026	3020/3021	3034/3002	3013	3012	3001/3003 / 3015	4101	SECT 2/3, CHAP 5	SECT 5, CHAP 5	3032
2-1	EVENING DRESS "A"	2001	DRESS	EVENING W/STRIP COLLAR & WHITE WAISTCOAT	WHITE W/PIQUE PLACKET	NONE	EVENING (SUSPENDERS OPTIONAL)	WHITE (b)	BLACK SHOES & SOCKS	AWC/ OPTIONAL BOATCLOAK	DRESS COLLAR/ CAP	MINIATURE MEDALS	NOT WORN	NOT WORN
2-3 2-4	EVENING DRESS "B"	2001	DRESS	EVENING W/STRIP COLLAR & SCARLET WAISTCOAT OR CUMMERBUND (c)	WHITE W/PIQUE PLACKET	NONE	EVENING (SUSPENDERS OPTIONAL)	WHITE (b)	BLACK SHOES & SOCKS	AWC/ OPTIONAL BOATCLOAK	DRESS COLLAR/ CAP	MINIATURE MEDALS	NOT WORN	NOT WORN
2-7	BLUE DRESS "A"	2002	DRESS	BLUE W/STRIP COLLAR	WHITE PLAIN FRONT	NONE	SKY BLUE (d) W/WEB BELT OR SUSPENDERS	WHITE (b)	BLACK SHOES & SOCKS	AWC/ OPTIONAL BOATCLOAK	DRESS COLLAR/ CAP	LARGE MEDALS (RIBBONS WORN PER PARA. 5205.3)	NOT WORN	(a)
2-17	BLUE-WHITE DRESS "A"	2003	DRESS	BLUE W/STRIP COLLAR	WHITE PLAIN FRONT	NONE	WHITE W/WEB BELT OR SUSPENDERS	WHITE	BLACK SHOES & SOCKS	AWC/ OPTIONAL BOATCLOAK	DRESS COLLAR/ CAP	LARGE MEDALS (RIBBONS WORN PER PARA. (5205.3)	NOT WORN	(a)
2-10	BLUE DRESS "B"	2002	DRESS	BLUE W/STRIP COLLAR	WHITE PLAIN FRONT	NONE	SKY BLUE (d) W/WEB BELT OR SUSPENDERS	WHITE (b)	BLACK SHOES & SOCKS	AWC/ OPTIONAL BOATCLOAK	DRESS COLLAR/ CAP	RIBBONS	OPTIONAL (a)	(a)
	BLUE WHITE DRESS "B"	2003	DRESS	BLUE W/STRIP COLLAR	WHITE PLAIN FRONT	NONE	WHITE W/WEB BELT OR SUSPENDERS	WHITE (b)	BLACK SHOES & SOCKS	AWC/ OPTIONAL BOATCLOAK	DRESS COLLAR/ CAP	RIBBONS	OPTIONAL (a)	(a)
	BLUE DRESS "C"	2002	DRESS	BLUE SWEATER (OPTIONAL)	KHAKI LONG SLEEVE	KHAKI W/ CLASP	SKY BLUE (d) W/WEB BELT	(b)	BLACK SHOES & SOCKS	AWC OR TANKER JACKET	DRESS CAP	RIBBONS OPTIONAL (a)	OPTIONAL (a)	(a)
2-15	BLUE DRESS "D"	2002	DRESS	BLUE SWEATER (OPTIONAL)	KHAKI SHORT SLEET	NONE	SKY BLUE (d) W/WEB BELT	(b)	BLACK SHOES & SOCKS	AWC OR TANKER JACKET	DRESS CAP	RIBBONS OPTIONAL (a)	OPTIONAL (a)	(a)
2-22	SERVICE "A"	2004	GARRISON/ FRAME	GREEN	KHAKI LONG SLEEVE	KHAKI W/ CLASP	GREEN W/WEB BELT	(b)	BLACK SHOES & SOCKS	AWC (e)	SERVICE COLLAR/ CAP	RIBBONS	OPTIONAL (a)	(a)
	SERVICE "B"	2004	GARRISON/ FRAME	GREEN SWEATER (OPTIONAL)	KHAKI LONG SLEEVE	KHAKI W/ CLASP	GREEN W/WEB BELT	(b)	BLACK SHOES & SOCKS	AWC OR TANKER JACKET (e)	CAP	RIBBONS OPTIONAL (a)	OPTIONAL (a)	(a)
	SERVICE "C"	2004	GARRISON/ FRAME	GREEN SWEATER (OPTIONAL)	KHAKI SHORT SLEEVE	NONE	GREEN W/WEB BELT	(b)	BLACK SHOES & SOCKS	AWC OR TANKER JACKET (e)	CAP	RIBBONS OPTIONAL (a)	OPTIONAL (a)	(a)
2-33	UTILITY UNIFORM	2005	UTILITY	UTILITY	GREEN UNDERSHIRT OPTIONAL	NONE	WEB BELT OR MARTIAL ARTS UTILITY BELT	(b,d)	COMBAT BOOTS/ SOCKS	AWC (e) OR ECWCS	EMBLEM DECAL/ NAME & SERVICE TAPES	NOT WORN	NOT WORN	NOT WORN

a. If required or prescribed.

b. Black gloves always worn or carried with all-weather coat during winter uniform months. Optional when coat not worn.

c. Scarlet waistcoat for general officers only. Scarlet cummerbund for all other officers.

d. Dark blue trousers for general officers.

e. Green scarf optional for wear with all-weather Coat/tanker jacket during winter months.

Table 2-3.--Types and Components of Authorized Uniforms for Female Officers.

FIG. NO.	DESIGNATION	REF PARA	CAP	COAT OR JACKET	SHIRT	NECKTAB	SKIRT/ SLACKS	HANDBAG/ PURSE	GLOVES	FOOT WEAR	OUTER COAT (a)	INSIGNIA BOS	MEDALS/ RIBBONS	BADGES	SWORD
			3005	3001/3006/ 3016	3026	3020	3027/3028	3014	3013	3012	3001/3003 /3005	4101	SEC 2/3, CHAP 5	SECT 5, CHAP 5	3032
2-2	EVENING DRESS "A"	2001	DRESS	EVENING W/ CUMMERBUND (e)	WHITE PLEATED FRONT	BLACK	LONG BLACK SKIRT	BLACK PURSE	WHITE (b)	BLACK PUMPS (CLOTH/ SUEDE)	AWC/ OPTIONAL CAPE	DRESS COLLAR/ CAP	MINIATURE MEDALS	NOT WORN	NOT WORN
	EVENING DRESS "B"	2001	DRESS	EVENING W/ CUMMERBUND (e)	WHITE PLEATEDFR ONT	BLACK	LONG/ SHORT BLACK SKIRT	BLACK PURSE	WHITE (b)	BLACK PUMPS (CLOTH/ SUEDE)	AWC/ OPTIONAL CAPE	DRESS COLLAR/ CAP	MINIATURE MEDALS	NOT WORN	NOT WORN
2-8	BLUE DRESS "A"	2002	DRESS	BLUE	WHITE PLAIN FRONT	SCARLET W/SKIRT, BLACK W/SLACKS	BLUE SKIRT/ SLACKS	BLACK PURSE OR HANDBAG OPTIONAL	WHITE (b)	BLACK PUMPS (c)	AWC/ OPTIONAL CAPE	DRESS COLLAR/ CAP	LARGE MEDALS (RIBBONS PER PARA. 5205.3)	NOT WORN	(a)
	BLUE-WHITE DRESS "A"	2003	DRESS	BLUE	WHITE PLAIN FRONT	SCARLET W/SKIRT, BLACK W/SLACKS	WHITE SKIRT/ SLACKS	BLACK PURSE OR HANDBAG OPTIONAL	WHITE (b)	BLACK PUMPS (c)	AWC/ OPTIONAL CAPE	DRESS COLLAR/ CAP	LARGE MEDALS (RIBBONS PER PARA. 5205.3)	NOT WORN	(a)
	BLUE DRESS "B"	2002	DRESS	BLUE	WHITE PLAIN FRONT	SCARLET W/SKIRT, BLACK W/SLACKS	BLUE SKIRT/ SLACKS	BLACK PURSE OR HANDBAG OPTIONAL	WHITE (b)	BLACK PUMPS (c)	AWC/ OPTIONAL CAPE	DRESS COLLAR/ CAP	RIBBONS	OPTIONAL (a)	(a)
	BLUE-WHITE DRESS "B"	2003	DRESS	BLUE	WHITE PLAIN FRONT	SCARLET W/SKIRT, BLACK W/SLACKS	WHITE SKIRT/ SLACKS	BLACK PURSE OR HANDBAG OPTIONAL	WHITE (b)	BLACK PUMPS (c)	AWC/ OPTIONAL CAPE	DRESS COLLAR/ CAP	RIBBONS	OPTIONAL (a)	(a)
2-13	BLUE DRESS "C"	2002	DRESS		KHAKI LONG SLEEVE	BLACK	BLUE SKIRT/ SLACKS	BLACK HANDBAG OPTIONAL	(b)	BLACK PUMPS (c)	AWC OR TANKER JACKET	DRESS CAP	RIBBONS	OPTIONAL (a)	(a)
	BLUE DRESS "D"	2002	DRESS	NONE	KHAKI SHORT SLEEVE	NONE	BLUE SKIRT/ SLACKS	BLACK HANDBAG OPTIONAL	(b)	BLACK PUMPS (c)	AWC OR TANKER JACKET	DRESS CAP	RIBBONS OPTIONAL (a)	OPTIONAL (a)	(a)
2-19	SERVICE "A"	2004	GREEN SERVICE/ GARRISON	GREEN	KHAKI LONG OR SHORT SLEEVE	GREEN	GREEN SKIRT/ SLACKS	BLACK HANDBAG OPTIONAL	(b)	BLACK PUMPS (c)	AWC OR TANKER JACKET (d)	SERVICE COLLAR/ CAP	RIBBONS	OPTIONAL (a)	(a)
	SERVICE "B"	2004	GREEN SERVICE/ GARRISON	GREEN V- NECK SWEATER (OPTIONAL)	KHAKI LONG SLEEVE	GREEN	GREEN SKIRT/ SLACKS	BLACK HANDBAG OPTIONAL	(b)	BLACK PUMPS (c)	AWC OR TANKER JACKET (d)	SERVICE CAP	RIBBONS (a)	OPTIONAL (a)	(a)
2-25	SERVICE "C"	2004	GREEN SERVICE/ GARRISON	NONE	KHAKI SHORT SLEEVE	NONE	GREEN SKIRT/ SLACKS	BLACK HANDBAG OPTIONAL	(b)	BLACK PUMPS (c)	AWC OR TANKER JACKET (d)	SERVICE CAP	RIBBONS OPTIONAL (a)	OPTIONAL (a)	(a)
2-30	MATERNITY SERVICE UNIFORM	2007	GARRISON SERVICE/ GARRISON	GREEN TUNIC (SEE PARA 3016)	KHAKI LONG OR SHORT SLEEVE	GREEN (a)	GREEN SKIRT/ SLACKS	BLACK HANDBAG OPTIONAL	(b)	BLACK PUMPS/ OXFORDS OR FLATS	AWC (d)	SERVICE CAP	RIBBONS OPTIONAL (a)	OPTIOANL (a)	NOT WORN
	UTILITY UNIFORM	2005	UTILITY	UTILITY	GREEN UNDER SHIRT OPTIONAL	NONE	WEB BELT OR MARTIAL ARTS BELT	NOT WORN	(b)	COMBAT BOOTS/ SOCKS	AWC OR ECWCS	EMBLEM DECAL/ NAME & SERVICE TAPES	NOT WORN	NOT WORN	NOT WORN

- a. If required or prescribed.
- b. Black gloves always worn or carried with all-weather coat during winter period. Optional when coat is worn.
- c. Oxford/flats may be worn per paragraph 3010.
- d. Green scarf optional for wear with all-weather coat/tanker jacket during winter uniform period.
- e. Evening Dress with scarlet waistcoat and plain front shirt worn by general officers.

TABLE 2-2.--Types and Components of Authorized Uniforms for Male Enlisted.

FIG. NO.	DESIGNATION	REF PARA	CAP	COAT OR JACKET	SHIRT	NECKTIE	TROUSER/ BELT	GLOVES	FOOTWEAR	OUTER COAT (a)	INSIGNIA BOFS	MEDALS/RIBBONS	BADGES	SWORD
			3004	3016/3006/ 3016	3026	3020/ 3021	3034/3002	3013	3012	3001/3003 /3015	4101	SECT 2/3, CHAP 5	SECT 5, CHAP 5	3032
	EVENING DRESS "A"	2001	DRESS	EVENING W/STRIP COLLAR & SCARLET WAISTCOAT	WHITE W/PIQUE PLACKET	NONE	EVENING (SUSPENDERS OPTIONAL)	WHITE (b)	BLACK SHOES & SOCKS	AWC/ OPTIONAL BOATCLOAK	DRESS COLLAR/ CAP	MINIATURE MEDALS	NOT WORN	NOT WORN
2-5	EVENING DRESS "B"	2001	DRESS	EVENING W/STRIP COLLAR & SCARLET WAISTCOAT OR CUMMERBUND	WHITE W/PIQUE PLACKET	NONE	EVENING (SUSPENDERS OPTIONAL)	WHITE (b)	BLACK SHOES & SOCKS	AWC/ OPTIONAL BOATCLOAK	DRESS COLLAR/ CAP	MIN. IATURE MEDALS	NOT WORN	NOT WORN
2-9	BLUE DRESS "A"	2002	DRESS	BLUE W/STRIP COLLAR	WHITE PLAIN FRONT	NONE	SKY BLUE W/WEB BELT OR SUSPENDERS	WHITE (b)	BLACK SHOES & SOCKS	AWC/ OPTIONAL BOATCLOAK	DRESS COLLAR/ CAP	LARGE MEDALS (RIBBONS WORN PER PARA. 5205.3)	NOT WORN	(a)
2-18	BLUE-WHITE DRESS "A"	2003	DRESS	BLUE W/STRIP COLLAR	WHITE PLAIN FRONT	NONE	WHITE W/WEB BELT OR SUSPENDERS	WHITE	BLACK SHOES & SOCKS	AWC/ OPTIONAL BOATCLOAK	DRESS COLLAR/ CAP	LARGE MEDALS (RIBBONS PER PARA. (5205.3)	NOT WORN	(a)
2-12	BLUE DRESS "B"	2002	DRESS	BLUE W/STRIP COLLAR	WHITE PLAIN FRONT	NONE	SKY BLUE W/WEB BELT OR SUSPENDERS	WHITE (b)	BLACK SHOES & SOCKS	AWC/ OPTIONAL BOATCLOAK	DRESS COLLAR/ CAP	RIBBONS	OPTIONAL (a)	(a)
	BLUE WHITE DRESS "B"	2003	DRESS	BLUE W/STRIP COLLAR	WHITE PLAIN FRONT	NONE	WHITE W/WEB BELT OR SUSPENDERS	WHITE (b)	BLACK SHOES & SOCKS	AWC/ OPTIONAL BOATCLOAK	DRESS COLLAR/ CAP	RIBBONS	OPTIONAL (a)	(a)
2-14	BLUE DRESS "C"	2002	DRESS	BLUE SWEATER (OPTIONAL)	KHAKI LONG SLEEVE	KHAKI W/CLASP	SKY BLUE W/WEB BELT	(b)	BLACK SHOES & SOCKS	AWC OR TANKER JACKET	DRESS CAP	RIBBONS OPTIONAL (a)	OPTIONAL (a)	(a)
	BLUE DRESS "D"	2002	DRESS	BLUE SWEATER (OPTIONAL)	KHAKI SHORT SLEET	NONE	SKY BLUE W/WEB BELT	(b)	BLACK SHOES & SOCKS	AWC OR TANKER JACKET	DRESS CAP	RIBBONS OPTIONAL (a)	OPTIONAL (a)	(a)
2-20	SERVICE "A"	2004	GARRISON/ FRAME	GREEN	KHAKI LONG SLEEVE	KHAKI W/CLASP	GREEN W/WEB BELT	(b)	BLACK SHOES & SOCKS	AWC (c)	SERVICE COLLAR/ CAP	RIBBONS	OPTIONAL (a)	(a)
2-24	SERVICE "B"	2004	GARRISON/ FRAME	GREEN SWEATER (OPTIONAL)	KHAKI LONG SLEEVE	KHAKI W/CLASP	GREEN W/WEB BELT	(b)	BLACK SHOES & SOCKS	AWC OR TANKER JACKET (c)	CAP	RIBBONS OPTIONAL (a)	OPTIONAL (a)	(a)
2-26	SERVICE "C"	2004	GARRISON/ FRAME	GREEN SWEATER (OPTIONAL)	KHAKI SHORT SLEEVE	NONE	GREEN W/WEB BELT	(b)	BLACK SHOES & SOCKS	AWC OR TANKER JACKET (c)	CAP	RIBBONS OPTIONAL (a)	OPTIONAL (a)	(a)
2-34	UTILITY UNIFORM	2005	UTILITY	UTILITY	GREEN UNDERSHIRT OPTIONAL	NONE	WEB BELT OR MARTIAL ARTS UTILITY BELT	(b)	COMBAT BOOTS/ SOCKS	AWC (c) OR ECWCS	EMBLEM DECAL/ NAME & SERVICE TAPES	NOT WORN	NOT WORN	NOT WORN

a. If required or prescribed.

b. Black gloves always worn or carried with all-weather coat during winter uniform months. Gloves are optional when the coat is not worn.

c. Green scarf optional for wear with all-weather coat/tanker jacket during winter months.

Table 2-3.--Types and Components of Authorized Uniforms for Female Enlisted.

FIG. NO.	DESIGNATION	REFERENCE PARAGRAPH	CAP	COAT OR JACKET	SHIRT	NECKTAB	SKIRT/ SLACKS	HANDBAG/ PURSE	GLOVES	FOOT WEAR	OUTER COAT (a)	INSIGNIA BOS	MEDALS/ RIBBONS	BADGES	SWORD
			3005	3001/3006/ 3016	3026	3020	3027/3028	3014	3012	3010 (B)	3001/3003 /3005	4101	SEC 2/3, CHAP 5	SECT 5, CHAP 5	3032
2-6	EVENING DRESS "A"	2001	DRESS	EVENING W/ CUMMERBUND	WHITE PLEATED FRONT	BLACK	LONG BLACK SKIRT	BLACK PURSE	WHITE (b)	BLACK PUMPS (CLOTH/ SUEDE)	AWC/ OPTIONAL CAPE	DRESS COLLAR/ CAP	MIN. MEDALS	NOT WORN	NOT WORN
	EVENING DRESS "B"	2001	DRESS	EVENING W/ SCARLET CUMMERBUND	WHITE PLEATED FRONT	BLACK	LONG/ SHORT BLACK SKIRT	BLACK PURSE	WHITE (b)	BLACK PUMPS (CLOTH/ SUEDE)	AWC/ OPTIONAL CAPE	DRESS COLLAR/ CAP	MIN. MEDALS	NOT WORN	NOT WORN
	BLUE DRESS "A"	2002	DRESS	BLUE	WHITE PLAIN FRONT	BLACK	BLUE SKIRT/ SLACKS	BLACK PURSE OR HANDBAG OPTIONAL	WHITE (b)	BLACK PUMPS (c)	AWC/ OPTIONAL CAPE	DRESS COLLAR/ CAP	LARGE MEDALS (RIBBONS PER PARA. 5205.3)	NOT WORN	(a)
	BLUE-WHITE DRESS "A"	2003	DRESS	BLUE	WHITE PLAIN FRONT	BLACK	WHITE SKIRT/ SLACKS	BLACK PURSE OR HANDBAG OPTIONAL	WHITE (b)	BLACK PUMPS (c)	AWC/ OPTIONAL CAPE	DRESS COLLAR/ CAP	LARGE MEDALS (RIBBONS PER PARA. 5205.3)	NOT WORN	(a)
2-11	BLUE DRESS "B"	2002	DRESS	BLUE	WHITE PLAIN FRONT	BLACK	BLUE SKIRT/ SLACKS	BLACK PURSE OR HANDBAG OPTIONAL	WHITE (b)	BLACK PUMPS (c)	AWC/ OPTIONAL CAPE	DRESS COLLAR/ CAP	RIBBONS	OPTIONAL (a)	(a)
	BLUE-WHITE DRESS "B"	2003	DRESS	BLUE	WHITE PLAIN FRONT	BLACK	WHITE SKIRT/ SLACKS	BLACK PURSE OR HANDBAG OPTIONAL	WHITE (b)	BLACK PUMPS (c)	AWC/ OPTIONAL CAPE	DRESS COLLAR/ CAP	RIBBONS	OPTIONAL (a)	(a)
	BLUE DRESS "C"	2002	DRESS		KHAKI LONG SLEEVE	BLACK	BLUE SKIRT/ SLACKS	BLACK HANDBAG OPTIONAL	(b)	BLACK PUMPS (c)	AWC OR TANKER JACKET	DRESS CAP	RIBBONS	OPTIONAL (a)	(a)
2-16	BLUE DRESS "D"	2002	DRESS	NONE	KHAKI SHORT SLEEVE	NONE	BLUE SKIRT/ SLACKS	BLACK HANDBAG OPTIONAL	(b)	BLACK PUMPS (c)	AWC OR TANKER JACKET	DRESS CAP	RIBBONS OPTIONAL (a)	OPTIONAL (a)	(a)
2-28	SERVICE "A"	2004	GREEN SERVICE/ GARRISON	GREEN	KHAKI LONG OR SHORT SLEEVE	GREEN	GREEN SKIRT/ SLACKS	BLACK HANDBAG OPTIONAL	(b)	BLACK PUMPS (c)	AWC OR TANKER JACKET (d)	SERVICE COLLAR/ CAP	RIBBONS	OPTIONAL (a)	(a)
2-23	SERVICE "B"	2004	GREEN SERVICE/ GARRISON	GREEN V- NECKSWEATER (OPTIONAL)	KHAKI LONG SLEEVE	GREEN	GREEN SKIRT/ SLACKS	BLACK HANDBAG OPTIONAL	(b)	BLACK PUMPS (c)	AWC OR TANKER JACKET (d)	SERVICE CAP	RIBBONS (a)	OPTIONAL (a)	(a)
2-21	SERVICE "C"	2004	GREEN SERVICE/ GARRISON	NONE	KHAKI SHORT SLEEVE	NONE	GREEN SKIRT/ SLACKS	BLACK HANDBAG OPTIONAL	(b)	BLACK PUMPS (c)	AWC OR TANKER JACKET (d)	SERVICE CAP	RIBBONS OPTIONAL (a)	OPTIONAL (a)	(a)
2-29	MATERNITY SERVICE UNIFORM	2007	GARRISON SERVICE/ GARRISON	GREEN TUNIC	KHAKI LONG OR SHORT SLEEVE	GREEN (IF REQUIRED)	GREEN SKIRT/ SLACKS	BLACK HANDBAG OPTIONAL	(b)	BLACK PUMPS/ OXFORDS OR FLATS	AWC (d)	SERVICE CAP	RIBBONS OPTIONAL (a)	OPTIONAL (a)	NOT WORN
2-31 2-32	UTILITY UNIFORM	2005	UTILITY	UTILITY	GREEN UNDER SHIRT OPTIONAL	NONE	UTILITY W/ WEB BELT OR MARTIAL ARTS BELT	NOT WORN	(b)	COMBAT BOOTS/ SOCKS	AWC OR ECWCS	EMBLEM DECAL/ NAME & SERVICE TAPES	NOT WORN	NOT WORN	NOT WORN

MARINE CORPS UNIFORM REGULATIONS

- a. If required or prescribed.
- b. Black gloves always worn or carried with all-weather coat during winter period. Gloves optional when coat not worn.
- c. Oxford/flats may be worn per paragraph 3010.
- d. Green scarf optional for wear with all-weather coat/tanker jacket during winter uniform period.

MARINE CORPS UNIFORM REGULATIONS

CHAPTER 3

UNIFORM ITEMS AND REGULATIONS FOR THEIR WEAR

	<u>PARAGRAPH</u>	<u>PAGE</u>
GENERAL	3000	3-3
ALL-WEATHER COAT (AWC)	3001	3-3
BELTS AND BUCKLES	3002	3-4
BOATCLOAK/DRESS CAPE	3003	3-5
BRASS ITEMS	3004	3-5
CAPS/HEADGEAR	3005	3-6
COATS	3006	3-9
COLLAR, WHITE STRIP	3007	3-10
CUFF LINKS SETS (MALES)	3008	3-10
CUMMERBUNDS	3009	3-10
EARRINGS (FEMALES)	3010	3-10
EXTENDED COLD WEATHER CLOTHING SYSTEM (ECWCS) PARKA AND TROUSER	3011	3-11
FOOTWEAR	3012	3-11
GLOVES	3013	3-16
HANDBAG/PURSE (FEMALES)	3014	3-17
JACKET, TANKER	3015	3-17
JACKETS, EVENING DRESS	3016	3-18
MATERNITY UNIFORMS	3017	3-20
MOURNING BAND	3018	3-21
NAMETAGS	3019	3-21
NECKTABS/NECKTIES	3020	3-22
NECKTIE CLASPS	3021	3-23
OPTIONAL UNIFORMS FOR SNCOS	3022	3-23

MARINE CORPS UNIFORM REGULATIONS

	<u>PARAGRAPH</u>	<u>PAGE</u>
PHYSICAL TRAINING CLOTHING	3023	3-25
PROTECTIVE MOTORCYCLE CLOTHING	3024	3-25
SCARF	3025	3-25
SHIRTS	3026	3-26
SKIRTS	3027	3-27
SLACKS (FEMALES)	3028	3-27
SOCKS/HOSE	3029	3-28
SUSPENDERS (MALE)	3030	3-29
SWEATERS	3031	3-29
SWORD AND ACCESSORIES, OFFICERS	3032	3-30
TAPES, NAME/SERVICE	3033	3-34
TROUSERS	3034	3-35
UMBRELLAS (FEMALES)	3035	3-35
UNDERGARMENTS	3036	3-36
CAMOUFLAGE UTILITY UNIFORM	3037	3-36
COMBAT UTILITY UNIFORM	3038	3-37
WAISTCOATS	3039	3-38

FIGURE

3-1	OFFICER'S CAP COMPONENTS	3-8
3-2	MALE FOOTWEAR	3-13
3-3	FEMALE FOOTWEAR	3-14
3-4	FEMALE OFFICER SLEEVE ORNAMENTATION	3-19
3-5	OFFICERS' COLLAR ORNAMENTATION	3-19
3-6	NECKTIE CLASP	3-23
3-7	OFFICER'S SWORD	3-31

MARINE CORPS UNIFORM REGULATIONS

CHAPTER 3

UNIFORM ITEMS AND REGULATIONS FOR THEIR WEAR

3000. GENERAL

1. Detailed fitting instructions for uniform items are contained in the current edition of TM-10120-15/1, Technical Manual for Uniform Fitting and Alteration.
2. All uniform items are standard as sold/issued through the DoD Supply System. Items sold through the Military Clothing Sales Stores or approved commercial sources are considered standard if properly labeled as described in chapter 1. Uniform items that are not approved as conforming to Marine Corps specifications are not authorized for wear and cannot be used to satisfy minimum requirements, except as otherwise stated in these regulations.
3. Detailed descriptions are omitted from this chapter for uniform items, which are issued/sold through the DoD Supply System and are standard for enlisted personnel. Brief descriptions are provided for officers' and optional items that are sold through the Marine Corps Exchange System bearing Marine Corps approval identification. Detailed descriptions of these items are available from the CG, MARCORSYSCOM (PM, ICE).

3001. ALL-WEATHER COAT (AWC) (See figs. 2-36 and 2-37.)

1. The pewter gray AWC is a full-length, double-breasted, belted coat with detachable liner and is made of polyester/cotton poplin fabric that has been treated to be water-repellent/resistant.
2. The correct length of the AWC will be to a point midway between the knee and mid-calf. The coat must be long enough to reach the bottom of the kneecap for males, and 1 inch below for females. It must not extend below the mid-calf. With the liner inserted, the coat will fit smoothly across the chest and shoulder blades and will have a noticeable fullness on the back waist, providing a pleated effect of the material under the belt. The belt will be adjusted loosely enough to provide a smooth appearance, maintained in a horizontal position and not sagging at center front or back. The tapered end of the belt will pass through the buckle to the wearer's left and will extend from 1 inch beyond the belt keeper to 1-1/2 inches beyond the left belt loop on the coat. The buckle will be centered between the vertical rows of buttons on the front of the coat.
3. The coat's top button may be worn buttoned or may be left open with the collar neatly folded back to form lapels. The back of the collar will cover all garment collars worn underneath the AWC. The sleeves and collar will be roll-pressed, not creased. Creases in the skirt of the coat, except for the center back pleat, are prohibited.
4. The design of the AWC does not include a sword slit. If the sword must be worn with the coat, the service belt may be utilized. Commanders will not

prescribe the AWC with sword unless service belts are available as organizational property.

5. The AWC may be worn or prescribed for wear with the service, dress, and utility uniforms. It may be worn with or without the liner at the individual's option.

3002. BELTS AND BUCKLES

1. Belts for all uniforms will be worn at the natural waistline with the right edge of the buckle (wearer's right) on line with the edge of the fly or coat front.

2. Belts for all male's service coats and male officers' blue coats must match the color and material of the uniform with which they are worn. The buckle will cover the bottom button of the coat. The belt's tapered end will pass through the buckle to the wearer's left and will extend from 2-3/4 inches to 3-3/4 inches beyond the buckle. The free end of the belt will be held in place by a cloth keeper 1/2 inch wide and may be fitted with a snap fastener to secure the belt point. Buckles will be kept highly polished.

3. The 1-1/4 inch wide cotton khaki web belt, with buckle, will be worn by all Marines with the utility uniform, until qualified to wear the martial arts utility belt. Male Marines will wear the khaki web belt with service and blue dress trousers and it may be worn with the white dress trousers. The tip end of the web belt will pass through the buckle to the wearer's left and will extend from 2 to 4 inches beyond the buckle. The metal belt tip and the buckle will be kept highly polished. The buckle will be worn with the buckle tongue depressed into the buckle.

4. The optional white nylon web belt, with buckle, may be worn by males only with the white dress trousers.

5. Enlisted males will wear the white web coat belt with waist plate with the blue and blue-white dress "A"/"B" uniforms. This belt may also be worn with the male enlisted blue dress "C" and "D" uniforms when the sword is prescribed. Enlisted females will wear this belt with the blue dress uniform when armed with the NCO sword.

a. The enlisted waist plate has a highly polished, natural plain brass finish, is about 2 inches by 3 inches in size, and is worn centered on the coat front buttons.

b. The NCO waist plate will be the same as the plain waist plate except that the NCO waist plate has brass Marine Corps emblem attached on the center of the plate.

c. The waist plate worn by SNCOs will be the same as the NCO waist plate except that it has an ornamental wreath design surrounding the Marine Corps emblem.

6. Martial Arts Utility Belt. The 1-3/4 inch wide nylon utility belt having black D-type buckle with locking bar will be worn by all martial arts qualified Marines with the utility uniform. The tip end of the utility belt

will pass through the buckle, feeding back around the locking bar to the wearer's left, with the belt-end extending 4 to 8 inches beyond the buckle. The buckle will be kept subdued in flat black finish. The buckle will be worn with the locking bar cinched tightly into the buckle.

a. Qualified Marines will wear only the single color of utility belt with or without instructor stripes appropriate to their martial arts proficiency, per the current edition of MCO 1500.54. Martial arts utility belts are not authorized for wear with civilian attire.

b. Personnel designated as close combat instructors or instructor-trainers will wear the appropriate identifying stripes on their belts. Instructor stripes will be 1/2-inch tan or red stripes, as appropriate, sewn on perpendicular to the length of the belt in thread that matches the color of the stripe. First stripe will be placed 2 inches from the belt-end holding the buckle, and each subsequent stripe placed 1/4 inch intervals from the previous stripe.

3003. BOATCLOAK/DRESS CAPE. (See fig. 2-1.)

1. The boatcloak, made of dark blue broadcloth material lined with scarlet wool broadcloth, is an optional item which may be worn by male officers and SNCOs with evening dress and blue dress "A"/"B" uniforms for official and social functions. It will not be worn when the blue dress uniform is worn as the uniform of the day.

2. The dress cape, made of dark blue polyester-wool tropical material lined with scarlet satin rayon cloth, is an optional item which may be worn by female officers and SNCOs with the evening dress and blue dress "A"/"B" uniforms for official and social functions. It will not be worn when the blue dress uniform is worn as the uniform of the day.

3004. BRASS ITEMS.

1. Brass items that have a gold or silver-plated mirror finish are considered anodized. Brass items that have a dull gold or silver appearance are considered oxidized. In addition to anodized and oxidized brass items, subdued insignia may be worn on the utility uniform and other field clothing as detailed in chapter 4.

2. Marines may purchase and wear anodized brass items not available through the DoD supply system, but only as authorized in these regulations. Marines may also have their own brass items anodized at the individual's expense. Anodized brass items not available through the DoD supply system may be purchased through Retail Clothing outlets and approved commercial sources.

3. The following oxidized brass items are authorized until 1 March 2005, on which date their wear as anodized brass items becomes mandatory: khaki web belt and buckle, necktie clasp, Branch of Service cap insignia (screw post), dress blue coat buttons (small and large), dress coat waist plates, and dress cap screw post buttons.

4. Unless otherwise authorized by this manual, anodized, oxidized and subdued brass items will not be mixed on the uniform.

3005. CAPS/HEADGEAR (See fig. 3-1.)

1. General

a. Dress and service caps will be worn centered and straight with the tip of the visor in line with the eyebrows. Leather chinstraps and visors will be kept polished. Garrison caps will be worn centered squarely or slightly tilted to the right, with the top unbroken, and with the base of the sweatband about 1 inch above the eyebrows.

b. Male cap crowns should fit on the frame and be free of wrinkles. Male officers' cap crowns will have a quatrefoil (fig. 3-1) centered on the top panel and an outer band of mohair braid.

c. When outdoors, Marines should remain covered, including during invocations and other religious portions of military ceremonies (i.e., changes of command, ship commissioning, military burials, etc.). Marines will uncover outdoors when so ordered or during religious services not associated with a military ceremony. Chaplains will be guided by the customs of their respective churches with respect to wearing head coverings.

d. Headgear is normally removed indoors. Marines in a duty status and wearing side-arms or a pistol belt will remain covered indoors except when entering a space where a meal is in progress or religious services are being conducted. Headgear will be worn in Government vehicles, and in privately owned vehicles on military bases and installations, except when doing so would present a hazard to safe driving.

e. Males may wear a rain cap cover to protect service or dress caps in inclement weather with or without the all-weather coat. Male rain cap covers sold by Marine Corps exchanges will be considered standard. Females may wear the previously issued/required rain cap cover (havelock) with service/dress caps in inclement weather as long as the havelock is serviceable.

2. Dress Cap Components

a. Males

(1) Cap Frame

(a) Field grade/general officers, black cloth-covered visor with gold bullion or synthetic ornamentation as prescribed (fig. 3-1).

(b) Company grade officers/enlisted, black leather/synthetic leather (high gloss) visor.

(2) Dress chinstrap (officers), or black leather/synthetic leather (high gloss) chinstrap (enlisted).

(3) Two 27-line gold uniform screw post buttons.

(4) Dress cap insignia (officers), or gold branch of service insignia (enlisted).

(5) White crown, cloth or vinyl. Officer crowns with quatrefoil. The Commandant and former Commandants will have general officers' gold ornamentation embroidered on the front half of the crown's braid band.

b. Females

(1) Officers will wear the white vinyl dress cap with dress chinstrap. Field grade/general officers will have a black cloth visor with synthetic gold ornamentation as prescribed (see fig. 3-1).

(2) Company grade officers/enlisted caps will have a black synthetic leather (high gloss) visor. Enlisted females will wear the black synthetic leather (high gloss) chinstrap.

3. Service Caps

a. Males

(1) Components

(a) Frame with plain black leather/synthetic leather (high gloss) visor (captains and below). Field grade and general officers will wear the dress frame with ornamented visor with the green service crown.

(b) Black leather/synthetic leather (high gloss) chinstrap.

(c) Two 27-line black uniform screw post buttons.

(d) Branch of service cap insignia, black (officer/enlisted, as appropriate).

(e) Service crowns (with quatrefoil for officers) of green all-season fabric or of phase-out summer weight polyester-wool fabrics may be worn with service uniforms of any fabric.

(2) The service cap may be worn optionally by male Marines with the service uniform on all occasions. Commanders may prescribe the wear of the service cap on specific occasions.

b. Females

(1) Service caps of green all-season fabric or of phase-out summer weight polyester-wool or winter weight all-wool fabrics may be worn with service uniforms of any fabric.

(2) Field grade/general officers will wear the service cap with black chinstrap and black cloth visor with synthetic gold ornamentation as prescribed (see fig. 3-1.).

MARINE CORPS UNIFORM REGULATIONS

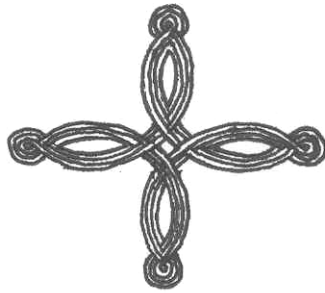

Quatrefoil, Male Officers (All Frame Cap Crowns)



Dress Chin Strap (All Officers)



Service Chin Strap (Male Officers and Female General/Field Grade Officers).



General Officer (All Dress and Service Caps)

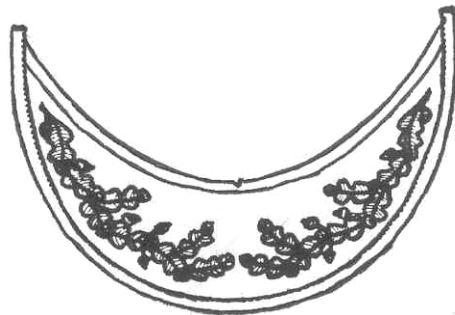

Field Grade Officer (All Dress and Service Caps)

Figure 3-1. Officer's Cap Components.

(3) Company grade officer/enlisted caps will have a plain green fabric visor and a scarlet cord.

(4) Females may wear either the service cap or garrison cap on all occasions. Commanders, however, may choose to prescribe which cap will be worn for specific occasions.

4. Garrison Caps

a. Males

(1) Garrison caps of either green all-season fabric or phase-out summer weight polyester/wool fabric may be worn with service uniforms of any fabric.

(2) Male Marines will wear the garrison cap with the service uniform except when the service cap is authorized/required per subparagraph 3004.3a(2).

(3) The garrison cap will normally be worn in formation with the service uniform, except when the service cap is prescribed by the Commander for specific occasions.

b. Females

(1) Garrison caps of either green all-season fabric or phase-out summer weight polyester/wool fabric may be worn with service uniforms of any fabric.

(2) The garrison cap may always be worn except when the service cap is prescribed for specific occasions.

5. Utility Caps. The camouflage utility cap, combat utility garrison cap, and combat utility field hat will be worn with the respective utility uniform according to paragraph 3037 and paragraph 3038, except when another type of headgear is specifically authorized by these regulations or as directed by the commander. Field hats will not be worn with the maternity work uniform.

3006. COATS

1. General

a. Utility coats will only be worn as a part of the utility uniform and will have the Marine Corps emblem decal placed/embroidered on the left breast pocket according to paragraph 3037. There will be no mixing of combat and camouflage utility uniform components.

b. Buttons on all service/dress coats may be detachable with worked eyelets provided for them.

2. Males

a. Service coats are semi-formfitting garments and will not be fitted to present a tight or formfitting appearance. Approximately 2 inches of freedom

should be allowed through the chest and 1 inch at the waist, with the belt of sufficient length to fit the coat waist rather than pulled snugly against the waist of the individual. A properly fitted service coat will ride freely up and down the body when the arms are raised/lowered.

b. Blue dress coats are formfitting garments and will be fitted and altered accordingly.

c. Only the sleeves, collars, and lapels of the service coat will be creased and pressed flat. Creases in the back skirt of the coats are prohibited.

d. The length of all coats will extend about 1 to 2 inches below the individual's crotch. The sleeve cuff bottom will extend to about 1 inch above the second/large joint of the thumb.

3. Females

a. The blue dress coats will be worn at all times with the blue and blue-white uniforms.

b. Service and dress coats are semi-formfitting garments and will be fitted and altered accordingly. The coat should fit smoothly but not tightly across the bust and shoulders with sufficient looseness to permit both arms to move freely.

c. Coat sleeves/lapels will be roll pressed.

3007. COLLAR, WHITE STRIP. The standing white strip collar is worn by male officers with the evening dress and blue dress uniforms, attached in the inside of the coat or jacket with eyelet fasteners. The collar will have a straight edge high enough to extend not more than 1/4 inch above the uniform collar and will be long enough for the ends to meet in the front without a gap or with a slight overlap.

3008. CUFF LINKS SETS (MALES). The officer or SNCO gold service cuff links sets (Officers have superimposed sterling silver, rhodium-finished Marine Corps emblems; SNCOs have gold-plated Marine Corps emblems superimposed), concave gold or gold-plated cuff links, and MSC and above command level cuff links may be worn at the wearer's option with the with the male French cuff khaki shirt and dress shirts.

3009. CUMMERBUNDS

1. Scarlet cummerbunds will be worn with the female officers' evening dress "A" (except general officers), the male and female officers' evening dress "B" (except general officers), and the SNCOs evening dress.

2. Cummerbunds will be worn with the pleats opening towards the top.

3010. EARRINGS (FEMALE)

1. Female Marines may wear earrings with service and dress uniforms at the individual's option, according to the following regulations:

a. Small, polished, yellow gold color, ball, or round stud earrings (post, screw-on, or clip), not to exceed 6 millimeters (about 1/4 inch) in diameter, may be worn with the service, blue dress, and blue-white dress.

b. Small white pearl or pearl-like earrings (post, screw-on, or clip), not to exceed 6 millimeters (about 1/4 inch) in diameter, may be worn with evening dress uniforms and with the blue dress "A" and blue-white dress "A" uniforms when worn for social events.

2. When worn, earrings will fit tightly against, and will not extend below, the earlobe. Only one earring will be worn on or in each earlobe.

3. Earrings will not be worn with the utility uniform, or while participating in a parade, ceremony, or other similar military functions.

3011. ECWCS PARKA AND TROUSERS.

1. Marines are allowed to purchase the Extended Cold Weather Clothing System (ECWCS) parka and trousers as an optional uniform item and wear it with the utility uniform at their option during cold or inclement weather, except when specifically prohibited by the commander for reasons of uniformity. Marines are authorized to wear ECWCS items with the traditional woodland pattern with the desert and woodland combat utility uniforms.

2. Whenever the optional ECWCS parka is worn, grade insignia will be worn as prescribed in chapter 4. Name tapes may be sewn on the right shoulder pocket flap of the parka/right seat pocket flap of the trouser and service tapes may be sewn on the left shoulder pocket flap of the parka, as the commander prescribes, in a manner that does not damage the weather-proof integrity of the item.

3. Marines who purchase ECWCS parkas or trousers from sources other than Marine Corps Exchange/DoD supply system may wear them provided they are identical in appearance to the standard item, as well as functional and suitable for combat and field wear. Marines who purchase their own ECWCS items may wear them with civilian attire, provided all grade insignia is removed. Organizationally issued ECWCS parkas may not be worn with civilian attire.

3012. FOOTWEAR. (See figs. 3-2 and 3-3.)

1. General

a. All Marines may purchase and wear approved commercial black leather and synthetic leather shoes in semi-gloss or high gloss (patent) finishes on an optional basis (approval identification not required for pumps). These shoes may be used to satisfy minimum requirements. Chukka boots are authorized for male officers and SNCO's only.

b. Double/platform soles, heels, metal heel or toe plates are prohibited.

c. All Marines may wear clear, smoky gray, or black zipper-closure overshoes or rubbers of plain design with the uniform during inclement weather. Additionally, females may wear plain black boots which do not

extend above the knee. Female boots with a one-piece sole/heel construction in flat or wedge style may be worn; however, platform soles are prohibited. If boots with separate heels are worn, the heel dimensions will conform to those prescribed for female oxfords/pumps. Soles and heels must be black and linings will be inconspicuous. These items will not be worn indoors.

2. Combat Boots. Temperate weather and hot weather boots may be worn with any version of the utility uniform at the individual's option. Organizational issue safety boots and deviations as approved by commanding officers and/or medical officers are also authorized. Authorized boots are as follows:

a. Marine Corps Combat Boot, Temperate Weather (MCCB (TW)). The standard temperate weather combat boot is the brown rough-side-out leather boot, and will be worn as issued/sold through the DoD Supply System/Retail Clothing Outlet and those private vendors who have authority to sell the patented boot. A Marine Corps emblem heat-embossed on the outer ankle identifies MCCBs that are authorized for wear. The mandatory possession date for the MCCB (TW) is 1 October 2004.

b. Infantry Combat Boot (ICB), Black. The temperate weather black ICB, with all black smooth-side-out leather uppers, will be worn as issued/sold through the DoD Supply System/Retail Clothing Outlet and those private vendors who have authority to sell the patented boot. Marines who entered the Marine Corps before 1 June 2002 are authorized to continue to wear this boot until 1 October 2004, at which time they are required to replace it with the MCCB (TW).

c. Marine Corps Combat Boot, Hot Weather (MCCB (HW)). The standard hot weather combat boot is the brown rough-side-out leather boot, and will be worn as issued/sold through the DoD Supply System/Retail Clothing Outlet and those private vendors who have authority to sell the patented boot. A Marine Corps emblem heat-embossed on the outer ankle identifies MCCBs authorized that are for wear by Marines. The mandatory possession date for the MCCB (HW) is 1 April 2004.

d. Jungle Boot, Black and Green. The hot weather jungle boot, with either green or black fabric upper, will be worn as issued/sold through the DoD Supply System/Retail Clothing Outlet and those private vendors who have authority to sell the patented boot. Marines who entered the Marine Corps before 1 June 2002 are authorized to continue to wear these boots until 1 April 2004, at which time they are required to replace them with the MCCB(HW).

>CH 2 e. Optional Boots. Optional boots (black or green) may continue to be worn with the combat utility uniform until 1 April 2004. Optional boots (black only) may be worn with camouflage utility uniform until 1 October 2004. The boots may be worn per the following guidance:

>CH 2 f. Optional MCCBS. Optional MCCBS with a Marine Corps approval identification number (see figure 1-3) and Marine Corps emblem on the outside heel of the boot, are authorize for wear with the utility uniform and will meet the minimum requirement.

MARINE CORPS UNIFORM REGULATIONS

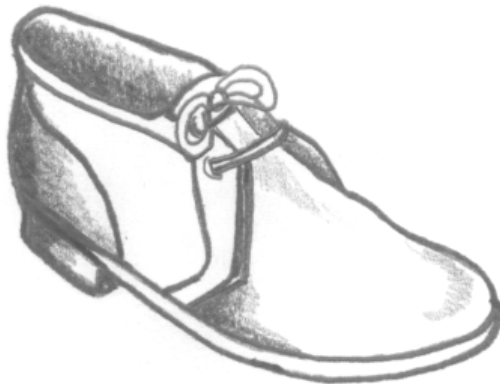

Chukka Boot, Blucher, Black



Oxford, Bal, Black

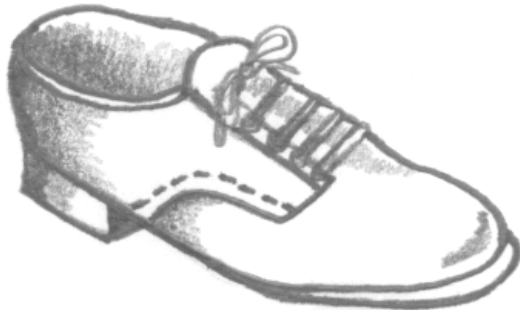

Oxford, Blucher, Black

Figure 3-2. Male Footwear.

MARINE CORPS UNIFORM REGULATIONS



OXFORDS

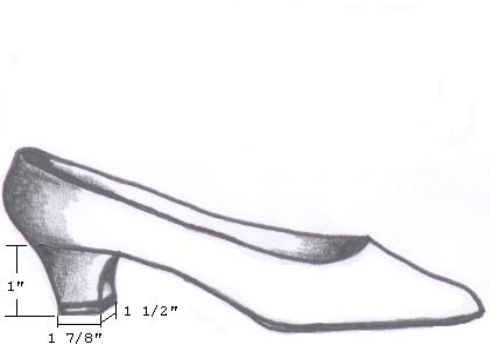

Minimum Heel Height



Maximum Heel Height



Minimum Heel Height

Figure 3-3. Female Footwear.

(1) All Marines may purchase optional commercially available black leather or black hot weather tropical (jungle) combat boots from any source provided they meet criteria set forth in the following paragraphs. These items will not be used to satisfy minimum requirements. These boots may be worn at the option of the individual whenever combat boots are prescribed/authorized for wear, except that commanders may require the wear of the standard issue boots on specific occasions when uniformity is required, i.e., inspections, parades, ceremonies (as authorized by above timelines).

(2) All optional boots will meet the following general appearance standards. The boots will be of all-black leather or, for hot weather boots, all-black leather with black fabric uppers. Boots with a patent leather or glossy finish are not authorized. Speed laces or eyelet lacing is acceptable. The total height of the boots will be from 8 to 12 inches. Lining, insulation, or padding is optional.

(3) Boots worn under this authority will be functional and suitable for combat and field wear. Examples of boots which do not meet this criteria are lightweight hiking shoes/boots based on running shoe lasts or technology, boots with patent leather and/or zippers, or boots made entirely of canvas and rubber. Boots designed for police and SWAT use in urban areas are not acceptable combat boots because they are not suited for load bearing in rough terrain.

3. Male Dress Shoes. (see fig. 3-2). Officers' dress black shoes will be either oxford or chukka boot in style and may be either the bal- or blucher-type.

4. Female Dress Shoes. (See fig. 3-3.)

a. All pumps will be of conservative cut with closed toes and heel without ornamental stitching or seams.

b. Black suede or fabric pumps will be worn with evening dress uniforms. Heels will measure from 1-1/2 inches to 2-1/2 inches in height. The base of the heel will measure from 3/8 by 3/8 inch to 1-1/4 by 1-1/2 inches.

c. Black pumps (except evening dress) will be smooth leather or synthetic leather. Any elastic binding around the throat of the pump will match the color of the shoe. Heels will measure from 1 inch to 2-1/2 inches in height. The base of the heel will measure from 3/8 by 3/8 inch to 1-1/2 by 1-7/8 inches.

d. Black dress flats are authorized for optional purchase and wear with dress and service uniforms instead of black pumps or oxfords under certain conditions. The flats will not be used to satisfy minimum requirements for either the black pumps or oxfords. They may be purchased from commercial sources or Marine Corps Exchanges and are not required to contain USMC approval identification. Black dress flats worn under this authority will be of smooth leather or synthetic leather, with the same general appearance standards as pumps. They will have a maximum heel height of 7/8 inch. The flats will have heels that are separate and distinct from the sole of the shoe; "wedged" heels are prohibited.

e. Black pumps, dress flats, and oxfords will be worn with the blue dress, blue-white dress, service and maternity uniforms per the following guidance:

(1) When the skirt is worn as part of the blue dress, blue-white dress, or service uniform, either black pumps or black dress flats will be worn at the individual's option, except as follows:

(a) If the skirt is worn for drill, parades, and other occasions that require functional uniformity, oxfords will be the prescribed footwear.

(b) Black pumps will be worn with the blue dress or blue-white dress uniform with skirt for formal occasions. However, flats may be worn by those engaged in ceremonial details on such occasions at the individual's option, unless oxfords are prescribed by the Commander.

(c) Oxfords are authorized for wear when a duty involves prolonged walking or standing, when pumps are considered unsafe, when prescribed for medical reasons, or when otherwise deemed appropriate by the commander. However, low-heeled pumps or flats are encouraged when skirts are worn for duties involving moderate walking or standing.

(2) When slacks are worn as part of the blue dress or service uniform, either black oxfords or black dress flats will be worn at the individual's option, except that oxfords will be prescribed for drill, parades, and other occasions which require functional uniformity. When slacks and oxfords are worn, either dark hose or black socks will be worn at the individual's option. Dark hose will be worn with slacks and dress flats.

(3) When the maternity service uniform with skirt is worn, pumps, oxfords, or flats will be worn. Oxfords will be worn with the maternity service uniform when slacks are worn.

3013. GLOVES

1. During the winter uniform period, Marines will wear/carry black leather, vinyl, or cloth (females only) gloves when an outer coat is worn with the service uniform. Black gloves may be worn/carried with the service "A" uniform or service uniform with sweater or tanker jacket at the individual's option; however, local commanders will designate whether gloves will be worn by troops in formation.

2. Marines may wear black gloves with the utility uniform.

3. White gloves will be worn or carried with evening dress, blue-dress, or blue-white dress during summer and winter uniform seasons. When an outer garment is worn during the winter uniform seasons, black gloves are worn or carried. During the summer season, black gloves are worn or carried when the AWC is worn as the outer garment, and white gloves are worn or carried when the boat cloak or dress cape is worn as the outer garment.

3014. HANDBAG/PURSE

1. Females may purchase optional handbags through the Marine Corps Exchange or commercial sources provided they conform to the following guidelines:

a. The optional handbag must be of plain natural grain black leather or synthetic leather. Exotic materials such as eel skin, alligator, or ostrich are not authorized. The closure hardware will be brass-plated or gold-colored.

b. The handbag will be of rectangular design with a flap. If the flap has a closure, it must be a clasp (no buckles, zippers, or string ties are allowed). The handbag may not have any visible ornamentation, decorative stitching, embossed design, or manufacturer's logo. The handbag will not be any smaller than 7-1/2 inches wide by 5-1/2 inches high by 2 inches deep nor will it be larger than 12 inches wide by 8 inches high by 3-1/2 inches deep.

c. The strap may be removable or non-removable and may have a gold-colored or black-coated buckle. It will be of the same material as the purse and no part of the strap will be made of chain. The strap will be of sufficient length to allow the handbag to be carried properly per subparagraph 3013.3.

2. The handbag may be carried at the individual's option with the service, blue dress, and blue-white dress uniforms. The handbag will not be carried in formation or when the utility uniform or maternity work uniform is worn.

3. The handbag will be carried either over the left shoulder or left arm. The strap will be adjusted so that the bottom of the handbag will be near the bottom of the uniform coat. When carried over the left arm, the strap will be adjusted to its shortest length.

4. Officers will procure a clutch purse(s) to wear with dress uniforms. Black clutch purses purchased from commercial sources may be used with appropriate dress uniforms. The clutch purse will be plain, unadorned, rectangular, and will not exceed 6 inches by 9 inches. USMC approval identification is not required for the clutch purse.

5. A black clutch purse will be carried with all evening dress uniforms, and may be carried with the officers' blue dress or blue-white dress "A"/"B" uniforms when worn in lieu of the evening dress uniform.

3015. JACKET, TANKER

1. The tanker jacket, authorized for individual optional purchase and wear, is made of a pewter gray polyester/wool gabardine material that has been treated to be water-repellent/resistant.

2. The jacket may be worn with the dress "C"/"D" uniforms, the service "B"/"C" uniforms and service or blue dress uniform with sweater. When worn the jacket will be zipped at least to the top (i.e., the highest point) of the external slash pockets. When worn with the sweater, the sleeves and the waistband of the sweater will be rolled up or under to ensure they do not extend below the jacket's sleeves/waistband.

3. Officers will wear their insignia of grade on the shoulder straps in the same manner as worn on the all-weather coat. Enlisted Marines will wear metal/plastic insignia of grade on the shoulder straps, single point inboard, and placed in the same manner as field/company grade officer's insignia.

4. The jacket will not be worn with the all-weather coat, nor will it be worn with the utility uniform. It will not be worn for inspections, ceremonial formations, or parades. It may be worn for leave/liberty. The jacket is authorized for wear, without insignia, with civilian clothing.

3016. JACKET, EVENING DRESS

1. Officers

a. General

(1) Embroidered uniform components with either tarnish-resistant gold embroidery thread or the all-gold bullion are authorized. The mixed wear of synthetic and all-gold bullion uniform components is authorized.

(2) Sleeve ornamentation for the jacket will be worked on dark blue cloth of the same color and texture as the jacket. The rear edge has three points for males and a diagonal edge for females. Forward edges are finished with two rows of gold beading separated by a row of scarlet silk embroidery. Prescribed ornamentation differs by grade (See fig. 3-4).

(a) General Officers. One border of zigzag rows of acorns and oak leaves, embroidered large and clearly outlined in high relief with gold embroidery thread. The midrib of each leaf will be in gold Jaceron.

(b) Field Grade Officers. Will be as outlined for general officers, except leaves and acorns will be smaller in size and in lower relief.

(c) Company Grade Officers. Four overhand loops in center, of No. 26-1/2 gold embroidery thread, which will be in one continuous piece.

b. Males. The jacket is a round shell design made of dark-blue or black broadcloth, fully lined with scarlet rayon lining material, including the collar. Front edges of the jacket are slightly curved, and the waistline opening is about 6 inches, for the average man. The jacket, which is worn open, extends at the sides to the points of the hipbones, and then curves slightly to the front and with the point at center of the back. It has a standing collar, about two inches high, finished all around, and provided with hook and eye closures. The collar edges are ornamented with two rows of gold beading separated by a row of scarlet silk embroidery, and dress collar insignia will be worn in the eyelets provided. The jacket has shoulder straps upon which embroidered insignia of grade will be worn. Edges of the straps will be finished with two rows of gold beading separated by a row of scarlet silk embroidery. Sleeve embroidery will be as listed above.

c. Females. The jacket is of black polyester-wool tropical fabric with black rayon lining. The collar is scarlet wool tropical with a

MARINE CORPS UNIFORM REGULATIONS

Male Officers

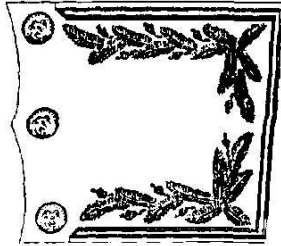

Female Officers

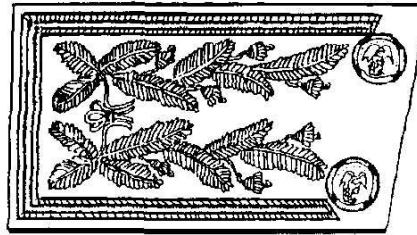

General Officers

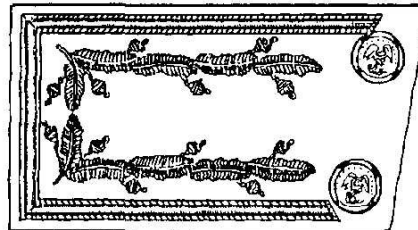
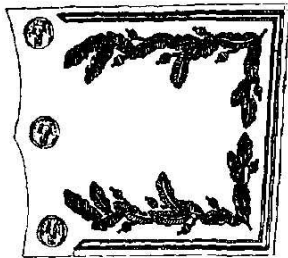

Field Officers

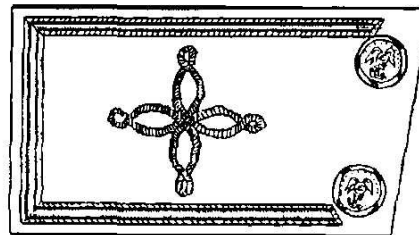
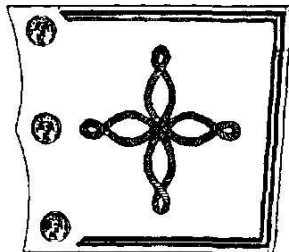

Company Officers

Figure 3-4.--Officer Sleeve Ornamentation.

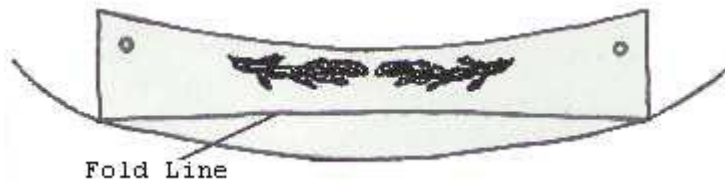

Figure 3-5.--Evening Dress Jacket Collar Ornamentation (Female Officers).

row of gold embroidered ornamentation centered along the back seam (See fig. 3-5). The jacket is semi-formfitting, waist length, with rolled lapels, plain shoulder straps upon which embroidered insignia of grade will be worn, and embroidered sleeve ornamentation as prescribed in subparagraph 3015.1. Dress collar insignia will be worn in the eyelets provided.

2. Staff Noncommissioned Officers

a. Males. The jacket is a round shell design made of dark blue gabardine fabric. The jacket, with rolled collar, shoulder straps with red piping, and peaked cuffs, is worn open, held together with two small uniform buttons with 1-inch link. Dress collar insignia will be worn in the eyelets provided. Distinctive 1890's style gold on scarlet insignia of grade will be worn on the jacket sleeves, which will be flat pressed.

b. Females. The jacket is of black polyester-wool tropical fabric with black rayon lining. The collar is of scarlet wool tropical without ornamentation. The jacket is semi-formfitting, waist length, with rolled lapels, peaked cuffs, but without shoulder straps. Dress collar insignia will be worn in the eyelets provided. Standard gold on scarlet insignia of grade as prescribed for the blue dress uniform will be worn on the jacket sleeves.

3017. MATERNITY UNIFORMS

1. Maternity uniforms will be worn by pregnant Marines when the local commander determines that the standard uniforms can no longer be worn. Either the maternity service uniform or the maternity camouflage work uniform, as appropriate, will be worn as authorized herein.

2. The maternity service uniform consists of green tunic top, skirt or slacks, and khaki long or short sleeve maternity shirt. Either the skirt or slacks may be worn with the tunic, at the individual's option according to paragraph 3026. Either the long or short sleeve shirt may be worn with or without the tunic at the individual's option except that the tunic must be worn when the service "A" uniform is prescribed. The green necktab will always be worn when the tunic and/or long sleeve shirt are worn. When the short sleeve shirt is worn without the tunic, it will be worn with open collar and no necktab. This uniform may be worn on leave/liberty under the same conditions as the standard service uniform.

3. The maternity camouflage work uniform consists of a coat and slacks fabricated of 100 percent rip-stop fabric in the woodland camouflage pattern. This uniform is authorized for wear by pregnant Marines in the Fleet Marine Force and by those in non-FMF commands who are required to wear the utility uniform in the performance of their duties. The work uniform will be worn under the same general regulations as the standard utility uniform except that the web belt will not be worn.

4. Name/service tapes will be worn on the maternity work uniform with the top of the tapes placed approximately on line with the second buttonhole from the top of the coat. Placement of the tapes may be adjusted to the individual as necessary to ensure proper appearance and comfort. Each tape will be the same length, not to exceed 6 inches. The emblem decal will be

centered between the ends of the service tape and with the top of the emblem 1 inch below the bottom of the tape.

5. When the maternity service uniform with skirt is worn, pumps, oxfords or flats with hose will be worn. Oxfords, with either dark hose or black socks at the individual's option, will be worn with service slacks. The maternity work uniform will be worn with green or black hot weather tropical or black leather combat boots and cushion sole socks.

>CH 4 6. Unless otherwise prescribed, other uniform items (i.e., headgear, AWC, scarf, gloves, handbag) not specifically addressed will be worn with maternity uniforms when and as prescribed by current regulations for wear with service or utility uniforms, as applicable. The AWC may be worn unbuttoned or with its buttons temporarily repositioned to the coat edge during the latter stages of pregnancy. The service sweater and tanker jacket are not authorized with maternity uniforms. The black maternity sweater (cardigan style with epaulettes) is authorized for optional wear with the maternity service sweater. Rank insignia will be worn with the maternity sweater per the sweater (with epaulette) regulations detailed in chapter 4 of these regulations. The green necktab will be worn when the maternity sweater is worn. The sweater may be worn over the tunic and underneath the all-weather coat, but must be buttoned at all times. The sweater is authorized for leave and liberty and for commuting to and from work.

3018. MOURNING BAND

1. The mourning band will be worn on the left sleeve of the outer garment, midway between the shoulder and elbow.

2. Officers will only wear mourning bands approved for sale through the Marine Corps Exchange System. Enlisted Marines will wear mourning bands issued as organizational clothing by their unit. Mourning bands are not available through the DoD Supply System and must be purchased via open purchase. The officer's mourning band may be used for this purpose.

3. Marines will wear mourning bands when serving as honorary pallbearers at military funerals in an official capacity, and at such times as prescribed by competent authority. Mourning bands may be worn for family mourning.

4. When directed by competent authority, Marines will wear mourning bands while stationed in or officially visiting a foreign nation that is undergoing a period of national mourning.

3019. NAMETAGS

1. No valid general requirement for nametags exists; however, the standard black Marine Corps nametag may be prescribed at the option of local commanders at schools, conferences, and related activities. Marines assigned to non-Marine Corps commands or schools may wear nonstandard nametags, without prior CMC approval, if they are similar in size and shape to standard Marine Corps nametags and are required by the local commander.

2. The standard Marine Corps nametag will be of flexible thermo-plastic translucent base material with black velvet mar-resistant, non-glare finished surface and a white core, as sold by approved sources. When prescribed by commanders, nametags and engraving services will be procured according to the current edition of MCO P4200.15, utilizing local command funds. The tag is 5/8 inch wide by 3 inches long with clutch-type fastener. Engraved white block-type lettering will be 3/8 inch high by about 3/16 inch wide (unless it must be smaller to accommodate a lengthy name within standard length) indicating the Marine's last name only. Symbols, initials, nicknames, or

organizational identification will not be placed on nametags. Wearing nametags that do not conform with these provisions, except as noted above, is prohibited.

3. Nametags may only be worn on service and blue dress uniforms when worn as the uniform of the day. A nametag will not be worn on the female white shirt. Nametags will not be worn on leave or liberty, but may be worn at off-base events when prescribed by the local commander.

4. The nametag will be centered 1/8 inch above the right breast pocket on uniforms with such pockets and in the same general position on uniforms that do not have pockets. On the female service coat with slanted pockets, a horizontal line tangent to the highest point of the pocket will be considered the top of the pocket.

3020. NECKTABS/NECKTIES

1. Necktabs (Females)

a. The green service necktab will be worn when the long sleeve khaki shirt is worn with the service "A"/"B" uniforms and when the short sleeve shirt is worn with the service "A" uniform. No necktab will be worn with service "C" uniform or when the service sweater is worn.

b. Green necktabs will be worn with the maternity uniform according to paragraph 3016.

c. The black necktab will be worn by enlisted Marines with the blue dress "A," "B," and "C" or blue-white dress "A"/"B" uniforms. No necktab will be worn with the blue dress "D" uniform.

d. Officers will wear scarlet or black necktabs with the blue dress or blue-white dress uniforms as follows:

(1) The scarlet necktab will be worn with the blue dress or blue-white dress "A"/"B" (coat and skirt).

(2) The black necktab will be worn with the blue dress "C" uniform. No necktab will be worn with the blue dress "D" uniform.

(3) When slacks are worn with the blue dress "A," "B," or "C" uniform or the blue-white dress "A"/"B" uniform, the black necktab will be worn.

e. The necktab's outer edges should be parallel to the outer edges of the collar. An equal amount of necktab should show on each side of the collar.

2. Neckties (Male)

a. Marines will wear a 3-1/8 inch khaki necktie of any approved cloth with the service "A"/"B" and blue dress "C" uniforms. It will not be worn with the crew-neck service sweater. Neckties may be tied with any type of standard necktie knot which presents a neat military appearance.

b. Approved hook-on (pre-tied) khaki neckties may be worn with the service and dress uniforms at the individual's option and may be used to satisfy minimum requirements.

c. The plain black bow tie with square ends will be worn with the SNCO's evening dress uniform.

d. The necktie will be tied so that the tip of the bottom of the tie is between 1/2-inches above the belt buckle and 1/2-inches below the belt buckle.

3021. NECKTIE CLASPS (MALES). (See fig. 3-6.)

1. The gold necktie clasp as sold through the Marine Corps Supply System is standard for all male Marines. However, all Marines may purchase at their option approved tie clasps with stamped or superimposed Marine Corps emblems through the Marine Corps exchange or commercial sources. For officers, the optional tie clasp will have a silver-colored emblem; and for all enlisted, a gold-colored emblem.

2. The clasp will always be worn on the necktie when the khaki shirt is worn as the outer garment and it may be worn with the service "A" uniform. It will be placed horizontally on the lower half of the necktie midway between the third and fourth buttons from the top.



Figure 3-6.--Necktie Clasp.

3022. OPTIONAL UNIFORMS FOR SNCOS

1. General

a. SNCOs are authorized to wear officers' service uniforms. These uniforms are authorized at all times including in formation with troops. SNCOs who exercise this option are not required to maintain equivalent enlisted uniforms. Male SNCOs who wear service coats of officer-type fabric must have the large pockets sewn down in the same manner as the pockets on enlisted service coats.

b. Shirts worn with these uniforms may be of any cloth of adopted standard. Enlisted branch of service insignia and enlisted grade and service stripes will be worn with optional uniforms. The service crown worn with the male frame cap will be without quatrefoil or mohair braid.

2. Optional Uniforms (Males). SNCOs may wear the evening dress (blue) jacket. The following accessories and uniform items, available through the DoD Supply System, Marine Corps Exchange System, or approved commercial sources will be worn with the jacket.

- a. High-waisted or standard enlisted blue dress trousers with scarlet trouser stripe
- b. Frame cap with enlisted dress crown
- c. Scarlet cummerbund
- d. White, pleated, soft bosom shirt
- e. Black bow tie
- f. Black dress shoes
- g. Black socks
- h. White gloves (carried or worn)
- i. AWC (may be worn)
- j. Dress cuff links and studs
- k. Gold button set
- l. Gold enlisted branch of service insignia, cap, and collar
- m. Miniature medals
- n. Insignia of grade, distinctive 1890's style, gold on scarlet

3. Optional Uniforms (Females). SNCOs may wear the dress cap, and branch of service insignia, evening dress (blue) jacket. The following accessories and uniform items will be worn:

- a. Black skirt, short or long (See subparagraph 3025.3.)
- b. White shirt, evening dress (See subparagraph 3024.2.)
- c. Dress cap, when required for ceremonial participation
- d. Scarlet cummerbund
- e. Black clutch purse (See subparagraph 3013.5.)
- f. Black dress shoes, suede or fabric
- g. Gold buttons, medium
- h. Gold enlisted branch of service insignia, and collar
- i. Miniature medals
- j. White gloves (worn or carried)
- k. AWC (may be worn)

1. Insignia of grade, standard gold on scarlet

3023. PHYSICAL TRAINING CLOTHING.

1. General Purpose Trunks. The standard issue general purpose trunks are fabricated from a polyester twill fabric, are olive green in color, are of thigh length, have an elastic waist with a draw cord, and have a bound V-notch at the outer leg seams.

a. When worn with the standard green undershirt, the trunks comprise the standard Marine Corps-wide physical training (PT) uniform and will be worn according to paragraph 2006.

b. Olive green trunks of any material, similar in design to the standard issue trunks, may be worn at the option of the individual on all occasions for which the PT uniform is authorized/prescribed. Optional trunks may be purchased through Marine Corps Exchanges or commercial sources and are not required to contain Marine Corps approval identification.

2. The required cold weather PT uniform is of olive green knit fabric and consists of a pull-over crew-neck sweatshirt and elastic waist sweatpants. The shirt and pants will have "USMC" in 3-inch block lettering and the Marine Corps emblem imprinted on the left breast of the shirt and upper left leg. The crew-neck sweatshirt may be worn under the utility uniform coat when sleeves are not rolled.

3024. PROTECTIVE MOTORCYCLE CLOTHING

1. An unornamented protective helmet which meets the standards of the Snell Memorial Foundation, the American National Standards Institute (ANSI) Z90.1-1971, or the Federal Motor Vehicle Safety Standard (FMVSS) number 218; eye protection consisting of impact-resistant goggles or full-face shield attached to the helmet; and a high-visibility reflective vest are authorized for wear by Marines in uniform while operating or riding as passengers on a motorcycle, MOPED, motorscooter, or similar two- or three-wheeled vehicle. The vest must have two vertical or horizontal retro reflective stripes at least 1 1/2 inches wide front and back such as the Motorcycle Safety Foundation black vest or vests of international orange, lime green, or bright yellow with retro reflective stripes."

2. The safety equipment described will be worn whenever directed by Marine Corps safety regulations. When helmets are worn, chin-straps/eye protection will be properly fastened and in place. Reflective vests must not be covered or concealed.

3025. SCARF

1. During the winter uniform period, Marines may wear the green wool scarf when the AWC/tanker/ECWCS parka/field coat is worn with the service or utility uniform, at the individual's option. The scarf will not be prescribed for wear.

2. When worn, the scarf will overlap to form a "V" at the base of the throat, hiding the garment beneath.

3026. SHIRTS

1. Khaki Shirts (Long and Short Sleeves)

a. When the service "A" uniform is worn, males wear the long sleeve khaki shirt and females wear either the long- or short-sleeve khaki shirt. The khaki necktie or green necktab, as appropriate, is worn with this uniform.

b. The long-sleeve khaki shirt is part of the service "B" and blue dress "C" uniforms. The khaki necktie/appropriate necktab is worn at all times.

c. The short-sleeve khaki shirt is part of the service "C" and blue dress "D" uniforms, and will be worn with the collar open and no necktie/necktab.

d. Marines may purchase and wear shirts with approval identification from commercial sources on an optional basis. Enlisted Marines may use these shirts (with the exception of the French cuff shirt), to satisfy minimum requirements.

e. The male khaki shirt with French cuffs will be of the same design and style as the standard shirt except with French cuffs instead of barrel cuffs. Officers and SNCOs may wear the French cuff shirt optionally for duty, on leave and liberty, for parades and ceremonial occasions at the commander's discretion.

f. Male wool- and polyester-blend shirts will be pressed with military creases. Cotton-blend shirts may be pressed with military creases at the individual's option. Military creases are formed by pressing two vertical creases in the front of the shirt, from the shoulder seam through the center of each pocket to the bottom of the shirt, and three evenly spaced vertical creases in the back of the shirt, from the yoke seam to the bottom of the shirt.

g. Female khaki shirts will be worn outside the skirt/slacks, except that those females who are required to wear a duty/sword belt will tuck their shirts into their slacks/skirts. The sleeves of the khaki shirts will be creased and lapels roll-pressed; however, shirts will not be pressed with military creases.

h. Khaki maternity uniform shirts will be worn according to paragraph 3016.

2. Female Dress Shirts

a. The female white dress shirt will be worn with the blue dress or blue-white dress "A"/"B" uniforms. The standard over-blouse style shirt will be worn outside the skirt/slacks at all times. The old-style white shirt, which is worn tucked in, is authorized until replacement is required.

b. The female white ruffled tuck-in dress shirt (with black polyester-wool necktab and white pearl buttons), sold through the Marine Corps Exchange

System, is worn with all female evening dress uniforms, except that general officers will have a plain-front shirt.

3. Male Dress Shirts

a. The male white soft-bosom shirt is a plain, neckband-style shirt with French cuffs, five pearl buttons, and a collar stud for top buttonhole. It is worn with the officers' blue dress coat. The shirt cuffs should extend 1/8 inch below the bottoms of the coat sleeves.

b. The male white soft-bosom shirt with pique placket is a plain neckband style evening shirt. It has barrel-type cuffs fastened with cuff links and three buttonholes for studs on the front placket. It is worn with the officers' evening dress uniform. The white stiff-bosom shirt with one or two buttonholes may be worn until replacement is required.

c. The male white pleated soft-bosom shirt is an evening style shirt with turned-down collar, pleated front, with two to three buttonholes for studs on the front shirt placket, and French cuffs. It is worn with the SNCOs evening dress uniforms.

3027. SKIRTS

1. Skirts will be of conventional length and sweep appropriate to the appearance of the uniform and the individual. Service and dress uniform skirts, except the long skirt, will be from 1 inch above the kneecap to 1 inch below the kneecap.

2. Skirts will have a hem or facing from 2 inches to 3 inches wide and the seams will be pressed open and flat.

3. The evening dress skirt will be black polyester-wool tropical material, floor length with center back pleat and fully lined with black rayon lining. The short evening dress skirt will be of the same material as the long skirt but will be knee length. The long black skirt will always be worn with the officers' evening dress "A" uniform. Either the long or short black skirt may be worn with all other officer and SNCO evening dress uniforms, depending on the degree of formality required. The old-style long skirt without center back pleat may continue to be worn until replacement is required. Officers and SNCOs will wear white skirts as part of the blue-white uniform during the summer uniform season, unless the commander prescribes blue-white slacks per guidance discussed in paragraph 3026.

3028. SLACKS

1. General

a. Slacks will be long enough to break slightly over the shoe in front and to reach the juncture of the welt of the shoe in the rear. A variation of 1/2 inch above the welt is acceptable. The hem on the slacks will be from 2 to 3 inches wide.

b. Slacks will be pressed to present a smooth vertical crease at about the center front and rear of each leg. The crease will extend from the bottom of the hem to about 2 inches above the crotch.

2. Service Slacks. Slacks may be worn as part of the service "A," "B," or "C" uniform. Wearing the service slacks as a working uniform is at the individual's option. On specific occasions that require uniformity (i.e., formations, ceremonies, inspections, parades, social events), commanders at their discretion may direct either that the skirt or slacks be worn. Slacks are authorized for wear on leave/liberty.

3. Blue Dress Slacks

a. When the blue dress uniform is prescribed, commanders may prescribe females to wear blue dress slacks as part of all blue dress uniforms when specific occasions require uniformity, as discussed in subparagraph 3026.2. On all other occasions, either the blue dress skirt or blue dress slacks may be worn at the option of the individual.

b. All NCOs will wear the scarlet stripe on blue slacks according to paragraph 4009.

c. Officers' dress blue slacks will have a 1-1/2 inch wide scarlet stripe down the outer seam of each leg.

4. Blue-White Dress Slacks. At commands where the blue-white dress uniform is required, commanders may prescribe the wear of either the white skirt or white slacks for enlisted if they have been provided by the command via organizational issue or supplemental allowance. For SNCOs whose commands do not provide blue-white dress slacks via organizational clothing or supplemental allowance, either the blue-white dress skirt or blue-white dress slacks may be worn at the option of the individual.

3029. SOCKS/HOSE

1. Black dress socks, as issued by the supply system or sold in MCSSs, will be plain and without ornamental stitching, and when worn with boots, will serve as the liner sock underneath the cushion sole sock. Calf-length, black socks of plain design as sold through the Marine Corps exchanges, may be worn as an optional uniform item and may be used to satisfy minimum requirements.

2. Males will wear black dress socks with all service and dress uniforms. Females may wear black socks when slacks are worn.

> CH 1 3. Coyote brown cushion socks will be standard as issued green cushion and black cushion sole socks may continue to be worn until replacement is required.

4. Females will wear full-length nylon hose with service and dress uniform skirts. Dark hose or black socks will be worn with slacks per paragraph 3010.

5. Hose should harmonize with the natural skin tone of the individual. Dark nylon hose of gray/smoky shades will be worn with blue dress and evening dress uniforms on formal occasions.

6. Hose with seams, designs, pronounced open-work mesh, or fancy heels are not authorized. Snag-proof, run-resistant hose of an inconspicuous mesh may be worn.

3030. SUSPENDERS. Suspenders will be of plain design as commercially available. They may be worn under evening dress coat, and under the blue dress coat in lieu of the web belt. Suspenders may also be worn with the white web sword belt per subparagraph 3031.6.

3031. SWEATERS. (See figs. 2-23 and 2-24)

1. Green Crew-neck Service Sweater With Epaulettes

a. The olive green crew-neck service sweater with epaulettes is of 100 percent wool, in a heavy ribbed knit crew-neck design with shoulder and elbow patches. An acrylic knit sweater of the same design may be purchased and worn at the individual's option in lieu of the wool sweater. The crew-neck service sweater may be worn as a component of the service "B"/"C" and utility uniforms only. When the service uniform is worn, the long sleeve khaki shirt may be worn with the sweater on a year-round basis at the individual's option. The short sleeve khaki shirt may be worn with the service sweater at those locations and during those periods when the service "C" uniform is authorized.

b. When the sweater is worn with the service uniform, the shirt collar will be worn outside the sweater without necktie/necktab and the shirt collar button will be unbuttoned. The sleeves of the sweater may be turned up; however, the sleeves should be long enough to cover the shirt cuff. The waistband of the sweater may be turned under; however, the sweater should cover the trousers/skirt/slacks waistband. When worn with the camouflage utility uniform, the sweater will be worn under the utility coat. Insignia of grade will be worn on the epaulettes according to paragraphs 4004 and 4005. Officers will wear insignia of grade on the khaki shirt collar. Enlisted will not wear insignia of grade on the khaki shirt collar when the crew neck sweater with epaulettes is worn.

c. Commanders may prescribe the service uniforms with sweater for inspections; however, it will not be worn in ceremonial formations or parades on or off the military installation. The sweater will not be worn on occasions for which the commander determines the service "A" uniform more appropriate. The sweater may be worn with the service uniform for leave and liberty and commuting to and from work.

d. An optional blue crew neck sweater with epaulettes is authorized for all Marines, to be worn in the same manner as the green service sweater with epaulettes. Brushed brass insignia of grade will be worn by enlisted on the epaulettes.

2. Green Crew-neck Service Sweater Without Epaulettes. The green and blue crew neck sweaters without epaulettes will be worn in the same manner as the crew-neck sweaters with epaulettes, with the exception that:

a. Insignia of grade will not be worn on the crew-neck sweater without epaulettes, and;

b. Enlisted will wear insignia of grade on the collar of khaki shirts.

3032. SWORD AND ACCESSORIES, OFFICERS. (See fig. 3-7.)

1. Sword

a. The sword may be prescribed with all uniforms except the evening dress and utility.

b. Sword blade lengths are available in a range from 26 to 35 inches. The regulation sword length for an individual is determined with the sword at the carry position. The tip of the blade will fall not more than 1 inch above or below eye level.

c. The sword blade is a cut and thrust blade of stainless or forged steel. The sword blade has prescribed etched ornamentation and a scroll on each side bearing the words "United States Marines" reading on the right side from hilt to point, and on the left side from point to hilt. The sword blade has a double channel from the bottom of the etching to the point of the blade, and all exposed surfaces are either polished stainless steel or heavily nickel-plated on a copper base, then polished.

d. The Mameluke-type grip of yellow metal with leaves of ivory or ivory-like plastic is secured by two five-pointed star rivets of yellow metal. The pommel has an eye of yellow metal through which the loop of the sword knot passes and a straight cross with acorn design on the ends.

e. The owner's name may be engraved on the sword at the individual's option. If engraved, the owner's name (reading from point to hilt) will be etched or engraved on the scroll on the left side near the hilt. A Marine officer who inherits/purchases a sword previously engraved with another Marine's name may wear and maintain it as long as the sword remains serviceable. Removing the previous owner's name is not required.

2. Scabbard

a. The scabbard is stainless steel or cold-rolled steel, chrome-plated, brightly polished, and will accommodate the sword blade snugly.

b. The solid brass, highly polished, ornamented metal trimmings consist of a flush fitting mouthpiece, two locketts each with a ring for sling suspensions, and the tip of the scabbard shoe. The scabbard is lined with durable material.

3. Leather Sword Sling

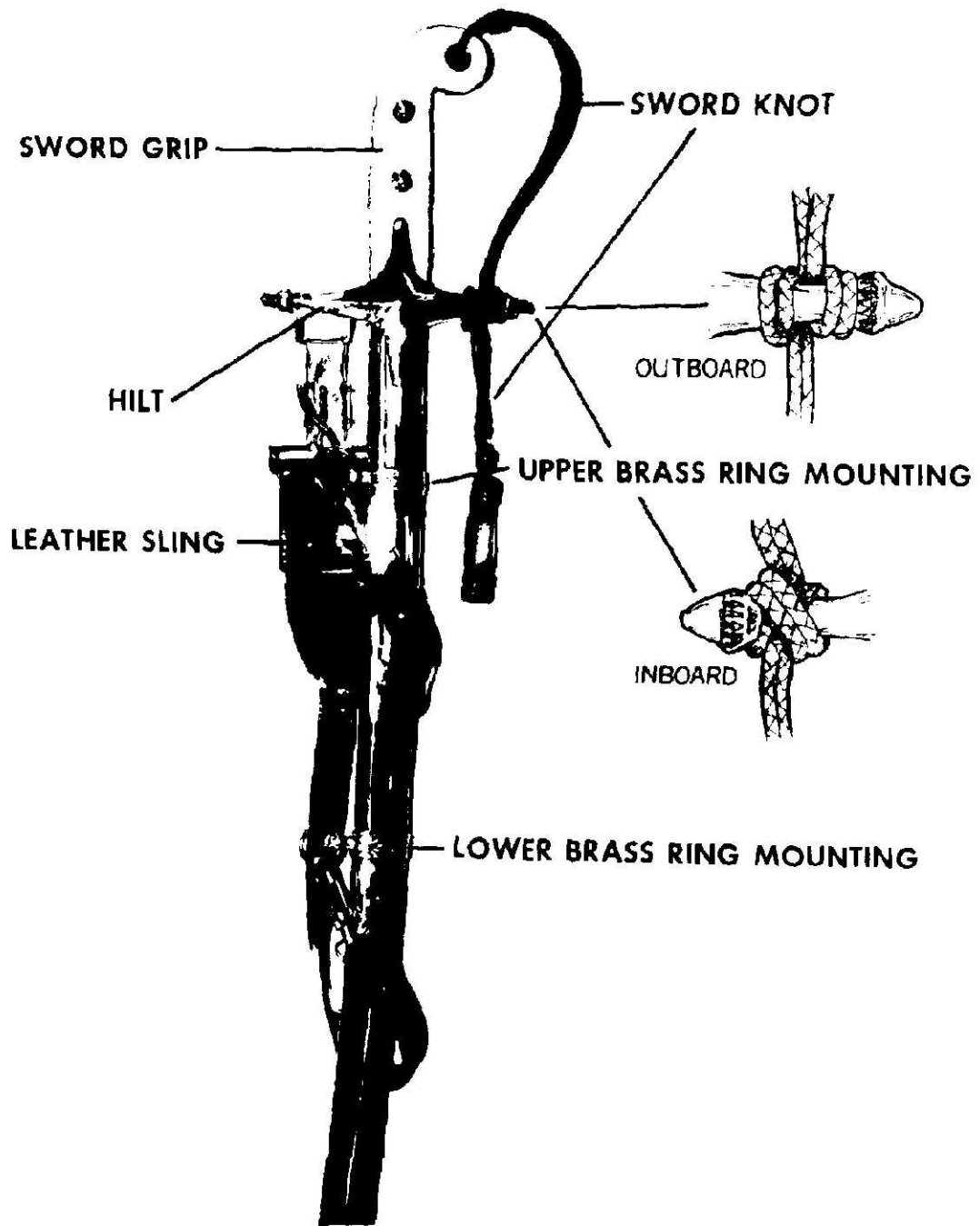

Figure 3-7.--Officer's Sword.

a. The leather sword sling is made of black leather or approved synthetic leather in semi-gloss or high-gloss (patent) finishes. The outer side of the leather is smoothly finished. The inner side of the sling is darkened to present about the same shade as the outer side. The sword sling consists of the following parts:

(1) A leather tongue, four snap fasteners, and two straps (one strap 18-1/2 inches long and the other 11-3/4 inches long).

(2) The hardware, which is removable to facilitate polishing, consists of the brass snap fastener with sword hook to which the tongue is attached, and two locking snap swivel fasteners attached to the ends of the straps. The tongue is attached to the brass snap fastener by inserting the rounded tip through the squared loop at the bottom of the fastener toward the back, folding the tip down and closing the four button snap fasteners.

(3) The locking snap swivels are attached by inserting the tip ends of the straps through the loops of the locking swivels, folding the tip back and inserting a brass button into the two aligned holes of the strap. The tip end of the straps will be on the under side of the straps. The large face of the button will be on the outside of the strap.

b. The sword will not be worn without the leather sword sling attached to it.

c. The sword is worn hooked up with the hilt inclined to the rear and the sling outside the scabbard. To attach the sword and scabbard, use the following procedure:

(1) The snap fastener of the leather sling is engaged in the ring of the shoulder sling or the leather frog.

(2) The scabbard is held in the right hand to the left front, with the scabbard rings to the rear.

(3) Engage the snap swivel of the short sling strap to the top ring on the scabbard.

(4) Engage the snap swivel of the long sling strap to the bottom ring of the scabbard.

(5) Turn the scabbard 180 degrees clockwise, and loop the upper scabbard ring over the prong protruding from the outside of the snap fastener of the leather sling.

4. Service Sword Frog

a. The service sword frog is worn when the sword is suspended from the leather service belt.

b. The service frog is made of black leather or approved synthetic leather in semi-gloss or high-gloss (patent) finish. The frog has polished brass hooks to fit the 1-inch slit at stop (when folded).

c. The frog is attached to the belt at a point over the highest portion of the hipbone, generally along the seam of the trousers/ slacks/skirt. The snap hook of the leather sling is engaged in the ring attachment of the frog.

5. Shoulder Sword Sling

a. The shoulder sword sling consists of white cotton webbing with sliding shoulder pad, an adjusting buckle, and a sword attaching ring.

b. The sling is worn by male officers only when a coat is worn. It is worn beneath the coat, over the right shoulder extending across the torso, with the ring attachment over the top of the left hipbone, at a point where the sword slit is located in the coat. The sling is worn so that the ring attachment protrudes through the sword slit of the coat, but so that the white webbing is not visible from the outside.

6. White Web Sword Belt With Suspenders

a. The white web sword belt consists of a white cotton webbing belt with an adjustable hook and pile closure and a white leather frog attachment stitched to the belt to hold the sword. White suspenders are worn attached to the belt to afford additional support and stability.

b. The sling may be worn by male officers as an option to the shoulder sling. It is worn beneath the coat, with the frog attachment over the top of the left hipbone, at a point where the sword slit is located in the coat. The ring attachment of the frog will protrude through the sword slit of the coat.

7. Sword Knot

a. The service sword knot is braided of black leather or approved synthetic material, with a simulated large knot, two sliding keepers, and a hook and eye closure. The sword knot will be attached to the sword at all times.

b. The knot is attached to the sword by passing the small end through the eye in the pommel and securing it to the hook above the large end of the knot. One keeper will be drawn taut immediately below the pommel; the other immediately above the large end of the knot. Both strands of the knot are then looped in a clove hitch over the rear hilt at the cross guard, next to the acorn, and drawn taut so that the large end of the knot hangs free and does not fall below the upper brass rings of the scabbard. The clove hitch "crossover" is worn inboard.

8. Sword Mourning Knot

a. The mourning knot is a black ribbon of silk or similar material, 3 inches wide by 27 inches long. The two flowing ends are 12 inches long when the band is knotted upon the sword hilt.

b. The mourning knot is worn attached to the service sword knot when mourning is ordered. The knot is formed by passing the free ends around and under the service knot, immediately below the eye in the pommel, and then

passing them back through the bight formed at the center of the band. The knot is then drawn taut.

3033. TAPES, NAME/SERVICE

1. Name/service tapes will be worn on the green and desert camouflage utility uniforms, combat utility uniforms, and the maternity camouflage work uniform. The camouflage utility uniform name and service tapes will be of olive green cloth, one inch wide, with embroidered 3/4 inch high black block lettering, except that tapes for the desert utility uniform will utilize brown lettering on a tan background. The combat utility uniform name and service tapes will be of the same MARPAT material as the uniform it is sewn on to, with embroidered 3/4 inch high black (for woodland combat utilities) and brown (for desert combat utilities) block lettering. If necessary to accommodate longer names the lettering may be in condensed print, 1/2 inch high. Nametapes will include the individual's last name only in upper case letters. Service tapes will be inscribed with "U.S. MARINES" in upper case letters, with a space before "MARINES."
2. Tapes for utility coats will be long enough to align with the edges of the pocket flaps when the ends of the tape are turned under and stitched down. Tapes for utility trousers and the maternity camouflage work uniform will not exceed 6 inches in length when sewn on. For the maternity camouflage work uniform, both the name and service tape will be the same length. Tapes will be sewn on uniforms with the ends of the tape turned under and using a plain straight stitch with thread that matches the tape fabric.
3. On the utility coats, the nametape will be worn over the right breast pocket and the service tape will be worn over the left breast pocket. Tapes on the camouflage utility uniform will be sewn with the bottom of the tape immediately above and parallel to the top of the pocket flap, with the ends of the tape aligned with the edges of the pocket flap. On coats with slanted breast pockets, to include the desert and woodland combat utility uniforms, tapes will be placed immediately above and parallel with the top of the slanted chest pocket flaps. On the utility trousers, a nametape will be worn above the right rear trouser pocket. Name/service tapes may be worn on utility uniforms which already have the "USMC"/emblem decal affixed as long as these uniforms are serviceable. However, only the emblem portion (eagle, globe and anchor) of the decal, centered on the left breast pocket, is required.
4. Tapes will be worn on the desert camouflage utility uniform at the commander's discretion only if it is expected that the individual will retain the uniform for at least 60 days. The Marine Corps emblem may be ironed on the left breast pocket when commanders authorize wear of tapes. The emblem will not be placed on the desert camouflage utility field hat. Prior to recovery of the uniform the individual Marine will be responsible for removing name/service tapes from desert utilities. These requirements for the desert camouflage utility uniform will not be necessary once the desert camouflage utility uniform becomes obsolete 1 October 2006.
5. On the maternity camouflage work uniform tapes will be vertically centered, with the top of the tape placed approximately on line with the

second buttonhole from the top of the coat. Placement may be adjusted to the individual as necessary to ensure proper appearance and comfort. On uniforms which have the complete "USMC"/emblem decal affixed the service tape will be worn with the bottom of the tape 1/2 inch above the emblem and the nametape will be worn in a corresponding position on the right side.

6. Marines who experience name changes will replace nametapes with tapes bearing their new names as soon as possible. The wear of tapes with minor deviations, such as the use of some lower case letters in certain names, is authorized as long as the tapes are serviceable. Marines are responsible for ensuring that replacement tapes meet guidelines.

3034. TROUSERS (MALES)

1. General

a. Service and dress trousers will be full cut, straight hanging, zipper fly front, and without cuffs. Trouser legs will provide easy fit and will be long enough to break slightly over the shoe in front and to reach the juncture of the welt of the shoe in the rear. A variation of 1/4 inch above/below the welt is acceptable. Hems will be from 2 inches to 3 inches wide.

b. Trousers will be pressed to present a smooth vertical crease at about the center front and rear of each leg. The crease will extend from the bottom of the hem to about 2 inches above the trouser crotch.

c. Enlisted service and dress trousers are standard as issued/sold through the DoD Supply System. Optional high-waisted blue dress trousers with approval identification labels, as sold through Marine Corps exchanges or commercial sources, are authorized for optional purchase and wear by staff NCOs with the evening dress uniform. Officers' service trousers, of any authorized material, may be worn by SNCOs.

2. Officers' Blue and Evening Dress Trousers

a. Blue dress trousers for colonels and below are sky blue with a 1-1/2 inch wide scarlet stripe down the outer seam of each leg. Blue dress trousers for general officers are dark blue with a 2-inch wide scarlet stripe down the outer seam of each leg.

b. Field and company grade officers are authorized to wear blue dress uniforms with coats and trousers of different fabrics.

c. Evening dress trousers are made of dark blue broadcloth and will have a long waist, high in back, fitting snugly and without wrinkles, without hip or side pockets, buckle straps or belt loops; suspender buttons will be inside the waistband. An ornamented gold lace stripe of tarnish resistant gold thread or gold-plated braid is sewn down the outer seam of each leg.

3035. UMBRELLAS. Female Marines may carry an all-black, plain standard or collapsible umbrella at their option during inclement weather with the service and dress uniforms. It will be carried in the left hand so that the

hand salute can be properly rendered. Umbrellas may not be used/carried in formation nor will they be carried with the utility uniform.

3036. UNDERGARMENTS

1. Undershirts

a. Standard undershirts will be made of cotton with quarter length sleeves and have an elliptical (crew-neck) collar. White V-neck undershirts are optional.

b. The white crew-neck or the V-neck undershirt is authorized with male service and dress uniforms at the individual's option. Whether an undershirt is worn is at the individual's option except that the crew-neck undershirt will be worn when required by the commander at such times when uniformity is considered essential such as at formations, ceremonies, or parades.

>Ch 3 c. The issue utility uniform undershirt is a plain cotton olive green, short-sleeve, crew-neck shirt. Marines may wear optional plain, olive green long- or short-sleeve undershirts of any material, as long as the shirts meet the command's minimum safety standards and have a Marine Corps approval identification number. Optional shirts (long- or short-sleeve) will meet the minimum requirement, however, commanders may dictate the wear of only short-sleeve shirts when uniformity is required. Wearing the undershirt with the utility uniform is at the individual's option, except that the undershirt will be worn when the utility coat is removed. An undershirt may be required by the commander at such times when uniformity is considered essential such as at formations, ceremonies, or parades.

2. Drawers (Males). The standard drawers (boxer or jockey style) are made of plain white cotton. White drawers (same style/design as the standard drawers), as sold through commercial sources, may be purchased, worn, and used to satisfy minimum requirements.

3. Undergarments (Females). Females will wear adequate undergarments, (e.g., slip, bra, camisole, girdle, etc.) to ensure the proper fit, appearance, and opaqueness of the uniform. Undergarments will be worn so that they are not conspicuously visible. The white v-neck undershirt is authorized for wear with service and dress uniforms at the individual's option.

3037. CAMOUFLAGE UTILITY UNIFORM

1. Woodland style camouflage pattern and poplin style camouflage utilities are authorized for wear at the individual's option. No items of woodland and poplin uniforms will be mixed with the exception of the utility cap per subparagraph 3037.7.

2. The camouflage utility uniform is designed for field wear and should be loose fitting and comfortable. Items should be fitted loosely enough to allow for some shrinkage without rendering the garment unusable. Utility uniforms may be starched or sized at the option of the individual but starching/sizing will not be mandated by commanders. See paragraph 10103 for laundering instructions for camouflage utility uniforms.

3. The emblem decal will be placed on the left breast pocket of the camouflage utility coat centered horizontally and vertically. To apply the decal, use a dry iron set at 300 degrees (synthetic). Press over the decal for 3 to 4 seconds. Do not use steam. Utility coats marked with the

"USMC"/emblem decal according to previously published instructions may be worn until they become unserviceable.

4. Name/service tapes will be worn on the utility uniform as prescribed in paragraph 3032.

5. The camouflage utility coat will be worn outside the trousers. Sleeves may be rolled up at the option of local commanders. When authorized, utility sleeves will be rolled with the inside out, forming a roll about 3 inches wide, and terminating at a point about 2 inches above the elbow. When combat boots are worn, the trousers will be bloused in a neat uniform manner. When utility uniforms are prescribed for parades, reviews, and ceremonies, the helmet with camouflage cover may be prescribed.

6. On the camouflage utility coat and trousers the replacement of pocket flap buttons with hook-and-pile ("Velcro") fasteners at the option and expense of the individual is authorized. These uniforms will meet minimum requirements; however, commanders will not mandate the use of hook-and-pile fasteners.

7. The camouflage utility cap will be machine or hand laundered in warm water. It may be starched or sized but may not be bleached. The woodland style camouflage utility cap may be worn with any authorized style camouflage uniform.

8. When the helmet is worn with utilities, the pocket size iron-on emblem of the Marine Corps decal will be centered on the front of the helmet cover. With the helmet cover removed from the helmet, the bottom of the emblem will be placed approximately 2 inches up from the front seam, taking care to avoid placing the emblem over any of the open slits in the helmet cover material. The emblem will not be worn by recruits undergoing training. Local commanders may direct placement of the emblem on desert helmet covers only if it is expected that desert utilities will be worn at least 60 days. Improperly ironed-on decals will not render the helmet cover unserviceable.

3038. COMBAT UTILITY UNIFORM

1. The combat utility uniform should be loose fitting and comfortable. Items should be fitted loosely enough to allow for some shrinkage without rendering the garment unusable. No items of desert and woodland camouflage patterns will be mixed. Care of the combat utility uniform will observe guidance provided in paragraph 10104.

2. Name/service tapes will be worn on the combat utility uniform as prescribed in paragraph 3032, with the exception that name/service tapes will be placed immediately above and slanted parallel with the top of the slanted chest pockets flaps. The background of the name/service tapes is of the same fabric and print as the uniform itself.

3. The combat utility coat will be worn outside the trousers. When authorized by the commander, sleeves will be rolled with the inside out, forming a roll about 3 inches wide, and terminating at a point about 2 inches above the elbow. When combat boots are worn, the trousers will be bloused in a neat uniform manner. When the combat utility uniform is prescribed for

parades, reviews and ceremonies, the helmet with camouflage cover may also be prescribed.

>CH 1 4. The combat utility field cap may be worn during field type exercise only, and may not be prescribed for parades, reviews or other ceremonies. When worn, the combat utility field cap brim will be worn straight or angled slightly down.

5. No woodland or poplin fabric items of the camouflage utility uniform will be mixed with the combat utility uniform. (ALMAR 15/02)

3039. WAISTCOATS

1. The white pique waistcoat is backless with adjustable neck and back straps; single-breasted with shawl-type lapels, and V-shaped opening. The front fastens with three detachable small gold uniform buttons set closely together on the right side, with corresponding buttonholes on the left. It has two welted outside pockets, one on each lower part of the front. The front edges of the waistcoat, from bottom of lower button to bottom of waistcoat are cut away to form an inverted "V." Previously authorized white waistcoats with back panel may continue to be worn.

2. The white waistcoat is worn by all male officers with the evening dress "A" uniform. It will be adjusted so that no part extends below the bottom of the evening jacket.

3. The scarlet waistcoat made of wool tropical fabric will be worn only by male general officers with the evening dress "B" uniform and by female generals with the evening dress "A"/"B" uniforms. The standard design scarlet waistcoat is available CG, MARCORSYSCOM (PM, ICE). A backless version is authorized for sale through approved sources.

MARINE CORPS UNIFORM REGULATIONS

CHAPTER 4

INSIGNIA AND REGULATIONS FOR WEAR

	<u>PARAGRAPH</u>	<u>PAGE</u>
AIGUILLETTES	4000	4-3
BRANCH OF SERVICE INSIGNIA	4001	4-7
BREAST INSIGNIA	4002	4-9
BUTTONS, INSIGNIA	4003	4-14
INSIGNIA OF GRADE, ENLISTED	4004	4-15
INSIGNIA OF GRADE, OFFICERS	4005	4-24
MARINE GUNNER INSIGNIA	4006	4-27
SERVICE/IDENTIFICATION BADGES	4007	4-28
SERVICE STRIPES	4008	4-31
SLACKS/TROUSER STRIPES (OFFICER/NCO)	4009	4-32

FIGURE

4-1	AIDE-DE-CAMP ACCESSORIES	4-4
4-2	WEARING AIGUILLETTES	4-5
4-3	PLACEMENT OF BRANCH OF SERVICE AND OFFICERS' GRADE INSIGNIA	4-8
4-4	BREAST INSIGNIA	4-11
4-5	ENLISTED INSIGNIA OF GRADE	4-16
4-6	PLACEMENT OF ENLISTED GRADE INSIGNIA AND SERVICE STRIPES (MEN)	4-17
4-7	PLACEMENT OF ENLISTED GRADE INSIGNIA AND SERVICE STRIPES (WOMEN)	4-17
4-8	GRADE INSIGNIA FOR MALE SNCO EVENING DRESS	4-18

MARINE CORPS UNIFORM REGULATIONS

	FIGURE	<u>PAGE</u>
4-9	ENLISTED GRADE INSIGNIA (METAL/PLASTIC) ..	4-19
4-10	PLACEMENT OF METAL/PLASTIC INSIGNIA OF GRADE (UTILITY COAT FIELD COAT, AND KHAKI SHIRT WITH SERVICE SWEATER)	4-19
4-11	OFFICERS' GRADE INSIGNIA (SHOULDER)	4-21
4-12	PLACEMENT OF COLLAR INSIGNIA (OFFICER)	4-22
4-13	GENERAL OFFICER COLLAR INSIGNIA	4-23
4-14	PLACEMENT OF SHOULDER INSIGNIA (OFFICER)	4-23
4-15	PLACEMENT OF INSIGNIA ON COMBAT UTILITIES COAT (OFFICER)	4-24
4-16	PLACEMENT OF RANK INSIGNIA ON THE MALE OFFICER GARRISON CAP	4-26
4-17	MARINE GUNNER COLLAR INSIGNIA	4-27
4-18	SERVICE/IDENTIFICATION BADGES	4-28

MARINE CORPS UNIFORM REGULATIONS

CHAPTER 4

INSIGNIA AND REGULATIONS FOR WEAR

4000. AIGUILLETTES (See figs. 4-1 and 4-2.)

1. General. Unless specifically authorized by the CMC, only those officers listed below will wear aiguillettes.

a. Service aiguillettes consist of the number of loops indicated:

(1) Four Loops. Personal aides to the President or Vice President; aides at the White House; aides to the Secretary or Deputy Secretary of Defense, Secretary or Under Secretary of the Navy, and Assistant Secretaries of Defense or the Navy; aide to the General Counsel of the Navy; and naval attaches and assistant attaches assigned to an embassy. Naval attaches and assistant attaches may wear aiguillettes only within areas of accreditation, except when specifically requested and accompanying an ambassador or foreign service officer to whom accredited at an official function.

(2) Four Loops. Aides to generals, admirals, or officials of higher grade.

(3) Three Loops. Aides to lieutenant generals or vice admirals.

(4) Two Loops. Aides to major/brigadier generals, rear admirals, or other officers of lower grade entitled to an aide.

b. Officers appointed as aides to a governor of a state or territory may wear aiguillettes on official occasions. If worn, service aiguillettes will have two loops.

c. Aides to top-ranking foreign representatives visiting the United States will wear aiguillettes when so ordered. An aiguillette appropriate to the official's grade to whom attached will be worn.

d. Administrative assistants to deputy commandants at Headquarters Marine Corps may wear the aiguillette when acting in the capacity of Aide de Camp. The aiguillette appropriate to the grade of the deputy commandants to will be worn.

e. Aides to the President, Vice-President, foreign heads of state, and aides at the White House will wear aiguillettes on the right shoulder. All other aides will wear aiguillettes on the left shoulder.

f. When the Fourragere is worn with an aiguillette, it will be worn under the aiguillette.

2. Dress

MARINE CORPS UNIFORM REGULATIONS

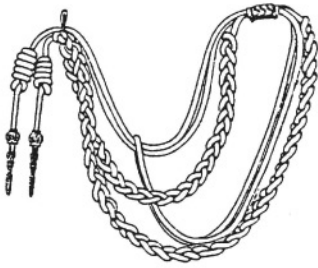

Aiguillette, Dress



Pencil Attachment



Aide to General, Admiral, or official of higher grade; Naval Attaches and Assistant Naval Attaches



Aide to Lieutenant General or Vice Admiral



Aide to Major General, Rear Admiral or officer of lower grade; to a governor of a state or territory

Figure 4.1.--Aide-de-Camp Accessories.

MARINE CORPS UNIFORM REGULATIONS

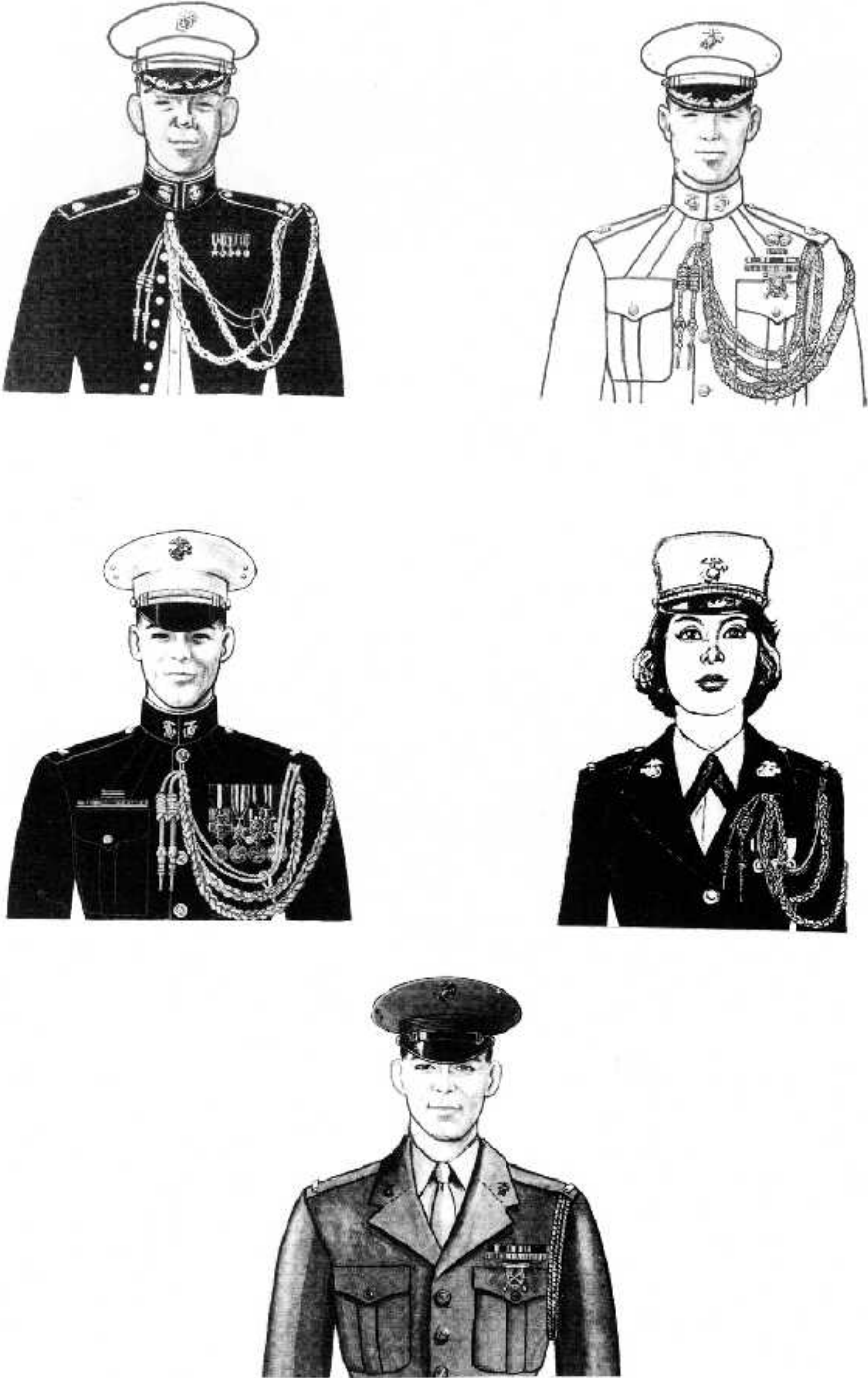

Figure 4-2.--Wearing Aiguillettes.

a. Dress aiguillettes are of round gold cord $\frac{1}{4}$ inch in diameter, with a core of yellow cotton covered with gold or gilt thread. It consists of two cords made in three plaits, with a pencil attachment on the end of each plaited cord, and of two loops of single cord. The rear-plaited cord is 28 inches long and the front-plaited cord is 20 inches long; the front single cord is 17 inches long and the rear single cord is 21 inches long. The two-plaited cords and front single loop (after the latter has been passed through rear single loop) are securely fastened together and have a 1-inch loop of No. 9 gold braid for attaching aiguillettes to top button of coat, collar opening of dress coat, or button or hook of jackets; the rear-plaited cord passing over the front-plaited cord and fastening underneath the front-plaited cord at the loop. From the point where the cords are secured together, the two-plaited cords extend as single cords for 2 inches, then they form coils of five laps, ends passing through coils and extending 2 inches to the gilt pencil attachment. The position separating the front- and rear-plaited cords is fitted with a bar pin about 1-1/2 inches long and 3/8 inch wide, covered with a 1-1/2 inch strip of No. 3 gold braid covering the ends of the cord, and the bar, to allow attaching the aiguillette to the coat or jacket at the shoulder, just inside the armhole seam. The pencil attachment is gold-plated brass, 3.015 inches long, the cap is 0.656 inches long, and the pencil is 2.359 inches long. The cap has six leaves; the pencil has two miniature Marine Corps emblems (omitting motto ribbon and anchor rope) on the upper part and two wreaths on the lower part, all in relief around the circumference. The smooth surfaces are polished; the cap or upper part is stamped; and the lower part hollow-cast, turned, milled, and knurled.

b. Dress aiguillettes are worn on the evening dress, blue dress "A"/"B", blue-white dress, and white dress uniforms. Both plaited cords and the front single loop are worn in the front of the arm, the rear single loop passing from the rear under the arm.

c. Males. On the evening dress jacket, dress aiguillettes worn on the right side will be suspended from a hook at the inside at the base of the collar closure; those worn on the left side will be suspended from the top button. The shoulder straps on the evening dress jacket may be modified, at the individual's option, to allow the aiguillette to pass under the shoulder strap as depicted in figure 4-2. Dress aiguillettes will be suspended from the top button of the blue dress and white dress coats.

d. Females. On the evening dress jackets and dress coats, dress aiguillettes will be suspended from the milled nut securing the branch of service insignia or from a small button attached to the body of the jacket/coat under the extreme inside point of slash between lapel and collar on the side on which the aiguillette is worn.

3. Service

a. Service aiguillettes are of round gold wire and scarlet cord, 1/4 inch in diameter, and consist of two, three, or four loops sewn together all the way around. The lengths of the cords forming loops are: the first/inside loop, 27 inches; the second loop, 28-1/2 inches; third loop, 28-3/8 inches, and fourth loop, 30-3/4 inches. Where the ends meet, the cords are fitted

with a bar pin about 1-1/2 inches long by 3/8 inch wide and bound together with a 1-1/2-inch strip of No. 3 gold braid covering the ends of the cord to allow attachment of the aiguillettes to uniform coats at the shoulder, just inside the armhole seam. The loops are arranged to lie flat in a horizontal position where they are fastened to the armhole seam, continuing thus for about half their length, then twisting obliquely and becoming superimposed vertically around the lower curve.

b. Service aiguillettes are worn on the service "A," "B," and "C" uniforms and the blue dress "C"/"D" uniforms. Service aiguillettes are not worn on the service sweater, tanker jacket or all-weather coat.

c. To prevent the scarlet color from running, service aiguillettes should not be worn outdoors during periods of precipitation.

d. Service aiguillettes will be fastened under the shoulder strap and go around the shoulder just under the armpit, with the longest loop nearest the collar.

e. On the khaki shirt, service aiguillettes will go around the shoulder just under the armpit, with the longest loop nearest the collar, and fastened at the shoulder just inside the armhole seam.

4001. BRANCH OF SERVICE INSIGNIA

1. Design

a. The officers' branch of service insignia for the dress/service cap is modeled after the Marine Corps emblem without motto ribbon. It consists of a view of the globe (Western Hemisphere) about 7/8 inch in diameter, intersected by a fouled anchor, and surmounted by an eagle. The rope of the fouled anchor is only connected at distinct points. The insignia is provided with a screwpost securely soldered to and projecting from the approximate center rear of the globe, and fitted with a milled nut. The dress insignia is gold and silver while the service insignia is finished in a nonglossy black.

b. The design of the officers' dress collar insignia is identical to the dress cap insignia, except that it is about 11/16 inch in diameter.

c. The design of the officers' service collar insignia is identical to the service cap insignia, except that it is 9/16 inch in diameter.

d. Enlisted branch of service insignia is the same general design as officers' insignia, except that the rope is continuously connected to the fouled anchor of the emblem. Dress insignia is stamped of gold color metal while service insignia is stamped and finished in non-glossy black.

2. Cap Insignia

a. Dress cap insignia will be worn with the dress cap, centered vertically in the eyelet provided.

MARINE CORPS UNIFORM REGULATIONS

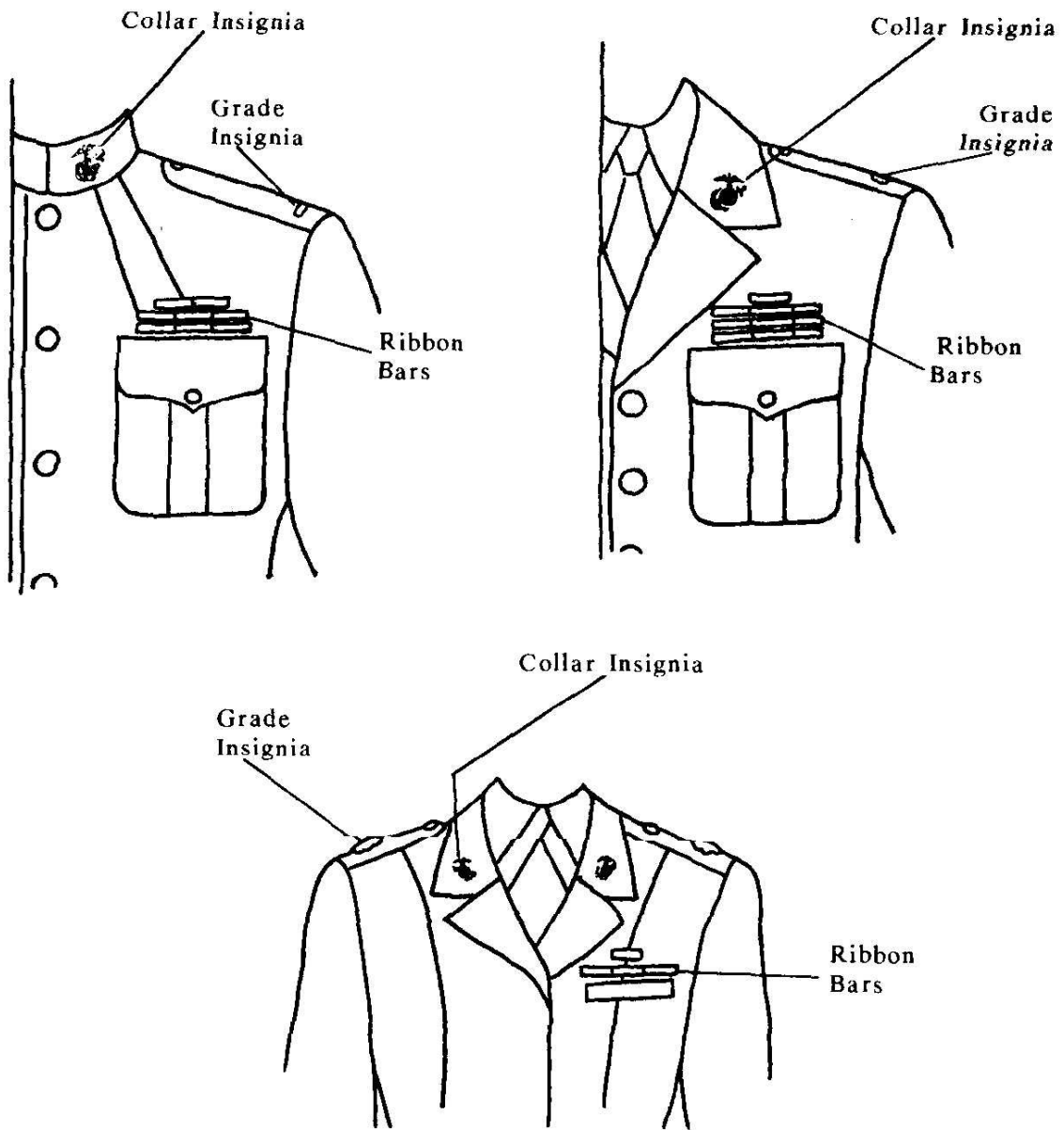

Figure 4-3.--Placement of Branch of Service and Officers' Grade Insignia.

b. When the service frame cap is worn with service uniforms, service cap insignia will be worn centered vertically in the eyelet provided. It will also be worn in the same manner on the fiber sun helmet and campaign hat.

c. The left service collar insignia will be worn on the left front side of the garrison cap, with the insignia centered vertically in the eyelet provided.

3. Collar Insignia. (See figs. 4-3, 5-3, and 5-4.)

a. Dress collar insignia will be worn on the blue and white dress coats and evening dress jackets placed in the eyelets provided, with eagles facing inboard, as follows:

(1) For male personnel the insignia will be aligned vertically in the center of each side of the collar on the blue dress coats and the officers' evening dress jacket. On the SNCO evening dress jacket the insignia will be worn on each side with the wing span horizontally parallel to the deck.

(2) For female personnel, the insignia will be worn on each side centered between the crease roll and edge of the collar on the evening dress jacket and the blue dress coats, with the wing span parallel to the bottom edge of the coat or jacket.

b. Service collar insignia will be worn on the collar of the service coat, centered on the collar in the eyelets provided, eagles facing inboard, with the wing tips parallel to the bottom of the coat.

4002. BREAST INSIGNIA. (See fig. 4-4.)

1. General

a. Per the current edition of MCO P1000.6, Assignment Classification and Travel Systems (ACTS) Manual and whose right to wear the insignia has not been specifically revoked, a Marine qualified or designated as a naval aviator, naval flight officer, Marine aerial navigator, naval aviation observer, naval or combat aircrew member, parachutist, explosive ordnance disposal technician, or U.S. Navy diver, will wear appropriate breast insignia according to the following regulations.

b. A Marine designated as a naval astronaut (pilot, NFO, or mission specialist) will wear the appropriate naval astronaut insignia as prescribed by the Department of the Navy.

c. In addition to the breast insignia authorized in these regulations, naval medical officers assigned to Marine Corps units who are designated flight surgeons may wear the U.S. Navy gold metal flight surgeon insignia on Marine Corps service and utility uniforms.

d. Only those breast insignia listed in these regulations are authorized for wear on Marine Corps uniforms.

e. Other U.S. service pilot/navigator insignia and foreign pilot insignia may be worn, but only as authorized in subparagraph 4002.3.

f. Any other U.S. service/foreign/civilian breast insignia may be accepted by an individual, but will not be worn on Marine Corps uniforms.

2. Insignia Descriptions

a. Aviation Insignia. Basic naval aviation wings are gold metal wings 2-3/4 inches from tip to tip. Centerpieces vary to distinguish aviation specialties.

(1) The naval aviator insignia is a bronze, gold metal pin consisting of a fouled anchor surmounted by a shield, centered on the basic wings. The fouled anchor is 7/8 inch long. The height and width of the shield is 1/2 inch.

(2) The naval flight officer insignia is a gold metal pin consisting of two crossed fouled anchors surcharged with a shield, centered on the basic wings. The fouled anchors are 7/8 inch long. The height and width of the shield is 1/2 inch.

(3) The Marine aerial navigator insignia is a gold metal pin consisting of the basic wings with a central device of two fouled anchors surmounted by a replica of a mariner's compass, superimposed on a silver-colored disk. The fouled anchors are 5/8 inch long; diameter of the disk, 1/2 inch; diameter of the compass, 3/8 inch.

(4) The naval aviation observer insignia is a gold metal pin consisting of the basic wings with a central device of an "O" circumscribing an erect plain anchor, both in silver in bold relief, the center of the "O" being filled with gold. The outer diameter of the "O" is 3/4 inch; inner diameter, 9/16 inch; height of the anchor, 1/2 inch.

(5) The naval aircrew insignia is a gold metal pin consisting of the basic wings with a circular center design and anchor with the block letters "AC" superimposed. The circle diameter is 3/4 inch; anchor height is 1/2 inch.

(6) The combat aircrew insignia is an metal pin having silver wings, with a gold-colored circular shield with superimposed fouled anchor; the word "AIRCREW" in raised letters on a silver-colored background below the circular shield; above the shield is a silver-colored scroll; the insignia measures 2 inches from wing tip to wing tip; circle on the shield, 5/16 inch in diameter. Gold stars, up to a total of three, as merited, will be mounted on the scroll, necessary holes being pierced to receive them. A silver star may be worn in lieu of three gold stars.

b. Parachutist Insignia

(1) The basic parachutist insignia is a silver pin about 1-1/2 inches long and 3/4 inch high, consisting of an open parachute flanked on either side by wings curving up and inward so that the tips join the edge of the parachute canopy.

MARINE CORPS UNIFORM REGULATIONS

AVIATION



Naval Aviator and Naval Aviation Pilot



Naval Flight Officer



Marine Aerial Navigator



Naval Aviation Observer



Naval Aircrew



Combat Aircrew

PARACHUTIST



Basic Parachutist



Navy/Marine Corps Parachutist

EXPLOSIVE ORDNANCE DISPOSAL



Basic EOD



Senior EOD



Master EOD

DIVER



Master Diver



1st Class Diver



Combatant Diver



2nd Class Diver



SCUBA Diver

Figure 4-4.--Breast Insignia.

(2) The Navy/Marine Corps parachutist insignia is a gold metal pin, consisting of the basic aviation wings with a gold-colored open parachute centered on the wings. The parachute is 1/2 inch wide at its widest part and 13/16 inch long from top to bottom.

c. Explosive Ordnance Disposal.

(1) The basic EOD insignia is an silver pin consisting of a 1-inch high shield with a conventional drop bomb, point down, and 4 lightning bolts, all in front of a laurel leaf wreath 1-3/4 inches wide.

(2) The senior EOD insignia is the same as the basic EOD insignia, but with a 7/32-inch star on the drop bomb.

(3) The master EOD insignia is the same as the senior EOD insignia with a star in a laurel wreath above the shield.

d. Diver Insignia

(1) The master diver insignia is a silver pin approximately 1 inch high and 1-1/4 inches wide, with 2 upright seahorses facing a diving helmet, and 2 tridents projecting upward and canted outward from the diving helmet's cover. A double carrick bend is superimposed on the breastplate.

(2) The diving medical technician insignia is same as the master diver insignia, with a caduceus on the breastplate.

(3) The first class diver insignia is a silver metal pin approximately 1 inch high and 1-inch wide, with a diving helmet surrounded by sea serpents.

(4) The combatant diver insignia is a gold pin approximately 1-inch and 15/16 inch wide, consisting of wet suit headgear and low profile facemask with chest mounted breathing apparatus.

(5) The second class diver insignia is a silver metal pin approximately one inch high and 3/4 inches wide, with a diving helmet and breastplate.

(6) The SCUBA diver insignia is a silver pin approximately 1-1/16 inches high and 1 inch wide, consisting of wet suit headgear and facemask with breathing apparatus around the neck.

3. Regulations for Wear

a. Authorized insignia will be worn on the left breast of all service and dress coats. It may be worn at the individual's option on khaki shirts worn as the outer garment (with or without ribbons), utility coats or the maternity work uniform coats. Miniature insignia, one-half regular size, will be worn on evening dress jackets. Breast insignia will not be worn on the cloak/cape, AWC, extreme cold weather parka, tanker jacket, field coat or sweater.

b. Anodized breast insignia will be worn on all evening dress and dress uniforms. Either anodized or oxidized breast insignia may be worn at the individual's option on the service uniforms, but mixing of anodized and oxidized breast insignia is not authorized. When breast insignia are worn on the utility uniform, oxidized breast insignia will be worn, with the exception that subdued brown or black breast insignia may be worn in a field environment in lieu of oxidized breast insignia.

c. When worn on the dress coat, service coat, khaki shirt, or maternity tunic, the insignia will be placed with wings horizontal and parallel to the top of the breast pockets (if any). On women's coats with slanted pockets, a horizontal line tangent to the highest point of the pocket is considered the top of the pocket.

(1) When worn alone, the insignia will be worn in the same position a single ribbon would be worn.

(2) When worn with medals, ribbons, or membership badges, the bottom of the insignia will be centered 1/8 inch above the top row of such awards. When successively decreasing rows of ribbon bars are worn (as in subparagraph 5301.5), and the top row of ribbons is such that centering the insignia presents an unsatisfactory appearance, the insignia may be centered between the outer edge of the coat lapel and the left edge of the vertically aligned ribbon rows.

d. When worn on the camouflage utility coat, the bottom of the insignia will be centered 1/2 inch above the service tape.

e. When worn on the camouflage maternity work uniform, the bottom of the insignia will be centered 1/2 inch above the service tape.

f. When worn on male officers' evening dress jacket, the miniature insignia will be placed on the left-front panel on a line 1/8 inch above the second blind buttonhole, and spaced midway between the inner edge and left-armhole seam.

g. When worn on evening dress jackets with lapels, the miniature insignia will be centered 1/8 inch above the miniature medals, or if no medals are authorized, the miniature insignia will be centered on the lapel at the position prescribed for the top of the medal bar.

h. Other U.S. service pilot/navigator insignia or foreign pilot insignia earned while the individual was a member of the foreign or other U.S. service may be worn provided the insignia is a duly authorized qualification insignia. These insignia may be worn on the right breast, in the same manner as Navy/Marine Corps insignia are worn on the left breast, without specific CMC authorization.

i. Other U.S. service pilot insignia earned as a Marine while undergoing training leading to qualification for the naval aviation insignia will be worn on the left breast as prescribed above, until qualified and authorized to wear the naval aviator insignia, at which time the other service insignia will no longer be worn.

j. When two Navy/Marine Corps aviation insignia are worn at a time, the senior insignia will be worn 1/8 inch above the other as follows (from top to bottom):

(1) Naval Aviator and Naval Aviation Pilot

(2) Naval Flight Officer

(3) Marine Aerial Navigator

(4) Naval Aviation Observer

(5) Combat Aircrew. Individual option, but may not be worn with naval aircrew.

(6) Naval Aircrew. Individual option, but may not be worn with naval aircrew.

k. When the Navy/Marine Corps parachutist insignia is worn, the basic parachutist insignia will not be worn. When aviation insignia is worn with the basic or Navy/Marine Corps parachutist insignia, the parachutist insignia will be centered 1/8 inch above any aviation insignia.

l. When EOD insignia is worn with aviation or parachutist insignia, the EOD insignia will be centered 1/8 inch above the other insignia.

m. A Marine with more than one diver insignia will wear the senior insignia, per the current edition of MCO P1000.6, ACTS Manual. When diver insignia are worn with any other breast insignia, the diver insignia will be centered 1/8 inch above the other insignia.

n. Not more than two USMC-approved breast insignia will be worn on the left, and not more than one foreign pilot or other U.S. service pilot/navigator insignia will be worn on the right, at any time.

4003. BUTTONS, INSIGNIA

1. The nonglossy black plastic buttons and gold-plated buttons have the regulation USMC eagle and anchor design stamped on the front (high dome is on gold buttons only) with black or bright gold background, as appropriate, and a burnished rim on gold buttons.

2. Gold metal buttons are either small (22-line), medium (27-line), or large (40-line), and will be worn on the dress uniforms as follows:

a. Blue and white dress coat: 27-line on shoulder straps, enlisted cuffs, and men's pockets, 40-line on coat fronts.

b. Evening dress jacket: 27-line on shoulder straps (except female SNCOs), on the front of the jacket, and on officers' cuffs. Male SNCOs also have a 27-line chain-link closure button on the jacket front.

c. Waistcoats: 22-line on front.

- d. Dress frame cap: 27-line with screw-type back.
3. The black plastic buttons are either medium (27-line) or large (40-line) and will be worn on the service uniform as follows:
- a. Service coat: 27-line on shoulder straps and men's pockets, 40-line on coat fronts.
 - b. Service frame cap: 27-line with screw-type back.

4004. INSIGNIA OF GRADE, ENLISTED (see figures 4-5 thru 4-10)

1. General

- a. Enlisted Marines will wear only the grade insignia prescribed for their grade/gender, as available through the DoD Supply System or MCCSs.
- b. Cloth insignia is available in two sizes, large for men and small for women. Insignia will be sewn on garments with thread that matches the background material of the insignia using a straight machine stitch. No other style of stitching will be used.
- c. Scarlet broadcloth insignia (green on scarlet or gold on scarlet) may be finished with either a merrowed (whip-stitched) edge or a cut edge. Insignia and service stripes on the service and blue dress coats are to be of the same edge style.

2. Regulations for Cloth Insignia

- a. Insignia will be of the design illustrated in figure 4-5 and will be worn single point up, centered on the outer half of each sleeve. Insignia will be placed 4 inches below the shoulder seam (3 inches for male first sergeant/master sergeant and above) except as otherwise noted below. (See figs. 4-6 and 4-7.)
- b. Green on scarlet insignia will be worn on green service coats.
- c. Green on khaki insignia will be worn on khaki shirts. On short sleeve khaki shirts, insignia will be centered between the shoulder seam and the bottom edge of the sleeve (men) or the peak of the cuff (women).
- d. Standard gold on scarlet insignia will be worn on blue dress coats.
- e. Washable gold on scarlet insignia may be worn on women's (blue dress) white shirts, centered between the shoulder seam and the peak of the cuff. However, they are no longer required.
- f. Distinctive 1890's style gold on scarlet insignia, as depicted in figure 4-8, will be worn on the SNCOs evening dress jacket, placed 3 inches below the shoulder seam. A reduced version (70 percent of original size) of this insignia will be worn on female SNCO evening dress jackets, three inches below the shoulder seam.

MARINE CORPS UNIFORM REGULATIONS



Sergeant Major
of the
Marine Corps



Sergeant Major



Master Gunnery
Sergeant



First Sergeant



Master Sergeant



Gunnery Sergeant



Staff Sergeant



Sergeant



Corporal



Lance
Corporal



Private
First
Class



12 years

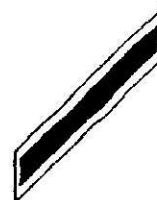

4 years

Service Stripes

Figure 4-5.--Enlisted Insignia of Grade.

MARINE CORPS UNIFORM REGULATIONS

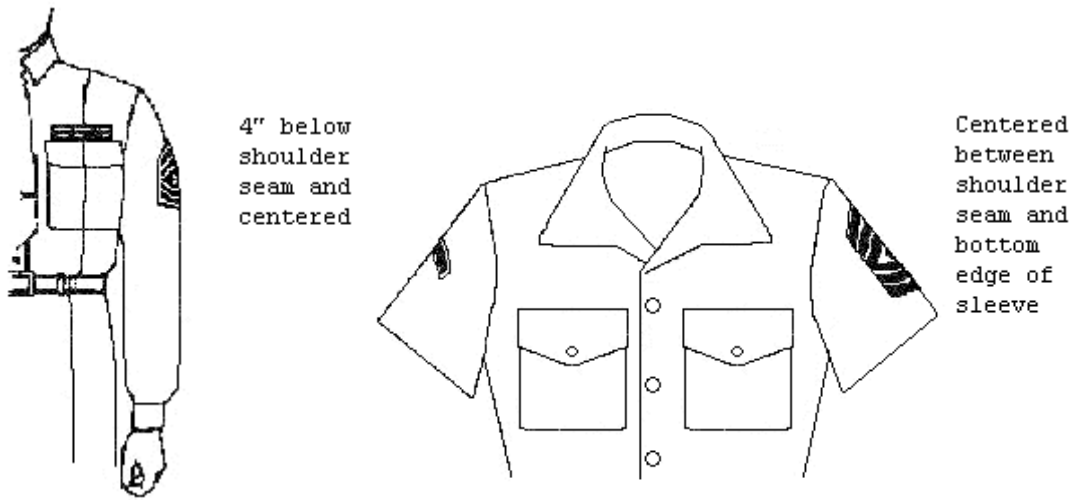

Figure 4-6. Placement of Enlisted Grade Insignia and Service Stripes (Males)

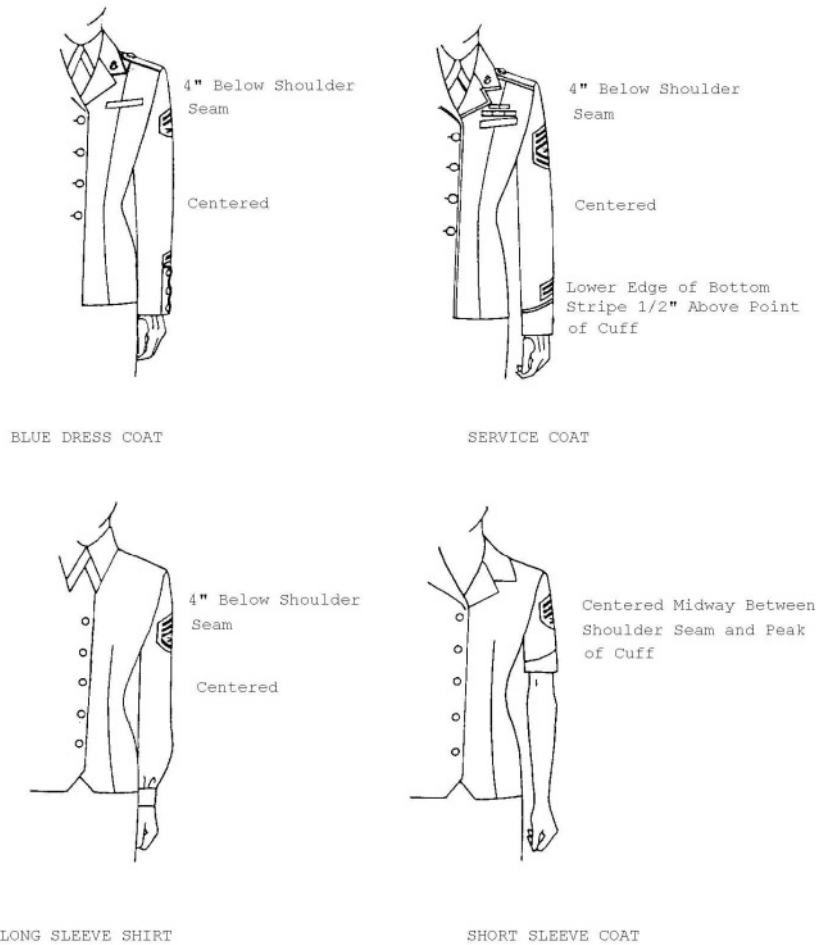

Figure 4-7.--Placement of Enlisted Grade Insignia and Service Stripes (Women).

MARINE CORPS UNIFORM REGULATIONS



Sergeant Major of the Marine Corps



Sergeant Major



Master Gunnery



First Sergeant



Master Sergeant



Gunnery Sergeant



Staff Sergeant

Figure 4-8.--Grade Insignia for Male SNCO Evening Dress.

MARINE CORPS UNIFORM REGULATIONS

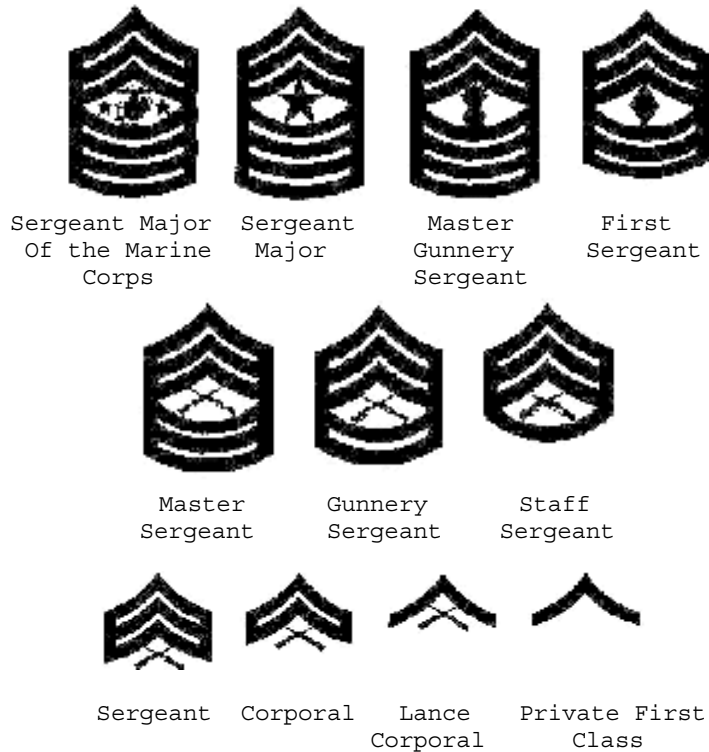

Figure 4-9.--Enlisted Grade Insignia (Metal/Plastic).

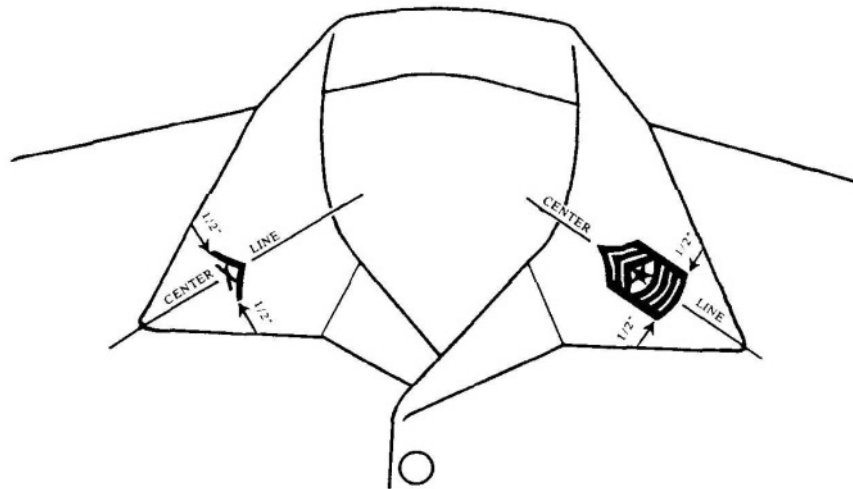

Figure 4-10.--Placement of Metal/Plastic Insignia of Grade.

3. Regulations for Plastic/Metal Insignia

a. Black metal/plastic insignia of the design illustrated in figure 4-9 will be worn as indicated below:

(1) AWC, field coat, utility coat and maternity work uniform coat: vertically, on each side of the collar with the single point up and the center of the insignia on a line bisecting the angle of the point of the collar. The lower outside edge of the insignia will be equally spaced 1/2 inch from both sides of the collar. (See fig. 4-10.)

(2) Khaki shirt: only when the service sweater is worn, in the same manner as above.

> CH 3 (3) Tanker jacket and sweaters with epaulettes: insignia will be worn on each shoulder strap, single point inboard, and placed so that it is equidistant from the front and rear edges of the shoulder straps with the lowest point of the insignia's outer edge 3/4 inch from the armhole seam.

(4) Extreme Cold Weather Clothing System (ECWCS) parka: one insignia will be worn centered on the zipper flap in the space provided.

(5) Organizational clothing (coveralls, food service uniforms, aviation clothing, etc.): insignia will be worn, in the same manner as worn on the utility coat, unless otherwise prescribed by the commander.

b. Gold-plated (brushed brass) metal insignia of the design illustrated in figure 4-9 will be worn centered vertically on each shoulder strap of the blue dress sweater, single point inboard, and placed so that it is equidistant from the front and rear edges of the shoulder straps with the lowest point of the insignia's outer edge 3/4 inch from the armhole seam.

4005. INSIGNIA OF GRADE, OFFICERS. (See fig. 4-11.)

1. General. Officers will wear only the grade insignia prescribed for their grade. Insignia is made of metal with clutch-type fasteners except for the evening dress uniform, upon which full-size shoulder grade insignia will either be embroidered directly on the shoulder strap, or embroidered on dark blue cloth, stitched to the shoulder straps of the jacket.

2. Descriptions by Grade

a. General. Four silver-colored, five-pointed, pyramid-shaped stars. Shoulder stars are 1 inch in diameter and are either fastened together on a metal holding bar or placed individually with one point of each star in the same line; distance between the centers of adjacent stars will be 3/4 inch. Collar stars are 9/16 inch in diameter and will be fastened together on a metal holding bar in a straight line with one ray of each star pointing upward and at right angles to the holding bar.

b. Lieutenant General. Three silver-colored stars, of the same type and arranged in the same manner as for a general, except the distance between centers of adjacent shoulder stars will be 1 inch.

MARINE CORPS UNIFORM REGULATIONS

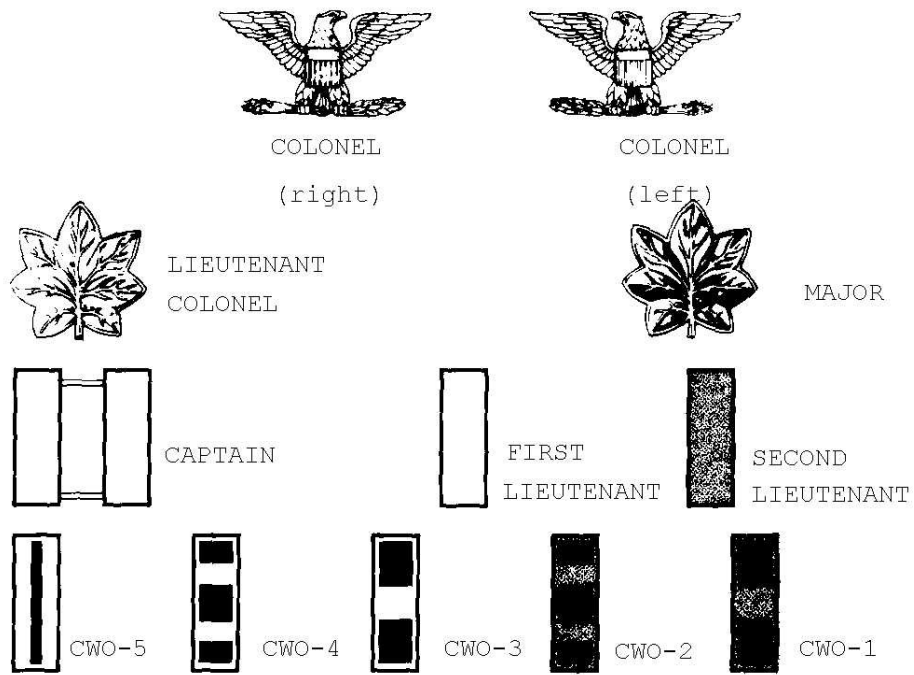
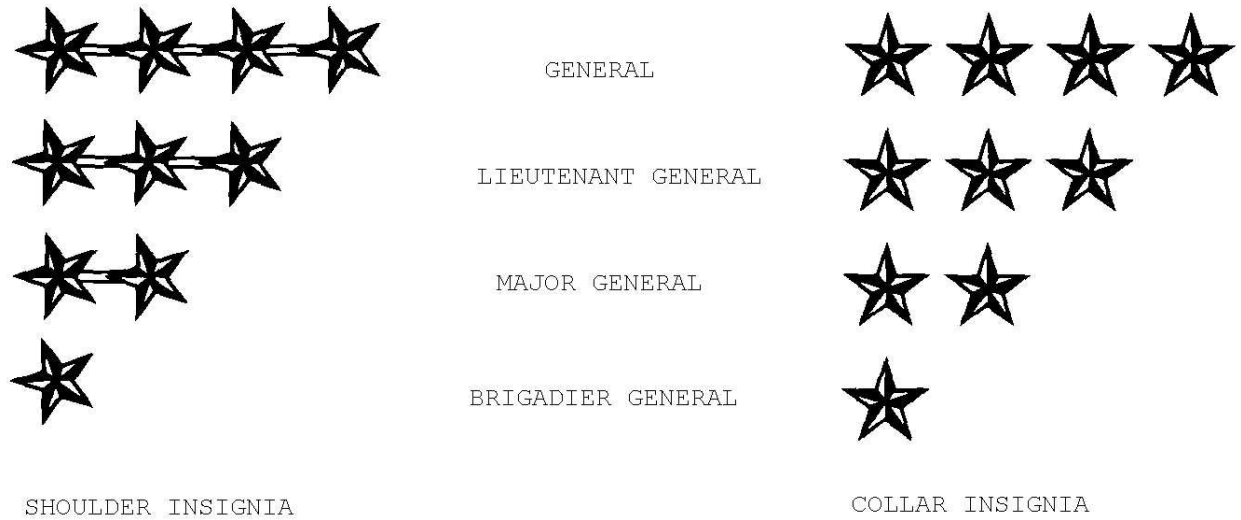

Figure 4-11.--Officers' Grade Insignia (Shoulder/Collar).

MARINE CORPS UNIFORM REGULATIONS

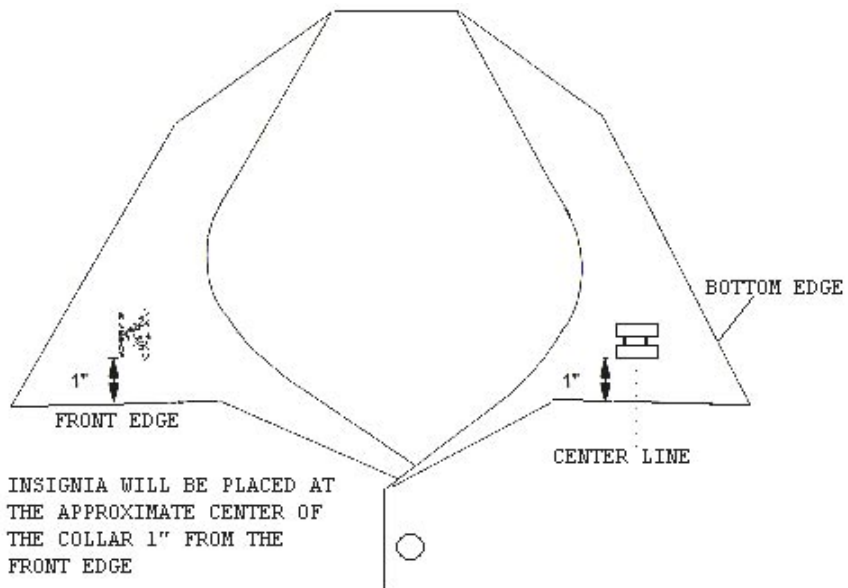
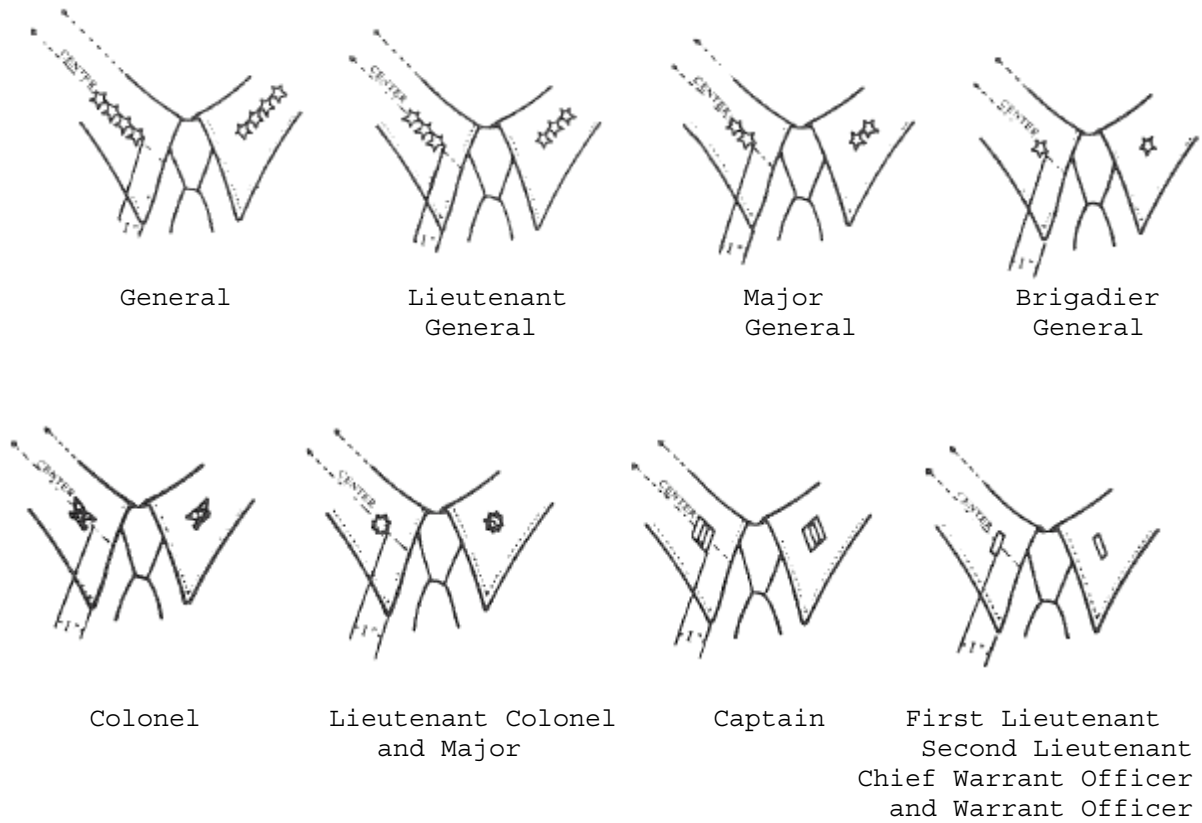

Figure 4-12.--Placement of Collar Insignia.

MARINE CORPS UNIFORM REGULATIONS

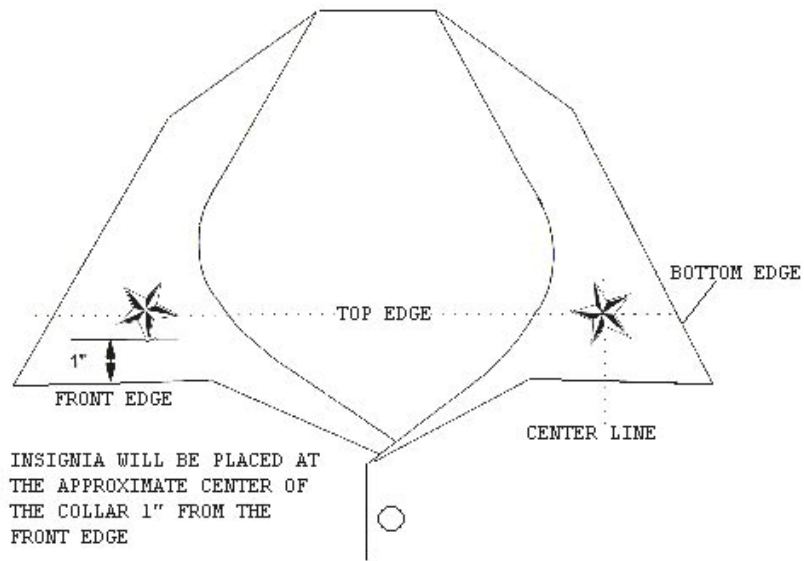

Figure 4-13.--Placement of general officer collar insignia.

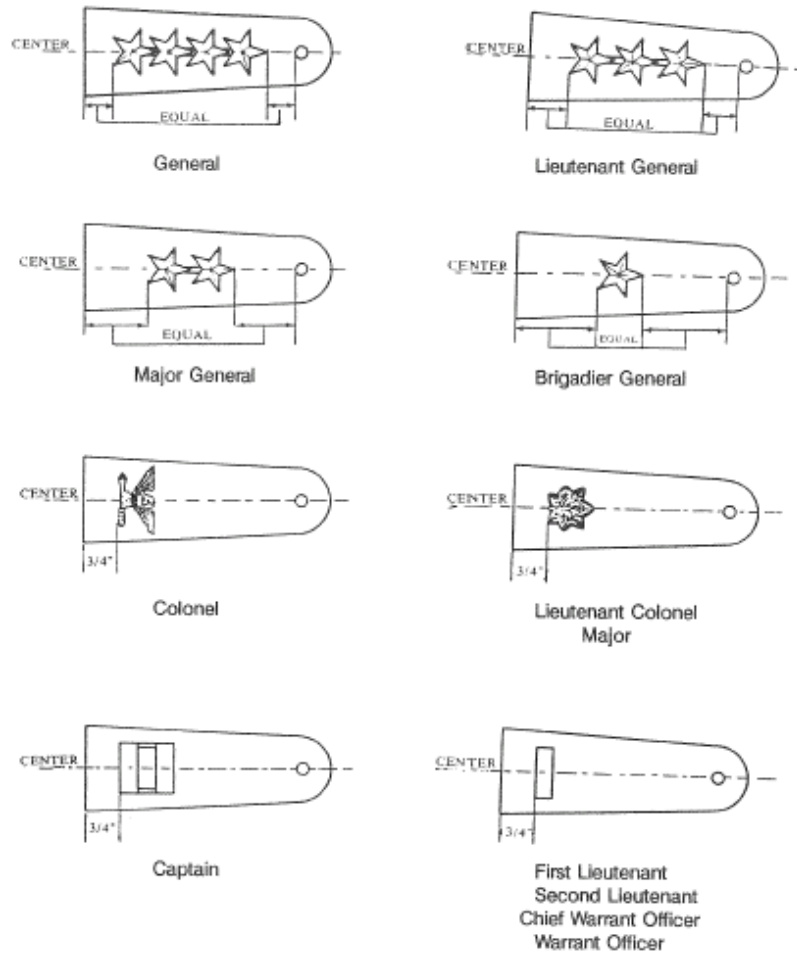

Figure 4-14.--Placement of Shoulder Insignia.

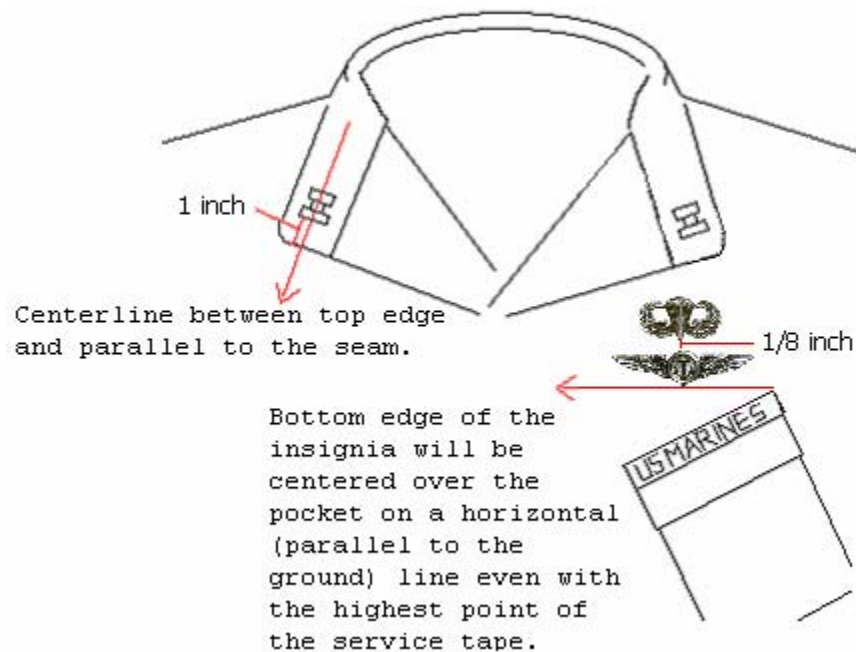

Figure 4-15. Placement of Insignia on Combat Utilities Coat (Officer).

c. Major General. Two silver-colored stars of the same type and arranged in the same manner as for a lieutenant general.

>CH 1 d. Brigadier General. One silver-colored star (same type as above). Additionally, the 5/8-inch insignia is authorized for wear as long as the same size insignia is worn on both collars.

e. Colonel. A silver-colored spread eagle, made in pairs, right and left, talons of 1 foot grasping an olive branch, the other, a bundle of arrows. Shoulder insignia; slightly curved, with 1-1/2-inch wingspan. Collar insignia; flat, with 31/32-inch wingspan.

f. Lieutenant Colonel. A seven-pointed, silver-colored oak leaf, raised and veined. Shoulder insignia; slightly curved, 1 inch from stem tip to center leaf tip. Collar insignia; flat, 23/32 inch from stem tip to center leaf tip.

g. Major. A gold-colored oak leaf of the same type as for a lieutenant colonel.

h. Captain. Two smooth silver-colored bars, without bevel, attached at each end by a holding bar. Shoulder insignia; each bar slightly curved, 1-1/8 inches long by 3/8-inch wide, and 3/8-inch apart. Collar insignia; flat, each bar 3/4-inch long by 1/4-inch wide and 1/4-inch apart.

i. First Lieutenant. One silver-colored bar of the same type as for a captain.

j. Second Lieutenant. One gold-colored bar of the same type as for a first lieutenant.

k. Chief Warrant Officer, CWO-5. One silver-colored bar of the same type as for a first lieutenant, with one scarlet enamel stripe superimposed lengthwise. Shoulder insignia; center enamel stripe is 1/8-inch wide and 1-1/8 inch long. Collar insignia; center enamel stripe is 1/8-inch wide and 3/4-inch long.

l. Chief Warrant Officer, CWO-4. One silver-colored bar of the same type as for a first lieutenant, with three scarlet enamel blocks superimposed. Shoulder insignia; center enamel block is 1/4 inch wide, with 1/8 inch wide outer blocks, 1/4 inch from the edges of the center block. Collar insignia; center enamel block is 5/32 inch wide, with 3/32 inch wide outer blocks, 5/32 inch from the edges of the center block.

m. Chief Warrant Officer, CWO-3. One silver-colored bar of the same type as for a CWO-4, with two scarlet enamel blocks superimposed. Shoulder insignia blocks are 3/8-inch wide and 1/4-inch apart. Collar insignia; blocks are 1/4-inch wide and 5/32-inch apart.

n. Chief Warrant Officer, CWO-2. One gold-colored bar of the same type as for a second lieutenant, with three scarlet enamel blocks arranged in the same manner as for a CWO-4.

o. Warrant Officer, WO-1. One gold-colored bar of the same type as for a CWO-2, with two scarlet enamel blocks arranged in the same manner as for a CWO-3.

3. Insignia Placement. (See figs. 4-11, 4-13, 4-14 and 4-15, 4-16.)

a. Metal grade insignia will be worn on all uniforms except for the evening dress jacket. Evening dress jacket insignia will be embroidered, either directly on the shoulder straps, or on dark blue cloth stitched to the shoulder straps.

>Ch 3 b. Shoulder grade insignia will be placed on each shoulder strap of dress jackets, dress/service coats, the AWC, the tanker jacket and field coat in the manner described below. Shoulder grade insignia will not be worn on the service or dress blue sweater.

(1) All officers will wear their insignia so that it is equidistant from the front and rear edges of the shoulder straps. Colonels and below will position their insignia so that the midpoint of the insignia's outer edge is 3/4 inch from the armhole seam.

(2) General officers' stars will be worn equally spaced between the armhole seam and the shoulder strap button or edge of the collar, whichever is closer. One ray of each star points toward the collar.

(3) Colonels' eagles will be worn with the wings at right angles to the center line of the shoulder strap with the eagle's head toward the collar and facing front.

(4) Field grade oak leaves will be worn with the stem toward the armhole seam.

(5) Company grade bars will be worn with the long axis of the bars at right angles to the center of the shoulder strap.

c. Collar grade insignia will be worn on both sides of the collar of khaki shirts, and the utility and camouflage maternity coats. When the service "A" uniform is worn by officers, the wear of the collar insignia is required at all times. Collar insignia is worn on women's white shirts only when it is anticipated that the blue dress coat may be removed in office spaces. The insignia will be centered between the top and bottom edge of the collar, with the outer edge of the insignia one inch from the front edge of the collar.

(1) General officers' stars will be worn with one ray of each star pointing toward the top edge of the collar.

>Ch 3 (2) Colonels' eagles will be worn with the head toward the top of the collar facing to the front, with the wings perpendicular to the front edge of the collar. On the combat utility coat, the eagle will be worn with the wings perpendicular to the deck.

>Ch 3 (3) Field grade oak leaves will be worn with the stem toward the bottom of the collar and the line from the tip to the stem parallel to the deck.

>Ch 3 (4) Company grade insignia will be worn with the long axis of the bars parallel to the deck.

d. Collar grade insignia will be worn on the right side of the garrison cap opposite to the branch of service collar insignia, with the insignia placed at a point midway on the arc of the flap and the flap generally bisecting the insignia (see Fig. 4-11)

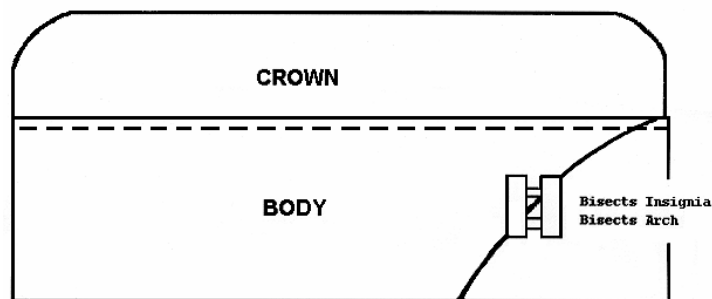

Figure 4-16. Placement of Rank Insignia on the Male Officer Garrison Cap

(1) Generals' stars will be worn with one ray of each star pointing toward the top of the cap, with the long axis horizontal.

(2) Colonels' eagles will be worn with the head toward the top of the cap. The right insignia for the garrison cap will have the head facing forward.

(3) Field grade oak leaves will be worn with the stem toward the bottom of the cap.

(4) Company grade bars will be worn so the long axis of the bar is essentially vertical.

e. Collar grade insignia will also be worn on the front of the ECWCS parka, centered on the zipper flap in the space provided. Colonel's eagles will be worn so that the eagle is facing to the wearer's right.

4006. MARINE GUNNER INSIGNIA. (See fig. 4-17.)

1. Those warrant officers officially designated as "Marine Gunner" per current edition of MCO P1000.6, ACTS Manual, will wear the Marine Gunner insignia.
2. The Marine Gunner dress shoulder insignia is a gold-colored replica of a bursting bomb. The overall height of the bomb is about 1-1/4 inches.
3. Dress insignia will be worn on both shoulder straps of the dress coat/jacket. The burst of the bomb faces inboard, parallel to the sides of the shoulder strap with the center bottom of the sphere 3/4 inch from the inboard edge of the grade insignia.
4. The Marine Gunner service insignia is black, of the same design as the dress insignia. The large insignia is the same size as the dress insignia. The miniature device has an overall height of about 3/4 inch.
5. The large service insignia will be worn on both shoulder straps of the service coat, AWC, field coat, tanker jacket, and blue dress sweater. The burst of the bomb faces inboard, worn in the same manner as the dress insignia.
6. The miniature service insignia will be worn on the left collar point of khaki shirts and utility coats. The insignia will be centered 1 inch from and parallel to the front edge of the collar with the burst of the bomb toward the top edge of the collar.
7. On the ECWCS parka the collar grade insignia shall be worn vertically aligned with the miniature service insignia placed 1/8 inch above it. The rank insignia and the miniature service insignia together will be centered on the zipper flap.

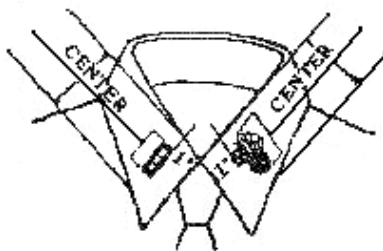

Figure 4-17.--Marine Gunner Collar Insignia.

4007. SERVICE/IDENTIFICATION BADGES. (See fig. 4-18.)1. General

a. The following badges are authorized to be worn on Marine Corps uniforms; Presidential Service Badge (PSB), Vice-Presidential Service Badge (VPSB), Office of the Secretary of Defense Identification Badge (OSD ID Badge), and the Joint Chiefs of Staff Identification Badge (JCS ID Badge). Marines who have met established criteria for the permanent wear of these badges may wear them after detachment from qualifying duty.

b. Marines assigned to joint/unified commands may be authorized to wear distinctive command identification badges, but only upon approval from the CMC (MCUB). Requests will originate from the Marine Corps commander or the command's senior Marine Corps representative and will include a photograph, drawing, or sample of the device and local regulations regarding its wear. Unless otherwise prescribed in the approval letter, command ID badges will be worn in the same general manner as prescribed for the OSD and JCS ID badges. Approved command identification devices will be worn for the duration of assignment to that command only.

c. No more than two service/identification badges will be worn on the same side of the uniform. When two badges are worn, they will be worn vertically aligned on the upper pocket or corresponding position on uniforms that do not have pockets in this position. On pockets with flaps, these



Presidential Service Badge

Vice Presidential Service
BadgeOffice of the Secretary of
Defense Identification BadgeJoint Chiefs of Staff
Identification Badge

Figure 4-18.--Service/Identification Badges.

badges will be vertically centered between the lower point of the flap and bottom of the pocket, midway between the two sides. When both the PSB and VPSB are worn, the PSB will be uppermost. If both OSD and JCS badges are worn, the OSD will be uppermost. If an OSD or JCS badge is worn with a command identification device, the OSD/JCS badge will be uppermost. On women's coats and khaki shirts, the lower badge will be placed per the regulations for a single badge with the second badge worn centered 1/8" above the first. However, on women's uniforms, if the wear of two badges on the same side presents an unsatisfactory appearance or cannot be accommodated only the badge of the current assignment will be worn.

2. Regulations for Wear

a. Male Marines

(1) Presidential Service Badge (PSB). The PSB consists of a blue enameled disc, 1-15/16 inches in diameter, surrounded by 27 gold rays radiating from the center. Superimposed on the disc is a gold-colored device taken from the seal of the President of the United States, encircled with 50 stars.

(a) Placement of the PSB. On the blue dress coat, service coat, and khaki long/short-sleeve shirts, the PSB is centered on the upper right pocket. On the evening dress uniforms, the PSB will be positioned in a location that corresponds to that of the dress coat. On pockets that have flaps, the badge will be centered between the lower point of the flap and the bottom of the pocket and midway between the two sides.

(b) The PSB will not be worn on the AWC, tanker jacket, service, ECWCS parka, blue dress sweaters, or utility uniforms.

(2) Vice-Presidential Service Badge (VPSB)

(a) The VPSB consists of a white enameled disc, 1-15/16 inches in diameter, surrounded by 27 gold rays radiating from the center. Superimposed on the disc is a gold-colored device taken from the seal of the Vice-President of the United States.

(b) Placement of the VPSB. Marines authorized to wear the VPSB will wear it according to the regulations for the PSB, above.

(3) Office of the Secretary of Defense Identification Badge (OSD ID Badge). The OSD ID badge consists of an eagle with wings displayed horizontally, grasping three crossed gold arrows, and having on its breast, an enamel shield consisting of a blue upper portion and 13 alternating red and white stripes on the lower portion; a gold annulet passing behind the wing tips bearing 13 gold stars above the eagle and a wreath of laurel and olive in green enamel below the eagle; all superimposed on a silver sunburst of 33 rays, 2 inches in diameter.

(a) Only personnel assigned to duty in the OSD and who received a certificate of eligibility may wear the badge.

(b) Placement of the OSD ID Badge. On the blue dress coat, service coat, and khaki long/short-sleeve shirts, the OSD ID Badge is centered on the upper left pocket. On the evening dress uniform, the badge will be positioned in a location that corresponds to that of the dress coat. On pockets with flaps, the badge will be centered between the lower point of the flap and the bottom of the pocket and midway between the two sides.

(c) The miniature OSD ID badge is a smaller version of the standard 2-inch diameter badge which has been reduced in size to 1-1/2 inches in diameter. Only the miniature badge may be worn on the evening dress, blue dress "C"/"D," and service "B"/"C" uniforms. Placement will be as follows:

1 On the male officers' evening dress jacket, the badge will be placed on the left front panel with the top of the badge centered 1 inch below the bottom edge of the miniature medals.

2 On the male SMCs evening dress jacket, the badge will be placed on the left-front panel on an extension of an imaginary line formed by the three front buttons of the left panel. The badge will be placed midway between the top button and the point where the imaginary line meets the lapel.

3 On the male khaki shirts, the badge will be worn centered on the left pocket.

(4) Joint Chiefs of Staff Identification Badge (JCS ID Badge). The standard size JCS ID badge consists of the United States shield (upper portion in blue, and 13 stripes of alternating red and white enamel) superimposed on four gold metal unsheathed swords (two placed vertically and two diagonally), pointing to the top, with points and pommels resting on the wreath, blades and grips entwined with a gold metal continuous scroll surrounding the shield with the word "JOINT" at the top and the words "CHIEFS OF STAFF" at bottom, in blue enamel letters; all within an oval silver metal wreath of laurel 2-1/4 inches high by 2 inches wide.

(a) The badge may be permanently awarded to any Marine assigned to the organization of the JCS who serves at least 365 consecutive days after 14 January 1961 and who receives a certificate of eligibility. The JCS, the operations deputies, and the deputy operations deputies are eligible to wear the badge immediately upon assumption of tenure. All other assigned personnel may wear the badge on a temporary basis, for identification purposes, for the first 365 days of their tours.

(b) Placement of the JCS ID Badge. The standard JCS ID badge will be worn in the same manner as the OSD ID badge.

(c) The miniature JCS ID badge is reduced in size by one third, with nine stripes on the shield, but otherwise is identical to the standard badge. The miniature badge will be worn in the same manner as the miniature OSD ID badge.

>Ch 3 b. Female Marines. The guidance and badge description provided in subparagraph 4007.2a is germane, only the actual placement of the badges on the female uniforms differs. Badges will be prescribed as described below:

(1) Placement of badges on female uniforms

(a) On women's service and dress coats, badges will be placed on the left front jacket panel, on a horizontal line midway between the second and third buttons with a tolerance of 1-1/2 inches. On evening dress jackets, badges will be centered on the left-front jacket panel so that the bottom of the badge is slightly higher than the highest button. The placement of the badge may be adjusted slightly to ensure the proper flat appearance. On women's khaki shirts, badges will be centered on the right side, on a horizontal line even with or up to 2 inches above the first visible button from the top.

(b) Placement of the OSD ID Badge. On women's coats the badge will be worn on the left in the manner described in subparagraph 4007.2b(1)(a), above; however while on duty with OSD, it will be worn according to OSD instructions.

(c) The miniature OSD Id badge is a smaller version of the standard 2-inch diameter badge, which has been reduced in size to 1-1/2 inches in diameter. Only the miniature badge may be worn on the evening dress, blue dress "C"/"D," and service "B"/"C" uniforms. Placement will be as follows:

(1) On officers' and SNCOs evening dress jacket, the badge will be placed centered on the left-front panel with the bottom of badge about 2 inches higher than the top button. The placement of the badge may be adjusted slightly to ensure the proper flat appearance.

(2) On khaki shirts, the badge will be worn on the right side, centered on a horizontal line even with or 2 inches above the first visible button from the top.

>Ch 3 (2) Placement of the PSB/VPSB. On women's coats, the PSB/VPSB will be worn on the right in the manner prescribed in subparagraph 4007.2b(1).

4008. SERVICE STRIPES. (See figs. 4-5, 4-6, and 4-7.)

1. All enlisted personnel will wear one service stripe for any four-year period of honorable service, creditable for retirement (under 10 U.S.C. 1332), in any, or a combination of the following services:

- a. U.S. Marine Corps
- b. U.S. Navy
- c. U.S. Army
- d. U.S. Air Force
- e. U.S. Coast Guard
- f. Any Reserve component of the Armed Forces or the National Guard (other than on the retired list).
- g. Commissioned Corps of the U.S. Public Health Service or Coast and Geodetic Survey (only under certain circumstances).

MARINE CORPS UNIFORM REGULATIONS

4009

2. Entitlement to service stripes starts with the Armed Forces Active Duty Base Date and is computed by adding all periods of qualifying service, continuous or otherwise. Qualifying service for reservists are earned only for full years - 1 year of creditable service for each one-year period when a minimum of 50 retirement points are accumulated.

3. Regulations for Wear

a. Service stripes will be worn on the outer half of each sleeve of dress/service coats; gold on scarlet on the blue dress coat and green on scarlet on the green coat. Service stripes finished with either a merrowed (whip-stitched) edge or a cut edge may be worn.

b. Service stripes will be placed at a 30 degree angle to the bottom of the sleeve. The first stripe will be placed as follows:

(1) On the blue dress coat, lower scarlet point of the stripe will meet the point of the piping of the cuff.

(2) On the green service coat,; lower scarlet edge of the stripe centered 1/2 inch above the point of the cuff.

(3) Succeeding stripes will be 1/8 inch above and parallel to the next lower stripe.

c. Service stripes will be sewn on with thread that matches the background material of the stripe using a straight machine stitch. Cross-stitches, whip-stitches or other nonstandard stitching will not be used.

d. Service stripes will not be worn on the AWC, tanker jacket or on the SNCO evening dress uniforms.

4009. SLACKS/TROUSER STRIPES (OFFICER/NCO)

1. Male officers will wear a stripe of ornamented gold lace down the outer seam of each leg of the evening dress trousers.

2. General officers will wear a 2-inch-wide scarlet stripe down the outer seam of each leg of blue dress trousers/slacks.

3. Field and company grade officers will wear a 1-1/2-inch-wide scarlet stripe down the outer seam of each leg of blue dress trousers/slacks.

4. SNCOs and NCOs will wear a 1-1/8-inch-wide scarlet stripe down the outer seam of each leg of blue dress trousers/slacks.

5. Stripes will be sewn onto trousers as directed in the Uniform Fitting and Alterations Manual (TM-10120-15/1), which requires that the stripe finish at or in the waist seam. However, stripes that were previously sewn so that the top of the stripe was finished over the top of the waistband are authorized for wear until such time as the trousers/stripes require replacement. Blue dress stripes will be made of Marine Corps standard scarlet cloth and will be sewn with red silk thread.

MARINE CORPS UNIFORM REGULATIONS

CHAPTER 5

AWARDS

SECTION 1: GENERAL

	<u>PARAGRAPH</u>	<u>PAGE</u>
AUTHORIZATION	5100	5-3
DEFINITION OF TERMS	5101	5-3
PRECEDENCE	5102	5-4
AWARDS OF MILITARY SOCIETIES AND OTHER ORGANIZATIONS	5103	5-9
SENIORITY OF COLORS	5104	5-10
DECORATIONS, MEDALS, RIBBON BARS, AND LAPEL BUTTONS WORN ON CIVILIAN CLOTHING	5105	5-10

SECTION 2: LARGE AND MINIATURE MEDALS

GENERAL	5200	5-13
MOUNTED MEDALS	5201	5-13
WEARING LARGE MEDALS	5202	5-14
WEARING MINIATURE MEDALS	5203	5-15

SECTION 3: RIBBON BARS AND FOURRAGERE

GENERAL	5300	5-21
WEARING RIBBONS	5301	5-21
FOURRAGERE	5302	5-23

SECTION 4: ATTACHMENTS

GENERAL	5400	5-25
STARS	5401	5-25
LETTERS/NUMERALS	5402	5-27
CLASPS	5403	5-29

MARINE CORPS UNIFORM REGULATIONS

	<u>PARAGRAPH</u>	<u>PAGE</u>
MISCELLANEOUS DEVICES	5404	5-30

SECTION 5: MARKSMANSHIP BADGES

PRECEDENCE	5500	5-33
REGULATIONS FOR WEAR	5501	5-34

FIGURE

5-1 WEAR OF LAPEL PINS ON CIVILIAN COATS		5-11
5-2 MOUNTED LARGE MEDALS		5-17
5-3 MOUNTED MINIATURE MEDALS		5-17
5-4 PLACEMENT OF LARGE MEDALS		5-20
5-5 PLACEMENT OF MINIATURE MEDALS		5-20
5-6 PLACEMENT OF RIBBONS		5-22
5-7 WEARING OF FOURRAGERE		5-24
5-8 AWARD ATTACHMENTS		5-32
5-9 MARKSMANSHIP (COMPETITION) BADGES		5-36
5-10 MARKSMANSHIP (QUALIFICATION) BADGES		5-39

TABLE

5-1 WEARING OF MEDALS BY MALE PERSONNEL		5-18
5-2 WEARING OF MEDALS BY FEMALE PERSONNEL		5-19

MARINE CORPS UNIFORM REGULATIONS

CHAPTER 5

SECTION 1: GENERAL

5100. AUTHORIZATION

1. Marines may wear those awards described in the Navy and Marine Corps Awards Manual (SECNAVINST 1650.1), when authorized by competent authority.
2. Marines who receive awards from other services, or departments of the United States Government; or from foreign governments or other agencies may wear such awards on the Marine Corps uniform only as authorized herein.
3. Marines who served in or were attached to another branch of the U.S. military services and received a decoration, unit award, or service award of comparable criteria to one issued by the naval service may wear the award on Marine Corps uniforms, unless otherwise prohibited by these regulations.
4. Examples of other U.S. service awards which are not authorized include: marksmanship medals/ribbons (Navy/Coast Guard/Air Force), USAF Outstanding Airman of the Year, USAF Recognition Ribbon, USAF Longevity Service Award, NCO Professional Development/Education ribbons (Army/Air Force), Army Service/USAF training ribbons.
5. The Combat Infantryman's Badge or the Combat Medical Badge is not authorized for wear on the Marine Corps uniform. Upon submission of evidence to their commanding officer, personnel who earned the Combat Infantryman Badge or Combat Medical Badge may be authorized to wear the Combat Action Ribbon.
6. Officers suspended from grade and command, and enlisted personnel serving sentence of confinement will not wear any awards.
7. Marines will not wear awards on the boat cloak, cape, tanker jacket, AWC, service or dress sweater, utility uniform, maternity work uniform or the maternity service tunic.

5101. DEFINITION OF TERMS

1. Award. An all-inclusive term covering any decoration, medal, badge, ribbon bar, or attachment bestowed on an individual.
2. Decoration. An award bestowed on an individual for a specific individual act or acts of gallantry or for meritorious service.
3. Unit Award. An award made to an operating unit for outstanding heroism or achievement and worn only by members of that unit who participated in the cited action. Marines who were assigned to the cited unit while in a civilian status must be specifically included by name in the recommendation or citation to be eligible to wear the award on the uniform.

4. Service Award. An award issued to an individual to denote participation in a campaign, war, national emergency or expedition, or to denote service requirements fulfilled in a creditable manner.
5. Medal. An award issued to an individual for performance of certain duties, acts or services, consisting of a medallion hanging from a suspension ribbon of distinctive colors.
6. Miniature Medal. A replica of a standard size medal, made to 1/2 original scale. Foreign medal miniatures will not exceed the size of American miniatures. The Medal of Honor will NOT be worn in miniature.
7. Badge. An award to an individual for some special proficiency or skill, which consists of a medallion, or a medallion hung from a bar or bars.
8. Ribbon Bar. A portion of the suspension ribbon of a medal, worn in lieu of the medal. The dimensions of all ribbons shall be 1-3/8 by 3/8 inches, except as specified in subparagraph 5300.2. Ribbon bars are also authorized for certain awards which have no medals; e.g., Presidential Unit Citation, Navy Unit Commendation, etc.
9. Rosette. Lapel device made by gathering the suspension ribbon of the medal into a circular shape.
10. Lapel Button. A miniature enameled replica of the ribbon bar.
11. Attachment. Any appurtenance such as a star, letter, clasp, or other device worn on the suspension ribbon of a medal or on the ribbon bar.

5102. PRECEDENCE

1. U.S. personal decorations, U.S. unit awards, U.S. nonmilitary decorations, U.S. campaign and service awards, U.S. nonmilitary service awards, foreign personal decorations, foreign unit awards, non-U.S. service awards, foreign service awards, marksmanship badges (see paragraph 5500), and awards of military societies and other organizations will be given precedence in the order listed.
2. When Marines are entitled to similar awards from two or more services; e.g., good conduct awards, the Marine Corps award will take precedence. After the Marine Corps award, similar awards of other services will be worn in the following precedence: Navy, Army, Air Force, and Coast Guard.
3. All ribbons and medals must be mounted and worn according to the precedence listed herein.
4. Awards shall be worn in order of precedence from top down and from the wearer's right to left, unless otherwise specified herein.
5. Personal Decorations. (Listed in order of precedence.)
 - a. Medal of Honor
 - b. Navy Cross

- c. Defense Distinguished Service Medal
 - d. Distinguished Service Medal
 - e. Silver Star Medal
 - f. Defense Superior Service Medal
 - g. Legion of Merit
 - h. Distinguished Flying Cross
 - i. Navy and Marine Corps Medal
 - j. Bronze Star Medal
 - k. Purple Heart
 - l. Defense Meritorious Service Medal
 - m. Meritorious Service Medal
 - n. Air Medal
 - o. Joint Service Commendation Medal
 - p. Navy Commendation Medal
 - q. Joint Service Achievement Medal
 - r. Navy Achievement Medal
 - s. Combat Action Ribbon (no medal authorized)
6. Navy Unit Awards. (Listed in order of precedence and worn after all personal decorations) (No medals authorized.)
- a. Presidential Unit Citation
 - b. Joint Meritorious Unit Award
 - c. Navy Unit Commendation
 - d. Meritorious Unit Commendation
 - e. Navy "E" Ribbon
7. U.S. Nonmilitary Decorations
- a. Listed below, not necessarily in order of precedence, are certain nonmilitary decorations worn after all unit awards.
 - (1) Presidential Medal of Freedom

- (2) National Security Medal
- (3) National Sciences Medal
- (4) Life Saving Medals (Gold and Silver)
- (5) Medal of Merit
- (6) National Intelligence Distinguished Service Medal
- (7) National Intelligence Medal of Achievement
- (8) Navy Distinguished Civilian Service Award
- (9) Navy Award for Distinguished Achievement in Science
- (10) President's Distinguished Federal Civilian Service Medal
- (11) Department of Defense Distinguished Civilian Service Medal
- (12) Navy Distinguished Public Service Award
- (13) NASA Distinguished Service Medal
- (14) NASA Flight Medal
- (15) NASA Medal for Exceptional Bravery
- (16) NASA Medal for Exceptional Service
- (17) Merchant Marine Distinguished Service Medal
- (18) Merchant Marine Meritorious Service Medal
- (19) Merchant Marine Mariners Medal
- (20) Selective Service Distinguished Service Award
- (21) Selective Service Exceptional Service Award
- (22) Selective Service Meritorious Service Award
- (23) Congressional Space Medal of Honor
- (24) United States Public Health Achievement Medal

b. When an individual is authorized to wear more than one nonmilitary decoration, they will be worn in the order of acceptance date, except that when two or more decorations from the same agency are worn, the order of precedence will be established by the awarding agency regardless of acceptance date.

c. Nonmilitary decorations will not be worn unless at least one military award is worn at the same time.

8. Campaign and Service Awards. (Listed in order of precedence and worn after all U.S. nonmilitary decorations.)

a. Prisoner of War Medal

b. Marine Corps Good Conduct Medal

c. Selected Marine Corps Reserve Medal (formerly the Organized Marine Corps Reserve Medal)

d. Marine Corps Expeditionary Medal

e. China Service Medal

f. American Defense Service Medal

g. American Campaign Medal

h. European-African-Middle Eastern Campaign Medal

i. Asiatic-Pacific Campaign Medal

j. World War II Victory Medal

k. Navy Occupation Service Medal

l. Medal for Humane Action

m. National Defense Service Medal

n. Korean Service Medal

o. Antarctica Service Medal

p. Armed Forces Expeditionary Medal

q. Vietnam Service Medal

r. Southwest Asia Service Medal

s. Armed Forces Service Medal

t. Humanitarian Service Medal

u. Military Outstanding Volunteer Service Medal

v. Sea Service Deployment Ribbon (no medal authorized)

w. Navy Arctic Service Ribbon

x. Overseas Service Ribbon (no medal authorized)

- y. Marine Corps Recruiting Ribbon
- z. Drill Instructor Ribbon (no medal authorized)
- aa. Marine Security Guard Ribbon (no medal authorized)
- ab. Coast Guard Special Operations Service Ribbon (no medal authorized)
- ac. Armed Forces Reserve Medal
- ad. Marine Corps Reserve Ribbon (no medal authorized)

9. Nonmilitary Service Awards. (Listed in order of precedence and worn after all campaign and service awards)

- a. Merchant Marine Gallant Ship Unit Citation
- b. Merchant Marine Defense Bar
- c. Merchant Marine Combat Bar
- d. Merchant Marine War Zone Bars (worn in order earned)
 - (1) Atlantic War Zone
 - (2) Mediterranean-Middle East War Zone
 - (3) Pacific War Zone
- e. Merchant Marine World War II Victory Medal
- f. Merchant Marine Korean Service Bar
- g. Merchant Marine Vietnam Service Bar

10. Foreign Personal Decorations. Marines who have been specifically authorized by law to accept decorations from foreign governments may wear them after all U.S. campaign and service awards in the order of their receipt. When an individual is authorized to wear more than one award from the same country, the order of precedence of those particular awards will be determined by the rules of the country concerned.

11. Foreign Unit Awards. (Listed in order of precedence and worn after all foreign personal decorations.)

- a. Philippine Presidential Unit Citation (no medal authorized)
- b. Korean Presidential Unit Citation (no medal authorized)
- c. Vietnam Presidential Unit Citation (no medal authorized)
- d. Republic of Vietnam Meritorious Unit Citation Gallantry Cross Color (no medal authorized)

e. Republic of Vietnam Meritorious Unit Citation Civil Actions Color
(no medal authorized)

12. Non-U.S. Service Awards. (Listed in order of precedence and worn after all foreign unit awards.)

- a. Philippine Defense Ribbon (no medal authorized)
- b. Philippine Liberation Ribbon (no medal authorized)
- Philippine Independence Ribbon (no medal authorized)
- c. United Nations Service Medal
- d. United Nations Medal
- e. NATO Medal
- f. Multinational Force and Observers Medal
- g. Inter-American Defense Board Medal

13. Foreign Service Awards. Listed below in order of precedence are the only foreign service awards authorized for wear on the Marine Corps uniform without individual legislative authority. These awards are worn after all non-U.S. service awards.

- a. Republic of Vietnam Campaign Medal
- b. Kuwait Liberation Medal
- c. Kuwait Liberation Medal (Saudi Arabia)
- d. Kuwait Liberation Medal (Kuwait)
- e. Republic of Korea War Service Medal

5103. AWARDS OF MILITARY SOCIETIES AND OTHER ORGANIZATIONS

1. Miscellaneous awards and badges may be worn on the Marine Corps uniform at the holder's option, unless otherwise ordered, and provided no awards, decorations, badges, or breast insignia are worn at the same time.

2. Those organizations which issue awards and badges recognized by the Department of the Navy for wear under conditions noted above, include the following:

- a. Military societies of persons who have served in the U.S. Armed Forces during various wars, campaigns, or expeditions in which the U.S. has been engaged.
- b. Medical scientific societies.

3. Medals, ribbons, and badges adopted by these societies may be worn only while actually attending meetings or conventions or while participating in parades or other ceremonies as a member of these organizations.

5104. SENIORITY OF COLORS

1. Based on heraldry, blue, the senior color, will be uppermost and/or to the wearer's right.

2. Awards which do not have a symmetrical color design, or which have stars as part of the design, will be worn as follows:

a. Medal of Honor. The stars will form an "M" with the single ray of all stars pointing up.

b. Navy and Marine Corps Medal. The blue stripe will be to the wearer's right.

c. Presidential Unit Citation. The blue stripe will be uppermost.

d. Merchant Marine Mariner's Medal. Blue stripe will be to the wearer's right.

e. World War II Theater/Campaign Medals. The blue stripe in the center will be to the wearer's right.

f. Navy Occupation Service Medal. Black stripe will be to the wearer's right.

g. Merchant Marine Combat Medal. The light blue stripe will be uppermost.

h. Philippine Defense Ribbon. The stars will form a triangle, base down.

i. Philippine Liberation Ribbon. The blue stripe in the center will be to the wearer's right.

j. Philippine Presidential Unit Citation. Blue stripe will be to the wearer's right. The ribbon bar is worn with a gold frame.

k. Korean Presidential Unit Citation. The red portion of the circular device in the center will be uppermost; ribbon bar is worn with a gold frame.

l. Combat Action Ribbon. The large blue field will be to the wearer's right.

m. Inter-American Defense Board Medal. The red stripe will be to the wearer's right.

5105. DECORATIONS, MEDALS, RIBBON BARS, AND LAPEL BUTTONS WORN ON CIVILIAN CLOTHING

1. Decorations, medals, appropriate ribbon bars, or lapel buttons may be worn on civilian clothes at the individual's discretion, per the guidance

provided below. Individuals should ensure that the occasion and the manner of wearing will not reflect discredit on the award.

2. Miniature medals may be worn with civilian evening dress (see paragraph 5203).

3. The Medal of Honor may be worn with civilian evening dress. It will be worn around the neck with the ribbon under the coat jacket and the medallion hanging one inch below the bow tie.

4. Miniature replicas of ribbons made in the form of enameled lapel buttons, or ribbons made in rosette form, may be worn on the left lapel of civilian clothes except civilian evening dress. Enameled lapel buttons should be worn with the long axis parallel to the ground.

5. Honorable discharge, retirement, and FMCR buttons may be worn on the left lapel of civilian clothes except civilian evening dress. Those buttons manufactured with prong and clutch fasteners may be worn as tie tacs.

MARINE CORPS UNIFORM REGULATIONS

CHAPTER 5

AWARDS

SECTION 2: LARGE AND MINIATURE MEDALS

5200. GENERAL

1. With the exception of those decorations worn pendent from the neck, medals will be arranged in a horizontal line in order of precedence from the wearer's right. The bottom edge of all medallions will be aligned.
2. Hamilton Wash large and miniature medals, also known as "anodized," may be worn at the individual's option. Marines who exercise this option will have their own medals anodized at the individual's expense. Anodized medals will not be worn together with non-anodized medals by the same individual; however, Marines with anodized medals may wear them in formation with Marines who have standard non-anodized medals.
3. Medals with suspension ribbons bonded to a plastic backing instead of a metal bar are approved for wear at the option of the individual. These medals lie flatter than the standard medals and may include magnetic fasteners in lieu of clutches for attaching to the uniform. These medals will bear Marine Corps approval identification.
4. Marines will wear all large medals to which they are entitled on dress "A" coats.
5. Miniatures of all medals entitled are required for officers/SNCO's when evening dress uniforms are worn. The Medal of Honor will NOT be mounted nor reproduced in miniature.
6. A person in receipt of an award from a foreign government which includes stars, sashes, orders, or devices (except the Fourragere) dissimilar to, or required to be worn differently than United States awards, may wear the medal or ribbon bar as a courtesy to that country only when attending a public function in the country, or in the house of or in honor of a public official or other distinguished citizen of that foreign country. Foreign medals and ribbon bars will be worn as similar to the foreign country's regulations as is practicable; however, at least one U.S. award must be worn when a foreign award is worn. Marines awarded a foreign medal, which, under the rules of the country concerned, is required to be worn at the neck, will so wear it. A Marine awarded both the Medal of Honor and a foreign medal worn at the neck, will wear the foreign award so that it shows below the Medal of Honor.

5201. MOUNTED MEDALS. (See figs. 5-1 and 5-2)

1. When only one medal is worn, it will be worn as issued through the DoD Supply System, or purchased in miniature.

2. When more than one medal is worn, they will be suspended from a holding bar of sufficient stiffness to support the weight of the medals.
3. When more than one row of medals is worn, the medals will be worn overlapped and in rows arranged according to tables 5-1 and 5-2. Upper or first row of medals will be mounted so that the medallions of the upper row cover the holding bar and suspension ribbons of the medals below.
4. For men, the maximum width of the holding bar for large medals will be 5-3/4 inches, and the length of the medals from top of holding bar to bottom of medallions will be 3-1/4 inches. A maximum of four large medals side by side will fit on the maximum width of holding bar; however, a maximum of seven medals will fit on the holding bar if overlapped. The overlapping on each row will be equal (not to exceed 50 percent). The right or inboard medal will show in full.
5. Women will wear no more than three large medals side by side on a single holding bar not to exceed 4-1/4 inches; however, a maximum of five medals will fit on the holding bar if overlapped.
6. For men, the maximum width of the holding bar for miniature medals will be 4 inches, and the length of the medals from the top of the holding bar to the bottom of medals will be 2-1/4 inches. A maximum of five miniature medals side by side will fit on a 4-inch holding bar; however, a maximum of 10 medals will fit on the holding bar if overlapped. The overlapping on each row will be equal (not to exceed 50 percent). The right or inboard medal will show in full.
7. For women, the holding bar for miniature medals will be no wider than 3-1/4 inches. A maximum of four medals side by side will fit on this width-holding bar; however, a maximum of eight medals will fit on the holding bar if overlapped.

5202. WEARING LARGE MEDALS. (See fig. 5-3.)

1. Medal of Honor. On the officer's evening dress and all other dress "A" uniforms, the Medal of Honor will be worn around the neck with the ribbon under the coat or jacket collar. The medallion will emerge at the opening between the collar hook and the top button of the coat or jacket, and hang 1 inch below the bottom edge of the collar. On the SNCO evening dress uniform, the Medal of Honor will be worn around the neck with the ribbon under the jacket collar. The medallion will hang 1 inch below the men's bow tie.

2. Large Medals

- a. On the men's blue dress and blue-white dress coats, large medals will be worn centered above the left breast pocket with the upper edge of the holding bar on a line midway between the first and second buttons of the coats.

- b. On women's blue dress coats, one row of large medals will be placed centered over the left breast pocket with the top of the holding bar about 1 inch above a horizontal line tangent to the highest part of the pocket. When two or more rows of medals are worn, the top of the holding bars of the

bottom row of the medals will be approximately 1/4 to 1 inch above a horizontal line tangent to the highest point of the pocket. The holding bars of the top row of medals will be at least 1/8 of an inch below the collar. If necessary the medals may be shifted from center towards the armhole seam between 1/4 and 1/2 inches so that no more than one-third of any medal is covered by the coat lapel.

3. Wearing Ribbon Bars With Large Medals. When large medals are worn, all unit citations and other ribbons with no medal authorized will be worn centered over the right breast pocket, the bottom edge of the lower row 1/8 inch above the top of the pocket. Women will wear these ribbons on the right side of the coat front in about the same vertical position as worn with dress "B" and service "A" uniforms. Ribbon bars are normally worn in rows of three in the order of precedence from the wearer's right to left and from top down (for example: top row, Combat Action Ribbon, Presidential Unit Citation, Navy Unit Commendation; bottom row, Meritorious Unit Commendation, Korean Presidential Unit Citation, Vietnam Presidential Unit Citation). Marines who have not been awarded large medals, but who are entitled to wear a ribbon(s) for which no medal is authorized will wear such ribbon(s) over the right breast pocket as described above.

5203. WEARING MINIATURE MEDALS. (See fig. 5-4)

1. The Medal of Honor and miniature medals will be worn on all evening dress uniforms. When miniature medals are worn, no ribbons will be worn.

2. On male officers' evening dress jackets, miniature medals will be centered on the left-front panel of the jacket midway between the inner edge and the left armhole seam, with the top of the holding bar on line with the second blind buttonhole.

3. On the male SNCOs evening dress jacket, the miniature medals will be centered on the left lapel with the top of the holding bar approximately 1 inch below the left lapel notch. If regulation size holding bars will not fit on the lapel, medals may extend beyond the lapel edge onto the jacket's left breast.

4. On the women's evening dress jacket, miniature medals will be placed centered on the left lapel with the top of the holding bar at the lapel's widest part. If regulation size holding bars will not fit centered on the lapel, medals may extend beyond the lapel's edge onto the jacket's left breast.

5. Wear on Civilian Evening Clothes

a. Males. Miniature medals may be worn on the left lapel of the civilian evening coat on ceremonial occasions, but only when strictly appropriate to the occasion. On the full dress and tuxedo coats, miniatures will be worn centered on the wearer's left lapel, placed horizontally and one inch below the end of the collar gorge. The top edge of the holding bar will completely cover the buttonhole. If current styles preclude wearing on the lapel, miniatures will be placed in the same relative position as if there was a lapel.

b. Females. Miniature medals may be worn on civilian evening attire on ceremonial occasions, but only when strictly appropriate to the occasion. Miniatures will be worn in approximately the same position where they would be worn on the uniform. If current styles preclude the wearing of miniatures in a place approximating the position where they would be worn on the uniform, miniatures will not be worn.

c. If a second row of miniatures is worn, it will be placed 1 inch below the first row. In no case will more than two rows of miniatures be worn on civilian attire.

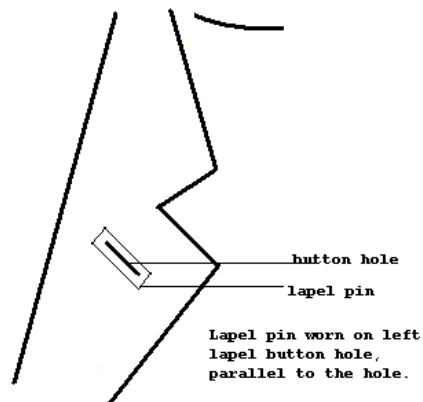

Figure 5-1.—Wear of lapel pins on civilian coats.

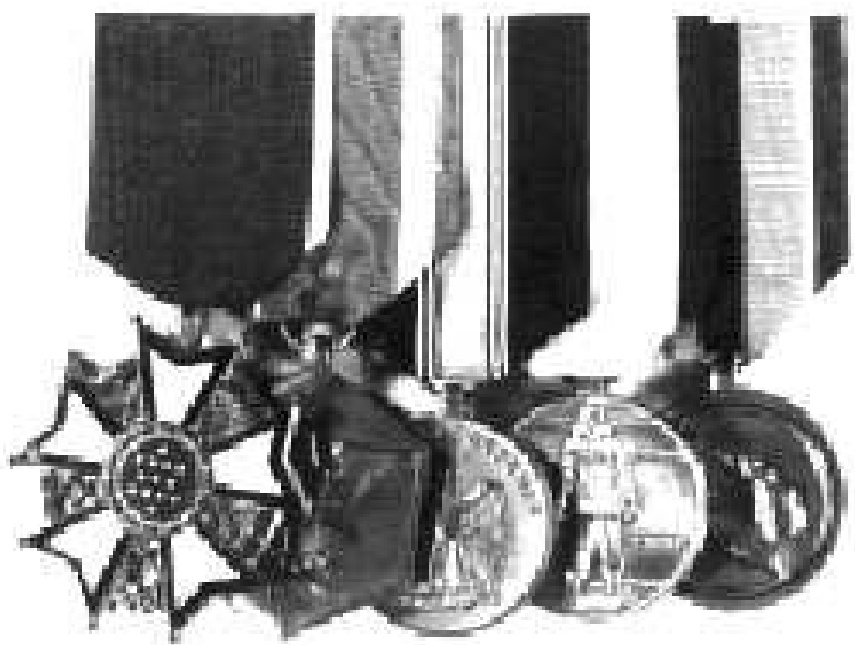

Figure 5-2.-- Mounted Large Medals.



Figure 5-3.--Mounted Miniature Medals.

MARINE CORPS UNIFORM REGULATIONS

Table 5-1.--Wearing of Medals by Male Personnel.

Wearing of Large Medals

		Number of Medals per Row		
Total Number of Medals	Number of Rows	1st Row	2nd Row	3d Row
1-7	1 row only	1-7	-	-
8	2	4	4	-
9	2	4	5	-
10	2	5	5	-
11	2	5	6	-
12	2	6	6	-
13	2	6	7	-
14	2	7	7	-
15	3	5	5	5
16	3	5	5	6
17	3	5	6	6
18	3	6	6	6
19	3	6	6	7
20	3	6	7	7
21	3	7	7	7

Wearing of Miniature Medals

		Number of Medals per Row		
Total Number of Medals	Number of Rows	1st Row	2nd Row	3d Row
1-10	1 row only	1-10	-	-
11	2	5	6	-
12	2	6	6	-
13	2	6	7	-
14	2	7	7	-
15	2	7	8	-
16	2	8	8	-
17	2	8	9	-
18	2	9	9	-
19	2	9	10	-
20	2	10	10	-

MARINE CORPS UNIFORM REGULATIONS

Table 5-2.--Wearing of Medals by Female Personnel.

Wearing of Large Medals

		Number of Medals per Row		
Total Number of Medals	Number of Rows	1st Row	2nd Row	3d Row
1-5	1 row only	1-5	-	-
6	2	3	3	-
7	2	3	4	-
8	2	4	4	-
9	2	4	5	-
10	2	5	5	-
11	3	3	4	4
12	3	4	4	4
13	3	4	4	5
14	3	4	5	5
15	3	5	5	5

Wearing of Miniature Medals

		Number of Medals per Row		
Total Number of Medals	Number of Rows	1st Row	2nd Row	3d Row
1-8	1 row only	1-8	-	-
9	2	4	5	-
10	2	5	5	-
11	2	5	6	-
12	2	6	6	-
13	2	6	7	-
14	2	7	7	-
15	2	7	8	-
16	2	8	8	-

MARINE CORPS UNIFORM REGULATIONS

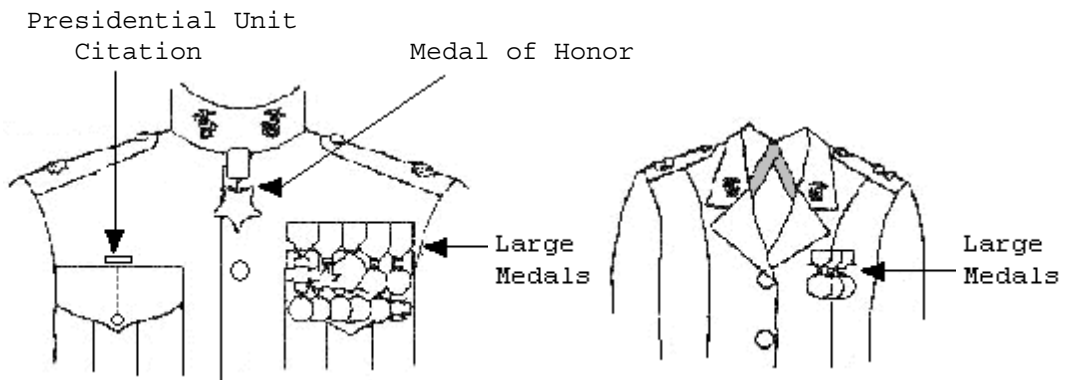

Figure 5-4.--Placement of Large Medals.

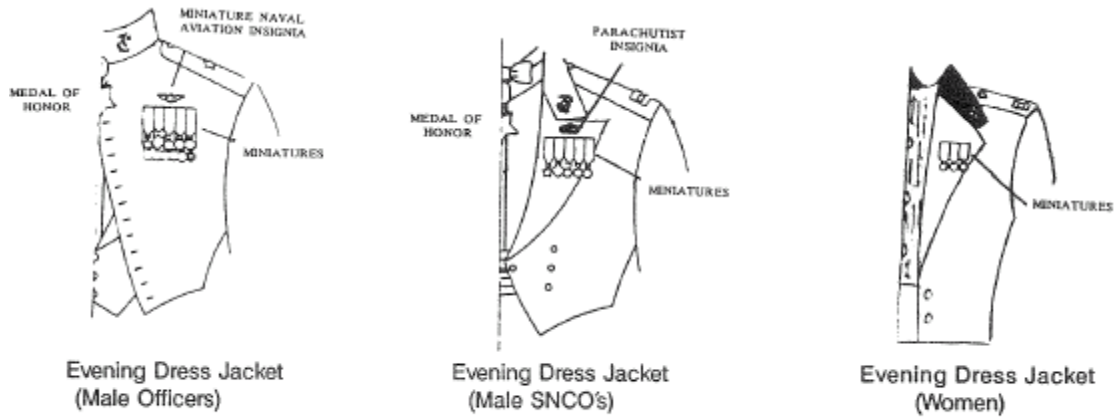

Figure 5-5.--Placement of Miniature Medals.

MARINE CORPS UNIFORM REGULATIONS

CHAPTER 5

AWARDS

SECTION 3: RIBBON BARS AND FOURRAGERE

5300. GENERAL

1. Ribbons for ribbon bars will be of the same material as the medal's suspension ribbon. Ribbon bars authorized for awards that have no medal such as the Presidential Unit Citation, Navy Unit Commendation, etc., will be of the material prescribed in applicable military specifications.
2. Each U.S. ribbon bar will be 3/8 inch high and 1-3/8 inch wide (same as the width of the medal's suspension ribbon). Foreign ribbon bars (including those with devices) that have been authorized by law may be worn only if they can be adapted to meet regulation height requirement and do not exceed twice the width of the standard U.S. ribbon bar.
3. Ribbon bars will not be impregnated with preservatives which change the appearance of the ribbon, nor will they be worn with any type of transparent coverings.
4. Ribbons bonded to a plastic backing instead of a metal bar are approved for wear at the option of the individual. These ribbon bars lie flatter than the standard ribbon bars and may include magnetic fasteners in lieu of clutches for attaching to the uniform. These ribbon bars will bear Marine Corps approval identification.
5. Stars and other attachments will be worn as prescribed in section 4 of this chapter.

5301. WEARING RIBBONS. (See fig. 5-5.)

1. Marines will wear all ribbons to which they are entitled on service and dress "B" coats. Ribbons will be worn on the dress "A" coats only as authorized in paragraph 5202.
2. When the blue dress "C"/"D" or service "B"/"C" uniforms are worn the wearing of ribbons on khaki shirts is at the individual's option unless the commander prescribes that ribbons be worn. If ribbons are worn on these uniforms, either all ribbons, or personal U.S. decorations with U.S. unit awards and the Good Conduct Medal, may be worn at the individual's option.
3. Ribbon bars will be worn on a bar or bars and pinned to the coat or shirt. No portion of the bar or pin will be visible.
4. Ribbon bars are normally worn in rows of three; however, rows of four may be worn when displaying a large number of awards. Two-ribbon rows may

MARINE CORPS UNIFORM REGULATIONS

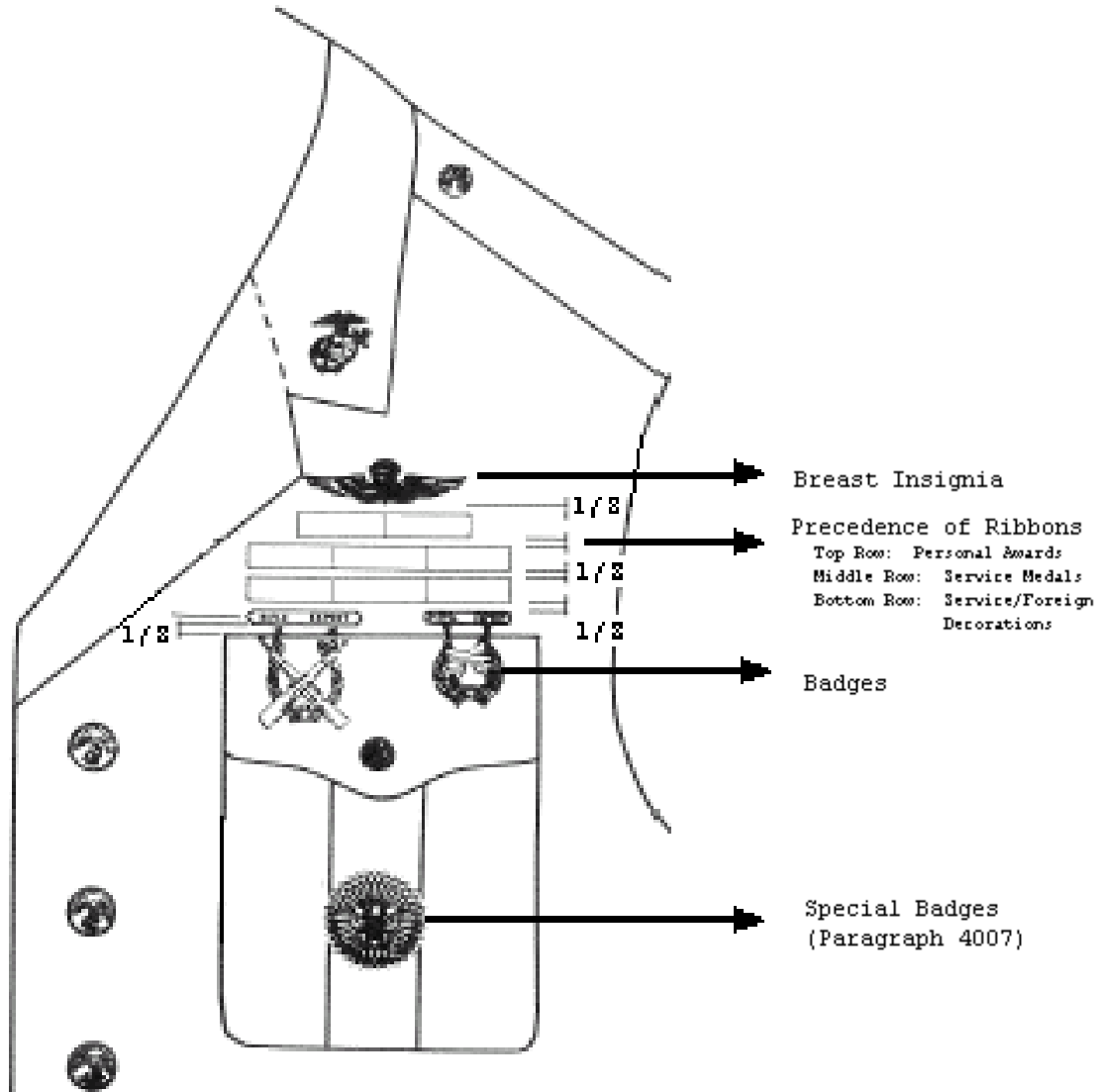

Parallel rows of ribbon bars shall be either spaced $1/8$ " apart or placed together without spacing at the wearer's option.

Figure 5-6.--Placement of Ribbons.

be worn when ribbon bars are worn in successively decreasing rows per subparagraph 5301.5. Female Marines may also wear two-ribbon rows when a three-ribbon row would not lay flat or would extend too close to the armhole seam.

5. When more than one row of ribbon bars is worn, all rows except the uppermost will contain the same number of ribbons. If the number of ribbons worn causes the ribbons to be concealed by the service coat lapel (one-third or more of a ribbon concealed), ribbon bars will be placed in successively decreasing rows; e.g., four-ribbon rows, three-ribbon rows, two-ribbon rows, single ribbon. The left (outer) edge of all decreasing rows will be in line vertically; except that when the top row presents an unsatisfactory appearance when so aligned, it will be placed in the position presenting the neatest appearance (usually centered over the row immediately below it).

6. Parallel rows of ribbon bars will either be spaced 1/8 inch apart or placed together without spacing at the individual's option.

7. Ribbon bars will be centered 1/8 inch above and parallel to the top edge of the upper left pocket of dress "B" coats, service coats, and men's khaki shirts. When marksmanship badges are worn, ribbon bars will be centered over the pocket with the bottom edge of the ribbon bar 1/8 inch above the widest holding bar of the marksmanship badge(s).

>CH 1 8. On women's coats with horizontal pockets, ribbons will be worn as prescribed above. On women's coats with slanted upper pockets, a horizontal line tangent to the highest point of the pocket will be considered the top of the pocket (see fig. 4-3). On women's khaki shirts and coats without the faux pocket, ribbon bars will be placed even with or up to 2 inches above the first visible button and centered so that they are in about the same position as when worn on the coat. On the maternity tunic, ribbon bars will be placed so that they are in about the same position as when worn on the service coats. On the khaki maternity shirt, when worn as an outer garment, ribbon bars will be worn in the same manner as on the standard khaki shirt, except they will be placed 1/2 to 1 inch above the horizontal yoke seam stitching and may be adjusted to the individual to present a military appearance.

5302. FOURRAGERE. (See fig. 5-6.)

1. The Fourragere was awarded by the French Ministry of War to those units which were cited two or more times in the French Orders of the Army, and when awarded became part of the cited unit's uniform.

2. The 5th and 6th Marine Regiments were so cited during World War I, and therefore, all Marines serving in these units are authorized to wear the Fourragere.

3. Marines entitled to wear the Fourragere will wear it on all uniform service and dress coats/jackets when medals or ribbons are prescribed. The Fourragere will not be worn on the tanker jacket or the AWC.

4. The Fourragere will have a pencil attachment with a polished brass or black tip, will be of the same shades as the ribbon of the Croix de Guerre Medal,

Medal, and will conform to applicable military specifications per direction from CMC (MMAA).

5. The Fourragere will be worn over the left shoulder with the left arm passing through the large loop of the cord; the small loop will engage the button under the shoulder strap, except on the enlisted men's blue dress coat when it will engage the button above the strap, and the metal pencil attachment will hang naturally to the front.

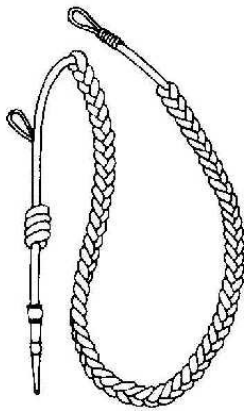

Fourragere

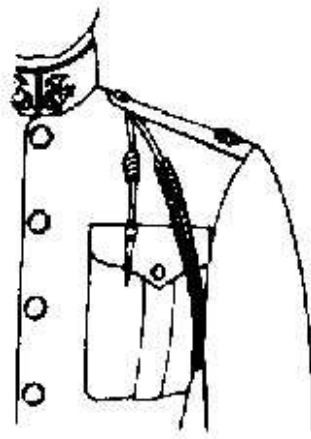

Blue Dress Coat
(Male Officers)



Pencil Attachment

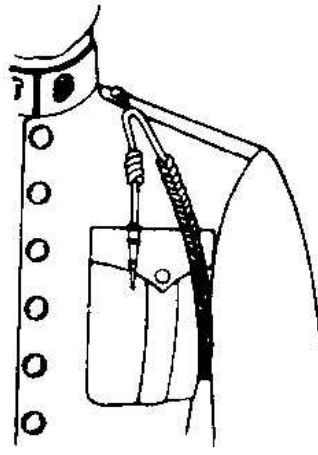

Blue Dress Coat
(Male Enlisted)

Figure 5-7.--Wearing of Fourragere.

MARINE CORPS UNIFORM REGULATIONS

CHAPTER 5

AWARDS

SECTION 4: ATTACHMENTS

5400. GENERAL. (See fig. 5-7.)

1. Stars, clasps, numerals, letter devices, and other miscellaneous devices will be worn on the suspension ribbon of large and miniature medals, and on the ribbon bars prescribed herein.

2. Anodized ribbon attachments (stars, clasps, numerals, letter/miscellaneous devices) and ribbon frames are authorized for optional purchase and wear. Oxidized and anodized attachments and ribbon frames will not be mixed.

3. Multiple Attachments

a. The following ribbon attachments of a one-piece construction in multiples of two, three, and four are authorized for optional purchase and wear:

(1) 3/16-inch bronze stars

(2) 5/16-inch gold stars

(3) Bronze oak leaf clusters

b. The above ribbon attachments are available through Marine Corps exchanges and approved commercial sources.

c. These multiple attachments are worn centered on ribbon bars and will not be worn on the same ribbon in combination with single stars or other devices. They will not be worn on suspension ribbons of large or miniature medals.

5401. STARS

1. Placement of Stars

a. On suspension ribbons of large/miniature medals, stars are placed with one ray of each star pointing up. If one star is authorized, it will be centered on the suspension ribbon. For more than one star, they will be evenly spaced in a vertical line at the center of the suspension ribbon with the senior star uppermost.

b. On ribbon bars, stars are placed with one ray of each star pointing up. If one star is authorized, it will be centered on the ribbon bar. For more than one star, they will be evenly spaced in a horizontal line on the ribbon bar, except when multiple star attachments are worn. Silver star(s)

worn with a bronze or gold star(s) will be worn as stated above, except the first bronze or gold star is placed to the wearer's left of the silver star(s) with additional stars alternating to the right of the silver star and so on.

c. When stars are worn with other devices such as the bronze letter "V," paragraph 5402 applies.

2. Gold Stars. A gold star is worn on suspension ribbons of large/miniature medals and on the ribbon bars for all personal decorations in lieu of a second or subsequent award, except for strike/flight awards of the Air Medal (see subparagraphs 5402.4 and 5402.5). The gold star worn on the suspension ribbons of large medals and ribbon bars will be 5/16 inch in diameter. Those worn on suspension ribbons of miniature medals will be 1/8 inch in diameter. For regulations on wearing oak leaf clusters in lieu of gold stars see subparagraph 5404.1.

3. Silver Stars. A silver star is worn on suspension ribbons of large/miniature medals and on ribbon bars in lieu of five gold stars, or in lieu of five bronze stars, except for strike/flight awards of the Air Medal (see subparagraphs 5402.4 and 5402.5). The 5/16-inch silver star will replace five 5/16-inch gold stars. The 3/16-inch silver star will replace the five 3/16-inch bronze stars. The silver star worn on suspension ribbons of miniature medals will be 1/8 inch in diameter.

4. Bronze Stars

a. Bronze stars are worn on suspension ribbons of medals or ribbon bars of the following awards to indicate a second or subsequent award or to indicate major engagements in which the individual participated:

- (1) Presidential Unit Citation
- (2) Navy Unit Commendation
- (3) Meritorious Unit Commendation
- (4) Prisoner of War Medal
- (5) Marine Corps Good Conduct Medal
- (6) Organized Marine Corps Reserve Medal
- (7) Marine Corps Expeditionary Medal
- (8) China Service Medal
- (9) World War II Campaign Medals
- (10) National Defense Service Medal
- (11) Korean Service Medal
- (12) Armed Forces Expeditionary Medal

- (13) Vietnam Service Medal
- (14) Southwest Asia Service Medal
- (15) Humanitarian Service Medal
- (16) Military Outstanding Volunteer Service Medal
- (17) Sea Service Deployment Ribbon
- (18) Overseas Service Ribbon
- (19) Marine Corps Recruiting Ribbon
- (20) Marine Corps Reserve Medal
- (21) Philippine Defense Ribbon
- (22) Philippine Liberation Ribbon
- (23) NATO Medal
- (24) Armed Forces Service Medal

b. Bronze stars worn on the suspension ribbon of large medals and on ribbon bars will be 3/16 inch in diameter. Stars worn on the suspension ribbon of miniature medals will be 1/8 inch in diameter.

c. A bronze star is also worn on the initial award of the Air Medal to denote a single mission/individual award (see paragraph 5402.5).

5402. LETTERS/NUMERALS

1. Manner of Wearing. A letter device is worn centered on the ribbon. These devices are block letters 1/4 inch high for large medal suspension ribbons or ribbon bars, and 1/8 inch high for miniature medal suspension ribbons.

2. Bronze Letter "M." Authorized Marines will wear the bronze "M" device, positioned on the ribbon and medal along with a number indicating the number of times the "M" Device has been awarded on the ribbon and suspension ribbon of the AFRM medal. Multiple periods of service during one contingency operation shall count as one "M" Device award. Appropriate wear of the AFRM and "M" Device shall be as follows:

a. Not entitled to "M" Device, but entitled to the AFRM: the AFRM with appropriate bronze/silver/gold hourglass is centered on the ribbon bar and suspension ribbon.

b. Entitled to "M" Device and AFRM based upon qualifying years of service: the "M" Device is centered on the AFRM with the appropriate hourglass device positioned on the wearer's right.

c. Entitled to "M" Device, but not otherwise entitled to the AFRM: The "M" Device is centered on the ribbon bar and suspension ribbon. The ribbon is authorized upon receipt of the "M" Device despite having served less than ten years.

d. Entitlement to numerous "M" Devices and AFRM: the "M" Device is centered on the ribbon bar and suspension ribbon with the appropriate hour glass to the wearer's right and a bronze Arabic numeral to the wearer's left. Numerals will begin with the second award (2).

3. Bronze Letter "V" (Combat Distinguishing Device)

a. The bronze letter "V" may be authorized for wear on the following combat decorations if the award is approved for acts or services involving direct participation in combat operations:

- (1) Legion of Merit
- (2) Distinguished Flying Cross
- (3) Bronze Star Medal
- (4) Air Medal
- (5) Joint Service Commendation Medal
- (6) Navy/Marine Corps Commendation Medal
- (7) Navy/Marine Corps Achievement Medal

b. The approved bronze letter "V" is gold in color. Black or darkened devices may continue to be worn until the individual's awards require remounting, at which time the appropriate gold-colored "V" will be worn.

c. Whenever the "V" device is authorized, the citation must contain a statement of authorization. The bronze letter "V" awarded under previous criteria may continue to be worn on all awards if the citation specifically authorizes its wear.

d. Only one "V" will be worn. Gold, bronze, or silver stars, or oak leaf clusters worn to indicate subsequent awards are evenly spaced in a vertical line above the "V" at the center of suspension ribbons of large and miniature medals. They will be evenly spaced in a horizontal line on the ribbon bar with the "V" at the approximate center and the stars arranged symmetrically in relation to the "V"; the first star to the wearer's right, the second to the left, and so on.

4. Silver Letter "E." Individuals awarded the Navy "E" Ribbon will wear a silver block letter "E," 1/8-inch high, centered on the ribbon. Subsequent awards are indicated by an additional silver "E" attachment for each award. When more than one "E" attachment is worn, they are placed in a horizontal line evenly spaced, centered on the ribbon. For four or more awards, only one 1/8-inch silver-wreathed "E" attachment centered on the ribbon is worn.

5. Strike/Flight Numerals. Personnel receiving strike/flight awards of the Air Medal will wear a bronze Arabic numeral 3/16-inch in diameter to indicate the total number of awards of this type after 9 April 1962. Numerals are placed on the ribbon bar as far to the wearer's left as possible without overlapping the edge of the ribbon. On the suspension ribbons of the large and miniature medals, the numerals are placed symmetrically immediately below the center of the suspension ribbon.

6. Single Mission/Individual Numerals. By order of the Secretary of the Navy, the use of numerals to represent single mission/individual awards of the Air Medal was discontinued effective 22 November 1989. However, personnel who received single mission/individual awards of the Air Medal prior to that date will continue to wear 3/16 inch gold Arabic numerals to indicate the total number of awards of this type received. If any subsequent awards are received after the effective date, stars will be used to indicate all awards received before and after 22 November 1989.

a. Awards Prior to 22 November 1989. Gold Arabic numerals are placed on the ribbon bar as far to the wearer's right as possible without overlapping the edge of the ribbon. Bronze letter "V" (Combat Distinguishing Device), if authorized, is centered on the ribbon bar. On suspension ribbons of large and miniature medals, the bronze letter "V" is centered directly below the Single Mission/Individual numerals.

b. Awards After 22 November 1989. Bronze stars, 3/16 inch in diameter, are worn to denote the first award. Subsequent awards will be indicated by 5/16-inch gold stars (Note: If the individual is entitled to subsequent awards, the bronze star indicating the first award will not be worn). A 5/16-inch silver star will be worn in lieu of five gold stars. Bronze, gold, and silver stars and the bronze letter "V" are worn on the ribbon bar/suspension ribbon as indicated in the paragraph above.

5403. CLASPS

1. General. Clasps or bars are worn on suspension ribbons only. A single clasp is worn in the center with additional clasps equally spaced according to dates during which earned, earliest date uppermost. If worn with other attachments, however, clasps are worn below such attachments. Miniature clasps or bars, when available are similarly worn with appropriate miniature medals.

2. Navy Occupation Service Medal. Appropriate clasps marked "EUROPE" and "ASIA" are worn on suspension ribbons of large and miniature medals to denote service in Europe and Asia, respectively.

3. Antarctica Service Medal. Personnel who stay or have stayed on the Antarctic continent during the winter months are eligible to wear a bronze clasp with the words "Wintered Over" on the suspension ribbon of the large medal. A gold clasp is authorized for the second wintering over period, and a silver clasp is worn for the third or subsequent wintering over period. Only one bronze, gold or silver clasp is worn on the suspension ribbon of the medal.

4. Gold/Silver Life Saving Medals. Gold or silver bars awarded in lieu of a second or subsequent award are worn at the bottom of the suspension ribbon, the first award uppermost.

5404. MISCELLANEOUS DEVICES

1. Oak Leaf Cluster. If a second or subsequent award of a personal military decoration or the Joint Meritorious Unit Award is bestowed upon a Marine by the Department of Defense, Army, or Air Force, a bronze (or silver) twig of four oak leaves with three acorns on the stem, 13/32 inch in length is worn on the suspension ribbon of the large medal, and a 5/16-inch twig is worn on the ribbon bar. A 7/32" inch twig is worn on miniature medals. Oak leaf clusters are worn with the stem of the oak leaves toward the wearer's right, stem down. A silver oak leaf cluster is worn in lieu of five bronze oak leaf clusters for the same decoration.

2. Gold Compass Rose. A gold compass rose is authorized for the suspension ribbon of the medal and ribbon bar of the National Security Medal to denote each subsequent award earned.

3. Planet Symbol. A ball-shaped object symbolizing a planet, with wing configuration is authorized for the suspension ribbon of the medal and ribbon bar of the NASA Distinguished Service Medal to denote each subsequent award earned.

4. Space Oak Leaf Cluster. An oak leaf cluster will be worn on the suspension ribbon of the medal and ribbon bar of the NASA Space Flight Medal to denote subsequent awards. A silver cluster will denote each subsequent award for the second through the fourth awards. A gold oak leaf cluster will denote the fifth award.

5. Hour Glass. Marines are awarded the Armed Forces Reserve Medal with the bronze hourglass device upon completion of 10 years of service. A silver hourglass device is awarded upon completion of the second 10-year period, a gold device upon completion of the third 10 year period, and a gold hourglass device followed by a bronze Hour Glass device will be awarded upon completion of the fourth 10-year period of service. This device represents an hourglass with the Roman numeral X superimposed thereon. It is worn centered on the suspension ribbon and the ribbon bar. The device for the suspension ribbon of the large medal and the ribbon bar will be 3/8-inch high. The device for the suspension ribbon of the miniature medal will be 1/8-inch high.

6. Antarctica Continental Disc. Personnel who stay or have stayed on the Antarctic continent during the winter months will be eligible to wear a bronze disc 5/16 inch in diameter with the outline of the Antarctic continent, on the suspension ribbon of the miniature medal and on the ribbon bar of the Antarctica Service Medal. A gold disc is authorized for a second wintering over period and a silver disc for three or more wintering over periods. The disc is worn with peninsula pointing up. Only one disc will be worn on the ribbon.

7. Vietnam "60" Device. Marines authorized to wear the Republic of Vietnam Campaign Medal will wear the silver banner device with the numerals "60" on the suspension ribbons and ribbon bar. The device for the suspension ribbon

of the large medal will be 1-1/4 inches in length; the device for the suspension ribbon of the miniature medal and ribbon bar will be 5/8 inch in length.

8. Vietnam Gallantry Cross with Devices. Marines authorized to wear the Gallantry Cross as a personal decoration will wear the award with appropriate devices designating the level for which the award was presented. A palm indicates "cited before the Army," a gold star indicates "cited before the Corps," a silver star indicates "cited before the Division," and a bronze star indicates "cited before the Regiment." No frame is worn with the ribbon bar.

a. Only one medal and/or ribbon bar is worn regardless of the number of awards received. In the event more than one award is authorized, an individual will wear as many of the authorized devices, using the most senior awards, that will fit onto one suspension ribbon or ribbon bar. If more than one device is authorized, the senior device is worn to the wearer's right. The palm is worn with the stem to the wearer's right and the stars are worn with the single ray pointing upward.

b. For the initial award, the size of the devices designating the appropriate level of the award are as issued by the government of South Vietnam (on the ribbon bar, the palm is 6/8 inch and the stars are 3/8 inch; on the suspension ribbon, the palm is 1-7/16 inches and the stars are 3/8 inch).

c. The size of the palm device for subsequent awards is reduced to 6/8 inch for the suspension ribbon of the large medal and to 3/8 inch for the ribbon bar. The star devices (gold, silver, or bronze) remain the same size as authorized for the initial award.

9. Republic of Vietnam Meritorious Unit Citation with Gallantry Cross Color and Civil Actions Color. Authorized personnel wear the ribbon bars for the Republic of Vietnam Meritorious Unit Citation Gallantry Cross Color and Civil Actions Color with the palm and gold frame. No medals are authorized for these citations. The palm is 5/32 inch high and 9/16 inch wide, lightly oxidized with a satin finish. The stem of the palm will be worn to the wearer's right. No device is worn on the ribbon bar to indicate a subsequent award.

10. Gold Frame. A gold frame is worn on ribbon bars for foreign unit awards. The frame is 7/16 inch high by 1-7/16 inches wide, gold-plated matte finish with polished highlights. Unless otherwise specified by the awarding authority/nation, the frame is worn so that the leaves at either end will form a "V."

MARINE CORPS UNIFORM REGULATIONS

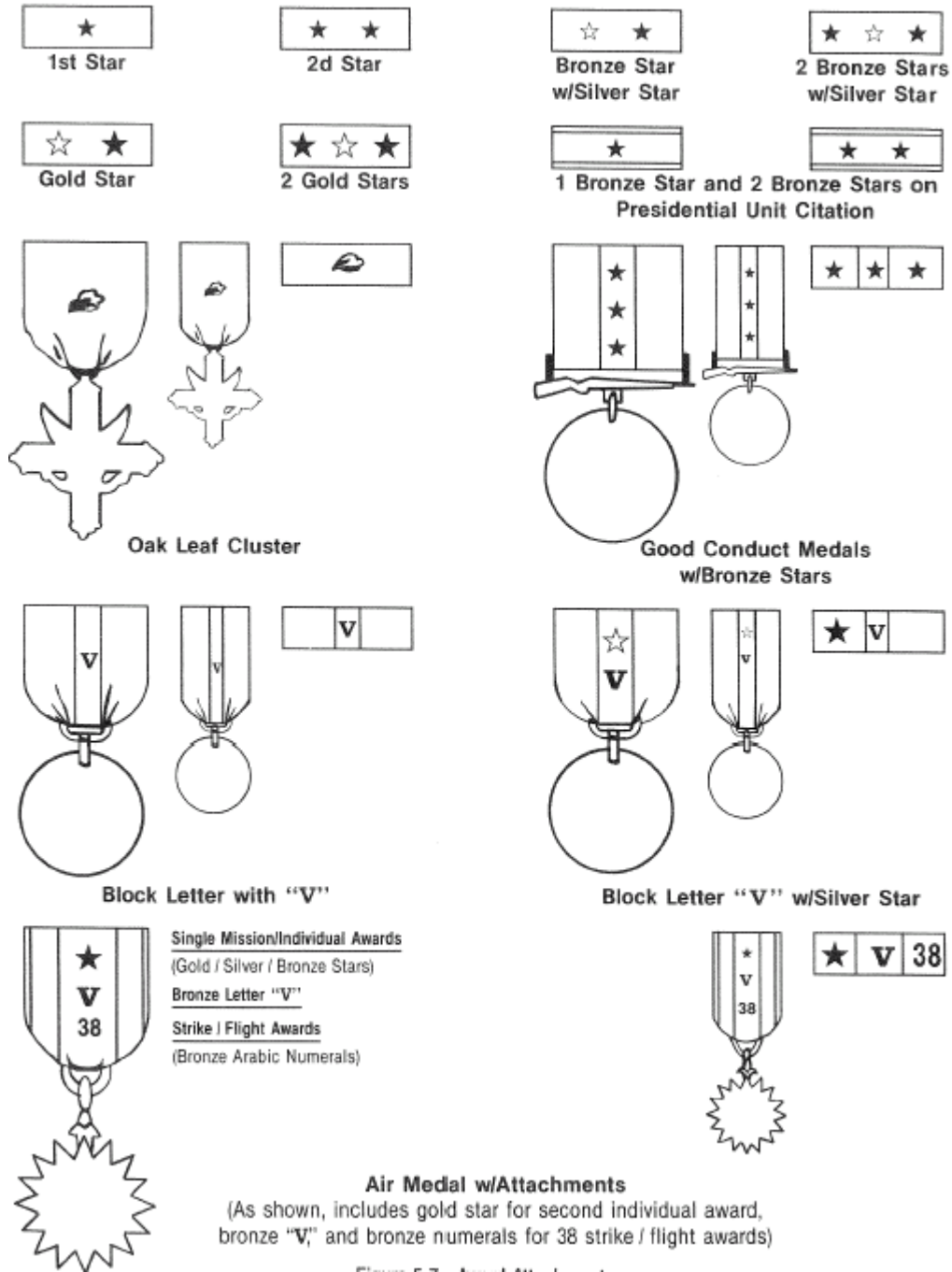

Figure 5-8.--Award Attachments.

MARINE CORPS UNIFORM REGULATIONS

CHAPTER 5

AWARDS

SECTION 5: MARKSMANSHIP BADGES

5500. PRECEDENCE. (See figs. 5-8 and 5-9.) Listed below, in order of precedence, are the only marksmanship awards authorized for wear on the Marine Corps uniform.

1. U.S. Distinguished International Shooter Badge (Gold)
2. Distinguished Marksman Badge (Gold)
3. Distinguished Pistol Shot Badge (Gold)
4. Lauchheimer Trophy Badge (Gold, Silver, and Bronze)
5. Marine Corps Rifle Championship Badge (McDougal Trophy Badge) (Gold)
6. Marine Corps Pistol Championship Badge (Walsh Trophy Badge) (Gold)
7. Marine Corps Rifle Competition Badge (Gold)
National Trophy Rifle Match Badge (Gold)
Interservice Rifle Match Badge (Gold)
8. Marine Corps Pistol Competition Badge (Gold)
National Trophy Pistol Match Badge (Gold)
Interservice Pistol Match Badge (Gold)
9. Marine Corps Rifle Competition Badge (Silver)
National Trophy Rifle Match Badge (Silver)
Interservice Rifle Match Badge (Silver)
10. Marine Corps Pistol Competition Badge (Silver)
National Trophy Pistol Match Badge (Silver)
Interservice Pistol Match Badge (Silver)
11. Marine Corps Rifle Competition Badge (Bronze)
National Trophy Rifle Match Badge (Bronze)
Interservice Rifle Match Badge (Bronze)
12. Marine Corps Pistol Competition Badge (Bronze)
National Trophy Pistol Match Badge (Bronze)
Interservice Pistol Match Badge (Bronze)
13. Inter-Division Rifle Competition Badge (Gold)
14. Inter-Division Pistol Competition Badge (Gold)
15. FMF Combat Infantry Trophy Match Badge (Bronze)

16. Annual Rifle Squad Combat Practice Competition Badge (Gold, Silver, and Bronze)
17. Division Rifle Competition Badge (Gold)
National Board for the Promotion of Rifle Practice (NBPRP) Rifle Competition Badge (Gold)
18. Division Pistol Competition Badge (Gold)
NBPRP Pistol Competition Badge (Gold)
19. Division Rifle Competition Badge (Silver)
NBPRP Rifle Competition Badge (Silver)
20. Division Pistol Competition Badge (Silver)
NBPRP Pistol Competition Badge (Silver)
21. Division Rifle Competition Badge (Bronze)
NBPRP Rifle Competition Badge (Bronze)
22. Division Pistol Competition Badge (Bronze)
NBPRP Pistol Competition Badge (Bronze)
23. San Diego, Wharton, Elliott, Wirgman, Lloyd, and Smith Trophy Rifle Team Match Badges (Gold)
24. Holcomb, Edson, Shively, and Pacific Trophy Pistol Team Match Badges (Gold)
25. Rifle Qualification Badges
 - a. Expert (with last requalification bar)
 - b. Sharpshooter
 - c. Marksman
26. Pistol Qualification Badges
 - a. Expert (with last requalification bar)
 - b. Sharpshooter
 - c. Marksman

5501. REGULATIONS FOR WEAR

1. Marksmanship badges will not be worn with the evening dress, blue dress "A," blue-white dress "A," utility, and camouflage maternity work uniforms. Commanders may prescribe marksmanship badges for wear on all other uniforms. Unless otherwise prescribed by the commander, wearing marksmanship badges is at the option of the individual.

2. Badges are worn, according to seniority, centered above the left breast pocket, with the bottom edge of the highest holding bar $\frac{1}{8}$ inch above the pocket's top edge (see fig. 5-5). The top edges of all badges will be aligned.

3. When men wear two badges, they are symmetrically placed on a line with about $\frac{3}{4}$ -inch space between holding bars, but in no case will they span more than $4\frac{1}{4}$ -inches. When three marksmanship badges are worn, they are symmetrically placed above the left pocket with $\frac{1}{4}$ -inch spacing between the holding bars of each badge.

4. When women wear two badges, they are symmetrically placed on a line so that their outermost edges are approximately even with the pocket edges. However, there must be at least a $\frac{1}{4}$ -inch space between holding bars; in no case will the space exceed $\frac{1}{2}$ inch. When three marksmanship badges are worn, they are symmetrically placed above the left pocket with $\frac{1}{8}$ -inch spacing between the holding bar of each badge.

>CH 1 5. On women's coats with horizontal pockets, ribbons will be worn as prescribed above. To determine the proper location for marksmanship badges on women's coats with slanted upper pockets, a horizontal line tangent to the highest point of the pocket is considered the top of the pocket. On women's khaki shirts and coats without the faux pocket, badges are placed even with or up to two inches above the first visible button and centered so that they are in about the same position as on the coat. On the khaki maternity shirt, badges are worn in the same manner as on the standard khaki shirt, except they are placed $\frac{1}{2}$ to 1 inch above the horizontal yoke seam stitching and may be adjusted to the individual to present a military appearance.

6. Only one qualification badge for a specific type of weapon may be worn at any time except that two competition badges for the same weapon may be worn. No more than three marksmanship badges will be worn at any time. Marines entitled to more than three awards may select the three to be worn.

7. When ribbon bars are worn with the badges, the lowest row of ribbons is $\frac{1}{8}$ inch above the top edge of the marksmanship badges. If only marksmanship badges and breast insignia are worn, the insignia is centered $\frac{1}{8}$ inch above the top edge of the marksmanship badge(s).

MARINE CORPS UNIFORM REGULATIONS



Distinguished International Shooter



Distinguished Marksman



Distinguished Pistol Shot



Lauchheimer Trophy



Marine Corps Rifle
Championship (McDougal Trophy)



Marine Corps Pistol
Championship (Walsh Trophy)

Figure 5-9.--Marksmanship (Competition) Badges.

MARINE CORPS UNIFORM REGULATIONS



Marine Corps Rifle Competition



Marine Corps Pistol Competition



Marine Corps Division Rifle Competition



Marine Corps Division Pistol Competition



Inter-Division Rifle Team



Inter-Division Pistol Team

Figure 5-9.--Marksmanship (Competition) Badges (Continued).

MARINE CORPS UNIFORM REGULATIONS



San Diego Trophy



Elliott Trophy



Wirgman Trophy



Shively Trophy



Edson Trophy



Holcomb Trophy

Figure 5-9.--Marksmanship (Competition) Badges (Continued).

MARINE CORPS UNIFORM REGULATIONS



Lloyd Trophy



Smith Trophy



Wharton Trophy



FMF Combat Infantry Trophy



Annual Rifle Squad Practice



Pacific Trophy

Figure 5-9.--Marksmanship (Competition) Badges (Continued).

MARINE CORPS UNIFORM REGULATIONS



Rifle Expert



Pistol Expert



Rifle Requalification Bar (Expert only)



Pistol Requalification Bar (Expert only)



Rifle Sharpshooter



Pistol Sharpshooter



Rifle Marksman



Pistol Marksman

Figure 5-10.--Marksmanship (Qualification) Badges.

MARINE CORPS UNIFORM REGULATIONS

CHAPTER 6

MUSICAL UNITS

SECTION 1: UNITED STATES MARINE BAND

	<u>PARAGRAPH</u>	<u>PAGE</u>
GENERAL	6100	6-3
UNIFORM DESIGNATION	6101	6-3
REGULATIONS FOR WEAR	6102	6-3
INSIGNIA	6103	6-4

SECTION 2: REGULAR ESTABLISHMENT

	<u>PARAGRAPH</u>	<u>PAGE</u>
GENERAL	6200	6-11
U.S. MARINE DRUM AND BUGLE CORPS	6101	6-11
ORGANIZATIONAL CLOTHING/EQUIPMENT	6102	6-12
REGULATIONS FOR WEAR	6103	6-13

FIGURE

6-1 MARINE BAND ENLISTED GRADE INSIGNIA	6-1
6-2 FULL DRESS (DIRECTOR, U.S. MARINE BAND) (MALE)	6-7
6-3 FULL DRESS (SUMMER) (ASST. DIRECTORS/STAF OFFICERS, U.S. MARINE BAND) (MALE)	6-7
6-4 FULL DRESS (DRUM MAJOR, U.S. MARINE BAND) (MALE)	6-8
6-5 FULL DRESS CONCERT (SUMMER) (MUSICIAN, U.S. MARINE BAND) (FEMALE)	6-8
6-6 FULL DRESS (SUMMER) (MUSICIAN, U.S. MARINE BAND) (MALE)	6-9

MARINE CORPS UNIFORM REGULATIONS

6-7 FULL DRESS CEREMONIAL (MUSICIAN, U.S. MARINE BAND) (FEMALE)	6-9
6-8 SPECIAL FULL DRESS (MUSICIAN, U.S. MARINE BAND) (MALE)	6-10
6-9 SPECIAL FULL DRESS (MUSICIAN, U.S. MARINE BAND) (FEMALE)	6-10
6-10 FULL DRESS (MUSICIAN USMC DRUM & BUGLE CORPS) (FEMALE)	6-14
6-11 FULL DRESS (MUSICIAN USMC DRUM & BUGLE CORPS) (MALE)	6-14

TABLE

6-1 SPECIAL UNIFORMS ISSUED TO U.S. MARINE BAND OFFICERS AND ENLISTED PERSONNEL	6-5
6-2 SPECIAL UNIFORMS ISSUED TO U.S. MARINE BAND ENLISTED WOMEN	6-6

MARINE CORPS UNIFORM REGULATIONS

CHAPTER 6

MUSICAL UNITS

SECTION 1: UNITED STATES MARINE BAND

6100. GENERAL

1. Except as prescribed in this chapter, uniforms worn by officers and enlisted musicians of the Marine Band will be as designated in chapter 2.
2. Officers of the Marine Band will possess uniforms and accessories prescribed in chapter 9, except that the white dress and utility uniforms are not required. They may also be furnished additional organizational clothing items as prescribed. (See table 6-1.)
3. Enlisted musicians of the Marine Band will maintain in good and serviceable condition, uniforms and accessories listed in the current edition of MCBul 10120, Individual Clothing Allowances for Enlisted Personnel, as well as additional items of organizational clothing as prescribed. (See tables 6-1 and 6-2.)
4. Organizational property allowances in tables 6-1 and 6-2 are the maximum amounts that may be issued, dependent upon duties to be performed. Lesser quantities may be issued as determined by the Director, U.S. Marine Band.

6101. UNIFORM DESIGNATION (See figs. 6-2 through 6-9)

1. The uniforms shown in figures 6-2 and 6-3 are designated "full dress" for officers of the Marine Band.
2. The uniforms shown in figures 6-4 through 6-9 are designated "full dress" or "special full dress" for enlisted Marine Band musicians.

6102. REGULATIONS FOR WEAR

1. Except as provided herein uniforms worn while performing musical duties will be prescribed by the Director, U.S. Marine Band. Uniforms designated in chapter 2 will be worn according to those regulations.
2. Band members will wear their awards according to regulations in chapter 5, except that on the full dress coat or jacket, large medals and ribbons are worn on a line midway between the first and second buttons. Medals are worn on the left and ribbons on the right of the front of the coat or jacket. Awards will not be worn on special full dress coats or jackets.

3. Drum majors will wear the baldric across the left shoulder and may wear gauntlets as necessary.
4. Wearing gloves is not mandatory while performing musical duties. When white gloves are prescribed, appropriate instrumentalists may wear sensitized gloves. White gloves may be prescribed with all uniforms.
5. Black shoes and black socks will be worn by male musicians with all dress uniforms.
6. The sword may be prescribed for officers and the drum major only.
7. Officers of the Marine Band will wear aiguillettes on the left side of the full dress coat. Both plaited cords will be worn in front of the arm. The single lay is worn under the arm. Aiguillettes will be attached to the shoulder knot with the loop suspended from the center top button of the coat.

6103. INSIGNIA

1. Officers of the Marine Band will wear appropriate insignia prescribed in paragraph 4005, except that on the full dress coat, embroidered insignia of grade will be attached to the shoulder knots.
2. Insignia for Marine Band musicians will contain the musical lyre (See fig. 6-1). Insignia will be worn in the same manner prescribed for equivalent enlisted grade insignia in chapter 4. On special full dress coats or jackets, branch of service insignia, grade insignia, and service stripes will not be worn. Musicians will not wear grade insignia or service stripes on full dress coats or jackets; however, drum majors, the operations chief and assistant operations chief will wear grade insignia. Insignia of grade will be worn on the blue all-weather coat in the same manner as worn on the standard gray all-weather coat. Enlisted musicians will wear the black metal/plastic grade insignia.

MARINE CORPS UNIFORM REGULATIONS

Table 6-1. Special Uniforms Issued to U.S. Marine Band Officers and Enlisted Men

Item Description	Dir	Asst Dir's	Staff Off's	Drum Majors	Enl Band	Enl Orch
ALL-WEATHER COAT, Ceremonial, Blue, ea.	1	1	1	1	1	1
BALDRIC, DRUM MAJOR, Full Dress, ea.				1		
BEARSKIN, w/Chin Strap				1		
BELT, w/Buckle, Full Dress, ea.	2	2	1	2		
COAT, MB, Full Dress, ea.					3	
COAT, MB, Special Full Dress, ea.					2	2
COAT, MB, Asst. Director, Full Dress, ea.		4	1			
COAT, MB, Director, Blk, Full Dress, ea.	4					
COAT, MB, Drum Major, Full Dress, ea.				4		
COVER, Cap, White, ea	2	2	1	1	1	1
FRAME, Cap, ea	1	1	1	1	1	1
GAUNTLETS, White, ea.				6		
KNOT, Gold Shoulder w/Aiguillette & Grade Insignia, pr.	3	3	2			
KNOT, Sword, Gold, Full Dress, ea.	1	1	1			
KNOT, White Shoulder w/Aiguillette, pr.					2	
SHIRT, White, Long Sleeve, ea.	3	3	2			
SHIRT, White, Short Sleeve, ea.	3	3	1	1	3	1
SHOES, Dress, Blk, High Gloss, pr.	2	2	2	2	2	1
SWORD, NCO, w/Scabbard, ea.					1	

MARINE CORPS UNIFORM REGULATIONS

Table 6-1. Special Uniforms Issued to U.S. Marine Band Officers and Enlisted Men (Continued)

Item Description	Asst Staff		Drum	Enl	Enl
	Dir	Dir's Off's	Majors	Band	Orch
TROUSERS, MB, Sky Blue, pr.			2	2	2
TROUSERS, MB, Blk, Full Dress, pr.	3	3	2		
TROUSERS, White, pr.	4	4	2	4	1

Table 6-2 Special Uniforms Issued to U.S. Marine Band Women.

Item Description	Enl Band	Enl Orch
ALL-WEATHER COAT, Ceremonial, Blue, ea.	1	1
COAT, MB, Full Dress, ea.	3	
JACKET, MB, Full Dress, ea.	2	
JACKET, MB, Special Full Dress, ea.	2	2
KNOT, White Shoulder w/Aiguillette, ea.	2	
SHOES, Dress, Pump, Black, High Gloss, pr.	1	1
SHOES, Oxford, Black, High Gloss, pr.	2	1
SKIRT, MB, (Floor Length), Sky Blue, (Split Skirt Style Optional), ea.	2	2
SKIRT, MB, (Floor Length), White, (Split Skirt Style Optional), ea.	4	1
SLACKS, Sky Blue, pr.	2	2
SLACKS, White, pr.	4	2

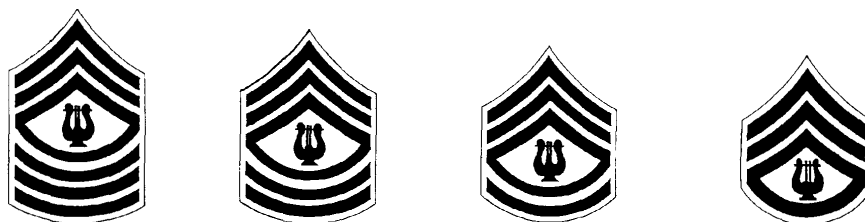

Figure 6-1. Marine Band Enlisted Grade Insignia.

MARINE CORPS UNIFORM REGULATIONS



Figure 6-2.---Full Dress
(Director, U.S. Marine Band)



Figure 6-3.---Full Dress (Summer)
(Assistant Directors/Staff
Officers U.S. Marine Band)

MARINE CORPS UNIFORM REGULATIONS



Figure 6-4.--Full Dress
(Drum Major, U.S. Marine Band)



Figure 6-5.--Full Dress Concert
(Summer) (Musician,
U.S. Marine Band)

MARINE CORPS UNIFORM REGULATIONS



Figure 6-6. Full Dress (Summer)
(Musician, U.S. Marine Band)



Figure 6-7. Full Dress Ceremonial
(Musician, U.S. Marine Band)

MARINE CORPS UNIFORM REGULATIONS



Figure 6-8. Special Full Dress
(Musician, U.S. Marine Band)



Figure 6-9. Special Full Dress
(Musician, U.S. Marine Band)

MARINE CORPS UNIFORM REGULATIONS

CHAPTER 6

Musical Units

Section 2: Regular Establishment

6200. GENERAL

1. Regular establishment musical units include the U.S. Marine Drum and Bugle Corps and all field bands/drum and bugle corps. Except as otherwise prescribed in this chapter, uniforms worn by officers and enlisted members assigned to musical units will be as designated in chapter 2.
2. Officers will possess uniforms prescribed in chapter 9. Enlisted members will possess uniforms and accessories prescribed in the Minimum Requirements List, and in addition are authorized the dress blue supplementary clothing allowances listed in MCBul 10120, Individual Clothing Allowances for Enlisted Personnel.
3. Except as provided herein:
 - a. Uniforms worn while performing musical duties will be as designated in chapter 2 and will be prescribed by the commander.
 - b. Appropriate insignia will be worn on all uniforms according to chapter 4.
 - c. Personnel will wear their awards according to chapter 5.

6201. U.S. MARINE DRUM AND BUGLE CORPS (See figs. 6-10 and 6-11.)

1. In addition to those items listed in subparagraph 6202.1, items of organizational clothing/equipment as prescribed herein may be worn by members of the U.S. Marine Drum and Bugle Corps.
2. A full dress uniform consisting of a scarlet coat, frame cap with white vinyl crown, blue or white trousers/slacks, and high gloss dress shoes may be worn. Blue or white trousers/slacks will be prescribed dependent upon climatic conditions.
3. Blue all-weather coats are authorized for members of the U.S. Marine Drum and Bugle Corps.
4. Medals will be worn on the scarlet coat as prescribed for full dress coats for U.S. Marine Band musicians.

5. Insignia of grade and service stripes will not be worn on the scarlet coat, except that grade insignia will be worn on the drum major's scarlet coat.
6. The scarlet and gold breast cord will be worn when and as prescribed by the commander, except that it will not be worn on the utility uniform.
7. The director's waistplate will be worn by the director, assistant director, and drum major only.

6202. ORGANIZATIONAL CLOTHING/EQUIPMENT

1. The following items of organizational clothing/equipment may be worn with uniforms of musical units' members while performing musical duties:

- a. Anodized brass items (i.e., buttons, cap/collar devices, and waistplates)
- b. Baldric
- c. Drum Sling (Harness)
- d. Gauntlets (D&B, some band members)
- e. Gloves, white, sensitized (bands)
- f. Honor guard equipment
- g. Music pouch, with cover/sling (bands)
- *h. Shoe, men's, black high gloss, dress
- *i. Shoe, woman's, black high gloss, oxford
- *j. Shoe, woman's, black high gloss, pump
- k. Skirt, woman's (floor length), dark blue
- l. Slacks, woman's, white, ceremonial
- m. Trousers, man's, white, ceremonial

*These items may be procured from Marine Corps exchanges or commercial sources.

2. To allow removal of anodized buttons prior to cleaning blue coats, musical units are authorized to buttonhole enlisted blue coats at the command's expense.

3. Organizational clothing/equipment other than authorized above will not be worn with musical unit uniforms unless specifically authorized by the CMC.

6203. REGULATIONS FOR WEAR

1. Except for the U.S. Marine Drum and Bugle Corps, blue dress "A"/"B" or blue-white dress "A"/"B" should normally be prescribed for off-station functions. When the band is performing in the blue dress uniform, and in a concert setting, it is appropriate for the conductors to wear the evening dress uniform. The musical unit officer will determine which uniform is most appropriate dependent upon the nature of the function.

2. The white military police belt may be prescribed with all service uniforms. Except when prescribed by the commander for wear during Honor Guard ceremonies, the white military police belt will not be worn with blue dress/blue-white dress uniforms. Commanders may prescribe the wear of the olive drab pistol/cartridge belts with the utility uniform by musicians during the performance of musical duties.

3. The dress cap will be worn with dress blue or blue-white uniforms only. The service cap or garrison cap will be worn with service uniforms. Organizational or non-regulation headgear will not be worn.

4. Gauntlets will be worn by drum and bugle corps members and may be worn by band drum majors and drummers.

5. Wearing gloves is not mandatory while performing musical duties; however, white gloves may be prescribed with all uniforms except the utility uniform. When white gloves are prescribed, woodwind instrumentalists may wear sensitized gloves.

6. Band members may wear the music pouch with cover and sling with all uniforms.

7. The sword may be prescribed for band officers and, when approved by the commander, for drum majors. Drum majors may wear the sword with the blue or blue-white dress "A" and "B" uniforms only. When worn, the sword will remain in the scabbard at all times.

8. Musical units that require the women's floor length dark blue skirt will submit a completed measurement form (DD Form 1111) and a funded document (DD Form 1348) citing O&M funds, with Routing Identifier Code MAU to the Commanding General (855), MCLB, Albany, GA 31704. The floor length sky blue and white split skirts are authorized for wear by members of the Marine Band in lieu of the floor length sky blue and white skirts.

9. Unless authorized herein, modifying designated uniforms is prohibited.

MARINE CORPS UNIFORM REGULATIONS



Figure 6-10. Full Dress
(Musician, USMC Drum & Bugle Corps)
(Female)



Figure 6-11. Full Dress (Musician,
USMC Drum & Bugle Corps) (Male)

MARINE CORPS UNIFORM REGULATIONS

CHAPTER 7

ORGANIZATIONAL CLOTHING AND EQUIPMENT

	<u>PARAGRAPH</u>	<u>PAGE</u>
DEFINITION AND AUTHORIZATION	7000	7-3
BRASSARDS	7001	7-3
BREASTCORDS	7002	7-3
CAMPAIGN (SERVICE) HAT	7003	7-3
FIELD COAT (JACKET)	7004	7-4
FLIGHT CLOTHING	7005	7-5
FOOD SERVICE CLOTHING	7006	7-6
FOOD SERVICE CLOTHING, SPECIAL	7007	7-6
HEADGEAR, SPECIAL	7008	7-6
HONOR GUARD EQUIPMENT	7009	7-6
MARINE SECURITY GUARDS	7010	7-7
MILITARY POLICE EQUIPMENT	7011	7-7
MOURNING BAND	7012	7-9
PHYSICAL TRAINING CLOTHING	7013	7-9
SAM BROWNE BELT	7014	7-10
SERVICE BELT	7015	7-10
SHORE PARTY DESIGNATION	7016	7-11
SWORD MOURNING KNOT	7017	7-11
SWORD AND SCABBARD, NCO	7018	7-11
TROUSERS OR SKIRT/SLACKS, WHITE	7019	7-11
ORGANIZATIONAL CLOTHING FOR SELECTED ENLISTED MARINES	7020	7-12

MARINE CORPS UNIFORM REGULATIONS

TABLE

		<u>PAGE</u>
7-1	ORGANIZATIONAL CLOTHING ALLOWANCE FOR FIELD TRAINING PERSONNEL (FTP), MCRD PARRIS ISLAND	7-12
7-2	SPECIAL FOOD SERVICE ASSIGNMENT ORGANIZATIONAL CLOTHING ALLOWANCE	7-12
7-3	ORGANIZATIONAL CLOTHING ALLOWANCES FOR ENLISTED MARINES ASSIGNED TO CEREMONIAL UNITS, MARINE BARRACKS, WASHINGTON, DC	7-13
7-4	ORGANIZATIONAL CLOTHING ALLOWANCES FOR MALE DRILL INSTRUCTORS AND MARKSMANSHIP INSTRUCTORS AT MCRDS PARRIS ISLAND AND SAN DIEGO	7-14
7-5	ORGANIZATIONAL CLOTHING ALLOWANCES FOR FEMALE DRILL INSTRUCTORS AND MARKSMANSHIP INSTRUCTORS AT MCRDS PARRIS ISLAND AND SAN DIEGO	7-15

MARINE CORPS UNIFORM REGULATIONS

CHAPTER 7

ORGANIZATIONAL CLOTHING AND EQUIPMENT

7000. DEFINITION AND AUTHORIZATION

1. Organizational clothing and equipment are those individual clothing items on the unit's allowance list that are purchased using local Operations and Maintenance, Marine Corps (O&MMC) funds and issued to Marines on a temporary basis to accomplish assigned duties. The Marine is accountable for organizational clothing and equipment issued, and will return it upon reassignment. Organizational clothing will be issued only at the discretion of the commander, according to guidelines and directives published by HQMC.
2. Special organizational clothing such as coveralls, cold weather clothing, desert clothing (with exception of desert combat utility uniforms), aviation clothing and equipment, NBC defense protective clothing and physical training clothing will be worn when and as prescribed by the commander.
3. Separate items of organizational clothing or equipment listed in this chapter may be prescribed with the uniform of the day at the commander's discretion.
4. Organizational clothing and equipment other than listed in this chapter, such as cartridge belts, pistol belts, lanyards, helmets, cellular phones, pagers, etc., may be worn with the uniform when and as prescribed by the commander.

7001. BRASSARDS

1. Brassards are cloth bands suitably marked with symbols, letters, or words indicating a type of temporary duty to which the wearer is assigned.
2. Brassards will be worn with the lettering, if any, on the outer half of the left sleeve, midway between the armhole seam and the elbow, or directly below the insignia of grade.
3. Military police brassards are authorized for wear by personnel assigned to military police units only. The standard gold on scarlet brassard will be worn with the service and dress uniforms. The black on olive green brassard will be worn only with the utility uniform.

7002. BREASTCORDS. Scarlet and gold breastcords will be worn by enlisted Marines on duty at State functions at the White House.

7003. CAMPAIGN (SERVICE) HAT

1. The campaign hat may be worn with the duty uniform by Marines listed below, and is not authorized for leave, liberty, or in formation with troops, except as required for drill instructors. It will not be worn with the blue dress or blue-white "A"/"B" uniforms. Service cap branch of service insignia will be worn in the center front ventilation eyelet. Hats, brims,

chinstraps, and hat cords will be kept in a neat and serviceable condition. No deviation from the original shape and design of the hat is authorized.

a. Enlisted Marines. The hat is felt, Montana peak-type, with a 5-1/4-inch- deep crown, 3-inch-wide stiff brim, evenly formed, and thoroughly pressed. The hat is trimmed with a grosgrain ribbon and bow, has four round eyelets in the crown for ventilation and two oblong eyelets for the leather chinstrap which is fitted with leather sliding keepers and a tongue-type center bar buckle.

b. Officers. To be identical to the enlisted hat except that the chinstrap is three-piece leather with a snap hook and fastener at two ends, and an adjustable tongue-type center bar buckle on the center piece. Officers will wear a scarlet and gold hat cord consisting of two rows of scarlet and gold cord held together by a sliding keeper, covered with scarlet and gold material of the same design as the cord. Each end of the cord projecting beyond the sliding keeper is finished with an acorn.

2. The hat is authorized for wear by the following personnel only:

a. At recruit depots/recruit rifle ranges when approved by the commanding generals.

(1) Assigned drill instructors

(2) Sergeants major, recruit training regiments

(3) Recruit company first sergeants

(4) Primary marksmanship instructors conducting recruit marksmanship training

(5) Chief marksmanship instructors

(6) Line NCOs and coaches

(7) Range officers (MOS 9925)

b. Drill instructors at Naval Aviation Officer Candidate School

c. Range officers (MOS 9925) at Marine Corps Combat Development Command, Quantico.

d. Members of the USMC rifle and pistol teams (Regular/Reserve) funded by HQMC.

7004. FIELD COAT (JACKET)

1. The field coat is intended for wear with the utility uniform. However, the all-weather coat may still be prescribed and is still authorized for wear with the utility uniform. Local regulations will not restrict locations where the field coat can be worn provided it is clean and serviceable. The field coat will not be marked with the USMC/emblem decal nor will it be worn with name and service tapes.

2. The field coat will be replaced by the ECWCS parka per ULSSs 001996-15 and ULSS 002096. As of 1 October 2005, the field coat will be deemed obsolete and no longer authorized for wear.

7005. FLIGHT CLOTHING

1. Aviation clothing and equipment will be as supplied by the U.S. Navy and by the U.S. Marine Corps. Such clothing and equipment will be worn only when and as prescribed by commanders.

2. The flight suit will be worn with flight boots, green/black cushion-sole socks, green crew-neck undershirt, garrison cap, black leather nametags, and no more than two CNO-/CMC-approved unit/squadron patches. The flight suit is authorized for aircrew members outside the working/squadron areas subject to the same regulations that apply to the utility uniform.

3. The flight jacket may be worn with the service uniform by only those Marines properly issued and required to maintain an authorized flight jacket according to existing regulations. The flight jacket may be worn with the service "B," "C," and service with sweater uniforms. These uniform combinations will only be worn on base, or while traveling in a private/government vehicle between local military facilities, or to and from a domicile. While traveling outside a military installation no stops are permitted. The jacket will not be worn when the service "A" uniform is considered more appropriate, nor will it be worn on leave or liberty, or with the utility uniform or civilian clothing. When the flight jacket is worn with the service uniform, only one unit/squadron (CNO/CMC approved) patch may be worn. The patch, if worn, will be on the right front of the jacket, level with the nametape on the left side.

4. Listed are the four types of flight jackets authorized with the service uniform:

- a. Jacket, flying, men's intermediate, type G-1 (leather)
- b. Jacket, suits, flying, winter (green, poopie suit liner)
- c. Jacket, flyers, cold weather, fire resistant (AF CWU-45 sage green)
- d. Jacket, flyers, cold weather, fire resistant (AF CWU-36 sage green)

5. Nametapes will be worn on flight suits and flight jackets and will be 2 inches wide by 4 inches long, made of black leather or synthetic leather material only, with hook and pile (velcro) backing. The following information will be embossed in gold on the name tape:

- a. Line 1. Aviation breast insignia (or Marine Corps emblem if aviation breast insignia is not rated).
- b. Line 2. Initials and last name.
- c. Line 3. Grade and component (USMC, USMCR).

7006. FOOD SERVICE CLOTHING

1. Food Service Specialists (MOS 3381) and those Marines with a secondary MOS of Quality Assurance Technician (MOS 8033) or filling a designated billet of Food Service Attendant (MOS 8915) assigned to enlisted messhalls and clubs may be issued the following clothing as prescribed by the commander:

- a. Shirt, men's, polyester/cotton, white w/quarter length sleeve.
- b. Trousers, men's, polyester/cotton, white.
- c. Apron, polyester/cotton, white.

2. Metal/plastic insignia of grade will be worn on the collar of the organizational white shirt by food service personnel in the same manner as prescribed for the utility uniform.

7007. FOOD SERVICE CLOTHING, SPECIAL ASSIGNMENT

1. Special assignment food service clothing will be issued to and worn by Marines with the primary MOS 3381 serving as enlisted aides in general officer's quarters (MOS 3372) or Food Service Specialists in the General Officers' Mess as discussed in paragraph 7021.

2. Insignia of grade and branch of service insignia will not be worn on special food service clothing.

3. Special food service clothing will not be worn beyond organizational limits.

7008. HEADGEAR, SPECIAL

1. Protective Motor Vehicle Helmet. The approved helmet is issued as organizational clothing only to military or civilian personnel required to operate, or ride as a passenger on a government-owned motorcycle or similar two or three-wheeled vehicle while performing official duties. Such personnel are required to wear, and will be furnished at government expense, a helmet of the type described in subparagraph 3022.1.

2. Fiber Helmet. The standard issue fiber helmet may be prescribed by commanders for wear in the tropics as part of the service uniform only, or if authorized by the CMC, it may be worn at posts where climatic conditions warrant its use.

7009. HONOR GUARD EQUIPMENT

1. The following items may be worn at the discretion of commanders by Marines performing duties as honor guards:

- a. Belt, military police, cotton webbing, white w/waistplate
- b. Carrier, pistol holster, cotton webbing, white
- c. Cover, scabbard, bayonet, white
- d. Gloves, cloth, white

- e. Pocket, ammunition magazine, webbing, white, for pistol
- f. Protector, holster, white

2. Marines will wear the garrison cap or the service cap with the service uniform as prescribed by the commander. Paragraph 3004 provides guidance on appropriate headgear.

7010. MARINE SECURITY GUARDS. Marine security guards at State Department posts where the service/blue dress uniform is worn are authorized to wear black leather military police equipment (belt, holster, etc.) listed in paragraph 7011 or as provided by the State Department.

7011. MILITARY POLICE EQUIPMENT

1. The following equipment will be worn as required by Marines in authorized military police (MOS 58XX) billets performing duty under the cognizance of Marine Corps installation provost marshals' offices, the security department of Marine Helicopter Squadron One, and Armed Forces police detachments:

- a. Badge, USMC, military police
- b. Belt, military police, smooth leather, black
- c. Carrier, key or whistle, smooth leather, black
- d. Carrier, nightstick, policeman's, smooth leather, black, w/chrome ring for side-handle baton
- e. Case, handcuffs, smooth leather, black
- f. Gloves, cloth, white
- g. Handcuffs, conventional or hinged, blued
- h. Holder, ammunition magazine, smooth leather, cal. 9mm, double-pocket
- i. Holder, flashlight, smooth leather, black
- j. Holster, pistol, 9mm, smooth leather, black, high-rise
- k. Keeper, belt, smooth leather, black, single width (4 each)
- l. Nametag, black with white letters, standard
- m. Nightstick, side-handle, policeman's, fiberglass/plastic
- n. Raincoat, yellow
- o. Whistle, ball, plastic, green

2. Military police with operating forces will wear appropriate field equipment; however, they may wear the following additional items as the mission dictates:

- a. Brassard, MP standard, gold on scarlet
- b. Brassard, MP subdued, black on olive green
- c. Carrier, key or whistle, nylon, olive drab
- d. Carrier, side-handle baton, policeman's, nylon, olive drab, with black nylon ring
- e. Case, handcuffs, nylon, olive drab
- f. Handcuffs, conventional or hinged, blued
- g. Nightstick, side-handled, policeman's, fiberglass/plastic
- h. Whistle, ball, plastic, green

3. Marines assigned to security force duty will wear as required the following items:

- a. Belt, military police, cotton webbing, white w/waist plate
- b. Carrier, nightstick, white, with slide for belt (alternate carriers are authorized to accommodate side-handle baton if necessary)
- c. Carrier, pistol holder, cotton webbing, white
- d. Gloves, cloth, white
- e. Holster, pistol, 9mm, hip or shoulder, leather, black
- f. Nametag, black with white letters, standard
- g. Nightstick/baton, standard or nightstick, side-handle, policeman's, fiberglass/plastic
- h. Pocket, ammunition magazine, webbing, white,
- i. Protector, holster, white
- j. Raincoat, yellow
- k. Whistle, ball, plastic, green

4. Any items authorized for wear for military police/security force duties that are not available through the DoD Supply System are authorized for local purchase utilizing the command's Operation and Maintenance (O&M) funds.

5. The standard U.S. Marine Corps Military Police Badge will be issued to Marines performing duties in an authorized MOS 58XX billet under the

cognizance of a Marine Corps installation provost marshal, the Commanding Officer of Marine Helicopter Squadron One, or the commanding officer of a Marine Corps correctional facility. FMF and Marine Corps Reserve personnel are not authorized to wear the badge, but will continue to use the standard military police brassards described in subparagraph 7001.3.

a. The badge will be worn only when the individual is in a duty status performing garrison law enforcement functions. Badges will not be worn during FMF combat operations or training. Badges will not be carried or displayed under any circumstances when off duty. When the military police badge is worn, neither marksmanship badges nor JCS or OSD Identification Badges will be worn.

b. The badge will be worn by male Marines on the upper-left pocket. The badge will be centered on the pocket between the lower point of the pocket flap and the bottom of the pocket, midway between the two sides.

c. On the women's coat, the badge will be centered 1/8 inch below the top seam of the pocket. On women's khaki shirts, it will be centered 1/8 inch below the bottom line of ribbons. The placement of the badge may be adjusted if necessary to ensure the proper flat appearance.

d. The badge will be worn on outer garments including the sweaters, AWC, tanker jacket and field coat in the same approximate position as on the service coat.

6. Commanders may prescribe military police equipment with the utility uniform when it is impractical to wear the service uniform due to local climatic conditions.

7. Wearing clear plastic or other types of covers over white belts is not authorized.

7012. MOURNING BAND. The mourning band may be issued to enlisted Marines according to paragraph 3017.

7013. PHYSICAL TRAINING CLOTHING, SPECIAL ORGANIZATIONAL

1. Commanders that procure PT shirts and issue them as organizational property may prescribe such shirts for unit physical training. These shirts may be olive green or other, with unit distinct logos, or other markings, as commanders deem appropriate. Unit issued PT shirts will not be worn with civilian attire during leave and liberty.

1. Training and education commands are authorized to procure, using locally held O&M funds, and issue as organizational property colored physical training clothing to training supervisory personnel. The intent of this authorization is to provide a PT uniform that distinguishes supervisory personnel from students/recruits/candidates for safety reasons.

2. Training and education commands with water survival as part of their course curriculum are authorized to issue as organizational property UDT shorts and colored tank tops to their water survival instructors. In

addition, they are authorized to issue female swimsuits to female water survival instructors.

7014. SAM BROWNE BELT

1. The Sam Browne Belt may be worn by officers when the sword is prescribed, or at such times as are deemed appropriate by the local commander. The Sam Browne Belt may be worn with the blue dress "A"/"B," blue-white dress "A"/"B," and service "A" uniforms. It will not be worn with the AWC.

2. The belt is worn over the service or dress coats around the natural waist, shoulder strap over the right shoulder, and tightened with the buckle centered in front. The frog/carrier is attached to the belt at a point over the highest portion of the hipbone, generally along the seam of the left side of the coat.

7015. SERVICE BELT

1. The leather service belt is the standard sword belt for officers and may be issued to SNCOs and NCOs for ceremonies, parades, honor guards, and reviews when the sword is prescribed, and upon other occasions when an individual is actually or symbolically "under arms." The service belt may be worn with all uniforms.

>Ch 3 a. The service belt may be work with the AWC according to subparagraph 3001.4.

b. The belt is worn over the uniform belt, or at the waist covering the waistband, or at the natural waist of the women's coat, and is tightened with the buckle centered in front. The frog or carrier is attached to the belt at a point over the highest portion of the hipbone, generally along the seam of the left trouser/slack leg or side of the coat or skirt. When women wear the belt without a coat, the shirt will be tucked in.

2. Synthetic leather service belts in semi gloss or high gloss finish are approved for optional purchase and wear. These belts are not available in the DoD Supply System, but may be purchased through the Marine Corps Exchanges and approved commercial sources.

7016. SHORE PARTY DESIGNATION

1. Landing support battalion Marines are authorized to wear red patches on the utility uniform. The patch will be made of red material which is available through the Marine Corps Supply System, sewn on with red thread, and will be of a temporary nature so that it may be removed without adverse affect to the uniform.

2. Patches will be worn as follows:

a. A 1-inch by 3-inch red patch will be worn on the outboard side of each utility trouser leg. It will be centered on the seam, positioned 2-1/2 inches below the large side pockets with the three-inch edge parallel to the bottom side of the pocket.

b. A 1-inch square red patch will be worn on the utility cap, above the visor, centered on the sweatband.

c. A 1-inch square red patch will be worn centered, approximately 1 inch above the front helmet cover seam, with the emblem decal placed directly above the patch. The patch will also be worn centered, two inches from the bottom, on the back of the helmet cover.

7017. SWORD MOURNING KNOT

1. The mourning knot will be worn when NCOs are detailed to military funerals when the sword is prescribed. The knot is formed by doubling the band, passing free ends around the guard at the pommel, back through the bight thus formed and drawn taut.

2. The mourning knot is a black ribbon of silk or other similar material, 3 inches wide and 27 inches long, each end finished with a small hem, the two flowing ends being 12 inches long when the band is knotted upon the sword hilt.

7018. SWORD AND SCABBARD, NCO

1. The NCO sword and scabbard may be prescribed for corporals or above when the blue dress, blue-white dress, or service uniforms are worn.

2. The sword may be prescribed for drill with troops and for parades, reviews and ceremonies.

3. The sword scabbard is of black leather and fitted with highly polished brass mountings.

4. The sword will be suspended from the dress white or service belt by means of the leather sword/scabbard carrier. The carrier will be provided to NCOs whenever required to wear the sword.

7019. TROUSERS OR SKIRT/SLACKS, WHITE

1. Units that prescribe the wear of the blue-white dress uniforms for ceremonial wear will procure white trousers, skirts, and slacks for enlisted Marines and white slacks for female officers from commercial sources per subparagraph 2005.1. Marine Barracks, Washington D.C., may also procure white trousers and skirts for officers as required.

2. These items will be maintained as organizational property using the local commander's operation and maintenance funds.

7020. ORGANIZATIONAL CLOTHING FOR SELECTED ENLISTED MARINES

1. All clothing issued under these organizational allowances will be adequately marked to provide positive identification separate from individually owned clothing. No article will be altered for an individual to the extent that it can not be re-altered for issue to another individual.

All items, except headgear, underwear, gloves, and footwear will be recovered prior to reassignment to other duties, unless otherwise specified herein.

2. The organizational allowances contained in Tables 7-1 through 7-5 are provided as a guide. At their discretion and depending upon existing circumstances, commanders may issue a lesser or greater quantity of any item to authorized recipients, based upon mission requirements.

Table 7-1.--Organizational Clothing Allowance for Field Training Personnel (FTP), MCRD Parris Island

ITEM	QUANTITY (a)
Sweatshirts, Cold Weather PT (Organizational)	53
Undershirts, PT (Organizational)	53
Logos (Organizational)	53

Explanatory Notes:

(a) Quantity of items depicts the total quantity for the FTP, MCRD Parris Island.

Table 7-2.--Special Food Service Assignment Organizational Clothing Allowance.

MALE

ITEM	QUANTITY
Belt, leather, black with gold buckle	2
Coat, tuxedo, white	2
Necktie, black	2
Shirt, dress, polyester/cotton, white, Short-sleeve	5
Trouser, dress, polyester/cotton, black	5
Windbreaker, polyester, black	1 (a)
Sweater, v-neck, lightweight, black	1 (a)

FEMALE

ITEM	QUANTITY
Belt, leather, black with gold buckle	2
Coat, tuxedo, white	2
Necktab, black	2
Shirt, dress, polyester/cotton, white, Short-sleeve	5

MARINE CORPS UNIFORM REGULATIONS

Table 7-2.--Special Food Service Assignment Organizational Clothing Allowance (Continued).

Slacks, dress, polyester/cotton, black	<u>4</u>
Skirt, polyester/cotton, black	1
Windbreaker, polyester, black	1 (a)
Sweater, v-neck, lightweight, black	1 (a)

Explanatory Notes

(a) These items are available through the DoD Supply System. They will be worn without rank insignia. These items should be issued to all personnel serving as enlisted aides and food service personnel in the General Officers' Mess.

Table 7-3.--Organizational Clothing Allowances for Enlisted Marines Assigned to Ceremonial Units, Marine Barracks, Washington, DC.

Males

ITEM	QUANTITY
Coat, all-weather, ceremonial, black	1
Medals, "anodized", set	1
Raincoat, blue	1
Trousers, men's, white, pr	(a)

Females

ITEM	QUANTITY
Belt, coat, men's, cotton, white	1
Coat, all-weather, ceremonial, black	1
Medals, "anodized", set	1
Raincoat, blue	1
Skirt, women's, white	2
Slacks, women's, blue, pr	1
Slacks, women's, white, pr	2
Waistplate, insignia (SNCOs)	1
Waistplate, plain (sergeants and below)	1

Explanatory Notes:

(a) Quantity of items issued to be determined by the commander

MARINE CORPS UNIFORM REGULATIONS

Table 7-3.--Organizational Clothing Allowances for Enlisted Marines Assigned to Ceremonial Units, Marine Barracks, Washington, DC. (Continued)

based on duty assignment.

Table 7-4.--Organizational Clothing Allowances for Male Drill Instructors and Marksmanship Instructors at MCRDs Parris Island and San Diego.

ITEM	QUANTITY
Boot, Marine Corps combat, pr	1 (a) (b)
Coat, combat utility.....	6 (b)
Hat, service, campaign	2 (b) (c)
Insignia, branch of service, cap, black	2 (b)
Necktie, khaki	3
Shirt, men's, polyester/wool, khaki, long- sleeve	5
Shirt, men's, polyester/wool, khaki, short-sleeve	8
Shoes, dress, black, pr	1 (a)
Sweatshirt, PT	3
Sword and scabbard	1
Tape, name, combat utility	12 (b)
Tape, service, combat utility	6 (b)
Trousers, camouflage, pr	6 (b)
Trousers, men's, polyester/wool, green, pr	4
Undershirt, PT	3 (a)

Explanatory Notes:

(a) Footwear/underwear will be maintained at individual expense and will not be recovered.

(b) Marksmanship Instructors (MOS 8531) will be authorized only these items.

(c) Upon detachment, campaign hats may be retained.

MARINE CORPS UNIFORM REGULATIONS

Table 7-5.--Organizational Clothing Allowances for Female Drill Instructors and Marksmanship Instructors at MCRDs Parris Island and San Diego.

ITEM	QUANTITY
Boot, Marine Corps combat, pr	1 (a) (b)
Coat, combat utility	6 (b)
Hat, Service, Campaign	2 (b) (c)
Insignia, branch of service, cap, black	2 (b)
Necktab, green	1
Shirt, women's, polyester/wool, khaki, long sleeve	5
Shirt, women's, polyester/wool, khaki, short sleeve	8
Shoes, dress, oxford, black, pr	1 (a)
Skirt, women's, polyester/wool, green	6
Slacks, women's, polyester/wool, green	2
Sword and scabbard	1
Tape, name, combat utility	12 (b)
Tape, service, combat utility	6 (b)
Undershirt, PT	3
Trousers, combat utility, pr	6 (b)

Explanatory Notes:

- (a) Footwear/underwear will be maintained at the individual expense and will not be recovered.
- (b) Only those filling the billet of Marksmanship Instructors (MOS 8531) will be authorized these items.
- (c) Upon detachment, campaign hats may be retained.

MARINE CORPS UNIFORM REGULATIONS

CHAPTER 8

UNIFORMS FOR NAVY PERSONNEL, RESERVE/RETIRED MARINES,
MCJROTC, AND CIVILIANS

	<u>PARAGRAPH</u>	<u>PAGE</u>
GENERAL	8000	8-3
NAVY PERSONNEL SERVING WITH MARINE CORPS UNITS	8001	8-3
RESERVE PERSONNEL	8002	8-9
RETIRED PERSONNEL (INCLUDING FLEET MARINE CORPS RESERVE)	8003	8-10
MARINE CORPS JUNIOR RESERVE OFFICERS TRAINING CORPS MEMBERS	8004	8-10
CIVILIANS SERVING WITH MARINE CORPS UNITS	8005	8-11

FIGURE

8-1 PLACEMENT OF OFFICERS' GRADE INSIGNIA/ STAFF CORPS DEVICE (COLLAR)	8-6
8-2 PLACEMENT OF ENLISTED BRANCH OF SERVICE/ GRADE INSIGNIA (COLLAR)	8-7
8-3 ENLISTED CORPS DEVICES	8-7

MARINE CORPS UNIFORM REGULATIONS

CHAPTER 8

UNIFORMS FOR NAVY PERSONNEL, RESERVE/ RETIRED MARINES, MCJROTC, AND CIVILIANS

8000. GENERAL

1. Any individual wearing the Marine Corps uniform is expected to reflect the high personal appearance standards and esprit de corps that all Marines in uniform represent. To this end, particular attention will be paid not only to the correct and military wear of uniform components, but also to the individual's personal and physical appearance.

2. All personnel exercising the privilege of wearing the Marine Corps service or dress uniform will comply fully with Marine Corps grooming and weight control standards.

8001. NAVY PERSONNEL SERVING WITH MARINE CORPS UNITS. (See figs. 8-1 through 8-3.)

1. Service Uniforms. The wear of Navy or Marine Corps service uniforms by Navy personnel serving with Marine Corps units will be as follows:

a. Officers. Navy officers may purchase and wear Marine Corps service uniforms at their option. When the Marine Corps service uniform is worn, Navy officers will abide by Marine Corps grooming and physical appearance standards and the uniform will be worn in the manner prescribed for Marine officers, except as otherwise specified in this chapter. Those officers who do not elect to wear Marine Corps service uniforms will wear the equivalent Navy service uniform and abide by Navy grooming and physical appearance standards.

b. Enlisted

(1) Marine Corps service uniforms are provided only to those Navy hospital corpsmen, dental technicians, or religious program specialists who elect to wear them. These Navy enlisted will wear Marine Corps service uniforms for the duration of their continuous service with Marine Corps units when directed by the commander. They will abide by Marine Corps grooming and physical appearance standards and, except as otherwise prescribed in this chapter, wear the service uniforms with the same required/optional components and in the same manner as prescribed for Marines.

(2) Navy hospital corpsmen, dental technicians, or religious program specialists who do not elect to wear Marine Corps service uniforms, or those Navy enlisted personnel in other specialties not entitled to the service uniform option, will wear the equivalent Navy service uniform when required and abide by Navy grooming and physical appearance standards.

(3) All Navy enlisted personnel serving with Marine Corps units and who wear Navy service uniforms will be issued sufficient quantities of unit identification marks (UIM's) for wear on their service uniforms. Unit supply

officers will procure UIM's with local operation and maintenance funds. The marks will reflect the short title at the major command level and will be worn per the guidance contained in U.S. Navy Uniform Regulations.

2. Utility Uniforms. The Marine Corps issues the utility uniform to all Navy hospital corpsmen, dental technicians, or religious program specialists with Marine Corps units and to Navy counselors, yeomen, personnel men and disbursing clerks assigned to Marine units. The utility uniform, when it is issued by and at the expense of the Marine Corps, shall be worn in accordance with the provisions of this manual. There are two utility uniforms, as described by paragraph 2005. The camouflage utility uniform is a standard uniform authorized by the U.S. Navy and the U.S. Marine Corps, but the Navy issues it only to Sailors in certain specialties. The combat utility uniform is unique to the Marine Corps and may only be worn by Sailors when they are serving with Marine Corps units. The wear of the utility uniform by Navy personnel serving with Marine Corps units will be as follows:

a. Officers. Navy officers do not receive a uniform allowance and therefore will not be mandated to wear the utility uniform, but they may purchase and wear the utility uniform at their option. When camouflage utilities are worn, Navy officers may elect abide by either Navy uniform regulations or Marine Corps, as described by this manual. However, while serving with the Marine Corps embroidered insignia will not be worn on the camouflage utility uniform, regardless of whether Navy or Marine Corps regulations are being followed. When combat utilities are worn, Navy officers will abide by Marine Corps uniform regulations, as outlined below.

b. Enlisted

(1) Those Navy enlisted personnel who elect to wear Marine Corps service uniforms are also issued utility uniforms. When worn by these personnel, the utility uniform is considered to be a Marine Corps uniform and will be worn with the same required/optional components and in the same manner as prescribed for Marines, except as otherwise prescribed in this chapter. Marine Corps grooming and physical appearance standards will apply.

(2) Those Navy enlisted personnel who do not elect to wear the Marine Corps service uniform, but are issued the utility uniform at the Marine Corps expense, shall wear the utility uniform in accordance with this manual, with the following exceptions:

(a) Navy appearance standards may apply at the option of the individual.

(b) Either Navy or Marine Corps uniform accessories (e.g., belt buckle, undershirt and outerwear) may be worn at the individual's option, however, those Marine Corps items not issued must be purchased at the individual's expense.

c. General. The following regulations apply to the wear of utility uniforms worn by Navy personnel serving with Marine units:

(1) Name and service tapes will be worn on utility uniforms. Tapes will be worn on the utility coat and trousers as prescribed for Marines in

Chapter 3, except that service tapes will be inscribed with "U.S. NAVY" in upper case letters with a space before "NAVY."

(2) The left breast pocket of the camouflage utility coat will not have iron on decals or embroidery. The left breast pocket of the combat utility coat will have the embroidered Marine Corps emblem. No alterations of the utility uniform worn by Navy personnel is permitted unless otherwise authorized by this manual.

(3) If the wear of a camouflage helmet is required and issued by the Marine Corps, Navy personnel will wear a helmet cover with a Marine Corps emblem decal.

(4) The extended cold weather clothing system (ECWCS) parka is normally issued to Sailors, and when issued as an organizational item, will be worn in accordance with the regulations provided in chapter 7 of this manual. The ECWCS parka may also be purchased by the individual as an optional uniform item and worn with utilities, except when specifically prohibited by the commander for reasons of uniformity. Whenever the organizational or optional ECWCS parka is worn, collar grade insignia will be worn centered on the zipper flap in the space provided.

(5) Female Navy personnel are not authorized to wear earrings or carry handbags with the utility uniform.

3. Insignia. When Navy personnel wear the Marine Corps service uniform or Marine Corps utility uniform, branch of service insignia, insignia of grade and staff corps insignia will be worn according to the following:

a. Caps (service, garrison and utility)

(1) Navy officers and chief petty officers will wear their black miniature cap device on the left side of the garrison cap in the manner prescribed in paragraphs 4004 and 4005 of these regulations. Additionally, Navy officer collar grade insignia will be worn on the right side of the garrison cap. Personnel below the grade of chief petty officer will wear enlisted Marine Corps branch of service insignia on the garrison cap, as prescribed in subparagraph 4001.2. If the service frame cap is worn, the Marine Corps service cap insignia will be worn in the eyelet provided.

(2) The utility cap will not be stenciled or embroidered with the Marine Corps emblem, but the combat utility field hat will have the Marine Corps emblem embroidered on the center panel (as issued/sold through approved sources). Navy officers will wear the appropriate subdued, pin-on cap insignia, while chief petty officers and petty officers will wear the appropriate subdued pin-on insignia of grade at the position on the cap where the Marine Corps emblem is normally stenciled or embroidered (except for the combat utility field hat). Enlisted Sailors, E-1 to E-3, will not wear insignia of grade on utility caps. Cap insignia of grade will not be worn on the field hat.

b. Service Coat

MARINE CORPS UNIFORM REGULATIONS

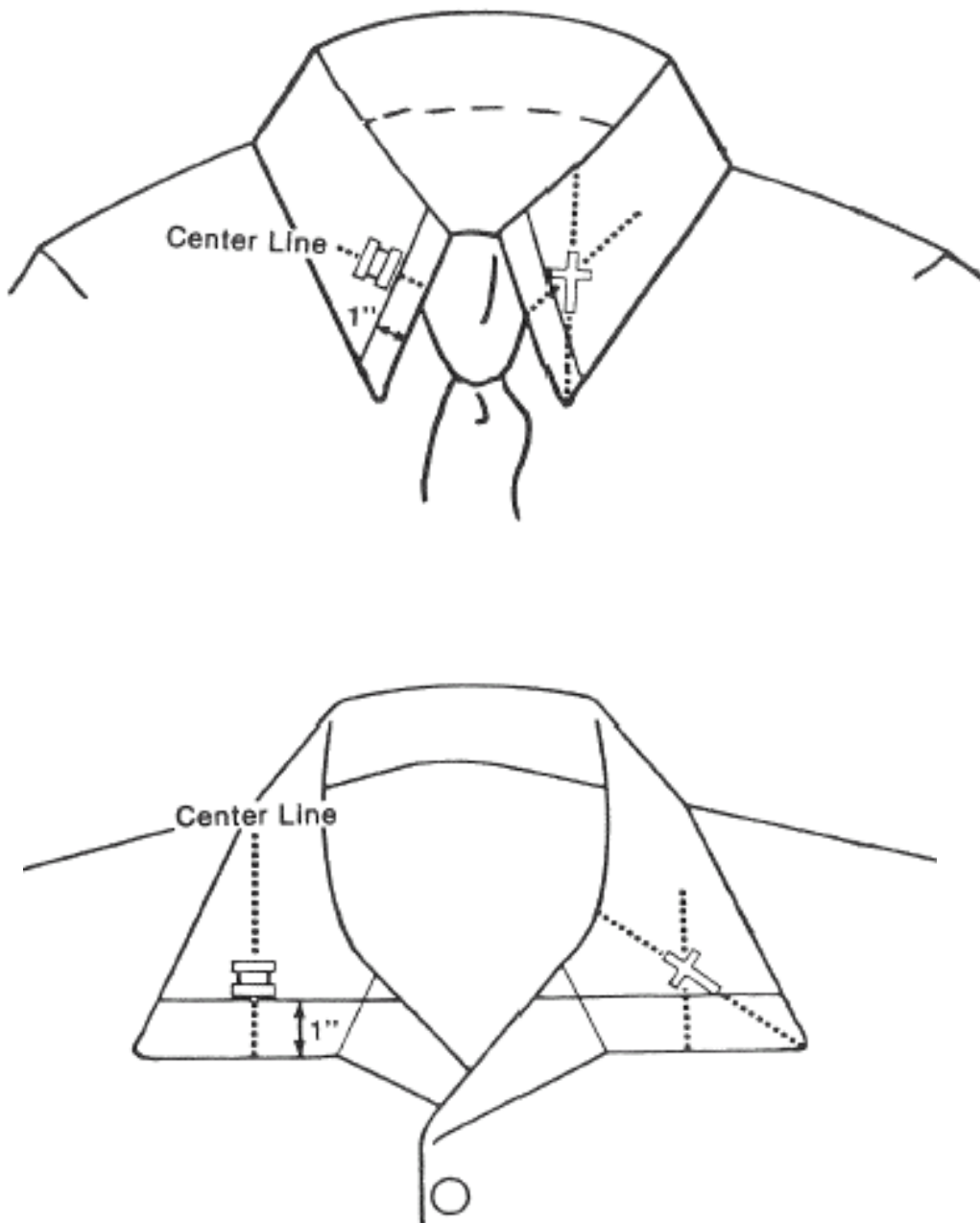

Figure 8-1.--Placement of Officer's Grade Insignia/Staff Corps Device (Collar).

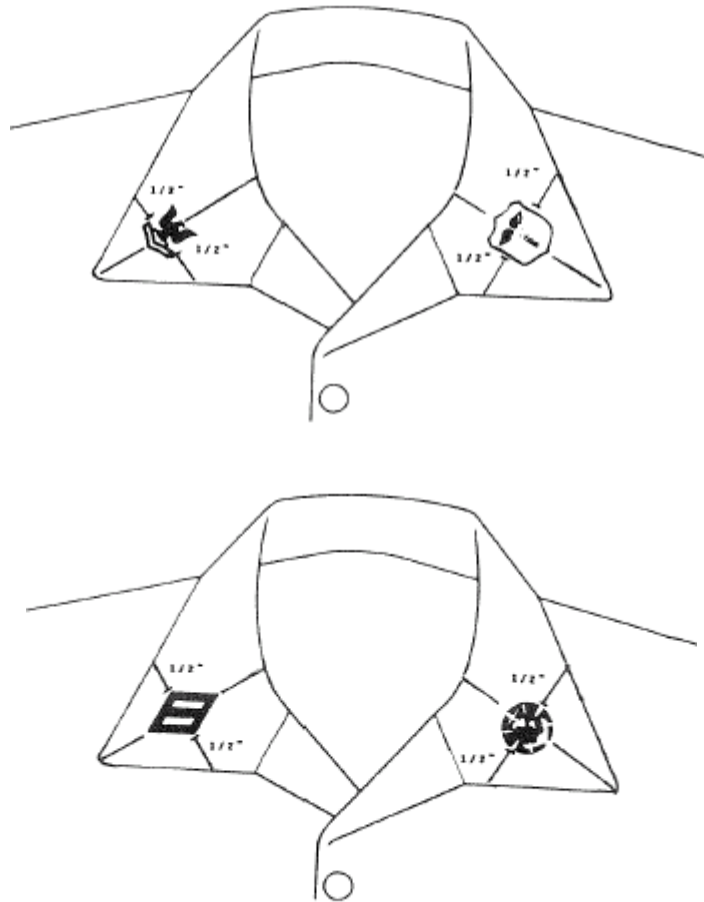

Figure 8-2.--Placement of Enlisted Branch of Service/Grade Insignia (Collar).



Hospital Corpsman

Dental Technician

Religious Program Specialist

Figure 8-3.--Enlisted Corps Devices.

(1) Navy officers and warrant officers will wear appropriate Navy grade insignia on each shoulder strap in the manner prescribed in subparagraph 4005.3. Marine Corps branch of service insignia will be worn in the eyelets provided with the wing tips parallel to the bottom edge of the coat.

(2) Navy grade insignia and service stripes for Marine Corps service uniforms consist of blue markings on a green background. Grade insignia is worn on the left sleeve in the same general manner as on Navy uniforms. Service stripes will be worn centered on the outer half of the left sleeve sloping toward the front at an angle of 45 degrees. The bottom stripe will be about 1/2 inch above the point of the cuff. Marine Corps branch of service insignia will be worn on the service coats as prescribed in paragraph 4001.

c. Khaki Shirts (Long and Short Sleeve) and Utility Coat

(1) Navy Officers. Navy collar grade insignia will be worn on khaki shirts and utility coats as prescribed in paragraph 4005. Staff corps and warrant officers (except for Christian chaplains) will wear their gold staff corps device on the left collar in lieu of the grade insignia, in the same general manner as prescribed in subparagraph 4006.6. Christian chaplains will wear the staff corps device centered vertically on the left collar with the center of the device on a line bisecting the angle of the point of the collar, as illustrated in figure 8-1.

(2) Chief Petty Officers. Chief petty officers will wear Navy 5/8 inch by one inch black metal insignia of grade on each collar point of the khaki long sleeve shirt in the same manner as the officers' insignia show in figure 8-1, and on the khaki short sleeve shirt coat as illustrated in figure 8-2. The black metal 1-1/4 inch device of the size worn with the garrison cap will be worn on each collar point of the utility uniform, in the same manner as worn on the short sleeve khaki shirt.

(3) Personnel Below the Grade of Chief Petty Officer

(a) Khaki Shirts. Navy insignia of grade consists of blue markings on a khaki background and is worn on the left sleeve in the same general manner as on the Navy uniform shirts. When the green service sweater is worn, Navy black metal grade insignia is worn on the right collar and the appropriate branch of service insignia (specialty device) is worn on the left collar of the khaki shirt in the same manner as on the utility coat. Navy enlisted who do not rate a specialty device, as described below, will wear black grade insignia on both collar points.

(b) Utility Coat. For first class petty officers and below, the black insignia of grade is worn on the right collar point in the same general manner as prescribed in figure 8-2. The rating insignia (i.e., HM, DT, RP) will be worn on the left collar point as illustrated in figure 8-2.

d. Field Coat and AWC

(1) Navy Officers and Warrant Officers. Navy insignia of grade is worn in accordance with subparagraph 4005.3.

(2) Chief Petty Officers. Navy black metal grade insignia one inch in width by 1-3/8 inches in length is worn in accordance with subparagraph 4004.3.

(3) Personnel Below the Grade of Chief Petty Officer. Navy black metal grade insignia is worn on the right collar and the appropriate branch of service insignia (specialty device) on the left collar as illustrated in figure 8-2. Navy enlisted who do not rate a specialty device will wear black grade insignia on both collar points.

4. Awards/Breast Insignia

a. Awards. In addition to those awards listed in chapter 5 that Marines may wear, Navy personnel may wear, when so entitled, the FMF Service Ribbon and, on designated awards, the FMF Combat Operation Insignia. Navy marksmanship ribbons may also be worn on Marine Corps service uniforms. Navy personnel who subsequently qualify for Marine Corps marksmanship badges may wear them in lieu of Navy marksmanship ribbons at their option.

b. Breast Insignia

(1) Warfare/Qualification Breast Insignia. All accouterments identified as warfare and other qualification breast insignia in the current edition of the Navy Uniform Regulations or as identified in these regulations may be worn; but the manner of wear will be consistent with paragraph 4002 of these regulations. Shiny metal, vice subdued or embroidered, breast insignia will be worn.

(2) Other Insignia. Naval officers serving in the capacity of command may wear the appropriate command insignia. Incumbent command insignia will be worn over the right breast pocket and post tour insignia will be worn over the left breast pocket in a manner consistent with paragraph 4002 of these Regulations. While serving in the capacity of command master chief, senior chief, or chief, designated personnel will wear the appropriate identification badge centered on the right breast pocket per paragraph 4007 of these Regulations.

(3) No other Navy identification or command insignia (other than those identified in chapters 4 and 8 of these Regulations) is authorized for wear on this uniform.

5. Requirements. A Marine Corps bulletin in the 10120 series is published annually which lists the uniform articles prescribed for Navy personnel assigned to Marine Corps units. Guidance on the issue and entitlement to these allowances is contained in the current edition of MCO P10120.28.

8002. RESERVE PERSONNEL

1. Members of the Marine Corps Reserve not on active duty will wear the uniform of their grade when attending drills, and when performing authorized active or training duty, with or without pay, except when civilian clothing is authorized.

2. Reservists not on active duty may wear the uniform of their grade when engaged in military instruction or in attendance as a student under official orders at any school or course of instruction under the auspices of the Armed Forces or Reserve components.
3. Reservists not on active duty may wear the uniform at social or informal gatherings of a military character.
4. Reservists not on active duty, residing or visiting in a foreign country, will not wear the uniform except when attending, by formal invitation, ceremonies or social functions at which wear of the uniform is required by the invitation or by the country's regulations or customs.
5. Marine Corps Reservists employed in any capacity by a military school will not wear the uniform unless specifically authorized by the CMC. Requests for such authority should be addressed to the CMC (MCUB) and will contain a written statement from school officials indicating that the individual is or will be employed there, to include job title. When such authority is granted, personnel will wear the insignia of their grade in the Marine Corps Reserve. No school or other unauthorized insignia will be worn on the Marine Corps uniform.

8003. RETIRED PERSONNEL (INCLUDING FLEET MARINE CORPS RESERVE)

1. Retired officers and enlisted personnel not on active duty are entitled to wear the prescribed uniform of the grade held on the retired list when wear of the uniform is appropriate, and not specifically prohibited under the provisions of subparagraph 11002.1.
2. Retirees not on active duty, residing or visiting in a foreign country, will not wear the uniform except when attending, by formal invitation, ceremonies or social functions at which wear of the uniform is required by the invitation or by the country's regulations or customs.
3. Retirees not on active duty may wear appropriate uniform or civilian clothing when traveling as passengers aboard MSC ships and AMC aircraft.
4. Retirees employed in any capacity by a military school, except the MCJROTC program, will not wear the uniform unless specifically authorized by the CMC. Requests for such authority should be addressed to the CMC (MCUB) and will contain a written statement from school officials indicating that the individual is or will be employed there, to include job title. When such authority is granted, personnel will wear uniforms prescribed for persons of corresponding grade on the active list. No school or other unauthorized insignia will be worn on the Marine Corps uniform.
5. Retirees employed as instructors under the MCJROTC program will wear the Marine Corps uniform during school hours and at other appropriate times according to these regulations.
6. Retirees not on active duty who wear the uniform other than under the conditions outlined in subparagraphs 8003.4 and 5, above, will wear the uniform as prescribed for persons of their corresponding grade on the active list.

8004. MARINE CORPS JUNIOR RESERVE OFFICERS TRAINING CORPS MEMBERS

1. Members of the MCJROTC will wear the uniform and insignia according to these regulations, and as amplified by MCO P1533.6.
2. All cadets, regardless of rank, will wear the 9/16-inch wide scarlet stripe on the blue trousers/slacks.
3. A distinctive MCJROTC round patch will be worn on the left sleeve of all outer clothing except the service sweater and AWC. It will be centered on the outer half of the sleeve, 1/2 inch below the shoulder seam. The patch will be 3 inches in diameter and contain a gold Marine Corps emblem centered on a scarlet field, which is surrounded with a blue border containing the words "US Marine Corps Junior ROTC" in white lettering. A gold border surrounds the blue field.
4. In addition to the required distinctive patch, one school patch may be worn on the right sleeve of all outer clothing, except the service sweater and AWC, centered on the outer half of the sleeve, 1/2 inch below the shoulder seam. Sample patches will be submitted to the Commanding General, Training and Education Command (46JR), Quantico, VA for approval, and if approved, will be procured at other than Marine Corps expense. Patches will be from two inches to 2-1/2 inches in length or diameter. Normally only Marine Corps or school colors will be approved for use in school patches.

8005. CIVILIANS SERVING WITH MARINE CORPS UNITS

1. When authorized by CMC, U.S. civilian technicians serving with the Marine Corps may wear the Marine Corps service and utility uniforms except that no distinctive grade, corps device, or other Navy or Marine Corps insignia will be worn. Plain buttons of the approximate size and color of the buttons prescribed for the Marine Corps uniforms will be worn on all coats.
2. The insignia as described below will be worn on these uniforms by civilian technicians:
 - a. Breast insignia will be worn on the left-breast pocket of all coats and khaki shirts. The breast insignia will consist of an embroidered spread eagle facing dexter with a group of tools clutched in the left claw and an olive branch in the right claw. The lettering "U.S. TECHNICIAN" will be centered immediately below the eagle. The insignia will be placed on a 3-1/4-inch square background material of the same color as the coat or shirt.
 - b. Cap insignia will be worn on the garrison cap. The insignia shall be worn on the left side 2 inches from the front edge and 1-1/2 inches from the bottom edge. The garrison cap insignia shall consist of a 5/8-inch by 3/4-inch gilt pin with the inscription "U.S. TECHNICIAN."
 - c. Collar insignia will be worn on both sides of the collar of the khaki shirt and the utility coat, with the center of the insignia 1 inch from the front edge, and 1 inch from the upper edge of the collar. The collar insignia is identical to the garrison cap insignia described above.

MARINE CORPS UNIFORM REGULATIONS

CHAPTER 9

UNIFORM REQUIREMENTS

SECTION 1: OFFICERS

	<u>PARAGRAPH</u>	<u>PAGE</u>
GENERAL	9100	9-3
CATEGORIES	9101	9-3
MINIMUM REQUIREMENTS FOR MALE OFFICERS	9102	9-3
MINIMUM REQUIREMENTS FOR FEMALE OFFICERS	9103	9-3
ENLISTED UNIFORMS AND ACCESSORIES AUTHORIZED FOR OFFICERS	9104	9-3
OPTIONAL UNIFORM ARTICLES	9105	9-4
EFFECT OF UNIFORM CHANGES ON LIST OF REQUIRED ITEMS	9106	9-5
EVENINGS DRESS UNIFORMS	9107	9-5

SECTION 2: ENLISTED MARINES

GENERAL	9200	9-13
EXCEPTIONS TO MINIMUM REQUIREMENTS	9201	9-13
SOURCES OTHER THAN MARINE CORPS SUPPLY SYSTEM	9202	9-13
OPTIONAL UNIFORM ARTICLES	9203	9-14
EFFECT OF UNIFORM CHANGES ON LIST OF REQUIRED ITEMS	9204	9-15

TABLE

9-1	MINIMUM REQUIREMENTS FOR MALE OFFICERS	9-6
9-2	MINIMUM REQUIREMENTS FOR FEMALE OFFICERS	9-9

MARINE CORPS UNIFORM REGULATIONS

CHAPTER 9

UNIFORM REQUIREMENTS

SECTION 1: OFFICERS

9100. GENERAL

1. Officers will procure and maintain, in good and wearable condition at all times, the uniform items prescribed in paragraph 9102. This list represents an absolute minimum; specific assignments may require additional uniforms.
2. Unless otherwise prescribed for a particular duty assignment, officers will have their full requirement with them at all times.
3. Items listed as required for category 1 officers only may be worn as optional uniform items by category 2 officers.

9101. CATEGORIES. For the purpose of prescribing minimum requirements, the following officer categories are established:

1. Category 1. Officers of the Regular Marine Corps; officers of the Marine Corps Reserve who are retained on, or ordered to, active duty for periods in excess of two years, and temporary limited duty officers.
2. Category 2. Reserve officers in the Selected Marine Corps Reserve; Reserve officers ordered to active duty for periods of two years or less; and temporary officers having permanent enlisted status (except temporary limited duty officers). Unless otherwise indicated, the mandatory quantity for Category 2 officers is the same as for Category 1 officers.

9102. MINIMUM REQUIREMENTS FOR MALE OFFICERS. Male officers, based on the categories above, will possess all items as described in table 9-1.

9103. MINIMUM REQUIREMENTS FOR FEMALE OFFICERS. Female officers, based on the categories above, will possess all items as described in table 9-2.

9104. ENLISTED UNIFORMS AND ACCESSORIES AUTHORIZED FOR OFFICERS

1. To satisfy minimum requirements, officers may purchase and wear enlisted uniform items as sold through the Marine Corps Supply System that are similar to like items listed in paragraphs 9102 and 9103. The following men's items are not authorized unless modified as indicated:
 - a. Coat, blue, dress
 - b. Crowns, cap, service, and dress
 - c. Insignia, branch of service

d. Uniforms, service (authorized if sword slit added and lower pockets replaced with bellows pockets).

2. The enlisted women's blue dress uniform and branch of service insignia are not authorized for female officers.

9105. OPTIONAL OFFICER UNIFORM ARTICLES

1. The following uniform items are optional for both male and female officers, except as indicated below:

- (a) Belt, trouser, web, nylon, white (men only)
- (b) Boatcloak/Cape
- (c) Boots, combat, non-system (until 1 April 2004)
- (d) Cap, watch, wool
- (e) *Cover, cap, rain (men only)
- (f) Crown, cap, vinyl, white (men only)
- (g) Cuff link set and necktie clasp set (men only)
- (h) Frog, sword, service
- (i) *Hamilton Wash (gold plated) brass items
- (j) *Handbag, black, (women only)
- (k) *Havelock (women only)
- (l) Necktie, hook-on (pre-tied), khaki (men only)
- (m) Overshoes, boots, and rubbers
- (n) Parka, ECWCS
- (o) Purse, clutch, white (women only)
- (p) *Scarf, wool, green
- (q) *Suspenders (men only)
- (r) Sweater, blue dress, w/slip-on insignia, crew-neck
- (s) *Sweat suit, green w/black emblem and "USMC" (cold weather P.T. uniform)
- (t) Tanker jacket
- (u) *Undershirt, v-neck, white

2. The above items, unless otherwise noted with an asterisk (*), must bear the USMC approval identification. Items purchased outside the Marine Corps Supply System that do not bear the USMC approved identification are prohibited, unless otherwise specified herein.

9106. EFFECT OF UNIFORM CHANGES ON LIST OF REQUIRED ITEMS

1. Unless otherwise specified, changes made in officers' uniforms/ accessories will not become effective until it is necessary to replace that particular uniform item.

2. Limited standard uniform items procured from the Marine Corps Supply System will satisfy the requirement for any standard item until replacement is required or until the item is officially declared obsolete and no longer authorized.

9107. EVENING DRESS UNIFORMS

1. Evening dress uniforms are required for the following officers:

a. All officers assigned duty as naval attaches or assistant naval attaches.

b. All category 1 officers in the grade of major or above.

2. The following officers are not required to possess evening dress uniforms:

a. All company grade officers except those assigned duties outlined above. Captains who are selected for major will be granted a 120-day grace period after the effective date of their promotion in which to purchase the required uniforms.

b. Officers stationed outside the continental United States, except when assigned duties outlined in subparagraph 9106.1a, above (upon transfer to a duty station within the continental United States, majors will be granted a 120-day grace period in which to procure the uniforms).

3. All Regular and Reserve officers are authorized and encouraged to possess the evening dress uniform.

MARINE CORPS UNIFORM REGULATIONS

Table 9-1.--Minimum Requirements for Male Officers.

ITEM	QUANTITY	COMMENT
Bag, duffel (Seabag)	1 (a)	
Belts:		
Coat, dress, blue	1	
Coat, service	1(b)	
Service, leather, black	1(a)	Not req cat 2
Trouser, web or martial arts utility belt	2(c)	
Buckle:		
Belt, coat	1	
Belt, trouser	2 (c)	
Cap:		
Garrison	1(b)	
Utility	2(d)	
Clasp, necktie, gold	2	
Coat:		
All-weather, dress, gray	1	
Dress, blue	1	
Service	1(b)	
Utility	2(d)	
Collar, strip, white, standing	1	
Crown, cap:		
Service	1(b)	
Dress, white	1	
Cuff Links, dress, pr	1	
Cummerbund, scarlet	1(g)	
Footwear:		
Boots, combat, infantry, pr or boots, Marine Corps combat (temperate weather) .	1(d)(e)	
Boots, combat, tropical, pr or boots, Marine Corps combat (hot weather)	1(d)(e)	
Shoes, dress, black, pr	2	Cat 2 qty 1
Frame, cap	1	
Gloves:		
Service, black, pr	1	
Dress, white, pr	1	
Insignia:		
Grade, large, pr	2	
Grade, small, pr	2	
Distinguishing Marine Gunner	as required	

MARINE CORPS UNIFORM REGULATIONS

Table 9-1.--Minimum Requirements for Male Officers (Continued).

ITEM	QUANTITY	COMMENT
Branch of Service, cap, dress	1	
Branch of Service, cap, service	1	
Branch of Service, collar, dress, pr	1	
Branch of Service, collar, service, pr ..	1	
Branch of Service, collar, left, ea	1	
Jacket, dress, evening	1(f)	Not req cat 2
Knot, sword:		
Service	1	Not req cat 2
Necktie, service	2	
Shirt:		
Khaki, long sleeve	2	
Khaki, short sleeve	2	
White, blue dress	1	
White, evening dress	1(f)	Not req cat 2
Sling:		
Leather or synthetic leather,	1	Not req cat 2
Socks:		
Black, pr	4	
Cushion sole, pr	4	
Studs, dress set	1(f)	Not req cat 2
Sword with Scabbard	1	Not req cat 2
Trousers:		
Dress, blue, pr	1(h)	
Dress, evening, pr	1(f)	Not req cat 2
Dress, white, pr	1(g)	
Service	2(b)	
Utility, camouflage, pr	4(d)	
Trunks, general purpose, pr	1	
Undershirt, cotton, olive green	6	
Waistcoat:		
Scarlet	1(i)	Not req cat 2
White	1(i)	Not req cat 2

Explanatory Notes:

- (a) Mandatory possession date is 1 October 2004.
- (b) Service uniform items may be of either summer weight polyester/wool or all-season fabric; however, the coat and at least one pair of trousers must be of the same fabric. All-season uniform items will be required when the summer weight polyester/wool items become unserviceable.
- (c) Will maintain one khaki web belt (with buckle) for wear with the service uniform trousers and either one khaki web belt (with buckle) or 1 martial arts utility belt for wear with the utility uniform.
- (d) The minimum requirement of utility uniforms is 4 sets of either camouflage utility or combat utility uniforms, per the deadlines established in ALMAR 28/02. The minimum requirement for camouflage utility uniforms will decrease annually by one set beginning 1 October 2003, while the minimum requirement for combat utilities will increase by one set beginning 1 October 2003. As of 1 October 2006, the camouflage utility uniform will be obsolete

MARINE CORPS UNIFORM REGULATIONS

Table 9-1.--Minimum Requirements for Male Officers (Continued).

and the mandatory requirement will be 4 sets (2 desert, 2 woodland sets) of combat utility uniforms.

- 1 One set of camouflage utility uniforms is comprised of:
 - cap, woodland camouflage pattern (total cap requirement is 2). The Basic School students must maintain one additional cap.
 - coat, woodland camouflage pattern
 - trousers, woodland camouflage pattern
 - tape, service, woodland camouflage pattern (qty 1 per set)
 - tape, name, woodland camouflage pattern (qty 2 per set)
 - boots, black ICB (total requirement is 1 pair) and boots, hot weather, green or black (total requirement is 1 pair)
- 2 One set of combat utility uniforms, is comprised of:
 - cap, combat utility, field, woodland or desert MARPAT (total requirement is 2 caps, one of each MARPAT).
 - cap, combat utility, garrison, woodland or desert MARPAT (total requirement is 2 caps, one of each MARPAT). The Basic School students must maintain an two additional combat utility garrison caps (one woodland and one desert MARPAT).
 - coat, combat utility, woodland or desert MARPAT
 - trousers, combat utility, woodland or desert MARPAT
 - tape, service, combat utility, woodland or desert MARPAT (qty 1 per set)
 - tape, name, combat utility, woodland or desert MARPAT (qty 2 per set)
 - boot, Marine Corps Combat (hot weather) (total requirement is 1 pair)
 - boot, Marine Corps Combat (temperate weather) (total requirement is 1 pair)

(e) Black leather combat boots (to include hot weather black or green leather boots and optional boots) are authorized for wear with all utility uniforms until such time as they become unserviceable or until 1 April 2004). From 1 April 2004 to 1 October 2004 black leather boots may only be worn with the camouflage utility uniform. As of 1 October 2004 black boots (except safety boots) are deemed obsolete and are no longer authorized for wear and the optional boot policy is rescinded.

(f) Evening dress required per paragraph 9107.

(g) May be required by commanders for category 2 officers, except temporary officers with permanent enlisted status, assigned to the following duties:

- 1 Marine Security Force Battalion Commands
- 2 Marine Barracks
- 3 Recruiting Service
- 4 Military Entrance Processing Stations
- 5 Billets supporting the Reserve Establishment
- 6 Marine Detachment/Marine Aviation Detachments/Marine Detachments Afloat
- 7 State Department/MAAG/Embassy
- 8 USNA/NROTC Staffs
- 9 Officers within the European Area
- 10 Band Officer
- 11 Information Service Officer
- 12 As designated by the Commandant for special assignments

(h) May be of either officer's all-wool or all-season fabric or may be the standard enlisted blue dress trousers (not applicable to general officers).

(i) Scarlet waistcoat required for general officers only. White waistcoat may be required for those officers required to wear evening dress "A."

MARINE CORPS UNIFORM REGULATIONS

Table 9-2.--Minimum Requirements for Female Officers.

ITEM	QUANTITY	COMMENT
Bag, duffel (Seabag)	1 (a)	
Belts:		
Service, leather, black	1 (a)	Not req cat 2
Trouser, web or martial arts utility belt	1 (b)	
Buckle, belt, trouser (for khaki belt)	1 (b)	
Cap:		
Dress, white	1	
Garrison	1 (c)	
Service	1 (c)	
Utility	2 (d)	
Coat:		
All-weather, dress, gray	1	
Dress, blue	1	
Service	1 (c)	
Utility, camouflage	4 (d)	
Cummerbund, scarlet	1 (e)	Not req cat 2
Footwear:		
Boots, combat, infantry, pr or boots, Marine Corps combat (temperate weather) ..	1 (f)	
Boots, combat, tropical, pr or boots, Marine Corps combat (hot weather)	1 (f)	
Oxford, black, pr	2	
Pumps, black, pr	1	
Pumps, black, suede, fabric.....	1 (e)	Not req cat 2
Gloves:		
Service, black, pr	1	
Dress, white, pr	1	
Insignia:		
Grade, large, pr	2	
Grade, small, pr	2	
Distinguishing Marine Gunner	as required	
Branch of Service, cap, dress	1	
Branch of Service, cap, service	1	
Branch of Service, collar, dress, pr	1	
Branch of Service, collar, service, pr ...	1	
Branch of Service, collar, left, ea	1	

MARINE CORPS UNIFORM REGULATIONS

Table 9-1.--Minimum Requirements for Female Officers (Continued).

ITEM	Quantity	COMMENT
Jacket, dress, evening	1 (e)	Not req cat 2
Knot, sword:		
Service	1 (a)	Not req cat 2
Necktab:		
Dress, black	1	
Dress, scarlet	1	
Service, green	1	
Shirt:		
Khaki, long sleeve	2	
Khaki, short sleeve	2	
White, blue dress	1	
White, evening dress	1 (e)	Not req cat 2
Skirt:		
Dress, blue	1	
Dress, evening, black, long	1 (e)	Not req cat 2
Dress, evening, black, short	1 (e)	Not req cat 2
Service	1 (c)	
White	1	
Slacks:		
Dress, blue	1	Cat 2 see note (g)
Service	1 (c)	
Sling, leather or synthetic leather, black	1	Not req cat 2
Socks, cushion sole, pr	4	
Sword with scabbard	1	Not req cat 2
Trousers, utility, camouflage, pr	4 (d)	
Trunks, general purpose, pr	1	
Undershirt, cotton, olive green	6	

Explanatory Notes:

- (a) Mandatory possession date is 1 October 2004.
- (b) Marine will maintain either the khaki web belt and buckle or the martial arts utility belt with buckle (whichever belt the Marine is entitled to wear per paragraph 3002) with the utility uniforms.
- (c) Service uniform items may be of either summer weight polyester/wool or all-season fabric; however, the coat and at least one pair of trousers must be of the same fabric. All-season uniform items will be required when the summer weight polyester/wool items become unserviceable.
- (d) See note "(d)" in table 9-1.
- (e) Evening dress required per paragraph 9107. General officers will maintain a scarlet vest (waistcoat) in lieu of cummerbund.

MARINE CORPS UNIFORM REGULATIONS

Table 9-1.--Minimum Requirements for Female Officers (Continued).

(f) See note "(e)" in table 9-1.

(g) Required for officers assigned to duties listed in explanatory note of paragraph 9102, only.

MARINE CORPS UNIFORM REGULATIONS

CHAPTER 9

UNIFORM REQUIREMENTS

SECTION 1: ENLISTED MARINES

9200. GENERAL

1. Enlisted Marines will maintain the articles of uniform prescribed in the current MCBul 10120, Individual Clothing Allowances for Enlisted Personnel, in good and serviceable condition at all times. This list is the absolute minimum; specific assignments may require additional uniforms.
2. All enlisted Marines receive a Clothing Replacement Allowance (CRA) annually on their enlistment anniversary. This allowance is intended to provide sufficient compensation to replace minimum issue clothing required per the applicable MCBul 10120 at a reasonable rate due to normal wear. The CRA is a replacement allowance to buy new clothing and not a maintenance allowance to alter or clean previously purchased clothing or to buy new grade insignia.
3. Enlisted Marines will have all required uniforms with them at all times, unless otherwise prescribed for a particular duty assignment.

9201. EXCEPTIONS TO MINIMUM REQUIREMENTS

1. The current edition of MCO P10120.28, Individual Clothing Regulations, prescribes exceptions to the minimum requirements for personnel who are returned from combat duty.
2. When Marines are assigned temporary duty at locations other than those of their parent unit and their return is contemplated upon completion of the temporary duty period, the minimum uniform requirements may be waived. Marines need to take with them only those quantities and types of clothing that will be required for the season and the type of duty assigned.

9202. SOURCES OTHER THAN MARINE CORPS SUPPLY SYSTEM

1. Only the following uniform items may be purchased by Marines from sources other than the Marine Corps Supply System:
 - a. Buttons, black or gold
 - b. Clasp, necktie, gold (men only)
 - c. Coat, all-weather, pewter gray
 - d. Gloves

- e. Insignia, grade, enlisted
- f. Marksmanship badges
- g. Neckties/necktabs
- h. Service ribbons, ribbon bars, and attachments
- i. Service stripes
- j. Shirts, khaki
- k. Shoes, dress, black (includes oxfords/pumps*)
- l. Socks, black, stretch-type
- m. Sweater, green service
- n. *Trunks, general purpose
- o. *Underclothing

2. The above items, unless otherwise noted with an asterisk (*), must bear the USMC approval identification. Items purchased outside the Marine Corps Supply System that do not bear the USMC approved identification are prohibited, unless otherwise specified herein.

9203. OPTIONAL UNIFORM ARTICLES. The following uniform items are optional for enlisted Marines as indicated, and may be purchased from sources other than the Marine Corps Supply System, provided these items bear the USMC approval identification, unless noted otherwise with an asterisk (*):

- 1. Belt, service, synthetic leather
- 2. Boots, combat, non-system (see paragraph 3010.2)
- 3. Cap, watch, wool
- 4. Cape, dress (SSgt and above, women only)
- 5. *Cover, cap, rain (men only)
- 6. Crown, cap, vinyl, white, dress (men only)
- 7. Cuff link and necktie clasp set, service (SSgt and above, men only)
- 8. *Hamilton Wash (gold plated) brass items
- 9. *Handbag, black, leather
- 10. *Havelock (women only)
- 11. Necktie, hook-on (pre-tied), khaki (men only)

- 12.*Overshoes, boots, and rubbers
13. Parka, ECWCS
- 14.*Scarf, wool, green
15. Shirt, khaki, w/French cuffs (SSgt and above, men only)
16. Shoes, chukka boot (SSgt and above, men only)
17. Suspenders, plain, without ornamentation (men only when wearing the blue coat)
18. Sweater, blue dress
- 19.*Sweat suit, olive green, w/emblem and "USMC" (cold weather PT uniform)
20. Sword and accessories, NCO
21. Tanker jacket
22. Undershirt, v-neck, white
23. Uniforms, evening dress (SNCOs)
24. Uniforms, service, officers' (SNCOs)

9204. EFFECT OF UNIFORM CHANGES ON LIST OF REQUIRED ITEMS

1. Unless otherwise specified, changes made in enlisted uniforms/ accessories will not become effective until it is necessary to replace that particular item of uniform.
2. Limited standard uniform items procured from the Marine Corps Supply System will satisfy the requirement for any standard item until replacement is required, or until the item is officially declared obsolete and no longer authorized.

MARINE CORPS UNIFORM REGULATIONS

CHAPTER 10

CARE AND MARKING OF UNIFORMS

SECTION 1: CARE OF THE UNIFORM

	<u>PARAGRAPH</u>	<u>PAGE</u>
GENERAL	10100	10-3
DRESS UNIFORMS	10101	10-3
SERVICE UNIFORMS	10102	10-4
CAMOUFLAGE UTILITY UNIFORMS	10103	10-4
COMBAT UTILITY UNIFORMS	10104	10-4
ALL-WEATHER COAT/TANKER JACKET	10105	10-5
BUTTONS AND INSIGNIA	10106	10-5
FOOTWEAR	10107	10-5
GREEN UNDERSHIRTS	10108	10-6
KHAKI WEB BELTS	10109	10-6
STORING WOMEN'S SERVICE AND DRESS CAPS	10110	10-6
SERVICE/DRESS SWEATERS	10111	10-7
SWORD AND SCABBARD	10112	10-7
WHITE VINYL COVERS/CAPS	10113	10-7
MARTIAL ARTS UTILITY BELT	10114	10-7
MATERNITY UNIFORMS	10115	10-7
CUTS IN CLOTH	10116	10-7
PREVENTING MOTH DAMAGE	10117	10-8

SECTION 2: MARKING OF CLOTHING

GENERAL	10200	10-9
LOCATION OF NAME ON ARTICLES	10201	10-9

MARINE CORPS UNIFORM REGULATIONS

CHAPTER 10

CARE AND MARKING OF UNIFORMS

SECTION 1: CARE OF THE UNIFORM

10100. GENERAL

1. The following information is presented to help prolong the useful life of uniforms and accessories so that they may be worn with the justifiable pride, which distinguishes Marines in uniform.

2. No matter how well-fitting a uniform is when new, it will not continue to look its best unless well cared for both during wear and when not in use. A uniform should be put on carefully and kept buttoned. Large or heavy objects carried in the pockets will soon destroy the shape of the uniform. When not in use, carefully place uniforms on hangers and keep in a well-ventilated storage space. Well-constructed wooden or plastic hangers shaped to fit the shoulder contour, with locking trouser bar or clips, are recommended. When uniforms are folded in duffel bags or other containers for storage or shipment, fold them carefully to preserve their original shape.

10101. DRESS UNIFORMS

1. Because of less frequent wear, use particular care when storing dress uniforms. Gold braid on evening dress uniforms may deteriorate if in close proximity to any substance containing sulphur, such as rubber and manila or craft paper. High humidity or sharp temperature changes will also cause tarnishing if the uniform is not adequately protected. An airtight plastic clothing bag with a packet of desiccant (drying agent) enclosed will give greatest protection. Place the uniform carefully on a substantial hanger and store in a dry, cool, well-ventilated closet. An experienced tailor should normally clean gold braid, although liquid nontoxic preparations available may be used if applied according to manufacturer's instructions. Embroidered insignia may be kept bright by occasional scrubbing with a nail brush and a solution of ammonia and water. Do this periodically, or as soon as any signs of tarnish or corrosion appears. In case of severe corrosion, the insignia cannot be restored to its original condition and must be replaced. The synthetic tarnish-resistant gold braided accessory items do not require heavy cleaning. A soft cloth may be carefully used to remove dust. Since temperature changes do not affect these items, store as required to protect the uniform fabric itself.

2. According to manufacturer's label instructions, blue-white dress uniforms white items of polyester or polyester/ rayon gabardine may be either professionally dry cleaned, or laundered and pressed. As dry cleaning has frequently caused the polyester/ rayon uniforms to become yellow or gray, hand or machine laundering of these uniforms is preferable. Hand launder in warm water using mild detergent; scrub soiled areas; rinse thoroughly in clear warm water; dry without wringing. Machine launder using a mild detergent; complete washing cycle for 30 minutes in 90-degree to 120-degree water; rinse thoroughly in clear warm water; set automatic dryer for regular fabrics and

dry for 15 minutes. If pressing is required, use a cool iron. Do not use iron above rayon setting. Do not use hot iron.

3. Other dress uniforms should receive maximum care according to general instructions above and those for the particular type of uniform material. Wool and polyester/wool uniforms are best maintained by dry cleaning by experienced dry cleaning establishments.

4. Medals, insignia and other accessories should be cleaned and removed from the uniforms when not in use to reduce unnecessary strain on the material.

10102. SERVICE UNIFORMS

1. The same care required for a dress uniform is applicable to service uniforms; however, due to more constant use some additional measures may prove beneficial. As heat, friction, and pressure have a deteriorating effect on materials, service uniforms generally show more wear at creased areas. This may be partially offset by periodically pressing out old creases and reforming them slightly to either side of the previous crease. Sleeve cuffs and trousers/slacks/skirt hems should be periodically examined and turned if material permits. Dry cleaning preserves the original appearance and finish of wool and polyester/wool garments and is recommended over hand laundering. However, when dry cleaning facilities are not available, and only as a last resort, wool and polyester/wool uniforms may be hand laundered. Hand launder with a neutral soap and fresh lukewarm water 70 to 80 degrees. If hard water is used, add small amount of water softener to the water. Do not use chlorine bleach. In laundering, thick suds are necessary for best results. The soap should be thoroughly dissolved in hot water and added to the cool water to reach a temperature of approximately 70 to 80 degrees. In order to preserve the finish, rubbing should be minimized. Rinse thoroughly to remove all traces of the soap. Avoid high temperature, friction, and pressure as much as possible. Never run through a wringer or never twist to remove the excess water before drying. After washing the garments, squeeze gently to remove surplus water, shape garment by hand, and dry in open air. Colored garments should not be hung in the sun to dry. If this is unavoidable, garments should be turned inside out to dry.

2. Uniform items manufactured of polyester/cotton should not be bleached or starched.

10103. CAMOUFLAGE UTILITY UNIFORMS. Washing instructions, to preclude shrinking of the camouflage utility uniform, are as follows: during the washing, drying, and finishing cycles, use the lowest possible temperature setting so that at no time will the garment be exposed to temperatures greater than 130 degrees. Some laundry facilities may not press utilities due to potential damage from automated presses. Thus, any pressing required will be the individual Marine's responsibility. Although the use of starch or sizing is authorized as an individual option, it may adversely affect the comfort and durability of the uniform.

10104. COMBAT UTILITY UNIFORM. In order to maximize service life and maintain optimum performance, the following instructions should be followed when caring for the uniform:

1. Wash in warm water and mild detergent containing no optical brighteners or bleach. Tumble dry at low heat (not to exceed 130° F). Remove immediately from the dryer and fold flat or place on a rustproof hanger to ensure heat from the dryer does not set wrinkles. To drip dry, remove from the washer/water and place on a rustproof hanger. Do not wring or twist.
2. A hand iron set on low heat may be used to individually press areas such as collar points or pocket flaps to help maintain a neat appearance. Care should be taken when pressing creases, as the uniform is manufactured with permanent creases. Improper pressing may result in multiple permanent creases. No new creases may be created.
3. The use of starch, sizing and any process that involves dry-cleaning or a steam press will adversely affect the treatments and durability of the uniform and is not authorized.

10105. ALL-WEATHER COAT/TANKER JACKET. The AWC and tanker jacket should be dry-cleaned only. A water repellency treatment should be applied after four- or five-dry cleanings.

10106. BUTTONS AND INSIGNIA

1. Gold buttons are plated to prevent tarnishing and should not be polished with abrasives or polishing cloths containing chemicals. Clean gold buttons with a weak solution of household ammonia and water.
2. Gold-plated buttons that have had the plating removed are likely to turn green due to exposure to moist air. This can be removed by rubbing gently with acetic acid or any substance containing this acid, such as vinegar, followed by a thorough washing in fresh water and drying.
3. The gold-filled parts and the sterling silver rhodium-finished parts of metal insignia are cleaned by washing with soap and water. Avoid using silver polish or abrasive.
4. Service insignia will not be polished. If the black finish wears off, replace the insignia or refinish with USMC approved liquid, black protective coating as sold through the Marine Corps Exchange. Use of paints or other unapproved coloring agents is prohibited.

10107. FOOTWEAR

1. Maintenance of leather footwear is necessary to ensure maximum wear and to protect the healthy, sanitary condition of the feet. When not in use, the shape of the shoes should be maintained using shoe trees. Foot powder should be liberally sprinkled inside the shoe to absorb moisture. Constant inspection is necessary to ensure prompt repair to avoid breakdown of the upper leather.
2. Shoes should be kept clean as sand, dirt, grit, etc., have a deterioration action on shoe threads and shoe leather. Clean leather uppers periodically with saddle soap, which is a leather preservative. Dubbing should never be used on footwear as such compounds seal the pores of the leather and cause excessive perspiration.

3. Synthetic Leather Shoes. For normal care, these shoes may be cleaned by wiping with a damp cloth or sponge. Occasional polishing with paste wax or cream polishes may be required; however, excess dust and dirt should be removed before polishing. Use liquid polish with care to avoid streaking. For white synthetic shoes use a good polish in moderate amounts. To cover abrasion or scuff marks, apply a paste wax shoe polish, and then paste wax. Stains should be wiped off as quickly as possible, and then cleaned. For stubborn stains, try lighter fluid. On white synthetic shoes, a mild abrasive cleaner may be used if rubbed gently. Do not use chlorinated cleaners, bleaches, or harsh abrasives. For cleaning, never use acetone, nail polish remover, chlorinated dry cleaning solvents, or alcohol. When in doubt about a cleaner or polish, try a little on the instep, close to the sole.

4. Marine Corps Combat Boots (MCCBs). The brown MCCB (TW) and MCCB (HW) should be kept clean by using a stiff bristle brush to remove mud and dirt and then rinsing with plain water. Allow the boots to naturally dry by placing them in cool, dry area with good air circulation. Use of forced hot air to dry boots will stiffen the leather and cause cracks. Application of special treatments, such as waterproofing sealants and wax polish will seal pores and restrict breathing of the leather and is not authorized. Other treatments such as leather conditioning and saddle soap will cause excessive and permanent fading or darkening of the brown leather tanning and is not authorized. The use of edge dressing is prohibited. Spots worn smooth by excessive wear may be gently abraded with either a wire-bristle brush or rough-grain sandpaper until they have a surface area consistent with the other areas of the leather upper.

10108. GREEN UNDERSHIRTS

1. Although the dyed cotton material used in green undershirt has a strong tendency to fade, proper laundering and care will eliminate or reduce the probability of this occurring. However, fading/discoloration alone does not render the undershirt unserviceable.

2. Launder the green undershirt using the permanent press cycle or hand wash in cold or warm water. Do not use bleach or detergents that contain bleaching agents. Tumble dry on the permanent press cycle, drip dry on a rust-proof hanger, or line dry out of the sun's direct rays. Allowing the undershirt to come in contact with oxidizing agents, such as benzyl peroxide (used in most acne medications) may cause spots that cannot be removed without ruining the shirt.

10109. KHAKI WEB BELTS. When belts are laundered, shrinkage is a normal reaction of untreated webbing. To compensate for shrinkage, the belts are manufactured in two lengths, 45 and 50 inches. Belts should be washed at least three times before cutting to normal waist size. To prevent excess shrinkage after laundering, hand stretch the belts while wet.

10110. STORING WOMEN'S SERVICE AND DRESS CAPS. Utilize the packaging material (tissue paper and chipboard cylinder) as it was originally used for storing. The cap should fit snugly within the box, with

tissue paper used to prevent shifting of the cap and to support the crown. The chipboard cylinder should be placed flat (not on edge) within the crown to afford additional support.

10111. SERVICE/DRESS SWEATERS. Dry cleaning sweaters is recommended. However, the sweaters may be hand laundered following the guidance in subparagraph 10102.1 for service uniforms.

10112. SWORD AND SCABBARD

1. The sword blade and scabbard with chrome plating have been plated to prevent rust; however, should the plating be removed by use of abrasives or as a result of scratches or misuse, rust is likely. When not in use, the blade and the scabbard should be kept in a dry place and should be coated with a film of light oil.

2. Clean the grip by wiping it with a damp cloth and drying thoroughly.

3. The mountings on the sword and scabbard, including the hilt, are made of solid brass, highly polished or anodized. For best results clean all mountings with a cloth moistened with soapsuds to which a few drops of household ammonia have been added. Do not use abrasives or polishing cloths containing chemicals. Wipe with a cloth moistened with clear water and dry thoroughly.

4. The scabbard of the noncommissioned officers' sword is covered with leather and should be cleaned with saddle soap. The sword blade and the gold-plated brass mountings should be maintained as indicated above.

10113. WHITE VINYL COVERS/CAPS. The white vinyl frame cap covers and the women's white dress vinyl caps may be cleaned with a soft brush (for light dirt/dust) or with a soft cloth dipped in warm soapy water. Brushing/cleaning motion should be in the direction of the grain of the vinyl.

10114. MARTIAL ARTS UTILITY BELTS. These belts are 46 inches in length and made of treated nylon. They come in five colors, tan, gray, green, brown, and black, and as appropriate, have accompanying woven red or tan nylon stripes indicating instructor qualification. The martial arts belt can be hand or machine laundered without bleach.

10115. MATERNITY UNIFORMS. The maternity tunic, slacks, and skirt may be dry cleaned or washed in warm water on the gentle cycle with mild detergent and allowed to drip dry. Items may be tumble-dried if the dryer has an air cycle with no heat. Do not bleach. The maternity uniform should not be washed with other dark clothes. If touch-up pressing is desired, a cool iron should be used. Maternity shirts and the camouflage work uniform will be maintained in the same manner as the equivalent standard uniform items.

10116. CUTS IN CLOTH. For the utility uniform only, a clean cut in the uniform can be repaired by being re woven with threads drawn from the material in another part of the garment. This must be done by an experienced tailor and is an expensive process; however, a well re-woven cut cannot be noticed.

10117. PREVENTING MOTH DAMAGE. Frequent brushing and exposure to sunlight and fresh air will effectively prevent moths. If uniforms are to be put away for a long time and left unattended, they should be thoroughly cleaned and packed in an airtight plastic bag or protected from moth damage.

MARINE CORPS UNIFORM REGULATIONS

CHAPTER 10

CARE AND MARKING OF UNIFORMS

SECTION 2: MARKING OF CLOTHING

10200. GENERAL

1. Enlisted Marines will plainly and indelibly mark every article of uniform clothing with the owner's name (except for organizational clothing). Marks will be of a size appropriate to the article and the space available for marking and will consist of block letters not more than 1/2 inch in size. Marking machines, stencil, marking tape or labels, or stamp, as appropriate, may be used. Names will be marked in black on light-colored material and inside the utility uniform and in white on dark-colored materials. Marks will be placed so that they do not show when the uniform is worn except that nametapes will be worn on the outside of the utility uniform as prescribed in paragraph 3032. When a marking tape or label is used, it should either be commercial or one made by printing or stamping the name on white tape, other than adhesive tape. In order to standardize throughout the Marine Corps and prevent variation from station to station, no elaboration of the following guide for marking will be made, nor will any greater preciseness of location be prescribed.

2. Articles marked with another individual's name will have the first owner's name obliterated by blocking out the name or using a commercial eradicator. The new owner's name will be re-marked according to these instructions. All re-marked clothing, with the exception of uniforms stamped "Recovered Clothing 1/2 Price" (RC 1/2) must be substantiated with an appropriate entry on the administrative remarks page of the service record book.

3. If Marines have clothing marked according to previously published instructions, re-marking is not required until the markings become illegible. If a Marine's name is legally changed, re-marking with the new name is not required until the old markings become illegible; however, an appropriate remark will be entered on the administrative remarks page of the service record book.

10201. LOCATION OF NAME ON ARTICLES

1. Bag, Duffel. On the outside of the bottom of the bag.

2. Belts (Coats and all sword belts). On the underside, near the buckle end.

3. Belts, Trouser (Khaki/white web and martial arts utility). On one side only, as near the buckle end as possible.

4. Caps. Inside, on the sweatband.

5. Coats. Inside, on the neckband.
6. Crown, Cap. Inside, on the band.
7. Drawers. Outside, immediately below the waistband, near the front.
8. Gloves. Inside, at the wrist.
9. Handbag. On the space provided.
10. Liner (AWC). Centered near the top.
11. Necktabs. On the underside near left end.
12. Neckties. On the inside of the neck loop. (Hook-on ties; on the inside, near the top.)
13. Shirts. Inside, on the neckband.
14. Shoes/Boots. Inside, near the top.
15. Socks. Outside, on top of the foot.
16. Sweater. Stamped on manufacturing label or use marking tape/label sewn inside the back of sweater, below the neckband, with thread to match the sweater.
17. Trousers, Skirts, and Slacks. Inside, near the top.
18. Trunks. Inside, immediately below the waistband.
19. Undershirts. Inside back, near the neckband.

MARINE CORPS UNIFORM REGULATIONS

CHAPTER 11

LAWS AND DIRECTIVES

	<u>PARAGRAPH</u>	<u>PAGE</u>
GENERAL	11000	11-3
U.S. NAVY REGULATIONS PERTAINING TO UNIFORMS	11001	11-3
DEPARTMENT OF DEFENSE DIRECTIVES PERTAINING TO UNIFORMS	11002	11-3
SECRETARY OF THE NAVY POLICY PERTAINING TO UNIFORMS	11003	11-4
LAWS PERTAINING TO THE UNIFORM	11004	11-5

MARINE CORPS UNIFORM REGULATIONS

CHAPTER 11

LAWS AND DIRECTIVES

11000. GENERAL

1. In addition to these regulations and other directives issued by the CMC, U.S. Navy Regulations and Department of Defense directives, State and Federal laws have also been promulgated which pertain to Armed Forces uniforms. Portions of these regulations, directives, and laws that are applicable to Marine Corps personnel, or to Marine Corps uniforms, are contained in this chapter.
2. No attempt has been made to excerpt or interpret the laws of any State. Commanders are responsible for becoming acquainted with and publicizing any State law that may affect the administration of their commands.

11001. U.S. NAVY REGULATIONS PERTAINING TO UNIFORMS

1. Article 1161 states that regulation clothing will not be disposed of except when authorized by proper authority; and that no enlisted person will possess, without proper permission, any clothing articles belonging to any other person in the naval service.
2. Articles 1245 and 1251 indicate what uniforms are required in connection with official visits.
3. Articles 1286 and 1289 set forth the requirements for the wearing of the mourning badge.

11002. DEPARTMENT OF DEFENSE DIRECTIVES PERTAINING TO UNIFORMS

1. Implementing 10 U.S.C. 772, the President, by Executive Order 10554 of 18 August 1954, delegated to the Secretary of Defense the authority to prescribe regulations under which persons may wear the uniform. The following excerpts from DoD Directive 1334.1 of 11 August 1969 outline these regulations:

a. Members of the Armed Forces (including retired members and members of reserve components). The wearing of the uniform is prohibited under any of the following circumstances:

(1) At any meeting or demonstration which is a function of, or sponsored by an organization, association, movement, group, or combination of persons which the Attorney General of the United States has designated, pursuant to E.O. 10450, as amended as totalitarian, fascist, communist, or subversive, or as having adopted a policy of advocating or approving the commission of acts of force or violence to deny others their rights under The Constitution of the United States, or as seeking to alter the form of Government of the United States by unconstitutional means.

(2) During or in connection with the furtherance of political activities, private employment or commercial interests, when an inference of official sponsorship for the activity or interest could be drawn.

(3) Except when authorized by competent Service authority, when participating in activities such as public speeches, interviews, picket lines, marches, rallies or any public demonstration (including those pertaining to civil rights), which may imply Service sanction of the cause for which the demonstration or activity is conducted.

(4) When wearing of the uniform would tend to bring discredit upon the Armed Forces.

(5) When specifically prohibited by regulations of the department concerned.

b. Former Members of the Armed Forces. Unless qualified under another provision of this Order or under the provisions of 10 U.S.C. 772, former members who served honorably during a declared or undeclared war and whose most recent service was terminated under honorable conditions may wear the uniform in the highest grade held during such war service only upon the following occasions and in the course of travel incident thereto:

(1) Military funerals, memorial services, weddings, and inaugurals.

(2) Parades on national or state holidays; or other parades or ceremonies of a patriotic character in which any active or reserve United States military unit are taking part. 'Wearing of the uniform or any part thereof at any other time or for any purpose is prohibited.'

c. Medal of Honor Holders. Persons who have been awarded the Medal of Honor may wear the uniform at their pleasure except under the circumstances set forth in Subsection a., above."

2. Pursuant to DoD Instruction 5410.20, unauthorized use of approved Marine Corps uniform emblems or insignia on civilian attire, or other non-uniform attire, is prohibited.

3. The President, by Executive Order 10113 of 24 February 1950, delegated to the Secretary of Defense the authority to prescribe the quantity and kind of clothing that shall be furnished to enlisted Marines, or the cash allowance to be provided in lieu thereof. Department of Defense Directive 1338.18 of 29 Jul 85 outlines the policies and regulations pertaining thereto.

11003. SECRETARY OF THE NAVY POLICY PERTAINING TO UNIFORMS

1. Pursuant to subparagraph 11002.1a(5), the Secretary of the Navy has prescribed that:

a. The exercise of the rights of freedom of speech and assembly does not include the right to borrow the inherent dignity, prestige, and traditions represented by uniforms of the naval service to lend weight and significance to privately held convictions on public issues.

b. Members of the Navy and Marine Corps (including retired members and members of Reserve components) are prohibited from wearing uniforms of the naval service while attending or participating in, or continuing to attend or participate in, a demonstration, assembly, or activity with knowledge that a purpose of such demonstration, assembly, or activity is the furtherance of personal or partisan views on political, social, economic, or religious issues except:

(1) In connection with official duties or as otherwise authorized in advance by competent authority; or

(2) Incident to attendance at or participation in a bona fide religious service or observance.

c. Authorization to wear the uniform should be granted by a commanding officer when reasonably assured that the service member's appearance in uniform at the particular event, viewed objectively, is not for the purpose of lending substantial weight or significance to privately held convictions or interests; would not be so construed by an observer; and that the demonstration, assembly, or activity does not relate to matters in public controversy.

2. To implement 10 U.S.C 773, the Secretary of the Navy has prescribed the following distinctive mark for wear by members of military societies which are composed entirely of honorably discharged officers and enlisted personnel, or by the instructors and members of duly organized cadet corps.

a. The distinctive mark will be a diamond, 3-1/2 inches long by two inches wide, of any cloth material. A white distinctive mark will be worn on blue, green, or khaki clothing; and a blue distinctive mark will be worn on white clothing.

b. The distinctive mark will be worn on all outer clothing on the right sleeve, at the point of the shoulder, the upper tip of the diamond to be 1/4 inch below the shoulder seam.

11004. LAWS PERTAINING TO THE UNIFORM

1. Per 10 U.S.C. 771, no person, unless otherwise authorized by law, may wear the uniform or a distinctive part of the uniform of which is similar to a distinctive part of the Marine Corps uniform.

2. According to 18 U.S.C. 702, whoever wears the Marine Corps uniform without authority, in any place within the jurisdiction of the United States will be fined not more than \$250 or imprisoned not more than six months, or both.

3. According to 10 U.S.C. 772, the Marine Corps uniform may be worn by personnel not on active duty under the following conditions:

a. Retired Marine Corps officers may bear the title and wear the uniform of their retired grade.

b. Former Marines who are discharged honorably or under honorable conditions from the Marine Corps may wear their uniform while going from the place of discharge to their home of record, within three months after discharge.

c. Former Marines not on active duty who served honorably in time of war in the Marine Corps may bear the title, and as authorized by regulations prescribed by the President, wear the uniform of the highest grade held during that war (subparagraph 11002.1).

d. While portraying a member of the Marine Corps, an actor in a theatrical or motion picture production may wear the Marine Corps uniform provided the portrayal does not tend to discredit the Marine Corps.

e. While attending a course of military instruction conducted by the Marine Corps, a civilian may wear the uniform prescribed by the commander of the installation conducting the instruction.

4. According to 10 U.S.C. 773, a person for whom one of the following uniforms is prescribed may wear it, if it includes distinctive insignia prescribed by the Secretary of the military department concerned to distinguish it from the uniform of the Marine Corps (subparagraph 11003.2).

a. The uniform prescribed by the university, college, or school for an instructor or member of the organized cadet corps of:

(1) A State university or college, or a public high school, having a regular course of military instruction.

(2) An educational institution having a regular course of military instruction, and having a member of the Marine Corps as instructor of military science and tactics.

b. A uniform prescribed under subparagraph 11004.4a, above, may not include insignia of grade the same as, or similar to, those prescribed for Marine Corps officers.

c. Under such regulations as the secretary of the military department concerned may prescribe, any person who is permitted to attend a course of instruction prescribed for members of Reserve Officers' Training Corps, and who is not a member of that corps, may, while attending that course of instruction, wear the uniform of that corps.

5. According to 18 U.S.C. 244, whoever, being a proprietor, manager, or employee of a theater or other public place of entertainment or amusement in the District of Columbia or in any territory, or possession of the United States, causes any person wearing the uniform of any of the Armed Forces of the United States to be discriminated against because of that uniform, shall be fined not more than \$500.

MARINE CORPS UNIFORM REGULATIONS

Item/Subject	Paragraph	Table/Figure
Aerial navigator	4002	fig. 4-4
Aide-de-camp accessories ...	4000	fig. 4-1
Aiguillette	4000, 6102	
All-season uniform	2002, 2004	
All-weather coat	3001, 4004, 4005, 10105	figs. 2-27, 2-28
Alterations	1008	
Approval identification, Commercial	1007, 9105, 9202, 9203	fig. 1-3
Athletic attire	2006, 3023, 7013	
Attachments	Chapter 5, sect. 4	fig. 5-8
Aviation breast insignia ...	4002	fig. 4-4
Awards	Chap. 5	
Badge, marksmanship	Chap. 5, sect. 5	fig. 5-9, 5-10
Badge, military police	7011	
Badge, special ID/service ..	4007	fig. 4-28
Bands, Regular Establishment, Uniforms	Chap. 6, sect. 2	
Belts	3002, 7009, 7011, 7015, 7016	
Blue dress "A"	2002	fig. 2-7 thru 2-9
Blue dress "B"	2002	fig. 2-10 thru 2- 12
Blue dress "C"	2002	fig. 2-13, 2-14
Blue dress "D"	2002	fig. 2-15, 2-16
Blue dress sweater	2002, 3031, 4004, 4005, 4006	
Blue-white dress "A"	2003	fig. 2-17, 2-18
Blue-white dress "B"	2003	
Boatcloak	3003	fig. 2-1
Boots (see footwear)	3012	

MARINE CORPS UNIFORM REGULATIONS

Item/Subject	Paragraph	Table/Figure
Branch of service insignia .	4001	
Brassards	7001, 7011	
Breastcord	6201, 7002	
Breast insignia	4002	fig. 4-4
Buckles	3002	
Buttons, insignia	3004, 4003	
Campaign hat	7003	
Cape, evening/blue dress ...	3003	
Caps	3005	fig. 3-1
Care and maintenance of Uniforms	Chap. 10, sect. 1	
Chin straps	3005, 7003	fig. 3-1
Civilian clothing	1005	
Civilians serving with USMC Units	8005	
Clasp, decorations	5403	
Coats	3006, 7004	
Collar strip, white	3007	
Color seniority for awards .	5104	
Combat aircrew	4002	fig. 4-4
Combat boots	3012	
Combatant Diver Insignia ...	4002	fig. 4-4
"Corfam"	3012	
Cosmetics	1004	
Covers, frame, cap	3005	fig. 3-1
Cuff links and necktie clasp Set	3008	

MARINE CORPS UNIFORM REGULATIONS

Item/Subject	Paragraph	Table/Figure
Cummerbund	3009	
Decal, utility uniform	3037, 7004, 8001	
Decorations	Chap. 5	
Designation of uniforms	Chap. 2	
Devices for awards	Chap. 5, sect. 2	fig. 5-8
DoD Directives - uniforms ..	11002	
Drawers	3036	
Dress "A", "B", "C", "D" Uniforms	Chap. 2	
Dress blue uniform	2002	
Dress uniforms, care of	10101	
Drill/marksmanship instructors' allowances	7020	Tables 7-4, 7-5
Drum and Bugle Corps, uniforms	6201	fig. 6-10, 6-11
Duty (working) uniform	1002	Table 2-1
Earrings	1005, 30010	
Emblem decal	3037, 7004, 8001	
Emblem, USMC	3037, 7004, 8001	
Enlisted uniforms authorized for officers	9104	
EOD insignia	4002	fig. 4-4
Evening dress "A"	2001	figs. 2-1, 2-2
Evening dress "B"	2001	figs. 2-3, 2-4
Evening dress SNCO	2001	figs. 2-5, 2-6
Evening dress uniform, occasions for wear	2001	
Evening dress uniform, requirement for	9107	

MARINE CORPS UNIFORM REGULATIONS

Item/Subject	Paragraph	Table/Figure
Eyeglasses	1004	
Fiber helmet	7008	
Field coat (jacket)	7004	
Field uniforms	2005, 3037, 3038, 8001	
Fitting of uniforms	1008	
Flight clothing	7005	
Flats	3012	fig. 3-4
Food service clothing, special	7007	
Footwear	3012	fig. 3-2, 3-3
Foreign insignia	4002	fig. 4-4
Foreign personal decorations	5100, 5102, 5200, 5300	
Foreign service awards	5100, 5102, 5200, 5300	
Foreign unit award	5100, 5102, 5200, 5300	
Fourragere	5302	
Frame Caps	3005	fig. 3-1
Garrison caps	3005	
Gloves	3013	
Grade insignia	4004, 4005, 4016	figs. 4-3, 4-5 thru 4-7, 6-1
Grooming standards	1004,	figs. 1-1, 1-2
Hamilton wash brass	3004, 5200, 5400	
Handbag	3014	
Havelock	3005	
Headgear, individual	3005	
Headgear, organizational ...	7003, 7008	fig. 3-1
Helmets, motorcycle	3024, 7008	

MARINE CORPS UNIFORM REGULATIONS

Item/Subject	Paragraph	Table/Figure
Honor guard equipment	7009	
Hose	3029	
Identification badges	4007	fig. 4-18
Insignia, branch of service .	4001, 8001 (Navy)	
Insignia of grade, enlisted	4004	figs. 4-5 thru 4-10, 4-17
Insignia of grade, Navy	8001	figs. 8-1, 8-2
Insignia of grade, officer .	4005	figs 4-3, 4-11 thru 4-16
Jacket, tanker (see Tanker Jacket)	3015	
Jackets, evening dress	3015	
JCS ID badge (see special Badges)	4007	fig. 4-18
Jewelry	1004	
Jungle boots (see footwear)	3012	
Lapel buttons	5105	
Laws pertaining to uniforms	Chap. 11	
Leave and liberty, uniforms For	2000	table 2-1
Letter devices for awards ..	5402	
Laundrying (see care and Maintenance)	Chap. 11, sect. 1	
Marine aerial navigator (see Breast insignia)	4002	fig. 4-4
Marine Corps Birthday, Uniforms for	2001	
Marine Corps exchange & Commercial sources	1006	
MCX & commercial uniforms for Enlisted	9202, 9203	
Marine Corps Junior ROTC ...	8004	

MARINE CORPS UNIFORM REGULATIONS

Item/Subject	Paragraph	Table/Figure
Marine gunner distinguishing Insignia	4006	fig. 4-15
Marine security guards	7010	
Marking uniforms	Chap. 10, sect. 2	
Marksmanship badges	Chap. 5, sect. 5	figs. 5-9, 5-10
Maternity uniforms	2007, 3017	figs. 2-29, 2-30
Medal of Honor holders, wear Of uniform	11002	
Medals, large and miniature	Chap. 5, sect. 2	
Military police equipment ..	7011	
Miniature medals	Chap. 5, sect. 2	
Minimum requirements	Chap. 9	
Minimum requirements, Exceptions to	9201	
Minimum requirements, effects Of changes to	9016, 9204	
Motorcycle protective clothing	3024, 7008	
Mounted medals	5201	
Mourning band	3018, 7012	
Multiple ribbon attachments	5400	
Nametags	3019	
Nametapes	3033	
Naval aircrew	4002	fig. 4-4
Naval aviation observer	4002	fig. 4-4
Naval aviator	4002	fig. 4-4
Naval flight officer	4002	fig. 4-4
Navy branch of service Insignia	8001	fig. 8-2

MARINE CORPS UNIFORM REGULATIONS

Item/Subject	Paragraph	Table/Figure
Navy insignia of grade	8001	figs. 8-1, 8-2
Navy/Marine Corps parachutist	4002	fig. 4-4
Navy personnel serving with USMC units	8001	
Navy regulations, uniforms .	11001	
NCO stripes	4008	
Necktab	3020	
Necktie	3020	fig. 3-6
Necktie clasp	3020	fig. 3-6
Nonmilitary decorations	5102	
Non-U.S. service awards	5102	
Numeral devices for awards .	5402	
Office of the SecDef ID badge	4007	fig.4-18
Officer uniform requirements	Chap. 9, sect. 1	
Optional uniform items, Enlisted	9203	
Optional uniform items, Officer	9105	
Organizational clothing	Chap. 7	
Overshoes	3012	
Oxfords	3012	
Parachutist insignia	4002	fig. 4-4
Parka, ECWCS	3011, 4004, 4005,	
Personal appearance	1004	
Personal decorations	5102, 5301	
Physical training uniforms .	2006, 3023, 7013	
Pilot insignia	4002	fig. 4-4

MARINE CORPS UNIFORM REGULATIONS

Item/Subject	Paragraph	Table/Figure
Precedence for awards	5102	
Presidential Service Badge .	4007	fig. 4-18
Procurement of uniforms	1006	
Pumps	3012	Fig. 3-3
Purse	3014	
Quality control/complaints .	1006	
Quatrefoil	3005	Fig. 3-1
Rank insignia, Navy	4004, 4005, 8001	
Religious articles	1004	
Reporting for duty ashore, Uniform for	2006	
Reservists, wearing uniforms	8002	
Restrictions on wearing Uniforms	1003, Chap. 11	
Retired Marines, wearing Uniforms	8003	
Ribbon bars	5202, Chap. 5, sect. 3	
Rosette	5404	
Sam Browne Belt	7015	
Scarf	3025	
SCUBA diver	4002	fig. 4-2
Secretary of the Navy, Uniform policy	11003	
Service awards (campaign/ service awards)	5101, 5102	
Service "A"	2004	figs. 2-19, 2-20
Service "B"	2004	figs. 2-23, 2-24
Service "C"	2004	figs. 2-25, 2-26

MARINE CORPS UNIFORM REGULATIONS

Item/Subject	Paragraph	Table/Figure
Service badges	4007	fig. 4-18
Service belt	7016	
Service cap	3005	
Service stripes	4009	
Service sweater	3031	
Service sweater, service "B"/"C"	3031	figs. 2-21, 2-22
Service tape (see tapes, name/service)	3033	
Service uniforms, occasions for wear	2004	
Shirts	3026	
Shoes (see footwear)	3012	fig. 3-2, 3-3
Shore party designation	7017	
Skirts	3027	
Skirts, white, organizational	7019	
Slacks (female)	3028, 7019	
Slacks, white, organizational	7019	
Sleeve ornamentation	3016	fig. 3-4
SNCO optional uniforms	9203	
Socks	3029	
Stars, gold, silver, bronze, for awards	Chap. 5, sect. 4	
Summer weight uniform	2004	
Sunglasses	1004	
Suspenders	3030	
Sweaters, service/dress	2002, 2004, 3031, 9105, 9203	

MARINE CORPS UNIFORM REGULATIONS

Item/Subject	Paragraph	Table/Figure
Sweatsuit (see physical training uniforms)	1005, 2006, 3023	
Sword and Scabbard, NCO	7019	
Sword, officers	3032	fig. 3-7
Sword mourning knot	3032, 7018	fig. 3-7
Sword scabbard	3032	fig. 3-7
Tanker jacket	3015	
Tapes, name and service	3033, 7004	
Travel uniform	1005	
Trousers; service, dress, Utility	3034	
Trousers, white, Organizational	7019	
Trunks, general purpose	2006, 3023	
Types and components of Uniforms	2008	
Umbrellas	3035	
Undergarments	3036	
Undershirts	3036	
Uniform combinations & components, tables of		Table 2-1
Uniform "Hotline"	1006	
Uniform of the day	1002	
Uniform requirements (officer/enlisted)	Chap. 9	
Unit awards	5101, 5102, 5301	
Unit identification marks (Navy personnel)	8001	
U.S. Marine Band uniforms ..	Chap. 6, sect. 1	

MARINE CORPS UNIFORM REGULATIONS

Item/Subject	Paragraph	Table/Figure
"USMC/emblem" iron-on decal	3037, 7004, 8001	
Utility uniform (camouflage)	2005, 3037	figs. 2-31, 2-32
Utility uniform (combat)	2006	figs. 2-32 thru 2-34
Vice-Presidential Service Badges	4007	fig. 4-18
Vietnam Gallantry Cross Devices	5404	
Visor, cap	3005	fig. 3-1
Waistcoat	3039	
Waistplate	3002, 3004, 6201, 7009	
White House, wear of uniform At	2001, 2004	
"White tie" occasions, uniforms for	2001	
Winter weight uniform	2004	
"Wooley-pulley" (see service sweater)	3031	