

ARMY, MARINE CORPS, NAVY, AIR FORCE



**AIR LAND SEA
APPLICATION
CENTER**

JATC

***MULTI-SERVICE
PROCEDURES FOR JOINT
AIR TRAFFIC CONTROL***

FM 3-52.3 (FM 100-104)

MCRP 3-25A

NTTP 3-56.3

AFTTP(I) 3-2.23

JULY 2003

DISTRIBUTION RESTRICTION Approved for public release;
distribution is unlimited.

MULTI-SERVICE TACTICS, TECHNIQUES, AND PROCEDURES

FOREWORD

This publication has been prepared under our direction for use by our respective commands and other commands as appropriate.



MICHAEL A. VANE
Brigadier General, US Army
Deputy Chief of Staff for
Doctrine, Concepts and Strategy
US Army Training and Doctrine
Command



EDWARD HANEON, JR.
Lieutenant General, USMC
Commanding General
Marine Corps Combat
Development Command



R. A. ROUTE
Rear Admiral, USN
Commander
Navy Warfare Development
Command



DAVID P. MacGHEE, JR.
Major General, USAF
Commander
Headquarters Air Force
Doctrine Center

This publication is available at Army
Knowledge Online (www.us.army.mil)
and at the General Dennis J. Reimer
Training and Doctrine Digital Library
(www.adtdl.army.mil).

PREFACE

1. Purpose

This joint air traffic control (JATC) publication meets the needs of the Services by providing procedures on JATC employment and by detailing Service relationships for initial, transition, and sustained JATC operations within the theater or AOR. It also outlines how to synchronize and integrate JATC forces and specialized air traffic control (ATC) equipment.

2. Scope

This multi-Service procedures publication acts as a ready reference source for guidance on ATC responsibilities, procedures, and employment in a joint environment. This publication discusses JATC employment and Service relationships for initial, transition, and sustained ATC operations across the spectrum of joint operations within the theater or area of responsibility (AOR). This publication is UNCLASSIFIED and specifically addresses Service ATC doctrine, forces, capabilities, equipment, and training.

3. Applicability

This publication applies to the operating forces of all Services. Although the focus of the publication is at the tactical level, it has application for planning and warfighting personnel at all levels. The target audience for this publication includes commanders, staffs, warfighters, and agencies at all levels within and supporting a joint force.

4. Implementation Plan

Participating Service command offices of primary responsibility will review this publication, validate the information, and reference and incorporate it in Service and command manuals, regulations, and curricula as follows:

Army. Upon approval and authentication, this publication incorporates the procedures contained herein into the US Army Doctrine and Training Literature Program as directed by the Commander, US Army Training and Doctrine Command (TRADOC). Distribution is in accordance with (IAW) initial distribution number (IDN) 115756.

Marine Corps. The Marine Corps will incorporate the procedures in this publication in US Marine Corps training and doctrine publications as directed by the Commanding General, US Marine Corps Combat Development Command (MCCDC). Distribution is in accordance with the Marine Corps Publication Distribution System (MCPDS).

Navy. The Navy will incorporate these procedures in US Navy training and doctrine publications as directed by the Commander, Navy Warfare Development Command (NWDC)[I5]. Distribution is in accordance with Military Standard Requisition and Issue Procedure Desk Guide (MILSTRIP Desk Guide) and Navy Standing Operating Procedure Publication 409 (NAV SOP Pub 409).

Marine Corps PCN: 144 00055 00

Air Force. The Air Force will incorporate the procedures in this publication in accordance with applicable governing directives. Distribution is in accordance with Air Force Instruction (AFI) 33-360.

5. User Information

a. TRADOC, MCCDC, NWDC, Headquarters AFDC, and the Air Land Sea Application (ALSA) Center developed this publication with the joint participation of the approving Service commands. ALSA will review and update this publication as necessary.

b. This publication reflects current joint and Service doctrine, command and control organizations, facilities, personnel, responsibilities, and procedures. Changes in Service protocol, appropriately reflected in joint and Service publications, will likewise be incorporated in revisions to this document.

c. We encourage recommended changes for improving this publication. Key your comments to the specific page and paragraph and provide a rationale for each recommendation. Send comments and recommendations directly to—

Army

Commander
US Army Training and Doctrine Command
ATTN: ATDO-A
Fort Monroe, VA 23651-5000
DSN 680-3951 COMM (757) 788-3951
E-mail: doctrine@monroe.army.mil

Marine Corps

Commanding General
US Marine Corps Combat Development Command
ATTN: C42
3300 Russell Road, Suite 318A
Quantico, VA 22134-5021
DSN 278-6233/6234 COMM (703) 784-6233/6234
E-mail: deputydirectordoctrine@mccdc.usmc.mil

Navy

Commander
Navy Warfare Development Command
ATTN: N5
686 Cushing Road
Newport, RI 02841-1207
DSN 948-1164/4189 COMM (401) 841-1164/4189
E-mail: alsapubs@nwdc.navy.mil

Air Force

HQ AFDC/DJ
204 Dodd Blvd, Ste 301
Langley AFB, VA 23665-2788
DSN 574-8091 COMM (757) 764-8091
E-mail: afdc.dj@langley.af.mil

ALSA

ALSA Center
ATTN: Director
114 Andrews Street
Langley AFB, VA 23665-2785
DSN 575-0902 COMM (757) 225-0902
E-mail: alsa.director@langley.af.mil

*FM 3-52.3 (FM 100-104)
 *MCRP 3-25A
 *NTTP 3-56.3
 *AFTTP(I) 3-2.23

FM 3-52.3	US Army Training and Doctrine Command Fort Monroe, Virginia
MCRP 3-25A	Marine Corps Combat Development Command Quantico, Virginia
NTTP 3-56.3	Navy Warfare Development Command Newport, Rhode Island
AFTTP(I) 3-2.23	Headquarters Air Force Doctrine Center Maxwell Air Force Base, Alabama

17 July 2003

JATC

MULTI-SERVICE PROCEDURES FOR JOINT AIR TRAFFIC CONTROL

TABLE OF CONTENTS

		Page
EXECUTIVE SUMMARY		VIII
CHAPTER I	PLANNING	I-1
	Background.....	I-1
	Command and Control Relationships	I-1
	Suggested Organization.....	I-3
	Planning Considerations	I-6
CHAPTER II	INITIAL DEPLOYMENT	II-1
	Background.....	II-1
	Initial Entry Planning Considerations	II-1
	Initial Operations.....	II-1
	Transition to Sustained Operations.....	II-4
CHAPTER III	AIR TRAFFIC CONTROL TRANSITION OPERATIONS.....	III-1
	Background.....	III-1

* This publication supersedes FM 100-104, MCRP 3-25A, NWP 3-56.3, and AFTTP(I) 3-2.23, dated 25 January 1999.

	Forces and timelines	III-1
	Transfer of Control.....	III-1
	Example of Air Traffic Control Transition.....	III-2
	Additional Considerations	III-3
CHAPTER IV	SUSTAINMENT OF AIR TRAFFIC CONTROL OPERATIONS	IV-1
	Background.....	IV-1
	Sustained Operations.....	IV-1
	End of Operations	IV-2
APPENDIX A	AIR FORCE AIR TRAFFIC CONTROL.....	A-1
	Doctrine	A-1
	Forces.....	A-1
	Training	A-2
	Air Force ATC Duties and Command and Control Relationships.....	A-3
	Future Plans.....	A-5
	Deployed locations.....	A-6
	Air Force ATC Points of Contact	A-6
APPENDIX B	ARMY TACTICAL AIR TRAFFIC SERVICES	B-1
	Mission.....	B-1
	Doctrine	B-1
	Army Air Traffic Controllers Training.....	B-1
	Organization.....	B-2
	Communications Architecture.....	B-4
	Tactical ATS Points of Contact.....	B-7
APPENDIX C	MARINE CORPS AIR TRAFFIC CONTROL	C-1
	Doctrine	C-1
	Capabilities.....	C-4
	Functions	C-5
	Employment	C-5
	Expeditionary operations.....	C-7
	ATC Detachment Equipment.....	C-8
	Training and Proficiency.....	C-8
	Planning.....	C-10
	Equipment selection and siting considerations	C-16
	Points of Contact.....	C-17
APPENDIX D	NAVY AIR TRAFFIC CONTROL	D-1
	Doctrine	D-1
	Forces.....	D-2
	Training	D-4
	Navy Tactical Air Control Squadron Operating Positions.....	D-5

	Tactical Air Control Squadron Required Operational Capabilities	D-7
	Navy ATC Duties, Responsibilities, and C2 Relationships	D-10
	Navy POCs	D-11
APPENDIX E	AIR TRAFFIC CONTROL EQUIPMENT	E-1
	Army ATC Equipment	E-1
	Marine ATC Equipment	E-4
	Navy Amphibious ATC Equipment.....	E-9
	General Purpose Air Force ATC Equipment.....	E-10
	Communications Capabilities.....	E-23
APPENDIX F	SAMPLE ATC HANDOVER CHECKLIST	F-1
APPENDIX G	SAMPLE NOTICE TO AIRMEN.....	G-1
APPENDIX H	SAMPLE LETTER OF AGREEMENT.....	H-1
REFERENCES	Reference-1
GLOSSARY	Glossary-1
INDEX	Index-1
 FIGURES		
	Figure I-1 Example Regional Air Movement Control Center Manning	I-5
	Figure II-1 Scenario With Example Timeline for Initial ATC Capability	II-2
	Figure III-1 Scenario With Transition to Sustained ATC Operations	III-2
	Figure III-2 Planners' Transition Checklist	III-3
	Figure IV-1 Sustainment Options.....	IV-2
	Figure A-1 Air Force ATC Structure.....	A-3
	Figure A-2 Special Tactics Squadron C2 Structure (SOF JATC).....	A-5
	Figure B-1 A2C2 Cell/AIC Cell Support to Division/Corps.....	B-4
	Figure B-2 Army Tactical ATS Architecture	B-6
	Figure C-1 Marine Air Control Group Subordinate Agencies and Detachments	C-2
	Figure C-2 Marine Air Command and Control System (MACCS).....	C-3
	Figure D-1 Navy Tactical Air Control System.....	D-11
	Figure E-1 AN/MSN-7 Tower Restoral Vehicle	E-14
	Figure E-2 AN/MPN-26 Mobile Air Traffic Control System	E-20

TABLES

Table I-1 JATC Planning Considerations	I-9
Table I-2 Service ATC Capabilities	I-10
Table II-1 Initial JATC Capabilities	II-3
Table III-1 Service Capabilities to Transition to Sustained JATC Operations	III-4
Table A-1 Air Force ATC Special Experience Identifiers (SEI).....	A-2
Table A-2 Air Force Specialty Codes (AFSC) Referenced in JATC MTTP	A-3
Table B-1 Army ATC Skill Identifiers	B-2
Table B-2 Army Communications Capabilities	B-7
Table C-9 Marine ATC Military Occupational Specialties (MOS).....	C-9
Table D-1 US Navy ATC Naval Experience Codes	D-5
Table E-1 AMPHIBIOUS ATC EQUIPMENT.....	E-10
Table E-2 Service-Specific Communications Capabilities	E-23

EXECUTIVE SUMMARY

JATC

Multi-Service Tactics, Techniques, and Procedures for Joint Air Traffic Control

- Provides basic background information on JATC operations
- Outlines the duties, responsibilities, and command and control relationships that influence JATC operations and handover procedures
- Illustrates how Service ATC forces are deployed and employed to perform ATC operations
 - Describes how Service ATC forces conduct ATC during initial, transition, and sustained operations, and provides example timelines
 - Outlines how to synchronize and integrate JATC forces within the theater or AOR
 - Explains how to integrate the Services' ATC equipment and ATC force
 - Describes each Service's ATC doctrine, forces, capabilities, training, and equipment used to perform JATC operations and any additional information and considerations deemed appropriate by individual Services

Joint force planners must understand the elements of each Service's ATC capabilities and be able to synchronize and integrate them to effectively support the joint force commander's requirements. A general understanding of how these forces fit into the flow of a developing theater is required to execute this responsibility. This publication provides the Service-unique information a planner requires in order to employ air traffic services (ATS) in a joint environment. Included are considerations and checklists for planning and executing ATC services during the initial, transition, and sustained phases of operation.

Planning

Chapter I addresses organization modifications; specifically of primary importance is the suggested establishment of an Airspace Integration Entity (specialty team or cell) and a Regional Air Movement Control Center (RAMCC)(especially for nations with a non-functioning civil ATC system) to ensure ATC issues are handled competently. It also details the command and control relationships and planning considerations for tasking ATC capabilities of all four Services, and includes a snapshot of their capabilities. Finally, the chapter details planning considerations for providing instrument navigational aids and/or instrument procedures within a theater or AOR.

Initial Deployment

Chapter II describes how individual Service's ATC capabilities are initially employed in the joint environment. It discusses that, unlike flight operations, where aircraft from several Services may share an airfield, the ATC support is normally provided by a single

Service. Also, the individual Services have not previously pursued joint ATC operations doctrine and efficiencies, which may produce enhanced capabilities and improved flight safety resulting from the combination of multi-Service ATC functions when feasible. It recommends that, now, due to strains in manning, equipment, and mission requirements, the joint planners/multi-Service ATC community should consider joint ATC operations. The chapter also provides planning considerations, Service initial capabilities, and an example scenario for initial ATC operations.

Air Traffic Control Transition Operations

Chapter III describes transitional ATC operations conducted from the time the initial entry ATC resources require replacement, replenishment, augmentation, or upgrade of ATC services until the time that sustainment ATC forces are established. It provides an example transition timeline, transition checklists, Service transition capabilities, and considerations.

Sustainment of Air Traffic Control Operations

Chapter IV covers sustained, long-term ATC operations, through termination of ATC services and end-state considerations. It includes considerations for synchronization, integration, and interoperability of ATC forces within the theater or AOR.

Service Doctrine, Forces, Capabilities, Training, Equipment, etc., and Examples

The appendices provide details on the four Services' ATC doctrine, forces, capabilities, equipment, and training, as well as helpful example checklists and documents. The appendices provide a baseline understanding of component capabilities for conducting ATC operations in a joint environment by providing a description of:

- The doctrinal framework which each Service uses to execute JATC operations
- The Service-specific forces capable of deploying and executing JATC operations
- The Service-specific equipment and systems used to control air traffic in the theater or AOR
- The specific ATC organizations and capabilities each Service has available
- The training each Service provides for ATC personnel
- Additional information and considerations deemed appropriate by individual Services
- ATC operations handover checklists
- Sample NOTAMs
- Memorandum/Letter of Agreement

PROGRAM PARTICIPANTS

The following commands and agencies participated in the development of this publication:

Joint

US Transportation Command, Scott AFB, IL

Army

US Army Training and Doctrine Command, DCSDCS (ATDO-A), Ft Monroe, VA

US Army Aviation Center, Directorate of Combat Developments (ATZQ-CD), Ft Rucker, AL

US Army Air Traffic Services Command (Provisional) (AFATS-C), Ft McPherson, GA

Marine Corps

Marine Corps Combat Development Command, Joint Doctrine Br (C427), Quantico, VA

Marine Aviation Weapons and Tactics Squadron 1, C-3 MATC Division, Yuma AZ

Navy

Commander, Navy Warfare Development Command, Newport, RI

Commander, Tactical Air Control Group 2, NAB Little Creek, Norfolk, VA

Commander, Tactical Air Control Squadron 22, NAB Little Creek, Norfolk, VA

Air Force

Air Force Doctrine Center, Detachment 1, Langley AFB, VA

Headquarters Air Combat Command (DOR), Langley AFB, VA

Headquarters Air Force Special Operations Command (DOOF), Hurlburt Field, FL

Headquarters United States Air Force (XOOS), Washington, DC

720th Special Tactics Group, Hurlburt Field, FL

Air Force Flight Standard Agency, Andrews AFB, MD

Aerospace Command and Control Agency, Langley AFB, VA

Air National Guard

Headquarters Air National Guard (C4A), Washington, DC

Chapter I

PLANNING

1. Background

a. When planning the deployment of air traffic services (ATS), it is crucial for a joint planner to know the condition and capabilities of airfields, navigational aids, airspace considerations, and other air traffic control (ATC) resources in the area of operations (AO). This information enables the joint force planner to determine the types and mix of assets required to support initial operations up until the time in which a full ATC sustainment package is deployed.

b. This chapter details the command and control (C2) relationships and planning considerations for tasking ATC capabilities of all four Services and includes a snapshot of their capabilities for conducting joint air traffic control (JATC).

2. Command and Control Relationships

a. Relationships. The following guidance outlines duties and responsibilities during a joint operation. Discussion of an airspace integration entity (specialty team or cell) and a RAMCC will be covered in section 3.

(1) Combatant Commander: The Combatant Commander's joint forces air component commander (JFACC) determines initial ATC requirements at specific deployment locations based upon the operational requirements.

(2) Joint Force Commander (JFC). A general term applied to a combatant commander, subunified commander, or joint task force (JTF) commander authorized to exercise combatant command (command authority) or operational control over a joint force (Joint Publication [JP] 1-02). In addition, the JFC exercises operational control (OPCON) over assigned forces, and normally over attached forces, to include ATC forces. The JFC directs employment of ATC assets and handoff of responsibility from one unit to another (single Service, joint, multinational [coalition or allied], or host nation) through the airspace control plan (ACP), published by the airspace control authority (ACA). Additionally, the JFC establishes requirements for liaisons in inter-Service, coalition, and host nation facilities.

(3) Joint Force Air Component Commander . The commander, within a unified command, subordinate unified command, or joint task force responsible to the establishing commander for making recommendations on the proper employment of assigned, attached, and/or made available for tasking air forces; planning and coordinating air operations; or accomplishing such operational missions as may be assigned. The JFACC is given the authority necessary to accomplish missions and tasks assigned by the establishing commander. (JP 1-02)

(4) Airspace Control Authority. The commander designated to assume overall responsibility for the operation of airspace control system in the airspace control area (JP 1-02). When the JFC designates a JFACC, the JFACC normally assumes ACA responsibilities since airspace control is an integral part of joint air operations. As the designated commander for joint air operations, the responsibility for planning, coordinating, and developing airspace control procedures and operating an airspace control

system also rests with the JFACC. When the situation dictates, the JFC may designate a separate ACA. In those joint operations where separate commanders are required and designated, close coordination between the JFACC and ACA is essential for unity of effort, prevention of fratricide, and deconfliction of joint air operations (JP 3-30). Broad responsibilities include coordinating and integrating the use of the airspace control area, establishing an airspace control system (ACS), and developing the ACP and implementing it through the airspace control order (ACO), which must be complied with by all components. Additionally, the JFACC should coordinate with ICAO to plan for and ensure deconfliction of flights by civilian aircraft within or near the combat zone. This coordination is critical to enhance aviation safety for military aircraft and aircraft from humanitarian assistance (HA) and other international organization/non-governmental organization (IO/NGO) sponsored flights. ACA activities are conducted with JFC guidance and with J-3 authority. All missions are subject to the ACO; however, centralized direction by the ACA does not imply OPCON or tactical control (TACON) over any air assets. The ACA promulgates JFC requirements, plans, and tasks for ATC units through the ACP and ACO (see discussion on ACP and ACO, below).

(5) Air Operations Center (AOC). The principal air operations installation from which aircraft and air warning functions of combat air operations are directed, controlled, and executed. It is the senior agency of the Air Force Component Commander from which command and control of air operations are coordinated with other components and Services. (JP 1-02).

(6) Functional Component Command. A command normally, but not necessarily, composed of forces of two or more Military Departments that may be established across the range of military operations to perform particular operational missions that may be of short duration or may extend over a period of time (JP 1-02).

(7) Service Component Command. A command consisting of the Service component commander and all those Service forces, such as individuals, units, detachments, organizations, and installations under that command, including the support forces that have been assigned to a combatant command or further assigned to a subordinate unified command or JTF (JP 1-02). The Service component command retains TACON of component forces and advises JFC on employment of component forces and direction and control of those forces. Service component command functions include:

(a) Coordinating and deconflicting the employment of assigned and attached forces with other subordinate commands as required by the operational situation.

(b) Providing ATC in areas designated by the ACA in accordance with directives and/or procedures in the ACP.

(c) Developing detailed ATC instructions, plans, and procedures in accordance with guidance in the ACP.

(d) Providing necessary facilities and personnel for ATC in assigned areas of operations and identifies these facilities and personnel to the ACA for inclusion in the ACP.

(e) Providing ATC liaisons to the other components to ensure component capabilities, limitations, needs, and desires are considered in planning and execution at all levels of C2.

(8) Component Liaison Elements. The component liaison elements to the JFACC (for example, the special operations liaison element [SOLE], the battlefield coordination detachment [BCD], naval and amphibious liaison element [NALE], and the Marine liaison officer (MARLO)), may also provide representation to the ACA if the JFACC has been designated the ACA by the JFC or is collocated in the joint air operations center (JAOC) (For simplicity, combined air operations center [CAOC] will be used in this publication from this point forward to represent any such unit to include a joint air operations center or simply an air operations center). Otherwise, additional liaison elements may be required. All components are not required to send a liaison to the control reporting center (CRC).

(9) ATC Unit. This unit provides ATC service to aircraft operating within airspace defined in the ACP. The unit develops local operating procedures in accordance with ICAO, Federal Aviation Administration (FAA), host nation, Service-specific, and joint directives, as well as the ACP, air tasking order (ATO), ACO, and other applicable ACA/JFC instructions. The unit is also responsible for coordinating and establishing communication links with adjacent air defense units and fire support elements to ensure identification criteria are implemented in accordance with standing directives and are useable and understandable. The ATC unit also establishes procedures for interoperability with adjacent collateral, subordinate, and superior component, joint, coalition, and host nation ATC facilities.

b. JFC Products. The following JFC-approved products contain guidance supplemental to ICAO, FAA, host nation, and Service specific, and joint directives:

(1) Airspace Control Plan. The document approved by the JFC that provides specific planning guidance and procedures for the airspace control system (ACS) for the joint force area of responsibility (AOR) and/or joint operations area (JOA) (JP 1-02). The ACP is developed by the ACA and approved by the JFC to establish procedures for the ACS in the joint force AOR/ JOA. The ACP must consider procedures and interfaces with the international or regional air traffic systems necessary to effectively support air logistics, augmenting forces, and JFC objectives. One broad area of concern for developing the ACP is familiarity with capabilities and procedures of military and civil ATC systems. The ACP establishes initial ATC system structure, outlines procedures for transition from peacetime to wartime ATC operations (if required), and details procedures for handing-off ATC responsibility from one ATC unit to another (if required). The ACP should provide procedures to fully integrate the resources of the military ATC facility responsible for terminal-area airspace control. ATC facilities should interface and link with ACS communications to form a system that ensures safe efficient flow of air traffic supporting the combat effort while permitting maximum combat flexibility.

(2) Airspace Control Order. An order implementing the airspace control plan that provides the details of the approved requests for airspace control measures. It is published either as part of the air tasking order or as a separate document (JP 1-02).

(3) Special Instructions (SPINS). Special instructions provide details of the approved requests for special airspace control measures (ACM). It is published either as part of the ATO or as a separate document.

3. Suggested Organization

a. While the four Services have extensive ATC-specific expertise, individuals with such skills are usually not assigned to unified command staffs. Having embedded ATC expertise

in a staff can help to overcome the difficulties associated with either establishing an ATC system where none exists or integrating an existing civil aviation structure with US and/or coalition operations. To address these difficulties, an airspace integration entity should be established, composed of appropriate representatives from the Service's and/or coalition partners involved in the operation (whether the airspace integration function is stood up as a specialty team or cell is dependent upon both the nature of the operations and also the recommendation of the JFACC and approval of the JFC, unless a separate ACA is designated). Airspace integration personnel perform the key functions of ATC coordination, airspace management, and TERPS liaison. A RAMCC may also be required (especially for nations with a non-functioning civil ATC system). The airspace integration entity will coordinate with the appropriate CAOC divisions (and the RAMCC, if established).

b. Airspace Integration Entity. The airspace integration entity responsibilities include the following:

(1) Planning for the full range of ATC operations to support deliberate and crisis action planning, deployment, employment, sustainment, and redeployment of ATC forces (reference AFDD 2-1.7, *Airspace Control in the Combat Zone*, 4 Jun 1998.).

(2) Coordinating host nation integration of the civil ATC system to include host nation agreements and international and national air traffic coordination and negotiation of international level agreements.

(3) Collaborating with combat plans division to integrate airspace design in development of the airspace control plan.

(4) Coordinating terminal instrument procedures (TERPS). This includes coordinating airfield and environmental obstacle surveys, and deployable ATC and landing system (DATCALs). This could include surveys, host nation coordination, host nation /Jeppesen instrument procedures or review and publication of procedures.

(5) Coordinating FAA flight checks.

(6) Coordinating with ICAO, civil ATC authorities, and nongovernmental organizations (NGOs)/private volunteer organizations for integration of humanitarian air missions.

(7) Overseeing airspace management (ATC) personnel in the CAOC.

Note: Personnel with ATC expertise should perform airspace integration within the CAOC. See tables A-1 for Air Force special experience identifiers (SEI), A-2 for Air Force specialty codes (AFSC), B-1 for Army skill identifiers, C-1 for Marine military occupational specialties (MOS), and D-1 for Navy designators and Navy enlisted codes (NECs).

c. Airspace Integration Entity (Specialty Team or Cell) recommended composition.

(1) Airspace Integration Chief. Field grade officer (O-4 to O-6) with ATC/airspace experience (see Annex A through D for Service-specific qualification identifier codes). Responsible for oversight of ATC Coordination and Airspace Management Cadre, TERPS, and airspace management (ATC) personnel within the CAOC.

(2) ATC Coordination and Airspace Management Cadre. One field grade and three to five company grade officers/ Senior NCOs. All personnel should have ATC experience (TERPS experience desired).

(3) TERPS liaison (if required). Manning: as necessary. Usually only one in-theater coordinator is required as most TERPS work is done at the Services and regional offices level. (See Para I-4.a. Terminal Instrument Procedures of this publication)

(4) RAMCC. A RAMCC may be established to provide a centralized facility to coordinate arrival and departure times to help de-conflict both military and civilian air traffic at designated airfields in a particular operational area. It also provides visibility on this traffic to ground-based and airborne air control units. Figure I-1 provides a notional organization and rank structure for a RAMCC.

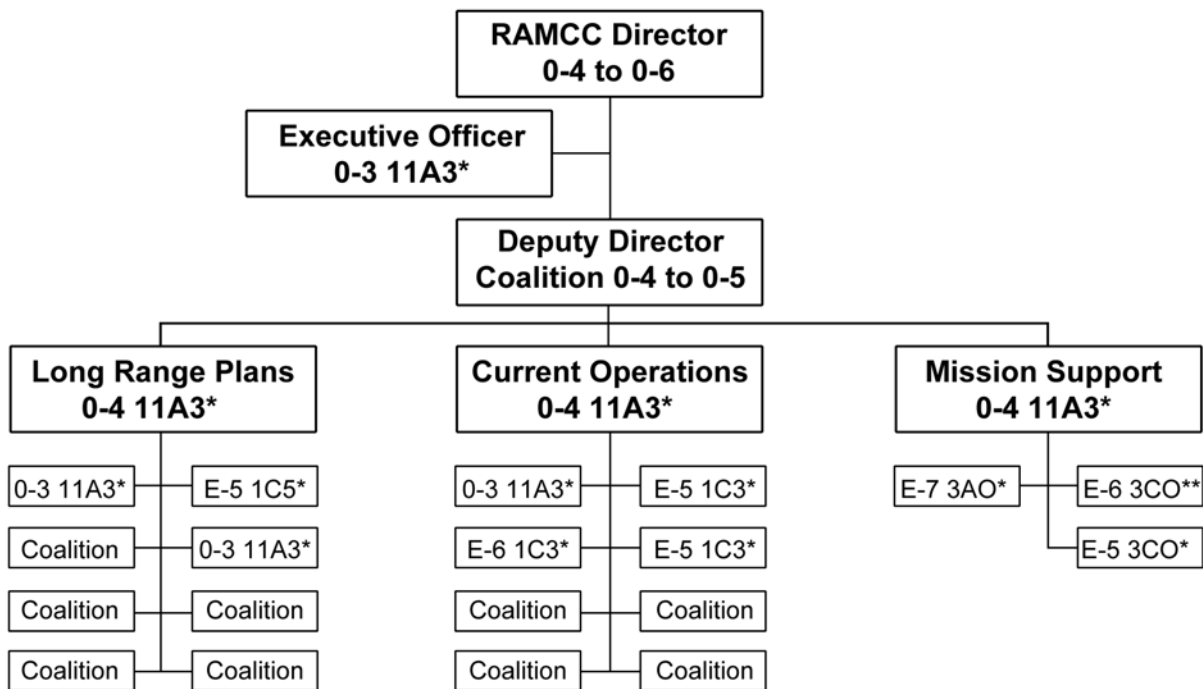

Note: 15 U.S. personnel and 10 coalition personnel, based on a single on-going operation, such as OPERATION ENDURING FREEDOM

*See Table A-2 for AFSC definitions

**Includes a 2E1 communications-electric maintenance person in ATCALs specialty

Figure I-1 Example Regional Air Movement Control Center Manning

4. Planning Considerations

Many factors need to be considered before determining the type of ATC required for mission success. At the end of this chapter, table I-1 outlines JATC planning considerations, and table I-2 provides a snapshot of Service ATC capabilities. However, if instrument navigational aids (NAVAIDS) and/or instrument flight rules (IFR) procedures are necessary, the following two areas are required:

a. Terminal Instrument Procedures. Survey-qualified TERPS specialists (Marine, Army, Air Force, and National Imagery and Mapping Agency (NIMA)) conduct/participate in initial site surveys. (NIMA may be able to provide geodetic control for the airfield, which could prove valuable for Global Positioning System (GPS) precision approaches in the future). TERPS specialists use the site survey information to develop approach procedure packages and forward them to the appropriate higher headquarters TERPS office responsible for the designated AOR. Authorization to use the procedures ultimately remains with the appropriate flying operations authority and/or the commander exercising operational control of the aircraft. During contingency operations, an in-theater TERPS liaison may be established to develop and approve instrument procedures and scheduling flight inspections. Ideally, this liaison will work within the airspace integration entity.

b. Flight Inspection. Flight Inspection aircraft certify instrument procedures and their associated NAVAIDS. The flight inspections ensure the safety of NAVAIDS signals and published instrument procedures for IFR use (especially for use during instrument meteorological conditions (IMC) and night operations). Coordinate flight inspection aircraft as early as possible in the planning process to ensure they are available when required. The Air Force's headquarters (HQ) Air Force flight standards agency (AFFSA), detachment (Det) 1, has military flight check aircraft (C-29) and aircrews within the FAA Flight Check Center in Oklahoma City, OK. The Army also has one flight check aircraft (C-12) based at Ft Rucker, AL. Flight Inspection has both operational and legal ramifications. Flight inspection of instrument procedures is required in accordance with Air Force instruction (AFI) 11-230, *Instrument Procedures*, August 01; Air Force manual (AFMAN) 11-225; United States Standard Flight Inspection Manual, January 03; (FAAO 8200.1, NAVAIR 16-1-520, and Army TM 95-225) and Office of the Chief of Naval Operations (OPNAV) 3722.16C, United States Standards for Terminal Instrument Procedures, August 1993 (Army TM 95-226, FAAH 8260.3). Flight inspection verifies that the performance of air navigation services and their associated instrument flight procedures conform to prescribed standards documented in FAA and department of defense DOD directives, and in Annex 10 to the Convention on ICAO. The following four options reflect the different degrees of flight inspection available to the JFACC (listed from higher to lower risk).

Note: Options 1 and 2 are available in cases where a flight inspection is impossible/limited and military operations must be conducted. However, Options 1 and 2 do not eliminate the requirement to conduct a flight inspection. The flight inspection requirement is postponed until the situation permits inspection in accordance with (IAW) Options 3 or 4.

(1) Option 1. Approval without Flight Inspection. Commanders have the final authority and responsibility for accomplishing their assigned mission. If the military situation dictates, the JFC may approve the use of a NAVAIDS/approach without a flight inspection (see Note above). This can be approved only for military aircraft under the JFC OPCON. Aircrews who fly the procedures should be advised that flight inspection

certification has not been accomplished, and the instrument procedures should be labeled and limited to those aircrews specifically authorized. Other aircraft (FAA/Civil Reserve Air Fleet (CRAF)/ICAO, etc.) would not be authorized to use the procedure.

(2) Option 2. Military Emergency Flight Inspection. In accordance with AFMAN 11-225, when it is deemed necessary by military authorities the abbreviated flight inspection procedures of Section 109 may be used. However, as soon as the conditions allow, the NAVAIDS and instrument procedures must be re-inspected using normal procedures and tolerances. The JFC may approve the use of Section 109 abbreviated flight inspection procedures. For additional flexibility, radar approaches and certain new instrument procedures may be certified using a local military aircraft with a flight inspector riding on the flight deck. This option is intended to permit a commander to continue flight operations while waiting for a restricted or normal commissioning inspection (see Note below). This inspection will allow a theater commander to have temporary IFR capability for aircraft under OPCON of the JFC/JFACC. However, other aircraft (FAA/CRAF/ICAO, etc.) may be authorized to use the facility at the discretion of the JFC.

Note: Nearly all flight inspections must be performed during daylight hours and require visual meteorological conditions (VMC) weather. An inspection of a single NAVAID normally takes ½ day and 1 sortie to complete.

(3) Option 3. Restricted Facility Commissioning. This inspection certifies the facility using normal procedures, but only to the extent necessary to support a minimal number of IFR approach procedures. Optimally it will take 1 day and 2 sorties (in VMC weather) to complete. The restricted facility commissioning inspection permits use by any aircraft. Areas that are evaluated to be acceptable are certified for use, and the remaining areas/procedures not evaluated are restricted. The local (deployed) airfield operations/ATC manager will publish the restrictions in appropriate NOTAM.

(4) Option 4. Normal Commissioning. This is the certification of all procedures (arrival/approach/departure) and areas of NAVAID coverage. Optimally this inspection takes 2 to 3 days and 4 to 5 sorties (VMC weather) to complete. This inspection is required for full use by DOD, CRAF, FAA, and ICAO aircraft.

c. Flight Inspection Bed Down. Specific UTC for deliberate planning exist to task and deploy flight inspection assets if a long-term inspection capability is deemed necessary. If a limited number of flight inspections are required, or inspections will be infrequent, the requirement can be tasked via a message to the FAA and HQ AFFSA. Notification of possible tasking is encouraged and may be made via telephone to AFFSA Det 1, collocated with the FAA International Flight Inspection Office in Oklahoma City, OK. The FAA can supply mobility readiness spares package (MRSP) equipment for operations, but depends upon the military for airlift. For contingency operations, aircraft maintenance support should be located outside hostile areas with an optimum bed-down location within 300 miles of airfields to be flight inspected. The requesting ATC representative must provide approach procedures packages, NAVAID facility data, and specific airfield site survey data to flight inspection aircrews, the FAA International Flight Inspection Office in Oklahoma City, OK and the flight inspection liaison at the CAOC, before flight inspection can begin.

Note: Details on tasking flight inspection assets, including FAA contact procedures, can be found in AFMAN 13-220. *Deployment of airfield Operations*, 1997. The FAA office responsible for flight inspection is Aviation System Standards (AVN) based at the Mike Monroney Aeronautical Center in Oklahoma City, OK.

d. Distribution of Approaches. The AOR TERPS office completes the TERPS database using survey information and develops an approach procedure. The developed approach procedure is transmitted to the airfield for flyability check/flight inspection as required. Based on results of flyability check/flight inspection, and if required, JFACC approval, the AOR TERPS office disseminates the completed procedure(s) to theater aircrews through various means.

Note: Procedures developed by the AOR TERPS office only apply to aircraft under operational control of the JFC (after his approval) until a flight inspection can be accomplished (see AFMAN 11-225, Section 109 and FAAO 8200.1 for flight inspection requirements).

Table I-1 JATC Planning Considerations

JATC Planning Considerations			
Length of Operation	[<i>Initial Operations</i>] Short duration (<14 days) - Consider STS, TACT, MMT (man portable capability), NOTAM dissemination [<i>Transitional</i>] Mid-term (<180 days) - Service ATC unit rotations [<i>Sustainment</i>] Long-term (>180 days) - Service ATC taskings, coalition ATC units, contract services		
Type of Operations	Main base, FOB, FARP, equipment, reliability, back-up capability, communications connectivity, etc., drives need for robustness		
Complexity of Area	Mixture and volume of existing civilian structure, services, navigational aides		
Type/Density of Traffic	___ Rotary, fixed-wing, UAVs ___ Primary users: SOF, Fighters, Cargo, ISR, Fueling, unique ___ Civilian, coalition, humanitarian (What avionics are aboard the using aircraft?)		
Type of Service	(VFR/IFR) Radar/non-radar, terminal, precision/non-precision approaches, en route, overflight traffic		
Future Mission of Base	Will base transition to different use with different Service/equipment requirements? (i.e. humanitarian relief)		
Environment	Permissive/non-permissive, terrain (mountainous/flat), climatology (VMC, IMC, winds, temperature/density altitude)		
Adjacent Nation ATC Capabilities	Does existing adjacent nation capability meet mission needs? Can adjacent nations provide en route services? Does political will/host nation agreements allow usage?(Also drives the number of ATC liaison requirements)		
Interface Between Terminal and En Route ATC Systems	Who can provide en route support? Naval assets? Adjacent nations? Airborne assets?		
Base Operations Support	Equipment support: power, protection, supply, maintenance personnel support: billeting, security, medical, food/water....		
Host Nation Airspace/ATC Agreements/Directives	Airfields and areas approved for use (or restricted); Agreements with adjoining nations/ICAO; Determine regulatory guidance to be used by ATC (common operating procedures? ICAO? FAA? other?)		
Existing Host Nation Capabilities/Procedures	Equipment, reliability, backup capability; Ability and confidence of host nation controller and pilot skills & language ability; Are existing procedures acceptable?		
Existing Site Surveys	(refer to Services/coalition/MAJCOMS or air staff databases)		
Frequency Requirements	Requesting timelines, radio, radar, NAVAIDs, nets, etc.		
Airfield Lighting	Night time and IFR services require airfield lighting		
Redeployment of Air Traffic Services(I.E. DATCALs, Etc)	Recommended practice is to leave follow on/sustainment equipment in place (i.e. DATCALs, etc.) when rotating personnel. This reduces repetitive airlift and flight inspection requirements.		
Intertheater Transportation	The process and procedures for intertheater transportation of JATC requirements are contained in Joint Pub 4-01, "Joint Doctrine for the Defense Transportation System."		
Precision Approach	Consideration for defining whether requirement is for single or multiple precision approach capability		
Legend			
FARP	forward arming and refueling point	MMT	Marine ATC mobile team
FOB	forward operation/operating base	UAV	unmanned aerial vehicle
STS	special tactics squadron	ISR	intelligence, surveillance, and reconnaissance
TACT	tactical aviation control team		

Table I-2 Service ATC Capabilities

Service	Air Traffic Control Capabilities								
	TERPS Site Survey	TERPS	Airfield Survey	Day /Night VFR ⁴	Tactical Airfield Lighting	Limited IFR Services ⁴	Full IFR Services ⁴	PAR ⁵	Airfield Management
Air Force¹									
Special Tactics Teams (STT)	X		X ²	X	X ¹¹	X ⁶			X ^{7,9}
Combat Communications	X	X	X	X		X	X	X ⁸	X ⁵
Fixed Base ¹⁰		X		X		X	X	X ⁸	X
Air National Guard	X	X	X	X		X	X	X ⁸	X
Army	X	X	X	X		X	X	X	
Marine Corps									
Marine ATC Det	X	X	X	X	X ¹¹	X	X	X	X
Marine ATC Mobile Team (MMT)	X		X ²	X	X ¹¹	X ⁶			X ⁷
Navy				X ³		X ³	X ³	X ³	X ⁹

¹ TERPS specialists (Air Force SEI 361) should also be used to conduct site surveys. If possible, utilize the same personnel for the survey and to build the approaches.

² Basic airfield survey done during initial entry phase, which is not a formal site survey that may be used to gather data for TERPS certified approaches.

³ Navy AATCC's/TACC's aboard LHA/LHD class ships primarily provide ATC services to aircraft in support of the amphibious force and have the capability to provide approach control services to land-based satellite airports. TACRONS are capable of temporarily staffing (or augmenting) and operating shore-based ATC facilities.

⁴ Requires tactical airfield lighting or operational host nation lighting or aircrew NVG systems are required.

⁵ Airfield management services at austere locations may be provided by Air Mobility Command (AMC) Tanker-Airlift Control Element (TALCE).

⁶ Limited to TACAN, NDB, or MMLS systems. No approach control or precision approach radar (PAR) functions. May be limited to non-radar operations that may hamper operational tempo.

⁷ Limited to tactical airfield markings, lighting, runway surveillance, and landing surface evaluations.

⁸ Air Force PAR controllers require SEI 365 and must be tasked accordingly to ensure qualified controllers are deployed.

⁹ Air Force airfield management personnel are tasked by the same command authority as ATC personnel. Navy controllers are qualified in both specialties.

¹⁰ Fixed-base UTCs consist of personnel only that normally join with Air Force Combat Communications equipment in the forward area or may be tailored (TPFDD) to work in host nation or inter-Service facilities.

¹¹ STS and MMT carry man portable, battery operated, short duration, airfield lighting (all others require tactical lighting systems or operational host-nation systems).

Chapter II

INITIAL DEPLOYMENT

1. Background

This chapter describes how individual Services' ATC capabilities are initially employed in the joint environment. Unlike flight operations, where aircraft from several Services may share an airfield, a single Service normally provides the ATC support. The individual Services have not previously pursued joint ATC doctrine and efficiencies, which could produce enhanced capabilities and improved flight safety, resulting from the combination of multi-Service ATC functions when feasible. The joint planners/multi-Service ATC communities need to consider joint ATC functions due to manning, equipment, and mission requirements. This chapter discusses the initial deployment of ATC assets.

2. Initial Entry Planning Considerations

a. In the preplanning or during the initial process of implementing the JTF commander's decisions, the following are considerations for the joint planner: A team from the Air Force special tactics squadron (STS), Marine ATC mobile team (MMT), a full Marine ATC Det, or an Army tactical aviation control team (TACT) must conduct an initial deployment assessment, preferably on-site. Then a determination of the required force mix must be made. Minimal airfield operations and ATC services should be provided until sustaining DATCALs arrive. Small, lightweight, minimum capability and highly mobile packages will provide initial VFR or limited (procedural control rather than positive control) IFR ATC. Airborne deployed fighting forces and supporting units deploying in initial phases of a crisis should be self-sufficient, bringing enough food, water, shelter, etc. for up to 72 hours. After this time, the ATC forces will require resupply and/or augmentation controllers to continue operations. These initial ATC assets may or may not remain at the location after initial deployment airflow is complete.

b. The initial entry phase would normally end with sustainment or transition ATC forces deploying to relieve initial ATC forces, usually providing greater or more robust airfield capability in the process. The joint planner must consider resources required to support a transition period if sustainment assets are not available to relieve the initial deployment capability. Requirements of higher priority forces may delay the arrival of sustainment ATC assets. Reliance on the initially deployed ATC asset delays the full capability of an airfield until the more robust sustainment package arrives in theater. The paradox is that the equipment required to provide full IFR capability is airlift intensive.

3. Initial Operations

a. For the purposes of this publication and the timeline demonstration scenario (figure II-1), initial entry is defined as military actions required to airland forces with inter- or intra-theater airlift to meet the JFC's strategic or operational objectives. Initial entry starts with deployment of ATC assets into an airfield through opposed or unopposed entry. This deployment could be accomplished through use of surface, amphibious, airborne, airland, or heliborne operations.

b. The Army, Marine Corps, and Air Force have the capability of providing an initial airfield ATC capability, either stand-alone or jointly. Initial ATC forces are normally short duration and require follow-on sustainment (<14 days). As an example, a scenario is provided in figure II-1 to illustrate a notional timeline for initial stand-up of an ATC capability at a bare base airfield.

Example Scenario: Establish IFR-Capable Airfield for Inter-theater & Theater Airlift										
ATC Services/Actions	Timeline									
	D-72 to 12HRS	H HOUR	1 HR	TBD	5 HRS	5-12 HRS	12-24 HRS	24 HRS	48 HRS	72 HRS
Initial Forces (STS, MMT, TACT) Alerted	X									
Gather Intel	X									
Forces Deploy/Employ		X								
Airfield Seizure		X								
Airfield Assessment, Comm Established			X							
Marking/Lights, Beacon, & TACAN Operational			X							
Airfield Ready To Receive Traffic			X, 1							
Airfield Secure w/ Light Hostilities				X, 2						
Initial Day/Night VFR ATC Begins				X, 3						
Airland Additional Forces/Equipment					X					
Airland Additional Ground Forces/Equipment					X	X	X	X	X	X
MMLS/TACAN/NDB/GCA Operational						X				
TERPS Information Forwarded							X			
NAVAIDS/Procedures Flight Checked							X, 4	X, 4	X, 4	
AMC TALCE Arrives									X	
AMC TALCE Operational									X	
MMLS Approach Approved							X, 4	X, 4	X, 4	X, 4
LIMITED IFR Services Available							X, 4	X, 4	X, 4	X, 4
1 - Determined by ATC 2 - Determined by ground forces commander (GFC) 3 - Determined jointly by ATC, GFC, and air mission commander 4 - JFC risk acceptance, flyability check, or FAA flight check required										

Figure II-1 Scenario With Example Timeline for Initial ATC Capability

c. General Capabilities. All Services have initial ATC radio communications deployment capability. The initially deployable ATC systems/DATCALs limit the airfield IFR capability. These systems are matched to very specific aircraft systems such as the TACAN, the Marine Corps' ARA-63 airborne radar, the Army nondirectional beacon (NDB), or the Air Force mobile microwave landing system (MMLS). The Marine Corps and Air Force special tactics teams (STT) have packable/portable airfield lighting systems organic to their units, allowing them to provide a complete initial airfield-

operating package. Coordinate the layout of the deployed tactical airfield lighting and marking patterns among the initial ATC unit and follow-on aircrews to ensure the arriving aircrews have the equipment and familiarity with the set marking patterns (Reference AFI 13-217, or Marine ATC Mobile Team Tactical Standard Operating Procedures [MMT TACSOP]).

(1) Subsequent replacement or augmentation should occur within approximately 14 days for the initially-deployed ATC forces. Contingency planners should program ATC transition packages carefully because deployment of sustainment ATC forces for both the Air Force and Marines require significant airlift assets and may not be a high priority in the air flow or time-phased force and deployment data (TPFDD). For example, if initial entry forces need airport surveillance radar (ASR) or precision approach radar (PAR) early in the entry, the Army radar system is the most compact and capable of early deployment. On initial entry, Army ATC forces are capable of VFR (tower)/IFR NDB airfield operations.

(2) Table II-1 provides a quick reference of individual Service’s initial capabilities. Paragraphs d through g explain individual Services’ capabilities in greater detail.

Table II-1 Initial JATC Capabilities

Service	Voice Communication			Deployable NAVAIDS	Runway Lighting	Visual Flight Rules (VFR)	Limited Instrument Flight Rules (IFR)
	VHF (Secure)	UHF (Secure)	FM (Secure)				
Army	YES	YES	YES	NDB	NO	YES	YES
Air Force	YES	YES	YES	MMLS, TACAN	YES	YES	YES
Marine	YES	YES	YES	MRAALS, TACAN	YES	YES	YES

d. Air Force Special Tactics Teams. Although all Services are capable of providing an initial ATC capability, Air Force STT are highly trained and specifically equipped to provide initial airfield operations for inter- and intra-theater airlift in a joint environment. Another Service’s initial ATC capability can augment Air Force STT, depending on the method of insertion and type of aircraft in the airflow.

(1) Air Force STT will be organized under the OPCON of the Special Operations Command or TACON to the JFACC. When these forces are air-dropped into the objective area, security forces will secure the area and the Air Force STT will initiate setup of the communications, runway lighting system, tactical air navigation (TACAN), MMLS, and initiate the TERPS process for the landing zone/airfield. To complete the process of preparing for air operations, the responsible authority must determine the acceptable level of risk. Once the Air Force STT establishes the airfield and the ground forces commander determines the area is secure (acceptable risk level), airland operations may begin.

e. Marine ATC Mobile Team. MMTs are trained and equipped to provide initial rapid response ATC. One MMT is available for direct deployment to the AO from each continental United States (CONUS) base and each Marine Expeditionary Unit (MEU).

While all MEUs are usually highly trained, most also receive additional training to be designated as special operations capable (SOC). MMTs will establish landing zones/airfields in accordance with established doctrine. MMTs are self-sustaining for up to 72 hours without re-supply. Rotary-wing, fixed-wing, or surface vehicles can insert the MMT. MMTs can provide NAVAID capabilities in the form of a man portable TACAN and/or the Marine Remote Area Automatic Landing System (MRAALS) (see appendix E for descriptions). The team gathers initial data for TERPS development for possible transitional and sustainment operations. MMTs attached to the MEU(SOC) remain TACON to the MEU(SOC) commander, while teams activated directly to the AO will be TACON to the senior Marine/joint air control agency.

f. Army Tactical Aviation Control Team. Army ATC forces can integrate into either the initial entry forces or during the transition period, based on special requirements in the initial entry or based on the need to prepare for forward deployment of Army forces (ARFOR) arriving after the landing zone (LZ)/airfield is established. TACTs are capable of providing non-precision approaches and VFR ATC functions. They are also capable of airdropping into the objective area and simultaneously assisting in the TERPS and establishment of a LZ/airfield. The Army alone could not provide a limited-IFR airfield capability for other Services' aircraft without significant resourcing from another Service for equipment such as runway lighting and airfield marking. Army ATC forces can establish an instrumented airfield with limited fixed-wing capability using only organic equipment.

g. Navy Tactical Air Control Squadron (TACRON): During the initial entry phase, Navy TACRON controllers perform their duties aboard the amphibious flagship for operations in direct support of amphibious force operations. They are responsible for providing centralized command, control, planning, and coordination of all air support and airspace required for amphibious operations. Navy TACRON control continues until control is passed ashore, normally to a Marine direct air support center (DASC). TACRONs maintain the capability to temporarily staff and operate an existing ATC facility ashore or augment a remote facility ashore with personnel to control air traffic during the sustained operations phase.

4. Transition to Sustained Operations

Transitioning to sustained operations may require additional personnel and equipment to supplement the initially deployed capabilities, such as providing a positive control IFR capability or dual runway precision approach capability. The sustained operations plan should consider requirements for full base airfield operations support for an extended period of time. A full range of terminal (including mobile control tower), ASR, precision landing capabilities, and/or NAVAIDS, and transmission medium equipment is normally included for the sustained operations phase. Airfield management augmentation personnel, normally from CONUS bases, are required for a transition to sustained operations. Chapters 3 and 4 identify planning considerations for transition and sustained operations.

Chapter III

AIR TRAFFIC CONTROL TRANSITION OPERATIONS

1. Background

Transition operations are defined as operations during the period where the initial entry ATC resources require replacement, replenishment, augmentation, or upgrade of ATC services until sustainment ATC forces are established. For planning purposes, transitional ATC operations could be for an extended period of time based on the intended time frame of the operation or availability of airlift or sealift resources to deploy sustainment ATC forces. Planners should consider initial entry capabilities to meet the desired operational requirements. However, initial ATC forces will require relief to reconstitute the initial entry capability, and to provide a sustained or more capable conventional airfield environment.

2. Forces and timelines

The synchronization of ATC resources to produce maximum operational effectiveness requires special attention to differences in individual Service capabilities to ensure a smooth transition. Timelines for replacement of initial ATC forces are situation dependent. Airborne deployed fighting forces and supporting units deploying in initial phases of a crisis should be self-sufficient with enough food, water, shelter, etc. for up to 72 hours. After this time, the ATC forces will require resupply and/or augmentation controllers to continue operations.

a. Air Force STT should be relieved at approximately D+14. Air Force STT are normally unable to conduct extended operations based on higher HQ tasking to move forward. To ensure uninterrupted services, have transition ATC forces in place and ready to begin assumption of responsibility for ATC by D+10 and able to relieve all initial forces by D+30.

b. Army TACTs are force packaged and task organized. Extended ATC operations will require minimal logistical support no later than (NLT) D+3.

c. Marine MMTs will be task organized to meet mission requirements. MMTs attached to a MEU(SOC) will require resupply of food, water, batteries, etc. NLT D+3. MMTs attached to a MEU(SOC) should be relieved NLT D+14 to allow reconstitution and re-tasking. MMTs deployed directly to the AOR from CONUS will conduct operations in preparation for transitional/sustainment operations. MMTs are the precursor for additional ATC forces entering the AOR.

d. Update the ACO and ACP to reflect new sustainment ATC capability. If required, release national or international NOTAMS.

3. Transfer of Control

Under ideal conditions, ATC operations will flow from initial to sustained operations without the need for a distinct transition phase (figure III-1). Transitional ATC operations require procedures to transfer control of operations from one ATC Service provider to another. See appendix F for sample ATC transition checklists.

Transition to Sustained ATC Operations (Best-Case Example)				
OBJECTIVE: Initial ATC Forces relieved, and more robust (IFR service) systems in place from Air Force, Marine, or Army tactical ATC Units				
ACTION	TIMELINE			
	3-7 Days	8-14 Days	15-25 Days	45+ Days
Sustainment ATC Forces/Equipment Arrives	X			
Air Force Combat Communications	X			
Marine ATC	X			
Army ATC	X			
Transitional ATC Begins		X		
Transition to Sustainment Forces			X	
Initial ATC Forces Relieved/Forward Deploy/Reassigned			X	
Sustainment NAVAIDS Operational			X	
GCA/RAPCON Operational			X	
PAR Operational			X	
TACAN/NDB/MMLS Operational			X	
PAR/GCA/TERPS Approaches Approved			X	
Host Nation Resumes ATC Services				X
Sustainment ATC Redeploys				X

Figure III-1 Scenario With Transition to Sustained ATC Operations

4. Example of Air Traffic Control Transition

The following steps demonstrate bridging the gap between the initial entry force and the sustaining ATC force, and are built around a worst-case, medium threat, IMC scenario example. For discussion purposes, the initial entry force has conducted a forced entry, secured the airfield, and established limited instrument approach procedures (Marine MMT, Air Force STT, or Army TACT could accomplish this). The objective is to eventually land inter-theater airlift aircraft and conduct operations until sustainment forces assume responsibility for the airfield.

a. The JFC temporarily authorizes use of instrument procedures without any flight inspection because of mission necessity. This is accomplished using flight inspection option 1 identified in chapter 1 (see chapter 1, section 4b).

b. Sustainment forces begin arriving within 3 to 7 days. The sustainment forces immediately begin the transition to assume ATC responsibility. The following occurs simultaneously (airflow dependent):

(1) New controllers are integrated into the initial ATC force's work shifts. The personnel immediately become familiar and certified in required ATC positions by existing controllers.

(2) ATC management personnel use the ATC transition checklist in appendix F to gather required information for assumption of duties.

(3) Sustainment ATC and landing systems (ATCALs) are sited and set up.

(4) Additional instrument procedures are built and all procedures and NAVAIDS are certified for IFR use by flight inspection. JFC rescinds previous flight inspection waiver.

c. Transition continues through D+12 as initial controller force is replaced with new controllers. At D+13, enough sustainment controllers are certified to meet ATC mission requirements and the ATC management personnel from both forces agree on a final transition date of D+14. Initial ATC forces redeploy and reconstitute for follow-on missions.

5. Additional Considerations

a. Integration and Interoperability. ATC systems are highly complex and may require extensive research into equipment capabilities and support requirements. Service systems are designed as stand-alone with some limited connectivity. Planners must first identify what systems are in place and what capabilities are required. The key to solving integration and interoperability issues lies within each Service. A limited description of each Service's equipment is included in appendix E.

b. Additional Issues. All possible contingencies could not be incorporated into the ATC transition scenario described in Paragraph 4, above. Some additional issues to consider when resourcing a transition force, including planner's checklists and Service capabilities, can be found in figure III-2 and table III-1.

PLANNERS' TRANSITION CHECKLIST <i>(Issues to consider when sourcing a transition force)</i>	
Mission	Airflow: aircraft type/volume/type of ATC service
Environment	Hostile/permissive/base support/terrain/weather
Time (airlift)	Airflow availability and timeliness
TACS Interface	ATC with air defense, AEW, WOC, etc
Host Nation	Compatibility with host nation ATC systems
ATC & NOTAM Interface	Communication connectivity, automation, and interoperability
Transfer	ATC transition checklist
	Key contacts (maintenance, communications, weather, etc)
	Procedures (ATC, air defense, etc)
	Airspace
	Flight inspections
	Communication capability/interoperability/automation
	Coordination requirements/procedures with adjacent facilities
	Base support
	Rules of engagement (ROE)/standard operating procedures (SOP)
	Equipment left behind (who will maintain it?)
	What equipment is compatible/incompatible
Overlap, continuity of service	

Figure III-2 Planners' Transition Checklist

Table III-1 Service Capabilities to Transition to Sustained JATC Operations

Service/System	Approach	GCA	Tower	Limitations
Army		X	X	See appendix B
Air Force	X	X	X	See AFMAN 13-220, <i>Deployment of Airfield Operations</i> , 1997
Marine	X	X	X	See MCWP 3-25.8, <i>Marine Air Traffic Control Detachment Handbook</i> , Aug 97

Chapter IV

SUSTAINMENT OF AIR TRAFFIC CONTROL OPERATIONS

1. Background

Sustained ATC operations are defined as those operations in which sustainable ATC forces have achieved the desired operational capability. They conclude when operations requiring ATC services are terminated. Sustainable ATC operations can occur through multiple venues: continuous military rotation, returning services to host nation responsibility (which may still require US oversight, assistance or support) or through contracted service. Establishing a sustainable ATC capability requires significant planning to ensure appropriate resources are available to meet the JFC's requirements. Sustainment of airfield operations requires long-term ATC support.

2. Sustained Operations

a. **Service Capabilities.** Services can provide VFR and IFR service to all aircraft through mobile control towers, radar systems, and communications connectivity. All forces are limited by the extent they can be re-supplied/maintained. Navy shipboard systems are only limited by the ability of the ship to remain on station, and to maintain the operational health of its systems. Air Force and Marine ATC sustainment equipment is extremely robust and provides complete ATC service to support a theater airbase mission, but requires extensive airlift to deploy. Currently, the Army does not have the capability to provide an approach control, and airfield lighting. However, the Army can provide a fully instrumented airfield, which includes a tower and radar services. Because of these limitations, the Army requires less airlift assets to deploy. The fielding of the Portable Airfield Lighting System (PALS), scheduled to begin in 2005, will provide lighted landing areas on improved or unimproved airfields for fixed or rotary-wing aircraft. Variants of the system will be fielded with the Tactical Terminal Control System (TTCS) and Mobile Tower System (MOTS). As the Army transforms into the interim and objective force, the fielding of new ATC systems will make Army air traffic service (ATS) units even lighter and more capable (see appendix E).

b. **Synchronization.** The planning considerations for a sustained ATC operations phase are the same as for the transition phase. Equipment availability is only one of the major planning factors in determining the airfield/ATC capability. ATC equipment support requirements are critical logistical considerations. Replacement parts and trained maintenance technicians are Service-specific, and often equipment-specific. Sustainable ATC operations require base support to be in place (power, communications, supply, and personnel). Depending on the equipment deployed, setup time will vary from hours to 2 days (in good weather conditions) and then requires a complete flight check. Therefore, plan flight operations requiring a sustained ATC capability to begin no sooner than 3 days after the arrival of sustainment ATC equipment.

c. **Integration.** Determination of an air base's purpose may require joint Service integration. If the base is strictly a single Service location (an Army, Air Force, Marine, or Navy base), then joint Service integration may not be a consideration. However, if multi-Service flight operations will occur, appropriate Service ATC augmentation could be required in the ATC facilities. While English is one of the international flight

languages, working host nation/ATC issues may require a foreign language-qualified individual.

d. Interoperability. Current deployable ATC systems are not fully compatible with other ATC systems. Each Service's equipment has different capabilities. Landlines and radios can provide inter-facility voice communications. The Marine ATC radar system can data link with other tactical air control systems via tactical digital information link (TADIL) B to provide radar surveillance and other information to the theater recognized air picture. However, other Services' data links and procedures do not exist to connect tactical air control systems with deployable ATC systems, or Radar ATC systems with each other. Finally, due to distinct differences between aircraft performance and procedures, planners should request experienced controllers who are current with anticipated traffic types (e.g., rotary-wing, fighter, transport, unmanned aerial vehicle [UAV], etc.).

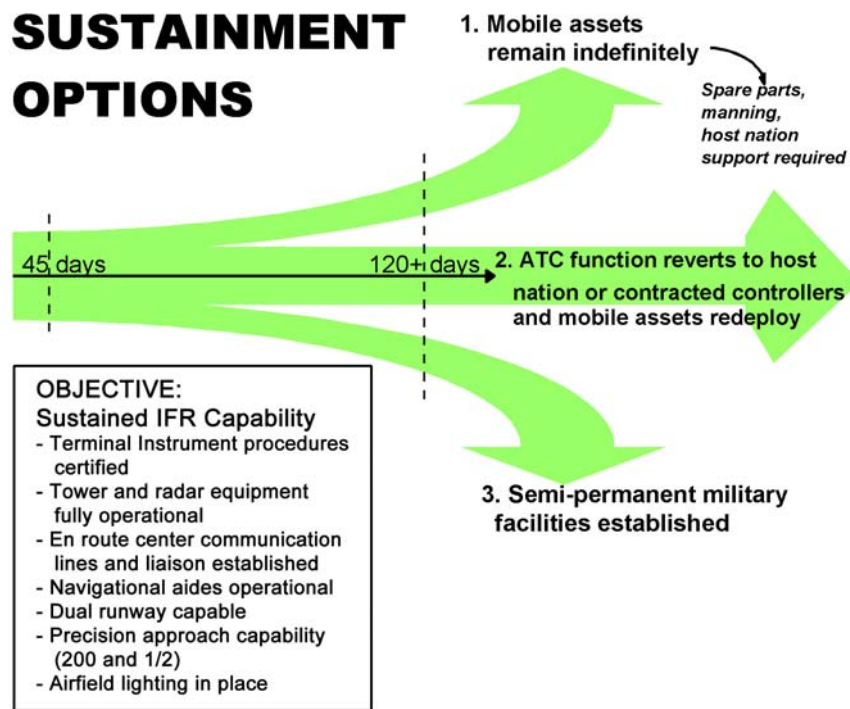

Figure IV-1 Sustainment Options

3. End of Operations

a. Planning considerations. Begin planning for the transition/restoration back to civil ATC services and/or cessation of military ATC operations early and continually throughout operations. Consider coordinating with ICAO, NGO, and JFC planners for the restoration or contracting of ATC services to relieve military ATC units once hostilities end. ICAO should survey airfield and ATC facility infrastructure to determine needed improvements to ensure these facilities will meet ICAO standards and recommended practices (SARPs).

b. Continued responsibility. The sustainment phase does not end when military ATC personnel and equipment are completely redeployed. With host nation or

contracted services, there is still a responsibility of oversight, quality assurance evaluation, procedures review, host nation agreements, etc. The sustainment phase ends when the JFC determines the mission is complete.

c. Draw down. Draw down of operations may require reversing the buildup process and necessitate the second deployment of initial entry ATC assets who are able to operate without base support (for example, Marine MTT, Army TACT, Air Force STT). End of operations will require a handover or phase-out of ATC services. See appendix F for sample handover checklists. The deployed ATC equipment may be redeployed to another location, returned to home station, or even transferred to the host nation as determined by higher authority.

Appendix A

AIR FORCE AIR TRAFFIC CONTROL

1. Doctrine

The Air Force provides ATC services in support of theater tactical combat operations and combat airspace management, similar to what the Service's fixed-base facilities provide in CONUS and overseas. The Air Force ATC is involved in a multitude of missions from combat to military operations other than war (MOOTW). Reserve components play a key role in ATC operations and in some cases could be tasked instead of active duty forces.

2. Forces

The Air Force has 17 DATCALs. Seven systems are located at three Combat Communications Groups (CCG) and 10 systems are located at the Air National Guard (ANG) ATC squadrons across the country. The remaining ATC personnel are dispersed across various units, to include Air Force Special Operations Command's special tactics squadrons, active duty combat ATC units, and DATCALs-augmentees from fixed-based MAJCOM operations support squadrons, and communications squadrons.

a. **Initial Forces.** Air Force STT provides initial ATC capability and executes missions for both SOF and conventional forces/operations. Air Force STS are ground combat forces assigned to Air Force Special Operations Command, Hurlburt Field, Florida. Air Force STT consist of combat control, pararescue, and combat weather personnel who are organized, trained and equipped to establish and control the air-ground interface and provide airmanship skills in the objective area. Combat controllers provide the ATC capability. Combat controllers are parachute and combat diver qualified personnel trained and equipped to quickly establish and control terminal air objectives (drop or landing zones) in austere or hostile environments. They perform reconnaissance, surveillance, and survey and assessment of potential terminal airheads (airfields or assault zones). They conduct ATC, terminal attack control, and initial C2 communications during assault operations. They can also perform limited weather observations and obstacle or ordnance removal with demolitions.

b. **Sustainment Forces.** These forces are comprised of combat communications groups, air national guard/reserve units, fixed base maintainers, and fixed base air traffic controllers. These units/individuals normally provide sustainment ATC after a handoff from STT; however, in some cases, they can provide the initial ATC service at permissible locations.

(1) **Combat Communications Groups (CCGs).** These ACC/SC or US Air Forces Europe Director of Operations units can deploy as either an entire airfield package including tower, TACAN, and radar approach control; or as individual tower, TACAN, and radar packages. The tower and radar UTCs include a limited number of air traffic controllers. All UTCs come with an initial cadre of maintenance personnel. Source ATC augmentees from MAJCOM UTC-tasked fixed base assets to operate. CCGs can provide a full range of ATC service and positive control capabilities (see appendix E).

(2) Air National Guard/Reserve. The ANG units normally deploy as complete squadrons comprised of deployable radar/tower facilities, maintenance, and air traffic controllers. They are aligned under Air Combat Command and provide ATC service and positive control capabilities. Although Reserve units are utilized to support airfield management UTCs, Reserve units do not normally deploy in support of ATC operations.

(3) Fixed Base Controllers. The preponderance of controllers are located at fixed base locations and assigned to facility-specific UTCs designed to support a wide range of ATC taskings. They are identified and trained to support DATCALs, ATC liaison, and combat airspace requirements.

3. Training

a. General Training. The foundation of Air Force controller training process is the ATC technical training center at Keesler Technical Training Center, Biloxi, Mississippi. Upon graduation, apprentice controllers possess basic skills and core knowledge of FAA ATC procedures. These fundamentals and principals are expanded upon in unit training programs and with meeting local unit facility and qualification training requirements. Training requirements for all Air Force controllers are defined in AFI 13-203. SEIs are critical to the Air Force ATC planning process as they can identify controllers who meet the specific ATC qualification requirements at a deployed location (see table A-1). When SEIs are not used, poor utilization of controllers can result in greatly extended training time and degraded service to air operations at the deployed location.

Table A-1 Air Force ATC Special Experience Identifiers (SEI)

<i>Air Force ATC Special Experience Identifiers (SEI)</i>	
Enlisted	
Position	SEI
Tower Controller	056
Tower Watch Supervisor	055
GCA Controller	053
GCA Supervisor	054
Radar Approach Controller	364
Radar Approach Control Watch Supervisor	362
Air Route Traffic Control Center	363
Airspace Management	350
Combat Airspace Management	900
Precision Approach Radar (PAR)	365
TERPS	361
Automation Specialist	376
Officers	
Position	SEI
Airfield Management	OCH
Combat Airspace Management	OCK
Airspace Management	OUL

Table A-2 Air Force Specialty Codes (AFSC) Referenced in JATC MTPP

<i>Air Force Specialty Codes (AFSC) referenced JATC</i>	
Enlisted	
AFSC	Description
1C1	ATC
1C151	ATC Journeyman (“5-level”)
1C171	ATC Craftsman (“7-level”)
1C3	Command Post
2E1	Communications/Electric Maintenance
2E071	Ground radar Systems Craftsman
3A0	Information Management
3C0	Communications/Computer System Operations
Officers	
AFSC	Description
11A3	Airlift Pilot
13M3	Air Traffic Control

b. Advanced Training. The MAJCOMs/numbered air forces should promote “joint” exercises and ensure integration of the DATCALS into training exercises whenever feasible. Exercises should use realistic planning, deployment, and maintenance training for DATCALS UTCs. Field exercises whereby deployable equipment usage and skills are taught are important in the training process to practice how the USAF will fight. UTCs tasked to support DATCALS and combat airspace/liaison positions must be indoctrinated through exercises prior to “real world” deployments if they will be responsible for establishing/managing these systems while deployed.



Figure A-1 Air Force ATC Structure

4. Air Force ATC Duties and Command and Control Relationships

The Air Force ATC system provides service and coordination from CONUS, through en route locations and international airspace, to the bed-down locations for combat aircraft, to aerial ports of debarkation, to forward-deployed austere airfields, and return. While combat and force enhancement aircraft (all Services) usually conduct a singular deployment/re-deployment to the theater, ongoing passenger (flown by both CRAF and military aircraft) and cargo flights comprise the steady stream

transcontinental air traffic. Therefore, the Air Force focuses on both the en route and distant end, deployed ATC service. Requesting additional ATC officers/senior enlisted personnel to serve as liaisons for areas of operations is an important planning consideration.

The theater-based Air Force ATC is aligned primarily within the wing operations center (WOC). Generally, in a JOA, air traffic and airspace C2 systems are integrated under a single combined/joint forces airspace control authority. Since ATC units are subordinate to the WOC, their facilities and personnel (fixed, tactical, and augmented), in some theaters, become a part of the Theater Air Control System (TACS). It is only through this relationship that they are considered part of the TACS. Controllers perform terminal air traffic operations, or liaison/augmentation at host nation control facilities. ATC planning, training, and operating procedures must reflect this concept and any additional mission/roles, prioritized in the Defense Planning Guidance; MOOTW, such as humanitarian relief and disaster response; operational readiness inspections; and test or demonstrations. See figure A-1 for the Air Force ATC structure.

a. En Route Support. Provide a liaison to the FAA and host nation ATC organizations or facilities when deploying large numbers of military aircraft. The Air Force has liaisons in all the FAA regions and a central contingency cell at the flow control office in Washington Center. Part of their function is to ensure enough FAA controllers are available to meet unusual military traffic loads. Additionally, the Air Force has ATC liaisons in several foreign ATC facilities to assist host nation controllers in understanding of US military aircraft requirements/procedures. Furthermore, ATC liaisons can deploy into theater to coordinate with the deployed US ATC units, the CAOC, the host nation ATC system, the US Embassy, the Air Force Air Mobility Command's Tanker Airlift Control Center, and other ATC liaisons to de-conflict air flow problems.

b. Deployed Terminal Locations. At the deployed base the senior Air Force ATC representative, normally the airfield operations flight commander, will coordinate:

(1) Terminal instrument procedure and flight check support.

(2) Any change in airfield status immediately with the CAOC airspace management and ATC specialty team.

(3) Terminal area operation procedures with the base defense operations center for integration into the base air defense and air base ground defense plans and operations.

(4) Integration into the Theater Air Control System IAW CAOC guidance contained in the ACP.

(5) With the host Service for host-provided base operating support to include billeting and messing facilities, fuel, power production, vehicle support, secure communications, and security.

c. Air Force Special Tactics Squadron. Air Force STS forces will normally plan, deploy/employ, and operate as part of a joint/combined force. Air Force STT usually deploys to the intermediate staging base (ISB) for joint employment into the AO or target area; however, units may employ directly from home station if required. See figure A-2 for the STS forces C2 structure.

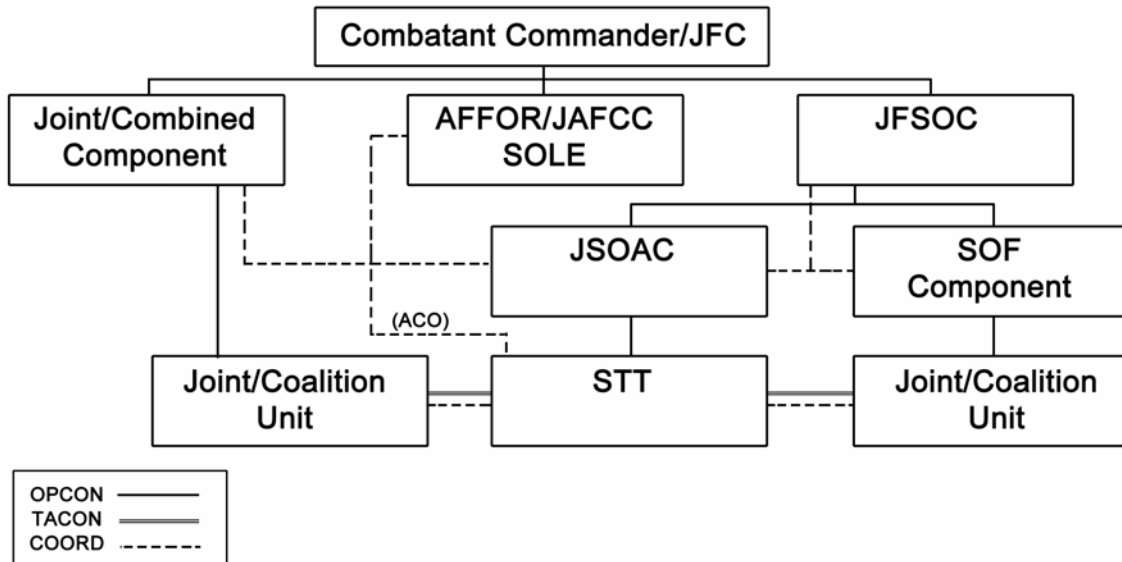

Figure A-2 Special Tactics Squadron C2 Structure (SOF JATC)

5. Future Plans

a. Global Mobility Task Force Initiative and Force Module Initiative. The Air Force is undergoing structural changes that will improve its ability to conduct force beddown for contingency operations. This includes Global Mobility Task Force and Force Module initiatives that will improve the transition phase from the STS mission to the sustainment mission. To replace the STS mission, the task force is establishing a short-notice deployment capability to stand up IFR flight operations within 72 hours. To relieve the task force, the Force Module initiative is establishing a force beddown package required to sustain flight operations for the long-term. This sustainment mission could consist of activating ANG assets, combat communication groups, MAJCOM contingency response units, the development of a squadron specifically designed to provide full airfield operations support at a bare base, or an expeditionary airfield operations squadron.

b. Expeditionary Airfield Operations Squadron. The Air Force is evaluating the possibility of creating expeditionary airfield operations squadrons. These squadrons would be built by consolidating DATCALs from Air Mobility Command and Air Combat Command's Combat Communications Groups' Airfield Systems Flights into a new squadron structure that provides a focused management of airfield operations equipment and robust force module support. The squadrons would consist of DATCALs (radar systems, towers and NAVAIDS) airfield lighting, weather equipment, and a combat-ready pool of deployable airfield operations personnel (airfield manager, air traffic controllers, DATCALs maintainers, TERPS, civil engineers, airfield support

personnel, and weather specialists). Personnel would require specialized training through establishment of a combat skill training course and exercise participation. Most personnel assigned to these squadrons would be attached to a wing in peacetime. During contingencies, they would return to the squadron, as required, to establish a squadron to deploy in the Force Module construct. The new squadron structure would provide a fully trained and easily deployable contingency response force. This future proposal does not affect Air Force Special Tactics ATC personnel or their structure.

6. Deployed locations

Host nation regulations and procedures apply to Air Force controllers who augment a civil or foreign ATC facility. In addition, Air Force controllers who augment a host Service facility will comply with the procedures of the host Service branch (See Air Force Doctrine Document 2-1.7, *Airspace Control in the Combat Zone*, May 2001).

7. Air Force ATC Points of Contact

a. Air Force Flight Standards Agency: Andrews AFB, MD. DSN 857-2155 or Commercial (301) 240-2155.

b. 720 Special Tactics Group: 223 Cody Ave, Hurlburt Field, FL, 32544.
DSN 579-3706, Commercial (850) 884-3706.

Appendix B

ARMY TACTICAL AIR TRAFFIC SERVICES

1. Mission

Army ATS units are a strategic asset with a global mission. Today's ATS tasks include TACT operations, force projection airfield operations, and battlespace trafficability operations. ATS units, both active and reserve, provide a full range of fixed-based and tactical services before, during and after deployment of forces in support of Army, joint, and Multinational Operations. Army air traffic service units promote safe, flexible, and efficient use of airspace. ATC units also enhance air operations for ground force initiatives, and are responsible for conducting Army Airspace Command and Control (A2C2) and ATS.

2. Doctrine

Army ATS are an extremely important function in the synchronization of combat power. ATS tasks will endure to provide the full range of fixed-based and tactical services before, during, and after deployment of forces in support of Army, joint, and Multinational Operations. Army will remain the core enabler for A2C2, ensuring synchronized access of the increasingly congested joint airspace. ATS tactical units function as an integral element of joint, multinational, and interagency forces. As a tailored force, ATS supports the Army during all phases of operations. ATS tactical units coordinate airspace requirements, provide an interface for airspace coordination during execution, and provide a terminal (VFR/IFR) instrument recovery airfield capability. ATS battalions provide real-time situational awareness and airspace information services to support flight following, national assistance, airspace coordination, and A2C2 interface throughout the force projection stages. Army ATS Tactical Aviation Control Teams are specially trained and equipped to deploy into austere environments to establish assault zones with ATC capabilities, emplace en-route and terminal navigations aids, and perform limited Army Airspace Command and Control.

3. Army Air Traffic Controllers Training

Initial training for Army air traffic controllers is conducted at Fort Rucker, Alabama. Upon completion of initial training, a graduate is qualified for worldwide assignment to a fixed base tower, GCA radar, or a tactical ATC unit. FM 3-04.303 covers the requirements and qualifications of individuals completing this training. The individual qualification and skill identifiers are listed in table B-1.

Table B-1 Army ATC Skill Identifiers

Qualification – Officers	Army Skill Identifier
ATS Group Commander	15B Colonel
ATS Battalion Commander/LNO/Staff	15B Lieutenant Colonel
ATS Group/ Battalion XO/S-3/Staff	15B Major
ATS Company Commander/LNO/Staff	15B Captain
Qualification – Enlisted	Army Skill Identifier
Aviation Operations Sergeant/Sergeant Major	**93P50 (E-8, E-9)
ATS Platoon Sergeant/Facility Chief/A2C2 LNO	*93C40 (E-7)
Facility Chief Tower, Radar, AIC	*93C30 (E-6)
Shift Leader Tower, Radar, AIC	*93C20 (E-5)
Air Traffic Controller Tower, Radar, AIC	*93C10 (E-1-E-4)
NOTE: *93C10--93C40 becomes 15Q10 –15Q40 in FY04 **93P50 will become 15P50 in FY04 F7 Pathfinder, Q8 Airspace Management, and 2S Battlestaff are additional skill identifiers that all enlisted personnel above may also have	

4. Organization

Army tactical ATS forces consist of a combination of active, reserve component, and multi-component units. Current force structure consists of two ATS Groups and four ATS Battalions. Army ATS units are located in CONUS, European, and Pacific Theaters.

a. Air Traffic Services Group. The Air Traffic Services Group consists of a headquarters company and air traffic services battalions. There are currently two ATS Groups-164th ATS Group and the 204th ATS Group.

(1) Overarching responsibilities include:

(a) C2 of all theater Army ATS assets.

(b) Advising the ARFOR commander on airspace/ATC implementation and employment.

(c) Implementing the ARFOR commander’s guidance. Providing liaison teams to the CAOC (J3-Air), the BCD at the CAOC, and the CRC (theater support company) to perform ATS and A2C2 planning and coordination.

(2) ATS Group C2. The group headquarters exercises command, control, and supervision of all subordinate ATS battalions; functions as a coordination center for logistical, personnel, and administrative actions; provides staff planning for group operations; and supports airspace management operations. It also provides A2C2 liaison to the joint Services BCD and the land component command G-3 cell.

b. Air Traffic Services Battalion. The ATS battalion normally consists of a headquarters company and three or more ATS companies. There are four ATS Battalions: 1-58 ATS Battalion, 3-58 ATS Battalion, 1-245 ATS Battalion, and 2-114 ATS Battalion. Each battalion consists of ATS companies responsible for providing forward ATS support, airspace information center operations, instrumented airfields and army airspace command and control operations. Each battalion variation is

uniquely configured to support a particular EAC, corps and/or division. The companies are corps units but are habitually aligned with the appropriate echelons. The ATS battalion furnishes an A2C2 liaison team to the EAC, corps, and division A2C2 element.

(1) Overarching responsibilities include:

(a) Advising corps/division commanders on airspace/air traffic implementation/employment.

(b) Implementing corps/division commanders' guidance.

(c) Providing LNO team to Corps A2C2 element.

- Responsible to G-3 Air.
- Integrates activities within A2C2 element.
- De-conflicts, synchronizes, and integrates all airspace users.
- Represents air traffic requirements to corps, BCD/AOC, and CRC.
- Disseminates ACP and ACO/SPINS as required.

(d) Publishes Aviation Procedures Guide for JOA.

(e) Provides quality assurance (QA) for ATS ratings, standard, procedures, TERPS and training.

(f) Reviews and forwards terminal instrument procedures developed by subordinate elements through A2C2 elements to AOC for integration in joint procedures.

(g) Coordinates Army ATS locations, capabilities, and status.

(2) ATS Battalion C2. The ATS battalion headquarters provide command and control, supervision, and staff planning for all organic units. At Corps level, the ATS battalion is employed in support of Corps operations with companies in direct support of a division, the corps, and the theater area of operations.

c. Air Traffic Services Company. The ATS company provides air traffic services to division, corps, EAC, and/or communication zone AO. There may be slight variations of each battalion organization and capabilities based on the echelon that it supports.

(1) Overarching responsibilities include:

(a) Implementing battalion commander's guidance.

(b) Providing inputs to corps/division planning.

(c) Providing liaison team to division A2C2 element.

- Responsible to G-3 Air.
- Integrates activities within A2C2 element.
- De-conflicts, synchronizes, and integrates all airspace users.
- Represents air traffic requirements to corps, BCD/AOC, and CRC.
- Disseminates ACP and ACO/SPINS as required.
- Coordinates Army ATS locations, capabilities, and status.

- (d) Providing tactical terminal control teams.
- (e) Providing instrumented tactical airfields.
- (f) Airspace information services.

(2) ATC Company Missions. The ATC company provides en route air traffic services and NAVAIDS for the distribution of timely airspace management information for divisional, corps, and/or theater aircraft, A2C2, tower services, ground controlled approach (GCA) services, airspace information services and terminal NAVAIDS to sequence arriving and departing flights. The ATS company is organized with a headquarters platoon, terminal control platoon, and airspace information platoon. The company headquarters provide command, control, and coordinate activities of the ATS company. It also provides an A2C2 element to division and corps headquarters. The A2C2 element deploys with the supported division A2C2 element and serves as the A2C2/ATS subject matter expertise to the division/corps. The A2C2 element consist of 4 personnel: two 15B O-3s and two 93C40 E-7s. They perform the A2C2 planning and execution using the AN/TSQ-221 Tactical Airspace Integration System (TAIS) vehicle. See figure B-1 for A2C2Cell organizational structure. Additionally, the EAC ATS company provides an A2C2 liaison team to the theater's CRC.

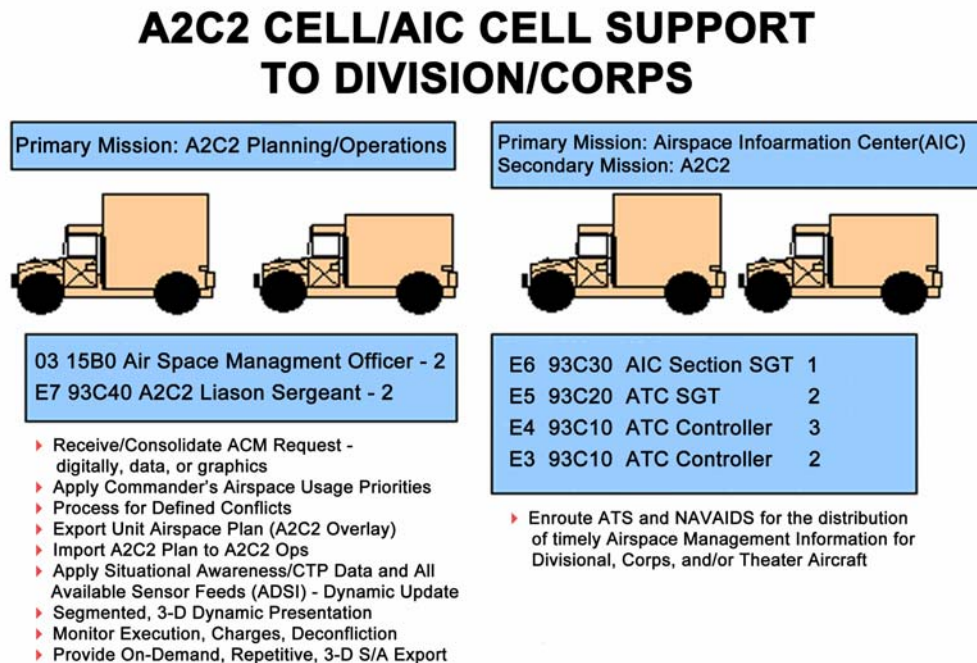

Figure B-1 A2C2 Cell/AIC Cell Support to Division/Corps

5. Communications Architecture

a. Command, Control, Communications, and Computers (C4) Requirements (group/battalion). Command and control is vital in the synchronization of Army ATS operations.

(1) ATS group/battalion commanders and staff must be able to communicate with their subordinate battalions/companies and separate companies.

(2) ATS units must be able to communicate with local airspace authorities and host-nation airspace infrastructures using telephones and radios.

(3) Army ATS units have certain C4 requirements that support the force with real-time airspace information. These requirements enhance the synchronization of combat power.

(a) ATS Battalions are responsible for coordinating with their sister battalions and parent group to ensure there is positive control and coordination of the airspace throughout the theater.

(b) Radio normally is the primary means of internal and external communications.

- ATS units require FM, dual HF for simultaneous voice and data transmission and reception, UHF, VHF, common-user systems, and internal wire to expedite command and control.

- The group and battalion also requires UHF-FM demand-assigned multiple access satellite communications intelligence and weather broadcasts. Satellite communication (SATCOM) serves as the non-line-of-sight (NLOS communications HF) backup means of communications.

- The dual HF requirement also supports the air coordination A2C2 net (ground-to-ground) and NLOS requirements for ground-to-air. Additionally, ATS requires one primary SATCOM Net to pass critical flight information among airspace control elements and also pass safety of flight information to aircrews transitioning throughout the theater area of operations (AO) (Theater Airspace Information Net).

b. Army tactical ATS architecture overview. See figure B-2.

c. ATS communications capabilities. See table B-2.

Tactical ATS Architecture

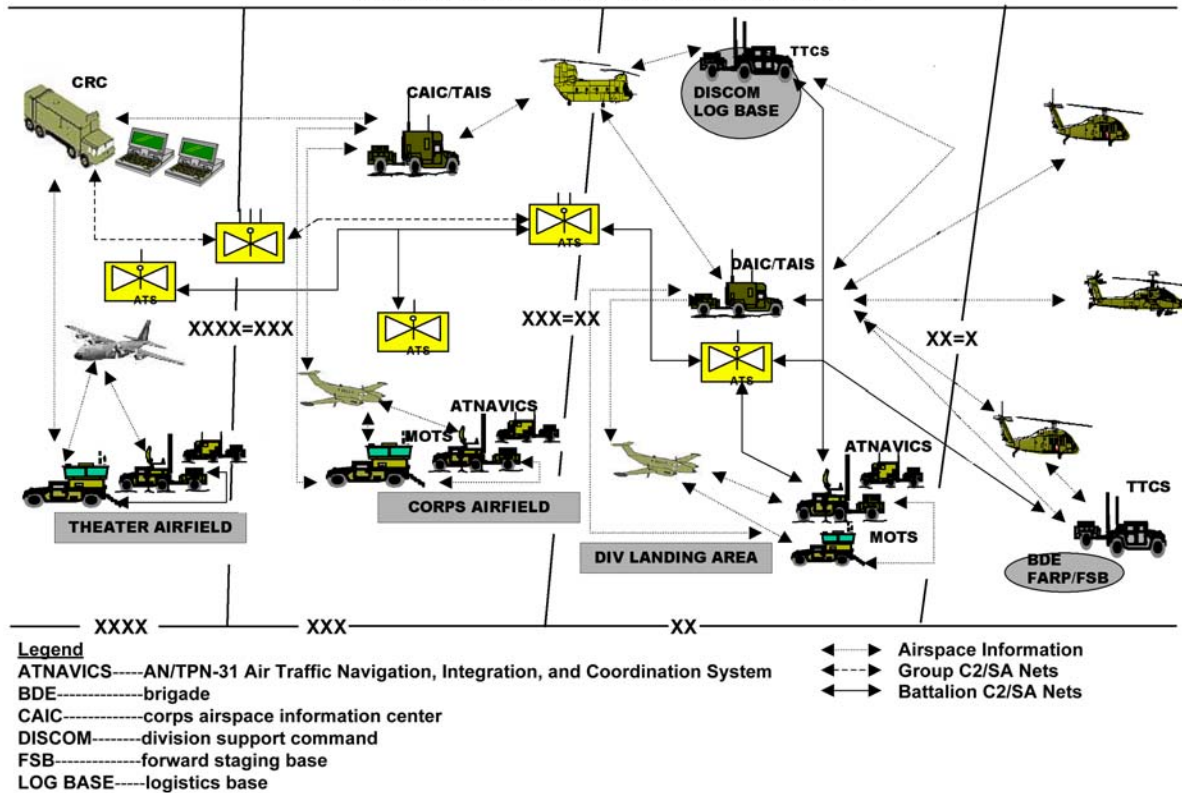

Figure B-2 Army Tactical ATS Architecture

Table B-2 Army Communications Capabilities

Army Communications Capabilities						
Equipment	ATS GP	ATS BN	TAIS	TTCS	ATNAVICS	MOTS
AN/VRC-90F SINGARS	X	X	X	X		
AN/VRC-92E SINGARS	X	X	X	X	X	X
AN/VRC-83 Have-quick radio set	X	X	X	X	X	
AN/ARC-220 HF Radio set		X	X	X		X
TADIL A, HF (95-S)			X			
SATCOM, UHF (PSC-5)	X	X	X	X		
AN/PRC-117, VHF						X
UHF/VHF COMM (URC 200)			X			
AN/VSQ-2 EPLRS Radio Set	X	X	X			
Secure telephones	X	X	X		X	X
GPS	X	X	X	X	X	X
FAAD			X			
ABCS	X	X	X			
TBMCS			X			

6. Tactical ATS Points of Contact

- d. Doctrine /Training. USAAVNC; ATZQ-TDS; Ft Rucker, AL 36362; DSN 558-3320
- e. School. 93C School. 1-13th Aviation Battalion; ATZQ-BDE-E; Ft Rucker, AL 36362; DSN 558-1314
- f. Organization. USAAVNC; ATZQ-CDO; Ft Rucker, AL 36362; DSN 558-2220
- g. Material. USAAVNC; ATZQ-CDM; Ft Rucker, AL 36362; DSN 558-9568
- h. Soldier. USAAVNC; ATZQ-AP; Ft Rucker, AL 36362; DSN 558-3423
- i. Command. ATS Command (Provisional); AFATS-C, Ft. McPherson, GA 36330; DSN 367-2272

Appendix C

MARINE CORPS AIR TRAFFIC CONTROL

1. Doctrine

The Marine Corps organizes its forces for employment by integrating four functional elements: ground combat, aviation combat, combat service support, and command into one cohesive task force, the Marine air-ground task force (MAGTF). A MAGTF can range in size from small special purpose units to large Marine expeditionary forces (MEFs). The MAGTF is organized to meet the continuing demands of modern combat by integrating a diverse array of assets under the control of a single commander.

a. The aviation combat element (ACE). The ACE adds a unique capability and dimension to the MAGTF by dramatically increasing its firepower, mobility, and area of influence. This common theme links the six major functional responsibilities of Marine aviation and establishes the foundation for aviation support. The Marine Air Command and Control System (MACCS) provides units required to command, control, and communicate within the ACE. Marine ATC functions as a critical part of the MACCS operating as the principal terminal control agency at airfields and assault zones.

b. Marine ATC. Marine ATC provides initial, transition, and sustained air traffic support for joint and MAGTF air operations in any environment. Depending on the scope of operations, it is often necessary to establish ATC service at a main air base, air facility, and air site but also at assault zones, a FARP, rapid ground refueling (RGR) points, and laager points.

(1) Support Operations. Marine ATC is capable of deploying and operating independent of the MAGTF, joint force, or JTF to provide ATC support for various types of operations. Examples of this type of ATC support include:

(a) Providing ATC service to assist humanitarian efforts and military operations other than war (MOOTW).

(b) Assisting other joint/allied Services with air traffic operations.

(c) Supporting intergovernmental ATC requirements.

(d) Airspace/ATC liaison to host nation and civil ATC agencies.

c. MACCS. The employment of a MAGTF requires the close integration of air and ground force operations. The MAGTF commander employs the MACCS to monitor, supervise, and influence ACE air operations. The MACCS is not a piece of hardware but rather an integrated group of C2 agencies. The MACCS provides the ACE commander with the air C2 support facilities and infrastructure necessary to command, coordinate, and control air operations within an assigned area of operation or airspace sector and to coordinate MAGTF air operations with other Services. Principal MACCS agencies are provided, operated, and maintained by a Marine air control group (MACG). See figure C-1.

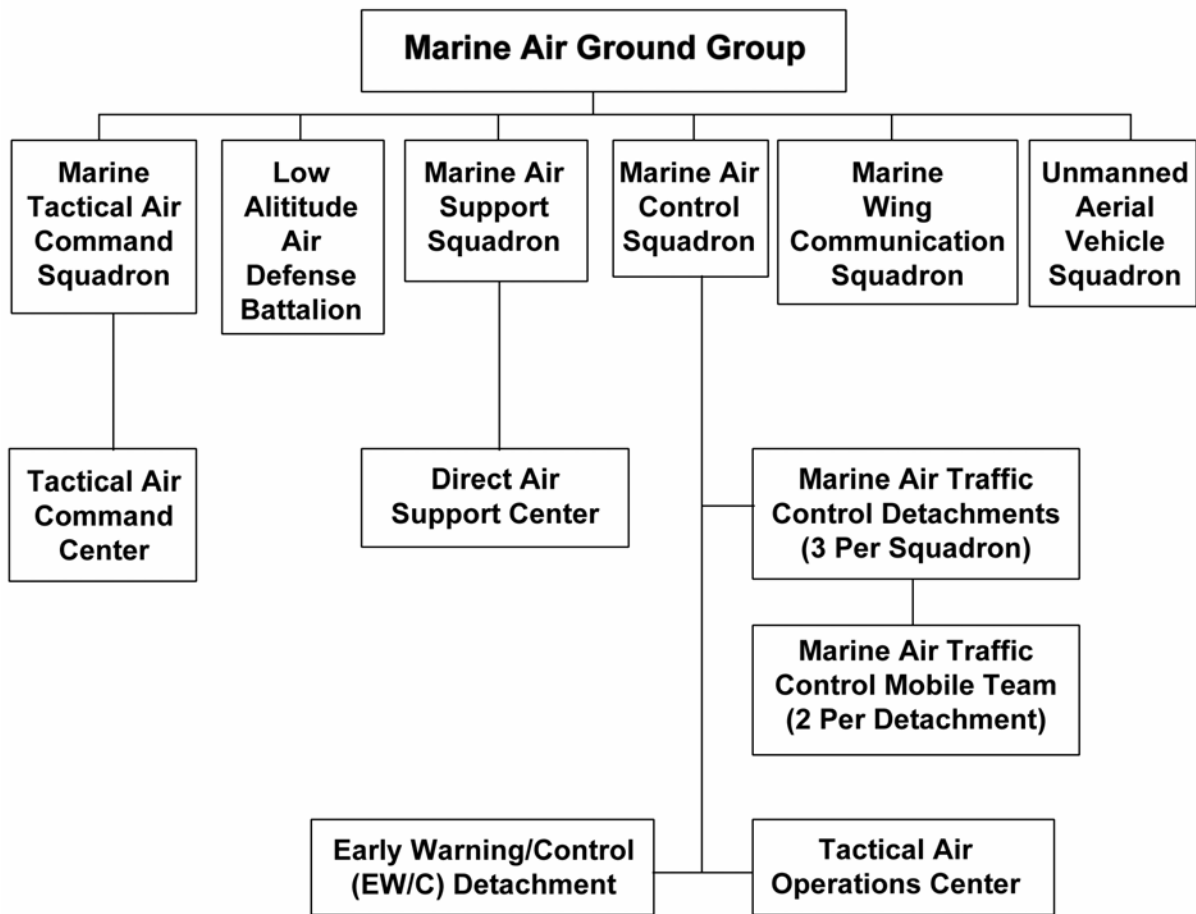

Figure C-1 Marine Air Control Group Subordinate Agencies and Detachments

(1) When deployed within the traditional MAGTF, the ATC detachment provides critical airspace and ATC services as a part of the MACCS. The MACCS gives the ACE commander the ability to exercise centralized command and decentralized control of MAGTF air assets and operations. The MACCS allows interface of MAGTF air with joint or combined operations. The MACCS is an air C2 system, which provides the ACE commander the means to command, coordinate, and control all air operations within an assigned sector as directed by the JFC. It allows the ACE commander to coordinate air operations with other Services. See figure C-2.

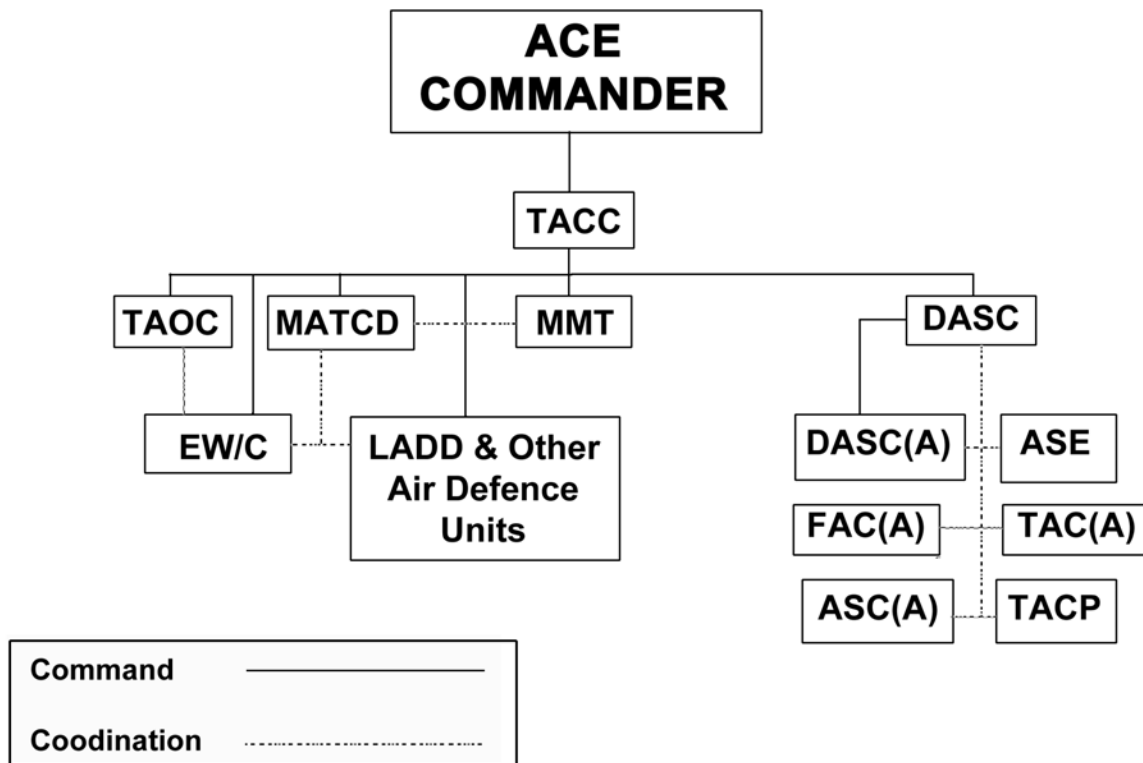

Figure C-2 Marine Air Command and Control System (MACCS)

(2) The Marine ATC detachment (MATCD). The MATCD is the principal terminal ATC organization within the MACCS. Three MATCDs are structured to operate as subordinate elements of the Marine Air Control Squadron (MACS). There are eight active duty and one reserve MATCDs. Each MATCD is organized and equipped to provide continuous all-weather ATC services to an independent and geographically separated main air base or air facility and/or remote air site or point. The MATCD also functions as an integral part of a MAGTF Integrated Air Defense System (IADS) by providing its surveillance radar information to other units through tactical digital information links (TADIL) and participating in air defense operations. Marine ATC equipment is maintained by MATCD personnel and supported by NAVAIR.

(a) If deployed independently in a joint environment, MATCDs will operate as a part of the theater's command and control system in accordance with the ACP and ACO. If deployed as a part of the MACCS, MATCDs will fulfill their traditional role of supporting MAGTF air operations. Regardless of who is being supported, Marine ATC will operate in accordance with FAA, ICAO, host nation, Service specific, and joint directives.

(b) The MATCD's assigned mission and supporting task organization determine the ATC element's exact crew requirements. The MATCD is headed by a detachment commander who coordinates detachment activities and supervises the detachment's ATC watch officers. Watch officers are crew managers. ATC crews are operationally organized into command, radar control, and tower control sections.

- Command section. The command section supervises and coordinates each MATCDs' activities. It is composed of an ATC watch officer, a radar supervisor, and a tower supervisor.
- Radar control section. The radar control section is responsible for the management of assigned/designated airspace and is composed of an approach controller, an arrival/departure controller, final controller(s), and a data link/flight data coordinator. The radar control section conducts radar ATC, transmits information via data link or voice crosstell (coordination) to other air control agencies, supervises MATCD execution of the emission control (EMCON) conditions set by the Marine tactical air command center (TACC), and employs electronic protection measures as appropriate.
- Tower control section. The tower control section is responsible for the control of friendly aircraft operating within the tower's assigned airspace. This airspace is typically limited to an area that can be visually observed and surveyed from the tower, approximately a 5-mile radius from the airport up to an altitude of 2,500 feet above ground level. The tower control section is also responsible for air and vehicular traffic operating on runways, taxiways, and other designated areas of the airfield. The tower control section is composed of a local controller, ground controller, and a flight data operator.

(c) Detachment organization. Each detachment is organized to provide the MAGTF with two MMTs. The MMT is a task-organized sub-element of the MATCD. Normally the lead element in establishing initial ATC service, the MMT is responsible for rapidly establishing and controlling tactical landing zones (TLZs) for fixed-wing aircraft, helicopter landing zones (HLZs) for rotary-wing aircraft, and vertical/short takeoff and landing aircraft in remote locations under both VMC and IMC. MMTs also deploy independently of the MATCD while assigned with a special operations capable MEU(SOC) or in support of MAGTF/joint operations/exercises.

2. Capabilities

a. Air Traffic Control. Detachments may be tasked to provide ATC services for any joint, coalition, or MAGTF air operation. In addition, Marine ATC personnel can provide airspace and air traffic liaisons for critical billets within the joint staff, air operations center, or host nation/civil ATC system.

b. Air Defense. The MATCD plays a critical role in air defense and command and control. Utilizing TADIL B, the ATC detachment participates in the theater recognized air picture by providing surveillance radar coverage out to 60 nm. Additionally, the MATCD operates in close coordination with air defense units to provide for a base defense zone. Utilizing the TPS-73 radar system and a composite radar picture from other theater radar surveillance assets, Marines work closely with air defense units to provide radar cueing for early engagement of enemy aircraft.

c. Marine Liaison Officers. MARLOs are one of the most important elements of both airspace planning and control provided to the CAOC and other key organizations. In accordance with JFACC/AADC/ACA directives, MARLOs at the CAOC will affect the largest portion of the control and coordination relative to Marine Corps ATC issues. As issues come up the chain of command (warfighting), the MARLO has the ability to

coordinate ATC issues as part of or directly with the airspace control cell within the CAOC.

d. TERPS. Each MATCD and Marine Corps air station employs fully certified TERPS specialists. Detachments are capable of conducting detailed site surveys, and producing terminal instrument procedures for airfields worldwide. Instrument procedures are submitted and approved in accordance with FAA regulations and are flight certified in accordance with FAA Order 8200.1A (NAVAIR 16-1-520).

3. Functions

The MATCD functions as an integral part of the MAGTF's airspace management and air defense networks. In the accomplishment of its mission, the MATCD:

a. Provides control tower, radar, and non radar approach/departure control services within its assigned airspace.

b. Provides precision and non precision NAVAIDS.

c. Provides ground control approach and automatic landing system approaches under all-weather conditions.

d. Displays and disseminates appropriate air and ground situation information to designated higher and adjacent air C2 agencies to include Marine TACC, tactical air operations center (TAOC), DASC, and low altitude air defense units while functioning as an integral element of the MACCS. This information may also be provided to joint/combined C2 agencies as the mission dictates.

e. Serves as the operational liaison between the MAGTF and national/international ATC agencies.

f. Coordinates the activation of the airfield base defense zone (BDZ).

g. Provides airspace control, management, and surveillance within its designated airspace sector.

h. Provides navigational assistance to friendly aircraft, to include en route ATC services.

i. Interfaces with the MACCS, other military air control agencies, and/or civilian agencies/authorities, as necessary.

j. Provides required ATC services in support of MAGTF operations.

k. Provides personnel to the survey liaison reconnaissance party (SLRP) team to ensure MATCD siting criteria and TERPS are considered and addressed during the site survey.

4. Employment

The MATCD can be task organized to meet any number of different contingency operations. The ATC services required at a forward operating base (FOB) will dictate the specific number of personnel and types of equipment necessary to support the mission. While a particular MATCD configuration may normally be associated with a Marine Expeditionary Force (MEF), Marine Expeditionary Brigade (MEB), special

purpose MAGTF , or MEU(SOC), the specific requirements for a given tactical situation will dictate the actual configuration suitable for mission success.

a. Each MATCD is capable of providing the full range of terminal ATC services. Primary employment options may include, but are not limited to:

(1) Full Service MATCD. This detachment is designed to support continuous all-weather ATC services at a main air base. Services provided by these detachments typically include-control tower, tactical air navigation (TACAN), radar approach, and arrival/departure control, precision/non precision, and instrument approaches. Each detachment also maintains the capability to survey, and create TERPS.

(2) Tower and TACAN Detachment. This detachment's capabilities focus on providing all-weather ATC services at a designated site. Services provided by these detachments include control tower and TACAN instrument approaches and departures.

(3) Marine MMT. The MMT is trained and equipped to provide initial rapid response ATC, and command, control and communications in support of MAGTF and joint missions. The MMT's small logistic footprint is conducive to rapid site establishment and retrogrades. The MMT is equipped to operate for 72 hours without resupply or augmentation. It is capable of supporting a variety of ATC missions as an independent unit or as a part of a larger force in joint/multinational operations. Like all Marine air traffic operations, the MMT provides FAA certified ATC specialists who have been uniquely trained in rapid tactical ATC operations. The MMT can provide positive and procedural ATC services up to 40 nm from a TLZ using portable NAVAIDS. The MMT is specifically designed for insertion into remote locations to support MAGTF and joint air operations. Common methods of insertion include:

(a) Tactical Vehicle. To facilitate movement of personnel and equipment to the air point, each MMT is equipped with a high mobility multipurpose wheeled vehicle (HMMWV). Normally, all MMT personnel and equipment will fit within a single HMMWV.

(b) Air Insert. Air insert operations deliver the MMT to their assigned air point by fixed- or rotary-wing aircraft. During these operations, the MMT is typically inserted with the first air element into the objective area. The early establishment of ATC service at the air point ensures that all succeeding aviation elements have ATC and navigational guidance available, thus enhancing the safe and expeditious flow of air traffic into and out of the air point and surrounding airspace.

(4) The MMT is typically task organized to provide ATC services for airfield seizures, noncombatant evacuation operations, humanitarian/civil assistance operations, MOOTW, and opposed entry operations as a part of a larger force. The MMT is specifically trained and task organized to:

(a) Recommend/assist in Assault Zone (TLZ/HLZ) site selection. Determine each site's operational suitability for both numbers and types of aircraft.

(b) Conduct TLZ/HLZ and assault zone surveys. Surveys determine the suitability of the landing surface for operations, annotate hazards to aviation to include obstructions /obstacles, and to provide operational data.

(c) Mark and operate Assault Zones (TLZ's/HLZ's) for fixed and rotary-wing aircraft.

- (d) Provide terminal NAVAIDS and beacons.
- (e) Coordinate with civil and military control agencies.
- (f) Establish ground-to-air and ground-to-ground communications to link austere sites with higher and adjacent command and control agencies.
- (g) Provide ATC services at designated Assault Zones (TLZ/HLZ's) to include formulating ATC procedures, and issuing clearances, instructions, and advisories to effect safe, orderly, and expeditious movement of air traffic in their assigned airspace.
- (h) Provide positive control of personnel and equipment within the FOB, air site, air point, FARP, RGR, or lager area.
- (i) Establishing a terminal control area around each Assault Zone (TLZ/HLZ) and controlling all air traffic within this area under VFR and IFR conditions. This task may be extended to include procedural control services.
- (j) Developing terminal instrument procedures for Assault Zones (TLZs/HLZs).
- (k) Providing limited weather observations and information.
- (l) May act as the Air Boss if an aviator is not available.

5. Expeditionary operations

a. Units supported by ATC. Coordination of MAGTF air operations during MEF-sized operations requires a considerable amount of ATC support. Typically, the MAGTF bases all ATC support upon the number of FOBs from which Marine aircraft are operating. Normally, three full MATCDs will deploy in support of a MEF to provide continuous, all-weather ATC services at up to three main air bases. The three detachments can also field two MMTs (six total) to provide limited ATC services at air facilities or air sites as required. Two MATCDs normally support the forward element of a MEF or MEB. The two detachments can provide continuous, fully capable ATC services at up to two main air bases and four MMTs for ATC support at four air facilities or air sites. A special purpose MAGTF is normally supported by a task-organized MATCD ranging in capability from an MMT to a full MATCD. Its mission and tasks are situational dependent. Limited ATC services are typically provided to the MEU(SOC) by one MMT. The MMT's mission and tasks are dependent on the situation.

b. The MAGTF commander. The commander uses MAGTF aviation to assist efforts in support of the amphibious task force, the naval expeditionary force commander, or the JFC in preparing and defending the battlespace. In its most common employment, the MATCD will operate in support of expeditionary operations ashore. Each MATCD has the capability of supporting two remote air sites or points with MMT's.

(1) MATCD. The detachment has a full range of ATC capabilities to include air surveillance radar, IFF, automatic carrier landing system radar, communications, NAVAIDS, and control towers. This equipment provides a MATCD with positive airspace control capabilities out to 60 nm from a main air base using radar control procedures and out to the limits of MACTD designated airspace using non radar procedures (procedural control).

(2) Elements of the MATCD. Elements of the MATCD, notably the MMT and liaison officers, may be among the first MACCS air control capabilities introduced ashore. MMTs used in either a stand-alone role or as a precursor for a buildup for a larger MATCD are initially established to coincide with initiation of FOB air operations or short duration aviation operations. As required, phase additional ATC capabilities into the amphibious objective area (AOA)/AO to provide additional, continuous ATC services for Marine, joint, and allied Service aircraft operating from AOA/AO airfields. In situations where MAGTF aviation elements are forward based at an allied nation's airfield located in proximity to the AOA/AO, assign MATCD personnel as liaisons to the host nation's ATC administration. With the introduction of ATC radars into the MAGTF/joint Force's AO, the MATCD will coordinate for the requisite voice and data links necessary to contribute to the force's IADS through the Marine/joint sector air defense facility (SADF) , or as may be designated by the JFACC.

6. ATC Detachment Equipment

Expeditionary equipment. The MATCD equipment consists of the Marine Air Traffic Control and Landing System (MATCALs), NAVAIDS, ATC towers, mobile electric power, and maintenance shelters. MATCD equipment is deployed by conventional ground, rail, air, and sealift means. Additionally, Marine CH-53E helicopters can transport all MATCD equipment. All MATCD radars and communications-electronics shelters are considered oversized cargo. A principal concern, when deploying the MATCD, is ensuring that adequate transportation and materials handling equipment are available to support the carriers loading and off loading, movement to the site, and equipment emplacement.

a. Marine Air Traffic Control and Landing System. The MATCALs provides continuous radar approach, arrival/departure, and en route ATC capabilities. MATCALs collects, evaluates, and displays air track data and disseminates information to other air control agencies. MATCALs consists of three subsystems: AN/TPS-73, ATC subsystem, AN/TPN-22; all-weather landing subsystem; and the AN/TSQ-131, control and communications subsystem. A description of these systems and a variety of other MATCD systems and equipment are contained in appendix E.

b. Marine Air Traffic Control Mobile Team equipment. The equipment assigned to MMT is either man portable or highly mobile via HMMWV. The equipment can be deployed to mark and control runways for fixed-wing and landing zones for rotary-wing assets. This equipment includes portable airfield lighting, UHF/VHF/HF/SATCOM communications, NAVAIDS, and portable beacons.

(1) Core Package. The core package can provide ATC services for 72 hours without resupply or augmentation. This package includes 6 personnel, HMMWV, NAVAIDS, portable radios, and portable airfield lighting. Resupply of consumable items is required after 72 hours. This package can be deployed in several different configurations dependant upon the mission.

7. Training and Proficiency

Marine ATC personnel control aircraft at Marine Corps Air Stations maintaining their controlling proficiency through daily air operations. Marine Corps Air Stations, and MATCDs, work closely together to provide controllers with tactical training on

expeditionary equipment and procedures. Upon commencement of hostilities or assignment to an operation or exercise, controllers detach from Air Stations and are assigned to their tactical units. Through this unique relationship, MATCDs and MMTs are manned with fully qualified and FAA certified ATC personnel. See qualifications in table C-1. The following list supplies a synopsis of controller training, but is not all-inclusive.

a. Air Traffic Controller Course. Marine air traffic controller training is conducted at Naval Air Technical Training Center Pensacola, Florida, in the Air Traffic Controller “A” Course. Basic ATC trainees receive 16 weeks of training. The trainees receive the basic skills and knowledge required to perform routine duties in the control and handling of aircraft in a tower and radar environment in accordance with FAA standards. Officers receive a basic introduction the MACCS, and ATC management issues.

b. MATCALs Basic Operators Course. This is a 1-week course that provides Marine ATC personnel with familiarization training on the MATCALs following entry level schooling. Marines receive instruction on the operation of MATCALs equipment and are introduced to the mission and structure of Marine aviation.

c. ATC On-The-Job Training. Upon successful completion of this course, personnel are assigned to an ATC facility, or a MACS for reservists assigned to the 4th Marine Air Wing, New Orleans, Louisiana. At their assigned duty station, enlisted personnel receive further training and become qualified for MOS 7257 Air Traffic Controller Basic, MOS 7252 Air Traffic Controller- Tower, MOS 7253 Air Traffic Controller-Radar, MOS 7254 Air Traffic Controller-Radar Approach and officers become qualified for MOS 7220 Air Traffic Control Officer. This training combines on the job training and formal instruction.

Table C-9 Marine ATC Military Occupational Specialties (MOS)

Qualification	Marine MOS
Air Traffic Controller Basic	7257 (enlisted)
Air Traffic Controller- Tower	7252 (enlisted)
Air Traffic Controller-Radar	7253 (enlisted)
Air Traffic Controller-Radar Approach	7254 (enlisted)
Air Traffic Control Officer	7220 (officer)

d. Advanced Radar ATC Course. Selected air traffic controllers receive nine weeks of training in Course C1, Advanced Radar ATC (ARATC). This phase of training provides students with the skill and knowledge to perform at a basic level as radar approach controller at all operating positions at a radar approach facility.

e. MATCALs Advanced Operators Course. This is a four-week course that provides senior Marine ATC personnel with comprehensive training on the employment and operation of MATCALs. Students receive instruction on the operation, capabilities, and limitations of the MATCALs. Students are also instructed on developing/designing US Standard TERPS.

f. Marine MMT Leaders Course. This is a six-week course that provides Marine officers and mid-level enlisted personnel comprehensive training in tactics and employment of MMT. Students receive instruction in employment concepts in support

of MAGTF/joint forces, contingency planning processes, communications, weapons, joint ATC procedures, and threat systems.

g. Weapons and Tactics Instructor Course. This is a six-week course that provides Marine officers and senior enlisted personnel comprehensive training in tactics and employment of the Marine ATC detachment and the MACCS. Students receive comprehensive training in concepts of employment for the detachment and the MACCS, joint operational doctrine, contingency planning processes, interoperability issues, and threat systems.

8. Planning

Specific information on the MAGTF planning process and the documents useful in conducting MAGTF and ACE planning are contained in MCWP 5-1 *Marine Corps Planning*, MCWP 5-11.1 *MAGTF Aviation Planning*, and , MCRP 5-11.1A *MAGTF Aviation Planning Documents*. MCO 3501.9B, *Marine Corps Combat Readiness Evaluation System (MCCRES)*, outlines MATCD specific planning requirements. Though the planning phases outlined below may occur in sequence, most of these steps are conducted concurrently.

a. Initial Planning. Considerations for the initial planning phase include:

(1) Conducting a mission analysis, utilizing mission, enemy, terrain and weather, troops and support available - time available (METT-T) and including specified and implied tasks, based on the MAGTF and ACE commander's intent and concept of operations.

(2) Identifying assumptions necessary for continuation of the planning process. These assumptions should supplement assumptions already addressed by higher headquarters and be in concert with the planning guidance received by higher headquarters.

(3) Analyzing the friendly force composition from the joint/multinational level down to the MACCS and addressing integration/interface requirements with the MAGTF and/or joint force planners (specifically the ACA, the area air defense commander [AADC], and adjacent air control agencies).

(4) Conducting initial coordination/liaison with the ICAO, host nation ATC facilities, and the FAA for airspace and liaison requirements.

(5) Analyzing the threat's air and ground order of battle and electronic warfare (EW), reconnaissance, and unconventional warfare capabilities.

(6) Analyzing the AOA/AO, with particular emphasis on the ACA's guidance to begin initial planning for terminal control airspace, Class D airspace, and minimum risk routes (MRRs). Class D airspace is that airspace from the surface to 2,500 feet above the airport elevation surrounding those airports/airfields that have an operational control tower.

(7) Identifying communications requirements for subordinate, adjacent, and higher level circuits with the ACE/MAGTF communications planners. Initial communications planning should focus on the critical information flow and the desired connectivity necessary to achieve this flow.

(8) Providing ATC specialist input to aviation estimates of supportability for all assigned operations. Input should summarize significant aviation aspects of the situation that might influence any course of action (COA) proposals. The input is also used to evaluate and determine how aviation units can best be employed to support contemplated MAGTF COAs. The aviation estimate is prepared by the ACE commander, his staff, and subordinate elements. The end product of the aviation estimates of supportability will include recommending a COA to the MAGTF commander. At a minimum, aviation estimates of supportability will include:

- (a) Which contemplated COA(s) can best be supported by the ACE.
- (b) Salient disadvantages of less desirable COAs.
- (c) Significant aviation limitations (including command and control) and problems of an operational or logistical nature.

b. Intelligence Planning. MATCD personnel will coordinate intelligence planning with the squadron S-2 or higher headquarters. Intelligence planning considerations include:

- (1) Obtaining preliminary and detailed aviation intelligence estimates.
- (2) Identifying intelligence requirements and submitting them to the squadron S-2 in the form of simple, concise requests. Intelligence requirements should state the preferred product format.
- (3) Determining the MATCD staff's requirements for maps, charts, photographs, and other graphic aids.
- (4) Obtaining a complete enemy order of battle including information on the threat's missiles, aviation assets, EW, naval, and ground force capabilities.
- (5) Preparing a detailed rear area assessment for the MATCD and any deployed sites within its assigned sector.
- (6) Determining the enemy's access to and the overhead times for satellite systems and the enemy's processing time for the imagery.

c. Communications Planning. Communications planning involves a coordinated effort between MATCD/MACS representatives and communications planners within the MACCS and ACE/MAGTF staffs. Communications planning considerations include—

- (1) Establishing required communications connectivity between adjacent MACCS agencies, as well as those agencies external and internal to the supported airfield (including civil ATC agencies).
- (2) Determining required communications nets, as well as a prioritization and restoration plan for the use of these nets.
- (3) Determining data link connectivity requirements for both TADIL B and TADIL C.
- (4) Developing a security control of air traffic and NAVAIDS plan. The security control plan will include procedures for silent aircraft taxi, launch, and recovery procedures for day and night operations, secured NAVAIDS, and the securing authority for the NAVAIDS.

(5) Identifying communications security material. Planners should address required encryption hardware and software, authentication tables, brevity codes, and challenge/password changeover times.

(6) Ensuring the MATCD is included on distribution lists for the automated communications electronics operating instruction and air tasking order (ATO).

(7) Addressing ATC unique frequency requirements with ACE/MAGTF communications planners. The necessity for like communications media between the MATCD and civil aviation authorities requires MATCD planning for using frequencies within the VHF(AM) frequency spectrum (116-134 MHz w/50 kHz spacings). This frequency band is used for the control of civil aircraft; 50 kHz spacing may also be necessary for the UHF band for communicating with allied nations' aircraft.

d. Electronic Warfare Planning. When the enemy has a known EW and electronics intelligence capability, planning considerations may include:

(1) Requesting an assessment of the enemy's electronic order of battle (communications and radar jamming capabilities, antiradiation missile capabilities, and delivery profiles).

(2) Submitting recommendations for EMCON and radiation control standards within the MATCD's assigned sector. EMCON and radiation control plans should incorporate all ground-based sensors operating within the sector and consider the antiradiation missile threat to maintain effective sector surveillance. Planning considerations should address:

(a) Minimum communications procedures.

(b) Use of brevity codes and authentication devices.

(c) Use and security of communications security (COMSEC) materials.

(d) Delegation of EMCON authority.

(e) Signals security.

(f) Beadwindow calls.

(g) Gingerbread procedures.

(h) Employment of directional antennas.

(i) Circuit discipline.

(j) Appropriate radio wattage.

(k) Radar blinking and blanking.

(l) Use of frequency diversity and frequency agile radios.

(m) Physical dispersion and appropriate siting of communications emitters (including radars, radios, and NAVAIDs).

(n) Available demand features on NAVAIDs and their use.

(3) Considering the EW threat when determining the locations of MATCD radars.

(4) Providing input to the MAGTF command and control warfare plan.

(5) Ensuring that planners, operators, and users of electronic equipment thoroughly understand the EW threat and the EMCON/electronic protection measures techniques used to counter that threat.

e. Site Selection Planning. The site selection process begins once the MATCD's sector is assigned. Planners must ensure adequate space for site establishment, access to the site, and radar coverage of the sector are maximized. The site selection process includes:

(1) Conducting surveys using maps, aerial photos, charts, and other graphic aids to identify candidate sites.

(2) Producing/obtaining radar coverage diagrams from the tactical aviation mission planning system, joint Electronics Office, other automated sources, or manual computations.

(3) Determining optimum siting locations for communications connectivity with higher/adjacent and subordinate agencies using applicable computer programs, line of sight (LOS) diagrams, and HF frequency propagation predictions.

(4) Submitting a list of candidate sites to the ACE commander based on map surveys and other studies. MATCD siting considerations should encompass all task-organized equipment and personnel in both movement and physical requirements. Physical site characteristics considerations include:

- (a) Radar coverage of the assigned airspace.
- (b) Ground that has no more than 10 degrees of slope.
- (c) Spatial requirements (e.g., antennas or radio frequency hazards).
- (d) Logistics supportability.
- (e) Camouflage and concealment.
- (f) Trafficability and access.
- (g) Emergency destruction and/or movement.
- (h) Drainage.
- (i) Defensibility.

(5) In addition to the physical geography of the site, planners should consider the candidate site's proximity to related activities occurring in or around the forward operating base. These functional site considerations should address the locations of:

- (a) Fuel points and fuel storage areas.
- (b) Ordnance storage areas.
- (c) Arming/dearming areas.
- (d) Air lift control element locations.
- (e) Pre-existing NAVAIDs.
- (f) Arresting gear.
- (g) Medical evacuation areas.

- (h) Search and rescue aircraft.
 - (i) Crash, fire, and rescue units/hot spots.
 - (j) Field weather observation services.
 - (k) Field of view.
 - (l) Obstructions.
- (6) Requesting radar frequency authorization from the appropriate authorities.
- (7) Establishing a phased plan of equipment arrival at the site to facilitate rapid commencement of operational capabilities and communications.
- (8) Selecting an advanced party to conduct physical reconnaissance, locate positions for equipment, and plan specific equipment sites.
- (9) Preparing diagrams or models that depict equipment locations and are the basis for set up crew briefings.
- (10) Ensuring site plans consider maximum dispersal and remoting of equipment to reduce electromagnetic and infrared signatures.
- (11) Designating alternate site locations.

f. **Airspace Management Planning.** Airspace management planning involves segmenting assigned airspace by volume and/or time for the safe and expeditious flow of air traffic. Airspace management also involves establishing various air defense control measures, which are designed to protect friendly installations from enemy air attack. Planning considerations include:

- (1) Analyzing the AOA/AO to determine dimensions, suitable airfields within, possible conflicts with civil aviation, unmanned aerial vehicles (UAV), and preferred routings for friendly aircraft.
- (2) Determining the size and shape of terminal control airspace. Usable NAVAIDs, civil air traffic patterns, UAVs, and conflicts with other users of this airspace will affect the airspace's configuration.
- (3) Determining the size and shape of Class D airspace. Military (manned and unmanned aircraft) and applicable civil traffic patterns should be considered.
- (4) Ascertaining the size and shape of the BDZ. BDZ dimensions are normally determined by the effective engagement envelope of the supporting air defense systems (e.g., Stinger) and anticipated air traffic patterns. Establish entry and exit procedures, including safe lanes and IFF mode and code requirements, during BDZ construction.
- (5) Coordinating with local ground-based air defense unit(s) for BDZ early warning cueing.
- (6) Preparing TERPs for designated airfields and submitting the approach plates to the Naval Flight Information Group for approval and publication.
- (7) Participating with other MACCS agencies in the planning and development of MRRs. Planning should include consideration of UAV and civil aircraft routing.
- (8) Coordinating with ICAO, host nation ATC, and/or FAA authorities for the effective use of existing airspace.

(9) Coordinating with higher headquarters to publish ATC procedures in the airspace control order/airspace control plan (ACO/ACP) and pilot controller handbook.

(10) Developing procedures for handling transient aircraft within the MAGTF/joint AO.

g. External Support Planning. MATCD-unique external support planning considerations include:

(1) Identifying and coordinating sufficient transportation and materials handling equipment necessary to rapidly emplace the MATCD.

(2) Coordinating aviation supply/logistics support for Naval Air Systems Command-supported equipment through the Marine aviation logistics squadron.

(3) Multi-channel communications support for data link operations.

(4) Ground security requirements.

h. Joint/Multinational Operations Planning

(1) The MAGTF must ensure its operations are integrated and coordinated with joint/multinational forces. Include MAGTF air command and control representatives as part of the joint operations planning (e.g., development of the joint air operations plan, ACP, or the air defense plan). The ACE commander, his staff, and/or MACCS agencies normally provide these subject matter experts. They also identify MAGTF capabilities and requirements relative to airspace control and air defense operations. Joint/multinational operations plans must specifically—

(a) Integrate with and complement the joint/multinational force's mission.

(b) Ensure the interoperability of equipment and personnel.

(c) Ensure the common use and understanding of terminology.

(d) Allow responsiveness and the massing of firepower whenever and wherever needed.

(e) Identify the proper liaison and staff/agency representation between joint force components. Representatives from each component must enable and improve the information flow and provide expertise.

(f) Outline procedures for airspace control and air defense degradation.

(g) Facilitate transition from peacetime conditions to hostilities.

(h) Delineate logistical support.

(2) Integrate air operations, airspace, and air defense planning with the joint force's planning cycle. Consolidate and integrate input from all components into the joint air operations plan, the ACP, and the air defense plan. The ACP and air defense plan are part of the joint air operations plan, and must be included in the joint force operations plan. The ACO is published and disseminated based on guidelines established in the ACP. As an integral part of the joint ATO, integrated tasking order, or air tasking message (NATO), the ACO may be distributed as a part of these documents or may be issued separately.

9. Equipment selection and siting considerations

Upon receipt of a warning order, or after initial tasking, MATCD planners begin determining the equipment needed to support operations. Generally, equipment requirements are based on the detachment's mission, location(s), available lift and logistics support, anticipated duration, and space available at the site. The MATCD commander and maintenance officer will conduct a mission analysis utilizing METT-T to determine the equipment suites necessary to support operations, necessary maintenance facilities, mobile electric power support, and parts pack-up. The initial equipment plan is briefed to the MACS commanding officer for initial approval. Specific concerns for selecting potential sites that follow apply to all MATCD operations, whether the MATCD is operating in a garrison or tactical situation.

a. Surveys. Two types of surveys are necessary for determining the equipment needed to support operations: the map imagery and the physical survey.

(1) The map imagery is normally conducted concurrently with initial equipment planning. Map imagery of potential airfields/air sites are used to gain an initial impression of the surrounding terrain, runways, taxiways, and parking aprons and to determine how these factors influence MATCD equipment siting and air traffic flow. The goal of the map imagery is to ascertain the practicality of providing unobstructed "views" for the tower and radars and to identify potential locations for the detachment's equipment as well as maximizing ATC procedures. Key considerations to be addressed during the map imagery include identification of the limitations on equipment separation based on cable length, etc., safety zones around radiation hazards, and potential of electromagnetic interference from other radio-electronic sources.

(2) When practical, conduct a physical site survey to confirm or refute site locations identified during the map survey. The physical survey affords MATCD personnel the opportunity to update site information that was not available from a map, adjust equipment locations, and determine the types of support, such as commercial power and telephone access, available at the airfield/air site. Physical site surveys conducted by qualified MATCD personnel are recommended prior to deployment of the detachment's equipment.

b. Equipment Siting. When conducting the map and physical surveys and during the actual equipment emplacement, MATCD Marines should consider unique properties associated with the various equipment.

(1) AN/TSQ-120 (ATC Control Tower). When siting the control tower, give priority to the controller's field of vision. A clear view of runways, movement areas, and approach surfaces is paramount. Tower personnel should have unobstructed views of taxiways, ramp areas, and arming/dearming sites to enhance safe movement in and around the airfield. The tower requires a 10-foot x 15-foot level area with firm soil for erection. Keep the tower height as low as practical to reduce its vulnerability as a target.

(2) AN/TRN-44 (TACAN). The TACAN is an LOS transmitter. Antenna height is determined by local terrain and obstacles. Like the control tower, do not raise it higher than necessary. To achieve the best approach possible, a straight-in approach to the minimum distance of 1 mile, 500 feet, the TACAN must be located within 1 mile of the airport reference point. The site should be a clear, flat area free of obstructions; e.g.,

buildings or trees, for 1/4 mile if possible. Avoid hard surfaces; e.g., runways or taxiways, especially if constructed of metal matting, due to reflections that distort the TACAN's pattern.

(3) Radars. Siting of the radars is generally more difficult than the other equipment suites, due to their susceptibility to terrain effects, necessary logistics support, and limitations to interface with other equipment suites. An operational analysis of the airfield, number of approaches to different runways, number of touchdown points, and desired landing minimums should be made before selecting radar sites. The primary instrument runway is selected after taking into account factors such as weather, terrain, and obstacles. Normally, this runway will have the least restrictive (lowest) landing minimums. Secondary instrument runways and their attendant touchdown points are identified and covered if possible. Two key factors for radar site consideration are the landing operations to be supported and physical and electromagnetic effects on a radar's tracking. Place the airport surveillance radar so that radar blind spots are eliminated. Site the precision approach radar to maximize coverage and preclude drop-tracks due to clutter. Clear all obstructions from the approach corridor for the primary instrument runway. The TPN-22 precision approach radar's siting is the most critical as it provides terminal guidance for aircraft landing in adverse weather and/or poor visibility situation.

10. Points of Contact

a. Commandant of the Marine Corps (APC); Attn: ATC Action Officer;
Headquarters Marine Corps; Washington, DC 20380; DSN: 224-1850

b. Marine Aviation Weapons and Tactics Squadron One; Attn: C-3 MATC Division;
P.O. Box 99200; Yuma, AZ 85369-9200; DSN: 269-2957

Appendix D

NAVY AIR TRAFFIC CONTROL

1. Doctrine

a. Navy Amphibious Groups (PHIBGRUs)

(1) PHIBGRU 1 is located at Naval Amphibious Base (NAB) Coronado, San Diego, CA. Its subordinate units are tactical air control squadrons (TACRONs). TACRONs Eleven and Twelve are squadrons under Group 1. The TACRONs deploy as detachments throughout the Pacific Fleet AOR to provide centralized planning, control, and integration of all air operations in support of amphibious operations.

(2) PHIBGRU 2 is located at NAB Little Creek, Norfolk, VA. Its subordinate units are TACRONs. TACRONs Twenty-one and Twenty-two are squadrons under Group 2. The TACRONs deploy as detachments throughout the Atlantic Fleet AOR to provide centralized planning, control, and integration of all air operations in support of amphibious operations.

b. Amphibious Control. There are basically two levels of operations for the tactical air control group, squadron, or detachments. They are identified as MEU(SOC) or MEF level operations. The MEU(SOC) comprises the landing force for an amphibious ready groups PHIBGRU/TACRON. Support for MEU(SOC) level operations will normally consist of a detachment. MEFs, as part of an amphibious force, are much larger and often have special support requirements and PHIBGRU/TACRON support for these levels of operations will be necessary to successfully complete the mission.

(1) Amphibious Ready Group. Typically, a TACRON deploys as one of numerous embarked elements onboard an amphibious carrier. The detachment officer-in-charge (OIC) is normally assigned as the amphibious commander's air officer. The amphibious squadron commander is operationally in command of the group. The group may consist of a variety of ships to include the following:

- (a) General-purpose amphibious assault ship (LHA).
- (b) General-purpose amphibious assault ship (with transport dock)--(LHD).
- (c) Amphibious assault ship, landing platform helicopter (LPH).
- (d) Landing ship dock (LSD).
- (e) Amphibious transport dock (LPD).

(2) The Amphibious Ready Group also has a MEU(SOC) embarked, which consists of approximately 2100 Marines in ground, air, and support elements. The group is capable of landing and supporting combat troops from both the air and sea.

(3) Control. When an amphibious operation has been identified and an AOA/HIDACZ or AOR has been delineated (including all of its control points), the TACRON becomes responsible for the control, monitoring, and coordination of all fixed-wing assets entering, exiting, or operating within the assigned area. Typically this function is performed in the TACC aboard LHA, LHD, and LPH class ships. Control of

helicopters is generally retained by the ship's air operations control center (AOCC)/helicopter direction center (HDC). All aircraft will check-in with the tactical air traffic control (TATC) before entering assigned airspace in order to receive control instructions, traffic deconfliction, mission information/briefing, and transfer to subsequent control agencies. Transition control may be a function of another individual, such as the tactical air director (TAD), within the TACC or it may be an outside agency. Following mission completion, aircraft will check out of the area via the TATC in order to ensure that required information is passed to affect aircrews.

c. Aircraft Carrier Control. Airspace around a carrier battle group (CVBG) is monitored, controlled, and defended by the air warfare commander (AWC). The AWC is usually the commanding officer of an AEGIS Cruiser or Destroyer. The AWC releases operational tasking (OPTASKs) and daily intention messages that describe the air posture, airspace restrictions, and general air procedures to be followed by CVBG air assets. The AWC usually has in place a positive identification and radar advisory zone (PIRAZ). The AWC and PIRAZ control units are usually collocated. A PIRAZ allows the AWC to identify all aircraft operating in the defended area as well as maintain track integrity. The PIRAZ circuit is UHF, usually callsign "RED-CROWN." Contact "RED-CROWN" when entering or exiting airspace around a CVBG.

(1) Carrier ATC. Carrier ATC is the mission of the carrier air traffic control center (CATCC). Navy air traffic controllers man CATCC. CATCC positions include approach, departure, marshal, and final control. All ATC control frequencies and various administrative circuits for special aircrew information/instructions are UHF. During VMC conditions, the tower controls airspace within 5 miles of the carrier. Aircraft requesting landing, transit, or fly-by must contact tower before entering this airspace. Additionally, a 50-mile radius around the carrier is considered the control area and is under the control of CATCC and the combat direction center (CDC).

(2) Other Considerations. In addition to CATCC, the air resource element coordinator maintains an administrative UHF circuit for passing aircraft status, amending recovery times, coordinating non-organic assets (for example, KC-135), etc. This circuit is called "Strike." The tactical action officer (TAO) controls this. Frequencies for CATCC, "RED-CROWN," "STRIKE," and the tower can be found in the standing OPTASK COMMUNICATIONS, daily-intentions messages, or carrier communication kneeboard cards. SPINS often list some of these frequencies when a CVBG is operating in support of a joint operation.

2. Forces

Forces available for Naval ATC operations are derived from two Amphibious Groups (PHIBGRUs). PHIBGRUs or TACRONs will deploy aboard amphibious flag or amphibious command ships for operations in direct support of amphibious force operations when directed. They are responsible for providing centralized command, control, and planning coordination of all air support and airspace required for amphibious operations for numbered fleet Commanders. When the PHIBGRU/TACRON deploys, it will be composed of elements of each TACRON or the entire group.

a. Tactical Air Control Squadron. Typically a TACRON has approximately 15-20 officers and 60-70 enlisted personnel assigned. Officer manning is comprised of naval

aviators and naval flight officers of nearly every warfare specialty and Marine aviators. Enlisted manning consists primarily of air traffic controllers (ATC) and operations specialists, but squadrons also have personnel assigned to provide operational and administrative support. Some of the important positions in the TACRON and its detachments are described later in this chapter.

b. Ashore. Ashore, the TACRON is typically organized like any other command with administrative operations, training, and other supporting departments. Detachment composition, while deployed, generally is as follows: OIC (O-5) and 4-5 other officers and 18-22 enlisted personnel. Manning will vary somewhat, depending on the ship embarked.

c. Tactical Action Officer (TAO). The TACRON commanding officer deploys as the TAO, in support of amphibious group commanders. The TACRON will man and operate a TACC to provide centralized planning, control, coordination, and integration of all air operations in support of amphibious operations, training, and transits. Each squadron is currently capable of providing two detachments a year with a projected cycle of 6 months deployed and 12 months in port as directed by the Chief of Naval Operations. Detachments are required continuously.

(1) Tactical air control squadron detachments. These detachments, as operational units of a TACRON, deploy in support of amphibious squadron commanders. The detachment OIC shall serve as the TAO while deployed. The detachment will staff and operate the TACC to provide centralized planning control coordination and integration of all air operations in support of amphibious operations, training and transits. A detachment will be tailored to meet the tasking and will reflect the ship type assigned for the deployment. TACC is divided into the following five functional areas (sections):

(a) Helicopter Coordination Section. This section is responsible for the coordination of all helicopter operations conducted by HDCs and other subordinate control agencies within the amphibious ready group and the operational control of specific helicopter missions when required.

(b) Air Traffic Control Section (ATCS). The section responsible for controlling all air traffic entering, operating within, or traversing the assigned operating area and for coordination of search and rescue (SAR) operations.

(c) Air Support Control Section. The section responsible for controlling all fixed-wing and rotary-wing aircraft assigned to close and deep air support missions.

(d) Air Warfare Section. The section responsible for coordinating and evaluating all air warning reports and controlling all air warfare assets including fighter aircraft, anti-aircraft missiles and guns, and electronic attack assigned. Air Warfare Section personnel supervise qualified TACRON, flagship, and staff personnel that are integrated into the section.

(e) Plans and Support Section. The plans and support section is responsible for all communications support, conducting current and future planning, and assembling and distributing current air operations data and reports.

d. Capabilities. The TACRONs operate in and as part of a joint or unified force. They are capable of operating as an element of the JFACC, providing air control and

planning in a unified or multinational theater of operations. Helicopters are employed in the moving of troops and materiel ashore while fixed-wing aircraft provide close air support (CAS) for friendly ground forces and ensure air superiority by employing combat air patrols. They are capable of performing all assigned primary missions simultaneously while maintaining continuous readiness conditions I, IA, III (wartime/deployment/cruising readiness) or IV (peacetime steaming) at sea, and V (in port). In addition, the TACRONs maintain the capability to temporarily staff and operate an existing ATC facility ashore or augment a remote facility ashore with personnel to control air traffic in support of other military, emergency, or disaster relief operations.

e. Equipment. With the exception of PRC-113s, TACRONs do not own any ATC equipment. Amphibious ATC equipment is installed on LHA-1 (Tarawa-San Diego), LHA-2 (Saipan-Norfolk), LHA-3 (Belleau Wood-Japan), LHA-4 (Nassau-Norfolk), LHA-5 (Peleliu-San Diego), LHD-1 (Wasp-Norfolk), LHD-2 (Essex-San Diego), LHD-3 (Kearsarge-Norfolk), LHD-4 (Boxer-San Diego), LHD-5 (Bataan-Norfolk), LHD-6 (Bon Homme Richard-San Diego); and LHD-7 (Iwo Jima-Norfolk)

f. Acquisition Programs. Current radar displays are undergoing updating on several ships. Some updating has been completed at the time of this printing.

3. Training

a. General. Consistent with the Navy's mission, training is oriented toward all aspects of ATC to provide a competent sea and shore based training program. This section outlines all aspects of Navy ATC training to allow comparison/familiarity by other personnel and other users of this manual.

b. Population. Navy/Marine ATC personnel are located around the globe at Naval/Marine Corps Air Stations, with CATCC aboard every aircraft carrier (CV/CVN), and at amphibious ATC centers (AATCC) aboard every large deck amphibious ship (LHA/LHD/LPH) and TACRONs. In addition, there are unique locations such as Fleet Area Control and Surveillance Facility that are responsible for US-based over-water control of fleet air assets. In general, where Navy ATC personnel are required to fill land-based positions as directed by the JFC, the Navy provides only 1 ATC combat control from shore-based TACRON detachments. Familiarity with the information contained in this chapter is needed if a non-United States Navy (USN) ATC organization is expected to assume control of established TACRON ATC operations.

c. Training. All phases of Navy air traffic controller training are conducted at NATTC, Pensacola, Florida. Initial ATC training consists of 16 weeks of basic AC "A1" school. This is the foundation of the controller training process. Upon graduation, Navy controllers possess the basic skills and core knowledge of FAA ATC procedures in both tower and radar facilities.

d. Advanced Courses. Additionally, there are four ATC advanced courses, CATCC Operations (CV/CVN personnel)-NEC 6902, AATCC Operations (TACRON and LHA/LHD/LPH/MCS personnel)-NEC 6903, ARATC (approach control personnel), NEC 6901, ATCMAN (ATC Managers Course)-NEC-6904. Advanced courses are all approximately 6 weeks in length. In most instances, newly designated Navy air traffic controllers are sent directly to the fleet (sea or shore). Senior controllers may attend advanced courses when en route to their next duty assignment. CATCC Operations and

AATCC Operations courses both offer a 2-week, team-training course that is used to provide refresher training necessary to retain overall team performance and individual skill proficiency in performing ATC operations at sea. The appropriate fleet type commander (TYCOM) schedules this course throughout the year.

e. Proficiency Training. JATC planners must understand there are two types of proficiency training necessary to bring any ATC personnel up to maximum efficiency: qualification training and proficiency training.

(1) Qualification training refers to obtaining the initial qualification training to achieve an initial level of proficiency.

(2) Proficiency training refers to training on specific ATC equipment to achieve proficiency on that particular equipment. Proficiency training can also be related to learning specific local area procedures and including standard operating procedures (SOP), flight advisories, etc. Qualifications are listed in table D-1.

Table D-1 US Navy ATC Naval Experience Codes

Qualification	Naval Experience Code (NEC)
ARATC (approach control personnel)	NEC 6901
CATCC Operations (CV/CVN personnel)	NEC 6902
AATCC Operations (TACRON and LHA/LHD/LPH/MCS personnel)	NEC 6903
ATCMAN (ATC Managers Course)	NEC-6904

4. Navy Tactical Air Control Squadron Operating Positions

a. Tactical Air Control Officer (TAC). The TAC is the senior officer in the TACC, responsible for management and execution of air operations within and around the AOA. Except in very large operations, most detachment OICs will fill both TAO and TAC billets. The TAC receives notification of and initiates SAR missions, notifying the amphibious squadron staff of fixed and rotary-wing assets available. He determines the need for rescue combat air patrol. The TAC also coordinates the use of airspace coordination areas. For underway operations, the TAC has overall responsibility for TACRON operations. There are three main areas that are managed by the TAC and subordinates: helicopter coordination, air warfare, and CAS. Each of these three areas is headed by a coordinator to ensure safety and mission accomplishment and all are functions of the TACC.

b. Air Support Coordinator (ASC). The ASC supervises the Air Support Control Section and advises supporting arms coordinator (SAC) on the use of close air support aircraft.

c. Assistant Air Support Coordinator (AASC). The AASC is responsible to the ASC. Functions of the AASC include:

(1) Exercising supervision and direction over all aircraft assigned to the CAS section.

- (2) Monitoring performance, fuel, and weaponry of CAS aircraft.
- (3) Recommending to ASC all units that are best suited to carry out assigned missions.
- (4) Assigning aircraft for strike and support missions.
- (5) Advising ASC on the execution status of air support missions.
- (6) Directing orbiting, air refueling, and/or return to base.
- (7) Aiding ASC in coordination and use of airspace coordination area(s).

d. Tactical Air Control Center Supervisor (TACC SUP). Functions of the TACC SUP include:

- (1) Ensuring all air traffic services provided are safe, orderly, and expeditious.
- (2) Monitoring all air operations and services provided in the AOA.
- (3) Qualifying at all positions in ATC coordination.
- (4) Being responsible for the safe and expeditious handling of all aircraft operating within the AOA.
- (5) Supervising the tactical air control section.
- (6) Being responsible over tactical air traffic controllers (TATCs) and tactical air direction controllers.
- (7) Keeping the TAC and TACC watch officers informed regarding all aspects of TACC operations, from helicopter coordination to SAR operations.

e. Tactical Air Traffic Control Controller. The TATC controller is responsible for separation and coordination of air traffic during approach to, operations within, and retirement from the AOA/HIDACZ/AOR. This function is performed normally under radar airspace management conditions. The TATC controller, with the concurrence of TACC Supervisor, will assign entry, holding, and exit points for all aircraft. He identifies and checks-in all aircraft entering the AOA, and passes the following: weather, diverts, deconfliction information, changes to the expected route, altitude information, and traffic. He separates and controls all inbound and outbound aircraft and effects hand over to the TAD, air intercept controller (AIC), air warfare coordinator, or to a point clear of the AOA. He coordinates with air warfare coordinator all combat air patrol arrival/departure missions. He also coordinates airspace usage for mission deconfliction and route and altitude for safety, separation, deconfliction, and efficiency. The TATC section is responsible for tactical ATC and for the dissemination of all tactical information to aircraft that check into the AOA. The TATC controller will pass control over to the TAD.

f. Tactical Air Director. The TAD coordinates with TATC, as required, to ensure the safe, efficient, and orderly control of tactical air traffic. TACRONs normally plan for manning of two TAD positions in operations of any size. The coordination and movement of strike aircraft is TATC-to-TAD direct.

- (1) Duties include—

- (a) Providing separation and direction of aircraft assigned
- (b) Coordinating and deconflicting traffic situations as required
- (c) Coordinating and directing assistance during SAR and emergency operations.

(2) The TAD passes control of CAS mission flights to the TACP for individual tasks. The TAD responds directly to tasking provided by the ASC. The ASC ensures that aircraft carrying the proper ordnance are assigned appropriate targets. This requires a thorough knowledge of the different types and uses of ordnance and also air delivery methods.

(3) The ASC passes the target location to the TAD who directs the aircraft to their assigned targets. Upon completion of the aircraft mission, the aircraft checks in with the TAD who receives the battle damage assessment and passes this information to the ASC to determine if additional aircraft are needed to ensure target destruction.

g. Helicopter Coordinator. A typical amphibious assault will employ multiple waves of helicopters. The helicopter coordinator is responsible for the coordination of all helicopter traffic within the assigned AOA; including, passing direction to the HDC/AOCC, who provides direct radar control of the assault force helicopters. HDC/AOCC is a function of every LHA/LHD and LPH within the US Navy and provides ATC to the helicopters. The helicopter coordinator utilizes the console for monitoring the progress of the aircraft ashore. It is also the coordinator's function to prepare and ensure the ATO is carried out and disseminated.

h. Air Warfare (AW) Coordinator. The AW section is manned by an AW coordinator whose responsibility it is to ensure every air contact within the area is positively identified. In the event of a hostile contact, it is the AW coordinator's function to destroy the threat with all the assets that are available. Directly under the air warfare coordinator is the air intercept control supervisor who assists the AW coordinator in the employment of fighter aircraft and surface to air systems through use of a senior operations specialists who is assigned to the position of AW console operator.

5. Tactical Air Control Squadron Required Operational Capabilities

The TACRON controls, manages, and creates air space within an amphibious objective area in support of amphibious operations from the sea and/or shore. During amphibious ops, the TACRON is responsible for the safe control of all aircraft within the AOA. The TACRON's air traffic controllers are responsible for the safe, orderly, and speedy movement of aircraft into and around landing areas. In order to accomplish its mission, the TACRON has required operational capabilities that include: air warfare, amphibious warfare, surface warfare, undersea warfare, fleet support operations, intelligence, non-combat operations, and strike warfare.

a. Air Warfare*.

(1) Provide air defense in cooperation with other forces.

(a) Coordinate air defense planning as air warfare coordinator for Battle Group convoy amphibious operations.

(2) Provide air defense of a geographic area (zone) in cooperation with other forces.

(3) Engage air targets during battle group operations in cooperation with other forces.

(4) Control combat air patrol.

(a) Support/conduct air intercept missions against multiple aircraft and subsurface, surface, or air launched missiles.

(b) Provide continuous multiple air intercept control capability.

(5) Coordinate the overall conduct of AW operations with all other warfare requirements of the amphibious force commander; allocate air assets as required to counter threats to the ATF.

*Note: Amphibious Group 2 TACRONs are not manned to support the AW Commander.

b. Amphibious Warfare.

(1) In Amphibious Warfare, provide air control and coordination of air operations in an AOA and in transit.

(a) Provide ATC, control all air support aircraft, and coordinate helicopter operations in an AOA and in transit.

(b) Provide coordination of AW, surface warfare (SUW), and under sea warfare (USW) air assets for protection of the force in an AOA.

(c) Control air search and rescue operations in AOA. Coordinate air assets in the AOA with supporting arms to provide safe, coordinated action.

(2) Provide for air operations in support of amphibious operations.

(a) Control aircraft under all conditions of active jamming.

(b) Provide air strike control to direct or assist attack aircraft.

(3) Conduct tactical recovery of aircraft and personnel.

c. Surface Warfare.

(1) Support surface ship defense of geographical area in cooperation with other forces.

(2) Provide for air operations in support of surface attack operations.

(a) Provide air strike control to direct or assist attack aircraft.

(b) Perform duties of aircraft control unit for aircraft involved in SUW operations.

d. Under Sea Warfare.

(1) Provide for USW defense in support of amphibious operations.

e. Command, Control, Communications.

(1) Coordinate and control the operations of the task organization or functional force to carry out assigned missions.

(2) Coordinate the reconnaissance of multiple surface, subsurface and/or air contacts

(3) Function as air warfare coordinator for force or sector.

(4) Function as on-scene commander for a SAR operation.

(5) Establish a TACC and/or TADC, as appropriate, to support the TAO. TACC will control and/or coordinate all fixed-wing air assets within the AOA and in transit.

(6) Establish a Helicopter Coordination Section to support the TAO; that section will coordinate helicopter operations within the AOA and in transit during multi-deck operations.

(7) Control close air support aircraft in support of amphibious operations; control function will include coordination with other supporting arms.

(8) Coordinate and control air SAR operations in the AOA.

(9) Function as either Air Element Coordinator, LAMPS Element Coordinator, or both.

(10) Assist in the planning of AW, SUW, and USW for the coordination of air operations in the AOA and transit.

f. Fleet Support Operations.

(1) Support/conduct search and rescue operations in a combat/noncombat environment.

(2) Support/conduct combat/non-combat SAR operations by fixed or rotary-wing aircraft.

(3) Acquire and display distress data.

(4) Report situation assessment.

(5) Coordinate SAR operations.

(6) Conduct multi-unit SAR operation.

g. Intelligence.

(1) Support/conduct unarmed reconnaissance (weather, visual, battle damage assessment, etc.).

(2) Support the processing of surveillance and reconnaissance information.

(3) Support the dissemination of surveillance and reconnaissance information.

(4) Operate a contingency planning cell to support fleet commanders.

h. Mobility.

(1) Operate from a ship with a helicopter platform.

(2) Operate from a ship capable of supporting air control activities in support of amphibious operations.

(3) Conduct operations ashore in climatic extremes ranging from cold weather to tropical to desert environments.

i. Non-combat Operation.

(1) Under non-combat operations, provide disaster assistance and evacuation.

(a) Man ATC facilities ashore.

(2) Support/provide for the evacuation of noncombatant personnel in areas of civil or international crisis.

(a) Support/conduct helicopter/boat evacuation of noncombatant personnel as directed by higher authority from areas of civil or international crisis.

(b) Support/conduct day/night rotary-wing aircraft operations.

(c) Support/conduct rotary-wing aircraft flight operations during all EMCON conditions.

(3) Conduct counter narcotic and other law enforcement support operations in conjunction with other forces.

(a) Conduct operations with Coast Guard units.

(4) Detect and monitor suspicious air contacts.

j. Strike Warfare.

(1) Support and conduct air strikes by supporting/participating in conventional air strike operations or major air strike operations under all conditions of readiness.

(2) Provide for air operations in support of air strike operations by providing control of all aircraft en route to and returning from assigned missions.

6. Navy ATC Duties, Responsibilities, and C2 Relationships

a. Introduction. C2 of Navy ATC assets and personnel will be closely related to the C2 structure for airspace control. As such, decision making, asset allocation and implementation will flow through the existing airspace control infrastructure. Additionally, in most operations the amount of land based Navy ATC, relative to the other Services, will be smaller with most assets and effort sea-based. Once Marines are established ashore, ATC operations become a subset of the existing airspace control organization and will rely on that organization for communications and coordination.

b. Sea-based. For the Navy, ATC facilities (sea-based) are resident in the specific platforms that are capable of launching and recovering aircraft. The two biggest platforms are the aircraft carrier and the “large deck” amphibious assault carrier. These two platforms form the preponderance of sea-based ATC. There are smaller ships that launch and recover aircraft; however, their capabilities are generally restricted to terminal approach and landing on their specific platform. Sea-based airspace control nodes are built around sensor assets and capabilities including the ability to receive and transmit data. These are also centered on the larger ships in the battle group; however, most of the other ships can provide information via data link to these larger ships.

c. NTACS. Figure D-1 illustrates the Navy Tactical Air Control System (NTACS). This is the primary airspace control and communications structure designed as warfighting entities. Not shown in the diagram, and illustrated below, are two key links that join Navy sea-based airspace control and coordination (war fighting) with sea-based ATC entities:

- (1) Carrier: CWC—CVBG/ CDC—carrier ATC center (CATCC).
- (2) Amphib: CWC—TACC/CDC— amphibious ATC center (AATCC).
- (3) (War fighting/Airspace Control)—ATC coordination

d. Because of these key links, any ATC coordination and control can use the same channels of communication within a JTF that the war fighting C2 uses.

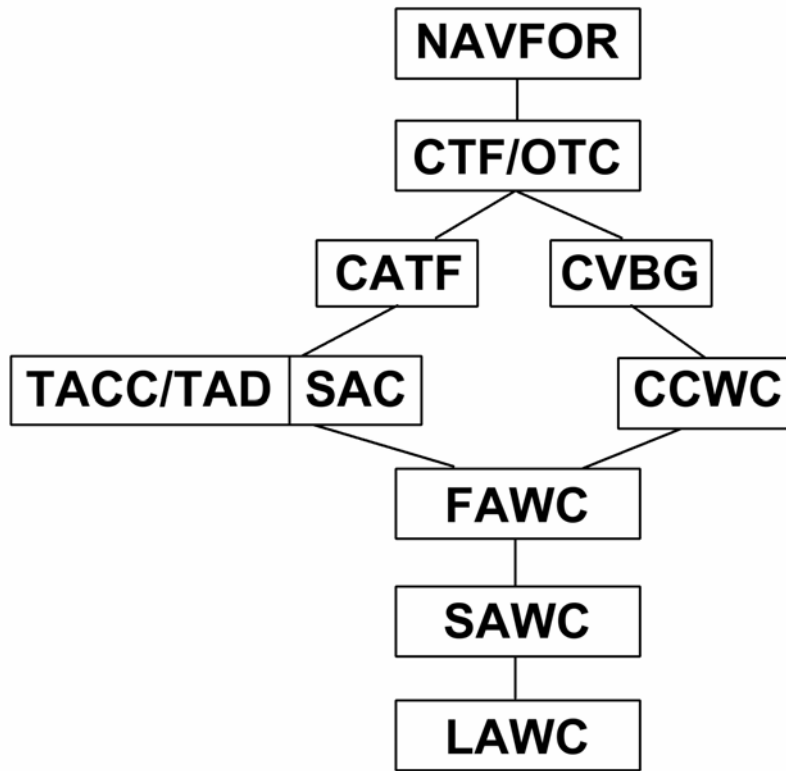

Figure D-1 Navy Tactical Air Control System

7. Navy POCs

e. PHIBGRU 2; 2600 Tarawa Court, Building 1602; NAB Little Creek; Norfolk, VA 23521; (757) 462-7403; DSN 253-7403.

Appendix E

AIR TRAFFIC CONTROL EQUIPMENT

1. Army ATC Equipment

a. AN/TSQ-198 Tactical Terminal Control System. The AN/TSQ-198 is a HMMWV mounted ATC system used to provide arrival/departure information, limited weather, wind direction and speed information, and sequencing instructions. The AN/TSQ-198 will provide VFR control of air traffic at LZs, DZs, PZs, initial airfield, and temporary helicopter operating areas. The AN/TSQ-198 communications system can also convert to a portable battery-operated man-pack configuration. Major communications components include the AN/VRC-83 Have-Quick radio sets, AN/VRC-90F single channel ground and airborne radio system (SINCGARS), and the AN/ARC-220 high frequency radio set. When the AN/TSQ-198 is used at an airfield, it is only used until larger and more capable facilities are installed. Four air traffic controllers are normally assigned to operate the AN/TSQ-198 for a 24-hour period. The AN/TSQ-198 is sling loadable by a UH-60 or similar helicopter and can be transported by a single C-130 aircraft load.

b. AN/TSQ-70A Aircraft Control Central. The AN/TSQ-70A provides tactical air traffic control tower facilities. The AN/TSQ-70A is used at airfields/landing areas to provide air traffic regulation, aircraft separation, in-flight assistance, landing and takeoff control, and ground control. Personnel may operate it from controls inside the shelter or by portable consoles remotely located within 100-foot radius of the shelter. Its major components include UHF/VHF/FM/HF radios. Six air traffic controllers are normally assigned to operate the AN/TSQ-70A for a 24-hour period. The AN/TSQ-70A can interface with other facilities via landline or VHF/UHF/FM/HF non-secure radios.

Note: The TSQ-70A uses analog equipment for communications and requires special consideration when interfacing with digital equipment. The AN/TSQ-70A (shelter only) is sling loadable by a CH-47D or similar helicopter and can be transported by a single C-141 or similar aircraft load. The AN/TSQ-70A is fielded to the Army National Guard and will be replaced with the AN/MSQ-135 MOTS by 2008.

c. AN/TSW-7A Air Traffic Control Central. The AN/TSW-7A provides tactical ATC tower facilities. The ATC Central provides ground-to-aircraft, aircraft-to-ground, and surface communications within a designated tactical landing area or airfield. It is used to provide air traffic regulation, aircraft separation, in-flight assistance, landing and takeoff control, and ground control. Major components of the AN/TSW-7A include AN/VRC-83 Have-Quick radio sets, AN/VRC-92E (SINCGARS) radios and one HF radio. Nine air traffic controllers normally assigned to operate the AN/TSW-7A for a 24-hour period. The AN/TSW-7A (shelter only) is sling loadable by a CH47-D or similar helicopter and can be transported by a single C-17 or similar aircraft load. The AN/TSW-7A is fielded to both the active Army and Army National Guard and will be replaced with the AN/MSQ-135 MOTS by 2008.

d. AN/TSQ-71B Landing Control Central. The AN/TSQ-71B ground controlled approach (GCA) radar is a precision radar set, providing course line and glide path

tracking of aircraft to within 20 feet (altitude) and 1.3° runway alignment of a predetermined landing point (touchdown). Aircraft position, as determined by the GCA radar, is relayed to the aircraft pilot using the radio communications facilities provided with the AN/TSQ-71B. An ASR capability is provided to a maximum radar range of 40 nm. Major components of the AN/TSQ-71B include the shelter, AN/TPX-44 IFF interrogator antenna, the AN/MJQ-15 power generation set, and the AN/TPN-18 Radar Set (GCA). Radio communications include UHF/VHF/FM radios. The AN/TSQ-71B can interface with other facilities via landline or VHF/UHF/FM radios. Normally, the AN/TSQ-71B will only interface with the tower facility on the same airfield/landing area. The AN/TSQ-71B uses analog equipment for communications and requires special consideration when interfacing with digital equipment. Seven air traffic controllers are normally assigned to operate the AN/TSQ-71B for a 24-hour period. The AN/TSQ-71B (shelter only) is sling loadable by a CH-47D or similar helicopter and can be transported by a single C-141 or similar aircraft load or dismounted configuration by a single C-130 aircraft. The AN/TSQ-71B is fielded to the active Army and the AN/TSQ-71A is fielded to the Army National Guard. Both systems are being replaced with the AN/TPN-31 Air Traffic Navigation, Integration, and Coordination System (ATNAVICS).

e. AN/TSC-61B Airspace Information Center (AIC). The AN/TSC-61B provides facilities for air traffic coordination and in-flight assistance within an assigned zone of responsibility on a continuous basis. The AN/TSC-61B is used by the AIC section to establish air-to-ground radio communications. There are also facilities for telephone and ground-to-ground radio communications with associated airfields and ground installations, as well as adjacent ATC facilities. Eight air traffic controllers are normally assigned to operate the AN/TSC-61B for a 24-hour period. The AN/TSC-61B provides radio/landline communications capabilities to include UHF/VHF/FM/HF radio sets. The AN/TSC-61B (shelter only) is sling loadable by a CH-47D or similar helicopter and can be transported by a single C-141 or similar aircraft load. A single C-130 aircraft can transport the dismounted shelter configuration. The AN/TSC-61B is fielded to both the active Army and Army National Guard and is being replaced with the AN/TSQ-221 TAIS.

f. AN/TRN-30 (V) 1/(V) 2 Radio Beacon Set. The AN/TRN-30 (V) 1/(V) 2 non directional radio beacon set transmits a homing signal that is used in airborne direction finding sets installed in selected helicopters and fixed-wing aircraft. The radio beacon set provides an AM radio frequency signal on any one of 964 channels in the frequency ranges from 200 to 535.5 kHz and 1605 to 1750.5 kHz in tunable increments of 5 kHz. The radio frequency output is modulated by a 1020-Hz tone, which is automatically keyed to form Morse Code characters in four-letter groups, as selected by the operator, or manually keyed as desired. The transmission ranges of the radio beacon set are: AN/TRN-30 (V) 1 - 28 KM (15 nm) with 15-foot antenna /6 KM (25 nm) with 30-foot antenna and AN/TRN-30 (V) 2 - 93 KM (50 nm), tactical mode/186 KM (100 nm), semi-fixed mode. Both systems are air or ground transportable. The AN/TRN-30 (V)1 is deployed with the tactical aviation control team and tower section and the AN/TRN-30 (V)2 is deployed with the AIC section.

g. AN/MSQ-135 Mobile Tower System. The AN/MSQ-135 MOTS will replace the AN/TSQ-70A and the AN/TSW-7A, Aircraft Control Central. The AN/MSQ-135 is a highly mobile ATC tower shelter mounted on a HMMWV. The AN/MSQ-135 provides terminal ATC services for selected high traffic landing areas in the EAC, corps, and

division areas. The AN/MSQ-135 has digital air/ground communication and digital linkage into A2C2, air traffic services, and local command nets. The AN/MSQ-135 is normally manned with six to nine ATC operators. The AN/MSQ-135 is equipped with the AN/VRC-92E SINCGARS radio sets, AN/ARC-220 HF radio set, and the AN/PRC-117 multi-mode radio sets. The AN/MSQ-135 can be deployed mounted on a HMMWV or be air lifted by C-130 aircraft or CH47D or similar helicopter. The AN/MSQ-135 will be fielded to both the active Army and Army National Guard.

h. AN/TPN-31 Air Traffic Navigation, Integration, and Coordination System (ATNAVICS). The AN/TPN-31 is currently being fielded to replace the AN/TSQ-71A and AN/TSQ-71B, Landing Control Central. The AN/TPN-31 is a HMMWV mounted survivable radar system that will provide continuous, near all weather, landing precision assistance and departure recovery capability at Army tactical airfields and landing areas. Additionally, the AN/TPN-31 will provide area surveillance and aircraft identification capability for a minimum of a 25 nm radius of all sites where employed. The AN/TPN-31 is designed for employment at division, corps, and echelon above corps. The system consists of three integrated radars: ASR, PAR, and secondary surveillance radar. Seven air traffic controllers normally man the AN/TPN-31. The AN/TPN-31 can be airlifted by C-130 aircraft or sling loaded by CH-47 or larger helicopter. The AN/TPN-31 is being fielded to both the active Army and Army National Guard.

i. AN/TSQ-221 Tactical Airspace Integration System. The AN/TSQ-221 is a battlefield automation system to meet both Army Airspace Command and Control (A2C2) and ATS AIC requirements. It is being fielded to division, corps, and EAC to replace the AN/TSC-61B, Flight Coordination Central. The AN/TSQ-221 is a member of the Army Battle Command System (ABCS) family of systems and is capable of exchanging critical battlefield information with other ABCS systems and the Theater Battle Management Control System. Each sub system is a modified standard army shelter mounted on a HMMWV variant. Each shelter contains an Air Defense System Integrator (ADSI) - the AN/TSQ-214 (V). The ADSI system can accept inputs from up to eight TADILs, forward area air defense (FAAD) data link (FDL), and sensor-linked data from a variety of digitized radar systems. The ADSI fuses these inputs of real-time airspace user data, creating a near real-time A2C2 picture. The AN/TSQ-211 also contains an extensive communications suite, which includes AN/VRC-90 SINCGARS radio set, AN/VRC-92 SINCGARS radio sets, AN/VRC-83 Have Quick radio sets, AN/VRC-220 HF radio set, AN/PSC-5 SATCOM radio set, VRC-200 UHF radio set, EPLRS radio set, and S95 HF receiver set. Two workstations, using ABCS common hardware and software, are permanently mounted inside the shelter with two additional remote workstations with transit cases, which can be remoted up to 2,000 meters (basic issue cabling limits this to 500 meters). The workstations also employ airspace management software capable of near real-time airspace deconfliction and two or three-dimensional displays of airspace situational awareness.

j. An airspace workstation is being fielded to critical A2C2 cells to include liaisons to the LCC, CRC, corps command post, Striker Brigade Combat Team, and BCD.

k. Portable Airfield Lighting System. PALS will provide ATS units with a lighted landing area on improved or unimproved airfields for fixed or rotary-wing aircraft. PALS provide precision visual approach with course and glide slope cues. Variants of the system will be fielded with the TTCS and MOTS. The system includes a laser centerline indicator laser glide slope indicator, portable airfield lighting for 5,000 feet of

runway, trailer, generator, and battery charging system. Fielding of PALS is tentatively scheduled to begin in 2005.

2. Marine ATC Equipment

a. Marine ATC Detachment Equipment

(1) AN/TPS-73 Air Traffic Control Section. The AN/TPS-73 is a two-dimensional, transportable tactical airport surveillance radar system operating in the E-band (2705-2895 MHz). It is designed for a tactical environment with electronic countermeasures features, including blanking sectors and polarization diversity. The AN/TPS-73 is manned and controlled from the AN/TSQ-131, using the AN/TPS-73 control panel. The AN/TPN-73 is enclosed in an International Organization for Standardization (ISO) shelter for independent transport. The antenna drive tilts to permit ground level assembly/disassembly of the 10-piece antenna. The antenna, 16-inch air conditioning ducts, and shelter skids are packed within the shelter. Unmanned during operations, the AN/TPS-73 must be physically located within cable radius (500 feet) of the AN/TSQ-131. The AN/TPN-73 is a two-dimensional nonlinear radar capable of a 60 nm surveillance range for its primary radar, 120 nm search range for its secondary radar (IFF), and is capable of detecting airborne targets up to an altitude of 60,000 feet. The ATCS is capable of interrogating IFF modes I, II, IIIC, and IV. Radar and IFF information from the ATCS are processed within the control and communications subsystem (CCS) and can be forwarded to other agencies via data link and or voice communications.

(a) Interface.

- Radio, phone, and intercom access.
- With AN/TSQ-131 via orderwire control unit (OCU) or field phone.

(b) Transportation.

- By air: C-130, C-141, C-17, C-5, CH-53 can transport as an external load using 40,000 pound slings.
- By ground: tractor-trailer, logistic vehicle system (LVS), or mobilizers.

(c) Setup. The system can be packed-out or set up in four hours by four Marines.

(2) AN/TPN-22 All-Weather Landing Subsystem. The AN/TPN-22 is an I-band (9000-9200 MHz), three-dimensional, track while search, air transportable, phased array radar that provides the data input to the TSQ-131 for display, enabling controllers to monitor and control aircraft within the landing area airspace. The AN/TPN-22's pencil beam radar has 46-degree azimuth coverage, a 10 nm range, and an 8-degree (minus 1 to plus 7 degrees) angular coverage in elevation. The AN/TPN-22 provides Mode I/IA, Mode II, and Mode III approach services via tactical digital information link (TADIL) C for all-weather landings. The AN/TPN-22 is capable of automatic tracking for up to six aircraft simultaneously. The AN/TPN-22 operates in concert with the AN/TSQ-131.

(a) Modes.

- Mode I is automatic and functions as the landing control and guidance sensor, providing detection and position data to the AN/TSQ-131.
- Mode II is semiautomatic and provides position, glideslope, and course lines to the TSQ-131 that sends the information to the instruments of equipped aircraft. The final controller in AN/TSQ-131 must monitor approach(s).
- Mode III sends GCA azimuth/elevation data to the controller in the AN/TSQ-131, allowing the controller to verbally guide aircraft to the runway. Upon initial setup, AN/TPN-22 is unmanned and its functions are monitored remotely from AN/TSQ-131.

(b) Antenna Placement. Consider the number and layout of runways before antenna placement, additionally, place the antenna within 500 feet of the CCS, due to cable restrictions. The AN/TPN-22 can maintain data on four transmitter distributor points but can provide service to only one runway at a time.

(c) Interface. The AN/TPN-22 provides for transmission of radar, video, antenna, and mode/status information from the AN/TPN-22 to the AN/TSQ-131. Remote control and status panel interface is only operative when the AN/TPN-22 is in auto mode and is required to be fully operable for Mode I and II operations.

(d) Transportation Requirements.

- By air: C-130, C-141, C-5, CH-53 can transport as an external load using 40,000 pound slings.
- By ground: tractor-trailer, LVS.

(e) Setup. Three Marines can site survey and set up the system for one runway within 3 hours.*

(3) CCS-AN/TSQ-131.

(a) The AN/TSQ-131 is the heart of the MATCALs. It is an air transportable facility containing all equipment, excluding sensors, to meet display and communications requirements for providing full IFR ATC services to expeditionary airfields. It functions as a collection point for radar data produced by the ATCS and the All Weather Landing System. The CCS consists of two ISO shelters, which allow its employment in either a single or dual shelter configuration. Each shelter provides four processor display system (PDS) consoles, which serve as operational workstations for crewmembers. Each PDS has its own communications capability. In addition to intercommunications and switchboard circuits, the CCS provide access to 1 x HF, 2 x VHF amplitude modulation (AM), 1 x VHF FM, 6 x UHF, and 2 x multi-band ARC-210 radios. One UHF radio is reserved for TADIL-C. In addition to accessing single channel radios, the CCS provides access to 10 external telephone lines. A dual shelter configuration would then double the communications capabilities. The CCS has the capability to automatically exchange certain elements of command, tactical intelligence, and situation data with other MATCDs, TAOCs, and the TACC via TADIL-B. The AN/TSQ-131 has a 20-channel tape recorder and has secure voice capability. The CCS is a software driven system.

(b) Interface. Provides for digital interface (not video) of control and data messages between various peripherals. Remote control units located within the

AN/TSQ-131 provide status and remote control of the AN/TPN-22, AN/TPS-73, and AN/TRN-44. Interface with the TSQ-120A/B if accomplished by OCU radios and field phones. External agencies (weather, VFR, air operations) by field phones and ground-to-ground radio nets. Crash alarm wired from tower.

(c) Transportation Requirements.

- By air: C-130, C-141, C-17, C-5, CH-53 can transport as an external load.

- By ground: tractor-trailer, LVS.

(d) Setup.

- six Marines can set up 1 x AN/TSQ-131 in 2 hours.*
- six Marines can set up 2 x AN/TSQ-131s in 5 hours.*
- Two AN-TSQ-131s with 1 x AN/TPS-73 and 1 x AN/TPN-22 can be set up in 10 hours by 12 Marines.

(4) AN/TSQ-120A/B Air Traffic Control Central (ATC Tower).

(a) Description. The AN/TSQ-120 is a transportable ATC tower facility, which provides operators with 360-degree visual observance of aircraft, both on the ground and in the air, operating within a designated control zone and visual control over ground vehicles operating in the vicinity of the runway. The ATC tower can be erected to heights of 8 feet, 16 feet, or 24 feet. The ATC tower provides operator positions from where aircraft and airfield control is effected through the use of radio communications and visual aids. The ATC tower provides operators with access to 1 x HF, 3 x VHF/AM, 1 x VHF/FM, 5 x UHF single channel radios, and up to 10 telephone lines. The TSQ-120B ATC tower provides operators with access to 1 HF and 8 multi-band ARC-210 radios and up to 10 telephone lines. The AN/TSQ-120B model is capable of encrypted communications, has a second crash net radio, and is equipped with an ISO shelter. All audio communications are recorded.

(b) Transportation Requirements.

- By air: C-130, C-141, C-17, And C-5.
- By ground: tractor-trailer, LVS, 5 ton.

(c) Setup. four Marines can erect the system to a height of 24 feet within 5 hours.*

(5) AN/TRN-44 Tactical Air Navigation (TACAN).

(a) The AN/TRN-44 set is a transportable, dual-channel navigational aid which operates in the D-band (962-1213 MHz) and provides up to 100 TACAN equipped aircraft with range, bearing and station identification information within an effective radius coverage of 200 nm. It is used for both en route navigation guidance and as an instrument approach aid. When employed as a stand-alone, NAVAID technicians man it, but when employed with the AN/TSQ-120 or AN/TSQ-131, it can unmanned and remotely monitored.

(b) Transportation Requirements.

- By air: C-130, C-141, C-17, C-5.

- By ground: tractor-trailer, LVS, 5 ton.

(c) Setup. 4 hours by four Marines.*

(6) Maintenance Repair Group-AN/TSM-170.

(a) Description. The AN/TSM-170 group consists of four standard ISO shelters, which contain the workbenches, test equipment, cabinets, tools, and other equipment necessary for section maintenance of Fleet Marine Force (FMF) ATC equipment. All shelters allow some degree of flexibility to accommodate changed maintenance demands based on mission and equipment configuration. The AN/TSM-170 group consists of the following shelters:

- OA-9141/TSM-170 - Auxiliary Equipment Repair Group.
- OA-9142/TSM-170 - Communications Equipment Repair Group.
- OA-9143/TSM-170 - Radar Equipment Repair Group.
- OA-9144/TSM-170 - Electronic Module Repair Group.

(b) Interface. With other FMF ATC equipment is by field phone.

(c) Transportation Requirements.

- By air: C-130, C-141, C-17, And C-5. CH-53 can transport as an external load.

- By ground: tractor-trailer, LVS.

(d) Setup. Each AN/TSM-170 is configured for immediate deployment and requires 30 minutes setup time.*

*NOTE: All references to personnel utilized for setup of equipment refers to maintenance personnel. Controllers may assist but do not have the expertise to erect radar, NAVAID, or tower systems outside of the RLST, manpack radios and portable NAVAIDS.

b. Marine ATC Mobile Team Equipment. In addition to airfield marking equipment the MMT utilizes the following equipment.

(1) VHF/UHF Manpack Radios

(a) AN/PRC-113 Transceiver. This equipment operates in secure and non-secure voice mode. It can be used for Have Quick/whisper mode operations.

(b) AN/PRC-117F Transceiver. This multi-band radio operates VHF/UHF secure and non-secure communications. It operates in SINCGARS, Have Quick, and satellite communications (SATCOM) mode. The COMSEC equipment is a built-in module.

(c) AN/PSC-5 Satellite Transceiver. This multi-band radio operates VHF/UHF LOS and SATCOM/demand assigned multiple access. Embedded COMSEC allows secure and non-secure communications.

(2) HF Manpack Radios.

(a) AN/PRC-138 HF-single side band/VHF-FM Transceiver. This equipment operates 1.6-60 MHz using electronic counter-countermeasures, automatic link establishment, voice, data, digital voice, or encryption.

(b) AN/PRC-150 HF-(single side band) SSB/VHF-FM Transceiver. Embedded crypto, digital voice and data, automated link establishment, and electronic counter-countermeasures features.

(3) AN/TSQ-216 Remote Landing Site Tower. The AN/TSQ-216 provides a tower capability for remote site operations. Designed for initial and transitional operations the RLST is mounted on a heavy HMMWV. The AN/TSQ-216 provides up to two controllers with communications access to three UHF AM, two VHF AM/FM, one HF SSB and six landlines. All radios are capable of encrypted communications. Power and ECU's are provided by a trailer mounted generator system that provides a primary and a backup. Personnel can operate the system while it is attached to the HMMWV or act as a stand-alone system with antennas remotable up to 1 kilometer. The system has both overt and infrared ALDIS lamp capabilities, a weather sensor station and AN/PSN-11 GPS.

(a) Transportation Requirements.

- By air: C-130, C141, C-17, C-5, CH-53
- By ground: flatbed, railroad cars, self-transportable.

(b) Setup. 45 minutes by 2 Marines

(4) AN/TPN-30 Marine Remote Area Approach and Landing System. The AN/TPN-30 MRAALS is a 2-person, portable, all-weather instrument landing system. It transmits azimuth, distance, and elevation data in the J-band (15.412-15.680 GHz) and distance measuring equipment (DME)/station identification data in the D-band (962-1213 MHz). It provides 40-degree azimuth and 20-degree elevation guidance out to 10 nm on final approach to aircraft equipped with the ARA-63 airborne radar system. It also provides 360-degree DME and station identification information out to 40 nm.

(a) Transportation Requirements.

- By air: C-130, C-141, C-17, C-5, CH-53, CH-46, And UH-1N.
- By ground: tractor-trailer, LVS, 5-ton, HMMWV or equivalent.

(b) Setup. 10-15 minutes by 2 Marines.

(5) Distance Azimuth Measuring Equipment. This equipment is a man portable stand-alone TACAN system. It is a LOS transmitter providing azimuth and DME to a range of 40 nm. It operates in the D-band (962-1213 MHz).

(a) Setup. 10 minutes by 1 Marine.

(6) AN/PPN-19 Multiband Transponder. This equipment is used as a radar reference point for landing zones. It is compatible with most radar equipped aircraft including the KC-130, AC-130, and MC-130.

(7) Runway Marking Systems. The MMT uses ACR/L-32 remote control runway lights, VS-17 Airfield Marker Panels, P-Nut lights, or chemlights to mark various zones for day and night use, either overtly or covertly.

c. Equipment Acquisition Programs. Planned improvements to Marine ATC equipment include the TTCS and the Common Aviation Command and Control System (CAC2S) described below:

(1) Tactical Terminal Control System. TTCS is designed to replace the MATCALs system in order to provide a rapidly deployable surveillance and precision approach radar system. TTCS will allow for data link connectivity with other C2 assets to contribute to a common tactical air picture. TTCS will consist of three HMMWVs with trailers and required logistics support vehicles. Capable of rapidly deploying via KC-130 transport aircraft, TTCS will provide the Marine Corps with the capability to provide surveillance coverage and ATC services to 60 nm and 60,000 feet above ground level in IMCs with minimal footprint.

(2) Aviation Command and Control System. CAC2S and its communications suite may replace the AN/TSQ-131 upon the end of its service life. The CAC2S initiative will provide a common equipment suite within the MACCS, thus enhancing interoperability and reducing logistics requirements. CAC2S's standardized hardware suite will be equipped with a MACCS-common complement of servers, workstations, processors, etc. CAC2S's software will consist of standardized common components with agency specific (TACC, TAOC, DASC, etc.) applications. Each system will have a modular design and will be configured to meet each agency's mission requirements

3. Navy Amphibious ATC Equipment.

With the exception of PRC-113s, TACRONs do not own any ATC equipment. Amphibious ATC equipment is installed on LHA-1 (Tarawa-San Diego), LHA-2 (Saipan-Norfolk), LHA-3 (Belleau Wood-Japan), LHA-4 (Nassau-Norfolk), LHA-5 (Peleliu-San Diego), LHD-1 (Wasp-Norfolk), LHD-2 (Essex-San Diego), LHD-3 (Kearsarge-Norfolk), LHD-4 (Boxer-San Diego), LHD-5 (Bataan-Norfolk), and LHD-6 (Bon Homme Richard-San Diego). Table E-1 lists Navy Amphibious ATC Equipment

Table E-1 AMPHIBIOUS ATC EQUIPMENT

HULL UIC	SHIP	CURRENT DISPLAY	LOAD DTS	FUTURE DISPLAY	CDC SYSTEM	COM SUITE	PLAY BACK	HEADSET JACKBOX	PAR	SPN-41A ILS	NAV SRCE	RADARS /IFF
LHA-1 20550	TARAWA (SAN DIEGO)	TPX-42V-13 V-002 ADSOD201	USQ69B-D USQ69B-S	TPX-42V-13 V-XX ADS	NTDS ACDS BLK 1	LS537 IVN - 98	RD390	(10) (8)	SPN-35B	DONE	KCMX	SPN43B, 52, 40, 67 IFF - SAME
LHA-2 20632	SAIPAN (NORFOLK)	TPX-42V12 V002.Y8 OD201	USH26 USQ69	TPX-42V-13 V-XX ADS 2ND QTR FY 04	ACDS B0/L10	LS537 IVN - 01	RD379A SPKR	10 8	SPN-35B	DONE	ACDS KCMX	SPN43C, 48E, 40, 67 IFF - 43, 48 (CIFF)
LHA-3 20633	BELLEAU WOOD (JAPAN)	TPX-42V13 V002.Y9 OD-201	USQ69B-D USQ69B-S	TPX-42V-13 V-XX ADS 2ND QTR FY 04	NTDS ACDS B0/L10	LS537 IVN - 01	RC3212 SPKR	10 8	SPN-35A	DONE	SRN-25 KCMX	SPN43C, 48E,40, 67 IFF - SAME
LHA-4 20725	NASSAU (NORFOLK)	TPX-42V-13 V002.Y8 OD201	USQ69B-D USQ69B-S	TPX-42V-13 V-XX ADS 2ND QTR FY 04	ACDS B0/L10	LS537 IVN - 99	RC3212 SPKR	10 8	SPN-35B	DONE	ACDS KCMX	SPN43B, 48E, 40, 67 IFF - 43, 48 (CIFF)
LHA-5 20748	PELELIU (SAN DIEGO)	TPX-42V13 V002.Y9 OD-201	USQ69B-D USQ69B-S	TPX-42V-13 V-XX ADS 2ND QTR FY 04	NTDS ACDS BLK 1	LS537 IVN - 01	RC3212 SPKR	10 8	SPN-35B	FY03	PCNAV KCMX	SPN43C, 48E, 40, 67 IFF - SAME
LHD-1 21560	WASP (NORFOLK)	TPX-42V- 12V002.Y8OD 201	USH26 USQ69	TPX-42V-13 V-XX ADS 3RD QTR FY 03	ACDS BLK 1	LS654	RD379A SPKR	10 8	SPN-35B	DONE	SDMS KCMX	SPN43C, 49, 48E, 67 IFF - 43, 49
LHD-2 21533	ESSEX (SAN DIEGO)	TPX-42V12 V002.Y8 OD-201	USH26 USQ69	TPX-42V-13 V-XX ADS 3RD QTR FY 04	ACDS BLK 0/L 9	LS654	RD379A	10 8	SPN-35B	DONE	SDMS KCMX	SPN43C, 49, 48E, 67 IFF - 43, 49
LHD-3 21700	KEARSARGE (NORFOLK)	TPX-42V12 V002.Y8 OD-201	USH26 USQ69	TPX-42V-13 V-XX ADS 2ND QTR FY 03	ACDS BLK 0/L 10	LS654	RD379A	10 8	SPN-35B	DONE	SDMS KCMX	SPN43C, 49, 48E, 67 IFF - 43, 49
LHD-4 21808	BOXER (SAN DIEGO)	TPX-42V12 V002.Y8 OD-201	USH26 USQ69	TPX-42V-13 V-XX ADS 4TH QTR FY 04	ACDS BLK 0/L 9	LS654	RD379A	10 8	SPN-35A	DONE	SDMS KCMX	SPN43B, 49, 48E, 67 IFF - 43, 49
LHD-5 21879	BATAAN (NORFOLK)	TPX-42V13 V002.Y8 OD-201	USQ69B-S USQ69B-D	TPX-42V-13 V-XX ADS 2ND QTR FY 04	ACDS BLK 0/L 10	PICT	RC3212 SPKR	10	SPN-35B	DONE	SDMS KCMX	SPN43C, 49, 48E, 67 IFF - 43, 49
LHD-6 22202	BON HOMME RICHARD (SAN DIEGO)	TPX-42V13 V002.Y8 OD-201	USH26 USQ69B-S	TPX-42V-13 V-XX ADS 2ND QTR FY 04	ACDS BLK 0/L 10	PICT	RC3212	(10)	SPN-35B	DONE	SDMS KCMX	SPN43C, 49, 48E, 67 IFF - 43, 49
LHD-7	IWO JIMA (NORFOLK)	TPX-42V-13 V-V002.Y8 ADS OD201	USH26 USQ69B-S	TPX-42V-13 V-XX ADS	ACDS BLK 0/L 10	PICT	WORD SAFE	(10)	SPN-35B	DONE	SDMS KCMX	SPN43C, 49, 48E, 67 IFF - 43, 49
MCS-12	INCHON (INGALSIDE)	SPA-25G RPTR	N/A	N/A	LINK 14	TA970	RD390	5 4	SPN-35B	N/A	GYRO	SPN43B

Amphibious ATC Equipment – equipment and displays are being updated on several ships, which are depicted.

4. General Purpose Air Force ATC Equipment.

- a. AN/TPN-19 Landing Control Central.

(1) Description. The active duty operated and maintained AN/TPN-19 Landing Control Central (Radar Set) can be configured as a complete radar approach control (RAPCON) with radar final control, RAPCON with ASR only, or a GCA only facility.

(2) Capabilities. The radar unit is used by air traffic controllers to locate and identify arriving and departing aircraft and provide final approach guidance. These services can be provided in all types of weather. The radar unit is capable of identifying aircraft using secondary radar within a 200 nm radius, SFC - 60,000 feet, and primary radar coverage to 60 nm, SFC - 40,000 feet. The PAR portion provides both azimuth and elevation information from 20 nm to touchdown. The unit has six display indicators that are capable of providing both ASR and PAR displays in the operations shelter. With all these indicators and communications equipment installed, the unit is capable of taking over ATC operations at busy airports. Since personnel can rotate the PAR antenna and lock it into numerous positions, the unit is capable of providing approaches to four runways, but the unit can provide guidance to only one runway at a time.

(3) Personnel. Normally, required ATC personnel include 2 air traffic controllers from a combat communications group (CCG), 10 radar maintenance, 1 radio maintenance, 1 power production, 1 refrigeration maintenance, and 18 air traffic controllers (UTC-tasked from fixed base assets).

(4) Interface. The AN/TPN-19 can interface with other facilities via landline or UHF/VHF radio. These facilities include other ATC facilities and wing operations centers.

Note: The TPN-19 uses analog equipment for communications, and requires special consideration when interfacing with digital equipment.

(5) Transportation requirements by air using one of the following four methods:

- (a) 7 x C-130s
- (b) 2 x C-17s
- (c) 3 x C-141s
- (d) 1 x C-5 (36 pallet positions without self-propelled vehicles)

(6) Transportations requirements by road requires a combination of the following methods:

(a) M-923 loaded with mobility readiness spares package (MRSP) towing PAR shelter.

(b) M-923 loaded with MRSP towing ASR shelter M-923 loaded with support towing Ops A shelter.

(c) M-923 loaded with support towing Ops B shelter.

(d) M-35 loaded with power support towing ASR/OPS Pallet.

(e) M-35 towing S530A shelter.

(f) M-35 loaded with MRSP, towing S530B shelter or 280 shelter.

(g) M-35 loaded with life support, towing the PAR pallet.

(h) M-35 loaded with fuel drums, towing mobile electric power (MEP) 005.

- (i) M-35 loaded with fuel drums, towing MEP 005.
- (j) M-35 loaded with baggage, towing MEP 005.
- (k) M-35 loaded with support towing MEP 005.
- (l) M-35 loaded with support towing MEP 006.
- (m) M-35 loaded with support towing MEP 006.

(7) A minimum of 10 trained maintenance personnel and 2 trained air traffic controllers can install the AN/TPN-19 with a minimum of 1 operational PAR display, 2 surveillance displays with primary and secondary radar data, 4 UHF radios and 1 VHF radio in 36 hours. If the 18 controllers sent in to augment the team are included this time should drop to 26 hours for the same capabilities.

Note: After being set up, the AN/TPN-19 must be flight inspected prior to being declared mission capable.

b. AN/MPN-14K Landing Control Central.

(1) Description. The ANG operated and maintained AN/MPN-14K Landing Control Central (Instrument Landing Aid) can be configured as a complete RAPCON with radar final control, RAPCON with ASR only, or a GCA only facility. The system can deploy autonomously, configured as a GCA only facility, providing limited final approach guidance. The radar unit is used by air traffic controllers to locate and identify arriving and departing aircraft and provide final approach guidance. They can provide these services in all types of weather.

(2) Capabilities. The radar unit is capable of providing 60 nm primary radar coverage, SFC – 40,000 feet and 200 nm secondary, SFC – 60,000 feet IFF/Selective Identification Feature sweep coverage. The PAR portion provides both azimuth and elevation information from 20 nm to touchdown. The unit has three ASR indicators and one PAR indicator in the operations shelter. The unit is capable of ATC operations at busy airports with single runway operations.

(3) Personnel. Normally, required ATC personnel include 1 ATC officer, 16 air traffic controllers and 1 TERPS specialist.

(4) Interface. The AN/MPN-14K is capable of interface with the AN/MSN-7 mobile control tower and other facilities via landline, radio (UHF/VHF) and microwave link. The system uses analog equipment for communications and requires special consideration when interfacing with digital equipment.

(5) Transportation requirements by air using one of the following three methods:

- (a) 3 x C-130s
- (b) 1 x C-17s
- (c) 1 x C-5

(6) Transportation requirements by road using a combination of the following methods:

- (a) M-923 loaded with MSRP towing ops shelter
- (b) M-923 loaded with support towing maintenance shelter

- (c) M-35 loaded with fuel drums, towing MEP 806B generator
- (d) M-35 loaded with support towing MEP 806B generator
- (e) M-35 loaded with support cables

(7) Minimal Mission Capability and Setup Timing. A minimum of 11 maintenance and 16 ATC personnel are required to install the AN/MPN-14K with 1 operational PAR scope, 3 operational ASR scopes, secondary radar, 4 UHF and 2 VHF radios within 24 hours. After being set up, the AN/MPN-14K must receive a flight inspection prior to being declared mission capable.

c. AN/MPN-25 Rapid deployment Landing System (GCA-2000).

(1) Description. The AN/MPN-25 is a rapidly deployable tactical ground control approach system capable of providing both ASR and PAR service. The Air Mobility Command operates and maintains 3 x AN/MPN-25 (Ground Controlled Approach-2000) systems. These radar units will allow air traffic controllers to provide surveillance and precision approach landing capability down to 200-foot ceilings and ½ mile visibility.

(2) Capability. 'X' band radar (mode 1-4 capable) range: PAR 20 nm to touchdown, ASR 30 nm, and secondary surveillance radar (SSR) 100 nm. Six programmable VHF/UHF radios with commercial interface capability for power and telephonic communications. Deployed as a self-contained system providing power through a trailerable generator system. Four operating positions (ASR/PAR) three control positions and one supervisor /maintenance position. The PAR is capable of being sited and aligned to provide radar coverage to at least six runways. The number of runways to be covered is an important factor in siting sensor.

(3) Personnel and AFSCs. Normally deploys with one 13M3, four 1C171, four 1C151 (one TERPS qualified) and two dedicated 2E071 (one minimum staff sergeant) radar maintenance technicians. Additionally one maintenance and two controller site survey qualified personnel.

(4) Interface. The AN/MPN-25 uses digital equipment and requires special consideration when interfacing with analog equipment. Radar signal can be remoted to fixed radar facility, distance determined on available wiring. Can be connected to commercial power and phone lines.

(5) Transportation requirements by air:

- (a) 1 x C130 (7 pallet positions)
- (b) 1 x C-17 (7 pallet positions)
- (c) 1 x C-5 (7 pallet positions)

Note: 7 pallet positions does not include personnel support equipment or vehicle (Heavy Hummer) if required.

(6) Transportation by ground.

- (a) Heavy Hummer - Short distances
- (b) 1 x Extended flat bed semi trailer (low bed)
- (c) 2 x Standard size Flat bed trucks (low bed)

(7) Minimum mission capability and setup timing. Once unit is on site and TERPS is completed, it can be operational in 3 hours. After system is operational a flyability check is required IAW AFMAN 11-225 paragraphs 107.31 and 109.5c (emergency military use only) for military aircraft. A flight check is required prior to allowing contract civil air carriers to conduct approaches.

d. AN/MSN-7 Tower Restoral Vehicle (TRV).



Figure E-1 AN/MSN-7 Tower Restoral Vehicle

(1) Description. The AN/MSN-7 consists of a vehicle-mounted shelter (M-1113 HMMWV) containing ATC equipment and space for three air traffic controller personnel to perform aircraft launch and recovery operations. Transported to the theater of operations by air, personnel can drive it to its final operating location, set it up quickly, and conduct self-sustained operations in a bare-base environment. If necessary, the system can be quickly torn down and moved to a new operating location. The system's communications capabilities are robust, allowing the AN/MSN-7 to temporarily replace existing ATC tower facilities while they are being repaired or refurbished.

(2) Threats. The AN/MSN-7 mission, to supply ATC service in bare-base locations, may make the system a primary target of surface-to-surface and air-to-surface munitions.

(a) Although the AN/MSN-7 may be located in vulnerable areas during an attack against the airfield, the system's high mobility and relatively small size will allow its crew to react quickly and move the system to a sheltered area.

(b) A threat also exists from hostile special operations forces. Due to its small size and weight, small arms fire and lightweight explosives easily damage the AN/MSN-7.

(c) A secondary threat is present due to the AN/MSN-7's close proximity to other primary targets on the airfield. The system could suffer collateral damage if it is near one of these targets during an airfield attack. Survivability may be aided by camouflage and the fact that emissions from the AN/MSN-7 need be present only during aircraft launch and recovery operations.

(d) Electronic warfare and electronic countermeasures will be a partial jamming threat to communications used by the system. The use of HAVE QUICK

capable radios will give anti-jam protection to ultrahigh frequency (UHF) communications.

(3) Capabilities. During wartime, the AN/MSN-7 is capable of quickly deploying and operating in a bare base environment. Forward operating locations demand that the system be self-supporting. If hostile airfields are captured, the AN/MSN-7 is capable of rapid redeployment to the captured area in order to exploit these resources and render ATC service to friendly forces. The system will remain mostly in a non-operational state (in storage) during peacetime. The storage requirements allow storage almost anywhere space is available. Personnel can rapidly ready and transport the system to locations where ATC service has been lost, e.g. due to natural disaster. Once there, the system will supply temporary service until repairs are made to fixed tower assets. The system is designed for setup and operation under all expected environmental conditions.

(4) Personnel. The proposed number of ATC personnel required to operate the AN/MSN-7 include two air traffic controllers (from active duty CCG or ANG UTC-tasked), four radio maintenance, one power production, one refrigerator maintenance, and eight air traffic controllers (ANG or active duty fixed base UTC-tasked).

(5) Interface. The AN/MSN-7 is inter-operable with the host wing C2 structure for fixed base operations. The AN/MSN-7 does not require a Wing Command and Control System workstation. Any communications with Theater Air Control or the Airlift Control System will take place via radio or landline. Frequency allocations for ground-to-air radios are such that operation of the AN/MSN-7 is transparent to aircraft supported by ATC operations conducted from the AN/MSN-7 within the constraints of the system's intended mission. Frequency allocations for the land mobile radios (LMRs) ensure interoperability with other base functions such as communications squadrons and base operations. Since the AN/MSN-7 operates in foreign countries, interface and interoperability considerations with existing and potential allied ATC and C2 systems are imperative.

(6) Transportation Requirements. A single AN/MSN-7 system must fit, without disassembly, into one C-130 aircraft. This requirement is limited to the prime mover and support vehicle; it does not include manpower or all the necessary sustainment equipment detailed in the UTC. Personnel can drive the AN/MSN-7 to its operating location using either unimproved roads or, if necessary, by crossing moderately rough open terrain. The ability to travel at a 50 mph cruising speed on paved roads enables the AN/MSN-7 to move reasonable distances from its storage location to embarkation point, or from its debarkation point to its operating location. This capability conserves airlift sorties.

(7) Minimal Mission Capability and Setup Timing. Personnel can make the AN/MSN-7 fully operational within 1 1/2 hours, after arrival on site by a maximum of four trained personnel. AN/MSN-7 setup time will be no more than 2 hours when these personnel are wearing chemical, biological, and radiological or arctic weather gear. The same time and personnel constraints apply to the system when dismantling and packing for storage or redeployment.

e. AN/TRN-26 Tactical Air Navigation (TACAN)

(1) Description. The active duty and ANG operated and maintained AN/TRN-26 is designed for use at remote landing strips and forward operating areas. The system provides radio navigation information (azimuth or bearing, identification, and range) to as many as 100 aircraft simultaneously. Due to the UHF carrier, the transmitted information is limited to LOS.

(2) Capabilities. The system has an acquisition range of 35 nm at 1,500 feet above unobstructed terrain and a maximum reception range of 100 nm. Internal monitoring equipment provides a continuous check of all significant TACAN parameters and shuts the TACAN off when a fault occurs. The shelterized AN/TRN-26B is preferred for long-term deployments and those to locations with extreme climate conditions but both A and B models meet the same operational requirements. Frequency Range: Low band, TX 962 - 1024 MHz, channels 1-63, RX 1025 - 1087 MHz, High band, TX 1151 - 1213 MHz, channels 64-126, RX 1088 - 1150 MHz. The AN/TRN-26 operates in "X" mode only which is related to pulse spacing of 12 micro seconds. AN/TRN-26A only operates in high band, AN/TRN-26B can operate either high band or low band dependent on antenna used.

(3) Personnel. The proposed number of personnel required to operate the AN/TRN-26 TACAN includes three METNAV maintenance and one power production personnel.

(4) Interface. The AN/TRN-26 does not require interface with other facilities. However, it normally has an indicator connected to the RAPCON or tower to allow 24-hour status observation. Frequency authorization is required.

(5) Transportation requirements by air:

(a) 1 x C-130

(b) 1 x C-141 (AN/TRN-26A: two pallet positions, AN/TRN-26B: three pallet positions without self-propelled vehicle)

(6) Transportation requirements by road:

(a) AN/TRN-26A: M-923 loaded with MRSP & AN/TRN-26A TACAN

(b) M-923/925 with pallet towing TRN-26B shelter and M-35 with pallet towing M-103

(7) Siting requirements: When siting the AN/TRN-26B, there are three things to keep in mind: airfield, equipment, and operational requirements. One may find a good site that meets both airfield and equipment requirements, but does not provide final approach guidance to the aircraft. The main purpose in siting the AN/TRN-26 is to ensure that a building or a flat surface that may reflect the TACAN signal does not block line of sight for final approach. The TERPS specialist inputs all necessary requirements to ensure compatibility with existing and/or proposed instrument approach procedures when siting the TACAN.

(a) Airfield Requirements: Site the TACAN no less than 500 feet from the runway centerline, 200 feet from the centerline of any taxiway, and 125 feet from the edge of any runway apron. The system should also be 1,000 feet from any 25-foot obstacles to prevent signal degradation.

(b) Equipment Requirements: The AN/TRN-26 TACAN signal can be reflected. If the reflected signal hits the line of sight signal, the signal is canceled out, and the pilot will not receive guidance information. To prevent signal reflection, site the TACAN in a rough area, free of large, hard, flat surfaces such as lakes, highways, metal building, and even taxiways.

(c) Operational Requirements: The TACAN final approach radials must be less than 30 degrees off of the final approach course and intersect the extended runway centerline between the end of the runway and points 3,000 feet out. The ideal location is mid-field and 500 feet from the runway centerline. For ATC purposes, the TACAN should be sited within 6,000 feet of the radar unit. For communications between ATC facilities, one should site the TACAN on the same side of the runway as the tower.

(d) Minimal Mission Capability and Setup Timing. Three maintenance personnel can make the TACAN operational within four hours. At least one integral monitor and one receiver/transmitter with 63-channel capability identification, and at least 360-watt output power are required to declare the TACAN operational. Prior to being declared mission capable, the AN/TRN-26 must receive a flight inspection.

f. AN/TRN-41 Tactical Air Navigation (TACAN).

(1) Description. The AN/TRN-41 is a portable, lightweight, air droppable, unmanned TACAN designed to provide bearing, facility identification, and distance information. The ground equipment consists of a transponder with associated antenna system and the aircraft is equipped with an interrogator. The TACAN transmits continuous bearing information to an unlimited number of aircraft and provides slant range distance information to as many as 100 aircraft simultaneously. Due to the UHF carrier, the transmitted information is limited to LOS use only, with a range of 75 nm. The AN/TRN-41 does not require any other type of equipment to be operational.

(2) Transportation requirements by air:

(a) 1 x C-130

(b) 1 x C-141 (1 pallet position, without self-propelled vehicle)

(3) Transportation requirements by road: 1 x M-35 with AN/TRN-41 TACAN/Generator /Generator MRSP/support

(4) Minimal Mission Capability and Setup Timing. Two meteorological/ navigational aid technicians should setup 63 channels with identification and at least 100 watts of power output in 4 hours.

g. AN/MRC-144 Mobile HF/UHF/VHF Radio System (currently STT only)

(1) Description. The AN/MRC-144 is a mobile HF/VHF/UHF communications facility with an AN/GRC-206 package mounted in an M-998 HMMWV. It provides SSB HF, VHF/FM, VHF/AM, and UHF communications, with a full compliment of portable backup radios. This system can be remotely operated up to 2 km away. All radios have secure voice capability. When used in an ATC capacity, task air traffic controllers separately. Four air traffic controllers (modified UTC from fixed base assets) are required.

(2) Interface. The AN/MRC-144 can communicate with any radio in the UHF/VHF AM, VHF FM, and HF range. Also, it can communicate with any UHF AM radio that has been modified with HAVE QUICK II.

(3) Transportation requirements by air:

(a) 1 x C-130

(b) 1 x C-141 (5 pallet positions, includes one self-propelled vehicle [M-998])

(4) Transportation requirements by road: M-998 HMMWV and towing M-101 trailer

(5) Minimal Mission Capability and Setup Timing. One radio technician and one radio operator should have HF/SSB, VHF/FM, UHF/AM, and VHF/AM radios available over 90 percent of the tuning range in 45 minutes.

h. AN/MRN-23 Mobile VORTAC

(1) Description. Air Mobility Command (AMC) purchased two MRN-23s to resolve a Global Reach Laydown program deficiency that called for a deployable contingency ATCALs that supports both military and civil aircraft requirements. Prior to the development of this unit, DOD had no deployable equipment that met the civil requirements. The MRN-23 is an integrated very high frequency omnidirectional range station (VOR) (FRN-44) and TACAN (TRN-41) facility and provides both military and civilian aircraft with suitable radio navigation information (azimuth, bearing, and range).

(2) Capabilities. The TACAN has a LOS usable range of 150 nm and the VOR is 50-plus nm. The system provides VOR, DME, and TACAN for en route navigation and non-precision approaches.

(3) Interface. The AN/MRN-23 does not require interface with other facilities, however, it is capable of being remotely monitored.

(4) The system is certified for transportation on a C-130, C-141, C-17, or C-5 aircraft. It is packaged with a prime mover (HMMVV) and is capable of being loaded and unloaded without the use of specialized cargo handling equipment.

(5) Minimal Mission Capability and Setup Time. The MRN-23 provides reliability and is capable of being setup and maintained by two technicians.

i. AN/TRN-45 Mobile Microwave Landing System.

(1) Description. The MMLS provides precision navigation guidance for exact aircraft alignment and descent of aircraft on approach to a selected runway by providing three-dimensional navigation guidance. It integrates azimuth, elevation angle, and range DME information to provide precise aircraft positioning. The components of an MMLS are similar to an instrument landing system (ILS). There is a glideslope antenna known as an elevation station and a localizer antenna known as an azimuth station.

(2) Capabilities. The MMLS can fulfill a variety of needs in the transition, approach, landing, missed approach, and departure phases of flight. Some additional capabilities associated with MMLS include curved and segmented approaches, selectable glideslope angles, accurate three-dimensional positioning of the aircraft in

space, and the establishment of boundaries to ensure clearance from obstructions in the terminal area. The azimuth service limitation is 15 nm from the facility, with lateral coverage extending to a maximum of 40 degrees either side of the facility. The elevation service limitation is 15 nm from the facility, from 0 degrees to 15 degrees, and up to at least 20,000 feet. The minimum glide path angle is 2.50 degrees with a maximum angle of 6.40 degrees. Any glide path angle established over 3.60 degrees requires a waiver. The elevation station transmits its guidance signals on the same carrier frequency as the azimuth station. The single frequency is time-shared between angle and data function. Coverage extends to a distance of at least 15 nm. MMLS has 200 discrete channels. The system has low susceptibility to interference from weather conditions and airport ground traffic, but has a high susceptibility to television signals.

(3) Interface. The MMLS is similar to an ILS system in operation (providing both azimuth and elevation guidance) and can be set up in two different configurations. The system is normally installed in the collocated configuration where the elevation antenna (glide slope) and azimuth antenna (localizer) are set up near the touchdown point of the runway. A split site configuration of the system is set up more like a traditional ILS system where the elevation station is near the touchdown point and the azimuth station is located at the stop end of the runway.

(4) The elevation station is located approximately 156 feet to 306 feet either side of runway centerline for a collocated site (up to 450 feet for a split-site installation). On assault landing strips, the MMLS shall be configured to allow a RPI of 300 to 500 feet from threshold. For fixed runway configurations, site the system for coincidence with an established VGSI system and/or established precision procedures.

(5) Transportation requirements air: 1 x C-130

(6) Transportation requirements by road: 1 x M-35/M-923

(7) Minimal Mission Capability and Setup Timing. The system requires four personnel. Currently, there personnel are not assigned to the system. Special Operations Command uses combat controllers (operations section) to install the system, and the ANG has embedded the system into the TACAN UTC (maintenance section). The system can be operational within 1.5 hours.

j. Special Tactics Squadrons. In addition to the AN/MRC-144, AN/TRN-41 TACAN, AN/TRN-45 Mobile Microwave Landing System (MMLS) and airfield marking equipment, the STS possess VHF/UHF/HF/FM manpack radios.

k. Future Acquisitions of AN/MPN-26 Mobile Approach Control System (MACS)

(1) Description. The AN/MPN-26 MACS is scheduled for delivery starting in FY04 and continuing through FY07. This 18 unit purchase will replace both the Air Force AN/TPN-19s and the ANG AN/MPN-14K radar systems. This lighter, more transportable, modern equipment will fix on-going maintenance and readiness problems of these older legacy systems. The total MACS system consists of an ASR subsystem, PAR subsystem, and an operations center subsystem (see figure E-2).

Operational Configuration

Ops Configuration

- Displays, Automation, Voice
- 5 Controllers, 1 Supervisor,
- 2 Assistants, Coordinator
- Full Communications

ASR

- 2 Controllers
- Full Communications

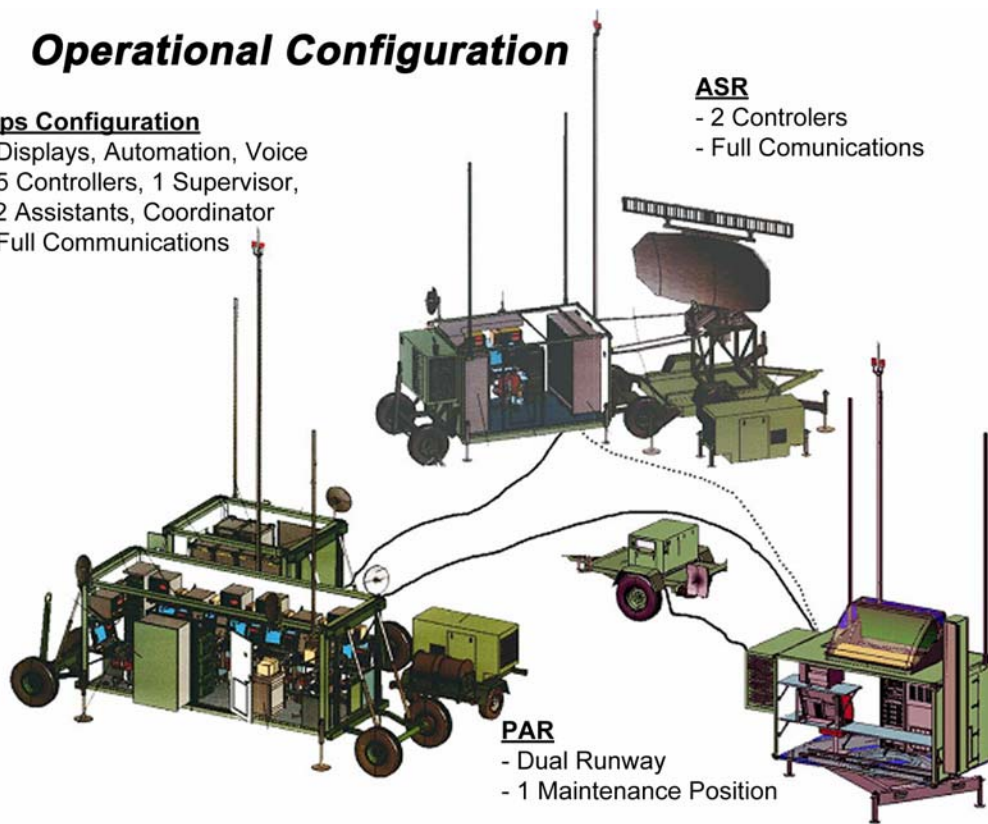

Figure E-2 AN/MPN-26 Mobile Air Traffic Control System

(a) The operations center is contained in two DOD standard shelters. Ops 1 is a 20-foot ISO container and is transported using an M-1022A1 mobilizer. It contains the automation software (MTAS), distributed communications, and the airfield automation and weather display systems. Operationally it consists five controller positions, two assistant controller positions one supervisor position and one coordinator position. Ops 2 is contained in a DOD Standard S-280 shelter and transported with a M-720 mobilizer. It consists of all electronics required for the ASR system to include, radio equipment racks, MTAS processors, TRI-terminal access controller interface, and the maintenance computer.

(b) The ASR subsystem is contained in a DOD standard S-280 shelter and transported on a M-720 Mobilizer. It consists of the Primary Surveillance Radar (PSR) System, SSR System, automation capabilities, airfield automation weather display system, distributed communications, and two operator positions. The communications equipment, which are accessible from all MACS operator positions, consists of UHF/VHF radios, intercom capability, landlines, and voice switching systems. The ASR/PRS antennas and generator are trailer mounted for transportation and remain on the trailer during operation.

(c) The PAR system is contained in a modified S-280 shelter and transported on a M-832 mobilizer. It consists of a precision approach radar, PAR automation system, communications, and 1 display position. The PAR should be solid

state. The communications equipment consists of UHF/VHF radios, intercom capability, and landlines.

(d) MACS is required to support many different missions. As such, make MACS flexible in order to meet the needs of the Air Force and ANG. Each MACS subsystem is housed in separate shelters for both operations and transport, equipped with its own environmental control unit and power generation equipment, and capable of autonomous operation as dictated by the deployment scenarios:

- Full MACS (ASR, PAR and OPS)
- ASR only
- Operations only
- Operations and ASR only
- Operations and PAR only
- ASR and PAR both

(2) Capabilities. The MACS will provide ATC services, day and night, in all weather conditions, to military and civil aircraft. Tailor The system will be tailorable to meet the requirements of the theater commander and operate within FAA performance parameters. MACS will be interoperable with the civil system to conduct force training and in response to crisis such as domestic disaster relief, or catastrophic failure of fixed systems.

(a) The PSR is capable of providing surveillance coverage from surface to 20,000 feet over 360 degree azimuth, and has a range of 0.5 nm to 60 nm from the radar. The PSR can process a total of 400 aircraft and 300 non aircraft targets. The SSR provides aircraft surveillance information to the system's automation system. It shall interface with aircraft equipped with all ATC Radar Beacon System (ATCRBS) transponders and be capable of interrogating modes 2, 3/A, and C. The SSR system provides coverage from surface to 40,000 feet, 360 degree azimuth, and a range of 0.5 to 200 nm from the radar antenna.

(b) MACS PAR provides coverage from -1 to +7 degrees elevation, ±15 degrees azimuth and 20 nm in range. PAR can display up to 40 uncontrolled tracks with associated data in the PAR surveillance coverage volume. MACS PAR will have the capability to display up to 40 uncontrolled tracks with associated data in the PAR surveillance coverage volume. The operator can designate up to six tracks as controlled tracks and is able to select/de-select the display of controlled track information at the PAR operations console. Unique symbology is used to differentiate between uncontrolled and controlled tracks. A built in test for the PAR will be able to detect and isolate at least 95 percent of all failures to a single LRU, as well as detect and isolate at least 98 percent of all failures to three or less LRUs.

(3) Personnel.

(a) In Garrison. The planned personnel authorization (UTC) for each MACS in-garrison at Air Force locations is: eight radar maintenance, two air traffic controllers, one communications maintenance, one power production, one heating, ventilation, air conditioning (HVAC), and three air traffic control automation system specialists (ATCSSs) to maintain the MACS Terminal Automation System (MTAS)

software. The radar maintenance personnel assigned with the MACS will accomplish MTAS hardware maintenance.

(b) Personnel Assigned for Deployment. The number of Air Force personnel for deployment will vary depending on the mission scenario. In a typical scenario, MACS deploys with the in-garrison UTC personnel package (6 people) and an additional 18 controllers and automation personnel from fixed base RAPCONS will augment if required. Only two UTC ATCSSs will deploy on an initial tasking with one left in reserve to support the AEF 90-day rotation with a fixed base ATCSS. The ANG deployment UTC (34) will include the same number of personnel as required by the Air Force and meet the same deployment criteria.

(4) Interface. The MACS will be capable of setup using a microwave links or fiber optic links between shelters (up to 15,000 feet). The MACS will interface with other facilities via landline or UHF/VHF radios. These facilities include other ATC facilities and wing operations centers. The MACS will interface with other ATC long range and short range radars using a common digitizer (CD-2) input and CD-2 output. MACS will also interface with the MSN-7 Mobile Tower using a microwave link or fiber optic link and will have a radar tower coordination system as part of the MACS. Additionally, MACS will interface with Tri-Tac and TDC equipment.

(5) Transportation by Air. The MACS shall be air transportable by inter- and intra-theater airlift (e.g., C-130, C-141, C-5, C-17 aircraft, etc.). The MACS, equipment only, will be transportable on three C-130 aircraft including system placement and setup equipment, 10 crew members, cables and interconnects, calibration and performance monitoring aids, spare parts and test equipment required for 30 days of operations. System equipment includes power generation and environmental control units but excludes consumables such as fuel normally found at an operational location. This only includes MACS operational equipment and does not include base operational support items and a back up power source

(6) Transportation by Ground. MACS is ground transported by semi-trailer flatbed trucks, military cargo vehicles, or towed using standard military dolly sets that support the MACS weight and cubic feet. MACS is capable of being towed at highway speeds on improved roads and reduced speeds on unimproved roads and various terrains prior to setup. The exact configuration of ground transportation of MACS will not be determined until the units are fielded and deployment documents are produced.

(7) Mission Capability and Setup Timing. The MACS System (ASR, Ops and PAR) shall be capable of physical, on-site setup and tear down by 15 personnel shall be accomplished in 12 hours or less. Personnel wearing appropriate cold weather clothing and/or full nuclear, biological, chemical mission oriented protective posture clothing shall accomplish the same task in 18 hours or less. The setup includes the MTAS adaptation as well as the shelter and hardware positioning. The 15 setup personnel are normally assigned to the UTC (In Garrison). Additional deployed air traffic controllers may augment these personnel. The preliminary site survey time is not included in the setup time. Additionally, prior to being declared mission capable the MACS must receive a flight inspection. (See chapter 1).

5. Communications Capabilities

The Services have different communications capabilities as depicted in table E-2.

Table E-2 Service-Specific Communications Capabilities

Organization	Systems	Comm Capability
Air Force (STT)	Provide VFR/Limited IFR MMLS Precision Landing Capability for MLS-equipped C-130 / C-17	UHF AM/FM/Voice/Data Secure, VHF AM/FM/Voice /Data/Secure, HF Secure/Voice/Data, SATCOM- TACSAT/Secure, IMARSAT, HAVE QUICK, SINGARS
Air Force (Combat Comm)	MSN-7 L+2 Hours Mobile Control Tower	5 UHF/4 VHF 3 Landlines 3 Direct hotlines
	TPN-19 L+36 Hours Mobile RAPCON	HAVE QUICK/9 UHF/5 VHF 3 Landlines 13 Direct hotlines
Air Force ANG (ATCS)	MPN-14 L+24 Hours Mobile RAPCON	HAVE QUICK/7 UHF/5 VHF 6 Landlines 1 Direct hotlines
	MSN-7 L+2 Hours Mobile Control Tower	5 UHF/4 VHF 3 Landlines 3 Direct hotlines
	AN-26 TACAN L+4 hours	N/A
Army	TSQ-198 VFR Service	1 UHF HAVE QUICK /Voice/Data (Secure) 1 VHF HAVE QUICK /Voice/Data (Secure) 1 HF Voice/Data (Secure) 1 FM SINGARS (Secure)
	TSQ-71B VFR/IFR ATS Service Precision Approaches	3 UHF/3 VHF 2 FM SINGARS (Secure)
	TSC-61B En route Flight Following Airspace Integration	3 VHF/3 UHF/3 SINGARS (Secure) 1 HF
	TSW-7A VFR/IFR ATS Tower Service	3 VHF/3 UHF/3 SINGARS (Secure) 1 HF
Marine MMT Initial	Provide VFR/Limited IFR MRAALS (ARA-63 Radar Equipped Aircraft) Distance Azimuth Measuring Equipment (TACAN)	4 PRC-117 (F) Multiband Transceivers 1 PRC-150 HF/VHF Transceiver UHF AM/FM/Voice/Data Secure VHF AM/FM/Voice/Data Secure HF Secure/Voice/Data/automated link establishment SATCOM, HAVE QUICK, SINCGARS
Marine ATC Detachment Transition/ Sustainment	TSQ-120A Control Tower	5 GRC-171 UHF/AM Radios 3 GRC-211 VHF/AM Radios 1 VRC-82 VHF/FM Radio 10 Landlines
	TSQ-120B Control Tower	8 ARC-210 Multiband Radios 2 URC-94 HF Radio 1 HT-1000 VHF/FM Radio 10 Landlines SATCOM/ HAVE QUICK /SINCGARS
	TSQ-131 Radar Command And Control Subsystem (Dual Shelter Configuration Double Capability)	2 ARC-210 Multiband Radios 6 GRC-171 UHF/AM Radios 3 GRC-211 VHF/AM Radios 1 URC-94 HF Radio UHF AM/FM/Voice/Data Secure VHF AM/FM/Voice/Data Secure HF Secure/Voice SATCOM, HAVE QUICK, SINCGARS, TADIL B&C

Appendix F
Sample ATC Handover Checklist

SAMPLE ONE

1. CONTROL # _____
2. MISSION # _____ A. CHANGE # _____ B. REF # _____
3. FREQUENCY (PRIMARY/Alternate):
 - A. UHF (P) _____ (A) _____
 - B. VHF (P) _____ (A) _____
 - C. HF (P) _____ (A) _____
 - D. FM (P) _____ (A) _____
 - E. SATCOM (UP) _____ (DN) _____
4. THREAT _____
5. FLD ELEV _____ FT MSL
6. TD ZONE ELEV _____ FT MSL
7. DIMENSIONS

	L	W
A. RWY	_____ FT	_____ FT
B. TXWY	_____ FT	_____ FT
C. OVRN	_____ FT	_____ FT
D. HELIPD	_____ FT	_____ FT
8. USABLE TXWY Y / N
9. ACTIVE RWY _____ / _____ RUNWAY CROSSING POINTS (RCP) _____
10. MAXIMUM ON GROUND:
 - A. C-130 _____
 - B. C-141 _____
 - C. C-5 _____
 - D. MC-130 _____
 - E. C-17 _____
 - F. HELO _____
 - G. OTHER _____
11. PARKING SPOTS
 - A. LOCATIONS
 - (1) FIXED-WING _____
 - (2) HELO _____

12. MARSHALLERS REQ: A. FIXED-WING : Y / N B. HELO: Y / N
13. HOT CARGO AREA Y / N
 LOCATION _____
14. REFUELING PTS Y / N
 LOCATION _____
15. ARMING AREAS Y / N
 LOCATION _____
16. AVERAGE ON LOAD TIME _____ MIN
17. AVERAGE OFF LOAD TIME _____ MIN
18. OBSTACLES ON AIRFIELD: Y / N
- A. TREES Y / N _____ FT
- B. WIRES Y / N _____ FT
- C. HOUSES Y / N _____ FT
- D. PERSONNEL Y / N _____ FT
- E. DITCHES Y / N _____ FT
- F. TERRAIN Y / N _____ FT
- G. POLES Y / N _____ FT
19. OBSTACLES IN CLASS D AIRSPACE: Y / N
- A. TREES Y / N _____ FT
- B. WIRES Y / N _____ FT
- C. HOUSES Y / N _____ FT
- D. PERSONNEL Y / N _____ FT
- E. DITCHES Y / N _____ FT
- F. TERRAIN Y / N _____ FT
- G. POLES Y / N _____ FT
20. BLIND SPOTS
- A. VISUAL _____
- B. RADIO _____
21. NAVAIDS
- A. TACAN G / R
- (1) LOCATION _____
- (2) FREQUENCY _____
- (3) POWER SOURCE _____

B. MMLS G / R

(1) LOCATION _____

(2) FREQUENCY _____

(3) POWER SOURCE _____

C. ZM G / R

(1) LOCATION _____

(2) FREQUENCY _____

(3) POWER SOURCE _____

D. ILS G / R

(1) LOCATION _____

(2) FREQUENCY _____

(3) POWER SOURCE _____

E. NDB G / R

(1) LOCATION _____

(2) FREQUENCY _____

(3) POWER SOURCE _____

22. NONRADAR HANDOFF PROCEDURES

A. HDG _____

B. HANDOFF

(1) TIME (hhmm) _____

(2) FIX _____

(3) ALT _____

(4) FREQUENCY _____

(5) LOCATION _____

(6) C/S _____

23. AIRFIELD LIGHTING:

A. AMP 1 _____

B. AMP 2 _____

C. AMP 3 _____

D. AMP 4 _____

E. NONE _____

24. SR _____

25. SS _____

26. TERPS _____ Y / N
27. REPORTING POINTS
- A. LOC _____
 - B. ALT _____
 - C. PATTERN _____
28. HOLDING POINTS VFR
- A. LOC _____
 - B. ALT _____
 - C. PATTERN _____
29. HOLDING POINTS IFR
- A. LOC _____
 - B. ALT _____
 - C. PATTERN _____
30. TRAFFIC PATTERNS
- A. LEFT _____
 - B. RIGHT _____
 - C. STRAIGHT IN _____
 - D. OVHD _____
 - E. OTHER _____
31. JETTISON AREA
- A. LOC _____
 - B. ALT _____
32. BAILOUT AREA
- A. LOC _____
 - B. ALT _____
33. FUEL DUMP AREA
- A. LOC _____
 - B. ALT _____
34. NOTAMS _____
- _____
35. CURRENT TRAFFIC _____
36. PROJECTED TRAFFIC _____
37. ALTERNATE AIRFIELDS _____

38. FRIENDLY FORCES:

- | AGENCY C/S | MGRS LOCATION | FREQ | KEY TAPE |
|---------------------------|---------------|-------|----------|
| A. DEPARTING ATC | _____ | _____ | _____ |
| B. ARTY COLUMN | _____ | _____ | _____ |
| C. FDCC. AIR BASE DEFENSE | _____ | _____ | _____ |
| E. ALCE | _____ | _____ | _____ |
| F. ALCC | _____ | _____ | _____ |
| G. AFSOB | _____ | _____ | _____ |
| H. CRASH/RESCUE | _____ | _____ | _____ |
| I. CLOSE AIR SUPPORT | _____ | _____ | _____ |
| J. MEDEVAC | _____ | _____ | _____ |
| K. TOC | _____ | _____ | _____ |
| L. US ARMY MAIN FORCES | _____ | _____ | _____ |
| M. US MARINE FORCES | _____ | _____ | _____ |
| N. US NAVY MAIN FLEET | _____ | _____ | _____ |
| O. ALLIED FORCES | _____ | _____ | _____ |
| P. ABCCC | _____ | _____ | _____ |
| Q. AWACS | _____ | _____ | _____ |

39. TRAFFIC INFORMATION: (Use DELTA THREE message format flow tasking)

40. WEATHER: (Use GOLF message format)

41. ARTILLERY: (Use HOTEL ONE message format)

42. REMARKS:

43. PASSED TO _____ DTG _____ Z
INITIALS _____ (dd/hhmm/mm/yy)

CHANGE # _____

PASSED TO _____ DTG _____ Z
INITIALS _____ (dd/hhmm/mm/yy)

NOTES:

Sample ATC Handover Checklist

SAMPLE TWO

1. Airfield Name: _____

2. Airfield Location: _____

LAT/LONG: _____ / _____

3. ICAO Identifier: _____

4. Airfield Frequencies:	(P) UHF/VHF	(S) UHF/VHF
ATIS	_____/_____	_____/_____
Approach Control	_____/_____	_____/_____
Tower Control	_____/_____	_____/_____
Ground Control	_____/_____	_____/_____
Clearance Delivery	_____/_____	_____/_____
Base Operations	_____/_____	_____/_____
SAR	_____/_____	_____/_____
WX Metro	_____/_____	_____/_____

5. Airfield Diagram:

6. Usable Runways: _____/_____/_____/_____/_____/_____

7. Usable Taxiways: _____/_____/_____/_____/_____/_____

8. Dimensions:

	<i>Length</i>	<i>Width</i>	<i>Composition</i>	<i>PCN</i>
Runway	_____ft	_____ft	_____	___/___/___/___/___
	_____ft	_____ft	_____	___/___/___/___/___
	_____ft	_____ft	_____	___/___/___/___/___
	_____ft	_____ft	_____	___/___/___/___/___

	<i>Length</i>	<i>Width</i>	<i>Composition</i>	<i>PCN</i>
Taxiway	_____ft	_____ft	_____	___/___/___/___/___
	_____ft	_____ft	_____	___/___/___/___/___
	_____ft	_____ft	_____	___/___/___/___/___
	_____ft	_____ft	_____	___/___/___/___/___
	_____ft	_____ft	_____	___/___/___/___/___
	_____ft	_____ft	_____	___/___/___/___/___
	_____ft	_____ft	_____	___/___/___/___/___
	_____ft	_____ft	_____	___/___/___/___/___

Helipad	_____ft	_____ft	_____	___/___/___/___/___
	_____ft	_____ft	_____	___/___/___/___/___
	_____ft	_____ft	_____	___/___/___/___/___
	_____ft	_____ft	_____	___/___/___/___/___

AV-8B Pad	_____ft	_____ft	_____	___/___/___/___/___
	_____ft	_____ft	_____	___/___/___/___/___
	_____ft	_____ft	_____	___/___/___/___/___
	_____ft	_____ft	_____	___/___/___/___/___

9. Traffic Pattern:

	Entry Point	Altitude	Point of Descent
Left	_____	_____	_____
Right	_____	_____	_____
Straight-in	_____	_____	_____
Overhead	_____	_____	_____
Other	_____	_____	_____

10. Pattern Altitude:

Turbo-Jet _____

Propeller-Driven _____

Helicopter _____

Altitude Remarks:

11. NAVAIDs *Location* / *Frequency* / *Power Source*

(Lat/Long)

NDB _____ / _____ / _____

VOR _____ / _____ / _____

TACAN _____ / _____ / _____

VORTAC _____ / _____ / _____

MLS _____ / _____ / _____

ILS _____ / _____ / _____

GPS _____ / _____ / _____

VASI _____ / _____ / _____

ASR _____ / _____ / _____

PAR _____ / _____ / _____

12. Hot Cargo Area: Y___ N___

Location _____

13. Refueling Points: Y___ N___

Location _____

14. Arming/De-arming Area: Y___ N___

Location _____

15. Parking Locations/Spots/Restrictions:

Fixed-Wing _____

Rotary-Wing _____

VIP/VAL _____

16. Obstacles on Airfield: Y__ N__

Trees	Y__	N__	_____Ft
Wires	Y__	N__	_____Ft
Houses	Y__	N__	_____Ft
Personnel	Y__	N__	_____Ft
Ditches	Y__	N__	_____Ft
Terrain	Y__	N__	_____Ft
Poles	Y__	N__	_____Ft

17. Blind Spots:
 Visual _____
 Radio _____

18. Non-Radar Procedures:
 Heading _____
 Handoff Time _____
 Fix _____
 Altitude _____
 Frequency _____
 Location _____

19. TERPS: Y__ N__

20. Reporting Points:	#1	#2	#3	#4
Location	_____	_____	_____	_____
Altitude	_____	_____	_____	_____

21. Holding Points VFR:				
Location	_____	_____	_____	_____
Altitude	_____	_____	_____	_____
Pattern	_____	_____	_____	_____

22. Holding Points IFR:				
Location	_____	_____	_____	_____
Altitude	_____	_____	_____	_____
Pattern	_____	_____	_____	_____

23. Bailout Area:				
Location	_____	_____	_____	_____
Altitude	_____	_____	_____	_____

24. Jettison Area:

Location _____

Altitude _____

25. Fuel Dump Area:

Location _____

Altitude _____

26. Alternate/Divert Airfields Information:

NAME	TACAN channel	Heading from airfield	Dist (nm)	ELEV	FUEL	Longest Runway	APCH freq	TWR freq	NAVAID

27. Weather:

Wind: Prevailing _____/_____ Surface _____/_____

VSBY _____Mi

Ice Y___ N___

Wet Y___ N___ Rain/Snow

Breaking Action

Good___ Fair___ Poor___ NIL___ UNK___

Other:_____

Remarks:

Appendix G

SAMPLE NOTICE TO AIRMEN

EXAMPLE #1

Key FIRs: A, B, C, D, etc

A0XXX/01 - SPECIAL NOTICE. FOR US OPERATORS: CIVIL AIRCRAFT OPERATIONS INTO "X COUNTRY" ARE NOT PERMITTED UNLESS AUTHORIZED IN ACCORDANCE WITH THE PROVISIONS OF SFAR 90. IN ORDER TO PROVIDE GREATER SAFETY AND VISIBILITY FOR CIVIL AVIATION FLIGHTS INTO AND OUT OF "X COUNTRY" ("X" FIR), THE FOLLOWING PROCEDURES ARE RECOMMENDED AND WILL CONTINUE UNTIL FURTHER NOTICE. PARTICIPATION IS VOLUNTARY BUT HIGHLY RECOMMENDED TO ENHANCE SAFETY FOR ALL HUMANITARIAN ASSISTANCE (HA) AND OTHER INTERNATIONAL ORGANIZATION/NON-GOVERNMENT ORGANIZATION (IO/NGO) SPONSORED FLIGHTS, AND OTHER CIVIL AVIATION FLIGHTS WITHIN "X" FIR WHERE INTENSE MILITARY COMBAT OPERATIONS ARE CONTINUING INTO THE FORESEEABLE FUTURE. PARTICIPATING AGENCIES MUST UNDERSTAND THERE IS AN ONGOING MILITARY OPERATION IN "X" AND NON-MILITARY FLIGHT OPERATIONS WILL BE CONDUCTED AT SIGNIFICANT RISK. COMPLYING WITH THESE PROCEDURES DOES NOT RELIEVE PILOTS OF THE RESPONSIBILITY TO SEE AND AVOID OTHER AIRCRAFT OR FOR MAINTAINING SAFE TERRAIN/OBSTACLE CLEARANCE AT ALL TIMES. IN ADDITION, THESE PROCEDURES DO NOT REPLACE OR NEGATE THE NEED FOR A FLIGHT PLAN. AN INTERNATIONAL FLIGHT PLAN IS STILL REQUIRED. ALSO, WHILE IN THE "X" FIR, ALL CIVIL AIRCRAFT SHOULD MAINTAIN A CONTINUOUS LISTENING WATCH ON ONE OR BOTH INTERNATIONAL EMERGENCY FREQUENCIES (VHF 121.5 AND/OR UHF 243.0 MHZ). END PART 1 OF 6 WIE UNTIL UFN

A0XXX/01 - SPECIAL NOTICE. FURTHERMORE, ATC PROCEDURES, AS NOTIFIED, APPLY OUTSIDE "X". THE PROCEDURES BELOW SIMPLY PROVIDE FORCES CONDUCTING COMBAT OPERATIONS IN "X" WITH A MEANS OF PLANNING FOR, MONITORING AND, WHERE POSSIBLE, DECONFLICTING FLIGHTS BY CIVILIAN AIRCRAFT OPERATING WITHIN THE COMBAT ZONE. UNTIL THE SITUATION SETTLES IN "X", PROCEDURES FOR CIVIL AVIATION MUST NECESSARILY BE RESTRICTIVE TO PREVENT INVOLVING CIVILIANS WITH MILITARY OPERATIONS. AIRCREW OF CIVIL AIRCRAFT WILL FORFEIT ANY PROTECTIONS DUE THEIR CIVILIAN STATUS AND SERIOUSLY ENDANGER THEIR SAFETY AND THE SAFETY OF THEIR AIRCRAFT IF THEY TRANSPORT MILITARY MATERIAL FOR "X FORCES", PROVIDE TRANSPORTATION TO "X FORCES" PERSONNEL, OR OTHERWISE SUPPORT "X FORCES". THE PROCEDURES DETAILED BELOW SHALL BE ACCOMPLISHED ONLY DURING DAYLIGHT HOURS AND IN VISUAL METEOROLOGICAL CONDITIONS. HA AND IO/NGO FLIGHTS ARE NOT RECOMMENDED AT NIGHT OR DURING INSTRUMENT METEOROLOGICAL CONDITIONS. PRE-NOTIFICATION OF CIVILIAN FLIGHTS SHOULD BE ACCOMPLISHED AT LEAST 24-HOURS PRIOR TO FLIGHT INTO "X". THIS PRE-NOTIFICATION MAY BE ACCOMPLISHED BY PASSING DETAILS OF THE PROPOSED FLIGHT TO ONE OF THE FOLLOWING AGENCIES: END PART 2 OF 6 WIE UNTIL UFN

A0XXX/01 - SPECIAL NOTICE. A. THE UNITED STATES XXXXXXXX COMMAND (XXXXXXCOM) JOINT CIVIL- MILITARY OPERATIONS TASK FORCE (JCMOTF). THIS OFFICE IS OPEN 24 HOURS A DAY AND CAN BE REACHED VIA ANY OF THE FOLLOWING MEANS: TELEPHONE: USA XX-XXX-XXX-XXXX FAX: USA XX-XXX-XXX-XXXX E-MAIL: XXXXXXXXXXXX@XXXXXX.XXX B. THE COALITION HUMANITARIAN LIAISON CENTER (CHLC) IN XXXXXX, XXXXXXXX. THIS OFFICE IS OPEN 24 HOURS A DAY AND CAN BE REACHED VIA THE FOLLOWING MEANS: POINT OF CONTACT: XXXXXXXX XXXXXXXX TELEPHONE: XX-XXX-XXX-XXXX E-MAIL: XXXXXXXXXXXX@XXXXXX.XXX (PREFERRED CONTACT METHOD) C. THE CHLC IN XXXXXXXXXXX, XXXXXXXX. THIS OFFICE IS OPEN 24 HOURS A DAY AND CAN BE REACHED VIA THE FOLLOWING MEANS: POINT OF CONTACT: XXX XXXXXX PHONE: XX-XXX-XXX-XXXX EMAIL: XXXXXXXXXXXX@XXXXXX.XXX IF PRE-NOTIFICATION MUST BE MADE WITH LESS THAN 24 HOURS, OPERATORS ARE TO CONTACT THE CHLC AS SOON AS POSSIBLE. IF CHANGES MUST BE MADE TO A PREVIOUSLY NOTIFIED FLIGHT, OPERATORS ARE TO CONTACT ANY OF THE ABOVE AGENCIES AS SOON AS POSSIBLE PRIOR TO THE FLIGHT COMMENCING OR IF AN EMERGENCY DICTATES A CHANGE TO A FLIGHT ALREADY IN PROGRESS, FOLLOW THE COMMUNICATIONS PROCEDURES OUTLINED BELOW. END PART 3 OF 6 WIE UNTIL UFN

A0XXX/01 - SPECIAL NOTICE. COMMUNICATIONS PROCEDURES FOR ALL HA AND IO/NGO FLIGHTS: BEFORE ENTERING "X COUNTRY" FIR CONTACT AIRBORNE EARLY WARNING (AEW), AIR CONTROL AGENCY (ACA), CALLSIGN XXXXX OR XXXXXXXX ON XXX.XXX MHZ (P) (VHF) OR XXX.XX MHZ (S) (UHF) EMERGENCY: 121.5 (INTERNATIONAL EMERGENCY FREQUENCY) "IF REQUIRED ADD" NOTE: AEW OR ACA IS NOT AN ATC AGENCY AND CANNOT PROVIDE ANY AIR TRAFFIC SERVICES. THEY WILL ONLY PROVIDE A LISTENING WATCH AND, WHERE POSSIBLE, INFORMATION ON OTHER TRAFFIC KNOWN TO BE OPERATING IN THE AREA. RESPONSIBILITY FOR SEPARATION FROM OTHER TRAFFIC ON A SEE AND AVOID BASIS REMAINS AT ALL TIMES WITH THE PILOT OF THE CIVIL AIRCRAFT. FAILURE TO COMPLY WITH THESE PROCEDURES MAY RESULT IN INTERCEPTION BY ARMED COALITION AIRCRAFT. TRANSPONDER CODE: MODE 3/A CODE XXXX OR (OR AS ASSIGNED DURING PRE-NOTIFICATION BY THE JCMOTF OR CHLC). HUMANITARIAN AIRCRAFT/ ASSISTANCE AIRCRAFT ASSIGNED AN ATC DISCRETE MODE 3/A CODE EN ROUTE TO THE AUTHORIZED "X COUNTRY" ENTRY POINT MUST CHANGE MODE 3/A CODE TO XXXX OR AS ASSIGNED BY JCMOTF/CHLC WHEN ENTERING "X COUNTRY" AIRSPACE, PRIOR TO CONTACTING AEW. AEW MAY ASSIGN A DISCRETE MODE 3/A CODE TO DISCRIMINATE BETWEEN INDIVIDUAL FLIGHTS. APPROVED "X COUNTRY" ENTRY POINTS: END PART 4 OF 6 WIE UNTIL UFN

A0XXX/01 - SPECIAL NOTICE. FROM XXX (COUNTRY) & (AIRWAY) ROUTINGS AVAILABLE: VXXX, AXXX, VXXX, ETC. CURRENT AIRFIELDS USED FOR HUMANITARIAN AID/ASSISTANCE: XXXXX, XXXXX, XXXXX, ETC ROUTINGS: NOTE _ RETURN ROUTINGS WILL BE BY REVERSE PATH. FLY APPROPRIATE ICAO SEMI-CIRCULAR LEVELS. END PART 5 OF 6 WIE UNTIL UFN

A0XXX/01 - SPECIAL NOTICE. XXXXXX AIRFIELD HAS SUSTAINED CONSIDERABLE DAMAGE AS A RESULT OF RECENT HOSTILITIES. USE CAUTION DURING APPROACH AS THERE ARE LIKELY TO BE OTHER AIRCRAFT OPERATING IN THE AREA; LIMITED TERMINAL CONTROL IS CURRENTLY PROVIDED AT XXXXXX AIRFIELD BY UNITED STATES AIR FORCE, MARINE CORPS, AND ARMY TACTICAL CONTROLLERS WHO WILL ISSUE LANDING AND TAKE OFF CLEARANCES.

RUNWAY XX IS THE PRIMARY RUNWAY. PILOTS ARE TO CONTACT TOWER ON XXX.XX MHZ WHEN 10 MINUTES FLYING TIME FROM THE AIRFIELD. IF NO CONTACT IS ACHIEVED AT 10 MINUTES, PILOTS SHOULD ATTEMPT CONTACT AGAIN WHEN 5 MINUTES FLYING TIME FROM THE AIRFIELD; IF NO CONTACT IS ACHIEVED, PILOTS MAY CONTINUE THEIR APPROACH VISUALLY AND LAND AT PILOT'S DISCRETION. FOR DEPARTURE, PILOTS SHOULD CONTACT TOWER 10 MINUTES PRIOR TO TAKEOFF IN ORDER THAT THEIR DEPARTURE CAN BE DE-CONFLICTED FROM ANY MILITARY OPERATIONS TAKING PLACE IN THE IMMEDIATE VICINITY OF THE AIRFIELD OR AFFECTING THEIR OUTBOUND ROUTE. ONCE AIRBORNE, PILOTS SHOULD CONTACT XXXXX ON XXX.XX MHZ AS SOON AFTER DEPARTURE AS POSSIBLE IN ORDER THAT THEIR DEPARTURE CAN BE DE-CONFLICTED FROM ANY MILITARY OPERATIONS TAKING PLACE IN THE IMMEDIATE VICINITY OF THE AIRFIELD OR AFFECTING THEIR OUTBOUND ROUTE. DEPARTING AIRCRAFT SHOULD RETAIN THE MODE 3/A SQUAWK ASSIGNED FOR THE INBOUND FLIGHT AND SELECT SQUAWK PRIOR TO DEPARTURE. END PART 6 OF 6 WIE UNTIL UFN

EXAMPLE #2

Key FIRs: A, B, C, D, etc

AXXX-01 COALITION MILITARY FORCES ARE OPERATING IN THE MIDDLE EAST, PERSIAN GULF, AND THE ARABIAN SEA. THE TIMELY AND ACCURATE IDENTIFICATION OF CIVIL AIRCRAFT IN THESE AREAS IS CRITICAL TO PRECLUDE THE USE OF FORCE AGAINST CIVIL AIRCRAFT. COALITION MILITARY FORCES ARE PREPARED TO EXERCISE SELF DEFENSE MEASURES AS MAY BE NECESSARY TO ENSURE THEIR SAFETY IN THE EVENT THEY ARE APPROACHED BY UNIDENTIFIED AIRCRAFT OR AIRCRAFT WHOSE INTENSIONS ARE AMBIGUOUS. TO THIS END, THE FOLLOWING "X COUNTRY" AIRSPACE IS CLOSED TO ALL NON-COALITION AIRCRAFT, EXCEPT AUTHORIZED MEDICAL AND HUMANITARIAN FLIGHTS, UNTIL FURTHER NOTICE. THIS NOTICE IS ALSO PROVIDED TO ENSURE THE SAFETY OF ALL COALITION FORCES AND THEIR FACILITIES. ALL CIVIL AVIATION ASSETS OR ACTIVITIES THAT ARE DETERMINED TO BE THREATS TO COALITION FORCES MAY BE SUBJECT TO QUARANTINE, DISABLING, FORCE DOWN, OR DESTRUCTION. THIS INCLUDES AIRBORNE AND GROUND BASED ASSETS AND ACTIVITIES WITHOUT REGARD TO REGISTRY OR NATIONALITY WITHIN "X COUNTRY" AIRSPACE. THIS NOTICE IS EFFECTIVE IMMEDIATELY AND WILL REMAIN IN EFFECT UNTIL FURTHER NOTICE.

LETTERS/MEMORANDUM OF AGREEMENT

EXAMPLE #1

THE INTERNATIONAL CIVIL AVIATION ORGANIZATION

AND

THE COMBINED FORCES AIRSPACE CONTROL AUTHORITY,

“X COUNTRY” THEATER OF OPERATIONS

Clause I

In order to enhance the safety in civil aviation and to facilitate humanitarian assistance within Iraq, the International Civil Aviation Organization (ICAO) and the Combined Forces Airspace Control Authority (ACA) for the United States/Coalition mission in “X COUNTRY” acknowledge that, for an interim and limited period, the ACA will control the airspace within “X COUNTRY” (XXXXX Flight Information Region). The ACA will exercise this control for so long as United States/Coalition military operations require or until such time as the ACA and ICAO determine a new government in “X COUNTRY” is capable, either independently or through ICAO assistance under appropriate technical co-operation projects, of assuming responsibility for air traffic services and aviation facilities within “X COUNTRY” which conform to the Standards and Recommended Practices found in the Annexes to the Convention on International Civil Aviation (Chicago, 1944). The ICAO will assist at the appropriate time in the transfer of such control from the ACA to a new “X COUNTRY” government.

Clause 2

It is the intent of the ACA and the ICAO to work in an atmosphere of mutual understanding to provide for the rehabilitation of the “X COUNTRY” civil aviation system by providing, inter alia, essential air traffic control where possible within the confines of available resources, access to air routes for the conduct of international overflights, and continued access to “X COUNTRY” airspace and airports by Coalition partners and Non-Governmental Organizations conducting Humanitarian Operations. The ACA will cooperate with the ICAO in this effort consistent with United States/Coalition military requirements.

Clause 3

Furthermore, the ICAO, through its Technical Co-operation Programme, and at the appropriate time, will work with the newly established representative government of “X COUNTRY” to facilitate the progressive introduction of civil authority and resources to the airspace and air traffic infrastructure in “X COUNTRY”, thereby facilitating the ultimate objective of transitioning the “X COUNTRY” national airspace system to civil control under the guidance and direction of the duly designated “X COUNTRY” government.

Clause 4

The ICAO and ACA will cooperate and support each other in the dissemination of essential flight information to provide for the secure and safe conduct of military and civil aviation interests. International Notices to Airmen (NOTAMs), determined essential by the ACA, will be distributed by any available means. ICAO will assist the ACA through active encouragement of member states to support NOTAM dissemination until such a time as the “X COUNTRY” AIS is determined capable of fulfilling this requirement.

Clause 5

This memorandum of arrangement will be effective upon the date of signature.

Appendix H
SAMPLE LETTER OF AGREEMENT

between _____ ACC _____ ACC

1. **PREAMBLE**

The authorized representatives of _____ and _____ agree that the procedures contained in this document shall remain in force from the effective date specified until either amended or cancelled.

(This letter of Agreement supersedes and cancels the existing Letters of Agreement between _____ and _____ dated _____) (If applicable).

2. **EFFECTIVE DATE**

The provisions in the Letter of Agreement shall be implemented on _____ at 0001 UTC.

3. **OBJECTIVE**

The objective of this Letter of Agreement is to specify co-ordination procedures between _____ and _____

4. **SCOPE**

4.1 The procedures contained herein are supplementary to the ICAO Standards and Recommended Practices in Annexes 2 and 11, the Procedures for Air Navigation Services in Document 4444 and the Regional Supplementary Procedures (Doc 7030). They detail the conditions under which the responsibility for the provision of air traffic services shall be transferred between the ATS units mentioned in paragraph 3 above.

4.2 This Letter of Agreement also formalizes the delegation of responsibility from _____ to _____, and vice versa for the provision of air traffic services within those portions of airspace that lie between the FIR boundaries and the agreed points of transfer of responsibility as defined in paragraph 6.4.1. The establishment of transfer points is based on operational considerations only and does not therefore contribute to, neither can it be invoked for, any other purpose beyond this context.

5. **AMENDMENTS**

5.1 Any change to this Letter of Agreement, including its cancellation or replacement, requires the consent of the ATS units concerned. This applies to the substance of the change as well as to its date of-applicability. Any change shall be made either in the context of a meeting between the two units, or by exchange of correspondence, or by exchange of aeronautical fixed telecommunications network (AFTN) messages, with acknowledgement by all signatories.

5.2 Whilst temporary deviations from these procedures may be agreed between the ACC supervisors concerned, as specified in paragraph 7.1 below, permanent amendments to this document shall be effective only in the form of a written amendment duly signed by authorized representatives.

6. PROCEDURES

6.1 Movement and control messages

6.1.1 Flight plans

a) Filed Flight Plan (FPL) messages shall be transmitted for flights originating within one FIR and entering the other, not less than 30 minutes before the estimated time of the aircraft over the common FIR boundary.

b) Repetitive Flight Plans (RPL) are accepted for flights operating between _____ and _____ (or any other applicable circumstances or conditions).

6.1.2 Departures

Departure (DEP) messages shall be transmitted for all flights mentioned in 6.1.1 above, as soon as practicable after the aircraft is airborne.

6.1.3 Estimates

Estimate (EST) messages shall be transmitted for all flights crossing the common FIR boundary, in sufficient time to permit its receipt by the receiving ATS unit at least _____ minutes below the estimated time of the aircraft over the transfer points specified in paragraph 6.4.1 below.

6.1.4 Revisions

Co-ordination (CON) messages shall be transmitted as soon as practicable whenever the estimated time of the aircraft over the transfer point differs _____ minutes or more from the estimated time originally passed or when a change of cleared level and/or crossing condition is planned.

6.1.5 Acceptance

Co-ordination messages (EST and CDN) require an operational acceptance, in the form of an acceptance (ACP) message, to be transmitted to the transferring unit.

6.2 Message transmission and co-ordination procedures

6.2.1 FPL Messages shall be messages shall be transmitted via AFTN. DEP messages shall be transmitted by AFTN or ATS/DS both as applicable).

6.2.2 Co-ordination messages (EST, CDN and ACP) shall be transmitted using (the ATS direct speech circuits or AFTN as applicable).

6.2.2.1 In case of non-availability of the ATS direct speech circuit between the ATS units concerned, the transferring ATS unit shall forward the relevant flight data to the receiving ATS unit by means of the AFTN and/or HF radiotelephone (RTF), if available.

6.2.2.2 When effecting the necessary co-ordination by use of the AFTN or HF RTF, the transferring ATS unit shall send the appropriate co-ordination message in sufficient time to permit its receipt by the receiving ATS unit at least _____ minutes prior to the aircraft's estimated time over the transfer point.

6.2.3 After co-ordination of the transfer, the conditions of transfer shall not be changed by the transferring unit, unless prior agreement has been obtained from the accepting unit.

6.2.4 In the event of communications failure between the ATS units concerned, a departing aircraft shall be cleared only to such a level as can be reached before it arrives within 10 minutes flying time from the transfer of control point. If such a level is lower than that specified in the flight plan, the aircraft shall be instructed to request approval for a higher level direct from the accepting unit and then obtain clearance from the transferring unit to climb to the level approved by the accepting unit.

6.2.5 In case of flights departing from aerodromes (_____) for which, due to their proximity to the FIR boundary, application of the procedures set out in 6.2.2 above would not be possible after departure, co-ordination between the transferring ATS unit and the accepting ATS unit shall be effected prior to the issuance of the ATC clearance to the aircraft concerned, procedures for air navigation services-rules of the air and air traffic services (PANS-RAC), Part VII, paragraph 3.2.3 and Part IX, paragraph 3.5.4 refers.

6.2.5.1 In those exceptional cases where the procedures described above cannot be applied, e.g. in case of communications failure between the ATS units concerned, the transferring ATS unit will inform the aircraft of the absence of co-ordination between the two ATS units and will instruct the aircraft to establish contact with the accepting ATS unit in order to provide it with the necessary ~light data.

6.2.5.2 (List any other agreed detailed procedures for these flights)

6.3 Transfer of communications

6.3.1 Aircraft shall be instructed to establish communications with the accepting unit over the transfer point. Transfer of communications does not constitute transfer of control (paragraph 6.4. refers).

6.3.1.1 In case of communications failure between the ATS units concerned, the transferring ATS unit will inform the aircraft of the absence of co-ordination between the two ATS units and will instruct the aircraft to establish contact with the accepting ATS unit 10 minutes before the boundary in order to provide it with the necessary flight data.

6.3.2 Whenever the accepting ATS unit is unable to establish contact with an aircraft within _____ minutes after its estimated time over the transfer point, it shall inform the transferring ATS unit so that appropriate measures may be taken.

6.3.3 With reference to paragraph 3.2.12 of Part VII of the PANS-RAC, the accepting ATS unit need not, as a matter of routine, notify the transferring ATS unit that radio communication has been established with a~ aircraft being transferred.

6.3.4 Whenever an aircraft is unable to establish or maintain radio communication with the ATS unit responsible for the provision of air traffic services in the airspace in which it is operating, other ATS units shall, if possible, assume relay functions between them.

6.3.5 Primary frequency assignment for transfer of communications is as follows:

<u>ATS route</u>	<u>ATS unit call sign</u>	<u>Frequency</u>
_____	_____	_____
_____	_____	_____
_____	_____	_____
_____	_____	_____
_____	_____	_____
_____	_____	_____
_____	_____	_____
_____	_____	_____

6.3.5.1 Secondary frequency assignment, for use when no contact can be made on the primary frequencies, is as follows:

6.4 Transfer of Responsibility

6.4.1 Control of responsibility for the provision of air traffic services shall be transferred to the accepting unit at the following significant points:

<u>ATS route</u>	<u>Transfer Point</u>
------------------	-----------------------

- a.
(example: ABAB at 30308 9015E, or bearing a distance from a VOR/DME)
- b.
- c.

6.4.1.1 If transfer of responsibility is required at points other than those specified in 6.4.1 above, this shall be coordinated individually for each flight.

6.4.2 The accepting unit shall assume responsibility of a transferred aircraft as soon as it has reported to that unit passing the appropriated transfer pint. There is no requirement for additional transfer or acceptance messages unless requested.

6.4.3 Control of traffic communicating with the accepting unit shall not be assumed prior to the aircraft passing the transfer pint, unless specifically agreed by the transferring unit.

6.5 Flight Levels

6.5.1 Aircraft on ATS routes shat be assigned levels as follows:

<u>ATS route</u>	<u>From</u>	<u>To</u>	<u>Flight Levels</u>
_____.	_____	_____	_____
_____.	_____	_____	_____
_____.	_____	_____	_____
_____.	_____	_____	_____

Aircraft outside ATS route shall be assigned flight levels in accordance with the table of cruising levels in appendix C to Annex 2.

6.6 Separation

6.6.1 Aircraft at the same level shall be longitudinally separated by not less than:

- a. _____.; and
- b. _____.

When the succeeding aircraft is faster than the preceding aircraft, the transferring unit shall notify the accepting unit and seek its approval of the transfer of control. The accepting unit shall have the right to determine the transfer of control conditions.

6.7 Clearance limit

6.7.1 The clearance limit shall normally be the destination aerodrome. However, if the necessary co-ordination cannot be effected in good time (paragraph 6.2.2.2 refers) e.g. due to communications failure between ATS units, the clearance limit shall be the transfer point and the aircraft instructed to request onward clearance from the accepting unit before proceeding beyond that point.

6.8 Weather Information

6.8.1 ATS units shall keep each other informed of significant meteorological information (SIGMET) information and of weather conditions at destination aerodromes within their respective FIRs whenever such conditions may fall below aircraft operating minima and consequently may result in diversion or holding for weather improvement.

6.9 Flow control (if applicable)

6.9.1 Should it become necessary to implement flow control to avoid excessive delays at destination aerodromes within their respective FIRs, ATS units shall negotiate and agree a mutually acceptable number of aircraft per hour. Such agreements shall not be valid beyond 2400 hours UTC on the day of implementation. An extension of such agreements must be negotiated prior to the above mentioned expiry time. All such agreements shall be terminated as soon as circumstances permit resumption of normal operations. The decision of the ACC supervisors shall be sufficient authority in all such cases.

7. DEVIATIONS

7.1 Deviation from the procedures specified in this Letter of Agreement shall only be permitted in exceptional circumstances and not without prior co-ordination on a case-by-case basis.

7.2 Any deviations from these provisions, that arise due to an emergency or are applied to ensure the safety of air traffic, shall immediately be notified to the other ATS unit(s) concerned and shall be terminated as soon as the circumstances that caused the deviation cease to exist.

8. AUTHORIZED SIGNATORIES

Place: _____

Date: _____

REFERENCES

Joint/Multi-Service Publications

Joint Pub 1-02, *DOD Dictionary of Military and Associated Terms*

Joint Pub 3-52, *Joint Airspace in the Combat Zone*

Joint Pub 3-56.1, *Command and Control for Joint Air Operations*

Multi-Service Procedures for Integrated Combat Airspace Command and Control (ICAC2)

Multi-Service Procedures for Theater Air Ground System

Army

FM 3-04.120 (FM 1-120), *Army Air Traffic Services Contingency and Combat Zone Operations*

FM 3-04.303 (FM 1-303), *Air Traffic Control Facility Operations and Training*

FM 4-24 (FM 24-24), *Signal Data References Signal Equipment*

FM 3-09.13 (FM 100-13), *Battlefield Coordination Detachment (BCD)*

FM 101-5-1, *Operational Terms and Graphics*

US Army Operations Concept for Air Traffic Services, 6 May 1996

USAAVNC Pam 525-5, *Aviation in Force XXI Operations*, 2 Jan 1996

Vision for Force XXI Air Traffic Services, DA/ODCSOPS,- 14 Feb 1996

TRADOC Pamphlet 525-72, *Army Airspace Command and Control (A2C2)*

ATS Concept Briefing, United States Army Aviation Center, 26 Jun 1995

TAIS Operational Requirements Document, 5 May 1995

ATNAVICS Operational Requirements Document, 20 Sep 1994

TTCS Operational Requirements Document - 23 Nov 1992

MOTS Operation Requirements Document, 8 Nov 1999

Information Paper, ATC Tactical and Fixed Base Modernization, United States Army Aviation Center, Directorate of Combat Development (DCD), 1 Jan 1996

Marine Corps

MCWP 3-2, *Aviation Operations*

MCWP 3-25, *Control of Aircraft and Missiles*

MCWP 3-25.8, *Marine Air Traffic Control Detachment Handbook*

Marine Air Traffic Control Mobile Team Tactical SOP (MMT TACSOP)

Navy

AE-LHATC-OPM-000, *Amphibious Ships Air Traffic Control Manual*

NAVAIR 00-80T-105, *CV NATOPS*

NAVAIR 00-80T-106 *LHA/LHD NATOPS Manual*

Air Force

AFDD 2-1.7, *Airspace Control in the Combat Zone*, 4 Jun 1998

AFI 13-AO, Volume 3, *Operational Procedures—Air Operations Center*, 1 Jul 02

AFI 13-203, *Air Traffic Control*

AFI 13-204, *Functional Management of Airfield Operations*, 28 Aug 2002

AFMAN 11-225, *United States Standard Flight Inspection Manual*

AFMAN 13-220, *Deployment of Airfield Operations*, 1997

Air Force Program Guidance Letter on the Organization of Air Force Deployable Command, Control, Communications, and Computers (C4) and Deployable Air Traffic Control and Landing Systems (DATCALs) Force Structure - 1 Jun 1996

Memorandums

HQ ACC/CV, Memo, Joint Air Traffic Control (JATC) Comparative Analysis, Date not on memo--approximate date April to May 1996

HQ USAF/XO, Memo, Deployable Air Traffic Control and Landing System (ATCALs) Comparative Analysis, 16 Apr 96

GLOSSARY

PART I—ABBREVIATIONS AND ACRONYMS

A

A2C2	Army airspace command and control
AASC	assistant air support coordinator
AATCC	amphibious ATC center
ABCS	Army Battle Command System
ACA	airspace control authority
ACE	aviation combat element (MAGTF)
ACM	airspace control measure
ACO	airspace control order
ACP	airspace control plan, acceptance letter
ACS	airspace control system
ADSI	Air Defense System Integrator
AEW	airborne early warning
AFDC	Air Force Doctrine Center
AFFSA	Air Force Flight Standards Agency
AFI	Air Force Instruction
AFMAN	Air Force manual
AFSC	Air Force specialty code
AFTN	aeronautical fixed telecommunications network
AIC	air intercept controller (Navy), airspace information center (Army)
ALSA	Air Land Sea Application Center
AM	amplitude modulating
AN	analog non-secure
ANG	Air National Guard
AO	area of operations
AOA	amphibious objective area
AOC	air operations center
AOCC	air operations control center
AOR	area of responsibility
ARATC	advanced radar air traffic control
ARFOR	Army forces
ASC	air support coordinator

ASC(A) assault support coordinator (airborne)
ASR airport surveillance radar
ATC air traffic control
ATC air traffic control radar beacon system
ATCS air traffic control section, air traffic control specialist
ATCSS air traffic control system specialist
ATNAVICS air traffic navigation, integration, and coordination system
ATO air tasking order
ATS air traffic service
AW air warfare
AWC air warfare commander
AZ Arizona

B

BCD battlefield coordination detachment (USA)
BDZ base defense zone
BN battalion
BSC Battle Staff Course (USA)

C

C2 command and control
C4 command, control, communications, and computers
CAC2S common aviation command and control system
CAIC corps airspace information center
CAOC combined air operations center (For simplicity, CAOC will be used in this publication to represent any such unit to include a joint air operations center or simply an air operations center)
CAS close air support
CATCC carrier air traffic control center
CCG combat communications groups
CCS control and communications subsystem
CDC combat direction center
CHLC coalition humanitarian liaison center
COA course of action

COMSEC	communications security
CONUS	continental United States
CON	coordination
CRAF	Civil Reserve Air Fleet
CRC	control and reporting center
CTF	Commander, Task Force
CVBG	carrier battle group
CWC	composite warfare commander

D

DA	Department of the Army
DASC	direct air support center (Marine)
DATCALs	deployable air traffic control and landing system
DEP	departure
DET	detachment
DME	distance measuring equipment
DOD	Department of Defense
DZ	drop zone

E

EAC	echelons above corps
EMCON	emission control
EST	Estimate
EW	electronic warfare
EW/C	early warning/control

F

FAA	Federal Aviation Administration
FAAD	forward area air defense
FAC(A)	forward air controller (airborne)
FARP	forward arming and refueling point
FAWC	Fleet Air Warfare Commander (USN)
FM	frequency modulation, field manual
FMF	Fleet Marine Force

FOB forward operations/operating base (Army)/(Marine)
FPL filed flight plan
FSB forward staging base, forward support battalion
FSC fire support coordinator
FTP facility training program
FUE first unit equipped

G

G-3 Army or Marine Corps component operations staff officer
(Army division or higher, Marine Corps aircraft wing or
division or higher staff)
GCA ground controlled approach
GCP ground commander's pointer
GFC ground forces commander
GP Group
GPS global positioning system
GS general support

H

HA humanitarian assistance
HDC helicopter direction center
HF high frequency
HIDACZ high-density airspace control zone
HLZ helicopter landing zone
HMMWV high mobility multipurpose wheeled vehicle
HQ headquarters

I

IADS Integrated Air Defense System
IAW in accordance with
ICAO International Civil Aviation Organization
IFF identification, friend or foe
IFR instrument flight rules
ILS instrument landing system

IMC instrument meteorological conditions
IO international organization
ISB intermediate staging base
ISO International Organization for Standardization
IVCSS internal voice communication switching system

J

J-3 Operations Directorate of a joint staff
JAOC joint air operations center
JASC Joint Actions Steering Committee
JATC joint air traffic control
JCACC joint Combat Airspace Command and Control Course (Army)
JCMOTF joint civil-military operations task force
JCS Joint Chiefs of Staff
JFACC joint force air component commander
JFC joint force commander
JFCC Joint Firepower Control Course (USA)
JMCIS Joint Maritime Command Information System
JOA joint operations area
JPALS joint precision approach and landing system
JSOACC joint special operations air component commander
JSRC joint search and rescue center
JSTE joint service training exercises
JTF joint task force
JTTP joint tactics, techniques, and procedures
JWG joint working group

K

KM kilometer

L

LAWC local airwarfare commander (USN)
LHA general-purpose amphibious assault ship

LHD	multipurpose amphibious assault ships (with internal dock)
LID	light infantry division
LLTR	low-level transit routes
LMR	land mobile radio
LNO	liaison officer
LOS	line of sight
LPD	amphibious transport dock
LPH	amphibious assault ship, landing platform helicopter
LRIP	low rate initial production
LRS	long range surveillance
LSB	lower side band
LSD	landing ship, dock
LTD	laser target designators
LVS	logistic vehicle system
LZ	landing zone

M

MACCS	Marine Corps Air Command and Control System
MACG	Marine Air Control Group
MACOM	major Army command
MACS	Marine Air Control Squadron (USMC). Mobile Approach Control System (USAF)
MAGTF	Marine Air Ground Task Force
MAJCOM	major command (Air Force)
MANPRINT	Manpower and Personnel Integration Program (USA)
MARFOR	Marine Corps Forces
MARLO	Marine liaison officer
MATC	Marine air traffic control
MATCAL	Marine air traffic control and landing system
MATCD	Marine air traffic control detachment
MCAS	Marine Corps Air Station
MCB	Marine Corps Base
MCCDC	Marine Corps Combat Development Command
MCS	maneuver control system
MCWP	Marine Corps Warfighting Publication
MEF	Marine Expeditionary Force

MEP	mobile electric power
METNAV	METeorological/NAVigational
METT-T	mission, enemy, terrain, and weather, troops and support available -- time available
MEU	Marine expeditionary unit
MEU (SOC)	Marine expeditionary unit (special operations capable)
MFC	multinational force commander
MHE	materials handling equipment
MI	military intelligence
MMLS	Mobile Microwave Landing System
MMT	Marine air traffic control mobile team
MOA	memorandum of agreement
MOB	main operations base
MOOTW	military operations other than war
MOPP	mission-oriented protective posture
MOS	military occupational specialty
MOTS	Mobile Tower System
MRAALS	Marine Remote Area Approach and Landing System
MRC	major regional contingency
MRR	minimum-risk routes
MRSP	mobility readiness spares package
MSE	mobile subscriber equipment
MTAS	MACS terminal automation software
MTTP	multi-Service tactics, techniques, and procedures

N

NALE	naval air liaison element
NAB	naval amphibious base
NAS	naval air station; national airspace system
NATO	North Atlantic Treaty Organization
NAVAIDS	navigational aids
NAVAIR	naval air
NAVFOR	Navy forces
NBC	nuclear, biological, and chemical
NCO	noncommissioned officer
NDB	nondirectional beacon

NEA	Northeast Asia
NEF	naval expeditionary force
NFA	no-fire area, no fuels area
NG	National Guard
NGF	naval gunfire
NLOS	non-line of sight
nm	nautical miles
NOE	nap of the earth
NOTAM	notice to airmen
NTACS	Navy tactical air control system
NVD	night vision device
NWDC	Navy Warfare Development Command

O

OCONUS	outside the continental United States
OCU	orderwire control unit
OIC	officer in charge
OJT	on-the-job-training
OPCON	operational control
OPLAN	operation plan
OPORD	operation order
OPR	office of primary responsibility
OPTASK	operational tasks
ORD	operational requirements document
OTC	officer in tactical command (USN)

P

PANS-RAC	Procedures for Air Navigation Service-Rules of the Air and Air Traffic Services
PAR	precision approach radar
PBX	private branch exchange
PCC	Pre-command Course (USA)
PDS	processor display system
PDS	power distribution system
PHIBGRU	amphibious group

PIRAZ positive identification radar advisory zone
PIREP pilot report
PJ individual pararescue specialist; project code
PLS personal locator system
PLS palletized loading system
POL petroleum, oils, and lubricants
PR personnel recovery
PSR Primary Surveillance Radar System
PSRC Presidential selective Reserve call-up
PZ pickup zone

R

R&S reconnaissance and surveillance
RAM reliability, availability, and maintainability
RAMCC regional air movement control center
RAPCON radar approach control
REC radio electronic combat
RGR rapid ground refueling
RLST remote landing site tower
ROZ restricted operations zone
RPL repetitive flight plans
RRP rapid refueling point
RST regional survey team
RX receive

S

SAAWC sector anti-air warfare coordinator (Marine Corps)
SAC supporting arms coordinator
SACC supporting arms coordination center (USN)
SAR search and rescue
SARP standards and recommended practices (ICAO)
SATCOM satellite communications
SAWC sector air warfare commander (USN)
SAWC sector air warfare coordinator
SB side band

SEI	special experience identifier (Air Force)
SFC	surface
SINGARS	Single-channel Ground and Airborne Radio System
SIGMET	significant meteorological information
SLRP	survey, liaison, and reconnaissance party
SOC	special operations capable
SOF	special operations forces
SOLE	special operations liaison element
SOP	standing operating procedures
SPINS	special instructions
SSB	single side band
SSR	Secondary Surveillance Radar System
STT	special tactics team
STG	special tactics group
STP	system training plan
STS	special tactics squadron
STT	special tactics team
STTL	special tactics team leader
SUW	surface warfare
SWA	Southwest Asia
T	
TAB	tactical air base
TAC	tactical air controller (USMC), tactical air commander (USN)
TAC SUP	tactical air support coordinator supervisor
TACAN	tactical air navigation
TACC	tactical air command center (Marine Corps); tactical air control center (USN); tanker/airlift control center (Air Force)
TACGRU	tactical air control groups
TACON	tactical control
TACP	tactical air control party
TACRON	tactical air control squadron
TACS	theater air control system
TACT	tactical aviation control team
TAD	tactical air director
TADC	tactical air direction center (USN)
TADIL	tactical digital information link

TAGS	Theater Air/Ground System
TAIS	Tactical Airspace Integration System
TALCE	tanker airlift control element
TAO	tactical air officer
TAOC	tactical air operations center (Marine Corps)
TATC	tactical air traffic control
TB	technical bulletins
TCG	Task Certification Guide (Air Force)
TD	transmitter distributor
TERPES	Tactical Electronic Reconnaissance Processing and Evaluation System
TERPS	terminal instrument procedures
TLZ	tactical landing zone
TM	training manual
TOE	table of organization and equipment
TPFDD	time-phased force and deployment data
TRADOC	Training and Doctrine Command (USA)
TRV	tower restoral vehicle
TTCS	tactical terminal control system (Marines use T2CS)
TTP	tactics, techniques, and procedures
TX	transmit

U

UAV	unmanned aerial vehicle
UHF	ultra high frequency
UIC	unit identification code
USA	United States Army
USAAVNC	United States Army Aviation Center
USAF	United States Air Force
USAREUR	United States Army Forces, United States European Command
USB	upper side band
USCENTCOM	United States Central Command
USEUCOM	United States European Command
USFK	United States Forces, Korea
USN	United States Navy

USOUTHCOM United States Southern Command
USSOCOM United States Special Operations Command
USSTRATCOM United States Strategic Command
USTRANSCOM United States Transportation Command
USW under sea warfare
UTC unit type code (Air Force); Coordinated Universal Time

V

VFR visual flight rules
VHF very high frequency
VIDS visual information display system
VMC visual meteorological conditions
VOR very high frequency omnidirectional range station

W,X

WESTPAC Western Pacific
WIC-P wing initial communications package
WOC wing operations center
XFLOT cross forward line of own troops

PART II – TERMS AND DEFINITIONS

airland Personnel inserted at a landing zone by fixed-wing/rotary-wing aircraft (Army)

air operations center The principal air operations installation from which aircraft and air warning functions of combat air operations are directed, controlled, and executed. It is the senior agency of the Air Force Component Commander from which command and control of air operations are coordinated with other components and Services. Also called AOC. (Joint Pub 1-02)

airspace control authority The commander designated to assume overall responsibility for the operation of the airspace control system in the airspace control area. Also called ACA. (Joint Pub 1-02)

airspace control order An order implementing the airspace control plan that provides the details of the approved requests for airspace control measures. It is published either as part of the air tasking order or as a separate document. Also called ACO. (Joint Pub 1-02)

airspace control plan The document approved by the joint force commander that provides specific planning guidance and procedures for the airspace control system for the joint force area of responsibility and/or joint operations area. Also called ACP. (Joint Pub 1-02)

airspace information center The ATS facility that performs the primary A²C² Services mission and the secondary airspace information services mission.

air tasking order A method used to task and disseminate to components, subordinate units, and command and control agencies projected sorties, capabilities, and/or forces to targets and specific missions. Normally provides specific instructions to include call signs, targets, controlling agencies, etc., as well as general instructions. Also called ATO. (Joint Pub 1-02)

air traffic control and landing systems Department of Defense facilities, personnel, and equipment (fixed, mobile, and seaborne) with associated avionics to provide safe, orderly, and expeditious aerospace vehicle movements worldwide. Also called ATCALs. (Joint Pub 1-02)

air traffic control center A unit combining the functions of an area control center and a flight information center. Also called ATCC. (Joint Pub 1-02)

air traffic control clearance Authorization by an air traffic control authority for an aircraft to proceed under specified conditions. (Joint Pub 1-02)

air traffic control facility Any of the component airspace control facilities primarily responsible for providing air traffic control services and, as required, limited tactical control services. (Joint Pub 1-02)

air traffic controller An air controller especially trained for and assigned to the duty of airspace management and traffic control of airborne objects. (Joint Pub 1-02)

air traffic control service A service provided for the purpose of: a. preventing collisions: (1) between aircraft; and (2) on the maneuvering area between aircraft and obstructions; and b. expediting and maintaining an orderly flow of air traffic. (Joint Pub 1-02)

air traffic services Air traffic services are defined as those services performed by ATC specialist or ATC organizations across the range of military operations. These include, but are not limited to, Army airspace command and control (A²C²) services, airspace information services, terminal services, forward area support services, landing area/airfield services, navigational aid services, and ATC maintenance services.

Army air-ground system The Army system which provides for interface between Army and tactical air support agencies of other Services in the planning, evaluating, processing, and coordinating of air support requirements and operations. It is composed of appropriate staff members, including G-2 air and G-3 air personnel, and necessary communication equipment. (Joint Pub 1-02)

Army airspace command and control The Army's application of airspace control to coordinate airspace users for concurrent employment in the accomplishment of assigned missions. (FM 101-5-1/MCRP 5-2A)

battlefield coordination detachment An Army liaison provided by the Army component or force commander to the air operations center (AOC) and/or to the component designated by the joint force commander to plan, coordinate, and deconflict air operations. The battlefield coordination detachment processes Army requests for air support, monitors and interprets the land battle situation for the AOC, and provides the necessary interface for exchange of current intelligence and operational data. Also called BCD. (Joint Pub 1-02)

control and reporting center A mobile command, control, and communications radar element of the Air Force theater air control system subordinate to the air operations center. The control and reporting center possesses four Modular Control Equipment

operations modules and integrates a comprehensive air picture via multiple data links from air-, sea-, and land-based sensors as well as from its surveillance and control radars. It performs decentralized command and control of joint operations by conducting threat warning, battle management, theater missile defense, weapons control, combat identification, and strategic communications. Also called CRC.

coordinating altitude A procedural airspace control method to separate fixed- and rotary-wing aircraft by determining an altitude below which fixed-wing aircraft will normally not fly and above which rotary-wing aircraft normally will not fly. The coordinating altitude is normally specified in the airspace control plan and may include a buffer zone for small altitude deviations. (Joint Pub 1-02)

Dynamic Airspace Management System An automated airspace management computer software program providing a data and graphics display of airspace control measures, handle airspace requests, help resolve airspace conflicts, and helps in the planning of airspace. Used in the AOC during Desert Storm.

flight coordination center A primary Army ATC agency that is subordinate to the flight operations center. It provides flight following as well as information on air traffic movement within its assigned area; monitors Army aircraft operations and provides hostile activity warnings to Army aviation units operating in the airspace; passes instrument flight rules flight plans to the airspace management center for approval and visual flight rules flight plans to the appropriate air traffic services facility; establishes liaison with the air defense command post; and provides communications link between terminal facilities of existing airfields, other nearby airfields, division command posts, other FCCs, and the FOC when the flight coordination center locates in a division area. (FM 101-5-1)

flight operations center The element of the tactical Army air traffic regulation system which provides for aircraft flight following, separation of aircraft under instrument conditions, and identification of friendly aircraft to friendly air defense agencies. (Joint Pub 1-02)

force beddown The provision of expedient facilities for troop support to provide a platform for the projection of force. These facilities may include modular or kit-type facility substitutes. See also facility substitutes. (Joint Pub 1-02)

joint search and rescue center A primary search and rescue facility suitably staffed by supervisory personnel and equipped for planning, coordinating, and executing joint search and rescue and combat search and rescue operations within the geographical area assigned to the joint force. The facility is operated jointly by personnel from two or more Service or functional components or it may have a multinational staff of personnel from two or more allied or coalition nations (multinational search and rescue center). The joint search and rescue center should be staffed equitably by trained personnel drawn from each joint force component, including US Coast Guard participation where practical. Also called JSRC. (Joint Pub 1-02)

low level transit route A temporary corridor of defined dimensions established in the forward area to minimize the risk to friendly aircraft from friendly air defenses or surface forces. (Joint Pub 1-02)

minimum-risk route A temporary corridor of defined dimensions recommended for use by high-speed, fixed-wing aircraft that presents the minimum known hazards to low-flying aircraft transiting the combat zone. Also called MRR. (Joint Pub 1-02)

Mobile Microwave Landing System An Air Force and Marine Corps precision approach system for landing sites/airfields to land MLS equipped aircraft. Also called MMLS.

Mobile Tower System A vehicular mounted tower with the voice/data digitized communications packages, which replaces the TSQ-70 and the TSW-7A for landing sites/airfields.

precision/non-precision approaches A precision approach is an instrument approach that provides glideslope information to the pilot of an aircraft. A non-precision approach is an instrument approach that does not provide glideslope information to the pilot of an aircraft.

Theater Air-Ground System A system of systems consisting of the Theater Air Control System (TACS) (Air Force), the Army Air Ground System (USA), the Marine Air Command and Control System

(MACCS) (Marine), and the Navy Tactical Air Control System (NTACS) (USN).

INDEX

A

advanced radar air traffic control (ARATC), C-11, D-5, D-6
aeronautical fixed telecommunications network (AFTN), H-1, H-2, H-3
Air Defense System Integrator (ADSI), E-4
Air Force flight standards agency (AFFSA), I-7, I-9
Air Force Instruction (AFI), ii, I-7, II-3, A-2
Air Force manual (AFMAN), I-7, I-8, I-10, III-5, E-17
Air Force specialty code (AFSC), I-5, A-3
Air Land Sea Applicaiton Center (ALSA), ii, iii
Air National Guard (ANG), A-1, A-2, A-6, E-15, E-18, E-19, E-23, E-24, E-25, E-26, E-27
air operation control center (AOCC), D-2, D-8
air operations center (AOC), I-2, B-3, B-4
air tasking order (ATO), I-3, I-4, C-14, C-18, D-8
air traffic navigation, integration, and coordination system (ATNAVICs), B-8, E-2, E-4
air traffic service (ATS), viii, I-1, IV-1, B-1, B-2, B-3, B-4, B-5, B-6, B-7, B-8, B-9, E-4, E-5, E-28, H-1, H-2, H-3, H-4, H-5, H-6
air warfare (AW), D-8, D-9, D-10
air warfare commander (AWC), D-2
airborne early warning (AEW), III-3, G-2
airport surveillance radar (ASR), II-3, II-5, E-2, E-4, E-14, E-15, E-16, E-24, E-25, E-27, F-9
airspace control authority (ACA), I-1, I-2, I-3, I-4, C-5, C-12, G-2, G-5, G-6
airspace control measure (ACM), I-4
airspace control order (ACO), I-2, I-3, III-1, B-3, B-4, C-4, C-17, C-18
airspace control plan (ACP), I-1, I-2, I-3, III-1, A-5, B-3, B-4, C-4, C-17, C-18, H-2
airspace control system (ACS), I-2, I-3
amphibious assault ship, landing platform helicopter (LPH), D-1, D-2, D-5, D-6, D-8
Amphibious ATC Center (AATCC), I-14, D-5, D-6, D-12
amphibious group (PHIBGRU), D-1, D-3, D-13
amphibious objective area (AOA), C-9, C-12, C-16, D-2, D-6, D-7, D-8, D-9, D-10
amplitude modulating (AM), C-14, E-3, E-7, E-8, E-10, E-21, E-22, E-27, E-28, E-29
analog non secure (AN), B-5, B-8, B-9, C-10, C-19, E-1, E-2, E-3, E-4, E-5, E-6, E-7, E-8, E-9, E-10, E-11, E-13, E-14, E-15, E-16, E-17, E-18, E-19, E-20, E-21, E-22, E-24, E-27, G-1, G-2
area of operations (AO), I-1, II-4, II-5, A-6, B-4, B-6, C-9, C-12, C-16, C-17
area of responsibility (AOR), i, viii, ix, I-3, I-4, I-7, I-10, III-1, D-1, D-2, D-7
Army airspace command and control (A2C2), B-1, B-2, B-3, B-4, B-5, B-6, E-3, E-4, E-5
Army Battle Command System (ABCS), B-9, E-4
Army forces (ARFOR), II-5, B-2
Assistant Air Support Coordinator (AASC), D-6
aviation combat element (ACE), C-1, C-2, C-3, C-12, C-13, C-14, C-15, C-17

B

base defense zone (BDZ), C-6, C-16, C-17

battalion (BN), B-8
battlefield coordination detachment (BCD), I-3, B-2, B-3, B-4, E-5
Beacon Set, E-3

C

carrier battle group (CVBG), D-2, D-3, D-12
carrier air traffic control center (CATCC), D-2, D-3, D-5, D-6, D-12
Civil Reserve Air Fleet (CRAF), I-8, I-9, A-4
close air support (CAS), D-4, D-6, D-7, D-8
coalition humanitarian liaison center (CHLC), G-2
combat communications groups (CCG), A-1, E-14, E-18
Combat Communications, I-13, I-14, III-2, A-1, A-6
Combat controllers, A-1
combat direction center (CDC), D-2, D-12, E-13
combined air operations center (CAOC), I-3, I-4, I-5, I-6, I-9, A-5, B-2, C-5
command and control (C2), I-1, I-3, A-1, A-4, A-6, B-2, B-3, B-4, C-2, C-3, C-5, C-6, D-11, D-12, E-11, E-18, E-19
command, control, communications, and computers (C4), B-5, B-6
common aviation command and control system (CAC2S), E-11
communication zone, B-4
communications security (COMSEC), C-14, E-9, E-10
composite warfare commander (CWC), D-12
control and communications subsystem (CCS), E-5, E-6, E-7
control and reporting center (CRC), I-3, B-2, B-3, B-4, B-5, E-5
Control Central, E-1, E-2, E-3, E-4, E-8, E-13, E-14, E-15

D

deployable air traffic control and landing system (DATCAL), I-5, I-11, II-1, II-3, A-1, A-2, A-3, A-6, A-7
direct air support center (DASC), II-5, C-5, E-11
Distribution of Approaches, I-10

E

End of Operations, v, IV-2

F

filed flight plan (FPL), H-2
forward area air defense (FAAD), B-9, E-4
forward arming and refueling point (FARP), I-11, I-12, C-1, C-8
forward operating base (FOB), I-11, I-12, C-6, C-8, C-9

G

global positioning system (GPS), I-7, B-9, E-10, F-9
ground controlled approach (GCA), II-2, III-2, III-5, A-2, B-1, B-4, E-2, E-6, E-14, E-15, E-16
ground forces commander (GFC), II-3

H

helicopter direction center (HDC), D-2, D-8
helicopter landing zone (HLZ), C-7, C-8
high density airspace control zone (HIDACZ), D-2, D-7
high frequency (HF), B-6, B-8, C-10, C-15, E-1, E-2, E-3, E-4, E-7, E-8, E-10, E-21, E-22, E-24, E-27, E-28, E-29, F-1, H-3
humanitarian assistance (HA), I-2, G-1, G-2

I

identification, friend or foe (IFF), C-9, C-17, E-2, E-5, E-13, E-15
initial operations, I-1
instrument flight rules (IFR), I-7, I-8, I-11, I-13, II-1, II-2, II-3, II-4, II-5, III-2, III-3, IV-1, A-6, B-1, C-8, E-7, E-27, E-28, F-4, F-10
Integrated Air Defense System (IADS), C-3, C-9
integration, ix, I-1, I-4, I-5, I-7, III-3, IV-1, A-3, A-5, B-4, C-1, C-12, D-1, D-3
International Civil Aviation Organization (ICAO), I-2, I-3, I-5, I-7, I-8, I-9, I-11, IV-2, IV-3, C-4, C-12, C-17, F-7, G-3, G-5, G-6, H-1
International Organization for Standardization (ISO), E-5, E-7, E-8, E-9, E-24
interoperability, ix, I-3, III-3, C-11, C-17, E-11, E-19

J

joint air operations center (JAOC), I-3
joint civil-military operations task force (JCMOTF), G-2
joint force air component commander (JFACC), I-1, I-2, I-3, I-4, I-7, I-8, I-10, II-4, C-5, C-9, D-4

L

landing zone (LZ), II-5
liaison officer (LNO), B-2, B-3

M

Marine Air Control Group (MACG), C-2
Marine Air Ground Task Force (MAGTF), C-1, C-2, C-3, C-4, C-5, C-6, C-7, C-8, C-9, C-11, C-12, C-13, C-14, C-15, C-17
Marine air traffic control and landing system (MATCALs), C-9, C-10, C-11, E-7, E-11
Marine air traffic control mobile team (MMT), I-11, I-12, I-13, I-14, II-1, II-2, II-3, II-4, II-5, III-2, C-4, C-7, C-8, C-9, C-10, C-11, E-9, E-11, E-28
Marine Corps Air Command and Control System (MACCS), C-1, C-2, C-3, C-4, C-6, C-9, C-10, C-11, C-12, C-13, C-17, E-11
Marine Expeditionary Force (MEF), C-6, C-8, D-1
Marine Expeditionary Unit (MEU), II-4, II-5, III-1, C-4, C-6, C-8, D-1
Marine liaison officer (MARLO), I-3, C-5
Marine Remote Area Approach and Landing System (MRAALS), II-4, II-5, E-10, E-28
METeorological/NAVigational (METNAV), E-20
military operations other than war (MOOTW), A-1, A-4, C-1, C-7

mission, enemy, terrain, and weather, troops and support available -- time available (METT-T), C-12, C-18
Mobile Microwave Landing System (MMLS), I-14, II-2, II-3, II-4, III-2, E-22, E-23, E-24, E-27, F-2
Mobile Tower System (MOTS), IV-1, B-8, E-1, E-2, E-3, E-5
multipurpose amphibious assault ships, with internal dock (LHD), I-14, D-1, D-2, D-4, D-5, D-6, D-8, E-12, E-13
multi-Service tactics, techniques, and procedures (MTTP), ii, A-3

N

navigational aids (NAVAIDS), I-7, I-8, II-2, II-4, II-5, III-2, III-3, A-7, B-4, B-5, C-5, C-7, C-8, C-9, C-10, C-13, E-9, F-2
North Atlantic Treaty Organization (NATO), C-18

O

Operations Directorate of a joint staff (J-3), I-2
operations staff officer (G-3), B-3, B-4

P

pick up zones (PZ), E-1
Primary Surveillance Radar System (PSR), E-25
Procedures for Air Navigation Service-Rules of the Air and Air Traffic Services (PANS-RAC), H-3, H-4

S

Secondary Surveillance Radar System (SSR), E-16, E-25, E-26
Single-channel Ground and Airborne Radio System (SINCGARS), B-8, E-1, E-2, E-3, E-4, E-9, E-28, E-29
special instructions (SPINS), I-4, B-3, B-4, D-3
Suggested Organization, iv, I-4

T

TACC, I-14, C-4, C-5, D-2, D-3, D-6, D-7, D-10, D-12, E-7, E-11
tactical air navigation (TACAN), I-14, II-2, II-3, II-4, II-5, III-2, A-1, A-2, C-6, C-19, E-8, E-11, E-19, E-20, E-21, E-22, E-23, E-24, E-27, E-28, F-2, F-9, F-11
Tactical Airspace Integration System (TAIS), B-5, B-8, E-3
tactics, techniques, and procedures (TTP), i
tanker airlift control element (TALCE), I-14, II-2, II-3
terminal instrument procedures (TERPS), I-4, I-5, I-6, I-7, I-10, I-13, I-14, II-2, II-4, II-5, III-2, A-2, A-7, B-3, C-5, C-6, C-11, E-15, E-16, E-17, E-20, F-3, F-10

U

ultra high frequency (UHF), II-4, B-6, B-8, B-9, C-10, C-14, D-2, D-3, E-1, E-2, E-3, E-4, E-7, E-8, E-9, E-10, E-14, E-15, E-16, E-18, E-19, E-21, E-22, E-24, E-25, E-26, E-27, E-28, E-29, F-1, F-7, G-1, G-2
unmanned aerial vehicle (UAV), I-12, IV-2, C-16, C-17

FM 3-52.3 (FM 100-104)
MCRP 3-25A
NTTP 3-56.3
AFTTP(I) 3-2.23

17 July 2003

By Order of the Secretary of the Army:

Official:

ERIC K. SHINSEKI
General, United States Army
Chief of Staff

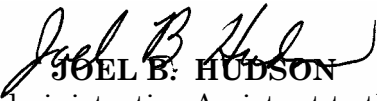
JOEL B. HUDSON
Administrative Assistant to the
Secretary of the Army
XXXXXXX

DISTRIBUTION:

Active Army, Army National Guard, and US Army Reserve: Distribute in accordance with the initial distribution number (IDN) 115657, requirements for FM 3-52.3.

By Order of the Secretary of the Air Force:

DAVID F. MacGHEE, JR.
Major General, USAF
Commander
Headquarters Air Force Doctrine Center

Air Force Distribution: F or X if restricted publication

