

Geological, Geochemical, and Operational Summary, Aurora Well, OCS Y-0943-1, Beaufort Sea, Alaska

OCS Report
MMS 94-0001

Geological, Geochemical, and Operational Summary, Aurora Well

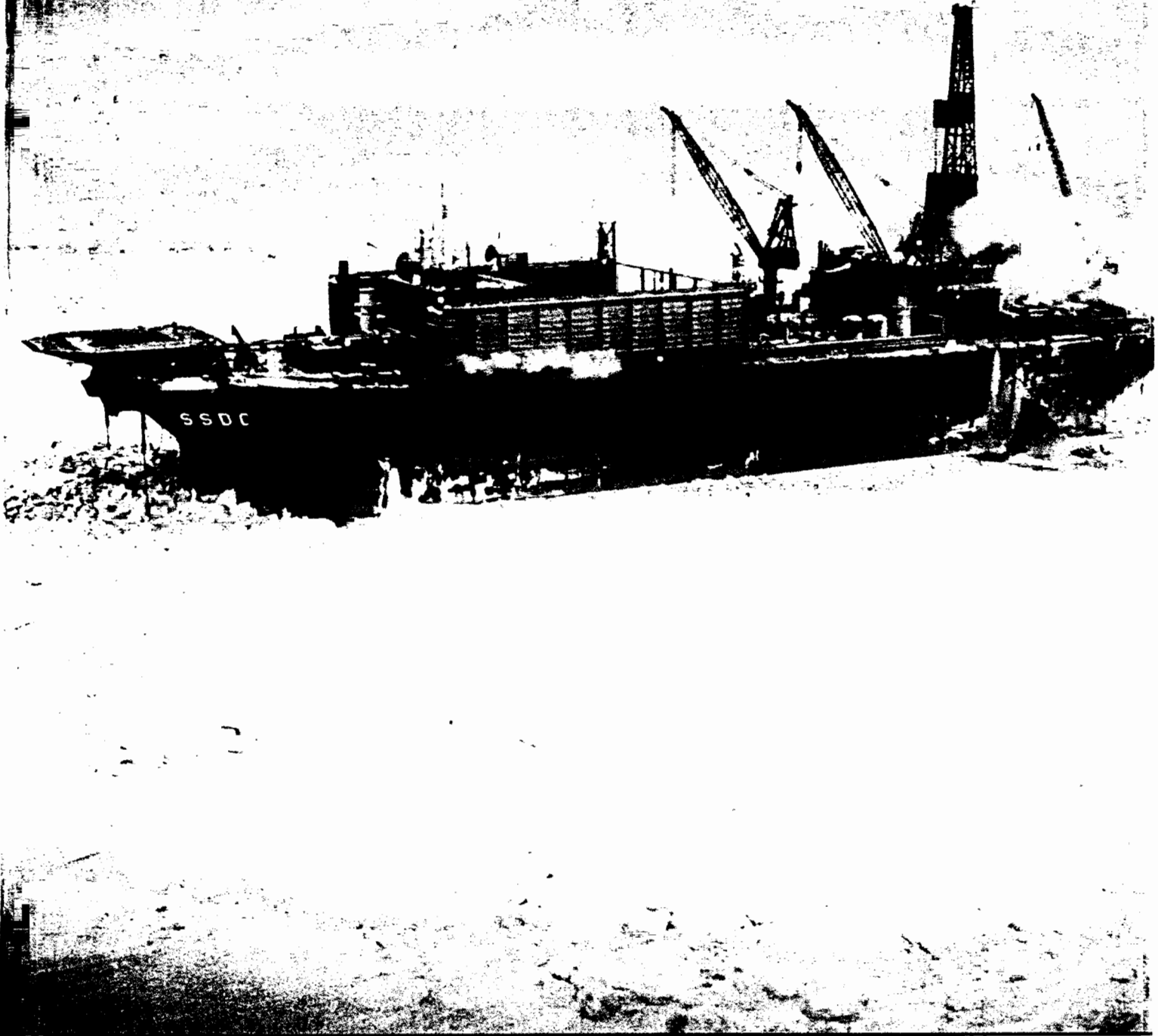

OCS Report MMS 94-0001



U.S. Department of the Interior
Minerals Management Service
Alaska Outer Continental Shelf Region

Cover photograph courtesy of
Canadian Marine Drilling, Ltd. (CANMAR),
Calgary, Alberta, Canada

**Geological, Geochemical, and Operational Summary,
Aurora Well, OCS Y-0943-1, Beaufort Sea, Alaska**

by

**Lawrence E. Paul
Douglas R. Choromanski
Ronald F. Turner
Tabe O. Flett**

edited by

Lawrence E. Paul

Library of Congress Cataloging-in-Publication Data

Geological, geochemical, and operational summary, Aurora Well, OCS Y-0943-1,
Beaufort Sea, Alaska / by Lawrence E. Paul ... [et al.] ; edited by Lawrence E. Paul.
p. cm. -- (OCS report)

"MMS 94-0001."

Includes bibliographical references.

1. Oil well drilling, Submarine--Beaufort Sea. 2. Petroleum--Geology--Beaufort
Sea. 3. Petroleum--Prospecting--Beaufort Sea. I. Paul, Lawrence E. (Lawrence
Eugene), 1954- . II. United States. Minerals Management Service. Alaska OCS
Region. III. Series.

TN871.3.G47 1994

553.2'82'0916327--dc20

94-2868
CIP

Available from the National Technical Information Service, 5285 Port Royal Road,
Springfield, VA 22161, Order Number PB94-140928.

*Any use of trade names is for descriptive purposes only and does not constitute
endorsement of these products by the Minerals Management Service.*

ACKNOWLEDGMENTS

As editor, I wish to thank all the authors who contributed chapters to this report, the various staff members for their contributions to the graphics (Devon Peterson, Don Nelson, and Ida Menge) and text (Irene Reeder), and technical editor Jody Lindemann for her excellent work. I gratefully acknowledge technical reviewers John Wills and Kirk Sherwood for their many helpful suggestions and comments that made publication of this report possible.

CONTENTS

Abbreviations	vii
Abstract	1
Introduction	3
1. Operational Summary and Drilling Program	4
by Douglas Choromanski	
2. Biostratigraphy	15
by Ronald F. Turner	
3. Well Log Interpretation and Lithology	26
by Lawrence E. Paul	
4. Geothermal Gradient	34
by Lawrence E. Paul	
5. Organic Geochemistry	38
by Tabe O. Flett and Lawrence E. Paul	
Summary and Conclusions	55
References	58
Appendices	
I. Wellbore Casing and Cement Summary	66
II. Final Reports and Well Logs	67
III. Geothermal Data	69
Figures	
1.1. Location map for the OCS Y-0943-1 (Aurora) well ...	5
1.2. Diagram of CANMAR's SSDC/MAT	6
1.3. Schematic diagram summarizing drilling operations for the Aurora well	8
1.4. Schematic diagram of the Aurora well plugging and abandonment	9
2.1. Palynological zonation used in this report	16

3.1. Well log interpretation and lithologic descriptions from the Aurora well	27
4.1. Geothermal gradient of the Aurora well	35
4.2. Horner plot for log run 2	37
5.1. Various parameters used for determining the thermal maturity and the oil window in the Aurora well	39
5.2. Classification of organic matter and kerogen type	43
5.3. Thermal alteration of C ₁₅₊ extractable hydrocarbons from the Canning Formation in the Aurora well	48
5.4. Isoprenoid ratios from the Canning Formation in the Aurora well	51
5.5. Chromatograms showing the unidentified hydrocarbon (probably the isoprenoid C ₂₁) between the normal C ₂₀ and C ₂₁ alkanes	53

Tables

2.1. Biostratigraphic summary	25
4.1. Corrected BHT's for log runs 1,2,3, and 5	36
5.1. Suggested threshold values for genetic potential (S ₁ +S ₂) from pyrolysis	47

Plate

1. Various parameters defining the organic richness and hydrocarbon source potential, Aurora well, OCS Y-0943-1

ABBREVIATIONS

ANWR	Arctic National Wildlife Refuge
APD	application for permit to drill
bbl(s)	barrel(s)
bbl(s)/hr	barrel(s) per hour
BHA	bottom hole assembly
BHC	Borehole Compensated Sonic Log
BHT	bottom hole temperature
BML	below mud line
BOP	blowout preventer
BP	Borehole Profile Log
CANMAR	Canadian Marine Drilling Limited
cm ³	cubic centimeter
CNL	Compensated Neutron Lithodensity Log
°C	degrees Centigrade
°F	degrees Fahrenheit
DI/SFL	Dual Induction/Spherically Focused Log
EXLOG	Exploration Logging USA, Inc.
EZSV	easy-drill cement retainer (Halliburton trade name)
FEL	from east line
FMS	formation micro scanner log
FNL	from north line
ft	foot, feet
ft ³	cubic foot, feet
ft/hr	foot, feet per hour
g	gram
GR	gamma ray log
HRZ	highly radioactive zone
in.	inch(es)
lb(s)	pound(s)
lb(s)/ft	pound(s) per foot
KIC	Kaktovik Inupiat Corporation
LCM	lost circulation material(s)
LCU	Lower Cretaceous Unconformity
m	meter(s)
md	millidarcies
MD	measured depth
mg/g	milligram(s) per gram
mi	mile(s)
MMS	Minerals Management Service
MWD	Measurement While Drilling Log
OCS	Outer Continental Shelf

ppg	pounds per gallon
ppm	parts per million
psi	pounds per square inch
R _o	vitrite reflectance (in percent)
RFT	repeat formation tester
RKB	rotary kelly bushing
RMF	resistivity of mud filtrate
S1	free and/or adsorbed volatile hydrocarbons present in rock (mg hydrocarbons/g rock)
S2	hydrocarbons generated from kerogen pyrolysis (mg hydrocarbons/g rock)
S2/TOC	hydrogen index (mg hydrocarbons/g TOC)
S3	CO ₂ generated from kerogen pyrolysis (mg CO ₂ /g rock)
SP	spontaneous potential log
SSDC/MAT	Single Steel Drilling Caisson and Submersible Mat
SWC	sidewall core(s)
TAI	thermal alteration index (spore coloration index)
TD	total depth
T _{max}	temperature where maximum amount of S ₂ hydrocarbons are generated from kerogen pyrolysis (in °C)
TOC	total organic carbon
TVD	true vertical depth
vol.	volume
WST	wellbore seismic tester log
wt.	weight

All depths are measured depths (MD), given as feet below RKB.

ABSTRACT

Tenneco Oil Company's Outer Continental Shelf (OCS) Y-0943-1 (Aurora) well is of considerable interest because it is the closest offshore OCS well to the Arctic National Wildlife Refuge (ANWR) — a little more than 3 miles out from Griffin Point — and is less than 7 miles from the Chevron KIC-1 well, the only well drilled inside Kaktovik Inupiat Corporation (KIC) native lands (which border the ANWR coastal plain).

The Aurora well is essentially a deep stratigraphic test well that was drilled to try to penetrate the same sequences encountered in the KIC-1 well in an effort to evaluate the petroleum potential of ANWR. Interpretation of surface outcrops of Jurassic shales in northern ANWR suggests that reservoir and source rocks of the Ellesmerian sequence (i.e., the Mississippian to Early Permian Lisburne Group and the Permian to Triassic Sadlerochit Group) might be in the area of the Aurora well (Grantz and Mull, 1978, p. 9; Craig and others, 1985, p. 108).

The Aurora well bottomed at 18,325 ft in Jurassic-age Kingak Shale of the Beaufortian sequence. Perhaps rocks of the Ellesmerian sequence lie below the Kingak, as is seen at Prudhoe Bay. Alternatively, perhaps a thick Beaufortian sequence rests directly on basement-complex rocks with Ellesmerian absent, as is seen in northwest Canada.

The Aurora well penetrated lithology which is predominantly claystone, siltstone, and shale, with minor sandstone. There were two units encountered that may be of interest: a lower Brookian conglomerate (14,685 to 14,830 ft) and an Early Cretaceous sandstone (16,442 to 16,620 ft). Both exhibit poor to very marginal reservoir potential, but may have good reservoir potential at shallower depths. However, they may only be localized deposits.

The top of the oil window in the Aurora well occurs at approximately 11,000 ft and the bottom (the "oil floor") probably begins at about 15,700 ft. This is essentially the early Paleocene section of Canning Formation Unit B and the upper part of an unnamed Early Cretaceous shale. Only minor light-hydrocarbon shows were recorded by the mud log and none are associated

with the lower Brookian conglomerate or the Early Cretaceous sandstone.

The sedimentary sequences encountered in the Aurora well contain predominantly gas-prone type III kerogen with very limited potential for generating hydrocarbons.

The Aurora well samples yielded two types of hydrocarbons that appear to have migrated from unidentified sources. The neritic to bathyal sediments of Unit A of the Canning Formation contain C₁₅₊ hydrocarbon extracts that appear to be generated from mixed organic sources in a marine environment. Unit A, at the well, is insufficiently mature to have generated these hydrocarbons. The neritic to marginal marine Unit B of the Canning Formation yielded C₁₅₊ extracts characteristic of a nearshore or terrestrial environment that were probably generated by a type III kerogen. However, Unit B is organically lean at this location and saturate contents of extracts do not support an indigenous origin.

INTRODUCTION

Code of Federal Regulations (CFR), Title 30, paragraph 250.18(b)(2) stipulates that for a lease in effect, geological data and analyzed geological information may be released to the public 2 years after submission¹ of the data or information, or 60 days after a lease sale such that any portion of an offered block is within 50 miles of a well, whichever is later. All data and information concerning the Aurora well are now released to the public and may be viewed at the State of Alaska's Geologic Materials Center (GMC) in Eagle River, Alaska, and at the Minerals Management Service (MMS) Field Operations office in Anchorage, Alaska. (For a complete listing of all data available from the MMS, refer to Appendix II.)

The Aurora well is located just off the coast of the Arctic National Wildlife Refuge (ANWR). It is approximately 22 miles ENE. of the village of Kaktovik, at latitude 70°06'33" N., longitude 142°47'06" W., in Outer Continental Shelf (OCS) block 890 of protraction diagram NR 7-3. The well was spudded November 2, 1987, in 68 ft of water and plugged and abandoned 286 days later on August 30, 1988, after drilling to a total depth (TD) of 18,325 ft below the Kelly Bushing (RKB). The well was drilled using Canadian Marine Drilling Ltd.'s (CANMAR) Single Steel Drilling Caisson (SSDC/MAT).

This report presents our interpretations of the geologic and geochemical information collected from the Aurora well. A large amount of good-quality data was obtained from the well, and it is hoped that the data and interpretations presented here will be of reference value to other researchers. Additionally, a significant section of this report is devoted to the operational aspects of drilling the Aurora well. We hope this section will provide useful information for future offshore drilling ventures.

¹ MMS requires submission of all geological information within 30 days of completion of a well.

1. OPERATIONAL SUMMARY AND DRILLING PROGRAM

Tenneco Oil Company drilled the exploratory well OCS Y-0943-1, Aurora Prospect, on a lease originally won by ARCO Alaska, Inc., on August 22, 1984, at the Sale 87 Diapir Field OCS lease offering. ARCO was the sole bidder with a high bid of \$437,000 (\$722.19 per acre). Tenneco was designated operator and assigned 50% lease holder by ARCO on June 23, 1987.

The Aurora well is located at latitude 70°06'33" N., longitude 142°47'06" W., in OCS block 890 of protraction diagram NR 7-3, Eastern Beaufort Sea, in approximately 68 feet of water. The location of the Aurora well is significant because it is the closest Federal offshore well to ANWR, slightly over 3 miles northeast of Griffin Point and 6.3 miles northeast of the Chevron KIC-1 well (figure 1.1).

Operational Summary

The well was drilled utilizing CANMAR's Single Steel Drilling Caisson (SSDC/MAT). The SSDC/MAT (figure 1.2) is a modified ice-strengthened Very Large Crude Carrier tanker which is mated to a specially designed and constructed steel mat. Classified as a Mobile Offshore Drilling Unit, the SSDC/MAT can operate in water depths between 30 and 80 ft.

A geotechnical stability evaluation for the SSDC/MAT was prepared by EBA Engineering, Inc., based on borehole, sample probe, and cone penetration tests obtained during the open-water season of 1987. The analysis specifically addressed the following items:

1. Review and interpretation of the soil conditions at the Aurora location to develop a design shear-strength profile.
2. Evaluation of setdown conditions for the SSDC/MAT in relation to the microrelief and shear strength of the seabed.
3. Investigation of skirt-soil interaction mechanisms to determine the ultimate skirt lateral resistance.
4. Determination of global lateral resistance under symmetric and eccentric ice load.

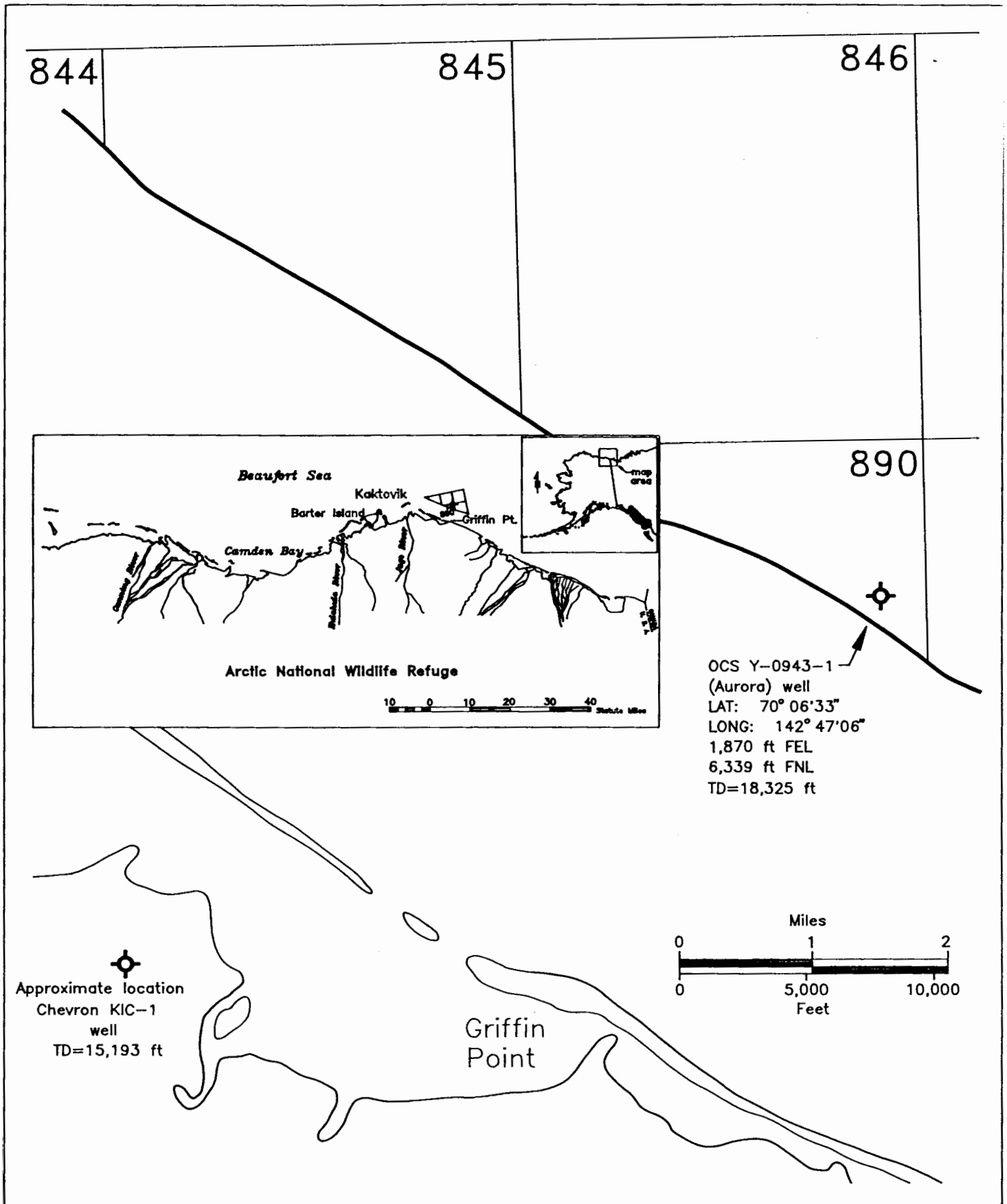

Figure 1.1. Location map for the OCS Y-0943-1 (Aurora) well.

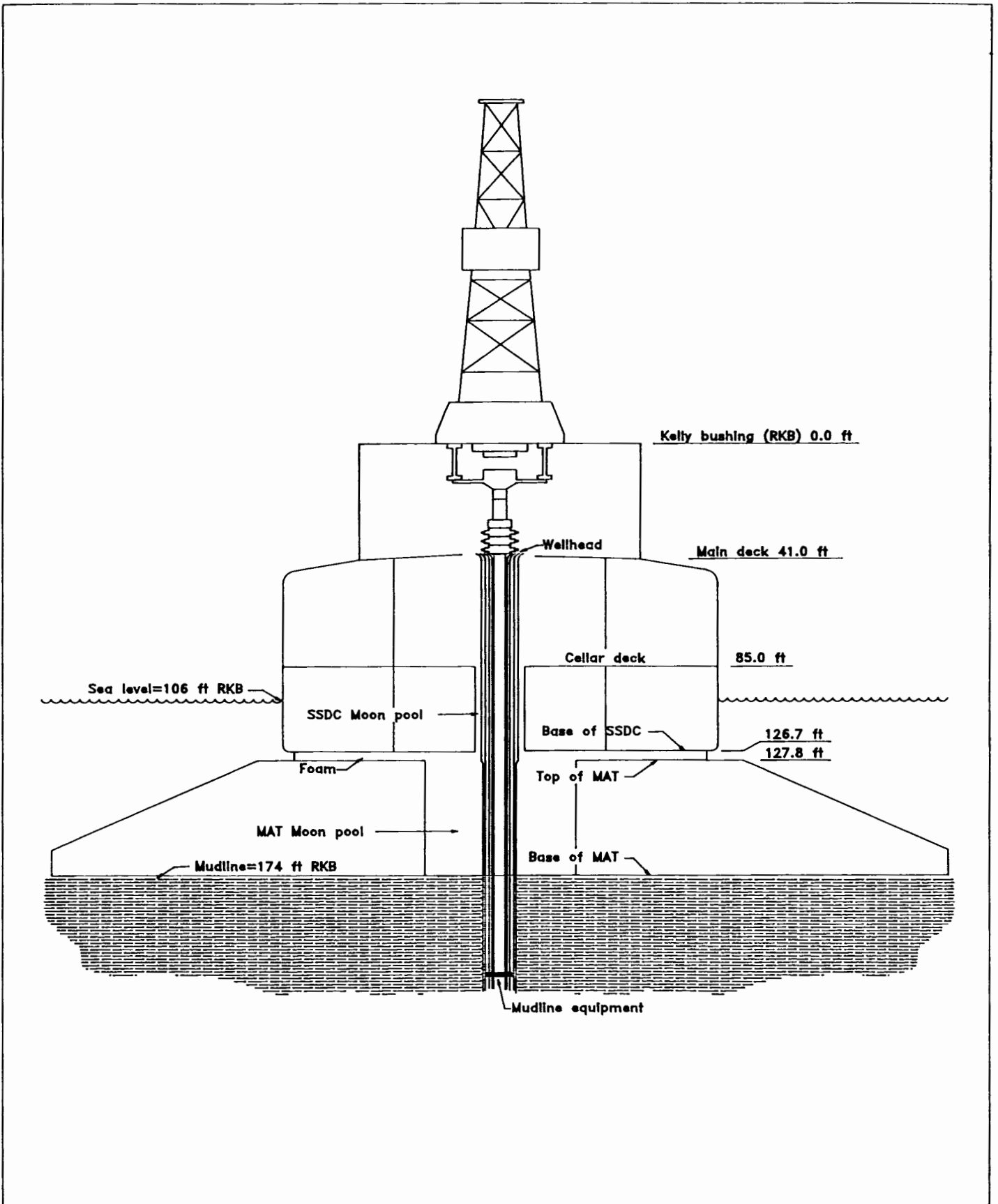

Figure 1.2. Diagram of CANMAR's SSDC/MAT.

A high-resolution geophysical survey was run by Western Geophysical in August 1987. Based on the data obtained, a shallow-hazards report was prepared for Tenneco Oil by Pelagos Corporation. The objective of the report was to identify any potential shallow hazards, constraints, anomalies, or any other condition which might adversely affect the proposed operations. Utilizing both the geotechnical and hazards reports, Tenneco selected the site which best met all the operational and exploratory criteria for the proposed operations.

On September 13, 1987, the SSDC/MAT was positioned and ballasted in place at the approved drill site. Placement of the SSDC/MAT was considered critical to the proposed operations, so verification of positioning was essential. Tenneco accomplished the verification by using CANMAR Navigation Software and a Syledis radio-navigation network operated by Western Research. An MX-1502 satellite receiver system satisfactorily confirmed the Syledis positioning system.

The Application for Permit to Drill (APD) was conditionally approved on October 28, 1987, and the well was permitted to a planned TD of 16,500 ft. The primary objectives of the Aurora well were to test the hydrocarbon potential of Tertiary and possibly Cretaceous sands, and to penetrate the pre-Mississippian basement, anticipated at 16,100 ft.

The Aurora well was spudded on November 2, 1987. It was plugged and abandoned 286 days later on August 30, 1988. Minerals Management Service (MMS) personnel were on board to inspect and observe throughout the operational period to ensure compliance with all regulations, orders, and conditions of approval required by the APD. It should be noted that there were no operational down days due to environmental conditions (e.g., ice movements, winter storms), and that operations were conducted during the early stage of the annual fall bowhead whale migration without incident. Drilling operations are summarized in figure 1.3. The plugging and abandonment program is summarized in figure 1.4.

Drilling Program

Interval 1: Surface to 908 ft

A 40-in. structural casing was driven to a depth of 276 ft. A 26-in. bit was used to ream out the hole because significant amounts of gravel were encountered in the formation. At this point, a diverter flow line system was coupled to the 40-in. structural casing.

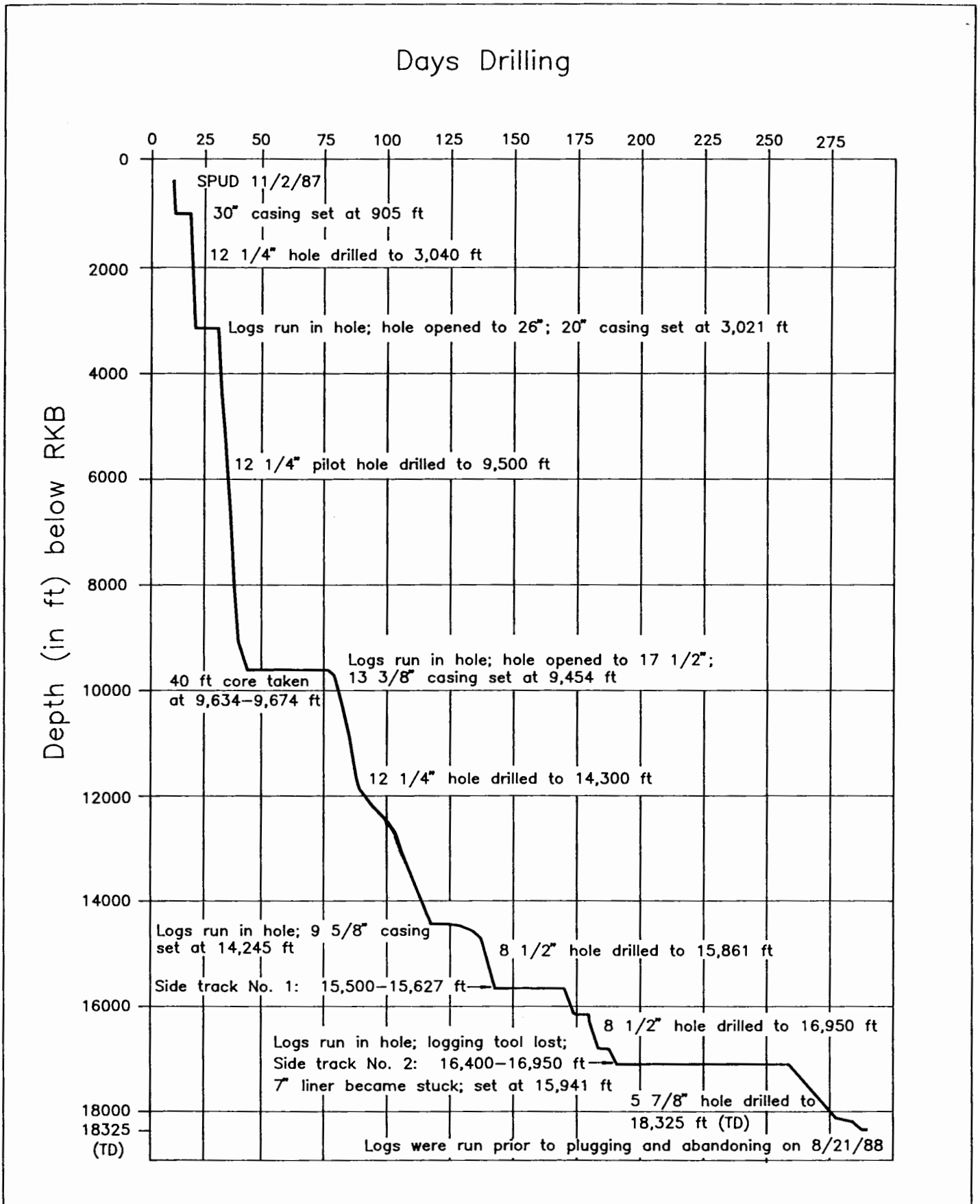

Figure 1.3. Schematic diagram summarizing drilling operations for the Aurora well.

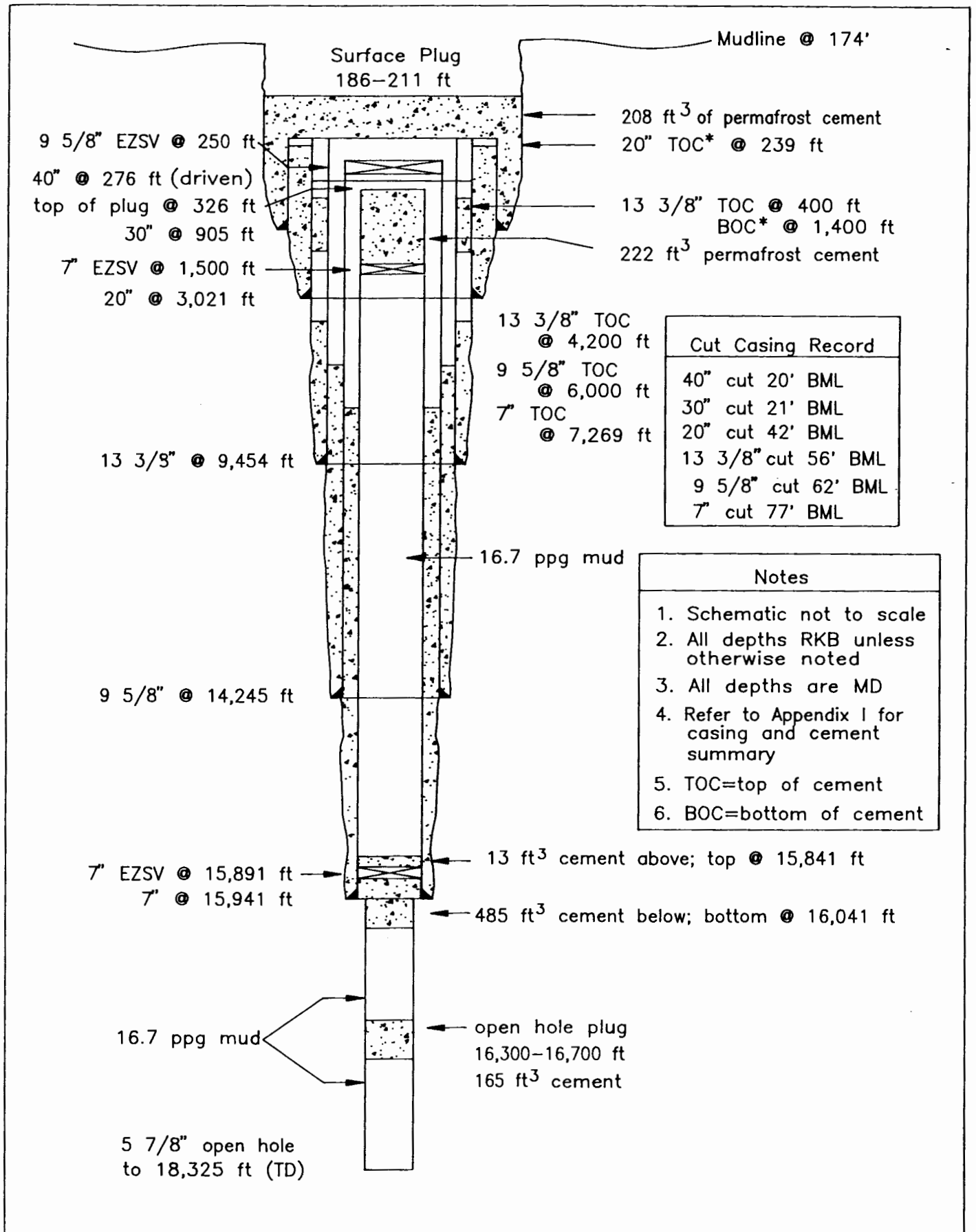

Figure 1.4. Schematic diagram of the Aurora well plugging and abandonment.

A 17½-in. pilot hole was drilled to 908 ft at a rate of 100 ft/hr. The pilot hole was drilled partly as a well-control precaution in case shallow gas or gas hydrates were encountered. A 40-in. hole-opening assembly was run with an average penetration rate of 30 ft/hr. The slow rate of penetration was designed to assist in controlling the amount of cuttings separated at the shakers. A 30-in., 310-lbs/ft casing was then run and cemented in place at 905 ft. A gel/water mud program with mud weights ranging between 8.9 and 9.7 pounds per gallon (ppg) was used while drilling this section of the well.

The lithology of this interval is composed dominantly of silty clay with minor amounts of gravel. Pore pressures encountered were within normal ranges. No shallow gas or gas hydrates were observed. It required 7 days to complete this interval of the well.

Interval 2: 908 to 3,040 ft

A 12¼-in. pilot hole was drilled below the 30-in. casing at a rate of 100 ft/hr down to the 20-in. casing interval TD of 3,040 ft. The pilot hole was required because of the unknown probability of encountering shallow gas hydrates. Electric logs were then run to evaluate this section of the well. The hole was then opened using a 26-in. opener and a 26-in. bit, and conditioned in preparation for running the 20-in., 133-lbs/ft casing. The 20-in. casing was cemented at 3,021 ft. The only drilling problem of note was associated with formation clay balling around the bit and bottom hole assembly (BHA). Increasing the mud weights from 10.0 to 10.5 ppg helped to stabilize these tight hole conditions. A small amount of connection gas was observed at 2,875 ft, which was probably the result of increased swabbing effects caused by the clay-balling situation. This section of the well was drilled using gel/water with mud weights ranging between 9.2 and 10.5 ppg.

The lithology of this interval is composed dominantly of clay, with thinly bedded silts and sands. There were no indications of any gas hydrates or shallow gas in this interval. It required 13 days to complete this interval of the well.

Interval 3: 3,040 to 9,500 ft

At 3,040 ft, a 3,000-psi blowout preventer (BOP) stack was coupled to the 20-in. casing. After testing the BOP and performing a leak-off test (14.0-ppg equivalent mud weight) on the 20-in. casing shoe, a 12¼-in. pilot hole was drilled to the 13⅝-in. casing TD at 9,500 ft. On December 1, Tenneco received approval for a departure from the APD to deepen their proposed

13 7/8-in. casing depth from 8,000 to 9,500 ft. Various bits and BHA's were used in order to improve penetration rates while drilling this interval. Formation clay balling and tight hole conditions, which led to swabbing in trip gas, were the most significant problems encountered while drilling this section of the well.

Nudrill Polymer mud was used while drilling this interval. Mud weights varied between 9.5 and 12.1 ppg. The mud weights were first increased to 11.3 ppg when a pore pressure transition zone was observed between 6,700 and 7,650 ft. A slight increase in formation pressure between 8,500 and 8,750 ft required the mud weights to be increased to 11.6 ppg. The mud weight was increased to 11.8 ppg at 8,847 ft to stop the accumulation of fill at the bottom of the hole. The mud weight was raised to 12.1 ppg while circulating and conditioning the well prior to running logs.

A 17 1/2-in. adjustable-blade hole opener was used to open the hole down to 6,900 ft because the hardness of the claystone/siltstone formation exceeded the design characteristics of the bit. Conventional roller cutters were used to complete the hole-opening procedure down to the interval TD. A 13 3/8-in., 72-lbs/ft casing was then run and cemented to 9,454 ft. The hole-opening procedure for the 13 3/8-in. casing required 22 days to complete.

The lithology of this interval is composed dominantly of claystone, thin sandstones, and moderately indurated siltstone and shale. It required 46 days to complete this interval of the well.

Interval 4: 9,500 to 14,300 ft

A 13 3/8-in., 10,000-psi BOP was coupled to the 13 3/8-in. casing. A leak-off test was performed after drilling out the float collar, shoe, and 7 ft of new hole. A fracture-pressure equivalent of 15.6 ppg was obtained. On February 9, Tenneco received approval to modify their drilling plan in order to set the 9 5/8-in. casing at 14,300 ft.

Because of poor bit performance and very poor penetration rates, several 12 1/4-in. bits were used to drill to 9,634 ft. A conventional core was taken from 9,634 to 9,674 ft. While drilling at 10,405 ft, a slight change in pore pressure was noted. This change became more apparent after a drilling break occurred while penetrating a sandstone sequence between 10,750 and 10,775 ft. High background and connection gas readings indicated a significant transition zone which required mud weights to be increased from 11.8 to 12.4 ppg by 10,975 ft. Mud weights were increased again to 12.6 ppg by 11,475 ft. The mud weight was raised to 13.0 ppg

while reaming in order to control shale sloughing. Continuing problems with shale sloughing, poor bit performance, and possible junk in the hole necessitated numerous bit and BHA changes while drilling down to the interval TD of 14,300 ft. A change in pore pressure was observed while drilling sands between 13,750 and 13,900 ft. The mud weight was raised to 13.3 ppg in order to counter this increase in pore pressure. Mud weights were further raised to 13.5 ppg at 14,240 ft and to 13.7 ppg at 14,295 ft prior to running logs. After completing 7 days of logging operations, the well was conditioned and the 9 5/8-in. casing was run and cemented at 14,245 ft.

The lithology of this interval consists of firm to hard siltstones and shale, thin coal stringers, and moderately indurated tight sands. It required 57 days to complete this interval of the well.

Interval 5: 14,300 to 16,950 ft

After drilling out the float collar, shoe, and 5 ft of new hole, a leak-off test was performed which equated to a 17.1-ppg-equivalent mud weight. Drilling conditions continued to be difficult with high background and connection gas, premature bit failure (possibly caused by junk in the hole), shale sloughing, excessive bit torque, hole deviation, lost circulation, and stuck drill pipe. While drilling at approximately 15,861 ft, the bit and 10 ft of BHA separated below the Teleco Measurement-While-Drilling (MWD) tool and all attempts to retrieve them failed. Tenneco received approval on April 12 to plug back and sidetrack the well. A cement plug was set and the well was sidetracked around the BHA. A bent sub and mud motor was used to kick-off Sidetrack No. 1 from 15,500 to 15,627 ft. On May 3, Tenneco received approval to change their proposed TD to 16,600 ft; on May 4, to 16,850 ft; and on May 11, to 16,950 ft. The well continued to experience tight hole conditions, high torque, shale sloughing, lost circulation, and bit failures while drilling to the interval TD at 16,950 ft. Below 16,600 ft, the Teleco MWD tool failed. According to Tenneco, excessive well bore temperatures caused the failure (the maximum temperature recorded by the MWD tool was 251 °F). Very limited logging data were obtained because of the severe well bore problems. Two Schlumberger logging tools were lost in the hole and eventually were pushed to the bottom of the well. Tenneco received approval to plug and sidetrack around the tools on June 20. The well was plugged back to 16,400 ft and Sidetrack No. 2 was directionally drilled to the interval TD of 16,950 ft. Tenneco then ran 3,208 ft of 7-in. liner in the hole on drill pipe. The casing became stuck at 15,941 ft, leaving over 1,000 ft of open hole below the liner shoe. A 7-in. tie-back string was run in the hole, cemented to the top of the liner, and tested to 5,000 psi.

The mud program used in this section of hole utilized Nudrill Polymer muds. Mud weights varied between 13.7 and 16.1 ppg. Several drilling problems associated with the drilling fluids were encountered in this section of the well. A lost-circulation zone was encountered while drilling at 14,680 ft in which approximately 10 bbl/hr of drilling fluids were lost. A background gas reading of 20 to 30 units and a trip gas reading of 68 units were recorded. A significant transition in pressures was observed while making a connection at 14,708 ft which yielded 3,200 units of gas requiring the mud weight to be increased from 13.6 to 13.9 ppg. Mud weights were steadily increased to 15.1 ppg by 14,875 ft. Lost circulation material (LCM) was added as the mud weights were increased to control continued fluid loss, which had increased to 20 bbls/hr. A sand encountered at 15,100 ft required an increase in mud weight to 15.7 ppg. Additional LCM was added to control the increased fluid loss at 14,680 ft. The mud weight was raised to 15.9 ppg by 15,861 ft to help stabilize hole conditions. Partial returns were observed due to the increased mud weight which accounted for approximately 130 bbls of drilling fluids being lost to the formation through this section of the well.

A slight increase in pore pressure was observed while drilling a dark, fissile shale in Sidetrack No. 1 at 15,900 ft, which required increasing the mud weight from 15.5 to 15.7 ppg. By 16,200 ft, the mud weight had been increased to 16.1 ppg. Once again, the well started to lose fluids while drilling at 16,215 ft and LCM was added to help control the rate of fluid loss. The well was circulated and the mud weight was lowered to 15.9 ppg. An estimated 225 bbls of drilling fluids was lost to this section of the well. The mud weight was gradually raised to 16.0 ppg while reaming to control high torque and shale sloughing. At 16,445 ft, a drilling break occurred in a very abrasive sandstone. The sandstone was slightly lower pressured than the overlying shale. Sidetrack No. 2 was drilled without any significant problems.

The lithology of this interval consists of firm to hard siltstones, shale, conglomeratic sandstone, and a dolomite-cemented glauconitic sandstone. Between 15,000 and 15,500 ft, the lithology changes to a dark-gray to black carbonaceous shale. Because of the significant drilling problems encountered, 137 days were required to complete this interval of the well.

Interval 6: 16,950 to 18,325 ft (TD)

A leak-off test was performed at 15,963 ft after drill out of the 7-in. liner shoe, float collar, and excess cement. A fracture-pressure equivalent of 17.9 ppg was obtained. On July 5, Tenneco received approval to deepen to 18,500 ft. Drilling conditions for

the 5 $\frac{7}{8}$ -in. hole were far less severe than those encountered in the previously drilled 8 $\frac{1}{2}$ -in. hole. While drilling at 17,600 ft, increased pore pressures were observed, requiring the mud weight to be raised to 16.0 ppg. Formation pressures continued to increase, and by 17,780 ft the mud weight had been raised to 16.3 ppg in order to control increased connection gas readings. The mud weight was raised to 16.5 ppg by 17,950 ft to counter increased drag and bit torque. The mud weight was increased to 16.8 ppg to help stabilize the hole while reaming. At 17,893 ft, a lost-circulation condition was encountered which required the addition of LCM and the lowering of the mud weight to 16.7 ppg. The well was drilled to its TD of 18,325 ft without any additional drilling problems. The interval was logged and evaluated prior to initiating plugging and abandonment procedures on August 21, 1988.

The lithology of this interval is composed dominantly of shale with minor silty sections. A total of 26 days were required to complete this interval of the well.

Plugging and abandonment (figure 1.4)

The first plug was an open-hole balanced plug of 165 ft³ of class G cement and additives set between 16,700 and 16,300 ft. An EZSV retainer was set at 15,891 ft, 50 ft above the 7-in. casing shoe. After testing the EZSV with 25,000 lbs of weight, 485 ft³ of class G cement and additives were squeezed between 16,041 and 15,891 ft. A displacement plug of 13.3 ft³ of class G cement and additives was set on top of the retainer between 15,891 and 15,841 ft. The 7-in. casing was then pressure-tested to 1,500 psi for 30 minutes. A second 7-in. EZSV was set at 1,500 ft and tested with 25,000 lbs of weight, followed by a balanced plug of 222 ft³ of Canadian Permafrost cement between 1,500 and 326 ft. The 7-in. casing was cut and pulled at 251 ft, 77 ft below mud line (BML). A 9 $\frac{5}{8}$ -in. EZSV retainer was set at 250 ft (76 ft BML) and tested with 15,000 lbs of weight. The 9 $\frac{5}{8}$ -in. casing was then cut and pulled at 236 ft (62 ft BML). The 13 $\frac{3}{8}$ -in. casing was cut and pulled at 230 ft (56 ft BML). The 20-in. casing was cut and pulled at 216 ft (42 ft BML). The 30-in. casing was cut at 195 ft (21 ft BML) and pulled together with the 40-in. casing (cut at 194 ft, 20 ft BML). A final surface plug of 208 ft³ of Canadian Permafrost cement was set between 211 and 186 ft (37 to 12 ft BML). A diver inspected the moon pool area prior to final abandonment. A total of 10 days were required to complete the plugging and abandonment program. Tenneco received final approval of the Aurora well abandonment on October 7, 1988. Appendix I summarizes the casing and cementing history for the Aurora well.

2. BIOSTRATIGRAPHY

The biostratigraphic analysis of the OCS Y-0943-1 (Aurora) well is based on benthic foraminifera, dinoflagellates, spores, and pollen. Four sets of samples were examined: a set of samples processed by the MMS, two sets of samples processed by Micropaleo Consultants, Inc. (one for the original participants and a later set made from samples curated by the State of Alaska Geologic Materials Center), and an additional set processed for the MMS by the Bujak Davies Group. This latter set was re-examined for the MMS by Ed Davies of Branta Biostratigraphy, Ltd. Three of the sample sets were made from drill bit cuttings collected at 30-ft intervals. The fourth set (prepared for the well participants) contains samples from the cuttings, the sidewall cores, and the one conventional core.

The biostratigraphy presented here must be considered provisional for a number of reasons. Both reworking and downhole caving make interpretation difficult in some sections of the well. There are also variations in microfossil recovery from the four sample sets. The lignitic mud additives used introduced extraneous and confusing Paleogene palynomorphs into the samples. And, lastly, the regional biostratigraphy of the Beaufort Sea and Mackenzie Delta is still in a developmental stage. Although the MMS benefited from discussions of the data with personnel from Micropaleo Consultants, Inc., the Bujak Davies Group, and Branta Biostratigraphy, Ltd., the interpretations presented here must be considered our own. The interpretations made by Micropaleo Consultants, Inc., for the well participants remain proprietary.

Palynological analyses prepared for the MMS by the Bujak Davies Group (Bujak, 1990), and re-evaluated by Ed Davies of Branta Biostratigraphy, Ltd. (Davies, 1991), represent a major element of the biostratigraphic zonation of the Aurora well.

Fossil identifications and the integrated foraminiferal and palynomorph zonations used are based on, among many others, ten Dam and Reinhold (1942), Tappen (1955, 1957, 1962), Todd (1957), Batjes (1958), Doerenkamp and others (1976), Staplin (1976), Rouse (1977), Ioannides and McIntyre (1980), Young and McNeil (1984), Norris (1986), and charts provided by Micropaleo Consultants, Inc., and the Bujak Davies Group. The Cenozoic zonation scheme (fig. 2.1) was developed by the Bujak Davies

CENOZOIC

AGE	C#	ZONATION
PLEISTOCENE	9	Laevigatosporites ovatus
PLIOCENE	B	Naiadinium coronutum
	A	N.coronutum S.obscura
MIOCENE	D	F.filifera
	C	Tsugaepollenites igniculus
	B	S.ancyrea P.laticinctum
	A	P.paradoxum
OLIGOCENE	C	Ericipites compacti-pollenites
	B	----- C.pseudopoculum
	A	-----
	5	Boisduvalia clavatites
	4	Tiliaepollenites vespites
EOCENE	C	Pesavis tagluensis
	B	L.wetzeli P.echinatum
	A	G.ordinata cf.
	2	Apectodinium homomorphum
PALEOCENE	B	Paraalni-pollenites confusus
	A	P.confusus P.pyrophorum

CRETACEOUS

AGE	K#	ZONATION
MAASTRICHTIAN	24	Cyclonephelium distinctum
	23	Isabeldinium amphiatum
CAMPANIAN	22	Hystichosphaeridium difficile
	21	Chatangiella coronata
SANTONIAN	20	Chatangiella difissima
	19	Chatangiella verrucosa
CONIACIAN	18	Eurydinium glomeratum
TURONIAN	17	Isabeldinium magnum
CENOMANIAN	16	Kiokansium polypes
	15	Luxadinium propatum
ALBIAN	14	Chichaoquadinium davidii
	13	Chichaoquadinium vestitum
APTIAN	12	Vesperopsis mayi
	11	Oligosphaeridium asterigerum
	10	Pilosporites crassiangularis
BARREMIAN	9	Pseudoceratium regium
	8	Dingodinium cerviculum
HAUTERIVIAN	7	Canningia reticulata
	6	Oligosphaeridium abaculum
VALANGINIAN	5	Parvocavatus sp. S
	4	Gochteodinium dasyformis
BERRIASIAN	3	Gochteodinium judilentinae
	2	Paragonyaulacysta borealis
	1	Horologinella spinosigibberosa

JURASSIC

AGE	J#	ZONATION
TITHONIAN	19	Paragonyaulacysta capillosa
	18	Cribroperidinium jubaris
	17	Chytroeisphaeridium chytroeides
KIMMERIDGIAN	16	Oligosphaeridium sp. A
	15	Gonyaulacysta dualis
OXFORDIAN	14	Stephanelytron redcliffense
	13	Acanthaulax senta
CALLOVIAN	12	Occisucysta thulia
	11	Gonyaulacysta adecta
	10	Paragonyaulacysta calloviense
BATHONIAN	9	Ctenidodinium combazii
	8	Energlynia sp. A
BAJOCIAN	7	Kylindrocysta sp. C
	6	Gonglyodinium hocneratum
AALENIAN	5	Comparodinium aquilonium
	4	Waliodinium elongatum
TOARCIAN	3	Dapcodinium coalitum
PLIENSBACHIAN	2	Lithodinia serrulata
SINEMURIAN	1	Dapcodinium priscum
HETTANGIAN		

Figure 2.1. Palynological zonation used in this report (modified from Bujak, 1990, and from Davies, 1991).

Group and utilized by Branta Biostratigraphy, Ltd. (Davies, 1991). Much of the literature on Mesozoic foraminifera was examined along with the sample suites at the offices of Micropaleo Consultants, Inc., in Encinitas, California. For a complete summary, refer to Table 2.1 at the end of this chapter.

Tertiary

Based on biostratigraphic analyses, the interval from 300 to 15,480 ft is Tertiary in age. All epochs of the Tertiary except the Pliocene were identified in the well.

Miocene

The interval from 300 to 1,650 ft is Miocene in age and assigned to the *Tsugaepollenites igniculus* Zone. This assignment is based on an abundant and diverse pollen and spore assemblage that includes *Tsugaepollenites igniculus*, *Tsugaepollenites viridiflaminipites*, *Ercipites antecursorinoides*, *Pterocarypollenites stellatus*, *Carpenipites* cf. *C. spackmaniana*, *Caryapollenites simplex*, *Tiliapollenites* sp., *Camazonosporites* sp., *Osmundacidites* sp., *Rouseisporites* sp., *Sphagnumsporites* sp., and *Cicatricosisporites "daviesii"*.

The Miocene *Tsugaepollenites igniculus* Zone is further subdivided on the basis of occurrences of marine and brackish-water dinoflagellate species. The interval from 330 to 1,260 ft is assigned to the *Systematophora ancyrea* Subzone (middle to late Miocene) based on the occurrences of the dinoflagellates *Systematophora ancyrea*, *Impagidinium japonicum*, and *Lingulodinium machaeporum*.

The interval from 1,260 to 1,650 ft is assigned to the early Miocene *Pentatinium laticinctum* Subzone based on the occurrences of the dinoflagellates *Pentatinium laticinctum* and *Multispinula* sp., and the pollen *Ilexpollenites margaritus*.

The palynofloral assemblage is characterized by conspicuous and abundant reworked Mesozoic dinocysts, spores, and pollen, including species of *Chatangiella*, *Odontochitina*, *Spongodinium*, *Converrucosisporites*, and *Aquilapollenites*. Reworked taxa are common throughout the well and, combined with downhole caving, make age interpretations quite difficult.

The Miocene foraminiferal assemblage is characterized by a mixture of differently preserved specimens that suggests some minor reworking of older taxa as well as some caving of younger

taxa, possibly from the overlying Gubik Formation. The foraminiferal fauna indicate an older age (early Miocene to Oligocene) than the palynoflora. Overall, the assemblage has a Carter Creek aspect, as described by Todd (1957) and Fouch and others (1990). The most significant species are *Turrilina alsatica*, *Cibicides* cf. *C. grossa*, *Cibicides perlucidus*, *Melonis* cf. *M. pompilioides*, *Melonis zaandamae*, *Elphidium ustulatum*, *Elphidiella brunnescens*, *Criboelphidium katanglensis*, *Protoelphidium orbiculare*, *Gyroidina* cf. *G. soldanii*, *Dentalina* spp., *Cassidulina* spp., and *Globobulimina affinis*. The age significance of *Turrilina alsatica* remains in dispute, with some workers contending that it is restricted to the Oligocene, others contending that it extends higher in the section. In the Aurora well, it appears to range as young as middle Miocene if the palynological ranges are correct.

Several ornate trachylebrid(?) ostracodes are present as well as an alate specimen assigned to *Cytheropteron* sp. This may be correlative with the "upper" ostracode assemblage of Brouwers (Fouch and others, 1990). Fish teeth and pyritized radiolaria are also present.

The environment of deposition was outer shelf to upper bathyal. The climate was cool temperate.

Oligocene

The interval from 1,650 to 2,550 ft is Oligocene in age. The section is subdivided into late and early Oligocene by an unconformity at 2,380 ft.

The late Oligocene section (1,650 to 2,380 ft) is in the *Ericipites compactipollenites* Zone and is characterized by the highest occurrences of *Ericipites compactipollenites*, *Chenopodipollis* sp. A of Norris 1986, and persistent *Quercoidites microhenrici*. The dinoflagellate *Phthanoperidinium?* sp., a species considered to be environmentally tolerant, is present at 1,650 ft.

The early Oligocene section (2,380 to 2,550 ft) is within the *Boisduvalia clavatites* Zone based on the presence of this pollen and *Parviprojectus* sp., Compositae, *Juglanspollenites nigripites*, and the spore *Stereisporites stereoides*. Reworked Eocene dinoflagellates are also present.

The Oligocene foraminiferal assemblage is very similar to that of the overlying Miocene. Additional taxa include a large species of *Pyrgo*, *Oolina apiopleura*, *Pullenia quinqueloba*, *Dentalina* spp., *Nodosaria* spp., *Lenticulina cultratus*, *Lenticulina occidentalis*, and

Marginulina hantkeni, *Turrilina alsatica* and *Cibicides perlucidus* remain significant faunal elements.

Shell shards, fish teeth, radiolaria, and echinoid and ophiuroid fragments are also present, as are calcareous worm tubes.

The Oligocene depositional environment was similar to that of the Miocene, outer neritic to upper bathyal. The climate was cool temperate.

Eocene

The interval from 2,550 to 7,360 ft is Eocene in age. The section is provisionally subdivided into late Eocene (2,550 to 4,680 ft), middle Eocene (4,680 to 5,850 ft), and early Eocene (5,850 to 7,360 ft). However, this section is characterized by such extensive reworking and caving that none of these subdivisions can be considered firm.

The interval from 2,550 to 4,680 ft is tentatively assigned to the late Eocene *Lentina wetzeli* Subzone of the *Pesavis tagluensis* Zone on the basis of *Tiliaepollenites vespites*, *Quercoidites* sp. A of Rouse 1977, *Sequoiapollenites* spp., *Pachysandra* sp., *Multicellaesporites* sp., and *Striadiporites sanctaebarae*. *Pesavis tagluensis*, a fungal spore, occurs intermittently in this section. The dinoflagellate assemblage, especially lower in the interval, contains species typical of the middle Eocene and it is possible that much of the late Eocene is actually missing, although these specimens are associated with a diverse and very abundant reworked microfloral assemblage. Dinoflagellates that may be in place include *Cordosphaeridium gracile*, *Cordosphaeridium inodes*, *Cordosphaeridium tiara*, *Wetzeliiella hampdenensis*, *Deflandrea sagitulla*, *Deflandrea* sp., *Lingulodinium disjunctum*, *Ceratiopsis pannucea*, *Thalassiphora patula*, *Achomosphaera* sp., *Phthanoperidinium levimurum*, *Homotryblium oceanicum*, *Systemtophora placacantha*, *Impagidinium californiense*, and *Lentina wetzeli*.

The foraminifera in this interval are sparse and poorly preserved. The dominantly agglutinated assemblage contains *Haplophragmoides excavata*, *Haplophragmoides* spp., *Bathysiphon* sp., *Cyclamina* sp., *Glomospira* sp., *Recurvoides* sp., *Trochammina* sp., *Jadammina* sp., and *Alveolophragmium* (*Reticulophragmium*) cf. *A. rotundidorsata*.

The late Eocene environment of deposition was probably outer shelf to upper bathyal. The climate was warm temperate.

The interval from 4,680 to 5,850 ft is middle Eocene in age and is assigned to the *Glaphrocysta ordinata* Subzone of the *Pesavis tagluensis* Zone on the basis of its dinoflagellate assemblage and the consistent presence of the fungal spore *Pesavis tagluensis*. The Bujak Davies Group (Bujak, 1990) suggests that although many of these dinocyst species range into the late Eocene, they appear to be restricted to the middle Eocene in the Beaufort Sea area. The highest occurrence of the dinoflagellate *Glaphrocysta ordinata* is at 4,680 ft. Other dinoflagellates supporting a middle Eocene age include *Achilleodinium biformoides*, *Deflandrea phosphoritica*, *Kisselovia crassiramosa*, *Ceratiopsis* spp., *Glaphrocysta semitecta*, *Phthanoperidinium alectrolophum*, *Phthanoperidinium comatum*, *Palaeoperidinium* sp., and *Aerosphaeridium* sp. A of Bujak and Williams 1975.

The middle Eocene pollen and spore assemblage, characterized by the angiosperm pollen *Tiliaepollenites vescipites*, is similar to that of the late Eocene section. The fungal spore *Dicellaesporites* sp. A of Rouse 1977 also supports an Eocene age. Megaspores and glochidia of the water fern *Azolla* are particularly conspicuous and abundant from approximately 4,600 to 5,000 ft and are present in both palynological and micropaleontological preparations. The common to abundant presence of this genus indicates significant organic input from freshwater lakes.

The relatively sparse middle Eocene foraminiferal assemblage is characterized by several species of *Alveolophragmium* (*Reticulophragmium*): *A. amplectens*, *A. arctica*, *A. borealis*, and *A. rotundidorsata*. *Melonis* sp., *Cibicides* cf. *C. grossa*, *Recurvoides* sp., *Saccamina* sp., and *Jadammina statuminus* are also present, mostly near the top of the interval. Fish bones and pyrite are common.

Deposition probably occurred in a shelf setting. Some of the rather rare foraminifera indicate deeper water, but the generally neritic dinoflagellate assemblage, particularly species of *Glaphrocysta* and abundant freshwater *Azolla* material, suggests an environment closer to shore (Liengjarern and others, 1980, and Eshet and others, 1992). The climate was warm temperate.

The interval from 5,850 to 7,360 ft is early Eocene in age and assigned to the *Apectodinium homomorphum* Subzone on the basis of dinoflagellate occurrences. The top of the zone is marked by the highest occurrence of *Areoligera senonensis* and *Apectodinium hyperacanthum*, and the base of the zone is picked where the pollen *Paraalnipollenites confusus* sensu stricto becomes a consistent floral element. Again, this subdivision must be considered provisional because of reworking, caving, and the preliminary nature of high-latitude palynological zonations. The

plexus of species represented by the pollen *Paraalnipollenites confusus* (first downhole occurrence at 6,360 ft) now appears to range from the Paleocene up into the Eocene (McIntyre, 1985).

Eocene dinoflagellates considered to be in place include *Areoligera senonensis*, *Apectodinium hypercanthum*, *Lentina wetzeli*, *Wetzeliella hampdenensis*, *Deflandrea* sp., and *Adnatosphaeridium vittatum*. A late Eocene and Oligocene assemblage seen downhole between 7,600 and 9,100 ft is considered to be caved.

The foraminiferal assemblage is very sparse and similar to that of the overlying middle Eocene. Fish bones, megaspores, and pyrite are common.

The depositional environment and climate were probably similar to those of the middle Eocene — shallow shelf and warm temperate.

Paleocene

The interval from 7,360 to 15,480 ft is Paleocene in age. The section is divided into late Paleocene (*Paraalnipollenites confusus* Subzone) and early Paleocene (*Palaeoperidinium pyrophorum* var. A Subzone) at 10,720 ft.

The top of the late Paleocene is picked at the depth where the pollen *Paraalnipollenites confusus* sensu stricto becomes a consistent floral element. Somewhat below this depth (between 8,320 and 9,100 ft) are the highest occurrences of the Paleocene dinoflagellates *Ceratium markovae*, *Deflandrea* sp. C of Drugg 1967, *Phelodinium magnificum*, and *Spinidinium densispinatum*.

Aside from common and consistent *Paraalnipollenites confusus*, a late Paleocene age is also supported by *Plicatopollis pseudoalnoides* (9,300 ft); *Plicatopollis lunata* and *Plicatopollis plicata* (10,370 ft); *Pesavis* sp. of Ioannides and McIntyre 1980 (10,540 ft); and *Santalicitis minor* (10,610 ft). There are no Eocene pollen, spores, or dinoflagellates below 9,100 ft, but reworked Cretaceous dinoflagellates are quite common.

Foraminifera are almost absent in this interval and those that are present may be caved from uphole. The small *Alveolophragmium* (*Reticulophragmium*) cf. *A. arctica* at 10,160 ft is consistent with a late Paleocene age. Pyrite and fish bones are common, and pyritized diatoms are sporadically present between 8,900 and 10,490 ft.

The depositional environment is difficult to determine paleontologically. The presence of a relatively diverse dinoflagellate assemblage suggests a shelf setting. The general lack of in-place foraminifera could mean that it was a more nearshore environment. The climate was probably cool temperate.

The interval from 10,720 to 15,480 ft is early Paleocene in age and is assigned to the *Palaeoperidinium pyrophorum* var. A Subzone. This zonal assignment is suggested by the presence of three dinoflagellates of the genus *Manumiella*: *M. cretacea*, *M. delicata*, and *M. druggi*. Similar assemblages have been recorded near the top of the early Paleocene in the western Canadian Beaufort Sea section. Bujak and Davies (1983) note that the Manumiellaceae are common from the latest Cretaceous to the mid-Paleocene, with a few rare members occurring in the late Paleocene to early Eocene.

The pollen assemblage has a late Paleocene character and includes *Momipites tenuipolis*, *Insulapollenites rugulatus*, *Triatriopollenites triangulatus*, *Ulmipollenites undosus*, *Momipites ventifluminus*, and the *Caryapollenites versipites* complex of Nichols and Otts, 1978.

Between 12,180 and 13,630 ft, the most conspicuous palynofloral elements are abundant and diverse reworked Cretaceous dinoflagellates. Reworked Mesozoic foraminifera, pyritized *Inoceramus* prism packets, and pyritized radiolaria are also quite common over this interval.

Between 13,630 and 15,020 ft, there are well-preserved palynomorphs that suggest a Danian (early Paleocene) to possible Maastrichtian (Late Cretaceous) age. However, there are similar Cretaceous palynomorphs higher in the well that are reworked. Palynomorphs present include the dinoflagellates *Trithyrodinium suspectum* and *Williamsidinium banksianum*, and the pollen *Aquilapollenites formosus*, *Aquilapollenites proteus*, *Translucentipollis(?) granuistriatus*, *Cranwellia striata*, *Megatripollis* sp. of Christopher 1979, and *Pseudoplicapollis cuneata*. The ranges of some species of *Aquilapollenites*, particularly in higher latitudes, have been extended into the Cenozoic in recent years.

The foraminiferal assemblage appears to be mostly made up of reworked Mesozoic foraminifera and caved Paleogene agglutinated forms.

The environment of deposition is difficult to determine, but was probably neritic. The climate was probably cool temperate.

Early Cretaceous

The interval from 15,480 to 17,473 ft is Early Cretaceous in age. The section is separated from the overlying Paleocene by a major unconformity at 15,480 ft. The Early Cretaceous is divided into an Aptian to Albian section (15,480 to 16,210 ft), a Hauterivian to Barremian section (16,210 to 16,620 ft), and a Berriasian to Valanginian section (16,620 to 17,473 ft). Lignitic mud additives dominate the palynological assemblages in the cuttings samples between 15,020 and 15,960 ft, masking the unconformity at the top of the section. The unconformity marking the base of the Cretaceous section is placed at 17,473 ft on the basis of sidewall core (SWC) data. (An alternative placement suggested by well log data is presented in the following chapter.)

Aptian to Albian

The interval from 15,480 to 16,210 ft is Aptian to Albian in age on the basis of its benthic foraminiferal fauna. Age-diagnostic forms include *Ammodiscus rotarius*, *Conorboides umiatensis*, *Dentalina dettermanni*, *Globulina prisca*, *Haplophragmoides excavata*, *Haplophragmoides topagorukensis*, *Lenticulina muensteri*, *Miliammina manitobensis*, and *Verneuilinoides borealis*. There are also abundant caved Paleogene foraminifera in this section.

The sparse dinoflagellate assemblage supports an Early Cretaceous age. Species present include *Cyclonephelium distinctum*, *Gardodinium trabeculosum*, and *Odontochitina operculata*. Other palynomorphs include *Densosporites* sp., *Vitreisporites* sp., *Classopollis* sp., and *Gleicheniidites senonicus*.

The environment of deposition was probably upper bathyal on the basis of the composition of the foraminiferal fauna. However, the presence of the dinoflagellate *Cyclonephelium* has been considered to be indicative of warm, inner neritic settings (Eshet and others, 1992) or environments of nearshore anoxic stress (Marshall and Batten, 1988).

Hauterivian to Barremian

The interval from 16,210 to 16,620 ft is Hauterivian to Barremian in age. The foraminiferal fauna includes *Ammobaculites reophacoides*, *Ammobaculites fragmentarius*, *Dentalina* spp., *Bathysiphon scintillata*, *Gaudryina tailleuri*, *Gaudryina tappanae*, *Marginulinopsis bergquisti*, *Marginulinopsis collinsi*, *Haplophragmoides coronis*, *Haplophragmoides duoflatis*,

Haplophragmoides inflatigrandis, *Trochammina squamata*, and *Recurvoides* spp. Pyritized radiolaria are common.

The sparse and poorly preserved palynomorph assemblage is similar to that of the overlying interval, with the addition of the dinoflagellate *Oligosphaeridium complex*.

Berriasian to Valanginian

The interval from 16,620 to 17,473 ft is Berriasian to Valanginian in age. The foraminiferal fauna contains many of the species recovered from the overlying section as well as *Ammobaculites erectus*, *Bathysiphon granulocoelia*, *Gaudryina leffingwelli*, *Gaudryina milleri*, *Gaudryina tailleuri*, *Glomospirella arctica*, *Haplophragmoides goodenoughensis*, *Marginulinopsis reiseri*, *Sarcenaria projectura*, *Sarcenaria valanginiana*, *Reophax* sp., *Trochammina* spp., *Thurammoides* sp., and *Lituotuba gallupi*.

The palynomorph assemblage consists mostly of poorly preserved spore material.

The depositional environment was probably bathyal.

Jurassic

The interval from 17,473 to 18,325 ft (TD) is Jurassic. The interval from 17,473 to 18,130 ft is Late Jurassic, probably Kimmeridgian to Oxfordian, on the basis of an abundant, diverse, and well-preserved boreal foraminiferal fauna. No Tithonian biostratigraphic marker species were identified in the well and this interval may be missing, as it is in many areas of the North Slope (Carman and Hardwick, 1983, figures 4-6, p. 1024). Caving is a major problem, with some samples containing mostly Early Cretaceous specimens. The interval from 18,130 to 18,325 ft may be Middle to Early Jurassic in age. The older Jurassic forms near TD, such as *Ammodiscus siliceus*, may be reworked, although because this particular species is rare in Early to Middle Jurassic sediments, its presence as a reworked form would be quite fortuitous (M. Mickey, personal communication, 1992).

Sidewall cores generally provided good faunal assemblages even when cuttings from the same interval were full of caved forms or essentially barren.

The Late Jurassic fauna includes *Astacolus pediacus*, *Ammobaculites alaskensis*, *Ammobaculites barrowensis*, *Ammodiscus asperus*, *Ammodiscus cheradospirus*,

Arenoturrispirillina jeletzyki, *Dentalina* spp., *Gaudryina dyscrita*, *Glomospira pattoni*, *Haplophragmoides canui*, *Haplophragmoides* spp., *Textularia* sp., *Trochammina canningensis*, *Trochammina instowensis*, *Trochammina kumaensis*, *Frondicularia lustrata*, *Lenticulina audax*, *Lenticulina (Darbyella) volgaensis*, *Lenticulina queenstadtii*, *Marginulina interrupta*, *Marginulinopsis brandyi*, *Marginulinopsis phragmites*, *Nodosaria detruncata*, *Nodosaria mecista*, *Nodosaria orthostecha*, *Rectoglandulina oviformis*, *Rectoglandulina brandi*, *Rheinholdella hofkeri*, *Sarcenaria navicula*, and *Sarcenaria oxfordiana*. Pyritized radiolaria are common.

The interval from 18,130 to 18,325 ft may be Early to Middle Jurassic based on the presence of *Ammodiscus siliceus*, *Eoguttulina liassica*, and rare cyprid ostracodes.

The Jurassic palynomorph assemblage consists of rare spores and the Jurassic dinoflagellates *Gonyaulacysta jurassica*, *Pareodina osmingtonense*, and *Tubotuberella apatella*. The environment of deposition was probably bathyal.

Table 2.1. Biostratigraphic Summary

300 to 1,650 ft 330 - 1,260 1,260 - 1,650	Miocene <i>Tsugaepollenites igniculus</i> Zone <i>Systematophora ancyrea</i> Subzone (middle to late Miocene) <i>Pentatium laticinctum</i> Subzone (early Miocene)
1,650 to 2,550 ft 1,650 - 2,380 2,380 - 2,550	Oligocene <i>Ericipites compactipollenites</i> Zone (late Oligocene) <i>Boisduvalia clavatites</i> Zone (early Oligocene)
2,550 to 7,360 ft 2,550 - 4,680 4,680 - 5,850 5,850 - 7,360	Eocene <i>Pesavis tagluensis</i> Zone <i>Lentinia wetzelii</i> Subzone (late Eocene) <i>Glyphyrocysta ordinata</i> Subzone (middle Eocene) <i>Apectodinium homomorphum</i> Subzone (early Eocene)
7,360 to 15,480 ft 7,360 - 10,720 10,720 - 15,480	Paleocene <i>Paraalnipollenites confusus</i> Zone <i>Paraalnipollenites confusus</i> Subzone (late Paleocene) <i>Palaeoperidinium pyrophorum</i> var. A Subzone (early Paleocene)
15,480 to 17,473 ft 15,480 - 16,210 16,210 - 16,620 16,620 - 17,473	Early Cretaceous Aptian to Albian Hauterivian to Barremian Berriasian to Valanginian
17,473 to 18,130 ft	Late Jurassic Kimmeridgian to Oxfordian
18,130 to 18,325 ft Total Depth	Possible Early to Middle Jurassic

3. WELL LOG INTERPRETATION AND LITHOLOGY

The OCS Y-0943-1 (Aurora) well was logged with a conventional mud log from 300 to 18,325 ft (TD), MWD logs over selected intervals, and an extensive suite of Schlumberger wireline open-hole logs. Overall, the quality of the logs is good, with the exceptions noted below. In addition, drill cuttings, sidewall cores, and one conventional core were obtained from the well, and lithologic descriptions of the samples were done. (For a complete list of all logs and final reports released to the public, refer to Appendix II.)

The sample interval of the mud log was one sample every 90 ft from 300 to 6,300 ft, one sample every 60 ft from 6,300 to 9,500 ft, and one sample every 30 ft from 9,500 to 18,325 ft.

Below 3,000 ft, the well was drilled with a high-salt mud system, yielding resistivity of the mud filtrate (RMF) values in the range of 0.06 to 0.20 ohm-meters at formation temperature. Because the salinity of the mud system was similar to the salinity of the formation waters, the spontaneous potential (SP) log curve displays little response over most of the well and therefore is not used in the interpretation. Below 16,100 ft, the SP curve appears to respond more normally, indicating that the formation waters have become more saline than the borehole fluid.

The gamma-ray (GR) log curve appears to be a reliable discriminator of sand-shale lithology in this well, and is the most useful wireline log for that purpose (figure 3.1).

During drilling, numerous hole problems were encountered below 9,500 ft, and the hole was sidetracked at 15,500 ft and again at 16,400 ft. The hole was drilled with a 5 7/8-in. bit below 16,950 ft. The extensive drilling problems resulted in some incomplete coverage of the logging tools. Notably, the compensated-neutron-lithodensity (CNL) log is missing from 14,788 to 15,952 ft (figure 3.1). Also, washouts and overgauge hole were a problem below 9,500 ft, affecting the pad contact tools through some intervals. The CNL was severely affected by sticking and high drag below 17,100 ft.

High temperatures also became a problem in the well, causing the MWD log to fail to operate properly below 16,600 ft.

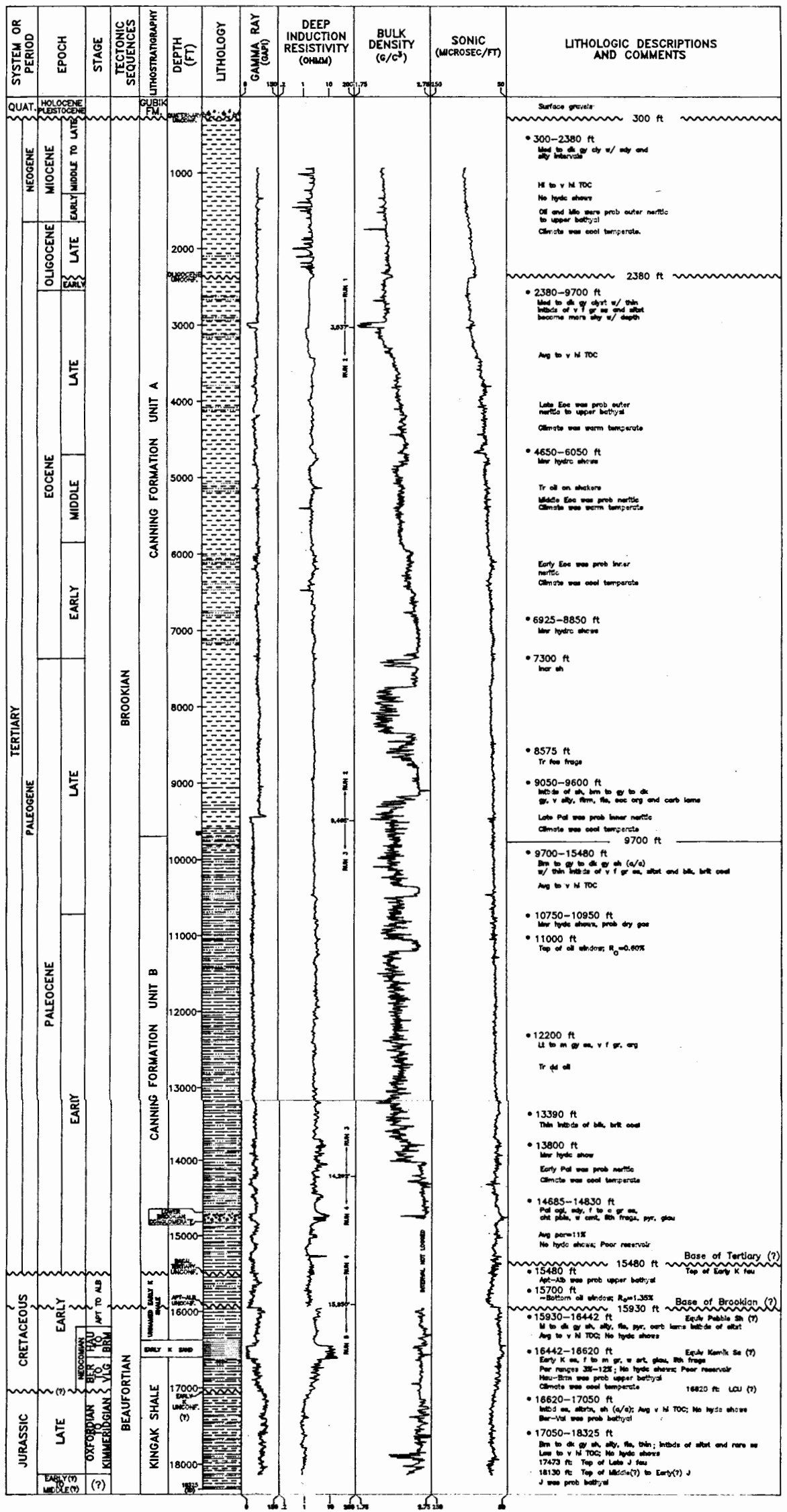

EXPLANATION

	SANDSTONE		UNCONFORMITY
	SHALE		CONGLOMERATE
	SILTSTONE		CONVENTIONAL CORE (8634-9674 ft)
	CLAYSTONE		

Vertical scale: 1"=1000'
 Depths in feet below Kelly Bushing

Figure 3.1. Well log interpretation and lithologic descriptions from the Aurora well.

Formation Evaluation

No zones suspected of containing producible hydrocarbons were penetrated by the Aurora well, and no formal formation evaluation log analysis was performed for this report. Minor hydrocarbon shows were recorded on the mud log in the intervals from 6,930 to 7,300 ft, 10,745 to 10,950 ft, and 13,750 to 14,300 ft. Potential reservoir rocks at 14,685 ft indicate a very minor gas show, but no shows are associated with the sandstone unit at 16,442 ft.

Permafrost

There is no indication on the well logs that permafrost was penetrated by the Aurora well. However, no open-hole logs were run above the 30-in. casing set at 905 ft, so resistivity and sonic velocity data are not available above that depth. The lowest temperature recorded from the various temperature log runs is 45.6 °F, at a depth of 1,250 ft, in open hole two hours after circulation stopped.

Brookian Sequence

The Brookian sequence rocks penetrated by the Aurora well are Tertiary (300 to 15,480 ft) and Early Cretaceous (15,480 to 15,930 ft) in age and are composed dominantly of clay and claystone, with only minor interbedded siltstone, sandstone, conglomerate, and coal (figure 3.1). Log responses are typical of a clayey or shaly section, with few significant deflections of the GR and resistivity curves from their shale baselines. Sandstones are generally present only as thin interbeds less than 10 ft thick.

Correlation of Brookian stratigraphic nomenclature into the Aurora well is problematic. Based on the lithology and log response of the Brookian sequence penetrated in the well, the entire Tertiary section of the well is identified as the Canning Formation of Molenaar and others (1987) and Scherr and others (1991). The base of the Tertiary is placed at 15,480 ft owing to the occurrence of Early Cretaceous fauna (in sidewall cores) at that depth. Molenaar and others (1987) define the Canning Formation as a thick, dominantly shale unit with turbidites in the lower part. Their type section is from the Mobil West Staines State No. 2 well, just west of the Canning River. In that well, as elsewhere across the eastern Arctic Slope, the Canning Formation is overlain by (and intertongues with) the Sagavanirktok Formation, a thick deltaic shallow-marine and nonmarine sequence consisting dominantly of sandstone, with bentonitic shale, conglomerate, and minor coal

(Molenaar and others, 1987). At the West Staines No. 2 well, the Canning Formation ranges in age from Paleocene to late Eocene, and the overlying Sagavanirktok Formation from late Eocene to Pliocene (Bird and Molenaar, 1987, p. 54, figure 5.10).

Scherr and others (1991) differentiate between the Canning and Sagavanirktok Formations on the basis of log response and lithology. They describe the Canning Formation as consisting largely of prodelta shales with featureless GR and resistivity curves, whereas the Sagavanirktok Formation exhibits a serrated pattern on both the GR and resistivity logs, indicative of interbedding of sandstone and shale.

The entire Tertiary sequence above 15,480 ft is characterized by an absence of sandstone and by featureless log profiles. No conclusive lateral correlation can be made between the lithology at the West Staines State No. 2 well and the Aurora well, but it appears, on the basis of the available data, that the Sagavanirktok Formation does not extend into the Aurora well. Furthermore, the micropaleontologic data indicate only neritic and bathyal environments of deposition for the Tertiary rocks above 15,480 ft, including late Eocene and younger rocks that are time equivalent to the deltaic Sagavanirktok Formation at the West Staines No. 2 well.

An unconformity occurs at 2,380 ft, subdividing the section of the well from 1,650 to 2,550 ft into late and early Oligocene. It is identified by micropaleontologic data and by the shift in the profile of the resistivity, CNL, and sonic logs (figure 3.1). Perhaps the Sagavanirktok Formation may have once been present in the Aurora well but erosion at this late Oligocene unconformity removed it, or perhaps the section of the well above 2,380 ft represents a prodelta facies of the Sagavanirktok Formation. However, this "unconformity" places outer neritic to bathyal rocks atop older outer neritic to bathyal rocks, and may instead represent a submarine scour.

It appears most likely that the section of the well above 2,380 ft represents an upper prodelta Canning Formation facies, perhaps transitional to the Sagavanirktok Formation.

The Canning Formation in the Aurora well is subdivided at 9,700 ft into two informal subunits, called Unit A (300 to 9,700 ft) and Unit B (9,700 to 15,480 ft), based on a gradual change in the lithology from a dominantly claystone sequence (Unit A) to a sandier sequence (Unit B) containing thin interbeds of coal.

A sandy conglomerate 145 ft thick is present in Unit B from 14,685 to 14,830 ft. The log profiles of the GR and resistivity

curves exhibit a spikey, or sawtooth, appearance, typical of a conglomeratic interval. Sidewall-core recovery from this interval was very poor: no core-derived porosity and permeability data were obtained. Density-log-derived porosity averages near zero, with maximum values near 6 percent. Sonic-log-derived porosity averages 11 to 13 percent, with maximum values of 15 to 17 percent and minimum values of 8 to 10 percent. Reservoir quality of this interval is poor to very poor.

Overall, the Brookian section in the Aurora well contains remarkably little reservoir potential.

As mentioned above, the base of the Canning Formation in the Aurora well is placed at 15,480 ft owing to the presence of Early Cretaceous (Aptian-Albian) fauna in the sidewall core samples. Based on the micropaleontologic analysis, Late Cretaceous rocks typically included in the Brookian sequence to the west are absent in the Aurora well. This suggests that a major unconformity separating Paleocene and Early Cretaceous rocks is penetrated at the well. The Paleocene to Early Cretaceous break in the rock record involves a hiatus of at least 30 to 40 million years, and one would expect to see a significant change in log character (due to a change in induration of the rocks) across such a boundary. No significant change in log character is evident at or near 15,480 ft; however, the foraminiferal evidence for the Early Cretaceous at this depth is very strong. Therefore, the age boundary at 15,480 ft is informally referred to as a basal Tertiary unconformity in the area around the Aurora well.

A significant change in log character does exist at 15,930 ft. The GR, resistivity, and sonic values all increase abruptly at that point,² indicating the advent of a more highly indurated section (figure 3.1). This boundary is informally referred to as an Aptian-Albian unconformity.

Correlation of the interval of the well (from 15,480 to 15,930 ft) between these two unconformities to the regional stratigraphy is problematic. Whether these uppermost Aptian-Albian rocks belong to the southerly sourced Brookian sequence or the northerly sourced Beaufortian sequence is uncertain at this time. In this report, the boundary that separates the Brookian sequence from the Beaufortian sequence is tentatively placed at 15,930 ft on the basis of the abrupt shift in the well logs. This placement is

² Coincidentally, a well casing point occurs at 15,941 ft, and one might think that this shift in the well log curves is due to logging through the casing. However, a sonic/GR log was run from 16,793 to 14,325 ft in uncased hole, and both curves indicate a major shift at 15,930 ft (figure 3.1). Therefore, the shift in the well log curves is not due to the occurrence of the casing point.

supported by regional seismic mapping (see discussion of the Beaufortian sequence below). However, it is also possible that the sequence boundary occurs at 15,480 ft at the basal Tertiary unconformity identified from paleontologic data.

Beaufortian Sequence

Beaufortian sequence rocks penetrated by the Aurora well from 15,930 to 18,325 ft (TD) are Early Cretaceous (Aptian-Albian) to Late (possible Early to Middle) Jurassic in age and are composed dominantly of shale and siltstone, with one significant sandstone unit (figure 3.1).

The top of the Beaufortian sequence is placed at the Aptian-Albian unconformity at 15,930 ft, based on the shift of the well log curves. This placement of the unconformity is also supported by the seismic interpretation: regional seismic mapping of the top of the Beaufortian sequence by the MMS from west to east places that event at or near 15,930 ft in the Aurora well.

Correlating the lithology of the Beaufortian sequence penetrated by the Aurora well to the regional stratigraphy is complicated, because of the absence of key markers and the great distance from the nearest established control. The section of the well from 15,930 to 16,620 ft is especially difficult. Considering the Albian to Hauterivian age of these Early Cretaceous rocks, a correlation with the Hue Shale, Highly Radioactive Zone (HRZ), Pebble Shale Unit, Kemik Sandstone, and Lower Cretaceous Unconformity (LCU) is tempting. The HRZ is not evident on the GR log, and there is no evidence for the LCU; therefore these Early Cretaceous rocks are unnamed in this report. However, the lithostratigraphy and micropaleontological data suggest some possible correlations.

The section of the well from 15,930 to 16,442 ft ranges in age from Hauterivian/Barremian to Aptian/Albian and consists dominantly of shale, minor siltstone, and trace sandstone. The micropaleontologic data suggest a possible correlation to the Pebble Shale Unit of Molenaar and others (1987). However, the lithology does not accurately fit their description of the Pebble Shale and none of the key markers (e.g., the HRZ) are present.

A sandstone of Early Cretaceous age (Hauterivian/Barremian) was penetrated in the well from 16,442 to 16,620 ft, or 178 ft of gross thickness (figure 3.1). Sidewall core recovery from this interval was very poor, and no core analysis for porosity and permeability was performed. Petrographic image analysis of thin sections through the sandstone unit indicates maximum porosities of

approximately 10 percent, with permeabilities ranging from less than 1 md to 20 md and averaging 9 md. Sonic-log-derived porosities average 10 percent. Density-log-derived porosities average only about 3 percent, assuming a matrix density of 2.65 gm/cm³. However, the presence of siderite cement identified on the thin sections may indicate that the correct matrix density is higher than 2.65 gm/cm³. In general, the reservoir quality of this Early Cretaceous sandstone is poor to very poor.

This sandstone may be stratigraphically correlative to the Kemik Sandstone; however, such a correlation would suggest the presence of the LCU at the base of the sandstone, which does not appear to be the case. The sandstone is Hauterivian/Barremian in age, and on this basis could be correlated to the Kemik Sandstone.³ Molenaar and others (1987) indicate a shallow marine environment of deposition for the Kemik Sandstone, but the sandstone encountered in the Aurora well appears to be an upper bathyal to bathyal deposit.

Below this sandstone unit, the Beaufortian sequence exhibits a log signature typical of the Kingak Shale seen in other wells to the west. In the Aurora well, the Kingak Shale ranges in age from Early(?) to Middle(?) Jurassic to Valanginian.

It appears, on the basis of the micropaleontologic data, that an Early Cretaceous unconformity may separate the Cretaceous and Jurassic strata. The highest occurrence of Jurassic foraminifera (Kimmeridgian to Oxfordian) is at 17,473 (SWC) ft. No Tithonian-aged foraminifera are observed in the well. This represents a hiatus of approximately 8 million years. The unconformity(?), however, is placed at 17,050 ft, where the electric logs indicate a change in lithology from a zone of interbedded shale, claystone, siltstone, and sandstone to an interval consisting predominantly of shale. It is presumed that the presence of Early Cretaceous microfossils in samples below 17,050 ft is due to caving or mudcake contamination.

The Aurora well bottomed in Late (or Early? to Middle?) Jurassic shale exhibiting a log signature typical of the Kingak Shale sequence seen elsewhere in wells on the north slope of Alaska.

³ The Kemik Sandstone is described as Hauterivian in age by Bird and Molenaar (1987, p. 48).

4. GEOTHERMAL GRADIENT

A temperature gradient for the Aurora well (figure 4.1) was calculated from a linear regression of the corrected static bottom hole temperatures (BHT's) of the logging runs. The maximum BHT's recorded by the well log tools during logging runs 1, 2, 3, and 5 were extrapolated to static BHT's using the correction technique suggested by Fertl and Wichman (1977). Figure 4.2, the regression for logging run 2, illustrates this extrapolation technique. (For an explanation of this method, and a listing of all temperatures and data used in these calculations, refer to Appendix III.)

According to Fertl and Wichman (1977), circulation times greater than 24 hours lead to corrected static BHT's lower than actual. Therefore, in calculating the geothermal gradient for the Aurora well, measured BHT's associated with circulation times greater than 24 hours are not used, with one notable exception described below.

All the maximum recorded temperatures from logging run 1 (911 to 3,040 ft) and logging run 2 (3,040 to 9,500 ft) are used in the gradient calculations. All three logs in run 1 recorded the same temperature and exhibit no correction from measured to estimated static BHT. Successive logs in run 2 show only a slight rise in temperatures. The data from these runs appear reliable because mud circulation times do not exceed 24 hours and no prolonged periods of time were spent logging the intervals.

For logging run 3 (9,500 to 14,300 ft), the temperature data from the DI/SFL, Array Sonic, and the CNL log are considered valid and were used in the BHT correction. The temperatures from the various logs run after these logs are all considered anomalously low and were not used in the correction. The DI/SFL and Array Sonic logs record maximum temperatures of 218 °F. These logs were run 19.27 hours after circulation stopped (Δt) with a mud circulation time (t) of 11.5 hours. The CNL log was run many hours later ($\Delta t=61$ hours, $t=21$ hours) and recorded a maximum temperature of 238 °F. The logs run after the CNL recorded maximum temperatures of 198 °F and 218 °F with aggregate Δt 's exceeding 100 hours and t of 6.5 additional hours from the time the CNL was run. One would assume that with the hole sitting idle for that amount of time these maximum recorded

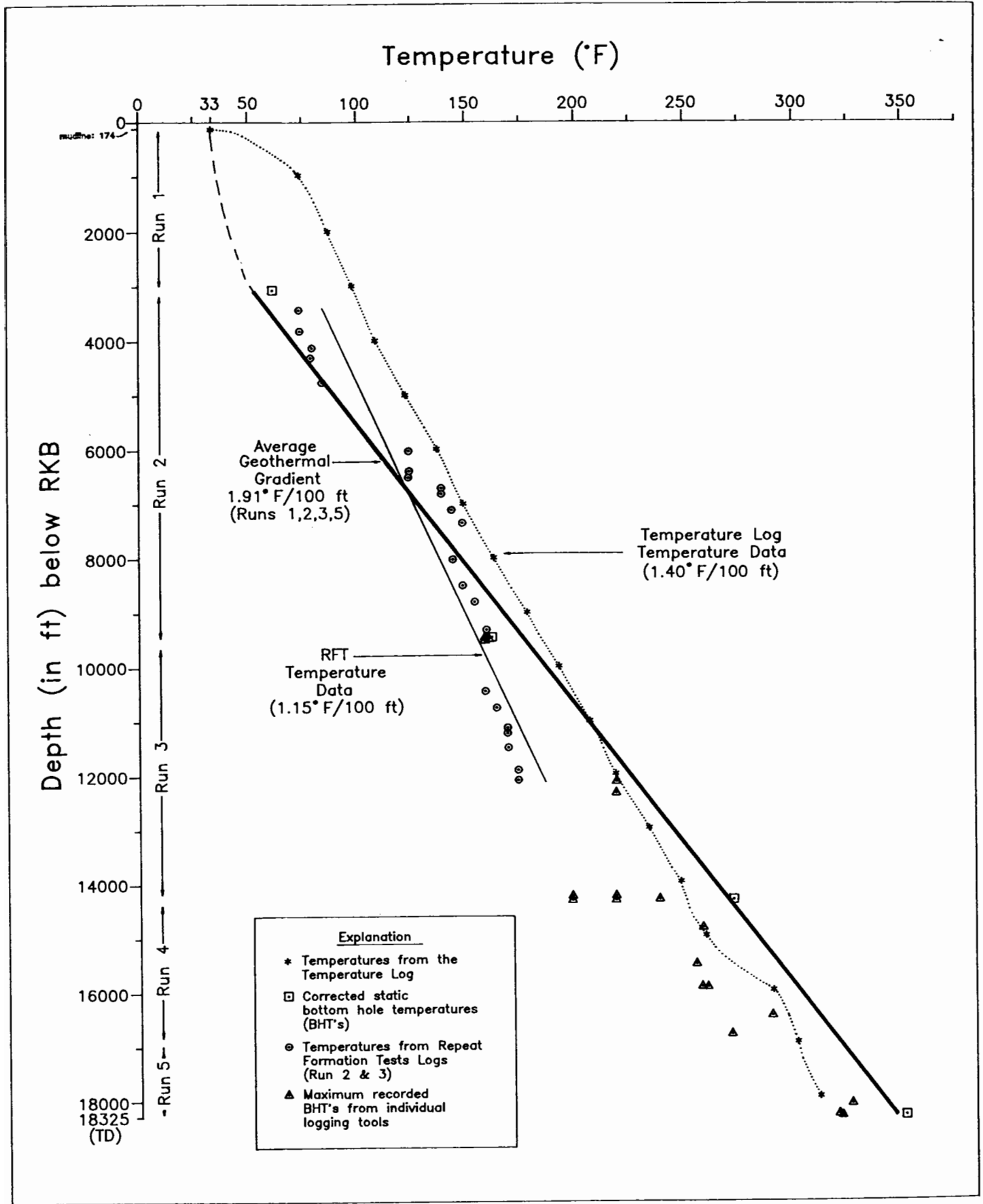

Figure 4.1. Geothermal gradient of the Aurora well.

temperatures would be higher than that from the CNL log. Perhaps these anomalously low temperatures might best be explained as resulting from tripping in the hole with drill pipe that was exposed to surface temperatures and/or circulating with very cold mud from the surface. These two factors may have strongly chilled the wellbore when it was re-entered and circulated just prior to logging (the additional 6.5 hours of mud circulation may have "erased" the restorative effects of the previous Δt of 100+ hours).

The temperature correction work does not include logging run 4 (14,300 to 16,950 ft) because of the lack of confidence in the temperature data. Severe problems encountered in drilling this interval of the well resulted in circulation times exceeding 50 hours. Applying the Fertl and Wichman technique to these maximum recorded temperatures resulted in corrected static BHT's lower than the measured BHT's.

As mentioned above, measured BHT's associated with circulation times greater than 24 hours are not used, with the exception of logging run 5 (16,950 to 18,325 ft (TD)). This interval also had severe problems, requiring a minimum of 39 hours of mud circulation to stabilize the hole before logging. Applying the Fertl and Wichman (1977) technique to two maximum recorded temperatures (from the DI/SFL and Array Sonic logs) produces an estimated static BHT of 351 °F for the bottom of the wellbore. This corrected BHT is likely lower than actual, but is reasonable and necessary to establish the temperature gradient. Temperatures from the other logs of logging run 5 are considered invalid due to higher circulation times (Δt of 66.5+ hours) and therefore were not used.

Applying a least-squares linear regression to the estimated corrected true static BHT's for runs 1, 2, 3, and 5 produces an average geothermal gradient of 1.91 °F/100 ft (figure 4.1). Table 4.1 lists the data which define this gradient.

Table 4.1. Corrected BHT's for Log Runs 1, 2, 3, and 5.

Log Run	Corrected BHT (°F)	Average Depth (ft)*
1	62	3,026
2	162	9,468
3	272	14,291
5	351	18,314

* average of maximum depths reached by the logs used in the corrections.

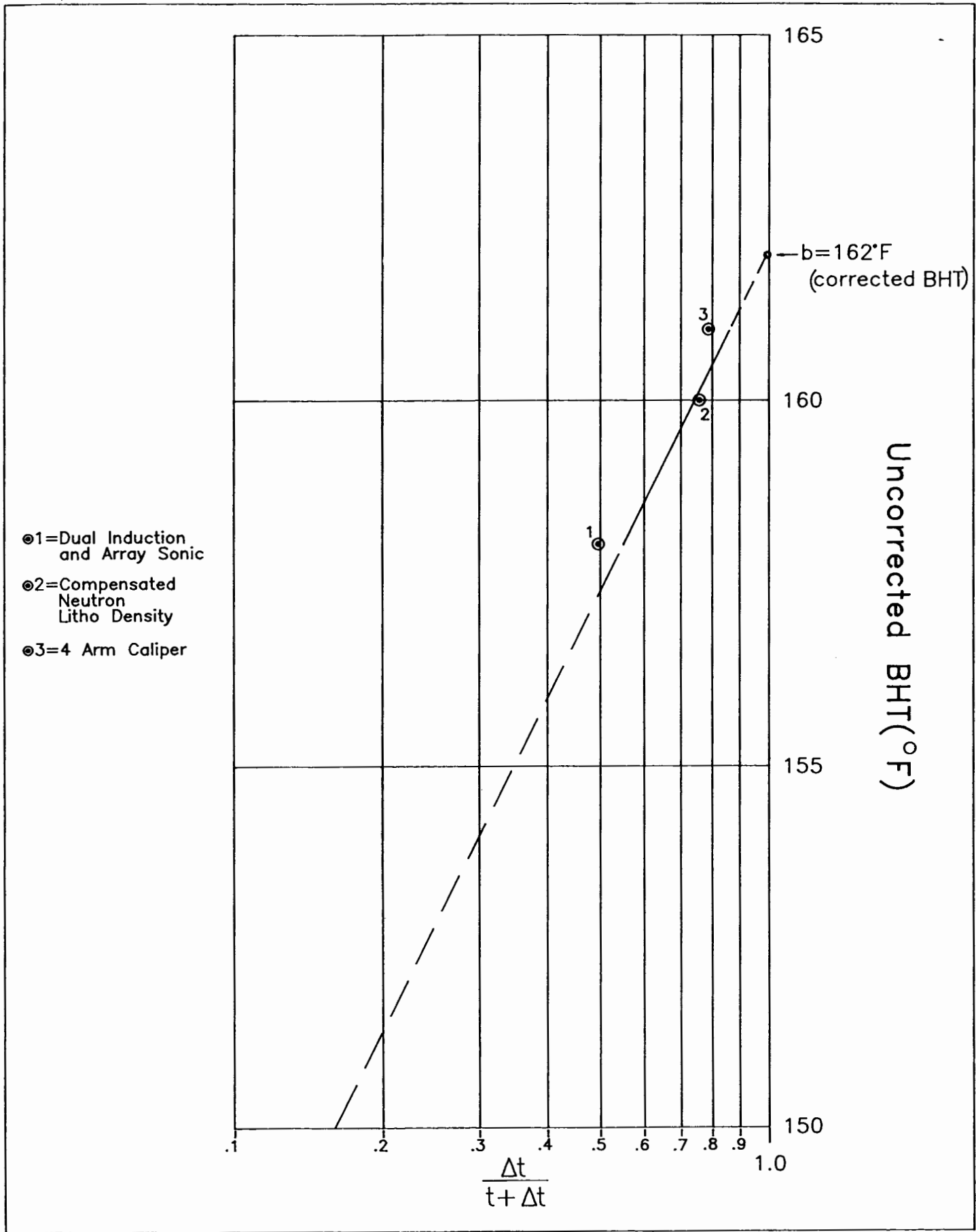

Figure 4.2. Horner plot for log run 2.

5. ORGANIC GEOCHEMISTRY

Geochemical analyses were performed on cuttings and sidewall core samples obtained from the Aurora well over the interval from 990 to 18,325 ft. The objectives of these analyses were to determine the level of thermal maturation (i.e., identify the "oil window") of the sediments penetrated in the well, their total organic carbon (TOC) richness and organic matter type (kerogen analysis), and their potential for generating hydrocarbons.

Thermal Maturity

The evaluation of the level of thermal maturity in the Aurora well is based upon mean random vitrinite reflectance (R_o), spore coloration (i.e., the Thermal Alteration Index--TAI), Rock-Eval pyrolysis parameters (T_{max} values and production indices,⁴ $S_1/(S_1+S_2)$), and light-hydrocarbon data (C_1 to C_4).

These maturity data, displayed in figure 5.1, are of good quality and the various parameters agree quite well. The best agreement occurs between R_o ,⁵ TAI, and T_{max} data. These three parameters are used to conservatively define the oil window, and the other parameters are good supporting members. The oil window encompasses almost the entire early Paleocene section of Unit B of the Canning Formation and the upper part of the unnamed Early Cretaceous shale.

Based on R_o , TAI, and T_{max} data, the depth where the rocks in Aurora first reach sufficient thermal maturity to generate liquid hydrocarbons occurs at approximately 11,000 ft ($R_o=0.6\%$, TAI=2, and $T_{max}=435$ °C). This oil window extends to about 15,700 ft ($R_o=1.35\%$, TAI=3, and $T_{max}=470$ °C). Below this depth the rocks

⁴ The production index (also called the transformation ratio), the ratio of the free and/or adsorbed hydrocarbons in the rock (S_1) divided by the total hydrocarbons generated from pyrolysis (S_1+S_2), is a measure of the hydrocarbons available for accumulation. It always increases in the mature zone if the kerogen is capable of generating oil or gas (Hunt, 1979, pp. 459-460).

⁵ Vitrinite populations plotted are interpreted as indigenous. Each data point represents the mean of a population defined by a minimum of 40 reflectance readings.

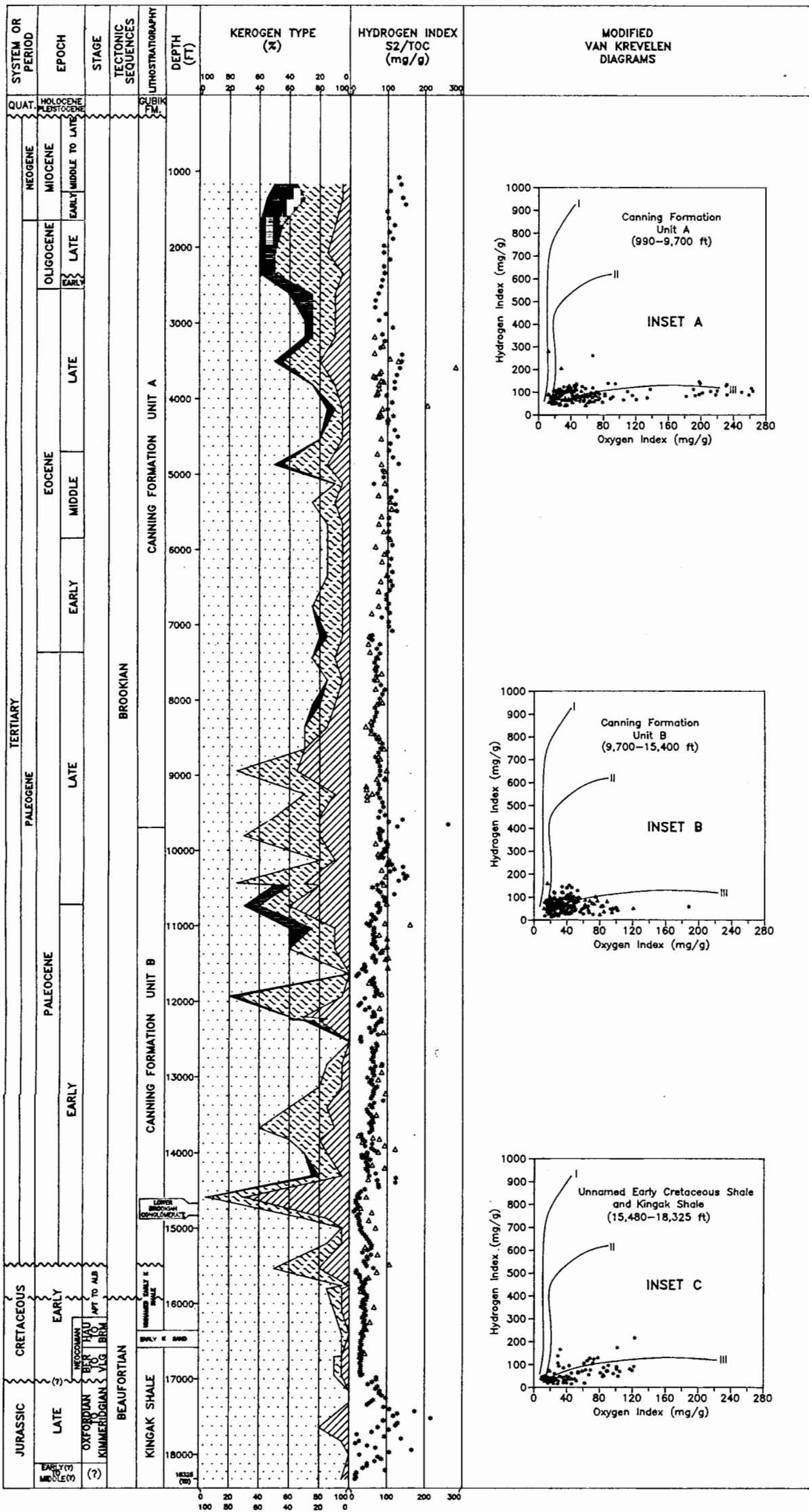

EXPLANATION

	AMPHIBOLITE		WACKELITE
	ALGONITE		INERTINITE
	EXONITE		CUTTINGS
			SEAWALL CORES

Vertical scale: 1"=1,000'
Depth: in feet below RBS

Figure 5.2. Classification of organic matter and kerogen type.

are overmature for oil generation. From 15,700 ft ($R_o=1.35\%$) to approximately 17,700 ft ($R_o=2.0\%$) wet gas and condensate may be generated, but below this depth ($R_o>2.0\%$) only dry gas generation would be expected (Hunt, 1979, p. 328-350).

Definition of the oil window using R_o , TAI, and T_{max} is supported by the light-hydrocarbon (C_1 to C_4) data. The gas wetness ratio ($[(C_2+C_3+C_4)/(C_1+C_2+C_3+C_4)]$) shows a positive increase from about 9,000 to 14,000 ft and then decreases until becoming almost dry gas at 16,000 ft. The increase from 9,000 to 11,000 ft is attributed to the presence of gas migrated from depth, and therefore this zone is not considered to be in the oil window.

The pyrolysis production indices also support the placement of the oil window, but to a lesser degree. At the top of the oil window, the production indices show a slight increase (from 0.11 at 10,000 ft to 0.15 at 11,000 ft), but they do not reach values indicative of significant oil generation (approximately 0.20; EXLOG, 1988) until about 12,600 ft. The values continue to increase to peak values at 14,400 to 14,800 ft and then steadily decrease to values of 0.20 at the bottom of the predicted oil window.

Organic Carbon

The TOC values from cuttings and sidewall core samples from the Aurora well are displayed on plate 1 (EXLOG, 1988). The TOC values decrease from about 2.0 percent at 1,000 ft, to about 0.9 percent at 12,000 ft, in sediments of Miocene to Paleocene age of the Canning Formation. From 12,000 to 14,000 ft, TOC values increase to about 1.2 percent in Paleocene sediments of the Canning Formation. Several high values stand out. Organic carbon contents of 2.19, 3.48, and 7.52 percent occur at 12,110, 13,370, and 13,400 ft, respectively. The cuttings samples that produced these analyses all contain coal in quantities varying from trace amounts to 10 percent (visual estimate) of the sample. The coal probably produced these high TOC values.

Still higher values occur at greater depth. From 14,000 to 18,325 ft (TD), TOC values range from about 0.5 to nearly 6.0 percent. The highest values occur between approximately 15,500 and 16,500 ft in lithologies described as dark-gray to black shale in cuttings and as brownish-black claystone in sidewall core samples. Although these sediments are quite mature ($R_o\approx 1.35\%$), the production index ratio from Rock-Eval pyrolysis is low (about 20%, plate 1), indicating that very little hydrocarbon has been generated in this interval. A small increase in headspace gas (C_1 to C_4) does occur. Pore pressure increase in the interval from 15,500 to 16,500 ft necessitated higher mud weights, resulting in

severe drilling-fluid loss, which in turn required the addition of lost circulation material (Patton, 1988). The nature of these additives is not reported, but they frequently include walnut hulls, lignitic materials, and so forth. Organic contaminants may explain the higher than normal TOC values in this interval.

From 15,656 to 15,940 ft, TOC values from sidewall cores range from 4.39 to 5.97 percent. However, these high organic carbon levels are not reflected in the cuttings samples for the same interval. Hunt (1979) says that since sidewall cores are usually taken after a well has been drilled to total depth, the formations have been subjected to the high pressures of the drilling mud. If the mud contains diesel oil, lubricants from the drill rig, or crude oil, the petroleum could invade the annulus of the drill hole and in this way contaminate sidewalls. In the Aurora well, contamination by drilling fluids probably caused the few high TOC values between 15,656 and 15,940 ft.

Description of Kerogen

The results of reflected-light petrography and Rock-Eval pyrolysis are presented in figure 5.2. Four petrographic classes of kerogen are reported by EXLOG (1988):

1. alginite (recognizable algal structures),
2. exinite (also called liptinite; herbaceous, lipid-rich relics),
3. vitrinite (woody and humic components), and
4. inertinite (hard, carbon-rich, nonreactive brittle particles).

Additionally, EXLOG (1988) reports amorphous (structureless) material, a subgroup within the exinite category. Amorphous organic matter is frequently termed sapropelic, but it actually means "without shape or form." It can be produced by the decomposition of high-lipid⁶ organic materials such as spores and planktonic algae (Hunt, 1979), but it can also be produced by the precipitation or adsorption of dissolved or colloidal organic matter such as humic acids. Reworking of organic debris may also destroy original morphological structures of various biological origins. These nonsapropelic sources of amorphous material could produce a kerogen with a low petroleum potential. It follows that the identification of amorphous organic matter by microscopy is by no means proof of good petroleum potential (Tissot and Welte, 1984). The modest values exhibited by the hydrogen

⁶ Lipid is a broad term that includes all oil-soluble, water-insoluble substances such as fats, waxes, fatty acids, sterols, pigments, and terpenoids (Hunt, 1979).

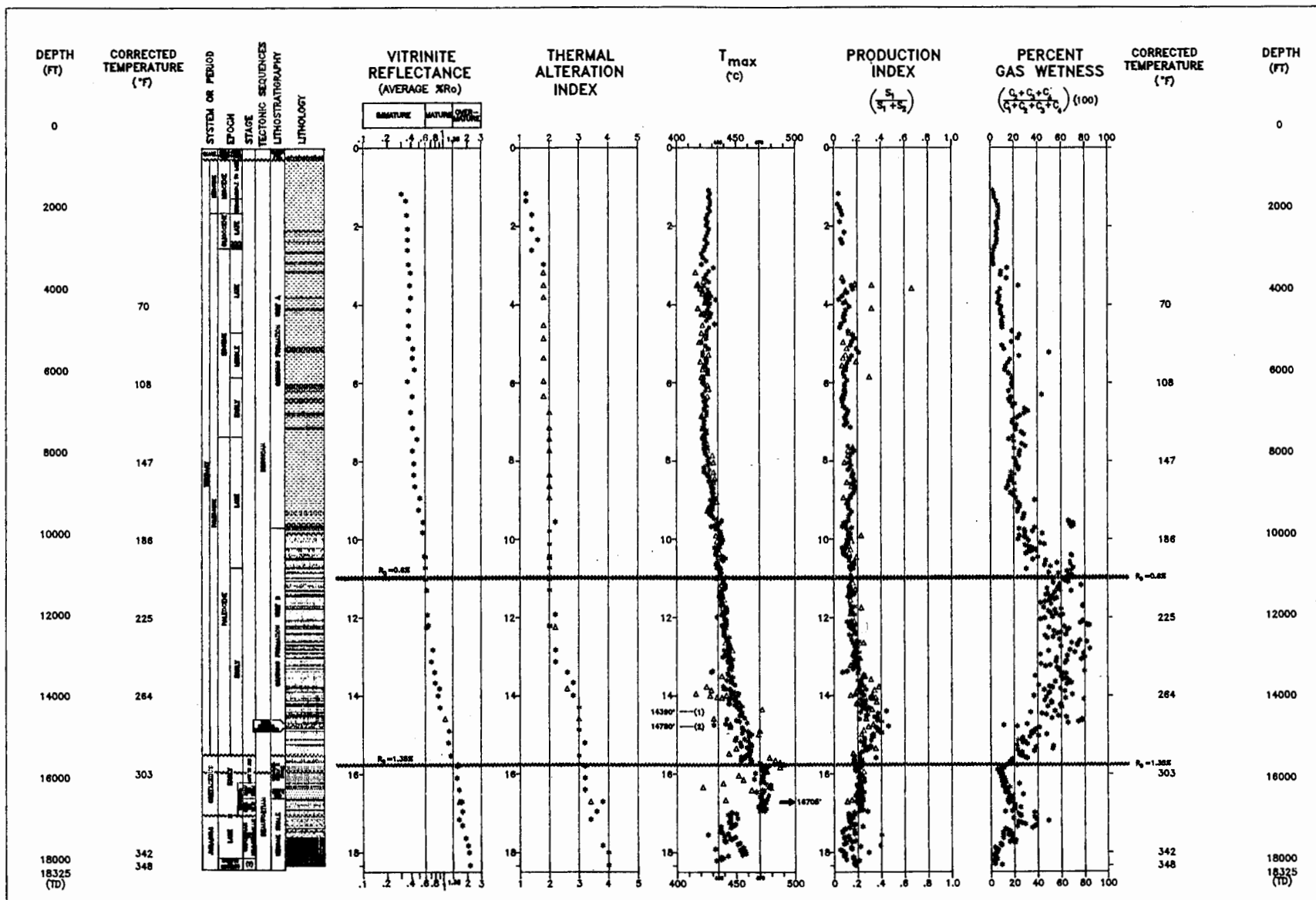

Figure 5.1. Various parameters used for determining the therm maturity and the oil window in the Aurora well.

indices (S_2/TOC) from pyrolysis (figure 5.2) plotted adjacent to the profile of the microscopic identification of the kerogen suggest that the amorphous debris in the Aurora well is largely nonsapropelic and a poor hydrocarbon source.

The modified Van Krevelen diagrams (figure 5.2) indicate that Unit A of the Canning Formation (990 to 9,700 ft) is largely gas-prone type III kerogen. The two sidewall cores at 3,592 and 4,097 ft with hydrogen indices (mg hydrocarbons/g TOC) of 281 and 206, respectively, contain very large amounts of C_{15+} extractable organic matter (plate 1). Clementz (1979) observed that solid bitumen and the "heavy end" fraction of petroleum produce a measurable pyrolytic (S_2) response in the 350 to 450 °C range as well as in the same region where kerogen conversion to hydrocarbon occurs. The pyrolytic temperatures (T_{max}) for the samples that produced the high levels of C_{15+} extract range between 418 and 425 °C. It is probable that the two sidewall cores that produced hydrogen indices of 281 and 206 contain migrated bitumen.

Anomalously large amounts of C_{15+} extract are also present in a cuttings sample from 4,770 to 4,860 ft and in a sidewall core sample from 5,464 ft (plate 1). Despite the fact that these bitumens occur in sediments with immature kerogen (plate 1 and figure 5.1), they contain in excess of 20 percent saturated hydrocarbons (figure 5.3). This suggests that these extracts are thermally mature. It is probable that the extracts migrated into the sediments that contain them.

Finally, a cuttings sample from 9,620 to 9,650 ft appears to contain a combination of type II and type III kerogen (figure 5.2). However, sediments at this depth are thermally immature and have probably not produced petroleum at this site (plate 1 and figure 5.1).

Unit B of the Canning Formation (9,700 to 15,480 ft) exhibits hydrogen indices that tend to be generally lower (<100) than Unit A (figure 5.2), indicating a predominantly type IV kerogen. Petrographic analysis also reveals greater amounts of inertinite in Unit B than in Unit A. Catagenetic alteration, the "oil window," occurs between about 11,000 and 15,700 ft in the Aurora well and may also contribute to the lower hydrogen indices in Unit B.

The unnamed Early Cretaceous shale (15,480 to 16,442 ft) and the Kingak Shale (16,620 to 18,325 ft) consist of mostly amorphous organic matter with low hydrogen indices (figure 5.2). The unnamed Early Cretaceous shale is thermally mature ($1.23\% \leq R_o \leq 1.57\%$) and consists of type IV with some type III kerogen (figure 5.2). The Kingak Shale is mature to overmature

($1.57\% \leq R_o \leq 2.14\%$, figure 5.1), so pyrolysis data cannot be used to identify kerogen type. However, if the amorphous kerogen in the Kingak Shale (figure 5.2) is actually composed of lipids, some hydrocarbons should be present. Neither the mud log nor the pyrolysis results indicate significant amounts of hydrocarbons for this interval. The amorphous organic material from the Kingak Shale is probably composed of nonsapropelic debris. There is an additional problem with pyrolysis samples from the Kingak Shale.

At 16,950 ft there is an abrupt change in the character of the Rock-Eval pyrolysis of the cuttings samples. The S_2 response becomes erratic with both unusually high and unusually low values, producing highly variable hydrogen indices (figure 5.2) and a general decrease in the production index. This is accompanied by an abrupt drop in T_{max} values (figure 5.1).

Most chemical reactions that lead to the condition commonly referred to as thermal maturity are irreversible. It is unlikely that T_{max} values would first increase, then suddenly decrease as seen in this well below 16,950 ft. Even though the drill hole was cased to just 15,941 ft, leaving over 1,000 ft of open hole below the casing, the decrease in the T_{max} values is not likely to have been produced by sloughing or caving since cuttings with such low T_{max} values would have to have originated thousands of feet up the hole.

A drop in T_{max} can be caused by the addition of drilling-mud additives or by natural contaminants such as bitumen and migrated oil. All organic contaminants tend to increase the hydrogen index (Clementz, 1979; Peters, 1986). Therefore, it seems most likely that the lower T_{max} values (and the variable hydrogen index values as well) are due to contamination by the drilling-mud additives used to stabilize the well bore, or by migrated hydrocarbons.

Unfortunately EXLOG did not include pyrograms in their report, nor did they perform gas chromatography below 15,080 ft. It is, therefore, not possible to identify the kerogen in the interval from 16,950 to 18,325 ft (TD) other than to characterize it as mostly amorphous organic material that is probably not sapropelic.

Hydrocarbon Source Potential

The composition of kerogen depends on the nature of the organic matter deposited with the sediments and on the extent of microbial degradation. The kerogen's composition determines its genetic potential (the amount of hydrocarbons that it can generate during

burial). One measure of genetic potential is the sum of volatile plus pyrolytic hydrocarbons, S_1+S_2 , from Rock-Eval pyrolysis, because it accounts for both type and abundance of organic matter (Tissot and Welte, 1984). Table 5.1 summarizes the threshold values used for evaluating the oil and gas potential of source rocks. Only samples with genetic potentials in excess of 2,000 ppm are considered prospective.

Table 5.1. Suggested threshold values for genetic potential from pyrolysis (from Tissot and Welte, 1984).

<u>Genetic Potential</u> <u>S_1+S_2 (ppm)</u>	<u>Hydrocarbon</u> <u>Source Rock Potential</u>
Less than 2,000	No oil; some potential for gas.
2,000 to 6,000	Moderate source rock.
Greater than 6,000	Good source rock.

In Unit A of the Canning Formation (990 to 9,700 ft), sediments exhibiting genetic potentials in excess of 2,000 ppm between about 3,500 and 5,500 ft contain unusually high amounts of C_{15+} extract (plate 1). Solid bitumen and the "heavy-end" fraction of petroleum can affect the S_2 value from pyrolysis (Clementz, 1979; Peters, 1986) and, therefore, drive up the genetic potential. The hydrocarbons contained in these immature sediments must have migrated into them.

The interval in Unit A from 9,620 to 9,680 ft produced two cuttings samples with genetic potentials of 3,890 and 2,190 ppm and TOC values of 1.34 and 1.63 percent, respectively. The samples, described as olive-gray muds with a trace of shale, have R_o values of about 0.5 percent, indicative of thermally immature sediments. If thermally mature, these sediments would have a moderate potential as a gas source, possibly containing both types II and III kerogen.

In Unit B of the Canning Formation (9,700 to 15,480 ft), a sidewall core sample of "olive-black" shale at 10,990 ft has a genetic potential of 3,970 ppm, a TOC of 2.14 percent, and an R_o of near 0.6 percent. However, its hydrogen index is only 160, suggesting a gas-prone type III kerogen with moderate source potential for gas.

In the interval from 13,340 to 13,400 ft, two cuttings samples have genetic potentials of 2,080 and 4,780 ppm with TOC values of 3.48 and 7.52 percent, respectively. However, the samples are composed of sandstone containing coal, which accounts for the high genetic potentials and TOC values. This interval is an

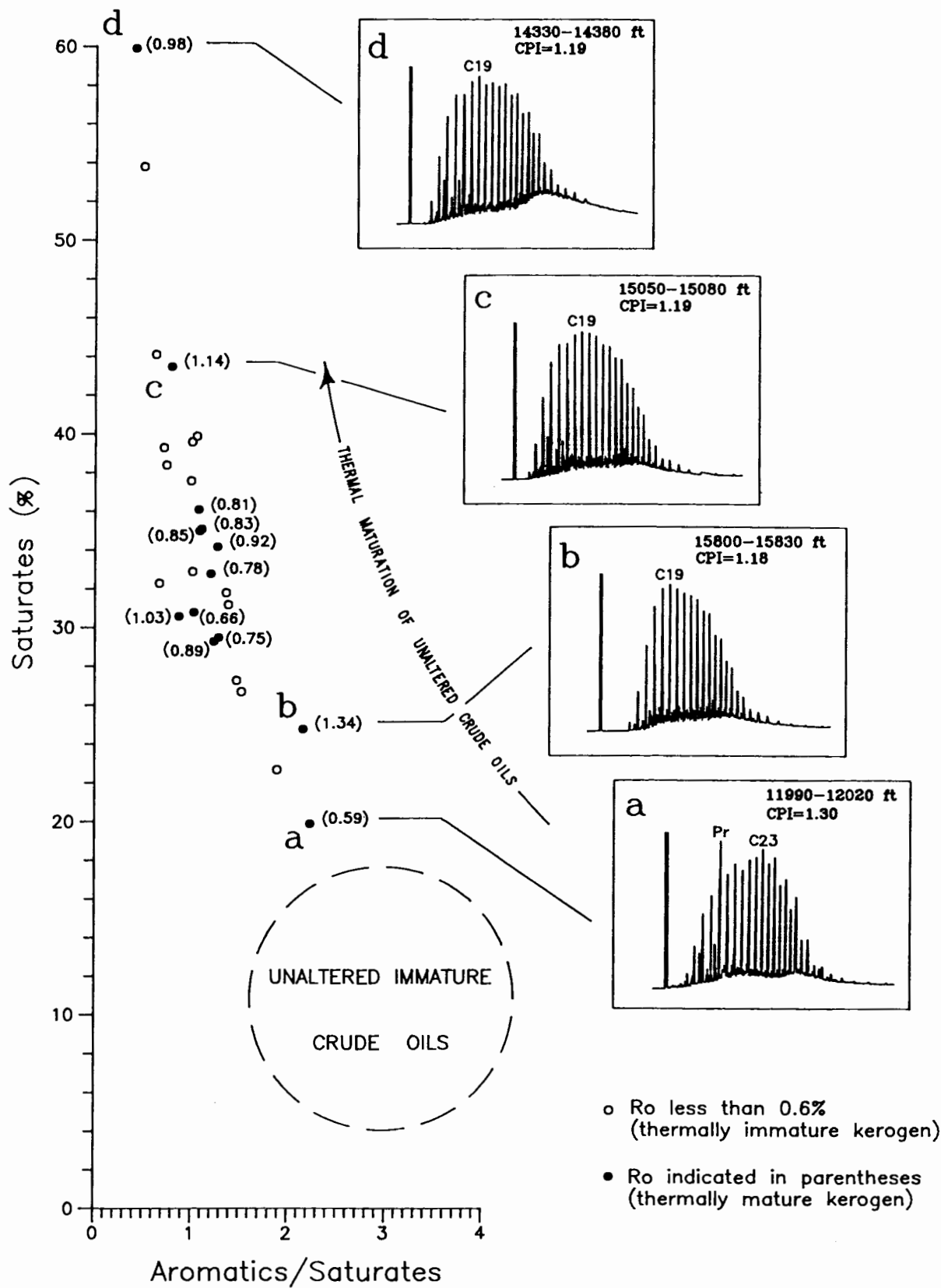

Figure 5.3. Thermal alteration of C_{15+} extractable hydrocarbons from the Canning Formation in the Aurora well. The saturate content of these hydrocarbons is unrelated to depth or to R_o . (Diagram adapted from Connan and others, 1975.)

unlikely source of petroleum, but if hydrocarbons are generated, they would most probably be composed of dry gas.

In the interval from 13,906 to 14,330 ft, sidewall cores in dark-gray and dusky yellowish brown shale at 13,906 and 14,201 ft have genetic potentials of 2,430 and 2,400 ppm with TOC values of 2.10 and 2.08 percent, respectively. However, the mud log indicates coal between 13,975 and 13,980 ft. The hydrogen indices for both these samples are 93 at an R_o level of about 0.9 percent, consistent with an organically lean, type III kerogen. These two sidewall cores may well contain traces of coal which increased their genetic potentials. The two cuttings samples from the interval between 14,300 and 14,390 ft, with genetic potentials of 2,800 and 3,280 ppm, both contain pipe dope, an obvious contributor to the S_2 value (Clementz, 1979) and consequently to the genetic potential.

The hydrocarbon source potential of the unnamed Early Cretaceous shale (15,480 to 16,442 ft) and the Kingak Shale (16,620 to 18,325 ft, TD) is unimpressive. Genetic potentials are less than 2,000 ppm down to 16,950 ft, with four exceptions. Sidewall cores at 15,584, 15,656, 15,709, and 15,762 ft in brownish black claystone have genetic potentials of 2,220, 2,670, 2,510, and 2,632 ppm, with TOC values of 2.54, 4.39, 5.16, and 5.97 percent, respectively. Hydrogen indices are not high for these samples (figure 5.2), but with R_o values approaching 1.35 percent, they can be expected to plot near the origin of the modified Van Krevelen diagram. The low production index for these samples (plate 1) is the result of low S_1 values (0.37, 0.45, 0.40, and 0.52 mg hydrocarbons/g rock, respectively), which indicates they have produced only small amounts of hydrocarbons. These sediments appear to contain organically lean type III kerogens despite their organic carbon contents.

Between 16,950 ft and TD, genetic potentials exceed 2,000 ppm in several cuttings samples. As noted in the description of the kerogen, there is a suspicious drop in the T_{max} values accompanied by an increase in S_2 values that points to contamination of some kind.

EXLOG's production index, shown on plate 1, is sometimes termed the "transformation ratio" because it is a measure of the degree to which kerogen has been transformed to petroleum. Other ways to measure the transformation ratio include the ratio of C_{15+} bitumen extract to TOC (the bitumen ratio) or the ratio of C_{15+} extractable hydrocarbons to TOC (the hydrocarbon ratio) (Tissot and Welte, 1984). These transformation ratios also appear on plate 1. The striking feature about all three of these transformation ratios in Aurora is that they exhibit very little

increase within the zone of catagenetic alteration (11,000 to 15,700 ft), where these ratios should reach maximum values. What, then, is the origin of the bitumen present throughout most of the well?

Figure 5.3 shows saturate content versus the aromatic-to-saturate ratios of extracted hydrocarbons from both cuttings and sidewall core samples. The diagram, intended to evaluate the thermal maturity of unaltered oils, is based on what Seifert and Moldowan (1978) have described as a classic law of organic geochemistry: the most mature oils possess the largest amount of saturates. This law was devised by observing changes in composition in a large number of crude oils and rock extracts of various origins and degrees of maturity (Bajor and others, 1969; Connan and others, 1975). Hollow data points on figure 5.3 represent extracts from samples that contain vitrinite populations with reflectances of less than 0.6 percent. That is, the kerogen was thermally immature and theoretically incapable of generating significant amounts of petroleum, particularly with high amounts of saturates. These hydrocarbons must have migrated into the sediments from which they were extracted. Solid data points represent thermally mature sediments from below 11,600 ft. Their respective R_o values are listed beside them.

Bitumens can be immature, heavy asphalts that probably never existed as light oil, or they may result from physical, chemical, and biological degradation of normal crude oil (Hunt, 1979). The C_{15+} hydrocarbons shown on figure 5.3 appear to belong to the latter group because of their saturate content. However, no correlation exists between the saturate content of these extracts and the R_o . Saturate content should increase as the R_o increases in response to increasing temperatures downhole. This implies that these heavy hydrocarbons migrated into the sediments that presently contain them.

The isoprenoids pristane (Pr) and phytane (Ph) have been used as indicators of depositional environment and as biomarkers (Powell and McKirdy, 1977; Lijmbach, 1975; Chung and others, 1992). A high Pr/Ph ratio indicates an oxidizing environment and a low Pr/Ph ratio a reducing environment (Powell and McKirdy, 1977). Most oils with Pr/Ph ratios greater than 2 have a significant input of terrestrial matter (Chung and others, 1992). Pristane-to-heptadecane ($n-C_{17}$) and phytane-to-octadecane ($n-C_{18}$) ratios are also used to evaluate the source of organic matter and its environment of deposition, because the pairs of compounds elute almost simultaneously from the gas chromatograph.

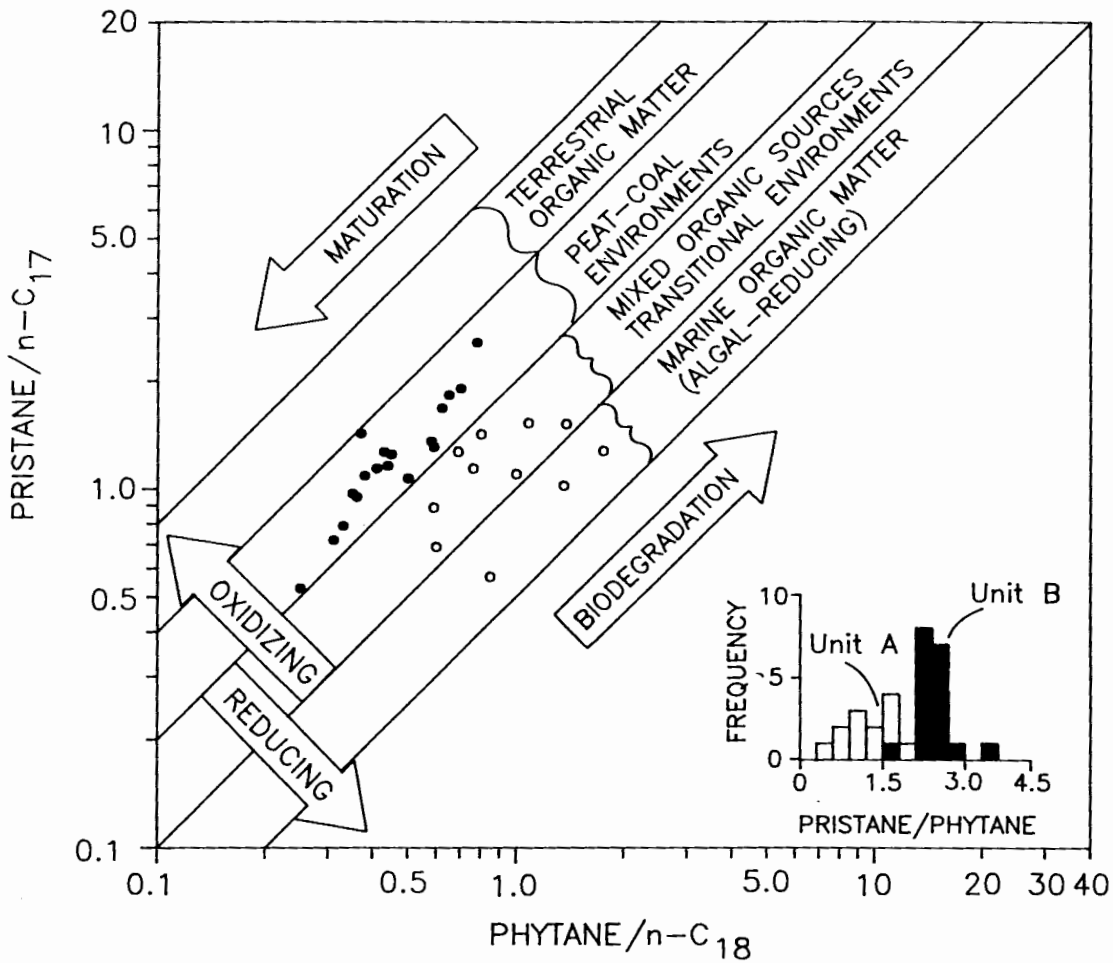

○ Canning Formation,
Unit A
Mean pristane/phytane=1.17
No. of measurements: 11

● Canning Formation,
Unit B
Mean pristane/phytane=2.43
No. of measurements: 18

Figure 5.4. Isoprenoid ratios from the Canning Formation in the Aurora Well. This diagram is adapted from a plot constructed by W. L. Orr *in* Shanmugam, 1985, and is based on concepts proposed by Lijmbach, 1975.

Figure 5.4 shows Pr/Ph, Pr/n-C₁₇, and Ph/n-C₁₈ ratios for C₁₅₊ extracts from the Aurora well. The Pr/Ph ratios yield a bimodal distribution, with values for Unit A of the Canning Formation (990 to 9,700 ft) ranging from 0.58 to 1.71. The Pr/Ph values from Unit B of the Canning Formation (9,700 to 15,480 ft) range from 1.63 to 3.38. The loci of Pr/n-C₁₇ versus Ph/n-C₁₈ ratios also produce separate populations. These isoprenoids indicate that C₁₅₊ hydrocarbons extracted from the two stratigraphic units are apparently derived from different source rocks: those extracted from Unit A of the Canning Formation have a more marine character than those extracted from Unit B.

EXLOG (1988) observed the presence of an unidentified compound eluting between the C₂₀ and C₂₁ n-alkanes from 13,100 to 14,600 ft in Unit B of the Canning Formation (figure 5.5). They speculate that this compound might be derived from "the lignite additive," even though they performed heavy-liquid separation to remove lignitic additives. EXLOG also notes that if the compound is indigenous, it could be useful for correlation studies if oils are found in the area. Records indicating where and what type of drilling-mud additives are used in a well are typically not detailed. Soltex, a sodium asphalt sulfonate, was added at about 9,000 ft (Patton, 1988). A casing point occurs at 9,454 ft, so the Soltex should not have affected the samples below this depth, provided it was not also used in the succeeding drilling run. Patton (1988) says that "specific mud chemicals" were added to the mud system below 12,800 ft to lower water loss and provide better shale stabilization. The only very convincing evidence of contamination occurs below 16,950 ft, where T_{max} decreases dramatically and the pyrolytic hydrocarbon content (S₂) increases.

The unidentified compounds on figure 5.5 occur where the isoprenoid C₂₁ would be expected. This isoprenoid is a derivative of beta-carotane (G. Bayliss, oral communication, July 1992). Additionally, the chromatograms exhibiting these peaks appear to contain unusual amounts of the alkanes C₂₃, C₂₅, C₂₇, and C₂₉. The presence of plant pigments and odd-carbon-number paraffin waxes suggests terrestrially derived organic debris, consistent with the kerogen type in Unit B of the Canning Formation. These chromatograms all come from intervals that lack evidence of contamination.

Geochemistry Summary and Conclusions

In the Aurora well, sufficient thermal maturity for the generation of crude oil exists below about 11,000 ft, and degeneration of liquid hydrocarbons due to thermal cracking (the "oil floor") probably begins at about 15,700 ft.

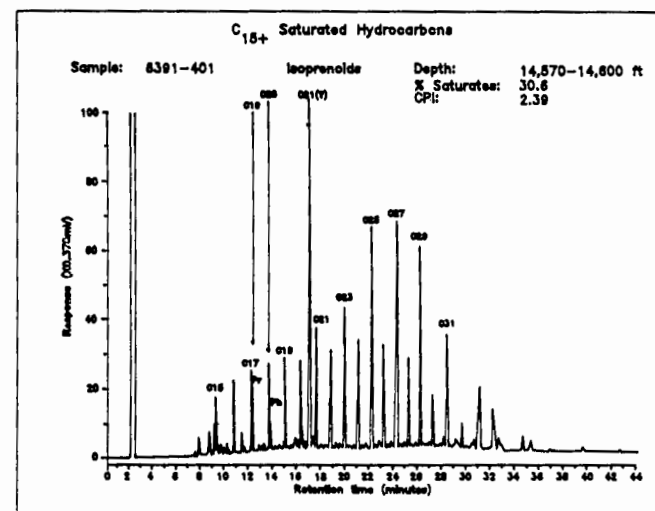
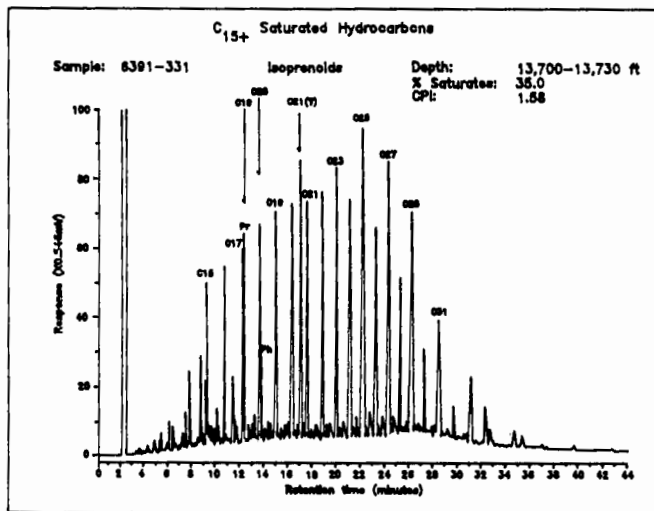
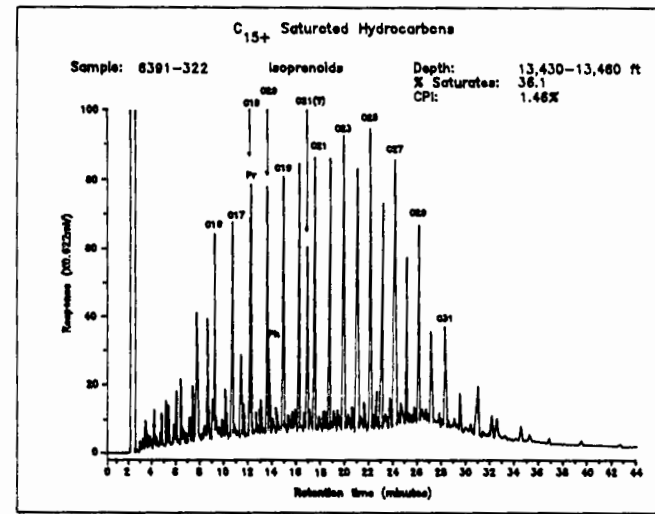
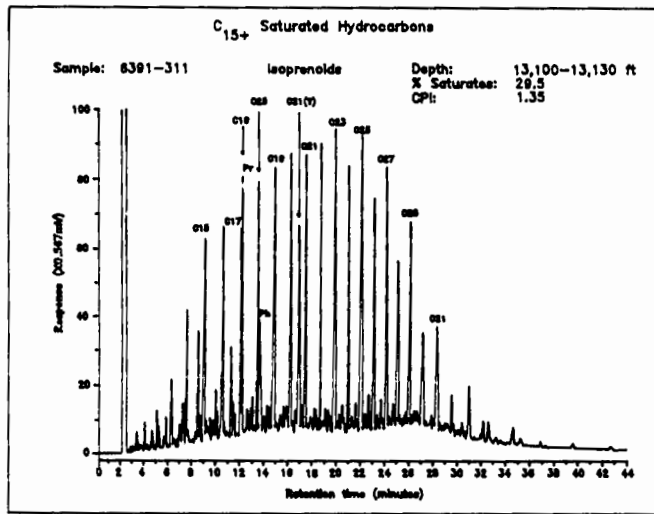

Figure 5.5. Chromatograms showing the unidentified hydrocarbon (probably the isoprenoid C₂₁) between the normal C₂₀ and C₂₁ alkanes. These C₁₅₊ extracts also contained unusually large amounts of C₂₃, C₂₅, C₂₇, C₂₉, and C₃₁ alkanes. The carbon preference indices (CPI) for these hydrocarbons are high and exhibit an increase with depth rather than a decrease. (Chromatograms from EXLOG, 1988.)

The Tertiary and Early Cretaceous sedimentary rocks which the well penetrated to 15,930 ft contain gas-prone type III kerogen with a limited potential for the generation of hydrocarbons. In the Canning Formation and part of the unnamed Early Cretaceous shale (15,480 to 15,930 ft) there are three intervals having limited petroleum potential:

- an interval of olive-gray muds between 9,620 and 9,690 ft in Unit A,
- a sidewall core in olive-black shale at 10,990 ft in Unit B, and
- four sidewall cores from 15,584 to 15,762 ft from brownish-black claystone in the unnamed Early Cretaceous shale.

The Mesozoic rocks from 15,930 to 16,950 ft are similar to the Tertiary and Early Cretaceous sediments above them but exhibit possibly even less hydrocarbon potential. The Mesozoic sediments from 16,950 to 18,325 ft (TD) exhibit no significant potential for hydrocarbon generation. Samples from this lowest interval in the well appear to be contaminated.

C₁₅₊ extracts indicate two types of hydrocarbons are present in the Canning Formation in the Aurora well. Neither of these hydrocarbons are believed to have been generated by the lean type III kerogens sampled at this site. The immature sediments of Unit A of the Canning Formation (300 to 9,700 ft) could not have generated the hydrocarbons they contain. C₁₅₊ hydrocarbon extracts from Unit A appear to be generated from mixed organic sources in a marine environment on the basis of their isoprenoid content. In contrast, Unit B of the Canning Formation (9,700 to 15,480 ft) yielded C₁₅₊ extracts characteristic of a nearshore or terrestrial environment, possibly even containing coal. A type III kerogen probably generated the Unit B hydrocarbons. However, the leanness of the organic matter at this location, and the lack of systematic increase in thermal maturity of the extracted hydrocarbons as measured by their content of saturates, indicate that these heavy hydrocarbons were not generated at this location.

SUMMARY AND CONCLUSIONS

The OCS Y-0943-1 Aurora well is the closest offshore well to the ANWR coastal plain — a little more than 3 miles out from Griffin Point — and is less than 7 miles from the only well drilled inside ANWR's borders, the Chevron KIC-1 well. The KIC-1 well remains a tight well and no information about it is available.

The Aurora well is essentially a deep stratigraphic test well, drilled to penetrate the same sequences encountered in the KIC-1 well in an effort to evaluate the hydrocarbon potential of the ANWR coastal plain. However, the well did not answer the most important question: Are reservoir and source rocks of the Ellesmerian sequence (i.e., the Sadlerochit and Lisburne Groups) present in the area of the Aurora well and the ANWR coastal plain?

The main implication for the stratigraphy of the onshore and offshore areas adjacent to the Aurora well comes from the presence of rocks older than Hauterivian (Early Cretaceous) penetrated in the well. The well bottomed at 18,325 ft in Jurassic-age Kingak Shale of the Beaufortian sequence. The regional trend seen in the nearshore and offshore wells west of the Aurora well suggests that the erosional event marked by the Lower Cretaceous Unconformity (LCU) removed all rocks older than Hauterivian down to basement-complex rocks. The strata removed include the principal reservoir and source rocks of the North Slope — the Triassic to Middle Devonian Ellesmerian sequence. The fact that the Kingak Shale escaped the denudation by the LCU at the Aurora well suggests that the oil-prone Ellesmerian rocks did also and may underlie the area. Alternatively, perhaps a thick Beaufortian sequence rests directly on basement-complex rocks, with Ellesmerian absent, as is seen in northwest Canada.

The Aurora well penetrated Brookian and Beaufortian sequence rocks that are composed dominantly of claystone and shale with only minor interbedded siltstone, sandstone, conglomerate, and coal. However, two units were encountered that may be of interest: a 145-ft-thick lower Brookian conglomerate of early Paleocene age and a 178-ft-thick Early Cretaceous sandstone. No significant hydrocarbon shows are associated with either unit and overall both show very poor reservoir potential. If these units

extend beyond the Aurora well updip to shallower depths, they may exhibit better reservoir potential. However, these two units may just be localized deposits typical of a prodelta/deltaic environment.

Correlation of Brookian and Beaufortian sequence regional stratigraphic nomenclature into the Aurora well is problematic because of the absence of key markers and the distance from the nearest established control (the West Staines State No. 2 well). On the basis of lithology and log response, the Tertiary section of the well is identified as the Canning Formation of Molenaar and others (1987) and Scherr and others (1991).

Identification of the Mesozoic section of the well is more difficult; however, the lithostratigraphic and micropaleontologic data suggest some possible correlations. The section of the well from 15,930 to 16,442 ft ranges in age from Hauterivian/Barremian to Aptian/Albian and consists dominantly of shale with minor siltstone and sandstone. The micropaleontologic data suggest a possible correlation to the Pebble Shale Unit of Molenaar and others (1987), but the lithology of this section of the well does not accurately fit their description and none of the key markers associated with the Pebble Shale are present.

A sandstone of Hauterivian/Barremian age was penetrated in the well from 16,442 to 16,620 ft. This unit may be stratigraphically correlative to the Kemik Sandstone; however, such a correlation would suggest the presence of the LCU at the base of this sandstone unit, which does not appear to be the case. Additionally, Molenaar and others (1987) indicate a shallow-marine environment of deposition for the Kemik Sandstone, but the sandstone encountered in the Aurora well appears to be an upper bathyal to bathyal deposit.

Below this sandstone unit, from 16,620 to 18,325 ft (TD), the Beaufortian sequence exhibits a log signature typical of the Kingak Shale seen in other wells to the west. The Aurora well bottomed in this Jurassic Kingak Shale.

The geochemical data obtained from the Aurora well are of very good quality and a very thorough interpretation is offered. For a complete geochemical summary, refer to the end of the Organic Geochemistry chapter. The sediments encountered in the Aurora well contain gas-prone type III kerogen and exhibit very poor potential for the generation of hydrocarbons, with the exception of three intervals in the well that have limited petroleum potential.

C₁₅₊ extracts indicate that two types of hydrocarbons are present in the Canning Formation in the Aurora well. However, these

hydrocarbons are not believed to have been generated by the lean type III kerogens sampled at these sites. The evidence indicates that the heavy hydrocarbons identified in the well are migrated.

REFERENCES

- Bajor, M., Roquebert, M.-H, and Van Der Deide, B. M., 1969, Transformation of sedimentary organic matter under the influence of temperature: Société Nationale Elf-Aquitaine (Production), Bulletin du Centre de Recherches de Pau, v. 3, no. 1, p. 113-124.
- Batjes, A. J., 1958, Foraminifera of the Oligocene of Belgium: Institute Royal des Sciences Naturelles de Belgique, Mémoire no. 143, 188 p., 13 pl.
- Bayliss, G. S., and Smith, M. R., 1980, Source rock evaluation reference manual: Houston, Texas, GeoChem Laboratories, Inc., 80 p.
- Bird, K. J., and Molenaar, C. M., 1987, Stratigraphy, chap. 5 *in* Bird, K. J., and Magoon, L. B., eds., Petroleum geology of the northern part of the Arctic National Wildlife Refuge, northeastern Alaska: U. S. Geological Survey Bulletin 1778, p. 37-59.
- Brideaux, W. W., 1977, Taxonomy of Upper Jurassic-Lower Cretaceous microplankton from the Richardson Mountains, District of Mackenzie, Canada: Geological Survey of Canada, Bulletin 281.
- Brideaux, W. W., Clowser, D. R., Norford, B. S., Norris, A. W., Pedder, A. E. H., Sweet, A. R., Thorsteinsson, R., Uyeno, T. T., Wall, J., 1976, Biostratigraphic determinations from the surface of the Districts of Franklin and Mackenzie and the Yukon Territory: Geological Survey of Canada, Paper 75-10, p. 1-18.
- Bruns, T. R., Fisher, M. A., and Leinbach, W. J., Jr., 1987, Regional structure of rocks beneath the coastal plain, chap. 19, *in* Bird, K. J., and Magoon, L. B., eds., Petroleum geology of the northern part of the Arctic National Wildlife Refuge, northeastern Alaska: U. S. Geological Survey Bulletin 1778, p. 249-254.
- Buckingham, M. L., 1987, Fluvio-deltaic sedimentation patterns of the Upper Cretaceous to Lower Tertiary Jago River Formation,

- Arctic National Wildlife Refuge (ANWR), northeastern Alaska, *in* Tailleux, I. L., and Weimer, P., eds., Alaskan North Slope geology: Pacific Section, Society of Economic Paleontologists and Mineralogists, Bakersfield, California, and the Alaska Geological Society, Anchorage, Alaska, Book 50, v. 1, p. 529-540.
- Bujak, J. P., 1984a, Beaufort-Mackenzie paleontological atlas, v. 1, Palynology: Bujak Research Limited, Biostratigraphic Report, November 1984, p. 1-67.
- ____ 1984b, Cenozoic dinoflagellate cysts and acritarchs from the Bering Sea and northern North Pacific, DSDP Leg 10: Micropaleontology, v. 30, p. 180-212.
- ____ 1990, Palynological analysis of the interval 330-18,310 ft, MMS Well XX, Alaska: Calgary, Alberta, Canada, Bujak Davies Group Report no. 89-0054, February 1990.
- Bujak, J. P., and Davies, E. H., 1983, Modern and fossil Peridiniineae: American Association of Stratigraphic Palynologists Contribution Series, no. 13, p. 203.
- Bujak Davies Group, 1984, Beaufort-Mackenzie paleontological atlas, v. 1, Palynology: Bujak Research Limited, Biostratigraphic Report, November 1984, p. 1-67.
- Bujak, J. P., Downie, C., Eaton, G. L., and Williams, G. L., 1980, Taxonomy of some Eocene dinoflagellate cyst species from southern England, *in* Bujak, J. P., Downie, C., Eaton, G. L., and Williams, G. L., Dinoflagellate cysts and acritarchs from the Eocene of southern England: The Paleontological Association, Special Paper in Paleontology no. 24, p. 26-36.
- Bujak, J. P., and Matsuoka, K., 1986, Late Cenozoic dinoflagellate cyst zonation in the western and northern Pacific, *in* Wrenn, J. H. (ed.), Papers from the first symposium on Neogene dinoflagellate cyst biostratigraphy, New York, October 31, 1986: American Association of Stratigraphic Palynologists, AASP Contributions Series no. 17, p. 7-27.
- Bujak, J. P., and Matsuoka, K., in press, Palynology of upper Cenozoic sediments from the Mackenzie Delta and Beaufort Sea, Arctic Canada, taxonomy, zonation and paleoenvironment: Geological Survey of Canada Bulletin.
- Carman, G. J., and Hardwick, P., 1983, Geology and regional setting of Kuparuk oil field, Alaska: AAPG Bulletin, v. 67, no. 6, p. 1014-1031.

- Chamney, P. T., 1969, Barremian Textularia, Foraminiferida from Lower Cretaceous Beds, Mount Goodenough section, Aklavik Range, District of Mackenzie: Geological Survey of Canada, Bulletin 185, 91 p., 6 pl.
- Christopher, R. A., 1979, Normapolles and triporate pollen assemblages from the Raritan and Magothy Formations (Upper Cretaceous) of New Jersey: *Palynology*, v. 3, p. 1-121.
- Chung, H. M., Rooney, M. A., Toon, M. B., and Claypool, G. E., 1992, Carbon isotope composition of marine crude oils: *AAPG Bulletin*, v. 76, no. 7, p. 1000-1007.
- Clementz, D. M., 1979, Effect of oil and bitumen saturation on source rock pyrolysis: *AAPG Bulletin*, v. 63, p. 227-2232.
- Connan, J., Le Tran, K., and Van Der Wiede, B., 1975, Alteration of petroleum in reservoirs, *in* 9th World Petroleum Congress Proceedings, v. 2: London, Applied Science Publishers, p. 171-178.
- Costa, L. I., and Downie, C., 1979, Cenozoic dinocyst stratigraphy of Sites 403 to 406 (Rockall Plateau), IPOD, Leg 48, *in* Initial reports of the deep sea drilling project, v. 48: National Science Foundation, p. 513-529.
- Craig, J. D., Sherwood, K. W., and Johnson, P. P., 1985, Geologic report for the Beaufort Sea planning area, Alaska: regional geology, petroleum geology, environmental geology: USDOI, Minerals Management Service, OCS Report MMS 85-0111, 192 p.
- Davies, E. H., 1983, The dinoflagellate Opper-zonation of the Jurassic-Lower Cretaceous sequence in the Sverdrup Basin, Arctic Canada: Geological Survey of Canada, Bulletin 359, p. 1-59.
- _____, 1991, Palynological analysis of the interval 5,850-15,960 ft, MMS Well XX, Alaska, a reappraisal: Calgary, Alberta, Canada, Branta Biostratigraphy Ltd., Report no. 91-025/1, October 1991, p. 1-6, 2 charts.
- Dixon, J., McNeil, D. H., Dietrich, J. R., Bujak, J. P., and Davies, E. H., 1984, Geology and biostratigraphy of the Dome Gulf et al. Hunt Kopanoar M-13 well, Beaufort Sea: Geological Survey of Canada, Paper 82-13, 28 pp.
- Doerenkamp, A., Jardine, S., and Moreau, P., 1976, Cretaceous and Tertiary palynomorph assemblages from Banks Island and

adjacent areas (N.W.T.): Bulletin of Canadian Petroleum Geology, v. 24, p. 372-417.

Dow, W. G., and O'Connor, D. I., 1982, Kerogen maturity and type by reflected light microscopy applied to petroleum exploration, *in* How to assess maturation and paleotemperatures, SEPM Short Course No. 7: Tulsa, Oklahoma, Society of Economic Paleontologists and Mineralogists, p. 133-157.

Drugg, W. S., 1967, Palynology of the Upper Moreno Formation (Late Cretaceous-Paleocene) Escarpado Canyon, California: *Palaeontographica*, Abt. B, v. 120, p. 1-71, pl. 1.

Eshet, Y., Moshkovitz, S., Habib, D., Benjammi, C., and Magaritz, M., 1992, Calcareous nannofossil and dinoflagellate stratigraphy across the Cretaceous/Tertiary boundary at Hor Haher, Israel: *Marine Micropaleontology*, v. 18, no. 3, p. 199-228, 5 pl.

EXLOG, 1988, Unpublished geochemical report prepared by Exploration Logging, Inc., for Tenneco Oil Company, Aurora OCS-Y-0943-1 well, Beaufort Sea, Alaska, 152 p.

Fertl, W. H., and Wichman, P. A., 1977, How to determine static bottom hole temperature (BHT) from well log data: *World Oil*, v. 184, no. 1, p. 105-106.

Fouch, T. D., Brouwers, E. M., McNeil, D. H., Marinovich, L., Bird, K. J., and Reick, H., 1990, New information on the Nuwok member of the Sagavanirktok Formation, implications for petroleum geology of the North Slope and Beaufort Sea, evidence from Carter Creek, Arctic National Wildlife Refuge (ANWR), Alaska: U. S. Geological Survey Research on Energy Resources, 1990, Program and Abstracts, U. S. Geological Survey Circular 1060, p. 30-31.

Grantz, Arthur, May, S. D., and Hart, P. E., 1990, Geology of the arctic continental margin of Alaska, chap. 16 *in* Grantz, Arthur, Johnson, L., and Sweeney, J. F., eds., *The Arctic Ocean region, the geology of North America*, v. L: Geological Society of America, p. 257-288.

Grantz, Arthur, and Mull, C. G., 1978, Preliminary analysis of the petroleum potential of the Arctic National Wildlife Range, Alaska: U. S. Geological Survey Open-File Report 78-489, p. 9.

- Harland, R., 1979, Dinoflagellate biostratigraphy of Neogene and Quaternary sediments at holes 400/400A in the Bay of Biscay (Deep Sea Drilling Project Leg 48), *in* Initial reports of the Deep Sea Drilling Project, v. 48: National Science Foundation, p. 531-545.
- Hubbard, R. J., Edrich, S. P., and Rattey, R. P., 1987, Geological evolution and hydrocarbon habitat of the 'Arctic Alaska Microplate': *Marine and Petroleum Geology*, v. 4, February 1987, p. 2-34.
- Hunt, J. M., 1979, *Petroleum geochemistry and geology*: San Francisco, W. H. Freeman, 617 p.
- Ioannides, N. W., and McIntyre, D. J., 1980, A preliminary palynological study of the Caribou Hills outcrop section along the Mackenzie River, District of Mackenzie: *Current Research, Part A, Geological Survey of Canada, Paper 80-1A*, p. 197-208.
- Liengjarem, M., Costa, L., and Downie, C., 1980, Dinoflagellate cysts from the upper Eocene-lower Oligocene of the Isle of Wight: *Paleontology*, v. 23, p. 475-499.
- Lijmbach, G. W. M., 1975, On the origin of petroleum: *Proceedings of the Ninth World Petroleum Congress, Geology*, v. 2, p. 357-369.
- Manum, S. B., 1976, Dinocysts in Tertiary Norwegian-Greenland Sea sediments (Deep Sea Drilling Project Leg 38), with observations on palynomorphs and palynodebris in relation to environment, *in* Initial reports of the Deep Sea Drilling Project, v. 38: National Science Foundation, p. 897-919.
- Marshal, K. L., and Batten, D. J., 1988, Dinoflagellate cyst associations in Cenomanian-Turonian "black shale" sequence of northern Europe: *Review of Paleobotany and Palynology*, v. 54, p. 85-103.
- Matsuoka, K., 1983, Late Cenozoic dinoflagellates and acritarchs in the Niigato District, Central Japan: *Palaeontographica*, v. 87B, p. 89-154.
- _____, 1985, Distribution of the dinoflagellate cyst in surface sediments of the Tsushima Warm Current: *Daiyonik-kenkyu (Quaternary Research)*, v. 24, p. 1-12.

- Matsuoka, K., Bujak, J. P., and Shimakura, T., in press, Late Cenozoic dinoflagellate cyst biostratigraphy in the Niigata and Akita areas, Japan: *Micropaleontology*.
- McIntyre, D. J., 1985, Geology, biostratigraphy and organic geochemistry of Jurassic to Pleistocene strata, Beaufort-Mackenzie area, northwest Canada: Calgary, Alberta, Canada, Canadian Society of Petroleum Geologists, course notes, p. 39-50, 2 pl.
- McIntyre, D. J., and Brideaux, W. W., 1980, Valanginian miospore and microplankton assemblages from the northern Richardson Mountains, District of Mackenzie, Canada: Geological Survey of Canada, Bulletin 320.
- Moldowan, J. M., Seifert, W. K., and Gallegos, E. J., 1985, Relationship between petroleum composition and depositional environment of petroleum source rocks: *AAPG Bulletin*, v. 69, no. 8, p.1255-1268.
- Molenaar, C. M., Bird, K. J., and Kirk, A. R., 1987, Cretaceous and Tertiary stratigraphy of northeastern Alaska, *in* Tailleux, I. L., and Weimer, P., eds., *Alaskan North Slope geology: Pacific Section, Society of Economic Paleontologists and Mineralogists, Bakersfield, California, and the Alaska Geological Society, Anchorage, Alaska, Book 50, v. 1, p. 513-528.*
- Nichols, D. J., and Otts, H. L., 1978, Biostratigraphy and evolution of the *Momipites-Caryapollenites* lineage in the early Tertiary in the Wind River Basin, Wyoming: *Palynology*, v. 2, p. 93-112, 2 pl.
- Norris, G., 1986, Systematic and stratigraphic palynology of Eocene to Pliocene strata in Imperial Nuktak C-22 well, Mackenzie Delta region, District of Mackenzie, N.W.T.: Geological Survey of Canada, Bulletin.
- Patton, John, 1988, ADT well summary report, OCS-Y-0943 Aurora No. 1 Beaufort Sea, Alaska, Anchorage: NL Baroid Logging Systems, unpublished report prepared for Tenneco Oil Company, 100 p.
- Peters, K. E., 1986, Guidelines for evaluating petroleum source rock using programmed pyrolysis: *American Association of Petroleum Geologists Bulletin*, v. 70, no. 3, p. 318-329.

- Piel, K. M., 1971, Palynology of Oligocene sediments from central British Columbia: *Canadian Journal of Botany*, v. 49, p. 1885-1920.
- Powell, T. G., and McKirdy, D. M., 1977, The effect of source material, rock type, and diagenesis on the n-alkane content of sediments: *Geochimica et Cosmochimica Acta*, v. 37, p. 623-633.
- Rouse, G. E., 1977, Paleogene palynomorph ranges in western and northern Canada, *in* Elsik, W. C., ed., *Contributions of stratigraphic palynology*, v. 1, *Cenozoic palynology: American Association of Stratigraphic Palynologists, Contribution Series no. 5A*, p. 48-65.
- Scherr, J. M., Banet, S. M., and Bascle, B. J., 1991, Correlation study of selected exploration wells for the North Slope and Beaufort Sea, Alaska: U. S. Minerals Management Service, Alaska OCS Region, OCS Report, MMS 91-0076, 29 p.
- Seifert, W. K., and Moldowan, J. M., 1978, Applications of steranes, terpanes, and monoaromatics to the maturation, migration, and source of crude oils: *Geochimica et Cosmochimica Acta*, v. 42, p. 77-95.
- Shanmugam, G., 1985, Significance of coniferous rain forests and related organic matter in generating commercial quantities of oil, Gippsland Basin, Australia: *AAPG Bulletin*, v. 69, no. 8, p. 1241-1254.
- Sliter, W. V., 1979, Cretaceous foraminifers from the North Slope of Alaska, *in* Albrandt, T. S., ed., *Preliminary geologic, petrologic, and paleontologic results of the study of Nanushuk Group rocks, North Slope, Alaska*: U. S. Geological Survey Circular 794, p. 147-163.
- Soffer, Z., 1984, Stable carbon isotope composition of crude oils: application to source depositional environments and petroleum alteration: *AAPG Bulletin*, v. 68, no. 1, p. 31-49.
- Staplin F. L., 1976, Tertiary biostratigraphy, Mackenzie Delta region, Canada: *Bulletin of Canadian Petroleum Geology*, v. 24, p. 117-136.
- Tappen, Helen, 1955, Foraminifera from the Arctic Slope of Alaska, pt. 11, Jurassic foraminifera: U.S. Geological Survey Professional Paper 236-B, 91 p.

- ___ 1957, New Cretaceous Index Foraminifera from northern Alaska: U.S. National Museum, Bulletin 215, p. 201-222, pls. 65-71.
- ___ 1962, Foraminifera from the Arctic Slope of Alaska, pt. 111, Cretaceous Foraminifera: U.S. Geological Survey Professional Paper 236-C, 326 p.
- ten Dam, A., and Reinhold, T., 1942, Die stratigraphische Gliederung des neiderlandischen Oligo-Miozoans nach foraminiferen: Mededeelingen van de Geologische Stichting, Serie C-V-No 2, 106 p.
- Tissot, B. P., and Welte, D. H., 1984, Petroleum formation and occurrence (2nd ed.): New York, Springer-Verlag, 699 p.
- Todd, Ruth, 1957, Foraminifera from Carter Creek, northeastern Alaska: U. S. Geological Survey Professional Paper 294-F, p. 223-235, 2 pl.
- Williams, G. L., and Bujak, J. P., 1977, Cenozoic palynostratigraphy of offshore eastern Canada: American Association of Stratigraphic Palynologists, Contribution Series, No. 5A, p. 14-47.
- ___ 1980, Palynological stratigraphy of Deep Sea Drilling Project Site 416, *in* Initial Reports of the Deep Sea Drilling Project, v. 50, National Science Foundation, p. 467-495.
- ___ 1985, Mesozoic and Cenozoic dinoflagellates, *in* Bolli, H.M., Saunders, J.B., and Perch-Nielsen, K., eds., Plankton stratigraphy: Cambridge University Press, p. 846-964.
- Young, F. G., and McNeil, D. M., 1984, Cenozoic stratigraphy of Mackenzie Delta, Northwest Territories, NTS 107B,107C: Geological Survey of Canada Bulletin 336, 63 p.

APPENDIX I: WELLBORE CASING AND CEMENT SUMMARY

Hole size (in.)	Casing size (in.)	Casing wt. (lbs/ft)	Grade(s)	Setting depth (ft)	Cement vol. (ft ³)	Cement type
	40/42	517/725	X-42	276	none	none; casing driven.
40	30	310	X-52	905	4,585	Canadian Permafrost and additives.
26	20	133	X-70 X-56 X-42	3,021	6,061	Canadian Permafrost and additives.
17½	13¾	72	K080T L-80	9,454	5,204 944	Class G and additives. Canadian Permafrost and additives.
12¼	9¾	47/53½	L-80	14,245	4,047	Class G and additives.
8½	7	32/35	P-110 TCA80HC L-80	15,941	3,080	Class G and additives.

APPENDIX II: FINAL REPORTS AND WELL LOGS

Final Reports

Sundry File
ADT Well Summary Report
Sidewall Core Descriptions
Sidewall Core Analysis (2 files)
Directional Survey
Well Seismic Report
Biostratigraphy with Paleontology
Geochemistry (2 files)

Schlumberger Electric Logs

Depth Interval

I. Log Run 1	
Phasor Dual Induction/Array Sonic	880' - 3,033'
Compensated Neutron Litho Density	880' - 3,037'
Borehole Profile	860' - 3,037'
AMS Temperature Down Log	70' - 3,025'
II. Log Run 2	
Phasor Dual Induction/Array Sonic	2,918' - 9,471'
Compensated Neutron Litho Density	2,989' - 9,476'
Borehole Profile	2,994' - 9,455'
AMS Temperature	2,994' - 9,454'
Formation Microscanner (Dipmeter)	2,994' - 9,455'
Natural Gamma Ray Spectrometry	2,902' - 9,438'
Repeat Formation Tester (RFT)	3,443' - 9,334'
III. Log Run 3	
Phasor Dual Induction/Array Sonic	9,430' - 14,292'
Compensated Neutron Litho Density	9,400' - 14,290'
Borehole Profile	9,410' - 14,290'
Temperature Down Log	0' - 14,248'
Formation Microscanner (Dipmeter)	9,410' - 14,290'
Spontaneous Potential (SP) Log	9,455' - 12,300'
Repeat Formation Tester (RFT)	10,458' - 12,086'
V. Log Run 4	
Phasor Dual Induction/Array Sonic	13,880' - 15,944'
Borehole Compensated Sonic/Gamma Ray	14,235' - 16,793'

Compensated Neutron Litho Density	14,240' - 14,864'
Borehole Profile	14,185' - 16,423'
Temperature Log	10' - 16,424'
Formation Microscanner (Dipmeter)	14,190' - 16,424'
Multi Fingered Caliper	33' - 14,032'

VI. Log Run 5

Phasor Dual Induction/Array Sonic	15,880' - 18,315'
Compensated Neutron Litho Density	14,760' - 18,312'
SHDT Borehole Profile	15,839' - 17,750'
Temperature Log	15,847' - 18,172'
Formation Microscanner (Dipmeter)	15,839' - 17,750'

Other Logs

I. Teleco MWD (measurement while drilling)

Gamma Ray/Resistivity/Directional Data	916' - 16,757'
--	----------------

II. Baroid MWD

Compensated Neutron Porosity/ Electromagnetic Wave Resistivity/Gamma Ray	14,222' - 16,848'
---	-------------------

III. Baroid Mud Log

	276' - 18,325'
--	----------------

APPENDIX III: GEOTHERMAL DATA

I. Description of Fertl and Wichman's (1977) correction technique for static BHT's from well log data.

Using the correction technique suggested by Fertl and Wichman (1977), the maximum BHT's recorded by the well log tools during logging runs 1, 2, 3, and 5 are extrapolated to estimate true formation temperatures (static BHT's) by plotting a logarithmic regression of the measured BHT's as a function of the ratio

$$\frac{\Delta t}{t + \Delta t}$$

Where

Δt = time after mud circulation stopped, in hours
 t = mud circulation time, in hours

This straight line is extrapolated to $\Delta t \approx \infty$, or, a time ratio of

$$\frac{\Delta t}{t + \Delta t} = 1$$

which estimates the corrected static BHT. Figure 4.2, the regression for logging run 2, illustrates this extrapolation technique.

II. Temperature Log

<u>Depth (ft)</u>	<u>Temperature (°F)</u>
1,000	66
2,000	89
3,000	100
4,000	111
5,000	124
6,000	138
7,000	152
8,000	165
9,000	180
10,000	194
11,000	208
12,000	221
13,000	235
14,000	249
15,000	262
16,000	292
17,000	303
18,000	313

III. RFT Log, Runs 2 and 3

<u>Depth (ft)</u>	<u>Temperature (°F)</u>
3,444	75
3,802	75
4,097	80
4,338	80
4,768	85
5,137	125
6,035	125
6,397	125
6,474	125
6,739	140
6,811	140
7,142	145
7,372	150
8,032	145
8,499	150
8,826	155
9,334	160
10,459	160
10,766	165
10,969	170
11,042	170
11,287	170
11,931	174
12,086	174

IV. Well Log BHT's and Circulation Data

<u>Log Run</u>	<u>Log Type</u>	<u>Date Run</u>	<u>Δt(hrs)</u>	<u>t(hrs)</u>	<u>BHT(°F)</u>
1	DI/SFL	1/13/87	7.43	10.0	62
1	Array Sonic	11/13/87	17.43	10.0	62
1	CNLD	11/13/87	22.75	10.0	62
2	DI/SFL	12/06/87	14.93	15.5	158
2	Array Sonic	12/06/87	14.93	15.5	158
2	CNLD	12/08/87	58.82	19.0	160
2	4-Arm Caliper	12/09/87	68.33	19.0	161
3	DI/SFL	02/22/88	19.27	11.5	218
3	Array Sonic	02/22/88	19.27	11.5	218
3	CNLD	02/24/87	61.00	21.0	238
3	4-Arm Caliper	02/26/88	(unreliable data)		198
3	FMS	02/26/88	(unreliable data)		198
3	BP	02/26/88	(unreliable data)		198
3	SATA Checkshot	02/26/88	(unreliable data)		218
3	RFT	02/26/88	(unreliable data)		218
4	DI/SFL	05/18/88	(unreliable data)		257
4	Array Sonic	05/19/88	(unreliable data)		255
4	4-Arm Caliper	06/01/88	(unreliable data)		289
4	FMS	06/01/88	(unreliable data)		289
4	CNLD	06/06/88	(unreliable data)		260
4	WST	06/06/88	(unreliable data)		258
4	SATA Velocity	06/06/88	(unreliable data)		258
4	SATA Checkshot	06/08/88	(unreliable data)		260
4	BHC/GR	06/14/88	(unreliable data)		271
5	DI/SFL	08/16/88	25.00	39.0	321
5	Array Sonic	08/16/88	30.97	39.0	325
5	CNLD	08/18/88	(unreliable data)		320
5	4-Arm Caliper	08/18/88	(unreliable data)		325
5	BP	08/18/88	(unreliable data)		325
5	WST	08/19/88	(unreliable data)		322

* BHT's as measured by the logging tools, not corrected to true formation temperature.

As the Nation's principal conservation agency, the Department of the Interior has responsibility for most of our nationally owned public lands and natural resources. This includes fostering the wisest use of our land and water resources, protecting our fish and wildlife, preserving the environmental and cultural values of our national parks and historical places, and providing for the enjoyment of life through outdoor recreation. The Department assesses our energy and mineral resources and works to assure that their development is in the best interest of all our people. The Department also has a major responsibility for American Indian reservation communities and for people who live in Island Territories under U.S. Administration.



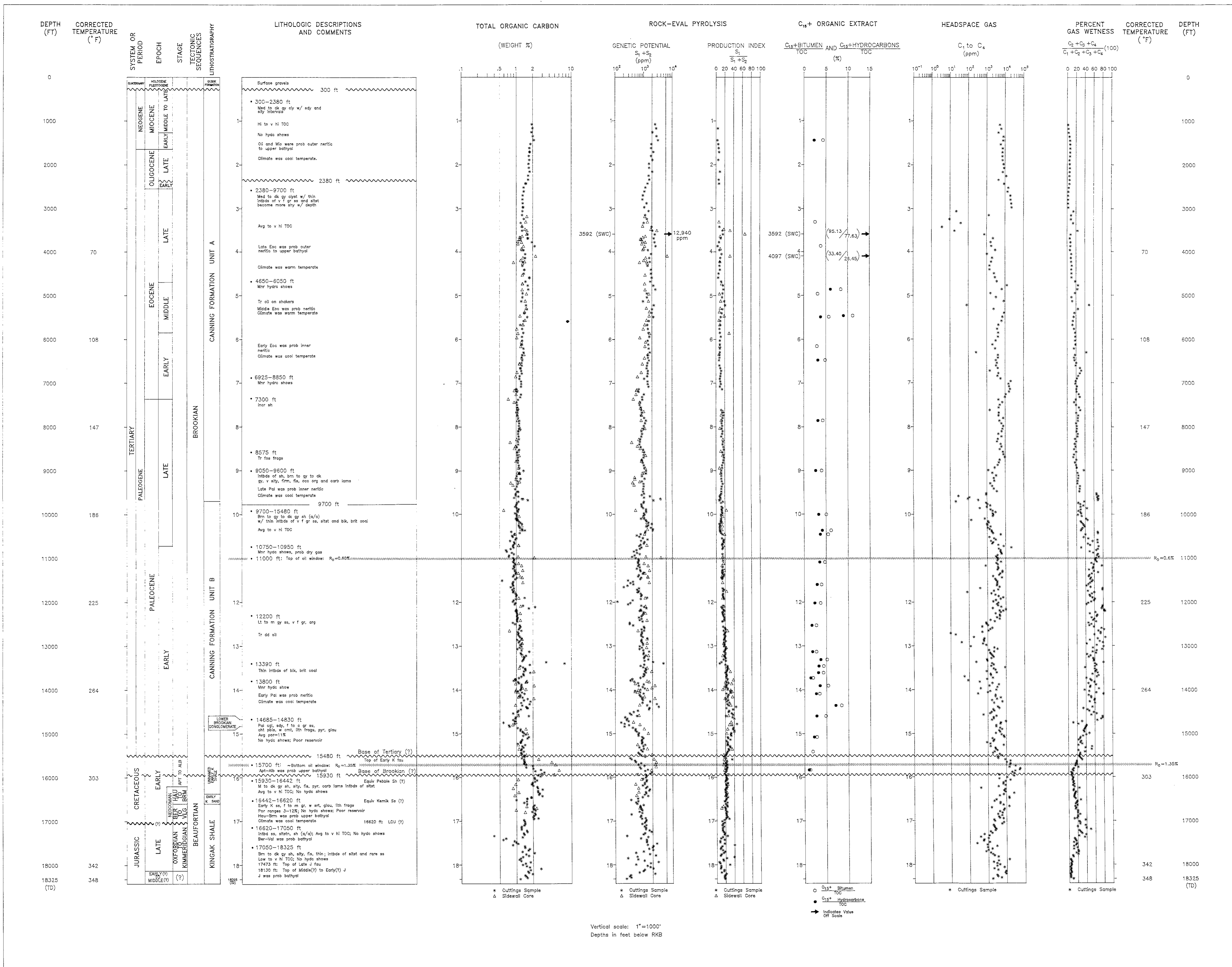

PLATE 1. VARIOUS PARAMETERS DEFINING THE ORGANIC RICHNESS AND HYDROCARBON SOURCE POTENTIAL, AURORA WELL, OCS Y-0943-1.