

**United States**  
**National Search and Rescue Supplement**  
to the  
**International Aeronautical and Maritime**  
**Search and Rescue Manual**



**National Search and Rescue Committee**  
**Washington DC**

May 2000

(This page intentionally left blank)

---

**United States National Search and Rescue Supplement  
to the  
International Aeronautical and Maritime Search and Rescue Manual  
Foreword**

**1. PURPOSE.**

This National Search and Rescue Supplement (NSS), prepared under the direction of the National Search and Rescue Committee (NSARC), provides guidance to federal agencies concerning implementation of the National Search and Rescue Plan (NSP). The NSS provides specific additional national standards and guidance that build upon the baseline established by the International Aeronautical and Maritime Search and Rescue (IAMSAR) Manual. The IAMSAR Manual is a three-volume set published jointly by both the International Civil Aviation Organization (ICAO) and the International Maritime Organization (IMO) for use by all countries. The NSS provides guidance to all federal forces, military and civilian, that support civil search and rescue (SAR) operations.

**2. BACKGROUND.**

- a. The NSP, included as Appendix A to this NSS, centers on three key concepts. First, the Plan implements provisions of relevant conventions, standards, and recommendations of ICAO, IMO and other international organizations. International law requires establishment of a national civil SAR system with internationally recognized aeronautical and maritime SAR coordination responsibilities. Secondly, the Plan includes provisions to satisfy national civil SAR requirements. Finally, since no single U.S. organization has sufficient SAR resources to provide adequate SAR services, the NSP establishes the principle that SAR authorities should use "all available" resources, including federal, state, local, private and volunteer resources, to respond to persons and property in distress.
- b. The objectives of the NSP, and of NSARC, are described in Appendix A. The Plan provides insight regarding principles upon which the SAR-related international conventions, the IAMSAR Manual, and this NSS were all based.
- c. The member agencies of NSARC are: the Department of Transportation, the Department of Defense, the Department of Commerce, the Federal Communications Commission, the National Aeronautics and Space Administration, and the Department of Interior.
- d. This NSS builds upon, as appropriate, the baseline established by the IAMSAR Manual. It is written for use in conjunction with the IAMSAR Manual.

**3. SCOPE.**

This NSS is designed to serve as both a training and operational tool for civil SAR operations.

- a. SAR planning is both an art and a science, relying greatly on the creativity and experience of the personnel involved. Because of the many variables encountered during SAR operations and the individuality of each SAR case, the guidance provided in this NSS must be tempered with sound judgement, having due regard for the individual situation. Nothing in this NSS should be construed as relieving SAR personnel of the need for initiative and sound judgement. Therefore, few actions or procedures discussed in this NSS are mandatory. Use of the words "must" or "shall" only distinguish those actions or procedures normally considered mandatory from those that are discretionary.
- b. Any federal agency that is signatory to the NSP may promulgate an "Addendum" to this NSS for their respective agency. Such documents would include information, policies, procedures, etc., on civil SAR matters applicable to the agency concerned, and consistent with provisions of the IAMSAR Manual and NSS. Similarly, the Civil Air Patrol and the Coast Guard Auxiliary are each authorized to develop an Addendum to the NSS.

---

## Record of Changes

Change Number	Date of Change	Date Entered	Entered By

---

# Table of Contents

**Title Page**

**Foreword**

**Table of Contents**

**Abbreviations and Acronyms**

**Glossary**

## **Chapter 1 Search and Rescue Service and Organization**

- 1.1 Search and Rescue Service
- 1.2 Search and Rescue System
- 1.3 National Search and Rescue Plan
- 1.4 National Search and Rescue Supplement
- 1.5 Addenda to the National Search and Rescue Supplement
- 1.6 Response to Search and Rescue Situations
- 1.7 Search and Rescue System Organization
- 1.8 Search and Rescue Regions and Sub-regions
- 1.9 Search and Rescue Plans
- 1.10 Elements of the Search and Rescue System
- 1.11 Search and Rescue Coordinator
- 1.12 Search and Rescue Mission Coordinator (SMC)
- 1.13 Rescue Coordination Center (RCC)
- 1.14 Rescue Sub-Center (RSC)
- 1.15 Alerting Post
- 1.16 Staging Base
- 1.17 On-scene Coordinator (OSC) and Aircraft Coordinator (ACO)
- 1.18 Search and Rescue Facilities
- 1.19 Liaison, Base, and Briefing Officers
- 1.20 Incident Command System (ICS)

## **Chapter 2 Agencies and Resources**

- 2.1 Domestic Agencies
- 2.2 Federal Agencies
- 2.3 State Agencies
- 2.4 County Agencies
- 2.5 Municipal Agencies
- 2.6 Law Enforcement Agencies
- 2.7 Commercial Agencies and Resources
- 2.8 Private Agencies and Resources
- 2.9 SAR Resources
- 2.10 Aeronautical Facilities
- 2.11 Maritime Facilities
- 2.12 Land Facilities
- 2.13 Primary Federal SAR Resources

## **Chapter 3 Communications**

- 3.1 General
- 3.2 Emergency Communications
- 3.3 Visual Signals
- 3.4 IFF Equipment
- 3.5 EPIRB and ELT

- 3.6 Sound Communications
- 3.7 Global Maritime Distress and Safety System
- 3.8 Communication Facilities
- 3.9 SAR Operations Communications
- 3.10 Mobile Facility Communications
- 3.11 SAR Operations Messages
- 3.12 Alerting Ships at Sea and En Route Aircraft

#### **Chapter 4 Search Planning and Operations**

- 4.1 General
- 4.2 FAA Emergency Phases
- 4.3 Communications Searches
- 4.4 Preliminary Communication Search
- 4.5 Extended Communication Search
- 4.6 Search Planning Methods
- 4.7 Airspace Control
- 4.8 Search Operations
- 4.9 Search Object
- 4.10 SAR Facilities Movement
- 4.11 Conclusion of SAR Operations

#### **Chapter 5 Land SAR Operations**

- 5.1 General
- 5.2 Terrain
- 5.3 Searches by Aircraft
- 5.4 Grid Searches
- 5.5 Land Probability of Detection
- 5.6 Weather Conditions
- 5.7 Aerial Sightings
- 5.8 Mountain Searches
- 5.9 Helicopter Operations in Mountainous Terrain
- 5.10 Contour Search Patterns
- 5.11 Air/Ground Coordination
- 5.12 Search Execution
- 5.13 Recording Search Coverage
- 5.14 Information Gathering
- 5.15 Wreckage Precautions
- 5.16 Lost Persons
- 5.17 Preplanning
- 5.18 Incident Command System (ICS)
- 5.19 Action Plans
- 5.20 Urban SAR

#### **Chapter 6 Rescue Planning and Operations**

- 6.1 General
- 6.2 Rescue Planning
- 6.3 Survivability Considerations
- 6.4 Environmental Considerations
- 6.5 Rescue Method
- 6.6 Selection of Rescue Facilities
- 6.7 Rescue Plan
- 6.8 Delivery Planning

- 6.9 Selection of a Safe Delivery Point
- 6.10 Rescues in Difficult Environments
- 6.11 Rescue Operations
- 6.12 Briefing and Debriefing of SAR Personnel
- 6.13 SAR Helicopter Escort
- 6.14 Coordinated Helicopter-Boat Rescue
- 6.15 Underwater Rescue
- 6.16 Cold Water Near-Drowning
- 6.17 Special Considerations
- 6.18 Debriefing of Survivors
- 6.19 Emergency Medical Services
- 6.20 EMS Personnel
- 6.21 Emergency Care
- 6.22 SAR Facility Procedures
- 6.23 Survivor Evacuation and Transport
- 6.24 Evacuation From Marine Craft
- 6.25 Evacuation From Land Areas
- 6.26 Survivor Delivery
- 6.27 Fixed Medical Facilities

## **Chapter 7 Legal Aspects**

- 7.1 Relevance of Law to SAR Managers
- 7.2 General Background
- 7.3 Domestic Legislation and National SAR Plans
- 7.4 International Law
- 7.5 Charging for SAR Services
- 7.6 Liability
- 7.7 Assistance by Commercial Ships
- 7.8 Post-SAR Handling of Deceased persons and Alien Survivors
- 7.9 International SAR Agreements

## **Appendices**

- A National Search and Rescue Plan - 1999
- B SAR Treaties and International Instruments
- C Temporary Flight Restrictions
- D Emergency Assistance to Aircraft Other Than Search and Rescue
- E Gridding
- F SAR References and Web Sites
- G Tables and Graphs
- H Coordinated Search Patterns

## **U.S. Search and Rescue Regions**

### **Index**

This page intentionally blank



## Abbreviations and Acronyms

*Note: Entry in bold font is from the IAMSAR Manual*

<b>A</b>	<b>search area</b>	<b>B</b>	cross-over barrier pattern
<b>A/C</b>	<b>aircraft</b>	<b>BC</b>	bottom current
<b>ACC</b>	<b>area control center</b>	<b>C</b>	<b>coverage factor</b>
<b>ACO</b>	<b>aircraft coordinator</b>	<b>C</b>	creeping line pattern
<b>ACP</b>	Allied Communications Publication	<b>CAP</b>	Civil Air Patrol
<b>ACV</b>	air cushion vehicle	<b>CASP</b>	Computer-Assisted Search Planning
<b>ADF</b>	automatic direction finding	<b>CASPER</b>	Contact Area Summary Position Report
<b>AE</b>	assistance entry	<b>CC</b>	command center
<b>AES</b>	<b>aeronautical earth station</b>	<b>C/C</b>	<b>cabin cruiser</b>
<b>AFB</b>	air force base	<b>CCIR</b>	International Radio Consultative Committee
<b>AFN</b>	<b>aeronautical fixed network</b>	<b>CES</b>	<b>coast earth station</b>
<b>AFRCC</b>	Air Force Rescue Coordination Center	<b>CF</b>	drift error confidence factor
<b>AFS</b>	aeronautical fixed service	<b>CGAS</b>	Coast Guard Air Station
<b>AFTN</b>	<b>aeronautical fixed telecommunications network</b>	<b>CGAUX</b>	Coast Guard Auxiliary
<b>AIM</b>	Airman's Information Manual	<b>CHOP</b>	Change Operational Control
<b>AIP</b>	<b>Aeronautical Information Publication</b>	<b>CHRIS</b>	Chemical Hazard Response Information System
<b>AIS</b>	<b>aeronautical information services</b>	<b>CIC</b>	combat information center
<b>AIS</b>	automatic identification system	<b>CIRM</b>	<b>Centro Internazionale Radio- Medico</b>
<b>ALNOT</b>	alert notice	<b>CMSS</b>	commercial mobile satellite services
<b>AM</b>	<b>amplitude modulation</b>	<b>COMCEN</b>	communications center
<b>AMS</b>	<b>aeronautical mobile service</b>	<b>Cospas</b>	<b>Cosmicheskaya Sistyema Poiska Avarynykh Sudov (Russian language for "Space System for Search of Vessels in Distress")</b>
<b>AMS(R)S</b>	<b>aeronautical mobile satellite (route) service</b>	<b>COTP</b>	captain of the port
<b>AMSS</b>	<b>aeronautical mobile satellite service</b>	<b>CPA</b>	closest point of approach
<b>Amver</b>	<b>Automated Mutual-assistance Vessel Rescue</b>	<b>CPR</b>	cardiopulmonary resuscitation
<b>ANC</b>	<b>Air Navigation Commission</b>	<b>CRS</b>	<b>coast radio station</b>
<b>ARC</b>	American (National) Red Cross	<b>C/S</b>	<b>call sign</b>
<b>ARCC</b>	<b>aeronautical rescue coordination center</b>	<b>CS</b>	<b>creeping line single-unit</b>
<b>ARSC</b>	<b>aeronautical rescue sub-center</b>	<b>CSC</b>	<b>creeping line single-unit coordinated</b>
<b>ARINC</b>	Aeronautical Radio Incorporated	<b>CSP</b>	<b>commence search point</b>
<b>ARTCC</b>	air route traffic control center	<b>CW</b>	<b>continuous wave</b>
<b>ARTSIII</b>	Automated Radar Tracking System	<b>D</b>	<b>total drift</b>
<b>ASCC</b>	Air Standardization Coordinating Committee	<b>d</b>	surface drift
<b>ASW</b>	anti-submarine warfare	<b>D<sub>a</sub></b>	aeronautical drift
<b>ASW</b>	average surface wind	<b>DAN</b>	Diver's Alert Network
<b>ATC</b>	<b>air traffic control</b>	<b>DD</b>	Navy destroyer
<b>ATCC</b>	air traffic control center	<b>D<sub>e</sub></b>	<b>total drift error</b>
<b>ATN</b>	<b>aeronautical telecommunications network</b>	<b>de</b>	individual drift error
<b>ATS</b>	<b>air traffic service</b>	<b>dea</b>	aerospace drift error
<b>AUSREP</b>	Australian ship reporting system	<b>DF</b>	<b>direction finding</b>
<b>AWACS</b>	airborne warning and control system		

<b>DMB</b>	<b>datum marker buoy</b>	FOV	field of view
<b>DME</b>	<b>distance measuring equipment</b>	FS	flare single-unit
DMS	defense message system	<b>f<sub>s</sub></b>	<b>optimal search factor</b>
DOC	Department of Commerce	FSS	flight service station
DOD	Department of Defense	Fv	aircraft speed correction factor
DOI	Department of Interior	<b>F/V</b>	<b>fishing vessel</b>
DOT	Department of Transportation	<b>f<sub>w</sub></b>	<b>weather correction factor</b>
dp	parachute drift	<b>f<sub>z</sub></b>	<b>effort factor</b>
<b>DR</b>	<b>dead reckoning</b>		
DR	disaster response	GCI	ground control intercept
DRe	dead reckoning error	GEOREF	geographic reference
<b>DRU</b>	<b>desert rescue unit</b>	<b>GES</b>	<b>ground earth station</b>
<b>DSC</b>	<b>digital selective calling</b>	<b>GHz</b>	<b>gigahertz</b>
DSN	defense switched network	<b>GLONASS</b>	<b>Global Orbiting Navigation Satellite System</b>
DTG	date-time group		
		<b>GMDSS</b>	<b>Global Maritime Distress and Safety System</b>
<b>E</b>	<b>total probable error of position</b>	<b>GNSS</b>	<b>global navigation satellite system</b>
E-ARTS	En Route Automated Radar Tracking System	<b>GPS</b>	<b>global positioning system</b>
ECM	electronic countermeasures	<b>GS</b>	<b>ground speed</b>
<b>EGC</b>	<b>enhanced group calling</b>	<b>gt</b>	<b>gross tons</b>
ELINT	electronic intelligence		
<b>ELR</b>	<b>extra-long-range aircraft</b>	H	homing pattern
<b>ELT</b>	<b>emergency locator transmitter</b>	<b>HEL-H</b>	<b>heavy helicopter</b>
EMS	emergency medical services	<b>HEL-L</b>	<b>light helicopter</b>
EMT	emergency medical technician	<b>HEL-M</b>	<b>medium helicopter</b>
<b>ENID</b>	<b>enhanced identity</b>	<b>HF</b>	<b>high frequency</b>
<b>EPIRB</b>	<b>emergency position-indicating radio beacon</b>	HFDF	high frequency direction-finding
		<b>HQ</b>	<b>headquarters</b>
<b>ETA</b>	<b>estimated time of arrival</b>	HS	homing single-unit
<b>ETD</b>	<b>estimated time of departure</b>		
ETI	estimated time of intercept	IADB	Inter-American Defense Board
EXCOM	extended communication search	IAMSAR	International Aeronautical and Maritime Search and Rescue
		<b>I/B</b>	<b>inboard</b>
F	flare patterns	IC	Incident Commander
FACSFAC	Fleet Area Control and Surveillance Facility	<b>ICAO</b>	<b>International Civil Aviation Organization</b>
FAA	Federal Aviation Administration	<b>ICS</b>	<b>incident command system</b>
FAR	federal aviation regulation	IFF	identification, friend or foe
FBI	Federal Bureau of Investigation	<b>IFR</b>	<b>instrument flight rules</b>
FCC	Federal Communications Commission	<b>ILS</b>	<b>instrument landing system</b>
FEMA	Federal Emergency Management Agency	<b>IMC</b>	<b>instrument meteorological conditions</b>
FF	Navy fast frigate	<b>IMO</b>	<b>International Maritime Organization</b>
<b>FIC</b>	<b>flight information center</b>	IMSO	International Mobile Satellite Organization
<b>FIR</b>	<b>flight information region</b>	<b>Inmarsat</b>	<b>International Mobile Satellite Organization</b>
FIS	flight information Service	INREQ	information request
FIXe	navigational fix error	<b>INS</b>	<b>inertial navigation system</b>
<b>FLAR</b>	<b>forward-looking airborne radar</b>	INS	Immigration and Naturalization Service
FLIP	flight information publication	<b>INTERCO</b>	<b>International Code of Signals</b>
<b>FLIR</b>	<b>forward-looking infrared</b>	<b>IP</b>	<b>initial position</b>
FM	flare multiunit		
<b>FM</b>	<b>frequency modulation</b>		
FNOC	Fleet Numerical Oceanographic Command		

IRC	International Red Cross	MTTSI	<b>minimum time to scene intercept</b>
ITU	<b>International Telecommunication Union</b>	M/V	<b>merchant vessel</b>
JANAP	Joint Army Navy Allied Publication	<b>n</b>	<b>number of required track spacings</b>
JASREP	Japanese ship reporting system	<b>N</b>	<b>number of SAR facilities</b>
JRCC	<b>joint (aeronautical and maritime) rescue coordination center</b>	NAS	Naval Air Station
JRSC	<b>joint rescue sub-center</b>	NASA	National Aeronautics and Space Administration
<b>kHz</b>	<b>kilohertz</b>	NASAR	National Association for Search and Rescue
<b>km</b>	<b>kilometers</b>	NAS Computer	National Airspace System Computer
<b>kt</b>	<b>knot (nautical miles per hour)</b>	NATO	North Atlantic Treaty Organization
<b>l</b>	<b>search sub-area length</b>	NAVSAT	navigation satellite
<b>L</b>	<b>length</b>	<b>NBDP</b>	<b>narrow band direct printing</b>
LC	lake current	NCIC	National Crime Information Center
<b>LCB</b>	<b>line of constant bearing</b>	NIUSR	National Institute for Urban Search and Rescue
<b>LES</b>	<b>land earth station</b>	<b>NM</b>	<b>nautical mile</b>
<b>LKP</b>	<b>last known position</b>	NOAA	National Oceanic and Atmospheric Administration
<b>LOP</b>	<b>line of position</b>	<b>NOTAM</b>	notice to airmen
<b>Loran</b>	<b>long-range aid to navigation</b>	NPS	National Park Service
<b>LRG</b>	<b>long-range aircraft</b>	NSARC	National Search and Rescue Committee
<b>LSB</b>	<b>lower side band</b>	NSP	National Search and Rescue Plan
<b>LUT</b>	<b>local user terminal</b>	NSS	National Search and Rescue Supplement
<b>LW</b>	<b>leeway</b>	NTAP	National Track Analysis Program
<b>m</b>	<b>meters</b>	NTSB	National Transportation Safety Board
MARAD	Maritime Administration; USMER vessels tracked by Amver	<b>NVG</b>	<b>night vision goggles</b>
MAROP	marine operators	NWS	National Weather Service
MARSA	Military Assumes Responsibility for Separation of Aircraft	<b>O</b>	contour pattern
MAST	Military Assistance to Safety and Traffic	<b>O/B</b>	<b>outboard</b>
<b>MCC</b>	<b>mission control center</b>	OCA	oceanic control area
<b>MCW</b>	<b>modulated carrier wave</b>	OCMI	Officer in Charge, Marine Inspection
M-DARC	Military Direct Access Radar Channel	ODIN	Operational Digital Network
<b>MEDEVAC</b>	<b>medical evacuation</b>	OM	contour multiunit
<b>MEDICO</b>	<b>medical advice, usually by radio</b>	OPCEN	Coast Guard Operations Center (Group or Activity)
<b>MF</b>	<b>medium frequency</b>	<b>O/S</b>	<b>on-scene</b>
<b>MHz</b>	<b>megahertz</b>	<b>OS</b>	<b>contour single-unit</b>
<b>MMSI</b>	maritime mobile service identity	<b>OSC</b>	<b>on-scene coordinator</b>
MOA	military operating area	OSC	Coast Guard Operations Systems Center
MPA	maritime patrol aircraft	OSE	on-scene endurance
<b>MRCC</b>	<b>maritime rescue coordination center</b>	<b>OSV</b>	<b>offshore supply vessel</b>
<b>MRG</b>	<b>medium-range aircraft</b>	P	parallel pattern
<b>MRSC</b>	<b>maritime rescue sub-center</b>	PANS	Procedures for Air Navigation Services
<b>MRU</b>	<b>mountain rescue unit</b>	PB	patrol boat
<b>MSI</b>	<b>maritime safety information</b>		
MSIS	Marine Safety Information System		
MSO	Marine Safety Office		
MSS	mobile satellite services		

<b>P/C</b>	<b>pleasure craft</b>	<b>SITOR</b>	simplex telex over radio
Pd	drift compensated parallelogram pattern	<b>SITREP</b>	<b>situation report</b>
PFD	personal flotation device	SL	sea level
<b>PIW</b>	<b>person in water</b>	SLAR	side-looking airborne radar
<b>PLB</b>	<b>personal locator beacon</b>	SM	Searchmaster (Canadian term)
PM	parallel track multiunit	<b>SMC</b>	<b>SAR mission coordinator</b>
PMC	parallel multiunit circle	SMIO	SAR mission information officer
PMN	parallel track multiunit non-return	<b>SOA</b>	<b>speed of advance</b>
PMR	parallel track multiunit return	SOFAR	Sound Fixing and Ranging
<b>POB</b>	<b>persons on board</b>	<b>SOLAS</b>	<b>Safety of Life at Sea</b>
<b>POC</b>	<b>probability of containment</b>	<b>SPOC</b>	<b>search and rescue point of contact</b>
<b>POD</b>	<b>probability of detection</b>	<b>SRG</b>	<b>short-range aircraft</b>
<b>POS</b>	<b>probability of success</b>	<b>SRR</b>	<b>search and rescue region</b>
<b>POS<sub>c</sub></b>	<b>cumulative probability of success</b>	<b>SRS</b>	<b>search and rescue sub-region</b>
PR	personnel recovery	<b>SRU</b>	<b>search and rescue unit</b>
PRECOM	preliminary communication search	<b>SS</b>	<b>expanding square search</b>
<b>PRU</b>	<b>parachute rescue unit</b>	SS	submarine
<b>PS</b>	<b>parallel track single-unit</b>	<b>S/S</b>	<b>steam ship</b>
PSL	parallel track single-unit Loran	<b>SSB</b>	<b>single side band</b>
PSS	parallel single-unit spiral	ST	strike team
<b>R</b>	<b>search radius</b>	<b>SU</b>	<b>search unit</b>
<b>R&amp;D</b>	<b>research and development</b>	SUC	surf current
RADF	radarfind	<b>SURPIC</b>	<b>surface picture</b>
RATT	radio teletype	<b>S/V</b>	<b>sailing vessel</b>
<b>RANP</b>	<b>regional air navigation plan</b>	SVR	surface vessel radar
<b>RB</b>	<b>rescue boat</b>	SWC	swell/wave current
<b>RC</b>	<b>river current</b>	<b>T</b>	<b>search time available</b>
<b>RCC</b>	<b>rescue coordination center</b>	<b>T</b>	<b>true course</b>
RDF	radio direction finder	T	trackline pattern
<b>RF</b>	<b>radio frequency</b>	TACAN	Tactical Air Navigation
RNAV	Area Navigation (ICAO term)	<b>TAS</b>	<b>true air speed</b>
Ro	search radius rounded to next highest whole number	<b>TC</b>	<b>tidal current</b>
<b>RSC</b>	<b>rescue sub-center</b>	<b>TCA</b>	<b>time of closest approach</b>
<b>R/T</b>	<b>radio telephony</b>	TCA	terminal control area
<b>RTG</b>	<b>radio telegraphy</b>	<b>TELEX</b>	<b>teletype</b>
<b>RTT</b>	<b>radio teletype</b>	<b>TFR</b>	<b>temporary flight restriction</b>
<b>RV</b>	<b>rescue vessel</b>	<b>TLX</b>	<b>teletype</b>
S	square pattern	TMN	trackline multiunit non-return
<b>S</b>	<b>track spacing</b>	TMR	trackline multiunit return
<b>SAR</b>	<b>search and rescue</b>	TPL	telephone Private Lines
SARMIS	Search and Rescue Management Information System	TPX-42(DAIR)	TPX-42 Direct (Altitude and Identity Readout)
<b>Sarsat</b>	<b>Search and Rescue Satellite-Aided Tracking</b>	TRACON	Terminal Radar Approach Control Facility
<b>SART</b>	<b>search and rescue transponder</b>	<b>TSN</b>	<b>trackline single-unit non-return</b>
SARTEL	SAR telephone (Private Hotline)	<b>TSR</b>	<b>trackline single-unit return</b>
SATCOM	satellite communications	<b>T/V</b>	<b>tank vessel</b>
<b>SC</b>	<b>SAR coordinator</b>	<b>TWC</b>	<b>total water current</b>
<b>SC</b>	<b>sea current</b>	<b>U</b>	<b>wind speed</b>
<b>SDP</b>	<b>SAR data provider</b>	<b>UHF</b>	<b>ultra high frequency</b>
SEAL	Navy Sea-Air-Land Unit	<b>UIR</b>	<b>upper flight information region</b>
<b>SES</b>	<b>ship earth station</b>	<b>ULR</b>	<b>ultra long-range aircraft</b>

UMIB	urgent marine information broadcast	VORTAC	VHF Omnidirectional Range Station/Tactical Air Navigation
USA	United States Army	VS	sector single-unit
USAF	United States Air Force	VSR	sector single-unit radar
USAR	<b>urban search and rescue</b> (may also be written as US&R)	w	<b>search sub-area width</b>
USB	<b>upper side band</b>	W	<b>sweep width</b>
USC	United States Code	WC	<b>wind current</b>
USCG	United States Coast Guard	WHEC	Coast Guard High-Endurance cutter
USMER	U.S. Merchant Ship Vessel Locator Reporting System	WHO	World Health Organization
USN	United States Navy	WMEC	Coast Guard Medium-Endurance cutter
UTC	<b>coordinated universal time</b>	WMO	<b>World Meteorological Organization</b>
UTM	<b>universal transverse mercator grid</b>	WPB	Coast Guard patrol boat
v	<b>speed of search object</b>	WT	<b>radio telegraph</b>
V	<b>SAR facility ground speed</b>	W <sub>U</sub>	<b>uncorrected sweep width</b>
V	sector pattern	WWNWS	World Wide Navigation Warning System
VARVAL	Vessel Arrival Data, List of vessels available to MSOs and COTPs.	X	<b>initial (distressed craft) position error</b>
VDSB	visual distress signaling device	XCVR	transceiver
VFR	<b>visual flight rules</b>	XSB	barrier single unit
VHF	<b>very high frequency</b>	Y	<b>SAR facility position error</b>
VLR	<b>very-long-range aircraft</b>	Z	<b>effort</b>
VMC	<b>visual meteorological conditions</b>	Z <sub>t</sub>	<b>total available effort</b>
VOR	<b>Very High Frequency omnidirectional radio range</b>		

This page intentionally blank

---

## Glossary

*Notes: (1) Entry in bold font is from the IAMSAR Manual  
(2) Terms specific to Cospas-Sarsat will have “(Cospas-Sarsat)” after the term*

active site (Cospas-Sarsat): A site for which satellite data is still being collected.

advanced SAR staging base: A suitable preselected location with the SMC near possible SAR incidents for staging SRUs, and supporting personnel.

advisory area: A designated area within a flight information region where air traffic advisory service is available.

aerodrome: A defined area on land or water (including any buildings, installations and equipment) intended to be used either wholly or in part for the arrival, departure and surface movement of aircraft. Airport.

aeronautical fixed service (AFS): A telecommunication service between specified fixed points provided primarily for the safety of air navigation and for the regular, efficient and economical operation of air services.

**aeronautical drift ( $D_a$ ): Drift caused by bailout trajectory or aircraft gliding distance.**

**aeronautical position: Initial position of a distressed aircraft at the time of re-entry, engine failure, aircrew ejection or bailout.**

airborne warning and control system (AWACS): USAF Boeing E-3 airborne radar system. Records primary and secondary radar targets. System capabilities classified. Recorded data is retained for a period not exceeding 10 days by the 552nd AWAC Wing (TAC), Tinker AFB, Oklahoma.

**aircraft coordinator (ACO): A person who coordinates the involvement of multiple aircraft in SAR operations.**

**aircraft glide: Maximum ground distance an aircraft could cover during descent.**

air route traffic control center (ARTCC): An FAA facility providing air traffic control service principally during en route flight to aircraft operating on IFR flight plans within controlled airspace.

air traffic control (ATC): A service operated by an appropriate authority to promote the safe, orderly, and expeditious flow of air traffic.

alert: Report of an apparent distress routed to the search and rescue system.

alert notice (ALNOT): A message sent by an FSS or an ARTCC that requests an extensive communications search for overdue, unreported, or missing aircraft. This is an FAA term.

**Alert Phase: A situation wherein *apprehension* exists as to the safety of an aircraft or marine vessel, and of the persons on board.**

**alerting post: Any facility intended to serve as an intermediary between a person reporting an emergency and a rescue coordination center or rescue sub-center.**

ambiguity resolution (Cospas-Sarsat): The process of determining which of the available computed Doppler positions and/or encoded positions for a transmitting beacon is the resolved (confirmed or composite) position.

**area control center: An air traffic control facility primarily responsible for providing ATC services to IFR aircraft in controlled areas under its jurisdiction. (An ICAO term, the U. S. Equivalent is ARTCC.)**

assistance entry (AE): Entry of search and rescue facilities into or over foreign territorial seas to assist persons in distress.

assistant RCC controller: A person assigned to assist an RCC controller.

Automated Mutual-assistance Vessel Rescue System (Amver): A worldwide vessel-reporting system for SAR, operated by the Coast Guard for maintaining estimated position and other data of merchant vessels that voluntarily participate.

Automated Radar Tracking System (ARTSIII/IIIa): FAA terminal ATC radar tracking system, usually associated with a single radar sensor or antenna with a 60 nautical mile range. Some ARTSIIIa computers located at major metropolitan area record from multiple radar sensors. ARTSIII records secondary radar targets only. ARTSIIIa records both primary and secondary radar data. Data is retained for 15 days.

**awareness range: Distance at which a search scanner can first detect something different from its surroundings but not yet recognize it.**

**awareness stage: A period during which the SAR system becomes aware of an actual or potential incident.**

beacon: Device operating on 121.5, 243, or 406 MHz intended solely for distress signaling.

beacon alarm: Alert determined to result from a beacon signal.

beacon ID (Cospas-Sarsat): The 15 hexadecimal characters that uniquely identify each 406 MHz beacon. The beacon identification (ID) comprises bits 26 to 85 of the 406 MHz beacon message. For location protocols, the position data in bits 26 to 85 are set to specified default values and the position provided in the alert message.

beacon protocol: The type of information that may be digitally encoded in a 406 MHz beacon. User protocols allow the identification (i.e., ship station identifier, radio call sign, aircraft registration marking or a serial number) to be encoded. Location protocols allow a position (derived internally or externally to the beacon) as well as identification (i.e., those listed above as well as MMSI, aircraft 24-bit address, aircraft operator designator, or serial number) to be encoded.

boats: Coast Guard marine SRUs under 65 feet in length.

buffer zone (Cospas-Sarsat): Area of defined width overlapping adjacent search and rescue regions for which alerts will be provided to the Rescue Coordination Centers responsible of both regions.

**captain: Master of a ship or pilot-in-command of an aircraft, commanding officer of a warship, or an operator of any other vessel.**

Captain of the Port (COTP): Operational Coast Guard command that monitors vessel entries, exits and inspections within their area of control.

**checksum digit: A digit which is appended to a numeric data element and used to verify its accuracy. Checksum digits are computed by adding the digits of the data element.**

closed site (Cospas-Sarsat): A site that is no longer considered active based on a set of pre-defined criteria (e.g., time from last detection or number of satellite passes that have passed over a position but have not detected a signal.)

**coast earth station (CES): Maritime name for an Inmarsat shore-based station linking ship earth stations with terrestrial communications networks.**

combatant command: A command with a broad continuing mission under a single commander and composed of significant assigned components of two or more Services.



command center (CC): Multi-mission center that may perform the function of a rescue coordination center in addition to having staff and capabilities to perform other functions.

**commence search point (CSP): Point normally specified by the SMC where a SAR facility is to begin its search pattern.**

composite position (Cospas-Sarsat): Position generated by the USMCC by combining data from two or more satellite passes over a beacon. Any ambiguity from previous satellite passes is resolved and solutions from different satellite passes merged to refine the position of the beacon.

Computer-Assisted Search Planning (CASP): A computer search planning system uses simulation techniques to produce multiple datum points that are displayed as a map of all possible locations.

**conclusion stage: A period during a SAR incident when SAR facilities return to their regular location and prepare for another mission.**

confidence factor (CF): Value, normally 0.3, applied to account for errors in assumed initial distress position, sea current, wind current, and leeway. Used to determine drift error ( $d_c$ ).

continuous data recording (CDR): Data extraction terminology associated with FAA ARTSIII/IIIA and E-ARTS tracking systems.

**coordinated search pattern: Multiunit pattern using vessel(s) and aircraft.**

**coordinated universal time (UTC): International term for time at the prime meridian.**

core frequency (Cospas-Sarsat): Estimate of the primary frequency of a signal detected by Cospas-Sarsat.

coriolis force: The effect of earth rotation upon wind-driven currents.

**Cospas-Sarsat system: A satellite system designed to detect distress beacons transmitting on the frequencies 121.5 MHz and 406 MHz.**

country of registration (Cospas-Sarsat): Country identified in coding of a 406 MHz beacon, and from where registration data can be obtained.

**course: The intended horizontal direction of travel of a craft.**

**coverage factor (C): The ratio of the search effort (Z) to the area searched (A).  $C = Z/A$ . For parallel sweep searches, it may be computed as the ratio of sweep width (W) to track spacing (S).  $C = W/S$**

**craft: Any air or sea-surface vehicle, or submersible of any kind or size.**

**cumulative probability of success ( $POS_C$ ): The accumulated probability of finding the search object with all the search effort expended over all searches to date.  $POS_C$  is the sum of all individual search POS values.**

**cumulative relative effort ( $Z_{rc}$ ): The sum of all previous relative efforts plus the relative effort for the next planned search effort. This value determines the optimal search factor.  $Z_{rc} = Z_{r-1} + Z_{r-2} + Z_{r-3} + \dots + Z_{r-next\ search}$**

**datum: A geographic point, line, or area used as a reference in search planning.**

**datum area: Area in where it is estimated that the search object is most likely to be located.**

**datum line: A line, such as the distressed craft's intended track line or a line of bearing, which defines the center of the area where it is estimated that the search object is most likely to be located.**

**datum marker buoy (DMB):** Droppable floating beacon used to determine actual total water current, or to serve as a location reference.

**datum point:** A point, such as a reported or estimated position, at the center of the area where it is estimated that the search object is most likely to be located.

**dead reckoning (DR):** Determination of position of a craft by adding to the last fix the craft's course and speed for a given time.

**digital selective calling (DSC):** A technique using digital codes which enables a radio station to establish contact with, and transfer information to, another station or group of stations.

**direction of current:** Direction *toward* which a current is flowing. See set.

**direction of waves, swells, or seas:** Direction *from* which the waves, swells, or seas are moving.

**direction of wind:** Direction *from* which the wind is blowing.

disabled: Term describing a surface craft that has lost propulsion or steering and needs assistance.

distress alarm: Alarm confirmed to be for an actual distress situation.

distress alarm rate: Ratio of distress alarms to beacon alarms.

distress incident: Situation in which life, limb or property is imperiled.

**distress alerting:** The reporting of a distress incident to a unit which can provide or coordinate assistance.

**Distress Phase:** A situation wherein there is reasonable certainty that a vessel or other craft, including an aircraft or a person, is threatened by grave and imminent danger and requires immediate assistance.

**ditching:** The forced landing of an aircraft on water.

Douglas Sea State: A wave height scale, similar to WMO code 75 and Beaufort Scale, used in determining radar detection capabilities under certain sea conditions.

**drift:** The movement of a search object caused by environmental factors.

drift compensation: A correction used to account for search object motion during a search.

**drift error ( $D_e$ ):** See Total Probable Drift Error.

**effort factor ( $f_z$ ):** For point and leeway divergence datums, the effort factor is the square of the total probable error of position (E).  $f_{zp} = E^2$  For line datums, the effort factor is the product of the total probable error of position (E) and the length of the line (L).  $f_l = E \times L$

elemental solution (Cospas-Sarsat): Single satellite pass solution used to determine a composite position.

**emergency locator transmitter (ELT):** Aeronautical radio distress beacon for alerting and transmitting homing signals.

**emergency phase:** A generic term meaning, as the case may be, uncertainty phase, alert phase, or distress phase.

**emergency position-indicating radio beacon (EPIRB):** A device, usually carried aboard maritime craft, that transmits a signal that alerts search and rescue authorities and enables rescue units to locate the scene of the distress.

encoded position data (Cospas-Sarsat): Latitude and longitude data derived from an associated navigation device which are encoded in the 406 MHz beacon message.

En Route Automated Radar Tracking System (E-ARTS): ARTCC tracking computer similar to the terminal ARTSIII systems. E-ARTS facilities are located at San Juan, PR, Anchorage, AK, and Honolulu, HI. Records primary and secondary radar data from multiple radar sensors or antennas. Recorded data is retained for 15 days.

ephemeris data: Information from which the location of a Cospas-Sarsat satellite relative to the earth may be determined for any time within a specified time interval.

extended communication search (EXCOM): Comprehensive communications search to find information or clues about the location of missing persons. Normally conducted after a PRECOM has yielded no results, or when the mission is upgraded to the Alert phase.

**false alert: Distress alert received from any source, including communications equipment intended for alerting, when no distress situation actually exists, and a notification of distress should not have resulted.**

**fetch: The distance over which the wind blows in a constant direction, without obstruction.**

first alert (Cospas-Sarsat): First detection of a beacon by the Cospas-Sarsat System, position information may or may not be available.

**First RCC: RCC affiliated with the shore station that first acknowledges a distress alert, and which should assume responsibility for all subsequent SAR coordination unless and until responsibility is accepted by another RCC better able to take action.**

**fix: A geographical position determined by visual reference to the surface, referencing to one or more radio navigation aids, celestial plotting, or other navigation device.**

Fleet Area Control and Surveillance Facility (FACSFAC): U.S. Navy computerized radar tracking facilities located along coastlines of the continental U.S. and Hawaii. Record primary and secondary data from coastline out to sea. Recorded data is retained for 15 days.

**flight information center (FIC): A unit established to provide flight information and alerting services.**

flight information region (FIR): An airspace of defined dimensions within which flight information service and alerting service are provided.

flight information service (FIS): A service provided for the purpose of giving advice and information useful for the safe and efficient conduct of flights.

flight service station (FSS): An air traffic facility that provides en route communications and VFR SAR services, assists lost aircraft and aircraft in emergency situations, and originates Notices to Airmen.

**forward-looking airborne radar (FLAR): Any aircraft-mounted radar designed to detect search objects on or near the ocean surface by scanning a sector typically centered in the direction of aircraft heading. FLAR may also perform weather-avoidance/navigation in support of aircraft operations.**

**forward-looking infrared (FLIR): An imaging system, mounted on board surface vessels or aircraft, designed to detect thermal energy (heat) emitted by search objects and convert it into a visual display.**

**general communications: Operational and public correspondence traffic other than distress, urgency and safety messages, transmitted or received by radio.**

**Global Maritime Distress and Safety System (GMDSS): A global communications service based on automated**

**systems, both satellite-based and terrestrial, to provide distress alerting and promulgation of maritime safety information for mariners.**

**Global Positioning System (GPS): A specific satellite-based system used in conjunction with mobile equipment to determine the precise position of the mobile equipment.**

**Global Navigation Satellite System (GNSS): Worldwide position and time determination system that includes one or more satellite constellations and receivers.**

great circle: Line between two points on a gnomonic projection chart.

**grid: Any set of intersecting perpendicular lines spaced at regular intervals.**

**grid cell: A square or rectangular area formed by pairs of adjacent, perpendicular, grid lines.**

**ground speed (GS): The speed an aircraft is making relative to the earth's surface.**

ground track: See Satellite Ground Track.

**heading: The horizontal direction in which a craft is pointed.**

hoax: Alert determined to result from any distress signal intended for deceptive purposes.

**hypothermia: Abnormal lowering of internal body temperature (heat loss) from exposure to cold air, wind, or water.**

IFF: Outdated recognized term, "Identification, Friend or Foe," for radar interrogation of aircraft.

image (mirror image) (Cospas-Sarsat): Of the two positions associated with a single satellite pass, the one from which a signal is not emanating.

inadvertent alarm (Cospas-Sarsat): Unintentional beacon alert determined to result from an improperly conducted beacon test or accidental beacon activation.

inadvertent alarm rate (Cospas-Sarsat): Ratio of inadvertent alerts to beacon alarms.

incident command system (ICS): An all-risk on-scene system of coordination for any type of incident involving multiple responding authorities and multiple jurisdictions.

**indicated air speed (IAS): The aircraft speed shown on the air speed indicator gauge. IAS corrected for instrument error and atmospheric density equals true air speed.**

individual drift error ( $d_c$ ): Individual Drift multiplied by Confidence Factor.

information request (INREQ): A message request for information about an unreported or overdue aircraft in United States domestic airspace. Corresponds to the declaration of the Uncertainty phase. This is an FAA term.

**initial action stage: A period during which preliminary action is taken to alert SAR facilities and obtain amplifying information.**

**initial position error (X): The estimated probable error of the initial position(s) at the beginning of a drift interval. For the first drift interval, this will be the probable error of the initially reported or estimated position of the SAR incident. For subsequent drift intervals, it will be the total probable error of the previous datum position(s).**

**Inmarsat: A system of geo-stationary satellites for worldwide mobile communications services, and which support**

**the Global Maritime Distress and Safety System and other emergency communications systems.**

**instrument flight rules (IFR): Rules governing the procedures for conducting instrument flight. Also a term used by pilots and controllers to indicate type of flight plan.**

**instrument meteorological conditions (IMC): Meteorological conditions expressed in terms of visibility, distance from cloud, and ceiling less than the minimum specified for visual meteorological conditions.**

interferer: A signal on a frequency mainly reserved for other uses, which disrupts legitimate signals, or which generates false alerts on distress frequencies.

**joint rescue coordination center: An RCC responsible for more than one primary type of SAR services, e.g., both aeronautical and maritime SAR incidents. Note: the term "JRCC" will not be used for civil SAR purposes solely based on the fact that an RCC is staffed by personnel from, or is sponsored by, more than one organization.**

**knot (kt): A unit of speed equal to one nautical mile per hour.**

**last known position (LKP): Last witnessed, reported, or computed DR position of a distressed craft.**

**leeway (LW): The movement of a search object through water caused by winds blowing against exposed surfaces.**

local base SAR officer: An officer, appointed by the commanding officer of an operational military base, to coordinate the use of local resources with the regional RCC.

**local user terminal (LUT) (Cospas-Sarsat): An earth receiving station that receives beacon signals relayed by Cospas-Sarsat satellites, processes them to determine the location of the beacons, and forwards the signals.**

location: Exact geographical position of a beacon or other search object.

locating: Process of pinpointing the location of a beacon or search object by homing or other means.

Maritime Assistance Request Broadcast (MARB): A relay request for assistance made by Coast Guard units for vessels needing non-emergency assistance.

maritime safety information (MSI): Navigational and meteorological warnings, meteorological forecasts, distress alerts and other urgent safety related messages broadcast to ships.

match (Cospas-Sarsat): Determination that solutions from different satellite passes likely emanate from the same signal source. (Matched solutions are merged to produce composite solutions. Unmatched positions are designated "images".)

**MAYDAY: The international radiotelephony distress signal, repeated three times.**

**MEDEVAC: Evacuation of a person for medical reasons.**

**MEDICO: Medical advice. Exchange of medical information and recommended treatment for sick or injured persons where treatment cannot be administered directly by prescribing medical personnel.**

merge (Cospas-Sarsat): Process of developing composite solutions by combining matched single pass (elemental) solutions.

**meteorological visibility: The maximum range at which a large object, such as landmasses or mountains, can be seen. Also referred to as meteorological range.**

Military Assistance to Safety and Traffic (MAST): An Army and Air Force program to assist in serious civilian medical emergencies by providing transportation.

**Military Direct Access Radar Channel (M-DARC):** Computerized radar tracking system operated by the 6521st Test Squadron at Edwards Air Force Base in California. Records primary and secondary radar data from 10 radar sensors located in south central California. Recorded data is retained for 30 days.

**mission conclusion stage:** A period during a SAR incident when SAR facilities return to their regular location and prepare for another mission.

**mission control center (MCC) (Cospas-Sarsat):** Part of the Cospas-Sarsat system that accepts alert messages from the local user terminal(s) and other mission control centers to distribute to the appropriate rescue coordination centers or other search and rescue points of contact.

**narrow band direct printing (NBDP):** Automated telegraphy, as used by the NAVTEX system and telex-over-radio.

**National Airspace System Computer (NAS computer):** Terminology associated with ARTCC ATC tracking computers.

**National Search and Rescue Committee (NSARC):** Established to oversee the National Search and Rescue Plan and to act as a coordinating forum for national SAR matters.

**National Search and Rescue Plan (NSP):** An interagency agreement providing national arrangements for coordination of search and rescue services to meet domestic needs and international commitments.

**National Track Analysis Program (NTAP):** An FAA system for retrieval of computer-stored radar data to locate a missing aircraft's last position.

**NAVAREA:** One of 16 areas into which the world's oceans are divided by the International Maritime Organization for dissemination of navigation and meteorological warnings.

**NAVTEX:** Telegraphy system for transmission of maritime safety information, navigation and meteorological warnings and urgent information to ships.

**non-beacon alert:** Alert determined to result from other than a beacon activation.

**on-scene:** The search area or the actual distress site.

**on-scene coordinator (OSC):** A person designated to coordinate search and rescue operations within a specified search area.

**on-scene endurance:** The amount of time a facility may spend at the scene engaged in SAR activities.

**operations stage:** A period during a SAR incident when SAR facilities proceed to the scene, conduct search, rescue survivors, assist distressed craft, provide emergency care for survivors, and deliver survivors to a suitable facility.

**optimal search area:** The search area which will produce the highest probability of success when searched uniformly with the search effort available.

**optimal search factor ( $f_s$ ):** A value, based on the amount of relative effort available, which is used to estimate the optimal search area to search so the chances of finding the search object are maximized. (see **Optimal Search Radius**).

**optimal search plan:** A plan that maximizes the probability of success of finding the search object using the available search effort.

**optimal search radius:** One-half the width of the optimal search area. Optimal search radius is computed as the

**product of the total probable error of position (E) and the optimal search factor ( $f_s$ ).  $R = E \times f_s$**

**overdue:** A situation where a craft has failed to arrive at its intended destination when expected and remains missing.

overlap zone (Cospas-Sarsat): Area of predetermined width common to two or more service areas.

**PAN-PAN:** The international radiotelephony urgency signal. When repeated three times, indicates uncertainty or alert, followed by nature of urgency.

parachute drift ( $d_p$ ): The combined drift of parachute glide ratio and its displacement due to winds aloft.

**personal locator beacon (PLB):** Personal radio distress beacon for alerting and transmitting homing signals.

**pilot-in-command:** The pilot responsible for the operation and safety of the aircraft during flight time.

**planning stage:** A period during a SAR incident when an effective plan of operations is developed.

**position:** A geographical location normally expressed in degrees and minutes of latitude and longitude.

**positioning:** Process of determining a position which can serve as a geographical reference for conducting a search.

**possibility area:** (1) The smallest area containing all possible survivor or search object locations. (2) For a scenario, the possibility area is the smallest area containing all possible survivor or search object locations that are consistent with the facts and assumptions used to form the scenario.

preliminary communication search (PRECOM): Initial limited communications check, normally directed by the SMC during the Uncertainty phase, of areas where the missing persons may be.

primary radar return: Radar signal energy reflected off of skin or surface of an aircraft.

**primary swell:** The swell system having the greatest height from trough to crest.

**probability of containment (POC):** The probability that the search object is contained within the boundaries of an area, sub-area, or grid cell.

**probability of detection (POD):** The probability of the search object being detected, assuming it was in the areas that were searched. POD is a function of coverage factor, sensor, search conditions and the accuracy with which the search facility navigates its assigned search pattern. Measures sensor effectiveness under the prevailing search conditions.

**probability of success (POS):** The probability of finding the search object with a particular search. For each sub-area searched,  $POS = POC \times POD$ . Measures search effectiveness.

**probability map:** A set of grid cells covering a scenario's possibility area where each grid cell is labeled with the probability of the search object being in that grid cell. That is, each grid cell is labeled with its own POC value.

**probable error (from statistics):** The range on either side of the average or expected value such that the probability of being within that range is 50%.

Radarfind (RADF): Computer program designed to rapidly locate available recorded radar data to assist in the location of missing/downed aircraft.

RCC controller: The SAR mission coordinator's duty officer in the RCC.

real position (Cospas-Sarsat): Position from which a signal is emanating.

**relative effort ( $Z_r$ ):** The amount of available search effort ( $Z$ ) divided by the effort factor. The relative effort relates the size of the effort available for a particular search to the size of the search object's location probability distribution at the time of the search.  $Z_r = Z/f_z$

repeated expansion: Successive enlargement of the search area.

**rescue:** An operation to retrieve persons in distress, provide for their initial medical or other needs, and deliver them to a place of safety.

**rescue coordination center (RCC):** A unit responsible for promoting efficient organization of SAR services and for coordinating the conduct of SAR operations within a search and rescue region. *Note: The term RCC will be used within this NSS to apply to either aeronautical or maritime centers, ARCC or MRCC will be used as the context warrants.* (Recognized RCCs are identified by ICAO and IMO for international purposes.)

**rescue sub-center (RSC):** A unit subordinate to an RCC established to complement the latter according to particular provisions of the responsible authorities. *Note: The term RSC will be used within this NSS to apply to either aeronautical or maritime centers, ARSC or MRSC will be used as the context warrants.*

**rhumb line:** Straight line between two points on a mercator projection chart.

safety factor (fs): A factor used to enlarge the search area to increase the chance of the search object being in the search area.

**SafetyNET:** Communications service provided via Inmarsat for promulgation of maritime safety information, including shore-to-ship relays of distress alerts and communications for SAR coordination.

**SAR airspace reservation:** Temporary airspace reservation to prevent non-SAR aircraft from interfering with SAR operations.

**SAR briefing officer:** An officer appointed, usually by the SMC, to brief departing SAR facilities and debrief returning SAR facilities.

**SAR case:** Any potential or actual distress about which a facility opens a documentary file, whether or not SAR resources are dispatched.

**SAR coordinating communications:** Communications necessary for the coordination of facilities participating in a SAR operation.

**SAR coordinator (SC):** One or more persons or agencies within an Administration with overall responsibility for establishing and providing SAR services, and ensuring that planning for those services is properly coordinated.

**SAR data provider (SDP):** A source for an RCC to contact to obtain data to support SAR operations, including emergency information from communications equipment registration databases, ship reporting systems, and environmental data systems (e.g., weather or sea current).

**SAR facility:** Any mobile resource, including designated SRUs, used to conduct SAR operations.

**SAR incident:** Any situation requiring notification and alerting of the SAR system and which may require SAR operations.

**SAR liaison officer:** An officer assigned to promote coordination during a SAR mission.



SAR mission: Any SAR situation involving dispatch of SAR resources.

**SAR mission coordinator (SMC): The official temporarily assigned to coordinate response to an actual or apparent distress situation.**

SAR mission information officer (SMIO): The official designated by the SMC for coordinating, controlling, and disseminating news releases, or other information, concerning a specific SAR mission.

**SarNET: A broadcast system between RCCs within the footprint of an individual satellite.**

**SAR plan: A general term used to describe documents which exist at all levels of the national and international SAR structure to describe goals, arrangements, and procedures which support the provision of SAR services**

**SAR point of contact (SPOC) (Cospas-Sarsat): Rescue coordination centers and other established and recognized national points of contact which can accept responsibility to receive Cospas-Sarsat alert data to enable the rescue of persons in distress.**

**SAR stage: Typical steps in the orderly progression of SAR missions. These are normally Awareness, Initial Action, Planning, Operations, and Mission Conclusion.**

satellite ground track: Path on the earth's surface directly below a satellite's orbit.

**scenario: a consistent set of known facts and assumptions describing what may have happened to the survivors.**

**sea: Condition of the surface resulting from waves and swells.**

**sea current (SC): The residual current when currents caused by tides and local winds are subtracted from local current. It is the main, large-scale flow of ocean waters.**

**search: An operation, normally coordinated by an RCC or RSC, using available personnel and facilities to locate persons in distress.**

**search action plan: Message, normally developed by the SMC, for passing instructions to SAR facilities and agencies participating in a SAR mission.**

**search and rescue region (SRR): An area of defined dimensions, associated with an RCC, within which SAR services are provided.**

**search and rescue services: The performance of distress monitoring, communication, coordination and SAR functions, including provision of medical advice, initial medical assistance, or medical evacuation, through the use of public and private resources including cooperating aircraft, vessels and other craft and installations.**

search and rescue system: An arrangement of components activated as needed to efficiently and effectively aid persons or property in actual or potential distress.

**search and rescue sub-region (SRS): A specified area within a search and rescue region associated with a rescue sub-center.**

**search and rescue unit (SRU): A unit composed of trained personnel and provided with equipment suitable for the expeditious conduct of SAR operations.**

**search area: The area, determined by the search planner, that is to be searched. This area may be sub-divided into search sub-areas for the purpose of assigning specific responsibilities to the available search facilities.**

**search effort (Z): A measure of the area a search facility can effectively search within the limits of search speed,**

**endurance, and sweep width. Search effort is computed as the product of search speed (V), search endurance (T), and sweep width (W).  $Z = V \times T \times W$**

**search endurance (T): The amount of “productive” search time available at the scene. This figure is usually taken to be 85% of the on-scene endurance, leaving a 15% allowance for investigating sightings and navigating turns at the ends of search legs.**

**search facility position error (Y): Probable error in a search craft’s position based on its navigational capabilities.**

searchmaster (SM): Canadian term for an individual appointed to coordinate and direct a specific SAR operation.

**search object: A ship, aircraft, or other craft missing or in distress or survivors or related search objects or evidence for which a search is being conducted.**

**search pattern: A trackline or procedure assigned to an SRU for searching a specified area.**

**search speed (V): The speed (or velocity) with which a search facility moves over the ground when searching.**

**search sub-area: A designated area to be searched by a specific assigned search facility or possibly two facilities working together in close coordination.**

secondary radar return: A radio signal received from an aircraft equipped with an airborne radar beacon system. More commonly referred to as a transponder or beacon return.

**secondary swells: Swell systems of less height than the primary swell.**

**sensors: Human senses (sight, hearing, touch, etc.), those of specially trained animals (such as dogs), or electronic devices used to detect the object of a search.**

service area (Cospas-Sarsat): Geographic area for which a mission control center accepts responsibility to forward alerts to RCCs and SAR Points of Contact.

set: The direction in which water or an object moves under the influence of wind or current.

ship earth station (SES): A mobile station in the maritime mobile service located on board a vessel which is not permanently moored, other than a survival craft station.

side-looking airborne radar (SLAR): Aircraft-mounted radar designed to detect search objects on or near the ocean surface by transmitting signals perpendicular to the aircraft flight track. Signal coverage of an area is achieved by aircraft motion alone, without antenna rotation.

single pass position (Cospas-Sarsat): Position obtained from a single pass solution.

single pass solution (Cospas-Sarsat): One of two positions equidistant on each side of a ground track, one position corresponding to a real location and the other being its image, computed using Doppler data from a single pass.

site (Cospas-Sarsat): A collection of satellite data associated with a unique beacon or signal source.

site ID (Cospas-Sarsat): Alphanumeric code assigned by the USMCC to each first alert solution. For beacons operating on 121.5 and 243 MHz, the code gives frequency, specifies whether the solution is an "A" or a "B" solution, and assigns a sequential number; for 406 MHz beacons, the site ID is a 5 digit identifier.

**situation report (SITREP): Reports, from the OSC to the SMC or the SMC to interested agencies, to keep informed of on-scene conditions and mission progress.**

solution (Cospas-Sarsat): Position determined by Cospas-Sarsat ground processing using Doppler data.

**sortie: Individual movement of a resource in conducting a search or rendering assistance.**

speed of advance: Speed a surface vessel is making relative to the earth's surface.

spurious solutions (Cospas-Sarsat): Solutions generated due to causes other than beacon signals.

strike team (ST): A unit of resources with a leader and communications.

**surface drift: Vector sum of total water current and leeway. Sometimes called Total Drift.**

**surface picture (SURPIC): A list or graphic display from a ship reporting system of information about vessels in the vicinity of a distress situation that may be called upon to render assistance.**

**surface position: The position of the search object on the earth's surface at the time of initial distress, or its first contact with the earth's surface.**

sweep rate: The presence of swept audio-frequency amplitude modulation in a processed signal.

**sweep width (W): A measure of the effectiveness with which a particular sensor can detect a particular object under specific environmental conditions.**

**swell: Condition of the surface caused by a distant wind system. The individual swell appears to be regular and smooth, with considerable distance between rounded crests.**

**swell direction: The direction from which a swell is moving. The direction toward which a swell is moving is called the down swell direction.**

**swell face: The side of the swell toward the observer. The *backside* is the side away from the observer. These definitions apply regardless of the direction of swell movement.**

swell height: The height between crest and trough, measured in feet.

swell length: Horizontal distance between successive crests, measured in feet.

swell period: Time interval between the passage of two successive crests.

**swell velocity: Velocity with which the swells advance with relation to a fixed reference point, measured in *knots*.**

tactical air navigation (TACAN): An air navigation aid used by suitably equipped aircraft.

terminal radar approach control facility (TRACON): FAA terminal ATC facility usually equipped with an ARTSIII/IIIa tracking computer with one or more radar sensors.

tidal current (TC): Near-shore currents caused by the rise and fall of the tides.

**time of closest approach (TCA): Time during a satellite pass when the satellite is closest to a signal source.**

**total drift error ( $D_e$ ): Also "total probable drift error" or "drift error". The total probable error in the datum position that is contributed by the total drift velocity error ( $DV_e$ ).  $D_e = DV_e \times t$  where  $t$  is the length of the drift interval in hours.**

**total probable error (E):** The estimated error in the datum position. It is the square root of the sum of the squares of the total drift error, initial position error, and search facility error.

**total water current (TWC):** The vector sum of currents affecting search objects.

**track spacing (S):** The distance between adjacent parallel search tracks.

**triage:** The process of sorting survivors according to medical condition and assigning them priorities for emergency care, treatment, and evacuation.

**true air speed (TAS):** The speed an aircraft is travelling through the air mass. TAS corrected for wind equals ground speed.

**Uncertainty Phase:** A situation wherein *doubt* exists about the safety of an aircraft or a marine vessel, and of the persons on board.

**Unnecessary SAR alert (UNSAR):** A message sent by an RCC to the appropriate authorities as a follow-up when the SAR system is unnecessarily activated by a false alert.

**unreported:** A situation where a craft has failed to report its location or status when expected and remains missing.

**unresolved alert (Cospas-Sarsat):** Alert for which the cause remains undetermined.

**unresolved alarm (Cospas-Sarsat):** Alert known to result from a beacon activation, but for which the cause of activation remains undetermined.

**unresolved alarm rate (Cospas-Sarsat):** Ratio of unresolved alarms to beacon alarms.

**USMER:** System implemented under U.S. Maritime Administration's authority to collect vessel information for national emergency purposes; Amver reports on USMER vessels are released to MARAD when the reporting vessel includes the word "MAREP" on the "x" line of the Amver reports.

**vector:** A graphic representation of a physical quantity or measurement, such as wind velocity, having both magnitude and direction.

**vessel:** A maritime craft.

**visual flight rules (VFR):** Rules governing procedures for conducting flight under visual meteorological conditions. In addition, used by pilots and controllers to indicate type of flight plan. (The term "VFR" is also used in the U. S. to indicate weather conditions equal to or greater than minimum VFR requirements.)

**visual meteorological conditions:** Meteorological conditions expressed in terms of visibility, distance from cloud, and ceiling equal to or better than specified minima.

**wave (or chop):** The condition of the surface caused by local wind and characterized by irregularity, short distance between crests, whitecaps, and breaking motion.

**wind-corrected heading:** The actual heading an aircraft is required to fly to make good an intended course.

**wind current (WC):** The water current generated by wind acting upon the surface of water over a period of time.

---

# CHAPTER 1. SEARCH AND RESCUE SERVICE AND ORGANIZATION

- 1.1 Search and Rescue Service
- 1.2 Search and Rescue System
- 1.3 National Search and Rescue Plan (NSP)
- 1.4 National Search and Rescue Supplement (NSS)
- 1.5 Addenda to the National Search and Rescue Supplement
- 1.6 Response to Search and Rescue Situations
- 1.7 Search and Rescue System Organization
- 1.8 Search and Rescue Regions and Sub-regions
- 1.9 Search and Rescue Plans
- 1.10 Elements of the Search and Rescue System
- 1.11 Search and Rescue Coordinator
- 1.12 Search and Rescue Mission Coordinator (SMC)
- 1.13 Rescue Coordination Center (RCC)
- 1.14 Rescue Sub-Center (RSC)
- 1.15 Alerting Post
- 1.16 Staging Base
- 1.17 On-scene Coordinator (OSC) and Aircraft Coordinator (ACO)
- 1.18 Search and Rescue Facilities
- 1.19 Liaison, Base, and Briefing Officers
- 1.20 Incident Command System (ICS)

## **1.1 Search and Rescue Service**

- 1.1.1 Search and Rescue Service is the performance of distress monitoring, communication, coordination and search and rescue (SAR) functions. This includes the provision of medical advice, initial medical assistance, or medical evacuation, through the use of public and private resources, including cooperating aircraft, vessels and other craft and installations.

## **1.2 Search and Rescue System**

- 1.2.1 Nations establish national (or regional) SAR systems to provide SAR services as part of the global (worldwide) SAR system. SAR services help nations meet national and international humanitarian and legal obligations. The U.S. is obligated to provide SAR services as a Party to the *International Convention on Maritime Search and Rescue*, the *Convention on International Civil Aviation*, the *Safety of Life at Sea Convention*, and other international treaties and agreements. Legal aspects of SAR are discussed further in Chapter 7. *The International Aeronautical and Maritime Search and Rescue (IAMSAR) Manual*, a three-volume set published jointly by the International Maritime Organization (IMO) and the International Civil Aviation Organization (ICAO), provides overall guidance and standards for implementing the Conventions mentioned in this paragraph. The U.S. SAR services are provided by a variety of components, the relationships of which are described in our *National Search and Rescue Plan*.

## **1.3 National Search and Rescue Plan (NSP)**

- 1.3.1 The primary framework for the U.S. SAR system is provided in the NSP. This key document, which is produced by the National Search and Rescue Committee (NSARC) and signed by high-level officials within the Federal government, should be familiar to all SAR personnel, and is included as Appendix A to this Supplement. The NSP describes the U.S. SAR organization, key authorities and their responsibilities, and primary principles and policies upon which our SAR system is based. The NSP was developed taking into account the provisions of the IAMSAR Manual, Volume 1, Chapter 5 and its Appendix I.

## **1.4 National Search and Rescue Supplement (NSS)**

- 1.4.1 This U.S. document, the *United States National Search and Rescue Supplement (NSS) to the International Aeronautical and Maritime Search and Rescue Manual*, provides guidance on implementation of the NSP, and information in addition to the contents of the IAMSAR Manual, especially where it applies specifically to the U.S. The IAMSAR Manual and NSS together are the primary references regarding implementation of the NSP. The NSS does not contain policies, procedures, etc., specific to a single federal agency.

## 1.5 Addenda to the National Search and Rescue Supplement

- 1.5.1 As provided for in the Forward of this Supplement, any federal agency that is signatory to the NSP may, at their option, develop an Addendum to the NSS. While the NSS provisions apply on a national or interagency basis, an agency Addendum would be intended to address civil SAR information, policies, procedures, etc., consistent with the provisions of the NSP, IAMSAR Manual, and NSS, which are particularly relevant to the particular agency concerned. The Forward also authorized development of an Addendum by the Civil Air Patrol and by the Coast Guard Auxiliary.

## 1.6 Response to Search and Rescue Situations

- 1.6.1 SAR services typically result from notification to the SAR system of a potential or actual distress situation, SAR incident, that may involve the need for assistance. If the situation warrants, a documentary file may be opened, whether or not a SAR facility is dispatched, and the incident can be designated as a SAR case. If the level of effort grows to where SAR facilities are dispatched, the SAR case may then be referred to as a SAR mission. The response to a SAR incident usually proceeds through a sequence of five typical stages. These stages define the nature of SAR assistance provided at any particular time. A SAR incident may not necessarily include each and every stage, or the stages may overlap. Expanded discussion of each SAR stage is found in the IAMSAR Manual, Volume 2. The major stages are:

<b>Awareness:</b>	SAR system becomes aware of an actual or potential incident.
<b>Initial Action:</b>	Preliminary action taken to alert SAR facilities and obtain amplifying information. This stage may include evaluation and classification of the information, alerting of SAR facilities, preliminary communication checks (PRECOM), extended communication checks (EXCOM), and in urgent cases, immediate action from other stages.
<b>Planning:</b>	Effective plan of operation is developed, including plans for search, rescue, and final delivery.
<b>Operations:</b>	SAR facilities proceed to the scene, conduct searches, rescue survivors, assist distressed craft, provide emergency care for survivors, and deliver survivors to a suitable facility.
<b>Conclusion:</b>	SAR facilities return to their regular location, are debriefed, refueled, replenished, provided with a fresh crew, and prepared for another mission; documentation of the SAR case is completed.

## 1.7 Search and Rescue System Organization

- 1.7.1 Volume 1 and Chapter 2 of Volume 2 of the IAMSAR Manual describe the general organization of SAR services. The following information pertains specifically to the organization of U.S. SAR services.

## 1.8 Search and Rescue Regions and Sub-regions

- 1.8.1 By definition, for civil SAR there is a one-to-one correlation between a rescue coordination center (RCC) and its associated search and rescue region (SRR). RCCs are, however, expected to handle operational coordination with U.S. and foreign RCCs responsible for other SRRs whenever appropriate. An SRR may have one or more sub-divisions called search and rescue sub-regions (SRSSs), within which all or part of the

RCC's function is assumed by a rescue sub-center (RSC) under the oversight of the RCC. SAR Coordinators may also establish an RSC with specified functional duties, but no geographic responsibilities, e.g., to handle a subset of an RCC's communications or SAR responsibilities. SAR Coordinator roles are discussed in the IAMSAR Manual Volume 1, Chapter 1, and in NSP.

- 1.8.2 To the extent practicable, aeronautical and maritime SRRs should be geographically aligned, regardless of whether they are served by a Joint (aeronautical and maritime) RCC (JRCC) or a separate aeronautical RCC (ARCC) and maritime RCC (MRCC). It is customary to avoid use of the term "boundaries" in the context of SAR because of political connotations, but rather to speak of SRR "limits" or of "lines separating" SRRs. Lines separating SRRs of neighboring nations should be negotiated, documented in an official manner, and reflected in the relevant reference documents of IMO and ICAO by following applicable procedures of those Organizations. As stated in the SAR Convention, the purposes of establishing SRRs are to ensure provision of adequate land-based communications infrastructure, efficient distress alert routing, and proper operational coordination to effectively support SAR services. SRRs effect an understanding concerning where nations have accepted primary responsibility for coordinating or providing SAR services. SRR limits should never be viewed as a basis to restrict, delay, or limit in any way the prompt and effective action necessary to relieve distress situations.
- 1.8.3 U.S. RCCs and an RSC have been established as follows (see charts at the back of this Supplement):

RCC NORFOLK  
RCC BOSTON  
RCC MIAMI  
    RSC SAN JUAN (under RCC MIAMI)  
RCC NEW ORLEANS  
RCC CLEVELAND  
RCC ALAMEDA  
RCC SEATTLE  
RCC HONOLULU  
RCC JUNEAU  
RCC LANGLEY  
RCC ELMENDORF

## **1.9 Search and Rescue Plans**

- 1.9.1 "SAR plan" is a general term often associated with three types of plans: a national or regional SAR plan (like the NSP or a similar multi-national plan); plans of operation which should be prepared by RCCs and RSC for handling various types of distress scenarios; and SAR or emergency response plans carried onboard some ships.
- 1.9.2 Plans of operation are discussed further in the IAMSAR Manual, Volume 2, Chapter 1 and its Appendix C.
- 1.9.3 The SOLAS Convention requires certain passenger vessels to carry a SAR plan. The International Safety Management Code requires most merchant ships to carry an emergency response plan. Both of these plans are intended to improve cooperation and response among the ship in distress, its company, and the SAR services responsible for waters where the ship sails.
- 1.9.4 SAR plans that are operational in nature should be exercised periodically, with the cognizant RCC involved.

## **1.10 Elements of the Search and Rescue System**

- 1.10.1 SAR operations are normally coordinated at the lowest practical level within the SAR organization. However, when involvement of a U.S. RCC is appropriate, only fully-functional RCCs with internationally-recognized SRRs should coordinate domestic and international civil SAR operations. To provide for the maximum practicable support of civil SAR, SAR coordinators may make SAR agreements with federal,

state, local, and private agencies. Civil SAR agreements with foreign nations are discussed in the NSP and relevant agency directives. International agreements require prior consultation with the Department of State and other interested federal authorities. However, military commanders may retain control of their own forces conducting SAR for their own units.

### **1.11 Search and Rescue Coordinator**

1.11.1 SAR Coordinators are executive-level leaders and managers, and as such are normally not personally involved in actual coordination or provision of SAR services. The SAR Coordinator is the federal person or agency with overall responsibility for establishing and providing civil SAR services for a U.S. SRR. This responsibility includes establishing RCCs as necessary, and providing or arranging for provision of SAR services within the SRRs. SAR Coordinator duties include:

- establishing, staffing, equipping and managing the SAR system;
- providing appropriate legal and funding support;
- establishing RCCs and RSCs;
- providing or arranging for SAR facilities and SAR resources;
- coordinating SAR training and exercises; and,
- promulgating SAR policies and supporting documents.

### **1.12 Search and Rescue Mission Coordinator (SMC)**

1.12.1 An SMC is a designated person, usually in an RCC, who manages a specific SAR operation, and has the full operational authority of the SAR Coordinator. Any SAR mission involving an RCC should have an SMC designated, either on a case-by-case basis, or in accordance with standing procedures. Handoff of the SMC function to other persons for a particular incident should be kept to a minimum. The SMC must use good judgement to modify, combine, or bypass SAR stages and procedures to cope with unique, unusual, or changing circumstances. The IAMSAR Manual, Volume 2, Chapter 4 discusses evaluation of situations an SMC may face, and Volume 2 was written specifically for SMCs and other RCC staff.

1.12.2 SMC duties may be provided by an agency other than the SAR Coordinator's organization when that agency is in a better position to handle a particular civil SAR operation. Any agency likely to be assigned SMC functions should ensure that its responsible personnel are properly identified and trained, and that adequate communications capabilities are maintained. SMC responsibilities for a mission may be divided geographically with other authorities when appropriate, as long as all involved SMCs work closely with each other.

### **1.13 Rescue Coordination Center (RCC)**

1.13.1 The RCC usually coordinates SAR operations within its assigned SRR, requesting assistance from other RCCs or RSCs as appropriate. The RCC chief supervises operations and staff. More experienced RCC personnel should be used to supervise any operations requiring extensive planning and coordination. All personnel assigned to RCC watches should be fully trained and capable of performing their duties. The IAMSAR Manual, Volume 1, Chapters 2 and 3, discuss RCC staffing and related matters.

1.13.2 The IAMSAR Manual, Volume 2, Chapter 3 includes guidelines for "first RCCs" to help determine which RCC should be responsible for coordination of a distress situation when an alert is first received. Additionally:

- a) The alerting post nearest the reported alert should acknowledge the alert. Another alerting post receiving



the alert should acknowledge it if the nearest one does not appear to respond. The alerting post that acknowledges the alert should maintain communications with the distressed craft unless relieved of this duty under SAR arrangements described below.

- b) The RCC affiliated with the alerting post that first acknowledges the alert (first RCC) should assume responsibility for all subsequent SAR coordination unless and until responsibility is accepted by another RCC better able to take action. If it is not immediately clear which RCC has become the first RCC because more than one alerting post has acknowledged the alert, the RCCs concerned should as soon as possible agree which is to become the first RCC to ensure the distress is acted upon promptly.
- c) If, for any reason, the responsible RCC informs the first RCC that it cannot take effective action, the first RCC should, until the responsible RCC makes alternative arrangements, retain SAR coordination, maintain communications with the casualty, alert shipping or aircraft in the vicinity of the distress, and seek assistance from other RCCs, if appropriate.
- d) If the distress situation is outside any established SRR, the first RCC should assume SAR coordination. If another RCC appears better able to take responsibility, inform that RCC of the alert and request it to assume coordination. Then follow the guidance in the IAMSAR Manual, Volume 2, Chapter 3.

1.13.3 **RCC watchstanders** should only include persons who have been properly trained, qualified, and certified, and should be fully competent to perform SMC duties unless he or she is assisting such qualified person who is also on watch. All watchstanders should be thoroughly familiar with the IAMSAR SAR Manual, the NSS, local SAR plans, and the communications capabilities in the area. Watchstanders should maintain an effective and efficient RCC watch, and be able to rapidly perform all functions required, often without complete information or advice from seniors. They should:

- a) Be familiar with available communication, including communications with parent agencies, military services, civilian agencies, law enforcement agencies, and commercial sources.
- b) Know the geographic features of the SRR, such as terrain heights, hazards to low-level aircraft searches, navigational aids, water depths, and capabilities and limitations of available facilities.
- c) Upon reporting for duty:

receive a complete briefing, including past, present, and forecast weather, from the relieved watch;

review all entries in the log pertaining to ongoing missions, unsuccessful missions closed during the past 24 hours, and other matters requiring action;

stay informed about the mission-ready status of all SAR resources; and,

test primary lines of communication, as appropriate.

1.13.4 Assistant RCC watchstanders may relieve the SMC of routine duties such as plotting, information retrieval, investigative work, monitoring the operational status of resources, reading and filing message traffic, ensuring that the SMC sees all pertinent messages, assisting in preparing messages, and making entries in pertinent files, logs, and folders.

1.13.5 The IAMSAR Manual, Volume 1, Chapters 2 and 4 discuss RCC/RSC **communications** equipment and procedures. The communications linking SAR facilities should be rapid and reliable. SAR-dedicated lines may be needed. Communications should access major military commands, adjacent RCCs/RSCs, SAR facilities, other agencies that can supplement SAR resources, Air Traffic Control (ATC), military airway air/ground stations and communications centers, coast radio stations (CRSs), other alerting posts and regional weather, radar, and direction-finding (DF) stations. Communications, including RCC telephones,

should be attached to recording equipment with a timing capability to archive voice and data, so the RCC can review and, if necessary, resolve disputes about information received. Archived information should be retained in accordance with agency directives.

1.13.6 **RCC equipment** is discussed in the IAMSAR Manual, Volume 1, Chapter 2. Equipment varies, but should normally include:

- a) Appropriate wall, paper, and electronic charts. Charts should depict SRRs and SRSs, locations and status of primary SAR facilities (and possibly their ranges) and other key resources, and other pertinent features of the area concerned.
- b) Manual or computer plotting equipment for plotting mission information, including multiple searches.
- c) Capability of storing, and rapidly retrieving and displaying mission information previously accumulated.

1.13.7 **Information** readily available in the RCC should generally include:

- a) SAR databases accessible in or from the RCC, for search planning, environment, communications, resources, or other important information that should be readily available, such as SAR contacts, wreckage locations, historical knowledge, missing craft data, and support facility information.
- b) Reference library, including:
  - 1) The IAMSAR Manual and other relevant ICAO and IMO documents, such as Regional Air Navigation Plans (RANPs), the GMDSS Master Plan, SAR Circulars, etc.
  - 2) The NSS.
  - 3) Agency directives relating to civil SAR.
  - 4) Relevant SAR agreements, plans and similar documents.
  - 5) Aviation publications, such as the military *Flight Information Publications* (FLIPs), the Federal Aviation Administration (FAA) *Airman's Information Manual* (AIM), specification sheets for aircraft likely to be used as SAR facilities, the Aircraft Owner's and Pilot's Association (AOPA) Airport Directory, and airport heliport/hospital landing directories.
  - 6) Communications and other SAR-related publications such as Joint Army Navy Allied Publications (JANAP), Allied Communications Publications (ACP), ICAO series, nautical and air almanacs, nautical and tidal publications, Civil Aircraft Registry, *Lloyd's Register of Ships*, manuals governing emergency procedures, and oceanographic atlases showing ocean currents, wind, and sea surface temperatures.
  - 7) Appropriate documents or extracts from those listed in Appendix F, SAR References and Web Sites.

## 1.14 **Rescue Sub-Center (RSC)**

1.14.1 The SAR Coordinator may establish a rescue sub-center (RSC) as appropriate for more effective coordination of SAR facilities in remote areas of an SRR, or where local facilities can be directed more effectively by local authorities. The RSC should have immediate voice or printed communications via direct landline or radio link with its parent RCC, and rapid and reliable communications with alerting posts, flight-following and DF stations serving the RSC, adjacent RSCs, primary and secondary SAR facilities in the RSC operational area, and sources of meteorological information. RSC equipment is comparable to, but usually less extensive than, that of an RCC. The IAMSAR Manual, Volume 1, Chapter 2 provides related discussion

on the RSC.

### **1.15 Alerting Post**

- 1.15.1 Alerting posts include any facility involved in receiving information about an apparent distress situation and relaying it to an RCC or RSC. They include facilities such as air traffic services (ATS) units, coast radio stations (CRSs) and mission control centers (MCCs). Communications may or may not be the primary purpose for the alerting post, but the post must be able to forward the distress information to the RCC. The IAMSAR Manual, Volume 1, Chapter 4 discusses alerting posts in more detail.

### **1.16 Staging Base**

- 1.16.1 When SAR operations occur in remote areas, or where communications facilities are inadequate, a SAR Staging Base may be used. The SMC and supporting staff may travel to a more effective base of operations. This base should have appropriate communications equipment, transient dining and housing facilities, SMC working spaces, and SAR facility refueling facilities. If an advanced base is foreseeable, RCCs and RSCs should maintain SMC kits. The kits may contain appropriate publications, charts, the IAMSAR Manual, the NSS, appropriate plans of operation, telephone directories, SMC planning and documentation forms, aircraft clearance forms, purchase order forms, and plotting equipment.

### **1.17 On-scene Coordinator (OSC) and Aircraft Coordinator (ACO)**

- 1.17.1 The IAMSAR Manual, Volume 3 has a section written specifically for on-scene coordinator (OSC) operational matters; Volume 2, Chapter 1 provides other general guidance. More specific guidance for land SAR OSCs is provided in Chapter 5 of this NSS. The SMC designates an OSC to manage SAR operations at the scene. The OSC is usually the best qualified person or unit among those available, which may mean the OSC will be someone without any special SAR training for the task. In such cases the SMC must assess and take into account the OSC's capabilities when assigning OSC duties. Like an SMC, the OSC may be assigned by name or position, or a particular facility may be named as OSC. An OSC is not required for all operations, although one is usually assigned if two or more facilities on scene are involved in the SAR operations. Basically, an OSC should be designated whenever doing so stands to improve on-scene coordination. If an OSC is not designated, the first facility on scene should assume OSC duties and advise the responsible RCC. An advanced staging base may serve as an OSC to relieve a SAR facility of that burden. The OSC should be the most capable person, facility, or other unit available, taking into consideration SAR training, communications capabilities, and the length of time that the facility can stay in the search area.
- 1.17.2 The IAMSAR Manual, Volume 2, Chapter 1, and Volume 3, Section 3 discuss aircraft coordinators (ACOs). For flight safety, it may be wise to split on-scene coordination responsibilities between a surface OSC and an ACO. Assignment of an ACO may be appropriate when there are no communications links between the OSC and participating aircraft.
- 1.17.3 An OSC conducts the SAR mission on scene using SAR facilities made available by the SMC, and should safely carry out the search or rescue action plan. If the SMC does not provide a sufficient action plan, the OSC must develop a plan and notify the SMC. The OSC retains OSC responsibilities from the time of designation until relieved or mission completion.
- 1.17.4 Frequent changes in OSC or ACO assignment are not desirable. Any individual arriving on scene who is senior to the OSC or ACO should normally not assume those duties without SMC concurrence. If the senior person concludes that such a change is important to mission success or if the OSC requests to be relieved for good reason, and the SMC concurs, a change may take place. The relieved OSC or ACO should report the relief to the SMC.
- 1.17.5 An OSC and ACO have full operational authority of the SMC, and together coordinate all SAR facilities on scene. The parent agency retains operational control of a facility en route to and from the scene. If an agency

must withdraw a facility from a mission, it should advise the SMC as early as possible to permit suitable reliefs to be dispatched to maintain adequate on-scene resources.

- 1.17.6 Multiple OSCs may be assigned, especially when the search area is large and can be divided for OSC assignments.
- 1.17.7 OSCs should have adequate available resources and, if possible, be familiar with the IAMSAR Manual, Volume 3 and this section of the NSS. However, the OSC function may need to be performed by a unit of opportunity that is not familiar with these documents.
- 1.17.8 For best continuity of operations, OSCs should be able to remain on scene for an extended time, and be able to communicate with all on-scene facilities, the SMC, and the distressed craft. Large fixed-wing SAR aircraft make excellent OSC platforms because of their communication capability, on-scene endurance, and adequate space for planning, plotting, and coordination duties. For long searches the flight crew should be augmented to help with OSC or ACO duties. Coast Guard cutters and Navy vessels make excellent OSC platforms. A suitable ground facility may serve as an OSC if communications and adequately trained personnel are available. Training and experience of OSC and ACO personnel are important. Preference should be given to units having SAR as a primary mission. The SMC should try to assess the available capabilities and assign commensurate duties.
- 1.17.9 In addition to duties discussed in the IAMSAR Manual, OSCs, and ACOs should normally:
  - a) Establish and maintain communications with all SAR facilities using assigned on-scene channels, requiring all aircraft to make "operations normal" reports to the OSC every 15 minutes (30 minutes for multi-engine fixed-wing). Position reports from SAR facilities are optional, as long as they remain in their assigned search areas.
  - b) Establish a common altimeter setting for on-scene aircraft.
  - c) Obtain information from arriving facilities, provide initial briefing and search instructions, and provide advisory air traffic service for maintaining aircraft separation.
  - d) Receive and evaluate sighting reports, and divert facilities to investigate sightings.
  - e) If the OSC must depart, consult with the SMC if practicable, and shift OSC duty to the remaining facility best able to perform OSC duties.
  - f) Submit serially numbered situation reports (SITREPs) to the SMC at regular intervals. SITREP ONE should be submitted immediately upon arrival on scene or upon assuming OSC. When an OSC is relieved, the new OSC continues the SITREP numbering sequence. SITREP information and formats are discussed in the IAMSAR Manual, Volume 2, Chapter 2 and its Appendix I.

## **1.18 Search and Rescue Facilities**

- 1.18.1 The IAMSAR Manual Volume 2, Chapter 2 and its Appendix G provide general information about SAR facilities. A SAR facility is any mobile resource used to conduct SAR operations, including designated SAR units (SRUs) that have the training and equipment necessary for proficient operations. An SRU may have SAR as a primary duty, or it may be made available for a SAR mission by a parent agency not having primary SAR duty. SAR facilities are normally assigned by name if a large vessel, submarine, or ground party, or by type, "TAIL" number, or call sign if an aircraft, boat, or ground vehicle. SAR facility designation by classified, tactical call signs should be used only in hostile territory. Specialized SRUs with specialized training and equipment, such as mountain rescue units (MRUs) and desert rescue units (DRUs), may be available.
- 1.18.2 SAR facilities should have appropriate personnel, equipment and skills to accomplish the mission. Normally,

SRUs are used first. Multiple SAR facilities comply with OSC or ACO directions, ensuring that SAR facilities in adjacent areas are not endangered, that search efficiency is not reduced by duplication of search effort, and that all assigned areas are searched.

- 1.18.3 SAR facilities should contact the OSC or ACO about 15 minutes before arrival concerning estimated time of arrival (ETA), operational limitations, communications capabilities, search speed, and on-scene endurance. If no OSC or ACO is assigned, SAR facilities should be coordinated directly by the SMC while on scene.
- 1.18.4 In addition to the duties discussed in the IAMSAR Manual, Volume 2, Chapters 5 and 6, SAR facilities should normally:
- a) Execute search or rescue action plans, and afterwards report to the OSC the area searched, ceiling, visibility, wind, and search results, including results of any electronic searches.
  - b) Maintain communications with the OSC until released by the OSC. Aircraft SRUs make "operations normal" reports every 15 minutes (30 minutes for multi-engine, fixed-wing).
  - c) When survivors are sighted, promptly advise the OSC or ACO of the position, survivor identity and physical condition, wind, weather, sea conditions, and remaining endurance on scene. Signal to the survivors, keep them in sight and effect a rescue if possible. If a rescue is not possible and the facility must depart, note survivor position precisely, and mark if possible.
  - d) When wreckage, unusual ground disfiguration, debris, empty lifeboats or life rafts, oil slicks, sea dye marker, flares, smoke, or any unusual object is sighted, inform the OSC or ACO of the position, nature of the sighting, concentration of multiple objects, wind, weather and sea condition, and evaluation of the sighting.
  - e) If a radio, radar, sonar, emergency signal, or survivor transmission is detected, advise the OSC or ACO of signal type, exact times; facility position, course, speed, and altitude; when signal was lost or ended; bearing, frequency and strength of signal and evaluation of signal; and actions taken by the facility.

### 1.19. Liaison, Local Base, and Briefing Officers

- 1.19.1 The SMC may send a **SAR Liaison Officer** to parent authorities providing SAR facilities to help coordinate activities, conduct briefings and debriefings, and keep the SMC informed of facility availability. A liaison officer from the parent command of a missing unit may be sent to the SMC's location to provide background information, develop hypotheses on what actions might have been taken by the missing craft, provide expertise about the craft to aid in search planning, and keep the parent authority fully informed of progress. Liaison officers may also be sent to foreign RCCs to help coordinate U.S. SAR efforts with their Governments.
- 1.19.2 Commanding Officers of major military bases may appoint a **Base SAR Officer** to coordinate use of their resources. Base SAR officers should be familiar with the IAMSAR Manual, Volume 2, and the NSS, and be prepared to work closely with or serve as, as appropriate, an SMC, OSC, RCC staff, SAR liaison officer, and SAR briefing officer.
- 1.19.3 The SMC may appoint a **SAR Briefing Officer** during missions involving many facilities. This officer briefs and debriefs SAR facilities on SAR mission progress, search or rescue action plans, and requirements. The SAR briefing officer may prepare briefing folders for the SAR facilities containing information, charts, and messages. Briefing should take place close to departure time. Untrained personnel should be briefed on:
- scanner techniques,
  - sighting report procedures, and

methods for minimizing fatigue.

Briefing and debriefing guidance is found in the IAMSAR Manual, Volume 2, Chapter 5, and its appended forms.

- 1.19.4 **Public Affairs Specialists** may be used to keep the public informed during SAR operations. The media and relatives of missing persons typically expect the RCC to release information. The IAMSAR Manual, Volume 2, Chapter 1 provides general guidance. An agency may publish additional guidance. The SMC should also consider coordination with the involved company, such as cruise lines and airlines, which may have competent public relations capabilities.

## 1.20 Incident Command System (ICS)

- 1.20.1 Depending on the situation, e.g., incident duration, type of response, location, potential for pollution, or other issues, use of the incident command system (ICS) may be appropriate. Also, if SAR operations are a subset of a larger scale emergency response (especially one involving multiple jurisdictions or multiple authorities) where ICS is being used, the SMC may need to operate under the overall coordination of (or even serve as) an incident commander (IC). In such cases, the SAR system should coordinate its activities in accordance with the IAMSAR Manual, this Supplement, and other pertinent directives, but, in addition, should work within the ICS parameters with respect to the IC and facilities performing emergency response activities other than SAR. In these cases, SAR is one component of the overall response. The lead agency typically sets up a command post with an IC in charge. Appropriate federal, state, and local agencies and non-governmental organizations, including the SAR system, may have representatives assigned to serve at or in close association with, the command post. Owners of a craft in distress may also have a representative assigned to the command post. Where ICS is implemented, SAR facilities may conduct simultaneous operations along with other types of responders under ICS management or may serve as part of the ICS strike team. ICS does not take responsibility, control or authority away from the SAR service. Rather, the SMC, OSC, or someone designated by the SMC, serves as the coordinator of SAR response (SAR “agency representative”) to the IC recognized by an applicable emergency response plan. Chapter 5 of this NSS provides more detail.

---

## CHAPTER 2. AGENCIES AND RESOURCES

- 2.1 Domestic Agencies
- 2.2 Federal Agencies
- 2.3 State Agencies
- 2.4 County Agencies
- 2.5 Municipal Agencies
- 2.6 Law Enforcement Agencies
- 2.7 Commercial Agencies and Resources
- 2.8 Private Agencies and Resources
- 2.9 SAR Resources
- 2.10 Aeronautical Facilities
- 2.11 Maritime Facilities
- 2.12 Land Facilities
- 2.13 Primary Federal SAR Resources

### 2.1 Domestic Agencies

- 2.1.1 Agencies for civil SAR activities exist at all governmental levels and throughout the private sector.

### 2.2 Federal Agencies

- 2.2.1 Federal agencies with SAR relevance are coordinated by the National SAR Plan (NSP), Appendix A, to fulfill international, national, and local responsibilities. Signatory agencies to the NSP form the National Search and Rescue Committee (NSARC) that oversees the NSP and coordinates its implementation. Their roles and SAR responsibilities are given in the NSP. Sponsored and chaired by the Coast Guard, the NSARC, through the Coast Guard Commandant, reports to the Secretary of Transportation. Member agencies of the NSARC are listed below.

**Department of Transportation (DOT)**

**Department of Defense (DOD)**

**Department of Commerce (DOC)**

**Federal Communications Commission (FCC)**

**National Aeronautics and Space Administration (NASA)**

**Department of the Interior (DOI)**

- 2.2.2 Other federal agencies have a special interest in emergency services, or can provide helpful ancillary SAR services, or special facilities needed for SAR. Such agencies include:

- a) **Federal Emergency Management Agency (FEMA):** coordinates emergency management with local, state, and other federal agencies. FEMA's mission is to reduce loss of life and property and protect our nation's critical infrastructure from all types of hazards through a comprehensive, risk-based, emergency management program of mitigation, preparedness, response and recovery. The National Urban Search and Rescue Response System is coordinated by FEMA.

- b) **Federal Bureau of Investigation (FBI):** operates the National Crime Information Center (NCIC) in Washington, D.C. This center is the computerized hub of a nationwide criminal justice information network indexing crime and criminals, and storing and retrieving crime information furnished by all levels of government. NCIC provides data to any authorized criminal justice agency on six categories of stolen/missing property, a category on wanted persons, and another on criminal histories. Contact with NCIC is normally made by law enforcement agencies.

- c) **National Transportation Safety Board (NTSB):** investigates and determines probable causes of aircraft, marine, highway, railroad, and pipeline accidents, and recommends improvements to prevent accidents.

## **2.3 State Agencies**

- 2.3.1 SAR arrangements in the states vary considerably. Some states have a designated SAR Coordinator (such personnel may have quite different responsibilities of national SAR Coordinators as designated in the NSP). Most states have a statewide law enforcement agency that handle locating lost, stranded, or overdue persons, boats, aircraft, and other vehicles. States can assist elsewhere through interstate communications. Some states have highly sophisticated communications networks, including automatic message routing and processing, priority preemption, and automatic relay. State officials, such as Aviation Directors, State Boating Law Administrators, and Park Service Directors or their equivalent, can also assist. While coordination with state agencies may be important to SAR efforts, operational control of federal resources is not normally assigned to states.

## **2.4 County Agencies**

- 2.4.1 In almost all areas, county agencies can provide SAR assistance. Most counties have a sheriff, some with land, water, or air SAR responsibility. Some sheriff's departments have highly developed SAR resources and extensive communications networks. The sheriff is usually empowered to form ground search parties, requisition rescue equipment, and coordinate municipal, county, and state efforts during SAR operations.

## **2.5 Municipal Agencies**

- 2.5.1 The municipal agencies and resources that are most helpful are police and fire departments, and hospitals. Some have helicopters, light aircraft, boats, or vehicles that can perform local SAR and provide emergency care within the immediate area of a mishap. In some areas lifeguard and beach patrols provide trained swimmers, scuba divers, boats, and emergency care equipment.

## **2.6 Law Enforcement Agencies**

- 2.6.1 On all government levels, law enforcement agencies provide a variety of services and facilities, including aircraft, boats, patrol cars, ambulances, snowmobiles, scuba teams, and tracking dog teams. Most of these facilities are radio equipped and coordinated by a central communications system. These agencies can perform harbor, boat launching ramp, and airport checks. They also can provide data, recover drowning victims, coordinate ground search teams, provide vehicle and spectator control at distress scenes, and transport survivors.

## **2.7 Commercial Agencies and Resources**

- 2.7.1 Assistance of various types may be available from commercial agencies and resources. Oil companies, fishing companies, rescue squads, and aeroclubs may voluntarily help with SAR missions. Aircraft and vessels in transit, while not suited for extensive searching, often assist in SAR as they may have a moral or legal obligation. The SAR coordinator can only request assistance from such craft. Commercial towing and salvage companies have a variety of equipment to assist distressed vessels, and may provide vessels to take over towing or salvage of a vessel no longer in immediate danger. The owner or agent of the disabled vessel usually arranges for such services. SRUs should not interfere if commercial facilities can safely complete the operation. SAR coordinators usually do not have authority to hire commercial facilities or personnel for SAR missions, and should be guided by agency directives. SAR coordinators may be able to have local or state officials procure such services, if they are legally able.

## **2.8 Private Agencies and Resources**



- 2.8.1 SAR services may be provided by various private organizations and resources. Such organizations should be asked to coordinate activities with rescue coordination center (RCC) SAR operations. If such groups want to assist, the RCC may advise them of cases occurring in their area. Specialized private groups are described below.
- a) **National Association for Search and Rescue (NASAR):** members are dedicated to increasing federal, state, local, and volunteer coordination, to making improvements in SAR services, and to promoting survival education programs. NASAR promotes improvement in SAR throughout the U.S., but does not have dedicated SAR facilities.
  - b) **Mountain Rescue Association (MRA):** mountain rescue teams are located in Alaska, Canada, and numerous states. Mountain rescue teams are proficient in conducting rough terrain or mountain searches and rescues of lost or stranded persons. These teams may be requested by contacting AFRCC, which maintains a 24-hour alert list.
  - c) **National Ski Patrol:** members are trained in first aid, search in snow-covered and avalanches areas, and ground evacuation of injured persons from such terrain. Ski patrol rescue teams can usually be alerted through any major ski resort.
  - d) **National Speleological Society:** members explore and map underground caves. They have established a national cave rescue coordinator and staff for compiling procedures and practices for cave rescues. Each "grotto" (local club) throughout the U.S. maintains a rescue team, often including a doctor. Assistance can be requested by contacting AFRCC.
  - e) **Divers Alert Network (DAN):** located at Duke University Medical Center in North Carolina, is a nonprofit organization that provides emergency medical advice and assistance for underwater diving accidents. Any Coast Guard RCC can provide the current telephone number to contact DAN.

## 2.9 SAR Resources

- 2.9.1 Resources available for SAR response include any mobile SAR facility, station, operational activity, or other resource that can be used during SAR operations. SAR coordinators organize them to provide the most effective response. SMCs normally select resources from a SAR facility list or those listed in the plans of operation, but may request other resources during a SAR mission. A SAR facility is any mobile resource, including designated SAR units (SRUs), used to conduct search and rescue operations. The use of any SAR facility depends on SMC judgment, and is governed not only by the SAR facility's ability to reach the distress scene, but also by other capabilities, training, and experience. IAMSAR Manual, Volume 2, Appendix G provides information on SAR facilities – sources of, equipment to have, and factors to consider in selection for SAR operations.

## 2.10 Aeronautical Facilities

- 2.10.1 Aeronautical SAR facilities can quickly search large areas, intercept and escort aircraft in distress or other SRUs, and perform aerial delivery of supplies, equipment, and personnel. See IAMSAR Manual Volume 2 Appendix G for general types, capabilities, and operating considerations.

## 2.11 Maritime Facilities

- 2.11.1 Maritime SAR facilities are usually most effective when combined with aircraft SRUs for a coordinated air/surface search, where their long endurance allows assignment as OSC, or when responding to nearby incidents where search is not a major factor. They are most satisfactory for rescues involving large numbers of survivors. A marine SRU may also be used to escort or tow disabled surface craft, and for surface delivery of supplies, equipment, and rescue or medical personnel to the distress scene. See IAMSAR Manual Volume 2 Appendix G for general types, capabilities, and operating considerations.

## 2.12 Land Facilities

- 2.12.1 Land SAR services can include wilderness and urban areas, and may include aeronautical SAR operations. Personnel utilizing animals, vehicles, and other equipment, may be used as land SRUs to penetrate remote or difficult areas to provide immediate emergency medical care and subsequent evacuation of survivors, or to track survivors. Although search by land SAR facilities alone is usually impractical for large search areas, it can be conducted in most weather conditions, and can provide complete coverage of the area searched.
- 2.12.2 Although many SRUs are organized for search, rescue, or both, and many are specialized for a particular environment, SMCs may organize a ground search from available personnel and equipment rather than use specialized teams. Land SAR facilities should not normally be used without adequate transportation, navigation, rescue and medical training and equipment, physical training, skill in communications and survival, leadership, and familiarization with the locale and terrain.
- 2.12.3 DOD resources that may be available to assist include Air Force pararescue personnel, and specialized teams such as Army, Navy, and Air Force explosive ordnance disposal (EOD) teams, Navy sea-air-land (SEAL) teams, or CAP ranger teams.
- 2.12.4 Nonmilitary governmental SAR teams, such as those of county sheriffs, and U.S. Forest and National Park Services are normally also well qualified. Privately organized amateur rescue teams that are active in land SAR, exist nationwide. Volunteers may be used for ground search missions if appropriate equipment and supervision are provided. Chapter 5 of this NSS provides guidance for the use of land SAR facilities.

## 2.13 Primary Federal SAR Resources

- 2.13.1 The Coast Guard, other Armed Services, the FAA, and the FCC maintain resources that may be used for SAR. Each SAR Coordinator establishes procedures for alerting and using SAR resources within the SRR. Generally, use of any resource is arranged by contact between the RCC and the parent agency. Primary SAR resources are described below, by agency.
- 2.13.2 **Coast Guard:** maintains a wide variety of SAR resources, primarily dedicated to maritime SAR throughout the U.S. and its territories. Coast Guard operations are supported by an extensive communications network of coastal radio stations, specialized landline circuits, and communications centers that are all guided by RCCs. Primary resources include:
  - a) *Aircraft*, the long-range HC-130 and medium-range HU-25 fixed-wing and HH-60, and HH-65 helicopters.
  - b) *Cutters*, classified as high-endurance cutters (WHECs), medium-endurance cutters (WMECs), and patrol boats (WPBs), along with buoy tenders, icebreakers, and harbor tugs.
    - 1) WHECs, 378 feet in length, are capable of sustained search operations at sea without replenishment for approximately 30 days. They are equipped with helicopter flight decks and support equipment for servicing helicopters at sea, and have air and surface search radar, "Identification, Friend or Foe" (IFF) interrogator and transponder, DF, sonar, and oceanographic equipment.
    - 2) WMECs, 180 to 270 feet in length, are capable of sustained operations and usually have surface search radar, IFF interrogator and transponder, and DF. WMECs 210 and 270 feet in length are equipped with helicopter flight decks and support facilities for servicing helicopters. Replenishment of supplies and refueling can extend WHEC and WMEC endurance. Their sustained operational capability, especially when they are paired with a SAR helicopter, makes them ideal SRUs. Patrol boats, 80 to 110 feet in length, are capable of sustained operations for 4 days, and usually have surface search radar and DF.

- c) *Boats* ranging up to 65 feet in length. The 41-foot utility boats and 30 - and 44-foot motor lifeboats are especially designed for short-range SAR operations. They are excellent for water rescue and can be used for search. The 44-and 47-foot motor lifeboats have surface search radar, DF, Loran-C and GPS and are self-righting and self-bailing in severe weather or surf. The 52-foot motor lifeboat has the same capability.
- d) *Stations*, located along the coastlines of the U.S., on the shores of the Great Lakes, and on some of the major river systems. They are equipped with various types of SAR boats, four-wheel-drive vehicles, direct communications links with an RCC, and, in some cases, amphibious vehicles or helicopters. A primary purpose of these stations is to obtain early information of life and property in danger within the operational range of station SRUs and take immediate action to assist. These stations also supervise SAR ground parties, usually limited to shoreline or beach areas.
- e) *Groups*, consisting of two or more SAR stations and sometimes including WPBs and a Coast Guard Air Station (CGAS). Group commands are an operational level, designed to coordinate SRU efforts, between the Coast Guard District Commanders and Coast Guard stations.
- f) *Coast Guard Auxiliary (CGAUX)*, a volunteer civilian organization formed to assist the Coast Guard in preventive and direct SAR activities, consisting of boat, yacht, aircraft, or amateur radio station owners, or persons with special qualifications desirable in the field of either boating safety or SAR. Members train in seamanship, navigation, communication, SAR, patrol procedures, weather, and administration. CGAUX provides several thousand privately owned SRUs throughout the U.S. for SAR operations. In some locations CGAUX SRUs are the only available SAR facilities. CGAUX personnel may also supplement Coast Guard personnel at various SAR stations during heavy SAR operations. Single-engine CGAUX aircraft are limited to operations within gliding distance of the shoreline for coastal search. The CGAUX communications net often supplements the established coastal radio net.
- g) *Automated Mutual-assistance Vessel Rescue System (Amver)*, a computerized system for maintaining the DR position of participating merchant vessels worldwide. Merchant vessels of all nations making coastal and oceanic voyages are encouraged to send movement reports and periodic position reports to the Amver Center at the Coast Guard Operations Systems Center via assigned coastal or international radio stations or satellite service providers. Norway, Poland, and U.S. (for certain vessels) require their merchant vessels to participate; other merchant vessels participate voluntarily. The Amver Center can deliver a surface picture (SURPIC) of vessels in the area of a SAR incident, including predicted positions and SAR capabilities. SURPICs can usually be generated for the current time, a point up to 30 days in the past, or a point up to 14 days in the future. Recognized RCCs worldwide handling an oceanic SAR operation can request a SURPIC from any U.S. Coast Guard RCC.

2.13.3 **Air Force:** resources include limited numbers of helicopters and fixed-wing aircraft capable of being used for civil SAR purposes. In addition, limited numbers of pararescue personnel may be available to assist civil resources in specific situations. The Air Force also operates radar sites either in conjunction with the FAA or as stand-alone systems that can be helpful when attempting to locate missing aircraft. These resources are listed below.

- a) Aircraft types include various short and long range helicopters and various types of transport aircraft, some of which can air refuel, providing a versatile SAR asset.
- b) *Jet interceptors* can proceed at high speed to intercept a distressed aircraft, fix the location, provide navigation and communications aid, and escort. If the intercept cannot be made before the distressed craft is forced to land, the jet may be in position to locate the landing or crash site. FAA ATC facilities are equipped to provide intercept advisories to all SAR aircraft.
- c) Some aircraft also perform aeromedical evacuation of military personnel, their dependents, and

authorized civilian patients worldwide, and many are located throughout the U.S.

- d) *Special-Purpose Aircraft*, such as photographic reconnaissance aircraft or Side-Looking Radar Reconnaissance (SLAR) aircraft have capabilities that may be useful for SAR over both water and land. In addition, Electronic Intelligence (ELINT) and Electronic Countermeasures (ECM) aircraft are equipped with a variety of sensors for determining the location of electromagnetic emitters. Their equipment includes sophisticated DF and usually some type of filmstrip recording capability for photographic, radar, and electronic targets. Flights may be requested through AFRCC. Other aircraft also have general illumination. It is effective in search efforts and invaluable in the lighting of distress areas. This system is more dependable, more economical, and less hazardous than parachute flares.
- e) The *Civil Air Patrol (CAP)*, using corporate and privately owned aircraft, flies the majority of search missions over land. The CAP, composed of aviation-oriented civilians, military reservists, and active duty military volunteers, is organized along conventional military lines, by state wings. CAP facilities operate in every state and Puerto Rico. CAP forces are activated by the AFRCC, which authorizes CAP SAR missions. The Alaskan CAP Wing is activated by the Alaska SAR coordinator. Except in Hawaii and Puerto Rico, single-engine CAP aircraft are not used over water beyond gliding distance of a shoreline. CAP also has SAR ground teams supported by other CAP members who can establish base camps providing meals and shelter.
- f) *Pararescue personnel*, SAR personnel highly trained in such fields as parachuting, mountaineering, survival in all environments, advanced emergency medical care, underwater scuba swimming, and aircraft crash fire fighting, can deploy from aircraft over any type of terrain or ocean, day or night, to assist survivors. The pararescue team usually consists of two pararescue personnel equipped with emergency medical care kits, survival kits, and either scuba or forest penetration parachute kits.
- g) *Joint Air Force – FAA Surveillance System*, is a nationwide array of linked radar that may provide valuable “near real-time information, including last known position, to SAR planners handling maritime or land aircraft incidents. This radar information is fully archived for a 90-day period and playback of an event can give a “near real-time” dynamic picture of the subject aircraft’s activities leading up to, and at the time of, the incident. The 84<sup>th</sup> Radar Evaluation Squadron (RADES) will endeavor to develop aircraft flight path data for aircraft that are the object of a search. The data will be provided as expeditiously as practicable, and on a not-to-interfere basis with the Squadron’s primary mission. RCCs may request the radar data via the following telephone points of contact:

Western Air Defense Sector:	Commercial Pager	253 984 4311 or 4312 DSN 984 2233 #660//2/leave number
Southeast Air Defense Sector	Commercial Pager	850 283-5205 or 5206 850 283 1678
Northeast Air Defense Sector	Commercial Pager	315 334-6802 800 730 0516

Give ADS as much information as possible, as the radar system archives all air contacts received, and the incident aircraft must be selected from the data available. The request from the RCC is to include the following information when it is known:

aircraft call sign,

date and UTC time to search,

beacon code,

last known position and altitude,

route of flight, and

type of aircraft.

ADS may be able to provide an electronic copy of the aircraft incident to the RCC, and assist in its interpretation. This playback will usually fit on one diskette and/or may be sent electronically for use on a Windows-based personal computer. No special training, hardware or software is required to perform the playback which can be advanced rapidly, slowed, and paused as required. Each data point of the incident may be "clicked" to show that data point's related information (altitude, etc.).

h) *Recorded Radar Systems*

- 1) 6521st Test Squadron, Edwards AFB Range Control. In support of the mission of the USAF Flight Test Center located at Edwards AFB, CA, the 6521st Test Squadron records primary and secondary radar data received from 10 radar sites (2 long range/8 short range). Data is retained for approximately 30 days and can be retrieved via a playback of the recording medium.
- 2) 552nd Airborne Warning and Control Wing (AWACS). In support of the global mission of the USAF, the 552nd AW&C Wing, based at Tinker AFB, OK, operates the Boeing E-3 "Sentry". Many of the aircraft operate within U.S. airspace during their daily flight operations. Radar data from the on-board search radar records both primary and secondary data. Although much of the information regarding the E-3's operating system is classified, recorded data is normally retained for 10 days and can be retrieved via a playback of the system recording. Additionally, the 552nd AW&C Wing (ADUE) personnel can copy recorded data to a printer or to a plotter. Initial request for a search of data should include date and time (UTC), and a latitude/longitude position.

- i) *Military Assistance to Safety and Traffic (MAST)* assists in serious civilian medical emergencies in areas that do not have available civilian services. Assistance is given if it does not interfere with primary military missions.

2.13.4 **Navy:** resources include extensive numbers and types of aircraft, surface and submarine vessels, sea-air-land (SEAL) teams, diving teams, salvage forces, and radar nets, Sound Fixing and Ranging (SOFAR) nets, and worldwide communications and DF networks. Naval commanders will normally assist SAR coordinators in handling SAR missions. Selected resources that may be used for SAR are described below.

- a) *Aircraft* types include both fixed-wing and helicopters. The P-3 Orion long-range aircraft is equipped with radar, extensive communications, and a variety of sophisticated sensors, including, forward-looking infrared (FLIR), making it an excellent search and OSC platform. Also of use for SAR are the carrier-based S-3 Viking and early warning (E-2 Hawkeye) fixed-wing aircraft. The primary SAR helicopter for visual conditions is the HH-46, also used is the HH-60, and the SH-60 Seahawk is an excellent all-weather SAR helicopter. The SH-2 Sea Sprite, carried on some cruisers and destroyers, can also be used. The endurance of these helicopters can be increased if used with ships having helicopter-refueling facilities. Special-purpose aircraft, similar to those operated by the Air Force, are also available.
- b) *Vessels* most often used for SAR are destroyers (DD) and fast frigates (FF) for surface search, aircraft carriers for air search, and submarines, salvage vessels, and oceanographic vessels for subsurface search. Destroyers and fast frigates are comparable to Coast Guard WHECs in operational capabilities and equipment for SAR missions, and many can refuel a hovering helicopter equipped to receive a fueling hose. *Shipboard Aviation Facilities Resume*, NAEC-ENG-7576, describes helicopter-refueling capabilities.
- c) *Boats*, such as crash-rescue boats, patrol craft, patrol torpedo boats, and river craft, may be used for sheltered or semi-sheltered water surface search. They are most effective in rescuing personnel from

the water.

- d) *Navy "salvage" units* may salvage public and private vessels, and claim reimbursement for such operations. Navy policy is to assist in the salvage of non-Navy shipping when such assistance is requested, and where adequate privately-owned salvage facilities are not available. Seagoing tugs or salvage vessels may be deployed for salvage missions. Stocks of salvage equipment and material suitable for airlifting are also maintained.
- e) *Underwater demolition and sea-air-land (UDT/SEAL) teams* are qualified in parachuting, underwater swimming, survival, and demolition. Each UDT/SEAL team normally has at least one member highly trained in advanced emergency medical care.
- f) *A Movement Reporting System* monitors Navy vessel positions worldwide. If an SMC wants to find a suitable Navy ship for an oceanic SAR mission, the appropriate fleet commander can be queried, via Contact Area Summary Position Report (CASPER), for Navy vessels in the area. Navy vessel movements are classified and will not normally be released. While individual vessel data may be provided, the information source, code words, departure points, and destinations are not revealed.
- g) *Sound Fixing and Ranging (SOFAR) nets* can pinpoint the location of small SOFAR devices detonating at predetermined depths underwater. SOFAR nets are effective only in ocean depths greater than the continental shelves (600 feet). Landmasses, including underwater seamounts, will block the SOFAR sound signals.
  - 1) SOFAR devices may be released by aircraft, vessels, or boats experiencing difficulties, or by survivors adrift on the ocean; if time does not permit release before the distressed craft ditches or sinks, a device may automatically arm itself at approximately 800 feet and detonate between 2,400 and 4,000 feet. One station can obtain a line of position (LOP) and an approximate range on each signal. Two stations can cross LOPs to obtain a fix with an accuracy of approximately 2 miles.
  - 2) SMCs can query the SOFAR net any time a craft known to carry a SOFAR device is missing. If a craft is definitely overdue, the SOFAR net can search its recordings for SOFAR signals from the last contact with the distressed craft to the present, since survivors may have SOFAR devices in rafts as well as in their vessel.
  - 3) SAR aircraft carrying SOFAR devices can use them in conjunction with SOFAR stations to maintain a constant bearing with a distressed craft. When a SAR aircraft arrives on scene, the SOFAR net may be able to vector it directly to the SOFAR datum. The SAR aircraft may also be able to release a SOFAR device at a distress scene where a lack of navigational aids prevents accurately fixing the distress position.
- h) *The High-Frequency Direction-Finding (HFDF) net* has a frequency range between 2000 kHz and 30,000 kHz, and covers both the Atlantic and the Pacific oceans. This net is alerted when there is a reasonable expectation of locating the distressed craft. To alert, SMCs provide certain information, outlined by Navy OPNAVINST C2520.1 series and Coast Guard COMDTINST 3130.16 series. The SMC should de-alert the net as soon as possible after the distressed craft is located.
- i) *Recording Radar Systems.*
  - 1) USN Fleet Area Control and Surveillance Facility (FACSFAC). The U.S. Navy operates FACSFAC facilities at Oceana, VA, Jacksonville, FL, San Diego, CA, and Honolulu, HI. These facilities utilize both long and short-range radars in support of the Navy's offshore surveillance requirements for aircraft operating in coastal warning areas. These facilities generally provide radar coverage from the shoreline, out to sea. FACSFAC facilities record primary and secondary radar data which is retained for a period of 15 days. Data can be rapidly extracted via a visual

playback of the recording medium while also producing a hard copy of the playback.

- 2) TPX-42 (DAIR) Terminal ATC Radar Systems. USN and Marine Corps Air Stations record terminal ATC radar data via the TPX-42 (DAIR) recorder. Data from these systems are limited to secondary radar only to a maximum range of 60 nautical miles. Recorded data is retained for 15 days and can be rapidly extracted via a playback of the recording medium.

2.13.5 **Army:** the designated Executive Agent for Military Support to Civil Authority (MSCA), responds to natural disasters within U.S. territory, maintains a large variety of resources, including a large number of helicopters, light aircraft, ground vehicles, and surface detection nets. In addition, the Army is responsible for managing the MAST program. Selected resources that may be used for SAR are described below.

- a) *Aircraft*, either helicopters or light fixed-wing, are excellent search aircraft. Most helicopters do not have hoisting capability, and must land or hover just off the terrain to retrieve survivors, or use alternative devices. Some aircraft have SLAR and other sensors for electronic and radar searches. Pilots are experienced in low-level flying and trained in visually detecting search objects. Aircraft are usually restricted to operations over land.
- b) *Land SRUs* may be provided due to large numbers of personnel who are trained to operate in inclement conditions. However, they are not specifically trained in civil SAR operations.
- c) *Disaster equipment* includes portable hospitals that can be transported by truck or airlifted. Stocks of cots, food, medicines, and other equipment exist to meet the Army mission of disaster assistance. Equipment may be issued directly at disaster sites or to the American Red Cross.

2.13.6 **Federal Aviation Administration (FAA):** in addition to other resources, maintains a nationwide communications net, coordinated with international aeronautical communications services for the control, coordination, and assistance of civil and military air traffic. Primary resources that may be used for SAR are:

- a) *Aircraft of various types*, usually operated to check the proper functioning of aids to air navigation and to perform other regulatory missions. These aircraft are equipped with sophisticated sensors and area navigation equipment.
- b) *Flight-following and alerting services*, ARTCCs provide flight-following service for aircraft on flight plans under instrument flight rules (IFR) and alert RCCs when an aircraft is overdue. Flight Service Stations (FSSs) provide flight-following service for aircraft on flight plans under visual flight rules (VFR) and alert RCCs when these aircraft become overdue.
- c) *Radar nets*, independent and joint radar sites operated by the FAA and the Air Force. They provide almost complete coverage of the continental U.S., Alaska, Hawaii, Panama, and Puerto Rico. All sites are equipped with IFF interrogators for use in ATC. Most major civil and military aerodromes have short-range terminal radar that may obtain radar contact with distressed aircraft in the vicinity. The National Track Analysis Program (NTAP) can retrieve computer-stored radar data up to 15 days old to pinpoint a missing aircraft's last known position. The key item for a successful NTAP solution is the object's last fix. Many aircraft have been found near the end of their radar track. However, due to the possibility of errors in producing radar tracks, or when multiple tracks exist, search planners should not disregard other search leads. Distress is not the only reason an aircraft may be lost from radar coverage. Radar tracks from an objective aircraft may disappear and reappear more than once along a route of flight due to terrain interference. NTAP information should be requested through AFRCC, Langley AFB, VA who will coordinate directly with the radar facility for the release of data. The minimum information required to process an NTAP request are: correlating time and location, direction of travel, and an estimated destination. In addition to the recording radar nets listed for USAF and USN, FAA recording radar nets include:

- 1) Air Route Traffic Control Centers (ARTCC) facilities operated by FAA within the continental U.S. and at offshore locations, record primary and secondary radar data through a series of long range radar sited via NAS computers. Recorded data is retained for a period of 15 days. Data can be extracted in a hard copy form. In some cases, data can be viewed on a CRT providing a more rapid form of review.
  - 2) Automatic Radar Terminal System 3 (ARTSIII). The FAA operates 62 Terminal Radar Approach Control (TRACON) facilities equipped with the ARTSIII tracking computer. ARTSIII systems generally record both primary and secondary radar. Recorded data is retained for 15 days and is extracted in a hard copy format.
- d) *VHF direction-finding nets*, covering the frequency bands of 118-156 MHz. These nets, composed of DF sites at airports and FSSs, are supplemented by military airport DF sites, and provide almost complete coverage of the continental U.S. and Alaska. DF sites are also located in Puerto Rico, the Virgin Islands, the Hawaiian Islands, and Wake Island.
- 1) The FAA operates approximately 27 ARTCCs for all areas where the U.S. provides ATC services. Each ARTCC is responsible for maintaining a VHF DF net within its area of control, and acts as the net control station. ARTCCs may pass net control to any DF station within their net. VHF DF nets locate aircraft that are lost or experiencing an emergency and then vector them to the nearest suitable airport. The net can also vector SAR aircraft to the same bearing line as the distressed aircraft, help the SAR aircraft to maintain the same bearing line, and aid in completing an intercept.
  - 2) A DF net is alerted any time a pilot admits being lost or declares an emergency, and may be alerted via any ARTCC, FSS, FAA tower, military tower, or RCC. When an RCC alerts a net, it should provide the following:
    - a) Call sign or other identification of the distressed aircraft.
    - b) Frequency and type of transmission (MCW or voice) being used by the distressed aircraft.
    - c) Call sign or other identification of intercepting aircraft.
    - d) Whether the distressed aircraft is or is not transmitting at the time of the call, or when it is next scheduled to transmit.
    - e) Nature of the emergency, including emergency phase (Distress, Alert, or Uncertainty).
    - f) Organization requesting DF assistance.

The net usually continues alert status for aircraft forced to ditch, or crash land, to obtain bearings on emergency distress beacons. The net control station de-alerts the net automatically when the emergency is over.

2.13.7 **Federal Communications Commission (FCC):** operates an HF direction-finding net that covers the inland U.S. and parts of the Pacific and the Atlantic Oceans. Their Communications and Crisis Management Center (CCMC) is staffed 24 hours a days and has the capability to provide the location of aircraft, ships or persons in distress. The FCC also operates field offices with personnel who can locate ELTs and EPIRBs using mobile and portable DF equipment. FCC services should be used for urgent SAR only and are generally not available to the public.

- a) SMCs may activate the FCC's HF net by calling the CCMC at 202-632-6975, or the nearest FCC office during normal business hours, and providing the same information needed to alert the FAA net. SMCs should ensure the FCC net is de-alerted as soon as possible after the distressed craft is located.
- b) The FCC net provides an elliptical area containing the most probable location of the distress and the longitude and latitude of the ellipse's center. While the net usually does not provide DF bearings with a fix, SMCs should request all available bearings.



This page intentionally blank

---

## CHAPTER 3. COMMUNICATIONS

- 3.1 General
- 3.2 Emergency Communications
- 3.3 Visual Signals
- 3.4 IFF Equipment
- 3.5 EPIRB, ELT and PLB
- 3.6 Sound Communications
- 3.7 Global Maritime Distress and Safety System
- 3.8 Communication Facilities
- 3.9 SAR Operations Communications
- 3.10 Mobile Facility Communications
- 3.11 SAR Operations Messages
- 3.12 Alerting Ships at Sea and En Route Aircraft

### 3.1 General

- 3.1.1 SAR Communications are a critical but often weak link in the SAR system. IAMSAR Manual Volume 1, Chapter 4 summarizes the general communications capability and equipment the RCC should have. Volume 2, Chapter 2 introduces distress alerting, SAR communications and distress mobile and land-based uses of communications equipment. Volume 3 discusses many communication aspects for mobile facilities and its Section 3 is the source of much of the information tabulated within this chapter. See Chapter 5 for specifics involving Land SAR.

### 3.2 Emergency Communications

- 3.2.2 Personnel in distress have a variety of methods, ranging from sophisticated electronic devices to waving a piece of cloth, for alerting the SAR system. SAR personnel should be familiar with emergency signals and devices.

### 3.3 Visual Signals

- 3.3.1 Commonly used visual distress signals and other types of distress communications are listed in IAMSAR Manual, Volume 2, Appendix A and Volume 3, Section 2. In addition to these signals, daylight visual signals may include fluorescent material and night devices may include strobes, incandescent or chemical lights, pyrotechnics or reflective materials.

### 3.4 IFF Equipment

- 3.4.1 Identification Friend or Foe (IFF) equipment consists of a radar interrogator and a transponder. The interrogator, incorporated into an air search radar system, transmits an electronic challenge. Any transponder within range replies with a user-entered code and, in most transponders, altitude. Transponder replies may be detected at greater range than the radar return of the craft itself. The user can dial codes into the transponder to signal a message to the interrogator operator.

Code 7700 indicates a distress,

Code 7600 a communications failure, and

Code 7500 an unlawful interference with the aircraft.

When no other code is assigned, Air Force and Coast Guard aircraft are authorized to use Mode 3, Code 1277 in domestic airspace, on official SAR missions, and en route to or within an assigned search area.

### 3.5 EPIRB, ELT and PLB

3.5.1 The Emergency Position Indicating Radio Beacon (EPIRB), Emergency Locator Transmitter (ELT), and Personal Locator Beacon (PLB) are devices specifically designed to transmit emergency signals to alert the SAR system and that can be located by satellites and by direction finding (DF) equipment. Each device is battery operated and engineered for a particular environment. EPIRBs are maritime devices and as such are required to be waterproof, corrosion resistant and able to float upright on their own (for those designed to float). ELTs are built to survive the tremendous force of an aircraft crash. However, they are carried inside the aircraft and are usually less waterproof and non-floating. PLBs are designed to be manually activated and operate on land.

*Note: Rulemaking to authorize the sale and use of PLBs within the U.S. was pending as of May 2000.*

3.5.2 EPIRBs, ELTs and PLBs transmit on 121.5 MHz, 243 MHz, 406 MHz or on a combination of these frequencies. Those that transmit on 406 MHz are specifically designed to operate with the Cospas-Sarsat satellite system. (The actual frequency is 406.025 MHz but the beacon is typically referred to as 406 MHz.) Their signal consists of a 0.44-second burst of data transmitted every 50 seconds to polar orbiting and geostationary orbiting satellites. This data burst contains a unique identifier number that links each individual EPIRB, ELT or PLB to a registration database that contains information on the vessel or aircraft, and emergency points of contact. In the U.S., all 406 MHz EPIRBs, ELTs and PLBs are required to be registered with the National Oceanic and Atmospheric Administration (NOAA). Two of the three classifications of ELTs use 121.5 MHz frequency for distress alerting. However, the space-based monitoring of 121.5 MHz is expected to be terminated on 1 February 2009. While non-space-based systems could still monitor this frequency and all ELTs will keep the 121.5 MHz homing capability, the Cospas-Sarsat system will not be able to detect or determine the position of 121.5 MHz distress alerts once processing of 121.5 MHz signals by satellite is halted.

3.5.3 **EPIRBs** are devices for transmitting maritime distress alerts. Five classes of EPIRBs are of significance to U.S. SAR authorities but only the initial four listed below are authorized for use by U.S. vessels:

- a) *Class A EPIRBs* operate on 121.5 and 243 MHz and are automatically activated.
- b) *Class B EPIRBs* operate on 121.5 and 243 MHz and are manually activated.

*Note: The U.S. Coast Guard intends to terminate the sale and use of all 121.5 MHz EPIRBs in the U.S. prior to 2007*

- c) *Category I 406 MHz Satellite EPIRBs* are automatically activated, float free devices operating in the 406 MHz band internationally allocated for satellite EPIRBs. These devices are coded with vessel information and when activated, this coded information will be transmitted via the satellite system to the appropriate RCCs. These devices provide accurate location information worldwide. Safety of Life at Sea (SOLAS) Convention and other classes of vessels (U.S. fishing vessels) are required to carry Category I 406 MHz Satellite EPIRBs. These EPIRBs transmit for at least 48 hours and have the 121.5 MHz homing capability.
- d) *Category II 406 MHz EPIRBs* are similar to the Category I devices except the Category II EPIRBs are manually activated. Vessels are encouraged to replace aging 121.5 MHz EPIRBs with the 406 MHz Satellite EPIRBs. These EPIRBs transmit for at least 48 hours. These EPIRBs transmit for at least 48 hours and have the 121.5 MHz homing capability.
- e) *Inmarsat-E EPIRBs* operate on 1.6 GHz L band via Inmarsat satellites, through Inmarsat-E CESs and relayed to RCCs. While the SOLAS Convention allows use of the Inmarsat E-EPIRB in lieu of 406 MHz satellite EPIRBs, the U.S. does not allow this option for U.S. ships. Inmarsat-E EPIRBs are, however, used by a limited number of foreign flag vessels, and U.S. RCCs can expect to receive occasional distress alerts from them.

*Note: Some 406 MHz EPIRBs may also transmit a position within the distress alert. This position may be a one-time input from the ship's navigation system or may be periodically updated from a GPS processor internal*

to the EPIRB. The one-time position input may not represent the most accurate position of the EPIRB since it may not be known when that position was last inserted.

- 3.5.4 **ELTs** emit a distress signal on 406 MHz, 121.5 MHz and/or 243.0 MHz either when turned on manually or when subjected to G-forces, such as an aircraft crash. They are required on most noncommercial aircraft registered in the U.S. Certain classes of aircraft, such as agricultural and aerobatic, are not required to carry an ELT. Commercial aircraft with extended overwater operation carry an ELT for use in one life raft.
- 3.5.5 **PLBs** emit a distress signal on 406 MHz and a homing signal on 121.5 MHz when turned on manually. Currently they are illegal for general use in the U.S. However, there are some special state-run programs and government agencies that use PLBs. Alerts from these PLBs may be routed to special destinations in addition to the SAR system.
- 3.5.6. The **Cospas-Sarsat** satellite system for detecting distress beacons is discussed in IAMSAR Manual, Volume 2, Chapter 2; and, its Appendix B contains message formats used between RCCs and the Cospas-Sarsat system. Terms unique to Cospas-Sarsat and likely to be encountered and used by SAR personnel have been incorporated into the Abbreviations/Acronyms and Glossary of this NSS.
- a) Cospas-Sarsat alarms are when a signal emanates from the beacon but is not detected by authorities. False alarms are a result from an inadvertent activation of the beacon.
  - b) Cospas-Sarsat alerts are when a signal emanates from the beacon and is detected by authorities. The alerts can be a result from signals emanating from beacons that are either unresolved (unresolved alerts may result from unknown signal sources) or determined to result from a non-beacon source, hoaxes, inadvertent alarms or the unresolved alarms that are not related to a distress incident.
  - c) For Cospas-Sarsat purposes, beacon alerts are either distress-related, inadvertent, intended to deceive, or unresolved.
- 3.5.7 **EPIRB/ELT/PLB False Alerts**
- a) Incidents involving activation of an EPIRB/ELT/PLB, in non-distress or non-emergency situations, which result in the deployment of SAR units, are frequent. Often these false alerts can be attributed to improper storage and handling of these devices. It is important that users of EPIRB/ELT/PLBs understand that beacon activations result in the expenditure of SAR resources. The Federal Communications Commission (FCC) will issue warning letters, violation notices and fines, if appropriate, in cases involving non-distress activation of EPIRB/ELT/PLBs. Before the FCC can take action, each case of false activation must be fully identified, documented and reported.
  - b) Cases involving activation of an EPIRB/ELT/PLB as a hoax or through gross negligence should be reported to the FCC field office nearest to the infraction location. Contact the FCC's CCMC for the nearest FCC field office.
  - c) Cases involving violations by federal agencies or foreign governments should be referred to the Reporting Agency or Department's Frequency Management Office.

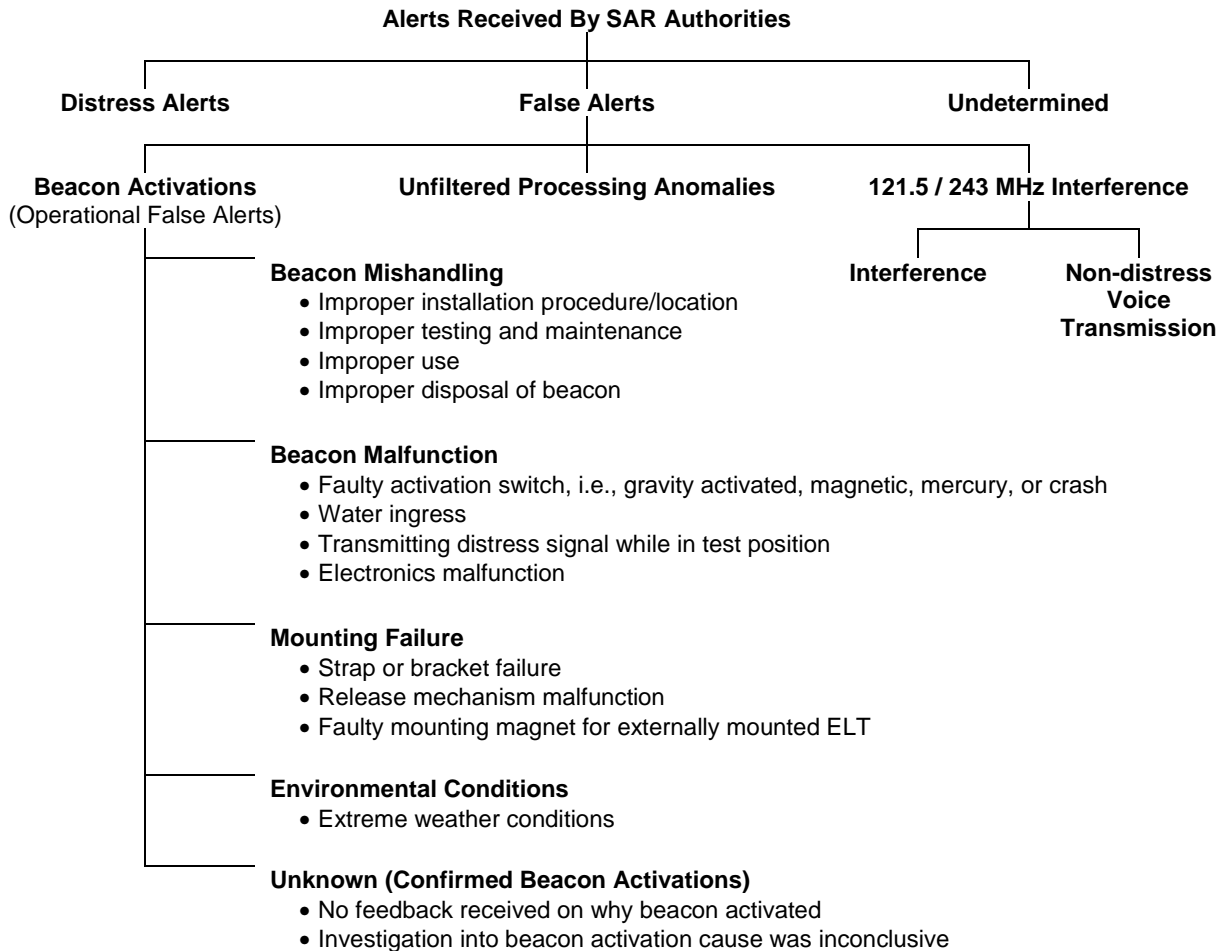

**Figure 3-1. Classification of Cospas-Sarsat Alerts**

### 3.6 Sound Communications

3.6.1 Sound communications of various sorts are used in underwater and surface search operations. SOFAR devices have been detected as far as 6,000 miles when detonated underwater. Acoustic beacons (pingers) installed on some aircraft and self-contained pingers, actuated by immersion in salt water or by remote sound signals, can be detected by sonar at ranges of up to 3 miles, but have an average range of 1 mile. Surface sound devices include gunshots, whistle signals, sirens and the human voice. Gunshots are usually limited to a range of approximately 1-mile, while whistles are limited to about 100 yards. Detecting sound on the earth's surface depends on the loudness of the device, the amount of moisture in the air and the direction and force of the surface wind.

### 3.7 Global Maritime Distress and Safety System (GMDSS)

3.7.1 Ships subject to the Safety Of Life At Sea (SOLAS) Convention are to be outfitted with certain communications equipment, collectively referred to as the shipboard portion of the GMDSS. Certain fishing vessels and other marine craft may also be required to carry GMDSS-compatible equipment; and, other vessels may voluntarily carry this equipment. GMDSS is intended to provide:

automatic alerting and locating with minimal delay,

reliable network of SAR communications,

integration of satellite and terrestrial communications, and  
adequate frequencies in all maritime bands.

- 3.7.2 RCC personnel are to be familiar with the SOLAS GMDSS provisions, and associated IMO documents. Of particular value is the GMDSS Master Plan published by IMO to distribute information from all nations on their shore-based facilities in support of GMDSS-equipped ships. The general goal of GMDSS is to shift alerting emphasis from ship-to-ship (though this can still be done), towards ship-to-shore where SAR professionals can help arrange assistance. GMDSS capabilities of vessels not subject to SOLAS may range from full compliance to no GMDSS capabilities at all.
- 3.7.3 Introduction of GMDSS aboard only some vessels adds capabilities for those vessels but also introduces incompatibility between those vessels and vessels not GMDSS-equipped. It also creates the need to support two maritime mobile and fixed systems. When most ocean-going ships discontinue watchkeeping (guard) on VHF-FM channel 16, most small vessels will still depend on channel 16 for distress, safety, and calling. The requirement for many vessels to maintain a watch on channel 16 VHF-FM, even on GMDSS-equipped vessels, will be in effect until at least 1 February 2005. The U.S. Coast Guard plans to guard channel 16 ashore indefinitely. Vessels are not required to guard 2182 kHz MF. Shore networks may also cease guard on the 2182 kHz frequency but the U.S. Coast Guard will maintain the 2182 guard ashore.
- 3.7.4 Further information on GMDSS is provided in the IAMSAR Manual, Volume 1, Chapter 4 and Appendix G; Volume 2, Chapter 2; and, Volume 3, Section 3.
- 3.7.5 GMDSS radiocommunication functions include:
- ship-to-shore distress alerting by at least two separate and independent means,
  - shore-to-ship distress alerting,
  - ship-to-ship distress alerting,
  - SAR coordinating communications,
  - on-scene communications,
  - locating,
  - maritime safety information,
  - general radio communications, and
  - bridge-to-bridge communications.
- 3.7.6 GMDSS elements are:
- a) Satellite terminals, typically Inmarsat (International Mobile Satellite Organization) earth stations.
  - b) EPIRBs.
  - c) NAVTEX.
  - d) Inmarsat SafetyNET, also called Enhanced Group Call. Used to provide high seas maritime safety information outside NAVTEX coverage. HF telex allowed as a substitute.
  - e) HF telex (also called SITOR or NBDP).

- f) HF radiotelephone.
- g) VHF radiotelephone.
- h) VHF handheld (for survival craft).
- i) SART. The Search and Rescue Transponder (SART) has been defined by the IMO as the main means for locating a survival craft within GMDSS. This device operates in the 9.2-9.5 GHz frequency band and generates 20 dots on a radar display on being interrogated by a shipborne or airborne radar operating in this frequency band.
- j) VHF DSC (Channel 70) transmitter and watch receiver.
- k) MF DSC used to initiate ship-to-ship call or ship-to-shore call when within 100 NM of shore. Call can be initiated without anyone listening to radio.
- l) HF DSC, same purpose as MF DSC, except provides worldwide coverage.

3.7.7 GMDSS communications equipment has unique registration identifiers that are to be registered. This information is intended to be maintained in national databases, kept up to date, and readily available to all RCCs. Such information may not always be readily available or up to date.

3.7.8 If a distress alert is inadvertently transmitted by GMDSS equipment, the GMDSS equipment operators are supposed to carry out the actions as outlined below.

<b>VHF DSC</b>	<ul style="list-style-type: none"> <li>⇒ Reset the equipment immediately;</li> <li>⇒ Set to Channel 16, and</li> <li>⇒ Transmit a broadcast message to “All Stations” giving the ship’s name, call sign and maritime mobile service identity (MMSI), and cancel the false distress alert.</li> </ul>
<b>MF DSC</b>	<ul style="list-style-type: none"> <li>⇒ Reset the equipment immediately;</li> <li>⇒ Tune for radiotelephony transmission on 2182 kHz; and</li> <li>⇒ Transmit a broadcast message to “All Stations” giving the ship’s name, call sign and MMSI, and cancel the false alert.</li> </ul>
<b>HF DSC</b>	<ul style="list-style-type: none"> <li>⇒ Reset the equipment immediately;</li> <li>⇒ Tune for radiotelephony on the distress and safety frequency in each band in which a false distress alert was transmitted; and</li> <li>⇒ Transmit a broadcast message to “All Stations” giving the ship’s name, call sign and MMSI, and cancel the false alert on the distress and safety frequency in each band in which the false distress alert was transmitted.</li> </ul>
<b>Inmarsat SES</b>	<ul style="list-style-type: none"> <li>⇒ Notify the appropriate RCC that the alert is canceled by sending a distress priority message by way of the same CES through which the false distress alert was sent. Provide ship name, call sign and Inmarsat identity with the canceled alert message.</li> </ul>
<b>EPIRB</b>	<ul style="list-style-type: none"> <li>⇒ Contact the appropriate RCC through a CES or LES and cancel the distress alert. Keep the EPIRB activated until an appropriate RCC can be contacted to cancel the alert. (This reduces incomplete alerts and uncertainty associated with why an EPIRB signal ceased.)</li> </ul>
<b>General</b>	<ul style="list-style-type: none"> <li>⇒ Ships may use additional appropriate means available to them to inform the appropriate authorities that a false distress alert has been transmitted and should be canceled. RCCs should not count on the above procedures being followed by the equipment operators at sea.</li> </ul>

**Figure 3-2. Canceling of False Distress Alerts**

### 3.8 Communication Facilities

3.8.1 **Voice Communications** provide the most rapid means of transmitting urgent information, and usually are the most practical for directing on-scene operations. They may be accomplished by using:

- a) *Telephone Private Lines (TPL)*, when established specifically for SAR nets, they may be called SARTELS. (Due to commercially available service being so widespread and reliable, SARTELS have typically outlived their usefulness and may no longer be needed.) ARTCCs have widespread voice circuits for domestic and international traffic control. These can be extremely valuable for SAR, particularly in aircraft incidents. Urgent communications between two RCCs can often be relayed by an ARTCC.
- b) *Defense Switched Network (DSN)*, a worldwide direct-dial system of voice communications for U.S. military agencies.
- c) *Federal Telephone System (FTS)*, a direct-dial system within the U.S. for use by U.S. government agencies.
- d) *Commercial telephone*, the most widespread method of domestic and international voice communications. It often provides the most rapid means of transmitting or obtaining information.
- e) *Radiotelephone*, the most common type of radio communications among surface, air and fixed stations. There are innumerable uses of radiotelephone circuits and a considerable number of networks that can be used in SAR operations. Radiotelephone links, commonly called phone patches, provide important links through the commercial telephone system and marine operator to craft at sea and by aeronautical radio stations to en route aircraft.
- f) *Mobile satellite services (MSS)*, provide telephone direct-voice communication via satellites. The primary service currently used is Inmarsat, which is available to Inmarsat-equipped vessels. Commercial MSS is being provided by a growing number of companies for afloat, airborne and land mobile use but distress or related SAR communications arrangements have not been formally established.

3.8.1 **Printed Communications** that may be used are:

- a) *Teletypewriter Private Lines (TWPL)*, installed when the volume of traffic justifies a private line dedicated to printed communications. In some areas, particularly the continental U.S., special SAR dedicated circuits have been established to carry operational SAR traffic.
- b) *Defense Message System (DMS)*, a widespread teletype network using automatic switching circuits, used extensively for military communications and by other government agencies for operational and administrative printed communications.
- c) *Aeronautical Fixed Telecommunications Network (AFTN)*, an international teletype network based on ICAO requirements for air navigation services, including SAR. FAA Flight Service Stations (FSSs) are the normal points of interface for U.S. RCCs. Diagrams of implemented and planned circuits are contained in the communications sections of the ICAO Regional Air Navigation Plans. AFTN may be helpful when language is a barrier. AFTN should not be routinely used for maritime SAR when reliable alternative systems exist. However, ICAO has agreed that it can be used by maritime RCCs. It has the advantages of being global, allowing message priorities to be established and is often the best alternative when communicating with developing nations.
- d) *Aeronautical Fixed Network (AFN)*, a digital network based on ICAO requirements that is replacing AFTN.
- e) *FAA Domestic Teletype Networks*, operated extensively within the U.S., primarily for ATC service. They carry information concerning missing or overdue aircraft. ARTCCs and FSSs work directly with RCCs.



- f) *Teletypewriter Exchange (TWX)*, a commercial method of establishing direct communications with subscribers within the U.S. and Canada, connecting subscribers through a commercial switchboard. The switchboard can also connect with international TELEX systems.
- g) *Teletype (TELEX)*, an international commercial service similar to TWX, that serves domestic needs in some foreign countries. While in other countries the various TELEX systems provided by different international companies interconnect so it is possible to have two or three different and separate systems. In such cases, the use of TELEX for SAR can be complicated.
- h) *Radio Teletype (RATT)*, a generic term for teletype circuits which use radio connection instead of cable or landline. They may be integrated with some of the systems described above or they may be special purpose. More and more ships and aircraft are becoming equipped with RATT. SMCs may find it convenient in many cases to use a RATT circuit for the control channel during SAR operations.
- i) *NAVTEX*, is an internationally adopted, automated system for instantly distributing marine navigational warnings, meteorological information and search and rescue information to approximately 200 nautical miles offshore.
- j) *Inmarsat*, allows direct TELEX service to and from Inmarsat-equipped vessels. Priority is given to distress and related SAR communications.
- k) *Commercial Mobile Satellite Services (MSS)*, are services provided by various commercial companies, however, distress or related SAR communications arrangements have not been formally established.

3.8.2 **Telegraphy** used in SAR communications is usually radiotelegraphy between fixed stations and ships. This is seldom used now, but may be used by large ships at sea through a coast radio station.

3.8.3 **Facsimile** (by either cable or radio) is used for transmission of a picture and is most often used to transmit charts, such as weather maps.

3.8.4 **Data Link**, used in several contexts in communications, generally indicates communications circuits designed for transmitting raw data from one place to another. They are most useful when transferring data to and from computers.

### 3.9 SAR Operations Communications

3.9.1 General categories of frequencies for SAR operations are discussed below. Specific frequencies should be published in the SAR plan. Tables below provide many of the frequencies and their use.

3.9.2 **Control Channels** are used for communications between the OSC or ACO and the SMC. This link may be direct or, if necessary, via a radio station monitored by the SMC. The SMC assigns control frequencies from those available in the SAR plan. The control channel should be a dedicated frequency apart from the on-scene frequency.

3.9.3 **On-scene Channels** are used between SAR facilities and the OSC or ACO. All SAR facilities on scene should use the same frequency. Distress frequencies should not be used for on-scene SAR communications. Non-SAR units on scene are prohibited from using on-scene channels unless authorized by the OSC.

3.9.4 **Monitor Channels** are guarded by SAR facilities throughout the search for possible transmission from distressed craft or survivors. The SMC assigns monitor frequencies based on the type of survival radio equipment believed to be available to the distressed craft.

3.9.5 **En Route Channel Frequencies** are used by SAR facilities en route to the SAR operations area. SRUs do not change operational control (CHOP) from their parent agency to the OSC or ACO until shortly before arriving on scene. When departing the scene, the SRU CHOPs back to its parent agency and reestablishes en route communications.

3.9.6 **Homing Channels** are used to locate a distressed craft or person. Any distress or on-scene frequency may be used as a homing channel subject to availability of DF equipment for the frequency.

3.9.7 **Press Channels** are used by news media personnel for filing stories.

### 3.10 Mobile Facility Communications

3.10.1 **Aeronautical, maritime, and land mobile facilities** operate on different radio frequencies and normally are not authorized to communicate on the other's frequency. A typical exception is the SRU that may carry radio equipment to communicate with other types of mobile SAR facilities. Aircraft typically have at least one radio, so it may be easiest for the air facility and land facility to use an aeronautical frequency. If the land facility does not have a portable aircraft radio, then equipping an aircraft with a radio operating on ground frequencies may provide communications. Communications between vessels and aircraft is discussed in the IAMSAR Manual, Volume 2, Chapter 2. Tables containing frequency information summarized in IAMSAR Manual Volume 3 and provided below.

3.10.2 **Aircraft** normally communicate on voice channels only, and usually guard at least one channel. Both military and civilian aircraft use HF (AM/SSB) for long-range. Civil aircraft use VHF (AM) for short-range, and military aircraft use UHF (AM) or VHF for short-range. If the ground aeronautical radio station that is working the aircraft is known, contact may be established through it. Military aircraft flights normally maintain communications guard with a military ground aeronautical radio station. Civil commercial aircraft on both long-range and short-range flights normally maintain communications guard with Aeronautical Radio Incorporated (ARINC) radio stations. Military aircraft not on IFR flight plans normally maintain communications guards with a parent radio station, usually "home base." All aircraft on IFR flight plans maintain a communications guard with an ATC facility and may be contacted through the nearest ARTCC.

3.10.3 **Merchant vessels** have the capability to communicate on MF or HF voice frequencies while the use of MF and HF radio telegraph continues its global decline. Inmarsat provides a full range of communications, including voice, data, Telex and facsimile depending on the type of terminal installed on board. The NAVTEX system can also be used to contact vessels equipped with NAVTEX receivers. When attempting to establish contact with a merchant vessel, a call should be made on the DSC distress frequencies for GMDSS-equipped vessels, or 2182 kHz voice or 156.8 MHz voice. Mandatory use of 500 kHz has been phased out. Since some merchant ships may keep a continuous guard on 2182 kHz, if a distress occurs, the MF auto alarm signal may be transmitted. After contact is made on 2182 kHz, a shift to a working frequency should be made.

- a) Commercial providers such as COMSAT, Mobile Marine Radio, and Globe Wireless may be able to provide assistance in contacting merchant ships. Certain stations broadcast a "Traffic List" every 2 hours, copied by many merchant ships. If a maritime SMC is unable to contact a ship directly, assistance from a commercial station may be obtained by notifying either RCC Norfolk or RCC Alameda. That RCC can contact the commercial radio station and request that the ship's call sign be included in the next traffic list. If the ship does not establish contact after two traffic list broadcasts, the SMC should begin the process again.
- b) Ships equipped with Inmarsat terminals may be contacted immediately by voice or TELEX. If desired, Inmarsat can alert all ships in an area simultaneously. Information on procedures and participating ships is available from:

COMSAT Corporation, 6560 Rock Spring Drive, Bethesda, MD 20817; Tele: 301 428 4000

- c) A vessel may have its Ships' Earth Station (SES) barred by its communications service provider, similar to a telephone being disconnected for non-payment. When barred, only distress and urgent safety messages can be sent and SafetyNET broadcasts received. That means the vessel can not receive distress alerts from other vessels or RCC requests to provide assistance. To contact a barred vessel, an RCC must have arrangements in place with the CES it works with, and then contact the CES to implement them and unbar the SES. IAMSAR Manual, Volume 2, Chapter 2 provides further discussion on unbarring a SES. There is

no automatic way for the RCC to be advised that a vessel has its SES barred. If contact can not be established through the SES then the RCC should consider calling the CES and ask if the SES is barred.

- d) Merchant ships under way in U.S. harbors and waterways monitor bridge-to-bridge or vessel traffic system frequencies.

**Figure 3-3. Alerting, SAR Operations, and Maritime Safety Frequencies**

Function	System	Frequency			
Alerting	406 EPIRBs	406-406.1 MHz (earth to space)			
	Inmarsat-E EPIRB	1644.3-1644.5 MHz (earth to space)			
	Inmarsat SES	1544-1545 MHz (space to earth)			
		1626.5-1646.5 MHz (earth to space)			
		1645.6-1645.8 MHz (earth to space)			
	VHF DSC (Channel 70)	156.525 MHz <sup>1</sup>			
	MF/HF DSC <sup>2</sup>	2187.5 kHz <sup>3</sup>		4207.5 kHz	6312 kHz
		8414.5 kHz		12577 kHz	16804.5 kHz
VHF AM	121.5 MHz				
VHF FM	156.8 MHz				
On-scene communications	VHF Channel 16	156.8 MHz			
	MF Radiotelephony	2182 kHz			
	MF NBDP	2174.5 kHz			
Communications involving aircraft	On scene including SAR	156.8 MHz <sup>4</sup>	121.5 MHz <sup>5</sup>	123.1 MHz	
		156.3 MHz	2182 kHz	3023 kHz	
		4125 kHz	5680 kHz <sup>6</sup>		
Homing signals	406 MHz EPIRB	121.5 MHz			
	9 GHz radar transponders (SART)	9200-9500 MHz			
Maritime safety information (MSI)	NAVTEX Warnings	518 kHz <sup>7</sup>			
	NBDP	490 kHz	4209.5 kHz <sup>8</sup>	4210 kHz	
		6314 kHz	8416.5 kHz	12579 kHz	
		16806.5 kHz	19680.5 kHz	22376 kHz	
		26100.5 kHz			
Satellite	1530-1545 MHz (space to earth)				
Safety of Navigation	VHF Channel 13	156.650 MHz			
Distress and Safety Traffic	Satellite	1530-1544 MHz (space to earth)			
		1626.5-1646.5 MHz (earth to space)			
	Radiotelephony	2182 kHz	4125 kHz	6215 kHz	
		8291 kHz	12290 kHz	16420 kHz	
		156.8 MHz			
NBDP	2174.5 kHz	4177.5 kHz	6268 kHz		
	8376.5 kHz	12520 kHz	16695 kHz		
Survival craft	VHF Radiotelephony	156.8 MHz & one other frequency in the 156-174 MHz band			
	9 GHz radar transponders (SART) <sup>1</sup>	9200-9500MHz			

<sup>1</sup> Frequency 156.525 MHz can be used for ship to ship alerting and, if within Sea Area A1, for ship-to-shore alerting.

<sup>2</sup> For ships equipped with MF/HF DSC equipment, there is a watch requirement on 2187.5 kHz, 8414.5 kHz, and one other frequency.

<sup>3</sup> Frequency 2187.5 kHz is used for ship to ship alerting and, if within Sea Areas A2, for ship-to-shore alerting.

<sup>4</sup> Frequencies 156.3 and 156.8 MHz may also be used by aircraft for safety purposes only.

<sup>5</sup> Frequency 121.5 MHz may be used by ships for distress and urgency purposes.

- <sup>6</sup> The priority of use for ship aircraft communication is 4125 kHz. Additionally, frequencies 123.1 MHz, 3023 kHz, and 5680 kHz may be used for intercommunication between mobile stations and these stations and participating land stations engaged in coordinated search and rescue operations.
- <sup>7</sup> The international NAVTEX frequency 518 kHz is the primary frequency for the transmission by coast stations of maritime safety information by NBDP. The other frequencies are used only to augment the coverage or information provided on 518 kHz.
- <sup>8</sup> Frequency 4209.5 kHz is not used by all nations.

Frequencies for Use in the GMDSS		
DSC Distress & Safety Calling	Radiotelephony Distress & Safety Traffic	NBDP Distress & Safety Traffic
2187.5 kHz	2182.0 kHz	2174.5 kHz
4207.5 kHz	4125.0 kHz	4177.5 kHz
6312.0 kHz	6215.0 kHz	6268.0 kHz
8414.5 kHz	8291.0 kHz	8376.5 kHz
12577.0 kHz	12290.0 kHz	12520.0 kHz
16804.5 kHz	16420.0 kHz	16695.0 kHz
156.525 MHz (VHF Channel 70)	156.8 MHz (VHF Channel 16)	
MSI NBDP Broadcasts by Coast Radio and Earth Stations		
490.0 kHz	518.0 kHz	
4209.5 kHz*	4210.0 kHz	
6314.0 kHz	8516.5 kHz	
12579.0 kHz	16806.5 kHz	
19680.5 kHz	22376.0 kHz	26100.5 kHz
*NAVTEX service (coastal maritime safety information)		
On-scene Search & Rescue-Radio Telephony		
2182.0 kHz	(R/T)	
3023.0 kHz	(Aeronautical frequency)	
4125.0 kHz	(R/T)	
5680.0 kHz	(Aeronautical frequency)	
123.1 MHz	(Aeronautical frequency)	
156.8 MHz	(VHF Channel 16)	
156.5 MHz	(VHF Channel 10)	
156.3 MHz	(VHF Channel 6)	
Locating/Homing Signals		
121.5 MHz	(Cospas-Sarsat satellite location & aircraft homing)	
156-174 MHz	(VHF maritime band-radiotelephony)	
406.025 MHz	(Cospas-Sarsat satellite location)	
1.6 GHz	(L band Inmarsat EPIRB)	
9200 to 9500 MHz	(X band radar transponders-SART)	

Figure 3-4. General Distress and Safety and Survival Craft Frequencies

3.10.4 Other general information regarding SAR operations communications includes:

- a) **Maritime:** Ships transmitting a distress message on any of the frequencies in the tables above should use the appropriate alarm signals before transmitting the message until contact has been established.
- b) **Aeronautical:** The aeronautical frequencies 3023 kHz and 5680 kHz may be used for communications by ships and participating CRSs engaged in coordinated SAR operations. However, since these frequencies are not continuously monitored, shore authorities may be needed to help establish communications on these frequencies.
- c) **Land:** Land SAR can be conducted for many types of incidents, ranging from a downed aircraft to a hiker lost in the wilderness. Land facilities and aeronautical facilities may conduct coordinated land searches. Since each normally operates on different radio frequencies, advance co-ordination amongst local agencies may be necessary to establish effective communications.

3.10.5 **Small craft**, such as fishing vessels and pleasure craft, normally communicate on MF voice and VHF-FM voice. Only commercial boats carrying passengers for hire are required to guard 2182 kHz continuously. **IF** initial attempts to contact fishing boats or pleasure craft on

2182 kHz **or**

156.8 MHz (channel 16 VHF FM) **or**

156.450 MHz (channel 9 VHF FM) are unsuccessful, **THEN** try the following voice frequencies:

Frequency/channel	Area
2003 kHz	Great Lakes
2635 kHz	All areas
2638 kHz	All areas
2738 kHz	All areas except Great Lakes and Gulf of Mexico
2830 kHz	Gulf of Mexico
4125 kHz	Alaska
156.3 MHz (channel 6)	All areas

**3.11 SAR Operations Messages**

- 3.11.1 SAR operations messages under IAMSAR Manual, Volume 2, Chapter 2 include “operations normal” and position reports.
- 3.11.2 Armed Forces, Civil Air Patrol, or Coast Guard Auxiliary aircraft should use the word "rescue" in their call sign when priority handling is critical. The use of "rescue" in the call sign for ATC communications should be arranged locally between aviation units and ATC authorities. SRUs initially checking in with the OSC should use their full plain-language call sign. Thereafter, search area assignments, such as Alpha-3 or Bravo-2, should be used as call signs.
- 3.11.3 For SAR facility safety, the OSC should establish periodic reporting procedures for marine craft, aircraft, and land search parties. The OSC should require an "operations normal" report at least every 30 minutes for multi-engine, fixed-wing aircraft and every 15 minutes for single-engine aircraft and helicopters. The OSC will assign each SRU an "operations normal" reporting time. If an SRU is unable to make the report directly to the OSC over an on-scene channel, it should relay the report through another SRU.
- 3.11.4 Position reports are not required from SAR facilities in their assigned search areas. However, it is good practice for the OSC to periodically obtain and chart SAR facility positions to ensure that they are in the correct areas.

### **3.12 Alerting Ships at Sea and En Route Aircraft**

- 3.12.1 Ships or aircraft already in the vicinity provide the most immediate help available to a distressed ship or aircraft.
- 3.12.2 A maritime coast radio station (CRS) can best alert ships. Normally, the RCC originates a message to all ships and sends it to a CRS for broadcast. The RCC should include instructions on whether to use the alarm signal, and whether to issue the broadcast as a distress broadcast or as an urgent marine broadcast. The CRS should then use the procedures in international radio regulations.
- a) An urgent broadcast should be used during the Alert Phase.
  - b) A distress broadcast should be used during the Distress Phase when the distressed unit may not be able to transmit a distress alert, or when a distressed unit has sent a distress alert not acknowledged by assisting units.
  - c) When the incident is within about 150 nautical miles of shore, vessels equipped with GMDSS can be called on DSC distress frequencies, and other vessels can be called on 2182 kHz MF voice. When the incident is within about 20 nautical miles of shore, emergency calls should be made on VHF DSC (channel 70), or 156.8 MHz voice (channel 16). Since use of GMDSS equipment varies with the type of vessel and the vessel's distance from the transmitting site may be unknown, it may be necessary to make calls on DSC and broadcasts on MF and VHF voice frequencies.
  - d) In exceptional circumstances, the SMC may direct an additional broadcast on another commonly used frequency after calling on the DSC distress frequencies or broadcasting on 2182 kHz, or 156.8 MHz voice. Local factors, such as ship-to-ship and ship-to-shore frequencies in use by fishing or pleasure craft in the area of the incident, determine additional frequencies to be used.
  - e) The SMC may alert small craft listening to the above frequencies by contacting marine operators, commercial radio broadcast stations, and the National Weather Service (NWS). They should be asked to include the missing craft information in their regular marine news or weather broadcasts, asking anyone who has information to contact the controlling RCC.
  - f) If a need exists to alert surface craft for an extended time, a Notice to Mariners should be issued in a coastal area and a Navy Hydro message for ocean areas.
- 3.12.3 En route aircraft on IFR flight plans can be informed of emergency situations in their vicinity by ARTCC, which is aware of and able to communicate with aircraft available to assist. Under some circumstances en route aircraft might be alerted by aircraft towers or approach control facilities, usually when incidents occur in the vicinity of these facilities. Alerting of aircraft should be done during the Alert or Distress phases, when en route aircraft may intercept and escort distressed craft, locate survivors transmitting on aeronautical emergency frequencies, or sight the incident. SMCs should consult with aeronautical authorities in advance to determine the best method of alerting en route aircraft in their area.

This page intentionally blank

---

## CHAPTER 4. SEARCH PLANNING AND OPERATIONS

- 4.1 General
- 4.2 FAA Emergency Phases
- 4.3 Communications Searches
- 4.4 Preliminary Communication Search
- 4.5 Extended Communication Search
- 4.6 Search Planning Methods
- 4.7 Airspace Control
- 4.8 Search Operations
- 4.9 Search Object
- 4.10 SAR Facilities Movement
- 4.11 Conclusion of SAR Operations

### 4.1 General

- 4.1.1 Search planning and search operations will be conducted in accordance with the IAMSAR Manual and as augmented by this NSS. IAMSAR Manual, Volume 2 was written specifically for conducting RCC and SMC duties, and is the primary source document for both search planning and search operations. Chapters of particular relevance include: Chapter 3, "Awareness and Initial Action" that discusses SAR stages and emergency phases; Chapter 4 "Search Planning and Evaluation Concepts"; Chapter 5 "Search Techniques and Operations"; Chapter 7 "Emergency Assistance Other Than Search and Rescue"; and an extensive array of appendices with tables, formats, forms, and other pertinent information.
- 4.1.2 Appendix G to this NSS, Tables and Graphs, provide specific search planning information that has not yet been incorporated into the IAMSAR Manual. These tables and graphs should be reviewed for use where they may provide more accuracy. Appendix H provides coordinated search patterns involving aircraft with vessels.
- 4.1.3 IAMSAR Manual, Volume 3 provides guidance for SAR facilities when an RCC or SMC has not yet provided such support (e.g., SMC has not yet been designated or communications from the SMC are lost). Detailed search procedures for in-flight SAR aircraft are included in IAMSAR Manual, Volume 3.

### 4.2 FAA Emergency Phases

- 4.2.1 FAA emergency phases differ from the SAR emergency phases used by other U.S agencies and also as detailed in IAMSAR Manual Volume 2. The FAA uses "Information Request" (INREQ) and "Alert Notice" (ALNOT) to indicate emergency conditions over land. INREQ, corresponding to the SAR Uncertainty phase, is a message request for aircraft information to flight service stations (FSSs) along the aircraft's planned route. ALNOT, corresponding to the SAR Alert phase, is an alerting message containing all known aircraft data and addressed to the appropriate RCC and all aeronautical facilities within 50 miles of the aircraft's planned route. Both INREQs and ALNOTs must be answered within 60 minutes. In oceanic airspace, the emergency phase terms used by the FAA are the same as those used for SAR, but in coastal areas either terminology may be used in reporting aircraft emergencies to RCCs. Appropriate FAA facilities will clarify any confusion.

### 4.3 Communication Searches

- 4.3.1 SMCs conduct communication searches when facts are needed to supplement initially reported information. SAR facility movement to check potential areas of craft location may be necessary. Communication searches continue efforts to contact the craft, determine whether the craft is overdue or simply unreported, better define the search area, and obtain more information for determining subsequent SAR action. The two types of communication searches are the preliminary communication search (PRECOM) and the extended communication search (EXCOM). They are usually conducted sequentially.

### 4.4 Preliminary Communication Search (PRECOM)



4.4.1 PRECOM search involves contacting major facilities where the craft might be or might have been seen, and is normally conducted during the Uncertainty phase. PRECOM establishes limits for the area to be covered during EXCOM or physical search efforts, and should be conducted as quickly as possible. Each facility should be contacted only once, and the SMC briefed when PRECOM is completed.

4.4.2 PRECOM efforts for *marine craft* will vary depending on the type of craft. Marine craft PRECOM usually includes contacting local sources such as:

all designated SAR resources in the area for any information in radio logs and records;

bridge and lock tenders;

local harbor patrols, harbor masters, and dockmasters;

marinas, yacht clubs, and other waterside facilities, such as ice and fuel supplies, chandleries, repair yards, fishing concerns, and vessel agents;

tug companies and fishing vessels;

local police, pilot boats, customs and immigration authorities; and

relatives and friends.

a) If the missing craft is known to have a radio aboard, appropriate facilities should attempt contact. Marine operators in areas being searched should be asked to check their logs for information on the search object. Public correspondence marine operators (MAROP) should be asked to attempt at least one contact.

b) When a vessel is overdue from a long sea voyage, SAR officials in other countries may be asked to assist through their RCCs, Navy, or other military channels. Other sources, such as Amver, Naval Intelligence Operations Center, Lloyd's, or International Telecommunication Union (ITU), could be queried. United States Embassy or consular officials may also be contacted directly for assistance, with the Department of State an information addressee on messages.

4.4.3 PRECOM for *aircraft* is usually begun by the FAA and conducted by the responsible air route traffic control center (ARTCC) for instrument flight rules (IFR) aircraft and by the responsible FSS for visual flight rules (VFR) aircraft. When an aircraft not on a flight plan is reported overdue, the RCC should begin an EXCOM immediately, while at the same time requesting the appropriate flight-following facility to start a PRECOM. Aircraft PRECOM usually includes:

contacting the departure airport to confirm departure and non-return. The inquiry verifies flight plan data, weather briefing the pilot received, and any other available facts;

contacting the destination and alternate airports to confirm that the aircraft has not arrived. Physical ramp checks are requested of all uncontrolled airports;

requesting aircraft along or near the route to attempt radio contact; and

contacting airfields, aeronautical radio stations, aeronautical aids to navigation stations, and radar and DF nets within areas through which the aircraft may have flown.

## 4.5 Extended Communication Search (EXCOM)

4.5.1 EXCOM search, normally conducted after the PRECOM, involves contacting all possible sources of information on the missing craft, and normally occurs during the Alert phase. It may include asking organizations or persons to physically check harbors, marinas, or airport ramps. EXCOM continues until either the search object is located or the search is suspended.

- 4.5.2 Facilities checked during PRECOM, and additional facilities that might provide leads, should be checked at least every 24 hours, and preferably every 8 to 12 hours. Choice of facilities contacted usually is left to the discretion of the command conducting the EXCOM. However, the SMC should have a listing of these facilities, and should monitor EXCOM SITREPs to ensure thorough area coverage. EXCOM for an aircraft is begun by FSSs and monitored by the RCC. Since there are numerous facilities that may be checked, EXCOM takes time. If the check is begun at night or on a weekend, it may be necessary to wait for normal working hours to contact many sources.
- 4.5.3 All facilities and persons contacted during EXCOM, including marine operators and the Coast Guard Auxiliary, should be asked to maintain a lookout for the search object during their normal operations and to notify the nearest SAR unit if sighted. A definite time limit should be set for the watch in case facilities are overlooked and not de-alerted after the search object has been located or the search is suspended. If information is still desired after this period, another EXCOM should be initiated.
- 4.5.4 Local press, radio and television should be contacted during this phase to give out information on the missing craft and request assistance of the public.

#### 4.6 Search Planning Methods

- 4.6.1 Methods used in search planning depend on incident complexity and available planning capabilities. For complex incidents, sophisticated computer programs can aid in data analysis, and are preferred if initial information is incomplete or conflicting, many variables exist, or searching continues for more than one day. For less complex cases or if computer aids are not available, a manual method can be used.
- 4.6.2 All search planning methods use the same types of information. The manual method is presented in detail in the IAMSAR Manual, Volume 2. The computations require knowledge of vectors and simple algebra. A scientific-function electronic calculator is helpful.

#### CASP

- 4.6.3 **Computer-Assisted Search Planning (CASP)** is a computer program available at Coast Guard RCCs. It can be used in most search planning and is most useful in situations too complex for the manual method. Maritime cases with more than 24 hours of search object drift and cases, inland or maritime, with two or more successive searches can benefit significantly from CASP. Advantages offered by CASP are that the program:
  - a) Accepts more available incident data than is possible in a manual solution. The SMC can evaluate many possible scenarios with a range of incident times, positions, search objects, situations, and environmental factors. The manual method averages data to estimate search object location.
  - b) Uses computer simulation to graphically depict the range of possible search object locations, and areas most likely to contain the search object. When more than one search is needed, CASP can use previous search results in estimating the probable search object location for the next search.
  - c) Calculates the Probability of Success (POS), a measure of search effectiveness, for each search and for cumulative searches. POS is the probability the search object is in the search area and that it will be located. It is always less than or equal to Probability of Detection (POD) and is often significantly lower than POD, particularly in complex cases involving several days of searching. Used primarily in computer search planning, POS is seldom calculated in a manual solution. CASP uses POS with SAR facility information to determine optimal allocation of search effort, enabling the SMC to decide where to deploy SAR facilities for maximum effectiveness.
- 4.6.4 For drift calculations CASP uses average historical and forecast environmental data or on-scene data. Actual on-scene data should always be used when available because relatively minor differences in information can greatly affect predicted datum. Even well established currents can vary in location, direction, and intensity, and weather forecasts are sometimes inaccurate. OSCs should report observed drift and wind data to the SMC to

update CASP inputs.

- 4.6.5 To improve CASP reliability and accuracy, successful and unsuccessful SAR missions are compared with CASP predictions. Copies of SITREPs, planning worksheets, and other information potentially useful in validating CASP should be sent to:

Commandant (G-OPR)  
U. S. Coast Guard  
2100 2<sup>nd</sup> Street, S.W.  
Washington, DC 20593-0001

*Radar ground track*

- 4.6.6 **Radar ground track** is an important tool that can help update the last known position of an aircraft known or suspected to be in distress. Search planners should consider a wide area around the end of these ground tracks as a possible location for downed aircraft. Several ground tracks may exist for an aircraft that is not squawking discrete transponder codes. In such cases, the areas near the end of all of these multiple tracks may merit investigation. Search planners should not disregard other search leads, however, as errors may occur in producing radar tracks. Further, distress is not the only reason an aircraft may be lost from radar coverage. Radar tracks from an aircraft may disappear and reappear more than once along a route of flight due to interference from terrain.

- a) SMCs can request radar ground track data via the Air Force Rescue Coordination Center (AFRCC). Any questions regarding the use of radar ground tracks in search planning should also be referred to the AFRCC. Chapter 2 of this NSS provides more information on the Air Force and FAA radar nets.

- 4.6.7 Other SAR planning tools, such as the Navy's NAVSAR package, are available for determining search area and resource allocation. Before such tools are used, their limitations and proper application should be determined.

## 4.7 **Airspace Control**

- 4.7.1 The SMC has two concerns for controlled airspace:

- 1) gaining access to controlled airspace over the scene of SAR operations, and
- 2) establishing airspace reservations, as needed.

- 4.7.2 The **Department of Defense** controls many areas that are designated as special use airspace. These include Military Operating Areas (MOAs), Low Level Training Routes, and Restricted Areas over land and Warning Areas over the ocean. If a distress requires SAR facility operation in these areas, prior coordination with the military command exercising control over the special use airspace is necessary. The names and telephone numbers for the controlling agencies are available in various military Flight Information Publications (FLIPs).

- 4.7.3 The SMC must often coordinate with air traffic control (ATC) facilities during a mission and should be familiar with ATC procedures. Aircraft are prohibited from flying in instrument meteorological conditions (IMC) in controlled airspace unless flying on an IFR clearance provided by ATC. It is usually not possible to obtain an IFR clearance in uncontrolled airspace, and, as a result, aircraft may operate only if visual separation from other aircraft and obstacles can be maintained. State-owned aircraft flying over open ocean may operate in IMC without an IFR clearance, provided certain criteria are met. The parent agency or the pilot-in-command should be consulted regarding these operations.

*Airspace Reservations*

- 4.7.4 The SMC may request ATCs to establish temporary airspace or altitude reservations during SAR operations to prevent non-SAR aircraft from interfering with search operations, especially general aviation aircraft and helicopters which pose in-flight safety hazards and noise interference to surface operations.

- 4.7.5 Temporary Flight Restrictions (TFRs) are obtainable in domestic airspace, and may be imposed for forest fires, floods, earthquakes, or similar disasters (see Appendix C). The designated area normally is within 5 statute miles of the disaster boundaries and includes altitudes to 2,000 feet above the surface.
- a) No person may operate an aircraft within the area unless:
    - 1) Operating under direction of the agency responsible for relief activities.
    - 2) Transiting to or from an airport within the area and operating so as not to hamper or endanger relief activities.
    - 3) Operating under an IFR-ATC clearance.
    - 4) Operating because VFR flight around or above the area is impracticable due to weather, terrain, or other considerations, with prior notice given to the ATC facility specified in the Notice to Airmen (NOTAM), and provided that en route operation through the area does not hamper or endanger relief activities.
    - 5) Carrying accredited news representatives, or persons on official business concerning the incident. Prior to entering the area the operator must file with the ATC facility a flight plan including identification of aircraft, communications frequencies, times of entry and exit, and name of news media or purpose of flight.
  - b) When a temporary flight restriction area is designated, ARTCC issues a NOTAM and specifies the Flight Service Station (FSS) nearest the disaster for air traffic coordination. If the disaster scene is large, the ARTCC will usually assign ATC coordination to the FSS nearest the RCC or disaster control operations base. The assigned FSS coordinates between the SMC and all affected aircraft.
  - c) For a flight restriction area containing numerous operating SAR aircraft, the SMC should prohibit news media aircraft from the same altitudes as SAR aircraft. If SAR aircraft traffic increases, and the SMC has previously permitted entry by news media aircraft, the OSC should rescind this authorization if their presence creates a hazard. News media aircraft should be instructed to contact the OSC prior to entry, and to remain outside the area if unable to establish communications.
- 4.7.6 SAR Operations Warning Areas can be reserved in either domestic airspace or international airspace and are usually in uncontrolled airspace. Restraint on aircraft entering the area is voluntary. ARTCC will not routinely issue a NOTAM for this type of reservation. However, the SMC may want to consider requesting a NOTAM for non-SAR aircraft to remain outside the area.
- a) After the SMC has developed the search area, 5 miles should be added to the outer boundaries of the coordinates passed to the ARTCC. The SAR operations warning area will include airspace within the expanded boundaries from the surface normally up to 2,000 feet over land or 6,000 feet over water. For international waters, the ceiling should not exceed the base of the Oceanic Control Area (OCA) found in the ICAO Air Navigation Plan for that region.
  - b) While the SAR operations warning area is in effect, ATC will not route IFR traffic to within 60 miles of the boundaries laterally, or 1,000 feet above the area ceiling.
- 4.7.7 SAR Altitude Reservation is usually controlled airspace, and provides for separation from ATC of controlled aircraft. There is no assurance of separation from aircraft not under ATC control. ATC does not issue a NOTAM for this reservation.
- 4.7.8 When requesting SAR airspace reservation, the SMC should provide ATC with the following:
- 1) Name and organization of the person making the request.

- 2) Brief incident description.
- 3) Estimated time of area reservation.
- 4) Method of contacting SMC.
- 5) Description of area by geographic features or coordinates.
- 6) Nature of operations and altitudes for aircraft SRUs.
- 7) SAR aircraft staging bases, and whether non-SAR aircraft should be asked to avoid these bases.
- 8) Whether aircraft carrying news media or persons on official SAR business should operate at altitudes used by SAR aircraft, including special instructions such as radio call signs, frequencies of SAR aircraft, requirement to contact the OSC, specific areas to be avoided, and direction of traffic flow. The SMC notifies ATC when reservations are no longer required.

4.7.9 During large-scale operations, or operations remote from adequate communications facilities, the SMC may require an aircraft coordinator (ACO) to establish a high-altitude orbit over the search area for better communications with SAR facilities and shore stations. The SMC selects a position over the search area that allows the ACO to establish early radio contact with SAR aircraft approaching from staging bases. Altitude and orbit distance is requested from the ACO for both the search and to record in the flight plan.

4.7.10 SAR aircraft should use the word "rescue" in their call signs when requesting priority handling or when in a restricted area.

4.7.11 The SMC should advise the OSC of authorized non-SAR craft in the area.

## **4.8 Search Operations**

4.8.1 As discussed in the beginning of this chapter, search operations will be conducted in accordance with the IAMSAR Manual and as augmented by this NSS.

## **4.9 Search Object**

4.9.1 IAMSAR Manual, Volume 2, Chapter 5 and Volume 3, Appendix C discuss how search object characteristics and search conditions affect its detection. Search planners and lookouts should be aware of such characteristics and conditions, and their effect, especially for visual searches.

4.9.2 Color helps in detection because it contrasts with the surrounding or background colors. A small search object that contrasts with the background can often be seen more easily than a larger search object that blends with surroundings. However, small search objects can be seen only at limited distance regardless of the color contrast. For color to be effective, the eye must look directly at the search object because the color receptors are concentrated in the center of the retina and objects seen out of the corner of the eye are unlikely to be detected by color contrast. White, yellow, red, and orange colors provide good contrast against a water background, but yellow and white objects are not easily seen against whitecaps. Under whitecap conditions, red and orange appear to be the easiest colors to detect.

4.9.3 Brightness will also influence a search object's contrast with its surroundings. For example, fluorescent colors (such as international orange) are typically sighted at greater distances than flat or dyed colors. The density of color in fluorescent paint and tapes is so great that brightness contrast combines with color contrast to improve search object detection probability by reflecting greater amounts of light.

4.9.4 In general, water wakes and colors are more easily sighted when looking away from the sun, whereas a craft's silhouette is likely to be sighted first if viewed looking towards the sun. Thus, color and brightness contrasts are

most influential when the search object is down-sun.

- 4.9.5 Search object motion influences detection range by contributing to the "something different" in a look-out's visual field and by disturbing the water. As a vessel moves faster, wake is larger and the detection range from the air increases due to the effective increase in search object size. Any movement by an object in light seas is likely to attract attention. Conversely, a stationary search object can sometimes be detected among whitecaps because search object position remains the same while the whitecaps "blink" on and off.
- 4.9.6 The relative amount of time that a search object is exposed to the observer affects search object detectability. Search object shape, particularly freeboard, can influence duration of exposure because waves and swells may hide the search object intermittently. Small search objects are especially difficult to detect in high seas and swells because of this effect.
- 4.9.7 Search object characteristics influencing detectability and, therefore, visual sweep width are summarized in Figure 4-1.

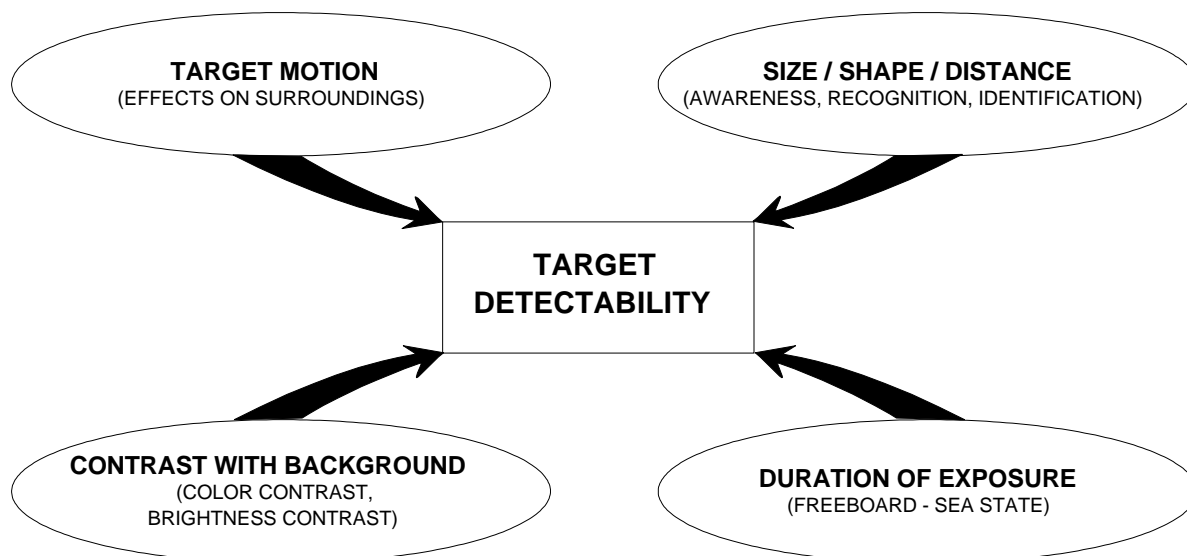

**Figure 4-1. Search Object Detectability Factor**

- 4.9.8 Search altitude affects a number of aspects of the visual detection process. As altitude decreases, the search object passes through the field of vision more rapidly than at higher altitudes, search objects with low-freeboard are more difficult to sight, and surface irregularities become more pronounced. Also, at lower altitudes pilots tend to concentrate more on their instruments and flying than they would if they had more of a safety margin. These effects are most pronounced at altitudes below 150 meters (500 feet). For a surface search craft, the freeboard and the length of the search object are more important than its beam. However, as altitude increases, the beam and length of the search object become more important because they determine the size of the search object as viewed from overhead. See Figure 4-2.

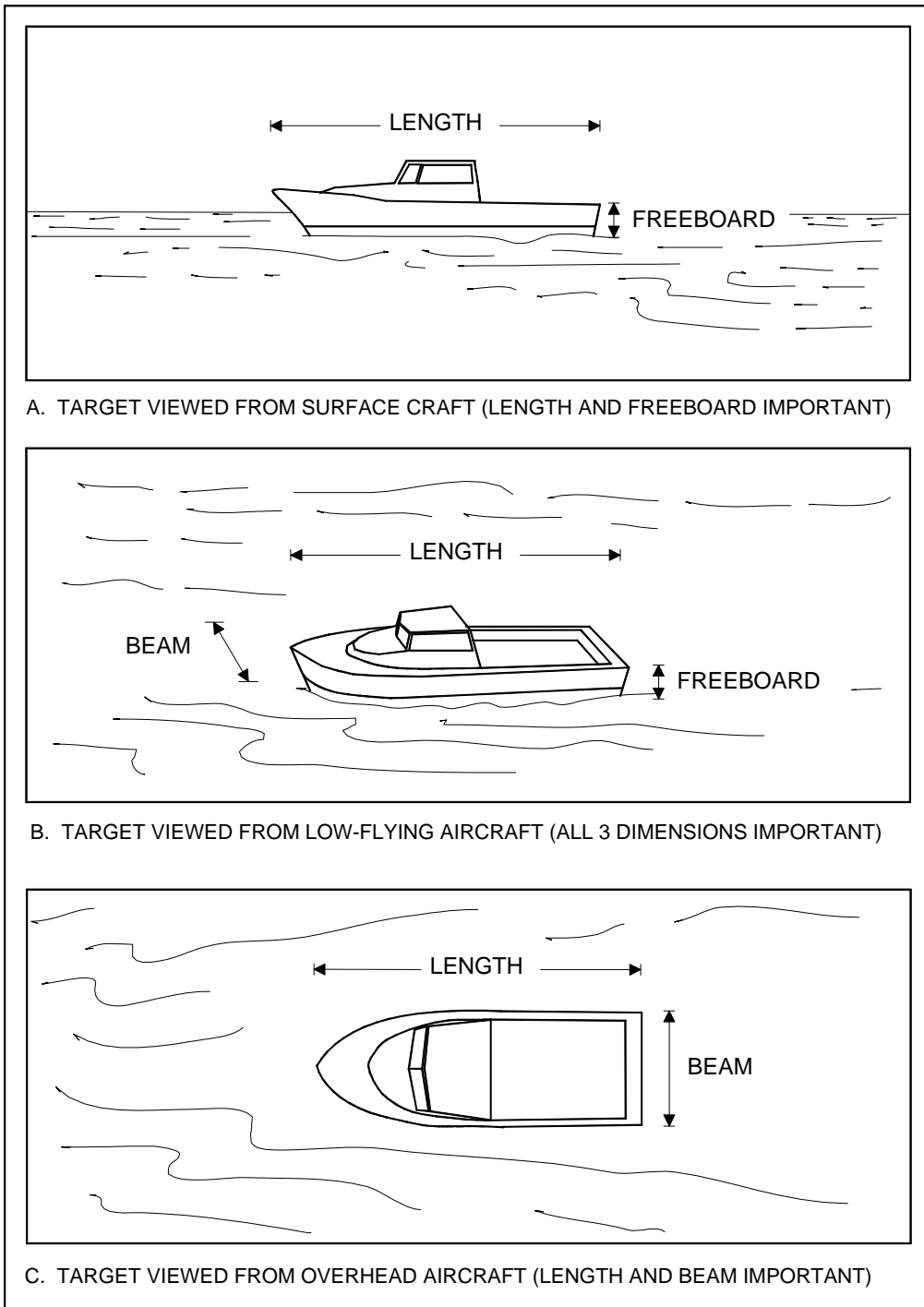

Figure 4-2. Effects of Altitude on Detectability

4.10 SAR Facilities Movement

*Arrival on scene*

- 4.10.1 The SMC schedules on-scene arrival or rendezvous times for SAR facilities. If requirements change during SAR facility transit, these must be coordinated with parent agencies, the SAR facilities, and the OSC. The SMC specifies CHOP (change operational control) requirements in the search action plan message. When arriving search aircraft CHOP to the OSC or ACO who provides flight-following service and assumes communications guard for each SAR facility.
- 4.10.2 Safety procedures for aircraft are a major concern. If no airspace reservations are provided, aircraft SRUs are responsible for complying with all FAA and ICAO requirements. During large-scale searches, the SMC normally obtains a SAR airspace reservation from ATC. When ATC facilities are unable to provide airspace reservation for search aircraft, the SMC and OSC will normally provide safety and alerting services. All aircraft within the area will maintain their own VFR separation. When instrument meteorological conditions (IMC) exist in the SAR airspace reservation, aircraft should not be assigned for visual searches. In the absence of adequate ATC facilities, aircraft control in the SAR area will often be advisory rather than directive. Unless the OSC has a qualified and experienced air controller or ACO to handle air traffic, each aircraft pilot-in-command should make technical air safety decisions.
- a) *Assigned altitudes.* The OSC or ACO should monitor the progress of arriving or departing aircraft, and assign altitudes to ensure separation of aircraft and clearance of obstructions. Assigned altitudes may not provide separation between aircraft unless all aircraft have the same altimeter setting. Altimeter settings may be obtained from ground stations or vessels, and are based on prevailing atmospheric pressure. A common setting should be assigned to all aircraft on scene unless the search area is large. "Flight level" is used over ocean areas where sea level barometric pressure is not available. Flight levels provide vertical separation of aircraft because a common altimeter setting of 29.92 is used. They should never be used to assign altitudes for low-level searches.
  - b) *Military Assumes Responsibility for Separation of Aircraft (MARSA).* When the SMC and OSC or ACO directs search aircraft to specific search altitudes, they must ensure that aircraft do not interfere with each other. The SMC uses search altitudes, CSP, and direction of creep to provide aircraft separation. In addition, the OSC, ACO or pilot provides vertical separation during descent and ascent. Participating search aircraft should file flight plans with the phrase "MARSA and safety of flight in search area" noted in the remarks section.
  - c) *Aircraft descent procedures via CSP.* When several search areas are involved and a large total area is being searched, all search aircraft should be directed to file for either their CSP or the center point of their assigned search areas. If altitudes below are clear, the aircraft should descend to search altitudes and keep the OSC or ACO advised.
  - d) *Cancellation of air search.* If visibility in the search area has deteriorated so that flight safety becomes a concern, the OSC or ACO should suspend searching and direct arriving aircraft to return to base.

#### *Diverting vessels*

- 4.10.3 Vessels at sea, although not always available to participate in extended search operations, are potential aeronautical and maritime SAR assets. Masters of vessels have a duty to assist others at sea whenever it can be done without endangering the assisting vessel or crew. The master makes the final decision to proceed to the distress. The responsibility international law imposes on masters to assist applies to distress situations, and not to Uncertainty and Alert phases of SAR operations. Vessel assistance should be requested by SAR authorities rather than directed. The SMC or OSC should arrange for the ship requiring assistance to communicate directly with other ships which seem best able to assist. When a ship is no longer needed, the SMC or OSC should thank the vessel, in terms of "your assistance is no longer needed" rather than "you are released."
- 4.10.4 Navigators of SAR facilities should plot the position, course, and speed of all vessels sighted during a search and the vessels listed in the Amver SURPIC (or from other ship reporting systems). If survivors are sighted, or the distress scene is located, the nearest vessel can then be quickly determined.
- 4.10.5 The following methods may be useful in the effort to divert a vessel:



- a) Radio message to the vessel giving survivor position, and requesting the vessel to divert to assist. If unsure of the frequency guarded by the vessel, contact should be first attempted on channel 16 VHF-FM, then 2182 kHz or satellite telephone such as Inmarsat.
- b) Homing signal transmitted on 522 kHz, 410 kHz, 500 kHz, or other frequency allowing the vessel to obtain a DF bearing.
- c) Message block airdropped to the vessel, giving survivor position(s), and requesting assistance.
- d) Pyrotechnic signal flare fired.
- e) Vessel circled at least once at low altitude, then the bow crossed while rocking wings, opening and closing throttles, or changing propeller pitch, followed by flying in the direction of the distress, repeated until the vessel follows, or indicates it is unable to comply by hoisting the international flag "November" (a blue and white checkered flag), or signals the Morse code signal "N" ( — • ) by lamp. (Air-to-surface and surface-to-air signals are displayed in IAMSAR Manual Volume 2, Appendix A and Volume 3, Section 2.)
- f) Radio request from the OSC or SMC.

*On-scene relief and departure*

- 4.10.6 SMCs obtain, brief, and dispatch relief SAR facilities, OSCs, and ACOs. As relief SAR facilities arrive on scene, each should be given an initial briefing by the OSC or ACO and monitored until in its assigned search area. The SAR facility being relieved, or finishing the assigned search, reports search results to the OSC or ACO and departs after OSC or ACO clearance.
- 4.10.7 Arrangements for on-scene SAR facility reliefs must be made by the SMC with the providing agencies. If the aircraft or vessel assigned as OSC or ACO experiences a malfunction that prevents it from effectively carrying out OSC or ACO duties, one of the SAR facilities already on scene is usually selected as an immediate relief.
- 4.10.8 OSC or ACO relief involves passing information normally given to each arriving SAR facility and information about SAR facilities currently within the search area or SAR airspace reservation.
- 4.10.9 When several search areas are involved, departing aircraft may be authorized to climb out of the search area airspace within the lateral boundaries of the assigned search area, obtaining clearance from ATC for the return flight.
- 4.10.10 Vessel departures are controlled by the OSC. Normally surface vessels are cleared to depart the search area from their present position. They may be used to search en route.

**4.11 Conclusion of SAR Operations**

- 4.11.1 Continuation of search and termination of rescue are briefly discussed in IAMSAR Manual, Volume 2, Chapter 5 "Search Techniques and Operations" and Chapter 6 "Rescue Planning and Operations"; however, Chapter 8, "Conclusion of SAR Operations" is of particular relevance.
- 4.11.2 **De-alerting Participating Agencies.** A SAR mission is not complete until all agencies and facilities are de-alerted. Failure to de-alert an agency, when services are no longer required, may impose unnecessary expense or inconvenience. SMCs should continually monitor the mission to de-alert facilities and agencies when their assistance is no longer required.
- 4.11.3 **Accident Investigation.** The SMC should inform appropriate accident investigation authorities when the case involves a casualty to aircraft or marine craft. The National Transportation Safety Board (NTSB) normally investigates all aircraft and major marine accidents. The SMC should ensure that marine casualty debris and

lifesaving equipment are recovered and protected for examination by accident investigators.

- 4.11.4 **Post-Mission Events.** It may be necessary to inform other agencies to take follow-up action. The Coast Guard may need to check marine aids to navigation after a grounding, the FAA may need to check aeronautical aids after aircraft accidents and the Army Corps of Engineers may need to remove stranded or wrecked ships in navigable waters. Other agencies may also be involved.

This page intentionally blank

---

## CHAPTER 5. LAND SAR OPERATIONS

- 5.1 General
- 5.2 Terrain
- 5.3 Searches by Aircraft
- 5.4 Grid Searches
- 5.5 Land Probability of Detection
- 5.6 Weather Conditions
- 5.7 Aerial Sightings
- 5.8 Mountain Searches
- 5.9 Helicopter Operations in Mountainous Terrain
- 5.10 Contour Search Patterns
- 5.11 Air/Ground Coordination
- 5.12 Search Execution
- 5.13 Recording Search Coverage
- 5.14 Information Gathering
- 5.15 Wreckage Precautions
- 5.16 Lost Persons
- 5.17 Preplanning
- 5.18 Incident Command System (ICS)
- 5.19 Action Plans
- 5.20 Urban SAR

### 5.1 General

- 5.1.1 SAR operations specific to the land environment are discussed in this chapter; however, this is not a standalone chapter. Aspects common to aeronautical, maritime, and land SAR are discussed throughout this NSS and so all of its chapters and appendices should be reviewed for applicable text. Land SAR operations include such environments as wilderness areas, swift water, caves and mountains, and aeronautical operations. Urban search and rescue, while not part of the civil SAR responsibility under the NSP, is briefly discussed here to avoid confusion as to how it fits in with the U.S. civil SAR system. IAMSAR Manual Volume 2, Chapter 5 provides related guidance.

### 5.2 Terrain

- 5.2.1 The terrain may determine the type of search pattern needed and the SAR facility selected. Highly maneuverable aircraft effective at high altitudes may be required in rugged mountain areas. Helicopters may not be able to operate in the thin air and turbulence associated with mountain contour searches. The survival kit carried by the distressed craft and the hoist devices available also influence decision-making. Dense foliage may hamper visual and electronic searches and require a greater number of aircraft and ground SAR facilities, and closer search track spacing. The presence of electrical power lines, towers, and bridges should be considered when planning search altitudes and areas. Prominent landmarks can be used as boundaries and checkpoints for laying out aeronautical and ground search areas. Some aircraft may have poor navigation equipment, and some members of ground parties may be inexperienced outdoors and more effective when using readily recognizable boundaries. The type of rescue team used after the distress site has been located is also terrain dependent. Local law enforcement authorities, forest service personnel, mountain rescue clubs, ski clubs, or pararescue personnel may be required.

### 5.3 Searches by Aircraft

- 5.3.1 Aircraft searches over land differ from maritime searching in that diverse and often changing terrain usually makes location of search objects more difficult. Repeated searches of an area are almost always necessary to attain an acceptable cumulative probability of success. Natural and man-made obstacles and turbulence in mountainous areas may make flying more dangerous.

**5.4 Grid Searches**

5.4.1 To promote uniformity, and to maximize coordination of SAR facilities, the Civil Air Patrol (CAP) has established a complete nationwide system of sequentially numbered square search grids. These grids are 15 minutes of latitude by 15 minutes of longitude. Complete information may be found in Appendix E to this NSS.

**5.5 Land Probability of Detection Tables**

5.5.1 The following land POD tables used by the CAP and Air Force assume a crash location is more difficult to see in heavy terrain, and the search object is relatively small, such as a light aircraft.

<i>Open, Flat Terrain</i>					<i>Moderate Tree Cover (or Hilly)</i>					<i>Heavy Tree Cover (or Very Hilly)</i>				
<i>Search Alt. Track Spacing</i>	<i>Search Visibility</i>				<i>Search Alt. Track Spacing</i>	<i>Search Visibility</i>				<i>Search Alt. Track Spacing</i>	<i>Search Visibility</i>			
	<i>1 mi</i>	<i>2 mi</i>	<i>3 mi</i>	<i>4 mi</i>		<i>1 mi</i>	<i>2 mi</i>	<i>3 mi</i>	<i>4 mi</i>		<i>1 mi</i>	<i>2 mi</i>	<i>3 mi</i>	<i>4 mi</i>
<b>500 ft</b>					<b>500 ft</b>					<b>500 ft</b>				
0.5 mi	35%	60%	75%	75%	0.5 mi	20%	35%	50%	50%	0.5 mi	10%	20%	30%	30%
1.0 mi	20	35	50	50	1.0 mi	10	20	30	30	1.0 mi	5	10	15	15
1.5 mi	15	25	35	40	1.5 mi	5	15	20	20	1.5 mi	5	5	10	10
2.0 mi	10	20	30	30	2.0 mi	5	10	15	15	2.0 mi	5	5	10	10
<b>700 ft</b>					<b>700 ft</b>					<b>700 ft</b>				
0.5 mi	40%	60%	75%	80%	0.5 mi	20%	35%	50%	55%	0.5 mi	10%	20%	30%	35%
1.0 mi	20	35	50	55	1.0 mi	10	20	30	35	1.0 mi	5	10	15	20
1.5 mi	15	25	40	40	1.5 mi	10	15	20	25	1.5 mi	5	5	10	15
2.0 mi	10	20	30	35	2.0 mi	5	10	15	20	2.0 mi	5	5	10	10
<b>1,000 ft</b>					<b>1,000 ft</b>					<b>1,000 ft</b>				
0.5 mi	40%	65%	80%	85%	0.5 mi	25%	40%	55%	60%	0.5 mi	15%	20%	30%	35%
1.0 mi	25	40	55	60	1.0 mi	15	20	30	35	1.0 mi	5	10	15	20
1.5 mi	15	30	40	45	1.5 mi	10	15	20	25	1.5 mi	5	10	10	15
2.0 mi	15	20	30	35	2.0 mi	5	10	15	20	2.0 mi	5	5	10	10

**Table 5-1. Land Probability of Detection: Single Search**

5.5.2 **Single Search POD.** PODs in Table 5-1 should be adjusted for each search object and for conditions encountered in individual search sub-areas.

5.5.3 **Cumulative POD.** POD will increase if the same area is searched more than once. Table 5-2 allows for calculation of cumulative POD. The table is entered with cumulative POD to date and POD of the latest search. The intersection of the two PODs gives the new cumulative POD.

5.5.4 Considerations when estimating POD include:

- ability to maintain optimum altitude and airspeed,
- visibility and weather conditions,

- nature of terrain,
- accuracy of navigation,
- size and characteristics of search object, and
- search crew fatigue.

Previous or Cumulative POD	Cumulative POD Chart									
5-10 %	15									
11-20 %	20	25								
21-30 %	30	35	45							
31-40 %	40	45	50	60						
41-50 %	50	55	60	65	70					
51-60 %	60	65	65	70	75	80				
61-70 %	70	70	75	80	80	85	90			
71-80 %	80	80	80	85	85	90	90	95		
over 80 %	85	85	90	90	90	95	95	95	95+	
	5-10 %	11-20 %	21-30 %	31-40 %	41-50 %	51-60 %	61-70 %	71-80 %	80 % +	
	POD This Search									

**Table 5-2. Land Probability of Detection: Cumulative**

**5.6 Weather Conditions**

5.6.1 Weather conditions must be evaluated before an aircraft SAR facility is dispatched. Clouds, especially thunderstorms, create turbulence and reduced visibility. Inadvertent entry into clouds should be avoided. Air currents are unpredictable and may cause cloud formations to shift rapidly. Since it is hard to judge distance from cloud formations and cloud movement, low-hanging clouds and scud should be avoided.

**5.7 Aerial Sightings**

5.7.1 In timbered mountainous areas, search objects will often be obscured by terrain, covered by snow, or otherwise extremely difficult to locate. The only visible clue to a crash site may be broken treetops or a reflection from a broken fuselage or windshield. Anything that appears out of the ordinary may be a clue. Persons in distress may be impossible to see unless they signal or move into an open area. In these cases, the SAR facility may prove effective as a loud hailer platform.

**5.8 Mountain Searches**

5.8.1 Prerequisites for a safe and effective mountain search are thorough preparation and constant aircrew vigilance. Full attention of one pilot should be dedicated to flying. Only highly experienced pilots should be permitted to fly mountain searches. Certain precautions and procedures should be observed in planning and executing a SAR mission.

5.8.2 Extreme caution should be used when searching canyons and valleys. Pilots should maintain adequate terrain

clearance and "exit" plans ahead of the SRU. They should know which way to turn at all times in case of an emergency, and should be aware of power lines and other hazards to low-level flight. Searches should be flown close to one side of a canyon or valley so the entire width may be used if a 180-degree turn becomes necessary. Aircraft should not enter any valley too narrow to permit a 180-degree turn.

#### *Turbulence*

- 5.8.3 Areas of possible severe turbulence should be identified. Pilots should determine turbulence and downdrafts before descending to search altitude or flying close to a mountainside. Wind direction and air currents in mountainous areas may vary greatly. If turbulence is encountered, the pilot should take immediate steps to keep from exceeding SAR facility structural limits.
- 5.8.4 While turbulence is often associated with thunderstorms, up and down drafts may be encountered in clear air. In mountainous terrain, any surface wind will be diverted by natural obstructions and possibly create hazardous flying conditions.
- a) Orographic turbulence is proportional to wind velocity and dangerous if severe. Updrafts occur on the upwind side of slopes and ridges, and downdrafts on the downwind side. The amount of downdraft depends on the strength of the wind and steepness of the slope. If the wind is fairly strong (15 to 20 knots) and the slope is steep, wind will tend to blow off the slope and not follow it down. In this situation there will probably be severe turbulence several hundred yards downwind of the ridge just below the top. Under certain atmospheric conditions, a cloud may be observed at this point. On more gentle slopes turbulence will follow the slope, but will be more severe near the top.
  - b) Orographic turbulence will be affected by other factors. The intensity will be less climbing a smooth surface than climbing a rough surface. It will not follow sharp contours as readily as gentle contours.
  - c) Convective turbulence, caused by rising air currents created by surface heating, is most prevalent over bare areas. It is normally found below 2,000 feet above the terrain, but may reach as high as 8,000 feet. When practical, flight paths should be over vegetated areas. Morning searches will often avoid the convective turbulence.
- 5.8.5 When crossing mountain peaks and ridges at low altitude under windy or turbulent conditions, the safest crossing is downwind, where downdrafts will be met after the terrain is crossed. If this is not practical, altitude should be increased before crossing. The safest ridgeline crossing may be at an angle, so a shallow descending turn away from the terrain can be made if unexpected weather or turbulence is encountered.
- 5.8.6 When wind blows across a narrow canyon or gorge, as shown in Figure 5-1, it will often veer down into the canyon. Turbulence will be near the middle and the downwind side of the canyon or gorge.
- 5.8.7 When wind blows parallel to the valley or canyon axis, typical turbulence patterns are as shown in Figure 5-2

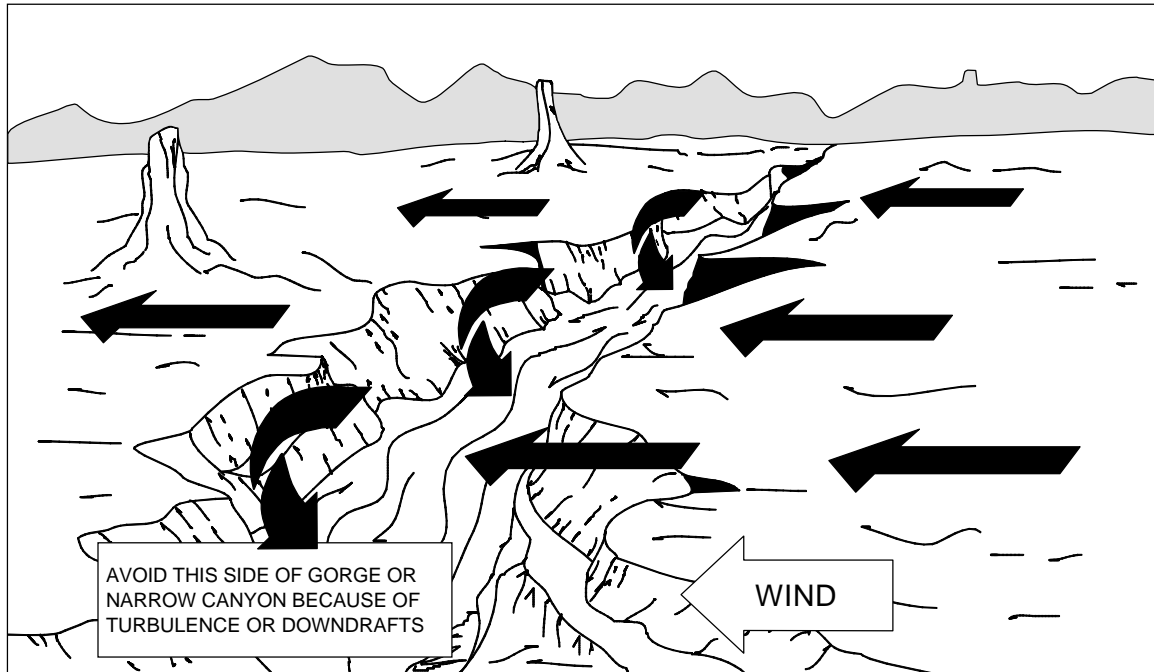

Figure 5-1. Wind Flow Over Gorge or Canyon

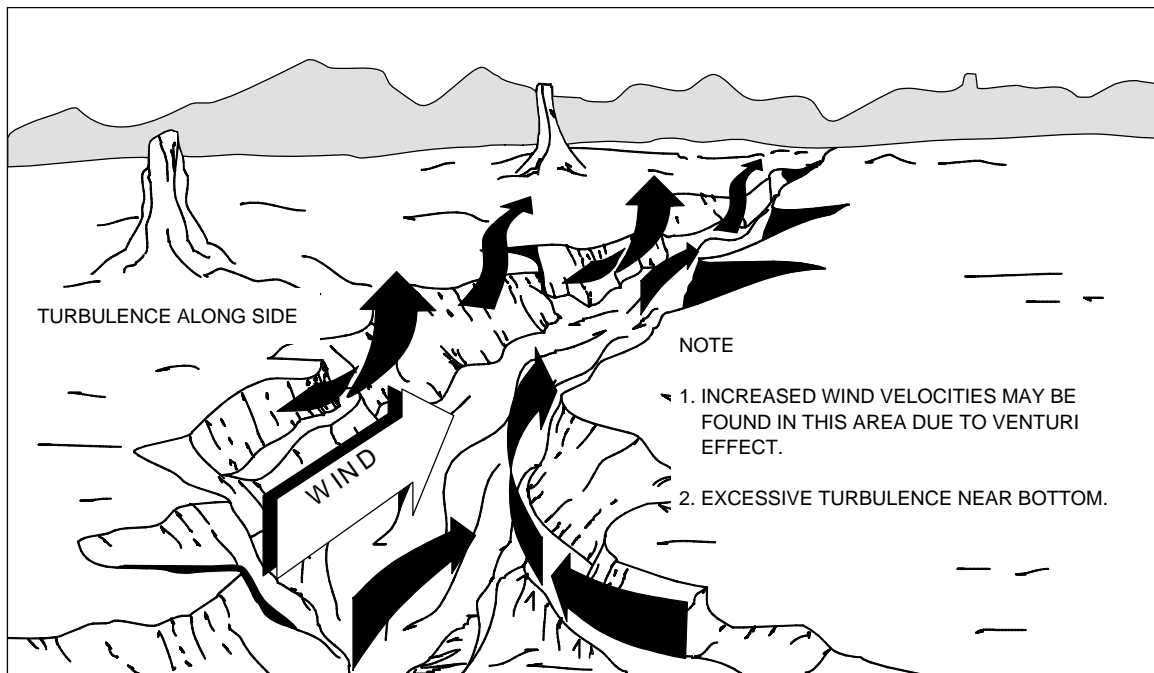

Figure 5-2. Wind Flow in Valley or Canyon

*Other Considerations is Mountainous Terrain*



- 5.8.8 When an aircraft is operated at or near its “service ceiling” and encounters a downdraft, the aircraft may be forced to descend. Although the downdraft may not continue to the ground, the rate of descent may be such that the aircraft will continue descending and crash even though it is no longer affected by the downdraft. Therefore, the procedure to transit a mountain pass is to fly close to that side of the pass or canyon that has an upslope wind. This provides additional lift for an exit in case of emergency. Maximum turning space is available, and a turn into the wind will be a turn to lower terrain. Flying through the middle of a pass to avoid mountains is dangerous, as this is frequently the area of greatest turbulence, and, in case of emergency, provides insufficient turning space.
- 5.8.9 Do not rely solely on terrain elevations or contour lines printed on aeronautical charts. Errors in position, altimeter setting, or chart information may result in less terrain clearance than anticipated.
- 5.8.10 For safety, mountainous search areas should be assigned to multi-engine aircraft when possible.
- 5.8.11 ELT signals can “bounce” and be blocked in mountainous areas. Homing may be difficult. Occasionally, location of an ELT will require coordination of Cospas-Sarsat alert data with both high- and low-flying aircraft.

## 5.9 Helicopter Operations in Mountainous Terrain

- 5.9.1 High altitude causes several undesirable effects on helicopters. Available power and hovering ability is reduced. Helicopters are also susceptible to blade stall, aggravated by high forward speed, high gross weight, high altitude, low rpm, induced “G” loading, and turbulence. Since power-to-weight ratio may be critical, shallow turns and slow air speeds will be required. Thermal heating in mountainous terrain may cause “heat bubbles” localized higher temperatures. Higher than expected temperatures should be anticipated, and power or SAR facility selection made for that air density.
- 5.9.2 Extreme caution should be used when operating or hovering near objects or foliage. Turbulence may reduce clearances suddenly and the rotor tips may be below the landing gear or skids at angles of bank over 45 degrees.

## 5.10 Contour Search Patterns

- 5.10.1 Contour search patterns are often used in mountainous and hilly areas.
- 5.10.2 Contour searches involving aircraft use the **contour single-unit (OS)** pattern as a safety precaution in lieu of multiple aircraft in any one area. As shown in Figure 5-3, the SRU searches from top to bottom, starting above the highest peak and flies around the mountain “tucked in” closely to the mountainside. As one contour circuit is completed, the altitude is normally decreased 500 feet (descending 360 degree turn opposite to direction of search pattern) and a new contour circuit begun. Contour searches can be extremely dangerous and ineffective, unless:
- The crew is experienced, well briefed, and possesses accurate large-scale contour maps.
  - Weather conditions are good, with both good visibility and lack of turbulence. Flight should be avoided in mountainous areas when winds exceed 30 knots, because downdrafts can exceed 2000 ft/minute.
  - The SRU is highly maneuverable and has a high climbing rate and small turning radius.
  - An accurate record is kept of the area searched. There may be some mountain peaks and valleys shrouded in clouds which need to be searched again when conditions permit. The aircrew should plot actual search coverage as tracks are flown. One method is to shade areas searched and outline areas not searched on a large-scale topographical map with overlays. This should be provided to search planners at the first opportunity.

- 5.10.3 **Contour Multiunit (OM)** searches are conducted only by ground search teams because of difficulty in maintaining aircraft separation in multiunit searches.

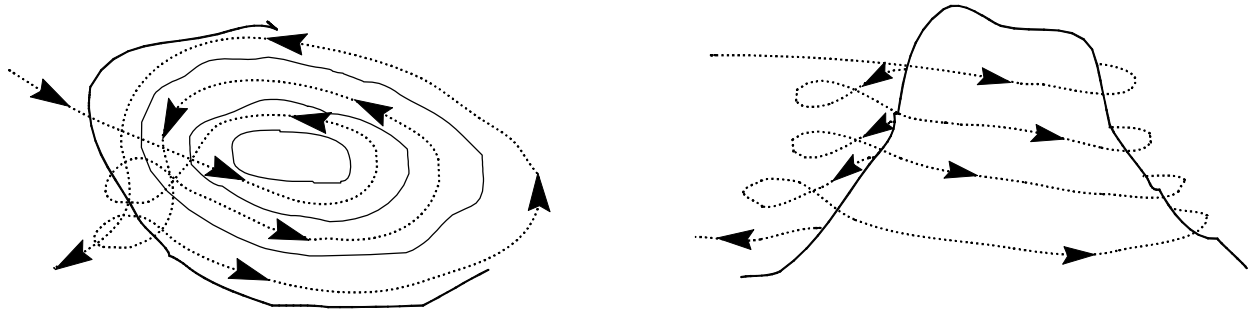

**Figure 5-3. Contour Search Pattern**

## 5.11 Air-Ground Coordination

- 5.11.1 An SMC, IC or OSC should not hesitate using air and ground SAR facilities on the same search. For air searches, ground units may be needed to check possible search objects, secure distress beacons and rescue persons in distress. Air SAR facilities may be able to provide airlift to ground units, locate the objective sooner, signal survivors or indicate to them that they have been located, and lead ground units to the scene. The aircrew may be able to ascertain whether a distress situation exists, allowing ground response to be modified as appropriate. Airborne communications support is also possible.
- 5.11.2 When either element is supporting the other, effective communications are needed. Common radio frequencies should be established when possible; standard air-to-ground and ground-to-air signals are not adequate.
- a) Since aircraft have at least one radio, it is easiest for the aircrew and ground units to use an aeronautical frequency.
  - b) Since portable aircraft radios are normally not available to ground SAR facilities, communications can be provided by equipping an aircraft with a radio operating on ground frequencies. This is particularly useful when working with military aircraft that normally have only UHF communications. Generally, ground frequencies provide more complete communications since there are usually more ground units than aircraft involved.
  - c) A portable radio used by one of the aircrew can suffice. If a particular aircraft is used for air support often, an external antenna should be mounted on the aircraft with a connection inside for the portable radio. The best method is to permanently mount in the aircraft a multi-channel radio covering normal ground SAR facility frequencies.
  - d) Regardless of the radio system used, all units should have knowledge of, and access to, the list of standard air-to-ground and ground-to-air signals.
- 5.11.3 Air and ground SAR facilities should use the same maps.
- a) Aircraft sectionals and military Joint Operations Graphics (JOG, scale: 1:250,000) are not detailed enough for ground search, but are necessary for land SAR facilities working with air SAR facilities. U.S. Geological Survey (USGS) and National Imagery and Mapping Agency (NIMA) topographic maps are difficult for aircrews to use but are needed when low level and contour searches are flown.

- b) Medium scale maps, such as U.S. Forest Service, Bureau of Land Management, USGS intermediate scale (1:100,000), and local road maps are most versatile for air/ground coordination.
  - c) If each SAR facility has similar maps and charts, search efficiency and coordination will be maximized.
- 5.11.4 When air and ground SAR facilities are used on the same mission, consideration must be given to time differences required for each to be dispatched and reach the scene.
- a) If aircraft are the primary search resource, ground units should be put on standby at the same time, or preferably be dispatched to advance positions. Sudden weather changes may force suspension of the air search, and if ground units have not been alerted, considerable time can be lost in organizing them. Should the aircrew make a sighting and ground SAR facilities are not immediately available, valuable time is lost in organizing and transporting units to the area.
  - b) If ground SAR facilities are the primary resource, but air SAR facilities may be needed, the air units should be alerted at the beginning of the search. Besides time needed to locate proper aircraft, time is needed by aircrews to get to the aircraft, pre-flight them, and launch. This is true of both military and civilian air resources.
- 5.11.5 SAR personnel should be selected for physical stamina, knowledge of the outdoors, and search experience. The number of search parties and their size will be determined by available personnel and type of terrain to be searched. Volunteers may be enthusiastic but underqualified and should be used accordingly.
- 5.11.6 Use of team leaders is recommended for typical ground search operations. Leaders should be selected on the basis of experience and knowledge of SAR operations. As a minimum, they should be equipped with radios, portable loud hailers, whistles, and maps of the search area. The team leader is responsible for:
- individual equipment;
  - team equipment;
  - team transportation;
  - briefing, debriefing, and accounting for all team members;
  - obtaining search data and outlining search area and sub-areas on maps;
  - execution of the search action plan;
  - recording search coverage;
  - providing life support and evacuation of located survivors; and
  - obtaining primary and alternate communication frequencies and schedules, and establishing communications with the SMC, IC or OSC.

## 5.12 Search Execution

### *Land Search Area and Patterns*

- 5.12.1 Parallel-track, contour, and track line patterns may be used for ground searches. Each search sub-area should be well marked and reasonably small, so the team can move in and effectively cover the entire area within imposed time limits. Generally, the maximum area size will be a 1-mile by 1/2-mile block. Close track spacing and thorough area coverage are essential when searching for typical small search objects. If the area is densely wooded, helicopter SRUs may be used to assist in maintaining the search pattern.

- 5.12.2 The total search area may be subdivided into SAR facility search sub-areas according to terrain. Moderately level terrain may be divided into squares or rectangles for parallel track searches. Contour patterns are used to search along and around peaks, razorbacks, steep slopes, or other mountain features, or irregular shorelines. Track line patterns are used to check trails, paths, streams, or other routes a lost person may naturally follow.
- 5.12.3 A baseline may be blazed through the area to designate each search area border. Trail blazing with small flags, aerosol paint, or string is preferred over methods that damage trees. Natural borders or prominent landmarks may be used to correct any progressive errors that may develop during the search.
- 5.12.4 Lost persons often fight topography and are likely to be found in the most rugged portion of the surrounding country. Persons who follow natural routes are seldom lost for long periods. Children under 5 years old frequently travel uphill.
- 5.12.5 Search Patterns

*Parallel Pattern*

- a) Parallel patterns are generally the most effective for ground search. Execution requires a team leader, normally two flankers and as many linemen as the terrain will allow. The searchline is first formed along the search area boundary, with individual linemen positioned one track spacing apart. The team leader maintains overall team control in the same manner as an OSC maintains control of a multiunit search. Boundary control of each successive sweep through an area is normally assigned to the pivoting flanker.
- b) After the searchline is formed, it moves forward on a signal from the team leader. Linemen remain evenly spaced as the team progresses. If part of a team encounters an obstacle, they should investigate it while the rest of the team continues just past the obstacle and stops to wait. When the checkers have rejoined the searchline, the entire searchline again moves forward on signal of the team leader.
- c) When the searchline completes its first search leg, it does not use the flanking movement of a multi-aircraft or multi-vessel searchline to reposition itself for the second search leg. Instead, the land SAR facility will use a pivoting movement about the flanker. As each sweep is made, the inboard flanker is blazing the line of search, possibly with a string. At the end of the search leg the searchline pivots about that flanker, and then is guided by the same flanker on the return search leg, retracing the blaze line. Meanwhile, the other flanker is blazing a search track during the second search leg, and will be the pivot flanker for the maneuver between the second and third sweeps (see Figure 5-4).

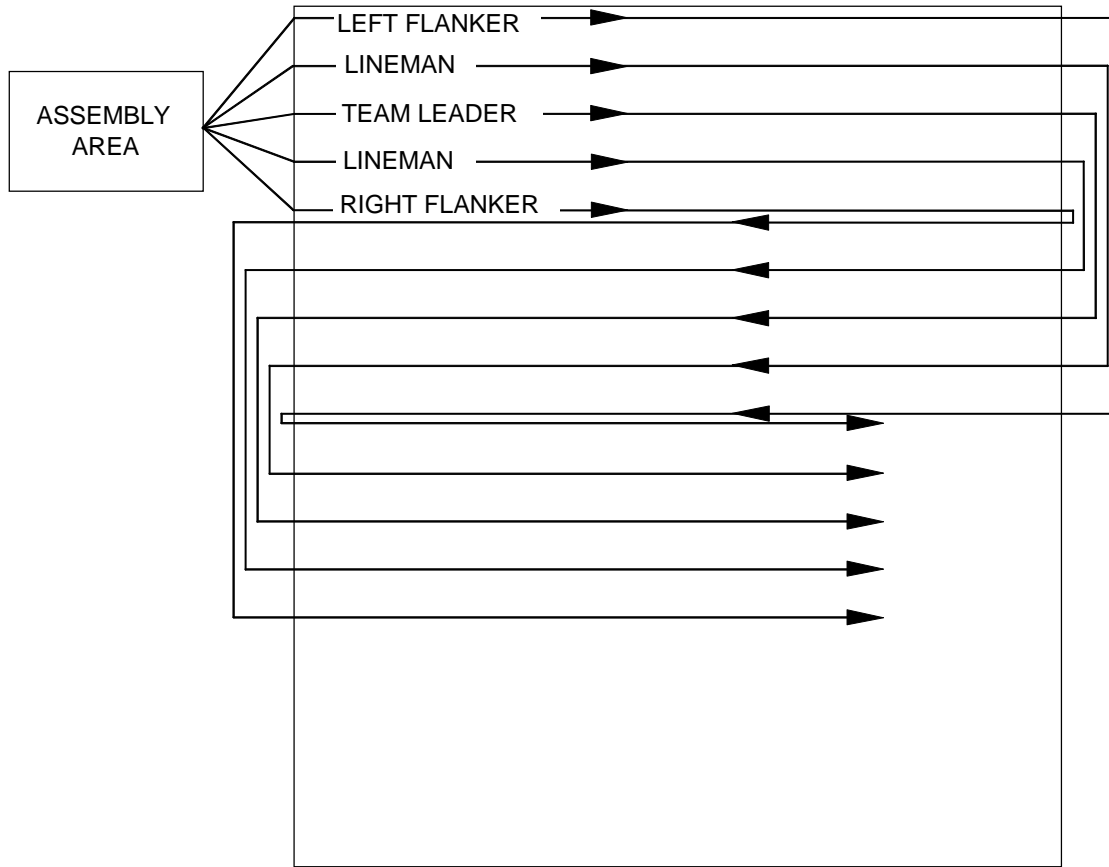

**Figure 5-4. PM Search Pattern for Land SAR Facility**

*Contour Pattern*

- d) Contour patterns are normally used for mountainous or steep terrain. Their execution requires a team leader, normally two flankers, and up to 25 linemen. The searchline is initially formed on a line perpendicular to the ridgeline or on a radial from the mountaintop. The team leader maintains overall team control, with sweep boundary control assigned to the upper flanker.
- e) The searchline of the contour pattern starts at the highest level to be searched. It maintains a constant altitude during each sweep, and progresses down the slope on successive sweeps. When the searchline completes each sweep, it reforms on the low side of the bottom flanker. The lineup order is reversed as in the parallel pattern pivoting maneuver between search sweeps. The line then continues the search moving in the same direction around the mountain as was followed on previous search sweeps. Searchline checking, starting, and stopping are all controlled by the team leader, as when executing a parallel pattern.
- f) Contour patterns are also useful for terrain that prevents using straight search legs efficiently, such as long irregular shorelines or other irregular terrain. This procedure may require special SRUs to cover areas missed by the weaving searchline.

*Trackline Pattern*

- g) Trackline patterns are executed by one or more searches along a trail or track suspected of having been followed by a lost person. The SMC, IC or OSC should designate a team leader and two flankers when

three or more persons are assigned for a trackline search. Normally a "V" searchline is used, with the team leader following the center of the suspected path, and an equal number of searchers on either side of the track.

*Track Spacing*

5.12.6 Track Spacing.

- a) In executing a ground search pattern, constant distance is maintained between searchers. Ground search track spacing is determined by the distance a person can effectively search while keeping adjacent searchers in visual or audible contact. For example, if each searcher could effectively search 50 feet on each side of their track, the track spacing would be 100 feet, and searchers would be spaced at 100-foot intervals. If searchers were unable to see adjacent searchers from 100 feet away, then track spacing would have to be reduced.
- b) In jungle or thick underbrush, both visual and vocal contact must be maintained between adjacent searchers. This ensures full area coverage and protection for inexperienced searchers. Whenever contact with a lineman is lost, the team leader must be immediately notified. The searchline will then stop until complete team contact is reestablished. If the searchline is more open, only adjacent visual contact must be maintained, though vocal contact is usually also maintained.
- c) The team leader always makes the final determination of track spacing. Generally, track spacing depends on search object characteristics, weather, and terrain.
- d) Track spacing for lost persons is typically between 15 and 25 feet, with search progress through wooded areas conducted at a slow gait, and each thicket and depression checked. About one square mile of woods can be searched by a land SRU of 20-25 persons in slightly less than 4 hours.

*Searchline*

5.12.7 Searchline. Searchers may proceed in a straight line abreast, a "V" formation, or a right or left slanting formation. "V" and slanting searchlines are more efficient than line-abreast searchlines because it is easier for each searcher to keep only the searcher ahead in visual contact. The team leader takes position in the center of a straight line-abreast or "V" formation, or as the leading searcher in a right or left slanting searchline. The "dress" of the searchline is on the team leader. Two flankers are needed for line-abreast or "V" searchlines, while only one flanker is needed for a slanting searchline (see Figure 5-5). Flankers also assist in maintaining searchline dress. Both the team leader and flanker must continuously check their compasses, marked base lines, or topographical lineup features to ensure correct search legs are maintained.

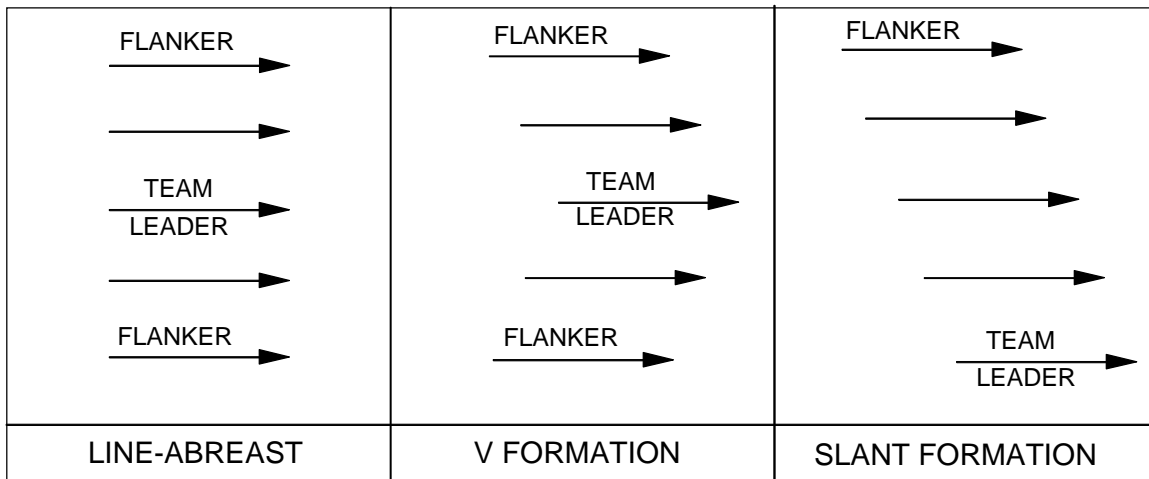

**Figure 5-5. Searchlines for Land SAR Facility**

### 5.13 Recording Search Coverage

- 5.13.1 To accurately plot positions of various finds, a large-scale grid plot of the search area should be made. As the search progresses, search sweeps are shown on the plot, providing an exact position of each sweep. Forward distances may be estimated by pacing off forward movement of the searchers. Exact locations of finds may then be shown, as the relative position is known both forward and across each search sweep or search leg. These findings may be transcribed from the large-scale to a smaller scale chart as necessary. When search of an area is completed, the team leader should cross-hatch the areas searched, note areas not searched, and report these areas to the OSC, IC or SMC, along with the search results, weather and other debriefing information.
- 5.13.2 U.S. Geological Survey Charts are best for executing ground searches.
- Scale 1:24,000 is the best for ground searches as it shows the most detail. This chart reduces 2,000 feet of horizontal topography to 1 inch. Each chart covers 7.5 minutes of latitude and longitude.
  - Scale 1:62,500 reduces 1 mile of horizontal topography to 1 inch. Each chart covers 15 minutes of latitude and longitude.
  - Scale 1:125,000 reduces 2 miles of horizontal topography to 1 inch. Each chart covers 30 minutes of latitude and longitude.
  - Scale 1:250,000 reduces 4 miles of horizontal topography to 1 inch. Each chart covers 60 minutes of latitude and 120 minutes of longitude. This scale is useful when a large view of the search area and surrounding terrain is desired.
- 5.13.3 Topographical charts may use any of four coordinate systems: latitude and longitude, Universal Transverse Mercator (UTM) grid, state plane, or rectangular surveys. When reporting the positions of finds, the latitude and longitude should be used if known, supported by, if possible, a bearing and distance from a prominent geographical feature.

#### *Search Area Plot*

- 5.13.4. Search Area Plot
- The search area should be plotted on a topographical chart, showing all search sub-area and sweep boundaries. Two adjacent sides are designated as baselines, each running from a common corner point.
  - On a sheet of paper of suitable size, an area, sized in proportion to the search area depicted on the topographical chart, should be drawn. Each side of the expanded search area should be marked with a scale, for every tenth of a mile, creating a grid system.
  - The grid lines should be numbered in two directions, starting from zero at a convenient corner. Each grid can be identified by referring first to a vertical grid line number, then to a horizontal grid line number. Furthermore, found objects can be referred to by fractional estimates of the grid line number at their locations. Grid lines are numbered only for convenience of the team leader. Positions of found objects are always converted to latitude and longitude for reporting to the OSC, IC or SMC.
  - The gridded, large-scale plot of the search area is now ready for depiction of each search sweep and any findings. To determine search sweep boundaries, the team leader should estimate track spacing. The track spacing is then multiplied by the number of team searchers to obtain the full width of the area

searched on each search leg. This is then measured on the search area plot, using double lines to indicate boundaries and arrows for direction of each sweep. Actual search progress can now be monitored using the search area plot, and findings readily plotted. Figure 5-6 shows a typical search plot.

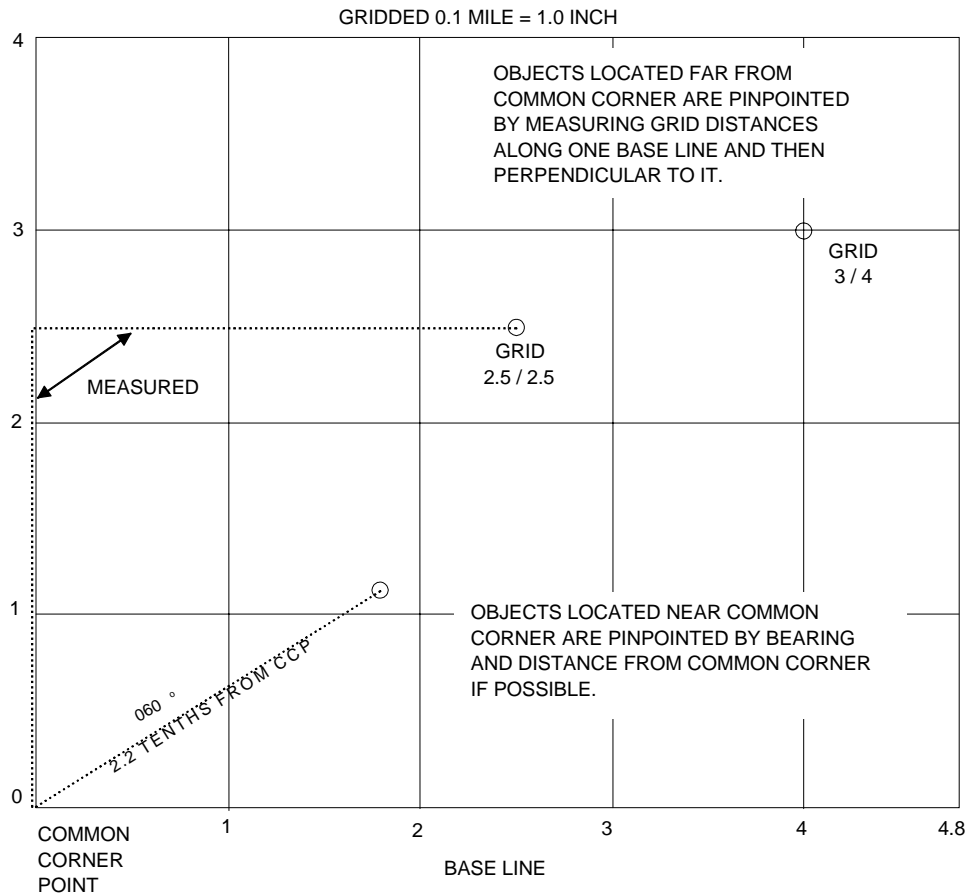

**Figure 5-6. Ground Search Area Plot**

#### 5.14 Information Gathering

- 5.14.1 Appeals for information through press and radio, on-scene interrogation, or interviews with local population may lead to discovery of the search object. Land SRUs are often used as interrogation parties or the nucleus of such parties. However, before assigning this function, the SMC or IC should ensure that another SRU is readily available for the search area.
- 5.14.2 Normal communication equipment and a portable tape recorder will be adequate for interrogation.
- 5.14.3 Proper interviewing obtains pertinent information from witnesses. Individuals seeking publicity, those with overactive imaginations, or those who desire to help despite lack of information should be interviewed with caution. Unnecessarily revealing factual data to such a person may encourage "exaggeration." Leading questions should be avoided. Try to eliminate false leads based on imagination or power of suggestion.
- 5.14.4 Details are important. Information obtained should be given to the SMC or IC at the earliest opportunity. Addresses and telephone numbers of persons interviewed should be recorded in case more information is needed.

#### 5.15 Wreckage Precautions



- 5.15.1 Both motor vehicle and aircraft crash sites can pose hazards to searchers from wreckage, chemicals, explosive munitions, or radiation. An aircraft crash site may have each hazard spread over several miles following impact. Appropriate safety precautions should be observed. IAMSAR Manual, Volume 2, Chapter 6, provides additional guidance.
- 5.15.2 Search parties should not disturb aircraft wreckage, except to assist in the recovery of survivors. Not only does the wreckage pose dangers but other mechanisms, such as ejection seats, may be hazardous. See Chapter 6 of this NSS for rescue procedures. The position of flight controls, location of debris, and other factors are important in post-flight accident analysis. Charts, flight plans, and other documents should be preserved if threatened with destruction, and if preservation can be accomplished without danger or undue movement of debris.
- 5.15.3 DOD personnel, and CAP or Coast Guard Auxiliary members do not have authority to enforce laws, and can normally only take action necessary to preserve federal property. In general, SRUs should not take any chance in a situation that might endanger SAR personnel. See Chapter 7, Legal Aspects of this NSS for more detail.

## **5.16 Lost Persons**

- 5.16.1 Land SAR is implemented for many types of incidents including lost children, mental patients, the elderly, and lost hunters. The following procedures apply to any ground search, but are only a guide because of the large variations in topography, SRUs, and search objects. Close coordination is advisable with the local sheriff, state police, or state emergency services office, as well as with local volunteer SAR groups.
- 5.16.2 Be aware that some "lost" persons may not want to be located. The possibility exists that survivors were engaged in illegal activity, such as drug trafficking, or of intruding upon unlawful activities while searching.
  - a) Some remote rural areas have marijuana farms guarded by armed people. To ensure the safety of search personnel, searchers should be alert for such activity.
  - b) ELT signals may sometimes be false alarms from aircraft smuggling illegal drugs. SAR facilities should be alert when approaching aircraft, especially if there is no apparent damage and especially at night.

## **5.17 Preplanning**

- 5.17.1 Preplanning allows rapid and flexible activation of resources in the event of a distress or possible distress situation.
- 5.17.2 Local jurisdictions can increase efficiency and minimize costs by developing a SAR preplan. The preplan allows resource identification, recognizes hazards, creates its own critical review, avoids duplication of effort and is an orientation guide for new personnel.
- 5.17.3 Preplanning should consider the history of local ground searches, potential problems created by local terrain, legal constraints, etc. The preplan also establishes clear lines of authority.
- 5.17.4 Each SAR facility should have adequate communications with the SMC, IC or OSC, either directly or via the base camp or covering SAR aircraft. Hand-held or portable backpack radios are best for land use. If the radio communications link is broken, ground-air visual codes in IAMSAR Manual, Volume 2, Appendix A can be used to communicate with aircraft. The SAR facility should also carry backup communications equipment such as pyrotechnics, signaling mirrors, flashlights and whistles.
- 5.17.5 Each preplan should identify all known SAR resources in the area and contact procedures. This information should be updated annually. Resources such as trained search dogs are available throughout the United States, and can usually be located through state or local law enforcement agencies, or through the AFRCC

that maintains 24-hour call-up lists of qualified teams.

- a) Tracking or trailing dogs usually work from the last known position of the objective. A tracking dog will need an unlaundered carefully preserved scent article. The dog's effectiveness may be limited because ground scent will begin to fade in a short time. It is important that the search area remain undisturbed until the dogs arrive. If the search is for snow-buried survivors, most dogs may be used successfully. Avalanche case histories show that untrained dogs that happened on the scene and instinctively joined the search have sometimes located buried victims.
- b) Air-scenting dogs work free of their handlers in a sterile search area cleared of all other searchers. The dogs generally work upwind across the air currents through the scent core transmitted by the objective. These dogs should alert if they pass a ground scent, but should continue to track the air scent. They are usually not limited by rain, snow or other precipitation that erases ground scent.

## **5.18 Incident Command System (ICS)**

5.18.1 Many local and state agencies employ ICS to manage their SAR incidents on scene. ICS is mainly designed for situations involving multiple organizations or multiple jurisdictions.

5.18.2 The following basic components work interactively to provide direction and control over the incident response:

- common terminology,
- measurable objectives,
- modular organization,
- integrated communications,
- establishment and transfer of command,
- chain of command/unity of command,
- unified command structure,
- consolidated action plans,
- manageable span of control,
- pre-designated incident facilities, and
- comprehensive resource management.

The key elements for a successful search mission are unified command and consolidated action plans.

5.18.3 Unified command simply means all agencies involved with the SAR effort jointly:

- determine overall incident objectives,
- select strategies,
- plan and integrate tactics, and
- maximize use of resources.

5.18.4 Consolidated action plans list objectives and strategies and include an organizational chart, divisional assignments and incident maps. The plans are updated for each operational period.

## **5.19 Action Plans**

5.19.1 The first consideration is search urgency which is influenced by subject profile, experience and equipment, and by weather and topography.

5.19.2 Once urgency is established, information to plan search strategies is collected and analyzed, including the subject's personality traits and last known position, and elapsed time since last observation of the subject.

5.19.3 Certain actions require immediate implementation once the urgency of distress is known. Many of these actions will continue throughout the search mission building on leads obtained, and possibly generating new information.

- a) Investigation should be started to determine the subject profile and gather other clues. The investigation should continue throughout the mission and, if clues indicate, investigative effort increased.
- b) Determine the outer perimeter of the search area by locating the last known position and computing the distance the subject could have traveled. Mission personnel should be assigned to this perimeter to preserve clues and confine the subject to the known area. Confinement should be maintained throughout the search. Using devices such as signs, flags, sirens or whistles can help the subject locate the searchers.
- c) Two to three person teams that are clue conscious and equipped to operate independently for 24 to 48 hours should check hazards and high probability areas within the search area.
- d) If available, persons highly trained as trackers should be called in immediately, while tracks and other clues are still fresh. The area should be protected until the tracker arrives.
- e) As indicated previously, it is important that the search area be protected until the search dogs arrive.
- f) Air scent dogs can search portions of the search area. They will be attracted to any human in the search area, so the segment of the area to be searched should be cleared at least 15 minutes prior to using a dog.

19.4 Once the initial tactics have been implemented, the IC needs to refine and segment the search area. The IC should use statistical data, subjective and deductive and group consensus reasoning to determine areas of high probability. This provides high probability areas that are more easily managed and searchable in one shift as a search sub-area. The IC can assign probabilities to these search sub-areas so when additional resources arrive they will be placed in high probability areas.

19.5 Upon completing their search, each team will provide the IC with their POD. This indicates the confidence level that if the subject were in the area, he or she would have been found. This provides the IC with information to evaluate the search sub-areas and continually update the search strategy and Action Plan so the most efficient use of all resources is maintained.

19.6 Briefings and debriefings should be conducted for each shift action plan. IAMSAR Manual, Volume 2, Chapter 5 and its Appendix H provide more information and sample forms for these briefings and debriefings.

## **5.20 Urban Search and Rescue**

5.20.1 The National Urban Search and Rescue (US&R) Response System provides specialized life-saving assistance to state and local authorities in the event of a major disaster or emergency. US&R operational activities include locating, extricating, and providing on-site medical treatment to victims trapped in collapsed structures. The National US&R Response System consists of deployable urban search and rescue

task forces, Incident Support Teams (ISTs), and technical specialists. At the core of the System are task forces, sponsored by state and local government emergency response organizations, that can be deployed by the Federal government. ISTs are formed with personnel from US&R task forces; federal, state, and local government emergency response organizations; and private sector organizations. These resources may also be deployed internationally.

5.20.2 US&R is activated as part of the Federal Response Plan (FRP). As stated in the NSP, civil SAR does not include operations such as “Typical disaster response operations, such as: locating and rescuing victims trapped in collapsed structures; or other assistance provided under the scope of the Federal Response Plan.” US&R is discussed here to avoid confusion as to how it fits in with the U.S. civil SAR system.

5.20.3 The Federal Emergency Management Agency (FEMA), as the primary agency, is responsible to establish, maintain, and manage the National US&R Response System. Several other agencies have support roles. DOD has a major support role to serve as the primary source for:

fixed-wing transportation of US&R task forces and ISTs from base locations to mobilization centers or Base Support Installations. Target time frame for airlift missions is 6 hours from the time of task force activation;

rotary-wing transportation of US&R task forces and ISTs to and from isolated, surface-inaccessible, or other limited-access locations;

through the U.S. Army Corps of Engineers, provide trained Structures Specialists and System to Locate Survivors teams to supplement resources of US&R resources; and

through the U.S. Army Corps of Engineers, provide pre-disaster training for US&R task force and IST Structures Specialists.

This page intentionally blank

---

## CHAPTER 6. RESCUE PLANNING AND OPERATIONS

- 6.1 General
- 6.2 Rescue Planning
- 6.3 Survivability Considerations
- 6.4 Environmental Considerations
- 6.5 Rescue Method
- 6.6 Selection of Rescue Facilities
- 6.7 Rescue Plan
- 6.8 Delivery Planning
- 6.9 Selection of a Safe Delivery Point
- 6.10 Rescues in Difficult Environments
- 6.11 Rescue Operations
- 6.12 Briefing and Debriefing of SAR Personnel
- 6.13 SAR Helicopter Escort
- 6.14 Coordinated Helicopter-Boat Rescue
- 6.15 Underwater Rescue
- 6.16 Cold Water Near-Drowning
- 6.17 Special Considerations
- 6.18 Debriefing of Survivors
- 6.19 Emergency Medical Services
- 6.20 EMS Personnel
- 6.21 Emergency Care
- 6.22 SAR Facility Procedures
- 6.23 Survivor Evacuation and Transport
- 6.24 Evacuation from Marine Craft
- 6.25 Evacuation from Land Areas
- 6.26 Survivor Delivery
- 6.27 Fixed Medical Facilities

### **6.1 General**

- 6.1.1 Rescue planning and operations will be conducted in accordance with the IAMSAR Manual and as augmented by this NSS. IAMSAR Manual, Volume 2, is the primary source document. Chapters of particular relevance include Chapter 6, “Rescue Planning and Operations” and Chapter 8, “Conclusion of SAR Operations.” IAMSAR Manual, Volume 3, Section 2, “Rendering Assistance”, provides further information on the rescue function from the viewpoint of assisting craft.

### **6.2 Rescue Planning**

- 6.2.1 Rescue planning involves dispatching or diverting SAR facilities for rescue of persons and property in distress. SAR facilities at the distress scene should, if able, rescue without delay; if they are unable, rescue planning may be necessary to effect rescue. Rescue planning follows a logical sequence:
  - (1) Evaluating survivability.
  - (2) Evaluating the environment.
  - (3) Selecting the rescue method.
  - (4) Selecting rescue facilities.
  - (5) Developing a rescue plan.

### **6.3 Survivability Considerations**

- 6.3.1 When evaluating rescue response, survival time of distressed persons is the foremost consideration. The SMC should consider injuries or other medical conditions that might require special rescue response, such as the need

for quick recovery or specialized rescue equipment. Factors to consider include:

- number of survivors;
- condition of survivors; (If not known, assume urgent medical attention will be required. If known, obtain a detailed description of injuries. This will determine the need for stretchers, oxygen, blood plasma, intravenous fluids, or other medical supplies);
- medical action taken by the survivors or resources at the scene; and
- hazardous environmental conditions.

#### **6.4 Environmental Considerations**

6.4.1 Environmental considerations are many and varied. IAMSAR Manual, Volume 2, Chapter 3, provides general information on this aspect.

#### **6.5 Rescue Method**

6.5.1 Selecting the rescue method usually depends on the environment on scene, available SAR facilities, and the number of survivors and their condition. Selection of a rescue method is sometimes left to the discretion of the OSC or SAR facility. However, the SMC usually develops a rescue plan and coordinates its execution, if needed.

#### **6.6 Selection of Rescue Facilities**

6.6.1 IAMSAR Manual, Volume 2, Appendix G, discusses selection of SAR facilities, and also provides a guide on supplies and survival equipment. SMCs should consult with parent agencies to determine SAR facility capabilities, limitations and availability.

#### **6.7 Rescue Plan**

6.7.1 IAMSAR Manual, Volume 2, Chapter 2, discusses the rescue action plan and the message that typically distributes it. Many SAR missions do not need a rescue plan to be developed by the SMC. In such a situation, the responding SAR facility would develop some form of rescue plan of action. When necessary to develop a rescue plan, the SMC should weigh the considerations provided earlier in this chapter and also:

- type of casualty or incident,
- urgency and magnitude of the situation,
- results of an aerial survey (if conducted) and the available access routes to the scene, and
- most suitable SAR facility for each route (least time en route but with adequate safety and navigational references for the facility).

6.7.2 In developing the rescue plan, the SMC:

- determines SAR facility availability,
- selects specific SAR facilities for various tasks,
- specifies a rescue method for the circumstances (subject to approval by the person in charge of the SAR facility),
- considers need for and method of delivery of supplies and other supporting equipment,
- provides technical advice to SAR facilities, as appropriate,
- coordinates with parent agencies having suitable SAR facilities for implementing the plan,
- adjusts the rescue plan to meet changing conditions, especially availability of SAR facilities, and
- informs all participating agencies of the final rescue plan.

#### **6.8 Delivery Planning**

6.8.1 The final step in the planning sequence involves the safe transport and delivery of all survivors and, where

possible, their property. (The saving of property is secondary to that of saving of lives.) The SMC should select a safe delivery point, such as a hospital, airport, or safe haven, and a means of transport.

## **6.9 Selection of a Safe Delivery Point**

- 6.9.1 Selection of a delivery point is usually based on distance to the distress scene and suitability for receiving survivors or accepting delivery of a distressed craft. Generally, the closest safe delivery point that the transporting SAR facility can reach is selected.
- 6.9.2 Selection of emergency care points for survivors is made easier by having safe delivery points pre-selected and plotted on the RCC response chart. Many major metropolitan areas have disaster plans. Many first aid stations, clinics, private hospitals, city/county hospitals, and emergency medical care centers are available but they vary in capacity to handle survivors.
- 6.9.3 Suitability of airports for escorted aircraft involves consideration of runway length, approach and landing aids, availability of adequate crash/rescue equipment, and weather. Normally, the first suitable airport along the aircraft route or within a reasonable distance is selected as the safe delivery point. If the suitability of an airport is in question, the pilot-in-command or the unit's parent organization should be consulted. If an escorted aircraft indicates that it does not desire to land at the nearest safe airport, the aircraft may be advised that their situation is not severe enough to require an escort. Unless the aircraft diverts to the nearest safe airport, normally SAR system response ends and the escort service is withdrawn.
- 6.9.4 In missions involving emergency services such as towing or escort of marine craft, the normal procedure is to deliver the disabled craft to the nearest safe haven (a place that can accommodate and will accept the safe mooring of the vessel and has an available means of communication, normally a telephone). SAR system response to vessels being towed or escorted ends when they are safely delivered. Harbors should have sufficient depth to receive both the SAR facility and the disabled craft, and should be protected from the elements so that, upon delivery, the SAR facility can depart without expecting a further emergency to develop. If the disabled craft declines delivery to a safe haven, the SMC may withdraw the SAR service assistance or make an exception to the safe haven policy based on humanitarian or other pertinent concerns. If the SMC decides to withdraw assistance, the disabled craft should be advised of the reason for SAR service termination.
- 6.9.5 For mass casualties, it may be necessary to establish a temporary safe delivery point for intermediate handling of survivors. In major aircraft or marine disasters a short distance offshore, survivors might be transported to a suitable nearby landing area where a temporary emergency care center could be established. The survivors should be processed, provided with emergency care, and transported to a permanently established emergency care center. By using a temporary delivery point, a large number of survivors can be evacuated quickly from an immediate hostile environment, and secondary SAR facilities, such as local police and ambulance services, can then transfer survivors to medical care centers. IAMSAR Manual, Volume 2, Appendix C, provides a sample plan of operation for a mass casualty incident.

## **6.10 Rescues in Difficult Environments**

- 6.10.1 Certain geographical areas with unique terrain, weather, or accessibility conditions pose special considerations.
- 6.10.2 Pararescue teams can place medically trained personnel at the distress scene with a minimum of delay. These teams are qualified for jumping into both open ocean and land environments. RCCs are to maintain a list of available pararescue teams, their basic capabilities, and means for requesting their use.

### *Polar Environment*

- 6.10.3 The polar environment with its harsh weather, sparse population, and a lack of natural food and shelter makes extended survival doubtful. Extreme cold, snow, ice, and lack of bases for rescue operations further complicate survivor recovery. Unless otherwise known, it should be assumed that persons stranded in polar areas lack the physical ability, equipment, and necessary skills for survival. Rescue planning should begin early during the

search. Once the distress site is found, the means of rescue should be determined. Aerial evacuation is normally preferable. Where rescue is by land facility, logistical support will usually be via aerial delivery. Continuous air coverage should be maintained for any land facility dispatched until recovery is effected.

- 6.10.4 Immediately upon locating the distress site in a polar environment, the SAR facility should deliver supplies and survival equipment even if it appears no survivors are present. Survivors may have built snow caves or other shelters and may not be visible from the air. Polar SAR aircraft should carry air-droppable polar survival kits or substitutes. The SMC should also consider:
- a) *Polar survival professionals may assist.* Pararescue teams should be considered as a primary means of polar rescue. Appropriate agencies should be alerted and briefed as to the possible need for pararescue teams.
  - b) *Continuous, regular support of survivors and the safety of rescue teams are paramount.* Harsh conditions in polar areas can cause death in minutes without proper equipment and in hours even with good survival equipment.
- 6.10.5 The most effective polar rescue methods depend on the location, weather, and physiological condition of the survivors. A base camp may be established and aerial recovery from it should normally be used. Related matters include:
- a) Aircrew qualifications should be considered in polar rescue by helicopters, including training in emergency medical care and polar survival. Icebreakers as helicopter advance bases may be desired.
  - b) When using fixed-wing aircraft, an evaluation of surface conditions, ice thickness, and terrain features is essential.
  - c) If land SAR facilities are used, survivors should not leave the incident site unless accompanied by a rescue party member. Surface transportation should be provided for the ground party. The first choice is usually snowmobiles, followed by dog teams and sleds, and lastly, snowshoes and skis.

#### *Swamp Environment*

- 6.10.6 Swamp rescue is usually performed by helicopter, but airboats and hovercraft may be used in tidal grass swamps. All types of swamps have been penetrated by land SAR facilities, but the time required and difficulties encountered indicate that all other possible methods of reaching the distress scene and evacuating survivors should be considered first. When SAR facilities must be dispatched into swamp areas, the following should be considered:
- a) While the bottom in a cypress swamp is relatively firm, it is pocketed with many holes not visible from the surface.
  - b) Ground party visibility is limited in tropical cypress, palmetto, and mangrove swamps. Covering aircraft may have to be used to vector the SAR facility to the distress scene.
  - c) Mangrove trees and root systems present considerable barriers to walk-in penetration.
  - d) The many tidal runs in tidal swamps, averaging 3 feet in depth, will impede progress. Both wetlands and tidal grass swamps have areas of silt-laden mud that may be quite deep.

### **6.11 Rescue Operations**

6.11.1 Rescue operations consist of:

- briefing of SAR personnel,
- dispatch of SAR facilities and en route travel,



- on-scene procedures,
- survivor transport and debriefing,
- SAR facility return to base or prior tasking, and
- debriefing of SAR personnel.

6.11.2 Rescue operations do not end until all located distressed persons or craft are rescued or accounted for. Since search operations continue until all survivors or distressed craft are located, or the search is suspended by the SMC, there may be more than one rescue operation for the same SAR mission as multiple distressed persons or craft are located separately.

6.11.3 Safety considerations are critical during rescue operations. No SAR facility should be directed to execute a maneuver hazardous to the craft or crew unless a thorough evaluation indicates that the risk is acceptable. While the OSC and SMC should have the experience, training, and knowledge of the capabilities of the SAR facility to make the evaluation, the person in charge of the SAR facility has ultimate authority and responsibility for determining whether an operation can be executed safely.

## **6.12 Briefing and Debriefing of SAR Personnel**

6.12.1 The crew of the responding SAR facility should be thoroughly briefed in preparation for SAR operations. Also, debriefing of SAR personnel after SAR operations can provide valuable information. IAMSAR Manual, Volume 2, Chapter 5, and its Appendix H provide more information and sample forms for these briefings and debriefings.

## **6.13 SAR Helicopter Escort**

6.13.1 Reasons for and the advantages of fixed-wing aircraft escort for SAR helicopters are provided in IAMSAR Manual, Volume 2, Chapter 5. Agency directives provide other specific flight guidance. Keeping in mind that the pilot-in-command makes the final decision whether it is safe to conduct a specific evolution, general information is provided below for the SMC.

6.13.2 Prior to escort the escorted pilot will be briefed on the escort flight pattern. The escort crew should know the number of persons on the escorted aircraft and advise what method of rescue would be used if an emergency arises.

6.13.3 Visual and communications contact should be maintained. MF, VHF, or UHF homing procedures may be used to aid navigation. If weather conditions prevent visual contact, the escorted aircraft should be advised. Based on fuel remaining, terrain, terminal facilities, terminal weather, and mission urgency, a decision will be made on whether the helicopter should land and wait for favorable weather, return to base, or continue with the mission. The escort should continue to monitor and assist the aircraft being escorted, using any effective electronics or communications equipment.

6.13.4 Depending on the difference of speed between the escort aircraft and the helicopter, one of the following patterns may be used:

- a) *Procedure Turn Escort Pattern.* The escort will proceed on track in front of the helicopter, not to exceed the visual range of the helicopter. Upon notification from the helicopter, the escort will make a procedure turn and return to the helicopter's position. Altitude of the escort will normally be 300 to 500 feet higher than the escorted helicopter. This type of escort gives the maximum navigation assistance.
- b) *Dogleg Escort Pattern.* The escort normally flies 300 to 500 feet above and with 45-degree legs alternately to the left and right side of the escorted aircraft flight path. Length of the legs is adjusted to ensure the escort passes approximately one-half mile behind the escorted aircraft. See Figure 6-1.
- c) *Racetrack Escort Pattern.* The escort normally flies 300 to 500 feet above and in a racetrack pattern that

progresses along the flight path of the escorted aircraft. Size of the pattern flown by the escort may be adjusted to provide maximum coverage. See Figure 6-2.

- d) *Formation.* If the two aircraft are capable of maintaining the same speed, the escort may wish to maintain a constant position relative to the helicopter.

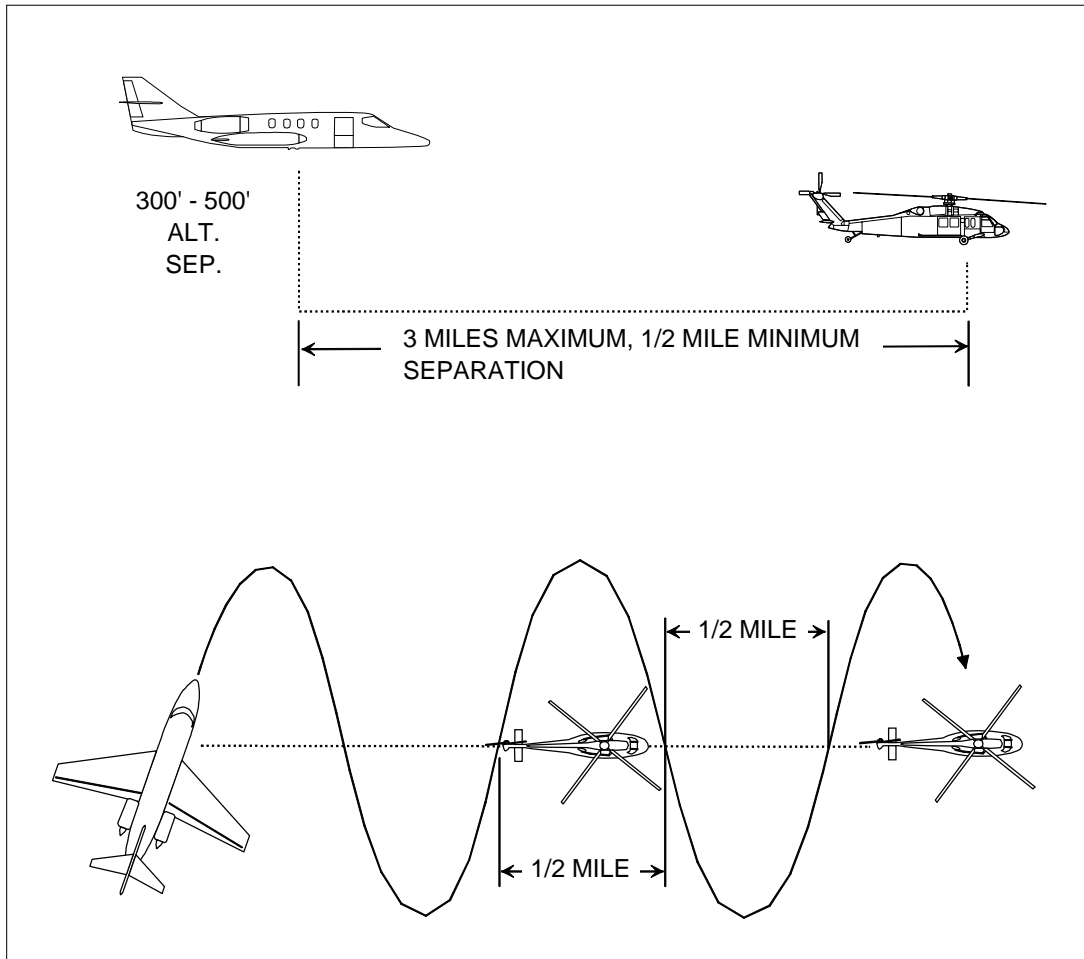
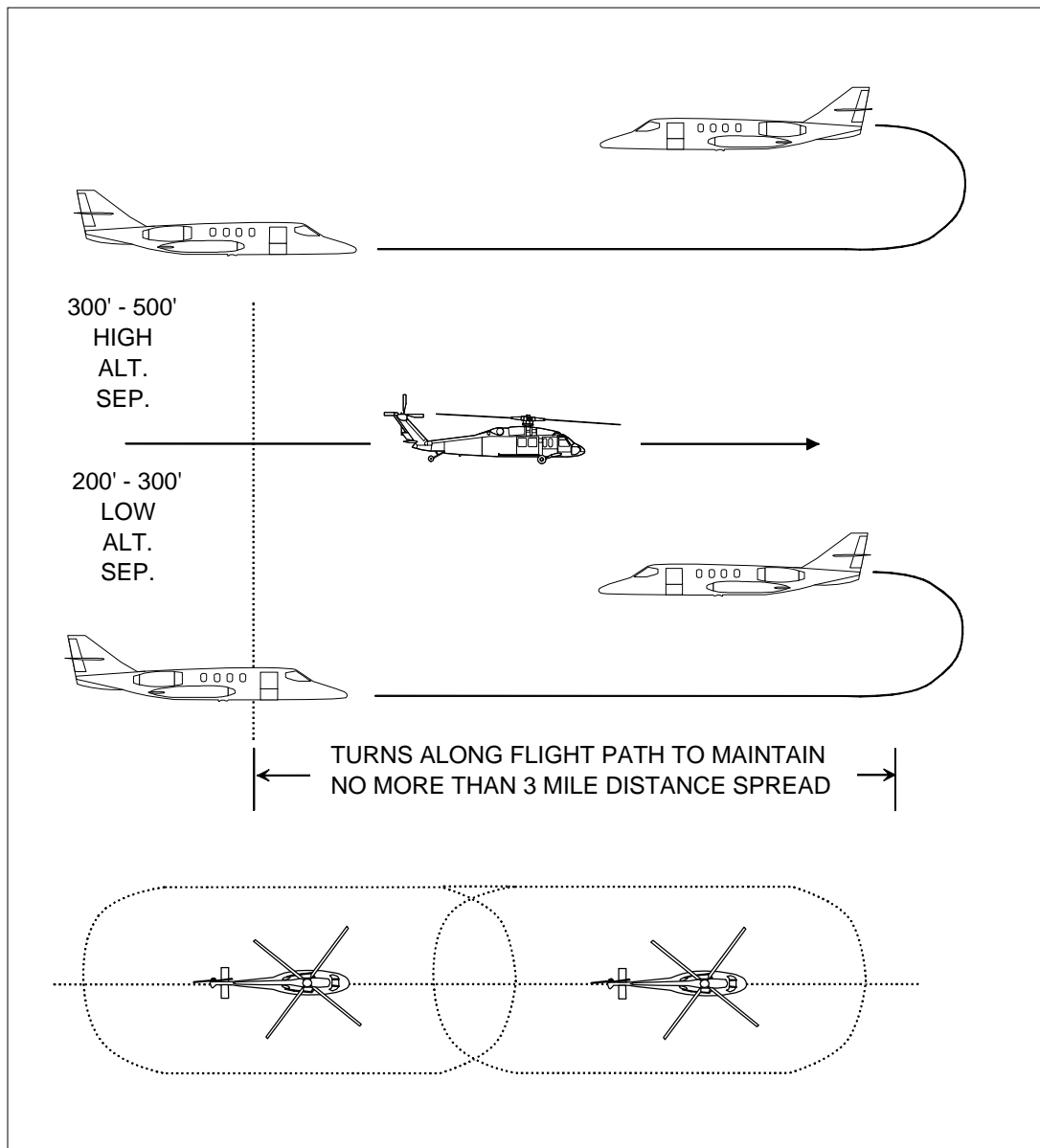

Figure 6-1. Helicopter Dogleg Escort Pattern



**Figure 6-2. Helicopter Racetrack Escort Pattern**

#### 6.13.5 Precautions with Helicopters.

- a) A minimum vertical separation of at least 200 feet must be maintained whenever a fixed-wing aircraft passes over a helicopter. Otherwise the downwash and slipstream turbulence from the fixed-wing aircraft may cause the helicopter to lose control.
- b) Even though many SAR helicopters can operate at night and in near-zero visibility, they require more time to maneuver under these conditions. Radio discipline is essential for uninterrupted crew communication during the approach, and to permit DF equipment to give a steady bearing when homing. Aircraft should avoid transmitting to helicopters executing a pick-up.

#### 6.14 Coordinated Helicopter-Boat Rescue

- 6.14.1 Occasionally both a helicopter and a boat will be dispatched. When the helicopter arrives first and begins its rescue attempt, the boat should take position upwind of the helicopter in the 2 o'clock position at a safe distance and stand by as a backup. The boat must not cross over the helicopter hoisting cable, nor cross between the survivor and helicopter, and must stay within pilot vision.

*Note: Helicopter-boat positioning is different for helicopter pick-up operations and should be discussed in agency directives.*

- 6.14.2 If the helicopter aborts the attempt, the pilot should depart the immediate area of the survivor and signal for the boat to attempt rescue. Helicopters may turn out the anticollision rotating beacon to indicate they require boat assistance or are unable to complete the rescue. Specific signals should be prearranged.
- 6.14.3 If the boat arrives first and makes the rescue, transfer of survivors to the helicopter for more rapid delivery to medical facilities may be advisable.

#### 6.15 Underwater Rescue

- 6.15.1 IAMSAR Manual, Volume 2, Chapter 6 discusses rescue of persons from inside damaged, capsized or ditched craft. Common casualties include entrapment in capsized, damaged, or sunken vessels and submersibles, crashed aircraft, and swimming and diving mishaps. Often, the Coast Guard or local resources can respond effectively. However, in more complex or major cases, the resources and expertise of the Navy are used. In such cases, the Navy normally assumes SMC and the Coast Guard provides support. For rescue of civilian submersibles, the SMC may request use of Navy submarine rescue capability through the Navy Command Center Duty Captain at the Pentagon (on 24-hour duty). Specific Coast Guard guidance for underwater incidents is provided in the Coast Guard Addendum to this NSS.

- 6.15.2 Victims of diving accidents, professional and recreational divers, often have medical injuries that few SAR personnel on scene may understand or are prepared to handle. SAR personnel are not required to be experts in providing medical diagnosis or treatment for such injuries. However, SAR personnel in places with known diving activity should be able to recognize the general symptoms of dive-related injuries so that their potential severity is recognized and medical advice obtained, and basic steps are taken to minimize worsening the medical condition. Symptoms of diving-related illnesses are quite varied. Any unusual occurrences, including pain, confusion, dizziness, numbness, or shortness of breath, within 24 hours of diving should also be considered a possible diving accident. General categories of dive-related injuries are:

- decompression sickness (“the bends”),
- air embolism, and
- nitrogen narcosis (“rapture of the deep”).

- 6.15.3. For all reported or potential diving accidents, SAR personnel should:

- a) Obtain the dive history: time, depth, activity, problems encountered, stops during ascent, time at the surface, time to onset of symptoms, pre-dive problems and activities, the symptoms or signs currently being experienced.
- b) Obtain emergency medical advice as necessary, and if recompression is needed, locate the closest available chamber. (RCCs should maintain a list of chambers in their area.) Such information is available 24 hours per day from **Divers Alert Network (DAN)**, located at Duke University Medical Center in North Carolina.
- c) Be prepared to transport both diver and the diving partner (diving buddy), who may develop the same symptoms.

- d) Be aware of limitations of air transport. Air transportation of a diving accident victim is safest in a pressurized aircraft that can maintain sea level cabin altitude. Nonpressurized aircraft should maintain an altitude safe for flying and no higher than 200 feet above the location from which the victim was received. Cabin altitudes should also not exceed 200 feet above this location except in life-threatening situations where no other form of transportation is available. If oxygen is available, it should be administered by mask at the highest concentration available.

6.15.4 A thorough discussion on diving casualties is presented in the *U.S. Navy Diving Manual*, NAVSHIPS 0994-001-9010 (available from Commander, Naval Sea Systems Command) and the *National Oceanic and Atmospheric Administration Diving Manual* (available from the Superintendent of Documents, Government Printing Office, Washington, D.C. 20402, Stock Number 003-017-00468-6). The general information contained in these publications should not replace or delay SAR consultation with experts.

## **6.16 Cold Water Near-Drowning**

6.16.1 Victims of near drowning in cold water (70 degrees F or less) often appear lifeless, cold, blue, non-breathing, and show no detectable heartbeat. If immersion is less than one hour, prompt CPR should begin and the victim rapidly transferred to a suitable medical facility.

## **6.17 Special Considerations**

6.17.1 Rescue operations can create physical and psychological threats to SAR personnel. IAMSAR Manual, Volume 2, Chapter 6 discusses special requirements at aircraft crash sites. Any type of site can pose hazards, especially fuel, and to a lesser extent, chemical and radiation hazards. Rescue personnel must exercise caution when approaching or boarding an unfamiliar vessel, or when approaching a vehicle or aircraft crash site. In addition to obvious dangers of fire and explosion, there may be danger of exposure to chemicals or radiation. For example, many fishing vessels use liquid ammonia to refrigerate their catch. If a fishing vessel crew is sick or unconscious, there may be an ammonia leak in the refrigeration system. The Chemical Hazard Response Information System (CHRIS) Manual provides information on chemical hazards, symptoms following exposure, and treatment of exposure victims. It also shows hazardous material labels that should, but may not, accompany chemicals.

6.17.2 Proper hazardous materials (HAZMAT) handling by on-scene personnel is an important element to a rapid recovery of victims. While SAR and medical personnel are not expected to be experts in hazardous materials, they must be knowledgeable enough or forewarned of on-scene conditions, for their own safety. Appropriate actions could include hazardous materials identification, on-scene safety strategies, and barricade zoning for the protection of the general public. Specialized hazardous material personal protective equipment and decontamination procedures should comply with previously established guidelines. Incidents that involve hazardous materials will include medical conditions that require decontamination on site or upon arrival to a medical facility with decontamination areas. Due to the unknown exposure to agents, contact in the hot zone should be limited to the appropriate rescue personnel equipped with personal protection gear. Poisons, gases, vapors and corrosives are a few of the elements that could be present. Follow established EMS HAZMAT and Poison Control center guidelines when treating contaminated victims.

6.17.3 Survivors as well as SAR personnel can experience post traumatic stress. This suffering is most common after handling of deceased persons and mass casualty incidents. Grief, despair, or the ordeal of survival may cause irrational behavior such as neglect of personal safety, or attempts at suicide during the rescue. Resources permitting, rescued persons should not be left alone, especially if injured or showing signs of physical or mental exhaustion. Uninjured survivors may possibly be on the verge of complete mental collapse due to their basic temperament or occurrences they encountered or witnessed. This condition could result in a state of uncontrollable shock. Specialized federal and local counselors are often available upon request to help operational personnel, survivors and relatives of the victims meet their emotional needs. Counseling professionals, including Navy teams of psychologists and chaplains, should be considered for counseling SAR personnel following a mass casualty incident, crash of a SAR facility, or if SAR personnel have perished during a rescue attempt.

## **6.18 Debriefing of Survivors**

- 6.18.1 IAMSAR Manual, Volume 2, Chapter 6 provides information on debriefing of survivors. A useful tool for this is a survivor/rescuer debriefing kit. The kit should contain debriefing forms for the gathering of data important for future SAR planning. The form should guide the questioner through a logical and orderly set of questions without omitting essential information, and provide an on-scene record of information that might be forgotten before the mission is completed and documented. Forms should be short and self-explanatory, and should be filed in the SAR mission documentation folder.
- 6.18.2 Survivors should be debriefed about:
- a) Other survivor or occupant information. The survivor should first be asked about other survivors, and leads as to their whereabouts. Additional information, such as bailout altitude and position, may be important in determining the probable datum for subsequent search efforts.
  - b) Self-help and clinical medical treatment, particularly prescribed or over-the-counter medication. If a survivor has a history of a recurring disease, such as heart trouble, diabetes or epilepsy, this information should be noted on survivor processing tags or in the medical log for future attending medical personnel. The RCC should be informed of these situations.
  - c) Experiences during the survival, search, and rescue phases. Debriefing survivors helps to ensure that search personnel are aware of information that may be important for further SAR efforts, and assists in evaluating procedures used. It also may help prevent future accidents. Depending on the case, this step may be delayed until survivors are adequately cared for and rested.
- 6.18.3 Each survivor should be informed that replies are voluntary and will, if given, be used in pursuing the SAR case, or preventing such incidents in the future. Survivors should be provided with a copy of their statement on request. Information obtained from survivors should be treated with discretion. Survivors should also be advised that release of the information is governed by the Freedom of Information Act, 5 USC 552, and the Privacy Act of 1974, 5 USC 552a. Service directives implementing these laws should be consulted.

## **6.19 Emergency Medical Services**

- 6.19.1 IAMSAR Manual, Volume 2, Chapter 1 and 2 provide general medical information, and some details on MEDICO (medical advice) and MEDEVAC (medical evacuation). Appendix C provides a sample plan of operation for a MEDEVAC and Appendix D provides a checklist for a MEDICO or MEDEVAC operation. Chapter 6 provides advice on medical personnel and care of survivors. IAMSAR Manual Volume 3, Section 2, provides a wide range of advice on medical assistance from the viewpoint of a SAR facility or craft in distress, including assistance by helicopter, care of survivors, and training for SAR personnel.
- 6.19.2 The capability of sustaining life after rescue is as important as the searching for, and rescuing of, survivors. The SAR system has four major Emergency Medical Services (EMS) capabilities:
- (1) Personnel trained in emergency care.
  - (2) Lifesaving and life sustaining services to survivors.
  - (3) Survivor evacuation and transport.
  - (4) Medical facilities to receive injured survivors.

## **6.20 EMS Personnel**

- 6.20.1 Emergency medical services personnel are trained to provide emergency medical care lifesaving services at the distress scene. In addition, these personnel may be trained to provide life support and life-sustaining services during survivor extraction from wreckage, evacuation, and transport to a receiving medical facility. They include SAR crewmen and pararescue personnel qualified to administer basic lifesaving first aid and specially

trained EMS personnel such as doctors, nurses, corpsmen, paramedics, or SAR emergency medical technicians (EMTs).

## **6.21 Emergency Care**

6.21.1 Emergency care may include: extraction or removal from wreckage, triage (the sorting and assignment of priorities for attendance, care, treatment, and transportation of multiple survivors), first aid and emergency care to stabilize survivor condition, survivor debriefing, transport to a delivery point, life support during transport, transfer/delivery of survivors at the delivery point and briefing of receiving authorities at the delivery point.

## **6.22 SAR Facility Procedures**

6.22.1 SAR personnel should ensure the rescue of all persons trapped in a hazardous environment who can be rescued without unduly compromising the survival of others. Survivor processing begins as soon as possible after the survivor is extracted from wreckage, or boards a rescue craft. The number of survivors, type of SAR facility and medical resources available determine the nature of processing and any further SAR efforts. Medical evacuation involving transport by aircraft should be coordinated closely with a recognized medical authority. A search team should:

- conduct triage and render medical care,
- begin extraction if it will not unduly jeopardize other survivors,
- provide shelter for survivors until evacuation, and
- evacuate survivors.

6.22.2 Aircraft crash sites present particular problems for rescue facilities, as discussed in IAMSAR Manual Volume 2, Chapter 6. The aircraft wreckage and its surroundings should not be disturbed except to assist in the recovery of survivors. And, control of access to the crash site should be established as soon as possible.

## **6.23 Survivor Evacuation and Transport**

6.23.1 Survivors should be removed from the distress scene, transported to a safe delivery point, or medically evacuated (MEDEVAC) to receiving medical facilities by the most expeditious means. IAMSAR Manual Volume 2, Chapter 1, lists factors to consider when planning a MEDEVAC and Chapter 6 contains a list for a medical assessment. When relying on medical advice from doctors who are not well versed in SAR, it may be necessary to explain the hazards involved to the doctor, so that a decision can be reached on whether a MEDEVAC is warranted. Operational authorities should advise consulting doctors of the fear-inducing nature of any operation necessary to evacuate a patient. For example, transfer of a heart attack patient to a SAR facility may cause apprehension and worsen the situation. The risk of the overall transport mission is weighed against the risk to the patient. Also, operational mission risk must be balanced against the patient's present clinical status and the patient's probable clinical course if MEDEVAC is delayed or not performed.

## **6.24 Evacuation from Marine Craft**

6.24.1 IAMSAR Manual, Volume 3, Sections 2 and 4 provide specific guidance on evacuations from marine craft by helicopters. For a MEDEVAC at sea, the primary controlling factors are distance, weather, and threat to patient and crew. Normally the SMC will ask the vessel to divert and head for a certain position or port. The sooner the vessel acknowledges it will divert and gives an ETA, the sooner the helicopter flight or surface rescue can be planned. If the vessel is already within helicopter range, it may still be preferable to divert in the direction of the SAR facility departure point to expedite patient removal.

6.24.2 Fixed-wing aircraft may be dispatched to serve as escort, navigation aid, and communication relay for the SAR facility. The vessel should provide as accurate a position as possible, time of position, course, speed, weather and sea conditions, wind direction, and velocity. Medical information should include whether the patient is ambulatory. SAR facilities do not normally carry a stretcher, and, if one is needed, this information should be

obtained prior to dispatch.

- 6.24.3 After the SAR facility has departed base, the vessel should be advised of its ETA. The vessel should stand a continuous radio guard on a specified frequency to establish communications with the fixed-wing escort and later with the SAR facility. Frequent transmissions may be requested from the ship for homing.
- 6.24.4 When personnel are removed from vessels, all customs, immigration, and quarantine laws must be observed. RCCs should make the necessary arrangements with the appropriate customs, immigration, health or other authorities with a view to expediting such entry. Agencies concerned with these laws are normally advised. If the patient is a foreign national, the appropriate embassy or consulate should be notified.
- 6.24.5 If the vessel is far at sea, the MEDEVAC is often accomplished by another vessel, possibly the Coast Guard or Navy. Merchant vessels with doctors or medical facilities may provide a source of medical treatment, or the patient may be transferred from an outbound merchant vessel to one inbound. The Amver system can be of great help in finding a suitable merchant vessel to assist. SMCs can only request, not direct, assistance from merchant vessels.

## **6.25 Evacuation from Land Areas**

- 6.25.1 Experience has shown that medical response, particularly to collapsed structures encountered in disaster situations, as well as daily emergencies, requires specialized training and education beyond that normally acquired in the traditional emergency medicine and prehospital setting. The FEMA National Urban Search & Rescue Response System medical response component has the capability and specialized training to provide advanced medical care to injured /trapped victims and US&R task force members in austere, confined space environments. Other general information can be found in NSS Chapter 5, "Land SAR Operations".

## **6.26 Survivor Delivery**

- 6.26.1 When survivors are delivered to a medical facility, the person in charge of the delivering unit should provide number of patients, age and information on all first aid and emergency treatment given. The degree of briefing depends on the medical competence of the personnel who administered emergency treatment. Information passed should include:
- type of injury or condition,
  - treatment given and medications, including time and amounts, and
  - times when tourniquets, splints, or compress bandages were applied.

The survivor processing tag, medical logs, and any other medical records should be delivered to medical personnel.

## **6.27 Fixed Medical Facilities**

- 6.27.1 The SMC normally selects, based on knowledge of local capabilities, a suitable medical facility to receive injured survivors. Fixed medical facilities involved in SAR work include emergency medical care centers, general hospitals, private hospitals, clinics, sanitariums, and first aid stations. Some military hospitals and clinics provide medical advisory services to the SAR system, but they are survivor-receiving hospitals only for those persons authorized to be admitted. Generally, this service is limited to military personnel, their dependents, and certain government officials. Where civil hospitals are not available, military hospitals will usually admit civilian patients for emergency treatment.



---

## CHAPTER 7. LEGAL ASPECTS

- 7.1 Relevance of Law to SAR Managers
- 7.2 General Background
- 7.3 Domestic Legislation and National SAR Plans
- 7.4 International Law
- 7.5 Charging for SAR Services
- 7.6 Liability
- 7.7 Assistance by Commercial Ships
- 7.8 Post-SAR Handling of Deceased Persons and Alien Survivors
- 7.9 International SAR Agreements

### 7.1 Relevance of Law to SAR Managers

- 7.1.1 This Chapter is written as an overview of legal aspects of search and rescue (SAR) to provide general information and guidance for U.S. SAR managers and others interested. It covers general legal principles, selected legal provisions, and specific applications where such might be helpful. The Chapter is not intended to qualify anyone as an attorney, nor to represent the legal views of any nation other than the U.S., although we believe that the information and views presented will withstand international scrutiny.
- 7.1.2 Having a sound legal basis for establishing SAR services and for assisting persons in danger or distress, and having access to competent legal advisors who can help in development and application of such provisions, are among the keys to successful lifesaving. And, because of the time-critical nature of SAR operations, having legal matters resolved in advance is wise. It is equally important to ensure that legal advisors on SAR matters are familiar with the practical principles and constraints of SAR operations. SAR managers should ensure that arrangements are in place for timely access to competent legal advice when it is needed.
- 7.1.3 SAR managers should understand enough about domestic and international law to ensure that sufficient legal provisions are in place to support and protect the interests of the SAR organizations, SAR services, and persons in danger or distress with which they are involved. They should be familiar with relevant provisions, interpretations, and applications of existing law, and pursue new legal initiatives, as appropriate, that would benefit lifesaving. Finally, they should ensure that SAR personnel understand all they need to know about legal aspects of SAR to perform their respective duties confidently and properly.

### 7.2 General Background

- 7.2.1 What is meant by “legal aspects of SAR”? Domestically, legal aspects normally include written provisions that create legal obligations, such as national legislation, regulations, and documents such as agreements. Negligence in following established policies and standards, which may or may not be legally binding, may also, in some circumstances, create legal liability. International law exists mainly in the forms of multilateral treaties and associated documents, agreements in their various forms (including memoranda of understanding), international regulations, and customary international practice. The U.S. has committed itself to support many such instruments. Customary practice is a collection of laws established by custom, i.e., by usual practice. Customary law may be enforceable even though it may not be established in writing.
- 7.2.2 American citizens are familiar with the territorial and political units called “States” that make up our nation. However, SAR personnel should not be surprised to see or hear the word “State” used to refer to a country; it is a common way of recognizing a country and its government as a sovereign authority. The meaning of the word “State” is usually clear from the context in which it is used.
- 7.2.3 Forms of the terms “save” and “salve” are used internationally regarding removal of property from risk. *The International Aeronautical and Maritime Search Rescue Manual (IAMSAR Manual)* discusses reasons why

SAR managers may want to develop authority, policies and practices for saving property in danger or distress as well as persons, though international law overall has more to do with saving persons. Saving property:

Is often a natural extension of lifesaving efforts;

May be a means of lifesaving;

Helps justify SAR resources due to the value of the property saved; and

Takes advantage of the capabilities of SAR facilities, which are often the only resources available, to perform a needed salvage function.

7.2.4 Considerations in providing for saving property may include:

Cost and risks involved in saving the property;  
Estimated value of the property;

Whether abandoning the property may introduce other problems, like pollution or hazards to navigation;

Whether proper facilities, equipment, and skill seem to be available to conduct the operation;

Whether available units need to handle higher priority missions or duties at the time; and

Advice of SAR personnel on scene who are usually in the best position to assess the situation.

**7.3 Domestic Legislation and National SAR Plans**

7.3.1 Every State (nation) should provide a general legislative basis for carrying out SAR services. In the U.S., this is accomplished by a combination of authority and responsibility established in legislation applicable to individual federal agencies, as well as by a department-level agreement called our National SAR Plan (Appendix A to this NSS).

7.3.2 Such provisions help to describe the broad framework within which SAR services function, and often help to support SAR resource proposals, agreements, plans, and other matters for which SAR managers may be responsible.

7.3.3 While SAR-related legal provisions vary among nations, similarities are growing as SAR authorities around the world become more aware in this area.

7.3.4 The IAMSAR Manual emphasizes that every nation should have in place statutes and related provisions that establish a legal foundation for establishing a SAR organization and its resources, policies, and procedures. SAR managers should seek legal advice on how domestic and international laws pertain to SAR policies and procedures. National legislative provisions should be aligned with accepted principles of international law.

7.3.5 Ways that national legislation may help produce stronger and more flexible SAR services include the following:

Ensure that the SAR mission is recognized in legislation as a national responsibility to help SAR managers obtain the essential support they need up to the department level;

Designate primary responsible SAR authorities, and broadly describe their responsibilities;

Provide that SAR services be carried out in accordance with the *International Convention on Maritime Search and Rescue, 1979*, and the *Convention on International Civil Aviation, 1944, Annex 12*, and with recognized international procedures;

Require that general SAR plans and arrangements provide for use, as practicable, of all available resources;

Require that adequate facilities be provided by responsible authorities to receive distress alerts, and provide a practical and effective level of SAR services; and

Adopt measures that promote safe design, construction, maintenance, equipment, and operation of aircraft, ships, and other marine craft (these measures should account for common causes of casualties, and help prevent or deal with emergency situations).

- 7.3.6 Part of using all appropriate resources to support SAR involves agencies of the government cooperating and providing mutual support. Examples of U.S. legal authorities that provide for such cooperation are as follows:

DOD: DOD Directive Number 2310.2 Personnel Recovery

Coast Guard: 14 USC 2 and 141

National Aeronautics and Space Administration: National Aeronautics and Space Act of 1958 as amended, 42 USC 2451

National Oceanic and Atmospheric Administration: 15 USC §313, 49 USC 44720, and, for joint project authority, 15 USC 1525

National Park Service (operates under the Secretary of Interior): 16 USC. 1b. The National Park Service authority is quoted below as an example:

16 USC 1b. Secretary of the Interior's authorization of additional activities; administration of National Park System

“In order to facilitate the administration of the National Park System, the Secretary of the Interior is authorized to carry out the following activities, and he may use applicable appropriations for the aforesaid system for the following purposes:

- (1) Emergency assistance

“Rendering of emergency rescue, fire fighting, and cooperative assistance to nearby law enforcement and fire prevention agencies and for related purposes outside of the National Park System.”

- 7.3.7 SAR Plans can be developed appropriate to any level of national or regional SAR organization. A regional SAR organization is one in which: two or more nations cooperate to provide an integrated SAR organization or one nation accepts overall responsibility for SAR services for itself and neighboring nations that recognize it to do so and support the lead nation to the extent of their capabilities. Ministry-level authorities should normally sign a national or regional SAR Plan as an indication of the importance of the SAR mission and as a symbol of commitment to support the mission with adequate resources.

- 7.3.8 The National SAR Plan states its objectives, which should be noted as an indication of what such a Plan can do to support SAR services

- 7.3.9 Any basic principles or policies that apply generally to all the organizations involved can be documented in the plan; the U.S. Plan provides these, along with a summary of basic principles upon which SAR conventions and the IAMSAR Manual were based.
- 7.3.10 Finally, since any effective SAR organization usually involves cooperation between civil and military authorities, the basis for such cooperation should be described in the plan.

#### **7.4 International Law**

- 7.4.1 In the following sections of this Chapter, selected provisions of SAR-related treaties will be presented and briefly discussed for awareness, since SAR managers may not have these documents readily available. Some of these treaties are available in multiple languages, which can make them convenient to use in international training or consultations on SAR. These provisions will first be sorted as they apply to ships, aircraft and States, with a brief discussion on how the U.S. views the provisions. Then the conduct of SAR operations in foreign territories, charging for SAR, liability, repatriating survivors and other legal topics SAR managers must deal with will be discussed.

##### *Ships*

- 7.4.2 Besides the tradition established by long practice, duties of mariners to assist others at sea are documented in conventions such as those discussed below:

Article 11, of the 1910 International Convention for the Unification of Certain Rules Relating to Salvage of Vessels at Sea, provides that "Every master is bound, so far as he can do so without serious danger to his vessel, crew and passengers, to render assistance to everybody even though an enemy, found at sea is in danger of being lost". This mandate is reiterated in Article 10 of the 1989 International Convention on Salvage;

Article 8, of the 1910 International Convention for the Unification of Certain Rules of Law with regard to Collisions Between Vessels, provides that "After a collision, the masters of each vessel in the collision shall be bound, as far as he can do so without serious danger to his vessel, crew and passengers, to render assistance to the other vessel, her crew, and her passengers."

Regulation 10, Chapter V of the 1948 International Convention for the Safety of Life at Sea (SOLAS) states, "The Master of a ship at sea, on receiving a signal from any source that a ship or aircraft or survival craft thereof is in distress, is bound to proceed with all speed to the assistance of the persons in distress and informing them, if possible, that he is doing so." This regulation was based on Article 45 of the 1929 SOLAS Convention, and subsequently included in the 1960 and 1974 SOLAS Conventions. The provisions of Regulation V/10 of the International Convention for the Safety of Life at Sea, 1974 has now been expanded to read as follows:

##### **Distress Messages - Obligations and Procedures**

- (a) The master of a ship at sea, on receiving a signal from any source that a ship or aircraft or survival craft thereof is in distress, is bound to proceed with all speed to the assistance of the persons in distress informing them if possible that he is doing so. If he is unable or, in the special circumstances of the case, considers it unreasonable or unnecessary to proceed to their assistance, he must enter in the logbook the reason for failing to proceed to the assistance of the persons in distress.
- (b) The master of a ship in distress, after consultation, so far as may be possible, with the masters of the ships which answer his call for assistance, has the right to requisition such one or more of those ships as he considers best able to render assistance and it shall be the duty of the master or masters of the ship or ships requisitioned to comply with the requisition by continuing to proceed with all speed to the assistance of persons in distress.

- (c) The master of a ship shall be released from the obligation imposed by paragraph (a) of this regulation when he learns that one or more ships other than his own have been requisitioned and are complying with the requisition.
- (d) The master of a ship shall be released from the obligation imposed by paragraph (a) of this regulation, and if his ship has been requisitioned, from the obligation imposed by paragraph (b) of this regulation, if he is informed by the persons in distress or by the master of another ship which has reached such persons that assistance is no longer necessary.
- (e) The provisions of this regulation do not prejudice the International Convention for the Unification of Certain Rules relating to Assistance and Salvage at Sea, signed at Brussels on 23 September 1910, particularly the obligation to render assistance imposed by article 11 of that Convention.

Article 21, of the Second Geneva Convention of 1949 permits belligerents to appeal to the charity of commanders of neutral merchant vessels, yachts or other craft, to take on board and care for the wounded, sick or shipwrecked persons, and to collect the dead, and accord special protection to those who respond to such appeals.

The 1958 Geneva Convention on the High Seas, and the 1982 United Nations Convention on the Law of the Sea (Article 98) cite similar duties for ship masters to provide assistance. Codifying customary international law, Article 12 of the 1958 High Seas Convention states:

“Every State shall require the Master of a ship sailing under its flag, in so far as he can do so without serious danger to the ship, the crew, or the passengers,

to render assistance to any person found at sea in danger of being lost;

to proceed with all possible speed to the rescue of persons in distress if informed of their need of assistance, in so far as such action may reasonably be expected of him;

after a collision, to render assistance to the other ship, her crew and her passengers and, where possible, to inform the other ship of the name of his own ship, her port of registry and the nearest port at which she will call.”

Every coastal state shall promote the establishment and maintenance of an adequate and effective search and rescue service regarding safety on and over the sea and -- where circumstances so require -- by way of mutual regional arrangements cooperate with neighboring states for this purpose.”

*Note: As with the other Conventions mentioned above, Article 12 does not limit duty to assist solely to "high seas." Also, the need for formal regional SAR arrangements was recognized here for the first time in an international convention.*

- 7.4.3 Innocent passage through territorial seas and archipelagic waters includes stopping and anchoring when necessitated by force majeure or by distress; stopping and anchoring to assist others in danger or distress is also permitted. See the Territorial Sea Convention, Article 14 and the 1982 Law of the Sea Convention, Articles 18 and 52. Article 18(2) says that passage includes stopping and anchoring only when necessitated by force majeure or distress or to assist persons, ships or aircraft in danger or distress. While this Article includes no provision for notifying the coastal state, concurrent or subsequent notification is always considered appropriate. It might be argued that the Law of the Sea Convention merely allows a ship already in innocent passage to divert to provide assistance; however, customary practice of some nations, and the negotiating history of Article 18(2), show this humanitarian activity was not intended to be so limited. The provision, by its placement in the Convention, is more like force majeure than like innocent passage covered in Article 19, though it includes the right to divert to assist during innocent passage.

*Note: Although the U.S. is not Party to the 1982 United Nations Convention on the Law of the Sea (UNCLOS) many other nations are.*

- 7.4.4 Assisting persons in danger or distress within foreign territorial seas and archipelagic waters is a legal right and is further discussed later in this Chapter.
- 7.4.5 It is helpful to understand some key terms associated with international law. They are generally understood as follows, but legal advice should be sought when precise meanings are needed. Territorial seas begin at a land-sea baseline and nations may claim such out as far as 12 nautical miles seaward. Exclusive economic zones (EEZs) comprise those waters seaward of the territorial seas and extending no further than 200 nautical miles from the baseline. Archipelagic waters are like territorial seas that island nations can claim if recognized as archipelagic nations, for which the baseline is drawn in accordance with certain rules around a group of islands as though they were a single landmass. High seas are waters beyond EEZs. International waters and airspace exist beyond the limits of territorial seas and archipelagic waters. Areas such as those associated with “exclusive economic zones” are not restricted in any way regarding SAR activities carried out by a SAR facility. High seas freedoms apply within EEZs. Oceanic SAR regions (SRRs) for maritime and aeronautical SAR may overlay any of the areas referred to in this paragraph.

#### *Aircraft*

- 7.4.6 It appears reasonable to accord rescue aircraft the same consideration as ships when lives are in jeopardy. Account must be taken, of course, of the unique SAR capabilities and limitations of various types of aircraft when compared to each other or to ships.
- 7.4.7 While this is true, when foreign territorial entry is involved, the applicable principles for aircraft are not yet as fully developed as for ships. This is why a distinction is made in U.S. guidance as it relates to use of aircraft, as will be noted below. Account is taken of differences in how the law of the sea and law of the air were developed. Some discussion of these differences may help the relevant law and U.S. procedures make more sense. Following are some historical reasons why foreign rescue aircraft and ships have been treated differently in international law:

There is no innocent passage provision for aircraft, and the concept of force majeure is less developed;

Some nations have feared a military aircraft's overflight of territorial seas more than a warship's passage through it, due to the aircraft's relatively high speed and ability to pass landward of the coast;

Since early aviation involved little overflight of marine areas, territorial seas were viewed more as an extension of land for aeronautical purposes;

While sea law is rooted more in tradition and customary practice, air law is based mostly on the 1919 Paris Convention, the 1929 Havana Convention and the 1944 Chicago Convention;

While security interests of coastal States tend to take priority over air navigation interests of other nations, the balance is shifted when the factor of saving lives is considered. Saving lives is also an essential part of international air law. Some international SAR agreements establish right of assistance entry for aircraft as well as surface rescue units (as with ships, the right is based on need for immediate assistance); and

While aircraft also appear to have a duty to assist those in distress when they can safely do so, it may not always be prudent. Due to limitations on types of services an aircraft can provide, there may be cases that warrant immediate entry by a surface unit, but not by aircraft. A foreign ship is more likely to be in a unique position to assist than a foreign aircraft. Also, a coastal State may be able to have its own aircraft on scene quickly but may not be able to respond in a timely manner with surface units.

## States

- 7.4.8 The duty of coastal States to assist persons in distress was first recognized in Regulation 18 of Chapter V of the 1948 SOLAS Convention which states, "Each Contracting Government undertakes to ensure that any necessary arrangements are made for coast watching and for the rescue of persons in distress at sea round its coasts." A similar provision of the 1958 High Seas Convention was previously cited.
- 7.4.9 The two primary international Conventions that address SAR responsibilities of States are the IMO *International Convention on Maritime Search and Rescue, 1979*, and the *Convention on International Aviation, 1944*. Annex 12 of the 1944 Convention deals with SAR. The relevant provisions of the 1979 Convention have been substantially updated effective January 1, 2000. The principle of these Conventions is that neighboring nations cooperate to establish rescue coordination centers (RCCs), each with an associated SRR to ensure effective SAR services can be provided in their part of the world, including any high seas areas between them.
- 7.4.10 A state's aeronautical SRRs and maritime SRRs are established and recognized in accordance with procedures of ICAO and IMO, respectively, which involve agreement among neighboring States. These recognized SRRs and their RCCs are published in IMO's Global SAR Plan and ICAO's Regional Air Navigation Plans. SRRs should be contiguous, without overlapping. Aeronautical and maritime SRRs should be harmonized where practicable, but aeronautical SRRs are also recommended to be aligned with flight information regions (FIRs) established for air traffic control. U.S. aeronautical and maritime SRRs, and those of many other nations, are not all completely harmonized.
- 7.4.11 IMO and ICAO, to provide guidance to States, RCCs and SAR facilities on implementing the provisions of the 1979 and 1944 Conventions, jointly developed the IAMSAR Manual. The SAR provisions Annexed to the two Conventions are so important to SAR, and so comprehensive, that every SAR manager should hold copies of and be familiar with them. Listed below are some of the key topics addressed by one or both of these Conventions:
- Terms and definitions
  - Arrangements for developing and providing SAR services
  - Establishment of necessary legislation, communications, RCCs, associated SAR regions, RSCs, and SAR facilities
  - International cooperation
  - Fundamental operating procedures and plans
  - Parameters for terminating or suspending SAR operations
  - Ship reporting systems
- 7.4.12 There are six key paragraphs in the 1979 Convention that were deemed to be of sufficient significance that they require a more robust procedure to amend. Paragraphs 2.1.4, 2.1.5, and 2.1.7 deal with delimitation of geographic SAR regions, which must be coordinated between states having neighboring SAR regions. IMO and ICAO have procedures to follow in establishing internationally recognized SAR regions. The main purpose of such regions is to ensure that distress alerts are routed to the proper RCC in a timely manner. 2.1.10 provides that States ensure that any person in distress at sea is assisted without regard to nationality or circumstances. 3.1.2 and 3.1.3 relate to entry of foreign territorial waters for SAR, and taken together with other international law, help form the basis for U.S. policy on this matter.
- 7.4.13 Regarding entry of foreign territory, the 1979 SAR Convention, in part, provides that:

“Parties shall ensure that assistance be provided to any person in distress at sea, regardless of the nationality or status of such a person or the circumstances in which that person is found.” (paragraph 2.1.10);

“Unless otherwise agreed between states, a Party should authorize, subject to applicable national laws, rules and regulations, immediate entry into or over its territorial seas or territory of rescue units of other Parties solely for searching for maritime casualties and rescuing survivors of such casualties.” (paragraph 3.1.2);

“States should enter into agreements with neighboring states to expedite entry of SAR units with the least possible formalities.” (paragraph 3.1.5); and

“Any unit receiving information of a distress incident shall take whatever immediate action to assist as is within its capability, or alert other units that might assist, and notify the RCC or RSC in whose area the incident has occurred.” (paragraph 5.9.1).

7.4.14 Though the term "search and rescue" is often used, "search" and "rescue" are not synonymous. The process of locating persons in distress is different from the process of assisting them. Some cases involve extended search and some do not. Sovereignty tends to be a greater factor in cases involving searches than it is when the response only involves assisting the person(s) in distress. Time and area involved in a rescue operation where the location is known are more limited than time and area involved in a search operation. These subtleties are particularly significant when reading the SAR Convention provisions regarding requesting permission to enter foreign territories to conduct SAR operations. One needs to find an interpretation of the SAR Convention that is consistent with provisions of other relevant Conventions, such as the Law of the Sea.

7.4.15 In times of armed conflict, SAR services will normally continue to be provided in accordance with the Second Geneva Convention of 1949 (Geneva Convention for the Amelioration of the Condition of Wounded, Sick and Shipwrecked Members of Armed Forces at Sea, or 12 August 1949) and Additional Protocol 1 to the Conventions.

7.4.16 The 1949 Geneva Convention affords SAR facilities protection for their humanitarian missions so far as operational requirements permit. Such protection applies to coastal rescue craft, their personnel, and fixed coastal SAR installations. SAR personnel should be informed about their Administration's status regarding, and views on implementation of, the Second Geneva Convention and its Additional Protocol 1.

*Note: Article 27 of the Second Geneva Convention of 1949 does not explicitly include aircraft, air installations or aircrews in its discussion of activities afforded the protection discussed immediately above. Also, the U.S. is not Party to the Additional Protocol 1 to the Geneva Conventions of 1949*

7.4.17 Chapter XIV of the International Code of Signals illustrates the different means of identification that shall be used to provide effective protection for rescue.

#### *Communications*

7.4.18 International requirements, regarding GMDSS equipment to be carried at sea, are primarily in the SOLAS Convention (1988 Amendments); in comparable provisions of the Torremolinos Protocol of 1993 to the Torremolinos Convention (which, when it enters into force, will apply to fishing vessels 45 meters or more in length, and which, although the U.S. is not Party to, over 120 nations are); and in the International Radio Regulations of ITU. IMO has performance standards in place for all such GMDSS equipment.

7.4.19 Regardless of whether vessels are GMDSS-equipped, they will be sharing the waters with vessels which are. Many ships that maintained a listening watch on 2182 kHz are no longer required to do so, effective 1 February 1999. Eventually, fewer vessels will be maintaining a listening watch on Channel 16 (IMO mandates listening to



Channel 16 until at least 2005). Non-GMDSS vessels that routinely operate near large ships should equip with VHF-DSC to facilitate emergency contact.

7.4.20 States are obligated to keep the IMO Secretary General informed of the status of their respective shoreside facilities, because accurate information needs to be published in the GMDSS Master Plan for use by SAR authorities, shipping authorities, and other States.

7.4.21 The SAR Convention explains the main purpose of SAR regions, and emphasizes the importance of shore-based infrastructure with the following words:

“To help ensure the provision of adequate shore-based communication infrastructure, efficient distress alert routing, and proper operational co-ordination to effectively support search and rescue services, Parties shall, individually or in co-operation with other States, ensure that sufficient search and rescue regions are established within each sea area. Such regions should be contiguous and, as far as practicable, not overlap.”

7.4.22 The IMO SAR Convention promotes development of a Global SAR Plan. A key principle is that where responsible RCCs and SRRs have been established in accordance with this Plan, distress alerts should be routed as automatically and directly as possible to such RCCs. The automatic retrieval and decoding of registration data, and direct routing of alerts, recognizes the critical importance of eliminating avoidable time delays in responding to persons in distress.

7.4.23 Registration of all GMDSS equipment is required by the SOLAS, Chapter, IV as follows:

“Each Contracting Government undertakes to ensure that suitable arrangements are made for registering Global Maritime Distress and Safety System (GMDSS) identities and for making information on these identities available to rescue co-ordination centres on a 24-hour basis. Where appropriate, international organisations maintaining a registry of these identities shall be notified by the Contracting Government of these assignments.”

7.4.24 Each state must ensure that arrangements are in place to require and enforce registration of all GMDSS equipment, to provide means to register the equipment and to ensure that registration data is kept up to date and is readily available to any RCC on a 24 hour basis.

7.4.25 Registration data is often critically important to RCCs for verifying and responding properly to distress situations. Each record contains an electronic identity that links it to the vessel or device being registered. IMO specifies the minimum elements of information to include in registries; all these elements are important, but none more so than the information about emergency contacts ashore.

7.4.26 SOLAS Chapter IV provides for certification of GMDSS operators as follows:

“Every ship shall carry personnel qualified for distress and safety radiocommunication purposes. The personnel shall be holders of certificates specified in the Radio Regulations as appropriate.”

7.4.27 SOLAS Chapter IX, “Management for the Safe Operation of Ships,” makes the International Safety Management (ISM) Code mandatory. ISM provides for the continuous management of personnel skills and procedures, including those required to handle emergencies. Shipping companies must develop a safety management system (SMS) to ensure compliance with mandatory IMO provisions and to ensure that codes, guidelines, and standards of the Organization are taken into account. Governments are to ensure compliance with the Code, and certificate companies that operate in compliance with the Code.

7.4.28 The Convention on Standards of Training, Certification and Watchkeeping (STCW) will have a major impact on training in years to come. Chapter IV of STCW clarifies the skills and competence required of communication personnel. Communications is one of seven areas of competence addressed by STCW. Part A of the Convention

lists minimum standards, while Part B provides recommended standards. STCW addresses both knowledge requirements and how work should be done. In short, STCW attempts to ensure professionalism and teamwork as they relate to safety and pollution prevention. Parties to the Convention must submit information to IMO on compliance with training and certification procedures. Based on this information IMO will publish a list of complying countries.

- 7.4.29 Certificates issued by countries not included on the IMO list will be suspect, and ships on which seafarers sail who hold these certificates may suffer costly delays while foreign port authorities verify the competence of these shipboard personnel to perform their duties.
- 7.4.30 The minimum knowledge, understanding and proficiency required for certification of GMDSS radio personnel shall be sufficient to carry out radio duties. The knowledge required to obtain each type of certificate is defined in the Radio Regulations. Every candidate must demonstrate ability to undertake the tasks and duties identified. Additionally, knowledge is required of SAR communications, means of preventing false alerts, ship reporting systems, radio medical services, International Code of Signals, Standard Marine Communication Phrases, and the English language. Both written examinations and demonstration of procedures in accordance with the Radio Regulations demonstrate competence.
- 7.4.31 The SAR system should always receive distress alerts when SAR services are needed, and never receive alerts when no emergency exists to warrant SAR assistance. Furthermore, alert information should always be complete and accurate, especially with regard to the identity and position of those in distress, how to contact those in distress if possible and how to reach emergency contacts ashore. Some of the alert information is generated by alerting equipment and some is part of the registration data associated with this equipment. If equipment is not properly coded and registered or if navigation input to the equipment is wrong, all or part of its alert information will be false. Radio interference is a problem that has often obstructed receipt of distress alerts and has generated false alerts.
- 7.4.32 Interference and false alerts are serious violations of the International Radio Regulations and appropriate enforcement actions should be carried out as a means of controlling such infractions.
- 7.4.33 While false alerts are a problem, it is *essential* that SAR personnel treat every distress alert as genuine until they know differently.

*Foreign Territorial Seas and Archipelagic Waters*

- 7.4.34 For purposes of discussion in this section of the Chapter, references to “territorial seas” should be considered to read “territorial seas and archipelagic waters.”
- 7.4.35 Entry onto or over foreign territorial seas to assist persons in distress will be referred to below as “assistance entry” or AE. Operation of vessels or aircraft, including military craft, to enter or overfly the territorial sea of a foreign nation to render emergency assistance to persons, ships or aircraft in danger or distress from perils of the sea, is AE. International law and U.S. policy recognize the duty and right of such craft to carry out AE operations under certain conditions.
- Note: DOD refers to AE as “RAE” (right of assistance entry).*
- 7.4.36 The legal basis for AE was discussed earlier in this Chapter. Later, when SAR agreements are discussed, how to handle AE as a topic in agreements will be addressed. This section will further discuss principles involved AE. Other facilities used for SAR besides those of the Coast Guard, including ships at sea and Department of Defense facilities, may carry out AE operations basically on the same legal basis as the Coast Guard.
- 7.4.37 As discussed earlier, it is important to be aware that a legal right does exist to engage in such operations.

- 7.4.38 A relatively small percentage of SAR missions carried out in accordance with international law involve entry of SAR facilities into foreign territory. However, due to obvious sensitivities, these operations must be carried out knowledgeably and with care.
- 7.4.39 SAR managers should authorize their SAR facilities to enter foreign territories to respond to information of persons missing or in distress; and such assistance is to be provided without regard to the nationality of those in distress. Although international law recognizes and provides for both the duty and the right to save lives in danger or distress, even when they are within foreign waters, these provisions must be balanced with international concerns for national sovereignty and security. How is this balance achieved in practical terms?
- 7.4.40 The U.S. is Party to numerous international agreements (e.g., treaties, conventions and SAR agreements) to promote cooperation with other countries in assisting persons in distress. Some federal agencies have similar plans, agreements, and procedures for coordinating SAR efforts. AE is carried out within this cooperative framework to the extent practicable.
- 7.4.41 AE generally involves two principles which sometimes conflict—the sovereign right of nations to control and regulate entry into, and operations within, their territory; and the humanitarian need to quickly and effectively assist persons or property in danger or distress without regard to nationality or circumstances. International instruments, and national policies of some countries, attempt to balance these concerns. While it is wrong to recognize one of these concerns and exclude the other, reconciling them requires knowledge and cooperation.
- 7.4.42 Relations with foreign countries and the protection of citizens abroad are primarily the responsibility of ministries of external affairs (Department of State for the U.S.). Such ministries usually have no SAR facilities, so when they or their subordinate entities, such as U.S. embassies, need SAR facilities, they typically depend upon others to carry out operations. This may involve help provided by other ministries, such as transportation, defense, assistance from host or neighboring nations or civilian organizations established to provide SAR services, etc.
- 7.4.43 The obligation to rescue distressed mariners regardless of nationality is based on the principle and time-honored tradition that those at sea will, whenever they can without undue risk, assist fellow mariners in danger or distress.
- 7.4.44 Factors affecting need for foreign units to render assistance in territorial seas or archipelagic waters include the following:
- These geographic areas are normally small compared to the high seas and associated landmasses;
- The ability to effectively become aware of distress situations off their shores and respond quickly varies among States, and around their respective coasts; and
- Distress cases tend to concentrate in coastal areas.
- 7.4.45 Perils of the sea are dangers commonly associated with operating on, over or under the oceans. They do not include law enforcement actions taken by a coastal State.
- 7.4.46 AE does not depend upon seeking or receiving permission of the coastal nation; however, a nation may be Party to some international agreements that limit such actions.
- 7.4.47 Customary practice for aircraft entry is not as fully developed as for vessels, i.e., some nations may recognize the right to carry out AE more readily for vessels than for aircraft. Also, entry by nonmilitary vessels is apt to cause less coastal nation concern than entry by military vessels. Therefore, safety of the SAR facility must be considered in light of the views of the nation whose territorial sea or overlying airspace is being entered.

- 7.4.48 The right to carry out AE extends only to bona-fide rescue operations, not to search operations. Also, there is no right under international law to enter foreign internal waters or landmass to carry out AE. Coastal State permission should be secured prior to flying over or landing in territory or territorial seas of a foreign nation for search operations unless other prior arrangements have been made. This can sometimes be arranged internationally between RCCs or in SAR agreements.
- 7.4.49 Ships and aircraft of other nations should be afforded comparable freedom to enter U.S. territorial seas in a reciprocal fashion. Actions of a State that unreasonably restrict entry will inevitably jeopardize the ability of vessels and aircraft to carry out AE.
- 7.4.50 SAR Coordinators should develop directives for their respective agencies covering detail procedures to follow concerning AE operations.

## **7.5 Charging for SAR Services**

- 7.5.1 Customary practice worldwide is not to charge for SAR services. A long tradition exists of assisting persons in distress without regard for reimbursement.
- 7.5.2 With government efforts to reduce costs, activism by political interest groups, etc, it is increasingly difficult to keep the humanitarian nature of lifesaving purely humanitarian. Current policies and legal provisions, potential policies and legal provisions, and what constitutes the right thing to do, are all factors.
- 7.5.3 U.S. policies on charging for SAR, documented in the National SAR Plan, are as follows:

Each Participant will fund its own activities in relation to this Plan unless otherwise arranged by the Participants in advance, and will not allow a matter of reimbursement of cost among themselves to delay response to any person in danger or distress.

The Participants agree that SAR services that they provide to persons in danger or distress will be without subsequent cost-recovery from the person(s) assisted.

In accordance with customary international law, when one nation requests help from another nation to assist a person(s) in danger or distress, if such help is provided, it will be done voluntarily, and the U.S. will neither request nor pay reimbursement of cost for such assistance.

*Note: "Participants" are the federal agencies signatory to the National SAR Plan.*

- 7.5.4 U.S. SAR authorities do not charge fees for SAR assistance, and strongly discourage such a move. They do, however, aggressively recover expenses for hoaxes when they identify and successfully prosecute the offender(s), and for fuel they provide to a vessel so it can reach the nearest port.
- 7.5.5 SAR operations are typically high tempo and require sophisticated communications and command infrastructure, and costly fixed wing aircraft, helicopters, cutters and a variety of boats. To directly charge for rescues involving use of these resources would impose enormous financial burdens on survivors. Typical SAR operations cost in excess of \$3,000 per aircraft-hour, and can run into the hundreds of thousands of dollars for extensive searches. We cannot choose whom to rescue based on ability or willingness to pay, even if this could be quickly determined before rescue.
- 7.5.6 SAR services must be provided without regard to nationality or circumstances. U.S. citizens should not be given priority or exclusive assistance by virtue of citizenship. In cases involving illegal immigration or other law enforcement issues, lifesaving efforts take priority and precedence over enforcement actions.
- 7.5.7 The U.S. and some SAR authorities are signatory to international agreements that preclude the Parties charging for assisting each other in lifesaving efforts. We neither charge nor pay foreign governments for reimbursement

of expenses for SAR assistance. The practice of charging for SAR services would detract from treatment of SAR in purely humanitarian terms, and financial factors could adversely affect both cooperation and safety at sea.

- 7.5.8 A practice of charging would cause people to wait until they are in dire straits before notifying the SAR system of their situation. A critical element in most successful SAR operations is initiation of response before persons are in extremis. Charging creates incentive to delay calling for help until it is too late to save them. Often, delayed alerting results in added losses and SAR effort costs that are much larger than potential funds received by charging.
- 7.5.9 Internationally, those providing SAR services customarily fund the services, even if the assistance is provided at the request of another authority, e.g., an RCC of another State. Most States prefer that this aspect of international law be preserved because an environment should be avoided that might dictate resolution of funding prior to providing assistance, and it is difficult to see where charging would end if it became an accepted practice. An exception to non-charging would be when services are provided by an organization under a contractual arrangement with the requesting organization, in which case this service provider is acting on behalf, and as a primary resource of, the responsible SAR authority.

## 7.6 Liability

### *Government*

- 7.6.1 Nations that are Party to the Safety of Life at Sea (SOLAS) Convention, the International Convention on Maritime Search and Rescue, and the Convention on International Civil Aviation (Annex 12), are obligated to provide aeronautical and maritime SAR coordination and services for their territories, territorial seas, and, where appropriate, on the high seas. These services are to be available on a 24-hour basis. To carry out these responsibilities, a State should either establish a national SAR organization, or join with one or more other countries to form a regional SAR organization.
- 7.6.2 Negligence in following established and recognized policies, standards and procedures, regardless of whether they are legally binding, may, in some circumstances, create legal liability.
- 7.6.3 The following general legal observations apply to the Coast Guard. The situation may vary for other U.S. or foreign SAR authorities.

Voluntarily rendering aid to a vessel constitutes salvage service. Every salvor is bound to act in good faith and exercise ordinary skill or diligence. While common law imposes no duty to rescue, it does impose on the Good Samaritan the duty to act with due care once rescue operations are undertaken. The law imposes an obligation upon anyone attempting to assist another person, even gratuitously, not to injure the person being assisted by the negligent performance of that act. Volunteer salvors have always been favored by the courts in order to encourage the saving of life and property.

Courts have held that the Coast Guard is a volunteer salvor and should not be held to a higher standard of care, either because of its traditional rescue role or because it is analogous to professional salvors. Similarly, Coast Guard obligations rise no higher than those of a private salvor. The Coast Guard renders voluntary assistance where no duty to help is owed the person or vessel in distress. 14 USC 88 authorizes the Coast Guard to establish a rescue service and places on the Coast Guard the responsibility of attempting rescues at sea; it does not create a duty to the persons needing assistance or a right to be rescued, and does not impose a liability upon the Government for failure in effecting a rescue to the satisfaction of all concerned.

If there is only property damage in rescue cases, the courts are likely to look for clear negligence causing an independent injury before holding the Coast Guard responsible.

In a situation where the location of a distress situation is unknown, and a search area would involve enormous search effort with negligible probability of success in locating those in distress, it may be impractical or prohibitively expensive to dispatch SAR facilities. In such cases, RCC initiatives such as to see if a better location or time of the actual distress can be determined, broadcasts for more information and to alert passing vessels and aircraft to keep a lookout for distress signals or other signs, etc., may be deemed sufficiently prudent by the courts to limit liability.

- 7.6.4 Admiralty salvage law addresses different concerns and sets different priorities than negligence tort law. One U.S. Supreme Court Justice opinion declared:

“For all the branches of jurisprudence, the admiralty must be the one most hospitable to the impulses of man and law to save life and limb and property...Maritime law in every way and in every context encourages the salvor to salve - to save . . . And to eliminate a deterrent to voluntary, impulsive response to need as the forces of nature or man, or both, imperil ship or seamen, the law accords a considerable latitude in the standard of performance of the salvage service. The salvor is seldom held liable for just a failure to save and liability for negligent salvage is limited to situations in which the salvor, through want of due care, has worsened the position of the victim.”

- 7.6.5 If an attempted rescue or other voluntary service is conducted so that it injures or worsens the situation of the one in distress, liability may be incurred (lack of adequate equipment, preparation, or personnel have not been considered to be liability-creating factors). The Government has been found liable, however, when RCC personnel failed to properly evaluate all the information received, so that Coast Guard actions reasonably kept other available vessels from acting to assist, when the other vessels would probably have been successful (distressed craft was put in a worse position).

- 7.6.6 Steps to improve SAR professionalism, while reducing risks and liability, are suggested below:

ensure that SAR personnel have maturity and competency appropriate to their duties, and that applicable recognized procedures, facilities and equipment are used;

ensure that RCC personnel are prepared to receive, collect, assess, use, preserve, and provide information related to a distress situation and SAR co-ordination;

ensure that operational personnel are trained to work together as a team, to recognize and avoid undue risks, and to prevent accidents, damage, injury, death, or worsening of the situation of those in distress;

recognize that rescue operations are often carried out under circumstances of extreme stress, hazards, and crisis where quick decisions and choices must be made that might be different if they could be made with more time and information, and in a more conducive environment;

recognize that perils inherent to distress situations often have worse consequences than errors made by rescuers in removing victims from those perils;

carefully document whatever goes wrong, getting statements from witnesses, keep a complete and accurate log, carry out a proper investigation and report of an incident, and find ways to apply lessons learned to prevent recurrences;

once any step is taken, perhaps during acknowledgement of a distress alert, which would lead those in distress to expect assistance from the SAR system, make every effort to follow through, particularly since survivors may forego other opportunities for help based on this understanding;

do not assume that a lifesaving effort creates a property salvage obligation;

realize that damage or injury that results from salvage efforts would often have resulted even if salvage had not been undertaken;

do not, without justification, automatically view the harm to have been caused by salvor negligence (it is not always possible for those on scene or others to know the best course of action; e.g., pulling a grounded boat free may result in its sinking, and leaving it grounded may result in its destruction by pounding on the rocks); and

seek authority to stop or terminate flights, voyages or other manifestly dangerous activities such as adventurers and novices tend to engage in, which are likely to require a dangerous rescue effort if allowed to proceed (examples include inadequately prepared and equipped persons, unsuitable craft design, configuration, stability, or loading, and inadequate availability of rescue resources should the need for assistance arise.)

### *Mariners*

- 7.6.7 Some applicable legal cites which apply to mariners in general seem to require that “reasonable care” be exercised when assisting others, along with a fairly strong obligation to assist.

46 USC 2303 requires mariners to render assistance when involved in a marine casualty and specifically exempts those rendering assistance from any liability if the assistance is provided with reasonable care.

46 USC 2304 makes it a duty, punishable by a fine or imprisonment for failing to, for all mariners to render assistance to any individuals found in distress on the sea if the assistance can be provided without serious danger to the assistance provider’s vessel or individuals on board.

Regulation V/10 of the International Convention for the Safety of Life at Sea (SOLAS) places obligations and procedures upon the master of a ship, including: “The master of a ship at sea, on receiving a signal from any source that a ship or aircraft or survival craft thereof is in distress, is bound to proceed with all speed to the assistance of the persons in distress.”

## **7.7 Assistance by Commercial Ships**

- 7.7.1 As discussed earlier in this Chapter, masters of vessels have a duty to assist others whenever it can be done without endangering the assisting vessel or crew. This has implications not only for persons in charge of merchant ships, but also for persons in charge of SAR facilities and other craft at sea.
- 7.7.2 Several countries operate vessel reporting systems that can be used by RCCs to identify and locate vessels that can assist with SAR operations. An entire Chapter of the Annex to the 1979 SAR Convention is devoted to this topic. Although such systems are used more frequently for maritime SAR, they are equally relevant to aeronautical SAR. Most systems apply to a region around the sponsoring country, and are referred to as “regional” systems. Reporting by vessels to regional systems may be mandatory, voluntary, or both, depending upon the type and status of the vessels reporting.
- 7.7.3 The only worldwide reporting system devoted to SAR is Amver, a system sponsored by the U.S. Coast Guard, supported by many shipping companies and communications service providers worldwide, and available to be used by any recognized RCC worldwide that needs Amver data to arrange assistance.

*Note: A “recognized RCC” is one that is identified in an ICAO Regional Air Navigation Plan or the IMO Global SAR Plan.*

- 7.7.4 Participation in Amver (as with most vessel reporting systems) is “free” in that the Coast Guard does not charge for accepting and processing reports, maintaining the database, or providing information to bona fide SAR

authorities responding to a SAR incident. Amver is endorsed by IMO. Data provided to Amver is treated as “commercial proprietary” information, and its confidentiality is protected under U.S. law, i.e., it is exempted from availability to the public under provisions of the Freedom of Information Act. Amver data may be released only to bona fide SAR authorities, and used only for SAR purposes.

Legally, the duty to assist others is no greater or less for vessels participating in ship reporting systems than for those not participating. Advantages of vessel participation are operational and humanitarian, and do not affect obligations of the persons in charge of any vessel.

## **7.8 Post-SAR Handling of Deceased Persons and Alien Survivors**

7.8.1 Once a SAR mission is concluded, practical and legal considerations may govern how the victims of a distress situation are handled. Humanitarian considerations govern, and the reputation of the SAR organization or of the nation may be adversely affected by improper actions with regard to such victims.

### *Human Remains*

7.8.2 Searching for and recovering bodies is not normally considered to be a SAR mission. However, humanitarian interests and practical concerns may involve SAR personnel to some degree in such efforts, normal SAR activities may lead to discovery of persons who died before they could be rescued, and lives are sometimes lost after rescue.

7.8.3 Proper handling of such situations may provide practical benefits for persons affected by the loss of life, improve public relations, and reduce SAR organization liability.

7.8.4 SAR authorities should make prior arrangements with other authorities, often law enforcement officials, concerned with removal and disposal of human remains, so that plans for proper coordination can be developed and implemented quickly as necessary. If human remains are recovered, they should be preserved as well as possible until others assume responsibility for them. Availability of body bags can be particularly useful where some time has passed since death occurred, or where bodily damage or deterioration has taken place.

7.8.5 Policies regarding human remains, including handling by civilian and military authorities, should be established and familiar to SAR personnel.

7.8.6 Removal of human remains across international borders may be affected by the laws of both nations involved, and may need to be coordinated via diplomatic channels.

7.8.7 Careful preservation of human remains has important humanitarian, legal, and accident investigation implications. Medical examinations of bodies may lead to important conclusions by accident investigators. Medical examiners may need to issue a certificate of death.

7.8.8 Handling of human remains can be unpleasant and even traumatic. SAR personnel need to be informed on proper procedures to use and, subsequent to their involvement, counseled as appropriate to help meet emotional needs.

### *Repatriation of Survivors*

7.8.9 It is important that SAR authorities and immigration authorities cooperate regarding the delivery of foreign survivors ashore.

7.8.10 SAR managers should be strong advocates of “Good Samaritans” assisting persons in distress at sea. It is a violation of both U.S. law (46 USC 2304) and of a recognized duty under international law, not to render needed assistance at sea. Rescuing craft already place themselves at risk by attempting a rescue by difficult maneuvering, threat of storm damage, etc. To require rescuers to detain and remove the rescued alien once the



survivor has been safely brought to port unfairly penalizes those who are fulfilling a legal obligation to render assistance. It is neither reasonable nor good policy to add to the rescuing craft the burden and financial responsibility for those found shipwrecked, or in similar circumstances.

- 7.8.11 States need regulations that allow appropriate authorities the discretion not to impose a deportation and removal requirement upon rescuers under circumstances in which an alien was rescued at sea.
- 7.8.12 In the U.S., when such aliens have no money for their return home, they may be issued a visa for admission to the U.S. by requesting a waiver from the Immigration and Naturalization Service (INS) to the requirements which apply to excluded, deported or removed aliens using the INS Form I-212. They will be treated by the INS as aliens in distress under 8 Code of Federal Regulations § 250. Under this provision, repayment of cost of removal from the U.S. is not a prerequisite for admission.

## **7.9 International SAR Agreements**

- 7.9.1 SAR agreements expedite responses to distress at sea through improved cooperation and, where applicable, designation of SAR regions. Agreements enhance information exchanges and rescue coordination between RCCs, and among rescue units at the scene of distress. SAR agreements also provide basic operational policies and procedures as a basis for development and implementation of detailed national plans. Additionally, SAR agreements pave the way for smooth and prompt coordination and cooperation at the operation level when distress situations occur.
- 7.9.2 Paragraphs 35 and 36 of the National SAR Plan (Appendix A to this NSS) include key guidance which U.S. authorities follow with regard to civil SAR agreements.
- 7.9.3 Generically, an agreement is a compact or treaty that is duly executed and legally binding. When established among domestic or international SAR authorities or governments, agreements provide a sound basis for the ensuing relationships among the two or more signatories.
- 7.9.4 Conclusion of an agreement may document existing relationships, or pave the way for better cooperation. SAR agreements can take various forms and names, can contain both binding and recommended provisions and can identify contacts and other information relevant to cooperation among the parties.
- 7.9.5 Sometimes a “plan” can be developed and followed as an option to an agreement and for similar purposes. The text of a plan might be quite similar to that of an agreement, but signatures on the plan may be optional. If the plan is signed, it might be signed at a lower level within the organizations concerned than an agreement would be.
- 7.9.6 Considerable care should be exercised when developing agreements because mistakes can result in: conflicts with other binding arrangements, lost opportunities, poor use of resources, confusion about responsibilities and authorities, legal difficulties, use of inconsistent terminology, establishment of inappropriate precedents, greater-than-anticipated demands on resources, undermining established principles, etc. To avoid such problems, SAR managers involved in negotiating such agreements should have proper authority to do so. Additionally, SAR managers should be aware of any sensitivities relating to other potential parties or organizations involved in SAR, and involve persons with pertinent high level management responsibilities, political cognizance, and legal competence.
- 7.9.7 International SAR agreements, like customary practice, become part of the whole body of international law. For this reason it is quite easy for SAR managers or other SAR personnel to undermine principles important to lifesaving, to conflict with established policies, or to establish unfavorable precedents, if they are not knowledgeable concerning legal aspects of SAR. Therefore, SAR personnel must have an appropriate level of familiarity with legal matters, as well as ready access to qualified legal advice.

- 7.9.8 Use of international SAR agreements is promoted by the 1979 SAR Convention as a means of helping to implement the Convention goals of saving more lives and establishing a global (worldwide) SAR plan. The 1979 Convention recognizes the importance of coordinating activities regarding safety on and over the sea. Since establishment of international arrangements for the rescue of persons in distress at sea furthers principles of the Convention, States are urged to enter into agreements on coordination of SAR operations. The IAMSAR Manual, Volume 1, Appendix I, provides a good sample SAR agreement that can be adapted to suit most nations.
- 7.9.9 If SAR agreements are international, persons with extensive experience in international agreements and SAR standards should be involved in their development if possible. International SAR agreements involving the U.S. Coast Guard may only be negotiated by SAR program managers at Coast Guard Headquarters, with the advice of legal and international affairs personnel, in coordination with other federal authorities (as appropriate) involved with SAR, and (as required by 1 USC 112b) under the oversight of the Department of State.
- 7.9.10 Domestic and local SAR agreements are very useful for ensuring that all available resources are used for SAR. A National SAR Plan is quite useful for this purpose as well.
- 7.9.11 Paragraphs 35 and 36 of the National SAR Plan (Appendix A to this NSS), and introductory comments of the IAMSAR Manual, Volume 1, Appendix I, provide general guidance on negotiating and concluding SAR agreements. These references should be studied.
- 7.9.12 SAR agreements become much more valuable when they deal with and resolve matters that would be difficult to resolve in a timely manner during actual time-critical SAR operations. Such issues might include, for example, funding, jurisdiction, resource availability, coordination procedures, SAR regions, military-civilian relationships, and prior arrangements for territorial entry.
- 7.9.13 Agreements should protect the right of mariners and aviators to enter foreign territorial seas to attempt to rescue persons, ships and aircraft in danger or distress when the distress location is reasonably well known. States should support this international right to the extent practicable, and exercise it as situations warrant. Some States have SAR agreements with neighboring states that provide for automatic entry of SAR facilities into territorial seas with timely notification to the nation entered. Such arrangements are strongly encouraged, with pertinent provisions being as liberal as possible.
- 7.9.14 It is important to involve advisors who are expert in the areas of international law pertinent to AE, because the complexities make it easy to conclude improper provisions. The following text is offered as a preferred example of what can be included in the provisions of a SAR agreement on how two or more States can provide for AE for lifesaving:

“Entry of SAR units onto or over the territory of the countries of those Participants conducting SAR operations will, to the best of their ability, be expeditiously arranged via the appropriate rescue co-ordination centers (RCCs).

Solely for the purpose of rendering emergency rescue assistance to persons, vessels, or aircraft in danger or distress, when the location is reasonably well known, SAR facilities of a Participant may immediately enter onto or over the territorial seas or archipelagic waters of another Participant country, with notification of such entry made as soon as practicable.

To facilitate the co-ordination referred to in this Section, the Participants of each country will, to the best of their ability, keep the Participants of the other countries fully and promptly informed of all relevant SAR operations, and should develop appropriate procedures to provide for the most effective and efficient means of communication.”

---

# Appendix A

## United States National Search and Rescue Plan--1999

### POLICY

1. It is the policy of the signatory federal agencies to provide a National Search and Rescue Plan for coordinating civil search and rescue (SAR) services to meet domestic needs and international commitments. Implementing guidance for this Plan is provided in the *International Aeronautical and Maritime Search and Rescue Manual* (IAMSAR Manual discussed below), the *National Search and Rescue Supplement* (a domestic interagency supplement to the IAMSAR Manual), and other relevant directives of the Participants to this Plan.

### PURPOSE

2. This Plan continues, by interagency agreement, the effective use of all available facilities in all types of SAR missions. The National Search and Rescue Plan-1986 is superseded by this Plan.

### TERMS AND DEFINITIONS

3. The following terms and definitions are based on international usage for civil SAR. For more information about these terms and others commonly used for civil SAR, refer to the IAMSAR Manual, which is jointly published by the International Civil Aviation Organization (ICAO) and the International Maritime Organization (IMO).

Search and rescue coordinator. A federal person or agency with overall responsibility for establishing and providing civil SAR services for a search and rescue region(s) for which the U.S. has primary responsibility.

Search and rescue region (SRR). An area of defined dimensions, recognized by ICAO, IMO or other cognizant international body, and associated with a rescue coordination center within which SAR services are provided.

Search and rescue services. The performance of distress monitoring, communication, coordination and SAR functions, including provision of medical advice, initial medical assistance, or medical evacuation, through the use of public and private resources including cooperating aircraft, vessels and other craft and installations.

Rescue coordination center (RCC). A unit, recognized by ICAO, IMO or other cognizant international body, responsible for promoting efficient organization of civil SAR services and for coordinating the conduct of SAR operations within an SRR.

Rescue sub-center (RSC). A unit subordinate to an RCC established to complement the latter according to particular provisions of the responsible authorities.

Joint rescue coordination center (JRCC). An RCC responsible for more than one primary type of SAR services, e.g., both aeronautical and maritime SAR incidents. *NOTE: The term "JRCC" will not be used for civil SAR purposes solely on the basis that an RCC is staffed by personnel from, or is sponsored by, more than one organization.*

### OBJECTIVES

4. Knowing the importance of cooperation in providing expeditious and effective SAR services, the Participants to this Plan desire to:
  - Provide a national plan for coordinating SAR services to meet domestic needs and international commitments, and to document related basic national policies;

- Support lifesaving provisions of the International Convention on Maritime Search and Rescue of IMO, the Convention on International Civil Aviation of ICAO, certain international agreements to which the U.S. is Party, and similar international instruments;
  - Provide an overall Plan for coordination of SAR operations, effective use of all available resources, mutual assistance, and efforts to improve such cooperation and services; and
  - Integrate available resources which can be used for SAR into a cooperative network for greater protection of life and property and to ensure greater efficiency and economy.
5. This Plan is further intended to:
- Help the U.S. satisfy its humanitarian, national, and international SAR-related obligations;
  - Provide national guidance for development of SAR-related systems;
  - Describe its Participants and their roles in a pro-lifesaving context;
  - Recognize lead federal agencies, respectively, for the types of operations covered by this Plan, and describe geographic regions of SAR responsibility, as appropriate;
  - Account for saving property, but on a secondary basis to saving lives;
  - Account for all operations up to and including providing initial assistance (food, clothing, medical, etc.) to survivors and delivering them to a place of safety; and
  - Have, as a primary concept, cooperation for overall and continual development, coordination and improvement of SAR services.

## **SCOPE**

6. It is intended that this Plan not conflict in any way with SAR responsibilities agreed to by contracting States of the Convention on International Civil Aviation, the International Convention on Maritime Search and Rescue, or other appropriate international instruments to which the U.S. is or may become a Party.
7. No provisions of this Plan or any supporting plan are to be construed in such a way as to contravene responsibilities and authorities of any Participant as defined by statutes, executive orders or international agreements, or of established responsibilities of other agencies and organizations which regularly assist persons and property in distress resulting from incidents of a local nature.
8. This Plan is solely intended to provide internal guidance to all signatory federal agencies. State organizations may wish to retain established SAR responsibilities within their boundaries for incidents primarily local or intrastate in character. In such cases, appropriate agreements are generally made between SAR coordinator(s) and relevant State organizations.

## **PARTICIPANTS**

9. The Participants to this Plan are as follows:
- The agencies of the Department of Transportation (DOT) carry out broad responsibilities in transportation safety. The Coast Guard develops, establishes, maintains and operates rescue facilities for the promotion of safety on, under and over international waters and waters subject to U.S. jurisdiction, conducts safety inspections of most merchant vessels, and investigates marine casualties. The Federal Aviation Administration has air traffic control and flight service facilities available to assist in SAR operations. The Maritime Administration operates a fleet of merchant ships for government use and promotes a safe merchant marine.
  - Department of Defense (DOD) components have facilities and other resources that are used to support their own operations. These resources may be used for civil SAR needs on a not-to-interfere basis with military missions.
  - The Department of Commerce (DOC) participates in or supports SAR operations through the National Oceanic

and Atmospheric Administration (NOAA). NOAA provides nautical and aeronautical charting; information on tides and tidal currents; marine environmental forecasts and warnings for the high seas, and coastal and inland waterways; and satellite services for detecting and locating aircraft, ships or individuals in potential or actual distress.

- The Federal Communications Commission (FCC) promulgates rules and regulations for non-government use of wire and radio facilities for promoting safety of life and property, and cooperates in SAR operations through its long-range direction finder network.
  - The National Aeronautics and Space Administration (NASA) has aircraft, spacecraft and worldwide tracking, data acquisition and communications networks which can assist in SAR operations. Additionally, NASA supports SAR objectives through research and development or application of technology to search, rescue, survival, and recovery systems and equipment, such as location tracking systems, transmitters, receivers, and antennas capable of locating aircraft, ships, spacecraft, or individuals in potential or actual distress.
  - Land managing components of the Department of the Interior (DOI) provide SAR services on lands and waters administered by DOI and may assist in operations in adjacent jurisdictions. The degrees of responsibility assumed in each DOI field area depends upon the legislative and jurisdictional character of the bureau and field area. Responses range from support of law enforcement authorities or other local units to primary SAR coordination and operations. Similarly, components assume varying degrees of responsibility for preventative measures to protect the visiting public.
10. A federal agency that is not a Participant to this Plan may become a Participant by unanimous vote of the National SAR Coordinating Committee, followed by written notification by the agency to the Chairman of the National SAR Coordinating Committee of its accession to the Plan.

#### **U.S. SEARCH AND RESCUE REGIONS**

11. SRRs are established to ensure provision of adequate land-based communications infrastructure, efficient distress alert routing, and proper operational coordination to effectively support SAR services.
12. SRRs should be contiguous and, as far as practicable, not overlap.
13. Establishment of SRRs is intended to effect an understanding concerning where nations have accepted primary responsibility for coordinating or providing SAR services. The existence of SRR limits should not be viewed as a basis to restrict, delay, or limit in any way, prompt and effective action to relieve distress situations.
14. All SRRs of the U.S. are established in cooperation with neighboring nations, are internationally recognized, and are described in pertinent documents of IMO or ICAO.

*NOTE: U. S. maritime and aeronautical SRRs are established in accordance with the relevant IMO and ICAO Conventions and with the guidance of the IAMSAR Manual. These SRRs are internationally-recognized and documented in the appropriate ICAO Regional Air Navigation Plans and in the IMO SAR Plan. More specific information on U.S. SRRs can also be found in the U.S. "National Search and Rescue Supplement," in which SRR charts will be included for convenient reference.*

15. U.S. maritime and aeronautical SRRs will be harmonized with each other to the extent practicable, recognizing, however, that lines separating SRRs must normally be agreed by governments having neighboring SRRs when possible. SRRs will not be allowed to unduly affect or be affected by any political boundaries.
16. For civil SAR there must be, by definition, one RCC associated with each recognized SRR. Comprehensive standards and guidance pertinent to these RCCs have been developed by IMO and ICAO, and may be found in relevant Conventions, the IAMSAR Manual, and other publications which should be held and used by U.S. RCCs. U.S. SAR Coordinators as designated in this Plan are responsible for arranging for SAR services and establishing the

RCCs for these SRRs. The U.S. civil SAR system becomes integrated into the global SAR system by establishing recognized SRRs and RCCs which comply with international standards.

17. SRRs may be subdivided as long as the delimitation of the sub-regions coincide with pertinent SRR limits. Where this is not practicable, changes to international limits should be proposed to the appropriate international organization through proper channels by the agency primarily concerned.

## **PARTICIPANT RESPONSIBILITIES**

### **Primary Responsibilities**

18. The SAR Coordinators, designated below, have overall responsibility for establishing RCCs as necessary, and for providing or arranging for SAR services within U.S. SRRs. Only RCCs properly established by these SAR Coordinators should carry out domestic and international coordination of civil SAR operations.
19. U.S. SAR Coordinators are as follows (see paragraph 14):
  - The U.S. Air Force for the recognized U.S. aeronautical SRR corresponding to the continental U.S. other than Alaska;
  - The U.S. Pacific Command for the recognized U.S. aeronautical SRR corresponding to Alaska;
  - The U.S. Coast Guard for the recognized U.S. aeronautical and maritime SRRs which coincide with the ocean environments, and including Hawaii.

*NOTE: State and local authorities often designate a person to be a "SAR Coordinator" within their respective jurisdictions. Responsibilities of such personnel may be quite different from the responsibilities of national SAR Coordinators as designated in this Plan, but often these personnel are important contacts for the national SAR coordinators.*

20. The National Park Service (NPS) is the lead agency that provides SAR and other emergency services within national parks.
21. The Department of State has designated the U.S. Coast Guard to lead and coordinate national participation in the SAR and safety-related initiatives of IMO.
22. The Department of State has designated the Federal Aviation Administration to lead and coordinate national participation in safety-related initiatives of ICAO.
23. Based upon invitations from ICAO and IMO, respectively, the U.S. Air Force will provide an aeronautical SAR expert and the U.S. Coast Guard will provide a maritime SAR expert, to serve as members of the ICAO-IMO Joint SAR Working Group.

### **Support Outside U. S. Search and Rescue Regions**

24. SAR Coordinators, as well as other U.S. authorities, may support civil SAR operations anywhere in the world, consistent with their expertise and capabilities and legal authority. This is consistent with the principles of assisting persons in distress without regard to nationality or circumstances and of using all available resources for SAR. It is in the interest of the safety of U.S. citizens who travel or live worldwide. It is also consistent with U.S. humanitarian goals and the advantages of domestic and international cooperation.
25. In accordance with international law, U.S. SAR facilities, in a position to render timely and effective assistance, may exercise the right to enter into or over the territorial seas or archipelagic waters of another state for the purposes of rendering assistance to a person, ship, or aircraft whose position is reasonably well known, is in danger or distress

due to perils of the seas, and requires emergency assistance.

26. Participants to this Plan, consistent with their capabilities and legal authority, will support civil SAR operations of other countries in territory and international waters beyond recognized U.S. aeronautical and maritime SRRs. As appropriate, and within their capabilities, DOD combatant commands should provide such support within their respective geographic areas of responsibility.
27. In carrying out civil SAR support functions with other nations, such as training, exercises, and liaison, each Participant will coordinate its activities with other Participants having civil SAR expertise with respect to the support concerned.

*Note: A wealth of valuable reference material is available which should be used working with other nations in the area of civil SAR. These include, but are not limited to, the SAR-related conventions, the IAMSAR Manual (three volumes), this Plan, the National Search and Rescue Supplement, information about the Amver ship reporting system, and many documents of Cospas-Sarsat, IMO, ICAO, etc. Some of these references are available in languages other than English. Participants should be familiar with such references, and use them as appropriate.*

28. While it is appropriate, to the fullest extent the Participants have the authority to do so, to maintain liaison and cooperate with authorities of other nations that have comparable civil SAR responsibilities, such support should be carried out in coordination with the U.S. SAR Coordinators, and with other neighboring SAR authorities, as appropriate. Such coordination will normally include U.S. Coast Guard Headquarters, Office of Search and Rescue, in order to ensure consistency with U.S. obligations under international agreements to which the U.S. is a Party, and compliance with the IAMSAR Manual and other relevant international guidance relevant to implementing such agreements.
29. Participants should not accept a SAR Coordinator or RCC role for SAR operations for SRRs for which other nations are responsible. However, the Participants may provide and support SAR operations in such areas when:
  - Assistance is requested (normally this should be in accordance with RCC-to-RCC procedures prescribed in the IAMSAR Manual);
  - U.S. citizens are involved; or
  - U.S. facilities become aware of a distress situation to which no other suitable facilities are responding, or where other available SAR services appear to be inadequate.
30. For distress situations in international waters or airspace where no SRR exists for which an RCC is responsible, or where it appears that the responsible RCC is not responding in a suitable manner, U.S. RCCs or facilities will assist as appropriate. Such assistance will be subject to availability of resources, legal constraints, and other applicable U.S. policies.

*NOTE: Provisions of international conventions dealing with SAR are intended to ensure that wherever any person goes in the world, suitable SAR services and responsibilities will be in place to assist should that person become in danger or distress. However, there may be nations which are not Parties to, or which have not yet fully complied with, these conventions. Therefore, situations may exist for U.S. resources to supplement SAR capabilities in certain geographic areas, or to support these nations by training or other means, consistent with U.S. domestic law, to help develop their SAR capabilities. Participants to this Plan may take advantage of such situations as appropriate.*

31. When assisting civil SAR authorities of other nations, or other agencies or organizations supporting these authorities, Participants to this Plan should ensure that:
  - They have appropriate legal authority and expertise to do so;
  - Principles or provisions of conventions or agreements to which the U.S. is Party are not violated;

- Applicable procedures set forth in the IAMSAR Manual, National SAR Supplement, and other relevant directives are known and followed;
  - Such efforts are carried out in consultation with other Participants to this Plan as appropriate; and that
  - The authorities assisted are responsible for the SAR functions in that country.
32. Policies on rendering assistance in foreign territories or territorial waters must have the goal of balancing concerns for saving lives, for sovereignty, and for national security. Provisions for territorial entry as necessary should be addressed in international SAR agreements where relevant, as discussed below, and care should be taken to ensure that such agreements are compatible with national policies in this regard.
33. When any Participant to this Plan is addressing civil SAR-related inquiries or proposals from other nations or organizations outside the U.S., or when hosting or attending international meetings on civil SAR, care should be taken that interested U.S. agencies, organizations, or persons are consulted and involved as appropriate.

#### **CIVIL SAR AGREEMENTS**

34. Bilateral or multilateral SAR agreements with other U.S. agencies or organizations, or with authorities of other nations, may be of practical value to civil SAR, and beneficial for purposes including:
- Helping to fulfil U.S. domestic or international obligations and needs;
  - Enabling more effective use of all available resources;
  - Better integration of U.S. SAR services with the global SAR system;
  - Building commitment to support civil SAR;
  - Resolving SAR procedures and sensitive matters in advance of time-critical distress situations; and
  - Identifying types of cooperative matters and efforts which may enhance or support SAR operations, such as access to medical or fueling facilities; training and exercises; meetings; information exchanges; use of communications capabilities, or joint research and development projects.
35. Negotiation and conclusion of such agreements should consider matters such as the following:
- Which authorities of the governments, agencies, or organizations concerned are the proper ones to be involved with the agreement;
  - Which types of SAR operations (e.g., aeronautical, maritime, etc.) or SAR support functions should be included within the scope of the agreement;
  - Consistency with international and domestic SAR principles or policies;
  - Establishment of lines separating SRRs if relevant;
  - Whether other treaties, agreements, etc., exist which should be superseded or accounted for in preparation of a new agreement; and
  - Relevant guidance of the IAMSAR Manual, National SAR Supplement, and other pertinent directives.
36. Participants which develop any agreement dealing with civil SAR shall ensure that such efforts are coordinated with



other interested Participants.

37. Any such international agreement may not be signed or otherwise concluded without prior consultation with the Secretary of State (see Title 1 USC 112b).

#### **NATIONAL SEARCH AND RESCUE COMMITTEE**

38. The sponsor of this Plan is the National Search and Rescue Committee. The National Search and Rescue Committee, consistent with applicable laws and executive orders:

- Coordinates implementation of this Plan;
- Reviews matters relating to the Plan affecting more than one Participant, including recommendations for Plan revision or amendment;
- Encourages federal, state, local and private agencies to develop equipment and procedures to enhance national capabilities for implementing the Plan; and
- Promotes coordinated development of all national resources for this purpose.

39. In particular, the Committee is intended to accomplish the following:

- Oversee this Plan;
- Provide a standing national forum for coordination of administrative and operational civil SAR matters;
- Provide an interface with other national, regional, and international organizations involved with providing or supporting civil SAR services;
- Develop and maintain suitable guidance for implementation of this Plan, such as a National SAR Supplement to the IAMSAR Manual;
- Promote effective use of all available resources for support of civil SAR;
- Serve as a cooperative forum to exchange information and develop positions and policies of interest to more than one Participant;
- Promote close cooperation and coordination between civilian and military authorities and organizations for provision of effective civil SAR services;
- Improve cooperation among the various SAR communities for the provision of effective services; and
- Determine other ways to enhance the overall effectiveness and efficiency of SAR services, and to standardize procedures, equipment, and personnel training where practicable.

#### **SAR SERVICES COVERED BY THIS PLAN**

40. This Plan covers civil SAR operations such as:

- Maritime (involving rescue from a water environment);
- Aeronautical (including SAR assistance in the vicinity of airports);
- Land (including SAR operations associated with environments such as wilderness areas, swift water, caves, mountains, etc.)

- Provision of initial assistance at or near the scene of a distress situation (e.g., initial medical assistance or advice, medical evacuations, provision of needed food or clothing to survivors, etc.);
- Delivery of survivors to a place of safety or where further assistance can be provided; and
- Saving of property when it can be done in conjunction with or for the saving of lives.

*NOTE: Outside national parks, state and local authorities or SAR units often accept responsibility for providing domestic land SAR services.*

41. Civil SAR does *not* include operations such as:

- Air ambulance services which did not result from a rescue or recovery operation;
- Assistance in cases of civil disturbance, insurrection or other emergencies which endanger life or property or disrupt the usual process of government;
- Rescues from space (although rescue of persons returned from space can be included);
- Military operations, such as combat SAR or other types of recovery by military operations to remove military or civilian personnel from harm's way;
- Salvage operations;
- Overall response to natural or man-made disasters or terrorist incidents; and
- Typical disaster response operations such as locating and rescuing victims trapped in collapsed structures or other assistance provided under the scope of the Federal Response Plan.

*NOTE: No provision of this Plan or any supporting plan is to be construed as an obstruction to prompt and effective action by any agency or individual to relieve distress whenever and wherever found.*

#### **EXTENT OF MUTUAL ASSISTANCE**

42. The Participants agree to cooperate as follows:

- Support each other by pooling relevant facilities and support services as appropriate for operations within their respective SRRs, and consistent with each participant's relevant legal authorities;
- Make, and respond to, requests for operational assistance between the designated RCCs, RSCs, or comparable command centers (CCs) of the Participants as capabilities allow;
- Develop procedures, communications, and databases appropriate for coordination of facilities responding to distress incidents, and for coordination between the RCCs, RSCs or CCs of the Participants;
- Normally follow applicable guidance of the IMO, ICAO, or other relevant international bodies regarding operational procedures and communications; and
- In areas where more than one authority may respond to distress situations, agreed procedures should be in place, which balance concerns for saving lives and for jurisdiction.

43. The Participants may also enter into other collaborative efforts with each other such as:

- Mutual visits, information exchanges, and cooperative projects for support of SAR;
- Joint training or exercises;
- Cooperation in development of procedures, techniques, equipment, or facilities;
- Establishment of groups subordinate to the National Search and Rescue Committee as a means for more in-depth focus on matters of common concern; and
- Carry out cooperative efforts similar to those indicated above on an international level.

#### **GENERAL TERMS**

44. Cooperative arrangements between a Participant with operational responsibilities and state, local, and private agencies should provide for the fullest practicable cooperation of such agencies for operational missions, consistent with the willingness and ability of such agencies to act, and for such coordination by the responsible RCC, RSC, or CC of their facilities as may be necessary and practicable.
45. Participants with operational responsibilities may request assistance from other federal agencies having capabilities useful for a mission.
46. The Federal government does not compel state, local or private agencies to conform to this Plan; such entities can direct and control their own facilities within their boundaries, and cooperation will be pursued through liaison and consultation.

#### **CHARGING FOR SAR SERVICES**

47. Each Participant will fund its own activities in relation to this Plan unless otherwise arranged by the Participants in advance, and will not allow a matter of reimbursement of cost among themselves to delay response to any person in danger or distress.
48. The Participants agree that SAR services that they provide to persons in danger or distress will be without subsequent cost-recovery from the person(s) assisted.
49. In accordance with customary international law, when one nation requests help from another nation to assist a person(s) in danger or distress, if such help is provided, it will be done voluntarily, and the U.S. will neither request nor pay reimbursement of cost for such assistance.

#### **PRINCIPLES ACCEPTED BY THE PARTICIPANTS**

##### **General**

50. Participants coordinating operations should, consistent with applicable laws and executive orders, organize existing agencies and their facilities through suitable agreements into a basic network to assist military and non-military persons and property in actual or potential danger or distress, and to carry out obligations under customary international law and international instruments to which the U.S. is a Party.
51. The Participants will seek to keep political, economic, jurisdictional, or other such factors secondary when dealing with civil lifesaving matters, i.e., where possible, what is best for lifesaving will govern their decisions.
52. Consistency and harmonization will be fostered wherever practicable among plans, procedures, equipment, agreements, training, terminology, etc., for the various types of lifesaving and recovery operations, taking into account terms and definitions adopted internationally as much as possible.

53. Terminology and definitions used throughout the U.S. SAR community will be standardized to the extent possible, and be as consistent as possible with usage in pertinent international conventions and the IAMSAR Manual.
54. If a distress situation appears to exist or may exist, rescue or similar recovery efforts will be based on the assumption that a distress situation does actually exist until it is known differently.
55. Assistance will always be provided to persons in distress without regard to their nationality, status, or circumstances.
56. Generally, cost-effective safety, regulatory, or diplomatic measures that tend to minimize the need for U.S. SAR services will be supported.
57. Close cooperation will be established between services and organizations, which may support improvements in lifesaving functions in areas such as operations, planning, training, exercises, communications and research and development.
58. Recognizing the critical importance of reduced response time to the successful rescue and similar recovery efforts, a continual focus will be maintained on developing and implementing means to reduce the time required for:
  - Receiving alerts and information associated with distress situations;
  - Planning and coordinating operations;
  - Facility transits and searches;
  - Rescues or recoveries; and
  - Providing immediate assistance, such as medical assistance, as appropriate.

#### **Aeronautical and Maritime Search and Rescue**

59. All SAR personnel should be generally familiar with the International Convention on Maritime Search and Rescue of the IMO, the Convention on International Civil Aviation, Annex 12 ("Search and Rescue") of ICAO, the joint ICAO-IMO IAMSAR Manual, the National SAR Supplement, and other primary directives or information applicable to their work in civil SAR.
60. Local cooperative arrangements within the U.S. should be made in advance between SAR, air traffic, and airport authorities for close coordination in handling aircraft emergencies, unless the same authorities hold all the involved responsibilities.
61. The SAR principles and procedures of relevant customary international law and international Conventions and the IAMSAR Manual will serve as the framework for coordination of any SAR operations, and especially those involving multiple countries, organizations or jurisdictions; U.S. organizational or operational SAR plans and provisions of the National SAR Supplement will be consistent with these international provisions to the extent practicable.
62. The U.S. Coast Guard will sponsor a global voluntary ship reporting system for maritime and aeronautical SAR and offer pertinent information from the associated database to recognized RCCs worldwide. (This system will be used only for SAR, with its information being treated as "commercial proprietary" as promised to the ships reporting. Continuation of this system as just described will be reconsidered if need for the reporting system changes, or acceptable alternative international systems develop.)
63. Operational responsibilities for maritime and aeronautical SAR will generally be associated with internationally-recognized geographic maritime and aeronautical SRRs, and a single federal agency will be given primary responsibility for coordinating SAR operations within each SRR, with other agencies and organizations providing

support as appropriate. However, in some specific sub-areas, such as within national parks, other federal authorities may be responsible.

64. Distress situations involving airborne aircraft will normally be handled by the maritime or aeronautical SAR authorities responsible for the SRR concerned once the distressed aircraft is down, and cooperatively between these authorities and air traffic service authorities as long as the aircraft remains airborne.

*NOTE: Land SAR services may include aeronautical SAR operations. Involvement of Participants in such operations may be governed by agreements between SAR coordinators and various state and local authorities. Participants will support such operations as appropriate, bearing in mind the provisions of paragraph 7 of this Plan.*

### **Coordination of Operations**

65. Each agency responsible for operations under this Plan will:

- Keep information readily available on the status and availability of key SAR facilities or other resources which may be needed for operations; and
- Keep each other fully and promptly informed of operations of mutual interest, or which may involve use of facilities of another Participant;

66. SAR Coordinators will delegate to their RCCs the authority to:

- Request assistance via other RCCs/RSCs including those of other nations;
- Promptly respond to requests for assistance from other RCCs/RSCs, including those of other nations as discussed below;
- Grant permission for entry into the U.S. of SAR facilities of other countries; and
- Make arrangements with appropriate customs, immigration, health or other authorities to expedite entry of foreign SAR facilities as appropriate

67. SAR Coordinators will authorize their RCCs to arrange promptly or in advance for entry of foreign rescue units into the U.S. should it ever become necessary. Such arrangements should involve appropriate U.S. authorities as well as proper authorities of the nation or SAR facility involved with the entry. Such entry may include overflight or landing of SAR aircraft, and similar accommodation of surface (land or water) SAR units) as circumstances dictate for fueling, medical, or other appropriate and available operational support, or delivery of survivors, or it could also be in response to a request from a U.S. RCC to the RCC of another nation for assistance of those facilities.

68. Establishment of JRCCs, and of jointly sponsored and staffed RCCs or RSCs, are encouraged where appropriate.

69. Operations of SAR facilities committed to any SAR mission normally should be coordinated, and, as appropriate, directed, by an appropriate RCC or RSC consistent with the provisions of this Plan.

70. On-scene coordination may be delegated to any appropriate unit participating in a particular incident under the cognizance of the SAR mission coordinator at an RCC or an incident commander.

71. No provision of this Plan or any supporting plan is to be construed as an obstruction to prompt and effective action by any agency or individual to relieve distress whenever and wherever found.

72. If an RSC is established by any agency, it must operate under the oversight of an RCC, and be responsible for certain tasks or for portions of the RCC's SRR, as determined by the agency concerned.

73. SAR Coordinators shall arrange for the receipt of distress alerts originating from within SRRs for which they are responsible, and ensure that every RCC and RSC can communicate with persons in distress, with SAR facilities, and with other RCCs/RSCs

### **Incident Command System**

74. A coordination system often used in local areas, and for emergency response scenarios involving multiple agencies and multiple jurisdictions, is the Incident Command System (ICS).
75. When SAR forces become involved in situations where ICS is being used, an on-scene incident commander will be in charge of coordinating operations overall. In such cases the SAR mission coordinator or person designated by the SAR mission coordinator will normally serve as a SAR Agency Representative to the incident commander.
76. RCCs should normally use the coordination procedures of the IAMSAR Manual and the National SAR Supplement, but should also be familiar with the ICS system, and may use or support ICS as the situation warrants.

### **Military Roles and Military-Civilian Relationships**

77. Arrangements between federal military and civil agencies should provide for the fullest practicable cooperation among themselves, consistent with statutory responsibilities and authorities and assigned SAR functions.
78. Cooperative arrangements involving DOD and Coast Guard commands should provide for the fullest practicable use of their facilities for civil SAR on a not-to-interfere basis with military missions, consistent with statutory responsibilities and authorities and assigned agency functions.
79. Participants with operational responsibilities should develop plans and procedures for effective use of all available SAR facilities, and for contingencies to continue civil SAR operations if military forces are withdrawn because of another emergency or a change in military missions.
80. DOD responsibilities under this Plan include support of civil SAR on a not-to-interfere basis with primary military duties, in accordance with applicable national directives, plans, guidelines, agreements, etc.

### **Resources**

81. To optimize delivery of efficient and effective services, and, where practicable and consistent with agency authorities, provide the organizations and persons interested in supporting these services the opportunity to do so, all available resources will be used for civil SAR. Certain state and local governments, civil and volunteer organizations, and private enterprises have facilities, which contribute to the effectiveness of the over-all SAR network, although they are not Participants to this Plan.
82. To help identify, locate and quantify primary SAR facilities, Coast Guard and DOD commands may designate facilities which meet international standards for equipment and personnel training as "SAR units" (SRUs). (Such facilities do not need to be dedicated exclusively to the associated type of operations, and this designation is not intended to preclude use of other resources.)
83. Recognizing the critical role of communications in receiving information about distress situations and coordinating responses, and noting that such responses sometimes involve multiple organizations and jurisdictions, the Participants will work aggressively to develop suitable SAR provisions for:
- Interoperability;
  - Means of sending and receiving alerting;

- Means of identification;
- Effective provisions for equipment registration and continual access to registration data by SAR authorities;
- Rapid, automatic, and direct routing of emergency communications;
- High system reliability; and
- Preemptive or priority processing of distress communications.

### **Technical and Support Services**

84. The Participants will strive together to:

- Apply the most effective systems to save the most lives at the least operational risk and cost; and
- Foster innovation in technical, administrative and informational systems, which will improve the ability of the Participants and associated non-governmental organizations to carry out their civil SAR duties.

85. Management, operational, and support personnel of the Participants will be partners, assisting each other with the goal of maximum operational effectiveness.

86. Priority goals of the Participants shall include:

- Make distress alerts and associated data available to operational personnel as quickly, comprehensively, and reliably as possible;
- Provide communications systems which are highly reliable, simple, problem-free, interoperable, and as functionally effective as possible; and
- Enable operational personnel to be as highly effective in planning and conducting operations as possible, by providing them with the training, equipment, procedures, facilities, information, and other tools necessary to carry out planning and operational duties in a consistent, highly professional, and effective manner.

87. Participants should:

- Encourage development and maintenance of proficiency in SAR techniques and procedures by other agencies participating in civil SAR, and assist them as appropriate;
- Encourage continued development of state and local SAR facilities as appropriate; and
- Enter into agreements, as appropriate, with State, local, and private organizations to provide for the fullest practicable cooperation in civil SAR consistent with their capabilities and resources, and to account for use of federal facilities in SAR missions with which these organizations are involved.

### **Suspension or Termination of Operations**

88. SAR operations shall normally continue until all reasonable hope of rescuing survivors or victims has passed.

89. The responsible RCC/RSC concerned shall normally decide when to discontinue these operations. If no such center is involved in coordinating the operations, the OSC or IC may make this decision. If there is no OSC or IC involved, the decision will be made at an appropriate level of the chain-of-command of the facility conducting the operations.

90. When an RCC/RSC or other appropriate authority considers, on the basis of reliable information that a rescue or

recovery operation has been successful, or that the emergency no longer exists, it shall terminate the SAR operation and promptly so inform any authority, facility or service which has been activated or notified.

91. If an operation on scene becomes impracticable and the RCC/RSC or other appropriate authority concludes that survivors might still be alive, it may temporarily suspend the on-scene activities pending further developments, and shall promptly so inform any authority, facility or service which has been activated or notified. Information subsequently received shall be evaluated and operations resumed when justified on the basis of such information.

### **ENTRY INTO FORCE, AMENDMENT, OR TERMINATION**

92. This Plan:

- shall enter into force effective January 1, 1999;
- may be amended by written agreement among the Participants; and
- may be terminated or superseded by a new Plan or by written agreement among the Participants.

An individual Participant may terminate its status as a Participant to this Plan by notifying the other Participants in writing at least six months in advance of such termination. Since the National Search and Rescue Committee sponsors this Plan, and it is intended that the Participants to this Plan correspond to the member agencies of that Committee, such termination will be deemed to also terminate the Participant's membership on the Committee.

For the Department of Transportation  
Rodney E. Slater  
January 14, 1999

For the Department of Commerce  
William M. Daley  
February 10, 1999

For the Department of Defense  
William S. Cohen  
March 3, 1999

For the Department of Interior  
Bruce Babbitt  
May 3, 1999

For the Federal Communications  
Commission  
William C. Kennard  
May 18, 1999

For the National Aeronautics  
and Space Administration  
Daniel S. Goldin  
March 2, 1999



---

## Appendix B

### SAR Treaties and International Instruments

#### MULTILATERAL AGREEMENTS

##### **Convention on International Civil Aviation**

*December 7, 1944 (61 Stat. 1180; TIAS 1591)*

Under Article 25, each contracting party "Undertakes to provide such measures of assistance to aircraft in distress in its territory as it may find practicable, and to permit, subject to control by its own authorities, the owners of the aircraft or authorities of the State in which the aircraft is registered to provide such measures of assistance as may be necessitated by the circumstances." That article also provides that "Each Contracting State, when undertaking search for missing aircraft, will collaborate in coordinated measures...".

Article 37 provides that the International Civil Aviation Organization (ICAO) shall adopt international standards and recommended practices and procedures, including "(K) Aircraft in distress and investigation of accidents. States finding it impracticable to comply in all respects with any such standard or procedure shall notify the Organization to that effect, as provided in Article 38.

ICAO has from time to time adopted and amended various International Standards and Recommended Practices, including those on SAR printed as Annex 12 to the Convention. That annex is "applicable to the establishment, maintenance and operation of SAR services in the territories of Contracting States and over neighboring seas, and to the coordination of such services with those of neighboring States." The foreword also indicates standards or specifications "for physical characteristics, configurations, material, personnel, or procedures ... to which Contracting States will conform in accordance with the Convention. In the event of impossibility of compliance, notification to the Council is compulsory under Article 38."

Under the Standards in Annex 12, contracting States are required to provide assistance to aircraft in distress and to survivors of aircraft accidents, regardless of their nationality. They must also permit immediate entry of aircraft, equipment, and personnel (subject to their control) necessary to search for aircraft in distress or rescue survivors of aircraft accidents, and coordinate their SAR organizations with those of neighboring Contracting States. They are required to delimit, either separately or jointly, SAR areas and establish in each an RCC equipped with rapid and reliable communications. They are to designate rescue units and provide them with equipment suitable for the region. Procedures for RCCs and SAR are specified.

##### **International Convention on Maritime Search and Rescue, 1979**

This is the primary international convention that applies to personnel involved in maritime SAR in the United States. The objectives of this Convention are to standardize SAR worldwide, facilitate intergovernmental direct contact, ensure cooperation between surface and air SAR units, and provide guidance where needed for development of national SAR services. The Convention and its technical annex apply to parties to the Convention. Certain conference resolutions applicable to all maritime nations are also published with the Convention. Implementation of the Convention should result in fewer delayed rescue attempts, more economical use of resources, and minimized duplication of effort.

One article provides that the Convention will not interfere with, or otherwise prejudice, other laws of the sea or national jurisdictions; that is, provisions of other conventions are preserved.

The technical annex has six chapters, one each on terms and definitions, organization, cooperation, preparatory measures, operating procedures, and ship reporting systems. The IAMSAR Manual provides additional guidance for implementing the Convention.

Chapter 2 deals with the structure of national SAR organizations. Parties to the Convention are required to take urgent steps to assist any person in distress at sea, regardless of nationality, status, or circumstance. Information on national SAR resources is to be collected by IMO, which will publish it as part of a worldwide SAR plan. Parties should establish SAR regions by mutual agreement with their SAR neighbors, or provide for an equivalent way of coordinating SAR services internationally.

Chapter 3 embraces the key to success of the Convention, coordination with neighboring nations.

It discusses territorial issues and provides for development of bilateral and multilateral SAR agreements. RCCs are identified as having the key role in international SAR operational coordination. Resolution 6 provides for IMO development of a global distress and safety communications system, another key to success of the Convention.

### **Convention with Respect to Assistance and Salvage at Sea**

*September 23, 1910 (37 Stat. 1658; TIAS 576)*

This Convention contains the provision that "Every master is bound, so far as he can do so without serious danger to his vessel, her crew and passengers, to render assistance to everybody, even though an enemy, found at sea in danger of being lost." It also has provisions regarding remuneration in connection with assistance and salvage at sea.

### **Convention on the High Seas**

*April 29, 1958 (13 UST 2312; TIAS 5200; 450 UNTS 82)*

Article 12 of this treaty provides that every State shall require the master of a ship sailing under its flag, insofar as he can do so without serious danger to the ship, to render assistance to any person at sea in danger of being lost, and to proceed with all possible speed to the rescue of persons in distress if informed of their need of assistance, insofar as such action may reasonably be expected of him. After a collision, he is to render assistance to another ship, her crew, and passengers, and where possible, to inform the other ship of the name of his own ship, her port of registry, and the nearest port of call. These provisions are codified in United States law at 46 USC 2304 and 2305.

The article also requires every coastal State to promote the establishment and maintenance of an adequate and effective rescue service and -- where circumstances so require -- to cooperate with neighboring States for this purpose through mutual regional arrangements.

### **International Convention for Safety of Life at Sea, 1974**

*(32 UST 49, TIAS 9700)*

Regulation 10 of Chapter V of the regulations annexed to this Convention (TIAS 5780, p. 320) requires the master of a ship at sea, on receiving a message from any source that a ship or aircraft or survival craft thereof is in distress, to proceed with all speed to the assistance of the persons in distress, informing them, if possible, that he is doing so. Regulation 15 of the same chapter requires each government party to the Convention to make the necessary arrangements for coast watching and rescue of persons in distress at sea and around its coasts. This should include establishing, operating and maintaining of such maritime safety facilities as are deemed practicable and necessary relative to the density of the seagoing traffic and navigational dangers, and should, so far as possible, afford adequate means of locating and rescuing persons in distress. Each contracting government undertakes to make information available concerning its existing facilities and plans.

Regulation 16 specifies life-saving signals that are to be used.

### **International Regulations for Preventing Collisions at Sea, 1972**

*(28 UST 3459, TIAS 8587)*

Rule 31 of these regulations specifies the distress signals that are to be used or displayed by a vessel or seaplane in distress on the water and requires assistance from other vessels or shore. (Distress signals are also stated in Regulation 37 and Annex IV of the 1972 COLREGS.)

**Recommendations of the First Antarctic Treaty Consultative Meeting**

*Adopted at Canberra July 24, 1961 (13 UST 1349; TIAS 4780)*

Recommendations I-X, along with other recommendations, were adopted in accordance with Article IX of the Antarctic Treaty signed December 1, 1959 (12 UST 794; TIAS 4780; 402 UNTS 71) and became effective on April 30, 1962. They provide as follows:

"The Representatives affirm the traditional Antarctic principle that expeditions render all assistance feasible in the event of an emergency request for help and recommend to their Governments that consideration be given to arranging consultations among them, and to the matter being discussed at the appropriate time at any meeting of experts qualified to discuss it."

**International Telecommunications Convention**

*October 25, 1973 (28 UST 2495; TIAS 8572)*

Article 25 specifies that the international telecommunications services must give absolute priority to all telecommunications concerning safety of life at sea, on land, in the air, and in outer space, as well as to World Health Organization epidemiological telecommunications of exceptional urgency. Article 36 specifies that "Radio stations shall be obliged to accept, with absolute priority, distress calls and messages regardless of their origin, to reply in the same manner to such messages, and immediately to take such action in regard thereto as may be required."

The radio regulations annexed to the Convention specify the communications procedures to be followed in distress and emergency cases.

**Treaty on Principles Governing the Activities of States in the Exploration and use of outer space, Including the Moon and other Celestial Bodies**

*Signed at Washington, London, and Moscow January 27, 1967 (18 UST 2410; TIAS 6347)*

Article V provides: "State Parties to the Treaty shall regard astronauts as envoys of mankind in outer space and shall render to them all possible assistance in the event of accident, distress, or emergency landing on the territory of another State Party or on the high seas. When astronauts make such a landing, they shall be safely and promptly returned to the State of registry of their space vehicle."

"In carrying out activities in outer space and on celestial bodies, the astronauts of one State Party shall render all possible assistance to astronauts of other State Parties. "

"State Parties to the Treaty shall immediately inform the other States Parties to the Treaty or the Secretary-General of the United Nations of any phenomena they discover in outer space, including the moon and other celestial bodies, which could constitute a danger to the life or health of astronauts."

**Agreement on the Rescue of Astronauts, the Return of Astronauts and the Return of Objects Launched into Outer Space**

*Done at Washington, London, and Moscow April 22, 1968 (19 UST 7570; TIAS 6599)*

Article 2 of the agreement specifies: "If, owing to accident, distress, emergency or unintended landing, the personnel of a spacecraft land in territory under the jurisdiction of a Contracting Party, it shall immediately take all possible steps to rescue them and render them all necessary assistance. It shall inform the launching authority and also the Secretary-General of the United Nations of the steps it is taking and of their progress. If assistance by the launching authority would help to effect a prompt rescue or would contribute substantially to the effectiveness of search and rescue operations, the launching authority shall cooperate with the contracting party with a view to the effective conduct of search and rescue operations. Such operations shall be subject to the direction and control of the Contracting Party, which shall act in close and continuing consultations with the launching authority." Article 3 of the agreement specifies: "If information is received or it is discovered that the personnel of a spacecraft have alighted on the high seas or in any other place not under the jurisdiction of any State, those Contracting Parties which are in a position to do so shall, if necessary, extend assistance in search and rescue operations for such personnel to assure their speedy rescue. They shall inform the launching authority and the Secretary-General of the United Nations of the steps they are taking and of their progress."

## **BILATERAL AGREEMENTS**

### **CANADA**

#### **Treaty Regarding Reciprocal Rights for the United States and Canada in the Matters of Conveyance of Prisoners and Wrecking and Salvage**

*Signed at Washington May 18, 1908 (35 Stat. 2035; TIAS 502)*

Article II of this treaty permits vessels and wrecking appliances, either from the United States or from Canada, to salvage property wrecked and to render aid and assistance to any vessels wrecked, disabled, or in distress in that portion of the St. Lawrence River through which the international boundary line extends; on Lake Ontario, Lake Erie, Lake St. Clair, Lake Huron, and Lake Superior; on the Niagara, Detroit, St. Clair, and Ste. Marie Rivers, and Canals at Sault Ste. Marie; and on the shores and in the waters of the other country along the Atlantic and Pacific coasts within a distance of 30 miles from the international boundary on those coasts.

The reciprocal wrecking and salvage privileges include all necessary towing, and nothing in the Customs, Coasting or other laws or regulations of either country is to restrict in any manner the salvaging operations of vessels or wrecking appliances.

Vessels from either country employed in salvaging in the waters of the other are required, as soon as practicable afterwards, to make full report at the nearest custom house in the country in whose waters the salvaging takes place.

#### **Agreement Regarding Air Search and Rescue Operations**

*Effected by exchange of notes signed at Washington, January 24 and 31, 1949 (63 Stat. 2328; TIAS 1882)*

Under this agreement public aircraft of either country which are engaged in emergency air search and rescue operations may enter or leave either country without being subject to immigration or customs formalities normally required, provided that the RCC involved in the SAR assumes the responsibility for providing information, by telephone or telegraph on the intended operation to:

- (a) The immigration office at the point of entry nearest the territory over which any SAR is to be conducted, furnishing details on purpose of the flight, identification marking of each aircraft, and number of persons in the crew; or
- (b) The customs office nearest to the territory over which any SAR is to be conducted, giving details on the territory to be searched, the possible duration of the stay of the aircraft, the identification markings of each aircraft, and the number of persons in the crew.

In case such aircraft of one country land in the territory of the other country in the course of emergency SAR, a verbal or

telephone report must be made to the nearest collector of customs so that he may assist in any way possible with entry requirements for SAR operations.

## HONDURAS

### **Exchange of Notes Regarding Rescue Coordination Facilities in Honduras**

*Effected by exchange of notes at Tegucigalpa November 7 and 25, 1952*

Under this exchange of notes before Honduras became a member of ICAO, the Honduran Government informed the U.S. Government that, regarding RCC activities at Albrook AFB, Panama, the Honduran Bureau of Civil Aeronautics had made provision for SAR flights to be allowed to enter their country without any requirement other than to request clearances from their Flight Control Center, to coordinate their activities with ours and to be able to provide more effective assistance for SAR missions.

## JAMAICA

### **Authorization for Aircraft Engaged in SAR Operations to Fly Over and Land in Jamaica**

*Order issued March 21, 1950*

The Governor of Jamaica authorized State aircraft of the United States, Colombia, and Venezuela while engaged in SAR operations and assigned for such purposes by the RCCs of the Caribbean Area, established by the Convention on International Civil Aviation, to fly over and land in the Island of Jamaica and its dependencies and the adjacent territorial waters. (Note No. 203 dated April 25, 1950 from the British Ambassador to the Secretary of State with an enclosed copy of the Jamaican "Colonial Foreign State Aircraft (SAR) Authorization, 1950").

This arrangement is considered to be continued in force after Jamaica, on August 6, 1962, attained a fully responsible status within the British Commonwealth. Jamaica adhered to the Convention on International Civil Aviation March 26, 1963 and thus became a separate member of ICAO.

## MEXICO

### **Treaty to Facilitate Assistance to and Salvage of Vessels in Territorial waters**

*Signed at Mexico City June 13, 1935 (49 Stat. 3359; TIAS 905)*

Under this treaty vessels and rescue equipment, public or private of either country, may assist vessels and crews of their own nationality which may be disabled or in distress on the shores or within the territorial waters of the other country:

- (a) Within a radius of 720 nautical miles of the intersection of the international boundary line and the coast of the Pacific Ocean; or
- (b) Within a radius of 200 nautical miles of the intersection of the international boundary line and the coast of the Gulf of Mexico (Article I).

The commanding officer, master, owner of a vessel or rescue apparatus of either country entering or intending to enter the territory or territorial waters of the other to assist a distressed vessel is required, at the earliest possible moment, to send notice of such action to the authorities of that other country nearest the scene of distress. The vessel or apparatus may freely proceed to, and assist the distressed vessel unless the authorities advise that adequate assistance is available, or that, for any other reason, such assistance is not considered necessary (Article II). Notification is necessary when a vessel or apparatus of one country departs from the territory or waters of the other country entered to render assistance. Private vessels that have so entered, as well as private distressed vessels and the cargo, equipment, stores, crew and passengers thereof, are subject to the laws in force in the country in whose territorial waters such assistance is rendered.

"Assistance" in this treaty means any act necessary or desirable to prevent injury arising from a marine peril of persons or property, and "vessel" includes aircraft as well as every kind of conveyance used or capable of being used for transportation on water (Article III).

## **RUSSIAN FEDERATION**

### **Air Transport Agreement with Annex, and Supplementary Exchange of Notes**

*Signed at Washington November 4, 1966 (17 UST 1909; TIAS 6135)*

(This agreement was signed by the government of the Union of Soviet Socialist Republics but has been ratified for continuation by the government of the Russian Federation.)

Article 11 of this agreement provides for the measures that may be taken and the procedures to be followed in the event of a forced landing, accident, or other incident involving an aircraft of the designated airline of one contracting party within the territory of the other contracting party.

Article I of the supplementary agreement requires, among other things, that each contracting party shall provide within its territory "search and rescue facilities."

Such provisions are not normally included in bilateral air transport agreements concluded by the United States, because other countries with which such agreements are concluded are members of ICAO which, as indicated under "Multilateral" above, has established SAR standards. The U.S.S.R. was not a member of the Organization in 1966 but is now.

## **GENERAL SAR AGREEMENTS**

The following agreements provide for coordinated SAR activities in areas of mutual interest to the parties. Each agreement identifies its scope in terms of maritime SAR, aeronautical SAR, or both. Some agreements discuss lines separating SAR regions and some may have implementing annexes.

### **Agreement between the Government of the United States of America and the Government of Japan on Maritime Search and Rescue**

*December 12, 1986*

### **Agreement Concerning Maritime Search and Rescue Cooperation between the Bureau of Harbour Superintendency of the People's Republic of China and the United States Coast Guard of the United States of America**

*January 20, 1987*

### **Agreement between the Government of the United States of America and the Government of the Union of Soviet Socialist Republics on Maritime Search and Rescue** (This agreement was signed by the government of the Union of Soviet Socialist Republics but is in effect with the government of the Russian Federation.)

*May 31, 1988*

### **Maritime Search and Rescue Agreement between the United States Coast Guard of the United States of America and the Federated States of Micronesia Department of External Affairs**

*June 10, 1988*

### **Agreement between the Government of the United States of America and the Government of the Republic of Indonesia on Maritime Search and Rescue**

*July 5, 1988*

### **Maritime Search and Rescue Agreement between the Government of the United States of America and the Government of the Dominican Republic**

*March 20, 1992*

**Memorandum of Understanding for Cooperation Among the Department of National Defense of Canada; the Department of Fisheries and Oceans of Canada; the United States Coast Guard; the United States Air Force; the United Kingdom Maritime and Coastguard Agency; the United Kingdom Civil Aviation Division of the Department of Environment, Transport and the Regions; and the United Kingdom Ministry of Defense Concerning Search and Rescue, 1999**

**Memorandum of Understanding Regarding Search and Rescue Satellite-aided Tracking (SARSAT) Among the Department of Defense, Department of Commerce, Department of Transportation, and the National Aeronautics and Space Administration, 1998**

**Memorandum of Understanding between the Maritime Administration and the U.S. Coast Guard, 1999**

**United States National Search and Rescue Plan, 1999**

This page intentionally blank



---

## Appendix C

### Temporary Flight Restrictions

**C.1 Temporary Flight Restrictions (TFRs), issued by the FAA under Federal Aviation Regulations (FAR) Part 91, restrict aircraft operation over the site of disasters or other areas where rescue or relief operations are being conducted. TFRs are implemented by a notice to airmen (NOTAM) and issued only at the request of authorities responsible for disaster relief activities. For additional information refer to applicable FAA Advisory Circulars or FAR Part 91.**

**C.2 TFRs are designated to:**

- a) Protect persons and property from a hazard when the presence of low-flying aircraft might increase the danger.
- b) Provide a safe environment for the operation of disaster relief aircraft.
- c) Prevent an unsafe congestion of sightseeing aircraft above an incident or event that may generate a high degree of public interest.

**C.3 The FAA has authority to implement TFRs.**

- a) When the conditions of paragraphs C.2 a) or C.2 b) are involved, the TFR NOTAM may be implemented only through the area manager at the air route traffic control center (ARTCC) having jurisdiction over the area.
- b) TFRs involving the conditions of paragraph C.2 c) may be established only at the direction of the regional air traffic division manager having oversight of the airspace.
- c) In a hijacking, the TFR will be established through **FAA Washington Headquarters Office of Civil Aviation Security**. The FAA air traffic element receiving the request will establish TFRs under paragraph C.2 a).

**C.4 Disaster Control Authorities**

- a) TFRs may be recommended or requested for the conditions under paragraph C.2 a) by major military command headquarters, regional directors of the Office of Emergency Planning, Civil Defense State directors, State governors, or similar authority.
- b) TFRs may be recommended or requested for the conditions under paragraph C.2 b) by:
  - 1) Military commanders serving as regional, sub-regional, or SAR mission coordinators.
  - 2) Military commanders coordinating disaster relief air operations.
  - 3) Civil authorities coordinating organized relief air operations.
- c) TFRs may be recommended or requested for conditions under paragraph C.2 c) by the above authorities, and state, county, or city government agencies.

**C.5 The number of TFRs should be kept to a minimum.**

- a) Requests for TFRs for conditions under paragraph C.2 a) must originate with the authorities in paragraph C.4 a), as resulting restrictions prohibit all flight in the designated area except for those in hazard relief activities. Such conditions include:
  - 1) Toxic gas leaks or spills, flammable agents, or fumes which, if fanned by rotor or propeller wash, could endanger persons or property on the surface, or if entered by an aircraft could endanger persons or property in the air.
  - 2) Imminent volcano eruptions which could endanger aircraft.
  - 3) A nuclear incident.
  - 4) A hijacking.
- b) Requests for a TFR for conditions under paragraph C.2 b) are allowed for air rescue or air relief activities, such as:
  - 1) Forest fires using aircraft releasing fire retardants.
  - 2) Aircraft relief activities following natural disasters.
  - 3) The restricted airspace needed can normally be limited to within 2,000 feet above the surface and a 5-NM radius.
  - 4) Normally, incidents in an aircraft traffic area or terminal control area (TCA) should not require a TFR.

**C.6 Air traffic facilities coordinate assistance to relief agencies, relief aircraft, and OSCs. When requesting a TFR, the FAA needs:**

- a) Name and organization of the person requesting or recommending the TFR.
- b) Brief description of situation.
- c) Estimated duration of restriction.
- d) Telephone number or other communications contact and agency name responsible for on-scene activities.
- e) Description of area by reference to prominent geographical features depicted on aeronautical charts or by geographical coordinates and VOR/DME fix.
- f) Description of material or activity posing hazard to persons or property in the air.
- g) Description of hazard that would be worsened by low-flying aircraft or rotor wash.
- h) Nature of airborne relief, aircraft operations, and location of relief aircraft base.
- i) Contact point or radio frequency for handling news media requests to operate at altitudes used by relief aircraft.

**C.7 Coordination Facility Designation.** ARTCC assigns the flight service station (FSS) nearest the incident as the "coordination facility" and forwards the information contained in paragraph C.6 to the station responsible for issuing the NOTAM. When FAA communications assistance is required, the designated FSS will function as the primary communication facility for coordination between the emergency control authorities and aircraft.

**C.8 Revisions and Cancellations**

- a) When restrictions are necessary beyond the published termination date/time, ARTCC ensures that a revised NOTAM and cancellation are issued.
- b) The agency requesting a TFR should notify ARTCC to cancel it when it is no longer needed. Such notices received by another facility should be immediately relayed to the appropriate ARTCC.

This page intentionally blank

---

## Appendix D

### Emergency Assistance to Aircraft Other Than Search and Rescue

#### D.1 General

D.1.1 This appendix provides information in support of guidance provided in IAMSAR Manual Volume 2, Chapter 7, *Emergency Assistance Other than Search and Rescue*, and Volume 3, Section 2 and especially Section 4. IAMSAR Manual Volume 2, Appendix J provides detailed information on intercepts.

#### D.2 Lost Aircraft Procedures

D.2.1 If an aircraft declares that its position is unknown or uncertain, the entire communications system should be used to locate its approximate position. Radar or DF stations can establish a bearing indicating the general intercept direction. The following procedures have proven effective:

- a) SAR aircraft should attempt to contact the lost aircraft by climbing to the highest practical altitude to increase communications range.
- b) If the lost aircraft is in contact with an air/ground station, the SAR aircraft should orbit above the station until the lost aircraft is contacted or until some clue indicates the general direction of the lost aircraft.
- c) If communications prove unsuccessful, the SAR aircraft should proceed in the most logical direction to the lost aircraft.
- d) A second SAR aircraft may be launched and directed to proceed on a course 90 degree different than that of the first SAR aircraft. This aircraft could be used to obtain a second bearing line on the distressed aircraft if communications can be established.
- e) The distressed aircraft is instructed to maintain radio contact at all costs, orbit its present position to keep from flying beyond communications range, and maintain the highest altitude practical.
- f) Fuel, endurance, and POB of the distressed aircraft, are determined.
- g) Communications with air/ground stations capable of providing bearings, fixes, and other assistance are maintained.
- h) The electronic aid that can provide the quickest and most reliable bearing or fix of the lost aircraft is used first. Other aids should be used as the mission progresses.
- i) As soon as the first reliable bearing or fix is established for the lost aircraft, the pilot is instructed to leave his orbit position and take up a heading to the SAR aircraft or to the closest suitable landing area.
- j) If voice contact with the lost aircraft can be maintained but a bearing or fix cannot be established, approximate position may be determined from a surface object, landmark, or peculiar cloud formation the pilot can identify and report to the SAR aircraft. Landing lights and pyrotechnic flares may be used at night to improve detection capabilities.

D.2.2 If the lost aircraft must land immediately, and only one SAR aircraft is available, the following procedure may be used to fix aircraft position prior to vectoring it to a suitable field (see Figure D-1):

- a) With lost aircraft (C) orbiting a fixed unknown position and the SAR aircraft (A) at a known position, a bearing is taken.
- b) The SAR aircraft is then flown on a heading perpendicular to the bearing obtained for a period of 5

minutes, and a second bearing is taken on the lost aircraft from the new position (B).

- c) Distance to the lost aircraft may be computed with the formula:

$$\text{Distance} = \frac{(\text{TAS})(\text{minutes flown})}{\text{Bearing change}}$$

- d) The bearings from the appropriate known positions of the SAR aircraft are plotted.
- e) The point where the two bearings cross is the approximate position of the lost aircraft. The bearing and distance to the closest suitable airfield (D) are then relayed to the lost aircraft.

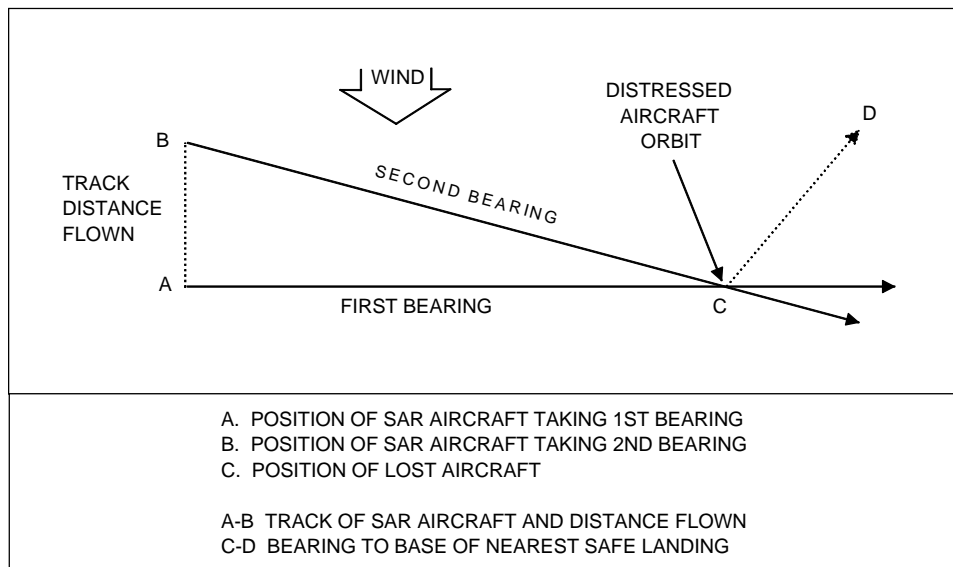

**Figure D-1. Lost Aircraft Fixing Procedure**

- D.2.3 The above procedure may be worked in reverse, that is, the SAR aircraft orbits and takes bearings as the lost aircraft flies directed headings. This procedure should be used only if the SAR aircraft cannot complete the normal lost aircraft fixing procedure.
- D.2.4 In either case, before a course is recommended to a distressed aircraft, a reasonably accurate position should be obtained. The course provided must ensure adequate terrain clearance for the altitude of the lost aircraft.

**D.3 Bailout or Ditching Prior to Intercept**

- D.3.1 If it appears that the distressed aircraft may ditch or crash land, or the crew bail out before the SAR aircraft arrives, the following actions should be taken by the SAR aircraft:
- a) Advise the distressed crew to delay bailout, crash landing, or ditching until it is absolutely necessary for safety of personnel. This delay gives the SAR crew time to alert air/ground stations and request their assistance. It also precludes a distressed crew taking emergency actions prematurely because of erroneous analysis of the fuel reserve, navigation, or the degree of emergency. Many times a distressed aircraft has been escorted to a safe landing even though the distressed crew had given up all hope.
- b) Use the electronic aids and begin homing procedures immediately to close the distance between the two aircraft.

- c) Alert air/ground stations of the following:
  - 1) The emergency and intentions, anticipated or actual incident site, and frequency used to maintain contact with the distressed aircraft.
  - 2) The need to maintain continuous bearings and fixes on the distressed aircraft. Aircraft, surface vessels, rescue teams or other SAR resources need to be dispatched to the scene and should contact the SAR aircraft for further instructions.
- d) Determine the time the aircraft can remain airborne and the number of POB.
- e) Provide the location and heading to the best area or the closest facility for bailout, crash landing, or ditching. If over land, advise the pilot of the least hazardous land area for bailout or crash landing. If over water, recommend bailout or ditching as follows:
  - 1) Alongside a Coast Guard or Navy vessel or any other surface vessel in the area. Coast Guard personnel are equipped and trained to assist distressed aircraft and to rescue personnel immediately after ditching. Amver may be of assistance in locating the closest merchant vessels. The RCC will provide Amver information as well as nearby Navy or Coast Guard ships. Other ships can give complete weather including the length, height, speed, and direction from which waves and swells are moving. They may also provide other assistance, such as night illumination.
  - 2) On the lee side of an island or in a lagoon.
  - 3) Under the visual or electronic guidance of the SAR aircraft.
- f) Assist the distressed crew with advice to continue flight or prepare for emergency action, such as:
  - 1) Jettisoning cargo, equipment, and/or fuel.
  - 2) Using maximum range power settings and altitudes.
  - 3) Proper altimeter settings, minimum safe altitude, and other pertinent flight data should be provided.
- g) If over water, evaluate sea surface conditions and provide the distressed pilot with ditching information discussed in IAMSAR Manual Volume 3, Section 4.
- h) Instruct the distressed aircraft crew to place their EPIRB/ELT in operation as soon as possible after abandoning their aircraft. Request actual heading, altitude, and notification just prior to bailout, crash landing, or ditching, and plot the estimated position of the incident site. Log the time of the ditching and monitor emergency frequencies for transmission from emergency radio devices.
- i) Maintain altitude while proceeding to the incident site to increase the receiving range of transmissions from the emergency radios and to conserve fuel.
- j) If over water, drop sea dye and/or pyrotechnic markers over the estimated position of the incident site to be used as a reference point for search. If available, drop a datum marker buoy for on-scene drift information.

#### **D.4 Aircraft Ditching Procedures**

- D.4.1 **Selection of Ditching Heading.** IAMSAR Manual Volume 3, Section 4 is an excellent source for guidance and may be carried on board the distressed aircraft. Selecting the heading for aircraft ditching depends on basic knowledge of sea conditions. An optimal ditch heading minimizes rapid deceleration, the greatest danger in ditching. While the suggested procedures and information in this Appendix are correct in most ditching situations, the primary source of information for ditching of a specific aircraft is normally the aircraft flight manual.

D.4.2 Choosing a Heading

- a) *Effect of Swells.* It is extremely dangerous to land into the wind without considering sea conditions. There are two formulas for determining the length and velocity of swells:

$$\text{Length (ft)} = 5 \times \text{period}^2 \text{ (sec), and}$$

$$\text{Velocity (kts)} = 3 \times \text{period (sec)}$$

*Example:* Assuming a 10-second swell period, by substitution in the formulas the swell length is found to be 500 feet with a velocity of 30 knots.

- 1) Figure D-2 illustrates an aircraft *landing into the swell*. If it is assumed that the aircraft takes 450 feet and 7 seconds to come to rest, during the 7 seconds of runout the swell moves toward the aircraft a distance of about 300 feet, thereby shortening effective swell length to about 200 feet. Since the aircraft takes 450 feet to come to rest, it would meet an oncoming swell about halfway through its runout and possibly be swamped, or thrown into the air out of control. Therefore, this ditching heading should be avoided.

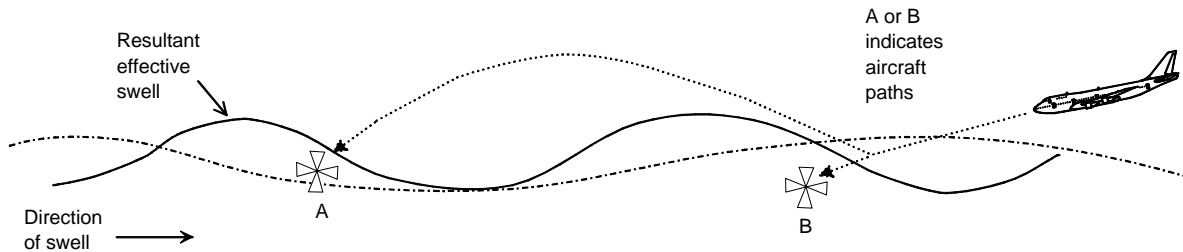

Figure D-2. Landing into the Swell

- 2) Figure D-3 illustrates an aircraft *landing with a swell*. The swell is moving with the aircraft, increasing the effective swell length to about 800 feet. The aircraft, if touched down just beyond the crest, will come to rest short of the next crest. In the long swells of the Pacific, this can be an easy landing. Shorter swell lengths ordinarily prevent this heading except when landing down a secondary swell system. Selection of a ditching heading to parallel a primary swell system may require landing down swell on a secondary system.

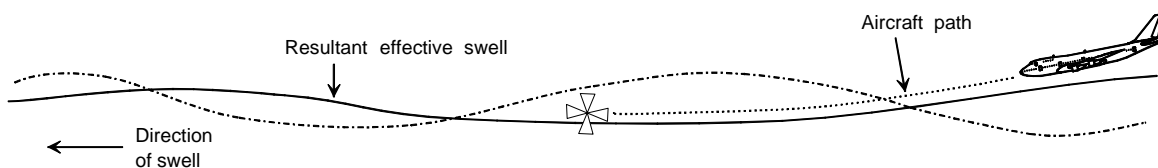

Figure D-3. Landing with the Swell

- 3) Figure D-4 shows a *landing parallel with the swell*. This is the best ditching heading. Landing on the top or backside of the swell is preferable.

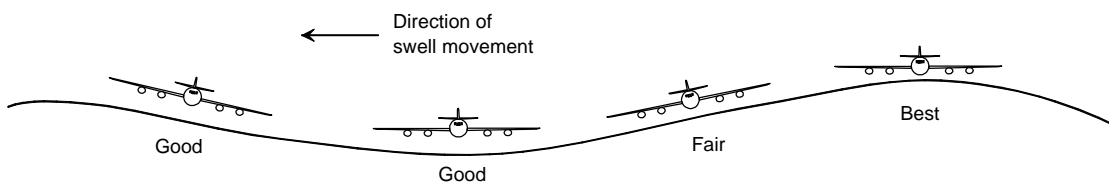
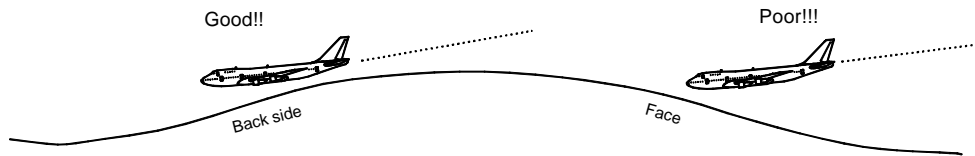

Figure D-4. Landing Parallel with the Swell



- 4) If only one swell system exists, the problem is relatively simple, even with a high, fast system. Unfortunately, most cases involve two or more systems running in different directions. With several systems, the sea presents a confused appearance. One of the most difficult situations occurs when two swell systems are at right angles. If the pilot parallels one, landing should be into, or down, the second. A landing parallel to the primary system, and down swell on the secondary system is indicated. If both systems are of equal height, a compromise may be advisable -- selecting an intermediate heading at 45 degrees down swell to both systems. When landing down a secondary swell, touchdown should be on the backside, not on the face, as shown in Figure D-5, avoid the face of a swell.



**Figure D-5. Landing on the Back Side of a Swell**

- b) *Effect of Chop.* Local winds create chop which acts much the same as a swell system. When winds are over 14 knots, chop rides on top of the resultant uneven surface and, if severe, may serve to hide the underlying swell system. Moderate chop, alone, can be discounted as a danger to ditching.
- c) *Effect of Surface Wind.* The best condition is one that permits landing parallel to a single swell system and into the wind, but this situation seldom exists. Some crosswind is usually present, and should be accepted in order to parallel the major swell. The recommended procedures in the manufacturer's flight handbook and augmented by IAMSAR Manual Volume 3, Section 4, should be used. Also:
- 1) For surface winds over 35 knots, generally, landing should be made into the wind regardless of the swell, because ground speed is significantly reduced. If the swell is so formidable as to make a successful landing into it doubtful, it may be advisable to land at an angle to, or parallel to, the swell, accepting large crosswinds.
  - 2) In general, low-wing land aircraft can accept a much higher crosswind component than seaplanes. If the swell system is formidable, land planes should accept more crosswind in order to avoid landing directly into the swell.
  - 3) When the secondary swell system is from the same direction as the wind, the landing may be made parallel to the primary system, with the wind and secondary system at an angle. There is a choice of two headings paralleling the primary system. One heading is downwind and down the secondary swell; the other is into the wind and into the secondary swell. The choice is based on the velocity of the wind versus the velocity and height of the secondary swell.

**D.4.3 Surface Wind Evaluation.** The simplest method of estimating wind direction and velocity is to examine wind streaks on the water. These appear as long streaks up and down wind. Whitecaps fall forward with the wind, but are overrun by waves, thus producing the illusion that the foam is sliding backward. Knowing this, and by observing the direction of the streaks, the pilot can easily determine wind direction. Wind velocity can be accurately estimated by noting the appearance of the whitecaps, foam, and wind streaks. The Beaufort scale in IAMSAR Manual, Volume 3, Section 4 may prove useful in making this evaluation.

**D.4.4 Sea Evaluation.**

- a) The primary or basic swell can readily be distinguished from high altitude (above 2000 feet/600 meters) and should be seen first. It appears as a definite pattern or differences in light intensity on the surface. By watching the pattern for a few seconds, the direction of motion of the system can easily be determined. Once the primary system is found, observers should look in different directions for other systems.

- b) Once the aircraft is below 1500 feet/450 meters, the basic system may disappear from view, hidden by the secondary system and local chop. Thus it is essential to plot the direction of various systems as they are recognized. The secondary system may not be visible until under 800 feet/250 meters. The wind-driven sea current, if any, will be easily recognized by the appearance of whitecaps.
- c) Once primary and secondary systems are recognized, the analysis may be easily checked by flying on various headings just above the water. When flying into any system, the sea appears to be steep, fast, and rough. When flying down or parallel to the systems, the surface will appear calm.
- d) If the surface is not visible from altitude, the speed and direction of the seas underlying the local chop may be approximated with a ceiling as low as 75 to 100 feet/25-30 meters by dropping a smoke float, dye marker, or other floating object:
  - 1) Swell direction can be determined as crests pass under the float.
  - 2) Swell period can be found by timing the interval between passage of successive crests under the float.
  - 3) The primary swell length and velocity are computed by use of the formulas in paragraph D.4.2.a.
  - 4) Length and velocity of the secondary swell are computed.
  - 5) Direction and velocity of the surface wind are estimated.
- e) Pilots flying over water should make a habit of evaluating the sea. This ensures a tentative ditching heading at all times and provides practice in identifying swell systems. In some ocean areas there are prevailing swells from a fairly constant direction. These conditions should be recognized regularly by pilots flying certain routes.

D.4.5 **Assistance in Ditching Heading Determination.** A pilot with an emergency may obtain a recommended ditch heading in a number of ways. If escorted, the pilot of the escort aircraft may make the sea evaluation and recommend a ditch heading, particularly if the escort is a SAR aircraft. If the ditching is alongside a ship, the wind and sea state can be obtained from the ship if communication has been established. A Navy or Coast Guard ship may also be able to recommend a ditch heading. An RCC may provide an estimated ditch heading based on weather and sea state reports if on-scene evaluation cannot be made.

D.4.6 **Ditch Heading Summary.** Major considerations in selecting a ditch heading are summarized below. Various ditching situations are illustrated in Figure D-6.

- a) Never land into the face of a primary swell system (or within 30 to 35 degrees) unless winds are extremely high.
- b) The best ditch heading usually is parallel to the major swell system and down the secondary swell system.
- c) The next best choice is parallel to the minor swell system and down the major swell system.
- d) The choice between 2 and 3, above, will be determined by which heading gives the greatest headwind component.
- e) In moderately strong winds it may be desirable to compromise the above rules by landing more into the wind and slightly across the swell system.
- f) If the pilot is unable to evaluate various headings, the one that appears to be the smoothest and that does not run into the face of a primary swell is usually the best.

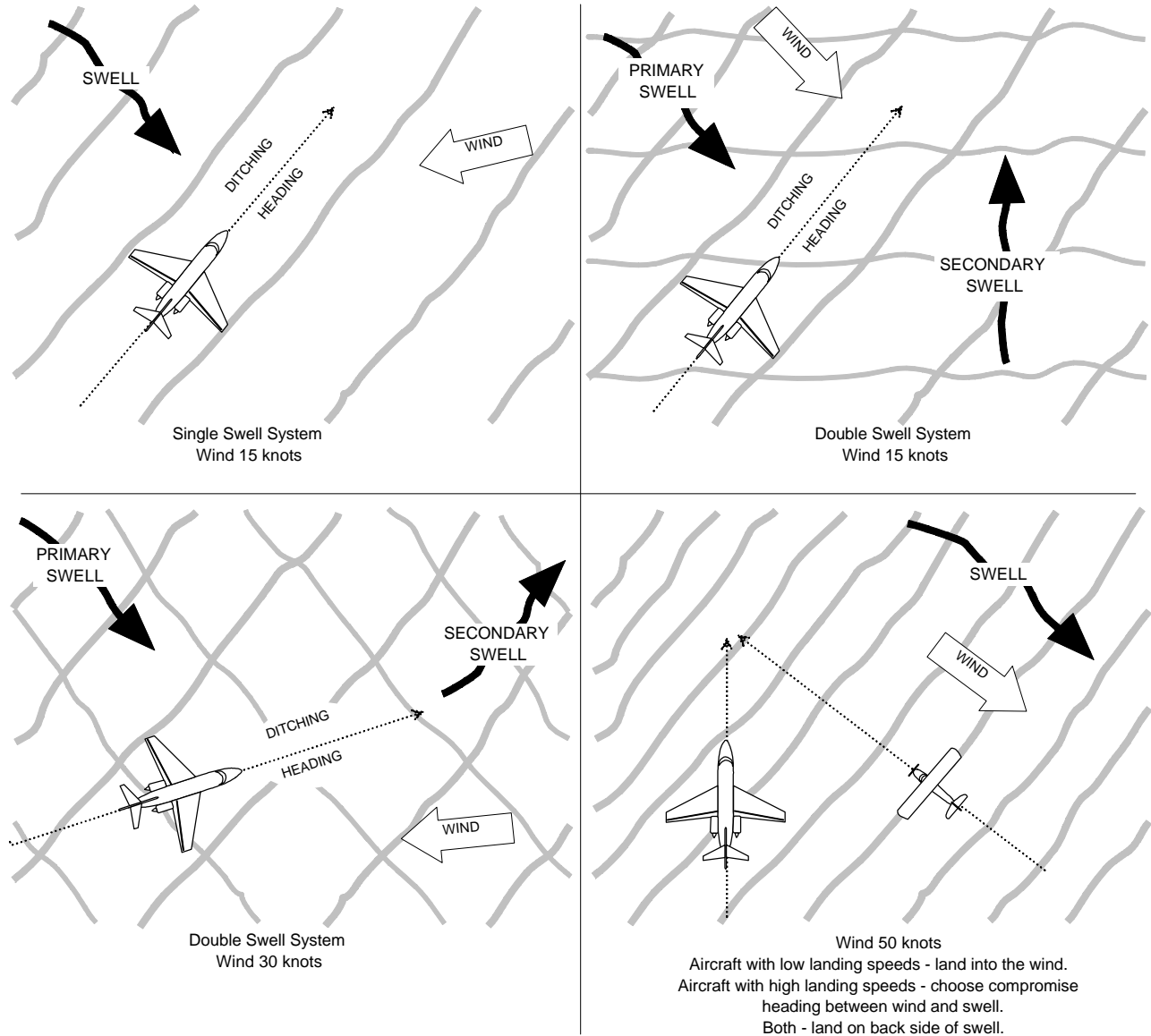

**Figure D-6. Some Wind-Swell-Ditching Heading Situations**

D.4.7 **Aircraft Type.** By knowing the characteristics of an aircraft, and its expected behavior on the water, the pilot can take certain steps to ensure best ditching performance. The general ditching performance of several types of aircraft is discussed below.

- a) Other factors being equal, larger aircraft have better ditching characteristics. Fighter aircraft, due to their high landing speeds and smaller size, often react violently to ditching. Standard procedure in fighter type aircraft is to eject and descend by parachute rather than ditch. This is true also of most modern bomber aircraft.
- b) Transport aircraft are generally better in a ditching situation than combat aircraft. Aircraft bottoms, where most failures occur during ditching, are stronger in transports than in bombers (which are greatly weakened by large bomb bay doors). In most aircraft, bottom damage may be expected, primarily in the midsection, and nose windows will probably collapse. The behavior of the aircraft on runout depends on the damage suffered, and is more violent if the fuselage is damaged on first impact. Double deck aircraft may suffer rapid flooding of the lower deck, but the upper deck may be relatively safe. Aircraft equipped with cabin

pressurization have good watertight integrity and, if the fuselage is intact, afford good protection against rapid flooding. In all cases, however, the aircraft must be depressurized before ditching.

- c) Aircraft with long afterbodies may break forward of the tail, especially when ditching in a fully stalled attitude into the face of a swell. In several military patrol aircraft ditchings, the afterbody of the aircraft separated entirely.
- d) Low-wing aircraft, due to wing flotation support, are safer for ditching than high-wing types. High-wing aircraft tend to sink rapidly after impact until the wings settle in the water, so most of the fuselage is under water soon after the aircraft comes to rest. However, high-wing C-130 aircraft have been successfully ditched.
- e) External appendages affect ditching characteristics. Landing gear must be retracted. Low-wing aircraft with large underslung engines, if landed wing low, may dig one nacelle first, causing a waterloop. This rotation around the vertical axis may also cause structural failure to the fuselage afterbody. Although flaps may break away on initial impact, the importance of flaps in slowing down the aircraft on approach makes their use mandatory. Generally, auxiliary fuel tanks and ordnance located beneath the wing or fuselage should be jettisoned prior to touchdown. Wingtip tanks have no marked adverse effect, and if empty provide additional flotation.
- f) Jet-engine aircraft have higher landing speeds, large jet intakes, and, in most cases, underslung engines. The increased landing speed of jets will increase deceleration forces of ditching, however, the strengthened fuselage may offset this. Some underslung engines will break away under water loads, or cause a diving moment.

D.4.8 **Pilot Skill and Technique.** The recommended procedures for ditching techniques published in the manufacturer's flight handbook should normally be followed. In the absence of these procedures or as general guidelines, the following techniques may be used.

- a) An understanding of the technical aspects of the deceleration forces is necessary in applying the recommended techniques. Kinetic energy must be fully expended before the aircraft can come to rest. This energy is determined by the formula:

$$E = MV^2$$

where:

E = energy

M = the mass of the aircraft

V = velocity

- b) To reduce the energy to be expended, and thereby reduce damage to the aircraft, it must be made as light as possible and landing speed must be as slow as possible consistent with good control. This factor emphasizes the need for a power approach, if power is available, since this will appreciably lower the touchdown speed.
- c) When ditching in rough water or into the face of a swell, much greater forces are to be expected. The length of runout will depend on whether the aircraft is swamped or thrown back into the air by contact with a swell. Landings parallel to a major swell system more nearly approximate those on calm water.
- d) Seaplanes and landplanes differ considerably in ditching characteristics. Seaplanes are conducive to fairly smooth deceleration, even in rough water. A landplane, due to its shape and probable impact damage, may be subjected to irregular deceleration. Vertical forces are also severe if the aircraft is stalled from too high an altitude or thrown back into the air with insufficient airspeed. In a landplane ditching, the pilot should set down on a proper heading in the right spot at the best combination of attitude and speed. Touchdown should be at the lowest speed and rate of descent which permit safe handling and optimum nose-up attitude

- on impact. Once first impact has been made, there is often little the pilot can do-- especially if the control surfaces are broken away. In a seaplane, the pilot is normally able to control the aircraft through the runout. Maximum deflection of controls will normally be required to maintain heading and attitude.
- e) Once preditching preparations are completed, the pilot should turn to the ditching heading and begin letdown. The pilot should observe the sea surface ahead. Shadows and whitecaps close together indicate that the seas are short and rough; touchdown in these areas should be avoided. Touchdown should be in an area (only about 500 feet is needed) where the shadows and whitecaps are not so numerous. These areas are usually caused by swell systems being in opposition to one another, which tends to cancel out the effect of each. The aircraft should be flown low over the water and slowed to approximately 10 knots above stall. At this point, additional power should be used to overcome the increased drag caused by the nose-up attitude. When a smooth stretch of water appears ahead, the pilot should cut power and touchdown at the best recommended speed or 5 to 10 knots above stall speed. Do not stall the aircraft prior to touch down. By cutting power when approaching a relatively smooth area, the pilot will prevent overshooting and will touch down with less chance of becoming airborne a second time.
  - f) Most experienced seaplane pilots prefer to make contact with the water in a semi-stalled attitude, cutting power as the tail makes contact. This technique eliminates the chance of misjudging altitude with a resultant heavy drop in a fully stalled condition. Care must be taken not to drop the aircraft from too high an altitude or to balloon due to excessive speed.
    - 1) Over glassy smooth water, or at night with insufficient light, it is easy to misjudge altitude by 50 feet or more. Under such conditions, enough power should be carried to maintain 9-degree to 12-degree nose-up attitude and 10 to 20 percent over stall speed until contact is made in the water.
    - 2) The proper use of power on the approach is of great importance. If power is available on one side only, a little power should be used to flatten the approach. However, the engine should not be used to such an extent that the aircraft cannot be turned against the good engines, right down to the stall with a margin of rudder movement available. When near the stall, sudden application of excessive unbalanced power may result in loss of directional control. If power is available on one side only, a slightly higher than normal glide approach speed should be used. This ensures good control, and some margin of speed after leveling off, without excessive use of power.
    - 3) The use of power in ditching is so important that the pilot should, if possible, ditch before fuel is exhausted. The use of power in a night or instrument ditching is far more essential than during daylight. If no power is available, a greater than normal approach speed should be used down to the flare-out to allow the glide to be broken early and more gradually.
  - g) When landing parallel to a swell system, there is little difference between landing on a crest or in the trough. The wings of the aircraft should be trimmed to the surface of the sea rather than the horizon. If forced to land into a swell, touchdown should be made just after passage of the crest. The forces acting on the aircraft after touchdown are of such magnitude that crosswind drift will be only a secondary consideration. If the aircraft is under good control, the "crab" may be kicked out with rudder just prior to touchdown. This is more important with high-wing aircraft, which are laterally unstable on the water in a crosswind, and may roll to the side in ditching.
  - h) Ditching a helicopter can be done with little or no ground speed which should decrease the resultant decelerative violence. However, without built-in flotation, the helicopter will sink so rapidly that timely evacuation becomes a major problem. This danger is compounded by the fact that evacuation cannot be started until rotating components have come to a stop, by which time the cabin spaces are filling or filled with water. The following generalizations are based on actual ditching experience in single rotor helicopters without built-in flotation:
    - 1) If possible, prior to water contact, jettison doors that open outward. Cabin doors that slide should be opened or windows removed. Care must be taken when jettisoning doors to preclude damage to the main or tail rotor blades.

- 2) A normal landing should be made at zero ground speed into the wind and minimum rate of sink. Excessive tail flare should be avoided; premature water contact of the tail rotor may result in loss of anti-torque control before the main fuselage settles in the water. In the event of ditching due to anticipated fuel starvation or for any reason where ditching is imminent but not immediate, much can be done to protect personnel and survival gear if planned ditching procedures are established and followed. In a planned ditching, the helicopter should be hover taxied approximately 50 yards downwind after the crew and equipment have been evacuated. A hovering auto-rotation should then be accomplished to attain minimum rotor speed upon contact with the water. Under any ditching conditions, water spray may reduce visibility.
- 3) Main rotor brake (when available) should be applied and the aircraft kept level while rotor RPM decays. As the fuselage settles in the water, pitch should be pulled until the aircraft tends to roll. At that time, cyclic should be applied in the same direction so water contact will stop the main rotor without violent reactions or flipping the aircraft in the opposite direction. If one side of the aircraft provides better exits the helicopter should be rolled in the opposite direction before effective rotor control is completely lost.
- 4) It is important that all occupants remain strapped in their seats until the cabin spaces have filled with water. This prevents being swept around inside the cabin with inrushing water. Each occupant must identify and hold onto a reference until the aircraft has submerged. This minimizes disorientation with respect to the nearest exit, regardless of aircraft attitude after submersion. Personal flotation devices should not be inflated until positively clear of the aircraft.

D.4.9 **Surface Craft Assistance.** If an aircraft has to ditch, or the crew bail out over water, the most advantageous place is near a surface craft. This is discussed further in IAMSAR Manual Volume 3, Section 2 and Section 4.

#### D.4.10 **Communications.**

- a) **Radio.** The different maritime and aeronautical radio bands make direct communications between vessel (especially merchant vessel) and aircraft difficult.
  - 1) Most civil aircraft flying over ocean areas are equipped with VHF radios (118-136 MHz) and HF/SSB radios (3-20 MHz). Military aircraft normally have UHF radios (225-399.9 MHz) and HF/SSB radios (3-30 MHz). Both military and civil aircraft maintain contact with ATC facilities on HF while over ocean areas. In emergencies, the pilot normally advises ATC of the situation and intentions. If not able to continue toward an airport, the pilot usually asks the ATC agency to advise of any ships in the area and ask them to establish a voice watch on 4125 kHz to assist in ditching and rescue.
  - 2) Merchant ships are ordinarily informed of aircraft distress situations by broadcast messages from coast radio stations on the international distress frequencies of 2182 kHz, or 156.8 MHz (VHF channel 16). Few aircraft can operate on these frequencies.
  - 3) Emergency communications are usually established with aircraft on 4125 kHz or 3023 kHz.
  - 4) Communication between an aircraft and a merchant vessel often may have to be relayed via a SAR aircraft, military vessel, or ground station.
- b) **Visual.** While there is no standard emergency signal to indicate ditching, an aircraft in distress can use any means to attract attention, make its position known and obtain help. Lowering landing gear and flashing landing lights on and off may be used to signal ditching intentions.

#### D.4.11 Assistance from Ships

##### Navy and Coast Guard Ships.

- a) Ditching assistance can be provided by U.S. Navy and Coast Guard ships. The extent of their capability will vary according to the type and size of the ship. Navy combat ships of destroyer size and above and WHECs may be able to provide the full range of assistance -- including aircraft radio frequencies. Other ships are more limited in assisting with the approach and ditching phase, but they have excellent capability to rescue survivors. Assistance that might be provided in a ditching situation includes:
  - b) Establishing and maintaining communications with the aircraft. Every effort will be made to establish immediate direct voice communication between the ship and distressed aircraft. When contact is made, a lost-contact procedure should be arranged with the ship for use in the event that contact is lost.
  - c) Locating the aircraft. The ship may locate the aircraft by:
    - 1) *Radar*. Identification of the distressed aircraft will probably be made by IFF interrogation. Standard procedure is for the distressed aircraft to put its transponder beacon on Code 7700. If this is not possible, the pilot may be able to make a 90 degree identification turn. The pilot should hold the new course for 3 minutes and then return to base course.
    - 2) *Radio direction finder*.
    - 3) *Homing signals*. If the ship can send homing signals on a frequency compatible with the aircraft's direction finder, the pilot may be able to provide a reciprocal bearing.
    - 4) *Shore-based assistance*. Authorities may be able to provide a position on the aircraft from DF nets or other available information.
    - 5) *Aircraft's navigational data*. The pilot may be able to give a position from navigational data.
    - 6) *Weather data*. Unusual weather conditions reported by the pilot may give clues about the aircraft's position.
  - d) Vectoring or assisting in homing the Aircraft to the ship. A ship may assist an aircraft by providing homing signal or steers based on radar or DF bearings from the ship. During daylight, a ship may make black smoke, cruise at high speeds to form a wake, or use other means to attract attention visually. At night, star shells, searchlights, pyrotechnics, deck lights, or water lights may be used.
  - e) Furnishing weather, sea information, and recommended ditching heading. Final determination of the ditching heading is the responsibility of the pilot, who should inform the ship of the selected ditching heading as soon as possible.
  - f) Marking the sea lane along the selected ditching heading. During daylight, with relatively calm sea conditions, a ship may mark the sea lane with fire extinguisher foam. At night, or during a low-visibility daytime ditching, a ship may lay a series of floating lights along the selected ditching heading.
  - g) Providing approach assistance. Approach may be made visually, by ADF using the homing signals from the ship, by radar assistance from the ship, or by a combination of these. The ship will normally be to one side of the sea lane.
    - 1) *Visual approach*. Under visual conditions, day or night, the aircraft should make a visual approach.
    - 2) *Instrument approach*. During low ceiling or poor visibility, a ship may provide continuous homing signals through the final approach stage. It may also operate air navigation aids to allow an instrument approach. The pilot should be aware of the height of the masts on the ship and must allow some

deviation on final approach in order not to collide with the ship. If the pilot desires, and radar contact is held by the ship, it may give radar ranges. Full radar-controlled approach should not be attempted unless the ship is qualified in such approaches.

- h) Providing illumination. Ships with flare or star shell capability can provide illumination at night for a visual approach. Illumination may be placed over the expected ditching location and over-shoot area, approximately 1200 yards past the end of the sea lane. The ship may also fire an orientation flare when the pilot begins the final approach.
- i) Rescuing and Caring for Survivors. Rescue may be by boats or the ship itself. Survivors in the water or aircraft should be rescued first and those in rafts last. If there are serious injuries, the SMC can make medical arrangements.

### Merchant Ships

- j) The nearest ship to a distressed aircraft will probably be a merchant ship. The traditions of the sea and the general agreement among nations as expressed in international conventions call for these ships to assist anyone in distress. Since merchant ships provide a source of rescue capability at sea, SAR authorities have developed methods, procedures, and guidance material for rescue by merchant ships in the IAMSAR Manual, Volume 3 issued by the International Maritime Organization and the International Civil Aviation Organization.
- k) Rendezvous procedure with merchant ship:
  - 1) *Alerting the ship.* Aircraft normally transmit a distress or urgency message on their air-ground frequency. This is relayed to the RCC via Air Traffic Control. For aircraft incidents over water, steps are taken to obtain the positions of ships near the projected aircraft trackline. The ships in best position to assist in a ditching are alerted by the RCC. When a ship is selected, the RCC passes instruction for aiding in rendezvous, approach, and rescue.
  - 2) Providing the ship with an estimated ditching location. Information on the projected track will enable the ship to alter course to reduce time to rendezvous.
  - 3) *Communicating.* Direct communications between aircraft and ship is normally possible only on HF frequency 4125 kHz or 3023 kHz. Where direct communication cannot be established, relay through a SAR aircraft or a ground station should be set up.
  - 4) *Homing.* This is the most positive method for rendezvous but relies upon compatible equipment between the ship and aircraft. The RCC may become involved in passing this information between the ship and the aircraft.
  - 5) *Visual aids by the ship.* At night the ship should turn on as many deck lights as possible and use searchlights directed upward or sweeping the horizon. During the daytime the ship may make black smoke. The sea level altimeter setting should be transmitted to the aircraft.
- l) A merchant ship can provide only a limited amount of assistance during ditching. The pilot can use information on weather and sea conditions to select a ditch heading, and should inform the ship of this as soon as possible. The ship will probably set course parallel to the ditching heading. If the pilot wants to use the ship for an ADF approach, the pilot should ask the ship for continuous transmissions. This is the only instrument approach practicable with merchant ships.
- m) Rescue and care of survivors is dictated by sea conditions, weather conditions and medical facilities aboard the ship that may range from a medicine chest to full hospital facilities. If sea conditions prohibit the use of lifeboats, the ship is maneuvered to the survivors. The survivor's board the ship by using ladders or cargo nets, or they are hoisted in slings by using the ship's cargo booms. If they need care beyond the ship's capabilities, the SMC should arrange a MEDEVAC as necessary.



---

## Appendix E

### Gridding

- E.1** The standard sectional aeronautical chart and the following grid identifications system is used by CAP when coordinating missions with the AFRCC and other agencies. CAP does not preclude the use of local procedures where they are deemed necessary or more practicable. Many missions are "local" in nature, and local procedures may be highly efficient and effective in the management of SAR resources within a defined geographical boundary.
- E.2 Standardized Sectional Aeronautical Chart Grid and Identification System**
- E.2.1 The Sectional Aeronautical Chart (scale: 1-500,000) is divided into 30 minute intervals. Consider both the north and south sides of a sectional chart as one unit. Identify the northern and southern most latitude limits, and the western and eastern most longitude limits from Table E-1. The rectangular area thus formed is the area to be gridded. Line off each 15-minutes of latitude and longitude within this area. Start with the first full 15-minute quadrangle in the northwest corner of the chart as number one (1) and number in sequence from west to east. Continue in this manner until reaching the southeast corner of the gridded area, which serves as the last full 15-minute quadrangle. The number of quadrangles in each respective chart is scheduled in column 7, Table E-1.
- E.2.2 The basic 15-minute quadrangle (grid) is further broken down into quarter sections. The northwest quarter is labeled "A"; the northeast "B"; the southwest "C"; and the southeast "D". This breakdown is used when concentrated search is required and as a means of identifying 7 minute quadrangles, they need not be annotated on the charts but should be understood to exist and used in mission assignment and reporting.
- E.2.3 Where charts overlap (the same grid is located on two or more charts) the grids on all charts will be assigned the number and identifier of the primary chart (the most westerly chart will be designated as the primary chart). Consider the Kansas City and St. Louis charts as an example. The Kansas City chart will be numbered in accordance with paragraph E.2.1. above; that portion of the St. Louis that is overlapped by the Kansas City chart will be labeled with the number identical to the same grid on the Kansas City chart preceded by the letters "MKC" to identify the origin of the grid numbers. (See Table E-1) The normal sequential numbers on the overlap area that are displaced by the primary chart will simply be omitted for use.
- a) The Los Angeles chart has a 15-minute latitude overlap on the Las Vegas chart within the area defined by 36-00N to 35-45N, and 118-00W. (Total of 12 grids)
  - b) The Los Angeles chart has one (1) degree longitude overlap on the Phoenix chart within the area defined by 35-45N to 32-00N, and 116-00W to 115-00W. (Total of 60 grids)
  - c) The Denver chart has a 15-minute latitude overlap on the Albuquerque chart within the area defined by 36-00N to 35-45N, and 109-00W to 104-00W. (Total of 12 grids)
  - d) The Kansas City chart has one (1) degree longitude overlap on the St. Louis chart within the area defined by 40-00N to 36-00N, and 91-00W. (Total of 64 grids)
  - e) The St. Louis chart has one (1) degree longitude overlap on the Cincinnati chart within the area defined by 40-00N to 36-00N, and 85-00W to 84-00W. (Total of 64 grids)
  - f) The Cincinnati chart has one (1) degree longitude overlap on the Washington chart within the area defined by 40-00N to 36-00N, and 79-00W to 78-00W. (Total of 64 grids)
- E.2.4 Chart identifiers are listed in Table E-1.
- E.2.5 On charts with inserts over oceanic areas, number consecutively through the insert just as would be

accomplished were the insert not published.

**E.3** Grids and numbering for the Sectional Aeronautical Charts listed in Table E-1 are depicted in Figures E-1 through E-37.

**Table E-1. Sectional Aeronautical Chart Grids**

<i>Chart</i>	<i>Identifier</i>	<i>North Grid Limit</i>	<i>South Grid Limit</i>	<i>West Grid Limit</i>	<i>East Grid Limit</i>	<i>Total Grids</i>
Seattle	SEA	49-00N	44-30N	125-00W	117-00W	576
Great Falls	GTF	49-00N	44-30N	117-00W	109-00W	576
Billings	BIL	49-00N	44-30N	109-00W	101-00W	576
Twin Cities	MSP	49-00N	44-30N	101-00W	93-00W	576
Green Bay	GRB	48-15N	44-00N	93-00W	85-00W	544
Lake Huron	LHN	48-00N	44-00N	85-00W	77-00W	512
Montreal	MON	48-00N	44-00N	77-00W	69-00W	512
Halifax	HFX	48-00N	44-00N	69-00W	61-00W	512
Klamath Falls	LMT	44-30N	40-00N	125-00W	117-00W	576
Salt Lake City	SLC	44-30N	40-00N	117-00W	109-00W	576
Cheyenne	CYS	44-30N	40-00N	109-00W	101-00W	576
Omaha	OMA	44-30N	40-00N	101-00W	93-00W	576
Chicago	ORD	44-00N	40-00N	93-00W	85-00W	512
Detroit	DET	44-00N	40-00N	85-00W	77-00W	512
New York	NYC	44-00N	40-00N	77-00W	69-00W	512
San Francisco	SFO	40-00N	36-00N	125-00W	118-00W	448
Las Vegas	LAS	40-00N	35-45N	118-00W	111-00W	476
Denver	DEN	40-00N	35-45N	111-00W	104-00W	476
Wichita	ICT	40-00N	36-00N	104-00W	97-00W	448
Kansas City	MKC	40-00N	36-00N	97-00W	90-00W	448
St. Louis	STL	40-00N	36-00N	91-00W	84-00W	448
Cincinnati	LUK	40-00N	36-00N	85-00W	78-00W	448
Washington	DCA	40-00N	36-00N	79-00W	72-00W	448
Los Angeles	LAX	36-00N	32-00N	121-30W	115-00W	416
Phoenix	PHX	35-45N	31-15N	116-00W	109-00W	504
Albuquerque	ABQ	36-00N	32-00N	109-00W	102-00W	448
Dallas - Ft. Worth	GSW	36-00N	32-00N	102-00W	95-00W	448
Memphis	MEM	36-00N	32-00N	95-00W	88-00W	448
Atlanta	ATL	36-00N	32-00N	88-00W	81-00W	448
Charlotte	CLT	36-00N	32-00N	81-00W	75-00W	384
El Paso	ELP	32-00N	28-00N	109-00W	103-00W	384
San Antonio	SAT	32-00N	28-00N	103-00W	97-00W	384
Houston	HOU	32-00N	28-00N	97-00W	91-00W	384
New Orleans	MSY	32-00N	28-00N	91-00W	85-00W	384
Jacksonville	JAX	32-00N	28-00N	85-00W	79-00W	384
Brownsville	BRO	28-00N	24-00N	103-00W	97-00W	384
Miami	MIA	28-00N	24-00N	83-00W	77-00W	384

36N	109W		DENVER				108W				107W				106W				105W				104W				103W				102W				36N
	457	458	459	460	461	462	463	464	465	466	467	468	469	470	471	472	473	474	475	476	21	22	23	24	25	26	27	28							
	29	30	31	32	33	34	35	36	37	38	39	40	41	42	43	44	45	46	47	48	49	50	51	52	53	54	55	56							
	57	58	59	60	61	62	63	64	65	66	67	68	69	70	71	72	73	74	75	76	77	78	79	80	81	82	83	84							
35N	85	86	87	88	89	90	91	92	93	94	95	96	97	98	99	100	101	102	103	104	105	106	107	108	109	110	111	112	35N						
	113	114	115	116	117	118	119	120	121	122	123	124	125	126	127	128	129	130	131	132	133	134	135	136	137	138	139	140							
	141	142	143	144	145	146	147	148	149	150	151	152	153	154	155	156	157	158	159	160	161	162	163	164	165	166	167	168							
	169	170	171	172	173	174	175	176	177	178	179	180	181	182	183	184	185	186	187	188	189	190	191	192	193	194	195	196							
34N	197	198	199	200	201	202	203	204	205	206	207	208	209	210	211	212	213	214	215	216	217	218	219	220	221	222	223	224	34N						
	225	226	227	228	229	230	231	232	233	234	235	236	237	238	239	240	241	242	243	244	245	246	247	248	249	250	251	252							
	253	254	255	256	257	258	259	260	261	262	263	264	265	266	267	268	269	270	271	272	273	274	275	276	277	278	279	280							
	281	282	283	284	285	286	287	288	289	290	291	292	293	294	295	296	297	298	299	300	301	302	303	304	305	306	307	308							
33N	309	310	311	312	313	314	315	316	317	318	319	320	321	322	323	324	325	326	327	328	329	330	331	332	333	334	335	336	33N						
	337	338	339	340	341	342	343	344	345	346	347	348	349	350	351	352	353	354	355	356	357	358	359	360	361	362	363	364							
	365	366	367	368	369	370	371	372	373	374	375	376	377	378	379	380	381	382	383	384	385	386	387	388	389	390	391	392							
	393	394	395	396	397	398	399	400	401	402	403	404	405	406	407	408	409	410	411	412	413	414	415	416	417	418	419	420							
32N	421	422	423	424	425	426	427	428	429	430	431	432	433	434	435	436	437	438	439	440	441	442	443	444	445	446	447	448	32N						
	109W				108W				107W				106W				105W				104W				103W				102W						

Figure E-1. Albuquerque Chart Grid

36N	088W				087W				086W				085W				084W				083W				082W				081W				36N
	1	2	3	4	5	6	7	8	9	10	11	12	13	14	15	16	17	18	19	20	21	22	23	24	25	26	27	28					
	29	30	31	32	33	34	35	36	37	38	39	40	41	42	43	44	45	46	47	48	49	50	51	52	53	54	55	56					
	57	58	59	60	61	62	63	64	65	66	67	68	69	70	71	72	73	74	75	76	77	78	79	80	81	82	83	84					
35N	85	86	87	88	89	90	91	92	93	94	95	96	97	98	99	100	101	102	103	104	105	106	107	108	109	110	111	112	35N				
	113	114	115	116	117	118	119	120	121	122	123	124	125	126	127	128	129	130	131	132	133	134	135	136	137	138	139	140					
	141	142	143	144	145	146	147	148	149	150	151	152	153	154	155	156	157	158	159	160	161	162	163	164	165	166	167	168					
	169	170	171	172	173	174	175	176	177	178	179	180	181	182	183	184	185	186	187	188	189	190	191	192	193	194	195	196					
34N	197	198	199	200	201	202	203	204	205	206	207	208	209	210	211	212	213	214	215	216	217	218	219	220	221	222	223	224	34N				
	225	226	227	228	229	230	231	232	233	234	235	236	237	238	239	240	241	242	243	244	245	246	247	248	249	250	251	252					
	253	254	255	256	257	258	259	260	261	262	263	264	265	266	267	268	269	270	271	272	273	274	275	276	277	278	279	280					
	281	282	283	284	285	286	287	288	289	290	291	292	293	294	295	296	297	298	299	300	301	302	303	304	305	306	307	308					
33N	309	310	311	312	313	314	315	316	317	318	319	320	321	322	323	324	325	326	327	328	329	330	331	332	333	334	335	336	33N				
	337	338	339	340	341	342	343	344	345	346	347	348	349	350	351	352	353	354	355	356	357	358	359	360	361	362	363	364					
	365	366	367	368	369	370	371	372	373	374	375	376	377	378	379	380	381	382	383	384	385	386	387	388	389	390	391	392					
	393	394	395	396	397	398	399	400	401	402	403	404	405	406	407	408	409	410	411	412	413	414	415	416	417	418	419	420					
32N	421	422	423	424	425	426	427	428	429	430	431	432	433	434	435	436	437	438	439	440	441	442	443	444	445	446	447	448	32N				
	088W				087W				086W				085W				084W				083W				082W				081W				

Figure E-2. Atlanta Chart Grid

Appendix E - Gridding

49 N	109W				108W				107W				106W				105W				104W				103W				102W				101W				49 N
	1	2	3	4	5	6	7	8	9	10	11	12	13	14	15	16	17	18	19	20	21	22	23	24	25	26	27	28	29	30	31	32					
	33	31	35	36	37	38	39	40	41	42	43	44	45	46	47	48	49	50	51	52	53	54	55	56	57	58	59	60	61	62	63	64					
48 N	65	66	67	68	69	70	71	72	73	74	75	76	77	78	79	80	81	82	83	84	85	86	87	88	89	90	91	92	93	94	95	96	48 N				
	97	98	99	100	101	102	103	104	105	106	107	108	109	110	111	112	113	114	115	116	117	118	119	120	121	122	123	124	125	126	127	128					
	129	130	131	132	133	134	135	136	137	138	139	140	141	142	143	144	145	146	147	148	149	150	151	152	153	154	155	156	157	158	159	160					
	161	162	163	164	165	166	167	168	169	170	171	172	173	174	175	176	177	178	179	180	181	182	183	184	185	186	187	188	189	190	191	192					
47 N	193	194	195	196	197	198	199	200	201	202	203	204	205	206	207	208	209	210	211	212	213	214	215	216	217	218	219	220	221	222	223	224	47 N				
	225	226	227	228	229	230	231	232	233	234	235	236	237	238	239	240	241	242	243	244	245	246	247	248	249	250	251	252	253	254	255	256					
	257	258	259	260	261	262	263	264	265	266	267	268	269	270	271	272	273	274	275	276	277	278	279	280	281	282	283	284	285	286	287	288					
	289	290	291	292	293	294	295	296	297	298	299	300	301	302	303	304	305	306	307	308	309	310	311	312	313	314	315	316	317	318	319	320					
46 N	321	322	323	324	325	326	327	328	329	330	331	332	333	334	335	336	337	338	339	340	341	342	343	344	345	346	347	348	349	350	351	352	46 N				
	353	354	355	356	357	358	359	360	361	362	363	364	365	366	367	368	369	370	371	372	373	374	375	376	377	378	379	380	381	382	383	384					
	385	386	387	388	389	390	391	392	393	394	395	396	397	398	399	400	401	402	403	404	405	406	407	408	409	410	411	412	413	414	415	416					
	417	418	419	420	421	422	423	424	425	426	427	428	429	430	431	432	433	434	435	436	437	438	439	440	441	442	443	444	445	446	447	448					
45 N	449	450	451	452	453	454	455	456	457	458	459	460	461	462	463	464	465	466	467	468	469	470	471	472	473	474	475	476	477	478	479	480	45 N				
	481	482	483	484	485	486	487	488	489	490	491	492	493	494	495	496	497	498	499	500	501	502	503	504	505	506	507	508	509	510	511	512					
	513	514	515	516	517	518	519	520	521	522	523	524	525	526	527	528	529	530	531	532	533	534	535	536	537	538	539	540	541	542	543	544					
	545	546	547	548	549	550	551	552	553	554	555	556	557	558	559	560	561	562	563	564	565	566	567	568	569	570	571	572	573	574	575	576					
	109W				108W				107W				106W				105W				104W				103W				102W				101W				

Figure E-3. Billings Chart Grid

28N	103W				102W				101W				100W				099W				098W				097W				28N
	1	2	3	4	5	6	7	8	9	10	11	12	13	14	15	16	17	18	19	20	21	22	23	24					
	25	26	27	28	29	30	31	32	33	34	35	36	37	38	39	40	41	42	43	44	45	46	47	48					
	49	50	51	52	53	54	55	56	57	58	59	60	61	62	63	64	65	66	67	68	69	70	71	72					
27N	73	74	75	76	77	78	79	80	81	82	83	84	85	86	87	88	89	90	91	92	93	94	95	96	27N				
	97	98	99	100	101	102	103	104	105	106	107	108	109	110	111	112	113	114	115	116	117	118	119	120					
	121	122	123	124	125	126	127	128	129	130	131	132	133	134	135	136	137	138	139	140	141	142	143	144					
	145	146	147	148	149	150	151	152	153	154	155	156	157	158	159	160	161	162	163	164	165	166	167	168					
26N	169	170	171	172	173	174	175	176	177	178	179	180	181	182	183	184	185	186	187	188	189	190	191	192	26N				
	193	194	195	196	197	198	199	200	201	202	203	204	205	206	207	208	209	210	211	212	213	214	215	216					
	217	218	219	220	221	222	223	224	225	226	227	228	229	230	231	232	233	234	235	236	237	238	239	240					
	241	242	243	244	245	246	247	248	249	250	251	252	253	254	255	256	257	258	259	260	261	262	263	264					
25N	265	266	267	268	269	270	271	272	273	274	275	276	277	278	279	280	281	282	283	284	285	286	287	288	25N				
	289	290	291	292	293	294	295	296	297	298	299	300	301	302	303	304	305	306	307	308	309	310	311	312					
	313	314	315	316	317	318	319	320	321	322	323	324	325	326	327	328	329	330	331	332	333	334	335	336					
	337	338	339	340	341	342	343	344	345	346	347	348	349	350	351	352	353	354	355	356	357	358	359	360					
24N	361	362	363	364	365	366	367	368	369	370	371	372	373	374	375	376	377	378	379	380	381	382	383	384	24N				
	103W				102W				101W				100W				099W				098W				097W				

Figure E-4. Brownsville Chart Grid

082W to 081W included on ATLANTA Chart Grid

36N	081W				080W				079W				078W				077W				076W				075W				36N																				
	1	2	3	4	5	6	7	8	9	10	11	12	13	14	15	16	17	18	19	20	21	22	23	24	25	26	27	28	29	30	31	32	33	34	35	36	37	38	39	40	41	42	43	44	45	46	47	48	
	49	50	51	52	53	54	55	56	57	58	59	60	61	62	63	64	65	66	67	68	69	70	71	72	73	74	75	76	77	78	79	80	81	82	83	84	85	86	87	88	89	90	91	92	93	94	95	96	35N
	97	98	99	100	101	102	103	104	105	106	107	108	109	110	111	112	113	114	115	116	117	118	119	120	121	122	123	124	125	126	127	128	129	130	131	132	133	134	135	136	137	138	139	140	141	142	143	144	
	145	146	147	148	149	150	151	152	153	154	155	156	157	158	159	160	161	162	163	164	165	166	167	168	169	170	171	172	173	174	175	176	177	178	179	180	181	182	183	184	185	186	187	188	189	190	191	192	34N
	193	194	195	196	197	198	199	200	201	202	203	204	205	206	207	208	209	210	211	212	213	214	215	216	217	218	219	220	221	222	223	224	225	226	227	228	229	230	231	232	233	234	235	236	237	238	239	240	
	241	242	243	244	245	246	247	248	249	250	251	252	253	254	255	256	257	258	259	260	261	262	263	264	265	266	267	268	269	270	271	272	273	274	275	276	277	278	279	280	281	282	283	284	285	286	287	288	33N
	289	290	291	292	293	294	295	296	297	298	299	300	301	302	303	304	305	306	307	308	309	310	311	312	313	314	315	316	317	318	319	320	321	322	323	324	325	326	327	328	329	330	331	332	333	334	335	336	
	337	338	339	340	341	342	343	344	345	346	347	348	349	350	351	352	353	354	355	356	357	358	359	360	361	362	363	364	365	366	367	368	369	370	371	372	373	374	375	376	377	378	379	380	381	382	383	384	32N
	081W				080W				079W				078W				077W				076W				075W																								

Figure E-5. Charlotte Chart Grid

	109W				108W				107W				106W				105W				104W				103W				102W				101W																																
44 N	1	2	3	4	5	6	7	8	9	10	11	12	13	14	15	16	17	18	19	20	21	22	23	24	25	26	27	28	29	30	31	32	33	34	35	36	37	38	39	40	41	42	43	44	45	46	47	48	49	50	51	52	53	54	55	56	57	58	59	60	61	62	63	64	44 N
	65	66	67	68	69	70	71	72	73	74	75	76	77	78	79	80	81	82	83	84	85	86	87	88	89	90	91	92	93	94	95	96	97	98	99	100	101	102	103	104	105	106	107	108	109	110	111	112	113	114	115	116	117	118	119	120	121	122	123	124	125	126	127	128	
43 N	129	130	131	132	133	134	135	136	137	138	139	140	141	142	143	144	145	146	147	148	149	150	151	152	153	154	155	156	157	158	159	160	161	162	163	164	165	166	167	168	169	170	171	172	173	174	175	176	177	178	179	180	181	182	183	184	185	186	187	188	189	190	191	192	43 N
	193	194	195	196	197	198	199	200	201	202	203	204	205	206	207	208	209	210	211	212	213	214	215	216	217	218	219	220	221	222	223	224	225	226	227	228	229	230	231	232	233	234	235	236	237	238	239	240	241	242	243	244	245	246	247	248	249	250	251	252	253	254	255	256	
42 N	257	258	259	260	261	262	263	264	265	266	267	268	269	270	271	272	273	274	275	276	277	278	279	280	281	282	283	284	285	286	287	288	289	290	291	292	293	294	295	296	297	298	299	300	301	302	303	304	305	306	307	308	309	310	311	312	313	314	315	316	317	318	319	320	42 N
	321	322	323	324	325	326	327	328	329	330	331	332	333	334	335	336	337	338	339	340	341	342	343	344	345	346	347	348	349	350	351	352	353	354	355	356	357	358	359	360	361	362	363	364	365	366	367	368	369	370	371	372	373	374	375	376	377	378	379	380	381	382	383	384	
41 N	385	386	387	388	389	390	391	392	393	394	395	396	397	398	399	400	401	402	403	404	405	406	407	408	409	410	411	412	413	414	415	416	417	418	419	420	421	422	423	424	425	426	427	428	429	430	431	432	433	434	435	436	437	438	439	440	441	442	443	444	445	446	447	448	41 N
	449	450	451	452	453	454	455	456	457	458	459	460	461	462	463	464	465	466	467	468	469	470	471	472	473	474	475	476	477	478	479	480	481	482	483	484	485	486	487	488	489	490	491	492	493	494	495	496	497	498	499	500	501	502	503	504	505	506	507	508	509	510	511	512	
40 N	513	514	515	516	517	518	519	520	521	522	523	524	525	526	527	528	529	530	531	532	533	534	535	536	537	538	539	540	541	542	543	544	545	546	547	548	549	550	551	552	553	554	555	556	557	558	559	560	561	562	563	564	565	566	567	568	569	570	571	572	573	574	575	576	40 N
	109W				108W				107W				106W				105W				104W				103W				102W				101W																																

Figure E-6. Cheyenne Chart Grid

Appendix E - Gridding

44 N	093W				092W				091W				090W				089W				088W				087W				086W				085W				44 N
	1	2	3	4	5	6	7	8	9	10	11	12	13	14	15	16	17	18	19	20	21	22	23	24	25	26	27	28	29	30	31	32					
	33	31	35	36	37	38	39	40	41	42	43	44	45	46	47	48	49	50	51	52	53	54	55	56	57	58	59	60	61	62	63	64					
43 N	65	66	67	68	69	70	71	72	73	74	75	76	77	78	79	80	81	82	83	84	85	86	87	88	89	90	91	92	93	94	95	96	43 N				
	97	98	99	100	101	102	103	104	105	106	107	108	109	110	111	112	113	114	115	116	117	118	119	120	121	122	123	124	125	126	127	128					
	129	130	131	132	133	134	135	136	137	138	139	140	141	142	143	144	145	146	147	148	149	150	151	152	153	154	155	156	157	158	159	160					
	161	162	163	164	165	166	167	168	169	170	171	172	173	174	175	176	177	178	179	180	181	182	183	184	185	186	187	188	189	190	191	192					
42 N	193	194	195	196	197	198	199	200	201	202	203	204	205	206	207	208	209	210	211	212	213	214	215	216	217	218	219	220	221	222	223	224	42 N				
	225	226	227	228	229	230	231	232	233	234	235	236	237	238	239	240	241	242	243	244	245	246	247	248	249	250	251	252	253	254	255	256					
	257	258	259	260	261	262	263	264	265	266	267	268	269	270	271	272	273	274	275	276	277	278	279	280	281	282	283	284	285	286	287	288					
	289	290	291	292	293	294	295	296	297	298	299	300	301	302	303	304	305	306	307	308	309	310	311	312	313	314	315	316	317	318	319	320					
41 N	321	322	323	324	325	326	327	328	329	330	331	332	333	334	335	336	337	338	339	340	341	342	343	344	345	346	347	348	349	350	351	352	41 N				
	353	354	355	356	357	358	359	360	361	362	363	364	365	366	367	368	369	370	371	372	373	374	375	376	377	378	379	380	381	382	383	384					
	385	386	387	388	389	390	391	392	393	394	395	396	397	398	399	400	401	402	403	404	405	406	407	408	409	410	411	412	413	414	415	416					
	417	418	419	420	421	422	423	424	425	426	427	428	429	430	431	432	433	434	435	436	437	438	439	440	441	442	443	444	445	446	447	448					
40 N	449	450	451	452	453	454	455	456	457	458	459	460	461	462	463	464	465	466	467	468	469	470	471	472	473	474	475	476	477	478	479	480	40 N				
	481	482	483	484	485	486	487	488	489	490	491	492	493	494	495	496	497	498	499	500	501	502	503	504	505	506	507	508	509	510	511	512					
	093W				092W				091W				090W				089W				088W				087W				086W				085W				

Figure E-7. Chicago Chart Grid

40N	085W				084W				083W				082W				081W				080W				079W				078W				40N
	1	2	3	4	5	6	7	8	9	10	11	12	13	14	15	16	17	18	19	20	21	22	23	24	25	26	27	28					
	29	30	31	32	33	34	35	36	37	38	39	40	41	42	43	44	45	46	47	48	49	50	51	52	53	54	55	56					
	57	58	59	60	61	62	63	64	65	66	67	68	69	70	71	72	73	74	75	76	77	78	79	80	81	82	83	84					
39N	85	86	87	88	89	90	91	92	93	94	95	96	97	98	99	100	101	102	103	104	105	106	107	108	109	110	111	112	39N				
	113	114	115	116	117	118	119	120	121	122	123	124	125	126	127	128	129	130	131	132	133	134	135	136	137	138	139	140					
	141	142	143	144	145	146	147	148	149	150	151	152	153	154	155	156	157	158	159	160	161	162	163	164	165	166	167	168					
	169	170	171	172	173	174	175	176	177	178	179	180	181	182	183	184	185	186	187	188	189	190	191	192	193	194	195	196					
38N	197	198	199	200	201	202	203	204	205	206	207	208	209	210	211	212	213	214	215	216	217	218	219	220	221	222	223	224	38N				
	225	226	227	228	229	230	231	232	233	234	235	236	237	238	239	240	241	242	243	244	245	246	247	248	249	250	251	252					
	253	254	255	256	257	258	259	260	261	262	263	264	265	266	267	268	269	270	271	272	273	274	275	276	277	278	279	280					
	281	282	283	284	285	286	287	288	289	290	291	292	293	294	295	296	297	298	299	300	301	302	303	304	305	306	307	308					
37N	309	310	311	312	313	314	315	316	317	318	319	320	321	322	323	324	325	326	327	328	329	330	331	332	333	334	335	336	37N				
	337	338	339	340	341	342	343	344	345	346	347	348	349	350	351	352	353	354	355	356	357	358	359	360	361	362	363	364					
	365	366	367	368	369	370	371	372	373	374	375	376	377	378	379	380	381	382	383	384	385	386	387	388	389	390	391	392					
	393	394	395	396	397	398	399	400	401	402	403	404	405	406	407	408	409	410	411	412	413	414	415	416	417	418	419	420					
36N	421	422	423	424	425	426	427	428	429	430	431	432	433	434	435	436	437	438	439	440	441	442	443	444	445	446	447	448	36N				
	085W				084W				083W				082W				081W				080W				079W				078W				

Figure E-8. Cincinnati Chart Grid

36N	102W				101W				100W				099W				098W				097W				096W		095W		36N
	1	2	3	4	5	6	7	8	9	10	11	12	13	14	15	16	17	18	19	20	21	22	23	24	25	26	27	28	
	29	30	31	32	33	34	35	36	37	38	39	40	41	42	43	44	45	46	47	48	49	50	51	52	53	54	55	56	
	57	58	59	60	61	62	63	64	65	66	67	68	69	70	71	72	73	74	75	76	77	78	79	80	81	82	83	84	
35N	85	86	87	88	89	90	91	92	93	94	95	96	97	98	99	100	101	102	103	104	105	106	107	108	109	110	111	112	35N
	113	114	115	116	117	118	119	120	121	122	123	124	125	126	127	128	129	130	131	132	133	134	135	136	137	138	139	140	
	141	142	143	144	145	146	147	148	149	150	151	152	153	154	155	156	157	158	159	160	161	162	163	164	165	166	167	168	
	169	170	171	172	173	174	175	176	177	178	179	180	181	182	183	184	185	186	187	188	189	190	191	192	193	194	195	196	
34N	197	198	199	200	201	202	203	204	205	206	207	208	209	210	211	212	213	214	215	216	217	218	219	220	221	222	223	224	34N
	225	226	227	228	229	230	231	232	233	234	235	236	237	238	239	240	241	242	243	244	245	246	247	248	249	250	251	252	
	253	254	255	256	257	258	259	260	261	262	263	264	265	266	267	268	269	270	271	272	273	274	275	276	277	278	279	280	
	281	282	283	284	285	286	287	288	289	290	291	292	293	294	295	296	297	298	299	300	301	302	303	304	305	306	307	308	
33N	309	310	311	312	313	314	315	316	317	318	319	320	321	322	323	324	325	326	327	328	329	330	331	332	333	334	335	336	33N
	337	338	339	340	341	342	343	344	345	346	347	348	349	350	351	352	353	354	355	356	357	358	359	360	361	362	363	364	
	365	366	367	368	369	370	371	372	373	374	375	376	377	378	379	380	381	382	383	384	385	386	387	388	389	390	391	392	
	393	394	395	396	397	398	399	400	401	402	403	404	405	406	407	408	409	410	411	412	413	414	415	416	417	418	419	420	
32N	421	422	423	424	425	426	427	428	429	430	431	432	433	434	435	436	437	438	439	440	441	442	443	444	445	446	447	448	32N
	102W				101W				100W				099W				098W				097W				096W		095W		

Figure E-9. Dallas - Fort Worth Chart Grid

40N	085W				084W				083W				082W				081W				080W				079W		078W		40N
	1	2	3	4	5	6	7	8	9	10	11	12	13	14	15	16	17	18	19	20	21	22	23	24	25	26	27	28	
	29	30	31	32	33	34	35	36	37	38	39	40	41	42	43	44	45	46	47	48	49	50	51	52	53	54	55	56	
	57	58	59	60	61	62	63	64	65	66	67	68	69	70	71	72	73	74	75	76	77	78	79	80	81	82	83	84	
39N	85	86	87	88	89	90	91	92	93	94	95	96	97	98	99	100	101	102	103	104	105	106	107	108	109	110	111	112	39N
	113	114	115	116	117	118	119	120	121	122	123	124	125	126	127	128	129	130	131	132	133	134	135	136	137	138	139	140	
	141	142	143	144	145	146	147	148	149	150	151	152	153	154	155	156	157	158	159	160	161	162	163	164	165	166	167	168	
	169	170	171	172	173	174	175	176	177	178	179	180	181	182	183	184	185	186	187	188	189	190	191	192	193	194	195	196	
38N	197	198	199	200	201	202	203	204	205	206	207	208	209	210	211	212	213	214	215	216	217	218	219	220	221	222	223	224	38N
	225	226	227	228	229	230	231	232	233	234	235	236	237	238	239	240	241	242	243	244	245	246	247	248	249	250	251	252	
	253	254	255	256	257	258	259	260	261	262	263	264	265	266	267	268	269	270	271	272	273	274	275	276	277	278	279	280	
	281	282	283	284	285	286	287	288	289	290	291	292	293	294	295	296	297	298	299	300	301	302	303	304	305	306	307	308	
37N	309	310	311	312	313	314	315	316	317	318	319	320	321	322	323	324	325	326	327	328	329	330	331	332	333	334	335	336	37N
	337	338	339	340	341	342	343	344	345	346	347	348	349	350	351	352	353	354	355	356	357	358	359	360	361	362	363	364	
	365	366	367	368	369	370	371	372	373	374	375	376	377	378	379	380	381	382	383	384	385	386	387	388	389	390	391	392	
	393	394	395	396	397	398	399	400	401	402	403	404	405	406	407	408	409	410	411	412	413	414	415	416	417	418	419	420	
36N	421	422	423	424	425	426	427	428	429	430	431	432	433	434	435	436	437	438	439	440	441	442	443	444	445	446	447	448	36N
	449	450	451	452	453	454	455	456	457	458	459	460	461	462	463	464	465	466	467	468	469	470	471	472	473	474	475	476	
	085W				084W				083W				082W				081W				080W				079W		078W		

Figure E-10. Denver Chart Grid

Appendix E - Gridding

44 N	085W				084W				083W				082W				081W				080W				079W				078W				077W				44 N
	1	2	3	4	5	6	7	8	9	10	11	12	13	14	15	16	17	18	19	20	21	22	23	24	25	26	27	28	29	30	31	32					
	33	31	35	36	37	38	39	40	41	42	43	44	45	46	47	48	49	50	51	52	53	54	55	56	57	58	59	60	61	62	63	64					
43 N	65	66	67	68	69	70	71	72	73	74	75	76	77	78	79	80	81	82	83	84	85	86	87	88	89	90	91	92	93	94	95	96	43 N				
	97	98	99	100	101	102	103	104	105	106	107	108	109	110	111	112	113	114	115	116	117	118	119	120	121	122	123	124	125	126	127	128					
	129	130	131	132	133	134	135	136	137	138	139	140	141	142	143	144	145	146	147	148	149	150	151	152	153	154	155	156	157	158	159	160					
	161	162	163	164	165	166	167	168	169	170	171	172	173	174	175	176	177	178	179	180	181	182	183	184	185	186	187	188	189	190	191	192					
42 N	193	194	195	196	197	198	199	200	201	202	203	204	205	206	207	208	209	210	211	212	213	214	215	216	217	218	219	220	221	222	223	224	42 N				
	225	226	227	228	229	230	231	232	233	234	235	236	237	238	239	240	241	242	243	244	245	246	247	248	249	250	251	252	253	254	255	256					
	257	258	259	260	261	262	263	264	265	266	267	268	269	270	271	272	273	274	275	276	277	278	279	280	281	282	283	284	285	286	287	288					
	289	290	291	292	293	294	295	296	297	298	299	300	301	302	303	304	305	306	307	308	309	310	311	312	313	314	315	316	317	318	319	320					
41 N	321	322	323	324	325	326	327	328	329	330	331	332	333	334	335	336	337	338	339	340	341	342	343	344	345	346	347	348	349	350	351	352	41 N				
	353	354	355	356	357	358	359	360	361	362	363	364	365	366	367	368	369	370	371	372	373	374	375	376	377	378	379	380	381	382	383	384					
	385	386	387	388	389	390	391	392	393	394	395	396	397	398	399	400	401	402	403	404	405	406	407	408	409	410	411	412	413	414	415	416					
	417	418	419	420	421	422	423	424	425	426	427	428	429	430	431	432	433	434	435	436	437	438	439	440	441	442	443	444	445	446	447	448					
40 N	449	450	451	452	453	454	455	456	457	458	459	460	461	462	463	464	465	466	467	468	469	470	471	472	473	474	475	476	477	478	479	480	40 N				
	481	482	483	484	485	486	487	488	489	490	491	492	493	494	495	496	497	498	499	500	501	502	503	504	505	506	507	508	509	510	511	512					
	085W				084W				083W				082W				081W				080W				079W				078W				077W				

Figure E-11. Detroit Chart Grid

32N	109W				108W				107W				106W				105W				104W				103W				32N
	1	2	3	4	5	6	7	8	9	10	11	12	13	14	15	16	17	18	19	20	21	22	23	24					
	25	26	27	28	29	30	31	32	33	34	35	36	37	38	39	40	41	42	43	44	45	46	47	48					
	49	50	51	52	53	54	55	56	57	58	59	60	61	62	63	64	65	66	67	68	69	70	71	72					
31N	73	74	75	76	77	78	79	80	81	82	83	84	85	86	87	88	89	90	91	92	93	94	95	96	31N				
	97	98	99	100	101	102	103	104	105	106	107	108	109	110	111	112	113	114	115	116	117	118	119	120					
	121	122	123	124	125	126	127	128	129	130	131	132	133	134	135	136	137	138	139	140	141	142	143	144					
	145	146	147	148	149	150	151	152	153	154	155	156	157	158	159	160	161	162	163	164	165	166	167	168					
30N	169	170	171	172	173	174	175	176	177	178	179	180	181	182	183	184	185	186	187	188	189	190	191	192	30N				
	193	194	195	196	197	198	199	200	201	202	203	204	205	206	207	208	209	210	211	212	213	214	215	216					
	217	218	219	220	221	222	223	224	225	226	227	228	229	230	231	232	233	234	235	236	237	238	239	240					
	241	242	243	244	245	246	247	248	249	250	251	252	253	254	255	256	257	258	259	260	261	262	263	264					
29N	265	266	267	268	269	270	271	272	273	274	275	276	277	278	279	280	281	282	283	284	285	286	287	288	29N				
	289	290	291	292	293	294	295	296	297	298	299	300	301	302	303	304	305	306	307	308	309	310	311	312					
	313	314	315	316	317	318	319	320	321	322	323	324	325	326	327	328	329	330	331	332	333	334	335	336					
	337	338	339	340	341	342	343	344	345	346	347	348	349	350	351	352	353	354	355	356	357	358	359	360					
28N	361	362	363	364	365	366	367	368	369	370	371	372	373	374	375	376	377	378	379	380	381	382	383	384	28N				
	109W				108W				107W				106W				105W				104W				103W				

Figure E-12. El Paso Chart Grid



49 N	117W				116W				115W				114W				113W				112W				111W				110W				109W				49 N
	1	2	3	4	5	6	7	8	9	10	11	12	13	14	15	16	17	18	19	20	21	22	23	24	25	26	27	28	29	30	31	32					
48 N	33	31	35	36	37	38	39	40	41	42	43	44	45	46	47	48	49	50	51	52	53	54	55	56	57	58	59	60	61	62	63	64					
	65	66	67	68	69	70	71	72	73	74	75	76	77	78	79	80	81	82	83	84	85	86	87	88	89	90	91	92	93	94	95	96					
47 N	97	98	99	100	101	102	103	104	105	106	107	108	109	110	111	112	113	114	115	116	117	118	119	120	121	122	123	124	125	126	127	128					
	129	130	131	132	133	134	135	136	137	138	139	140	141	142	143	144	145	146	147	148	149	150	151	152	153	154	155	156	157	158	159	160					
	161	162	163	164	165	166	167	168	169	170	171	172	173	174	175	176	177	178	179	180	181	182	183	184	185	186	187	188	189	190	191	192					
	193	194	195	196	197	198	199	200	201	202	203	204	205	206	207	208	209	210	211	212	213	214	215	216	217	218	219	220	221	222	223	224					
46 N	225	226	227	228	229	230	231	232	233	234	235	236	237	238	239	240	241	242	243	244	245	246	247	248	249	250	251	252	253	254	255	256					
	257	258	259	260	261	262	263	264	265	266	267	268	269	270	271	272	273	274	275	276	277	278	279	280	281	282	283	284	285	286	287	288					
	289	290	291	292	293	294	295	296	297	298	299	300	301	302	303	304	305	306	307	308	309	310	311	312	313	314	315	316	317	318	319	320					
	321	322	323	324	325	326	327	328	329	330	331	332	333	334	335	336	337	338	339	340	341	342	343	344	345	346	347	348	349	350	351	352					
45 N	353	354	355	356	357	358	359	360	361	362	363	364	365	366	367	368	369	370	371	372	373	374	375	376	377	378	379	380	381	382	383	384					
	385	386	387	388	389	390	391	392	393	394	395	396	397	398	399	400	401	402	403	404	405	406	407	408	409	410	411	412	413	414	415	416					
	417	418	419	420	421	422	423	424	425	426	427	428	429	430	431	432	433	434	435	436	437	438	439	440	441	442	443	444	445	446	447	448					
	449	450	451	452	453	454	455	456	457	458	459	460	461	462	463	464	465	466	467	468	469	470	471	472	473	474	475	476	477	478	479	480					
44 N	481	482	483	484	485	486	487	488	489	490	491	492	493	494	495	496	497	498	499	500	501	502	503	504	505	506	507	508	509	510	511	512					
	513	514	515	516	517	518	519	520	521	522	523	524	525	526	527	528	529	530	531	532	533	534	535	536	537	538	539	540	541	542	543	544					
	545	546	547	548	549	550	551	552	553	554	555	556	557	558	559	560	561	562	563	564	565	566	567	568	569	570	571	572	573	574	575	576					
	117W				116W				115W				114W				113W				112W				111W				110W				109W				

Figure E-13. Great Falls Chart Grid

48 N	093W				092W				091W				090W				089W				088W				087W				086W				085W				48 N
	1	2	3	4	5	6	7	8	9	10	11	12	13	14	15	16	17	18	19	20	21	22	23	24	25	26	27	28	29	30	31	32					
47 N	33	31	35	36	37	38	39	40	41	42	43	44	45	46	47	48	49	50	51	52	53	54	55	56	57	58	59	60	61	62	63	64					
	65	66	67	68	69	70	71	72	73	74	75	76	77	78	79	80	81	82	83	84	85	86	87	88	89	90	91	92	93	94	95	96					
46 N	97	98	99	100	101	102	103	104	105	106	107	108	109	110	111	112	113	114	115	116	117	118	119	120	121	122	123	124	125	126	127	128					
	129	130	131	132	133	134	135	136	137	138	139	140	141	142	143	144	145	146	147	148	149	150	151	152	153	154	155	156	157	158	159	160					
	161	162	163	164	165	166	167	168	169	170	171	172	173	174	175	176	177	178	179	180	181	182	183	184	185	186	187	188	189	190	191	192					
	193	194	195	196	197	198	199	200	201	202	203	204	205	206	207	208	209	210	211	212	213	214	215	216	217	218	219	220	221	222	223	224					
45 N	225	226	227	228	229	230	231	232	233	234	235	236	237	238	239	240	241	242	243	244	245	246	247	248	249	250	251	252	253	254	255	256					
	257	258	259	260	261	262	263	264	265	266	267	268	269	270	271	272	273	274	275	276	277	278	279	280	281	282	283	284	285	286	287	288					
	289	290	291	292	293	294	295	296	297	298	299	300	301	302	303	304	305	306	307	308	309	310	311	312	313	314	315	316	317	318	319	320					
	321	322	323	324	325	326	327	328	329	330	331	332	333	334	335	336	337	338	339	340	341	342	343	344	345	346	347	348	349	350	351	352					
44 N	353	354	355	356	357	358	359	360	361	362	363	364	365	366	367	368	369	370	371	372	373	374	375	376	377	378	379	380	381	382	383	384					
	385	386	387	388	389	390	391	392	393	394	395	396	397	398	399	400	401	402	403	404	405	406	407	408	409	410	411	412	413	414	415	416					
	417	418	419	420	421	422	423	424	425	426	427	428	429	430	431	432	433	434	435	436	437	438	439	440	441	442	443	444	445	446	447	448					
	449	450	451	452	453	454	455	456	457	458	459	460	461	462	463	464	465	466	467	468	469	470	471	472	473	474	475	476	477	478	479	480					
44 N	481	482	483	484	485	486	487	488	489	490	491	492	493	494	495	496	497	498	499	500	501	502	503	504	505	506	507	508	509	510	511	512					
	513	514	515	516	517	518	519	520	521	522	523	524	525	526	527	528	529	530	531	532	533	534	535	536	537	538	539	540	541	542	543	544					
	093W				092W				091W				090W				089W				088W				087W				086W				085W				

Figure E-14. Green Bay Chart Grid

Appendix E - Gridding

48 N	069W				068W				067W				066W				065W				064W				063W				062W				061W				48 N
	1	2	3	4	5	6	7	8	9	10	11	12	13	14	15	16	17	18	19	20	21	22	23	24	25	26	27	28	29	30	31	32					
	33	31	35	36	37	38	39	40	41	42	43	44	45	46	47	48	49	50	51	52	53	54	55	56	57	58	59	60	61	62	63	64					
47 N	65	66	67	68	69	70	71	72	73	74	75	76	77	78	79	80	81	82	83	84	85	86	87	88	89	90	91	92	93	94	95	96	47 N				
	97	98	99	100	101	102	103	104	105	106	107	108	109	110	111	112	113	114	115	116	117	118	119	120	121	122	123	124	125	126	127	128					
	129	130	131	132	133	134	135	136	137	138	139	140	141	142	143	144	145	146	147	148	149	150	151	152	153	154	155	156	157	158	159	160					
	161	162	163	164	165	166	167	168	169	170	171	172	173	174	175	176	177	178	179	180	181	182	183	184	185	186	187	188	189	190	191	192					
46 N	193	194	195	196	197	198	199	200	201	202	203	204	205	206	207	208	209	210	211	212	213	214	215	216	217	218	219	220	221	222	223	224	46 N				
	225	226	227	228	229	230	231	232	233	234	235	236	237	238	239	240	241	242	243	244	245	246	247	248	249	250	251	252	253	254	255	256					
	257	258	259	260	261	262	263	264	265	266	267	268	269	270	271	272	273	274	275	276	277	278	279	280	281	282	283	284	285	286	287	288					
	289	290	291	292	293	294	295	296	297	298	299	300	301	302	303	304	305	306	307	308	309	310	311	312	313	314	315	316	317	318	319	320					
45 N	321	322	323	324	325	326	327	328	329	330	331	332	333	334	335	336	337	338	339	340	341	342	343	344	345	346	347	348	349	350	351	352	45 N				
	353	354	355	356	357	358	359	360	361	362	363	364	365	366	367	368	369	370	371	372	373	374	375	376	377	378	379	380	381	382	383	384					
	385	386	387	388	389	390	391	392	393	394	395	396	397	398	399	400	401	402	403	404	405	406	407	408	409	410	411	412	413	414	415	416					
	417	418	419	420	421	422	423	424	425	426	427	428	429	430	431	432	433	434	435	436	437	438	439	440	441	442	443	444	445	446	447	448					
44 N	449	450	451	452	453	454	455	456	457	458	459	460	461	462	463	464	465	466	467	468	469	470	471	472	473	474	475	476	477	478	479	480	44 N				
	481	482	483	484	485	486	487	488	489	490	491	492	493	494	495	496	497	498	499	500	501	502	503	504	505	506	507	508	509	510	511	512					
	069W				068W				067W				066W				065W				064W				063W				062W				061W				

Figure E-15. Halifax Chart Grid

32N	097W				096W				095W				094W				093W				092W				091W				32N
	1	2	3	4	5	6	7	8	9	10	11	12	13	14	15	16	17	18	19	20	21	22	23	24					
	25	26	27	28	29	30	31	32	33	34	35	36	37	38	39	40	41	42	43	44	45	46	47	48					
	49	50	51	52	53	54	55	56	57	58	59	60	61	62	63	64	65	66	67	68	69	70	71	72					
31N	73	74	75	76	77	78	79	80	81	82	83	84	85	86	87	88	89	90	91	92	93	94	95	96	31N				
	97	98	99	100	101	102	103	104	105	106	107	108	109	110	111	112	113	114	115	116	117	118	119	120					
	121	122	123	124	125	126	127	128	129	130	131	132	133	134	135	136	137	138	139	140	141	142	143	144					
	145	146	147	148	149	150	151	152	153	154	155	156	157	158	159	160	161	162	163	164	165	166	167	168					
30N	169	170	171	172	173	174	175	176	177	178	179	180	181	182	183	184	185	186	187	188	189	190	191	192	30N				
	193	194	195	196	197	198	199	200	201	202	203	204	205	206	207	208	209	210	211	212	213	214	215	216					
	217	218	219	220	221	222	223	224	225	226	227	228	229	230	231	232	233	234	235	236	237	238	239	240					
	241	242	243	244	245	246	247	248	249	250	251	252	253	254	255	256	257	258	259	260	261	262	263	264					
29N	265	266	267	268	269	270	271	272	273	274	275	276	277	278	279	280	281	282	283	284	285	286	287	288	29N				
	289	290	291	292	293	294	295	296	297	298	299	300	301	302	303	304	305	306	307	308	309	310	311	312					
	313	314	315	316	317	318	319	320	321	322	323	324	325	326	327	328	329	330	331	332	333	334	335	336					
	337	338	339	340	341	342	343	344	345	346	347	348	349	350	351	352	353	354	355	356	357	358	359	360					
28N	361	362	363	364	365	366	367	368	369	370	371	372	373	374	375	376	377	378	379	380	381	382	383	384	28N				
	097W				096W				095W				094W				093W				092W				091W				

Figure E-16. Houston Chart Grid

32N	085W				084W				083W				082W				081W				080W				079W		32N
	1	2	3	4	5	6	7	8	9	10	11	12	13	14	15	16	17	18	19	20	21	22	23	24			
	25	26	27	28	29	30	31	32	33	34	35	36	37	38	39	40	41	42	43	44	45	46	47	48			
	49	50	51	52	53	54	55	56	57	58	59	60	61	62	63	64	65	66	67	68	69	70	71	72			
31N	73	74	75	76	77	78	79	80	81	82	83	84	85	86	87	88	89	90	91	92	93	94	95	96	31N		
	97	98	99	100	101	102	103	104	105	106	107	108	109	110	111	112	113	114	115	116	117	118	119	120			
	121	122	123	124	125	126	127	128	129	130	131	132	133	134	135	136	137	138	139	140	141	142	143	144			
	145	146	147	148	149	150	151	152	153	154	155	156	157	158	159	160	161	162	163	164	165	166	167	168			
30N	169	170	171	172	173	174	175	176	177	178	179	180	181	182	183	184	185	186	187	188	189	190	191	192	30N		
	193	194	195	196	197	198	199	200	201	202	203	204	205	206	207	208	209	210	211	212	213	214	215	216			
	217	218	219	220	221	222	223	224	225	226	227	228	229	230	231	232	233	234	235	236	237	238	239	240			
	241	242	243	244	245	246	247	248	249	250	251	252	253	254	255	256	257	258	259	260	261	262	263	264			
29N	265	266	267	268	269	270	271	272	273	274	275	276	277	278	279	280	281	282	283	284	285	286	287	288	29N		
	289	290	291	292	293	294	295	296	297	298	299	300	301	302	303	304	305	306	307	308	309	310	311	312			
	313	314	315	316	317	318	319	320	321	322	323	324	325	326	327	328	329	330	331	332	333	334	335	336			
	337	338	339	340	341	342	343	344	345	346	347	348	349	350	351	352	353	354	355	356	357	358	359	360			
28N	361	362	363	364	365	366	367	368	369	370	371	372	373	374	375	376	377	378	379	380	381	382	383	384	28N		
	085W				084W				083W				082W				081W				080W				079W		

Figure E-17. Jacksonville Chart Grid

40N	097W				096W				095W				094W				093W				092W				091W				090W		40N
	1	2	3	4	5	6	7	8	9	10	11	12	13	14	15	16	17	18	19	20	21	22	23	24	25	26	27	28			
	29	30	31	32	33	34	35	36	37	38	39	40	41	42	43	44	45	46	47	48	49	50	51	52	53	54	55	56			
	57	58	59	60	61	62	63	64	65	66	67	68	69	70	71	72	73	74	75	76	77	78	79	80	81	82	83	84			
39N	85	86	87	88	89	90	91	92	93	94	95	96	97	98	99	100	101	102	103	104	105	106	107	108	109	110	111	112	39N		
	113	114	115	116	117	118	119	120	121	122	123	124	125	126	127	128	129	130	131	132	133	134	135	136	137	138	139	140			
	141	142	143	144	145	146	147	148	149	150	151	152	153	154	155	156	157	158	159	160	161	162	163	164	165	166	167	168			
	169	170	171	172	173	174	175	176	177	178	179	180	181	182	183	184	185	186	187	188	189	190	191	192	193	194	195	196			
38N	197	198	199	200	201	202	203	204	205	206	207	208	209	210	211	212	213	214	215	216	217	218	219	220	221	222	223	224	38N		
	225	226	227	228	229	230	231	232	233	234	235	236	237	238	239	240	241	242	243	244	245	246	247	248	249	250	251	252			
	253	254	255	256	257	258	259	260	261	262	263	264	265	266	267	268	269	270	271	272	273	274	275	276	277	278	279	280			
	281	282	283	284	285	286	287	288	289	290	291	292	293	294	295	296	297	298	299	300	301	302	303	304	305	306	307	308			
37N	309	310	311	312	313	314	315	316	317	318	319	320	321	322	323	324	325	326	327	328	329	330	331	332	333	334	335	336	37N		
	337	338	339	340	341	342	343	344	345	346	347	348	349	350	351	352	353	354	355	356	357	358	359	360	361	362	363	364			
	365	366	367	368	369	370	371	372	373	374	375	376	377	378	379	380	381	382	383	384	385	386	387	388	389	390	391	392			
	393	394	395	396	397	398	399	400	401	402	403	404	405	406	407	408	409	410	411	412	413	414	415	416	417	418	419	420			
36N	421	422	423	424	425	426	427	428	429	430	431	432	433	434	435	436	437	438	439	440	441	442	443	444	445	446	447	448	36N		
	097W				096W				095W				094W				093W				092W				091W				090W		

Figure E-18. Kansas City Chart Grid

Appendix E - Gridding

	125W				124W				123W				122W				121W				120W				119W				118W				117W				
44	1	2	3	4	5	6	7	8	9	10	11	12	13	14	15	16	17	18	19	20	21	22	23	24	25	26	27	28	29	30	31	32	44				
N	33	31	35	36	37	38	39	40	41	42	43	44	45	46	47	48	49	50	51	52	53	54	55	56	57	58	59	60	61	62	63	64	N				
	65	66	67	68	69	70	71	72	73	74	75	76	77	78	79	80	81	82	83	84	85	86	87	88	89	90	91	92	93	94	95	96					
	97	98	99	100	101	102	103	104	105	106	107	108	109	110	111	112	113	114	115	116	117	118	119	120	121	122	123	124	125	126	127	128					
43	129	130	131	132	133	134	135	136	137	138	139	140	141	142	143	144	145	146	147	148	149	150	151	152	153	154	155	156	157	158	159	160	43				
N	161	162	163	164	165	166	167	168	169	170	171	172	173	174	175	176	177	178	179	180	181	182	183	184	185	186	187	188	189	190	191	192	N				
	193	194	195	196	197	198	199	200	201	202	203	204	205	206	207	208	209	210	211	212	213	214	215	216	217	218	219	220	221	222	223	224					
	225	226	227	228	229	230	231	232	233	234	235	236	237	238	239	240	241	242	243	244	245	246	247	248	249	250	251	252	253	254	255	256					
42	257	258	259	260	261	262	263	264	265	266	267	268	269	270	271	272	273	274	275	276	277	278	279	280	281	282	283	284	285	286	287	288	42				
N	289	290	291	292	293	294	295	296	297	298	299	300	301	302	303	304	305	306	307	308	309	310	311	312	313	314	315	316	317	318	319	320	N				
	321	322	323	324	325	326	327	328	329	330	331	332	333	334	335	336	337	338	339	340	341	342	343	344	345	346	347	348	349	350	351	352					
	353	354	355	356	357	358	359	360	361	362	363	364	365	366	367	368	369	370	371	372	373	374	375	376	377	378	379	380	381	382	383	384					
41	385	386	387	388	389	390	391	392	393	394	395	396	397	398	399	400	401	402	403	404	405	406	407	408	409	410	411	412	413	414	415	416	41				
N	417	418	419	420	421	422	423	424	425	426	427	428	429	430	431	432	433	434	435	436	437	438	439	440	441	442	443	444	445	446	447	448	N				
	449	450	451	452	453	454	455	456	457	458	459	460	461	462	463	464	465	466	467	468	469	470	471	472	473	474	475	476	477	478	479	480					
	481	482	483	484	485	486	487	488	489	490	491	492	493	494	495	496	497	498	499	500	501	502	503	504	505	506	507	508	509	510	511	512					
40	513	514	515	516	517	518	519	520	521	522	523	524	525	526	527	528	529	530	531	532	533	534	535	536	537	538	539	540	541	542	543	544	40				
N	545	546	547	548	549	550	551	552	553	554	555	556	557	558	559	560	561	562	563	564	565	566	567	568	569	570	571	572	573	574	575	576	N				
	125W				124W				123W				122W				121W				120W				119W				118W				117W				

Figure E-19. Klamath Falls Chart Grid

	085W				084W				083W				082W				081W				080W				079W				078W				077W				
48	1	2	3	4	5	6	7	8	9	10	11	12	13	14	15	16	17	18	19	20	21	22	23	24	25	26	27	28	29	30	31	32	48				
N	33	31	35	36	37	38	39	40	41	42	43	44	45	46	47	48	49	50	51	52	53	54	55	56	57	58	59	60	61	62	63	64	N				
	65	66	67	68	69	70	71	72	73	74	75	76	77	78	79	80	81	82	83	84	85	86	87	88	89	90	91	92	93	94	95	96					
47	97	98	99	100	101	102	103	104	105	106	107	108	109	110	111	112	113	114	115	116	117	118	119	120	121	122	123	124	125	126	127	128	47				
N	129	130	131	132	133	134	135	136	137	138	139	140	141	142	143	144	145	146	147	148	149	150	151	152	153	154	155	156	157	158	159	160	N				
	161	162	163	164	165	166	167	168	169	170	171	172	173	174	175	176	177	178	179	180	181	182	183	184	185	186	187	188	189	190	191	192					
46	193	194	195	196	197	198	199	200	201	202	203	204	205	206	207	208	209	210	211	212	213	214	215	216	217	218	219	220	221	222	223	224	46				
N	225	226	227	228	229	230	231	232	233	234	235	236	237	238	239	240	241	242	243	244	245	246	247	248	249	250	251	252	253	254	255	256	N				
	257	258	259	260	261	262	263	264	265	266	267	268	269	270	271	272	273	274	275	276	277	278	279	280	281	282	283	284	285	286	287	288					
	289	290	291	292	293	294	295	296	297	298	299	300	301	302	303	304	305	306	307	308	309	310	311	312	313	314	315	316	317	318	319	320					
45	321	322	323	324	325	326	327	328	329	330	331	332	333	334	335	336	337	338	339	340	341	342	343	344	345	346	347	348	349	350	351	352	45				
N	353	354	355	356	357	358	359	360	361	362	363	364	365	366	367	368	369	370	371	372	373	374	375	376	377	378	379	380	381	382	383	384	N				
	385	386	387	388	389	390	391	392	393	394	395	396	397	398	399	400	401	402	403	404	405	406	407	408	409	410	411	412	413	414	415	416					
	417	418	419	420	421	422	423	424	425	426	427	428	429	430	431	432	433	434	435	436	437	438	439	440	441	442	443	444	445	446	447	448					
44	449	450	451	452	453	454	455	456	457	458	459	460	461	462	463	464	465	466	467	468	469	470	471	472	473	474	475	476	477	478	479	480	44				
N	481	482	483	484	485	486	487	488	489	490	491	492	493	494	495	496	497	498	499	500	501	502	503	504	505	506	507	508	509	510	511	512	N				
	085W				084W				083W				082W				081W				080W				079W				078W				077W				

Figure E-20. Lake Huron Chart Grid

40N	118W				117W				116W				115W				114W				113W				112W				111W				40N
	1	2	3	4	5	6	7	8	9	10	11	12	13	14	15	16	17	18	19	20	21	22	23	24	25	26	27	28					
	29	30	31	32	33	34	35	36	37	38	39	40	41	42	43	44	45	46	47	48	49	50	51	52	53	54	55	56					
	57	58	59	60	61	62	63	64	65	66	67	68	69	70	71	72	73	74	75	76	77	78	79	80	81	82	83	84					
39N	85	86	87	88	89	90	91	92	93	94	95	96	97	98	99	100	101	102	103	104	105	106	107	108	109	110	111	112	39N				
	113	114	115	116	117	118	119	120	121	122	123	124	125	126	127	128	129	130	131	132	133	134	135	136	137	138	139	140					
	141	142	143	144	145	146	147	148	149	150	151	152	153	154	155	156	157	158	159	160	161	162	163	164	165	166	167	168					
	169	170	171	172	173	174	175	176	177	178	179	180	181	182	183	184	185	186	187	188	189	190	191	192	193	194	195	196					
38N	197	198	199	200	201	202	203	204	205	206	207	208	209	210	211	212	213	214	215	216	217	218	219	220	221	222	223	224	38N				
	225	226	227	228	229	230	231	232	233	234	235	236	237	238	239	240	241	242	243	244	245	246	247	248	249	250	251	252					
	253	254	255	256	257	258	259	260	261	262	263	264	265	266	267	268	269	270	271	272	273	274	275	276	277	278	279	280					
	281	282	283	284	285	286	287	288	289	290	291	292	293	294	295	296	297	298	299	300	301	302	303	304	305	306	307	308					
37N	309	310	311	312	313	314	315	316	317	318	319	320	321	322	323	324	325	326	327	328	329	330	331	332	333	334	335	336	37N				
	337	338	339	340	341	342	343	344	345	346	347	348	349	350	351	352	353	354	355	356	357	358	359	360	361	362	363	364					
	365	366	367	368	369	370	371	372	373	374	375	376	377	378	379	380	381	382	383	384	385	386	387	388	389	390	391	392					
	393	394	395	396	397	398	399	400	401	402	403	404	405	406	407	408	409	410	411	412	413	414	415	416	417	418	419	420					
36N	421	422	423	424	425	426	427	428	429	430	431	432	433	434	435	436	437	438	439	440	441	442	443	444	445	446	447	448	36N				
	15	16	17	18	19	20	21	22	23	24	25	26	461	462	463	464	465	466	467	468	469	470	471	472	473	474	475	476					
	118W		LOS ANGELES		117W				116W				115W				114W				113W				112W				111W				

Figure E-21. Las Vegas Chart Grid

36N	121W				120W				119W				118W				117W				116W				115W				36N
	1	2	3	4	5	6	7	8	9	10	11	12	13	14	15	16	17	18	19	20	21	22	23	24	25	26			
	27	28	29	30	31	32	33	34	35	36	37	38	39	40	41	42	43	44	45	46	47	48	49	50	51	52			
	53	54	55	56	57	58	59	60	61	62	63	64	65	66	67	68	69	70	71	72	73	74	75	76	77	78			
35N	79	80	81	82	83	84	85	86	87	88	89	90	91	92	93	94	95	96	97	98	99	100	101	102	103	104	35N		
	105	106	107	108	109	110	111	112	113	114	115	116	117	118	119	120	121	122	123	124	125	126	127	128	129	130			
	131	132	133	134	135	136	137	138	139	140	141	142	143	144	145	146	147	148	149	150	151	152	153	154	155	156			
	157	158	159	160	161	162	163	164	165	166	167	168	169	170	171	172	173	174	175	176	177	178	179	180	181	182			
34N	183	184	185	186	187	188	189	190	191	192	193	194	195	196	197	198	199	200	201	202	203	204	205	206	207	208	34N		
	209	210	211	212	213	214	215	216	217	218	219	220	221	222	223	224	225	226	227	228	229	230	231	232	233	234			
	235	236	237	238	239	240	241	242	243	244	245	246	247	248	249	250	251	252	253	254	255	256	257	258	259	260			
	261	262	263	264	265	266	267	268	269	270	271	272	273	274	275	276	277	278	279	280	281	282	283	284	285	286			
33N	287	288	289	290	291	292	293	294	295	296	297	298	299	300	301	302	303	304	305	306	307	308	309	310	311	312	33N		
	313	314	315	316	317	318	319	320	321	322	323	324	325	326	327	328	329	330	331	332	333	334	335	336	337	338			
	339	340	341	342	343	344	345	346	347	348	349	350	351	352	353	354	355	356	357	358	359	360	361	362	363	364			
	365	366	367	368	369	370	371	372	373	374	375	376	377	378	379	380	381	382	383	384	385	386	387	388	389	390			
32N	391	392	393	394	395	396	397	398	399	400	401	402	403	404	405	406	407	408	409	410	411	412	413	414	415	416	32N		
	121W				120W				119W				118W				117W				116W				115W				

Figure E-22. Los Angeles Chart Grid

Appendix E - Gridding

36N	095W				094W				093W				092W				091W				090				089W				088W				36N
	1	2	3	4	5	6	7	8	9	10	11	12	13	14	15	16	17	18	19	20	21	22	23	24	25	26	27	28					
	29	30	31	32	33	34	35	36	37	38	39	40	41	42	43	44	45	46	47	48	49	50	51	52	53	54	55	56					
	57	58	59	60	61	62	63	64	65	66	67	68	69	70	71	72	73	74	75	76	77	78	79	80	81	82	83	84					
35N	85	86	87	88	89	90	91	92	93	94	95	96	97	98	99	100	101	102	103	104	105	106	107	108	109	110	111	112	35N				
	113	114	115	116	117	118	119	120	121	122	123	124	125	126	127	128	129	130	131	132	133	134	135	136	137	138	139	140					
	141	142	143	144	145	146	147	148	149	150	151	152	153	154	155	156	157	158	159	160	161	162	163	164	165	166	167	168					
	169	170	171	172	173	174	175	176	177	178	179	180	181	182	183	184	185	186	187	188	189	190	191	192	193	194	195	196					
34N	197	198	199	200	201	202	203	204	205	206	207	208	209	210	211	212	213	214	215	216	217	218	219	220	221	222	223	224	34N				
	225	226	227	228	229	230	231	232	233	234	235	236	237	238	239	240	241	242	243	244	245	246	247	248	249	250	251	252					
	253	254	255	256	257	258	259	260	261	262	263	264	265	266	267	268	269	270	271	272	273	274	275	276	277	278	279	280					
	281	282	283	284	285	286	287	288	289	290	291	292	293	294	295	296	297	298	299	300	301	302	303	304	305	306	307	308					
33N	309	310	311	312	313	314	315	316	317	318	319	320	321	322	323	324	325	326	327	328	329	330	331	332	333	334	335	336	33N				
	337	338	339	340	341	342	343	344	345	346	347	348	349	350	351	352	353	354	355	356	357	358	359	360	361	362	363	364					
	365	366	367	368	369	370	371	372	373	374	375	376	377	378	379	380	381	382	383	384	385	386	387	388	389	390	391	392					
	393	394	395	396	397	398	399	400	401	402	403	404	405	406	407	408	409	410	411	412	413	414	415	416	417	418	419	420					
32N	421	422	423	424	425	426	427	428	429	430	431	432	433	434	435	436	437	438	439	440	441	442	443	444	445	446	447	448	32N				
	095W				094W				093W				092W				091W				090W				089W				088W				

Figure E-23. Memphis Chart Grid

28N	083W				082W				081W				080W				079W				078W				077W				28N
	1	2	3	4	5	6	7	8	9	10	11	12	13	14	15	16	17	18	19	20	21	22	23	24					
	25	26	27	28	29	30	31	32	33	34	35	36	37	38	39	40	41	42	43	44	45	46	47	48					
	49	50	51	52	53	54	55	56	57	58	59	60	61	62	63	64	65	66	67	68	69	70	71	72					
27N	73	74	75	76	77	78	79	80	81	82	83	84	85	86	87	88	89	90	91	92	93	94	95	96	27N				
	97	98	99	100	101	102	103	104	105	106	107	108	109	110	111	112	113	114	115	116	117	118	119	120					
	121	122	123	124	125	126	127	128	129	130	131	132	133	134	135	136	137	138	139	140	141	142	143	144					
	145	146	147	148	149	150	151	152	153	154	155	156	157	158	159	160	161	162	163	164	165	166	167	168					
26N	169	170	171	172	173	174	175	176	177	178	179	180	181	182	183	184	185	186	187	188	189	190	191	192	26N				
	193	194	195	196	197	198	199	200	201	202	203	204	205	206	207	208	209	210	211	212	213	214	215	216					
	217	218	219	220	221	222	223	224	225	226	227	228	229	230	231	232	233	234	235	236	237	238	239	240					
	241	242	243	244	245	246	247	248	249	250	251	252	253	254	255	256	257	258	259	260	261	262	263	264					
25N	265	266	267	268	269	270	271	272	273	274	275	276	277	278	279	280	281	282	283	284	285	286	287	288	25N				
	289	290	291	292	293	294	295	296	297	298	299	300	301	302	303	304	305	306	307	308	309	310	311	312					
	313	314	315	316	317	318	319	320	321	322	323	324	325	326	327	328	329	330	331	332	333	334	335	336					
	337	338	339	340	341	342	343	344	345	346	347	348	349	350	351	352	353	354	355	356	357	358	359	360					
24N	361	362	363	364	365	366	367	368	369	370	371	372	373	374	375	376	377	378	379	380	381	382	383	384	24N				
	083W				082W				081W				080W				079W				078W				077W				

Figure E-24. Miami Chart Grid

48 N	077W				076W				075W				074W				073W				072W				071W				070W				069W				48 N
	1	2	3	4	5	6	7	8	9	10	11	12	13	14	15	16	17	18	19	20	21	22	23	24	25	26	27	28	29	30	31	32					
	33	31	35	36	37	38	39	40	41	42	43	44	45	46	47	48	49	50	51	52	53	54	55	56	57	58	59	60	61	62	63	64					
47 N	65	66	67	68	69	70	71	72	73	74	75	76	77	78	79	80	81	82	83	84	85	86	87	88	89	90	91	92	93	94	95	96	47 N				
	97	98	99	100	101	102	103	104	105	106	107	108	109	110	111	112	113	114	115	116	117	118	119	120	121	122	123	124	125	126	127	128					
	129	130	131	132	133	134	135	136	137	138	139	140	141	142	143	144	145	146	147	148	149	150	151	152	153	154	155	156	157	158	159	160					
	161	162	163	164	165	166	167	168	169	170	171	172	173	174	175	176	177	178	179	180	181	182	183	184	185	186	187	188	189	190	191	192					
46 N	193	194	195	196	197	198	199	200	201	202	203	204	205	206	207	208	209	210	211	212	213	214	215	216	217	218	219	220	221	222	223	224	46 N				
	225	226	227	228	229	230	231	232	233	234	235	236	237	238	239	240	241	242	243	244	245	246	247	248	249	250	251	252	253	254	255	256					
	257	258	259	260	261	262	263	264	265	266	267	268	269	270	271	272	273	274	275	276	277	278	279	280	281	282	283	284	285	286	287	288					
	289	290	291	292	293	294	295	296	297	298	299	300	301	302	303	304	305	306	307	308	309	310	311	312	313	314	315	316	317	318	319	320					
45 N	321	322	323	324	325	326	327	328	329	330	331	332	333	334	335	336	337	338	339	340	341	342	343	344	345	346	347	348	349	350	351	352	45 N				
	353	354	355	356	357	358	359	360	361	362	363	364	365	366	367	368	369	370	371	372	373	374	375	376	377	378	379	380	381	382	383	384					
	385	386	387	388	389	390	391	392	393	394	395	396	397	398	399	400	401	402	403	404	405	406	407	408	409	410	411	412	413	414	415	416					
	417	418	419	420	421	422	423	424	425	426	427	428	429	430	431	432	433	434	435	436	437	438	439	440	441	442	443	444	445	446	447	448					
44 N	449	450	451	452	453	454	455	456	457	458	459	460	461	462	463	464	465	466	467	468	469	470	471	472	473	474	475	476	477	478	479	480	44 N				
	481	482	483	484	485	486	487	488	489	490	491	492	493	494	495	496	497	498	499	500	501	502	503	504	505	506	507	508	509	510	511	512					
	077W				076W				075W				074W				073W				072W				071W				070W				069W				

Figure E-25. Montreal Chart Grid

32N	091W				090W				089W				088W				087W				086W				085W				32N
	1	2	3	4	5	6	7	8	9	10	11	12	13	14	15	16	17	18	19	20	21	22	23	24					
	25	26	27	28	29	30	31	32	33	34	35	36	37	38	39	40	41	42	43	44	45	46	47	48					
	49	50	51	52	53	54	55	56	57	58	59	60	61	62	63	64	65	66	67	68	69	70	71	72					
31N	73	74	75	76	77	78	79	80	81	82	83	84	85	86	87	88	89	90	91	92	93	94	95	96	31N				
	97	98	99	100	101	102	103	104	105	106	107	108	109	110	111	112	113	114	115	116	117	118	119	120					
	121	122	123	124	125	126	127	128	129	130	131	132	133	134	135	136	137	138	139	140	141	142	143	144					
	145	146	147	148	149	150	151	152	153	154	155	156	157	158	159	160	161	162	163	164	165	166	167	168					
30N	169	170	171	172	173	174	175	176	177	178	179	180	181	182	183	184	185	186	187	188	189	190	191	192	30N				
	193	194	195	196	197	198	199	200	201	202	203	204	205	206	207	208	209	210	211	212	213	214	215	216					
	217	218	219	220	221	222	223	224	225	226	227	228	229	230	231	232	233	234	235	236	237	238	239	240					
	241	242	243	244	245	246	247	248	249	250	251	252	253	254	255	256	257	258	259	260	261	262	263	264					
29N	265	266	267	268	269	270	271	272	273	274	275	276	277	278	279	280	281	282	283	284	285	286	287	288	29N				
	289	290	291	292	293	294	295	296	297	298	299	300	301	302	303	304	305	306	307	308	309	310	311	312					
	313	314	315	316	317	318	319	320	321	322	323	324	325	326	327	328	329	330	331	332	333	334	335	336					
	337	338	339	340	341	342	343	344	345	346	347	348	349	350	351	352	353	354	355	356	357	358	359	360					
28N	361	362	363	364	365	366	367	368	369	370	371	372	373	374	375	376	377	378	379	380	381	382	383	384	28N				
	091W				090W				089W				088W				087W				086W				085W				

Figure E-26. New Orleans Chart Grid

Appendix E - Gridding

44 N	077W				076W				075W				074W				073W				072W				071W				070W				069W				44 N
	1	2	3	4	5	6	7	8	9	10	11	12	13	14	15	16	17	18	19	20	21	22	23	24	25	26	27	28	29	30	31	32	33	34	35	36	
43 N	33	31	35	36	37	38	39	40	41	42	43	44	45	46	47	48	49	50	51	52	53	54	55	56	57	58	59	60	61	62	63	64	65	66	67	68	
	65	66	67	68	69	70	71	72	73	74	75	76	77	78	79	80	81	82	83	84	85	86	87	88	89	90	91	92	93	94	95	96	97	98	99	100	
42 N	129	130	131	132	133	134	135	136	137	138	139	140	141	142	143	144	145	146	147	148	149	150	151	152	153	154	155	156	157	158	159	160	161	162	163	164	
	161	162	163	164	165	166	167	168	169	170	171	172	173	174	175	176	177	178	179	180	181	182	183	184	185	186	187	188	189	190	191	192	193	194	195	196	
	193	194	195	196	197	198	199	200	201	202	203	204	205	206	207	208	209	210	211	212	213	214	215	216	217	218	219	220	221	222	223	224	225	226	227	228	
	225	226	227	228	229	230	231	232	233	234	235	236	237	238	239	240	241	242	243	244	245	246	247	248	249	250	251	252	253	254	255	256	257	258	259	260	
41 N	257	258	259	260	261	262	263	264	265	266	267	268	269	270	271	272	273	274	275	276	277	278	279	280	281	282	283	284	285	286	287	288	289	290	291	292	
	289	290	291	292	293	294	295	296	297	298	299	300	301	302	303	304	305	306	307	308	309	310	311	312	313	314	315	316	317	318	319	320	321	322	323	324	
	321	322	323	324	325	326	327	328	329	330	331	332	333	334	335	336	337	338	339	340	341	342	343	344	345	346	347	348	349	350	351	352	353	354	355	356	
	353	354	355	356	357	358	359	360	361	362	363	364	365	366	367	368	369	370	371	372	373	374	375	376	377	378	379	380	381	382	383	384	385	386	387	388	
40 N	385	386	387	388	389	390	391	392	393	394	395	396	397	398	399	400	401	402	403	404	405	406	407	408	409	410	411	412	413	414	415	416	417	418	419	420	
	417	418	419	420	421	422	423	424	425	426	427	428	429	430	431	432	433	434	435	436	437	438	439	440	441	442	443	444	445	446	447	448	449	450	451	452	
	449	450	451	452	453	454	455	456	457	458	459	460	461	462	463	464	465	466	467	468	469	470	471	472	473	474	475	476	477	478	479	480	481	482	483	484	
	481	482	483	484	485	486	487	488	489	490	491	492	493	494	495	496	497	498	499	500	501	502	503	504	505	506	507	508	509	510	511	512	513	514	515	516	
	077W				076W				075W				074W				073W				072W				071W				070W				069W				

Figure E-27. New York Chart Grid

44 N	101W				100W				099W				098W				097W				096W				095W				094W				093W				44 N
	1	2	3	4	5	6	7	8	9	10	11	12	13	14	15	16	17	18	19	20	21	22	23	24	25	26	27	28	29	30	31	32	33	34	35	36	
43 N	33	31	35	36	37	38	39	40	41	42	43	44	45	46	47	48	49	50	51	52	53	54	55	56	57	58	59	60	61	62	63	64	65	66	67	68	
	65	66	67	68	69	70	71	72	73	74	75	76	77	78	79	80	81	82	83	84	85	86	87	88	89	90	91	92	93	94	95	96	97	98	99	100	
42 N	129	130	131	132	133	134	135	136	137	138	139	140	141	142	143	144	145	146	147	148	149	150	151	152	153	154	155	156	157	158	159	160	161	162	163	164	
	161	162	163	164	165	166	167	168	169	170	171	172	173	174	175	176	177	178	179	180	181	182	183	184	185	186	187	188	189	190	191	192	193	194	195	196	
	193	194	195	196	197	198	199	200	201	202	203	204	205	206	207	208	209	210	211	212	213	214	215	216	217	218	219	220	221	222	223	224	225	226	227	228	
	225	226	227	228	229	230	231	232	233	234	235	236	237	238	239	240	241	242	243	244	245	246	247	248	249	250	251	252	253	254	255	256	257	258	259	260	
41 N	257	258	259	260	261	262	263	264	265	266	267	268	269	270	271	272	273	274	275	276	277	278	279	280	281	282	283	284	285	286	287	288	289	290	291	292	
	289	290	291	292	293	294	295	296	297	298	299	300	301	302	303	304	305	306	307	308	309	310	311	312	313	314	315	316	317	318	319	320	321	322	323	324	
	321	322	323	324	325	326	327	328	329	330	331	332	333	334	335	336	337	338	339	340	341	342	343	344	345	346	347	348	349	350	351	352	353	354	355	356	
	353	354	355	356	357	358	359	360	361	362	363	364	365	366	367	368	369	370	371	372	373	374	375	376	377	378	379	380	381	382	383	384	385	386	387	388	
40 N	385	386	387	388	389	390	391	392	393	394	395	396	397	398	399	400	401	402	403	404	405	406	407	408	409	410	411	412	413	414	415	416	417	418	419	420	
	417	418	419	420	421	422	423	424	425	426	427	428	429	430	431	432	433	434	435	436	437	438	439	440	441	442	443	444	445	446	447	448	449	450	451	452	
	449	450	451	452	453	454	455	456	457	458	459	460	461	462	463	464	465	466	467	468	469	470	471	472	473	474	475	476	477	478	479	480	481	482	483	484	
	481	482	483	484	485	486	487	488	489	490	491	492	493	494	495	496	497	498	499	500	501	502	503	504	505	506	507	508	509	510	511	512	513	514	515	516	
	101W				100W				099W				098W				097W				096W				095W				094W				093W				
	513	514	515	516	517	518	519	520	521	522	523	524	525	526	527	528	529	530	531	532	533	534	535	536	537	538	539	540	541	542	543	544	545	546	547	548	
	545	546	547	548	549	550	551	552	553	554	555	556	557	558	559	560	561	562	563	564	565	566	567	568	569	570	571	572	573	574	575	576	577	578	579	580	

Figure E-28. Omaha Chart Grid



	116W				LOS ANGELES				115W				114W				113W				112W				111W				110W				109W			
	49	50	51	52	5	6	7	8	9	10	11	12	13	14	15	16	17	18	19	20	21	22	23	24	25	26	27	28	29	30	31	32	33	34	35	36
	75	76	77	78	33	34	35	36	37	38	39	40	41	42	43	44	45	46	47	48	49	50	51	52	53	54	55	56	57	58	59	60	61	62	63	64
35N	101	102	103	104	61	62	63	64	65	66	67	68	69	70	71	72	73	74	75	76	77	78	79	80	81	82	83	84	85	86	87	88	89	90	91	92
	127	128	129	130	89	90	91	92	93	94	95	96	97	98	99	100	101	102	103	104	105	106	107	108	109	110	111	112	113	114	115	116	117	118	119	120
	153	154	155	156	117	118	119	120	121	122	123	124	125	126	127	128	129	130	131	132	133	134	135	136	137	138	139	140	141	142	143	144	145	146	147	148
	179	180	181	182	145	146	147	148	149	150	151	152	153	154	155	156	157	158	159	160	161	162	163	164	165	166	167	168	169	170	171	172	173	174	175	176
34N	205	206	207	208	173	174	175	176	177	178	179	180	181	182	183	184	185	186	187	188	189	190	191	192	193	194	195	196	197	198	199	200	201	202	203	204
	231	232	233	234	201	202	203	204	205	206	207	208	209	210	211	212	213	214	215	216	217	218	219	220	221	222	223	224	225	226	227	228	229	230	231	232
	257	258	259	260	229	230	231	232	233	234	235	236	237	238	239	240	241	242	243	244	245	246	247	248	249	250	251	252	253	254	255	256	257	258	259	260
	283	284	285	286	257	258	259	260	261	262	263	264	265	266	267	268	269	270	271	272	273	274	275	276	277	278	279	280	281	282	283	284	285	286	287	288
33N	309	310	311	312	285	286	287	288	289	290	291	292	293	294	295	296	297	298	299	300	301	302	303	304	305	306	307	308	309	310	311	312	313	314	315	316
	335	336	337	338	313	314	315	316	317	318	319	320	321	322	323	324	325	326	327	328	329	330	331	332	333	334	335	336	337	338	339	340	341	342	343	344
	361	362	363	364	341	342	343	344	345	346	347	348	349	350	351	352	353	354	355	356	357	358	359	360	361	362	363	364	365	366	367	368	369	370	371	372
	387	388	389	390	369	370	371	372	373	374	375	376	377	378	379	380	381	382	383	384	385	386	387	388	389	390	391	392	393	394	395	396	397	398	399	400
32N	413	414	415	416	397	398	399	400	401	402	403	404	405	406	407	408	409	410	411	412	413	414	415	416	417	418	419	420	421	422	423	424	425	426	427	428
	421	422	423	424	425	426	427	428	429	430	431	432	433	434	435	436	437	438	439	440	441	442	443	444	445	446	447	448	449	450	451	452	453	454	455	456
	449	450	451	452	453	454	455	456	457	458	459	460	461	462	463	464	465	466	467	468	469	470	471	472	473	474	475	476	477	478	479	480	481	482	483	484
	477	478	479	480	481	482	483	484	485	486	487	488	489	490	491	492	493	494	495	496	497	498	499	500	501	502	503	504	505	506	507	508	509	510	511	512
	116W				115W				114W				113W				112W				111W				110W				109W							

Figure E-29. Phoenix Chart Grid

	117W				116W				115W				114W				113W				112W				111W				110W				109W			
	1	2	3	4	5	6	7	8	9	10	11	12	13	14	15	16	17	18	19	20	21	22	23	24	25	26	27	28	29	30	31	32				
44 N	33	31	35	36	37	38	39	40	41	42	43	44	45	46	47	48	49	50	51	52	53	54	55	56	57	58	59	60	61	62	63	64				
	65	66	67	68	69	70	71	72	73	74	75	76	77	78	79	80	81	82	83	84	85	86	87	88	89	90	91	92	93	94	95	96				
	97	98	99	100	101	102	103	104	105	106	107	108	109	110	111	112	113	114	115	116	117	118	119	120	121	122	123	124	125	126	127	128				
43 N	129	130	131	132	133	134	135	136	137	138	139	140	141	142	143	144	145	146	147	148	149	150	151	152	153	154	155	156	157	158	159	160				
	161	162	163	164	165	166	167	168	169	170	171	172	173	174	175	176	177	178	179	180	181	182	183	184	185	186	187	188	189	190	191	192				
	193	194	195	196	197	198	199	200	201	202	203	204	205	206	207	208	209	210	211	212	213	214	215	216	217	218	219	220	221	222	223	224				
42 N	225	226	227	228	229	230	231	232	233	234	235	236	237	238	239	240	241	242	243	244	245	246	247	248	249	250	251	252	253	254	255	256				
	257	258	259	260	261	262	263	264	265	266	267	268	269	270	271	272	273	274	275	276	277	278	279	280	281	282	283	284	285	286	287	288				
	289	290	291	292	293	294	295	296	297	298	299	300	301	302	303	304	305	306	307	308	309	310	311	312	313	314	315	316	317	318	319	320				
	321	322	323	324	325	326	327	328	329	330	331	332	333	334	335	336	337	338	339	340	341	342	343	344	345	346	347	348	349	350	351	352				
41 N	353	354	355	356	357	358	359	360	361	362	363	364	365	366	367	368	369	370	371	372	373	374	375	376	377	378	379	380	381	382	383	384				
	385	386	387	388	389	390	391	392	393	394	395	396	397	398	399	400	401	402	403	404	405	406	407	408	409	410	411	412	413	414	415	416				
	417	418	419	420	421	422	423	424	425	426	427	428	429	430	431	432	433	434	435	436	437	438	439	440	441	442	443	444	445	446	447	448				
	449	450	451	452	453	454	455	456	457	458	459	460	461	462	463	464	465	466	467	468	469	470	471	472	473	474	475	476	477	478	479	480				
	481	482	483	484	485	486	487	488	489	490	491	492	493	494	495	496	497	498	499	500	501	502	503	504	505	506	507	508	509	510	511	512				
40 N	513	514	515	516	517	518	519	520	521	522	523	524	525	526	527	528	529	530	531	532	533	534	535	536	537	538	539	540	541	542	543	544				
	545	546	547	548	549	550	551	552	553	554	555	556	557	558	559	560	561	562	563	564	565	566	567	568	569	570	571	572	573	574	575	576				
	117W				116W				115W				114W				113W				112W				111W				110W				109W			

Figure E-30. Salt Lake City Chart Grid

Appendix E - Gridding

32N	103W				102W				101W				100W				099W				098W				097W				32N
	1	2	3	4	5	6	7	8	9	10	11	12	13	14	15	16	17	18	19	20	21	22	23	24	25	26	27	28	
	25	26	27	28	29	30	31	32	33	34	35	36	37	38	39	40	41	42	43	44	45	46	47	48	49	50	51	52	
	49	50	51	52	53	54	55	56	57	58	59	60	61	62	63	64	65	66	67	68	69	70	71	72	73	74	75	76	
31N	73	74	75	76	77	78	79	80	81	82	83	84	85	86	87	88	89	90	91	92	93	94	95	96	97	98	99	100	31N
	97	98	99	100	101	102	103	104	105	106	107	108	109	110	111	112	113	114	115	116	117	118	119	120	121	122	123	124	
	121	122	123	124	125	126	127	128	129	130	131	132	133	134	135	136	137	138	139	140	141	142	143	144	145	146	147	148	
	145	146	147	148	149	150	151	152	153	154	155	156	157	158	159	160	161	162	163	164	165	166	167	168	169	170	171	172	
30N	169	170	171	172	173	174	175	176	177	178	179	180	181	182	183	184	185	186	187	188	189	190	191	192	193	194	195	196	30N
	193	194	195	196	197	198	199	200	201	202	203	204	205	206	207	208	209	210	211	212	213	214	215	216	217	218	219	220	
	217	218	219	220	221	222	223	224	225	226	227	228	229	230	231	232	233	234	235	236	237	238	239	240	241	242	243	244	
	241	242	243	244	245	246	247	248	249	250	251	252	253	254	255	256	257	258	259	260	261	262	263	264	265	266	267	268	
29N	265	266	267	268	269	270	271	272	273	274	275	276	277	278	279	280	281	282	283	284	285	286	287	288	289	290	291	292	29N
	289	290	291	292	293	294	295	296	297	298	299	300	301	302	303	304	305	306	307	308	309	310	311	312	313	314	315	316	
	313	314	315	316	317	318	319	320	321	322	323	324	325	326	327	328	329	330	331	332	333	334	335	336	337	338	339	340	
	337	338	339	340	341	342	343	344	345	346	347	348	349	350	351	352	353	354	355	356	357	358	359	360	361	362	363	364	
28N	361	362	363	364	365	366	367	368	369	370	371	372	373	374	375	376	377	378	379	380	381	382	383	384	385	386	387	388	28N
	103W				102W				101W				100W				099W				098W				097W				

Figure E-31. San Antonio Chart Grid

40N	125W				124W				123W				122W				121W				120W				119W				118W				40N
	1	2	3	4	5	6	7	8	9	10	11	12	13	14	15	16	17	18	19	20	21	22	23	24	25	26	27	28					
	29	30	31	32	33	34	35	36	37	38	39	40	41	42	43	44	45	46	47	48	49	50	51	52	53	54	55	56					
	57	58	59	60	61	62	63	64	65	66	67	68	69	70	71	72	73	74	75	76	77	78	79	80	81	82	83	84					
39N	85	86	87	88	89	90	91	92	93	94	95	96	97	98	99	100	101	102	103	104	105	106	107	108	109	110	111	112	39N				
	113	114	115	116	117	118	119	120	121	122	123	124	125	126	127	128	129	130	131	132	133	134	135	136	137	138	139	140					
	141	142	143	144	145	146	147	148	149	150	151	152	153	154	155	156	157	158	159	160	161	162	163	164	165	166	167	168					
	169	170	171	172	173	174	175	176	177	178	179	180	181	182	183	184	185	186	187	188	189	190	191	192	193	194	195	196					
38N	197	198	199	200	201	202	203	204	205	206	207	208	209	210	211	212	213	214	215	216	217	218	219	220	221	222	223	224	38N				
	225	226	227	228	229	230	231	232	233	234	235	236	237	238	239	240	241	242	243	244	245	246	247	248	249	250	251	252					
	253	254	255	256	257	258	259	260	261	262	263	264	265	266	267	268	269	270	271	272	273	274	275	276	277	278	279	280					
	281	282	283	284	285	286	287	288	289	290	291	292	293	294	295	296	297	298	299	300	301	302	303	304	305	306	307	308					
37N	309	310	311	312	313	314	315	316	317	318	319	320	321	322	323	324	325	326	327	328	329	330	331	332	333	334	335	336	37N				
	337	338	339	340	341	342	343	344	345	346	347	348	349	350	351	352	353	354	355	356	357	358	359	360	361	362	363	364					
	365	366	367	368	369	370	371	372	373	374	375	376	377	378	379	380	381	382	383	384	385	386	387	388	389	390	391	392					
	393	394	395	396	397	398	399	400	401	402	403	404	405	406	407	408	409	410	411	412	413	414	415	416	417	418	419	420					
36N	421	422	423	424	425	426	427	428	429	430	431	432	433	434	435	436	437	438	439	440	441	442	443	444	445	446	447	448	36N				
	125W				124W				123W				122W				121W				120W				119W				118W				

Figure E-32. San Francisco Chart Grid

49 N	125W				124W				123W				122W				121W				120W				119W				118W				117W				49 N
	1	2	3	4	5	6	7	8	9	10	11	12	13	14	15	16	17	18	19	20	21	22	23	24	25	26	27	28	29	30	31	32					
	33	31	35	36	37	38	39	40	41	42	43	44	45	46	47	48	49	50	51	52	53	54	55	56	57	58	59	60	61	62	63	64					
48 N	65	66	67	68	69	70	71	72	73	74	75	76	77	78	79	80	81	82	83	84	85	86	87	88	89	90	91	92	93	94	95	96	48 N				
	97	98	99	100	101	102	103	104	105	106	107	108	109	110	111	112	113	114	115	116	117	118	119	120	121	122	123	124	125	126	127	128					
47 N	129	130	131	132	133	134	135	136	137	138	139	140	141	142	143	144	145	146	147	148	149	150	151	152	153	154	155	156	157	158	159	160	47 N				
	161	162	163	164	165	166	167	168	169	170	171	172	173	174	175	176	177	178	179	180	181	182	183	184	185	186	187	188	189	190	191	192					
	193	194	195	196	197	198	199	200	201	202	203	204	205	206	207	208	209	210	211	212	213	214	215	216	217	218	219	220	221	222	223	224					
	225	226	227	228	229	230	231	232	233	234	235	236	237	238	239	240	241	242	243	244	245	246	247	248	249	250	251	252	253	254	255	256					
46 N	257	258	259	260	261	262	263	264	265	266	267	268	269	270	271	272	273	274	275	276	277	278	279	280	281	282	283	284	285	286	287	288	46 N				
	289	290	291	292	293	294	295	296	297	298	299	300	301	302	303	304	305	306	307	308	309	310	311	312	313	314	315	316	317	318	319	320					
	321	322	323	324	325	326	327	328	329	330	331	332	333	334	335	336	337	338	339	340	341	342	343	344	345	346	347	348	349	350	351	352					
	353	354	355	356	357	358	359	360	361	362	363	364	365	366	367	368	369	370	371	372	373	374	375	376	377	378	379	380	381	382	383	384					
45 N	385	386	387	388	389	390	391	392	393	394	395	396	397	398	399	400	401	402	403	404	405	406	407	408	409	410	411	412	413	414	415	416	45 N				
	417	418	419	420	421	422	423	424	425	426	427	428	429	430	431	432	433	434	435	436	437	438	439	440	441	442	443	444	445	446	447	448					
	449	450	451	452	453	454	455	456	457	458	459	460	461	462	463	464	465	466	467	468	469	470	471	472	473	474	475	476	477	478	479	480					
	481	482	483	484	485	486	487	488	489	490	491	492	493	494	495	496	497	498	499	500	501	502	503	504	505	506	507	508	509	510	511	512					
	513	514	515	516	517	518	519	520	521	522	523	524	525	526	527	528	529	530	531	532	533	534	535	536	537	538	539	540	541	542	543	544					
	545	546	547	548	549	550	551	552	553	554	555	556	557	558	559	560	561	562	563	564	565	566	567	568	569	570	571	572	573	574	575	576					
	125W				124W				123W				122W				121W				120W				119W				118W				117W				

Figure E-33. Seattle Chart Grid

40N	091W	KANSAS CITY				090W				089W				088W				087W				086W				085W				084W				40N
	25	26	27	28	5	6	7	8	9	10	11	12	13	14	15	16	17	18	19	20	21	22	23	24	25	26	27	28						
	53	54	55	56	33	34	35	36	37	38	39	40	41	42	43	44	45	46	47	48	49	50	51	52	53	54	55	56						
	81	82	83	84	61	62	63	64	65	66	67	68	69	70	71	72	73	74	75	76	77	78	79	80	81	82	83	84						
39N	109	110	111	112	89	90	91	92	93	94	95	96	97	98	99	100	101	102	103	104	105	106	107	108	109	110	111	112	39N					
	137	138	139	140	117	118	119	120	121	122	123	124	125	126	127	128	129	130	131	132	133	134	135	136	137	138	139	140						
	165	166	167	168	145	146	147	148	149	150	151	152	153	154	155	156	157	158	159	160	161	162	163	164	165	166	167	168						
	193	194	195	196	173	174	175	176	177	178	179	180	181	182	183	184	185	186	187	188	189	190	191	192	193	194	195	196						
38N	221	222	223	224	201	202	203	204	205	206	207	208	209	210	211	212	213	214	215	216	217	218	219	220	221	222	223	224	38N					
	249	250	251	252	229	230	231	232	233	234	235	236	237	238	239	240	241	242	243	244	245	246	247	248	249	250	251	252						
	277	278	279	280	257	258	259	260	261	262	263	264	265	266	267	268	269	270	271	272	273	274	275	276	277	278	279	280						
	305	306	307	308	285	286	287	288	289	290	291	292	293	294	295	296	297	298	299	300	301	302	303	304	305	306	307	308						
37N	333	334	335	336	313	314	315	316	317	318	319	320	321	322	323	324	325	326	327	328	329	330	331	332	333	334	335	336	37N					
	361	362	363	364	341	342	343	344	345	346	347	348	349	350	351	352	353	354	355	356	357	358	359	360	361	362	363	364						
	389	390	391	392	369	370	371	372	373	374	375	376	377	378	379	380	381	382	383	384	385	386	387	388	389	390	391	392						
	417	418	419	420	397	398	399	400	401	402	403	404	405	406	407	408	409	410	411	412	413	414	415	416	417	418	419	420						
36N	445	446	447	448	425	426	427	428	429	430	431	432	433	434	435	436	437	438	439	440	441	442	443	444	445	446	447	448	36N					
	091W				090W				089W				088W				087W				086W				085W				084W					

Figure E-34. St. Louis Chart Grid

Appendix E - Gridding

49 N	101W				100W				099W				098W				097W				096W				095W				094W		093W		49 N
	1	2	3	4	5	6	7	8	9	10	11	12	13	14	15	16	17	18	19	20	21	22	23	24	25	26	27	28	29	30	31	32	
48 N	33	31	35	36	37	38	39	40	41	42	43	44	45	46	47	48	49	50	51	52	53	54	55	56	57	58	59	60	61	62	63	64	
	65	66	67	68	69	70	71	72	73	74	75	76	77	78	79	80	81	82	83	84	85	86	87	88	89	90	91	92	93	94	95	96	
	97	98	99	100	101	102	103	104	105	106	107	108	109	110	111	112	113	114	115	116	117	118	119	120	121	122	123	124	125	126	127	128	
47 N	129	130	131	132	133	134	135	136	137	138	139	140	141	142	143	144	145	146	147	148	149	150	151	152	153	154	155	156	157	158	159	160	
	161	162	163	164	165	166	167	168	169	170	171	172	173	174	175	176	177	178	179	180	181	182	183	184	185	186	187	188	189	190	191	192	
	193	194	195	196	197	198	199	200	201	202	203	204	205	206	207	208	209	210	211	212	213	214	215	216	217	218	219	220	221	222	223	224	
	225	226	227	228	229	230	231	232	233	234	235	236	237	238	239	240	241	242	243	244	245	246	247	248	249	250	251	252	253	254	255	256	
46 N	257	258	259	260	261	262	263	264	265	266	267	268	269	270	271	272	273	274	275	276	277	278	279	280	281	282	283	284	285	286	287	288	
	289	290	291	292	293	294	295	296	297	298	299	300	301	302	303	304	305	306	307	308	309	310	311	312	313	314	315	316	317	318	319	320	
	321	322	323	324	325	326	327	328	329	330	331	332	333	334	335	336	337	338	339	340	341	342	343	344	345	346	347	348	349	350	351	352	
	353	354	355	356	357	358	359	360	361	362	363	364	365	366	367	368	369	370	371	372	373	374	375	376	377	378	379	380	381	382	383	384	
	385	386	387	388	389	390	391	392	393	394	395	396	397	398	399	400	401	402	403	404	405	406	407	408	409	410	411	412	413	414	415	416	
45 N	417	418	419	420	421	422	423	424	425	426	427	428	429	430	431	432	433	434	435	436	437	438	439	440	441	442	443	444	445	446	447	448	
	449	450	451	452	453	454	455	456	457	458	459	460	461	462	463	464	465	466	467	468	469	470	471	472	473	474	475	476	477	478	479	480	
	481	482	483	484	485	486	487	488	489	490	491	492	493	494	495	496	497	498	499	500	501	502	503	504	505	506	507	508	509	510	511	512	
	513	514	515	516	517	518	519	520	521	522	523	524	525	526	527	528	529	530	531	532	533	534	535	536	537	538	539	540	541	542	543	544	
	545	546	547	548	549	550	551	552	553	554	555	556	557	558	559	560	561	562	563	564	565	566	567	568	569	570	571	572	573	574	575	576	
	101W				100W				099W				098W				097W				096W				095W				094W		093W		

Figure E-35. Twin Cities Chart Grid

40N	079W		CINCINNATI				078W		077W				076W				075W				074W				073W		072W		40N
	25	26	27	28	5	6	7	8	9	10	11	12	13	14	15	16	17	18	19	20	21	22	23	24	25	26	27	28	
39N	53	54	55	56	33	34	35	36	37	38	39	40	41	42	43	44	45	46	47	48	49	50	51	52	53	54	55	56	
	81	82	83	84	61	62	63	64	65	66	67	68	69	70	71	72	73	74	75	76	77	78	79	80	81	82	83	84	
	109	110	111	112	89	90	91	92	93	94	95	96	97	98	99	100	101	102	103	104	105	106	107	108	109	110	111	112	
38N	137	138	139	140	117	118	119	120	121	122	123	124	125	126	127	128	129	130	131	132	133	134	135	136	137	138	139	140	
	165	166	167	168	145	146	147	148	149	150	151	152	153	154	155	156	157	158	159	160	161	162	163	164	165	166	167	168	
	193	194	195	196	173	174	175	176	177	178	179	180	181	182	183	184	185	186	187	188	189	190	191	192	193	194	195	196	
	221	222	223	224	201	202	203	204	205	206	207	208	209	210	211	212	213	214	215	216	217	218	219	220	221	222	223	224	
37N	249	250	251	252	229	230	231	232	233	234	235	236	237	238	239	240	241	242	243	244	245	246	247	248	249	250	251	252	
	277	278	279	280	257	258	259	260	261	262	263	264	265	266	267	268	269	270	271	272	273	274	275	276	277	278	279	280	
	305	306	307	308	285	286	287	288	289	290	291	292	293	294	295	296	297	298	299	300	301	302	303	304	305	306	307	308	
	333	334	335	336	313	314	315	316	317	318	319	320	321	322	323	324	325	326	327	328	329	330	331	332	333	334	335	336	
	361	362	363	364	341	342	343	344	345	346	347	348	349	350	351	352	353	354	355	356	357	358	359	360	361	362	363	364	
36N	389	390	391	392	369	370	371	372	373	374	375	376	377	378	379	380	381	382	383	384	385	386	387	388	389	390	391	392	
	417	418	419	420	397	398	399	400	401	402	403	404	405	406	407	408	409	410	411	412	413	414	415	416	417	418	419	420	
	445	446	447	448	425	426	427	428	429	430	431	432	433	434	435	436	437	438	439	440	441	442	443	444	445	446	447	448	
079W				078W				077W				076W				075W				074W				073W		072W			

Figure E-36. Washington Chart Grid

40N	104W				103W				102W				101W				100W				099W				098W		097W		40N
	1	2	3	4	5	6	7	8	9	10	11	12	13	14	15	16	17	18	19	20	21	22	23	24	25	26	27	28	
	29	30	31	32	33	34	35	36	37	38	39	40	41	42	43	44	45	46	47	48	49	50	51	52	53	54	55	56	
	57	58	59	60	61	62	63	64	65	66	67	68	69	70	71	72	73	74	75	76	77	78	79	80	81	82	83	84	
39N	85	86	87	88	89	90	91	92	93	94	95	96	97	98	99	100	101	102	103	104	105	106	107	108	109	110	111	112	39N
	113	114	115	116	117	118	119	120	121	122	123	124	125	126	127	128	129	130	131	132	133	134	135	136	137	138	139	140	
	141	142	143	144	145	146	147	148	149	150	151	152	153	154	155	156	157	158	159	160	161	162	163	164	165	166	167	168	
	169	170	171	172	173	174	175	176	177	178	179	180	181	182	183	184	185	186	187	188	189	190	191	192	193	194	195	196	
38N	197	198	199	200	201	202	203	204	205	206	207	208	209	210	211	212	213	214	215	216	217	218	219	220	221	222	223	224	38N
	225	226	227	228	229	230	231	232	233	234	235	236	237	238	239	240	241	242	243	244	245	246	247	248	249	250	251	252	
	253	254	255	256	257	258	259	260	261	262	263	264	265	266	267	268	269	270	271	272	273	274	275	276	277	278	279	280	
	281	282	283	284	285	286	287	288	289	290	291	292	293	294	295	296	297	298	299	300	301	302	303	304	305	306	307	308	
37N	309	310	311	312	313	314	315	316	317	318	319	320	321	322	323	324	325	326	327	328	329	330	331	332	333	334	335	336	37N
	337	338	339	340	341	342	343	344	345	346	347	348	349	350	351	352	353	354	355	356	357	358	359	360	361	362	363	364	
	365	366	367	368	369	370	371	372	373	374	375	376	377	378	379	380	381	382	383	384	385	386	387	388	389	390	391	392	
	393	394	395	396	397	398	399	400	401	402	403	404	405	406	407	408	409	410	411	412	413	414	415	416	417	418	419	420	
36N	421	422	423	424	425	426	427	428	429	430	431	432	433	434	435	436	437	438	439	440	441	442	443	444	445	446	447	448	36N
	104W				103W				102W				101W				100W				099W				098W		097W		

Figure E-37. Wichita Chart Grid

This page intentionally blank

---

## Appendix F

### SAR References and Web Sites

This section is a partial listing of other suggested sources of SAR information. It does not include SAR case studies, SAR research projects, or standards manuals for types of boats or aircraft. The most current edition available should be used in the various technical series. The publications and web sites in this list are not necessarily "approved" for use by users of this NSS, but are noted as possible sources of supplementary information.

#### SERVICE PUBLICATIONS

- Bigelow, Henry B. and Edmondson, W.T. Wind Waves at Sea, Breakers and Surf. U.S. Naval Oceanographic Office. H.O. Pub 602, 1947.
- Boat Crew Seamanship Manual. U.S. Coast Guard. COMDTINST M16114.5 (Series).
- Boating Statistics (Year). U.S. Coast Guard. COMDTINST M16754 (Series).
- Bowditch, Nathaniel. American Practical Navigator. Defense Mapping Agency. Pub No. 9.
- Busby, R. Frank. Manned Submersibles. Office of the Oceanographer of the Navy, 1976.
- Catalog of Deep Submergence Systems (Unmanned) Navy Owned or Operated. U.S. Navy. S9DSV-00-CAT-010, 1981. Distribution limited to U.S. Government agencies only.
- Deep Ocean Search, Inspection, and Recovery. U.S. Navy. NWP 19-3.
- Directory of World-Wide, Shore-Based Hyperbaric Chambers. U.S. Navy. NAVSHIPS 0994-010-4012.
- Evacuation of the Sick and Wounded. U.S. Army. FM 8-35, 1977.
- International Code of Signals. Defense Mapping Agency Hydrographic/Topographic Center. Pub 102.
- Inventory of Navy Laboratory R & D Equipment Available for Emergency Undersea Operations. U.S. Navy. NOSC TD 112, 1983.
- Maneuvering Board Manual. Defense Mapping Agency. Pub 217.
- Marine Radiotelephone Users Handbook. Radio Technical Commission for Maritime Services, 1982.
- Merchant Marine House Flags and Stack Insignia. U.S. Navy Hydrographic Office. H.O. Pub 100.
- Navy Safety Precautions for Forces Afloat. U.S. Navy. OPNAVINST 5100.19.
- Pilot Rescue Facts. U.S. Navy. NAVWEPS 00-80J-2, 1962.
- Radar Navigation Manual. Defense Mapping Agency. Pub 1310.
- Rescue and Survival Systems Manual (CG). U.S. Coast Guard. COMDTINST M10470.10 (Series).
- Sarsat Users Manual for Use by Coast Guard SAR Personnel. U.S. Coast Guard, 1982.

Standard First Aid Training Course. U.S. Navy. NAVEDTRA 10081-C.

Submarine Disaster Search and Rescue Operations. U.S. Navy. USN Addendum to NWP 19(Series).

Survival Training Guide. U.S. Navy. NAVWEPS 00-80T-56.

Telecommunications Manual, USCG. U.S. Coast Guard. COMDTINST M2000.3 (Series).

U.S. Air Force Foreign Clearance Guide. St. Louis, Missouri: The Defense Mapping Agency Aerospace Center. Several volumes for different areas of the world, published and updated periodically. Not releasable outside U.S. Government.

U.S. Navy Aircraft Firefighting and Rescue Manual. U.S. Navy. NAVAIR 00-80R-14.

Weather for Aircrews. U.S. Air Force. AFM 51-12, Vol. 1.

### **OTHER U.S. PUBLICATIONS**

Airman's Information Manual, Basic Flight Information and ATC Procedures. Federal Aviation Administration.  
Published periodically as required (normally two or three times annually).

Airport Emergency Plan. Federal Aviation Administration. Advisory Circular 150/5200-31

Air Traffic Control. Federal Aviation Administration. FAA 7110.65(Series).

Amver User's Manual (Ship Reporting System for Search and Rescue). Amver Maritime Relations, U.S. Coast Guard

Diving Accident Manual. Diving Accident Network, Duke University, Durham, North Carolina.

Emergency Response Institute. Helicopter Operations and Personnel Safety (Helirescue Manual). Tacoma, Washington: Survival Education Association, 1970, Rev. 1978.

En Route Air Traffic Control. Federal Aviation Administration. FAA 7110.9(Series).

Fear, Gene. Surviving the Unexpected Wilderness Emergency. Tacoma, Washington: Survival Education Association, 1973.

First Aid Roundup. Denver, Colorado: National Ski Patrol System, Inc.

Flight Services Handbook. Federal Aviation Administration. FAA 7110.10(Series).

Federal Aviation Regulations, Part 1, Definitions and Abbreviations. Federal Aviation Administration.

Federal Aviation Regulations, Part 91, General Operating and Flight Rules. Federal Aviation Administration.

Frost, J.R.. The Theory of Search. Soza & Company, Ltd. and Office of Search and Rescue, U.S. Coast Guard, February, 1998.

Geisinger, Norman; Jensen, Thomas E.; Kreider, Glen D. Land Search and Rescue, A Manual for the Training of Civil Air Patrol Ranger Teams. Lehigh Valley, Pennsylvania: Ranger Section, Pennsylvania Wing, Civil Air Patrol, 1969.

Hayward, John S. Ph.D. "The Physiology of Immersion Hypothermia" In: The Nature and Treatment of Hypothermia edited by Robert S. Pozos and Lorentz E. Wittmers, University of Minnesota Press, Minneapolis, 1983.

High Seas Maritime Mobile Radio-Telephone Service. The American Telephone and Telegraph Co.



- Incident Command System Manual. International Fire Service Training Association, USDA Forest Service, Boise, ID.
- Joseph, Peter A. Underwater Search and Rescue for Non-Military Submersibles. The United States Naval War College, 1972.
- Kelley, Dennis. Mountain Search for the Lost Victim. Montrose, California: Dennis E. Kelley, 1973.
- La Chapelle, E.R. The ABC of Avalanche Safety. Colorado Outdoor Sports Company, 1970.
- Manual of Manned Submersibles. Design, Operations, Safety, and Instrumentation. Conducted by Busby Associates, Inc., New York, for the U.S. Navy, U.S. Coast Guard, and National Oceanic and Atmospheric Administration, 1984.
- Manual of U.S. Cave Rescue Techniques. Toni Lewis Williams, editor. National Cave Rescue Commission of the National Speleological Society, Huntsville, Alabama, 1981.
- Ohio Department of Natural Resources, Division of Watercraft. River Rescue. Vocational Instructional Materials Laboratory, The Ohio State University, 1980.
- Robbins, Roland. Mantracking, Introduction to the Step-by-Step Method. Montrose, California: Dennis E. Kelley, 1977.
- Setnicka, T.J. Wilderness Search and Rescue. Appalachian Mountain Club, 1980.
- Stoffel, Robert. Emergency Preparedness Today. State of Washington Department of Emergency Services.
- Stoffel, Robert and LaValla, Patrick. Survival Sense for Pilots and Passengers. Tacoma, Washington: Outdoor Empire Publishing, Inc., 1980.
- University of Hawaii. Studies on Human Performance in the Sea. Honolulu, Hawaii: University of Hawaii Sea Grant College Program, 1975. A Collection of studies on the physiological effects on man of immersion in water.
- Wartes, Jon. An Experimental Analysis of Grid Sweep Searching. Sunnyvale, California: Western Region Explorer Search and Rescue, 1974.
- Wartes, Jon. Explorer Search and Rescue: The Taylor Mountain Evidence Search. Western Region, Explorer Search and Rescue, 1975.
- Water Rescue Plans, Facilities, and Equipment. Federal Aviation Administration. Advisory Circular 150/5210-13
- Williams, Paul. Mountain Rescue Leadership. Mountain Rescue Council, 1970.
- Winter First Aid Manual. Denver, Colorado: National Ski Patrol System, Inc., 1973.

## **INTERNATIONAL PUBLICATIONS**

- Access to 406 MHz Beacon Resisters. Cospas-Sarsat
- Air Navigation Plan (applicable regional plan(s)). International Civil Aviation Organization.
- Alphabetical List of Call Signs of Stations Used by the Maritime Mobile Service. Geneva, Switzerland: International Telecommunication Union.
- Global Maritime Distress and Safety System Master Plan, International Maritime Organization.

International Aeronautical and Maritime Search and Rescue (IAMSAR) Manual. London, England: International Maritime Organization and International Civil Aviation Organization, 1998.

International Convention on Maritime Search and Rescue 1979. London, England: International Maritime Organization, 1979.

International Standards: Rules of the Air. Annex 2 to the Convention on International Civil Aviation. Montreal, Quebec: International Civil Aviation Organization.

International Standards: Meteorological Service for International Air Navigation, Annex 3 to the Convention on International Civil Aviation. Montreal, Quebec: International Civil Aviation Organization.

International Standards: Operation of Aircraft. Annex 6 to the Convention on International Civil Aviation. Montreal, Quebec: International Civil Aviation Organization.

International Standards: Airworthiness of Aircraft. Annex 8 to the Convention on International Civil Aviation. Montreal, Quebec: International Civil Aviation Organization.

International Standards: Facilitation. Annex 9 to the Convention on International Civil Aviation. Montreal, Quebec: International Civil Aviation Organization.

International Standards: Aeronautical Telecommunications. Annex 10 to the Convention on International Civil Aviation. Montreal, Quebec: International Civil Aviation Organization.

International Standards: Air Traffic Services. Annex 11 to the Convention on International Civil Aviation. Montreal, Quebec: International Civil Aviation Organization.

International Standards: Search and Rescue. Annex 12 to the Convention on International Civil Aviation. Montreal, Quebec: International Civil Aviation Organization.

International Standards: Aircraft Accident Investigation. Annex 13 to the Convention on International Civil Aviation. Montreal, Quebec: International Civil Aviation Organization.

Jane's All the World's Aircraft. London, England: Jane's Publishing Company, Limited. Annual editions.

Jane's Fighting Ships. London, England: Jane's Publishing Company, Limited. Annual editions.

List of Ship Stations. Geneva, Switzerland: International Telecommunication Union, 1978.

Manual of Aircraft Accident Investigation. Montreal, Quebec: International Civil Aviation Organization.

Mayday, Mayday, Mayday. Canadian National Defence Headquarters, Ottawa, Ontario, 1982. Overview of Canadian Armed Forces Search and Rescue, including a section on survival and aiding searchers. 88 pp.

Procedures for Air Navigation Services: Aircraft Operations. Montreal, Quebec: International Civil Aviation Organization.

Procedures for Air Navigation Services: ICAO Abbreviations and Codes. Montreal, Quebec: International Civil Aviation Organization.

Procedures for Air Navigation Services; Rules of the Air and Air Traffic Services. Tenth Edition. Montreal, Quebec: International Civil Aviation Organization.

Provisional Search and Rescue Plan. International Maritime Organization. Published as SAR circulars.

Radio Regulations. Geneva, Switzerland: International Telecommunication Union, 1976. 2 volumes.

Radio-Medical Assistance, Volume I: Part I - Coded Medical Messages. Rome, Italy: L'Assistenza Radio-Medica.

Radio-Medical Assistance, Volume II: Part I - The More Common Acute Illnesses. Part II - Assistance and First Aid on Board. Rome, Italy: L'Assistenza Radio-Medica.

Register of Offshore Units, Submersibles, and Diving Systems. London, England: Lloyd's Register of Shipping. Published annually.

Register of Ships. London, England: Lloyd's Register of Shipping. Published annually in two volumes.

Search and Rescue. North Atlantic Treaty Organization (NATO). ATP-10(Series).

Standard Marine Navigational Vocabulary. London, England: International Maritime Organization.

## WEB SITES

<b>NATIONAL</b>	
Federal Emergency Management Agency	<a href="http://www.fema.gov">www.fema.gov</a>
National SAR Committee (NSARC)	<a href="http://www.uscg.mil/hq/g-o/g-opr/nsarc">www.uscg.mil/hq/g-o/g-opr/nsarc</a>
National SAR School	<a href="http://www.uscg.mil/hq/rtc/rtsar.html">www.uscg.mil/hq/rtc/rtsar.html</a>
National Association for SAR (NASAR)	<a href="http://www.nasar.org">www.nasar.org</a>
National Institute of Urban SAR	<a href="http://niusr.org/welcome">niusr.org/welcome</a>
NOAA SRSAT	<a href="http://psbsgi1.nesdis.noaa.gov:8080/SARSAT">psbsgi1.nesdis.noaa.gov:8080/SARSAT</a>
US Air Force RCC (AFRCC Langley AFB)	<a href="http://www.acc.af.mil/afrc">www.acc.af.mil/afrc</a>
Civil Air Patrol	<a href="http://www.cap.af.mil">www.cap.af.mil</a>
USCG CGHQ SAR Program Manager	<a href="http://www.uscg.mil/hq/g-o/g-opr/sar.htm">www.uscg.mil/hq/g-o/g-opr/sar.htm</a>
USCG R&D Center	<a href="http://www.rdc.uscg.mil">www.rdc.uscg.mil</a>
USCG International Ice Patrol	<a href="http://www.rdc.uscg.mil/iippages/home.htm">www.rdc.uscg.mil/iippages/home.htm</a>
USCG Navcen Maritime Communications	<a href="http://www.navcen.uscg.mil/marcomms">www.navcen.uscg.mil/marcomms</a>
USCG Operations Systems Center	<a href="http://www.uscg.mil/hq/osc">www.uscg.mil/hq/osc</a>
USCG Auxiliary	<a href="http://www.cgaux.org">www.cgaux.org</a>
US Navy SAR Model Manager (HC3)	<a href="http://www.nasi.navy.mil/wings/hc3/index">www.nasi.navy.mil/wings/hc3/index</a>
<b>OTHER NATIONS'S ORGANIZATIONS</b>	
Maritime and Coastguard Agency, United Kingdom	<a href="http://www.mcagency.org.uk">www.mcagency.org.uk</a>
Canadian National SAR Secretariat	<a href="http://www.nss.gc.ca">www.nss.gc.ca</a>
Canadian Coast Guard Home Page	<a href="http://www.ccg-gcc.gc.ca">www.ccg-gcc.gc.ca</a>
Canadian Coast Guard SAR College	<a href="http://www.ns.ca">www.ns.ca</a>
Canadian Coast Guard (Rescue, Safety and Environmental Response)	<a href="http://www.ccrser.org">www.ccrser.org</a>
CASARA Canada Home Page	<a href="http://www.casara.ca">www.casara.ca</a>
Canadian Mission Control Centre	<a href="http://gpsl.cmcc.tren.dnd.ca">gpsl.cmcc.tren.dnd.ca</a>
Canadian Forces SAR	<a href="http://www.dnd.ca/menu/SAR/eng">www.dnd.ca/menu/SAR/eng</a>
Lifboat Services Around the World	<a href="http://members.xoom.com/lrztzsche">members.xoom.com/lrztzsche</a>
Royal National Lifeboat Institution (RNLI)	<a href="http://www.rnli.org.uk">www.rnli.org.uk</a>
<b>INTERNATIONAL ORGANIZATIONS and GLOBAL SYSTEMS</b>	

Amver	<a href="http://www.amver.com">www.amver.com</a>
Cospas-Sarsat	<a href="http://www.worldserver.pipex.com/cospas-sarsat">www.worldserver.pipex.com/cospas-sarsat</a>
International Civil Aviation Organization (ICAO)	<a href="http://www.icao.int">www.icao.int</a>
International Maritime Organization (IMO)	<a href="http://www.imo.org">www.imo.org</a>
Inmarsat	<a href="http://www.inmarsat.org">www.inmarsat.org</a>
International Telecommunication Union (ITU)	<a href="http://www.itu.int">www.itu.int</a>
International Search and Rescue Society (ISARS)	<a href="http://www.isars.org">www.isars.org</a>
<b>EMERGENCY RESPONSE ORGANIZATION DIRECTORIES</b>	
Emergency Services www Site List	<a href="http://www.district.north-van.bc.ca/eswsl/www-911">www.district.north-van.bc.ca/eswsl/www-911</a>
Rescue Coordination Centre Network (listing of worldwide RCC, SAR links, R&D)	<a href="http://www.rcc-net.org">www.rcc-net.org</a>
International Search and Rescue Forum	<a href="http://www.hypernews.org/HyperNews/get/trails/sar.html">www.hypernews.org/HyperNews/get/trails/sar.html</a>
Search and Rescue Information	<a href="http://Web20.mindlink.net/sarinfo">Web20.mindlink.net/sarinfo</a>
<b>ENVIRONMENTAL INFORMATION</b>	
Great Lakes Forecasting System	<a href="http://superior.eng.ohio-state.edu">superior.eng.ohio-state.edu</a>
GEOSAT Coverage	<a href="http://www.worldserver.pipex.com/cospas-sarsat">www.worldserver.pipex.com/cospas-sarsat</a>
National Data Buoy Center	<a href="http://www.ndbc.noaa.gov">www.ndbc.noaa.gov</a>
NOAA Environmental Modeling Center	<a href="http://nic.fb4.noaa.gov:8000">nic.fb4.noaa.gov:8000</a>
NOAA Ocean Modeling Branch	<a href="http://polar.wwb.noaa.gov/Welcome">polar.wwb.noaa.gov/Welcome</a>
Weather Net (forecasts for various cities)	<a href="http://cirrus.sprl.umich.edu/wxnet">cirrus.sprl.umich.edu/wxnet</a>
WWW Tide and Current Predictor	<a href="http://tbone.biol.sc.edu/tide/sitesel">tbone.biol.sc.edu/tide/sitesel</a>
<b>COMPUTERS and SAR</b>	
Computers in SAR Digest	<a href="http://www.basarc.org/csar/CSARDigest">www.basarc.org/csar/CSARDigest</a>

# Appendix G

## Tables and Graphs

**G.1** As stated in Chapter 4 of this NSS, search planning and search operations will be conducted in accordance with the IAMSAR Manual and as augmented by this NSS. IAMSAR Manual, Volume 2 was written specifically for conducting RCC and SMC duties, and is the primary source document for search planning and search operations. However, other information or more specific data has been developed nationally and is provided for use in addition to or, as appropriate, in lieu of similar tables and graphs within the IAMSAR Manual. This national data will be considered for incorporation into the IAMSAR Manual, as appropriate.

**G.2 Wind Current (WC)**

G.2.1 IAMSAR Manual Vol. 2, Appendix, Figure N-1 pertains. The below Tables G-1a and G-1b provide comparable information. To calculate wind with the below figures, select the column with latitude closest to the desired position. Do not interpolate.

**Table G-1a. Wind Current - North Latitudes**

Period	NORTH LATITUDES													
	0°N	5°N	10°N	15°N	20°N	25°N	30°N	35°N	40°N	45°N	50°N	55°N	60°N	65°N
1	With sustained winds of 6 hours or more wind current speed will be 5% of wind speed with direction downwind.	185° 0.029	190° 0.028	196° 0.028	200° 0.027	205° 0.027	210° 0.026	214° 0.025	217° 0.024	221° 0.023	224° 0.022	226° 0.021	228° 0.020	230° 0.020
2		203° 0.012	226° 0.012	249° 0.012	271° 0.011	292° 0.011	312° 0.011	332° 0.011	350° 0.010	007° 0.010	022° 0.009	036° 0.009	049° 0.009	059° 0.008
3		219° 0.009	258° 0.009	296° 0.009	333° 0.009	009° 0.008	043° 0.008	076° 0.008	107° 0.008	136° 0.007	162° 0.007	186° 0.007	207° 0.007	224° 0.006
4		235° 0.008	289° 0.008	342° 0.008	035° 0.007	085° 0.007	134° 0.007	180° 0.007	223° 0.006	264° 0.006	301° 0.006	334° 0.006	003° 0.006	028° 0.005
5		250° 0.007	320° 0.007	029° 0.007	096° 0.006	162° 0.006	224° 0.006	283° 0.006	339° 0.006	031° 0.005	079° 0.005	121° 0.005	159° 0.005	192° 0.004
6		266° 0.006	352° 0.006	076° 0.006	158° 0.006	238° 0.006	314° 0.005	027° 0.005	095° 0.005	159° 0.004	217° 0.004	269° 0.004	315° 0.004	355° 0.004
7		282° 0.006	023° 0.006	123° 0.006	220° 0.005	314° 0.005	044° 0.005	130° 0.005	211° 0.004	286° 0.004	355° 0.004	056° 0.004	111° 0.003	158° 0.003
8		298° 0.005	054° 0.005	169° 0.005	281° 0.005	030° 0.005	134° 0.004	233° 0.004	327° 0.004	053° 0.004	132° 0.003	204° 0.003	267° 0.003	321° 0.003

**Note:** In each time period, the number shows the relationship between wind direction and current direction, and the lower number shows the relationship between wind speed and current speed.

**Table G-1b. Wind Current - South Latitudes**

Period	SOUTH LATITUDES													
	0°S	5°S	10°S	15°S	20°S	25°S	30°S	35°S	40°S	45°S	50°S	55°S	60°S	65°S
1	175° 0.029	170° 0.028	164° 0.028	160° 0.027	155° 0.027	150° 0.026	146° 0.025	143° 0.024	139° 0.023	136° 0.022	134° 0.021	132° 0.020	130° 0.020	
2	157° 0.012	134° 0.012	111° 0.012	089° 0.011	068° 0.011	048° 0.011	028° 0.011	010° 0.010	353° 0.010	338° 0.009	324° 0.009	311° 0.009	301° 0.008	
3	141° 0.009	102° 0.009	064° 0.009	027° 0.009	351° 0.008	317° 0.008	284° 0.008	253° 0.008	224° 0.007	198° 0.007	174° 0.007	153° 0.007	136° 0.006	
4	125° 0.008	071° 0.008	018° 0.008	325° 0.007	275° 0.007	226° 0.007	180° 0.007	137° 0.006	396° 0.006	059° 0.006	026° 0.006	357° 0.006	332° 0.005	
5	110° 0.007	040° 0.007	331° 0.007	264° 0.006	198° 0.006	136° 0.006	077° 0.006	021° 0.006	329° 0.005	281° 0.005	239° 0.005	201° 0.005	168° 0.004	
6	094° 0.006	008° 0.006	284° 0.006	202° 0.006	122° 0.006	046° 0.005	333° 0.005	265° 0.005	201° 0.004	143° 0.004	091° 0.004	045° 0.004	005° 0.004	
7	078° 0.006	337° 0.006	237° 0.006	140° 0.005	046° 0.005	316° 0.005	230° 0.005	149° 0.004	074° 0.004	005° 0.004	304° 0.004	249° 0.003	202° 0.003	
8	062° 0.005	306° 0.005	191° 0.005	079° 0.005	330° 0.005	226° 0.004	127° 0.004	033° 0.004	307° 0.004	228° 0.003	156° 0.003	093° 0.003	039° 0.003	

With sustained winds of 6 hours or more wind current speed will be 5% of wind speed with direction downwind.

**G.3 Leeway (LW)**

G.3.1 Leeway can be estimated using the graphs in IAMSAR Manual, Appendix N, Figures N-2 and N-3. For more precise values, the following formulas may be used for wind speeds up to 40 knots:

Leeway Formulas	
Type of Craft	Leeway Speed
Light displacement cabin cruisers, outboards, rubber rafts, etc. (without drogue)	0.07U + 0.04*
Large cabin cruisers	0.05U
Light displacement cabin cruisers, outboards, rubber rafts, etc. (with drogue)	0.05U – 0.12*
Medium displacement sailboats, fishing vessels such as trawlers, trollers, tuna boats, etc.	0.04U
Heavy displacement deep draft sailing vessels	0.03U
Surfboards	0.02U
Notes:	
(1) Do not use for values of U below 5 knots, use graphs instead as applicable.	
(2) The formulas do not apply to rubber rafts with neither canopies or ballast systems, IAMSAR Manual Volume 2 Figures B-2 applies best.	

**G.4 Sweep Width Tables**

G.4.1 Maritime visual. Uncorrected sweep width tables, Tables G-2 through G-10 present uncorrected sweep width data for various types of SAR facilities and various altitudes and visibility conditions. Locate the table for the type of SAR facility (fixed-wing, helicopter, vessel, or boat). For aircraft, enter the column for the appropriate altitude and visibility. For surface craft, enter the column for the appropriate visibility. Read down this column to the target type that most closely describes the search object. The value is the uncorrected sweep width. Interpolate as necessary.

**Table G-2. Uncorrected Visual Sweep Width – Fixed-wing Aircraft for Altitudes 300-500 Feet**

Search Object	Altitude 300 Feet Visibility (NM)							Altitude 500 Feet Visibility (NM)						
	1	3	5	10	15	20	30	1	3	5	10	15	20	30
Person in Water*	0.1	0.1	0.1	0.1	0.1	0.1	0.1	0.0	0.1	0.1	0.1	0.1	0.1	0.1
Raft 1 person	0.3	0.7	0.9	1.2	1.3	1.3	1.3	0.3	0.7	0.9	1.2	1.4	1.4	1.4
Raft 4 person	0.4	0.9	1.3	1.7	2.0	2.2	2.2	0.4	1.0	1.3	1.8	2.0	2.2	2.2
Raft 6 person	0.1	1.1	1.5	2.1	2.5	2.7	2.7	0.4	1.1	1.5	2.2	2.5	2.8	2.8
Raft 8 person	0.4	1.2	1.6	2.3	2.6	2.9	2.9	0.4	1.2	1.6	2.3	2.7	2.9	2.9
Raft 10 person	0.4	1.2	1.7	2.4	2.9	3.2	3.2	0.4	1.2	1.7	2.5	2.9	3.2	3.2
Raft 15 person	0.5	1.3	1.9	2.7	3.2	3.5	4.0	0.5	1.3	1.9	2.7	3.3	3.6	4.0
Raft 20 person	0.5	1.4	2.1	3.1	3.7	4.2	4.8	0.5	1.5	2.1	3.2	3.8	4.2	4.8
Raft 25 person	0.5	1.5	2.2	3.4	4.1	4.6	5.2	0.5	1.6	2.3	3.4	4.1	4.6	5.3
Power Boat < 15 ft	0.4	0.8	1.1	1.4	1.6	1.7	1.7	0.4	0.9	1.2	1.5	1.7	1.8	1.8
Power Boat 16-25 ft	0.5	1.6	2.4	3.5	4.3	4.8	4.8	0.5	1.7	2.4	3.6	4.3	4.8	4.8
Power Boat 26-40 ft	0.6	2.1	3.3	5.3	6.6	7.6	9.1	0.6	2.1	3.3	5.3	6.7	7.7	9.1
Power Boat 41-65 ft	0.6	2.6	4.5	8.1	10.9	13.1	16.4	0.6	2.7	4.5	8.1	10.9	13.1	16.5
Power Boat 66-90 ft	0.6	2.8	5.0	9.7	13.5	16.6	21.6	0.6	2.8	5.0	9.8	13.5	16.7	21.7
Sail Boat 15 ft	0.5	1.5	2.2	3.2	3.8	4.3	4.3	0.5	1.6	2.2	3.2	3.9	4.3	4.3
Sail Boat 20 ft	0.6	1.8	2.6	4.0	4.9	5.6	5.6	0.6	1.8	2.7	4.0	5.0	5.6	5.6
Sail Boat 25 ft	0.6	2.0	3.1	4.8	6.0	6.9	6.9	0.6	2.0	3.1	4.9	6.1	7.0	7.0
Sail Boat 30 ft	0.6	2.3	3.6	5.9	7.5	8.8	10.6	0.6	2.3	3.6	5.9	7.6	8.8	10.6
Sail Boat 40 ft	0.6	2.6	4.3	7.5	10.0	11.9	14.8	0.6	2.6	4.3	7.6	10.0	11.9	14.8
Sail Boat 50 ft	0.6	2.7	4.6	8.4	11.3	13.6	17.3	0.6	2.7	4.6	8.4	11.3	13.7	17.3
Sail Boat 65-75 ft	0.6	2.8	4.9	9.3	12.7	15.5	20.0	0.6	2.8	4.9	9.3	12.7	15.5	20.0
Sail Boat 76-90 ft	0.6	2.8	5.1	9.9	13.7	16.9	22.1	0.6	2.8	5.1	9.9	13.7	17.0	22.1
Ship 90-150 ft	0.6	2.9	5.4	11.1	15.9	20.0	26.9	0.6	2.9	5.4	11.1	15.9	20.1	26.9
Ship 150-300 ft	0.6	3.0	5.7	12.5	18.8	24.7	34.8	0.6	3.0	5.7	12.5	18.9	24.7	34.8
Ship > 300 ft	0.7	3.0	5.8	13.2	20.6	27.9	41.4	0.7	3.0	5.8	13.2	20.6	27.9	41.4

\* For search altitudes up to 500 feet only, the values given for sweep width for a person in water may be increased by a factor of 4. If it is known that the person is wearing a personal flotation device.

**Table G-3. Uncorrected Visual Sweep Width – Fixed-wing Aircraft for Altitudes 750-1000 Feet**

Search Object	Altitude 750 Feet Visibility (NM)							Altitude 1000 Feet Visibility (NM)						
	1	3	5	10	15	20	30	1	3	5	10	15	20	30
Person in Water	0.1	0.1	0.1	0.1	0.1	0.1	0.1	0.0	0.1	0.1	0.1	0.1	0.1	0.1
Raft 1 person	0.3	0.7	0.9	1.2	1.4	1.4	1.4	0.3	0.7	0.9	1.2	1.4	1.4	1.4
Raft 4 person	0.4	1.0	1.3	1.8	2.1	2.2	2.2	0.3	1.0	1.3	1.8	2.1	2.3	2.3
Raft 6 person	0.1	1.1	1.6	2.2	2.6	2.8	2.8	0.4	1.1	1.6	2.2	2.6	2.8	2.8
Raft 8 person	0.4	1.2	1.7	2.3	2.7	3.0	3.0	0.4	1.2	1.7	2.4	2.8	3.0	3.0
Raft 10 person	0.4	1.3	1.8	2.5	3.0	3.3	3.3	0.4	1.3	1.8	2.6	3.0	3.3	3.3
Raft 15 person	0.4	1.4	1.9	2.8	3.3	3.7	4.1	0.4	1.4	2.0	2.8	3.4	3.7	4.2
Raft 20 person	0.5	1.5	2.2	3.2	3.8	4.3	4.9	0.4	1.5	2.2	3.2	3.9	4.3	4.9
Raft 25 person	0.5	1.6	2.3	3.5	4.2	4.7	5.4	0.4	1.6	2.3	3.5	4.2	4.7	5.4
Power Boat < 15 ft	0.4	0.9	1.2	1.6	1.8	1.9	1.9	0.4	1.0	1.3	1.7	1.8	2.0	2.0
Power Boat 16-25 ft	0.5	1.7	2.4	3.6	4.4	4.9	4.9	0.5	1.7	2.5	3.7	4.4	5.0	5.0
Power Boat 26-40 ft	0.6	2.1	3.3	5.3	6.7	7.7	9.2	0.5	2.2	3.4	5.4	6.8	7.8	9.3
Power Boat 41-65 ft	0.6	2.7	4.5	8.2	10.9	13.1	16.5	0.6	2.7	4.5	8.2	10.9	13.1	16.6
Power Boat 66-90 ft	0.6	2.8	5.0	9.8	13.5	16.7	21.7	0.6	2.8	5.1	9.8	13.6	16.7	21.7
Sail Boat 15 ft	0.5	1.6	2.3	3.3	3.9	4.4	4.4	0.5	1.6	2.3	3.3	4.0	4.4	4.4
Sail Boat 20 ft	0.5	1.8	2.7	4.1	5.0	5.7	5.7	0.5	1.8	2.7	4.2	5.1	5.7	5.7
Sail Boat 25 ft	0.6	2.1	3.1	5.0	6.2	7.0	7.0	0.5	2.1	3.2	5.0	6.2	7.1	7.1
Sail Boat 30 ft	0.6	2.3	3.6	6.0	7.5	8.9	10.7	0.6	2.3	3.6	6.0	7.6	8.9	10.7
Sail Boat 40 ft	0.6	2.6	4.3	7.6	10.0	11.9	14.9	0.6	2.6	4.3	7.6	10.9	12.0	14.9
Sail Boat 50 ft	0.6	2.7	4.6	8.5	11.4	13.7	17.4	0.6	2.7	4.6	8.5	11.4	13.7	17.4
Sail Boat 65-75 ft	0.6	2.8	4.9	9.3	12.7	15.6	20.0	0.6	2.8	4.9	9.3	12.8	15.6	20.1
Sail Boat 76-90 ft	0.6	2.8	5.1	9.9	13.8	17.0	22.2	0.6	2.8	5.1	9.9	13.8	17.0	22.2
Ship 90-150 ft	0.6	2.9	5.4	11.1	15.9	20.1	27.0	0.6	2.9	5.4	11.1	15.9	20.1	27.0
Ship 150-300 ft	0.6	3.0	5.7	12.5	18.9	24.7	34.9	0.6	3.0	5.7	12.5	18.9	24.7	34.9
Ship > 300 ft	0.7	3.0	5.8	13.2	20.6	27.9	41.4	0.6	3.0	5.8	13.2	20.6	27.9	41.4

**Table G-4. Uncorrected Visual Sweep Width – Fixed-wing Aircraft for Altitudes 1500-2000 Feet**

Search Object	Altitude 1500 Feet Visibility (NM)							Altitude 2000 Feet Visibility (NM)						
	1	3	5	10	15	20	30	1	3	5	10	15	20	30
Person in Water	0.0	0.0	0.0	0.0	0.0	0.1	0.1	0.0	0.0	0.0	0.0	0.0	0.0	0.1
Raft 1 person	0.2	0.7	0.9	1.3	1.4	1.4	1.4	0.1	0.6	0.9	1.2	1.4	1.4	1.4
Raft 4 person	0.3	1.0	1.3	1.9	2.1	2.3	2.3	0.2	0.9	1.3	1.9	2.2	2.3	2.3
Raft 6 person	0.3	1.1	1.6	2.3	2.6	2.9	2.9	0.2	1.1	1.6	2.3	2.7	2.9	2.9
Raft 8 person	0.3	1.2	1.7	2.4	2.8	3.1	3.1	0.2	1.2	1.7	2.5	2.9	3.2	3.2
Raft 10 person	0.3	1.3	1.8	2.6	3.1	3.4	3.4	0.2	1.2	1.8	2.7	3.1	3.5	3.5
Raft 15 person	0.3	1.4	2.0	2.9	3.4	3.8	4.3	0.2	1.4	2.0	3.0	3.5	3.9	4.4
Raft 20 person	0.4	1.5	2.2	3.3	4.0	4.4	5.1	0.4	1.5	2.2	3.4	4.0	4.5	5.1
Raft 25 person	0.4	1.6	2.4	3.6	4.3	4.8	5.6	0.3	1.6	2.4	3.6	4.4	4.9	5.7
Power Boat < 15 ft	0.3	1.0	1.3	1.7	2.0	2.1	2.1	0.2	1.0	1.3	1.8	2.0	2.2	2.2
Power Boat 16-25 ft	0.4	1.7	2.5	3.7	4.5	5.1	5.1	0.3	1.7	2.5	3.8	4.6	5.1	5.1
Power Boat 26-40 ft	0.5	2.2	3.4	5.5	6.8	7.9	9.4	0.3	2.2	3.4	5.5	6.9	8.0	9.5
Power Boat 41-65 ft	0.5	2.6	4.5	8.2	11.0	13.2	16.6	0.4	2.6	4.5	8.3	11.0	13.3	16.7
Power Boat 66-90 ft	0.5	2.8	5.1	9.8	13.6	16.7	21.8	0.4	2.8	5.0	9.8	13.6	16.8	21.8
Sail Boat 15 ft	0.4	1.6	2.3	3.4	4.1	4.5	4.5	0.3	1.6	2.3	3.5	4.1	4.5	4.5
Sail Boat 20 ft	0.4	1.8	2.8	4.2	5.2	5.8	5.8	0.3	1.8	2.8	4.3	5.2	5.9	5.9
Sail Boat 25 ft	0.5	2.1	3.2	5.1	6.3	7.2	7.2	0.3	2.1	3.3	5.2	6.4	7.3	7.3
Sail Boat 30 ft	0.5	2.3	3.7	6.1	7.7	9.0	10.8	0.3	2.3	3.7	6.1	7.8	9.1	10.9
Sail Boat 40 ft	0.5	2.6	4.3	7.6	10.1	12.0	14.9	0.4	2.5	4.3	7.7	10.1	12.1	15.0
Sail Boat 50 ft	0.5	2.7	4.6	8.5	11.4	13.8	17.5	0.4	2.7	4.6	8.6	11.5	13.9	17.5
Sail Boat 65-75 ft	0.5	2.8	4.9	9.4	12.8	15.7	20.2	0.4	2.7	4.9	9.4	12.9	15.7	20.2
Sail Boat 76-90 ft	0.5	2.8	5.1	10.0	13.8	17.1	22.3	0.4	2.8	5.1	10.0	13.9	17.1	22.3
Ship 90-150 ft	0.5	2.9	5.4	11.1	16.0	20.1	27.0	0.4	2.9	5.4	11.1	16.0	20.1	27.1
Ship 150-300 ft	0.5	3.0	5.7	12.5	18.9	24.7	34.9	0.4	3.0	5.7	12.5	18.9	24.7	34.9
Ship > 300 ft	0.6	3.0	5.8	13.2	20.7	27.9	41.4	0.5	3.0	5.8	13.2	20.7	27.9	41.5

**Table G-5 Uncorrected Visual Sweep Width - Fixed Wing Aircraft for Altitudes 2500-3000 Feet**

Search Object	Altitude 2500 Feet Visibility (NM)							Altitude 3000 Feet* Visibility (NM)						
	1	3	5	10	15	20	30	1	3	5	10	15	20	30
Person in Water	0.0	0.0	0.0	0.0	0.0	0.0	0.0	0.0	0.0	0.0	0.0	0.0	0.0	0.0
Raft 1 person	0.1	0.5	0.8	1.2	1.4	1.4	1.4	0.1	0.5	0.8	1.1	1.3	1.3	1.3
Raft 4 person	0.1	0.8	1.3	1.8	2.2	2.4	2.4	0.1	0.7	1.2	1.8	2.1	2.3	2.3
Raft 6 person	0.1	1.0	1.5	2.3	2.7	2.9	2.9	0.1	0.9	1.5	2.2	2.7	2.9	2.9
Raft 8 person	0.1	1.1	1.7	2.5	2.9	3.2	3.2	0.1	1.0	1.6	2.5	2.9	3.2	3.2
Raft 10 person	0.2	1.2	1.8	2.7	3.2	3.5	3.5	0.1	1.1	1.8	2.7	3.2	3.5	3.5
Raft 15 person	0.2	1.3	2.0	3.0	3.6	4.0	4.5	0.1	1.2	2.0	3.0	3.6	4.0	4.5
Raft 20 person	0.2	1.4	2.2	3.4	4.1	4.6	5.2	0.1	1.4	2.2	3.4	4.1	4.6	5.3
Raft 25 person	0.2	1.5	2.4	3.7	4.5	5.0	5.7	0.1	1.5	2.4	3.7	4.5	5.1	5.8
Power Boat < 15 ft	0.1	0.9	1.3	1.8	2.1	2.2	2.2	0.1	0.8	1.3	1.8	2.1	2.3	2.3
Power Boat 16-25 ft	0.2	1.6	2.5	3.8	4.6	5.2	5.2	0.1	1.6	2.5	3.9	4.7	5.3	5.3
Power Boat 26-40 ft	0.2	2.1	3.4	5.6	7.0	8.1	9.6	0.2	2.1	3.4	5.6	7.1	8.1	9.7
Power Boat 41-65 ft	0.3	2.6	4.5	8.3	11.3	13.3	16.7	0.2	2.5	4.5	8.3	11.1	13.4	16.8
Power Boat 66-90 ft	0.3	2.7	5.0	9.8	13.6	16.8	21.9	0.2	2.7	5.0	9.9	13.7	16.8	21.9
Sail Boat 15 ft	0.2	1.5	2.3	3.5	4.2	4.7	4.7	0.1	1.5	2.3	3.5	4.3	4.7	4.7
Sail Boat 20 ft	0.2	1.8	2.8	4.3	5.3	6.0	6.0	0.1	1.7	2.8	4.4	5.3	6.0	6.0
Sail Boat 25 ft	0.2	2.1	3.3	5.2	6.5	7.5	7.5	0.2	2.0	3.3	5.3	6.6	7.5	7.5
Sail Boat 30 ft	0.2	2.2	3.7	6.1	7.8	9.1	11.0	0.2	2.2	3.7	6.2	7.9	9.2	11.1
Sail Boat 40 ft	0.3	2.5	4.3	7.7	10.2	12.1	15.1	0.2	2.4	4.3	7.7	10.2	12.1	15.1
Sail Boat 50 ft	0.3	2.6	4.6	8.6	11.5	13.9	17.6	0.2	2.6	4.6	8.6	11.6	14.0	17.7
Sail Boat 65-75 ft	0.3	2.7	4.9	9.4	12.9	15.8	20.3	0.2	2.6	4.9	9.4	13.0	15.8	20.3
Sail Boat 76-90 ft	0.3	2.8	5.1	10.0	13.9	17.2	22.4	0.2	2.7	5.1	10.0	14.0	17.2	22.5
Ship 90-150 ft	0.3	2.8	5.4	11.1	16.0	20.2	27.1	0.2	2.8	5.3	11.1	16.0	20.2	27.1
Ship 150-300 ft	0.3	2.9	5.6	12.5	18.9	24.8	35.0	0.2	2.8	5.6	12.5	18.9	24.8	35.0
Ship > 300 ft	0.3	2.9	5.7	13.2	20.7	27.9	41.5	0.2	2.9	5.7	13.2	20.7	27.9	41.5

\* Visual searches are seldom conducted from altitudes above 3000 feet; however, for altitudes up to 5000 feet where visibility exceeds 3 NM and target size exceeds 25 feet, the sweep widths given for 3000 feet remain applicable.



**Table G-6. Uncorrected Visual Sweep Width – Helicopters for Altitudes 300-500 Feet**

Search Object	Altitude 300 Feet Visibility (NM)							Altitude 500 Feet Visibility (NM)						
	1	3	5	10	15	20	30	1	3	5	10	15	20	30
Person in Water*	0.1	0.1	0.1	0.1	0.1	0.1	0.1	0.0	0.1	0.1	0.1	0.1	0.1	0.1
Raft 1 person	0.4	0.9	1.2	1.5	1.7	1.7	1.7	0.4	0.9	1.2	1.6	1.8	1.8	1.8
Raft 4 person	0.5	1.2	1.6	2.2	2.5	2.7	2.7	0.5	1.2	1.6	2.2	2.6	2.8	2.8
Raft 6 person	0.5	1.4	1.9	2.7	3.1	3.4	3.4	0.5	1.4	1.9	2.7	3.2	3.5	3.5
Raft 8 person	0.6	1.4	2.0	2.8	3.3	3.6	3.6	0.6	1.5	2.0	2.8	3.3	3.7	3.7
Raft 10 person	0.6	1.5	2.1	3.0	3.6	3.9	3.9	0.6	1.6	2.2	3.1	3.6	4.0	4.0
Raft 15 person	0.6	1.6	2.3	3.3	3.9	4.3	4.9	0.6	1.7	2.3	3.3	4.0	4.4	5.0
Raft 20 person	0.6	1.8	2.6	3.8	4.5	5.1	5.8	0.6	1.8	2.6	3.8	4.6	5.1	5.9
Raft 25 person	0.6	1.9	2.7	4.1	4.9	5.5	6.3	0.6	1.9	2.7	4.1	5.0	5.6	6.4
Power Boat < 15 ft	0.5	1.1	1.4	1.9	2.1	2.2	2.2	0.5	1.2	1.5	1.9	2.2	2.3	2.3
Power Boat 16-25 ft	0.7	2.0	2.9	4.3	5.2	5.8	5.8	0.7	2.0	2.9	4.3	5.2	5.8	5.8
Power Boat 26-40 ft	0.8	2.5	3.8	6.1	7.7	8.9	10.6	0.8	2.5	3.9	6.2	7.8	9.0	10.7
Power Boat 41-65 ft	0.8	3.1	5.1	9.2	12.2	14.7	18.5	0.8	3.1	5.1	9.2	12.3	14.7	18.5
Power Boat 66-90 ft	0.8	3.3	5.7	10.8	15.0	18.4	23.9	0.8	3.3	5.7	10.8	15.0	18.4	23.9
Sail Boat 15 ft	0.7	1.9	2.7	3.9	4.6	5.2	5.2	0.7	1.9	2.7	3.9	4.7	5.2	5.2
Sail Boat 20 ft	0.7	2.2	3.2	4.8	5.9	6.6	6.6	0.7	2.2	3.2	4.8	5.9	6.7	6.7
Sail Boat 25 ft	0.8	2.4	3.6	5.7	7.1	8.1	8.1	0.8	2.4	3.7	5.7	7.1	8.2	8.2
Sail Boat 30 ft	0.8	2.7	4.2	6.8	8.7	10.1	12.2	0.8	2.7	4.2	6.9	8.7	10.2	12.3
Sail Boat 40 ft	0.8	3.0	4.9	8.6	11.3	13.4	16.7	0.8	3.0	4.9	8.3	11.3	13.5	16.8
Sail Boat 50 ft	0.8	3.1	5.2	9.5	12.7	15.3	19.3	0.8	3.1	5.2	9.5	12.7	15.3	19.4
Sail Boat 65-75 ft	0.8	3.2	5.5	10.3	14.1	17.2	22.1	0.8	3.2	5.5	10.4	14.1	17.3	22.2
Sail Boat 76-90 ft	0.8	3.3	5.7	11.0	15.2	18.7	24.3	0.8	3.3	5.7	11.0	15.2	18.7	24.4
Ship 90-150 ft	0.8	3.4	6.0	12.2	17.4	21.9	29.3	0.8	3.4	6.0	12.2	17.4	21.9	29.3
Ship 150-300 ft	0.8	3.4	6.3	13.6	20.4	26.6	37.7	0.8	3.4	6.3	13.6	20.4	26.6	37.3
Ship > 300 ft	0.8	3.5	6.4	14.3	22.1	29.8	43.8	0.8	3.5	6.4	14.3	22.1	29.8	43.8

\* For search altitudes up to 500 feet only, the values given for sweep width for a person in water may be increased by a factor of 4. If it is known that the person is wearing a personal flotation device.

**Table G-7. Uncorrected Visual Sweep Width – Helicopters for Altitudes 750-1000 Feet**

Search Object	Altitude 750 Feet Visibility (NM)							Altitude 1000 Feet Visibility (NM)						
	1	3	5	10	15	20	30	1	3	5	10	15	20	30
Person in Water*	0.0	0.1	0.1	0.1	0.1	0.1	0.1	0.0	0.1	0.1	0.1	0.1	0.1	0.1
Raft 1 person	0.4	0.9	1.2	1.6	1.7	1.8	1.8	0.4	0.9	1.2	1.6	1.8	1.8	1.8
Raft 4 person	0.5	1.2	1.7	2.3	2.6	2.8	2.8	0.5	1.2	1.7	2.3	2.6	2.9	2.9
Raft 6 person	0.5	1.4	2.0	2.7	3.2	3.5	3.5	0.5	1.4	2.0	2.8	3.2	3.5	3.5
Raft 8 person	0.5	1.5	2.1	2.9	3.4	3.7	3.7	0.5	1.5	2.1	2.9	3.4	3.8	3.8
Raft 10 person	0.6	1.6	2.2	3.1	3.7	4.0	4.0	0.5	1.6	2.2	3.2	3.7	4.1	4.1
Raft 15 person	0.6	1.7	2.4	3.4	4.0	4.5	5.0	0.6	1.7	2.4	3.5	4.1	4.5	5.1
Raft 20 person	0.6	1.8	2.6	3.9	4.6	5.2	5.9	0.6	1.8	2.7	3.9	4.7	5.2	6.0
Raft 25 person	0.6	1.9	2.8	4.2	5.0	5.6	6.5	0.6	1.9	2.8	4.2	5.1	5.7	6.5
Power Boat < 15 ft	0.5	1.2	1.6	2.0	2.3	2.4	2.4	0.5	1.2	1.6	2.1	2.3	2.5	2.5
Power Boat 16-25 ft	0.7	2.0	2.9	4.4	5.3	5.9	5.9	0.7	2.1	3.0	4.4	5.3	5.9	5.9
Power Boat 26-40 ft	0.7	2.5	3.9	6.2	7.8	9.0	10.7	0.7	2.6	3.9	6.3	7.9	9.1	10.8
Power Boat 41-65 ft	0.8	3.1	5.1	9.2	12.3	14.7	18.5	0.7	3.1	5.2	9.2	12.3	14.8	18.6
Power Boat 66-90 ft	0.8	3.3	5.7	10.9	15.0	18.4	23.9	0.8	3.3	5.7	10.9	15.0	18.5	23.9
Sail Boat 15 ft	0.7	1.9	2.7	4.0	4.8	5.3	5.3	0.6	1.9	2.8	4.0	4.8	5.4	5.4
Sail Boat 20 ft	0.7	2.2	3.2	4.9	6.0	6.7	6.7	0.7	2.2	3.2	4.9	6.0	6.8	6.8
Sail Boat 25 ft	0.7	2.5	3.7	5.8	7.2	8.3	8.3	0.7	2.5	3.7	5.8	7.3	8.3	8.3
Sail Boat 30 ft	0.8	2.7	4.2	6.9	8.8	10.2	12.3	0.7	2.7	4.2	6.9	8.8	10.3	12.4
Sail Boat 40 ft	0.8	3.0	4.9	8.6	11.3	13.5	16.8	0.7	3.0	4.9	8.6	11.4	13.5	16.8
Sail Boat 50 ft	0.8	3.1	5.3	9.5	12.7	15.4	19.4	0.7	3.1	5.3	9.5	12.8	15.4	19.5
Sail Boat 65-75 ft	0.8	3.2	5.5	10.4	14.2	17.3	22.2	0.8	3.2	5.6	10.4	14.2	17.3	22.2
Sail Boat 76-90 ft	0.8	3.3	5.7	11.0	15.2	18.8	24.4	0.8	3.3	5.7	11.0	15.3	18.8	24.4
Ship 90-150 ft	0.8	3.4	6.0	12.2	17.4	21.9	29.3	0.8	3.4	6.0	12.2	17.4	21.9	29.3
Ship 150-300 ft	0.8	3.4	6.3	13.6	20.4	26.6	37.3	0.8	3.4	6.3	13.6	20.4	26.6	37.3
Ship > 300 ft	0.8	3.5	6.4	14.3	22.2	29.8	43.8	0.8	3.5	6.4	14.3	22.2	29.8	43.9

**Table G-8. Uncorrected Visual Sweep Width – Helicopters for Altitudes 1500-2000 Feet**

Search Object	Altitude 1500 Feet Visibility (NM)							Altitude 2000 Feet Visibility (NM)						
	1	3	5	10	15	20	30	1	3	5	10	15	20	30
Person in Water*	0.0	0.0	0.0	0.1	0.1	0.1	0.1	0.0	0.0	0.0	0.0	0.0	0.1	0.1
Raft 1 person	0.3	0.9	1.2	1.6	1.8	1.8	1.8	0.2	0.8	1.2	1.6	1.8	1.8	1.8
Raft 4 person	0.4	1.2	1.7	2.3	2.7	2.9	2.9	0.3	1.2	1.7	2.3	2.7	3.0	3.0
Raft 6 person	0.4	1.4	2.0	2.8	3.3	3.6	3.6	0.3	1.4	2.0	2.8	3.3	3.6	3.6
Raft 8 person	0.4	1.5	2.1	3.0	3.5	3.9	3.9	0.3	1.5	2.1	3.0	3.6	3.9	3.9
Raft 10 person	0.4	1.6	2.2	3.2	3.8	4.2	4.2	0.3	1.6	2.3	3.3	3.9	4.2	4.2
Raft 15 person	0.5	1.7	2.4	3.5	4.2	4.6	5.2	0.3	1.7	2.5	3.6	4.3	4.7	5.3
Raft 20 person	0.5	1.9	2.7	4.0	4.8	5.3	6.1	0.4	1.8	2.7	4.0	4.9	5.4	6.2
Raft 25 person	0.5	2.0	2.9	4.3	5.2	5.8	6.7	0.4	1.9	2.9	4.3	5.3	5.9	6.8
Power Boat < 15 ft	0.4	1.3	1.7	2.2	2.5	2.6	2.6	0.3	1.3	1.7	2.3	2.6	2.7	2.7
Power Boat 16-25 ft	0.6	2.1	3.0	4.5	5.4	6.1	6.1	0.4	2.1	3.0	4.5	5.5	6.1	6.1
Power Boat 26-40 ft	0.6	2.6	4.0	6.3	7.9	9.2	10.9	0.5	2.6	4.0	6.4	8.0	9.3	11.0
Power Boat 41-65 ft	0.7	3.1	5.2	9.3	12.4	14.8	18.6	0.5	3.0	5.2	9.3	12.4	14.9	18.7
Power Boat 66-90 ft	0.7	3.2	5.7	10.9	15.1	18.5	24.0	0.5	3.2	5.7	10.9	15.1	18.5	24.0
Sail Boat 15 ft	0.6	2.0	2.8	4.1	4.9	5.5	5.5	0.4	1.9	2.8	4.2	5.0	5.6	5.6
Sail Boat 20 ft	0.6	2.2	3.3	5.0	6.1	6.9	6.9	0.5	2.2	3.3	5.1	6.2	7.0	7.0
Sail Boat 25 ft	0.6	2.5	3.8	5.9	7.4	8.4	8.4	0.5	2.5	3.8	6.0	7.5	8.6	8.6
Sail Boat 30 ft	0.6	2.7	4.2	7.0	8.9	10.3	12.5	0.5	2.7	4.3	7.0	9.0	10.4	12.6
Sail Boat 40 ft	0.6	3.0	4.9	8.7	11.4	13.6	16.9	0.5	3.0	4.9	8.7	11.4	13.6	17.0
Sail Boat 50 ft	0.7	3.1	5.3	9.6	12.8	15.5	19.5	0.5	3.1	5.3	9.6	12.9	15.5	19.6
Sail Boat 65-75 ft	0.7	3.2	5.6	10.4	14.3	17.4	22.3	0.5	3.2	5.6	10.5	14.3	17.4	22.4
Sail Boat 76-90 ft	0.7	3.3	5.7	11.1	15.3	18.8	24.5	0.5	3.2	5.7	11.1	15.4	18.9	24.6
Ship 90-150 ft	0.7	3.3	6.0	12.2	17.5	22.0	29.4	0.5	3.3	6.0	12.2	17.5	22.0	29.4
Ship 150-300 ft	0.7	3.4	6.3	13.6	20.4	26.6	37.3	0.5	3.4	6.3	13.6	20.4	26.6	37.4
Ship > 300 ft	0.7	3.4	6.4	14.3	22.2	29.8	43.9	0.6	3.4	6.4	14.3	22.2	29.8	43.9

**Table G-9. Uncorrected Visual Sweep Width - Helicopters for Altitudes 2500-3000 Feet**

Search Object	Altitude 2500 Feet Visibility (NM)							Altitude 3000 Feet Visibility (NM)						
	1	3	5	10	15	20	30	1	3	5	10	15	20	30
Person in Water*	0.0	0.0	0.0	0.0	0.0	0.0	0.1	0.0	0.0	0.0	0.0	0.0	0.0	0.0
Raft 1 person	0.1	0.8	1.1	1.6	1.8	1.8	1.8	0.1	0.7	1.0	1.5	1.8	1.8	1.8
Raft 4 person	0.2	1.1	1.6	2.3	2.7	3.0	3.0	0.1	1.0	1.6	2.3	2.7	3.0	3.0
Raft 6 person	0.2	1.3	1.9	2.8	3.3	3.7	3.7	0.1	1.2	1.9	2.8	3.3	3.7	3.7
Raft 8 person	0.2	1.4	2.1	3.1	3.6	4.0	4.0	0.1	1.3	2.1	3.1	3.6	4.0	4.0
Raft 10 person	0.2	1.5	2.2	3.3	3.9	4.3	4.3	0.1	1.4	2.2	3.3	3.9	4.3	4.3
Raft 15 person	0.2	1.7	2.5	3.6	4.3	4.8	5.4	0.2	1.6	2.4	3.7	4.4	4.9	5.5
Raft 20 person	0.3	1.8	2.7	4.1	4.9	5.5	6.3	0.2	1.7	2.7	4.1	5.0	5.6	6.3
Raft 25 person	0.3	1.9	2.9	4.4	5.3	6.0	6.9	0.2	1.9	2.9	4.4	5.4	6.0	6.9
Power Boat < 15 ft	0.2	1.2	1.7	2.3	2.6	2.8	2.8	0.1	1.1	1.7	2.3	2.7	2.9	2.9
Power Boat 16-25 ft	0.3	2.0	3.0	4.6	5.5	6.2	6.2	0.2	2.0	3.0	4.6	5.6	6.3	6.3
Power Boat 26-40 ft	0.4	2.5	4.0	6.5	8.1	9.3	11.1	0.2	2.5	4.0	6.5	8.2	9.4	11.2
Power Boat 41-65 ft	0.4	3.0	5.2	9.3	12.4	14.9	18.8	0.3	3.0	5.2	9.3	12.5	15.0	18.8
Power Boat 66-90 ft	0.4	3.2	5.7	10.9	15.1	18.6	24.1	0.3	3.1	5.7	10.9	15.1	18.6	24.1
Sail Boat 15 ft	0.3	1.9	2.8	4.2	5.1	5.6	5.6	0.2	1.9	2.8	4.3	5.1	5.7	5.7
Sail Boat 20 ft	0.3	2.2	3.3	5.1	6.3	7.1	7.1	0.2	2.1	3.3	5.2	6.3	7.1	7.1
Sail Boat 25 ft	0.4	2.5	3.8	6.1	7.6	8.7	8.7	0.2	2.4	3.9	6.1	7.7	8.8	8.8
Sail Boat 30 ft	0.4	2.7	4.3	7.1	9.0	10.5	12.6	0.2	2.6	4.3	7.1	9.1	10.6	12.7
Sail Boat 40 ft	0.4	2.9	4.9	8.7	11.5	13.7	17.0	0.3	2.9	4.9	8.7	11.5	13.7	17.1
Sail Boat 50 ft	0.4	3.1	5.3	9.6	12.9	15.6	19.7	0.3	3.0	5.3	9.7	13.0	15.6	19.7
Sail Boat 65-75 ft	0.4	3.1	5.6	10.5	14.3	17.5	22.4	0.3	3.1	5.6	10.5	14.4	17.5	22.5
Sail Boat 76-90 ft	0.4	3.2	5.7	11.1	15.4	18.9	24.6	0.3	3.1	5.7	11.1	15.4	19.0	24.7
Ship 90-150 ft	0.4	3.3	6.0	12.2	17.5	22.0	29.4	0.3	3.2	6.0	12.2	17.5	22.0	29.5
Ship 150-300 ft	0.4	3.3	6.3	13.6	20.4	26.6	37.4	0.3	3.3	6.3	13.6	20.4	26.6	37.4
Ship > 300 ft	0.5	3.4	6.4	14.3	22.2	29.8	43.9	0.3	3.3	6.4	14.3	22.2	29.8	43.9

\* Visual searches are seldom conducted from altitudes above 3000 feet; however, for altitudes up to 5000 feet where visibility exceeds 3 NM and target size exceeds 25 feet, the sweep widths given for 3000 feet remain applicable.

**Table G-10. Uncorrected Visual Sweep Width – Vessels and Boats**

Search Object	Vessel SRU (90' WPB) Visibility (NM)						Small Boat SRU (41' UTB) Visibility (NM)					
	1	3	5	10	15	20	1	3	5	10	15	20
Person in Water*	0.3	0.4	0.5	0.5	0.5	0.5	0.2	0.2	0.3	0.3	0.3	0.3
Raft 1 person	0.9	1.8	2.3	3.1	3.4	3.7	0.7	1.3	1.7	2.3	2.6	2.7
Raft 4 person	1.0	2.2	3.0	4.0	4.6	5.0	0.7	1.7	2.2	3.1	3.5	3.9
Raft 6 person	1.1	2.5	3.4	4.7	5.5	6.0	0.8	1.9	2.6	3.6	4.3	4.7
Raft 8 person	1.1	2.5	3.5	4.8	5.7	6.2	0.8	2.0	2.7	3.8	4.4	4.9
Raft 10 person	1.1	2.6	3.6	5.1	6.1	6.7	0.8	2.0	2.8	4.0	4.8	5.3
Raft 15 person	1.1	2.8	3.8	5.5	6.5	7.2	0.9	2.2	3.0	4.3	5.1	5.7
Raft 20 person	1.2	3.0	4.1	6.1	7.3	8.1	0.9	2.3	3.3	4.9	5.8	6.5
Raft 25 person	1.2	3.1	4.3	6.4	7.8	8.7	0.9	2.4	3.5	5.2	6.3	7.0
Power Boat < 15 ft	0.5	1.1	1.4	1.9	2.1	2.3	0.4	0.8	1.1	1.5	1.6	1.8
Power Boat 16-25 ft	1.0	2.0	2.9	4.3	5.2	5.8	0.8	1.5	2.2	3.3	4.0	4.5
Power Boat 26-40 ft	1.1	2.5	3.8	6.1	7.7	8.8	0.8	1.9	2.9	4.7	5.9	6.8
Power Boat 41-65 ft	1.2	3.1	5.1	9.1	12.1	14.4	0.9	2.4	3.9	7.0	9.3	11.1
Power Boat 66-90 ft	1.2	3.2	5.6	10.7	14.7	18.1	0.9	2.5	4.3	8.3	11.4	14.0
Sail Boat 15 ft	1.0	1.9	2.7	3.9	4.7	5.2	0.8	1.5	2.1	3.0	3.6	4.0
Sail Boat 20 ft	1.0	2.2	3.2	4.8	5.9	6.6	0.8	1.7	2.5	3.7	4.6	5.1
Sail Boat 25 ft	1.1	2.4	3.6	5.7	7.0	8.1	0.9	1.9	2.8	4.4	5.4	6.3
Sail Boat 30 ft	1.1	2.7	4.1	6.8	8.6	10.0	0.9	2.1	3.2	5.3	6.6	7.7
Sail Boat 40 ft	1.2	3.0	4.9	8.5	11.2	13.3	0.9	2.3	3.8	6.6	8.6	10.3
Sail Boat 50 ft	1.2	3.1	5.2	9.4	12.5	15.0	0.9	2.4	4.0	7.3	9.7	11.6
Sail Boat 65-75 ft	1.2	3.2	5.5	10.2	13.9	16.9	0.9	2.5	4.2	7.9	10.7	13.1
Sail Boat 76-90 ft	1.2	3.3	5.7	10.8	15.0	18.4	0.9	2.5	4.4	8.3	11.6	14.2
Ship 90-150 ft	1.8	3.3	6.0	12.0	17.1	21.5	1.4	2.5	4.6	9.3	13.2	16.6
Ship 150-300 ft	1.8	3.4	6.3	13.4	20.1	26.0	1.4	2.6	4.9	10.3	15.5	20.2
Ship > 300 ft	1.8	3.4	6.4	14.1	21.8	29.2	1.4	2.6	4.9	10.9	16.8	22.5

**G.5 Correcting for Weather.** Table G-11 can be used to determine the weather correction factor (if conditions of both columns apply, use correction factor in right column). IAMSAR Manual Volume 2, Table N-7 provides corresponding information but under categories of “person in the water” and “life raft”, it does not include “Other Targets”.

**Table G-11. Weather Correction Factor**

Target Type	Winds > 15 kts / Seas 2-3 ft	Winds > 25 kts / Seas > 4 ft
Person in water, or < 30-ft length boat	0.5	0.25
Other targets	0.9	0.9

**G.6 Correcting for Fatigue.** If feedback from on-scene SRUs indicates search crews were excessively fatigued, reduce sweep width values by 10 percent (multiply by 0.9).

**G.7 Correcting for Search Aircraft Speed.** Enter the speed correction table (Table G-12) with aircraft type (fixed-wing or helicopter) and the speed flown. Read down the column to the search object. This value is the speed correction. Interpolate as required. There is no speed correction for surface SRUs.

**Table G-12. Search Aircraft Speed Correction**

Search Object	Fixed Wing Speed (Knots)			Helicopter Speed (Knots)			
	150 or less	180	210	60 or less	90	120	140
Person in Water	1.2	1.0	0.9	1.5	1.0	0.8	0.7
Raft - 1-4 Man	1.1	1.0	0.9	1.3	1.0	0.9	0.8
Raft - 6-25 Man	1.1	1.0	0.9	1.2	1.0	0.9	0.8
Power Boat - to 25 ft	1.1	1.0	0.9	1.2	1.0	0.9	0.8
Power Boat - 26-40 ft	1.1	1.0	0.9	1.1	1.0	0.9	0.9
Power Boat - 41-65 ft	1.1	1.0	1.0	1.1	1.0	0.9	0.9
Power Boat - 66-90 ft	1.1	1.0	1.0	1.1	1.0	1.0	0.9
Sail Boat - to 26 ft	1.1	1.0	0.9	1.2	1.0	0.9	0.9
Sail Boat - 30-52 ft	1.1	1.0	1.0	1.1	1.0	0.9	0.9
Sail Boat - 65-90 ft	1.1	1.0	1.0	1.1	1.0	1.0	0.9
Ship - over 90 ft	1.0	1.0	1.0	1.1	1.0	1.0	0.9

**G.8 Visual Distress Signaling Devices (VDSDs).** When estimating sweep widths for VDSDs, such as pyrotechnics, dye markers, tracer bullets, or signal mirrors, use either twice the range at which survivors can be expected to detect the SRU, or the value given in Tables G-13, G-14, G-15, G-16 or G-17, whichever is smaller.

- a) *Daylight Detection Aids.* Effectiveness of daylight aids is marginal due to the difficulty in achieving target contrast in a sunlit environment. Estimated sweep widths for various daylight detection aids are given in Tables G-13 and G-14. Hand held orange smoke detectability varies by type of SRU, and also by time on task for surface SRUs. Estimated sweep widths for hand held orange smoke are given in Table G-14 for winds 10 knots or less. For winds over 10 knots the smoke tends to dissipate and sweep width degrades to less than 2 nautical miles.
- b) *Night Detection Aids.* If it is known, or suspected, that survivors can make a night signal, night visual searches should be conducted.

*Daylight Detection Aids*

**Table G-13. Visual Sweep Width Estimates for Daylight Detection Aids**

Device	Estimated Sweep Width (NM)	SRU Type
Red/orange balloon	0.5	Air or surface
Orange flight suit	0.5	Air
Red hand flare (500 candlepower)	0.5	Air or surface
Day/night flare	0.5	Air or surface
Red pen gun flare	0.75	Air or surface
Red reflective paulin	2.0	Air or surface
Tracer bullets	2.0	Air or surface
Green dye marker*	2.0	Air
Red/orange flag (waving) (3 ft x 3 ft)	2.5	Air or surface
Sun signal mirror	5.0	Air or surface
White parachute	5.0	Air or surface
Red meteor (star) or parachute flare (10,000 candlepower)*	6.0	Air or surface

\*Greatly reduced in heavy seas

**Table G-14. Visual Sweep Width Estimates for Hand Held Orange Smoke**

<i>SRU Type</i>	<i>Time on Task (hr)</i>	
	<i>&lt; 3</i>	<i>≥ 3</i>
Small boat (41' UTB)	4.6	2.8
Vessel (90' WPB)	6.9	5.0
Air*	7.7	

\* Sweep width based on test results involving helicopters only

### Night Detection Aids

**Table G-15. Visual Sweep Width Estimates for Night Detection Aids**

<i>Device</i>	<i>Estimated Sweep Width (NM)</i>	<i>SRU Type</i>
Strobe (2,000 candlepower peak)	0.5	Air or surface
Cyalume personnel marker light	1.0	Air or surface
Electric flashing SOS lantern or hand flashlight*	3.0	Air or surface
Tracer bullets	4.0	Air or surface
Red Very signals	8.0	Air or surface
Aircraft marine markers	8.0	Air or surface
Red pen gun flare	8.0	Air or surface
Red meteor (star) or parachute flare (10,000 candlepower)	10.0 or twice limit of survivor/SRU visibility	Air or surface

\* These estimates were derived from test data collected only on surface searches

**Table G-16. Visual Sweep Width Estimates for Hand Held Red Flare (500 candlepower)**

<i>SRU Type</i>	<i>Time on Task (hr)</i>	
	<i>&lt; 3</i>	<i>≥ 3</i>
Small boat (41' UTB)	10.7	10.2
Vessel (90' WPB)	13.0	12.6
Air*	15.4	

\* Sweep width based on test results involving helicopters only

**Table G-17. Visual Sweep Width Estimates for Life ring/Life jacket White Strobe (50,000-peak candlepower)**

<i>SRU Type</i>	<i>Time on Task (hr)</i>					
	<i>&lt; 3</i>			<i>≥ 3</i>		
	<i>&lt; 10</i>	<i>10 - 15</i>	<i>&gt; 15*</i>	<i>&lt; 10</i>	<i>10 - 15</i>	<i>&gt; 15*</i>
Surface	3.9	2.6	1.3	2.1	1.1	0.5

<i>SRU Type</i>	<i>Time on Task (hr)</i>	
	<i>&lt; 1</i>	<i>&gt; 1</i>
Air**	4.4	3.9

\* Values for this category were extrapolated from test data

\*\* Based on test results with helicopters only

## G.9 RADAR

G.9.1 Radar is primarily used for maritime search. Most aircraft radar available for SAR would be unlikely to detect typical search objects on land except for metal wreckage or vehicles in open desert or tundra. Sweep width depends on the type of radar, height of eye to the horizon, environmental clutter and noise, radar cross section of the target, radar beam refraction due to atmospheric, and sensor operator ability.

- a) This section provides sweep widths for a limited range of target types and sea conditions. For other targets and sea conditions, the manufacturer's detection performance estimates should be used when available. Manufacturers should have completed extensive testing of their products, and may be able to provide detection capabilities for particular targets and specified environmental conditions. If this information is not available, the SMC may ask radar operators for estimates of sweep width based on operational experience. An experienced radar operator familiar with the assigned radar should be able to offer fairly accurate estimates of effective (not maximum) detection range. Radar operators should be told that the effective detection range is the range at which they believe the target will certainly be detected under prevailing conditions. Sweep width can be calculated as about twice this estimate of effective range. Sweep width estimates for small fiberglass or wooden craft that may be capsized are based on the assumption that the target has no engine or significant metal equipment exposed.
- b) The Douglas Sea State scale (see Table G-23) is a series of numbers from 0 to 9 to indicate sea condition, and was used in the development of the radar sweep width tables. Douglas Sea States over 3 are not used because little data has been collected under these conditions, and most radar show excessive sea return (clutter) above sea state 3.

G.9.2 Surface Vessel Radar. In addition to the sweep width information provided in the table G-18 below, the following information should be considered when planning searches utilizing surface vessel radars:

- The effective search range of radars varies greatly. (The AN/SPS-64(V) is more effective for small targets than the AN/SPS-66 model.)
- The AN/SPS-64(V) and AN/SPS-66 models both provide better search performance at the 3 NM scale than the 6 NM scale.
- Radar range sweep widths for small targets should only be applied in low sea states.
- Radar reflective devices significantly improve target detection probability.
- The decision of whether or not to utilize the surface vessel radar in a search, especially if it requires dedicating a crew member who could be used for visual search, should be based on a comparison of the radar sweep width to those for other available sensors. Surface radar searches will generally be preferred when visibility is poor, sea state is low to moderate, and the target is equipped with a radar reflector or has a high amount of reflective material. Radar sweep widths deteriorate rapidly with the onset of precipitation and/or seas of greater than 4 feet.
- Visual scanners should concentrate on the area in the immediate vicinity of the search unit during low visibility radar searches to avoid missing targets that pass through the area of heavy sea return.

**Table G-18. Sweep Widths for Surface Vessel Radar\*(NM)**

<i>Target Type</i>	<i>Douglas Sea State</i>	<i>Sweep Width (NM) Surface Vessel Radar System</i>	
		<i>AN/SPS-64(V)</i>	<i>AN/SPS-66</i>
Small (20 feet or less) fiberglass boats, without radar reflector or engine/metal equipment	0 to 1	1.4	0.8
	2 to 3	1.1	0.0
Small (20 feet or less) fiberglass boats, with radar reflector or engine/metal equipment	0 to 1	5.0	2.0
	2 to 3	1.6	0.4
Medium to large vessels (40 feet or over) with significant amounts of reflective material	0 to 2	13	9.5

\* For intermediate size targets in sea states below 3, the information from the SVR table should be interpolated. For sea states greater than 3, sweep width should be estimated on the basis of sea state and target characteristics

G.9.3 Forward-Looking Airborne Radar (FLAR). Research has been conducted on various fixed wing aircraft to determine the detection capabilities of FLARs for SAR operations. From detection data collected under realistic search scenarios estimates of sweep width have been calculated.

a) The AN/APS-137 FLAR is an X-band, air-to-surface Inverse Synthetic Aperture Radar that provides high resolution, small-target detection, weather avoidance, sea surveillance, and Doppler display. The AN/APS-137 system has special selectable features that enhance system performance against weak targets. Sweep widths for conducting and planning AN/APS-137 (aircraft) SAR searches are summarized in table G-20 with consideration of the following general recommendations:

- Search altitude - 1500 feet or lower.
- Search speed - 180-220 knots IAS.
- Use only 16 NM range scale for life raft searches.
- Search full radar display, do not limit search by track spacing.
- Screen cursor may hide weak targets.
- Refresh radar screen when 1/4 of display in front of the aircraft is off-screen.

**Table G-19. Sweep Widths for Forward-Looking Airborne Radar (AN/APS-133, AN/APN-215)**

<i>Target Type</i>	<i>Douglas Sea State</i>	<i>Sweep Width (NM) Radar System</i>	
		<i>AN/SPS-133 MAP-1 and MAP-2 Modes)</i>	<i>AN/APN-215 SEARCH-1 and SEARCH-2 Modes</i>
Small (20 feet or less) fiberglass boats, without radar reflector or engine/metal equipment	0 to 1	7	4
	2	2	2
Small (20 feet or less) fiberglass boats, with radar reflector or engine/metal equipment	0 to 1	8	6
	2	3	3
Medium to large (40 to 100 feet) targets with significant amounts of reflective material	0 to 1	40	40
	2 to 3	4	4
Metal targets longer than 100 feet	0 to 1	> 50	> 50
	2 to 3	16	16

**Table G-20. Sweep Widths for Forward-Looking Airborne Radar (AN/APS-127)**

Target Type	Range Scale (NM)	Search Altitudes (FT)	Significant Waves (FT)	Sweep Width (NM)
6 to 10 person life rafts	10	500 to 4500	< 2	5.4
			2 to 5	1.8
			> 5	0
24 to 43 foot boats	10	500 to 1000	< 2	12.8
			2 to 5	10.8
			6 to 10*	6.3
			> 10*	3.1
		1100 to 2400*	< 2	11.2
			2 to 5	9.2
			6 to 10	4.7
			> 10	2.3
		2500 to 5000	< 2	8.5
			2 to 5	7.2
			6 to 10*	3.5
			> 10*	1.5
6 to 10 person life rafts	20	500 to 4500	< 2	7.0
			2 to 5*	1.8
			>6*	0
24 to 30 foot boats	20	500 to 4000	< 2	14.1
			2 to 5*	7.0
			6 to 10*	4.9
			> 10*	2.4
31 to 43 foot boats	20	500 to 4000	< 2	24.9
			2 to 5*	15.3
			6 to 10*	7.0
			> 10*	3.5

\* Values for this category were extrapolated from test data

**Table G-21. Sweep Widths for Forward-Looking Airborne Radar (AN/APS-137)**

16 Nautical Mile Radar Range Scale (Sweep Width in Nautical Miles)										
Target Type	On-scene Surface Winds (kts)									
	< 5	to 10	to 15	to 20	to 25	to 35	to 45	to 55	to 65	> 65
4 to 10 person life raft	12.1	8.6	3.1	0	0	0	0	0	0	0
17 to 25 foot recreational boat	13.6	11.9	8.2	2.8	0	0	0	0	0	0
26 to 35 foot recreational boat	16.6	16.3	15.4	14.2	12.6	9.5	3.9	0	0	0
36 to 50 foot recreational boat	21.0	20.7	19.9	18.9	17.5	14.7	9.8	3.5	0	0

32 Nautical Mile Radar Range Scale (Sweep Width in Nautical Miles)										
Target Type	On-scene Surface Winds (kts)									
	< 5	to 10	to 15	to 20	to 25	to 35	to 45	to 55	to 65	> 65
17 to 25 foot recreational boat	17.4	15.7	12.0	6.6	0	0	0	0	0	0
26 to 35 foot recreational boat	22.1	21.7	20.9	19.7	18.1	14.9	9.3	2.1	0	0
36 to 50 foot recreational boat	29.0	28.7	27.9	26.9	25.5	22.7	17.8	11.5	3.8	0



G.9.4 Side-Looking Airborne Radar (SLAR). SLAR has limited use during a search. SLAR is essentially an aerial surveying system. To adequately survey an area, the aircraft must fly level and straight. The resultant SLAR film's targets can then be identified by the SLAR aircraft or other SRUs. Specific research on SLAR use which are of interest to SAR planners:

- SLAR models tested are capable of detecting 180 foot ships nearly 100% of the time in seas up to at least 6 feet and ranges up to 30 NM.
- Targets as small as 16 foot boats with metal equipment (engine, gas tanks, frames, etc.) can be detected better than 90% of the time in seas less than 3 feet and 30% to 50% of the time in seas of 3 to 6 feet. These targets can be detected in low sea states out to the 30 NM swath width limit.
- Four to ten person life rafts can be detected 40% to 70% of the time in seas less than 3 feet, but can be detected less than 15% of the time in seas of 3 to 6 feet.

Sweep widths shown in Table G-22 are based on altitudes of 2,500 to 4,000 feet for targets under 40 feet long, and 8,000 feet for targets over 40 feet long, with range scales no greater than 27 NM.

**Table G-22. Sweep Widths For Side-Looking Airborne Radar (NM)**

<i>Target Type</i>	<i>Douglas Sea State</i>	
	<i>0 to 1</i>	<i>2 to 3</i>
Fiberglass or wooden boats, 20 feet or less, without radar reflector or engine/metal equipment	16	< 6
Fiberglass or wooden boats, 20 feet or less, with radar reflector or engine/metal equipment	21	6
Life rafts, 4 to 10 persons without radar reflectors	12	< 5
Targets, 40 to 100 feet, with significant metal equipment	47	24
Metal targets longer than 100 feet	57	54

G.9.5 Forward-Looking Infrared (FLIR). Sweep widths should be approximated on the basis of Table G-23, using the operator's best estimate of effective detection ranges for other target types and field of view/scan width limits. Operators should be told the effective detection range is the range at which they believe the target will certainly be detected under prevailing conditions. Sweep width should not exceed the effective azimuthal coverage of the FLIR system in use, regardless of target size.

**Table G-23. Sweep Widths For Forward-Looking Infrared**

<i>Target Type</i>	<i>Douglas Sea State</i>	
	<i>0 to 1</i>	<i>2</i>
Persons in the water	0.3	0
Small boats and life rafts	1.5	0.5

**G.10 Multi-sensor**

G.10.1 Environmental parameters limit all types of search methods. Multi-sensor searching, both sensor and combinations of sensor and visual, can be used to mitigate environmental limitations.

- a) Sweep width tables for various combinations of search sensors, based on the type of conditions, type of target, and sensors used.
- b) Combined sensor searches should be planned so that sensor capabilities complement each other. Search patterns and track spacing should be selected on the basis of the effectiveness of the different SRU sensors available. The most effective sensor should be favored and controllable parameters, such as speed and altitude, should be selected to maximize the performance of the most capable sensor.

- c) Multi-sensor searches are normally assigned only if they provide the maximum sweep width possible with the available personnel. Scanners should not be manning sensors ineffective for the search conditions if they might be used as visual scanners.
- d) Visual searching may supplement sensor coverage by filling in blind zones created by antenna configuration and physical or operational limitations of the electronic equipment.

G.10.2 SLAR/Visual. The multi-sensor sweep width tables assume searching at 200 knots at 2000 feet altitude. Combined sweep widths for metal-hulled targets over 40 feet long are estimated to be the same as for SLAR search alone.

**Table G-24. SLAR/Visual Weather Conditions**

<i>Parameter</i>	<i>Good Conditions</i>	<i>Fair Conditions</i>
Wind Speed	8	15
Significant Wave Height (ft)	0.5	2
Visibility (NM)	10	5
Cloud Cover (%)	50	100
Time on Task (hr)	2	2
Search Speed (knots)	200	200
Search Altitude (ft)	2000	2000

**Table G-25. SLAR/Visual Sweep Widths (NM)**

<i>Target Type</i>	<i>Environmental Conditions</i>	
	<i>Good</i>	<i>Fair</i>
High-Contrast (e.g. white), 16- to 21-ft Fiberglass or Aluminum Boat with Engine and/or Other Metal Equipment	22.0	21.8
Medium-Contrast (e.g. Blue), 16-ft Fiberglass Boat Without Engine or Other Metal Equipment	17.1	16.8
Low-Contrast (e.g. Black), Life Raft without Metal Equipment or Canopy	13.7	13.3

\* "Good" and "Fair" environmental conditions from Table 4-19.

G.10.3 SVR/Visual. Combined sweep widths for targets with a radar cross section of at least 50 square meters are estimated as twice the radar horizon range in conditions up to sea-state 3. For vessels with antenna heights above 30 feet, sweep widths in the tables should be considered as minimum values since the radar horizon will be longer for these SRUs.

**Table G-26. UTB SVR/Visual Sweep Width for Targets With Radar Reflectors**

<i>Environmental Conditions</i>	<i>High-Contrast 16-Ft Boat or Life Raft w/ Canopy</i>	<i>Medium-Contrast 16-Ft Boat or Life Raft w/o Canopy</i>	<i>Low-Contrast Life Raft w/o Canopy</i>
Good Weather;0.5-ft Seas	3.6	3.2	3.0
Fair Weather;3-ft Seas	1.1	0.8	0.7
Light Rain (1 mm/hr);1-ft Seas	3.0	2.6	2.5
Moderate Rain (4 mm/hr);1-ft Seas	2.2	1.8	1.6
Heavy Rain (16 mm/hr);2-ft Seas	0.8	0.7	0.6
Moderately Heavy Snow (4 mm/hr of water);2-ft Seas	0.7	0.6	0.6
Dense Fog (100-ft visibility);0.5-ft Seas	1.9	1.9	1.9

Note: Sweep widths are rounded to nearest 0.1 nautical mile.

**Table G-27. UTB SVR/Visual Sweep Width for Targets Without Radar Reflectors**

<i>Environmental Conditions</i>	<i>High-Contrast 16-Ft Boat or Life Raft w/ Canopy</i>	<i>Medium-Contrast 16-Ft Boat or Life Raft w/o Canopy</i>	<i>Low-Contrast Life Raft w/o Canopy</i>
Good Weather; 0.5-ft Seas	3.5	3.0	2.9
Fair Weather; 3-ft Seas	*	*	*
Light Rain (1 mm/hr); 1-ft Seas	2.7	2.3	2.1
Moderate Rain (4 mm/hr); 1-ft Seas	2.1	1.6	1.4
Heavy Rain (16 mm/hr); 2-ft Seas	0.4	0.3	0.3
Moderately Heavy Snow (4 mm/hr of water); 2-ft Seas	0.2	0.2	0.1
Dense Fog (100-ft visibility); 0.5-ft Seas	0.4	0.4	0.4

Note: Sweep widths are rounded to nearest 0.1 nautical mile.

\* The AN/SPS-66 radar was unable to detect targets without radar reflectors in these conditions. Visual sweep width alone applies.

**Table G-28. WPB SVR/Visual Sweep Width for Targets With Radar Reflectors**

<i>Environmental Conditions</i>	<i>High-Contrast 16-Ft Boat or Life Raft w/ Canopy</i>	<i>Medium-Contrast 16-Ft Boat or Life Raft w/o Canopy</i>	<i>Low-Contrast Life Raft w/o Canopy</i>
Good Weather; 0.5-ft Seas	5.5	5.1	5.1
Fair Weather; 3-ft Seas	1.7	1.6	1.6
Light Rain (1 mm/hr); 1-ft Seas	4.3	4.1	3.9
Moderate Rain (4 mm/hr); 1-ft Seas	2.5	2.2	2.2
Heavy Rain (16 mm/hr); 2-ft Seas	0.8	0.7	0.7
Moderately Heavy Snow (4 mm/hr of water); 2-ft Seas	1.7	1.7	1.7
Dense Fog (100-ft visibility ); 0.5-ft Seas	3.6	3.6	3.6

Note: Sweep widths are rounded to nearest 0.1 nautical mile.

**Table G-29. WPB SVR/Visual Sweep Width for Targets Without Radar Reflectors**

<i>Environmental Conditions</i>	<i>High-Contrast 16-Ft Boat or Life Raft w/ Canopy</i>	<i>Medium-Contrast 16-Ft Boat or Life Raft w/o Canopy</i>	<i>Low-Contrast Life Raft w/o Canopy</i>
Good Weather; 0.5-ft Seas	4.9	4.3	4.1
Fair Weather; 3-ft Seas	1.3	1.2	1.2
Light Rain (1 mm/hr); 1-ft Seas	3.3	2.7	2.6
Moderate Rain (4 mm/hr); 1-ft Seas	2.1	1.6	1.4
Heavy Rain (16 mm/hr); 2-ft Seas	0.4	0.3	0.3
Moderately Heavy Snow (4 mm/hr of water); 2-ft Seas	0.3	0.2	0.2
Dense Fog (100-ft visibility); 0.5-ft Seas	0.8	0.8	0.8

Note: Sweep widths are rounded to nearest 0.1 nautical mile.

**G.11 Miscellaneous information**

**Table G-30. Douglas Sea State Scale**

<i>Douglas Sea State</i>	<i>Description</i>	<i>Wave Height</i>
0	Calm	-----
1	Smooth	0 - 1 foot
2	Slight	1 - 3 feet
3	Moderate	3 - 5 feet
4	Rough	5 - 8 feet
5	Very Rough	8 - 12 feet
6	High	12 - 20 feet
7	Very High	20 - 40 feet
8	Precipitous	over 40 feet
9	Confused	-----

**Table G-31 Height of Eye vs. Horizon Range**

Height feet	Nautical miles	Statute miles	Height feet	Nautical miles	Statute miles	Height feet	Nautical miles	Statute miles
1	1.1	1.3	120	12.5	14.4	940	35.1	40.4
2	1.6	1.9	125	12.8	14.7	960	35.4	40.8
3	2.0	2.3	130	13.0	15.0	980	35.8	41.2
4	2.3	2.6	135	13.3	15.3	1,000	36.2	41.6
5	2.6	2.9	140	13.5	15.6	1,100	37.9	43.7
6	2.8	3.2	145	13.8	15.9	1,200	39.6	45.6
7	3.0	3.5	150	14.0	16.1	1,300	41.2	47.5
8	3.2	3.7	160	14.5	16.7	1,400	42.8	49.3
9	3.4	4.0	170	14.9	17.2	1,500	44.3	51.0
10	3.6	4.2	180	15.3	17.7	1,600	45.8	52.7
11	3.8	4.4	190	15.8	18.2	1,700	47.2	54.3
12	4.0	4.6	200	16.2	18.6	1,800	48.5	55.9
13	4.1	4.7	210	16.6	19.1	1,900	49.9	57.4
14	4.3	4.9	220	17.0	19.5	2,000	51.2	58.9
15	4.4	5.1	230	17.3	20.2	2,100	52.4	60.4
16	4.6	5.3	240	17.7	20.4	2,200	53.7	61.8
17	4.7	5.4	250	18.1	20.8	2,300	54.9	63.2
18	4.9	5.6	260	18.4	21.2	2,400	56.0	64.5
19	5.0	5.7	270	18.8	21.6	2,500	57.2	65.8
20	5.1	5.9	280	19.1	22.0	2,600	58.3	67.2
21	5.2	6.0	290	19.5	22.4	2,700	59.4	68.4
22	5.4	6.2	300	19.8	22.8	2,800	60.5	69.7
23	5.5	6.3	310	20.1	23.2	2,900	61.6	70.9
24	5.6	6.5	320	20.5	23.6	3,000	62.7	72.1
25	5.7	6.6	330	20.8	23.9	3,100	63.7	73.3
26	5.8	6.7	340	21.1	24.3	3,200	64.7	74.5
27	5.9	6.8	350	21.4	24.6	3,300	65.7	75.7
28	6.1	7.0	360	21.7	25.0	3,400	66.7	76.8
29	6.2	7.1	370	22.0	25.3	3,500	67.7	77.9
30	6.3	7.2	380	22.3	25.7	3,600	68.6	79.0
31	6.4	7.3	390	22.6	26.0	3,700	69.6	80.1
32	6.5	7.5	400	22.9	26.3	3,800	70.5	81.2
33	6.6	7.6	410	23.2	26.7	3,900	71.4	82.2
34	6.7	7.7	420	23.4	27.0	4,000	72.4	83.3
35	6.8	7.8	430	23.7	27.3	4,100	73.3	84.3
36	6.9	7.9	440	24.0	27.6	4,200	74.1	85.4
37	7.0	8.0	450	24.3	27.9	4,300	75.0	86.4
38	7.1	8.1	460	24.5	28.2	4,400	75.9	87.4
39	7.1	8.2	470	24.8	28.6	4,500	76.7	88.3
40	7.2	8.3	480	25.1	28.9	4,600	77.6	89.3
41	7.3	8.4	490	25.3	29.2	4,700	78.4	90.3
42	7.4	8.5	500	25.6	29.4	4,800	79.3	91.2
43	7.5	8.6	520	26.1	30.3	4,900	80.1	92.2
44	7.6	8.7	540	26.6	30.6	5,000	80.9	93.1
45	7.7	8.8	560	27.1	31.2	6,000	88.6	102.0
46	7.8	8.9	580	27.6	31.7	7,000	95.7	110.2
47	7.8	9.0	600	28.0	32.3	8,000	102.3	117.8
48	7.9	9.1	620	28.5	32.8	9,000	108.5	124.9
49	8.0	9.2	640	28.9	33.3	10,000	114.4	131.7
50	8.1	9.3	660	29.4	33.8	15,000	140.1	161.3
55	8.5	9.8	680	29.8	34.3	20,000	161.8	186.3
60	8.9	10.2	700	30.3	34.8	25,000	180.9	208.2
65	9.2	10.6	720	30.7	35.3	30,000	198.1	228.1
70	9.6	11.0	740	31.1	35.8	35,000	214.0	246.4
75	9.9	11.4	760	31.5	36.3	40,000	228.8	263.4
80	10.2	11.8	780	31.9	36.8	45,000	242.7	279.4
85	10.5	12.1	800	32.4	37.3	50,000	255.8	294.5
90	10.9	12.5	820	32.8	37.7	60,000	280.2	322.6
95	11.2	12.8	840	33.2	38.2	70,000	302.7	348.4
100	11.4	13.2	860	33.5	38.6	80,000	323.6	372.5
105	11.7	13.5	880	33.9	39.1	90,000	343.2	395.1
110	12.0	13.8	900	34.3	39.5	100,000	361.8	416.5
115	12.3	14.1	920	34.7	39.9	200,000	511.6	589.0

**Table G-31. Search Pattern Summary**

<i>Pattern</i>	<i>Name</i>	<i>SRU required</i>	<i>Remarks</i>
TSR	Trackline single-unit return	1	For search of a trackline or line of position when unit must break off search at same end of track as search originated.
TMR	Trackline multiunit return	2 or more	Same AS TSR except that 2 or more SRUs are used cruising abeam of each other.
TSN	Trackline single-unit	1	Same as TSR except that search terminates at nonreturn at opposite end of track from commence search point.
TMN	Trackline multiunit	2 or more	Same as TMR except that search terminates at nonreturn opposite end of track from commence search point.
PS	Parallel track single-unit	1	Search of a large area when position of distress is unknown.
PM	Parallel track multiunit	2 or more	Same as PS except two or more SRUs search abeam of each other a distance S apart.
PMR	Parallel track multiunit	2 or more	Used for search of long rectangular area where return only one track out and back is possible.
PMN	Parallel track multiunit	2 or more	Only en route SRUs or transient craft available nonreturn for one track through search area.
PSL	Parallel track single-unit	1	Same as PS except SRU uses Loran lines for Loran line greater navigational accuracy on tracks.
PMC	Parallel multiunit circle	2 or more	Underwater pattern only.
PSS	Parallel single-unit spiral	1	Underwater pattern only.
Pd	Parallel drift compensated	1 or more	Used when target motion requires drift Compensation
CS	Creeping line single-unit	1	Distress generally known to be between two points. Wider than trackline patterns.
CSC	Creeping line single-unit coordinated	1 acft + 1 ship	Same as PS except coordinated ship movement used to obtain greater navigational accuracy.
SS	Square single-unit	1	Distress Position known within close limits and search area not extensive.
SM	Square multiunit	2 acft	Same as SS except two SRUs fly at different altitudes on tracks which differ by 45°
VS	Sector single-unit	1	Distress position known within close limits and search area not extensive.
VSR	Sector single-unit radar	1 acft + 1 ship	Same as VS except ship controls aircraft by radar.
OS	Contour single-unit	1	Search of mountainous/hilly terrain.
OM	Contour multiunit	2 or more	Search of mountainous/hilly terrain by land search teams.
FS	Flare single-unit	1 acft + 1 ship or 2 acft.	Night visual search only.
FM	Flare multiunit	1 acft + ships	Night visual search only.
HSA	Homing single-unit aural	1	Electronic homing-in use.
HSM	Homing single-unit meter	1	Electronic homing-in use.
HMN	Homing multiunit nonreturn	2 or more	Electronic positioning use.
B	Cross-over Barrier	1 or more	Used when target motion requires drift compensation.

---

## Appendix H

### Coordinated Search Patterns

**H.1** This appendix provides the OSC (and the SMC) with a guide for planning and executing coordinated search patterns. Teaming an aircraft with a vessel takes advantage of each facility's best features. Aircraft provide rapid coverage of the search area from a good search platform. Vessels may be able to quickly investigate objects detected and rescue survivors sighted from the aircraft. Information contained herein builds upon the coordinated air-maritime search discussion in IAMSAR Manual Volume 2, Chapter 5 (creeping line search, coordinated (CSC)).

**H.2** **Coordinated search symbology and definitions** used in computing and discussing aircraft search tracks are:

**Al** is the search area length.

**Aw** (search area width) is the sum of one search leg and one-track spacing ( $A_w = L + S$ ).

**Awf** is the search area width for faster aircraft in a CMCS pattern.

**AwS** is the search area width for slower aircraft in a CMCS pattern.

**C** (course) is the intended path of travel by an SRU.

**GS** (ground speed) is the speed of an aircraft relative to the earth's surface.

**H** (heading) is the horizontal direction in which an SRU is pointing.

**L** (search leg or search leg length) is the sum of the search leg straightaway ( $y$ ) and the search craft's turn diameter (TD). Subscripts further define L.

**L<sub>1</sub>** is the search leg with the highest headwind component.

**L<sub>2</sub>** is the search leg with the highest tailwind component.

**S** (track spacing) is the distance between adjacent search legs.

**T<sub>1</sub>** is the time required for a search aircraft to fly one-half of the straightaway length ( $y_1$ ) of the search leg with the highest headwind component (**L<sub>1</sub>**).

**T<sub>2</sub>** is the time required for a search aircraft to fly one-half of the straightaway length ( $y_2$ ) of the search leg with the highest tailwind component (**L<sub>2</sub>**).

**T<sub>3</sub>** is the time required for a search aircraft to fly the full straightaway length ( $x$ ) of the cross leg between two search areas.

**TAS** (true air speed) is the speed of an aircraft relative to the air mass it is in.

**TD** (turn diameter) is the diameter of a turning circle executed at a constant rate of turn, constant angle of bank (aircraft), or constant angle of rudder (vessel).

**Tr** (track) is the actual path of travel by an SRU.

**TTT** (time to turn) is the clock time specified for a search craft to begin a turn, usually onto the cross leg.

**V** (velocity or speed) denotes either rate of motion (speed), or both rate and direction of motion (velocity). Subscripts further define V.

**V<sub>1</sub>** is the ground speed of an aircraft flying on L<sub>1</sub>.

**V<sub>2</sub>** is the ground speed of a searching aircraft flying on L<sub>2</sub>.

**V<sub>3</sub>** is the ground speed of a searching aircraft flying on the cross leg between two search legs.

**V<sub>a</sub>** is aircraft TAS.

**V<sub>s</sub>** is surface craft velocity.

**X** is the distance the vessel travels from the time the aircraft flying on search leg L<sub>1</sub> is above the vessel to the “time to turn” (TTT) onto cross leg. Time required = t<sub>1</sub>.

**X** is the straightaway length of the cross leg.

**Y** is the distance the vessel travels from the time the aircraft flying on search leg L<sub>2</sub> completes its turnoff of the cross leg until above the vessel.

**Y** is the straightaway length of the search leg.

**Y<sub>1</sub>** is the straightaway length of the search leg with the highest headwind component.

**Y<sub>2</sub>** is the straightaway length of the search leg with the highest tailwind component.

**H.3 Coordinated search formulas** used to preplan or execute coordinated air/surface search patterns are summarized below and explained in subsequent paragraphs.

1. *Ship speed:*

$$V_s = \frac{SV_a}{L + S}$$

2. *Aircraft turn diameter:*

$$TD = \frac{TAS + 10}{100}$$

3. *General half search leg timing:*

$$t = \frac{60}{GS} \times \frac{L - TD}{2} \quad (\text{in minutes})$$

4. *Into the wind half search leg timing:*



$$t_1 = \frac{30(L - TD)}{V_1} = \frac{30y_1}{V_1} \text{ (in minutes)}$$

5. Downwind half search leg timing:

$$t_2 = \frac{30(L - TD)}{V_2} = \frac{30y_2}{V_2} \text{ (in minutes)}$$

6. Cross leg timing:

$$t_3 = \frac{3600(S - TD)}{V_3} \text{ (in seconds)}$$

7. Bowtie solution:

$$X = \frac{LV_s}{2V_1} \qquad Y = \frac{LV_s}{2V_2}$$

#### H.4 Coordinated search patterns are:

CSC – Creeping Line Single-Unit Coordinated.

CSR – Creeping Line Single-Unit Radar.

These patterns are variations of the Creeping Line Pattern. If the only available surface craft is a boat or larger vessel untrained in directing or coordinating aircraft, the CSC pattern is used. If the surface craft is a Navy vessel or a Coast Guard cutter, trained in directing or coordinating aircraft, the CSR pattern is normally used.

#### H.5 Search Pattern Variables

H.5.1 *Vessel heading and track.* The vessel track will normally be the direction of creep specified in the SMC SAR action plan. If an ocean current set is present, vessel heading should be corrected to ensure the desired search track.

H.5.2 *Vessel speed.* The vessel speed ( $V_s$ ) is adjusted so that the time required for the aircraft to fly along one complete search leg and one cross leg is equal to the time required for the vessel to advance on cross leg.

H.5.3 *Aircraft headings and speeds.* After the vessel search speed has been determined, the aircraft wind-corrected headings and ground speeds are computed. Most aircraft navigational computers can quickly provide the wind-corrected headings, ground speeds, and length of time required to fly search legs. The aircraft pilot should be given the necessary information to allow a check of vessel computations.

H.5.4 *Aircraft turn diameter.* The formula for aircraft turn diameter (paragraph H.3.2) is predicated on the aircraft making standard rate turns (3 degree heading change per second). Unlike a surface vessel, aircraft do not experience a noticeable difference between advance and transfer during the first 90 degree of turn. An aircraft starts its turn one-half turn diameter before the end of the search leg, and rolls out of the turn one-half turn diameter down the new search leg. The search leg length equals the straightaway plus one full turn

diameter ( $L = y + TD$ ), and the cross leg equals the straightaway plus one full turn diameter ( $S = x + TD$ ).

H.5.5 Aircraft cross leg time

- a) The vessel should compute the time required for the aircraft to fly the straightaway distance of the cross leg. This information is included in one of the early advisories passed to the aircraft after arrival.
- b) The aircraft requires 30 seconds to execute a 90-degree standard rate turn. Since the aircraft will be making two 90 degree turns on each end of the cross leg straightaway in any creeping line pattern, all maneuvering onto and off of cross legs requires 60 seconds plus  $t_3$ . See Figure H-1.

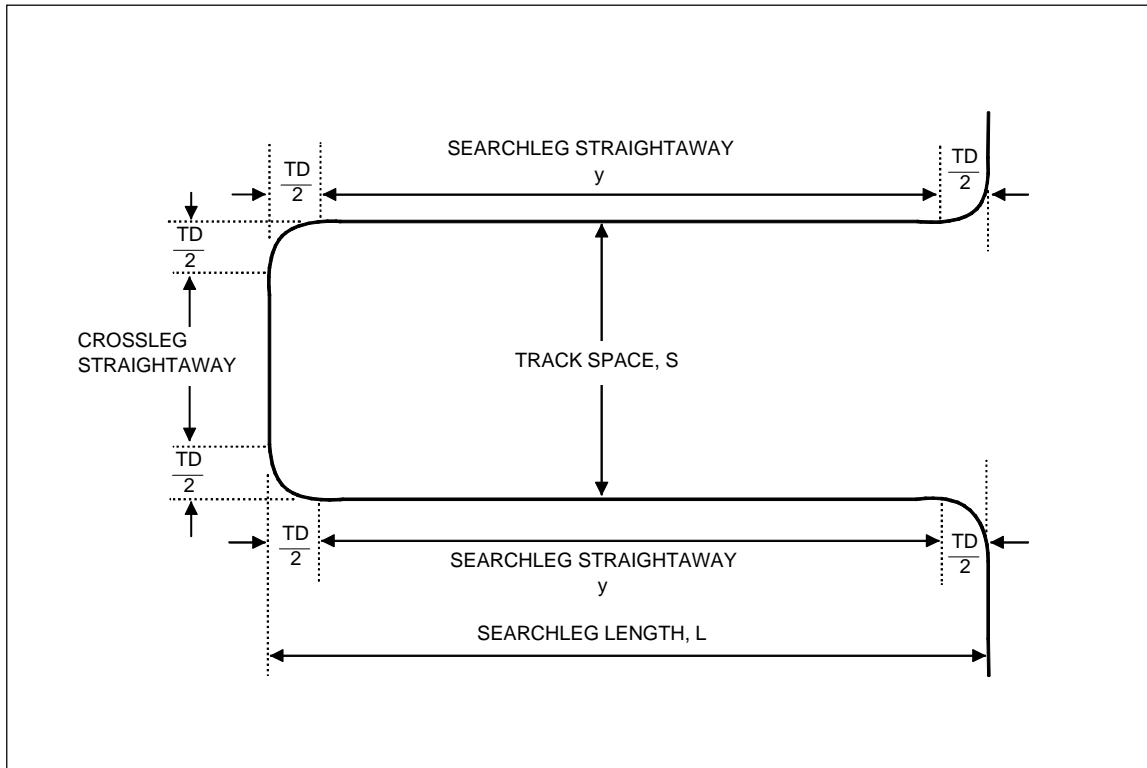

Figure H-1. Aircraft SRU Crosslegs

H.5.6 Aircraft searching time

- a) Unless winds are calm or perpendicular to the search legs, times for flying the two directions will be different. The search legs will usually be designated “downwind” and “upwind”. The formula for computing times required to fly one half of each search leg is given in paragraphs. H.3.3, H.3.4, and H.3.5.
- b) Times  $t_1$ ,  $t_2$ , and  $t_3$  are given to the aircraft before beginning the pattern. If radar contact with the aircraft is lost during the search, these times may be used to determine time to turn for the aircraft.

H.5.7 Pattern timing

- a) The aircraft and vessel should restart their elapsed time clock or stopwatch every time the aircraft passes over the vessel. Both the aircraft and vessel time the second half of each search leg. When the computed time ( $t_1$  or  $t_2$ ) has elapsed, the aircraft should start its turn onto the cross leg.
- b) In the CSC pattern, the aircraft uses this timing procedure to determine its own time to turn. The vessel

may use the timing required for the aircraft to fly from overhead to overhead as a check on the aircraft's completion of full search legs on both sides of the vessel. The timing is  $t_1 + t_2 + t$  turning or  $t_1 + t_2 + 60$  seconds.

- c) In the CSR pattern, the radar/visual plots aboard the vessel control the actual commencement of the turn onto the cross leg. Timing of search legs by the vessel provides a backup control if radar fails. The air controller can tell the aircraft when to turn, but this has to be done while simultaneously shifting from the relative plot to the true plot for the information. Therefore, the aircraft should time itself in the event of radar problems aboard the vessel.
- d) Cross leg timing is executed by the aircraft pilot independently of the vessel.

## H.6 Surface plot/true plot

H.6.1 *General.* With known values for vessel course, search leg length (L), and track spacing (S), the search pattern is laid out on the ship dead reckoning tracer (DRT) before the aircraft arrives on scene. When ready to begin the search, the ship takes position one-half track spacing outside of the search area, and vectors the aircraft to the ship and then onto its initial "startup" search leg. As the aircraft passes overhead the vessel and begins its initial search leg, the DRT is started, with the ship search speed ( $V_s$ ) set in. The mechanically controlled DRT produces a two-dimensional, lateral movement proportional to the headings and speeds of the ship. Aircraft and vessel positions are marked each minute on the DRT surface plot. The surface plot, or true plot, is used as a backup for the relative motion plot. Although most radar advisories to the aircraft are based on the relative motion plot, the plotted information is removed after each leg is completed. The surface plot provides the only permanent history of the search, so all sightings should be plotted on the surface plot. See Figure H-2.

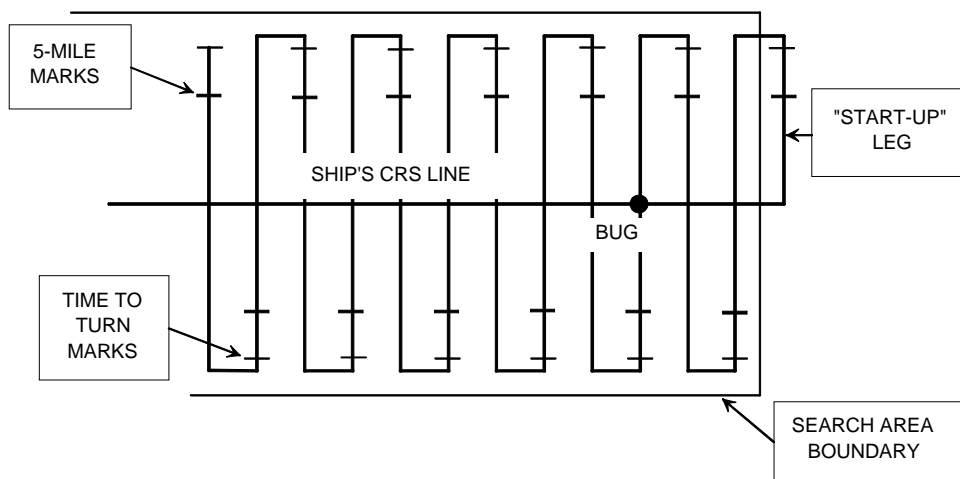

**Figure H-2. Surface Plot/True Plot**

### H.6.2 Surface plot data

- a) Within the coordinated search area, using the largest scale possible, the following information is plotted on the surface plot: ship course, search pattern with search legs drawn at proper track spacing (each leg marked at 5 miles from its end and at TTT onto cross leg), coordinates of datum and time and position of all sightings.
- b) Plotted within the search areas adjacent to the coordinated search area, are the following: area designation, coordinate of center point, major axis, search legs (direction of creep – arrow – and the first two or three search legs), search altitude, type and call sign of SRU, vector from OSC position to commence search point (CSP), and IFF/SIF squawk and air-to-air TACAN channel assignment.

- c) Plotted outside the coordinated search area, but adjacent to it, are the following: aircraft radio call sign, aircraft assigned search altitude, assigned track spacing, type of pattern, and times required to fly  $t_1$ ,  $t_2$ , and  $t_3$ .

## **H.7** Air Plot/Relative Plot

### H.7.1 *General*

- a) Although a true plot may be used to plot and vector the search aircraft during coordinated search patterns, an easier method is to employ a relative motion pattern. The relative motion pattern is laid out on the vessel air plot or relative plot board, and is the primary source of information for the advisories furnished the aircraft by the vessel during the search.
- b) The true plot, or surface plot, is laid out on the vessel DRT in the vessel Combat Information Center (CIC). The vessel relative plot or air plot board is close to the DRT. This board is usually edge-lighted or back-lighted, has permanently inscribed bearing lines and range circles similar to a maneuvering board, and is used to plot aircraft targets relative to vessel position.

### H.7.2 *Relative plot and true plot comparison*

- a) The vessel air controllers should thoroughly understand the difference between the true plot and the relative plot, as well as their relationship. The air controller may have to rapidly shift from using the relative plot to using the true plot if ship radar fails or radar contact with the aircraft is lost.
- b) With known values for ship course and speed, existing wind direction and speed, length of searchlegs, and track spacing, the relative motion pattern may be computed and laid out by the vessel before the search aircraft arrives. The shape of the relative motion pattern, when executing any of the creeping line coordinated patterns, is similar to a bowtie.
- c) Figure H-3 illustrates the common-time relative bearings of vessel and aircraft, and Figure H-4 is a simplified form of Figure H-3, showing the relationship between the true plot and relative plot patterns. Only four common time positions are shown for the vessel and aircraft, aircraft turning diameter is ignored.
  - 1) The comparison is started with the aircraft in position ahead of the vessel, at position 1. The relative bearing of the aircraft from the vessel stays constant until the aircraft reaches position 2 at the end of search leg  $L_1$ , which has the greatest headwind component. To an observer on the ship, the aircraft has gradually moved from a position abeam of the ship (when overhead) to a position behind the beam position a distance equal to  $X$  (when at the end of search leg  $L_1$ ).
  - 2) When the aircraft is on its cross leg, both the vessel and the aircraft are moving in the same direction, from position 2 to position 3. The distance the aircraft travels as the ship moves from position 2 to position 3 is not seen as relative motion by an observer on the ship.
  - 3) When the aircraft turns from the cross leg onto search leg  $L_2$  at position 3, it appears to the observer to be forward of the beam a distance equal to  $Y$ . The aircraft will then gradually appear to move back toward the beam position during its inbound period, reaching the abeam position when again passing overhead the vessel at position 4 in Figure H-4.

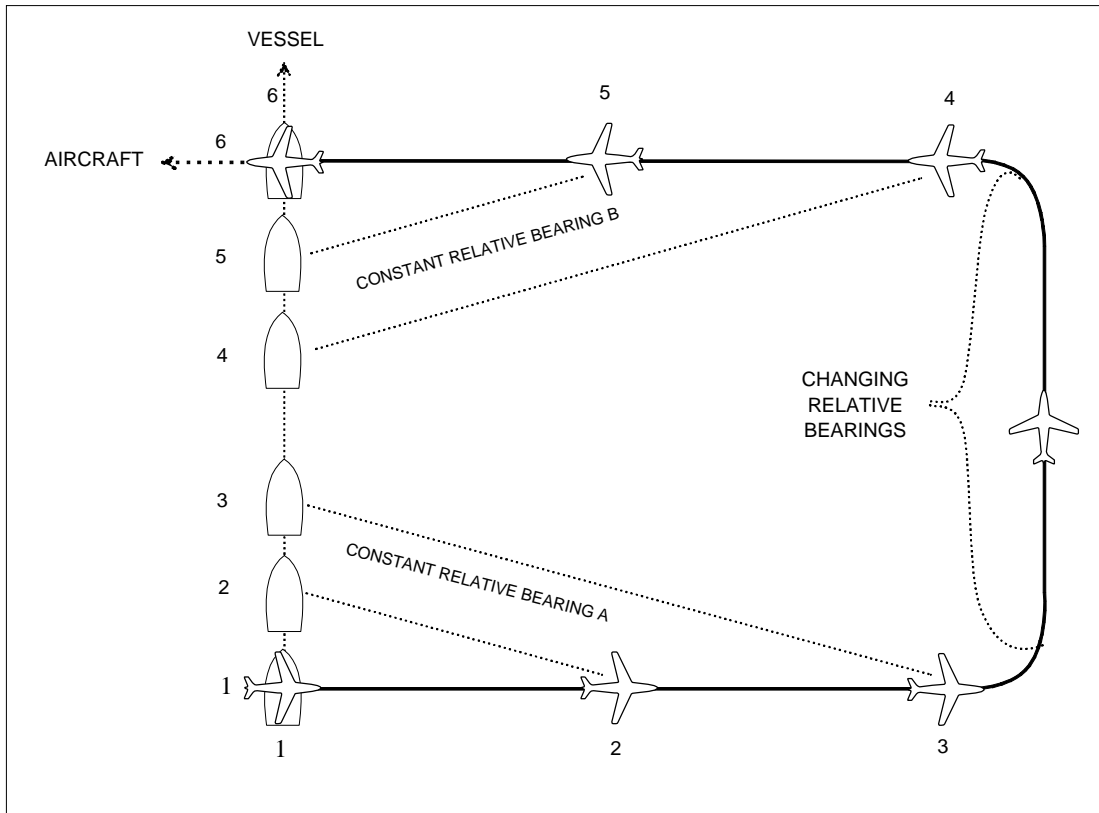

Figure H-3. Common-Time Relative Bearings

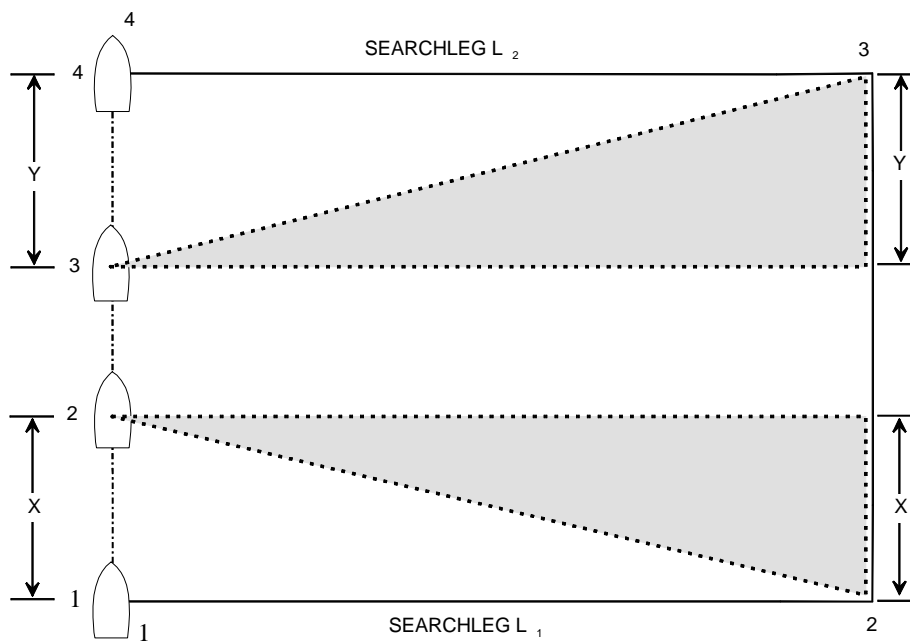

Figure H-4. Comparison of Relative Motion and True Motion Patterns

d) If the shaded portions of Figure H-4 were brought together, they would be the upwind portion of the

relative motion pattern on the starboard side of the vessel. The portion of the relative motion pattern on the port side or downwind side of the vessel is geometrically similar to the pattern on the opposite side, as shown in Figures H-5A and H-5B.

- e) The relative movement cross leg may now be defined in two ways. In either definition, the relative motion cross leg is the sum of X and Y.
- (1) It is equal to the track spacing minus the distance the ship travels while the aircraft is on its cross leg.
  - (2) It is equal to the distance the ship travels while the aircraft is moving outbound into the wind (X) us the distance the ship travels while the aircraft is inbound with a tailwind component (Y).

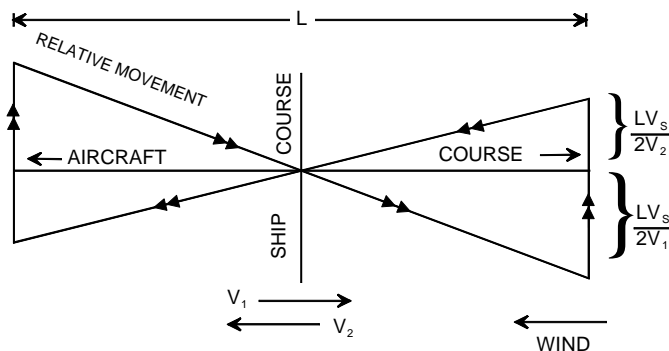

Figure H-5A

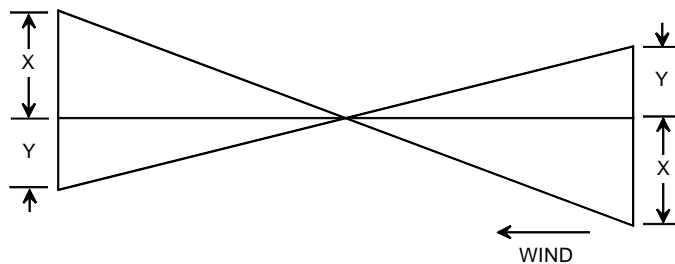

Figure H-5B

Figure H-5. Full Relative Motion Pattern

H.7.3 *Relative motion pattern solutions.* The distances X and Y vary with the strength and direction of the wind at search altitude. X and Y may be derived either geometrically or algebraically. The geometrical solution is recommended.

- a) *Geometric solution.* Utilizing a Universal Plotting Sheet, follow these steps:
  - 1) Use 20:1 scale.
  - 2) Plot vector from center representing ship course and speed.
  - 3) Construct a line perpendicular to ship course through plot center.
  - 4) Mark off  $V_1$  on upwind side.

- 5) Mark off  $V_2$  on downwind side.
- 6) Lay out lines parallel to ship's course at distance  $L/2$  on each side (2:1 scale).
- 7) Construct:
  - (a) Temporary line connecting the head of the ship vector and  $V_1$  where  $V_1$  intersects with the line drawn perpendicular to the ship course ((3) above).
  - (b) A line parallel to the line described above, but through the tail of the ship's vector (plot center). Extend this line out to  $L/2$  on both sides of the ship.
  - (c) Erase all construction lines.
- b) *Algebraic solution.* Magnitude of X and Y depend on aircraft ground speed (GS) for a given leg and ship speed. Y is never greater than X.
  - 1)  $X = \frac{LV_s}{2V_1}$  ( $V_1$  is GS on the leg with the headwind component)
  - 2)  $Y = \frac{LV_s}{2V_2}$  ( $V_2$  is GS on the leg with the tailwind component)
  - 3) Construct:
    - (a) Ship course from plot center.
    - (b) Line perpendicular to ship course through plot center.
    - (c) Line parallel to ship course on upwind side a distance  $L/2$  from plot center.
    - (d) Line parallel to ship's course on downwind side a distance  $L/2$  from plot center. Mark off X and Y reversed from upwind side.
    - (e) Connect points through center.
    - (f) Remove construction line.

H.7.4 *Air plot data.* After the relative motion pattern has been solved, it is laid out on the air plot. It should then be covered with transparent plastic tape in lieu of Plexiglas, as the tape will not introduce any parallax errors. The following information is depicted upon the air plot:

- a) Aircraft magnetic courses (box in, cover with transparent tape).
- b) Aircraft wind-corrected headings (above or below box; do not cover).
- c) Magnitude directions every 10 degrees around edge of plot.
- d) Wind direction and speed.
- e) Swell systems, labeled primary "P" and secondary "S".

- f) Recommended ditch heading, large arrowhead labeled "DH".
- g) Mark on each leg at 5 miles from end.
- h) Mark on each leg at TTT lead point for turn onto cross leg.
- i) Time on cross leg straightaway ( $t_3$ ).
- j) Times for one half of each search leg straightaway ( $t_1$  and  $t_2$ ).

## **H.8 Execution of the CSR Search Pattern**

### *H.8.1. Basic sequence for vessel:*

- a) Position vessel one-half track spacing outside of the arc on the centerline.
- b) Start aircraft outbound, in either direction, from overhead and get under way. Ship will lag pattern slightly on first leg due to need to accelerate to search speed.
- c) Direct the aircraft to correct his track to pass overhead when within 1 mile of the vessel on each inbound leg. Request the aircraft to report amount of correction needed.
- d) Request pilot evaluation of pattern computations after one or two legs.
- e) Obtain radar range of vessel from aircraft when aircraft turns inbound if vessel has no information.
- f) Plot radar fixes of the aircraft directly on the air plot, and then keep aircraft corrected to track by use of the relative motion pattern.
- g) Adjust times and headings if necessary. If other than minor changes are necessary, recheck wind, TAS, and computations, and replot the relative motion pattern (bowtie).
- h) Replot bowtie only when the aircraft is overhead.

*H.8.2. CSR computation sheets.* It is recommended that ships, which normally serve as SAR vessels, prepare computation sheets for CIC in order to efficiently preplan for the air/surface coordinated search. The sheet requires that search data be recorded in a logical order and computed in the proper sequence, and that initial advisories are readied for delivery to arriving aircraft.

### *H.8.3. Aircraft advisories*

- a) Before the aircraft arrives on scene for a coordinated ship/air search, the ship should prepare several advisories for the aircraft, including "search information," "correction to course," "search legs," "cross legs," and similar advisories needed for efficient execution of coordinated searches. All instructional types of advisories are passed to the aircraft before starting the search pattern, if possible. Directive advisories are passed to the aircraft as required during the search.
- b) In order to give "off course" advisories to the aircraft as soon as the search pattern is begun, the vessel should furnish the aircraft with the "Correction to Course Table" for its search TAS (Table H-1) together with a brief explanation of its use, prior to starting the pattern.
- c) The distance off course is given in quarter mile increments and should be based on the average of several plotted fixes. Upon being advised it is off course, the aircraft corrects back to course by turning the number of degrees prescribed in the "Correction to Course Table," and immediately reverses the turning direction to return to the search leg heading. All aircraft correction turns are standard rate turns.



The aircraft should be instructed to visually correct as necessary in order to pass over the ship on each inbound leg.

**Table H-1. Correction to Course Table**

<i>Distance off Course (miles)</i>	<i>Degrees of turn for</i>				
	<i>TAS 110</i>	<i>TAS 120</i>	<i>TAS 130</i>	<i>TAS 140</i>	<i>TAS 150</i>
0.25	24	23	22	21	20
0.50	42	40	38	36	34
0.75	56	52	50	47	44
1.00	68	64	61	57	55
1.25	78	74	71	67	65
1.50	86	82	79	76	73

- d) When the aircraft arrives where it should begin the turn onto the cross leg, the controller directs the pilot to turn. The aircraft turn point is short of the end of the search leg by a distance of one-half its turn diameter, usually 15 seconds of flight time. The air controller must allow for the lag between the turn command and the actual turn, so most controllers mark the relative plot and true plot with TTT marks at a distance equal to one-half TD + 0.3 mile from the end of the search leg. No position or off course advisories are passed to the aircraft while it is executing its cross leg.
- e) If during the search the aircraft repeatedly drifts off the search course in the same direction, the wind at search altitude is different from that used to originally compute the aircraft headings. A more accurate wind should be estimated from the plot fixes, or obtained from the aircraft, and the aircraft headings replotted. The correct heading advisory is passed to the pilot.
- f) If the aircraft breaks off the search to investigate a sighting, it is advised that the vessel will hold relative position in the pattern by either stopping or circling present position. If the report proves negative, the vessel will vector the aircraft back to the last position in the pattern.

#### H.8.4 *Range and bearing information*

- a) The CSR search pattern is the same as the CSC pattern except that the vessel assists the aircraft with keeping on the proper search course by furnishing frequent advisories based on the ship's radar/visual plots of the aircraft. The vessel normally maintains a true plot and a relative plot. Both are a composite of information from air search radar, surface search radar, IFF/SIF interrogator displays, ECM information, TACAN/DME ranging displays, and visual bearings. When the aircraft is within visual range of the ship, visual bearings are taken and plotted with radar ranges. This provides a more accurate plot than one relying entirely upon electronic information. Radar bearings are susceptible to errors, although a constant error may also exist with radar ranges from a particular piece of equipment. Early in the search, radar and visual bearings should be compared for any difference that would reveal a radar bearing error. If a constant radar bearing error is detected, all subsequent radar bearings are corrected during the search.
- b) Using a gyroscope and a pelorus, visual bearings are taken from a position on the wing of the vessel's bridge by the "bearing taker" who has communications with the vessel "air plotter" in CIC.

#### H.8.5 *Plotting standards*

- a) The following standard symbols should be used on both the air plot and the surface plot to visually indicate the source of the fix/DR data:

P	Air search radar,
$\phi$	Surface search radar,
$\kappa$	Radar range and visual bearing, and
$\epsilon$	DR position.

- b) A fix or DR should be plotted:

- 1) Initially, every 15 seconds on the air plot. This provides the air controller with the best presentation on the aircraft track and allows more precise control.
- 2) Every 30 seconds on the air plot after wind drift correction is established.
- 3) Every 60 seconds on surface plots.

#### H.8.6. *Air controller procedures*

- a) Use the air plot as the primary means of coordination, to ensure that the aircraft will pass overhead the vessel on each search leg.
- b) Correct the aircraft back to the search course whenever it is off more than one-quarter mile.
- c) Pin down drift as early as possible. Frequent corrections to track reduce search effectiveness, because the pilot is distracted from scanning, and the lowered wing obstructs visibility for that lookout while the up-wing lookout can see only sky.
- d) Base track corrections on the trend of several marks and determine new headings by inspection of aircraft drift, if consistently into or downwind. If a heading change of more than a couple of degrees is necessary to hold the aircraft on track, recheck computations for X and Y. If original computations are correct, check for change in wind or aircraft TAS. Recompute X and Y with new values and replot bowtie.
- e) Direct aircraft to "execute cross leg" when it reaches the lead mark (time to turn mark). The aircraft follows cross leg instructions passed previously and keeps its own time on straightaway. The vessel does not attempt to coordinate the aircraft on cross legs. The air controller should correct recurring overshoots or undershoots by adjusting time on straightaway.

---

## U.S. Search and Rescue Regions

This Section of the *Supplement* contains Charts of search and rescue regions (SRRs) and the SAR sub-region (SRS) for which the U.S. is responsible. Maritime SRRs are in various degrees of finalization, and information for the Charts come from a variety of sources. Aeronautical SRRs are relatively complete worldwide, but are changed occasionally. Some discussion of the basis for the Charts should help some in understanding the necessary complexities. Key international documents associated with SRRs are IMO's *Provisional Search and Rescue Plan*, which serves to help establish a maritime *Global Search and Rescue Plan*, and *Regional Air Navigation Plans* (RANPs) developed by the International Civil Aviation Organization (ICAO). International SAR agreements are also important in developing SRRs, and are referred to as applicable within this Section.

SRRs determine what authorities are responsible for providing SAR services. RCCs associated with SRRs also handle any necessary international operational coordination that may be needed.

The following paragraphs discuss the key types of SAR regions and the primary international source documents used for the U.S. maritime and aeronautical SAR Charts in this Section. The final paragraphs before the Charts provide guidance on applicability of the Provisional Plan.

### Global Search and Rescue Plan

In 1979, the International Maritime Organization (IMO) sponsored a SAR Conference to develop provisions of what would become the *International Convention on Maritime Search and Rescue*. This Conference also resolved, *inter alia*, to do the following:

- Urge nations to provide maritime search and rescue (SAR) services for all sea areas
- Urge nations to provide information about their SAR services to IMO for circulation to its member Governments
- Invite IMO to publish information on how nations agree to provide for SAR coordination (this information would later become known as the *Global SAR Plan* or the *IMO SAR Plan*), and to advise and assist nations in establishing SAR services

The Global SAR Plan (sometimes called the IMO SAR Plan) is intended to include information:

About how SAR responsibilities are divided up geographically based on SRRs to ensure that SAR services are available everywhere; and

About national and regional SAR systems that provide these services.

Establishment of SRRs is critically important to implementation of the SAR Convention and completion of the Global SAR Plan.

An SRR is an area of defined dimensions associated with a rescue coordination center (RCC), within which SAR services are provided. An RCC is a unit responsible for promoting efficient organization of SAR services and for coordinating the conduct of SAR operations within an SRR. By definition, there is a one-to-one correlation between SRRs and RCCs.

The Global SAR Plan identifies responsible SAR agencies; maritime RCCs (MRCCs) and their associated communications capabilities; primary types of SAR facilities available to each MRCC; and other information that might be helpful to either persons in distress or other SAR authorities that might be involved

The SAR Convention promotes development of effective SAR services, and promotes international cooperation for that purpose. The Global SAR Plan is a primary means of helping to implement the Convention. The Global SAR Plan supplements the Convention by providing details on how to achieve the SAR goals of the Convention.

The Global SAR Plan is needed to:

Help ensure that SAR services are available wherever mariners might need assistance in a distress situation; and

So that persons in distress, SAR communication service providers (such as Cospas-Sarsat and Inmarsat), and SAR authorities will know where to send or relay distress alerts. (The most important information in the Global SAR Plan is about the maritime RCC responsible for any particular distress location.)

The SAR Convention makes the importance of the Global SAR Plan and of SRRs clear in this provision:

*To help ensure the provision of adequate shore-based communication infrastructure, efficient distress alert routing, and proper operational co-ordination to effectively support search and rescue services, Parties shall, individually or in co-operation with other States, ensure that sufficient search and rescue regions are established within each sea area...Such regions should be contiguous and, as far as practicable, not overlap.*

Chapters 1 and 2 of Volume 1 of the *International Aeronautical and Maritime Search and Rescue Manual* (IAMSAR) provide additional information on establishment of SAR services, RCCs and SRRs.

In summary, the intent of the SAR Convention is that a Global SAR Plan be developed that makes effective arrangements, through domestic efforts and international cooperation, for SAR services to be provided to assist persons in distress anywhere at sea.

### **Harmonization with Aeronautical SAR**

IMO and ICAO are agencies of the United Nations devoted to maritime and aviation safety, respectively. IMO and ICAO have been fostering close SAR cooperation between themselves, neighboring nations, and maritime and aeronautical authorities to harmonize maritime and aeronautical SAR services. One product of this cooperation is IAMSAR.

The SAR Convention itself specifically provides for coordination with aeronautical authorities with the following words:

*Parties shall ensure the closest practicable co-ordination between maritime and aeronautical services so as to provide for the most effective and efficient search and rescue services in and over their search and rescue regions.*

*Whenever practicable, each Party should establish joint rescue co-ordination centres and rescue sub-centres to serve both maritime and aeronautical purposes.*

*Whenever separate maritime and aeronautical rescue co-ordination centres or rescue sub-centres are established to serve the same area, the Party concerned shall ensure the closest practicable co-ordination between the centres or sub-centres.*

*Parties shall ensure as far as is possible the use of common procedures by search and rescue units established for maritime purposes and those established for aeronautical purposes.*

ICAO RANPs collectively comprise a “global SAR plan” for aeronautical SAR covering land and sea areas.

Cooperative arrangements between maritime and aeronautical authorities, like cooperation between nations, offer opportunities to provide SAR services more efficiently and effectively.

In addition, there are substantial advantages not only to harmonizing aeronautical and maritime SRRs where practicable, but also in establishing joint (maritime and aeronautical) RCCs in some locations. The U.S. uses appropriate international opportunities with other nations to amend aeronautical or maritime SRRs to more closely harmonize them as appropriate.

### **Provisional Plan: Purpose and Contents**

The Provisional Plan is a *temporary* interim step in development of the Global SAR Plan. The Plan is considered to be provisional because it is a draft Plan developed for consideration and adoption by each nation, in cooperation with neighboring nations, which removes its provisional status piece by piece. The word “provisional” means lasting for a limited time. For the SAR Convention to achieve its purpose, the Provisional Plan must be replaced by a more permanent Global SAR Plan. This important effort will require many years to complete.

To enable completion of the Global SAR Plan, every coastal nation must do two things:

First, every nation must, *individually or in cooperation with other nations*, ensure that arrangements are in place to provide SAR services.

Inherent in these arrangements is the necessity of neighboring nations agreeing on the geographic areas of responsibility they will accept. As provided in the SAR Convention, there should be no gaps or overlaps in the areas covered by SRRs.

All sea areas should be covered by an SRR with an associated operational MRCC. (Notes that responsibility for providing SAR services within an SRR may belong to a single nation or to a group of neighboring nations. Typically, an MRCC is operated by authorities of a single nation. Each RSC should be affiliated with one of the RCCs for purposes of regional coordination, and should be at a minimum able to coordinate SAR services close to shore for the nation concerned.)

Secondly, nations must provide information to the Secretary-General of IMO about its SAR services for inclusion in the Global SAR Plan. In the U.S., the Department of Transportation has this responsibility.

It is essential that neighboring nations agree on establishment of SRRs, or agree on alternative arrangements or procedures that would provide equivalent assurance that calls for assistance from those in danger at sea will be received and acted upon. (It is difficult to develop such equivalent arrangements for purposes of routing distress alerts to responsible authorities.) Completion of the Global SAR Plan depends on such cooperation. But more importantly, establishment of adequate SAR services depends on such cooperative commitments.

### **Provisional Plan: Status**

The IMO Provisional Plan is essentially complete worldwide. However, there has been a practical need for the Global SAR Plan to be in place from when the SAR Convention originally entered into force on June 22, 1985. The amended Annex to the SAR Convention entered into force on January 1, 2000, and the primary changes to it were intended to broaden the available options for compliance with the Convention so that it would be easier to complete the Global SAR Plan. It appears that throughout most of the first decade of this century we still mainly have a provisional or temporary plan, an intermediate step toward implementing the SAR Convention. This is a critical problem.

IMO did not intend for the Provisional Plan to have operational applicability. It is provisional because it has not yet been properly accepted by nations concerned. Such acceptance is not a unilateral process, but depends on reaching and formalizing agreement on SRRs and other SAR matters with nations having neighboring SRRs. However, in many areas of the world, the Provisional Plan is all that exists for maritime SAR. Therefore, it should not be ignored, but should be regarded as an interim plan, parts of which are likely to eventually convert intact into parts of the Global SAR Plan, which is intended to support operations. Therefore, some neighboring nations are either applying the Provisional Plan operationally on an interim basis, or using or updating cooperative arrangements with their respective neighbors that were in place before the Provisional Plan was developed.

U.S. SAR authorities should recognize both the limitations and potential value of the Provisional Plan. Since all U.S. maritime SRRs that have adjacent provisional SRRs are the responsibility of the Coast Guard, Coast Guard SAR authorities should maintain cooperative relationships with SAR authorities of neighboring nations that have provisional SRRs (not just those immediately adjacent) to ensure that adequate SAR services are available. One way that neighboring nations with inadequate SAR services, mostly in the Caribbean, can satisfy their SAR obligations in the near future is by continuing to supplement their own SAR capabilities with arrangements for assistance from other nations, including the U.S. via the U.S. Coast Guard. The Coast Guard can assist not only with its own resources, but also by arranging to use DOD, commercial and other available resources as well.

### **U.S. SAR Region Coordinates**

U.S. SRR coordinates are published in various documents: (1) SAR agreements signed with other countries (maritime-only or maritime and aeronautical), (2) ICAO documents, and (3) IMO SAR Plan (Provisional and Global). Sometimes ICAO and IMO coordinates agree and form congruent aeronautical and maritime segments. Many times, the aeronautical and maritime coordinates do not align and thus form distinct segments. ICAO and IMO charts may not receive timely updates to accurately depict the SRRs based on U.S. SAR agreements or understandings reached in bilateral/regional forums.

Since some nations have limited search and rescue capabilities, the U.S. Coast Guard shall continue to provide search and rescue services as necessary beyond the maritime SRR's for which it is primarily responsible. Search and rescue operations should be coordinated, as appropriate, in cooperation or in support of search and rescue authorities of other nations.

## U.S. Maritime SAR Region Coordinates

### Source documents:

- (1) Applicable SAR agreements noted below, maritime-only or maritime and aeronautical
- (2) IMO Provisional SAR Plan as provided in SAR.2/Circ.5 and SAR.3/Circ.5 both dated 19 January 1996
- (3) IMO's "Report on the Pacific Ocean Conference on Maritime Search and Rescue and the GMDSS, Seoul, Republic of Korea, 7 to 11 April 1997
- (4) U.S.-Japan SAR Agreement amendment dated September 30, 1998
- (5) IMO Circular letter No. 2131 dated 28 May 1999 (Communication from France regarding SRR in the Central Atlantic Ocean-Caribbean Sea area)

Key: (1) Maritime SAR agreement country name in **bold** font and underlined.  
(2) IMO Provisional SAR Plan SRR name in *italic* font and underlined.

### *In the Pacific Ocean*

#### **Russia:**

From North Pole south along 168° 58' 37" W meridian to 65° 30'N, 168° 58' 37"W, southwestward connecting the following geographic positions: ..." A list totaling 87 geographical positions is detailed on "United States- U.S.S.R. Maritime Boundary" chartlet; significant points include:

64° 07' 50" N, 172° 00' 00" W; 60° 11' 39" N, 179° 46' 49"W;  
59° 58' 22" N, 179° 40' 55" W; 53° 43' 42" N, 170° 18' 31" E;  
51° 11' 22" N, 167° 26' 52" E; 51° 12' 17" N, 167° 15' 35" E to ending point  
50° 58' 39" N, 167° 00' 00" E

*Note 1:* SAR Agreement signed 31 May 1988 but not yet ratified by the Russian Federation.

*Note 2:* Not all coordinates are plotted, the general trend of the line is depicted.

*Note 3:* SRR began at the North Pole due to: (1) U.S.-U.S.S.R. Maritime Boundary Agreement signed 1 June 1990 states "From the initial point, 65° 30'N, 168° 58' 37"W, the maritime boundary extends north along the 168° 58' 37" W meridian through the Bering Strait and Chukchi Sea into the Arctic Ocean as far as permitted under international law."; (2) U.S. aeronautical SRR under ICAO starts at the North Pole; and (3) U.S.-Canada aeronautical and maritime SRR ends at the North Pole.

#### **Japan:**

52° 30' N, 165° E; 17° N, 165° E; 17° N, 130° E."

*Note 4:* Gap between Japanese and Russian SRRs with U.S. still requires trilateral negotiations as of October 2000 to formally connect between Russian ending point and Japanese beginning point: northwestward from 50° 58' 39" N, 167° 00' 00" E to 52° 30' N, 165° E

#### **Philippines**

17° N, 130° E; 06° N, 130° E

#### **Indonesia:**

06° N, 130° E; 06° N, 132° E; 03° 30' N, 132° E; 03° 30' N, 141° E; and 00° N, 141° E

#### **Papua New Guinea**

00° N, 141° E; 00° N, 160° E

#### **Nauru**

00° N, 160° E; 03° 30' N, 160° 00' E; 03° 30' N, 170° 00' E;

*Micronesia: IMO's Pacific Conference report "noted that Micronesia, at present part of the U.S./Honolulu SRR, was in the process of undertaking it's own coordination. Pending discussions with the United States, a draft Micronesian SRR was delimited on the chart."*

*Micronesia's draft SRR coordinates are provided for future reference and are not plotted on Chart 1:*

00° 00'N, 166° 00'E; 06° 00'N, 166° 00'E; 11° 35'N, 157° 00'E; 11° 35'N, 137° 00'E; 07° 00'N, 137° 00'E; 07° 00'N, 142° 30'E; 00° 00'N, 145° 00'E

Fiji (Nandi)

03° 30'N, 170° 00'E; 03° 30'N, 180° 00'; 05° 00'S, 180°; 05° 00'S, 160° 00'W

New Zealand

05° 00'S, 160° 00'W; and 05° 00'S, 157° 00'W

French Polynesia (Tahiti)

05° 00'S, 157° 00'W; 05° 00'S, 120° 00'W

Peru

05° 00'S, 120° 00'W; 03° 24'S, 120° 00'W; 03° 24'S, approximate 095° 00'W

then northeast to Guatemala-Mexico SRR point 11° 58.1'N, 094° 26'W

**Note 5:** Peru – U.S. maritime SRR delimitation pends further discussion.

Ecuador

03° 24'S, 095° 00'W; 01° 28'N, 095° 00'W; 01° 28'N, 078° 48.45'W

**Mexico:**

In the Pacific Ocean:

32° 35' 22.11" N, 117° 27' 49.42" W to 32° 37' 37.00" N, 117° 49' 31.00" W  
32° 37' 37.00" N, 117° 49' 31.00" W to 31° 07' 58.00" N, 118° 36' 18.00" W  
31° 07' 58.00" N, 118° 36' 18.00" W to 30° 32' 31.20" N, 121° 51' 58.37" W

**Note 6:** SRR Alameda will continue to be responsible for the additional areas delimited by the line following the 200 mile EEZ of Costa Rica, Nicaragua, El Salvador, Guatemala to a point 11° 58.1'N, 094° 26'W pending further discussions. See Annex 10 to "Report on the Pacific Ocean Conference on Maritime Search and Rescue and the GMDSS, April 1997."

**Canada (aeronautical and maritime SAR agreement):**

48° 30' N 124° 45'W; 48° 30' N 125° 00' W, 48° 20' N 128° 00' W, 48° 20' N 145° 00' W, 54° 40' N 140° 00' W, 54° 40' N 136° 00' W, 54° 00' N 136° 00' W, 54° 13' N 134° 57' W, 54° 39' 27" N 132° 41' W, 54° 42' 30" N 130° 36' 30" W, northerly along the national boundary to the Beaufort Sea, and thence north to the North Pole.

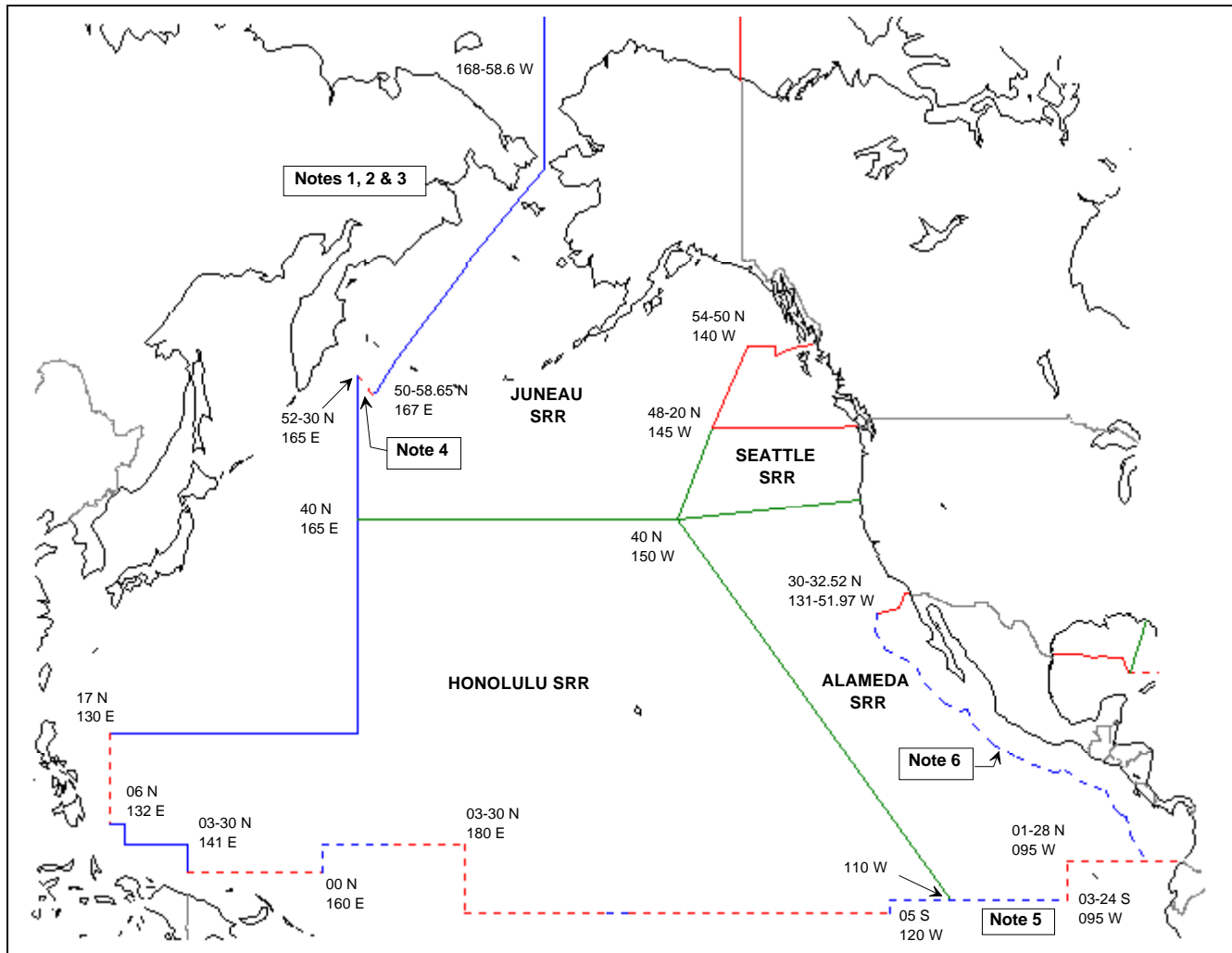

**Chart 1 - United States Maritime Search and Rescue Region - Pacific**

**Key:**

- (1) Maritime SAR agreement SRR lines are solid.
- (2) IMO Provisional SAR Plan SRR lines are dashed (as of October 2000).

**Note 1:** SAR Agreement signed 31 May 1988 but not yet ratified by the Russian Federation.

**Note 2:** Not all coordinates are plotted, the general trend of the line is depicted.

**Note 3:** SRR began at the North Pole due to: (1) U.S.-U.S.S.R. Maritime Boundary Agreement signed 1 June 1990 states "From the initial point, 65° 30'N, 168° 58' 37" W, the maritime boundary extends north along the 168° 58' 37" W meridian through the Bering Strait and Chukchi Sea into the Arctic Ocean as far as permitted under international law."; (2) U.S. aeronautical SRR under ICAO starts at the North Pole; and (3) U.S.-Canada aeronautical and maritime SRR ends at the North Pole.

**Note 4:** Gap between Japanese and Russian SRRs with U.S. still requires trilateral negotiations as of October 2000 to formally connect between Russian ending point and Japanese beginning point: northwestward from 50° 58' 39" N, 167° 00' 00" E to 52° 30' N, 165° E

**Note 5:** Peru – U.S. maritime SRR delimitation pends further discussion.

**Note 6:** SRR Alameda will continue to be responsible for the additional areas delimited by the line following the 200 mile EEZ of Costa Rica, Nicaragua, El Salvador, Guatemala to a point 11° 58.1'N, 094° 26'W pending further discussions. See Annex 10 to "Report on the Pacific Ocean Conference on Maritime Search and Rescue and the GMDSS, April 1997."



*In the Atlantic Ocean, Caribbean Sea and Gulf of Mexico*

**Mexico:**

25° 58' 30.57" N, 096° 55' 27.37" W to 26° 00' 31.00" N, 096° 48' 29.00" W  
26° 00' 30.00" N, 095° 39' 26.00" W to 25° 59' 48.28" N, 093° 26' 42.19" W  
25° 42' 13.05" N, 091° 05' 24.89" W to 25° 46' 52.00" N, 090° 29' 41.00" W  
25° 41' 56.52" N, 088° 23' 05.54" W

**Cuba**

24° 00'N, 086° 35'W; 24° 00'N, 080° 30'W

**Bahamas** U.S.-Bahamas SAR Understanding (Sir Grey memo dated 4 December 1964) does not delimit an SRR; Bahamas has subsequently delimited an SRR under IMO's Provisional SAR Plan with limits partly coinciding with limits of the Miami SRR.

24° 00'N, 080° 30'W; 23° 40'N, 080° 30'W; Quinchos Cay; Cay Lobos;  
Cay Santo Domingo; 21° 30'N, 075° 00'W; 20° 25'N, 073° 00'W;  
20° 25'N, 070° 00'W; 21° 45'N, 070° 00'W; 27° 00'N, 076° 00'W;  
28° 20'N, 079° 25'W; 25° 40'N, 079° 25'W

**Haiti**

20° 25'N, 073° 00'W; 20° 25'N, 071° 40'W

**Dominican Republic:**

20° 25'N, 071° 40'W; 20° 25' N, 70° 00' W; 19° 00' N, 68° 00' W; 16° 00' N, 68° 00' W

**Netherlands Antilles and Aruba**

16° 00' N 068° 00' W, 15° 41' N 067° 04' W

**Venezuela**

15° 41' N 067° 04' W; 16° 00' N, 065° 30' W; 16° 00' N, 062° 20' W

**French Antilles (France)**

16° 00' N, 062° 20' W; 17° 00' N, 063° 30' W; 19° 00' N, 063° 30' W;  
19° 00' N, 052° 00' W (RSC San Juan/RCC Norfolk intersection point)  
19° 00' N, 048° 00' W; 18° 00' N, 048° 00' W; 18° 00' N, 040° 00' W

**Portugal**

18° 00' N, 040° 00' W and 45° 00' N, 040° 00' W

**Canada (aeronautical and maritime SAR agreement):**

45° 00' N 040° 00' W, 45° 00' N 053° 00' W, 43° 36' N 060° 00' W, 41° 52' N 067° 00' W, 44° 30' N 067° 00' W, north to the intersection with the national boundary, westerly along the transcontinental national boundary to 48° 30' N 124° 45' W

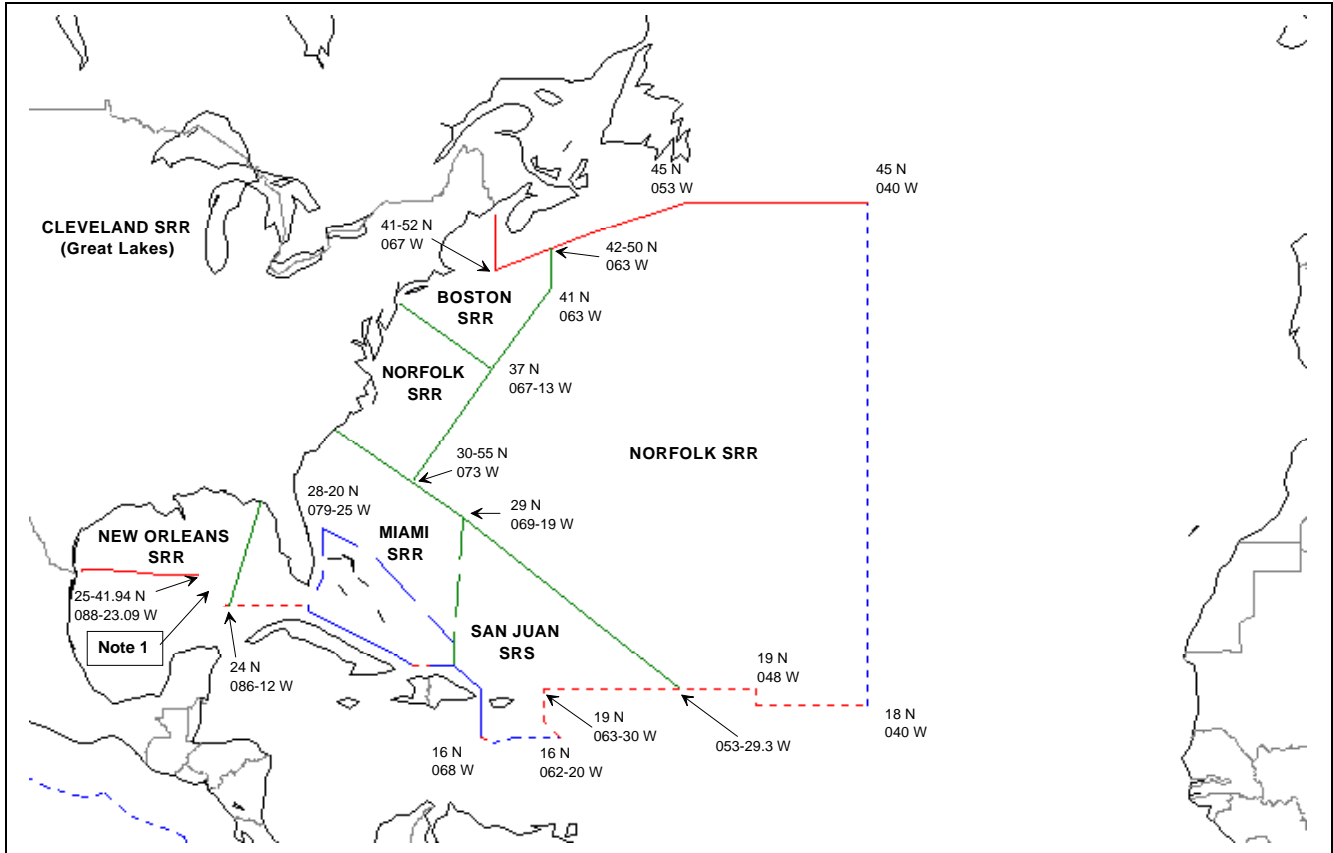

Chart 2 - United States Maritime Search and Rescue Region - Atlantic

Key:

- (1) Maritime SAR agreement SRR lines are solid.
- (2) IMO Provisional SAR Plan SRR lines are dashed (as of October 2000).

**Note 1:** Mexico - U.S. maritime SRR delimitation in the Gulf of Mexico pends further discussion.

## Aeronautical Search and Rescue Region

Source documents:

- (1) Maritime and aeronautical SAR agreement among Canada, United States and the United Kingdom (Trilateral)
- (2) ICAO Regional Air Navigation Plans (RANPs): Asia and Pacific 1996 edition with Change 1; Caribbean and South American 1991 edition with Change 6; North Atlantic, North American and Pacific 1990 edition with Change 3; and North Atlantic Region Facilities and Services Implementation Document (FASID) 1995 "Trial Edition" with Change Corr. 1

### *In the Pacific Ocean*

ASIA/PAC RANP plus Trilateral SAR Agreement:

From the North Pole south along the 168° 58' W to 65° 00'N, 168° 58'W; 64° 03'N, 172° 12'W; 60° 00'N, 180° 00'W; 54° 49'N, 170° 12' E; 54° 41'N, 170° 00' E; 54° 00'N, 169° 00' E; 50° 05'N, 159° 00' E; 43° 00'N, 165° 00' E; 27° 00'N, 165° 00' E; 27° 00'N, 155° 00' E; 21° 00'N, 155° 00' E; 21° 00'N, 130° 00' E; 07° 00'N, 130° 00' E; 03° 30'N, 133° 00' E; 03° 30'N, 141° 00' E; 00° 00'N, 141° 00' E; 00° 00'N, 160° 00' E; 03° 30'N, 160° 00' E; 03° 30'N, 180° 00' E; 05° 00'S, 180° 00' E; 05° 00'S, 155° 00' W; 03° 30'N, 145° 00'W; 03° 30'N, 120° 00'W; 30° 00'N, 120° 00'W; 30° 45'N, 120° 50'W; to U.S. – Mexico border (Pacific coast)

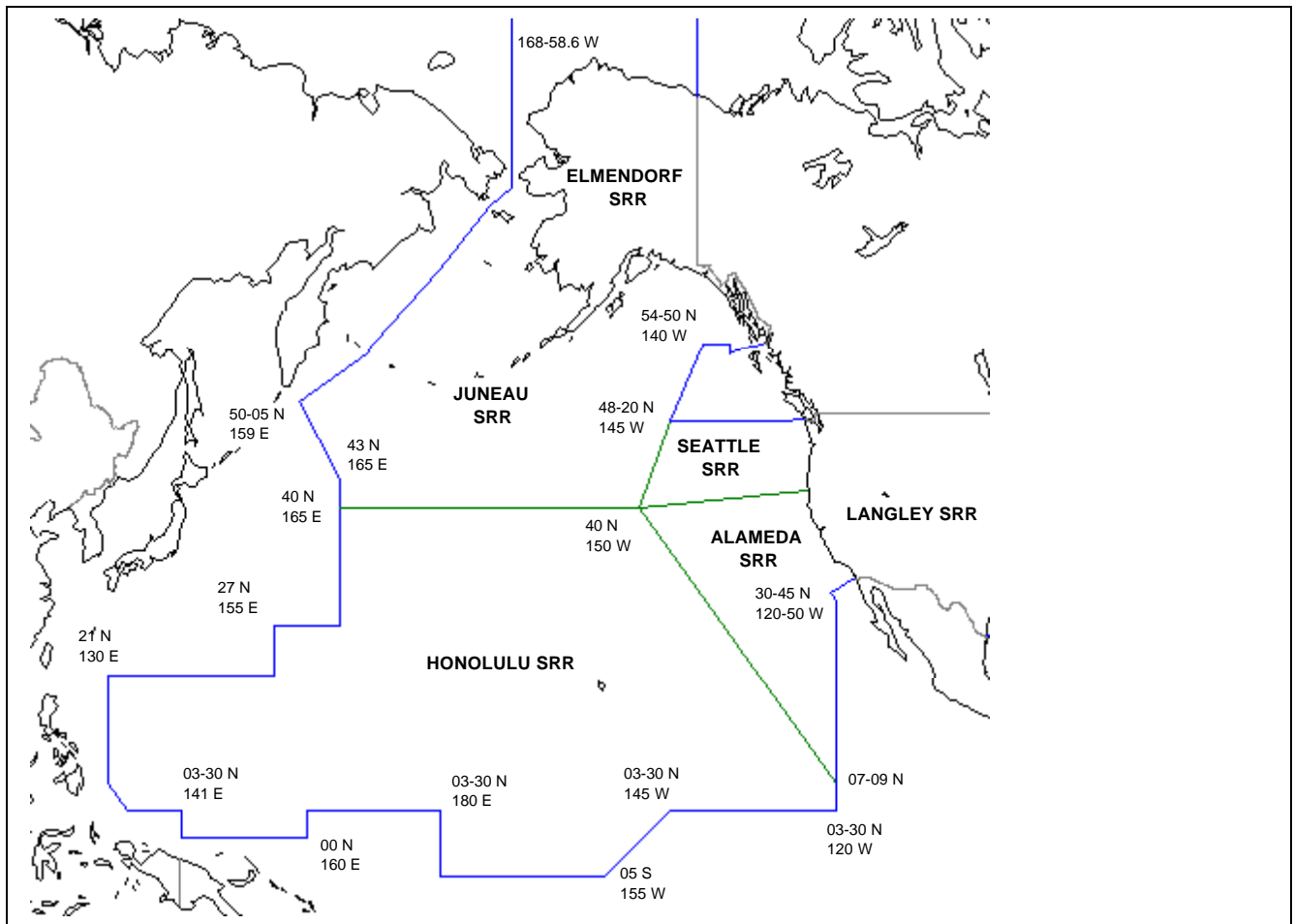

Chart 3 - United States Aeronautical Search and Rescue Region - Pacific

*In the Atlantic Ocean, Caribbean Sea and Gulf of Mexico*

**CAR/SAM RANP:**

U.S. – Mexico (Gulf of Mexico) border to 26° 00'N, 095° 55'W; 24° 30'N, 093° 00'W; 24° 30'N, 088° 00'W; 24° 00'N, 086° 00'W; 24° 00'N, 078° 00'W; 22° 00'N, 075° 10'W; 20° 00'N, 073° 20'W; 20° 25'N, 073° 00'W; 20° 25'N, 070° 29'W; 19° 30'N, 068° 53'W; 19° 00'N, 068° 00'W; 16° 00'N, 068° 00'W; 15° 41'N, 067° 04'W; 15° 00'N, 065° 00'W; 15° 00'N, 063° 15'W; 15° 20'N, 063° 00'W; 17° 22'N, 063° 00'W; 18° 00'N, 062° 00'W; 18° 00'N, 061° 30'W; 18° 00'N, 045° 00'W; 22° 18'N, 040° 00'W

**NAT FASID plus Trilateral SAR agreement**

22° 18'N, 040° 00'W; 45° 00'N, 040° 00'W; 45° 00'N, 053° 00'W; 43° 36'N, 060° 00'W; 41° 52'N, 067° 00'W; 44° 30'N, 067° 00'W, north to the intersection with the national boundary, westerly along transcontinental national boundary to 48° 30'N, 124° 45'W; 48° 30'N, 125° 00'W; 48° 20'N, 128° 00'W; 48° 20'N, 145° 00'W; 54° 40'N, 140° 00'W; 54° 40'N, 136° 00'W; 54° 00'N, 136° 00'W; 54° 13'N, 134° 57'W; 54° 39' 27"N, 132° 41' W; 54° 42' 30" N, 130° 36' 30" W; northerly along the national boundary to the Beaufort Sea, and thence north to the North Pole.

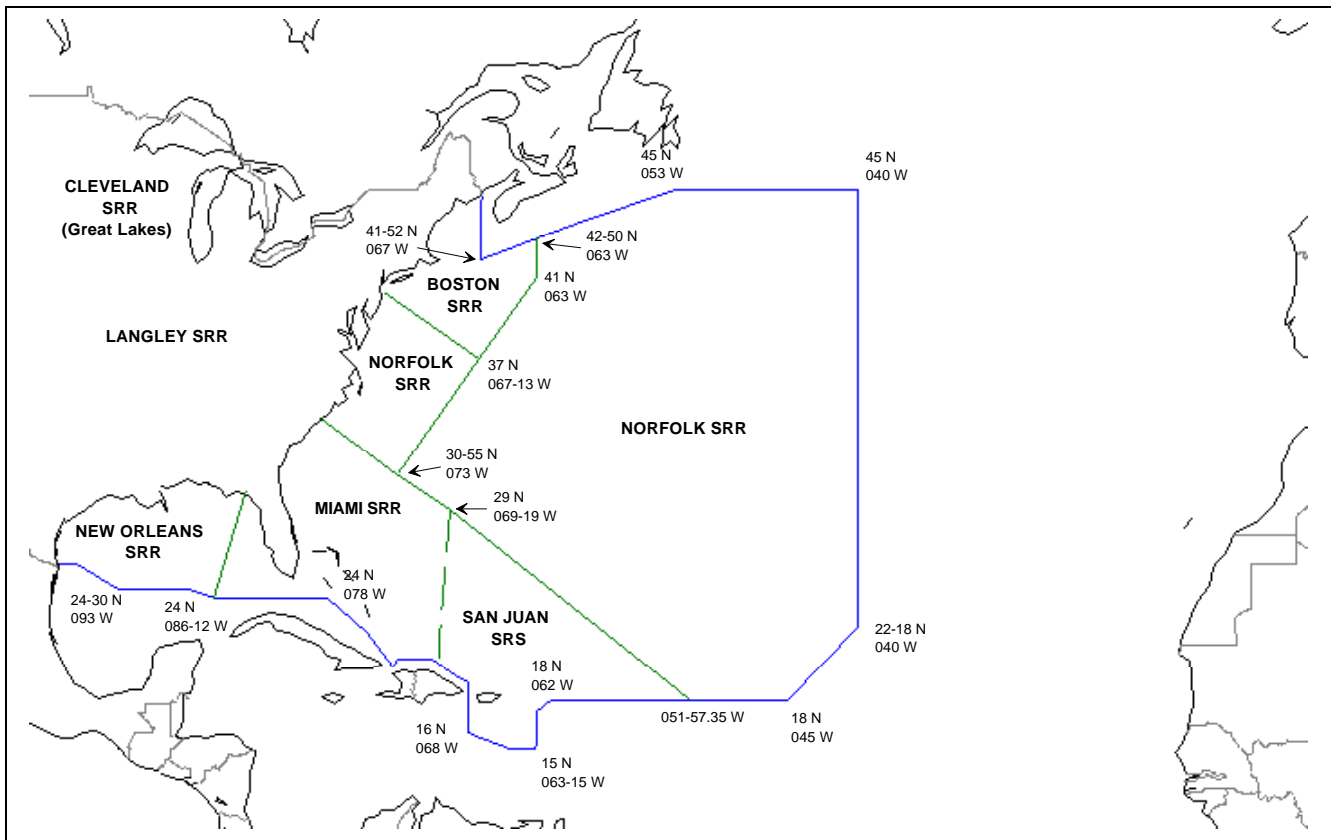

**Chart 4 - United States Aeronautical Search and Rescue Region - Atlantic**

---

## INDEX

- 121.5/243 MHz Beacon, 3-2, 3-3, 3-10, 3-11
- 123.1 MHz, 3-10, 3-11
- 156.3 MHz, 3-10, 3-11, 3-12
- 156.8 MHz, 3-5, 3-6, 3-9, 3-10, 3-11, 3-12, 3-13, 4-10, 7-9, D-10
- 243.0 MHz, 3-3
- 3023 kHz, 3-10, 3-11, 3-12, D-10, D-12
- 406 MHz Beacon, 3-2, 3-3, 3-10, F-3
- 4125 kHz, 3-10, 3-11, 3-12, D-10, D-12
- 500 kHz, 3-9, 4-10
- 5680 kHz, 3-10, 3-11, 3-12
  
- Acoustic beacon, 3-4
- Aeronautical Fixed Network (AFN), 3-7
- Aeronautical Fixed Telecommunications Network (AFTN), 3-7
- Aeronautical RCC (ARCC), 1-3, *see also Rescue Coordination Center*
- Agencies, SAR, 2-1, 2-2, 2-3, 4-10, 6-12
- Air ambulance service, A-8
- Air Defense Sector (ADS), 2-6, 2-7
- Air Force Rescue Coordination Center (AFRCC), 2-3, 2-6, 2-10, 4-4, 5-15, E-1, F-5
- Air Route Traffic control Centers (ARTCCs), 2-9, 2-10, 3-7, 3-9, 3-13, 4-2, 4-5, C-1, C-2, C-3
- Air station rescue swimmers, 2-7
- Air Traffic Control (ATC), 1-6, 2-6, 2-9, 2-10, 3-7, 3-9, 3-12, 4-4, 4-5, 4-6, 4-9, 4-10, D-10, D-12, F-2
- Air Traffic Control airspace reservations, 4-4, 4-9
- Air Traffic Control, separation of aircraft, 4-9
- Air Traffic Service, F-4, F-5
- Aircraft, 1-1, 1-6, 1-7, 1-9, 2-2, 2-4, 2-5, 2-6, 2-7, 2-9, 3-1, 3-9, 3-13, 4-2, 4-4, 4-9, 5-1, 5-4, 5-7, 6-7, 6-11, 7-6, B-1, B-5, C-2, D-1, D-2, D-3, D-7, D-8, D-11, D-12, F-2, F-4, G-3, G-4, G-7, G-8, G-9, H-1, H-2, H-3, H-4, H-5, H-9, H-10
- Aircraft Coordinator (ACO), 1-1, 1-7, 1-8, 1-9, 3-8, 4-6, 4-9, 4-10
- Aircraft crash site, 6-11
- Aircraft SRUs, 1-9
- Alert, 2-10, 3-13, 4-1, 4-2, 4-9, D-3
- Alerting post, 1-7
- Alerting, 1-1, 1-7, 3-1, 3-10, 3-13, D-12
- Alerts, 3-3, 3-4, 3-6
- Analysis, 2-9, F-3
- Assistance entry (AE), 7-10, 7-11, 7-12, 7-18
- Automated Mutual-assistance Vessel Rescue System (Amver), 2-5, 4-2, 4-9, 6-12, 7-15, 7-16, A-5, D-3, F-2, F-6
- Awareness stage, 7-4
  
- Boats, 2-5, 2-8, G-7
- Boundary, 5-9
- Briefings, 1-5, 1-8, 1-10, 4-2, 4-10, 5-8, 5-17, 6-5, 6-11, 6-12
  
- Canada, 2-3, 3-8, B-4, B-7, F-5
- Case documentation, 1-2, 1-7, 6-10
- Case studies, F-1
- Case, SAR folders studies, F-1
- Casualties, 6-9
- Channel 16, *see 156.8 MHz*
- Channels, 3-8, 3-9
- Charts and overlays, 1-3, 1-6, 1-7, 1-10, 3-8, 5-6, 5-7, 5-8, 5-12, 5-16, A-3, C-2, E-1
- Coast Earth Station (CES), 3-6, 3-9
- Coast Guard, *see U.S. Coast Guard*
- Coast Guard Auxiliary, i, 1-2, 2-5, 3-12, 4-3, 5-14
- Coast Radio Station (CRS), 3-13
- Commercial providers, 3-9
- Communications, 1-6, 1-7, 2-10, 3-1, 3-4, 3-7, 3-8, 3-9, 3-10, 4-1, 7-8, 7-10, A-14, D-1, D-10, F-5
- Communications, emergency, A-13
- Communications, printed, 1-7, 3-7
- Communications, voice, 3-7
- Composite solutions, H-11
- Computer Assisted Search Planning (CASP), 4-3, 4-4
- Computers, F-6
- Contour searches, 5-6
- Cooperation, A-9, B-6, B-7
- Coordinated search patterns, *see Search patterns, coordinated*
- Coordination, 5-1, 5-7, A-11, B-5, C-2, F-6
- Coordinator, SAR (SC), *see SAR Coordinator*
- Coordinator, SAR chain of command, 5-15
- Coordinator, SAR mission (SMC), *see SAR Mission Coordinator*
- Cospas-Sarsat, 3-2, 3-3, 3-4, 3-11, 5-6, A-5, F-1, F-3, F-6
- Cost recovery, 2-8, 7-12, 7-13, A-9
- Cutters, 2-4
  
- Data, 2-7, 2-9, 2-10, 3-8, 7-16, F-6
- Datum, 2-8, 4-3, 6-10, D-3, H-5
- Debriefing, 6-1, 6-5, 6-10
- Debriefing, survivor, 6-11
- Deceased persons, 6-3, 6-8, 6-9, 7-3, 7-8, A-2
- Delivery, 6-1, 6-3, 6-12, A-8
- Delivery, aerial, 2-3, 6-4
- Department of Defense (DOD), i, 2-1, 2-4, 4-4, 5-14, 5-17, 7-3, 7-10, A-2, A-5, A-12, A-14, B-7

- Detection, Probability of (POD), *see Probability of Detection*
- Digital Selective Calling (DSC), 3-6, 3-9, 3-10, 3-11, 3-13
- Direction finding (DF), 1-6, 1-7, 2-4, 2-5, 2-6, 2-7, 2-10, 2-11, 3-2, 3-9, 4-2, 4-10, 6-7, D-1, D-11
- Distress, 2-10, 3-4, 3-6, 3-8, 3-10, 3-11, 3-13, 7-4, 7-11, A-11, B-3, G-8, G-18
- Distress Phase, 3-13
- Distress signals, B-3
- Ditching, D-2, D-3, D-6, D-9, D-11
- Dive related injuries, 6-8
- Divers Alert Network (DAN), 2-3, 6-8
- Divers, 2-3, 6-8
- Dominican Republic, B-7
- Drift, aircraft, H-12
- Drift, compensation for, G-18
- Effectiveness, G-8
- Electronic sensors and sensor searches, G-13
- Emergency, 3-1, 3-2, 4-1, 6-1, 6-10, 6-11, 7-3, C-1, D-1, D-10, F-1, F-2, F-3, F-6
- Emergency care, 6-11
- Emergency communications, D-10
- Emergency Locator Transmitter (ELT), 2-11, 3-1, 3-2, 3-3, 3-4, 5-6, 5-14, D-3
- Emergency medical services (EMS), 6-1, 6-9, 6-10
- Emergency Medical Technicians (EMTs), 6-11
- Emergency Position Indicating Radio Beacon (EPIRB), 2-11, 3-1, 3-2, 3-3, 3-5, 3-6, 3-10, 3-11, D-3
- English language, 7-10
- Equipment, 1-6, 2-9, 3-1, F-1, F-3, G-14
- Equipment, RCC, 1-6
- Escort, 6-1, 6-5, 6-6, 6-7
- Extended communications search (EXCOM), 1-2, 4-1, 4-2, 4-3
- Facilities, 1-1, 1-8, 2-1, 2-3, 2-4, 2-8, 3-1, 3-7, 4-1, 4-3, 4-8, 6-1, 6-2, 6-12, B-5, F-3 *see also SAR facilities*
- Facilities, communications, 1-7, 4-6
- False alarms, 3-3
- Federal Aviation Administration (FAA), 1-6, 2-4, 2-5, 2-6, 2-9, 2-10, 2-11, 3-7, 4-1, 4-2, 4-4, 4-9, 4-11, A-2, A-4, C-1, C-2, F-2, F-3
- Federal Aviation Administration emergency phases, 4-1
- Federal Communications Commission (FCC), i, 2-1, 2-4, 2-10, 2-11, 3-3, A-3
- Federal Emergency Management Agency (FEMA), 2-1, 5-17, 6-12, F-5
- Flight Service Stations (FSSs), 2-9, 2-10, 3-7, 4-2, 4-5, C-2
- Forms, 6-10, 7-1
- Forward-Looking Airborne Radar (FLAR), G-11, G-12
- Forward-Looking Infrared System (FLIR), 2-7, G-13
- Freedom of Information Act (FOIA), 6-10, 7-16
- Frequency, 2-10, 3-3, 3-10, 3-11, 3-12
- Geneva Convention, 7-5, 7-8
- Global Maritime Distress and Safety System (GMDSS), 1-6, 3-1, 3-4, 3-5, 3-6, 3-11, 3-13, 7-8, 7-9, 7-10, F-4
- Global Positioning System (GPS), 2-5, 3-2
- Grid, 5-1, 5-2, 5-13, E-1, E-5, F-3
- Helicopter hoisting, 6-8
- Helicopters, 5-1, 5-6, 6-7, 6-8, G-5, G-6
- HF radio, 3-6, 3-9
- Homing, 3-9, 3-10, 3-11, 4-10, 5-6, D-11, D-12, G-18
- Human remains disposal, 7-16
- Hypothermia, F-2
- Incident Command System (ICS), 1-1, 1-10, 5-1, 5-15, A-12, F-3
- Incident, 1-1, 1-10, 5-1, 5-15, 5-17, A-12, F-3
- Information sources, 4-2
- Inmarsat E-EPIRB, 3-2
- Inmarsat SafetyNET, *see SafetyNET*
- Inmarsat, 3-2, 3-5, 3-6, 3-7, 3-8, 3-9, 3-10, 3-11, 4-10, F-6
- Intercept, D-2
- International Aeronautical and Maritime Search and Rescue Manual (IAMSAR), i, 1-1, 1-2, 1-3, 1-4, 1-5, 1-6, 1-7, 1-8, 1-9, 1-10, 2-3, 2-4, 3-1, 3-3, 3-5, 3-9, 3-12, 4-1, 4-3, 4-6, 4-10, 5-1, 5-14, 5-15, 5-17, 6-1, 6-2, 6-3, 6-5, 6-8, 6-9, 6-10, 6-11, 7-1, 7-2, 7-4, 7-7, 7-18, A-1, A-3, A-4, A-5, A-6, A-7, A-10, A-12, B-1, D-1, D-3, D-5, D-10, D-12, F-4, G-1, G-2, G-7, H-1
- International Civil Aviation Organization (ICAO), i, 1-1, 1-3, 1-6, 3-7, 4-5, 4-9, 7-7, 7-15, A-1, A-2, A-3, A-4, A-5, A-8, A-10, B-1, B-5, B-6, D-12, F-3, F-4, F-5, F-6
- International Code of Signals, 7-8, 7-10, F-1
- International Convention for the Safety of Life at Sea (SOLAS), *see Safety of Life at Sea*
- International Convention on Maritime Search and Rescue, 1-1, 7-3, 7-7, 7-13, A-2, A-10, B-1, F-4
- International Ice Patrol (IIP), F-5
- International Maritime Organization (IMO), i, 1-1, 1-3, 1-6, 3-5, 3-6, 7-7, 7-8, 7-9, 7-10, 7-15, 7-16, A-1, A-2, A-3, A-4, A-5, A-8, A-10, B-2, D-12, F-4, F-5, F-6
- International SAR agreements, 7-17, 7-18
- International Telecommunication Union (ITU), 4-2, 7-8, F-4, F-5, F-6
- Interoperability, A-13
- Inverse Synthetic Aperture Radar (ISAR), G-11
- Joint RCC (JRCC), 1-3, A-1
- Kits, SMC, 1-7

- Land Earth Station (LES), 3-6  
 Land facilities, 3-12  
 Land SRUs, 2-9, 5-14  
 Laws affecting SAR, statutes, 7-2, A-2  
 Leeway (LW), G-2  
 Legal aspects, 1-1  
 Liaison, 1-1, 1-9  
 Liaison officers, 1-9  
 Line of Position (LOP), 2-8  
 Locating, 3-11, D-11  
 Logs and diaries, 1-5, 4-2, 6-12  
 Lost person, 5-9
- Marine operator, 4-2  
 Marine pollution, 1-10, 7-2, 7-10  
 Maritime Mobile Service Identities (MMSI), 3-6  
 Maritime Rescue Coordination Center (MRCC), 1-3,  
*see also Rescue Coordination Center*  
 Measure of search effectiveness, 4-3, H-12  
 Medical advice, *see MEDICO*  
 Medical evacuation (MEDEVAC), 6-10, 6-11, 6-12, D-12  
 MEDICO, 6-10  
 Merchant vessels, 2-5, 3-9, 3-10, 6-12, D-10  
 Message block, 4-10  
 Messages, 3-1, 3-12, 7-4, F-5  
 Meteorological, F-4  
 Mexico, 3-12, B-5  
 Military, 2-7, 2-9, 3-9, 4-4, 4-9, A-8, A-12, C-1, D-10  
 Military Assistance to Safety and Traffic (MAST), 2-7, 2-9  
 Mission completion, follow-up tasks, 1-7  
 Mission, 1-1, 1-4, 5-16, F-6  
 Mobile satellite, 3-7
- National Association of Search and Rescue (NASAR), 2-3, F-5  
 National SAR Plan (NSP), i, 1-1, 1-2, 1-3, 1-4, 2-1, 2-2, 5-1, 5-17, 7-1, 7-2, 7-3, 7-12, 7-17, 7-18  
 National SAR School, F-5  
 National SAR Supplement (NSS), i, 1-1, 1-2, 1-5, 1-6, 1-7, 1-8, 1-9, 1-10, 2-4, 3-3, 4-1, 4-4, 4-6, 5-1, 5-2, 5-14, 6-1, 6-8, 6-12, 7-2, 7-17, 7-18, A-6, A-7, A-10, A-12, F-1, G-1  
 National Search And Rescue Committee (NSARC), i, 1-1, 2-1, F-5  
 NAVTEX, 3-5, 3-8, 3-9, 3-10, 3-11  
 News, 4-5  
 Non-distress, 3-4  
 North Atlantic Treaty Organization (NATO), F-5
- Office of Search and Rescue, U.S. Coast Guard (G-OPR), 4-4, A-5, F-2  
 On scene, 3-10
- On Scene Coordinator (OSC), 1-1, 1-7, 1-8, 1-9, 1-10, 2-3, 2-7, 3-8, 3-12, 4-5, 4-6, 4-9, 4-10, 5-7, 5-8, 5-9, 5-11, 5-12, 5-13, 5-15, 6-2, 6-5, A-14, H-1, H-6  
 Operations Center (OPCEN), 4-2
- Pararescue, 2-6, 6-3, 6-4  
 Patrol boats, 2-4, 2-5, G-7, G-9, G-15  
 Personal Locator Beacon (PLB), 3-1, 3-2, 3-3  
 Persons in the water (PIW), G-13  
 Phases, emergency, 4-1  
 Planning, 1-2, 4-1, 4-3, 4-10, 6-1, 6-3, A-10, C-1  
 Plans, 1-1, 1-3, 5-1, 5-16, 7-3, F-3  
 Plans, national, 7-17  
 Plans, rescue action, 1-9, 1-10  
 Plans, SAR, *see SAR plan*  
 Preliminary Communications Search (PRECOM), 1-2, 4-1, 4-2, 4-3  
 Priority, 3-8, A-13  
 Probability of Detection (POD), 4-3, 5-1, 5-2, 5-3, 5-17  
 Probability of Success (POS), 4-3  
 Publications, 1-6, 4-4  
 Pyrotechnics, 1-9, 2-6, D-1
- Radar, 2-6, 2-7, 2-9, 2-10, 4-4, D-1, D-11, F-1, G-10, G-11, G-12, G-14, G-15, H-3, H-11, H-12  
 Radar transponder, 3-6, 3-10  
 Radar, Forward-Looking Airborne (FLAR), *see Forward-Looking Airborne Radar*  
 Radar, IFF equipment, 2-4, 2-9, 3-1, D-11, H-6, H-11  
 Radar, Side-Looking Airborne (SLAR), *see Side-Looking Airborne Radar*  
 Regional Air Navigation Plan (RANP), 1-6, 3-7, 7-7, 7-15, A-3  
 Rescue, i, 1-1, 1-4, 1-6, 2-1, 2-3, 4-1, 4-10, 6-1, 6-2, 6-4, 6-5, 6-8, 6-9, 6-12, 7-1, A-1, A-3, A-5, A-7, A-10, B-4, B-5, D-12, F-1, F-2, F-3, F-5, F-6  
 Rescue Coordination Center (RCC), 1-1, 1-2, 1-3, 1-4, 1-5, 1-6, 1-7, 1-9, 1-10, 2-3, 2-4, 2-5, 2-6, 2-7, 2-10, 3-1, 3-5, 3-6, 3-9, 3-13, 4-1, 4-2, 4-3, 4-5, 6-3, 6-10, 7-7, 7-8, 7-9, 7-13, 7-14, 7-15, A-1, A-3, A-5, A-9, A-11, A-12, A-14, B-1, B-4, B-5, D-3, D-6, D-12, F-5, F-6, G-1  
 Rescue planning, 6-1, 6-4  
 Rescue Sub-Center (RSC), 1-1, 1-3, 1-5, 1-6, 1-7, 7-8, A-1, A-9, A-11, A-12, A-14  
 Research and development (R&D), F-5, F-6  
 Resources, SAR, *see SAR resources*
- Safety, 1-1, 1-3, 2-2, 3-2, 3-4, 3-10, 3-11, 4-9, 4-10, 6-5, 7-4, 7-9, 7-13, B-2, F-1, F-2, F-3, F-5  
 Safety Of Life At Sea (SOLAS), 1-3, 3-2, 3-4, 3-5, 7-4, 7-7, 7-8, 7-9, 7-13, 7-15  
 SafetyNET, 3-5, 3-9  
 Salvage, 7-4, 7-5, A-8, B-2, B-4, B-5  
 SAR agreements, 1-4, 1-6, 7-6, 7-10, 7-11, 7-12, 7-17, 7-18, A-6, B-2

- SAR authorities, i, 3-2, 4-9, 7-2, 7-9, 7-12, 7-13, 7-16, 7-17, A-5, A-13, D-12
- SAR case study, F-1
- SAR Coordinating Committee (SCC), A-3
- SAR coordination, 1-5, A-3
- SAR Coordinator (SC), 1-3, 1-4, 1-7, 2-2, 2-4, 7-12, A-4, A-5, A-11, A-12
- SAR facilities, 1-2, 1-4, 1-6, 1-7, 1-8, 1-9, 1-10, 2-3, 2-4, 2-5, 3-8, 3-9, 3-12, 4-1, 4-3, 4-6, 4-9, 4-10, 5-1, 5-2, 5-7, 5-8, 5-14, 6-1, 6-2, 6-3, 6-4, 6-5, 6-12, 7-2, 7-7, 7-8, 7-11, 7-14, 7-15, 7-18, A-4, A-11, A-12, A-13, G-2
- SAR facility list (SARFAC), 2-3
- SAR incident, 1-2, 2-5, 5-15, 7-16
- SAR Mission Coordinator (SMC), 1-1, 1-4, 1-5, 1-7, 1-8, 1-9, 1-10, 2-3, 2-8, 2-9, 3-8, 3-9, 3-13, 4-1, 4-2, 4-3, 4-4, 4-5, 4-6, 4-9, 4-10, 5-7, 5-8, 5-11, 5-12, 5-13, 5-14, 5-15, 6-1, 6-2, 6-3, 6-4, 6-5, 6-8, 6-11, 6-12, A-12, C-1, D-12, G-1, G-10, H-1, H-3
- SAR plan, i, 1-3, 1-5, 2-6, 3-8, 4-4, 6-10, 7-3, 7-18, A-10, B-2, G-13
- SAR planner, 2-6, G-13
- SAR plans, *see SAR plan*
- SAR Region (SRR), *see Search and Rescue Region*
- SAR resources, i, 1-4, 1-5, 1-6, 2-1, 2-2, 2-3, 2-4, 3-3, 4-2, 5-15, 7-2, B-2, D-3, E-1
- SAR response, 1-10, 2-3
- SAR stages, 1-4, 4-1
- SAR system, i, 1-1, 1-2, 1-4, 1-10, 3-1, 3-2, 3-3, 5-1, 5-17, 6-3, 6-10, 6-12, 7-10, 7-13, 7-14, A-4, A-6
- SAR Transponder (SART), 3-6, 3-10
- SAR Unit (SRU), *see Search and Rescue Unit*
- SAR, aeronautical, 2-4l, 7-6, 7-15, A-4, A-10, A-11, B-6
- SAR, *see Search and Rescue*
- SAR, land, 1-7, 2-4, 5-1, 5-7, 5-9, 6-4, A-8
- SAR, maritime, i, 2-4, 3-7, 4-9, 7-13, 7-15, A-1, A-4, B-1, B-6
- satellite, 2-5, 3-2, 3-3, 3-5, 3-11, 4-10, A-3
- Search, 1-1, 1-2, 1-3, 1-4, 1-8, 2-1, 2-3, 3-6, 3-11, 4-1, 4-2, 4-3, 4-4, 4-6, 4-7, 4-10, 5-1, 5-2, 5-3, 5-6, 5-7, 5-8, 5-9, 5-10, 5-12, 5-13, 5-14, 5-17, 6-12, 7-1, A-1, A-3, A-4, A-5, A-7, A-9, A-10, A-14, B-4, B-6, B-7, D-1
- Search and Rescue (SAR), i, 1-1, A-1
- Search and Rescue Radar Transponder (SART), *see SAR Transponder*
- Search and Rescue Region (SRR), 1-1, 1-2, 1-3, 1-4, 1-5, 1-7, 2-4, 7-7, A-1, A-3, A-4, A-5, A-11, A-12
- Search and Rescue Unit (SRU), 1-9, 2-3, 2-5, 3-8, 3-9, 3-12, 5-4, 5-6, 5-11, 5-14, G-7, G-8, G-9, G-13, G-18, H-1, H-4, H-6
- Search and Rescue Unit, arrival on scene, 1-8
- Search endurance, 1-8, 1-9, 2-3, 2-5, 2-7, D-1
- Search object, 4-7
- Search operations, extended, 4-9
- Search patterns, G-13
- Search patterns, coordinated, 4-1, H-1, H-3, H-6
- Search planners, 4-4, 4-6
- Search planning, 4-1
- Search planning, datum, *see Datum*
- Search speed, G-11
- Search, datum, *see Datum*
- Search, electronic, 1-9, 5-1
- Search, F-1, F-2, F-3, F-4, F-5, F-6, G-3, G-4, G-5, G-6, G-7, G-8, G-11, G-12, G-13, G-14, G-18, H-1, H-3, H-10
- Search, vessel, H-3
- Searches, 4-1, 5-1, 5-2, 5-3, 5-4
- Searches, aircraft, 1-5
- Searches, contour pattern, 5-1, 5-8
- Searches, electronic, *see Search, electronic*
- Ship reporting system, 2-5, 4-2, 4-9, 6-12, 7-7, 7-15, 7-16, A-5, D-3, F-2, F-6
- Short-Range Recovery (SRR) Helicopters, 1-2, 1-3, 1-4, 1-5, 1-7, 2-4, 7-7, A-1, A-3, A-4, A-5, A-11, A-12
- Side-Looking Airborne Radar (SLAR), 2-6, 2-9, G-13, G-14
- Signals, 3-1, 3-11
- Signals, emergency, 3-1, 3-2
- Signals, visual, 3-1
- Situation reports (SITREPs), 1-8, 4-3, 4-4
- Sound communications, 3-4
- Sound Fixing and Ranging (SOFAR), 2-7, 2-8, 3-4
- Space, outer, B-3
- Specialized SRU, 1-9
- Stages, SAR, *see SAR stages*
- Standard Marine Navigational Vocabulary, F-5
- Submersibles, F-1, F-3, F-5
- Surface vessel radar, G-10
- SURPIC, 2-5, 4-9
- Survivability, 6-1
- Survival, 3-10, 3-11, F-1, F-2, F-3
- Survivors evacuation and transport, 6-10
- Survivors, 5-17, 6-1, 6-4, 6-9, 6-10, 6-11, 7-1, 7-16, D-12
- Survivors, delivery, 6-11, A-11
- Survivors, emergency care, 1-2, 2-2, 6-3, 6-10, 6-11
- Sweep width, G-9, G-10, G-11, G-13, G-14, G-15
- Sweep width tables, G-13
- Temporary Flight Restrictions (TFRs), 4-5, C-1, C-2
- Terrain, 5-1, 5-2, 5-6
- Track Spacing, 5-2, 5-11
- Trackline, 5-10, G-18
- Training, 1-8, 4-4, 7-10, F-2, F-3
- U.S. Air Force, 2-4, 2-5, 2-6, 2-7, 2-9, 3-1, 4-4, 5-2, A-4, B-7, F-2, F-5
- U.S. Air Force Foreign Clearance Guide, F-2



U.S. Coast Guard, i, 1-2, 1-8, 2-1, 2-3, 2-4, 2-5, 2-8, 3-1, 3-2, 3-5, 3-12, 4-3, 4-4, 4-11, 5-14, 6-8, 6-12, 7-3, 7-10, 7-13, 7-14, 7-15, 7-16, 7-18, A-2, A-4, A-5, A-10, A-12, B-6, B-7, D-3, D-6, D-11, F-1, F-2, F-3, F-5, H-3

U.S. Navy, 1-6, 1-8, 2-4, 2-7, 2-8, 2-9, 3-13, 4-2, 4-4, 6-8, 6-9, 6-12, D-3, D-6, D-11, F-1, F-2, F-3, F-5, H-3

VHF radio, 3-6, D-10

VHF-FM, 3-5, 3-12, 4-10

Visual scanners, G-10

Visual search, G-4, G-6, G-14

VS, G-18

Weather, 3-13, 5-1, 5-3, 5-6, D-11, F-2, F-6, G-7, G-14, G-15

World Health Organization (WHO), B-3

X-band, G-11

This page intentionally blank