

**RI 9660**  
**REPORT OF INVESTIGATIONS/2003**

# **Evaluation of Systems to Monitor Blind Areas Behind Trucks Used in Road Construction and Maintenance: Phase 1**



Department of Health and Human Services  
Centers for Disease Control and Prevention  
National Institute for Occupational Safety and Health



**Report of Investigations 9660**

**Evaluation of Systems to Monitor Blind Areas  
Behind Trucks Used in Road Construction  
and Maintenance: Phase 1**

**Todd M. Ruff**

U.S. DEPARTMENT OF HEALTH AND HUMAN SERVICES  
Public Health Service  
Centers for Disease Control and Prevention  
National Institute for Occupational Safety and Health  
Pittsburgh Research Laboratory  
Pittsburgh, PA

February 2003

## ORDERING INFORMATION

Copies of National Institute for Occupational Safety and Health (NIOSH)  
documents and information  
about occupational safety and health are available from

NIOSH–Publications Dissemination  
4676 Columbia Parkway  
Cincinnati, OH 45226-1998

FAX: 513-533-8573  
Telephone: 1-800-35-NIOSH  
(1-800-356-4674)  
E-mail: [pubstaft@cdc.gov](mailto:pubstaft@cdc.gov)  
Web site: [www.cdc.gov/niosh](http://www.cdc.gov/niosh)

*This document is the public domain and may be freely copied or reprinted.*

---

Disclaimer: Mention of any company or product does not constitute endorsement by NIOSH.

# CONTENTS

Page

Abstract .....	1
Introduction .....	2
Short-term test procedure .....	2
Long-term test procedure .....	3
Test results .....	4
System 1 .....	4
System description .....	4
Short-term test .....	4
Long-term test .....	5
System 2 .....	5
System description .....	5
Short-term test .....	5
Long-term test–sanding truck .....	5
Long-term test–dump truck .....	7
System 3 .....	9
System description .....	9
Short-term test .....	9
Long-term test–sanding truck .....	9
Long-term test–dump truck .....	10
System 4 .....	10
System description .....	10
Short-term test .....	11
Long-term test–dump truck .....	11
System 5 .....	12
System description .....	12
Short-term test .....	12
Long-term test–dump truck .....	12
Conclusions .....	14
Future work .....	14
References .....	14
Appendix A.–Data collection form .....	15

# ILLUSTRATIONS

1. WSDOT sanding truck .....	2
2. WSDOT dump truck .....	3
3. Test area and test subject .....	3
4. Guardian Alert radar system on sanding truck for short-term use .....	4
5. Detection zones for person and Guardian Alert radar system .....	4
6. Preview radar system temporarily mounted above hitch on sanding truck .....	5
7. Preview radar system mounted on sand hopper .....	5
8. Detection zone for person and Preview radar system .....	6
9. Final mounting of Preview radar system on sanding truck .....	6
10. Clarion video monitor with Preview alarm display mounted on top .....	6
11. Detection zone for Preview radar system and field of view for Clarion camera on sanding truck .....	6
12. Mud build-up on radar enclosure .....	7
13. Thin layer of snow on Preview radar that caused alarm .....	7
14. A, Mounting bridge; B, radar and camera mounting .....	8
15. Detection zone for Preview radar system and field of view for Clarion camera on dump truck .....	8
16. Summer test site .....	8
17. Clarion camera mounted on back of sand hopper .....	9
18. Mud build-up on Clarion camera .....	10

## CONTENTS—Continued

Page

19.	Intec camera mounted for short-term test .....	11
20.	Field of view for person and Intec camera system .....	11
21.	Final installation of Intec camera on dump truck .....	11
22.	Intec camera installed in truck cab .....	11
23.	Hindsight sensors mounted on dump box for short-term use .....	12
24.	Detection zone for person and Hindsight sensors mounted on dump box corners .....	12
25.	Final mounting position of Hindsight sensors .....	13
26.	Detection zone for person and Hindsight sensors mounted on hitch plate .....	13

### UNIT OF MEASURE ABBREVIATIONS USED IN THIS REPORT

cm	centimeter	km/hr	kilometer per hour
ft	foot	lb	pound
ft <sup>3</sup>	cubic foot	m	meter
hr	hour	m <sup>3</sup>	cubic meter
in	inch	°	degree
kg	kilogram		

# **EVALUATION OF SYSTEMS TO MONITOR BLIND AREAS BEHIND TRUCKS USED IN ROAD CONSTRUCTION AND MAINTENANCE: PHASE 1**

**By Todd M. Ruff**

---

## **ABSTRACT**

The majority of fatalities that occur in road construction work zones in the United States involve a worker being struck by a piece of construction equipment or other vehicle. The Spokane Research Laboratory of the National Institute for Occupational Safety and Health, in cooperation with the Washington State Department of Transportation, is evaluating methods to decrease these accidents. One such method uses devices that assist equipment operators in monitoring blind areas around the equipment to prevent collisions with workers on foot or other objects. Several cameras and sensor systems are available for this application, and a study was conducted to evaluate these systems on various trucks used in road construction and maintenance. Tests were conducted using sanding trucks during the winter months, which allowed researchers to investigate the effectiveness and limitations of various technologies under the most extreme conditions. Tests were also conducted using dump trucks during the warmer months to study the effectiveness of the systems in highway work zones. Results show that many difficulties arise when using camera and sensor systems in cold, snowy climates. And, while the operation of these systems is more reliable during the warmer months, challenges still exist in using them on equipment in crowded work areas.

---

<sup>1</sup>Electrical engineer, Spokane Research Laboratory, National Institute for Occupational Safety and Health, Spokane, WA.

## INTRODUCTION

The Spokane Research Laboratory of the National Institute for Occupational Safety and Health (NIOSH) is cooperating with the Washington State Department of Transportation (WSDOT) in an evaluation of methods to decrease injuries and fatalities caused when road construction equipment strikes a worker or another vehicle. NIOSH has previously tested various technologies that monitor the blind areas around mining equipment (Ruff, 2001). These technologies consist of cameras that provide a view of the blind area, and sensor-based collision warning systems that warn the driver if an object or person is nearby. Significant differences in size and function between mining and construction equipment required another study to determine the most effective technologies for road construction equipment.

Road construction workers must work very close to moving equipment. According to Pratt et al. (2001), the majority of fatalities occurring in highway construction work zones nationwide involve a worker being struck by construction equipment or another type of vehicle, and a worker in this industry is just as likely to be struck by a piece of construction equipment inside the work zone as by passing traffic. Also, half the fatalities involving construction equipment occur while the equipment is backing. These conditions and the blind areas associated with construction equipment contribute to making road construction a dangerous occupation.

In the state of Washington, accidents involving WSDOT equipment most often involve some type of truck hitting a worker or another vehicle. For this reason, a study was initiated to evaluate methods of monitoring blind areas around trucks used in road construction and maintenance. Several cameras and sensor systems are available for this application, and understanding the difficulties in implementing these systems on trucks used in all types of weather was important. Tests were conducted using WSDOT sanding trucks during the winter months, which allowed researchers to investigate the effectiveness and limitations of various technologies under the most extreme conditions. Other tests were conducted on dump trucks during the warmer months to study the effectiveness of the systems in highway work zones. Results of these tests could then be used to determine an effective technology for other types of equipment.

NIOSH researchers' experience with camera systems and collision warning systems on mining equipment helped narrow the list of technologies to be evaluated. Systems were selected on the basis of their ability to see through snow and rain, to handle the tough environment of roadway construction, and to meet minimum standards regarding mounting position and detection range. All systems went through an initial short-term test to determine if the system could be mounted on a particular

piece of equipment and function according to minimum specifications. If the system operated satisfactorily in this initial test, then long-term tests were conducted over several months while the equipment was used in actual road construction and maintenance activities.

### SHORT-TERM TEST PROCEDURE

Several systems were selected by NIOSH engineers for short-term tests on a WSDOT sanding truck (figure 1) or dump truck (figure 2), depending on the time of year and the type of test to be conducted. These tests consisted of temporarily mounting each system on the truck to determine if a suitable mounting location could be found and to determine the system's effectiveness in detecting a person standing or crouching behind the truck.

The temporary test area consisted of a large empty area in the WSDOT office parking lot (figure 3). The area was approximately 30 m (100 ft) wide and 150 m (500 ft) long. A grid was marked on the asphalt pavement in order to record the detection zone for each system. The grid was 9 m (30 ft) wide by 14 m (45 ft) long with test points marked every 0.76 m (2.5 ft).

The reliable detection zone for sensor-based collision warning systems, or the field of view (FOV) for a camera, was evaluated using a person as the test subject. At actual road construction sites, the most serious accidents involve a worker on foot being struck by moving equipment, so each system's ability to detect a person was thoroughly evaluated. The test subject was a NIOSH engineer, 1.9 m (75 in) tall, weighing 84 kg (185 lb), and wearing a cotton jacket and jeans. Other



Figure 1.—WSDOT sanding truck.





Figure 2.—WSDOT dump truck.



Figure 3.—Test area and test subject.

personnel from NIOSH and WSDOT were occasionally used to verify the size of the detection zone, but results from those test subjects were not recorded.

Each system was temporarily and separately mounted on the back of the truck. The alarm display normally mounted in the cab was also mounted on the back of the truck so the state of the alarm could be seen by the test subject. The sensing or camera portion of the system was mounted in various locations and with various tilt angles so the optimum detection zone could be determined and false alarms minimized.

After the system was installed, the truck was moved slowly in reverse (3-5 km/hr [2-3 mile/hr]) with no obstacles or people

behind the truck to determine if false alarms would be generated. If false alarms occurred, the system was moved or tilted differently to minimize them. Tests continued if an acceptable mounting location was found.

The next step was to determine the reliable detection zone for a person. For these tests, the test subject walked toward the stationary truck (motor running) along the grid lines that ran parallel to the long axis of the truck. A marker was placed on the ground along each line where detection began and where it ended so the zone could be recorded on a graph. After this zone was marked, reliable detection was verified by moving the truck in reverse toward the stationary test subject. For safety, a spotter was used during this test to tell the driver to stop the truck at a safe distance from the test subject. Another test was performed in which the test subject crouched near the tires of the stationary truck. The ability of the system to detect a crouching person near the truck was also recorded on the detection zone graph.

### LONG-TERM TEST PROCEDURE

After a system went through the short-term test, a determination was made whether to continue testing the system under actual field conditions. This determination was based on several criteria.

- Low probability of a false alarm.
- Reliable detection of a person in a zone starting immediately behind the truck, extending at least 4.6 m (15 ft) behind the truck and at least the width of the truck.
- Apparent ability of the system to handle harsh conditions.
- Minimal maintenance requirements.
- Favorable impression of the system by the driver.
- Feasible mounting configuration.

Systems selected for long-term tests were permanently mounted on a WSDOT truck according to the manufacturer's suggestions. Long-term tests in the winter were conducted on a tandem-axle sanding truck (figure 1), and long-term tests during the warmer months were conducted on a 7.6-m<sup>3</sup> (10-yd<sup>3</sup>) dump truck (figure 2). Test duration was 2 months or more.

To evaluate the systems, a form was available in the cab of the truck so the driver could make daily comments and record the effectiveness of the system (appendix A). Informal discussions with drivers also helped researchers understand a system's problems and capabilities. Finally, a NIOSH engineer rode in the truck during actual construction or maintenance to observe how the driver used and reacted to the system. When the long-term test was completed, the system was removed from the truck and inspected for damage or abnormal wear.



## TEST RESULTS

### SYSTEM 1: GUARDIAN ALERT RADAR SYSTEM<sup>1</sup>

Distributor: S&S Distributing, Elkhorn, NE

#### System Description

This radar system (model 1700) uses Doppler radar techniques to detect an object or person and consists of a radar antenna and processing electronics, an alarm display, and cables. The radar generates an alarm only when the distance to an object decreases. This can be achieved by an object moving toward the radar or by moving the vehicle in reverse. There are no sensitivity or range adjustments available on this system, and the radar is only active in reverse gear. The alarm display is mounted in the cab and consists of warning lights (LED's) and an audible tone that changes frequency depending on the distance to the detected object.

#### Short-Term Test

For the first set of tests, this radar system was mounted level on a sanding truck on the right side of the hitch plate at a height of 79 cm (31 in) (figure 4). The alarm display was mounted on the back of the truck so the state of the alarm could be easily recorded during tests. No false alarms occurred when the truck was moved in reverse in a clear area.

To determine the detection zone of a person, the test subject walked toward the rear of the truck and recorded where reliable detection occurred. The detection zone for a person with a stationary truck is shown by the solid line in figure 5. The total

<sup>1</sup>Mention of specific products or manufacturers does not imply endorsement by the National Institute for Occupational Safety and Health.



Figure 4.—Guardian Alert radar system on sanding truck for short-term test.

range of this radar was 6 m (20 ft) for detecting a person, and the width was adequate to detect a person near the tires.

Significant differences in the detection zone were seen when tests were conducted with the truck moving in reverse. The dashed line of figure 5 shows the detection zone for a person standing still and facing the radar while the truck moved slowly (3-5 km/hr [2-3 mile/hr]) in reverse. The range of the system decreased to approximately 3 m (10 ft), and the width no longer covered the width of the truck. An exact reason for this decrease in the detection zone was not found, but the manufacturer suggested the cause could be vibration or moving at a speed too slow for reliable detection (Guardian Alert, 2000). However, tests conducted by moving at the same reverse speed toward other objects, such as a building or vehicle, did not show the same decrease in detection. It is suspected that a combination of slow reverse speeds and the smaller radar cross section of a person contributed to the decrease in the detection zone.

Several different mounting locations were tried to determine if the detection zone could be improved for a moving truck. The radar unit was relocated to the center of the bumper area, just above the hitch, and no improvement was seen. The radar unit was then moved to a higher location in the center of the sand hopper at a height of 1.8 m (6 ft). Still no improvement in detecting a person was seen when the truck moved. The system was also tested on a dump truck with several different mounting configurations, and the same problems were seen.

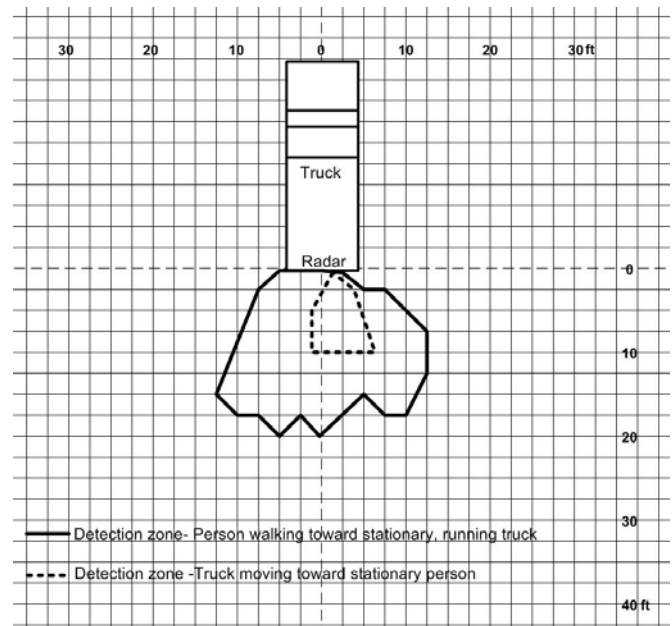

Figure 5.—Detection zones for person and Guardian Alert radar system.

## Long-Term Test

Long-term tests were not conducted with this radar on a sanding truck or dump truck because of poor detection of a person when the truck was moved in reverse. However, it did adequately detect other objects, such as cars, buildings, and guard rails. WSDOT independently conducted long-term tests of this system on a truck used for bridge inspection. Results of these tests are not published here, but may be obtained from the WSDOT Eastern Region Office.

## SYSTEM 2: PREVIEW RADAR SYSTEM

Manufacturer: Preco Electronics, Boise, ID

### System Description

This radar system uses a pulsed signal technique to detect the presence of an object. It consists of a radar antenna and processing electronics, an alarm display, and cables. No motion of the object or vehicle is needed for detection. The alarm display shows distance in 1-m increments using a series of LED's, and an audible alarm is generated that changes in frequency as the distance to an object changes. The radar system is activated when the vehicle's ignition is on, but the audible portion of the alarm is activated only when in reverse. There are no user-adjustable settings on this model.

### Short-Term Test

Initially, the radar unit was mounted on the sanding truck's hitch plate area on the right side of the hitch at a height of 86 cm (34 in). The alarm display was mounted on the back of the truck so the state of the display could be easily recorded during tests. Because the radar system's presence-sensing abilities do not require motion, false alarms occurred in a clear area because the system sensed the nearby hitch. False alarms also occurred when the unit was moved to a position just above the hitch (figure 6). Because of the size of the radar antenna and its sensitivity to any nearby metal, the antenna could not be mounted on the hitch plate or frame and was reinstalled at the center of the sand hopper at a height of 188 cm (74 in) (figure 7). The radar was tilted downward 20° to improve detection of a person close to the truck. At this mounting position, no false alarms occurred when the truck was moved in reverse in a clear area.

To determine the detection zone for a person, the test subject walked toward the rear of the sanding truck and recorded where reliable detection occurred (figure 8). The test subject then remained stationary while the truck was moved slowly (3-5 km/hr [2-3 mile/hr]) in reverse. No significant changes were seen in the detection zone. The range for both scenarios was 7.6 m (25 ft), and the width of the detection zone was adequate to detect a person standing 30 to 60 cm (1 to 2 ft) away from the outer edge of the rear tires. However, at this mounting



Figure 6.—Preview radar system temporarily mounted above hitch on sanding truck.



Figure 7.—Preview radar system mounted on sand hopper. height, a crouching person might not be detected immediately next to the tires, and the tilt of the radar would need to be increased if possible.

### Long-Term Test—Sanding Truck

The Preview radar system's reliable detection of a person, low false alarm rate, and apparent ability to handle tough environments made it a candidate for continued testing. The radar system was selected for tests on both a sanding truck during the winter and a dump truck the following spring. This system was tested in combination with a Clarion camera system on the same truck. Results for the camera system are discussed later.

A 2-month test (December through January) was planned to evaluate the effectiveness of the radar system on the sanding truck in winter conditions. The radar system was mounted at a height of 1.7 m (68 in) and downward tilt of 20° (figure 9).



The downward tilt was required in order to detect a crouching person as close as possible to the rear tires. The radar unit was mounted inside a polyethylene enclosure to protect the radar's aluminum case from corrosion (the salt and magnesium chloride used for de-icing are notorious for quickly corroding aluminum parts on the truck). The radar alarm display was mounted on the top of the camera system's video monitor in the cab and can be seen as a gray-colored box with LED's in figure 10.

After mounting the systems, the final radar detection zone and the FOV for the camera were recorded as shown in figure 11. The radar's detection zone for a person standing behind the truck (inner solid line) adequately covered the width of the truck and extended 7.6 m (25 ft) from the back. However, the system did not detect a person crouching or



Figure 10.—Clarion video monitor with Preview alarm display mounted on top.

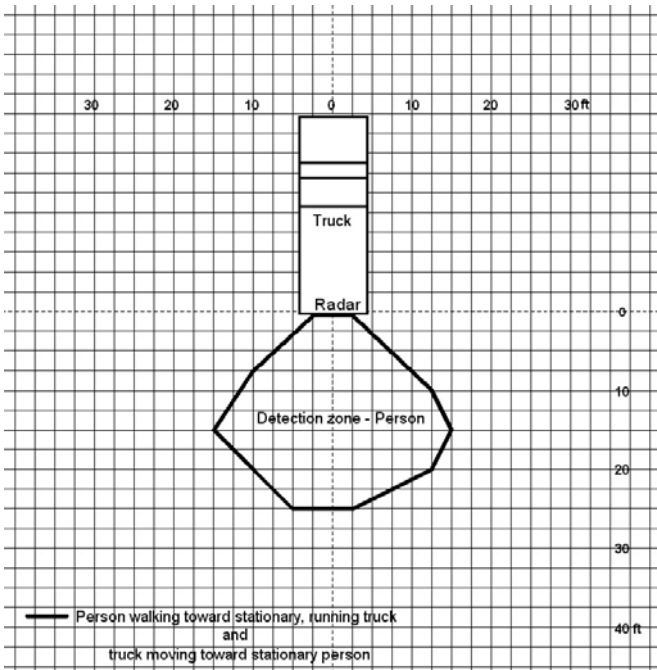

Figure 8.—Detection zone for person and Preview radar system.



Figure 9.—Final mounting of Preview radar system on sanding truck.

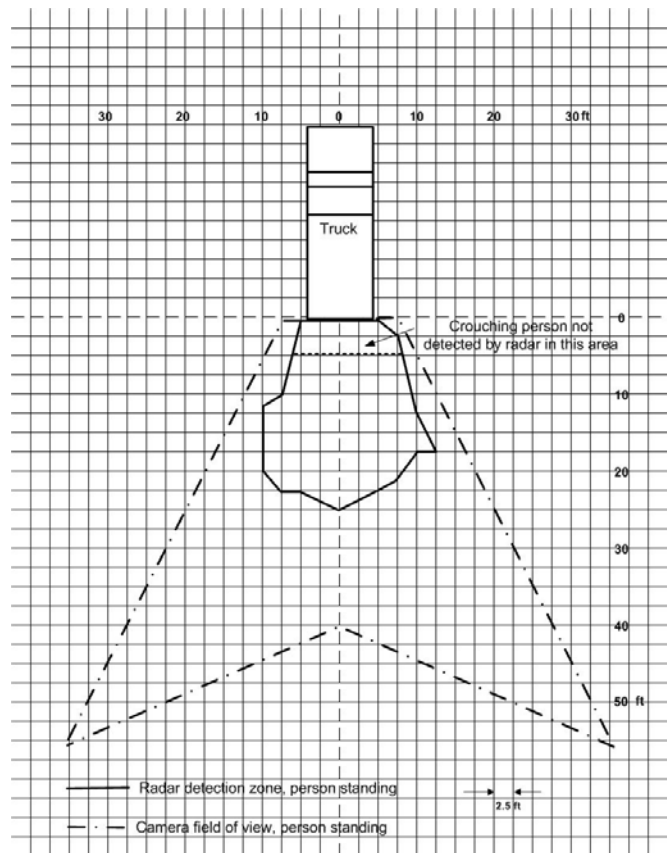

Figure 11.—Detection zone for Preview radar system and field of view for Clarion camera on a sanding truck.

kneeling immediately behind the truck. The downward tilt of the radar system was increased to improve detection of a crouching person, but the system began to sense the truck itself, which caused false alarms. The tilt angle was reset to 20°.

Driver comments stated that the system was useful at the beginning of the shift, when backing to the sand pile and driving around the maintenance yard. The radar accurately detected and displayed the distance to the sand pile, loading equipment, and other objects. However, problems with the radar system became evident after driving on the highway a few kilometers. On days when it was not snowing, mud and grime from the road covered the radar enclosure, as shown in figure 12. On days when it was snowing, snow mixed with sand built up on the enclosure (sometimes several centimeters thick). Snow or grime on the radar enclosure caused the system to generate a constant false alarm (all LED's were lit, indicating an object immediately in front of the radar unit).

Initially, it was believed that removing the additional enclosure for the radar system would solve the problem. The radar system manufacturer stated that snow or ice directly on the face of the radar unit (with no extra enclosure) should not cause an alarm. By adding the extra enclosure, we introduced an offset of about 2.5 cm (1 in) between the radar unit and the snow/mud. By removing the extra enclosure and mounting the radar as received from the manufacturer, the snow would build up directly on the radar unit and should be ignored.

Tests at NIOSH were conducted to see if the radar system would ignore snow. Figure 13 shows a simple test where a thin



Figure 12.—Mud build-up on radar enclosure.



Figure 13.—Thin layer of snow on Preview radar, which caused an alarm.

layer of dirty snow was piled on top of the radar unit. This caused a false alarm, showing that remounting an unprotected radar system on the truck would not solve the problem. The manufacturer indicated that software changes could be made to ignore objects or snow build-up closer than 30 cm (1 ft) to the radar. This change has been made, but tests results are not available yet.

The radar system was removed from the sanding truck after 2 months of testing. The radar antenna, alarm display, and cabling were in good shape, but the false alarm problem from snow/mud build-up could not be immediately solved.

### Long-Term Test—Dump Truck

A 5-month test (April through August) was planned to evaluate the effectiveness of the Preview radar system on a dump truck used in road construction and maintenance. (A Clarion camera system was tested in combination with the radar system, and results for the camera system are discussed later.) The first step in the installation of the system involved finding a suitable mounting position on the back of the dump truck. Several positions were tried, including the bumper area (hitch plate) just below the dump box and the tailgate area. However, the radar system could not be mounted in the bumper area because (1) it would detect the nearby metal of the tailgate and hitch and (2) the tailgate can be hinged at the bottom, which would obstruct the radar signal. The system could not be easily mounted on the tailgate because (1) slamming the tailgate during unloading would cause high levels of vibration and shock and (2) special connectors and wiring would have to be retrofitted to the system to allow it to be disconnected quickly when the tailgate was hinged at the bottom instead of at the top. Therefore, it was determined that a bridge-type mounting apparatus would need to be designed to allow the radar to be mounted above the tailgate.

NIOSH and WSDOT personnel designed the mounting bridge shown in figure 14. The size of material to be hauled, such as boulders, must be considered when determining the height of this bridge so that the bridge will not obstruct dumping. However, if the bridge is too high, it can be easily struck by a loader bucket or, as discussed later, it may not fit under some material loading bins.

The radar system was mounted beside the Clarion camera system at a height of 2.7 m (107 in) and with a downward tilt of 30°. The downward tilt was required to detect a person as close as possible to the back of the truck. Some experimentation was required to determine the optimum tilt angle because adjusting the tilt to detect objects close to the truck may increase false alarms due to the ground or truck being sensed. The radar alarm display was mounted on the top of the video monitor in the cab (figure 10).

After the system was mounted, the final radar detection zone and FOV for the camera were recorded as shown in figure 15. Because of the mounting height of the radar, a person was not detected immediately behind the truck. This was because a person could walk underneath the radar beam at close distances.



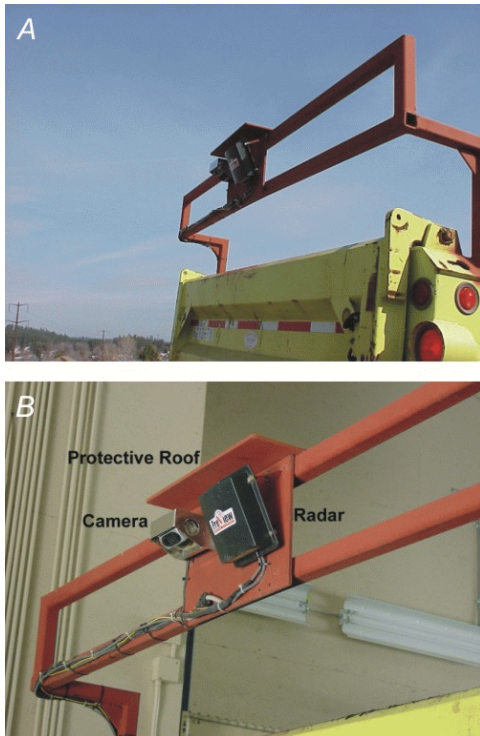

Figure 14.—A, Mounting bridge; B, radar and camera mounting.

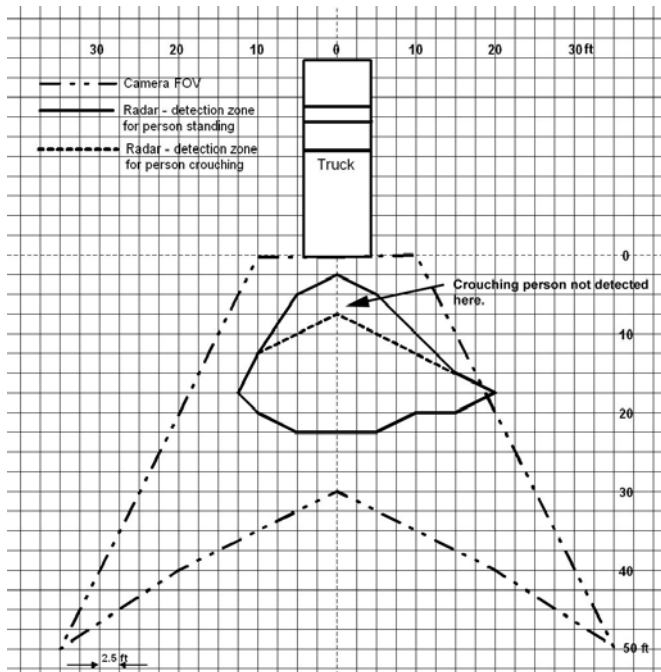

Figure 15.—Detection zone for Preview radar system and field of view for Clarion camera on dump truck.

The mounting height also resulted in poor detection of a crouching person when close to the truck, as indicated by the dashed line inside the solid line of figure 15. A standing person was detected at distances between 0.76 and 6.9 m (2.5 and 22.5 ft) from the back of the truck, while a crouching person was detected at distances between 2.3 and 6.9 m (7.5 and 22.5 ft). The radar system was mounted several feet above the manufacturer's suggested mounting height, which caused the detection zone to be inadequate for this truck. Tests continued, however, because the addition of the camera system provided redundancy.

Most of the tests were conducted at a site where the ground was being leveled for the relocation of high-capacity power lines in preparation for a new highway (figure 16). The haulage road surface and material being moved consisted mostly of sand. Moisture content of the sand varied according to weather, but a water truck kept most of the haulage roads damp to reduce dust. The dump truck was loaded by a front-end loader and then driven to the dump area. Each truck traveled between 50 and 70 round trips in a workday. Truck drivers' comments on the radar system are summarized below.

- The radar system was useful in that it prompted the driver to check the camera system's video monitor, but most often the alarms were caused by items that posed no danger, e.g., sand piles or other equipment of which the driver was already aware.
- Very few false alarms were heard, i.e., alarms generated for no apparent reason.
- The radar system was reliable in detecting and displaying an approximate distance to the sand pile when backing to the dump point.
- The mounting bridge caused the loader operator to slow down to avoid hitting the bridge during loading.



Figure 16.—Summer test site.

- The mounting bridge was too high and would not pass under the asphalt loading bin in later tests. This truck could not be used for paving projects.

NIOSH personnel made additional observations while riding in the truck.

- A short false alarm (one or two beeps) was sometimes generated by the radar system when the truck started to move in reverse. The cause could not be determined. No other false alarms were generated.
- False alarms did not increase when road surface moisture increased.
- The width of the radar's detection zone was wider than the truck, and this caused some nuisance alarms, especially when reversing near roadside berms or when loading equipment.
- The driver did check the video monitor when the radar generated an alarm.

While the radar system operated well on this truck, the fact that it must be mounted high in order to avoid tailgate mounting is a major drawback. As designed, the mounting bridge interfered with operations, and so other mounting positions are being investigated. Based on the above observations and the fact that this truck could not be used for paving projects, it was decided to pursue other sensor systems that could be mounted on the truck's rear bumper, hitch plate, or on the side of the dump box near the taillights.

### SYSTEM 3: CLARION CAMERA SYSTEM

Distributor: Safety Vision, Houston, TX

#### System Description

This system consists of a Clarion camera (model CC853E), a 15-cm (6-in) video monitor (model CJ762E) mounted in the cab, and cables to connect the camera and monitor. The camera has a motorized shield that covers the lens when the camera is not in use. This can be used to protect the lens when the vehicle is in forward gear or when the vehicle is not running.

#### Short-Term Test

Short-term tests were conducted on the sanding truck. The camera was temporarily mounted at several different heights and angles to determine the best FOV for the truck driver. The best mounting position was high at the center of the sand hopper. With a slight downward tilt of the camera, this location allowed detection of a crouching person near the back of the truck and out to 12 m (40 ft) away. Results of this initial test showed that the camera system could be useful, so long-term tests were conducted during both winter and summer.

### Long-Term Test—Sanding Truck

As mentioned earlier, this camera system was tested in combination with the Preview radar system to determine if a combination of radar and camera would compliment one another. While the camera provides an actual view of the blind area, the radar provides an alarm to prompt the driver to check the video monitor. A 2-month test (December through January) was planned to evaluate the effectiveness of the camera on the sanding truck. The camera was mounted on the rear of the sand hopper at a height of 2.2 m (87 in) (figure 17). The downward tilt of the camera was adjusted to 35° so that a crouching person could be seen immediately behind the truck. The video monitor was mounted on the cab floor on a pedestal just to the right of the gear shift, as shown in figure 10. The monitor was positioned so that it could be easily viewed by looking slightly downward after checking the right mirror.

After mounting the system, the FOV for the camera was recorded as shown by the outer dashed line in figure 11. The FOV was adequate to show a person standing or crouching immediately behind the truck. This view extended to 12 m (40 ft) from the center of the hitch plate. The fisheye effects of the wide-angle lens account for the odd shape of the FOV.

The camera system had similar problems as the radar when driving on the road during the winter months. Ice, snow, and mud build-up on the camera caused several problems. Initially, the motorized lens shield on the camera was left in the open position for forward and reverse gears. This was requested so the driver could monitor vehicles behind the truck during sanding and plowing operations. After the first few days of operation, it was necessary to change this configuration so the lens shield closed when the truck was in forward gear, allowing the camera view to be activated only in reverse. This was because (1) mud and snow build-up on the lens occurred



Figure 17.—Clarion camera mounted on back of sand hopper.



because (1) mud and snow build-up on the lens occurred quickly in forward gear (figure 18), obstructing the camera view, and (2) glare from headlights distracted the driver during night operations. After this change was made, the camera system operated reliably on warmer days. However, in snowy conditions, ice and snow quickly covered the camera when traveling forward. This caused the lens shield to become frozen in the closed position, making the camera unusable even in reverse. After a few days of operating under these conditions, the lens shield mechanism failed and was stuck in the closed position even after snow and ice were cleared from the camera. A heated camera enclosure or some other method to keep snow and ice from building up on the camera would be required before using this system on a sanding truck.

The camera system was removed from the truck and inspected after 2 months of use. In addition to the broken lens shield mechanism, the glass window protecting the camera lens was cracked. The monitor and cables appeared in good shape.

### Long-Term Test—Dump Truck

Even though there were problems during the winter months, the camera system worked well on warmer days. Long-term tests during summer months were planned with a new camera (same model). Again, tests were conducted in combination with the Preview radar system. A 5-month test (April through August) was planned to evaluate the effectiveness of the Clarion camera and Preview radar system on a dump truck used in road construction and maintenance. The camera was mounted on the bridge apparatus next to the radar system as shown in figure 14.

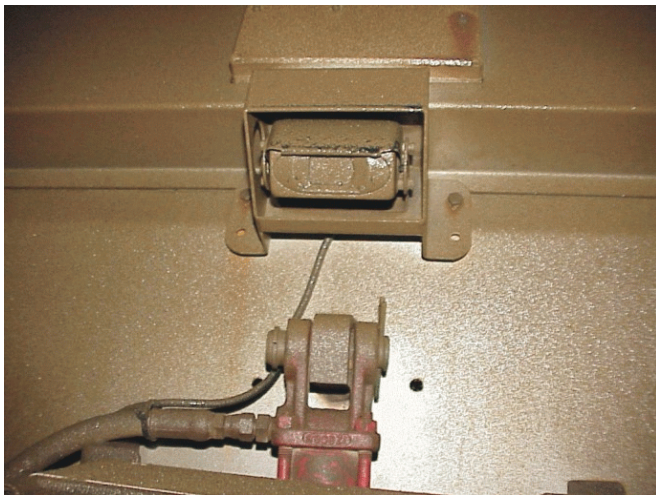

Figure 18.—Mud build-up on Clarion camera.

The high mounting position provided the best FOV for the camera and avoided the problems associated with vibration and tailgate articulation at lower mounting positions.

The camera was mounted at a height of 2.8 m (112 in). The downward tilt of the camera was adjusted to 50° from vertical so that a crouching person could be detected immediately behind the truck. The video monitor was mounted on a pedestal on the cab floor just to the right of the gear shift, as shown in figure 10.

After mounting the systems, the final radar detection zone and the FOV for the camera were recorded as shown in figure 15. The FOV for the camera (outer dashed line) was able to show a person standing or crouching immediately behind the truck. This view extended to 9.1 m (30 ft) from the rear of the truck.

Tests were conducted at an earth-moving operation for a new highway as described earlier. Truck driver comments are summarized below.

- The camera system is more useful than radar because an actual view of the area behind the truck is preferred over just an alarm.
- The camera lens did get some dust and mud on it during the day, but not enough to obstruct the view. Wiping the lens once a shift was usually sufficient to keep it clear.
- Using the camera at night was difficult because lighting behind the truck was poor.

General impressions of the system by the drivers and by NIOSH observers indicated that the camera system was useful. However, because of the problems with the mounting bridge, it was determined that a smaller camera that could be mounted in a lower position, preferably on the side of the dump box, was needed.

The camera system was removed from the truck after 5 months of operation. The camera appeared to be in good shape, and the lens shield operated correctly. There were a few grains of sand between the glass window and the camera lens, which caused some concern about the integrity of the camera enclosure. The monitor and cables appeared to be in good shape.

### SYSTEM 4: INTEC CAMERA SYSTEM

Distributor: Intec, Laguna Hills, CA

#### System Description

The Intec camera system consists of a small camera the size of a 5-cm (2-in) cube (model CVC210XL), an 11.4-cm (4.5-in) video monitor (model CVM450LPP), and cables.



### Short-Term Test

The camera was temporarily mounted in various positions on the bed of a dump truck. The goal was to find a position on the side of the box near the taillights that would be high enough to achieve an adequate FOV, but where the camera would not protrude too far from the side of the truck. The final position selected was near the top of the dump box, just above the taillights (figure 19).

The monitor was temporarily mounted in the cab of the truck between the two seats. The FOV for the camera was tested by recording where a person could be seen behind the truck in both a standing and a crouching position. As seen in the graph in figure 20, the FOV for a person in a standing position

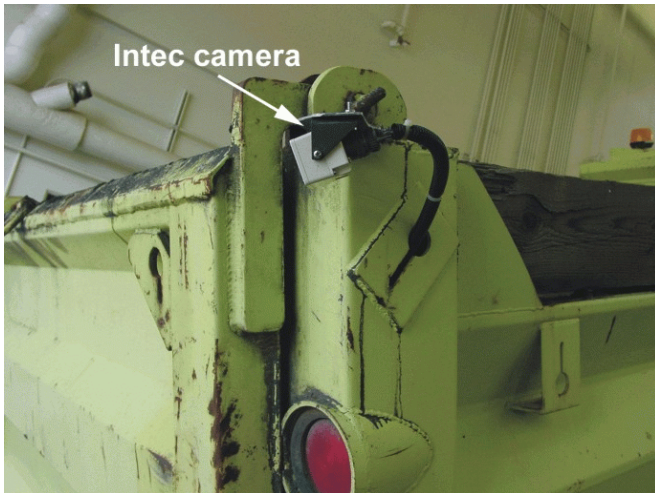

Figure 19.—Intec camera mounted for short-term test.

extended from the back of the truck out to the horizon. The right side of the FOV was blocked by the camera enclosure. The area between the dotted line and the truck represents the area where a crouching person could not be seen in the video monitor because the person was beneath the camera’s FOV. Full coverage of a crouching person behind the truck could be achieved by tilting the camera further downward, but there is a tradeoff between close coverage and the distance that the FOV extends on the left side of the truck. Results of this initial test showed that the camera system could be useful, so long-term tests on a dump truck were conducted during the summer months.

### Long-Term Test—Dump Truck

The Intec camera was permanently mounted on the right side of the dump box just above the highest taillight at a height of 2.2 m (87 in) and a downward tilt angle of 20° (figure 21). The video monitor was mounted on a pedestal between the seats in the cab (figure 22). Figure 20 shows the FOV of the



Figure 21.—Final installation of Intec camera on dump truck.

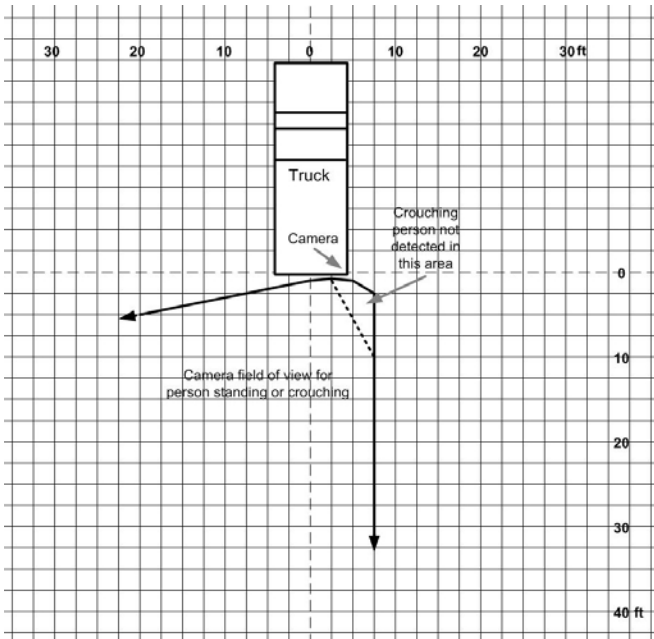

Figure 20.—Field of view for a person and Intec camera system.



Figure 22.—Intec monitor installed in truck cab.

camera for both a standing and a crouching person. Tests were conducted during the summer months at patching/paving jobs and during other various road construction and maintenance activities. No evaluation forms were turned in, but driver interviews were held in which the drivers commented that the system worked well and was effective in monitoring the rear blind area. However, they also commented that the view from the camera was sometimes confusing because the camera did not point in the same direction that the truck traveled when in reverse.

Finally, it was suggested that the camera be moved to the other side of the dump bed to provide a better view of the larger blind area on the right side of the truck. At the time of this writing, the camera system had been on the truck for 5 months, and tests were continuing with no other problems reported.

The dump box on this truck will likely be removed in the fall months and replaced with a sand hopper. There is a connector on the camera, so the camera can remain with the dump box and cables can be stored until the dump box is replaced. No winter tests were planned for this camera. However, at the time of this writing, designs for a heated enclosure were being considered, and test results may be available at a later date.

**SYSTEM 5: HINDSIGHT 20/20 ULTRASONIC SENSOR SYSTEM**

Distributor: Sonar Safety Systems, Santa Fe Springs, CA

**System Description**

Collision warning systems based on sonar or ultrasonic sensors are popular in the automotive and delivery truck industries. The system works by transmitting high-frequency sound waves and detecting reflections of these waves from objects within the sound beam. The maximum range of these systems is typically around 3 m (10 ft). Also, system sensors must be kept clean of mud and debris for correct operation. A Hindsight 20/20 system (model HS300) was selected for these tests. It consisted of two sensors with rubber enclosures, an alarm display that consisted of LED's and an audible alarm that changes frequency depending on distance to the detected object, a cable junction box, and cables.

**Short-Term Test**

As suggested by the manufacturer, the two sensors were temporarily mounted on the lower corners of the dump truck's box (just below the tailgate hinge points) as shown in figure 23. The alarm was situated at the rear of the truck for easy viewing for these initial tests. Several problems were seen with this mounting configuration, including the potential for damage to the sensors when material flowed through the tailgate and the lack of continuous detection of a crouching person behind the truck, as shown by the dashed lines in figure 24.



Figure 23.—Hindsight sensors mounted on dump box for short-term test.

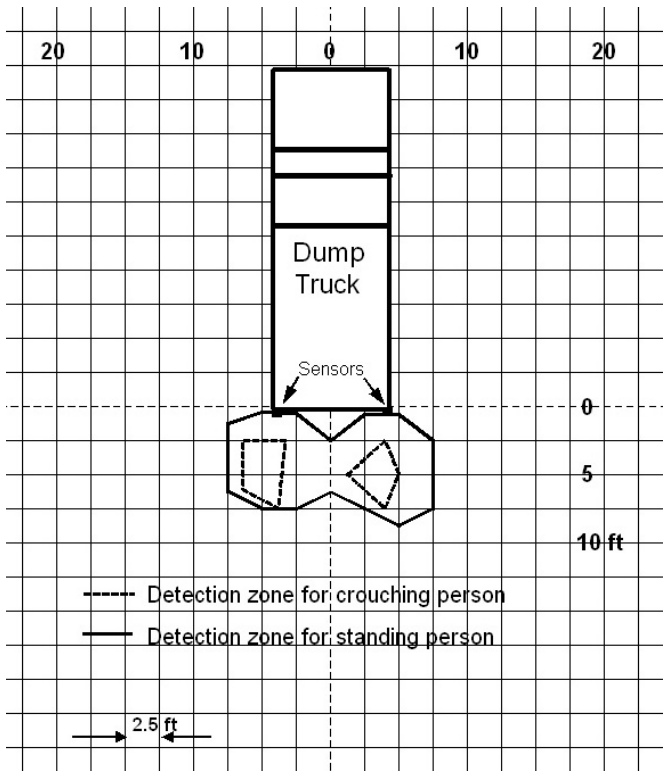

Figure 24.—Detection zone for person and Hindsight sensors mounted on dump box corners.



An alternative mounting position for the sensors was tested (figure 25). This placed the sensors on the hitch plate and closer together, which resulted in a more continuous detection zone for a person, as seen in figure 26. The total range of the system was 2.4 m (8 ft), and detection covered most of the width of the truck except the corners of the dump box. The system did not generate false alarms in a clear area on asphalt, and the mud flaps were not detected. Despite the short detection range, long-term tests on a dump truck were conducted.

An additional short-term test was conducted on a sanding truck. The same positions on the hitch plate were used for sensor mounting (figure 25). Frequent false alarms were produced, but the source of the alarms was not obvious. It was suspected that the slightly different configuration of the mud flaps was causing the flaps to be detected. No long-term tests were planned on the sanding truck because it was obvious that the sensors would be covered with snow and mud during winter operations.

**Long-Term Test—Dump Truck**

The final mounting position for the sensors on a dump truck was near the taillights, as shown in figure 25. The sensors were mounted at a height of 76 cm (30 in) with 81 cm (32 in) spacing. The alarm was mounted on the dashboard. The detection zones for a standing and crouching person were the same as in the short-term results (figure 26). The system was tested during the summer months on road-patching and materials-hauling jobs. No evaluation forms were turned in, but comments from drivers were received through interviews and are summarized below.

- The system was reliable, and false alarms were rare in most situations.
- The system produced false alarms when backing through thick airborne dust.
- The system alarmed continuously when a trailer was pulled behind the truck, and there was no way to temporarily turn the system off (without disconnecting it).

Modifications will be needed for this system to function on trucks that pull trailers. This is true for all sensor-based systems that do not require object motion for an alarm. Sonar Safety Systems sells an add-on to the system that detects a trailer when the trailer light connector is plugged into the truck. If the trailer lights are connected, then the system is temporarily disabled. This was not tested, but would be an acceptable solution.

Sensing dust was a problem with this sonar system according to the drivers, which brought up concerns about false alarms in snow and rain. The manufacturer did acknowledge the possibility of false alarms in heavy snow. Additional tests are needed to determine what precipitation rates would cause an alarm, if any. Concerns were also raised regarding the short detection range of the system. A person immediately behind a very slow-moving truck might be detected in time for the driver to react.

However, in fast-moving situations, 2.4 m (8 ft) of detection does not give adequate time to respond (Society of Automotive Engineers, 1999).

At the end of the summer, the system was removed and inspected. All components were in good working order.

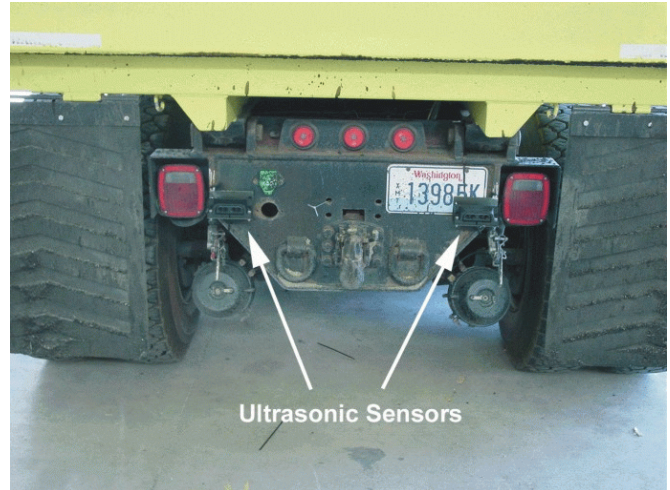

**Figure 25.—Final mounting position of Hindsight sensors.**

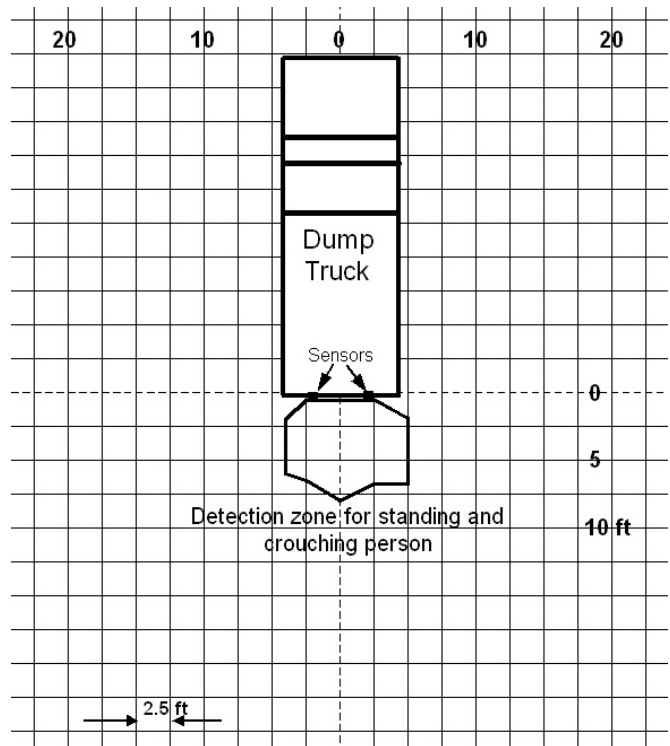

**Figure 26.—Detection zone for person and Hindsight sensors mounted on hitch plate.**

## CONCLUSIONS

While many more collision warning and cameras systems are available than were tested here, tests of the above systems did show the challenges associated with implementing these types of systems on trucks used in the winter or in crowded highway work zones. The following general observations can be made based on these test results.

- Roadway construction zones are typically crowded with equipment and workers on foot. Sensor-based collision warning systems, e.g., radar or sonar, will alarm often in this environment. These alarms will most often be nuisance alarms caused from workers or objects of which the driver is already aware. If too many alarms are associated with objects that are not in real danger, all alarms will eventually be ignored, making the system useless. For this reason, camera systems may be more appropriate in this environment.
- The alarm function of sensor-based systems provides a warning to the driver and is a more active method of monitoring, while camera systems are a more passive technology, much like mirrors. Using the two systems in combination on the same truck may have many advantages. The camera system provides an actual view of the blind area near the truck and provides a method to check the source of any alarms. At the same time, the sensor provides an alarm that prompts the driver to check the video monitor so a potential collision does not go unnoticed. There would still be a problem with frequent nuisance alarms in highway work zones, but they may be more tolerable if there is a quick method of checking the source of any alarm.
- If sensor-based systems are used to provide a warning of an object or person near the truck, some method must be used to eliminate false alarms from mud, dirt, or snow build-up on the sensing portion of the system. This can be done using processing methods that ignore object detection directly in front of the sensor or by using some other means that prevents debris from blocking the sensor's signal.
- Most trucks used in construction are also used to pull trailers. Most sensor-based collision warning systems will sense the trailer and produce an alarm. Some method must be provided to disable the system when a trailer is being pulled or allow quick connection to separate sensors mounted on the trailer.
- Cameras work well during the warmer months, and daily cleaning of the lens is usually sufficient. However, on some types of equipment, snow and grime build up on the lens quickly during winter. Some method of preventing snow, ice, and grime from covering the camera must be employed.
- It is often difficult to find a mounting position for sensors or cameras, especially on dump trucks. Mounting these devices on the side of the dump box was found to be an acceptable solution if the size of the device will allow this. Durability is also an important consideration when the device is mounted in an exposed area.
- Many camera and sensor systems are available for automobiles and on-road trucking. The construction equipment application is more demanding and harsher than standard transportation applications. It is important to choose systems made for and proven on heavy construction equipment.

## FUTURE WORK

Cooperation with collision warning and camera system manufacturers will continue so improvements can be made to existing systems. Methods to prevent build-up of snow and ice on cameras used on sanding trucks, plows, and other equipment used in the winter need to be studied further. This could include heated enclosures and air deflectors/spoilers. For collision warning systems that use radar technology, smaller

radar antennas would make it easier to find acceptable mounting locations.

Evaluations of new cameras or collision warning systems will be conducted as they come on the market. Final tests of one or two systems will be conducted on a fleet of equipment at a large highway construction worksite, and the results of these tests will be available at a later date.

## REFERENCES

Pratt, S.G., D.E. Fosbroke, and S.M. Marsh. 2001. Building Safer Highway Work Zones: Measures To Prevent Worker Injuries from Vehicles and Equipment. DHHS (NIOSH) Pub. No. 2001-128, 71 pp.

Ruff, Todd M. 2001. Monitoring Blind Spots – A Major Concern for Haul Trucks. *Engineering and Mining Journal*, v. 202, no.12, Dec., pp. 17-26.

Society for Automotive Engineers [SAE]. 1999. Discriminating Back-Up Alarm System. Surface Vehicle Standard J1741, June.

S&S Distributing. 2000. Guardian Alert Back-Up Warning System - Warning System vs. Parking Aid. Product literature available by calling S&S Distributing 1-800-998-0555, 1 p.

### Appendix A.—Data Collection Form

NIOSH Data Collection Form – Preview Radar System and Clarion Camera System			
Date: 12/22/2K	Time: 4P-1A.	<input checked="" type="checkbox"/> am <input checked="" type="checkbox"/> pm	Weather: LIGHT SNOW 27°-32°
Location: I90, 902, 90A			
<b>RADAR</b> Check one and provide a description:			
<input checked="" type="checkbox"/> False alarm – no object nearby.			
<input checked="" type="checkbox"/> Nuisance alarm – small object nearby (examples: rock, curb, foliage, ice chunk). Object: SNOW/GRIT			
<input type="checkbox"/> Nuisance alarm – object nearby but not in danger of being hit. Object: _____			
<input type="checkbox"/> Real alarm – object nearby and it was detected. Object: _____			
<input type="checkbox"/> Missed alarm – object nearby but it was not detected. Object: _____			
<b>CAMERA</b> Check one and provide a description:			
<input type="checkbox"/> Object was visible in video monitor.			
<input checked="" type="checkbox"/> Object was not visible in video monitor.			
Description or comments: SNOW & SANDER GRIT / ROAD FILM COVERS COMPONENTS. CAMERA COVER WILL NOT OPEN - TOO MUCH SNOW/GRIT. NO PICTURE ON MONITOR. FALSE ALARMS.			
<b>SUMMARY</b> Check all appropriate boxes:			
<input type="checkbox"/> A collision was avoided because an object was detected by the radar system.			
<input type="checkbox"/> A collision was avoided because an object could be seen in the video monitor.			
<input type="checkbox"/> A collision occurred. Please provide comments.			
Driver's Initials: 			



***Delivering on the Nation's Promise:  
Safety and health at work for all people  
Through research and prevention***

For information about occupational safety and health topics contact NIOSH at:

1-800-35-NIOSH (1-800-356-4674)

Fax: 513-533-8573

E-mail: [pubstaf@cdc.gov](mailto:pubstaf@cdc.gov)

[www.cdc.gov/niosh](http://www.cdc.gov/niosh)

**DHHS (NIOSH) Publication No. 2003-113**