

Int. Cls.: 1, 2, 3 and 5

**Prior U.S. Cls.: 1, 4, 5, 6, 10, 11, 16, 18, 26, 44, 46, 50,
51 and 52**

Reg. No. 2,892,106

United States Patent and Trademark Office

Registered Oct. 12, 2004

**TRADEMARK
PRINCIPAL REGISTER**

SCOT

SCOTT FETZER COMPANY, THE (DELAWARE CORPORATION)
28800 CLEMENS ROAD
WESTLAKE, OH 44145

FOR: WATERPROOFING CHEMICAL PREPARATIONS FOR ARTICLES OF MASONRY, CONCRETE, QUARRY TILE, TERRAZZO, BRICK AND SLATE, IN CLASS 1 (U.S. CLS. 1, 5, 6, 10, 26 AND 46).

FIRST USE 8-15-1983; IN COMMERCE 8-15-1983.

FOR: SEALANT IN THE NATURE OF A PROTECTIVE WOOD COATING, IN CLASS 2 (U.S. CLS. 6, 11 AND 16).

FIRST USE 8-15-1983; IN COMMERCE 8-15-1983.

FOR: LIQUID DRAIN OPENER, WATERLESS HAND CLEANERS AND WATERLESS HAND CLEANING LOTIONS, CARPET AND UPHOLSTERY CARE PREPARATIONS, NAMELY, SHAMPOOS, PRE-CLEANING STAIN REMOVERS, SPOT REMOVERS, DEODORIZERS, FLOOR CARE PREPARATIONS, NAMELY, CLEANERS, DEGREASERS,

STRIPPERS, FINISHES AND SEALERS; WASHROOM CLEANING PREPARATIONS, NAMELY TOILET BOWL AND URINAL CLEANERS, GROUT CLEANER, GLASS CLEANER AND LIQUID SCOURING CLEANER; CLEANING AND DEGREASING PREPARATIONS FOR USE ON WASHABLE HARD SURFACES, CONCRETE, GLASS, PLASTIC, METAL, GLAZED CERAMIC TILE, WOOD, VINYL, MACHINERY, ENGINES, ENGINE AND MACHINERY PARTS AND VEHICLES, IN CLASS 3 (U.S. CLS. 1, 4, 6, 50, 51 AND 52).

FIRST USE 2-28-1974; IN COMMERCE 2-28-1974.

FOR: ALL PURPOSE DISINFECTANT; FUNGICIDE AND GERMICIDE FOR COMMERCIAL USE, IN CLASS 5 (U.S. CLS. 6, 18, 44, 46, 51 AND 52).

FIRST USE 8-15-1993; IN COMMERCE 8-15-1993.

SER. NO. 74-443,904, FILED 10-4-1993.

ANGELA M. MICHELI, EXAMINING ATTORNEY

Int. Cl.: 25

Prior U.S. Cls.: 22 and 39

United States Patent and Trademark Office

Reg. No. 2,892,107

Registered Oct. 12, 2004

**TRADEMARK
PRINCIPAL REGISTER**

GRIZZLIES

HOOPS, L.P. (DELAWARE LIMITED PARTNER-
SHIP)
C/O HEICO
5600 THREE 1ST NATIONAL PLAZA
CHICAGO, IL 60602

FOR: CLOTHING, NAMELY, HOSIERY, T-
SHIRTS, SWEAT SHIRTS, SWEATPANTS, PANTS,
TANK TOPS, JERSEYS, WARM-UP SUITS, PAJA-
MAS, SPORT SHIRTS, RUGBY SHIRTS, SWEATERS,
BELTS, TIES, NIGHTSHIRTS, HATS, JACKETS,

PARKAS, COATS, CLOTH BIBS, HEAD BANDS,
WRIST BANDS, APRONS, BOXER SHORTS,
SLACKS, CAPS, INFANTWEAR, EAR MUFFS,
AND GLOVES, IN CLASS 25 (U.S. CLS. 22 AND 39).

FIRST USE 8-0-1994; IN COMMERCE 8-0-1994.

SER. NO. 74-530,473, FILED 5-27-1994.

MARY ROSSMAN, EXAMINING ATTORNEY

Int. Cl.: 32

Prior U.S. Cl.: 48

United States Patent and Trademark Office

Reg. No. 2,892,108

Registered Oct. 12, 2004

TRADEMARK
PRINCIPAL REGISTER



BAVARIA S.A. (COLOMBIA CORPORATION)
CALLE 94 NO. 7A-47
BOGOTA, D.C., COLOMBIA

FOR: BEER, IN CLASS 32 (U.S. CL. 48).

FIRST USE 4-13-1990; IN COMMERCE 4-13-1990.

OWNER OF U.S. REG. NO. 2,714,763.

NO CLAIM IS MADE TO THE EXCLUSIVE RIGHT TO USE "CERVECERIA DE BARRANQUILLA", "PRODUCT OF COLOMBIA", "BEER", "NET CONT. 12 FL. OZ 355 ML." AND "BREWED AND BOTTLED BY BARRANQUILLA", APART FROM THE MARK AS SHOWN.

SER. NO. 74-537,234, FILED 6-13-1994.

MARK T. MULLEN, EXAMINING ATTORNEY

Int. Cl.: 41

Prior U.S. Cls.: 100, 101 and 107

United States Patent and Trademark Office

Reg. No. 2,892,109

Registered Oct. 12, 2004

**SERVICE MARK
PRINCIPAL REGISTER**

VANCOUVER GRIZZLIES

HOOPS L.P. (DELAWARE LIMITED PARTNER-
SHIP)
800 GRIFFITHS WAY
VANCOUVER
BRITISH COLUMBIA, CANADA V6B6G1

FOR: ENTERTAINMENT SERVICES IN THE
NATURE OF BASKETBALL GAMES AND BASKET-
BALL EXHIBITIONS RENDERED LIVE AND IN
STADIA AND THROUGH THE MEDIA OF RADIO
AND TELEVISION BROADCASTS; MASCOT AND
DANCE TEAMS PERFORMANCES; CONDUCTING
AND ARRANGING BASKETBALL CLINICS, IN
CLASS 41 (U.S. CLS. 100, 101 AND 107).

PRIORITY CLAIMED UNDER SEC. 44(D) ON
CANADA APPLICATION NO. 757049, FILED 6-13-
1994, REG. NO. TMA522997, DATED 2-14-2000, EX-
PIRES 2-14-2015.

NO CLAIM IS MADE TO THE EXCLUSIVE
RIGHT TO USE "VANCOUVER", APART FROM
THE MARK AS SHOWN.

SER. NO. 74-551,729, FILED 7-20-1994.

MARY ROSSMAN, EXAMINING ATTORNEY

Int. Cl.: 9

Prior U.S. Cls.: 21, 23, 26, 36 and 38

Reg. No. 2,892,110

United States Patent and Trademark Office

Registered Oct. 12, 2004

TRADEMARK
PRINCIPAL REGISTER

infinite

VODAVI COMMUNICATIONS SYSTEMS, INC.
(ARIZONA CORPORATION)
8300 EAST RAINTREE DRIVE
SCOTTSDALE, AZ 85260

FOR: ELECTRONIC AND DIGITAL HYBRID
TELECOMMUNICATION SYSTEMS AND VOICE
PROCESSING SYSTEMS, NAMELY, VOICE MAIL,
INTERACTIVE VOICE RESPONSE AND AUTOMA-

TED CALL DISTRIBUTOR APPARATUS, IN CLASS
9 (U.S. CLS. 21, 23, 26, 36 AND 38).

FIRST USE 10-1-1991; IN COMMERCE 10-1-1991.

SER. NO. 74-709,452, FILED 8-1-1995.

J. TINGLEY, EXAMINING ATTORNEY

Int. Cl.: 16

Prior U.S. Cls.: 2, 5, 22, 23, 29, 37, 38 and 50

United States Patent and Trademark Office

Reg. No. 2,892,111

Registered Oct. 12, 2004

TRADEMARK
PRINCIPAL REGISTER



SINGAPORE PRESS HOLDINGS LTD. (SINGAPORE CORPORATION)
82 GENTING LANE, NEWS CENTRE
SINGAPORE 349567

FOR: PRINTED PUBLICATIONS, NAMELY, NEWSLETTERS, BULLETINS, TIMETABLES, GUIDES, BOOKS, BOOKLETS AND CATALOGUES, IN THE FIELD OF TRANSPORT AND TRAVEL, ENTERTAINMENT, WORLD AND LOCAL NEWS, FASHION, INFORMATION TECHNOLOGY, COMPUTER SOFTWARE AND HARDWARE, BUSINESS AND FINANCIAL, HUMAN INTEREST TOPICS, CURRENT EVENTS, FOOD AND RESTAURANTS, LEISURE, HOME AND GARDEN, SEWING AND CRAFT, GAMES, BEAUTY AND HEALTH, SPORTS AND MOTORING, ADVENTURE; NEWSPAPERS, JOURNALS, BROCHURES, REVIEWS, TABLOIDS, CHRONICLES, GAZETTES, ANNUALS, DISPATCHES, COMMUNIQUEs, PROCLAMATIONS, COMPOSITIONS, AND MAGAZINES, ALL IN THE FIELD OF TRANSPORT AND TRAVEL, ENTERTAINMENT, WORLD AND LOCAL NEWS, FASHION, INFORMATION TECHNOLOGY, COMPUTER SOFTWARE AND HARDWARE, BUSINESS AND

FINANCIAL, HUMAN INTEREST TOPICS, CURRENT EVENTS, FOOD AND RESTAURANTS, LEISURE, HOME AND GARDEN, SEWING AND CRAFT, GAMES, BEAUTY AND HEALTH, SPORTS AND MOTORING, ADVENTURE, IN CLASS 16 (U.S. CLS. 2, 5, 22, 23, 29, 37, 38 AND 50).

FIRST USE 0-0-1984; IN COMMERCE 0-0-1984.

PRIORITY CLAIMED UNDER SEC. 44(D) ON SINGAPORE APPLICATION NO. 3661/96, FILED 4-15-1996.

THE LINING IN THE DRAWING IS A FEATURE OF THE MARK AND IS NOT INTENDED TO INDICATE COLOR.

THE MARK CONSISTS OF THE STYLIZED LETTERS "S" "P" AND "H" SUPERIMPOSED OVER EACH OTHER.

SER. NO. 75-181,827, FILED 10-15-1996.

GWEN STOKOLS, EXAMINING ATTORNEY

Int. Cls.: 9, 14, 18, 20, 21, 24, 25, 38 and 41

Prior U.S. Cls.: 1, 2, 3, 13, 21, 22, 23, 25, 26, 27, 28, 29, 30, 32, 33, 36, 38, 39, 40, 41, 42, 50, 100, 101, 104 and 107

Reg. No. 2,892,112

United States Patent and Trademark Office

Registered Oct. 12, 2004

**TRADEMARK
SERVICE MARK
PRINCIPAL REGISTER**

MARIE FRANCE

EDI SIC (FRANCE COMPANY)
10, BOULEVARD DES FRERES VOISIN
92130 ISSY-LES MOULINEAUX, FRANCE

LOWS, IN CLASS 20 (U.S. CLS. 2, 13, 22, 25, 32 AND 50).

FOR: SPECTACLES, EYEGLASS CASES, EYEGLASS FRAMES, EYEGLASS LENSES; BLANK AND/OR PRE-RECORDED AUDIO AND VIDEO CASSETTES AND CD-ROMS FEATURING INFORMATION ON FASHION, BEAUTY AND COMMUNICATION; COMPUTER SOFTWARE FOR DATABASE MANAGEMENT OR FOR WORD PROCESSING FOR USE IN PRINTED MATTERS, FASHION, BEAUTY AND COMMUNICATION; TELEPHONES; AND TELEVISION SETS, IN CLASS 9 (U.S. CLS. 21, 23, 26, 36 AND 38).

FOR: JEWELRY MADE FROM PRECIOUS METAL OR COATED THEREWITH, NAMELY, BRACELETS, NECKLACES, RINGS, EARRINGS, BROOCHES, WATCHES, WATCH-BRACELETS, ALARM CLOCKS AND CLOCKS, IN CLASS 14 (U.S. CLS. 2, 27, 28 AND 50).

FOR: LEATHER SOLD IN BULK AND IMITATION LEATHER SOLD IN BULK; HANDBAGS, ALL PURPOSE SPORT BAGS, BEACH BAGS, LEATHER SHOPPING BAGS, SCHOOL BAGS, TRAVEL BAGS, TRAVELING BAGS, LEATHER BAGS FOR MERCHANDISE PACKAGING, TRUNKS, BRIEFCASES, COIN PURSES, WALLETS, PURSES, CALLING CARD CASES, CREDIT-CARD CASES, KEY-CASES, UMBRELLAS, PARASOLS AND WALKING STICKS, IN CLASS 18 (U.S. CLS. 1, 2, 3, 22 AND 41).

FOR: FURNITURE, MIRRORS, PICTURE FRAMES, JEWELRY BOXES NOT MADE OF PRECIOUS METALS, WOOD OR PLASTIC BOXES, CUSHIONS, BEDS, SLEEPING BAGS, WINDOW BLINDS, COAT HANGERS AND BOLSTER PIL-

LOW, WICKER, STRAW AND WOOD BASKETS, HAIR COMBS, SPONGES FOR HOUSEHOLD USE, HAIR BRUSHES, CONTAINERS FOR HOUSEHOLD OR KITCHEN USE, VASES, FLOWER POTS, PORCELAIN BOWLS, SOUP BOWLS, SMALL BOWLS, CUPS, TEA CUPS, PLATES, CUPS AND SAUCERS, CREAM POTS, TEAPOTS NOT OF PRECIOUS METAL, SUGAR BOWLS, DESSERT DISHES, SALAD BOWLS, NON-ELECTRIC COFFEE POTS NOT OF PRECIOUS METAL, DRINKING CLASSES, CARAFES, AND KNIFE RESTS FOR THE TABLE; HOUSEHOLD OR KITCHEN UTENSILS, NAMELY, BREAD BOARDS, CARVING BOARDS, BOOT JACKS, BOOT TREES, BOTTLE OPENERS, BOTTLE STANDS, BROOMS, CAKE SERVERS, CAKE STANDS, CANDLE HOLDERS NOT OF PRECIOUS METAL, CANDLE STICKS NOT OF PRECIOUS METAL, WOOD CHOPPING BLOCKS FOR KITCHEN USE, CLOTHES DRYING RACKS, COCKTAIL PICKS, HAND-OPERATED COFFEE GRINDERS, NON-ELECTRIC COFFEE PERCOLATORS, COLANDERS FOR HOUSEHOLD USE, COOKIES CUTTERS, NON-ELECTRIC EGG BEATERS, FEATHER DUSTERS, FLY SWATTERS, FRYING PANS, FUNNELS, FURNITURE DUSTERS, GARLIC PRESSES, GRATERS, NON-ELECTRIC GRIDDLES, GRILLS, HAND-OPERATED COFFEE GRINDERS, PEPPER MILLS, POT AND PAN SCRAPERS, ROLLING PINS, SPATULAS, TURNERS, WHISKS, IRONING BOARDS, KITCHEN LADLES, METAL PANS, POTS, SCOOPS, SCRUBBING BRUSHES, MIXING AND SERVING SPOONS, TIE PRESSES, TOOTHPICKS, TOWEL RACKS, TRIVETS; TOILETRY TRAVEL PACKS COMPRISING HAIR BRUSHES, HAIR COMBS AND TOOTHBRUSHES, IN CLASS 21 (U.S. CLS. 2, 13, 23, 29, 30, 33, 40 AND 50).

FOR: BATH LINEN; TOWELS; BED LINEN; BED SHEETS; DUVETS; PILLOWCASES; EIDERDOWNS; BED BLANKETS; BED SPREADS; HAND TOWELS; TEA TOWELS; TABLE CLOTHS; TEXTILE NAPKINS; FABRIC TABLE RUNNERS; TEXTILE DOLLIES; CUSHION COVERS; TEXTILE WALL HANGINGS; TEXTILE OR PLASTIC CURTAINS; CLOTH PLACE MATS; WATER PROOF CLOTHS, NAMELY, UNFITTED WATER PROOF FABRIC FURNITURE COVERS, WATERPROOF COTTON, POLYESTER NYLON AND WOOLEN FABRIC, IN CLASS 24 (U.S. CLS. 42 AND 50).

FOR: CLOTHING, NAMELY, SCARVES, UNDERWEAR, LINGERIE, SOCKS, STOCKINGS, TIGHTS, SHOES, AND HEADGEAR FOR MEN, WOMEN AND CHILDREN, IN CLASS 25 (U.S. CLS. 22 AND 39).

FOR: TELEVISION BROADCASTING, BROADCASTING PROGRAMS VIA A GLOBAL COMPUTER NETWORK, ELECTRONIC TRANSMISSION OF MESSAGES AND DATA, NETWORK CONFERENCE SERVICES, PAY-PER-VIEW TELEVISION TRANSMISSION SERVICES, RADIO BROADCASTING, AND VIDEO BROADCASTING, IN CLASS 38 (U.S. CLS. 100, 101 AND 104).

FOR: PUBLICATION OF BOOKS AND MAGAZINES; ENTERTAINMENT IN THE NATURE OF

FASHION SHOWS; EDUCATIONAL SERVICES, NAMELY, CONDUCTING SEMINARS AND WORKSHOPS IN THE FIELDS OF PUBLISHING AND NEWS, FASHION, BEAUTY, TELECOMMUNICATIONS, TELEVISION AND RADIO; PRODUCTION OF RADIO AND TELEVISION PROGRAMS; MOTION PICTURE FILM PRODUCTION; ENTERTAINMENT IN THE NATURE OF COMPETITIONS IN THE FIELDS OF PUBLISHING AND NEWS, FASHION, BEAUTY, TELECOMMUNICATIONS, TELEVISION AND RADIO; AND ORGANIZING AND CONDUCTING ENTERTAINMENT EXHIBITIONS IN A WIDE VARIETY OF EVENTS PERTAINING TO FASHION, BEAUTY, WOMEN, WORLDWIDE NEWS, AND MOTION PICTURES, IN CLASS 41 (U.S. CLS. 100, 101 AND 107).

OWNER OF FRANCE REG. NO. 1525904, DATED 4-24-1989, EXPIRES 4-24-2009.

OWNER OF U.S. REG. NO. 2,042,871.

"MARIE FRANCE" DOES NOT IDENTIFY A PARTICULAR LIVING INDIVIDUAL.

SER. NO. 75-322,899, FILED 7-11-1997.

PATRICIA HORRALL, EXAMINING ATTORNEY

Int. Cl.: 9

Prior U.S. Cls.: 21, 23, 26, 36 and 38

United States Patent and Trademark Office

Reg. No. 2,892,113

Registered Oct. 12, 2004

**TRADEMARK
PRINCIPAL REGISTER**

HD-LINX

GENNUM CORPORATION (CANADA COR-
PORATION)
P.O. BOX 489, STATION A
BURLINGTON, ONTARIO, L7R 3Y3, CANADA

FOR: INTERCONNECT INTEGRATED CIRCUITS
FOR HIGH DEFINITION TELEVISION, IN CLASS 9
(U.S. CLS. 21, 23, 26, 36 AND 38).

PRIORITY CLAIMED UNDER SEC. 44(D) ON
CANADA APPLICATION NO. 866691, FILED 1-20-
1998, REG. NO. TMA589406, DATED 9-10-2003, EX-
PIRES 9-10-2018.

SER. NO. 75-430,271, FILED 2-6-1998.

JILL C. ALT, EXAMINING ATTORNEY

Int. Cl.: 36

Prior U.S. Cls.: 100, 101 and 102

United States Patent and Trademark Office

Reg. No. 2,892,114

Registered Oct. 12, 2004

**SERVICE MARK
PRINCIPAL REGISTER**

NVEST

NVEST COMPANIES, L.P. (MASSACHUSETTS
LIMITED PARTNERSHIP)
399 BOYLSTON ST.
BOSTON, MA 02116

FOR: PROVIDING INVESTMENT ADMINISTRATION SERVICES FOR OTHERS; INVESTMENT ADVISORY SERVICES; FINANCIAL PORTFOLIO AND ASSET MANAGEMENT; INVESTMENT, MANAGEMENT AND ADVISORY SERVICES IN THE FIELD

OF REAL ESTATE; AND MUTUAL FUND INVESTMENT AND DISTRIBUTION, IN CLASS 36 (U.S. CLS. 100, 101 AND 102).

FIRST USE 3-31-1998; IN COMMERCE 3-31-1998.

SER. NO. 75-432,900, FILED 2-12-1998.

STEVEN R. FINE, EXAMINING ATTORNEY

Int. Cl.: 3

Prior U.S. Cls.: 1, 4, 6, 50, 51 and 52

United States Patent and Trademark Office

Reg. No. 2,892,115

Registered Oct. 12, 2004

**TRADEMARK
PRINCIPAL REGISTER**

HUBER THE NOSE.

DR. W. HUBER AG (SWITZERLAND CORPORATION)
STRUBENACHER 1
CH-8126 ZUMIKON, SWITZERLAND

FOR: PERFUME OILS USED IN THE MANUFACTURE OF PERFUMES AND SCENTS; ESSENTIAL OILS FOR FOOD FLAVORING; ESSENTIAL OILS FOR USE IN THE MANUFACTURE OF FRAGRANCES; MIXTURES OF ESSENTIAL OILS AND EITHER OTHER ODIFEROUS RAW MATERIALS OR FLAVOR COMPOUNDS FOR USE IN THE MANUFACTURE OF PERFUMES, COSMETICS AND TOILETRIES, SOAPS AND DETERGENTS, TECHNICAL

PRODUCTS, FOOD AND BEVERAGES, TOBACCO AND LIQUOR, IN CLASS 3 (U.S. CLS. 1, 4, 6, 50, 51 AND 52).

PRIORITY CLAIMED UNDER SEC. 44(D) ON SWITZERLAND APPLICATION NO. 04713/1997, FILED 2-12-1998, REG. NO. 450350, DATED 2-12-1998, EXPIRES 2-12-2008.

SER. NO. 75-451,461, FILED 3-17-1998.

SHAUNIA WALLACE, EXAMINING ATTORNEY

Int. Cls.: 5, 32 and 43

Prior U.S. Cls.: 6, 18, 44, 45, 46, 48, 51, 52, 100 and 101

United States Patent and Trademark Office

Reg. No. 2,892,116

Registered Oct. 12, 2004

**TRADEMARK
SERVICE MARK
PRINCIPAL REGISTER**

MALIBU SMOOTHIE

SURF CITY SQUEEZE, INC. (ARIZONA CORPORATION)
7730 EAST GREENWAY, SUITE 203
SCOTTSDALE, AZ 85260

FOR: MEAL REPLACEMENT AND DIETARY SUPPLEMENT NON-DAIRY POWDERED DRINK MIXES; AND NUTRITIONAL SUPPLEMENTS, IN CLASS 5 (U.S. CLS. 6, 18, 44, 46, 51 AND 52).

FIRST USE 5-1-1997; IN COMMERCE 5-1-1997.

FOR: FRUIT AND VEGETABLE BLENDED JUICE DRINKS; FRUIT SMOOTHIES; POWDERS USED IN THE PREPARATION OF FRUIT SMOOTHIES; AND FRUIT FLAVORED DRINKS, IN CLASS 32 (U.S. CLS. 45, 46 AND 48).

FIRST USE 5-1-1997; IN COMMERCE 5-1-1997.

FOR: RESTAURANTS FEATURING FRUIT, VEGETABLE AND NON-DAIRY DRINKS, DRINK MIXES, POWDERS TO MAKE DRINKS AND NUTRITIONAL SUPPLEMENTS, IN CLASS 43 (U.S. CLS. 100 AND 101).

FIRST USE 5-1-1997; IN COMMERCE 5-1-1997.

NO CLAIM IS MADE TO THE EXCLUSIVE RIGHT TO USE "SMOOTHIE", APART FROM THE MARK AS SHOWN.

SER. NO. 75-455,272, FILED 3-23-1998.

SAMUEL E. SHARPER JR., EXAMINING ATTORNEY

Int. Cl.: 34

Prior U.S. Cls.: 2, 8, 9 and 17

United States Patent and Trademark Office

Reg. No. 2,892,117

Registered Oct. 12, 2004

**TRADEMARK
PRINCIPAL REGISTER**

CLASSICO DE CONTINENTAL

CLASSICO DE CONTINENTAL CIGAR COMPA-
NY (GEORGIA CORPORATION)
11205 ALPHARETTA HIGHWAY, SUITE G-3
ROSWELL, GA 30076

FOR: CIGARS AND SMOKERS' ARTICLES,
NAMELY, HUMIDORS, LIGHTERS NOT OF PRE-
CIOUS METAL AND CIGAR CUTTERS, IN CLASS
34 (U.S. CLS. 2, 8, 9 AND 17).

FIRST USE 5-4-1996; IN COMMERCE 5-21-1996.

THE PHRASE "CLASSICO DE" MEANS "CLAS-
SICS OF" IN SPANISH.

SER. NO. 75-460,423, FILED 3-31-1998.

NANCY CLARKE, EXAMINING ATTORNEY

Int. Cls.: 35, 39 and 40

Prior U.S. Cls.: 100, 101, 102, 103, 105 and 106

United States Patent and Trademark Office

Reg. No. 2,892,118

Registered Oct. 12, 2004

**SERVICE MARK
PRINCIPAL REGISTER**



INFORMATION MANAGEMENT SOLUTIONS,
LLC (TEXAS LIMITED LIABILITY COMPA-
NY)
2422 FREEDOM
SAN ANTONIO, TX 78217

FOR: DATA MANAGEMENT, STORAGE AND
RETRIEVAL, IN CLASS 35 (U.S. CLS. 100, 101 AND
102).

FIRST USE 4-0-1996; IN COMMERCE 4-0-1996.

FOR: ELECTRONIC STORAGE OF DATA, IN
CLASS 39 (U.S. CLS. 100 AND 105).

FIRST USE 4-0-1996; IN COMMERCE 4-0-1996.

FOR: DOCUMENT DATA TRANSFER AND PHY-
SICAL CONVERSION FROM ONE MEDIA TO AN-
OTHER MEDIA, IN CLASS 40 (U.S. CLS. 100, 103
AND 106).

FIRST USE 4-0-1996; IN COMMERCE 4-0-1996.

SER. NO. 75-470,468, FILED 4-20-1998.

CHERYL STEPLIGHT, EXAMINING ATTORNEY

Int. Cls.: 9 and 42

Prior U.S. Cls.: 21, 23, 26, 36, 38, 100 and 101

United States Patent and Trademark Office

Reg. No. 2,892,119

Registered Oct. 12, 2004

**TRADEMARK
SERVICE MARK
PRINCIPAL REGISTER**

TRANGO SOFTWARE

TRANGO SOFTWARE CANADA CORPORATION
(CANADA CORPORATION)
45 VOGELL ROAD, SUITE 201
RICHMOND HILL, ONTARIO L4B 3P6, CANADA

FOR: COMPUTER SOFTWARE DESIGNED FOR
CALL, INFORMATION AND TELEPHONE DATA
MANAGEMENT IN A CALL CENTER, IN CLASS 9
(U.S. CLS. 21, 23, 26, 36 AND 38).

FIRST USE 5-3-1996; IN COMMERCE 5-3-1996.

FOR: CONSULTING SERVICES IN THE FIELD
OF TELEPHONY AND TELEPHONIC DATA
TRANSMISSION, IN CLASS 42 (U.S. CLS. 100 AND
101).

FIRST USE 5-3-1996; IN COMMERCE 5-3-1996.

PRIORITY CLAIMED UNDER SEC. 44(D) ON
CANADA APPLICATION NO. 871,123, FILED 3-4-
1998, REG. NO. TMA590506, DATED 9-23-2003, EX-
PIRES 9-23-2018.

NO CLAIM IS MADE TO THE EXCLUSIVE
RIGHT TO USE "SOFTWARE" , APART FROM
THE MARK AS SHOWN.

SER. NO. 75-479,927, FILED 5-5-1998.

KATHLEEN M. VANSTON, EXAMINING ATTOR-
NEY

Int. Cls.: 12, 16 and 25

**Prior U.S. Cls.: 2, 5, 19, 21, 22, 23, 29, 31, 35, 37, 38,
39, 44 and 50**

Reg. No. 2,892,120

United States Patent and Trademark Office

Registered Oct. 12, 2004

**TRADEMARK
PRINCIPAL REGISTER**



DAVIS, MCKAY H. (UNITED STATES INDIVIDUAL)
P.O. BOX 520084
SALT LAKE CITY, UT 84152

FOR: VEHICLES, NAMELY BICYCLES, IN CLASS 12 (U.S. CLS. 19, 21, 23, 31, 35 AND 44).

FIRST USE 9-0-1991; IN COMMERCE 3-0-1992.

FOR: PAPER PRODUCTS, NAMELY DECALS, IN CLASS 16 (U.S. CLS. 2, 5, 22, 23, 29, 37, 38 AND 50).

FIRST USE 9-0-1991; IN COMMERCE 3-0-1992.

FOR: WEARING APPAREL, NAMELY SHIRTS, IN CLASS 25 (U.S. CLS. 22 AND 39).

FIRST USE 9-0-1991; IN COMMERCE 3-0-1992.

THE MARK COMPRISES A REPRESENTATION OF A ROCK ART FIGURE, KNOWN AS KOKOPELLI, SHOWN UPON A REPRESENTATION OF A BICYCLE.

SER. NO. 75-482,477, FILED 5-11-1998.

THEODORE MCBRIDE, EXAMINING ATTORNEY

Int. Cl.: 12

Prior U.S. Cls.: 19, 21, 23, 31, 35 and 44

Reg. No. 2,892,121

United States Patent and Trademark Office

Registered Oct. 12, 2004

**TRADEMARK
PRINCIPAL REGISTER**



EXPRESSO DEUTSCHLAND TRANSPORTGE-
RATE GMBH (FED REP GERMANY LTD
LIAB CO)
ANTONIUS-RAAB-STRASSE 19
D-34123 KASSEL, FED REP GERMANY

FOR: HAND TRUCKS, PUSHCARTS; CARTS FOR
TRANSPORTING PARCELS; CARTS FOR MOVING
AND TRANSPORTING VATS; CARTS FOR MOV-
ING AND TRANSPORTING BOTTLES; CARTS FOR
MOVING AND TRANSPORTING CANS; CARTS

FOR MOVING AND TRANSPORTING SACKS, IN
CLASS 12 (U.S. CLS. 19, 21, 23, 31, 35 AND 44).

OWNER OF FED REP GERMANY REG. NO.
764550, DATED 8-17-1962, EXPIRES 2-28-2009.

SER. NO. 75-483,414, FILED 5-12-1998.

JULIE WATSON, EXAMINING ATTORNEY

Int. Cl.: 36

Prior U.S. Cls.: 100, 101 and 102

United States Patent and Trademark Office

Reg. No. 2,892,122

Registered Oct. 12, 2004

**SERVICE MARK
PRINCIPAL REGISTER**

Q INVESTMENTS

ACME WIDGET, L.P. (TEXAS LIMITED PART-
NERSHIP)
301 COMMERCE STREET, SUITE 2975
FORT WORTH, TX 76102

FOR: FINANCIAL INVESTMENT SERVICES,
NAMELY PROVIDING SPECIALIZED SECURITIES
INVESTMENTS FOR ACCREDITED INVESTORS,
IN CLASS 36 (U.S. CLS. 100, 101 AND 102).

FIRST USE 10-1-1994; IN COMMERCE 10-1-1994.

NO CLAIM IS MADE TO THE EXCLUSIVE
RIGHT TO USE "INVESTMENTS", APART FROM
THE MARK AS SHOWN.

SER. NO. 75-483,421, FILED 5-12-1998.

MELVIN AXILBUND, EXAMINING ATTORNEY

Int. Cl.: 36

Prior U.S. Cls.: 100, 101 and 102

United States Patent and Trademark Office

Reg. No. 2,892,123

Registered Oct. 12, 2004

**SERVICE MARK
PRINCIPAL REGISTER**

Q FUNDING II

ACME WIDGET, L.P. (TEXAS LIMITED PART-
NERSHIP)
301 COMMERCE STREET, SUITE 2975
FORT WORTH, TX 76102

FOR: FINANCIAL INVESTMENT SERVICES,
NAMELY PROVIDING SPECIALIZED SECURITIES
INVESTMENTS FOR ACCREDITED INVESTORS,
IN CLASS 36 (U.S. CLS. 100, 101 AND 102).

FIRST USE 11-1-1997; IN COMMERCE 11-1-1997.

NO CLAIM IS MADE TO THE EXCLUSIVE
RIGHT TO USE "FUNDING", APART FROM THE
MARK AS SHOWN.

SER. NO. 75-483,422, FILED 5-12-1998.

MELVIN AXILBUND, EXAMINING ATTORNEY

Int. Cl.: 36

Prior U.S. Cls.: 100, 101 and 102

United States Patent and Trademark Office

Reg. No. 2,892,124

Registered Oct. 12, 2004

**SERVICE MARK
PRINCIPAL REGISTER**

Q OPPORTUNITY FUND

ACME WIDGET, L.P. (TEXAS LIMITED PART-
NERSHIP)
301 COMMERCE STREET, SUITE 2975
FORT WORTH, TX 76102

FOR: FINANCIAL INVESTMENT SERVICES,
NAMELY PROVIDING SPECIALIZED SECURITIES
INVESTMENTS FOR ACCREDITED INVESTORS,
IN CLASS 36 (U.S. CLS. 100, 101 AND 102).

FIRST USE 5-1-1998; IN COMMERCE 5-1-1998.

NO CLAIM IS MADE TO THE EXCLUSIVE
RIGHT TO USE "FUND", APART FROM THE
MARK AS SHOWN.

SER. NO. 75-483,833, FILED 5-12-1998.

MELVIN AXILBUND, EXAMINING ATTORNEY

Int. Cl.: 30

Prior U.S. Cl.: 46

United States Patent and Trademark Office

Reg. No. 2,892,125

Registered Oct. 12, 2004

**TRADEMARK
PRINCIPAL REGISTER**

MEMPHIS MELTDOWN

TIP TOP INVESTMENTS LIMITED (NEW ZEAL-
AND LIMITED LIABILITY COMPANY)
113 CARBINE ROAD, MT WELLINGTON
AUCKLAND, NEW ZEALAND

OWNER OF NEW ZEALAND REG. NO. 275115,
DATED 8-10-1998, EXPIRES 4-8-2018.

SER. NO. 75-508,693, FILED 6-25-1998.

FOR: ICE CREAM, IN CLASS 30 (U.S. CL. 46).

HOWARD FRIEDMAN, EXAMINING ATTORNEY

Int. Cl.: 41

Prior U.S. Cls.: 100, 101 and 107

United States Patent and Trademark Office

Reg. No. 2,892,126

Registered Oct. 12, 2004

**SERVICE MARK
PRINCIPAL REGISTER**



E! ENTERTAINMENT TELEVISION, INC. (DELA-
WARE CORPORATION)
5750 WILSHIRE BOULEVARD
LOS ANGELES, CA 90036

FIRST USE 10-1-1998; IN COMMERCE 10-1-1998.

SEC. 2(F).

FOR: ENTERTAINMENT IN THE NATURE OF
ON-GOING TELEVISION PROGRAMS IN THE
FIELDS OF ENTERTAINMENT, FASHION AND
DESIGN, IN CLASS 41 (U.S. CLS. 100, 101 AND 107).

SER. NO. 75-519,975, FILED 7-16-1998.

ANN E. SAPPENFIELD, EXAMINING ATTORNEY

Int. Cl.: 41

Prior U.S. Cls.: 100, 101 and 107

United States Patent and Trademark Office

Reg. No. 2,892,127

Registered Oct. 12, 2004

**SERVICE MARK
PRINCIPAL REGISTER**



E! ENTERTAINMENT TELEVISION, INC. (DELA-
WARE CORPORATION)
5750 WILSHIRE BOULEVARD
LOS ANGELES, CA 90036

FIRST USE 10-1-1998; IN COMMERCE 10-1-1998.

SEC. 2(F).

FOR: ENTERTAINMENT IN THE NATURE OF
ON-GOING TELEVISION PROGRAMS IN THE
FIELDS OF ENTERTAINMENT, FASHION AND
DESIGN, IN CLASS 41 (U.S. CLS. 100, 101 AND 107).

SER. NO. 75-519,977, FILED 7-16-1998.

ANN E. SAPPENFIELD, EXAMINING ATTORNEY

Int. Cl.: 41

Prior U.S. Cls.: 100, 101 and 107

United States Patent and Trademark Office

Reg. No. 2,892,128

Registered Oct. 12, 2004

**SERVICE MARK
PRINCIPAL REGISTER**



E! ENTERTAINMENT TELEVISION, INC. (DELA-
WARE CORPORATION)
5750 WILSHIRE BOULEVARD
LOS ANGELES, CA 90036

FIRST USE 10-1-1998; IN COMMERCE 10-1-1998.

SEC. 2(F).

FOR: ENTERTAINMENT IN THE NATURE OF
ON-GOING TELEVISION PROGRAMS IN THE
FIELDS OF ENTERTAINMENT, FASHION AND
DESIGN, IN CLASS 41 (U.S. CLS. 100, 101 AND 107).

SER. NO. 75-519,979, FILED 7-16-1998.

ANN E. SAPPENFIELD, EXAMINING ATTORNEY

Int. Cl.: 41

Prior U.S. Cls.: 100, 101 and 107

United States Patent and Trademark Office

Reg. No. 2,892,129

Registered Oct. 12, 2004

**SERVICE MARK
PRINCIPAL REGISTER**

style.

E! ENTERTAINMENT TELEVISION, INC. (DELA-
WARE CORPORATION)
5750 WILSHIRE BOULEVARD
LOS ANGELES, CA 90036

FIRST USE 10-1-1998; IN COMMERCE 10-1-1998.

SEC. 2(F).

FOR: ENTERTAINMENT IN THE NATURE OF
ON-GOING TELEVISION PROGRAMS IN THE
FIELDS OF ENTERTAINMENT, FASHION AND
DESIGN, IN CLASS 41 (U.S. CLS. 100, 101 AND 107).

SER. NO. 75-519,981, FILED 7-16-1998.

ANN E. SAPPENFIELD, EXAMINING ATTORNEY

Int. Cl.: 9

Prior U.S. Cls.: 21, 23, 26, 36 and 38

Reg. No. 2,892,130

United States Patent and Trademark Office

Registered Oct. 12, 2004

**TRADEMARK
PRINCIPAL REGISTER**

SOLUTION CENTER

OGILVY GROUP, INC., THE (NEW YORK CORPORATION), DBA OGILVY & MATHER
309 WEST 39TH STREET
NEW YORK, NY 10019

FIRST USE 10-0-1995; IN COMMERCE 1-0-1996.

SER. NO. 75-526,677, FILED 7-28-1998.

FOR: SOFTWARE, NAMELY, DATABASE MANAGEMENT SYSTEMS FOR THE ADVERTISING INDUSTRY, IN CLASS 9 (U.S. CLS. 21, 23, 26, 36 AND 38).

KATHERINE STOIDES, EXAMINING ATTORNEY

Int. Cls.: 35 and 42

Prior U.S. Cls.: 100, 101 and 102

United States Patent and Trademark Office

Reg. No. 2,892,131

Registered Oct. 12, 2004

**SERVICE MARK
PRINCIPAL REGISTER**

WOLF

WOLF GROUP INTEGRATED COMMUNICATIONS LTD. (CANADA CORPORATION)
35 PRINCE ARTHUR AVENUE
TORONTO, ONTARIO M5R 1B2, CANADA

FOR: ADVERTISING AGENCIES; AND INTEGRATED MARKETING COMMUNICATION SERVICES, NAMELY, PUBLIC RELATIONS, DIRECT RESPONSE ADVERTISING AND MARKETING, PROMOTING THE SALE OF THE GOODS AND SERVICES OF OTHERS THROUGH THE ADMINISTRATION OF SWEEPSTAKES CONTESTS AND OTHER TYPES OF CONTESTS AND THROUGH THE PLACEMENT OF IN-STORE PRODUCT DISPLAYS, EVENT MARKETING, AND DEVELOPMENT AND IMPLEMENTATION OF CORPORATE

IDENTITY PROGRAMS, IN CLASS 35 (U.S. CLS. 100, 101 AND 102).

FIRST USE 2-1-1967; IN COMMERCE 2-1-1967.

FOR: INTEGRATED MARKETING AND COMMUNICATION SERVICES, NAMELY, GRAPHIC AND COMMERCIAL ART DESIGN, IN CLASS 42 (U.S. CLS. 100 AND 101).

FIRST USE 2-1-1967; IN COMMERCE 2-1-1967.

SER. NO. 75-528,235, FILED 7-30-1998.

NANCY CLARKE, EXAMINING ATTORNEY

Int. Cls.: 7 and 12

Prior U.S. Cls.: 13, 19, 21, 23, 31, 34, 35 and 44

Reg. No. 2,892,132

United States Patent and Trademark Office

Registered Oct. 12, 2004

TRADEMARK
PRINCIPAL REGISTER

RENOLD
HiTec

RENOLD PUBLIC LIMITED COMPANY (UNITED KINGDOM COMPANY)
RENOLD HOUSE, STYAL ROAD
WYTHENSHAW, MANCHESTER, ENGLAND

FOR: MACHINE AND MACHINE TOOL PARTS, NAMELY - CAM DRIVES FOR INTERNAL COMBUSTION ENGINES; POWER TRANSMISSIONS AND PARTS THEREOF; GEARS AND GEAR BOXES AND PARTS THEREOF; DRIVING CHAINS; CONVEYING CHAINS; CHAIN CLUTCHES; CHAIN COUPLINGS; CHAIN RACKS AND PINIONS; COUNTER WEIGHT CHAINS AND PINIONS IN COMBINATION; SPEED CHANGE DRIVES; SPEED CHANGE GEARS; CHAIN CASES AND SPLASH GUARDS; CHAIN TENSION ADJUSTERS; CHAIN GUIDES; CHAIN WHEEL CUTTERS; CHAIN GRINDING MACHINES; MORTISE CHAINS; GUIDE BARS AND SPROCKET WHEELS FOR USE WITH MORTISE CHAINS; POWER TRANSMISSION CHAINS; CHAIN WHEELS; FLEXIBLE COUPLINGS; TOOTH AND MILLING CUTTER CHAINS; CHAIN GUARD CASTINGS; TOOTHED WHEEL FOR CHAIN DRIVERS; TOOTHED WHEELS FOR DRIVING CHAINS; BLOCK CHAINS; GALLE CHAINS; POLYMER AND RUBBER BLOCK CHAINS; CHAIN JOINTS; FENDERS AND MUDGUARDS FOR MACHINES; DRIVER CHAIN WHEELS AND CHAIN WHEELS; CHAINS FOR RUNWAYS; ESCALATOR CHAINS; WRINGING NAILS; CONVEYOR BELTS; TOOTHED BELTS AND TOOTHED WHEELS FOR MACHINES; TRANSMISSION WHEELS; CHAINED TOOTHED COUPLINGS; SPRAG CLUTCHES; CRANK COUPLINGS; ELECTRO-MAGNETIC, MECHANICAL AND HYDRAULIC CLUTCHES AND PARTS THEREOF; PUSH-PULL REMOTE CONTROLS AND CHAIN SPEED TRANSFORMERS; AUTO-ADJUSTERS FOR CHAINS; ROLLER CHAINS; BUSHLESS ROLLER CHAINS; AXLES FOR MACHINES; DIRECT DRIVE DOG CLUTCHES; OVERRIDING CLUTCHES FOR MACHINES; SHIFTING CLUTCHES FOR MACHINES; FLYBACK

SUPPRESSORS FOR MACHINES; INVERTED TOOTH TYPE CHAIN GEARS AND WHEELS; INVERTED TOOTH TYPE CHAINS; CHAIN FINISHERS; ELASTIC COUPLINGS; TORQUE LIMITERS; CONVEYORS FOR AGRICULTURAL AND HORTICULTURAL MACHINERY AND PARTS THEREOF; PLASTIC CHAINS; PLASTIC ROLLER AND BUSHLESS CHAINS; PLASTIC CONVEYOR TYPE CHAINS; STEEL AND PLASTIC TABLETOP AND SLAT BAND TYPE CHAINS; PINE KERNELS AND RATCHET FOR CHAINS; SPIGOT PINS; STAY BARS; ROLLER CHAINS AND METAL TUBING FOR CONTROLLING MECHANISMS; CONNECTING PINS, JOINTS AND COMPONENTS FOR CHAINS; AXLE PIVOTS; SPACER BARS; DENTENT CHAINS; AND ELECTRICAL DRIVEN TOOLS FOR ROLLER AND BLOCK CHAINS, IN CLASS 7 (U.S. CLS. 13, 19, 21, 23, 31, 34 AND 35).

FIRST USE 11-1-1997; IN COMMERCE 11-1-1997.

FOR: LAND VEHICLE PARTS, NAMELY, AUTOMOTIVE CAM DRIVE SYSTEMS FOR MOTOR VEHICLES; CAM DRIVES FOR INTERNAL COMBUSTION ENGINES; POWER TRANSMISSIONS AND PARTS THEREOF; GEARS AND GEAR BOXES AND PARTS THEREOF; DRIVING CHAINS; CONVEYING CHAINS; CHAIN CLUTCHES; CHAIN COUPLINGS; CHAIN RACKS AND PINIONS; COUNTER WEIGHT CHAINS AND PINIONS IN COMBINATION; SPEED CHANGE DRIVES; SPEED CHANGE GEARS; CHAIN CASES AND SPLASH GUARDS; CHAIN TENSION ADJUSTERS; CHAIN GUIDES; CHAIN WHEEL CUTTERS; CHAIN GRINDING MACHINES; MORTISE CHAINS; GUIDE BARS AND SPROCKET WHEELS FOR USE WITH MORTISE CHAINS; POWER TRANSMISSION CHAINS; CHAIN WHEELS; FLEXIBLE COUPLINGS; CHAIN GUARD CASTINGS; TOOTHED WHEELS FOR CHAIN DRIVERS; TOOTHED WHEELS FOR DRIVING CHAINS; BLOCK CHAINS; CHAIN

JOINTS; FENDERS AND MUDGUARDS FOR LAND VEHICLES; DRIVER CHAINWHEELS AND CHAINWHEELS; WRINGING NAILS; TOOTHED BELTS AND TOOTHED WHEELS; TRANSMISSION WHEELS; CHAIN TOOTHED COUPLINGS; SPRAG CLUTCHES; CRANK COUPLINGS; ELECTROMAGNETIC, MECHANICAL AND HYDRAULIC CLUTCHES AND PARTS THEREOF; PUSH-PULL REMOTE CONTROLS AND CHAIN SPEED TRANSFORMERS; AUTO ADJUSTERS FOR CHAINS; DIRECT DRIVE DOG CLUTCHES; INVERTED TOOTH TYPE CHAIN GEARS; INVERTED TOOTH TYPE CHAINS; CHAIN FINISHERS; ELASTIC COUPLINGS; TORQUE LIMITERS; ROLLER CHAINS; BUSHLESS CHAINS; PINE KERNELS AND RATCHETS FOR CHAINS; SPIGOT PINS; STAY BARS; ROLLER CHAINS AND METAL TUBING FOR CONTROLLING MECHANISMS; FORK LIFT TRUCK CHAINS, LINKS, CONNECTORS, ANCHOR BOLTS AND WHEELS; CONNECTING PINS, JOINTS AND COMPONENTS FOR CHAINS; AXLE PIVOTS;

SPACER BARS, AND DENTENT CHAINS, IN CLASS 12 (U.S. CLS. 19, 21, 23, 31, 35 AND 44).

FIRST USE 11-1-1997; IN COMMERCE 11-1-1997.

PRIORITY CLAIMED UNDER SEC. 44(D) ON ERPN CMNTY TM OFC APPLICATION NO. 00658252, FILED 10-21-1997, REG. NO. 00658252, DATED 10-21-1997, EXPIRES 10-21-2007.

OWNER OF U.S. REG. NOS. 373,826, 1,378,970 AND OTHERS.

NO CLAIM IS MADE TO THE EXCLUSIVE RIGHT TO USE "HIGH TECH", APART FROM THE MARK AS SHOWN.

SER. NO. 75-529,549, FILED 8-3-1998.

JOHN LINCOSKI, EXAMINING ATTORNEY

Int. Cls.: 1 and 7

**Prior U.S. Cls.: 1, 5, 6, 10, 13, 19, 21, 23, 26, 31, 34, 35
and 46**

Reg. No. 2,892,133

United States Patent and Trademark Office

Registered Oct. 12, 2004

**TRADEMARK
PRINCIPAL REGISTER**

ESPOR

PORTEC AG (SWITZERLAND CORPORATION)
POSTFACH
8404 WINTERTHUR, SWITZERLAND

FOR: CHEMICAL PRODUCTS, NAMELY, BINDERS CONTAINING MIXTURES OF EPOXY RESINS AND ALUMINUM FOR USE IN FABRICATING MICRO-POROUS AND GAS PERMEABLE MOLDS, DEEP-DRAWING TOOLS FOR THERMOFORMING AND MACHINE ELEMENTS, IN CLASS 1 (U.S. CLS. 1, 5, 6, 10, 26 AND 46).

FIRST USE 9-24-1997; IN COMMERCE 9-24-1997.

FOR: FORMING TOOLS MADE OF ALUMINUM, NAMELY, ALUMINUM AND EPOXY RESIN, FOR USE IN FABRICATING MICRO-POROUS AND GAS PERMEABLE MOLDS, DEEP-DRAWING TOOLS FOR THERMOFORMING AND MACHINE ELEMENTS, IN CLASS 7 (U.S. CLS. 13, 19, 21, 23, 31, 34 AND 35).

FIRST USE 9-24-1997; IN COMMERCE 9-24-1997.

SER. NO. 75-573,125, FILED 10-19-1998.

CIMMERIAN COLEMAN, EXAMINING ATTORNEY

Int. Cl.: 9

Prior U.S. Cls.: 21, 23, 26, 36 and 38

Reg. No. 2,892,134

United States Patent and Trademark Office

Registered Oct. 12, 2004

**TRADEMARK
PRINCIPAL REGISTER**

POWER READING

NATIONAL READING STYLES INSTITUTE, INC.
(NEW YORK CORPORATION)
P.O. BOX 737
SYVOSSET, NY 11791

FOR: AUDIO CASSETTES, AUDIO TAPES AND
AUDIO COMPACT DISCS EACH FEATURING
WRITTEN WORKS RECORDED IN A MANNER/
TECHNIQUE TO PROMOTE READING IMPROVE-
MENT AND READING/READING COMPREHEN-

SION AIDS AND DEVICES IN CONNECTION
THEREWITH, IN CLASS 9 (U.S. CLS. 21, 23, 26, 36
AND 38).

FIRST USE 9-30-2001; IN COMMERCE 9-30-2001.

SER. NO. 75-606,773, FILED 12-16-1998.

AISHA CLARKE, EXAMINING ATTORNEY

Int. Cls.: 16, 35, 36 and 38

**Prior U.S. Cls.: 2, 5, 22, 23, 29, 37, 38, 50, 100, 101, 102
and 104**

Reg. No. 2,892,135

United States Patent and Trademark Office

Registered Oct. 12, 2004

**TRADEMARK
SERVICE MARK
PRINCIPAL REGISTER**

BSCH

BANCO SANTANDER CENTRAL HISPANO, S.A.
(SPAIN CORPORATION)
PLAZA DE CANALEJAS
MADRID, SPAIN 28014

FOR: PUBLICATIONS AND PRINTED MATTER, NAMELY, NEWSPAPERS, MAGAZINES, NEWSLETTERS, BROCHURES, PAMPHLETS, BOOKS AND JOURNALS DEALING WITH ECONOMIC AND FINANCIAL SUBJECTS, IN CLASS 16 (U.S. CLS. 2, 5, 22, 23, 29, 37, 38 AND 50).

FOR: IMPORT/EXPORT AGENCY SERVICES; BUSINESS MANAGEMENT AND CONSULTATION; PREPARING BUSINESS REPORTS; BOOKKEEPING, ACCOUNTING AND BUSINESS AND ACCOUNT AUDITING; COST PRICE ANALYSIS; CONDUCTING MARKETING RESEARCH STUDIES; AND ADVERTISING AGENCY SERVICES, IN CLASS 35 (U.S. CLS. 100, 101 AND 102).

FOR: COMMODITY AND PRICE QUOTATIONS; INSURANCE AGENCY SERVICES IN THE FIELD OF HEALTH, LIFE, HOME, DISABILITY, ACCIDENT, FIRE, AND AUTO; CURRENCY EXCHANGE SERVICES; FINANCIAL CLEARINGHOUSE SERVICES; CO-OPERATIVE CREDIT SERVICES; INVESTMENT TRUST SERVICES FOR HOLDING COMPANIES; BROKERAGE SERVICES RELATING TO STOCKS, BONDS, AND REAL ESTATE; REAL ESTATE TRUSTEE SERVICES AND TRUSTEESHIP REPRESENTATIVES; ISSUING OF TRAVELERS CHECKS, CREDIT CARDS AND LETTERS OF CREDIT; FINANCIAL ANALYSIS; BANKING SERVICES; INVESTMENT OF FUNDS FOR OTHERS; COLLECTION AND CREDIT AGENCIES; FIDUCIARY REPRESENTATIVE, LEASE-PURCHASE

AND LOAN FINANCING SERVICES; REAL ESTATE APPRAISAL AND MANAGEMENT; SAFE DEPOSIT BOX SERVICES, IN CLASS 36 (U.S. CLS. 100, 101 AND 102).

FOR: ELECTRONIC COMMUNICATION SERVICES, NAMELY, ELECTRONIC TRANSMISSION OF DATA AND MESSAGES; TELEPHONE SERVICES, NAMELY, TELEPHONE COMMUNICATION SERVICES; RADIO COMMUNICATION SERVICES; AND TELEVISION BROADCASTING, IN CLASS 38 (U.S. CLS. 100, 101 AND 104).

PRIORITY CLAIMED UNDER SEC. 44(D) ON SPAIN APPLICATION NO. 2.208.105, FILED 1-18-1999, REG. NO. 2.208.105, DATED 6-5-1999, EXPIRES 6-5-2009.

PRIORITY CLAIMED UNDER SEC. 44(D) ON SPAIN APPLICATION NO. 2.208.103, FILED 1-18-1999, REG. NO. 2.208.103, DATED 6-4-1999, EXPIRES 6-4-2009.

PRIORITY CLAIMED UNDER SEC. 44(D) ON SPAIN APPLICATION NO. 2.208.102, FILED 1-18-1999, REG. NO. 2.208.102, DATED 6-4-1999, EXPIRES 6-4-2009.

PRIORITY CLAIMED UNDER SEC. 44(D) ON SPAIN APPLICATION NO. 2.208.083, FILED 1-18-1999, REG. NO. 2.208.083, DATED 6-7-1999, EXPIRES 6-7-2009.

SER. NO. 75-622,628, FILED 1-19-1999.

LESLIE RICHARDS, EXAMINING ATTORNEY

Int. Cls.: 35, 36, 37, 38, 39, 40, 41 and 42

Prior U.S. Cls.: 100, 101, 102, 103, 104, 105, 106 and 107

Reg. No. 2,892,136

United States Patent and Trademark Office

Registered Oct. 12, 2004

**SERVICE MARK
PRINCIPAL REGISTER**

egg.com

GS THIRTEEN LIMITED (UNITED KINGDOM CORPORATION)
142 HOLBORN BARS
LONDON EC1N 2NH, UNITED KINGDOM

ADVERTISING, BUSINESS MANAGEMENT AND CONSULTATION, BUSINESS MARKETING, BUSINESS RESEARCH, IN CLASS 35 (U.S. CLS. 100, 101 AND 102).

FOR: ADVERTISING SERVICES, NAMELY, DIRECT MAIL ADVERTISING, ELECTRONIC BILLBOARD ADVERTISING, PREPARING ADVERTISEMENTS FOR OTHERS, PLACING ADVERTISEMENTS FOR OTHERS, COMPILATION AND DISSEMINATION OF ADVERTISEMENTS FOR USE AT WEB PAGES OF OTHERS, DISSEMINATION OF ADVERTISING OF OTHERS VIA AN ON-LINE ELECTRONIC COMMUNICATIONS NETWORK; BUSINESS MANAGEMENT AND CONSULTATION; BUSINESS MARKETING, NAMELY, CONDUCTING MARKETING STUDIES, DIRECT MARKETING ADVERTISING, DIRECT MAIL CONSULTING SERVICES, PROVIDING BUSINESS MARKETING INFORMATION; BUSINESS RESEARCH, DEVELOPING PROMOTIONAL CAMPAIGNS FOR BUSINESS; PROVIDING INFORMATION AND CONSULTATION SERVICES IN THE FIELDS OF ADVERTISING, BUSINESS ADMINISTRATION, BUSINESS MANAGEMENT, BUSINESS MARKETING, BUSINESS RESEARCH, INCLUDING PROVISION BY MEANS OF A GLOBAL COMPUTER INFORMATION NETWORK, ON-LINE AND INTERACTIVE COMPUTER SERVICE; PROVIDING ACCESS TO, AND LEASING ACCESS TIME TO, AN INTERACTIVE COMPUTER DATABASES IN THE FIELDS OF BUSINESS, NAMELY, BUSINESS PLANNING, BUSINESS ADMINISTRATION, BUSINESS OPERATION; PROVIDING LINKS TO WEB SITES OF OTHERS FEATURING DATABASES OF

FOR: INSURANCE SERVICES, NAMELY, INSURANCE BROKERAGE, INSURANCE CLAIM ADMINISTRATION, INSURANCE CLAIMS PROCESSING, ACCIDENT, FIRE, LIFE, MARINE, MEDICAL INSURANCE UNDERWRITING, INSURANCE CONSULTATION; FINANCIAL AFFAIRS, NAMELY, FINANCIAL MANAGEMENT, FINANCIAL PLANNING, FINANCIAL PORTFOLIO MANAGEMENT, FINANCIAL RESEARCH, FINANCIAL SERVICES IN THE NATURE OF AN INVESTMENT SECURITY; PENSION FUND ADMINISTRATION, UNIT TRUST SERVICES, FINANCING SERVICES FOR SECURING FUNDS, DEBT RECOVERY SERVICES, FINANCIAL VALUATION OF PERSONAL PROPERTY AND REAL ESTATE; MONETARY AFFAIRS, NAMELY, BANKING SERVICES, SAVINGS ACCOUNT SERVICES, CREDIT CARD AND DEBIT CARD SERVICES, DEPOSIT TAKING SERVICES, NAMELY SAVINGS BANK SERVICES, ADMINISTRATION OF SAVINGS ACCOUNTS; FUNDS TRANSFER SERVICES, NAMELY ELECTRONIC FUNDS TRANSFER, INVESTMENT FUND TRANSFER AND TRANSACTION SERVICES; MORTGAGE BANKING SERVICES, LENDING ON MORTGAGES, ARRANGING THE FINANCE FOR HOME LOANS, LOAN ADVICE AND LOAN PROCUREMENT SERVICES; PROVISION OF GUARANTEES AND SECURITIES, NAMELY, GUARANTEEING LOANS, FINANCIAL GUARANTEE AND SURETY, - GUARANTEE ASSURANCE UNDERWRITING, SE-

CURITY BROKERAGE; MONETARY EXCHANGE REAL ESTATE AFFAIRS, NAMELY, REAL ESTATE APPRAISAL, LOAN ACQUISITION, REAL ESTATE AGENCY SERVICES AND REAL ESTATE BROKERAGE SERVICES, FINANCIAL INVESTMENT IN THE FIELD OF REAL ESTATE, REAL ESTATE MANAGEMENT; PROVIDING INFORMATION AND CONSULTATION SERVICES IN THE FIELDS OF INSURANCE, FINANCIAL MANAGEMENT, FINANCIAL PLANNING, FINANCIAL RESEARCH, FINANCIAL INVESTMENTS, PENSIONS, LOANS, MORTGAGES, BANKING AND REAL ESTATE; INCLUDING PROVISION BY MEANS OF A GLOBAL COMPUTER INFORMATION NETWORK, ON-LINE AND INTERACTIVE COMPUTER SERVICES; PROVIDING ACCESS TO, AND LEASING ACCESS TIME TO, AN INTERACTIVE COMPUTER DATABASE IN THE FIELDS OF INSURANCE, FINANCIAL AND MONETARY INFORMATION AND REAL ESTATE INFORMATION, PROVIDING LINKS TO WEB SITES OF OTHERS FEATURING DATABASES OF INSURANCE, FINANCIAL MANAGEMENT, FINANCIAL PLANNING, FINANCIAL RESEARCH, FINANCIAL INVESTMENTS, PENSIONS, LOANS, MORTGAGES, BANKING AND REAL ESTATE, IN CLASS 36 (U.S. CLS. 100, 101 AND 102).

FOR: PROVIDING INFORMATION AND CONSULTATION SERVICES IN THE FIELDS OF BUILDING CONSTRUCTION, HOUSE AND BUILDING REPAIR, HOME MAINTENANCE, FIRE AND BURGLAR ALARMS, BUILDING INSULATION AND SECURITY SYSTEMS INCLUDING PROVIDING SUCH SERVICES BY MEANS OF A GLOBAL COMPUTER INFORMATION NETWORK, ON-LINE AND INTERACTIVE COMPUTER SERVICE; PROVIDING LINKS TO WEB SITES OF OTHERS FEATURING DATABASES OF BUILDING CONSTRUCTION, HOUSE AND BUILDING REPAIR, HOME MAINTENANCE, FIRE AND BURGLAR ALARMS, BUILDING INSULATION AND SECURITY SYSTEMS, IN CLASS 37 (U.S. CLS. 100, 103 AND 106).

FOR: TELECOMMUNICATION SERVICES, NAMELY PROVIDING TELECOMMUNICATIONS ACCESS, NAMELY PROVIDING TELECOMMUNICATIONS CONNECTIONS VIA A GLOBAL COMPUTER NETWORK; PERSONAL COMMUNICATION SERVICES AND COMMERCIAL TELEPHONE COMMUNICATION SERVICES; PROVIDING MULTIPLE USER ACCESS TO A GLOBAL COMPUTER INFORMATION NETWORK; ELECTRONIC MAIL SERVICES; BROADCASTING PROGRAMS VIA A GLOBAL COMPUTER INFORMATION NETWORK; PROVIDING INFORMATION AND CONSULTATION SERVICES IN THE FIELDS(S) OF TELECOMMUNICATION ACCESS AND CONNECTIONS, INCLUDING PROVIDING SUCH SERVICES BY MEANS OF A GLOBAL, COMPUTER INFORMATION NETWORK, ON-LINE AND INTERACTIVE COMPUTER SERVICE; PROVIDING LINKS TO WEB SITES OF OTHERS FEATURING DATABASES OF TELECOMMUNICATION ACCESS AND CONNECTIONS, IN CLASS 38 (U.S. CLS. 100, 101 AND 104).

FOR: TRANSPORT SERVICES, NAMELY, PROVIDING INFORMATION AND CONSULTATION SERVICES IN THE FIELDS OF TRANSPORTATION OF PASSENGERS AND GOODS, STORAGE OF GOODS, PACKAGING OF GOODS, TRAVEL BOOKING, TRANSPORTATION RESERVATIONS, TRAVEL VISAS AND PASSPORTS, INCLUDING PROVIDING SUCH SERVICES BY MEANS OF A GLOBAL COMPUTER INFORMATION NETWORK, ON-LINE AND INTERACTIVE COMPUTER SERVICE; PROVIDING LINKS TO WEB SITES OF OTHERS FEATURING DATABASES OF TRANSPORTATION OF PASSENGERS AND GOODS, STORAGE OF GOODS, PACKAGING OF GOODS, TRAVEL BOOKING, TRANSPORTATION RESERVATIONS, TRAVEL VISAS AND PASSPORTS, IN CLASS 39 (U.S. CLS. 100 AND 105).

FOR: PROVIDING INFORMATION AND CONSULTATION SERVICES IN THE FIELDS OF MATERIAL TREATMENT, DYEING, TEXTILE TREATMENT, WASTE TREATMENT AND RECYCLING, FUEL TREATMENT, OIL AND GAS WELL TREATMENT, NUCLEAR WASTE TREATMENT, METAL TREATMENT, WATER TREATMENT, PAPER TREATMENT, INCLUDING PROVIDING SUCH SERVICES BY MEANS OF A GLOBAL COMPUTER INFORMATION NETWORK, ON-LINE AND INTERACTIVE COMPUTER SERVICE; PROVIDING LINKS TO WEB SITES OF OTHERS FEATURING DATABASES OF MATERIAL TREATMENT, DYEING, TEXTILE TREATMENT, WASTE TREATMENT AND RECYCLING, FUEL TREATMENT, OIL AND GAS WELL TREATMENT, NUCLEAR WASTE TREATMENT, METAL TREATMENT, WATER TREATMENT, PAPER TREATMENT, IN CLASS 40 (U.S. CLS. 100, 103 AND 106).

FOR: EDUCATIONAL SERVICES, NAMELY, CONDUCTING CLASSES, SEMINARS, WORKSHOPS, CONFERENCES IN THE FIELD OF INSURANCE, FINANCIAL TRANSACTIONS, BUSINESS, MONETARY AND REAL ESTATE SERVICES AND DISTRIBUTING COURSE MATERIALS IN CONNECTION THERE WITH; PROVIDING OF TRAINING, NAMELY, COMPUTER EDUCATION TRAINING, TRAINING IN THE USE AND OPERATION OF DATA PROCESSORS; ENTERTAINMENT SERVICES, NAMELY, ENTERTAINMENT IN THE NATURE OF AIR SHOWS, SPORTS GAMES; CIRCUSES, DANCE PERFORMANCES, FASHION SHOWS, LIVE MUSICAL CONCERTS, PROVIDING ON-LINE COMPUTER GAMES, PROVIDING A COMPUTER GAME THAT MAY BE ACCESSED NETWORK-WIDE BY NETWORK USERS; PROVIDING INFORMATION AND CONSULTATION SERVICES IN THE FIELDS OF EDUCATION IN THE FIELDS OF INSURANCE, FINANCIAL TRANSACTIONS, BUSINESS, MONETARY AND REAL ESTATE SERVICES, COMPUTER EDUCATION TRAINING, DATA PROCESSING TRAINING, ENTERTAINMENT EVENTS, AND ON-LINE COMPUTER GAMES, INCLUDING PROVIDING SUCH SERVICES BY MEANS OF A GLOBAL COMPUTER INFORMATION NETWORK, ON-LINE AND INTERACTIVE COMPUTER SERVICE; PROVIDING LINKS TO WEB SITES OF OTHERS FEATURING

DATABASES OF EDUCATION IN THE FIELDS OF INSURANCE, FINANCIAL TRANSACTIONS, BUSINESS, MONETARY AND REAL ESTATE SERVICES, COMPUTER EDUCATION TRAINING, DATA PROCESSING TRAINING, ENTERTAINMENT EVENTS, AND ON-LINE COMPUTER GAMES, IN CLASS 41 (U.S. CLS. 100, 101 AND 107).

FOR: COMPUTER PROGRAMMING FOR OTHERS; COMPUTER RENTAL; DESIGN, DRAWING AND COMMISSIONED WRITING, ALL FOR IMPLEMENTING AND MAINTAINING WEB SITES AND WEB PAGES FOR OTHERS; INFORMATION AND ADVISORY SERVICES CONCERNING OR RELATING TO ALL OF THE ABOVE SERVICES; PROVIDING INFORMATION AND CONSULTATION SERVICES IN THE FIELDS OF COMPUTER PROGRAMMING, IMPLEMENTING AND MAINTAINING WEB SITES AND WEB PAGES FOR

OTHERS, INCLUDING PROVIDING SUCH SERVICES BY MEANS OF A GLOBAL COMPUTER INFORMATION NETWORK, ON-LINE AND INTERACTIVE COMPUTER SERVICE; PROVIDING LINKS TO WEB SITES OF OTHERS FEATURING DATABASES OF COMPUTER PROGRAMMING, IMPLEMENTING AND MAINTAINING WEB SITES AND WEB PAGES FOR OTHERS, IN CLASS 42 (U.S. CLS. 100 AND 101).

PRIORITY CLAIMED UNDER SEC. 44(D) ON UNITED KINGDOM APPLICATION NO. 2175722, FILED 8-25-1998, REG. NO. 2175722, DATED 4-27-2001, EXPIRES 8-25-2008.

SER. NO. 75-626,096, FILED 1-22-1999.

MARY CRAWFORD, EXAMINING ATTORNEY

Int. Cls.: 9, 28 and 37

Prior U.S. Cls.: 21, 22, 23, 26, 36, 38, 50, 100, 103 and 106

Reg. No. 2,892,137

United States Patent and Trademark Office

Registered Oct. 12, 2004

**TRADEMARK
SERVICE MARK
PRINCIPAL REGISTER**



LOWEN AUTOMATEN GERHARD W. SCHULZE
GMBH (FED REP GERMANY CORPORATION)

SAARLANDSTRASSE 240

D-55411 BINGEN AM RHEIN, FED REP GERMANY

FOR: MACHINES, NAMELY, MUSICAL JUKEBOXES OPERATED BY THE INSERTION OF MONEY, TOKENS, MAGNETICALLY AND/OR ELECTRONICALLY-CODED CARDS, CASHLESS AND COIN-OPERATED VENDING MACHINES FOR SELLING GOODS, ISSUING AND DISPENSING CARDS, TICKETS, CARDS FEATURING MAGNETICALLY ENCODED DATA, AND/OR TAKING BACK OF GOODS; COMPUTER HARDWARE, COMPUTER PERIPHERALS, HARDWARE MICROPROCESSORS FOR STORING, ARCHIVING, RECORDING, TRANSMITTING AND REPRODUCING DATA; COMPUTER TERMINALS FOR USE IN CONNECTION WITH MULTI-MEDIA APPLICATIONS DATA PRINTERS; POINT OF SALE TERMINALS, VENDING MACHINES, MONEY CHANGE MACHINES, AND ELECTRONIC DATA PROCESSORS DESIGNED FOR USE WITH MAGNETICALLY AND ELECTRONICALLY CODED, MACHINE-READABLE CARDS, MACHINE-READABLE DATA CARRIERS, IDENTIFICATION CARDS, CREDIT AND DEBIT CARDS, BANK NOTES; PAPER MONEY AND COINS; COMPUTER PROGRAMS USED FOR PROCESSING DATA IN CONNECTION WITH

THE FOREGOING, NAMELY, MUSICAL JUKEBOXES, CASHLESS AND COIN-OPERATED VENDING MACHINES FOR SELLING GOODS, ISSUING AND DISPENSING CARDS, TICKETS, CARDS FEATURING MAGNETICALLY ENCODED DATA, AND/OR TAKING BACK OF GOODS; COMPUTER HARDWARE, COMPUTER PERIPHERALS, HARDWARE MICROPROCESSORS FOR STORING, ARCHIVING, RECORDING, TRANSMITTING AND REPRODUCING DATA; COMPUTER TERMINALS FOR USE IN CONNECTION WITH MULTIMEDIA APPLICATIONS DATA PRINTERS, POINT OF SALE TERMINALS, VENDING MACHINES, MONEY CHANGE MACHINES AND ELECTRONIC DATA PROCESSORS DESIGNED FOR USE WITH MAGNETICALLY AND ELECTRONICALLY CODED, MACHINE-READABLE CARDS, MACHINE-READABLE DATA CARRIERS, IDENTIFICATION CARDS, CREDIT AND DEBIT CARDS, BANK NOTES, PAPER MONEY AND COINS, IN CLASS 9 (U.S. CLS. 21, 23, 26, 36 AND 38).

FOR: ELECTRONIC GAMES OPERATED BY THE INSERTION OF MONEY, TOKENS, MAGNETICALLY AND/OR ELECTRICALLY-CODED CARDS FOR USE IN AMUSEMENT FACILITIES, NAMELY, ELECTRONIC VIDEO GAMES, ELECTRONIC GAME AND AMUSEMENT MACHINES, ELECTRONIC CHILDREN'S GAME AND AMUSEMENT MACHINES, ACTION-SKILL GAMES; ELECTRONIC

GAMES, NAMELY, DARTS, TABLE SOCCER, POOL, SNOOKER, SHOOTING GALLERIES, AND LASER SHOOTING GAMES, IN CLASS 28 (U.S. CLS. 22, 23, 38 AND 50).

FOR: REPAIR AND MAINTENANCE OF MACHINES, NAMELY, GAMBLING MACHINES (SPECIFICALLY NOT INCLUDING SLOT MACHINES), JUKEBOXES, VENDING MACHINES, MONEY CHANGE MACHINES, IN CLASS 37 (U.S. CLS. 100, 103 AND 106).

PRIORITY CLAIMED UNDER SEC. 44(D) ON FED REP GERMANY APPLICATION NO. 39846098, FILED 8-13-1998, REG. NO. 39846098, DATED 2-3-1999, EXPIRES 8-31-2008.

SER. NO. 75-640,577, FILED 2-12-1999.

KIMBERLY PERRY, EXAMINING ATTORNEY

Int. Cls.: 12 and 37

Prior U.S. Cls.: 19, 21, 23, 31, 35, 44, 100, 103 and 106

United States Patent and Trademark Office

Reg. No. 2,892,138

Registered Oct. 12, 2004

**TRADEMARK
SERVICE MARK
PRINCIPAL REGISTER**

proton

PERUSAHAAN OTOMOBIL NASIONAL BERHAD (MALAYSIA CORPORATION)
HICOM INDUSTRIAL ESTATE, BATU 3
P.O. BOX 7100, SHAH ALAM
SELANGOR DARUL EHSAN 40918, MALAYSIA

FOR: CARS; TRUCKS; TRACTORS; BRAKE PADS FOR LAND VEHICLES; BRAKE LININGS FOR LAND VEHICLES; DIESEL ENGINES FOR LAND VEHICLES; ENGINES FOR LAND VEHICLES; TIRES FOR LAND VEHICLES; WHEEL BEARINGS FOR LAND VEHICLES; LAND VEHICLE PARTS, NAMELY TIRE CHAINS, WINDSHIELDS, MUD GUARDS, WIPER BLADES, CHILDREN'S CAR SEATS; LAND VEHICLE SUNROOFS; THRUSTERS FOR LAND VEHICLES; SPOILERS FOR LAND VEHICLES AND SPECIFICALLY EXCLUDING ELECTRIC VEHICLES, IN CLASS 12 (U.S. CLS. 19, 21, 23, 31, 35 AND 44).

FOR: REPAIR AND MAINTENANCE OF MOTOR LAND VEHICLES; RESTORATION IN THE FIELD OF MOTOR LAND VEHICLES; AUTOMOBILE AND MOTORCYCLE BODY REPAIR AND FINISHING FOR OTHERS, IN CLASS 37 (U.S. CLS. 100, 103 AND 106).

OWNER OF MALAYSIA REG. NO. 98013544, DATED 11-24-1998, EXPIRES 11-24-2012.

OWNER OF MALAYSIA REG. NO. 84/01801, DATED 4-18-1984, RENEWED AS REG. NO. 84/01801, DATED 4-18-1991, EXPIRES 4-18-2005.

SER. NO. 75-642,263, FILED 2-16-1999.

JANICE L. MCMORROW, EXAMINING ATTORNEY

Int. Cls.: 25, 28, 35, 36, 37, 41 and 43

**Prior U.S. Cls.: 22, 23, 38, 39, 50, 100, 101, 102, 103,
106 and 107**

Reg. No. 2,892,139

United States Patent and Trademark Office

Registered Oct. 12, 2004

**TRADEMARK
SERVICE MARK
PRINCIPAL REGISTER**

CONWAY FARMS

CONWAY FARMS (PARTNERSHIP)
100 FIELD DRIVE
SUITE 150
LAKE FOREST, IL 60045

FOR: NIGHT SHIRTS; JOGGING SUITS; SHORTS;
PANTS; SLACKS; SHIRTS; JACKETS; SWEATERS;
RAIN WEAR, NAMELY RAIN PONCHOS AND
JACKETS; JACKETS IN THE NATURE OF NYLON
SHELLS; HATS; CAPS; VISORS; APRONS; WIND
RESISTANT JACKETS; GOLF SUITS AND HATS;
BLAZERS; SPORTS APPAREL, NAMELY, SHORTS,
JACKETS, SLACKS, AND SHIRTS; T-SHIRTS;
SWEAT SHIRTS; SWEAT PANTS, IN CLASS 25 (U.S.
CLS. 22 AND 39).

FIRST USE 0-0-1990; IN COMMERCE 0-0-1991.

FOR: SPORTING GOODS EQUIPMENT, NAME-
LY GOLF ACCESSORY POUCHES, GOLF BAG
COVERS, GOLF BAG TAGS, GOLF BAGS, GOLF
UMBRELLAS, GOLF TOWELS, GOLF BALL MAR-
KERS, GOLF BALLS; NON-MOTORIZED GOLF
CARTS; GOLF CLUB HEADS; GOLF CLUB IN-
SERTS; GOLF CLUB SHAFTS; GOLF CLUBS; GRIP
TAPE FOR GOLF CLUBS; HAND GRIPS FOR GOLF
CLUBS; HEAD COVERS FOR GOLF CLUBS, GOLF
GLOVES; GOLF IRONS; GOLF PUTTER COVERS;
GOLF PUTTERS; GOLF TEES; GOLF TEE MAR-
KERS, IN CLASS 28 (U.S. CLS. 22, 23, 38 AND 50).

FIRST USE 0-0-1990; IN COMMERCE 0-0-1991.

FOR: RETAIL GIFT SHOP SERVICES FOR GOLF-
ING ATTIRE AND ACCESSORIES; ASSOCIATION
SERVICES, NAMELY, PROMOTING THE INTER-
ESTS OF HOMEOWNERS , IN CLASS 35 (U.S. CLS.
100, 101 AND 102).

FIRST USE 0-0-1990; IN COMMERCE 0-0-1991.

FOR: REAL ESTATE BROKERAGE SERVICES, IN
CLASS 36 (U.S. CLS. 100, 101 AND 102).

FIRST USE 0-0-1988; IN COMMERCE 0-0-1991.

FOR: REAL ESTATE DEVELOPMENT SERVICES,
IN CLASS 37 (U.S. CLS. 100, 103 AND 106).

FIRST USE 0-0-1988; IN COMMERCE 0-0-1991.

FOR: GOLF COURSE SERVICES; GOLF CADDIE
SERVICES, AND INSTRUCTION IN THE FIELD OF
GOLF, IN CLASS 41 (U.S. CLS. 100, 101 AND 107).

FIRST USE 0-0-1990; IN COMMERCE 0-0-1991.

FOR: RESTAURANT SERVICES, IN CLASS 43
(U.S. CLS. 100 AND 101).

FIRST USE 0-0-1990; IN COMMERCE 0-0-1991.

SEC. 2(F).

SER. NO. 75-649,249, FILED 2-26-1999.

BRIAN BROWN, EXAMINING ATTORNEY

Int. Cl.: 38

Prior U.S. Cls.: 100, 101 and 104

United States Patent and Trademark Office

Reg. No. 2,892,140

Registered Oct. 12, 2004

SERVICE MARK
PRINCIPAL REGISTER



PACIFIC SPANISH NETWORK, INC. (CALIFORNIA CORPORATION)
296 H STREET
THIRD FLOOR
CHULA VISTA, CA 91910

FIRST USE 3-23-1998; IN COMMERCE 3-23-1998.

SER. NO. 75-671,428, FILED 3-29-1999.

FOR: RADIO BROADCASTING SERVICES, IN CLASS 38 (U.S. CLS. 100, 101 AND 104).

ALICE SUE CARRUTHERS, EXAMINING ATTORNEY

Int. Cl.: 43

Prior U.S. Cls.: 100 and 101

United States Patent and Trademark Office

Reg. No. 2,892,141

Registered Oct. 12, 2004

**SERVICE MARK
PRINCIPAL REGISTER**

MAYA

TONALI INCORPORATED (DELAWARE COR-
PORATION)
1191 FIRST STREET
NEW YORK, NY 10021

FIRST USE 5-8-1997; IN COMMERCE 5-8-1997.

SER. NO. 75-692,207, FILED 4-26-1999.

FOR: RESTAURANT SERVICES, IN CLASS 43
(U.S. CLS. 100 AND 101).

SAMUEL E. SHARPER JR., EXAMINING ATTOR-
NEY

Int. Cl.: 41

Prior U.S. Cls.: 100, 101 and 107

Reg. No. 2,892,142

United States Patent and Trademark Office

Registered Oct. 12, 2004

**SERVICE MARK
PRINCIPAL REGISTER**

KING OF THE HILL

MCDONALD, BONNIE (UNITED STATES INDIVIDUAL)
2739 INGRA STREET
ANCHORAGE, AK 99508 AND
PERATA, NICHOLAS JOSEPH (UNITED STATES INDIVIDUAL)
2739 INGRA STREET
ANCHORAGE, AK 99508

TREME SNOWBOARDING AND/OR SKIING, IN CLASS 41 (U.S. CLS. 100, 101 AND 107).

FIRST USE 5-15-1993; IN COMMERCE 5-15-1993.

SER. NO. 75-713,982, FILED 5-26-1999.

FOR: ENTERTAINMENT SERVICES, NAMELY, WINTER SPORTS COMPETITIONS, NAMELY, EX-

GIANCARLO CASTRO, EXAMINING ATTORNEY

Int. Cls.: 29 and 30

Prior U.S. Cl.: 46

United States Patent and Trademark Office

Reg. No. 2,892,143

Registered Oct. 12, 2004

**TRADEMARK
PRINCIPAL REGISTER**

COUNTRY KETTLE

INTERNATIONAL MARKET BRANDS, INC.
(PENNSYLVANIA CORPORATION)
1717 E 12TH STREET
P.O. BOX 797
ERIE, PA 16512

FOR: FROZEN SOUPS, CANNED SOUPS, AND
FROZEN ENTREES CONSISTING PRIMARILY OF
MEAT, CHICKEN, FISH OR VEGETABLES SOLD
TO INSTITUTIONAL BUYERS , IN CLASS 29 (U.S.
CL. 46).

FIRST USE 0-0-1992; IN COMMERCE 0-0-1992.

FOR: FROZEN ENTREES CONSISTING PRIMARILY
OF PASTA OR RICE SOLD TO INSTITUTIONAL
BUYERS, IN CLASS 30 (U.S. CL. 46).

FIRST USE 0-0-1992; IN COMMERCE 0-0-1992.

SER. NO. 75-716,333, FILED 5-20-1999.

LINDA M. KING, EXAMINING ATTORNEY

Int. Cls.: 9, 16, 35, 36, 37, 41 and 42

**Prior U.S. Cls.: 2, 5, 21, 22, 23, 26, 29, 36, 37, 38, 50,
100, 101, 102, 103, 106 and 107**

Reg. No. 2,892,144

United States Patent and Trademark Office

Registered Oct. 12, 2004

**TRADEMARK
SERVICE MARK
PRINCIPAL REGISTER**

HVB PROJEKT

BAYERISCHE HYPO-UND VEREINSBANK AG
(FED REP GERMANY CORPORATION)
AM TUCKERPARK 16
D-80538 MUNICH, FED REP GERMANY

FOR: ELECTRONIC INFORMATION SYSTEMS COMPRISING DATA INPUT EQUIPMENT, NAMELY, KEYBOARDS, OPTICAL SCANNERS, CAMERAS, MICROPHONES, BAR CODE READERS, POINTING DEVICES AND JOYSTICKS; DATA OUTPUT EQUIPMENT, NAMELY, PRINTERS, MONITORS AND SPEAKERS; DATA COMMUNICATIONS EQUIPMENT, NAMELY, MODEMS, ROUTERS, CABLES AND CONNECTORS; AND DATA MEMORY EQUIPMENT, NAMELY, HARD DRIVES, STATIC RAMS, DYNAMIC RAMS, MAGNETIC DISKS, FLOPPY DISKS, MAGNETIC TAPES AND OPTICAL DISKS; COMPUTER PROGRAMS RECORDED ON MAGNETIC DISKS, FLOPPY DISKS, MAGNETIC TAPES, OPTICAL DISKS, ELECTRONIC MEMORY DEVICES, PERFORATED TAPES AND SIMILAR DATA CARRIERS, NAMELY, COMPUTER PROGRAMS FOR USE IN NEGOTIATION AND SETTLEMENT OF COMMERCIAL TRANSACTIONS, MORTGAGE LENDING, MORTGAGE BROKERAGE, FINANCING, COMMERCIAL LENDING, REAL ESTATE DEVELOPMENT, MANAGEMENT OF CONSTRUCTION AND ENGINEERING PROJECTS, PERSONNEL MANAGEMENT CONSULTING AND BUSINESS CONSULTING IN THE FIELDS OF MARKETING STRATEGY AND BUSINESS STRATEGY, IN CLASS 9 (U.S. CLS. 21, 23, 26, 36 AND 38).

FOR: PAPER, CARDBOARD AND GOODS FROM THESE MATERIALS, NAMELY, ACCOUNT BOOKS, ACCOUNTING FORMS, ARCHITECTURAL PLANS AND SPECIFICATIONS, BOOKKEEPING FORMS, BUSINESS RECORD BOOKS, DATA BOOKS AND BUSINESS FORMS; PRINTED MATTER AND PUBLICATIONS, NAMELY, BOOKS CONTAINING IN-

STRUCTIONS ON REAL ESTATE DEVELOPMENT, REAL ESTATE FINANCE, INSURANCE, BUSINESS CONSULTING, MANAGEMENT OF CONSTRUCTION AND ENGINEERING PROJECTS, FINANCE, FINANCIAL TRANSACTIONS, COMMERCIAL TRANSACTIONS, MORTGAGE LENDING AND COMMERCIAL LENDING; PAMPHLETS AND BROCHURES CONTAINING INFORMATION ON REAL ESTATE DEVELOPMENT, REAL ESTATE FINANCE, INSURANCE, BUSINESS CONSULTING, MANAGEMENT OF CONSTRUCTION AND ENGINEERING PROJECTS, FINANCE, FINANCIAL TRANSACTIONS, COMMERCIAL TRANSACTIONS, MORTGAGE LENDING AND COMMERCIAL LENDING, IN CLASS 16 (U.S. CLS. 2, 5, 22, 23, 29, 37, 38 AND 50).

FOR: PERSONNEL MANAGEMENT CONSULTING, BUSINESS CONSULTING IN THE FIELD OF MARKETING STRATEGY AND BUSINESS STRATEGY; MANAGEMENT CONSULTING IN THE FIELD OF ADMINISTRATION OF CONSTRUCTION AND ENGINEERING PROJECTS, REAL ESTATE DEVELOPMENT, COMMERCIAL TRANSACTIONS AND FINANCIAL OF BUSINESS ACTIVITIES; BUSINESS MARKETING CONSULTING SERVICES FOR OWNERS OF BUILDINGS UNDER CONSTRUCTION; LAND ACQUISITION, NAMELY, BROKERAGE OF BUILDINGS, REAL ESTATE, PROJECTS AND PROPERTY; PROVIDING NEGOTIATION AND SETTLEMENT SERVICES OF COMMERCIAL TRANSACTIONS FOR THIRD PARTIES THROUGH COMMERCIAL AGENTS AND COMMERCIAL BROKERS; MANAGEMENT OF BUSINESS; BUSINESS RESEARCH; MARKETING RESEARCH AND MARKET ANALYSIS; ADVERTISING AGENCIES; PROMOTING THE SALE OF MATERIAL AND PRODUCT SAMPLES; ECONOMIC ANALYSIS OF REAL ESTATE HOLDINGS; MANAGERIAL ADVISORY SERVICES REGARDING COST ESTIMATING; CONDUCTING BUSINESS

AND MARKET RESEARCH SURVEYS, IN CLASS 35 (U.S. CLS. 100, 101 AND 102).

FOR: MORTGAGE LENDING SERVICES; MORTGAGE BROKERAGE SERVICES; FINANCING SERVICES; LOAN FINANCING; COMMERCIAL LENDING SERVICES; AUTOMATED SECURITIES BROKERAGE; MORTGAGING OF SECURITIES FOR OTHERS; FINANCIAL INVESTMENT IN THE FIELD OF SECURITIES; FINANCIAL PORTFOLIO MANAGEMENT; FINANCIAL GUARANTEE AND SURETY; COMMODITY TRADING FOR OTHERS; CAPITAL INVESTMENT CONSULTATION; CURRENCY EXCHANGE AND ADVICE; LEASING OF OFFICE SPACE, REAL ESTATE AND REAL PROPERTY; ESTATE TRUST MANAGEMENT; BROKERAGE HOUSES IN THE FIELD OF STOCKS, COMMODITIES, AND FUTURES; TRADING IN MORTGAGE DEBENTURES, PUBLIC MORTGAGE BONDS, MUNICIPAL BONDS AND OTHER DEBENTURES FOR OTHERS; SALES CREDIT FINANCING AND CREDIT RISK INSURANCE FACTORING; CREDIT AGENCIES AND CREDIT CONSULTATION, NAMELY, GRANTING OF CREDIT AND CREDIT BROKERAGE, GRANTING OF MORTGAGE LOANS, MUNICIPAL LOANS AND OF MONEY LOANS, GRANTING OF ACCEPTANCE CREDITS, NEGOTIATION AND GRANTING OF ADVANCE LOANS ON THE STRENGTH OF AN ACCOUNT WITH A HOME SAVINGS INSTITUTION, AND INTERIM FINANCING OF CREDIT FROM HOME SAVINGS INSTITUTIONS; LIFE INSURANCE UNDERWRITING; SURETY SERVICES; CREDIT CARD SERVICES, NAMELY, ISSUING AND MANAGEMENT OF CREDIT CARDS AND ADMINISTRATION OF CREDIT CARD ACCOUNTS; BANKING SERVICES, NAMELY, ACCEPTANCE OF HOME SAVINGS DEPOSITS, ADMINISTRATION OF CHECKING ACCOUNTS AND SAVINGS ACCOUNTS, MONEY TRANSFERS, CONDUCTING OF MONEY TRANSFER TRANSACTIONS WITH CASH PAYMENT BY MEANS OF CURRENCY EXCHANGE MACHINES, ISSUING TRAVELER'S CHECKS, TELEPHONE BANKING SERVICE FOR THE TRANSMISSION OF PAYMENT ORDERS, TRANSFERS AND DEBIT ENTRIES BETWEEN THE CUSTOMER AND THE BANK; ELECTRONIC BANKING IN THE FORM OF THE OFFERING AND PERFORMING OF SERVICES AND CREDIT CARD SERVICES BY MEANS OF ELECTRONIC DATA EXCHANGE FOR PRIVATE AND COMMERCIAL CUSTOMERS; PROVIDING COMPUTER-AIDED FINANCIAL PLANNING; FINANCIAL RESEARCH; DEFERRED FREIGHT PAYMENT SERVICES; CONSULTING SERVICES IN THE FIELDS OF REAL ESTATE MANAGEMENT, REAL ESTATE DEVELOPMENT, REAL ESTATE INVESTMENT, AND REAL ESTATE APPRAISAL; INSURANCE ADMINISTRATION IN THE FIELD OF FINANCIAL RISK IN CONNECTION WITH THE CONCLUSION OF LOAN TRANSACTIONS; RENTAL AND BROKERAGE OF OFFICE SPACE AND FACILITIES FOR CONFERENCES, EXHIBITIONS, AND LECTURES FINANCIAL INFORMATION INVESTIGATION SERVICES, NAMELY, PROVIDING FINANCIAL INFORMATION OF OTHERS FOR THE INITIATION, CONCLUSION,

AND CONDUCTING OF LENDING TRANSACTIONS; PROVIDING FINANCIAL ANALYSIS REGARDING VALUE OF COLLATERAL AND LIMIT OF CREDIT; COLLECTION, ANALYSIS AND SUPPLY OF FINANCIAL INFORMATION REGARDING THE CAPITAL MARKETS AND REGARDING BUSINESS PROSPECTS, IN CLASS 36 (U.S. CLS. 100, 101 AND 102).

FOR: CONSTRUCTION SERVICES, NAMELY, PLANNING, LAYING OUT AND CUSTOM CONSTRUCTION OF RESIDENTIAL AND COMMERCIAL COMMUNITIES; REAL ESTATE DEVELOPMENT SERVICES, NAMELY, DEVELOPING, PLANNING, PREPARATION, IMPLEMENTATION, AND PARTICIPATION OF MUNICIPAL ZONING, APPROVAL, AND AUTHORIZATION PROCEEDINGS OF THIRD-PARTY CONSTRUCTION PROJECTS, HOUSING PROJECTS, AND COMMERCIAL PROJECTS; REAL ESTATE SITE SELECTION; LAND DEVELOPMENT SERVICES, NAMELY, PLANNING AND LAYING OUT OF RESIDENTIAL AND COMMERCIAL COMMUNITIES BY CUTTING DOWN TREES, CLEARING THE LAND AND PREPARING THE LAND FOR CONNECTION OF UTILITIES; CLEARING OF PUBLIC AND PRIVATE STREETS, ROADS AND PLAZAS FROM SNOW, AND SPREADING OF SALT ON PUBLIC AND PRIVATE STREETS, ROADS, AND PLAZAS; INSTALLATION, REPAIR AND MAINTENANCE OF HEATING EQUIPMENT, AIR CONDITIONING EQUIPMENT, ELEVATORS, SANITARY APPLIANCES, INTERCOMS, AND ELECTRICAL SYSTEMS; CLEANING OF INTERIORS AND EXTERIORS OF RESIDENTIAL AND COMMERCIAL BUILDINGS, IN CLASS 37 (U.S. CLS. 100, 103 AND 106).

FOR: EDUCATIONAL SERVICES, NAMELY, PROVIDING COURSES OF INSTRUCTION AND SEMINARS IN THE FIELDS OF REAL ESTATE AND FINANCE, CONSTRUCTION SAFETY, AND PROTECTION OF REAL ESTATE; ARRANGING, CONDUCTING AND ORGANIZING TRADE SHOW EXHIBITIONS IN THE FIELDS OF REAL ESTATE AND FINANCE FOR CULTURAL, EDUCATIONAL, ECONOMIC, MARKETING AND CUSTOMER SERVICE PURPOSES; PUBLICATION OF REAL ESTATE MARKET SURVEYS, IN CLASS 41 (U.S. CLS. 100, 101 AND 107).

FOR: WRITTEN TEXT EDITING SERVICES, NAMELY, EDITING OF REAL ESTATE MARKET SURVEYS; COMPUTER PROGRAMMING FOR OTHERS; ARCHITECTURAL DESIGN SERVICES; LAND SURVEYING, NAMELY, COMPILING LOCATION CONCEPTS FOR REAL ESTATE PROJECTS; ENGINEERING; TECHNICAL CONSULTING IN THE FIELD OF ENGINEERING; LANDSCAPE GARDENING AND LANDSCAPE GARDENING DESIGN FOR OTHERS ARBITRATION, IN CLASS 42 (U.S. CLS. 100 AND 101).

PRIORITY CLAIMED UNDER SEC. 44(D) ON FED REP GERMANY APPLICATION NO. 39870169.5, FILED 12-4-1998, REG. NO. 39870169, DATED 5-19-1999, EXPIRES 12-31-2008.

NO CLAIM IS MADE TO THE EXCLUSIVE
RIGHT TO USE "PROJEKT", APART FROM THE
MARK AS SHOWN.

SER. NO. 75-722,052, FILED 6-4-1999.

THE WORD "PROJEKT" IS TRANSLATED IN
ENGLISH AS "PROJECT".

IRENE D. WILLIAMS, EXAMINING ATTORNEY

Int. Cl.: 42

Prior U.S. Cls.: 100 and 101

United States Patent and Trademark Office

Reg. No. 2,892,145

Registered Oct. 12, 2004

**SERVICE MARK
PRINCIPAL REGISTER**

ELISTEN

SCANTRON CORPORATION (DELAWARE CORPORATION)
34 PARKER
IRVINE, CA 92618

CUSTOMIZED SURVEYS , IN CLASS 42 (U.S. CLS. 100 AND 101).

FIRST USE 10-12-1998; IN COMMERCE 3-8-1999.

FOR: COMPUTER SERVICES, NAMELY, ELECTRONIC DEVELOPMENT OF CUSTOMIZED SURVEYS TO THE SPECIFICATIONS OF OTHERS; AND HOSTING WEBSITES OF OTHERS FEATURING

SER. NO. 75-723,610, FILED 6-7-1999.

CAROLINE WEIMER, EXAMINING ATTORNEY

Int. Cl.: 41

Prior U.S. Cls.: 100, 101 and 107

United States Patent and Trademark Office

Reg. No. 2,892,146

Registered Oct. 12, 2004

**SERVICE MARK
PRINCIPAL REGISTER**

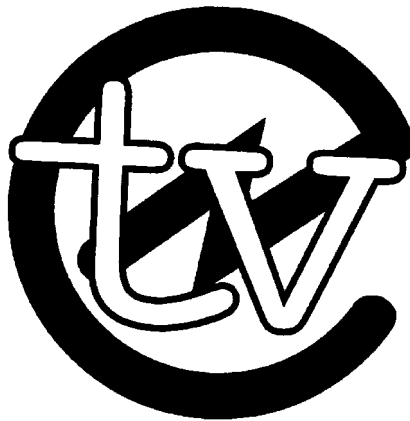

A.G. EDWARDS & SONS, INC. (DELAWARE CORPORATION)
ONE NORTH JEFFERSON
ST. LOUIS, MO 63103

NO CLAIM IS MADE TO THE EXCLUSIVE RIGHT TO USE "TV", APART FROM THE MARK AS SHOWN.

FOR: ENTERTAINMENT SERVICES, NAMELY PROVIDING TELEVISION PROGRAMS IN THE FINANCIAL, INVESTMENT AND SECURITIES FIELD, IN CLASS 41 (U.S. CLS. 100, 101 AND 107).

SER. NO. 75-731,610, FILED 6-18-1999.

FIRST USE 1-0-1999; IN COMMERCE 1-0-1999.

MICHELE SWAIN, EXAMINING ATTORNEY

Int. Cl.: 16

Prior U.S. Cls.: 2, 5, 22, 23, 29, 37, 38 and 50

United States Patent and Trademark Office

Reg. No. 2,892,147

Registered Oct. 12, 2004

**TRADEMARK
PRINCIPAL REGISTER**

Q

EMAP CONSUMER MEDIA LIMITED (UNITED
KINGDOM CORPORATION)
1 LINCOLN COURT
LINCOLN ROAD
PETERBOROUGH, UNITED KINGDOM PE1 2RF

FOR: MAGAZINES, BOOKS, NEWSPAPERS,
PRINTED BOOKLETS AND GUIDE BOOKS CON-
TAINING INFORMATION ABOUT MUSIC, THE
MUSIC INDUSTRY, MUSICIANS AND MUSIC PER-

SONALITIES THROUGHOUT THE WORLD, IN
CLASS 16 (U.S. CLS. 2, 5, 22, 23, 29, 37, 38 AND 50).

OWNER OF UNITED KINGDOM REG. NO.
2047706, DATED 12-19-1997, EXPIRES 12-6-2005.

SER. NO. 75-743,896, FILED 7-6-1999.

HENRY S. ZAK, EXAMINING ATTORNEY

Int. Cl.: 25

Prior U.S. Cls.: 22 and 39

United States Patent and Trademark Office

Reg. No. 2,892,148

Registered Oct. 12, 2004

**TRADEMARK
PRINCIPAL REGISTER**

COLUMBINE

COLUMBINE HOSIERY LIMITED (NEW ZEAL-
AND COMPANY)
164- 166 DISRAELI STREET
GISBORNE, NEW ZEALAND

FOR: STOCKINGS, SOCKS, HOSIERY, IN CLASS
25 (U.S. CLS. 22 AND 39).

OWNER OF NEW ZEALAND REG. NO. 52910,
DATED 1-14-1953, RENEWED AS REG. NO. 52910,
DATED 1-31-2001, EXPIRES 1-14-2016.

SER. NO. 75-749,428, FILED 7-13-1999.

MICHAEL ENGEL, EXAMINING ATTORNEY

Int. Cl.: 9

Prior U.S. Cls.: 21, 23, 26, 36 and 38

United States Patent and Trademark Office

Reg. No. 2,892,149

Registered Oct. 12, 2004

**TRADEMARK
PRINCIPAL REGISTER**

INCOGNITA

AUDIO PRODUCTS INTERNATIONAL CORP.
(CANADA CORPORATION)
3641 MCNICOLL AVENUE
SCARBOROUGH, ONTARIO MLX LG5, CANADA

FOR: SOUND EQUIPMENT NAMELY LOUD
SPEAKERS, IN CLASS 9 (U.S. CLS. 21, 23, 26, 36
AND 38).

PRIORITY CLAIMED UNDER SEC. 44(D) ON
CANADA APPLICATION NO. 1021715, FILED 7-9-

1999, REG. NO. TMA586,390, DATED 8-1-2003, EX-
PIRES 8-1-2018.

THE ENGLISH TRANSLATION OF THE MARK IS
"UNKNOWN QUANTITY".

SER. NO. 75-761,897, FILED 7-27-1999.

ESTHER A. BORSUK, EXAMINING ATTORNEY

Int. Cl.: 35

Prior U.S. Cls.: 100, 101 and 102

United States Patent and Trademark Office

Reg. No. 2,892,150

Registered Oct. 12, 2004

SERVICE MARK
PRINCIPAL REGISTER



WALNUT CREEK FOODS INC. (OHIO CORPORATION)
2617 STATE ROUTE 39
WALNUT CREEK, OH 44687

FOR: WHOLESALE DISTRIBUTORSHIPS FEATURING BEEF JERKY AND SMOKED MEATS, NAMELY BEEF AND BACON, IN CLASS 35 (U.S. CLS. 100, 101 AND 102).

FIRST USE 4-15-1999; IN COMMERCE 4-15-1999.

NO CLAIM IS MADE TO THE EXCLUSIVE RIGHT TO USE "THE ORIGINAL" AND "COUNTRY CURED BEEF JERKY", APART FROM THE MARK AS SHOWN.

"UNCLE MIKE'S" SHOWN IN THE MARK DOES NOT REFER TO THE NAME OF ANY INDIVIDUAL.

SER. NO. 75-778,407, FILED 8-19-1999.

MICHAEL SOUDERS, EXAMINING ATTORNEY

Int. Cls.: 7, 9, 10, 11, 12, 15, 16, 20 and 28

Prior U.S. Cls.: 2, 5, 13, 19, 21, 22, 23, 25, 26, 29, 31, 32, 34, 35, 36, 37, 38, 39, 44 and 50

Reg. No. 2,892,151

United States Patent and Trademark Office

Registered Oct. 12, 2004

**TRADEMARK
PRINCIPAL REGISTER**

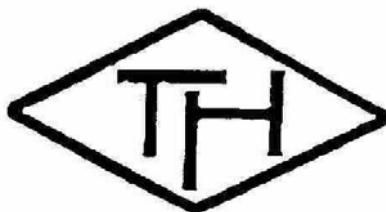

TH-HOLDING AG (SWITZERLAND CORPORATION)
HAUPTSTRASSE 35
CH-4437 WALDENBURG, SWITZERLAND

FOR: PRECISION TURNED METALLIC AND NON-METALLIC PIECES AND HIGH PRECISION UNASSEMBLED PARTS AND SYSTEMS MADE TO ORDER, NAMELY, AXLES, SHAFTS, ROLLERS, TUBES AND PINS FOR USE WITH TEXTILE MACHINES; ROLLER BEARING PARTS, NAMELY, ROLLERS AND NEEDLES, IN CLASS 7 (U.S. CLS. 13, 19, 21, 23, 31, 34 AND 35).

FOR: PRECISION TURNED METALLIC AND NON-METALLIC PIECES AND HIGH PRECISION UNASSEMBLED PARTS AND SYSTEMS MADE TO ORDER, AXLES, SHAFTS, ROLLERS, TUBES AND PINS FOR USE WITH ELECTRONIC OFFICE EQUIPMENT SUCH AS COMPUTERS, SCALES AND ELECTRICAL INSTALLATION MATERIAL, NAMELY, ELECTRICAL SWITCHES; ELECTRO-TECHNICAL MATERIAL AND ASSEMBLIES COMPOSED THEREOF, NAMELY, PUSHBUTTON SWITCHES, KEY OPERATED SWITCHES AND INDICATORS, MUSHROOM STYLE SWITCHES, EMERGENCY STOP SWITCHES, ROTARY SWITCHES, RUBBER KEYPADS, BUZZERS, VANDAL RESISTANT SWITCHES, KEYPADS AND KEYBOARDS, IN CLASS 9 (U.S. CLS. 21, 23, 26, 36 AND 38).

FOR: PRECISION TURNED METALLIC AND NON-METALLIC PIECES AND HIGH PRECISION UNASSEMBLED PARTS AND SYSTEMS MADE TO ORDER, NAMELY, AXLES, SHAFTS, ROLLERS, TUBES AND PINS FOR USE WITH MEDICAL

INSTRUMENTS, IN CLASS 10 (U.S. CLS. 26, 39 AND 44).

FOR: PRECISION TURNED METALLIC AND NON-METALLIC PIECES AND HIGH PRECISION UNASSEMBLED PARTS AND SYSTEMS MADE TO ORDER, NAMELY, AXLES, SHAFTS, ROLLERS, TUBES AND PINS FOR USE WITH HOUSEHOLD APPLIANCES, IN CLASS 11 (U.S. CLS. 13, 21, 23, 31 AND 34).

FOR: PRECISION TURNED METALLIC AND NON-METALLIC PIECES AND HIGH PRECISION UNASSEMBLED PARTS AND SYSTEMS MADE TO ORDER, NAMELY, AXLES, SHAFTS, ROLLERS, TUBES AND PINS FOR USE WITH MOTORED VEHICLES AND AIRPLANES, IN CLASS 12 (U.S. CLS. 19, 21, 23, 31, 35 AND 44).

FOR: PRECISION TURNED METALLIC AND NON-METALLIC PIECES AND HIGH PRECISION UNASSEMBLED PARTS AND SYSTEMS MADE TO ORDER, NAMELY, SHAFTS, TUBES AND PINS FOR USE WITH ELECTRICAL AND MECHANICAL MUSICAL INSTRUMENTS, IN CLASS 15 (U.S. CLS. 2, 21 AND 36).

FOR: PRECISION TURNED METALLIC AND NON-METALLIC PIECES AND HIGH PRECISION UNASSEMBLED PARTS AND SYSTEMS MADE TO ORDER, NAMELY, SHAFTS, AND PINS FOR USE WITH STRUCTURAL OFFICE EQUIPMENT SUCH AS DOCUMENT FILE RACKS AND LETTER TRAYS, IN CLASS 16 (U.S. CLS. 2, 5, 22, 23, 29, 37, 38 AND 50).

FOR: PRECISION TURNED METALLIC AND NON-METALLIC PIECES AND HIGH PRECISION UNASSEMBLED PARTS AND SYSTEMS MADE TO ORDER, NAMELY, AXLES, SHAFTS, ROLLERS, TUBES AND PINS FOR USE WITH OFFICE EQUIPMENT, NAMELY, OFFICE FURNITURE, IN CLASS 20 (U.S. CLS. 2, 13, 22, 25, 32 AND 50).

FOR: PRECISION TURNED METALLIC AND NON-METALLIC PIECES AND HIGH PRECISION UNASSEMBLED PARTS AND SYSTEMS MADE TO

ORDER, NAMELY, AXLES, SHAFTS, ROLLERS, TUBES AND PINS FOR USE WITH FISHING EQUIPMENT, IN CLASS 28 (U.S. CLS. 22, 23, 38 AND 50).

OWNER OF SWITZERLAND REG. NO. 356643, DATED 7-20-1987, EXPIRES 7-20-2007.

SER. NO. 75-789,536, FILED 9-1-1999.

WILLIAM BRECKENFELD, EXAMINING ATTORNEY

Int. Cls.: 16, 20, 21 and 25

Prior U.S. Cls.: 2, 5, 13, 22, 23, 25, 29, 30, 32, 33, 37,
38, 39, 40 and 50

Reg. No. 2,892,152

United States Patent and Trademark Office

Registered Oct. 12, 2004

TRADEMARK
PRINCIPAL REGISTER



ASSOCIATION OF CERTIFIED FRAUD SPECIALISTS, INC. (CALIFORNIA CORPORATION)
8124 ARDENNESS DRIVE
SACRAMENTO, CA 95829

FOR: PRINTED CERTIFICATES AND AWARDS; BINDERS; FOLDERS; BUSINESS CARDS; PRINTED CORPORATE DOCUMENTS, NAMELY, PRINTED FORMS, STATIONERY, ENVELOPES, MAILING LABELS; PRINTED PUBLICATIONS, NAMELY, NEWSLETTERS, LEAFLETS, POSTCARDS, MAGAZINES, CATALOGS IN THE FIELD OF FRAUD INVESTIGATION; BOOKS, NAMELY, ADDRESS BOOKS, APPOINTMENT BOOKS, BUSINESS RECORDS, NOTE BOOKS, NOTE PADS, LEDGER BOOKS; PRINTED INSTRUCTIONAL, EDUCATIONAL AND TEACHING MATERIALS NAMELY IN THE FRAUD INVESTIGATION FIELD FOR THE CONTINUING EDUCATION COURSES FOR ACCOUNTANTS, LAWYERS, LAW ENFORCEMENT, PRIVATE INVESTIGATORS, AND THE GENERAL PUBLIC, IN CLASS 16 (U.S. CLS. 2, 5, 22, 23, 29, 37, 38 AND 50).

FIRST USE 3-21-1999; IN COMMERCE 1-1-1999.

FOR: ACRYLIC AWARDS, WOOD PODIUMS, PLASTIC BANNERS, IN CLASS 20 (U.S. CLS. 2, 13, 22, 25, 32 AND 50).

FIRST USE 3-21-1999; IN COMMERCE 1-1-1999.

FOR: HOUSEHOLD KITCHENWARE, NAMELY COFFEE MUGS AND GLASSWARE FOR DRINKING, IN CLASS 21 (U.S. CLS. 2, 13, 23, 29, 30, 33, 40 AND 50).

FIRST USE 3-21-1999; IN COMMERCE 1-1-1999.

FOR: CLOTHING, NAMELY SHIRTS, JACKETS, HATS, IN CLASS 25 (U.S. CLS. 22 AND 39).

FIRST USE 3-21-1999; IN COMMERCE 1-0-1999.

NO CLAIM IS MADE TO THE EXCLUSIVE RIGHT TO USE "EST MCMXCIX", APART FROM THE MARK AS SHOWN.

SEC. 2(F).

SER. NO. 75-793,617, FILED 9-7-1999.

ROBIN CHOSID, EXAMINING ATTORNEY

Int. Cls.: 3, 6, 9, 14, 18, 24, 25 and 28

Prior U.S. Cls.: 1, 2, 3, 4, 6, 12, 13, 14, 21, 22, 23, 25, 26, 27, 28, 36, 38, 39, 41, 42, 50, 51 and 52

Reg. No. 2,892,153

United States Patent and Trademark Office

Registered Oct. 12, 2004

**TRADEMARK
PRINCIPAL REGISTER**

KOMPRESSOR

DAIMLERCHRYSLER AG (FED REP GERMANY CORPORATION)
EPPELSTRASSE 225
70567 STUTTGART, FED REP GERMANY

FOR: PREPARATIONS FOR BODY AND BEAUTY CARE, NAMELY, TOILET WATER, AFTER SHAVE LOTION AND SHAVING CREAM, HAIR LOTIONS, PERFUMES, ESSENTIAL OILS FOR PERSONAL USE, TOILET SOAPS, TOOTHPASTE, NAIL VARNISH, NAIL CARE PREPARATIONS, LIPSTICKS, EYEBROW PENCILS, MASCARA, IN CLASS 3 (U.S. CLS. 1, 4, 6, 50, 51 AND 52).

FOR: METAL KEY FOBS, IN CLASS 6 (U.S. CLS. 2, 12, 13, 14, 23, 25 AND 50).

FOR: BLANK AUDIO AND VIDEO CASSETTES, PRERECORDED AUDIO AND VIDEO CASSETTES AND COMPACT DISCS FEATURING AUTOMOTIVE TOPICS, MUSIC, AND RELATED MATTERS OF INTEREST TO OWNERS OF APPLICANT'S AUTOMOBILES, NAMELY, AUTOMOBILE SERVICING, MAINTENANCE, REPAIR, TOWING, TRANSPORTATION, LEASING, RENTING AND TRAVELLING; SPECTACLES, SPECTACLE FRAMES, SPECTACLE CASES AND DIRECTIONAL COMPASSES, IN CLASS 9 (U.S. CLS. 21, 23, 26, 36 AND 38).

FOR: WATCHES AND WATCH ATTACHMENTS, NAMELY, WATCH FOBS AND WATCH CHAINS, IN CLASS 14 (U.S. CLS. 2, 27, 28 AND 50).

FOR: HANDBAGS, BRIEFCASES, SHOPPING BAGS OF LEATHER, BACK PACKS, LARGE AND SMALL SUITCASES, UMBRELLAS AND PARASOLS, WALLETS AND PURSES, IN CLASS 18 (U.S. CLS. 1, 2, 3, 22 AND 41).

FOR: LAP ROBES, IN CLASS 24 (U.S. CLS. 42 AND 50).

FOR: WEARING APPAREL, NAMELY, T-SHIRTS, SWEATSHIRTS, TIES, GLOVES, ANORAKS, PONCHOS, JACKETS, VESTS, SWEATERS, SPORT SHIRTS, SCARVES, BELTS, FOOTWEAR AND HEADWEAR, NAMELY, HATS AND CAPS, IN CLASS 25 (U.S. CLS. 22 AND 39).

FOR: BOARD GAMES, AND OTHER GAME AND TOYS, NAMELY, TOY AUTOMOBILES, JIGSAW PUZZLES, DOMINOES, YO-YOS, AND BADMINTON SETS, IN CLASS 28 (U.S. CLS. 22, 23, 38 AND 50).

PRIORITY CLAIMED UNDER SEC. 44(D) ON FED REP GERMANY APPLICATION NO. 39917352.82, FILED 3-24-1999, REG. NO. 39917352, DATED 2-28-2000, EXPIRES 2-28-2010.

SER. NO. 75-794,471, FILED 9-8-1999.

TRACY FLETCHER, EXAMINING ATTORNEY

Int. Cl.: 5

Prior U.S. Cls.: 6, 18, 44, 46, 51 and 52

United States Patent and Trademark Office

Reg. No. 2,892,154

Registered Oct. 12, 2004

**TRADEMARK
PRINCIPAL REGISTER**

RESIDERM

STRAKAN GROUP LIMITED (SCOTLAND COMPANY)
BUCKHOLM MILL, BUCKHOLM MILL BREA
GALASHIELS TD1 2HB, SCOTLAND

FOR: PHARMACEUTICAL PREPARATIONS FOR
THE TREATMENT OF SKIN DISEASES, IN CLASS 5
(U.S. CLS. 6, 18, 44, 46, 51 AND 52).

OWNER OF UNITED KINGDOM REG. NO.
2129028, DATED 4-8-1997, EXPIRES 4-8-2007.

SER. NO. 75-796,469, FILED 9-8-1999.

DORITT L. CARROLL, EXAMINING ATTORNEY

Int. Cls.: 14, 16, 25 and 28

Prior U.S. Cls.: 2, 5, 22, 23, 27, 28, 29, 37, 38, 39 and 50

United States Patent and Trademark Office

Reg. No. 2,892,155

Registered Oct. 12, 2004

**TRADEMARK
PRINCIPAL REGISTER**

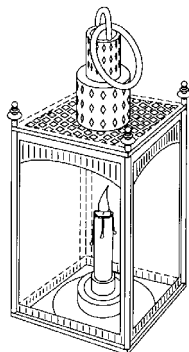

CHRIST CHURCH IN THE CITY OF BOSTON,
INC. (MASSACHUSETTS CORPORATION)
193 SALEM STREET
BOSTON, MA 02113

FOR: JEWELRY, NAMELY, PINS, CHARMS,
EARRINGS, NECKLACES, AND TIE TACKS, IN
CLASS 14 (U.S. CLS. 2, 27, 28 AND 50).

FIRST USE 6-15-1955; IN COMMERCE 6-15-1955.

FOR: POSTCARDS, COLORING BOOKS, AND
EDUCATIONAL AND REFERENCE BOOKS ON
THE SUBJECT OF THE OLD NORTH CHURCH
AND THE HISTORY OF BOSTON, IN CLASS 16 (U.S.
CLS. 2, 5, 22, 23, 29, 37, 38 AND 50).

FIRST USE 6-15-1955; IN COMMERCE 6-15-1955.

FOR: CLOTHING, NAMELY, SHIRTS, HEAD-
WEAR, SOCKS, AND NECKTIES, IN CLASS 25
(U.S. CLS. 22 AND 39).

FIRST USE 6-15-1955; IN COMMERCE 6-15-1955.

FOR: TOYS, NAMELY JIGSAW PUZZLES, IN
CLASS 28 (U.S. CLS. 22, 23, 38 AND 50).

FIRST USE 6-15-1955; IN COMMERCE 6-15-1955.

THE LINING SHOWN IN THE DRAWING OF
THE ABOVE-REFERENCED APPLICATION IS NOT
INTENDED TO INDICATE COLOR.

SEC. 2(F).

SER. NO. 75-821,192, FILED 10-13-1999.

AMOS T. MATTHEWS, JR., EXAMINING ATTOR-
NEY

Int. Cls.: 7, 8, 9, 11 and 16

Prior U.S. Cls.: 2, 5, 13, 19, 21, 22, 23, 26, 28, 29, 31, 34, 35, 36, 37, 38, 44 and 50

Reg. No. 2,892,156

United States Patent and Trademark Office

Registered Oct. 12, 2004

**TRADEMARK
PRINCIPAL REGISTER**

**CONRAD
ELECTRONIC**

CONRAD ELECTRONIC GMBH (FED REP GERMANY JOINT STOCK COMPANY)
KLAUS - CONRAD - STRASSE 1
D-92240 HIRSCHAU, FED REP GERMANY

FOR: SMALL ELECTRIC MOTORS AND SMALL ELECTRICALLY DRIVEN PUMPS, MOTOR-OPERATED OR ELECTRICAL TOOLS, NAMELY MOTOR-OPERATED OR ELECTRICAL HAND TOOLS, NAMELY ELECTRIC DRILLS, ELECTRIC SCREWDRIVERS, ELECTRIC SAWS, BENCH SAWS, KEY-HOLE SAWS, TACKERS, GRINDING MACHINES, POLISHING MACHINES, ACCESSORIES FOR THE AFOREMENTIONED TOOLS, NAMELY SENSITIVE DRILL UPRIGHTS, DRILL CHUCKS, FLEXIBLE SHAFTS, POWER SUPPLY DEVICE FOR DRILLS, NAMELY MINIATURE DRILLS, BATTERY CHARGERS FOR BATTERY OPERATED TOOLS; FOG MAKING MACHINES FOR USE BY THEATER GROUPS, BY ENTERTAINERS, OR BY PARTY PLANNERS, IN CLASS 7 (U.S. CLS. 13, 19, 21, 23, 31, 34 AND 35).

FOR: HAND-OPERATED TOOLS, NAMELY, PINNERS, INCLUDING FLAT-NOSE PLIERS, NIPPERS, AND WIRE STRIPPERS, STRIPPING TOOLS, TWEEZERS, SIDE CUTTING PLIERS, SCREWDRIVERS, SOCKET SPANNERS, RING SPANNERS, FILES, KNIVES, SAW BOWS, DRILLS, CUTTING-OFF WHEELS, POLISHING INSERTS, KEYHOLE SAW ATTACHMENTS, COLLECT CHUCKS AND CLAMPS, IN CLASS 8 (U.S. CLS. 23, 28 AND 44).

FOR: ELECTRICAL AND ELECTRONIC EQUIPMENT, NAMELY, TELEVISIONS, RADIO SETS, TUNERS, ELECTRIC AMPLIFIERS, MIXING AMPLIFIERS, ECHO DEVICES, MIXING CONSOLES, EQUALIZERS, RECORD PLAYERS, RECORD CHANGERS, AUDIO AND/OR VIDEO CD PLAYERS; SOUND RECORDING AND REPRODUCTION EQUIPMENT, NAMELY, CASSETTE RECORDERS,

TAPE RECORDERS, MICROPHONES, HEADPHONES, LOUDSPEAKER BOXES, LOUDSPEAKER CHASSIS, LOUDSPEAKERS; VIDEO EQUIPMENT, NAMELY, VIDEO RECORDERS, VIDEO TEXT EQUIPMENT, NAMELY, LASERS AND LASER EQUIPMENT FOR LIGHTING EFFECTS; LIGHT SOURCE EQUIPMENT, NAMELY, OPTICAL SCANNERS FOR LIGHT EFFECTS; ELECTRONIC CONTROL EQUIPMENT AND CONTROLLERS FOR CONTROLLING EQUIPMENT AND LIGHT SOURCES, NAMELY, HAND-HELD, MOBILE, STATION-BASED CB RADIOS, AMATEUR RADIO TRANSMITTERS AND RECEIVERS, SERVICE RADIO TRANSMITTERS AND RECEIVERS, RADIO AMPLIFIERS; ELECTRICAL, ELECTRONIC AND OPTO-ELECTRONIC COMPONENTS, NAMELY, RESISTORS, POTENTIOMETERS, ADJUSTING AND SLIDING ATTENUATORS, CAPACITORS, VARIABLE CAPACITORS, DIMMERS, COILS AND COILS FORMERS FOR ELECTRICAL AND ELECTRONIC CIRCUITS, FERRITE AND IRON CORES, DIODES, TRANSISTORS, THYRISTORS AND TRIACS, INTEGRATED CIRCUITS AND SWITCHING CIRCUITS, TEMPERATURE AND LIGHT-DEPENDENT RESISTORS, PHOTO DIODE AND LIGHT-EMITTING DIODES, PHOTO TRANSISTORS, RECTIFIERS, HEAT SINKS FOR ELECTRICAL, ELECTRONIC AND OPTO-ELECTRONIC COMPONENTS, SWITCHES, PUSH-BUTTONS, RELAYS, TRANSFORMERS, FUSES, MOUNTS AND HOLDERS FOR ELECTRICAL AND ELECTRONIC OR OPTO-ELECTRONIC COMPONENTS, PLUGS, JACKS, AND PLUG AND SOCKET CONNECTIONS FOR ELECTRICAL AND ELECTRONIC CIRCUITS AND DEVICES; ELECTRICAL AND ELECTRONIC COMPONENTS FOR SOLAR TECHNOLOGY AND COMPONENTS FOR LASER TECHNOLOGY, NAMELY, ELECTRONICS FOR MODEL-MAKING, NAMELY, TRANSMITTERS AND RECEIVERS FOR REMOTE CONTROL DEVICES AND THE UNITS OF

WHICH THEY ARE COMPOSED, SWITCHING AND CONTROL CIRCUITS FOR MODELS, ELECTRONIC SWITCHING CIRCUITS FOR FLASHING LIGHTS FOR MODELS, ELECTRONIC NOISE GENERATORS; ELECTRICAL ENTERTAINMENT EQUIPMENT DESIGNED AS ACCESSORIES FOR TELEVISIONS, ELECTRICAL, ELECTRONIC AND ELECTROMECHANICAL MEASURING INSTRUMENTS, BUILT-IN MEASURING INSTRUMENTS, MULTIPLE MEASURING INSTRUMENTS, DIGITAL DISPLAY MULTIPLE INSTRUMENTS, OSCILLOGRAPHS, SIGNAL TRACERS, FREQUENCY COUNTERS, ADJUSTABLE AND NONADJUSTABLE POWER SUPPLY UNITS, LOW VOLTAGE POWER SUPPLY UNITS, BATTERY CHARGERS, TELEVISION AUDIO TRANSPORTERS OR ADAPTERS, ELECTRICAL AND ELECTRONIC ALARMS AND ALARM INSTALLATIONS AND ACCESSORIES, NAMELY OPTICAL AND ACOUSTIC SIGNAL TRANSMITTERS, ACOUSTIC SENSORS FOR INDICATING ULTRASOUND MOVEMENT; OPTICAL SENSORS AND LIGHT BARRIERS; ELECTROMECHANICAL SENSORS, MICROCOMPUTERS, COMPONENTS AND KITS FOR BUILDING ALL THE AFOREMENTIONED EQUIPMENT; RADIO AND TELEVISION AERIALS, INDOOR AERIALS, CAR AERIALS, AMATEUR RADIO AND CB RADIO AERIALS, MOBILE AERIALS AND STATIONARY AERIALS, ELECTRICAL AND ELECTRONIC AERIAL ACCESSORIES, NAMELY, AERIAL AMPLIFIERS, AERIAL DIPLEXERS, AERIAL CABLES, LEVEL ADJUSTERS AND DISTRIBUTORS FOR AERIALS, AERIAL SOCKETS, MOVING LOADS FOR AERIAL LEADS, JACKS, PLUGS AND ADAPTERS FOR AERIALS, BALANCING TRANSMITTERS FOR AERIAL, COAXIAL SWITCHES AND COAXIAL RELAYS, POWER SUPPLY UNITS FOR AERIAL AMPLIFIERS AND ROTORS FOR AERIALS; MECHANICAL AERIALS ACCESSORIES, NAMELY, AERIAL MASTS, BEARINGS FOR ROTATING AERIALS, MECHANICAL FASTENING ELEMENTS FOR AERIALS AND AERIAL MASTS, NAMELY, FASTENING ELEMENTS FOR FIXING MOBILE AERIALS ONTO CARS, MAST CLIPS AND MAST HOLDERS FOR SECURING AERIAL AMPLIFIERS AND DIPLEXERS; ELECTRICAL INSULATION MATERIAL, BRIGHTNESS REGULATORS OR DIMMERS FOR ELECTRICAL ROOM LIGHTING, MAINS CONNECTORS, NAMELY, PLUG AND SOCKETS, ELECTRICAL LEADS, WIRES AND FLEXES, BATTERIES AND ACCUMULATORS, TIMERS, INTERCOM INSTALLATIONS, CONSISTING OF OUTDOOR AND INDOOR SPEAKERS POINTS, SWITCH OVER DEVICES, POWER SUPPLY UNITS, AMPLIFIERS AND VIDEO EQUIPMENT; ELECTRICAL AND ELECTRONIC DEMONSTRATION BOXES, CONSISTING OF ELECTRICAL AND ELECTRONIC COMPONENTS AND SUB-ASSEMBLIES; ELECTRONIC DESK CALCULATORS AND POCKET CALCULATORS; ELECTRONIC AND MECHANICAL VOLTAGE TESTERS, ELECTRONIC METAL DETECTORS, ELECTRICAL SOLDERING

IRONS, ELECTRICAL SOLDERING STATIONS CONSISTING OF SOLDERING IRONS AND ELECTRICAL SUPPLY AND CONTROL DEVICES FOR SOLDERING IRONS; TELECOMMUNICATIONS EQUIPMENT, NAMELY TELEPHONES, ANSWERING MACHINES, FAX MACHINES, SOUND RECORDING MACHINES, MODEMS, MOBILE TELEPHONES; TELEPHONE ACCESSORIES, NAMELY, PRIVATE BRANCH EXCHANGE SYSTEMS, HANDS-FREE DEVICES, TELEPHONE CHARGE COUNTERS, TELEPHONE SOCKET POINTS, MANUAL AND ELECTRONIC TELEPHONE SWITCHING EQUIPMENT, TELEPHONE PLUGS AND JACKS; TELEPHONE CORDS, COMPUTERS, PC'S PRINTERS, SCANNERS, MONITORS, HARD DISKS, CD DRIVERS, CD PRINTERS, DISK DRIVERS, KEYBOARDS, COMPUTER MICE, COMPUTER CARDS, NAMELY GRAPHIC CARDS AND INTERFACE CARDS, MEMORY CARDS, COMPUTER PLUG AND SOCKET CONNECTIONS; COMPUTER PROGRAMS RECORDED ON MACHINE READABLE MEDIUM AND RELATING TO COMPUTERS; COMPUTER PROGRAMS FOR USE IN RESOURCE ALLOCATION, FOR SCHEDULING, FOR DATA INPUT/OUTPUT CONTROL, FOR DATA MANAGEMENT, FOR COMMUNICATION MANAGEMENT, FOR NETWORK MANAGEMENT, FOR ELECTRONIC DATA EXCHANGE BETWEEN COMPUTERS, FOR COMPUTER SYSTEMS; FOR OPERATING SYSTEMS FOR COMPUTERS; SPECIAL EFFECTS PHOTOGRAPH PROJECTORS, IN CLASS 9 (U.S. CLS. 21, 23, 26, 36 AND 38).

FOR: ELECTRIC LIGHTING FIXTURES, SPOT LIGHTS, VENTILATORS, NAMELY FANS FOR COOLING ELECTRICAL COILS, FANS OR BLOWERS FOR USE IN THE KITCHEN OR BATHROOM, WINDOW FANS, FANS FOR USE IN AIR CONDITIONING AND HEATING SYSTEMS, CEILING FANS, LAMPS, FLASH LIGHTS, SPECIAL EFFECT LAMPS, GLOW LAMPS, INCANDESCENT LAMPS, GAS DISCHARGE LAMPS, HOLDERS AND SOCKETS FOR THE AFOREMENTIONED LAMPS, IN CLASS 11 (U.S. CLS. 13, 21, 23, 31 AND 34).

FOR: PAMPHLETS, BROCHURES, NEWSLETTERS, JOURNALS AND MAGAZINES IN THE FIELDS OF ELECTRONICS AND COMPUTERS, IN CLASS 16 (U.S. CLS. 2, 5, 22, 23, 29, 37, 38 AND 50).

OWNER OF FED REP GERMANY REG. NO. 2103314, DATED 9-23-1986, EXPIRES 9-30-2006.

NO CLAIM IS MADE TO THE EXCLUSIVE RIGHT TO USE "ELECTRONIC" , APART FROM THE MARK AS SHOWN.

SER. NO. 75-829,954, FILED 10-25-1999.

EDWARD NELSON, EXAMINING ATTORNEY

Int. Cls.: 40 and 42

Prior U.S. Cls.: 100, 101, 103 and 106

United States Patent and Trademark Office

Reg. No. 2,892,157

Registered Oct. 12, 2004

**SERVICE MARK
PRINCIPAL REGISTER**

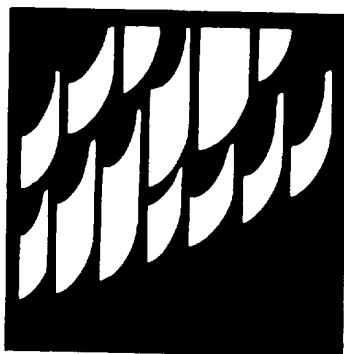

DIAMOND MINES INC. (CANADA CORPORATION)
SUITE 2300, 639 - 5TH AVENUE SOUTHWEST
CALGARY, ALBERTA, CANADA T2P 0M9

FOR: DIAMOND PROCESSING, NAMELY LASER ENGRAVING OF DIAMONDS AND GEMSTONES FOR OTHERS; CUTTING AND POLISHING DIAMONDS FOR OTHERS; DIAMOND REFINING AND DEEP DIAMOND BOILING PROCESSING SERVICES, NAMELY, EXPOSING DIAMONDS TO SOLVENTS, CONCENTRATED CAUSTICS AND ACIDS UNDER HIGH TEMPERATURES AND

PRESSURES, IN CLASS 40 (U.S. CLS. 100, 103 AND 106).

FOR: MINING OF DIAMONDS, NAMELY MINING AND MINERAL EXPLORATION SERVICES, IN CLASS 42 (U.S. CLS. 100 AND 101).

OWNER OF CANADA REG. NO. TMA573391, DATED 1-10-2003, EXPIRES 1-10-2018.

SER. NO. 75-829,967, FILED 10-25-1999.

MICHAEL LEVY, EXAMINING ATTORNEY

Int. Cl.: 42

Prior U.S. Cls.: 100 and 101

United States Patent and Trademark Office

Reg. No. 2,892,158

Registered Oct. 12, 2004

SERVICE MARK
PRINCIPAL REGISTER



PROTEIN SCIENCES CORPORATION (DELA-
WARE CORPORATION)
1000 RESEARCH PARKWAY
MERIDEN, CT 064507159

FOR: GENETIC ENGINEERING SERVICES FOR
THE PRODUCTION OF A SPECIFIED GENE-DE-
FINED AND GENE-DERIVED PROTEIN, BUT NOT
INCLUDING THE SERVICE OF PROVIDING AND
MAINTAINING AN INTERACTIVE COMPUTER
DATABASE IN THE FIELD OF GENE EXPRESSION
PATTERNS, CDNA AND GENOMIC SEQUENCES
AND REGULATORY COMPONENTS, IN CLASS 42
(U.S. CLS. 100 AND 101).

FIRST USE 6-14-1998; IN COMMERCE 6-14-1998.

OWNER OF U.S. REG. NO. 1,730,487.

THE STIPPLING AND LINING ARE FEATURES
OF THE MARK AND DO NOT INDICATE COLOR.

THE MARK CONSISTS OF THE WORD "GENEX-
PRESS" SET IN A TRIANGULAR SLASH ACROSS A
STYLIZED GLOBE.

SER. NO. 75-837,517, FILED 11-1-1999.

RUDY R. SINGLETON, EXAMINING ATTORNEY

Int. Cls.: 9 and 12

Prior U.S. Cls.: 19, 21, 23, 26, 31, 35, 36, 38 and 44

United States Patent and Trademark Office

Reg. No. 2,892,159

Registered Oct. 12, 2004

**TRADEMARK
PRINCIPAL REGISTER**

Défi

NIPPON SEIKI CO., LTD. (JAPAN CORPORATION)
2-2-34 HIGASHI-ZAOH
NAGAOKA, NIIGATA 940, JAPAN

FOR: ELECTRICAL AND FLUID-RESPONSIVE METERS, INSTRUMENTS, INDICATORS AND GAUGES, NAMELY, TEMPERATURE GAUGES, FUEL GAUGES, OIL GAUGES, PRESSURE GAUGES, SPEEDOMETERS, TACHOMETERS, TURBO GAUGES, DIRECTIONAL COMPASSES, ELECTRICAL CONNECTORS, AND COMPONENT PARTS THEREOF, AND SENSOR AND TRANSMITTER UNITS THEREFOR; INSTRUMENT PANEL CONTROLS, CONTROL UNITS AND INDICATORS; INSTRUMENT PANEL DISPLAYS; PARTS OF THE FOREGOING; AND USER MANUALS SOLD THEREWITH, ALL OF THE FOREGOING FOR USE WITH AUTOMOBILES, OTHER VEHICLES AND AGRICULTURAL AND CONSTRUCTION MACHINERY, IN CLASS 9 (U.S. CLS. 21, 23, 26, 36 AND 38).

FIRST USE 6-0-1996; IN COMMERCE 10-0-1999.

FOR: STRUCTURAL PARTS FOR AUTOMOBILES; AND USER MANUALS SOLD THEREWITH, IN CLASS 12 (U.S. CLS. 19, 21, 23, 31, 35 AND 44).

FIRST USE 6-0-1996; IN COMMERCE 10-0-1999.

OWNER OF JAPAN REG. NO. 4080255, DATED 11-7-1997, EXPIRES 11-7-2007.

OWNER OF JAPAN REG. NO. 4122247, DATED 3-6-1998, EXPIRES 3-6-2008.

THE ENGLISH TRANSLATION OF THE FRENCH TERM "DEFI" IS "CHALLENGE".

SER. NO. 75-837,769, FILED 11-2-1999.

INGA ERVIN, EXAMINING ATTORNEY

Int. Cls.: 9 and 35

Prior U.S. Cls.: 21, 23, 26, 36, 38, 100, 101 and 102

Reg. No. 2,892,160

United States Patent and Trademark Office

Registered Oct. 12, 2004

**TRADEMARK
SERVICE MARK
PRINCIPAL REGISTER**

REAL MEDIA

REAL MEDIA, INC. (DELAWARE CORPORATION)

32 EAST 41ST STREET

9TH FLOOR

NEW YORK, NY 10016

FOR: COMPUTER SOFTWARE FOR USE IN CONNECTION WITH PROVIDING ADVERTISING SERVICES OVER A GLOBAL COMPUTER NETWORK AND USER MANUALS SOLD AS A UNIT THEREWITH, IN CLASS 9 (U.S. CLS. 21, 23, 26, 36 AND 38).

FIRST USE 12-0-1995; IN COMMERCE 12-0-1995.

FOR: ADVERTISING SERVICES, NAMELY, TARGETING, PLACING AND DISSEMINATING OF ADVERTISEMENTS OF OTHERS OVER A GLOBAL COMPUTER NETWORK, IN CLASS 35 (U.S. CLS. 100, 101 AND 102).

FIRST USE 10-0-1995; IN COMMERCE 10-0-1995.

NO CLAIM IS MADE TO THE EXCLUSIVE RIGHT TO USE "MEDIA", APART FROM THE MARK AS SHOWN.

SER. NO. 75-848,939, FILED 11-15-1999.

WENDY GOODMAN, EXAMINING ATTORNEY

Int. Cl.: 35

Prior U.S. Cls.: 100, 101 and 102

United States Patent and Trademark Office

Reg. No. 2,892,161

Registered Oct. 12, 2004

**SERVICE MARK
PRINCIPAL REGISTER**

ADVANCED TECHNOLOGY SOLUTIONS

INSTITUTE FOR INDEPENDENT INFORMATION TECHNOLOGY PROFESSIONALS, INC.
(CALIFORNIA CORPORATION)
220 TWIN DOLPHIN DRIVE
REDWOOD SHORES, CA 94065

FOR: SPECIALTY INFORMATION TECHNOLOGY STAFFING SERVICES IN THE FIELD OF COMPUTER HARDWARE AND SOFTWARE, IN CLASS 35 (U.S. CLS. 100, 101 AND 102).

FIRST USE 8-18-1999; IN COMMERCE 8-18-1999.

NO CLAIM IS MADE TO THE EXCLUSIVE RIGHT TO USE "TECHNOLOGY SOLUTIONS", APART FROM THE MARK AS SHOWN.

SER. NO. 75-876,375, FILED 12-20-1999.

NAAKWAMA ANKRAH, EXAMINING ATTORNEY

Int. Cl.: 42

Prior U.S. Cls.: 100 and 101

United States Patent and Trademark Office

Reg. No. 2,892,162

Registered Oct. 12, 2004

**SERVICE MARK
PRINCIPAL REGISTER**

IMAGINVEST

MONGON, EMMANUEL (FRANCE INDIVIDUAL)
5 AVENUE DE MADRID
92200 NEUILLY SUR SEINE, FRANCE

FOR: TECHNICAL ANALYSIS AND CONSULTATION SERVICES IN THE FIELDS OF CONSTRUCTION, ENGINEERING AND ARCHITECTURAL DESIGN FOR ALL TYPES OF CULTURAL, LEISURE, RECREATIONAL, HOTEL/RESORT AND ENTERTAINMENT SITES AND FACILITIES; ENGINEERING, NAMELY, STUDY, DESIGN AND IMPLEMENTATION OF PLANS AND DESIGNS FOR THE CREATION/CONSTRUCTION OF RECREATIONAL SITES; ARCHITECTURAL DESIGN AND PLANNING SERVICES IN CONNECTION WITH

RECREATIONAL SITES; LANDSCAPE DESIGN SERVICES FOR OTHERS; GRAPHIC ART DESIGN SERVICES; QUALITY CONTROL SERVICES FOR OTHERS RELATING TO RECREATIONAL SITES, IN CLASS 42 (U.S. CLS. 100 AND 101).

OWNER OF FRANCE REG. NO. 93480489, DATED 8-16-1993, RENEWED AS REG. NO. 93480489, DATED 8-16-2003, EXPIRES 8-16-2013.

OWNER OF U.S. REG. NO. 2,327,525.

SER. NO. 75-892,583, FILED 1-7-2000.

TRACY FLETCHER, EXAMINING ATTORNEY

Int. Cls.: 25 and 35

Prior U.S. Cls.: 22, 39, 100, 101 and 102

United States Patent and Trademark Office

Reg. No. 2,892,163

Registered Oct. 12, 2004

**TRADEMARK
SERVICE MARK
PRINCIPAL REGISTER**

NO BALL. NO GAME

JUSTBALLSCOM, INC. (DELAWARE CORPORATION)
4478 ROUTE 27.
KINGSTON., NJ 08528

FOR: CLOTHING, NAMELY SHIRTS, TEE SHIRTS SWEATSHIRTS, SWEAT PANTS, SHORTS NECKTIES, JACKETS, UNDERWEAR, HATS AND SHOES, IN CLASS 25 (U.S. CLS. 22 AND 39).

FIRST USE 10-0-1999; IN COMMERCE 10-0-1999.

FOR: ON-LINE RETAIL SERVICES IN THE CATEGORY OF SPORTING GOODS TOYS, FITNESS EQUIPMENT, AND RELATED ACCESSORIES NAMELY BAGS, BALL MACHINES, BALL STO-

RAGE PRODUCTS SPORTS TRAINING EQUIPMENT, PET-TOYS, GOLF TEES, AIR PUMPS, PUMP NEEDLES, GOALS FOR BASKETBALL SOCCER HOCKEY, LACROSSE, INFORMATIONAL BOOKS, VIDEOS, CD-ROMS, AND OTHER MEDIA ABOUT BALLS AND BALL SPORTS INCLUDING RULES OF THE GAME, IN CLASS 35 (U.S. CLS. 100, 101 AND 102).

FIRST USE 10-0-1999; IN COMMERCE 10-0-1999.

SER. NO. 75-902,887, FILED 1-24-2000.

RUDY R. SINGLETON, EXAMINING ATTORNEY

Int. Cl.: 42

Prior U.S. Cls.: 100 and 101

United States Patent and Trademark Office

Reg. No. 2,892,164

Registered Oct. 12, 2004

**SERVICE MARK
PRINCIPAL REGISTER**

DAIQUIRI ISLAND

DAIQUIRI ISLAND, INC. (GEORGIA CORPORATION)
7102 ABERCOM STREET
SAVANNAH, GA 31406

FOR: RESTAURANT AND BAR SERVICES, IN
CLASS 42 (U.S. CLS. 100 AND 101).

FIRST USE 5-22-1992; IN COMMERCE 5-22-1992.

NO CLAIM IS MADE TO THE EXCLUSIVE
RIGHT TO USE "CAFE" , APART FROM THE
MARK AS SHOWN.

SEC. 2(F) AS TO "DAIQUIRI".

SER. NO. 75-903,797, FILED 1-27-2000.

ROBERT LORENZO, EXAMINING ATTORNEY

Int. Cl.: 20

Prior U.S. Cls.: 2, 13, 22, 25, 32 and 50

United States Patent and Trademark Office

Reg. No. 2,892,165

Registered Oct. 12, 2004

**TRADEMARK
PRINCIPAL REGISTER**



CRAZY CREEK PRODUCTS, INC. (MONTANA CORPORATION)
P.O. BOX 1050
1401 SOUTH BROADWAY
RED LODGE, MT 59068

NO CLAIM IS MADE TO THE EXCLUSIVE RIGHT TO USE "PRODUCTS RED LODGE - MONTANA - USA", APART FROM THE MARK AS SHOWN.

FOR: CHAIRS, AND STUFF SACKS AND COMPRESSIONS SACKS FOR COLLAPSIBLE CHAIRS FOR USE IN HIKING, CAMPING AND BACKPACKING, IN CLASS 20 (U.S. CLS. 2, 13, 22, 25, 32 AND 50).

SER. NO. 75-909,397, FILED 2-4-2000.

FIRST USE 6-20-1987; IN COMMERCE 6-20-1987.

VIVIAN MICZNIK FIRST, EXAMINING ATTORNEY

Int. Cl.: 9

Prior U.S. Cls.: 21, 23, 26, 36 and 38

United States Patent and Trademark Office

Reg. No. 2,892,166

Registered Oct. 12, 2004

**TRADEMARK
PRINCIPAL REGISTER**

METABLUE WEBNOTES

METABLUE, INC. (CALIFORNIA CORPORATION)
463 SHERWOOD DRIVE
SUITE 302
SAUSALITO, CA 94965

FOR: COMPUTER SOFTWARE USED FOR ADDING ANNOTATIONS TO WEB PAGES, MANAGING, SORTING, AND SEARCHING THE ANNOTATIONS, AND NAVIGATING BETWEEN RELATED DOCU-

MENTS AND PEOPLE VIA THE GLOBAL COMPUTER AND LOCAL AREA NETWORKS, IN CLASS 9 (U.S. CLS. 21, 23, 26, 36 AND 38).

FIRST USE 11-28-1999; IN COMMERCE 11-28-1999.

SER. NO. 75-915,125, FILED 1-31-2000.

KEVON CHISOLM, EXAMINING ATTORNEY

Int. Cl.: 1

Prior U.S. Cls.: 1, 5, 6, 10, 26 and 46

United States Patent and Trademark Office

Reg. No. 2,892,167

Registered Oct. 12, 2004

TRADEMARK
PRINCIPAL REGISTER

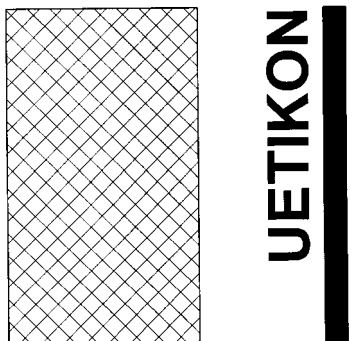

CU CHEMIE UETIKON A.G. (SWITZERLAND
JOINT STOCK CORPORATION)
SEESTRASSE 108
CH-8707 UETIKON AM SEE, SWITZERLAND

FOR: CHEMICALS, NAMELY, INORGANIC ACIDS, ALKALIS AND SALTS, ORGANIC FINE CHEMICALS, ADSORBENTS AND ADSORBING AGENTS AND DRYING AGENTS, ALL FOR USE IN THE CHEMICAL, PHARMACEUTICAL, PETRO-CHEMICAL AND THE INSULATED GLASS INDUSTRIES; FERTILIZERS FOR AGRICULTURAL AND DOMESTIC USE; CHEMICALS FOR USE IN THE MANUFACTURE OF PHARMACEUTICAL AND VETERINARY PREPARATIONS; PLANT PROTECTION PREPARATIONS FOR AGRICULTURAL

AND DOMESTIC USE, IN CLASS 1 (U.S. CLS. 1, 5, 6, 10, 26 AND 46).

FIRST USE 5-0-1993; IN COMMERCE 5-0-1993.

NO CLAIM IS MADE TO THE EXCLUSIVE RIGHT TO USE "UETIKON", APART FROM THE MARK AS SHOWN.

THE DRAWING IS LINED FOR THE COLOR(S) ORANGE.

SER. NO. 75-916,320, FILED 2-11-2000.

YONG KIM, EXAMINING ATTORNEY

Int. Cls.: 3, 9, 14, 16, 18, 25, 38, 41 and 42

**Prior U.S. Cls.: 1, 2, 3, 4, 5, 6, 21, 22, 23, 26, 27, 28, 29,
36, 37, 38, 39, 41, 50, 51, 52, 100, 101, 104 and 107**

Reg. No. 2,892,168

United States Patent and Trademark Office

Registered Oct. 12, 2004

**TRADEMARK
SERVICE MARK
PRINCIPAL REGISTER**

SHERCO

TEISSIER, MARC (FRANCE INDIVIDUAL)
1720, CHEMIN DE LA CIGALE
30900 NIMES, FRANCE

FOR: BODY, BATH, MASSAGE AND AROMATHERAPY OILS; ESSENTIAL OILS FOR PERSONAL USE; BODY PAINTS FOR COSMETIC USE; HAND, BODY AND FACE CREAMS AND LOTIONS; SKIN MOISTURIZING CREAMS AND LOTIONS; BATH AND SKIN GELS; BODY POWDER; BODY GLITTER, NON-MEDICATED BREAST STIMULATING CREAMS, OILS AND GELS; SKIN CLEANSERS, SKIN LOTIONS, SKIN SOAPS, BUBBLE BATH, BATH GELS, BATH OIL, BATH POWDER, NON-MEDICATED BATH SALTS, SHAVING BALM, AFTER-SHAVE LOTIONS, SHOWER GELS, BODY SHAMPOOS, AND FACIAL CONDITIONER GELS, HAIR RELAXERS; DENTIFRICES; HAIR CARE PRODUCTS AND NON-MEDICATED HAIR LOSS TREATMENT PRODUCTS, NAMELY, SHAMPOO, CONDITIONER, RINSE, SCALP ACTIVATOR LOTION, TOPICAL NON-MEDICATED TREATMENT LOTION FOR HAIR AND SCALP, HAIR SPRAY, HAIR STYLING GELS, HAIR STYLING MOUSSE, HAIR CREAMS, HAIR MASKS, HAIR GEL, HAIR MOUSSE, HAIR DETANGLER, HAIR POMADE, HAIR STRENGTHENING SOLUTIONS AND HAIR DYES; FRAGRANCES, NAMELY, PERFUME, EAU DE TOILETTE, COLOGNE, AND TOILET WATER; COSMETICS, NAMELY, LIPSTICKS, LIP GLOSS, LIP LINER, LIP BALM, BLUSH, FOUNDATION, EYE SHADOW, EYE LINER, MASCARA, CONCEALER, COSMETIC PENCILS, FACIAL POWDER, MAKE-UP REMOVING CREAMS AND LOTIONS, FACIAL SCRUBS, TONERS, SKIN CONDITIONING LOTIONS, SKIN EXFOLIATING LOTIONS, SKIN CLARIFIERS, SKIN FIRING CREAMS, GELS AND LOTIONS, WRINKLE REDUCING CREAMS AND LOTIONS, MOISTURIZERS AND SUNSCREEN CREAMS, GELS AND LOTIONS; NAIL POLISH AND ENAMEL; LAUNDRY BLEACH,

LAUNDRY STARCH, LAUNDRY DETERGENT, CLEANING, POLISHING AND SCOURING PREPARATIONS FOR USE ON MOTORBIKES, BICYCLES AND SCOOTERS, IN CLASS 3 (U.S. CLS. 1, 4, 6, 50, 51 AND 52).

FOR: SCIENTIFIC, PHOTOGRAPHIC APPARATUS, SURVEYING, WEIGHING, MEASURING, SIGNALING AND MONITORING APPARATUS AND INSTRUMENTS RELATING TO MOTORBIKES, MOTORCYCLES, SCOOTERS, SNOWMOBILES AND RECREATIONAL WATERCRAFT, NAMELY, APPARATUS FOR RECORDING, TRANSMISSION, REPRODUCTION OF SOUND OR IMAGES, NAMELY COMPUTERS, TELEVISIONS, AUDIO TAPE RECORDERS, CELLULAR AND WIRELESS TELEPHONE ACCESSORIES, NAMELY, AUTOMOTIVE ELECTRICAL POWER ADAPTERS, RECHARGEABLE BATTERIES, BATTERY CHARGERS; COMPUTER SOFTWARE FOR USE WITH DIGITAL CAMERAS FOR VISUALIZING, MODIFYING, AND STORING DIGITAL PHOTOGRAPHS; TELECOMMUNICATIONS EQUIPMENT, NAMELY, CELLULAR PHONES AND PERIPHERALS, NAMELY, OPTICAL WIRES AND CABLES; AUDIO AND VIDEO EQUIPMENT, NAMELY, KARAOKE SYSTEMS COMPRISED OF SPEAKERS, MICROPHONES, PROJECTORS, SCREENS, VIDEO MONITORS, MIXERS AND AMPLIFIERS, SOUND SYSTEMS FOR COMMERCIAL AND HOME USE COMPRISED OF MICROPHONES, VIDEO CASSETTE RECORDER, VIDEO DISPLAYER, BLANK VIDEO DISKS AND VIDEO LONG PLAY RECORDER, AUTOMOBILE SOUND SYSTEMS COMPRISED OF AUDIO CASSETTE RECORDERS, COMPACT DISK PLAYERS AND VIDEO CASSETTE RECORDERS, PUBLIC ANNOUNCEMENT SYSTEM COMPRISED OF MICROPHONES, SPEAKERS, TUNER, STEREO SPEAKERS, RECORD PLAYER, AMPLIFIERS, STEREO COMPONENT SYSTEMS COMPRISED OF AUTOMATIC RECORD CHANGER, CASSETTE DECK

AND STEREO RECEIVER, AUDIO VISUAL EQUIPMENT FOR STAGING AND BUSINESS AND TRADE SHOW PRESENTATIONS, NAMELY, SPEAKERS, MICROPHONES, PROJECTORS, SCREENS, VIDEO MONITORS, MIXERS AND AMPLIFIERS; PERSONAL ANALYZERS FOR TEST AND MEASUREMENT, NAMELY, PERSONAL DIGITAL ASSISTANTS (PDAS) FOR USE IN MEASURING RESIDUAL GASES IN MOTORBIKES, MOTORCYCLES, SNOWMOBILES AND RECREATIONAL WATERCRAFT; COMPUTER SYSTEMS, COMPOSED OF COMPUTER HARDWARE SOLD AS A UNIT, COMPUTER CIRCUIT BOARDS, AND COMPUTER OPERATING SOFTWARE IN THE FIELD OF MOTORBIKES, MOTORCYCLES, SCOOTERS, SNOWMOBILES AND RECREATIONAL WATERCRAFT; MUSICAL, AUDIOVISUAL AND SOUND RECORDINGS ON COMPACT DISKS, VIDEO CASSETTES, AUDIO CASSETTES; COMPUTER VIDEO GAME AND COMPUTER GAME SOFTWARE; VIDEO GAME CARTRIDGES AND DISCS; EYEGLASSES; BLANK MAGNETIC DATA CARRIERS; BLANK DISCS FOR COMPUTERS; VENDING MACHINES; COIN-OPERATED VIDEO GAMES FEATURING MOTORBIKES, MOTORCYCLES, SCOOTERS, SNOWMOBILES AND RECREATIONAL WATERCRAFT; CASH REGISTERS, CALCULATORS AND DATA PROCESSORS; FIRE EXTINGUISHERS; AND ELECTRIC VIBRATING HAIR HOT BRUSHES, IN CLASS 9 (U.S. CLS. 21, 23, 26, 36 AND 38).

FOR: PRECIOUS METAL AND THEIR ALLOYS SOLD IN BULK; JEWELRY, PRECIOUS GEMSTONES; HOROLOGICAL AND CHRONOMETRIC INSTRUMENTS, NAMELY, CHROMOMETERS, WATCHES, CLOCKS, CHRONOSCOPES, WRIST WATCHES, AND ALARM CLOCKS, IN CLASS 14 (U.S. CLS. 2, 27, 28 AND 50).

FOR: PAPER, NAMELY, ART PAPER, COMPUTER PAPER, DECALS, WRITING PAPER, POSTERS, CRAFT PAPER, GIFT-WRAPPING PAPER, NEWS-PRINT PAPER, NOTE PAPER, PACKING PAPER, NOTE PADS, NOTE CARDS, STATIONERY, CARDBOARD; PRINTED MATTER, NAMELY, NEWSPAPERS, MAGAZINES RELATING TO MOTORBIKES, MOTORCYCLES, SCOOTERS, SNOWMOBILES AND RECREATIONAL WATERCRAFT; BOOK-BINDINGS; MOUNTED AND UNMOUNTED PHOTOGRAPHS; ADHESIVES FOR STATIONERY OR HOUSEHOLD PURPOSES; ARTISTS' MATERIAL, NAMELY ART PADS, ARTISTS' BRUSHES; ELECTRONIC, ELECTRIC OR NON-ELECTRIC TYPEWRITERS; OFFICE REQUISITES, NAMELY, PENS, MARKERS, PENCILS; PRINTED INSTRUCTIONAL AND TEACHING MATERIAL IN THE FIELD OF MOTORBIKES, MOTORCYCLES, SCOOTERS, SNOWMOBILES, RECREATIONAL WATERCRAFT OR COMPETITION RELATING TO MOTORBIKES, MOTORCYCLES, SCOOTERS, SNOWMOBILES AND RECREATIONAL WATERCRAFT; PRINTING TYPE; PRINTING BLOCKS; SERIES OF FICTION BOOKS; NON-FICTION BOOKS, PRINTED MANUALS, CATALOGS, MAGAZINES, JOURNALS AND NEWSPAPERS IN THE FIELD OF MOTORBIKES, MOTORCYCLES, SCOOTERS, SNOWMOBILES

AND RECREATIONAL WATERCRAFT OR COMPETITION RELATING TO MOTORBIKES, MOTORCYCLES, SCOOTERS, SNOWMOBILES AND RECREATIONAL WATERCRAFT, IN CLASS 16 (U.S. CLS. 2, 5, 22, 23, 29, 37, 38 AND 50).

FOR: LEATHER AND IMITATIONS OF LEATHER SOLD IN BULK; ANIMAL SKINS AND HIDES; TRUNKS AND TRAVELLING BAGS; UMBRELLAS, PARASOLS AND WALING STICKS; WHIPS, HARNESES, SADDLERY; ARTICLES OF LEATHER OR IMITATIONS OF LEATHER, NAMELY, WALLETS, HANDBAGS, SCHOOL BAGS; REINS, IN CLASS 18 (U.S. CLS. 1, 2, 3, 22 AND 41).

FOR: CLOTHING, HEADWEAR AND FOOTWEAR, NAMELY, HEADBANDS, STOCKING, BERETS, OVERALLS, TEDDIES, BOOTS, HALF BOOTS, BRACES, DRAWERS, HOODS, CAPS, BELTS, SHAWLS, DRESSING GOWNS, PULL-OVERS, HATS, CHASUBLES, SOCKS, SLIPPERS, SHOES, SHIRTS, CHEMISETTES, TIGHTS, SLIPS, JUMPSUITS, CORSETS, SUITS, EARMUFFS, BREECHES, CYCLIST'S OR MOTORBIKERS' CLOTHING, NAMELY, SHORTS, TROUSERS, OR T-SHIRTS, FUR STOLE, SCARVES, FUR JACKETS, COATS AND FUR MUFFS; PANTS AND SLACKS, GLOVES, VESTS, RAINCOATS, LEGGINGS, STOCKING SUSPENDERS, GARTERS, JERSEYS, SKIRTS, PETTICOATS, UNDERCLOTHES, SINGLET, MUFFS, MITTENS, OVERCOATS, TROUSERS, SLIPPERS, TOPCOATS, PARKAS, PELERINES, PELISSES, PAJAMAS, DRESSES, SANDALS, UNDERPANTS, UNDERWEAR, UNDERSHIRTS, BRASSIERES, KNITWEAR, NAMELY, KNITTED DRESSES, KNITTED SHIRTS, KNITTED TROUSERS, KNITTED SWEATCLOTHES, NAMELY, SWEATSHIRTS; JACKETS, CAP PEAKS, IN CLASS 25 (U.S. CLS. 22 AND 39).

FOR: ELECTRONIC TRANSMISSION OF DATA AND DOCUMENTS VIA COMPUTER TERMINALS, CABLE RADIO AND TELEVISION TRANSMISSION; RADIO BROADCASTING; SATELLITE TRANSMISSION SERVICES; TELEVISION BROADCASTING AND TRANSMITTING SPORTS EVENTS BY TELEVISION, IN CLASS 38 (U.S. CLS. 100, 101 AND 104).

FOR: ARRANGING AND CONDUCTING ATHLETIC COMPETITIONS, PROVIDING INFORMATION VIA A GLOBAL COMPUTER NETWORK IN THE FIELD OF MOTORBIKE OR CAR RACING SPORTING EVENTS; ENTERTAINMENT NAMELY, MOTORBIKE OR CAR RACES; ORGANIZING EXHIBITIONS FOR SPORTING AND ENTERTAINMENT PURPOSES, NAMELY BASEBALL GAMES, SOCCER MATCHES, MOTORCYCLE RACES, CAR RACES, SCOOTER RACES, SNOWMOBILE AND SKI RACES, RECREATIONAL WATERCRAFT RACES; PUBLICATION OF BOOKS, REVIEWS, MAGAZINES AND JOURNALS; ELECTRONIC PUBLISHING SERVICES, NAMELY PUBLICATION OF TEXT AND GRAPHIC WORKS OF OTHERS ON CD-ROMS FEATURING OR RELATING TO SPORTING EVENTS, MOTORBIKE OR CAR RACING TRACKS, MOTORBIKES AND CARS; PROVIDING

DATABASES FEATURING SPORTING EVENTS, IN CLASS 41 (U.S. CLS. 100, 101 AND 107).

FOR: HOSTING THE WEBSITES OF OTHERS ON A COMPUTER SERVER FOR A GLOBAL COMPUTER NETWORK; COMPUTER SERVICES, NAMELY, PROVIDING SEARCH ENGINES FOR OBTAINING DATA ON A GLOBAL COMPUTER NETWORK; PROVIDING DATABASES FEATURING GENERAL AND LOCAL NEWS, AND INFOR-

MATION OF INTEREST TO SPECIFIC GEOGRAPHIC AREAS IN THE FIELD OF SPORTS, IN CLASS 42 (U.S. CLS. 100 AND 101).

OWNER OF FRANCE REG. NO. 98746750, DATED 12-31-1999, EXPIRES 12-31-2009.

SER. NO. 75-917,022, FILED 2-11-2000.

STEVEN BERK, EXAMINING ATTORNEY

Int. Cl.: 42

Prior U.S. Cls.: 100 and 101

United States Patent and Trademark Office

Reg. No. 2,892,169

Registered Oct. 12, 2004

**SERVICE MARK
PRINCIPAL REGISTER**



PIRONET AG (FED REP GERMANY CORPORATION)
MEDIAPARK 5
50670 KOELN, FED REP GERMANY

FOR: COMPUTER PROGRAMMING FOR OTHERS, NAMELY PROVIDING A WEB-BASED CONTENT-MANAGEMENT SYSTEM FOR ENABLING DISTRIBUTED ORGANIZATIONS TO BUILD AND MANAGE COMPLEX GLOBAL COMPUTER NETWORKS, IN CLASS 42 (U.S. CLS. 100 AND 101).

OWNER OF FED REP GERMANY REG. NO. 001486828, DATED 2-13-2001, EXPIRES 2-13-2011.

THE MARK CONSISTS OF THE WORD "PIROBASE" WITHIN A DESIGN, THE DESIGN BEING AN ELONGATED RECTANGLE WITH ROUNDED ENDS. THE ELONGATED RECTANGLE IS IN BLUE, WITH THE WORD "PIROBASE" IN WHITE. THE RECTANGLE IS SURROUNDED BY A CORRESPONDING OUTLINE FRAME, WHICH IS THE COLOR GRAY. THE BLUE PORTION IS ALSO LINED FOR SHADING, INTENDED TO INDICATE AN CONVEX ORIENTATION.

SER. NO. 75-919,241, FILED 2-15-2000.

LEIGH CAROLINE CASE, EXAMINING ATTORNEY

Int. Cls.: 41 and 42

Prior U.S. Cls.: 100, 101 and 107

United States Patent and Trademark Office

Reg. No. 2,892,170

Registered Oct. 12, 2004

**SERVICE MARK
PRINCIPAL REGISTER**

THE AMERICAN JEWISH COMMITTEE

THE AMERICAN JEWISH COMMITTEE (NEW YORK NOT-FOR-PROFIT CORPORATION)
165 EAST 56 STREET
NEW YORK, NY 10022

FOR: EDUCATIONAL SERVICES, NAMELY, CONDUCTING AND SPONSORING CONFERENCES, LECTURES, ROUNDTABLE DISCUSSIONS, AND EDUCATIONAL PROGRAMS, AND DISTRIBUTING MATERIALS IN CONNECTION THEREWITH; AND CONDUCTING SCHOLARLY RESEARCH; ALL IN THE AREAS OF INTER-GROUP RELATIONS, RELIGIOUS PLURALISM, HUMAN RIGHTS, CIVIL RIGHTS, RELIGIOUS FREEDOM, IMMIGRATION TRENDS AND POLICIES, INTERRELIGIOUS AND JEWISH COMMUNAL AFFAIRS, ECONOMIC POLICY AND POVERTY, COMBATING ANTI-SEMITISM AND OTHER FORMS OF RACIAL AND ETHNIC HATRED AND BIGOTRY, AND ENSURING THE SECURITY OF ISRAEL, IN CLASS 41 (U.S. CLS. 100, 101 AND 107).

FIRST USE 12-31-1909; IN COMMERCE 12-31-1909.

FOR: PROMOTING PUBLIC AWARENESS OF THE NEED FOR RELIGIOUS PLURALISM, HUMAN RIGHTS, CIVIL RIGHTS, RELIGIOUS FREEDOM, FREER IMMIGRATION, AND COMBATING POVERTY IN THE UNITED STATES AND AROUND THE WORLD; ASSOCIATION SERVICES, NAMELY, PROMOTING THE INTERESTS OF JEWS AND OTHER ETHNIC AND RACIAL GROUPS IN THE UNITED STATES AND AROUND THE WORLD IN

THE AREAS OF INTER-GROUP RELATIONS, RELIGIOUS PLURALISM, HUMAN RIGHTS, CIVIL RIGHTS, RELIGIOUS FREEDOM, IMMIGRATION TRENDS AND POLICIES, INTERRELIGIOUS AND JEWISH COMMUNAL AFFAIRS, ECONOMIC POLICY AND POVERTY, COMBATING ANTI-SEMITISM AND OTHER FORMS OF RACIAL AND ETHNIC HATRED AND BIGOTRY, AND ENSURING THE SECURITY OF ISRAEL; ADVOCATING PUBLIC POLICY POSITIONS ROOTED IN AMERICAN DEMOCRATIC VALUES AND THE PERSPECTIVES OF JEWISH HERITAGE, NAMELY, SUPPORTING LEGAL, JUDICIAL AND LEGISLATIVE EFFORTS TO IMPLEMENT AND EXPAND RELIGIOUS PLURALISM, HUMAN RIGHTS, CIVIL RIGHTS, AND RELIGIOUS FREEDOM, IN THE UNITED STATES AND AROUND THE WORLD, IN CLASS 42 (U.S. CLS. 100 AND 101).

FIRST USE 11-11-1906; IN COMMERCE 11-11-1906.

OWNER OF U.S. REG. NO. 1,723,644.

NO CLAIM IS MADE TO THE EXCLUSIVE RIGHT TO USE "JEWISH COMMITTEE", APART FROM THE MARK AS SHOWN.

SEC. 2(F).

SER. NO. 75-923,107, FILED 2-18-2000.

REBECCA GILBERT, EXAMINING ATTORNEY

Int. Cls.: 6, 9, 14, 15, 16, 18, 19, 20, 21, 24, 25, 26, 28, 29, 30 and 32

Prior U.S. Cls.: 1, 2, 3, 5, 12, 13, 14, 21, 22, 23, 25, 26, 27, 28, 29, 30, 32, 33, 36, 37, 38, 39, 40, 41, 42, 45, 46, 48 and 50

Reg. No. 2,892,171

United States Patent and Trademark Office

Registered Oct. 12, 2004

**TRADEMARK
PRINCIPAL REGISTER**

ASTRO BOY

KABUSHIKI KAISHA TEZUKA PRODUCTION
(JAPAN CORPORATION)
4-32-11, TAKADANOBABA, SHINJUKU-KU
TOKYO, JAPAN

FOR: SCULPTURES MADE OF NON-PRECIOUS METAL, MEDALS FOR CLOTHING MADE OF COMMON METAL; BADGES FOR CLOTHING MADE OF COMMON METAL; AND BROOCHES FOR CLOTHING MADE OF COMMON METAL, IN CLASS 6 (U.S. CLS. 2, 12, 13, 14, 23, 25 AND 50).

FOR: APPLIED ELECTRONIC MACHINES AND INSTRUMENTS, NAMELY, COMPUTERS, COMPUTER GAME DISKS, WORD PROCESSORS, CALCULATORS, AND PARTS THEREOF; EXPOSED OR PRE-RECORDED CINEMATOGRAPHIC FILMS FEATURING COMIC BOOK CHARACTERS, SLIDE FILMS, SLIDE FILM MOUNTS, PRE-RECORDED VIDEO DISKS AND VIDEO TAPES FEATURING COMIC BOOK CHARACTERS, COMPUTER GAME PROGRAMS, MAGNETIC DISKS AND MAGNETIC TAPES FEATURING COMPUTER GAME PROGRAMS, RECORDS, NAMELY, PHONOGRAPH RECORDS, MAGNETIC TAPES, MAGNETIC DISKS, COMPACT DISKS, FEATURING COMIC BOOK CHARACTERS AND SCREEN MUSIC, SLOT MACHINES, IN CLASS 9 (U.S. CLS. 21, 23, 26, 36 AND 38).

FOR: PERSONAL ACCESSORIES, NAMELY, NECKLACES, PENDANTS, EARRINGS, BRACELETS, BROOCHES, LOCKETS, RINGS, TIE PINS, TIE CLIPS, BADGES FOR CLOTHING MADE OF PRECIOUS METAL, BUCKLES OF PRECIOUS METAL, MEDALS, JEWELRY AND COSTUME JEWELRY, SCULPTURES MADE OF PRECIOUS METAL; MEDALS FOR CLOTHING MADE OF PRECIOUS METAL; AND BROOCHES FOR CLOTHING MADE OF PRECIOUS METAL, IN CLASS 14 (U.S. CLS. 2, 27, 28 AND 50).

FOR: MUSICAL INSTRUMENTS, NAMELY GUITARS, ELECTRIC GUITARS, BASS GUITARS, DRUMS, KEYBOARDS TAMBOURINES, IN CLASS 15 (U.S. CLS. 2, 21 AND 36).

FOR: BAGS, NAMELY, PAPER BAGS, POUCHES, NAMELY PAPER POUCHES FOR PACKAGING, RECREATION EQUIPMENT, NAMELY, PLAYING CARDS, PAPERS, NAMELY, CONSTRUCTION PAPERS, WRITING PAPERS, WRAPPING PAPERS, STATIONERY, PRINTED MATTER, NAMELY, PUBLICATIONS IN THE NATURE OF BOOKS AND MAGAZINES FEATURING COMIC BOOK CHARACTERS, COMIC BOOKS, COMIC MAGAZINES, CHILDREN'S BOOKS, CARTOON PRINTS, CALENDARS, POSTCARDS, PICTURE POSTCARDS, DIARIES, CATALOGUES FEATURING CINEMATOGRAPHIC FILMS, VIDEOTAPES, BOOKS AND MAGAZINES, ALL IN THE FIELD OF ENTERTAINMENT, PAMPHLETS FEATURING COMIC BOOK CHARACTERS, PAPER LABELS, STICKERS, CALLIGRAPHIC WORKS, NAMELY, ENGRAVINGS, ART ETCHINGS, PAINTINGS, MOUNTED AND/OR UNMOUNTED PHOTOGRAPHS, PHOTOGRAPHIC STANDS, IN CLASS 16 (U.S. CLS. 2, 5, 22, 23, 29, 37, 38 AND 50).

FOR: BAGS, NAMELY, TOTE BAGS, SHOPPING BAGS, TRAVELING BAGS, SCHOOL BAGS, CARRY-ON BAGS, SUITCASES, DOCUMENT CASES, VANITY CASES SOLD EMPTY, POUCHES, NAMELY, DRAWSTRING POUCHES, POCKET WALLETS, PURSES, COMMUTATION TICKET HOLDERS, KEY CASES, UMBRELLAS AND PARASOLS, WALKING STICKS, IN CLASS 18 (U.S. CLS. 1, 2, 3, 22 AND 41).

FOR: SCULPTURES MADE OF CEMENT, MARBLE OR STONE, IN CLASS 19 (U.S. CLS. 1, 12, 33 AND 50).

FOR: SCULPTURES MADE OF PLASTER, PLASTIC OR WOOD, PHOTO FRAMES, POCKET MIRRORS, IN CLASS 20 (U.S. CLS. 2, 13, 22, 25, 32 AND 50).

FOR: TOILETRY ARTICLES, NAMELY, COMPACTS NOT OF PRECIOUS METAL, SOLD EMPTY, TOILET BRUSHES, TOOTHBRUSHES, TOOTHBRUSH CASES, PLASTIC SOAP CASES SOLD EMPTY, POWDER BOXES AND CREAM CASES, NOT OF PRECIOUS METAL, SOLD EMPTY, VANITY CASES, VANITY SETS COMPRISED OF HAIR COMBS AND BRUSHES, EMPTY PLASTIC BOTTLES AND CASES, AND HAND HELD MIRRORS, TOILET SET CASES, SOLD EMPTY, HAIR COMBS, HAIR BRUSHES, SCULPTURES MADE OF CHINA, CRYSTAL, EARTHENWARE, GLASS, PORCELAIN OR TERRA COTTA, MEDALS FOR CLOTHING MADE OF PLASTIC; BADGES FOR CLOTHING MADE OF PLASTIC; AND BROOCHES FOR CLOTHING MADE OF PLASTIC, IN CLASS 21 (U.S. CLS. 2, 13, 23, 29, 30, 33, 40 AND 50).

FOR: FABRIC APPAREL ACCESSORIES, NAMELY, HANDKERCHIEFS, TOWELS, BEDDING, NAMELY, BED LINENS, BED SHEETS, BED SPREADS, BED COVERS, BLANKETS, PILLOWCASES, IN CLASS 24 (U.S. CLS. 42 AND 50).

FOR: CLOTHING, NAMELY, PARKAS, ANORAKS, JOGGING SUITS, SPORTS JERSEYS, JACKETS, SWEATSHIRTS, T-SHIRTS, POLO SHIRTS, JUMPERS, UNDERWEAR, SOCKS, HATS, CAPS, SCARVES, NECKTIES, APRONS, PERSONAL ACCESSORIES, NAMELY, BELTS, SWEAT BANDS, WRIST BANDS, HEAD BANDS, FOOTWEAR, IN CLASS 25 (U.S. CLS. 22 AND 39).

FOR: PERSONAL ACCESSORIES, NAMELY, BUCKLES FOR CLOTHING, HAIR ORNAMENTS, HAIR PINS, HAIR BANDS, HAIR RIBBONS, BUTTONS FOR CLOTHING, ARTIFICIAL FLOWERS, IN CLASS 26 (U.S. CLS. 37, 39, 40, 42 AND 50).

FOR: TOYS, NAMELY, PLAY BALLOONS, TOY BALLS, TOY BATS, BELLS FOR CHRISTMAS TREES, BUILDING BLOCKS, BOARD GAMES, BUILDING GAMES, ORNAMENTS FOR CHRISTMAS TREES, FLYING DISKS, PRACTICAL JOKES, NAMELY, JACK-IN-THE-BOXES, KITE REELS, KITES, MARIONETTES, TOY MASKS, MOBILES, PUPPETS, QUILTS, BABY RATTLES, PLAYGROUND EQUIPMENT, NAMELY, SLIDES, ARTIFICIAL SNOWS FOR CHRISTMAS TREES, SOAP BUBBLE SOLUTION AND BUBBLE MAKING WAND SET, SPINNING TOPS, TOY VEHICLES, MANIPULATIVE GAMES, CARD GAMES,

STUFFED TOYS, BATH TOYS, TOY FIGURES, TOY FIGURINES, TOY MODELS, TOY PIANOS, TOY HARMONICAS, TOY XYLOPHONES, TOY IRON XYLOPHONES, TOY MUSICAL BOXES, APPARATUS FOR ELECTRONIC GAMES OTHER THAN THOSE ADAPTED FOR USE WITH TELEVISION RECEIVERS ONLY, NAMELY, HAND-HELD ELECTRONIC GAME MACHINES, TOY CLOCKS, TOY WATCHES, DOLLS, DOLLS' CLOTHES, DOLLS' HOUSES, DOLLS' FURNITURE, DOLLS' ROOMS, RECREATION EQUIPMENT, NAMELY, DICE, DOMINOES, THEATRICAL MASKS, SPORTING GOODS, NAMELY, BALLS FOR GAMES, NAMELY, BASEBALLS, TENNIS BALLS, BASKETBALLS, GOLF BALLS, FOOTBALLS (SOCCER BALLS), AMERICAN FOOTBALLS, AND RUGBY FOOTBALLS, SMALL BALLS FOR GAMES, BASEBALL GLOVES, BATS FOR GAMES, NAMELY, BASEBALL BATS, BLADDERS OF BALLS FOR GAMES, SOLE COVERINGS FOR SKIS, SKATEBOARDS, SURFBOARDS, FISHING EQUIPMENT, NAMELY, FISHING RODS, FISHING LINES, FISHING LURES, FISHING REELS, FISHING NETS, MECHANICAL TOY PHONOGRAPHS, IN CLASS 28 (U.S. CLS. 22, 23, 38 AND 50).

FOR: FRUIT JELLIES, IN CLASS 29 (U.S. CL. 46).

FOR: TEA, COFFEE, COCOA, ICE, CONFECTIONERY, NAMELY, CAKES, PIES, COOKIES, BISCUITS, CHEWING GUMS, CHOCOLATES, CANDY, ICE CANDY, ICE CREAMS, SHERBETS, PASTRIES, BREAD AND BUNS, IN CLASS 30 (U.S. CL. 46).

FOR: SOFT DRINKS, NAMELY, ISOTONIC BEVERAGES, GUARANA DRINKS, MINERAL WATERS, COFFEE SYRUPS, COLA DRINKS, SODA POPS, SHERBET DRINKS, SYRUPS FOR BEVERAGES, GINGER ALES, CARBONATED DRINK MIXES, AERATED WATERS (SODA WATERS), LEMONADES, LEMON SQUASHES AND FRUIT DRINKS, IN CLASS 32 (U.S. CLS. 45, 46 AND 48).

OWNER OF JAPAN REG. NO. 4018178, DATED 6-27-1997, EXPIRES 6-27-2007.

OWNER OF JAPAN REG. NO. 2248168, DATED 7-30-1990, EXPIRES 7-30-2010.

OWNER OF JAPAN REG. NO. 3300843, DATED 5-9-1997, EXPIRES 5-9-2007.

OWNER OF U.S. REG. NO. 2,241,936.

SER. NO. 75-929,399, FILED 2-28-2000.

FLORENTINA BLANDU, EXAMINING ATTORNEY

Int. Cl.: 21

Prior U.S. Cls.: 2, 13, 23, 29, 30, 33, 40 and 50

United States Patent and Trademark Office

Reg. No. 2,892,172

Registered Oct. 12, 2004

**TRADEMARK
PRINCIPAL REGISTER**

H-E-B THE BIG COOL BAG

HEB GROCERY COMPANY, LP (TEXAS LIMITED PARTNERSHIP)
646 SOUTH MAIN STREET
SAN ANTONIO, TX 78204

NO CLAIM IS MADE TO THE EXCLUSIVE RIGHT TO USE THE BIG COOL BAG, APART FROM THE MARK AS SHOWN.

FOR: THERMAL INSULATED TOTE BAGS FOR FOOD, IN CLASS 21 (U.S. CLS. 2, 13, 23, 29, 30, 33, 40 AND 50).

SER. NO. 75-930,775, FILED 2-28-2000.

FIRST USE 2-1-2000; IN COMMERCE 2-1-2000.

DEZMONA MIZELLE, EXAMINING ATTORNEY

Int. Cl.: 9

Prior U.S. Cls.: 21, 23, 26, 36 and 38

Reg. No. 2,892,173

United States Patent and Trademark Office

Registered Oct. 12, 2004

**TRADEMARK
PRINCIPAL REGISTER**



GENKI CO., LTD. (JAPAN CORPORATION)
SHINJUKU AX BLDG., 6F, 2-4-12
OKUBO, SHINJYUKU-KU, TOKYO, JAPAN

GAME MACHINES FOR USE WITH TELEVISIONS,
IN CLASS 9 (U.S. CLS. 21, 23, 26, 36 AND 38).

FIRST USE 4-25-1997; IN COMMERCE 7-28-1999.

FOR: ELECTRIC CIRCUITS, MAGNETIC TAPES,
MAGNETIC DISCS, OPTICAL DISCS, ROM-CAR-
TRIDGES, CD-ROM, DVD-ROM AND AUDIO/VI-
DEO COMPACT DISCS, ALL RECORDED WITH
TELEVISION GAME PROGRAMS; VIDEO OUTPUT

SER. NO. 75-936,882, FILED 3-7-2000.

TANYA AMOS, EXAMINING ATTORNEY

Int. Cls.: 16 and 38

Prior U.S. Cls.: 2, 5, 22, 23, 29, 37, 38, 50, 100, 101 and 104

Reg. No. 2,892,174

United States Patent and Trademark Office

Registered Oct. 12, 2004

**TRADEMARK
SERVICE MARK
PRINCIPAL REGISTER**



STARFONE (CALIFORNIA CORPORATION)
ONE WORLD TRADE CENTER SUITE 2455
LONG BEACH, CA 90831

FIRST USE 5-1-1999; IN COMMERCE 11-15-1999.

FOR: PREPAID TELEPHONE CALLING CARDS,
NOT MAGNETICALLY ENCODED, IN CLASS 16
(U.S. CLS. 2, 5, 22, 23, 29, 37, 38 AND 50).

NO CLAIM IS MADE TO THE EXCLUSIVE
RIGHT TO USE "NETWORK & COMMUNICA-
TION", APART FROM THE MARK AS SHOWN.

FIRST USE 9-1-1999; IN COMMERCE 2-1-2000.

THE MARK IS LINED FOR THE COLORS NAVY
BLUE AND GOLD.

FOR: TELECOMMUNICATION SERVICES,
NAMELY ELECTRONIC TRANSMISSION OF
DATA, VOICE AND INFORMATION, AND AIR-
TIME TO CARRIERS, IN CLASS 38 (U.S. CLS. 100, 101
AND 104).

SER. NO. 75-937,652, FILED 3-6-2000.

TRICIA THOMPkins, EXAMINING ATTORNEY

Int. Cls.: 9, 12, 37 and 42

Prior U.S. Cls.: 19, 21, 23, 26, 31, 35, 36, 38, 44, 100, 101, 103 and 106

Reg. No. 2,892,175

United States Patent and Trademark Office

Registered Oct. 12, 2004

**TRADEMARK
SERVICE MARK
PRINCIPAL REGISTER**

E WHEEL

COMPAGNIE GENERALE DES ETABLISSEMENTS MICHELIN - MICHELIN & CIE
(FRANCE CORPORATION)
12 COURS SABLON
63040 CLERMONT
FERRAND CEDEX 09, FRANCE

FOR: COLLECTION OF MECHANICAL AND ELECTRICAL COMPONENTS, NAMELY PRESSURE GAUGES, TIRE TREAD DEPTH GAUGES, COMPUTER SOFTWARE, HARDWARE, AND DATA PROCESSORS FOR PROCESSING AND GENERATING INFORMATION FOR ACTION ON VEHICLE DYNAMIC MANAGEMENT, AND FOR VEHICLE TRANSMISSION OPERATING PARAMETERS; COMPUTER SOFTWARE FOR CONTROL OF VEHICLES DYNAMICS AND ENGINE CONTROL; TIMING SENSORS FOR VEHICLE TRANSMISSION OPERATING PARAMETERS; COMPUTER SOFTWARE, HARDWARE AND DATA PROCESSORS FOR VEHICLE DYNAMIC CONTROL, IN CLASS 9 (U.S. CLS. 21, 23, 26, 36 AND 38).

FOR: TIRES, INNER TUBES FOR VEHICLES, TIRE TREADS FOR VEHICLES; CHASSIS SYSTEMS FOR VEHICLES AND THEIR COMPONENTS COMPRISED OF AXLES, SUSPENSION SYSTEMS FOR AUTOMOBILES, HUB CAPS, WHEEL COVERS FOR VEHICLES, FRONT AND REAR SPRINGS, SHOCK ABSORBERS AND ELASTIC BUSHINGS FOR MOTOR VEHICLES, IN CLASS 12 (U.S. CLS. 19, 21, 23, 31, 35 AND 44).

FOR: AUTOMOBILE REPAIR AND MAINTENANCE SERVICES RELATING TO MONITORING AND CONTROL DEVICES FOR TIRES, CHASSIS SYSTEMS FOR VEHICLES, OPERATING DEVICES AND PROCESSING DEVICES FOR PARAMETERS MEASURED ON TIRES AND CHASSIS SYSTEMS FOR VEHICLES, AUTOMOBILE REPAIR AND MAINTENANCE OF SENSORS FOR OPERATING

PARAMETERS OF TIRES AND CHASSIS SYSTEMS FOR VEHICLES, AUTOMOBILE REPAIR AND MAINTENANCE OF CHASSIS SYSTEMS FOR VEHICLES AND THEIR COMPONENTS, NAMELY, AXLES, SUSPENSIONS, HUBS, WHEEL CARRIERS, WHEELS, RIMS, SPRINGS, SHOCK ABSORBERS, ELASTIC BUSHINGS, TRANSMISSION, DRIVING, TRACTION AND BRAKING DEVICES FOR AUTOMOBILE VEHICLES, IN CLASS 37 (U.S. CLS. 100, 103 AND 106).

FOR: TECHNICAL CONSULTATION IN THE FIELD OF MONITORING CONTROL DEVICES FOR TIRES, CHASSIS SYSTEMS FOR VEHICLES, OPERATING PARAMETER MEASURING DEVICES FOR TIRES, OPERATING DEVICES, AND PROCESSING DEVICES FOR PARAMETERS MEASURED ON TIRES, SENSORS FOR OPERATING PARAMETERS OF TIRES, TECHNICAL CONSULTATION RELATING TO COMPONENTS FOR CHASSIS SYSTEMS FOR VEHICLES, NAMELY, AXLES, SUSPENSIONS, HUBS, WHEEL CARRIERS, WHEELS, RIMS, SPRINGS, SHOCK ABSORBERS, ELASTIC BUSHINGS, TRANSMISSION, DRIVING, TRACTION AND BRAKING DEVICES FOR AUTOMOBILE VEHICLES, IN CLASS 42 (U.S. CLS. 100 AND 101).

PRIORITY CLAIMED UNDER SEC. 44(D) ON FRANCE APPLICATION NO. 99812068, FILED 9-9-1999, REG. NO. 99/812068, DATED 9-9-1999, EXPIRES 9-9-2009.

NO CLAIM IS MADE TO THE EXCLUSIVE RIGHT TO USE "WHEEL", APART FROM THE MARK AS SHOWN.

SER. NO. 75-937,843, FILED 3-7-2000.

CHARLES L. JENKINS, EXAMINING ATTORNEY

Int. Cls.: 16, 36, 38, 41 and 42

Prior U.S. Cls.: 2, 5, 22, 23, 29, 37, 38, 50, 100, 101, 102, 104 and 107

Reg. No. 2,892,176

United States Patent and Trademark Office

Registered Oct. 12, 2004

**TRADEMARK
SERVICE MARK
PRINCIPAL REGISTER**

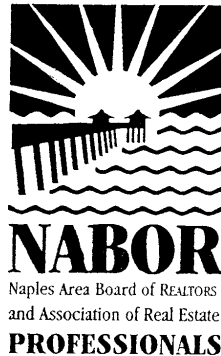

NAPLES AREA BOARD OF REALTORS AND
ASSOCIATION OF REAL ESTATE PROFES-
SIONALS, INC. (FLORIDA CORPORATION)
1455 PINE RIDGE ROAD
NAPLES, FL 341092187

FOR: PRINTED MATTER, NAMELY, ASSOCIA-
TION MEMBERSHIP ROSTERS, MAGAZINES FEAT-
URING INFORMATION IN THE AREA OF REAL
ESTATE, AND REAL ESTATE TRANSACTION
DOCUMENTS FOR THE REAL ESTATE PROFES-
SION AND INDUSTRY, IN CLASS 16 (U.S. CLS. 2, 5,
22, 23, 29, 37, 38 AND 50).

FIRST USE 8-3-1997; IN COMMERCE 8-3-1997.

FOR: REAL ESTATE SERVICES, NAMELY,
MAINTAINING AND LEASING CONFERENCE
ROOMS; REAL ESTATE MULTIPLE LISTING SER-
VICES ACCESSIBLE VIA THE INTERNET; PROVID-
ING AN ON-LINE COMPUTER DATABASE OF
REAL ESTATE TRANSACTION AND TAX INFOR-
MATION; FINANCIAL SERVICES, NAMELY, AD-
MINISTRATION OF 401(K) PLANS,
RECONCILIATION OF ESCROW AND TRUST
BANK ACCOUNTS; PROVIDING REAL ESTATE
INFORMATION VIA THE INTERNET, NAMELY,
INFORMATION ON CURRENT LEGISLATION RE-
LATING TO REAL ESTATE, AND INFORMATION
ON LOCAL REAL ESTATE NEWS, IN CLASS 36 (U.S.
CLS. 100, 101 AND 102).

FIRST USE 8-3-1997; IN COMMERCE 8-3-1997.

FOR: ELECTRONIC MESSAGING SERVICES,
NAMELY, THE TRANSMISSION AND RECEIPT
OF DATA VIA THE INTERNET; PROVIDING TELE-
COMMUNICATIONS CONNECTIONS TO THE IN-
TERNET; PROVIDING TELECOMMUNICATIONS
CONNECTIONS TO A LIMITED ACCESS COMPU-
TER NETWORK, IN CLASS 38 (U.S. CLS. 100, 101
AND 104).

FIRST USE 8-3-1997; IN COMMERCE 8-3-1997.

FOR: EDUCATIONAL SERVICES, NAMELY,
CONDUCTING SEMINARS AND TRAINING RE-
LATING TO CURRENT REAL ESTATE TOPICS,
COMPUTER SOFTWARE USE, CONTINUING
REAL ESTATE EDUCATION, REAL ESTATE DES-
IGNATION COURSES FOR THE CONTINUING
EDUCATION OF REAL ESTATE PROFESSIONALS,
AND MANAGING LEGAL AND BUSINESS RISKS
IN CONDUCTING REAL ESTATE BUSINESS AC-
TIVITIES, AND DISTRIBUTING COURSE MATERI-
ALS IN CONNECTION THEREWITH;
ORGANIZING AND CONDUCTING SPEECHES
ON REAL ESTATE TOPICS; LIBRARY SERVICES,
NAMELY, PROVIDING ACCESS TO MATERIALS
RELATING TO THE REAL ESTATE PROFESSION
AND INDUSTRY; PUBLICATION OF MAGAZINES,
IN CLASS 41 (U.S. CLS. 100, 101 AND 107).

FIRST USE 8-3-1997; IN COMMERCE 8-3-1997.

FOR: PROVIDING LEGAL INFORMATION RE-
GARDING REAL ESTATE ISSUES TO REAL ES-

TATE PROFESSIONALS; ARBITRATION AND DISPUTE RESOLUTION SERVICES IN THE FIELD OF REAL ESTATE; ASSOCIATION SERVICES, NAME- LY, PROMOTING THE INTEREST OF REAL ES- TATE PROFESSIONALS BY MAINTAINING AND PROVIDING ACCESS TO A MEMBERSHIP ROSTER FOR REAL ESTATE PROGRAMS, IN CLASS 42 (U.S. CLS. 100 AND 101).

FIRST USE 8-3-1997; IN COMMERCE 8-3-1997.

NO CLAIM IS MADE TO THE EXCLUSIVE RIGHT TO USE "ASSOCIATION OF REAL ESTATE PROFESSIONALS", APART FROM THE MARK AS SHOWN.

SEC. 2(F) AS TO "NAPLES AREA BOARD OF REALTORS".

SER. NO. 75-943,518, FILED 3-14-2000.

LAURA KOVAISKY, EXAMINING ATTORNEY

Int. Cls.: 16, 18, 28, 35, 39, 41 and 42

Prior U.S. Cls.: 1, 2, 3, 5, 22, 23, 29, 37, 38, 41, 50, 100, 101, 102, 105 and 107

Reg. No. 2,892,177

United States Patent and Trademark Office

Registered Oct. 12, 2004

**TRADEMARK
SERVICE MARK
PRINCIPAL REGISTER**

MILESTONE

DAIMLER-BENZ AKTIENGESELLSCHAFT (FED
REP GERMANY CORPORATION)

70546 STUTTGART, FED REP GERMANY

FOR: PAMPHLETS, NEWSPAPERS, MAGAZINES,
BROCHURES, NEWSLETTERS, MANUALS, CATA-
LOGS AND PRINTED INSTRUCTIONAL MATERIAL,
ALL PERTAINING TO AUTOMOTIVE TRAVEL
AND RELATED MATTERS OF INTEREST OF OWN-
ERS OF APPLICANT'S AUTOMOBILES; UNMOUN-
TED AUTOMOBILES, IN CLASS 16 (U.S. CLS. 2, 5, 22,
23, 29, 37, 38 AND 50).

FOR: LEATHER GOODS, NAMELY, PURSES,
WALLETS, KEY CASES, LARGE AND SMALL
SUITCASES, BRIEFCASES, UMBRELLAS, PARA-
SOLS AND WALKING STICKS, IN CLASS 18 (U.S.
CLS. 1, 2, 3, 22 AND 41).

FOR: BOARD GAMES, PLUSH ANIMALS, AND
OTHER GAMES AND TOYS, NAMELY, TOY AUTO-
MOBILES, JIGSAW PUZZLES, DOMINOES, BAD-
MINTON GAME PLAYING EQUIPMENT,
BADMINTON RACKETS, BADMINTON SETS, TEN-
NIS BALLS, TENNIS RACKETS, TENNIS RACKET
COVERS, TABLE TENNIS, PADDLE BALL, RACKET
BALL AND SQUASH GAMES, YO YOS, AND MOD-
EL TOY AUTOMOBILES, IN CLASS 28 (U.S. CLS. 22,
23, 38 AND 50).

FOR: ARRANGING AND CONDUCTING AUTO-
MOBILE TRADE SHOW EXHIBITIONS, IN CLASS 35
(U.S. CLS. 100, 101 AND 102).

FOR: TRANSPORTATION OF PASSENGERS BY
MOTOR VEHICLES, TRAINS, AIRCRAFT AND
BOATS; TRAVEL AGENCY SERVICES, NAMELY,
MAKING RESERVATIONS AND BOOKINGS FOR
TRANSPORTATION, IN CLASS 39 (U.S. CLS. 100
AND 105).

FOR: ARRANGING AND CONDUCTING
SPORTS COMPETITIONS, IN CLASS 41 (U.S. CLS.
100, 101 AND 107).

FOR: TRAVEL AGENCY SERVICES, NAMELY,
MAKING RESERVATIONS AND BOOKINGS FOR
TEMPORARY LODGING; CONTRACT FOOD SER-
VICES; ARRANGING FOR TRAVELING COMPA-
NIONS, NAMELY, PROVIDING A PERSON TO
ACCOMPANY A PERSON IN TRAVEL, IN CLASS
42 (U.S. CLS. 100 AND 101).

PRIORITY CLAIMED UNDER SEC. 44(D) ON FED
REP GERMANY APPLICATION NO. 39707251.1,
FILED 2-19-1997, REG. NO. 39707251, DATED 7-27-
1998, EXPIRES 2-28-2007.

SER. NO. 75-978,318, FILED 8-19-1997.

ALICE BENMAMAN, EXAMINING ATTORNEY

Int. Cl.: 42

Prior U.S. Cls.: 100 and 101

United States Patent and Trademark Office

Reg. No. 2,892,178

Registered Oct. 12, 2004

**SERVICE MARK
PRINCIPAL REGISTER**



**POWER
MEASUREMENT**

POWER MEASUREMENT LTD. (CANADA CORPORATION)
2195 KEATING CROSS ROAD
SAANICHTON, BRITISH COLUMBIA, CANADA
V8M 2A5

FOR: PRODUCT DEVELOPMENT FOR OTHERS AND DESIGN FOR OTHERS, NAMELY PRODUCT DEVELOPMENT AND CUSTOM DESIGN OF POWER AND ENERGY METERING, MONITORING AND CONTROL SYSTEMS FOR INSTITUTIONAL, COMMERCIAL, INDUSTRIAL AND POWER UTILI-

TY CUSTOMERS, IN CLASS 42 (U.S. CLS. 100 AND 101).

FIRST USE 0-0-1984; IN COMMERCE 0-0-1984.

SEC. 2(F) AS TO "POWER MEASUREMENT".

SER. NO. 75-981,813, FILED 12-5-2000.

STEVEN BERK, EXAMINING ATTORNEY

Int. Cl.: 36

Prior U.S. Cls.: 100, 101 and 102

United States Patent and Trademark Office

Reg. No. 2,892,179

Registered Oct. 12, 2004

**SERVICE MARK
PRINCIPAL REGISTER**

GOAL

UBS AG (SWITZERLAND COMPANY)
P.O. BOX
CH-8098 ZURICH, SWITZERLAND

FOR: FINANCIAL INVESTMENT IN THE FIELD
OF DERIVATIVES, NAMELY, A STRUCTURED
EQUITY-LINKED SECURITY THAT COMBINES A
BOND AND AN OPTION ON A SPECIFIC STOCK, IN
CLASS 36 (U.S. CLS. 100, 101 AND 102).

FIRST USE 2-21-2001; IN COMMERCE 2-21-2001.

PRIORITY CLAIMED UNDER SEC. 44(D) ON
SWITZERLAND APPLICATION NO. 182501, FILED
2-21-2001.

SER. NO. 75-982,291, FILED 6-22-2001.

CAROLINE WEIMER, EXAMINING ATTORNEY

Int. Cl.: 28

Prior U.S. Cls.: 22, 23, 38 and 50

Reg. No. 2,892,180

United States Patent and Trademark Office

Registered Oct. 12, 2004

**TRADEMARK
PRINCIPAL REGISTER**



SANTA CRUZ SURF SHOP, INC. (CALIFORNIA
CORPORATION)
753 - 41ST AVENUE
SANTA CRUZ, CA 95062

SURFBOARD BAGS, AND SURFBOARD LEASHES,
IN CLASS 28 (U.S. CLS. 22, 23, 38 AND 50).

FIRST USE 1-0-1996; IN COMMERCE 9-0-1996.

FOR: TOYS AND SPORTING GOODS; NAMELY,
SURFBOARDS, BODYBOARDS, SNOWBOARDS,
SKATEBOARDS, SCOOTERS, WAKEBOARDS,

SER. NO. 75-983,073, FILED 3-14-2001.

STACY WAHLBERG, EXAMINING ATTORNEY

Int. Cl.: 21

Prior U.S. Cls.: 2, 13, 23, 29, 30, 33, 40 and 50

Reg. No. 2,892,181

United States Patent and Trademark Office

Registered Oct. 12, 2004

**TRADEMARK
PRINCIPAL REGISTER**



TOLCO CORPORATION (OHIO CORPORATION)
1920 LINWOOD AVENUE
TOLEDO, OH 43624

FIRST USE 12-31-1999; IN COMMERCE 12-31-1999.

FOR: SPRAY BOTTLES SOLD EMPTY AND
HAND-OPERATED TRIGGER SPRAYER HEADS
THEREFOR, IN CLASS 21 (U.S. CLS. 2, 13, 23, 29, 30,
33, 40 AND 50).

SER. NO. 76-011,873, FILED 3-29-2000.

MATTHEW PAPPAS, EXAMINING ATTORNEY

Int. Cl.: 16

Prior U.S. Cls.: 2, 5, 22, 23, 29, 37, 38 and 50

Reg. No. 2,892,182

United States Patent and Trademark Office

Registered Oct. 12, 2004

**TRADEMARK
PRINCIPAL REGISTER**



A.W. FABER-CASTELL S.A. (BRAZIL FIRM)
RUA 1 DE MAIO 61
CENTRO, SAO CARLOS-SP, BRAZIL

OWNER OF U.S. REG. NOS. 2,282,352 AND
2,342,032.

FOR: PENCILS AND COLORED PENCILS, IN
CLASS 16 (U.S. CLS. 2, 5, 22, 23, 29, 37, 38 AND 50).

NO CLAIM IS MADE TO THE EXCLUSIVE
RIGHT TO USE "PENCILS MADE FROM REFOR-
ESTED WOOD", APART FROM THE MARK AS
SHOWN.

PRIORITY CLAIMED UNDER SEC. 44(D) ON
BRAZIL APPLICATION NO. 822101211, FILED 10-
13-1999, REG. NO. 822101211, DATED 9-30-2003, EX-
PIRES 9-30-2013.

SER. NO. 76-020,578, FILED 4-7-2000.

AMY GEARIN, EXAMINING ATTORNEY

Int. Cl.: 12

Prior U.S. Cls.: 19, 21, 23, 31, 35 and 44

United States Patent and Trademark Office

Reg. No. 2,892,183

Registered Oct. 12, 2004

**TRADEMARK
PRINCIPAL REGISTER**

PREMIUM WIDE TRAC

TITAN INTERNATIONAL, INC. (ILLINOIS CORPORATION)
2701 SPRUCE STREET
QUINCY, IL 62301

FIRST USE 1-1-1994; IN COMMERCE 1-1-1994.

SEC. 2(F).

FOR: TIRES, NAMELY, TIRES FOR VEHICLES USED IN THE CONSTRUCTION, EARTHMOVING, AND MINING INDUSTRIES, IN CLASS 12 (U.S. CLS. 19, 21, 23, 31, 35 AND 44).

SER. NO. 76-020,793, FILED 4-5-2000.

WON TEAK OH, EXAMINING ATTORNEY

Int. Cls.: 7 and 12

Prior U.S. Cls.: 13, 19, 21, 23, 31, 34, 35 and 44

United States Patent and Trademark Office

Reg. No. 2,892,184

Registered Oct. 12, 2004

**TRADEMARK
PRINCIPAL REGISTER**

POWERTOROS UNIT

NIPPON SEIKO KABUSHIKI KAISHA (JAPAN CORPORATION), DBA NSK LTD.
L-6-3, OSAKI, SHINAGAWA-KU
TOKYO, JAPAN

FOR: TRANSMISSIONS FOR MACHINES, NAME-
LY, POWER TRANSMISSIONS FOR CARGO AND
FREIGHT EQUIPMENT; POWER TRANSMISSIONS
FOR OUTDOOR INDUSTRIAL USES; AND OTHER
POWER TRANSMISSIONS; BUT NOT FOR USE
WITH TURF MOWERS, TURF SPRAYERS, LAWN
AND GARDEN SPREADERS, SNOW THROWERS,
LAWN AND GARDEN UTILITY TRUCKS, AND
ALL OTHER OUTDOOR LAWN AND GARDEN
POWER EQUIPMENT, IN CLASS 7 (U.S. CLS. 13, 19,
21, 23, 31, 34 AND 35).

FOR: TRANSMISSIONS FOR LAND VEHICLES,
NAMELY, SPEED CHANGE GEARS FOR LAND
VEHICLES; OTHER POWER TRANSMISSIONS FOR
LAND VEHICLES; BUT NOT FOR USE WITH TURF

MOWERS, TURF SPRAYERS, LAWN AND GAR-
DEN SPREADERS, SNOW THROWERS, LAWN
AND GARDEN UTILITY TRUCKS, AND ALL
OTHER OUTDOOR LAWN AND GARDEN POWER
EQUIPMENT, IN CLASS 12 (U.S. CLS. 19, 21, 23, 31, 35
AND 44).

PRIORITY CLAIMED UNDER SEC. 44(D) ON
JAPAN APPLICATION NO. 11-99496, FILED 11-2-
1999, REG. NO. 4418685, DATED 9-22-2000, EXPIRES
9-22-2010.

NO CLAIM IS MADE TO THE EXCLUSIVE
RIGHT TO USE "UNIT", APART FROM THE MARK
AS SHOWN.

SER. NO. 76-035,017, FILED 4-26-2000.

MATTHEW KLINE, EXAMINING ATTORNEY

Int. Cl.: 5

Prior U.S. Cls.: 6, 18, 44, 46, 51 and 52

United States Patent and Trademark Office

Reg. No. 2,892,185

Registered Oct. 12, 2004

**TRADEMARK
PRINCIPAL REGISTER**

PAK

SOLVAY (BELGIUM CORPORATION)
33 RUE DU PRINCE ALBERT
B-1050 BRUSSELS, BELGIUM

FOR: CHEMICAL PRODUCTS, NAMELY, PER-
OXYGENS FOR USE AS ALGAECIDES FOR USE IN
LAKES, PONDS, DRINKING WATER RESERVOIRS,
AND A VARIETY OF OTHER GENERAL PURPOSE

INDUSTRIAL AND COMMERCIAL USES, IN CLASS
5 (U.S. CLS. 6, 18, 44, 46, 51 AND 52).

FIRST USE 9-29-1998; IN COMMERCE 9-29-1998.

SER. NO. 76-037,132, FILED 4-28-2000.

ALICIA COLLINS, EXAMINING ATTORNEY

Int. Cl.: 9

Prior U.S. Cls.: 21, 23, 26, 36 and 38

Reg. No. 2,892,186

United States Patent and Trademark Office

Registered Oct. 12, 2004

**TRADEMARK
PRINCIPAL REGISTER**

RANGER

RANGER ELECTRONIC COMMUNICATIONS,
INC. (TAIWAN CORPORATION)
70 PEI NEI STREET
SHULIN, TAIWAN

FOR: AMATEUR RADIOS, 2-WAY RADIO COM-
MUNICATION DEVICES, BUSINESS RADIOS, CITI-
ZEN BAND RADIOS, COMMERCIAL RADIOS,

LAND MOBILE RADIOS, IN CLASS 9 (U.S. CLS. 21,
23, 26, 36 AND 38).

FIRST USE 1-0-1989; IN COMMERCE 1-0-1989.

SER. NO. 76-038,833, FILED 5-2-2000.

MICHAEL BAIRD, EXAMINING ATTORNEY

Int. Cl.: 16

Prior U.S. Cls.: 2, 5, 22, 23, 29, 37, 38 and 50

United States Patent and Trademark Office

Reg. No. 2,892,187

Registered Oct. 12, 2004

**TRADEMARK
PRINCIPAL REGISTER**

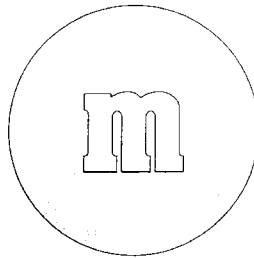

MARS, INCORPORATED (DELAWARE CORPORATION)
6885 ELM STREET
MCLEAN, VA 221013883

FOR: CHILDREN'S ACTIVITY SET CONTAINING ACTIVITY BOOK, POSTERS, CARDBOARD PUZZLES TO BE COLORED, ADHESIVE STICKER SHEETS, STICKER PUZZLES AND COLORED MARKER PENS, IN CLASS 16 (U.S. CLS. 2, 5, 22, 23, 29, 37, 38 AND 50).

FIRST USE 7-0-1999; IN COMMERCE 7-0-1999.

OWNER OF U.S. REG. NOS. 418,332 AND 1,687,121.

THE DRAWING IS NOT LINED FOR COLOR. THE STIPPLING IS FOR SHADING PURPOSES ONLY AND DOES NOT INDICATE COLOR.

SER. NO. 76-046,100, FILED 5-11-2000.

EDWARD NELSON, EXAMINING ATTORNEY

Int. Cl.: 25

Prior U.S. Cls.: 22 and 39

United States Patent and Trademark Office

Reg. No. 2,892,188

Registered Oct. 12, 2004

**TRADEMARK
PRINCIPAL REGISTER**

717

BOEING MANAGEMENT COMPANY (DELA-
WARE CORPORATION)
2201 SEAL BEACH BLVD.
M/S 110-SB-70
SEAL BEACH, CA 907401515

FIRST USE 5-17-1999; IN COMMERCE 5-17-1999.

OWNER OF U.S. REG. NOS. 1,435,743, 1,780,858,
AND 1,815,137.

FOR: SHORTS, CAPS, T-SHIRTS, JACKETS,
SWEATSHIRTS, SWEATPANTS, POLO SHIRTS,
RUGBY SHIRTS, DRESSES, ROMPERS, BUTTON-
DOWN SHIRTS, VESTS, SLEEVELESS SHIRTS,
MOCK NECK SHIRTS, AND TANK TOPS, IN CLASS
25 (U.S. CLS. 22 AND 39).

SER. NO. 76-047,865, FILED 5-11-2000.

GENE MACIOL, EXAMINING ATTORNEY

Int. Cls.: 8, 20, 21 and 24

**Prior U.S. Cls.: 2, 13, 22, 23, 25, 28, 29, 30, 32, 33, 40,
42, 44 and 50**

Reg. No. 2,892,189

United States Patent and Trademark Office

Registered Oct. 12, 2004

**TRADEMARK
PRINCIPAL REGISTER**

TEXTILIER

TEXTILIER INC. (CANADA CORPORATION)
2305 ROCKLAND BLVD., SUITE 154
MONT-ROYAL, QUEBEC, CANADA H3P 3E9

FOR: CUTLERY, NAMELY, KNIVES, FORKS AND SPOONS MADE OF STAINLESS STEEL OR SILVER PLATE; SODA SPOONS; KNIVES, NAMELY, STEAK KNIVES, CARVING KNIVES, PARING KNIVES, BREAD KNIVES, DEBONING, KNIVES, TOMATO KNIVES, GRAPEFRUIT KNIVES, CHEF KNIVES, UTILITY KNIVES, FILLETING KNIVES, CAKE KNIVES, CHEESE KNIVES, AND OYSTER KNIVES; HAND TOOLS, NAMELY, MANUALLY-OPERATED KNIFE SHARPENERS, CLEAVERS, ZESTERS, SCISSORS, APPLE CORERS, MUSHROOM SLICERS, JULIENNE SLICERS, SEAFOOD FORKS, SEAFOOD PICKS, NON ELECTRIC-VEGETABLE AND FRUIT PEELERS, PIZZA CUTTERS, MANUAL BAGEL CUTTERS, PICKLE FORKS, MUSHROOM BRUSHES, BUTTER CURLERS, CHERRY PITTERS, NUT CRACKERS NOT OF PRECIOUS METAL; MANUAL JUICERS AND MANUAL MILK FROTHERS; NON-ELECTRIC CAN OPENERS, IN CLASS 8 (U.S. CLS. 23, 28 AND 44).

FOR: PICTURE FRAMES, IN CLASS 20 (U.S. CLS. 2, 13, 22, 25, 32 AND 50).

FOR: DINNERWARE, NAMELY, PLATES CUPS SAUCERS, BOWLS, AND PLATTERS MADE OF BONE CHINA, EARTHENWARE, STONE WARE OR FINE CHINA; STEMWARE AND BARWARE, NAMELY, WINE GLASSES, GOBLETS, FLUTES, PITCHERS AND DECANTERS MADE OF GLASS OR CRYSTAL; VASES; BOWLS AND PLATTERS MADE OF CRYSTAL CERAMIC, PORCELAIN, STAINLESS STEEL OR SILVER PLATE; COOKWARE, NAMELY, POTS AND PANS MADE OF STAINLESS STEEL AND COPPER SKILLETS; BAKEWARE, NAMELY, COOKIE SHEETS, MUFFIN PANS, CAKE MOULDS, SPRING FORM PANS, LASAGNA PANS, CASSEROLE BAKERS, CASSEROLE DISHES, SOUFFLE CUPS, MIXING BOWLS,

COOKING RACKS, MADELEINE PANS, QUICHE PANS AND GRATIN DISHES MADE OF TIN, STAINLESS STEEL, ALUMINUM OR TEMPERED GLASS; COOKING UTENSILS, NAMELY, PIE SERVERS, BOTTLE OPENERS, COOKIE MOULDS, SPATULAS, WHISKS, WINE BOTTLE OPENERS, STRAINERS, COLANDERS, SALAD SPINNERS, ROLLING PINS, MIXING SPOONS, SKIMMERS, SERVING SPOONS, WINE POURING SPOUTS; HOUSEHOLD UTENSILS, NAMELY, GRATERS AND NUT GRATERS, POTATO MASHERS, GARLIC KEEPERS, GARLIC PRESSES, TEA BALLS NOT OF PRECIOUS METAL, WOODEN OR MELAMINE CUTTING BOARDS, BOWL COVERS, CHEESE PLANES, PASTRY WHEELS, ICE CREAM SCOPPERS, SPOON RESTS, BASTING BRUSHES, BASTERS, WOODEN BANANA TREES, NAMELY, HOUSEHOLD UTENSILS FOR HOLDING BUNCHES OF BANANAS; SERVING UTENSILS, NAMELY, MEAT FORKS AND LADLES; SALT AND PEPPER SHAKERS, MANUALLY-OPERATED SALT AND PEPPER GRINDERS; RECIPE BOOK HOLDERS, RECIPE HOLDERS, ARTICHOKE STEAMER RACKS, COASTERS NOT MADE OF PAPER AND NOT BEING TABLE LINENS; SPICE, CHEESE, FLOUR AND ICING SHAKERS; OIL AND VINEGAR SETS; SOAP DISPENSERS, KITCHEN UTENSIL TOOL CADDIES, TEA BAG HOLDERS, NON ELECTRIC COOKWARE, NAMELY, ROASTERS, VEGETABLE STEAMERS, AND VEGETABLE ROASTERS; DISH STRAINERS, DISH RACKS, PIZZA STONES, HONEY DIPPERS, VERTICAL TOWEL HOLDERS, MORTAR AND PESTLES, SALAD DRESSING SHAKERS, NON-ELECTRIC COFFEE POTS NOT OF PRECIOUS METAL, FRENCH PRESSES, NAMELY, NON-ELECTRIC COFFEE MAKERS AND NON ELECTRIC TEA MAKERS; BEVERAGE GLASSWARE, NAMELY HIGHBALL GLASSES AND OLD FASHIONED GLASSES; KNIFE BLOCKS, MELON BALLERS, IN CLASS 21 (U.S. CLS. 2, 13, 23, 29, 30, 33, 40 AND 50).

FOR: WINDOW TREATMENTS, NAMELY, DRAPERIES AND VALANCES; MATTRESS PADS; SHOWER CURTAINS; BATH TOWELS, HAND TOWELS, WASH CLOTHS, TUB MATS; PILLOW CASES OF A BED LINEN TYPE, PILLOW SHAMS OF A BED LINEN TYPE, AND PILLOW PROTECTORS OF A BED LINEN TYPE; DUVET AND DUVET COVERS; COMFORTERS; DUST RUFFLES; BED SHEETS; BED SHAMS AND BED SKIRTS, IN CLASS 24 (U.S. CLS. 42 AND 50).

PRIORITY CLAIMED UNDER SEC. 44(D) ON CANADA APPLICATION NO. 1,040,089, FILED 12-16-1999, REG. NO. TMA551201, DATED 9-20-2001, EXPIRES 9-20-2016.

SER. NO. 76-048,075, FILED 5-15-2000.

HELEN BRYAN, EXAMINING ATTORNEY

Int. Cls.: 3, 6, 9, 14, 16, 18, 20, 24, 25, 28 and 41

Prior U.S. Cls.: 1, 2, 3, 4, 5, 6, 12, 13, 14, 21, 22, 23, 25, 26, 27, 28, 29, 32, 36, 37, 38, 39, 41, 42, 50, 51, 52, 100, 101 and 107

Reg. No. 2,892,190

United States Patent and Trademark Office

Registered Oct. 12, 2004

**TRADEMARK
SERVICE MARK
PRINCIPAL REGISTER**



WILLIAMS, ROBERT PETER (UNITED KINGDOM INDIVIDUAL)
C/O IE MUSIC
111 FRITHVILLE GARDENS
LONDON W12 7JG, UNITED KINGDOM

FOR: PERFUMES; TOILET WATER; EAU DE COLOGNE; ESSENTIAL OILS FOR PERSONAL USE; COSMETICS, NAMELY EYE SHADOW, LIP GLOSS, LIPSTICK, MASCARA, FOUNDATION MAKEUP; TOILET PREPARATIONS, NAMELY EAU DE TOILETTE; SOAPS, ANTI-BACTERIAL SOAP, DEODORANT SOAP, DETERGENT SOAP, MEDICATED SOAP, SHAVING SOAP, SKIN SOAP, TOILET SOAP; ANTIPERSPIRANTS; DEODORANTS FOR PERSONAL CARE; SKIN CARE PREPARATIONS, NAMELY LOTIONS, CREAMS AND CONDITIONERS; BEAUTY CARE PREPARATIONS, NAMELY BEAUTY MASKS; BODY CARE PREPARATIONS, NAMELY CREAM, MASKS, OIL, POWDER, SCRUBS; HAND AND BODY LOTIONS; DENTIFRICE; SHAVING PREPARATIONS, BATH PREPARATIONS, NAMELY BEADS, CRYSTALS, FOAM, GELS, OIL, POWDER; SCENTED BODY SPRAYS; AFTER SHAVE LOTIONS; PRE-ELECTRIC SHAVING PREPARATIONS, IN CLASS 3 (U.S. CLS. 1, 4, 6, 50, 51 AND 52).

FOR: GOODS MADE WHOLLY OR PRINCIPALLY OF NON-PRECIOUS METAL, NAMELY, NAME BADGES, KEYS, KEY BLANKS, KEY RINGS, KEY

FOBS, KEY CHAINS, IDENTIFICATION TAGS OF METAL, LOCKS, FIGURINES OF METAL, TROPHIES, STATUES AND STATUETTES, BOXES, MONEY BOXES AND TOOL BOXES, IN CLASS 6 (U.S. CLS. 2, 12, 13, 14, 23, 25 AND 50).

FOR: VIDEO RECORDINGS AND SOUNDS RECORDINGS; GRAMOPHONE RECORDS FEATURING MUSIC; COMPACT DISCS FEATURING MUSIC; PRE-RECORDED AUDIO TAPES, CASSETTES AND CARTRIDGES FEATURING MUSIC; PRE-RECORDED VIDEO TAPES, CASSETTES AND CARTRIDGES FEATURING IMAGES AND MUSIC; MULTIMEDIA SOFTWARE RECORDED ON CD-ROM FEATURING MUSIC; ELECTRONIC GAMES ADAPTED FOR USE WITH TELEVISION RECEIVERS; COMPUTER GAMES AND VIDEO GAMES FEATURING MUSIC; BLANK MAGNETIC COMPUTER TAPES; AUDIO DISCS FEATURING MUSIC; VIDEO DISCS FEATURING IMAGES AND MUSIC; OPTICAL DISCS BEARING SOUND, OPTICAL DISCS BEARING VIDEO RECORDINGS; MOTION PICTURE FILMS FEATURING MUSIC OR MUSICAL ARTISTS; INTERACTIVE VIDEO GAMES OF VIRTUAL REALITY COMPRISED OF COMPUTER HARDWARE AND SOFTWARE; EYEGLASSES; SUNGLASSES; SPECTACLES; PARTS AND FITTINGS FOR ALL THE AFORESAID GOODS; CYCLE HELMETS, IN CLASS 9 (U.S. CLS. 21, 23, 26, 36 AND 38).

FOR: GOODS ALL MADE WHOLLY OR PRINCIPALLY OF PRECIOUS METALS AND THEIR ALLOYS OR COATED THEREWITH, NAMELY, TROPHIES, ORNAMENTS, FIGURINES, NAME BADGES, COFFEE POTS, TEAPOTS, GOBLET, CUPS, SERVING TRAYS, VASES, DECORATIVE AND JEWELRY BOXES, WATCH CASES, JEWELRY CASES, CIGARETTE CASES, HOUSEHOLD CONTAINERS, HOUSEHOLD UTENSILS, NAMELY, WHISKS, SPATULAS, LADLES, SPOONS, CUTLERY, TOWEL HOLDERS, AND NAPKIN HOLDERS; CLOCKS, ALARM CLOCKS; WATCHES; JEWELRY; PRECIOUS STONES, NAMELY, DIAMONDS, RUBIES, SAPPHIRES; BRACELETS, JEWELRY CHAINS, WATCH CHAINS, NON-MONETARY COINS, MEDALS, MEDALLIONS, KEY RINGS, TIE CLIPS, TIE PINS, CUFFLINKS, HAT PINS, JEWELRY PINS FOR USE ON HATS, ORNAMENTAL LAPEL PINS, AND JEWELRY PINS, IN CLASS 14 (U.S. CLS. 2, 27, 28 AND 50).

FOR: PRINTED MATTER, NAMELY, BOOKS, NEWSPAPERS, NEWSLETTERS, PAMPHLETS, MAGAZINES, PERIODICALS, CATALOGUES, BROCHURES, AND PROGRAMS, ALL RELATING TO ENTERTAINMENT, MUSIC AND MUSICAL ARTISTS; BOOK COVERS; CALENDARS; PICTURES; MOUNTED PHOTOGRAPHS; UNMOUNTED PHOTOGRAPHS; STATIONERY; PENCILS; PENS; PRINTED PLANS; PRINTED CHARTS; POSTERS; ORDINARY PLAYING CARDS; PAINT BRUSHES; DIARIES; DRAWING INSTRUMENTS; GREETING CARDS; ADDRESS BOOKS; ADHESIVES FOR STATIONERY PURPOSES; PAPER HANDKERCHIEFS; TABLE NAPKINS OF PAPER; BINDERS, IN CLASS 16 (U.S. CLS. 2, 5, 22, 23, 29, 37, 38 AND 50).

FOR: ARTICLES OF LEATHER OR IMITATION LEATHER, NAMELY, HANDBAGS, DIAPER BAGS, DUFFEL BAGS, BOOK BAGS, BEACH BAGS, BAGS FOR CARRYING RECORDS; BAGS FOR CARRYING SHOES; BRIEFCASES; WRIST MOUNTED CARRYALL BAGS, RUCKSACKS, ALL PURPOSES SPORTS BAGS, SATCHELS; WALLETS; BELTS; PURSES; CREDIT CARD HOLDERS; UMBRELLAS; PARASOLS, IN CLASS 18 (U.S. CLS. 1, 2, 3, 22 AND 41).

FOR: PLAQUES; FURNITURE MIRRORS; PICTURE FRAMES; PLASTIC LUGGAGE TAGS; FIGURINES AND ORNAMENTS MADE OF WOOD, WAX, PLASTER AND PLASTIC; PLASTIC PENNANTS, NON-METAL KEY FOBS; PLASTIC KEY RINGS; BEDS; PLASTIC SIGN BOARDS; SLEEPING BAGS; NON-METALLIC TRAYS; WINDOW BLINDS, IN CLASS 20 (U.S. CLS. 2, 13, 22, 25, 32 AND 50).

FOR: TEXTILE ARTICLES, NAMELY BED LINEN, DUVET COVERS, PILLOW CASES, BED SHEETS, BED BLANKETS; TABLE LINEN; NAMELY TABLE CLOTHS AND NAPKINS; HAND-

KERCHIEFS, CURTAINS, CLOTH PENNANTS, CLOTH BANNERS, CLOTH FLAGS, TOWELS, BEACH TOWELS, TEXTILE WALL HANGINGS, FACE TOWELS, TEA TOWELS, FLANNELS, TEXTILE PLACE MATS, SILK FABRICS, IN CLASS 24 (U.S. CLS. 42 AND 50).

FOR: ARTICLES OF CLOTHING, NAMELY T-SHIRTS, SHIRTS, SWEATSHIRTS, JACKETS, PYJAMAS, TROUSERS, WRISTBANDS, HEADBANDS, PANTS, HATS, SOCKS, UNDERWEAR, SHORTS, SCARVES, PULLOVERS, TIES, GLOVES, CAPS, IN CLASS 25 (U.S. CLS. 22 AND 39).

FOR: TOYS, NAMELY ACTION FIGURES, DOLLS, DOLLHOUSES, GAMES, NAMELY BOARD GAMES; COIN-OPERATED VIDEO GAMES, ARCADE GAMES; TEDDY BEARS, PLUSH TOYS, PUZZLES, NAMELY JIGSAW PUZZLES, MANIPULATIVE PUZZLES, CUBE PUZZLES; BALLOONS, TOY MODELS, HOBBY CRAFT KITS, TOY FIGURES; SPORTING ARTICLES, NAMELY SPORT BALLS, BATS, RACQUETS, ROLLER SKATES, CHEST PROTECTORS; GYMNASIUM APPARATUS, IN CLASS 28 (U.S. CLS. 22, 23, 38 AND 50).

FOR: ENTERTAINMENT SERVICES IN THE NATURE OF LIVE CONCERT AND MUSICAL PERFORMANCE; MUSICAL SERVICES PROVIDED ONLINE, FROM AN INTERNET OR WEBSITE; AUDIO AND VIDEO RECORDING SERVICES; PRODUCTION OF VIDEO AND/OR SOUND RECORDINGS; ENTERTAINMENT IN THE NATURE OF TELEVISION AND RADIO PROGRAMS IN THE FIELD OF VARIETY, COMEDY AND MUSIC; ENTERTAINMENT, NAMELY PRESENTATION, PRODUCTION AND PERFORMANCE OF SHOWS, MUSICAL SHOWS, CONCERTS, VIDEOS, MULTIMEDIA VIDEOS AND RADIO AND TELEVISION PROGRAMS; AUDIO AND VIDEO PRODUCTION SERVICES; RECORDING FILM, VIDEO TAPES AND TELEVISION STUDIO SERVICES; MUSIC PUBLISHING SERVICES; PRODUCTION AND DISTRIBUTION OF MOTION PICTURES; EDUCATIONAL SERVICES, NAMELY CONDUCTING SEMINARS AND CONFERENCES IN THE FIELD OF ENTERTAINMENT AND MUSIC; CONDUCTING ENTERTAINMENT EXHIBITIONS IN THE NATURE OF MUSICAL SHOWS; PUBLICATION OF BOOKS, MAGAZINES AND OTHER TEXTS, IN CLASS 41 (U.S. CLS. 100, 101 AND 107).

PRIORITY CLAIMED UNDER SEC. 44(D) ON UNITED KINGDOM APPLICATION NO. 2215134, FILED 11-24-1999, REG. NO. 2215134, DATED 10-6-2000, EXPIRES 11-24-2009.

SER. NO. 76-054,302, FILED 5-22-2000.

LINDA MICKLEBURGH, EXAMINING ATTORNEY

Int. Cl.: 9

Prior U.S. Cls.: 21, 23, 26, 36 and 38

United States Patent and Trademark Office

Reg. No. 2,892,191

Registered Oct. 12, 2004

**TRADEMARK
PRINCIPAL REGISTER**



TRINTECH TECHNOLOGIES LIMITED (IRE-
LAND CORPORATION)
SOUTH COUNTY BUSINESS PARK
LEOPARDSTOWN
DUBLIN 18, IRELAND

FOR: COMPUTER SOFTWARE FOR FACILITAT-
ING AND PROCESSING ELECTRONIC PURCHA-
SES AND COMMERCIAL TRANSACTIONS VIA A
GLOBAL COMPUTER INFORMATION NETWORK,
IN CLASS 9 (U.S. CLS. 21, 23, 26, 36 AND 38).

PRIORITY CLAIMED UNDER SEC. 44(D) ON
ERPNTM CMNTY TM OFC APPLICATION NO.

1619105, FILED 4-19-2000, REG. NO. 1619105, DATED
6-11-2001, EXPIRES 4-19-2010.

OWNER OF U.S. REG. NO. 2,065,192.

THE LINING IN THE MARK INDICATES COL-
OR. THE LINING IN THE TERM PAYWARE AND
THE ATTACHED ARC INDICATES THE COLOR
PURPLE. THE LINING IN THE TERM EVERY-
WHERE INDICATES THE COLOR ORANGE.

SER. NO. 76-062,719, FILED 6-5-2000.

TRACY CROSS, EXAMINING ATTORNEY

Int. Cl.: 16

Prior U.S. Cls.: 2, 5, 22, 23, 29, 37, 38 and 50

United States Patent and Trademark Office

Reg. No. 2,892,192

Registered Oct. 12, 2004

**TRADEMARK
PRINCIPAL REGISTER**

SOUP TO NUTZ

STROMOSKI, RICK (UNITED STATES INDIVIDUAL)
569 N. MAIN STREET
SUFFIELD, CT 06078

FIRST USE 3-27-2000; IN COMMERCE 3-27-2000.

SER. NO. 76-069,080, FILED 6-12-2000.

FOR: SYNDICATED NEWSPAPER COMIC STRIP,
IN CLASS 16 (U.S. CLS. 2, 5, 22, 23, 29, 37, 38 AND 50).

MICHAEL KAZAZIAN, EXAMINING ATTORNEY

Int. Cl.: 41

Prior U.S. Cls.: 100, 101 and 107

United States Patent and Trademark Office

Reg. No. 2,892,193

Registered Oct. 12, 2004

**SERVICE MARK
PRINCIPAL REGISTER**

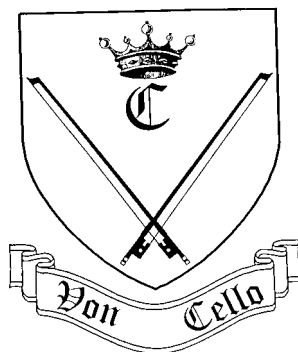

VON CELLO, INC. (NEW YORK CORPORATION)
AARON MINSKY
102-30 67TH AVE. #2F
FOREST HILLS, NY 11375

FIRST USE 8-6-1999; IN COMMERCE 5-31-2000.

FOR: AUDIO RECORDING AND PRODUCTION USED IN COMPACT DISCS, CASSETTE TAPES, RECORDS, VIDEO, DVDS, FLOPPY DISKS, ZIP DISKS, JAZZ DISKS, DOWNLOADABLE AND STREAMING INTERNET AND COMPUTER FILES; ENTERTAINMENT SERVICES, NAMELY, LIVE PERFORMANCES BY AN INDIVIDUAL CELLIST AND MUSICAL GROUP; EDUCATIONAL SERVICES, NAMELY, CONDUCTING CLASSES, WORKSHOP AND SEMINARS IN THE FIELD OF MUSICAL STUDY AND PERFORMANCE, IN CLASS 41 (U.S. CLS. 100, 101 AND 107).

NO CLAIM IS MADE TO THE EXCLUSIVE RIGHT TO USE "CELLO", APART FROM THE MARK AS SHOWN.

THE LINING ON THE DRAWING IS A FEATURE OF THE DRAWING, AND IS NOT MEANT TO REPRESENT COLOR LINING.

THE ENGLISH TRANSLATION OF "VON" IS "OF".

SER. NO. 76-069,480, FILED 6-14-2000.

CHARLES L. JENKINS, EXAMINING ATTORNEY

Int. Cls.: 9, 16, 35, 36, 38 and 42

**Prior U.S. Cls.: 2, 5, 21, 22, 23, 26, 29, 36, 37, 38, 50,
100, 101, 102 and 104**

Reg. No. 2,892,194

United States Patent and Trademark Office

Registered Oct. 12, 2004

**TRADEMARK
SERVICE MARK
PRINCIPAL REGISTER**

BRAINJUNCTION

BUSCH, CHRISTIAN (FED REP GERMANY IN-
DIVIDUAL)
HECTORSTR. 4
D-40545, DUESSELDORF, FED REP GERMANY

FOR: COMPUTER SOFTWARE FOR BUSINESS
WORKFLOW MANAGEMENT AND PROJECT
MANAGEMENT; COMPUTER SOFTWARE FOR
USE IN DATABASE MANAGEMENT; COMPUTER
SOFTWARE FOR THE DESIGN AND MAINTEN-
ANCE OF CORPORATE WEBSITES, IN CLASS 9
(U.S. CLS. 21, 23, 26, 36 AND 38).

FOR: PRINTED PRODUCTS, NAMELY BOOKS,
BROCHURES, JOURNALS AND MAGAZINES IN
THE FIELD OF BUSINESS AND COMMERCE; RE-
PORTS RELATING TO TECHNICAL, ECONOMIC
AND COMMERCIAL STUDIES, IN CLASS 16 (U.S.
CLS. 2, 5, 22, 23, 29, 37, 38 AND 50).

FOR: ADVERTISING AGENCY SERVICES, BUSI-
NESS MANAGEMENT, SECRETARIAL SERVICES,
WORD PROCESSING AND TYPING SERVICES,
TEMPORARY EMPLOYMENT AGENCIES, NAME-
LY PROVIDING TEMPORARY OFFICE WORKERS
FOR OTHERS; BUSINESS CONSULTATION; COR-
PORATE CONSULTING; PROVIDING AND ON-
LINE COMPUTER DATABASE FEATURING
COMMERCIAL AND BUSINESS INFORMATION,
IN CLASS 35 (U.S. CLS. 100, 101 AND 102).

FOR: ELECTRONIC OFFER/DEMAND BROKER-
AGE IN THE FIELD OF HUMAN RESOURCES AND

BUSINESS SERVICES, BROKERAGE, INCLUDING
ONLINE BROKERAGE, FEATURING INTELLEC-
TUAL PROPERTY AS WELL AS TECHNICAL AND
ECONOMIC KNOW-HOW , IN CLASS 36 (U.S. CLS.
100, 101 AND 102).

FOR: TELECOMMUNICATION SERVICES,
NAMELY TELEPHONE SERVICES AND MESSAGE
AND DATA TRANSMISSION SERVICES; PROVID-
ING MULTIPLE USER ACCESS TO THE INTERNET,
IN CLASS 38 (U.S. CLS. 100, 101 AND 104).

FOR: COMPUTER SOFTWARE DESIGN FOR
OTHERS, NAMELY CREATION OF PROGRAMS
FOR DATA PROCESSING, CREATION OF PRO-
GRAMS IN CONNECTION WITH INTERNET TECH-
NOLOGIES, COMPUTER SOFTWARE
CONSULTATION; COMPUTER SERVICES, NAME-
LY CREATING WEB PAGES FOR OTHERS; LICEN-
SING OF INTELLECTUAL PROPERTY;
APPLICATION SERVICES PROVIDER FEATURING
SOFTWARE IN THE FIELDS OF OFFICE MANAGE-
MENT, PROJECT MANAGEMENT AND DATA-
BASE MANAGEMENT, IN CLASS 42 (U.S. CLS. 100
AND 101).

OWNER OF ERP N CMNTY TM OFC REG. NO.
001703669, DATED 4-15-2002, EXPIRES 6-13-2010.

SER. NO. 76-069,958, FILED 6-14-2000.

MICHAEL BAIRD, EXAMINING ATTORNEY

Int. Cls.: 9 and 42

Prior U.S. Cls.: 21, 23, 26, 36, 38, 100 and 101

United States Patent and Trademark Office

Reg. No. 2,892,195

Registered Oct. 12, 2004

**TRADEMARK
SERVICE MARK
PRINCIPAL REGISTER**



BSI SA (SWITZERLAND CORPORATION)
VIA MAGATTI 2
6900 LUGANO, SWITZERLAND

FOR: COMPUTER HARDWARE AND COMPUTER PERIPHERALS; AND SOFTWARE IN THE FIELD OF BANKING TRANSACTIONS, NAMELY DEVELOPMENT SOFTWARE, EXPERT SYSTEMS, CONTROL PROGRAMS TO MONITOR DATA AND INFORMATION EXCHANGE, AND COMPUTER COMMUNICATIONS AND ENCRYPTION PROGRAMS ALL FOR COMMUNICATIONS BETWEEN A BANKING ESTABLISHMENT AND ITS CUSTOMERS, TELEBANKING PROGRAMS, AND PROGRAMS FOR BANKING OPERATIONS AND COMMUNICATIONS, IN CLASS 9 (U.S. CLS. 21, 23, 26, 36 AND 38).

FOR: SECURITY SERVICES IN THE FIELD OF ELECTRONIC DATA COMMUNICATION, NAMELY IDENTIFYING AND AUTHORIZING ACCESS TO USERS AND SUPERVISING ELECTRONIC AND COMMUNICATION, IN CLASS 42 (U.S. CLS. 100 AND 101).

PRIORITY CLAIMED UNDER SEC. 44(D) ON SWITZERLAND APPLICATION NO. 11691/1999, FILED 12-17-1999, REG. NO. 473035, DATED 7-3-2000, EXPIRES 12-17-2009.

SER. NO. 76-070,726, FILED 6-13-2000.

SHARI SHEFFIELD, EXAMINING ATTORNEY

Int. Cl.: 9

Prior U.S. Cls.: 21, 23, 26, 36 and 38

Reg. No. 2,892,196

United States Patent and Trademark Office

Registered Oct. 12, 2004

**TRADEMARK
PRINCIPAL REGISTER**

NXTWAVE

NXTWAVE COMMUNICATIONS, INC. (DELA-
WARE CORPORATION)
ONE SUMMIT SQUARE BUILDING
ROUTE 413 AND DOUBLEWOODS ROADFIRST
FLOOR, SUITE 105
LANGHORNE, PA 19047

AND RELATED COMMERCIAL AND CONSUMER
PRODUCTS, IN CLASS 9 (U.S. CLS. 21, 23, 26, 36 AND
38).

FIRST USE 8-24-1999; IN COMMERCE 9-24-1999.

FOR: BROADBAND-COMMUNICATIONS INTE-
GRATED CIRCUITS FOR USE WITH CABLE MOD-
EMS, INTERACTIVE SET-TOP BOXES, DIGITAL
TELEVISION, PERSONAL COMPUTER VIDEO,

SER. NO. 76-075,855, FILED 6-23-2000.

BARBARA A. GOLD, EXAMINING ATTORNEY

Int. Cl.: 41

Prior U.S. Cls.: 100, 101 and 107

United States Patent and Trademark Office

Reg. No. 2,892,197

Registered Oct. 12, 2004

**SERVICE MARK
PRINCIPAL REGISTER**



TRUSTEES OF THE CALIFORNIA STATE UNIVERSITY, THE (CALIFORNIA STATE AGENCY)

401 GOLDEN SHORE
LONG BEACH, CA 90802

FOR: EDUCATIONAL SERVICES, NAMELY, PROVIDING COURSES OF INSTRUCTION AT THE UNDERGRADUATE, GRADUATE AND PROFESSIONAL LEVEL; COMPUTER SERVICES, NAMELY, PROVIDING AN ON-LINE NEWSPAPER IN THE FIELD OF EDUCATION AND UNIVERSITY LIFE; PROVIDING UNIVERSITY ADMISSION IN-

FORMATION VIA A GLOBAL COMPUTER NETWORK; AND COMPUTER SERVICES, NAMELY, PROVIDING AN ON-LINE APPLICATION SERVICE FEATURING ELECTRONIC APPLICATIONS TO BE USED FOR ADMISSION TO A UNIVERSITY BY INTERESTED STUDENTS, IN CLASS 41 (U.S. CLS. 100, 101 AND 107).

FIRST USE 12-0-1983; IN COMMERCE 12-0-1983.

SER. NO. 76-077,789, FILED 6-27-2000.

LESLIE RICHARDS, EXAMINING ATTORNEY

Int. Cl.: 36

Prior U.S. Cls.: 100, 101 and 102

United States Patent and Trademark Office

Reg. No. 2,892,198

Registered Oct. 12, 2004

**SERVICE MARK
PRINCIPAL REGISTER**

MY TRAVEL WALLET

THOMAS COOK GROUP LIMITED, THE (UNI-
TED KINGDOM CORPORATION)
6 MIDFORD PLACE
LONDON W1A 1EB, ENGLAND

FOR: FINANCIAL SERVICES, NAMELY, ISSU-
ANCE OF STORED VALUE CARDS, FOREIGN
BANK NOTES AND TRAVELERS' CHECKS; TRA-
VEL INSURANCE BROKERAGE, IN CLASS 36 (U.S.
CLS. 100, 101 AND 102).

FIRST USE 4-0-2000; IN COMMERCE 4-0-2000.

NO CLAIM IS MADE TO THE EXCLUSIVE
RIGHT TO USE "TRAVEL", APART FROM THE
MARK AS SHOWN.

SER. NO. 76-078,068, FILED 6-26-2000.

TRICIA THOMPkins, EXAMINING ATTORNEY

Int. Cl.: 1

Prior U.S. Cls.: 1, 5, 6, 10, 26 and 46

United States Patent and Trademark Office

Reg. No. 2,892,199

Registered Oct. 12, 2004

**TRADEMARK
PRINCIPAL REGISTER**

ULTRABOND

ENVIRO-COATINGS CANADA LTD. (CANADA
CORPORATION)
P.O. BOX 459
PORT CREDIT STN.
MISSISSAUGA, ONTARIO, CANADA L5G 4M2

FOR: WATER RESISTANT ADHESIVE CONTAIN-
ING A MODIFIED STARCH OR A ROSIN WITH A
MODIFIED STARCH FOR USE IN THE MANUFAC-

TURE OF CORRUGATED BOARD OR PAPER-
BOARD, IN CLASS 1 (U.S. CLS. 1, 5, 6, 10, 26 AND 46).

FIRST USE 5-0-2000; IN COMMERCE 5-0-2000.

SER. NO. 76-084,224, FILED 7-5-2000.

RONALD MCMORROW, EXAMINING ATTORNEY

Int. Cl.: 35

Prior U.S. Cls.: 100, 101 and 102

United States Patent and Trademark Office

Reg. No. 2,892,200

Registered Oct. 12, 2004

**SERVICE MARK
PRINCIPAL REGISTER**



THE SAVVY TRAVELLER, INC. (ILLINOIS CORPORATION)
310 SOUTH MICHIGAN AVENUE
CHICAGO, IL 60604

FOR: RETAIL STORE AND ONLINE STORE SERVICES FEATURING TRAVEL BOOKS, LUGGAGE, MAPS, TRAVEL-RELATED SOFTWARE AND TRAVEL-RELATED ACCESSORIES, IN CLASS 35 (U.S. CLS. 100, 101 AND 102).

FIRST USE 9-5-1996; IN COMMERCE 9-5-1996.

NO CLAIM IS MADE TO THE EXCLUSIVE RIGHT TO USE "TRAVELLER", APART FROM THE MARK AS SHOWN.

SER. NO. 76-084,467, FILED 7-7-2000.

RAUL CORDOVA, EXAMINING ATTORNEY

Int. Cls.: 1, 17 and 19

Prior U.S. Cls.: 1, 5, 6, 10, 12, 13, 26, 33, 35, 46 and 50

Reg. No. 2,892,201

United States Patent and Trademark Office

Registered Oct. 12, 2004

**TRADEMARK
PRINCIPAL REGISTER**

FINAPRENE SX

PETROFINA S.A. (BELGIUM JOINT STOCK COMPANY)
52 RUE DE L'INDUSTRIE
1040 BRUSSELS, BELGIUM

FOR: CHEMICAL COMPOUNDS FOR USE IN THE MANUFACTURE OF PLASTICS; UNPROCESSED ARTIFICIAL RESINS, NAMELY, POLYMERIC RESINS IN THE FORM OF POWDER, PASTE, LIQUID, DISPERSION, EMULSIONS AND GRANULAR FORM FOR USE IN THE MANUFACTURE OF PLASTIC MOLDING COMPOUNDS, FOR USE IN PLASTIC EXTRUSION OPERATIONS AND FOR GENERAL INDUSTRIAL USE, IN CLASS 1 (U.S. CLS. 1, 5, 6, 10, 26 AND 46).

FOR: SEMI-PROCESSED ARTIFICIAL RESINS, NAMELY, POLYMERIC RESINS IN THE FORM OF SHEETS, PLATES, BULLETS, BLOCKS, BANDS AND FIBERS, NAMELY, POLYETHYLENE, POLYSTYRENE, POLYPROPYLENE, ACRYLO BETA-DIENE STYRENE, STYRENE ACRYLO NITRO; SYNTHETIC RUBBER IN THE FORM OF SHEETS, BLOCKS, BULLETS, PLATES AND FIBERS FOR USE IN THE MANUFACTURE OF PLASTIC MOLDING COMPOUNDS, FOR USE IN PLASTIC EXTRUSION AND FOR GENERAL INDUSTRIAL USES; PLASTIC FIBERS AND POLYMERIC RESINS FOR USE IN THE MANUFACTURE OF PLASTIC MOLDING COMPOUNDS, FOR USE IN PLASTIC EXTRUSION OPERATIONS AND FOR GENERAL INDUSTRIAL USE; ELECTRIC, THERMIC OR ACOUSTIC INSULATING MATERIALS, NAMELY, ELECTRICAL INSULATING TAPE, BUILDING IN-

SULATION, ACOUSTICAL INSULATION BARRIER PANELS, INSULATING COVERS FOR INDUSTRIAL MACHINERY, INSULATION FOR AIRCRAFT, INSULATION FOR UNDERGROUND PIPES AND TANKS, INSULATION FOR UNDERGROUND PIPES AND TANKS, INSULATION FOR USE IN CONSTRUCTION, INSULATION JACKETS FOR INDUSTRIAL PIPES, AND INSULATING OILS FOR TRANSFORMERS; SEMI-PROCESSED PLASTICS IN THE FORM OF SHEETS, PLATES, BULLETS, BLOCKS, BANDS AND FIBERS FOR USE IN THE MANUFACTURE OF PLASTIC MOLDING COMPOUNDS, FOR USE IN PLASTIC EXTRUSION OPERATIONS AND FOR GENERAL INDUSTRIAL USE; ARTIFICIAL POLYMERIC FIBERS FOR USE IN CONCRETE AND BITUMEN, IN CLASS 17 (U.S. CLS. 1, 5, 12, 13, 35 AND 50).

FOR: NON-METALLIC BUILDING MATERIALS, NAMELY, NON-METALLIC PLASTIC, RUBBER, SYNTHETIC RUBBER, AND POLYMERIC FIBERS FOR CONSTRUCTION AND REPAIR OF BUILDING AND ROADS, IN CLASS 19 (U.S. CLS. 1, 12, 33 AND 50).

PRIORITY CLAIMED UNDER SEC. 44(D) ON BENELUX APPLICATION NO. 0086897, FILED 3-13-2000, REG. NO. 0667311, DATED 3-13-2000, EXPIRES 3-13-2010.

SER. NO. 76-084,805, FILED 7-7-2000.

TONI HICKEY, EXAMINING ATTORNEY

Int. Cl.: 38

Prior U.S. Cls.: 100, 101 and 104

United States Patent and Trademark Office

Reg. No. 2,892,202

Registered Oct. 12, 2004

**SERVICE MARK
PRINCIPAL REGISTER**

**A BETTER CHOICE IN LOCAL AND LONG DISTANCE PHONE
SERVICE**

COX COMMUNICATIONS, INC. (DELAWARE
CORPORATION)
1400 LAKE HEARN DRIVE, N.E.
ATLANTA, GA 30319

FIRST USE 9-0-2000; IN COMMERCE 9-0-2000.

SER. NO. 76-091,551, FILED 7-19-2000.

FOR: COMMUNICATIONS SERVICES, NAMELY
WIRELINE TELEPHONE SERVICES, IN CLASS 38
(U.S. CLS. 100, 101 AND 104).

JEFF DEFORD, EXAMINING ATTORNEY

Int. Cl.: 38

Prior U.S. Cls.: 100, 101 and 104

United States Patent and Trademark Office

Reg. No. 2,892,203

Registered Oct. 12, 2004

**SERVICE MARK
PRINCIPAL REGISTER**

ANNOUNCING A BETTER CHOICE IN LOCAL PHONE SERVICE

COX COMMUNICATIONS, INC. (DELAWARE
CORPORATION)
1400 LAKE HEARN DRIVE, N.E.
ATLANTA, GA 30319

FIRST USE 9-20-1997; IN COMMERCE 9-20-1997.

SER. NO. 76-091,552, FILED 7-19-2000.

FOR: COMMUNICATIONS SERVICES, NAMELY,
WIRELINE TELEPHONE SERVICES, IN CLASS 38
(U.S. CLS. 100, 101 AND 104).

JEFF DEFORD, EXAMINING ATTORNEY

Int. Cl.: 41

Prior U.S. Cls.: 100, 101 and 107

United States Patent and Trademark Office

Reg. No. 2,892,204

Registered Oct. 12, 2004

SERVICE MARK
PRINCIPAL REGISTER



DAUGHERTY, SHARON (UNITED STATES INDIVIDUAL)
POST OFFICE BOX 030232
FORT LAUDERDALE, FL 33303

FOR: EDUCATIONAL SERVICES, NAMELY, PROVIDING CLASSES FOR VICTIMS OF ABUSE IN THE FIELD OF DANCE; ENTERTAINMENT SERVICES, NAMELY, PROVIDING ENTERTAINMENT BY VICTIMS OF ABUSE IN THE NATURE OF LIVE DANCE PERFORMANCES, IN CLASS 41 (U.S. CLS. 100, 101 AND 107).

FIRST USE 8-16-1990; IN COMMERCE 6-11-1991.

NO CLAIM IS MADE TO THE EXCLUSIVE RIGHT TO USE "THE SURVIVOR DANCE THEATER COMPANY", APART FROM THE MARK AS SHOWN.

THE STIPPLING SHOWN IN DRAWING IS A FEATURE OF THE MARK.

SER. NO. 76-094,497, FILED 7-24-2000.

YONG KIM, EXAMINING ATTORNEY

Int. Cl.: 32

Prior U.S. Cls.: 45, 46 and 48

Reg. No. 2,892,205

United States Patent and Trademark Office

Registered Oct. 12, 2004

**TRADEMARK
PRINCIPAL REGISTER**

ALDO

ALDO GROUP INC./LE GROUPE ALDO INC.,
THE (CANADA CORPORATION)
905 HODGE STREET
VILLE ST-LAURENT, QUEBEC, CANADA H4N 2B3

PRIORITY CLAIMED UNDER SEC. 44(D) ON
CANADA APPLICATION NO. 1064535, FILED 6-22-
2000, REG. NO. TMA574,326, DATED 1-24-2003, EX-
PIRES 1-24-2018.

SER. NO. 76-094,793, FILED 7-24-2000.

FOR: BOTTLED SPRING WATER, IN CLASS 32
(U.S. CLS. 45, 46 AND 48).

PAULA MAHONEY, EXAMINING ATTORNEY

Int. Cl.: 35

Prior U.S. Cls.: 100, 101 and 102

United States Patent and Trademark Office

Reg. No. 2,892,206

Registered Oct. 12, 2004

**SERVICE MARK
PRINCIPAL REGISTER**



PAYSTATION INC. (CANADA COMPANY)
5155 SPECTRUM WAY, UNIT 17
MISSISSAUGA, ONTARIO, L4W 5A1, CANADA

FOR: RISK MANAGEMENT, NAMELY, BUSINESS RISK MANAGEMENT SERVICES IN THE FIELD OF CRIME PREVENTION, CRIME DETECTION AND CRIME CONTROL SOLUTIONS , IN CLASS 35 (U.S. CLS. 100, 101 AND 102).

FIRST USE 0-0-1999; IN COMMERCE 0-0-1999.

PRIORITY CLAIMED UNDER SEC. 44(D) ON CANADA APPLICATION NO. 1,044,159, FILED 1-27-

2000, REG. NO. TMA554678, DATED 11-29-2001, EXPIRES 11-29-2016.

NO CLAIM IS MADE TO THE EXCLUSIVE RIGHT TO USE "CRIME", APART FROM THE MARK AS SHOWN.

THE STIPPLING SHOWN IN THE DRAWING IS A FEATURE OF THE MARK AND IS NOT INTENDED TO INDICATE COLOR.

SER. NO. 76-097,733, FILED 7-26-2000.

D. E. SHALLANT, EXAMINING ATTORNEY

Int. Cls.: 9 and 28

Prior U.S. Cls.: 21, 22, 23, 26, 36, 38 and 50

United States Patent and Trademark Office

Reg. No. 2,892,207

Registered Oct. 12, 2004

**TRADEMARK
PRINCIPAL REGISTER**



KABUSHIKI KAISHA SEGA (JAPAN CORPORATION), DBA SEGA CORPORATION
2-12, HANEDA 1-CHOME, OHTA-KU
TOKYO 144-0043, JAPAN

FOR: VIDEO GAME SOFTWARE; COMPUTER GAME PROGRAMS; COMPUTER GAME CARTRIDGES, DISCS AND CASSETTES; VIDEO COMPUTER GAME PROGRAMS; HOME VIDEO COMPUTER GAME CARTRIDGES, DISCS AND CASSETTES; GAME CARTRIDGES, DISCS, CASSETTES AND CIRCUIT BOARDS CONTAINING GAME PROGRAMS FOR USE WITH HAND-HELD OR ARCADE VIDEO GAME MACHINES WITH BUILT-IN SCREENS; HOME VIDEO GAME MACHINES FOR USE WITH TELEVISIONS; MUSICAL SOUND RECORDINGS, MUSICAL VIDEO RECORDINGS AND CARTOON VIDEO RECORDINGS; COMPUTER TERMINALS AND VIDEO GAME MACHINE TERMINALS FOR USE WITH THE INTERNET; INTERACTIVE TELEVISION TERMINAL SETS; SET TOP BOXES FOR THE RECEPTION OF CODED OR COMPRESSED AUDIO, VIDEO OR DATA SIGNALS, IN CLASS 9 (U.S. CLS. 21, 23, 26, 36 AND 38).

FOR: STAND ALONE VIDEO GAME MACHINES; ARCADE GAME MACHINES WITH BUILT-IN SCREENS; PLAYTHINGS, NAMELY DOLLS AND ACTION FIGURES AND ACCESSORIES THEREFOR, PLUSH TOYS, ELECTRONIC PLUSH TOYS, VEHICLES AND PLAYSETS, WIND UP VEHICLES, BENDABLE FIGURES, REMOTE CONTROL FIGURES, AND WATER-SQUIRTING TOYS, IN CLASS 28 (U.S. CLS. 22, 23, 38 AND 50).

PRIORITY CLAIMED UNDER SEC. 44(D) ON JAPAN APPLICATION NO. 2000-73461, FILED 6-30-2000, REG. NO. 4517338, DATED 10-26-2001, EXPIRES 10-26-2011.

OWNER OF U.S. REG. NOS. 1,882,347, 1,945,715 AND OTHERS.

NO CLAIM IS MADE TO THE EXCLUSIVE RIGHT TO USE "TEAM", APART FROM THE MARK AS SHOWN.

SER. NO. 76-099,337, FILED 7-28-2000.

ANNE MADDEN, EXAMINING ATTORNEY

Int. Cl.: 35

Prior U.S. Cls.: 100, 101 and 102

United States Patent and Trademark Office

Reg. No. 2,892,208

Registered Oct. 12, 2004

**SERVICE MARK
PRINCIPAL REGISTER**

GUARANTEED GROUND SERVICE

CNF INC. (DELAWARE CORPORATION)
3240 HILLVIEW AVENUE
PALO ALTO, CA 94304

NO CLAIM IS MADE TO THE EXCLUSIVE
RIGHT TO USE "GROUND SERVICE", APART
FROM THE MARK AS SHOWN.

FOR: COMPUTERIZED TRACKING SERVICES
FOR MONITORING THE SHIPMENT OF GOODS
AND PACKAGES OF OTHERS DURING TRANS-
PORT, IN CLASS 35 (U.S. CLS. 100, 101 AND 102).

SER. NO. 76-099,662, FILED 7-28-2000.

FIRST USE 3-0-2000; IN COMMERCE 3-0-2000.

JOHN DALIER, EXAMINING ATTORNEY

Int. Cl.: 38

Prior U.S. Cls.: 100, 101 and 104

United States Patent and Trademark Office

Reg. No. 2,892,209

Registered Oct. 12, 2004

**SERVICE MARK
PRINCIPAL REGISTER**

TALK IS CHEAP

CNM NETWORK, INC. (CALIFORNIA CORPORATION)
4100 GUARDIAN ST.
SIMI VALLEY, CA 93063

FOR: VOICE OVER THE INTERNET (VOIP) TELEPHONE COMMUNICATION SERVICES; TELEPHONE CALL ROUTING SERVICES; VOICE MAIL; FAX MAIL; CONFERENCE CALLING AND CALL FORWARDING; PAGING SERVICES; ELECTRONIC, ELECTRIC AND DIGITAL TRANSMISSION

OF VOICE, DATA, IMAGES, SIGNALS, AND MESSAGES, IN CLASS 38 (U.S. CLS. 100, 101 AND 104).

FIRST USE 6-16-1993; IN COMMERCE 6-16-1993.

OWNER OF U.S. REG. NO. 1,837,463.

SER. NO. 76-103,018, FILED 8-4-2000.

ZACHARY BELLO, EXAMINING ATTORNEY

Int. Cls.: 35 and 38

Prior U.S. Cls.: 100, 101, 102 and 104

United States Patent and Trademark Office

Reg. No. 2,892,210

Registered Oct. 12, 2004

**SERVICE MARK
PRINCIPAL REGISTER**

LUCK(Y)CYCLE

MOYERSOEN, JEAN-FRANCOIS (MONACO IN-
DIVIDUAL)
AVENUE PRINCESSE GRACE, 31
98000 MONTE-CARLO, MONACO

FOR: PROMOTING THE GOODS AND SERVICES
OF OTHERS BY PREPARING AND PLACING AD-
VERTISEMENTS IN AN ELECTRONIC MAGAZINE
ACCESSED THROUGH A GLOBAL COMPUTER
NETWORK; ONLINE BUSINESS MANAGEMENT
SERVICES FOR INDIVIDUAL AND/OR THIRD
PARTY ACCOUNTS; ONLINE BUSINESS PLAN-
NING SERVICES, IN CLASS 35 (U.S. CLS. 100, 101
AND 102).

FOR: PROVIDING TELECOMMUNICATION
CONNECTIONS TO A GLOBAL COMPUTER NET-
WORK, IN CLASS 38 (U.S. CLS. 100, 101 AND 104).

PRIORITY CLAIMED UNDER SEC. 44(D) ON
BENELUX APPLICATION NO. 0957164, FILED 2-17-
2000, REG. NO. 0666443, DATED 2-17-2000, EXPIRES
2-17-2010.

SER. NO. 76-103,386, FILED 8-3-2000.

KAREN M. STRYZ, EXAMINING ATTORNEY

Int. Cls.: 35 and 41

Prior U.S. Cls.: 100, 101, 102 and 107

United States Patent and Trademark Office

Reg. No. 2,892,211

Registered Oct. 12, 2004

**SERVICE MARK
PRINCIPAL REGISTER**

SILVER TO SILICON

DAYMEN PHOTO MARKETING LTD. (CANADA
CORPORATION)
121 SPY COURT
MARKHAM, ONTARIO, CANADA L3R 5H6

FOR: ARRANGING AND CONDUCTING TRADE
SHOWS IN THE FIELD OF PHOTOGRAPHY, IN
CLASS 35 (U.S. CLS. 100, 101 AND 102).

FOR: ARRANGING AND CONDUCTING SEMI-
NARS IN THE FIELD OF PHOTOGRAPHY, IN
CLASS 41 (U.S. CLS. 100, 101 AND 107).

PRIORITY CLAIMED UNDER SEC. 44(D) ON
CANADA APPLICATION NO. 1046049, FILED 2-10-
2000, REG. NO. TMA554157, DATED 11-21-2001, EX-
PIRES 11-21-2016.

SER. NO. 76-107,001, FILED 8-10-2000.

RUDY R. SINGLETON, EXAMINING ATTORNEY

Int. Cl.: 36

Prior U.S. Cls.: 100, 101 and 102

United States Patent and Trademark Office

Reg. No. 2,892,212

Registered Oct. 12, 2004

**SERVICE MARK
PRINCIPAL REGISTER**

ALLIED SOLUTIONS

ELDREDGE LENDER SERVICES, INC. (INDIANA CORPORATION)
1030 E. 169TH STREET
P.O. BOX 554
WESTFIELD, IN 46074

VEHICLE SERVICE CONTRACTS AGENCIES AND ADMINISTRATION; FINANCIAL SERVICES, NAMELY INDIRECT LENDING AGENCIES, ADMINISTRATION AND UNDERWRITING, IN CLASS 36 (U.S. CLS. 100, 101 AND 102).

FOR: INSURANCE SERVICES, NAMELY COLLATERAL PROTECTION INSURANCE AGENCIES AND ADMINISTRATION, HOME EQUITY LOAN IMPAIRMENT INSURANCE AGENCIES AND ADMINISTRATION, LIFE AND DISABILITY INSURANCE AGENCIES AND ADMINISTRATION,

FIRST USE 9-11-2000; IN COMMERCE 9-11-2000.

SER. NO. 76-107,283, FILED 8-10-2000.

TRACY CROSS, EXAMINING ATTORNEY

Int. Cls.: 9, 35, 37, 38, 39 and 42

Prior U.S. Cls.: 21, 23, 26, 36, 38, 100, 101, 102, 103, 104, 105 and 106

Reg. No. 2,892,213

United States Patent and Trademark Office

Registered Oct. 12, 2004

**TRADEMARK
SERVICE MARK
PRINCIPAL REGISTER**



VITERRA ENERGY SERVICES AG (FED REP GERMANY CORPORATION)
GRUGAPLATZ 4
D-45131 ESSEN, FED REP GERMANY

FOR: HEAT, WATER, GAS AND ELECTRICITY MEASURING DEVICES, NAMELY, METERS; HEAT, WATER, GAS AND ELECTRICITY CONSUMPTION RECORDING DEVICES, NAMELY, RECORDERS; HEAT, WATER, GAS AND ELECTRICITY CONTROL DEVICES, NAMELY, ELECTRONIC CONTROLS, ELECTRONIC UTILITY BILLING DEVICES COMPRISED OF COMPUTER HARDWARE AND OPERATING SOFTWARE FOR USE IN CALCULATING HEAT, WATER, GAS, ELECTRICITY, AND UTILITIES CONSUMPTION, AND FOR METERING, RECORDING AND INVOICING HEAT, WATER, GAS, AND ELECTRICITY USAGE AND UTILITY COSTS; APPARATUS AND INSTRUMENTS, NAMELY HEAT, WATER, GAS, ELECTRICITY AND UTILITY DATA PROCESSORS; HEAT, WATER, GAS, ELECTRICITY AND UTILITY DATA TRANSMISSION DEVICES, NAMELY TRANSMITTERS, USED TO PROCESS, REPRODUCE AND TRANSMIT DATA RELATED TO MEASURING, METERING, RECORDING, CONTROLLING AND INVOICING HEAT, WATER, GAS, AND ELECTRICITY USAGE AND UTILITY COSTS, ALL FOR USE IN THE SANITATION AND HEATING FIELDS, IN CLASS 9 (U.S. CLS. 21, 23, 26, 36 AND 38).

FOR: PREPARING BUSINESS REPORTS FOR OTHERS; DATA PROCESSING SERVICES RELATED TO THE MEASURING, METERING, RECORDING, CONTROLLING AND INVOICING OF HEAT, WATER, GAS, AND ELECTRICITY USAGE AND

UTILITY COSTS; PROVIDING STATISTICAL INFORMATION RELATED TO THE MEASURING, METERING, RECORDING, CONTROLLING AND INVOICING OF HEAT, WATER, GAS, AND ELECTRICITY USAGE AND UTILITY COSTS; CONDUCTING BUSINESS SURVEYS AND PROVIDING INVOICING SERVICES RELATED TO THE MEASURING, METERING, RECORDING, CONTROLLING AND INVOICING OF HEAT, WATER, GAS AND ELECTRICITY USAGE AND UTILITY COSTS, IN CLASS 35 (U.S. CLS. 100, 101 AND 102).

FOR: INSTALLATION AND REPAIR OF APPARATUS AND INSTRUMENTS NAMELY, HEAT, WATER, GAS AND ELECTRICITY MEASURING DEVICES, NAMELY, METERS; INSTALLATION AND REPAIR OF HEAT, WATER, GAS AND ELECTRICITY CONSUMPTION RECORDING DEVICES, NAMELY, RECORDERS; HEAT, WATER, GAS AND ELECTRICITY CONTROL DEVICES, NAMELY, ELECTRONIC CONTROLS, ELECTRONIC UTILITY BILLING DEVICES COMPRISED OF COMPUTER HARDWARE AND OPERATING SOFTWARE FOR USE IN CALCULATING HEAT, WATER, GAS, ELECTRICITY, AND UTILITIES CONSUMPTION, AND FOR METERING, RECORDING AND INVOICING HEAT, WATER, GAS, AND ELECTRICITY USAGE AND UTILITY COSTS; INSTALLATION AND REPAIR OF APPARATUS AND INSTRUMENTS, NAMELY HEAT, WATER, GAS, ELECTRICITY AND UTILITY DATA PROCESSORS; HEAT, WATER, GAS, ELECTRICITY AND UTILITY DATA TRANSMISSION DEVICES, NAMELY TRANSMITTERS, USED TO PROCESS, REPRODUCE AND TRANSMIT DATA RELATED TO MEASURING, METERING, RECORDING, CONTROLLING AND INVOICING HEAT, WATER, GAS, AND ELECTRI-

CITY USAGE AND UTILITY COSTS, ALL FOR USE IN THE SANITATION AND HEATING FIELDS, IN CLASS 37 (U.S. CLS. 100, 103 AND 106).

FOR: TELECOMMUNICATION SERVICES, NAMELY, THE TRANSMISSION OF DATA RELATED TO THE MEASURING, METERING, RECORDING, CONTROLLING AND INVOICING OF HEAT, WATER, GAS, AND ELECTRICITY USAGE AND UTILITY COSTS THROUGH TELECOMMUNICATION TECHNOLOGIES, NAMELY, TELEPHONE, MODEM, GLOBAL COMPUTER NETWORK, RADIO, TELEVISION, ULTRASONICS, IN CLASS 38 (U.S. CLS. 100, 101 AND 104).

FOR: PUBLIC UTILITY SERVICES IN THE NATURE OF ELECTRICITY, WATER, HEAT AND GAS DISTRIBUTION, IN CLASS 39 (U.S. CLS. 100 AND 105).

FOR: DESIGN FOR OTHERS OF APPARATUSES FOR MEASURING, COUNTING, RECORDING, CONTROLLING AND ACCOUNTING OF HEAT, WATER, GAS, ELECTRICITY AND HOUSEHOLD EXPENSES AS WELL AS FOR PROCESSING, REPRODUCING AND TRANSMITTING OF RELATED DATA, IN PARTICULAR IN THE SANITARY AND HEATING FIELDS; DESIGN FOR OTHERS OF COMPUTER PROGRAMS FOR DATA PROCES-

SING; HEAT, WATER, GAS AND ELECTRICITY SERVICES, NAMELY, METERING, METER READING AND METER DATA MANAGEMENT AND ANALYSIS; PUBLIC UTILITY SERVICES, NAMELY, FURNISHING, SUPPLYING, TRANSMITTING AND DISTRIBUTING HEAT, WATER, GAS AND ELECTRICITY; CONSULTING SERVICES IN THE FIELD OF PUBLIC UTILITIES, NAMELY, HEAT, WATER, GAS AND ELECTRICITY, IN CLASS 42 (U.S. CLS. 100 AND 101).

PRIORITY CLAIMED UNDER SEC. 44(D) ON FED REP GERMANY APPLICATION NO. 30010842.742, FILED 2-14-2000, REG. NO. 30010842, DATED 7-10-2000, EXPIRES 2-28-2010.

NO CLAIM IS MADE TO THE EXCLUSIVE RIGHT TO USE "ENERGY SERVICES", APART FROM THE MARK AS SHOWN.

THE LETTERS OF THE MARK AND THE LEFT DESIGN PART ARE IN THE COLOR BLUE WHEREAS THE RIGHT DESIGN PART INDICATED WITH THE DOTS IS IN THE COLOR ORANGE.

SER. NO. 76-108,424, FILED 8-11-2000.

TANYA AMOS, EXAMINING ATTORNEY

Int. Cl.: 35

Prior U.S. Cls.: 100, 101 and 102

United States Patent and Trademark Office

Reg. No. 2,892,214

Registered Oct. 12, 2004

**SERVICE MARK
PRINCIPAL REGISTER**

MARKET PROBE INTERNATIONAL

MARKET PROBE INTERNATIONAL, INC. (NEW
YORK CORPORATION)
114 EAST 32ND STREET, SUITE 1603
NEW YORK, NY 10016

FOR: MARKET RESEARCH SERVICES; CON-
DUCTING BUSINESS AND MARKET RESEARCH
SURVEYS; COMPUTERIZED DATA MANAGE-
MENT SERVICES FOR OTHERS , IN CLASS 35
(U.S. CLS. 100, 101 AND 102).

FIRST USE 8-0-1967; IN COMMERCE 8-0-1967.

NO CLAIM IS MADE TO THE EXCLUSIVE
RIGHT TO USE "MARKET", APART FROM THE
MARK AS SHOWN.

SEC. 2(F) AS TO "INTERNATIONAL".

SER. NO. 76-110,074, FILED 8-16-2000.

KAREN M. STRYZ, EXAMINING ATTORNEY

Int. Cls.: 5 and 30

Prior U.S. Cls.: 6, 18, 44, 46, 51 and 52

Reg. No. 2,892,215

United States Patent and Trademark Office

Registered Oct. 12, 2004

**TRADEMARK
PRINCIPAL REGISTER**

NOSTRESS

LABORATOIRES ROBERT SCHWARTZ
(FRANCE CORPORATION)
PARC D'INNOVATION
BOULEVARD GONTHIER D'ANDERNACH
67400 ILLKIRCH GRAFFENSTADEN, FRANCE

FOR: AIR DEODORANTS, AIR FRESHENERS, MEDICATED SUNBURN OINTMENTS, MEDICATED BATH PREPARATIONS, NAMELY, MEDICATED BATH SALTS, MEDICINAL MUD, MEDICINAL BATH PREPARATIONS, MEDICATED BALM FOR TREATING ANXIETY; MEDICATED MOUTHWASH; OILS FOR MEDICAL USE FOR TREATING ANXIETY, MEDICATED LOTIONS FOR THE SKIN, HAIR, FACE AND BODY; MEDICATED PRE-MOISTENED TOWELETTES; PREPARATIONS OF TRACE ELEMENTS COMPRISED OF AMINO ACIDS, MINERAL SALTS, METALLIC SALTS OF NATURAL ORIGIN, LATCOFERMENTS AND MACROELEMENTS FOR MEDICAL USE FOR TREATING ANXIETY HUMAN USE; MEDICATED SKIN CARE CREAMS AND LOTIONS; DIETARY DRINK MIX FOR MEDICINAL USE, MEDICATED CANDY FOR USE IN ANXIETY REDUCTION; MEDICATED PREPARATIONS FOR USE IN WEIGHT REDUCTION, IN CLASS 5 (U.S. CLS. 6, 18, 44, 46, 51 AND 52).

FOR: PROCESSED CEREALS, SPICES, FLAVORED ICES, PASTA, RUSKS, BISCUITS, NON-ESSENTIAL OILS USED IN THE PREPARATION OF DRINK FLAVORINGS, COCOA-BASED FOOD BEVERAGES, NOT BEING DAIRY-BASED OR VEGETABLE-BASED, COFFEE-BASED FOOD BEVERAGES, NOT BEING DAIRY-BASED OR VEGETABLE-BASED, CHOCOLATE-BASED FOOD BEVERAGES, NOT BEING DAIRY-BASED OR VEGETABLE-BASED, CANDY, COCOA, COCOA MIXES, COFFEE, COFFEE FLAVORINGS, CORN FLAKES, CHOCOLATE, KETCHUP, MUSTARD AND VINEGAR IN GENERAL, CANDY, NON-ESSENTIAL OIL FOOD FLAVORINGS CAKES, CHEWING GUM, HONEY, MUESLI, NON-MEDICATED LOZENGES, RICE, SORBETS, SUGAR, SUGAR CONFECTIONERY, IN CLASS 30 (U.S. CL. 46).

PRIORITY CLAIMED UNDER SEC. 44(D) ON FRANCE APPLICATION NO. 00/3021496, FILED 4-10-2000, REG. NO. 003021496, DATED 4-10-2000, EXPIRES 4-10-2010.

SER. NO. 76-141,552, FILED 10-5-2000.

FRED MANDIR, EXAMINING ATTORNEY

Int. Cls.: 35 and 36

Prior U.S. Cls.: 100, 101 and 102

United States Patent and Trademark Office

Reg. No. 2,892,216

Registered Oct. 12, 2004

**SERVICE MARK
PRINCIPAL REGISTER**



PIONEER LICENSING SERVICES, INC. (NEVADA CORPORATION)
3050 EAST DESERT INN ROAD, #125
LAS VEGAS, NV 89121

FOR: RETAIL STORE SERVICES FEATURING
GENERAL CONSUMER GOODS, IN CLASS 35 (U.S.
CLS. 100, 101 AND 102).

FIRST USE 7-1-2000; IN COMMERCE 7-1-2000.

FOR: CONSUMER LOAN SERVICES; CONSUMER
CREDIT COUNSELING, IN CLASS 36 (U.S.
CLS. 100, 101 AND 102).

FIRST USE 7-1-2000; IN COMMERCE 7-1-2000.

OWNER OF U.S. REG. NOS. 1,995,683 AND
1,995,684.

NO CLAIM IS MADE TO THE EXCLUSIVE
RIGHT TO USE "SERVICES" AND "SINCE 1932",
APART FROM THE MARK AS SHOWN.

SER. NO. 76-143,542, FILED 10-10-2000.

MICHAEL BAIRD, EXAMINING ATTORNEY

Int. Cls.: 18 and 25

Prior U.S. Cls.: 1, 2, 3, 22, 39 and 41

United States Patent and Trademark Office

Reg. No. 2,892,217

Registered Oct. 12, 2004

**TRADEMARK
PRINCIPAL REGISTER**



AGUIRRE Y COMPANIA, S.A. (SPAIN CORPORATION)

CASTELLANA 30

28046 MADRID, SPAIN

FOR: TRAVELLING BAGS, TOTE BAGS, ATHLETIC BAGS, KNAPSACKS, BACKPACKS, RUCKSACKS, BRIEFCASES, LUGGAGE, SUITCASES; BUSINESS CARD CASES, CREDIT CARD CASES, COVERS, WALLETS, COIN PURSES, PURSES; HANDBAGS; UMBRELLAS, FITTED COVERS FOR THE AFOREMENTIONED GOODS, IN CLASS 18 (U.S. CLS. 1, 2, 3, 22 AND 41).

FOR: FOOTWEAR, IN CLASS 25 (U.S. CLS. 22 AND 39).

PRIORITY CLAIMED UNDER SEC. 44(D) ON ERPN CMNTY TM OFC APPLICATION NO. 001608017, FILED 4-12-2000, REG. NO. 001608017, DATED 1-14-2004, EXPIRES 4-12-2010.

THE MARK CONSISTS OF THE WORD "HABIT" AND A STYLIZED LETTER "H".

SER. NO. 76-143,995, FILED 10-10-2000.

SCOTT OSLICK, EXAMINING ATTORNEY

Int. Cl.: 9

Prior U.S. Cls.: 21, 23, 26, 36 and 38

United States Patent and Trademark Office

Reg. No. 2,892,218

Registered Oct. 12, 2004

**TRADEMARK
PRINCIPAL REGISTER**

BONUS POKER

IGT (NEVADA CORPORATION)
9295 PROTOTYPE DRIVE
RENO, NV 89511

FOR: GAMING MACHINES, IN CLASS 9 (U.S.
CLS. 21, 23, 26, 36 AND 38).

FIRST USE 5-16-1990; IN COMMERCE 5-16-1990.

OWNER OF U.S. REG. NOS. 2,145,783 AND
2,184,694.

NO CLAIM IS MADE TO THE EXCLUSIVE
RIGHT TO USE "POKER", APART FROM THE
MARK AS SHOWN.

SEC. 2(F).

SER. NO. 76-157,447, FILED 11-1-2000.

PAUL F. GAST, EXAMINING ATTORNEY

Int. Cls.: 9, 35 and 41

Prior U.S. Cls.: 21, 23, 26, 36, 38, 100, 101, 102 and 107

United States Patent and Trademark Office

Reg. No. 2,892,219

Registered Oct. 12, 2004

**TRADEMARK
SERVICE MARK
PRINCIPAL REGISTER**

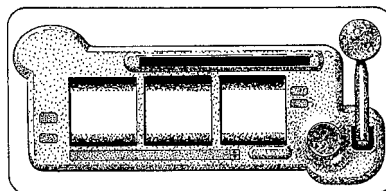

EXCITE NETWORK, INC., THE (DELAWARE CORPORATION), DBA IWON.COM
ONE BRIDGE STREET
IRVINGTON, NY 10533

FOR: COMPUTER SOFTWARE FOR USE IN CONJUNCTION WITH A NETWORK BROWSER FOR CONTROLLING AND AUTOMATING THE BROWSER VIA A TOOLBAR, IN CLASS 9 (U.S. CLS. 21, 23, 26, 36 AND 38).

FIRST USE 7-13-2000; IN COMMERCE 7-13-2000.

FOR: ADVERTISING AND PROMOTIONAL SERVICES, NAMELY, PROMOTING THE GOODS AND SERVICES OF OTHERS THROUGH THE PLACEMENT OF ADVERTISING AND PROMOTIONAL DISPLAYS ON GLOBAL COMPUTER NETWORK BROWSERS, THROUGH SWEEPSTAKES AND SPONSORSHIPS, AND THROUGH THE DISTRIBUTION OF PRINTED MATERIAL AND PROMOTIONAL CONTACTS THAT MAY BE ACCESSED VIA A

GLOBAL COMPUTER NETWORK, IN CLASS 35 (U.S. CLS. 100, 101 AND 102).

FIRST USE 7-13-2000; IN COMMERCE 7-13-2000.

FOR: ENTERTAINMENT SERVICES, NAMELY, PROVIDING AN ON-LINE COMPUTER GAME IN THE NATURE OF A SWEEPSTAKES, IN CLASS 41 (U.S. CLS. 100, 101 AND 107).

FIRST USE 7-13-2000; IN COMMERCE 7-13-2000.

THE BALL ON THE HANDLE IN THE MARK IS RED. THE BUTTON TO THE LOWER LEFT OF THE HANDLE IS RED.

THE MARK CONSISTS OF A STYLIZED SLOT MACHINE DESIGN.

SER. NO. 76-157,491, FILED 11-1-2000.

ROBERT LORENZO, EXAMINING ATTORNEY

Int. Cl.: 20

Prior U.S. Cls.: 2, 13, 22, 25, 32 and 50

United States Patent and Trademark Office

Reg. No. 2,892,220

Registered Oct. 12, 2004

**TRADEMARK
PRINCIPAL REGISTER**

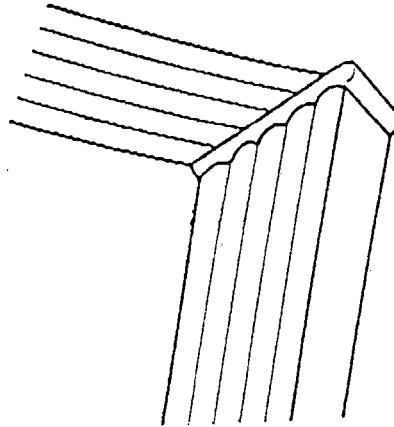

BURGESS FURNITURE LTD (UNITED KING-
DOM CORPORATION)
FELTHAM
HANWORTH TRADING ESTATE
MIDDLESEX TW13 6EH, UNITED KINGDOM

FOR: CHAIRS, IN CLASS 20 (U.S. CLS. 2, 13, 22, 25,
32 AND 50).

FIRST USE 3-0-1996; IN COMMERCE 3-0-1996.

THE DRAWING PRESENTS A SINGLE THREE-
DIMENSIONAL VIEW OF APPLICANT'S MARK.
THE MARK CONSISTS OF AN UPPER CORNER OF
A BACKREST OF A CHAIR.

SEC. 2(F).

SER. NO. 76-162,020, FILED 11-7-2000.

ESTHER BELENKER, EXAMINING ATTORNEY

Int. Cls.: 35 and 42

Prior U.S. Cls.: 100, 101 and 102

United States Patent and Trademark Office

Reg. No. 2,892,221

Registered Oct. 12, 2004

**SERVICE MARK
PRINCIPAL REGISTER**

BULLDOG

BULLDOG OFFICE PRODUCTS, INC. (PENN-
SYLVANIA CORPORATION)
500 GLASS ROAD
P.O. BOX 4469
PITTSBURGH, PA 15205

FOR: COMPUTERIZED ON-LINE ORDERING
AND MAIL ORDER CATALOG SERVICES FEATURING
AUDIO VISUAL SUPPLIES, CLEANING SUPPLIES
FOR OFFICE USE, COMPUTER SUPPLIES, ENVELOPES,
BUSINESS FORMS, FILE FOLDERS, LABELS,
MAILING SUPPLIES, PADS, PAPER, RIBBONS,
WRITING SUPPLIES, COPY MACHINES, FAX
AND PRINTER SUPPLIES, BUSINESS MACHINES
INCLUDING COMPUTER HARDWARE, COMPUTER
MONITORS, COPY MACHINES, FAX MACHINES
AND PRINTERS, AND OFFICE FURNITURE
INCLUDING BOOKCASES, COMPUTER FURNITURE,
DESK, FILES, OFFICE SUITES, SAFES AND
WORK STATIONS; DISTRIBUTORSHIPS FEATURING
AUDIO AND VISUAL SUPPLIES, CLEANING
SUPPLIES FOR OFFICE USE, COMPUTER
SUPPLIES, ENVELOPES, FILE

FOLDERS, LABELS, MAILING SUPPLIES, PADS,
PAPER, RIBBONS, WRITING SUPPLIES, COPY
MACHINE, FAX AND PRINTER SUPPLIES,
BUSINESS MACHINES INCLUDING COMPUTER
HARDWARE, COMPUTER MONITORS, COPY
MACHINES, FAX MACHINES AND PRINTERS,
AND OFFICE FURNITURE INCLUDING BOOKCASES,
COMPUTER FURNITURE, DESKS, FILES, OFFICE
SUITES, SAFES AND WORK STATIONS, IN CLASS
35 (U.S. CLS. 100, 101 AND 102).

FIRST USE 2-14-1997; IN COMMERCE 2-14-1997.

FOR: PRINTING SERVICES, IN CLASS 42 (U.S.
CLS. 100 AND 101).

FIRST USE 1-1-1979; IN COMMERCE 1-1-1979.

SER. NO. 76-163,595, FILED 11-10-2000.

KAREN M. STRYZ, EXAMINING ATTORNEY

Int. Cl.: 35

Prior U.S. Cls.: 100, 101 and 102

United States Patent and Trademark Office

Reg. No. 2,892,222

Registered Oct. 12, 2004

**SERVICE MARK
PRINCIPAL REGISTER**

C.L. WATT

AFFILIATED INDEPENDENT DISTRIBUTORS,
INC. (PENNSYLVANIA CORPORATION)
2700 HORIZON DRIVE
KING OF PRUSSIA, PA 19406

FOR: DISTRIBUTORSHIP SERVICES IN THE
FIELD OF PLUMBING PRODUCTS AND SUPPLIES,
IN CLASS 35 (U.S. CLS. 100, 101 AND 102).

FIRST USE 0-0-1967; IN COMMERCE 0-0-1967.

SEC. 2(F).

SER. NO. 76-165,397, FILED 11-15-2000.

BARNEY CHARLON, EXAMINING ATTORNEY

Int. Cl.: 35

Prior U.S. Cls.: 100, 101 and 102

United States Patent and Trademark Office

Reg. No. 2,892,223

Registered Oct. 12, 2004

**SERVICE MARK
PRINCIPAL REGISTER**

WEBCLIENTS.NET

WEB CLIENTS, INC. (DELAWARE CORPORATION)
2210 N. FRONT STREET
HARRISBURG, PA 17110

FOR: PROVIDING AN ON-LINE, INTERNET
BASED ADVERTISING NETWORK FOR BUSINESS
CLIENTS, NAMELY PREPARATION, PLACEMENT
AND DISSEMINATION OF ADVERTISEMENT FOR

OTHERS VIA THE INTERNET, IN CLASS 35 (U.S.
CLS. 100, 101 AND 102).

FIRST USE 10-18-1998; IN COMMERCE 10-18-1998.

SER. NO. 76-166,221, FILED 11-16-2000.

RUDY R. SINGLETON, EXAMINING ATTORNEY

Int. Cl.: 36

Prior U.S. Cls.: 100, 101 and 102

United States Patent and Trademark Office

Reg. No. 2,892,224

Registered Oct. 12, 2004

**SERVICE MARK
PRINCIPAL REGISTER**

LEGENDARY RESORT CARD

LEGENDARY, INC. (FLORIDA CORPORATION)
4460 LEGENDARY, DRIVE
DESTIN, FL 32541

FOR: CREDIT CARDS SERVICES, NAMELY CARDS PROVIDING CREDIT, MEMBERSHIP AND OTHER PRIVILEGES TO THEIR HOLDERS FOR USE IN CONNECTION WITH RESORT SERVICES, NAMELY RESORT AND HEALTH SPA, DINING AND RESTAURANT SERVICES, TENNIS, GOLF, BEACH, FISHING, WATER SPORTS, POOL, RECREATIONAL ACTIVITIES AND LODGING AND HOTEL SERVICES, HOT TUBS FACILITIES, MASSAGES AND BEAUTY SALON SERVICES, PROVID-

ING BANQUET AND SOCIAL FUNCTION FACILITIES FOR SPECIAL OCCASIONS, SOCIAL CLUB SERVICES, AND MARINA AND MARINA SERVICES, IN CLASS 36 (U.S. CLS. 100, 101 AND 102).

FIRST USE 4-0-2000; IN COMMERCE 4-0-2000.

NO CLAIM IS MADE TO THE EXCLUSIVE RIGHT TO USE "RESORT CARD" , APART FROM THE MARK AS SHOWN.

SER. NO. 76-169,466, FILED 11-21-2000.

KAREN BRACEY, EXAMINING ATTORNEY

Int. Cl.: 41

Prior U.S. Cls.: 100, 101 and 107

United States Patent and Trademark Office

Reg. No. 2,892,225

Registered Oct. 12, 2004

**SERVICE MARK
PRINCIPAL REGISTER**

CYBERAGE

HYE WEB PRODUCTIONS, LLC (CALIFORNIA CORPORATION)
613 W. SALEM STREET
GLENDALE, CA 91203

FOR: PROVIDING ON-LINE INFORMATION IN THE FIELD OF ENTERTAINMENT; PROVIDING ENTERTAINMENT INFORMATION ON A COMPUTER NETWORK, NAMELY, PHOTOGRAPHS, COMPUTER GAMES, SOUND RECORDINGS, MUSIC PROGRAMS AND AUDIOVISUAL WORKS; PRO-

VIDING AN ON-LINE SEARCHABLE COMPUTER DATABASE IN THE FIELD OF ENTERTAINMENT, IN CLASS 41 (U.S. CLS. 100, 101 AND 107).

FIRST USE 11-22-2000; IN COMMERCE 11-22-2000.

SER. NO. 76-169,606, FILED 11-21-2000.

JOHN SCHUYLER YARD, EXAMINING ATTORNEY

Int. Cls.: 29, 30, 31, 32 and 35

Prior U.S. Cls.: 1, 45, 46, 48, 100, 101 and 102

United States Patent and Trademark Office

Reg. No. 2,892,226

Registered Oct. 12, 2004

**TRADEMARK
SERVICE MARK
PRINCIPAL REGISTER**

BAREFOOT CONTESSA

GARTEN FOOD CORPORATION (NEW YORK CORPORATION)
46 NEWTOWN LANE
EAST HAMPTON, NY 11937

FOR: DIPS, NAMELY, VEGETABLE, YOGURT, FISH AND HERB BASED DIPS; HUMMUS, CHILI, STEWS RIBOLLITA, SOUPS, NAMELY, GAZPACHO AND CHOWDERS; SALADS EXCEPT MACARONI, RICE AND PASTA; CRANBERRY SAUCE; APPLE SAUCE, DRIED FRUITS, PROCESSED NUTS, CANDIED NUTS, SNACK MIX CONSISTING PRIMARILY OF PROCESSED FRUITS, PROCESSED NUTS AND/OR RAISINS; PROCESSED PEAS WITH WASABI FLAVORING, IN CLASS 29 (U.S. CL. 46).

FIRST USE 0-0-1979; IN COMMERCE 0-0-1979.

FOR: VEGETABLE STRUDEL, VEGETABLE COBBLERS, SPRING ROLLS, COFFEE, BREAD CRUMBS, CROUTONS, GRANOLA, CAKES, NAMELY SOUR CREAM COFFEE CAKE; CANDY, NAMELY, STRAWBERRY FLAVORED LACES; QUESADILLA, SALSA, IN CLASS 30 (U.S. CL. 46).

FIRST USE 0-0-1979; IN COMMERCE 0-0-1979.

FOR: FRESH VEGETABLES AND FRESH NUTS, IN CLASS 31 (U.S. CLS. 1 AND 46).

FIRST USE 0-0-1994; IN COMMERCE 0-0-1994.

FOR: ORANGE JUICE, GRAPEFRUIT JUICE, LEMONADE; NON-ALCOHOLIC COCKTAIL MIXES, IN CLASS 32 (U.S. CLS. 45, 46 AND 48).

FIRST USE 0-0-1997; IN COMMERCE 0-0-1997.

FOR: RETAIL STORE SERVICES FEATURING GOURMET FOODS AND BOOKS, IN CLASS 35 (U.S. CLS. 100, 101 AND 102).

FIRST USE 0-0-1978; IN COMMERCE 0-0-1978.

THE ENGLISH TRANSLATION OF "CONTESSA" IS "COUNTESS".

SER. NO. 76-172,249, FILED 11-22-2000.

ELIZABETH HUGHITT, EXAMINING ATTORNEY

Int. Cl.: 25

Prior U.S. Cls.: 22 and 39

United States Patent and Trademark Office

Reg. No. 2,892,227

Registered Oct. 12, 2004

**TRADEMARK
PRINCIPAL REGISTER**

L.A. KIDZ

L.A. KIDZ INC. (NEW YORK CORPORATION)
34 34TH STREET
BROOKLYN, NY 11232

NO CLAIM IS MADE TO THE EXCLUSIVE
RIGHT TO USE "KIDS" , APART FROM THE MARK
AS SHOWN.

FOR: CHILDREN'S UNDERWEAR AND PAJA-
MAS, IN CLASS 25 (U.S. CLS. 22 AND 39).

SER. NO. 76-173,078, FILED 11-26-2000.

FIRST USE 4-0-2000; IN COMMERCE 4-0-2000.

CHRISIE B. KING, EXAMINING ATTORNEY

Int. Cls.: 9 and 35

Prior U.S. Cls.: 21, 23, 26, 36, 38, 100, 101 and 102

United States Patent and Trademark Office

Reg. No. 2,892,228

Registered Oct. 12, 2004

**TRADEMARK
SERVICE MARK
PRINCIPAL REGISTER**



CDJ WAX, LLC. (CALIFORNIA LIMITED LIABILITY CORPORATION), DBA WAX RECORDS
7201 MELROSE AVENUE UNIT A
LOS ANGELES, CA 90046

FOR: PHONOGRAPH RECORDS, PRE-RECORDED AUDIOTAPES AND COMPACT DISCS AND PRE-RECORDED VIDEOTAPES AND DIGITAL VIDEO DISCS ALL FEATURING MUSICAL PERFORMANCES, IN CLASS 9 (U.S. CLS. 21, 23, 26, 36 AND 38).

FIRST USE 4-2-1999; IN COMMERCE 4-2-1999.

FOR: RETAIL STORE SERVICES, NAMELY, RECORD STORES, IN CLASS 35 (U.S. CLS. 100, 101 AND 102).

FIRST USE 4-2-1999; IN COMMERCE 4-2-1999.

NO CLAIM IS MADE TO THE EXCLUSIVE RIGHT TO USE "WAX", APART FROM THE MARK AS SHOWN.

SER. NO. 76-177,199, FILED 12-8-2000.

SONYA STEPHENS, EXAMINING ATTORNEY

Int. Cl.: 7

Prior U.S. Cls.: 13, 19, 21, 23, 31, 34 and 35

Reg. No. 2,892,229

United States Patent and Trademark Office

Registered Oct. 12, 2004

**TRADEMARK
PRINCIPAL REGISTER**

TESTBOURNE

TESTBOURNE LIMITED (UNITED KINGDOM
CORPORATION)
UNIT 12, HASSOCKS WOOD
STROUDLEY ROAD, BASINGSTOKE
HAMPSHIRE, ENGLAND RG24 8UQ

FOR: MACHINES UTILIZING HIGH-VACUUM
TECHNOLOGY, NAMELY, MACHINES FOR DE-
POSITING VERY THIN FILMS OF MATERIALS,
MACHINES FOR PRODUCING SOURCES OF HIGH
VACUUM, MACHINES FOR IMPREGNATING
ELECTRICAL COMPONENTS AND MACHINES
FOR EFFECTING MOLECULAR BEAM EPITAXY;
SPUTTER COATING MACHINES; MACHINES FOR
ETCHING OR REMOVING ORGANICS FROM SPE-
CIMENS; MACHINES FOR PREPARING SAMPLES
FOR CHEMICAL AND PHYSICAL ANALYSIS WITH
LOW-TEMPERATURE PLASMA OXIDATION;
CLUSTER FLANGES; MACHINES CONTAINING

THERMAL EVAPORATION SOURCES, SPUTTER-
ING SOURCES, SUBSTRATE HEATERS, ION SOUR-
CES, DIES OF GRAPHITE OR METAL, CRUCIBLES,
AND MANIPULATORS; COUPLINGS FOR MA-
CHINES; TRANSMISSIONS FOR MACHINES
OTHER THAN LAND VEHICLES; VACUUM PUMPS
FOR MACHINES; REPLACEMENT PARTS FOR
THE AFORESAID GOODS, IN CLASS 7 (U.S. CLS.
13, 19, 21, 23, 31, 34 AND 35).

PRIORITY CLAIMED UNDER SEC. 44(D) ON
ERPNTY TM OFC APPLICATION NO.
1988252, FILED 12-6-2000, REG. NO. 1988252, DATED
9-27-2002, EXPIRES 12-6-2010.

SER. NO. 76-177,383, FILED 12-7-2000.

MICHAEL SOUDERS, EXAMINING ATTORNEY

Int. Cl.: 6

Prior U.S. Cls.: 2, 12, 13, 14, 23, 25 and 50

Reg. No. 2,892,230

United States Patent and Trademark Office

Registered Oct. 12, 2004

**TRADEMARK
PRINCIPAL REGISTER**

TESTBOURNE

TESTBOURNE LIMITED (UNITED KINGDOM CORPORATION)
UNIT 12, HASSOCKS WOOD
STROUDLEY ROAD, BASINGSTOKE
HAMPSHIRE, ENGLAND RG24 8UQ

FOR: SPUTTERING TARGETS OF COMMON METAL AND ALLOYS THEREOF; COMMON METALS AND THEIR ALLOYS FOR FURTHER MANUFACTURE; METAL CABLE WIRES AND WIRES OF COMMON METAL; COMMON METAL AND ALLOYS THEREOF IN THE FORM OF FOILS, SHEETS, DISCS, GRANULES, INGOTS, PELLETS, PIECES, SHOT, POWDER, RODS, CONES, BARS, TABLETS AND CUBES FOR FURTHER MANUFACTURE; WIRES OF COMMON METAL AND ALLOYS THEREOF; ALUMINIUM, ANTIMONY, ARSENIC, BARIUM, BERYLLIUM, BISMUTH, BORON, CADMIUM, CERIUM, CAESIUM, CHROMIUM, COBALT, COPPER, DYSPROSIUM, ERBIUM, EUROPIUM, GADOLINIUM, GALLIUM, GERMANIUM, HAFNIUM, HOLMIUM, INDIUM, IODINE,

IRON, LANTHANUM, LEAD, LITHIUM, LUTETIUM, MAGNESIUM, MANGANESE, MOLYBDENUM, NEODYMIUM, NICKEL, NIOBIUM, PRASEODYMIUM, RHENIUM, RUBIDIUM, RUTHENIUM, SAMARIUM, SCANDIUM, SELENIUM, SODIUM, STRONTIUM, TANTALUM, TELLURIUM, TERBIUM, THALLIUM, THULIUM, TIN, TITANIUM, TUNGSTEN, VANADIUM, YTTERBIUM, YTTRIUM, ZINC AND ZIRCONIUM; COMMON METALS AND THEIR ALLOYS FOR USE IN THE DEPOSITION OF THIN FILMS, IN CLASS 6 (U.S. CLS. 2, 12, 13, 14, 23, 25 AND 50).

PRIORITY CLAIMED UNDER SEC. 44(D) ON ERPN CMNTY TM OFC APPLICATION NO. 1988252, FILED 12-6-2000, REG. NO. 1988252, DATED 9-27-2002, EXPIRES 12-6-2010.

SER. NO. 76-177,384, FILED 12-7-2000.

MICHAEL SOUDERS, EXAMINING ATTORNEY

Int. Cls.: 9, 38 and 42

Prior U.S. Cls.: 21, 23, 26, 36, 38, 100, 101 and 104

Reg. No. 2,892,231

United States Patent and Trademark Office

Registered Oct. 12, 2004

**TRADEMARK
SERVICE MARK
PRINCIPAL REGISTER**



SKYLINE SOFTWARE SYSTEMS LTD. (ISRAEL CORPORATION)
13 GUSH-EZION ST
GIVAT-SHMUEL, ISRAEL

FOR: COMPUTER SOFTWARE THAT CONVERT TWO-DIMENSIONAL GEOGRAPHIC IMAGES INTO THREE-DIMENSIONAL IMAGES, ENABLING THE DISPLAY OF SUCH IMAGERY, AND ENABLING STREAMING OF SUCH THREE-DIMENSIONAL IMAGERY OVER COMPUTER NETWORKS, NAMELY, THE INTERNET, IN CLASS 9 (U.S. CLS. 21, 23, 26, 36 AND 38).

FIRST USE 1-18-2000; IN COMMERCE 3-15-2000.

FOR: STREAMING OF THREE-DIMENSIONAL IMAGERY OVER THE INTERNET, IN CLASS 38 (U.S. CLS. 100, 101 AND 104).

FIRST USE 3-15-2000; IN COMMERCE 3-15-2000.

FOR: PROVIDING TEMPORARY USE OF ON-LINE NON-DOWNLOADABLE SOFTWARE USED TO CONVERT TWO-DIMENSIONAL GEOGRAPHIC IMAGES INTO THREE-DIMENSIONAL IMAGES

AND ENABLING THE DISPLAY OF SUCH IMAGERY, IN CLASS 42 (U.S. CLS. 100 AND 101).

FIRST USE 1-18-2000; IN COMMERCE 3-15-2000.

NO CLAIM IS MADE TO THE EXCLUSIVE RIGHT TO USE "DIGITAL", APART FROM THE MARK AS SHOWN.

THIS MARK CONSISTS OF A GLOBE-LIKE ORB, WHICH IS DARK BLUE ON THE LEFT UNDERSIDE FADING TO A LIGHTER BLUE ON THE RIGHT UPSIDE, WITH A NEARLY WHITE SPOT IN THE CENTER RESEMBLING A REFLECTION. THE ORB HAS A GOLD 'S' WRAPPED AROUND IT FROM TOP TO BOTTOM. THE LETTERING OF THE WORD "SKYLINE" IS THE SAME DARK BLUE COLOR AS THE LEFT UNDERSIDE OF THE GLOBE. THE LETTERING OF THE PHRASE "DELIVERING THE DIGITAL EARTH" IS BLACK. THE BACKGROUND IS WHITE.

SER. NO. 76-179,753, FILED 12-8-2000.

WENDY GOODMAN, EXAMINING ATTORNEY

Int. Cls.: 9, 38 and 42

Prior U.S. Cls.: 21, 23, 26, 36, 38, 100, 101 and 104

Reg. No. 2,892,232

United States Patent and Trademark Office

Registered Oct. 12, 2004

**TRADEMARK
SERVICE MARK
PRINCIPAL REGISTER**



SKYLINE SOFTWARE SYSTEMS LTD. (ISRAEL CORPORATION)
13 GUSH-EZION ST.
GIVAT-SHMUEL, ISRAEL

FOR: COMPUTER SOFTWARE THAT CONVERT TWO-DIMENSIONAL GEOGRAPHIC IMAGES INTO THREE-DIMENSIONAL IMAGES, ENABLING THE DISPLAY OF SUCH IMAGERY, AND ENABLING STREAMING OF SUCH THREE-DIMENSIONAL IMAGERY OVER COMPUTER NETWORKS, NAMELY, THE INTERNET, IN CLASS 9 (U.S. CLS. 21, 23, 26, 36 AND 38).

FIRST USE 1-18-2000; IN COMMERCE 3-15-2000.

FOR: STREAMING OF THREE-DIMENSIONAL IMAGERY OVER THE INTERNET, IN CLASS 38 (U.S. CLS. 100, 101 AND 104).

FIRST USE 3-15-2000; IN COMMERCE 3-15-2000.

FOR: COMPUTER SERVICES, NAMELY, CONVERTING TWO-DIMENSIONAL GEOGRAPHIC IMAGES INTO THREE-DIMENSIONAL IMAGES FOR OTHERS AND ENABLING THE DISPLAY OF SUCH IMAGERY, IN CLASS 42 (U.S. CLS. 100 AND 101).

FIRST USE 1-18-2000; IN COMMERCE 3-15-2000.

THE MARK CONSISTS OF A GLOBE-LIKE ORB, WHICH IS DARK BLUE ON THE LEFT UNDERSIDE FADING TO A LIGHTER BLUE ON THE RIGHT UPPER SIDE, TO NEARLY WHITE IN THE CENTER. THE ORB HAS A GOLD "S" WRAPPED AROUND IT FROM TOP TO BOTTOM. THE LETTERING OF THE WORD "SKYLINE" IS THE SAME DARK BLUE COLOR AS THE LEFT UNDERSIDE OF THE GLOBE.

SER. NO. 76-179,754, FILED 12-8-2000.

WENDY GOODMAN, EXAMINING ATTORNEY

Int. Cls.: 9, 16, 41 and 42

**Prior U.S. Cls.: 2, 5, 21, 22, 23, 26, 29, 36, 37, 38, 50,
100, 101 and 107**

Reg. No. 2,892,233

United States Patent and Trademark Office

Registered Oct. 12, 2004

**TRADEMARK
SERVICE MARK
PRINCIPAL REGISTER**

VERITAS VISION

VERITAS OPERATING CORPORATION (DELAWARE CORPORATION)
350 ELLIS STREET
MOUNTAIN VIEW, CA 94043

FOR: PUBLICATIONS IN ELECTRONIC FORM, ON MAGNETIC AND OPTICAL COMPUTER-READABLE MEDIA OR DOWNLOADABLE VIA COMPUTER AND COMMUNICATION NETWORKS, INCLUDING THE INTERNET, NAMELY, NEWSLETTERS, BOOKS, MAGAZINES, WORK BOOKS, TECHNICAL REFERENCE MANUALS, TECHNICAL REFERENCE GUIDES, COMPUTER USER MANUALS, MANUALS, BROCHURES, GUIDES AND TUTORIALS IN THE FIELDS OF COMPUTER SOFTWARE, COMPUTER NETWORKS, COMPUTER DATA STORAGE AND DATA STORAGE MANAGEMENT; CONFERENCE, WORKSHOP, AND SEMINAR PUBLICATIONS IN ELECTRONIC FORM, ON MAGNETIC AND OPTICAL COMPUTER-READABLE MEDIA OR DOWNLOADABLE VIA COMPUTER AND COMMUNICATION NETWORKS, INCLUDING THE INTERNET, NAMELY, NEWSLETTERS, BOOKS, MAGAZINES, WORK BOOKS, TECHNICAL REFERENCE MANUALS, TECHNICAL REFERENCE GUIDES, COMPUTER USER MANUALS, MANUALS, BROCHURES, GUIDES, AND TUTORIALS IN THE FIELDS OF COMPUTER SOFTWARE, COMPUTER NETWORKS, COMPUTER DATA STORAGE AND DATA STORAGE MANAGEMENT, IN CLASS 9 (U.S. CLS. 21, 23, 26, 36 AND 38).

FIRST USE 7-1-2000; IN COMMERCE 7-1-2000.

FOR: PRINTED PUBLICATIONS NAMELY, NEWSLETTERS, BOOKS, MAGAZINES, WORK BOOKS, TECHNICAL REFERENCE MANUALS, TECHNICAL REFERENCE GUIDES, COMPUTER USER MANUALS, MANUALS, BROCHURES, GUIDES, AND TUTORIALS IN THE FIELDS OF

COMPUTER SOFTWARE, COMPUTER NETWORKS, COMPUTER DATA STORAGE AND DATA STORAGE MANAGEMENT; PRINTED CONFERENCE, WORKSHOP, AND SEMINAR MATERIALS, NAMELY, NEWSLETTERS, BOOKS, MAGAZINES, WORK BOOKS, TECHNICAL REFERENCE MANUALS, TECHNICAL REFERENCE GUIDES, COMPUTER USER MANUALS, MANUALS, BROCHURES, GUIDES, AND TUTORIALS IN THE FIELDS OF COMPUTER SOFTWARE, COMPUTER NETWORKS, COMPUTER DATA STORAGE AND DATA STORAGE MANAGEMENT, IN CLASS 16 (U.S. CLS. 2, 5, 22, 23, 29, 37, 38 AND 50).

FIRST USE 7-1-2000; IN COMMERCE 7-1-2000.

FOR: EDUCATIONAL SERVICES, NAMELY, ARRANGING AND CONDUCTING WORKSHOPS, SEMINARS, AND CONFERENCES IN THE FIELDS OF COMPUTER SOFTWARE, COMPUTER NETWORKS, COMPUTER DATA STORAGE, AND DATA STORAGE MANAGEMENT AND DISTRIBUTION OF COURSE MATERIALS IN CONNECTION THEREWITH; PROVISION OF INFORMATION AND ONLINE DATABASES REGARDING WORKSHOPS, SEMINARS AND CONFERENCES IN THE FIELDS OF COMPUTER SOFTWARE, COMPUTER NETWORKS, COMPUTER DATA STORAGE, AND DATA STORAGE MANAGEMENT AND DISTRIBUTION OF COURSE MATERIALS IN CONNECTION THEREWITH, IN CLASS 41 (U.S. CLS. 100, 101 AND 107).

FIRST USE 7-1-2000; IN COMMERCE 7-1-2000.

FOR: PROVISION OF INFORMATION AND ONLINE DATABASES REGARDING COMPUTER SOFTWARE, COMPUTER NETWORKS, COMPUTER DATA STORAGE, AND DATA STORAGE MANAGEMENT, IN CLASS 42 (U.S. CLS. 100 AND 101).

FIRST USE 7-1-2000; IN COMMERCE 7-1-2000.

SER. NO. 76-184,955, FILED 12-22-2000.

THE ENGLISH TRANSLATION OF THE WORD-
ING "VERITAS" IN THE MARK IS "TRUTH".

DANIELLE MATTESSICH, EXAMINING ATTOR-
NEY

Int. Cls.: 2 and 8

Prior U.S. Cls.: 6, 11, 16, 23, 28 and 44

United States Patent and Trademark Office

Reg. No. 2,892,234

Registered Oct. 12, 2004

**TRADEMARK
PRINCIPAL REGISTER**



PETER KWASNY GMBH (FED REP GERMANY
LIMITED LIABILITY COMPANY)
HEILBRONNER STRASSE 96
D-74831 GUNDELSHEIM, FED REP GERMANY

FOR: PAINTS FOR THE COATING OF FURNITURE, AUTOMOBILES, INTERIOR, EXTERIOR AND BUILDING SURFACES; VARNISHES; LACQUERS IN THE NATURE OF A COATING; PAINTING PREPARATION MATERIALS, NAMELY, PRIMERS FOR PREPARING SURFACES TO BE PAINTED AND PROTECTIVE SPRAYS, NAMELY, PAINT PRIMERS, CORROSION PREVENTING PRIMERS, CLEAR SEALING VARNISH, WOOD FILLS FOR SMOOTHING OUT SURFACES PRIOR TO PAINTING, REPAIR PRIMERS AND HARDENER, IN CLASS 2 (U.S. CLS. 6, 11 AND 16).

FIRST USE 9-0-1996; IN COMMERCE 5-0-1998.

FOR: ATOMIZING DEVICES, NAMELY, HAND-OPERATED SPRAYCANS, HAND-PUMPED SPRAY-

ERS AND HAND-OPERATED SPRAYGUNS FOR PAINTS, VARNISHES, LACQUERS AND PAINTING PREPARATION MATERIAL, IN CLASS 8 (U.S. CLS. 23, 28 AND 44).

FIRST USE 9-0-1996; IN COMMERCE 5-0-1998.

OWNER OF ERPN CMNTY TM OFC REG. NO. 000384859, DATED 11-4-1998, EXPIRES 11-4-2008.

THE WORD "SPRAY" IS IN WHITE ON A RED BACKGROUND; THE WORD "MAX" IS IN DARK BLUE; THE SHAPE TO THE RIGHT OF THE LETTER "X" IS BLUE-GREEN; AND COLOR IS CLAIMED AS A FEATURE OF THE MARK.

SER. NO. 76-186,962, FILED 12-27-2000.

MICHAEL SOUDERS, EXAMINING ATTORNEY

Int. Cls.: 7 and 8

Prior U.S. Cls.: 13, 19, 21, 23, 28, 31, 34, 35 and 44

United States Patent and Trademark Office

Reg. No. 2,892,235

Registered Oct. 12, 2004

**TRADEMARK
PRINCIPAL REGISTER**

PRO SERIES

JOHN DEERE CONSUMER PRODUCTS, INC.
(DELAWARE CORPORATION)
14401 CAROWINDS BOULEVARD
CHARLOTTE, NC 28273

FOR: GASOLINE POWER DRIVEN HEDGE TRIMMER; GASOLINE POWER DRIVEN STRING TRIMMER FOR CUTTING VEGETATION AND MONOFILAMENT CUTTING LINE FOR STRING TRIMMERS; GASOLINE POWER DRIVEN BRUSH CUTTERS; GASOLINE POWER DRIVEN CHAIN SAW, SAW CHAIN AND CHAIN SAW GUIDE BARS; GASOLINE POWER DRIVEN LAWN EDGERS; GASOLINE POWER DRIVEN BLOWERS FOR YARDS, LAWNS AND GARDENS, VACUUM BAG ATTACHMENTS FOR BLOWERS, AND BACKPACKS FOR CARRYING BLOWERS; GASOLINE POWER DRIVEN GARDEN TILLERS; GASOLINE POWER DRIVEN CULTIVATORS; POWER TOOL ACCESSORIES, NAMELY, SAW CHAIN FOR CHAIN SAWS, GUIDE BARS FOR CHAIN SAWS, MANUALLY POWERED GREASE GUNS, LINE FOR STRING TRIMMERS,

STRING TRIMMER FOR LINE HEADS AND BRUSH BLADES, AND REPLACEMENT PARTS FOR THE FOREGOING, IN CLASS 7 (U.S. CLS. 13, 19, 21, 23, 31, 34 AND 35).

FIRST USE 4-0-1993; IN COMMERCE 4-0-1993.

FOR: MANUALLY OPERATED GREASE GUNS; HAND TOOLS, NAMELY, FILES, IN CLASS 8 (U.S. CLS. 23, 28 AND 44).

FIRST USE 4-0-1993; IN COMMERCE 4-0-1993.

NO CLAIM IS MADE TO THE EXCLUSIVE RIGHT TO USE "SERIES", APART FROM THE MARK AS SHOWN.

SER. NO. 76-187,536, FILED 12-29-2000.

CATHERINE CAIN, EXAMINING ATTORNEY

Int. Cl.: 35

Prior U.S. Cls.: 100, 101 and 102

United States Patent and Trademark Office

Reg. No. 2,892,236

Registered Oct. 12, 2004

**SERVICE MARK
PRINCIPAL REGISTER**



ABS COMPUTER TECHNOLOGY (CALIFORNIA
CORPORATION)
9997 E. ROSE HILLS RD.
WHITTIER, CA 90601

FIRST USE 7-26-2000; IN COMMERCE 7-26-2000.

SER. NO. 76-194,750, FILED 1-16-2001.

FOR: ONLINE RETAIL STORE FEATURING
COMPUTER HARDWARE PRODUCTS, IN CLASS
35 (U.S. CLS. 100, 101 AND 102).

ALICE BENMAMAN, EXAMINING ATTORNEY

Int. Cls.: 9 and 16

Prior U.S. Cls.: 2, 5, 21, 22, 23, 26, 29, 36, 37, 38 and 50

Reg. No. 2,892,237

United States Patent and Trademark Office

Registered Oct. 12, 2004

**TRADEMARK
PRINCIPAL REGISTER**

LEAPFROG

LEAPFROG MEDIA CORP. (COLORADO CORPORATION)
1562 S. PARKER RD.
DENVER, CO 80231

FOR: PRE-RECORDED AUDIO AND VIDEO
TAPES IN THE FIELD OF BUSINESS, IN CLASS 9
(U.S. CLS. 21, 23, 26, 36 AND 38).

FIRST USE 1-17-2001; IN COMMERCE 1-17-2001.

FOR: BUSINESS MAGAZINE, IN CLASS 16 (U.S.
CLS. 2, 5, 22, 23, 29, 37, 38 AND 50).

FIRST USE 1-8-2001; IN COMMERCE 1-8-2001.

SER. NO. 76-195,953, FILED 1-19-2001.

ALICE BENMAMAN, EXAMINING ATTORNEY

Int. Cl.: 35

Prior U.S. Cls.: 100, 101 and 102

United States Patent and Trademark Office

Reg. No. 2,892,238

Registered Oct. 12, 2004

**SERVICE MARK
PRINCIPAL REGISTER**

HOME FOCUS

HSN IMPROVEMENTS, LLC (DELAWARE LTD
LIAB JT ST CO)
1 HSN DRIVE
ST. PETERSBURG, FL 33729

FOR: MAIL ORDER CATALOG AND ON-LINE
RETAIL STORE SERVICES ALL FEATURING STO-
RAGE PRODUCTS, CLEANING PRODUCTS, HOME
MAINTENANCE PRODUCTS AND TOOLS, AUTO-
MOBILE AND TRAVEL PRODUCTS, PEST CON-
TROL PRODUCTS, BATH AND PERSONAL CARE
PRODUCTS, HOME SAFETY AND SECURITY PRO-

DUCTS, AND HOUSEWARES, IN CLASS 35 (U.S.
CLS. 100, 101 AND 102).

FIRST USE 7-18-2000; IN COMMERCE 7-18-2000.

NO CLAIM IS MADE TO THE EXCLUSIVE
RIGHT TO USE "HOME", APART FROM THE
MARK AS SHOWN.

SER. NO. 76-201,839, FILED 1-30-2001.

MICHAEL KEATING, EXAMINING ATTORNEY

Int. Cl.: 20

Prior U.S. Cls.: 2, 13, 22, 25, 32 and 50

Reg. No. 2,892,239

United States Patent and Trademark Office

Registered Oct. 12, 2004

**TRADEMARK
PRINCIPAL REGISTER**



LEMA S.P.A. (ITALY JOINT STOCK COMPANY)
ALZATE BRIANZA (COMO)
STRADA STATALE BRIANTEA, 2, ITALY

SOFA-BEDS; BEDFRAMES; MATTRESSES; PIL-
LOWS, IN CLASS 20 (U.S. CLS. 2, 13, 22, 25, 32 AND
50).

FOR: FURNITURE, NAMELY BEDROOM FUR-
NITURE, LIVING ROOM FURNITURE, OFFICE
FURNITURE, COMPUTER FURNITURE; FURNI-
TURE FRAMES; FURNITURE DOORS; FURNI-
TURE MIRRORS; SHELVES; WARDROBES;
FURNITURE TABLES; CHAIRS; DESKS; CUP-
BOARDS; SIDEBOARDS; DIVANS; SOFAS; BEDS;

OWNER OF ITALY REG. NO. 00833993, DATED 1-
26-2001, EXPIRES 7-9-2020.

SER. NO. 76-203,235, FILED 2-1-2001.

VERNA BETH RIRIE, EXAMINING ATTORNEY

Int. Cls.: 9, 11 and 12

Prior U.S. Cls.: 13, 19, 21, 23, 26, 31, 34, 35, 36, 38 and 44

Reg. No. 2,892,240

United States Patent and Trademark Office

Registered Oct. 12, 2004

**TRADEMARK
PRINCIPAL REGISTER**

FUSION

FUSION ELECTRONICS LIMITED (NEW ZEALAND CORPORATION)
11 HEREMAI STREET
HENDERSON, AUCKLAND, NEW ZEALAND

FOR: TACHOMETERS AND BOOST GAUGES FOR MOTOR VEHICLES, IN CLASS 9 (U.S. CLS. 21, 23, 26, 36 AND 38).

FOR: VEHICLE LIGHTS, NEON LIGHTS, LED TUBES FOR LIGHTING, INTERIOR AND EXTERIOR HIGHLIGHTS FOR VEHICLES, PILLAR MOUNT SHIFT LIGHTS, IN CLASS 11 (U.S. CLS. 13, 21, 23, 31 AND 34).

FOR: STEERING WHEELS, ALLOY WHEEL RIMS, GEAR KNOBS, FLOOR MATS, HANDBRAKE HANDLES, KEYS, SEATS AND RAILS, BLOW OFF VALVES, MUFFLERS, STRUT BRACES, LOWER-

ING SPRINGS, AIR FILTERS, RADIATOR AND OIL CAPS, IN CLASS 12 (U.S. CLS. 19, 21, 23, 31, 35 AND 44).

PRIORITY CLAIMED UNDER SEC. 44(D) ON NEW ZEALAND APPLICATION NO. 627686, FILED 11-23-2000, REG. NO. 627686, DATED 6-6-2001, EXPIRES 11-23-2007.

PRIORITY CLAIMED UNDER SEC. 44(D) ON NEW ZEALAND APPLICATION NO. 627687, FILED 11-23-2000, REG. NO. 627687, DATED 6-6-2002, EXPIRES 11-23-2007.

SER. NO. 76-203,558, FILED 2-1-2001.

RICHARD A. STRASER, EXAMINING ATTORNEY

Int. Cl.: 36

Prior U.S. Cls.: 100, 101 and 102

United States Patent and Trademark Office

Reg. No. 2,892,241

Registered Oct. 12, 2004

**SERVICE MARK
PRINCIPAL REGISTER**

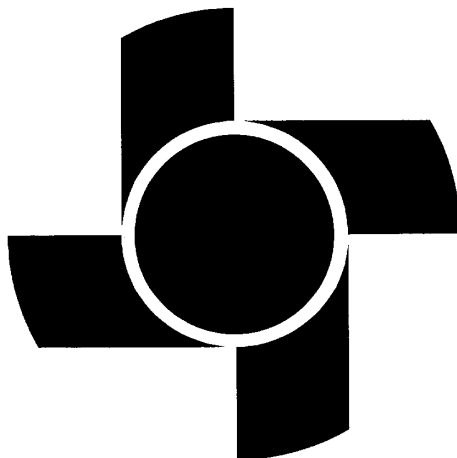

GRUPO FINANCIERO INBURSA, S.A. DE C.V.
(MEXICO CORPORATION)

AV. INSURGENTES SUR 3500

COL. PENA POBRE, MEXICO 14060

FOR: BANKING, INSURANCE CONSULTATION,
INSURANCE CLAIMS ADMINISTRATION, INSURANCE
BROKERAGE IN THE FIELD OF HOME
INSURANCE, ACCIDENT INSURANCE, LIFE IN-
SURANCE, LIABILITY INSURANCE, LEASING OF
REAL PROPERTY, BROKERAGE HOUSE SERVI-
CES IN THE FIELD OF STOCKS, COMMODITIES
AND FUTURES, INVESTMENT OF RETIREMENT
SAVINGS FUNDS, IN CLASS 36 (U.S. CLS. 100, 101
AND 102).

OWNER OF MEXICO REG. NO. 442001, DATED 1-
12-1993, RENEWED AS REG. NO. 14329/2002, DATED
1-12-2003, EXPIRES 1-12-2013.

THE MARK CONSISTS OF A DESIGN WITH A
CIRCLE IN THE MIDDLE SURROUNDED WITH A
WHITE BAND WITH FOUR EQUALLY SIZED
ELONGATED PARTIAL RECTANGLES EMINAT-
ING FROM THE CIRCLE. THE CIRCLE AND THE
ELONGATED PARTIAL RECTANGLES ARE BLUE-
GRAY. THE COLORS BLUE-GRAY AND WHITE
ARE CLAIMED.

SER. NO. 76-205,938, FILED 2-7-2001.

JOHN SCHUYLER YARD, EXAMINING ATTOR-
NEY

Int. Cls.: 12 and 24

Prior U.S. Cls.: 19, 21, 23, 31, 35, 42, 44 and 50

United States Patent and Trademark Office

Reg. No. 2,892,242

Registered Oct. 12, 2004

**TRADEMARK
PRINCIPAL REGISTER**



ARACO KABUSHIKI KAISHA (JAPAN CORPORATION)
25, KAMIFUJIIKE, YOSHIWARA-CHO
TOYOTA-SHI, AICHI-KEN 473-8512, JAPAN

FOR: SHIPS AND PARTS THEREOF EXCLUDING AIR CUSHION VEHICLES; AIRPLANES AND PARTS THEREOF; RAIL ROLLING STOCK AND PARTS THEREOF; AUTOMOBILES AND PARTS THEREOF; MOTORCYCLES AND BICYCLES AND PARTS THEREOF; UTILITY CARTS FOR TRANSPORTING AND HAULING OBJECTS; WHEELCHAIRS, IN CLASS 12 (U.S. CLS. 19, 21, 23, 31, 35 AND 44).

FOR: FELT AND NON-WOVEN CLOTH, IN CLASS 24 (U.S. CLS. 42 AND 50).

PRIORITY CLAIMED UNDER SEC. 44(D) ON JAPAN APPLICATION NO. 2001-002986, FILED 1-18-2001, REG. NO. 4587216, DATED 7-19-2002, EXPIRES 7-19-2012.

PRIORITY CLAIMED UNDER SEC. 44(D) ON JAPAN APPLICATION NO. 2001-105077, FILED 1-18-2001, REG. NO. 4554147, DATED 3-22-2002, EXPIRES 3-22-2012.

THE MARK CONSISTS OF THE WORD "ARACO" WITH A STYLIZED "A".

SER. NO. 76-207,171, FILED 2-9-2001.

JOHN LINCOSKI, EXAMINING ATTORNEY

Int. Cl.: 14

Prior U.S. Cls.: 2, 27, 28 and 50

United States Patent and Trademark Office

Reg. No. 2,892,243

Registered Oct. 12, 2004

**TRADEMARK
PRINCIPAL REGISTER**

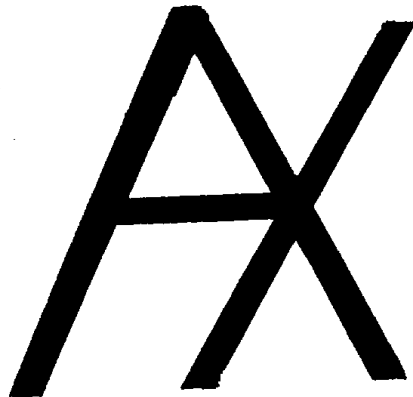

HALLMARK-SWEET, INC. (RHODE ISLAND
CORPORATION)
49 PEARL STREET, PO BOX 358
ATTLEBORO, ME 02703

FOR: JEWELRY FINDINGS; NAMELY, SPRING
RINGS, CLASPS, HOOKS, RINGS, CATCHES,
SNAPS, EAR WIRES, SWIVELS, CLUTCHES, POSTS,

SETTINGS, PENDANTS, BEADS AND BALLS, AND
CHAINS , IN CLASS 14 (U.S. CLS. 2, 27, 28 AND 50).

FIRST USE 10-20-1987; IN COMMERCE 10-20-1987.

SER. NO. 76-208,776, FILED 2-12-2001.

CHRISIE B. KING, EXAMINING ATTORNEY

Int. Cls.: 3, 16, 26 and 42

Prior U.S. Cls.: 1, 2, 4, 5, 6, 22, 23, 29, 37, 38, 39, 40, 42, 50, 51, 52, 100 and 101

Reg. No. 2,892,244

United States Patent and Trademark Office

Registered Oct. 12, 2004

**TRADEMARK
SERVICE MARK
PRINCIPAL REGISTER**

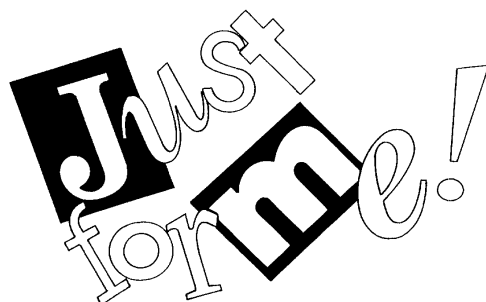

PRO-LINE INTERNATIONAL (DELAWARE CORPORATION)
2121 PANORAMIC CIRCLE
DALLAS, TX 75212

FOR: NON-MEDICATED HAIR CARE PRODUCTS, NAMELY, NO-LYE CONDITIONING CREAM RELAXER, HAIR SHAMPOOS, HAIR CONDITIONERS, HAIR DETANGLERS, SCALP CONDITIONERS AND HAIR DRESSING OIL, IN CLASS 3 (U.S. CLS. 1, 4, 6, 50, 51 AND 52).

FIRST USE 2-0-1992; IN COMMERCE 2-0-1992.

FOR: PRINTED NEWSLETTER THAT PROMOTES HAIR CARE PRODUCTS AND THE INTERESTS OF YOUNG GIRLS; PAPER BOOK MARKS, PAPER CARDS FOR IDENTIFICATION; STATIONERY AND PAPER DOOR KNOW HANGERS, IN CLASS 16 (U.S. CLS. 2, 5, 22, 23, 29, 37, 38 AND 50).

FIRST USE 3-0-1994; IN COMMERCE 3-0-1994.

FOR: HAIR SCRUNCHES, IN CLASS 26 (U.S. CLS. 37, 39, 40, 42 AND 50).

FIRST USE 3-0-1994; IN COMMERCE 3-0-1994.

FOR: SOCIAL CLUB SERVICES, NAMELY, A CLUB THAT PROMOTES THE INTERESTS OF YOUNG GIRLS; COMPUTER SERVICES, NAMELY, PROVIDING AN ONLINE NEWSLETTER THAT PROMOTES THE INTERESTS OF YOUNG GIRLS, IN CLASS 42 (U.S. CLS. 100 AND 101).

FIRST USE 3-0-1994; IN COMMERCE 3-0-1994.

THE MARK CONSISTS OF COLOR. THE RECTANGLE CONTAINING THE LETTER "J" IS MAGENTA, THE "J" IS WHITE, THE "U" IS ORANGE, THE "S" IS TEAL AND THE "T" IS GREEN. THE "F" IS BLUE, THE "O" IS GREEN AND THE "R" IS MAGENTA. THE RECTANGLE CONTAINING THE LETTER "M" IS ORANGE, THE "M" IS WHITE AND THE "E" IS TEAL. THE EXCLAMATION MARK IS MAGENTA.

SER. NO. 76-209,953, FILED 2-14-2001.

BERYL GARDNER, EXAMINING ATTORNEY

Int. Cl.: 9

Prior U.S. Cls.: 21, 23, 26, 36 and 38

United States Patent and Trademark Office

Reg. No. 2,892,245

Registered Oct. 12, 2004

**TRADEMARK
PRINCIPAL REGISTER**

ACD/LABS

ADVANCED CHEMISTRY DEVELOPMENT INC.
(CANADA CORPORATION)
90 ADELAIDE STREET WEST, SUITE 702
TORONTO, ONTARIO, M5H 3V9, CANADA

FOR: COMPUTER SOFTWARE FOR CHEMICAL
CHROMATOGRAPHY, SPECTROSCOPY, CHEMI-
CAL SEARCHING AND NAMING, CHEMICAL
PROPERTY PREDICATION, SPECTRAL PREDIC-
TION, MOLECULAR MODELLING, STRUCTURE
DRAWING AND DATABASE MANAGEMENT, FOR

USE IN CHEMISTRY, BIOCHEMISTRY, PHARMA-
COLOGY AND CHEMICAL STRUCTURE HAND-
LING, IN CLASS 9 (U.S. CLS. 21, 23, 26, 36 AND 38).

FIRST USE 9-0-1995; IN COMMERCE 9-0-1995.

SER. NO. 76-210,105, FILED 2-14-2001.

MONIQUE MILLER, EXAMINING ATTORNEY

Int. Cls.: 9, 35, 37, 41 and 42

**Prior U.S. Cls.: 21, 23, 26, 36, 38, 100, 101, 102, 103,
106 and 107**

Reg. No. 2,892,246

United States Patent and Trademark Office

Registered Oct. 12, 2004

**TRADEMARK
SERVICE MARK
PRINCIPAL REGISTER**

SAFIRE

SOLINET GMBH TELECOMMUNICATIONS
(FED REP GERMANY CORPORATION)
MITTLERER PFAD 26
STUTT GART 70499, FED REP GERMANY

FOR: SCIENTIFIC MEASUREMENT, SIGNALING AND CONTROL APPARATUSES, AND INSTRUMENTS FOR USE IN TELECOMMUNICATIONS, NAMELY, SIGNALING TRACERS, SIGNALING AND PROTOCOL ANALYZERS AND SIGNALING VALIDATORS AND SIGNALING OBSERVERS; DEVICES FOR RECORDING, TRANSFERRING, AND REPRODUCING SOUND, IMAGES, AND DATA, NAMELY, CASSETTES, VIDEO DISKS, AND TAPES; DATA PROCESSING DEVICES; COMPACT AND CENTRAL DATA PROCESSING UNITS, NAMELY, COMPUTERS, PROCESSORS AND DEVICES CONNECTIBLE TO COMPUTERS AND PROCESSORS FOR INPUTTING, OUTPUTTING, AND REPRODUCING DATA AND INFORMATION; PROTOCOL ANALYSIS AND PROTOCOL TEST SYSTEMS COMPRISED OF DIGITAL/ANALOG MEASUREMENT AND CONTROL DEVICES; AND COMPUTER SOFTWARE FOR USE IN TELECOMMUNICATIONS AND SIGNALING SYSTEMS FOR TRACING, ANALYZING AND MEASURING OF TELECOMMUNICATION SIGNALS AND FOR PERFORMING SIMULATION AND CONFORMANCE TESTS, RAPID PROTOTYPING, IN CLASS 9 (U.S. CLS. 21, 23, 26, 36 AND 38).

FOR: ADMINISTRATION OF TELECOMMUNICATION NETWORKS FOR OTHERS; LICENSING OF COMPUTER SOFTWARE, IN CLASS 35 (U.S. CLS. 100, 101 AND 102).

FOR: INSTALLATION OF COMPUTER SYSTEMS AND TELECOMMUNICATIONS AND SIGNALING SYSTEMS, IN CLASS 37 (U.S. CLS. 100, 103 AND 106).

FOR: TRAINING SERVICES IN USE AND APPLICATION OF DATA PROCESSING PROGRAMS, IN CLASS 41 (U.S. CLS. 100, 101 AND 107).

FOR: INSTALLATION OF COMPUTER SOFTWARE; COMPUTER HARDWARE AND SOFTWARE DEVELOPMENT FOR USE IN TELECOMMUNICATIONS; IMPLEMENTATION, CONSULTING AND MAINTENANCE OF COMPUTER PROGRAMS AND COMPUTER SOFTWARE; CONSULTING ON THE USE AND APPLICATION OF DATA PROCESSING PROGRAMS; COMPUTER SERVICES, NAMELY, RENTAL OF TIME FOR ACCESSING COMPUTER DATABASES; CONSULTING AND TECHNICAL ASSISTANCE IN THE DESIGN AND USE OF COMPUTER PROGRAMS, COMPUTER HARDWARE AND COMPUTER SYSTEMS; CONSULTING IN THE FIELD OF TELECOMMUNICATIONS AND SIGNALING SYSTEMS FOR USE IN TELECOMMUNICATIONS, TECHNICAL PROJECT PLANNING IN THE FIELD OF TELECOMMUNICATIONS AND SIGNALING SYSTEMS FOR USE IN TELECOMMUNICATIONS; ENGINEERING SERVICES; PROVIDING DATABASES IN THE FIELD OF COMPUTER SYSTEMS; COMPUTER SCIENTISTS SERVICES; TESTING OF DEVICES AND SYSTEMS IN TELECOMMUNICATIONS, ENTERTAINMENT, ELECTRONICS, AND DATA, IN CLASS 42 (U.S. CLS. 100 AND 101).

PRIORITY CLAIMED UNDER SEC. 44(D) ON FED REP GERMANY APPLICATION NO. 30064323.3/4, FILED 8-28-2000, REG. NO. 30064323, DATED 6-19-2001, EXPIRES 8-31-2010.

SER. NO. 76-210,148, FILED 2-14-2001.

KELLEY WELLS, EXAMINING ATTORNEY

Int. Cl.: 31

Prior U.S. Cls.: 1 and 46

United States Patent and Trademark Office

Reg. No. 2,892,247

Registered Oct. 12, 2004

**TRADEMARK
PRINCIPAL REGISTER**



STONEVILLE PEDIGREED SEED CO. (DELA-
WARE CORPORATION)
6625 LENOX PARK DRIVE, SUITE 117
MEMPHIS, TN 38115

FOR: AGRICULTURAL SEED, IN CLASS 31 (U.S.
CLS. 1 AND 46).

FIRST USE 12-15-2000; IN COMMERCE 12-15-2000.

OWNER OF U.S. REG. NOS. 1,617,821 AND
1,620,248.

NO CLAIM IS MADE TO THE EXCLUSIVE
RIGHT TO USE "SEED" OR THE PICTORIAL DE-
SIGN OF THE STATE OF TEXAS, APART FROM
THE MARK AS SHOWN.

SER. NO. 76-213,413, FILED 2-20-2001.

ROBERT LORENZO, EXAMINING ATTORNEY

Int. Cl.: 41

Prior U.S. Cls.: 100, 101 and 107

United States Patent and Trademark Office

Reg. No. 2,892,248

Registered Oct. 12, 2004

**SERVICE MARK
PRINCIPAL REGISTER**

SCHOLAR - ATHLETE GAMES

INSTITUTE FOR INTERNATIONAL SPORT, INC.
(RHODE ISLAND CORPORATION)
2 BUTTERFIELD ROAD
P. O. BOX 104
KINGSTON, RI 02881

FOR: EDUCATIONAL AND ATHLETIC PRO-
GRAMS FOR YOUNG ADULTS, IN CLASS 41 (U.S.
CLS. 100, 101 AND 107).

FIRST USE 6-20-1993; IN COMMERCE 6-20-1993.

NO CLAIM IS MADE TO THE EXCLUSIVE
RIGHT TO USE "GAMES", APART FROM THE
MARK AS SHOWN.

SEC. 2(F).

SER. NO. 76-213,504, FILED 2-22-2001.

TRACY FLETCHER, EXAMINING ATTORNEY

Int. Cl.: 28

Prior U.S. Cls.: 22, 23, 38 and 50

United States Patent and Trademark Office

Reg. No. 2,892,249

Registered Oct. 12, 2004

**TRADEMARK
PRINCIPAL REGISTER**

STEALTH

CENTRAL MFG. CO. (DELAWARE CORPORATION)
P.O. BOX 35189
CHICAGO, IL 35189

FIRST USE 1-3-2001; IN COMMERCE 1-3-2001.

SER. NO. 76-215,703, FILED 2-9-2001.

FOR: BASEBALL, SOFTBALL, T-BALL BATS, IN
CLASS 28 (U.S. CLS. 22, 23, 38 AND 50).

MARTHA FROMM, EXAMINING ATTORNEY

Int. Cl.: 41

Prior U.S. Cls.: 100, 101 and 107

United States Patent and Trademark Office

Reg. No. 2,892,250

Registered Oct. 12, 2004

**SERVICE MARK
PRINCIPAL REGISTER**

THE REAL LEARNING COMPANY

REAL LEARNING COMPANY, THE (CALIFORNIA CORPORATION)
7373 EAST DOUBLETREE RANCH ROAD
SUITE NO. 220
SCOTTSDALE, AZ 85258

FOR: ARRANGING AND CONDUCTING EDUCATIONAL AND TRAINING CONFERENCES; DEVELOPING EDUCATIONAL MANUALS FOR OTHERS IN THE FIELD OF MANAGEMENT; EDUCATIONAL SERVICES, NAMELY, CONDUCTING WORKSHOPS IN THE FIELD OF MANAGEMENT, IN CLASS 41 (U.S. CLS. 100, 101 AND 107).

FIRST USE 0-0-1995; IN COMMERCE 0-0-1995.

NO CLAIM IS MADE TO THE EXCLUSIVE RIGHT TO USE "LEARNING COMPANY", APART FROM THE MARK AS SHOWN.

SER. NO. 76-217,438, FILED 2-28-2001.

MARLENE BELL, EXAMINING ATTORNEY

Int. Cl.: 25

Prior U.S. Cls.: 22 and 39

United States Patent and Trademark Office

Reg. No. 2,892,251

Registered Oct. 12, 2004

**TRADEMARK
PRINCIPAL REGISTER**

COOL CAT

LESLIE JORDAN, INC. (OREGON CORPORATION)
1230 S.W. FIRST AVENUE, FOURTH FLOOR
PORTLAND, OR 97204

FIRST USE 4-22-1999; IN COMMERCE 5-21-1999.

SER. NO. 76-222,389, FILED 3-12-2001.

FOR: CLOTHING, NAMELY, JACKETS, COATS, PULLOVERS, SHIRTS, SINGLETS, FLEECE SHIRTS, VESTS, T-SHIRTS, AND BIKE JERSEYS, IN CLASS 25 (U.S. CLS. 22 AND 39).

ANDREA SAUNDERS, EXAMINING ATTORNEY

Int. Cls.: 9 and 28

Prior U.S. Cls.: 21, 22, 23, 26, 36, 38 and 50

United States Patent and Trademark Office

Reg. No. 2,892,252

Registered Oct. 12, 2004

**TRADEMARK
PRINCIPAL REGISTER**

VIRTUA GOLF

KABUSHIKI KAISHA SEGA (JAPAN CORPORATION), DBA SEGA CORPORATION
2-12 HANEDA 1-CHOME
OHTA-KU, TOKYO 144-0043, JAPAN

FOR: VIDEO GAME SOFTWARE; COMPUTER GAME PROGRAMS; COMPUTER GAME DISCS; VIDEO COMPUTER GAME PROGRAMS; HOME VIDEO COMPUTER GAME DISCS; GAME DISCS AND CIRCUIT BOARDS CONTAINING GAME PROGRAMS FOR USE WITH HAND-HELD OR ARCADE VIDEO GAME MACHINES WITH BUILT-IN SCREENS, IN CLASS 9 (U.S. CLS. 21, 23, 26, 36 AND 38).

FOR: STAND ALONE VIDEO GAME MACHINES; ARCADE GAME MACHINES WITH BUILT-IN SCREENS, IN CLASS 28 (U.S. CLS. 22, 23, 38 AND 50).

PRIORITY CLAIMED UNDER SEC. 44(D) ON JAPAN APPLICATION NO. 2001-1626, FILED 1-12-2001, REG. NO. 4566578, DATED 5-10-2002, EXPIRES 5-10-2012.

OWNER OF U.S. REG. NOS. 1,804,622, 2,503,379 AND OTHERS.

NO CLAIM IS MADE TO THE EXCLUSIVE RIGHT TO USE "GOLF", APART FROM THE MARK AS SHOWN.

SER. NO. 76-225,249, FILED 3-15-2001.

ROBERT COGGINS, EXAMINING ATTORNEY

Int. Cl.: 25

Prior U.S. Cls.: 22 and 39

United States Patent and Trademark Office

Reg. No. 2,892,253

Registered Oct. 12, 2004

TRADEMARK
PRINCIPAL REGISTER



APLSTOLIC PENTECOST CHURCH OF GOD,
INC. (FLORIDA CORPORATION)
129 WEST HUBBARD AVE.
DELAND, FL 32720

THE COLOR(S) RED IS/ARE CLAIMED AS A
FEATURE OF THE MARK.

FOR: CLOTHING; NAMELY JACKETS, JOGGING
SUITS, POLO SHIRTS AND T-SHIRTS, IN CLASS 25
(U.S. CLS. 22 AND 39).

THE COLOR RED APPEARS ON THE SWORD
HANDLE, AND THE COLOR YELLOW APPEARS
ON THE SWORD BLADE.

FIRST USE 10-26-2000; IN COMMERCE 10-26-2000.

NO CLAIM IS MADE TO THE EXCLUSIVE
RIGHT TO USE "APOSTOLIC PENTECOST
CHURCH OF GOD", APART FROM THE MARK
AS SHOWN.

SER. NO. 76-225,364, FILED 3-16-2001.

HENRY S. ZAK, EXAMINING ATTORNEY

Int. Cls.: 3 and 25

Prior U.S. Cls.: 1, 4, 6, 22, 39, 50, 51 and 52

Reg. No. 2,892,254

United States Patent and Trademark Office

Registered Oct. 12, 2004

**TRADEMARK
PRINCIPAL REGISTER**

OFF CORSS MC CORSS

HERMECO S.A. (COLOMBIA CORPORATION)
CARRERA 46 NO. 27-69
MEDELLIN, COLOMBIA

FOR: BLEACHING PREPARATIONS AND OTHER SUBSTANCES FOR LAUNDRY USE, CLEANING, POLISHING, SCOURING AND ABRASIVE PREPARATIONS, NAMELY, LAUNDRY BLEACH; BLUEING FOR LAUNDRY; LAUNDRY DETERGENT; LAUNDRY PRE-SOAK; LAUNDRY STARCH; ALL-PURPOSE CLEANING PREPARATIONS; CHROME POLISH; FLOOR POLISH; FURNITURE POLISH; SCOURING LIQUIDS; SCOURING POWDERS; DISINFECTANT SOAPS; DEODORANT SOAP; AND DETERGENT SOAP; SOAPS, PERFUMERY, ESSENTIAL OILS, COSMETICS, HAIR LOTIONS AND DENTIFRICES, NAMELY, AFTERSHAVE, ANTIPERSPIRANT, FALSE NAILS, FACIAL ASTRINGENTS, ASTRINGENTS FOR COSMETIC PURPOSES, BATH OIL, BATH BEADS, NON-MEDICATED BATH SALTS, BLUSH, BODY GLITTER, BODY OIL, BODY SCRUB, BUBBLE BATH, COLOGNE, CREAM FOR THE BODY, CREAM FOR THE CUTICLES, CREAM FOR THE EYES, CREAM FOR THE FACE, CREAM FOR THE HANDS, DEODORANT, ESSENTIAL OILS FOR PERSONAL USE, EXFOLIATORS FOR THE SKIN, EYE GELS, EYE MAKEUP PENCILS, EYE SHADOW, FACIAL HIGHLIGHTER, FACIAL MASKS, FACE MIST, FACIAL SCRUB, NON-MEDICATED FOOT SOAK, FOUNDATION MAKE-UP, FRAGRANT BODY SPLASH, FRAGRANT BODY MIST, HAIR CONDITIONER, HAIR DYES, HAIR GLITTER, HAIR HIGHLIGHTER, HAIR MASCARA, HAIR POMADE, HAIR RINSES, HAIR REMOVING CREAMS, HAIR SHAMPOO, HAIR SPRAY, HAIR STRAIGHTENER, HAIR STYLING GEL, HAIR STYLING MOUSSE, LOTION FOR THE BODY, LOTION FOR THE HANDS, LOTION FOR THE FACE, LIP BALM, LIP GLOSS, LIP LINER, LIP MAKEUP PENCILS, LIPSTICK, MAKEUP FOR THE BODY, MAKEUP FOR THE FACE, MAKEUP REMOVER, MASCARA, NAIL POLISH, NAIL POLISH REMOVER, NAIL STENCILS FOR USE WITH NAIL POLISH,

NON-MEDICATED BLEMISH STICKS, NON-MEDICATED CLEANSER FOR THE FACE, NON-MEDICATED FOOT DEODORANT SPRAY, NON-MEDICATED MOOD ENHANCING SKIN CREAM, OIL BLOTTING SHEETS FOR THE SKIN, PERFUME, POWDER FOR THE BODY, POWDER FOR THE FACE, NON-MEDICATED POWDER FOR THE FEET, PUMICE STONES FOR PERSONAL USE, NON-MEDICATED SALT SCRUBS FOR THE SKIN, SHAVING CREAM, SHOWER GEL, SKIN BRONZING CREAM, SOAP FOR THE BODY, SOAP FOR THE FACE, SOAP FOR THE HANDS, SUN BLOCK FOR THE BODY, SUN BLOCK FOR THE FACE, SUNTAN LOTION FOR THE BODY, SUNTAN LOTION FOR THE FACE, SUNLESS TANNING LOTION FOR THE BODY, SUNLESS TANNING LOTION FOR THE FACE, PRE-SUNTANNING LOTION FOR THE BODY, PRE-SUNTANNING LOTION FOR THE FACE, POST-SUNTANNING LOTION FOR THE BODY, POST-SUNTANNING LOTION FOR THE FACE; AND TALCUM POWDER, IN CLASS 3 (U.S. CLS. 1, 4, 6, 50, 51 AND 52).

FOR: CLOTHING, NAMELY, DRESSES, BLOUSES, HOSIERY, LINGERIE, AFTER SKI BOOTS, ANKLETS, ASCOTS, ATHLETIC FOOTWEAR, ATHLETIC SHOES, ATHLETIC UNIFORMS, SKI BOOT BAGS, HEADBANDS, NECKBANDS, SWEATBANDS, WRISTBANDS, BATHING SUITS, BATHING TRUNKS, BATHROBES, BEACH COVER-UPS, BEACHWEAR, GARTER BELTS, MONEY BELTS, BELTS, BERETS, BERMUDA SHORTS, CLOTH BIBS, SKI BIBS, BIKINIS, BLAZERS, BLOOMERS, BODY SHAPERS, BODY SUITS, BOOTIES, BOOTS, SKI BOOTS, HIKING BOOTS, BOTTOMS, BOW TIES, BOXER SHORTS, TOE BOXES, BRIEFS, BATHING CAPS, SHOWER CAPS, HATS, COATS, EAR MUFFS AND HAND MUFFS, FOOTWEAR, GLOVES, SKI-GLOVES, GOLF SHIRTS, GOLF SHOES, GOWNS, INFANTWEAR, INSOLES, JACKETS, LEGGINGS, LEOTARDS, MITTENS, MOCCASINS, NECKTIES, OVERALLS, PAJAMAS, PANTIES, ALL TYPES OF PANTS, PANTSUITS, POLO SHIRTS, RAINWEAR, ROBES, RUBBERS, SANDALS, SCARVES, SHIRTS,

SHOES, NIGHT SHIRTS, UNDERSHIRTS, SWEAT-SHORTS, SKIWEAR, SKIRTS, SLACKS, SLEEPWEAR, SNEAKERS, SNOW PANTS, SNOW SUITS, SOCKS, SUITS, FLIGHT SUITS, GYM SUITS, JOGGING SUITS, PLAY SUITS, SKI SUITS, SWEAT SUITS, VESTED SUITS, WARM UP SUITS, WET SUITS, SUN VISORS, SUSPENDERS, SWEATERS, T-SHIRTS, TENNIS WEAR, TIGHTS, HALTER AND TANK TOPS, TRACKSUITS, UNDERCLOTHING, UNIFORMS, VESTS, FOUL WEATHER GEAR, FABRIC WRISTBANDS, CAPS, SLIPPERS, SETS OF BLOUSES WITH SHORT OR LONG PANTS, SETS OF BLOUSES WITH LONG SKIRTS, IN CLASS 25 (U.S. CLS. 22 AND 39).

PRIORITY CLAIMED UNDER SEC. 44(D) ON COLOMBIA APPLICATION NO. 246031, FILED 1-19-2001, REG. NO. 246031, DATED 9-26-2001, EXPIRES 9-27-2011.

OWNER OF COLOMBIA REG. NO. 205507, DATED 1-30-1998, EXPIRES 1-30-2008.

SER. NO. 76-233,436, FILED 3-30-2001.

BILL DAWE, EXAMINING ATTORNEY

Int. Cl.: 1

Prior U.S. Cls.: 1, 5, 6, 10, 26 and 46

Reg. No. 2,892,255

United States Patent and Trademark Office

Registered Oct. 12, 2004

**TRADEMARK
PRINCIPAL REGISTER**

RUSTBAN

MICHELMAN, INC. (OHIO CORPORATION)
9080 SHELL ROAD
CINCINNATI, OH 45236

FOR: RUST PREVENTING CHEMICALS, NAME-
LY, WATER-BASED VOLATILE CORROSION INHI-
BITORS USED ON PACKAGING AND WRAPPING
MATERIAL, NAMELY, PAPER, CORRUGATED
BOARD, CHIP BOARD, PLASTIC FILM AND NON-
WOVEN SURFACES, USED TO INHIBIT RUST,
TARNISH AND CORROSION OF THE PACKAGE

CONTENTS AND SOLD EXCLUSIVELY TO MAN-
UFACTURERS IN THE PAPERBOARD AND COR-
RUGATED CONTAINER INDUSTRY, IN CLASS 1
(U.S. CLS. 1, 5, 6, 10, 26 AND 46).

FIRST USE 11-0-2000; IN COMMERCE 4-0-2001.

SER. NO. 76-238,768, FILED 4-9-2001.

CURTIS FRENCH, EXAMINING ATTORNEY

Int. Cl.: 10

Prior U.S. Cls.: 26, 39 and 44

United States Patent and Trademark Office

Reg. No. 2,892,256

Registered Oct. 12, 2004

**TRADEMARK
PRINCIPAL REGISTER**

SAFEJECT

JK MEDICINKONSULT FORVALTNING AB
(SWEDEN CORPORATION)
HASSELSTIGEN 2
SE-133 33 SALTSJOBADEN, SWEDEN

PRIORITY CLAIMED UNDER SEC. 44(D) ON
SWEDEN APPLICATION NO. 00-07614, FILED 10-
12-2000, REG. NO. 350963, DATED 12-14-2001, EX-
PIRES 12-14-2011.

SER. NO. 76-239,736, FILED 4-12-2001.

FOR: MEDICAL SYRINGES AND PARTS THERE-
FOR, IN CLASS 10 (U.S. CLS. 26, 39 AND 44).

CURTIS FRENCH, EXAMINING ATTORNEY

Int. Cl.: 1

Prior U.S. Cls.: 1, 5, 6, 10, 26 and 46

Reg. No. 2,892,257

United States Patent and Trademark Office

Registered Oct. 12, 2004

**TRADEMARK
PRINCIPAL REGISTER**

PROTEOPREP

SIGMA-ALDRICH BIOTECHNOLOGY LP (MISSOURI LIMITED PARTNERSHIP)
3050 SPRUCE STREET
ST. LOUIS, MO 63103

FOR: KITS FOR THE SEPARATION OF SOLUBLE CYTOPLASMIC AND MEMBRANE FRACTIONS FROM CELLS CONSISTING PRIMARILY OF CHEMICAL REAGENTS, CHEMICAL POWDERS, CHEMICAL SOLUTIONS, AMPULES, VIALS, AND PRINTED INSTRUCTIONS FOR RESEARCH AND DEVELOPMENT USE; KITS FOR THE ISOLATION OF MEMBRANE PROTEIN FRACTIONS FROM CELLS CONSISTING PRIMARILY OF CHEMICAL REAGENTS, CHEMICAL POWDERS, CHEMICAL SOLUTIONS, AMPULES, VIALS, AND PRINTED INSTRUCTIONS FOR RESEARCH AND DEVELOPMENT USE; KITS FOR THE EXTRACTION OF

PROTEIN FROM CELLS OR TISSUES CONSISTING PRIMARILY OF CHEMICAL REAGENTS, CHEMICAL POWDERS, CHEMICAL SOLUTIONS, AMPULES, VIALS, AND PRINTED INSTRUCTIONS FOR RESEARCH AND DEVELOPMENT USE; CHEMICAL REAGENTS FOR SCIENTIFIC RESEARCH USE, NAMELY, REAGENTS FOR REDUCTION AND ALKYLATION; PROTEIN CHEMICAL REAGENTS FOR SCIENTIFIC RESEARCH USE, IN CLASS 1 (U.S. CLS. 1, 5, 6, 10, 26 AND 46).

FIRST USE 3-9-2001; IN COMMERCE 3-9-2001.

SER. NO. 76-240,160, FILED 4-12-2001.

YONG KIM, EXAMINING ATTORNEY

Int. Cl.: 42

Prior U.S. Cls.: 100 and 101

United States Patent and Trademark Office

Reg. No. 2,892,258

Registered Oct. 12, 2004

**SERVICE MARK
PRINCIPAL REGISTER**

ACCELICS

ACCELICS, INC. (DELAWARE CORPORATION)
2918 POLAND SPRINGS DRIVE
ELLCOTT CITY, MD 21042

FOR: COMPUTER SERVICES, NAMELY PROVID-
ING SOFTWARE SOLUTIONS, NAMELY, DATA
WAREHOUSING, DATA MINING, VISUALIZA-
TION, EXPERIMENTAL DESIGN, SIMULATION,
INTEGRATION AND/OR MODELING FOR USE IN

THE CHEMISTRY FIELD, IN CLASS 42 (U.S. CLS.
100 AND 101).

FIRST USE 3-13-2001; IN COMMERCE 3-13-2001.

SER. NO. 76-244,284, FILED 4-23-2001.

KEVON CHISOLM, EXAMINING ATTORNEY

Int. Cl.: 36

Prior U.S. Cls.: 100, 101 and 102

United States Patent and Trademark Office

Reg. No. 2,892,259

Registered Oct. 12, 2004

**SERVICE MARK
PRINCIPAL REGISTER**

ERIEXPRESSPAY

ERIE INSURANCE EXCHANGE (PENNSYLVANIA UNINCORPORATED RECIPROCAL INSURANCE EXCHANGE)
100 ERIE INSURANCE PLACE
P.O. BOX 1699
ERIE, PA 16530

FOR: ELECTRONIC FUND TRANSFER SERVICES FOR PAYMENT OF INSURANCE PREMIUMS, IN CLASS 36 (U.S. CLS. 100, 101 AND 102).

FIRST USE 7-1-2001; IN COMMERCE 7-1-2001.

OWNER OF U.S. REG. NOS. 1,335,915 AND 1,335,916.

SER. NO. 76-245,817, FILED 4-25-2001.

MARK T. MULLEN, EXAMINING ATTORNEY

Int. Cl.: 41

Prior U.S. Cls.: 100, 101 and 107

United States Patent and Trademark Office

Reg. No. 2,892,260

Registered Oct. 12, 2004

**SERVICE MARK
PRINCIPAL REGISTER**

CAMP WALT WHITMAN

WHITMAN OPERATING CO., LLC (NEW YORK
LIMITED LIABILITY COMPANY)
3 NEW KING STREET
WHITE PLAINS, NY 10604

FOR: RESIDENT SUMMER CAMP SERVICES, IN
CLASS 41 (U.S. CLS. 100, 101 AND 107).

FIRST USE 0-0-1948; IN COMMERCE 0-0-1948.

NO CLAIM IS MADE TO THE EXCLUSIVE
RIGHT TO USE "CAMP", APART FROM THE
MARK AS SHOWN.

THE NAME SHOWN IN THE MARK IS NOT
INTENDED TO, AND TO THE BEST OF APPLI-
CANT'S KNOWLEDGE DOES NOT, IDENTIFY A
LIVING INDIVIDUAL.

SER. NO. 76-245,919, FILED 4-24-2001.

MARY ROSSMAN, EXAMINING ATTORNEY

Int. Cls.: 2, 7, 8, 9, 11, 16, 18 and 21

Prior U.S. Cls.: 1, 2, 3, 5, 6, 11, 13, 16, 19, 21, 22, 23, 26, 28, 29, 30, 31, 33, 34, 35, 36, 37, 38, 40, 41, 44 and 50

Reg. No. 2,892,261

United States Patent and Trademark Office

Registered Oct. 12, 2004

**TRADEMARK
PRINCIPAL REGISTER**

otto-office

OTTO VERSAND, (GMBH & CO) (FED REP GERMANY LIMITED PARTNERSHIP)
WANDSBEKER STRASSE 3-7
D22172 HAMBURG, FED REP GERMANY

FORKS, SPOONS, AND KNIVES; BAND SAWS, HAND SAWS, NAMELY HACK SAWS, MITER SAWS AND WOOD SAWS; AND ELECTRIC RAZORS, IN CLASS 8 (U.S. CLS. 23, 28 AND 44).

FOR: COLORANTS FOR USE IN THE MANUFACTURE OF PAINT; CORROSION INHIBITING PAINT TYPE COATINGS FOR COMMERCIAL MARINE USE; ENAMELS IN THE NATURE OF HOUSE PAINT; PAINT FOR USE IN THE MANUFACTURE OF FURNITURE; INTERIOR AND EXTERIOR HOUSE PAINT; PAINT PRIMER, PAINT SEALERS; PAINT THINNER, IN CLASS 2 (U.S. CLS. 6, 11 AND 16).

FOR: DIGITAL CAMERAS, DISPOSABLE CAMERAS, PHOTOGRAPHIC CAMERAS; FILM PROJECTORS, SLIDE PROJECTORS, TRANSPARENCY PROJECTORS; MOTION PICTURE EQUIPMENT, NAMELY, MOVIE PROJECTORS, MOVIE CAMERAS, PROJECTION SCREENS, AND VIDEO CAMERAS; RADIO SETS; TELEVISION SETS; SOUND RECORDING AND REPRODUCING EQUIPMENT, NAMELY AUDIO CASSETTE RECORDERS AND PLAYERS, AUDIO RECEIVERS, DIGITAL AUDIO TAPE (DAT) RECORDERS, COMPACT DISC MUSIC PLAYERS; COMPACT AUDIO MINI-SYSTEMS AND AUDIO SYSTEMS CONSISTING OF COMPONENTS, NAMELY PHONOGRAPH RECORD PLAYERS, AUDIO RECEIVERS, AUDIO CASSETTE RECORDERS, COMPACT DISC MUSIC PLAYERS, RADIOS, SOUND AMPLIFIERS AND LOUDSPEAKERS, RANGING IN SIZE FROM 29 TO 36 CENTIMETERS IN WIDTH; STEREO CABINETS; PHONOGRAPH RECORDS FEATURING MUSIC; PHONOGRAPH RECORD PLAYERS; AUDIO AND VIDEO TAPE PLAYERS; BLANK AUDIO TAPES; PRERECORDED AUDIO TAPES FEATURING MUSIC; BLANK VIDEO TAPES; PRERECORDED VIDEO TAPES FEATURING GENERAL ENTERTAINMENT MOVIES, HOME EXERCISE, CHILDREN'S PROGRAMS AND DOCUMENTARIES; ELECTRIC BATTERIES; SCALES FOR HOUSEHOLD PURPOSES, BATHROOMS AND INFANTS; OPTICAL APPLIANCES, NAMELY BINOCULARS, TELESCOPES, FIELD GLASSES, MAGNIFYING GLASSES, AND MICROSCOPES; BAROMETERS; COMPASSES; THERMOMETERS NOT FOR MEDICAL USE; SAFETY

FOR: ELECTRO-MECHANICAL CLEANING APPARATUS FOR HOUSEHOLD PURPOSES, NAMELY VACUUM CLEANERS AND FLOOR POLISHERS, IN CLASS 7 (U.S. CLS. 13, 19, 21, 23, 31, 34 AND 35).

FOR: HAND TOOLS, NAMELY HAND JACKS, MANUALLY OPERATED JACKS, NIPPERS, HAMMERS, SPATULAS FOR SPREADING PLASTER, PAINT, AND BUILDING COMPOUNDS, SCISSORS, KITCHEN KNIVES, SPORT KNIVES, BUTCHER KNIVES, HAND SAW BLADES, RAZOR BLADES, SCREWDRIVERS, HAND DRILLS, HAND SAWS, CHISELS, SET SQUARES AND TRIANGLES, FILES, VISES, SCREW CLAMPS, AND TOOL KITS CONTAINING HAND TOOLS, NAMELY HAND JACKS, MANUALLY OPERATED JACKS, NIPPERS, HAMMERS, SPATULAS FOR SPREADING PLASTER, PAINT, AND BUILDING COMPOUNDS, SCISSORS, KITCHEN KNIVES, SPORT KNIVES, BUTCHER KNIVES, HAND SAW BLADES, RAZOR BLADES, SCREWDRIVERS, HAND DRILLS, HAND SAWS, CHISELS, SET SQUARES AND TRIANGLES, FILES, VISES, SCREW CLAMPS; CUTLERY, NAMELY

GLASSES FOR DRIVING; SUNGLASSES; GLASSES FOR COMBINED PROTECTION AGAINST SUN AND FOG; EMERGENCY WARNING LIGHTS AND VEHICLE HAZARD WARNING SIGNAL EQUIPMENT, NAMELY EMERGENCY REFLECTIVE TRIANGLES; ELECTRIC PRESSING IRONS INCLUDING PORTABLE PRESSING IRONS; ELECTRIC SOLDERING IRONS; ELECTRIC CIGAR LIGHTERS; PHOTOCOPIERS AND PHOTOCOPYING MACHINES; DIVING EQUIPMENT AND ACCESSORIES, NAMELY, COMPRESSED AIR TANKS, DEPTH PRESSURE METERS, DEPTH INDICATORS, UNDERWATER BREATHING APPARATUS, NAMELY, REGULATORS, BREATHING TUBES, EAR PROTECTORS, DIVING SUITS, AND DIVING BELTS WITH AND WITHOUT WEIGHTS; LIFE JACKETS; MOVIE PROJECTING SCREENS; FIRE EXTINGUISHERS FOR HOUSEHOLD USE AND VEHICLES; FLASH EQUIPMENT FOR CAMERAS, NAMELY PHOTOGRAPHIC FLASH BULBS, ATTACHMENTS AND HOUSING FOR PHOTOGRAPHIC FLASH BULBS; EXCLUDING PORTABLE TRANSMITTERS AND RECEIVERS AND PROFESSIONAL TELECOMMUNICATIONS EAR RECEIVERS; COMPUTER E-COMMERCE SOFTWARE, TO ALLOW USERS TO PERFORM ELECTRONIC BUSINESS TRANSACTIONS VIA A GLOBAL COMPUTER NETWORK, IN CLASS 9 (U.S. CLS. 21, 23, 26, 36 AND 38).

FOR: ELECTRIC LIGHT FIXTURES; PORTABLE ELECTRIC HEATERS; WATER HEATERS FOR DOMESTIC USE; COOKING OVENS FOR DOMESTIC USE; ELECTRIC TOASTER OVENS; MICROWAVE OVENS FOR COOKING; FREEZERS; CEILING FANS, ELECTRIC FANS AND PORTABLE ELECTRIC FANS; ELECTRIC IMITATION FIREPLACES; ELECTRIC COFFEE MAKERS FOR COMMERCIAL AND/OR DOMESTIC USE; ELECTRIC HAND-HELD HAIR DRYERS; PORTABLE ILLUMINATED DECORATIVE WATER FOUNTAINS; HUMIDIFIERS; FLASHLIGHT LAMPS; UNDERWATER LAMPS AND SPOTLIGHTS; BICYCLE LIGHTS; HOME SAUNAS; SPIN DRYERS FOR CLOTHES; REFRIGERATORS; ELECTRIC FOOT WARMERS; ELECTRIC LIGHTS FOR CHRISTMAS TREES; ELECTRIC HEATING PADS AND BLANKETS NOT FOR MEDICAL PURPOSES, IN CLASS 11 (U.S. CLS. 13, 21, 23, 31 AND 34).

FOR: PAPER, CARDBOARD, AND GOODS MADE FROM PAPER AND CARDBOARD, NAMELY GENERAL MERCHANDISE CATALOGS, POSTERS AND STATIONERY; TYPEWRITERS; OFFICE EQUIPMENT, NAMELY PAPER STAPLERS, LETTER OPENERS, BLOTTERS, PEN HOLDERS, DISPENSERS OF ADHESIVE TAPE FOR STATIONERY OR HOUSEHOLD PURPOSES, HOLDERS FOR DESK ACCESSORIES INCLUDING PAPER CLIPS; PLAYING CARDS; GOODS MADE FROM PAPER

AS A SUBSTITUTE FOR CLOTH, NAMELY HANDKERCHIEFS, NAPKINS, FACE CLOTHS, TOWELS, TABLECLOTHS, KITCHEN TOWEL ROLLS AND DIAPER INSERTS; PLASTIC PLACE MATS, IN CLASS 16 (U.S. CLS. 2, 5, 22, 23, 29, 37, 38 AND 50).

FOR: UMBRELLAS; CANES; TRAVEL EQUIPMENT, NAMELY SUITCASES; SADDLERY; STRAPS FOR LUGGAGE; LEATHER GOODS, NAMELY HANDBAGS AND PURSES, IN CLASS 18 (U.S. CLS. 1, 2, 3, 22 AND 41).

FOR: SMALL HOUSEHOLD AND KITCHEN DEVICES, NAMELY, NON-ELECTRIC COFFEE POTS NOT OF PRECIOUS METAL, NON-ELECTRIC TEA POTS NOT OF PRECIOUS METAL, TRIVETS, BUTTER DISHES, EGG CUPS AND VASES; PORTABLE CONTAINERS FOR HOUSEHOLD, KITCHEN AND GARDEN USE; HAIR COMBS; SPONGES FOR HOUSEHOLD PURPOSES; CLOTHES BRUSHES; HAIR BRUSHES; STEEL WOOL FOR CLEANING; CLOTHS FOR CAR POLISHING; COOKING UTENSILS, NAMELY PANS, NON-ELECTRIC ROASTERS, NON-ELECTRIC KETTLES, TEA KETTLES, NON-ELECTRIC PRESSURE COOKERS, SAUTEUSES AND CASSEROLE DISHES; DISH WASHING TUBS; POURING DEVICES FOR BOTTLES, NAMELY FUNNELS AND ATTACHMENTS WHICH AID IN POURING; BAKING MOLDS; BREAD BOXES; GLASS BEVERAGE WARE; GOODS MADE OF PORCELAIN AND EARTHENWARE, NAMELY COFFEE SERVICES, PLATES, BOWLS, DISHES, BEVERAGE WARE, CUPS, MUGS, SERVING FORKS, SERVING SPOONS, SPICE AND HERB CONTAINERS, SALT AND PEPPER SHAKERS, BUTTER DISHES, BREAD BOWLS, CANDY BOWLS, FOOD AND BEVERAGE STAND WITH CANDLE FOR WARMING FOOT OR BEVERAGES, CANDLESTICKS, AND VASES; GOODS MADE FROM POTTERY, NAMELY DISHES, PITCHERS, VASES, BOWLS, AND KETTLES; BAKING AND GRILLING TINS; ELECTRIC TOOTHBRUSHES; GOODS MADE OF WOOD, NAMELY COOKING SPOONS, CUTTING BOARDS, ROLLING PINS, PAPER TOWEL HOLDERS, TOILET PAPER HOLDERS, PAPER NAPKIN HOLDERS, CANDLESTICKS, AND NON-ELECTRIC CANDELABRAS; FLOWER POTS; PICNIC CONTAINERS; ICE CONTAINERS; FOOD CONTAINERS; EATING DISHES; PLASTIC BASKETS FOR HOLDING FLOWERS; THERMAL INSULATED CONTAINERS FOR FOOD OR BEVERAGES FOR DOMESTIC USE, IN CLASS 21 (U.S. CLS. 2, 13, 23, 29, 30, 33, 40 AND 50).

OWNER OF FED REP GERMANY REG. NO. 30006612, DATED 4-26-2000, EXPIRES 1-31-2010.

SER. NO. 76-246,098, FILED 4-24-2001.

STACY WAHLBERG, EXAMINING ATTORNEY

Int. Cl.: 36

Prior U.S. Cls.: 100, 101 and 102

United States Patent and Trademark Office

Reg. No. 2,892,262

Registered Oct. 12, 2004

**SERVICE MARK
PRINCIPAL REGISTER**

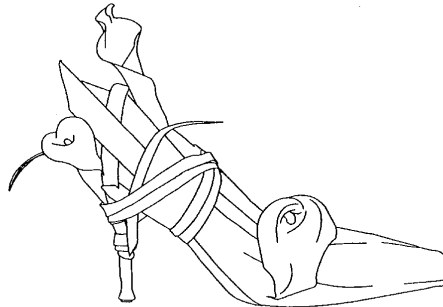

QVC, INC. (DELAWARE CORPORATION)
STUDIO PARK
WEST CHESTER, PA 19380

THE MARK CONSISTS OF A HIGH-HEEL SHOE
DESIGN.

FOR: CHARITABLE FUNDRAISING SERVICES,
IN CLASS 36 (U.S. CLS. 100, 101 AND 102).

SER. NO. 76-247,629, FILED 4-27-2001.

FIRST USE 10-1-1995; IN COMMERCE 10-1-1995.

JERI J. FICKES, EXAMINING ATTORNEY

Int. Cls.: 5 and 32

Prior U.S. Cls.: 6, 18, 44, 45, 46, 48, 51 and 52

United States Patent and Trademark Office

Reg. No. 2,892,263

Registered Oct. 12, 2004

**TRADEMARK
PRINCIPAL REGISTER**

EXTREME XXL

AMERICAN BODY BUILDING PRODUCTS,
L.L.C. (ILLINOIS LTD LIAB CO)
600 N. COMMERCE STREET
AURORA, IL 60504

FOR: DIETARY SUPPLEMENTS IN READY TO
DRINK FORM, IN CLASS 5 (U.S. CLS. 6, 18, 44, 46, 51
AND 52).

FIRST USE 1-27-2000; IN COMMERCE 1-27-2000.

FOR: SPORTS DRINK, IN CLASS 32 (U.S. CLS. 45,
46 AND 48).

FIRST USE 1-27-2000; IN COMMERCE 1-27-2000.

OWNER OF U.S. REG. NOS. 2,008,846 AND
2,010,449.

SER. NO. 76-248,314, FILED 4-30-2001.

INGA ERVIN, EXAMINING ATTORNEY

Int. Cls.: 7 and 12

Prior U.S. Cls.: 13, 19, 21, 23, 31, 34, 35 and 44

Reg. No. 2,892,264

United States Patent and Trademark Office

Registered Oct. 12, 2004

**TRADEMARK
PRINCIPAL REGISTER**

RENOLD PLAZMA

RENOLD PUBLIC LIMITED COMPANY (UNITED KINGDOM COMPANY)
RENOLD HOUSE STYAL ROAD
WYTHENSHAW, MANCHESTER, ENGLAND

FOR: MACHINE AND MACHINE TOOL PARTS, NAMELY- CAM DRIVES FOR INTERNAL COMBUSTION ENGINES; POWER TRANSMISSIONS AND PARTS THEREFOR; GEARS AND GEAR BOXES AND PARTS AND FITTINGS THEREFOR; INDEXING GEARS AND INDEXING GEAR BOXES AND PARTS AND FITTINGS THEREFOR; DRIVING CHAINS; CONVEYING CHAINS; CHAIN CLUTCHES; CHAIN COUPLINGS; CHAIN RACKS AND PINIONS; COUNTER-WEIGHT CHAINS AND PINIONS IN COMBINATION; SPEED CHANGE DRIVES; SPEED CHANGE GEARS; CHAIN CASES AND SPLASH GUARDS; CHAIN TENSION ADJUSTERS; CHAIN GUIDES; CHAIN WHEEL CUTTERS; CHAIN GRINDING MACHINES; MORTISE CHAINS; GUIDE BARS AND SPROCKET WHEELS FOR USE WITH MORTISE CHAINS; POWER TRANSMISSION CHAINS; CHAIN WHEELS; FLEXIBLE COUPLINGS; TOOTH AND MILLING CUTTER CHAINS; CHAIN GUARD CASTINGS; TOOTHED WHEELS FOR CHAIN DRIVERS; TOOTHED WHEELS FOR DRIVING CHAINS; BLOCK CHAINS; GALLE CHAINS; POLYMER AND RUBBER BLOCK CHAINS; CHAIN JOINTS; FENDERS AND MUDGUARDS FOR MACHINES; DRIVER CHAIN WHEELS AND CHAIN WHEELS; CHAINS FOR RUNWAYS; ESCALATOR CHAINS; WRINGING NAILS; CONVEYOR BELTS; TOOTHED BELTS AND TOOTHED WHEELS FOR MACHINES; TRANSMISSION WHEELS; CHAINED TOOTHED COUPLINGS; SPRAG CLUTCHES; CRANK COUPLINGS; ELECTRO-MAGNETIC, MECHANICAL AND HYDRAULIC CLUTCHES AND PARTS AND FITTINGS THEREFOR; PUSH-PULL REMOTE CONTROL SYSTEMS AND CHAIN SPEED TRANSFORMERS; AUTO-ADJUSTERS FOR CHAINS; ROLLER CHAINS; BUSHLESS ROLLER CHAINS; AXLES FOR MACHINES; DIRECT DRIVE DOG CLUTCHES; OVERRIDING CLUTCHES FOR MA-

CHINES; SHIFTING CLUTCHES FOR MACHINES; FLYBACK SUPPRESSERS FOR MACHINES; INVERTED TOOTH TYPE CHAIN GEARS AND WHEELS; INVERTED TOOTH TYPE CHAINS; CHAIN FINISHERS; ELASTIC COUPLINGS; TORQUE LIMITERS; CONVEYORS FOR AGRICULTURAL AND HORTICULTURAL MACHINERY AND PARTS AND FITTINGS THEREFOR; PLASTIC CHAINS; PLASTIC ROLLER AND BUSHLESS CHAINS; PLASTIC CONVEYOR TYPE CHAINS; STEEL AND PLASTIC TABLETOP AND SLAT BAND TYPE CHAINS; PINE KERNELS AND RATCHETS FOR CHAINS; SPIGOT PINS; STAY BARS; ROLLER CHAINS AND METAL TUBING FOR CONTROLLING MECHANISMS; CONNECTING PINS, JOINTS AND COMPONENTS FOR CHAINS; AXLE PIVOTS; SPACER BARS; DENTENT CHAINS; FORK LIFT TRUCK CHAINS AND WHEELS AND SPROCKETS; FORK LIFT TRUCK LINKS, CONNECTORS AND ANCHOR BOLTS, IN CLASS 7 (U.S. CLS. 13, 19, 21, 23, 31, 34 AND 35).

FOR: LAND VEHICLE PARTS, NAMELY- AUTOMOTIVE CAM DRIVES; CAM DRIVES FOR INTERNAL COMBUSTION ENGINES; POWER TRANSMISSIONS AND PARTS THEREFOR; GEARS AND GEAR BOXES AND PARTS AND FITTINGS THEREFOR; INDEXING GEARS AND INDEXING GEAR BOXES AND PARTS AND FITTINGS THEREFOR; DRIVING CHAINS; CONVEYING CHAINS; CHAIN CLUTCHES; CHAIN COUPLINGS; CHAIN RACKS AND PINIONS; COUNTER-WEIGHT CHAINS AND PINIONS IN COMBINATION; SPEED CHANGE DRIVES; SPEED CHANGE GEARS; CHAIN CASES AND SPLASH GUARDS; CHAIN TENSION ADJUSTERS; CHAIN GUIDES; CHAIN WHEEL CUTTERS; CHAIN GRINDING MACHINES; MORTISE CHAINS; GUIDE BARS AND SPROCKET WHEELS FOR USE WITH MORTISE CHAINS; POWER TRANSMISSION CHAINS; CHAIN WHEELS; FLEXIBLE COUPLINGS; CHAIN GUARD CASTINGS; TOOTHED WHEELS FOR CHAIN DRIVERS; TOOTHED WHEELS FOR DRIVING CHAINS; BLOCK CHAINS; CHAIN JOINTS; FENDERS AND MUDGUARDS FOR LAND VEHICLES; DRIVER

CHAIN WHEELS AND CHAIN WHEELS; WRINGING NAILS; TOOTHED BELTS AND TOOTHED WHEELS; TRANSMISSION WHEELS; CHAIN TOOTHED COUPLINGS; SPRAG CLUTCHES; CRANK COUPLINGS; ELECTRO-MAGNETIC, MECHANICAL AND HYDRAULIC CLUTCHES AND PARTS AND FITTINGS THEREFOR; PUSH-PULL REMOTE CONTROL SYSTEMS AND CHAIN SPEED TRANSFORMERS; AUTO-ADJUSTERS FOR CHAINS; DIRECT DRIVE DOG CLUTCHES; INVERTED TOOTH TYPE CHAIN GEARS; INVERTED TOOTH TYPE CHAINS; CHAIN FINISHERS; ELASTIC COUPLINGS; TORQUE LIMITERS; ROLLER CHAINS; BUSHLESS CHAINS; PINE KERNELS AND RATCHETS FOR CHAINS; SPIGOT PINS; STAY BARS; ROLLER CHAINS AND METAL TUBING FOR CONTROLLING MECHANISMS; FORK LIFT

TRUCK CHAINS, LINKS, WHEELS AND SPROCKETS; CONNECTING PINS, JOINTS AND COMPONENTS FOR CHAINS; AXLE PIVOTS; SPACER BARS; DENTENT CHAINS; BICYCLE CHAINS, IN CLASS 12 (U.S. CLS. 19, 21, 23, 31, 35 AND 44).

PRIORITY CLAIMED UNDER SEC. 44(D) ON ERPN CMNTY TM OFC APPLICATION NO. 002188738, FILED 4-24-2001, REG. NO. 002188738, DATED 3-19-2003, EXPIRES 4-24-2011.

OWNER OF U.S. REG. NOS. 373,826, 373,827, AND 942,721.

SER. NO. 76-248,472, FILED 4-25-2001.

JOHN LINCOSKI, EXAMINING ATTORNEY

Int. Cl.: 16

Prior U.S. Cls.: 2, 5, 22, 23, 29, 37, 38 and 50

United States Patent and Trademark Office

Reg. No. 2,892,265

Registered Oct. 12, 2004

**TRADEMARK
PRINCIPAL REGISTER**

MAGNA PAPER

MAGNA PAPER LLC (MICHIGAN CORPORATION)
73 WASHINGTON STREET
MENDON, MA 01756

NO CLAIM IS MADE TO THE EXCLUSIVE
RIGHT TO USE "PAPER", APART FROM THE
MARK AS SHOWN.

FOR: MAGNETIC PAPER, IN CLASS 16 (U.S. CLS.
2, 5, 22, 23, 29, 37, 38 AND 50).

SER. NO. 76-250,041, FILED 5-2-2001.

FIRST USE 12-3-1999; IN COMMERCE 11-0-2000.

TRACY CROSS, EXAMINING ATTORNEY

Int. Cl.: 10

Prior U.S. Cls.: 26, 39 and 44

United States Patent and Trademark Office

Reg. No. 2,892,266

Registered Oct. 12, 2004

**TRADEMARK
PRINCIPAL REGISTER**

TRIHEDRON

TERRAY CORPORATION (CANADA CORPORATION)
49 JACKSON LANE
ARNPRIOR, ONTARIO, CANADA K7S 3G8

FOR: ORTHOPEDIC IMPLANTS, NAMELY,
JOINT IMPLANTS FOR THE FOOT, IN CLASS 10
(U.S. CLS. 26, 39 AND 44).

PRIORITY CLAIMED UNDER SEC. 44(D) ON
CANADA APPLICATION NO. 1,094,985, FILED 3-6-
2001, REG. NO. TMA605757, DATED 3-19-2004, EX-
PIRES 3-19-2019.

SER. NO. 76-255,430, FILED 5-10-2001.

LINDA ESTRADA, EXAMINING ATTORNEY

Int. Cls.: 39 and 42

Prior U.S. Cls.: 100, 101 and 105

United States Patent and Trademark Office

Reg. No. 2,892,267

Registered Oct. 12, 2004

**SERVICE MARK
PRINCIPAL REGISTER**

GREAT CANADIAN TRAIN VACATIONS

BREWSTER TRANSPORT COMPANY LIMITED
(CANADA CORPORATION)
100 GOPHER STREET
BANFF, ALBERTA T0L 0C0, CANADA

FOR: TRAVEL AGENCY SERVICES, NAMELY,
MAKING RESERVATIONS AND BOOKINGS FOR
TRANSPORTATION AND PACKAGED TOURS, IN
CLASS 39 (U.S. CLS. 100 AND 105).

FIRST USE 1-26-1990; IN COMMERCE 1-26-1990.

FOR: TRAVEL AGENCY SERVICES, NAMELY,
MAKING RESERVATIONS AND BOOKINGS FOR

TEMPORARY LODGING, IN CLASS 42 (U.S. CLS.
100 AND 101).

FIRST USE 1-26-1990; IN COMMERCE 1-26-1990.

NO CLAIM IS MADE TO THE EXCLUSIVE
RIGHT TO USE "TRAIN VACATIONS", APART
FROM THE MARK AS SHOWN.

SEC. 2(F).

SER. NO. 76-257,304, FILED 5-15-2001.

MARK T. MULLEN, EXAMINING ATTORNEY

Int. Cls.: 35 and 36

Prior U.S. Cls.: 100, 101 and 102

United States Patent and Trademark Office

Reg. No. 2,892,268

Registered Oct. 12, 2004

**SERVICE MARK
PRINCIPAL REGISTER**

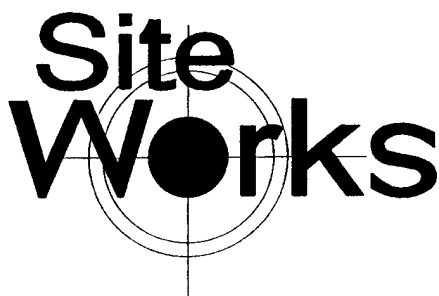

REALTICORP (DELAWARE CORPORATION)
220 N. MAIN STREET, SUITE 200A
GREENVILLE, SC 29601

FOR: MARKET ANALYSIS SERVICES, IN CLASS
35 (U.S. CLS. 100, 101 AND 102).

FIRST USE 5-20-2001; IN COMMERCE 5-20-2001.

FOR: REAL ESTATE MARKET ANALYSIS SER-
VICES AND REAL ESTATE ACQUISITION CON-
SULTING SERVICES; REAL ESTATE ACQUISITION

SERVICES AND REAL ESTATE BROKERAGE SER-
VICES, IN CLASS 36 (U.S. CLS. 100, 101 AND 102).

FIRST USE 5-20-2001; IN COMMERCE 5-20-2001.

NO CLAIM IS MADE TO THE EXCLUSIVE
RIGHT TO USE "SITE", APART FROM THE MARK
AS SHOWN.

SER. NO. 76-259,917, FILED 5-21-2001.

CURTIS FRENCH, EXAMINING ATTORNEY

Int. Cls.: 1, 6, 7, 8, 10, 12, 13, 37, 40 and 42

Prior U.S. Cls.: 1, 2, 5, 6, 9, 10, 12, 13, 14, 19, 21, 23, 25, 26, 28, 31, 34, 35, 39, 44, 46, 50, 100, 101, 103 and 106

Reg. No. 2,892,269

United States Patent and Trademark Office

Registered Oct. 12, 2004

**TRADEMARK
SERVICE MARK
PRINCIPAL REGISTER**

ULTRACEM

MCCOMAS TECHNOLOGIES AG (FED REP GERMANY CORPORATION)
POSSARTSTRASSE 20
MUNCHEN, FED REP GERMANY 81679

FOR: CHEMICALS FOR USE IN HARDENING, SURFACE-REFINING AND PLATING OF METALS AND SYNTHETIC MATERIALS, IN CLASS 1 (U.S. CLS. 1, 5, 6, 10, 26 AND 46).

FOR: RAW AND PARTLY WORKED COMMON METALS; SHAPED METAL PARTS, NAMELY ORES FOR USE IN FURTHER MANUFACTURE, SHAPED CONSTRUCTION ELEMENTS MADE OF METAL, NAMELY WINDOWS, DOORS, BEAMS, SUPPORTS, BRACES, SLIDES, METAL PULLEYS AND SPRINGS; METAL JUNCTIONS FOR PIPES, AND METAL FLANGES; RAW AND PARTLY WORKED METAL CASTINGS; IRONMONGERY AND SMALL ITEMS OF METAL HARDWARE, NAMELY BOLTS, METAL PINS OR WIRE NAILS, TOOL HANDLES, METAL PIPES; METAL TUBES; METAL CASTINGS; METAL EXPANDING SLEEVES FOR AFFIXING SCREWS; METAL VALVE FITTINGS, IN CLASS 6 (U.S. CLS. 2, 12, 13, 14, 23, 25 AND 50).

FOR: MACHINES FOR CUTTING, DRILLING AND PRESSING OF METAL, WOOD AND SYNTHETIC MATERIAL AND PARTS THEREFOR; ELECTRIC KITCHEN MACHINES FOR CHOPPING, GRINDING, CUTTING AND CRUSHING, NAMELY FOOD PROCESSORS, ICE CRUSHERS AND PARTS THEREFOR; BEARINGS AND SLIDE BEARINGS, NAMELY ENGINE BEARINGS AND BEARINGS FOR TRANSMISSION SHAFTS, BEING PARTS OF ENGINES; PARTS FOR LARGE AGRICULTURAL EQUIPMENT, NAMELY WHEELS, PLOWS, FORKS, COUPLINGS, SHAFTS, SAWS, NAMELY BAND SAWS AND CIRCULAR SAWS; BLADES FOR POWER SAWS, ELECTRIC SCISSORS, ELECTRIC KNI-

VES, IN CLASS 7 (U.S. CLS. 13, 19, 21, 23, 31, 34 AND 35).

FOR: CUTLERY, NAMELY, FORKS, SPOONS AND KNIVES, HAND TOOLS, NAMELY PLANERS, DRILL SHOVELS, SCREW DRIVERS, TONGS; PLIERS AND FORCEPS, SCYTHES, SICKLES; ELECTRIC HAIR CUTTERS; ELECTRIC NAIL CLIPPERS, IN CLASS 8 (U.S. CLS. 23, 28 AND 44).

FOR: APPARATUS AND INSTRUMENTS IN THE MEDICAL, DENTAL AND VETERINARIAN FIELDS, NAMELY LAPAROSCOPES, ENDOSCOPES, TROCARS, CANNULAS, CUTTERS, CLAMPS AND GOUGES FOR SURGICAL PURPOSES; KNIVES FOR SURGICAL PURPOSES, SURGICAL CLIP APPLIERS AND CLIPS, SURGICAL TACK APPLIERS AND TACKS, NEEDLES, SURGICAL SNARES, FORCEPS, DISSECTORS, SURGICAL SCISSORS, OSTEOTOMES, SURGICAL SAWS, BONE CHISELS, LANCETS, SURGICAL MALLETS, SURGICAL PLIERS, SURGICAL HAMMERS, SURGICAL RASPS, SURGICAL SPATULAS AND TENDON STRIPPERS, A FULL LINE OF FDA CLASSES I AND II EXEMPT SURGICAL INSTRUMENTS, NAMELY, SCALPELS, SCALPEL, SCALPEL BLADES AND HANDLES, STAPLERS, CLIP APPLIERS, ELECTROCAUTERY TOOLS, NEEDLE HOLDERS, NEEDLE GUIDES AND GRASPERS, IN CLASS 10 (U.S. CLS. 26, 39 AND 44).

FOR: VEHICLES FOR AIR AND SPACE-TRAVEL, NAMELY AIRPLANES AND SPACE SHUTTLES; AUTOMOBILES AND WHEEL BEARINGS FOR LAND VEHICLES, IN CLASS 12 (U.S. CLS. 19, 21, 23, 31, 35 AND 44).

FOR: FIREARMS; COMPONENT PARTS FOR RIFLES, IN CLASS 13 (U.S. CLS. 2 AND 9).

FOR: REPAIR AND MAINTENANCE OF TOOLS, VEHICLES AND MACHINES FOR THE CUTTING, DRILLING AND PRESSING OF METAL, WOOD AND SYNTHETIC MATERIAL AND PARTS THEREFOR, ELECTRIC KITCHEN MACHINES FOR CHOPPING, GRINDING, CUTTING, AND CRUSHING, ENGINES; PARTS FOR LARGE AGRICULTURAL EQUIPMENT, SHEARING MACHINES FOR ANIMALS, POWER-OPERATED SHEARS, AND ALL THEIR WEARING PARTS, IN CLASS 37 (U.S. CLS. 100, 103 AND 106).

FOR: PLATING, NAMELY METAL PLATING; APPLYING PROTECTIVE COATING TO SYNTHETIC MATERIAL, CARBON FIBRES, CARBON STEEL, POWDERED METAL AND OTHER METALS; ME-

TAL TREATMENT, IN CLASS 40 (U.S. CLS. 100, 103 AND 106).

FOR: CHEMIST SERVICES; TECHNICAL CONSULTATION IN THE FIELD OF PLATING AND COATING; PATENT LICENSING, IN CLASS 42 (U.S. CLS. 100 AND 101).

PRIORITY CLAIMED UNDER SEC. 44(D) ON FED REP GERMANY APPLICATION NO. 30087753.601, FILED 11-29-2000, REG. NO. 30087753, DATED 5-3-2001, EXPIRES 11-30-2010.

SER. NO. 76-263,545, FILED 5-29-2001.

YONG KIM, EXAMINING ATTORNEY

Int. Cl.: 25

Prior U.S. Cls.: 22 and 39

United States Patent and Trademark Office

Reg. No. 2,892,270

Registered Oct. 12, 2004

**TRADEMARK
PRINCIPAL REGISTER**



BOES INC. (CANADA CORPORATION)
42 INDUSTRIAL STREET
TORONTO, ONTARIO, CANADA M4G 1Y9

FOR: BOXING AND MARTIAL ARTS UNIFORMS, SHOES AND BOXING SHORTS FOR PARTICIPATING IN THE SPORT OF BOXING AND/OR MARTIAL ARTS, AND RUGBY ATHLETIC WEAR, NAMELY SHORTS FOR PARTICIPATING IN THE SPORT OF RUGBY SOLD IN STORES OR DEPART-

MENTS OF STORES SPECIALIZING IN SPORTING GOODS, AND THROUGH INTERNET SITES SELLING SPORTING GOODS, IN CLASS 25 (U.S. CLS. 22 AND 39).

FIRST USE 6-0-1997; IN COMMERCE 4-0-2000.

SER. NO. 76-266,710, FILED 6-4-2001.

BILL DAWE, EXAMINING ATTORNEY

Int. Cl.: 28

Prior U.S. Cls.: 22, 23, 38 and 50

Reg. No. 2,892,271

United States Patent and Trademark Office

Registered Oct. 12, 2004

TRADEMARK
PRINCIPAL REGISTER



BOES INC. (CANADA CORPORATION)
42 INDUSTRIAL STREET
TORONTO, ONTARIO, CANADA M4G 1Y9

FOR: RUGBY EQUIPMENT, NAMELY BALLS AND PROTECTIVE PADDING, AND BOXING AND MARTIAL ARTS EQUIPMENT, NAMELY HARD GUARDS, HAND WRAPS, COACHING PADS FOR BOXING AND MARTIAL ARTS TO PROTECT THE HANDS, BOXING GLOVES, TRAINING GLOVES, MOUTH PIECES, ABDOMEN PROTECTORS, CHEST PROTECTORS, SPEED BAGS, SKIPPING ROPES, HEAVY BOXING BAGS, PINCHING

BAGS, AIR-FILLED BAGS FOR PUNCHING AND/OR KICKING, SPEED BAG BLADDERS FOR PUNCHING, AND SPARRING GLOVES SOLD IN STORES OR DEPARTMENTS OF STORES SPECIALIZING IN SPORTING GOODS, AND THROUGH INTERNET SITES SELLING SPORTING GOODS, IN CLASS 28 (U.S. CLS. 22, 23, 38 AND 50).

FIRST USE 6-0-1997; IN COMMERCE 4-0-2000.

SER. NO. 76-266,716, FILED 6-4-2001.

BILL DAWE, EXAMINING ATTORNEY

Int. Cl.: 32

Prior U.S. Cls.: 45, 46 and 48

United States Patent and Trademark Office

Reg. No. 2,892,272

Registered Oct. 12, 2004

**TRADEMARK
PRINCIPAL REGISTER**

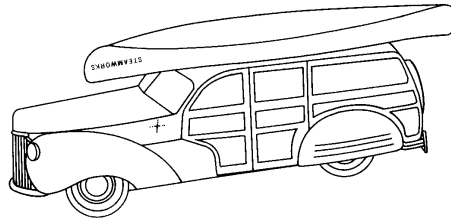

GERSHKOVITCH, ELI (CANADA INDIVIDUAL)
375 WATER STREET
SUITE 425
VANCOUVER, BRITISH COLUMBIA, CANADA V6B
5C6

OWNER OF CANADA REG. NO. TMA563422,
DATED 6-13-2002, EXPIRES 6-13-2017.

OWNER OF U.S. REG. NO. 2,320,072.

FOR: BREWED ALCOHOLIC BEVERAGES
NAMELY ALE; BREWED ALCOHOLIC BEVERA-
GES NAMELY BEER, LAGER, STOUT AND POR-
TER, IN CLASS 32 (U.S. CLS. 45, 46 AND 48).

SER. NO. 76-267,323, FILED 6-6-2001.

EUGENIA MARTIN, EXAMINING ATTORNEY

Int. Cl.: 25

Prior U.S. Cls.: 22 and 39

United States Patent and Trademark Office

Reg. No. 2,892,273

Registered Oct. 12, 2004

**TRADEMARK
PRINCIPAL REGISTER**



TRUSTEES OF DARTMOUTH COLLEGE (NEW
HAMPSHIRE NON-PROFIT CORPORATION),
DBA DARTMOUTH COLLEGE
HANOVER, NH 03755

FIRST USE 0-0-1900; IN COMMERCE 0-0-1900.

SER. NO. 76-272,061, FILED 6-15-2001.

FOR: CLOTHING, NAMELY CAPS, HATS, SWEATERS,
SWEAT PANTS, SWEAT SHIRTS, T-SHIRTS,
SHORTS, IN CLASS 25 (U.S. CLS. 22 AND 39).

RUDY R. SINGLETON, EXAMINING ATTORNEY

Int. Cl.: 5

Prior U.S. Cls.: 6, 18, 44, 46, 51 and 52

Reg. No. 2,892,274

United States Patent and Trademark Office

Registered Oct. 12, 2004

**TRADEMARK
PRINCIPAL REGISTER**

API-MED

BEE AND HERBAL NEW ZEALAND LIMITED
(NEW ZEALAND CORPORATION)
11 CARTERS CRESCENT
CAMBRIDGE, NEW ZEALAND

FOR: PROPOLIS AND PROCESSED BEE POLLEN
FOR MEDICINAL OR THERAPEUTIC PURPOSES,
NAMELY, MEDICINAL, VETERINARY AND SANI-
TARY PREPARATIONS; WOUND DRESSINGS;
BURN DRESSINGS; PREPARATIONS FOR TREAT-
ING COLDS, DIETARY, VITAMIN AND MINERAL
SUPPLEMENTS; LOTIONS, NAMELY MEDICATED
SKIN LOTIONS AND MEDICATED BODY LO-
TIONS, AND MEDICATED SUNBURN LOTIONS;

RUBBING COMPOUNDS FOR MEDICAL AND
THERAPEUTIC USE; TOPICAL GELS FOR MEDI-
CAL AND THERAPEUTIC USE IN THE TREAT-
MENT OF SKIN WOUNDS AND BURNS, IN CLASS
5 (U.S. CLS. 6, 18, 44, 46, 51 AND 52).

OWNER OF NEW ZEALAND REG. NO. 621891,
DATED 8-29-2000, EXPIRES 8-28-2010.

SER. NO. 76-273,862, FILED 6-20-2001.

KAREN K. BUSH, EXAMINING ATTORNEY

Int. Cl.: 9

Prior U.S. Cls.: 21, 23, 26, 36 and 38

United States Patent and Trademark Office

Reg. No. 2,892,275

Registered Oct. 12, 2004

**TRADEMARK
PRINCIPAL REGISTER**

BLUE TOP

JOHNSON CONTROLS BATTERY GROUP, INC.
(WISCONSIN CORPORATION)
5757 NORTH GREEN BAY AVENUE
MILWAUKEE, WI 53201

SEC. 2(F).

FOR: BATTERIES, NAMELY, VEHICULAR BATTERIES, IN CLASS 9 (U.S. CLS. 21, 23, 26, 36 AND 38).

SER. NO. 76-275,228, FILED 6-21-2001.

FIRST USE 6-0-1996; IN COMMERCE 6-0-1996.

GINA FINK, EXAMINING ATTORNEY

Int. Cls.: 7 and 11

Prior U.S. Cls.: 13, 19, 21, 23, 31, 34 and 35

United States Patent and Trademark Office

Reg. No. 2,892,276

Registered Oct. 12, 2004

**TRADEMARK
PRINCIPAL REGISTER**

COdiNOx

HANWEL B.V. (NETHERLANDS COMPANY)
PARALLELSTRAAT 30
7575 AM OLDENZAAL
NETHERLANDS

FOR: INTERNAL COMBUSTION ENGINE PARTS, NAMELY, EXHAUST GAS PURIFICATION SYSTEMS COMPRISING CATALYTIC REDUCTION CATALYST HONEYCOMBS, CATALYTIC OXIDATION HONEYCOMBS AND CATALYTIC SOOT FILTER CARTRIDGES, IN CLASS 7 (U.S. CLS. 13, 19, 21, 23, 31, 34 AND 35).

FOR: MACHINES PARTS FOR LIGHTING, HEATING, STEAM GENERATION, EXHAUST GAS KETTLES AND OTHER COMBUSTING INSTALLATIONS, NAMELY, EXHAUST GAS PUR-

IFICATION SYSTEMS COMPRISING CATALYTIC REDUCTION CATALYST HONEYCOMBS, CATALYTIC OXIDATION HONEYCOMBS AND CATALYTIC SOOT FILTER CARTRIDGES, IN CLASS 11 (U.S. CLS. 13, 21, 23, 31 AND 34).

OWNER OF BENELUX REG. NO. 528565, DATED 1-19-1993, RENEWED AS REG. NO. 528565, DATED 1-19-2003, EXPIRES 1-19-2013.

OWNER OF UNITED KINGDOM REG. NO. 2158066, DATED 7-24-1998, EXPIRES 2-12-2008.

SER. NO. 76-275,963, FILED 6-25-2001.

JOHN HWANG, EXAMINING ATTORNEY

Int. Cl.: 42

Prior U.S. Cls.: 100 and 101

United States Patent and Trademark Office

Reg. No. 2,892,277

Registered Oct. 12, 2004

**SERVICE MARK
PRINCIPAL REGISTER**

KAPALUA

KAPALUA LAND COMPANY, LTD. (HAWAII
CORPORATION)
500 OFFICE ROAD
KAPALUA MAUI, HI 96761

FOR: HOTEL, RESTAURANT, HEALTH AND
BEAUTY SPA SERVICES, IN CLASS 42 (U.S. CLS.
100 AND 101).

FIRST USE 12-0-1977; IN COMMERCE 12-0-1977.

SEC. 2(F).

SER. NO. 76-281,325, FILED 7-6-2001.

BARBARA GAYNOR, EXAMINING ATTORNEY

Int. Cls.: 16 and 28

Prior U.S. Cls.: 2, 5, 22, 23, 29, 37, 38 and 50

United States Patent and Trademark Office

Reg. No. 2,892,278

Registered Oct. 12, 2004

**TRADEMARK
PRINCIPAL REGISTER**

CHRIS MOUSE

BLESSING OUR WORLD, INC. (TEXAS CORPORATION)
P.O. BOX 642
PALESTINE, TX 75802

FOR: CHILDREN'S BOOKS, IN CLASS 16 (U.S. CLS. 2, 5, 22, 23, 29, 37, 38 AND 50).

FIRST USE 0-0-1981; IN COMMERCE 0-0-1981.

FOR: PLUSH TOYS, IN CLASS 28 (U.S. CLS. 22, 23, 38 AND 50).

FIRST USE 0-0-1981; IN COMMERCE 0-0-1981.

SER. NO. 76-281,440, FILED 6-27-2001.

JENNIFER CHICOSKI, EXAMINING ATTORNEY

Int. Cl.: 35

Prior U.S. Cls.: 100, 101 and 102

United States Patent and Trademark Office

Reg. No. 2,892,279

Registered Oct. 12, 2004

**SERVICE MARK
PRINCIPAL REGISTER**

CLEAR THINKING. COOL IDEAS.

CLEAR!BLUE HOLDINGS, LLC (MICHIGAN
LTD LIAB CO)
135 N. OLD WOODWARD AVENUE
BIRMINGHAM, MI 48009

FOR: STRATEGIC EVENT PLANNING IN THE
NATURE OF TRADESHOWS, PRODUCT EXHIBI-
TIONS, AND LIVE EVENTS; NAMELY, DESIGN-
ING, DEVELOPING, ORGANIZING, AND
FACILITATING CORPORATE, BUSINESS, AND IN-
DUSTRY PROGRAMS, EXHIBITIONS, AND SIMI-

LAR SPECIAL EVENTS, IN CLASS 35 (U.S. CLS. 100,
101 AND 102).

FIRST USE 8-2-2000; IN COMMERCE 8-2-2000.

SER. NO. 76-282,837, FILED 7-11-2001.

JULIA HARDY COFIELD, EXAMINING ATTOR-
NEY

Int. Cl.: 25

Prior U.S. Cls.: 22 and 39

United States Patent and Trademark Office

Reg. No. 2,892,280

Registered Oct. 12, 2004

**TRADEMARK
PRINCIPAL REGISTER**

TYCOON

CHOW, WAYNE (UNITED STATES INDIVIDUAL)
1549 EAST ELZA
HAZEL PARK, MI 48030

FOR: CLOTHING, NAMELY, SWEATSHIRTS, JEANS, JACKETS, COATS, SWEATPANTS, SLACKS, SUITS, HATS, HEADBANDS, VISORS, CAPS, DRESSES, FOOTWEAR, WRISTBANDS, SOCKS, T-SHIRTS, BELTS, UNDERGARMENTS, NECKTIES, SHIRTS, SWIMWEAR, PAJAMAS, SLEEPWEAR,

SHORTS AND SANDALS FOR MEN, WOMEN AND CHILDREN, IN CLASS 25 (U.S. CLS. 22 AND 39).

FIRST USE 11-9-2001; IN COMMERCE 11-9-2001.

SER. NO. 76-284,040, FILED 7-12-2001.

ALICE SUE CARRUTHERS, EXAMINING ATTORNEY

Int. Cls.: 9, 35 and 42

Prior U.S. Cls.: 21, 23, 26, 36, 38, 100, 101 and 102

Reg. No. 2,892,281

United States Patent and Trademark Office

Registered Oct. 12, 2004

**TRADEMARK
SERVICE MARK
PRINCIPAL REGISTER**

HEALTHTALK

HEALTHTALK, INC. (DELAWARE CORPORATION)

100 - 4TH AVENUE N., #460
SEATTLE, WA 98109

FOR: PRE-RECORDED AUDIO AND VIDEO TAPES FEATURING RECORDED CONFERENCES, INTERVIEWS, INTERNET AND RADIO TALK SHOWS, FACTUAL PRESENTATIONS, AND NARRATIVE STORIES, ALL CONCERNING HEALTH AND HEALTH CARE MATTERS, IN CLASS 9 (U.S. CLS. 21, 23, 26, 36 AND 38).

FIRST USE 6-0-1994; IN COMMERCE 6-0-1994.

FOR: PROMOTING THE GOODS AND SERVICES OF OTHERS BY PROVIDING LIVE AND DELAYED MEDIA EVENTS AND TRANSCRIBED AND RECORDED MATERIAL FROM SUCH EVENTS, ALL IN INTERACTIVE FORMATS AND ALL CONCERNING THE FIELDS OF HEALTHCARE, PHARMACEUTICAL, BIOTECHNOLOGY, AND MEDICAL DEVICES, IN CLASS 35 (U.S. CLS. 100, 101 AND 102).

FIRST USE 6-0-1994; IN COMMERCE 6-0-1994.

FOR: COMPUTER SERVICES, NAMELY, PROVIDING AN ONLINE DATABASE FEATURING GENERAL INFORMATION IN THE FIELD OF HEALTHCARE AND MEDICINE, BUT NOT INCLUDING SUBSCRIBER BASED CONFIDENTIAL EXCHANGES OF PATIENT HEALTH RECORDS; AND DESIGNING, CREATING, IMPLEMENTING AND MAINTAINING WEBSITES FOR OTHERS, IN CLASS 42 (U.S. CLS. 100 AND 101).

FIRST USE 11-0-1996; IN COMMERCE 11-0-1996.

OWNER OF U.S. REG. NOS. 1,888,873 AND 2,096,293.

SER. NO. 76-286,840, FILED 7-18-2001.

ESTHER BELENKER, EXAMINING ATTORNEY

Int. Cl.: 20

Prior U.S. Cls.: 2, 13, 22, 25, 32 and 50

United States Patent and Trademark Office

Reg. No. 2,892,282

Registered Oct. 12, 2004

**TRADEMARK
PRINCIPAL REGISTER**

ENGLISH STONE VILLA GARDEN TILES

EASY GARDENER PRODUCTS, LTD. (TEXAS
CORPORATION)
3022 FRANKLIN AVE.
WACO, TX 76710

FOR: LANDSCAPE EDGING AND BORDERS,
NAMELY LENGTHS OF PLASTIC DECORATIVE
EDGING FOR DELIMITING GARDENS AND

FLOWER BEDS, IN CLASS 20 (U.S. CLS. 2, 13, 22,
25, 32 AND 50).

FIRST USE 12-14-2001; IN COMMERCE 12-14-2001.

SER. NO. 76-293,339, FILED 8-2-2001.

GEORGIA CARTY, EXAMINING ATTORNEY

Int. Cl.: 20

Prior U.S. Cls.: 2, 13, 22, 25, 32 and 50

United States Patent and Trademark Office

Reg. No. 2,892,283

Registered Oct. 12, 2004

**TRADEMARK
PRINCIPAL REGISTER**

ENGLISH STONE FINIAL VILLA GARDEN TILES

EASY GARDENER PRODUCTS, LTD. (TEXAS
CORPORATION)
3022 FRANKLIN AVE.
WACO, TX 76710

FOR: LANDSCAPE EDGING AND BORDERS,
NAMELY PLASTIC COMPONENTS OF DECORA-
TIVE EDGING ASSEMBLIES FOR DELIMITING

GARDENS AND FLOWER BEDS , IN CLASS 20
(U.S. CLS. 2, 13, 22, 25, 32 AND 50).

FIRST USE 12-14-2001; IN COMMERCE 12-14-2001.

SER. NO. 76-293,340, FILED 8-2-2001.

GEORGIA CARTY, EXAMINING ATTORNEY

Int. Cl.: 12

Prior U.S. Cls.: 19, 21, 23, 31, 35 and 44

Reg. No. 2,892,284

United States Patent and Trademark Office

Registered Oct. 12, 2004

**TRADEMARK
PRINCIPAL REGISTER**

AERO A-KLASSE

AEROFLEX INTERNATIONAL CO. LTD. (THAI-
LAND CORPORATION)
NO. 111/1 MU 2, TAMBOL MAKHAM-KHOO
KHING AMPHOE NIKOMPATTANA
CHANGWAD RAYONG, THAILAND

OWNER OF THAILAND REG. NO. 174455, DA-
TED 1-2-2003, EXPIRES 1-2-2013.

SER. NO. 76-295,138, FILED 8-6-2001.

FOR: FITTED LINERS FOR THE CARGO AREA
OF PICK-UP TRUCKS, IN CLASS 12 (U.S. CLS. 19, 21,
23, 31, 35 AND 44).

DOUGLAS LEE, EXAMINING ATTORNEY

Int. Cls.: 1 and 17

Prior U.S. Cls.: 1, 5, 6, 10, 12, 13, 26, 35, 46 and 50

United States Patent and Trademark Office

Reg. No. 2,892,285

Registered Oct. 12, 2004

**TRADEMARK
PRINCIPAL REGISTER**

ULTRA LOW

NOVA CHEMICALS INC. (DELAWARE CORPORATION)
1550 CORAOPOLIS HEIGHTS ROAD
MOON TOWNSHIP, PA 15108

FOR: UNPROCESSED EXPANDABLE POLYSTYRENE COMPOSITIONS FOR USE IN THE MANUFACTURE OF FOAMED POLYSTYRENE PRODUCTS, IN CLASS 1 (U.S. CLS. 1, 5, 6, 10, 26 AND 46).

FIRST USE 3-14-2002; IN COMMERCE 3-14-2002.

FOR: SEMI-PROCESSED EXPANDABLE POLYSTYRENE COMPOSITIONS FOR USE IN THE MANUFACTURE OF FOAMED POLYSTYRENE PRODUCTS, IN CLASS 17 (U.S. CLS. 1, 5, 12, 13, 35 AND 50).

FIRST USE 3-14-2003; IN COMMERCE 3-14-2003.

SER. NO. 76-295,599, FILED 8-2-2001.

KELLEY WELLS, EXAMINING ATTORNEY

Int. Cl.: 42

Prior U.S. Cls.: 100 and 101

United States Patent and Trademark Office

Reg. No. 2,892,286

Registered Oct. 12, 2004

**SERVICE MARK
PRINCIPAL REGISTER**

SNPVISION

AFFINIUM PHARMACEUTICALS, INC. (CANADA CORPORATION)
100 UNIVERSITY AVENUE
10TH FLOOR, SOUTH TOWER
TORONTO, ONTARIO M5J 1V6, CANADA

FOR: DISCOVERY AND DEVELOPMENT OF MEDICINES AND CLINICAL DIAGNOSTIC PREPARATIONS; INTEGRATED BIOPHYSICAL SERVICES, NAMELY, THREE-DIMENSIONAL STRUCTURE DETERMINATION, FUNCTIONAL DETERMINATION AND BIOPHYSICAL AND BIOCHEMICAL DETERMINATION AND BIOPHYSI-

CAL AND CHEMICAL COMPUTATIONAL ANALYSIS, IN CLASS 42 (U.S. CLS. 100 AND 101).

PRIORITY CLAIMED UNDER SEC. 44(D) ON CANADA APPLICATION NO. 1092343, FILED 2-9-2001, REG. NO. TMA594802, DATED 11-14-2003, EXPIRES 11-14-2018.

SER. NO. 76-297,968, FILED 8-8-2001.

FRED MANDIR, EXAMINING ATTORNEY

Int. Cl.: 36

Prior U.S. Cls.: 100, 101 and 102

United States Patent and Trademark Office

Reg. No. 2,892,287

Registered Oct. 12, 2004

SERVICE MARK
PRINCIPAL REGISTER



LONG, ALAN (UNITED STATES INDIVIDUAL)
9200 SUNSET BOULEVARD, SUITE 200
LOS ANGELES, CA 90069

NO CLAIM IS MADE TO THE EXCLUSIVE
RIGHT TO USE "REALTORS", APART FROM THE
MARK AS SHOWN.

FOR: REAL ESTATE BROKERAGE SERVICES, IN
CLASS 36 (U.S. CLS. 100, 101 AND 102).

SER. NO. 76-298,683, FILED 8-10-2001.

FIRST USE 8-2-2001; IN COMMERCE 8-2-2001.

THEODORE MCBRIDE, EXAMINING ATTORNEY

Int. Cls.: 9, 16, 35, 36, 38, 39, 41 and 42

Prior U.S. Cls.: 2, 5, 21, 22, 23, 26, 29, 36, 37, 38, 50,
100, 101, 102, 104, 105 and 107

Reg. No. 2,892,288

United States Patent and Trademark Office

Registered Oct. 12, 2004

TRADEMARK
SERVICE MARK
PRINCIPAL REGISTER

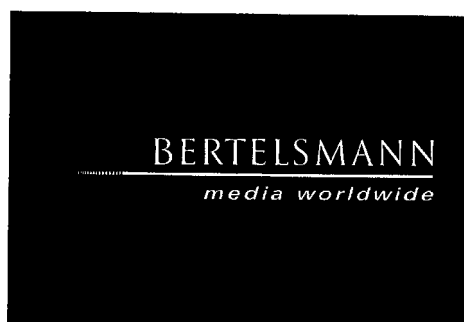

BERTELSMANN AKTIENGESELLSCHAFT (FED
REP GERMANY CORPORATION)
CARL-BERTELSMANN-STR. 270
D-33335 GUTERSLOH, FED REP GERMANY

FOR: PRERECORDED AUDIO CASSETTES, AUDIO TAPES, MAGNETIC DATA CARRIERS, VIDEO CASSETTES, VIDEO TAPES, DIGITAL AUDIOTAPES AND COMPACT DISCS ALL FEATURING MUSIC OF ALL VARIETIES, COMEDY, ANIMATION, CHILDREN'S EDUCATIONAL PROGRAMMING, DANCE PERFORMANCES, THEATRICAL PERFORMANCES AND ATHLETIC COMPETITIONS; PRERECORDED AUDIOCASSETTES, AUDIO TAPES, MAGNETIC DATA CARRIERS, VIDEO CASSETTES, VIDEO TAPES, DIGITAL AUDIO TAPES AND COMPACT DISCS ALL FEATURING HISTORICAL, POLITICAL, RELIGIOUS, BIOGRAPHICAL, FASHION, MEDICAL AND SCIENTIFIC DOCUMENTARIES AND MOTION PICTURES; COMPUTER SOFTWARE FOR DATA PROCESSING, COMPUTER SOFTWARE FOR GAMES, AND COMPUTER SOFTWARE FOR BUSINESS AND FINANCE MANAGEMENT; COMPUTER SEARCH ENGINE SOFTWARE AND COMPUTER SOFTWARE FOR NETWORKING COMPUTERS, IN CLASS 9 (U.S. CLS. 21, 23, 26, 36 AND 38).

FOR: NEWSPAPERS FOR GENERAL CIRCULATION, MAPS AND ATLASES, CALENDARS, GREETING CARDS; PHOTOGRAPHS; PRINTED MATTER, NAMELY BOOKS, BOOKLETS, AND PERIODICALS FEATURING FICTION; PRINTED

MATTER, NAMELY BOOKS, BOOKLETS, AND PERIODICALS FEATURING HISTORICAL, POLITICAL, RELIGIOUS, BIOGRAPHICAL, FASHION, MEDICAL, AND SCIENTIFIC SUBJECTS AND EDUCATIONAL SUBJECTS FOR ELEMENTARY SCHOOL, MIDDLE SCHOOL, HIGH SCHOOL AND COLLEGE-LEVEL INSTRUCTION, IN CLASS 16 (U.S. CLS. 2, 5, 22, 23, 29, 37, 38 AND 50).

FOR: ADVERTISING AGENCIES; BUSINESS MANAGEMENT; ADMINISTRATION OF BUSINESS PAYROLL FOR OTHERS; PROVIDING INTELLECTUAL PROPERTY LEGAL DOCKET MANAGEMENT SERVICES FOR OTHERS; ACCOUNTING SERVICES, NAMELY, ACCOUNTING OF ELECTRONIC ORDERING SYSTEMS; ON-LINE RETAIL STORE SERVICES FEATURING ALL TYPES OF MEDIA AND ENTERTAINMENT PRODUCTS, IN CLASS 35 (U.S. CLS. 100, 101 AND 102).

FOR: FINANCIAL ANALYSIS AND CONSULTATION; DEBT RECOVERY AND COLLECTION AGENCIES; PROVIDING ONLINE ELECTRONIC DATABASES ON A GLOBAL COMPUTER NETWORK IN THE FIELD OF FINANCE; AND BROKERAGE SERVICES FOR OTHERS TO FACILITATE THE PURCHASE AND SALE OF PRODUCTS OF OTHERS IN THE FIELD OF PRERECORDED AUDIO, VIDEO AND DIGITAL MEDIA AND PRINT PUBLICATIONS, IN CLASS 36 (U.S. CLS. 100, 101 AND 102).

FOR: TELECOMMUNICATIONS SERVICES, NAMELY, PERSONAL COMMUNICATION SERVICES; PROVIDING TELECOMMUNICATIONS CONNECTIONS TO THE INTERNET; PROVIDING MULTIPLE-USER ACCESS TO A GLOBAL COMPUTER INFORMATION NETWORK, IN CLASS 38 (U.S. CLS. 100, 101 AND 104).

FOR: DELIVERY OF PRINTED PRODUCTS PURCHASED VIA E-COMMERCE SERVICES BY MOTOR VEHICLE AND AIR, IN CLASS 39 (U.S. CLS. 100 AND 105).

FOR: EDUCATIONAL SERVICES, NAMELY, CONDUCTING CONFERENCES AND WORKSHOPS OVER A GLOBAL COMMUNICATIONS NETWORK IN THE FIELD OF PRINTED AND ELECTRONIC MEDIA; ENTERTAINMENT SERVICES IN THE NATURE OF ONGOING RADIO PROGRAMS AND TELEVISION PROGRAMS IN THE FIELDS OF NEWS, WEATHER, COMEDY, LIVE ACTION, ANIMATION, VARIETY SHOWS, TALK SHOWS, NEWS MAGAZINE SHOWS, SITCOMS, MUSIC, THEATER, GAME SHOWS, SOAP OPERAS, REALITY SHOWS AND DOCUMENTARIES AND MOVIES FEATURING HISTORICAL, POLITICAL, RELIGIOUS, BIOGRAPHICAL, FASHION, MEDICAL AND SCIENTIFIC SUBJECT MATTER; ENTERTAINMENT SERVICES IN THE NATURE OF LIVE CONCERTS AND LIVE PERFORMANCES BY MUSICAL GROUPS, MUSICAL BANDS, INDIVIDUAL PERFORMING ARTISTS, COMEDIANS, MAGICIANS, PUBLIC SPEAKERS, LIVE DANCE PERFORMANCES, LIVE THEATER, CIRCUSES, PROFESSIONAL AND COLLEGE FOOTBALL, BASEBALL, SOCCER, TENNIS AND BASKETBALL COMPETITIONS AND MOTOR VEHICLE RACES; ORGANIZING COMMUNITY CULTURAL EVENTS; ELECTRONIC PUBLISHING SERVICES, NAMELY,

PUBLICATION OF TEXT AND GRAPHIC WORKS OF OTHERS ON CD-ROMS FEATURING FICTIONAL CONTENT AND HISTORICAL, POLITICAL, RELIGIOUS, BIOGRAPHICAL, FASHION, MEDICAL AND SCIENTIFIC SUBJECT MATTER, IN CLASS 41 (U.S. CLS. 100, 101 AND 107).

FOR: HOSTING THE WEB SITES OF OTHERS ON A COMPUTER SERVER FOR A GLOBAL COMPUTER NETWORK; COMPUTER SERVICES, NAMELY PROVIDING ON-LINE MAGAZINES, NEWSPAPERS, JOURNALS, NEWSLETTERS, AND BOOKS IN THE FIELDS OF FINANCE, BUSINESS, GENERAL INTEREST, ENTERTAINMENT AND A VARIETY OF FICTIONAL SUBJECTS; MEDIATION SERVICES; LICENSING OF INTELLECTUAL PROPERTY INCLUDING COPYRIGHT; INTELLECTUAL PROPERTY CONSULTATION SERVICES; COMPUTER SERVICES, NAMELY, CREATING AND MAINTAINING SPECIALIZED WEB SITES AND INTERNET PLATFORMS FOR OTHERS FEATURING WEB SITE LINKS TO MULTIPLE BUSINESS ENTITIES WITH E-COMMERCE FUNCTIONALITY, IN CLASS 42 (U.S. CLS. 100 AND 101).

PRIORITY CLAIMED UNDER SEC. 44(D) ON FED REP GERMANY APPLICATION NO. 30136231.9/4, FILED 6-13-2001, REG. NO. 30136231, DATED 8-6-2002, EXPIRES 6-30-2011.

OWNER OF U.S. REG. NO. 2,703,382.

NO CLAIM IS MADE TO THE EXCLUSIVE RIGHT TO USE "MEDIA WORLDWIDE", APART FROM THE MARK AS SHOWN.

SER. NO. 76-299,050, FILED 8-13-2001.

KIM SAITO, EXAMINING ATTORNEY

Int. Cl.: 25

Prior U.S. Cls.: 22 and 39

United States Patent and Trademark Office

Reg. No. 2,892,289

Registered Oct. 12, 2004

**TRADEMARK
PRINCIPAL REGISTER**

URBAN SAFARI

SONALI CORPORATION (NEW JERSEY CORPORATION)
45 EVERETT DRIVE
PRINCETON JUNCTION, NJ 08550

FIRST USE 6-2-1987; IN COMMERCE 6-5-1987.

SER. NO. 76-299,245, FILED 8-15-2001.

FOR: MEN'S AND WOMEN'S CLOTHING NAME-
LY, SHORTS, SHIRTS, SKIRTS, PANTS, SWEATERS,
BLOUSES, JACKETS, SOCKS, SHAWLS AND
SCARFS, IN CLASS 25 (U.S. CLS. 22 AND 39).

RUDY R. SINGLETON, EXAMINING ATTORNEY

Int. Cls.: 9, 35, 38 and 42

Prior U.S. Cls.: 21, 23, 26, 36, 38, 100, 101, 102 and 104

Reg. No. 2,892,290

United States Patent and Trademark Office

Registered Oct. 12, 2004

**TRADEMARK
SERVICE MARK
PRINCIPAL REGISTER**

OMNIFETCH

AUTONOMY CORPORATION PLC (ENGLAND CORPORATION)
CAMBRIDGE BUSINESS PARK
COWLEY ROAD
CAMBRIDGE CB4 OWZ, UNITED KINGDOM

FOR: COMPUTER SOFTWARE THAT AUTOMATES THE PROCESSING OF UNSTRUCTURED, SEMI-STRUCTURED AND STRUCTURED INFORMATION AND DATA, NAMELY, COMPUTER SOFTWARE USED FOR MANAGEMENT OF INFORMATION STORED IN DATABASES, E-MAIL ARCHIVES, DOCUMENT MANAGEMENT SYSTEMS, MULTIMEDIA FILES, INTRANET SITES, INTERNET SITES AND CONTAINED IN TELEPHONE OR VOICEMAIL MESSAGES, AND FOR IDENTIFYING CONCEPTS AND TOPICS CONTAINED IN SUCH INFORMATION; COMPUTER SOFTWARE THAT ANALYZES CONCEPTS CONTAINED IN INFORMATION STORED IN DATABASES, E-MAIL ARCHIVES, DOCUMENT MANAGEMENT SYSTEMS, MULTIMEDIA FILES, INTRANET SITES, INTERNET SITES AND CONTAINED IN TELEPHONE OR VOICEMAIL MESSAGES AND FOR CREATING SUMMARIES OF THAT INFORMATION BASED ON THE CONCEPTS IDENTIFIED; COMPUTER SOFTWARE FOR CREATING AND INSERTING METATAGS INTO DOCUMENTS AND INFORMATION STORED IN DATABASES, E-MAIL ARCHIVES, DOCUMENT MANAGEMENT SYSTEMS, MULTIMEDIA FILES, INTRANET SITES, INTERNET SITES, TELEPHONE OR VOICEMAIL MESSAGES TO FACILITIES OPERATION OF SEARCH ENGINE SOFTWARE; COMPUTER SOFTWARE FOR CREATING AND INSERTING HYPERLINKS CONNECTING CONCEPTUALLY OR TOPICALLY RELATED DOCUMENT AND INFORMATION STORED IN DATABASES, E-MAIL ARCHIVES, DOCUMENT MANAGEMENT SYSTEMS, MULTIMEDIA FILES, INTRANET SITES, INTERNET SITES, TELEPHONE OR VOICEMAIL MESSAGES, COMPUTER DATABASE SOFTWARE FOR CREATING, MAINTAINING, AND UPDATING DA-

TABASES CONTAINING INFORMATION STORED IN E-MAIL ARCHIVES, DOCUMENT MANAGEMENT SYSTEMS, MULTIMEDIA FILES, INTRANET SITES, INTERNET SITES TELEPHONE OR VOICEMAIL MESSAGES; COMPUTER DATABASE SEARCHING SOFTWARE THAT ALLOWS USERS TO SEARCH AND RETRIEVE INFORMATION STORED IN DATABASES, E-MAIL ARCHIVES, DOCUMENT MANAGEMENT SYSTEMS, MULTIMEDIA FILES, INTRANET SITES, INTERNET SITES, TELEPHONE OR VOICEMAIL MESSAGES; COMPUTER SOFTWARE FOR ANALYZING AND GENERATING SUMMARIES OF INFORMATION STORED IN DATABASES, E-MAIL ARCHIVES, DOCUMENT MANAGEMENT SYSTEMS, MULTIMEDIA FILES, INTRANET SITES, INTERNET SITES AND CONTAINED IN TELEPHONE OR VOICEMAIL MESSAGES; COMPUTER SOFTWARE THAT CREATES, UPDATES AND MAINTAINS PROFILES OF USERS OF LOCAL, WIDE-AREA, AND GLOBAL COMPUTER NETWORKS AND DELIVERS INFORMATION FROM DATABASES, E-MAIL ARCHIVES, DOCUMENT MANAGEMENT SYSTEMS, MULTIMEDIA FILES, INTRANET SITES, INTERNET SITES AND CONTAINED IN TELEPHONE OR VOICEMAIL MESSAGES BASED ON THOSE PROFILES; COMPUTER SOFTWARE THAT TRANSMITS INFORMATION FROM COMPUTER NETWORK SERVERS, INTRANET AND THE INTERNET TO DESKTOP COMPUTERS, MOBILE TELEPHONES, PERSONAL DIGITAL ASSISTANTS, AND PORTABLE DIGITAL COMMUNICATION DEVICES; COMPUTER SOFTWARE THAT CREATES, UPDATES AND MAINTAINS CUSTOMIZED PORTAL SITES FOR USERS OF LOCAL, WORLD-AREA AND GLOBAL COMPUTER NETWORKS; COMPUTER SOFTWARE FOR CUSTOMER RELATIONSHIP MANAGEMENT, NAMELY, FOR RECEIVING CUSTOMER INQUIRIES VIA TELEPHONE AND E-MAIL, AUTOMATICALLY IDENTIFYING CONCEPTS AND TOPICS CONTAINED IN THOSE INQUIRES, AUTOMATICALLY GENERATING A RESPONSE TO THOSE INQUIRES, AND FOR-

WARDING THOSE INQUIRIES TO AN APPROPRIATE TECHNICAL ADVISOR; COMPUTER SOFTWARE FOR HUMAN RESOURCES MANAGEMENT, NAMELY, FOR RECEIVING EMPLOYEE INQUIRIES VIA TELEPHONE AND E-MAIL, AUTOMATICALLY IDENTIFYING CONCEPTS AND TOPICS CONTAINED IN THOSE INQUIRIES, AND AUTOMATICALLY GENERATING A RESPONSE TO THOSE INQUIRIES; SPEECH RECOGNITION COMPUTER SOFTWARE; TEXT RECOGNITION COMPUTER SOFTWARE; IMAGE RECOGNITION COMPUTER SOFTWARE; COMPUTER OPERATING SYSTEM SOFTWARE; COMPUTER SOFTWARE FOR USE IN DATA RETRIEVAL, MANAGEMENT AND DELIVERY IN KNOWLEDGE MANAGEMENT, NEW MEDIA, CUSTOMER RELATIONSHIP MANAGEMENT, ON-LINE AND OFF-LINE PUBLISHING AND E-COMMERCE COMPUTER SOFTWARE APPLICATIONS; COMPUTER SOFTWARE FOR PROVIDING ON-LINE AND OFF-LINE NAVIGATION OF THE GLOBAL COMPUTER INFORMATION NETWORK AND FOR RUNNING WEB-SITE SEARCHES; COMPUTER SOFTWARE FOR PERFORMING CONCEPT MATCHING, NAMELY, SEARCHING DATA AND RETURNING REFERENCES TO DOCUMENTS THAT ARE CONCEPTUALLY RELATED TO THE CONTENT IDENTIFIED AD THE INITIAL REFERENCE; COMPUTER SOFTWARE USED TO DEVELOP COMPUTER PROGRAMS FOR MANAGING MULTIMEDIA CONTENT, CUSTOMER SERVICE, ON-LINE AND OFF-LINE PUBLISHING AND ELECTRONIC COMMERCE; COMPUTER SOFTWARE OF CREATING, MAINTAINING AND UPDATING SOFTWARE AGENTS THAT AUTOMATICALLY AND SYSTEMATICALLY CONDUCT SEARCHES OF DATABASE, INTRANET AND THE INTERNET COMPUTER SEARCH ENGINE SOFTWARE; COMPUTER SOFTWARE USED FOR CONDUCTING STANDARD TEXT SEARCHES; COMPUTER PROGRAMS THAT ALLOW OTHER COMPUTER PROGRAMS TO ADAPT THEIR BEHAVIOR ACCORDING TO A USER'S INSTRUCTIONS OR RESPONSE BY PERSONALIZING AND PROFILING FOR INDIVIDUAL END-USERS THE RETRIEVAL, MANAGEMENT, AND DELIVERY OF DATA IN KNOWLEDGE MANAGEMENT, NEW MEDIA, CUSTOMER RELATIONSHIP MANAGEMENT, AND E-COMMERCE COMPUTER SOFTWARE APPLICATIONS; COMPUTER SOFTWARE USED TO CREATE AND MANAGE INTERNET AND INTRANET PORTAL SITES; COMPUTER SOFTWARE FOR MANAGEMENT AND PROCESSING OF ELECTRONIC COMMERCE TRANSACTIONS; COMPUTER SOFTWARE USED TO RETRIEVE INFORMATION ABOUT CURRENT EVENTS, BUSINESS, AND SPORTS FROM DATABASE, INTERNET, INTRANET AND OTHER COMPUTER NETWORKS AND TRANSMITTING THE SAME TO USERS VIA COMPUTER DATA NETWORKS; MOBILE TELEPHONES; PERSONAL DIGITAL ASSISTANTS, AND PORTABLE DIGITAL COMMUNICATION DEVICES; COMPUTER SOFTWARE FOR E-MAIL MANAGEMENT; COMPUTER SOFTWARE THE ALERTS USERS FOR COMPUTER NETWORKS TO THE EXISTENCE OF END CONTACT INFORMATION FOR OTHERS USERS WITH COMMON INTERESTS;

SOFTWARE FOR ANALYZING DATA CONTAINED IN E-MAIL ARCHIVES, DOCUMENT MANAGEMENT SYSTEMS, MULTIMEDIA FILES, INTRANET SITES, INTERNET SITES, TELEPHONE OR VOICEMAIL MESSAGES, IN CLASS 9 (U.S. CLS. 21, 23, 26, 36 AND 38).

FOR: LICENSING COMPUTER SOFTWARE, IN CLASS 35 (U.S. CLS. 100, 101 AND 102).

FOR: PROVIDING MULTIPLE USER ACCESS TO THE INTERNET, INTRANET AND COMPUTER NETWORKS; TELECOMMUNICATION SERVICES, NAMELY, TRANSMITTING INFORMATION STORED ON A DATABASE, COMPUTER NETWORK, INTRANET OR THE INTERNET TO MOBILE TELEPHONES AND OTHER HANDHELD DIGITAL DEVICES, IN CLASS 38 (U.S. CLS. 100, 101 AND 104).

FOR: COMPUTER SERVICES, NAMELY, SEARCH ENGINE SERVICES; LEASING AND RENTAL OF COMPUTER SOFTWARE; COMPUTER SERVICES, NAMELY, PROVIDING TEMPORARY USE OF ON-LINE NON-DOWNLOADABLE COMPUTER SOFTWARE FOR AUTOMATING INFORMATION MANAGEMENT, NAMELY, FOR ANALYZING INFORMATION STORED IN DATABASES, E-MAIL ARCHIVES, DOCUMENT MANAGEMENT SYSTEMS, MULTIMEDIA FILES, INTRANET SITES, INTERNET SITES, INTERNET SITES AND CONTAINED IN TELEPHONE OR VOICEMAIL MESSAGES, AND IDENTIFYING CONCEPTS AND TOPICS CONTAINED IN SUCH INFORMATION; COMPUTER SERVICES, NAMELY, PROVIDING TEMPORARY USE OF ON-LINE NON-DOWNLOADABLE COMPUTER SOFTWARE USED TO CREATE AND INSERT METATAGS INTO DOCUMENTS AND INFORMATION STORED IN DATABASES, E-MAIL ARCHIVES, DOCUMENT MANAGEMENT SYSTEMS, MULTIMEDIA FILES, INTRANET SITES, INTERNET SITES, TELEPHONE OR VOICEMAIL MESSAGES TO FACILITATE OPERATION OF SEARCH ENGINE SOFTWARE; COMPUTER SERVICES, NAMELY, PROVIDING TEMPORARY USE ON ON-LINE NON-DOWNLOADABLE COMPUTER SOFTWARE FOR CREATING AND INSERTING HYPERLINK CONNECTING CONCEPTUALLY OR TOPICALLY RELATED DOCUMENTS AND INFORMATION STORED IN DATABASE, E-MAIL ARCHIVES, DOCUMENT MANAGEMENT SYSTEMS, MULTIMEDIA FILES, INTRANET SITES, INTERNET SITES, TELEPHONE OR VOICE MAID MESSAGE; PROVIDING TEMPORARY USE OF SERVICE, NAMELY, PROVIDING TEMPORARY USE OF ON-LINE NON-DOWNLOADABLE COMPUTER DATABASE SEARCHING SOFTWARE THAT ALLOWS USERS TO SEARCH AND RETRIEVE INFORMATION STORED IN DATABASES, E-MAIL ARCHIVES, DOCUMENT MANAGEMENT SYSTEMS, MULTIMEDIA FILES, INTRANET SITES, INTERNET SITES, TELEPHONE OR VOICEMAIL MESSAGES; COMPUTER SERVICES, NAMELY, PROVIDING TEMPORARY USE OF ON-LINE NON-DOWNLOADABLE COMPUTER SOFTWARE FOR ANALYZING AND GENERATING SUMMARIES OF INFORMATION STORED IN DATABASES,

E-MAIL ARCHIVES, DOCUMENT MANAGEMENT SYSTEMS, MULTIMEDIA FILES, INTRANET SITES, INTERNET SITES AND CONTAINED IN TELEPHONE OR VOICEMAIL MESSAGES; COMPUTER SERVICES, NAMELY, PROVIDING TEMPORARY USE OF ON-LINE NON-DOWNLOADABLE COMPUTER SOFTWARE THAT CREATES, UPDATES AND MAINTAINS PROFILES OF USERS OF LOCAL, WIDE-AREA, AND GLOBAL COMPUTER NETWORKS AND DELIVER INFORMATION FROM DATABASE, E-MAIL ARCHIVES, DOCUMENT MANAGEMENT SYSTEMS, MULTIMEDIA FILES, INTRANET SITES, INTERNET SITES AND CONTAINED IN TELEPHONE OR VOICEMAIL MESSAGES BASED ON THOSE PROFILES; COMPUTER SERVICES, NAMELY, PROVIDING TEMPORARY USE OF ON-LINE NON-DOWNLOADABLE COMPUTER SOFTWARE THAT TRANSMITS INFORMATION FROM COMPUTER NETWORK SERVERS, INTRANET AND THE INTERNET TO DESKTOP COMPUTERS, MOBILE TELEPHONES, PERSONAL DIGITAL ASSISTANT AND PORTABLE DIGITAL COMMUNICATION DEVICES; COMPUTER SERVICES, NAMELY, PROVIDING TEMPORARY USE OF ON-LINE NON-DOWNLOADABLE COMPUTER SOFTWARE THAT CREATES, UPDATES AND MAINTAINS CUSTOMIZED PORTAL SITES FOR USERS OF LOCAL, WIDE-AREA AND GLOBAL COMPUTER NETWORKS; COMPUTER SERVICES, NAMELY, PROVIDING TEMPORARY USE OF ON-LINE NON-DOWNLOADABLE COMPUTER SOFTWARE FOR CUSTOMER RELATIONSHIP MANAGEMENT, NAMELY FOR RECEIVING CUSTOMER INQUIRIES VIA TELEPHONE AND E-MAIL, AUTOMATICALLY IDENTIFYING CONCEPTS AND TOPICS CONTAINED IN THOSE INQUIRIES, AUTOMATICALLY GENERATING A RESPONSE TO THOSE INQUIRIES, AND FORWARDING THOSE INQUIRIES TO AN APPROPRIATE TECHNICAL ADVISOR; COMPUTER SERVICES, NAMELY PROVIDING TEMPORARY USE OF ON-LINE NON-DOWNLOADABLE COMPUTER SOFTWARE FOR HUMAN RESOURCES MANAGEMENT, NAMELY, FOR RECEIVING EMPLOYEE INQUIRIES VIA TELEPHONE AND E-MAIL, AUTOMATICALLY IDENTIFYING CONCEPTS AND TOPICS CONTAINED IN THOSE INQUIRIES, AND AUTOMATICALLY GENERATING A RESPONSE TO THOSE INQUIRIES; COMPUTER SERVICES, NAMELY, PROVIDING TEMPORARY USE OF ON-LINE NON-DOWNLOADABLE TEXT RECOGNITION COMPUTER SOFTWARE; COMPUTER SERVICES NAMELY, PROVIDING TEMPORARY USE OF ON-LINE NON-DOWNLOADABLE IMAGE RECOGNITION COMPUTER SOFTWARE; COMPUTER SERVICES, NAMELY, PROVIDING TEMPORARY USE OF ON-LINE NON-DOWNLOADABLE COMPUTER OPERATING SYSTEM SOFTWARE; COMPUTER SERVICES, NAMELY, PROVIDING TEMPORARY USE OF ON-LINE NON-DOWNLOADABLE COMPUTER SOFTWARE FOR USE IN DATA RETRIEVAL, MANAGEMENT AND DELIVERY IN KNOWLEDGE MANAGEMENT, NEW MEDIA, CUSTOMER RELATIONSHIP MANAGEMENT, ON-LINE PUBLISHING AND E-COMMERCE COMPUTER SOFTWARE APPLICA-

TION; COMPUTER SERVICES, NAMELY, PROVIDING TEMPORARY USE OF ON-LINE NON-DOWNLOADABLE COMPUTER SOFTWARE FOR PROVIDING ON-LINE NAVIGATION OF THE GLOBAL COMPUTER INFORMATION NETWORK AND FOR RUNNING WEB-SITE SEARCHES; COMPUTER SERVICES, NAMELY, PROVIDING TEMPORARY USE OF ON-LINE NON-DOWNLOADABLE COMPUTER SOFTWARE FOR PERFORMING CONCEPT MATCHING, NAMELY, SEARCHING DATA AND RETURNING REFERENCES TO DOCUMENTS THAT ARE CONCEPTUALLY RELATED TO THE CONTENT IDENTIFIED AS THE INITIAL REFERENCE COMPUTER SERVICES, NAMELY, PROVIDING TEMPORARY USE OF ON-LINE NON-DOWNLOADABLE COMPUTER SOFTWARE USED TO DEVELOP COMPUTER PROGRAMS FOR MANAGING MULTIMEDIA CONTENT, CUSTOMER SERVICES, ON-LINE PUBLISHING AND ELECTRONIC COMMERCE; COMPUTER SERVICES, NAMELY, PROVIDING TEMPORARY USE OF ON-LINE NON-DOWNLOADABLE COMPUTER SOFTWARE FOR CREATING, MAINTAINING AND UPDATING SOFTWARE AGENTS THAT AUTOMATICALLY AND SYSTEMATICALLY CONDUCT SEARCHES OF DATABASES, INTRANET AND THE INTERNET; COMPUTER SERVICES, NAMELY, PROVIDING TEMPORARY USE OF ON-LINE NON-DOWNLOADABLE COMPUTER SEARCH ENGINE SOFTWARE; COMPUTER SERVICES, NAMELY, PROVIDING TEMPORARY USE OF ON-LINE NON-DOWNLOADABLE COMPUTER SOFTWARE USED FOR CONDUCTING STANDARD TEXT SEARCHES; COMPUTER SERVICES, NAMELY, PROVIDING TEMPORARY USE OF ON-LINE NON-DOWNLOADABLE COMPUTER PROGRAMS THAT ALLOWS OTHER COMPUTER PROGRAMS TO ADAPT THEIR BEHAVIOR ACCORDING TO USE'S A INSTRUCTIONS OR RESPONSES BY PERSONALIZING AND PROFILING FOR INDIVIDUAL END-USERS THE RETRIEVAL MANAGEMENT, AND DELIVERY OF DATA IN KNOWLEDGE MANAGEMENT, NEW MEDIA, CUSTOMER RELATIONSHIP MANAGEMENT, AND E-COMMERCE COMPUTER SOFTWARE APPLICATIONS; COMPUTER SERVICES, NAMELY PROVIDING TEMPORARY USE OF ON-LINE NON-DOWNLOADABLE COMPUTER PROGRAMS THAT ALLOW OTHER COMPUTER PROGRAMS TO ADAPT THEIR BEHAVIOR ACCORDING TO A USER'S INSTRUCTIONS OR RESPONSES BY PERSONALIZING AND PROFILING THE INDIVIDUAL END-USERS THE RETRIEVAL, MANAGEMENT, AND DELIVERY OF DATA IN KNOWLEDGE MANAGEMENT, NEW MEDIA, CUSTOMER RELATIONSHIP MANAGEMENT, AND E-COMMERCE COMPUTER SOFTWARE APPLICATION; COMPUTER SERVICES, NAMELY, PROVIDING TEMPORARY USE OF ON-LINE NON-DOWNLOADABLE COMPUTER SOFTWARE FOR MANAGEMENT AND PROCESSING OF ELECTRONIC COMMERCE TRANSACTIONS; COMPUTER SERVICES, NAMELY, PROVIDING TEMPORARY USE OF ON-LINE NON-DOWNLOADABLE COMPUTER SOFTWARE FOR MANAGEMENT AND PROCESSING OF ELECTRONIC COMMERCE TRANSACTION; COMPUTER SERVICES, NAMELY, PROVIDING TEMPORARY USE ON

ON-LINE NON-DOWNLOADABLE COMPUTER SOFTWARE USED TO RETRIEVE INFORMATION ABOUT CURRENT EVENTS, BUSINESS, AND SPORTS FROM DATABASES, INTERNET, INTRANET AND OTHER COMPUTER NETWORKS AND TRANSMITTING THE SAME VIA COMPUTER DATA NETWORKS, MOBILE TELEPHONES, PERSONAL DIGITAL ASSISTANTS AND OTHER PORTABLE DIGITAL COMMUNICATION DEVICE; COMPUTER SERVICES, NAMELY, PROVIDING TEMPORARY USE OF ON-LINE NON-DOWNLOADABLE COMPUTER SOFTWARE FOR E-MAIL MANAGEMENT; COMPUTER SERVICES, NAMELY, PROVIDING TEMPORARY USE OF ON-LINE NON-DOWNLOADABLE COMPUTER SOFTWARE THAT ALERTS USERS OF COMPUTER NETWORKS TO THE EXISTENCE OF AND CONTACT INFORMATION FOR OTHER USERS WITH COMMON INTERESTS; COMPUTER SERVICES, NAMELY, PROVIDING TEMPORARY USE OF ON-LINE NON-DOWNLOADABLE COMPUTER SOFTWARE OF DATA ANALYSIS; COMPUTER CONSULTATION; COMPUTER SOFTWARE DESIGN FOR OTHERS; MAINTENANCE OF COMPUTER SOFTWARE AND PROGRAMS FOR OTHERS; INSTALLATION OF COMPUTER SOFTWARE AND PROGRAMS FOR OTHERS; RENTAL OF COMPUTER SOFTWARE; COMPUTER SOFTWARE DESIGN SERVICES AND CONSULTING SERVICES IN THE FIELDS OF KNOWLEDGE MANAGEMENT, NEW MEDIA, AND E-COMMERCE COMPUTER SOFTWARE APPLICATIONS THAT PROVIDE INFORMATION VIA THE GLOBAL COMPUTER INFORMATION NETWORK, MOBILE TELEPHONES, PERSONAL DIGITAL ASSISTANTS AND PORTABLE DIGITAL COMMUNICATION DEVICES; COMPUTER SERVICES FOR CONCEPT MATCHING, NAMELY

SEARCHING FOR DATA ON COMPUTER NETWORKS, INTRANET AND THE INTERNET AND IDENTIFYING CONCEPTUALLY RELATED DOCUMENTS AVAILABLE ON COMPUTER NETWORKS, INTRANET AND THE INTRANET; COMPUTER SERVICES NAMELY, CREATING, UPDATING, MAINTAINING AND PROVIDING TEMPORARY USE OF ON-LINE NON-DOWNLOADABLE SOFTWARE USED TO CREATE, UPDATE AND MAINTAIN COMPUTER SOFTWARE AGENTS THAT CONDUCT USER-SPECIFIED TEXT SEARCHES ON AN AUTOMATIC AND SYSTEMATIC BASIS; COMPUTER SERVICES, NAMELY, DESIGNING, MAINTAINING AND UPDATING COMPUTER SOFTWARE USED TO NAVIGATE THE INTERNET AND CONDUCT SEARCHES ON WEBSITE; WEBSITE DESIGN AND HOSTING SERVICES FOR OTHERS; DATABASE SEARCHING SERVICES FOR OTHERS; PROVIDING DESIGN, DEVELOPMENT, CUSTOMIZATION, IMPLEMENTATION AND MAINTENANCE SERVICES IN RESPECT OF KNOWLEDGE MANAGEMENT, NEW MEDIA, E-COMMERCE, ON-LINE PUBLISHING, E-MAIL ROUTING, BUSINESS INTELLIGENCE, ENTERPRISE INFORMATION PORTALS, CUSTOMER RELATIONSHIP AND DOCUMENT MANAGEMENT SOFTWARE, IN CLASS 42 (U.S. CLS. 100 AND 101).

PRIORITY CLAIMED UNDER SEC. 44(D) ON UNITED KINGDOM APPLICATION NO. 2264514, FILED 3-16-2001, REG. NO. 2264514, DATED 12-14-2001, EXPIRES 3-16-2011.

SER. NO. 76-300,214, FILED 6-29-2001.

ANN LINNEHAN, EXAMINING ATTORNEY

Int. Cl.: 5

Prior U.S. Cls.: 6, 18, 44, 46, 51 and 52

United States Patent and Trademark Office

Reg. No. 2,892,291

Registered Oct. 12, 2004

**TRADEMARK
PRINCIPAL REGISTER**

BLISTOBAN

SEABERG COMPANY, INC. (OREGON CORPORATION)
4909 S. COAST HIGHWAY
NEWPORT, OR 97365

POLYURETHANE, IN CLASS 5 (U.S. CLS. 6, 18, 44, 46, 51 AND 52).

FIRST USE 4-10-2003; IN COMMERCE 4-10-2003.

FOR: ADHESIVE BANDAGES FOR RELIEVING SKIN FRICTION IN THE NATURE OF A THIN FILM OF ADHESIVE BACKED POLETHYLENE OR

SER. NO. 76-300,996, FILED 8-17-2001.

BRIDGETT SMITH, EXAMINING ATTORNEY

Int. Cls.: 37, 40 and 42

Prior U.S. Cls.: 100, 101, 103 and 106

United States Patent and Trademark Office

Reg. No. 2,892,292

Registered Oct. 12, 2004

**SERVICE MARK
PRINCIPAL REGISTER**

PREMIER POWER

PROGRESS ENERGY SERVICE COMPANY, LLC
(NORTH CAROLINA LIMITED LIABILITY
COMPANY)
POST OFFICE BOX 1551
RALEIGH, NC 27602

FOR: INSTALLATION, SUPERVISION AND
MAINTENANCE OF ELECTRICAL POWER GEN-
ERATOR SYSTEMS THAT PROTECT AGAINST
INTERMEDIATE AND LONG-TERM OUTAGES
TO COMMERCIAL, GOVERNMENTAL AND IN-
DUSTRIAL LOCATION, IN CLASS 37 (U.S. CLS. 100,
103 AND 106).

FIRST USE 2-0-1998; IN COMMERCE 2-0-1998.

FOR: LEASING AND RENTAL OF ELECTRICITY
GENERATOR SYSTEMS, IN CLASS 40 (U.S. CLS. 100,
103 AND 106).

FIRST USE 2-0-1998; IN COMMERCE 2-0-1998.

FOR: CONSULTING IN THE FIELD OF PROVID-
ING ELECTRICAL POWER PROTECTION PRO-
GRAMS, IN CLASS 42 (U.S. CLS. 100 AND 101).

FIRST USE 2-0-1998; IN COMMERCE 2-0-1998.

NO CLAIM IS MADE TO THE EXCLUSIVE
RIGHT TO USE "POWER", APART FROM THE
MARK AS SHOWN.

SER. NO. 76-306,351, FILED 8-29-2001.

SCOTT OSCLICK, EXAMINING ATTORNEY

Int. Cl.: 12

Prior U.S. Cls.: 19, 21, 23, 31, 35 and 44

Reg. No. 2,892,293

United States Patent and Trademark Office

Registered Oct. 12, 2004

**TRADEMARK
PRINCIPAL REGISTER**



BOSCH, W. BRUCE (UNITED STATES INDIVIDUAL)
3615 N.W. BLISS ROAD
VANCOUVER, WA 98685 AND
BOSCH, M. FRAN (UNITED STATES INDIVIDUAL)
3615 N.W. BLISS ROAD
VANCOUVER, WA 98685

FOR: METAL AUTOMOTIVE PARTS FOR EIGHTEEN WHEELER TRUCKING RIGS, NAMELY, AIR TANKS, WATER TANKS, FUEL TANKS, FLANGES, FUEL CAPS, DRAW AND RETURN TUBE ASSEMBLIES COMPRISED OF FUEL DRAW TUBES AND FUEL RETURN TUBES FOR USE IN FUEL TANKS, AND ANTI-SIPHON ASSEMBLIES COMPRISED OF SIPHON HOSE BARRIERS IN THE NATURE OF

SCREENS AND CRIMPED TUBES, FOR USE ON FUEL TANK INLETS, IN CLASS 12 (U.S. CLS. 19, 21, 23, 31, 35 AND 44).

FIRST USE 4-5-1966; IN COMMERCE 4-5-1966.

THE MARK CONSISTS OF A RECTANGULAR BLOCK HAVING A CAPITAL "T" POSITIONED THEREIN, WHEREIN THE WORD "TEMCO" IS POSITIONED INSIDE THE CROSSBAR OF THE CAPITAL "T".

SER. NO. 76-307,132, FILED 8-29-2001.

WON TEAK OH, EXAMINING ATTORNEY

Int. Cl.: 39

Prior U.S. Cls.: 100 and 105

United States Patent and Trademark Office

Reg. No. 2,892,294

Registered Oct. 12, 2004

SERVICE MARK
PRINCIPAL REGISTER



TIGER TEAM MOVERS, INC. (ARIZONA CORPORATION)
21088 E. ORCHARD LANE
QUEEN CREEK, AZ 85242

THE MARK CONSISTS OF AN ADULT TIGER CARRYING A BABY TIGER BY THE NAPE OF THE NECK IN COMBINATION WITH THE WORDS "TIGER TEAM MOVERS".

FOR: FURNITURE MOVING, IN CLASS 39 (U.S. CLS. 100 AND 105).

FIRST USE 5-1-2001; IN COMMERCE 5-1-2001.

SER. NO. 76-308,624, FILED 9-6-2001.

NO CLAIM IS MADE TO THE EXCLUSIVE RIGHT TO USE "MOVERS" , APART FROM THE MARK AS SHOWN.

KHANH LE, EXAMINING ATTORNEY

Int. Cls.: 3 and 5

Prior U.S. Cls.: 1, 4, 6, 18, 44, 46, 50, 51 and 52

Reg. No. 2,892,295

United States Patent and Trademark Office

Registered Oct. 12, 2004

**TRADEMARK
PRINCIPAL REGISTER**

GREAT SKIN IN 60 DAYS

RODAN & FIELDS INC. (DELAWARE CORPORATION)
767 FIFTH AVENUE
42ND. FLOOR
NEW YORK, NY 10153

FOR: COSMETICS, NAMELY, AFTER-SHAVE LOTIONS, AFTER-SUN LOTIONS, ANTI-AGING CREAM, ANTI-BACTERIAL SOAP, ANTI-WRINKLE CREAM, SHAVING BALM, BATH BEADS, BATH CRYSTALS, BATH FOAM, BATH GEL, BATH OIL, BATH PEARLS, BATH POWDER, NON-MEDICATED BATH SALTS, BEAUTY MASKS, BLUSH, BLUSHER, BODY CREAM, BODY EMULSIONS, BODY MASKS CREAMS, BODY MASK LOTIONS, BODY MASK POWDERS, BODY MASKS, BODY OIL, BODY POWER, BODY SCRUBS, BUBBLE BATH, COCOA BUTTER FOR COSMETIC PURPOSES, COLD CREAM, EYE CREAM, HAIR REMOVING CREAM, NIGHT CREAM, SHAVING CREAM, VANISHING CREAM, CREAMS FOR CELLULITE REDUCTION, DEODORANT SOAP, DEPILATORIES, DEPILATORY CREAMS, EYE SHADOW, SHAVING GEL, SHOWER GEL, LIP GLOSS, HAIR BLEACH, HAIR BLEACHING PREPARATIONS, NON-MEDICATED HAIR CARE PREPARATIONS, HAIR CLEANING PREPARATIONS, HAIR COLOR REMOVERS, HAIR COLOR, HAIR CONDITIONERS, HAIR DRESSINGS FOR MEN, HAIR DYE, HAIR GEL, HAIR LIGHTENERS, HAIR LOTIONS, HAIR MASCARA, HAIR MOUSSE, HAIR POMADES, HAIR RELAXERS, HAIR RELAXING PREPARATIONS, HAIR REMOVING CREAM, HAIR RINSES, HAIR SPRAY, HAIR STRAIGHTENING PREPARATIONS, HAIR STYLING PREPARATIONS, HAIR WAVING LOTION, NON-MEDICATED LIP BALM, LIP LINER, LIPSTICK, EYE MAKEUP, MAKEUP, MASSAGE OIL, MEDICATED SOAPS, NAIL CREAM, NAIL BUFFING PREPARATIONS, NAIL

ENAMEL, NAIL GLITTER, NAIL GROOMING PRODUCTS, NAMELY, TIPS, GLUE, LACQUER AND GLITTER, NAIL HARDENERS, NAIL POLISH BASE COAT, NAIL POLISH REMOVER, NAIL POLISH TOP COAT, NAIL POLISH, NAIL STRENGTHENERS, NON-MEDICATED BODY SOAKS, PERFUME OILS, LIP POMADES, ROUGE, SACHETS, SCENTED BODY SPRAY, SELF TANNING LOTIONS, SUN BLOCKS, SUN CREAMS, SUN TAN GEL, SUN TAN LOTION, TALCUM POWDER AND PERFUME, NON-MEDICATED SKIN CARE PRODUCTS, NAMELY, SKIN CONCEALERS, SKIN CONDITIONERS, SKIN CREAM, SKIN LOTIONS, SKIN MOISTURIZERS, SKIN FACIAL MOUSSE, PATCHES CONTAINING SUN SCREEN AND SUN BLOCK FOR USE ON THE SKIN, SKIN ABRASIVE PREPARATIONS, SKIN CLARIFIERS, SKIN CLEANSERS, SKIN CLEANING CREAM, SKIN CLEANSING LOTION, SKIN EMOLLIENTS, SKIN GELS FOR ACCELERATING, ENHANCING OR EXTENDING TANS, SKIN LIGHTENERS SKIN MASKS, SKIN MOISTURIZER MASKS, SKIN SOAP, SKIN TEXTURIZERS, SKIN TONERS, SKIN WHITENING CREAMS AND WRINKLE REMOVING SKIN CARE PREPARATIONS, IN CLASS 3 (U.S. CLS. 1, 4, 6, 50, 51 AND 52).

FIRST USE 5-15-2002; IN COMMERCE 5-15-2002.

FOR: MEDICATED SKIN CARE PREPARATIONS, IN CLASS 5 (U.S. CLS. 6, 18, 44, 46, 51 AND 52).

FIRST USE 5-15-2002; IN COMMERCE 5-15-2002.

SER. NO. 76-309,659, FILED 9-7-2001.

BERYL GARDNER, EXAMINING ATTORNEY

Int. Cl.: 9

Prior U.S. Cls.: 21, 23, 26, 36 and 38

United States Patent and Trademark Office

Reg. No. 2,892,296

Registered Oct. 12, 2004

TRADEMARK
PRINCIPAL REGISTER



HEALTH DATA CARD L.L.C. (NEBRASKA LIMITED LIABILITY COMPANY)

9910 NORTH 48TH STREET

OMAHA, NE 68152

FOR: COMPUTER SOFTWARE USED FOR READING, WRITING AND ENCODING MEDICAL INFORMATION ONTO SMART CARDS, IN CLASS 9 (U.S. CLS. 21, 23, 26, 36 AND 38).

FIRST USE 1-1-2001; IN COMMERCE 1-1-2001.

NO CLAIM IS MADE TO THE EXCLUSIVE RIGHT TO USE "HEALTH DATA CARD", APART FROM THE MARK AS SHOWN.

THE MARK CONSISTS OF A GOLD CADUCEUS SYMBOL NEXT TO RED WITH GOLD TRIM CAPITAL LETTERS "HDC" ABOVE THE WORDS "HEALTH DATA CARD" IN BLUE.

SER. NO. 76-310,650, FILED 9-10-2001.

CAROLYN CATALDO, EXAMINING ATTORNEY

Int. Cls.: 9, 37, 38 and 41

**Prior U.S. Cls.: 21, 23, 26, 36, 38, 100, 101, 103, 104,
106 and 107**

Reg. No. 2,892,297

United States Patent and Trademark Office

Registered Oct. 12, 2004

**TRADEMARK
SERVICE MARK
PRINCIPAL REGISTER**

SIERRA TEL NETWORKS DIGITAL SOLUTIONS

SIERRA TEL COMMUNICATIONS GROUP (CALIFORNIA CORPORATION)
POST OFFICE BOX 219
OAKHURST, CA 93644

FOR: TELEPHONES; CELLULAR TELEPHONES; RADIO PAGERS; TELECOMMUNICATION EQUIPMENT, NAMELY, ISDN TERMINAL ADAPTORS, HDSL ADAPTORS, ROUTERS, ACCESS SERVERS, TELECOMMUNICATION SWITCHES, HUBS, AND PROTOCOL CONVERTERS; TWO-WAY RADIOS; TELEPHONE ANSWERING MACHINES; AND TELEPHONE APPARATUS, NAMELY INTERCOMS, IN CLASS 9 (U.S. CLS. 21, 23, 26, 36 AND 38).

FIRST USE 6-1-2001; IN COMMERCE 6-1-2001.

FOR: MAINTENANCE, REPAIR AND INSTALLATION OF COMPUTER NETWORKS, IN CLASS 37 (U.S. CLS. 100, 103 AND 106).

FIRST USE 6-1-2001; IN COMMERCE 6-1-2001.

FOR: TELECOMMUNICATIONS SERVICES, NAMELY, AUDIO TELECONFERENCING, CELLULAR TELEPHONE SERVICES, ELECTRONIC MAIL SERVICES, ELECTRONIC TRANSMISSION OF DATA AND DOCUMENTS VIA COMPUTER TERMINALS, ELECTRONIC VOICE MESSAGING, NAMELY, THE RECORDING, STORAGE, AND SUBSEQUENT TRANSMISSION OF VOICE MESSA-

GES BY TELEPHONE, FACSIMILE TRANSMISSION, ISDN SERVICES, GATEWAY SERVICES, PAGING SERVICES, PBX DIALING SERVICES, PABX DIALING SERVICES, RENTAL OF TELECOMMUNICATION EQUIPMENT, TELEPHONE COMMUNICATION SERVICES, VIDEO TELECONFERENCING, VIDEOTEXT SERVICES, WIRELESS DIGITAL MESSAGING SERVICES, WIRELESS FACSIMILE MAIL SERVICES, AND PROVIDING TELECOMMUNICATIONS CONNECTIONS TO A GLOBAL COMPUTER NETWORK, IN CLASS 38 (U.S. CLS. 100, 101 AND 104).

FIRST USE 6-1-2001; IN COMMERCE 6-1-2001.

FOR: COMPUTER EDUCATION TRAINING SERVICES, IN CLASS 41 (U.S. CLS. 100, 101 AND 107).

FIRST USE 6-1-2001; IN COMMERCE 6-1-2001.

OWNER OF U.S. REG. NO. 2,478,286.

NO CLAIM IS MADE TO THE EXCLUSIVE RIGHT TO USE "TEL NETWORKS DIGITAL SOLUTIONS", APART FROM THE MARK AS SHOWN.

SER. NO. 76-311,609, FILED 9-10-2001.

JILL C. ALT, EXAMINING ATTORNEY

Int. Cls.: 9, 35 and 42

Prior U.S. Cls.: 21, 23, 26, 36, 38, 100, 101 and 102

Reg. No. 2,892,298

United States Patent and Trademark Office

Registered Oct. 12, 2004

**TRADEMARK
SERVICE MARK
PRINCIPAL REGISTER**

AVEVA

AVEVA GROUP PLC (ENGLAND CORPORATION)
HIGH CROSS, MADINGLEY ROAD
CAMBRIDGE, UNITED KINGDOM CB3 0HB

FOR: COMPUTER SOFTWARE, NAMELY, DATA MANAGEMENT, PROJECT MANAGEMENT AND COMPUTER-AIDED DESIGN SOFTWARE FOR THE CONSTRUCTION, ENGINEERING, PETRO-CHEMICAL, BIOCHEMICAL, BIOTECHNOLOGY, CHEMICAL, FOOD PROCESSING, OIL AND GAS, OIL AND GAS TRANSPORTATION AND STORAGE, SHIP BUILDING, NUCLEAR, POWER PLANT, WASTE DISPOSAL, CEMENT, TRANSPORT INDUSTRIES AND ALL PROCESS AND POWER INDUSTRIES WHICH INVOLVE CONTINUOUS MANUFACTURING OR PROCESSING, IN CLASS 9 (U.S. CLS. 21, 23, 26, 36 AND 38).

FOR: BUSINESS MANAGEMENT AND BUSINESS MANAGEMENT CONSULTATION, IN CLASS 35 (U.S. CLS. 100, 101 AND 102).

FOR: COMPUTER SERVICES, NAMELY, PROVIDING CONSULTANCY, INFORMATION, DESIGN, TESTING, RESEARCH AND ADVISING SERVICES, ALL RELATING TO COMPUTING AND COMPUTER PROGRAMMING; COMPUTER SYSTEMS ANALYSIS; RESEARCH AND DEVELOPMENT OF COMPUTER HARDWARE AND SOFTWARE, IN CLASS 42 (U.S. CLS. 100 AND 101).

PRIORITY CLAIMED UNDER SEC. 44(D) ON UNITED KINGDOM APPLICATION NO. 2265173, FILED 3-22-2001, REG. NO. 2265173, DATED 3-22-2001, EXPIRES 3-22-2011.

SER. NO. 76-315,666, FILED 9-21-2001.

AMOS T. MATTHEWS, JR., EXAMINING ATTORNEY

Int. Cl.: 7

Prior U.S. Cls.: 13, 19, 21, 23, 31, 34 and 35

United States Patent and Trademark Office

Reg. No. 2,892,299

Registered Oct. 12, 2004

**TRADEMARK
PRINCIPAL REGISTER**

**YARN
PUNCHER**

TEXTILMASCHINENFABRIK DR. ERNST FEHR-
ER AKTIENGESELLSCHAFT (AUSTRIA
JOINT STOCK CORPORATION)
WEGSCHEIDER STR. 15
A-4060 LEONDING, AUSTRIA

FOR: MACHINES FOR PROCESSING YARNS,
NAMELY, YARN STRENGTHENING MACHINES
CONTAINING NEEDLES AND BARB-LIKE INDEN-
TATIONS OR NOTCHES USED TO PULL FIBER
LOOPS TRANSVERSE TO THE LONGITUDINAL
DIRECTION OF THE YARN TO CREATE INTER-
LOCKED FIBERS THAT MAKE THE YARN STRON-
GER, IN CLASS 7 (U.S. CLS. 13, 19, 21, 23, 31, 34 AND
35).

FIRST USE 11-20-2000; IN COMMERCE 11-20-2000.

PRIORITY CLAIMED UNDER SEC. 44(D) ON
AUSTRIA APPLICATION NO. M2264/2001, FILED 3-

26-2001, REG. NO. 198306, DATED 3-26-2001, EX-
PIRES 3-26-2011.

NO CLAIM IS MADE TO THE EXCLUSIVE
RIGHT TO USE "YARN", APART FROM THE
MARK AS SHOWN.

THE MARK CONSISTS OF THE WORDS YARN
PUNCHER WITHIN A BLACK RECTANGLE, WITH
A PURPLE OR VIOLET HORIZONTAL LINE
THROUGH THE CENTER OF THE RECTANGLE.
COLOR IS CLAIMED AS A FEATURE OF THE
MARK.

SER. NO. 76-315,754, FILED 9-21-2001.

JOHN SCHUYLER YARD, EXAMINING ATTOR-
NEY

Int. Cls.: 9 and 41

Prior U.S. Cls.: 21, 23, 26, 36, 38, 100, 101 and 107

United States Patent and Trademark Office

Reg. No. 2,892,300

Registered Oct. 12, 2004

**TRADEMARK
SERVICE MARK
PRINCIPAL REGISTER**

THE CASH FLOW SYSTEMS

SDI LEGRAND PUBLISHING, INC. (FLORIDA CORPORATION)
9799 OLD ST. AUGUSTINE ROAD
JACKSONVILLE, FL 32257

FOR: EDUCATIONAL KIT CONSISTING OF PRE-RECORDED VIDEO AND AUDIOCASSETTES, INSTRUCTION BOOKLETS AND COMPUTER SOFTWARE PRESENTING REAL ESTATE INVESTMENT INSTRUCTION AIMED AT ACHIEVING PERSONAL WEALTH, IN CLASS 9 (U.S. CLS. 21, 23, 26, 36 AND 38).

FIRST USE 0-0-1995; IN COMMERCE 0-0-1995.

FOR: SERVICES, NAMELY CONDUCTING SEMINARS, PROGRAMS OF INSTRUCTION, LEC-

TURES, AND COURSES OF INSTRUCTION PRESENTING REAL ESTATE INVESTMENT INSTRUCTION AIMED AT ACHIEVING PERSONAL WEALTH, IN CLASS 41 (U.S. CLS. 100, 101 AND 107).

FIRST USE 0-0-1995; IN COMMERCE 0-0-1995.

NO CLAIM IS MADE TO THE EXCLUSIVE RIGHT TO USE "SYSTEMS", APART FROM THE MARK AS SHOWN.

SER. NO. 76-317,392, FILED 9-26-2001.

DOMINICK J. SALEMI, EXAMINING ATTORNEY

Int. Cl.: 3

Prior U.S. Cls.: 1, 4, 6, 50, 51 and 52

United States Patent and Trademark Office

Reg. No. 2,892,301

Registered Oct. 12, 2004

**TRADEMARK
PRINCIPAL REGISTER**

BIO-ZA

BIO-K PLUS INTERNATIONAL INC. (CANADA
CORPORATION)

495, BOUL. ARMAND FRAPPIER

LAVAL, QUEBEC, CANADA H7V 4A7

FOR: BODY CREAM, IN CLASS 3 (U.S. CLS. 1, 4, 6,
50, 51 AND 52).

PRIORITY CLAIMED UNDER SEC. 44(D) ON
CANADA APPLICATION NO. 1109946, FILED 7-18-
2001, REG. NO. TMA588,030, DATED 8-25-2003, EX-
PIRES 8-25-2018.

SER. NO. 76-319,316, FILED 9-28-2001.

CHRIS WELLS, EXAMINING ATTORNEY

Int. Cl.: 3

Prior U.S. Cls.: 1, 4, 6, 50, 51 and 52

United States Patent and Trademark Office

Reg. No. 2,892,302

Registered Oct. 12, 2004

**TRADEMARK
PRINCIPAL REGISTER**

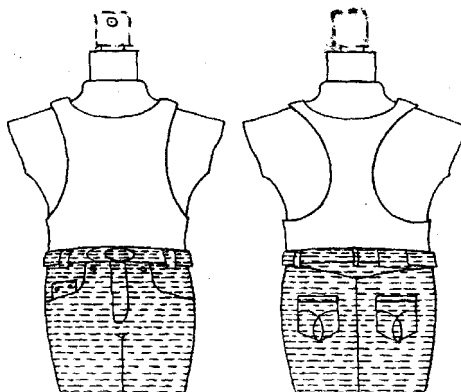

U.S. PERFUME HOUSE, INC. (NEW YORK CORPORATION)
5723 SECOND AVENUE
BROOKLYN, NY 11220

FOR: FRAGRANCES, NAMELY, PERFUMES, IN CLASS 3 (U.S. CLS. 1, 4, 6, 50, 51 AND 52).

FIRST USE 1-30-1998; IN COMMERCE 1-30-1998.

THE BOTTOM PORTION OF THE DRAWING IS LINED FOR THE COLOR SILVER.

THE MARK CONSISTS OF THE CONFIGURATION OF THE CONTAINER FOR THE GOODS,

NAMELY, PERFUMES. THE BOTTLE IS TRANSLUCENT. THE BOTTLE IS IN THE STYLIZED SHAPE OF THE MALE TORSO DRESSED IN A TANK TOP AND WEARING A PAIR OF JEANS. THE TANK TOP IS SLIGHTLY FROSTED AND THE JEANS ARE SILVER. THE DRAWING SHOWS THE FRONT AND THE BACK OF THE MARK. THE BOTTOM PORTION IS LINED FOR COLOR, NAMELY, SILVER.

SER. NO. 76-319,378, FILED 10-1-2001.

AMY GEARIN, EXAMINING ATTORNEY

Int. Cls.: 35 and 41

Prior U.S. Cls.: 100, 101, 102 and 107

United States Patent and Trademark Office

Reg. No. 2,892,303

Registered Oct. 12, 2004

**SERVICE MARK
PRINCIPAL REGISTER**

MYSTIC ENTERTAINMENT

LITTLE SIX, INC. (MINNESOTA CORPORATION
ORGANIZED AND EXISTING UNDER THE
LAWS OF THE SHAKOPEE MDEWAKANTON
SIOUX COMMUNITY)
2400 MYSTIC LAKE BOULEVARD
PRIOR LAKE, MN 55372

FOR: PROMOTING MUSICAL, SPORTING, CO-
MEDY, AND CELEBRITY PERFORMANCES AND
EVENTS, IN CLASS 35 (U.S. CLS. 100, 101 AND 102).

FIRST USE 7-28-2001; IN COMMERCE 7-29-2001.

FOR: ENTERTAINMENT SERVICES, NAMELY
PROVIDING LIVE ENTERTAINMENT IN THE NAT-
URE OF MUSICAL, SPORTING, COMEDY, AND

CELEBRITY PERFORMANCES AND EVENTS, IN
CLASS 41 (U.S. CLS. 100, 101 AND 107).

FIRST USE 7-29-2001; IN COMMERCE 7-29-2001.

OWNER OF U.S. REG. NOS. 1,783,495, 2,487,315
AND OTHERS.

NO CLAIM IS MADE TO THE EXCLUSIVE
RIGHT TO USE "ENTERTAINMENT", APART
FROM THE MARK AS SHOWN.

SER. NO. 76-322,519, FILED 10-5-2001.

CAROL SPILS, EXAMINING ATTORNEY

Int. Cl.: 30

Prior U.S. Cl.: 46

United States Patent and Trademark Office

Reg. No. 2,892,304

Registered Oct. 12, 2004

**TRADEMARK
PRINCIPAL REGISTER**

RUDOLPH'S ROAST

BOYD COFFEE COMPANY (OREGON COR-
PORATION)
19730 N.E. SANDY BOULEVARD
PORTLAND, OR 97230

NO CLAIM IS MADE TO THE EXCLUSIVE
RIGHT TO USE "ROAST", APART FROM THE
MARK AS SHOWN.

FOR: COFFEE, IN CLASS 30 (U.S. CL. 46).

SER. NO. 76-325,647, FILED 10-15-2001.

FIRST USE 11-0-1996; IN COMMERCE 11-0-1996.

CAROL SPILS, EXAMINING ATTORNEY

Int. Cls.: 16, 25, 35, 38, 41 and 42

Prior U.S. Cls.: 2, 5, 22, 23, 29, 37, 38, 39, 50, 100, 101, 102, 104 and 107

Reg. No. 2,892,305

United States Patent and Trademark Office

Registered Oct. 12, 2004

**TRADEMARK
SERVICE MARK
PRINCIPAL REGISTER**

ALLOY

ALLOY, INC. (DELAWARE CORPORATION)
151 WEST 26TH STREET, 11TH FLOOR
NEW YORK, NY 10001

FOR: PERIODICALS AND PRINTED PUBLICATION, NAMELY BOOKS, CATALOGUES AND MAGAZINES FOR TEENAGERS RELATING TO TEEN-RELATED ISSUES AND INTERESTS, IN CLASS 16 (U.S. CLS. 2, 5, 22, 23, 29, 37, 38 AND 50).

FIRST USE 6-0-1997; IN COMMERCE 6-0-1997.

FOR: CLOTHING, NAMELY T-SHIRTS, JACKETS, HATS, PANTS AND SHORTS FOR TEENAGERS AND YOUNG ADULTS, IN CLASS 25 (U.S. CLS. 22 AND 39).

FIRST USE 8-0-1997; IN COMMERCE 8-0-1997.

FOR: ON-LINE RETAIL STORE SERVICES FEATURING TEENAGER AND YOUNG ADULT FASHION AND CLOTHING, ACCESSORIES, BOOKS, MAGAZINES, CATALOGUES, ENTERTAINMENT AND RECREATIONAL GOODS; ADVERTISING SERVICES, NAMELY, PROMOTING THE GOODS AND SERVICES OF OTHERS BY PREPARING AND PLACING ADVERTISEMENTS ON GLOBAL COMPUTER NETWORKS, IN CLASS 35 (U.S. CLS. 100, 101 AND 102).

FIRST USE 8-0-1997; IN COMMERCE 8-0-1997.

FOR: WIRELESS SERVICES, NAMELY, WIRELESS DIGITAL MESSAGING SERVICES, IN CLASS 38 (U.S. CLS. 100, 101 AND 104).

FIRST USE 9-0-2000; IN COMMERCE 9-0-2000.

FOR: ENTERTAINMENT AND EDUCATIONAL SERVICES, NAMELY PROVIDING AN ON-LINE COMPUTER DATABASE FEATURING INFORMATION IN THE FIELD OF CELEBRITY NEWS, MOVIES, CONCERTS, MUSIC, FICTION AND NON-FICTION BOOKS, POETRY, QUIZZES, COLLEGE COURSEWORK AND COURSEWORK EXAMINATIONS, IN CLASS 41 (U.S. CLS. 100, 101 AND 107).

FIRST USE 3-0-1998; IN COMMERCE 3-0-1998.

FOR: COMPUTER SERVICES, NAMELY, DESIGNING AND IMPLEMENTING WEB SITES FOR OTHERS; PROVIDING FASHION INFORMATION ONLINE, IN CLASS 42 (U.S. CLS. 100 AND 101).

FIRST USE 10-0-1999; IN COMMERCE 10-0-1999.

OWNER OF U.S. REG. NO. 2,229,184.

SER. NO. 76-327,048, FILED 10-18-2001.

BARBARA A. LOUGHRAN, EXAMINING ATTORNEY

Int. Cl.: 35

Prior U.S. Cls.: 100, 101 and 102

United States Patent and Trademark Office

Reg. No. 2,892,306

Registered Oct. 12, 2004

**SERVICE MARK
PRINCIPAL REGISTER**

CHAMPIONSHIP SPORTS MARKETING

CHAMPIONSHIP SPORTS MARKETING, INC.
(GEORGIA CORPORATION)
3690 NORTH PEACHTREE ROAD
ATLANTA, GA 30341

FOR: PROMOTING GOODS AND SERVICES OF OTHERS BY ARRANGING SPONSORS TO AFFILIATE THEIR GOODS AND SERVICES WITH ENTERTAINMENT AND SPORTING EVENTS; BUSINESS MARKETING CONSULTING SERVICES IN THE FIELDS OF ENTERTAINMENT AND SPORTING EVENTS; DIRECT MARKETING ADVERTISING FOR OTHERS IN THE FIELDS OF ENTERTAINMENT AND SPORTING EVENTS; PREPARING PROMOTIONAL MATERIALS FOR OTHERS IN THE FIELDS OF ENTERTAINMENT AND SPORT-

ING EVENTS; AND BUSINESS MANAGEMENT IN THE FIELDS OF ENTERTAINMENT AND SPORTING EVENTS, IN CLASS 35 (U.S. CLS. 100, 101 AND 102).

FIRST USE 7-1-1980; IN COMMERCE 7-1-1980.

NO CLAIM IS MADE TO THE EXCLUSIVE RIGHT TO USE "SPORTS MARKETING", APART FROM THE MARK AS SHOWN.

SER. NO. 76-328,256, FILED 10-23-2001.

ALEXANDER L. POWERS, EXAMINING ATTORNEY

Int. Cl.: 9

Prior U.S. Cls.: 21, 23, 26, 36 and 38

Reg. No. 2,892,307

United States Patent and Trademark Office

Registered Oct. 12, 2004

**TRADEMARK
PRINCIPAL REGISTER**

OPTICOM

OPTICOM TECHNOLOGIES INC. (CANADA CORPORATION)
203 - 950 POWELL STREET
VANCOUVER BRITISH COLUMBIA, CANADA V6A 1H9

FOR: VIDEO SURVEILLANCE SYSTEMS, NAME-
LY, CLOSED CIRCUIT TELEVISION ("CCTV") VI-
DEO CAMERAS, VIDEO STORAGE UNITS, TIME
LAPSE VCRS, DIGITAL VIDEO RECORDERS;
EQUIPMENT USED TO CONTROL THE VIDEO
IMAGES, NAMELY, MULTIPLEXERS, VIDEO
QUAD SPLITTERS, AND VIDEO SWITCHERS; VI-
DEO SURVEILLANCE SYSTEM EQUIPMENT,
NAMELY, CCTV VIDEO CAMERAS, COVERT CCTV
VIDEO CAMERAS, BOARD CCTV VIDEO CAM-
ERAS, CCTV VIDEO MONITORS, CCTV VIDEO
CAMERA LENSES, DIGITAL VIDEO RECORDERS,
ANALOG TIME LAPSE EVENT RECORDERS, VI-
DEO CAMERA SWITCHERS, VIDEO CAMERA

QUAD SPLITTERS WHICH ALLOW FOUR CAM-
ERAS TO BE RECORDED SIMULTANEOUSLY;
WIRELESS VIDEO SURVEILLANCE SYSTEMS,
NAMELY CCTV VIDEO CAMERAS, VIDEO STO-
RAGE UNITS, TIME LAPSE VCRS, DIGITAL VIDEO
RECORDERS; STREAMING VIDEO SYSTEMS
WHICH TRANSMIT VIDEO CAMERA IMAGES
THROUGH A SERVER TO BE VIEWED IN REAL
TIME OVER THE INTERNET, NAMELY CCTV
VIDEO CAMERAS, VIDEO STORAGE UNITS, TIME
LAPSE VCRS, DIGITAL VIDEO RECORDERS, IN
CLASS 9 (U.S. CLS. 21, 23, 26, 36 AND 38).

FIRST USE 3-7-1996; IN COMMERCE 3-7-2002.

SER. NO. 76-329,842, FILED 10-25-2001.

SHARON MEIER, EXAMINING ATTORNEY

Int. Cl.: 6

Prior U.S. Cls.: 2, 12, 13, 14, 23, 25 and 50

United States Patent and Trademark Office

Reg. No. 2,892,308

Registered Oct. 12, 2004

TRADEMARK
PRINCIPAL REGISTER



America's Choice for Clog-free Gutters

GUTTERGUARD, INC. (GEORGIA CORPORATION)
SUITE 100 3690 N.
PEACHTREE ROAD
CHAMBLEE, GA 30341

NO CLAIM IS MADE TO THE EXCLUSIVE
RIGHT TO USE "GUTTER GUARD", APART FROM
THE MARK AS SHOWN.

FOR: METAL HOODED GUTTERS AND STRUCTURAL PARTS THEREOF, IN CLASS 6 (U.S. CLS. 2, 12, 13, 14, 23, 25 AND 50).

SER. NO. 76-330,109, FILED 10-29-2001.

FIRST USE 1-20-2000; IN COMMERCE 1-20-2000.

RICHARD A. STRASER, EXAMINING ATTORNEY

Int. Cls.: 24 and 25

Prior U.S. Cls.: 22, 39, 42 and 50

United States Patent and Trademark Office

Reg. No. 2,892,309

Registered Oct. 12, 2004

**TRADEMARK
PRINCIPAL REGISTER**



MARICLER S.R.L. (ITALY CORPORATION)
VIA STATALE, 371
I-51038 OLMI-QUARRATA (PT), ITALY

FOR: LINEN; BATH LINEN; BED LINEN; TABLE
LINEN; TEXTILES PRINTERS BLANKETS; BED
BLANKETS; BED SPREADS; QUILTS, IN CLASS 24
(U.S. CLS. 42 AND 50).

FOR: BATHROBES , IN CLASS 25 (U.S. CLS. 22
AND 39).

PRIORITY CLAIMED UNDER SEC. 44(D) ON
ITALY APPLICATION NO. N.PT2001C000, FILED 9-
13-2001, REG. NO. 00854863, DATED 9-13-2001, EX-
PIRES 9-13-2011.

THE MARK CONSISTS OF A STYLIZED DESIGN
OF A COTTON BOLL.

SER. NO. 76-330,192, FILED 10-26-2001.

MARY ROSSMAN, EXAMINING ATTORNEY

Int. Cls.: 9, 16 and 36

Prior U.S. Cls.: 2, 5, 21, 22, 23, 26, 29, 36, 37, 38, 50,
100, 101 and 102

Reg. No. 2,892,310

United States Patent and Trademark Office

Registered Oct. 12, 2004

TRADEMARK
SERVICE MARK
PRINCIPAL REGISTER

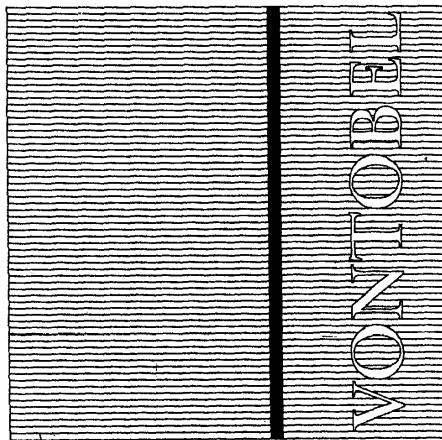

VONTOBEL HOLDING AG (SWITZERLAND
CORPORATION)

TODISTRASSE 27

8022 ZURICH, SWITZERLAND

FOR: PRE-RECORDED ELECTRONIC, MAGNETIC, AND OPTICAL DATA CARRIERS CONTAINING ECONOMIC, FINANCIAL AND BUSINESS DATA; COMPUTER COMMUNICATIONS SOFTWARE TO ALLOW CUSTOMERS TO ACCESS BANK ACCOUNT INFORMATION AND TRANSACT BANK BUSINESS; COMPUTER SEARCH ENGINE SOFTWARE; COMPUTER SOFTWARE FOR USE IN DATABASE MANAGEMENT AND FOR APPLICATION AND DATABASE INTEGRATION; MOUSEPADS, IN CLASS 9 (U.S. CLS. 21, 23, 26, 36 AND 38).

FOR: PRINTED MATTER, NAMELY, BOOKS, MAGAZINES, CATALOGUES, AND BROCHURES RELATED TO FINANCIAL AND INVESTMENT MATTERS; AND OFFICE REQUISITES, NAMELY, BAGS OF PAPER AND PLASTIC, BOOK MARKERS, BLANK BOOKS FOR WRITING, CALENDARS, CARDBOARD, CARDS, PAPER CUTTERS, DRAWING INSTRUMENTS, ENVELOPES, NOTEBOOKS, PADS, PAPER, PENS, PENCILS, PLANS, STAMP PADS, BOXES FOR STORAGE OF BUSINESS CARDS, DOCUMENT HOLDERS, IN CLASS 16 (U.S. CLS. 2, 5, 22, 23, 29, 37, 38 AND 50).

FOR: FINANCIAL SERVICES AND MONETARY SERVICES, NAMELY, FINANCIAL MANAGEMENT, INVESTMENTS, NAMELY, STOCKS, FUNDS, MUTUAL FUNDS, HEDGE FUNDS, AND BONDS; STOCK BROKERAGE SERVICES; TRADING OF EQUITIES AND WARRANTS; INVESTMENT CONSULTATION AND MANAGEMENT; FINANCING SERVICES, NAMELY MANAGING VENTURE CAPITAL AND COORDINATING PLACEMENT OF FUNDS FOR BUSINESS; BANKING SERVICES; PROVIDING INFORMATION ABOUT STOCK AND BOND INDICES; PROVIDING STOCK EXCHANGE PRICE QUOTATIONS; FINANCIAL ANALYSIS AND CONSULTATION; BANKING SERVICES; PRIVATE BANKING SERVICES, FINANCIAL PORTFOLIO MANAGEMENT SERVICES; COMMODITY TRADING FOR OTHERS; INVESTMENT MANAGEMENT; MARGIN LOAN FINANCING; NEUTRAL FUND INVESTMENT, FINANCIAL INVESTMENT IN THE FIELDS OF STOCKS, BONDS, INTERNATIONAL SHORT-TERM MONEY, MARKET FUNDS, AND PURCHASE MATTERS; FINANCIAL EXCHANGE, FINANCIAL INVESTMENTS IN THE FIELD OF SECURITIES, PRECIOUS METALS, AND REAL ESTATE; FINANCIAL MANAGEMENT AND FINANCIAL PLANNING; MONETARY EXCHANGE SERVICES; TRADING OF EQUITIES, WARRANTS, CONVERTIBLES, INVESTMENT FUNDS, FX TRANSACTIONS, SWAPS, NON-DELIVERABLE FORWARDS,

24/48 CALL MONEY TIME DEPOSITS, TREASURY BILLS, CERTIFICATES OF DEPOSIT, AND COMMERCIAL PAPER; PRECIOUS METAL TRADING; LOAN SERVICES; INFORMATION SERVICES, NAMELY PROVIDING INFORMATION ABOUT FINANCE, CORPORATIONS, LEGAL, BANKING, CREDIT INJURY AND CONSULTATION VIA THE GLOBAL COMPUTER NETWORK; TRANSMITTING INFORMATION IN THE FIELDS OF FINANCIAL AND MONETARY SERVICES, ECONOMIC AND FINANCIAL BUSINESS DATA VIA TELEPHONE, MOBILE PHONE (SMS), TELEVISION, TELETEXT, AND THE GLOBAL COMPUTER NETWORK, IN CLASS 36 (U.S. CLS. 100, 101 AND 102).

PRIORITY CLAIMED UNDER SEC. 44(D) ON SWITZERLAND APPLICATION NO. 07458/2001, FILED 7-27-2001, REG. NO. 488217, DATED 8-22-2001, EXPIRES 7-27-2011.

OWNER OF U.S. REG. NOS. 2,261,778, 2,263,871, AND 2,424,461.

THE MARK IS LINED FOR THE COLOR BLUE.

SER. NO. 76-332,555, FILED 10-31-2001.

RONALD AIKENS, EXAMINING ATTORNEY

Int. Cls.: 9, 12, 14, 18, 26, 28, 37 and 40

**Prior U.S. Cls.: 1, 2, 3, 19, 21, 22, 23, 26, 27, 28, 31, 35,
36, 37, 38, 39, 40, 41, 42, 44, 50, 100, 103 and 106**

Reg. No. 2,892,311

United States Patent and Trademark Office

Registered Oct. 12, 2004

**TRADEMARK
SERVICE MARK
PRINCIPAL REGISTER**

PHAETON

VOLKSWAGEN AKTIENSELLSCHAFT (FED REP
GERMANY CORPORATION)

BRIEFFACH 1770, D-38436

WOLFSBURG, FED REP GERMANY

FOR: SCIENTIFIC, NAUTICAL, SURVEYING, ELECTRIC, PHOTOGRAPHIC, CINEMATOGRAPHIC, OPTICAL, WEIGHING, MEASURING, SIGNALING, CHECKING, LIFE-SAVING AND TEACHING APPARATUS AND INSTRUMENTS, NAMELY, CONTACT LENSES, OPTICAL EYEGLASSES, SPECTACLES, EYEGLASS CASES, BINOCULARS, OPTICAL MAGNIFYING GLASSES, SUNGLASSES, SIMULATORS FOR STEERING AND CONTROL OF VEHICLES, EXCLUDING, HORSE-DRAWN CARRIAGES, STATIC VOLTAGE REGULATORS FOR VEHICLES, VEHICLE BREAKDOWN WARNING TRIANGLES, ELECTRIC CIGARETTE LIGHTERS FOR AUTOMOBILES; ALARM DEVICES, NAMELY, ANTI-INTRUSION ALARMS, BURGLAR ALARMS, FIRE ALARMS, PERSONAL SECURITY ALARMS, THEFT ALARMS; BATTERIES, BATTERY CHARGERS, ELECTRIC ANTI-THEFT WARNING ALARMS, ELECTRICAL ACCUMULATORS, SPEEDOMETERS, EMERGENCY WARNING LIGHTS FOR VEHICLES; MEASURING DEVICES AND MEASURING INSTRUMENTS, NAMELY, FOLDING RULERS, TAPE RULERS, GRADUATED RULERS, TACHOMETERS, LIFE SAVING DEVICES, NAMELY, LIFE-SAVING FIRE ESCAPE LADDERS, LIFE-SAVING NETS, LIFE-SAVING RINGS, LIFE-SAVING BUOYS, LIFE-SAVING JACKETS; ACID HYDROMETERS, ELECTRICAL FUSES, ELECTRICAL FUSES FOR AUTOMOBILES, ELECTRIC RELAYS, LASERS NOT FOR MEDICAL USE, LASER POINTERS, REMOTE CONTROLS FOR TELEVISIONS, REMOTE CONTROLS FOR THE STEERING AND CONTROL OF REMOTE CONTROL VEHICLES, NAMELY, AUTOMOBILES, VANS, SHIPS, AIRPLANES, AND MOTOR CYCLES, AND TOY AUTOMOBILES, TOY VANS, TOY SHIPS, TOY AIR-

PLANES, AND TOY MOTOR CYCLES, BUT EXCLUDING, HORSE-DRAWN CARRIAGES; SOLAR BATTERIES, COMPASSES, NAVIGATIONAL INSTRUMENTS, NAMELY, COMPASSES FOR USE IN AUTOMOBILES, BOATS, AIRPLANES AND FOR HIKING; CARPENTER'S LEVELS, PLUMB LEVELS, SURVEYORS' LEVELS, SCALES, DEVICES FOR RECORDING, TRANSMISSION AND REPRODUCTION OF SOUND AND IMAGES, NAMELY, ANTENNAS, RADIOS, TELEVISION SETS, TELEPHONES, VIDEO TELEPHONES, PROJECTION DEVICES, NAMELY, MOVIE PROJECTORS, MOTION PICTURE CAMERAS, FILM PORTRAIT CAMERAS, PHOTOCOPY EQUIPMENT, NAMELY, PHOTOCOPYING MACHINES, ELECTRONIC TRANSLATORS, ELECTRONIC POCKET TRANSLATORS, EXPOSED CAMERA FILM, AUDIO AND VIDEO TAPE RECORDERS, CD AND DVD PLAYERS, BLANK MAGNETIC, ELECTRONIC AND OPTICAL DATA CARRIERS, PHONOGRAPH RECORDS FEATURING MUSIC, BLANK RECORDING DISCS; MAGNETICALLY ENCODED CREDIT, DEBIT AND PREPAID TELEPHONE CALLING CARDS; ENCODED INTEGRATED CIRCUIT CARDS CONTAINING PROGRAMMING USED TO ACCESS AUTOMATIC TELLER MACHINES IN THE BANKING FIELD OF USE AND USED TO PURCHASE FARES ON BUSES, TRAINS AND FERRIES IN THE PUBLIC TRANSPORTATION FIELD OF USE; AUTOMATIC VENDING MACHINES, AUTOMATIC DISPENSING VENDING MACHINES, AUTOMATIC BANKING TELLER MACHINES, GAMBLING MACHINES; CASH REGISTERS, CALCULATORS, DATA PROCESSING EQUIPMENT, NAMELY, DATA PROCESSORS, COMPUTERS, ELECTRONIC PERSONAL APPOINTMENT ORGANIZERS AND CALENDARS, FAX EQUIPMENT, NAMELY, FAX MACHINES, COMPUTER MONITORS, COMPUTER PERIPHERALS, POCKET CALCULATORS, COMPUTER SOFTWARE PROGRAMS FOR USE TO PRODUCE SPREADSHEETS, PRODUCE WORD

PROCESSING DOCUMENTS, AND ENABLE CONNECTIONS TO A GLOBAL COMPUTER NETWORK, IN THE VEHICLE DESIGN, ENGINEERING AND MANUFACTURING FIELD OF USE; FIRE EXTINGUISHING EQUIPMENT, NAMELY, FIRE EXTINGUISHERS; AUTOMATED DISTRIBUTION MACHINES, NAMELY, COMPUTERS EQUIPPED WITH A KEYBOARD, A TRACKBALL AND/OR A MOUSE, FOR INTERFACE WITH HUMAN CUSTOMERS, CONNECTED TO THE GLOBAL COMPUTER NETWORK, FOR USE IN THE FIELD OF FACILITATING VEHICLE SALES, LEASING, RENTING, AND VEHICLE REPAIR SERVICES; ROCK CLIMBERS SAFETY HARNESS, IN CLASS 9 (U.S. CLS. 21, 23, 26, 36 AND 38).

FOR: APPARATUSES FOR TRANSPORTATION ON LAND, IN THE AIR OR ON WATER, NAMELY AUTOMOBILES, VANS, SHIPS, AIRPLANES, MOTOR CYCLES AND STRUCTURAL AND REPLACEMENT STRUCTURAL PARTS THEREFOR, COMPLETE ENGINES FOR LAND VEHICLES AND STRUCTURAL AND REPLACEMENT STRUCTURAL PARTS THEREFOR, EXCLUDING HORSE-DRAWN CARRIAGES AND PARTS THEREFOR AND EXCLUDING RECREATIONAL VEHICLES, NAMELY TRAVEL TRAILERS, MINI MOTOR HOMES, CONVENTIONAL MOTOR HOMES, MOTOR COACHES AND VACATION TRAILERS; ANTI-THEFT ALARMS FOR VEHICLES, IN CLASS 12 (U.S. CLS. 19, 21, 23, 31, 35 AND 44).

FOR: GOODS OF PRECIOUS METALS AND THEIR ALLOYS OR COATED THEREWITH, NAMELY, JEWELRY, ORNAMENTS, KEY RINGS MADE OF PRECIOUS METALS, WATCH FOBS, ORNAMENTAL PINS, ORNAMENTAL LAPEL PINS, TIE PINS, CUFFLINKS, HAT ORNAMENTS OF PRECIOUS METAL, SHOE ORNAMENTS OF PRECIOUS METAL; CLOCKS, TIME PIECES, NAMELY, CHRONOMETRICAL INSTRUMENTS, NAMELY, CHRONOGRAPHS FOR USE AS WATCHES AND CHRONOMETERS, WRIST WATCHES, STOP WATCHES AND POCKET WATCHES; WATCH CASES; CIGARETTE CASES MADE OF PRECIOUS METAL OR COATED THEREWITH, PRECIOUS AND SEMI-PRECIOUS GEM STONES, IN CLASS 14 (U.S. CLS. 2, 27, 28 AND 50).

FOR: GOODS MADE OF LEATHER, LEATHER IMITATIONS, SKINS AND FURS, NAMELY, UMBRELLAS, PARASOLS, WALKING CANES, KEY CASES, VALISES, WALLETS, SUITCASES, HAND LUGGAGE, HAND BAGS, EXECUTIVE CASES, DOCUMENT CASES, ATTACHE CASES, BRIEFCASES, BAGS, NAMELY, ALL PURPOSE ATHLETIC BAGS, ALL PURPOSE SPORTS BAGS, ANIMAL GAME BAGS, BARREL BAGS, BEACH BAGS, BOOK BAGS, CARRY-ON BAGS; LUGGAGE MADE OF LEATHER, LEATHER IMITATIONS, SKINS OR FURS; LUGGAGE TRUNKS MADE OF LEATHER, LEATHER IMITATIONS, SKINS OR FURS, IN CLASS 18 (U.S. CLS. 1, 2, 3, 22 AND 41).

FOR: TRAVELING SEWING KITS MADE OF LEATHER, LEATHER IMITATIONS, SKINS OR FURS, COMPRISED PRIMARILY OF NEEDLES,

BUTTONS, SAFETY PINS, AND THREAD, IN CLASS 26 (U.S. CLS. 37, 39, 40, 42 AND 50).

FOR: KALEIDOSCOPIES; SCALE MODEL TOY VEHICLES EXCLUDING TOY MODELS OF HORSE-DRAWN CARRIAGES, SCALE TOY MODEL CARS, PLUSH TOY ANIMALS AND OTHER PLUSH TOYS, BALLOONS; GYMNAS TIC APPARATUS; GYMNAS TIC HORIZONTAL BARS; GYMNAS TIC PARALLEL BARS; GYMNAS TIC TRAINING STOOLS; GYMNAS TIC VAULTING HORSES; SPORTING ARTICLES OF ALL KINDS, NAMELY, BALLOONS, SPORTS BALLS; BASEBALL GLOVES; BATS FOR GAMES, NAMELY, BASEBALL BATS AND CRICKET BATS; CHRISTMAS TREE ORNAMENTS, NAMELY, BELLS; BILLIARD TABLES; BOB-SLEDS; BODYBUILDING, BODY-TRAINING AND EXERCISE EQUIPMENT, NAMELY, WEIGHT LIFTING BENCHES AND BENCH ACCESSORIES, CHEST EXPANDERS, EXERCISE TREADMILLS, EXERCISE TABLES, EXERCISE BARS, EXERCISE BENCHES, STATIONARY EXERCISE BICYCLES, EXERCISE DOORWAY GYM BARS, MANUALLY OPERATED EXERCISE EQUIPMENT, EXERCISE EQUIPMENT FOR LATERAL MOVEMENT IN A SKATING MOTION, EXERCISE EQUIPMENT, NAMELY, STAIR-STEPPING MACHINES, EXERCISE MACHINES, POWERED TREADMILLS FORE-RUNNING, ROWING MACHINES, WEIGHT LIFTING MACHINES, EXERCISING PULLEYS AND MANUALLY OPERATED JOGGING MACHINES, EXERCISE PLATFORMS, EXERCISE TRAMPOLINES, EXERCISE WEIGHT CUFFS, EXERCISE WEIGHTS, MANUAL LEG EXERCISERS, WEIGHT LIFTING BELTS, WEIGHT LIFTING GLOVES, EXERCISE WEIGHTS, LEG WEIGHTS, ANKLE AND WRIST WEIGHTS FOR EXERCISE; BOWS FOR ARCHERY; BOXING GLOVES; TOY BUILDING BLOCKS; MANIPULATIVE GAMES; BOARD GAMES, NAMELY, CHECKER SETS; GOLF CLUBS; DARTS; DOLLS; KNEE GUARDS AND ELBOW GUARDS FOR ATHLETIC USE; FENCING EQUIPMENT, NAMELY FOILS; FISHING HOOKS; FLIPPERS FOR SWIMMING; GAME TABLES, NAMELY, TABLES FOR INDOOR FOOTBALL; GAMES, NAMELY, ACTION SKILL GAMES, ACTION-TYPE TARGET GAMES, EQUIPMENT SOLD AS A UNIT FOR PLAYING ACTION TYPE TARGET GAMES, ADULTS' AND CHILDREN'S PARTY GAMES, AERO-DYNAMIC DISK FOR USE IN PLAYING CATCHING GAMES, ARCADE GAMES, PADDLE BALL GAMES, BOARD GAMES, CARD GAMES, COIN-OPERATED VIDEO GAMES, ELECTRONIC DART GAMES, EQUIPMENT SOLD AS A UNIT FOR PLAYING BOARD GAMES, EQUIPMENT SOLD AS A UNIT FOR PLAYING CARD GAMES, HAND HELD UNIT FOR PLAYING ELECTRONIC GAMES, HAND HELD UNIT FOR PLAYING VIDEO GAMES EXCEPT AS ACCESSORY COMPONENTS FOR TELEVISION APPARATUSES AND VIDEO MONITORS, MANIPULATIVE GAMES, PARLOR GAMES, PINBALL GAMES, ROLE PLAYING GAMES, OUTDOOR ACTIVITY GAMES IN THE NATURE OF TREASURE HUNTS, HORSE-SHOES, CROQUET AND LAWN DARTS; GOLF GLOVES; GLOVES FOR GAMES, NAMELY, BASEBALL BATTING GLOVES, BASEBALL GLOVES,

BATTING GLOVES, BICYCLING GLOVES, BOXING GLOVES, GOALKEEPERS' GLOVES, HANDBALL GLOVES, HOCKEY GLOVES, KARATE GLOVES, SOFTBALL GLOVES, SWIMMING GLOVES, WATER SKI GLOVES; GOLF BAGS; GOLF CLUBS; SCUBA EQUIPMENT, NAMELY, SPEAR FISHING HARPOON GUNS; GUT FOR TENNIS RACKETS; HANG GLIDERS; HOCKEY STICKS; ICE SKATES; KITES; LINES FOR FISHING; COSTUME MASKS; TOY MOBILES; SCALE TOY MODEL VEHICLES AND RELATED ACCESSORIES SOLD AS UNITS; NETS FOR SPORTS, NAMELY, BILLIARD NETS, PLATFORM TENNIS NETS, VOLLEYBALL NETS, BASKETBALL NETS, RACQUET BALL NETS, SOCCER BALL GOAL NETS, TABLE TENNIS NETS, TENNIS NETS; PROTECTIVE PADDING FOR PLAYING BASEBALL, FOOTBALL, ICE HOCKEY AND CRICKET; PROTECTIVE PADS, NAMELY, FIELD HOCKEY GOALIE PADS, FOOTBALL SHOULDER PADS, ICE HOCKEY GOALIE PADS, KARATE KICK PADS, KARATE SHIN PADS, KARATE TARGET PADS, ELBOW PADS FOR ATHLETIC USE, HAND PADS FOR ATHLETIC USE, SHIN PADS FOR ATHLETIC USE, INFLATABLE FLOAT MATTRESSES OR PADS FOR RECREATIONAL USE; TOY PISTOLS; PLAY SWIMMING POOLS; PUPPETS; RACKETS FOR BADMINTON, FOR TENNIS, FOR TABLE TENNIS, FOR SQUASH, FOR RACQUETBALL; RODS FOR FISHING; TOY SCOOTERS; SKATEBOARDS; SKIS; SNOW SLEDS FOR RECREATIONAL USE; PLAYGROUND EQUIPMENT, NAMELY, SLIDES; SPINNING TOPS; SPRING BARS FOR EXERCISING, DIVING BOARDS FOR USE WITH SWIMMING POOLS; SURF BOARDS; SURF SKIS; TABLES FOR TABLE TENNIS; TARGETS; TEDDY BEARS; TOYS FOR DOMESTIC PETS; WATER SKIS, CRICKET BAGS MADE OF LEATHER, LEATHER IMITATIONS, SKINS OR FURS, IN CLASS 28 (U.S. CLS. 22, 23, 38 AND 50).

FOR: VEHICLE REPAIR AND MAINTENANCE, NAMELY, RETRO-FITTING, REPAIR, UPKEEP, DISMANTLING, MAINTENANCE, CARE, CLEANING AND PAINTING OF VEHICLES EXCLUDING HORSE-DRAWN CARRIAGES AND EXCLUDING RECREATIONAL VEHICLES, NAMELY TRAVEL TRAILERS, MINI MOTOR HOMES, CONVENTIONAL MOTOR HOMES, MOTOR COACHES AND VACATION TRAILERS; REPAIR AND MAINTENANCE OF VEHICLE MOTORS AND PARTS THEREFOR, EXCLUDING MOTORS AND PARTS FOR HORSE-DRAWN CARRIAGES AND MOTORS AND PARTS FOR RECREATIONAL VEHICLES, NAMELY TRAVEL TRAILERS, MINI MOTOR HOMES, CONVENTIONAL MOTOR HOMES, MOTOR COACHES AND VACATION TRAILERS; VEHICLE REPAIR AND MAINTENANCE IN THE NATURE OF EMERGENCY ROAD SIDE SERVICES, EXCLUDING REPAIR AND MAINTENANCE OF HORSE-DRAWN CARRIAGES AND RECREATIONAL VEHICLES, NAMELY TRAVEL TRAILERS, MINI MOTOR HOMES, CONVENTIONAL MOTOR HOMES, MOTOR COACHES AND VACATION TRAILERS; VEHICLE DETAILING EXCLUDING DETAILING OF HORSE-DRAWN CARRIAGES AND EXCLUDING RECREATIONAL VEHICLES,

NAMELY TRAVEL TRAILERS, MINI MOTOR HOMES, CONVENTIONAL MOTOR HOMES, MOTOR COACHES AND VACATION TRAILERS; INSTALLATION AND REPAIR OF VEHICLE AIR CONDITIONERS; AIRPLANE MAINTENANCE AND REPAIR, VEHICLE MAINTENANCE, NAMELY, ANTI-RUST TREATMENT OF VEHICLES; CAR MAINTENANCE; CAR WASHING SERVICES; INSTALLATION, MAINTENANCE AND REPAIR OF ELECTRICAL COMPONENTS OF VEHICLES EXCLUDING INSTALLATION, MAINTENANCE AND REPAIR OF ELECTRICAL COMPONENTS OF HORSE-DRAWN CARRIAGES AND RECREATIONAL VEHICLES, NAMELY TRAVEL TRAILERS, MINI MOTOR HOMES, CONVENTIONAL MOTOR HOMES, MOTOR COACHES AND VACATION TRAILERS; INSTALLATION, MAINTENANCE AND REPAIR OF FIRE ALARMS OF VEHICLES EXCLUDING INSTALLATION, MAINTENANCE AND REPAIR OF FIRE ALARMS OF HORSE-DRAWN CARRIAGES AND RECREATIONAL VEHICLES, NAMELY TRAVEL TRAILERS, MINI MOTOR HOMES, CONVENTIONAL MOTOR HOMES, MOTOR COACHES AND VACATION TRAILERS; INSTALLATION, MAINTENANCE AND REPAIR OF VEHICLE HEATING EQUIPMENT, NAMELY, VEHICLE HEATERS AND HEATER CORES, EXCLUDING INSTALLATION, MAINTENANCE AND REPAIR OF HEATING EQUIPMENT OF HORSE-DRAWN CARRIAGES AND RECREATIONAL VEHICLES, NAMELY TRAVEL TRAILERS, MINI MOTOR HOMES, CONVENTIONAL MOTOR HOMES, MOTOR COACHES AND VACATION TRAILERS; LEATHER CLEANING AND REPAIR OF VEHICLE INTERIOR LEATHER EXCLUDING CLEANING AND REPAIR OF LEATHER OF HORSE-DRAWN CARRIAGES AND RECREATIONAL VEHICLES, NAMELY TRAVEL TRAILERS, MINI MOTOR HOMES, CONVENTIONAL MOTOR HOMES, MOTOR COACHES AND VACATION TRAILERS; INSTALLATION, MAINTENANCE AND REPAIR OF MACHINERY, NAMELY, VEHICLE COMPONENTS, EXCLUDING COMPONENTS OF HORSE-DRAWN CARRIAGES AND RECREATIONAL VEHICLES, NAMELY TRAVEL TRAILERS, MINI MOTOR HOMES, CONVENTIONAL MOTOR HOMES, MOTOR COACHES AND VACATION TRAILERS; MOTOR VEHICLE WASHING; RETREADING OF TIRES; REPAIR OF TIRES; VEHICLE CLEANING AND POLISHING EXCLUDING HORSE-DRAWN CARRIAGES AND EXCLUDING RECREATIONAL VEHICLES, NAMELY TRAVEL TRAILERS, MINI MOTOR HOMES, CONVENTIONAL MOTOR HOMES, MOTOR COACHES AND VACATION TRAILERS; VEHICLE LUBRICATION EXCLUDING HORSE-DRAWN CARRIAGES AND EXCLUDING RECREATIONAL VEHICLES, NAMELY TRAVEL TRAILERS, MINI MOTOR HOMES, CONVENTIONAL MOTOR HOMES, MOTOR COACHES AND VACATION TRAILERS; VEHICLE SERVICE STATION SERVICES, EXCLUDING SERVICE STATION SERVICES FOR HORSE-DRAWN CARRIAGES AND RECREATIONAL VEHICLES, NAMELY TRAVEL TRAILERS, MINI MOTOR HOMES, CONVENTIONAL MOTOR HOMES, MOTOR COACHES AND VACATION TRAILERS, IN CLASS 37 (U.S. CLS. 100, 103 AND 106).

FOR: VULCANIZATION OF TIRES, IN CLASS 40
(U.S. CLS. 100, 103 AND 106).

FILED 8-22-2001, REG. NO. 30150202.1, DATED 8-15-
2001, EXPIRES 8-31-2011.

PRIORITY CLAIMED UNDER SEC. 44(D) ON FED
REP GERMANY APPLICATION NO. 30150202.1,

SER. NO. 76-333,393, FILED 11-2-2001.

SONYA STEPHENS, EXAMINING ATTORNEY

Int. Cl.: 9

Prior U.S. Cls.: 21, 23, 26, 36 and 38

Reg. No. 2,892,312

United States Patent and Trademark Office

Registered Oct. 12, 2004

**TRADEMARK
PRINCIPAL REGISTER**

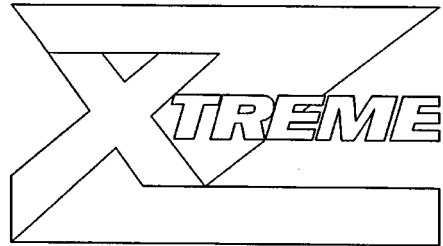

THALES NAVIGATION, INC. (DELAWARE CORPORATION)
471 EL CAMINO REAL
SANTA CLARA, CA 95050

FOR: GLOBAL POSITIONING SYSTEM (GPS) EQUIPMENT, NAMELY, GPS NAVIGATION DIGITAL SIGNAL RECEIVERS, UHF RADIOS, HANDHELD COMPUTERS, ANTENNAS, TRIPODS, AND INSTRUCTION MANUALS THEREFOR, SOLD AS A

UNIT THEREWITH, IN CLASS 9 (U.S. CLS. 21, 23, 26, 36 AND 38).

FIRST USE 3-1-2001; IN COMMERCE 3-1-2001.

SER. NO. 76-333,723, FILED 11-2-2001.

MICHAEL KAZAZIAN, EXAMINING ATTORNEY

Int. Cl.: 32

Prior U.S. Cls.: 45, 46 and 48

Reg. No. 2,892,313

United States Patent and Trademark Office

Registered Oct. 12, 2004

TRADEMARK
PRINCIPAL REGISTER



DREAM-COLA COMPANY, THE (NEVADA CORPORATION)
P.O. BOX 183
OCEAN CITY, NJ 08226

FIRST USE 2-15-2000; IN COMMERCE 7-25-2000.

SER. NO. 76-335,293, FILED 11-8-2001.

FOR: NON-ALCOHOLIC BEVERAGES, NAMELY
FRUIT DRINKS AND FRUIT JUICES, SPORTS
DRINKS; SYRUPS, CONCENTRATES AND POW-
DERS FOR MAKING THE SAME, IN CLASS 32 (U.S.
CLS. 45, 46 AND 48).

SAMUEL E. SHARPER JR., EXAMINING ATTOR-
NEY

Int. Cl.: 9

Prior U.S. Cls.: 21, 23, 26, 36 and 38

United States Patent and Trademark Office

Reg. No. 2,892,314

Registered Oct. 12, 2004

**TRADEMARK
PRINCIPAL REGISTER**

IMAGE|C|A|R|D|

KONINKLIJKE PHILIPS ELECTRONICS N.V.
(NETHERLANDS CORPORATION)
GROENEWOUDSEWEG 1
EINDHOVEN, NETHERLANDS

FOR: ENCODED ELECTRONIC CHIP CARDS,
SMART CARDS, CONTAINING PERSONAL CODES
AND A PASSWORD; WRITERS AND READERS
FOR ENCODED ELECTRONIC CHIP CARDS AND
SMART CARDS; PRERECORDED SOFTWARE PRO-
GRAMS FOR ENCODING, DECODING, PROCES-
SING, COMPRESSING, TRANSMITTING,
RECORDING PATIENT RELATED DATA AND
FILES; MAGNETIC CARDS AND SMART CARDS,
CONTAINING PERSONAL CODES AND A PASS-
WORD, IN CLASS 9 (U.S. CLS. 21, 23, 26, 36 AND 38).

PRIORITY CLAIMED UNDER SEC. 44(D) ON
BENELUX APPLICATION NO. 0989692, FILED 5-11-
2001, REG. NO. 0686934, DATED 5-11-2001, EXPIRES
5-11-2011.

OWNER OF U.S. REG. NOS. 2,671,675 AND
2,674,482.

SER. NO. 76-335,560, FILED 11-8-2001.

AMOS T. MATTHEWS, JR., EXAMINING ATTOR-
NEY

Int. Cls.: 29, 30 and 32

Prior U.S. Cls.: 45, 46 and 48

United States Patent and Trademark Office

Reg. No. 2,892,315

Registered Oct. 12, 2004

TRADEMARK
PRINCIPAL REGISTER

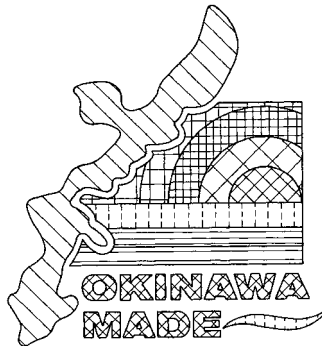

RYUKYU BIO-RESOURCE DEVELOPMENT CO.,
LTD. (JAPAN COMPANY)

606-2, AZA TOYOHARA

MOTOBU-CHO, OKINAWA 905-0204, JAPAN

FOR: MEAT; CHARCUTERIE; FISH AND SHELL-FISH; DRIED FISH, NAMELY, DRIED BONITO; FOODS PREPARED FROM AQUATIC ORGANIC MATERIAL, NAMELY, PROCESSED SEA VEGETABLES, PROCESSED EDIBLE SEAWEED, PROCESSED EDIBLE SEAWEED IN THE FORM OF TANGLE FLAKES, TOASTED LAVER, DRIED EDIBLE BROWN ALGAE, AND DRIED EDIBLE SEAWEED; PROCESSED BEANS; FOODS PREPARED FROM VEGETABLES AND FRUITS, NAMELY, JELLIES, JAMS, VEGETABLE PASTES, AND FRUIT PASTES, FROZEN FRUITS AND FROZEN VEGETABLES; EGGS AND PROCESSED EGG SUBSTITUTES; MILK PRODUCTS, NAMELY, MILK, CHOCOLATE MILK, SOUR CREAM, AND COTTAGE CHEESE; EDIBLE FATS AND EDIBLE OILS; RAGOUT PREPARATIONS, NAMELY, STEW, SOUP PREPARATIONS; FOOD PRODUCTS MADE FROM SOY BEANS, NAMELY, SOYBEAN OIL FOR COOKING AND SOYBEAN PASTE; KONNYAKU, NAMELY, JELLIES; SOY-BASED FOOD BEVERAGE USED AS A MILK SUBSTITUTE; TOFU; NATTO, NAMELY, FERMENTED SOYBEANS; PROTEIN FOR USE AS A FOOD ADDITIVE; YOGURT BASED BEVERAGES AND MILK DRINKS; PREPARED LUNCH MEALS CONSISTING PRIMARILY OF MEAT, FISH, POULTRY OR VEGETABLES; ALL OF THE FOREGOING GOODS ARE FROM OKINAWA, IN CLASS 29 (U.S. CL. 46).

FOR: COFFEE, COCOA, UNROASTED COFFEE, TEA; MISO PASTE; WORCESTERSHIRE SAUCE, KETCHUP, SOY SAUCE, VINEGAR, MAYONNAISE; FOOD ADDITIVES FOR NON-NUTRITIONAL PURPOSES FOR USE AS A FLAVORING, INGREDIENT OR FILLER, NAMELY, FRUCTOSE, MALTOSE, DEXTROSE, AND GLUCOSE; SUGAR CANDY, BROWN SUGAR, SUGAR, HONEY; BARBEQUE SAUCE; SEASONED SALT; SEASONING SPICES; RICE; MALTED RICE; FLOUR; GLUTEN FOR FOOD; FARINACEOUS FOODS, NAMELY, BISCUITS, CAKES, AND BREAD ROLLS; CHINESE DUMPLINGS, SANDWICHES, SUSHI, STEAMED BUNS WITH MEAT, HAMBURGER SANDWICHES, PIZZA, PREPARED LUNCH MEALS CONSISTING PRIMARILY OF PASTA OR RICE; HOT DOG SANDWICHES; MEAT PIES; PASTA, RAVIOLI, PASTRIES AND BREADS; SWEET PREPARATIONS, NAMELY, ICE CREAM, SORBETS AND FROZEN FLAVORED ICES; ALMOND PASTE; YEAST, BAKING POWDER; CURRY POWDER, AND FISH FLOUR; ALL OF THE FOREGOING GOODS ARE FROM OKINAWA, IN CLASS 30 (U.S. CL. 46).

FOR: BEER, SOFT DRINKS, FRUIT DRINKS, VEGETABLE JUICES, AND HOP EXTRACTS FOR MAKING BEER; ALL OF THE FOREGOING GOODS ARE FROM OKINAWA, IN CLASS 32 (U.S. CLS. 45, 46 AND 48).

OWNER OF JAPAN REG. NO. 4601269, DATED 9-6-2002, EXPIRES 9-6-2012.

NO CLAIM IS MADE TO THE EXCLUSIVE RIGHT TO USE "OKINAWA MADE" AND THE

PICTORIAL REPRESENTATION OF OKINAWA,
APART FROM THE MARK AS SHOWN.

THE DRAWING IS LINED FOR THE COLORS
RED, BLUE, ORANGE, GREEN, YELLOW AND

GOLD BUT COLOR IS NOT A FEATURE OF THE
MARK.

SER. NO. 76-336,118, FILED 11-9-2001.

KAREN M. STRYZ, EXAMINING ATTORNEY

Int. Cl.: 7

Prior U.S. Cls.: 13, 19, 21, 23, 31, 34 and 35

United States Patent and Trademark Office

Reg. No. 2,892,316

Registered Oct. 12, 2004

**TRADEMARK
PRINCIPAL REGISTER**

MAGNUM

WARNER ELECTRIC TECHNOLOGY, INC. (DE-
LAWARE CORPORATION)
9211 FOREST HILL AVENUE, SUITE 109
RICHMOND, VA 23235

FOR: AIR-APPLIED FRICTION DISC BRAKE
UNITS AND PARTS THEREFOR USED FOR IN-
DUSTRIAL MACHINERY, IN CLASS 7 (U.S. CLS. 13,
19, 21, 23, 31, 34 AND 35).

FIRST USE 0-0-1986; IN COMMERCE 0-0-1986.

OWNER OF U.S. REG. NO. 1,624,438.

SER. NO. 76-336,606, FILED 11-13-2001.

WON TEAK OH, EXAMINING ATTORNEY

Int. Cls.: 38, 39 and 42

Prior U.S. Cls.: 100, 101, 104 and 105

United States Patent and Trademark Office

Reg. No. 2,892,317

Registered Oct. 12, 2004

**SERVICE MARK
PRINCIPAL REGISTER**

NAVICI

NOVOSAT OY (FINLAND LTD LIAB CO)
VALIMOTIE 17
00380 HELSINKI, FINLAND

FOR: PROVIDING TELECOMMUNICATIONS CONNECTIONS TO A GLOBAL COMPUTER NETWORK; RENTAL OF TELECOMMUNICATIONS EQUIPMENT; TELECOMMUNICATION SERVICES, NAMELY, LOCAL AND LONG DISTANCE TRANSMISSION OF VOICE AND DATA BY MEANS OF A TELEPHONE, CABLE AND SATELLITE TRANSMISSIONS, IN CLASS 38 (U.S. CLS. 100, 101 AND 104).

FOR: PROVIDING ON-LINE TRAVEL INFORMATION, NAMELY, MAPS WITH POINTS-OF-INTEREST BASED ON CUSTOMERS GEOGRAPHIC LOCATION VIA THE INTERNET; PROVIDING DRIVING DIRECTIONS ON-LINE THROUGH A WEB SITE, IN CLASS 39 (U.S. CLS. 100 AND 105).

FOR: COMPUTER SERVICES, NAMELY, PROVIDING SEARCH ENGINES FOR OBTAINING LOCATION BASED DATA ON A GLOBAL COMPUTER NETWORK; PROVIDING LOCATION BASED INFORMATION AT THE SPECIFIC REQUEST OF END

USERS BY MEANS OF TELEPHONE OR GLOBAL COMPUTER NETWORKS; PROVIDING TEMPORARY USE OF NON DOWNLOADABLE SOFTWARE FOR USE BY CUSTOMERS TO DETERMINE PEDESTRIAN AND VEHICLE ROUTING INFORMATION BASED ON CUSTOMER'S LOCATION VIA THE INTERNET AND VIA A MOBILE TELEPHONE NETWORK; COMPUTER SERVICES, NAMELY, CREATING INDEXES OF LOCATION BASED INFORMATION, SITES AND OTHER RESOURCES AVAILABLE ON COMPUTER NETWORKS; PROVIDING AN ON-LINE COMPUTER DATABASE IN THE FIELD OF MAPS; COMPUTER PROGRAMMING FOR OTHERS IN THE FIELD OF LOCATION BASED SERVICES, NAMELY, MAPS, IN CLASS 42 (U.S. CLS. 100 AND 101).

PRIORITY CLAIMED UNDER SEC. 44(D) ON FINLAND APPLICATION NO. T200103323, FILED 11-6-2001, REG. NO. 225211, DATED 9-30-2002, EXPIRES 9-30-2012.

SER. NO. 76-337,099, FILED 11-14-2001.

AMY GEARIN, EXAMINING ATTORNEY

Int. Cl.: 10

Prior U.S. Cls.: 26, 39 and 44

Reg. No. 2,892,318

United States Patent and Trademark Office

Registered Oct. 12, 2004

**TRADEMARK
PRINCIPAL REGISTER**

EXACT

VARIAN MEDICAL SYSTEMS, INC. (DELA-
WARE CORPORATION)
3100 HANSEN WAY
PALO ALTO, CA 94304

FOR: MEDICAL APPARATUS FOR PATIENT
POSITIONING IN CONNECTION WITH RADIO-
THERAPY TREATMENT, PATIENT IMAGING
AND DIAGNOSIS USING SCANNING DEVICES,
AND TREATMENT SIMULATION; MEDICAL AP-
PARATUSES FOR LOCATING AND TARGETING
VOLUMES IN A BODY FOR USE IN THE FIELD OF

CANCER CARE; MEDICAL APPARATUSES FOR
MAINTAINING PATIENT POSITIONING BE-
TWEEN OR AMONG TREATMENT, IMAGING,
DIAGNOSTIC AND SIMULATION SYSTEMS, IN
CLASS 10 (U.S. CLS. 26, 39 AND 44).

FIRST USE 1-2-1997; IN COMMERCE 1-2-1997.

SER. NO. 76-337,151, FILED 11-8-2001.

BARNEY CHARLON, EXAMINING ATTORNEY

Int. Cl.: 3

Prior U.S. Cls.: 1, 4, 6, 50, 51 and 52

United States Patent and Trademark Office

Reg. No. 2,892,319

Registered Oct. 12, 2004

**TRADEMARK
PRINCIPAL REGISTER**

NAIL BAR

NAIL BAR, LTD. (ILLINOIS CORPORATION)
3228 N. BROADWAY
CHICAGO, IL 60657

FIRST USE 11-1-1999; IN COMMERCE 11-1-1999.

FOR: COSMETICS; MANICURE PRODUCTS, NAMELY, NAIL POLISH, NAIL TOP COAT AND ACETONE NAIL POLISH REMOVER, AND PEDICURE PRODUCTS, NAMELY, NON-MEDICATED FOOT LOTION, FOOT MASQUE AND FOOT SCRUB; HAND CREAM, HAND MASQUE AND HAND SCRUB, IN CLASS 3 (U.S. CLS. 1, 4, 6, 50, 51 AND 52).

NO CLAIM IS MADE TO THE EXCLUSIVE RIGHT TO USE "NAIL", APART FROM THE MARK AS SHOWN.

SER. NO. 76-338,772, FILED 11-19-2001.

AMY GEARIN, EXAMINING ATTORNEY

Int. Cl.: 28

Prior U.S. Cls.: 22, 23, 38 and 50

United States Patent and Trademark Office

Reg. No. 2,892,320

Registered Oct. 12, 2004

TRADEMARK
PRINCIPAL REGISTER

PRO MARK •

LONG'S AMUSEMENT COMPANY, INC. (VIRGINIA CORPORATION)
9908 WARWICK BOULEVARD
NEWPORT NEWS, VA 23601

FIRST USE 7-0-2001; IN COMMERCE 7-0-2001.

SER. NO. 76-341,671, FILED 11-26-2001.

FOR: BILLIARD CUE STICKS, IN CLASS 28 (U.S. CLS. 22, 23, 38 AND 50).

LESLIE RICHARDS, EXAMINING ATTORNEY

Int. Cls.: 5 and 10

Prior U.S. Cls.: 6, 18, 26, 39, 44, 46, 51 and 52

United States Patent and Trademark Office

Reg. No. 2,892,321

Registered Oct. 12, 2004

**TRADEMARK
PRINCIPAL REGISTER**

INJECTILE

INJECTILE TECHNOLOGIES GMBH (FED REP
GERMANY LIMITED LIABILITY COMPANY)
WIESENRING 13A
D-04159 LEIPZIG, FED REP GERMANY

FOR: STARCH CAPSULES SOLD EMPTY AND
SUITABLE FOR CONTAINING A WIDE RANGE OF
PHARMACEUTICAL AND THERAPEUTIC PRE-
PARATIONS FOR USE WITH HUMANS AND ANI-
MALS, IN CLASS 5 (U.S. CLS. 6, 18, 44, 51 AND 52).

FOR: PNEUMATIC AND HYDRAULIC NEEDLE-
FREE DELIVERY APPARATUS FOR IMPLANTING
STARCH CAPSULES CONTAINING PHARMACEU-

TICAL AND THERAPEUTIC PREPARATIONS IN
ANIMALS AND HUMANS, IN CLASS 10 (U.S. CLS.
26, 39 AND 44).

PRIORITY CLAIMED UNDER SEC. 44(D) ON FED
REP GERMANY APPLICATION NO. 30132615005,
FILED 5-25-2001, REG. NO. 30132615, DATED 11-12-
2001, EXPIRES 5-31-2011.

SER. NO. 76-341,885, FILED 11-20-2001.

CHARLES L. JENKINS, EXAMINING ATTORNEY

Int. Cl.: 36

Prior U.S. Cls.: 100, 101 and 102

United States Patent and Trademark Office

Reg. No. 2,892,322

Registered Oct. 12, 2004

**SERVICE MARK
PRINCIPAL REGISTER**

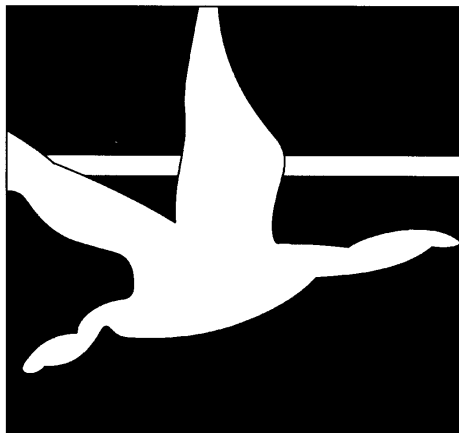

CRESTSTREET CAPITAL CORPORATION (CANADA CORPORATION)
130 ADELAIDE STREET SUITE 2320
TORONTO, ONTARIO M5H 3P5, CANADA

FOR: FINANCIAL SERVICES IN THE FIELD OF DISTRIBUTION, ADMINISTRATION AND MANAGEMENT OF INVESTMENT FUNDS, NAMELY, RECEIVING, INVESTING AND PAYING OUT OF MONIES; INVESTMENT MANAGEMENT SERVICES; INVESTMENT BANKING SERVICES; EQUITY, DEBIT, AND MEZZANINE FINANCING; INVESTMENT RESEARCH; SECURITY BROKERAGE AND ON-LINE, TELEPHONE AND IN PERSON SECURI-

TIES TRADING, IN CLASS 36 (U.S. CLS. 100, 101 AND 102).

FIRST USE 11-19-1999; IN COMMERCE 11-19-1999.

PRIORITY CLAIMED UNDER SEC. 44(D) ON CANADA APPLICATION NO. 1,106,964, FILED 6-18-2001, REG. NO. TMA602477, DATED 2-17-2004, EXPIRES 2-17-2019.

SER. NO. 76-345,526, FILED 12-5-2001.

KELLEY WELLS, EXAMINING ATTORNEY

Int. Cl.: 29

Prior U.S. Cl.: 46

United States Patent and Trademark Office

Reg. No. 2,892,323

Registered Oct. 12, 2004

**TRADEMARK
PRINCIPAL REGISTER**



SQUARE-H BRANDS, INC. (DELAWARE CORPORATION), DBA SQUARE-H BRANDS OR HOFFY'S
2731 SOUTH SOTO STREET
LOS ANGELES, CA 90023

FIRST USE 9-5-2001; IN COMMERCE 9-5-2001.

SER. NO. 76-345,830, FILED 12-6-2001.

FOR: MEAT PATTIES AND RAW MEAT IN FRESH AND FROZEN FORM FROM COWS, PIGS, FISH AND POULTRY, IN CLASS 29 (U.S. CL. 46).

LINDA M. KING, EXAMINING ATTORNEY

Int. Cl.: 3

Prior U.S. Cls.: 1, 4, 6, 50, 51 and 52

United States Patent and Trademark Office

Reg. No. 2,892,324

Registered Oct. 12, 2004

TRADEMARK
PRINCIPAL REGISTER



LANCÔME PARFUMS ET BEAUTE & CIE
(FRANCE SOCIETE EN NOM COLLECTIF)
29 RUE DU FAUBOURG SAINT-HONORE
75008 PARIS, FRANCE

FOR: PERFUMERY PRODUCTS, NAMELY PER-
FUMES, EAU DE COLOGNE, PERFUMED WATER,
AFTER SHAVE, SHAVING BALM, SKIN LOTIONS,
SOAPS, HAIR SHAMPOOS, BATH AND SHOWER
FOAMS AND GELS; COSMETICS, NAMELY
CREAMS, GELS, MILKS, POWDERS AND LOTIONS
FOR THE FACE, THE BODY AND THE HANDS;
BODY DEODORANTS, IN CLASS 3 (U.S. CLS. 1, 4, 6,
50, 51 AND 52).

PRIORITY CLAIMED UNDER SEC. 44(D) ON
FRANCE APPLICATION NO. 01/3.109.381, FILED 7-

4-2001, REG. NO. 013109381, DATED 7-4-2001, EX-
PIRES 7-4-2011.

NO CLAIM IS MADE TO THE EXCLUSIVE
RIGHT TO USE "HOMME", APART FROM THE
MARK AS SHOWN.

THE ENGLISH TRANSLATION OF "MIRACLE"
IS "MIRACLE". THE ENGLISH TRANSLATION OF
"HOMME" IS "MAN".

SER. NO. 76-345,978, FILED 12-6-2001.

THEODORE MCBRIDE, EXAMINING ATTORNEY

Int. Cl.: 7

Prior U.S. Cls.: 13, 19, 21, 23, 31, 34 and 35

United States Patent and Trademark Office

Reg. No. 2,892,325

Registered Oct. 12, 2004

**TRADEMARK
PRINCIPAL REGISTER**

QUADRO

SULZER CHEMTECH AG (SWITZERLAND CORPORATION)
HEGIFELDSTRASSE 10
8404, WINTERTHUR, SWITZERLAND

FOR: CHEMICAL APPARATUS AND INSTRUMENTS, NAMELY REUSABLE AND SINGLE USE STATIC MIXERS FOR MIXING AT LEAST TWO COMPONENTS OF SUBSTANCES SUCH AS ADHESIVES, RESINS AND LACQUERS; AND MIXING EQUIPMENT, NAMELY STATIC MECHANICAL TUBES TO BE PLACED ONTO AND/OR SCREWED ONTO CONTAINERS FOR COMPONENTS TO BE MIXED, IN CLASS 7 (U.S. CLS. 13, 19, 21, 23, 31, 34 AND 35).

PRIORITY CLAIMED UNDER SEC. 44(D) ON SWITZERLAND APPLICATION NO. 06648/2001, FILED 7-4-2001, REG. NO. 492711, DATED 12-12-2001, EXPIRES 7-4-2011.

THE ENGLISH TRANSLATION OF THE WORD "QUADRO" IN THE MARK IS "PAINTING, PICTURE; SITE, VIEW; SQUARE; TABLE; CADRE, LIST; BOARD; SCENE; FRAME".

SER. NO. 76-346,227, FILED 12-6-2001.

JOHN LINCOSKI, EXAMINING ATTORNEY

Int. Cl.: 28

Prior U.S. Cls.: 22, 23, 38 and 50

United States Patent and Trademark Office

Reg. No. 2,892,326

Registered Oct. 12, 2004

**TRADEMARK
PRINCIPAL REGISTER**

RELATIONAL GEOSOLIDS

A. DAIGGER AND COMPANY, INCORPORATED, THROUGH ITS DIVISION ETA/CUISENAIRE (ILLINOIS CORPORATION)
500 GREENVIEW COURT
VERNON HILLS, IL 60061

NO CLAIM IS MADE TO THE EXCLUSIVE RIGHT TO USE "RELATIONAL", APART FROM THE MARK AS SHOWN.

FOR: MANIPULATIVES USED FOR TEACHING MATHEMATICS, IN CLASS 28 (U.S. CLS. 22, 23, 38 AND 50).

SER. NO. 76-346,736, FILED 12-7-2001.

FIRST USE 0-0-1997; IN COMMERCE 0-0-1997.

PATRICIA HERRALL, EXAMINING ATTORNEY

Int. Cl.: 9

Prior U.S. Cls.: 21, 23, 26, 36 and 38

Reg. No. 2,892,327

United States Patent and Trademark Office

Registered Oct. 12, 2004

**TRADEMARK
PRINCIPAL REGISTER**

RED TOP

JOHNSON CONTROLS BATTERY GROUP, INC.
(WISCONSIN CORPORATION)
5757 NORTH GREEN BAY AVENUE
MILWAUKEE, WI 53201

SEC. 2(F).

FOR: BATTERIES, NAMELY VEHICULAR BATTERIES, IN CLASS 9 (U.S. CLS. 21, 23, 26, 36 AND 38).

SER. NO. 76-347,318, FILED 12-10-2001.

FIRST USE 7-0-1993; IN COMMERCE 7-0-1993.

GINA FINK, EXAMINING ATTORNEY

Int. Cl.: 16

Prior U.S. Cls.: 2, 5, 22, 23, 29, 37, 38 and 50

United States Patent and Trademark Office

Reg. No. 2,892,328

Registered Oct. 12, 2004

**TRADEMARK
PRINCIPAL REGISTER**

RATED: NOT TOO SCARY

TERFLE HOUSE LIMITED (OREGON CORPORATION)
1825 S.E. SEVENTH AVENUE
PORTLAND, OR 97214

FOR: BOOKS AND MAGAZINES ABOUT THE
FICTIONAL WORLD WHERE THE ADVENTURES
OF THE FICTIONAL CHARACTER HERMUX TAN-

TAMOQ TAKE PLACE, IN CLASS 16 (U.S. CLS. 2, 5,
22, 23, 29, 37, 38 AND 50).

FIRST USE 6-30-1999; IN COMMERCE 6-30-1999.

SER. NO. 76-347,575, FILED 12-13-2001.

MARGERY A. TIERNEY, EXAMINING ATTORNEY

Int. Cl.: 7

Prior U.S. Cls.: 13, 19, 21, 23, 31, 34 and 35

Reg. No. 2,892,329

United States Patent and Trademark Office

Registered Oct. 12, 2004

**TRADEMARK
PRINCIPAL REGISTER**

MK

PAUL H. GESSWEIN & CO., INC. (CONNECTI-
CUT CORPORATION)
255 HANCOCK AVENUE
P.O. BOX 3998
BRIDGEPORT, CT 06605

FOR: POWER TOOL ATTACHMENTS, NAMELY,
MOUNTED AND UNMOUNTED WHEEL BRUSHES

USED FOR POLISHING JEWELRY, IN CLASS 7 (U.S.
CLS. 13, 19, 21, 23, 31, 34 AND 35).

FIRST USE 9-18-1970; IN COMMERCE 9-18-1970.

SER. NO. 76-347,662, FILED 12-13-2001.

EDWARD NELSON, EXAMINING ATTORNEY

Int. Cl.: 21

Prior U.S. Cls.: 2, 13, 23, 29, 30, 33, 40 and 50

United States Patent and Trademark Office

Reg. No. 2,892,330

Registered Oct. 12, 2004

TRADEMARK
PRINCIPAL REGISTER

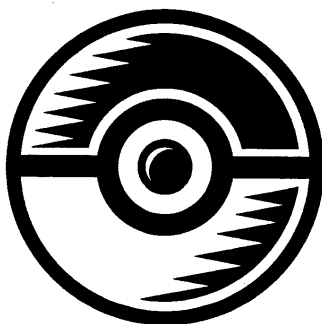

NINTENDO CO., LTD. (JAPAN CORPORATION)
1-11 KAMITOKA HOKOTATE-CHO
MINAMI-KU, KYOTO, JAPAN

FOR: BAKEWARE; BEVERAGE GLASSWARE; BIRD CAGES; BIRD FEEDERS; BIRD HOUSES; BOTTLE OPENERS; BOWLS; BROOMS; BRUSHES, NAMELY DISHWASHING BRUSHES, FLOOR BRUSHES, POT CLEANING BRUSHES, SCRUBBING BRUSHES, TOILET BRUSHES, DUSTING BRUSHES, HAIR BRUSHES, COSMETIC BRUSHES, NAIL BRUSHES, BRUSHES FOR PETS, BATH BRUSHES, SHOE BRUSHES; CAKE MOLDS; CANDLE EXTINGUISHERS AND CANDLE HOLDERS NOT MADE OF PRECIOUS METAL; CANTEENS; CLEANING IMPLEMENTS, NAMELY CLEANING CLOTHS, CLEANING COMBS, CLEANING COTTON, AND PRE-MOISTENED TOWELETTES FOR CLEANING; CLOTHESPINS; CLOTHING BRUSHES; COFFEE CUPS; COOKERY MOLDS; COASTERS NOT MADE OF PRECIOUS METAL, PAPER OR CLOTH; COOKING POTS AND PANS; COOLERS, NAMELY PORTABLE BEVERAGE COOLERS AND PORTABLE COOLERS; CUPS; CUTTING BOARDS; DISHES NOT MADE OF PRECIOUS METAL; DRINKING GLASSES; DUST CLOTHS; EGG CUPS, NAPKIN HOLDERS, NAPKIN RINGS, PEPPER MILLS, PEPPER SHAKERS, SALT SHAKERS, SUGAR BOWLS AND TRAYS, ALL OF WHICH ARE NOT MADE OF PRECIOUS METAL; FLOWER BOWLS, POTS AND

VASES NOT MADE OF PRECIOUS METAL; FOOD AND WATER DISHES FOR DOMESTIC PETS; GLASS OR CERAMIC CONTAINERS FOR HOUSEHOLD USE; HAIR BRUSHES; HAIR COMBS; INCENSE BURNERS; LADLES; LAUNDRY IMPLEMENTS, NAMELY IRONING BOARDS AND IRONING BOARD COVERS; LUNCH BOXES; LUNCH PAILS; NAIL BRUSHES; NON-ELECTRIC COFFEE MAKERS NOT MADE OF PRECIOUS METAL; NON-ELECTRIC KETTLES; PIGGY BANKS NOT MADE OF PRECIOUS METAL; PLANT POTS; PLASTIC CUPS; SERVING SPOONS; SHOE BRUSHES; SHOE HORNS; SHOPPING BASKETS MADE OF WICKER, STRAW OR CLOTH; SOAP DISHES; SPONGES; SPOONS; THERMAL BOTTLES, NAMELY THERMAL INSULATED CONTAINERS FOR FOOD OR BEVERAGES; ELECTRIC AND NON-ELECTRIC TOOTHBRUSHES; WASTEPAPER BASKETS; WATER BOTTLES SOLD EMPTY; WATER SPRINKLING CANS; WIND CHIMES, IN CLASS 21 (U.S. CLS. 2, 13, 23, 29, 30, 33, 40 AND 50).

PRIORITY CLAIMED UNDER SEC. 44(D) ON JAPAN APPLICATION NO. 2001-53757, FILED 6-13-2001, REG. NO. 4565926, DATED 5-10-2002, EXPIRES 5-10-2012.

SER. NO. 76-348,403, FILED 12-13-2001.

JOHN LINCOSKI, EXAMINING ATTORNEY

Int. Cls.: 9 and 42

Prior U.S. Cls.: 21, 23, 26, 36, 38, 100 and 101

Reg. No. 2,892,331

United States Patent and Trademark Office

Registered Oct. 12, 2004

**TRADEMARK
SERVICE MARK
PRINCIPAL REGISTER**

DirXmetaRole

SIEMENS AKTIENGESELLSCHAFT (FED REP
GERMANY CORPORATION)
WITTELSBACHERPLATZ 2
MUNCHEN, FED REP GERMANY

FOR: DATA PROCESSING AND TELECOMMUNIC-
ATION DEVICES, NAMELY, COMPUTER
HARDWARE FOR THE ADMINISTRATION AND
MANAGEMENT OF USERS AND ACCESS RIGHTS
IN INFORMATION TECHNOLOGY NETWORKS;
AND DATA PROCESSING PROGRAMS, NAMELY,
COMPUTER SOFTWARE FOR MANAGEMENT
AND ADMINISTRATION OF USERS AND ACCESS
RIGHTS IN INFORMATION TECHNOLOGY NET-
WORKS, IN CLASS 9 (U.S. CLS. 21, 23, 26, 36 AND 38).

FOR: CONSULTATION SERVICES IN THE FIELD
OF SECURING INFORMATION TECHNOLOGY

NETWORKS THROUGH MANAGEMENT AND
CONTROL OF ACCESS TO NETWORKS, NAMELY,
CONSULTATION REGARDING PLANNING, DE-
SIGNING, SETTING UP AND OPERATING COM-
PUTER HARDWARE AND COMPUTER
SOFTWARE FOR SECURING INFORMATION
TECHNOLOGY NETWORKS, IN CLASS 42 (U.S.
CLS. 100 AND 101).

PRIORITY CLAIMED UNDER SEC. 44(D) ON FED
REP GERMANY APPLICATION NO. 30151916,
FILED 8-29-2001, REG. NO. 30151916, DATED 10-5-
2001, EXPIRES 8-31-2011.

SER. NO. 76-349,408, FILED 12-13-2001.

HEATHER THOMPSON, EXAMINING ATTORNEY

Int. Cl.: 30

Prior U.S. Cl.: 46

United States Patent and Trademark Office

Reg. No. 2,892,332

Registered Oct. 12, 2004

**TRADEMARK
PRINCIPAL REGISTER**

LAILA

FLYING TRADE LIMITED (UNITED KINGDOM
LIMITED LIABILITY COMPANY)
4 EUROPA WAY
PARKESTON
HARWICH, ESSEX CO12 4PT, UNITED KINGDOM

OWNER OF ERPN CMNTY TM OFC REG. NO.
1262104, DATED 11-6-2000, EXPIRES 7-22-2009.

SER. NO. 76-349,739, FILED 12-18-2001.

FOR: FARINACEOUS PRODUCTS FOR FOOD
FOR HUMAN CONSUMPTION, NAMELY, RICE
AND RICE FLOUR, IN CLASS 30 (U.S. CL. 46).

YSA DEJESUS, EXAMINING ATTORNEY

Int. Cl.: 24

Prior U.S. Cls.: 42 and 50

United States Patent and Trademark Office

Reg. No. 2,892,333

Registered Oct. 12, 2004

**TRADEMARK
PRINCIPAL REGISTER**

MERRY MISTLETOES

JARVIE, DIANNE L. (CANADA INDIVIDUAL)
RR 1
ST. GEORGE, ONTARIO, CANADA N0E 1N0

PRIORITY CLAIMED UNDER SEC. 44(D) ON
CANADA APPLICATION NO. 1108247, FILED 6-22-
2001, REG. NO. TMA597309, DATED 12-11-2003, EX-
PIRES 12-11-2018.

FOR: TABLE AND DESK HOLIDAY ORNA-
MENTS MADE PRIMARILY OF FABRIC, IN CLASS
24 (U.S. CLS. 42 AND 50).

SER. NO. 76-350,325, FILED 12-20-2001.

MARTHA FROMM, EXAMINING ATTORNEY

Int. Cl.: 29

Prior U.S. Cl.: 46

United States Patent and Trademark Office

Reg. No. 2,892,334

Registered Oct. 12, 2004

**TRADEMARK
PRINCIPAL REGISTER**

FRESHER LASTING

HEB GROCERY COMPANY, LP (TEXAS LIMITED PARTNERSHIP)
646 SOUTH MAIN
SAN ANTONIO, TX 78204

NO CLAIM IS MADE TO THE EXCLUSIVE RIGHT TO USE "FRESHER" , APART FROM THE MARK AS SHOWN.

FOR: PRE-CUT FRESH FRUITS AND VEGETABLES, IN CLASS 29 (U.S. CL. 46).

SER. NO. 76-351,723, FILED 12-21-2001.

FIRST USE 2-24-2002; IN COMMERCE 2-24-2002.

ESTHER BELENKER, EXAMINING ATTORNEY

Int. Cls.: 16 and 28

Prior U.S. Cls.: 2, 5, 22, 23, 29, 37, 38 and 50

United States Patent and Trademark Office

Reg. No. 2,892,335

Registered Oct. 12, 2004

**TRADEMARK
PRINCIPAL REGISTER**

OLIVIA

FALCONER, IAN (UNITED STATES INDIVIDUAL)
C/O LEVINE PLOTKIN & MENIN, LLP
1740 BROADWAY, 22ND FLOOR
NEW YORK, NY 10019

FOR: CHILDREN'S BOOKS, ALL OF THE FOREGOING ASSOCIATED WITH A CHILDREN'S STORY BOOK PIGLET CHARACTER , IN CLASS 16 (U.S. CLS. 2, 5, 22, 23, 29, 37, 38 AND 50).

FIRST USE 6-0-2000; IN COMMERCE 6-0-2000.

FOR: DOLLS, ALL OF THE FOREGOING ASSOCIATED WITH A CHILDREN'S STORY BOOK PIGLET CHARACTER, IN CLASS 28 (U.S. CLS. 22, 23, 38 AND 50).

FIRST USE 9-0-2001; IN COMMERCE 9-0-2001.

THE NAME SHOWN IN THE MARK DOES NOT IDENTIFY A PARTICULAR LIVING INDIVIDUAL.

SER. NO. 76-351,858, FILED 12-21-2001.

MARTHA FROMM, EXAMINING ATTORNEY

Int. Cls.: 39 and 42

Prior U.S. Cls.: 100, 101 and 105

United States Patent and Trademark Office

Reg. No. 2,892,336

Registered Oct. 12, 2004

**SERVICE MARK
PRINCIPAL REGISTER**

TRAVEL COMMERCE MACHINERY

NEWTRADE TECHNOLOGIES INC. (CANADA CORPORATION)
63 DE BRESOLES, SUITE 100
MONTREAL, QUEBEC H2Y 1V7, CANADA

FOR: PROVIDING AN ON-LINE INTERACTIVE DATABASE FEATURING TRAVEL INDUSTRY INFORMATION, IN CLASS 39 (U.S. CLS. 100 AND 105).

FOR: PROVIDING REAL-TIME HOTEL INFORMATION AND RESERVATION SERVICES VIA GLOBAL COMPUTER NETWORK; CREATING AND MAINTAINING WEB SITES FOR OTHERS CONCERNING THE TRAVEL INDUSTRY; E-COMMERCE COMPUTER SOFTWARE DESIGN FOR

THE TRAVEL INDUSTRY, IN CLASS 42 (U.S. CLS. 100 AND 101).

PRIORITY CLAIMED UNDER SEC. 44(D) ON CANADA APPLICATION NO. 1124897, FILED 12-12-2001, REG. NO. 603664, DATED 3-1-2004, EXPIRES 3-1-2019.

NO CLAIM IS MADE TO THE EXCLUSIVE RIGHT TO USE "TRAVEL COMMERCE" , APART FROM THE MARK AS SHOWN.

SER. NO. 76-352,868, FILED 12-19-2001.

SHAUNIA WALLACE, EXAMINING ATTORNEY

Int. Cls.: 30, 41 and 43

Prior U.S. Cls.: 46, 100, 101 and 107

United States Patent and Trademark Office

Reg. No. 2,892,337

Registered Oct. 12, 2004

TRADEMARK
SERVICE MARK
PRINCIPAL REGISTER



INTERNATIONAL HOSPITALITY MANAGE-
MENT S.P.A. (ITALY CORPORATION)
26, VIA G. CARISSIMI
00198 ROME, ITALY

FOR: COFFEE, TEA, COCOA, SUGAR, RICE, TAPIOCA, SAGO, COFFEE SUBSTITUTES GRAIN OR CHICORY BASED; FLOUR AND CEREAL BASED SNACK FOOD; BREAD, AND PASTRY; FLAVORED ICES; HONEY, TREACLE, YEAST, BAKING POWDER; SALT, MUSTARD; VINEGAR; SAUCES, NAMELY, ARTICHOKE SAUCE, BARBECUE SAUCE, CHEESE SAUCE, CHILI SAUCE, HOT SAUCE, MIX FOR MAKING COMBINED NOODLE AND SAUCE DISH, PICANTE SAUCE, PIZZA SAUCE, SOY SAUCE, SPAGHETTI SAUCE, TARTAR SAUCE, TERIYAKI SAUCE, TOMATO SAUCE; CONDIMENTS, NAMELY, KETCHUP, AND MAYONNAISE; SPICES AND ICE, IN CLASS 30 (U.S. CL. 46).

FOR: EDUCATION SERVICES, NAMELY, CONDUCTING TRAINING PROGRAMS IN THE FIELD OF HOTEL AND RESTAURANT SERVICES; PROVIDING FACILITIES FOR RECREATION ACTIVITIES; PROVIDING TENNIS COURT AND GOLF COURSE FACILITIES; PROVIDING FITNESS AND

EXERCISE FACILITIES; AND PHYSICAL FITNESS CONSULTATION, IN CLASS 41 (U.S. CLS. 100, 101 AND 107).

FOR: PROVIDING BANQUET AND SOCIAL FUNCTION FACILITIES FOR SPECIAL OCCASIONS; HOTEL, RESORT AND LODGING SERVICES; RESTAURANT SERVICES, IN CLASS 43 (U.S. CLS. 100 AND 101).

PRIORITY CLAIMED UNDER SEC. 44(D) ON ITALY APPLICATION NO. RM2001C00402, FILED 7-6-2001, REG. NO. 00858333, DATED 1-30-2002, EXPIRES 7-6-2011.

NO CLAIM IS MADE TO THE EXCLUSIVE RIGHT TO USE "CAFÉ", APART FROM THE MARK AS SHOWN.

THE ENGLISH TRANSLATION OF "CAFÉ ROMANO" IS "ROMAN CAFETERIA".

SER. NO. 76-356,135, FILED 1-8-2002.

MARK T. MULLEN, EXAMINING ATTORNEY

Int. Cl.: 33

Prior U.S. Cls.: 47 and 49

United States Patent and Trademark Office

Reg. No. 2,892,338

Registered Oct. 12, 2004

**TRADEMARK
PRINCIPAL REGISTER**

GLACIER

NATIONAL DISTILLERS PRODUCTS CO., LLC
(DELAWARE CORPORATION)
700 CANAL STREET
STAMFORD, CT 06902

OWNER OF U.S. REG. NO. 2,058,981.

FOR: DOMESTIC VODKA, IN CLASS 33 (U.S. CLS.
47 AND 49).

SER. NO. 76-357,364, FILED 1-10-2002.

FIRST USE 6-26-1996; IN COMMERCE 6-26-1996.

MARK T. MULLEN, EXAMINING ATTORNEY

Int. Cl.: 17

Prior U.S. Cls.: 1, 5, 12, 13, 35 and 50

United States Patent and Trademark Office

Reg. No. 2,892,339

Registered Oct. 12, 2004

TRADEMARK
PRINCIPAL REGISTER

The logo for TP Tow-Preg features the letters 'TP' in a large, bold, italicized font. The 'P' is white with a black outline and is set against a thick black horizontal bar. To the right of this bar, the words 'Tow-Preg' are written in a bold, black, sans-serif font.

MITSUBISHI RAYON CO., LTD. (JAPAN CORPORATION)
6-41, KONAN 1-CHOME
MINATO-KU, TOKYO, JAPAN

FOR: PLASTIC IN THE FORM OF BARS, BLOCKS, PELLETS, RODS, SHEETS, AND TUBES FOR USE IN MANUFACTURING; PLASTIC LAMINATED SHEETS AND PANELS FOR USE IN THE MANUFACTURE OF COUNTERTOPS; PLASTIC TUBES FOR USE IN PLUMBING; PLASTIC SHEETS COATED WITH DEPOSITED METAL FOIL AND FIBER REINFORCED PLASTIC SHEETS FOR UNDERGROUND CONSTRUCTION PURPOSES, NAMELY, COVERING AND PROTECTING THE EXTERIOR SURFACES OF BASEMENT AND FOUNDATION WALLS; PLASTIC FOAM SHEETING FOR USE AS A BUILDING INSULATION; PLASTIC MOLDED FOAM INSULATED CONTAINER PACKING FOR COMMERCIAL TRANSPORTATION; ADHESIVE-BACKED PLASTIC FILMS FOR USE IN THE MANUFACTURE OF DURABLE LABELS AND NAMEPLATES; REFLECTIVE, LAMINATED AND TINTED PLASTIC FILM FOR USE IN

HOME OR AUTO WINDOWS; PLASTIC SOUND-PROOFING MATERIALS FOR BUILDINGS; PLASTIC COMPOSITE MATERIAL IN THE FORM OF PROFILES, BOARDS, SHEETS, BLOCKS, RODS, POWDER AND PELLETS FOR USE IN MANUFACTURING; CARBON-FIBER REINFORCED RESIN SHEETS, IN CLASS 17 (U.S. CLS. 1, 5, 12, 13, 35 AND 50).

PRIORITY CLAIMED UNDER SEC. 44(D) ON JAPAN APPLICATION NO. 2001-107729, FILED 12-3-2001, REG. NO. 4635726, DATED 1-10-2003, EXPIRES 1-10-2013.

THE APPLICANT HEREBY INDICATES THAT "P" PORTION OF THE DESIGN APPEARS IN THE COLOR GRAY. THE STIPPLING SHOWN IS A FEATURE OF THE MARK.

SER. NO. 76-357,436, FILED 1-14-2002.

CHRISTOPHER ADKINS, EXAMINING ATTORNEY

Int. Cls.: 18, 21, 23, 25 and 26

Prior U.S. Cls.: 1, 2, 3, 13, 22, 23, 29, 30, 33, 37, 39, 40, 41, 42, 43 and 50

Reg. No. 2,892,340

United States Patent and Trademark Office

Registered Oct. 12, 2004

**TRADEMARK
PRINCIPAL REGISTER**

Gustavo Arango

MUSA, YUSEF (UNITED STATES INDIVIDUAL)
PO BOX 1697
BAYAMON, PUERTO RICO 009601700

FOR: LEATHER AND IMITATION LEATHER
HANDBAGS, PURSES, SUITCASES AND LUG-
GAGE, IN CLASS 18 (U.S. CLS. 1, 2, 3, 22 AND 41).

FIRST USE 0-0-2001; IN COMMERCE 0-0-2001.

FOR: BUTTER DISHES, BAKING DISHES, CAS-
SEROLES, AND CUPS, IN CLASS 21 (U.S. CLS. 2, 13,
23, 29, 30, 33, 40 AND 50).

FIRST USE 0-0-2001; IN COMMERCE 0-0-2001.

FOR: YARN AND THREAD, IN CLASS 23 (U.S.
CL. 43).

FIRST USE 0-0-2001; IN COMMERCE 0-0-2001.

FOR: CLOTHING, NAMELY, HEADWEAR, CAPS,
HATS, FOOTWEAR, SHIRTS, T-SHIRTS, PANTS,

BERMUDA SHORTS, DENIM JACKETS, BEACH-
WEAR, BELTS, BIKINIS, BLOUSES, BOXERS
BRIEFS, BOXER SHORTS, GYM SHORTS, BLA-
ZERS, POLO SHIRTS, JACKETS, JEANS, JERSEYS,
JUMPERS, LEATHER JACKETS, PAJAMAS, BATH-
ROBES, TIES, GOLF SHIRTS, ATHLETIC FOOT-
WEAR AND SANDALS, IN CLASS 25 (U.S. CLS. 22
AND 39).

FIRST USE 0-0-2001; IN COMMERCE 0-0-2001.

FOR: LACE TRIMMING; EMBROIDERY, IN
CLASS 26 (U.S. CLS. 37, 39, 40, 42 AND 50).

FIRST USE 0-0-2001; IN COMMERCE 0-0-2001.

THE NAME "GUSTAVO ARANGO" IDENTIFIES
A LIVING INDIVIDUAL WHOSE CONSENT IS OF
RECORD.

SER. NO. 76-357,690, FILED 1-14-2002.

BARBARA A. GOLD, EXAMINING ATTORNEY

Int. Cls.: 35 and 42

Prior U.S. Cls.: 100, 101 and 102

United States Patent and Trademark Office

Reg. No. 2,892,341

Registered Oct. 12, 2004

**SERVICE MARK
PRINCIPAL REGISTER**



VOLTDELTA

VOLT INFORMATION SCIENCES, INC. (NEW YORK CORPORATION)
2401 N. GLASSELL STREET
ORANGE, CA 92665

FOR: TELEPHONE DIRECTORY ASSISTANCE AND BUSINESS DIRECTORY INFORMATION SERVICES, IN CLASS 35 (U.S. CLS. 100, 101 AND 102).

FIRST USE 5-0-1996; IN COMMERCE 5-0-1996.

FOR: DESIGN, CONFIGURATION AND INSTALLATION SERVICES IN THE FIELD OF DIRECTORY ASSISTANCE AND INFORMATION SERVICES;

PROVIDING DIRECTORY ASSISTANCE AND INFORMATION SERVICE DATABASES, IN CLASS 42 (U.S. CLS. 100 AND 101).

FIRST USE 5-0-1996; IN COMMERCE 5-0-1996.

OWNER OF U.S. REG. NO. 1,352,051 AND OTHERS.

SER. NO. 76-358,570, FILED 1-14-2002.

KENNETH D. BATTLE, EXAMINING ATTORNEY

Int. Cl.: 42

Prior U.S. Cls.: 100 and 101

United States Patent and Trademark Office

Reg. No. 2,892,342

Registered Oct. 12, 2004

**SERVICE MARK
PRINCIPAL REGISTER**

O₂GUARDIAN

COOLTEL, INC. (MINNESOTA CORPORATION)
3505 COUNTY ROAD 42 WEST
BURNSVILLE, MN 55306

FOR: ONLINE SERVICES DELIVERED BY GLOBAL COMPUTER NETWORK ALLOWING PROVIDERS OF MEDICAL HOME DELIVERED OXYGEN TO MONITOR TANK LEVEL INFORMATION FROM REMOTE LOCATIONS AND TO AUTOMATE THE SCHEDULING, DELIVERY AND ROUTING OF OXYGEN FOR THE HOME HEALTH CARE MARKET; AND PROVIDING ONLINE CUS-

TOMIZED INFORMATION REPORTING SERVICES AT THE REQUEST OF SUBSCRIBERS, NAMELY PROVIDERS OF HOME DELIVERED OXYGEN FOR MEDICAL USE, IN CLASS 42 (U.S. CLS. 100 AND 101).

FIRST USE 10-12-2001; IN COMMERCE 10-12-2001.

SER. NO. 76-358,619, FILED 1-4-2002.

TONI HICKEY, EXAMINING ATTORNEY

Int. Cl.: 29

Prior U.S. Cl.: 46

United States Patent and Trademark Office

Reg. No. 2,892,343

Registered Oct. 12, 2004

**TRADEMARK
PRINCIPAL REGISTER**

SUNSHINE

LUBERSKI, INC. (CALIFORNIA CORPORATION)
310 NORTH HARBOR BOULEVARD, SUITE 100
FULLERTON, CA 92834

OWNER OF U.S. REG. NO. 1,949,889.

FOR: EGGS SOLD EXCLUSIVELY THROUGH
MILITARY FACILITIES, IN CLASS 29 (U.S. CL. 46).

SER. NO. 76-359,428, FILED 1-15-2002.

FIRST USE 1-1-1989; IN COMMERCE 1-1-1989.

ZHALEH DELANEY, EXAMINING ATTORNEY

Int. Cl.: 32

Prior U.S. Cls.: 45, 46 and 48

Reg. No. 2,892,344

United States Patent and Trademark Office

Registered Oct. 12, 2004

**TRADEMARK
PRINCIPAL REGISTER**

REAL. GOLDEN. BEER.

COORS BREWING COMPANY (COLORADO
CORPORATION)
311 10TH STREET
GOLDEN, CO 80401

NO CLAIM IS MADE TO THE EXCLUSIVE
RIGHT TO USE "GOLDEN.BEER." , APART FROM
THE MARK AS SHOWN.

FOR: BEER, IN CLASS 32 (U.S. CLS. 45, 46 AND 48).

SER. NO. 76-360,369, FILED 1-18-2002.

FIRST USE 3-8-2002; IN COMMERCE 3-8-2002.

CAROLYN GRAY, EXAMINING ATTORNEY

Int. Cls.: 9 and 42

Prior U.S. Cls.: 21, 23, 26, 36, 38, 100 and 101

United States Patent and Trademark Office

Reg. No. 2,892,345

Registered Oct. 12, 2004

**TRADEMARK
SERVICE MARK
PRINCIPAL REGISTER**

SAQQARA CONTENTWORKS

SAQQARA SYSTEMS, INC. (CALIFORNIA CORPORATION)
2833 JUNCTION AVENUE, SUITE 100
SAN JOSE, CA 95134

FOR: COMPUTER SOFTWARE FOR ELECTRONIC PUBLISHING, NAMELY, FOR CREATING, MANAGING, AND PREPARING PRODUCT INFORMATION FOR PUBLICATION OF THE SAME, IN CLASS 9 (U.S. CLS. 21, 23, 26, 36 AND 38).

FIRST USE 3-30-2001; IN COMMERCE 3-30-2001.

FOR: APPLICATION SERVICE PROVIDER (ASP) FEATURING SOFTWARE IN THE FIELD OF ELECTRONIC PUBLISHING, NAMELY, FOR CREATING, MANAGING, AND PREPARING PRODUCT INFORMATION FOR PUBLICATION OF THE SAME, IN CLASS 42 (U.S. CLS. 100 AND 101).

FIRST USE 1-17-2001; IN COMMERCE 1-17-2001.

SER. NO. 76-361,445, FILED 1-22-2002.

LESLIE RICHARDS, EXAMINING ATTORNEY

Int. Cl.: 16

Prior U.S. Cls.: 2, 5, 22, 23, 29, 37, 38 and 50

United States Patent and Trademark Office

Reg. No. 2,892,346

Registered Oct. 12, 2004

**TRADEMARK
PRINCIPAL REGISTER**

ECOTONES

HOUSE OF DOOLITTLE, LTD. (ILLINOIS CORPORATION)
701 LUNT AVE.
ELK GROVE VILLAGE, IL 60007

FIRST USE 1-0-1995; IN COMMERCE 1-0-1995.

SER. NO. 76-361,955, FILED 1-22-2002.

FOR: CALENDARS, DESK PADS, NOTE PADS,
PAPER PADS AND WRITING PAPER, IN CLASS 16
(U.S. CLS. 2, 5, 22, 23, 29, 37, 38 AND 50).

MARTHA FROMM, EXAMINING ATTORNEY

Int. Cls.: 7, 9 and 42

**Prior U.S. Cls.: 13, 19, 21, 23, 26, 31, 34, 35, 36, 38, 100
and 101**

Reg. No. 2,892,347

United States Patent and Trademark Office

Registered Oct. 12, 2004

**TRADEMARK
SERVICE MARK
PRINCIPAL REGISTER**

MOLATTACK

MORPHOCHEM AG (FED REP GERMANY CORPORATION)
GMUNDER STR. 37-37A
MUNCHEN, FED REP GERMANY 81379

FOR: MACHINES, NAMELY DILUTORS FOR THE PREPARATION OF BIOLOGICAL AND CHEMICAL SAMPLES FOR SYNTHESIS OR SCREENING FOR THE CHEMICAL AND PHARMACEUTICAL INDUSTRY, IN CLASS 7 (U.S. CLS. 13, 19, 21, 23, 31, 34 AND 35).

FOR: SCREENING APPARATUS, NAMELY, MACHINES FOR THE TESTING OF BIOLOGICAL ACTIVITY AND SELECTIVITY OF BIOLOGICAL AND CHEMICAL SAMPLES, FOR THE CHEMICAL AND PHARMACEUTICAL INDUSTRY; ANALYTICAL INSTRUMENTS FOR THE IDENTIFICATION OF MOLECULES, NAMELY, SPECTROMETERS; SCIENTIFIC AND LABORATORY INSTRUMENTS WHICH READ OUT BIOLOGICAL INFORMATION AND DATA NAMELY, READERS AND SPECTROMETERS; COMPUTERS AND COMPUTER SOFT-

WARE FOR PROCESSING AND ANALYZING DATA TO ENABLE THE DISCOVERY OF CHEMICAL COMPOUNDS, IN CLASS 9 (U.S. CLS. 21, 23, 26, 36 AND 38).

FOR: SCIENTIFIC AND INDUSTRIAL RESEARCH IN THE FIELDS OF CHEMISTRY, BIOLOGY AND PHARMACY; COMPUTER PROGRAMMING FOR OTHERS; COMPUTER SOFTWARE DESIGN FOR OTHERS, IN CLASS 42 (U.S. CLS. 100 AND 101).

PRIORITY CLAIMED UNDER SEC. 44(D) ON FED REP GERMANY APPLICATION NO. DE30145247.4, FILED 7-25-2001, REG. NO. 30145247, DATED 8-23-2001, EXPIRES 7-31-2011.

SER. NO. 76-362,189, FILED 1-22-2002.

JOHN SCHUYLER YARD, EXAMINING ATTORNEY

Int. Cl.: 3

Prior U.S. Cls.: 1, 4, 6, 50, 51 and 52

United States Patent and Trademark Office

Reg. No. 2,892,348

Registered Oct. 12, 2004

**TRADEMARK
PRINCIPAL REGISTER**



CAMPBELL, JOHN W. (UNITED STATES INDIVIDUAL)
102 NATCHEZ STREET
STARKSVILLE, MA 39759

FIRST USE 11-17-2000; IN COMMERCE 11-17-2000.

SER. NO. 76-362,205, FILED 1-23-2002.

FOR: NON-MEDICATED SKIN CARE PREPARATIONS, IN CLASS 3 (U.S. CLS. 1, 4, 6, 50, 51 AND 52).

LESLIE RICHARDS, EXAMINING ATTORNEY

Int. Cl.: 25

Prior U.S. Cls.: 22 and 39

United States Patent and Trademark Office

Reg. No. 2,892,349

Registered Oct. 12, 2004

**TRADEMARK
PRINCIPAL REGISTER**

JUST WIN BABY

OAKLAND RAIDERS, THE (CALIFORNIA LIMITED PARTNERSHIP)
1220 HARBOR BAY PARKWAY
ALAMEDA, CA 94502

FOR: MEN'S, WOMEN'S AND CHILDREN'S CLOTHING, FOOTWEAR AND HEADGEAR, NAMELY, SHIRTS, T-SHIRTS, TANK TOPS, JACKETS, WARM-UP SUITS, DOWN JACKETS, JEANS, COATS, SWEATSHIRTS, SWEATPANTS, FOOTBALL JERSEYS, SHORTS, PULL-OVER JACKETS, ROBES, PAJAMAS, KNICKERS, APRONS, SKIRTS, KNIT SHIRTS AND KNIT SWEATERS, SCARVES, LONG JOHNS, SNOW SUITS, DRESSES, JOGGING SUITS, POLO SHIRTS, SWEATERS, SLACKS, TURTLENECKS, FLEECE PULLOVERS, FLEECE JERSEYS, JERSEY PANTS, SHORTS, NECK GAITERS, THERMAL SHIRTS, GLOVES, PARKAS, STADIUM

COATS, WRAPS, BATHING SUITS, RAINCOATS, PONCHOS, NIGHT SHIRTS, LEATHER JACKETS, LEG WARMERS, LEOTARDS, CARDIGANS, BOXER SHORTS, NECKTIES, SUSPENDERS, BELTS, ROMPERS, MITTENS, WRISTBANDS, UNDERWEAR, SNEAKERS, SOCKS, COACHES' CAPS, WOOL AND KNIT HATS, VISORS, KNIT SKI MASKS, EAR BANDS, BASEBALL CAPS, HEADBANDS, EAR MUFFS, PAINTER'S CAPS, BANDANAS, IN CLASS 25 (U.S. CLS. 22 AND 39).

FIRST USE 7-0-1980; IN COMMERCE 7-0-1980.

SER. NO. 76-362,416, FILED 1-24-2002.

MARY ROSSMAN, EXAMINING ATTORNEY

Int. Cls.: 10 and 35

Prior U.S. Cls.: 26, 39, 44, 100, 101 and 102

United States Patent and Trademark Office

Reg. No. 2,892,350

Registered Oct. 12, 2004

**TRADEMARK
SERVICE MARK
PRINCIPAL REGISTER**

TOTAL MEDICAL SOLUTIONS

TOTAL MEDICAL SOLUTIONS (FLORIDA LIMITED LIABILITY COMPANY)
321 E. GEORGIA AVENUE
LONGWOOD, FL 32750

FOR: MEDICAL EQUIPMENT, NAMELY, TRANSCUTANEOUS ELECTRICAL NERVE STIMULATION UNITS, MUSCLE STIMULATORS, GALVANIC STIMULATORS AND INFERENTIAL STIMULATORS; CANES FOR MEDICAL PURPOSES, INVALID WALKERS, CRUTCHES, BONE GROWTH STIMULATORS, AIR MATTRESSES FOR MEDICAL PURPOSES, IN CLASS 10 (U.S. CLS. 26, 39 AND 44).

FIRST USE 2-24-1998; IN COMMERCE 2-24-1998.

FOR: ON-LINE ORDERING SERVICES IN THE FIELD OF DURABLE MEDICAL EQUIPMENT AND PHARMACY ORDER FULFILLMENT SERVICES FOR WORKERS' COMPENSATION CLAIMANTS, IN CLASS 35 (U.S. CLS. 100, 101 AND 102).

FIRST USE 2-24-1998; IN COMMERCE 2-24-1998.

NO CLAIM IS MADE TO THE EXCLUSIVE RIGHT TO USE "MEDICAL SOLUTIONS", APART FROM THE MARK AS SHOWN.

SER. NO. 76-362,713, FILED 1-25-2002.

RONALD MCMORROW, EXAMINING ATTORNEY

Int. Cl.: 5

Prior U.S. Cls.: 6, 18, 44, 46, 51 and 52

United States Patent and Trademark Office

Reg. No. 2,892,351

Registered Oct. 12, 2004

**TRADEMARK
PRINCIPAL REGISTER**

FREDDY THE FIRE ANT

DIATECT INTERNATIONAL, INC. (CALIFOR-
NIA CORPORATION)
875 S. INDUSTRIAL PARKWAY
HEBER CITY, UT 84032

FIRST USE 1-0-2001; IN COMMERCE 1-0-2001.

SER. NO. 76-363,470, FILED 1-11-2002.

FOR: INSECTICIDES FOR DOMESTIC USE, IN
CLASS 5 (U.S. CLS. 6, 18, 44, 46, 51 AND 52).

CURTIS FRENCH, EXAMINING ATTORNEY

Int. Cls.: 10 and 28

Prior U.S. Cls.: 22, 23, 26, 38, 39, 44 and 50

United States Patent and Trademark Office

Reg. No. 2,892,352

Registered Oct. 12, 2004

**TRADEMARK
PRINCIPAL REGISTER**



CEFAR MEDICAL AB (SWEDEN CORPORATION)
SCHEELEVAGEN 19 F
SE-223 70, LUND, SWEDEN

FOR: MEDICAL, SURGICAL, DENTAL AND VETERINARY APPARATUS AND INSTRUMENTS, NAMELY, ELECTRICAL OR MECHANICAL STIMULATORS FOR SENSING AND MEASURING PAIN AND NAUSEA FOR THE PURPOSE OF DIAGNOSING NERVE AND MUSCLE DAMAGE, ELECTROSTIMULATORS FOR THE PURPOSE OF ALLEVIATING PAIN, STRENGTHENING AND STIMULATING MUSCLES OR FOR THE TREATMENT OF INFLAMMATION AS WELL AS FOR ACUPUNCTURE, IN CLASS 10 (U.S. CLS. 26, 39 AND 44).

FOR: SPORTING ARTICLES, NAMELY, ELECTRICAL AND ELECTRONIC DEVICES FOR STRENGTHENING AND STIMULATING MUSCLES, IN CLASS 28 (U.S. CLS. 22, 23, 38 AND 50).

PRIORITY CLAIMED UNDER SEC. 44(D) ON ERPN CMNTY TM OFC APPLICATION NO. 002366557, FILED 9-6-2001, REG. NO. 002366557, DATED 6-26-2003, EXPIRES 9-6-2011.

SER. NO. 76-364,006, FILED 1-29-2002.

BARNEY CHARLON, EXAMINING ATTORNEY

Int. Cl.: 36

Prior U.S. Cls.: 100, 101 and 102

United States Patent and Trademark Office

Reg. No. 2,892,353

Registered Oct. 12, 2004

**SERVICE MARK
PRINCIPAL REGISTER**

DBL REALTORS - EXCEPTIONAL HOMES

LONG, ALAN (UNITED STATES INDIVIDUAL)
9200 SUNSET BOULEVARD, SUITE 200
LOS ANGELES, CA 90069

FOR: REAL ESTATE BROKERAGE SERVICES, IN
CLASS 36 (U.S. CLS. 100, 101 AND 102).

FIRST USE 8-2-2001; IN COMMERCE 8-2-2001.

NO CLAIM IS MADE TO THE EXCLUSIVE
RIGHT TO USE "REALTORS" OR "EXCEPTIONAL
HOMES", APART FROM THE MARK AS SHOWN.

SER. NO. 76-364,261, FILED 1-29-2002.

THEODORE MCBRIDE, EXAMINING ATTORNEY

Int. Cl.: 43

Prior U.S. Cls.: 100 and 101

United States Patent and Trademark Office

Reg. No. 2,892,354

Registered Oct. 12, 2004

SERVICE MARK
PRINCIPAL REGISTER



RP INCORPORATED (SOUTH CAROLINA CORPORATION)
337 KING STREET
CHARLESTON, SC 29401

FIRST USE 1-1-1997; IN COMMERCE 1-1-1997.

SER. NO. 76-365,254, FILED 2-1-2002.

FOR: RESTAURANT SERVICES, IN CLASS 43
(U.S. CLS. 100 AND 101).

JULIA HARDY COFIELD, EXAMINING ATTORNEY

Int. Cl.: 35

Prior U.S. Cls.: 100, 101 and 102

United States Patent and Trademark Office

Reg. No. 2,892,355

Registered Oct. 12, 2004

**SERVICE MARK
PRINCIPAL REGISTER**

STATMED

MEDICAL STAFFING NETWORK, INC. (DELA-
WARE CORPORATION)
901 YAMATO ROAD
SUITE 110
BOCA RATON, FL 33431

FOR: EMPLOYMENT SERVICES RELATING TO
PLACEMENT OF EMPLOYEES IN THE MEDICAL

SERVICES FIELD, IN CLASS 35 (U.S. CLS. 100, 101
AND 102).

FIRST USE 11-26-2001; IN COMMERCE 11-26-2001.

SER. NO. 76-365,869, FILED 2-1-2002.

CHARLES L. JENKINS, EXAMINING ATTORNEY

Int. Cls.: 9 and 15

Prior U.S. Cls.: 2, 21, 23, 26, 36 and 38

United States Patent and Trademark Office

Reg. No. 2,892,356

Registered Oct. 12, 2004

**TRADEMARK
PRINCIPAL REGISTER**

DUMBLE

DUMBLE, HOWARD ALEXANDER (UNITED STATES INDIVIDUAL)
C/O 6242 MARMION
LOS ANGELES, CA 90042

FOR: ELECTRICAL APPARATUS FOR USE WITH GUITARS AND OTHER SERVICES PURPOSES - NAMELY AMPLIFIERS, LOUDSPEAKERS, AND COMPONENTS AND ACCESSORIES FOR SUCH ELECTRICAL APPARATUS—NAMELY, AMPLIFIER CORDS, FOOT PEDAL CONTROLS, AMPLIFIER COVERS, AMPLIFIER VOLUME AND TONE CONTROLS, AND SPEAKER CABINETS, IN CLASS 9 (U.S. CLS. 21, 23, 26, 36 AND 38).

FIRST USE 0-0-1965; IN COMMERCE 0-0-1969.

FOR: MUSICAL INSTRUMENTS - NAMELY ELECTRIC GUITARS, AND COMPONENTS AND ACCESSORIES FOR GUITARS - NAMELY NECKS, HEADS, BODIES, PICKUPS, PICKUP COVERS, PICKGUARDS, AND CUSTOM FINISHES, IN CLASS 15 (U.S. CLS. 2, 21 AND 36).

FIRST USE 0-0-1965; IN COMMERCE 0-0-1967.

SEC. 2(F).

SER. NO. 76-366,099, FILED 2-4-2002.

ANN LINNEHAN, EXAMINING ATTORNEY

Int. Cl.: 5

Prior U.S. Cls.: 6, 18, 44, 46, 51 and 52

United States Patent and Trademark Office

Reg. No. 2,892,357

Registered Oct. 12, 2004

**TRADEMARK
PRINCIPAL REGISTER**

SURESTRIP

APPLIED BIOTECH, INC. (CALIFORNIA COR-
PORATION)
10237 FLANDERS COURT
SAN DIEGO, CA 92121

FIRST USE 10-1-1995; IN COMMERCE 10-1-1995.

FOR: IMMUNODIAGNOSTIC DIPSTICKS FOR
TESTING LIQUID BIOLOGICAL SPECIMENS FOR
CLINICAL OR MEDICAL LABORATORY USE, IN
CLASS 5 (U.S. CLS. 6, 18, 44, 46, 51 AND 52).

SER. NO. 76-366,917, FILED 2-5-2002.

JEFF DEFORD, EXAMINING ATTORNEY

Int. Cl.: 38

Prior U.S. Cls.: 100, 101 and 104

United States Patent and Trademark Office

Reg. No. 2,892,358

Registered Oct. 12, 2004

**SERVICE MARK
PRINCIPAL REGISTER**



ANEW BROADBAND, INC. (FLORIDA CORPORATION)
815 NW 57TH AVENUE, SUITE 303
MIAMI, FL 33126

FOR: TELECOMMUNICATION SERVICES, NAMELY, PROVIDING DOMESTIC AND INTERNATIONAL HIGH SPEED INTERNET ACCESS TO BUSINESSES, IN CLASS 38 (U.S. CLS. 100, 101 AND 104).

FIRST USE 11-1-2001; IN COMMERCE 11-1-2001.

NO CLAIM IS MADE TO THE EXCLUSIVE RIGHT TO USE "BROADBAND", APART FROM THE MARK AS SHOWN.

SER. NO. 76-367,487, FILED 2-6-2002.

MICHAEL KAZAZIAN, EXAMINING ATTORNEY

Int. Cl.: 38

Prior U.S. Cls.: 100, 101 and 104

United States Patent and Trademark Office

Reg. No. 2,892,359

Registered Oct. 12, 2004

**SERVICE MARK
PRINCIPAL REGISTER**



ANEW
BROADBAND

Fast. Simple. Well Connected.

ANEW BROADBAND, INC. (FLORIDA CORPORATION)
815 NW 57TH AVENUE, SUITE 303
MIAMI, FL 33126

FOR: TELECOMMUNICATION SERVICES, NAMELY, PROVIDING DOMESTIC AND INTERNATIONAL HIGH SPEED INTERNET ACCESS TO BUSINESSES, IN CLASS 38 (U.S. CLS. 100, 101 AND 104).

FIRST USE 11-1-2001; IN COMMERCE 11-1-2001.

NO CLAIM IS MADE TO THE EXCLUSIVE RIGHT TO USE "BROADBAND", APART FROM THE MARK AS SHOWN.

SER. NO. 76-367,494, FILED 2-6-2002.

MICHAEL KAZAZIAN, EXAMINING ATTORNEY

Int. Cl.: 40

Prior U.S. Cls.: 100, 103 and 106

United States Patent and Trademark Office

Reg. No. 2,892,360

Registered Oct. 12, 2004

**SERVICE MARK
PRINCIPAL REGISTER**

WHERE NOWHERE, MEANS NOW HERE!

FOMAS S.P.A. (ITALY JOINT STOCK COMPANY)
VIA MARTIRI DELLA LIBERAZIONE 17
23875 OSNAGO (LECCO), ITALY

FIRST USE 12-31-1991; IN COMMERCE 12-31-1991.

FOR: TREATMENT AND TRANSFORMATION
SERVICES OF METALLIC MATERIALS, NAMELY,
CASTING, FORGING, MACHINING, HEAT TREAT-
ING, POLISHING AND SHAPING METAL ARTI-
CLES, IN CLASS 40 (U.S. CLS. 100, 103 AND 106).

SER. NO. 76-368,352, FILED 8-9-2001.

JOHN SCHUYLER YARD, EXAMINING ATTOR-
NEY

Int. Cl.: 3

Prior U.S. Cls.: 1, 4, 6, 50, 51 and 52

United States Patent and Trademark Office

Reg. No. 2,892,361

Registered Oct. 12, 2004

**TRADEMARK
PRINCIPAL REGISTER**

The logo for Vogue Corp. features the word "Vogue" in a large, elegant, black script font. Below it, the word "Corp." is written in a smaller, bold, black sans-serif font.

VOGUE USA CORP (FLORIDA CORPORATION)
C/O DAVID S. WILLIG, CHARTERED
2837 SW 3RD AVENUE
MIAMI, FL 33129

NO CLAIM IS MADE TO THE EXCLUSIVE
RIGHT TO USE "CORP.", APART FROM THE
MARK AS SHOWN.

FOR: PERFUMES, EAU DE TOILETTE AND
COLOGNES, IN CLASS 3 (U.S. CLS. 1, 4, 6, 50, 51
AND 52).

SER. NO. 76-368,532, FILED 2-11-2002.

FIRST USE 7-27-1999; IN COMMERCE 9-22-1999.

STEVEN R. FINE, EXAMINING ATTORNEY

Int. Cl.: 35

Prior U.S. Cls.: 100, 101 and 102

United States Patent and Trademark Office

Reg. No. 2,892,362

Registered Oct. 12, 2004

**SERVICE MARK
PRINCIPAL REGISTER**

REAL TIME CUSTOMER DRIVEN MANAGEMENT

SMARTREVENUE.COM (MARYLAND COR-
PORATION)
6905 ROCKLEDGE DRIVE
SUITE 600
BETHESDA, MD 20817

FIRST USE 4-0-2000; IN COMMERCE 4-0-2000.

SER. NO. 76-371,035, FILED 2-14-2002.

FOR: BUSINESS MANAGEMENT, IN CLASS 35
(U.S. CLS. 100, 101 AND 102).

DAVID C. REIHNER, EXAMINING ATTORNEY

Int. Cls.: 7 and 9

Prior U.S. Cls.: 13, 19, 21, 23, 26, 31, 34, 35, 36 and 38

Reg. No. 2,892,363

United States Patent and Trademark Office

Registered Oct. 12, 2004

**TRADEMARK
PRINCIPAL REGISTER**

REAMAX

DIHART AG (SWITZERLAND CORPORATION)
2, INDUSTRIESTRASSE
CH 4657 DULLIKEN, SWITZERLAND

FOR: MECHANICALLY OPERATED TOOLS, IN PARTICULAR TOOLS FOR MACHINE TOOLS, NAMELY, CUTTING TOOLS WITH FIRMLY CONNECTED OR INTERCHANGEABLE CUTTING EDGES OF HARD CUTTING MATERIALS, NAMELY, REAMING TOOLS, DRILLING, BORING, COUNTERBORING AND DEBURRING TOOLS COMBINED WITH REAMING TOOLS, REAMING TOOLS WITH FIXED AND ADJUSTABLE DIAMETERS; PARTS FOR MACHINE TOOLS, NAMELY, TOOL HOLDERS OR ADAPTERS FOR MECHANICALLY OPERATED TOOLS, NAMELY SPINDLE ATTACHMENT FLANGES, TAPER SHANKS, CHUCKS, EXTENSION PARTS AND REDUCING PIECES FOR TOOLS, ALIGNING HOLDERS WITH ADJUSTABLE CONCENTRICITY, FLOATING HOLDERS FOR ALIGNMENT AND ANGULAR COMPENSATION; ACCESSORIES FOR MECHANICALLY OPERATED TOOLS, NAMELY CUTTING INSERTS, INDEXABLE INSERTS, CUTTING RINGS AND CUTTING HEADS OF HARD CUTTING MATERIALS, PARTS FOR THESE ACCESSORIES, NAMELY BOLTS, CLAMPS AND SCREWS; DEVICES FOR MOUNTING MECHANICALLY OPERATED REAMING TOOLS AND THEIR CUTTING EDGES, NAMELY, ADJUSTING GAUGE AND AD-

JUSTING MACHINES FOR ADJUSTING AND ALIGNING TOOLS FOR THE AFORESAID GOODS; MECHANICAL EQUIPMENT AND DEVICES AS ACCESSORIES FOR MACHINE TOOLS FOR REGRINDING OR RESHARPENING THE REMAINING TOOLS, CUTTING EDGES, CUTTING RINGS AND ONE-WAY HEADS, NAMELY, GRINDERS, OR RESHARPENERS, IN CLASS 7 (U.S. CLS. 13, 19, 21, 23, 31, 34 AND 35).

FOR: DEVICES FOR MEASURING AND SETTING MECHANICALLY OPERATED REAMING TOOLS AND THEIR CUTTING EDGES, NAMELY, ADJUSTING GAUGES AND ADJUSTING MACHINES FOR ADJUSTING AND ALIGNING TOOLS FOR THE AFORESAID GOODS, WIREBOUND AND WIRELESS FIXED, MOTIVE, ELECTRONIC ENERGY AND DATA LOGGERS, TRANSMITTERS, TRANSDUCERS, DATA CONTROLLERS, DATA RECORDERS AND DATA TRANSLATORS , IN CLASS 9 (U.S. CLS. 21, 23, 26, 36 AND 38).

PRIORITY CLAIMED UNDER SEC. 44(D) ON FED REP GERMANY APPLICATION NO. DE30150285.4, FILED 8-16-2001, REG. NO. 30150285, DATED 8-16-2001, EXPIRES 8-31-2011.

SER. NO. 76-371,869, FILED 2-14-2002.

EUGENIA MARTIN, EXAMINING ATTORNEY

Int. Cls.: 19 and 37

Prior U.S. Cls.: 1, 12, 33, 50, 100, 103 and 106

United States Patent and Trademark Office

Reg. No. 2,892,364

Registered Oct. 12, 2004

**TRADEMARK
SERVICE MARK
PRINCIPAL REGISTER**

LEGACY

LEGACY TIMBER FRAMES, INC. (NEW YORK CORPORATION)
691 COUNTY ROAD 70
STILLWATER, NY 12170

FOR: NON-METAL BUILDING TIMBER PRODUCTS NOT INCLUDING FIBERBOARD, COMPOSITE BOARD, PARTICLE BOARD, HARDBOARD AND SYNTHETIC OR ARTIFICIAL LUMBER, NAMELY, TIMBER POSTS, TIMBER BEAMS AND TIMBER BOARDS, AND ASSEMBLIES THEREOF NOT INCLUDING DOORS AND DOOR FRAMES, AND TIMBER JOINTS FOR ASSEMBLING TIMBER FRAMES NOT INCLUDING DOOR FRAMES, FOR USE IN THE TIMBER FRAME BUILDING, DESIGN,

MANUFACTURE AND CONSTRUCTION INDUSTRY, IN CLASS 19 (U.S. CLS. 1, 12, 33 AND 50).

FIRST USE 0-0-1988; IN COMMERCE 0-0-1989.

FOR: CONSTRUCTION OF TIMBER FRAME BUILDINGS, TIMBER FRAME ENTRYWAYS AND TIMBER FRAME PAVILIONS, IN CLASS 37 (U.S. CLS. 100, 103 AND 106).

FIRST USE 0-0-1988; IN COMMERCE 0-0-1989.

SER. NO. 76-372,320, FILED 2-19-2002.

JOHN HWANG, EXAMINING ATTORNEY

Int. Cl.: 14

Prior U.S. Cls.: 2, 27, 28 and 50

United States Patent and Trademark Office

Reg. No. 2,892,365

Registered Oct. 12, 2004

**TRADEMARK
PRINCIPAL REGISTER**

CASSIDY

MOVADO LLC (DELAWARE LIMITED LIABILITY COMPANY)
SILVERSIDE CARR EXECUTIVE CENTER
501 SILVERSIDE ROAD
WILMINGTON, DE 19809

FIRST USE 9-0-2002; IN COMMERCE 9-0-2002.

SER. NO. 76-373,091, FILED 2-20-2002.

FOR: WATCHES, IN CLASS 14 (U.S. CLS. 2, 27, 28 AND 50).

KATHERINE STOIDES, EXAMINING ATTORNEY

Int. Cl.: 30

Prior U.S. Cl.: 46

United States Patent and Trademark Office

Reg. No. 2,892,366

Registered Oct. 12, 2004

**TRADEMARK
PRINCIPAL REGISTER**

AMEAL

CALPIS CO., LTD. (JAPAN CORPORATION)
20-3, 2-CHOME
EBUSI-NISHI, SHIBUYA-KU
TOKYO, JAPAN

FOR: BISCUITS, CANDY, CHOCOLATES, COOKIES, CARAMELS, NON-MEDICATED LOZENGES, PASTILLES, ICE CREAM, SORBET, FLAVORED ICES, FROZEN YOGURT; FLOUR FOR FOOD; CEREAL PREPARATIONS, NAMELY CORN FLAKES, MAIZE FLAKES, OAT FLAKES, CRACKERS, OATMEAL, MACARONI AND SPAGHETTI; BREAD, COCOA, COCOA BASED CHIPS FOR USE IN MAKING CONFECTIONS, COCOA MIXES, JEL-

LIES, MARZIPAN, PANCAKES, PIES, PUDDINGS; COFFEE, CHOCOLATE SHAKES, CHOCOLATE FOOD BEVERAGES NOT BEING DAIRY-BASED OR VEGETABLE BASED, COCOA BASED BEVERAGES, COFFEE-BASED BEVERAGES, COCOA BEVERAGES WITH MILK, COFFEE BEVERAGES WITH MILK, IN CLASS 30 (U.S. CL. 46).

OWNER OF JAPAN REG. NO. 4449986, DATED 2-2-2001, EXPIRES 2-2-2011.

SER. NO. 76-373,269, FILED 2-20-2002.

LINDA M. KING, EXAMINING ATTORNEY

Int. Cls.: 1, 40 and 42

Prior U.S. Cls.: 1, 5, 6, 10, 26, 46, 100, 101, 103 and 106

Reg. No. 2,892,367

United States Patent and Trademark Office

Registered Oct. 12, 2004

**TRADEMARK
SERVICE MARK
PRINCIPAL REGISTER**

CBWCHEM

CBW-CHEMIE GMBH BITTERFELD-WOLFEN
(FED REP GERMANY CORPORATION)
GREPPINER STRABE 19
06766 WOLFEN, FED REP GERMANY

FOR: CHEMICAL PREPARATIONS, NAMELY, ORGANIC INTERMEDIATES FOR PROCESSING TO DYESTUFFS, EXPLOSIVES, PESTICIDES, PEPTIDE SYNTHESIS REAGENTS, PHARMACEUTICALS, FLAVORS AND FRAGRANCES, COATINGS, AGROCHEMICALS, POLYMERS, ADDITIVES, EMULSIFIERS, PHOTO CHEMICALS, THIOPLASTS FOR USE IN THE FINE AND SPECIAL CHEMICALS INDUSTRY; CHEMICALS, NAMELY, SODIUM PERMANGANATE SOLUTIONS FOR USE IN SOIL REMEDIATION; CHEMICALS IN THE NATURE OF CLEANING PREPARATIONS, NAMELY, CESIUM SALTS FOR MANUFACTURING CATALYSTS AND SPECIAL TYPES OF GLASS, FOR ISOLATION AND CLEANING OF BIOLOGICAL MATERIAL; CHEMICAL OXIDANTS FOR USE IN THE FINE AND SPECIAL CHEMICALS INDUSTRY, NAMELY, OTHER MANGANESE COMPOUNDS FOR CATALYSIS, BATTERIES, PIGMENTS, AND FOR THE MANUFACTURE OF PERMANGANATES; CHEMICAL CLEANING PREPARATIONS FOR PROCESSING TO DYESTUFFS, EXPLOSIVES, PESTICIDES, PEPTIDE SYNTHESIS REAGENTS, PHARMACEUTICALS, FLAVORS AND FRAGRANCES, COATINGS, AGROCHEMICALS, POLYMERS, ADDITIVES, EMULSIFIERS, PHOTO CHEMICALS, THIOPLASTS FOR USE IN THE FINE AND SPECIAL

CHEMICALS INDUSTRY; CHEMICAL PREPARATIONS FOR FERTILIZERS USED IN THE FIELD OF AGRICULTURAL, HORTICULTURE AND FORESTRY; FIRE EXTINGUISHING PREPARATIONS; TANNING AGENTS FOR USE IN THE LEATHER INDUSTRY; PLANT GROWTH REGULATING PREPARATIONS FOR USE IN AGRICULTURAL, HORTICULTURE AND FORESTRY, IN CLASS 1 (U.S. CLS. 1, 5, 6, 10, 26 AND 46).

FOR: CUSTOM ORDER OF CHEMICAL PREPARATIONS ACCORDING TO GIVEN SYNTHESIS AND PROCESSES, IN CLASS 40 (U.S. CLS. 100, 103 AND 106).

FOR: CHEMICAL ANALYSIS, NAMELY, PREPARATION OF STUDIES AND REPORTS FOR CHEMICAL ANALYSIS; CHEMICAL RESEARCH; TECHNICAL CONSULTATION IN THE FIELD OF CHEMICAL ANALYSIS, CHEMICAL PRODUCTS AND PROCESSES; CHEMICAL PRODUCT RESEARCH AND DEVELOPMENT; CHEMISTRY CONSULTATION; CHEMICAL LABORATORIES, IN CLASS 42 (U.S. CLS. 100 AND 101).

OWNER OF FED REP GERMANY REG. NO. 30091903, DATED 5-17-2001, EXPIRES 12-31-2010.

SER. NO. 76-374,065, FILED 2-22-2002.

MICHAEL SOUDERS, EXAMINING ATTORNEY

Int. Cl.: 36

Prior U.S. Cls.: 100, 101 and 102

United States Patent and Trademark Office

Reg. No. 2,892,368

Registered Oct. 12, 2004

**SERVICE MARK
PRINCIPAL REGISTER**

CRESLEIGH

CRESLEIGH HOMES CORPORATION (CALIFORNIA CORPORATION)
433 CALIFORNIA STREET, 7TH FLOOR
SAN FRANCISCO, CA 941042011

FOR: CONSULTING SERVICES IN THE FIELD OF REAL ESTATE AND REAL ESTATE FINANCING; AND REAL ESTATE BROKERAGE AND AGENCY SERVICES, IN CLASS 36 (U.S. CLS. 100, 101 AND 102).

FIRST USE 9-0-2003; IN COMMERCE 9-0-2003.

OWNER OF U.S. REG. NOS. 1,735,286, 1,737,088, AND 2,503,118.

SER. NO. 76-374,302, FILED 2-22-2002.

MARC LEIPZIG, EXAMINING ATTORNEY

Int. Cls.: 35, 36 and 44

Prior U.S. Cls.: 100, 101 and 102

United States Patent and Trademark Office

Reg. No. 2,892,369

Registered Oct. 12, 2004

**SERVICE MARK
PRINCIPAL REGISTER**



VETCOR PROFESSIONAL PRACTICES LLC (DE-
LAWARE LIMITED LIABILITY COMPANY)
350 LINCOLN PLACE
HINGHAM, MA 02043

FOR: VETERINARY PRACTICE MANAGEMENT
SERVICES, NAMELY BUSINESS MANAGEMENT
SERVICES, ACCOUNTING SERVICES, PERSONNEL
MANAGEMENT AND PURCHASING AGENT SER-
VICES, IN CLASS 35 (U.S. CLS. 100, 101 AND 102).

FIRST USE 1-1-2002; IN COMMERCE 1-1-2002.

FOR: FINANCIAL MANAGEMENT SERVICES
FOR VETERINARIANS, VETERINARY HOSPITALS
AND VETERINARY CLINICS, IN CLASS 36 (U.S.
CLS. 100, 101 AND 102).

FIRST USE 1-1-2002; IN COMMERCE 1-1-2002.

FOR: VETERINARY SERVICES, IN CLASS 44 (U.S.
CLS. 100 AND 101).

FIRST USE 1-1-2002; IN COMMERCE 1-1-2002.

NO CLAIM IS MADE TO THE EXCLUSIVE
RIGHT TO USE "VETERINARY CADUCEUS",
APART FROM THE MARK AS SHOWN.

THE DESIGN OF THE MARK IS NOT INTENDED
TO REPRESENT AND DOES NOT REPRESENT A
SHIELD DESIGN

SER. NO. 76-375,654, FILED 2-27-2002.

CHRISTOPHER ADKINS, EXAMINING ATTOR-
NEY

Int. Cl.: 12

Prior U.S. Cls.: 19, 21, 23, 31, 35 and 44

United States Patent and Trademark Office

Reg. No. 2,892,370

Registered Oct. 12, 2004

**TRADEMARK
PRINCIPAL REGISTER**

KRYSTAL

KRYSTAL KOACH, INC. (CALIFORNIA CORPORATION)
2701 EAST IMPERIAL HIGHWAY
BREA, CA 928216713

OWNER OF U.S. REG. NOS. 2,105,354, 2,248,811,
AND 2,358,969.

FOR: FUNERAL CARS AND BUSES, IN CLASS 12
(U.S. CLS. 19, 21, 23, 31, 35 AND 44).

SER. NO. 76-375,902, FILED 2-27-2002.

FIRST USE 1-0-1994; IN COMMERCE 1-0-1994.

THEODORE MCBRIDE, EXAMINING ATTORNEY

Int. Cl.: 38

Prior U.S. Cls.: 100, 101 and 104

United States Patent and Trademark Office

Reg. No. 2,892,371

Registered Oct. 12, 2004

**SERVICE MARK
PRINCIPAL REGISTER**

LOS PROTAGONISTAS

TV AZTECA, S.A. DE C.V. (MEXICO CORPORATION)
PERIFERICO SUR 4121, COL. FUENTES DEL PEDREGAL
MEXICO, D.F. C.P. 14141, MEXICO

FOR: BROADCASTING OF RADIO AND TELEVISION PROGRAMS VIA SATELLITE, CABLE AND INTERNET TRANSMISSION, IN CLASS 38 (U.S. CLS. 100, 101 AND 104).

FIRST USE 4-0-2001; IN COMMERCE 4-0-2001.

THE ENGLISH TRANSLATION OF "LOS PROTAGONISTAS" IS "THE PROTAGONISTS".

SER. NO. 76-376,342, FILED 2-27-2002.

JOHN SCHUYLER YARD, EXAMINING ATTORNEY

Int. Cl.: 37

Prior U.S. Cls.: 100, 103 and 106

United States Patent and Trademark Office

Reg. No. 2,892,372

Registered Oct. 12, 2004

**SERVICE MARK
PRINCIPAL REGISTER**

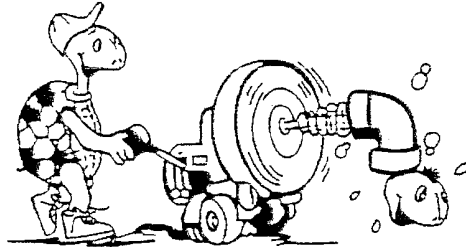

ROTARY MAN LTD. (OHIO LIMITED LIABILITY COMPANY)
1825 WELKER
TOLEDO, OH 43613

FOR: WATER AND SEWER LINE BORING SERVICES, IN CLASS 37 (U.S. CLS. 100, 103 AND 106).

FIRST USE 0-0-1991; IN COMMERCE 0-0-1991.

THE LINING IS A FEATURE OF THE MARK AND DOES NOT INDICATE COLOR.

SER. NO. 76-377,003, FILED 3-1-2002.

RONALD MCMORROW, EXAMINING ATTORNEY

Int. Cls.: 5 and 10

Prior U.S. Cls.: 6, 18, 26, 39, 44, 46, 51 and 52

United States Patent and Trademark Office

Reg. No. 2,892,373

Registered Oct. 12, 2004

**TRADEMARK
PRINCIPAL REGISTER**

ONCOSET

VASCUMED (BELGIUM JOINT STOCK COMPANY)
BURGGRAVENLAAN 350
B-9000 GENT, BELGIUM

FOR: PHARMACEUTICAL PREPARATIONS
USED IN CHEMOTHERAPY AND FOOD FOR
MEDICALLY RESTRICTED DIETS, IN CLASS 5
(U.S. CLS. 6, 18, 44, 46, 51 AND 52).

FOR: PUMPS FOR USE IN THE ADMINISTRATION
BY PERISTALTIC AND VOLUMETRIC
PUMPS OF FLUIDS ALL FOR ANTIBIOTIC THER-

APY, PAIN TREATMENT AND CYTOSTATIC
DRUGS, IN CLASS 10 (U.S. CLS. 26, 39 AND 44).

PRIORITY CLAIMED UNDER SEC. 44(D) ON
ERPNTY TM OFC APPLICATION NO.
2,365,096, FILED 9-5-2001, REG. NO. 0200408, DATED
9-5-2001, EXPIRES 9-5-2011.

SER. NO. 76-377,177, FILED 3-1-2002.

FRED MANDIR, EXAMINING ATTORNEY

Int. Cl.: 36

Prior U.S. Cls.: 100, 101 and 102

United States Patent and Trademark Office

Reg. No. 2,892,374

Registered Oct. 12, 2004

**SERVICE MARK
PRINCIPAL REGISTER**

SMART CHOICE AUTO CLUB

SMART CHOICE AUTO CLUB, INC. (INDIANA CORPORATION)
POST OFFICE BOX 607
NEWBURGH, IN 476290607

FOR: AUTOMOBILE CLUB SERVICES, NAMELY, PROVIDING MEMBERS WITH PROTECTION AGAINST AUTO THEFT BY POSTING A REWARD FOR INFORMATION LEADING TO THE ARREST AND CONVICTION OF ANYONE STEALING A MEMBER'S CAR; REIMBURSEMENT OF A MEMBER FOR THE COST OF A LOCKSMITH TO UNLOCK THE MEMBER'S CAR DOOR; REIMBURSEMENT OF A MEMBER FOR EXPENSES INCURRED IN WRECKER SERVICES USED TO MOVE A DISABLED AUTOMOBILE; REIMBURSEMENT OF A MEMBER'S AUTOMOBILE RENTAL EXPENSE WHILE THE MEMBER'S AUTOMOBILE IS BEING REPAIRED DUE TO AN ACCIDENT, FIRE OR THEFT; REIMBURSEMENT OF A MEMBER'S EXPENSES FOR REPAIRING DAMAGE TO THE

MEMBER'S AUTOMOBILE WINDSHIELD; AND REIMBURSING MEMBERS FOR EMERGENCY LIVING EXPENSES WHILE A MEMBER'S AUTOMOBILE IS BEING REPAIRED A PLACE REMOTE FROM THE MEMBER'S RESIDENCE; WITH MEMBERSHIP SERVICES LIMITED TO THE POLICY HOLDERS OF INSUREMAX INSURANCE COMPANY INSURANCE CONTRACTS, IN CLASS 36 (U.S. CLS. 100, 101 AND 102).

FIRST USE 2-4-1999; IN COMMERCE 2-4-1999.

NO CLAIM IS MADE TO THE EXCLUSIVE RIGHT TO USE "AUTO CLUB", APART FROM THE MARK AS SHOWN.

SER. NO. 76-378,514, FILED 3-5-2002.

LOURDES AYALA, EXAMINING ATTORNEY

Int. Cls.: 9, 16 and 42

**Prior U.S. Cls.: 2, 5, 21, 22, 23, 26, 29, 36, 37, 38, 50,
100 and 101**

Reg. No. 2,892,375

United States Patent and Trademark Office

Registered Oct. 12, 2004

**TRADEMARK
SERVICE MARK
PRINCIPAL REGISTER**

PS BUTLER

ONEVISION SOFTWARE AG (FED REP GERMA-
NY CORPORATION)
DR.-LEO-RITTER-STRASSE 9
D-93049 REGENSBURG, FED REP GERMANY

FOR: COMPUTERS; DATA PROCESSING DEVI-
CES IN THE NATURE OF AND DATA PROCESSING
SYSTEMS COMPOSED OF DATA PROCESSORS,
COMMUNICATIONS SERVERS, COMPUTER
WORKSTATIONS COMPRISED OF COMPUTER
TERMINALS, VISUAL DISPLAY UNITS, DATA EN-
TRY DEVICES, NAMELY, KEYBOARDS, COMPU-
TER PRINTERS, COMPUTER DISC DRIVES, AND
MODEMS FOR DATA INPUT, DATA OUTPUT,
DATA TRANSMISSION AND DATA STORAGE;
DESKTOP PUBLISHING SOFTWARE, NAMELY,
COMPUTER PROGRAMS FOR USE IN PUBLISH-
ING, PRINTING, AND EDITING TEXT AND GRA-
PHICS; PRERECORDED MAGNETIC DATA
CARRIERS FEATURING COMPUTER AND DATA
PROGRAMS FOR USE IN PUBLISHING, PRINTING
AND EDITING, IN CLASS 9 (U.S. CLS. 21, 23, 26, 36
AND 38).

FOR: USER'S MANUALS, HANDBOOKS, AND
DOCUMENTATION FOR COMPUTER PROGRAM-
MING, IN CLASS 16 (U.S. CLS. 2, 5, 22, 23, 29, 37, 38
AND 50).

FOR: COMPUTER PROGRAMMING FOR OTH-
ERS, CONSULTING SERVICES RELATING TO
COMPUTER PROGRAMS, AND RELATED ENGI-
NEERING SERVICES FOR IMPLEMENTING COM-
PUTER PROGRAMS IN HARDWARE AND
SOFTWARE, FOR WORD PROCESSING IN THE
FIELD OF PUBLISHING, PRINTING, AND EDIT-
ING, IN CLASS 42 (U.S. CLS. 100 AND 101).

PRIORITY CLAIMED UNDER SEC. 44(D) ON FED
REP GERMANY APPLICATION NO. 30154461.1,
FILED 9-12-2001, REG. NO. 30154461, DATED 4-11-
2002, EXPIRES 9-30-2011.

SER. NO. 76-379,670, FILED 3-8-2002.

STEPHANIE DAVIS, EXAMINING ATTORNEY

Int. Cl.: 33

Prior U.S. Cls.: 47 and 49

United States Patent and Trademark Office

Reg. No. 2,892,376

Registered Oct. 12, 2004

**TRADEMARK
PRINCIPAL REGISTER**

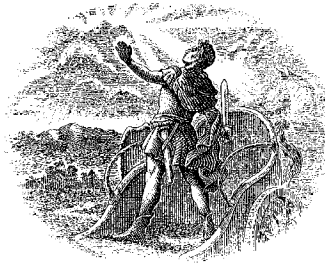

AXIOS

KALARIS, CONSTANTINE (UNITED STATES IN-
DIVIDUAL)
919 LOGTOWN ROAD
ELLCOTT CITY, MD 21043

FIRST USE 11-28-2001; IN COMMERCE 11-28-2001.

SER. NO. 76-379,880, FILED 3-7-2002.

FOR: BOTTLED WINE, IN CLASS 33 (U.S. CLS. 47
AND 49).

DAVID ELTON, EXAMINING ATTORNEY

Int. Cls.: 29 and 31

Prior U.S. Cls.: 1 and 46

United States Patent and Trademark Office

Reg. No. 2,892,377

Registered Oct. 12, 2004

**TRADEMARK
PRINCIPAL REGISTER**

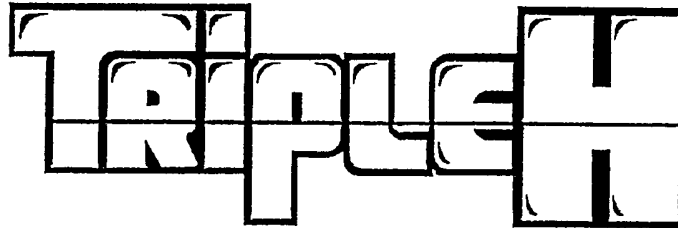

DISTRIBUIDORA HORTIMEX, S.A. DE C.V.
(MEXICO CORPORATION)
CALLE SEGUNDA, BODEGA 10
MODULO N, MERCADO DE ABASTOS
CULIACAN, SINALOA, MEXICO

FOR: PRESERVED, DRIED AND COOKED
FRUITS AND VEGETABLES, IN CLASS 29 (U.S. CL.
46).

FIRST USE 6-0-1983; IN COMMERCE 6-0-1983.

FOR: FRESH FRUITS AND VEGETABLES,
NAMELY, TOMATOES, HOT PEPPERS, PEPPERS,
CUCUMBERS AND WATERMELONS, IN CLASS 31
(U.S. CLS. 1 AND 46).

FIRST USE 6-0-1983; IN COMMERCE 6-0-1983.

SER. NO. 76-380,393, FILED 3-8-2002.

CHARLES JOYNER, EXAMINING ATTORNEY

Int. Cl.: 35

Prior U.S. Cls.: 100, 101 and 102

United States Patent and Trademark Office

Reg. No. 2,892,378

Registered Oct. 12, 2004

**SERVICE MARK
PRINCIPAL REGISTER**



OUTDOOR SERVICES

THE INTERPUBLIC GROUP OF COMPANIES,
INC. (DELAWARE CORPORATION)
1271 AVENUE OF THE AMERICAS
44TH FLOOR
NEW YORK, NY 10020

FOR: BUSINESS CONSULTATION IN THE FIELD
OF ADVERTISING; PREPARING AND PLACING
ADVERTISEMENTS FOR OTHERS, IN CLASS 35
(U.S. CLS. 100, 101 AND 102).

FIRST USE 9-0-1999; IN COMMERCE 9-0-1999.

NO CLAIM IS MADE TO THE EXCLUSIVE
RIGHT TO USE "OUTDOOR SERVICES", APART
FROM THE MARK AS SHOWN.

SEC. 2(F) AS TO "OUTDOOR SERVICES".

SER. NO. 76-380,834, FILED 3-8-2002.

IRA J. GOODSaid, EXAMINING ATTORNEY

Int. Cl.: 41

Prior U.S. Cls.: 100, 101 and 107

United States Patent and Trademark Office

Reg. No. 2,892,379

Registered Oct. 12, 2004

**SERVICE MARK
PRINCIPAL REGISTER**



ARCHER RECORDS, LLC (TENNESSEE LIMITED LIABILITY COMPANY)
66 MONROE AVENUE, SUITE 1201
MEMPHIS, TN 38103

NO CLAIM IS MADE TO THE EXCLUSIVE RIGHT TO USE "RECORDS", APART FROM THE MARK AS SHOWN.

FOR: PRODUCTION OF AUDIO RECORDINGS; MUSIC PUBLISHING SERVICES, IN CLASS 41 (U.S. CLS. 100, 101 AND 107).

SER. NO. 76-380,861, FILED 3-12-2002.

FIRST USE 12-4-2001; IN COMMERCE 12-4-2001.

STACY WAHLBERG, EXAMINING ATTORNEY

Int. Cl.: 9

Prior U.S. Cls.: 21, 23, 26, 36 and 38

United States Patent and Trademark Office

Reg. No. 2,892,380

Registered Oct. 12, 2004

**TRADEMARK
PRINCIPAL REGISTER**

VIRTUAL HIGH DEFINITION

RUNCO INTERNATIONAL, INC. (CALIFORNIA
CORPORATION)
2463 TRIPALDI WAY
HAYWARD, CA 94545

FOR: VIDEO PROCESSORS, NAMELY, VIDEO
MONITORS, TELEVISIONS AND VIDEO PROJEC-
TORS, IN CLASS 9 (U.S. CLS. 21, 23, 26, 36 AND 38).

FIRST USE 1-0-2001; IN COMMERCE 1-0-2001.

NO CLAIM IS MADE TO THE EXCLUSIVE
RIGHT TO USE "HIGH DEFINITION", APART
FROM THE MARK AS SHOWN.

SER. NO. 76-386,211, FILED 3-21-2002.

RONALD AIKENS, EXAMINING ATTORNEY

Int. Cl.: 12

Prior U.S. Cls.: 19, 21, 23, 31, 35 and 44

Reg. No. 2,892,381

United States Patent and Trademark Office

Registered Oct. 12, 2004

**TRADEMARK
PRINCIPAL REGISTER**

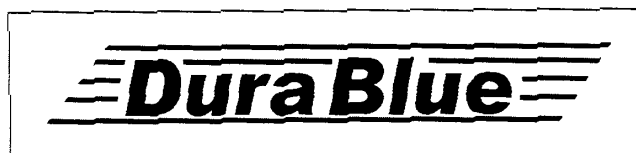

DURA BLUE, INC. (CALIFORNIA CORPORATION)
20521 CRESCENT BAY DRIVE
LAKE FOREST, CA 92630

FOR: AUTOMOTIVE VEHICLE COMPONENTS, NAMELY, AXLES FOR ALL-TERRAIN VEHICLES; AXLE PARTS FOR ALL-TERRAIN VEHICLES, NAMELY, AXLE END NUTS AND AXLE HOUSINGS; LUG NUTS FOR VEHICLE WHEELS; WHEEL BEARINGS FOR LAND VEHICLES; BEARINGS FOR LAND VEHICLE TRANSMISSION SHAFTS; VEHICLE ROLL BARS; PARTS AND ACCESSORIES FOR ALL-TERRAIN VEHICLES, NAMELY, SPROCKET HUBS, REAR HUBS, BRAKE HUBS,

HUB CAPS, AND WHEEL SPACERS, IN CLASS 12 (U.S. CLS. 19, 21, 23, 31, 35 AND 44).

FIRST USE 1-1-1980; IN COMMERCE 1-1-1980.

THE STIPPLING IS A FEATURE OF THE MARK.

THE MARK INCLUDES OF TWO WORDS, NAMELY, DURA BLUE WITHIN A RECTANGLE AND A DESIGN COMPRISING A SERIES OF PARALLEL LINES SURROUNDING THE WORDS.

SER. NO. 76-386,736, FILED 3-25-2002.

MATTHEW PAPPAS, EXAMINING ATTORNEY

Int. Cls.: 9, 35 and 42

Prior U.S. Cls.: 21, 23, 26, 36, 38, 100, 101 and 102

United States Patent and Trademark Office

Reg. No. 2,892,382

Registered Oct. 12, 2004

**TRADEMARK
SERVICE MARK
PRINCIPAL REGISTER**

METRON

METRON, INC. (VIRGINIA CORPORATION)
11911 FREEDOM DRIVE, SUITE 800
RESTON, VA 20190

FOR: COMPUTER HARDWARE AND COMPUTER SOFTWARE FOR USE IN THE FIELDS OF DEFENSE AND WARFARE, NAMELY, SUBMARINE OPTIMIZATION, SCHEDULING, VISUALIZATION, TRACKING AND PHYSICAL ACOUSTIC MODELING, MILITARY TACTICAL ANALYSIS AND SIMULATION, AIR LIFT OPTIMIZATION AND SCHEDULING OF STRATEGIC AIR LIFTS, SCHEDULING AND FORECASTING OF PRECISION OPTICS FACTORIES, AND MODELING, TESTING AND EVALUATING SENSORS FOR MINE COUNTERMEASURES; COMPUTER HARDWARE AND COMPUTER SOFTWARE FOR USE IN THE FIELD OF MILITARY SIMULATIONS, NAMELY, MULTI-WARFARE AND NAVAL MODELING AND SIMULATION; COMPUTER SOFTWARE FOR USE IN THE FIELD OF AVIATION, NAMELY, AIR TRAFFIC FLOW OPTIMIZATION AND MANAGEMENT; COMPUTER SOFTWARE FOR USE IN THE FIELD OF FINANCE, NAMELY, SPECULATIVE TRADING SYSTEMS FOR FINANCIAL INSTRUMENTS INCLUDING AGRICULTURAL COMMODITIES, CURRENCIES, METALS, ENERGY FUTURES, INTEREST-RATE INSTRUMENTS, EQUITIES, EQUITY INDICES, OPTIONS AND MUTUAL FUNDS; AND COMPUTER HARDWARE AND SOFTWARE FOR USE IN THE FIELDS OF APPLIED MATHEMATICS, PHYSICS, COMPUTER

SCIENCE, OPERATIONS RESEARCH AND PHYSICAL MODELING FOR USE IN PROVIDING MODELS, SIMULATIONS, AND AUTOMATED TECHNICAL SUPPORT SPECIFIC TO THESE FIELDS, IN CLASS 9 (U.S. CLS. 21, 23, 26, 36 AND 38).

FIRST USE 6-1-1984; IN COMMERCE 9-1-1984.

FOR: BUSINESS CONSULTING SERVICES IN THE FIELDS OF APPLIED MATHEMATICS, PHYSICS, COMPUTER SCIENCE, OPERATIONS RESEARCH AND PHYSICAL MODELING FOR USE IN THE DEFENSE, AVIATION, AND FINANCIAL INDUSTRIES, IN CLASS 35 (U.S. CLS. 100, 101 AND 102).

FIRST USE 3-1-1987; IN COMMERCE 3-1-1987.

FOR: CUSTOMIZED DESIGN AND DEVELOPMENT OF COMPUTER HARDWARE AND COMPUTER SOFTWARE FOR OTHERS, IN THE FIELDS OF APPLIED MATHEMATICS, PHYSICS, COMPUTER SCIENCE, OPERATIONS RESEARCH AND PHYSICAL MODELING FOR USE IN THE DEFENSE, AVIATION, AND FINANCIAL INDUSTRIES, IN CLASS 42 (U.S. CLS. 100 AND 101).

FIRST USE 6-1-1984; IN COMMERCE 9-1-1984.

SER. NO. 76-387,849, FILED 3-25-2002.

JAMES GRIFFIN, EXAMINING ATTORNEY

Int. Cls.: 9, 16, 38 and 42

**Prior U.S. Cls.: 2, 5, 21, 22, 23, 26, 29, 36, 37, 38, 50,
100, 101 and 104**

Reg. No. 2,892,383

United States Patent and Trademark Office

Registered Oct. 12, 2004

**TRADEMARK
SERVICE MARK
PRINCIPAL REGISTER**

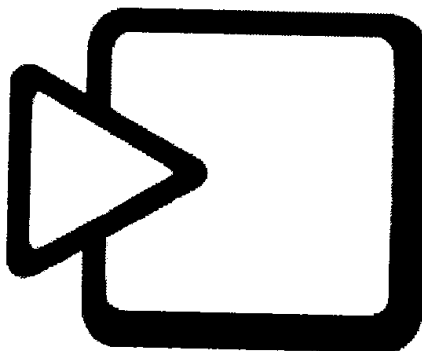

ANOTO AB (SWEDEN CORPORATION)
SCHEELEVAGEN 19C
223 70 LUND, SWEDEN

FOR: APPARATUS FOR RECORDING, TRANSMISSION AND REPRODUCTION OF SOUND AND IMAGES, NAMELY, DIGITAL PENS WHICH INCORPORATE A DIGITAL CAMERA, DIGITAL IMAGE STORAGE AND PROCESSING COMPUTER HARDWARE, SOFTWARE FOR RECORDING, ARCHIVING AND REPRODUCING DATA IN THE FORM OF IMAGES AND TEXT IN THE FIELD OF IMAGE AND DATA PROCESSING, AND A TRANSCIEVER FOR TRANSMISSION OF DATA AND IMAGES; ALL FOR REGISTERING, STORING AND TRANSMITTING AN IMAGE COMPRISING A SERIES OF MAP COORDINATES CREATED BY MOVING THE DIGITAL PEN ACROSS DIGITAL PAPER, NAMELY, PAPER CONTAINING A PATTERN OF DOTS, IN CLASS 9 (U.S. CLS. 21, 23, 26, 36 AND 38).

FOR: PAPER, NAMELY, PRINTED FORMS, PRINTED LABELS, PRINTED PATTERNS, MAPS, GREETING CARDS, MEMO PADS, WRITING PADS, NOTE PADS, RECIPE PADS, RECEIPT PADS, ADDRESS LABELS, BLANK CHECKS, CHECK BOOKS, ENVELOPES, NOTE CARDS, POSTCARDS, RECORDS CARDS, ADDRESS BOOKS, NOTEBOOKS, SKETCHBOOKS, SONGBOOKS, CALENDARS, AGENDAS, POCKET CALENDARS, PERSONAL OR-

GANIZERS MADE OF PAPER, WALL CALENDARS, DIARIES, WRITING PAPER, PRINTING PAPER, PAPER BOARD, ART PAPER, COPYING PAPER, NOTE PAPER, NOTEBOOK PAPER, PUBLICATION PAPER, COMPUTER PAPER, WHITEBOARDS, FLIPCHARTS AND STICKERS, ALL PRINTED WITH A PATTERN OF DOTS WHICH ARE REGISTERED BY A DIGITAL PEN WHEN WRITING THEREON, IN CLASS 16 (U.S. CLS. 2, 5, 22, 23, 29, 37, 38 AND 50).

FOR: TELECOMMUNICATION AND DATA COMMUNICATIONS SERVICES, NAMELY, COMPUTER AIDED TRANSMISSION OF WRITTEN MESSAGES AND IMAGES, THROUGH ELECTRONIC MAIL, FACSIMILE, GRAPHICAL SMS OR PERSONAL COMPUTER, IN CLASS 38 (U.S. CLS. 100, 101 AND 104).

FOR: COMPUTER HARDWARE DEVELOPMENT; COMPUTER SOFTWARE DEVELOPMENT; COMPUTER PROGRAMMING; COMPUTER NETWORK DESIGN; COMPUTER SOFTWARE DESIGN; MAINTENANCE OF COMPUTER SOFTWARE; UPGRADING OF COMPUTER SOFTWARE; CONSULTANCY REGARDING TELECOMMUNICATIONS; PROFESSIONAL CONSULTANCY; LICENSING OF INTELLECTUAL PROPERTY RIGHTS; SCIENTIFIC AND INDUSTRIAL RESEARCH, IN CLASS 42 (U.S. CLS. 100 AND 101).

PRIORITY CLAIMED UNDER SEC. 44(D) ON
SWEDEN APPLICATION NO. 01-05901, FILED 9-26-
2001, REG. NO. 353062, DATED 9-26-2001, EXPIRES 9-
26-2011.

SER. NO. 76-388,230, FILED 3-26-2002.

MARY ROSSMAN, EXAMINING ATTORNEY

Int. Cls.: 9, 16 and 38

**Prior U.S. Cls.: 2, 5, 21, 22, 23, 26, 29, 36, 37, 38, 50,
100, 101 and 104**

Reg. No. 2,892,384

United States Patent and Trademark Office

Registered Oct. 12, 2004

**TRADEMARK
SERVICE MARK
PRINCIPAL REGISTER**

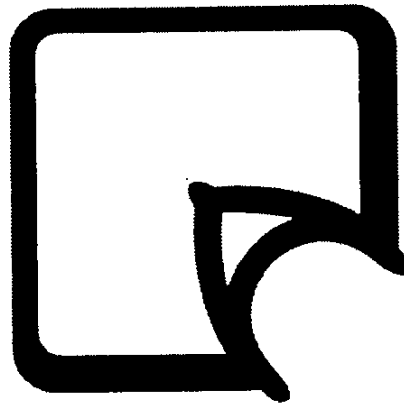

ANOTO AB (SWEDEN CORPORATION)
SCHEELEVAGEN 19C
223 70 LUND, SWEDEN

FOR: APPARATUS FOR RECORDING, TRANSMISSION AND REPRODUCTION OF SOUND AND IMAGES, NAMELY, DIGITAL PENS WHICH INCORPORATE A DIGITAL CAMERA, DIGITAL IMAGE STORAGE AND PROCESSING COMPUTER HARDWARE, SOFTWARE FOR RECORDING, ARCHIVING AND REPRODUCING DATA IN THE FORM OF IMAGES AND TEXT IN THE FIELD OF IMAGE AND DATA PROCESSING, AND A TRANSCEIVER FOR TRANSMISSION OF DATA AND IMAGES; ALL FOR REGISTERING, STORING AND TRANSMITTING AN IMAGE COMPRISING A SERIES OF MAP COORDINATES CREATED BY MOVING THE DIGITAL PEN ACROSS DIGITAL PAPER, NAMELY, PAPER CONTAINING A PATTERN OF DOTS, IN CLASS 9 (U.S. CLS. 21, 23, 26, 36 AND 38).

FOR: PAPER, NAMELY, PRINTED FORMS, PRINTED LABELS, PRINTED PATTERNS, MAPS, GREETING CARDS, MEMO PADS, WRITING PADS, NOTE PADS, RECIPE PADS, RECEIPT PADS, ADDRESS LABELS, BANK CHECKS, CHECK BOOKS, ENVELOPES, NOTE CARDS, POSTCARDS, RECORDS CARDS, ADDRESS BOOKS, NOTEBOOKS,

SKETCHBOOKS, SONGBOOKS, CALENDARS, AGENDAS, POCKET CALENDARS, PERSONAL ORGANIZERS MADE OF PAPER, WALL CALENDARS, DIARIES, WRITING PAPER, PRINTING PAPER, PAPER BOARD, ART PAPER, COPYING PAPER, NOTE PAPER, NOTEBOOK PAPER, PUBLICATION PAPER, COMPUTER PAPER, WHITEBOARDS, FLIPCHARTS AND STICKERS, ALL PRINTED WITH A PATTERN OF DOTS WHICH ARE REGISTERED BY A DIGITAL PEN WHEN WRITING THEREON, IN CLASS 16 (U.S. CLS. 2, 5, 22, 23, 29, 37, 38 AND 50).

FOR: TELECOMMUNICATION AND DATA COMMUNICATIONS SERVICES, NAMELY, COMPUTER AIDED TRANSMISSION OF WRITTEN MESSAGES AND IMAGES, THROUGH ELECTRONIC MAIL, FACSIMILE, GRAPHICAL SMS OR PERSONAL COMPUTER, IN CLASS 38 (U.S. CLS. 100, 101 AND 104).

PRIORITY CLAIMED UNDER SEC. 44(D) ON SWEDEN APPLICATION NO. 01-05902, FILED 9-26-2001, REG. NO. 0353063, DATED 9-26-2001, EXPIRES 9-26-2011.

SER. NO. 76-388,231, FILED 3-26-2002.

MARY ROSSMAN, EXAMINING ATTORNEY

Int. Cl.: 32

Prior U.S. Cls.: 45, 46 and 48

United States Patent and Trademark Office

Reg. No. 2,892,385

Registered Oct. 12, 2004

**TRADEMARK
PRINCIPAL REGISTER**

ALGONQUIN

MOLSON CANADA (PARTNERSHIP)
33 CARLINGVIEW DRIVE
ETOBICOKE, ONTARIO, CANADA M9W 5E4

29-2001, REG. NO. TMA604340, DATED 3-5-2004,
EXPIRES 3-5-2019.

FOR: BREWED ALCOHOLIC BEVERAGES,
NAMELY BEER, IN CLASS 32 (U.S. CLS. 45, 46
AND 48).

OWNER OF U.S. REG. NOS. 2,026,380 AND
2,165,039.

SER. NO. 76-388,311, FILED 3-28-2002.

PRIORITY CLAIMED UNDER SEC. 44(D) ON
CANADA APPLICATION NO. 1,123,865, FILED 11-

KATHY DE JONGE, EXAMINING ATTORNEY

Int. Cl.: 5

Prior U.S. Cls.: 6, 18, 44, 46, 51 and 52

Reg. No. 2,892,386

United States Patent and Trademark Office

Registered Oct. 12, 2004

**TRADEMARK
PRINCIPAL REGISTER**

HEALTHY GENERATIONS

SUPERVALU INC. (DELAWARE CORPORATION)
11840 VALLEY VIEW ROAD
EDEN PRAIRIE, MN 553443691

FOR: PHARMACEUTICAL PREPARATIONS, NAMELY, COLD MEDICINES, DECONGESTANTS, EXPECTORANTS, COUGH SUPPRESSANTS, NAMELY, COUGH LOZENGES AND COUGH LIQUIDS, ALLERGY MEDICINES, DECONGESTANT NASAL SPRAYS, BRONCHIAL RELIEF MEDICINES, NAMELY, EPINEPHRINE MISTS, SORE THROAT SPRAYS, THROAT LOZENGES, FLU MEDICINES, COLD CAPSULES, ANALGESICS, SI-

NUS MEDICATIONS AND MENTHOL VAPOR DECONGESTANT RUBS, IN CLASS 5 (U.S. CLS. 6, 18, 44, 46, 51 AND 52).

FIRST USE 9-6-2002; IN COMMERCE 9-6-2002.

NO CLAIM IS MADE TO THE EXCLUSIVE RIGHT TO USE "HEALTHY", APART FROM THE MARK AS SHOWN.

SER. NO. 76-388,397, FILED 3-27-2002.

MARLENE BELL, EXAMINING ATTORNEY

Int. Cl.: 1

Prior U.S. Cls.: 1, 5, 6, 10, 26 and 46

United States Patent and Trademark Office

Reg. No. 2,892,387

Registered Oct. 12, 2004

**TRADEMARK
PRINCIPAL REGISTER**

KANO LABORATORIES, INC.

KANO LABORATORIES, INC. (TENNESSEE
CORPORATION)
1000 THOMPSON LANE
NASHVILLE, TN 37211

FOR: ADHESIVES FOR USE IN THE PACKA-
GING/ SHIPPING INDUSTRY; CHEMICAL ADDI-
TIVES FOR GASOLINE, IN CLASS 1 (U.S. CLS. 1, 5, 6,
10, 26 AND 46).

FIRST USE 12-31-1939; IN COMMERCE 12-31-1939.

NO CLAIM IS MADE TO THE EXCLUSIVE
RIGHT TO USE "LABORATORIES, INC.", APART
FROM THE MARK AS SHOWN.

SEC. 2(F) AS TO KANO.

SER. NO. 76-388,810, FILED 3-27-2002.

LEIGH CAROLINE CASE, EXAMINING ATTOR-
NEY

Int. Cls.: 35 and 39

Prior U.S. Cls.: 100, 101, 102 and 105

United States Patent and Trademark Office

Reg. No. 2,892,388

Registered Oct. 12, 2004

**SERVICE MARK
PRINCIPAL REGISTER**

THE POWER OF PERSONAL SERVICE

ABF FREIGHT SYSTEM, INC. (DELAWARE
CORPORATION)
P.O. BOX 10048
FORT SMITH, AR 79217

FOR: CUSTOMER SUPPORT SERVICES IN CON-
NECTION WITH THE TRANSPORTATION OF
GOODS BY TRUCK, AIRPLANE, TRAIN, SHIP OR
A COMBINATION THEREOF, NAMELY, PROVID-
ING ROUTING, TRACKING AND TRACING IN-
FORMATION AND STATISTICAL REPORTS, IN
CLASS 35 (U.S. CLS. 100, 101 AND 102).

FIRST USE 1-1-2002; IN COMMERCE 1-1-2002.

FOR: FREIGHT TRANSPORTATION SERVICES
BY TRUCK, AIRPLANE, TRAIN, SHIP OR A COM-
BINATION THEREOF, IN CLASS 39 (U.S. CLS. 100
AND 105).

FIRST USE 1-1-2002; IN COMMERCE 1-1-2002.

SER. NO. 76-389,404, FILED 3-29-2002.

ALICE SUE CARRUTHERS, EXAMINING ATTOR-
NEY

Int. Cl.: 43

Prior U.S. Cls.: 100 and 101

United States Patent and Trademark Office

Reg. No. 2,892,389

Registered Oct. 12, 2004

**SERVICE MARK
PRINCIPAL REGISTER**

MMMM...TOASTY

QUIZNO'S MASTER LLC, THE (COLORADO LTD
LIAB CO)
1415 LARIMER STREET
DENVER, CO 80202

FIRST USE 2-3-2002; IN COMMERCE 2-3-2002.

SER. NO. 76-389,522, FILED 4-1-2002.

FOR: RESTAURANT SERVICES, IN CLASS 43
(U.S. CLS. 100 AND 101).

ESTHER BELENKER, EXAMINING ATTORNEY

Int. Cl.: 45

Prior U.S. Cls.: 100 and 101

United States Patent and Trademark Office

Reg. No. 2,892,390

Registered Oct. 12, 2004

**SERVICE MARK
PRINCIPAL REGISTER**

QUALYS

QUALYS, INC. (DELAWARE CORPORATION)
1600 BRIDGE PARKWAY
SECOND FLOOR
REDWOOD SHORES, CA 94065

AND SECURITY RISKS AND REPORTING THERE-
ON, IN CLASS 45 (U.S. CLS. 100 AND 101).

FIRST USE 6-15-1999; IN COMMERCE 6-15-1999.

FOR: COMPUTER NETWORK SECURITY SER-
VICES, NAMELY, ASSESSING, AUDITING, AND
MONITORING NETWORK VULNERABILITIES

SER. NO. 76-389,648, FILED 3-29-2002.

KAREN K. BUSH, EXAMINING ATTORNEY

Int. Cls.: 7 and 28

Prior U.S. Cls.: 13, 19, 21, 22, 23, 31, 34, 35, 38 and 50

United States Patent and Trademark Office

Reg. No. 2,892,391

Registered Oct. 12, 2004

**TRADEMARK
PRINCIPAL REGISTER**



STIGA FORVALTNING AB (SWEDEN CORPORATION)
C/O MANNHEIMER SWARTLING ADVOKAT-
BYRA AB
NORRMALMSTORG 4
SE-111 87 STOCKHOLM, SWEDEN

FOR: POWER OPERATED LAWN AND GARDEN RIDING MOWERS, LAWN MOWERS, CHIPPERS, SHREDDERS, GRASS/WEED TRIMMERS, BUSH CUTTERS, CLEARING SAWS, HEDGE CUTTERS, LAWN COMBERS/LAWN RAKES, REEL MOWERS, CHAIN SAWS, TILLERS AND SNOW THROWERS, IN CLASS 7 (U.S. CLS. 13, 19, 21, 23, 31, 34 AND 35).

FOR: RECREATIONAL DEVICES FOR SLIDING AND MOVING ON SNOW, NAMELY, TOBOGGANS, SLEDGES, PLAY-BOARDS AND SNOW-SHEETS, IN CLASS 28 (U.S. CLS. 22, 23, 38 AND 50).

PRIORITY CLAIMED UNDER SEC. 44(D) ON ERPN CMNTY TM OFC APPLICATION NO.

002460848, FILED 11-13-2001, REG. NO. 002460848, DATED 4-30-2003, EXPIRES 11-13-2011.

NO CLAIM IS MADE TO THE EXCLUSIVE RIGHT TO USE "GARDEN PRODUCTS" IN INTERNATIONAL CLASS 7 ONLY, APART FROM THE MARK AS SHOWN.

APPLICANT CLAIMS THE COLOR GREEN IN THE DESIGN OF A PICKET FENCE AND A LINE SHOWN IN THE MARK.

THE MARK CONSISTS, IN PART, OF A STYLIZED DEPICTION OF A PICKET FENCE AND A LINE.

SER. NO. 76-390,027, FILED 3-28-2002.

BARBARA GAYNOR, EXAMINING ATTORNEY

Int. Cls.: 9, 16, 17 and 40

**Prior U.S. Cls.: 1, 2, 5, 12, 13, 21, 22, 23, 26, 29, 35, 36,
37, 38, 50, 100, 103 and 106**

Reg. No. 2,892,392

United States Patent and Trademark Office

Registered Oct. 12, 2004

**TRADEMARK
SERVICE MARK
PRINCIPAL REGISTER**

POLARISAFE

LANDQUART (SWITZERLAND CORPORATION)
POSTFACH
7302 LANDQUART, SWITZERLAND

FOR: FORGERY-PROTECTED CARDS, NAME-
LY, MAGNETICALLY AND OPTICALLY-ENCO-
DED CREDIT CARDS AND CARDS FOR
IDENTIFICATION PURPOSES; BLANK INTEGRA-
TED CIRCUIT CARDS, ALSO KNOWN AS SMART
CARDS, IN CLASS 9 (U.S. CLS. 21, 23, 26, 36 AND 38).

FOR: FORGERY-PROOF PAPER, ALSO KNOWN
AS SAFETY PAPER; FORGERY-PROOF BOXES
MADE OF PAPER OR CARDBOARD; FORGERY-
PROOF BAGS, ENVELOPES, POUCHES MADE OF
PAPER, CARDBOARD, OR PLASTICS FOR PACKA-
GING; PLASTIC WRAPPING FOILS FOR PACKA-
GING LABELING, IN CLASS 16 (U.S. CLS. 2, 5, 22, 23,
29, 37, 38 AND 50).

FOR: PLASTICS IN EXTRUDED FORMS FOR
USE IN MANUFACTURE OF FORGERY-PROOF

PACKAGING MATERIAL, NAMELY, BAGS, EN-
VELOPES AND POUCHES; FOILS AND FILMS
MADE OF PLASTICS FOR INDUSTRIAL USE IN
SECURITY APPLICATIONS AS SECURITY
THREADS, HOT-STAMPING FOILS AND SAFETY
FOILS, IN CLASS 17 (U.S. CLS. 1, 5, 12, 13, 35 AND 50).

FOR: TREATMENT OF FOILS, PAPER SURFA-
CES, AND PLASTICS USED IN SECURITY-INTEN-
SIVE APPLICATIONS SUCH AS CREDIT CARDS
AND IDENTIFICATION CARDS, FOR FORGERY
PROTECTION, IN CLASS 40 (U.S. CLS. 100, 103 AND
106).

PRIORITY CLAIMED UNDER SEC. 44(D) ON
SWITZERLAND APPLICATION NO. 02983/2002,
FILED 4-3-2002, REG. NO. 499916, DATED 6-28-2002,
EXPIRES 4-3-2012.

SER. NO. 76-392,824, FILED 4-8-2002.

SUSAN STIGLITZ, EXAMINING ATTORNEY

Int. Cls.: 2, 9, 35, 36, 37, 39 and 40

Prior U.S. Cls.: 6, 11, 16, 21, 23, 26, 36, 38, 100, 101, 102, 103, 105 and 106

Reg. No. 2,892,393

United States Patent and Trademark Office

Registered Oct. 12, 2004

TRADEMARK
SERVICE MARK
PRINCIPAL REGISTER



AKZO NOBEL COATINGS INTERNATIONAL
B.V. (NETHERLANDS CORPORATION)
VELPERWEG 76
6824 BM ARNHEM, NETHERLANDS

FOR: PAINTS, VARNISHES, LACQUERS, CORROSION INHIBITORS, ALL FOR USE IN THE CAR REPAIR INDUSTRY, IN CLASS 2 (U.S. CLS. 6, 11 AND 16).

FOR: COMPUTER SOFTWARE, NAMELY ADMINISTRATIVE AND MANAGEMENT SUPPORT SOFTWARE AS WELL AS INFORMATION SUPPLY SOFTWARE, ALSO FOR USE ON THE INTERNET, ALL FOR USE IN THE FIELD OF CAR REPAIR, IN CLASS 9 (U.S. CLS. 21, 23, 26, 36 AND 38).

FOR: RETAIL STORE SERVICES FEATURING AUTOMOBILE AND MOTOR VEHICLE PARTS, IN CLASS 35 (U.S. CLS. 100, 101 AND 102).

FOR: INSURANCE CLAIMS ADMINISTRATION IN THE FIELD OF MOTOR VEHICLE INSURANCE; INSURANCE SERVICES, NAMELY, UNDERWRITING EXTENDED WARRANTY CONTRACTS IN THE FIELD OF AUTOMOBILES; PROVISION OF INFORMATION AND ADVICE IN THE FIELD OF MOTOR VEHICLE FINANCING; FINANCIAL INFORMATION PROVIDED BY ELECTRONIC MEANS; FINANCIAL SERVICE, NAMELY MONEY LENDING CREDIT CONSULTATION AND CREDIT CARD SERVICES, IN CLASS 36 (U.S. CLS. 100, 101 AND 102).

FOR: CAR AND VEHICLE REPAIR AND MAINTENANCE; CAR CLEANING AND WASHING RE-

PAIRING; PAINTING, SPRAYING, REFINISHING, CLEANING, WASHING AND APPLYING PROTECTANTS TO VEHICLE BODY SURFACES; VEHICLE REPAIR SERVICES, INSTALLATION OF AUTOMOTIVE ACCESSORIES, AND AUTOMOTIVE DETAILING, NAMELY, CLEANING, WASHING AND APPLICATION OF PROTECTANTS TO AUTOMOTIVE BODY, ENGINE AND INTERIOR SURFACES; REPAIR, SERVICING AND REMOVAL OF DENTS, SCRATCHES AND DINGS ON AUTOMOBILES AND TRUCKS WITHOUT PAINTING; COMMERCIAL INFORMATION AND ADVICE FOR CUSTOMERS IN THE FIELD OF CAR REPAIR, IN CLASS 37 (U.S. CLS. 100, 103 AND 106).

FOR: TRANSPORT BY AUTOMOBILES; RENTAL OF VEHICLES, MORE PARTICULARLY PROVIDING REPLACEMENT TRANSPORT, VEHICLE TOWING, IN CLASS 39 (U.S. CLS. 100 AND 105).

FOR: ENGRAVING CAR WINDOWS; MANUFACTURING TOOLING FOR OTHERS FOR THE PRODUCTION OF AUTOMOTIVE PARTS, COMPONENTS AND ASSEMBLIES TO THE ORDER AND SPECIFICATION OF OTHERS, IN CLASS 40 (U.S. CLS. 100, 103 AND 106).

OWNER OF BENELUX REG. NO. 0702657, DATED 5-2-2002, EXPIRES 5-2-2012.

SER. NO. 76-392,987, FILED 4-8-2002.

BRIAN BROWN, EXAMINING ATTORNEY

Int. Cl.: 10

Prior U.S. Cls.: 26, 39 and 44

United States Patent and Trademark Office

Reg. No. 2,892,394

Registered Oct. 12, 2004

**TRADEMARK
PRINCIPAL REGISTER**

YES SET

LH MEDICAL PRODUCTS, INC. (CALIFORNIA CORPORATION)
301 E. ARROW HIGHWAY, SUITE 104
SAN DIMAS, CA 91773

FOR: Y-PORT ENTERAL ADMINISTRATION SYSTEM COMPRISING A SPIKE SET AND ENTERAL IRRIGATION PISTON SYRINGE USED FOR ADMINISTERING ENTERAL FORMULAS VIA A FEEDING PUMP, IN CLASS 10 (U.S. CLS. 26, 39 AND 44).

FIRST USE 8-9-2000; IN COMMERCE 8-9-2000.

OWNER OF U.S. REG. NO. 2,532,797.

NO CLAIM IS MADE TO THE EXCLUSIVE RIGHT TO USE "SET", APART FROM THE MARK AS SHOWN.

SER. NO. 76-394,138, FILED 4-10-2002.

GLENN CLARK, EXAMINING ATTORNEY

Int. Cl.: 10

Prior U.S. Cls.: 26, 39 and 44

United States Patent and Trademark Office

Reg. No. 2,892,395

Registered Oct. 12, 2004

**TRADEMARK
PRINCIPAL REGISTER**

LSI ^{The} *Surgical Procedure*
SOLUTIONS[®] Company

LSI SOLUTIONS, INC. (NEW YORK CORPORATION)
7796 VICTOR-MENDON ROAD
VICTOR, NY 14564

FOR: MEDICAL VIDEOSCOPIIC DISPLAY SYSTEMS NAMELY A VIDEO PROJECTOR AND A VIDEO DISPLAY; SURGICAL SUTURING INSTRUMENTS; FIXTURES FOR RELOADING INSTRUMENTS FOR SUTURING, IN CLASS 10 (U.S. CLS. 26, 39 AND 44).

FIRST USE 4-12-2002; IN COMMERCE 3-28-2003.

OWNER OF U.S. REG. NO. 2,496,200.

SER. NO. 76-394,189, FILED 4-11-2002.

AISHA CLARKE, EXAMINING ATTORNEY

Int. Cls.: 40 and 42

Prior U.S. Cls.: 100, 101, 103 and 106

United States Patent and Trademark Office

Reg. No. 2,892,396

Registered Oct. 12, 2004

**SERVICE MARK
PRINCIPAL REGISTER**



ENVIRONMENTAL QUALITY MANAGEMENT,
INC. (OHIO CORPORATION)
1800 CARILLON BOULEVARD
CINCINNATI, OH 45240

FOR: ENVIRONMENTAL REMEDIAL SERVICES,
NAMELY, STRUCTURAL TREATMENT AND DE-
CONTAMINATION, IN CLASS 40 (U.S. CLS. 100, 103
AND 106).

FIRST USE 3-7-2002; IN COMMERCE 3-7-2002.

FOR: ENVIRONMENTAL ENGINEERING; EN-
VIRONMENTAL CONSULTATION; REVIEWING
STANDARDS AND PRACTICES OF OTHERS TO
ENSURE THEIR COMPLIANCE WITH ENVIRON-
MENTAL LAWS AND REGULATIONS; ENVIRON-
MENTAL ASSESSMENT SERVICES, NAMELY,
RESEARCHING AND EVALUATING THE IMPACT
OF THIRD-PARTY ACTIVITIES ON THE ENVIRON-
MENT; INDUSTRIAL HYGIENE SERVICES, NAME-

LY, REVIEWING STANDARDS AND PRACTICES
OF OTHERS TO ENSURE COMPLIANCE WITH
INDUSTRIAL HYGIENE AND WORK SAFETY EN-
VIRONMENT LAWS AND REGULATIONS, DE-
SIGNING PLANS TO CONTINUE COMPLIANCE
THERETO AND FOLLOW-UP MONITORING OF
WORK ENVIRONMENTS TO ENSURE CONTIN-
UED COMPLIANCE; DEVELOPMENT AND DE-
SIGN OF OPERATING SYSTEMS TO TREAT AND
DECONTAMINATE SOIL, WATER AND STRUC-
TURES, IN CLASS 42 (U.S. CLS. 100 AND 101).

FIRST USE 3-7-2002; IN COMMERCE 3-7-2002.

OWNER OF U.S. REG. NOS. 2,497,471 AND
2,497,472.

SER. NO. 76-394,370, FILED 4-10-2002.

DAVID C. REIHNER, EXAMINING ATTORNEY

Int. Cl.: 3

Prior U.S. Cls.: 1, 4, 6, 50, 51 and 52

United States Patent and Trademark Office

Reg. No. 2,892,397

Registered Oct. 12, 2004

**TRADEMARK
PRINCIPAL REGISTER**

SALON MILA, L.L.C. (ARIZONA LIMITED LIABILITY COMPANY)

37769 NORTH 94TH STREET
SCOTTSDALE, AZ 85004

FOR: COSMETICS FOR THE FACE AND BODY; NAMELY POWDER, LIPSTICK, EYESHADOW, MAKEUP, CONCEALER, LIP PENCILS, FOUNDATION, BLUSH/GLEAMER, BRONZER, LASH THICKENER, MASCARA, EYE PENCILS, EYEBROW PEN-

CILS, MASCARA, AND MAKEUP BRUSHES, IN CLASS 3 (U.S. CLS. 1, 4, 6, 50, 51 AND 52).

FIRST USE 12-0-2001; IN COMMERCE 12-0-2001.

THE ENGLISH TRANSLATION OF "MILA" IS "SWEETHEART" OR "DARLING."

SER. NO. 76-395,988, FILED 4-16-2002.

MARGERY A. TIERNEY, EXAMINING ATTORNEY

Int. Cl.: 12

Prior U.S. Cls.: 19, 21, 23, 31, 35 and 44

Reg. No. 2,892,398

United States Patent and Trademark Office

Registered Oct. 12, 2004

**TRADEMARK
PRINCIPAL REGISTER**

ACERTA

NISSAN JIDOSHA KABUSHIKI KAISHA (JAPAN CORPORATION), TA NISSAN MOTOR CO., LTD.

NO. 2 TAKARACHO, KANAGAWA-KU
YOKOHAMA-SHI, KANAGAWA-KEN, JAPAN

FOR: AUTOMOBILES, WAGONS, TRUCKS, VANS, FORK LIFT TRUCKS, TOWING TRACTORS, TRACTORS, AND OTHER UTILITY VEHICLES, NAMELY, SPORT UTILITY VEHICLES, AND

STRUCTURAL PARTS THEREFOR, IN CLASS 12 (U.S. CLS. 19, 21, 23, 31, 35 AND 44).

OWNER OF JAPAN REG. NO. 4,345,319, DATED 12-17-1999, EXPIRES 12-17-2009.

SER. NO. 76-396,102, FILED 4-18-2002.

RAUL CORDOVA, EXAMINING ATTORNEY

Int. Cls.: 35 and 36

Prior U.S. Cls.: 100, 101 and 102

United States Patent and Trademark Office

Reg. No. 2,892,399

Registered Oct. 12, 2004

**SERVICE MARK
PRINCIPAL REGISTER**



**FNIS INTELLECTUAL PROPERTY HOLDINGS,
INC. (DELAWARE CORPORATION)
4050 CALLE REAL
SANTA BARBARA, CA 93110**

**FOR: PREPARING BUSINESS REPORTS RE-
GARDING THE VALUATION OF REAL PROPERTY
FOR PURPOSES OF MORTGAGE LOAN APPLICA-
TION, ORIGINATION, SERVICING OR DEFAULT,
IN CLASS 35 (U.S. CLS. 100, 101 AND 102).**

FIRST USE 3-1-2001; IN COMMERCE 3-30-2001.

**FOR: REAL ESTATE AND FINANCIAL SERVI-
CES, NAMELY THE VALUATION OF REAL PROP-**

**ERTY FOR PURPOSES OF MORTGAGE LOAN
APPLICATION, ORIGINATION, SERVICING OR
DEFAULT, IN CLASS 36 (U.S. CLS. 100, 101 AND 102).**

FIRST USE 3-1-2001; IN COMMERCE 3-30-2001.

**NO CLAIM IS MADE TO THE EXCLUSIVE
RIGHT TO USE "VALUE", APART FROM THE
MARK AS SHOWN.**

SER. NO. 76-398,814, FILED 4-22-2002.

**TRACY WHITAKER-BOWN, EXAMINING ATTOR-
NEY**

Int. Cl.: 21

Prior U.S. Cls.: 2, 13, 23, 29, 30, 33, 40 and 50

Reg. No. 2,892,400

United States Patent and Trademark Office

Registered Oct. 12, 2004

**TRADEMARK
PRINCIPAL REGISTER**

VINTAGE

WATERFORD WEDGWOOD PLC (IRELAND
COMPANY)
KILBARRY
WATERFORD, IRELAND

FOR: ARTICLES OF GLASSWARE FOR DOMESTIC USE, NAMELY, STEMWARE, TUMBLERS, ICED TEA GLASSES, HIGH BALL GLASSES, GOBLETs, TUMBLERS, CHAMPAGNE GLASSES, LIQUEUR GLASSES, BRANDY GLASSES, WINE GLASSES, SHERBERT GLASSES, SHOT GLASSES, CARAFES, ICE BUCKETS, DECANTERS, VASES, PITCHERS, BOWLS, CANDLE HOLDERS NOT OF PRECIOUS METAL, CANDLE STICKS NOT OF PRECIOUS METAL, FINGER BOWLS, SALAD

BOWLS, CAKE STANDS, SALAD SERVING SPOONS AND FORKS, COCKTAIL SHAKERS, SERVING TRAYS NOT OF PRECIOUS METAL, PERFUME BOTTLES AND ATOMIZERS SOLD EMPTY, CORK-SCREWS, BOTTLE OPENERS, ICE BUCKETS, WINE COOLERS, GLASS STOPPERS, AND CUT CRYSTAL GLASSWARE, IN CLASS 21 (U.S. CLS. 2, 13, 23, 29, 30, 33, 40 AND 50).

FIRST USE 4-0-1997; IN COMMERCE 4-0-1997.

SER. NO. 76-399,145, FILED 4-23-2002.

KENNETH D. BATTLE, EXAMINING ATTORNEY

Int. Cls.: 9, 16, 25 and 28

**Prior U.S. Cls.: 2, 5, 21, 22, 23, 26, 29, 36, 37, 38, 39
and 50**

Reg. No. 2,892,401

United States Patent and Trademark Office

Registered Oct. 12, 2004

**TRADEMARK
PRINCIPAL REGISTER**

CLINTONS - WHEN ONLY THE BEST IS GOOD ENOUGH

CLINTON CARDS PLC (UNITED KINGDOM
CORPORATION)
THE CRYSTAL BUILDING
LANGSTON ROAD
LOUGHTON, ESSEX, IG10 3TH, UNITED KING-
DOM

FOR: AUDIO AND VIDEO TAPES SOLD BLANK;
RECORDABLE COMPACT DISCS SOLD BLANK;
PRE-RECORDED AUDIO TAPES, VIDEO TAPES
AND COMPACT DISCS FEATURING MUSIC AND
MOVIES, IN CLASS 9 (U.S. CLS. 21, 23, 26, 36 AND 38).

FOR: GREETING CARDS, IN CLASS 16 (U.S. CLS.
2, 5, 22, 23, 29, 37, 38 AND 50).

FOR: SOCKS, TIES AND ARTICLES OF HEAD-
GEAR, NAMELY HATS, CAPS AND SUN VISORS,
IN CLASS 25 (U.S. CLS. 22 AND 39).

FOR: SOFT SCULPTURE PLUSH TOYS; CARD
AND BOARD GAMES; DECORATIONS FOR
CHRISTMAS TREES, IN CLASS 28 (U.S. CLS. 22, 23,
38 AND 50).

OWNER OF UNITED KINGDOM REG. NO.
2193528, DATED 9-24-1999, EXPIRES 4-1-2009.

SER. NO. 76-399,236, FILED 4-23-2002.

CURTIS FRENCH, EXAMINING ATTORNEY

Int. Cl.: 7

Prior U.S. Cls.: 13, 19, 21, 23, 31, 34 and 35

United States Patent and Trademark Office

Reg. No. 2,892,402

Registered Oct. 12, 2004

**TRADEMARK
PRINCIPAL REGISTER**



NATIONAL BEARINGS COMPANY (DELAWARE
CORPORATION)
P.O. BOX 4726
LANCASTER, PA 17604

NO CLAIM IS MADE TO THE EXCLUSIVE
RIGHT TO USE "BEARINGS COMPANY", APART
FROM THE MARK AS SHOWN.

FOR: BALL BEARINGS FOR USE IN MACHIN-
ERY, IN CLASS 7 (U.S. CLS. 13, 19, 21, 23, 31, 34 AND
35).

SER. NO. 76-402,066, FILED 5-1-2002.

FIRST USE 5-30-1980; IN COMMERCE 5-30-1980.

JOHN LINCOSKI, EXAMINING ATTORNEY

Int. Cl.: 25

Prior U.S. Cls.: 22 and 39

United States Patent and Trademark Office

Reg. No. 2,892,403

Registered Oct. 12, 2004

**TRADEMARK
PRINCIPAL REGISTER**

FAIRLY FAMOUS

RIGHT STUFF, INC. (MASSACHUSETTS COR-
PORATION)
24 RAY AVENUE, SUITE 103
BURLINGTON, MA 01803

FIRST USE 1-1-2002; IN COMMERCE 1-1-2002.

SER. NO. 76-402,154, FILED 4-29-2002.

FOR: FOOTWEAR, IN CLASS 25 (U.S. CLS. 22 AND
39).

GENE MACIOL, EXAMINING ATTORNEY

Int. Cl.: 9

Prior U.S. Cls.: 21, 23, 26, 36 and 38

Reg. No. 2,892,404

United States Patent and Trademark Office

Registered Oct. 12, 2004

**TRADEMARK
PRINCIPAL REGISTER**



BIZI INTERNATIONAL, INC. (DELAWARE CORPORATION)
144 RANGWAY ROAD
NORTH BILLERICA, MA 01862

FIRST USE 3-30-2002; IN COMMERCE 3-30-2002.

OWNER OF U.S. REG. NO. 2,413,744.

FOR: ELECTRICAL AND SCIENTIFIC APPARATUS INCLUDING COMPUTER, COMMUNICATION AND NETWORKING EQUIPMENT, NAMELY, LAN BOARDS, HUBS, MODEMS, ROUTERS, COMMUNICATION SWITCHES, BRIDGES, GATEWAYS, CONCENTRATORS AND SERVERS, IN CLASS 9 (U.S. CLS. 21, 23, 26, 36 AND 38).

SER. NO. 76-402,370, FILED 4-29-2002.

AMOS T. MATTHEWS, JR., EXAMINING ATTORNEY

Int. Cls.: 35 and 41

Prior U.S. Cls.: 100, 101, 102 and 107

United States Patent and Trademark Office

Reg. No. 2,892,405

Registered Oct. 12, 2004

**SERVICE MARK
PRINCIPAL REGISTER**

RETAILTAINMENT

U.S. MARKETING & PROMOTIONS AGENCY,
INC. (CALIFORNIA CORPORATION)
23456 HAWTHORNE BLVD., SUITE 300
TORRANCE, CA 90505

FOR: PROMOTING THE GOODS AND SERVICES
OF OTHERS IN THE RETAIL INDUSTRY
THROUGH THE DISTRIBUTION OF PRINTED MA-
TERIALS, AND VIA INTERACTIVE MOBILE PRO-
MOTIONAL EVENTS AND PRODUCT EXHIBITS,
IN CLASS 35 (U.S. CLS. 100, 101 AND 102).

FIRST USE 10-0-1998; IN COMMERCE 10-0-1998.

FOR: ARRANGING ENTERTAINMENT EXHIBI-
TIONS IN THE NATURE OF LIVE PERFORMAN-
CES BY MUSICAL BANDS, SINGERS, DANCERS,
COMEDY ROUTINES, CELEBRITY SPEAKERS FOR
IN-STORE PROMOTIONS, IN CLASS 41 (U.S. CLS.
100, 101 AND 107).

FIRST USE 10-0-1998; IN COMMERCE 10-0-1998.

SER. NO. 76-402,511, FILED 4-29-2002.

GWEN STOKOLS, EXAMINING ATTORNEY

Int. Cl.: 40

Prior U.S. Cls.: 100, 103 and 106

United States Patent and Trademark Office

Reg. No. 2,892,406

Registered Oct. 12, 2004

**SERVICE MARK
PRINCIPAL REGISTER**

QUICKSET

GLADSON & ASSOCIATES, INC. (ILLINOIS CORPORATION), DBA GLADSON INTERACTIVE SERVICES
1973 OHIO STREET
LISLE, IL 60532

FOR: CUSTOM IMPRINTING OF FULL-SCALE, SHELF-LENGTH PHOTOGRAPHIC IMAGES OF PRODUCTS ARRANGED ON A SHELF TO BE ADHERED TO THE SHELF EDGE AS A TEMPOR-

ARY GUIDE FOR PERSONS WHO STOCK THE SHELVES, IN CLASS 40 (U.S. CLS. 100, 103 AND 106).

FIRST USE 4-26-2002; IN COMMERCE 4-26-2002.

SER. NO. 76-402,864, FILED 4-30-2002.

JOHN SCHUYLER YARD, EXAMINING ATTORNEY

Int. Cl.: 14

Prior U.S. Cls.: 2, 27, 28 and 50

United States Patent and Trademark Office

Reg. No. 2,892,407

Registered Oct. 12, 2004

**TRADEMARK
PRINCIPAL REGISTER**

FACETS OF FIRE

DIAMINTANGIBLES INTERNATIONAL, LTD.
(NEW YORK CORPORATION)
BRITISH COLONIA CENTER OF COMMERCE
ONE BAY STREET, 3RD FLOOR
NASSAU, BAHAMAS

FOR: DIAMONDS AND FINE JEWELRY, IN
CLASS 14 (U.S. CLS. 2, 27, 28 AND 50).

FIRST USE 9-5-2002; IN COMMERCE 9-5-2002.

NO CLAIM IS MADE TO THE EXCLUSIVE
RIGHT TO USE "FACETS", APART FROM THE
MARK AS SHOWN.

SER. NO. 76-403,049, FILED 5-1-2002.

CHRISIE B. KING, EXAMINING ATTORNEY

Int. Cl.: 25

Prior U.S. Cls.: 22 and 39

United States Patent and Trademark Office

Reg. No. 2,892,408

Registered Oct. 12, 2004

**TRADEMARK
PRINCIPAL REGISTER**

UNITED WE STACK

SPEED STACKS, INC. (COLORADO CORPORATION)
14 INVERNESS DRIVE EAST, #D112
ENGLEWOOD, CO 80112

FIRST USE 11-0-2002; IN COMMERCE 11-0-2002.

SER. NO. 76-403,113, FILED 5-1-2002.

FOR: CLOTHING, NAMELY T-SHIRTS, IN CLASS
25 (U.S. CLS. 22 AND 39).

LOURDES AYALA, EXAMINING ATTORNEY

Int. Cl.: 5

Prior U.S. Cls.: 6, 18, 44, 46, 51 and 52

United States Patent and Trademark Office

Reg. No. 2,892,409

Registered Oct. 12, 2004

**TRADEMARK
PRINCIPAL REGISTER**

ZACTIMA

ASTRAZENECA AB (SWEDEN LIMITED LIABILITY COMPANY)
S 151 85 SODERTALJE
SWEDEN

FOR: PHARMACEUTICAL PREPARATIONS FOR THE TREATMENT AND PREVENTION OF CANCER FOR PRESCRIPTION ONLY, IN CLASS 5 (U.S. CLS. 6, 18, 44, 46, 51 AND 52).

PRIORITY CLAIMED UNDER SEC. 44(D) ON SWEDEN APPLICATION NO. 02-03019, FILED 4-26-2002, REG. NO. 361056, DATED 5-16-2003, EXPIRES 5-16-2013.

SER. NO. 76-403,524, FILED 5-3-2002.

ALICIA COLLINS, EXAMINING ATTORNEY

Int. Cl.: 5

Prior U.S. Cls.: 6, 18, 44, 46, 51 and 52

United States Patent and Trademark Office

Reg. No. 2,892,410

Registered Oct. 12, 2004

**TRADEMARK
PRINCIPAL REGISTER**

ACTIMEL

COMPAGNIE GERVAIS DANONE (FRANCE SO-
CIE TE ANONYME)
126-130, RUE JULES-GUESDE
92300 LEVALLOIS-PERRET, FRANCE

FOR: DAIRY-BASED DIETARY SUPPLEMENTS,
IN CLASS 5 (U.S. CLS. 6, 18, 44, 46, 51 AND 52).

FIRST USE 7-15-2003; IN COMMERCE 7-15-2003.

OWNER OF U.S. REG. NOS. 1,972,261, 2,443,266,
AND 2,472,810.

SER. NO. 76-404,134, FILED 5-7-2002.

ALEXANDER L. POWERS, EXAMINING ATTOR-
NEY

Int. Cl.: 30

Prior U.S. Cl.: 46

United States Patent and Trademark Office

Reg. No. 2,892,411

Registered Oct. 12, 2004

**TRADEMARK
PRINCIPAL REGISTER**

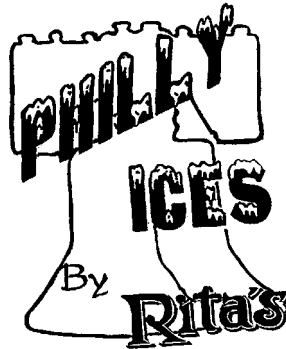

RITA'S WATER ICE, INC. (PENNSYLVANIA
CORPORATION)
1525 FORD ROAD
BENSALEM, PA 19020

FOR: FLAVORED WATER ICES AND FROZEN
DESSERTS, IN CLASS 30 (U.S. CL. 46).

FIRST USE 11-5-1997; IN COMMERCE 11-6-1997.

OWNER OF U.S. REG. NOS. 1,853,742, 2,384,763
AND OTHERS.

SEC. 2(F) AS TO "PHILLY ICES".

SER. NO. 76-404,540, FILED 4-15-2002.

CAROL SPILS, EXAMINING ATTORNEY

Int. Cls.: 35 and 36

Prior U.S. Cls.: 100, 101 and 102

United States Patent and Trademark Office

Reg. No. 2,892,412

Registered Oct. 12, 2004

**SERVICE MARK
PRINCIPAL REGISTER**

EXPERIENCE IS THE DIFFERENCE.

GUNNIP & COMPANY (PARTNERSHIP)
2751 CENTERVILLE ROAD SUITE 300
WILMINGTON, DE 19808

FOR: INCOME AND ESTATE TAX PLANNING
SERVICES, IN CLASS 35 (U.S. CLS. 100, 101 AND 102).

FIRST USE 6-1-2001; IN COMMERCE 6-1-2001.

FOR: FINANCIAL CONSULTING; FINANCIAL
MANAGEMENT; FINANCIAL PLANNING, IN
CLASS 36 (U.S. CLS. 100, 101 AND 102).

FIRST USE 6-1-2001; IN COMMERCE 6-1-2001.

SER. NO. 76-405,332, FILED 5-9-2002.

MARY BOAGNI, EXAMINING ATTORNEY

Int. Cls.: 35, 37 and 42

Prior U.S. Cls.: 100, 101, 102, 103 and 106

United States Patent and Trademark Office

Reg. No. 2,892,413

Registered Oct. 12, 2004

**SERVICE MARK
PRINCIPAL REGISTER**

INTERFORM

INTERFORM COMMERCIAL INTERIORS (CALIFORNIA CORPORATION)
2527 CAMINO RAMON, SUITE 175
SAN RAMON, CA 94583

FOR: RETAIL STORE SERVICES IN THE FIELD OF OFFICE FURNITURE AND RELATED OFFICE FURNISHINGS, NAMELY PANEL SYSTEMS, CHAIRS, DESKS, TABLES, FILE CABINETS, AND MOVEABLE OFFICE PARTITIONS; DISTRIBUTORSHIPS IN THE FIELD OF OFFICE FURNITURE AND RELATED OFFICE FURNISHINGS, NAMELY PANEL SYSTEMS, CHAIRS, DESKS, TABLES, FILE CABINETS, AND MOVEABLE OFFICE PARTITIONS; ON-LINE SERVICES, NAMELY PROVIDING, TRACKING, AND MANAGEMENT OF COMMERCIAL TRANSACTIONS RELATED TO INTERIOR DESIGN AND ARCHITECTURAL PROJECTS BY MEANS OF A GLOBAL COMPUTER NETWORK, IN CLASS 35 (U.S. CLS. 100, 101 AND 102).

FIRST USE 1-18-1982; IN COMMERCE 1-18-1982.

FOR: CONSTRUCTION MANAGEMENT SERVICES, CONSTRUCTION PLANNING AND SUPERVISION SERVICES, NAMELY ADMINISTERING

CONSTRUCTION, FOR INTERIOR OFFICE AND ARCHITECTURAL PROJECTS, IN CLASS 37 (U.S. CLS. 100, 103 AND 106).

FIRST USE 1-18-1982; IN COMMERCE 1-18-1982.

FOR: INTERIOR DESIGN FOR OTHERS AND ARCHITECTURAL DESIGN SERVICES, NAMELY CONCEPTUAL DESIGN, DESIGN DEVELOPMENT, SPACE PLANNING, DETERMINING SPECIFICATIONS AND PRODUCTS, INCLUDING, BUT NOT LIMITED TO COLOR, FLOOR PLANS, MATERIALS FOR FLOORING AND WALLS, LIGHTING AND FIXTURES, FABRICS AND FURNISHINGS, SPACE UTILIZATION PLANNING, SQUARE FOOTAGE ASSESSMENT AND ALLOCATIONS BY DEPARTMENT; ON-LINE COLLABORATIVE INTERIOR DESIGN SERVICES FOR INTERIOR DESIGN AND ARCHITECTURAL PROJECTS, IN CLASS 42 (U.S. CLS. 100 AND 101).

FIRST USE 1-18-1982; IN COMMERCE 1-18-1982.

SER. NO. 76-405,926, FILED 5-10-2002.

FRED MANDIR, EXAMINING ATTORNEY

Int. Cls.: 35, 37 and 42

Prior U.S. Cls.: 100, 101, 102, 103 and 106

United States Patent and Trademark Office

Reg. No. 2,892,414

Registered Oct. 12, 2004

SERVICE MARK
PRINCIPAL REGISTER



INTERFORM COMMERCIAL INTERIORS (CALIFORNIA CORPORATION)
2527 CAMINO RAMON
SUITE 175
SAN RAMON, CA 94583

FOR: RETAIL STORE SERVICES IN THE FIELD OF OFFICE FURNITURE AND RELATED OFFICE FURNISHINGS, NAMELY PANEL SYSTEMS, CHAIRS, DESKS, TABLES, FILE CABINETS, AND MOVEABLE OFFICE PARTITIONS; DISTRIBUTORSHIPS IN THE FIELD OF OFFICE FURNITURE AND RELATED OFFICE FURNISHINGS, NAMELY PANEL SYSTEMS, CHAIRS, DESKS, TABLES, FILE CABINETS, AND MOVEABLE OFFICE PARTITIONS; ON-LINE SERVICES, NAMELY PROVIDING, TRACKING, AND MANAGEMENT OF COMMERCIAL TRANSACTIONS RELATED TO INTERIOR DESIGN AND ARCHITECTURAL PROJECTS BY MEANS OF A GLOBAL COMPUTER NETWORK, IN CLASS 35 (U.S. CLS. 100, 101 AND 102).

FIRST USE 3-4-2002; IN COMMERCE 3-4-2002.

FOR: CONSTRUCTION MANAGEMENT SERVICES, CONSTRUCTION PLANNING AND SUPERVISION SERVICES, NAMELY ADMINISTERING CONSTRUCTION, FOR INTERIOR OFFICE AND

ARCHITECTURAL PROJECTS, IN CLASS 37 (U.S. CLS. 100, 103 AND 106).

FIRST USE 3-4-2002; IN COMMERCE 3-4-2002.

FOR: INTERIOR BUILDING DESIGN FOR OTHERS AND ARCHITECTURAL DESIGN SERVICES, NAMELY CONCEPTUAL DESIGN, DESIGN DEVELOPMENT, SPACE PLANNING, DETERMINING SPECIFICATIONS AND PRODUCTS, INCLUDING, BUT NOT LIMITED TO COLOR, FLOOR PLANS, MATERIALS FOR FLOORING AND WALLS, LIGHTING AND FIXTURES, FABRICS AND FURNISHINGS, SPACE UTILIZATION PLANNING, SQUARE FOOTAGE ASSESSMENTS AND ALLOCATIONS BY DEPARTMENT; ON-LINE COLLABORATIVE INTERIOR DESIGN SERVICES FOR INTERIOR DESIGN AND ARCHITECTURAL PROJECTS, IN CLASS 42 (U.S. CLS. 100 AND 101).

FIRST USE 3-4-2002; IN COMMERCE 3-4-2002.

NO CLAIM IS MADE TO THE EXCLUSIVE RIGHT TO USE "COMMERCIAL INTERIORS", APART FROM THE MARK AS SHOWN.

SER. NO. 76-405,927, FILED 5-10-2002.

FRED MANDIR, EXAMINING ATTORNEY

Int. Cls.: 9, 35 and 42

Prior U.S. Cls.: 21, 23, 26, 36, 38, 100, 101 and 102

United States Patent and Trademark Office

Reg. No. 2,892,415

Registered Oct. 12, 2004

**TRADEMARK
SERVICE MARK
PRINCIPAL REGISTER**

CHEKHOV

PRICEWATERHOUSECOOPERS (UNITED KING-
DOM LIMITED LIABILITY PARTNERSHIP)
1 EMBANKMENT PLACE
LONDON, ENGLAND WC2N 6RH

FOR: COMPUTER SOFTWARE FOR ASSISTING
IN AND FACILITATING THE MANAGEMENT OF
BUSINESS, OPERATIONAL AND FINANCIAL RISK
BY PROVIDING ON-LINE DATABASES AND SUR-
VEYS FOR USE IN THE SELF-ASSESSMENT OF
ORGANIZATIONS, IN CLASS 9 (U.S. CLS. 21, 23, 26,
36 AND 38).

FOR: PROVIDING BUSINESS MANAGEMENT
ASSISTANCE AND BUSINESS CONSULTATION IN
THE MANAGEMENT OF BUSINESS AND OPERA-
TIONAL RISK; FINANCIAL STATEMENT PRE-
PARATION AND ANALYSIS OF BUSINESS;

LICENSING OF COMPUTER SOFTWARE FOR AS-
SISTING IN AND FACILITATING THE MANAGE-
MENT OF BUSINESS, OPERATIONAL AND
FINANCIAL RISK, IN CLASS 35 (U.S. CLS. 100, 101
AND 102).

FOR: COMPUTER SOFTWARE SERVICES,
NAMELY COMPUTER SOFTWARE CONSULTA-
TION IN THE FIELD OF MANAGEMENT RISK, IN
CLASS 42 (U.S. CLS. 100 AND 101).

OWNER OF ERPN CMNTY TM OFC REG. NO.
2054765, DATED 5-2-2003, EXPIRES 1-15-2011.

SER. NO. 76-406,135, FILED 5-3-2002.

GINA FINK, EXAMINING ATTORNEY

Int. Cl.: 33

Prior U.S. Cls.: 47 and 49

United States Patent and Trademark Office

Reg. No. 2,892,416

Registered Oct. 12, 2004

**TRADEMARK
PRINCIPAL REGISTER**

LOMBARD STATION

RIVIERINA WINES PTY LTD (AUSTRALIA
COMPANY)
ACN 001 752 263
700 KIDMAN WAY
GRIFFITH NSW 2680, AUSTRALIA

PRIORITY CLAIMED UNDER SEC. 44(D) ON
AUSTRALIA APPLICATION NO. 851275, FILED 9-
22-2000, REG. NO. 851275, DATED 9-22-2000, EX-
PIRES 9-22-2010.

SER. NO. 76-406,421, FILED 5-13-2002.

FOR: ALCOHOLIC BEVERAGES, NAMELY,
WINE, IN CLASS 33 (U.S. CLS. 47 AND 49).

DANIELLE MATTESSICH, EXAMINING ATTOR-
NEY

Int. Cl.: 9

Prior U.S. Cls.: 21, 23, 26, 36 and 38

Reg. No. 2,892,417

United States Patent and Trademark Office

Registered Oct. 12, 2004

**TRADEMARK
PRINCIPAL REGISTER**

XSITE

ABDO, NASSER ABO (UNITED STATES INDIVIDUAL)
7050 VILLAGE DRIVE #G
BUENA PARK, CA 90621

FOR: MOBILE AUDIO, VIDEO SYSTEMS AND COMPONENTS, NAMELY, AUDIO SPEAKERS, WOOFERS, TWEETERS, AMPLIFIERS, CAPACITORS, SIGNAL PROCESSORS, SPEAKER ENCLOSURES, ELECTRICAL CONNECTORS, ELECTRICAL CONNECTORS, ELECTRICAL CONTROLLERS, ELECTRIC SWITCHES, GRAPHIC EQUALIZERS, VIDEO MONITORS, STEREO TUNERS, TELEVISION SETS, REMOTE CONTROLS

TO CONTROL VOLUME, DIRECTION OF SOUND, BASS, TREBLE, COLOR, INTENSITY OF IMAGE, AND LIKE USES, ELECTRICAL CABLES, ELECTRIC FUSE BOXES, AND ELECTRIC DISTRIBUTION CONSOLES, IN CLASS 9 (U.S. CLS. 21, 23, 26, 36 AND 38).

FIRST USE 11-1-2002; IN COMMERCE 11-15-2002.

SER. NO. 76-406,766, FILED 5-10-2002.

GIANCARLO CASTRO, EXAMINING ATTORNEY

Int. Cls.: 1, 5, 9, 10, 41, 42 and 44

**Prior U.S. Cls.: 1, 5, 6, 10, 18, 21, 23, 26, 36, 38, 39, 44,
46, 51, 52, 100, 101 and 107**

Reg. No. 2,892,418

United States Patent and Trademark Office

Registered Oct. 12, 2004

**TRADEMARK
SERVICE MARK
PRINCIPAL REGISTER**

SENSIDX

AMBRI LTD. (AUSTRALIA PUBLIC COMPANY
LIMITED BY SHARES (CORPORATION))
126 GREVILLE STREET
CHATSWOOD, NEW SOUTH WALES 2067, AUSTRALIA

FOR: CHEMICAL REAGENTS FOR SCIENTIFIC USE, IN CLASS 1 (U.S. CLS. 1, 5, 6, 10, 26 AND 46).

FOR: PHARMACEUTICAL PREPARATIONS FOR THE DIAGNOSIS AND TREATMENT OF BLOOD DISEASES, ELECTROLYTES, CARDIAC MARKERS, INFECTIOUS DISEASES, IMMUNE DEFICIENCIES, WHOLE BLOOD GLUCOSE, DRUGS OF ABUSE, URINALYSIS, COAGULATION AND HEMOGLOBIN/HEMATOCRIT, AND BIOTERRORISM DISEASES; MEDICAL DIAGNOSTIC REAGENTS; DIAGNOSTIC REAGENTS FOR CLINICAL AND MEDICAL LABORATORY USE, IN CLASS 5 (U.S. CLS. 6, 18, 44, 46, 51 AND 52).

FOR: BIOSENSORS, DETECTORS, ELECTRO-DYNAMIC APPARATUS FOR THE REMOTE CONTROL OF SIGNALS, INDICATORS, MEASURING APPARATUS AND INSTRUMENTS FOR USE IN SCIENTIFIC RESEARCH NAMELY, NON-MEDICAL ANALYSIS, BIOMEDICAL TEST SYSTEMS COMPRISED PRIMARILY OF READING AND ANALYZING INSTRUMENTS FOR USE IN SCIENTIFIC; RESEARCH NAMELY, NON-MEDICAL ANALYSIS INCLUDING ENVIRONMENTAL, FOOD AND WATER ANALYSIS, CASSETTES OR CARTRIDGES HAVING MEMBRANE BASED REACTION REGIMES DESIGNATED TO REACT WITH OR TEST FOR PARTICULAR BIOLOGICAL AND CHEMICAL COMPONENTS AND ANALYTES, IN CLASS 9 (U.S. CLS. 21, 23, 26, 36 AND 38).

FOR: BIOSENSORS, DETECTORS, ELECTRO-DYNAMIC APPARATUS FOR THE REMOTE CONTROL OF SIGNALS, INDICATORS, MEASURING

APPARATUS AND INSTRUMENTS FOR USE IN MEDICAL AND CLINICAL DIAGNOSTICS NAMELY CLINICAL DIAGNOSTIC MARKERS AND CARDIAC MARKERS; BIOMEDICAL TEST SYSTEMS, COMPRISED PRIMARILY OF READING AND ANALYZING INSTRUMENTS FOR USE IN THE DIAGNOSIS AND TREATMENT OF BLOOD DISEASES, ELECTROLYTES, CARDIAC MARKERS, INFECTIOUS DISEASES, IMMUNE DEFICIENCIES, WHOLE BLOOD GLUCOSE, DRUGS OF ABUSE, URINALYSIS, COAGULATION AND HEMOGLOBIN/HEMATOCRIT, AND BIOTERRORISM DISEASES; DIAGNOSTIC TEST CASSETTES OR CARTRIDGES HAVING MEMBRANE BASED REACTION REGIMES DESIGNATED TO REACT WITH OR TEST FOR PARTICULAR BIOLOGICAL AND CHEMICAL COMPONENTS AND ANALYTES, IN CLASS 10 (U.S. CLS. 26, 39 AND 44).

FOR: EDUCATIONAL SERVICES, NAMELY, CONDUCTING CLASSES, WORKSHOPS AND SEMINARS IN THE FIELD OF SCIENTIFIC RESEARCH; MUSEUM SERVICES, IN CLASS 41 (U.S. CLS. 100, 101 AND 107).

FOR: SCIENTIFIC, ENVIRONMENTAL, FOOD, WATER AND EDUCATIONAL RESEARCH AND DEVELOPMENT SERVICES FOR OTHERS, NAMELY, BIOLOGICAL, CHEMICAL, BIOCHEMICAL, MOLECULAR, GENETIC BASED RESEARCH AND DIAGNOSTIC SERVICES; SCIENTIFIC RESEARCH SERVICES; MEDICAL AND VETERINARY ANALYSIS SERVICES IN THE NATURE OF BIOLOGICAL, CHEMICAL, BIOCHEMICAL, MOLECULAR, GENETIC-BASED RESEARCH SERVICES, IN CLASS 42 (U.S. CLS. 100 AND 101).

FOR: MEDICAL AND VETERINARIAN SERVICES, MEDICAL AND VETERINARY DIAGNOSTIC SERVICES, IN CLASS 44 (U.S. CLS. 100 AND 101).

PRIORITY CLAIMED UNDER SEC. 44(D) ON
AUSTRALIA APPLICATION NO. 900041, FILED 1-
10-2002, REG. NO. 900041, DATED 1-10-2002, EX-
PIRES 1-10-2012.

SER. NO. 76-408,266, FILED 5-13-2002.

HOWARD B. LEVINE, EXAMINING ATTORNEY

Int. Cl.: 36

Prior U.S. Cls.: 100, 101 and 102

United States Patent and Trademark Office

Reg. No. 2,892,419

Registered Oct. 12, 2004

**SERVICE MARK
PRINCIPAL REGISTER**

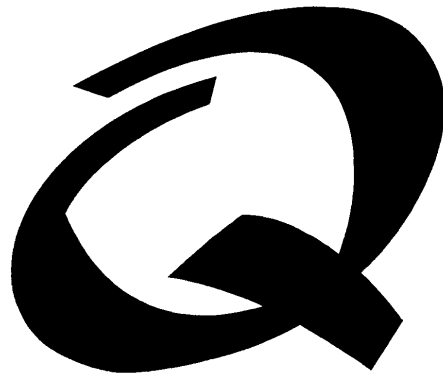

ACME WIDGET, L.P. (TEXAS LIMITED PART-
NERSHIP)
301 COMMERCE STREET, SUITE 2975
FORT WORTH, TX 76102

FIRST USE 9-0-1996; IN COMMERCE 9-0-1996.

FOR: FINANCIAL INVESTMENT SERVICES,
NAMELY PROVIDING SPECIALIZED SECURITIES
INVESTMENTS FOR ACCREDITED INVESTORS,
IN CLASS 36 (U.S. CLS. 100, 101 AND 102).

SER. NO. 76-408,363, FILED 5-15-2002.

MELVIN AXILBUND, EXAMINING ATTORNEY

Int. Cl.: 39

Prior U.S. Cls.: 100 and 105

United States Patent and Trademark Office

Reg. No. 2,892,420

Registered Oct. 12, 2004

**SERVICE MARK
PRINCIPAL REGISTER**

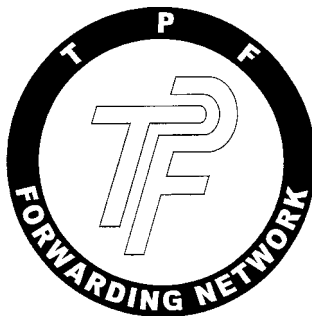

TPF ASSOCIATION, INC. (CALIFORNIA CORPORATION)
1350 ASHLEY RIVER ROAD
CHARLESTON, SC 29417

2.635.324, FILED 3-27-2002, REG. NO. 002635324,
DATED 11-19-2003, EXPIRES 3-27-2012.

FOR: INTERNATIONAL, NATIONAL AND LOCAL MARINE, AERIAL, TERRESTRIAL, FLUVIAL AND RAILWAY TRANSPORT SERVICES; MARINE, AERIAL, TERRESTRIAL, FLUVIAL AND RAILWAY WAREHOUSING SERVICES, NAMELY, STORAGE, DISTRIBUTION, PICK-UP, AND PACKING FOR SHIPMENT OF DOCUMENTS, PACKAGES, RAW MATERIALS, AND OTHER FREIGHT FOR OTHERS; MARINE, AERIAL, TERRESTRIAL, FLUVIAL AND RAILWAY STORAGE OF A WIDE VARIETY OF GOODS, IN CLASS 39 (U.S. CLS. 100 AND 105).

NO CLAIM IS MADE TO THE EXCLUSIVE RIGHT TO USE "FORWARDING NETWORK" , APART FROM THE MARK AS SHOWN.

THE DRAWING CONSISTS OF THE LETTERS TPF FORWARDING NETWORK IN WHITE; A SURROUNDING CIRCLE IN BLACK; INTERIOR LETTERS TPF IN WHITE; AND AN INTERIOR, BACKGROUND CIRCLE IN BLUE. COLOR IS CLAIMED AS A FEATURE OF THE MARK.

SER. NO. 76-408,767, FILED 5-16-2002.

PRIORITY CLAIMED UNDER SEC. 44(D) ON ERPNTM CMNTY TM OFC APPLICATION NO.

THEODORE MCBRIDE, EXAMINING ATTORNEY

Int. Cl.: 9

Prior U.S. Cls.: 21, 23, 26, 36 and 38

Reg. No. 2,892,421

United States Patent and Trademark Office

Registered Oct. 12, 2004

**TRADEMARK
PRINCIPAL REGISTER**

EASYSPOOT

U-VISION BIOTECH, INC. (TAIWAN CORPORATION)
3F NO. 132 LANE 235 PAO-CHIAO RD.
HSIN-TIEN CITY 231
TAIPEI, TAIWAN

FOR: SCIENTIFIC DEVICES, NAMELY BIOCHIPS, AND KITS CONTAINING BIOCHIPS, BOTH COMPRISED OF SUBSTRATES FOR ARRAYING DNA AND PROTEIN MICROARRAY BIOCHIPS,

WHICH HAVE BEEN ARRAYED WITH SAME;
ALL FOR USE IN BIOLOGICAL EXPERIMENTS,
IN CLASS 9 (U.S. CLS. 21, 23, 26, 36 AND 38).

FIRST USE 9-30-2001; IN COMMERCE 9-30-2001.

SER. NO. 76-409,203, FILED 5-16-2002.

CURTIS FRENCH, EXAMINING ATTORNEY

Int. Cls.: 9, 10 and 42

Prior U.S. Cls.: 21, 23, 26, 36, 38, 39, 44, 100 and 101

Reg. No. 2,892,422

United States Patent and Trademark Office

Registered Oct. 12, 2004

**TRADEMARK
SERVICE MARK
PRINCIPAL REGISTER**

PRECISENSE

TORSANA DIABETES DIAGNOSTICS A/S (DENMARK PUBLIC LIMITED LIABILITY COMPANY)

DR. NEERGAARDS VEJ 3
DK-2970 HORSHOLM, DENMARK

FOR: SCIENTIFIC AND ELECTRICAL APPARATUS AND INSTRUMENTS AS WELL AS APPARATUS AND INSTRUMENTS FOR WEIGHING, MEASURING, SIGNALLING, CHECKING (SUPERVISION), NAMELY, NON-MEDICAL APPARATUS AND NON-MEDICAL INSTRUMENTS FOR THE MEASUREMENT OF THE CONTENT OF GLUCOSE IN THE BLOOD; APPARATUS FOR RECORDING, TRANSMISSION OR REPRODUCTION OF SOUND OR IMAGES, NAMELY COMPUTER MEMORY (RAM); BLANK MAGNETIC DATA CARRIERS; BLANK RECORDING DISCS; COMPUTERS; COMPUTER SOFTWARE FOR DIAGNOSING DIABETES, FOR CONTROLLING THE OPERATION OF GLUCOSE MONITORS AND FOR WORD PROCESSING AND REPORT WRITING , IN CLASS 9 (U.S. CLS. 21, 23, 26, 36 AND 38).

FOR: SURGICAL, MEDICAL, DENTAL AND VETERINARY APPARATUS AND INSTRUMENTS, NAMELY APPARATUS AND INSTRUMENTS FOR THE MEASUREMENT OF THE CONTENT OF GLUCOSE IN THE BLOOD, IN CLASS 10 (U.S. CLS. 26, 39 AND 44).

FOR: SCIENTIFIC AND TECHNOLOGICAL RESEARCH, NAMELY RESEARCH RELATED TO DIABETES AND CONTROL OF DIABETES, PROGRAMMING OF COMPUTERS, NAMELY DEVELOPMENT AND MAINTENANCE OF SOFTWARE RELATED TO THE DIAGNOSIS AND CONTROL OF DIABETES , IN CLASS 42 (U.S. CLS. 100 AND 101).

PRIORITY CLAIMED UNDER SEC. 44(D) ON DENMARK APPLICATION NO. VA200104468, FILED 11-27-2001, REG. NO. VR200200012, DATED 1-2-2002, EXPIRES 1-2-2012.

SER. NO. 76-409,682, FILED 5-17-2002.

BRIAN PINO, EXAMINING ATTORNEY

Int. Cl.: 3

Prior U.S. Cls.: 1, 4, 6, 50, 51 and 52

United States Patent and Trademark Office

Reg. No. 2,892,423

Registered Oct. 12, 2004

**TRADEMARK
PRINCIPAL REGISTER**

**BLOCKBUSTER
III-C**

EPIC HOLDING COMPANY, INC. (NEW JERSEY
CORPORATION)
1007 JERSEY AVENUE
NEW BRUNSWICK, NJ 08901

FIRST USE 7-1-1991; IN COMMERCE 7-1-1991.

SER. NO. 76-410,056, FILED 5-21-2002.

FOR: AUTOMATIC GLASSWARE WASHING DE-
TERGENTS IN SOLID FORM FOR USE IN INSTI-
TUTIONAL AND INDUSTRIAL MACHINES, IN
CLASS 3 (U.S. CLS. 1, 4, 6, 50, 51 AND 52).

ALEXANDER L. POWERS, EXAMINING ATTOR-
NEY

Int. Cl.: 35

Prior U.S. Cls.: 100, 101 and 102

United States Patent and Trademark Office

Reg. No. 2,892,424

Registered Oct. 12, 2004

**SERVICE MARK
PRINCIPAL REGISTER**

TITLE SOLUTION

REMARKETING SOLUTIONS, INC. (DELAWARE CORPORATION)
1400 LAKE HEARN DRIVE, N.E.
ATLANTA, GA 30319

FOR: STATE VEHICULAR REGISTRATION AND TITLE TRANSFER SERVICES, NAMELY, MANAGING THE PREPARATION OF STATE VEHICULAR REGISTRATION AND TITLE APPLICATIONS , IN CLASS 35 (U.S. CLS. 100, 101 AND 102).

FIRST USE 3-0-2001; IN COMMERCE 3-0-2001.

NO CLAIM IS MADE TO THE EXCLUSIVE RIGHT TO USE "TITLE", APART FROM THE MARK AS SHOWN.

SER. NO. 76-410,870, FILED 5-15-2002.

YONG KIM, EXAMINING ATTORNEY

Int. Cls.: 25, 28 and 41

Prior U.S. Cls.: 22, 23, 38, 39, 50, 100, 101 and 107

United States Patent and Trademark Office

Reg. No. 2,892,425

Registered Oct. 12, 2004

**TRADEMARK
SERVICE MARK
PRINCIPAL REGISTER**

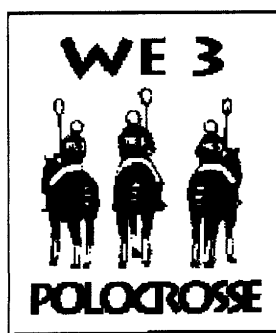

WE 3 POLOCROSSE (PARTNERSHIP)
1091 RIDGE ROAD
GRANTVILLE, PA 17028

FOR: CLOTHING, NAMELY, T-SHIRTS; SHIRTS, SHIRT FRONTS, HATS, POLO SHIRTS AND ATHLETIC UNIFORMS, IN CLASS 25 (U.S. CLS. 22 AND 39).

FIRST USE 2-1-2002; IN COMMERCE 1-1-2003.

FOR: SPORTING ARTICLES, NAMELY, A NUMNAH [COTTON OR SYNTHETIC PADS TO BE PLACED BETWEEN THE SADDLE AND THE HORSE], IN CLASS 28 (U.S. CLS. 22, 23, 38 AND 50).

FIRST USE 2-1-2002; IN COMMERCE 1-1-2003.

FOR: ORGANIZING POLOCROSSE EXHIBITIONS AND COMPETITIONS, POLOCROSSE

GAMES AND TRAINING CAMPS, TEACHING THE PRINCIPLES FOR PLAYING POLOCROSSE AND OFFICIATING IN POLOCROSSE COMPETITIONS; EDUCATIONAL SERVICES, NAMELY; CONDUCTING PROGRAMS IN THE FIELD OF HORSEBACK RIDING AND PLAYING POLOCROSSE, POLOCROSSE CLUB SERVICES, IN CLASS 41 (U.S. CLS. 100, 101 AND 107).

FIRST USE 2-1-2002; IN COMMERCE 5-1-2002.

NO CLAIM IS MADE TO THE EXCLUSIVE RIGHT TO USE "POLOCROSSE", APART FROM THE MARK AS SHOWN.

SER. NO. 76-412,532, FILED 5-20-2002.

DANIELLE MATTESSICH, EXAMINING ATTORNEY

Int. Cls.: 5 and 31

Prior U.S. Cls.: 1, 6, 18, 44, 46, 51 and 52

United States Patent and Trademark Office

Reg. No. 2,892,426

Registered Oct. 12, 2004

**TRADEMARK
PRINCIPAL REGISTER**

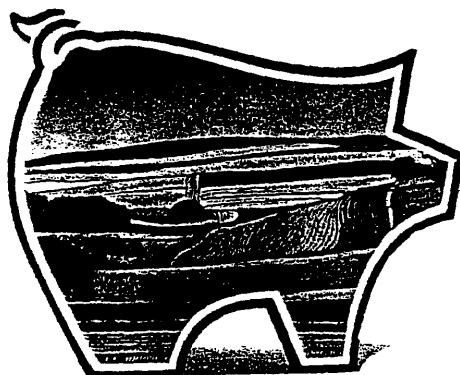

CRINA S.A. (SWITZERLAND CORPORATION)
15 CHEMIN DE LA COMBE
1096 GLAND, SWITZERLAND

FOR: VETERINARY PREPARATIONS FOR THE TREATMENT OF DISEASES IN THE GASTROINTESTINAL TRACT AND FOR THE STIMULATION OF DIGESTIBILITY IN PIGS; DIETARY SUPPLEMENTS FOR MAMMAL ANIMALS; FODDER ADDITIVES FOR MEDICAL PURPOSES, NAMELY MEDICATED ANIMAL FEED; ANIMAL FEED ADDITIVES FOR USE AS DIGESTIBILITY ENHANCERS, FLAVORINGS AND ANTIOXIDANTS, IN CLASS 5 (U.S. CLS. 6, 18, 44, 46, 51 AND 52).

FOR: ANIMAL FEED AND ANIMAL FODDER, IN CLASS 31 (U.S. CLS. 1 AND 46).

OWNER OF SWITZERLAND REG. NO. 494918, DATED 11-27-2001, EXPIRES 11-27-2011.

THE STIPPLING ON THE MARK IS FOR SHADING PURPOSES ONLY AND DOES NOT INDICATE COLOR.

SER. NO. 76-412,891, FILED 5-28-2002.

CHARLES L. JENKINS, EXAMINING ATTORNEY

Int. Cl.: 24

Prior U.S. Cls.: 42 and 50

United States Patent and Trademark Office

Reg. No. 2,892,427

Registered Oct. 12, 2004

**TRADEMARK
PRINCIPAL REGISTER**

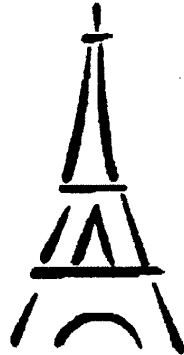

Eiffel Towel

SEALE, JILL (NORTH CAROLINA INDIVIDUAL)
2744 TRAVELER'S COURT
CHARLOTTE, NC 28226

FIRST USE 11-15-1997; IN COMMERCE 11-15-1997.

SEC. 2(F).

FOR: TOWELS, WASH CLOTHS AND KITCHEN
AND BATH LINENS, IN CLASS 24 (U.S. CLS. 42 AND
50).

SER. NO. 76-413,833, FILED 5-24-2002.

KIM SAITO, EXAMINING ATTORNEY

Int. Cl.: 3

Prior U.S. Cls.: 1, 4, 6, 50, 51 and 52

United States Patent and Trademark Office

Reg. No. 2,892,428

Registered Oct. 12, 2004

TRADEMARK
PRINCIPAL REGISTER



JUST KITTUNG INC. (CANADA CORPORATION)
44 BAMBOO GROVE
DON MILLS, ONTARIO M3B 2C7, CANADA

FOR: PERSONAL GROOMING KIT FOR PUBIC
AREA PRIMARILY COMPRISING OF A KIT WITH
WAX STRIPS, SOOTHING GEL, STENCIL STICKER
TEMPLATES, TWEEZERS, SCISSORS AND MINI
COMB, IN CLASS 3 (U.S. CLS. 1, 4, 6, 50, 51 AND 52).

PRIORITY CLAIMED UNDER SEC. 44(D) ON
CANADA APPLICATION NO. 1123486, FILED 12-4-
2001, REG. NO. TMA597040, DATED 12-10-2003, EX-
PIRES 12-10-2018.

SER. NO. 76-414,477, FILED 6-3-2002.

BARNEY CHARLON, EXAMINING ATTORNEY

Int. Cls.: 9 and 36

Prior U.S. Cls.: 21, 23, 26, 36, 38, 100, 101 and 102

United States Patent and Trademark Office

Reg. No. 2,892,429

Registered Oct. 12, 2004

**TRADEMARK
SERVICE MARK
PRINCIPAL REGISTER**

CHECKMATIC

TIPTON, CHRIS (UNITED STATES INDIVIDUAL)
PO BOX 130021
THE WOODLANDS, TX 773930021

FOR: COMPUTER SOFTWARE FOR ELECTRONIC VERIFICATION OF THE AVAILABILITY OF CHECKING ACCOUNT FUNDS FOR PAYMENT, ELECTRONIC READING OF CHECKING ACCOUNT AND BANK ROUTING NUMBERS, ELECTRONIC CHECK COLLECTION, AUTOMATED CLEARING HOUSE (ACH) AND ACCOUNT TRANSFERS, IN CLASS 9 (U.S. CLS. 21, 23, 26, 36 AND 38).

FIRST USE 3-1-2000; IN COMMERCE 3-1-2000.

FOR: BANK CHECK VERIFICATION, COLLECTION AND PAYMENT PROCESSING, IN CLASS 36 (U.S. CLS. 100, 101 AND 102).

FIRST USE 3-1-2000; IN COMMERCE 3-1-2000.

SER. NO. 76-415,564, FILED 6-4-2002.

STEPHANIE DAVIS, EXAMINING ATTORNEY

Int. Cls.: 9 and 42

Prior U.S. Cls.: 21, 23, 26, 36, 38, 100 and 101

United States Patent and Trademark Office

Reg. No. 2,892,430

Registered Oct. 12, 2004

**TRADEMARK
SERVICE MARK
PRINCIPAL REGISTER**

SIMATIC IT Framework

SIEMENS AKTIENGESELLSCHAFT (FED REP
GERMANY CORPORATION)
WITTELSBACHERPLATZ 2
MUNCHEN, FED REP GERMANY

FOR: COMPUTER SOFTWARE FOR USE IN INDUSTRIAL AUTOMATION, NAMELY, COMPUTER SOFTWARE FOR PROGRAMMING CONTROLLERS, COMPUTER SOFTWARE FOR INTEGRATING MANUFACTURING APPLICATIONS, MANAGING COMMUNICATIONS IN AND BETWEEN PLANTS, COORDINATING PLANT OPERATIONS, AND LINKING, INTEGRATING AND SYNCHRONIZING PRODUCTION PROCESSES AND SUPPLY CHAIN ACTIVITIES, IN CLASS 9 (U.S. CLS. 21, 23, 26, 36 AND 38).

FOR: DEVELOPMENT OF COMPUTER SOFTWARE FOR OTHERS, IN CLASS 42 (U.S. CLS. 100 AND 101).

PRIORITY CLAIMED UNDER SEC. 44(D) ON ERPN CMNTY TM OFC APPLICATION NO. 002508679, FILED 12-13-2001, REG. NO. 2508679, DATED 4-3-2003, EXPIRES 12-13-2011.

OWNER OF U.S. REG. NO. 1,957,082 AND OTHERS.

NO CLAIM IS MADE TO THE EXCLUSIVE RIGHT TO USE "IT FRAMEWORK", APART FROM THE MARK AS SHOWN.

SER. NO. 76-416,279, FILED 6-3-2002.

STEPHANIE DAVIS, EXAMINING ATTORNEY

Int. Cl.: 19

Prior U.S. Cls.: 1, 12, 33 and 50

United States Patent and Trademark Office

Reg. No. 2,892,431

Registered Oct. 12, 2004

**TRADEMARK
PRINCIPAL REGISTER**

MANOIR

BETON BOLDUC INC. (CANADA CORPORATION)
1358, 2E RUE, PARC INDUSTRIEL
C.P. 608, SAINTE-MARIE-DE-BEAUCE
QUEBEC, CANADA G6E 3B8

FOR: CONCRETE PAVING STONES, IN CLASS 19
(U.S. CLS. 1, 12, 33 AND 50).

FIRST USE 4-0-1996; IN COMMERCE 4-0-1996.

THE ENGLISH TRANSLATION OF "MANOIR" IS
"MANOR".

SER. NO. 76-416,529, FILED 5-31-2002.

CATHERINE CAIN, EXAMINING ATTORNEY

Int. Cl.: 3

Prior U.S. Cls.: 1, 4, 6, 50, 51 and 52

United States Patent and Trademark Office

Reg. No. 2,892,432

Registered Oct. 12, 2004

**TRADEMARK
PRINCIPAL REGISTER**

NUANCE VEIL

KOSE CORPORATION (JAPAN CORPORATION)
6-2 NIHONBASHI 3-CHOME
CHUO-KU, TOKYO, JAPAN

FIRST USE 7-12-1997; IN COMMERCE 7-12-1997.

SER. NO. 76-417,160, FILED 6-6-2002.

FOR: COSMETICS, PERFUMES, COSMETIC
SOAPS, IN CLASS 3 (U.S. CLS. 1, 4, 6, 50, 51 AND 52).

HOWARD B. LEVINE, EXAMINING ATTORNEY

Int. Cl.: 37

Prior U.S. Cls.: 100, 103 and 106

United States Patent and Trademark Office

Reg. No. 2,892,433

Registered Oct. 12, 2004

**SERVICE MARK
PRINCIPAL REGISTER**

MOBILEYES

MOBILEYES, INC. (NORTH CAROLINA COR-
PORATION)
4201 WYCKFORD PLACE
APEX, NC 27502

FIRST USE 9-24-2000; IN COMMERCE 9-24-2000.

SER. NO. 76-417,511, FILED 5-30-2002.

FOR: REPAIR AND SERVICE OF LASER SUR-
GERY EQUIPMENT FOR OPHTHALMOLOGISTS,
IN CLASS 37 (U.S. CLS. 100, 103 AND 106).

PAULA MAHONEY, EXAMINING ATTORNEY

Int. Cls.: 35 and 41

Prior U.S. Cls.: 100, 101, 102 and 107

United States Patent and Trademark Office

Reg. No. 2,892,434

Registered Oct. 12, 2004

SERVICE MARK
PRINCIPAL REGISTER

The logo consists of a stylized heart shape on the left, followed by the words "Risque Video" in a cursive, handwritten-style font. The heart is simple and outlined, with a small notch at the top. The text is fluid and connected, with "Risque" and "Video" written in a similar script.

RISQUE VIDEO, INC. (PENNSYLVANIA CORPORATION)
4301 CHESTNUT STREET
PHILADELPHIA, PA 19104

FOR: RETAIL STORE SERVICES FEATURING VIDEO TAPES, IN CLASS 35 (U.S. CLS. 100, 101 AND 102).

FIRST USE 1-11-1987; IN COMMERCE 1-11-1987.

FOR: RENTAL OF VIDEOCASSETTES, IN CLASS 41 (U.S. CLS. 100, 101 AND 107).

FIRST USE 1-11-1987; IN COMMERCE 1-11-1987.

NO CLAIM IS MADE TO THE EXCLUSIVE RIGHT TO USE "VIDEO", APART FROM THE MARK AS SHOWN.

SER. NO. 76-417,924, FILED 5-30-2002.

JOHN DALIER, EXAMINING ATTORNEY

Int. Cl.: 28

Prior U.S. Cls.: 22, 23, 38 and 50

United States Patent and Trademark Office

Reg. No. 2,892,435

Registered Oct. 12, 2004

**TRADEMARK
PRINCIPAL REGISTER**

BUZZ BEE TOYS

BUZZ BEE TOYS, INC. (DELAWARE CORPORATION)
SUITE 105 309 FELLOWSHIP ROAD
MT. LAUREL, NJ 08054

FIRST USE 11-27-2002; IN COMMERCE 11-27-2002.

FOR: TOYS, NAMELY, WATER SQUIRTING TOYS, TOY WATER SPRINKLERS, TOY LAWN SPRINKLERS, FOAM SPORTS BALLS AND ACCESSORIES THEREFOR, PROJECTILE SHOOTERS AND ACCESSORIES THEREFOR, FLYING TOYS, NAMELY FLYING SAUCERS, GLIDERS AND AIRPLANES, IN CLASS 28 (U.S. CLS. 22, 23, 38 AND 50).

NO CLAIM IS MADE TO THE EXCLUSIVE RIGHT TO USE "TOYS", APART FROM THE MARK AS SHOWN.

SER. NO. 76-418,035, FILED 6-7-2002.

HOWARD B. LEVINE, EXAMINING ATTORNEY

Int. Cl.: 35

Prior U.S. Cls.: 100, 101 and 102

United States Patent and Trademark Office

Reg. No. 2,892,436

Registered Oct. 12, 2004

**SERVICE MARK
PRINCIPAL REGISTER**

GET SOME

A.V. IMPORTS, INC. (MARYLAND CORPORATION)
6450 DOBBIN ROAD, SUITE G
COLUMBIA, MD 21045

ITEMS AND CONTESTS, IN CLASS 35 (U.S. CLS. 100, 101 AND 102).

FIRST USE 1-0-2002; IN COMMERCE 1-0-2002.

FOR: PROMOTING THE WINE AND DISTILLED SPIRITS OF OTHERS THROUGH THE DISTRIBUTION OF PRINTED MEDIA, PROMOTIONAL

SER. NO. 76-418,500, FILED 6-10-2002.

YSA DEJESUS, EXAMINING ATTORNEY

Int. Cls.: 16, 35, 36, 41 and 42

**Prior U.S. Cls.: 2, 5, 22, 23, 29, 37, 38, 50, 100, 101, 102
and 107**

Reg. No. 2,892,437

United States Patent and Trademark Office

Registered Oct. 12, 2004

**TRADEMARK
SERVICE MARK
PRINCIPAL REGISTER**

AAHIVM

AMERICAN ACADEMY OF HIV MEDICINE,
INC. (CALIFORNIA NON-PROFIT CORPORATION)
PMB 303
836 NORTH LA CIENEGA BOULEVARD
LOS ANGELES, CA 900694708

FOR: PRINTED MATTER, NAMELY, PROFESSIONAL EDUCATION, CREDENTIALING, CONFERENCE, AND INFORMATIONAL PUBLICATIONS, BOOKS, JOURNALS, MAGAZINES, REPORTS, NEWSLETTERS, BULLETINS, HANDOUTS, ADVERTISEMENTS, AND BROCHURES RELATED TO MEDICAL RESEARCH, PREVENTION, TREATMENTS, AND PROFESSIONAL DEVELOPMENT CONCERNING HUMAN IMMUNODEFICIENCY VIRUS/ACQUIRED IMMUNE DEFICIENCY SYNDROME (HIV/AIDS), IN CLASS 16 (U.S. CLS. 2, 5, 22, 23, 29, 37, 38 AND 50).

FIRST USE 1-0-2001; IN COMMERCE 1-0-2001.

FOR: ASSOCIATION SERVICES, NAMELY PROMOTING THE INTERESTS OF HIV/AIDS HEALTHCARE PROVIDERS; PROVIDING AN ON-LINE COMPUTER PHYSICIAN REFERRAL DATABASE; PROVIDING INFORMATION CONCERNING MANAGEMENT OF MEDICAL PRACTICES FOR OTHERS AND CONCERNING MANAGED CARE CONTRACTS; AND TESTING TO DETERMINE PROFESSIONAL KNOWLEDGE OF PHYSICIANS AND HEALTHCARE PRACTITIONERS IN THE FIELD OF HIV/AIDS HEALTHCARE, IN CLASS 35 (U.S. CLS. 100, 101 AND 102).

FIRST USE 1-0-1002; IN COMMERCE 1-0-2001.

FOR: PROVIDING INFORMATION CONCERNING PATIENT INSURANCE REIMBURSEMENT PROGRAMS, IN CLASS 36 (U.S. CLS. 100, 101 AND 102).

FIRST USE 10-0-2001; IN COMMERCE 10-0-2001.

FOR: PREPARING, ADMINISTERING, AND SCORING STANDARDIZED TESTS FOR THE PURPOSE OF CREDENTIALING TEST SUBJECTS; EDUCATIONAL SERVICES, NAMELY, ARRANGING AND CONDUCTING CLASSES, SEMINARS, CONFERENCES, SELF-DIRECTED EDUCATIONAL PROGRAMS, AND WORKSHOPS IN THE FIELD OF HIV/AIDS MEDICINE, IN CLASS 41 (U.S. CLS. 100, 101 AND 107).

FIRST USE 1-0-2001; IN COMMERCE 1-0-2001.

FOR: HIV/AIDS MEDICINE HEALTHCARE PROVIDERS CREDENTIALING, NAMELY CONDUCTING COMPREHENSIVE ANALYSIS AND EVALUATION OF THE PROFESSIONAL KNOWLEDGE AND EXPERIENCE OF PHYSICIANS AND HEALTHCARE PRACTITIONERS IN THE FIELD OF HIV/AIDS MEDICINE FOR THE PURPOSE OF CERTIFICATION, IN CLASS 42 (U.S. CLS. 100 AND 101).

FIRST USE 1-0-2001; IN COMMERCE 1-0-2001.

SER. NO. 76-419,456, FILED 6-11-2002.

TONI HICKEY, EXAMINING ATTORNEY

Int. Cls.: 12 and 25

Prior U.S. Cls.: 19, 21, 22, 23, 31, 35, 39 and 44

United States Patent and Trademark Office

Reg. No. 2,892,438

Registered Oct. 12, 2004

**TRADEMARK
PRINCIPAL REGISTER**

KORE

KORE PRODUCTS, INC. (CALIFORNIA CORPORATION)
121 PENN STREET
EL SEGUNDO, CA 90245

FOR: BICYCLE COMPONENTS AND ACCESSORIES, NAMELY, SEATPOSTS, WHEEL RELEASE MECHANISMS, STEMS, HANDLE BARS, HANDLE BAR EXTENSIONS, HEAD SET BEARINGS, CRANKS, BOTTOM BRACKETS FOR CRANKS, WHEEL, RIMS, TIRES AND GRIPS, IN CLASS 12 (U.S. CLS. 19, 21, 23, 31, 35 AND 44).

FIRST USE 1-25-1995; IN COMMERCE 1-2-1995.

FOR: CLOTHING, NAMELY- SHORTS, T-SHIRTS, SOCKS AND HATS, INTENDED ONLY FOR BICYCLING, IN CLASS 25 (U.S. CLS. 22 AND 39).

FIRST USE 1-25-1995; IN COMMERCE 1-2-1995.

SER. NO. 76-419,527, FILED 6-12-2002.

ALEX KEAM, EXAMINING ATTORNEY

Int. Cl.: 9

Prior U.S. Cls.: 21, 23, 26, 36 and 38

United States Patent and Trademark Office

Reg. No. 2,892,439

Registered Oct. 12, 2004

**TRADEMARK
PRINCIPAL REGISTER**

XUGUANG

CHENGDU XUGUANG TECHNOLOGY STOCK
CO. LTD. (CHINA CORPORATION)
#2 DUAN, PARK WAY
LONGQUAN TOWN
CHENGDU, SICHUAN, CHINA

FOR: ELECTRONIC TUNER, VIDEO ELECTRO-
NIC TUNER, ELECTRONIC TUNER FOR SATEL-
LITE BROADCASTING AND RECEIVING, RF
MODULATOR, RF SPLITTER, ANTENNA, TV IF
DEMODULATOR, TV IF AMPLIFIER, CABLE TEL-
EVISION DESCRAMBLER UNIT, SATELLITE

BROADCASTING RECEIVER, DATA PROCESSING
DEVICE, COMPUTER PERIPHERAL DEVICE, LIN-
KER DATA PROCESSING DEVICE, IN CLASS 9 (U.S.
CLS. 21, 23, 26, 36 AND 38).

OWNER OF CHINA REG. NO. 3033351, DATED 2-
21-2003, EXPIRES 2-20-2013.

SER. NO. 76-420,806, FILED 5-28-2002.

SHARI SHEFFIELD, EXAMINING ATTORNEY

Int. Cl.: 1

Prior U.S. Cls.: 1, 5, 6, 10, 26 and 46

Reg. No. 2,892,440

United States Patent and Trademark Office

Registered Oct. 12, 2004

**TRADEMARK
PRINCIPAL REGISTER**

MEH

NOF CORPORATION (JAPAN CORPORATION)
20-3, EBISU 4-CHOME, SHIBUYA-KU
TOKYO, JAPAN

FOR: CHEMICALS USED FOR SCIENTIFIC RE-
SEARCH OF DIAGNOSTIC AGENTS, TEXT
AGENTS USED IN THE MANUFACTURE OF
PHARMACEUTICALS REAGENTS AND DETECT-
ING AGENTS, USED IN THE MANUFACTURE OF
PHARMACEUTICALS AND ELECTRONIC DEVI-

CES, CHEMICALS FOR USE IN PHOTOGRAPHY,
AND IN THE MANUFACTURE OF COSMETICS
AND PHARMACEUTICALS, IN CLASS 1 (U.S. CLS.
1, 5, 6, 10, 26 AND 46).

FIRST USE 0-0-1991; IN COMMERCE 0-0-1991.

SER. NO. 76-421,633, FILED 6-11-2002.

BARNEY CHARLON, EXAMINING ATTORNEY

Int. Cl.: 35

Prior U.S. Cls.: 100, 101 and 102

United States Patent and Trademark Office

Reg. No. 2,892,441

Registered Oct. 12, 2004

**SERVICE MARK
PRINCIPAL REGISTER**

OPTISOURCE INTERNATIONAL

LALACCI, JOSEPH V. (UNITED STATES INDIVIDUAL)
585-4 BICYCLE PATH
PORT JEFFERSON STATION, NY 11776

FOR: ON-LINE STORE SERVICES AND MAIL ORDER CATALOG SERVICES FEATURING EYE CARE PRODUCTS, NAMELY, LENS CLEANERS, LENS CLEANING KITS, SCRATCH PROTECTANTS, LEAP PADS, BLOCKING PADS, LENS CLEANING CLOTHS, PRE-MOISTENED LENS WIPES, NOSE PADS FOR EYE GLASSES, LENS COATINGS FOR ULTRAVIOLET AND SCRATCH PROTECTION, COLOR DYES AND TINTS FOR LENSES, LENS CARE KITS CONTAINING CLEANERS AND WIPE CLOTHS, EYEGLASS CASES, EYEGLASS CHAINS

AND HOLDERS, CLIP-ON FRAMES AND LENSES, POLARIZED LENSES AND SUNGLASSES, NON-PRESCRIPTION MAGNIFIER GLASSES, EYE PATCHES, CONTACT LENS STORAGE CASE AND VIALS, IN CLASS 35 (U.S. CLS. 100, 101 AND 102).

FIRST USE 11-1-2001; IN COMMERCE 11-1-2001.

NO CLAIM IS MADE TO THE EXCLUSIVE RIGHT TO USE "INTERNATIONAL", APART FROM THE MARK AS SHOWN.

SER. NO. 76-422,700, FILED 6-19-2002.

J. TINGLEY, EXAMINING ATTORNEY

Int. Cls.: 29 and 30

Prior U.S. Cl.: 46

United States Patent and Trademark Office

Reg. No. 2,892,442

Registered Oct. 12, 2004

**TRADEMARK
PRINCIPAL REGISTER**

VOIELLO

BARILLA ALIMENTARE S.P.A. (ITALY CORPORATION)
VIA MANTOVA 166
PARMA, ITALY 43100

FOR: MEAT, FISH, POULTRY AND GAME, MEAT EXTRACTS; PRESERVED, DRIED AND COOKED FRUITS AND VEGETABLES; JELLIES, JAMS; FRUIT SAUCES, NAMELY, APPLESAUCE AND CRANBERRY SAUCE ; EGGS, MILK; EDIBLE OILS AND FATS, IN CLASS 29 (U.S. CL. 46).

FOR: COFFEE, TEA, COCOA, SUGAR, RICE, TAPIOCA, SAGO; FLOUR; BREAD, PASTRIES, ICES; HONEY, TREACLE; YEAST, BAKING POWDER;

SALT, MUSTARD; VINEGAR, SAUCES, SPICES; FLAVORED ICE; EDIBLE PASTA, IN CLASS 30 (U.S. CL. 46).

OWNER OF ITALY REG. NO. 587050, DATED 2-10-1993, RENEWED AS REG. NO. 906494, DATED 9-3-2003, EXPIRES 9-3-2013.

OWNER OF U.S. REG. NO. 1,847,802.

SER. NO. 76-422,850, FILED 6-19-2002.

GEORGIA CARTY, EXAMINING ATTORNEY

Int. Cl.: 25

Prior U.S. Cls.: 22 and 39

United States Patent and Trademark Office

Reg. No. 2,892,443

Registered Oct. 12, 2004

**TRADEMARK
PRINCIPAL REGISTER**

GREAT AMERICAN SPORTSWEAR CO. DRESS

S.W.A.K., INC. (NEW YORK CORPORATION)
47-38 METROPOLITAN AVENUE
MASPETH, NY 11385

FOR: CLOTHING, NAMELY, SHIRTS, BLOUSES,
PANTS, SLACKS, T-SHIRTS, DRESS SHIRTS, TROU-
SERS, SWEAT PANTS AND SWEAT SHIRTS, IN
CLASS 25 (U.S. CLS. 22 AND 39).

FIRST USE 12-0-2001; IN COMMERCE 12-0-2001.

OWNER OF U.S. REG. NOS. 1,306,002 AND
1,328,609.

NO CLAIM IS MADE TO THE EXCLUSIVE
RIGHT TO USE "SPORTSWEAR CO. DRESS",
APART FROM THE MARK AS SHOWN.

SER. NO. 76-423,315, FILED 6-19-2002.

PAUL F. GAST, EXAMINING ATTORNEY

Int. Cl.: 33

Prior U.S. Cls.: 47 and 49

United States Patent and Trademark Office

Reg. No. 2,892,444

Registered Oct. 12, 2004

**TRADEMARK
PRINCIPAL REGISTER**

J.J. DAVIES

SCHRAMSBERG VINEYARDS COMPANY (CALI-
FORNIA CORPORATION)
1400 SCHRAMSBERG ROAD
CALISTOGA, CA 94515

THE NAME "J.J. DAVIES" DOES NOT IDENTIFY
A LIVING INDIVIDUAL.

FOR: WINES AND CHAMPAGNES, IN CLASS 33
(U.S. CLS. 47 AND 49).

SER. NO. 76-423,391, FILED 6-20-2002.

FIRST USE 11-0-1990; IN COMMERCE 11-0-1990.

CAROLYN GRAY, EXAMINING ATTORNEY

Int. Cl.: 36

Prior U.S. Cls.: 100, 101 and 102

United States Patent and Trademark Office

Reg. No. 2,892,445

Registered Oct. 12, 2004

**SERVICE MARK
PRINCIPAL REGISTER**

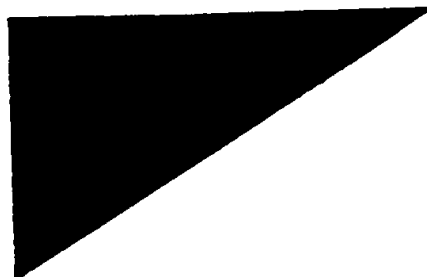

PRINCIPAL FINANCIAL SERVICES, INC. (IOWA CORPORATION)
711 HIGH STREET
DES MOINES, IA 503920001

FOR: FINANCIAL ANALYSIS AND CONSULTING, FINANCIAL INVESTMENT IN THE FIELD OF SECURITIES FOR OTHERS AND SECURITIES BROKERAGE SERVICES; LIFE, HEALTH, ACCIDENT AND CASUALTY INSURANCE AND REINSURANCE UNDERWRITING AND INSURANCE AND INVESTMENT BROKERAGE SERVICES; UNDERWRITING, INVESTMENT MANAGEMENT AND DISTRIBUTION OF ANNUITIES AND PENSION FUNDS FOR OTHERS; UNDERWRITING VARIABLE LIFE INSURANCE AND UNDERWRITING, INVESTMENT MANAGEMENT AND DISTRIBUTION OF VARIABLE ANNUITIES FUNDED THROUGH A VARIETY OF FUNDING MEDIA; COMMERCIAL AND RESIDENTIAL REAL ESTATE SERVICES, NAMELY, BROKERAGE, INVEST-

MENT, MANAGEMENT, MORTGAGE LOAN, AND FINANCIAL VALUATION SERVICES; INVESTMENT MANAGEMENT SERVICES, INVESTMENT MANAGEMENT AND DISTRIBUTION OF MUTUAL FUNDS AND INCOME PROGRAMS FOR OTHERS, INVESTMENT ADVICE AND CONSULTATION SERVICES AND SECURITY BROKERAGE SERVICES; REAL ESTATE LEASING AND MANAGEMENT SERVICES; FINANCIAL SERVICES, NAMELY, ADMINISTRATION OF HEALTHCARE PLANS AND INSURANCE CLAIMS ADMINISTRATION FOR HEALTHCARE PLANS, IN CLASS 36 (U.S. CLS. 100, 101 AND 102).

FIRST USE 11-1-1985; IN COMMERCE 11-1-1985.

SER. NO. 76-423,430, FILED 6-20-2002.

ANDREA SAUNDERS, EXAMINING ATTORNEY

Int. Cl.: 5

Prior U.S. Cls.: 6, 18, 44, 46, 51 and 52

United States Patent and Trademark Office

Reg. No. 2,892,446

Registered Oct. 12, 2004

**TRADEMARK
PRINCIPAL REGISTER**

PHAMATECH QUICKSCREEN

PHAM, TUAN (UNITED STATES INDIVIDUAL)
9530 PADGETT ST., STE. 101
SAN DIEGO, CA 92126

FIRST USE 12-5-1996; IN COMMERCE 12-5-1996.

OWNER OF U.S. REG. NOS. 2,413,537 AND
2,702,461.

FOR: MEDICAL AND PHARMACEUTICAL PRODUCTS IN THE NATURE OF TEST KITS FOR HOME USE COMPRISED PRIMARILY OF MEDICAL DIAGNOSTIC REAGENTS FOR DETECTING PREGNANCY, FERTILITY, CANCER MARKERS, INFECTIOUS DISEASE, AND CHOLESTEROL; TRANSDERMAL PATCHES FOR HOME USE FOR CONTINUOUS DELIVERY OF MEDICATION FOR MOTION SICKNESS AND FERTILITY ENHANCEMENT, IN CLASS 5 (U.S. CLS. 6, 18, 44, 46, 51 AND 52).

NO CLAIM IS MADE TO THE EXCLUSIVE RIGHT TO USE "QUICKSCREEN", APART FROM THE MARK AS SHOWN.

SER. NO. 76-423,501, FILED 6-18-2002.

YONG KIM, EXAMINING ATTORNEY

Int. Cl.: 24

Prior U.S. Cls.: 42 and 50

United States Patent and Trademark Office

Reg. No. 2,892,447

Registered Oct. 12, 2004

**TRADEMARK
PRINCIPAL REGISTER**

HANES

L & P PROPERTY MANAGEMENT COMPANY
(DELAWARE CORPORATION)
4095 FIRESTONE BOULEVARD
SOUTH GATE, CA 90280

OWNER OF U.S. REG. NOS. 1,874,905 AND
2,045,255.

SEC. 2(F).

FOR: DRAPERY LININGS AND FABRIC FOR
QUILT BACKING, IN CLASS 24 (U.S. CLS. 42 AND
50).

SER. NO. 76-423,609, FILED 6-18-2002.

FIRST USE 6-0-1992; IN COMMERCE 6-0-1992.

MARY ROSSMAN, EXAMINING ATTORNEY

Int. Cl.: 25

Prior U.S. Cls.: 22 and 39

United States Patent and Trademark Office

Reg. No. 2,892,448

Registered Oct. 12, 2004

**TRADEMARK
PRINCIPAL REGISTER**

PASSPORT

MS. BUBBLES, INC. (CALIFORNIA CORPORATION)
110 EAST NINTH STREET
SUITE B-835
LOS ANGELES, CA 90079

FIRST USE 5-0-1998; IN COMMERCE 5-0-1998.

SER. NO. 76-423,917, FILED 6-24-2002.

FOR: BLOUSES, SHIRTS, CAMISOLES, VESTS,
PANTS, JEANS, SHORTS, DRESSES, AND HAL-
TERS, IN CLASS 25 (U.S. CLS. 22 AND 39).

MARY ROSSMAN, EXAMINING ATTORNEY

Int. Cl.: 29

Prior U.S. Cl.: 46

United States Patent and Trademark Office

Reg. No. 2,892,449

Registered Oct. 12, 2004

TRADEMARK
PRINCIPAL REGISTER



FROMAGERIES F. PAUL-RENARD (FRANCE
CORPORATION)
89360 FLOGNY LA CHAPELLE
FRANCE

FOR: CHEESE, IN CLASS 29 (U.S. CL. 46).

FIRST USE 8-0-1984; IN COMMERCE 8-0-1984.

NO CLAIM IS MADE TO THE EXCLUSIVE
RIGHT TO USE "SUPREME", APART FROM THE
MARK AS SHOWN.

SER. NO. 76-423,987, FILED 6-19-2002.

SAMUEL E. SHARPER JR., EXAMINING ATTOR-
NEY

Int. Cls.: 16, 21, 25 and 28

**Prior U.S. Cls.: 2, 5, 13, 22, 23, 29, 30, 33, 37, 38, 39, 40
and 50**

Reg. No. 2,892,450

United States Patent and Trademark Office

Registered Oct. 12, 2004

**TRADEMARK
PRINCIPAL REGISTER**

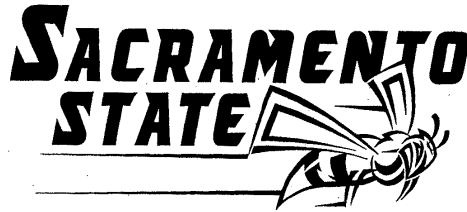

CALIFORNIA STATE UNIVERSITY, SACRA-
MENTO (CALIFORNIA CORPORATION)
6000 J STREET
SACRAMENTO, CA 958196055

FOR: BINDERS, NOTEBOOKS, FOLDERS, DATE-
BOOKS, NOTEPAD HOLDERS, STATIONERY, PA-
PER GIFT, BAGS, DECALS, ANNOUNCEMENT
CARDS, DESKTOP BUSINESS CARD HOLDERS,
LETTER OPENERS, MEMO PAD HOLDERS, PAPER
WEIGHTS, PENS AND PENCILS, IN CLASS 16 (U.S.
CLS. 2, 5, 22, 23, 29, 37, 38 AND 50).

FIRST USE 11-1-2000; IN COMMERCE 11-1-2000.

FOR: GLASSWARE, NAMELY, MUGS, DRINK-
ING FLASKS, CUPS, DRINKING GLASSES AND
SHOT GLASSES, IN CLASS 21 (U.S. CLS. 2, 13, 23, 29,
30, 33, 40 AND 50).

FIRST USE 11-1-2000; IN COMMERCE 11-1-2000.

FOR: CLOTHING; NAMELY, JACKETS, SHIRTS,
PANTS, SWEATSHIRTS, SOCKS, HEADWEAR , IN
CLASS 25 (U.S. CLS. 22 AND 39).

FIRST USE 11-1-2000; IN COMMERCE 11-1-2000.

FOR: SPORTING ARTICLES, NAMELY, GOLF
TEES, GOLF BALL MARKERS; CHRISTMAS TREE
DECORATIONS, IN CLASS 28 (U.S. CLS. 22, 23, 38
AND 50).

FIRST USE 11-1-2000; IN COMMERCE 11-1-2000.

OWNER OF U.S. REG. NOS. 1,084,527, 1,919,601
AND OTHERS.

NO CLAIM IS MADE TO THE EXCLUSIVE
RIGHT TO USE "SACRAMENTO STATE", APART
FROM THE MARK AS SHOWN.

THE LINING IS A FEATURE OF THE MARK
AND DOES NOT INDICATE COLOR.

SER. NO. 76-424,947, FILED 6-18-2002.

MARLENE BELL, EXAMINING ATTORNEY

Int. Cl.: 33

Prior U.S. Cls.: 47 and 49

United States Patent and Trademark Office

Reg. No. 2,892,451

Registered Oct. 12, 2004

**TRADEMARK
PRINCIPAL REGISTER**

CABO-ME-CRAZY

WILD WEST, INC. (NEBRASKA CORPORATION)
P.O. BOX 1630
KEARNEY, NE 688481630

FIRST USE 8-0-2000; IN COMMERCE 8-0-2000.

SER. NO. 76-425,980, FILED 6-28-2002.

FOR: PREPARED ALCOHOLIC DRINK, IN
CLASS 33 (U.S. CLS. 47 AND 49).

DARRYL SPRUILL, EXAMINING ATTORNEY

Int. Cls.: 9 and 42

Prior U.S. Cls.: 21, 23, 26, 36, 38, 100 and 101

United States Patent and Trademark Office

Reg. No. 2,892,452

Registered Oct. 12, 2004

**TRADEMARK
SERVICE MARK
PRINCIPAL REGISTER**



FUSIO AB (SWEDEN CORPORATION)
GARNISONSGATAN 10
254 66 HELSINGBORG, SWEDEN

FOR: RECORDED COMPUTER SOFTWARE AND COMPUTER PROGRAMS, NAMELY, SOFTWARE AND COMPUTER PROGRAMS FOR LAYOUT, DRAWING, RECORD KEEPING, BOOKKEEPING, AND BOOKING OF ADVERTISEMENTS, ALL FOR USE IN THE FIELDS OF ADVERTISING, PUBLISHING AND DESKTOP PUBLISHING, BUT NOT INCLUDING COMPUTER OPERATING SYSTEM SOFTWARE, IN CLASS 9 (U.S. CLS. 21, 23, 26, 36 AND 38).

FOR: PROFESSIONAL CONSULTATION IN DESIGN, DEVELOPMENT AND UPDATING OF SOFTWARE RELATED TO PRODUCTION AND ADMINISTRATION OF NEWSPAPERS; TECHNICAL CONSULTATION IN THE FIELD OF PRODUCTION AND ADMINISTRATION OF NEWSPAPERS; SOFTWARE SUPPORT AND TECHNICAL ASSISTANCE, NAMELY, TROUBLESHOOTING OF COMPUTER SOFTWARE PROBLEMS; DESIGN, PREPARATION, DEVELOPMENT, EDITING AND UPDATING OF MANUALS AND COMPUTER DATABASES FOR OTHERS; RENTAL AND LEASING OF COMPUTER PROGRAMS AND COMPUTER SOFTWARE, IN CLASS 42 (U.S. CLS. 100 AND 101).

OWNER OF ERPN CMNTY TM OFC REG. NO. 000594481, DATED 5-19-1999, EXPIRES 6-18-2007.

OWNER OF U.S. REG. NO. 2,312,180.

SER. NO. 76-426,310, FILED 6-21-2002.

CAROLINE WEIMER, EXAMINING ATTORNEY

Int. Cl.: 16

Prior U.S. Cls.: 2, 5, 22, 23, 29, 37, 38 and 50

United States Patent and Trademark Office

Reg. No. 2,892,453

Registered Oct. 12, 2004

**TRADEMARK
PRINCIPAL REGISTER**

THE WORD HOUSE

CUPP PUBLISHERS, INC. (GEORGIA CORPORATION)
52 WYLLY AVENUE
SAVANNAH, GA 31406

FOR: PRINTED MATTER, NAMELY, BOOKS, MAGAZINES, PAMPHLETS, BROCHURES, PRINTED INSTRUCTIONAL MATERIALS, PRINTED EDUCATIONAL MATERIALS AND MANUALS ALL IN THE FIELD OF INSTRUCTION OF READING, HOMEWORK, REASONING, LOGIC, WORDS,

SPELLING, WRITING, LANGUAGE SKILLS, AND OTHER PRIMARY AND SECONDARY EDUCATION TOPICS AND SKILLS, IN CLASS 16 (U.S. CLS. 2, 5, 22, 23, 29, 37, 38 AND 50).

FIRST USE 6-10-2002; IN COMMERCE 6-10-2002.

SER. NO. 76-426,549, FILED 6-25-2002.

IRA J. GOODSaid, EXAMINING ATTORNEY

Int. Cl.: 41

Prior U.S. Cls.: 100, 101 and 107

United States Patent and Trademark Office

Reg. No. 2,892,454

Registered Oct. 12, 2004

**SERVICE MARK
PRINCIPAL REGISTER**

PEOPLE BUY FROM PEOPLE

CAPPER, STEPHEN L. (UNITED STATES INDIVIDUAL)
2500 NORTH RITTER AVENUE
INDIANAPOLIS, IN 46218

FOR: EDUCATIONAL SERVICES NAMELY CONDUCTING MOTIVATIONAL SEMINARS AND LECTURES IN THE FIELD OF BUSINESS AND

DISTRIBUTING COURSE MATERIAL THEREWITH, IN CLASS 41 (U.S. CLS. 100, 101 AND 107).

FIRST USE 10-0-1979; IN COMMERCE 10-0-1979.

SER. NO. 76-426,577, FILED 7-1-2002.

HOWARD B. LEVINE, EXAMINING ATTORNEY

Int. Cls.: 9 and 42

Prior U.S. Cls.: 21, 23, 26, 36, 38, 100 and 101

United States Patent and Trademark Office

Reg. No. 2,892,455

Registered Oct. 12, 2004

**TRADEMARK
SERVICE MARK
PRINCIPAL REGISTER**

MACTIVE MAKING PUBLISHING MORE PROFITABLE

FUSIO AB (SWEDEN CORPORATION)
GARNISONSGATAN 10
254 66 HELSINGBORG, SWEDEN

FOR: RECORDED COMPUTER SOFTWARE AND COMPUTER PROGRAMS, NAMELY, SOFTWARE AND COMPUTER PROGRAMS FOR LAYOUT, DRAWING, RECORD KEEPING, BOOKKEEPING, AND BOOKING OF ADVERTISEMENTS, ALL FOR USE IN THE FIELDS OF ADVERTISING, PUBLISHING AND DESKTOP PUBLISHING, BUT NOT INCLUDING COMPUTER OPERATING SYSTEM SOFTWARE, IN CLASS 9 (U.S. CLS. 21, 23, 26, 36 AND 38).

FOR: PROFESSIONAL CONSULTATION IN DESIGN, DEVELOPMENT AND UPDATING OF SOFTWARE RELATED TO PRODUCTION AND ADMINISTRATION OF NEWSPAPERS; TECHNICAL CONSULTATION IN THE FIELD OF PRODUC-

TION AND ADMINISTRATION OF NEWSPAPERS; SOFTWARE SUPPORT AND TECHNICAL ASSISTANCE, NAMELY, TROUBLESHOOTING OF COMPUTER SOFTWARE PROBLEMS; DESIGN, PREPARATION, DEVELOPMENT, EDITING AND UPDATING OF MANUALS AND COMPUTER DATABASES FOR OTHERS; RENTAL AND LEASING OF COMPUTER PROGRAMS AND COMPUTER SOFTWARE, IN CLASS 42 (U.S. CLS. 100 AND 101).

PRIORITY CLAIMED UNDER SEC. 44(D) ON ERPN CMNTY TM OFC APPLICATION NO. 002685402, FILED 6-5-2002, REG. NO. 002685402, DATED 7-8-2003, EXPIRES 6-5-2012.

OWNER OF U.S. REG. NO. 2,312,180.

SER. NO. 76-426,948, FILED 6-21-2002.

CAROLINE WEIMER, EXAMINING ATTORNEY

Int. Cls.: 1 and 30

Prior U.S. Cls.: 1, 5, 6, 10, 26 and 46

United States Patent and Trademark Office

Reg. No. 2,892,456

Registered Oct. 12, 2004

**TRADEMARK
PRINCIPAL REGISTER**

The logo for Frutalose features a stylized leaf icon to the left of the word "Frutalose" in a bold, italicized, sans-serif font.

KONINKLIJKE COOPERATIE COSUN U.A.
(NETHERLANDS CORPORATION)
ZUILENSTRAAT 100
4814 ND BREDA, NETHERLANDS

FORM OF POWDER OR SYRUPS TO BE USED AS
FOOD SUPPLEMENTS OR FOOD INGREDIENTS,
IN CLASS 30 (U.S. CL. 46).

FOR: ARTIFICIAL SWEETENERS, NAMELY
INULINE AND FRUCTO-OLIGOSACCHARIDE IN
THE FORM OF POWDER OR SYRUPS, TO BE USED
FOR THE MANUFACTURING OF PRODUCTS IN
THE INDUSTRY OF FOOD PRODUCTS, PHARMA-
CEUTICAL AND HEALTH CARE PRODUCTS, IN
CLASS 1 (U.S. CLS. 1, 5, 6, 10, 26 AND 46).

PRIORITY CLAIMED UNDER SEC. 44(D) ON
ERPN CMNTY TM OFC APPLICATION NO.
002690659, FILED 5-8-2002, REG. NO. 002690659,
DATED 8-21-2003, EXPIRES 5-8-2012.

SER. NO. 76-427,874, FILED 7-5-2002.

FOR: NATURAL SWEETENERS, NAMELY, INU-
LINE AND FRUCTO-OLIGOSACCHARIDE IN THE

MICHAEL SOUDERS, EXAMINING ATTORNEY

Int. Cl.: 11

Prior U.S. Cls.: 13, 21, 23, 31 and 34

United States Patent and Trademark Office

Reg. No. 2,892,457

Registered Oct. 12, 2004

**TRADEMARK
PRINCIPAL REGISTER**

STONE ROYALE

OASIS INDUSTRIES, INC. (ILLINOIS CORPORATION)
1600 MOUNTAIN STREET
AURORA, IL 60505

FOR: SYNTHETIC SEALER COATING SOLD AS AN INTEGRAL COMPONENT OF FIBERGLASS BATH PRODUCTS, NAMELY, BATHTUBS, SHOW-

ERS AND SHOWER BASES, IN CLASS 11 (U.S. CLS. 13, 21, 23, 31 AND 34).

FIRST USE 5-13-2002; IN COMMERCE 5-13-2002.

SER. NO. 76-428,222, FILED 7-5-2002.

YONG KIM, EXAMINING ATTORNEY

Int. Cl.: 41

Prior U.S. Cls.: 100, 101 and 107

United States Patent and Trademark Office

Reg. No. 2,892,458

Registered Oct. 12, 2004

SERVICE MARK
PRINCIPAL REGISTER



Ayudando a los niños a lograr éxito en la vida.

UNITED WAY OF AMERICA (NEW YORK NOT-
FOR-PROFIT CORPORATION)
701 NORTH FAIRFAX ST.
ALEXANDRIA, VA 223142045

FOR: ORGANIZING AND CONDUCTING EDU-
CATIONAL WORKSHOPS, SEMINARS, AND LEC-
TURES FOR PRE-SCHOOL AGE CHILDREN AND
THEIR CARE GIVERS TO PROMOTE QUALITY
EARLY CHILDHOOD DEVELOPMENT, IN CLASS
41 (U.S. CLS. 100, 101 AND 107).

FIRST USE 12-31-1997; IN COMMERCE 12-31-1997.

OWNER OF U.S. REG. NOS. 1,000,815, 2,641,411
AND OTHERS.

THE ENGLISH TRANSLATION OF "EXITO A LOS
6 AYUNDANDO A LOS NINO A LOGRAR EXITO
EN LAW VIDA" MEANS "SUCCESS BY 6 HELPING
ALL CHILDREN SUCCEED FOR LIFE".

SER. NO. 76-429,912, FILED 7-3-2002.

ROBERT COGGINS, EXAMINING ATTORNEY

Int. Cl.: 17

Prior U.S. Cls.: 1, 5, 12, 13, 35 and 50

United States Patent and Trademark Office

Reg. No. 2,892,459

Registered Oct. 12, 2004

**TRADEMARK
PRINCIPAL REGISTER**

CANUSA

SHAWCOR, LTD. (CANADA COMPANY)
25 BETHRIDGE ROAD
TORONTO, ONTARIO M9W 1M7, CANADA

FOR: HEAT SHRINKABLE SLEEVES FOR PIPE JOINTS AND SLEEVES OF THERMALLY INSULATING MATERIAL FOR PIPE JOINTS; HEAT SHRINKABLE PLASTIC SLEEVES FOR ELECTRICAL, ELECTRONIC AND TELECOMMUNICATION CABLES AND HEAT SHRINKABLE PLASTIC SHEETS FOR WRAPPING AROUND, PROTECTING OR SEALING PIPE, PIPELINES AND ELECTRICAL AND TELECOMMUNICATION CABLES; ADHE-

SIVES, MASTICS AND SEALANTS FOR PIPE COATING AND LIQUID COATINGS FOR PIPE JOINT PROTECTION, IN CLASS 17 (U.S. CLS. 1, 5, 12, 13, 35 AND 50).

FIRST USE 0-0-1980; IN COMMERCE 0-0-1980.

OWNER OF CANADA REG. NO. TMA198513,
DATED 4-5-1974, EXPIRES 4-5-2019.

SER. NO. 76-430,009, FILED 7-11-2002.

GEORGIA CARTY, EXAMINING ATTORNEY

Int. Cl.: 7

Prior U.S. Cls.: 13, 19, 21, 23, 31, 34 and 35

United States Patent and Trademark Office

Reg. No. 2,892,460

Registered Oct. 12, 2004

TRADEMARK
PRINCIPAL REGISTER



INTERLAMAS SIGLO XXI, S.L. (SPAIN CORPORATION)
SANGUESA, 19
31003 PAMPLONA (NAVARRA), SPAIN

FOR: MACHINES FOR CLEANING ANIMALS, IN CLASS 7 (U.S. CLS. 13, 19, 21, 23, 31, 34 AND 35).

OWNER OF SPAIN REG. NO. 2426459, DATED 7-5-2002, EXPIRES 9-25-2011.

NO CLAIM IS MADE TO THE EXCLUSIVE RIGHT TO USE "PET", APART FROM THE MARK AS SHOWN.

THE MARK IS LINED FOR THE COLORS BLUE, BROWN AND LIGHT BROWN.

THE MARK CONSISTS OF A DOG HOLDING A WATER HOSE STANDING ON TOP OF THE WORDS "PET CLIN". THE BODY OF THE DOG IS BEIGE WITH BROWN SPOTS, EARS AND EYELIDS. THE DOG'S NOSE IS BLACK. THE DOG'S EYES ARE WHITE WITH GRAY PUPILS. THE WATER HOSE IS GRAY WITH ORANGE NOZZLE. THE WATER DROPS COMING OUT OF THE WATER HOSE ARE GRAY. THE DOG'S TAG IS ORANGE AND YELLOW. THE WORDS "PET CLIN" ARE IN WHITE WITH TWO OUTER BORDERS, ONE BLUE AND THE OTHER ONE IS BLACK.

SER. NO. 76-430,316, FILED 7-15-2002.

MARY BOAGNI, EXAMINING ATTORNEY

Int. Cl.: 9

Prior U.S. Cls.: 21, 23, 26, 36 and 38

Reg. No. 2,892,461

United States Patent and Trademark Office

Registered Oct. 12, 2004

**TRADEMARK
PRINCIPAL REGISTER**

TELEENERGY

MITSUBISHI ELECTRIC CORPORATION (JAPAN CORPORATION)
2-3 MARUNOUCHI 2-CHOME
CHIYODA-KU, TOKYO, JAPAN

FOR: ELECTROMAGNETIC WAVE TRANSMITTERS AND RECEIVERS, FOR COMMUNICATION, POSITION-FIXING AND NAVIGATION USE AND FOR USE IN REMOTE CONTROL OF OPERATION OF INDUSTRIAL MACHINES, INDUSTRIAL ROBOTS AND LIGHTING APPARATUS; ELECTROMAGNETIC WAVE TRANSMITTERS AND RECEIVERS AND CONVERTERS OF TRANSMITTED POWER TO DIRECT CURRENT ELECTRICITY, FOR USE IN CHARGE OF ELECTRICITY TO WATCHES AND CLOCKS, PORTABLE RADIOS, CELLULAR PHONES, PORTABLE TELECOMMUNICATION EQUIPMENT, COMMUNICATION SATELLITES, DIGITAL CAMERAS, PERSONAL DIGITAL ASSISTANT, CASSETTE TAPE RECOR-

DERS, TELEVISION RECEIVERS, PORTABLE VIDEO GAME PLAYERS, COMPUTERS, CALCULATORS, COMPUTERIZED DICTIONARIES, VENTILATORS, LIGHTING FIXTURES, REFRIGERATORS, AIR CONDITIONERS, LAUNDRY MACHINES, CLEANERS, ELECTRICITY HEATED CARPETS, RICE COOKERS, MICROWAVE OVENS, OVEN TOASTERS, WORKING MACHINES AND ELECTRIC TRAINS; ARTIFICIAL SATELLITES, IN CLASS 9 (U.S. CLS. 21, 23, 26, 36 AND 38).

PRIORITY CLAIMED UNDER SEC. 44(D) ON JAPAN APPLICATION NO. 2002-051698, FILED 6-21-2002, REG. NO. 4675022, DATED 5-23-2003, EXPIRES 5-23-2013.

SER. NO. 76-430,379, FILED 7-15-2002.

LESLEY LAMOTHE, EXAMINING ATTORNEY

Int. Cl.: 44

Prior U.S. Cls.: 100 and 101

United States Patent and Trademark Office

Reg. No. 2,892,462

Registered Oct. 12, 2004

**SERVICE MARK
PRINCIPAL REGISTER**

SKIN APEEL DAY SPA A RETREAT FOR SKIN, BODY AND NAILS

SKIN APEEL, INC. (FLORIDA CORPORATION)
GROVE CENTRE
21301 POWERLINE RD.
BOCA RATON, FL 33433

FOR: SPA SERVICES, NAMELY, MESSAGES,
SKIN PEELS, MANICURES, PEDICURES AND FA-
CIALS, IN CLASS 44 (U.S. CLS. 100 AND 101).

FIRST USE 10-1-1992; IN COMMERCE 10-1-1992.

NO CLAIM IS MADE TO THE EXCLUSIVE
RIGHT TO USE SKIN, DAY SPA OR A RETREAT
FOR SKIN, BODY, AND NAILS, APART FROM THE
MARK AS SHOWN.

SER. NO. 76-430,731, FILED 7-12-2002.

LEIGH CAROLINE CASE, EXAMINING ATTOR-
NEY

Int. Cls.: 35, 38 and 42

Prior U.S. Cls.: 100, 101, 102 and 104

United States Patent and Trademark Office

Reg. No. 2,892,463

Registered Oct. 12, 2004

**SERVICE MARK
PRINCIPAL REGISTER**

LEODOM

LEODOM (FED REP GERMANY CORPORATION)
HINDENBURGSTR. 14
91448 EMSHIRCHEN, FED REP GERMANY

FOR: ONLINE RETAIL STORES AND OUTLETS OF COMPUTERS, SERVERS, AND MODEMS, IN CLASS 35 (U.S. CLS. 100, 101 AND 102).

FIRST USE 2-1-1998; IN COMMERCE 2-1-1998.

FOR: PROVIDING MULTIPLE USER DIAL-UP AND DEDICATED ACCESS TO THE INTERNET, IN CLASS 38 (U.S. CLS. 100, 101 AND 104).

FIRST USE 2-1-1998; IN COMMERCE 2-1-1998.

FOR: HOSTING OF DIGITAL CONTENT ON THE INTERNET; HOSTING THE WEB SITES OF OTHERS ON A COMPUTER SERVER TO A GLOBAL COMPUTER NETWORK, IN CLASS 42 (U.S. CLS. 100 AND 101).

FIRST USE 2-1-1998; IN COMMERCE 2-1-1998.

SER. NO. 76-430,749, FILED 7-12-2002.

RAUL CORDOVA, EXAMINING ATTORNEY

Int. Cl.: 10

Prior U.S. Cls.: 26, 39 and 44

United States Patent and Trademark Office

Reg. No. 2,892,464

Registered Oct. 12, 2004

**TRADEMARK
PRINCIPAL REGISTER**

 **Blatchford**

CHAS. A. BLATCHFORD & SONS LIMITED
(UNITED KINGDOM COMPANY)
LISTER ROAD
BASINGSTOKE
HAMPSHIRE, UNITED KINGDOM RG22 4AH

FOR: PROSTHESES FOR HANDS, LEGS, ARMS
AND FEET; ORTHOSES FOR HANDS, LEGS, ARMS,
FEET, TRUNK AND NECK; ARTIFICIAL LIMBS;
ARTIFICIAL KNEES, FEET, ANKLES AND ARTIFI-
CIAL SKIN USED TO COVER PROSTHETIC DEVI-
CES; PARTS AND FITTINGS FOR THE AFORESAID
GOODS, IN CLASS 10 (U.S. CLS. 26, 39 AND 44).

FIRST USE 2-0-1991; IN COMMERCE 2-0-1991.

PRIORITY CLAIMED UNDER SEC. 44(D) ON
ERPNTY CMNTY TM OFC APPLICATION NO.
2535615, FILED 1-10-2002, REG. NO. 2535615, DATED
6-6-2003, EXPIRES 1-10-2012.

SER. NO. 76-430,928, FILED 7-10-2002.

CHARLES L. JENKINS, EXAMINING ATTORNEY

Int. Cl.: 28

Prior U.S. Cls.: 22, 23, 38 and 50

United States Patent and Trademark Office

Reg. No. 2,892,465

Registered Oct. 12, 2004

**TRADEMARK
PRINCIPAL REGISTER**

EDDIE BAUER

EDDIE BAUER, INC. (DELAWARE CORPORATION)
15010 N.E. 36TH STREET
REDMOND, WA 98052

FOR: CROQUET GAME PLAYING EQUIPMENT;
BOCCE GAME PLAYING EQUIPMENT; VOLLEYBALL
GAME PLAYING EQUIPMENT; BADMINTON
GAME PLAYING EQUIPMENT; HORSESHOE
GAME PLAYING EQUIPMENT , IN CLASS 28 (U.S.
CLS. 22, 23, 38 AND 50).

FIRST USE 2-15-2002; IN COMMERCE 2-15-2002.

OWNER OF U.S. REG. NOS. 880,279, 880,280 AND
OTHERS.

SER. NO. 76-431,073, FILED 7-16-2002.

AISHA CLARKE, EXAMINING ATTORNEY

Int. Cl.: 28

Prior U.S. Cls.: 22, 23, 38 and 50

United States Patent and Trademark Office

Reg. No. 2,892,466

Registered Oct. 12, 2004

TRADEMARK
PRINCIPAL REGISTER



EDDIE BAUER, INC. (DELAWARE CORPORATION)
15010 N.E. 36TH STREET
REDMOND, WA 98052

FOR: CROQUET GAME PLAYING EQUIPMENT;
BOCCE GAME PLAYING EQUIPMENT; VOLLEY-
BALL GAME PLAYING EQUIPMENT; BADMIN-
TON GAME PLAYING EQUIPMENT; HORSESHOE
GAME PLAYING EQUIPMENT , IN CLASS 28 (U.S.
CLS. 22, 23, 38 AND 50).

FIRST USE 2-15-2002; IN COMMERCE 2-15-2002.

OWNER OF U.S. REG. NOS. 880,279, 880,280 AND
OTHERS.

SER. NO. 76-431,074, FILED 7-16-2002.

AISHA CLARKE, EXAMINING ATTORNEY

Int. Cls.: 41 and 43

Prior U.S. Cls.: 100, 101 and 107

United States Patent and Trademark Office

Reg. No. 2,892,467

Registered Oct. 12, 2004

**SERVICE MARK
PRINCIPAL REGISTER**

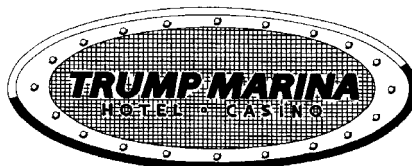

TRUMP, DONALD J. (UNITED STATES INDIVIDUAL)
725 FIFTH AVENUE
NEW YORK, NY 10022

FOR: CASINO SERVICES, IN CLASS 41 (U.S. CLS. 100, 101 AND 107).

FIRST USE 5-4-2002; IN COMMERCE 5-4-2002.

FOR: HOTEL SERVICES, IN CLASS 43 (U.S. CLS. 100 AND 101).

FIRST USE 5-4-2002; IN COMMERCE 5-4-2002.

NO CLAIM IS MADE TO THE EXCLUSIVE RIGHT TO USE THE TERM "MARINA HOTEL & CASINO", APART FROM THE MARK AS SHOWN.

THE LINING IS A FEATURE OF THE MARK AND DOES NOT INDICATE COLOR.

SER. NO. 76-431,346, FILED 7-15-2002.

ALEX KEAM, EXAMINING ATTORNEY

Int. Cls.: 9 and 16

Prior U.S. Cls.: 2, 5, 21, 22, 23, 26, 29, 36, 37, 38 and 50

United States Patent and Trademark Office

Reg. No. 2,892,468

Registered Oct. 12, 2004

**TRADEMARK
PRINCIPAL REGISTER**

NEWKIRK

NEWKIRK PRODUCTS, INC. (NEW YORK CORPORATION)
15 CORPORATE CIRCLE
ALBANY, NY 12203

FOR: DOWNLOADABLE ELECTRONIC ARTICLES IN THE FIELDS OF FINANCIAL, TAX, ESTATE, AND RETIREMENT PLANNING, FOR USE BY FINANCIAL INSTITUTIONS FOR INCORPORATION INTO THEIR WEBSITES AND IN THEIR MAILINGS TO THEIR CUSTOMERS, IN CLASS 9 (U.S. CLS. 21, 23, 26, 36 AND 38).

FIRST USE 1-0-1999; IN COMMERCE 1-0-1999.

FOR: PRINTED ARTICLES IN BROCHURE AND PAMPHLET FORM IN THE FIELDS OF FINAN-

CIAL, TAX, ESTATE, AND RETIREMENT PLANNING, FOR USE BY FINANCIAL INSTITUTIONS FOR INCORPORATION INTO THEIR WEBSITES AND IN THEIR MAILINGS TO THEIR CUSTOMERS, IN CLASS 16 (U.S. CLS. 2, 5, 22, 23, 29, 37, 38 AND 50).

FIRST USE 1-0-1999; IN COMMERCE 1-0-1999.

SEC. 2(F).

SER. NO. 76-431,487, FILED 7-17-2002.

ROBERT COGGINS, EXAMINING ATTORNEY

Int. Cl.: 25

Prior U.S. Cls.: 22 and 39

United States Patent and Trademark Office

Reg. No. 2,892,469

Registered Oct. 12, 2004

**TRADEMARK
PRINCIPAL REGISTER**

MISSANI LE COLLEZIONI

BNR LEATHER PRODUCTS CO. LLC (DELA-
WARE LTD LIAB CO)
4610 SANTA ANITA AVENUE
EL MONTE, CA 91731

FOR: LEATHER CLOTHING, NAMELY JACK-
ETS, PANTS, SHIRTS, OVERCOATS, COATS, VESTS,
SKIRTS, DRESSES AND BLOUSES, IN CLASS 25
(U.S. CLS. 22 AND 39).

FIRST USE 9-1-1996; IN COMMERCE 9-1-1996.

NO CLAIM IS MADE TO THE EXCLUSIVE
RIGHT TO USE "LE COLLEZIONI", APART FROM
THE MARK AS SHOWN.

THE ENGLISH TRANSLATION OF THE ITALIAN
WORDS "LE COLLEZIONI" IS "THE COLLECTION".

SER. NO. 76-432,006, FILED 7-15-2002.

RUSS HERMAN, EXAMINING ATTORNEY

Int. Cl.: 16

Prior U.S. Cls.: 2, 5, 22, 23, 29, 37, 38 and 50

United States Patent and Trademark Office

Reg. No. 2,892,470

Registered Oct. 12, 2004

TRADEMARK
PRINCIPAL REGISTER



CLEVER FACTORY, INC., THE (TENNESSEE CORPORATION)
545 MAINSTREAM DRIVE, SUITE 406
NASHVILLE, TN 37228

FOR: LOW COST EDUCATIONAL AND LEARNING PUBLICATIONS FOR CHILDREN, NAMELY, EDUCATIONAL BOOKS, WORKBOOKS, BOOKLETS, CHARTS, AND FLASH CARDS, ON A VARI-

ETY OF GRADE SCHOOL SUBJECTS, IN CLASS 16 (U.S. CLS. 2, 5, 22, 23, 29, 37, 38 AND 50).

FIRST USE 5-29-2002; IN COMMERCE 5-29-2002.

SER. NO. 76-433,206, FILED 7-23-2002.

STEVEN R. FOSTER, EXAMINING ATTORNEY

Int. Cl.: 25

Prior U.S. Cls.: 22 and 39

United States Patent and Trademark Office

Reg. No. 2,892,471

Registered Oct. 12, 2004

**TRADEMARK
PRINCIPAL REGISTER**

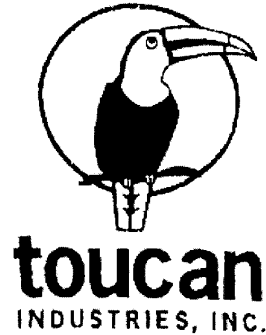

TOUCAN INDUSTRIES, INC. (FLORIDA CORPORATION)
2161 BLOUNT ROAD
POMPANO BEACH, FL 33069

FOR: CLOTHING, NAMELY, T-SHIRTS, IN CLASS 25 (U.S. CLS. 22 AND 39).

FIRST USE 4-0-1997; IN COMMERCE 4-0-1997.

NO CLAIM IS MADE TO THE EXCLUSIVE RIGHT TO USE "INDUSTRIES, INC." , APART FROM THE MARK AS SHOWN.

SER. NO. 76-433,815, FILED 7-23-2002.

KATHLEEN M. VANSTON, EXAMINING ATTORNEY

Int. Cl.: 12

Prior U.S. Cls.: 19, 21, 23, 31, 35 and 44

United States Patent and Trademark Office

Reg. No. 2,892,472

Registered Oct. 12, 2004

**TRADEMARK
PRINCIPAL REGISTER**

EMAC

HUTCHINSON SA (FRANCE CORPORATION)
2 RUE BALZAC
75008 PARIS, FRANCE

PRIORITY CLAIMED UNDER SEC. 44(D) ON
FRANCE APPLICATION NO. 023165858, FILED 5-
22-2002, REG. NO. 023165858, DATED 5-22-2002, EX-
PIRES 5-22-2013.

FOR: ENGINE MOUNTS FOR CARS, LIGHT
TRUCKS AND TRUCKS, IN CLASS 12 (U.S. CLS.
19, 21, 23, 31, 35 AND 44).

SER. NO. 76-434,046, FILED 7-23-2002.

TRICIA THOMPkins, EXAMINING ATTORNEY

Int. Cl.: 15

Prior U.S. Cls.: 2, 21 and 36

United States Patent and Trademark Office

Reg. No. 2,892,473

Registered Oct. 12, 2004

**TRADEMARK
PRINCIPAL REGISTER**

VALVEBOY

J. T. PEDALS, INC. (CALIFORNIA CORPORATION)
1823 GRACE AVENUE APARTMENT 408
LOS ANGELES, CA 90028

FIRST USE 1-26-2002; IN COMMERCE 1-26-2002.

SER. NO. 76-434,312, FILED 7-25-2002.

FOR: ELECTRONIC MUSICAL INSTRUMENT
EFFECT PEDAL, IN CLASS 15 (U.S. CLS. 2, 21 AND
36).

WON TEAK OH, EXAMINING ATTORNEY

Int. Cl.: 29

Prior U.S. Cl.: 46

United States Patent and Trademark Office

Reg. No. 2,892,474

Registered Oct. 12, 2004

**TRADEMARK
PRINCIPAL REGISTER**

CANIAC

RAISING CANE'S USA, L.L.C. (LOUISIANA LTD
LIAB CO)
1212 SOUTH ACADIAN THRUWAY, SUITE E
BATON ROUGE, LA 70806

FIRST USE 10-1-2000; IN COMMERCE 10-1-2000.

SER. NO. 76-434,878, FILED 7-26-2002.

FOR: PREPARED MEALS CONSISTING PRIMAR-
ILY OF CHICKEN, IN CLASS 29 (U.S. CL. 46).

CHRISTOPHER ADKINS, EXAMINING ATTOR-
NEY

Int. Cl.: 36

Prior U.S. Cls.: 100, 101 and 102

United States Patent and Trademark Office

Reg. No. 2,892,475

Registered Oct. 12, 2004

SERVICE MARK
PRINCIPAL REGISTER



BANK ONE CORPORATION (DELAWARE CORPORATION)
1 BANK ONE PLAZA
CHICAGO, IL 60670

FOR: BANKING AND BANK RELATED FINANCIAL SERVICES, NAMELY, FINANCIAL INVESTMENT AND ADVISORY SERVICES; AND THE ADMINISTRATION, MANAGEMENT AND BROKERAGE OF INVESTMENTS, IN CLASS 36 (U.S. CLS. 100, 101 AND 102).

FIRST USE 1-2-2002; IN COMMERCE 1-2-2002.

OWNER OF U.S. REG. NOS. 1,120,175, 2,329,454 AND OTHERS.

NO CLAIM IS MADE TO THE EXCLUSIVE RIGHT TO USE "INVESTMENTS", APART FROM THE MARK AS SHOWN.

SER. NO. 76-435,500, FILED 7-29-2002.

PAULA MAHONEY, EXAMINING ATTORNEY

Int. Cl.: 16

Prior U.S. Cls.: 2, 5, 22, 23, 29, 37, 38 and 50

United States Patent and Trademark Office

Reg. No. 2,892,476

Registered Oct. 12, 2004

**TRADEMARK
PRINCIPAL REGISTER**

LATINARTE

LATINARTE.COM, INC. (FLORIDA CORPORATION)
1900 SUNSET HARBOUR DRIVE
SUITE 2307
MIAMI, FL 33110

FOR: MAGAZINES IN THE FIELD OF CULTURAL EVENTS, IN CLASS 16 (U.S. CLS. 2, 5, 22, 23, 29, 37, 38 AND 50).

FIRST USE 11-0-2000; IN COMMERCE 11-0-2000.

THE ENGLISH TRANSLATION OF "LATIN ARTE" (AS TWO WORDS) IS "LATIN ART".

SER. NO. 76-435,924, FILED 7-31-2002.

KAREN K. BUSH, EXAMINING ATTORNEY

Int. Cl.: 40

Prior U.S. Cls.: 100, 103 and 106

United States Patent and Trademark Office

Reg. No. 2,892,477

Registered Oct. 12, 2004

**SERVICE MARK
PRINCIPAL REGISTER**



CHAS. A. BLATCHFORD & SONS LIMITED
(UNITED KINGDOM COMPANY)
LISTER ROAD
BASINGTOKE
HAMPSHIRE, UNITED KINGDOM RG22 4AH

PRIORITY CLAIMED UNDER SEC. 44(D) ON
ERPN CMNTY TM OFC APPLICATION NO.
2535615, FILED 1-10-2002, REG. NO. 2535615, DATED
6-6-2003, EXPIRES 1-10-2012.

FOR: CUSTOM MANUFACTURE OF PROSTHE-
SES AND ORTHOSES, IN CLASS 40 (U.S. CLS. 100,
103 AND 106).

SER. NO. 76-436,030, FILED 7-10-2002.

FIRST USE 2-0-1991; IN COMMERCE 2-0-1991.

CHARLES L. JENKINS, EXAMINING ATTORNEY

Int. Cl.: 3

Prior U.S. Cls.: 1, 4, 6, 50, 51 and 52

United States Patent and Trademark Office

Reg. No. 2,892,478

Registered Oct. 12, 2004

**TRADEMARK
PRINCIPAL REGISTER**

SUBLIM COLOR SYSTEM

LANCOME PARFUMS ET BEAUTE & CIE
(FRANCE SOCIETE EN NOM COLLECTIF)
29, RUE DU FAUBOURG SAINT-HONORE
PARIS, FRANCE 75008

FOR: NON-MEDICATED HAIR SHAMPOOS;
GELS, SPRAYS, MOUSSE SAND BALMS FOR HAIR
STYLING AND HAIR CARE; HAIR LACQUERS;
HAIR COLORING AND HAIR DEODORANT PRE-
PARATIONS; AND PERMANENT WAVING AND
CURLING PREPARATIONS, IN CLASS 3 (U.S. CLS.
1, 4, 6, 50, 51 AND 52).

PRIORITY CLAIMED UNDER SEC. 44(D) ON
FRANCE APPLICATION NO. 02/3.153.684, FILED 3-
14-2002, REG. NO. 023153684, DATED 3-14-2002, EX-
PIRES 3-14-2012.

NO CLAIM IS MADE TO THE EXCLUSIVE
RIGHT TO USE "COLOR SYSTEM", APART FROM
THE MARK AS SHOWN.

SER. NO. 76-436,173, FILED 7-31-2002.

LINDA ESTRADA, EXAMINING ATTORNEY

Prior U.S. Cl.: 200

United States Patent and Trademark Office

Reg. No. 2,892,479

Registered Oct. 12, 2004

**COLLECTIVE MEMBERSHIP
PRINCIPAL REGISTER**

TEAM UNSTOPPABLE

TEAM UNSTOPPABLE LLC (OHIO LTD LIAB
CO)
9100 CENTER POINT, SUITE 260
WEST CHESTER, OH 45069

FIRST USE 6-0-1999; IN COMMERCE 6-0-1999.

SER. NO. 76-436,225, FILED 7-25-2002.

FOR: INDICATING MEMBERSHIP IN AN ASSO-
CIATION OF FINANCIAL PRODUCT REPRESENT-
TIVES, IN CLASS 200 (U.S. CL. 200).

EUGENIA MARTIN, EXAMINING ATTORNEY

Int. Cl.: 3

Prior U.S. Cls.: 1, 4, 6, 50, 51 and 52

United States Patent and Trademark Office

Reg. No. 2,892,480

Registered Oct. 12, 2004

**TRADEMARK
PRINCIPAL REGISTER**

ECZA-CREME

HOLISTIC NATUROPATHIC CENTER, LLC
(NEW JERSEY CORPORATION)
256 COLFAX AVENUE
CLIFTON, NJ 07013

FIRST USE 6-3-2002; IN COMMERCE 6-3-2002.

SER. NO. 76-436,377, FILED 7-31-2002.

FOR: NON-MEDICATED TOPICAL SKIN
CREAM, IN CLASS 3 (U.S. CLS. 1, 4, 6, 50, 51 AND 52).

GLENN CLARK, EXAMINING ATTORNEY

Int. Cl.: 42

Prior U.S. Cls.: 100 and 101

United States Patent and Trademark Office

Reg. No. 2,892,481

Registered Oct. 12, 2004

**SERVICE MARK
PRINCIPAL REGISTER**

ENVIROCAST

STORMCENTER COMMUNICATIONS, INC.
(MARYLAND CORPORATION)
COLUMBIA CORPORATE PARK 100
6021 UNIVERSITY BOULEVARD, SUITE 140
ELLCOTT CITY, MD 21043

FOR: PROVIDING INFORMATION AND IMAGERY ABOUT WEATHER FORECASTING, WEATHER REPORTS AND THE ENVIRONMENT VIA THE INTERNET FOR BROADCAST BY OTH-

ERS ON TELEVISION, IN CLASS 42 (U.S. CLS. 100 AND 101).

FIRST USE 1-15-2001; IN COMMERCE 1-15-2001.

SER. NO. 76-436,422, FILED 7-31-2002.

GLENN CLARK, EXAMINING ATTORNEY

Int. Cl.: 3

Prior U.S. Cls.: 1, 4, 6, 50, 51 and 52

United States Patent and Trademark Office

Reg. No. 2,892,482

Registered Oct. 12, 2004

**TRADEMARK
PRINCIPAL REGISTER**

ECOMATE

SOQ ENVIRONMENTAL TECHNOLOGY COR-
PORATION (ARIZONA CORPORATION)
2413 EAST MANHATTON DRIVE
TEMPE, AZ 85282

FIRST USE 1-0-1992; IN COMMERCE 1-0-1992.

SER. NO. 76-437,109, FILED 8-2-2002.

FOR: WATER-BASED MULTI-PURPOSE CLEA-
NERS, IN CLASS 3 (U.S. CLS. 1, 4, 6, 50, 51 AND 52).

H. M. FISHER, EXAMINING ATTORNEY

Int. Cl.: 3

Prior U.S. Cls.: 1, 4, 6, 50, 51 and 52

United States Patent and Trademark Office

Reg. No. 2,892,483

Registered Oct. 12, 2004

**TRADEMARK
PRINCIPAL REGISTER**

AGE DEFYING EFFECTS

4LIFE RESEARCH, L.C. (UTAH LTD LIAB CO)
9850 SOUTH 300 WEST
SANDY, UT 840703262

NO CLAIM IS MADE TO THE EXCLUSIVE
RIGHT TO USE "AGE DEFYING", APART FROM
THE MARK AS SHOWN.

FOR: NON-MEDICATED SKIN CARE PREPARA-
TIONS, IN CLASS 3 (U.S. CLS. 1, 4, 6, 50, 51 AND 52).

SER. NO. 76-437,551, FILED 8-5-2002.

FIRST USE 9-0-2001; IN COMMERCE 9-0-2001.

BRIAN BROWN, EXAMINING ATTORNEY

Int. Cls.: 29, 30 and 43

Prior U.S. Cls.: 46, 100 and 101

United States Patent and Trademark Office

Reg. No. 2,892,484

Registered Oct. 12, 2004

TRADEMARK
SERVICE MARK
PRINCIPAL REGISTER



THE JCP COMPANY, LLC (VIRGINIA CORPORATION)
P.O. BOX 498
LIGHTFOOT, VA 23090

FOR: PROCESSED PEANUTS, IN CLASS 29 (U.S. CL. 46).

FIRST USE 0-0-1980; IN COMMERCE 0-0-1980.

FOR: SAUCE, IN CLASS 30 (U.S. CL. 46).

FIRST USE 0-0-1980; IN COMMERCE 0-0-1980.

FOR: RESTAURANT SERVICES, IN CLASS 43 (U.S. CLS. 100 AND 101).

FIRST USE 0-0-1950; IN COMMERCE 0-0-1950.

OWNER OF U.S. REG. NOS. 1,434,120 AND 1,442,336.

NO CLAIM IS MADE TO THE EXCLUSIVE RIGHT TO USE "PIT BARBEQUE", APART FROM THE MARK AS SHOWN.

THE LINING SHOWN IN THE MARK IS MERELY TO INDICATE SHADING. THE MARK IS LINED FOR THE COLORS: BURNT ORANGE FOR THE BRICK. YELLOW FOR THE FLAME. YELLOW WITH BURNT ORANGE AROUND THE WORD "BAR-B-QUE". WHITE WITH BURNT ORANGE AROUND THE WORD "PIERCE'S". BLACK BACKGROUND INSIDE PIT.

SER. NO. 76-438,154, FILED 8-5-2002.

JOSETTE BEVERLY, EXAMINING ATTORNEY

Int. Cls.: 13, 37 and 40

Prior U.S. Cls.: 2, 9, 100, 103 and 106

United States Patent and Trademark Office

Reg. No. 2,892,485

Registered Oct. 12, 2004

TRADEMARK
SERVICE MARK
PRINCIPAL REGISTER

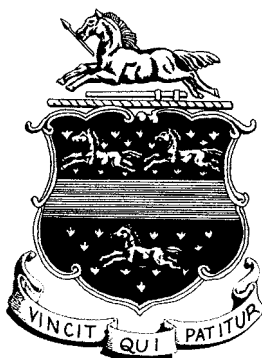

NEW COLT HOLDING CORPORATION (DELA-
WARE CORPORATION)
P.O. BOX 1868
HARTFORD, CT 06144

FOR: FIREARMS, NAMELY REVOLVERS, PIS-
TOLS AND LONGGUNS, IN CLASS 13 (U.S. CLS. 2
AND 9).

FIRST USE 0-0-1851; IN COMMERCE 0-0-1977.

FOR: REVOLVER RESTORATION, REPAIR AND
MAINTENANCE, IN CLASS 37 (U.S. CLS. 100, 103
AND 106).

FIRST USE 0-0-1851; IN COMMERCE 0-0-1977.

FOR: CUSTOM MANUFACTURE, DESIGN AND
ENGRAVING OF REVOLVERS, IN CLASS 40 (U.S.
CLS. 100, 103 AND 106).

FIRST USE 0-0-1851; IN COMMERCE 0-0-1977.

OWNER OF U.S. REG. NOS. 52,903, 821,006 AND
OTHERS.

THE STIPPLING IS A FEATURE OF THE MARK
AND SHADING PURPOSES ONLY.

THE ENGLISH TRANSLATION OF THE WORDS
"VINCIT QUI PATITUR" IN THE MARK IS "HE
WHO PERSEVERES IS VICTORIOUS" OR "HE WHO
SUFFERS CONQUERS".

SER. NO. 76-438,592, FILED 8-7-2002.

ANN LINNEHAN, EXAMINING ATTORNEY

Int. Cls.: 11, 18, 20 and 22

**Prior U.S. Cls.: 1, 2, 3, 7, 13, 19, 21, 22, 23, 25, 31, 32,
34, 41, 42 and 50**

Reg. No. 2,892,486

United States Patent and Trademark Office

Registered Oct. 12, 2004

**TRADEMARK
PRINCIPAL REGISTER**

CAFÉ JANUS

JANUS ET CIE (CALIFORNIA CORPORATION)
8687 MELROSE AVENUE
WEST HOLLYWOOD, CA 90069

FOR: SHOWERS, IN CLASS 11 (U.S. CLS. 13, 21, 23,
31 AND 34).

FIRST USE 0-0-1996; IN COMMERCE 0-0-1996.

FOR: UMBRELLAS, NAMELY, PATIO UMBRELLAS,
OUTDOOR UMBRELLAS, MARKET UMBRELLAS,
HALF UMBRELLAS, UMBRELLA BASES, GOLF UMBRELLAS,
BEACH UMBRELLAS, FRAMES FOR UMBRELLAS,
UMBRELLA COVERS, UMBRELLA HANDLES, AND UMBRELLA RINGS,
IN CLASS 18 (U.S. CLS. 1, 2, 3, 22 AND 41).

FIRST USE 0-0-1996; IN COMMERCE 0-0-1996.

FOR: INDOOR AND OUTDOOR FURNITURE,
NAMELY, ARMCHAIRS, ARMOIRES, BENCHES,
BOOK STANDS, BOOKCASES, CABINETS, PLANT
STANDS, HAND OPERATED NON-METAL GARDEN
HOSE REELS, HOSE HANGERS NOT OF METAL,
NON-METAL HOSE FITTINGS, CHAIRS,

ROCKING CHAIRS, CHAISE LOUNGES, SETTEES,
BEDROOM FURNITURE, CHESTS OF DRAWERS,
LOVE SEATS, COUCHES, CREDENZAS, PLASTIC
TUBS, CUSHIONS, DESKS, DINING ROOM TABLES,
COFFEE TABLES, CONSOLES, END TABLES,
CAFE TABLES, SOFA TABLES, PEDESTAL TABLES,
EXTENSION TABLES, OFFICE FURNITURE, CHILDREN'S
FURNITURE, OTTOMANS, DRESSERS, WALL UNITS,
SEATS, SOFAS AND STOOLS, IN CLASS 20 (U.S. CLS. 2, 13, 22, 25, 32 AND 50).

FIRST USE 0-0-1996; IN COMMERCE 0-0-1996.

FOR: CANVAS CANOPIES, TENTS, FABRIC
STRUCTURE IN THE NATURE OF A CABANA,
AWNINGS NOT OF METAL, CANVAS TARPAULINS,
IN CLASS 22 (U.S. CLS. 1, 2, 7, 19, 22, 42 AND 50).

FIRST USE 0-0-1996; IN COMMERCE 0-0-1996.

SER. NO. 76-438,763, FILED 8-8-2002.

STEPHANIE DAVIS, EXAMINING ATTORNEY

Int. Cl.: 9

Prior U.S. Cls.: 21, 23, 26, 36 and 38

Reg. No. 2,892,487

United States Patent and Trademark Office

Registered Oct. 12, 2004

**TRADEMARK
PRINCIPAL REGISTER**

NEXTGENID

NEXTGENLD, LTD. (TEXAS LIMITED PART-
NERSHIP)
21714 HARDY OAK BLVD., SUITE 104
SAN ANTONIO, TX 78258

FOR: SECURITY AND ACCESS AND EXIT CON-
TROL DEVICES FOR INTERNAL FACILITIES AND
BUILDINGS, NAMELY, ELECTRONICALLY OPER-
ATED READER PADS FOR BIOMETRIC RECOGNITION,
AND MOTION SENSITIVE SECURITY
ARRAYS; COMPUTER SOFTWARE FOR USE IN
MONITORING AND OPERATING SECURITY SYS-
TEMS AND ACCESS AND EXIT CONTROL DEVI-

CES IN INTERNAL FACILITIES AND BUILDINGS;
COMPUTER SOFTWARE, HARDWARE, AND PER-
IPHERALS FOR BIOMETRIC RECOGNITION AND
ANALYSIS, IN CLASS 9 (U.S. CLS. 21, 23, 26, 36 AND
38).

FIRST USE 8-1-2001; IN COMMERCE 8-1-2001.

SER. NO. 76-438,838, FILED 8-7-2002.

GINA FINK, EXAMINING ATTORNEY

Int. Cls.: 30 and 32

Prior U.S. Cls.: 45, 46 and 48

United States Patent and Trademark Office

Reg. No. 2,892,488

Registered Oct. 12, 2004

**TRADEMARK
PRINCIPAL REGISTER**

SOBE

SOUTH BEACH BEVERAGE COMPANY, INC.
(DELAWARE CORPORATION)
40 RICHARDS AVENUE
NORWALK, CT 06854

FOR: BEVERAGES, NAMELY, TEAS, ICED TEAS,
HERBAL TEAS, FLAVORED TEAS, AND COFFEE,
IN CLASS 30 (U.S. CL. 46).

FIRST USE 11-30-1995; IN COMMERCE 11-30-1995.

FOR: NON-ALCOHOLIC BEVERAGES, NAMELY,
FLAVORED AND UNFLAVORED WATERS, FRUIT
DRINKS, FRUIT JUICES, SOFT DRINKS, CARBO-
NATED AND NON-CARBONATED WATERS, CON-

CENTRATES AND PREPARATIONS FOR THE
MAKING OF SOFT DRINKS, FRUIT DRINKS
AND FRUIT JUICES, AND SPORTS DRINKS, IN
CLASS 32 (U.S. CLS. 45, 46 AND 48).

FIRST USE 11-30-1995; IN COMMERCE 11-30-1995.

OWNER OF U.S. REG. NOS. 2,154,152, 2,345,815
AND OTHERS.

SER. NO. 76-439,688, FILED 8-13-2002.

WON TEAK OH, EXAMINING ATTORNEY

Int. Cl.: 12

Prior U.S. Cls.: 19, 21, 23, 31, 35 and 44

United States Patent and Trademark Office

Reg. No. 2,892,489

Registered Oct. 12, 2004

**TRADEMARK
PRINCIPAL REGISTER**

SPIRIT OF AMERICA

COACHMEN RECREATIONAL VEHICLE COM-
PANY, LLC (INDIANA LTD LIAB CO)
423 NORTH MAIN STREET
MIDDLEBURY, IN 46540

FIRST USE 12-0-2001; IN COMMERCE 12-0-2001.

SER. NO. 76-440,638, FILED 8-15-2002.

FOR: TRAVEL TRAILERS, IN CLASS 12 (U.S. CLS.
19, 21, 23, 31, 35 AND 44).

WON TEAK OH, EXAMINING ATTORNEY

Int. Cls.: 9 and 28

Prior U.S. Cls.: 21, 22, 23, 26, 36, 38 and 50

United States Patent and Trademark Office

Reg. No. 2,892,490

Registered Oct. 12, 2004

**TRADEMARK
PRINCIPAL REGISTER**

REALCAM

UNIQUE DEVELOPMENT STUDIOS AB (SWEDEN CORPORATION)
VÄSTGÖTEGATAN 13
602 21 NORRKÖPING, SWEDEN

FOR: COMPUTER GAMES SOFTWARE; COMPUTER PROGRAMS FOR VIDEO GAMES; COMPUTER GAMES APPARATUS ADAPTED FOR USE WITH MONITORS AND TELEVISION RECEIVERS, NAMELY, GAME CONSOLES, IN CLASS 9 (U.S. CLS. 21, 23, 26, 36 AND 38).

FOR: HAND HELD UNITS FOR PLAYING VIDEO GAMES, IN CLASS 28 (U.S. CLS. 22, 23, 38 AND 50).

PRIORITY CLAIMED UNDER SEC. 44(D) ON ERPN CMNTY TM OFC APPLICATION NO. 002732030, FILED 11-6-2002, REG. NO. 002732030, DATED 2-10-2003, EXPIRES 11-6-2012.

SER. NO. 76-440,835, FILED 8-14-2002.

CAROLYN CATALDO, EXAMINING ATTORNEY

Int. Cls.: 9 and 41

Prior U.S. Cls.: 21, 23, 26, 36, 38, 100, 101 and 107

Reg. No. 2,892,491

United States Patent and Trademark Office

Registered Oct. 12, 2004

**TRADEMARK
SERVICE MARK
PRINCIPAL REGISTER**

NASHLABS

NASH LABORATORIES, INC. (WISCONSIN CORPORATION)
W264 N6521 HILLVIEW DRIVE
SUSSEX, WI 53089

FOR: COMPUTER SOFTWARE FOR PRODUCTION MANAGEMENT AND PROCESS ASSESSMENT, PROCESS DESIGN, METRICS DESIGN AND IMPLEMENTATION, PROCESS CONSULTING, ORGANIZATIONAL DEVELOPMENT AND DESIGN, QUANTITATIVE STATISTICAL ANALYSIS; COMPUTER SOFTWARE DEVELOPMENT TOOLS; DOWNLOADABLE COMPUTER SOFTWARE FOR ASSESSMENT SERVICES, PROCESS DESIGN, METRICS DESIGN AND IMPLEMENTATION, PROCESS CONSULTING, ORGANIZATION-

AL DEVELOPMENT AND DESIGN, AND QUANTITATIVE STATISTICAL ANALYSIS, IN CLASS 9 (U.S. CLS. 21, 23, 26, 36 AND 38).

FIRST USE 6-1-1991; IN COMMERCE 6-1-1991.

FOR: TRAINING IN THE USE OF COMPUTER SOFTWARE, IN CLASS 41 (U.S. CLS. 100, 101 AND 107).

FIRST USE 6-1-1991; IN COMMERCE 6-1-1991.

SER. NO. 76-440,989, FILED 8-16-2002.

CATHERINE FAINT, EXAMINING ATTORNEY

Int. Cls.: 9 and 41

Prior U.S. Cls.: 21, 23, 26, 36, 38, 100, 101 and 107

Reg. No. 2,892,492

United States Patent and Trademark Office

Registered Oct. 12, 2004

**TRADEMARK
SERVICE MARK
PRINCIPAL REGISTER**

NASH

NASH LABORATORIES, INC. (WISCONSIN CORPORATION)
W264 N6521 HILLVIEW DRIVE
SUSSEX, WI 53089

FOR: COMPUTER SOFTWARE FOR PRODUCTION MANAGEMENT AND PROCESS ASSESSMENT, PROCESS DESIGN, METRICS DESIGN AND IMPLEMENTATION, PROCESS CONSULTING, ORGANIZATIONAL DEVELOPMENT AND DESIGN, QUANTITATIVE STATISTICAL ANALYSIS; COMPUTER SOFTWARE DEVELOPMENT TOOLS; DOWNLOADABLE COMPUTER SOFTWARE FOR ASSESSMENT SERVICES, PROCESS DESIGN, METRICS DESIGN AND IMPLEMENTATION, PROCESS CONSULTING, ORGANIZATION-

AL DEVELOPMENT AND DESIGN, AND QUANTITATIVE STATISTICAL ANALYSIS, IN CLASS 9 (U.S. CLS. 21, 23, 26, 36 AND 38).

FIRST USE 6-1-1991; IN COMMERCE 6-1-1991.

FOR: TRAINING IN THE USE OF COMPUTER SOFTWARE, IN CLASS 41 (U.S. CLS. 100, 101 AND 107).

FIRST USE 6-1-1991; IN COMMERCE 6-1-1991.

SER. NO. 76-440,990, FILED 8-16-2002.

CATHERINE FAINT, EXAMINING ATTORNEY

Int. Cls.: 9 and 41

Prior U.S. Cls.: 21, 23, 26, 36, 38, 100, 101 and 107

United States Patent and Trademark Office

Reg. No. 2,892,493

Registered Oct. 12, 2004

**TRADEMARK
SERVICE MARK
PRINCIPAL REGISTER**

NASH LABORATORIES

NASH LABORATORIES, INC. (WISCONSIN CORPORATION)
W264 N6521 HILLVIEW DRIVE
SUSSEX, WI 53089

FOR: COMPUTER SOFTWARE FOR PRODUCTION MANAGEMENT AND PROCESS ASSESSMENT, PROCESS DESIGN, METRICS DESIGN AND IMPLEMENTATION, PROCESS CONSULTING, ORGANIZATIONAL DEVELOPMENT AND DESIGN, QUANTITATIVE STATISTICAL ANALYSIS; COMPUTER SOFTWARE DEVELOPMENT TOOLS; DOWNLOADABLE COMPUTER SOFTWARE FOR ASSESSMENT SERVICES, PROCESS DESIGN, METRICS DESIGN AND IMPLEMENTATION, PROCESS CONSULTING, ORGANIZATION-

AL DEVELOPMENT AND DESIGN, AND QUANTITATIVE STATISTICAL ANALYSIS, IN CLASS 9 (U.S. CLS. 21, 23, 26, 36 AND 38).

FIRST USE 6-1-1991; IN COMMERCE 6-1-1991.

FOR: TRAINING IN THE USE OF COMPUTER SOFTWARE, IN CLASS 41 (U.S. CLS. 100, 101 AND 107).

FIRST USE 6-1-1991; IN COMMERCE 6-1-1991.

SER. NO. 76-440,991, FILED 8-16-2002.

CATHERINE FAINT, EXAMINING ATTORNEY

Int. Cl.: 39

Prior U.S. Cls.: 100 and 105

United States Patent and Trademark Office

Reg. No. 2,892,494

Registered Oct. 12, 2004

SERVICE MARK
PRINCIPAL REGISTER



GREGORY, ROY (UNITED STATES INDIVIDUAL)
3037 INGELOW ST., UNIT 02
SAN DIEGO, CA 92106

FOR: SEDAN AND LIMOUSINE SERVICES, IN CLASS 39 (U.S. CLS. 100 AND 105).

FIRST USE 1-22-2002; IN COMMERCE 1-22-2002.

NO CLAIM IS MADE TO THE EXCLUSIVE RIGHT TO USE "AMERICAN CORPORATE SEDAN & LIMOUSINE", APART FROM THE MARK AS SHOWN.

SER. NO. 76-441,139, FILED 8-12-2002.

WILLIAM VERHOSEK, EXAMINING ATTORNEY

Int. Cls.: 9, 11, 24, 37, 41 and 42

**Prior U.S. Cls.: 13, 21, 23, 26, 31, 34, 36, 38, 42, 50,
100, 101, 103, 106 and 107**

Reg. No. 2,892,495

United States Patent and Trademark Office

Registered Oct. 12, 2004

**TRADEMARK
SERVICE MARK
PRINCIPAL REGISTER**

BHA

BHA GROUP HOLDINGS, INC. (DELAWARE CORPORATION)
8800 EAST 63RD STREET
KANSAS CITY, MO 64133

FOR: COMPUTER PROGRAMS AND REMOTE DIAGNOSTIC SYSTEMS COMPRISING SOFTWARE AND HARDWARE FOR ACQUIRING DATA, ANALYZING DATA, MONITORING, CHANGING OF SYSTEMS, AND CONTROLLING THE FUNCTIONING OF BAG HOUSE FABRIC FILTER DUST COLLECTION EQUIPMENT FOR REDUCING PARTICULATE EMISSION IN INDUSTRIAL APPLICATIONS; ELECTROSTATIC PRECIPITATORS FOR REDUCING PARTICULATE EMISSION IN INDUSTRIAL APPLICATIONS, IN CLASS 9 (U.S. CLS. 21, 23, 26, 36 AND 38).

FIRST USE 5-30-1975; IN COMMERCE 5-30-1975.

FOR: PARTS AND ENGINEERED SYSTEMS FOR INDUSTRIAL INSTALLATIONS FOR AIR POLLUTION CONTROL IN BAG HOUSES, NAMELY, AIR FILTERS, FILTER BAGS AND CARTRIDGES FOR FILTERING PARTICULATE LADEN AIR, CAGES, ACOUSTIC CLEANING HORNS, AND ACCESSORIES FOR AIR POLLUTION CONTROL BAG HOUSES, NAMELY, COLLECTORS, BLOWERS, DUCTS, BAFFLES, DOOR SEALS, CONVEYORS, DAMPERS, AIRLOCKS, TUBES, CLAMPS, GAUGES, TORSION AND CONICAL TENSIONING SPRINGS, VALVES, TUBE SHEET SEALS, EVAPORATIVE GAS CONDITIONERS, HUMIDIFIERS, WEIGHTS AND LEAK DETECTION SYSTEMS, ALL SOLD AS A UNIT AS PART OF THE AIR POLLUTION CONTROL BAG HOUSES, IN CLASS 11 (U.S. CLS. 13, 21, 23, 31 AND 34).

FIRST USE 5-30-1975; IN COMMERCE 5-30-1975.

FOR: FABRIC FOR FILTER BAGS AND CARTRIDGES FOR FILTERING PARTICULATE LADEN AIR IN INDUSTRIAL BAGHOUSES, IN CLASS 24 (U.S. CLS. 42 AND 50).

FIRST USE 5-30-1975; IN COMMERCE 5-30-1975.

FOR: INSTALLATION, REPAIR, AND MAINTENANCE OF INDUSTRIAL BAGHOUSE FABRIC FILTER DUST COLLECTION EQUIPMENT AND ELECTROSTATIC PRECIPITATORS, IN CLASS 37 (U.S. CLS. 100, 103 AND 106).

FIRST USE 5-30-1975; IN COMMERCE 5-30-1975.

FOR: TRAINING PROGRAMS AND MATERIALS, NAMELY CUSTOMER EDUCATIONAL PROGRAMS AND SEMINARS IN THE FIELD OF INDUSTRIAL BAGHOUSE FABRIC FILTER DUST COLLECTION AND ELECTROSTATIC PRECIPITATION, IN CLASS 41 (U.S. CLS. 100, 101 AND 107).

FIRST USE 5-30-1975; IN COMMERCE 5-30-1975.

FOR: ENGINEERING OF, DESIGN FOR OTHERS OF, FUNCTIONAL TESTING OF, TECHNICAL INSPECTION OF, AND DIAGNOSTIC TECHNICAL TROUBLESHOOTING OF, INDUSTRIAL BAGHOUSE FABRIC FILTER DUST COLLECTION EQUIPMENT AND ELECTROSTATIC PRECIPITATORS, IN CLASS 42 (U.S. CLS. 100 AND 101).

FIRST USE 5-30-1975; IN COMMERCE 5-30-1975.

OWNER OF U.S. REG. NOS. 1,073,465, 2,308,355 AND OTHERS.

SER. NO. 76-441,147, FILED 8-12-2002.

ALEX KEAM, EXAMINING ATTORNEY

Int. Cl.: 1

Prior U.S. Cls.: 1, 5, 6, 10, 26 and 46

Reg. No. 2,892,496

United States Patent and Trademark Office

Registered Oct. 12, 2004

**TRADEMARK
PRINCIPAL REGISTER**

SINCO

DYNAMIT NOBEL GMBH EXPLOSIVSTOFF-
UND SYSTEMTECHNIK (FED REP GERMA-
NY CORPORATION)
KAISERSTRASSE 1
TROISDORF, FED REP GERMANY D53840

FOR: CHEMICAL PRODUCTS; NAMELY, MIX-
TURES FOR GENERATING PRESSURIZED GAS IN
GAS GENERATORS FOR LIFE-SAVING SYSTEMS
SUCH AS INFLATABLE AIRBAGS AND BELT TEN-
SIONING DEVICES, IN CLASS 1 (U.S. CLS. 1, 5, 6, 10,
26 AND 46).

OWNER OF FED REP GERMANY REG. NO.
2023988, DATED 9-29-1992, RENEWED AS REG. NO.
2023988, DATED 9-30-2002, EXPIRES 9-30-2012.

OWNER OF U.S. REG. NO. 2,200,959.

SER. NO. 76-442,646, FILED 8-20-2002.

AISHA CLARKE, EXAMINING ATTORNEY

Int. Cl.: 43

Prior U.S. Cls.: 100 and 101

United States Patent and Trademark Office

Reg. No. 2,892,497

Registered Oct. 12, 2004

**SERVICE MARK
PRINCIPAL REGISTER**



YCP SALISHAN OPERATOR, INC., C/O LEND
LEASE REAL ESTATE INVESTMENTS (DELA-
WARE CORPORATION)

C/O JOSEPH THOMAS, PRES.
3424 PEACHTREE RD. NE
ATLANTA, GA 30326

FIRST USE 8-1-1965; IN COMMERCE 8-1-1965.

SER. NO. 76-443,878, FILED 8-26-2002.

FOR: HOTEL AND RESORT HOTEL SERVICES,
IN CLASS 43 (U.S. CLS. 100 AND 101).

ALICE SUE CARRUTHERS, EXAMINING ATTOR-
NEY

Int. Cl.: 35

Prior U.S. Cls.: 100, 101 and 102

United States Patent and Trademark Office

Reg. No. 2,892,498

Registered Oct. 12, 2004

**SERVICE MARK
PRINCIPAL REGISTER**

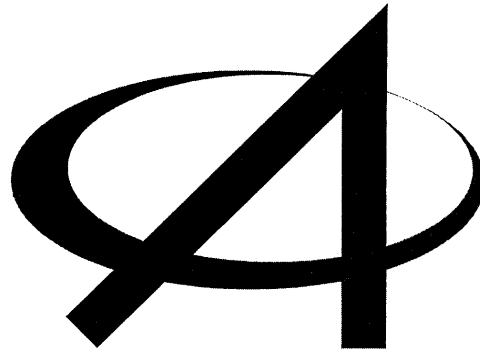

BALDEWSINGH, FRANK (NETHERLANDS IN-
DIVIDUAL)
1007 NORTH FEDERAL HIGHWAY
SUITE 235
FORT LAUDERDALE, FL 33304

FOR: WHOLESALE DISTRIBUTORSHIPS FEATURING NEW AND REFURBISHED ATM EQUIP-

MENT AND COMPONENTS THEREFORE, IN CLASS 35 (U.S. CLS. 100, 101 AND 102).

FIRST USE 12-15-1999; IN COMMERCE 12-15-1999.

SER. NO. 76-445,459, FILED 8-30-2002.

CHARLES JOYNER, EXAMINING ATTORNEY

Int. Cl.: 14

Prior U.S. Cls.: 2, 27, 28 and 50

United States Patent and Trademark Office

Reg. No. 2,892,499

Registered Oct. 12, 2004

TRADEMARK
PRINCIPAL REGISTER



"M.FREY WILLE" GMBH & CO. KG (AUSTRIA
LIMITED LIABILITY COMPANY)
GUMPENDORFER STRASSE 81
A-1060 WIEN, AUSTRIA

FOR: JEWELRY; COSTUME JEWELRY; ORNAMENTS MADE FROM PRECIOUS METALS OR COATED THEREWITH; EAR ORNAMENTS; PENDANTS; RINGS; BRACELETS; BANGLES; BROOCHES; TIE PINS; TIE CLIPS; CUFF LINKS; POWDER BOXES MADE FROM PRECIOUS METALS OR COATED THEREWITH; PILL BOXES AND BOXES AND CASES FOR ORNAMENTAL OR DECORATION PURPOSES MADE FROM PRECIOUS METALS OR COATED THEREWITH; CLOISONNE JEWELRY; NAPKIN RINGS AND EGG CUPS MADE FROM PRECIOUS METALS OR COATED THEREWITH; ASHTRAYS MADE FROM PRECIOUS METALS OR COATED THEREWITH; WATCHES; CLOCKS; CLOCK FACES; ITEMS MADE FROM PRECIOUS METALS OR PLATED WITH PRECIOUS METALS, NAMELY, AMULETS, EAR ORNAMENTS, WATCHBANDS, WATCH STRAPS, BADGES, BUTTONS, BOWLS, CUPS, PLATES, VASES, CONTAINERS FOR THE HOUSEHOLD AND KITCHEN, UTENSILS FOR SMOKING, CIGAR CASES, CIGARETTE CASES, MATCH BOXES, MATCH HOLDERS, SNUFF BOXES, SUGAR BOXES, CANDLE STICKS, SALT AND PEPPER POTS AND SHAKERS, BELT BUCKLES, AND BUCKLES AND HOOPS FOR HANDBAGS; ENAM-

ELED ITEMS, NAMELY, AMULETS, EAR ORNAMENTS, WATCHBANDS, WATCH STRAPS, AND CLOISONNE JEWELRY; AND ITEMS MADE FROM PRECIOUS METALS OR PLATED WITH PRECIOUS METALS AND CONTAINING ENAMELED DECORATIONS, NAMELY, AMULETS, EAR ORNAMENTS, RINGS, BRACELETS, BANGLES, BROOCHES, TIE PINS, TIE CLIPS, CUFF LINKS, KEY CHAINS, KEY PENDANTS, POWDER BOXES, PILL BOXES, WATCHBANDS, WATCH STRAPS, BADGES, BUTTONS, BOWLS, CUPS, PLATES, VASES, CONTAINERS FOR THE HOUSEHOLD AND KITCHEN, UTENSILS FOR SMOKING MADE OF PRECIOUS METALS, NAMELY, ASHTRAYS, CIGARETTE FILTERS AND CIGARETTE HOLDERS, CIGAR CASES, CIGARETTE CASES, MATCH BOXES, MATCH HOLDERS, SNUFF BOXES, SUGAR BOXES, CANDLE STICKS, SALT AND PEPPER POTS AND SHAKERS, BELT BUCKLES, AND BUCKLES AND HOOPS FOR HANDBAGS, IN CLASS 14 (U.S. CLS. 2, 27, 28 AND 50).

PRIORITY CLAIMED UNDER SEC. 44(D) ON AUSTRIA APPLICATION NO. AM2105/2002, FILED 3-27-2002, REG. NO. 203524, DATED 5-7-2002, EXPIRES 5-7-2012.

SER. NO. 76-445,543, FILED 8-28-2002.

ROBERT C. CLARK JR., EXAMINING ATTORNEY

Int. Cl.: 20

Prior U.S. Cls.: 2, 13, 22, 25, 32 and 50

United States Patent and Trademark Office

Reg. No. 2,892,500

Registered Oct. 12, 2004

**TRADEMARK
PRINCIPAL REGISTER**

BODY RESPONSIVE SLEEP SYSTEMS

FEDERAL FOAM TECHNOLOGIES INCORPORATED (MINNESOTA CORPORATION)
600 WISCONSIN DRIVE
NEW RICHMOND, WI 54017

FOR: PILLOWS, CUSHIONS, SEAT CUSHIONS, MATTRESSES, AND CHAIR PADS, IN CLASS 20 (U.S. CLS. 2, 13, 22, 25, 32 AND 50).

FIRST USE 4-12-2002; IN COMMERCE 4-12-2002.

NO CLAIM IS MADE TO THE EXCLUSIVE RIGHT TO USE "SLEEP SYSTEMS", APART FROM THE MARK AS SHOWN.

SER. NO. 76-445,934, FILED 9-3-2002.

JACQUELINE A. LAVINE, EXAMINING ATTORNEY

Int. Cl.: 9

Prior U.S. Cls.: 21, 23, 26, 36 and 38

United States Patent and Trademark Office

Reg. No. 2,892,501

Registered Oct. 12, 2004

**TRADEMARK
PRINCIPAL REGISTER**

CRISIS TECHNOLOGIES, INC.

CRISIS TECHNOLOGIES, INC. (NEW JERSEY
CORPORATION)
165 BORDEN ROAD
SUITE 201
MIDDLETOWN, NJ 07748

FOR: MULTIMEDIA SOFTWARE FOR EMER-
GENCY PLANNING AND MANAGEMENT OF A
FACILITY, NAMELY COMPILING INTERIOR VI-
SUALS OF THE FACILITY WITH TEXT, DIA-
GRAMS, CONTACT LISTS AND OTHER
FACILITY-RELATED INFORMATION, IN CLASS 9
(U.S. CLS. 21, 23, 26, 36 AND 38).

FIRST USE 3-0-2001; IN COMMERCE 4-0-2001.

NO CLAIM IS MADE TO THE EXCLUSIVE
RIGHT TO USE INC., APART FROM THE MARK
AS SHOWN.

SER. NO. 76-446,301, FILED 9-3-2002.

KELLEY WELLS, EXAMINING ATTORNEY

Int. Cl.: 9

Prior U.S. Cls.: 21, 23, 26, 36 and 38

United States Patent and Trademark Office

Reg. No. 2,892,502

Registered Oct. 12, 2004

TRADEMARK
PRINCIPAL REGISTER



CRISIS TECHNOLOGIES, INC. (NEW JERSEY CORPORATION)
165 BORDEN ROAD
SUITE 201
MIDDLETOWN, NJ 07748

FOR: MULTIMEDIA SOFTWARE FOR EMERGENCY PLANNING AND MANAGEMENT OF A FACILITY, NAMELY COMPILING INTERIOR VISUALS OF THE FACILITY WITH TEXT, DIAGRAMS, CONTACT LISTS AND OTHER FACILITY-RELATED INFORMATION, IN CLASS 9 (U.S. CLS. 21, 23, 26, 36 AND 38).

FIRST USE 3-0-2001; IN COMMERCE 4-0-2001.

NO CLAIM IS MADE TO THE EXCLUSIVE RIGHT TO USE INC., APART FROM THE MARK AS SHOWN.

STYLIZED "CRISIS TECHNOLOGIES INC." AND RECTANGLES DESIGN

SER. NO. 76-446,302, FILED 9-3-2002.

KELLEY WELLS, EXAMINING ATTORNEY

Int. Cl.: 35

Prior U.S. Cls.: 100, 101 and 102

United States Patent and Trademark Office

Reg. No. 2,892,503

Registered Oct. 12, 2004

**SERVICE MARK
PRINCIPAL REGISTER**

VIRTUAL EXPLOITATION & INFORMATION LEVERAGING (VEIL)

MZM, INC. (NEVADA CORPORATION)
1523 NEW HAMPSHIRE AVENUE, NW
WASHINGTON, DC 20036

FOR: BUSINESS PROCESS RE-ENGINEERING
AND BUSINESS INFORMATION MANAGEMENT
IN THE FIELD OF NATIONAL AND HOMELAND
SECURITY, IN CLASS 35 (U.S. CLS. 100, 101 AND
102).

NO CLAIM IS MADE TO THE EXCLUSIVE
RIGHT TO USE "VIRTUAL EXPLOITATION &
INFORMATION LEVERAGING", APART FROM
THE MARK AS SHOWN.

SER. NO. 76-446,623, FILED 9-4-2002.

FIRST USE 10-21-2003; IN COMMERCE 10-21-2003.

LINDA M. KING, EXAMINING ATTORNEY

Int. Cls.: 11 and 42

Prior U.S. Cls.: 13, 21, 23, 31, 34, 100 and 101

United States Patent and Trademark Office

Reg. No. 2,892,504

Registered Oct. 12, 2004

**TRADEMARK
SERVICE MARK
PRINCIPAL REGISTER**

DAGUA

DAGUA INC. (CANADA CORPORATION)
103, BOUCHARD ST., GRANBY
QUEBEC, CANADA J2G 2G9

FOR: WATER TREATMENT SYSTEMS COMPRISED OF WATER CONDITIONING UNITS, WATER FILTERS, WATER PURIFIERS, WATER PUMPS AND TANKS, HOSES AND PIPES FOR DISTRIBUTING AND DOSING WATER, AND A SYSTEM ENCLOSURE; OZONE SANITIZERS FOR WATER, IN CLASS 11 (U.S. CLS. 13, 21, 23, 31 AND 34).

FOR: ANALYSIS OF WATER FOR POTABILITY AND PURITY, IN CLASS 42 (U.S. CLS. 100 AND 101).

PRIORITY CLAIMED UNDER SEC. 44(D) ON CANADA APPLICATION NO. 1144488, FILED 6-26-2002, REG. NO. TMA604116, DATED 3-4-2004, EXPIRES 3-4-2019.

SER. NO. 76-446,991, FILED 7-29-2002.

IRA J. GOODSaid, EXAMINING ATTORNEY

Int. Cls.: 3, 5 and 35

**Prior U.S. Cls.: 1, 4, 6, 18, 44, 46, 50, 51, 52, 100, 101
and 102**

Reg. No. 2,892,505

United States Patent and Trademark Office

Registered Oct. 12, 2004

**TRADEMARK
SERVICE MARK
PRINCIPAL REGISTER**



SPIRULINA INTERNATIONAL B.V. (NETHERLANDS COMPANY)
EDISONWEG 22
HG GORINCHEM 4207, NETHERLANDS

FOR: PERFUMERY, ESSENTIAL OILS FOR PERSONAL USE, COSMETICS, HAIR LOTIONS AND DENTIFRICES, IN CLASS 3 (U.S. CLS. 1, 4, 6, 50, 51 AND 52).

FOR: PHARMACEUTICAL PREPARATIONS, NAMELY ANTI-OXIDANT SUPPLEMENTS; VETERINARY PREPARATIONS, NAMELY ANTI-OXIDANT SUPPLEMENTS; DIETETIC SUBSTANCES ADAPTED FOR MEDICAL USE; BABY FOOD; FOOD SUPPLEMENTS, IN CLASS 5 (U.S. CLS. 6, 18, 44, 46, 51 AND 52).

FOR: ADVERTISING AGENCIES; DIRECT MAIL ADVERTISING; PROVIDING STATISTICAL INFORMATION FOR BUSINESS PURPOSES; BOOKKEEP-

ING; AUCTIONEERING; COMMERCIAL INFORMATION IN THE FIELD OF HEALTH PRODUCTS; BUSINESS MARKETING CONSULTING SERVICES; MARKET RESEARCH AND MARKET ANALYSIS OPINION POLLING; SHOP WINDOW DRESSING SERVICES; BUSINESS ORGANIZATION CONSULTANCY AND BUSINESS MANAGEMENT CONSULTANCY; COPYING OF DOCUMENTS FOR OTHERS, IN CLASS 35 (U.S. CLS. 100, 101 AND 102).

OWNER OF BENELUX REG. NO. 0702248, DATED 2-25-2002, EXPIRES 2-25-2012.

MARCUS ROHRER IS A LIVING INDIVIDUAL WHOSE CONSENT IS OF RECORD.

SER. NO. 76-447,362, FILED 9-6-2002.

SHAUNIA WALLACE, EXAMINING ATTORNEY

Int. Cl.: 41

Prior U.S. Cls.: 100, 101 and 107

United States Patent and Trademark Office

Reg. No. 2,892,506

Registered Oct. 12, 2004

SERVICE MARK
PRINCIPAL REGISTER



BUIRSKI, NANCY (UNITED STATES INDIVIDUAL)
2616 AUGUSTA DRIVE
DURHAM, NC 27707

FOR: ENTERTAINMENT AND EDUCATION SERVICES, NAMELY, CONDUCTING ENTERTAINMENT EXHIBITIONS IN THE NATURE OF DOCUMENTARY FILM FESTIVALS; SPECIAL EVENT PLANNING, NAMELY FILM FESTIVALS; EDUCATIONAL SERVICES, NAMELY, CONDUCTING CLASSES, SEMINARS, CONFERENCES, WORKSHOPS IN A VARIETY OF DISCIPLINES USING DOCUMENTARY FILM TO ILLUSTRATE AND/OR

SUPPORT THE DISCUSSION, IN CLASS 41 (U.S. CLS. 100, 101 AND 107).

FIRST USE 4-4-2002; IN COMMERCE 4-4-2002.

NO CLAIM IS MADE TO THE EXCLUSIVE RIGHT TO USE "DOCUMENTARY FILM FESTIVAL", APART FROM THE MARK AS SHOWN.

THE STIPPLING IS A FEATURE OF THE MARK.

SER. NO. 76-448,043, FILED 9-9-2002.

DAWN FELDMAN, EXAMINING ATTORNEY

Int. Cl.: 8

Prior U.S. Cls.: 23, 28 and 44

United States Patent and Trademark Office

Reg. No. 2,892,507

Registered Oct. 12, 2004

**TRADEMARK
PRINCIPAL REGISTER**



CALLAWAY & KIRK COMPANY LLC (DELA-
WARE CORPORATION)
54 SEVENTH AVENUE SOUTH
NEW YORK, NY 11014

FIRST USE 1-1-2003; IN COMMERCE 1-1-2003.

SER. NO. 76-448,311, FILED 9-10-2002.

FOR: GARDEN TOOLS, NAMELY HOES, RAKES
AND TROWELS, IN CLASS 8 (U.S. CLS. 23, 28 AND
44).

HELEN BRYAN, EXAMINING ATTORNEY

Int. Cl.: 2

Prior U.S. Cls.: 6, 11 and 16

United States Patent and Trademark Office

Reg. No. 2,892,508

Registered Oct. 12, 2004

**TRADEMARK
PRINCIPAL REGISTER**

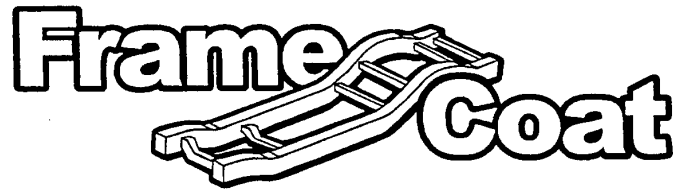

PPG INDUSTRIES OHIO, INC. (DELAWARE CORPORATION)
3800 WEST 143RD STREET
CLEVELAND, OH 44111

FOR: COATING COMPOSITIONS IN THE NATURE OF PAINT FOR AUTOMOTIVE AND INDUSTRIAL APPLICATIONS, IN CLASS 2 (U.S. CLS. 6, 11 AND 16).

FIRST USE 9-1-1999; IN COMMERCE 9-1-1999.

NO CLAIM IS MADE TO THE EXCLUSIVE RIGHT TO USE "FRAME COAT", APART FROM THE MARK AS SHOWN.

SER. NO. 76-448,344, FILED 9-10-2002.

MICHAEL SOUDERS, EXAMINING ATTORNEY

Int. Cl.: 37

Prior U.S. Cls.: 100, 103 and 106

United States Patent and Trademark Office

Reg. No. 2,892,509

Registered Oct. 12, 2004

**SERVICE MARK
PRINCIPAL REGISTER**

DOS VIENTOS RANCH

MILLER BROTHERS INVESTMENT, LLC (CALIFORNIA LTD LIAB CO)
4232-8 LAS VIRGENES ROAD, NO. 101
CALABASAS, CA 91302

THE FOREIGN WORDING IN THE MARK
TRANSLATES INTO ENGLISH AS TWO WINDS
RANCH.

FOR: HOUSING PLANNING SERVICES, NAME-
LY, PLANNING AND LAYING OUT OF RESIDEN-
TIAL COMMUNITIES, IN CLASS 37 (U.S. CLS. 100,
103 AND 106).

SER. NO. 76-449,795, FILED 9-10-2002.

FIRST USE 4-15-1995; IN COMMERCE 4-15-1995.

BRIAN NEVILLE, EXAMINING ATTORNEY

Int. Cl.: 9

Prior U.S. Cls.: 21, 23, 26, 36 and 38

United States Patent and Trademark Office

Reg. No. 2,892,510

Registered Oct. 12, 2004

**TRADEMARK
PRINCIPAL REGISTER**

MEMORYFRAME

PACIFIC DIGITAL CORPORATION (CALIFORNIA CORPORATION)
2052 ALTON PARKWAY
IRVINE, CA 92606

FOR: DIGITAL VIEWING SCREEN ADAPTED TO BE ELECTRONICALLY INTERFACED WITH A PERSONAL COMPUTER OR A DIGITAL CAMERA FROM WHICH PHOTOGRAPHIC IMAGES ARE

DOWNLOADED FOR PURPOSES OF DISPLAY, IN CLASS 9 (U.S. CLS. 21, 23, 26, 36 AND 38).

FIRST USE 12-14-2002; IN COMMERCE 12-15-2002.

SER. NO. 76-450,163, FILED 9-16-2002.

LESLEY LAMOTHE, EXAMINING ATTORNEY

Int. Cl.: 32

Prior U.S. Cls.: 45, 46 and 48

United States Patent and Trademark Office

Reg. No. 2,892,511

Registered Oct. 12, 2004

TRADEMARK
PRINCIPAL REGISTER



ECUABEVERAGE CORP. (NEW YORK CORPORATION)
541 BARRETO STREET
BRONX, NY 10474

FOR: SODA, NAMELY, CARBONATED SOFT DRINKS, IN CLASS 32 (U.S. CLS. 45, 46 AND 48).

FIRST USE 7-0-1990; IN COMMERCE 7-0-1990.

NO CLAIM IS MADE TO THE EXCLUSIVE RIGHT TO USE "PRODUCTO ORIGINAL ECUATORIANO, PURO SABOR ECUATORIANO" AND

"SODA DE FRESA", APART FROM THE MARK AS SHOWN.

THE ENGLISH TRANSLATION OF "PRODUCTO ORIGINAL ECUATORIANO, TOME, PURO SABOR ECUATORIANO, SODA DE FRESA" IS "ORIGINAL ECUATORIAN PRODUCT, TAKE, PURE ECUATORIAN FLAVOR, STRAWBERRY SODA"

SER. NO. 76-450,190, FILED 9-17-2002.

BRENDAN MCCAULEY, EXAMINING ATTORNEY

Int. Cl.: 14

Prior U.S. Cls.: 2, 27, 28 and 50

United States Patent and Trademark Office

Reg. No. 2,892,512

Registered Oct. 12, 2004

**TRADEMARK
PRINCIPAL REGISTER**

PRINCESS C

COLUMBIA GEM HOUSE, INC./ TRIGEM DE-
SIGNS (WASHINGTON CORPORATION)
P.O. BOX 820889
VANCOUVER, WA 986820020

NO CLAIM IS MADE TO THE EXCLUSIVE
RIGHT TO USE "PRINCESS", APART FROM THE
MARK AS SHOWN.

FOR: GOLD AND SILVER JEWELRY USING
GEMSTONES, IN CLASS 14 (U.S. CLS. 2, 27, 28 AND
50).

SER. NO. 76-450,374, FILED 9-17-2002.

FIRST USE 7-0-2002; IN COMMERCE 7-0-2002.

SCOTT OSCLICK, EXAMINING ATTORNEY

Int. Cl.: 7

Prior U.S. Cls.: 13, 19, 21, 23, 31, 34 and 35

United States Patent and Trademark Office

Reg. No. 2,892,513

Registered Oct. 12, 2004

**TRADEMARK
PRINCIPAL REGISTER**

TRUE BLUE

DICAR, INC. (NEW JERSEY CORPORATION)
10 BLOOMFIELD AVENUE
PINE BROOK, NJ 07058

BOX MATERIALS AND THE LIKE , IN CLASS 7
(U.S. CLS. 13, 19, 21, 23, 31, 34 AND 35).

FIRST USE 12-1-2001; IN COMMERCE 12-1-2001.

FOR: MACHINE PARTS NAMELY REPLACE-
ABLE ANVIL BLANKETS FOR ROTARY DIE CUT-
TING MACHINES USED FOR CUTTING AND
CREASING OF CORRUGATED PAPER BOARD,

SER. NO. 76-450,527, FILED 9-12-2002.

BRIAN NEVILLE, EXAMINING ATTORNEY

Int. Cl.: 10

Prior U.S. Cls.: 26, 39 and 44

United States Patent and Trademark Office

Reg. No. 2,892,514

Registered Oct. 12, 2004

**TRADEMARK
PRINCIPAL REGISTER**

TOP NEOPOLE NEEDLE

KABUSHIKI KAISHA TOP (JAPAN CORPORATION)
19-10, SENJUNAKAI-CHO
ADACHI-KU, TOKYO, JAPAN

FOR: NEEDLES FOR USE IN SURGERY; NEEDLES FOR THERAPEUTIC PROCEDURES; NEEDLES FOR ANAESTHETIC PROCEDURES; INJECTION NEEDLES FOR NERVE BLOCK; OTHER NEEDLES FOR MEDICAL PURPOSE, IN CLASS 10 (U.S. CLS. 26, 39 AND 44).

PRIORITY CLAIMED UNDER SEC. 44(D) ON JAPAN APPLICATION NO. 2002-054284, FILED 6-28-2002, REG. NO. 4662665, DATED 4-11-2003, EXPIRES 4-11-2013.

NO CLAIM IS MADE TO THE EXCLUSIVE RIGHT TO USE "NEEDLE", APART FROM THE MARK AS SHOWN.

SER. NO. 76-450,544, FILED 9-12-2002.

BARNEY CHARLON, EXAMINING ATTORNEY

Int. Cl.: 10

Prior U.S. Cls.: 26, 39 and 44

United States Patent and Trademark Office

Reg. No. 2,892,515

Registered Oct. 12, 2004

**TRADEMARK
PRINCIPAL REGISTER**

TOP NEUPOLE NEEDLE

KABUSHIKI KAISHA TOP (JAPAN CORPORATION)
19-10, SENJUNAKAI-CHO
ADACHI-KU, TOKYO, JAPAN

FOR: NEEDLES FOR USE IN SURGERY; NEEDLES FOR THERAPEUTIC PROCEDURES; NEEDLES FOR ANAESTHETIC PROCEDURES; INJECTION NEEDLES FOR NERVE BLOCK; OTHER NEEDLES FOR MEDICAL PURPOSE, IN CLASS 10 (U.S. CLS. 26, 39 AND 44).

PRIORITY CLAIMED UNDER SEC. 44(D) ON JAPAN APPLICATION NO. 2002-54281, FILED 6-28-2002, REG. NO. 4662664, DATED 4-11-2003, EXPIRES 4-11-2013.

NO CLAIM IS MADE TO THE EXCLUSIVE RIGHT TO USE "NEEDLE", APART FROM THE MARK AS SHOWN.

SER. NO. 76-450,546, FILED 9-12-2002.

BARNEY CHARLON, EXAMINING ATTORNEY

Int. Cl.: 9

Prior U.S. Cls.: 21, 23, 26, 36 and 38

United States Patent and Trademark Office

Reg. No. 2,892,516

Registered Oct. 12, 2004

**TRADEMARK
PRINCIPAL REGISTER**

DIPPF

MITSUBISHI ELECTRIC CORPORATION (JAPAN
CORPORATION)
2-3, MARUNOUCHI 2-CHOME
CHIYODA-KU, TOKYO, JAPAN

FOR: SEMICONDUCTORS, IN CLASS 9 (U.S. CLS.
21, 23, 26, 36 AND 38).

PRIORITY CLAIMED UNDER SEC. 44(D) ON
JAPAN APPLICATION NO. 2002-072783, FILED 8-27-
2002, REG. NO. 4668971, DATED 5-2-2003, EXPIRES 5-
2-2013.

SER. NO. 76-450,770, FILED 9-18-2002.

JAMES A. RAUEN, EXAMINING ATTORNEY

Prior U.S. Cl.: B

United States Patent and Trademark Office

Reg. No. 2,892,517

Registered Oct. 12, 2004

**CERTIFICATION MARK
PRINCIPAL REGISTER**

CPI

TRAINING AND EDUCATIONAL SERVICES,
INC. (MISSOURI CORPORATION)
7007 COLLEGE BLVD.
SUITE 250
OVERLAND PARK, KS 66211

FOR: CERTIFICATION OF SPECIFIED LEVEL OF
TRAINING, EDUCATION AND EXPERIENCE AS A
CERTIFIED POST-SECONDARY INSTRUCTOR, IN
CLASS B (U.S. CL. B).

FIRST USE 9-1-2002; IN COMMERCE 9-1-2002.

THE CERTIFICATION MARK, CPI, AS USED BY
AUTHORIZED PERSONS, CERTIFIES THAT INDI-
VIDUALS MEET APPLICANT'S SPECIFIC LEVEL
OF TRAINING, EDUCATION AND EXPERIENCE
AS A CERTIFIED POST-SECONDARY INSTRU-
CTOR.

SER. NO. 76-451,195, FILED 9-19-2002.

WILLIAM VERHOSEK, EXAMINING ATTORNEY

Int. Cl.: 37

Prior U.S. Cls.: 100, 103 and 106

United States Patent and Trademark Office

Reg. No. 2,892,518

Registered Oct. 12, 2004

SERVICE MARK
PRINCIPAL REGISTER



SERVICE EXPRESS OKLAHOMA LLC (OKLAHOMA LTD LIAB CO)
10610 EAST UTE
TULSA, OK 74116

FOR: VEHICLE LUBRICATION SERVICE, IN CLASS 37 (U.S. CLS. 100, 103 AND 106).

FIRST USE 1-1-2002; IN COMMERCE 1-1-2002.

NO CLAIM IS MADE TO THE EXCLUSIVE RIGHT TO USE "ON SITE LUBE MOBILE OIL CHANGE SERVICE", APART FROM THE MARK AS SHOWN.

SER. NO. 76-451,202, FILED 9-17-2002.

LOURDES AYALA, EXAMINING ATTORNEY

Int. Cl.: 9

Prior U.S. Cls.: 21, 23, 26, 36 and 38

Reg. No. 2,892,519

United States Patent and Trademark Office

Registered Oct. 12, 2004

**TRADEMARK
PRINCIPAL REGISTER**

MITHRYL

ESSILOR INTERNATIONAL (COMPAGNIE GENERALE D'OPTIQUE) (FRANCE SOCIETE ANONYME)
147, RUE DE PARIS
94220 CHARENTON LE PONT, FRANCE

FOR: OPHTHALMIC LENSES; SPECTACLE LENSES; SPECTACLE LENSES OF PLASTICS MATERIAL; CORRECTIVE SPECTACLE LENSES; PROGRESSIVE SPECTACLE LENSES; SUNGLASS LENSES; TINTED SPECTACLE LENSES; TREATED SPECTACLE LENSES; COATED SPECTACLE LENSES; ANTI-REFLECTIVE SPECTACLE LENSES;

CASES FOR ALL THE AFORESAID GOODS, IN CLASS 9 (U.S. CLS. 21, 23, 26, 36 AND 38).

PRIORITY CLAIMED UNDER SEC. 44(D) ON FRANCE APPLICATION NO. 02/3155026, FILED 3-21-2002, REG. NO. 02/3155026, DATED 3-21-2002, EXPIRES 3-21-2012.

SER. NO. 76-451,364, FILED 9-17-2002.

BRENDAN REGAN, EXAMINING ATTORNEY

Int. Cls.: 9 and 16

Prior U.S. Cls.: 2, 5, 21, 22, 23, 26, 29, 36, 37, 38 and 50

Reg. No. 2,892,520

United States Patent and Trademark Office

Registered Oct. 12, 2004

**TRADEMARK
PRINCIPAL REGISTER**

DMM

UNITED STATES POSTAL SERVICE (UNITED STATES INDEPENDENT ESTABLISHMENT OF THE EXECUTIVE BRANCH OF THE GOVERNMENT)
KAREN ESTILO OWCZARSKI
475 L'ENFANT PLAZA W, SW., ROOM 6503
WASHINGTON, DC 202601135

FOR: ONLINE DOWNLOADABLE SOFTWARE, NAMELY DOWNLOADABLE ELECTRONIC PUBLICATIONS IN THE NATURE OF INSTRUCTION MANUALS IN THE FIELD OF MAIL AND DELIVERY SERVICES, IN CLASS 9 (U.S. CLS. 21, 23, 26, 36 AND 38).

FIRST USE 10-0-1997; IN COMMERCE 10-0-1997.

FOR: SERIES OF PUBLICATIONS, NAMELY, INSTRUCTION MANUALS AND GUIDEBOOKS IN THE FIELD OF MAILING AND DELIVERY SERVICES, IN CLASS 16 (U.S. CLS. 2, 5, 22, 23, 29, 37, 38 AND 50).

FIRST USE 7-30-1979; IN COMMERCE 7-30-1979.

SER. NO. 76-452,653, FILED 9-17-2002.

JEFFERY COWARD, EXAMINING ATTORNEY

Int. Cl.: 25

Prior U.S. Cls.: 22 and 39

United States Patent and Trademark Office

Reg. No. 2,892,521

Registered Oct. 12, 2004

**TRADEMARK
PRINCIPAL REGISTER**

ELSIE MASSEY

LA MASTRA, SOROYA (UNITED STATES INDIVIDUAL)
401 RADIO ROAD #C-6
PALM SPRINGS, CA 92262

THE NAME IN THE MARK IDENTIFIES A LIVING INDIVIDUAL WHOSE CONSENT IS OF RECORD.

FOR: MASQUERADE COSTUMES AND MASKS
SOLD IN CONNECTION THEREWITH, IN CLASS 25
(U.S. CLS. 22 AND 39).

SER. NO. 76-454,321, FILED 9-26-2002.

FIRST USE 3-1-1994; IN COMMERCE 3-1-1994.

BILL DAWE, EXAMINING ATTORNEY

Int. Cl.: 41

Prior U.S. Cls.: 100, 101 and 107

Reg. No. 2,892,522

United States Patent and Trademark Office

Registered Oct. 12, 2004

SERVICE MARK
PRINCIPAL REGISTER



AMERICAN PUBLIC UNIVERSITY SYSTEM,
INC. (WEST VIRGINIA CORPORATION)
322 WASHINGTON STREET
CHARLES TOWN, WV 25414

FOR: EDUCATIONAL SERVICES, NAMELY,
PROVIDING INSTRUCTION AND TRAINING AT
THE UNDERGRADUATE AND GRADUATE LE-
VELS IN A VARIETY OF ACADEMIC SUBJECTS
AND DISCIPLINES VIA A GLOBAL COMPUTER
NETWORK, IN CLASS 41 (U.S. CLS. 100, 101 AND
107).

FIRST USE 6-17-2002; IN COMMERCE 6-17-2002.

NO CLAIM IS MADE TO THE EXCLUSIVE
RIGHT TO USE "AMERICAN COMMUNITY COL-
LEGE OF THE AMERICAN PUBLIC UNIVERSITY
SYSTEM", APART FROM THE MARK AS SHOWN.

THE MARK CONSISTS OF THE WORDS "AMER-
ICAN COMMUNITY COLLEGE" PUNCTUATED BY
STARS, IN A SEMI-CIRCLE ABOVE THE STATUE
OF LIBERTY, OVER A BANNER WITH THE WORD
"OF THE" AND "AMERICAN PUBLIC UNIVERSITY
SYSTEM".

SER. NO. 76-454,777, FILED 9-26-2002.

BRIAN PINO, EXAMINING ATTORNEY

Int. Cl.: 9

Prior U.S. Cls.: 21, 23, 26, 36 and 38

Reg. No. 2,892,523

United States Patent and Trademark Office

Registered Oct. 12, 2004

**TRADEMARK
PRINCIPAL REGISTER**

UTILICOR

TENNERGY PARTNERS, LLC (TENNESSEE LTD
LIAB CO)
119 EAST COLLEGE STREET
JACKSON, TN 38301

FOR: ELECTRICAL AND COMMUNICATION
PRODUCTS FOR THE ELECTRIC UTILITY AND
TELECOMMUNICATIONS INDUSTRIES, NAME-
LY, TRANSFORMERS, TRANSFORMER CLUSTER
MOUNTS, HEAVY-DUTY SWITCH PARTS,
CLAMPS, INSULATORS, CABLE CONNECTORS,
COPPER TELECOMMUNICATIONS WIRE AND

CABLE, METERS, CROSS ARM BRACES, CONDUCTOR WIRE, OVERHEAD CONDUCTORS, UNDERGROUND CONDUCTORS, FIBER OPTICS AND SIMILAR TOOLS TO BUILD ELECTRICAL POWER LINES, IN CLASS 9 (U.S. CLS. 21, 23, 26, 36 AND 38).

FIRST USE 6-3-2002; IN COMMERCE 6-3-2002.

SER. NO. 76-455,927, FILED 10-4-2002.

JILL C. ALT, EXAMINING ATTORNEY

Int. Cls.: 9 and 38

Prior U.S. Cls.: 21, 23, 26, 36, 38, 100, 101 and 104

Reg. No. 2,892,524

United States Patent and Trademark Office

Registered Oct. 12, 2004

**TRADEMARK
SERVICE MARK
PRINCIPAL REGISTER**

STELEUS

STELEUS SA (FRANCE CORPORATION)
IMMEUBLE LE MELTEM 2 ALLE DES SEQUOIAS
LIMONEST, FRANCE 69760

FOR: COMPUTER SOFTWARE FOR MEASURING AND MONITORING TELEPHONE AND DATA TRANSMISSION TRAFFIC FOR USE IN THE TELECOMMUNICATIONS AND COMMUNICATIONS INDUSTRY; COMPUTER SOFTWARE SERVERS FOR USE IN THE TELECOMMUNICATIONS AND COMMUNICATIONS INDUSTRY; COMMUNICATION AND TELECOMMUNICATION DEVICES AND INTERFACES, NAMELY COMPUTER NETWORK HUBS, SWITCHES, ROUTERS AND MODEMS; MEMORY CARDS, IN CLASS 9 (U.S. CLS. 21, 23, 26, 36 AND 38).

FIRST USE 6-18-2002; IN COMMERCE 6-18-2002.

FOR: TELECOMMUNICATIONS AND DATA TRANSMISSION SERVICES, NAMELY TELEGRAPHIC COMMUNICATIONS, TELEPHONE COMMUNICATIONS, TELECOMMUNICATIONS ROUTING AND JUNCTION SERVICES, ELECTRONIC TRANSMISSION OF DATA AND DOCUMENTS VIA COMPUTER TERMINALS, PROVIDING INFORMATION IN THE FIELD OF TELECOMMUNICATIONS, THE BROADCAST OF RADIO OR TELEVISION PROGRAMS, MOBILE TELEPHONY, DELIVERY OF MESSAGES BY ELECTRONIC TRANSMISSION, TELECOMMUNICATIONS SERVICES, NAMELY, DELIVERY OF MESSAGES IN THE NATURE OF DISPATCHES BY ELECTRONIC

TRANSMISSION, TRANSMISSION OF TELEGRAMS, TRANSMISSION OF FAXES, TELEPHONE COMMUNICATION SERVICES, CABLE TELEVISION TRANSMISSION, INTERACTIVE VIDEO TELECONFERENCING, ELECTRONIC TRANSMISSION OF MESSAGES AND DATA BY MINI AND MICRO-SERVERS, BY LOCAL NETWORKS, AND BY SERVER CENTERS, ELECTRONIC STORE-AND-FORWARD MESSAGING, ELECTRONIC, ELECTRIC, AND DIGITAL TRANSMISSION OF MESSAGES AND IMAGES VIA COMPUTERS, ELECTRONIC, ELECTRIC, AND DIGITAL TRANSMISSION AND BROADCAST OF VOICE, DATA, IMAGES, SIGNALS, AND MESSAGES, TELECOMMUNICATIONS SERVICES, NAMELY, TRANSMISSION OF VOICE, DATA, AND GRAPHICS BY MEANS OF CABLE NETWORKS, AND TELECOMMUNICATION SERVICES, NAMELY, LOCAL AND LONG-DISTANCE TELEPHONE CALL SERVICES; TELECOMMUNICATIONS CONSULTATION SERVICES, IN CLASS 38 (U.S. CLS. 100, 101 AND 104).

FIRST USE 6-18-2002; IN COMMERCE 6-18-2002.

PRIORITY CLAIMED UNDER SEC. 44(D) ON FRANCE APPLICATION NO. 023162337, FILED 4-30-2002, REG. NO. 023162337, DATED 4-30-2002, EXPIRES 4-30-2012.

SER. NO. 76-456,140, FILED 10-1-2002.

GINA FINK, EXAMINING ATTORNEY

Int. Cl.: 38

Prior U.S. Cls.: 100, 101 and 104

United States Patent and Trademark Office

Reg. No. 2,892,525

Registered Oct. 12, 2004

SERVICE MARK
PRINCIPAL REGISTER

Resound

ILEARNING, INC. (DELAWARE CORPORATION)
509 SOUTH EXETER STREET
BALTIMORE, MD 21202

FOR: TELECOMMUNICATION CONFERENCE SERVICES, NAMELY, DELIVERING LIVE AUDIO AND VIDEO TELECONFERENCING SERVICES AND ON-DEMAND AUDIO AND VIDEO TRANSMISSION SERVICES THROUGH TELECOMMUNI-

CATION AND GLOBAL COMPUTER NETWORKS, IN CLASS 38 (U.S. CLS. 100, 101 AND 104).

FIRST USE 9-16-2002; IN COMMERCE 9-16-2002.

SER. NO. 76-456,373, FILED 9-30-2002.

JEAN IM, EXAMINING ATTORNEY

Int. Cl.: 40

Prior U.S. Cls.: 100, 103 and 106

United States Patent and Trademark Office

Reg. No. 2,892,526

Registered Oct. 12, 2004

**SERVICE MARK
PRINCIPAL REGISTER**

ROSSI

AMADEO ROSSI S.A. METALURGICA E. MUNI-
COES (BRAZIL CORPORATION)
RUA AMADEO ROSSI 143
CAIXA POSTAL 28
93030 SAO LEOPOLDO, RS, BRAZIL

FOR: MANUFACTURING OF GUNS, REVOL-
VERS, RIFLES, SHOTGUNS, AIR RIFLES AND
CARBINES TO THE ORDER AND/OR SPECIFICA-
TION OF OTHERS, IN CLASS 40 (U.S. CLS. 100, 103
AND 106).

FIRST USE 12-20-1960; IN COMMERCE 12-20-1960.

OWNER OF U.S. REG. NO. 1,729,188.

SEC. 2(F).

SER. NO. 76-456,721, FILED 10-3-2002.

CAROLYN CATALDO, EXAMINING ATTORNEY

Int. Cl.: 41

Prior U.S. Cls.: 100, 101 and 107

United States Patent and Trademark Office

Reg. No. 2,892,527

Registered Oct. 12, 2004

**SERVICE MARK
PRINCIPAL REGISTER**

GIRLS OF GRACE

GIRLS OF GRACE, INC. (TENNESSEE CORPORATION)
300 10TH AVENUE SOUTH
NASHVILLE, TN 37203

FOR: EDUCATIONAL, CULTURAL AND ENTERTAINMENT SERVICES, NAMELY, ARRANGING AND CONDUCTING CONFERENCES, WORKSHOPS, CLASSES AND SEMINARS IN THE FIELDS OF RELIGION, ETHICS, SPIRITUALITY, AND PERSONAL HEALTH AND WELL-BEING, IN CLASS 41 (U.S. CLS. 100, 101 AND 107).

FIRST USE 4-24-2002; IN COMMERCE 4-24-2002.

NO CLAIM IS MADE TO THE EXCLUSIVE RIGHT TO USE "GIRLS", APART FROM THE MARK AS SHOWN.

SER. NO. 76-458,146, FILED 10-7-2002.

ALICIA COLLINS, EXAMINING ATTORNEY

Int. Cl.: 9

Prior U.S. Cls.: 21, 23, 26, 36 and 38

Reg. No. 2,892,528

United States Patent and Trademark Office

Registered Oct. 12, 2004

**TRADEMARK
PRINCIPAL REGISTER**



OmniPAD

FAR EAST MACHINERY CO., LTD. (TAIWAN
CORPORATION)
CHUNG HSIAO ROAD
CHIAYI, TAIWAN

FIRST USE 1-2-2002; IN COMMERCE 1-2-2002.

SER. NO. 76-458,280, FILED 10-15-2002.

FOR: HANDHELD PORTABLE COMPUTERS, IN
CLASS 9 (U.S. CLS. 21, 23, 26, 36 AND 38).

MELVIN AXILBUND, EXAMINING ATTORNEY

Int. Cl.: 28

Prior U.S. Cls.: 22, 23, 38 and 50

United States Patent and Trademark Office

Reg. No. 2,892,529

Registered Oct. 12, 2004

**TRADEMARK
PRINCIPAL REGISTER**

SURFLIFE

SURFLIFE, LLC (DELAWARE LTD LIAB CO)
408 MARINE AVENUE
MANHATTAN BEACH, CA 90266

NO CLAIM IS MADE TO THE EXCLUSIVE
RIGHT TO USE "SURF", APART FROM THE MARK
AS SHOWN.

FOR: SURFBOARDS THAT ARE USED IN THE
SPORT OF SURFING, IN CLASS 28 (U.S. CLS. 22, 23,
38 AND 50).

SER. NO. 76-458,353, FILED 10-8-2002.

FIRST USE 12-7-2000; IN COMMERCE 12-7-2000.

SHAUNIA WALLACE, EXAMINING ATTORNEY

Int. Cls.: 9 and 42

Prior U.S. Cls.: 21, 23, 26, 36, 38, 100 and 101

United States Patent and Trademark Office

Reg. No. 2,892,530

Registered Oct. 12, 2004

**TRADEMARK
SERVICE MARK
PRINCIPAL REGISTER**

VENATOR

QINETIQ LIMITED (UNITED KINGDOM CORPORATION)
CODY TECHNOLOGY PARK
A4 BLDG, ROOM G016, IVELY ROAD
FARNBOROUGH, HAMPSHIRE GU14 0LX, UNITED KINGDOM

FOR: DATA PROCESSING EQUIPMENT, NAME-
LY, PERSONAL COMPUTERS, SERVERS, AND
MONITORS; COMPUTER SOFTWARE USED FOR
DATA ANALYSIS AND DATA COMPARISON;
COMPUTER SOFTWARE FOR DATABASE MAN-
AGEMENT IN THE FIELDS OF MODELLING AND
SIMULATION AND MAPPING AND SURVEYING;
MEASURING, SURVEYING, CHECKING APPARA-
TUS AND INSTRUMENTS, NAMELY, IMAGE GEN-
ERATORS, COMPUTER GENERATED FORCES,
AND CONSTRUCTIVE SIMULATORS; APPARA-
TUS, NAMELY, TERRAIN DATABASE GENERA-

TION SYSTEMS FOR RECORDING,
TRANSMISSION OR REPRODUCTION OF IMAGES,
IN CLASS 9 (U.S. CLS. 21, 23, 26, 36 AND 38).

FOR: VALIDATION AND VERIFICATION OF
SPATIAL INFORMATION STORED ON A DATA-
BASE; MAPPING AND SURVEYING SERVICES, IN
CLASS 42 (U.S. CLS. 100 AND 101).

PRIORITY CLAIMED UNDER SEC. 44(D) ON
ERPNTY TM OFC APPLICATION NO.
002667145, FILED 4-24-2002, REG. NO. 2667145, DA-
TED 6-20-2003, EXPIRES 4-24-2012.

SER. NO. 76-458,357, FILED 10-8-2002.

KEVON CHISOLM, EXAMINING ATTORNEY

Int. Cl.: 5

Prior U.S. Cls.: 6, 18, 44, 46, 51 and 52

Reg. No. 2,892,531

United States Patent and Trademark Office

Registered Oct. 12, 2004

**TRADEMARK
PRINCIPAL REGISTER**

STERILEX

STERILEX CORPORATION, THE (MARYLAND CORPORATION)
11409 CRONHILL DRIVE, SUITE L
OWINGS MILLS, MD 21117

FOR: BIOCIDAL, ALGAECIDE, DISINFECTANT, SANITIZING, STERILIZING AND MILDEWSTATIC PREPARATIONS FOR HUMAN HEALTH CARE, ANIMAL HEALTH CARE, DENTAL CARE, HOUSEHOLD, INSTITUTIONAL INDUSTRIAL, WATER TREATMENT, FOOD PROCESSING, BEVERAGE PROCESSING, BOTTLING AND PACKAGING, AGRICULTURAL AND FARM PREMISES, LABORATORY, HORTICULTURAL, WOOD TREAT-

MENT AND PRESERVATION, BUILDINGS AND CONSTRUCTION MATERIALS USE, IN CLASS 5 (U.S. CLS. 6, 18, 44, 46, 51 AND 52).

FIRST USE 8-18-1999; IN COMMERCE 8-18-1999.

OWNER OF U.S. REG. NO. 1,813,311.

SER. NO. 76-458,360, FILED 10-8-2002.

JULIA HARDY COFIELD, EXAMINING ATTORNEY

Int. Cl.: 16

Prior U.S. Cls.: 2, 5, 22, 23, 29, 37, 38 and 50

Reg. No. 2,892,532

United States Patent and Trademark Office

Registered Oct. 12, 2004

**TRADEMARK
PRINCIPAL REGISTER**

SPARKLE POPS

TRANSGLOBAL COMMUNICATIONS GROUP
INC. (CANADA CORPORATION)
17971-106A AVENUE
EDMONTON ALBERTA, CANADA T5S 1V8

2002, REG. NO. TMA603732, DATED 3-2-2004, EX-
PIRES 3-2-2019.

FOR: BOOKS, NAMELY CHILDREN'S POP UP
BOOKS CONTAINING EITHER GLITTER OR FOIL
OR HOLOGRAPHIC FOIL, IN CLASS 16 (U.S. CLS. 2,
5, 22, 23, 29, 37, 38 AND 50).

NO CLAIM IS MADE TO THE EXCLUSIVE
RIGHT TO USE "SPARKLE", APART FROM THE
MARK AS SHOWN.

SER. NO. 76-458,670, FILED 10-10-2002.

PRIORITY CLAIMED UNDER SEC. 44(D) ON
CANADA APPLICATION NO. 1137244, FILED 4-12-

JENNIFER DIXON, EXAMINING ATTORNEY

Int. Cl.: 25

Prior U.S. Cls.: 22 and 39

United States Patent and Trademark Office

Reg. No. 2,892,533

Registered Oct. 12, 2004

TRADEMARK
PRINCIPAL REGISTER



TERELLE ANDRE COLEY (PARTNERSHIP)
113-C BRANFORD AVE.
FAYETTEVILLE, NC 28301 AND
ANTALAN WALKER (PARTNERSHIP)
113-C BRANFORD AVE.
FAYETTEVILLE, NC 28301

FOR: BELTS BUCKLES BELTS BLUE JEANS
BOXERS BUTTONS CAPS CLOTHING PATCHES
CLOTHING BUCKLES CLOTHING HOOKS (FAS-
TENERS) DRESSES DRESS SHIRTS EMBROI-

DERED PATCHES HEADBANDS JERSEYS
LINGERIE PANTS PANT SUITS SCARVES SHORTS
SHORTS SETS SKIRTS SOCKS SWIN WEAR TIES
TEE-SHIRTS TOPS WRISTBANDS, IN CLASS 25 (U.S.
CLS. 22 AND 39).

FIRST USE 7-10-2002; IN COMMERCE 9-14-2002.

SER. NO. 76-459,190, FILED 10-18-2002.

SCOTT OSCLICK, EXAMINING ATTORNEY

Int. Cls.: 1, 3 and 30

Prior U.S. Cls.: 1, 4, 5, 6, 10, 26, 46, 50, 51 and 52

United States Patent and Trademark Office

Reg. No. 2,892,534

Registered Oct. 12, 2004

**TRADEMARK
PRINCIPAL REGISTER**



DAVID MICHAEL & CO., INC. (PENNSYLVANIA CORPORATION)
10801 DECATUR ROAD
PHILADELPHIA, PA 19154

FOR: FOOD STABILIZERS FOR USE IN THE MANUFACTURE OF FOOD PRODUCTS, IN CLASS 1 (U.S. CLS. 1, 5, 6, 10, 26 AND 46).

FIRST USE 10-0-1993; IN COMMERCE 10-0-1993.

FOR: FOOD FLAVORINGS, BEING ESSENTIAL OILS, IN CLASS 3 (U.S. CLS. 1, 4, 6, 50, 51 AND 52).

FIRST USE 10-0-1993; IN COMMERCE 10-0-1993.

FOR: FOOD FLAVORINGS, BEING NON-ESSENTIAL OILS, IN CLASS 30 (U.S. CL. 46).

FIRST USE 10-0-1993; IN COMMERCE 10-0-1993.

OWNER OF U.S. REG. NOS. 1,740,768 AND 1,999,721.

THE STIPPLING IS FOR SHADING PURPOSES.

SER. NO. 76-459,323, FILED 10-21-2002.

LESLIE RICHARDS, EXAMINING ATTORNEY

Int. Cl.: 21

Prior U.S. Cls.: 2, 13, 23, 29, 30, 33, 40 and 50

United States Patent and Trademark Office

Reg. No. 2,892,535

Registered Oct. 12, 2004

**TRADEMARK
PRINCIPAL REGISTER**

GOOD TO GO

YNR MARKETING LLC (DELAWARE LTD LIAB
CO)
P.O. BOX 7735
LAGUNA NIGUEL, CA 92607

FIRST USE 10-1-2002; IN COMMERCE 10-3-2002.

SER. NO. 76-459,681, FILED 10-21-2002.

FOR: PLASTIC WATER BOTTLES, SOLD EMPTY
WITH FILTERS IN THE CAPS, IN CLASS 21 (U.S.
CLS. 2, 13, 23, 29, 30, 33, 40 AND 50).

JEFF DEFORD, EXAMINING ATTORNEY

Int. Cl.: 9

Prior U.S. Cls.: 21, 23, 26, 36 and 38

Reg. No. 2,892,536

United States Patent and Trademark Office

Registered Oct. 12, 2004

**TRADEMARK
PRINCIPAL REGISTER**

R 100

VOLKSWAGEN AKTIENGESELLSCHAFT (FED
REP GERMANY CORPORATION)
BRIEFFACH 1770
D-38436 WOLFSBURG, FED REP GERMANY

FOR: ELECTRIC THEFT PREVENTION APPARATUS, NAMELY, ALARMS, NAMELY, BURGLAR ALARMS, FIRE ALARMS, ANTI-THEFT ALARMS FOR VEHICLES, REMOTE CONTROL APPARATUS, NAMELY, AUTOMATIC CONTROL MECHANISMS FOR THE STEERING AND CONTROL OF VEHICLES AND ENGINES, SIMULATORS FOR THE STEERING AND CONTROL OF VEHICLES, IN THE NATURE OF, AIRPLANE FLIGHT SIMULATORS; AUTOMOBILE DRIVING SIMULATORS, REMOTE CONTROLS USED FOR, THE REMOTE OPERATION OF A MOTOR VEHICLE; ELECTRIC NAVIGATIONAL INSTRUMENTS, NAMELY, COMPASSES, NAMELY DIRECTIONAL COMPASSES, NAVIGATIONAL INSTRUMENTS, NAMELY, SEXTANTS, COMPASSES, NAVIGATIONAL BUOYS, MARKER BUOYS, SAFETY MARKERS, APPARATUS FOR RECORDING, TRANSMISSION OR REPRODUCTION OF SOUND OR IMAGES, NAMELY, ANTENNAS, RADIOS, TELEVISION APPARATUS, NAMELY, TELEVISION SETS, TELEVISION ANTENNAS, TELEPHONE APPARATUS, NAMELY VIDEO TELEPHONES, MAGNETIC, ELECTRONIC AND OPTICAL DATA CARRIERS, NAMELY, BLANK MAGNETIC DATA CARRIERS, RECORDING DISCS, NAMELY, MAGNETIC CODED CARDS, BLANK SMART CARDS, MAGNETIC ENCODED INTEGRATED CIRCUIT CARDS CONTAINING

PROGRAMMING, NAMELY, MAGNETIC CODED CARDS FOR USE IN THE FIELD OF BUILDING SECURITY SYSTEMS, AND MAGNETICALLY ENCODED PRE-PAID TELEPHONE CALLING CARDS; CALCULATORS; DATA PROCESSING APPARATUS, NAMELY, COMPUTERS, COMPUTER PROGRAMS, FOR USE IN DATA BASE MANAGEMENT, AND AS A SPREAD SHEET, COMPUTERS, ELECTRONIC CALENDARS AND ORGANIZERS, NAMELY, HANDHELD PERSONAL ELECTRONIC DEVICES FOR SCHEDULING APPOINTMENTS, FACSIMILE MACHINES, MONITORS, NAMELY, COMPUTER MONITORS, VIDEO MONITORS, COMPUTER PERIPHERALS, POCKET CALCULATORS; FIRE EXTINGUISHERS, RECORDED COMPUTER PROGRAMS AND SOFTWARE USED FOR DATA COLLECTIONS IN THE FIELD OF VEHICLE RESEARCH, ENGINEERING, DESIGN, MANUFACTURE, SALES AND MARKETING AS WELL AS SOFTWARE FOR THE CONTROLLING OF CD-PLAYERS, RADIOS, NAVIGATIONAL SYSTEMS AND DISPLAYS ALL AFORESAID FOR THE USE IN CARS, IN CLASS 9 (U.S. CLS. 21, 23, 26, 36 AND 38).

PRIORITY CLAIMED UNDER SEC. 44(D) ON FED REP GERMANY APPLICATION NO. 30224446.8/0, FILED 5-15-2002, REG. NO. 30224446, DATED 7-19-2002, EXPIRES 5-31-2012.

SER. NO. 76-459,963, FILED 10-10-2002.

KEVON CHISOLM, EXAMINING ATTORNEY

Int. Cl.: 6

Prior U.S. Cls.: 2, 12, 13, 14, 23, 25 and 50

United States Patent and Trademark Office

Reg. No. 2,892,537

Registered Oct. 12, 2004

**TRADEMARK
PRINCIPAL REGISTER**

MASTERSERIES

UNITED DOMINION INDUSTRIES, INC. (DELA-
WARE CORPORATION)
13515 BALLANTYNE CORPORATE PLACE
CHARLOTTE, NC 28277

FIRST USE 4-0-1996; IN COMMERCE 4-0-1996.

OWNER OF U.S. REG. NO. 2,136,717.

FOR: BACKFLOW PREVENTION DEVICES IN
THE NATURE OF MANUALLY OPERATED ME-
TAL VALVES FOR COMMERCIAL AND INDUS-
TRIAL USE, IN CLASS 6 (U.S. CLS. 2, 12, 13, 14, 23, 25
AND 50).

SER. NO. 76-459,967, FILED 10-10-2002.

HOWARD B. LEVINE, EXAMINING ATTORNEY

Int. Cl.: 17

Prior U.S. Cls.: 1, 5, 12, 13, 35 and 50

Reg. No. 2,892,538

United States Patent and Trademark Office

Registered Oct. 12, 2004

**TRADEMARK
PRINCIPAL REGISTER**

FROSTWICK

DIAMOND J. INDUSTRIES LTD. (CANADA
CORPORATION)
P.O. BOX 610
ROCKY MOUNTAIN HOUSE, ALBERTA, CANADA
T4T 1A5 AND
ANDREWS, MAX (CANADA INDIVIDUAL)
P.O. BOX 610
ROCKY MOUNTAIN HOUSE, ALBERTA, CANADA
T4T 1A5

FOR: GEOSYNTHETIC FABRIC AND POLYUR-
ETHANE FOAM INSULATING PANELS FOR USE
IN ROAD REPAIR, DRILLING RIG SITE PREPARA-

TION, UTILITY LINE INSTALLATION, IN CLASS 17
(U.S. CLS. 1, 5, 12, 13, 35 AND 50).

PRIORITY CLAIMED UNDER SEC. 44(D) ON
CANADA APPLICATION NO. 1,137,488, FILED 4-22-
2002, REG. NO. TMA593631, DATED 10-30-2003, EX-
PIRES 10-30-2018.

SER. NO. 76-460,141, FILED 10-16-2002.

INGRID C. EULIN, EXAMINING ATTORNEY

Int. Cl.: 5

Prior U.S. Cls.: 6, 18, 44, 46, 51 and 52

United States Patent and Trademark Office

Reg. No. 2,892,539

Registered Oct. 12, 2004

**TRADEMARK
PRINCIPAL REGISTER**

TONES SKIN CARE

KERN, SHELLEY (UNITED STATES INDIVIDUAL)
246 W. COLLEGE ST.
STE. 208
COVINA, CA 91723

NO CLAIM IS MADE TO THE EXCLUSIVE RIGHT TO USE "SKIN CARE", APART FROM THE MARK AS SHOWN.

FOR: MEDICATED SKIN CARE PREPARATIONS,
IN CLASS 5 (U.S. CLS. 6, 18, 44, 46, 51 AND 52).

SER. NO. 76-460,225, FILED 10-18-2002.

FIRST USE 10-10-2002; IN COMMERCE 10-10-2002.

IRA J. GOODSaid, EXAMINING ATTORNEY

Int. Cl.: 35

Prior U.S. Cls.: 100, 101 and 102

United States Patent and Trademark Office

Reg. No. 2,892,540

Registered Oct. 12, 2004

**SERVICE MARK
PRINCIPAL REGISTER**

NBA
NEW BUSINESS ADVISOR

GINSBERG, DARRIN (UNITED STATES INDIVIDUAL)
2173 OCEAN WAY
LAGUNA BEACH, CA 92651

FOR: BUSINESS DEVELOPMENT AND CONSULTING SERVICES, NAMELY PROVIDING "START-UP" SUPPORT FOR NEW BUSINESSES, IN CLASS 35 (U.S. CLS. 100, 101 AND 102).

FIRST USE 9-20-2002; IN COMMERCE 9-20-2002.

NO CLAIM IS MADE TO THE EXCLUSIVE RIGHT TO USE "NEW BUSINESS ADVISOR", APART FROM THE MARK AS SHOWN.

THE CAPITAL LETTERS "NBA" OVER THE WORDS "NEW BUSINESS ADVISOR".

SER. NO. 76-460,472, FILED 10-21-2002.

TRACY FLETCHER, EXAMINING ATTORNEY

Int. Cl.: 25

Prior U.S. Cls.: 22 and 39

United States Patent and Trademark Office

Reg. No. 2,892,541

Registered Oct. 12, 2004

**TRADEMARK
PRINCIPAL REGISTER**

INNERPIMP

INNERPIMP
3241 ROCKY WATER LN
SAN JOSE, CA 95148

FOR: SHOES, SOCKS, HATS, BELTS, JACKETS,
SWEATERS, SWEATSHIRTS, PANTS, BEANIES, UN-
DERWEAR, TANKTOPS, SHIRTS, BRAS, BATHING
SUITS, SWEAT SUITS, SANDALS, SHORTS, BOX-

ERS, SWEAT PANTS, HALTER TOPS, ROBES, IN
CLASS 25 (U.S. CLS. 22 AND 39).

FIRST USE 9-13-2002; IN COMMERCE 9-13-2002.

SER. NO. 76-460,474, FILED 10-21-2002.

JASON TURNER, EXAMINING ATTORNEY

Int. Cl.: 3

Prior U.S. Cls.: 1, 4, 6, 50, 51 and 52

United States Patent and Trademark Office

Reg. No. 2,892,542

Registered Oct. 12, 2004

**TRADEMARK
PRINCIPAL REGISTER**

ULTRA PINK

LANCÔME PARFUMS ET BEAUTE & CIE
(FRANCE SOCIETE EN NOM COLLECTIF)
29, RUE DU FAUBOURG SAINT-HONORE
PARIS, FRANCE 75008

FOR: PERFUME, TOILET WATER, IN CLASS 3
(U.S. CLS. 1, 4, 6, 50, 51 AND 52).

PRIORITY CLAIMED UNDER SEC. 44(D) ON
FRANCE APPLICATION NO. 02/3.167.552, FILED 6-
5-2002, REG. NO. 02/3.167.552, DATED 6-5-2002, EX-
PIRES 6-5-2012.

SER. NO. 76-460,516, FILED 10-21-2002.

MARTHA FROMM, EXAMINING ATTORNEY

Int. Cl.: 35

Prior U.S. Cls.: 100, 101 and 102

United States Patent and Trademark Office

Reg. No. 2,892,543

Registered Oct. 12, 2004

**SERVICE MARK
PRINCIPAL REGISTER**

BOCA BEADS

IRIS MOON INC. (FLORIDA CORPORATION)
1401 SOUTH MILITARY TRAIL
SUITE J
WEST PALM BEACH, FL 33415

FOR: RETAIL JEWELRY STORES FEATURING
JEWELRY, INCLUDING BEADS AND BEAD-RELA-

TED SUPPLIES, IN CLASS 35 (U.S. CLS. 100, 101 AND
102).

FIRST USE 10-0-2002; IN COMMERCE 10-0-2002.

SER. NO. 76-460,800, FILED 10-21-2002.

AISHA CLARKE, EXAMINING ATTORNEY

Int. Cl.: 25

Prior U.S. Cls.: 22 and 39

United States Patent and Trademark Office

Reg. No. 2,892,544

Registered Oct. 12, 2004

**TRADEMARK
PRINCIPAL REGISTER**

STORM BREAKER

WORK FORCE, INC. (MASSACHUSETTS COR-
PORATION)
272 TOSCA DRIVE
STOUGHTON, MA 02072

FIRST USE 10-1-1994; IN COMMERCE 10-1-1994.

SER. NO. 76-461,196, FILED 10-24-2002.

FOR: RAINWEAR, NAMELY RAIN SUITS, BIB
OVERALLS, PANTS, JACKETS, COATS AND HATS,
IN CLASS 25 (U.S. CLS. 22 AND 39).

ANDREA SAUNDERS, EXAMINING ATTORNEY

Int. Cl.: 9

Prior U.S. Cls.: 21, 23, 26, 36 and 38

United States Patent and Trademark Office

Reg. No. 2,892,545

Registered Oct. 12, 2004

**TRADEMARK
PRINCIPAL REGISTER**

PRESTIGE

FUTURE TRADING AB (SWEDEN CORPORATION)
EXPORTGATAN 17
SE 422 46 HISINGS BACKA, SWEDEN

FIRST USE 3-31-1987; IN COMMERCE 5-15-2002.

SER. NO. 76-461,827, FILED 10-28-2002.

FOR: SUNGLASSES, IN CLASS 9 (U.S. CLS. 21, 23,
26, 36 AND 38).

KEVON CHISOLM, EXAMINING ATTORNEY

Int. Cls.: 16 and 41

Prior U.S. Cls.: 2, 5, 22, 23, 29, 37, 38, 50, 100, 101 and 107

Reg. No. 2,892,546

United States Patent and Trademark Office

Registered Oct. 12, 2004

**TRADEMARK
SERVICE MARK
PRINCIPAL REGISTER**

NATIONAL YIDDISH BOOK CENTER

NATIONAL YIDDISH BOOK CENTER (MASSACHUSETTS CORPORATION)
1021 WEST STREET
AMHERST, MA 01002

FOR: BOOKS CONCERNING YIDDISH AND THE YIDDISH CULTURE; GREETING CARDS, STATIONERY, AND POSTERS, IN CLASS 16 (U.S. CLS. 2, 5, 22, 23, 29, 37, 38 AND 50).

FIRST USE 6-26-1980; IN COMMERCE 6-26-1980.

FOR: EDUCATIONAL SERVICES, NAMELY CLASSES AND SEMINARS IN THE FIELDS OF

YIDDISH AND AWARENESS OF YIDDISH CULTURE, IN CLASS 41 (U.S. CLS. 100, 101 AND 107).

FIRST USE 6-26-1980; IN COMMERCE 6-26-1980.

NO CLAIM IS MADE TO THE EXCLUSIVE RIGHT TO USE BOOK CENTER, APART FROM THE MARK AS SHOWN.

SEC. 2(F).

SER. NO. 76-462,119, FILED 10-28-2002.

STACY WAHLBERG, EXAMINING ATTORNEY

Int. Cl.: 30

Prior U.S. Cl.: 46

United States Patent and Trademark Office

Reg. No. 2,892,547

Registered Oct. 12, 2004

TRADEMARK
PRINCIPAL REGISTER

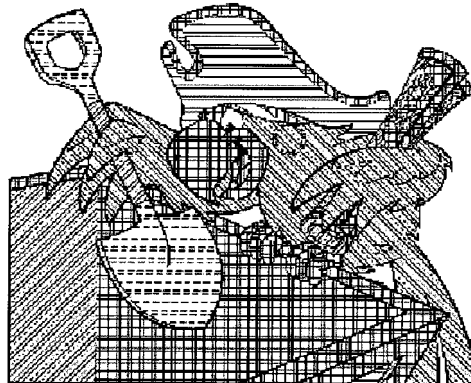

MEIJER, INC. (MICHIGAN CORPORATION)
2929 WALKER AVE., N.W.
GRAND RAPIDS, MI 49544

FOR: BREAKFAST CEREAL, NAMELY, SWEETENED RICE, IN CLASS 30 (U.S. CL. 46).

FIRST USE 9-29-2002; IN COMMERCE 9-29-2002.

THE DRAWING IS LINED FOR THE COLORS RED, BLUE, GREEN, YELLOW, BROWN, GOLD AND SILVER.

THE MARK CONSISTS OF DESIGN OF FANCIFUL IMAGE OF BIRD.

SER. NO. 76-462,183, FILED 10-28-2002.

H. M. FISHER, EXAMINING ATTORNEY

Int. Cls.: 7 and 9

Prior U.S. Cls.: 13, 19, 21, 23, 26, 31, 34, 35, 36 and 38

Reg. No. 2,892,548

United States Patent and Trademark Office

Registered Oct. 12, 2004

**TRADEMARK
PRINCIPAL REGISTER**

ANY-X

SAMSUNG ELECTRONICS CO., LTD. (REPUBLIC OF KOREA CORPORATION)
#416, MAETAN-DONG, PALDAL-GU
SUWON-CITY, KYUNGKI-DO, REPUBLIC OF KOREA

FOR: ELECTRIC MIXERS FOR HOUSEHOLD USE; ELECTRIC VACUUM CLEANERS FOR HOUSEHOLD USE; AUTOMATIC DISHWASHERS; ELECTRIC SCISSORS; ELECTRIC CLOTHES WASHING MACHINES; ELECTRIC VACUUM CLEANER BAGS; ELECTRIC TIN OPENERS; ELECTRIC FRUIT PRESS FOR HOUSEHOLD USE, IN CLASS 7 (U.S. CLS. 13, 19, 21, 23, 31, 34 AND 35).

FOR: CAMERAS, NAMELY DIGITAL AND PHOTOGRAPHIC CAMERAS; VIDEO CAMERAS; CAMERAS FOR FILM PRODUCTION; CAMCORDERS; ELECTRONIC DOOR CLOSERS; DOOR LOCKS EQUIPPED WITH A FINGERPRINT RECOGNIZER; ELECTRIC DOOR OPENERS; CONDENSERS; DRY CELL BATTERIES; STORAGE BATTERIES; ELECTRIC IRONS; ELECTRIC DOORBELLS; ELECTRIC HAIR CURLERS; ELECTRIC VENDING MACHINES; DVD PLAYERS; MP3 PLAYERS; FIXED MULTI-CHANNEL COMMUNICATION APPARATUS, NAMELY BASE STATIONS, TELEMATICS NAMELY, WIRELESS INTERNET DEVICES, WHICH PROVIDE TELEMATICS SERVICES AND HAVE A CELLULAR TELEPHONE FUNCTION; FIXED SINGLE-CHANNEL COMMUNICATION APPARATUS, NAMELY BASE STATIONS, TELEMATICS NAMELY, WIRELESS INTERNET DEVICES, WHICH PROVIDE TELEMATICS SERVICES AND HAVE A CELLULAR PHONE FUNCTION; BLANK RECORDING DISKS FOR RECORDING AUDIO, VIDEO; PLAYBACK MACHINES; RADIO RECEIVING AND TRANSMITTING MACHINES; RECORD PLAYERS; MICROPHONES; VIDEO CAMERAS FOR BROADCASTING; VIDEO DISK PLAYERS; VIDEO RECORDERS; BLANK VIDEO CASSETTES; BLANK VIDEO TAPES; VIDEO PHONES; PHOTOGRAPH

TRANSMISSION APPARATUS, NAMELY CAMERA PHONES; ANTENNAS; AUDIO AND VIDEO RECEIVERS; UNFORMATTED COMPACT DISCS FOR AUDIO AND VIDEO; WALKIE-TALKIES; SOUND TRANSMITTING APPARATUS; INTERPHONES; TELEPHONES; CASSETTE PLAYERS; COMPACT DISK PLAYERS; TELEVISION TRANSMITTING SETS, TELEVISION RECEIVING SETS; TELEVISION SATELLITE BROADCAST RECEIVING SETS; FACSIMILE MACHINES, HEADPHONES; TELEVISION SET-TOP BOXES; CELLULAR PHONES; CD-ROM DRIVES AND WRITERS; PDA; OPTICAL DISKS; LAPTOP COMPUTERS; NOTEBOOK COMPUTERS; MICE; BAR CODE READERS; SEMICONDUCTORS; CATHODE-RAY TUBES; TELEVISIONS WITH LIQUID CRYSTAL DISPLAY; PDP (PLASMA DISPLAY PANEL); SCANNERS; BLANK MAGNETIC DISKS; ELECTRONIC COPYING MACHINES; ELECTRONIC APPLIED AUTOMATIC DOORS; ELECTRONIC VENDING MACHINES; ELECTRONIC PENS; COMPUTERS; MONITORS FOR COMPUTER; PRINTERS FOR COMPUTER; KEYBOARDS FOR COMPUTER; ELECTRONIC POCKET CALCULATORS; ELECTRONIC POCKET TRANSLATORS; DOWNLOADABLE ELECTRONIC MUSIC; MPEG PLAYERS; DOORPHONES, NAMELY VIDEO SECURITY PHONES; COMPUTER SERVERS FOR HOME AUTOMATION; TELEVISIONS FOR KITCHEN, IN CLASS 9 (U.S. CLS. 21, 23, 26, 36 AND 38).

PRIORITY CLAIMED UNDER SEC. 44(D) ON REPUBLIC OF KOREA APPLICATION NO. 2002-0022171, FILED 5-14-2002, REG. NO. 0568596, DATED 12-12-2003, EXPIRES 12-12-2013.

SER. NO. 76-462,278, FILED 10-25-2002.

JANICE L. MCMORROW, EXAMINING ATTORNEY

Int. Cl.: 25

Prior U.S. Cls.: 22 and 39

United States Patent and Trademark Office

Reg. No. 2,892,549

Registered Oct. 12, 2004

**TRADEMARK
PRINCIPAL REGISTER**

BLACKBOARD

BLACKBOARD INC. (DELAWARE CORPORATION)
1899 L STREET, NW
SUITE 500
WASHINGTON, DC 20036

FOR: CAPS; POLO SHIRTS, T-SHIRTS, OXFORD SHIRTS; SWEATERS; SWEATER VESTS, IN CLASS 25 (U.S. CLS. 22 AND 39).

FIRST USE 6-1-1998; IN COMMERCE 6-1-1998.

OWNER OF U.S. REG. NOS. 2,315,293, 2,607,928 AND OTHERS.

SER. NO. 76-462,795, FILED 10-25-2002.

MITCHELL FRONT, EXAMINING ATTORNEY

Int. Cl.: 35

Prior U.S. Cls.: 100, 101 and 102

United States Patent and Trademark Office

Reg. No. 2,892,550

Registered Oct. 12, 2004

**SERVICE MARK
PRINCIPAL REGISTER**



IDEA FOUNDRY (PENNSYLVANIA NONPROFIT CORPORATION)
4551 FORBES AVENUE, SUITE 200
PITTSBURGH, PA 15213

FOR: PROVIDING BUSINESS MANAGEMENT CONSULTATION RELATING TO THE DEVELOPMENT AND PROTECTION OF NEW BUSINESS IDEAS; AND BUSINESS ADVICE RELATING TO DEVELOPMENT AND PROTECTION OF NEW

BUSINESS IDEAS, IN CLASS 35 (U.S. CLS. 100, 101 AND 102).

FIRST USE 8-24-2002; IN COMMERCE 8-24-2002.

SER. NO. 76-462,871, FILED 10-30-2002.

GLENN CLARK, EXAMINING ATTORNEY

Int. Cl.: 35

Prior U.S. Cls.: 100, 101 and 102

United States Patent and Trademark Office

Reg. No. 2,892,551

Registered Oct. 12, 2004

**SERVICE MARK
PRINCIPAL REGISTER**

IDEA FOUNDRY

IDEA FOUNDRY (PENNSYLVANIA NONPROFIT CORPORATION)
4551 FORBES AVENUE, SUITE 200
PITTSBURGH, PA 15213

FOR: PROVIDING BUSINESS MANAGEMENT CONSULTATION RELATING TO THE DEVELOPMENT AND PROTECTION OF NEW BUSINESS IDEAS; AND BUSINESS ADVICE RELATING TO DEVELOPMENT AND PROTECTION OF NEW

BUSINESS IDEAS, IN CLASS 35 (U.S. CLS. 100, 101 AND 102).

FIRST USE 8-24-2002; IN COMMERCE 8-24-2002.

SER. NO. 76-462,872, FILED 10-30-2002.

GLENN CLARK, EXAMINING ATTORNEY

Int. Cls.: 36 and 42

Prior U.S. Cls.: 100, 101 and 102

United States Patent and Trademark Office

Reg. No. 2,892,552

Registered Oct. 12, 2004

**SERVICE MARK
PRINCIPAL REGISTER**

RADIANEXPRESS

RADIAN GROUP INC. (DELAWARE CORPORATION)
1601 MARKET STREET
PHILADELPHIA, PA 191032337

FOR: SERVICES DELIVERED IN THE FIELD OF REAL ESTATE, NAMELY, CREDIT REPORTING SERVICES, REAL ESTATE APPRAISAL SERVICES, AND FLOOD ZONE DETERMINATION SERVICES, ALL OFFERED VIA A GLOBAL COMPUTER INFORMATION NETWORK; DISBURSING FUNDS ASSOCIATED WITH REAL ESTATE TRANSACTIONS VIA A GLOBAL COMPUTER INFORMATION NETWORK, IN CLASS 36 (U.S. CLS. 100, 101 AND 102).

FIRST USE 1-9-2002; IN COMMERCE 1-9-2002.

FOR: REAL ESTATE SERVICES, NAMELY, PROCESSING TITLE ORDERS, OBTAINING AND WITNESSING SIGNATURES ON DOCUMENTS ASSOCIATED WITH REAL ESTATE TRANSACTIONS, AND RECORDING DEEDS OF TRUST AND MORTGAGES, ALL OFFERED VIA A GLOBAL COMPUTER INFORMATION NETWORK, IN CLASS 42 (U.S. CLS. 100 AND 101).

FIRST USE 1-9-2002; IN COMMERCE 1-9-2002.

OWNER OF U.S. REG. NOS. 2,445,568, 2,513,095, AND 2,601,532.

SER. NO. 76-462,973, FILED 10-31-2002.

YONG KIM, EXAMINING ATTORNEY

Int. Cls.: 36 and 42

Prior U.S. Cls.: 100, 101 and 102

United States Patent and Trademark Office

Reg. No. 2,892,553

Registered Oct. 12, 2004

**SERVICE MARK
PRINCIPAL REGISTER**

**RADIAN
express**

RADIAN GROUP INC. (DELAWARE CORPORATION)
1601 MARKET STREET
PHILADELPHIA, PA 191032337

FOR: SERVICES DELIVERED IN THE FIELD OF REAL ESTATE, NAMELY, CREDIT REPORTING SERVICES, REAL ESTATE APPRAISAL SERVICES, AND FLOOD ZONE DETERMINATION SERVICES, ALL OFFERED VIA A GLOBAL COMPUTER INFORMATION NETWORK; DISBURSING FUNDS ASSOCIATED WITH REAL ESTATE TRANSACTIONS VIA A GLOBAL COMPUTER INFORMATION NETWORK, IN CLASS 36 (U.S. CLS. 100, 101 AND 102).

FIRST USE 1-29-2002; IN COMMERCE 1-29-2002.

FOR: REAL ESTATE SERVICES, NAMELY, PROCESSING TITLE ORDERS, OBTAINING AND WIT-

NESSING SIGNATURES ON DOCUMENTS ASSOCIATED WITH REAL ESTATE TRANSACTIONS, AND RECORDING DEEDS OF TRUST AND MORTGAGES, ALL OFFERED VIA A GLOBAL COMPUTER INFORMATION NETWORK, IN CLASS 42 (U.S. CLS. 100 AND 101).

FIRST USE 1-29-2002; IN COMMERCE 1-29-2002.

OWNER OF U.S. REG. NOS. 2,445,568, 2,513,095, AND 2,601,532.

NO CLAIM IS MADE TO THE EXCLUSIVE RIGHT TO USE "EXPRESS", APART FROM THE MARK AS SHOWN.

SER. NO. 76-463,237, FILED 10-31-2002.

YONG KIM, EXAMINING ATTORNEY

Int. Cl.: 32

Prior U.S. Cls.: 45, 46 and 48

United States Patent and Trademark Office

Reg. No. 2,892,554

Registered Oct. 12, 2004

TRADEMARK
PRINCIPAL REGISTER



SANGEMINI S.P.A. (ITALY CORPORATION)
VIA TIBERINA 1
SANGEMINI (TR), ITALY 05029

FOR: BEVERAGE CONCENTRATES MADE OF FRUIT JUICES, BEVERAGE CONCENTRATES IN SYRUP FORM USED IN THE PREPARATION OF SOFT DRINKS, POWDERS USED IN THE PREPARATION OF SOFT DRINKS, ESSENCES FOR PREPARATION OF MINERAL WATERS NOT IN THE NATURE OF ESSENTIAL OILS, ESSENCES FOR USE IN MAKING SOFT DRINKS, FRUIT DRINKS, FRUIT FLAVORED SOFT DRINKS, FRUIT JUICES, FRUIT-BASED SOFT DRINKS FLAVORED WITH TEA, JUICE BEVERAGES, AERATED FRUIT JUICES, LEMONADE, MINERAL WATER, SOFT DRINKS, SODA WATER, SOFT DRINKS FLAVORED WITH TEA, SPRING WATER, TABLE WATER, IN CLASS 32 (U.S. CLS. 45, 46 AND 48).

PRIORITY CLAIMED UNDER SEC. 44(D) ON ERPN CMNTY TM OFC APPLICATION NO. 2780161, FILED 7-18-2002, REG. NO. 2780161, DATED 2-6-2004, EXPIRES 7-18-2012.

NO CLAIM IS MADE TO THE EXCLUSIVE RIGHT TO USE "SORGENTI UMBRE" AND "AQUA MINERALE NATURALE OLIGOMINERALE", APART FROM THE MARK AS SHOWN.

"ANTICHE SORGENTI UMBRE" TRANSLATES TO "ANTIQUE SPRINGS OF UMBRIA" AND "AQUA MINERALE NATURALE OLIGOMINERALE" TRANSLATES TO "LOW MINERAL CONTENT NATURAL MINERAL WATER" IN ENGLISH.

SER. NO. 76-463,283, FILED 10-30-2002.

ZACHARY BELLO, EXAMINING ATTORNEY

Int. Cl.: 32

Prior U.S. Cls.: 45, 46 and 48

United States Patent and Trademark Office

Reg. No. 2,892,555

Registered Oct. 12, 2004

TRADEMARK
PRINCIPAL REGISTER



Acqua Minerale Naturale
SANGEMINI

SANGEMINI S.P.A. (ITALY CORPORATION)
VIA TIBERINA 1
SANGEMINI (TR), ITALY 05029

FOR: BEVERAGE CONCENTRATES MADE OF FRUIT JUICES, BEVERAGE CONCENTRATES IN SYRUP FORM USED IN THE PREPARATION OF SOFT DRINKS, POWDERS USED IN THE PREPARATION OF SOFT DRINKS, ESSENCES FOR PREPARATION OF MINERAL WATERS NOT IN THE NATURE OF ESSENTIAL OILS, ESSENCES FOR USE IN MAKING SOFT DRINKS, FRUIT DRINKS, FRUIT FLAVORED SOFT DRINKS, FRUIT JUICES, FRUIT-BASED SOFT DRINKS FLAVORED WITH TEA, JUICE BEVERAGES, AERATED FRUIT JUICES, LEMONADE, MINERAL WATER, SOFT DRINKS, SODA WATER, SOFT DRINKS FLAVORED WITH TEA, SPRING WATER, TABLE WATER, IN CLASS 32 (U.S. CLS. 45, 46 AND 48).

PRIORITY CLAIMED UNDER SEC. 44(D) ON ERPN CMNTY TM OFC APPLICATION NO. 2781078, FILED 7-18-2002, REG. NO. 2781078, DATED 2-6-2004, EXPIRES 7-18-2012.

NO CLAIM IS MADE TO THE EXCLUSIVE RIGHT TO USE "ACQUA MINERALE NATURALE", APART FROM THE MARK AS SHOWN.

THE ENGLISH TRANSLATION OF "AQUA MINERALE NATURALE" IS "NATURAL MINERAL WATER". THE WORD "SANGEMINI" IS THE NAME OF APPLICANT.

SER. NO. 76-463,284, FILED 10-30-2002.

ZACHARY BELLO, EXAMINING ATTORNEY

Int. Cls.: 36 and 42

Prior U.S. Cls.: 100, 101 and 102

United States Patent and Trademark Office

Reg. No. 2,892,556

Registered Oct. 12, 2004

**SERVICE MARK
PRINCIPAL REGISTER**

RADIAN

RADIAN GROUP INC. (DELAWARE CORPORATION)
1601 MARKET STREET
PHILADELPHIA, PA 191032337

FOR: INSURANCE SERVICES, NAMELY, FINANCIAL GUARANTY INSURANCE ADMINISTRATION, PROCESSING AND UNDERWRITING, FINANCIAL GUARANTY REINSURANCE ADMINISTRATION, PROCESSING AND UNDERWRITING, AND MORTGAGE GUARANTY INSURANCE ADMINISTRATION, PROCESSING AND UNDERWRITING; SERVICES DELIVERED IN THE FIELD OF REAL ESTATE, NAMELY, CREDIT REPORTING SERVICES, REAL ESTATE APPRAISAL SERVICES, AND FLOOD ZONE DETERMINATION SERVICES; DISBURSING FUNDS ASSOCIATED WITH REAL ESTATE TRANSACTIONS, IN CLASS 36 (U.S. CLS. 100, 101 AND 102).

FIRST USE 6-10-1999; IN COMMERCE 6-10-1999.

FOR: REAL ESTATE SERVICES, NAMELY, PROCESSING TITLE ORDERS, OBTAINING AND WITNESSING SIGNATURES ON DOCUMENTS ASSOCIATED WITH REAL ESTATE TRANSACTIONS, AND RECORDING DEEDS OF TRUST AND MORTGAGES, IN CLASS 42 (U.S. CLS. 100 AND 101).

FIRST USE 6-10-1999; IN COMMERCE 6-10-1999.

OWNER OF U.S. REG. NOS. 2,445,568, 2,513,095, AND 2,601,532.

SER. NO. 76-463,304, FILED 10-31-2002.

YONG KIM, EXAMINING ATTORNEY

Int. Cl.: 35

Prior U.S. Cls.: 100, 101 and 102

United States Patent and Trademark Office

Reg. No. 2,892,557

Registered Oct. 12, 2004

**SERVICE MARK
PRINCIPAL REGISTER**

LINDE HEALTHCARE

LINDE HEALTH CARE STAFFING, INC. (MISSOURI CORPORATION)
11325 CONCORD VILLAGE AVE
ST. LOUIS, MO 63123

FOR: PROVIDING TEMPORARY AND PERMANENT EMPLOYMENT PLACEMENT SERVICES FOR HEALTH CARE PROFESSIONALS, INCLUDING DOCTORS AND NURSES , IN CLASS 35 (U.S. CLS. 100, 101 AND 102).

FIRST USE 1-1-1995; IN COMMERCE 1-1-1995.

NO CLAIM IS MADE TO THE EXCLUSIVE RIGHT TO USE "HEALTHCARE", APART FROM THE MARK AS SHOWN.

SER. NO. 76-463,384, FILED 10-25-2002.

MARC LEIPZIG, EXAMINING ATTORNEY

Int. Cl.: 16

Prior U.S. Cls.: 2, 5, 22, 23, 29, 37, 38 and 50

United States Patent and Trademark Office

Reg. No. 2,892,558

Registered Oct. 12, 2004

**TRADEMARK
PRINCIPAL REGISTER**

ULTIMA

ECOLOGICAL FIBERS, INC. (MASSACHUSETTS
CORPORATION)
40 PIONEER DRIVE
LUNENBURG, MA 01462

FOR: PAPER COVER MATERIAL WITH A CLEAR
PROTECTIVE TOP COAT FOR SCUFF AND SOIL
RESISTANCE FOR GAME BOARDS, BOXES, PHOTO
ALBUMS, SLIPCASES, PICTURE FRAMES,

LOOSELEAF OR FILES, IN CLASS 16 (U.S. CLS. 2,
5, 22, 23, 29, 37, 38 AND 50).

FIRST USE 6-26-2002; IN COMMERCE 12-0-2002.

SER. NO. 76-465,422, FILED 11-7-2002.

DOMINICK J. SALEMI, EXAMINING ATTORNEY

Int. Cl.: 33

Prior U.S. Cls.: 47 and 49

United States Patent and Trademark Office

Reg. No. 2,892,559

Registered Oct. 12, 2004

TRADEMARK
PRINCIPAL REGISTER



Gamla

GOLAN HEIGHTS WINERY LTD. (ISRAEL COR-
PORATION)
P.O.B. 183
INDUSTRIAL AREA KATZRIN 12900, ISRAEL

SEC. 2(F).

SER. NO. 76-465,609, FILED 10-30-2002.

FOR: WINE, IN CLASS 33 (U.S. CLS. 47 AND 49).

FIRST USE 0-0-1983; IN COMMERCE 0-0-1984.

ZACHARY BELLO, EXAMINING ATTORNEY

Int. Cl.: 33

Prior U.S. Cls.: 47 and 49

United States Patent and Trademark Office

Reg. No. 2,892,560

Registered Oct. 12, 2004

**TRADEMARK
PRINCIPAL REGISTER**

TEQUILA LAPIS

TEQUILENA, S.A. DE C.V. (MEXICO COMPANY)
VENEZUELA 425, COL. AMERICANA
GUADALAJARA, JALISCO, MEXICO

NO CLAIM IS MADE TO THE EXCLUSIVE
RIGHT TO USE "TEQUILA" , APART FROM THE
MARK AS SHOWN.

FOR: TEQUILA, IN CLASS 33 (U.S. CLS. 47 AND
49).

SER. NO. 76-466,296, FILED 11-4-2002.

FIRST USE 7-0-1998; IN COMMERCE 7-0-1998.

INGRID C. EULIN, EXAMINING ATTORNEY

Int. Cls.: 7, 11 and 12

Prior U.S. Cls.: 13, 19, 21, 23, 31, 34, 35 and 44

Reg. No. 2,892,561

United States Patent and Trademark Office

Registered Oct. 12, 2004

**TRADEMARK
PRINCIPAL REGISTER**

KURYAKYN

KURYAKYN HOLDINGS, INC. (WISCONSIN CORPORATION)
P.O. BOX 37
STILLWATER, MN 55082

FOR: DECORATIVE PARTS OF MOTORCYCLES, NAMELY, OIL PUMP COVERS, OIL FILTER AND MOUNT COVERS, FRONT MOTOR MOUNT COVERS, EXHAUST EXTENSIONS, CHROME ENGINE COVERS, AND ENGINE COVER INSERTS, IGNITION COIL COVERS, IN CLASS 7 (U.S. CLS. 13, 19, 21, 23, 31, 34 AND 35).

FIRST USE 1-1-1992; IN COMMERCE 1-1-1992.

FOR: DECORATIVE PARTS OF MOTORCYCLES, NAMELY, FENDER TRIM LIGHTS, FENDER STRUT LIGHTS; LED LIGHTS, LOUVER LIGHTS, PLUG WIRE LIGHTS, STRIP LIGHTS, IN CLASS 11 (U.S. CLS. 13, 21, 23, 31 AND 34).

FIRST USE 1-1-1992; IN COMMERCE 1-1-1992.

FOR: STRUCTURAL PARTS FOR MOTORCYCLES; DECORATIVE PARTS OF MOTORCYCLES, NAMELY, ACCENT RINGS, BRAIDED LEVERS, SILHOUETTE LEVERS, CHROME RESERVOIR COVERS, BRAKE CONTROL DRESS-UP KITS COMPRISING CLUTCH HOUSING AND CLAMPS

AND BRAKE RESERVOIR AND CLAMPS, BANJO BOLT COVERS, FENDER EXTENSIONS, FENDER TIPS, FENDER ORNAMENTS IN THE NATURE OF FIGURINES IN DIFFERENT ANIMAL SHAPES, AXLE NUT CAPS, AXLE CAPS, SPEEDO DRIVE COVERS, CHROME HEADLIGHT VISORS, TRANSMISSION SHROUDS, TAPPET COVERS, HEAD BOLT COVERS, BRAKE CYLINDER BASE COVERS, INNER PRIMARY COVERS, HORN COVERS, NECK COVERS, DASH PANEL INSERTS, FLUSH MOUNT GAS CAPS, BOOMERANG COVERS, PHANTOM COVERS, HUB SPINNERS, LICENSE PLATE HOLDERS, TAILLIGHT COVERS, FRONT FENDER ACCENTS, DEBRIS MODULATORS, REAR FENDER TRIMS, BRAKE ROTOR AND PIVOT COVERS, TRIM RINGS, BANGO BOLT COVERS, BRAKE CALIPER COVERS, TRIPLE TREE COVERS, CHROME THROTTLE CABLE COVERS AND CLUTCH CABLE ADJUSTER CABLES, IN CLASS 12 (U.S. CLS. 19, 21, 23, 31, 35 AND 44).

FIRST USE 1-1-1992; IN COMMERCE 1-1-1992.

OWNER OF U.S. REG. NO. 1,963,632.

SER. NO. 76-466,572, FILED 11-4-2002.

ALEX KEAM, EXAMINING ATTORNEY

Int. Cl.: 30

Prior U.S. Cl.: 46

United States Patent and Trademark Office

Reg. No. 2,892,562

Registered Oct. 12, 2004

**TRADEMARK
PRINCIPAL REGISTER**

PENACHI

ORGANIC PRODUCTS TRADING COMPANY
(WASHINGTON CORPORATION)
10109 NW 12TH AVE
VANCOUVER, WA 98685

SEC. 2(F).

SER. NO. 76-467,359, FILED 11-18-2002.

FOR: COFFEE, IN CLASS 30 (U.S. CL. 46).

FIRST USE 2-1-1998; IN COMMERCE 5-1-1998.

SUSAN LESLIE DUBOIS, EXAMINING ATTORNEY

Int. Cl.: 41

Prior U.S. Cls.: 100, 101 and 107

United States Patent and Trademark Office

Reg. No. 2,892,563

Registered Oct. 12, 2004

**SERVICE MARK
PRINCIPAL REGISTER**

“FAFI”

COMMEMORATIVE AIR FORCE, INC. (TEXAS
CORPORATION)
P.O. BOX 62000
MIDLAND, TX 787112000

FIRST USE 9-1-1975; IN COMMERCE 9-1-1975.

SEC. 2(F).

FOR: PROVIDING AERONAUTICAL SHOWS
FEATURING HISTORICAL MILITARY AIRCRAFT
THAT HAVE BEEN RESTORED TO FLYING CON-
DITION, IN CLASS 41 (U.S. CLS. 100, 101 AND 107).

SER. NO. 76-467,740, FILED 11-18-2002.

TRACY FLETCHER, EXAMINING ATTORNEY

Int. Cl.: 25

Prior U.S. Cls.: 22 and 39

United States Patent and Trademark Office

Reg. No. 2,892,564

Registered Oct. 12, 2004

**TRADEMARK
PRINCIPAL REGISTER**

MIKINO

ITALIAN INTERNATIONAL DESIGNS, LLC
(FLORIDA CORPORATION)
11401 N.W. 12TH ST. #E193
MIAMI, FL 33172

FIRST USE 10-11-2002; IN COMMERCE 10-11-2002.

SER. NO. 76-468,822, FILED 11-18-2002.

FOR: CLOTHING, NAMELY, BLOUSES, SHIRTS,
TOPS, PANTS, SHORTS, DRESSES, UNDERWEAR
AND JACKETS, IN CLASS 25 (U.S. CLS. 22 AND 39).

MICHAEL KAZAZIAN, EXAMINING ATTORNEY

Int. Cl.: 9

Prior U.S. Cls.: 21, 23, 26, 36 and 38

United States Patent and Trademark Office

Reg. No. 2,892,565

Registered Oct. 12, 2004

**TRADEMARK
PRINCIPAL REGISTER**

PRO-EQ PLATINUM

FISHMAN TRANSDUCERS, INC. (DELAWARE
CORPORATION)
340-D FORDHAM ROAD
WILMINGTON, MA 01887

OWNER OF U.S. REG. NO. 2,514,252.

SEC. 2(F) AS TO "PRO-EQ".

FOR: SIGNAL CONDITIONING CIRCUITRY, IN
CLASS 9 (U.S. CLS. 21, 23, 26, 36 AND 38).

SER. NO. 76-469,055, FILED 11-21-2002.

FIRST USE 1-0-2000; IN COMMERCE 1-0-2000.

CAROLYN CATALDO, EXAMINING ATTORNEY

Int. Cl.: 9

Prior U.S. Cls.: 21, 23, 26, 36 and 38

Reg. No. 2,892,566

United States Patent and Trademark Office

Registered Oct. 12, 2004

**TRADEMARK
PRINCIPAL REGISTER**

CLAIMSTAT

HEALTH CARE DATA MANAGEMENT, INC.
(ARIZONA CORPORATION)
10851 N. BLACK CANYON HWY. SUITE 560
PHOENIX, AZ 85029

FOR: DOWNLOADABLE MEDICAL MANAGEMENT SOFTWARE FOR USE BY INSURANCE PROVIDERS, PAYORS AND MEMBERS FOR CLAIMS ADJUDICATION AND REPRICING, NAMELY FOR MANAGING CLAIMS, CLAIMS ADJUDICATION AND REPRICING, FOR MAINTAIN-

ING PROVIDER MEMBER SERVICES, FOR CONTRACT AND BENEFIT MANAGEMENT AND FOR MANAGING PROVIDER BILLING SERVICES, IN CLASS 9 (U.S. CLS. 21, 23, 26, 36 AND 38).

FIRST USE 5-1-1999; IN COMMERCE 5-1-1999.

SER. NO. 76-469,070, FILED 11-21-2002.

CAROLYN CATALDO, EXAMINING ATTORNEY

Int. Cl.: 10

Prior U.S. Cls.: 26, 39 and 44

United States Patent and Trademark Office

Reg. No. 2,892,567

Registered Oct. 12, 2004

**TRADEMARK
PRINCIPAL REGISTER**

StemQuick

ASAHI MEDICAL CO., LTD. (JAPAN CORPORATION)
9-1, KANDA MITOSHIRO-CHO
CHIYODA-KU, TOKYO, JAPAN

OWNER OF JAPAN REG. NO. 4704195, DATED 8-29-2003, EXPIRES 8-29-2013.

FOR: FILTRATION APPARATUS COMPRISED OF A FILTER FOR COLLECTING WHITE BLOOD CELLS CONTAINING HEMATOPOIETIC STEM CELLS FROM CORD BLOOD, IN CLASS 10 (U.S. CLS. 26, 39 AND 44).

SER. NO. 76-469,545, FILED 11-22-2002.

KAREN K. BUSH, EXAMINING ATTORNEY

Int. Cl.: 35

Prior U.S. Cls.: 100, 101 and 102

United States Patent and Trademark Office

Reg. No. 2,892,568

Registered Oct. 12, 2004

**SERVICE MARK
PRINCIPAL REGISTER**



ICD MEDIA, LLC (GEORGIA LTD LIAB CO)
5490 MCGINNIS VILLAGE PLACE, SUITE 106
ALPHARETTA, GA 30005

FOR: PRODUCTION AND DISTRIBUTION OF
PROMOTIONAL MATERIALS IN THE NATURE OF
MULTI-MEDIA COMPACT DISCS, VIDEO, AUDIO
AND PRINTED MATERIALS FOR OTHERS , IN
CLASS 35 (U.S. CLS. 100, 101 AND 102).

FIRST USE 4-0-2001; IN COMMERCE 4-0-2001.

NO CLAIM IS MADE TO THE EXCLUSIVE
RIGHT TO USE MEDIA, APART FROM THE MARK
AS SHOWN.

SER. NO. 76-470,004, FILED 11-25-2002.

BRIDGETT SMITH, EXAMINING ATTORNEY

Int. Cl.: 36

Prior U.S. Cls.: 100, 101 and 102

United States Patent and Trademark Office

Reg. No. 2,892,569

Registered Oct. 12, 2004

**SERVICE MARK
PRINCIPAL REGISTER**

E-INSERT

THE PRUDENTIAL INSURANCE COMPANY OF
AMERICA (NEW JERSEY CORPORATION)
751 BROAD STREET
21ST FLOOR
NEWARK, NJ 07102

FOR: DISTRIBUTION OF BENEFIT PLAN SPECI-
FIC INFORMATION AND MESSAGES IN SPONSOR

BENEFIT PLAN PARTICIPANT STATEMENTS, IN
CLASS 36 (U.S. CLS. 100, 101 AND 102).

FIRST USE 10-31-2002; IN COMMERCE 10-31-2002.

SER. NO. 76-470,153, FILED 11-25-2002.

JEFF DEFORD, EXAMINING ATTORNEY

Int. Cl.: 42

Prior U.S. Cls.: 100 and 101

United States Patent and Trademark Office

Reg. No. 2,892,570

Registered Oct. 12, 2004

**SERVICE MARK
PRINCIPAL REGISTER**

INTERIOR VIEWPOINTS

CAROLYN PHILLIPS-SANDKAMP (UNITED STATES INDIVIDUAL)
1262 270TH STREET
JANESVILLE, IA 50647

NO CLAIM IS MADE TO THE EXCLUSIVE RIGHT TO USE "INTERIOR", APART FROM THE MARK AS SHOWN.

FOR: INTERIOR DESIGN AND DECORATING SERVICES, NAMELY, THE PLANNING AND FURNISHING OF PRIVATE, PUBLIC, AND COMMERCIAL BUILDINGS, IN CLASS 42 (U.S. CLS. 100 AND 101).

SER. NO. 76-470,714, FILED 11-27-2002.

FIRST USE 8-1-2002; IN COMMERCE 12-1-2002.

JOHN SCHUYLER YARD, EXAMINING ATTORNEY

Int. Cl.: 39

Prior U.S. Cls.: 100 and 105

United States Patent and Trademark Office

Reg. No. 2,892,571

Registered Oct. 12, 2004

**SERVICE MARK
PRINCIPAL REGISTER**

SINGAPORE AIRLINES

SINGAPORE AIRLINES LIMITED (SINGAPORE
LTD LIAB CO)
AIRLINE HOUSE, 25 AIRLINE ROAD
SINGAPORE 819829

FIRST USE 0-0-1972; IN COMMERCE 0-0-1972.

OWNER OF U.S. REG. NOS. 1,071,963, 2,643,831
AND OTHERS.

FOR: AIR TRANSPORTATION OF PASSENGERS
AND PROPERTY; TRANSPORTATION OF PASSEN-
GERS' VEHICLES; TRANSPORTATION OF PASSEN-
GERS' LUGGAGE; LUGGAGE STORAGE
SERVICES; HANDLING OF BAGGAGE AND OF
GOODS, IN CLASS 39 (U.S. CLS. 100 AND 105).

SER. NO. 76-471,447, FILED 11-20-2002.

EDWARD NELSON, EXAMINING ATTORNEY

Int. Cl.: 5

Prior U.S. Cls.: 6, 18, 44, 46, 51 and 52

United States Patent and Trademark Office

Reg. No. 2,892,572

Registered Oct. 12, 2004

**TRADEMARK
PRINCIPAL REGISTER**

VIS.01

VSL PHARMA LIMITED (IRELAND COMPANY)
HARCOURT CENTRE BLOCK 3
HARCOURT ROAD
DUBLIN 2, IRELAND

FOR: LACTIC ACID BACTERIA PHARMACEU-
TICAL PREPARATIONS FOR USE IN THE PREVEN-
TION AND TREATMENT OF DISEASES OF THE
DIGESTIVE SYSTEM, GYNECOLOGICAL DISEA-
SES AND SKIN DISEASES; FOOD SUPPLEMENTS

CONTAINING LACTIC ACID BACTERIA, IN CLASS
5 (U.S. CLS. 6, 18, 44, 46, 51 AND 52).

PRIORITY CLAIMED UNDER SEC. 44(D) ON
ERPNTY TM OFC APPLICATION NO.
002716066, FILED 5-29-2002, REG. NO. 002716066,
DATED 8-12-2003, EXPIRES 5-29-2012.

SER. NO. 76-471,469, FILED 11-18-2002.

TONI HICKEY, EXAMINING ATTORNEY

Int. Cl.: 19

Prior U.S. Cls.: 1, 12, 33 and 50

United States Patent and Trademark Office

Reg. No. 2,892,573

Registered Oct. 12, 2004

**TRADEMARK
PRINCIPAL REGISTER**

PIRA-FORM

LES INDUSTRIES PIRANDELLO LTEE (CANADA CORPORATION)
7900 MARCO POLO
MONTREAL, PROVINCE OF QUEBEC, CANADA
H1E 2S5

FOR: TEXTILE LINER FOR CONCRETE FORMWORK, IN CLASS 19 (U.S. CLS. 1, 12, 33 AND 50).

PRIORITY CLAIMED UNDER SEC. 44(D) ON CANADA APPLICATION NO. 1159288, FILED 11-21-2002, REG. NO. TMA605538, DATED 3-17-2004, EXPIRES 3-17-2019.

SER. NO. 76-472,061, FILED 11-29-2002.

MATTHEW KLINE, EXAMINING ATTORNEY

Int. Cls.: 29, 30 and 32

Prior U.S. Cls.: 45, 46 and 48

United States Patent and Trademark Office

Reg. No. 2,892,574

Registered Oct. 12, 2004

**TRADEMARK
PRINCIPAL REGISTER**

WEEKS

CROWLEY FOODS, LLC (DELAWARE LTD LIAB
CO)
95 COURT STREET
BINGHAMTON, NY 13902

FOR: MILK, NAMELY, FLUID MILK, CREAM,
AND EGGS, IN CLASS 29 (U.S. CL. 46).

FIRST USE 12-0-1930; IN COMMERCE 12-0-1930.

FOR: ICE CREAM MIXES, IN CLASS 30 (U.S. CL.
46).

FIRST USE 12-0-1930; IN COMMERCE 12-0-1930.

FOR: FRUIT JUICES, NAMELY, ORANGE JUICE,
IN CLASS 32 (U.S. CLS. 45, 46 AND 48).

FIRST USE 12-0-1930; IN COMMERCE 12-0-1930.

SER. NO. 76-474,027, FILED 12-4-2002.

INGA ERVIN, EXAMINING ATTORNEY

Int. Cls.: 29, 30 and 32

Prior U.S. Cls.: 45, 46 and 48

United States Patent and Trademark Office

Reg. No. 2,892,575

Registered Oct. 12, 2004

TRADEMARK
PRINCIPAL REGISTER

Weeks

CROWLEY FOODS, LLC (DELAWARE LTD LIAB
CO)
95 COURT STREET
BINGHAMTON, NY 13902

FOR: MILK, NAMELY, FLUID MILK, CREAM,
AND EGGS, IN CLASS 29 (U.S. CL. 46).

FIRST USE 12-0-1985; IN COMMERCE 12-0-1985.

FOR: ICE CREAM MIXES, IN CLASS 30 (U.S. CL.
46).

FIRST USE 12-0-1985; IN COMMERCE 12-0-1985.

FOR: FRUIT JUICES, NAMELY, ORANGE JUICE,
IN CLASS 32 (U.S. CLS. 45, 46 AND 48).

FIRST USE 12-0-1985; IN COMMERCE 12-0-1985.

SER. NO. 76-474,028, FILED 12-4-2002.

INGA ERVIN, EXAMINING ATTORNEY

Int. Cl.: 9

Prior U.S. Cls.: 21, 23, 26, 36 and 38

United States Patent and Trademark Office

Reg. No. 2,892,576

Registered Oct. 12, 2004

**TRADEMARK
PRINCIPAL REGISTER**

MINK

BAE SYSTEMS PLC (UNITED KINGDOM COR-
PORATION)
6 CARLTON GARDENS
LONDON SW1Y 5AD, GREAT BRITAIN

FOR: KALMAN FILTER FOR SMOOTHING AND
FUSING NAVIGATION DATA INPUTS, IN CLASS 9
(U.S. CLS. 21, 23, 26, 36 AND 38).

PRIORITY CLAIMED UNDER SEC. 44(D) ON
ERPNTY TM OFC APPLICATION NO.
002770964, FILED 7-10-2002, REG. NO. 2770964, DA-
TED 12-15-2003, EXPIRES 7-10-2012.

SER. NO. 76-474,426, FILED 12-10-2002.

INGA ERVIN, EXAMINING ATTORNEY

Int. Cl.: 30

Prior U.S. Cl.: 46

United States Patent and Trademark Office

Reg. No. 2,892,577

Registered Oct. 12, 2004

TRADEMARK
PRINCIPAL REGISTER



BRUNELLI, PAOLO (ITALY INDIVIDUAL)
VIA F. NEGRI 12
RAVENNA, ITALY

FOR: COFFEE OF CUBAN ORIGIN, IN CLASS 30
(U.S. CL. 46).

PRIORITY CLAIMED UNDER SEC. 44(D) ON
ITALY APPLICATION NO. BO2002C00088, FILED 7-
24-2002, REG. NO. 903224, DATED 8-6-2003, EXPIRES
7-24-2012.

NO CLAIM IS MADE TO THE EXCLUSIVE
RIGHT TO USE "HAVANA CAFE DE CUBA",

"PINAR DEL RIO", "HAVANA", "MATANZAS",
"CIENFUEGOS", "SANTA CLARA", "CAMAGUEY",
"HOLGUIN", "SANTIAGO DE CUBA" AND "GUAN-
TANAMO", AND DESIGN OF CUBA, APART FROM
THE MARK AS SHOWN.

THE ENGLISH TRANSLATION OF "HAVANA
CAFE DE CUBA" IS "HAVANA CAFE OF CUBA".

SER. NO. 76-474,856, FILED 12-12-2002.

GEOFFREY FOSDICK, EXAMINING ATTORNEY

Int. Cl.: 9

Prior U.S. Cls.: 21, 23, 26, 36 and 38

Reg. No. 2,892,578

United States Patent and Trademark Office

Registered Oct. 12, 2004

**TRADEMARK
PRINCIPAL REGISTER**

VE-CORE

SONY KABUSHIKI KAISHA (JAPAN CORPORATION), TA SONY CORPORATION
7-35 KITASHINAGAWA
6-CHOME SHINAGAWA-KU
TOKYO, JAPAN

FOR DISPLAY APPARATUS AND OTHER ELECTRONIC MACHINES AND APPARATUS AND THEIR PARTS, IN CLASS 9 (U.S. CLS. 21, 23, 26, 36 AND 38).

FOR: LARGE-SCALE INTEGRATED CIRCUITS FOR CELLULAR TELEPHONES, LARGE-SCALE INTEGRATED CIRCUITS FOR TELEVISION RECEIVERS, LARGE-SCALE INTEGRATED CIRCUITS FOR AUDIO PRODUCTS, LARGE-SCALE INTEGRATED CIRCUITS FOR VIDEO CAMERAS, LARGE-SCALE INTEGRATED CIRCUITS FOR COMPUTERS AND PERSONAL DIGITAL ASSISTANTS, LARGE-SCALE INTEGRATED CIRCUITS

PRIORITY CLAIMED UNDER SEC. 44(D) ON JAPAN APPLICATION NO. 2002066926, FILED 8-7-2002, REG. NO. 4665988, DATED 4-25-2003, EXPIRES 4-25-2013.

SER. NO. 76-476,121, FILED 12-11-2002.

CAROLYN CATALDO, EXAMINING ATTORNEY

Int. Cl.: 29

Prior U.S. Cl.: 46

United States Patent and Trademark Office

Reg. No. 2,892,579

Registered Oct. 12, 2004

**TRADEMARK
PRINCIPAL REGISTER**

**100 YEAR OLD RECIPE GRANDMA MARONI'S GOURMET
MEATBALLS**

MEATBALLS INC. (NEW YORK CORPORATION), DBA MARONI CUISINE
18 WOODBINE AVE
NORTHPORT, NY 11768

FOR: PACKAGED MEAT, NAMELY, COOKED SEASONED MEATBALLS, IN CLASS 29 (U.S. CL. 46).

FIRST USE 3-1-2001; IN COMMERCE 3-1-2001.

NO CLAIM IS MADE TO THE EXCLUSIVE RIGHT TO USE "GOURMET MEATBALLS", APART FROM THE MARK AS SHOWN.

THE NAME GRANDMA MARONI DOES NOT IDENTIFY A LIVING INDIVIDUAL.

SER. NO. 76-476,484, FILED 12-18-2002.

MITCHELL FRONT, EXAMINING ATTORNEY

Int. Cl.: 34

Prior U.S. Cls.: 2, 8, 9 and 17

United States Patent and Trademark Office

Reg. No. 2,892,580

Registered Oct. 12, 2004

**TRADEMARK
PRINCIPAL REGISTER**

CASAMONTEZ

NICK'S CIGAR COMPANY (FLORIDA CORPORATION)
5150 NORTHWEST 167TH STREET
MIAMI LAKES, FL 33014

THE FOREIGN WORDING IN THE MARK
TRANSLATES INTO ENGLISH AS HOUSE MONTEZ.

FOR: CIGARS, IN CLASS 34 (U.S. CLS. 2, 8, 9 AND 17).

SER. NO. 76-476,490, FILED 12-18-2002.

FIRST USE 8-15-2001; IN COMMERCE 8-15-2001.

CAROLINE WEIMER, EXAMINING ATTORNEY

Int. Cl.: 36

Prior U.S. Cls.: 100, 101 and 102

United States Patent and Trademark Office

Reg. No. 2,892,581

Registered Oct. 12, 2004

**SERVICE MARK
PRINCIPAL REGISTER**

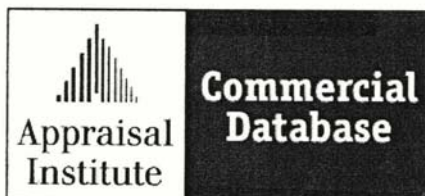

APPRAISAL INSTITUTE (ILLINOIS CORPORATION)
550 W. VAN BUREN STREET, SUITE 1000
CHICAGO, IL 60607

FOR: PROVIDING INFORMATION AND ONLINE DATABASES IN THE FIELDS OF REAL ESTATE AND REAL ESTATE APPRAISAL; PROVIDING INFORMATION CONCERNING REAL ESTATE AND APPRAISAL VIA GLOBAL COMPUTER NETWORKS; PROVIDING ONLINE DATABASES FEATURING INFORMATION IN THE NATURE OF ARCHIVED NEWSLETTERS AND PERIODICALS IN THE FIELDS OF REAL ESTATE AND APPRAISAL; AND PROVIDING CONSULTATION SERVICES RELATED THERETO, IN CLASS 36 (U.S. CLS. 100, 101 AND 102).

FIRST USE 6-1-2002, THE MARK WAS FIRST USED ANYWHERE IN A DIFFERENT FORM OTHER THAN THAT SOUGHT TO BE REGISTERED ON 04/30/2002.; IN COMMERCE 6-1-2002, THE MARK WAS FIRST USED IN COMMERCE IN A DIFFERENT FORM OTHER THAN THAT SOUGHT TO BE REGISTERED ON 04/30/2002..

OWNER OF U.S. REG. NOS. 1,704,217, 2,620,375 AND OTHERS.

NO CLAIM IS MADE TO THE EXCLUSIVE RIGHT TO USE COMMERCIAL DATABASE, APART FROM THE MARK AS SHOWN.

THE STIPPLING IS A FEATURE OF THE MARK.

THE MARK CONSISTS OF A HORIZONTAL RECTANGLE WITH A STYLIZED "AI" OVER THE WORDS "APPRAISAL INSTITUTE" IN DARK LETTERS IN A WHITE BLOCK ON THE LEFT OF THE RECTANGLE AND THE WORDS "COMMERCIAL DATABASE" IN WHITE LETTERS IN A DARK BLOCK ON THE RIGHT OF THE RECTANGLE.

SEC. 2(F) AS TO "APPRAISAL INSTITUTE".

SER. NO. 76-476,928, FILED 12-19-2002.

CHERYL STEPLIGHT, EXAMINING ATTORNEY

Int. Cl.: 36

Prior U.S. Cls.: 100, 101 and 102

United States Patent and Trademark Office

Reg. No. 2,892,582

Registered Oct. 12, 2004

**SERVICE MARK
PRINCIPAL REGISTER**



APPRAISAL INSTITUTE (ILLINOIS CORPORATION)
550 W. VAN BUREN STREET, SUITE 1000
CHICAGO, IL 60607

FOR: PROVIDING INFORMATION AND ONLINE DATABASES IN THE FIELDS OF REAL ESTATE AND REAL ESTATE APPRAISAL; PROVIDING INFORMATION CONCERNING REAL ESTATE AND APPRAISAL VIA GLOBAL COMPUTER NETWORKS; PROVIDING ONLINE DATABASES FEATURING INFORMATION IN THE NATURE OF ARCHIVED NEWSLETTERS AND PERIODICALS IN THE FIELDS OF REAL ESTATE AND APPRAISAL; AND PROVIDING CONSULTATION SERVICES RELATED THERETO, IN CLASS 36 (U.S. CLS. 100, 101 AND 102).

FIRST USE 4-30-2002; IN COMMERCE 4-30-2002.

OWNER OF U.S. REG. NOS. 1,704,217, 2,620,375 AND OTHERS.

NO CLAIM IS MADE TO THE EXCLUSIVE RIGHT TO USE COMMERCIAL DATABASE, APART FROM THE MARK AS SHOWN.

THE STIPPLING IS A FEATURE OF THE MARK.

THE MARK CONSISTS OF A VERTICAL RECTANGLE WITH A STYLIZED "AI" OVER THE WORDS "APPRAISAL INSTITUTE" IN DARK LETTERS IN A WHITE BLOCK ON THE TOP OF THE RECTANGLE AND THE WORDS "COMMERCIAL DATABASE" IN WHITE LETTERS IN A DARK BLOCK ON THE BOTTOM OF THE RECTANGLE.

SEC. 2(F) AS TO "APPRAISAL INSTITUTE".

SER. NO. 76-476,929, FILED 12-19-2002.

CHERYL STEPLIGHT, EXAMINING ATTORNEY

Int. Cl.: 44

Prior U.S. Cls.: 100 and 101

United States Patent and Trademark Office

Reg. No. 2,892,583

Registered Oct. 12, 2004

**SERVICE MARK
PRINCIPAL REGISTER**

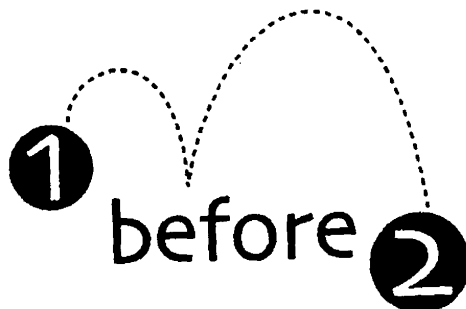

CHILD DEVELOPMENT SERVICES OF WYOMING (WYOMING NON-PROFIT ORGANIZATION)
2206 DELL RANGE, SUITE B
CHEYENNE, WY 82009

FOR: MEDICAL SERVICES, NAMELY, CHILD DEVELOPMENT SERVICES FEATURING MEDICAL PROGRAMS IN THE NATURE OF SCREENINGS, OCCUPATIONAL THERAPY, PHYSICAL THERAPY AND SPEECH AND LANGUAGE THER-

APY AIMED AT EARLY INTERVENTION FOR DEVELOPMENTALLY DELAYED CHILDREN, IN CLASS 44 (U.S. CLS. 100 AND 101).

FIRST USE 12-1-2002; IN COMMERCE 12-1-2002.

SER. NO. 76-477,606, FILED 12-20-2002.

GLENN CLARK, EXAMINING ATTORNEY

Int. Cl.: 10

Prior U.S. Cls.: 26, 39 and 44

United States Patent and Trademark Office

Reg. No. 2,892,584

Registered Oct. 12, 2004

**TRADEMARK
PRINCIPAL REGISTER**

The logo for WRIGHT features the word "WRIGHT." in a bold, sans-serif font. Below the text is a stylized graphic consisting of several overlapping, downward-pointing chevron-like shapes that create a sense of depth and movement, resembling a wing or a stylized 'W'.

WRIGHT MEDICAL TECHNOLOGY, INC. (DE-
LAWARE CORPORATION)
5677 AIRLINE ROAD
ARLINGTON, TN 380029501

FOR: MEDICAL APPARATUS, NAMELY, OR-
THOPEDIC IMPLANTS AND SURGICAL INSTRU-
MENTATION THEREFOR, IN CLASS 10 (U.S. CLS.
26, 39 AND 44).

FIRST USE 5-1-2003; IN COMMERCE 5-1-2003.

OWNER OF U.S. REG. NOS. 1,867,572, 1,986,341
AND OTHERS.

SER. NO. 76-477,625, FILED 12-20-2002.

TONI HICKEY, EXAMINING ATTORNEY

Int. Cl.: 28

Prior U.S. Cls.: 22, 23, 38 and 50

United States Patent and Trademark Office

Reg. No. 2,892,585

Registered Oct. 12, 2004

**TRADEMARK
PRINCIPAL REGISTER**

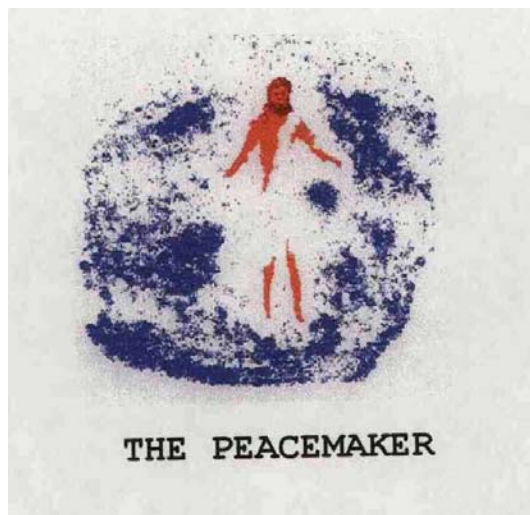

KLEINE, BARBARA RUTH (UNITED STATES
INDIVIDUAL)
3955 W HWY 47
TROY, MO 63379

FOR: BOARD GAMES, IN CLASS 28 (U.S. CLS. 22,
23, 38 AND 50).

FIRST USE 11-10-2002; IN COMMERCE 11-14-2002.

THE COLOR(S) DARKER BROWN HAIR AND
BEAR IS CLAIMED AS A FEATURE OF THE MARK.

THE MARK CONSISTS OF AN IMAGE OF JESUS
IN THE FLESH COLOR WITH DARKER BROWN

HAIR AND BEAR, HIS BODY DRAPED WITH A
WHITE CLOTH, RISING UP INTO A BLUE SKY
AND SURROUNDED BY WHITE CLOUDS. COLOR
IS CLAIMED AS A FEATURE OF THE MARK.

THE MARK CONSISTS OF AN IMAGE OF JESUS
IN FLESH COLOR WITH DARKER BROWN HAIR
AND BEARD, HIS BODY DRAPED WITH A WHITE
CLOTH, RISING UP INTO A BLUE SKY AND
SURROUNDED BY WHITE CLOUDS.

SER. NO. 76-478,821, FILED 12-27-2002.

LESLIE RICHARDS, EXAMINING ATTORNEY

Int. Cl.: 9

Prior U.S. Cls.: 21, 23, 26, 36 and 38

Reg. No. 2,892,586

United States Patent and Trademark Office

Registered Oct. 12, 2004

**TRADEMARK
PRINCIPAL REGISTER**

SILENTSEEK

SAMSUNG ELECTRONICS CO., LTD. (REPUBLIC OF KOREA CORPORATION)
416, METAN-DONG
YEONGTANG-GU, SUWON-SI, GYEONGGI-DO,
REPUBLIC OF KOREA

PRIORITY CLAIMED UNDER SEC. 44(D) ON
REPUBLIC OF KOREA APPLICATION NO. 2002-
0055742, FILED 12-3-2002, REG. NO. 0578253, DATED
3-23-2004, EXPIRES 3-23-2014.

FOR: COMPUTERS; PRINTERS FOR COMPUTER; COMPUTER DISK DRIVES; MP3 PLAYERS; DVD(DIGITAL VIDEO DISK) PLAYERS; DIGITAL CAMCORDERS; MOBILE PHONES; MODEMS; BATTERIES, IN CLASS 9 (U.S. CLS. 21, 23, 26, 36 AND 38).

SER. NO. 76-479,176, FILED 12-30-2002.

CAROLINE WEIMER, EXAMINING ATTORNEY

Int. Cl.: 9

Prior U.S. Cls.: 21, 23, 26, 36 and 38

Reg. No. 2,892,587

United States Patent and Trademark Office

Registered Oct. 12, 2004

**TRADEMARK
PRINCIPAL REGISTER**

NEOSEND

NEOTOOL DEVELOPMENT, LLC (COLORADO
LTD LIAB CO)
PO BOX 3586
MONTROSEO, CO 814023586

NETWORK COMMUNICATIONS NETWORKS,
ALL IN THE FIELD OF HEALTH CARE, IN CLASS
9 (U.S. CLS. 21, 23, 26, 36 AND 38).

FOR: DOWNLOADABLE COMMUNICATIONS
SOFTWARE FOR CONNECTING SOFTWARE
PLATFORMS AND DOWNLOADABLE MAIL MES-
SAGING SOFTWARE FOR SENDING AND RECEIV-
ING MESSAGES ACROSS PEER-TO-PEER AND

FIRST USE 1-0-2000; IN COMMERCE 2-0-2000.

SER. NO. 76-479,484, FILED 12-30-2002.

TRACY FLETCHER, EXAMINING ATTORNEY

Int. Cl.: 9

Prior U.S. Cls.: 21, 23, 26, 36 and 38

Reg. No. 2,892,588

United States Patent and Trademark Office

Registered Oct. 12, 2004

**TRADEMARK
PRINCIPAL REGISTER**

NEOENABLE

NEOTOOL DEVELOPMENT, LLC (COLORADO
LTD LIAB CO)
PO BOX 3586
MONTROSE, CO 814023586

NETWORK COMMUNICATIONS NETWORKS,
ALL IN THE FIELD OF HEALTH CARE, IN CLASS
9 (U.S. CLS. 21, 23, 26, 36 AND 38).

FOR: DOWNLOADABLE INTERFACING COM-
MUNICATIONS SOFTWARE FOR CONNECTING
SOFTWARE PLATFORMS AND DOWNLOADABLE
SOFTWARE FOR PARSING AND ENCODING MES-
SAGES ACROSS SOFTWARE PLATFORMS AND

FIRST USE 1-0-1999; IN COMMERCE 3-0-1999.

SER. NO. 76-479,490, FILED 12-30-2002.

TRACY FLETCHER, EXAMINING ATTORNEY

Int. Cl.: 41

Prior U.S. Cls.: 100, 101 and 107

United States Patent and Trademark Office

Reg. No. 2,892,589

Registered Oct. 12, 2004

SERVICE MARK
PRINCIPAL REGISTER

take 
CHARGE 
of your
CHALLENGE

SANDERS, MARY E. (UNITED STATES INDIVIDUAL)
5591 E. RAINBOW RIDGE CT
RENO, NV 89523

FOR: EDUCATIONAL SERVICES, NAMELY, PROVIDING SEMINARS AND WORKSHOPS IN THE FIELD OF PHYSICAL THERAPY AND DISTRIBUTING COURSE MATERIALS, NAMELY,

BROCHURES AND PRINTED INFORMATIONAL FLYERS, IN CLASS 41 (U.S. CLS. 100, 101 AND 107).

FIRST USE 7-1-2002; IN COMMERCE 7-1-2002.

SER. NO. 76-482,068, FILED 1-13-2003.

SOPHIA S. KIM, EXAMINING ATTORNEY

Int. Cls.: 9, 16 and 41

**Prior U.S. Cls.: 2, 5, 21, 22, 23, 26, 29, 36, 37, 38, 50,
100, 101 and 107**

Reg. No. 2,892,590

United States Patent and Trademark Office

Registered Oct. 12, 2004

**TRADEMARK
SERVICE MARK
PRINCIPAL REGISTER**

CLOSER

EMAP CONSUMER MEDIA LTD. (UNITED
KINGDOM CORPORATION)

1 LINCOLN COURT

LINCOLN ROAD

PETERBOROUGH, CAMBRIDGESHIRE PE1 2RF,
UNITED KINGDOM

FOR: DOWNLOADABLE PUBLICATIONS IN ELECTRONIC FORM, NAMELY, MAGAZINES, PERIODICAL PUBLICATIONS, NEWSPAPERS, BOOKS, NEWSLETTERS AND GUIDES, FEATURING LIFESTYLE, NEWS, RECREATIONAL ISSUES, TRAVEL, FASHION, HEALTH, BEAUTY AND FITNESS, CONSUMER INFORMATION RELATING TO PRODUCTS AND PRODUCT TESTING, ADVICE ABOUT FINANCE, CELEBRITY INTERVIEWS, MUSIC, FILM, THEATER, BOOK REVIEWS AND ASTROLOGY, TELEVISION LISTING GUIDES, CELEBRITY LIFESTYLES AND TRAVEL, SUPPLIED ON-LINE FROM DATABASES OR FROM FACILITIES PROVIDED ON THE INTERNET (INCLUDING WEBSITES), MULTI-MEDIA RECORDINGS AND PUBLICATIONS, NAMELY, CDS, CDIS, CD-ROMS FEATURING LIFESTYLE, NEWS, RECREATIONAL ISSUES, TRAVEL, FASHION, HEALTH, BEAUTY AND FITNESS, CONSUMER INFORMATION RELATING TO PRODUCTS AND PRODUCT TESTING, ADVICE ABOUT FINANCE, CELEBRITY INTERVIEWS, MUSIC, FILM, THEATER, BOOK REVIEWS AND ASTROLOGY, TELEVISION LISTING GUIDES, CELEBRITY LIFESTYLES AND TRAVEL; AUDIO AND VISUAL RECORDINGS, NAMELY, AUDIO CASSETTES, AUDIO TAPES, VIDEOCASSETTES, VIDEO TAPES AND DVDS FEATURING LIFESTYLE, NEWS, RECREATIONAL ISSUES, TRAVEL, FASHION, HEALTH, BEAUTY AND FITNESS, CONSUMER INFORMATION RELATING TO PRODUCTS AND PRODUCT TESTING, ADVICE ABOUT FINANCE, CELEBRITY INTERVIEWS, MUSIC, FILM, THEATER, BOOK REVIEWS AND ASTROLOGY, TELEVISION LISTING GUIDES, CELEBRITY LIFESTYLES AND TRAVEL; PRINTED TICKETS, STATIONERY; DIARIES; CALENDARS; NOTEBOOKS; ADDRESS BOOKS; WRITING IMPLEMENTS, NAMELY, PENS AND PENCILS, IN CLASS 16 (U.S. CLS. 2, 5, 22, 23, 29, 37, 38 AND 50).

ING GUIDES, CELEBRITY LIFE STYLES AND TRAVEL; PRE-RECORDED VIDEO TAPES AND PRE-RECORDED VIDEO CASSETTES FEATURING LIFESTYLE, NEWS, RECREATIONAL ISSUES, TRAVEL, FASHION, HEALTH, BEAUTY AND FITNESS, CONSUMER INFORMATION RELATING TO PRODUCTS AND PRODUCT TESTING, ADVICE ABOUT FINANCE, CELEBRITY INTERVIEWS, MUSIC, FILM, THEATER, BOOK REVIEWS AND ASTROLOGY, TELEVISION LISTING GUIDES, CELEBRITY LIFESTYLES AND TRAVEL PRE-RECORDED MULTIMEDIA RECORDING AND PUBLICATIONS, NAMELY, CDS, CDIS, CD-ROMS, DVD AND AUDIO AND VIDEO TAPES CONTAINING INFORMATION ABOUT LIFESTYLE, NEWS, RECREATIONAL ISSUES, TRAVEL, FASHION, HEALTH, BEAUTY AND FITNESS, CONSUMER INFORMATION RELATING TO PRODUCTS AND PRODUCT TESTING, ADVICE ABOUT FINANCE, CELEBRITY INTERVIEWS, MUSIC, FILM, THEATER, BOOK REVIEWS AND ASTROLOGY, TELEVISION LISTING GUIDES CELEBRITY LIFESTYLES AND TRAVEL, RECORDED IN MAGAZINE FORM, IN CLASS 9 (U.S. CLS. 21, 23, 26, 36 AND 38).

FOR: PRINTED MATTER AND PRINTED PUBLICATIONS, NAMELY, MAGAZINES, NEWSPAPERS, BOOKS, NEWSLETTERS AND GUIDES FEATURING LIFESTYLE, NEWS, RECREATIONAL ISSUES, TRAVEL, FASHION, HEALTH, BEAUTY AND FITNESS, CONSUMER INFORMATION RELATING TO PRODUCTS AND PRODUCT TESTING ADVICE ABOUT FINANCE CELEBRITY INTERVIEWS, MUSIC, FILM, THEATER, BOOK REVIEWS AND ASTROLOGY, TELEVISION LISTING GUIDES, CELEBRITY LIFESTYLES AND TRAVEL; PRINTED TICKETS, STATIONERY; DIARIES; CALENDARS; NOTEBOOKS; ADDRESS BOOKS; WRITING IMPLEMENTS, NAMELY, PENS AND PENCILS, IN CLASS 16 (U.S. CLS. 2, 5, 22, 23, 29, 37, 38 AND 50).

FOR: PUBLISHING SERVICES, NAMELY, PUBLICATION OF BOOKS, PERIODICALS AND MAGAZINES; ELECTRONIC PUBLISHING SERVICES, NAMELY, PUBLICATION OF TEXT AND GRAPHICAL WORKS OF OTHERS ON CD, CD-ROM, DVD, PRE-RECORDED VIDEO , IN CLASS 41 (U.S. CLS. 100, 101 AND 107).

OWNER OF UNITED KINGDOM REG. NO. 2280350, DATED 9-12-2001, EXPIRES 9-12-2011.

SER. NO. 76-482,208, FILED 1-14-2003.

SUSAN STIGLITZ, EXAMINING ATTORNEY

Int. Cl.: 7

Prior U.S. Cls.: 13, 19, 21, 23, 31, 34 and 35

Reg. No. 2,892,591

United States Patent and Trademark Office

Registered Oct. 12, 2004

**TRADEMARK
PRINCIPAL REGISTER**

SUPER BLUE

ASGCO MANUFACTURING, INC. (PENNSYLVANIA CORPORATION)
301-323 GORDON STREET
ALLENTOWN, PA 181023136

AND MINING INDUSTRIES , IN CLASS 7 (U.S. CLS. 13, 19, 21, 23, 31, 34 AND 35).

FIRST USE 4-30-1999; IN COMMERCE 4-30-1999.

FOR: CONVEYOR BELT CLEANER MECHANISM COMPRISED OF BLADE, HOLDER AND TENSIONING MECHANISM FOR USE IN AGGREGATE

SER. NO. 76-482,329, FILED 1-14-2003.

TONI HICKEY, EXAMINING ATTORNEY

Int. Cls.: 35, 41 and 42

Prior U.S. Cls.: 100, 101, 102 and 107

United States Patent and Trademark Office

Reg. No. 2,892,592

Registered Oct. 12, 2004

**SERVICE MARK
PRINCIPAL REGISTER**

CLINTRUST GLOBAL ALLIANCE

CTGA TRADEMARK HOLDINGS, INC. (DELA-
WARE NON-STOCK CORPORATION)
9 EAST LOCKERMAN STREET
DOVER, DE 19901

FOR: MANAGEMENT OF CLINICAL RESEARCH
FOR OTHERS, IN CLASS 35 (U.S. CLS. 100, 101 AND
102).

FIRST USE 5-30-2000; IN COMMERCE 9-29-2000.

FOR: EDUCATIONAL SERVICES, NAMELY,
CONDUCTING CLASSES, SEMINARS AND WORK-
SHOP IN THE FIELDS OF CLINICAL RESEARCH,
IN CLASS 41 (U.S. CLS. 100, 101 AND 107).

FIRST USE 5-30-2000; IN COMMERCE 9-29-2000.

FOR: CONSULTATION IN THE FIELD OF CLIN-
ICAL RESEARCH, IN CLASS 42 (U.S. CLS. 100 AND
101).

FIRST USE 5-30-2000; IN COMMERCE 9-29-2000.

NO CLAIM IS MADE TO THE EXCLUSIVE
RIGHT TO USE "GLOBAL" AND "ALLIANCE",
APART FROM THE MARK AS SHOWN.

SER. NO. 76-482,339, FILED 1-14-2003.

KELLEY WELLS, EXAMINING ATTORNEY

Int. Cl.: 29

Prior U.S. Cl.: 46

United States Patent and Trademark Office

Reg. No. 2,892,593

Registered Oct. 12, 2004

TRADEMARK
PRINCIPAL REGISTER



AGRO SEVILLA ACEITUNAS, S. COOP. AND.
(SPAIN CORPORATION)
AVE. DE LA INNOVACION S/N
EDIFICIO RENTA SEVILLA, PL. 8A.
41020 SEVILLA, SPAIN

FOR: OLIVE OILS AND PRESERVED OLIVES, IN
CLASS 29 (U.S. CL. 46).

PRIORITY CLAIMED UNDER SEC. 44(D) ON
SPAIN APPLICATION NO. 2503783, FILED 9-13-
2002, REG. NO. 2503783, DATED 2-20-2003, EXPIRES
2-20-2013.

OWNER OF U.S. REG. NO. 1,407,841.

NO CLAIM IS MADE TO THE EXCLUSIVE
RIGHT TO USE "SEVILLA", APART FROM THE
MARK AS SHOWN.

THE MARK HAD BEEN LINED FOR THE COL-
ORS GREEN, YELLOW, ORANGE AND BLUE. THE
STIPPLING IN THE DRAWING IS FOR SHADING
PURPOSES ONLY.

THE TERMS AGRO AND SEVILLA MAY BE
TRANSLATED INTO ENGLISH AS AGRICULTURE
AND SEVILLE.

SER. NO. 76-482,705, FILED 1-16-2003.

ZACHARY BELLO, EXAMINING ATTORNEY

Int. Cl.: 9

Prior U.S. Cls.: 21, 23, 26, 36 and 38

United States Patent and Trademark Office

Reg. No. 2,892,594

Registered Oct. 12, 2004

**TRADEMARK
PRINCIPAL REGISTER**

MARKET DIRECT

CHECKFREE SERVICES CORPORATION (DELA-
WARE CORPORATION)
4411 EAST JONES BRIDGE ROAD
NORCROSS, GA 30092

FOR: DOWNLOADABLE SOFTWARE TO ALLOW
USERS TO TARGET GROUPS OF CUSTOMERS,
DELIVER CUSTOMIZED MESSAGES TO THOSE
CUSTOMERS, AND MEASURE THE EFFECTIVE-
NESS OF SUCH MESSAGES, IN CLASS 9 (U.S. CLS.
21, 23, 26, 36 AND 38).

FIRST USE 4-0-2000; IN COMMERCE 4-0-2000.

NO CLAIM IS MADE TO THE EXCLUSIVE
RIGHT TO USE "MARKET", APART FROM THE
MARK AS SHOWN.

SER. NO. 76-483,473, FILED 1-21-2003.

BARNEY CHARLON, EXAMINING ATTORNEY

Int. Cls.: 16 and 41

Prior U.S. Cls.: 2, 5, 22, 23, 29, 37, 38, 50, 100, 101 and 107

United States Patent and Trademark Office

Reg. No. 2,892,595

Registered Oct. 12, 2004

**TRADEMARK
SERVICE MARK
PRINCIPAL REGISTER**



VERTICALSCOPE INC. (CANADA CORPORATION)
111 PETER STREET, SUITE 700
TORONTO, ONTARIO M5V 2H1, CANADA

FOR: (BASED ON 44(D) PRIORITY APPLICATION) PRINTED PUBLICATIONS, NAMELY A MAGAZINE CONTAINING INFORMATION REGARDING IMPORT RACING CULTURE, MUSIC, MOTOR SPORTS, SPORTS APPAREL, AUTOMOTIVE TECHNOLOGY AND LIFESTYLE, IN CLASS 16 (U.S. CLS. 2, 5, 22, 23, 29, 37, 38 AND 50).

FOR: (BASED ON USE IN COMMERCE) (BASED ON 44(D) PRIORITY APPLICATION) ONLINE INFORMATION SERVICES, NAMELY THE PROVISION OF A MAGAZINE CONTAINING INFORMATION REGARDING IMPORT RACING CULTURE, MUSIC, MOTOR SPORTS, SPORTS AP-

PAREL, AUTOMOTIVE TECHNOLOGY AND LIFESTYLE, IN CLASS 41 (U.S. CLS. 100, 101 AND 107).

FIRST USE 5-10-2002; IN COMMERCE 5-10-2002.

PRIORITY CLAIMED UNDER SEC. 44(D) ON CANADA APPLICATION NO. 1,157,288, FILED 10-29-2002, REG. NO. TMA593982, DATED 11-5-2003, EXPIRES 11-5-2018.

NO CLAIM IS MADE TO THE EXCLUSIVE RIGHT TO USE "MODIFIED" AND "COM", APART FROM THE MARK AS SHOWN.

SER. NO. 76-483,512, FILED 1-21-2003.

MICHAEL KEATING, EXAMINING ATTORNEY

Int. Cl.: 11

Prior U.S. Cls.: 13, 21, 23, 31 and 34

United States Patent and Trademark Office

Reg. No. 2,892,596

Registered Oct. 12, 2004

**TRADEMARK
PRINCIPAL REGISTER**

ARC FORCE

SWSI, INC. (TEXAS CORPORATION)
1603 N. MAIN
PEARLAND, TX 77581

NO CLAIM IS MADE TO THE EXCLUSIVE
RIGHT TO USE ARC , APART FROM THE MARK
AS SHOWN.

FOR: ELECTRODE OVENS FOR WELDING, IN
CLASS 11 (U.S. CLS. 13, 21, 23, 31 AND 34).

SER. NO. 76-483,576, FILED 1-21-2003.

FIRST USE 3-0-1999; IN COMMERCE 3-0-1999.

CAROLYN CATALDO, EXAMINING ATTORNEY

Int. Cls.: 7 and 12

Prior U.S. Cls.: 13, 19, 21, 23, 31, 34, 35 and 44

United States Patent and Trademark Office

Reg. No. 2,892,597

Registered Oct. 12, 2004

**TRADEMARK
PRINCIPAL REGISTER**

HOTBODIESRACING.COM

HOTBODIES RACING, INC. (CALIFORNIA CORPORATION)
12600 STOWE DRIVE, #4
POWAY, CA 92064

FOR: MOTORCYCLE AND AUTOMOBILE AIR-BOXES FOR HOLDING AIR FILTERS, MOTORCYCLE AND AUTOMOBILE EXHAUST SYSTEMS COMPRISING EXHAUST PIPES, MUFFLERS, SILENCERS, EXHAUST MANIFOLDS FOR ENGINES, IN CLASS 7 (U.S. CLS. 13, 19, 21, 23, 31, 34 AND 35).

FIRST USE 5-0-2001; IN COMMERCE 7-0-2001.

FOR: MOTORCYCLE AND AUTOMOBILE PARTS AND ACCESSORIES MANUFACTURED FROM FIBERGLASS, CARBON FIBER AND OTHER

COMPOSITE MATERIALS, NAMELY, MOTORCYCLE RACING BODYWORK, MOTORCYCLE REPLACEMENT BODY PANELS, MOTORCYCLE UNDER TAILS, MOTORCYCLE FENDERS, MOTORCYCLE BUMPERS, MOTORCYCLE HOOD SHIELDS AS STRUCTURAL PARTS OF VEHICLES, PICKUP-TRUCK BED SHELLS AND LIDS, NAMELY, PICKUP TRUCK BED COVERS AND PICKUP TRUCK CAPS, IN CLASS 12 (U.S. CLS. 19, 21, 23, 31, 35 AND 44).

FIRST USE 5-0-2001; IN COMMERCE 7-0-2001.

SER. NO. 76-484,114, FILED 1-23-2003.

JENNIFER MARTIN, EXAMINING ATTORNEY

Int. Cl.: 43

Prior U.S. Cls.: 100 and 101

United States Patent and Trademark Office

Reg. No. 2,892,598

Registered Oct. 12, 2004

**SERVICE MARK
PRINCIPAL REGISTER**

TROPICAL SMOOTHIE CAFÉ

TROPICAL SMOOTHIE FRANCHISE DEVELOPMENT CORPORATION (FLORIDA CORPORATION)

1190 EGLIN PARKWAY
SHALIMAR, FL 32579

FOR: FAST FOOD JUICE BAR SERVICES, IN CLASS 43 (U.S. CLS. 100 AND 101).

FIRST USE 10-1-1999; IN COMMERCE 10-1-1999.

OWNER OF U.S. REG. NO. 2,103,370.

NO CLAIM IS MADE TO THE EXCLUSIVE RIGHT TO USE "SMOOTHIE CAFE", APART FROM THE MARK AS SHOWN.

SER. NO. 76-485,193, FILED 1-27-2003.

WILLIAM VERHOSEK, EXAMINING ATTORNEY

Int. Cl.: 10

Prior U.S. Cls.: 26, 39 and 44

United States Patent and Trademark Office

Reg. No. 2,892,599

Registered Oct. 12, 2004

**TRADEMARK
PRINCIPAL REGISTER**

HearingPro

HEARINGPRO INC. (MISSOURI CORPORATION)
5222 S. LINDBERGH BLVD.
ST. LOUIS, MO 63126

FIRST USE 1-1-2000; IN COMMERCE 1-1-2000.

SER. NO. 76-486,262, FILED 1-30-2003.

FOR: HEARING AIDS, IN CLASS 10 (U.S. CLS. 26,
39 AND 44).

JOHN E. MICHOS, EXAMINING ATTORNEY

Int. Cl.: 32

Prior U.S. Cls.: 45, 46 and 48

United States Patent and Trademark Office

Reg. No. 2,892,600

Registered Oct. 12, 2004

TRADEMARK
PRINCIPAL REGISTER

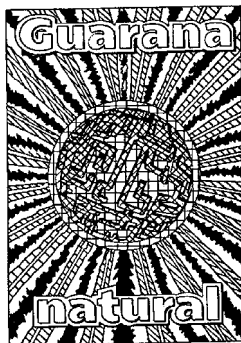

STEINER & CO. OEG. (AUSTRIA CORPORATION)
34/4/1, ERNST LOGERGASSE
BAD SAUERBRUNN, AT-7202, AUSTRIA

FOR: NON-ALCOHOLIC BEVERAGES, NAMELY,
ENERGY DRINKS; ISOTONIC BEVERAGES, IN
CLASS 32 (U.S. CLS. 45, 46 AND 48).

OWNER OF AUSTRIA REG. NO. 193144, DATED
10-25-2001, EXPIRES 10-31-2011.

NO CLAIM IS MADE TO THE EXCLUSIVE
RIGHT TO USE "GUARANA NATURAL", APART
FROM THE MARK AS SHOWN.

THE MARK HAS BEEN LINED FOR COLORS
GREEN, YELLOW BLACK AND ORANGE. THE
WORDS GUARANA NATURAL SHOULD BE CON-
SIDERED LINED FOR THE COLOR YELLOW.
COLORS ARE CLAIMED AS FEATURES OF THE
MARK.

SER. NO. 76-486,356, FILED 1-29-2003.

ALLISON HOLTZ, EXAMINING ATTORNEY

Int. Cls.: 1, 9, 10, 14, 15, 17, 19, 20, 21, 28 and 34

Prior U.S. Cls.: 1, 2, 5, 6, 8, 9, 10, 12, 13, 17, 21, 22, 23, 25, 26, 27, 28, 29, 30, 32, 33, 35, 36, 38, 39, 40, 44, 46 and 50

Reg. No. 2,892,601

United States Patent and Trademark Office

Registered Oct. 12, 2004

**TRADEMARK
PRINCIPAL REGISTER**

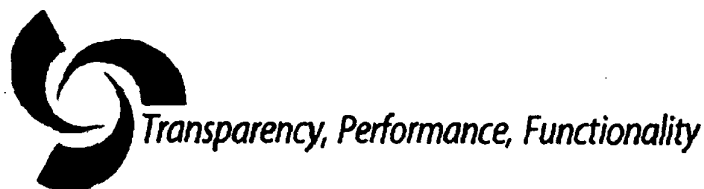

ROHM GMBH & CO. KG (FED REP GERMANY
LTD LIAB CO)
RODENBACHER CHAUSSEE 4
63457 HANAU, FED REP GERMANY

FOR: INDUSTRIAL CHEMICALS, NAMELY, CHEMICALS FOR PROCESSING PHOTOGRAPHS, UNPROCESSED ARTIFICIAL RESINS AND UNPROCESSED PLASTICS FOR USE IN MANUFACTURING PROCESSES, AND INDUSTRIAL ADHESIVES USED IN FURTHER MANUFACTURING PROCESSES; SYNTHETIC RESINS FOR USE IN THE MANUFACTURE OF MOLDING; ADHESIVES FOR GENERAL INDUSTRIAL USE; ARTIFICIAL RESIN BINDERS FOR COMPOUNDING OF ROAD MARKING MATERIALS; COMPOUNDS FOR ROAD MARKINGS AND FOR TRAFFIC SYMBOLS; CHEMICALS FOR USE AS BUILDING CHEMICALS; NAMELY, MULTI-COMPONENT SYSTEMS ON A MONOMER OR POLYMER BASE AND SYNTHETIC RESINS IN EMULSION FORM AND CHEMICAL BASES FOR ROAD MARKINGS, FLOOR COATINGS, SEWAGE PIPE REPAIRS, REPAIR MORTARS AND FOR THE MANUFACTURE OF POLYMER CONCRETE PARTS, IN CLASS 1 (U.S. CLS. 1, 5, 6, 10, 26 AND 46).

FOR: CASH REGISTERS, CALCULATORS; AUDIO RECORDING MACHINES; FIRE-EXTINGUISHERS MADE OF GLASS, GLASS REPLACEMENTS OR SAFETY GLASS; NEON SIGNS, NAMELY, ILLUMINATED LETTERS, WORDS, PANELS FOR OUTDOOR ADVERTISING, TIRE PRESSURE GAUGES AND SPECTACLES, PRESSURE GAUGES, DRAWING BOARDS, MEASURING INSTRUMENTS, NAMELY, MEASURING SPOONS AND CUPS MADE OF GLASS OR A GLASS SUBSTITUTE, MEASURING BEVELS MADE OF GLASS

OR A GLASS SUBSTITUTE, IN CLASS 9 (U.S. CLS. 21, 23, 26, 36 AND 38).

FOR: ORTHOPEDIC ARTICLES, NAMELY, ARCH SUPPORTS, INSOLES FOR SHOES; SURGICAL AND MEDICAL DEVICES, NAMELY, SCALPES, X-RAY APPARATUS, INCUBATORS, IRON LUNGS AND OXYGEN MASKS, OPERATION TABLES, ARTIFICIAL LIMBS, EYES AND TEETH, ALL MADE OF GLASS OR A GLASS SUBSTITUTE, IN CLASS 10 (U.S. CLS. 26, 39 AND 44).

FOR: JEWELRY; CLOCK AND WATCH FACES AND GLASSES AS WELL AS OTHER PARTS OF CLOCKS AND WATCHES OR OF OTHER HOROLOGICAL AND CHRONOMETRIC INSTRUMENTS, ALL MADE OF GLASS OR GLASS REPLACEMENTS, IN CLASS 14 (U.S. CLS. 2, 27, 28 AND 50).

FOR: PARTS OF MUSICAL INSTRUMENTS, NAMELY, BODIES OF PIANOS AND VIOLINS, ALL MADE OF GLASS OR GLASS SUBSTITUTES, IN CLASS 15 (U.S. CLS. 2, 21 AND 36).

FOR: EXTRUDED PLASTICS AS SEMI-FINISHED PRODUCTS IN THE FORM OF FOILS, SHEETS, BLOCKS, PROFILES, RODS, TUBES AND SHAPED PIECES, DOUBLE-SKIN PLASTIC IN SHEET FORM AND MULTI-SKIN PLASTICS IN SHEET FORM; ALL FOR USE IN FURTHER MANUFACTURING; PACKING, STOPPING AND INSULATING MATERIAL, ALL MADE OF GLASS OR GLASS SUBSTITUTES FOR FORMING SEALS, IN CLASS 17 (U.S. CLS. 1, 5, 12, 13, 35 AND 50).

FOR: BUILDING MATERIALS MADE OF PLASTICS IN THE FORM OF FILMS, SHEETS, WEBS, PROFILES, BLOCKS, RODS AND TUBES; WIN-

DOWNS MADE OF PLASTICS, WINDOW PANES AND DOOR PANELS MADE OF PLASTICS; SAFETY GLASS FOR CONSTRUCTION; BUILDING MATERIALS, NAMELY, WALLS, SCREENS, CUPOLAS, CEILINGS AND WALL COVERINGS MADE OF GLASS OR GLASS SUBSTITUTES; GLASS BLOCKS FOR BUILDING; STONE FOR BUILDING AND CONSTRUCTION, IN CLASS 19 (U.S. CLS. 1, 12, 33 AND 50).

FOR: DISPLAY TRIPOD STANDS; FURNITURE PARTS; MIRRORS, MIRROR AND PICTURE FRAMES AS WELL AS PARTS OF THESE GOODS, JOINTED MANNEQUINS, MANNEQUIN HEADS, LEGS AND ARMS FOR DISPLAYS AND FOR USE BY HAIRDRESSERS; BUSTS MADE OF PLASTIC; SCULPTURES MADE OF PLASTIC, IN CLASS 20 (U.S. CLS. 2, 13, 22, 25, 32 AND 50).

FOR: SCULPTURES MADE OF GLASS AND GLASS SUBSTITUTES; GLASS BEVERAGE WARE; GLASS BOWLS; GLASS FOR SIGNAL LIGHTS OR HEADLIGHTS FOR VEHICLES; UNFINISHED GLASS FOR VEHICLE WINDOWS; GLASS TUBES

NOT FOR SCIENTIFIC PURPOSES, IN CLASS 21 (U.S. CLS. 2, 13, 23, 29, 30, 33, 40 AND 50).

FOR: CHRISTMAS TREE ORNAMENTS MADE OF GLASS OR GLASS SUBSTITUTES; AND MARBLES; ACTION SKILL GAMES, BOARD GAMES, COIN-OPERATED VIDEO GAMES, GAME TABLES, IN CLASS 28 (U.S. CLS. 22, 23, 38 AND 50).

FOR: SMOKER'S ARTICLES, NAMELY, ASH-TRAYS MADE OF GLASS OR GLASS SUBSTITUTES; CIGARETTE HOLDERS MADE OF GLASS OR GLASS SUBSTITUTES, MATCH BOXES MADE OF GLASS OR GLASS SUBSTITUTES; MATCH HOLDERS MADE OF GLASS OR GLASS SUBSTITUTES, SNUFF BOXES MADE OF GLASS OR GLASS SUBSTITUTES, IN CLASS 34 (U.S. CLS. 2, 8, 9 AND 17).

OWNER OF FED REP GERMANY REG. NO. 30210485, DATED 10-21-2002, EXPIRES 2-29-2012.

SER. NO. 76-486,385, FILED 1-30-2003.

JOHN E. MICHOS, EXAMINING ATTORNEY

Int. Cl.: 35

Prior U.S. Cls.: 100, 101 and 102

United States Patent and Trademark Office

Reg. No. 2,892,602

Registered Oct. 12, 2004

**SERVICE MARK
PRINCIPAL REGISTER**



REED ELSEVIER INC. (MASSACHUSETTS CORPORATION)
275 WASHINGTON STREET
NEWTON, MA 02458

FOR: ARRANGING, PROMOTING AND CONDUCTING TRADESHOWS, EXHIBITIONS AND EXPOSITIONS IN THE FIELDS OF FISHING, BOATING, TRAVEL, HUNTING, RECREATIONAL VEHICLES, CAMPING, OUTDOOR SPORTS, OUTDOOR RECREATIONAL ACTIVITIES AND OUTDOOR EQUIPMENT, IN CLASS 35 (U.S. CLS. 100, 101 AND 102).

FIRST USE 1-15-2003; IN COMMERCE 1-15-2003.

OWNER OF U.S. REG. NO. 2,109,906.

NO CLAIM IS MADE TO THE EXCLUSIVE RIGHT TO USE "CHICAGOLAND" AND "SHOW", APART FROM THE MARK AS SHOWN.

THE LINING SHOWN IN THE DRAWING IS A FEATURE OF THE MARK AND IS NOT INTENDED TO INDICATED COLOR.

SER. NO. 76-488,926, FILED 2-10-2003.

CHARLES L. JENKINS, EXAMINING ATTORNEY

Int. Cls.: 25 and 28

Prior U.S. Cls.: 22, 23, 38, 39 and 50

United States Patent and Trademark Office

Reg. No. 2,892,603

Registered Oct. 12, 2004

**TRADEMARK
PRINCIPAL REGISTER**

BUCK WILDER

BUCK, L.L.C. (MICHIGAN CORPORATION)
4160 M-72 EAST
WILLIAMSBURG, MI 49690

FOR: CLOTHING, NAMELY, T-SHIRTS AND
HATS, IN CLASS 25 (U.S. CLS. 22 AND 39).

FIRST USE 6-0-1997; IN COMMERCE 6-0-1997.

FOR: TOYS AND OUTDOOR SPORTING EQUIP-
MENT, NAMELY, FISHING RODS AND REELS,
FISHING LINES AND FISHING HOOKS, AND

STUFFED ANIMALS, IN CLASS 28 (U.S. CLS. 22,
23, 38 AND 50).

FIRST USE 6-0-1995; IN COMMERCE 6-0-1995.

OWNER OF U.S. REG. NO. 1,981,651.

THE MARK "BUCK WILDER" DOES NOT IDENTIFY
THE LIVING INDIVIDUAL.

SER. NO. 76-489,103, FILED 2-10-2003.

ANDREA SAUNDERS, EXAMINING ATTORNEY

Int. Cl.: 31

Prior U.S. Cls.: 1 and 46

United States Patent and Trademark Office

Reg. No. 2,892,604

Registered Oct. 12, 2004

**TRADEMARK
PRINCIPAL REGISTER**

LITTER MASTER

SBC FIREMASTER LTD. (CANADA CORPORATION)
#101 - 22661 FRASER HIGHWAY
LANGLEY, BRITISH COLUMBIA, CANADA V2Z
2T5

FOR: PET LITTER AND BEDDING FOR PETS, IN
CLASS 31 (U.S. CLS. 1 AND 46).

PRIORITY CLAIMED UNDER SEC. 44(D) ON
CANADA APPLICATION NO. 1167076, FILED 2-5-

2003, REG. NO. TMA608471, DATED 4-26-2004, EX-
PIRES 4-26-2019.

NO CLAIM IS MADE TO THE EXCLUSIVE
RIGHT TO USE "LITTER", APART FROM THE
MARK AS SHOWN.

SER. NO. 76-489,709, FILED 2-11-2003.

DAWN FELDMAN, EXAMINING ATTORNEY

Int. Cls.: 3 and 5

Prior U.S. Cls.: 1, 4, 6, 18, 44, 46, 50, 51 and 52

United States Patent and Trademark Office

Reg. No. 2,892,605

Registered Oct. 12, 2004

**TRADEMARK
PRINCIPAL REGISTER**

OMNI INSTITUTIONAL

ACUITY BRANDS, INC. (DELAWARE CORPORATION)
1170 PEACHTREE STREET, SUITE 2400
ATLANTA, GA 30309

FOR: ALL PURPOSE CLEANERS, SHOWER AND RESTROOM CLEANING PREPARATIONS, GLASS CLEANERS, AND FLOOR CLEANERS, IN CLASS 3 (U.S. CLS. 1, 4, 6, 50, 51 AND 52).

FIRST USE 2-12-2003; IN COMMERCE 2-12-2003.

FOR: AIR FRESHENERS, IN CLASS 5 (U.S. CLS. 6, 18, 44, 46, 51 AND 52).

FIRST USE 2-12-2003; IN COMMERCE 2-12-2003.

NO CLAIM IS MADE TO THE EXCLUSIVE RIGHT TO USE INSTITUTIONAL, APART FROM THE MARK AS SHOWN.

SER. NO. 76-490,074, FILED 2-14-2003.

EDWARD NELSON, EXAMINING ATTORNEY

Int. Cl.: 11

Prior U.S. Cls.: 13, 21, 23, 31 and 34

United States Patent and Trademark Office

Reg. No. 2,892,606

Registered Oct. 12, 2004

**TRADEMARK
PRINCIPAL REGISTER**

ACCLARIO

BRITA GMBH (FED REP GERMANY CORPORATION)
HEINRICH-HERTZ-STRASSE 4
65232 TAUNUSSTEIN, FED REP GERMANY

FOR: WATER FILTERS FOR HOUSEHOLD PURPOSES AND FOR COMMERCIAL PURPOSES NOT CONSISTING OF PRECIOUS METALS OR PLATED; REFILL PACKAGES AND FILTER CARTRIDGES BASED ON ION-EXCHANGER RESINS AND/OR ADSORBENTS FOR WATER FILTERS; ELECTRICAL AND NON-ELECTRICAL WATER BOILERS USED FOR WATER PURIFICATION WITH INTEGRATED FILTERS UNIT NOT CONSISTING OF PRECIOUS METALS OR PLATED; ELECTRICAL AND NON-ELECTRICAL WATER BOILERS USED

FOR WATER PURIFICATION WITH INTEGRATED FILTERS UNIT MADE OR PLATED WITH PRECIOUS METAL; WATER FILTER FOR HOUSEHOLD PURPOSE AND FOR COMMERCIAL PURPOSES MADE OR PLATED WITH PRECIOUS METAL, IN CLASS 11 (U.S. CLS. 13, 21, 23, 31 AND 34).

PRIORITY CLAIMED UNDER SEC. 44(D) ON FED REP GERMANY APPLICATION NO. 30240933.5/1, FILED 8-15-2002, REG. NO. 30240933, DATED 10-10-2002, EXPIRES 8-31-2012.

SER. NO. 76-490,379, FILED 2-10-2003.

BRIAN PINO, EXAMINING ATTORNEY

Int. Cl.: 9

Prior U.S. Cls.: 21, 23, 26, 36 and 38

United States Patent and Trademark Office

Reg. No. 2,892,607

Registered Oct. 12, 2004

**TRADEMARK
PRINCIPAL REGISTER**

CONTAX

SAUQUOIT INDUSTRIES INC. (PENNSYLVANIA
CORPORATION)
300 PALM STREET
P.O. BOX 3807
SCRANTON, PA 18505

FOR: ELECTRICALLY CONDUCTIVE SHEETS
OF PLASTIC EMBEDDED WITH METALIZED FI-

BERS AND ELECTRICALLY CONDUCTIVE FAB-
RICS, IN CLASS 9 (U.S. CLS. 21, 23, 26, 36 AND 38).

FIRST USE 12-6-2002; IN COMMERCE 1-2-2003.

SER. NO. 76-490,525, FILED 2-19-2003.

STEPHANIE DAVIS, EXAMINING ATTORNEY

Int. Cls.: 41 and 45

Prior U.S. Cls.: 100, 101 and 107

United States Patent and Trademark Office

Reg. No. 2,892,608

Registered Oct. 12, 2004

**SERVICE MARK
PRINCIPAL REGISTER**

NATIONAL DISASTER SEARCH DOG FOUNDATION

NATIONAL DISASTER SEARCH DOG FOUNDATION, INC. (CALIFORNIA NONPROFIT PUBLIC BENEFIT CORPORATION)
323 EAST MATILJA STREET, NO. 110-245
OJAI, CA 930232740

FOR: PROVIDING TRAINING FOR DISASTER SEARCH DOGS , IN CLASS 41 (U.S. CLS. 100, 101 AND 107).

FIRST USE 10-1-1995; IN COMMERCE 10-1-1995.

FOR: PROVIDING TRAINED DISASTER SEARCH DOGS TO QUALIFIED HANDLERS, IN CLASS 45 (U.S. CLS. 100 AND 101).

FIRST USE 10-1-1995; IN COMMERCE 10-1-1995.

NO CLAIM IS MADE TO THE EXCLUSIVE RIGHT TO USE "DISASTER SEARCH DOG FOUNDATION", APART FROM THE MARK AS SHOWN.

SEC. 2(F).

SER. NO. 76-491,716, FILED 2-19-2003.

MATTHEW KLINE, EXAMINING ATTORNEY

Int. Cl.: 25

Prior U.S. Cls.: 22 and 39

United States Patent and Trademark Office

Reg. No. 2,892,609

Registered Oct. 12, 2004

TRADEMARK
PRINCIPAL REGISTER

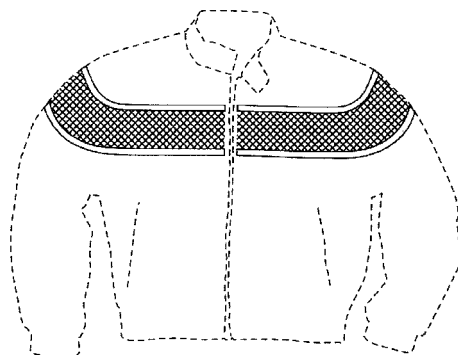

H-D MICHIGAN, INC. (MICHIGAN CORPORATION)
315 W. HURON, SUITE 400
ANN ARBOR, MI 48103

FOR: CLOTHING, NAMELY JACKETS, VEST, SHIRTS, IN CLASS 25 (U.S. CLS. 22 AND 39).

FIRST USE 0-0-1987; IN COMMERCE 0-0-1987.

THE DRAWING IS LINED FOR THE COLOR ORANGE; THE DOTTED LINES ARE NOT PART OF

THE MARK AND MERELY SHOW WHERE THE MARK APPEARS ON THE GOODS.

THE MARK CONSISTS OF AN ORANGE STRIPE DESIGN, NAMELY A WIDE ORANGE STRIPE OUTLINED BY TWO NARROW STRIPES.

SEC. 2(F).

SER. NO. 76-492,050, FILED 2-21-2003.

STEVEN R. FINE, EXAMINING ATTORNEY

Int. Cl.: 9

Prior U.S. Cls.: 21, 23, 26, 36 and 38

United States Patent and Trademark Office

Reg. No. 2,892,610

Registered Oct. 12, 2004

**TRADEMARK
PRINCIPAL REGISTER**

ACTIVECAMPUS

LIQUIDMATRIX CORP. (DELAWARE CORPORATION)
300 PEARL STREET, SUITE 900
BUFFALO, NY 14202

FOR: COMPUTER SOFTWARE FOR COMMUNICATIONS AND EXCHANGE OF INFORMATION OVER THE INTERNET WITH FACULTY, STAFF, STUDENTS, PROSPECTIVE STUDENTS, ALUMNI, ATHLETIC BOOSTERS AND OTHERS, CUSTOMIZED FOR EDUCATIONAL INSTITUTIONS, IN CLASS 9 (U.S. CLS. 21, 23, 26, 36 AND 38).

MIZED FOR EDUCATIONAL INSTITUTIONS, IN CLASS 9 (U.S. CLS. 21, 23, 26, 36 AND 38).

FIRST USE 9-5-2000; IN COMMERCE 9-5-2000.

SER. NO. 76-492,479, FILED 2-26-2003.

DAWN FELDMAN, EXAMINING ATTORNEY

Int. Cl.: 12

Prior U.S. Cls.: 19, 21, 23, 31, 35 and 44

United States Patent and Trademark Office

Reg. No. 2,892,611

Registered Oct. 12, 2004

**TRADEMARK
PRINCIPAL REGISTER**

SURE PLUS

SURE PLUS MANUFACTURING COMPANY (IL-
LINOIS CORPORATION)
12TH AND MCKINLEY
CHICAGO HEIGHTS, IL 60411

FOR: MIRRORS FOR VEHICLES, NAMELY, SIDE
VIEW/REAR VIEW MIRRORS, CONVEX SPOT MIR-
RORS, FRONT FENDER TRIPOD SAFETY MIR-
RORS, HOOD SAFETY MIRRORS AND REAR
CROSS-OVER MIRRORS, IN CLASS 12 (U.S. CLS.
19, 21, 23, 31, 35 AND 44).

FIRST USE 11-0-1965; IN COMMERCE 11-0-1965.

OWNER OF U.S. REG. NOS. 1,063,904 AND
1,443,233.

SER. NO. 76-492,663, FILED 2-24-2003.

ELISSA GARBER KON, EXAMINING ATTORNEY

Int. Cl.: 14

Prior U.S. Cls.: 2, 27, 28 and 50

United States Patent and Trademark Office

Reg. No. 2,892,612

Registered Oct. 12, 2004

**TRADEMARK
PRINCIPAL REGISTER**

MAXIMILIAN EMPEROR DIAMOND

SWAROVSKI AKTIENGESELLSCHAFT (LIECH-
TENSTEIN JOINT STOCK COMPANY)
DROSCHISTRASSE 15
FL-9495 TRIESEN, LIECHTENSTEIN

FOR: DIAMONDS, EXCLUDING DIAMONDS
CUT OR DESIGNED TO RESEMBLE ANY FAMOUS
DIAMONDS, IN CLASS 14 (U.S. CLS. 2, 27, 28 AND
50).

PRIORITY CLAIMED UNDER SEC. 44(D) ON
LIECHTENSTEIN APPLICATION NO. 12665, FILED
10-4-2002, REG. NO. 12665, DATED 10-4-2002, EX-
PIRES 10-4-2012.

NO CLAIM IS MADE TO THE EXCLUSIVE
RIGHT TO USE "DIAMOND", APART FROM THE
MARK AS SHOWN.

THE NAME IN THE MARK DOES NOT NAME
ANY LIVING INDIVIDUAL.

SER. NO. 76-493,237, FILED 2-27-2003.

ELISSA GARBER KON, EXAMINING ATTORNEY

Int. Cls.: 39 and 40

Prior U.S. Cls.: 100, 103, 105 and 106

United States Patent and Trademark Office

Reg. No. 2,892,613

Registered Oct. 12, 2004

**SERVICE MARK
PRINCIPAL REGISTER**

THE ANSWER IS IN THE FORMULA

SOUTHWESTERN ENERGY COMPANY (AR-
KANSAS CORPORATION)
2350 NORTH SAM HOUSTON PARKWAY EAST
SUITE 300
HOUSTON, TX 77032

FOR: PUBLIC UTILITY SERVICES IN THE NAT-
URE OF OIL AND NATURAL GAS DISTRIBUTION
TO RESIDENTIAL, COMMERCIAL AND INDUS-
TRIAL USERS; UTILITY SERVICES, NAMELY,
TRANSMISSION OF OIL AND NATURAL GAS, IN
CLASS 39 (U.S. CLS. 100 AND 105).

FIRST USE 3-20-2002; IN COMMERCE 3-20-2002.

FOR: OIL AND NATURAL GAS PRODUCTION,
IN CLASS 40 (U.S. CLS. 100, 103 AND 106).

FIRST USE 3-20-2002; IN COMMERCE 3-20-2002.

SER. NO. 76-493,524, FILED 2-27-2003.

ZHALEH DELANEY, EXAMINING ATTORNEY

Int. Cl.: 9

Prior U.S. Cls.: 21, 23, 26, 36 and 38

Reg. No. 2,892,614

United States Patent and Trademark Office

Registered Oct. 12, 2004

**TRADEMARK
PRINCIPAL REGISTER**

LA VISION

LA VISION GMBH (FED REP GERMANY CORPORATION)
ANNA-VANDENHOECK-RING 19
GOTTINGEN, FED REP GERMANY 37081

FOR: COMPUTER SOFTWARE USED IN PARTICLE IMAGE VELOCITY (PIV) SYSTEMS TO PERFORM OPTICAL DIAGNOSTIC PROCEDURES FOR THE VISUALIZATION ON NON-REACTIVE AND REACTIVE FLOW FIELDS FOR NON-DESTRUCTIVE MATERIAL TESTING AND FOR ANALYZING BIOLOGICAL SAMPLES; CAMERAS, NAMELY, IMAGE INTENSIFIED CAMERAS, OPTICAL LENSES, MICROSCOPES AND LASERS AND COMBINA-

TIONS THEREOF, NOT FOR MEDICAL PURPOSES, IN CLASS 9 (U.S. CLS. 21, 23, 26, 36 AND 38).

FIRST USE 4-14-1989; IN COMMERCE 4-1-1995.

NO CLAIM IS MADE TO THE EXCLUSIVE RIGHT TO USE "VISION", APART FROM THE MARK AS SHOWN.

SER. NO. 76-493,787, FILED 2-24-2003.

INGA ERVIN, EXAMINING ATTORNEY

Int. Cls.: 18 and 25

Prior U.S. Cls.: 1, 2, 3, 22, 39 and 41

United States Patent and Trademark Office

Reg. No. 2,892,615

Registered Oct. 12, 2004

**TRADEMARK
PRINCIPAL REGISTER**



MATINAL S.R.L. (ITALY CORPORATION)
VIA ENRICO BUTTI ANNIBALE 29
20158 - MILANO, ITALY

FOR: BAGS, NAMELY, TRAVELLING BAGS, HANDBAGS, GARMENT BAGS FOR TRAVEL, ALL PURPOSE SPORT BAGS, BEACH BAGS, CLUTCH BAGS, LEATHER SHOPPING BAGS, SCHOOL BAGS, TOTE BAGS; SUITCASES; BRIEF-CASES; PURSES; FOLDERS; DOCUMENT CASES, LEATHER DOCUMENT FOLDERS; LUGGAGE TRUNKS; LEATHER BAGS, NAMELY, HANDBAGS USED BY LADIES; IMITATION LEATHER SOLD IN BULK; LEATHER BAGS FOR MERCHANDISE PACKAGING, NAMELY, ENVELOPES AND POUCHES; LEATHER KEY CHAINS; LEATHER SHOPPING BAGS; PARASOLS; BEACH UMBRELLAS; UMBRELLAS; WALKING STICKS; AND HARNESSES, IN CLASS 18 (U.S. CLS. 1, 2, 3, 22 AND 41).

FOR: LADIES' GENTS' AND CHILDREN'S CLOTHING, NAMELY, SHIRTS, BLOUSES, SKIRTS,

JACKETS, TROUSERS, SHORTS, VESTS; JERSEYS; PYJAMAS; STOCKINGS; SINGLETs; CLOTHING CORSETS; GARTER BELTS; PANTS; BRAS; PETTY-COATS; SLIPPERS; SHOE WEAR, IN GENERAL, NAMELY, SLIPPERS, SHOES, SPORTS SHOES, BOOTS AND SANDALS; HATS; SCARVES; NECK-TIES; RAIN-COATS; OVERCOATS; GREAT-COATS; BATHING SUITS; SPORTS OVERALLS; WIND-RESISTANT JACKETS; SKI-PANT; GLOVES; FUR COATS; LEATHER WRIST BANDS AND SUITS MADE OF LEATHER, IN CLASS 25 (U.S. CLS. 22 AND 39).

PRIORITY CLAIMED UNDER SEC. 44(D) ON ITALY APPLICATION NO. MI2003001881, FILED 2-25-2003, REG. NO. 00902871, DATED 4-8-2003, EXPIRES 2-25-2013.

SER. NO. 76-494,014, FILED 3-3-2003.

ESTHER A. BORSUK, EXAMINING ATTORNEY

Int. Cl.: 10

Prior U.S. Cls.: 26, 39 and 44

United States Patent and Trademark Office

Reg. No. 2,892,616

Registered Oct. 12, 2004

**TRADEMARK
PRINCIPAL REGISTER**



INTERNATIONAL MEDICAL INDUSTRIES, INC.
(FLORIDA CORPORATION)
2881 WEST MCNAB ROAD
POMPANO BEACH, FL 33069

FOR: MEDICAL APPARATUS, NAMELY, BLOOD
TRANSFUSION SETS, ADAPTORS, CONNECTORS,
PLUGS, NEEDLES, TUBING, AND INJECTION AP-
PARATUS FOR INTRAVENOUS ADMINISTRA-
TION FOR FEEDING OF OR INFUSION OF

PHARMACEUTICALS OR RADIO-PHARMACEUTI-
CALS, IN CLASS 10 (U.S. CLS. 26, 39 AND 44).

FIRST USE 12-31-1983; IN COMMERCE 3-1-1984.

SEC. 2(F).

SER. NO. 76-494,215, FILED 3-3-2003.

ALLISON HOLTZ, EXAMINING ATTORNEY

Int. Cl.: 11

Prior U.S. Cls.: 13, 21, 23, 31 and 34

United States Patent and Trademark Office

Reg. No. 2,892,617

Registered Oct. 12, 2004

**TRADEMARK
PRINCIPAL REGISTER**

TRIMLINE

CENTURY SHOWER DOOR, INC. (NEW JERSEY
CORPORATION)
250 LACKAWANNA AVENUE
WEST PATERSON, NJ 07424

SEC. 2(F).

SER. NO. 76-494,218, FILED 3-3-2003.

FOR: SHOWER DOORS AND TUB ENCLOSURES,
IN CLASS 11 (U.S. CLS. 13, 21, 23, 31 AND 34).

FIRST USE 0-0-1997; IN COMMERCE 0-0-1997.

DANIELLE MATTESSICH, EXAMINING ATTOR-
NEY

Int. Cl.: 41

Prior U.S. Cls.: 100, 101 and 107

United States Patent and Trademark Office

Reg. No. 2,892,618

Registered Oct. 12, 2004

**SERVICE MARK
PRINCIPAL REGISTER**

INTERNATIONAL HOT ROD ASSOCIATION

INTERNATIONAL HOT ROD ASSOCIATION,
LLC (TEXAS LIMITED LIABILITY CORPORATION)
9 1/2 E. MAIN STREET
NORWALK, OH 44857

FOR: ENTERTAINMENT SERVICES, NAMELY,
CONDUCTING AND SANCTIONING DRAG RACING
EVENTS, IN CLASS 41 (U.S. CLS. 100, 101 AND
107).

FIRST USE 10-15-1970; IN COMMERCE 10-15-1970.

OWNER OF U.S. REG. NO. 2,549,883.

SEC. 2(F).

SER. NO. 76-494,857, FILED 3-5-2003.

MARK T. MULLEN, EXAMINING ATTORNEY

Int. Cl.: 41

Prior U.S. Cls.: 100, 101 and 107

United States Patent and Trademark Office

Reg. No. 2,892,619

Registered Oct. 12, 2004

**SERVICE MARK
PRINCIPAL REGISTER**



INTERNET EDUCATION EXCHANGE INC. (ARIZONA NONPROFIT CORPORATION)
8655 EAST VIA DE VENTURA, SUITE G-360
SCOTTSDALE, AZ 85258

FOR: PROVIDING NEWS, INFORMATION AND LINKS TO OTHER WEBSITES VIA THE INTERNET IN THE FIELD OF IMPROVING PUBLIC SCHOOLS

AND EDUCATION , IN CLASS 41 (U.S. CLS. 100, 101 AND 107).

FIRST USE 7-4-2002; IN COMMERCE 7-4-2002.

SER. NO. 76-495,074, FILED 3-6-2003.

ALLISON HOLTZ, EXAMINING ATTORNEY

Int. Cl.: 45

Prior U.S. Cls.: 100 and 101

United States Patent and Trademark Office

Reg. No. 2,892,620

Registered Oct. 12, 2004

**SERVICE MARK
PRINCIPAL REGISTER**



EXECUTIVE BOARD OF THE TENNESSEE BAPTIST CONVENTION (TENNESSEE CORPORATION)
5001 MARYLAND WAY
BRENTWOOD, TN 37027

NO CLAIM IS MADE TO THE EXCLUSIVE RIGHT TO USE "TENNESSEE BAPTIST CONVENTION" AND THE REPRESENTATION OF THE CROSS, APART FROM THE MARK AS SHOWN.

FOR: EVANGELISTIC AND MINISTERIAL SERVICES, IN CLASS 45 (U.S. CLS. 100 AND 101).

SER. NO. 76-495,120, FILED 3-5-2003.

FIRST USE 9-1-1998; IN COMMERCE 9-1-1998.

LOURDES AYALA, EXAMINING ATTORNEY

Int. Cl.: 17

Prior U.S. Cls.: 1, 5, 12, 13, 35 and 50

United States Patent and Trademark Office

Reg. No. 2,892,621

Registered Oct. 12, 2004

**TRADEMARK
PRINCIPAL REGISTER**

PLATINUM

S&B TECHNICAL PRODUCTS, INC. (TEXAS
CORPORATION)
1300 EAST BERRY
FT.WORTH, TX 76119

OWNER OF U.S. REG. NOS. 2,220,283, 2,588,836
AND OTHERS.

FOR: NON-MECHANICAL, NON-METAL SEAL-
ING RINGS, IN CLASS 17 (U.S. CLS. 1, 5, 12, 13, 35
AND 50).

SER. NO. 76-495,513, FILED 3-7-2003.

FIRST USE 11-15-2000; IN COMMERCE 11-15-2000.

NORA BUCHANAN WILL, EXAMINING ATTOR-
NEY

Int. Cls.: 9, 16, 35, 36, 37, 38, 39, 41, 42, 43, 44 and 45

**Prior U.S. Cls.: 2, 5, 21, 22, 23, 26, 29, 36, 37, 38, 50,
100, 101, 102, 103, 104, 105, 106 and 107**

Reg. No. 2,892,622

United States Patent and Trademark Office

Registered Oct. 12, 2004

**TRADEMARK
SERVICE MARK
PRINCIPAL REGISTER**



COMITE INTERNATIONAL OLYMPIQUE (SWITZERLAND ASSOCIATION)
CHATEAU DE VIDY
LAUSANNE, SWITZERLAND 1007

FIELD OF SPORTS AND CONSULTANCY RELATED TO THE ORGANIZATION OF SPORTING, CULTURAL OR COMMERCIAL EVENTS, IN CLASS 16 (U.S. CLS. 2, 5, 22, 23, 29, 37, 38 AND 50).

FOR: COMPUTER-READABLE DATA RECORDING MEDIA, DVDS AND VIDEO TAPES, ALL THE AFORESAID MEDIA, DVDS AND VIDEOS BEING PRE-RECORDED AND CONTAINING PRESENTATIONS OF TEXTS, DATA, GRAPHICS, SOUNDS, COMMENTARIES AND IMAGES, ANIMATED OR NOT IN THE FIELD OF SPORTS AND CONSULTANCY RELATED TO THE ORGANIZATION OF SPORTING, CULTURAL OR COMMERCIAL EVENTS; COMPUTER SOFTWARE TO OPERATE THE SAME, NAMELY, FOR ORGANIZING, PLANNING, TRAINING AND TESTING OF EVENTS, DATABASE MANAGEMENT, SUPERVISION AND ANALYSIS OF PROJECTS IN THE FIELD OF SPORTS AND CONSULTANCY RELATED TO THE ORGANIZATION OF SPORTING, CULTURAL OR COMMERCIAL EVENTS, IN CLASS 9 (U.S. CLS. 21, 23, 26, 36 AND 38).

FOR: BUSINESS MANAGEMENT ASSISTANCE FOR PRIVATE COMPANIES AND PUBLIC AUTHORITIES CONCERNING THE ORGANIZATION OF SPORTING, CULTURAL OR COMMERCIAL EVENTS; BUSINESS MANAGEMENT EXPERTISE, ASSISTANCE AND CONSULTANCY FOR THE ORGANIZERS OF SPORTING, CULTURAL OR COMMERCIAL EVENTS CONCERNING THE RELATIONS WITH PARTNERS OR SPONSORS OF SAID SPORTING, CULTURAL OR COMMERCIAL EVENTS; BUSINESS MANAGEMENT EXPERTISE, ASSISTANCE AND CONSULTANCY FOR THE PARTNERS OR THE SPONSORS OF SPORTING, CULTURAL OR COMMERCIAL EVENTS; MARKETING SERVICES, NAMELY BUSINESS MARKETING CONSULTING SERVICES; PROVIDING INFORMATION AND STATISTICS CONCERNING THE ORGANIZATION, THE SPONSORSHIP AND THE MARKETING OF SPORTING, CULTURAL OR COMMERCIAL EVENTS; CONSULTANTS AND OPERATIONAL SUPPORT SERVICES, NAMELY, BUSINESS CONSULTING SERVICES RELATING TO OPERATIONS MANAGEMENT SERVICES FOR PRIVATE COMPANIES AND PUBLIC AUTHORITIES SPONSORING AND ORGANIZING AN EVENT

FOR: PRINTED MATTER, NAMELY MAGAZINES, PRINTED INSTRUCTIONAL AND TEACHING MATERIALS IN THE FIELD OF SPORTS AND CONSULTANCY RELATED TO THE ORGANIZATION OF SPORTING, CULTURAL OR COMMERCIAL EVENTS, BROCHURES, BOOKS, IN THE

AND INVOLVED IN ITS MANAGEMENT; PUBLIC RELATIONS CONSULTANTS, NAMELY, RELATIONS WITH PUBLIC AND SPORTING AUTHORITIES; BUSINESS CONSULTANCY SERVICES CONCERNING THE MANNER OF SELECTING MANAGEMENT TEAMS OF SPORTING, CULTURAL OR COMMERCIAL EVENTS; BUSINESS MANAGEMENT, NAMELY, TAKING UP THE MANAGEMENT OF SPORTING, CULTURAL OR COMMERCIAL EVENTS FOR OTHERS; EMPLOYMENT RECRUITING, NAMELY, RECRUITMENT OF PERSONNEL EXPERIENCED IN THE ORGANIZATION OF SPORTING, CULTURAL OR COMMERCIAL EVENTS; BUSINESS MANAGEMENT OF DATABASES CONTAINING THE LIST OF QUALIFIED PERSONS, THEIR NAMES AND ADDRESSES, THEIR EXPERIENCE AND THEIR FIELD OF EXPERTISE; BUSINESS CONSULTANCY SERVICES CONCERNING THE MANNER OF ORGANIZING, STRUCTURING AND OPERATING CENTERS APERTAINING TO MEDIA, NAMELY, TELEVISION, RADIO AND WRITTEN PRESS; BUSINESS CONSULTANCY SERVICES IN THE FIELD OF PROTOCOL, RELATIONS WITH THE PRESS AND MEDIA; BUSINESS CONSULTANCY SERVICES IN THE FIELD OF TICKET SALES AND ACCREDITATION OF PARTICIPANTS, OF PRESS AND MEDIA OF REPRESENTATIVES, AND OF REPRESENTATIVES OF PUBLIC AND SPORTING AUTHORITIES; CONSULTANCY SERVICES IN THE FIELD OF MEDICAL REFERRAL INFORMATION CONCERNING MEDICAL AND HOSPITAL INFRASTRUCTURES INVOLVED WITH SPORTING, CULTURAL OR COMMERCIAL EVENTS, IN CLASS 35 (U.S. CLS. 100, 101 AND 102).

FOR: FINANCIAL EXPERTISE AND CONSULTANCY SERVICES CONCERNING ALL FINANCIAL ASPECTS OF THE ORGANIZATION OF SPORTING, CULTURAL OR COMMERCIAL EVENTS; PROVIDING INFORMATION AND STATISTICS CONCERNING THE FINANCIAL ASPECT OF THE ORGANIZATION, THE SPONSORSHIP AND THE MARKETING OF SPORTING, CULTURAL OR COMMERCIAL EVENTS; REAL ESTATE CONSULTANCY SERVICES AND INSURANCE CONSULTANCY, IN CLASS 36 (U.S. CLS. 100, 101 AND 102).

FOR: CONSULTANCY SERVICES CONCERNING CONSTRUCTION RELATING TO THE INFRASTRUCTURE INTENDED TO ACCOMPANY AND HOST SPORTING, CULTURAL OR COMMERCIAL EVENTS; PROVIDING INFORMATION AND STATISTICS CONCERNING THE BUILDING OF INFRASTRUCTURE, NAMELY, THE CONSTRUCTION OF ATHLETIC FACILITIES, INCLUDING STADIUMS, PRESS CENTERS AND ATHLETES VILLAGE, IN CLASS 37 (U.S. CLS. 100, 103 AND 106).

FOR: PROVIDING A HIGH SPEED ACCESS TO AREA NETWORKS AND A GLOBAL COMPUTER INFORMATION NETWORK; PROVIDING MULTIPLE-USER ACCESS TO GLOBAL COMPUTER INFORMATION NETWORK TO WEB SITES CONTAINING INFORMATION AND STATISTICAL

DATA RELATIVE TO SPORTING, CULTURAL OR COMMERCIAL EVENTS; CONSULTANCY SERVICES CONCERNING TELEVISION BROADCASTING; TELECOMMUNICATION CONSULTANCY SERVICES CONCERNING ELECTRONIC TELECOMMUNICATION SYSTEMS FOR THE MANAGEMENT OF INFORMATION INSIDE AND OUTSIDE SPORTING, CULTURAL OR COMMERCIAL EVENTS, INCLUDING RESULTS, EVENTS TIMETABLE, PARTICIPANTS LISTS, IN CLASS 38 (U.S. CLS. 100, 101 AND 104).

FOR: CONSULTANCY SERVICES RELATING TO THE ORGANIZATION OF TRANSPORTATION OF PASSENGERS BY AIR, BOAT, RAIL, BUS AND UNDERGROUND INSIDE AND OUTSIDE THE SITES INTENDED TO HOST SPORTING, CULTURAL OR COMMERCIAL EVENTS; PROVIDING INFORMATION AND STATISTICS CONCERNING TRANSPORTATION OF PASSENGERS BY AIR, BOAT, RAIL, BUS AND UNDERGROUND, IN CLASS 39 (U.S. CLS. 100 AND 105).

FOR: EDUCATIONAL SERVICES, NAMELY, PROVIDING TRAINING COURSES AND SEMINARS IN THE FIELD OF MANAGEMENT, SPECIFICALLY, IN THE AREA OF SPORTING, CULTURAL OR COMMERCIAL EVENTS FOR ORGANIZERS, SPONSORS OR PARTNERS; CONSULTANCY SERVICES FOR THE ORGANIZATION OF CEREMONIES; CONSULTANCY AND OPERATOR SERVICES, NAMELY, ORGANIZING, ARRANGING AND CONDUCTING SPORTING, CULTURAL, OR COMMERCIAL EVENTS, IN WHOLE OR IN PART AND PROVIDING OR EXERCISING ACQUIRED EXPERIENCE IN PROTOCOL MATTERS, NAMELY, ORGANIZING SPORTING, CULTURAL OR COMMERCIAL EVENTS, IN WHOLE OR IN PART, IN CLASS 41 (U.S. CLS. 100, 101 AND 107).

FOR: SCIENTIFIC AND TECHNOLOGICAL SERVICES, NAMELY SCIENTIFIC RESEARCH AND DEVELOPMENT OF NEW TECHNOLOGY IN THE FIELD OF SPORTS; SERVICES OF INDUSTRIAL ANALYSIS AND RESEARCH IN THE AREA OF SPORTS; PROVIDING OF TECHNICAL SUPPORT SERVICES AND SOFTWARE RENTAL FOR USE IN THE SIMULATION OF EVENTS, NAMELY, SPORTING, CULTURAL OR COMMERCIAL EVENTS AND THE REALIZATION OF TESTS AND ANALYSIS RELATING TO THEIR ORGANIZATION AND RUNNING; DESIGNING AND DEVELOPING COMPUTERS AND SOFTWARE, NAMELY, COMPUTER NETWORK DESIGN FOR OTHERS AND COMPUTER SOFTWARE DESIGN FOR OTHERS; RENTAL OF COMPUTERS; LEGAL SERVICES, INCLUDING THOSE IN RELATION TO THE NEGOTIATION AND THE DRAFTING OF CONTRACTS CONCERNING SPORTING, CULTURAL OR COMMERCIAL EVENTS, THEIR PARTICIPANTS, THEIR SPECTATORS, THEIR PERSONNEL, THEIR SPONSORS AND THEIR BROADCASTING BY THE MEDIA; LICENSING OF INTELLECTUAL PROPERTY; ENVIRONMENTAL CONSULTANCY SERVICES, NAMELY, STUDYING THE IMPACT OF INFRASTRUCTURE PROJECTS RELATIVE TO SPORTING, CULTURAL OR COMMERCIAL EVENTS TO AS-

SURE COMPLIANCE WITH ENVIRONMENTAL ZONING LAWS AND REGULATIONS, IN CLASS 42 (U.S. CLS. 100 AND 101).

FOR: CONSULTANCY SERVICES IN THE FIELD OF ACCOMMODATION, NAMELY, TEMPORARY ACCOMMODATION; PROVIDING INFORMATION AND STATISTICS CONCERNING TEMPORARY ACCOMMODATION; CONSULTANCY SERVICES RELATIVE TO THE INFRASTRUCTURE AND THE LOGISTICS CONCERNING CATERING IN THE FIELD OF SPORTING, CULTURAL OR COMMERCIAL EVENTS; PROVIDING INFORMATION AND STATISTICS CONCERNING CATERING; CONSULTING SERVICES IN THE FIELD OF HOSPITALITY, CONCERNING THE NEEDS FOR COMFORT AND TRANQUILLITY FOR PERSONS ATTENDING, ACTIVELY OR NOT, SPORTING, CULTURAL OR COMMERCIAL EVENTS, IN CLASS 43 (U.S. CLS. 100 AND 101).

FOR: CONSULTANCY SERVICES IN THE FIELD OF MEDICAL INFORMATION CONCERNING MEDICAL AND HOSPITAL INFRASTRUCTURES INVOLVED WITH SPORTING, CULTURAL OR

COMMERCIAL EVENTS; CONSULTANCY SERVICES REGARDING ASSISTANCE, NAMELY, EMERGENCY MEDICAL ASSISTANCE AND MEDICAL TESTING TO BE GIVEN TO THE PARTICIPANTS OF SPORTING, CULTURAL OR COMMERCIAL EVENTS, IN CLASS 44 (U.S. CLS. 100 AND 101).

FOR: CONSULTANCY SERVICES IN THE FIELD OF SECURITY FOR THE PROTECTION OF PROPERTY AND INDIVIDUALS AT SPORTING, CULTURAL OR COMMERCIAL EVENTS, IN CLASS 45 (U.S. CLS. 100 AND 101).

PRIORITY CLAIMED UNDER SEC. 44(D) ON SWITZERLAND APPLICATION NO. 03536/2000, FILED 9-10-2002, REG. NO. 508097, DATED 3-7-2003, EXPIRES 9-10-2012.

THE STIPPLING IS A FEATURE OF THE MARK AND NOT INTENDED TO INDICATE COLOR.

SER. NO. 76-496,157, FILED 3-10-2003.

MARLENE BELL, EXAMINING ATTORNEY

Int. Cl.: 44

Prior U.S. Cls.: 100 and 101

United States Patent and Trademark Office

Reg. No. 2,892,623

Registered Oct. 12, 2004

**SERVICE MARK
PRINCIPAL REGISTER**



NEWVIEW LASER EYE, INC. (VIRGINIA CORPORATION)
12110 SUNSET HILLS ROAD, SUITE 50
RESTON, VA 20190

FOR: MEDICAL AND EYE CARE SERVICES, NAMELY, LASER EYE SURGERY SERVICES, IN CLASS 44 (U.S. CLS. 100 AND 101).

FIRST USE 9-0-1999; IN COMMERCE 9-0-1999.

THE MARK CONSISTS, IN PART, OF "NEWVIEW".

SER. NO. 76-496,274, FILED 3-10-2003.

VIVIAN MICZNIK FIRST, EXAMINING ATTORNEY

Int. Cl.: 33

Prior U.S. Cls.: 47 and 49

United States Patent and Trademark Office

Reg. No. 2,892,624

Registered Oct. 12, 2004

**TRADEMARK
PRINCIPAL REGISTER**

FINCA EL BOSQUE

SIERRA CANTABRIA, S.A. (SPAIN CORPORATION)
C/ AMOREBIETA, 3
26338 SAN VICENTE DE LA SONSIERRA
LA RIOJA, SPAIN

FOR: WINE, IN CLASS 33 (U.S. CLS. 47 AND 49).

OWNER OF SPAIN REG. NO. 2385382, DATED 10-5-2001, EXPIRES 3-13-2011.

NO CLAIM IS MADE TO THE EXCLUSIVE RIGHT TO USE "FINCA", APART FROM THE MARK AS SHOWN.

THE ENGLISH TRANSLATION OF "FINCA EL BOSQUE" IS "WOOD COUNTRY PROPERTY".

SER. NO. 76-496,282, FILED 3-10-2003.

SUE LAWRENCE, EXAMINING ATTORNEY

Int. Cl.: 14

Prior U.S. Cls.: 2, 27, 28 and 50

United States Patent and Trademark Office

Reg. No. 2,892,625

Registered Oct. 12, 2004

**TRADEMARK
PRINCIPAL REGISTER**

P-5

P-5 JEWELERS CORP. (CALIFORNIA CORPORATION)
550 SOUTH HILL STREET, SUITE 780
LOS ANGELES, CA 90015

FIRST USE 1-2-1982; IN COMMERCE 1-2-1982.

SER. NO. 76-496,439, FILED 3-3-2003.

FOR: JEWELRY, IN CLASS 14 (U.S. CLS. 2, 27, 28 AND 50).

MICHAEL SOUDERS, EXAMINING ATTORNEY

Int. Cl.: 35

Prior U.S. Cls.: 100, 101 and 102

United States Patent and Trademark Office

Reg. No. 2,892,626

Registered Oct. 12, 2004

**SERVICE MARK
PRINCIPAL REGISTER**

IMEDIA BRAND SUMMIT

IMEDIA COMMUNICATIONS, INC. (CALIFORNIA CORPORATION)
24682 DEL PRADO, SUITE 300
DANA POINT, CA 92629

FOR: ARRANGING AND CONDUCTING TRADE SHOW EXHIBITIONS IN THE FIELD OF INTERACTING MEDIA AND MARKETING; PROVIDING TRADE INFORMATION IN THE FIELD OF INTERACTIVE MEDIA AND MARKETING; DISSEMINA-

TION OF ADVERTISING MATTER FOR OTHERS, IN CLASS 35 (U.S. CLS. 100, 101 AND 102).

FIRST USE 10-1-2001; IN COMMERCE 10-1-2001.

SER. NO. 76-496,628, FILED 3-11-2003.

SUSAN LESLIE DUBOIS, EXAMINING ATTORNEY

Int. Cl.: 43

Prior U.S. Cls.: 100 and 101

United States Patent and Trademark Office

Reg. No. 2,892,627

Registered Oct. 12, 2004

SERVICE MARK
PRINCIPAL REGISTER



JON SMITH, INC. (FLORIDA CORPORATION)
13083 MALLARD CREEK DRIVE
PALM BEACH GARDENS, FL 33418

FOR: RESTAURANT SERVICES, IN CLASS 43
(U.S. CLS. 100 AND 101).

FIRST USE 12-24-2002; IN COMMERCE 12-24-2002.

OWNER OF U.S. REG. NOS. 1,726,548 AND
2,004,145.

NO CLAIM IS MADE TO THE EXCLUSIVE
RIGHT TO USE "SUBS" AND "WORLD'S BEST
STEAK SUBS", APART FROM THE MARK AS
SHOWN.

SER. NO. 76-496,776, FILED 3-5-2003.

JEFF DEFORD, EXAMINING ATTORNEY

Int. Cl.: 41

Prior U.S. Cls.: 100, 101 and 107

United States Patent and Trademark Office

Reg. No. 2,892,628

Registered Oct. 12, 2004

**SERVICE MARK
PRINCIPAL REGISTER**

SCIL

CARDIN, SHOSHANA S. (UNITED STATES IN-
DIVIDUAL)
3624 ANTON FARMS ROAD
BALTIMORE, MD 21208

FOR: EDUCATION AND TRAINING SERVICES
ON AN INDIVIDUAL AND GROUP BASIS, NAME-
LY, CONDUCTING CLASSES, TRAINING PRO-
GRAMS, SEMINARS, CONFERENCES AND
WORKSHOPS IN THE FIELDS OF LEADERSHIP,
DECISION-MAKING, COMMUNICATION, EF-
FECTING CHANGE, STRATEGIZING, FORWARD-

THINKING, ORGANIZATIONAL DEVELOPMENT,
RELATIONSHIP MANAGEMENT AND TEAM-
BUILDING, AND DISTRIBUTING COURSE MATE-
RIALS IN CONNECTION THEREWITH, IN CLASS
41 (U.S. CLS. 100, 101 AND 107).

FIRST USE 5-6-2001; IN COMMERCE 1-13-2002.

SER. NO. 76-497,452, FILED 3-14-2003.

BARNEY CHARLON, EXAMINING ATTORNEY

Int. Cl.: 6

Prior U.S. Cls.: 2, 12, 13, 14, 23, 25 and 50

Reg. No. 2,892,629

United States Patent and Trademark Office

Registered Oct. 12, 2004

**TRADEMARK
PRINCIPAL REGISTER**

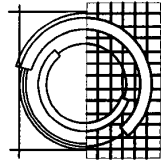

SuperiorTube
COMPANY

SUPERIOR TUBE COMPANY (PENNSYLVANIA CORPORATION)
3900 GERMANTOWN PIKE
COLLEGEVILLE, PA 194263112

THE LINING IS A FEATURE OF THE MARK AND DOES NOT INDICATE COLOR.

FOR: SPECIALTY METAL TUBING, IN CLASS 6 (U.S. CLS. 2, 12, 13, 14, 23, 25 AND 50).

SEC. 2(F) AS TO "SUPERIOR".

FIRST USE 6-0-2002; IN COMMERCE 6-0-2002.

SER. NO. 76-497,573, FILED 3-17-2003.

NO CLAIM IS MADE TO THE EXCLUSIVE RIGHT TO USE "TUBE COMPANY", APART FROM THE MARK AS SHOWN.

CYNTHIA SLOAN, EXAMINING ATTORNEY

Int. Cls.: 5 and 44

Prior U.S. Cls.: 6, 18, 44, 46, 51, 52, 100 and 101

United States Patent and Trademark Office

Reg. No. 2,892,630

Registered Oct. 12, 2004

**TRADEMARK
SERVICE MARK
PRINCIPAL REGISTER**

SMART CLINIC IMMUNIZATION SOLUTION

CONNAUGHT TECHNOLOGY CORPORATION
(DELAWARE CORPORATION)
3711 KENNETT PIKE
GREENVILLE, DE 19807

FOR: KIT CONSISTING PRIMARILY OF HUMAN VACCINES, AND ALSO CONTAINING ANTIBIOTICS, EPINEPHRINE, AND DIPHENHYDRAMINE HYDROCHLORIDE, SYRINGES, STERILIZED GLOVES, ALCOHOL PADS, HAND SANITIZER, BANDAGES, GAUZE SPONGES, BIOHAZARD BAG, INHALANTS, TABLE DRAPES, TRASH BAGS, FILTER NEEDLES, CONSENT, PAYMENT, INSURANCE FORMS, PENS, PAPER CLIPS, BINDERS CLIPS, NOTE PADS, RUBBER BANDS, MARKERS AND HIGHLIGHTERS AND PRINTED MATERIALS, NAMELY BOOKLETS FEATURING THE PUBLIC TO THE RISK OF DISEASES AND THE BENEFITS OF VACCINATIONS, POSTERS FLIERS AND IMMUNIZATION PROGRAM TRAINING GUIDES AND ALSO MULTIMEDIA SOFTWARE RECORDED ON CD-ROM FEATURING THE PUB-

LIC TO THE RISK OF DISEASES AND THE BENEFITS OF VACCINATIONS, IN CLASS 5 (U.S. CLS. 6, 18, 44, 46, 51 AND 52).

FIRST USE 3-13-2003; IN COMMERCE 3-13-2003.

FOR: IMMUNIZATION SERVICES, NAMELY, PROVIDING AWARENESS IN THE FIELD OF VACCINATIONS AND PATIENT CARE, IN CLASS 44 (U.S. CLS. 100 AND 101).

FIRST USE 3-13-2003; IN COMMERCE 3-13-2003.

NO CLAIM IS MADE TO THE EXCLUSIVE RIGHT TO USE CLINIC IMMUNIZATION, APART FROM THE MARK AS SHOWN.

SER. NO. 76-497,762, FILED 3-14-2003.

JOHN DALIER, EXAMINING ATTORNEY

Int. Cl.: 24

Prior U.S. Cls.: 42 and 50

United States Patent and Trademark Office

Reg. No. 2,892,631

Registered Oct. 12, 2004

**TRADEMARK
PRINCIPAL REGISTER**

SAFELY WE SLEEP

WROLSTAD, DUANE (UNITED STATES INDIVIDUAL)
19904 N 41ST LN
GLENDALE, AZ 85308 AND
WROLSTAD, CAROL (UNITED STATES INDIVIDUAL)
19904 N 41ST LN
GLENDALE, AZ 85308

FOR: PILLOWCASES, IN CLASS 24 (U.S. CLS. 42 AND 50).

FIRST USE 2-21-2003; IN COMMERCE 2-21-2003.

SER. NO. 76-497,831, FILED 3-17-2003.

BRIAN NEVILLE, EXAMINING ATTORNEY

Int. Cl.: 38

Prior U.S. Cls.: 100, 101 and 104

United States Patent and Trademark Office

Reg. No. 2,892,632

Registered Oct. 12, 2004

**SERVICE MARK
PRINCIPAL REGISTER**



SATELLITE COMMUNICATION SYSTEMS, INC.
(VIRGINIA CORPORATION)

2 EATON STREET, SUITE 1000
HAMPTON, VA 23669

FOR: PROVIDING MULTIPLE-USER ACCESS TO
GLOBAL COMPUTER INFORMATION NET-

WORKS VIA A WIRELESS FIDELITY NETWORK,
IN CLASS 38 (U.S. CLS. 100, 101 AND 104).

FIRST USE 11-1-2002; IN COMMERCE 1-1-2003.

SER. NO. 76-498,019, FILED 3-18-2003.

SHARON MEIER, EXAMINING ATTORNEY

Int. Cl.: 37

Prior U.S. Cls.: 100, 103 and 106

United States Patent and Trademark Office

Reg. No. 2,892,633

Registered Oct. 12, 2004

**SERVICE MARK
PRINCIPAL REGISTER**

DESTINY USA

PYRAMID COMPANY OF ONONDAGA (PART-
NERSHIP)
4 CLINTON SQUARE
SYRACUSE, NY 13202

NO CLAIM IS MADE TO THE EXCLUSIVE
RIGHT TO USE "USA", APART FROM THE MARK
AS SHOWN.

FOR: REAL ESTATE DEVELOPMENT SERVICES,
NAMELY DEVELOPMENT OF CONVENTION AND
TOURISM CENTERS, THEME PARKS, AND SHOP-
PING CENTERS, IN CLASS 37 (U.S. CLS. 100, 103
AND 106).

SER. NO. 76-498,105, FILED 2-19-2003.

FIRST USE 10-31-2001; IN COMMERCE 10-31-2001.

JOHN SCHUYLER YARD, EXAMINING ATTOR-
NEY

Int. Cl.: 41

Prior U.S. Cls.: 100, 101 and 107

United States Patent and Trademark Office

Reg. No. 2,892,634

Registered Oct. 12, 2004

**SERVICE MARK
PRINCIPAL REGISTER**

MONEY FARM

WINDOW TO THE WORLD COMMUNICA-
TIONS, INC. (ILLINOIS NOT-FOR-PROFIT
CORPORATION)
5400 N. ST. LOUIS AVENUE
CHICAGO, IL 60625

FOR: ENTERTAINMENT SERVICES IN THE
NATURE OF A SERIES OF EDUCATIONAL TELE-
VISION PROGRAMS CONCERNING THE FINAN-
CIAL LITERACY OF CHILDREN , IN CLASS 41 (U.S.
CLS. 100, 101 AND 107).

FIRST USE 1-20-2003; IN COMMERCE 1-20-2003.

NO CLAIM IS MADE TO THE EXCLUSIVE
RIGHT TO USE MONEY, APART FROM THE
MARK AS SHOWN.

SER. NO. 76-498,209, FILED 3-17-2003.

PRISCILLA MILTON, EXAMINING ATTORNEY

Int. Cl.: 15

Prior U.S. Cls.: 2, 21 and 36

United States Patent and Trademark Office

Reg. No. 2,892,635

Registered Oct. 12, 2004

**TRADEMARK
PRINCIPAL REGISTER**

FOX

FOX PRODUCTS CORPORATION (INDIANA
CORPORATION)
6110 SOUTH SR 5
SOUTH WHITLEY, IN 46787

FOR: WOODWIND INSTRUMENTS, NAMELY
BASSOONS, CONTRABASSOONS, OBOES AND
ENGLISH HORNS, IN CLASS 15 (U.S. CLS. 2, 21
AND 36).

FIRST USE 12-31-1970; IN COMMERCE 12-31-1970.

OWNER OF U.S. REG. NOS. 903,013 AND 979,027.

SER. NO. 76-498,317, FILED 3-18-2003.

WILLIAM VERHOSEK, EXAMINING ATTORNEY

Int. Cl.: 19

Prior U.S. Cls.: 1, 12, 33 and 50

United States Patent and Trademark Office

Reg. No. 2,892,636

Registered Oct. 12, 2004

**TRADEMARK
PRINCIPAL REGISTER**

SAFEHAVEN

INFRATECH.US, LLC (MARYLAND LTD LIAB
CO)
502B E. SOUTH STREET
FREDERICK, MD 21704

EMERGENCIES, IN CLASS 19 (U.S. CLS. 1, 12, 33
AND 50).

FIRST USE 3-18-2003; IN COMMERCE 7-1-2003.

FOR: PREFABRICATED NON-METAL COM-
PARTMENTS FOR PERSONAL AND FAMILY PRO-
TECTION AGAINST CHEMICAL, NUCLEAR,
BIOHAZARD AND OTHER CONTAMINATION

SER. NO. 76-498,329, FILED 3-18-2003.

H. M. FISHER, EXAMINING ATTORNEY

Int. Cls.: 41 and 45

Prior U.S. Cls.: 100, 101 and 107

United States Patent and Trademark Office

Reg. No. 2,892,637

Registered Oct. 12, 2004

**SERVICE MARK
PRINCIPAL REGISTER**



**The University Club
of Washington, DC**

THE UNIVERSITY CLUB OF WASHINGTON
D.C. (D.C. CORPORATION)

1135 16TH ST., NW

WASHINGTON, DC 20036

FOR: HEALTH CLUB SERVICES, NAMELY PROVIDING INSTRUCTION AND EQUIPMENT IN THE FIELD OF PHYSICAL EXERCISES, IN CLASS 41 (U.S. CLS. 100, 101 AND 107).

FIRST USE 12-31-1904; IN COMMERCE 12-31-1904.

FOR: ENTERTAINMENT SERVICES, NAMELY, A PRIVATE SOCIAL CLUB, IN CLASS 45 (U.S. CLS. 100 AND 101).

FIRST USE 12-31-1904; IN COMMERCE 12-31-1904.

NO CLAIM IS MADE TO THE EXCLUSIVE RIGHT TO USE "CLUB" AND "WASHINGTON, D.C.", APART FROM THE MARK AS SHOWN.

SER. NO. 76-498,334, FILED 3-18-2003.

ODESSA BIBBINS, EXAMINING ATTORNEY

Int. Cls.: 25, 41 and 45

Prior U.S. Cls.: 22, 39, 100, 101 and 107

United States Patent and Trademark Office

Reg. No. 2,892,638

Registered Oct. 12, 2004

**TRADEMARK
SERVICE MARK
PRINCIPAL REGISTER**

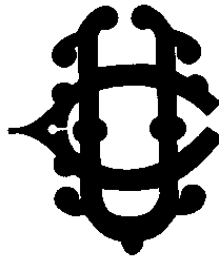

THE UNIVERSITY CLUB OF WASHINGTON
D.C. (D.C. CORPORATION)
1135 16TH ST., NW
WASHINGTON, DC 20036

FOR: ATHLETIC APPAREL, NAMELY SHIRTS,
SHORTS, CAPS, SWEATERS, SWEAT SHIRTS, IN
CLASS 25 (U.S. CLS. 22 AND 39).

FIRST USE 12-31-1980; IN COMMERCE 12-31-1980.

FOR: HEALTH CLUB SERVICES, NAMELY PRO-
VIDING INSTRUCTION AND EQUIPMENT IN THE
FIELD OF PHYSICAL EXERCISES, IN CLASS 41
(U.S. CLS. 100, 101 AND 107).

FIRST USE 12-31-1904; IN COMMERCE 12-31-1904.

FOR: ENTERTAINMENT SERVICES, NAMELY, A
PRIVATE SOCIAL CLUB, IN CLASS 45 (U.S. CLS. 100
AND 101).

FIRST USE 12-31-1904; IN COMMERCE 12-31-1904.

SER. NO. 76-498,335, FILED 3-18-2003.

ODESSA BIBBINS, EXAMINING ATTORNEY

Int. Cl.: 41

Prior U.S. Cls.: 100, 101 and 107

United States Patent and Trademark Office

Reg. No. 2,892,639

Registered Oct. 12, 2004

SERVICE MARK
PRINCIPAL REGISTER

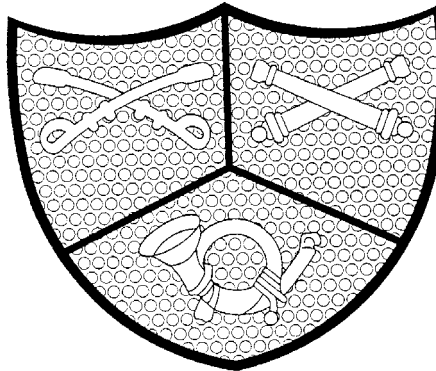

C.M. UBERMAN ENTERPRISES (D.C. CORPORATION)
1370 PICCARD DRIVE, SUITE 200
ROCKVILLE, MD 208504304

FOR: MUSEUM SERVICES, IN CLASS 41 (U.S. CLS. 100, 101 AND 107).

FIRST USE 1-1-2000; IN COMMERCE 1-1-2000.

THE LINING IS A FEATURE OF THE MARK AND DOES NOT INDICATE COLOR.

SER. NO. 76-498,357, FILED 3-18-2003.

RONALD MCMORROW, EXAMINING ATTORNEY

Int. Cls.: 9 and 41

Prior U.S. Cls.: 21, 23, 26, 36, 38, 100, 101 and 107

United States Patent and Trademark Office

Reg. No. 2,892,640

Registered Oct. 12, 2004

**TRADEMARK
SERVICE MARK
PRINCIPAL REGISTER**

PLAYERPAK

ACTIVE HOLDINGS LLC (CALIFORNIA LTD
LIAB CO)
150 EAST MEDA, SUITE 270
GLEN DORA, CA 91741

FOR: PRE-RECORDED COMPACT DISCS,
NAMELY, CD-ROMS FEATURING FILM CLIPS,
VIDEO AND AUDIO CLIPS, SCREEN SAVERS,
PDF DOCUMENTS, LINKS TO INTERNET WEB-
SITES, AND OTHER ENHANCED MULTIMEDIA
FEATURES, IN CLASS 9 (U.S. CLS. 21, 23, 26, 36 AND
38).

FIRST USE 12-18-2002; IN COMMERCE 1-7-2003.

FOR: MULTIMEDIA ENTERTAINMENT SOFT-
WARE PRODUCTION SERVICES, NAMELY, CD-
ROMS FEATURING FILM CLIPS, VIDEO AND

AUDIO CLIPS, SCREEN SAVERS, PDF DOCU-
MENTS, LINKS TO INTERNET WEBSITES, AND
OTHER ENHANCED MULTIMEDIA FEATURES
THAT PROVIDE ENTERTAINMENT AND INFOR-
MATION FOR OTHERS, IN CLASS 41 (U.S. CLS. 100,
101 AND 107).

FIRST USE 12-18-2002; IN COMMERCE 1-7-2003.

THE MARK CONSISTS OF STANDARD CHAR-
ACTERS WITHOUT CLAIM TO ANY PARTICULAR
FONT, STYLE, SIZE, OR COLOR.

SER. NO. 76-498,375, FILED 3-19-2003.

MARIA-VICTORIA SUAREZ, EXAMINING ATTOR-
NEY

Int. Cl.: 36

Prior U.S. Cls.: 100, 101 and 102

United States Patent and Trademark Office

Reg. No. 2,892,641

Registered Oct. 12, 2004

**SERVICE MARK
PRINCIPAL REGISTER**



FREE ENTERPRISE FOUNDATION (DELAWARE
NOT-FOR-PROFIT CORPORATION)

P.O. BOX 21569
CHARLESTON, SC 29413

FOR: CHARITABLE FUNDRAISING SERVICES
NAMELY, RAISING FUNDS FOR PURPOSES OF
SUPPORTING SCHOLARSHIP, FUNDING PUBLI-
CATIONS AND GRANTING AWARDS IN THE
FIELD OF ETHICS, CORPORATE RESPONSIBIL-
ITY, CONSTITUTIONAL FREEDOMS AND FREE

MARKET ECONOMICS, IN CLASS 36 (U.S. CLS. 100,
101 AND 102).

FIRST USE 10-31-2002; IN COMMERCE 10-31-2002.

NO CLAIM IS MADE TO THE EXCLUSIVE
RIGHT TO USE "FREE ENTERPRISE FOUNDA-
TION", APART FROM THE MARK AS SHOWN.

SER. NO. 76-498,388, FILED 3-18-2003.

WILLIAM VERHOSEK, EXAMINING ATTORNEY

Int. Cl.: 15

Prior U.S. Cls.: 2, 21 and 36

United States Patent and Trademark Office

Reg. No. 2,892,642

Registered Oct. 12, 2004

**TRADEMARK
PRINCIPAL REGISTER**

RENARD

FOX PRODUCTS CORPORATION (INDIANA CORPORATION)
6110 SOUTH SR 5
SOUTH WHITLEY, IN 46787

FOR: WOODWIND INSTRUMENTS, NAMELY ENGLISH HORNS, IN CLASS 15 (U.S. CLS. 2, 21 AND 36).

FIRST USE 8-11-1999; IN COMMERCE 8-11-1999.

OWNER OF U.S. REG. NOS. 903,013 AND 979,027.

THE ENGLISH TRANSLATION OF RENARD IS "FOX".

SER. NO. 76-498,511, FILED 3-18-2003.

WILLIAM VERHOSEK, EXAMINING ATTORNEY

Int. Cl.: 30

Prior U.S. Cl.: 46

United States Patent and Trademark Office

Reg. No. 2,892,643

Registered Oct. 12, 2004

TRADEMARK
PRINCIPAL REGISTER



SHUG INC (FLORIDA CORPORATION)
POB 50323
JAX BEACH, FL 32240

FOR: CHOCOLATE FOODS; NAMELY, DIPPED CANDIED NUTS, FRUITS, COOKIES, PRETZELS, POPCORN AND DIPPED CHOCOLATES, TRUFFLES, CANDY, CANDY BARS; CHOCOLATE TOPPING, CHOCOLATE CAKES, AND NOVELTY CONFECTIONS; NAMELY, CHOCOLATE CATS, CHOCOLATE DOGS, CHOCOLATE HORSES, CHOCOLATE ALLIGATORS, CHOCOLATE TEDDY BEARS, CHOCOLATE BUNNIES, CHOCOLATE HEARTS, CHOCOLATE GOLF BALLS, CHOCOLATE PIZZAS, CHOCOLATE COMPACT DISCS, IN CLASS 30 (U.S. CL. 46).

FIRST USE 2-0-1986; IN COMMERCE 3-0-2003.

NO CLAIM IS MADE TO THE EXCLUSIVE RIGHT TO USE CHOCOLATIER, APART FROM THE MARK AS SHOWN.

THE DRAWING IS LINED FOR THE COLOR(S) GREEN, YELLOW AND RED, AND THE COLOR IS CLAIMED AS A FEATURE OF THE MARK.

THE SPECIMEN CONSISTS OF TWO CONCENTRIC RED CIRCLES ENCASING THE STYLIZED WORDS "SUGAR SHACK"; THE INNER SPHERE PIERCED FROM THE REAL FOCUS MEDALLION BY AN EMERGING APEX-INTERSECTED, TRIBOLT SLOPED, WATERCOLOR FASHIONED PYRAMIDAL RAINBOW - ARRAYED IN GREEN, YELLOW, AND RED: A TRIANGULATED STRUCTURE SUGGESTED BY THE BASE WORD "CHOCOLATIER" FORMED IN A MARBLEIZED, GREEN LETTERING SUPPORTING THE UPWARD DIRECTED, MULTI-COLORED RAYS.

SER. NO. 76-498,889, FILED 3-20-2003.

ANDREW BENZMILLER, EXAMINING ATTORNEY

Int. Cl.: 9

Prior U.S. Cls.: 21, 23, 26, 36 and 38

Reg. No. 2,892,644

United States Patent and Trademark Office

Registered Oct. 12, 2004

**TRADEMARK
PRINCIPAL REGISTER**

HIGH GEAR

HIGH GEAR USA, LLC (NORTH CAROLINA
LTD LIAB CO)
P.O. BOX 890
SKYLAND, NC 28776

FOR: COMPASSES; THERMOMETERS NOT FOR
MEDICAL USE; BAROMETERS; WIND METERS;
ALTIMETERS; CHRONOGRAPHS FOR USE AS
SPECIALIZED TIME RECORDING APPARATUSES;
PEDOMETERS; STEP COUNTERS; ELECTRONIC
CALORIE COUNTERS; PORTABLE LISTENING DE-
VICES, NAMELY, MP3 PLAYERS; MULTI-PURPOSE
TOOL HAVING A COMPASS, THERMOMETER,
WHISTLE, MIRROR, STORAGE, LED LIGHT AND
MAGNIFIER; AND SATELLITE NAVIGATIONAL
SYSTEM, NAMELY, A GLOBAL POSITIONING

SYSTEM (GPS), IN CLASS 9 (U.S. CLS. 21, 23, 26, 36
AND 38).

FIRST USE 10-7-1999; IN COMMERCE 10-7-1999.

OWNER OF U.S. REG. NO. 2,360,814.

NO CLAIM IS MADE TO THE EXCLUSIVE
RIGHT TO USE "GEAR", APART FROM THE
MARK AS SHOWN.

SER. NO. 76-498,964, FILED 3-20-2003.

TRICIA SONNEBORN, EXAMINING ATTORNEY

Int. Cl.: 11

Prior U.S. Cls.: 13, 21, 23, 31 and 34

United States Patent and Trademark Office

Reg. No. 2,892,645

Registered Oct. 12, 2004

**TRADEMARK
PRINCIPAL REGISTER**

PowerSelect

DIMENSION ONE SPAS, INC (CALIFORNIA CORPORATION)
2611 BUSINESS PARK DRIVE
VISTA, CA 92083

FOR: WATER JETS SOLD AS AN INTEGRAL COMPONENT OF SPAS IN THE NATURE OF HEATED POOLS, WHIRLPOOLS BATHS AND RECREATIONAL POOLS, IN CLASS 11 (U.S. CLS. 13, 21, 23, 31 AND 34).

FIRST USE 9-24-2002; IN COMMERCE 9-24-2002.

THE MARK CONSISTS OF STANDARD CHARACTERS WITHOUT CLAIM TO ANY PARTICULAR FONT, STYLE, SIZE, OR COLOR.

SER. NO. 76-499,264, FILED 3-7-2003.

ALICIA COLLINS, EXAMINING ATTORNEY

Int. Cl.: 39

Prior U.S. Cls.: 100 and 105

United States Patent and Trademark Office

Reg. No. 2,892,646

Registered Oct. 12, 2004

**SERVICE MARK
PRINCIPAL REGISTER**

GO XPLOR

GOXPLO, LLC (TEXAS LTD LIAB CO)
2211 NORFOLK, STE. 460
HOUSTON, TX 77098

FIRST USE 11-1-2002; IN COMMERCE 11-1-2002.

FOR: TRAVEL GUIDE SERVICES FOR ADVENTURES AND EXPEDITIONS THROUGHOUT THE UNITED STATES AND INTERNATIONALLY, IN CLASS 39 (U.S. CLS. 100 AND 105).

SER. NO. 76-499,337, FILED 3-18-2003.

GIANCARLO CASTRO, EXAMINING ATTORNEY

Int. Cl.: 36

Prior U.S. Cls.: 100, 101 and 102

United States Patent and Trademark Office

Reg. No. 2,892,647

Registered Oct. 12, 2004

**SERVICE MARK
PRINCIPAL REGISTER**

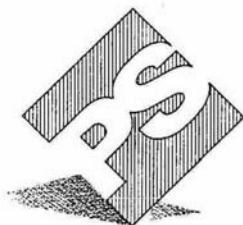

PSBUSINESSPARKS

PUBLIC STORAGE, INC. (CALIFORNIA CORPORATION)
701 WESTERN AVENUE, SUITE 200
P.O. BOX 25050
GLENDALE, CA 912012397

FOR: COMMERCIAL REAL ESTATE MANAGEMENT SERVICES, IN CLASS 36 (U.S. CLS. 100, 101 AND 102).

FIRST USE 3-13-2003; IN COMMERCE 3-13-2003.

OWNER OF U.S. REG. NOS. 1,067,870, 2,525,614 AND OTHERS.

THE LINING IN THE DRAWING IS TO SHOW THE COLOR RED, WHICH IS PART OF THE MARK.

SER. NO. 76-499,432, FILED 3-13-2003.

AMY GEARIN, EXAMINING ATTORNEY

Int. Cls.: 35 and 38

Prior U.S. Cls.: 100, 101, 102 and 104

United States Patent and Trademark Office

Reg. No. 2,892,648

Registered Oct. 12, 2004

**SERVICE MARK
PRINCIPAL REGISTER**

CLUBPLANET

CLUBPLANET, INC. (NEW YORK CORPORATION)
485 MADISON AVENUE
21ST FLOOR
NEW YORK, NY 10022

FOR: PROVIDING ON-LINE RETAIL INFORMATION SERVICES ON PURCHASING TICKETS FOR ENTERTAINMENT, MUSIC, NIGHT LIFE AND CULTURAL EVENTS INCLUSIVE OF A NIGHT-CLUB COVER CHARGE DISCOUNT PROGRAM AND ON-LINE TICKET AGENCY SERVICES, NAMELY, SALE OF TICKETS FOR LIVE ENTERTAINMENT, MUSICAL PERFORMANCES, THEATRICAL PERFORMANCES AND CULTURAL EVENTS; ON-LINE RETAIL STORE FEATURING CLOTHING, PRERECORDED MUSIC AND BOOKS; PROMOTING GOODS AND SERVICES OF OTHERS BY PLACEMENT OF CLASSIFIED ADVERTISEMENTS IN A WEB SITE ACCESSED THROUGH

THE GLOBAL COMPUTER INFORMATION NETWORK AND CONSULTING SERVICES CONNECTED THEREWITH, AND ELECTRONIC BILLBOARD ADVERTISING, IN CLASS 35 (U.S. CLS. 100, 101 AND 102).

FIRST USE 9-1-1997; IN COMMERCE 9-1-1997.

FOR: PROVIDING ON-LINE CHAT ROOMS FOR TRANSMISSION OF MESSAGES AMONG COMPUTER USERS CONCERNING NIGHTLIFE, NIGHT-CLUBS, ENTERTAINMENT AND CULTURAL EVENTS, IN CLASS 38 (U.S. CLS. 100, 101 AND 104).

FIRST USE 9-1-1997; IN COMMERCE 9-1-1997.

SER. NO. 76-499,679, FILED 3-10-2003.

JOHN E. MICHOS, EXAMINING ATTORNEY

Int. Cl.: 9

Prior U.S. Cls.: 21, 23, 26, 36 and 38

United States Patent and Trademark Office

Reg. No. 2,892,649

Registered Oct. 12, 2004

**TRADEMARK
PRINCIPAL REGISTER**

LIGHTSOFT

ECI TELECOM LTD. (ISRAEL CORPORATION)
30 HASIVIM STREET
PETACH TIKVA 49517, ISRAEL

FOR: SOFTWARE FOR USE IN MANAGING,
MONITORING, CONTROLLING, PLANNING AND
DESIGNING COMMUNICATION NETWORKS AND
PARTS THEREOF, IN CLASS 9 (U.S. CLS. 21, 23, 26, 36
AND 38).

PRIORITY CLAIMED UNDER SEC. 44(D) ON
ISRAEL APPLICATION NO. 159747, FILED 10-9-
2002, REG. NO. 159747, DATED 4-12-2003, EXPIRES
4-12-2013.

SER. NO. 76-499,738, FILED 3-24-2003.

MARTHA FROMM, EXAMINING ATTORNEY

Int. Cls.: 16 and 35

Prior U.S. Cls.: 2, 5, 22, 23, 29, 37, 38, 50, 100, 101 and 102

Reg. No. 2,892,650

United States Patent and Trademark Office

Registered Oct. 12, 2004

**TRADEMARK
SERVICE MARK
PRINCIPAL REGISTER**



CITY OF RED WING (MINNESOTA MUNICIPAL CORPORATION)
315 WEST 4TH ST.
RED WING, MN 55066

FOR: PRINTED MATTER, NAMELY, BUSINESS CARDS, LETTERHEAD, ENVELOPES, FOLDERS AND NEWSLETTERS ON LOCAL NEWS, STATIONERY AND DECALS, IN CLASS 16 (U.S. CLS. 2, 5, 22, 23, 29, 37, 38 AND 50).

FIRST USE 12-15-2002; IN COMMERCE 12-15-2002.

FOR: BUSINESS MARKETING CONSULTING SERVICES, IN CLASS 35 (U.S. CLS. 100, 101 AND 102).

FIRST USE 12-15-2002; IN COMMERCE 12-15-2002.

NO CLAIM IS MADE TO THE EXCLUSIVE RIGHT TO USE "CITY OF RED WING", APART FROM THE MARK AS SHOWN.

SER. NO. 76-499,783, FILED 3-24-2003.

JOHN E. MICHOS, EXAMINING ATTORNEY

Int. Cls.: 9, 36, 38 and 42

Prior U.S. Cls.: 21, 23, 26, 36, 38, 100, 101, 102 and 104

United States Patent and Trademark Office

Reg. No. 2,892,651

Registered Oct. 12, 2004

**TRADEMARK
SERVICE MARK
PRINCIPAL REGISTER**



CLS UK INTERMEDIATE HOLDINGS LTD.
(UNITED KINGDOM CORPORATION)
ONE HARBOUR EXCHANGE SQUARE
LONDON, UNITED KINGDOM E14 9GE

FOR: COMPUTER HARDWARE; COMPUTER SOFTWARE FOR THE PROVISION OF FINANCIAL INFORMATION AND CONDUCTING FINANCIAL TRANSACTIONS; INTERFACES FOR COMPUTERS; COMPUTERS; COMPUTER KEYBOARDS; COMPUTER PERIPHERAL DEVICES; COMPUTER SOFTWARE AND PUBLICATIONS IN ELECTRONIC FORM SUPPLIED ON-LINE FROM DATABASES OR FROM FACILITIES PROVIDED ON THE INTERNET, ALL FEATURING FINANCIAL INFORMATION; COMPUTER SOFTWARE AND TELECOMMUNICATION APPARATUS, NAMELY, MODEMS TO ENABLE CONNECTION TO DATABASES ON THE INTERNET; COMPUTER SOFTWARE FOR SEARCHING OF DATA ON THE INTERNET, IN CLASS 9 (U.S. CLS. 21, 23, 26, 36 AND 38).

FOR: FINANCIAL SERVICES, NAMELY, PROVIDING FOREIGN EXCHANGE TRANSACTIONS; ACTING AS A FINANCIAL SETTLEMENT AGENT; EFFECTING SETTLEMENTS THROUGH BOOK TRANSFERS AND CIRCLES PROCESSING; SPLITTING OF TRANSACTIONS FOR THE PURPOSES OF SETTLEMENTS; DEPOSIT-TAKING; PROVISION OF OVERDRAFTS AND THE TAKING OF SECURITIES AND OTHER COLLATERAL IN RELATION TO SUCH OVERDRAFTS; PROVISION OF BILATERAL AND MULTILATERAL FINANCING NETTING; TAKING FINANCIAL MARGINS; CALCULATING NET SETTLEMENT AMOUNTS; DEFAULT MANAGEMENT; LOSS SHARING; FINANCIAL CLEARING HOUSE SERVICES; FINANCIAL ANALYSIS; FINANCIAL CONSULTANCY; EXCHANGE SERVICES RELATING TO SHARES, SECURITIES, COMMODITIES, FUTURES AND OP-

TIONS; ORGANIZATION AND OPERATION OF TRADING MARKETS FOR FINANCIAL SERVICES AND FINANCIAL INSTRUMENTS; PROVISION OF FINANCIAL INFORMATION RELATING TO FOREIGN EXCHANGE TRANSACTIONS; CLEARING, PAYMENT, AND SETTLEMENT SERVICES RELATING TO INTERNATIONAL CURRENCY, SECURITIES, COMMODITIES AND OTHER FINANCIAL TRANSACTIONS AMONG FINANCIAL INSTITUTIONS AND OTHER PARTICIPANTS IN THE FINANCIAL MARKETS, IN CLASS 36 (U.S. CLS. 100, 101 AND 102).

FOR: TELECOMMUNICATION SERVICES, NAMELY, COMMUNICATION BY COMPUTER TERMINALS; COMPUTER-AIDED TRANSMISSION OF MESSAGES, INFORMATION AND IMAGES; ELECTRONIC MAIL; ELECTRONIC MESSAGE SENDING; RENTAL OF MESSAGE SENDING APPARATUS; LEASING ACCESS TO A GLOBAL COMPUTER NETWORK, IN CLASS 38 (U.S. CLS. 100, 101 AND 104).

FOR: COMPUTER PROGRAMMING; DEVELOPMENT OF SOFTWARE PROGRAMS; RENTAL AND DESIGN OF COMPUTER PROGRAMS; INFORMATION TECHNOLOGY CONSULTANCY SERVICES; UPDATING OF COMPUTER SOFTWARE; AND RENTAL OF COMPUTER SOFTWARE, IN CLASS 42 (U.S. CLS. 100 AND 101).

PRIORITY CLAIMED UNDER SEC. 44(D) ON UNITED KINGDOM APPLICATION NO. 2319218, FILED 12-18-2002, REG. NO. 2319218, DATED 8-8-2003, EXPIRES 12-18-2012.

SER. NO. 76-499,968, FILED 3-24-2003.

JOHN E. MICHOS, EXAMINING ATTORNEY

Int. Cls.: 2 and 17

Prior U.S. Cls.: 1, 5, 6, 11, 12, 13, 16, 35 and 50

United States Patent and Trademark Office

Reg. No. 2,892,652

Registered Oct. 12, 2004

**TRADEMARK
PRINCIPAL REGISTER**

SPRAYLAT

SPRAYLAT CORPORATION (NEW YORK CORPORATION)
143 SPARKS AVENUE
PELHAM, NY 10803

FOR: COATINGS, NAMELY AQUEOUS DISPERSIONS OF NATURAL OR SYNTHETIC RESINS OR OTHER PLASTIC COMPOSITIONS AND POWDERS FOR USE AS PROTECTIVE COATINGS ON ARTICLES EITHER IN THE FINISHED OR UNFINISHED STATE, WATER DISPERSION FILM FORMING MATERIAL USED AS MASKS AGAINST LACQUERS AND ENAMELS IN THE MANUFACTURE OF SIGNS, WATER DISPERSION FILM FORMING MATERIAL USED AS A TEMPORARY OR STRIP-PABLE COATINGS FOR PROTECTION OF SPRAY BOOTHS, COCOONING AIRCRAFT, PROTECTION OF WHITE WALL TIRES; INKS FOR USE IN SHIELDING ELECTRONIC COMPONENTS FROM ELECTROMAGNETIC INTERFERENCE AND/OR

RADIO FREQUENCY INTERFERENCE; INDOOR AND OUTDOOR PAINTS; PAINT PRIMERS; PAINT THINNERS AND VARNISHES, IN CLASS 2 (U.S. CLS. 6, 11 AND 16).

FIRST USE 12-0-1942; IN COMMERCE 12-0-1942.

FOR: THERMOFORMABLE POLYMER FILM SHEETS AND SHIELD GASKETS FOR USE IN SHIELDING ELECTRONIC COMPONENTS FROM ELECTROMAGNETIC INTERFERENCE AND/OR RADIO FREQUENCY INTERFERENCE, IN CLASS 17 (U.S. CLS. 1, 5, 12, 13, 35 AND 50).

FIRST USE 12-0-1942; IN COMMERCE 12-0-1942.

SER. NO. 76-500,194, FILED 3-25-2003.

KATHY DE JONGE, EXAMINING ATTORNEY

Int. Cl.: 41

Prior U.S. Cls.: 100, 101 and 107

United States Patent and Trademark Office

Reg. No. 2,892,653

Registered Oct. 12, 2004

**SERVICE MARK
PRINCIPAL REGISTER**

ARCHERS for the Lord
(Association of Relaxed Christian Home Educators), Inc.
Psalm 127

ARCHERS FOR THE LORD (ASSOCIATION OF
RELAXED CHRISTIAN HOME EDUCATORS),
INC. (GEORGIA CORPORATION)
ARCHERS FOR THE LORD
C/O MARY HOOD, PRESIDENT 6670 REDFIELD CT
ALWORTH, GA 30102

FOR: EDUCATIONAL SERVICES, NAMELY
CONDUCTING CLASSES, WORKSHOPS, CURRI-
CULUM FAIRS IN THE FIELD OF HOME SCHOOL
EDUCATION, INCLUDING DISTRIBUTING
COURSE MATERIALS IN CONNECTION THERE-
WITH, IN CLASS 41 (U.S. CLS. 100, 101 AND 107).

FIRST USE 1-6-2003; IN COMMERCE 1-6-2003.

NO CLAIM IS MADE TO THE EXCLUSIVE
RIGHT TO USE ASSOCIATION OF RELAXED
CHRISTIAN HOME EDUCATORS, INC AND
PSALM 127, APART FROM THE MARK AS SHOWN.

SER. NO. 76-500,517, FILED 2-10-2003.

CHERYL CLAYTON, EXAMINING ATTORNEY

Int. Cl.: 9

Prior U.S. Cls.: 21, 23, 26, 36 and 38

United States Patent and Trademark Office

Reg. No. 2,892,654

Registered Oct. 12, 2004

**TRADEMARK
PRINCIPAL REGISTER**

CEDARMONT NINOS

CEDARMONT MUSIC, LLC (TENNESSEE LTD
LIAB CO)
600 BEECH CREEK ROAD, SOUTH
BRENTWOOD, TN 37027

FOR: AUDIO/VISUAL RECORDINGS OF CHILDREN'S SONGS IN SPANISH, IN CLASS 9 (U.S. CLS. 21, 23, 26, 36 AND 38).

FIRST USE 11-9-1994; IN COMMERCE 11-9-1994.

NO CLAIM IS MADE TO THE EXCLUSIVE RIGHT TO USE NINOS, APART FROM THE MARK AS SHOWN.

THE ENGLISH TRANSLATION OF NINOS IS "CHILDREN".

SER. NO. 76-500,656, FILED 3-10-2003.

JOHN E. MICHOS, EXAMINING ATTORNEY

Int. Cl.: 9

Prior U.S. Cls.: 21, 23, 26, 36 and 38

United States Patent and Trademark Office

Reg. No. 2,892,655

Registered Oct. 12, 2004

**TRADEMARK
PRINCIPAL REGISTER**

CEDARMONT BABY

CEDARMONT MUSIC, LLC (TENNESSEE LTD
LIAB CO)
600 BEECH CREEK ROAD, SOUTH
BRENTWOOD, TN 37027

NO CLAIM IS MADE TO THE EXCLUSIVE
RIGHT TO USE BABY, APART FROM THE MARK
AS SHOWN.

FOR: AUDIO RECORDINGS ON CD AND CAS-
SETTE OF SONGS FOR YOUNG CHILDREN, IN
CLASS 9 (U.S. CLS. 21, 23, 26, 36 AND 38).

SER. NO. 76-500,659, FILED 3-10-2003.

FIRST USE 9-15-2001; IN COMMERCE 9-15-2001.

JOHN E. MICHOS, EXAMINING ATTORNEY

Int. Cl.: 41

Prior U.S. Cls.: 100, 101 and 107

United States Patent and Trademark Office

Reg. No. 2,892,656

Registered Oct. 12, 2004

**SERVICE MARK
PRINCIPAL REGISTER**

ENROLLCHK

CREDENTIALS INC. (ILLINOIS CORPORATION)
550 FRONTAGE ROAD
SUITE 3500
NORTHFIELD, IL 60093

FIRST USE 12-6-2000; IN COMMERCE 2-6-2001.

SER. NO. 76-501,469, FILED 3-27-2003.

FOR: ONLINE VERIFICATION OF STUDENT
ENROLLMENT STATUS, IN CLASS 41 (U.S. CLS.
100, 101 AND 107).

JOHN E. MICHOS, EXAMINING ATTORNEY

Int. Cls.: 41 and 44

Prior U.S. Cls.: 100, 101 and 107

United States Patent and Trademark Office

Reg. No. 2,892,657

Registered Oct. 12, 2004

**SERVICE MARK
PRINCIPAL REGISTER**



PROJECT ORBIS INTERNATIONAL, INC. (NEW YORK NOT FOR PROFIT CORPORATION)
520 EIGHTH AVE, 11TH FL.
NEW YORK, NY 10018

FOR: EDUCATIONAL SERVICES, NAMELY, PROVIDING ON-LINE CONTINUING MEDICAL EDUCATION COURSES REGARDING THE AVOIDANCE AND CURE OF BLINDNESS , IN CLASS 41 (U.S. CLS. 100, 101 AND 107).

FIRST USE 4-0-2001; IN COMMERCE 4-0-2001.

FOR: PROVIDING MEDICAL SERVICES; PROVIDING MEDICAL INFORMATION SERVICES RELATING TO THE AVOIDANCE AND CURE OF

BLINDNESS; AND TELEMEDICINE SERVICES, NAMELY, THE COLLECTION, ANALYSIS AND REPORTING OF PATIENT MEDICAL CONDITION, TREATMENT PROGRESS, DRUG HISTORY, AND HEALTHCARE BACKGROUND FOR DIAGNOSTIC PURPOSES BY USE OF TELECOMMUNICATIONS OR COMPUTER NETWORKS, AND CONSULTING SERVICES RELATED THERETO, IN CLASS 44 (U.S. CLS. 100 AND 101).

FIRST USE 4-0-2001; IN COMMERCE 4-0-2001.

SER. NO. 76-501,496, FILED 3-27-2003.

MARC LEIPZIG, EXAMINING ATTORNEY

Int. Cl.: 18

Prior U.S. Cls.: 1, 2, 3, 22 and 41

United States Patent and Trademark Office

Reg. No. 2,892,658

Registered Oct. 12, 2004

**TRADEMARK
PRINCIPAL REGISTER**



RIDE ON CARRIERS, INC. (COLORADO CORPORATION)
1932 N. HIGHWAY 287
BERTHOUD, CO 80513

FIRST USE 1-2-2003; IN COMMERCE 1-2-2003.

SER. NO. 76-502,296, FILED 3-31-2003.

FOR: BABY CARRIERS WORN ON THE BODY,
IN CLASS 18 (U.S. CLS. 1, 2, 3, 22 AND 41).

PRISCILLA MILTON, EXAMINING ATTORNEY

Int. Cl.: 39

Prior U.S. Cls.: 100 and 105

United States Patent and Trademark Office

Reg. No. 2,892,659

Registered Oct. 12, 2004

**SERVICE MARK
PRINCIPAL REGISTER**



EXWIRE, INC. (DELAWARE CORPORATION)
13159 SOLVANG WAY
TRUCKEE, CA 96161

FOR: TELECOMMUNICATION SERVICES,
NAMELY, PROVIDING BROADBAND ACCESS TO
THE INTERNET FOR RESIDENTIAL AND COM-
MERCIAL CUSTOMERS, IN CLASS 39 (U.S. CLS. 100
AND 105).

FIRST USE 10-30-2002; IN COMMERCE 1-20-2003.

THE MARK CONSISTS OF STYLIZED LETTER-
ING; THE STYLIZED LETTER X BRANCHES OUT
LEFT AND RIGHT - LEFT INTO A CIRCLE, WHICH
SURROUNDS THE STYLIZED LETTER E, AND
RIGHT INTO AN OVAL, WHICH SURROUNDS
THE STYLIZED LETTERS WIRE.

SER. NO. 76-502,541, FILED 3-31-2003.

MARTHA FROMM, EXAMINING ATTORNEY

Int. Cl.: 30

Prior U.S. Cl.: 46

United States Patent and Trademark Office

Reg. No. 2,892,660

Registered Oct. 12, 2004

**TRADEMARK
PRINCIPAL REGISTER**

HALF MOON BAY TRADING COMPANY

HALF MOON BAY TRADING COMPANY
(FLORIDA CORPORATION)
P.O. BOX 330718
ATLANTIC BEACH, FL 32233

NO CLAIM IS MADE TO THE EXCLUSIVE
RIGHT TO USE TRADING COMPANY, APART
FROM THE MARK AS SHOWN.

FOR: SAUCES AND MARINADES APPLIED TO
FOOD, NAMELY, PEPPER SAUCE, HOT SAUCE,
STEAK SAUCE, CATSUP, MUSTARD, IN CLASS 30
(U.S. CL. 46).

SER. NO. 76-502,757, FILED 3-10-2003.

FIRST USE 9-1-1992; IN COMMERCE 9-1-1992.

MICHAEL LEVY, EXAMINING ATTORNEY

Int. Cl.: 42

Prior U.S. Cls.: 100 and 101

United States Patent and Trademark Office

Reg. No. 2,892,661

Registered Oct. 12, 2004

**SERVICE MARK
PRINCIPAL REGISTER**

CULINARY WIZARD

CULINARY WIZARD, INC. (ILLINOIS CORPORATION)
25777 HILLVIEW CT.
MUNDELEIN, IL 60060

NO CLAIM IS MADE TO THE EXCLUSIVE RIGHT TO USE CULINARY, APART FROM THE MARK AS SHOWN.

FOR: FOOD PRODUCT RESEARCH AND DEVELOPMENT SERVICES, IN CLASS 42 (U.S. CLS. 100 AND 101).

SER. NO. 76-503,070, FILED 3-28-2003.

FIRST USE 1-0-1998; IN COMMERCE 12-0-2002.

CHARLES L. JENKINS, EXAMINING ATTORNEY

Int. Cls.: 9 and 41

Prior U.S. Cls.: 21, 23, 26, 36, 38, 100, 101 and 107

Reg. No. 2,892,662

United States Patent and Trademark Office

Registered Oct. 12, 2004

**TRADEMARK
SERVICE MARK
PRINCIPAL REGISTER**

CMR INTERACTIVE

THE CERTIFIED MEDICAL REPRESENTATIVES
INSTITUTE, INC. (VIRGINIA CORPORATION)
4423 PHEASANT RIDGE ROAD
SUITE 100
ROANOKE, VA 240145274

FOR: PRE-RECORDED MULTIMEDIA CD-ROMS
FEATURING EDUCATIONAL MATERIALS IN THE
FIELD OF HEALTH CARE, IN CLASS 9 (U.S. CLS. 21,
23, 26, 36 AND 38).

FIRST USE 1-1-2003; IN COMMERCE 1-1-2003.

FOR: EDUCATIONAL SERVICES, NAMELY,
PROVIDING COURSES IN THE FIELD OF THE
HUMAN BODY, PATHOLOGY AND TREATMENT,
THE PHARMACEUTICAL INDUSTRY AND THE

HEALTHCARE INDUSTRY, ALL INTENDED FOR
REPRESENTATIVES IN THE HEALTHCARE IN-
DUSTRY, IN CLASS 41 (U.S. CLS. 100, 101 AND 107).

FIRST USE 1-1-2003; IN COMMERCE 1-1-2003.

OWNER OF U.S. REG. NOS. 879,499, 2,174,945 AND
OTHERS.

NO CLAIM IS MADE TO THE EXCLUSIVE
RIGHT TO USE "INTERACTIVE", APART FROM
THE MARK AS SHOWN.

SER. NO. 76-503,085, FILED 4-1-2003.

CATHERINE CAIN, EXAMINING ATTORNEY

Int. Cl.: 16

Prior U.S. Cls.: 2, 5, 22, 23, 29, 37, 38 and 50

United States Patent and Trademark Office

Reg. No. 2,892,663

Registered Oct. 12, 2004

**TRADEMARK
PRINCIPAL REGISTER**

CMR TODAY

THE CERTIFIED MEDICAL REPRESENTATIVES
INSTITUTE, INC. (VIRGINIA CORPORATION)
4423 PHEASANT RIDGE ROAD
SUITE 100
ROANOKE, VA 240145274

FOR: NEWSLETTER IN THE FIELD OF HEALTH
CARE, IN CLASS 16 (U.S. CLS. 2, 5, 22, 23, 29, 37, 38
AND 50).

FIRST USE 8-0-2000; IN COMMERCE 11-0-2000.

OWNER OF U.S. REG. NOS. 879,499, 2,174,945 AND
OTHERS.

SER. NO. 76-503,087, FILED 4-1-2003.

CATHERINE CAIN, EXAMINING ATTORNEY

Int. Cls.: 35, 39 and 40

Prior U.S. Cls.: 100, 101, 102, 103, 105 and 106

United States Patent and Trademark Office

Reg. No. 2,892,664

Registered Oct. 12, 2004

SERVICE MARK
PRINCIPAL REGISTER

the Jay group

THE JAY GROUP, INC. (PENNSYLVANIA BUSINESS CORPORATION)
60 NORTH RONKS ROAD
RONKS, PA 17572

FOR: ADMINISTRATION OF REBATE PROGRAMS FOR OTHERS; ORDER FULFILLMENT SERVICES FOR OTHERS; PREPARATION OF CUSTOM PROMOTIONAL PRODUCTS FOR OTHERS; OPERATION OF CALL CENTERS FOR OTHERS, IN CLASS 35 (U.S. CLS. 100, 101 AND 102).

FIRST USE 1-2-1996; IN COMMERCE 1-2-1996.

FOR: PACKING ARTICLES OF OTHERS FOR TRANSPORTATION; WAREHOUSING SERVICES, NAMELY, STORAGE, DISTRIBUTION, AND PACKING FOR SHIPMENT OF THE PRODUCTS OF OTHERS; TRANSPORTATION AND DELIVERY SERVICES, NAMELY, SAME DAY SHIPMENT SERVICES, IN CLASS 39 (U.S. CLS. 100 AND 105).

FIRST USE 1-2-1996; IN COMMERCE 1-2-1996.

FOR: MANUFACTURE OF PROMOTIONAL PRODUCTS TO THE ORDER AND SPECIFICATION OF OTHERS; CUSTOMIZED PRINTING OF COMPANY NAMES AND LOGOS FOR PROMOTIONAL AND ADVERTISING PURPOSES ON THE GOODS OF OTHERS, IN CLASS 40 (U.S. CLS. 100, 103 AND 106).

FIRST USE 1-2-1996; IN COMMERCE 1-2-1996.

NO CLAIM IS MADE TO THE EXCLUSIVE RIGHT TO USE GROUP, APART FROM THE MARK AS SHOWN.

SER. NO. 76-503,103, FILED 3-27-2003.

BARBARA A. LOUGHRAN, EXAMINING ATTORNEY

Int. Cls.: 9 and 35

Prior U.S. Cls.: 21, 23, 26, 36, 38, 100, 101 and 102

Reg. No. 2,892,665

United States Patent and Trademark Office

Registered Oct. 12, 2004

**TRADEMARK
SERVICE MARK
PRINCIPAL REGISTER**

PICTOMETRY

PICTOMETRY INTERNATIONAL CORP. (DELA-
WARE CORPORATION)
100 TOWN CENTRE DRIVE, SUITE A
ROCHESTER, NY 146234260

FOR: COMPUTER SOFTWARE USED FOR STOR-
ING AND ACCESSING IMAGES AND GEOGRAPH-
IC AND LOCATIONAL DATA REGARDING THE
STORED AND ACCESSED IMAGES, IN CLASS 9
(U.S. CLS. 21, 23, 26, 36 AND 38).

FIRST USE 0-0-1996; IN COMMERCE 0-0-1996.

FOR: LICENSING OF SOFTWARE USED FOR
THE DISPLAY AND/OR REPRODUCTION OF IMA-
GES AND GEOLOCATIONAL DATA REGARDING
THE DISPLAYED AND/OR REPRODUCED IMA-
GES, IN CLASS 35 (U.S. CLS. 100, 101 AND 102).

FIRST USE 0-0-1996; IN COMMERCE 0-0-1996.

SER. NO. 76-503,226, FILED 3-21-2003.

HOWARD B. LEVINE, EXAMINING ATTORNEY

Int. Cls.: 35, 39 and 40

Prior U.S. Cls.: 100, 101, 102, 103, 105 and 106

United States Patent and Trademark Office

Reg. No. 2,892,666

Registered Oct. 12, 2004

**SERVICE MARK
PRINCIPAL REGISTER**

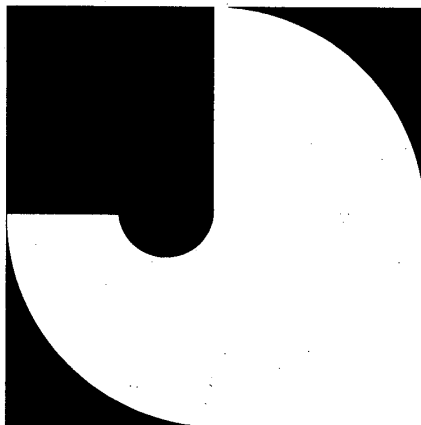

THE JAY GROUP, INC. (PENNSYLVANIA BUSINESS CORPORATION)
60 NORTH RONKS ROAD
RONKS, PA 17572

FOR: ADMINISTRATION OF REBATE PROGRAMS FOR OTHERS; ORDER FULFILLMENT SERVICES FOR OTHERS; PREPARATION OF CUSTOM PROMOTIONAL PRODUCTS FOR OTHERS; OPERATION OF CALL CENTERS FOR OTHERS, IN CLASS 35 (U.S. CLS. 100, 101 AND 102).

FIRST USE 1-2-1996; IN COMMERCE 1-2-1996.

FOR: PACKING ARTICLES OF OTHERS FOR TRANSPORTATION; WAREHOUSING SERVICES, NAMELY, STORAGE, DISTRIBUTION, AND PACKING FOR SHIPMENT OF THE PRODUCTS OF OTHERS; TRANSPORTATION AND DELIVERY SERVICES, NAMELY, SAME DAY SHIPMENT SERVICES, IN CLASS 39 (U.S. CLS. 100 AND 105).

FIRST USE 1-2-1996; IN COMMERCE 1-2-1996.

FOR: MANUFACTURE OF PROMOTIONAL PRODUCTS TO THE ORDER AND SPECIFICATION OF OTHERS; CUSTOMIZED PRINTING OF COMPANY NAMES AND LOGOS FOR PROMOTIONAL AND ADVERTISING PURPOSES ON THE GOODS OF OTHERS, IN CLASS 40 (U.S. CLS. 100, 103 AND 106).

FIRST USE 1-2-1996; IN COMMERCE 1-2-1996.

THE MARK CONSISTS OF THE LETTER "J" SHOWN IN A STYLIZED SQUARE DESIGN LOGO.

SER. NO. 76-503,231, FILED 3-27-2003.

BARBARA A. LOUGHRAN, EXAMINING ATTORNEY

Int. Cls.: 35, 39 and 40

Prior U.S. Cls.: 100, 101, 102, 103, 105 and 106

United States Patent and Trademark Office

Reg. No. 2,892,667

Registered Oct. 12, 2004

**SERVICE MARK
PRINCIPAL REGISTER**

THE JAY GROUP

THE JAY GROUP, INC. (PENNSYLVANIA CORPORATION)
60 NORTH RONKS ROAD
RONKS, PA 17572

FOR: ADMINISTRATION OF REBATE PROGRAMS FOR OTHERS; ORDER FULFILLMENT SERVICES FOR OTHERS; PREPARATION OF CUSTOM PROMOTIONAL PRODUCTS FOR OTHERS; OPERATION OF CALL CENTERS FOR OTHERS, IN CLASS 35 (U.S. CLS. 100, 101 AND 102).

FIRST USE 3-29-1989; IN COMMERCE 3-29-1989.

FOR: PACKING ARTICLES OF OTHERS FOR TRANSPORTATION; WAREHOUSING SERVICES, NAMELY, STORAGE, DISTRIBUTION, AND PACKING FOR SHIPMENT OF THE PRODUCTS OF OTHERS; TRANSPORTATION AND DELIVERY SERVICES, NAMELY, SAME DAY SHIPMENT SERVICES, IN CLASS 39 (U.S. CLS. 100 AND 105).

FIRST USE 3-29-1989; IN COMMERCE 3-29-1989.

FOR: MANUFACTURE OF PROMOTIONAL PRODUCTS TO THE ORDER AND SPECIFICATION OF OTHERS; CUSTOMIZED PRINTING OF COMPANY NAMES AND LOGOS FOR PROMOTIONAL AND ADVERTISING PURPOSES ON THE GOODS OF OTHERS, IN CLASS 40 (U.S. CLS. 100, 103 AND 106).

FIRST USE 3-29-1989; IN COMMERCE 3-29-1989.

NO CLAIM IS MADE TO THE EXCLUSIVE RIGHT TO USE "GROUP", APART FROM THE MARK AS SHOWN.

THE MARK CONSISTS OF THE WORDS "THE JAY GROUP", AS INDICATED IN THE ATTACHMENT TO THE ORIGINAL APPLICATION.

SER. NO. 76-503,250, FILED 3-27-2003.

BARBARA A. LOUGHRAN, EXAMINING ATTORNEY

Int. Cl.: 23

Prior U.S. Cl.: 43

United States Patent and Trademark Office

Reg. No. 2,892,668

Registered Oct. 12, 2004

**TRADEMARK
PRINCIPAL REGISTER**

**PERUVIAN PIMA COTTON IAFIL SPA INDUSTRIA AMBROSIANA
FILATI**

IAFIL - INDUSTRIA AMBROSIANA FILATI
S.P.A. (ITALY JOINT STOCK COMPANY)
VIA DEI CICLAMINI 3
20147 MILAN, ITALY

FOR: YARNS AND THREAD FOR TEXTILE USE
IN PIMA COTTON, IN CLASS 23 (U.S. CL. 43).

FIRST USE 1-0-1993; IN COMMERCE 3-0-1993.

NO CLAIM IS MADE TO THE EXCLUSIVE
RIGHT TO USE "PERUVIAN PIMA COTTON";

"SPA"; AND "INDUSTRIA AMBROSIANA FILATI",
APART FROM THE MARK AS SHOWN.

THE ENGLISH TRANSLATION OF THE WORDS
IN THE MARK IS "INDUSTRIA" IS "INDUSTRY";
"AMBROSIANA" IS "OF MILAN"; "FILATI" IS
YARN; AND "IAFIL" IS A FANCIFUL TERM WITH
NO TRANSLATION OR MEANING.

SER. NO. 76-503,395, FILED 4-2-2003.

GEORGIA CARTY, EXAMINING ATTORNEY

Int. Cl.: 44

Prior U.S. Cls.: 100 and 101

United States Patent and Trademark Office

Reg. No. 2,892,669

Registered Oct. 12, 2004

**SERVICE MARK
PRINCIPAL REGISTER**

CHIROVIEW PRESENTS

MILLER, SIGMUND DC (UNITED STATES IN-
DIVIDUAL)
3 TULLAMORE COURT
RINGOES, NJ 08551

FIRST USE 6-0-1999; IN COMMERCE 6-0-1999.

SER. NO. 76-503,531, FILED 4-2-2003.

FOR: PROVIDING INFORMATION ONLINE FOR
CHIROPRACTIC PROFESSIONALS AND STU-
DENTS IN THE FIELD OF CHIROPRACTIC MED-
ICINE, IN CLASS 44 (U.S. CLS. 100 AND 101).

SUELLEN HICKEY, EXAMINING ATTORNEY

Int. Cl.: 30

Prior U.S. Cl.: 46

United States Patent and Trademark Office

Reg. No. 2,892,670

Registered Oct. 12, 2004

**TRADEMARK
PRINCIPAL REGISTER**

TOFT'S "ONE QUALITY"

TOFT DAIRY, INC. (OHIO CORPORATION)
3717 VENICE ROAD
SANDUSKY, OH 44870

AND NO ADDED SUGAR ICE CREAM, IN CLASS 30
(U.S. CL. 46).

FIRST USE 0-0-1984; IN COMMERCE 0-0-1990.

FOR: ICE CREAM, SHERBET, FROZEN YO-
GURT, REDUCED FAT ICE CREAM, FAT-FREE
ICE CREAM, CHOLESTEROL-FREE ICE CREAM,

SER. NO. 76-503,821, FILED 4-3-2003.

JOHN LINCOSKI, EXAMINING ATTORNEY

Int. Cl.: 2

Prior U.S. Cls.: 6, 11 and 16

United States Patent and Trademark Office

Reg. No. 2,892,671

Registered Oct. 12, 2004

**TRADEMARK
PRINCIPAL REGISTER**

EVEREST

SUN CHEMICAL CORPORATION (DELAWARE
CORPORATION)
222 BRIDGE PLAZA SOUTH
FORT LEE, NJ 07024

FIRST USE 3-28-1999; IN COMMERCE 3-28-1999.

SER. NO. 76-503,850, FILED 4-4-2003.

FOR: PRINTING INKS, CLEAR OR PIGMENTED
COATINGS, PIGMENTS, AND PIGMENT DISPER-
SIONS FOR USE IN THE GRAPHIC ARTS INDUS-
TRY, IN CLASS 2 (U.S. CLS. 6, 11 AND 16).

LAURIEL DALIER, EXAMINING ATTORNEY

Int. Cl.: 2

Prior U.S. Cls.: 6, 11 and 16

United States Patent and Trademark Office

Reg. No. 2,892,672

Registered Oct. 12, 2004

**TRADEMARK
PRINCIPAL REGISTER**

CLEARMAX

SUN CHEMICAL CORPORATION (DELAWARE
CORPORATION)
222 BRIDGE PLAZA SOUTH
FORT LEE, NJ 07024

FOR: PRINTING INKS, CLEAR AND PIGMEN-
TED COATINGS, PIGMENTS, AND CLEAR AND
COLOR PIGMENT DISPERSIONS FOR USE IN THE

GRAPHIC ARTS INDUSTRY, IN CLASS 2 (U.S. CLS.
6, 11 AND 16).

FIRST USE 3-17-2003; IN COMMERCE 3-17-2003.

SER. NO. 76-503,851, FILED 4-4-2003.

LAURIEL DALIER, EXAMINING ATTORNEY

Int. Cl.: 36

Prior U.S. Cls.: 100, 101 and 102

United States Patent and Trademark Office

Reg. No. 2,892,673

Registered Oct. 12, 2004

**SERVICE MARK
PRINCIPAL REGISTER**

JACOBS LEVY

JACOBS LEVY EQUITY MANAGEMENT, INC.
(NEW JERSEY CORPORATION)
100 CAMPUS DRIVE
P.O. BOX 650
FLORHAM PARK, NJ 079320650

FIRST USE 9-16-1986; IN COMMERCE 9-16-1986.

THE NAMES JACOBS AND LEVY IDENTIFY
LIVING INDIVIDUALS WHOSE CONSENT IS OF
RECORD.

FOR: FINANCIAL SERVICES, NAMELY, INVEST-
MENT ADVISORY SERVICES AND EQUITY PORT-
FOLIO MANAGEMENT, IN CLASS 36 (U.S. CLS. 100,
101 AND 102).

SER. NO. 76-504,434, FILED 4-2-2003.

ALICIA COLLINS, EXAMINING ATTORNEY

Int. Cl.: 4

Prior U.S. Cls.: 1, 6 and 15

United States Patent and Trademark Office

Reg. No. 2,892,674

Registered Oct. 12, 2004

TRADEMARK
PRINCIPAL REGISTER

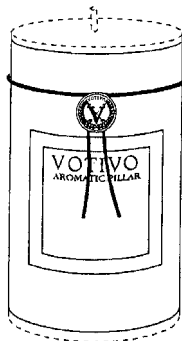

VOTIVO, LTD. (WASHINGTON CORPORATION)
3450 FOURTH AVENUE SOUTH
SEATTLE, WA 98134

FOR: CANDLES AND TAPERS, IN CLASS 4 (U.S.
CLS. 1, 6 AND 15).

FIRST USE 7-8-2001; IN COMMERCE 7-8-2001.

OWNER OF U.S. REG. NOS. 1,932,316, 2,766,047
AND OTHERS.

NO CLAIM IS MADE TO THE EXCLUSIVE
RIGHT TO USE "AROMATIC PILLAR", APART
FROM THE MARK AS SHOWN.

THE MARK CONSISTS OF AN OPEN ENDED,
ENCIRCLING WRAPPING LABEL POSSESSING
DISTINCTIVE COLOR BORDERS WHICH IDENTI-

FY THE AROMATIC SCENT ALONG WITH THE
VOTIVO NAME. THE GOODS, A TALL AROMATIC
CANDLE, AND WRAPPING LABEL ARE ENCIR-
CLED AND TIED BY A BLACK ELASTIC CORD
WHICH PASSES, BOLO STYLE, THROUGH A GRAY
LEAD "VOTIVO" SEAL. THE BOLO VOTIVO SEAL
AND RESULTING IMAGE ARE DESIGNED TO
REMAIN AFFIXED THROUGHOUT THE PRO-
DUCT'S LIFE. THE REPRESENTATION OF A WICK
AND CANDLE SHOWN IN DASHED LINING
FORMS NO PART OF THE MARK AND MERELY
SERVES TO SHOW THE POSITION OF THESE
ITEMS ON THE MARK.

SEC. 2(F).

SER. NO. 76-504,449, FILED 4-7-2003.

MICHAEL KAZAZIAN, EXAMINING ATTORNEY

Int. Cl.: 20

Prior U.S. Cls.: 2, 13, 22, 25, 32 and 50

United States Patent and Trademark Office

Reg. No. 2,892,675

Registered Oct. 12, 2004

TRADEMARK
PRINCIPAL REGISTER



THE TRUSTEES OF PHILLIPS ACADEMY (MAS-
SACHUSETTS CORPORATION)
180 MAIN STREET
ANDOVER, MA 01810

FOR: FURNITURE, NAMELY SIDE CHAIRS AND
DESK CHAIRS, IN CLASS 20 (U.S. CLS. 2, 13, 22, 25, 32
AND 50).

FIRST USE 12-0-1983; IN COMMERCE 12-0-1983.

NO CLAIM IS MADE TO THE EXCLUSIVE
RIGHT TO USE "ACAD." AND "MDCCLXXVIII",
APART FROM THE MARK AS SHOWN.

THE FOREIGN (LATIN) WORDING IN THE
MARK MAY BE TRANSLATED AS FOLLOWS:
"SEAL OF PHILLIPS ACADEMY ANDOVER 1778 -
NOT FOR SELF - THE END DEPENDS UPON THE
BEGINNING".

SEC. 2(F) AS TO "ANDOV".

SER. NO. 76-504,514, FILED 4-7-2003.

ELIZABETH J. WINTER, EXAMINING ATTORNEY

Int. Cl.: 16

Prior U.S. Cls.: 2, 5, 22, 23, 29, 37, 38 and 50

United States Patent and Trademark Office

Reg. No. 2,892,676

Registered Oct. 12, 2004

**TRADEMARK
PRINCIPAL REGISTER**

RAPAPORT DIAMOND REPORT

RAPAPORT, MARTIN (UNITED STATES INDIVIDUAL)
5 WEST 47TH ST., SUITE 600
NEW YORK, NY 100363305

FOR: MAGAZINE AND NEWSLETTERS CONCERNING JEWELRY, DIAMONDS, PRECIOUS STONES, SEMI-PRECIOUS STONES, GEMS, WATCHES AND THE JEWELRY INDUSTRY; PRICE LISTS OF DIAMONDS, PRECIOUS STONES, SEMI-PRECIOUS STONES AND GEMS PRINTED MATTERS AND CATALOGUES CONCERNING JEWELRY, DIAMONDS, PRECIOUS STONES, SEMI-PRECIOUS STONES, GEMS, WATCHES; REPORT ON SERVICES RELATED TO PRE-OWNED, USED, SECOND-HAND AND ESTATE JEWELRY, IN CLASS 16 (U.S. CLS. 2, 5, 22, 23, 29, 37, 38 AND 50).

FIRST USE 7-1-1978; IN COMMERCE 7-1-1978.

OWNER OF U.S. REG. NOS. 2,325,987 AND 2,715,130.

NO CLAIM IS MADE TO THE EXCLUSIVE RIGHT TO USE "DIAMOND REPORT" , APART FROM THE MARK AS SHOWN.

SEC. 2(F) AS TO "RAPAPORT".

SER. NO. 76-504,674, FILED 4-7-2003.

TARAH HARDY, EXAMINING ATTORNEY

Int. Cls.: 9, 36 and 45

Prior U.S. Cls.: 21, 23, 26, 36, 38, 100, 101 and 102

United States Patent and Trademark Office

Reg. No. 2,892,677

Registered Oct. 12, 2004

**TRADEMARK
SERVICE MARK
PRINCIPAL REGISTER**

LINKSHIELD

LINKPOINT INTERNATIONAL, INC. (NEVADA CORPORATION)
6101 CONDOR DRIVE
MOORPARK, CA 93021

FOR: FRAUD PROTECTION SOFTWARE DESIGNED TO IDENTIFY HIGH-RISK FINANCIAL TRANSACTIONS AT A MERCHANT'S POINT OF SALE, IN CLASS 9 (U.S. CLS. 21, 23, 26, 36 AND 38).

FIRST USE 9-17-2002; IN COMMERCE 9-17-2002.

FOR: PAYMENT PROCESSING SERVICES FOR CREDIT CARD, DEBIT CARD, AND CHECK TRANSACTIONS, IN CLASS 36 (U.S. CLS. 100, 101 AND 102).

FIRST USE 9-17-2002; IN COMMERCE 9-17-2002.

FOR: FRAUD DETECTION SERVICES IN THE FIELD OF CREDIT CARDS, DEBIT CARDS, AND CHECK TRANSACTIONS FOR ON-LINE PURCHASING, IN CLASS 45 (U.S. CLS. 100 AND 101).

FIRST USE 9-17-2002; IN COMMERCE 9-17-2002.

SER. NO. 76-504,914, FILED 4-4-2003.

GEORGIA CARTY, EXAMINING ATTORNEY

Int. Cl.: 20

Prior U.S. Cls.: 2, 13, 22, 25, 32 and 50

United States Patent and Trademark Office

Reg. No. 2,892,678

Registered Oct. 12, 2004

**TRADEMARK
PRINCIPAL REGISTER**

QUANTUM

THE-A-PEDIC ASSOCIATES, INC. (NEW JERSEY CORPORATION)
601 BOUND BROOK ROAD
MIDDLESEX, NJ 08846

FIRST USE 3-0-1991; IN COMMERCE 3-0-1991.

SER. NO. 76-505,026, FILED 4-7-2003.

FOR: MATTRESSES AND BOX SPRINGS, EXCLUDING WATERBED MATTRESSES, IN CLASS 20 (U.S. CLS. 2, 13, 22, 25, 32 AND 50).

CATHERINE CAIN, EXAMINING ATTORNEY

Int. Cls.: 9, 25 and 28

Prior U.S. Cls.: 21, 22, 23, 26, 36, 38, 39 and 50

United States Patent and Trademark Office

Reg. No. 2,892,679

Registered Oct. 12, 2004

TRADEMARK
PRINCIPAL REGISTER



HEAD TECHNOLOGY GMBH (AUSTRIA CORPORATION)
WUHRKOPFWEG 1
A-6921 KENNELBACH, AUSTRIA

FOR: SCUBA DIVING EQUIPMENT, NAMELY, WARNING FLAGS, MASKS, SNORKELS, BUOYANCY COMPENSATORS, WEIGHTS, WEIGHT HARNESES, WEIGHT BELTS, WEIGHT BELT STOPS, MARKER BUOYS, HUMAN UNDERWATER BREATHING APPARATUS, IN CLASS 9 (U.S. CLS. 21, 23, 26, 36 AND 38).

FIRST USE 4-0-2003; IN COMMERCE 4-0-2003.

FOR: SKI BOOTS, IN CLASS 25 (U.S. CLS. 22 AND 39).

FIRST USE 7-0-2003; IN COMMERCE 7-0-2003.

FOR: TENNIS RACKETS, SQUASH RACKETS, RACQUETBALL RACKETS, TENNIS ACCESSOR-

IES, NAMELY, COVERS, STRINGS, DAMPENERS, GRIPS, AND GRIP TAPES, TENNIS BALLS, BAGS FOR TENNIS EQUIPMENT, SKIS, SNOWBOARDS, AND SCUBA FINS AND SCUBA FIN STRAPS; SCUBA DIVING ACCESSORIES IN THE NATURE OF TOW ROPES; RECREATIONAL FLOATS FOR SWIMMING AND FLOATING SCUBA EQUIPMENT; BAGS FOR SCUBA DIVING EQUIPMENT, IN CLASS 28 (U.S. CLS. 22, 23, 38 AND 50).

FIRST USE 1-0-2003; IN COMMERCE 1-0-2003.

NO CLAIM IS MADE TO THE EXCLUSIVE RIGHT TO USE "SERVICE FIRST", APART FROM THE MARK AS SHOWN.

SER. NO. 76-505,037, FILED 4-7-2003.

AMY HELLA, EXAMINING ATTORNEY

Int. Cl.: 16

Prior U.S. Cls.: 2, 5, 22, 23, 29, 37, 38 and 50

Reg. No. 2,892,680

United States Patent and Trademark Office

Registered Oct. 12, 2004

**TRADEMARK
PRINCIPAL REGISTER**

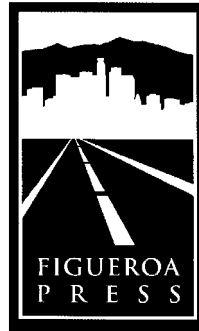

UNIVERSITY OF SOUTHERN CALIFORNIA (CA-
LIFORNIA NON-PROFIT CORPORATION)
UNIVERSITY PARK, ADM 352
LOS ANGELES, CA 900895013

NO CLAIM IS MADE TO THE EXCLUSIVE
RIGHT TO USE "PRESS", APART FROM THE
MARK AS SHOWN.

FOR: PRINTED BOOKS, NAMELY, FICTION
AND NON-FICTION BOOKS ON A VARIETY OF
TOPICS, IN CLASS 16 (U.S. CLS. 2, 5, 22, 23, 29, 37, 38
AND 50).

SER. NO. 76-505,136, FILED 4-9-2003.

FIRST USE 12-15-2002; IN COMMERCE 3-7-2003.

WILLIAM VERHOSEK, EXAMINING ATTORNEY

Int. Cl.: 12

Prior U.S. Cls.: 19, 21, 23, 31, 35 and 44

Reg. No. 2,892,681

United States Patent and Trademark Office

Registered Oct. 12, 2004

**TRADEMARK
PRINCIPAL REGISTER**

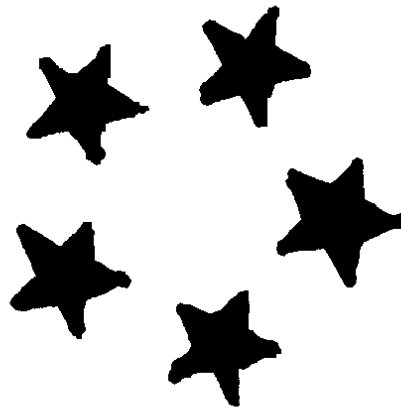

ELITE BICYCLES, INC. (PENNSYLVANIA LTD
LIAB CO)
2628 SOUTH ST.
PHILADELPHIA, PA 191462344

OWNER OF U.S. REG. NO. 2,694,908.

FOR: BICYCLES, IN CLASS 12 (U.S. CLS. 19, 21, 23,
31, 35 AND 44).

SER. NO. 76-505,845, FILED 4-11-2003.

FIRST USE 1-0-2001; IN COMMERCE 1-0-2001.

STEVEN R. FOSTER, EXAMINING ATTORNEY

Int. Cl.: 12

Prior U.S. Cls.: 19, 21, 23, 31, 35 and 44

Reg. No. 2,892,682

United States Patent and Trademark Office

Registered Oct. 12, 2004

**TRADEMARK
PRINCIPAL REGISTER**

ELITE

ELITE BICYCLES, INC. (PENNSYLVANIA LTD
LIAB CO)
2628 SOUTH ST.
PHILADELPHIA, PA 191462344

OWNER OF U.S. REG. NO. 2,694,908.

FOR: BICYCLES, IN CLASS 12 (U.S. CLS. 19, 21, 23,
31, 35 AND 44).

SER. NO. 76-505,846, FILED 4-11-2003.

FIRST USE 1-0-2001; IN COMMERCE 1-0-2001.

STEVEN R. FOSTER, EXAMINING ATTORNEY

Int. Cl.: 42

Prior U.S. Cls.: 100 and 101

United States Patent and Trademark Office

Reg. No. 2,892,683

Registered Oct. 12, 2004

**SERVICE MARK
PRINCIPAL REGISTER**



OPTIMUM HEALTHCARE SOLUTIONS, LLC
(NEW JERSEY LTD LIAB CO)
1015 MAIN STREET
VOORHEES, NJ 08043

FOR: PROVIDING TEMPORARY USE OF ON-LINE NON-DOWNLOADABLE SOFTWARE FOR THE PURPOSES OF TRACKING UNIVERSAL NEW-BORN HEARING SCREEN AND PEDIATRIC FOLLOW-UP DATA, IN CLASS 42 (U.S. CLS. 100 AND 101).

FIRST USE 3-24-2003; IN COMMERCE 3-24-2003.

NO CLAIM IS MADE TO THE EXCLUSIVE RIGHT TO USE "TRACK", APART FROM THE MARK AS SHOWN.

THE COLOR(S) YELLOW AND BLUE IS/ARE CLAIMED AS A DISTINCTIVE FEATURE OF THE MARK.

THE COLOR YELLOW APPEARS IN THE STAR DESIGN COMPONENT OF THE MARK. THE LETTERS THAT COMPRISE THE WORDING IN THE MARK APPEAR IN THE COLOR BLUE.

SER. NO. 76-505,908, FILED 4-11-2003.

GEORGIA CARTY, EXAMINING ATTORNEY

Int. Cl.: 29

Prior U.S. Cl.: 46

United States Patent and Trademark Office

Reg. No. 2,892,684

Registered Oct. 12, 2004

**TRADEMARK
PRINCIPAL REGISTER**

GARROBO RANCH EXOTIC FOODS

PRODUCTOS DEL NUEVO MUNDO S.A DE C.V.
(EL SALVADOR COMPANY)
FINAL 67AV SUR BLOCK B PASAJE A NO. 14
NUEVO REPARTO ROMA
SAN SALVADOR, EL SALVADOR

NO CLAIM IS MADE TO THE EXCLUSIVE
RIGHT TO USE "EXOTIC FOODS", APART FROM
THE MARK AS SHOWN.

FOR: FROZEN IGUANA MEAT, IN CLASS 29 (U.S.
CL. 46).

SER. NO. 76-505,949, FILED 4-7-2003.

FIRST USE 10-22-2001; IN COMMERCE 10-22-2001.

MARC LEIPZIG, EXAMINING ATTORNEY

Int. Cls.: 9 and 41

Prior U.S. Cls.: 21, 23, 26, 36, 38, 100, 101 and 107

Reg. No. 2,892,685

United States Patent and Trademark Office

Registered Oct. 12, 2004

**TRADEMARK
SERVICE MARK
PRINCIPAL REGISTER**

FAILSAFE

FAILSAFE (PARTNERSHIP)
5728 EAST 106TH STREET
TULSA, OK 74137

FOR: MUSICAL SOUND RECORDINGS; MUSICAL VIDEO RECORDINGS, IN CLASS 9 (U.S. CLS. 21, 23, 26, 36 AND 38).

FIRST USE 1-1-2001; IN COMMERCE 1-1-2001.

FOR: ENTERTAINMENT NAMELY, LIVE PERFORMANCES BY A MUSICAL BAND; AUDIO RECORDING AND PRODUCTION, IN CLASS 41 (U.S. CLS. 100, 101 AND 107).

FIRST USE 1-1-2001; IN COMMERCE 1-1-2001.

SER. NO. 76-505,977, FILED 4-14-2003.

WILLIAM VERHOSEK, EXAMINING ATTORNEY

Int. Cl.: 12

Prior U.S. Cls.: 19, 21, 23, 31, 35 and 44

United States Patent and Trademark Office

Reg. No. 2,892,686

Registered Oct. 12, 2004

**TRADEMARK
PRINCIPAL REGISTER**

RIDE MANAGEMENT SOLUTIONS

ARVINMERITOR TECHNOLOGY, LLC (DELA-
WARE LTD LIAB CO)
2135 W. MAPLE ROAD
TROY, MI 48084

FIRST USE 11-18-2002; IN COMMERCE 11-18-2002.

SER. NO. 76-506,150, FILED 4-14-2003.

FOR: SHOCK ABSORBERS, IN CLASS 12 (U.S.
CLS. 19, 21, 23, 31, 35 AND 44).

DOMINIC J. FERRAIUOLO, EXAMINING ATTOR-
NEY

Int. Cl.: 28

Prior U.S. Cls.: 22, 23, 38 and 50

United States Patent and Trademark Office

Reg. No. 2,892,687

Registered Oct. 12, 2004

**TRADEMARK
PRINCIPAL REGISTER**

FACT OR FICTION

IMAGINATION HOLDINGS PTY LTD. (AUSTRALIA CORPORATION)
64 NORTH TERRACE
KENT TOWN
SOUTH AUSTRALIA 5067, AUSTRALIA

FOR: TOYS, PLAYTHINGS AND GAMES, NAME-
LY, BOARD GAMES AND COMPONENT PIECES

THEREOF FOR USE AS A SET, IN CLASS 28 (U.S. CLS. 22, 23, 38 AND 50).

FIRST USE 1-0-2000; IN COMMERCE 1-0-2000.

SER. NO. 76-506,268, FILED 4-14-2003.

MARK T. MULLEN, EXAMINING ATTORNEY

Int. Cl.: 16

Prior U.S. Cls.: 2, 5, 22, 23, 29, 37, 38 and 50

Reg. No. 2,892,688

United States Patent and Trademark Office

Registered Oct. 12, 2004

**TRADEMARK
PRINCIPAL REGISTER**



NATURAL HAZARDS DISCLOSURE, LLC (CALIFORNIA LTD LIAB CO)
525 SOUTH VIRGIL AVENUE
LOS ANGELES, CA 90020

NO CLAIM IS MADE TO THE EXCLUSIVE RIGHT TO USE "THE DISCLOSURE COMPANY", APART FROM THE MARK AS SHOWN.

FOR: RESEARCH REPORTS FEATURING NATURAL HAZARDS DISCLOSURE, TAX AND TITLE INFORMATION REGARDING REAL PROPERTY, IN CLASS 16 (U.S. CLS. 2, 5, 22, 23, 29, 37, 38 AND 50).

SER. NO. 76-506,357, FILED 4-15-2003.

FIRST USE 4-1-2003; IN COMMERCE 4-1-2003.

WILLIAM VERHOSEK, EXAMINING ATTORNEY

Int. Cl.: 36

Prior U.S. Cls.: 100, 101 and 102

United States Patent and Trademark Office

Reg. No. 2,892,689

Registered Oct. 12, 2004

**SERVICE MARK
PRINCIPAL REGISTER**

TICKETSHIELD

NATIONAL ACCIDENT INSURANCE UNDER-
WRITERS, INC. (ILLINOIS CORPORATION)
85 WEST ALGONQUIN ROAD, 5TH FLOOR
ARLINGTON HEIGHTS, IL 60005

FOR: INSURANCE UNDERWRITING AND
CLAIMS ADMINISTRATION IN THE FIELD OF
PROVIDING PROTECTION AND REIMBURSE-
MENT FOR TICKET PURCHASES RELATED TO
ENTERTAINMENT, THEATRICAL AND RECREA-

TIONAL EVENTS AND AIRLINE EXCHANGE
FEES, IN CLASS 36 (U.S. CLS. 100, 101 AND 102).

FIRST USE 1-2-2003; IN COMMERCE 1-2-2003.

SER. NO. 76-506,393, FILED 4-14-2003.

VIVIAN MICZNIK FIRST, EXAMINING ATTOR-
NEY

Int. Cl.: 30

Prior U.S. Cl.: 46

United States Patent and Trademark Office

Reg. No. 2,892,690

Registered Oct. 12, 2004

**TRADEMARK
PRINCIPAL REGISTER**

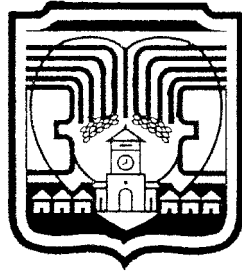

FOOCOSA

FOOD COMPANY OF HO CHI MINH CITY
(VIETNAM CORPORATION)
57 NGUYEN THI MINH KHAI STREET, DISTRICT 1
HO CHI MINH CITY, VIETNAM

FOR: WHEAT FLOUR, SPICES, PEPPER POW-
DER, SOY SAUCE, CHILI POWDER, TOMATO
SAUCE, PASTA, RICE NOODLES, PASTRIES AND
CONFECTIONARY CHIPS FOR BAKING, IN CLASS
30 (U.S. CL. 46).

OWNER OF VIETNAM REG. NO. 39459, DATED
12-28-2001, EXPIRES 7-11-2010.

SER. NO. 76-506,423, FILED 4-14-2003.

VIVIAN MICZNIK FIRST, EXAMINING ATTOR-
NEY

Int. Cls.: 35 and 42

Prior U.S. Cls.: 100, 101 and 102

United States Patent and Trademark Office

Reg. No. 2,892,691

Registered Oct. 12, 2004

**SERVICE MARK
PRINCIPAL REGISTER**

TIMEZONE

SCENARIO COMMUNICATIONS LIMITED (NEW
ZEALAND CORPORATION)
LEVEL 2, 90-92 DIXON STREET
WELLINGTON, NEW ZEALAND

FOR: ADVERTISING AGENCIES AND BUSINESS
MANAGEMENT SERVICES, IN CLASS 35 (U.S. CLS.
100, 101 AND 102).

FIRST USE 10-23-2000; IN COMMERCE 10-23-2000.

FOR: COMMERCIAL ART DESIGN INCLUDING
GRAPHIC DESIGN AND PACKAGING DESIGN
FOR OTHERS; COMPUTER PROGRAMMING FOR

OTHERS; APPLICATION SERVICES PROVIDER(-
ASP) FEATURING SOFTWARE IN THE FIELD OF
DATABASE ACCESSING, COMPUTER SERVICES,
NAMELY, DESIGNING AND IMPLEMENTING IN-
TERNET WEB PAGES FOR OTHERS; AND CREAT-
ING AND MAINTAINING WEBSITES FOR
OTHERS, IN CLASS 42 (U.S. CLS. 100 AND 101).

FIRST USE 10-23-2000; IN COMMERCE 10-23-2000.

SER. NO. 76-506,424, FILED 4-14-2003.

CYNTHIA SLOAN, EXAMINING ATTORNEY

Int. Cl.: 20

Prior U.S. Cls.: 2, 13, 22, 25, 32 and 50

United States Patent and Trademark Office

Reg. No. 2,892,692

Registered Oct. 12, 2004

**TRADEMARK
PRINCIPAL REGISTER**

THE FOOTLE

SIMPLE HOME SOLUTIONS, INC. (NEW YORK
CORPORATION)
243 OAK BEACH ROAD
BOX 4222
OAK BEACH, NY 117024608

FIRST USE 8-20-2002; IN COMMERCE 8-20-2002.

SER. NO. 76-506,554, FILED 4-15-2003.

FOR: NON-METAL FOOT ACTUATED HANDLES
FOR DOORS, IN CLASS 20 (U.S. CLS. 2, 13, 22, 25, 32
AND 50).

KAREN BRACEY, EXAMINING ATTORNEY

Int. Cl.: 40

Prior U.S. Cls.: 100, 103 and 106

United States Patent and Trademark Office

Reg. No. 2,892,693

Registered Oct. 12, 2004

**SERVICE MARK
PRINCIPAL REGISTER**

The logo features the text "Solutions To" in a sans-serif font at the top left. Below it, the word "CONTAIN" is written in a large, bold, black, sans-serif font. To the right of "CONTAIN", the words "Your World" are written in a smaller, lowercase, sans-serif font, with "Your" positioned below "CONTAIN" and "World" to its right.

INDUSTRIAL CONTAINER SYSTEMS, L.L.C.
(DELAWARE LTD LIAB CO)
415 NORTH EL CAMINO REAL, SUITE B
SAN CLEMENTE, CA 926726706

FIRST USE 9-30-2002; IN COMMERCE 10-17-2002.

SER. NO. 76-507,026, FILED 4-15-2003.

FOR: RECYCLING SERVICES, IN CLASS 40 (U.S.
CLS. 100, 103 AND 106).

SUSAN LESLIE DUBOIS, EXAMINING ATTORNEY

Int. Cl.: 40

Prior U.S. Cls.: 100, 103 and 106

Reg. No. 2,892,694

United States Patent and Trademark Office

Registered Oct. 12, 2004

**SERVICE MARK
PRINCIPAL REGISTER**



INDUSTRIAL CONTAINER SYSTEMS, L.L.C.
(DELAWARE LTD LIAB CO)
415 NORTH EL CAMINO REAL, SUITE B
SAN CLEMENTE, CA 926726706

NO CLAIM IS MADE TO THE EXCLUSIVE
RIGHT TO USE QUALITY AND PLUS, APART
FROM THE MARK AS SHOWN.

FOR: RECYCLING SERVICES, IN CLASS 40 (U.S.
CLS. 100, 103 AND 106).

SER. NO. 76-507,027, FILED 4-15-2003.

FIRST USE 10-17-2002; IN COMMERCE 10-17-2002.

SUSAN LESLIE DUBOIS, EXAMINING ATTORNEY

Int. Cl.: 40

Prior U.S. Cls.: 100, 103 and 106

Reg. No. 2,892,695

United States Patent and Trademark Office

Registered Oct. 12, 2004

**SERVICE MARK
PRINCIPAL REGISTER**



INDUSTRIAL CONTAINER SYSTEMS, L.L.C.
(DELAWARE LTD LIAB CO)
415 NORTH EL CAMINO REAL, SUITE B
SAN CLEMENTE, CA 926726706

NO CLAIM IS MADE TO THE EXCLUSIVE
RIGHT TO USE INDUSTRIAL CONTAINER SERVI-
CES, APART FROM THE MARK AS SHOWN.

FOR: RECYCLING SERVICES, IN CLASS 40 (U.S.
CLS. 100, 103 AND 106).

SER. NO. 76-507,028, FILED 4-15-2003.

FIRST USE 9-30-2002; IN COMMERCE 10-17-2002.

SUSAN LESLIE DUBOIS, EXAMINING ATTORNEY

Int. Cl.: 8

Prior U.S. Cls.: 23, 28 and 44

Reg. No. 2,892,696

United States Patent and Trademark Office

Registered Oct. 12, 2004

TRADEMARK
PRINCIPAL REGISTER



NAKAYAMA, TOSHIRO (UNITED STATES INDIVIDUAL)
2 SADDLE HORN LANE
ROLLING HILLS EST., CA 90274

FOR: MANUALLY OPERATED HAND-HELD SAWS FOR SAWING WOOD, PLASTIC PIPE, PLASTIC BOARD STOCK, ACRYLIC, DRYWALL, CEMENT WALLBOARD, PARTICLE BOARD, PLASTERBOARD, MELAMINE, FLAT FOAM SHEETS, WALLBOARD, ARTIFICIAL WOOD, AND COMPOSITE BOARD, IN CLASS 8 (U.S. CLS. 23, 28 AND 44).

FIRST USE 4-20-1988; IN COMMERCE 4-20-1988.

OWNER OF U.S. REG. NO. 2,526,815.

NO CLAIM IS MADE TO THE EXCLUSIVE RIGHT TO USE SERIES, APART FROM THE MARK AS SHOWN.

SER. NO. 76-507,057, FILED 4-11-2003.

KARANENDRA S. CHHINA, EXAMINING ATTORNEY

Int. Cl.: 35

Prior U.S. Cls.: 100, 101 and 102

United States Patent and Trademark Office

Reg. No. 2,892,697

Registered Oct. 12, 2004

**SERVICE MARK
PRINCIPAL REGISTER**

EXPANSION JOINT MANUFACTURERS ASSOCIATION

EXPANSION JOINT MANUFACTURERS ASSO-
CIATION (NEW YORK CORPORATION)
25 NORTH BROADWAY
TARRYTOWN, NY 10591

FOR: ASSOCIATION SERVICES, NAMELY, PRO-
MOTING THE INTERESTS OF MEMBERS OF THE
EXPANSION JOINT MANUFACTURING INDUS-
TRY, IN CLASS 35 (U.S. CLS. 100, 101 AND 102).

FIRST USE 4-1-1969; IN COMMERCE 4-1-1969.

NO CLAIM IS MADE TO THE EXCLUSIVE
RIGHT TO USE "ASSOCIATION", APART FROM
THE MARK AS SHOWN.

SEC. 2(F).

SER. NO. 76-507,072, FILED 4-14-2003.

DOMINICK J. SALEMI, EXAMINING ATTORNEY

Int. Cl.: 30

Prior U.S. Cl.: 46

United States Patent and Trademark Office

Reg. No. 2,892,698

Registered Oct. 12, 2004

**TRADEMARK
PRINCIPAL REGISTER**

JOHN WM MACY'S

JOHN WM. MACY CHEESESTICKS, INC. (NEW
JERSEY CORPORATION)
80 KIPP AVENUE
ELMWOOD PARK, NJ 07407

THE NAME "JOHN WM MACY'S" IDENTIFIES A
LIVING INDIVIDUAL WHOSE CONSENT IS OF
RECORD.

FOR: BAKED GOODS, NAMELY- CHEESE-FLA-
VORED BREAD STICKS, BREAD CRISPS, BREAD
STICKS AND SWEET BREAD STICKS, IN CLASS 30
(U.S. CL. 46).

SER. NO. 76-507,331, FILED 4-7-2003.

FIRST USE 2-10-1984; IN COMMERCE 2-10-1984.

ALICIA COLLINS, EXAMINING ATTORNEY

Int. Cl.: 11

Prior U.S. Cls.: 13, 21, 23, 31 and 34

United States Patent and Trademark Office

Reg. No. 2,892,699

Registered Oct. 12, 2004

**TRADEMARK
PRINCIPAL REGISTER**

LITEX

LITEX INDUSTRIES, INCORPORATED (TEXAS
CORPORATION)
3401 W. TRINITY BLVD.
GRAND PRAIRIE, TX 75050

FIRST USE 3-31-1980; IN COMMERCE 3-31-1980.

SER. NO. 76-507,471, FILED 4-17-2003.

FOR: CEILING FANS, IN CLASS 11 (U.S. CLS. 13,
21, 23, 31 AND 34).

H. M. FISHER, EXAMINING ATTORNEY

Int. Cls.: 35 and 42

Prior U.S. Cls.: 100, 101 and 102

United States Patent and Trademark Office

Reg. No. 2,892,700

Registered Oct. 12, 2004

**SERVICE MARK
PRINCIPAL REGISTER**

SILVERTRAIN

SILVERTRAIN, INC. (DELAWARE CORPORATION)
PLAZA EAST OFFICE CENTER
330 EAST KILBOURN AVENUE, SUITE 850
MILWAUKEE, WI 53202

FOR: INFORMATION TECHNOLOGY OUTSOURCING SERVICES; PROVIDING STAFFING SERVICES IN THE FIELD OF INFORMATION TECHNOLOGY, IN CLASS 35 (U.S. CLS. 100, 101 AND 102).

FIRST USE 10-0-2001; IN COMMERCE 10-0-2001.

FOR: INFORMATION TECHNOLOGY CONSULTING SERVICES, IN CLASS 42 (U.S. CLS. 100 AND 101).

FIRST USE 10-0-2001; IN COMMERCE 10-0-2001.

SER. NO. 76-507,650, FILED 4-18-2003.

CYNTHIA SLOAN, EXAMINING ATTORNEY

Int. Cl.: 42

Prior U.S. Cls.: 100 and 101

United States Patent and Trademark Office

Reg. No. 2,892,701

Registered Oct. 12, 2004

**SERVICE MARK
PRINCIPAL REGISTER**

PM CADDIE

BENCHMARK CONSULTING SERVICES LTD.
(ARIZONA CORPORATION)
213 E. STREET, SUITE A
DAVIS, CA 95616

FOR: PROVIDING TEMPORARY USE OF ON-
LINE NON-DOWNLOADABLE COMPUTER SOFT-
WARE FOR MANAGING AND SCHEDULING AC-

TIVITIES, PERSONNEL AND PAPERWORK, IN
CLASS 42 (U.S. CLS. 100 AND 101).

FIRST USE 4-1-2003; IN COMMERCE 4-1-2003.

SER. NO. 76-507,807, FILED 4-18-2003.

GINA FINK, EXAMINING ATTORNEY

Int. Cl.: 43

Prior U.S. Cls.: 100 and 101

United States Patent and Trademark Office

Reg. No. 2,892,702

Registered Oct. 12, 2004

**SERVICE MARK
PRINCIPAL REGISTER**



THE DOLLYWOOD COMPANY (TENNESSEE
JOINT VENTURE)
1020 DOLLYWOOD LANE
PIGEON FORGE, TN 378634101

OWNER OF U.S. REG. NO. 2,181,324 AND OTH-
ERS.

FOR: PET KENNEL SERVICES, IN CLASS 43 (U.S.
CLS. 100 AND 101).

SER. NO. 76-507,948, FILED 4-21-2003.

FIRST USE 11-9-2002; IN COMMERCE 11-9-2002.

ODESSA BIBBINS, EXAMINING ATTORNEY

Int. Cl.: 30

Prior U.S. Cl.: 46

United States Patent and Trademark Office

Reg. No. 2,892,703

Registered Oct. 12, 2004

**TRADEMARK
PRINCIPAL REGISTER**

ANGELICA'S BAKERY

ANGELICA'S BAKERY (ILLINOIS CORPORATION)

17535 SOUTH KEDZIE

HAZEL CREST, IL 60429

FOR: CAKES, PARTY CAKES, SHEET CAKES, WEDDING CAKES, PIES, COBBLERS, PUDDINGS, BREADS, IN CLASS 30 (U.S. CL. 46).

FIRST USE 12-0-1990; IN COMMERCE 12-0-1990.

THE MARK CONSISTS OF STANDARD CHARACTERS WITHOUT CLAIM TO ANY PARTICULAR FONT, STYLE, SIZE, OR COLOR.

NO CLAIM IS MADE TO THE EXCLUSIVE RIGHT TO USE "BAKERY", APART FROM THE MARK AS SHOWN.

SER. NO. 76-508,144, FILED 4-14-2003.

DOMINIC J. FERRAIUOLO, EXAMINING ATTORNEY

Int. Cl.: 29

Prior U.S. Cl.: 46

United States Patent and Trademark Office

Reg. No. 2,892,704

Registered Oct. 12, 2004

**TRADEMARK
PRINCIPAL REGISTER**

MAIN STREET GOURMET FOOD & GIFTS

LARRY WARD ENTERPRISES, INC. (OHIO CORPORATION)
43 EAST COLLEGE AVENUE
WESTERVILLE, OH 43081

FOR: JAMS AND JELLIES, IN CLASS 29 (U.S. CL. 46).

FIRST USE 7-24-1995; IN COMMERCE 7-24-1995.

OWNER OF U.S. REG. NO. 2,771,177.

NO CLAIM IS MADE TO THE EXCLUSIVE RIGHT TO USE "GOURMET FOOD & GIFTS", APART FROM THE MARK AS SHOWN.

SER. NO. 76-508,295, FILED 4-8-2003.

ROBERT LORENZO, EXAMINING ATTORNEY

Int. Cls.: 16 and 25

Prior U.S. Cls.: 2, 5, 22, 23, 29, 37, 38, 39 and 50

United States Patent and Trademark Office

Reg. No. 2,892,705

Registered Oct. 12, 2004

TRADEMARK
PRINCIPAL REGISTER



BEATTY, PATRICIA K. (UNITED STATES INDIVIDUAL)
6335 BLANCHARD ROAD
LA MESA, CA 91942

FOR: PRINTED MATTER, NAMELY, A SERIES OF BOOKS IN THE FIELD OF NATIVE AMERICAN TRIBAL AND FAMILY HISTORY, POSTERS, POSTCARDS, NOTE CARDS, BOOKMARKS, PAPER GIFT BAGS, CALENDARS, ORIGINAL ARTWORK, NAMELY OIL PAINTINGS, PENCIL DRAWINGS, PEN AND INK DRAWINGS AND WATERCOLOR WORKS, PHOTOGRAPHIC PRINTS, MAPS AND PHOTOGRAPHS IN THE FIELD OF HISTORY

AND GENEALOGY, IN CLASS 16 (U.S. CLS. 2, 5, 22, 23, 29, 37, 38 AND 50).

FIRST USE 9-13-2002; IN COMMERCE 10-2-2002.

FOR: CLOTHING, NAMELY, T-SHIRTS, HATS, VISORS, SWEATSHIRTS AND SHORTS, IN CLASS 25 (U.S. CLS. 22 AND 39).

FIRST USE 9-13-2002; IN COMMERCE 10-2-2002.

SER. NO. 76-508,730, FILED 4-22-2003.

STEPHANIE DAVIS, EXAMINING ATTORNEY

Int. Cl.: 35

Prior U.S. Cls.: 100, 101 and 102

United States Patent and Trademark Office

Reg. No. 2,892,706

Registered Oct. 12, 2004

**SERVICE MARK
PRINCIPAL REGISTER**

PET CARE STATION

PHOENIX INTANGIBLES HOLDING COMPANY
(DELAWARE CORPORATION)
TWO GREENVILLE CROSSING
4005 KENNETT PIKE, SUITE 220
GREENVILLE, DE 19807

FOR: SUPERMARKET SERVICES, NAMELY,
PROVIDING A PET FOOD AND SUPPLY AISLE IN
A SUPERMARKET , IN CLASS 35 (U.S. CLS. 100, 101
AND 102).

FIRST USE 7-15-1996; IN COMMERCE 7-15-1996.

OWNER OF U.S. REG. NO. 2,060,175.

NO CLAIM IS MADE TO THE EXCLUSIVE
RIGHT TO USE "PET CARE", APART FROM THE
MARK AS SHOWN.

SEC. 2(F).

SER. NO. 76-509,171, FILED 4-24-2003.

ALICIA COLLINS, EXAMINING ATTORNEY

Int. Cl.: 9

Prior U.S. Cls.: 21, 23, 26, 36 and 38

Reg. No. 2,892,707

United States Patent and Trademark Office

Registered Oct. 12, 2004

**TRADEMARK
PRINCIPAL REGISTER**



FTI FLOW TECHNOLOGY, INC. (DELAWARE CORPORATION)
4250 E. BROADWAY ROAD
PHOENIX, AZ 85040

OWNER OF U.S. REG. NO. 2,529,730.

FOR: FLOWMETERS FOR USE IN THE FIELD OF LIQUID AND GAS APPLICATIONS IN THE AEROSPACE, POWER GENERATION, FOOD AND BEVERAGE, AUTOMOTIVE, OIL AND GAS AND GENERAL INDUSTRIAL INDUSTRIES, IN CLASS 9 (U.S. CLS. 21, 23, 26, 36 AND 38).

NO CLAIM IS MADE TO THE EXCLUSIVE RIGHT TO USE FLOW TECHNOLOGY, APART FROM THE MARK AS SHOWN.

SER. NO. 76-509,226, FILED 4-23-2003.

FIRST USE 2-0-2001; IN COMMERCE 2-0-2001.

WILLIAM VERHOSEK, EXAMINING ATTORNEY

Int. Cl.: 41

Prior U.S. Cls.: 100, 101 and 107

United States Patent and Trademark Office

Reg. No. 2,892,708

Registered Oct. 12, 2004

**SERVICE MARK
PRINCIPAL REGISTER**

NASW SOCIAL WORK PIONEERS

NATIONAL ASSOCIATION OF SOCIAL WORK-
ERS (DELAWARE CORPORATION)
750 FIRST STREET, NE SUITE 700
WASHINGTON, DC 20002

FOR: PROVIDING RECOGNITION BY THE WAY
OF AWARDS TO DEMONSTRATE EXCELLENCE
IN THE FIELD OF SOCIAL WORK, IN CLASS 41
(U.S. CLS. 100, 101 AND 107).

FIRST USE 6-0-1994; IN COMMERCE 6-0-1994.

NO CLAIM IS MADE TO THE EXCLUSIVE
RIGHT TO USE SOCIAL WORK, APART FROM
THE MARK AS SHOWN.

SER. NO. 76-509,250, FILED 4-24-2003.

BRENDAN MCCAULEY, EXAMINING ATTORNEY

Int. Cl.: 2

Prior U.S. Cls.: 6, 11 and 16

United States Patent and Trademark Office

Reg. No. 2,892,709

Registered Oct. 12, 2004

**TRADEMARK
PRINCIPAL REGISTER**

SECRET SHIELD

DYNACRAFT INDUSTRIES INC. (NEW JERSEY CORPORATION), DBA BACK TO NATURE PRODUCTS
28 HARRISON AVENUE SUITE 238
ENGLISHTOWN, NJ 07726

FOR: COATINGS IN THE NATURE OF A PROTECTIVE FILM USED FOR PROTECTION OF FUR-

NITURE FINISH, IN CLASS 2 (U.S. CLS. 6, 11 AND 16).

FIRST USE 4-4-2003; IN COMMERCE 4-4-2003.

SER. NO. 76-509,276, FILED 4-24-2003.

G. T. GLYNN, EXAMINING ATTORNEY

Int. Cl.: 5

Prior U.S. Cls.: 6, 18, 44, 46, 51 and 52

United States Patent and Trademark Office

Reg. No. 2,892,710

Registered Oct. 12, 2004

**TRADEMARK
PRINCIPAL REGISTER**

VERAX BIOMEDICAL

VERAX BIOMEDICAL INCORPORATED (DELA-
WARE CORPORATION)
377 PLANTATION STREET
WORCESTER, MA 01605

NO CLAIM IS MADE TO THE EXCLUSIVE
RIGHT TO USE "BIOMEDICAL", APART FROM
THE MARK AS SHOWN.

FOR: IMMUNOASSAY SCREENING PREPARA-
TIONS FOR DETECTING BACTERIAL CONTAMI-
NATION, IN CLASS 5 (U.S. CLS. 6, 18, 44, 46, 51 AND
52).

SER. NO. 76-509,321, FILED 4-25-2003.

FIRST USE 11-5-2001; IN COMMERCE 11-5-2001.

MICHAEL KEATING, EXAMINING ATTORNEY

Int. Cl.: 16

Prior U.S. Cls.: 2, 5, 22, 23, 29, 37, 38 and 50

Reg. No. 2,892,711

United States Patent and Trademark Office

Registered Oct. 12, 2004

**TRADEMARK
PRINCIPAL REGISTER**

VERAX BIOMEDICAL

VERAX BIOMEDICAL INCORPORATED (DELA-
WARE CORPORATION)
377 PLANTATION STREET
WORCESTER, MA 01605

FIRST USE 11-5-2001; IN COMMERCE 11-5-2001.

FOR: PRINTED MATTER, NAMELY, MEETING
ABSTRACTS, POSTER PRESENTATIONS, NEWS-
LETTERS, PAMPHLETS, BROCHURES, PRODUCT
GUIDES, AND PRODUCT INSTRUCTIONS RELAT-
ING TO HEALTH AND SAFETY, IN CLASS 16 (U.S.
CLS. 2, 5, 22, 23, 29, 37, 38 AND 50).

NO CLAIM IS MADE TO THE EXCLUSIVE
RIGHT TO USE "BIOMEDICAL", APART FROM
THE MARK AS SHOWN.

SER. NO. 76-509,347, FILED 4-25-2003.

MICHAEL KEATING, EXAMINING ATTORNEY

Int. Cl.: 10

Prior U.S. Cls.: 26, 39 and 44

United States Patent and Trademark Office

Reg. No. 2,892,712

Registered Oct. 12, 2004

**TRADEMARK
PRINCIPAL REGISTER**

VERAX BIOMEDICAL

VERAX BIOMEDICAL INCORPORATED (DELA-
WARE CORPORATION)
377 PLANTATION STREET
WORCESTER, MA 01605

NO CLAIM IS MADE TO THE EXCLUSIVE
RIGHT TO USE "BIOMEDICAL", APART FROM
THE MARK AS SHOWN.

FOR: IMMUNOASSAY SCREENING TEST KITS
FOR USE IN DETECTING BACTERIAL CONTAM-
INATION, IN CLASS 10 (U.S. CLS. 26, 39 AND 44).

SER. NO. 76-509,348, FILED 4-25-2003.

FIRST USE 11-5-2001; IN COMMERCE 11-5-2001.

MICHAEL KEATING, EXAMINING ATTORNEY

Int. Cl.: 35

Prior U.S. Cls.: 100, 101 and 102

United States Patent and Trademark Office

Reg. No. 2,892,713

Registered Oct. 12, 2004

**SERVICE MARK
PRINCIPAL REGISTER**

NATIONAL CHAMBER LITIGATION CENTER

NATIONAL CHAMBER LITIGATION CENTER,
INC. (D.C. CORPORATION)
1615 H STREET N.W.
WASHINGTON, DC 20062

NO CLAIM IS MADE TO THE EXCLUSIVE
RIGHT TO USE "LITIGATION CENTER", APART
FROM THE MARK AS SHOWN.

FOR: ASSOCIATION SERVICES; NAMELY, PRO-
MOTING THE INTERESTS OF BUSINESS MEN
AND WOMEN, IN CLASS 35 (U.S. CLS. 100, 101
AND 102).

SER. NO. 76-509,366, FILED 4-25-2003.

FIRST USE 4-0-1977; IN COMMERCE 4-0-1977.

RICHARD A. STRASER, EXAMINING ATTORNEY

Int. Cls.: 35 and 42

Prior U.S. Cls.: 100, 101 and 102

United States Patent and Trademark Office

Reg. No. 2,892,714

Registered Oct. 12, 2004

**SERVICE MARK
PRINCIPAL REGISTER**



JUDICIAL WATCH, INC. (D.C. CORPORATION)
501 SCHOOL STREET, S.W.
WASHINGTON, DC 20024

FOR: PROMOTING PUBLIC AWARENESS OF THE NEED FOR INTEGRITY IN GOVERNMENT AND THE PROTECTION OF THE PUBLIC TRUST AGAINST GOVERNMENT AND JUDICIAL ABUSE AND TO PROMOTE JUSTICE AND PUBLIC SERVICE ETHICS, IN CLASS 35 (U.S. CLS. 100, 101 AND 102).

FIRST USE 0-0-1994; IN COMMERCE 0-0-1994.

FOR: LEGAL SERVICES, NAMELY THE INITIATION AND PROSECUTION OF LITIGATION ON BEHALF OF INDIVIDUALS AND THE PUBLIC-AT-LARGE IN ORDER TO EXPOSE CORRUPTION AT ALL LEVELS OF GOVERNMENT AND TO BRING THE PERPETRATORS TO JUSTICE; COURT OBSERVATION SERVICES AND THE ISSUANCE OF STUDIES AND REPORTS ON THE ACTIVITIES

AND CONDUCT OF JUDICIAL BODIES TO ENSURE THE INTEGRITY OF THE JUDICIAL SYSTEM FOR INDIVIDUALS AND THE PUBLIC-AT-LARGE; LEGAL SERVICES, NAMELY PROVIDING WATCHDOG AGENCY SERVICES TO PROVIDE VERIFICATION OF THE ETHICAL CONDUCT OF GOVERNMENT AND JUDICIAL OFFICIALS AND THE PREPARATION AND DISSEMINATION OF STUDIES AND REPORTS ON THE ACTIVITIES AND CONDUCT OF GOVERNMENT AND JUDICIAL BODIES AFFECTING THE LIVES OF THE GENERAL PUBLIC, IN CLASS 42 (U.S. CLS. 100 AND 101).

FIRST USE 0-0-1994; IN COMMERCE 0-0-1994.

SEC. 2(F) AS TO "JUDICIAL" AND "WASHINGTON D.C.".

SER. NO. 76-509,462, FILED 4-24-2003.

ALICIA COLLINS, EXAMINING ATTORNEY

Int. Cl.: 35

Prior U.S. Cls.: 100, 101 and 102

United States Patent and Trademark Office

Reg. No. 2,892,715

Registered Oct. 12, 2004

**SERVICE MARK
PRINCIPAL REGISTER**

PEAK RESULTS! MARKETING

PEAK MARKETING INC. (CALIFORNIA LTD
LIAB CO)
410 ALTA VISTA COURT
DANVILLE, CA 94506

NO CLAIM IS MADE TO THE EXCLUSIVE
RIGHT TO USE "MARKETING", APART FROM
THE MARK AS SHOWN.

FOR: BUSINESS MARKETING AND CONSULT-
ING SERVICES; AND DIRECT MARKETING AD-
VERTISING, IN CLASS 35 (U.S. CLS. 100, 101 AND
102).

SER. NO. 76-509,475, FILED 4-25-2003.

FIRST USE 2-3-2003; IN COMMERCE 3-1-2003.

MARC LEIPZIG, EXAMINING ATTORNEY

Int. Cl.: 35

Prior U.S. Cls.: 100, 101 and 102

United States Patent and Trademark Office

Reg. No. 2,892,716

Registered Oct. 12, 2004

**SERVICE MARK
PRINCIPAL REGISTER**

DETAIL WATCH

MARKET MEASURES/COZINT L.P. (NEW JERSEY LIMITED PARTNERSHIP)
120 EAGLE ROCK AVENUE
EAST HANOVER, NJ 07936

FOR: MARKET RESEARCH AND ANALYSIS;
COLLECTING AND PROVIDING BUSINESS MARKETING INFORMATION VIA THE INTERNET,

ALL PERTAINING TO THE PHARMACEUTICAL FIELD , IN CLASS 35 (U.S. CLS. 100, 101 AND 102).

FIRST USE 4-12-2002; IN COMMERCE 4-12-2002.

SER. NO. 76-509,627, FILED 4-25-2003.

FLORENTINA BLANDU, EXAMINING ATTORNEY

Int. Cl.: 7

Prior U.S. Cls.: 13, 19, 21, 23, 31, 34 and 35

Reg. No. 2,892,717

United States Patent and Trademark Office

Registered Oct. 12, 2004

**TRADEMARK
PRINCIPAL REGISTER**



HALL MANUFACTURING, INC. (ARKANSAS CORPORATION)
3706 EAST WASHINGTON
NORTH LITTLE ROCK, AR 72119

FOR: ROTARY INDUSTRIAL AND AGRICULTURAL MOWERS WHICH ARE ATTACHED TO TRACTORS AND DRIVEN BY A POWER TAKE-OFF SHAFT, WHICH ARE USED IN MOWING APPLICATIONS FOR FARMS, RANCHES, AIR-

PORTS, AND HIGHWAY RIGHT-OF-WAY AREAS, IN CLASS 7 (U.S. CLS. 13, 19, 21, 23, 31, 34 AND 35).

FIRST USE 8-1-2002; IN COMMERCE 8-1-2002.

OWNER OF U.S. REG. NO. 2,204,741.

SER. NO. 76-509,866, FILED 4-28-2003.

CAROLINE WOOD, EXAMINING ATTORNEY

Int. Cls.: 4, 35 and 37

Prior U.S. Cls.: 1, 6, 15, 100, 101, 102, 103 and 106

United States Patent and Trademark Office

Reg. No. 2,892,718

Registered Oct. 12, 2004

**TRADEMARK
SERVICE MARK
PRINCIPAL REGISTER**

DEBLOIS

PETRO HOLDINGS, INC. (MINNESOTA CORPORATION)
2187 ATLANTIC STREET
STAMFORD, CT 06902

FOR: INSTALLATION, REPAIR AND MAINTENANCE OF FUEL OIL EQUIPMENT, IN CLASS 37 (U.S. CLS. 100, 103 AND 106).

FOR: FUEL OIL FOR HEATING PURPOSES, IN CLASS 4 (U.S. CLS. 1, 6 AND 15).

FIRST USE 1-1-1959; IN COMMERCE 1-1-1959.

FIRST USE 1-1-1959; IN COMMERCE 1-1-1959.

SEC. 2(F).

FOR: FUEL OIL DISTRIBUTORSHIP SERVICES, IN CLASS 35 (U.S. CLS. 100, 101 AND 102).

SER. NO. 76-510,117, FILED 4-28-2003.

FIRST USE 1-1-1959; IN COMMERCE 1-1-1959.

IRA J. GOODSaid, EXAMINING ATTORNEY

Int. Cl.: 16

Prior U.S. Cls.: 2, 5, 22, 23, 29, 37, 38 and 50

United States Patent and Trademark Office

Reg. No. 2,892,719

Registered Oct. 12, 2004

**TRADEMARK
PRINCIPAL REGISTER**

CONNECT

VANCE PUBLISHING (NEW YORK CORPORATION)
400 KNIGHTSBRIDGE PARKWAY
LINCOLNSHIRE, IL 60069

FOR: TRADE PUBLICATIONS, NAMELY, PERIODIC MAGAZINES FOR SALON MANAGEMENT PROFESSIONALS, IN CLASS 16 (U.S. CLS. 2, 5, 22, 23, 29, 37, 38 AND 50).

FIRST USE 4-0-2003; IN COMMERCE 4-0-2003.

SER. NO. 76-510,119, FILED 4-28-2003.

RICHARD WHITE, EXAMINING ATTORNEY

Int. Cl.: 9

Prior U.S. Cls.: 21, 23, 26, 36 and 38

Reg. No. 2,892,720

United States Patent and Trademark Office

Registered Oct. 12, 2004

**TRADEMARK
PRINCIPAL REGISTER**

PULSTEC

PULSTEC INDUSTRIAL CO., LTD. (JAPAN CORPORATION)
90-3 HIGASHI-MIKATA-CHO
HAMAMATSU-CITY
SHIZUOKA-PREF., 433-8510, JAPAN

FOR: OPTICAL DISK DIAGNOSTIC TESTERS,
MOTOR VEHICLE ENGINE PERFORMANCE TESTERS,

AND PRINTED CIRCUIT BOARD TESTERS,
IN CLASS 9 (U.S. CLS. 21, 23, 26, 36 AND 38).

FIRST USE 12-5-1989; IN COMMERCE 12-5-1989.

SER. NO. 76-510,374, FILED 4-11-2003.

BRIDGETT SMITH, EXAMINING ATTORNEY

Int. Cl.: 3

Prior U.S. Cls.: 1, 4, 6, 50, 51 and 52

United States Patent and Trademark Office

Reg. No. 2,892,721

Registered Oct. 12, 2004

TRADEMARK
PRINCIPAL REGISTER



J. F. LABS, INC. (ILLINOIS CORPORATION)
7401 SOUTH PULASKI ROAD
UNIT E
CHICAGO, IL 60629

FOR: HAIR PRODUCTS, NAMELY, RELAXERS,
CONDITIONERS, SHAMPOOS, LOTIONS, STYLING
GLAZES; POMADES, SPRAYS, OILS, AND RELAX-
ER KITS COMPRISED OF RELAXERS, SHAMPOOS,
CONDITIONERS AND LOTIONS, IN CLASS 3 (U.S.
CLS. 1, 4, 6, 50, 51 AND 52).

FIRST USE 5-0-2003; IN COMMERCE 5-0-2003.

OWNER OF U.S. REG. NOS. 1,392,878 AND
2,724,025.

NO CLAIM IS MADE TO THE EXCLUSIVE
RIGHT TO USE "RELAXER SYSTEM", APART
FROM THE MARK AS SHOWN.

THE STIPPLING IN THE DRAWING IS FOR
SHADING PURPOSES ONLY AND DOES NOT
INDICATE COLOR.

SER. NO. 76-510,394, FILED 4-29-2003.

BARBARA GAYNOR, EXAMINING ATTORNEY

Int. Cl.: 41

Prior U.S. Cls.: 100, 101 and 107

United States Patent and Trademark Office

Reg. No. 2,892,722

Registered Oct. 12, 2004

SERVICE MARK
PRINCIPAL REGISTER

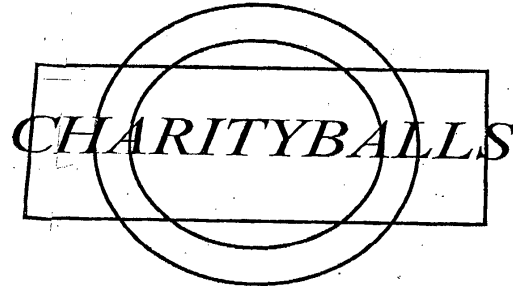

PEACOCK, LINDA C. (UNITED STATES INDIVIDUAL)
3038 NORTH MANOR DRIVE WEST
PHOENIX, AZ 85014

NO CLAIM IS MADE TO THE EXCLUSIVE RIGHT TO USE "CHARITY BALLS", APART FROM THE MARK AS SHOWN.

FOR: PROVIDING A WEB SITE VIA THE INTERNET FEATURING INFORMATION ABOUT CHARITY BALLS WORLDWIDE, IN CLASS 41 (U.S. CLS. 100, 101 AND 107).

SER. NO. 76-510,474, FILED 4-14-2003.

FIRST USE 7-30-2002; IN COMMERCE 7-30-2002.

HOWARD B. LEVINE, EXAMINING ATTORNEY

Int. Cl.: 16

Prior U.S. Cls.: 2, 5, 22, 23, 29, 37, 38 and 50

United States Patent and Trademark Office

Reg. No. 2,892,723

Registered Oct. 12, 2004

**TRADEMARK
PRINCIPAL REGISTER**



LEMANS CORPORATION (WISCONSIN COR-
PORATION)
3501 KENNEDY ROAD
BOX 5222
JANESVILLE, WI 535475222

OWNER OF U.S. REG. NOS. 2,663,140 AND
2,783,724.

THE MARK CONSISTS OF A STYLIZED "M".

FOR: DECALS, IN CLASS 16 (U.S. CLS. 2, 5, 22, 23,
29, 37, 38 AND 50).

SER. NO. 76-510,881, FILED 4-30-2003.

FIRST USE 10-0-2000; IN COMMERCE 10-0-2000.

H. M. FISHER, EXAMINING ATTORNEY

Int. Cls.: 3 and 5

Prior U.S. Cls.: 1, 4, 6, 18, 44, 46, 50, 51 and 52

United States Patent and Trademark Office

Reg. No. 2,892,724

Registered Oct. 12, 2004

**TRADEMARK
PRINCIPAL REGISTER**

DERMALIBOUR

PIERRE FABRE DERMO-COSMETIQUE
(FRANCE SOCIETE ANONYME)
45, PLACE ABEL GANCE
92100 BOULOGNE, FRANCE

OWNER OF FRANCE REG. NO. 1,702,673, DATED
10-2-1991, RENEWED AS REG. NO. 1,702,673, DATED
10-2-2001, EXPIRES 10-2-2011.

FOR: FACIAL AND SKIN CLEANSERS; SKIN
MOISTURIZER; BODY, EYE, FACE AND HAND
CREAMS; EYE GELS, IN CLASS 3 (U.S. CLS. 1, 4, 6,
50, 51 AND 52).

OWNER OF U.S. REG. NO. 2,132,472.

SER. NO. 76-510,970, FILED 5-1-2003.

FOR: MEDICATED SKIN CARE PREPARATIONS;
MEDICAL CLEANSERS FOR SKIN, IN CLASS 5 (U.S.
CLS. 6, 18, 44, 46, 51 AND 52).

IRA J. GOODSaid, EXAMINING ATTORNEY

Int. Cl.: 3

Prior U.S. Cls.: 1, 4, 6, 50, 51 and 52

United States Patent and Trademark Office

Reg. No. 2,892,725

Registered Oct. 12, 2004

**TRADEMARK
PRINCIPAL REGISTER**

ASHFIELD

PIERRE FABRE DERMO-COSMETIQUE
(FRANCE SOCIETE ANONYME)
45, PLACE ABEL GANCE
92100 BOULOGNE, FRANCE

FOR: PERFUME, EAU DE COLOGNE, TOILET
WATER, TOILET SOAPS, BATH SOAPS, AND TAL-
CUM POWDER, IN CLASS 3 (U.S. CLS. 1, 4, 6, 50, 51
AND 52).

OWNER OF FRANCE REG. NO. 1,522,908, DATED
4-25-1979, RENEWED AS REG. NO. 1,522,908, DATED
4-25-1999, EXPIRES 4-6-2009.

OWNER OF U.S. REG. NO. 1,252,010.

SER. NO. 76-510,972, FILED 5-1-2003.

IRA J. GOODSaid, EXAMINING ATTORNEY

Int. Cl.: 41

Prior U.S. Cls.: 100, 101 and 107

United States Patent and Trademark Office

Reg. No. 2,892,726

Registered Oct. 12, 2004

**SERVICE MARK
PRINCIPAL REGISTER**

ELITE DINING

EXHORT, LLC (CALIFORNIA LTD LIAB CO)
16885 VIA DEL CAMPO COURT
SUITE 400
SAN DIEGO, CA 921271722

FIRST USE 2-14-2003; IN COMMERCE 2-14-2003.

NO CLAIM IS MADE TO THE EXCLUSIVE
RIGHT TO USE "DINING", APART FROM THE
MARK AS SHOWN.

FOR: ENTERTAINMENT SERVICES, NAMELY
ON LINE REVIEWS WHICH COMPILE AND DIS-
SEMINATE RESTAURANT REVIEWS BY DINERS,
IN CLASS 41 (U.S. CLS. 100, 101 AND 107).

SER. NO. 76-511,655, FILED 5-5-2003.

J. TINGLEY, EXAMINING ATTORNEY

Int. Cl.: 11

Prior U.S. Cls.: 13, 21, 23, 31 and 34

Reg. No. 2,892,727

United States Patent and Trademark Office

Registered Oct. 12, 2004

**TRADEMARK
PRINCIPAL REGISTER**

LITEX

LITEX INDUSTRIES, INCORPORATED (TEXAS
CORPORATION)
3401 W. TRINITY BLVD.
GRAND PRAIRIE, TX 75050

NAMELY, WALL, CEILING AND PENDANT
LIGHTING FIXTURES, IN CLASS 11 (U.S. CLS. 13,
21, 23, 31 AND 34).

FOR: CEILING FANS WITH ELECTRIC LIGHT
FIXTURES, ELECTRIC LIGHT FIXTURES FOR
CEILING FANS, AND CEILING FAN KITS COM-
PRISED OF CEILING FANS, ELECTRIC LIGHT
FIXTURES, WIRING AND MOUNTING BRACKETS
SOLD AS A UNIT; AND ELECTRIC LIGHTING,

FIRST USE 4-11-2003; IN COMMERCE 4-11-2003.

SER. NO. 76-511,778, FILED 4-17-2003.

H. M. FISHER, EXAMINING ATTORNEY

Int. Cl.: 45

Prior U.S. Cls.: 100 and 101

United States Patent and Trademark Office

Reg. No. 2,892,728

Registered Oct. 12, 2004

**SERVICE MARK
PRINCIPAL REGISTER**

LLORENTE INVESTIGATIONS

LLORENTE INVESTIGATIONS, INC. (CALIFORNIA CORPORATION)
7400 CENTER AVENUE, SUITE 212
HUNTINGTON BEACH, CA 92647

FOR: PRIVATE INVESTIGATION AND INVESTIGATION SERVICES RELATED TO INSURANCE CLAIMS, IN CLASS 45 (U.S. CLS. 100 AND 101).

FIRST USE 4-0-1992; IN COMMERCE 6-0-1992.

NO CLAIM IS MADE TO THE EXCLUSIVE RIGHT TO USE INVESTIGATIONS, APART FROM THE MARK AS SHOWN.

SEC. 2(F).

SER. NO. 76-511,824, FILED 5-6-2003.

ESTHER BELENKER, EXAMINING ATTORNEY

Int. Cl.: 18

Prior U.S. Cls.: 1, 2, 3, 22 and 41

Reg. No. 2,892,729

United States Patent and Trademark Office

Registered Oct. 12, 2004

**TRADEMARK
PRINCIPAL REGISTER**

MECCA FEMME

INTERNATIONAL NEWS, INC. (WASHINGTON
CORPORATION)
19226 SEVENTIETH AVENUE SOUTH
KENT, WA 98032

FIRST USE 2-20-2000; IN COMMERCE 2-20-2000.

SER. NO. 76-511,933, FILED 4-21-2003.

FOR: HANDBAGS, BRIEFCASES, PURSES,
BACKPACKS, SUITCASES, BOOK BAGS, TRAVEL
BAGS, COSMETIC BAGS SOLD EMPTY AND WAL-
LETS, IN CLASS 18 (U.S. CLS. 1, 2, 3, 22 AND 41).

MARK T. MULLEN, EXAMINING ATTORNEY

Int. Cl.: 9

Prior U.S. Cls.: 21, 23, 26, 36 and 38

Reg. No. 2,892,730

United States Patent and Trademark Office

Registered Oct. 12, 2004

**TRADEMARK
PRINCIPAL REGISTER**

INTELLIMAP

HONEYWELL INTERNATIONAL INC. (DELA-
WARE CORPORATION)
101 COLUMBIA ROAD
MORRISTOWN, NJ 079622245

PULP AND PAPER MANUFACTURING MA-
CHINES, IN CLASS 9 (U.S. CLS. 21, 23, 26, 36 AND 38).

FIRST USE 2-28-1998; IN COMMERCE 2-28-1998.

FOR: COMPUTER SOFTWARE, NAMELY A
SOFTWARE APPLICATION USED FOR ALIGN-
MENT AND TUNING OF CONTROL SYSTEMS ON

SER. NO. 76-512,063, FILED 5-5-2003.

GEORGE LORENZO, EXAMINING ATTORNEY

Int. Cl.: 25

Prior U.S. Cls.: 22 and 39

United States Patent and Trademark Office

Reg. No. 2,892,731

Registered Oct. 12, 2004

**TRADEMARK
PRINCIPAL REGISTER**

CHESKA

THE GEMLO GROUP, INC. (FLORIDA CORPORATION), DBA STAR SUPPLY
2315 NW 107TH AVENUE
SUITE M56-57, BOX 67
MIAMI, FL 33172

FOR: CLOTHING MADE OF LEATHER AND OTHER MATERIALS, NAMELY, JEANS, PANTS, SKIRTS, SHORTS, OVERALLS, OVERCOATS, SUITS, DRESSES, SHIRTS, T-SHIRTS, SINGLETs, BLOUSES, JERSEYS, JACKETS, JUMPERS, SWEATERS, VESTS, NECKWEAR, SWIMSUITS, BEACH-

WEAR, UNDERCLOTHING, BATHROBES, PAJAMAS, ROBES; HEADWEAR; SHOES; AND CLOTHING ACCESSORIES, NAMELY, SCARVES, CLOTHING BELTS, GLOVES AND SHAWLS, IN CLASS 25 (U.S. CLS. 22 AND 39).

FIRST USE 4-0-2003; IN COMMERCE 4-0-2003.

SER. NO. 76-512,069, FILED 5-5-2003.

STACY WAHLBERG, EXAMINING ATTORNEY

Int. Cl.: 5

Prior U.S. Cls.: 6, 18, 44, 46, 51 and 52

Reg. No. 2,892,732

United States Patent and Trademark Office

Registered Oct. 12, 2004

**TRADEMARK
PRINCIPAL REGISTER**

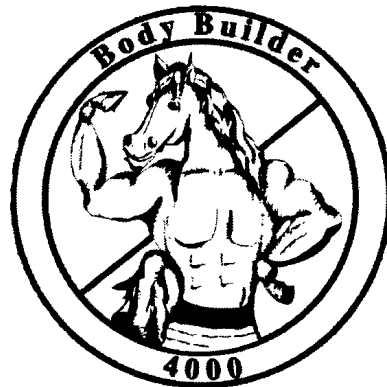

PENNWOODS EQUINE PRODUCTS, INC. (PENN-
SYLVANIA CORPORATION)
110 WEST ALLISON STREET
CENTRE HALL, PA 16828

NO CLAIM IS MADE TO THE EXCLUSIVE
RIGHT TO USE "BODY BUILDER", APART FROM
THE MARK AS SHOWN.

FOR: NATURAL AGRICULTURAL PRODUCTS,
NAMELY NUTRITIONAL SUPPLEMENTS FOR
HORSES, IN CLASS 5 (U.S. CLS. 6, 18, 44, 46, 51
AND 52).

SER. NO. 76-512,212, FILED 5-7-2003.

FIRST USE 1-1-2000; IN COMMERCE 1-1-2000.

JENNIFER CHICOSKI, EXAMINING ATTORNEY

Int. Cls.: 35 and 40

Prior U.S. Cls.: 100, 101, 102, 103 and 106

United States Patent and Trademark Office

Reg. No. 2,892,733

Registered Oct. 12, 2004

**SERVICE MARK
PRINCIPAL REGISTER**

BRAUN MEDIA SERVICES

BRAUN MEDIA SERVICES, INC. (MINNESOTA CORPORATION)
9200 WYOMING AVENUE NORTH
SUITE 375
BROOKLYN PARK, MN 55445

FOR: PROJECT MANAGEMENT SERVICES TO CLIENTS FOR PROJECTS THAT INVOLVE USE OF ELECTRONIC MEDIA IN MARKETING, PROMOTIONS, OR PRODUCT DISTRIBUTION, NAMELY PROJECT PLANNING AND COORDINATION; DESIGN AND ACQUISITION OF PACKAGING FOR ELECTRONIC MEDIA; AND FULFILLMENT OF ORDERS FOR CLIENTS' PRODUCTS, IN CLASS 35 (U.S. CLS. 100, 101 AND 102).

FIRST USE 7-1-2002; IN COMMERCE 7-1-2002.

FOR: PROVISION OF MEDIA REPLICATION, NAMELY, DUPLICATION OF DATA AND DIGITAL

INFORMATION AND CONSULTING SERVICES PROVIDED IN CONJUNCTION THEREWITH, IN CLASS 40 (U.S. CLS. 100, 103 AND 106).

FIRST USE 7-1-2002; IN COMMERCE 7-1-2002.

NO CLAIM IS MADE TO THE EXCLUSIVE RIGHT TO USE "MEDIA SERVICES", APART FROM THE MARK AS SHOWN.

THE ENGLISH TRANSLATION OF THE GERMAN WORD "BRAUN" IN THE MARK IS "BROWN".

SER. NO. 76-512,275, FILED 5-7-2003.

CATHERINE FAINT, EXAMINING ATTORNEY

Int. Cl.: 41

Prior U.S. Cls.: 100, 101 and 107

United States Patent and Trademark Office

Reg. No. 2,892,734

Registered Oct. 12, 2004

**SERVICE MARK
PRINCIPAL REGISTER**

INNOVATION ROADSHOW

DAVID MICHAEL & CO., INC. (PENNSYLVANIA
CORPORATION)
10801 DECATUR ROAD
PHILADELPHIA, PA 19154

FOR: ORGANIZING AND CONDUCTING EDU-
CATION EXHIBITIONS IN THE FIELD OF PRO-
DUCT IDEAS, APPLICATIONS, TECHNOLOGIES
AND FLAVOR SYSTEM CONCEPTS TO FOOD
PROCESSORS, IN CLASS 41 (U.S. CLS. 100, 101
AND 107).

FIRST USE 12-0-2000; IN COMMERCE 12-0-2002.

NO CLAIM IS MADE TO THE EXCLUSIVE
RIGHT TO USE ROADSHOW, APART FROM THE
MARK AS SHOWN.

SER. NO. 76-512,297, FILED 5-7-2003.

NAAKWAMA ANKRAH, EXAMINING ATTORNEY

Int. Cl.: 37

Prior U.S. Cls.: 100, 103 and 106

United States Patent and Trademark Office

Reg. No. 2,892,735

Registered Oct. 12, 2004

SERVICE MARK
PRINCIPAL REGISTER



INFINITY SITE DEVELOPMENT, INC. (TEXAS CORPORATION)
3445 GUILFORD AVENUE NW
CANTON, OH 44718

NO CLAIM IS MADE TO THE EXCLUSIVE RIGHT TO USE "SITE DEVELOPMENT, INC.", APART FROM THE MARK AS SHOWN.

FOR: DEVELOPMENT OF PROSPECTIVE LOCATIONS FOR WIRELESS MOBILE TELEPHONE ANTENNAS AND TOWERS, IN CLASS 37 (U.S. CLS. 100, 103 AND 106).

SER. NO. 76-512,336, FILED 5-6-2003.

FIRST USE 1-7-2003; IN COMMERCE 1-20-2003.

SUSAN LESLIE DUBOIS, EXAMINING ATTORNEY

Int. Cl.: 35

Prior U.S. Cls.: 100, 101 and 102

United States Patent and Trademark Office

Reg. No. 2,892,736

Registered Oct. 12, 2004

**SERVICE MARK
PRINCIPAL REGISTER**



ABSOLUTE BEST CARE INC. (NEW JERSEY CORPORATION)
10 E. 39TH ST. STE. 1108
NY, NY 10016

FOR: JOB PLACEMENT SERVICES IN THE DOMESTIC HELP FIELD, NAMELY MATCHING FAMILIES WITH NANNIES AND OTHER DOMESTIC ASSISTANTS, IN CLASS 35 (U.S. CLS. 100, 101 AND 102).

FIRST USE 8-10-2002; IN COMMERCE 8-10-2002.

NO CLAIM IS MADE TO THE EXCLUSIVE RIGHT TO USE ABSOLUTE BEST CARE INC., APART FROM THE MARK AS SHOWN.

THE COLOR(S) RED, YELLOW, AND BLUE IS/ ARE CLAIMED AS A FEATURE OF THE MARK.

THE DOLL WITH THE LETTER "A" APPEARS IN RED. THE DOLL WITH THE LETTER "B" APPEARS IN YELLOW. THE DOLL WITH THE LETTER "C" IS COLORED BLUE. THE WORDING "ABSOLUTE BEST CARE INC." APPEARS IN BLUE.

SER. NO. 76-513,456, FILED 5-12-2003.

STEVEN BERK, EXAMINING ATTORNEY

Int. Cl.: 42

Prior U.S. Cls.: 100 and 101

United States Patent and Trademark Office

Reg. No. 2,892,737

Registered Oct. 12, 2004

**SERVICE MARK
PRINCIPAL REGISTER**

WHEN IT'S A MATTER OF IMPORTANCE

JENNER & BLOCK LLP (ILLINOIS LIMITED
LIABILITY PARTNERSHIP)
ONE IBM PLAZA
CHICAGO, IL 60611

FOR: LEGAL SERVICES IN THE FIELDS OF
GENERAL LITIGATION, CLIENT COUNSELING,
COMMERCIAL LAW, EMPLOYEE BENEFITS AND
EXECUTIVE COMPENSATION, CORPORATE AND
SECURITIES LAW, CORPORATE TRANSACTIONS,
ANTITRUST/UNFAIR COMPETITION, APPELLATE
LITIGATION, FINANCIAL SERVICES/INSTITU-
TIONS LAW, TAX, LABOR/EMPLOYMENT/HU-

MAN RESOURCES, ENVIRONMENTAL,
TECHNOLOGY AND INTELLECTUAL PROPERTY,
INTERNATIONAL LAW, GOVERNMENT ISSUES,
AND MEDIA/COMMUNICATIONS/FIRST AMEND-
MENT LAW, IN CLASS 42 (U.S. CLS. 100 AND 101).

FIRST USE 6-0-2002; IN COMMERCE 6-0-2002.

SER. NO. 76-513,505, FILED 5-12-2003.

MARC LEIPZIG, EXAMINING ATTORNEY

Int. Cl.: 25

Prior U.S. Cls.: 22 and 39

United States Patent and Trademark Office

Reg. No. 2,892,738

Registered Oct. 12, 2004

TRADEMARK
PRINCIPAL REGISTER



GO OLD '50 S.R.L. (ITALY CORPORATION)
VIA MANARA 15
20121 MILANO, ITALY

FOR: LADIES', GENTS' AND CHILDREN'S CLOTHING, NAMELY, SUITS, MADE OF LEATHER; SHIRTS; BLOUSES; SKIRTS; TAILLEURS; JACKETS; TROUSERS; SHORTS; VESTS; JERSEYS; PAJAMAS; STOCKINGS; SINGLETS; CORSETS; GARTERS; PANTS; BRAS; PETTICOATS; HATS; FOULARDS; NECK-TIES; RAIN-COATS; OVERCOATS; GREAT-COATS; BATHING COSTUMES; SPORTS OVERALLS; WIND-RESISTANT JACKETS; SKI-PANTS; BELTS; FUR COATS; SCARVES;

GLOVES; DRESSING GOWNS; SHOEWEAR, NAMELY, SLIPPERS; SPORT SHOES; BOOTS AND SANDALS, IN CLASS 25 (U.S. CLS. 22 AND 39).

PRIORITY CLAIMED UNDER SEC. 44(D) ON ITALY APPLICATION NO. MI2003C00211, FILED 2-28-2003, REG. NO. 00911905, DATED 2-28-2003, EXPIRES 2-28-2013.

THE STIPPLING IS A FEATURE OF THE MARK.

SER. NO. 76-513,773, FILED 5-12-2003.

DOUGLAS LEE, EXAMINING ATTORNEY

Int. Cl.: 44

Prior U.S. Cls.: 100 and 101

United States Patent and Trademark Office

Reg. No. 2,892,739

Registered Oct. 12, 2004

SERVICE MARK
PRINCIPAL REGISTER



JANET WAN CHOU (MASSACHUSETTS CORPORATION), DBA IDEAL SKIN INC.
P.O. BOX 199
RANDOLPH, MA 02368

FOR: SKIN CARE SALON SERVICES AND SPA SERVICES NAMELY COSMETIC BODY CARE SERVICES, ALL INCLUDING THE FOLLOWING- FACIAL MICRODERMABRASION, BLUE PEELS AND VARIOUS CHEMICAL PEELS INCLUDING VITAMIN A, GLYCOLIC, LACTIC, SALICYLIC AND TRICHLOROACETIC ACID PEELS, AND SONOPHORESIS LASER HAIR REMOVAL, WAXING, AND BROW TINTING, IN CLASS 44 (U.S. CLS. 100 AND 101).

FIRST USE 3-10-2003; IN COMMERCE 3-12-2003.

NO CLAIM IS MADE TO THE EXCLUSIVE RIGHT TO USE SKIN CARE, APART FROM THE MARK AS SHOWN.

THE IS SKIN CARE LOGO IS CONTAINED WITHIN A SLIGHTLY RECTANGULAR FORMAT WITH ROUNDED CORNERS. THE INITIALS "I" AND "S" ARE REVERSED OUT OF THE RECTANGLE AND APPEAR AS WHITE. THE "I" IS LOWER CASE (BAUHAUS FONT) AND THE DOT OF THE "I" WHICH FLOATS ABOVE THE RECTANGLE, IS PMS 624 (PANTONE MATCHING SYSTEM), A SOFT SAGE GREEN. THIS IS ALSO THE COLOR USED TO OBTAIN THE LETTERS WITHIN THE RECTANGULAR SHAPE. THE FONT USED FOR THE "S" IS LUCIDA HANDWRITING. A LINE DRAWING OF A WHITE LEAF REVERSE OUT OF THE LOWER LEFT CORNER OF THE RECTANGLE, COMPLETING THE DESIGN.

SER. NO. 76-513,774, FILED 5-12-2003.

JOHN SCHUYLER YARD, EXAMINING ATTORNEY

Int. Cl.: 17

Prior U.S. Cls.: 1, 5, 12, 13, 35 and 50

United States Patent and Trademark Office

Reg. No. 2,892,740

Registered Oct. 12, 2004

**TRADEMARK
PRINCIPAL REGISTER**

CINEPANEL

PERFORMANCE MEDIA INDUSTRIES, LTD.
(CALIFORNIA CORPORATION)
9A MONO AVENUE
FAIRFAX, CA 94930

FIRST USE 11-12-2001; IN COMMERCE 11-12-2001.

SER. NO. 76-513,810, FILED 5-9-2003.

FOR: ARCHITECTURAL ACOUSTIC PRODUCTS,
NAMELY, SOUND ABSORBERS AND DIFFUSERS,
IN CLASS 17 (U.S. CLS. 1, 5, 12, 13, 35 AND 50).

BRIDGETT SMITH, EXAMINING ATTORNEY

Int. Cl.: 42

Prior U.S. Cls.: 100 and 101

United States Patent and Trademark Office

Reg. No. 2,892,741

Registered Oct. 12, 2004

**SERVICE MARK
PRINCIPAL REGISTER**

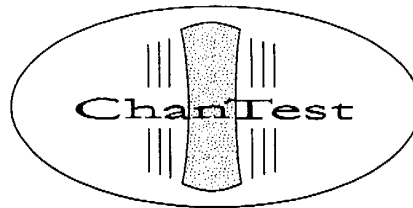

CHANTEST, INC. (OHIO CORPORATION)
14656 NEO PARKWAY
CLEVELAND, OH 44128

FIRST USE 0-0-1998; IN COMMERCE 0-0-1998.

FOR: SCIENTIFIC AND INDUSTRIAL RE-
SEARCH FOR OTHERS, NAMELY BIOTECHNOL-
OGY RESEARCH; PHARMACEUTICAL
RESEARCH; RESEARCH RELATING TO ION
CHANNELS; DRUG SCREENING; AND RESEARCH
ON THE SCREENING OF ION CHANNELS, IN
CLASS 42 (U.S. CLS. 100 AND 101).

THE STIPPLING IS FOR SHADING PURPOSES.

SER. NO. 76-513,924, FILED 5-14-2003.

ALEXANDER L. POWERS, EXAMINING ATTOR-
NEY

Int. Cl.: 42

Prior U.S. Cls.: 100 and 101

United States Patent and Trademark Office

Reg. No. 2,892,742

Registered Oct. 12, 2004

**SERVICE MARK
PRINCIPAL REGISTER**

GENE TO CELL TO SYSTEM

PARADIGM GENETICS, INC. (DELAWARE CORPORATION)
108 ALEXANDER DRIVE
P.O. BOX 14528
RESEARCH TRIANGLE PARK, NC 277094528

FOR: SCIENTIFIC RESEARCH IN THE FIELDS OF AGRICULTURE, BIOLOGY, BIOCHEMISTRY, BIOINFORMATICS, COMPUTATIONAL BIOLOGY, PHARMACOLOGY, TOXICOLOGY, DIAGNOSTIC AND PREDICTIVE MEDICINE; PRODUCT RESEARCH AND DEVELOPMENT FOR OTHERS IN THE FIELDS OF AGRICULTURE, BIOLOGY, BIO-

CHEMISTRY, BIOINFORMATICS, COMPUTATIONAL BIOLOGY, PHARMACOLOGY, TOXICOLOGY, DIAGNOSTIC AND PREDICTIVE MEDICINE; AND PHARMACEUTICAL DRUG DEVELOPMENT SERVICES, IN CLASS 42 (U.S. CLS. 100 AND 101).

FIRST USE 11-1-2002; IN COMMERCE 11-1-2002.

SER. NO. 76-514,132, FILED 5-12-2003.

ROBERT COGGINS, EXAMINING ATTORNEY

Int. Cl.: 43

Prior U.S. Cls.: 100 and 101

United States Patent and Trademark Office

Reg. No. 2,892,743

Registered Oct. 12, 2004

**SERVICE MARK
PRINCIPAL REGISTER**

OPEN SKY CAFE

KURIE, ANDREW E. (UNITED STATES INDIVIDUAL)
P.O. BOX 386
MARATHON, TX 798420386

NO CLAIM IS MADE TO THE EXCLUSIVE RIGHT TO USE "CAFE" , APART FROM THE MARK AS SHOWN.

FOR: RESTAURANT SERVICES, IN CLASS 43 (U.S. CLS. 100 AND 101).

SER. NO. 76-514,175, FILED 5-14-2003.

FIRST USE 1-1-1994; IN COMMERCE 1-1-1994.

CATHERINE FAINT, EXAMINING ATTORNEY

Int. Cls.: 35 and 41

Prior U.S. Cls.: 100, 101, 102 and 107

United States Patent and Trademark Office

Reg. No. 2,892,744

Registered Oct. 12, 2004

**SERVICE MARK
PRINCIPAL REGISTER**



ULTRA ENTERPRISES, INC. (FLORIDA CORPORATION)
1000 N.W. 14TH STREET
MIAMI, FL 33136

FOR: PROMOTING MUSIC FESTIVALS FOR OTHERS, IN CLASS 35 (U.S. CLS. 100, 101 AND 102).

FIRST USE 1-0-1998; IN COMMERCE 1-0-1998.

FOR: ENTERTAINMENT SERVICES, NAMELY ORGANIZING AND CONDUCTING MUSIC FESTI-

VALS AND PARTY EVENTS, IN CLASS 41 (U.S. CLS. 100, 101 AND 107).

FIRST USE 1-0-1998; IN COMMERCE 1-0-1998.

NO CLAIM IS MADE TO THE EXCLUSIVE RIGHT TO USE "MUSICFESTIVAL", APART FROM THE MARK AS SHOWN.

SER. NO. 76-514,796, FILED 5-16-2003.

MATTHEW KLINE, EXAMINING ATTORNEY

Int. Cls.: 41 and 42

Prior U.S. Cls.: 100, 101 and 107

United States Patent and Trademark Office

Reg. No. 2,892,745

Registered Oct. 12, 2004

**SERVICE MARK
PRINCIPAL REGISTER**

NETWORK OF WEATHERING

ATLAS MATERIAL TESTING TECHNOLOGY,
L.L.C. (DELAWARE LTD LIAB CO)
4114 N. RAVENSWOOD
CHICAGO, IL 60613

FOR: EDUCATION SERVICES, NAMELY, CLASSES, SEMINARS AND WORKSHOPS RELATING TO TESTING THE EFFECTS OF WEATHER UPON OBJECTS, IN CLASS 41 (U.S. CLS. 100, 101 AND 107).

FIRST USE 3-0-2001; IN COMMERCE 3-0-2001.

FOR: CONSULTING SERVICES RELATING TO TESTING THE EFFECTS OF WEATHER UPON OBJECTS, IN CLASS 42 (U.S. CLS. 100 AND 101).

FIRST USE 3-0-2001; IN COMMERCE 3-0-2001.

NO CLAIM IS MADE TO THE EXCLUSIVE RIGHT TO USE "WEATHERING", APART FROM THE MARK AS SHOWN.

SER. NO. 76-515,035, FILED 5-16-2003.

DOMINIC J. FERRAIUOLO, EXAMINING ATTORNEY

Int. Cls.: 1 and 5

Prior U.S. Cls.: 1, 5, 6, 10, 18, 26, 44, 46, 51 and 52

United States Patent and Trademark Office

Reg. No. 2,892,746

Registered Oct. 12, 2004

**TRADEMARK
PRINCIPAL REGISTER**

FRESHFX

STERIFX, INC. (LOUISIANA CORPORATION)
1868 KINGS HIGHWAY, SUITE 120
SHREVEPORT, LA 71103

FOR: SPECIALIZED CHEMICALS FOR USE AS ANTI-MICROBIALS, STERILANTS IN THE FOOD PROCESSING, CONSUMER PRODUCTS AND COSMETIC INDUSTRIES, IN CLASS 1 (U.S. CLS. 1, 5, 6, 10, 26 AND 46).

FIRST USE 4-15-2002; IN COMMERCE 4-15-2002.

FOR: DISINFECTANT PREPARATIONS FOR USE IN THE FOOD PROCESSING, CONSUMER PRODUCTS AND COSMETIC INDUSTRIES, IN CLASS 5 (U.S. CLS. 6, 18, 44, 46, 51 AND 52).

FIRST USE 4-15-2002; IN COMMERCE 4-15-2002.

SER. NO. 76-515,319, FILED 5-19-2003.

KAREN BRACEY, EXAMINING ATTORNEY

Int. Cl.: 19

Prior U.S. Cls.: 1, 12, 33 and 50

United States Patent and Trademark Office

Reg. No. 2,892,747

Registered Oct. 12, 2004

**TRADEMARK
PRINCIPAL REGISTER**

GERMINATOR

ANCHOR INDUSTRIES INC. (INDIANA COR-
PORATION)
1100 BURCH DRIVE
P.O. BOX 3477
EVANSVILLE, IN 477333477

FIRST USE 7-1-1992; IN COMMERCE 2-1-1997.

SER. NO. 76-515,405, FILED 5-19-2003.

FOR: COLLAPSIBLE AND PORTABLE PRE-FAB-
RICATED GREENHOUSES, IN CLASS 19 (U.S. CLS.
1, 12, 33 AND 50).

NANCY CLARKE, EXAMINING ATTORNEY

Int. Cls.: 9, 16, 35, 36 and 41

**Prior U.S. Cls.: 2, 5, 21, 22, 23, 26, 29, 36, 37, 38, 50,
100, 101, 102 and 107**

Reg. No. 2,892,748

United States Patent and Trademark Office

Registered Oct. 12, 2004

**TRADEMARK
SERVICE MARK
PRINCIPAL REGISTER**

AMERICARE

AMERICAN REPUBLIC INSURANCE COMPANY
(IOWA CORPORATION)
601 6TH AVENUE
DES MOINES, IA 50334

FOR: AUDIO TAPES, VIDEO TAPES, AND COMPUTER SOFTWARE IN THE FIELD OF RISK MANAGEMENT THROUGH FINANCIAL AND INSURANCE PRODUCTS AND SERVICES, IN CLASS 9 (U.S. CLS. 21, 23, 26, 36 AND 38).

FIRST USE 4-0-1965; IN COMMERCE 4-0-1965.

FOR: MANUALS PERTAINING TO FINANCIAL AND INSURANCE CONSULTING SERVICES; PRINTED MATERIALS FOR EDUCATIONAL TRAINING SEMINARS AND COURSES OF INSTRUCTION IN THE SALE AND MARKETING OF FINANCIAL AND INSURANCE PRODUCTS AND SERVICES; PUBLICATIONS IN THE FIELD OF RISK MANAGEMENT THROUGH FINANCIAL AND INSURANCE PRODUCTS AND SERVICES, NAMELY, NEWSLETTERS AND INFORMATIONAL BROCHURES, IN CLASS 16 (U.S. CLS. 2, 5, 22, 23, 29, 37, 38 AND 50).

FIRST USE 4-0-1965; IN COMMERCE 4-0-1965.

FOR: PROMOTING FINANCIAL AND INSURANCE SERVICES IN THE FIELD OF RISK MANAGEMENT OF OTHERS THROUGH THE

DISTRIBUTION OF PRINTED MATERIAL AND CONDUCTING PRESENTATIONS, IN CLASS 35 (U.S. CLS. 100, 101 AND 102).

FIRST USE 9-0-1998; IN COMMERCE 9-0-1998.

FOR: FINANCIAL AND INSURANCE CONSULTING IN THE FIELD OF MANAGEMENT OF RISK; INSURANCE AGENCIES AND BROKERAGE , IN CLASS 36 (U.S. CLS. 100, 101 AND 102).

FIRST USE 4-0-1965; IN COMMERCE 4-0-1965.

FOR: EDUCATIONAL SERVICES, NAMELY, CONDUCTING TRAINING SEMINARS AND COURSES OF INSTRUCTION IN THE SALE AND MARKETING OF FINANCIAL AND INSURANCE PRODUCTS AND SERVICES IN THE FIELD OF INSURANCE AND FINANCIAL CONSULTING, IN CLASS 41 (U.S. CLS. 100, 101 AND 107).

FIRST USE 4-0-1965; IN COMMERCE 4-0-1965.

OWNER OF U.S. REG. NOS. 800,031, 2,212,374 AND OTHERS.

SER. NO. 76-515,574, FILED 5-19-2003.

KARLA PERKINS, EXAMINING ATTORNEY

Int. Cl.: 2

Prior U.S. Cls.: 6, 11 and 16

United States Patent and Trademark Office

Reg. No. 2,892,749

Registered Oct. 12, 2004

TRADEMARK
PRINCIPAL REGISTER



PICARD INDUSTRIAL CORPORATION (TAI-
WAN CORPORATION)

200 TUN HUA SOUTH RD.

TAIPEI, TAIWAN 945983214

FOR: COMPATIBLE INK JET CARTRIDGES; RE-
FILL INK FOR INK JET PRINTER CARTRIDGES;
TONER CARTRIDGES, IN CLASS 2 (U.S. CLS. 6, 11
AND 16).

FIRST USE 1-1-2003; IN COMMERCE 1-1-2003.

NO CLAIM IS MADE TO THE EXCLUSIVE
RIGHT TO USE "COLOR", APART FROM THE
MARK AS SHOWN.

THE MARK CONSISTS OF THE WORD MISTER
COLORED RED, THE WORD KOLOR HAVING THE
LETTERS K, L, R COLORED BLUE AND THE
LETTERS O, O COLORED YELLOW.

SER. NO. 76-515,679, FILED 5-20-2003.

JOHN SCHUYLER YARD, EXAMINING ATTOR-
NEY

Int. Cl.: 9

Prior U.S. Cls.: 21, 23, 26, 36 and 38

Reg. No. 2,892,750

United States Patent and Trademark Office

Registered Oct. 12, 2004

TRADEMARK
PRINCIPAL REGISTER



MORITEX CORPORATION (JAPAN CORPORATION)
3-1-14, JINGU-MAE, SHIBUYA-KU
TOKYO 150-0001, JAPAN

FOR: LABORATORY APPARATUS AND INSTRUMENTS, NAMELY, SPECTROSCOPES, CONSTANT TEMPERATURE INCUBATORS, CONSTANT HUMIDITY INCUBATORS, SAMPLE PREPARATION ROBOTS FOR USE IN LABORATORIES, ELECTRONIC DEVICES FOR AUTOMATING MOLECULAR, PROTEIN, DNA AND COMBINATORIAL CHEMICAL SYNTHESIS, ELECTRONIC DEVICES FOR AUTOMATING HIGH-THROUGHPUT, HIGH PRECISION LABORATORY ASSAYS, ELECTRONIC DEVICES FOR MEASURING FLUORESCENCE, NAMELY, FLUORESCENCE READERS, ELECTRONIC DEVICES FOR LABORATORY SOLID PHASE EXTRACTION, ELECTRONIC DEVICES FOR AUTOMATING CELL ASSAYS, LASER MANIPULATORS; CAMERAS, LENS FILTERS, FLASH LAMPS, LENS HOODS; CINEMATOGRAPHIC CAMERA, MOVIE PROJECTOR; OPTICAL APPARATUS AND INSTRUMENTS, NAMELY, FIBER OPTIC CONNECTOR INSPECTION MICROSCOPES, TELESCOPE, REFLECTORS, PRISMS, OPTICAL LENSES, MICROSCOPES, MAGNIFYING GLASSES, BODY-TUBES FOR MICROSCOPES, LENS BARRELS FOR MICROSCOPES, OPTICAL MIRRORS, STEREOSCOPES; MEASURING OR TESTING MACHINES AND INSTRUMENTS, NAMELY, LUMINOFLUX METERS, PHOTOMETERS, INTERFEROMETERS, INTERFEROMETERS, SEMI-CONDUCTOR TESTER, PRECISION ABSOLUTE LENGTH MEASURER; POWER DISTRIBUTING BOXES, ELECTRIC SWITCHES, POWER CONTROLLERS; BATTERIES AND PHOTOVOLTAIC CELLS, ELECTRIC OR MAGNETIC METERS AND TESTERS, NAMELY, PHASE INDUCTORS, DETECTORS FOR THE DETECTION OF ELECTRI-

CAL AND MAGNETIC PHENOMENA, FREQUENCY METERS, MAGNETOMETERS, VOLTMETERS, WAVEMETERS, OSCILLATORS; ELECTRIC WIRES, ELECTRIC CABLES, ELECTRIC COILS, OPTICAL FIBER AND OPTICAL FIBER CABLE; COMMUNICATION, ESPECIALLY OPTICAL TELECOMMUNICATION, AND BROADCAST APPARATUS AND INSTRUMENTS, TELEPHONE APPARATUS, WIRED INTERCOMMUNICATION APPARATUS, MACHINES AND DEVICES FOR TRANSMITTING ELECTRICITY AND TRANSMITTING OPTICAL SIGNALS, WIRELESS INTERCOMMUNICATION APPARATUS, APPARATUS AND INSTRUMENTS FOR BROADCAST, REMOTE CONTROL APPARATUS, RADIO APPLICATION APPARATUS AND MACHINES, AUDIO APPARATUS AND INSTRUMENTS, VISUAL APPARATUS AND INSTRUMENTS, PARTS AND ACCESSORIES OF ABOVE-COMMUNICATION AND BROADCAST APPARATUS AND INSTRUMENTS, NAMELY, ALIGNMENT SYSTEMS USED IN OPTICAL COMMUNICATION DEVICE MANUFACTURING COMPRISING PRIMARILY OF OPTICAL FIBER COUPLERS, AND, ELECTRONIC DEVICES FOR AUTOMATED ALIGNMENT OF OPTICAL ARRAYS AND LASER-DIODE MODULE PRODUCTION; MICRO-BALL LENSES FOR OPTICAL COMMUNICATION BETWEEN LASER DIODES OR PHOTO DIODES AND OPTICAL FIBERS; OPTICAL FIBER CONNECTORS; LASER AND PHOTO DIODE MODULES FOR OPTICAL TELECOMMUNICATION; PHASE MASKS FOR FIBER BRAGG GRATINGS; FIBER BRAGG GRATINGS; OPTICAL FIBER ARRAYS; V-GROOVES FOR MANUFACTURING OPTICAL FIBER ARRAYS; FIBER COUPLERS FOR WAVELENGTH DIVISION MULTIPLEXING; TELEPHONE SETS, CELLULAR TELEPHONES, FACSIMILE MACHINES, RADIO, RECEIVERS, TELEVISION SETS, NAVIGATION MACHINES FOR VEHICLES CONSISTING OF COMPUTERS, COMPUTER SOFTWARE, TRANSMITTERS,

RECEIVERS, AND NETWORK INTERFACE DEVICES, AUDIO-RECORDER, VIDEO CAMERAS, VIDEO DISK PLAYERS; VIDEO MICROSCOPES; ELECTRONIC MACHINES, APPARATUS AND THEIR PARTS, NAMELY, COMPUTERS AND COMPUTER PERIPHERALS, DATA PROCESSING EQUIPMENT, NAMELY, COMPUTER MEMORY CHIPS, SOFTWARE FOR ANALYZING BIOCHEMICAL MATERIALS AND DRIVING COMPUTER PERIPHERALS, IN CLASS 9 (U.S. CLS. 21, 23, 26, 36 AND 38).

FIRST USE 10-1-1993; IN COMMERCE 10-1-1993.

NO CLAIM IS MADE TO THE EXCLUSIVE RIGHT TO USE "CORPORATION", APART FROM THE MARK AS SHOWN.

THE MARK CONSISTS IN PART OF THE STYLIZED LETTER M.

SER. NO. 76-515,779, FILED 5-21-2003.

JOSETTE BEVERLY, EXAMINING ATTORNEY

Int. Cl.: 5

Prior U.S. Cls.: 6, 18, 44, 46, 51 and 52

United States Patent and Trademark Office

Reg. No. 2,892,751

Registered Oct. 12, 2004

**TRADEMARK
PRINCIPAL REGISTER**

ELOINE

SCHERING AKTIENGESELLSCHAFT (FED REP
GERMANY CORPORATION)
BERLIN, FED REP GERMANY 13342

FOR: PHARMACEUTICAL PRODUCTS, NAME-
LY HORMONAL CONTRACEPTIVES, IN CLASS 5
(U.S. CLS. 6, 18, 44, 46, 51 AND 52).

OWNER OF FED REP GERMANY REG. NO.
30301755, DATED 2-7-2003, EXPIRES 1-31-2013.

SER. NO. 76-515,907, FILED 4-28-2003.

ELLEN B. AWRICH, EXAMINING ATTORNEY

Int. Cl.: 36

Prior U.S. Cls.: 100, 101 and 102

United States Patent and Trademark Office

Reg. No. 2,892,752

Registered Oct. 12, 2004

**SERVICE MARK
PRINCIPAL REGISTER**

THE PLAZA KING OF PRUSSIA

KING OF PRUSSIA ASSOCIATES (PARTNER-
SHIP)
C/O KRAVCO COMPANY
234 MALL BOULEVARD
KING OF PRUSSIA, PA 194061528

FOR: SHOPPING CENTER SERVICES, NAMELY,
LEASING AND MANAGEMENT OF RETAIL
SPACE, IN CLASS 36 (U.S. CLS. 100, 101 AND 102).

FIRST USE 0-0-1961; IN COMMERCE 0-0-1961.

NO CLAIM IS MADE TO THE EXCLUSIVE
RIGHT TO USE "PLAZA", APART FROM THE
MARK AS SHOWN.

SEC. 2(F).

SER. NO. 76-516,081, FILED 5-23-2003.

HEATHER THOMPSON, EXAMINING ATTORNEY

Int. Cl.: 36

Prior U.S. Cls.: 100, 101 and 102

United States Patent and Trademark Office

Reg. No. 2,892,753

Registered Oct. 12, 2004

**SERVICE MARK
PRINCIPAL REGISTER**

THE COURT KING OF PRUSSIA

KING OF PRUSSIA ASSOCIATES (PARTNER-
SHIP)
C/O KRAVCO COMPANY
234 MALL BOULEVARD
KING OF PRUSSIA, PA 194061528

FIRST USE 0-0-1981; IN COMMERCE 0-0-1981.

SEC. 2(F).

SER. NO. 76-516,082, FILED 5-23-2003.

FOR: SHOPPING CENTER SERVICES, NAMELY,
LEASING AND MANAGEMENT OF RETAIL
SPACE, IN CLASS 36 (U.S. CLS. 100, 101 AND 102).

HEATHER THOMPSON, EXAMINING ATTORNEY

Int. Cl.: 40

Prior U.S. Cls.: 100, 103 and 106

United States Patent and Trademark Office

Reg. No. 2,892,754

Registered Oct. 12, 2004

**SERVICE MARK
PRINCIPAL REGISTER**

KRUGER

KRUGER INC. (CANADA CORPORATION)
3285 BEDFORD ROAD
MONTREAL, QUEBEC, CANADA H3S 1G5

FOR: MANUFACTURE OF GENERAL PRODUCT
LINES IN THE FIELD OF WOOD FIBRE PRO-
DUCTS, NAMELY, NEWSPRINT, COATED PAPER,
LINER BOARD, RECOVERED PAPER, PACKA-
GING, LUMBER, WOOD PANELS AND TISSUES
TO THE ORDER OF SPECIFICATIONS OF OTHERS,
IN CLASS 40 (U.S. CLS. 100, 103 AND 106).

FIRST USE 0-0-1921; IN COMMERCE 0-0-1965.

PRIORITY CLAIMED UNDER SEC. 44(D) ON
CANADA APPLICATION NO. 1,160,900, FILED 12-2-
2002.

SEC. 2(F).

SER. NO. 76-516,283, FILED 5-22-2003.

CHRISIE B. KING, EXAMINING ATTORNEY

Int. Cl.: 9

Prior U.S. Cls.: 21, 23, 26, 36 and 38

United States Patent and Trademark Office

Reg. No. 2,892,755

Registered Oct. 12, 2004

TRADEMARK
PRINCIPAL REGISTER



JOUAN, INC. (VIRGINIA CORPORATION)
170 MARCEL DRIVE
WINCHESTER, VA 22602

FOR: LABORATORY APPARATUS, NAMELY
BIOLOGICAL INCUBATORS, CONSTANT TEM-
PERATURE LABORATORY INCUBATORS AND
PARTS THEREFOR, IN CLASS 9 (U.S. CLS. 21, 23,
26, 36 AND 38).

FIRST USE 11-0-2002; IN COMMERCE 11-0-2002.

OWNER OF U.S. REG. NO. 2,618,683.

THE STIPPLING SHOWN IN MARK IS A FEAT-
URE OF THE MARK AND NOT INTENDED TO
INDICATE COLOR.

THE MARK IS COMPRISED OF A DESIGN OF A
GROUP OF BACTERIA.

SER. NO. 76-516,668, FILED 4-22-2003.

GLENN CLARK, EXAMINING ATTORNEY

Int. Cls.: 10 and 11

Prior U.S. Cls.: 13, 21, 23, 26, 31, 34, 39 and 44

United States Patent and Trademark Office

Reg. No. 2,892,756

Registered Oct. 12, 2004

**TRADEMARK
PRINCIPAL REGISTER**

SPRINTER

HERAEUS NOBLELIGHT GMBH (FED REP GER-
MANY CORPORATION)
HERAEUSSTRASSE 12-14
D-63450 HANAU, FED REP GERMANY

FOR: ULTRAVIOLET TANNING TUBES AND
ULTRAVIOLET TANNING RADIATORS FOR MED-
ICAL PURPOSES, IN CLASS 10 (U.S. CLS. 26, 39 AND
44).

FOR: ULTRAVIOLET TANNING TUBES AND
ULTRAVIOLET TANNING RADIATORS FOR

NON-MEDICAL PURPOSES, IN CLASS 11 (U.S.
CLS. 13, 21, 23, 31 AND 34).

PRIORITY CLAIMED UNDER SEC. 44(D) ON FED
REP GERMANY APPLICATION NO. 30309524.510,
FILED 2-20-2003, REG. NO. 30309524, DATED 5-21-
2003, EXPIRES 2-20-2013.

SER. NO. 76-516,713, FILED 5-2-2003.

SHAUNIA WALLACE, EXAMINING ATTORNEY

Int. Cls.: 35 and 36

Prior U.S. Cls.: 100, 101 and 102

United States Patent and Trademark Office

Reg. No. 2,892,757

Registered Oct. 12, 2004

**SERVICE MARK
PRINCIPAL REGISTER**

LEARN & EARN

FUNDEVER, INC. (DELAWARE CORPORATION)
3100 FIVE FORKS TRICKUM RD. SW
SUITE 401
LILBURN, GA 30047

FOR: RETAIL, CATALOG AND ONLINE STORE
SERVICES FEATURING SOFTWARE, BOOKS, MA-
GAZINES, VIDEO GAMES, VIDEO RECORDINGS,
MUSIC CDS AND GLOBES , IN CLASS 35 (U.S. CLS.
100, 101 AND 102).

FIRST USE 4-1-2002; IN COMMERCE 4-1-2002.

FOR: EDUCATIONAL FUND RAISING SERVI-
CES, NAMELY MANAGING AND ADMINISTER-
ING FUND RAISING PROGRAMS, IN CLASS 36
(U.S. CLS. 100, 101 AND 102).

FIRST USE 4-1-2002; IN COMMERCE 4-1-2002.

SER. NO. 76-516,773, FILED 5-8-2003.

JOHN HWANG, EXAMINING ATTORNEY

Int. Cl.: 35

Prior U.S. Cls.: 100, 101 and 102

United States Patent and Trademark Office

Reg. No. 2,892,758

Registered Oct. 12, 2004

**SERVICE MARK
PRINCIPAL REGISTER**

EPRIZE

EPRIZE, LLC (MICHIGAN CORPORATION)
34405 WEST TWELVE MILE ROAD
SUITE 123
FARMINGTON HILLS, MI 48331

FOR: PROMOTING THE GOODS AND SERVICES OF OTHERS THROUGH THE DEVELOPMENT AND IMPLEMENTATION OF POOLED AND CUSTOM SWEEPSTAKES, CONTESTS, MARKETING REFERRAL PROGRAMS, COUPONS, AND PROMOTIONAL PRODUCTS; DEVELOPING AND PLACING ADVERTISEMENTS FOR OTHERS REGARDING SWEEPSTAKES, CONTESTS, MAR-

KETING REFERRAL PROGRAMS, COUPONS, AND PROMOTIONAL PRODUCTS; AND, COMPILING AND ANALYZING THE DATA GATHERED FROM PARTICIPANTS IN SWEEPSTAKES, CONTESTS, MARKETING REFERRAL PROGRAMS, COUPONS, AND PROMOTIONAL PRODUCTS, IN CLASS 35 (U.S. CLS. 100, 101 AND 102).

FIRST USE 4-0-1999; IN COMMERCE 4-0-1999.

SER. NO. 76-516,849, FILED 5-23-2003.

G. T. GLYNN, EXAMINING ATTORNEY

Int. Cls.: 9 and 18

Prior U.S. Cls.: 1, 2, 3, 21, 22, 23, 26, 36, 38 and 41

United States Patent and Trademark Office

Reg. No. 2,892,759

Registered Oct. 12, 2004

**TRADEMARK
PRINCIPAL REGISTER**

BECAUSE BUSINESS BECOMES HER

J. DE S., INC. (NEW YORK CORPORATION)
18 WEST 21ST STREET, SUITE 801
NEW YORK, NY 10010

FOR: CARRYING CASES FOR COMPUTERS,
ELECTRONIC ORGANIZERS, PERSONAL DATA
ASSISTANTS ("PDA") AND BEEPERS, IN CLASS 9
(U.S. CLS. 21, 23, 26, 36 AND 38).

FIRST USE 1-31-2003; IN COMMERCE 1-31-2003.

FOR: LEATHER BAGS, CARRYING CASES FOR
CREDIT CARDS AND BUSINESS CARDS, WAL-
LETS, PURSES AND BRIEFCASE-TYPE PORTFO-
LIOS, IN CLASS 18 (U.S. CLS. 1, 2, 3, 22 AND 41).

FIRST USE 1-31-2003; IN COMMERCE 1-31-2003.

SER. NO. 76-517,066, FILED 5-1-2003.

MARC LEIPZIG, EXAMINING ATTORNEY

Int. Cl.: 35

Prior U.S. Cls.: 100, 101 and 102

United States Patent and Trademark Office

Reg. No. 2,892,760

Registered Oct. 12, 2004

**SERVICE MARK
PRINCIPAL REGISTER**

HOME IMPROVEMENT GALLERY

HOME IMPROVEMENT GALLERY, INC. (NEW
YORK CORPORATION)
10 SARATOGA AVE.
SOUTH GLENS FALLS, NY 12803

FIRST USE 5-1-1993; IN COMMERCE 5-1-1993.

SEC. 2(F).

FOR: RETAIL STORE SERVICES FEATURING
WINDOWS, SIDING, ROOFING, CARPETING,
HARDWOOD FLOORING, LAMINATE, AND VI-
NYL FLOORING, IN CLASS 35 (U.S. CLS. 100, 101
AND 102).

SER. NO. 76-517,168, FILED 5-28-2003.

TARAH HARDY, EXAMINING ATTORNEY

Int. Cl.: 36

Prior U.S. Cls.: 100, 101 and 102

United States Patent and Trademark Office

Reg. No. 2,892,761

Registered Oct. 12, 2004

**SERVICE MARK
PRINCIPAL REGISTER**

CIRCLE BANK

NOVATO COMMUNITY BANK (CALIFORNIA
CORPORATION)
1400 GRANT AVENUE, SUITE A
NOVATO, CA 94945

NO CLAIM IS MADE TO THE EXCLUSIVE
RIGHT TO USE BANK, APART FROM THE MARK
AS SHOWN.

FOR: BANKING SERVICES, IN CLASS 36 (U.S.
CLS. 100, 101 AND 102).

SER. NO. 76-517,295, FILED 5-27-2003.

FIRST USE 12-15-2003; IN COMMERCE 12-15-2003.

MATTHEW KLINE, EXAMINING ATTORNEY

Int. Cl.: 9

Prior U.S. Cls.: 21, 23, 26, 36 and 38

United States Patent and Trademark Office

Reg. No. 2,892,762

Registered Oct. 12, 2004

**TRADEMARK
PRINCIPAL REGISTER**

CONFIDENTIAL CONVERSATIONS

AMERICAN MARKETING SYSTEMS, INC. (ILLI-
NOIS CORPORATION)
7020 HIGH GROVE BOULEVARD
BURR RIDGE, IL 60527

FOR: PRERECORDED CASSETTE TAPES, AND
COMPACT DISKS ON THE SUBJECT OF REAL
ESTATE INVESTING, IN CLASS 9 (U.S. CLS. 21, 23,
26, 36 AND 38).

FIRST USE 0-0-1996; IN COMMERCE 0-0-1996.

NO CLAIM IS MADE TO THE EXCLUSIVE
RIGHT TO USE CONVERSATIONS, APART FROM
THE MARK AS SHOWN.

SER. NO. 76-517,398, FILED 5-28-2003.

STEVEN BERK, EXAMINING ATTORNEY

Int. Cl.: 9

Prior U.S. Cls.: 21, 23, 26, 36 and 38

United States Patent and Trademark Office

Reg. No. 2,892,763

Registered Oct. 12, 2004

**TRADEMARK
PRINCIPAL REGISTER**

RPM REVPAR MAXIMIZER

CHOICE HOTELS INTERNATIONAL, INC. (DE-
LAWARE CORPORATION)
10750 COLUMBIA PIKE
SILVER SPRING, MD 20901

FOR: COMPUTER SOFTWARE AND INSTRU-
CTIONS MANUAL SOLD AS A UNIT FOR FORE-
CASTING ASSOCIATED WITH HOTEL AND
MOTEL RESERVATIONS, IN CLASS 9 (U.S. CLS.
21, 23, 26, 36 AND 38).

FIRST USE 0-0-1997; IN COMMERCE 0-0-1997.

NO CLAIM IS MADE TO THE EXCLUSIVE
RIGHT TO USE "REVPAR", APART FROM THE
MARK AS SHOWN.

SER. NO. 76-517,400, FILED 5-27-2003.

CHARLES L. JENKINS, EXAMINING ATTORNEY

Int. Cls.: 35 and 43

Prior U.S. Cls.: 100, 101 and 102

United States Patent and Trademark Office

Reg. No. 2,892,764

Registered Oct. 12, 2004

SERVICE MARK
PRINCIPAL REGISTER



CHOICE HOTELS INTERNATIONAL, INC. (DE-
LAWARE CORPORATION)
10750 COLUMBIA PIKE
SILVER SPRING, MD 20901

FOR: FRANCHISING, NAMELY OFFERING
TECHNICAL ASSISTANCE IN THE ESTABLISH-
MENT AND/OR OPERATION OF HOTELS AND
MOTELS, IN CLASS 35 (U.S. CLS. 100, 101 AND 102).

FIRST USE 2-0-2001; IN COMMERCE 2-0-2001.

FOR: HOTEL AND MOTEL SERVICES, IN CLASS
43 (U.S. CLS. 100 AND 101).

FIRST USE 2-0-2001; IN COMMERCE 2-0-2001.

OWNER OF U.S. REG. NOS. 1,316,274, 2,729,999
AND OTHERS.

NO CLAIM IS MADE TO THE EXCLUSIVE
RIGHT TO USE "HOTELS INTERNATIONAL",
"INN", "SUITES", AND "LODGE", APART FROM
THE MARK AS SHOWN.

SER. NO. 76-517,407, FILED 5-27-2003.

KELLEY WELLS, EXAMINING ATTORNEY

Int. Cl.: 37

Prior U.S. Cls.: 100, 103 and 106

United States Patent and Trademark Office

Reg. No. 2,892,765

Registered Oct. 12, 2004

**SERVICE MARK
PRINCIPAL REGISTER**



Hawthorne Greene

HAWTHORNE GREENE, LLC (MARYLAND LTD
LIAB CO)
P.O. BOX 70
9400 IRVING ROAD
BEL ALTON, MD 20611

FOR: RESIDENTIAL BUILDING CONSTRUCTION; CUSTOM BUILDING CONSTRUCTION AND RESIDENTIAL RENOVATION; CONSTRUCTION SERVICES, NAMELY, PLANNING, LAYING OUT AND CUSTOM CONSTRUCTION OF RESIDENTIAL COMMUNITIES, AND LAND DEVELOPMENT SERVICES, NAMELY, PLANNING AND LAYING OUT OF SENIOR RESIDENTIAL COMMUNITIES, IN CLASS 37 (U.S. CLS. 100, 103 AND 106).

FIRST USE 7-1-2002; IN COMMERCE 7-1-2002.

THE COLOR(S) BLACK, BEIGE, GREEN AND BROWN IS/ARE CLAIMED AS A DISTINCTIVE FEATURE OF THE MARK.

THE MARK CONSISTS OF BLACK LETTER HG ENTWINED WITH GREEN BRANCH ON BEIGE OVAL BACKGROUND OUTLINED IN BROWN.

THE MARK CONSISTS OF BLACK LETTER HG ENTWINED WITH GREEN BRANCH ON BEIGE OVAL BACKGROUND OUTLINED IN BROWN.

SER. NO. 76-517,617, FILED 5-27-2003.

TARAH HARDY, EXAMINING ATTORNEY

Int. Cl.: 11

Prior U.S. Cls.: 13, 21, 23, 31 and 34

United States Patent and Trademark Office

Reg. No. 2,892,766

Registered Oct. 12, 2004

TRADEMARK
PRINCIPAL REGISTER



LITEX INDUSTRIES, INCORPORATED (TEXAS CORPORATION)
3401 W. TRINITY BLVD.
GRAND PRAIRIE, TX 75050

FOR: CEILING FANS, CEILING FANS WITH ELECTRIC LIGHT FIXTURES, ELECTRIC LIGHT FIXTURES FOR CEILING FANS, AND CEILING FAN KITS COMPRISED OF CEILING FANS, ELECTRIC LIGHT FIXTURES, WIRING AND MOUNTING BRACKETS SOLD AS A UNIT; ELECTRIC LIGHTING, NAMELY, WALL CEILING AND PEN-

DANT LIGHTING FIXTURES, IN CLASS 11 (U.S. CLS. 13, 21, 23, 31 AND 34).

FIRST USE 5-28-2003; IN COMMERCE 5-28-2003.

NO CLAIM IS MADE TO THE EXCLUSIVE RIGHT TO USE "INDUSTRIES", APART FROM THE MARK AS SHOWN.

SER. NO. 76-517,963, FILED 5-29-2003.

H. M. FISHER, EXAMINING ATTORNEY

Int. Cl.: 43

Prior U.S. Cls.: 100 and 101

United States Patent and Trademark Office

Reg. No. 2,892,767

Registered Oct. 12, 2004

**SERVICE MARK
PRINCIPAL REGISTER**

THE LAZY DOG CAFE

CWH COMPANY, LLC (CALIFORNIA LTD LIAB
CO)
16310 BEACH BLVD.
WESTMINSTER, CA 926837857

NO CLAIM IS MADE TO THE EXCLUSIVE
RIGHT TO USE "CAFE", APART FROM THE MARK
AS SHOWN.

FOR: RESTAURANT AND CAFE SERVICES, IN
CLASS 43 (U.S. CLS. 100 AND 101).

SER. NO. 76-518,325, FILED 6-2-2003.

FIRST USE 9-15-2002; IN COMMERCE 9-15-2002.

CHARLES L. JENKINS, EXAMINING ATTORNEY

Int. Cl.: 9

Prior U.S. Cls.: 21, 23, 26, 36 and 38

United States Patent and Trademark Office

Reg. No. 2,892,768

Registered Oct. 12, 2004

**TRADEMARK
PRINCIPAL REGISTER**

ACG CHAPTER CONNECT

ASSOCIATION FOR CORPORATE GROWTH,
INC. (NEW YORK CORPORATION)
1926 WAUKEGAN ROAD
SUITE 1
GLENVIEW, IL 60025

FOR: COMPUTER PROGRAMS, NAMELY, FOR
USE IN DATABASE MANAGEMENT OF CHAPTER
MEMBERSHIP AND PROGRAM INFORMATION
AND FOR ELECTRONIC COMMUNICATION BE-
TWEEN CHAPTERS, IN CLASS 9 (U.S. CLS. 21, 23, 26,
36 AND 38).

FIRST USE 5-1-2002; IN COMMERCE 5-1-2002.

NO CLAIM IS MADE TO THE EXCLUSIVE
RIGHT TO USE "CHAPTER", APART FROM THE
MARK AS SHOWN.

SER. NO. 76-518,875, FILED 5-8-2003.

STANLEY I. OSBORNE, EXAMINING ATTORNEY

Int. Cl.: 9

Prior U.S. Cls.: 21, 23, 26, 36 and 38

United States Patent and Trademark Office

Reg. No. 2,892,769

Registered Oct. 12, 2004

TRADEMARK
PRINCIPAL REGISTER



MARCUS, BARBARA E. (UNITED STATES INDIVIDUAL)
25852 MCBEAN PARKWAY, SUITE 732
VALENCIA, CA 91355

FOR: PRE-RECORDED VIDEO TAPES, DVD'S, AND CD'S FEATURING ENTERTAINMENT IN THE NATURE OF CLASSICAL MUSIC FOR BABIES AND TODDLERS AND EDUCATIONAL INFORMATION IN THE NATURE OF STIMULATING A BABY'S SENSES, HELPING THE DEVELOPMENT OF A BABY'S BRAIN, TEACHING PARENTS AC-

TIVITIES AND INTERACTION WITH CHILDREN, IN CLASS 9 (U.S. CLS. 21, 23, 26, 36 AND 38).

FIRST USE 2-10-2000; IN COMMERCE 11-7-2002.

NO CLAIM IS MADE TO THE EXCLUSIVE RIGHT TO USE "BABY", APART FROM THE MARK AS SHOWN.

SER. NO. 76-518,912, FILED 6-2-2003.

KIMBERLY PERRY, EXAMINING ATTORNEY

Int. Cl.: 36

Prior U.S. Cls.: 100, 101 and 102

United States Patent and Trademark Office

Reg. No. 2,892,770

Registered Oct. 12, 2004

**SERVICE MARK
PRINCIPAL REGISTER**



CAUSEFORCE, INC. (CALIFORNIA CORPORATION)
2709 MEDIA CENTER DRIVE
LOS ANGELES, CA 90065

OTHER EVENTS, IN CLASS 36 (U.S. CLS. 100, 101 AND 102).

FIRST USE 11-19-2002; IN COMMERCE 11-19-2002.

FOR: CONSULTATION SERVICES IN THE FIELD OF CHARITABLE FUNDRAISING FEATURING WALK-A-THONS, BICYCLE RIDES, RACES AND

SER. NO. 76-519,075, FILED 5-16-2003.

VERNA BETH RIRIE, EXAMINING ATTORNEY

Int. Cl.: 36

Prior U.S. Cls.: 100, 101 and 102

United States Patent and Trademark Office

Reg. No. 2,892,771

Registered Oct. 12, 2004

**SERVICE MARK
PRINCIPAL REGISTER**

AMTECH RESEARCH

AMERICAN TECHNOLOGY RESEARCH, INC.
(DELAWARE CORPORATION)
53 FOREST AVENUE
OLD GREENWICH, CT 06870

FOR: FINANCIAL SERVICES IN THE NATURE
OF RESEARCH, ANALYSIS AND REPORTING OF
FINANCIAL INFORMATION; BROKERAGE
HOUSE SERVICES IN THE FIELD OF STOCKS
AND BONDS, AS WELL AS OTHER INVESTMENT
VEHICLES; INVESTMENT OF FUNDS FOR OTH-
ERS; INVESTMENT MANAGEMENT AND CON-

SULTATION, IN CLASS 36 (U.S. CLS. 100, 101 AND
102).

FIRST USE 9-0-2002; IN COMMERCE 9-0-2002.

NO CLAIM IS MADE TO THE EXCLUSIVE
RIGHT TO USE RESEARCH, APART FROM THE
MARK AS SHOWN.

SER. NO. 76-519,192, FILED 6-3-2003.

HOWARD SMIGA, EXAMINING ATTORNEY

Int. Cls.: 7 and 9

Prior U.S. Cls.: 13, 19, 21, 23, 26, 31, 34, 35, 36 and 38

Reg. No. 2,892,772

United States Patent and Trademark Office

Registered Oct. 12, 2004

**TRADEMARK
PRINCIPAL REGISTER**

SUPER ATD

OBARA CORPORATION (JAPAN CORPORATION)
4-2-37 OGAMI, AYASE-SHI
KANAGAWA-KEN 252-1104, JAPAN

FOR: ELECTRIC WELDING MACHINES, IN CLASS 7 (U.S. CLS. 13, 19, 21, 23, 31, 34 AND 35).

FOR: ELECTRIC ARC WELDERS AND ACCESSORIES THEREFOR, NAMELY, WELDING ELECTRODES AND WELDING TORCHES, IN CLASS 9 (U.S. CLS. 21, 23, 26, 36 AND 38).

OWNER OF JAPAN REG. NO. 4609815, DATED 10-4-2002, EXPIRES 10-4-2012.

SER. NO. 76-519,264, FILED 5-21-2003.

MITCHELL FRONT, EXAMINING ATTORNEY

Int. Cl.: 29

Prior U.S. Cl.: 46

United States Patent and Trademark Office

Reg. No. 2,892,773

Registered Oct. 12, 2004

TRADEMARK
PRINCIPAL REGISTER

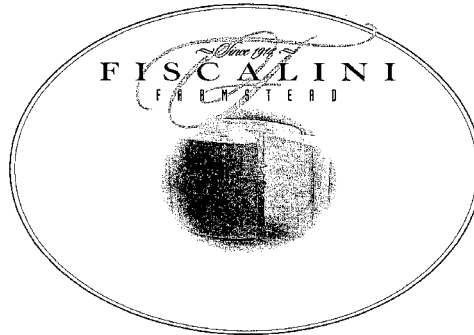

FISCALINI CHEESE COMPANY, LLC (CALIFORNIA LTD LIAB CO)
7231 COVERT ROAD
MODESTO, CA 95358

FOR: CHEESE AND CHEESE PRODUCTS, NAME-
LY, CHEESE SPREADS AND CHEESE DIPS, IN
CLASS 29 (U.S. CL. 46).

FIRST USE 11-1-2002; IN COMMERCE 11-1-2002.

NO CLAIM IS MADE TO THE EXCLUSIVE
RIGHT TO USE "SINCE 1914" AND "FARMSTEAD",
APART FROM THE MARK AS SHOWN.

THE MARK CONSISTS OF A "ROUND" OF
CHEESE WHICH IS CUT AND A WEDGE IS
PULLED OUT SLIGHTLY, WITH THE WORDS
"FISCALINI FARMSTEAD" ABOVE IT.

SER. NO. 76-519,438, FILED 5-19-2003.

JOHN HWANG, EXAMINING ATTORNEY

Int. Cl.: 19

Prior U.S. Cls.: 1, 12, 33 and 50

United States Patent and Trademark Office

Reg. No. 2,892,774

Registered Oct. 12, 2004

**TRADEMARK
PRINCIPAL REGISTER**

ROCKY MOUNTAIN DRY

MACDONALD LUMBER COMPANY (COLORADO CORPORATION)
929 WEST 1ST AVENUE
DENVER, CO 80223

NO CLAIM IS MADE TO THE EXCLUSIVE RIGHT TO USE "DRY", APART FROM THE MARK AS SHOWN.

FOR: HARDWOOD FLOORING, IN CLASS 19 (U.S. CLS. 1, 12, 33 AND 50).

SER. NO. 76-519,510, FILED 5-12-2003.

FIRST USE 1-1-1998; IN COMMERCE 1-1-1998.

TONJA GASKINS, EXAMINING ATTORNEY

Int. Cls.: 9 and 12

Prior U.S. Cls.: 19, 21, 23, 26, 31, 35, 36, 38 and 44

United States Patent and Trademark Office

Reg. No. 2,892,775

Registered Oct. 12, 2004

**TRADEMARK
PRINCIPAL REGISTER**

DAMPMATIC

THYSSENKRUPP BILSTEIN GMBH (FED REP
GERMANY CORPORATION)
AUGUST-BILSTEIN-STR. 4
D-58256 ENNEPETAL, FED REP GERMANY

FOR: ELECTRIC AND ELECTRONIC CONTROLS
FOR CONTROLLING DAMPING DEVICES FOR
WHEEL SUSPENSIONS AND SHOCK ABSORBERS
, IN CLASS 9 (U.S. CLS. 21, 23, 26, 36 AND 38).

FOR: MOTOR LAND VEHICLE AND TRACK-
GUIDED LAND VEHICLE PARTS NAMELY CHAS-
SIS DAMPING DEVICES, HYDRAULIC SHOCK

ABSORBERS, PNEUMATIC SHOCK ABSORBERS,
IN CLASS 12 (U.S. CLS. 19, 21, 23, 31, 35 AND 44).

PRIORITY CLAIMED UNDER SEC. 44(D) ON FED
REP GERMANY APPLICATION NO. 30260041.8/1,
FILED 12-6-2002, REG. NO. 30260041, DATED 2-13-
2003, EXPIRES 12-31-2012.

SER. NO. 76-520,330, FILED 5-21-2003.

CHRISTOPHER BUONGIORNO, EXAMINING AT-
TORNEY

Int. Cls.: 16 and 41

Prior U.S. Cls.: 2, 5, 22, 23, 29, 37, 38, 50, 100, 101 and 107

Reg. No. 2,892,776

United States Patent and Trademark Office

Registered Oct. 12, 2004

**TRADEMARK
SERVICE MARK
PRINCIPAL REGISTER**

STRAIGHT OFF THE WIRE

AMERICAN ASSOCIATION OF ORTHODONTISTS (MISSOURI NOT FOR PROFIT CORPORATION)

401 NORTH LINDBERGH BOULEVARD
ST. LOUIS, MO 631417816

FOR: PRINTED PUBLICATIONS, NAMELY, NEWSLETTERS AND MAGAZINES IN THE FIELD OF ORTHODONTICS, IN CLASS 16 (U.S. CLS. 2, 5, 22, 23, 29, 37, 38 AND 50).

FIRST USE 5-4-1995; IN COMMERCE 5-4-1995.

FOR: PROVIDING NON-DOWNLOADABLE NEWSLETTERS AND MAGAZINES IN THE FIELD OF ORTHODONTICS; PROVIDING NEWSLETTERS AND MAGAZINES IN THE FIELD OF ORTHODONTICS, VIA EMAIL, IN CLASS 41 (U.S. CLS. 100, 101 AND 107).

FIRST USE 5-4-1995; IN COMMERCE 5-4-1995.

SER. NO. 76-520,418, FILED 5-27-2003.

MARIA-VICTORIA SUAREZ, EXAMINING ATTORNEY

Int. Cl.: 30

Prior U.S. Cl.: 46

United States Patent and Trademark Office

Reg. No. 2,892,777

Registered Oct. 12, 2004

**TRADEMARK
PRINCIPAL REGISTER**

MZ. LEEZA

KAHN, LISA (NEW YORK CORPORATION)
6 PINE DRIVE
WOODBURY, NY 11797

FOR: CONDIMENTS, NAMELY, MINCED SWEET
SHALLOT, MINCED GARLIC, POWDERED SWEET
SHALLOT, POWDERED GARLIC; SAUCES, NAME-
LY, MARINADE AND BARBECUE SAUCE, IN
CLASS 30 (U.S. CL. 46).

FIRST USE 5-1-2002; IN COMMERCE 5-1-2002.

THE NAME MZ. LEEZA DOES NOT IDENTIFY A
LIVING INDIVIDUAL.

SER. NO. 76-520,842, FILED 5-27-2003.

ALLISON HOLTZ, EXAMINING ATTORNEY

Int. Cl.: 43

Prior U.S. Cls.: 100 and 101

United States Patent and Trademark Office

Reg. No. 2,892,778

Registered Oct. 12, 2004

**SERVICE MARK
PRINCIPAL REGISTER**

ANDREW'S OPEN PIT & SPIRITS

JIMMY'S RESTAURANT & LOUNGE, INC. (ILLI-
NOIS CORPORATION)
910 NORTH MILWAUKEE AVENUE
WHEELING, IL 60090

NO CLAIM IS MADE TO THE EXCLUSIVE
RIGHT TO USE "OPEN PIT & SPIRITS", APART
FROM THE MARK AS SHOWN.

FOR: RESTAURANT SERVICES, IN CLASS 43
(U.S. CLS. 100 AND 101).

SER. NO. 76-521,030, FILED 6-6-2003.

FIRST USE 12-31-1995; IN COMMERCE 12-31-1995.

GLENN CLARK, EXAMINING ATTORNEY

Int. Cl.: 35

Prior U.S. Cls.: 100, 101 and 102

United States Patent and Trademark Office

Reg. No. 2,892,779

Registered Oct. 12, 2004

**SERVICE MARK
PRINCIPAL REGISTER**

AJCCCLASSIFIEDS.COM

COX ENTERPRISES, INC. (DELAWARE CORPORATION)
6205 PEACHTREE DUNWOODY ROAD
ATLANTA, GA 30328

FOR: PROVIDING CLASSIFIED ADVERTISEMENTS AND RELATED INFORMATION ONLINE VIA THE INTERNET FOR THE GOODS AND SERVICES OF OTHERS IN THE FIELDS OF AUTOMOBILES, TRUCKS, MOTORCYCLES, BUSES AND OTHER VEHICLES, AND PARTS AND FINANCING THEREFOR, EMPLOYMENT, REAL ESTATE, GENERAL MERCHANDISE, PETS, RECREATIONAL

SERVICES AND PET SERVICES, IN CLASS 35 (U.S. CLS. 100, 101 AND 102).

FIRST USE 4-14-2003; IN COMMERCE 4-14-2003.

OWNER OF U.S. REG. NOS. 2,350,258, 2,781,346 AND OTHERS.

SER. NO. 76-521,051, FILED 6-6-2003.

G. MAYERSCHOFF, EXAMINING ATTORNEY

Int. Cl.: 14

Prior U.S. Cls.: 2, 27, 28 and 50

Reg. No. 2,892,780

United States Patent and Trademark Office

Registered Oct. 12, 2004

**TRADEMARK
PRINCIPAL REGISTER**



KORNBLAU, KATHERINE JANE (UNITED STATES INDIVIDUAL)
201 EAST 79TH STREET
NEW YORK, NY 10021

NO CLAIM IS MADE TO THE EXCLUSIVE RIGHT TO USE "NEW YORK" , APART FROM THE MARK AS SHOWN.

FOR: JEWELRY, IN CLASS 14 (U.S. CLS. 2, 27, 28 AND 50).

SER. NO. 76-521,303, FILED 5-30-2003.

FIRST USE 8-1-1990; IN COMMERCE 9-1-1990.

JAMES A. RAUEN, EXAMINING ATTORNEY

Int. Cl.: 3

Prior U.S. Cls.: 1, 4, 6, 50, 51 and 52

United States Patent and Trademark Office

Reg. No. 2,892,781

Registered Oct. 12, 2004

**TRADEMARK
PRINCIPAL REGISTER**

VOTIVO FLOWERS

VOTIVO, LTD. (WASHINGTON CORPORATION)
3450 4TH AVENUE S.
SEATTLE, WA 98134

NO CLAIM IS MADE TO THE EXCLUSIVE
RIGHT TO USE "FLOWERS", APART FROM THE
MARK AS SHOWN.

FOR: SCENTED BODY SOAPS AND SPRAYS, IN
CLASS 3 (U.S. CLS. 1, 4, 6, 50, 51 AND 52).

SER. NO. 76-521,378, FILED 6-9-2003.

FIRST USE 12-18-2000; IN COMMERCE 12-18-2000.

OWNER OF U.S. REG. NO. 2,758,447.

JAMES GRIFFIN, EXAMINING ATTORNEY

Int. Cls.: 41 and 44

Prior U.S. Cls.: 100, 101 and 107

United States Patent and Trademark Office

Reg. No. 2,892,782

Registered Oct. 12, 2004

SERVICE MARK
PRINCIPAL REGISTER



KEYS GROUP HOLDINGS, LLC (DELAWARE
LTD LIAB CO)
3401 WEST END AVENUE, SUITE 400
NASHVILLE, TN 37203

FOR: EDUCATIONAL SERVICES, NAMELY,
PROVIDING COURSES OF INSTRUCTION AT
THE PRIMARY AND SECONDARY LEVEL TO AT-
RISK STUDENTS IN GRADES K-12 IN DAY
SCHOOLS OR RESIDENTIAL SCHOOLS, IN CLASS
41 (U.S. CLS. 100, 101 AND 107).

FIRST USE 1-31-2003; IN COMMERCE 1-31-2003.

FOR: TREATMENT SERVICES FOR AT-RISK
AND TROUBLED YOUTHS, NAMELY, PSYCHIA-
TRIC BEHAVIORAL HEALTH CARE, COUNSEL-

ING IN THE FIELD OF BEHAVIORAL HEALTH
CARE, AND SUBSTANCE ABUSE TREATMENT,
PROVIDED THROUGH DAY SCHOOLS, RESIDEN-
TIAL SCHOOLS AND YOUTH CENTERS, IN CLASS
44 (U.S. CLS. 100 AND 101).

FIRST USE 1-31-2003; IN COMMERCE 1-31-2003.

NO CLAIM IS MADE TO THE EXCLUSIVE
RIGHT TO USE WHERE KIDS COME FIRST,
APART FROM THE MARK AS SHOWN.

SER. NO. 76-521,522, FILED 6-9-2003.

TRACY CROSS, EXAMINING ATTORNEY

Int. Cl.: 41

Prior U.S. Cls.: 100, 101 and 107

United States Patent and Trademark Office

Reg. No. 2,892,783

Registered Oct. 12, 2004

**SERVICE MARK
PRINCIPAL REGISTER**



NATIONAL COMMUNITY PHARMACISTS AS-
SOCIATION (VIRGINIA NOT-FOR-PROFIT
CORPORATION)
205 DAINGERFIELD ROAD
ALEXANDRIA, VA 223142885

FOR: PROVIDING INFORMATION FOR COM-
MUNITY PHARMACISTS RELATIVE TO PROFES-
SIONAL EDUCATION, IN CLASS 41 (U.S. CLS. 100,
101 AND 107).

FIRST USE 5-27-2003; IN COMMERCE 5-27-2003.

NO CLAIM IS MADE TO THE EXCLUSIVE
RIGHT TO USE "PHARMACIST" AND "ELINK",
APART FROM THE MARK AS SHOWN.

SER. NO. 76-521,723, FILED 6-10-2003.

MATTHEW KLINE, EXAMINING ATTORNEY

Int. Cl.: 41

Prior U.S. Cls.: 100, 101 and 107

United States Patent and Trademark Office

Reg. No. 2,892,784

Registered Oct. 12, 2004

**SERVICE MARK
PRINCIPAL REGISTER**



NATIONAL COMMUNITY PHARMACISTS AS-
SOCIATION (VIRGINIA NOT-FOR-PROFIT
CORPORATION)
205 DAINGERFIELD ROAD
ALEXANDRIA, VA 223142885

FOR: PROVIDING INFORMATION FOR COM-
MUNITY PHARMACISTS RELATIVE TO PROFES-
SIONAL EDUCATION, IN CLASS 41 (U.S. CLS. 100,
101 AND 107).

FIRST USE 5-27-2003; IN COMMERCE 5-27-2003.

NO CLAIM IS MADE TO THE EXCLUSIVE
RIGHT TO USE "ELINK", APART FROM THE
MARK AS SHOWN.

SER. NO. 76-521,784, FILED 6-10-2003.

MATTHEW KLINE, EXAMINING ATTORNEY

Int. Cl.: 35

Prior U.S. Cls.: 100, 101 and 102

United States Patent and Trademark Office

Reg. No. 2,892,785

Registered Oct. 12, 2004

**SERVICE MARK
PRINCIPAL REGISTER**



NATIONAL COMMUNITY PHARMACISTS AS-
SOCIATION (VIRGINIA NOT-FOR-PROFIT
CORPORATION)
205 DAINGERFIELD ROAD
ALEXANDRIA, VA 223142885

FOR: PROVIDING INFORMATION FOR COM-
MUNITY PHARMACISTS RELATIVE TO PRODUCT
INFORMATION AND PREFERRED SOURCES, RE-
SOURCE ABOUT PATIENT CARE, BUSINESS SUP-
PORT, AND PROMOTING THE INTERESTS OF
COMMUNITY PHARMACISTS, IN CLASS 35 (U.S.
CLS. 100, 101 AND 102).

FIRST USE 5-27-2003; IN COMMERCE 5-27-2003.

NO CLAIM IS MADE TO THE EXCLUSIVE
RIGHT TO USE "ELINK", APART FROM THE
MARK AS SHOWN.

SER. NO. 76-521,797, FILED 6-10-2003.

JOHN HWANG, EXAMINING ATTORNEY

Int. Cl.: 35

Prior U.S. Cls.: 100, 101 and 102

United States Patent and Trademark Office

Reg. No. 2,892,786

Registered Oct. 12, 2004

**SERVICE MARK
PRINCIPAL REGISTER**



NATIONAL COMMUNITY PHARMACISTS AS-
SOCIATION (VIRGINIA NOT-FOR-PROFIT
CORPORATION)
205 DAINGERFIELD ROAD
ALEXANDRIA, VA 223142885

FOR: PROVIDING INFORMATION FOR COM-
MUNITY PHARMACISTS RELATIVE TO PRODUCT
INFORMATION AND PREFERRED SOURCES, RE-
SOURCES ABOUT PATIENT CARE, BUSINESS SUP-
PORT, AND PROMOTING THE INTERESTS OF
COMMUNITY PHARMACISTS, IN CLASS 35 (U.S.
CLS. 100, 101 AND 102).

FIRST USE 5-27-2003; IN COMMERCE 5-27-2003.

NO CLAIM IS MADE TO THE EXCLUSIVE
RIGHT TO USE "PHARMACIST" AND "ELINK",
APART FROM THE MARK AS SHOWN.

SER. NO. 76-521,798, FILED 6-10-2003.

JOHN HWANG, EXAMINING ATTORNEY

Int. Cl.: 36

Prior U.S. Cls.: 100, 101 and 102

United States Patent and Trademark Office

Reg. No. 2,892,787

Registered Oct. 12, 2004

**SERVICE MARK
PRINCIPAL REGISTER**

GLOBAL ● PAYLINK

RUESCH HOLDING, INC. (DELAWARE CORPORATION)
700 ELEVENTH STREET, N.W.
WASHINGTON, DC 20001

FOR: BUSINESS-TO-BUSINESS SERVICES, NAMELY PLATFORM FOR FOREIGN EXCHANGE SERVICES OF BANKS, PROCESSING OF OUT-SOURCED FOREIGN EXCHANGE SERVICES OF BANKS, IN CLASS 36 (U.S. CLS. 100, 101 AND 102).

FIRST USE 10-15-2002; IN COMMERCE 11-18-2002.

NO CLAIM IS MADE TO THE EXCLUSIVE RIGHT TO USE GLOBAL, APART FROM THE MARK AS SHOWN.

SER. NO. 76-521,978, FILED 6-11-2003.

DEZMONA MIZELLE, EXAMINING ATTORNEY

Int. Cl.: 5

Prior U.S. Cls.: 6, 18, 44, 46, 51 and 52

United States Patent and Trademark Office

Reg. No. 2,892,788

Registered Oct. 12, 2004

**TRADEMARK
PRINCIPAL REGISTER**

WHEN YOU NEED AN EDGE

IMMUNOTEC RESEARCH LTD. (CANADA COMPANY)
292 ADRIEN PATENAUDE
VAUDREUIL-DORION, QUEBEC, J7V 5V5, CANADA

FOR: LIQUID HERBAL SUPPLEMENTS IN THE NATURE OF HERBAL TONICS FOR HUMAN CONSUMPTION; LIQUID DIETARY SUPPLEMENTS, NAMELY, HERBAL ENERGY DRINKS, IN CLASS 5 (U.S. CLS. 6, 18, 44, 46, 51 AND 52).

FIRST USE 3-1-2002; IN COMMERCE 3-1-2002.

PRIORITY CLAIMED UNDER SEC. 44(D) ON CANADA APPLICATION NO. 1175534, FILED 4-22-2003.

SER. NO. 76-522,147, FILED 6-11-2003.

G. T. GLYNN, EXAMINING ATTORNEY

Int. Cl.: 28

Prior U.S. Cls.: 22, 23, 38 and 50

United States Patent and Trademark Office

Reg. No. 2,892,789

Registered Oct. 12, 2004

**TRADEMARK
PRINCIPAL REGISTER**

BUNGEEBOUNCER

WORLDWISE, INC. (CALIFORNIA CORPORATION)
160 MITCHELL BLVD.
SAN RAFAEL, CA 949032044

FIRST USE 1-31-2003; IN COMMERCE 1-31-2003.

SER. NO. 76-522,476, FILED 6-13-2003.

FOR: PET TOY, NAMELY, A STRETCHABLE
CORD FOR USE BY DOMESTIC CATS, IN CLASS
28 (U.S. CLS. 22, 23, 38 AND 50).

MARY ROSSMAN, EXAMINING ATTORNEY

Int. Cl.: 38

Prior U.S. Cls.: 100, 101 and 104

United States Patent and Trademark Office

Reg. No. 2,892,790

Registered Oct. 12, 2004

**SERVICE MARK
PRINCIPAL REGISTER**

FIN FRANCHISE INFORMATION NETWORK

PINCH A PENNY, INC. (FLORIDA CORPORATION)
14480 - 62ND STREET NORTH
CLEARWATER, FL 33760

NO CLAIM IS MADE TO THE EXCLUSIVE
RIGHT TO USE FRANCHISE INFORMATION NET-
WORK, APART FROM THE MARK AS SHOWN.

FOR: COMMUNICATIONS SERVICES, NAMELY,
ELECTRONIC TRANSMISSION OF DATA AND
DOCUMENTS AMONG USERS OF AN EXTRA-
NET, IN CLASS 38 (U.S. CLS. 100, 101 AND 104).

SER. NO. 76-522,964, FILED 6-17-2003.

FIRST USE 6-15-2003; IN COMMERCE 6-15-2003.

MICHAEL SOUDERS, EXAMINING ATTORNEY

Int. Cl.: 41

Prior U.S. Cls.: 100, 101 and 107

United States Patent and Trademark Office

Reg. No. 2,892,791

Registered Oct. 12, 2004

**SERVICE MARK
PRINCIPAL REGISTER**

COMPASSIONWORKS

COMPASSION INTERNATIONAL, INC. (ILLI-
NOIS NON-PROFIT CORPORATION)
12290 VOYAGER PARKWAY
P.O. BOX 65000
COLORADO SPRINGS, CO 809625000

FOR: EDUCATIONAL SERVICES, NAMELY
SEMINARS AND CONFERENCES ADDRESSING
MINISTERING TO URBAN YOUTH AND YOUTH
LEADERS ON POVERTY, SPIRITUALITY AND
YOUTH DEVELOPMENT ISSUES, IN CLASS 41
(U.S. CLS. 100, 101 AND 107).

FIRST USE 3-31-2001; IN COMMERCE 3-31-2001.

OWNER OF U.S. REG. NOS. 850,777, 2,669,765 AND
OTHERS.

SER. NO. 76-523,033, FILED 6-6-2003.

BRIAN BROWN, EXAMINING ATTORNEY

Int. Cl.: 29

Prior U.S. Cl.: 46

United States Patent and Trademark Office

Reg. No. 2,892,792

Registered Oct. 12, 2004

TRADEMARK
PRINCIPAL REGISTER



CIBAO MEAT PRODUCTS, INC. (NEW YORK CORPORATION)
630 ST. ANN'S AVENUE
BRONX, NY 10455

FOR: PROCESSED MEATS, NAMELY SAUSAGE AND SALAMI, IN CLASS 29 (U.S. CL. 46).

FIRST USE 4-0-1996; IN COMMERCE 4-0-1996.

OWNER OF U.S. REG. NO. 2,263,038.

NO CLAIM IS MADE TO THE EXCLUSIVE RIGHT TO USE "CALIDAD" OR "QUALITY", APART FROM THE MARK AS SHOWN.

THE ENGLISH TRANSLATION OF THE WORDS "TRADICION DE CALIDAD" IN THE MARK IS "TRADITION OF QUALITY".

SER. NO. 76-523,039, FILED 6-6-2003.

FRED MANDIR, EXAMINING ATTORNEY

Int. Cls.: 35 and 42

Prior U.S. Cls.: 100, 101 and 102

United States Patent and Trademark Office

Reg. No. 2,892,793

Registered Oct. 12, 2004

**SERVICE MARK
PRINCIPAL REGISTER**



NORCRAFT COMPANIES, L.P. (DELAWARE
LIMITED PARTNERSHIP)
3020 DEMARK AVENUE, SUITE 100
EAGAN, MN 55121

FOR: RETAIL STORE SERVICES IN THE FIELD
OF KITCHEN AND BATH CABINETRY, APPLIAN-
CES, FIXTURES AND COUNTERTOPS, IN CLASS 35
(U.S. CLS. 100, 101 AND 102).

FIRST USE 5-0-2000; IN COMMERCE 5-0-2000.

FOR: DESIGN CONSULTING SERVICES, IN
CLASS 42 (U.S. CLS. 100 AND 101).

FIRST USE 5-0-2000; IN COMMERCE 5-0-2000.

OWNER OF U.S. REG. NOS. 2,072,305, 2,144,891,
AND 2,563,021.

NO CLAIM IS MADE TO THE EXCLUSIVE
RIGHT TO USE KITCHEN&BATH, APART FROM
THE MARK AS SHOWN.

SER. NO. 76-523,476, FILED 6-18-2003.

RAUL CORDOVA, EXAMINING ATTORNEY

Int. Cls.: 44 and 45

Prior U.S. Cls.: 100 and 101

United States Patent and Trademark Office

Reg. No. 2,892,794

Registered Oct. 12, 2004

**SERVICE MARK
PRINCIPAL REGISTER**

EBI

EMPLOYMENT BACKGROUND INVESTIGA-
TIONS, INC. (MARYLAND CORPORATION)
P.O. BOX 629
OWINGS MILLS, MD 21117

FOR: DRUG TESTING FOR SUBSTANCE ABUSE,
IN CLASS 44 (U.S. CLS. 100 AND 101).

FIRST USE 11-15-1994; IN COMMERCE 11-15-1994.

FOR: PRE-EMPLOYMENT SCREENING AND
EMPLOYMENT BACKGROUND INVESTIGATION
SERVICES, IN CLASS 45 (U.S. CLS. 100 AND 101).

FIRST USE 11-15-1994; IN COMMERCE 11-15-1994.

SER. NO. 76-523,561, FILED 5-30-2003.

NAAKWAMA ANKRAH, EXAMINING ATTORNEY

Int. Cl.: 33

Prior U.S. Cls.: 47 and 49

United States Patent and Trademark Office

Reg. No. 2,892,795

Registered Oct. 12, 2004

**TRADEMARK
PRINCIPAL REGISTER**

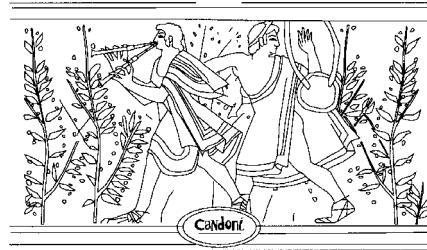

DEAR, INC. (GEORGIA CORPORATION)
3343 PEACHTREE ROAD, SUITE 1139
ATLANTA, GA 30326

OWNER OF U.S. REG. NO. 2,705,582.

FOR: WINES IN GENERAL, IN CLASS 33 (U.S.
CLS. 47 AND 49).

SER. NO. 76-523,967, FILED 6-19-2003.

FIRST USE 8-0-2002; IN COMMERCE 8-0-2002.

SOPHIA S. KIM, EXAMINING ATTORNEY

Int. Cl.: 35

Prior U.S. Cls.: 100, 101 and 102

United States Patent and Trademark Office

Reg. No. 2,892,796

Registered Oct. 12, 2004

**SERVICE MARK
PRINCIPAL REGISTER**

HIT THE STREETS

RECEPTASIGN, LLC (NEW YORK CORPORATION)
C/O CITY MEDIA CONCEPTS, INC.
10-38 46TH ROAD
LONG ISLAND CITY, NY 11101

FOR: PREPARING AND PLACING ADVERTISEMENTS FOR OTHERS ON OUTDOOR TRASH RE-

CEPTACLES, IN CLASS 35 (U.S. CLS. 100, 101 AND 102).

FIRST USE 5-31-2003; IN COMMERCE 5-31-2003.

SER. NO. 76-524,846, FILED 6-20-2003.

SHARI SHEFFIELD, EXAMINING ATTORNEY

Int. Cl.: 38

Prior U.S. Cls.: 100, 101 and 104

United States Patent and Trademark Office

Reg. No. 2,892,797

Registered Oct. 12, 2004

**SERVICE MARK
PRINCIPAL REGISTER**

CF AUDIO

CHROMATIC SOFTWARE, INC. (CANADA CORPORATION)
1190 HORNBY STREET
VANCOUVER, BC, CANADA V6Z 2K5

NO CLAIM IS MADE TO THE EXCLUSIVE RIGHT TO USE AUDIO, APART FROM THE MARK AS SHOWN.

FOR: AUDIO AND VIDEO TELECONFERENCING AND AUDIO AND VIDEO TELECONFERENCING VIA GLOBAL COMPUTER NETWORK, IN CLASS 38 (U.S. CLS. 100, 101 AND 104).

SER. NO. 76-524,868, FILED 6-12-2003.

FIRST USE 3-1-2003; IN COMMERCE 3-1-2003.

CHARLES L. JENKINS, EXAMINING ATTORNEY

Int. Cl.: 35

Prior U.S. Cls.: 100, 101 and 102

United States Patent and Trademark Office

Reg. No. 2,892,798

Registered Oct. 12, 2004

**SERVICE MARK
PRINCIPAL REGISTER**

POWER SEARCH

FRY'S ELECTRONICS, INC. (CALIFORNIA COR-
PORATION)
600 EAST BROKAW ROAD
SAN JOSE, CA 95112

FIRST USE 1-12-2001; IN COMMERCE 1-12-2001.

SER. NO. 76-524,958, FILED 6-23-2003.

FOR: ON-LINE RETAIL STORE SERVICES FEA-
TURING DVD'S, IN CLASS 35 (U.S. CLS. 100, 101
AND 102).

ANN LINNEHAN, EXAMINING ATTORNEY

Int. Cl.: 16

Prior U.S. Cls.: 2, 5, 22, 23, 29, 37, 38 and 50

United States Patent and Trademark Office

Reg. No. 2,892,799

Registered Oct. 12, 2004

**TRADEMARK
PRINCIPAL REGISTER**

RITTENHOUSE

NUVEEN INVESTMENTS, INC. (DELAWARE
CORPORATION)
333 WEST WACKER DRIVE
CHICAGO, IL 60606

FOR: PRINTED PUBLICATIONS, NAMELY,
NEWSLETTERS RELATING TO THE FIELDS OF
BANKING, FINANCE, INVESTMENT AND ASSET
MANAGEMENT, CASH MANAGEMENT, AND
PORTFOLIO MANAGEMENT, IN CLASS 16 (U.S.
CLS. 2, 5, 22, 23, 29, 37, 38 AND 50).

FIRST USE 11-0-1979; IN COMMERCE 11-0-1979.

OWNER OF U.S. REG. NOS. 2,020,367 AND
2,627,791.

SEC. 2(F).

SER. NO. 76-525,248, FILED 6-25-2003.

CURTIS FRENCH, EXAMINING ATTORNEY

Int. Cl.: 35

Prior U.S. Cls.: 100, 101 and 102

United States Patent and Trademark Office

Reg. No. 2,892,800

Registered Oct. 12, 2004

**SERVICE MARK
PRINCIPAL REGISTER**

RITTENHOUSE

NUVEEN INVESTMENTS, INC. (DELAWARE
CORPORATION)
333 WEST WACKER DRIVE
CHICAGO, IL 60606

FOR: BUSINESS MANAGEMENT CONSULTA-
TION SERVICES, IN CLASS 35 (U.S. CLS. 100, 101
AND 102).

FIRST USE 11-0-1979; IN COMMERCE 11-0-1979.

OWNER OF U.S. REG. NOS. 2,020,367 AND
2,627,791.

SEC. 2(F).

SER. NO. 76-525,489, FILED 6-25-2003.

TONI HICKEY, EXAMINING ATTORNEY

Int. Cl.: 25

Prior U.S. Cls.: 22 and 39

United States Patent and Trademark Office

Reg. No. 2,892,801

Registered Oct. 12, 2004

**TRADEMARK
PRINCIPAL REGISTER**

EXESS NY JEANS

PINHAS, NAHOUM (UNITED STATES INDIVIDUAL)
1887 EAST 22ND STREET
BROOKLYN, NY 11229

NO CLAIM IS MADE TO THE EXCLUSIVE RIGHT TO USE "NY JEANS", APART FROM THE MARK AS SHOWN.

FOR: CLOTHING, NAMELY, JEANS, SHORTS, JACKETS, SHIRTS, SKIRTS, SWEATERS, BLOUSES, SOCKS, HATS, GLOVES, SHOES AND UNDERGARMENTS, IN CLASS 25 (U.S. CLS. 22 AND 39).

SER. NO. 76-525,685, FILED 6-18-2003.

FIRST USE 9-1-2003; IN COMMERCE 10-1-2003.

CAROLINE WEIMER, EXAMINING ATTORNEY

Int. Cl.: 43

Prior U.S. Cls.: 100 and 101

United States Patent and Trademark Office

Reg. No. 2,892,802

Registered Oct. 12, 2004

**SERVICE MARK
PRINCIPAL REGISTER**

CHARLESTON PLACE

CHARLESTON CENTER LLC (DELAWARE LTD
LIAB CO)
130 MARKET STREET
CHARLESTON, SC 29401

OWNER OF U.S. REG. NO. 1,728,454.

SEC. 2(F) AS TO "CHARLESTON".

FOR: HOTEL SERVICES, HOTEL RESERVATION
SERVICES FOR OTHERS, HOTEL BAR AND RES-
TAURANT SERVICES, IN CLASS 43 (U.S. CLS. 100
AND 101).

SER. NO. 76-525,994, FILED 6-25-2003.

FIRST USE 9-0-1986; IN COMMERCE 9-0-1986.

G. MAYERSCHOFF, EXAMINING ATTORNEY

Int. Cls.: 36 and 38

Prior U.S. Cls.: 100, 101, 102 and 104

United States Patent and Trademark Office

Reg. No. 2,892,803

Registered Oct. 12, 2004

**SERVICE MARK
PRINCIPAL REGISTER**



DATAACCESS AMERICA INC. (DELAWARE CORPORATION)
8130 SHAFFER PARKWAY
LITTLETON, CO 80127

FOR: TELEPHONE CALLING CARD SERVICES, IN CLASS 36 (U.S. CLS. 100, 101 AND 102).

FIRST USE 5-12-2003; IN COMMERCE 5-12-2003.

FOR: TELECOMMUNICATION SERVICES, NAMELY, LOCAL AND LONG DISTANCE TRANSMISSION OF VOICE, VIDEO, DATA, DOCUMENTS, AND GRAPHICS BY MEANS OF TELEPHONE, TELEGRAPHIC, CABLE, AND SATELLITE TRANSMISSIONS; TELECOMMUNICATIONS GATEWAY SERVICES; FIBER OPTIC NETWORK SERVICES; PROVIDING TELECOMMUNICATIONS CONNECTIONS TO A GLOBAL COMPUTER NETWORK; PROVIDING MULTIPLE-USER ACCESS TO A GLOBAL COMPUTER INFORMATION NETWORK; FACSIMILE TRANSMISSION SERVICES; TELEPHONE VOICE MESSAGING SERVICES; PAGING SERVICES; CALL FORWARDING AND TRANSFER SERVICES; CALLER IDENTIFICATION SERVICES; CALL WAITING SERVICES; SPEED DIALING SERVICES; TOLL FREE SERVICES; CONFERENCE CALLING SERVICES; INTERNET DIAL-UP ACCESS SERVICES; UNIFIED MESSAGING SERVICES FOR INTEGRATING VOICE MAIL AND E-MAIL IN ONE

LOCATION; PROVIDING FRAME RELAY CONNECTIVITY SERVICES FOR DATA TRANSFER; VIRTUAL NETWORK TELECOMMUNICATIONS SERVICES; AUDIO AND VIDEO TELECONFERENCING SERVICES; PRIVATE LINE VOICE, TEXT, FACSIMILE, VIDEO AND DATA TELECOMMUNICATIONS SERVICES; INTEGRATED SERVICES DIGITAL NETWORK (ISDN) TELECOMMUNICATIONS SERVICES; 800 TELECOMMUNICATIONS SERVICES; 900 TELECOMMUNICATIONS SERVICES; SWITCHED VOICE, DATA, VIDEO AND MULTIMEDIA SERVICES; ASYNCHRONOUS TRANSFER MODE (ATM) SERVICES; LOCATION INDEPENDENT PERSONAL COMMUNICATIONS SERVICES COMPRISING MOBILE, VOICE, DATA AND FACSIMILE SERVICES, IN CLASS 38 (U.S. CLS. 100, 101 AND 104).

FIRST USE 5-12-2003; IN COMMERCE 5-12-2003.

THE MARK CONSISTS IN PART OF A STYLIZED SATELLITE CIRCLING THE EARTH AND A STYLIZED ARROW FORMING PART OF THE LETTER "A".

SER. NO. 76-526,226, FILED 6-27-2003.

EDWARD NELSON, EXAMINING ATTORNEY

Int. Cl.: 30

Prior U.S. Cl.: 46

United States Patent and Trademark Office

Reg. No. 2,892,804

Registered Oct. 12, 2004

TRADEMARK
PRINCIPAL REGISTER

The logo for 'El Premio' features the words 'El Premio' in a stylized, cursive script. The letter 'I' in 'Premio' is replaced by a solid black five-pointed star.

DRIGGS FARMS OF INDIANA, INC. (INDIANA CORPORATION)
400 SOUTH CHAMBER DRIVE
DECATUR, IN 46733

THE MARK CONSISTS OF A SCRIPT FORM OF EL PREMIO WITH A STAR USED AS A DOT FOR THE LETTER I.

FOR: ICE CREAM, SHERBET, ICE CREAM BARS, ICE CREAM SANDWICHES, ICE CREAM SUNDAE NUT CONES, FUDGE BARS, FLAVORED ICES, AND FLAVORED ICE BARS; FROZEN DESSERTS, NAMELY, MELLORINE, FROZEN YOGURT, AND FROZEN CONFECTIONS, IN CLASS 30 (U.S. CL. 46).

THE ENGLISH TRANSLATION OF "EL PREMIO" IS "THE PRIZE" OR "THE REWARD".

SER. NO. 76-526,512, FILED 6-27-2003.

FIRST USE 6-9-2003; IN COMMERCE 6-9-2003.

BARBARA A. GOLD, EXAMINING ATTORNEY

Int. Cl.: 35

Prior U.S. Cls.: 100, 101 and 102

United States Patent and Trademark Office

Reg. No. 2,892,805

Registered Oct. 12, 2004

**SERVICE MARK
PRINCIPAL REGISTER**

WHEN IT SNOWS, IT'S ANGELO'S!

ANGELO'S SUPPLIES, INC. (MICHIGAN CORPORATION)
29820 W. EIGHT MILE ROAD
FARMINGTON HILLS, MI 48336

SNOW PLOW PARTS AND SUPPLIES , IN CLASS 35
(U.S. CLS. 100, 101 AND 102).

FIRST USE 12-1-1995; IN COMMERCE 12-1-1995.

FOR: MAIL ORDER CATALOG SERVICES FEATURING SNOW PLOW PARTS AND SUPPLIES;
ONLINE RETAIL STORE SERVICES FEATURING

SER. NO. 76-526,667, FILED 6-16-2003.

STEVEN BERK, EXAMINING ATTORNEY

Int. Cl.: 35

Prior U.S. Cls.: 100, 101 and 102

United States Patent and Trademark Office

Reg. No. 2,892,806

Registered Oct. 12, 2004

**SERVICE MARK
PRINCIPAL REGISTER**

TELEMAX

AXIUM INTERNATIONAL, INC. (CALIFORNIA
CORPORATION)
5800 WILSHIRE BLVD.
LOS ANGELES, CA 90036

FIRST USE 3-15-2003; IN COMMERCE 3-15-2003.

SER. NO. 76-526,695, FILED 6-18-2003.

FOR: PAYROLL PREPARATION AND ADMINIS-
TRATION OF A BUSINESS PAYROLL FOR OTH-
ERS, IN CLASS 35 (U.S. CLS. 100, 101 AND 102).

BRETT J. GOLDEN, EXAMINING ATTORNEY

Int. Cl.: 5

Prior U.S. Cls.: 6, 18, 44, 46, 51 and 52

United States Patent and Trademark Office

Reg. No. 2,892,807

Registered Oct. 12, 2004

**TRADEMARK
PRINCIPAL REGISTER**

ESPASMOTEX

LABORATORIOS LIOMONT, S.A. DE C.V. (MEX-
ICO CORPORATION)
ADOLFO LOPEZ MATEOS NO. 68
DELEGACION CUAJIMALPA 05000
MEXICO, D.F., MEXICO

FOR: MEDICINAL PREPARATIONS, NAMELY
THERAPEUTIC ANALGESICS AND ANTISPASMO-
DICS, IN CLASS 5 (U.S. CLS. 6, 18, 44, 46, 51 AND 52).

OWNER OF MEXICO REG. NO. 43,576, DATED 1-
10-1942, RENEWED AS REG. NO. 11286/2002, DATED
10-16-2001, EXPIRES 10-16-2011.

SER. NO. 76-526,767, FILED 7-1-2003.

GEORGIA CARTY, EXAMINING ATTORNEY

Int. Cl.: 36

Prior U.S. Cls.: 100, 101 and 102

United States Patent and Trademark Office

Reg. No. 2,892,808

Registered Oct. 12, 2004

**SERVICE MARK
PRINCIPAL REGISTER**

IOWA REALTY COMMERCIAL

IOWA REALTY CO., INC. (IOWA CORPORATION)
3501 WESTOWN PARKWAY
WEST DES MOINES, IA 50266

FOR: REAL ESTATE BROKERAGE SERVICES, IN
CLASS 36 (U.S. CLS. 100, 101 AND 102).

FIRST USE 7-15-2002; IN COMMERCE 7-15-2002.

OWNER OF U.S. REG. NO. 2,266,331.

NO CLAIM IS MADE TO THE EXCLUSIVE
RIGHT TO USE "REALTY COMMERCIAL", APART
FROM THE MARK AS SHOWN.

SEC. 2(F) IOWA REALTY.

SER. NO. 76-526,906, FILED 6-30-2003.

MARGERY A. TIERNEY, EXAMINING ATTORNEY

Int. Cls.: 36 and 41

Prior U.S. Cls.: 100, 101, 102 and 107

United States Patent and Trademark Office

Reg. No. 2,892,809

Registered Oct. 12, 2004

**SERVICE MARK
PRINCIPAL REGISTER**



P.T. & ASSOCIATES COMMUNITY DEVELOPMENT CONSULTING, INC. (OHIO CORPORATION)
875 EAST BROAD STREET
COLUMBUS, OH 43205

FOR: FINANCIAL ASSISTANCE IN OBTAINING MORTGAGE LOANS, CHECKING ACCOUNTS, CREDIT CARDS AND SAVINGS ACCOUNTS FOR HARD-TO-QUALIFY INDIVIDUALS, AND DEBT COUNSELING SERVICES FOR THESE INDIVIDUALS, IN CLASS 36 (U.S. CLS. 100, 101 AND 102).

FIRST USE 9-0-1992; IN COMMERCE 9-0-1992.

FOR: EDUCATIONAL SERVICES, NAMELY, CONDUCTING SEMINARS AND WORKSHOPS IN

THE FIELDS OF FINANCIAL LITERACY AND PLANNING, FAMILY BUDGETING, AND HOME OWNERSHIP, IN CLASS 41 (U.S. CLS. 100, 101 AND 107).

FIRST USE 9-0-1992; IN COMMERCE 9-0-1992.

NO CLAIM IS MADE TO THE EXCLUSIVE RIGHT TO USE "ASSOCIATES COMMUNITY CENTERED BANKING", APART FROM THE MARK AS SHOWN.

SER. NO. 76-526,920, FILED 6-30-2003.

BRIDGETT SMITH, EXAMINING ATTORNEY

Int. Cl.: 39

Prior U.S. Cls.: 100 and 105

United States Patent and Trademark Office

Reg. No. 2,892,810

Registered Oct. 12, 2004

**SERVICE MARK
PRINCIPAL REGISTER**

THE PORT DELIVERS

PORT OF HOUSTON AUTHORITY (TEXAS
STATE AGENCY)
111 EAST LOOP NORTH
HOUSTON, TX 77029

FOR: MARINE TRANSPORT; NAMELY, TRANSPORT BY BOAT, SHIP, AND TRUCK; TRANSPORT BROKERAGE; MAKING RESERVATIONS AND BOOKINGS FOR TRANSPORTATION; FREIGHT BROKERAGE AND FREIGHT FORWARDING SERVICES; DELIVERY OF GOODS BY BOAT, SHIP, AND TRUCK; UNLOADING CARGO; PACKAGING

OF GOODS FOR TRANSPORTATION; SHIP BROKERAGE AND BARGE TRANSPORT; SHIP PILOTING; WAREHOUSING; STORAGE OF GOODS; AND RENTAL OF WAREHOUSE SPACE, IN CLASS 39 (U.S. CLS. 100 AND 105).

FIRST USE 1-0-2001; IN COMMERCE 1-0-2001.

SER. NO. 76-527,160, FILED 7-1-2003.

HOWARD B. LEVINE, EXAMINING ATTORNEY

Int. Cl.: 41

Prior U.S. Cls.: 100, 101 and 107

United States Patent and Trademark Office

Reg. No. 2,892,811

Registered Oct. 12, 2004

**SERVICE MARK
PRINCIPAL REGISTER**

SAVING LIVES, ONE PAGE AT A TIME

COLES, JULIANA (UNITED STATES INDIVIDUAL)
829 SAN LORENZO NW
ALBUQUERQUE, NM 87107

FOR: CONDUCTING WORKSHOPS AND SEMINARS ON PROCESSES AND TECHNIQUES IN THE COMBINED AREAS OF ART, SELF EXPLORATION

AND JOURNAL WRITING , IN CLASS 41 (U.S. CLS. 100, 101 AND 107).

FIRST USE 10-0-2002; IN COMMERCE 10-0-2002.

SER. NO. 76-527,210, FILED 6-30-2003.

MATTHEW PAPPAS, EXAMINING ATTORNEY

Int. Cl.: 42

Prior U.S. Cls.: 100 and 101

United States Patent and Trademark Office

Reg. No. 2,892,812

Registered Oct. 12, 2004

SERVICE MARK
PRINCIPAL REGISTER



TAYLOR, JOHN R. (UNITED STATES INDIVIDUAL)
6777 CAMP BOWIE BLVD. SUITE 332
FORT WORTH, TX 76116

THE MARK CONSISTS OF LETTERS THAT ARE YELLOW AT THE TOP AND GRADUALLY TURN TO RED AT THE BOTTOM.

FOR: PETROLEUM EXPLORATION, IN CLASS 42 (U.S. CLS. 100 AND 101).

SER. NO. 76-528,139, FILED 7-7-2003.

FIRST USE 0-0-1997; IN COMMERCE 0-0-1997.

KIM SAITO, EXAMINING ATTORNEY

Int. Cls.: 37 and 45

Prior U.S. Cls.: 100, 101, 103 and 106

United States Patent and Trademark Office

Reg. No. 2,892,813

Registered Oct. 12, 2004

**SERVICE MARK
PRINCIPAL REGISTER**

A HAWAIIAN SENSE OF PLACE

PARADISE MEMORIAL PARK, LLC (HAWAII
LTD LIAB CO)
1154 FORT STREET
HONOLULU, HI 96813

FOR: REAL ESTATE DEVELOPMENT OF CEME-
TERIES AND GRAVEYARDS, IN CLASS 37 (U.S.
CLS. 100, 103 AND 106).

FIRST USE 7-17-2001; IN COMMERCE 7-17-2001.

FOR: CEMETERY SERVICES, NAMELY, THE
PERPETUAL CARE AND MAINTENANCE OF CE-

METERIES AND THE OPENING AND CLOSING OF
GRAVES, IN CLASS 45 (U.S. CLS. 100 AND 101).

FIRST USE 7-17-2001; IN COMMERCE 7-17-2001.

THE MARK CONSISTS OF THE WORDS "A
HAWAIIAN SENSE OF PLACE" IN TYPED FORM.

SER. NO. 76-528,600, FILED 7-9-2003.

TRACY FLETCHER, EXAMINING ATTORNEY

Int. Cl.: 3

Prior U.S. Cls.: 1, 4, 6, 50, 51 and 52

United States Patent and Trademark Office

Reg. No. 2,892,814

Registered Oct. 12, 2004

**TRADEMARK
PRINCIPAL REGISTER**

FLOCKER

PERFECT PLUS, INC. (CALIFORNIA CORPORATION)
9595 WILSHIRE BOULEVARD, SUITE 601
BEVERLY HILLS, CA 90212

FIRST USE 1-15-2001; IN COMMERCE 1-15-2001.

SER. NO. 76-528,761, FILED 7-9-2003.

FOR: HAIR CARE PRODUCTS, NAMELY, SHAMPOOS, CONDITIONERS, HAIR SPRAY, STYLING GELS AND MOUSSE, IN CLASS 3 (U.S. CLS. 1, 4, 6, 50, 51 AND 52).

TRACY FLETCHER, EXAMINING ATTORNEY

Int. Cl.: 20

Prior U.S. Cls.: 2, 13, 22, 25, 32 and 50

United States Patent and Trademark Office

Reg. No. 2,892,815

Registered Oct. 12, 2004

**TRADEMARK
PRINCIPAL REGISTER**

CAMBERLIN

SOUND-CRAFT SYSTEMS, INC. (ARKANSAS
CORPORATION)
1584 PETIT JEAN MOUNTAIN ROAD
MORRILTON, AR 72110

FIRST USE 4-0-2002; IN COMMERCE 6-0-2002.

SER. NO. 76-529,034, FILED 7-2-2003.

FOR: LECTERNS; LECTERNS AND RACK
MOUNT ENCLOSURES THEREFORE SOLD AS A
UNIT, IN CLASS 20 (U.S. CLS. 2, 13, 22, 25, 32 AND 50).

JOHN KELLY, EXAMINING ATTORNEY

Int. Cl.: 5

Prior U.S. Cls.: 6, 18, 44, 46, 51 and 52

United States Patent and Trademark Office

Reg. No. 2,892,816

Registered Oct. 12, 2004

**TRADEMARK
PRINCIPAL REGISTER**

CICLOFERON

LABORATORIOS LIOMONT, S.A. DE C.V. (MEX-
ICO CORPORATION)
AVE. ADOLFO LOPEZ MATEOS NO. 68
DELEGACION CUAJIMALPA, 05000, MEXICO

OWNER OF MEXICO REG. NO. 345289, DATED 1-
6-1998, RENEWED AS REG. NO. 122092002, DATED
1-6-2003, EXPIRES 1-6-2013.

FOR: MEDICINAL AND PHARMACEUTICAL
PREPARATIONS, ESPECIALLY AN ANTIVIRUS
PREPARATION IN CREAM FORM FOR FEVER
BLISTERS AND COLD SORES, IN CLASS 5 (U.S.
CLS. 6, 18, 44, 46, 51 AND 52).

SER. NO. 76-529,211, FILED 7-10-2003.

JULIA HARDY COFIELD, EXAMINING ATTOR-
NEY

Int. Cls.: 35 and 42

Prior U.S. Cls.: 100, 101 and 102

United States Patent and Trademark Office

Reg. No. 2,892,817

Registered Oct. 12, 2004

**SERVICE MARK
PRINCIPAL REGISTER**

SHARP DECISIONS

SHARP DECISIONS INC. (NEW YORK CORPORATION)
55 WEST 39TH STREET
NEW YORK, NY 10018

FOR: PERSONNEL STAFFING SERVICES IN THE FIELD OF INFORMATION TECHNOLOGY; BUSINESS PLANNING IN THE NATURE OF ENTERPRISE RESOURCE PLANNING SERVICES; BUSINESS CONSULTATION IN THE AREA OF VENDOR PRODUCT EVALUATION, SELECTION AND ADAPTION; BUSINESS PROCESS RE-ENGINEERING SERVICES; OUTSOURCING SERVICES IN THE FIELDS OF MANUFACTURE OF ANY PRODUCTS, GOVERNMENT SERVICES AND FINANCIAL SERVICES; AND BUSINESS SUCCESSION PLANNING, IN CLASS 35 (U.S. CLS. 100, 101 AND 102).

FIRST USE 0-0-1990; IN COMMERCE 0-0-1990.

FOR: COMPUTER SERVICES, NAMELY, DESIGNING AND IMPLEMENTING WEB SITES FOR OTHERS; WEB-ENABLED DATABASE DEVELOPMENT SERVICES; DESIGN AND DEVELOPMENT OF COMPUTER SECURITY AND FIREWALL SYSTEMS FOR OTHERS; COMPUTER SYSTEMS ANALYSIS IN THE NATURE OF ASSESSING COMPUTER SYSTEMS REQUIREMENTS, DEFINITION, SPECIFICATION AND IMPLEMENTATION; INTEGRATION OF COMPUTER SYSTEMS AND NETWORKS; COMPUTER NETWORK DESIGN FOR OTHERS, IN CLASS 42 (U.S. CLS. 100 AND 101).

FIRST USE 0-0-1990; IN COMMERCE 0-0-1990.

SER. NO. 76-529,226, FILED 7-16-2003.

MARC LEIPZIG, EXAMINING ATTORNEY

Int. Cl.: 41

Prior U.S. Cls.: 100, 101 and 107

United States Patent and Trademark Office

Reg. No. 2,892,818

Registered Oct. 12, 2004

**SERVICE MARK
PRINCIPAL REGISTER**

***e*-TECEP**

THOMAS A. EDISON STATE COLLEGE (NEW
JERSEY CORPORATION)
101 WEST STATE STREET
TRENTON, NJ 086081176

FOR: ONLINE TESTING AND SCORING SER-
VICES FOR STANDARDIZED ACADEMIC TEST,
NAMELY A PROGRAM OFFERING STUDENTS
THE OPPORTUNITY TO RECEIVE THEIR SCORE
IMMEDIATELY UPON COMPLETION OF THE EX-

AMINATION, IN CLASS 41 (U.S. CLS. 100, 101 AND
107).

FIRST USE 2-5-2003; IN COMMERCE 2-5-2003.

SER. NO. 76-529,360, FILED 7-14-2003.

ODESSA BIBBINS, EXAMINING ATTORNEY

Int. Cl.: 42

Prior U.S. Cls.: 100 and 101

United States Patent and Trademark Office

Reg. No. 2,892,819

Registered Oct. 12, 2004

**SERVICE MARK
PRINCIPAL REGISTER**

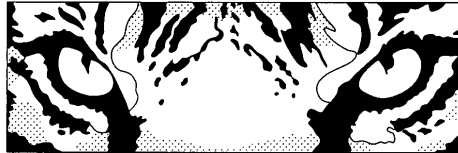

AMERICAN ASSOCIATION OF MOTORCYCLE
INJURY LAWYERS, INC. (ARIZONA COR-
PORATION)
362 NORTH THIRD AVENUE
PHOENIX, AZ 85003

FOR: LEGAL SERVICES, NAMELY, LEGAL SER-
VICES, LEGAL ADVISORY SERVICES, PROVISION
OF LEGAL CONSULTATIONS, LEGAL ADVICE
AND REPRESENTATION OF OTHERS IN LEGAL
MATTERS, LEGAL RESEARCH, NOTARY PUBLIC
SERVICES, AND PROVIDING INFORMATION IN

THE FIELD OF PERSONAL INJURY AND ACCI-
DENT LAW, IN CLASS 42 (U.S. CLS. 100 AND 101).

FIRST USE 1-1-2001; IN COMMERCE 1-1-2001.

THE DRAWING SHOWS STIPPLING, WHICH IS
USED TO INDICATE SHADING IN THE MARK.

SER. NO. 76-529,459, FILED 7-15-2003.

STEVEN BERK, EXAMINING ATTORNEY

Int. Cl.: 41

Prior U.S. Cls.: 100, 101 and 107

United States Patent and Trademark Office

Reg. No. 2,892,820

Registered Oct. 12, 2004

**SERVICE MARK
PRINCIPAL REGISTER**

LIFT

KABLER, SOPHIA M. (UNITED STATES INDIVIDUAL)
141 WALNUT AVENUE
MILL VALLEY, CA 94941

NAL, PROFESSIONAL AND FINANCIAL , IN
CLASS 41 (U.S. CLS. 100, 101 AND 107).

FIRST USE 6-1-2003; IN COMMERCE 7-11-2003.

FOR: EDUCATIONAL SERVICES, NAMELY
CONDUCTING WORKSHOPS AND TRAININGS
DESIGNED TO HELP WOMEN DEVELOP STRATEGIES
TO ACHIEVE THEIR LIFE GOALS - PERSONAL,

SER. NO. 76-529,496, FILED 7-14-2003.

CAROLYN CATALDO, EXAMINING ATTORNEY

Int. Cls.: 16, 18, 33, 35 and 41

Prior U.S. Cls.: 1, 2, 3, 5, 22, 23, 29, 37, 38, 41, 47, 49, 50, 100, 101, 102 and 107

Reg. No. 2,892,821

United States Patent and Trademark Office

Registered Oct. 12, 2004

**TRADEMARK
SERVICE MARK
PRINCIPAL REGISTER**

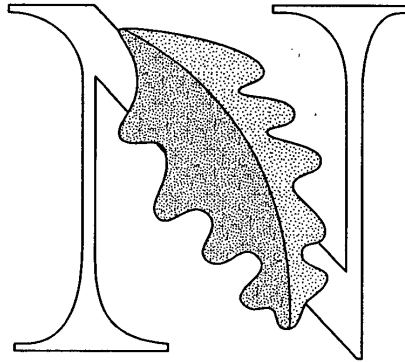

NORTHWESTERN UNIVERSITY (ILLINOIS CORPORATION)
633 CLARK STREET
EVANSTON, IL 602081109

FOR: BINDERS, STATIONERY, PAPER NAME BADGES, STATIONERY-TYPE PORTFOLIOS, BOOKMARKS, PRINTED INVITATIONS, CREDIT CARDS WITHOUT MAGNETIC CODING, IN CLASS 16 (U.S. CLS. 2, 5, 22, 23, 29, 37, 38 AND 50).

FIRST USE 11-0-2000; IN COMMERCE 11-0-2000.

FOR: TOTE BAGS AND UMBRELLAS, IN CLASS 18 (U.S. CLS. 1, 2, 3, 22 AND 41).

FIRST USE 11-0-2000; IN COMMERCE 11-0-2000.

FOR: WINE, IN CLASS 33 (U.S. CLS. 47 AND 49).

FIRST USE 11-0-2000; IN COMMERCE 11-0-2000.

FOR: ON-LINE SERVICES FOR ALUMNI, NAMELY PROVIDING ON-LINE DIRECTORY INFORMATION SERVICES REGARDING ALUMNI, IN CLASS 35 (U.S. CLS. 100, 101 AND 102).

FIRST USE 11-0-2000; IN COMMERCE 11-0-2000.

FOR: EDUCATIONAL SERVICES IN THE NATURE OF COURSES AT THE UNIVERSITY LEVEL; ARRANGING AND CONDUCTING ALUMNI EVENTS, NAMELY CONDUCTING TRAVEL STUDY PROGRAMS IN THE NATURE OF WORKSHOPS AND EXCURSIONS IN THE FIELDS OF HISTORY AND CULTURE, RECREATIONAL ACTIVITIES IN THE NATURE OF SPORTING EVENTS AND CLASS REUNIONS, AND SOCIAL AND CULTURAL PROGRAMS AND THEATER TRIPS; PROVIDING RECOGNITION AND INCENTIVES BY THE WAY OF AWARDS TO DEMONSTRATE EXCELLENCE IN THE FIELD OF EDUCATION, IN CLASS 41 (U.S. CLS. 100, 101 AND 107).

FIRST USE 11-0-2000; IN COMMERCE 11-0-2000.

THE STIPPLING IS FOR SHADING PURPOSES ONLY.

SER. NO. 76-529,530, FILED 7-14-2003.

BRENDAN MCCAULEY, EXAMINING ATTORNEY

Int. Cls.: 7, 9 and 37

**Prior U.S. Cls.: 13, 19, 21, 23, 26, 31, 34, 35, 36, 38,
100, 103 and 106**

Reg. No. 2,892,822

United States Patent and Trademark Office

Registered Oct. 12, 2004

**TRADEMARK
SERVICE MARK
PRINCIPAL REGISTER**

COMMANDER

KOENIG & BAUER AKTIENGESELLSCHAFT
(FED REP GERMANY CORPORATION)
FRIEDRICH-KOENIG-STR. 4
97080 WÜRZBURG, FED REP GERMANY

FOR: (BASED ON USE IN COMMERCE) PRINTING PRESSES AND THEIR STRUCTURAL AND REPLACEMENT PARTS; WEB OFFSET ROTARY PRINTING PRESSES; GRAPHIC ARTS MACHINES AND THEIR STRUCTURAL AND REPLACEMENT PARTS; PRINT CONVERTING MACHINES AND THEIR STRUCTURAL AND REPLACEMENT PARTS; ACCESSORIES FOR PRINTING PRESSES, GRAPHIC ARTS MACHINES AND PRINT CONVERTING MACHINES, NAMELY, MECHANICAL TRANSPORT SYSTEMS COMPRISED OF CONVEYORS AND CONVEYOR BELTS, PRINTING COUPLES, INKING UNITS, DAMPENERS, POWER OPERATED FOLDING MACHINES, REELSTANDS, IN CLASS 7 (U.S. CLS. 13, 19, 21, 23, 31, 34 AND 35).

FIRST USE 8-14-1973; IN COMMERCE 1-10-1978.

FOR: (BASED ON 44(D) PRIORITY APPLICATION) (BASED ON 44(E)) ELECTRONIC ACCESSOR-

IES FOR PRINTING PRESSES, GRAPHIC ARTS MACHINES AND PRINT CONVERTING MACHINES, NAMELY, REGULATORS, CONTROLLERS AND MONITORS, IN CLASS 9 (U.S. CLS. 21, 23, 26, 36 AND 38).

FOR: (BASED ON 44(D) PRIORITY APPLICATION) (BASED ON 44(E)) INSTALLATION, MAINTENANCE AND REPAIR SERVICES FOR THE ABOVE-MENTIONED GOODS, IN CLASS 37 (U.S. CLS. 100, 103 AND 106).

PRIORITY CLAIMED UNDER SEC. 44(D) ON FED REP GERMANY APPLICATION NO. 30311556.4/0, FILED 3-3-2003, REG. NO. 30311556, DATED 3-27-2003, EXPIRES 3-31-2013.

OWNER OF U.S. REG. NO. 1,389,718.

SER. NO. 76-529,967, FILED 7-15-2003.

HEATHER THOMPSON, EXAMINING ATTORNEY

Int. Cl.: 36

Prior U.S. Cls.: 100, 101 and 102

United States Patent and Trademark Office

Reg. No. 2,892,823

Registered Oct. 12, 2004

**SERVICE MARK
PRINCIPAL REGISTER**

CENTRUE BANK

CENTRUE BANK (ILLINOIS ILLINOIS BANK-
ING CORPORATION)
310 SOUTH SCHUYLER AVENUE
KANKAKEE, IL 60901

NO CLAIM IS MADE TO THE EXCLUSIVE
RIGHT TO USE "BANK", APART FROM THE
MARK AS SHOWN.

FOR: BANKING, AND INVESTMENT BROKER-
AGE SERVICES, IN CLASS 36 (U.S. CLS. 100, 101
AND 102).

SER. NO. 76-530,587, FILED 7-17-2003.

FIRST USE 10-17-2003; IN COMMERCE 10-17-2003.

TRACY CROSS, EXAMINING ATTORNEY

Int. Cls.: 35 and 42

Prior U.S. Cls.: 100, 101 and 102

United States Patent and Trademark Office

Reg. No. 2,892,824

Registered Oct. 12, 2004

**SERVICE MARK
PRINCIPAL REGISTER**



IDEAS OF THE MIND, L.L.C. (COLORADO LTD
LIAB CO)
1746 COLE BLVD, SUITE 225
GOLDEN, CO 80401

FOR: BUSINESS MARKETING CONSULTING
SERVICES, NAMELY, BUSINESS MARKETING
AND BUSINESS COMMUNICATIONS CONSULT-
ING SERVICES; CREATING CORPORATE AND
BRAND IDENTITY FOR OTHERS; PUBLIC RELA-
TIONS; PROVIDING STRATEGIC MARKETING
ADVICE, IN CLASS 35 (U.S. CLS. 100, 101 AND 102).

FIRST USE 4-0-2002; IN COMMERCE 5-0-2002.

FOR: COMPUTER SERVICES, NAMELY, DE-
SIGNING WEBSITES FOR OTHERS AND COMPU-
TER CONSULTING SERVICE, IN CLASS 42 (U.S.
CLS. 100 AND 101).

FIRST USE 4-0-2002; IN COMMERCE 5-0-2002.

SER. NO. 76-531,081, FILED 7-21-2003.

DAWN FELDMAN, EXAMINING ATTORNEY

Int. Cls.: 24 and 25

Prior U.S. Cls.: 22, 39, 42 and 50

United States Patent and Trademark Office

Reg. No. 2,892,825

Registered Oct. 12, 2004

TRADEMARK
PRINCIPAL REGISTER

BROGHAMER, SHARON A. (UNITED STATES
INDIVIDUAL)
1320 PENMAN ROAD
NEPTUNE BEACH, FL 32266

FOR: TOWELS, IN CLASS 24 (U.S. CLS. 42 AND 50).

FIRST USE 7-7-2003; IN COMMERCE 7-18-2003.

FOR: SWIMMING APPAREL, NAMELY SWIM-
SUITS, SWIM CAPS, SHORTS, T-SHIRTS, HATS,

FOOTWEAR, PANTS, SHIRTS, IN CLASS 25 (U.S.
CLS. 22 AND 39).

FIRST USE 7-7-2003; IN COMMERCE 7-18-2003.

SER. NO. 76-531,754, FILED 7-24-2003.

CHRISIE B. KING, EXAMINING ATTORNEY

Int. Cl.: 2

Prior U.S. Cls.: 6, 11 and 16

United States Patent and Trademark Office

Reg. No. 2,892,826

Registered Oct. 12, 2004

**TRADEMARK
PRINCIPAL REGISTER**

ProCraft

PROCRAFT OF SOUTH FLORIDA, LLC (FLOR-
IDA CORPORATION)
1486-D SKEES ROAD
WEST PALM BEACH, FL 33411

FOR: PROTECTIVE AND DECORATIVE ARCHI-
TECTURAL PAINTS AND COATINGS FOR INTER-
IOR AND EXTERIOR USE ON CEMENT, PLASTER,
SIDING, WOOD OR METAL, FOR TEXTURED AND
SMOOTH FINISHINGS; WOOD STAINS FOR TEX-

TURED AND SMOOTH FINISHES, IN CLASS 2 (U.S.
CLS. 6, 11 AND 16).

FIRST USE 5-29-2001; IN COMMERCE 5-29-2001.

SER. NO. 76-531,955, FILED 7-14-2003.

TRACY FLETCHER, EXAMINING ATTORNEY

Int. Cl.: 12

Prior U.S. Cls.: 19, 21, 23, 31, 35 and 44

Reg. No. 2,892,827

United States Patent and Trademark Office

Registered Oct. 12, 2004

**TRADEMARK
PRINCIPAL REGISTER**

MOXIE

NO BOUNDARIES MOBILITY, LLC. (CALIFORNIA LTD LIAB CO)
12882 VALLEY VIEW STREET
UNIT 5
GARDEN GROVE, CA 92845

WITH DISABILITIES AND/OR LIMITED MOBILITY, IN CLASS 12 (U.S. CLS. 19, 21, 23, 31, 35 AND 44).

FIRST USE 2-4-2003; IN COMMERCE 2-5-2003.

SER. NO. 76-532,379, FILED 7-11-2003.

FOR: LAND VEHICLES, NAMELY MOTORIZED SCOOTERS DESIGNED FOR ASSISTING PEOPLE

YSA DEJESUS, EXAMINING ATTORNEY

Int. Cl.: 41

Prior U.S. Cls.: 100, 101 and 107

United States Patent and Trademark Office

Reg. No. 2,892,828

Registered Oct. 12, 2004

**SERVICE MARK
PRINCIPAL REGISTER**

NATIONAL VISIONARY LEADERSHIP PROJECT

NATIONAL VISIONARY LEADERSHIP PROJECT
(D.C. NOT-FOR-PROFIT CORPORATION)
1218 16TH STREET NW
WASHINGTON, DC 20036

FOR: EDUCATIONAL SERVICES, NAMELY, VIDEOTAPING, AUDIO RECORDING, AND PRODUCING ORAL HISTORIES OF NATIONAL AND LOCAL AFRICAN AMERICAN LEADERS; PUBLISHING AND RECORDING OF AN ARCHIVE OF THEIR ORAL HISTORIES IN BOOKS AND AUDIO AND VIDEOTAPES; SPONSORING AN ACADEMIC FELLOWSHIP PROGRAM, NAMELY, ORGANIZING PARTNERSHIPS WITH ACADEMIC INSTITUTIONS TO FACILITATE STUDENTS' INDEPENDENT STUDY COURSEWORK AND

TRAINING IN CONNECTION WITH THE PRODUCTION OF ORAL HISTORIES OF AFRICAN AMERICAN LEADERS AND LEADERSHIP SKILLS, IN CLASS 41 (U.S. CLS. 100, 101 AND 107).

FIRST USE 8-0-2001; IN COMMERCE 2-27-2002.

NO CLAIM IS MADE TO THE EXCLUSIVE RIGHT TO USE "NATIONAL" AND "LEADERSHIP PROJECT", APART FROM THE MARK AS SHOWN.

SER. NO. 76-532,481, FILED 7-25-2003.

VIVIAN MICZNIK FIRST, EXAMINING ATTORNEY

Int. Cl.: 29

Prior U.S. Cl.: 46

United States Patent and Trademark Office

Reg. No. 2,892,829

Registered Oct. 12, 2004

**TRADEMARK
PRINCIPAL REGISTER**

ENTREE LEGENDS

ZARTIC, INC. (GEORGIA CORPORATION)
438 LAVENDER DRIVE
ROME, GA 30165

FIRST USE 1-0-1993; IN COMMERCE 1-0-1993.

FOR: READY TO COOK AND READY TO EAT
PACKAGED AND FROZEN BEEF, POULTRY, AND
PORK PRODUCTS, NAMELY, COMPLETE MEALS
AND DINNERS CONSISTING PRIMARILY OF
BEEF, POULTRY, AND PORK; AND INDIVIDUAL
ENTREES AND COURSES CONSISTING PRIMAR-
ILY OF BEEF, POULTRY, AND PORK, IN CLASS 29
(U.S. CL. 46).

NO CLAIM IS MADE TO THE EXCLUSIVE
RIGHT TO USE ENTRÉE, APART FROM THE
MARK AS SHOWN.

SER. NO. 76-532,542, FILED 7-25-2003.

KIM SAITO, EXAMINING ATTORNEY

Int. Cl.: 18

Prior U.S. Cls.: 1, 2, 3, 22 and 41

United States Patent and Trademark Office

Reg. No. 2,892,830

Registered Oct. 12, 2004

**TRADEMARK
PRINCIPAL REGISTER**

CADEAU

CADEAU HOLDINGS LLC (DELAWARE LTD
LIAB CO)
254 ELIZABETH STREET
NEW YORK, NY 10012

OWNER OF U.S. REG. NO. 2,810,499.

FOR: LEATHER AND IMITATION OF LEATHER
BAGS, NAMELY, DIAPER BAGS, TOTE BAGS AND
HANDBAGS, IN CLASS 18 (U.S. CLS. 1, 2, 3, 22 AND
41).

THE ENGLISH TRANSLATION OF "CADEAU" IS
GIFT.

SER. NO. 76-532,627, FILED 7-28-2003.

FIRST USE 10-1-2001; IN COMMERCE 10-1-2001.

FRED MANDIR, EXAMINING ATTORNEY

Int. Cl.: 44

Prior U.S. Cls.: 100 and 101

United States Patent and Trademark Office

Reg. No. 2,892,831

Registered Oct. 12, 2004

**SERVICE MARK
PRINCIPAL REGISTER**

OPTIMUM PERFORMANCE SOLUTIONS

THOMAS V. MATTHEWS, PH. D., LLC (KANSAS
LIMITED LIABILITY CORPORATION)
2709 SW 29TH STREET, SUITE 102
TOPEKA, KS 66614

FOR: MENTAL HEALTH SERVICES IN THE
FIELD OF CLINICAL PSYCHOLOGY AND PSY-
CHOPHYSIOLOGY, NAMELY, NEUROFEEDBACK,
BIOFEEDBACK, EYE MOVEMENT DESENSITIZA-
TION AND REPROCESSING, QUANTITATIVE EEG
BRAIN MAPPING, PSYCHOTHERAPY, PSYCHOLO-
GICAL ASSESSMENT, PERFORMANCE ENHANCE-
MENT, CONSULTATION IN THE FIELD OF
CLINICAL PSYCHOLOGY AND PSYCHOPHYSIOL-

OGY, AND STRESS MANAGEMENT, IN CLASS 44
(U.S. CLS. 100 AND 101).

FIRST USE 9-4-2002; IN COMMERCE 9-4-2002.

NO CLAIM IS MADE TO THE EXCLUSIVE
RIGHT TO USE "OPTIMUM PERFORMANCE",
APART FROM THE MARK AS SHOWN.

SER. NO. 76-533,095, FILED 7-28-2003.

ODESSA BIBBINS, EXAMINING ATTORNEY

Int. Cl.: 5

Prior U.S. Cls.: 6, 18, 44, 46, 51 and 52

United States Patent and Trademark Office

Reg. No. 2,892,832

Registered Oct. 12, 2004

**TRADEMARK
PRINCIPAL REGISTER**

BETTA WATER

XTREME TECHNOLOGIES, INC. (IDAHO CORPORATION), DBA BIO2 PET LABS
1620 B NORTHWEST BLVD., STE. 300
COEUR D'ALENE, ID 83814

FIRST USE 1-10-2003; IN COMMERCE 2-3-2003.

SER. NO. 76-533,132, FILED 7-28-2003.

FOR: NUTRITIONAL WATER SUPPLEMENT AND SOLUTION FOR FISH, REPTILES AND AMPHIBIANS, IN CLASS 5 (U.S. CLS. 6, 18, 44, 46, 51 AND 52).

AISHA CLARKE, EXAMINING ATTORNEY

Int. Cl.: 41

Prior U.S. Cls.: 100, 101 and 107

United States Patent and Trademark Office

Reg. No. 2,892,833

Registered Oct. 12, 2004

**SERVICE MARK
PRINCIPAL REGISTER**

THE LINGUIST 

COMMIT TO LANGUAGE LEARNING, LTD.
(CANADA CORPORATION)
200-2232 MARINE DRIVE
WEST VANCOUVER, BRITISH COLUMBIA V7V 1K4

FOR: EDUCATIONAL SERVICES, NAMELY,
PROVIDING INSTRUCTION VIA GLOBAL COMPU-
TER NETWORK IN FLUENCY AND LITERACY IN
A VARIETY OF LANGUAGES FEATURING, BUT
NOT LIMITED TO, ENGLISH, SPANISH, FRENCH,
GERMAN, AND ITALIAN, AND EDUCATIONAL
MATERIALS DISTRIBUTED IN CONNECTION
THEREWITH, IN CLASS 41 (U.S. CLS. 100, 101 AND
107).

FIRST USE 11-1-2003; IN COMMERCE 12-1-2003.

NO CLAIM IS MADE TO THE EXCLUSIVE
RIGHT TO USE "LINGUIST", APART FROM THE
MARK AS SHOWN.

THE MARK CONSISTS OF THE WORDS "THE
LINGUIST", WITHOUT CLAIM TO PARTICULAR
FONT, SIZE, OR COLOR, TO THE LEFT OF A
STYLIZED TREE.

SER. NO. 76-533,463, FILED 7-30-2003.

KATHLEEN M. VANSTON, EXAMINING ATTOR-
NEY

Int. Cl.: 31

Prior U.S. Cls.: 1 and 46

United States Patent and Trademark Office

Reg. No. 2,892,834

Registered Oct. 12, 2004

TRADEMARK
PRINCIPAL REGISTER



THE LAZY DOG COOKIE COMPANY, LLC
(PENNSYLVANIA LTD LIAB CO)
8838 SAND TREE DRIVE SE
ALTO, MI 49302

NO CLAIM IS MADE TO THE EXCLUSIVE
RIGHT TO USE "COOKIE CO. LLC" , APART FROM
THE MARK AS SHOWN.

FOR: ANIMAL BISCUITS, IN CLASS 31 (U.S. CLS.
1 AND 46).

SER. NO. 76-534,064, FILED 8-1-2003.

FIRST USE 8-11-2003; IN COMMERCE 8-11-2003.

ELIZABETH J. WINTER, EXAMINING ATTORNEY

Int. Cl.: 5

Prior U.S. Cls.: 6, 18, 44, 46, 51 and 52

United States Patent and Trademark Office

Reg. No. 2,892,835

Registered Oct. 12, 2004

**TRADEMARK
PRINCIPAL REGISTER**

The “6 Hour Miracle”

NQI, INC. (UTAH CORPORATION)
1163 SOUTH 1680 WEST
OREM, UT 84058

FIRST USE 12-1-2002; IN COMMERCE 12-1-2002.

SER. NO. 76-534,065, FILED 8-1-2003.

FOR: DIETARY SUPPLEMENT, IN CLASS 5 (U.S.
CLS. 6, 18, 44, 46, 51 AND 52).

BRENDAN MCCAULEY, EXAMINING ATTORNEY

Int. Cl.: 35

Prior U.S. Cls.: 100, 101 and 102

United States Patent and Trademark Office

Reg. No. 2,892,836

Registered Oct. 12, 2004

**SERVICE MARK
PRINCIPAL REGISTER**



FIFE, JACK (UNITED STATES INDIVIDUAL)
231 WELLINGTON ROAD
INDIANAPOLIS, IN 46260

FIRST USE 1-1-1980; IN COMMERCE 1-1-1980.

SER. NO. 76-534,128, FILED 8-4-2003.

FOR: REAL ESTATE AUCTION SERVICES, IN
CLASS 35 (U.S. CLS. 100, 101 AND 102).

JOHN HWANG, EXAMINING ATTORNEY

Int. Cl.: 42

Prior U.S. Cls.: 100 and 101

United States Patent and Trademark Office

Reg. No. 2,892,837

Registered Oct. 12, 2004

**SERVICE MARK
PRINCIPAL REGISTER**



SOFT COMPUTER CONSULTANTS, INC. (NEW
YORK CORPORATION)
34350 U.S. HIGHWAY 19 NORTH
PALM HARBOR, FL 34684

FOR: COMPUTER SOFTWARE DEVELOPMENT
OF LABORATORY INFORMATION SYSTEMS FOR
HOSPITALS AND CLINICS, IN CLASS 42 (U.S. CLS.
100 AND 101).

FIRST USE 3-1-2001; IN COMMERCE 3-1-2001.

NO CLAIM IS MADE TO THE EXCLUSIVE
RIGHT TO USE "COMPUTER", APART FROM
THE MARK AS SHOWN.

THE STIPPLING IS A FEATURE OF THE MARK.

SER. NO. 76-534,309, FILED 8-4-2003.

KAREN BRACEY, EXAMINING ATTORNEY

Int. Cl.: 35

Prior U.S. Cls.: 100, 101 and 102

United States Patent and Trademark Office

Reg. No. 2,892,838

Registered Oct. 12, 2004

SERVICE MARK
PRINCIPAL REGISTER



BERMUDEZ-ONOPA, R. DAVID (UNITED STATES INDIVIDUAL)
JAGUAS K27 SANTA CLARA
GUAYNABO, PUERTO RICO 00969

FIRST USE 0-0-2000; IN COMMERCE 1-1-2003.

SER. NO. 76-534,934, FILED 8-6-2003.

FOR: MANAGEMENT CONSULTING SERVICES,
IN CLASS 35 (U.S. CLS. 100, 101 AND 102).

CAROLYN CATALDO, EXAMINING ATTORNEY

Int. Cl.: 31

Prior U.S. Cls.: 1 and 46

United States Patent and Trademark Office

Reg. No. 2,892,839

Registered Oct. 12, 2004

**TRADEMARK
PRINCIPAL REGISTER**

VANILLA BUTTERFLY

PROVEN WINNERS NORTH AMERICA LLC
(CALIFORNIA LTD LIAB CO)
45 NORTH FIRST STREET, SUITE B
CAMPBELL, CA 95008

NO CLAIM IS MADE TO THE EXCLUSIVE
RIGHT TO USE "BUTTERFLY", APART FROM
THE MARK AS SHOWN.

FOR: LIVING PLANTS, IN CLASS 31 (U.S. CLS. 1
AND 46).

SER. NO. 76-534,952, FILED 8-6-2003.

FIRST USE 4-30-2003; IN COMMERCE 4-30-2003.

GLENN CLARK, EXAMINING ATTORNEY

Int. Cls.: 9, 25 and 41

Prior U.S. Cls.: 21, 22, 23, 26, 36, 38, 39, 100, 101 and 107

Reg. No. 2,892,840

United States Patent and Trademark Office

Registered Oct. 12, 2004

**TRADEMARK
SERVICE MARK
PRINCIPAL REGISTER**

MR. RAY

ANDERSEN, RAY (UNITED STATES INDIVIDUAL)
18 KINGSTON RUN
NORTH BRUNSWICK, NJ 089024251

FOR: ENTERTAINMENT PRODUCTS IN THE NATURE OF AUDIO/VIDEO RECORDINGS; NAMELY, PRERECORDED AUDIO/VIDEO TAPES AND DISCS, DVDS AND VIDEO CDS FEATURING ENTERTAINMENT PERFORMANCES BY AN INDIVIDUAL, IN CLASS 9 (U.S. CLS. 21, 23, 26, 36 AND 38).

FIRST USE 10-10-1994; IN COMMERCE 3-3-2000.

FOR: CLOTHING, NAMELY, HATS, SHIRTS, T-SHIRTS, SWEATSHIRTS, JACKETS, BELTS AND SOCKS, IN CLASS 25 (U.S. CLS. 22 AND 39).

FIRST USE 10-10-1994; IN COMMERCE 3-3-2000.

FOR: ENTERTAINMENT SERVICES IN THE NATURE OF LIVE MUSICAL PERFORMANCES BY AN INDIVIDUAL, IN CLASS 41 (U.S. CLS. 100, 101 AND 107).

FIRST USE 10-10-1994; IN COMMERCE 10-10-1994.

OWNER OF U.S. REG. NO. 2,527,680.

SER. NO. 76-535,174, FILED 8-7-2003.

MICHAEL WEBSTER, EXAMINING ATTORNEY

Int. Cl.: 9

Prior U.S. Cls.: 21, 23, 26, 36 and 38

Reg. No. 2,892,841

United States Patent and Trademark Office

Registered Oct. 12, 2004

**TRADEMARK
PRINCIPAL REGISTER**

VALUEROUTE

ECTEL LTD. (ISRAEL COMPANY)
43 HASIVIM STREET
PETACH TIKVA 49517, ISRAEL

TRACTABLE INFORMATION FROM COMMUNICATION NETWORKS, SWITCHES, AND SYSTEMS, IN CLASS 9 (U.S. CLS. 21, 23, 26, 36 AND 38).

FOR: TELECOMMUNICATION EQUIPMENT, NAMELY, COMPUTER SOFTWARE, COMPUTER HARDWARE AND COMPUTER PERIPHERALS FOR ROUTING, MANAGING AND CONTROL OF COMMUNICATION TRAFFIC; COMPUTER SOFTWARE AND COMPUTER HARDWARE FOR SECURITY MANAGING, NETWORK SURVEILLANCE, BILLING VERIFICATION, FRAUD DETECTION AND REPORTING ANY EX-

PRIORITY CLAIMED UNDER SEC. 44(D) ON ISRAEL APPLICATION NO. 163002, FILED 2-27-2003, REG. NO. 163002, DATED 1-4-2004, EXPIRES 2-27-2010.

SER. NO. 76-535,318, FILED 8-6-2003.

DAVID ELTON, EXAMINING ATTORNEY

Int. Cl.: 19

Prior U.S. Cls.: 1, 12, 33 and 50

United States Patent and Trademark Office

Reg. No. 2,892,842

Registered Oct. 12, 2004

**TRADEMARK
PRINCIPAL REGISTER**

EXTIRA

CRAFTMASTER MANUFACTURING, INC. (DE-
LAWARE CORPORATION)
500 WEST MONROE STREET, SUITE 2010
CHICAGO, IL 60661

FIRST USE 8-0-2002; IN COMMERCE 8-0-2002.

SER. NO. 76-535,636, FILED 8-8-2003.

FOR: UNPRIMED PANELS MADE OF WOOD
AND WOOD RESIN, IN CLASS 19 (U.S. CLS. 1, 12, 33
AND 50).

ESTHER A. BORSUK, EXAMINING ATTORNEY

Prior U.S. Cl.: 200

United States Patent and Trademark Office

Reg. No. 2,892,843

Registered Oct. 12, 2004

COLLECTIVE MEMBERSHIP
PRINCIPAL REGISTER

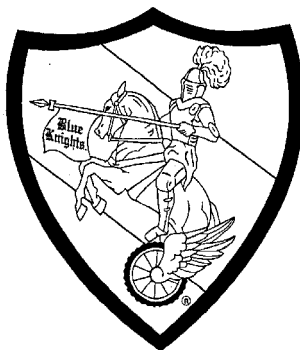

BLUE KNIGHTS INTERNATIONAL LAW EN-
FORCEMENT MOTORCYCLE CLUB, INC.
(MAINE CORPORATION)
38 ALDEN STREET
BANGOR, ME 04401

FOR: INDICATING MEMBERSHIP IN A LAW
ENFORCEMENT MOTORCYCLE CLUB, IN CLASS
200 (U.S. CL. 200).

FIRST USE 3-5-2003; IN COMMERCE 3-5-2003.

OWNER OF U.S. REG. NO. 1,165,984.

SER. NO. 76-536,349, FILED 8-11-2003.

CAROLYN CATALDO, EXAMINING ATTORNEY

Int. Cl.: 9

Prior U.S. Cls.: 21, 23, 26, 36 and 38

Reg. No. 2,892,844

United States Patent and Trademark Office

Registered Oct. 12, 2004

**TRADEMARK
PRINCIPAL REGISTER**

SIMMOD

ATAC CORPORATION (CALIFORNIA CORPORATION)
757 N. MARY AVENUE
SUNNYVALE, CA 94085

CONTROL SYSTEM ACTIVITIES, IN CLASS 9 (U.S. CLS. 21, 23, 26, 36 AND 38).

FIRST USE 12-1-1981; IN COMMERCE 11-1-1986.

FOR: COMPUTER SOFTWARE USED TO SIMULATE AIRPORT OPERATIONS AND AIRCRAFT FLIGHT OPERATIONS INCLUDING AIR TRAFFIC

SER. NO. 76-536,566, FILED 6-30-2003.

BRETT J. GOLDEN, EXAMINING ATTORNEY

Int. Cl.: 9

Prior U.S. Cls.: 21, 23, 26, 36 and 38

United States Patent and Trademark Office

Reg. No. 2,892,845

Registered Oct. 12, 2004

**TRADEMARK
PRINCIPAL REGISTER**

SIMMOD PLUS!

ATAC CORPORATION (CALIFORNIA CORPORATION)
757 N. MARY AVENUE
SUNNYVALE, CA 94085

FOR: COMPUTER SOFTWARE USED TO SIMULATE AIRPORT OPERATIONS AND AIRCRAFT FLIGHT OPERATIONS INCLUDING AIR TRAFFIC

CONTROL SYSTEM ACTIVITIES, IN CLASS 9 (U.S. CLS. 21, 23, 26, 36 AND 38).

FIRST USE 1-31-1997; IN COMMERCE 1-31-1997.

SER. NO. 76-536,568, FILED 6-30-2003.

BRETT J. GOLDEN, EXAMINING ATTORNEY

Int. Cl.: 9

Prior U.S. Cls.: 21, 23, 26, 36 and 38

United States Patent and Trademark Office

Reg. No. 2,892,846

Registered Oct. 12, 2004

**TRADEMARK
PRINCIPAL REGISTER**

SIMMOD PRO!

ATAC CORPORATION (CALIFORNIA CORPORATION)
757 N. MARY AVENUE
SUNNYVALE, CA 94085

CONTROL SYSTEM ACTIVITIES, IN CLASS 9 (U.S. CLS. 21, 23, 26, 36 AND 38).

FIRST USE 9-10-1999; IN COMMERCE 9-10-1999.

FOR: COMPUTER SOFTWARE USED TO SIMULATE AIRPORT OPERATIONS AND AIRCRAFT FLIGHT OPERATIONS INCLUDING AIR TRAFFIC

SER. NO. 76-536,569, FILED 6-30-2003.

BRETT J. GOLDEN, EXAMINING ATTORNEY

Int. Cl.: 19

Prior U.S. Cls.: 1, 12, 33 and 50

United States Patent and Trademark Office

Reg. No. 2,892,847

Registered Oct. 12, 2004

**TRADEMARK
PRINCIPAL REGISTER**

CARBOLITE

CARBO CERAMICS INC. (DELAWARE CORPORATION)
6565 MACARTHUR BOULEVARD, SUITE 1050
IRVING, TX 750382461

FOR: CERAMIC PELLETS, SHOTS, OR SPHERES
FOR USE IN OIL WELL AND GAS WELL HYDRAULIC
FRACTURING OPERATIONS AND AS A GRAVEL
PACK MATERIAL FOR SAND CONTROL OPERATIONS,
IN CLASS 19 (U.S. CLS. 1, 12, 33 AND 50).

FIRST USE 1-1-2003; IN COMMERCE 1-1-2003.

OWNER OF U.S. REG. NO. 1,488,463.

SER. NO. 76-536,578, FILED 7-1-2003.

JOHN DALIER, EXAMINING ATTORNEY

Int. Cl.: 20

Prior U.S. Cls.: 2, 13, 22, 25, 32 and 50

United States Patent and Trademark Office

Reg. No. 2,892,848

Registered Oct. 12, 2004

**TRADEMARK
PRINCIPAL REGISTER**

Mattress Matters

MATTRESS MATTERS, INC. (OHIO CORPORATION)
19536 TROTWOOD PARK
CLEVELAND, OH 44136

NO CLAIM IS MADE TO THE EXCLUSIVE
RIGHT TO USE "MATTRESS", APART FROM THE
MARK AS SHOWN.

FOR: MATTRESS CUSHIONS, IN CLASS 20 (U.S.
CLS. 2, 13, 22, 25, 32 AND 50).

SER. NO. 76-536,901, FILED 7-24-2003.

FIRST USE 0-0-2001; IN COMMERCE 0-0-2001.

CHARLES JOYNER, EXAMINING ATTORNEY

Int. Cl.: 41

Prior U.S. Cls.: 100, 101 and 107

United States Patent and Trademark Office

Reg. No. 2,892,849

Registered Oct. 12, 2004

**SERVICE MARK
PRINCIPAL REGISTER**

DIABLO SLIM

HALL, BROOKS PRESTON (UNITED STATES
INDIVIDUAL)
6304 MIDDLETON LANE
CAMP SPRINGS, MD 20748

FIRST USE 4-1-2003; IN COMMERCE 5-1-2003.

SER. NO. 76-536,966, FILED 8-1-2003.

FOR: ENTERTAINMENT, NAMELY, LIVE PER-
FORMANCES BY A RAP AND HIP HOP RECORD-
ING ARTIST, IN CLASS 41 (U.S. CLS. 100, 101 AND
107).

AMY HELLA, EXAMINING ATTORNEY

Int. Cl.: 4

Prior U.S. Cls.: 1, 6 and 15

United States Patent and Trademark Office

Reg. No. 2,892,850

Registered Oct. 12, 2004

**TRADEMARK
PRINCIPAL REGISTER**

PREMIER CANDLE CORP.

PREMIER CANDLE CORP. (CANADA CORPORATION)
960 BRITANNIA ROAD EAST
MISSISSAUGA, ONTARIO, CANADA L4W 5M7

FOR: CANDLES, CANDLE WICKS AND PETROLEUM WAX, IN CLASS 4 (U.S. CLS. 1, 6 AND 15).

FIRST USE 8-0-1996; IN COMMERCE 8-0-1996.

NO CLAIM IS MADE TO THE EXCLUSIVE RIGHT TO USE CANDLE CORP., APART FROM THE MARK AS SHOWN.

SEC. 2(F).

SER. NO. 76-537,197, FILED 8-4-2003.

JANICE L. MCMORROW, EXAMINING ATTORNEY

Int. Cls.: 16, 35, 41 and 42

**Prior U.S. Cls.: 2, 5, 22, 23, 29, 37, 38, 50, 100, 101, 102
and 107**

Reg. No. 2,892,851

United States Patent and Trademark Office

Registered Oct. 12, 2004

**TRADEMARK
SERVICE MARK
PRINCIPAL REGISTER**

VERDICTSEARCH

ALM PROPERTIES, INC. (DELAWARE CORPORATION)
220 CONTINENTAL DRIVE, SUITE 123
NEWARK, DE 19713

FOR: LEGAL NEWSPAPERS, REPORTS, MAGAZINES AND NEWSLETTERS CONCERNING THE LEGAL FIELD, IN CLASS 16 (U.S. CLS. 2, 5, 22, 23, 29, 37, 38 AND 50).

FIRST USE 5-12-2003; IN COMMERCE 5-12-2003.

FOR: BUSINESS MARKETING CONSULTING SERVICES; PROVIDING ON-LINE LEGAL DIRECTORY INFORMATION SERVICES ALSO FEATURING HYPERLINKS TO OTHER WEB SITES ON A GLOBAL COMPUTER NETWORK; DISSEMINATION OF ADVERTISING FOR OTHERS VIA AN INTERNET WEBSITE; PROVIDING ADVERTISING SPACE IN AN ON-LINE PERIODICAL; AND PREPARING AND PLACING ADVERTISEMENTS FOR LAWYERS, LAW FIRMS AND OTHER LEGAL PROFESSIONALS , IN CLASS 35 (U.S. CLS. 100, 101 AND 102).

FIRST USE 4-15-2003; IN COMMERCE 4-15-2003.

FOR: PROVIDING ON-LINE NEWSPAPERS, MAGAZINES, NEWSLETTERS AND REPORTS CONCERNING THE LEGAL FIELD, IN CLASS 41 (U.S. CLS. 100, 101 AND 107).

FIRST USE 4-15-2003; IN COMMERCE 4-15-2003.

FOR: LEGAL RESEARCH SERVICES, NAMELY, PERFORMING JURY VERDICT, SETTLEMENT AND APPELLATE DECISION STUDIES, AND WRITTEN REPORTS SUPPLIED IN CONNECTION THEREWITH, IN CLASS 42 (U.S. CLS. 100 AND 101).

FIRST USE 4-15-2003; IN COMMERCE 4-15-2003.

SER. NO. 76-537,321, FILED 8-14-2003.

HOWARD SMIGA, EXAMINING ATTORNEY

Int. Cls.: 20, 22 and 25

Prior U.S. Cls.: 1, 2, 7, 13, 19, 22, 25, 32, 39, 42 and 50

United States Patent and Trademark Office

Reg. No. 2,892,852

Registered Oct. 12, 2004

**TRADEMARK
PRINCIPAL REGISTER**

MOUNTAINSMITH

PACIFICA LTM, LLC (COLORADO LTD LIAB
CO)
18301 W. COLFAX, #P
GOLDEN, CO 80401

FOR: SLEEPING BAGS, IN CLASS 20 (U.S. CLS. 2,
13, 22, 25, 32 AND 50).

FIRST USE 4-0-2003; IN COMMERCE 4-0-2003.

FOR: TENTS AND TENT BAGS, IN CLASS 22 (U.S.
CLS. 1, 2, 7, 19, 22, 42 AND 50).

FIRST USE 4-0-2003; IN COMMERCE 4-0-2003.

FOR: CLOTHING, NAMELY, SHIRTS, PANTS,
SHORTS, JACKETS, UNDERWEAR, FOOTWEAR,
SOCKS, HATS, GLOVES AND CAPS, IN CLASS 25
(U.S. CLS. 22 AND 39).

FIRST USE 4-0-2003; IN COMMERCE 4-0-2003.

OWNER OF U.S. REG. NOS. 1,703,288, 1,768,568,
AND 2,587,762.

SER. NO. 76-537,423, FILED 8-14-2003.

ROBERT COGGINS, EXAMINING ATTORNEY

Int. Cl.: 18

Prior U.S. Cls.: 1, 2, 3, 22 and 41

United States Patent and Trademark Office

Reg. No. 2,892,853

Registered Oct. 12, 2004

**TRADEMARK
PRINCIPAL REGISTER**

MATERIAL THINGS

CHICO, RODRIGO (UNITED STATES INDIVIDUAL)
718 GLADYS AVENUE
LOS ANGELES, CA 90021

FIRST USE 5-25-1993; IN COMMERCE 5-25-1993.

SER. NO. 76-537,460, FILED 7-28-2003.

FOR: HANDCRAFTED HANDBAGS, SATCHELS
AND TOTE BAGS, IN CLASS 18 (U.S. CLS. 1, 2, 3, 22
AND 41).

JOHN DALIER, EXAMINING ATTORNEY

Int. Cl.: 4

Prior U.S. Cls.: 1, 6 and 15

United States Patent and Trademark Office

Reg. No. 2,892,854

Registered Oct. 12, 2004

**TRADEMARK
PRINCIPAL REGISTER**

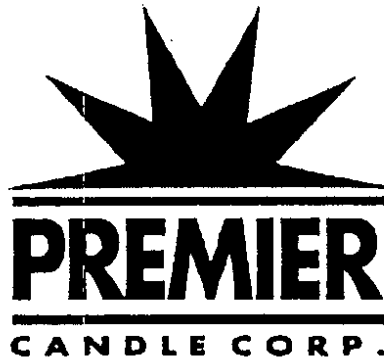

PREMIER CANDLE CORP. (CANADA CORPORATION)
960 BRITANNIA ROAD EAST
MISSISSAUGA, ONTARIO, CANADA L4W 5M7

FOR: CANDLES, CANDLE WICKS AND PETROLEUM WAX, IN CLASS 4 (U.S. CLS. 1, 6 AND 15).

FIRST USE 8-0-1996; IN COMMERCE 8-0-1996.

NO CLAIM IS MADE TO THE EXCLUSIVE RIGHT TO USE CANDLE CORP., APART FROM THE MARK AS SHOWN.

SEC. 2(F) AS TO "PREMIER".

SER. NO. 76-537,792, FILED 8-4-2003.

CAROLINE WEIMER, EXAMINING ATTORNEY

Int. Cls.: 18 and 44

Prior U.S. Cls.: 1, 2, 3, 22, 41, 100 and 101

United States Patent and Trademark Office

Reg. No. 2,892,855

Registered Oct. 12, 2004

**TRADEMARK
SERVICE MARK
PRINCIPAL REGISTER**

PetCall

PETCALL, INC. (MISSISSIPPI S CORPORATION)
132 PAVILION DRIVE
BRANDON, MS 390422328

FOR: DOG COLLARS, IN CLASS 18 (U.S. CLS. 1, 2,
3, 22 AND 41).

FIRST USE 4-15-2002; IN COMMERCE 8-1-2003.

FOR: PET SITTING SERVICES , IN CLASS 44 (U.S.
CLS. 100 AND 101).

FIRST USE 4-15-2002; IN COMMERCE 8-1-2003.

THE MARK CONSISTS OF STANDARD CHAR-
ACTERS WITHOUT CLAIM TO ANY PARTICULAR
FONT, STYLE, SIZE, OR COLOR.

SER. NO. 76-537,913, FILED 8-14-2003.

MARC LEIPZIG, EXAMINING ATTORNEY

Int. Cl.: 41

Prior U.S. Cls.: 100, 101 and 107

United States Patent and Trademark Office

Reg. No. 2,892,856

Registered Oct. 12, 2004

**SERVICE MARK
PRINCIPAL REGISTER**

ICECROSSE

PROSUS, LLC (VIRGINIA LTD LIAB CO)
11307 SUNSET HILLS ROAD
RESTON, VA 201905231

FIRST USE 4-21-2003; IN COMMERCE 4-21-2003.

SER. NO. 76-538,311, FILED 8-18-2003.

FOR: ORGANIZING ATHLETIC EXHIBITIONS
FEATURING THE SPORT OF LACROSSE PLAYED
ON ICE, IN CLASS 41 (U.S. CLS. 100, 101 AND 107).

MARC LEIPZIG, EXAMINING ATTORNEY

Int. Cl.: 39

Prior U.S. Cls.: 100 and 105

United States Patent and Trademark Office

Reg. No. 2,892,857

Registered Oct. 12, 2004

SERVICE MARK
PRINCIPAL REGISTER



THE SCOLAR COMPANY (NEBRASKA CORPORATION)
9401 INDIAN CREEK PARKWAY BUILDING 40
SUITE 850
OVERLAND PARK, KS 66210

NO CLAIM IS MADE TO THE EXCLUSIVE
RIGHT TO USE "CONTAINER FREIGHT", APART
FROM THE MARK AS SHOWN.

FOR: GLOBAL TRANSPORTATION OF FREIGHT
FOR OTHERS BY ALL AVAILABLE MEANS, IN
CLASS 39 (U.S. CLS. 100 AND 105).

SER. NO. 76-538,381, FILED 8-18-2003.

FIRST USE 9-1-1998; IN COMMERCE 9-1-1998.

CATHERINE CAIN, EXAMINING ATTORNEY

Int. Cl.: 9

Prior U.S. Cls.: 21, 23, 26, 36 and 38

Reg. No. 2,892,858

United States Patent and Trademark Office

Registered Oct. 12, 2004

**TRADEMARK
PRINCIPAL REGISTER**

OFFICEGT

BCA TECHNOLOGIES, INC. (FLORIDA CORPORATION)
1059 MAITLAND CENTER COMMONS BLVD.
STE. 100
MAITLAND, FL 32751

PROJECTS AND PERSONNEL INFORMATION , IN CLASS 9 (U.S. CLS. 21, 23, 26, 36 AND 38).

FIRST USE 3-1-2003; IN COMMERCE 5-1-2003.

FOR: COMPUTER SOFTWARE FOR OFFICE PRODUCTIVITY AND PROJECT MANAGEMENT PURPOSES USED TO TRACK TIME, EXPENSES,

SER. NO. 76-538,444, FILED 8-19-2003.

STEPHANIE DAVIS, EXAMINING ATTORNEY

Int. Cl.: 36

Prior U.S. Cls.: 100, 101 and 102

United States Patent and Trademark Office

Reg. No. 2,892,859

Registered Oct. 12, 2004

**SERVICE MARK
PRINCIPAL REGISTER**

OPENING DOORS TO HIGHER EDUCATION

SALLIE MAE FUND, INC., THE (VIRGINIA CORPORATION)
11600 SALLIE MAE DRIVE
RESTON, VA 20193

FOR: PROVIDING INFORMATION IN THE FIELD OF FINANCIAL AID RESOURCES AVAILABLE TO PAY FOR AND PLAN FOR HIGHER EDUCATION EXPENSES , IN CLASS 36 (U.S. CLS. 100, 101 AND 102).

FIRST USE 4-25-2003; IN COMMERCE 4-25-2003.

NO CLAIM IS MADE TO THE EXCLUSIVE RIGHT TO USE HIGHER EDUCATION, APART FROM THE MARK AS SHOWN.

SER. NO. 76-538,877, FILED 8-20-2003.

PAULA MAHONEY, EXAMINING ATTORNEY

Int. Cls.: 16, 35 and 36

Prior U.S. Cls.: 2, 5, 22, 23, 29, 37, 38, 50, 100, 101 and 102

United States Patent and Trademark Office

Reg. No. 2,892,860

Registered Oct. 12, 2004

**TRADEMARK
SERVICE MARK
PRINCIPAL REGISTER**



THE LEUKEMIA & LYMPHOMA SOCIETY, INC.
(NEW YORK NOT-FOR-PROFIT CORPORATION)
1311 MAMARONECK AVENUE
WHITE PLAINS, NY 10605

FOR: PAMPHLETS, BROCHURES, BOOKS AND NEWSLETTERS RELATING TO BLOOD RELATED CANCERS AND BLOOD RELATED CANCER RESEARCH, IN CLASS 16 (U.S. CLS. 2, 5, 22, 23, 29, 37, 38 AND 50).

FIRST USE 2-1-2000; IN COMMERCE 2-1-2000.

FOR: ASSOCIATION SERVICES, NAMELY, PROMOTING PUBLIC AND PROFESSIONAL INTEREST AND AWARENESS IN BLOOD RELATED CANCER

RESEARCH AND EDUCATION, IN CLASS 35 (U.S. CLS. 100, 101 AND 102).

FIRST USE 2-1-2000; IN COMMERCE 2-1-2000.

FOR: CHARITABLE FUNDRAISING SERVICES RELATING TO BLOOD RELATED CANCERS, IN CLASS 36 (U.S. CLS. 100, 101 AND 102).

FIRST USE 2-1-2000; IN COMMERCE 2-1-2000.

SER. NO. 76-539,010, FILED 8-19-2003.

WILLIAM BRECKENFELD, EXAMINING ATTORNEY

Int. Cl.: 37

Prior U.S. Cls.: 100, 103 and 106

United States Patent and Trademark Office

Reg. No. 2,892,861

Registered Oct. 12, 2004

**SERVICE MARK
PRINCIPAL REGISTER**

TECHSTART

CORNERSTONE SYSTEMS, INC. (CALIFORNIA
CORPORATION)
420 EXCHANGE PLACE, SUITE 150
IRVINE, CA 92602

FIRST USE 2-3-1999; IN COMMERCE 4-23-2003.

SER. NO. 76-539,025, FILED 8-8-2003.

FOR: INSTALLATION OF COMPUTER HARD-
WARE INTO COMPUTER SYSTEMS, IN CLASS 37
(U.S. CLS. 100, 103 AND 106).

VERNA BETH RIRIE, EXAMINING ATTORNEY

Int. Cl.: 41

Prior U.S. Cls.: 100, 101 and 107

United States Patent and Trademark Office

Reg. No. 2,892,862

Registered Oct. 12, 2004

**SERVICE MARK
PRINCIPAL REGISTER**

MOG

HUMUS MOG CO., LTD. (REPUBLIC OF KOREA CORPORATION)
130-7 CHUNGDAM-DONG, GANGNAM-GU
SEOUL, 135-100, REPUBLIC OF KOREA

FOR: RENTAL OF SPORTS EQUIPMENT, EXCEPT VEHICLES; PROVIDING OF RECREATION FACILITIES, PROVIDING SPORTS FACILITIES, HEALTH CLUB SERVICES, AND GAMES SERVICES PROVIDED ON-LINE FROM A COMPUTER NETWORK; PROVIDING OF GAME CENTERS, NAMELY, AMUSEMENT CENTERS; AND ORGANIZING

EXHIBITIONS FOR SPORTING AND ENTERTAINMENT PURPOSES, IN CLASS 41 (U.S. CLS. 100, 101 AND 107).

OWNER OF REPUBLIC OF KOREA REG. NO. 0091720, DATED 10-10-2003, EXPIRES 10-10-2013.

SER. NO. 76-539,204, FILED 8-20-2003.

GEORGE LORENZO, EXAMINING ATTORNEY

Int. Cl.: 30

Prior U.S. Cl.: 46

United States Patent and Trademark Office

Reg. No. 2,892,863

Registered Oct. 12, 2004

**TRADEMARK
PRINCIPAL REGISTER**

SCRUNCHIE MUNCHIE CARAMEL

CHICAGO COFFEE ROASTERY, INC. (ILLINOIS
CORPORATION)
11880 SMITH COURT
HUNTLEY, IL 60142

NO CLAIM IS MADE TO THE EXCLUSIVE
RIGHT TO USE CARAMEL , APART FROM THE
MARK AS SHOWN.

FOR: COFFEE, IN CLASS 30 (U.S. CL. 46).

SER. NO. 76-539,405, FILED 8-20-2003.

FIRST USE 1-0-2003; IN COMMERCE 1-0-2003.

JOHN E. MICHOS, EXAMINING ATTORNEY

Int. Cl.: 3

Prior U.S. Cls.: 1, 4, 6, 50, 51 and 52

United States Patent and Trademark Office

Reg. No. 2,892,864

Registered Oct. 12, 2004

TRADEMARK
PRINCIPAL REGISTER



LABORATOIRE BIODERMA (FRANCE SOCIÉTÉ
A RESPONSABILITÉ LIMITÉE)
75 COURS ALBERT THOMAS
69003 LYON, FRANCE

FOR: LAUNDRY BLEACH, GENERAL PURPOSE
CLEANING, POLISHING AND ABRASIVE LIQUIDS
AND POWDERS; SOAPS, PERFUMERY, ESSEN-
TIAL OILS FOR PERSONAL USE, COSMETICS,
HAIR LOTIONS AND DENTIFRICES, IN CLASS 3
(U.S. CLS. 1, 4, 6, 50, 51 AND 52).

OWNER OF FRANCE REG. NO. 023173317, DA-
TED 7-9-2002, EXPIRES 7-9-2012.

THE THREE(3) BLOCKS AND THE LETTERS
"DERM" APPEAR IN THE COLOR BLUE, AND

THE LETTERS "A", "B" AND "C" APPEAR IN
WHITE. COLOR IS CLAIMED AS A FEATURE OF
THE MARK AND ATTACHED IS A COLOR REPRE-
SENTATION OF THE MARK.

THE MARK IS COMPRISED OF THREE BLOCKS,
PRESENTED IN THREE DIMENSIONS, BEARING
THE LETTERS "A", "B" AND "C". THE REMAINDER
OF THE MARK COMPRISES THE LETTERS
"DERM".

SER. NO. 76-539,489, FILED 8-22-2003.

CAROLYN GRAY, EXAMINING ATTORNEY

Int. Cl.: 35

Prior U.S. Cls.: 100, 101 and 102

United States Patent and Trademark Office

Reg. No. 2,892,865

Registered Oct. 12, 2004

**SERVICE MARK
PRINCIPAL REGISTER**

PARTNER

ZIH CORP. (DELAWARE CORPORATION)
PEARMAN BUILDING
3 GORHAM ROAD, THIRD FLOOR
HAMILTON HM08, BERMUDA

OF PRINTERS, PRINTER LABELS AND SUPPLIES,
IN CLASS 35 (U.S. CLS. 100, 101 AND 102).

FIRST USE 1-0-2002; IN COMMERCE 1-0-2002.

SER. NO. 76-539,502, FILED 8-22-2003.

FOR: CONDUCTING DEALER INCENTIVE
AWARD PROGRAMS TO PROMOTE THE SALE

KELLY BOULTON, EXAMINING ATTORNEY

Int. Cl.: 16

Prior U.S. Cls.: 2, 5, 22, 23, 29, 37, 38 and 50

United States Patent and Trademark Office

Reg. No. 2,892,866

Registered Oct. 12, 2004

TRADEMARK
PRINCIPAL REGISTER

DAPCEP

DETROIT AREA PRE-COLLEGE ENGINEERING
PROGRAM, INC. (MICHIGAN CORPORATION)
100 FARNSWORTH, SUITE 249
DETROIT, MI 48202

FOR: TEACHING AND INSTRUCTIONAL PRINTED MATERIALS PREPARED FOR YOUNG STUDENTS IN A PRE-COLLEGE ENGINEERING PROGRAM, IN CLASS 16 (U.S. CLS. 2, 5, 22, 23, 29, 37, 38 AND 50).

FIRST USE 0-0-1977; IN COMMERCE 0-0-1977.

THE MARK CONSISTS OF STANDARD CHARACTERS WITHOUT CLAIM TO ANY PARTICULAR FONT, STYLE, SIZE, OR COLOR.

SER. NO. 76-539,647, FILED 8-25-2003.

G. MAYERSCHOFF, EXAMINING ATTORNEY

Int. Cl.: 41

Prior U.S. Cls.: 100, 101 and 107

United States Patent and Trademark Office

Reg. No. 2,892,867

Registered Oct. 12, 2004

**SERVICE MARK
PRINCIPAL REGISTER**

ELDER

ELDER HIGH SCHOOL (OHIO UNINC. ASSO-
CIATION)
3900 VINCENT AVENUE
CINCINNATI, OH 45205

FOR: EDUCATIONAL SERVICES, NAMELY,
PROVIDING COURSES OF INSTRUCTION AT
THE HIGH SCHOOL LEVEL; AND ENTERTAIN-
MENT IN THE NATURE OF HIGH SCHOOL ATH-
LETICS, BAND AND GLEE CLUB

PERFORMANCES, IN CLASS 41 (U.S. CLS. 100, 101
AND 107).

FIRST USE 0-0-1922; IN COMMERCE 0-0-1922.

SER. NO. 76-540,087, FILED 8-26-2003.

G. MAYERSCHOFF, EXAMINING ATTORNEY

Int. Cls.: 9 and 16

Prior U.S. Cls.: 2, 5, 21, 22, 23, 26, 29, 36, 37, 38 and 50

Reg. No. 2,892,868

United States Patent and Trademark Office

Registered Oct. 12, 2004

**TRADEMARK
PRINCIPAL REGISTER**

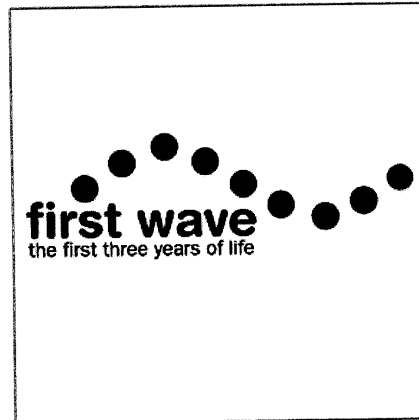

NEUMANN, MELISSA (UNITED STATES INDIVIDUAL)

424 WESR END AVENUE, #5F
NEW YORK, NY 10024 AND

NEUMANN, DOLORES (UNITED STATES INDIVIDUAL)

80 CENTRAL PARK WEST #5C
NEW YORK, NY 10023

FOR: EDUCATIONAL VIDEOS FOR THE 0-3 YEAR OLD, IN CLASS 9 (U.S. CLS. 21, 23, 26, 36 AND 38).

FIRST USE 7-20-2003; IN COMMERCE 7-30-2003.

FOR: PRINTED EDUCATIONAL MATERIAL, NAMELY BOOKS AND FLASH CARDS FOR THE 0-3 YEAR OLD, IN CLASS 16 (U.S. CLS. 2, 5, 22, 23, 29, 37, 38 AND 50).

FIRST USE 7-20-2003; IN COMMERCE 7-30-2003.

THE DOTS IN LOGO ARE ALL DIFFERENT AND MULTI-COLORED: RED, BLUE, GREEN, (STYLIZED AND/OR WITH DESIGN).

SER. NO. 76-540,373, FILED 8-11-2003.

BRIAN NEVILLE, EXAMINING ATTORNEY

Int. Cl.: 36

Prior U.S. Cls.: 100, 101 and 102

United States Patent and Trademark Office

Reg. No. 2,892,869

Registered Oct. 12, 2004

**SERVICE MARK
PRINCIPAL REGISTER**

HC PLUS

CENTRAL RESERVE LIFE INSURANCE COM-
PANY (OHIO CORPORATION)
17800 ROYALTON ROAD
STRONGSVILLE, OH 441365197

FOR: INSURANCE UNDERWRITING SERVICES
IN THE FIELD OF HEALTH INSURANCE, IN
CLASS 36 (U.S. CLS. 100, 101 AND 102).

FIRST USE 5-22-2003; IN COMMERCE 5-22-2003.

NO CLAIM IS MADE TO THE EXCLUSIVE
RIGHT TO USE HC, APART FROM THE MARK AS
SHOWN.

SER. NO. 76-540,514, FILED 8-27-2003.

LEIGH CAROLINE CASE, EXAMINING ATTOR-
NEY

Int. Cl.: 41

Prior U.S. Cls.: 100, 101 and 107

United States Patent and Trademark Office

Reg. No. 2,892,870

Registered Oct. 12, 2004

**SERVICE MARK
PRINCIPAL REGISTER**



UNCLE CHEF PRODUCTIONS, INC. (UNITED STATES CORPORATION)
8210 BROOKNELL TERRACE
CHARLOTTE, NC 28270

FOR: ENTERTAINMENT SERVICES, NAMELY, A CONTINUING ON-GOING TELEVISION PROGRAM IN THE NATURE OF A CHILDREN'S

COOKING SHOW, IN CLASS 41 (U.S. CLS. 100, 101 AND 107).

FIRST USE 12-1-1996; IN COMMERCE 12-1-1996.

SER. NO. 76-540,673, FILED 8-28-2003.

BRIAN NEVILLE, EXAMINING ATTORNEY

Int. Cl.: 37

Prior U.S. Cls.: 100, 103 and 106

Reg. No. 2,892,871

United States Patent and Trademark Office

Registered Oct. 12, 2004

**SERVICE MARK
PRINCIPAL REGISTER**



PATCO
CONSTRUCTION, INC.

PATCO CONSTRUCTION, INC. (MAINE CORPORATION)
1293 MAIN STREET
SANFORD, ME 04073

NO CLAIM IS MADE TO THE EXCLUSIVE RIGHT TO USE "CONSTRUCTION, INC.", APART FROM THE MARK AS SHOWN.

FOR: RESIDENTIAL AND COMMERCIAL BUILDING CONSTRUCTION, IN CLASS 37 (U.S. CLS. 100, 103 AND 106).

SER. NO. 76-540,708, FILED 8-15-2003.

FIRST USE 1-1-1990; IN COMMERCE 1-1-1990.

TONI HICKEY, EXAMINING ATTORNEY

Int. Cl.: 35

Prior U.S. Cls.: 100, 101 and 102

United States Patent and Trademark Office

Reg. No. 2,892,872

Registered Oct. 12, 2004

**SERVICE MARK
PRINCIPAL REGISTER**

PENMAN, INK

BRUBAKER, TOD R. (UNITED STATES INDIVIDUAL)
36A DANA STREET
CAMBRIDGE, MA 02138

FOR: PREPARATION OF COPY FOR MARKETING AND ADVERTISING CAMPAIGNS AND BUSINESS COMMUNICATIONS, AND THE GENERATION OF NAMES AND MARKS FOR PRODUCTS AND SERVICES, IN CLASS 35 (U.S. CLS. 100, 101 AND 102).

FIRST USE 1-0-2003; IN COMMERCE 1-0-2003.

NO CLAIM IS MADE TO THE EXCLUSIVE RIGHT TO USE PENMAN, APART FROM THE MARK AS SHOWN.

SER. NO. 76-540,811, FILED 8-28-2003.

CATHERINE FAINT, EXAMINING ATTORNEY

Int. Cl.: 41

Prior U.S. Cls.: 100, 101 and 107

United States Patent and Trademark Office

Reg. No. 2,892,873

Registered Oct. 12, 2004

**SERVICE MARK
PRINCIPAL REGISTER**

LOTTERY TENNESSEE

TENNESSEE EDUCATION LOTTERY CORPORATION (TENNESSEE CORPORATION)
PLAZA TOWER METRO CENTER
200 ATHENS WAY, SUITE 200
NASHVILLE, TN 37228

FOR: LOTTERY SERVICES, IN CLASS 41 (U.S. CLS. 100, 101 AND 107).

FIRST USE 1-20-2004; IN COMMERCE 1-20-2004.

NO CLAIM IS MADE TO THE EXCLUSIVE RIGHT TO USE "LOTTERY", APART FROM THE MARK AS SHOWN.

SEC. 2(F).

SER. NO. 76-540,875, FILED 8-29-2003.

MELVIN AXILBUND, EXAMINING ATTORNEY

Int. Cls.: 25 and 28

Prior U.S. Cls.: 22, 23, 38, 39 and 50

United States Patent and Trademark Office

Reg. No. 2,892,874

Registered Oct. 12, 2004

**TRADEMARK
PRINCIPAL REGISTER**

LOTTERY TENNESSEE

TENNESSEE EDUCATION LOTTERY CORPORATION (TENNESSEE CORPORATION)
PLAZA TOWER METRO CENTER
200 ATHENS WAY SUITE 200
NASHVILLE, TN 37228

FOR: CLOTHING; NAMELY, GOLF SHIRTS, SUN VISORS, CAPS, HATS AND T-SHIRTS, IN CLASS 25 (U.S. CLS. 22 AND 39).

FIRST USE 1-20-2004; IN COMMERCE 1-20-2004.

FOR: LOTTERY CARDS AND LOTTERY TICKETS, IN CLASS 28 (U.S. CLS. 22, 23, 38 AND 50).

FIRST USE 1-20-2004; IN COMMERCE 1-20-2004.

NO CLAIM IS MADE TO THE EXCLUSIVE RIGHT TO USE LOTTERY, APART FROM THE MARK AS SHOWN.

SEC. 2(F).

SER. NO. 76-540,881, FILED 8-29-2003.

MELVIN AXILBUND, EXAMINING ATTORNEY

Int. Cl.: 3

Prior U.S. Cls.: 1, 4, 6, 50, 51 and 52

United States Patent and Trademark Office

Reg. No. 2,892,875

Registered Oct. 12, 2004

**TRADEMARK
PRINCIPAL REGISTER**

SPORT MAGIC

CERCEDES, THOMAS F. (UNITED STATES IN-
DIVIDUAL)
13695 RAMONA AVE.
DESERT HOT SPRINGS, CA 92240

NO CLAIM IS MADE TO THE EXCLUSIVE
RIGHT TO USE "SPORT", APART FROM THE
MARK AS SHOWN.

FOR: CLEANING PREPARATIONS FOR USE IN
ATHLETIC AND CASUAL WEAR SHOES, IN CLASS
3 (U.S. CLS. 1, 4, 6, 50, 51 AND 52).

SER. NO. 76-541,016, FILED 8-29-2003.

FIRST USE 5-5-1989; IN COMMERCE 5-8-1990.

JOHN E. MICHOS, EXAMINING ATTORNEY

Int. Cl.: 38

Prior U.S. Cls.: 100, 101 and 104

United States Patent and Trademark Office

Reg. No. 2,892,876

Registered Oct. 12, 2004

**SERVICE MARK
PRINCIPAL REGISTER**

CITADEL BROADCASTING CORPORATION

CITADEL BROADCASTING COMPANY (NEVADA CORPORATION)
7201 W. LAKE MEAD BOULEVARD
SUITE 400
LAS VEGAS, NV 89128

FOR: RADIO BROADCASTING SERVICES, IN CLASS 38 (U.S. CLS. 100, 101 AND 104).

FIRST USE 8-1-2003; IN COMMERCE 8-1-2003.

OWNER OF U.S. REG. NOS. 2,724,655, 2,817,674 AND OTHERS.

NO CLAIM IS MADE TO THE EXCLUSIVE RIGHT TO USE "BROADCASTING CORPORATION", APART FROM THE MARK AS SHOWN.

SER. NO. 76-541,186, FILED 8-29-2003.

JOHN E. MICHOS, EXAMINING ATTORNEY

Int. Cl.: 40

Prior U.S. Cls.: 100, 103 and 106

United States Patent and Trademark Office

Reg. No. 2,892,877

Registered Oct. 12, 2004

**SERVICE MARK
PRINCIPAL REGISTER**

WESTERN COMPACTORS

BUCHANAN COMPANY, INC. (CALIFORNIA
CORPORATION)
1016 E. EDNA PLACE
COVINA, CA 91724

NO CLAIM IS MADE TO THE EXCLUSIVE
RIGHT TO USE COMPACTORS, APART FROM
THE MARK AS SHOWN.

FOR: CUSTOM MANUFACTURE OF TRASH
AND DEBRIS COMPACTORS, IN CLASS 40 (U.S.
CLS. 100, 103 AND 106).

SER. NO. 76-541,221, FILED 8-19-2003.

FIRST USE 1-2-2002; IN COMMERCE 1-2-2002.

STEPHANIE DAVIS, EXAMINING ATTORNEY

Int. Cl.: 10

Prior U.S. Cls.: 26, 39 and 44

Reg. No. 2,892,878

United States Patent and Trademark Office

Registered Oct. 12, 2004

**TRADEMARK
PRINCIPAL REGISTER**

CENTURION

TRI-STATE HOSPITAL SUPPLY CORPORATION
(MICHIGAN CORPORATION)
301 CATRELL DRIVE
HOWELL, MI 48843

FOR: CUSTOM MEDICAL PROCEDURAL TRAYS AND KITS NAMELY- AMNIOCENTESIS TRAYS, ANESTHESIA TRAYS, ANGIOGRAPHY TRAYS, ARTERIOGRAM TRAYS, ARTHROGRAM TRAYS, ASPIRATION TRAYS, BIOPSY DRAINAGE TRAYS, BONE MARROW PREP TRAYS, BONE MARROW TRAYS, BREAST BIOPSY TRAYS, BRONCHOSCOPY TRAYS, CATHETER PREP TRAYS, CVC INSERTION TRAYS, CHEST TROCAR TRAYS, CHEST TUBE INSERTION TRAYS, CHEST TUBE REMOVAL TRAYS, CIRCUMCISION TRAYS, CORE BIOPSY TRAYS, CRANIAL ACCESS TRAYS, CRICOTHYROIDOTOMY TRAYS, CUT DOWN TRAYS, CYSTOSCOPY TRAYS, D AND C TRAYS, DEBRIDEMENT TRAYS, DIALYSIS TRAYS, DISKOGRAM TRAYS, DRESSING CHANGE TRAYS, EGG RETRIEVAL TRAYS, ENDO BIOPSY TRAYS, EPIDURAL TRAYS, EPISIOTOMY TRAYS, EPITAXIS TRAYS, EXCISION TRAYS, ENT TRAYS, GENERAL UTILITY TRAYS, HAND TRAYS, HYPERALIMENTATION TRAYS, HYSTEOSALPINGOGRAM TRAYS, I;V; START SETS, I;V; TUBING EXTENSION SETS, INCISION AND DRAINAGE TRAYS, IUD INSERTION TRAYS, JOINT ASPIRATION TRAYS, LABOR AND DELIVERY TRAYS, LAP CHOLE TRAYS, LAPAROTOMY TRAYS, LINE PULL TRAYS, LIVER BIOPSY TRAYS, LOCAL TRAYS, MAJOR BASIN SETS, MAMMOGRAPHY TRAYS, MINOR BASIN SETS, MOUTH CARE KITS, MYELOGRAM TRAYS, NASAL TRAYS, NOSE-BLEED TRAYS, OB INSTRUMENT TRAYS, ON-OFF TRAYS, ORTHOPEDIC TRAYS, OTOTOLOGY TRAYS, PAP SMEAR TRAYS, PARACENTESIS

TRAYS, PELVIC EXAM TRAYS, PERITONEAL LAVAGE TRAYS, PERITONSILLAR ABSCESS TRAYS, PICC INSERTION TRAYS, PLACENTA BASIN SETS, PLASTIC SURGERY TRAYS, PORT ACCESS TRAYS, PRE-CIP TRAYS, PUNCTURE TRAYS, RADIOLOGY TRAYS, RAPE KITS, RSV TRAYS, RESUSCITATION TRAYS, SHAVE PREP KITS, SHEATH REMOVAL TRAYS, SIGMOIDOSCOPY TRAYS, SKIN PREP TRAYS, SKIN SCRUB TRAYS, STEREOTACTIC BREAST TRAYS, STEREOTACTIC CORE BIOPSY TRAYS, SUTURING TRAYS, THERMO THERAPY TRAYS, THORACOTOMY TRAYS, TONSIL TRAYS, TPN TRAYS TRACH INSERTION TRAYS, TRACHEOSTOMY CARE TRAYS, TRACHEOTOMY TRAYS, ULTRASOUND CORE BIOPSY TRAYS, UMBILICAL CATHETER INSERTION TRAYS, UMBILICAL CORD CUTTING TRAYS, UNIVERSAL TRAYS, URETHRAL CATHETER INTERMITTENT URINE SAMPLING KITS, VAGINAL BLEEDER TRAYS, VAGINAL DELIVERY TRAYS, VAGINAL PREP TRAYS, VASCULAR ACCESS TRAYS, VASECTOMY TRAYS, VENESECTION TRAYS, VENIPUNCTURE TRAYS, VENOUS CANNULA TRAYS, VENTRICULAR ASSIST DEVICE (VAD) TRAYS, WOUND CARE TRAYS, AND WOUND CLOSURE TRAYS, IN CLASS 10 (U.S. CLS. 26, 39 AND 44).

FIRST USE 2-21-1985; IN COMMERCE 2-21-1985.

OWNER OF U.S. REG. NOS. 1,206,998, 2,808,249 AND OTHERS.

SER. NO. 76-541,306, FILED 8-18-2003.

PAULA MAHONEY, EXAMINING ATTORNEY

Int. Cl.: 43

Prior U.S. Cls.: 100 and 101

United States Patent and Trademark Office

Reg. No. 2,892,879

Registered Oct. 12, 2004

**SERVICE MARK
PRINCIPAL REGISTER**

ASHLEY MANOR

ASHLEY MANOR, INC. (ARIZONA CORPORATION)
1380 S. PRICE RD
CHANDLER, AZ 85248

FIRST USE 4-2-1997; IN COMMERCE 4-2-1997.

SER. NO. 76-541,629, FILED 8-21-2003.

FOR: PROVIDING SOCIAL FUNCTION FACILITIES FOR SPECIAL OCCASIONS, IN CLASS 43 (U.S. CLS. 100 AND 101).

CHERYL CLAYTON, EXAMINING ATTORNEY

Int. Cl.: 41

Prior U.S. Cls.: 100, 101 and 107

United States Patent and Trademark Office

Reg. No. 2,892,880

Registered Oct. 12, 2004

**SERVICE MARK
PRINCIPAL REGISTER**

FUNCTIONAL HEALTH ANALYSIS PROFILE (FHAP)

TERAFORMA HEALTH, INC. (TEXAS COR-
PORATION)
14405 WALTERS ROAD, SUITE 800
HOUSTON, TX 77014

NO CLAIM IS MADE TO THE EXCLUSIVE
RIGHT TO USE FUNCTIONAL HEALTH ANALYSIS
PROFILE, APART FROM THE MARK AS SHOWN.

FOR: ON-LINE PUBLICATION, NAMELY A
HEALTH ASSESSMENT AND EVALUATION QUES-
TIONNAIRE, IN CLASS 41 (U.S. CLS. 100, 101 AND
107).

SER. NO. 76-541,782, FILED 8-25-2003.

FIRST USE 1-1-1998; IN COMMERCE 1-1-1998.

ELIZABETH J. WINTER, EXAMINING ATTORNEY

Int. Cl.: 43

Prior U.S. Cls.: 100 and 101

United States Patent and Trademark Office

Reg. No. 2,892,881

Registered Oct. 12, 2004

**SERVICE MARK
PRINCIPAL REGISTER**

YOUR ROAD TRAVEL AGENT

TRAVELOGISTICS, INC. (GEORGIA CORPORATION)
80 PEACHTREE PARK DRIVE, N.E.
ATLANTA, GA 303091320

FOR: TRAVEL AGENCY SERVICES, NAMELY,
MAKING RESERVATIONS AND BOOKINGS FOR
TEMPORARY LODGING FOR OTHERS, IN CLASS
43 (U.S. CLS. 100 AND 101).

FIRST USE 8-15-2003; IN COMMERCE 8-15-2003.

NO CLAIM IS MADE TO THE EXCLUSIVE
RIGHT TO USE "TRAVEL AGENT", APART FROM
THE MARK AS SHOWN.

SER. NO. 76-541,940, FILED 8-29-2003.

TANYA AMOS, EXAMINING ATTORNEY

Int. Cl.: 10

Prior U.S. Cls.: 26, 39 and 44

United States Patent and Trademark Office

Reg. No. 2,892,882

Registered Oct. 12, 2004

**TRADEMARK
PRINCIPAL REGISTER**

OPMI MOVENA

CARL-ZEISS-STIFTUNG (FED REP GERMANY
CORPORATION), DBA CARL ZEISS
73446 OBERKOCHEN, FED REP GERMANY

FOR: SURGICAL MICROSCOPES, IN CLASS 10
(U.S. CLS. 26, 39 AND 44).

PRIORITY CLAIMED UNDER SEC. 44(D) ON FED
REP GERMANY APPLICATION NO. 30325951.5/0,

FILED 5-23-2003, REG. NO. 30325951, DATED 5-23-
2003, EXPIRES 5-23-2013.

OWNER OF U.S. REG. NO. 1,173,004.

SER. NO. 76-542,162, FILED 9-2-2003.

VERNA BETH RIRIE, EXAMINING ATTORNEY

Int. Cl.: 41

Prior U.S. Cls.: 100, 101 and 107

United States Patent and Trademark Office

Reg. No. 2,892,883

Registered Oct. 12, 2004

**SERVICE MARK
PRINCIPAL REGISTER**

SWAP Records

SWAP RECORDS, LLC (ARIZONA LTD LIAB CO)
C/O BOGUTZ & GORDON, P.C.
3503 N. CAMPBELL AVE. 101
TUCSON, AZ 85719

NO CLAIM IS MADE TO THE EXCLUSIVE
RIGHT TO USE "RECORDS", APART FROM THE
MARK AS SHOWN.

FOR: MUSIC PRODUCTION SERVICES, IN
CLASS 41 (U.S. CLS. 100, 101 AND 107).

SER. NO. 76-542,923, FILED 9-8-2003.

FIRST USE 11-1-2002; IN COMMERCE 11-1-2002.

ELLEN B. AWRICH, EXAMINING ATTORNEY

Int. Cl.: 35

Prior U.S. Cls.: 100, 101 and 102

United States Patent and Trademark Office

Reg. No. 2,892,884

Registered Oct. 12, 2004

**SERVICE MARK
PRINCIPAL REGISTER**

THE WINE SELLER

EURO, JOSEPH M (UNITED STATES INDIVIDUAL)
THE WINE SELLER 940 WATER STREET
PORT TOWNSEND, WA 98368

NO CLAIM IS MADE TO THE EXCLUSIVE
RIGHT TO USE "WINE", APART FROM THE MARK
AS SHOWN.

FOR: RETAIL STORE SERVICES, FEATURING
WINE, BEER, GIFTS, GOURMET FOODS, CHEESE,
COFFEE, AND CHOCOLATES, IN CLASS 35 (U.S.
CLS. 100, 101 AND 102).

SER. NO. 76-543,132, FILED 8-26-2003.

FIRST USE 9-15-1982; IN COMMERCE 9-15-1982.

NAAKWAMA ANKRAH, EXAMINING ATTORNEY

Int. Cls.: 35 and 37

Prior U.S. Cls.: 100, 101, 102, 103 and 106

United States Patent and Trademark Office

Reg. No. 2,892,885

Registered Oct. 12, 2004

**SERVICE MARK
PRINCIPAL REGISTER**

Absolutely Fish 

ABSOLUTELY FISH INC. (NEW JERSEY CORPORATION)
1080 ROUTE 46 WEST
CLIFTON, NJ 07013

FOR: RETAIL STORE SERVICES FEATURING FISH AND AQUARIUM SUPPLIES, IN CLASS 35 (U.S. CLS. 100, 101 AND 102).

FIRST USE 9-30-1999; IN COMMERCE 9-30-1999.

FOR: INSTALLATION AND MAINTENANCE OF AQUARIUMS, IN CLASS 37 (U.S. CLS. 100, 103 AND 106).

FIRST USE 9-30-1999; IN COMMERCE 9-30-1999.

NO CLAIM IS MADE TO THE EXCLUSIVE RIGHT TO USE FISH, APART FROM THE MARK AS SHOWN.

SER. NO. 76-543,430, FILED 8-27-2003.

MARIA-VICTORIA SUAREZ, EXAMINING ATTORNEY

Int. Cl.: 35

Prior U.S. Cls.: 100, 101 and 102

United States Patent and Trademark Office

Reg. No. 2,892,886

Registered Oct. 12, 2004

**SERVICE MARK
PRINCIPAL REGISTER**



AMCOR SUNCLIPSE NORTH AMERICA (CALI-
FORNIA CORPORATION)
6600 VALLEY VIEW STREET
BUENA PARK, CA 90620

OWNER OF U.S. REG. NOS. 1,714,907 AND
2,415,163.

FOR: DISTRIBUTORSHIP SERVICES IN THE
FIELD OF PAPER AND PACKAGING SUPPLIES,
IN CLASS 35 (U.S. CLS. 100, 101 AND 102).

SER. NO. 76-543,520, FILED 9-9-2003.

FIRST USE 7-20-1989; IN COMMERCE 7-20-1989.

HOWARD SMIGA, EXAMINING ATTORNEY

Int. Cl.: 9

Prior U.S. Cls.: 21, 23, 26, 36 and 38

Reg. No. 2,892,887

United States Patent and Trademark Office

Registered Oct. 12, 2004

**TRADEMARK
PRINCIPAL REGISTER**

XTREME SPEED

GREAT BARRIER REEF, INC. (DELAWARE
CORPORATION)
220 WEST FOURTH STREET
JOPLIN, MO 64801

NET CONNECTIONS, IN CLASS 9 (U.S. CLS. 21, 23,
26, 36 AND 38).

FIRST USE 10-13-2003; IN COMMERCE 10-13-2003.

FOR: COMPUTER SOFTWARE, NAMELY COM-
PUTER SOFTWARE FOR PROVIDING ACCESS TO
THE INTERNET AND ACCELERATION OF INTER-

SER. NO. 76-543,623, FILED 9-10-2003.

SCOTT OSLICK, EXAMINING ATTORNEY

Int. Cls.: 37 and 40

Prior U.S. Cls.: 100, 103 and 106

United States Patent and Trademark Office

Reg. No. 2,892,888

Registered Oct. 12, 2004

**SERVICE MARK
PRINCIPAL REGISTER**



UNITED RECYCLING INDUSTRIES, INC. (ILLINOIS CORPORATION)
1600 HARVESTER
WEST CHICAGO, IL 60185

FOR: REPAIR, REFURBISHING, DE-MANUFACTURING AND DESTRUCTION OF ELECTRONIC EQUIPMENT, NAMELY, COMPUTERS AND COMPUTER PERIPHERALS, HARD DRIVES, MONITORS, KEYBOARDS, EXTERNAL MODEMS AND FACSIMILE MACHINES, IN CLASS 37 (U.S. CLS. 100, 103 AND 106).

FIRST USE 4-15-2002; IN COMMERCE 4-15-2002.

FOR: RECYCLING SERVICES, IN CLASS 40 (U.S. CLS. 100, 103 AND 106).

FIRST USE 4-15-2002; IN COMMERCE 4-15-2002.

NO CLAIM IS MADE TO THE EXCLUSIVE RIGHT TO USE "E-SCRAP RECY-KLOR", APART FROM THE MARK AS SHOWN.

SER. NO. 76-543,644, FILED 9-10-2003.

JILL C. ALT, EXAMINING ATTORNEY

Int. Cl.: 32

Prior U.S. Cls.: 45, 46 and 48

United States Patent and Trademark Office

Reg. No. 2,892,889

Registered Oct. 12, 2004

**TRADEMARK
PRINCIPAL REGISTER**

FEDERATION ANGEL ALE

NORTHERN CLUBS FEDERATION BREWERY
LIMITED, THE (UNITED KINGDOM COMPA-
NY)
LANCASTER ROAD
DUNSTON INDUSTRIAL ESTATE, DUNSTON
TYNE & WEAR NE11 9JR, UNITED KINGDOM

FOR: BEER, ALE, LAGER, STOUT, PORTER, AND
PREPARATIONS FOR MAKING THE SAME; NON-
ALCOHOLIC DRINKS, NAMELY, SOFT DRINKS,
FRUIT FLAVOURED DRINKS, FRUIT JUICES,
SWEET CIDER, AND PREPARATIONS FOR MAK-
ING THE SAME, IN CLASS 32 (U.S. CLS. 45, 46 AND
48).

FIRST USE 11-0-2002; IN COMMERCE 11-0-2002.

OWNER OF U.S. REG. NO. 2,744,218.

NO CLAIM IS MADE TO THE EXCLUSIVE
RIGHT TO USE ALE, APART FROM THE MARK
AS SHOWN.

SER. NO. 76-543,657, FILED 8-28-2003.

PAULA MAHONEY, EXAMINING ATTORNEY

Int. Cl.: 42

Prior U.S. Cls.: 100 and 101

United States Patent and Trademark Office

Reg. No. 2,892,890

Registered Oct. 12, 2004

**SERVICE MARK
PRINCIPAL REGISTER**

PINPOINT LEAK DETECTION

PINPOINT LEAK DETECTION, INC. (CALIFORNIA CORPORATION)
2835 SURFRIDER AVENUE
VENTURA, CA 93001

FOR: LOCATING, MARKING, AND MAPPING
PLACEMENT OF UNDERGROUND UTILITY
PIPES, CABLE OR WIRES, IN CLASS 42 (U.S. CLS.
100 AND 101).

FIRST USE 1-0-1991; IN COMMERCE 1-0-1991.

NO CLAIM IS MADE TO THE EXCLUSIVE
RIGHT TO USE "LEAK DETECTION", APART
FROM THE MARK AS SHOWN.

SEC. 2(F).

SER. NO. 76-543,922, FILED 8-29-2003.

BARBARA GAYNOR, EXAMINING ATTORNEY

Int. Cl.: 29

Prior U.S. Cl.: 46

United States Patent and Trademark Office

Reg. No. 2,892,891

Registered Oct. 12, 2004

**TRADEMARK
PRINCIPAL REGISTER**

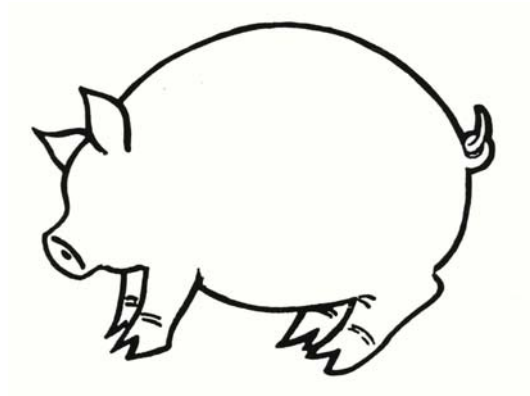

FARM FRESH FOOD SUPPLIERS, INC. (LOUISIANA CORPORATION)
32451 HIGHWAY 16
AMITE, LA 70422

FIRST USE 6-3-1983; IN COMMERCE 6-3-1983.

SER. NO. 76-544,085, FILED 8-29-2003.

FOR: MEATS, NAMELY, PICKLED MEATS AND PORK, IN CLASS 29 (U.S. CL. 46).

VIVIAN MICZNIK FIRST, EXAMINING ATTORNEY

Int. Cl.: 43

Prior U.S. Cls.: 100 and 101

United States Patent and Trademark Office

Reg. No. 2,892,892

Registered Oct. 12, 2004

**SERVICE MARK
PRINCIPAL REGISTER**

BIG FRESH CAFE

THE GREEN DOOR, INC. (MASSACHUSETTS
CORPORATION)
32 RUSSETT HILL ROAD
SHERBORN, MA 01770

NO CLAIM IS MADE TO THE EXCLUSIVE
RIGHT TO USE CAFE , APART FROM THE MARK
AS SHOWN.

FOR: RESTAURANT SERVICES, IN CLASS 43
(U.S. CLS. 100 AND 101).

SER. NO. 76-544,292, FILED 9-12-2003.

FIRST USE 11-24-2003; IN COMMERCE 11-24-2003.

JULIE WATSON, EXAMINING ATTORNEY

Int. Cl.: 14

Prior U.S. Cls.: 2, 27, 28 and 50

United States Patent and Trademark Office

Reg. No. 2,892,893

Registered Oct. 12, 2004

**TRADEMARK
PRINCIPAL REGISTER**

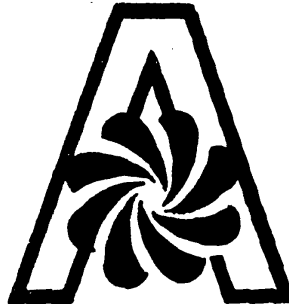

ALRUE IMPORT CORP. (NEW YORK CORPORATION)
10-40 45TH AVENUE
LONG ISLAND CITY, NY 11101

FIRST USE 6-1-1953; IN COMMERCE 6-1-1953.

OWNER OF U.S. REG. NO. 1,892,075.

FOR: JEWELRY, NAMELY BRACELETS, NECKLACES, BROOCHES, CHAINS, RINGS, CUFFLINKS, EARRINGS, TIE CLASPS AND MEDALLIONS ALL MADE OF OR COATED WITH PRECIOUS METALS, GEMSTONES, PRECIOUS AND SEMI-PRECIOUS STONES, IN CLASS 14 (U.S. CLS. 2, 27, 28 AND 50).

SER. NO. 76-544,778, FILED 9-15-2003.

CHERYL CLAYTON, EXAMINING ATTORNEY

Int. Cl.: 28

Prior U.S. Cls.: 22, 23, 38 and 50

United States Patent and Trademark Office

Reg. No. 2,892,894

Registered Oct. 12, 2004

**TRADEMARK
PRINCIPAL REGISTER**

TRIK STIK

HEDSTROM CORPORATION (DELAWARE COR-
PORATION)
BOX 432
SUNNYSIDE ROAD
BEDFORD, PA 15522

FIRST USE 7-0-2003; IN COMMERCE 7-0-2003.

SER. NO. 76-544,802, FILED 9-15-2003.

FOR: ADJUSTABLE JUMP BARS, IN CLASS 28
(U.S. CLS. 22, 23, 38 AND 50).

PRISCILLA MILTON, EXAMINING ATTORNEY

Int. Cl.: 3

Prior U.S. Cls.: 1, 4, 6, 50, 51 and 52

Reg. No. 2,892,895

United States Patent and Trademark Office

Registered Oct. 12, 2004

**TRADEMARK
PRINCIPAL REGISTER**

SILFATE

SILTECH LLC (GEORGIA LIMITED LIABILITY CORPORATION)
2170 LUKE EDWARDS ROAD
DACULA, GA 30019

FOR: SULFATED SILICONE BASED SURFACE ACTIVE AGENTS USED IN THE PERSONAL CARE, TEXTILE, HOUSEHOLD INDUSTRIAL AND INSTITUTIONAL AND AUTOMOTIVE MARKETS AS

EMULSIFIERS, WETTING AGENTS, AND DETERGENTS, IN CLASS 3 (U.S. CLS. 1, 4, 6, 50, 51 AND 52).

FIRST USE 4-12-1995; IN COMMERCE 4-12-1995.

SER. NO. 76-544,945, FILED 9-2-2003.

KATHY DE JONGE, EXAMINING ATTORNEY

Int. Cl.: 36

Prior U.S. Cls.: 100, 101 and 102

United States Patent and Trademark Office

Reg. No. 2,892,896

Registered Oct. 12, 2004

**SERVICE MARK
PRINCIPAL REGISTER**

**THE LEADER IN PRIVATE EQUITY FOR FAMILY OWNED
BUSINESSES**

HERITAGE PARTNERS MANAGEMENT COM-
PANY, INC. (DELAWARE CORPORATION)
30 ROWES WHARF
BOSTON, MA 02110

FOR: FINANCIAL SERVICES, NAMELY PRI-
VATE INVESTMENT SERVICES SPECIALIZING IN
THE ACQUISITION AND EQUITY-BASED RECAPI-
TALIZATION OF FAMILY OWNED BUSINESSES,
IN CLASS 36 (U.S. CLS. 100, 101 AND 102).

FIRST USE 0-0-1994; IN COMMERCE 0-0-1994.

NO CLAIM IS MADE TO THE EXCLUSIVE
RIGHT TO USE "FAMILY OWNED BUSINESSES",
APART FROM THE MARK AS SHOWN.

SEC. 2(F).

SER. NO. 76-544,983, FILED 9-2-2003.

TARAH HARDY, EXAMINING ATTORNEY

Int. Cl.: 35

Prior U.S. Cls.: 100, 101 and 102

United States Patent and Trademark Office

Reg. No. 2,892,897

Registered Oct. 12, 2004

**SERVICE MARK
PRINCIPAL REGISTER**



PUERTO RICO COMMUNITY FOUNDATION,
INC. (PUERTO RICO CORPORATION)
PO BOX 70362
SAN JUAN, PUERTO RICO 009368362

FOR: PROMOTING PUBLIC AWARENESS OF
THE NEED FOR PHILANTHROPY, IN CLASS 35
(U.S. CLS. 100, 101 AND 102).

FIRST USE 11-8-2002; IN COMMERCE 11-8-2002.

THE MARK CONSISTS OF A BRIGHT LIME BOW.

SER. NO. 76-545,062, FILED 9-16-2003.

MARC LEIPZIG, EXAMINING ATTORNEY

Int. Cls.: 16 and 35

Prior U.S. Cls.: 2, 5, 22, 23, 29, 37, 38, 50, 100, 101 and 102

Reg. No. 2,892,898

United States Patent and Trademark Office

Registered Oct. 12, 2004

**TRADEMARK
SERVICE MARK
PRINCIPAL REGISTER**

BAGS UNLIMITED

BAGS UNLIMITED, INC. (NEW YORK CORPORATION)
7 CANAL ST.
ROCHESTER, NY 14608

FOR: PLASTIC BAGS FOR PACKAGING; PLASTIC BAGS FOR PACKING; GENERAL PURPOSE PLASTIC BAGS; GROCERY BAGS; LUNCH BAGS; MERCHANDISE BAGS; PLASTIC BAGS FOR DISPOSABLE DIAPERS; PLASTIC BAGS FOR DISPOSING OF PET WASTE; PLASTIC FOOD STORAGE BAGS FOR HOUSEHOLD USE; PLASTIC GARBAGE BAGS; PLASTIC OR PAPER BAGS FOR HOUSEHOLD USE; PLASTIC OR PAPER BAGS FOR MERCHANDISE PACKAGING; PLASTIC SANDWICH BAGS; PLASTIC SHOPPING BAGS; PLASTIC TRASH BAGS; SANDWICH BAGS; TRASH BAGS; PAPER BAGS; PAPER BAGS FOR PACKAGING; PAPER GARBAGE BAGS; PAPER GIFT BAGS; PAPER PAR-

TY BAGS; PAPER REFUSE BAGS; PAPER SHOPPING BAGS, IN CLASS 16 (U.S. CLS. 2, 5, 22, 23, 29, 37, 38 AND 50).

FIRST USE 3-0-1975; IN COMMERCE 3-0-1975.

FOR: DISTRIBUTORSHIPS IN THE FIELD OF BAGS, IN CLASS 35 (U.S. CLS. 100, 101 AND 102).

FIRST USE 3-0-1975; IN COMMERCE 3-0-1975.

NO CLAIM IS MADE TO THE EXCLUSIVE RIGHT TO USE "BAGS", APART FROM THE MARK AS SHOWN.

SER. NO. 76-545,206, FILED 9-17-2003.

RONALD AIKENS, EXAMINING ATTORNEY

Int. Cl.: 41

Prior U.S. Cls.: 100, 101 and 107

United States Patent and Trademark Office

Reg. No. 2,892,899

Registered Oct. 12, 2004

**SERVICE MARK
PRINCIPAL REGISTER**

PERKINS SCHOOL FOR THE BLIND

PERKINS SCHOOL FOR THE BLIND (MASSACHUSETTS NON-PROFIT CORPORATION)
175 NORTH BEACON STREET
WATERTOWN, MA 02472

FOR: EDUCATIONAL SERVICES, NAMELY PROVIDING COURSES OF INSTRUCTION AT THE PRE-SCHOOL, PRIMARY AND SECONDARY LEVELS FOR THE VISUALLY IMPAIRED, THE BLIND, AND THE BLIND WITH MULTIPLE DISABILITIES; EDUCATIONAL SERVICES PROVIDING DOMESTICALLY AND INTERNATIONALLY, NAMELY PROVIDING CLASSES, WORKSHOPS AND SEMINARS FOR VISUALLY IMPAIRED, BLIND, AND BLIND WITH MULTIPLE DISABILITIES ADULTS AND CHILDREN IN LIFE-SKILLS, INDEPENDENCE SKILLS, SENSORY, LANGUAGE, PLAY AND MOVEMENT, AND CLASSES, WORKSHOPS AND SEMINARS FOR VISION AND EARLY INTERVENTION PROFESSIONALS, SCHOOL TEACHERS,

ELDER-CARE PROVIDERS, MEDICAL PROFESSIONALS, COMMUNITY RESOURCES, PARENTS AND FAMILY MEMBERS IN THE FIELD OF WORKING WITH, ASSISTING AND TEACHING THE VISUALLY IMPAIRED, THE BLIND, AND THE BLIND WITH MULTIPLE DISABILITIES, IN CLASS 41 (U.S. CLS. 100, 101 AND 107).

FIRST USE 11-7-1955; IN COMMERCE 11-30-1955.

NO CLAIM IS MADE TO THE EXCLUSIVE RIGHT TO USE "SCHOOL FOR THE BLIND", APART FROM THE MARK AS SHOWN.

SEC. 2(F).

SER. NO. 76-545,333, FILED 9-4-2003.

MARC LEIPZIG, EXAMINING ATTORNEY

Int. Cl.: 41

Prior U.S. Cls.: 100, 101 and 107

United States Patent and Trademark Office

Reg. No. 2,892,900

Registered Oct. 12, 2004

**SERVICE MARK
PRINCIPAL REGISTER**

PERKINS

PERKINS SCHOOL FOR THE BLIND (MASSACHUSETTS CORPORATION)
175 NORTH BEACON STREET
WATERTOWN, MA 02472

FOR: EDUCATIONAL SERVICES, NAMELY PROVIDING COURSES OF INSTRUCTION AT THE PRE-SCHOOL, PRIMARY AND SECONDARY LEVELS FOR THE VISUALLY IMPAIRED, THE BLIND, AND THE BLIND WITH MULTIPLE DISABILITIES; EDUCATIONAL SERVICES PROVIDING DOMESTICALLY AND INTERNATIONALLY, NAMELY PROVIDING CLASSES, WORKSHOPS AND SEMINARS FOR VISUALLY IMPAIRED, BLIND, AND BLIND WITH MULTIPLE DISABILITIES ADULTS AND CHILDREN IN LIFE-SKILLS, INDEPENDENCE SKILLS, SENSORY, LANGUAGE, PLAY AND MOVEMENT, AND CLASSES, WORKSHOPS

AND SEMINARS FOR VISION AND EARLY INTERVENTION PROFESSIONALS, SCHOOL TEACHERS, ELDER-CARE PROVIDERS, MEDICAL PROFESSIONALS, COMMUNITY RESOURCES, PARENTS AND FAMILY MEMBERS IN THE FIELD OF WORKING WITH, ASSISTING AND TEACHING THE VISUALLY IMPAIRED, THE BLIND, AND THE BLIND WITH MULTIPLE DISABILITIES, IN CLASS 41 (U.S. CLS. 100, 101 AND 107).

FIRST USE 0-0-1877; IN COMMERCE 0-0-1877.

SEC. 2(F).

SER. NO. 76-545,334, FILED 9-4-2003.

MARC LEIPZIG, EXAMINING ATTORNEY

Int. Cl.: 42

Prior U.S. Cls.: 100 and 101

United States Patent and Trademark Office

Reg. No. 2,892,901

Registered Oct. 12, 2004

**SERVICE MARK
PRINCIPAL REGISTER**

The logo for CampusNET features the word "Campus" in a large, bold, white font with a thick black outline. The word "NET" is positioned to the right of "Campus" and is rendered in a smaller, solid black, sans-serif font.

CAMPUS MANAGEMENT CORP (FLORIDA
CORPORATION)
777 YAMATO ROAD, SUITE 400
BOCA RATON, FL 33431

FIRST USE 3-15-2002; IN COMMERCE 3-15-2002.

FOR: APPLICATION SERVICE PROVIDER (ASP)
FEATURING SOFTWARE IN THE FIELD OF EDU-
CATIONAL INSTITUTION ADMINISTRATION, IN
CLASS 42 (U.S. CLS. 100 AND 101).

SER. NO. 76-545,882, FILED 9-22-2003.

JOHN DALIER, EXAMINING ATTORNEY

Int. Cl.: 29

Prior U.S. Cl.: 46

United States Patent and Trademark Office

Reg. No. 2,892,902

Registered Oct. 12, 2004

**TRADEMARK
PRINCIPAL REGISTER**

BOSS HOGG

PORK, INC. (INDIANA CORPORATION)
P.O. BOX 129
SILVER LAKE, IN 46982

OWNER OF U.S. REG. NOS. 2,064,735, 2,685,341,
AND 2,797,340.

FOR: BEEF JERKY, IN CLASS 29 (U.S. CL. 46).

SER. NO. 76-545,956, FILED 9-22-2003.

FIRST USE 1-1-1991; IN COMMERCE 1-1-1991.

CAROLINE WEIMER, EXAMINING ATTORNEY

Int. Cls.: 16, 35, 39 and 40

**Prior U.S. Cls.: 2, 5, 22, 23, 29, 37, 38, 50, 100, 101,
102, 103, 105 and 106**

Reg. No. 2,892,903

United States Patent and Trademark Office

Registered Oct. 12, 2004

**TRADEMARK
SERVICE MARK
PRINCIPAL REGISTER**

UNIVERSITY OF CHICAGO PRESS

UNIVERSITY OF CHICAGO (ILLINOIS NOT-
FOR-PROFIT CORPORATION)
5801 S. ELLIS AVENUE
CHICAGO, IL 60637

FOR: FULL LINE OF BOOKS AND JOURNALS IN
THE FIELDS OF SCHOLARLY AND PROFESSION-
AL DISCIPLINES ON A VARIETY OF TOPICS, IN
CLASS 16 (U.S. CLS. 2, 5, 22, 23, 29, 37, 38 AND 50).

FIRST USE 0-0-1891; IN COMMERCE 0-0-1891.

FOR: MARKETING OF BOOKS AND OTHER
PRINTED PUBLICATIONS IN THE FIELDS OF
SCHOLARLY AND PROFESSIONAL DISCIPLINES
FOR OTHERS, IN CLASS 35 (U.S. CLS. 100, 101 AND
102).

FIRST USE 0-0-1905; IN COMMERCE 0-0-1905.

FOR: WAREHOUSING, NAMELY, STORAGE
AND DISTRIBUTION OF BOOKS AND OTHER
PRINTED PUBLICATIONS FOR OTHERS, IN CLASS
39 (U.S. CLS. 100 AND 105).

FIRST USE 0-0-1905; IN COMMERCE 0-0-1905.

FOR: SHORT RUN DIGITAL PRINTING SERVI-
CES OF BOOKS AND OTHER PRINTED PUBLICA-
TIONS FOR OTHERS, IN CLASS 40 (U.S. CLS. 100, 103
AND 106).

FIRST USE 0-0-2001; IN COMMERCE 0-0-2001.

OWNER OF U.S. REG. NO. 1,876,527.

NO CLAIM IS MADE TO THE EXCLUSIVE
RIGHT TO USE "CHICAGO PRESS" FOR CLASSES
16 & 40 AND "CHICAGO" FOR CLASSES 35 & 39,
APART FROM THE MARK AS SHOWN.

SER. NO. 76-546,060, FILED 9-22-2003.

KARANENDRA S. CHHINA, EXAMINING ATTOR-
NEY

Int. Cl.: 2

Prior U.S. Cls.: 6, 11 and 16

United States Patent and Trademark Office

Reg. No. 2,892,904

Registered Oct. 12, 2004

**TRADEMARK
PRINCIPAL REGISTER**

ARISTOSHEEN

DUNN-EDWARDS CORPORATION (CALIFOR-
NIA CORPORATION)
4885 EAST 52ND PLACE
LOS ANGELES, CA 90040

FIRST USE 3-6-1996; IN COMMERCE 3-6-1996.

SER. NO. 76-546,145, FILED 9-4-2003.

FOR: PAINT, NAMELY SEMI-GLOSS ENAMEL
FOR INTERIOR USE, IN CLASS 2 (U.S. CLS. 6, 11
AND 16).

G. T. GLYNN, EXAMINING ATTORNEY

Int. Cl.: 25

Prior U.S. Cls.: 22 and 39

United States Patent and Trademark Office

Reg. No. 2,892,905

Registered Oct. 12, 2004

**TRADEMARK
PRINCIPAL REGISTER**



BECKERMAN, BRAD (UNITED STATES INDIVIDUAL)
C/O TUCKER & LATIFI, LLP
160 EAST 84TH STREET
NEW YORK, NY 10028

FOR: MEN'S AND WOMENS' CLOTHING,
NAMESLY, JACKETS, PANTS, SHIRTS, JEANS,
COATS, VESTS, DRESSES, SWIMWEAR, SKIRTS,

SOCKS, BELTS, SWEATERS, HEADWEAR AND
FOOTWEAR , IN CLASS 25 (U.S. CLS. 22 AND 39).

FIRST USE 6-1-2003; IN COMMERCE 6-1-2003.

SER. NO. 76-546,222, FILED 9-8-2003.

THEODORE MCBRIDE, EXAMINING ATTORNEY

Int. Cls.: 9, 35 and 36

Prior U.S. Cls.: 21, 23, 26, 36, 38, 100, 101 and 102

United States Patent and Trademark Office

Reg. No. 2,892,906

Registered Oct. 12, 2004

**TRADEMARK
SERVICE MARK
PRINCIPAL REGISTER**

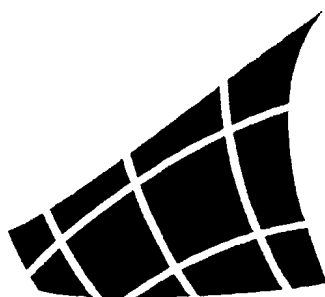

METAVANTE CORPORATION (WISCONSIN CORPORATION)
4900 WEST BROWN DEER ROAD
BROWN DEER, WI 532249004

FOR: COMPUTER SOFTWARE FOR USE BY FINANCIAL SERVICES PROVIDERS TO CONDUCT ELECTRONIC BANKING, TRUST ACCOUNTING, ELECTRONIC FUNDS TRANSFERS, ELECTRONIC BILL PRESENTMENT AND PAYMENT, AND FINANCIAL TRANSACTION PROCESSING, INCLUDING ATM, CREDIT AND DEBIT CARD TRANSACTIONS; COMPUTER SOFTWARE FOR USE BY FINANCIAL SERVICES PROVIDERS TO MANAGE CUSTOMER RELATIONSHIPS; COMPUTER SOFTWARE FOR CUSTOM STATEMENT FORMATTING, IN CLASS 9 (U.S. CLS. 21, 23, 26, 36 AND 38).

FIRST USE 8-0-2000; IN COMMERCE 8-0-2000.

FOR: PROVIDING OUTSOURCED SERVICES FOR OTHERS IN THE FIELD OF FINANCIAL SERVICES AND SOFTWARE, IN CLASS 35 (U.S. CLS. 100, 101 AND 102).

FIRST USE 8-0-2000; IN COMMERCE 8-0-2000.

FOR: COMPUTER SOFTWARE AND TECHNOLOGY IMPLEMENTATION CONSULTING FOR FINANCIAL SERVICE PROVIDERS; BILL PAYMENT SERVICES, IN CLASS 36 (U.S. CLS. 100, 101 AND 102).

FIRST USE 8-0-2000; IN COMMERCE 8-0-2000.

SER. NO. 76-546,329, FILED 9-22-2003.

ESTHER A. BORSUK, EXAMINING ATTORNEY

Int. Cl.: 25

Prior U.S. Cls.: 22 and 39

United States Patent and Trademark Office

Reg. No. 2,892,907

Registered Oct. 12, 2004

TRADEMARK
PRINCIPAL REGISTER



PADOVA INTERNATIONAL U.S.A., INC. (NEVADA CORPORATION)
23121 ARROYO VISTA SUITE B
RANCHO SANTA MARGARITA, CA 92688

FOR: CLOTHING, NAMELY- T-SHIRTS, SPORT SHIRTS, CAMP SHIRTS, POLO SHIRTS, SWEAT SHIRTS, SINGLETs, TANK TOPS, BOARD SHORTS, WALKING SHORTS, JACKETS, COATS, WIND RESISTANT JACKETS, VESTS, SURF WEAR, GLOVES, SKI GLOVES, SNOWBOARD GLOVES, RIDING GLOVES, RASH GUARDS, WET SUITS, DRY SUITS,

DRY TOPS, WATER SKI SUITS, NEOPRENE SOCKS, NEOPRENE SHORTS, RIDING BOOTS, SKI BOOTS, BOOTS FOR WATER SPORTS, HOODS FOR WATER SPORTS, HATS, CAPS, BEANIES AND VISORS, IN CLASS 25 (U.S. CLS. 22 AND 39).

FIRST USE 2-1-2001; IN COMMERCE 2-1-2001.

SER. NO. 76-546,661, FILED 9-24-2003.

KATHRYN COWARD, EXAMINING ATTORNEY

Int. Cl.: 5

Prior U.S. Cls.: 6, 18, 44, 46, 51 and 52

United States Patent and Trademark Office

Reg. No. 2,892,908

Registered Oct. 12, 2004

**TRADEMARK
PRINCIPAL REGISTER**

CURAD. WE HELP HEAL

BEIERSDORF AKTIENGESELLSCHAFT (FED
REP GERMANY CORPORATION)
UNNASTRASSE 48
20245 HAMBURG, FED REP GERMANY

FOR: ADHESIVE BANDAGES, SPRAY BANDA-
GES, MEDICAL ADHESIVE TAPES, GAUZE PADS
AND FIRST AID KITS, IN CLASS 5 (U.S. CLS. 6, 18,
44, 46, 51 AND 52).

FIRST USE 5-0-2001; IN COMMERCE 5-0-2001.

OWNER OF U.S. REG. NOS. 538,723, 2,549,982 AND
OTHERS.

SER. NO. 76-546,801, FILED 9-17-2003.

RONALD AIKENS, EXAMINING ATTORNEY

Int. Cl.: 26

Prior U.S. Cls.: 37, 39, 40, 42 and 50

Reg. No. 2,892,909

United States Patent and Trademark Office

Registered Oct. 12, 2004

TRADEMARK
PRINCIPAL REGISTER



WOLFF FORDING & COMPANY (VIRGINIA
CORPORATION)
2220 EAST MAIN STREET
RICHMOND, VA 23223

FIRST USE 3-1-2003; IN COMMERCE 3-1-2003.

SER. NO. 76-546,842, FILED 9-8-2003.

FOR: TAPS FOR DANCE SHOES, IN CLASS 26
(U.S. CLS. 37, 39, 40, 42 AND 50).

MARY ROSSMAN, EXAMINING ATTORNEY

Int. Cl.: 5

Prior U.S. Cls.: 6, 18, 44, 46, 51 and 52

United States Patent and Trademark Office

Reg. No. 2,892,910

Registered Oct. 12, 2004

TRADEMARK
PRINCIPAL REGISTER



L. PERRIGO COMPANY (MICHIGAN CORPORATION)
117 WATER STREET
ALLEGAN, MI 49010

FOR: PHARMACEUTICAL PREPARATIONS, NAMELY, ACID REDUCERS, ANALGESICS, ANTACIDS, ANTI-DIARRHEALS, ANTI-GAS PREPARATIONS, ANTIHISTAMINES, CHEMICALLY ACTIVATED HEAT RELEASING WRAPS FOR THERAPEUTIC PURPOSES, COLD AND ALLERGY RELIEF MEDICATIONS, COUGH SUPPRESSANTS, DIET PILLS/TABLETS, DIETARY SUPPLEMENTS, EXPECTORANTS, FUNGICIDAL AGENTS IN THE FORM OF SUPPOSITORIES AND CREAMS, GASTROINTESTINAL TREATMENT PREPARATIONS, HAIR RE-GROWTH TREATMENTS, HEMORRHOID TREATMENT PREPARATIONS, LAXATIVES, MIGRAINE TREATMENT

PREPARATIONS, NUTRITIONAL DRINKS, NASAL SPRAY PREPARATIONS, NASAL DECONGESTANTS, NUTRITIONAL SUPPLEMENTS, OVULATION TEST KITS, PAIN RELIEVER AND FEVER REDUCER MEDICATIONS, PREGNANCY TEST KITS FOR HOME USE, SLEEP AID PILLS/TABLETS, AND SMOKING CESSATION AIDS, IN CLASS 5 (U.S. CLS. 6, 18, 44, 46, 51 AND 52).

FIRST USE 3-22-2004; IN COMMERCE 3-22-2004.

NO CLAIM IS MADE TO THE EXCLUSIVE RIGHT TO USE "LABS", APART FROM THE MARK AS SHOWN.

SER. NO. 76-546,951, FILED 9-25-2003.

INGRID C. EULIN, EXAMINING ATTORNEY

Int. Cls.: 9 and 16

Prior U.S. Cls.: 2, 5, 21, 22, 23, 26, 29, 36, 37, 38 and 50

United States Patent and Trademark Office

Reg. No. 2,892,911

Registered Oct. 12, 2004

**TRADEMARK
PRINCIPAL REGISTER**

MAKE A JOYFUL NOISE

OBERKOTTER FOUNDATION (PENNSYLVANIA
NON-PROFIT CORPORATION)
1600 MARKET STREET, SUITE 3600
PHILADELPHIA, PA 19103

FOR: PRERECORDED COMPACT DISKS AND
VIDEOS ON THE SUBJECT OF ORAL DEAF EDU-
CATION, IN CLASS 9 (U.S. CLS. 21, 23, 26, 36 AND 38).

FIRST USE 2-0-2000; IN COMMERCE 2-0-2000.

FOR: PRINTED MATERIALS, NAMELY PARENT
HANDBOOKS, MANUALS, TEACHING MATERI-
ALS AND PAMPHLETS ON THE SUBJECT OF ORAL
DEAF EDUCATION, IN CLASS 16 (U.S. CLS. 2, 5, 22,
23, 29, 37, 38 AND 50).

FIRST USE 2-0-2000; IN COMMERCE 2-0-2000.

SER. NO. 76-546,957, FILED 9-25-2003.

DAWN FELDMAN, EXAMINING ATTORNEY

Int. Cl.: 25

Prior U.S. Cls.: 22 and 39

United States Patent and Trademark Office

Reg. No. 2,892,912

Registered Oct. 12, 2004

**TRADEMARK
PRINCIPAL REGISTER**

FIEND

RELIQ, INC. (NEW YORK CORPORATION)
1466 BROADWAY, SUITE 1610
NEW YORK, NY 10036

FOR: CLOTHING, OUTERWEAR AND SPORTS-WEAR, NAMELY, ATHLETIC SHOES, BANDANAS, BASEBALL CAPS, BELTS, BIKER SHORTS, BLAZERS, BLOUSES, BOARDSHORTS, BODY SUITS, BOOTS; BOXER SHORTS, BRAS, BRIEFS, BUSTIERS, CAMISOLES, CAPS, CHEMISES, CHINO PANTS, COATS, CORSETS, DRESSES, EAR MUFFS, FOOTIES, GIRDLES, GLOVES, GOWNS, HALTER TOPS, HATS, HEADBANDS, JOGGING SUITS, JACKETS, JEANS, LEGGINGS, MITTENS, NIGHT-GOWNS, PAJAMAS, PANTIES, PANTS, PANTY-

HOSE, RAINCOATS, ROBES, SCARVES, SHIRTS, SHOES, SHORTS, SKIRTS, SLACKS, SLIPS, SNEAKERS, SOCKS, STOCKINGS, SWEATERS, SWEAT-PANTS, SWEATSHIRTS, SWIMSUIT, TANK TOPS, TEDDIES, TIES, TIGHTS, T-SHIRTS, TUBE TOPS, TURTLENECKS, UNDERWEAR, VESTS AND WIND RESISTANT JACKETS , IN CLASS 25 (U.S. CLS. 22 AND 39).

FIRST USE 1-0-1998; IN COMMERCE 1-0-1998.

SER. NO. 76-546,958, FILED 9-25-2003.

REBECCA SMITH, EXAMINING ATTORNEY

Int. Cl.: 44

Prior U.S. Cls.: 100 and 101

United States Patent and Trademark Office

Reg. No. 2,892,913

Registered Oct. 12, 2004

**SERVICE MARK
PRINCIPAL REGISTER**

SHAVING GRACE BARBERS

SGARRA BROS., LLC (PENNSYLVANIA LTD
LIAB CO)
269 MAIN STREET
EXTON, PA 19341

NO CLAIM IS MADE TO THE EXCLUSIVE
RIGHT TO USE "BARBERS", APART FROM THE
MARK AS SHOWN.

FOR: BARBERSHOPS, HAIR CUTTING, HAIR
STYLING AND HAIRDRESSING SERVICES, IN
CLASS 44 (U.S. CLS. 100 AND 101).

SER. NO. 76-547,074, FILED 9-25-2003.

FIRST USE 1-3-2001; IN COMMERCE 1-3-2001.

ELLEN B. AWRICH, EXAMINING ATTORNEY

Int. Cl.: 30

Prior U.S. Cl.: 46

United States Patent and Trademark Office

Reg. No. 2,892,914

Registered Oct. 12, 2004

**TRADEMARK
PRINCIPAL REGISTER**

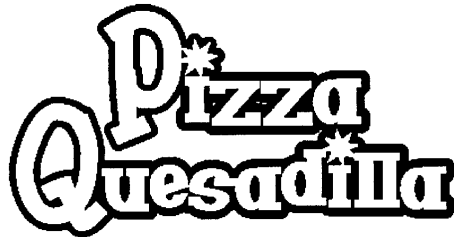

CONAGRA FOODS, INC. (DELAWARE CORPORATION)
ONE CONAGRA DRIVE
OMAHA, NE 68102

NO CLAIM IS MADE TO THE EXCLUSIVE RIGHT TO USE PIZZA QUESADILLA, APART FROM THE MARK AS SHOWN.

FOR: FROZEN PIZZA QUESADILLA, IN CLASS 30 (U.S. CL. 46).

SER. NO. 76-547,149, FILED 9-11-2003.

FIRST USE 12-11-2002; IN COMMERCE 12-11-2002.

CAROL SPILS, EXAMINING ATTORNEY

Int. Cls.: 25 and 41

Prior U.S. Cls.: 22, 39, 100, 101 and 107

United States Patent and Trademark Office

Reg. No. 2,892,915

Registered Oct. 12, 2004

**TRADEMARK
SERVICE MARK
PRINCIPAL REGISTER**

LIFESTYLES FOR LADIES ONLY

LIFESTYLES FOR LADIES ONLY, INC. (OHIO CORPORATION)
7116 SUMMERFIELD ROAD
LAMBERTVILLE, MI 48144

FOR: CLOTHING, NAMELY WOMEN'S EXERCISE CLOTHING, NAMELY, HEADBANDS, LEGGINGS, HALTERTOPS, T-SHIRTS, WARMUP JACKETS, AND SANDALS, IN CLASS 25 (U.S. CLS. 22 AND 39).

FIRST USE 10-1-1994; IN COMMERCE 10-1-1994.

FOR: HEALTH CLUB SERVICES, NAMELY, PROVIDING INSTRUCTION AND EQUIPMENT IN THE

FIELD OF PHYSICAL EXERCISE, IN CLASS 41 (U.S. CLS. 100, 101 AND 107).

FIRST USE 10-1-1994; IN COMMERCE 10-1-1994.

NO CLAIM IS MADE TO THE EXCLUSIVE RIGHT TO USE FOR LADIES ONLY, APART FROM THE MARK AS SHOWN.

SER. NO. 76-547,310, FILED 9-22-2003.

ESTHER BELENKER, EXAMINING ATTORNEY

Int. Cl.: 3

Prior U.S. Cls.: 1, 4, 6, 50, 51 and 52

United States Patent and Trademark Office

Reg. No. 2,892,916

Registered Oct. 12, 2004

TRADEMARK
PRINCIPAL REGISTER



J.F. LABS, INC. (ILLINOIS CORPORATION)
7401 S. PULASKI ROAD
CHICAGO, IL 60629

FOR: HAIR PRODUCTS, NAMELY, RELAXERS,
CONDITIONERS, SHAMPOOS, LOTIONS, STYLING
GLAZES POMADES, SPRAYS, OILS, AND RELAX-
ER KITS COMPRISED OF RELAXERS, SHAMPOOS,
CONDITIONERS AND LOTIONS, IN CLASS 3 (U.S.
CLS. 1, 4, 6, 50, 51 AND 52).

FIRST USE 5-1-2003; IN COMMERCE 5-1-2003.

NO CLAIM IS MADE TO THE EXCLUSIVE
RIGHT TO USE "ORGANICS", APART FROM THE
MARK AS SHOWN.

THE STIPPLING IS FOR SHADING PURPOSES.

SER. NO. 76-547,327, FILED 9-2-2003.

JOHN SCHUYLER YARD, EXAMINING ATTOR-
NEY

Int. Cl.: 9

Prior U.S. Cls.: 21, 23, 26, 36 and 38

Reg. No. 2,892,917

United States Patent and Trademark Office

Registered Oct. 12, 2004

**TRADEMARK
PRINCIPAL REGISTER**



411VIDEO PRODUCTIONS, INC. (CALIFORNIA CORPORATION)

16520 HARBOR BLVD., SUITE G
FOUNTAIN VALLEY, CA 92708

SKATEBOARDING TECHNIQUES, IN CLASS 9 (U.S. CLS. 21, 23, 26, 36 AND 38).

FIRST USE 7-15-2003; IN COMMERCE 7-15-2003.

SER. NO. 76-547,374, FILED 9-26-2003.

FOR: PRE-RECORDED INSTRUCTIONAL VIDEO
TAPES AND DIGITAL VIDEO DISKS FEATURING

MICHAEL WEBSTER, EXAMINING ATTORNEY

Int. Cl.: 9

Prior U.S. Cls.: 21, 23, 26, 36 and 38

United States Patent and Trademark Office

Reg. No. 2,892,918

Registered Oct. 12, 2004

**TRADEMARK
PRINCIPAL REGISTER**

MADE ON EARTH FOR THE HIGH OCTANE ATHLETE

KARASIK, RANDAL B. (UNITED STATES INDIVIDUAL)
4625 WEST 61ST PLACE
ARVADA, CO 80003

FIRST USE 3-1-2001; IN COMMERCE 9-19-2003.

SER. NO. 76-547,512, FILED 9-30-2003.

FOR: SUNGLASSES, IN CLASS 9 (U.S. CLS. 21, 23, 26, 36 AND 38).

KATHLEEN M. VANSTON, EXAMINING ATTORNEY

Int. Cls.: 9, 16 and 42

**Prior U.S. Cls.: 2, 5, 21, 22, 23, 26, 29, 36, 37, 38, 50,
100 and 101**

Reg. No. 2,892,919

United States Patent and Trademark Office

Registered Oct. 12, 2004

**TRADEMARK
SERVICE MARK
PRINCIPAL REGISTER**

CODENAME PANZERS

CDV SOFTWARE ENTERTAINMENT AG (FED
REP GERMANY CORPORATION)
NEUREUTER STR. 37B
KARLSRUHE, FED REP GERMANY 76185

FOR: COMPUTER SOFTWARE, CD-ROMS AND
DVDS IN THE FIELD OF COMPUTER GAMES AND
PRINTED INSTRUCTIONAL MANUALS, SOLD AS
A UNIT, IN CLASS 9 (U.S. CLS. 21, 23, 26, 36 AND 38).

FOR: PRINTED INSTRUCTION MANUALS,
STRATEGY GUIDES, MAGAZINES AND BRO-
CHURES PERTAINING TO COMPUTER GAMES,
IN CLASS 16 (U.S. CLS. 2, 5, 22, 23, 29, 37, 38 AND 50).

FOR: TECHNICAL SUPPORT SERVICES, NAME-
LY TROUBLESHOOTING OF COMPUTER HARD-
WARE AND SOFTWARE PROBLEMS ASSOCIATED
WITH COMPUTER GAMES, IN CLASS 42 (U.S. CLS.
100 AND 101).

OWNER OF FED REP GERMANY REG. NO.
30314188, DATED 4-17-2003, EXPIRES 3-31-2013.

SER. NO. 76-547,526, FILED 9-30-2003.

JOHN E. MICHOS, EXAMINING ATTORNEY

Int. Cl.: 9

Prior U.S. Cls.: 21, 23, 26, 36 and 38

Reg. No. 2,892,920

United States Patent and Trademark Office

Registered Oct. 12, 2004

**TRADEMARK
PRINCIPAL REGISTER**

Tech/Speak

ADVANCED MULTIMEDIA DEVICES INC. (NEW
YORK CORPORATION)
C/O JUEMIN CHU ESQ. CHU & ASSOCIATES LLC
200 FRANK ROAD
HICKSVILLE, NY 11801

FOR: PORTABLE, ELECTRONIC DEVICE USED
BY PERSONS WITH COMMUNICATION IMPAIR-
MENTS TO PROGRAM AND PLAY DIGITIZED

MESSAGES , IN CLASS 9 (U.S. CLS. 21, 23, 26, 36
AND 38).

FIRST USE 11-0-1998; IN COMMERCE 11-0-1998.

SER. NO. 76-547,992, FILED 9-29-2003.

BRETT J. GOLDEN, EXAMINING ATTORNEY

Int. Cl.: 44

Prior U.S. Cls.: 100 and 101

United States Patent and Trademark Office

Reg. No. 2,892,921

Registered Oct. 12, 2004

**SERVICE MARK
PRINCIPAL REGISTER**

REGENIX

PURE BALANCE, INC. (CALIFORNIA CORPORATION), DBA REGENIX HAIR RETENTION CLINIC
8631 WEST THIRD STREET, SUITE 420E
LOS ANGELES, CA 90048

FOR: HAIR AND SCALP ANALYSIS AND TREATMENT SERVICES RENDERED THROUGH THE USE OF HAIR AND SCALP TREATMENT

PREPARATIONS, IN CLASS 44 (U.S. CLS. 100 AND 101).

FIRST USE 11-0-1993; IN COMMERCE 11-0-1993.

SER. NO. 76-548,455, FILED 10-2-2003.

BRIDGETT SMITH, EXAMINING ATTORNEY

Int. Cl.: 35

Prior U.S. Cls.: 100, 101 and 102

United States Patent and Trademark Office

Reg. No. 2,892,922

Registered Oct. 12, 2004

**SERVICE MARK
PRINCIPAL REGISTER**

THE CORP DOCTOR

CALIFORNIA CORPORATE RESOURCES, INC.
(CALIFORNIA CORPORATION)
5360 HIDDEN GLEN DRIVE
ROCKLIN, CA 95677

NO CLAIM IS MADE TO THE EXCLUSIVE
RIGHT TO USE CORP, APART FROM THE MARK
AS SHOWN.

FOR: BUSINESS CONSULTING FOR EXISTING
CORPORATIONS, IN CLASS 35 (U.S. CLS. 100, 101
AND 102).

SER. NO. 76-548,640, FILED 10-3-2003.

FIRST USE 5-1-2002; IN COMMERCE 5-1-2002.

EUGENIA MARTIN, EXAMINING ATTORNEY

Int. Cls.: 35 and 41

Prior U.S. Cls.: 100, 101, 102 and 107

United States Patent and Trademark Office

Reg. No. 2,892,923

Registered Oct. 12, 2004

**SERVICE MARK
PRINCIPAL REGISTER**

SNIPPIES

BIKALES, EDWARD (UNITED STATES INDIVIDUAL)
505 8TH AVENUE, SUITE 2200
NEW YORK, NY 10018

FOR: ADVERTISING SERVICES, NAMELY, CREATING CORPORATE AND BRAND IDENTITY VIA ON THE STREET INTERVIEWS FOR AD AGENCIES AND MARKET RESEARCH FIRMS , IN CLASS 35 (U.S. CLS. 100, 101 AND 102).

FIRST USE 9-21-2000; IN COMMERCE 9-21-2000.

FOR: PRODUCTION OF VIDEOS FOR EVENT PRODUCTION AND MARKETING FIRMS; VIDEOTAPING AND VIDEO EDITING FOR EVENT PRODUCTION AND MARKETING FIRMS, IN CLASS 41 (U.S. CLS. 100, 101 AND 107).

FIRST USE 9-21-2000; IN COMMERCE 9-21-2000.

SER. NO. 76-548,775, FILED 10-3-2003.

KEVON CHISOLM, EXAMINING ATTORNEY

Int. Cl.: 31

Prior U.S. Cls.: 1 and 46

United States Patent and Trademark Office

Reg. No. 2,892,924

Registered Oct. 12, 2004

**TRADEMARK
PRINCIPAL REGISTER**

HEADSTART

TRIPLE CROWN NUTRITION, INC. (MINNESOTA CORPORATION)
319 BARRY AVENUE SOUTH, SUITE 303
WAYZATA, MN 55391

FIRST USE 3-6-1968; IN COMMERCE 3-6-1968.

SER. NO. 76-549,038, FILED 10-6-2003.

FOR: FEEDS FOR LIVESTOCK, IN CLASS 31 (U.S. CLS. 1 AND 46).

DOMINIC J. FERRAIUOLO, EXAMINING ATTORNEY

Int. Cl.: 44

Prior U.S. Cls.: 100 and 101

United States Patent and Trademark Office

Reg. No. 2,892,925

Registered Oct. 12, 2004

**SERVICE MARK
PRINCIPAL REGISTER**



PREFERRED MEDICAL PLAN, INC. (FLORIDA CORPORATION)
4950 S.W. 8TH STREET, SUITE 403
CORAL GABLES, FL 33134

NO CLAIM IS MADE TO THE EXCLUSIVE RIGHT TO USE "MEDICAL PLAN", APART FROM THE MARK AS SHOWN.

FOR: HEALTH CARE IN THE NATURE OF A HEALTH MAINTENANCE ORGANIZATION, IN CLASS 44 (U.S. CLS. 100 AND 101).

SER. NO. 76-549,064, FILED 10-6-2003.

FIRST USE 10-1-1994; IN COMMERCE 10-1-1994.

IRA J. GOODSaid, EXAMINING ATTORNEY

Int. Cl.: 41

Prior U.S. Cls.: 100, 101 and 107

United States Patent and Trademark Office

Reg. No. 2,892,926

Registered Oct. 12, 2004

**SERVICE MARK
PRINCIPAL REGISTER**

KWAYZAR

HOFFMAN, STANLEY JERRY (UNITED STATES
INDIVIDUAL)
9180 BUELL STREET
DOWNEY, CA 90241

FIRST USE 3-20-1994; IN COMMERCE 1-10-1996.

SER. NO. 76-549,128, FILED 9-11-2003.

FOR: ENTERTAINMENT, NAMELY, LIVE PER-
FORMANCES BY MUSICAL BANDS AND LIVE
MUSIC CONCERTS, IN CLASS 41 (U.S. CLS. 100,
101 AND 107).

MICHAEL LEVY, EXAMINING ATTORNEY

Int. Cl.: 7

Prior U.S. Cls.: 13, 19, 21, 23, 31, 34 and 35

United States Patent and Trademark Office

Reg. No. 2,892,927

Registered Oct. 12, 2004

**TRADEMARK
PRINCIPAL REGISTER**

TELCOMOTION

TELCO INTERCONTINENTAL CORPORATION
(TEXAS CORPORATION)
9812 WHITHORN DRIVE
HOUSTON, TX 77095

FIRST USE 3-3-2003; IN COMMERCE 3-3-2003.

SER. NO. 76-549,236, FILED 10-6-2003.

FOR: ELECTRIC MOTORS FOR MACHINES, IN
CLASS 7 (U.S. CLS. 13, 19, 21, 23, 31, 34 AND 35).

DOMINIC J. FERRAIUOLO, EXAMINING ATTOR-
NEY

Int. Cl.: 16

Prior U.S. Cls.: 2, 5, 22, 23, 29, 37, 38 and 50

Reg. No. 2,892,928

United States Patent and Trademark Office

Registered Oct. 12, 2004

**TRADEMARK
PRINCIPAL REGISTER**

DREAM KEEPERS

BERGSMA, JODY (UNITED STATES INDIVIDUAL)
1344 KING STREET
BELLINGHAM, WA 98229

FOR: GREETING CARDS, NOTE CARDS, LIMITED EDITION PRINTS, NOTEPAPER, ADDRESS BOOKS, JOURNALS, BOOKMARKS AND CHILDREN'S BOOKS, IN CLASS 16 (U.S. CLS. 2, 5, 22, 23, 29, 37, 38 AND 50).

FIRST USE 1-1-1994; IN COMMERCE 1-1-1994.

SER. NO. 76-549,326, FILED 10-3-2003.

KEVON CHISOLM, EXAMINING ATTORNEY

Int. Cl.: 31

Prior U.S. Cls.: 1 and 46

United States Patent and Trademark Office

Reg. No. 2,892,929

Registered Oct. 12, 2004

**TRADEMARK
PRINCIPAL REGISTER**

Shaped Sensations

EXCLUSIVELY PET, INC. (WISCONSIN CORPORATION)
7711 NORTH 81ST STREET
MILWAUKEE, WI 53224

NO CLAIM IS MADE TO THE EXCLUSIVE RIGHT TO USE "SHAPED" , APART FROM THE MARK AS SHOWN.

FOR: ANIMAL FOODSTUFFS, NAMELY, CAT TREATS, IN CLASS 31 (U.S. CLS. 1 AND 46).

SER. NO. 76-549,335, FILED 10-6-2003.

FIRST USE 1-1-1995; IN COMMERCE 1-1-1995.

EDWARD NELSON, EXAMINING ATTORNEY

Int. Cl.: 35

Prior U.S. Cls.: 100, 101 and 102

United States Patent and Trademark Office

Reg. No. 2,892,930

Registered Oct. 12, 2004

**SERVICE MARK
PRINCIPAL REGISTER**

FOUR DIRECTIONS TALENT SEARCH

ONEIDA INDIAN NATION (UNITED STATES
SOVEREIGN INDIAN NATION)
223 GENESEE STREET
ONEIDA, NY 13421

FOR: TALENT AGENCY SERVICES IN THE
NATURE OF CONDUCTING TALENT SEARCHES
AND PROVIDING TALENT DIRECTORIES FOR
EMPLOYMENT PLACEMENT , IN CLASS 35 (U.S.
CLS. 100, 101 AND 102).

FIRST USE 5-31-2001; IN COMMERCE 5-31-2001.

NO CLAIM IS MADE TO THE EXCLUSIVE
RIGHT TO USE "TALENT SEARCH", APART FROM
THE MARK AS SHOWN.

SER. NO. 76-549,415, FILED 9-15-2003.

MARK T. MULLEN, EXAMINING ATTORNEY

Int. Cl.: 41

Prior U.S. Cls.: 100, 101 and 107

Reg. No. 2,892,931

United States Patent and Trademark Office

Registered Oct. 12, 2004

**SERVICE MARK
PRINCIPAL REGISTER**



UGOKWE, E. KISZO (UNITED STATES INDIVIDUAL)
2152 BERRYHILL CIRCLE
SMYRNA, GA 30032

NO CLAIM IS MADE TO THE EXCLUSIVE RIGHT TO USE "ENTERTAINMENT GROUP", APART FROM THE MARK AS SHOWN.

FOR: ENTERTAINMENT SERVICES IN THE NATURE OF PRODUCTION, DISTRIBUTION AND EXHIBITION OF MOTION PICTURE FILMS, IN CLASS 41 (U.S. CLS. 100, 101 AND 107).

SER. NO. 76-549,543, FILED 10-6-2003.

FIRST USE 8-31-2000; IN COMMERCE 1-4-2001.

KARANENDRA S. CHHINA, EXAMINING ATTORNEY

Int. Cl.: 43

Prior U.S. Cls.: 100 and 101

United States Patent and Trademark Office

Reg. No. 2,892,932

Registered Oct. 12, 2004

**SERVICE MARK
PRINCIPAL REGISTER**



ST. THOMAS CATERING CORP. (DELAWARE CORPORATION)
NISKY MAILBOX #403
CYRIL E. KING AIRPORT, SUITE #2
ST. THOMAS, US VIRGIN ISLANDS 00802

NO CLAIM IS MADE TO THE EXCLUSIVE RIGHT TO USE "CATERING GROUP", APART FROM THE MARK AS SHOWN.

FOR: AIRLINE, INDUSTRIAL AND AIRPORT CATERING SERVICES, IN CLASS 43 (U.S. CLS. 100 AND 101).

SER. NO. 76-549,558, FILED 10-7-2003.

FIRST USE 5-12-2003; IN COMMERCE 5-12-2003.

ELLEN B. AWRICH, EXAMINING ATTORNEY

Int. Cl.: 9

Prior U.S. Cls.: 21, 23, 26, 36 and 38

United States Patent and Trademark Office

Reg. No. 2,892,933

Registered Oct. 12, 2004

**TRADEMARK
PRINCIPAL REGISTER**

ETOOLS@WORK

DIGITAL CONTROLS CORPORATION (OHIO
CORPORATION)
305 PIONEER BLVD.
SPRINGBORO, OH 45066

FIRST USE 8-0-2003; IN COMMERCE 8-0-2003.

SER. NO. 76-549,578, FILED 10-7-2003.

FOR: COMPUTER SOFTWARE USED FOR
MANAGING, CREATING AND PUBLISHING WEB
SITE CONTENT, IN CLASS 9 (U.S. CLS. 21, 23, 26, 36
AND 38).

EDWARD NELSON, EXAMINING ATTORNEY

Int. Cl.: 26

Prior U.S. Cls.: 37, 39, 40, 42 and 50

United States Patent and Trademark Office

Reg. No. 2,892,934

Registered Oct. 12, 2004

**TRADEMARK
PRINCIPAL REGISTER**

METROPOLITAN

TRUE SILVER CORPORATION (FLORIDA CORPORATION)
5688 WASHINGTON STREET
HOLLYWOOD, FL 330231478

FOR: HAIR PIECES, IN CLASS 26 (U.S. CLS. 37, 39, 40, 42 AND 50).

FIRST USE 1-0-1992; IN COMMERCE 1-0-1992.

OWNER OF U.S. REG. NO. 1,886,181.

SER. NO. 76-549,663, FILED 10-3-2003.

DOMINIC J. FERRAIUOLO, EXAMINING ATTORNEY

Int. Cl.: 44

Prior U.S. Cls.: 100 and 101

United States Patent and Trademark Office

Reg. No. 2,892,935

Registered Oct. 12, 2004

SERVICE MARK
PRINCIPAL REGISTER

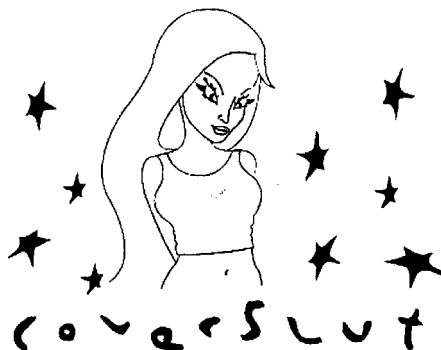

FARHOOD, JENNIFER (CANADA INDIVIDUAL)
1976 E. HIGH STREET SUITE 203
POTTSTOWN, PA 19464

FOR: AIRBRUSH MAKEUP ARTISTRY, NAME-
LY, COSMETIC MAKEUP SERVICES FOR OTHERS
BY MEANS OF SPRAY APPLICATION OF SPECIAL-
LY FORMULATED LIQUID MAKEUP THROUGH
AN AIRBRUSH; AIRBRUSH TANNING SERVICES

BY SPRAY APPLICATIONS, IN CLASS 44 (U.S. CLS.
100 AND 101).

FIRST USE 6-1-2000; IN COMMERCE 1-1-2001.

SER. NO. 76-549,917, FILED 10-8-2003.

BRENDAN MCCAULEY, EXAMINING ATTORNEY

Int. Cl.: 16

Prior U.S. Cls.: 2, 5, 22, 23, 29, 37, 38 and 50

United States Patent and Trademark Office

Reg. No. 2,892,936

Registered Oct. 12, 2004

**TRADEMARK
PRINCIPAL REGISTER**

LAWDIT

STOKES & MURPHY, P.C. (GEORGIA PROFESSIONAL CORPORATION)
P. O. BOX 87468
ATLANTA, GA 30337

FOR: PUBLICATIONS, NAMELY, JOURNALS, NEWSLETTERS, SUPPLEMENTS AND PAMPHLETS IN THE LEGAL FIELD, IN CLASS 16 (U.S. CLS. 2, 5, 22, 23, 29, 37, 38 AND 50).

FIRST USE 8-10-2003; IN COMMERCE 8-10-2003.

OWNER OF U.S. REG. NO. 2,133,704.

SER. NO. 76-549,963, FILED 9-22-2003.

NORA BUCHANAN WILL, EXAMINING ATTORNEY

Int. Cl.: 41

Prior U.S. Cls.: 100, 101 and 107

United States Patent and Trademark Office

Reg. No. 2,892,937

Registered Oct. 12, 2004

**SERVICE MARK
PRINCIPAL REGISTER**

ATTITUDE GIRLS

JOHN MILLER EVENTS, INC. (NEVADA CORPORATION)
6825 MIDPARK CIRCLE
LAS VEGAS, NV 89145

FOR: ENTERTAINMENT IN THE NATURE OF VISUAL AND AUDIO MIME, DANCE AND INTERACTIVE SKIT PERFORMANCES AT PUBLIC AND PRIVATE CONVENTIONS, EXHIBITIONS, PARTIES AND SIMILAR GATHERINGS OF PEOPLE FEATURING SHOWGIRLS UNIFORMLY-ATTIRED IN LATEX OUTFITS, IN CLASS 41 (U.S. CLS. 100, 101 AND 107).

FIRST USE 5-1-1996; IN COMMERCE 5-1-1996.

NO CLAIM IS MADE TO THE EXCLUSIVE RIGHT TO USE GIRLS, APART FROM THE MARK AS SHOWN.

SER. NO. 76-549,966, FILED 9-22-2003.

TRACY FLETCHER, EXAMINING ATTORNEY

Int. Cl.: 29

Prior U.S. Cl.: 46

United States Patent and Trademark Office

Reg. No. 2,892,938

Registered Oct. 12, 2004

**TRADEMARK
PRINCIPAL REGISTER**

TROPIC ISLE

TAMPA MAID FOODS, INC. (FLORIDA COR-
PORATION)
1600 KATHLEEN ROAD
P.O. BOX 3709
LAKELAND, FL 338023709

FOR: SEAFOOD, IN CLASS 29 (U.S. CL. 46).

FIRST USE 1-30-2004; IN COMMERCE 1-30-2004.

SER. NO. 76-550,079, FILED 10-8-2003.

DOMINIC J. FERRAIUOLO, EXAMINING ATTOR-
NEY

Int. Cl.: 24

Prior U.S. Cls.: 42 and 50

United States Patent and Trademark Office

Reg. No. 2,892,939

Registered Oct. 12, 2004

**TRADEMARK
PRINCIPAL REGISTER**

DINING FASHIONS

JOSIE ACCESSORIES, INC. (NEW YORK CORPORATION)
261 FIFTH AVENUE
NEW YORK, NY 10016

NO CLAIM IS MADE TO THE EXCLUSIVE RIGHT TO USE "DINING", APART FROM THE MARK AS SHOWN.

FOR: HOME FURNISHINGS, NAMELY TABLE-CLOTHS NOT OF PAPER AND TEXTILE PLACE MATS, IN CLASS 24 (U.S. CLS. 42 AND 50).

SER. NO. 76-550,177, FILED 10-8-2003.

FIRST USE 12-0-1993; IN COMMERCE 12-0-1993.

KATHRYN COWARD, EXAMINING ATTORNEY

Int. Cl.: 30

Prior U.S. Cl.: 46

United States Patent and Trademark Office

Reg. No. 2,892,940

Registered Oct. 12, 2004

**TRADEMARK
PRINCIPAL REGISTER**

THE PARTY GIRL

THE PARTY GIRL LLC (PENNSYLVANIA LTD
LIAB CO)
230 WEST ALLENS LANE
PHILADELPHIA, PA 19119

FIRST USE 6-1-2003; IN COMMERCE 6-1-2003.

SER. NO. 76-550,195, FILED 10-8-2003.

FOR: VEGETABLE SAUCES, FRUIT SAUCES
NOT SIDE DISHES, USED AS A SAUCE PLACED
ON FOOD; AND BAKERY GOODS, IN CLASS 30
(U.S. CL. 46).

CHRISTOPHER BUONGIORNO, EXAMINING AT-
TORNEY

Int. Cl.: 44

Prior U.S. Cls.: 100 and 101

United States Patent and Trademark Office

Reg. No. 2,892,941

Registered Oct. 12, 2004

**SERVICE MARK
PRINCIPAL REGISTER**

GOT VEINS?

JOHN L. HAPPEL, JR., M.D., INC. (PENNSYLVANIA CORPORATION)
3035 WASHINGTON ROAD
SUITE 4
MCMURRAY, PA 15317

NO CLAIM IS MADE TO THE EXCLUSIVE RIGHT TO USE "VEINS", APART FROM THE MARK AS SHOWN.

FOR: MEDICAL SERVICES FOR REMOVAL OF VEINS, IN CLASS 44 (U.S. CLS. 100 AND 101).

SER. NO. 76-550,198, FILED 10-8-2003.

FIRST USE 7-1-1999; IN COMMERCE 7-1-1999.

JENNIFER CHICOSKI, EXAMINING ATTORNEY

Int. Cl.: 36

Prior U.S. Cls.: 100, 101 and 102

United States Patent and Trademark Office

Reg. No. 2,892,942

Registered Oct. 12, 2004

**SERVICE MARK
PRINCIPAL REGISTER**

THE PRUDENT OPTIMIZATION PROCESS

PIECE OF PIE MARKETING, INC. (TEXAS CORPORATION)
401 16TH STREET SE # 203
ROCHESTER, MN 55904

FOR: FINANCIAL SERVICES, NAMELY, FINANCIAL ANALYSIS AND CONSULTATIONS, IN CLASS 36 (U.S. CLS. 100, 101 AND 102).

FIRST USE 4-1-2003; IN COMMERCE 4-1-2003.

NO CLAIM IS MADE TO THE EXCLUSIVE RIGHT TO USE PROCESS, APART FROM THE MARK AS SHOWN.

SER. NO. 76-550,590, FILED 10-10-2003.

JANICE L. MCMORROW, EXAMINING ATTORNEY

Int. Cl.: 36

Prior U.S. Cls.: 100, 101 and 102

United States Patent and Trademark Office

Reg. No. 2,892,943

Registered Oct. 12, 2004

**SERVICE MARK
PRINCIPAL REGISTER**

THE REED GROUP

THE REED GROUP, INC. (ALABAMA COR-
PORATION)
6171 OAKWOOD LANE
FAIRHOPE, AL 36532

NO CLAIM IS MADE TO THE EXCLUSIVE
RIGHT TO USE "GROUP" , APART FROM THE
MARK AS SHOWN.

FOR: BUSINESS BROKERAGE, IN CLASS 36 (U.S.
CLS. 100, 101 AND 102).

SER. NO. 76-550,681, FILED 10-10-2003.

FIRST USE 6-1-1996; IN COMMERCE 6-1-1996.

KELLY BOULTON, EXAMINING ATTORNEY

Int. Cl.: 9

Prior U.S. Cls.: 21, 23, 26, 36 and 38

United States Patent and Trademark Office

Reg. No. 2,892,944

Registered Oct. 12, 2004

**TRADEMARK
PRINCIPAL REGISTER**

STEINER DISCOVERY

STEINER-OPTIK GMBH (FED REP GERMANY
CORPORATION)
DR.-HANS-FRISCH-STRASSE 9
D-95448 BAYREUTH, FED REP GERMANY

FOR: BINOCULARS; PERISCOPES; TELESCOPES,
IN PARTICULAR FOR TERRESTRIAL OBSERVA-
TIONS AND ASTRONOMIC PURPOSES; AIMING
TELESCOPES FOR FIREARMS , IN CLASS 9 (U.S.
CLS. 21, 23, 26, 36 AND 38).

OWNER OF FED REP GERMANY REG. NO.
30244508, DATED 12-13-2002, EXPIRES 12-13-2012.

OWNER OF U.S. REG. NOS. 1,409,256, 2,665,199,
AND 2,746,333.

SER. NO. 76-550,756, FILED 10-14-2003.

JOHN DWYER, EXAMINING ATTORNEY

Int. Cl.: 5

Prior U.S. Cls.: 6, 18, 44, 46, 51 and 52

United States Patent and Trademark Office

Reg. No. 2,892,945

Registered Oct. 12, 2004

**TRADEMARK
PRINCIPAL REGISTER**

MICELLEAN BIOACTIVE SUPERFOOD

VITAL PHARMACEUTICALS, INC. (FLORIDA
CORPORATION)
4141 S.W. 47TH AVENUE
DAVIE, FL 33324

NO CLAIM IS MADE TO THE EXCLUSIVE
RIGHT TO USE BIOACTIVE SUPERFOOD, APART
FROM THE MARK AS SHOWN.

FOR: DIETARY SUPPLEMENT, IN CLASS 5 (U.S.
CLS. 6, 18, 44, 46, 51 AND 52).

SER. NO. 76-550,777, FILED 10-14-2003.

FIRST USE 10-0-2001; IN COMMERCE 10-0-2001.

KARLA PERKINS, EXAMINING ATTORNEY

Int. Cl.: 9

Prior U.S. Cls.: 21, 23, 26, 36 and 38

Reg. No. 2,892,946

United States Patent and Trademark Office

Registered Oct. 12, 2004

**TRADEMARK
PRINCIPAL REGISTER**

TRU-TEACH

VULCAN ENGINEERING COMPANY (ALABA-
MA CORPORATION)
ONE VULCAN DRIVE
HELENA INDUSTRIAL PARK
HELENA, AL 35080

FIRST USE 6-23-2003; IN COMMERCE 6-23-2003.

SER. NO. 76-550,843, FILED 10-10-2003.

FOR: DIGITAL PROGRAMMING SOFTWARE
FOR ROBOTICS USED IN INDUSTRIAL APPLICA-
TIONS, IN CLASS 9 (U.S. CLS. 21, 23, 26, 36 AND 38).

KELLY BOULTON, EXAMINING ATTORNEY

Int. Cl.: 28

Prior U.S. Cls.: 22, 23, 38 and 50

United States Patent and Trademark Office

Reg. No. 2,892,947

Registered Oct. 12, 2004

**TRADEMARK
PRINCIPAL REGISTER**

KOREC-BALL MARKER

BAROUH EATON ALLEN CORP. (NEW YORK
CORPORATION)
67 KENT AVENUE
BROOKLYN, NY 11211

NO CLAIM IS MADE TO THE EXCLUSIVE
RIGHT TO USE "MARKER" , APART FROM THE
MARK AS SHOWN.

FOR: GOLF BALL MARKERS, IN CLASS 28 (U.S.
CLS. 22, 23, 38 AND 50).

SER. NO. 76-550,862, FILED 10-14-2003.

FIRST USE 9-8-2003; IN COMMERCE 9-8-2003.

HEATHER THOMPSON, EXAMINING ATTORNEY

Int. Cl.: 36

Prior U.S. Cls.: 100, 101 and 102

United States Patent and Trademark Office

Reg. No. 2,892,948

Registered Oct. 12, 2004

**SERVICE MARK
PRINCIPAL REGISTER**

INVEST
FINANCIAL CORPORATION

JACKSON NATIONAL LIFE INSURANCE COM-
PANY (MICHIGAN CORPORATION)
ONE CORPORATE WAY
LANSING, MI 48951

NO CLAIM IS MADE TO THE EXCLUSIVE
RIGHT TO USE "INVEST FINANCIAL CORPORA-
TION", APART FROM THE MARK AS SHOWN.

FOR: INVESTMENT ADVISORY SERVICES FOR
OTHERS, IN CLASS 36 (U.S. CLS. 100, 101 AND 102).

SER. NO. 76-550,905, FILED 9-22-2003.

FIRST USE 8-1-2002; IN COMMERCE 8-1-2002.

ROBERT COGGINS, EXAMINING ATTORNEY

Int. Cl.: 9

Prior U.S. Cls.: 21, 23, 26, 36 and 38

Reg. No. 2,892,949

United States Patent and Trademark Office

Registered Oct. 12, 2004

**TRADEMARK
PRINCIPAL REGISTER**

YU YU HAKUSHO

PIERROT CO. LTD. (JAPAN CORPORATION)
2-29-13, SHIMORENJAKU, MITAKA-CITY
TOKYO 181-0013, JAPAN

FOR: PRE-RECORDED VIDEO TAPES CONTAINING CARTOON PROGRAMS; COMPUTER GAME SOFTWARE, NAMELY, INTERACTIVE VIDEO GAME PROGRAMS; VIDEO GAME DISCS , IN CLASS 9 (U.S. CLS. 21, 23, 26, 36 AND 38).

FIRST USE 4-16-2002; IN COMMERCE 4-16-2002.

THE MARK "YU YU HAKUSHO" DOES NOT IDENTIFY A PARTICULAR LIVING INDIVIDUAL.

THE FOREIGN WORDING IN THE MARK TRANSLATES INTO ENGLISH AS "GHOST" OR "SPIRIT FILES".

SER. NO. 76-550,944, FILED 9-22-2003.

MARC LEIPZIG, EXAMINING ATTORNEY

Int. Cls.: 35 and 36

Prior U.S. Cls.: 100, 101 and 102

United States Patent and Trademark Office

Reg. No. 2,892,950

Registered Oct. 12, 2004

**SERVICE MARK
PRINCIPAL REGISTER**

FEDEX INTERNATIONAL BROKER SELECT

FEDERAL EXPRESS CORPORATION (DELA-
WARE CORPORATION)
3620 HACKS CROSS ROAD
BUILDING B, 3RD FLOOR
MEMPHIS, TN 38125

FOR: CUSTOMS CLEARANCE SERVICES, IN
CLASS 35 (U.S. CLS. 100, 101 AND 102).

FIRST USE 6-19-1995; IN COMMERCE 6-19-1995.

FOR: CUSTOMS BROKERAGE, IN CLASS 36 (U.S.
CLS. 100, 101 AND 102).

FIRST USE 6-19-1995; IN COMMERCE 6-19-1995.

OWNER OF U.S. REG. NOS. 2,144,827, 2,237,717
AND OTHERS.

NO CLAIM IS MADE TO THE EXCLUSIVE
RIGHT TO USE INTERNATIONAL BROKER,
APART FROM THE MARK AS SHOWN.

SER. NO. 76-551,016, FILED 10-14-2003.

JOHN HWANG, EXAMINING ATTORNEY

Int. Cl.: 36

Prior U.S. Cls.: 100, 101 and 102

United States Patent and Trademark Office

Reg. No. 2,892,951

Registered Oct. 12, 2004

**SERVICE MARK
PRINCIPAL REGISTER**

CAVALRY ASSET MANAGEMENT

CAVALRY MANAGEMENT GROUP, LLC (DE-
LAWARE LTD LIAB CO)
ONE CALIFORNIA ST., SUITE 3000
SAN FRANCISCO, CA 94111

NO CLAIM IS MADE TO THE EXCLUSIVE
RIGHT TO USE ASSET MANAGEMENT, APART
FROM THE MARK AS SHOWN.

FOR: FINANCIAL SERVICES, NAMELY INVEST-
MENT ADVICE, IN CLASS 36 (U.S. CLS. 100, 101 AND
102).

SER. NO. 76-551,113, FILED 10-9-2003.

FIRST USE 12-12-2002; IN COMMERCE 12-25-2002.

LINDA ESTRADA, EXAMINING ATTORNEY

Int. Cls.: 9, 37, 40 and 42

Prior U.S. Cls.: 21, 23, 26, 36, 38, 100, 101, 103 and 106

United States Patent and Trademark Office

Reg. No. 2,892,952

Registered Oct. 12, 2004

**TRADEMARK
SERVICE MARK
PRINCIPAL REGISTER**

CAPE COMPUTING CORP.

CAPE COMPUTING CORP. (MARYLAND CORPORATION)
4601 HOLLINS FERRY ROAD
HALETHORPE, MD 21227

FOR: COMPUTER HARDWARE, IN CLASS 9 (U.S. CLS. 21, 23, 26, 36 AND 38).

FIRST USE 10-0-1992; IN COMMERCE 10-0-1992.

FOR: INSTALLATION OF COMPUTER NETWORKS AND SYSTEMS, IN CLASS 37 (U.S. CLS. 100, 103 AND 106).

FIRST USE 10-0-1992; IN COMMERCE 10-0-1992.

FOR: DATA TRANSFER AND CONVERSION FROM ONE MEDIA TO ANOTHER, IN CLASS 40 (U.S. CLS. 100, 103 AND 106).

FIRST USE 10-0-1992; IN COMMERCE 10-0-1992.

FOR: CONSULTING SERVICES IN THE FIELD OF SOFTWARE DEVELOPMENT, ENTERPRISE APPLICATION INTEGRATION, DESK TOP SOFTWARE SOLUTIONS, SOFTWARE INTEGRATION, IN CLASS 42 (U.S. CLS. 100 AND 101).

FIRST USE 10-0-1992; IN COMMERCE 10-0-1992.

NO CLAIM IS MADE TO THE EXCLUSIVE RIGHT TO USE "COMPUTING CORP.", APART FROM THE MARK AS SHOWN.

SER. NO. 76-551,121, FILED 9-22-2003.

CHARLES L. JENKINS, EXAMINING ATTORNEY

Int. Cl.: 44

Prior U.S. Cls.: 100 and 101

United States Patent and Trademark Office

Reg. No. 2,892,953

Registered Oct. 12, 2004

**SERVICE MARK
PRINCIPAL REGISTER**

WE DO IT LIKE NO ONE ELSE CAN

JAMACA ME TAN, INC. (IDAHO CORPORATION)
6910 WEST STATE STREET
BOISE, ID 83703

FIRST USE 11-28-2001; IN COMMERCE 11-28-2001.

SER. NO. 76-551,127, FILED 10-14-2003.

FOR: TANNING SALONS, IN CLASS 44 (U.S. CLS. 100 AND 101).

AMY GEARIN, EXAMINING ATTORNEY

Int. Cl.: 36

Prior U.S. Cls.: 100, 101 and 102

United States Patent and Trademark Office

Reg. No. 2,892,954

Registered Oct. 12, 2004

**SERVICE MARK
PRINCIPAL REGISTER**

LA WIN

LOS ANGELES WORK INITIATIVE NETWORK
(CALIFORNIA CORPORATION)
1000 CORPORATE POINTE, SUITE 200
CULVER CITY, CA 90230

FIRST USE 1-29-2002; IN COMMERCE 1-29-2002.

FOR: AFFORDABLE HOUSING FOR WORKING
FAMILIES EARNING BETWEEN \$34,000 AND
\$67,000 AND PAYING NO MORE THAN 30% OF
THEIR INCOME FOR HOUSING, NAMELY, FACIL-
ITATING AND ARRANGING FOR THE FINAN-
CING OF AFFORDABLE HOUSING THROUGH
HOME MORTGAGES, IN CLASS 36 (U.S. CLS. 100,
101 AND 102).

NO CLAIM IS MADE TO THE EXCLUSIVE
RIGHT TO USE "LA", APART FROM THE MARK
AS SHOWN.

SER. NO. 76-551,155, FILED 9-22-2003.

INGRID C. EULIN, EXAMINING ATTORNEY

Int. Cl.: 41

Prior U.S. Cls.: 100, 101 and 107

United States Patent and Trademark Office

Reg. No. 2,892,955

Registered Oct. 12, 2004

**SERVICE MARK
PRINCIPAL REGISTER**

BOXPOOL

MCCANN, JOHN (UNITED STATES INDIVIDUAL)
1816 RIVIERA PARKWAY
POINT PLEASANT, NJ 08742

FIRST USE 12-13-1998; IN COMMERCE 12-13-1998.

SER. NO. 76-551,275, FILED 9-24-2003.

FOR: PROVIDING AN ONLINE OFFICE POOL
GAME, IN CLASS 41 (U.S. CLS. 100, 101 AND 107).

PATRICIA EVANKO, EXAMINING ATTORNEY

Int. Cl.: 16

Prior U.S. Cls.: 2, 5, 22, 23, 29, 37, 38 and 50

Reg. No. 2,892,956

United States Patent and Trademark Office

Registered Oct. 12, 2004

**TRADEMARK
PRINCIPAL REGISTER**

CHARLÈSE

BROWN, CHARLESE ELIZABETH (UNITED STATES INDIVIDUAL), DBA CHARLESE: A WEDDING AND HOME MAGAZINE FOR TODAY'S UNIQUE BRIDE, L.L.C.
4734 GAWAIN DRIVE
NEW ORLEANS, LA 70127

FIRST USE 8-1-2003; IN COMMERCE 8-1-2003.

SER. NO. 76-551,488, FILED 9-26-2003.

FOR: PERIODIC MAGAZINE IN THE FIELD OF WEDDING PLANNING, IN CLASS 16 (U.S. CLS. 2, 5, 22, 23, 29, 37, 38 AND 50).

LESLEY LAMOTHE, EXAMINING ATTORNEY

Int. Cl.: 43

Prior U.S. Cls.: 100 and 101

United States Patent and Trademark Office

Reg. No. 2,892,957

Registered Oct. 12, 2004

**SERVICE MARK
PRINCIPAL REGISTER**

LOUIS PAPPAS MARKET CAFE

LOUIS PAPPAS RESTAURANT GROUP, LLC
(FLORIDA LTD LIAB CO)
731 WESLEY AVE.
TARPON SPRINGS, FL 34689

FOR: RESTAURANT, BAR, PREPARED TAKE-
OUT FOOD, AND CATERING SERVICES, IN CLASS
43 (U.S. CLS. 100 AND 101).

FIRST USE 5-11-2001; IN COMMERCE 5-11-2001.

OWNER OF U.S. REG. NO. 2,812,503.

NO CLAIM IS MADE TO THE EXCLUSIVE
RIGHT TO USE "MARKET CAFE", APART FROM
THE MARK AS SHOWN.

THE NAME SHOWN IN THE MARK IDENTIFIES
LOUIS PAPPAS, A LIVING INDIVIDUAL, WHOSE
CONSENT TO REGISTER IS HEREBY SUBMITTED
WITH THIS APPLICATION.

SER. NO. 76-551,643, FILED 10-16-2003.

ZACHARY BELLO, EXAMINING ATTORNEY

Int. Cl.: 43

Prior U.S. Cls.: 100 and 101

United States Patent and Trademark Office

Reg. No. 2,892,958

Registered Oct. 12, 2004

**SERVICE MARK
PRINCIPAL REGISTER**

THE COURT OF TWO SISTERS

KARNO, BILLIE FAYE VALENTINE (UNITED STATES INDIVIDUAL)
4828 JAMES DRIVE
METAIRIE, LA 70003

FIRST USE 5-4-1994; IN COMMERCE 5-4-1994.

SER. NO. 76-551,655, FILED 10-16-2003.

FOR: RESTAURANT SERVICES, IN CLASS 43
(U.S. CLS. 100 AND 101).

CHERYL STEPLIGHT, EXAMINING ATTORNEY

Int. Cl.: 41

Prior U.S. Cls.: 100, 101 and 107

United States Patent and Trademark Office

Reg. No. 2,892,959

Registered Oct. 12, 2004

**SERVICE MARK
PRINCIPAL REGISTER**

JOURNEY INTO POWER

BAPTISTE, BARON (UNITED STATES INDIVIDUAL)
33 RICHDAL AVENUE, SUITE 208
CAMBRIDGE, MA 02410

FIRST USE 7-0-1998; IN COMMERCE 7-0-1998.

OWNER OF U.S. REG. NO. 2,128,789.

FOR: EDUCATIONAL SERVICES, NAMELY, CONDUCTING YOGA INSTRUCTIONAL CLASSES, SEMINARS, CONFERENCES, WORKSHOPS, AND RETREATS, IN CLASS 41 (U.S. CLS. 100, 101 AND 107).

SER. NO. 76-551,670, FILED 10-16-2003.

CHERYL STEPLIGHT, EXAMINING ATTORNEY

Int. Cl.: 36

Prior U.S. Cls.: 100, 101 and 102

United States Patent and Trademark Office

Reg. No. 2,892,960

Registered Oct. 12, 2004

**SERVICE MARK
PRINCIPAL REGISTER**

SENSIBLE DENTAL PLUS SOLUTIONS

FORTIS BENEFITS INSURANCE COMPANY
(MINNESOTA CORPORATION)
576 BIELENBERG DRIVE
WOODBURY, MN 55125

FOR: UNDERWRITING AND ADMINISTRATION OF DENTAL INSURANCE, IN CLASS 36 (U.S. CLS. 100, 101 AND 102).

FIRST USE 9-0-2002; IN COMMERCE 9-0-2002.

OWNER OF U.S. REG. NOS. 2,398,569 AND 2,722,139.

NO CLAIM IS MADE TO THE EXCLUSIVE RIGHT TO USE DENTAL, APART FROM THE MARK AS SHOWN.

SER. NO. 76-551,715, FILED 9-25-2003.

MATTHEW KLINE, EXAMINING ATTORNEY

Int. Cl.: 32

Prior U.S. Cls.: 45, 46 and 48

United States Patent and Trademark Office

Reg. No. 2,892,961

Registered Oct. 12, 2004

**TRADEMARK
PRINCIPAL REGISTER**

CHRISTIAN MOERLEIN

INCOMMAND LLC (OHIO LTD LIAB CO)
SUITE 1800 425 WALNUT STREET
CINCINNATI, OH 45202

THE NAME CHRISTIAN MOERLEIN DOES NOT
IDENTIFY A LIVING INDIVIDUAL.

FOR: BEER AND ALE, IN CLASS 32 (U.S. CLS. 45,
46 AND 48).

SER. NO. 76-551,771, FILED 10-14-2003.

FIRST USE 12-4-1980; IN COMMERCE 12-4-1980.

ESTHER BELENKER, EXAMINING ATTORNEY

Int. Cl.: 35

Prior U.S. Cls.: 100, 101 and 102

United States Patent and Trademark Office

Reg. No. 2,892,962

Registered Oct. 12, 2004

**SERVICE MARK
PRINCIPAL REGISTER**

TOOLSOURCE.COM

AUTOMOTIVE TOOL PROFESSIONALS, INC.
(NEW YORK CORPORATION)
6277 SUGARTOWN RD.
P.O. BOX 950
ELLCOTTVILLE, NY 14731

OWNER OF U.S. REG. NO. 2,100,188.

SEC. 2(F).

FOR: ON-LINE RETAIL STORE SERVICES FEATURING HAND TOOLS, IN CLASS 35 (U.S. CLS. 100, 101 AND 102).

SER. NO. 76-551,796, FILED 10-14-2003.

FIRST USE 0-0-1995; IN COMMERCE 0-0-1995.

MICHAEL WEBSTER, EXAMINING ATTORNEY

Int. Cl.: 45

Prior U.S. Cls.: 100 and 101

United States Patent and Trademark Office

Reg. No. 2,892,963

Registered Oct. 12, 2004

**SERVICE MARK
PRINCIPAL REGISTER**

THE FAMILY FARM

THE FAMILY, INC. (CALIFORNIA NON-PROFIT
CORPORATION)
545 POWELL STREET
SAN FRANCISCO, CA 94108

FIRST USE 9-2-1902; IN COMMERCE 9-2-1902.

SER. NO. 76-551,832, FILED 10-16-2003.

FOR: SOCIAL CLUB, IN CLASS 45 (U.S. CLS. 100
AND 101).

STEVEN BERK, EXAMINING ATTORNEY

Int. Cl.: 43

Prior U.S. Cls.: 100 and 101

United States Patent and Trademark Office

Reg. No. 2,892,964

Registered Oct. 12, 2004

SERVICE MARK
PRINCIPAL REGISTER

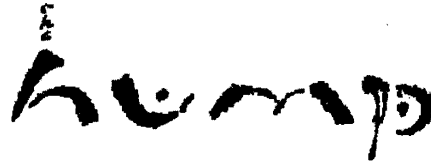

TYPHOON RESTAURANT, INC. (CALIFORNIA CORPORATION)
3221 DONALD DOUGLAS LOOP SOUTH
SANTA MONICA, CA 904053213

FOR: RESTAURANT SERVICES, BAR SERVICES, CATERING SERVICES, PROVIDING THE BANQUET AND SOCIAL FUNCTIONS FACILITIES FOR SPECIAL EVENTS , IN CLASS 43 (U.S. CLS. 100 AND 101).

FIRST USE 7-0-1998; IN COMMERCE 7-0-1998.

THE MARKS CONSISTS OF THE STYLIZED WORDING "THE HUMP".

SER. NO. 76-551,889, FILED 9-24-2003.

STEVEN BERK, EXAMINING ATTORNEY

Int. Cl.: 35

Prior U.S. Cls.: 100, 101 and 102

United States Patent and Trademark Office

Reg. No. 2,892,965

Registered Oct. 12, 2004

**SERVICE MARK
PRINCIPAL REGISTER**



EVERYTHING EQUESTRIAN, LTD. (MARY-
LAND CORPORATION)
9815 MAIN STREET
DAMASCUS, MD 20872

FIRST USE 1-1-2003; IN COMMERCE 1-1-2003.

SER. NO. 76-551,928, FILED 10-14-2003.

FOR: RETAIL STORE SERVICES IN THE FIELD
OF EQUESTRIAN PRODUCTS AND APPAREL FOR
RIDERS, IN CLASS 35 (U.S. CLS. 100, 101 AND 102).

MARTHA FROMM, EXAMINING ATTORNEY

Int. Cl.: 9

Prior U.S. Cls.: 21, 23, 26, 36 and 38

United States Patent and Trademark Office

Reg. No. 2,892,966

Registered Oct. 12, 2004

**TRADEMARK
PRINCIPAL REGISTER**

GENIE

A+ MANUFACTURING, LLC (LOUISIANA LTD
LIAB CO)
41041 BLACK BAYOU ROAD
GONZALES, LA 70737

FOR: ANALYZER SAMPLE CONDITIONING
COMPONENTS, NAMELY, MEMBRANE SEPARA-
TORS AND FILTERS, PROBES AND PROBE REG-
ULATORS, AND SAMPLE CYLINDERS FOR USE IN

THE SEPARATION OF LIQUIDS FROM GAS SAM-
PLES, IN CLASS 9 (U.S. CLS. 21, 23, 26, 36 AND 38).

FIRST USE 4-0-1989; IN COMMERCE 4-0-1989.

SER. NO. 76-551,939, FILED 10-14-2003.

MICHAEL WEBSTER, EXAMINING ATTORNEY

Int. Cl.: 35

Prior U.S. Cls.: 100, 101 and 102

United States Patent and Trademark Office

Reg. No. 2,892,967

Registered Oct. 12, 2004

**SERVICE MARK
PRINCIPAL REGISTER**

FOLIOLITE

PRICEWATERHOUSECOOPERS LLP (DELA-
WARE LIMITED LIABILITY PARTNERSHIP)
1177 AVENUE OF THE AMERICAS
NEW YORK, NY 10036

FOR: BUSINESS CONSULTATION SERVICES,
NAMELY, PROVIDING REPORTS AND ANALYSIS
ON A COMPANY'S IMPORT ACTIVITIES AND

RELATED IMPORT DATA AND INFORMATION,
IN CLASS 35 (U.S. CLS. 100, 101 AND 102).

FIRST USE 7-31-2002; IN COMMERCE 7-31-2002.

SER. NO. 76-551,950, FILED 10-14-2003.

IRA J. GOODSID, EXAMINING ATTORNEY

Int. Cl.: 2

Prior U.S. Cls.: 6, 11 and 16

United States Patent and Trademark Office

Reg. No. 2,892,968

Registered Oct. 12, 2004

**TRADEMARK
PRINCIPAL REGISTER**

PRO-COAT

PROFESSIONAL COATINGS, INC. (ARKANSAS
CORPORATION)
27010 HIGHWAY 107
CABOT, AR 72023

FOR: SEALER COATINGS FOR USE ON WOOD;
WOOD VARNISHES; WOOD LACQUERS IN THE
NATURE OF A COATING; COATINGS IN THE
NATURE OF ADHESION PROMOTERS FOR

OTHER WOOD COATINGS, IN CLASS 2 (U.S. CLS.
6, 11 AND 16).

FIRST USE 1-1-1989; IN COMMERCE 1-1-1989.

SER. NO. 76-551,953, FILED 10-14-2003.

IRA J. GOODSaid, EXAMINING ATTORNEY

Int. Cl.: 41

Prior U.S. Cls.: 100, 101 and 107

United States Patent and Trademark Office

Reg. No. 2,892,969

Registered Oct. 12, 2004

SERVICE MARK
PRINCIPAL REGISTER



PRIDDY LEARNING ACADEMY, INC. (NEW
JERSEY CORPORATION)
266 ESSEX STREET
MILLBURN, NJ 07041

FIRST USE 4-21-1996; IN COMMERCE 4-21-1996.

FOR: EDUCATIONAL SERVICES, NAMELY,
CONDUCTING REMEDIAL AND SUPPLEMENTAL
CLASSES IN THE FIELDS OF READING, WRITING,
MATHEMATICS, STUDY SKILLS AND TEST PRE-
PARATION, IN CLASS 41 (U.S. CLS. 100, 101 AND
107).

NO CLAIM IS MADE TO THE EXCLUSIVE
RIGHT TO USE "LEARNING ACADEMY", APART
FROM THE MARK AS SHOWN.

SER. NO. 76-551,998, FILED 10-14-2003.

IRA J. GOODSaid, EXAMINING ATTORNEY

Int. Cl.: 9

Prior U.S. Cls.: 21, 23, 26, 36 and 38

United States Patent and Trademark Office

Reg. No. 2,892,970

Registered Oct. 12, 2004

**TRADEMARK
PRINCIPAL REGISTER**

PRO PLUS

PELSTAR, LLC (ILLINOIS LTD LIAB CO)
7400 W. 100TH PLACE
BRIDGEVIEW, IL 60455

FIRST USE 1-1-1992; IN COMMERCE 1-1-1992.

SER. NO. 76-552,042, FILED 10-15-2003.

FOR: WEIGHING SCALES, IN CLASS 9 (U.S. CLS.
21, 23, 26, 36 AND 38).

AMY GEARIN, EXAMINING ATTORNEY

Int. Cl.: 35

Prior U.S. Cls.: 100, 101 and 102

United States Patent and Trademark Office

Reg. No. 2,892,971

Registered Oct. 12, 2004

**SERVICE MARK
PRINCIPAL REGISTER**

URBANMOUNTAIN

DILLINGHAM COMMUNICATIONS, INC. (MISSOURI CORPORATION)
5126 N. PENNSYLVANIA
GLADSTONE, MO 64118

GEAR AND CAMPING, IN CLASS 35 (U.S. CLS. 100, 101 AND 102).

FIRST USE 2-0-2003; IN COMMERCE 2-0-2003.

FOR: COMPUTERIZED ON-LINE ORDERING AND RETAIL STORE SERVICES IN THE FIELD OF GENERAL OUTDOOR GEAR AND CAMPING; MAIL ORDER SERVICES FEATURING OUTDOOR

SER. NO. 76-552,045, FILED 10-15-2003.

SOPHIA S. KIM, EXAMINING ATTORNEY

Int. Cl.: 36

Prior U.S. Cls.: 100, 101 and 102

United States Patent and Trademark Office

Reg. No. 2,892,972

Registered Oct. 12, 2004

**SERVICE MARK
PRINCIPAL REGISTER**

WALL STREET INTERNATIONAL

INTERNATIONAL BANCSHARES CORPORA-
TION (TEXAS CORPORATION)
1200 SAN BERNARDO
LAREDO, TX 78042

FOR: FINANCIAL SERVICES, NAMELY, PRO-
VIDING FINANCIAL INVESTMENT SERVICES IN
THE FIELD OF MUTUAL FUNDS, GENERAL SE-
CURITIES, ANNUITIES, UNIT INVESTMENT
TRUSTS, AND INSURANCE PRODUCTS, IN CLASS
36 (U.S. CLS. 100, 101 AND 102).

FIRST USE 3-1-1995; IN COMMERCE 3-1-1995.

OWNER OF U.S. REG. NOS. 2,200,696 AND
2,222,144.

SER. NO. 76-552,046, FILED 10-15-2003.

GEORGIA CARTY, EXAMINING ATTORNEY

Int. Cl.: 41

Prior U.S. Cls.: 100, 101 and 107

United States Patent and Trademark Office

Reg. No. 2,892,973

Registered Oct. 12, 2004

**SERVICE MARK
PRINCIPAL REGISTER**

POET

PERFORMANCE ASSESSMENT NETWORK, INC.
(INDIANA CORPORATION)
111 CONGRESSIONAL BLVD, SUITE 120
CARMEL, IN 46032

FOR: AUTOMATED TEST ADMINISTRATIVE
SERVICES, NAMELY, AUTOMATED TEST ADMIN-
ISTRATION SERVICES FOR STANDARDIZED

EDUCATIONAL TESTING , IN CLASS 41 (U.S. CLS.
100, 101 AND 107).

FIRST USE 9-15-2002; IN COMMERCE 9-15-2002.

SER. NO. 76-552,061, FILED 10-15-2003.

AMY GEARIN, EXAMINING ATTORNEY

Int. Cl.: 41

Prior U.S. Cls.: 100, 101 and 107

United States Patent and Trademark Office

Reg. No. 2,892,974

Registered Oct. 12, 2004

**SERVICE MARK
PRINCIPAL REGISTER**

poet

PERFORMANCE ASSESSMENT NETWORK, INC.
(INDIANA CORPORATION)
111 CONGRESSIONAL BLVD, SUITE 120
CARMEL, IN 46032

FOR: AUTOMATED TEST ADMINISTRATIVE
SERVICES, NAMELY, AUTOMATED TEST ADMIN-
ISTRATION SERVICES FOR STANDARDIZED

EDUCATIONAL TESTING , IN CLASS 41 (U.S. CLS.
100, 101 AND 107).

FIRST USE 8-20-2003; IN COMMERCE 8-20-2003.

SER. NO. 76-552,064, FILED 10-15-2003.

AMY GEARIN, EXAMINING ATTORNEY

Int. Cl.: 16

Prior U.S. Cls.: 2, 5, 22, 23, 29, 37, 38 and 50

United States Patent and Trademark Office

Reg. No. 2,892,975

Registered Oct. 12, 2004

**TRADEMARK
PRINCIPAL REGISTER**

JUNGLE LAW

JUNGLE MEDIA GROUP (DELAWARE CORPORATION)
632 BROADWAY, SEVENTH FLOOR
NEW YORK, NY 10012

FOR: MAGAZINES OF GENERAL INTEREST WITH A FOCUS ON LAW, BUSINESS, AND LIFESTYLE, IN CLASS 16 (U.S. CLS. 2, 5, 22, 23, 29, 37, 38 AND 50).

FIRST USE 9-0-2003; IN COMMERCE 9-0-2003.

OWNER OF U.S. REG. NOS. 2,602,302, 2,636,613, AND 2,651,332.

NO CLAIM IS MADE TO THE EXCLUSIVE RIGHT TO USE LAW, APART FROM THE MARK AS SHOWN.

SER. NO. 76-552,091, FILED 10-15-2003.

JENNIFER CHICOSKI, EXAMINING ATTORNEY

Int. Cl.: 11

Prior U.S. Cls.: 13, 21, 23, 31 and 34

United States Patent and Trademark Office

Reg. No. 2,892,976

Registered Oct. 12, 2004

**TRADEMARK
PRINCIPAL REGISTER**



ASTEC, INC. (TENNESSEE CORPORATION)
4101 JEROME AVENUE
CHATTANOOGA, TN 37407

FIRST USE 10-28-2003; IN COMMERCE 10-28-2003.

FOR: BURNERS FUELED BY GAS AND/OR OIL
FOR USE IN CONNECTION WITH ASPHALT
DRUM MIXERS AND AGGREGATE DRYERS, IN
CLASS 11 (U.S. CLS. 13, 21, 23, 31 AND 34).

SER. NO. 76-552,197, FILED 10-17-2003.

CHERYL CLAYTON, EXAMINING ATTORNEY

Int. Cl.: 35

Prior U.S. Cls.: 100, 101 and 102

United States Patent and Trademark Office

Reg. No. 2,892,977

Registered Oct. 12, 2004

**SERVICE MARK
PRINCIPAL REGISTER**

COALITION OF EXCLUSIVE AGENT ASSOCIATIONS

COALITION OF EXCLUSIVE AGENT ASSOCIATIONS, INC. (NEW YORK NOT-FOR-PROFIT CORPORATION)
8015 CORPORATE DRIVE, SUITE A
BALTIMORE, MD 21236

FOR: ASSOCIATION SERVICES, NAMELY, PROMOTING THE INTERESTS OF EXCLUSIVE INSURANCE AGENTS AND INSURANCE AGENT ASSOCIATIONS, IN CLASS 35 (U.S. CLS. 100, 101 AND 102).

FIRST USE 6-22-1993; IN COMMERCE 6-22-1993.

OWNER OF U.S. REG. NO. 1,788,104.

NO CLAIM IS MADE TO THE EXCLUSIVE RIGHT TO USE "COALITION" AND "ASSOCIATIONS", APART FROM THE MARK AS SHOWN.

SEC. 2(F).

SER. NO. 76-552,212, FILED 9-29-2003.

MATTHEW PAPPAS, EXAMINING ATTORNEY

Int. Cl.: 41

Prior U.S. Cls.: 100, 101 and 107

United States Patent and Trademark Office

Reg. No. 2,892,978

Registered Oct. 12, 2004

**SERVICE MARK
PRINCIPAL REGISTER**

GLORY GIRLS

STINSON, DENISE L. (UNITED STATES INDIVIDUAL)
33290 WEST 14 MILE ROAD #482
WEST BLOOMFIELD, MI 48322

FOR: ENTERTAINMENT SERVICES, NAMELY, ORGANIZING NATIONAL BOOK CLUBS WHEREBY INDIVIDUALS MEET TO DISCUSS BOOKS, ORGANIZED FOR SOCIAL PURPOSES, IN CLASS 41 (U.S. CLS. 100, 101 AND 107).

FIRST USE 6-14-2001; IN COMMERCE 11-1-2001.

NO CLAIM IS MADE TO THE EXCLUSIVE RIGHT TO USE "GIRLS", APART FROM THE MARK AS SHOWN.

SER. NO. 76-552,411, FILED 10-17-2003.

ELISSA GARBER KON, EXAMINING ATTORNEY

Int. Cl.: 25

Prior U.S. Cls.: 22 and 39

United States Patent and Trademark Office

Reg. No. 2,892,979

Registered Oct. 12, 2004

**TRADEMARK
PRINCIPAL REGISTER**

JUST A SPORT

TIERNEY & ASSOCIATES, INC. (TEXAS COR-
PORATION)
614 NORTH STREET
ARLINGTON, TX 76060

NO CLAIM IS MADE TO THE EXCLUSIVE
RIGHT TO USE SPORT , APART FROM THE MARK
AS SHOWN.

FOR: CLOTHING, NAMELY CAPS AND SHIRTS,
IN CLASS 25 (U.S. CLS. 22 AND 39).

SER. NO. 76-552,445, FILED 9-25-2003.

FIRST USE 8-1-2003; IN COMMERCE 8-1-2003.

STEVEN BERK, EXAMINING ATTORNEY

Int. Cl.: 25

Prior U.S. Cls.: 22 and 39

United States Patent and Trademark Office

Reg. No. 2,892,980

Registered Oct. 12, 2004

**TRADEMARK
PRINCIPAL REGISTER**

JUST A CAP

TIERNEY & ASSOCIATES, INC. (TEXAS CORPORATION)
614 NORTH STREET
ARLINGTON, TX 76060

NO CLAIM IS MADE TO THE EXCLUSIVE RIGHT TO USE CAP , APART FROM THE MARK AS SHOWN.

FOR: BASEBALL CAPS WITH STYLIZED LOGOS, IN CLASS 25 (U.S. CLS. 22 AND 39).

SER. NO. 76-552,446, FILED 9-25-2003.

FIRST USE 8-1-2003; IN COMMERCE 8-1-2003.

STEVEN BERK, EXAMINING ATTORNEY

Int. Cl.: 35

Prior U.S. Cls.: 100, 101 and 102

United States Patent and Trademark Office

Reg. No. 2,892,981

Registered Oct. 12, 2004

SERVICE MARK
PRINCIPAL REGISTER

Bellenza

BELLENZA, INC. (CALIFORNIA CORPORATION)
123 S. FIGUEROA STREET, SUITE 1215
LOS ANGELES, CA 90012

FOR: COMPUTERIZED ONLINE RETAIL STORE SERVICES, MAIL ORDER CATALOG SERVICES, TELEPHONE AND FACSIMILE ORDER SERVICES, AND RETAIL STORE SERVICES FEATURING PERSONALIZED AND NON-PERSONALIZED WEDDING AND BRIDAL SHOWER GIFTWARE, ACCESSORIES, KEEPSAKES, MEMENTOS, FAVORS, DECORATIONS, AND SUPPLIES, IN CLASS 35 (U.S. CLS. 100, 101 AND 102).

FIRST USE 3-5-2004; IN COMMERCE 3-5-2004.

THE MARK CONSISTS OF THE STYLIZED LETTERS "BELLENZA", WHERE THE CAPITAL "B" IS RENDERED IN HARRINGTON FONT AND THE SMALL LETTERS "ELLENZA" ARE RENDERED IN PERPETUA FONT. FURTHERMORE, THE COLOR OF THE STYLIZED LETTERS THAT COMPRISE THE NAME "BELLENZA" IS RENDERED IN PANTONE SOLID COATED COLOR 485 C.

SER. NO. 76-552,475, FILED 10-20-2003.

JEFFREY S. MOLINOFF, EXAMINING ATTORNEY

Int. Cl.: 36

Prior U.S. Cls.: 100, 101 and 102

United States Patent and Trademark Office

Reg. No. 2,892,982

Registered Oct. 12, 2004

**SERVICE MARK
PRINCIPAL REGISTER**

**DON'T LET YOUR MONEY RUN YOUR RETIREMENT. YOUR
RETIREMENT SHOULD RUN YOUR MONEY.**

PIECE OF PIE MARKETING, INC. (TEXAS COR-
PORATION)
401 16TH STREET SE #204
ROCHESTER, MN 55904

FIRST USE 2-1-2002; IN COMMERCE 2-1-2002.

SER. NO. 76-552,620, FILED 10-20-2003.

FOR: FINANCIAL SERVICES, NAMELY, FINAN-
CIAL ANALYSIS AND CONSULTATIONS, IN
CLASS 36 (U.S. CLS. 100, 101 AND 102).

IRA J. GOODSaid, EXAMINING ATTORNEY

Int. Cl.: 42

Prior U.S. Cls.: 100 and 101

United States Patent and Trademark Office

Reg. No. 2,892,983

Registered Oct. 12, 2004

**SERVICE MARK
PRINCIPAL REGISTER**

REAL WORLD LEGAL SOLUTIONS

STOKES LAZARUS & CARMICHAEL LLP
(GEORGIA LIMITED LIABILITY PARTNER-
SHIP)
80 PEACHTREE PARK DRIVE, N.E.
ATLANTA, GA 303091320

FOR: PROVISION OF LEGAL SERVICES AND
INFORMATION, IN CLASS 42 (U.S. CLS. 100 AND
101).

FIRST USE 5-20-2002; IN COMMERCE 5-20-2002.

NO CLAIM IS MADE TO THE EXCLUSIVE
RIGHT TO USE LEGAL SOLUTIONS, APART FROM
THE MARK AS SHOWN.

SER. NO. 76-552,621, FILED 10-20-2003.

ANDREW BENZMILLER, EXAMINING ATTOR-
NEY

Int. Cl.: 28

Prior U.S. Cls.: 22, 23, 38 and 50

United States Patent and Trademark Office

Reg. No. 2,892,984

Registered Oct. 12, 2004

**TRADEMARK
PRINCIPAL REGISTER**

STRAWBERRYLAND

THOSE CHARACTERS FROM CLEVELAND,
INC. (OHIO CORPORATION)
ONE AMERICAN ROAD
CLEVELAND, OH 44144

OWNER OF U.S. REG. NO. 2,827,479.

FOR: PLAYSETS FOR TOY FIGURES, IN CLASS
28 (U.S. CLS. 22, 23, 38 AND 50).

SER. NO. 76-552,677, FILED 10-20-2003.

FIRST USE 8-27-2003; IN COMMERCE 8-27-2003.

KARLA PERKINS, EXAMINING ATTORNEY

Int. Cl.: 9

Prior U.S. Cls.: 21, 23, 26, 36 and 38

United States Patent and Trademark Office

Reg. No. 2,892,985

Registered Oct. 12, 2004

**TRADEMARK
PRINCIPAL REGISTER**

SENTRY ALERT

SIGN SENTRY, L.L.C. (MARYLAND LTD LIAB
CO)
9818 DIVERSIFIED LANE
ELLCOTT CITY, MD 21042

FOR: REMOTE CIRCUIT MONITORING SYS-
TEMS COMPRISING COMPUTER HARDWARE
AND SOFTWARE USED TO NOTIFY OTHERS OF
COMMERCIAL ELECTRICAL CIRCUIT FAILURE
IN ELECTRIC SIGNAGE, ATM MACHINES, AND
ELECTRICAL SECURITY LIGHTING AND PARK-

ING LOT LIGHTING, IN CLASS 9 (U.S. CLS. 21, 23,
26, 36 AND 38).

FIRST USE 9-16-2003; IN COMMERCE 9-16-2003.

OWNER OF U.S. REG. NO. 2,831,515.

SER. NO. 76-552,709, FILED 10-20-2003.

ZHALEH DELANEY, EXAMINING ATTORNEY

Int. Cl.: 36

Prior U.S. Cls.: 100, 101 and 102

United States Patent and Trademark Office

Reg. No. 2,892,986

Registered Oct. 12, 2004

**SERVICE MARK
PRINCIPAL REGISTER**

VENCAP

VENCAP INTERNATIONAL PLC (UNITED
KINGDOM CORPORATION)
KING CHARLES HOUSE
PARK END STREET
OXFORD OX1 1JD, UNITED KINGDOM

FIRST USE 0-0-1988; IN COMMERCE 0-0-1988.

OWNER OF U.S. REG. NO. 2,753,152.

FOR: FINANCIAL INVESTMENT SERVICES,
NAMELY, INVESTMENT ADVISORY, INVEST-
MENT MANAGEMENT AND INVESTMENT OF
FUNDS FOR OTHERS, IN CLASS 36 (U.S. CLS. 100,
101 AND 102).

SER. NO. 76-552,732, FILED 10-20-2003.

STEVEN BERK, EXAMINING ATTORNEY

Int. Cl.: 10

Prior U.S. Cls.: 26, 39 and 44

Reg. No. 2,892,987

United States Patent and Trademark Office

Registered Oct. 12, 2004

**TRADEMARK
PRINCIPAL REGISTER**

WATERFORDE

PRO-STAT, INC. (DELAWARE CORPORATION)
7-11 FACTORY LANE
MIDDLESEX, NJ 08846

FIRST USE 9-28-1995; IN COMMERCE 9-28-1995.

OWNER OF U.S. REG. NO. 2,027,019.

FOR: LATEX EXAMINATION GLOVES; USED IN
MEDICAL AND HEALTHCARE FIELDS, IN CLASS
10 (U.S. CLS. 26, 39 AND 44).

SER. NO. 76-552,866, FILED 10-1-2003.

BRIDGETT SMITH, EXAMINING ATTORNEY

Int. Cls.: 35 and 42

Prior U.S. Cls.: 100, 101 and 102

United States Patent and Trademark Office

Reg. No. 2,892,988

Registered Oct. 12, 2004

**SERVICE MARK
PRINCIPAL REGISTER**

JRM

JEWISH RENAISSANCE MEDIA, LLC (MICHIGAN LTD LIAB CO)
29200 NORTHWESTERN HWY., SUITE 110
SOUTHFIELD, MI 48034

FOR: BUSINESS MARKETING AND CONSULTING SERVICES AND PROVIDING BUSINESS MARKETING INFORMATION, STATISTICAL DATA, AND PREDICTIVE MODELING , IN CLASS 35 (U.S. CLS. 100, 101 AND 102).

FIRST USE 9-16-2003; IN COMMERCE 9-16-2003.

FOR: DATA COLLECTION, DATA MINING AND DATA WAREHOUSING OF MARKETING INFORMATION AND STATISTICAL DATA, IN CLASS 42 (U.S. CLS. 100 AND 101).

FIRST USE 9-16-2003; IN COMMERCE 9-16-2003.

SER. NO. 76-552,969, FILED 10-21-2003.

HOWARD B. LEVINE, EXAMINING ATTORNEY

Int. Cl.: 29

Prior U.S. Cl.: 46

United States Patent and Trademark Office

Reg. No. 2,892,989

Registered Oct. 12, 2004

**TRADEMARK
PRINCIPAL REGISTER**

BIANCO D'ORO

FRANK BRUNCKHORST CO., L.L.C. (NEW
YORK LTD LIAB CO)
24 ROCK STREET
BROOKLYN, NY 11206

THE ENGLISH TRANSLATION OF THE WORD
BIANCO D'ORO IN THE MARK IS WHITE GOLD.

FOR: PROCESSED MEATS, NAMELY SALAMI,
IN CLASS 29 (U.S. CL. 46).

SER. NO. 76-553,031, FILED 10-21-2003.

FIRST USE 4-0-1999; IN COMMERCE 4-0-1999.

WILLIAM VERHOSEK, EXAMINING ATTORNEY

Int. Cl.: 29

Prior U.S. Cl.: 46

United States Patent and Trademark Office

Reg. No. 2,892,990

Registered Oct. 12, 2004

TRADEMARK
PRINCIPAL REGISTER



VIENNA SAUSAGE MANUFACTURING COM-
PANY (ILLINOIS CORPORATION)
2501 NORTH DAMEN AVENUE
CHICAGO, IL 60647

FOR: FROZEN CHILI, IN CLASS 29 (U.S. CL. 46).

FIRST USE 4-3-2003; IN COMMERCE 4-3-2003.

NO CLAIM IS MADE TO THE EXCLUSIVE
RIGHT TO USE "CHILI" , APART FROM THE
MARK AS SHOWN.

THE STIPPLING ON THE HOCKEY STICK POR-
TION OF THE MARK REPRESENTS SHADING
AND IS NOT INTENDED TO REPRESENT COLOR.

THE NAME SHOWN IN THE MARK IDENTIFIES
LIVING INDIVIDUAL "CHRISTOPHER CHELIOS",
WHOSE CONSENT TO REGISTER IS SUBMITTED.

SER. NO. 76-553,247, FILED 10-22-2003.

STEVEN BERK, EXAMINING ATTORNEY

Int. Cl.: 25

Prior U.S. Cls.: 22 and 39

United States Patent and Trademark Office

Reg. No. 2,892,991

Registered Oct. 12, 2004

**TRADEMARK
PRINCIPAL REGISTER**

SAINT JOSEPH'S UNIVERSITY

SAINT JOSEPH'S UNIVERSITY (PENNSYLVANIA CORPORATION)
5600 CITY AVENUE
PHILADELPHIA, PA 19131

FOR: CLOTHING, NAMELY, SWEATSHIRTS, SWEATPANTS, SOCKS, TIES, POLO SHIRTS, T-SHIRTS, SHORTS, TANK TOPS, UNIFORMS, HATS, JACKETS AND COATS , IN CLASS 25 (U.S. CLS. 22 AND 39).

FIRST USE 0-0-1971; IN COMMERCE 0-0-1971.

NO CLAIM IS MADE TO THE EXCLUSIVE RIGHT TO USE UNIVERSITY, APART FROM THE MARK AS SHOWN.

SER. NO. 76-553,370, FILED 10-3-2003.

JOHN DWYER, EXAMINING ATTORNEY

Int. Cl.: 43

Prior U.S. Cls.: 100 and 101

United States Patent and Trademark Office

Reg. No. 2,892,992

Registered Oct. 12, 2004

**SERVICE MARK
PRINCIPAL REGISTER**



ABC PIZZA INTERNATIONAL, INC. (FLORIDA
CORPORATION)
P.O. BOX 1999
LAND O'LAKES, FL 34639

FOR: RESTAURANT SERVICES, IN CLASS 43
(U.S. CLS. 100 AND 101).

FIRST USE 12-31-1966; IN COMMERCE 12-31-1966.

NO CLAIM IS MADE TO THE EXCLUSIVE
RIGHT TO USE "PIZZA" , APART FROM THE
MARK AS SHOWN.

SER. NO. 76-553,464, FILED 10-22-2003.

MARIA-VICTORIA SUAREZ, EXAMINING ATTOR-
NEY

Int. Cls.: 41 and 43

Prior U.S. Cls.: 100, 101 and 107

United States Patent and Trademark Office

Reg. No. 2,892,993

Registered Oct. 12, 2004

**SERVICE MARK
PRINCIPAL REGISTER**

WHERE LIFETIME LEARNING BEGINS

KNOWLEDGE LEARNING CORPORATION (DE-
LAWARE CORPORATION)
573 PARK POINT DRIVE
GOLDEN, CO 80401

FOR: EDUCATIONAL INSTRUCTION FOR IN-
FANTS, TODDLERS, PRE-SCHOOL, AND ELEMEN-
TARY SCHOOL-AGE CHILDREN; AND SUMMER
RECREATIONAL CAMPS , IN CLASS 41 (U.S. CLS.
100, 101 AND 107).

FIRST USE 11-30-2000; IN COMMERCE 11-30-2000.

FOR: CHILD CARE SERVICES, IN CLASS 43 (U.S.
CLS. 100 AND 101).

FIRST USE 11-30-2000; IN COMMERCE 11-30-2000.

SER. NO. 76-553,624, FILED 10-23-2003.

KEVON CHISOLM, EXAMINING ATTORNEY

Int. Cl.: 28

Prior U.S. Cls.: 22, 23, 38 and 50

United States Patent and Trademark Office

Reg. No. 2,892,994

Registered Oct. 12, 2004

**TRADEMARK
PRINCIPAL REGISTER**

Animaland

ANIMALAND, INC. (NEVADA CORPORATION)
3775 WEST TECO AVENUE, SUITE NO. 2
LAS VEGAS, NV 89118

TOY ANIMALS, IN CLASS 28 (U.S. CLS. 22, 23, 38
AND 50).

FIRST USE 11-20-2003; IN COMMERCE 11-20-2003.

FOR: STUFFED TOY ANIMALS AND ACCES-
SORIES THEREFORE, TOY ANIMAL SKINS WITH-
OUT STUFFING, AND CLOTHING FOR STUFFED

SER. NO. 76-553,672, FILED 10-23-2003.

HOWARD SMIGA, EXAMINING ATTORNEY

Int. Cl.: 41

Prior U.S. Cls.: 100, 101 and 107

United States Patent and Trademark Office

Reg. No. 2,892,995

Registered Oct. 12, 2004

**SERVICE MARK
PRINCIPAL REGISTER**

\$250,000 DELTA PRINCESS

BOYD GAMING CORPORATION (NEVADA
CORPORATION)
2950 INDUSTRIAL ROAD
LAS VEGAS, NV 89109

NO CLAIM IS MADE TO THE EXCLUSIVE
RIGHT TO USE "\$250,000", APART FROM THE
MARK AS SHOWN.

FOR: CASINO AND RACE BOOK SERVICES
NAMELY HORSE RACE BETTING SERVICES, IN
CLASS 41 (U.S. CLS. 100, 101 AND 107).

SER. NO. 76-553,679, FILED 10-6-2003.

FIRST USE 12-20-2002; IN COMMERCE 12-20-2002.

JAMES A. RAUEN, EXAMINING ATTORNEY

Int. Cl.: 37

Prior U.S. Cls.: 100, 103 and 106

United States Patent and Trademark Office

Reg. No. 2,892,996

Registered Oct. 12, 2004

**SERVICE MARK
PRINCIPAL REGISTER**

V.I.P. SUPREME

CSRA AIR, INC. (SOUTH CAROLINA CORPORATION)
2157 FOREST VIEW ROAD
AIKEN, SC 29803

FOR: HEATING, VENTILATION AND AIR CONDITIONING CONTRACTOR SERVICES; INSTALLATION, REPAIR AND MAINTENANCE OF HEATING, VENTILATION AND AIR CONDITIONING EQUIPMENT; SERVICE CONTRACTS FOR HEATING, VENTILATION AND AIR CONDITIONING SYSTEMS, IN CLASS 37 (U.S. CLS. 100, 103 AND 106).

FIRST USE 9-24-2003; IN COMMERCE 9-24-2003.

NO CLAIM IS MADE TO THE EXCLUSIVE RIGHT TO USE "SUPREME", APART FROM THE MARK AS SHOWN.

SER. NO. 76-553,686, FILED 10-6-2003.

MICHAEL HALL, EXAMINING ATTORNEY

Int. Cl.: 37

Prior U.S. Cls.: 100, 103 and 106

United States Patent and Trademark Office

Reg. No. 2,892,997

Registered Oct. 12, 2004

**SERVICE MARK
PRINCIPAL REGISTER**

V.I.P. PREMIUM

CSRA AIR, INC. (SOUTH CAROLINA CORPORATION)
2157 FOREST VIEW ROAD
AIKEN, SC 29803

FOR: HEATING, VENTILATION AND AIR CONDITIONING CONTRACTOR SERVICES; INSTALLATION, REPAIR AND MAINTENANCE OF HEATING, VENTILATION AND AIR CONDITIONING EQUIPMENT; SERVICE CONTRACTS FOR HEATING, VENTILATION AND AIR CONDITIONING SYSTEMS, IN CLASS 37 (U.S. CLS. 100, 103 AND 106).

FIRST USE 9-24-2003; IN COMMERCE 9-24-2003.

NO CLAIM IS MADE TO THE EXCLUSIVE RIGHT TO USE "PREMIUM", APART FROM THE MARK AS SHOWN.

SER. NO. 76-553,687, FILED 10-6-2003.

MICHAEL HALL, EXAMINING ATTORNEY

Int. Cl.: 33

Prior U.S. Cls.: 47 and 49

United States Patent and Trademark Office

Reg. No. 2,892,998

Registered Oct. 12, 2004

**TRADEMARK
PRINCIPAL REGISTER**

RANCHO SALINA VINEYARD

PAINO, DOMENIC J. (UNITED STATES INDIVIDUAL)
P.O. BOX 1245
SONOMA, CA 95476

NO CLAIM IS MADE TO THE EXCLUSIVE RIGHT TO USE VINEYARD , APART FROM THE MARK AS SHOWN.

FOR: WINE, IN CLASS 33 (U.S. CLS. 47 AND 49).

SER. NO. 76-553,744, FILED 10-6-2003.

FIRST USE 8-1-1995; IN COMMERCE 8-1-1995.

BRIDGETT SMITH, EXAMINING ATTORNEY

Int. Cl.: 42

Prior U.S. Cls.: 100 and 101

United States Patent and Trademark Office

Reg. No. 2,892,999

Registered Oct. 12, 2004

**SERVICE MARK
PRINCIPAL REGISTER**

WATER'S EDGE AQUATIC DESIGN

WATER'S EDGE AQUATIC DESIGN, LLC (KAN-
SAS LTD LIAB CO)
9812 PFLUMM ROAD
LENEXA, KS 66215

FOR: ENGINEERING AND DESIGN OF SWIM-
MING POOLS AND WATER PLAYGROUNDS AND
POURED-IN-PLACE FOUNTAINS, IN CLASS 42
(U.S. CLS. 100 AND 101).

FIRST USE 5-15-2000; IN COMMERCE 5-15-2000.

OWNER OF U.S. REG. NO. 2,741,277.

NO CLAIM IS MADE TO THE EXCLUSIVE
RIGHT TO USE "AQUATIC DESIGN", APART
FROM THE MARK AS SHOWN.

SER. NO. 76-553,772, FILED 10-23-2003.

SCOTT OSCLICK, EXAMINING ATTORNEY

Int. Cl.: 12

Prior U.S. Cls.: 19, 21, 23, 31, 35 and 44

Reg. No. 2,893,000

United States Patent and Trademark Office

Registered Oct. 12, 2004

**TRADEMARK
PRINCIPAL REGISTER**

ARTEMIS

JET-TERN MARINE COMPANY (TAIWAN CORPORATION)
71-6, NO. 83, SECTION 1, NAN-KAN ROAD
LUCHU SHIANG, TAOYUAN HSIEN, TAIWAN

FIRST USE 8-24-1999; IN COMMERCE 8-24-1999.

SER. NO. 76-553,981, FILED 10-6-2003.

FOR: SERIES OF LUXURY BOATS, IN CLASS 12
(U.S. CLS. 19, 21, 23, 31, 35 AND 44).

KATHRYN COWARD, EXAMINING ATTORNEY

Int. Cl.: 31

Prior U.S. Cls.: 1 and 46

United States Patent and Trademark Office

Reg. No. 2,893,001

Registered Oct. 12, 2004

**TRADEMARK
PRINCIPAL REGISTER**

MONSTER DIETS

ZEIGLER BROS., INC. (PENNSYLVANIA CORPORATION)
400 GARDNERS STATION ROAD
GARDNERS, PA 173240095

FOR: NON-MEDICATED ADDITIVES FOR ANIMAL FEED FOR NON-NUTRITIONAL PURPOSES FOR USE AS FLAVORING, INGREDIENT OR FILLER; ANIMAL FEED AND SPECIAL ANIMAL FEED, IN CLASS 31 (U.S. CLS. 1 AND 46).

FIRST USE 11-1-2002; IN COMMERCE 7-1-2003.

NO CLAIM IS MADE TO THE EXCLUSIVE RIGHT TO USE "DIET", APART FROM THE MARK AS SHOWN.

SER. NO. 76-553,995, FILED 10-6-2003.

DOMINIC J. FERRAIUOLO, EXAMINING ATTORNEY

Int. Cls.: 37 and 42

Prior U.S. Cls.: 100, 101, 103 and 106

United States Patent and Trademark Office

Reg. No. 2,893,002

Registered Oct. 12, 2004

**SERVICE MARK
PRINCIPAL REGISTER**

AIROOM

AIROOM, INC. (ILLINOIS CORPORATION)
6825 N. LINCOLN AVENUE
LINCOLNWOOD, IL 60712

FOR: REPAIR AND MAINTENANCE OF HOMES,
HOME FURNISHINGS, RESIDENTIAL AND COM-
MERCIAL BUILDING CONSTRUCTION AND RE-
MODELING; CUSTOM CONSTRUCTION AND
BUILDING RENOVATION, IN CLASS 37 (U.S. CLS.
100, 103 AND 106).

FIRST USE 1-1-1959; IN COMMERCE 1-1-1970.

FOR: ARCHITECTURAL DESIGN, IN CLASS 42
(U.S. CLS. 100 AND 101).

FIRST USE 1-1-1959; IN COMMERCE 1-1-1970.

SER. NO. 76-554,282, FILED 10-27-2003.

MICHAEL WEBSTER, EXAMINING ATTORNEY

Int. Cl.: 9

Prior U.S. Cls.: 21, 23, 26, 36 and 38

United States Patent and Trademark Office

Reg. No. 2,893,003

Registered Oct. 12, 2004

**TRADEMARK
PRINCIPAL REGISTER**

ACTIONLINK

DBLS HOLDINGS, LTD. (MASSACHUSETTS
CORPORATION)
TWO NEWTON PLACE SUITE 190
NEWTON, MA 02458

FOR: COMPUTER SOFTWARE RECORDED ON
CD-ROM OR DOWNLOADABLE FROM THE IN-
TERNET FOR USE IN OBTAINING TECHNICAL
SUPPORT OR TRAINING MATERIALS RELATED
TO WORK PROCEDURES IN THE FIELD OF MED-

ICAL SALES, IN CLASS 9 (U.S. CLS. 21, 23, 26, 36 AND
38).

FIRST USE 8-20-2001; IN COMMERCE 8-20-2001.

SER. NO. 76-554,376, FILED 10-8-2003.

CHRIS WELLS, EXAMINING ATTORNEY

Int. Cls.: 25 and 35

Prior U.S. Cls.: 22, 39, 100, 101 and 102

United States Patent and Trademark Office

Reg. No. 2,893,004

Registered Oct. 12, 2004

**TRADEMARK
SERVICE MARK
PRINCIPAL REGISTER**

ACADEMY OF COUNTRY MUSIC

ACADEMY OF COUNTRY MUSIC (CALIFORNIA CORPORATION)
4100 WEST ALAMEDA AVE. #208
BURBANK, CA 91505

FOR: MEMORABILIA, NAMELY, T-SHIRTS AND HATS, IN CLASS 25 (U.S. CLS. 22 AND 39).

FIRST USE 1-1-1972; IN COMMERCE 1-1-1972.

FOR: ASSOCIATION SERVICES, NAMELY, PROMOTING THE INTERESTS OF THOSE IN THE COUNTRY MUSIC INDUSTRY, IN CLASS 35 (U.S. CLS. 100, 101 AND 102).

FIRST USE 1-1-1972; IN COMMERCE 1-1-1972.

NO CLAIM IS MADE TO THE EXCLUSIVE RIGHT TO USE "COUNTRY MUSIC", APART FROM THE MARK AS SHOWN.

SEC. 2(F).

SER. NO. 76-554,443, FILED 10-27-2003.

MICHAEL WEBSTER, EXAMINING ATTORNEY

Int. Cl.: 9

Prior U.S. Cls.: 21, 23, 26, 36 and 38

Reg. No. 2,893,005

United States Patent and Trademark Office

Registered Oct. 12, 2004

**TRADEMARK
PRINCIPAL REGISTER**

μVISION

KEIL SOFTWARE, INC. (TEXAS CORPORATION)
P.O. BOX 520
ADDISON, TX 750010520

THE FIELD OF PROJECT MANAGEMENT, IN
CLASS 9 (U.S. CLS. 21, 23, 26, 36 AND 38).

FIRST USE 2-0-1995; IN COMMERCE 2-0-1995.

FOR: COMPUTER HARDWARE AND COMPU-
TER SOFTWARE FOR SOURCE CODE EDITING,
PROGRAM DEBUGGING AND SIMULATION IN

SER. NO. 76-554,482, FILED 10-8-2003.

LESLEY LAMOTHE, EXAMINING ATTORNEY

Int. Cl.: 41

Prior U.S. Cls.: 100, 101 and 107

Reg. No. 2,893,006

United States Patent and Trademark Office

Registered Oct. 12, 2004

**SERVICE MARK
PRINCIPAL REGISTER**



ADVANCED RESEARCH AND TECHNOLOGY
INSTITUTE, INC. (INDIANA CORPORATION)
501 N. MORTON STREET, SUITE 208
BLOOMINGTON, IN 47404

FOR: CONSULTING SERVICES, NAMELY CON-
SULTING OTHERS IN THE FIELD OF EDUCA-
TION, CONSULTING STUDENTS WITH RESPECT

TO UNIVERSITY AND CAREER CHOICES, IN
CLASS 41 (U.S. CLS. 100, 101 AND 107).

FIRST USE 11-1-1987; IN COMMERCE 11-1-1987.

SER. NO. 76-554,598, FILED 10-28-2003.

JOHN GARTNER, EXAMINING ATTORNEY

Int. Cl.: 20

Prior U.S. Cls.: 2, 13, 22, 25, 32 and 50

United States Patent and Trademark Office

Reg. No. 2,893,007

Registered Oct. 12, 2004

**TRADEMARK
PRINCIPAL REGISTER**

SACROPEDIC

BEMCO ASSOCIATES, INC. (DELAWARE CORPORATION)
2720 DES PLAINES/RIVER ROAD, SUITE 130
DES PLAINES, IL 600184106

FIRST USE 12-0-1958; IN COMMERCE 12-0-1958.

SER. NO. 76-554,726, FILED 10-14-2003.

FOR: MATTRESSES, IN CLASS 20 (U.S. CLS. 2, 13, 22, 25, 32 AND 50).

SUSAN STIGLITZ, EXAMINING ATTORNEY

Int. Cl.: 41

Prior U.S. Cls.: 100, 101 and 107

United States Patent and Trademark Office

Reg. No. 2,893,008

Registered Oct. 12, 2004

**SERVICE MARK
PRINCIPAL REGISTER**



BODY ZONE STUDIOS, INC. (NEW YORK COR-
PORATION)
P.O. BOX 794
BRIDGEHAMPTON, NY 11932

FIRST USE 12-1-2002; IN COMMERCE 12-1-2002.

SER. NO. 76-554,833, FILED 10-14-2003.

FOR: HEALTH CLUB SERVICES, IN CLASS 41
(U.S. CLS. 100, 101 AND 107).

JEFFREY S. MOLINOFF, EXAMINING ATTORNEY

Int. Cl.: 28

Prior U.S. Cls.: 22, 23, 38 and 50

United States Patent and Trademark Office

Reg. No. 2,893,009

Registered Oct. 12, 2004

**TRADEMARK
PRINCIPAL REGISTER**

ACMEPUPS.COM

ALL-STAR CORPORATE MARKETING ENTER-
PRISES (CALIFORNIA CORPORATION)
3104 FOURTH AVENUE
SAN DIEGO, CA 92103

FIRST USE 9-1-2003; IN COMMERCE 9-1-2003.

SER. NO. 76-555,175, FILED 10-29-2003.

FOR: HAND PUPPETS AND FINGER PUPPETS,
IN CLASS 28 (U.S. CLS. 22, 23, 38 AND 50).

BRETT J. GOLDEN, EXAMINING ATTORNEY

Int. Cl.: 35

Prior U.S. Cls.: 100, 101 and 102

United States Patent and Trademark Office

Reg. No. 2,893,010

Registered Oct. 12, 2004

**SERVICE MARK
PRINCIPAL REGISTER**

TAKE WING AND SOAR

TAKE WING AND SOAR PRODUCTIONS, INC.
(NEW YORK CORPORATION)
45 TIEMANN PLACE SUITE 3G
NEW YORK, NY 10027

FIRST USE 5-5-2000; IN COMMERCE 5-5-2000.

SER. NO. 76-555,198, FILED 10-29-2003.

FOR: THEATRICAL AGENCIES AND THEATRICAL
MANAGEMENT, IN CLASS 35 (U.S. CLS. 100,
101 AND 102).

REBECCA SMITH, EXAMINING ATTORNEY

Int. Cl.: 41

Prior U.S. Cls.: 100, 101 and 107

United States Patent and Trademark Office

Reg. No. 2,893,011

Registered Oct. 12, 2004

**SERVICE MARK
PRINCIPAL REGISTER**

TOUCHDOWN TO WIN!

AMERICAN CHEMISTRY COUNCIL, INC. (NEW
YORK CORPORATION)
1300 WILSON BOULEVARD
ARLINGTON, VA 22209

FIRST USE 9-0-2001; IN COMMERCE 9-0-2001.

SER. NO. 76-555,219, FILED 10-29-2003.

FOR: ENTERTAINMENT SERVICES, NAMELY,
CONDUCTING ONLINE FOOTBALL-RELATED
SWEEPSTAKES CONTESTS, IN CLASS 41 (U.S. CLS.
100, 101 AND 107).

RUDY R. SINGLETON, EXAMINING ATTORNEY

Int. Cl.: 10

Prior U.S. Cls.: 26, 39 and 44

Reg. No. 2,893,012

United States Patent and Trademark Office

Registered Oct. 12, 2004

TRADEMARK
PRINCIPAL REGISTER



BIOTOP TECHNOLOGY CO., LTD. (TAIWAN CORPORATION)
12FL-2, NO. 130, CHUNG-HSIAO E. RD., SEC. 2
TAIPEI, TAIWAN 100

FOR: HYPODERMIC SYRINGES; MEDICAL SYRINGES; URETHRAL PROBE SYRINGES; UTERINE SYRINGES; VAGINAL SYRINGES; DROPPERS FOR ADMINISTERING MEDICATION, SOLD EMPTY; DROPPER BOTTLES FOR ADMINISTERING MED-

ICATION, SOLD EMPTY; INTRAVENOUS FEEDING BOTTLES, IN CLASS 10 (U.S. CLS. 26, 39 AND 44).

FIRST USE 8-20-2003; IN COMMERCE 8-20-2003.

SER. NO. 76-555,322, FILED 10-22-2003.

JAMES A. RAUEN, EXAMINING ATTORNEY

Int. Cl.: 11

Prior U.S. Cls.: 13, 21, 23, 31 and 34

United States Patent and Trademark Office

Reg. No. 2,893,013

Registered Oct. 12, 2004

**TRADEMARK
PRINCIPAL REGISTER**

CYCLO MAZE

GARLAND COMMERCIAL INDUSTRIES IN-
CORPORATED (NEW YORK CORPORATION)
185 EAST SOUTH STREET
FREELAND, PA 18224

FOR: VENTILATORS USED IN CONNECTION
WITH COMMERCIAL COOKING OPERATIONS TO
REMOVE HEAT, GREASE COMBUSTION GASES

AND ODORS, IN CLASS 11 (U.S. CLS. 13, 21, 23, 31
AND 34).

FIRST USE 7-1-1995; IN COMMERCE 7-1-1995.

SER. NO. 76-555,444, FILED 10-30-2003.

MICHAEL ENGEL, EXAMINING ATTORNEY

Int. Cl.: 10

Prior U.S. Cls.: 26, 39 and 44

United States Patent and Trademark Office

Reg. No. 2,893,014

Registered Oct. 12, 2004

**TRADEMARK
PRINCIPAL REGISTER**

MENIVAC

ARTHROCARE CORPORATION (DELAWARE CORPORATION)
680 VAQUEROS AVENUE
SUNNYVALE, CA 940853523

FOR: MEDICAL DEVICES FOR ELECTROSURGERY AND ELECTRON PLASMA ASSISTED SURGERY IN ARTHROSCOPIC SURGICAL PROCEDURES; NAMELY, ELECTROSURGICAL PROBES, CATHETERS, ELECTRODES, AND POW-

ER SUPPLIES FOR THE ELECTRODES, IN CLASS 10 (U.S. CLS. 26, 39 AND 44).

FIRST USE 9-23-2003; IN COMMERCE 9-23-2003.

SER. NO. 76-555,509, FILED 10-31-2003.

CHERYL CLAYTON, EXAMINING ATTORNEY

Int. Cl.: 5

Prior U.S. Cls.: 6, 18, 44, 46, 51 and 52

United States Patent and Trademark Office

Reg. No. 2,893,015

Registered Oct. 12, 2004

**TRADEMARK
PRINCIPAL REGISTER**

LITE-FIL

SHOFU, INC. (JAPAN CORPORATION)
11 KAMITAKAMATSU-CHO
FUKUINE, HIGASHIYAMA-KU
KYOTO 605, JAPAN

FIRST USE 4-24-1991; IN COMMERCE 4-24-1991.

SER. NO. 76-555,827, FILED 10-14-2003.

FOR: LIGHT COMPOSITE RESTORATIVE MATERIAL FOR TOOTH FILLING, IN CLASS 5 (U.S. CLS. 6, 18, 44, 46, 51 AND 52).

JACQUELINE A. LAVINE, EXAMINING ATTORNEY

Int. Cl.: 5

Prior U.S. Cls.: 6, 18, 44, 46, 51 and 52

United States Patent and Trademark Office

Reg. No. 2,893,016

Registered Oct. 12, 2004

**TRADEMARK
PRINCIPAL REGISTER**

BALLISTIVAC

SOLIDTECH ANIMAL HEALTH, INC. (OKLAHOMA CORPORATION)
812 N.E. 24TH
NEWCASTLE, OK 73065

FIRST USE 7-25-2003; IN COMMERCE 7-15-2003.

SER. NO. 76-555,837, FILED 10-14-2003.

FOR: VACCINES FOR ANIMAL USE FOR THE BALLISTIC IMMUNIZATION AGAINST DISEASE CAUSED BY PATHOGENIC VIRUSES OR BACTERIA AND COMBINATIONS OF SAME, IN CLASS 5 (U.S. CLS. 6, 18, 44, 46, 51 AND 52).

JACQUELINE A. LAVINE, EXAMINING ATTORNEY

Int. Cl.: 20

Prior U.S. Cls.: 2, 13, 22, 25, 32 and 50

United States Patent and Trademark Office

Reg. No. 2,893,017

Registered Oct. 12, 2004

**TRADEMARK
PRINCIPAL REGISTER**

MODIRONDAK

JOVANNI INC. (CALIFORNIA CORPORATION)
23240 SAGELAND DRIVE
RAMONA, CA 92065

FIRST USE 4-22-2003; IN COMMERCE 6-3-2003.

SER. NO. 76-555,860, FILED 10-16-2003.

FOR: FURNITURE, IN CLASS 20 (U.S. CLS. 2, 13,
22, 25, 32 AND 50).

CURTIS FRENCH, EXAMINING ATTORNEY

Int. Cl.: 35

Prior U.S. Cls.: 100, 101 and 102

United States Patent and Trademark Office

Reg. No. 2,893,018

Registered Oct. 12, 2004

**SERVICE MARK
PRINCIPAL REGISTER**

WHEN SIGHT AND SOUND POWER IDEAS & INFORMATION

INTERNATIONAL COMMUNICATIONS INDUSTRIES ASSOCIATION, INC. (VIRGINIA CORPORATION)
11242 WAPLES MILL ROAD SUITE 200
FAIRFAX, VA 22032

FOR: PROMOTING THE INTERESTS OF THE PROJECTION, PRESENTATION AND AUDIOVI-

SUAL COMMUNICATIONS INDUSTRIES, IN CLASS 35 (U.S. CLS. 100, 101 AND 102).

FIRST USE 6-3-2003; IN COMMERCE 6-3-2003.

SER. NO. 76-555,861, FILED 10-16-2003.

IRENE D. WILLIAMS, EXAMINING ATTORNEY

Int. Cl.: 21

Prior U.S. Cls.: 2, 13, 23, 29, 30, 33, 40 and 50

United States Patent and Trademark Office

Reg. No. 2,893,019

Registered Oct. 12, 2004

TRADEMARK
PRINCIPAL REGISTER

The Original
CALIFORNIA
Water Blade

ORIGINAL CALIFORNIA CAR DUSTER COM-
PANY, INC. (CALIFORNIA CORPORATION)
9525 DESOTO AVENUE
CHATSWORTH, CA 91311

FOR: SQUEEGEES FOR USE ON VEHICLES, IN
CLASS 21 (U.S. CLS. 2, 13, 23, 29, 30, 33, 40 AND 50).

FIRST USE 6-0-1998; IN COMMERCE 6-0-1998.

OWNER OF U.S. REG. NOS. 2,085,125, 2,107,482,
AND 2,822,043.

SEC. 2(F).

SER. NO. 76-555,869, FILED 10-16-2003.

CHARLES JOYNER, EXAMINING ATTORNEY

Int. Cl.: 3

Prior U.S. Cls.: 1, 4, 6, 50, 51 and 52

United States Patent and Trademark Office

Reg. No. 2,893,020

Registered Oct. 12, 2004

**TRADEMARK
PRINCIPAL REGISTER**

PROSTRENGTHENER

PROSTRONG, INC. (CONNECTICUT CORPORATION)
20 MAIN STREET
OAKVILLE, CT 06779

FOR: NAIL CARE PREPARATIONS, NAMELY,
NAIL HARDENER, NAIL STRENGTHENER, NAIL
BUILDER, NAIL TREATMENTS, NAIL SEALER,
NAIL POLISH TOP COAT, IN CLASS 3 (U.S. CLS. 1,
4, 6, 50, 51 AND 52).

FIRST USE 12-1-2000; IN COMMERCE 6-16-2001.

OWNER OF U.S. REG. NOS. 2,169,729, 2,765,649
AND OTHERS.

SER. NO. 76-555,953, FILED 10-16-2003.

CURTIS FRENCH, EXAMINING ATTORNEY

Int. Cls.: 35, 40 and 42

Prior U.S. Cls.: 100, 101, 102, 103 and 106

United States Patent and Trademark Office

Reg. No. 2,893,021

Registered Oct. 12, 2004

**SERVICE MARK
PRINCIPAL REGISTER**

PDT PRODUCT DEVELOPMENT TECHNOLOGIES, INC.

PDT HOLDINGS, INC. (ILLINOIS CORPORATION)
600 HEATHROW DRIVE
LINCOLNSHIRE, IL 60069

FOR: BUSINESS AND MARKETING RESEARCH CONSULTATION IN THE FIELDS OF BUSINESS STRATEGY AND PRODUCT APPEARANCE, BRANDING, COST ANALYSIS AND CONTROL, MANUFACTURING, MARKETING AND QUALITY CONTROL, IN CLASS 35 (U.S. CLS. 100, 101 AND 102).

FIRST USE 1-0-1996; IN COMMERCE 1-0-1996.

FOR: CONTRACT MANUFACTURING AND CUSTOM MANUFACTURE OF DIES, MOLDS AND TOOLS; PROTOTYPE FABRICATION OF NEW PRODUCTS FOR OTHERS, IN CLASS 40 (U.S. CLS. 100, 103 AND 106).

FIRST USE 1-0-1996; IN COMMERCE 1-0-1996.

FOR: INDUSTRIAL DESIGN RESEARCH; DESIGN, MECHANICAL, ELECTRO-MECHANICAL AND TOOLING ENGINEERING; PRODUCT DEVELOPMENT CONSULTATION; DESIGN AND TESTING OF NEW PRODUCTS FOR OTHERS; INDUSTRIAL AND GRAPHIC ART DESIGN; PACKAGING DESIGN FOR OTHERS, IN CLASS 42 (U.S. CLS. 100 AND 101).

FIRST USE 1-0-1996; IN COMMERCE 1-0-1996.

NO CLAIM IS MADE TO THE EXCLUSIVE RIGHT TO USE "PRODUCT DEVELOPMENT TECHNOLOGIES, INC.", APART FROM THE MARK AS SHOWN.

SER. NO. 76-556,421, FILED 10-21-2003.

IRA J. GOODSaid, EXAMINING ATTORNEY

Int. Cls.: 35, 40 and 42

Prior U.S. Cls.: 100, 101, 102, 103 and 106

United States Patent and Trademark Office

Reg. No. 2,893,022

Registered Oct. 12, 2004

**SERVICE MARK
PRINCIPAL REGISTER**

PDT

PDT HOLDINGS, INC. (ILLINOIS CORPORATION)
600 HEATHROW DRIVE
LINCOLNSHIRE, IL 60069

FOR: BUSINESS AND MARKETING RESEARCH CONSULTATION IN THE FIELDS OF BUSINESS STRATEGY AND PRODUCT APPEARANCE, BRANDING, COST ANALYSIS AND CONTROL, MANUFACTURING, MARKETING AND QUALITY CONTROL, IN CLASS 35 (U.S. CLS. 100, 101 AND 102).

FIRST USE 6-0-1995; IN COMMERCE 6-0-1995.

FOR: CONTRACT MANUFACTURING AND CUSTOM MANUFACTURE OF DIES, MOLDS AND TOOLS; PROTOTYPE FABRICATION OF NEW PRODUCTS FOR OTHERS, IN CLASS 40 (U.S. CLS. 100, 103 AND 106).

FIRST USE 6-0-1995; IN COMMERCE 6-0-1995.

FOR: INDUSTRIAL DESIGN RESEARCH; DESIGN, MECHANICAL, ELECTRO-MECHANICAL AND TOOLING ENGINEERING; PRODUCT DEVELOPMENT CONSULTATION; DESIGN AND TESTING OF NEW PRODUCTS FOR OTHERS; INDUSTRIAL AND GRAPHIC ART DESIGN; PACKAGING DESIGN FOR OTHERS, IN CLASS 42 (U.S. CLS. 100 AND 101).

FIRST USE 6-0-1995; IN COMMERCE 6-0-1995.

SER. NO. 76-556,422, FILED 10-21-2003.

IRA J. GOODSaid, EXAMINING ATTORNEY

Int. Cl.: 20

Prior U.S. Cls.: 2, 13, 22, 25, 32 and 50

United States Patent and Trademark Office

Reg. No. 2,893,023

Registered Oct. 12, 2004

**TRADEMARK
PRINCIPAL REGISTER**

THE BIG GOOSE

PERFECT FIT INDUSTRIES, INC. (DELAWARE
CORPORATION)
8501 TOWER POINT DRIVE
CHARLOTTE, NC 28227

FIRST USE 9-20-2003; IN COMMERCE 9-20-2003.

SER. NO. 76-556,528, FILED 10-17-2003.

FOR: PILLOWS, IN CLASS 20 (U.S. CLS. 2, 13, 22,
25, 32 AND 50).

JENNIFER CHICOSKI, EXAMINING ATTORNEY

Int. Cl.: 16

Prior U.S. Cls.: 2, 5, 22, 23, 29, 37, 38 and 50

Reg. No. 2,893,024

United States Patent and Trademark Office

Registered Oct. 12, 2004

**TRADEMARK
PRINCIPAL REGISTER**



RODRIGUEZ-LONG, RICARDO (UNITED STATES INDIVIDUAL)
7668 TELEGRAPH RD
COMMERCE, CA 90040

FOR: MAGAZINE PUBLICATION WITH NEWS AND INFORMATION PERTAINING TO OVER THE ROAD TRUCKING IN SPANISH LANGUAGE, IN CLASS 16 (U.S. CLS. 2, 5, 22, 23, 29, 37, 38 AND 50).

FIRST USE 6-1-1999; IN COMMERCE 7-1-2000.

NO CLAIM IS MADE TO THE EXCLUSIVE RIGHT TO USE "MAGAZINE TRANSPORTE LATINO", APART FROM THE MARK AS SHOWN.

THE ENGLISH TRANSLATION OF TRANSPORTE LATINO IN THE MARK IS "HISPANICS IN TRUCKING" AND "LATIN TRANSPORTATION".

SER. NO. 76-556,749, FILED 10-21-2003.

TRICIA SONNEBORN, EXAMINING ATTORNEY

Int. Cl.: 20

Prior U.S. Cls.: 2, 13, 22, 25, 32 and 50

United States Patent and Trademark Office

Reg. No. 2,893,025

Registered Oct. 12, 2004

**TRADEMARK
PRINCIPAL REGISTER**

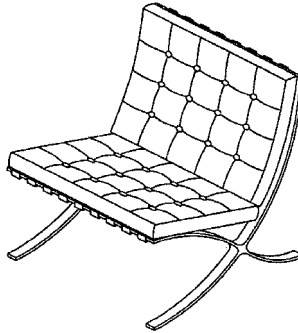

KNOLL, INC. (DELAWARE CORPORATION)
1235 WATER STREET
EAST GREENVILLE, PA 18041

FOR: CHAIRS, IN CLASS 20 (U.S. CLS. 2, 13, 22, 25,
32 AND 50).

FIRST USE 1-1-1954; IN COMMERCE 1-1-1954.

THE MARK CONSISTS OF A CONFIGURATION
OF A CHAIR WITH A METAL FRAME AND
LEATHER CUSHIONS.

SEC. 2(F).

SER. NO. 76-556,817, FILED 10-22-2003.

JAMES A. RAUEN, EXAMINING ATTORNEY

Int. Cl.: 5

Prior U.S. Cls.: 6, 18, 44, 46, 51 and 52

United States Patent and Trademark Office

Reg. No. 2,893,026

Registered Oct. 12, 2004

**TRADEMARK
PRINCIPAL REGISTER**

HYPOTHERMOSOL

BIOLIFE SOLUTIONS, INC. (NEW YORK COR-
PORATION)
SCIENCE 3 SUITE 144 SUNY PARK
BINGHAMTON, NY 139026000

FOR: FULL LINE OF CELL PRESERVATION
SOLUTIONS, IN CLASS 5 (U.S. CLS. 6, 18, 44, 46, 51
AND 52).

FIRST USE 1-20-1994; IN COMMERCE 4-3-1994.

OWNER OF U.S. REG. NO. 1,955,324.

SER. NO. 76-556,857, FILED 10-21-2003.

CAROLYN CATALDO, EXAMINING ATTORNEY

Int. Cls.: 9 and 42

Prior U.S. Cls.: 21, 23, 26, 36, 38, 100 and 101

United States Patent and Trademark Office

Reg. No. 2,893,027

Registered Oct. 12, 2004

**TRADEMARK
SERVICE MARK
PRINCIPAL REGISTER**

TELEGEA

TELEGEA, INC. (DELAWARE CORPORATION)
245 WINTER STREET
WALTHAM, MA 02451

FOR: COMPUTER SOFTWARE FOR USE BY TELECOMMUNICATION SERVICE PROVIDERS FOR AUTOMATION OF BUSINESS PROCESSES AND OPERATIONS, NAMELY ORDER PROCESSING, ORDER FULFILLMENT, ACCOUNT MANAGEMENT, PRODUCT CATALOGUE, WORKFLOW MANAGEMENT, CUSTOMER SERVICE, BILLING, QUALITY ASSURANCE, AND BACK-OFFICE OPERATIONS, IN CLASS 9 (U.S. CLS. 21, 23, 26, 36 AND 38).

FIRST USE 7-10-2000, THE MARK WAS FIRST USED ANYWHERE IN A DIFFERENT FORM OTHER THAN THAT SOUGHT TO BE REGISTERED ON 00/00/1999.; IN COMMERCE 7-10-2000.

FOR: COMPUTER SERVICES, NAMELY CUSTOM DESIGN, DEVELOPMENT, INSTALLATION AND MAINTENANCE OF BUSINESS PROCESS AUTOMATION SOFTWARE FOR TELECOMMUNICATIONS SERVICE PROVIDERS; TECHNICAL SUPPORT SERVICES, NAMELY TROUBLESHOOTING OF COMPUTER SOFTWARE PROBLEMS WITH RESPECT TO BUSINESS PROCESS AUTOMATION SOFTWARE FOR TELECOMMUNICATIONS SERVICE PROVIDERS, IN CLASS 42 (U.S. CLS. 100 AND 101).

FIRST USE 7-10-2000, THE MARK WAS FIRST USED ANYWHERE IN A DIFFERENT FORM OTHER THAN THAT SOUGHT TO BE REGISTERED ON 00/00/1999.; IN COMMERCE 7-10-2000.

SER. NO. 76-556,988, FILED 10-22-2003.

DAWN HAN, EXAMINING ATTORNEY

Int. Cl.: 11

Prior U.S. Cls.: 13, 21, 23, 31 and 34

Reg. No. 2,893,028

United States Patent and Trademark Office

Registered Oct. 12, 2004

**TRADEMARK
PRINCIPAL REGISTER**



AQUAFILTER, INC. (MARYLAND CORPORATION)
16031 YORK ROAD
SPARKS, MD 21152

FIRST USE 10-1-1999; IN COMMERCE 2-1-2000.

FOR: WATER FILTERS, WATER FILTRATION EQUIPMENT AND ACCESSORIES FOR HOME AND INDUSTRIAL USE, NAMELY WATER PURIFICATION FILTERS, FILTER HOUSINGS, SEDIMENT FILTERS, STAINLESS STEEL WATER FILTERS, KITCHEN FILTERS, REVERSE OSMOSIS SYSTEMS, FILTER CARTRIDGES AND WATER SOFTENERS, IN CLASS 11 (U.S. CLS. 13, 21, 23, 31 AND 34).

NO CLAIM IS MADE TO THE EXCLUSIVE RIGHT TO USE AQUA, APART FROM THE MARK AS SHOWN.

SER. NO. 76-557,068, FILED 10-6-2003.

DOMINIC J. FERRAIUOLO, EXAMINING ATTORNEY

Int. Cl.: 9

Prior U.S. Cls.: 21, 23, 26, 36 and 38

Reg. No. 2,893,029

United States Patent and Trademark Office

Registered Oct. 12, 2004

**TRADEMARK
PRINCIPAL REGISTER**

PED

JZB MARKETING GROUP, INC. (CALIFORNIA
CORPORATION)
27772 CAMINO LAS RAMBLAS
SAN JUAN CAPISTRANO, CA 92675

FIRST USE 6-1-2003; IN COMMERCE 6-1-2003.

SER. NO. 76-557,095, FILED 10-14-2003.

FOR: SELF-CONTAINED PORTABLE CHARGER
FOR ELECTRICAL DEVICES, IN CLASS 9 (U.S. CLS.
21, 23, 26, 36 AND 38).

JENNIFER CHICOSKI, EXAMINING ATTORNEY

Int. Cl.: 25

Prior U.S. Cls.: 22 and 39

United States Patent and Trademark Office

Reg. No. 2,893,030

Registered Oct. 12, 2004

**TRADEMARK
PRINCIPAL REGISTER**

GAWSIE



OZOA INC. (NEW YORK CORPORATION)
59 9TH AVENUE, SUITE 305A
NEW YORK, NY 10011

LINEN PANTS, SWEATSHIRTS AND SWEAT-
PANTS, IN CLASS 25 (U.S. CLS. 22 AND 39).

FIRST USE 0-0-1995; IN COMMERCE 0-0-1995.

FOR: JERSEY KNIT TOPS, DENIM JEANS, DEN-
IM JACKETS, DENIM SHIRTS, PIQUE POLO TOPS,
BLAZERS, OUTERWEAR JACKETS, CHINO AND

SER. NO. 76-557,295, FILED 11-5-2003.

ESTHER A. BORSUK, EXAMINING ATTORNEY

Int. Cl.: 36

Prior U.S. Cls.: 100, 101 and 102

United States Patent and Trademark Office

Reg. No. 2,893,031

Registered Oct. 12, 2004

**SERVICE MARK
PRINCIPAL REGISTER**

P-FLOATs

MERRILL LYNCH & CO., INC. (DELAWARE
CORPORATION)
222 BROADWAY, 17TH FLOOR
NEW YORK, NY 10038

FOR: FINANCIAL SERVICES, NAMELY AN IN-
VESTMENT PRODUCT WHICH IS A PUTTABLE
FLOATING RATE TAX EXEMPT CERTIFICATE
OFFERED TO TAX EXEMPT MONEY MARKET

INVESTORS, IN CLASS 36 (U.S. CLS. 100, 101 AND
102).

FIRST USE 1-0-1994; IN COMMERCE 1-0-1994.

SER. NO. 76-557,363, FILED 11-6-2003.

PATRICIA EVANKO, EXAMINING ATTORNEY

Int. Cl.: 30

Prior U.S. Cl.: 46

United States Patent and Trademark Office

Reg. No. 2,893,032

Registered Oct. 12, 2004

**TRADEMARK
PRINCIPAL REGISTER**

SUGARSHOTS

SUGARSHOTS, INC. (CALIFORNIA CORPORATION)
923 ALTURAS WAY
MILL VALLEY, CA 94941

FOR: SINGLE-SERVING AND MULTI-SERVING
PACKETS AND CONTAINERS OF LIQUID SUGAR,
IN CLASS 30 (U.S. CL. 46).

FIRST USE 11-0-2001; IN COMMERCE 11-0-2002.

NO CLAIM IS MADE TO THE EXCLUSIVE
RIGHT TO USE "SUGAR", APART FROM THE
MARK AS SHOWN.

SER. NO. 76-557,516, FILED 10-20-2003.

ANDREW BENZMILLER, EXAMINING ATTORNEY

Int. Cl.: 20

Prior U.S. Cls.: 2, 13, 22, 25, 32 and 50

United States Patent and Trademark Office

Reg. No. 2,893,033

Registered Oct. 12, 2004

**TRADEMARK
PRINCIPAL REGISTER**

CONTESSA

SHEPHERD PRODUCTS, INC. (CANADA CORPORATION)
25 PRECIDIO CT.
BRAMPTON, ONTARIO, CANADA L6S 6B7

FIRST USE 1-1-1998; IN COMMERCE 1-1-1998.

SER. NO. 76-557,524, FILED 10-20-2003.

FOR: CHAIR BASES, IN CLASS 20 (U.S. CLS. 2, 13, 22, 25, 32 AND 50).

ANDREW BENZMILLER, EXAMINING ATTORNEY

Int. Cl.: 10

Prior U.S. Cls.: 26, 39 and 44

Reg. No. 2,893,034

United States Patent and Trademark Office

Registered Oct. 12, 2004

**TRADEMARK
PRINCIPAL REGISTER**

SONOS

KONINKLIJKE PHILIPS ELECTRONICS N.V.
(NETHERLANDS CORPORATION)
GROENEWOUDSEWEG 1
EINDHOVEN, NETHERLANDS

FIRST USE 5-27-1988; IN COMMERCE 5-27-1988.

SER. NO. 76-557,999, FILED 10-20-2003.

FOR: ULTRASONIC MEDICAL DIAGNOSTIC
APPARATUS, IN CLASS 10 (U.S. CLS. 26, 39 AND 44).

JEFFREY S. MOLINOFF, EXAMINING ATTORNEY

Int. Cl.: 35

Prior U.S. Cls.: 100, 101 and 102

United States Patent and Trademark Office

Reg. No. 2,893,035

Registered Oct. 12, 2004

**SERVICE MARK
PRINCIPAL REGISTER**



NAME RITE, L.L.C. (DELAWARE LTD LIAB CO)
31797 HIGHWAY 79 SOUTH
TEMECULA, CA 92592

FOR: RETAIL PHARMACY SERVICES, AND RE-
TAIL STORE SERVICES, IN THE FIELDS OF BEAU-
TY, HEALTHCARE, COSMETICS, PERSONAL
CARE, CLOTHING, HOUSEWARES, GARDENING,
AUTO CARE, GROCERIES, PET SUPPLIES, OFFICE
SUPPLIES AND PHOTO PROCESSING, IN CLASS 35
(U.S. CLS. 100, 101 AND 102).

FIRST USE 12-3-1979, JANUARY 3, 1966; IN
COMMERCE 12-3-1979.

OWNER OF U.S. REG. NOS. 875,773, 2,483,026 AND
OTHERS.

SER. NO. 76-558,029, FILED 11-7-2003.

VIVIAN MICZNIK FIRST, EXAMINING ATTOR-
NEY

Int. Cl.: 29

Prior U.S. Cl.: 46

United States Patent and Trademark Office

Reg. No. 2,893,036

Registered Oct. 12, 2004

**TRADEMARK
PRINCIPAL REGISTER**

KEY

CONAGRA GROCERY PRODUCTS COMPANY
(DELAWARE CORPORATION)
3353 MICHELSON DRIVE
IRVINE, CA 926120650

OWNER OF U.S. REG. NO. 669,050.

SER. NO. 76-558,107, FILED 10-23-2003.

FOR: SHORTENING, IN CLASS 29 (U.S. CL. 46).

FIRST USE 10-18-1957; IN COMMERCE 10-18-1957.

BRIAN BROWN, EXAMINING ATTORNEY

Int. Cl.: 41

Prior U.S. Cls.: 100, 101 and 107

United States Patent and Trademark Office

Reg. No. 2,893,037

Registered Oct. 12, 2004

**SERVICE MARK
PRINCIPAL REGISTER**

TURNING ENERGY INTO SYNERGY

COUNCIL OF PETROLEUM ACCOUNTANTS
SOCIETIES (TEXAS NON-PROFIT CORPORATION)
305 W. WOODARD, SUITE 200
DENISON, TX 75020

FOR: EDUCATIONAL SERVICES, NAMELY,
TRAINING IN PETROLEUM RELATED ACCOUNT-
ING FUNCTIONS; AND PUBLICATION OF MODEL
FORMS AND AGREEMENTS FEATURING PETRO-

LEUM RELATED FUNCTIONS, IN CLASS 41 (U.S.
CLS. 100, 101 AND 107).

FIRST USE 9-0-2002; IN COMMERCE 9-0-2002.

SER. NO. 76-558,137, FILED 10-27-2003.

AISHA CLARKE, EXAMINING ATTORNEY

Int. Cl.: 16

Prior U.S. Cls.: 2, 5, 22, 23, 29, 37, 38 and 50

United States Patent and Trademark Office

Reg. No. 2,893,038

Registered Oct. 12, 2004

**TRADEMARK
PRINCIPAL REGISTER**

TURNING ENERGY INTO SYNERGY

COUNCIL OF PETROLEUM ACCOUNTANT SOCIETIES (TEXAS NON-PROFIT CORPORATION)

305 W. WOODARD, SUITE 200
DENISON, TX 75020

FOR: MAGAZINES AND NEWSLETTERS ON
PETROLEUM RELATED ACCOUNTING FUNC-

TIONS, IN CLASS 16 (U.S. CLS. 2, 5, 22, 23, 29, 37, 38 AND 50).

FIRST USE 6-1-2002; IN COMMERCE 6-1-2002.

SER. NO. 76-558,140, FILED 10-27-2003.

AISHA CLARKE, EXAMINING ATTORNEY

Int. Cl.: 9

Prior U.S. Cls.: 21, 23, 26, 36 and 38

Reg. No. 2,893,039

United States Patent and Trademark Office

Registered Oct. 12, 2004

**TRADEMARK
PRINCIPAL REGISTER**

TURNING ENERGY INTO SYNERGY

COUNCIL OF PETROLEUM ACCOUNTANT SOCIETIES (TEXAS NON-PROFIT CORPORATION)
305 W. WOODARD, SUITE 200
DENISON, TX 75020

FOR: COMPUTERIZED PRICING SOFTWARE; MULTIMEDIA SOFTWARE RECORDED ON CD-ROM FEATURING PETROLEUM RELATED ACCOUNTING FUNCTIONS; AND PRE-RECORDED

VIDEO CASSETTES AND DVD'S ON PETROLEUM RELATED ACCOUNTING FUNCTIONS, IN CLASS 9 (U.S. CLS. 21, 23, 26, 36 AND 38).

FIRST USE 9-0-2003; IN COMMERCE 9-0-2003.

SER. NO. 76-558,143, FILED 10-27-2003.

AISHA CLARKE, EXAMINING ATTORNEY

Int. Cl.: 28

Prior U.S. Cls.: 22, 23, 38 and 50

United States Patent and Trademark Office

Reg. No. 2,893,040

Registered Oct. 12, 2004

**TRADEMARK
PRINCIPAL REGISTER**

BIKER CLUB ESSENTIALS

LITTLE KIDS PREFERRED, LLC (NEW JERSEY
LTD LIAB CO)
182 RIDGE ROAD, SUITE H
DAYTON, NJ 08810

FIRST USE 9-0-2003; IN COMMERCE 9-0-2003.

SER. NO. 76-558,148, FILED 11-6-2003.

FOR: STUFFED TOYS FOR INFANTS AND TOD-
DLERS, IN CLASS 28 (U.S. CLS. 22, 23, 38 AND 50).

JENNIFER KRISP, EXAMINING ATTORNEY

Int. Cl.: 9

Prior U.S. Cls.: 21, 23, 26, 36 and 38

Reg. No. 2,893,041

United States Patent and Trademark Office

Registered Oct. 12, 2004

**TRADEMARK
PRINCIPAL REGISTER**



AVENUES IN LEATHER, INC. (NEW JERSEY CORPORATION)
750 HOPE ROAD
TINTON FALLS, NJ 07724

FOR: PERSONAL ELECTRONIC ACCESSORIES, NAMELY, ADAPTERS, CHARGERS AND CARRYING CASES FOR CELLULAR PHONES, PALMTOP COMPUTERS, LAPTOP COMPUTERS, PORTABLE AUDIO PLAYERS, PORTABLE GAME PLAYERS

AND CAMERAS, IN CLASS 9 (U.S. CLS. 21, 23, 26, 36 AND 38).

FIRST USE 12-0-2001; IN COMMERCE 12-0-2001.

OWNER OF U.S. REG. NO. 2,727,896.

SER. NO. 76-558,216, FILED 10-29-2003.

KARLA PERKINS, EXAMINING ATTORNEY

Int. Cl.: 30

Prior U.S. Cl.: 46

United States Patent and Trademark Office

Reg. No. 2,893,042

Registered Oct. 12, 2004

**TRADEMARK
PRINCIPAL REGISTER**

BUTTER CRAZY

TOPCO ASSOCIATES, LLC (DELAWARE LTD
LIAB CO)
7711 GROSS POINT ROAD
SKOKIE, IL 60077

NO CLAIM IS MADE TO THE EXCLUSIVE
RIGHT TO USE BUTTER, APART FROM THE
MARK AS SHOWN.

FOR: MICROWAVE POPCORN, IN CLASS 30 (U.S.
CL. 46).

SER. NO. 76-558,423, FILED 10-27-2003.

FIRST USE 6-0-1996; IN COMMERCE 6-0-1996.

REBECCA GILBERT, EXAMINING ATTORNEY

Int. Cl.: 43

Prior U.S. Cls.: 100 and 101

United States Patent and Trademark Office

Reg. No. 2,893,043

Registered Oct. 12, 2004

**SERVICE MARK
PRINCIPAL REGISTER**

PAPA CIRO'S

VETRANO, JOSEPH (UNITED STATES INDIVIDUAL)
1624 MARCUS AVENUE
NEW HYDE PARK, NY 11040

FIRST USE 1-10-1998; IN COMMERCE 1-10-1998.

SER. NO. 76-558,700, FILED 10-27-2003.

FOR: RESTAURANT SERVICES, IN CLASS 43
(U.S. CLS. 100 AND 101).

REBECCA GILBERT, EXAMINING ATTORNEY

Int. Cl.: 36

Prior U.S. Cls.: 100, 101 and 102

United States Patent and Trademark Office

Reg. No. 2,893,044

Registered Oct. 12, 2004

**SERVICE MARK
PRINCIPAL REGISTER**

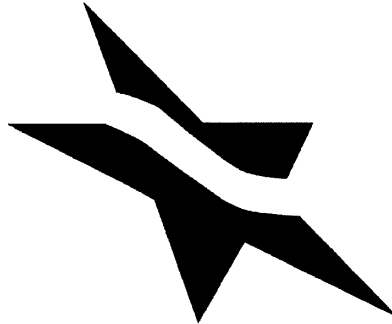

FORT JACKSON FEDERAL CREDIT UNION
(SOUTH CAROLINA FEDERALLY CHAR-
TERED FINANCIAL INSTITUTION)
6923 NORTH TRENHOLM ROAD
COLUMBIA, SC 29206

FIRST USE 3-1-2004; IN COMMERCE 3-1-2004.

SER. NO. 76-559,164, FILED 11-10-2003.

FOR: FINANCIAL SERVICES, NAMELY CREDIT
UNION SERVICES, IN CLASS 36 (U.S. CLS. 100, 101
AND 102).

RICHARD A. STRASER, EXAMINING ATTORNEY

Int. Cl.: 41

Prior U.S. Cls.: 100, 101 and 107

United States Patent and Trademark Office

Reg. No. 2,893,045

Registered Oct. 12, 2004

**SERVICE MARK
PRINCIPAL REGISTER**

THE VOICE FOR PUBLIC PENSIONS

NATIONAL CONFERENCE ON PUBLIC EM-
PLOYEE RETIREMENT SYSTEMS (D.C. NOT
FOR PROFIT CORPORATION)
HALL OF THE STATES
444 NORTH CAPITOL ST. NW, SUITE 221
WASHINGTON, DC 20001

FOR: EDUCATIONAL SERVICES, NAMELY, AR-
RANGING AND CONDUCTING CONFERENCES
IN THE FIELD OF PUBLIC EMPLOYEE RETIRE-

MENT SYSTEMS, IN CLASS 41 (U.S. CLS. 100, 101
AND 107).

FIRST USE 9-0-2002; IN COMMERCE 9-0-2002.

SER. NO. 76-559,680, FILED 10-31-2003.

BRIAN PINO, EXAMINING ATTORNEY

Int. Cl.: 35

Prior U.S. Cls.: 100, 101 and 102

United States Patent and Trademark Office

Reg. No. 2,893,046

Registered Oct. 12, 2004

SERVICE MARK
PRINCIPAL REGISTER



RJ PRINKEY ENTERPRISES, LLC (MISSOURI
LTD LIAB CO)
262 FOXTAIL
ST. CHARLES, MO 63303

NO CLAIM IS MADE TO THE EXCLUSIVE
RIGHT TO USE "ENTERTAINMENT & SPORTS",
APART FROM THE MARK AS SHOWN.

FOR: RETAIL STORES FEATURING ENTER-
TAINMENT AND SPORTS MEMORABILIA AND
CLOTHING, IN CLASS 35 (U.S. CLS. 100, 101 AND
102).

SER. NO. 76-559,702, FILED 10-30-2003.

FIRST USE 4-0-2001; IN COMMERCE 4-0-2001.

LINDA E. BLOHM, EXAMINING ATTORNEY

Int. Cl.: 16

Prior U.S. Cls.: 2, 5, 22, 23, 29, 37, 38 and 50

Reg. No. 2,893,047

United States Patent and Trademark Office

Registered Oct. 12, 2004

**TRADEMARK
PRINCIPAL REGISTER**

GLAMARAZZI

ADVANCE MAGAZINE PUBLISHERS INC. (NEW
YORK CORPORATION)
4 TIMES SQUARE
NEW YORK, NY 10036

FIRST USE 11-0-2001; IN COMMERCE 11-0-2001.

SER. NO. 76-559,786, FILED 10-30-2003.

FOR: PERIODIC MAGAZINE COLUMN AND
SECTION IN THE FIELD OF FASHION AND STYLE,
IN CLASS 16 (U.S. CLS. 2, 5, 22, 23, 29, 37, 38 AND 50).

DOMINIC J. FERRAIUOLO, EXAMINING ATTOR-
NEY

Int. Cl.: 25

Prior U.S. Cls.: 22 and 39

United States Patent and Trademark Office

Reg. No. 2,893,048

Registered Oct. 12, 2004

TRADEMARK
PRINCIPAL REGISTER

anvil

ANVIL KNITWEAR, INC. (DELAWARE CORPORATION)
228 EAST 45TH STREET 4TH FLOOR
NEW YORK, NY 10017

FOR: SHIRTS AND SHORTS, IN CLASS 25 (U.S. CLS. 22 AND 39).

FIRST USE 8-0-2003, THE MARK WAS FIRST USED ANYWHERE IN A DIFFERENT FORM OTHER THAN THAT SOUGHT TO BE REGISTERED ON 01/19/1965.; IN COMMERCE 8-0-2003, THE MARK WAS FIRST USED IN COMMERCE IN A DIFFERENT FORM OTHER

THAN THAT SOUGHT TO BE REGISTERED ON 05/29/1910..

OWNER OF U.S. REG. NOS. 783,710, 2,418,031 AND OTHERS.

THE MARK CONSISTS OF THE WORD ANVIL IN SCRIPT.

SER. NO. 76-559,816, FILED 10-30-2003.

DOMINIC J. FERRAIUOLO, EXAMINING ATTORNEY

Int. Cl.: 38

Prior U.S. Cls.: 100, 101 and 104

Reg. No. 2,893,049

United States Patent and Trademark Office

Registered Oct. 12, 2004

**SERVICE MARK
PRINCIPAL REGISTER**

INTERMAX

INTERMAX NETWORKS, INC. (IDAHO CORPORATION)
5077 BUILDING CENTER DR.
COEUR D'ALENE, ID 83814

FOR: TELECOMMUNICATION SERVICES, NAMELY, PROVIDING ELECTRIC, DIGITAL, CELLULAR AND WIRELESS TRANSMISSION OF VOICE, DATA, PICTURES, MUSIC AND VIDEO VIA WIRELESS NETWORKS; PROVIDING ACCESS TO A WIRELESS TELECOMMUNICATIONS NETWORK; PROVIDING MULTIPLE-USER ACCESS TO A GLOBAL COMPUTER NETWORK FOR THE TRANSFER AND DISSEMINATION OF A WIDE RANGE OF INFORMATION; LOCAL COMPUTER NETWORKS, FEATURING MOBILE ACCESS; BROADCASTING PROGRAMS VIA A GLOBAL COMPUTER NETWORK; VIDEO TELECONFERENCING SERVICES AND WIRELESS COMMUNICATION SERVICES; HIGH SPEED ELECTRONIC

DATA INTERCHANGE SERVICES PROVIDED VIA MODEMS, HYBRID FIBER COAXIAL CABLE AND FIBER OPTIC NETWORKS, ROUTERS AND SERVERS; PROVIDING MULTIPLE-USER DEDICATED ACCESS TO THE INTERNET; ELECTRONIC MAIL, AND MESSAGING SERVICES; TRANSMISSION AND BROADCAST OF AUDIO AND VIDEO PROGRAMMING; PROVIDING MULTIPLE-USER ACCESS TO A GLOBAL COMMUNICATION NETWORK; LEASING TELECOMMUNICATIONS EQUIPMENT, COMPONENTS, SYSTEMS AND SUPPLIES, IN CLASS 38 (U.S. CLS. 100, 101 AND 104).

FIRST USE 3-4-2003; IN COMMERCE 3-4-2003.

SER. NO. 76-559,942, FILED 11-3-2003.

MARK T. MULLEN, EXAMINING ATTORNEY

Int. Cl.: 25

Prior U.S. Cls.: 22 and 39

United States Patent and Trademark Office

Reg. No. 2,893,050

Registered Oct. 12, 2004

TRADEMARK
PRINCIPAL REGISTER



VANDERSHACK ENTERPRISES, LLC (TENNESSEE LTD LIAB CO)
P.O. BOX 216
PULASKI, TN 38478

FIRST USE 9-1-2002; IN COMMERCE 9-1-2002.

FOR: APPAREL, NAMELY, T-SHIRTS, SHIRTS, SWEATSHIRTS, TANK TOPS, SHORTS, PANTS, VISORS, SWIM TRUNKS, SHOES, CAPS, HATS, AND BELTS, IN CLASS 25 (U.S. CLS. 22 AND 39).

SER. NO. 76-559,983, FILED 10-27-2003.

TANYA AMOS, EXAMINING ATTORNEY

Int. Cls.: 21, 22 and 24

**Prior U.S. Cls.: 1, 2, 7, 13, 19, 22, 23, 29, 30, 33, 40, 42
and 50**

Reg. No. 2,893,051

United States Patent and Trademark Office

Registered Oct. 12, 2004

**TRADEMARK
PRINCIPAL REGISTER**

PROLINE

THE TRANZONIC COMPANIES (OHIO COR-
PORATION)

670 ALPHA DRIVE

HIGHLAND HEIGHTS, OH 44143

FOR: ALL-PURPOSE WIPING CLOTHS, PAINT-
ING SPONGES, STRIPING SPONGES, CLEANING
SPONGES, SPACKLING AND SANDING SPONGES,
TILE AND GROUT SPONGES AND WALLPAPER
SPONGES, IN CLASS 21 (U.S. CLS. 2, 13, 23, 29, 30, 33,
40 AND 50).

FIRST USE 4-15-2003; IN COMMERCE 4-15-2003.

FOR: TEXTILE DROP CLOTHS, IN CLASS 22 (U.S.
CLS. 1, 2, 7, 19, 22, 42 AND 50).

FIRST USE 4-15-2003; IN COMMERCE 4-15-2003.

FOR: TOWELS, IN CLASS 24 (U.S. CLS. 42 AND 50).

FIRST USE 4-15-2003; IN COMMERCE 4-15-2003.

OWNER OF U.S. REG. NO. 2,762,300.

SER. NO. 76-559,989, FILED 10-27-2003.

TANYA AMOS, EXAMINING ATTORNEY

Int. Cl.: 39

Prior U.S. Cls.: 100 and 105

United States Patent and Trademark Office

Reg. No. 2,893,052

Registered Oct. 12, 2004

**SERVICE MARK
PRINCIPAL REGISTER**

COMMON SENSE APPROACH, UNCOMMON RESULTS!

TRUCKLOAD MANAGEMENT, INC. (COLORADO CORPORATION), DBA TMI
5800 FRANKLIN STREET
DENVER, CO 80216

FIRST USE 2-0-2002; IN COMMERCE 2-0-2002.

SER. NO. 76-560,096, FILED 10-20-2003.

FOR: DOCUMENT DELIVERY SERVICE, IN
CLASS 39 (U.S. CLS. 100 AND 105).

RICHARD WHITE, EXAMINING ATTORNEY

Int. Cl.: 35

Prior U.S. Cls.: 100, 101 and 102

United States Patent and Trademark Office

Reg. No. 2,893,053

Registered Oct. 12, 2004

**SERVICE MARK
PRINCIPAL REGISTER**

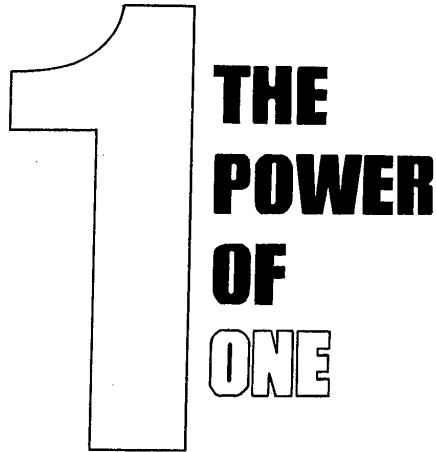

OATEY SUPPLY CHAIN SERVICES INC. (OHIO CORPORATION)
4700 WEST 160TH STREET
CLEVELAND, OH 44135

FIRST USE 10-1-2003; IN COMMERCE 10-1-2003.

SER. NO. 76-560,140, FILED 10-29-2003.

FOR: DISTRIBUTORSHIP SERVICES IN THE FIELD OF PLUMBING SUPPLIES, IN CLASS 35 (U.S. CLS. 100, 101 AND 102).

RENEE MCCRAY, EXAMINING ATTORNEY

Int. Cls.: 25 and 41

Prior U.S. Cls.: 22, 39, 100, 101 and 107

Reg. No. 2,893,054

United States Patent and Trademark Office

Registered Oct. 12, 2004

**TRADEMARK
SERVICE MARK
PRINCIPAL REGISTER**

JOHNNIES

ORDER OF SAINT BENEDICT (MINNESOTA CORPORATION)
SAINT JOHN'S UNIVERSITY
P.O. BOX 7222
COLLEGEVILLE, MN 56321

FOR: CLOTHING, NAMELY, SWEATSHIRTS, SWEAT PANTS, T-SHIRTS, TANK TOPS, POLO SHIRTS, RUGBY SHIRTS, SPORT SHIRTS, TURTLE-NECKS, JERSEYS, SWEATERS, BLAZERS, TIES, SHORTS, JEANS, PANTS, VESTS, JACKETS, COATS, WIND RESISTANT JACKETS AND PANTS, WARM-UP SUITS, GLOVES, MITTENS, HATS, CAPS, VISORS, SCARVES, ATHLETIC UNIFORMS, SOCKS, HOSIERY, LEOTARDS, APRONS, WRIST BANDS, BATHING SUITS, BATHING TRUNKS, BATH-ROBES, INFANT WEAR, CLOTH BIBS, GOLF SHIRTS, NIGHT SHIRTS, SLEEPWEAR, AND BOX-ER SHORTS, IN CLASS 25 (U.S. CLS. 22 AND 39).

FIRST USE 9-1-1900; IN COMMERCE 9-1-1940.

FOR: EDUCATIONAL SERVICES, NAMELY PROVIDING COLLEGE LEVEL ATHLETIC PROGRAMS AND EVENTS, INFORMATION REGARDING SUCH PROGRAMS AND EVENTS, STUDENT AND ALUMNI ACTIVITIES AND ORGANIZATIONS, AND ATHLETIC SUPPORTING ORGANIZATIONS AND CLUBS; ENTERTAINMENT SERVICES, NAMELY ATHLETIC AND SPORTING CONTESTS, EVENTS AND GAMES, IN CLASS 41 (U.S. CLS. 100, 101 AND 107).

FIRST USE 9-1-1900; IN COMMERCE 9-1-1940.

SER. NO. 76-560,410, FILED 10-24-2003.

ESTHER BELENKER, EXAMINING ATTORNEY

Int. Cl.: 36

Prior U.S. Cls.: 100, 101 and 102

United States Patent and Trademark Office

Reg. No. 2,893,055

Registered Oct. 12, 2004

**SERVICE MARK
PRINCIPAL REGISTER**

A TRADITION OF EXCELLENCE. A POSITION OF POWER.

CITIZENS FINANCIAL GROUP, INC. (DELA-
WARE CORPORATION)
ONE CITIZENS PLAZA
PROVIDENCE, RI 029031339

FIRST USE 9-0-1998; IN COMMERCE 9-0-1998.

SER. NO. 76-560,553, FILED 10-28-2003.

FOR: INSURANCE BROKERAGE SERVICES, IN
CLASS 36 (U.S. CLS. 100, 101 AND 102).

MATTHEW PAPPAS, EXAMINING ATTORNEY

Int. Cl.: 36

Prior U.S. Cls.: 100, 101 and 102

United States Patent and Trademark Office

Reg. No. 2,893,056

Registered Oct. 12, 2004

**SERVICE MARK
PRINCIPAL REGISTER**

NNN PLUS

FOR 1031 LLC (IDAHO LTD LIAB CO)
12426 W. EXPLORER DRIVE, STE 220
BOISE, ID 83713

NO CLAIM IS MADE TO THE EXCLUSIVE
RIGHT TO USE "NNN", APART FROM THE MARK
AS SHOWN.

FOR: REAL ESTATE ACQUISITION SERVICES,
IN CLASS 36 (U.S. CLS. 100, 101 AND 102).

SER. NO. 76-560,984, FILED 11-3-2003.

FIRST USE 8-18-2003; IN COMMERCE 8-20-2003.

THE MARK CONSISTS OF STANDARD CHAR-
ACTERS WITHOUT CLAIM TO ANY PARTICULAR
FONT, STYLE, SIZE, OR COLOR.

KARANENDRA S. CHHINA, EXAMINING ATTOR-
NEY

Int. Cl.: 3

Prior U.S. Cls.: 1, 4, 6, 50, 51 and 52

Reg. No. 2,893,057

United States Patent and Trademark Office

Registered Oct. 12, 2004

**TRADEMARK
PRINCIPAL REGISTER**

MICRO-GRIND

LINTECH INTERNATIONAL (PARTNERSHIP)
7705 N.E. INDUSTRIAL BLVD.
MACON, GA 31206

FIRST USE 8-0-1998; IN COMMERCE 8-0-1998.

SER. NO. 76-561,121, FILED 11-3-2003.

FOR: CERAMIC GRINDING MEDIA FOR PUL-
VERIZING MINERAL ORES, IN CLASS 3 (U.S. CLS.
1, 4, 6, 50, 51 AND 52).

KENNETH D. BATTLE, EXAMINING ATTORNEY

Int. Cl.: 3

Prior U.S. Cls.: 1, 4, 6, 50, 51 and 52

Reg. No. 2,893,058

United States Patent and Trademark Office

Registered Oct. 12, 2004

**TRADEMARK
PRINCIPAL REGISTER**

SOLAR DIFFUSION

FALLIEN COSMECEUTICALS LTD. (DELA-
WARE CORPORATION), DBA FALLENE,
LTD.
144 IVY LANE
KING OF PRUSSIA, PA 19406

FIRST USE 9-23-2003; IN COMMERCE 9-23-2003.

SER. NO. 76-561,174, FILED 11-6-2003.

FOR: SUN SCREEN, IN CLASS 3 (U.S. CLS. 1, 4, 6,
50, 51 AND 52).

KARANENDRA S. CHHINA, EXAMINING ATTOR-
NEY

Int. Cl.: 1

Prior U.S. Cls.: 1, 5, 6, 10, 26 and 46

United States Patent and Trademark Office

Reg. No. 2,893,059

Registered Oct. 12, 2004

**TRADEMARK
PRINCIPAL REGISTER**

PEAK GLOBAL

OLD WORLD INDUSTRIES, INC. (ILLINOIS
CORPORATION)
4065 COMMERCIAL AVENUE
NORTHBROOK, IL 600621851

OWNER OF U.S. REG. NOS. 759,028, 2,239,194 AND
OTHERS.

FOR: ANTIFREEZE AND COOLANT FOR VEHI-
CLE ENGINES, IN CLASS 1 (U.S. CLS. 1, 5, 6, 10, 26
AND 46).

SER. NO. 76-568,550, FILED 1-7-2004.

FIRST USE 6-0-2003; IN COMMERCE 6-0-2003.

SCOTT BALDWIN, EXAMINING ATTORNEY

Int. Cl.: 24

Prior U.S. Cls.: 42 and 50

United States Patent and Trademark Office

Reg. No. 2,893,060

Registered Oct. 12, 2004

**TRADEMARK
PRINCIPAL REGISTER**



WORLD TRIATHLON CORPORATION (FLORI-
DA CORPORATION)
P.O. BOX 1608
43309 U.S. HWY. 19 N.
TARPON SPRINGS, FL 346881608

OWNER OF U.S. REG. NOS. 1,226,245, 2,849,932
AND OTHERS.

FOR: FABRIC FLAGS AND BANNERS, IN CLASS
24 (U.S. CLS. 42 AND 50).

SER. NO. 76-571,191, FILED 1-21-2004.

FIRST USE 10-1-2003; IN COMMERCE 10-1-2003.

BRENDAN REGAN, EXAMINING ATTORNEY

Int. Cl.: 12

Prior U.S. Cls.: 19, 21, 23, 31, 35 and 44

Reg. No. 2,893,061

United States Patent and Trademark Office

Registered Oct. 12, 2004

**TRADEMARK
PRINCIPAL REGISTER**

PEAK

OLD WORLD INDUSTRIES, INC. (ILLINOIS
CORPORATION)
4065 COMMERCIAL AVENUE
NORTHBROOK, IL 600621851

OWNER OF U.S. REG. NOS. 759,028, 2,239,194 AND
OTHERS.

FOR: WINDSHIELD WIPERS AND WINDSHIELD
WIPER BLADES, IN CLASS 12 (U.S. CLS. 19, 21, 23, 31,
35 AND 44).

SER. NO. 76-571,201, FILED 1-21-2004.

FIRST USE 9-0-2001; IN COMMERCE 9-0-2001.

SCOTT BALDWIN, EXAMINING ATTORNEY

Int. Cl.: 41

Prior U.S. Cls.: 100, 101 and 107

United States Patent and Trademark Office

Reg. No. 2,893,062

Registered Oct. 12, 2004

**SERVICE MARK
PRINCIPAL REGISTER**

DRAW ME

ART INSTRUCTION SCHOOLS, INC. (MINNESOTA CORPORATION)
3400 TECHNOLOGY DRIVE
MINNEAPOLIS, MN 55418

FIRST USE 3-0-1920; IN COMMERCE 3-0-1920.

SER. NO. 76-582,905, FILED 3-24-2004.

FOR: EDUCATIONAL SERVICES, NAMELY, PROVIDING COURSES IN THE FIELD OF ART INSTRUCTION, IN CLASS 41 (U.S. CLS. 100, 101 AND 107).

JOHN GARTNER, EXAMINING ATTORNEY

Int. Cl.: 25

Prior U.S. Cls.: 22 and 39

United States Patent and Trademark Office

Reg. No. 2,893,063

Registered Oct. 12, 2004

**TRADEMARK
PRINCIPAL REGISTER**

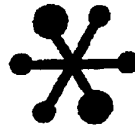

AKIABARA

DALVAFOX S.A. (URUGUAY CORPORATION)
MISIONES 1487
MONTEVIDEO, URUGUAY

FOR: SWEATERS, CARDIGANS, T-SHIRTS,
DRESSES, SHORTS, TOPS, BELTS, SKIRTS, SHIRTS,
SHIRTS WITH HOODS, SLIPPERS, SOCKS, SWIM-
SUITS, AND OUTERWEAR, NAMELY JACKETS,
COATS, PARKAS, OVERCOATS, AND RAINCOATS
, IN CLASS 25 (U.S. CLS. 22 AND 39).

PRIORITY CLAIMED UNDER SEC. 44(D) ON
URUGUAY APPLICATION NO. 141/02, FILED 9-26-
2001, REG. NO. 334237, DATED 2-20-2002, EXPIRES 2-
20-2012.

SER. NO. 76-976,413, FILED 12-13-2001.

SONYA STEPHENS, EXAMINING ATTORNEY

Int. Cl.: 42

Prior U.S. Cls.: 100 and 101

United States Patent and Trademark Office

Reg. No. 2,893,064

Registered Oct. 12, 2004

**SERVICE MARK
PRINCIPAL REGISTER**

CRS

COMMUNITY PAPERWORKS, INC. (MARY-
LAND CORPORATION)
50 WEST MONTGOMERY AVENUE
SUITE 10
ROCKVILLE, MD 20850

FOR: CONSULTING IN THE FIELD OF LEGAL
AND NON-LEGAL DOCUMENTS, CORPORATE
RECORDS AND REQUIREMENTS FOR HOME-

OWNERS AND COMMON INTEREST COMMUNI-
TIES , IN CLASS 42 (U.S. CLS. 100 AND 101).

FIRST USE 1-1-1997; IN COMMERCE 1-1-1997.

SER. NO. 76-976,624, FILED 11-1-2002.

KELLEY WELLS, EXAMINING ATTORNEY

Int. Cl.: 36

Prior U.S. Cls.: 100, 101 and 102

United States Patent and Trademark Office

Reg. No. 2,893,065

Registered Oct. 12, 2004

**SERVICE MARK
PRINCIPAL REGISTER**

PRICINGSTUDIO

THE BEAR STEARNS COMPANIES INC. (DELA-
WARE CORPORATION)
383 MADISON AVENUE
NEW YORK, NY 10179

FOR: FINANCIAL SERVICES, NAMELY, ANA-
LYZING THE PERFORMANCE OF FIXED INCOME
SECURITIES PORTFOLIOS AND PROVIDING IN-
FORMATION ABOUT FIXED INCOME SECURI-

TIES PORTFOLIOS , IN CLASS 36 (U.S. CLS. 100,
101 AND 102).

FIRST USE 2-28-2003; IN COMMERCE 2-28-2003.

SER. NO. 76-976,675, FILED 3-24-2003.

AMY ALFIERI, EXAMINING ATTORNEY

Int. Cl.: 41

Prior U.S. Cls.: 100, 101 and 107

United States Patent and Trademark Office

Reg. No. 2,893,066

Registered Oct. 12, 2004

**SERVICE MARK
PRINCIPAL REGISTER**

LONESTAR

LONESTAR (PARTNERSHIP)
1107 17TH AVE. SOUTH
NASHVILLE, TN 37212

FIRST USE 1-1-1995; IN COMMERCE 1-1-1995.

SER. NO. 76-976,692, FILED 5-30-2002.

FOR: ENTERTAINMENT SERVICES, NAMELY
PERFORMANCES BY A LIVE MUSIC GROUP, IN
CLASS 41 (U.S. CLS. 100, 101 AND 107).

CHRISIE B. KING, EXAMINING ATTORNEY

Int. Cl.: 42

Prior U.S. Cls.: 100 and 101

United States Patent and Trademark Office

Reg. No. 2,893,067

Registered Oct. 12, 2004

**SERVICE MARK
PRINCIPAL REGISTER**



PUGET SOUND ENERGY, INC. (WASHINGTON CORPORATION)
10885 NE 4TH STREET
BELLEVUE, WA 98004

FOR: (BASED ON USE IN COMMERCE) REMOTE ELECTRONIC MONITORING SERVICES PROVIDED TO BUSINESSES FOR HEATING, VENTILATION AND AIR CONDITIONING EQUIPMENT; PROVIDING ONLINE INFORMATION IN THE FIELD OF ENERGY CONSUMPTION BY BUSINESSES, IN CLASS 42 (U.S. CLS. 100 AND 101).

FIRST USE 11-26-2001; IN COMMERCE 11-26-2001.

NO CLAIM IS MADE TO THE EXCLUSIVE RIGHT TO USE "ENERGY MANAGEMENT FOR BUSINESS", APART FROM THE MARK AS SHOWN.

THE MARK CONSISTS OF A GROUP OF LOW TO HIGH-RISE BUILDINGS WITH STRAIGHT LINES EMANATING OUTWARDS FROM THE BUILDINGS WITH THE WORDS "PERSONAL ENERGY MANAGEMENT" ABOVE IT AND "FOR BUSINESS" BELOW IT.

SER. NO. 76-976,924, FILED 1-9-2002.

KAREN BRACEY, EXAMINING ATTORNEY

Int. Cl.: 9

Prior U.S. Cls.: 21, 23, 26, 36 and 38

Reg. No. 2,893,068

United States Patent and Trademark Office

Registered Oct. 12, 2004

**TRADEMARK
PRINCIPAL REGISTER**

PCIDM

INNOVATIVE CONCEPTS, INC. (VIRGINIA CORPORATION)
8200 GREENSBORO DR.
SUITE 801
MCLEAN, VA 22102

FIRST USE 1-1-1998; IN COMMERCE 1-1-1998.

SEC. 2(F).

SER. NO. 78-000,859, FILED 3-24-2000.

FOR: PCMCIA CARD, IN CLASS 9 (U.S. CLS. 21, 23, 26, 36 AND 38).

CHERYL CLAYTON, EXAMINING ATTORNEY

Int. Cl.: 9

Prior U.S. Cls.: 21, 23, 26, 36 and 38

Reg. No. 2,893,069

United States Patent and Trademark Office

Registered Oct. 12, 2004

**TRADEMARK
PRINCIPAL REGISTER**

PASSAGEPOINT

STOPWARE INC (CALIFORNIA CORPORATION)
1710 ZANKER ROAD SUITE 102
SAN JOSE, CA 95112

FIRST USE 1-1-2000; IN COMMERCE 1-1-2000.

FOR: COMPUTER SOFTWARE FOR USE IN
VISITOR REGISTRATION AND NAME BADGE
PRINTING, IN CLASS 9 (U.S. CLS. 21, 23, 26, 36
AND 38).

SER. NO. 78-019,456, FILED 8-2-2000.

ESTHER A. BORSUK, EXAMINING ATTORNEY

Int. Cls.: 38, 39 and 42

Prior U.S. Cls.: 100, 101, 104 and 105

United States Patent and Trademark Office

Reg. No. 2,893,070

Registered Oct. 12, 2004

**SERVICE MARK
PRINCIPAL REGISTER**

C I HOST

C I HOST (TEXAS CORPORATION)
1851 CENTRAL DRIVE, SUITE 110
BEDFORD, TX 76021

FOR: E-COMMERCE SOLUTIONS IN THE NATURE OF DELIVERY OF MESSAGES BY ELECTRONIC TRANSMISSION, IN CLASS 38 (U.S. CLS. 100, 101 AND 104).

FIRST USE 4-1-1995; IN COMMERCE 4-1-1995.

FOR: E-COMMERCE SOLUTIONS IN THE NATURE OF PROVIDING ELECTRONIC STORAGE SPACE FOR DATA AND ELECTRONIC RECORDS, IN CLASS 39 (U.S. CLS. 100 AND 105).

FIRST USE 4-1-1995; IN COMMERCE 4-1-1995.

FOR: DESIGNING AND IMPLEMENTING WEB SITES FOR OTHERS ON A GLOBAL COMPUTER INFORMATION NETWORK; HOSTING THE WEB SITES OF OTHERS ON A COMPUTER SERVER FOR A GLOBAL COMPUTER NETWORK; GRAPHIC ART DESIGN, COMPUTER SOFTWARE DESIGN FOR OTHERS; AND COMPUTER CONSULTATION, IN CLASS 42 (U.S. CLS. 100 AND 101).

FIRST USE 4-1-1995; IN COMMERCE 4-1-1995.

NO CLAIM IS MADE TO THE EXCLUSIVE RIGHT TO USE "HOST", APART FROM THE MARK AS SHOWN.

SER. NO. 78-028,225, FILED 9-29-2000.

JOHN KELLY, EXAMINING ATTORNEY

Int. Cl.: 9

Prior U.S. Cls.: 21, 23, 26, 36 and 38

Reg. No. 2,893,071

United States Patent and Trademark Office

Registered Oct. 12, 2004

TRADEMARK
PRINCIPAL REGISTER

電訊盈科

PCCW-HKT DATACOM SERVICES LIMITED
(HONG KONG LTD LIAB CO)
39TH FLOOR, HONG KONG TELECOM TOWER
TAIKOO PLACE, 979 KING'S ROAD
QUARRY BAY, HONG KONG

FOR: COMPUTER SOFTWARE PROGRAMS FOR USE IN DATABASE MANAGEMENT, FOR USE AS A SPREADSHEET AND FOR WORD PROCESSING IN THE FIELD OF TELECOMMUNICATIONS, ADVERTISING, SPORTS, GAMES, MUSIC, DRAMA, CARTOONS, FINANCE, INVESTMENTS, INSURANCE, TRANSPORTATION, TRAVEL, EDUCATION AND CONTROL OF COMPUTER HARDWARE; COMPUTER SOFTWARE FOR USE IN DATABASE MANAGEMENT, FOR USE AS A SPREADSHEET AND FOR WORD PROCESSING IN THE FIELD OF TELECOMMUNICATIONS, ADVERTISING, SPORTS, GAMES, MUSIC, DRAMA, CARTOONS, FINANCE, INVESTMENTS, INSURANCE, TRANSPORTATION, TRAVEL, EDUCATION AND CONTROL OF COMPUTER HARDWARE THAT MAY BE DOWNLOADED FROM A GLOBAL COMPUTER NETWORK; DOWNLOADABLE ELECTRONIC PUBLICATIONS IN THE NATURE OF MAGAZINES, BROCHURES, AND LEAFLETS IN THE FIELD OF TELECOMMUNICATIONS, ADVERTISING, SPORTS, GAMES, MUSIC, DRAMA, CARTOONS, FINANCE, INVESTMENTS, INSURANCE, TRANSPORTATION, TRAVEL, EDUCATION AND CONTROL OF COMPUTER HARDWARE; SCIENTIFIC, SURVEYING, ELECTRIC, PHOTOGRAPHIC, CINEMATOGRAPHIC, OPTICAL, WEIGHING, MEASURING, SIGNALING, CHECKING, SUPERVISION AND TEACHING APPARATUS AND INSTRUMENTS, NAMELY, COMPUTERS, COMPUTER HARDWARE, COMPUTER SOFTWARE, ELECTRICAL CABLES, FIBER OPTIC CABLES, INTEGRATED CIRCUITS, COMPUTER INTERFACE BOARDS, MONITORING CAMERAS, ELECTRONIC SCALES, GLASS TUBES FOR SCIENTIFIC PURPOSES,

TRANSMITTERS, RECEIVERS, MODEMS, STEREO SPEAKERS, BLANK MAGNETIC DISKS, SATELLITES, DISC DRIVES; APPARATUS AND INSTRUMENTS FOR RECORDING, RECEIVING, TRANSMITTING AND REPRODUCING DATA, INFORMATION, PICTURES, IMAGES, AND SOUND, AND FOR DISPLAYING AND PRINTING OUT DATA, INFORMATION, PICTURES, AND IMAGES, NAMELY, SATELLITES, DISK DRIVES, COMPUTER PRINTERS, COMPUTER MONITORS, TRANSMITTERS, RECEIVERS, STEREO SPEAKERS AND BLANK MAGNETIC DISKS; BLANK COMPUTER DISCS; AUTOMATIC VENDING MACHINES; CASH REGISTERS; FIRE EXTINGUISHING APPARATUS, NAMELY, FIRE SPRINKLERS AND FIRE EXTINGUISHERS; VIDEO TAPES, NAMELY, BLANK VIDEO TAPES AND PRERECORDED VIDEO TAPES FEATURING TELECOMMUNICATIONS, ADVERTISING, SPORTS, GAMES, MUSIC, DRAMA, CARTOONS, FINANCE, INVESTMENTS, INSURANCE, TRANSPORTATION, TRAVEL, EDUCATION, COMPUTER HARDWARE AND COMPUTER SOFTWARE; AUDIO CASSETTES, NAMELY, BLANK AUDIO TAPES AND PRERECORDED AUDIO TAPES FEATURING TELECOMMUNICATIONS, ADVERTISING, SPORTS, GAMES, MUSIC, DRAMA, CARTOONS, FINANCE, INVESTMENTS, INSURANCE, TRANSPORTATION, TRAVEL, EDUCATION, COMPUTER HARDWARE AND COMPUTER SOFTWARE; COMPACT DISCS, NAMELY, BLANK COMPACT DISCS AND PRERECORDED COMPACT DISCS FEATURING TELECOMMUNICATIONS, ADVERTISING, SPORTS, GAMES, MUSIC, DRAMA, CARTOONS, FINANCE, INVESTMENTS, INSURANCE, TRANSPORTATION, TRAVEL, EDUCATION, COMPUTER HARDWARE AND COMPUTER SOFTWARE; FLOPPY DISCS FOR COMPUTERS; MULTIMEDIA SOFTWARE RECORDED ON CD-ROM FEATURING TELECOMMUNICATIONS, ADVERTISING, SPORTS, GAMES, MUSIC, DRAMA, CARTOONS, FINANCE, INVEST-

MENTS, INSURANCE, TRANSPORTATION, TRAVEL, EDUCATION, COMPUTER HARDWARE AND COMPUTER SOFTWARE; DOWNLOADABLE VIDEO RECORDINGS FEATURING TELECOMMUNICATIONS, ADVERTISING, SPORTS, GAMES, MUSIC, DRAMA, CARTOONS, FINANCE, INVESTMENTS, INSURANCE, TRANSPORTATION, TRAVEL, EDUCATION, COMPUTER HARDWARE AND COMPUTER SOFTWARE; DOWNLOADABLE ELECTRONIC BOOKS IN THE FIELD OF TELECOMMUNICATIONS, ADVERTISING, SPORTS, GAMES, MUSIC, DRAMA, CARTOONS, FINANCE, INVESTMENTS, INSURANCE, TRANSPORTATION, TRAVEL, EDUCATION, COMPUTER HARDWARE AND COMPUTER SOFTWARE; CALCULATING MACHINES, NAMELY, CALCULATORS; DATA PROCESSING EQUIPMENT, NAMELY, COMPUTERS, COMPUTER SERVERS AND ELECTRONIC CALCULATORS; COMPUTERS; COMPUTER SOFTWARE FOR SEARCHING OF DATA, NAMELY, COMPUTER SEARCH ENGINE SOFTWARE; MAGNETICALLY CODED CARDS; ELECTRICAL WIRES; SEMICONDUCTOR DEVICES CARRYING COMPUTER PROGRAMS; TELECOMMUNICATION APPARATUS, INSTRUMENTS, NETWORKS AND CIRCUITRY, NAMELY, TELEPHONES, MOBILE TELECOMMUNICATION EQUIPMENT COMPRISING A CONTROL TELEPHONE UNIT, TRANSCEIVER AND ANTENNA, MOBILE TELEPHONES AND COMPONENT PARTS, PERSONAL COMMUNICATIONS TELEPHONE HANDSETS, BATTERIES FOR HANDSETS, CARRYING CASES FOR PERSONAL COMMUNICATIONS EQUIPMENT, TRAVEL AND DESKTOP CHARGERS FOR BATTERIES FOR TELEPHONE HANDSETS, HAND-FREE CAR KITS FOR TELEPHONES COMPRISED PRIMARILY OF A MICROPHONE, EXTERNAL SPEAKER, CRADLE, MOUNTING BRACKETS AND POWER CABLES, FACSIMILE MACHINES, MODEMS, COMPUTER PROGRAMS FOR MANAGING TELECOMMUNICATIONS NETWORKS, CORDLESS TELEPHONES, SPEAKERPHONES, TELEPHONE INSTALLATION APPARATUS, NAMELY, PHONE MOUNTS, DUAL OUTLET ADAPTERS, TELEPHONE OUTLETS, MODULAR JACKS, WIRE JUNCTIONS AND PLUG-IN CONVERTERS, TELEPHONE SYSTEMS COMPRISED OF A HANDSET AND CONSOLE UNIT WITH CONSOLE FEATURES, NAMELY, STANDARD TELEPHONE FUNCTIONS, ONE-TOUCH DIALING, CALL PROGRESS MONITORING, GROUP LISTENING, CLOCK/CALENDAR AND ALARM AND ELECTRONIC DISPLAY, TELEPHONE ANSWERING MACHINES, VIDEOPHONES, PAGERS, VIDEO TELECONFERENCING PRODUCTS, NAMELY, SWITCHES, MODEMS, SPEAKERS AND VIDEO DISPLAY TUBES, SATELLITE RECEIVERS AND PARTS, ELECTRONIC TELECOMMUNICATION EQUIPMENT, NAMELY, BASE RELAY STATIONS AND PORTABLE RELAY STATIONS FOR MOBILE, PUBLIC OR SPECIAL TELEPHONE NETWORKS, TWO WAY COMMUNICATIONS APPARATUS, PAGING RECEIVERS, APPARATUS FOR SCRAMBLING VOICE TRANSMISSIONS, INTERACTIVE TELEVISION UNITS FOR ACQUISITION OF INFORMATION FROM DATA BASES, DEDICATED COMMUNICATIONS NETWORKS AND INSULA-

TED TELECOMMUNICATION CABLES AND COMPONENT PARTS AND FITTINGS THEREFOR; COMMUNICATIONS SOFTWARE FOR CONNECTING GLOBAL COMPUTER NETWORKS; ELECTRICAL CIRCUITS; ELECTRICAL CABLES AND CABLE INSTALLATIONS, NAMELY, COMPUTER CABLES; FIBER OPTIC CABLES; OPTICAL COMMUNICATION APPARATUS AND CIRCUITRY FOR TELECOMMUNICATIONS PURPOSES AND FOR COMMUNICATION OF DATA, INFORMATION, PICTURES, VIDEO, IMAGES AND SOUND, NAMELY, COMPUTERS, COMPUTER HARDWARE, COMPUTER SOFTWARE, ELECTRICAL CABLES, FIBER OPTIC CABLES, INTEGRATED CIRCUITS, COMPUTER INTERFACE BOARDS, MONITORING CAMERAS, ELECTRONIC SCALES, GLASS TUBES FOR SCIENTIFIC PURPOSES, TRANSMITTERS, RECEIVERS, STEREO SPEAKERS, BLANK MAGNETIC DISCS, SATELLITES AND DISC DRIVES; ELECTRONIC APPARATUS AND INSTRUMENTS FOR DEBITING AND CREDITING FINANCIAL ACCOUNTS AND FOR PAYING FOR GOODS AND SERVICES, NAMELY, AUTOMATED TELLER MACHINES; MACHINE-READABLE MAGNETIC ENCODED DEBIT CARDS; MAGNETICALLY ENCODED CREDIT CARDS; APPARATUS AND INSTRUMENTS FOR COMMUNICATING WITH GLOBAL COMPUTER NETWORKS, NAMELY, COMPUTERS, COMPUTER HARDWARE, ELECTRICAL CABLES, FIBER OPTIC CABLES, COMMUNICATIONS SOFTWARE AND MODEMS; COMMUNICATIONS SOFTWARE FOR CONNECTING GLOBAL COMPUTER NETWORKS; TELEVISION SETS; RADIOS; VIDEO AND AUDIO APPARATUS, EQUIPMENT AND DEVICES, NAMELY, COMPUTERS, COMPUTER HARDWARE, COMPUTER SOFTWARE, ELECTRICAL CABLES, FIBER OPTIC CABLES, VIDEO CAMERAS, AUDIO TAPE RECORDERS, TRANSMITTERS, RECEIVERS, STEREO SPEAKERS, BLANK MAGNETIC DISCS, SATELLITES, DISC DRIVES FOR USE IN RECORDING, RECEIVING, TRANSMITTING AND REPRODUCING DATA, INFORMATION, PICTURES, IMAGES AND SOUND; DOWNLOADABLE DIGITAL AUDIO RECORDINGS FEATURING MUSIC; DOWNLOADABLE DIGITAL MUSIC PROVIDED FROM MP3 INTERNET WEB SITES; MP3 PLAYERS, DOWNLOADABLE COMPUTER SOFTWARE FOR EVENT SCHEDULING AND FOR MANAGING, VIEWING AND EDITING ADDRESS BOOKS AND OTHER PERSONAL AND PROFESSIONAL CONTACT INFORMATION; APPARATUS FOR CODING AND DECODING SIGNALS; AND PARTS AND FITTINGS FOR COMPUTERS, COMPUTER HARDWARE, COMPUTER SOFTWARE, COMPUTER PRINTERS, COMPUTER MONITORS, ELECTRICAL CABLES, FIBER OPTIC CABLES, INTEGRATED CIRCUITS, COMPUTER INTERFACE BOARDS, MONITORING CAMERAS, ELECTRONIC SCALES, GLASS TUBES FOR SCIENTIFIC PURPOSES, TRANSMITTERS, RECEIVERS, STEREO SPEAKERS, BLANK MAGNETIC DISCS, SATELLITES, MODEMS, AUTOMATED TELLER MACHINES, AND DISC DRIVES, IN CLASS 9 (U.S. CLS. 21, 23, 26, 36 AND 38).

PRIORITY CLAIMED UNDER SEC. 44(D) ON HONG KONG APPLICATION NO. 200016475, FILED 7-25-2000, REG. NO. 200310891, DATED 7-25-2000, EXPIRES 7-25-2007.

THE FOREIGN WORDING IN THE MARK TRANSLATES INTO ENGLISH AS "ELECTRICITY, MESSAGE, SURPLUS, SUBJECT". THE NON-LATIN

CHARACTERS IN THE MARK TRANSLITERATE INTO "DIN SHUN YING FOUR", AND THIS MEANS "ELECTRICITY, MESSAGE, SURPLUS, SUBJECT".

SER. NO. 78-036,981, FILED 11-29-2000.

ANDREA K. NADELMAN, EXAMINING ATTORNEY

Int. Cls.: 8 and 14

Prior U.S. Cls.: 2, 23, 27, 28, 44 and 50

United States Patent and Trademark Office

Reg. No. 2,893,072

Registered Oct. 12, 2004

**TRADEMARK
PRINCIPAL REGISTER**



ABERT S.P.A. (ITALY CORPORATION)
VIA DON P. MAZZOLARI 17
PASSIRANO (BRESCIA), ITALY

FOR: CUTLERY, NAMELY, KNIVES, SPOONS,
AND FORKS PLATED OR MADE OF PRECIOUS
METALS AND THEIR ALLOYS, IN CLASS 8 (U.S.
CLS. 23, 28 AND 44).

FOR: HOUSEWARE AND KITCHENWARE, SER-
VING PIECES, AND ACCESSORIES THEREOF PLA-

TED OR MADE OF PRECIOUS METAL AND THEIR
ALLOYS, IN CLASS 14 (U.S. CLS. 2, 27, 28 AND 50).

OWNER OF ITALY REG. NO. 671317, DATED 2-27-
1996, EXPIRES 2-27-2006.

SEC. 2(F).

SER. NO. 78-043,557, FILED 1-17-2001.

JENNIFER KRISP, EXAMINING ATTORNEY

Int. Cl.: 3

Prior U.S. Cls.: 1, 4, 6, 50, 51 and 52

Reg. No. 2,893,073

United States Patent and Trademark Office

Registered Oct. 12, 2004

**TRADEMARK
PRINCIPAL REGISTER**

SAVON DE~LUXE FRENCH MILLED SOAPS

TRUESCENTS, LLC (WASHINGTON LIMITED
LIABILITY COMPANY)
20423 10TH PL. SW
NORMANDY PARK, WA 98166

FOR: SKIN SOAPS, TOILET SOAPS, DEODOR-
ANT SOAPS, AND LIQUID SOAPS FOR HANDS,
FACE, AND BODY, IN CLASS 3 (U.S. CLS. 1, 4, 6, 50,
51 AND 52).

FIRST USE 5-1-2001; IN COMMERCE 5-1-2001.

NO CLAIM IS MADE TO THE EXCLUSIVE
RIGHT TO USE "SAVON" AND "FRENCH MILLED
SOAPS", APART FROM THE MARK AS SHOWN.

THE FOREIGN WORDING IN THE MARK
TRANSLATES INTO ENGLISH AS "LUXURY
SOAP".

SER. NO. 78-052,614, FILED 3-12-2001.

MICHAEL WEBSTER, EXAMINING ATTORNEY

Int. Cls.: 41 and 42

Prior U.S. Cls.: 100, 101 and 107

United States Patent and Trademark Office

Reg. No. 2,893,074

Registered Oct. 12, 2004

**SERVICE MARK
PRINCIPAL REGISTER**



THERON PRODUCTIONS, INC. (CALIFORNIA CORPORATION)
6671 SUNSET BOULEVARD, SUITE 1535
HOLLYWOOD, CA 90028

FOR: MOTION PICTURE FILM PRODUCTION; TELEVISION PRODUCTION; MULTIMEDIA ENTERTAINMENT SOFTWARE PRODUCTION SERVICES, NAMELY, VIDEO GAMES DELIVERED VIA COMPACT DISC, DIGITAL VIDEO DISC, AND THE GLOBAL COMPUTER INFORMATION NETWORK; BROADBAND, INTERACTIVE AND DIGITAL MEDIA PRODUCTION SERVICES, NAMELY, VIDEO GAMES, AND INTEGRATED AUDIO AND VIDEO CONTENT DELIVERED VIA COMPACT DISC, DIGITAL VIDEO DISC, AND THE GLOBAL COMPUTER INFORMATION NETWORK; INTERNET AND WEB PRODUCTION SERVICES, NAMELY PRODUCTION OF AUDIO AND AUDIOVISUAL PROGRAMMING FOR DISTRIBUTION VIA A GLOBAL COMPUTER INFORMATION NETWORK; EDUCATIONAL SERVICES, NAMELY, CONDUCTING PROGRAMS IN THE FIELDS OF COMPUTER ANIMATION AND INTERNET AND WEB PRODUCTION SERVICES; AND, TRAINING SERVICES IN THE FIELDS OF COMPUTER ANIMATION AND INTERNET AND WEB PRODUCTION SERVICES, IN CLASS 41 (U.S. CLS. 100, 101 AND 107).

FIRST USE 1-15-1999; IN COMMERCE 5-23-1999.

FOR: RESEARCH AND DEVELOPMENT FOR NEW PRODUCTS FOR OTHERS, NAMELY, PRODUCTS AND TECHNIQUES FOR THE FILM INDUSTRY; PRINTING AND GRAPHIC ART DESIGN; HOSTING THE WEBSITES OF OTHERS ON A COMPUTER SERVER FOR A GLOBAL COMPUTER NETWORK; AND, COMPUTER SERVICES, NAMELY, CREATING ANIMATION AND SPECIAL EFFECTS DESIGNS FOR OTHERS FOR USE IN THEIR WEBSITES, IN CLASS 42 (U.S. CLS. 100 AND 101).

FIRST USE 1-15-1999; IN COMMERCE 5-23-1999.

NO CLAIM IS MADE TO THE EXCLUSIVE RIGHT TO USE "PRODUCTIONS", APART FROM THE MARK AS SHOWN.

THE MARK CONSISTS OF STYLIZED LETTERING OF "THERON PRODUCTIONS", CONSISTING OF "THERN" IN GOLD, AND "PRODUCTIONS" IN PURPLE. A STYLIZED BIRD HEAD IS THE "O" IN "THERON" AND CONSISTS OF A PURPLE FACE, GOLD BEAK, AND ORANGE FEATHERS ON TOP OF THE HEAD.

SER. NO. 78-061,474, FILED 5-2-2001.

KARLA PERKINS, EXAMINING ATTORNEY

Int. Cls.: 38, 39 and 42

Prior U.S. Cls.: 100, 101, 104 and 105

United States Patent and Trademark Office

Reg. No. 2,893,075

Registered Oct. 12, 2004

**SERVICE MARK
PRINCIPAL REGISTER**

ALTALINK

ALTALINK, L.P. (CANADA LIMITED PARTNER-
SHIP)
C/O MACLEOD DIXON LLP
3700, 400 THIRD AVENUE S.W.
CALGARY, ALBERTA, CANADA T2P 4H2

FOR: TELECOMMUNICATION SERVICES,
NAMELY, LOCAL AND LONG DISTANCE TRANS-
MISSION OF VOICE, DATA, GRAPHICS, BY MEANS
OF TELEPHONE, TELEGRAPHIC, CABLE, AND
SATELLITE TRANSMISSION, IN CLASS 38 (U.S.
CLS. 100, 101 AND 104).

FOR: PUBLIC UTILITY SERVICES IN THE FIELD
OF ELECTRICITY DISTRIBUTION, IN CLASS 39
(U.S. CLS. 100 AND 105).

FOR: ENGINEERING SERVICES IN THE FIELD
OF ELECTRICITY TRANSMISSION AND TELE-

COMMUNICATIONS, IN CLASS 42 (U.S. CLS. 100
AND 101).

PRIORITY CLAIMED UNDER SEC. 44(D) ON
CANADA APPLICATION NO. 1108219, FILED 7-4-
2001, REG. NO. TMA589475, DATED 9-10-2003, EX-
PIRES 9-10-2018.

APPLICANT CLAIMS COLOR AS A FEATURE OF
THE MARK AS FOLLOWS- THE LETTERS "ALTA"
ARE MEDIUM/DARK BLUE; AND THE LETTERS
"LINK" ARE GRAY.

SER. NO. 78-072,270, FILED 7-3-2001.

DEZMONA MIZELLE, EXAMINING ATTORNEY

Int. Cls.: 38, 39 and 42

Prior U.S. Cls.: 100, 101, 104 and 105

United States Patent and Trademark Office

Reg. No. 2,893,076

Registered Oct. 12, 2004

**SERVICE MARK
PRINCIPAL REGISTER**

ALTALINK

ALTALINK L.P. (CANADA LIMITED PARTNER-
SHIP)
C/O MACLEOD DIXON LLP
3700, 400 THIRD AVENUE S.W.
CALGARY, ALBERTA, CANADA T2P 4H2

FOR: TELECOMMUNICATION SERVICES,
NAMELY, LOCAL AND LONG DISTANCE TRANS-
MISSION OF VOICE, DATA, GRAPHICS, BY MEANS
OF TELEPHONE, TELEGRAPHIC, CABLE, AND
SATELLITE TRANSMISSION, IN CLASS 38 (U.S.
CLS. 100, 101 AND 104).

FOR: PUBLIC UTILITY SERVICES IN THE FIELD
OF ELECTRICITY DISTRIBUTION, IN CLASS 39
(U.S. CLS. 100 AND 105).

FOR: ENGINEERING SERVICES IN THE FIELD
OF ELECTRICITY TRANSMISSION AND TELE-
COMMUNICATIONS, IN CLASS 42 (U.S. CLS. 100
AND 101).

PRIORITY CLAIMED UNDER SEC. 44(D) ON
CANADA APPLICATION NO. 1108218, FILED 7-3-
2001, REG. NO. TMA587271, DATED 8-14-2003, EX-
PIRES 8-14-2018.

SER. NO. 78-072,274, FILED 7-3-2001.

DEZMONA MIZELLE, EXAMINING ATTORNEY

Int. Cl.: 5

Prior U.S. Cls.: 6, 18, 44, 46, 51 and 52

United States Patent and Trademark Office

Reg. No. 2,893,077

Registered Oct. 12, 2004

**TRADEMARK
PRINCIPAL REGISTER**

ZONALON

BIOGLAN PHARMACEUTICALS COMPANY
(NORTH CAROLINA CORPORATION)
7 GREAT VALLEY PARKWAY, SUITE 301
MALVERN, PA 19355

FIRST USE 4-6-1994; IN COMMERCE 4-6-1994.

FOR: PHARMACEUTICAL PREPARATIONS FOR
THE TREATMENT OF DERMATOLOGICAL DIS-
ORDERS, IN CLASS 5 (U.S. CLS. 6, 18, 44, 46, 51 AND
52).

SER. NO. 78-076,391, FILED 7-30-2001.

KELLY BOULTON, EXAMINING ATTORNEY

Int. Cl.: 30

Prior U.S. Cl.: 46

United States Patent and Trademark Office

Reg. No. 2,893,078

Registered Oct. 12, 2004

**TRADEMARK
PRINCIPAL REGISTER**

SHAHBANOU

H&R IMPORT-EXPORT INC. (CANADA CORPORATION)
700 PROGRESS AVENUE
SUITE 11
TORONTO, ONTARIO, CANADA M1H 2Z7

FOR: RICE, NAMELY, COMMON RICE, BASMATI RICE AND THAI JASMINE RICE, IN CLASS 30 (U.S. CL. 46).

PRIORITY CLAIMED UNDER SEC. 44(D) ON CANADA APPLICATION NO. 1107096, FILED 6-20-

2001, REG. NO. TMA580420, DATED 5-1-2003, EXPIRES 5-1-2018.

THE ENGLISH TRANSLATION OF THE WORD "SHAHBANOU" IN THE MARK IS "WIFE OF A KING".

SER. NO. 78-089,431, FILED 10-22-2001.

ARETHA MASTERSON, EXAMINING ATTORNEY

Int. Cls.: 6, 7, 17, 35 and 42

**Prior U.S. Cls.: 1, 2, 5, 12, 13, 14, 19, 21, 23, 25, 31, 34,
35, 50, 100, 101 and 102**

Reg. No. 2,893,079

United States Patent and Trademark Office

Registered Oct. 12, 2004

**TRADEMARK
SERVICE MARK
PRINCIPAL REGISTER**

KENDRION

KENDRION N.V. (NETHERLANDS CORPORATION)
UTRECHTSEWEG 46
ZEIST, NETHERLANDS 3704 HD

FOR: SEMI-FINISHED PRODUCTS MADE OF METAL, NAMELY, IRONMONGERY, NAMELY, BOLTS, SCREWS AND FASTENERS, NAMELY, PIPE CLAMPS FOR ASSEMBLY OF EXHAUST SYSTEMS IN THE AUTOMOTIVE INDUSTRY, FITTINGS USED FOR THE PRODUCTION OF PALLET COLLARS, IN CLASS 6 (U.S. CLS. 2, 12, 13, 14, 23, 25 AND 50).

FOR: ELECTROMAGNETIC COMPONENTS AND PRODUCTS THAT TRANSFORM ELECTRICAL SIGNALS INTO THE MOVEMENT OF APPARATUS, MACHINES AND VEHICLES, NAMELY, AUTOMATIC TRANSMISSION PARTS, NAMELY, GEARS AND BELTS, AND COMPUTER OPERATING SYSTEMS FOR MEDICAL PURPOSES AND TO CONTROL ELEVATORS, COMPRISED PRIMARILY OF INTEGRATED ELECTROMAGNETIC COMPONENTS, NAMELY, GEARS AND BELTS, HOLDING MAGNETS, SOLENOIDS, VIBRATORS AND LATCHING DEVICES FOR MECHANICAL ENGINEERING INDUSTRIAL USE, IN CLASS 7 (U.S. CLS. 13, 19, 21, 23, 31, 34 AND 35).

FOR: SYNTHETIC MATERIALS AND PLASTICS AS SEMI-FINISHED PRODUCTS, NAMELY, PACKING, STOPPING AND INSULATING MATERIALS IN THE FORM OF METAL FOILS FOR BUILDING INSULATION, SHEETS, NON-METAL FLEXIBLE

PIPES, FIBERGLASS FABRICS AND ELECTRICAL TAPES FOR GENERAL INDUSTRIAL AND CONSTRUCTION USE, IN CLASS 17 (U.S. CLS. 1, 5, 12, 13, 35 AND 50).

FOR: COMMERCIAL INTERMEDIARY SERVICES WITH REGARD TO LOGISTICS MANAGEMENT IN THE TRADE OF METAL FOILS FOR BUILDING INSULATION, SHEETS, NON-METAL FLEXIBLE PIPES, FIBERGLASS FABRICS AND ELECTRICAL TAPES FOR GENERAL INDUSTRIAL AND CONSTRUCTION USE; COMMERCIAL AND INDUSTRIAL MANAGEMENT ASSISTANCE; ADVERTISING SERVICES, NAMELY, PREPARING AND PLACING ADVERTISEMENTS FOR OTHERS, IN CLASS 35 (U.S. CLS. 100, 101 AND 102).

FOR: DESIGN AND DEVELOPMENT OF PRODUCTS FOR OTHERS, NAMELY, HIGH VALUE METAL AND SYNTHETIC PARTS FOR MOTOR VEHICLES, SYNTHETIC SEMI-FINISHED PRODUCTS FOR CONSTRUCTION AND INDUSTRIAL USE, FRAMES AND MEDICAL EQUIPMENT; INDUSTRIAL DESIGN, IN CLASS 42 (U.S. CLS. 100 AND 101).

OWNER OF BENELUX REG. NO. 640987, DATED 12-23-1998, EXPIRES 12-23-2008.

SER. NO. 78-093,241, FILED 11-14-2001.

Laura Kovaisky, Examining Attorney

Int. Cls.: 18 and 25

Prior U.S. Cls.: 1, 2, 3, 22, 39 and 41

United States Patent and Trademark Office

Reg. No. 2,893,080

Registered Oct. 12, 2004

**TRADEMARK
PRINCIPAL REGISTER**

POULSEN SKONE

NEW & LINGWOOD LIMITED (UNITED KING-
DOM LIMITED COMPANY)
118 HIGH STREET
ETON, NR WINDSOR, UNITED KINGDOM SL4 6AN

FOR: GOODS MADE FROM LEATHER AND
IMITATION LEATHER, NAMELY, WALLETS, PUR-
SES, SHOPPING BAGS, CARRY ALL BAGS, ALL-
PURPOSE SPORT BAGS; LUGGAGE TRUNKS;
TRAVEL BAGS; UMBRELLAS; PARASOLS, WALK-
ING STICKS, IN CLASS 18 (U.S. CLS. 1, 2, 3, 22 AND
41).

FOR: CLOTHING, NAMELY, FOOTWEAR,
HEADWEAR, UNDERWEAR, NECKWEAR, RAIN-

WEAR, SHIRTS, PANTS, HATS, SOCKS, DRESSES,
BLOUSES, TEE-SHIRTS, IN CLASS 25 (U.S. CLS. 22
AND 39).

PRIORITY CLAIMED UNDER SEC. 44(D) ON
ERPN CMNTY TM OFC APPLICATION NO.
0025226572, FILED 1-2-2002, REG. NO. 2526572, DA-
TED 6-6-2003, EXPIRES 1-3-2012.

SER. NO. 78-100,692, FILED 1-3-2002.

ANDREA K. NADELMAN, EXAMINING ATTOR-
NEY

Int. Cl.: 5

Prior U.S. Cls.: 6, 18, 44, 46, 51 and 52

United States Patent and Trademark Office

Reg. No. 2,893,081

Registered Oct. 12, 2004

**TRADEMARK
PRINCIPAL REGISTER**

RENUAID

DEER RIVER RANCH (PENNSYLVANIA COR-
PORATION)
4000 EAST HARRISBURG PIKE
MIDDLETOWN, PA 17057

FIRST USE 3-21-2001; IN COMMERCE 5-24-2001.

FOR: DIETARY SUPPLEMENTS AND FOOD
SUPPLEMENTS FOR DOMESTIC ANIMALS AND
FOR HUMANS, IN CLASS 5 (U.S. CLS. 6, 18, 44, 46, 51
AND 52).

SER. NO. 78-107,463, FILED 2-7-2002.

ALLISON HOLTZ, EXAMINING ATTORNEY

Int. Cl.: 21

Prior U.S. Cls.: 2, 13, 23, 29, 30, 33, 40 and 50

United States Patent and Trademark Office

Reg. No. 2,893,082

Registered Oct. 12, 2004

TRADEMARK
PRINCIPAL REGISTER

BORMIOLI LUIGI ^{SPA}

BORMIOLI LUIGI S.P.A. (ITALY CORPORATION)
VIA MOLETOLO 6
PARMA, ITALY 43100

FOR: SMALL DOMESTIC UTENSILS AND CONTAINERS, NAMELY, ICE BUCKETS, CHAMPAGNE BUCKETS, WINE BUCKETS, COOLING BUCKETS FOR WINE, SALT, PEPPER AND MUSTARD CRUET SETS NOT OF PRECIOUS METAL, SALT CELLARS, PEPPER GRINDERS, SAUCE BOATS, EGG HOLDERS, BUTTER COOLERS, BUTTER DISHES, CANDLE HOLDERS NOT OF PRECIOUS METAL, CASSEROLE DISHES, CAVIAR COOLERS, APPLE GRATERS, SERVING TRAYS NOT OF PRECIOUS METAL, ICE PAILS, CRUETS, FLOWER VASES, NON-METAL DECORATIVE BOXES, CANISTERS, GLASS BOTTLES FOR PERFUME SOLD EMPTY, GLASS CONTAINERS FOR COSMETICS SOLD EMPTY; SCULPTURES, STATUES, AND FIGURINES MADE OF CHINA, CRYSTAL, EARTHENWARE, GLASS, PORCELAIN AND TERRA COTTA; DINNERWARE OF GLASS, PORCELAIN AND EARTHENWARE NAMELY, PLATES, DISHES,

DISH COVERS, DISH STANDS, CUPS, SAUCERS, TEA AND COFFEE POTS, GLASSES, DRINKING GLASSES, BEER MUGS, PORTABLE BEVERAGE DISPENSERS, BEVERAGE GLASSWARE, BEVERAGE WARE, BOWLS, RINSING BOWLS, SALAD BOWLS, TUMBLERS, PITCHERS, BOTTLES, BOTTLE WINE RACKS, CARAFES, DRINKING FLASKS, DECANTERS, JARS, JUGS, POTS, IN CLASS 21 (U.S. CLS. 2, 13, 23, 29, 30, 33, 40 AND 50).

PRIORITY CLAIMED UNDER SEC. 44(D) ON ERPN CMNTY TM OFC APPLICATION NO. 2550051, FILED 1-25-2002, REG. NO. 2550051, DATED 6-5-2003, EXPIRES 1-25-2012.

NO CLAIM IS MADE TO THE EXCLUSIVE RIGHT TO USE "SPA", APART FROM THE MARK AS SHOWN.

SER. NO. 78-116,486, FILED 3-21-2002.

CHERYL CLAYTON, EXAMINING ATTORNEY

Int. Cl.: 9

Prior U.S. Cls.: 21, 23, 26, 36 and 38

Reg. No. 2,893,083

United States Patent and Trademark Office

Registered Oct. 12, 2004

**TRADEMARK
PRINCIPAL REGISTER**

EGUARD

GUARDIAN GROUP, INC. (CALIFORNIA CORPORATION)
2350 W. 205TH STREET
TORRANCE, CA 90501

GLOBAL COMPUTER NETWORK, IN CLASS 9 (U.S. CLS. 21, 23, 26, 36 AND 38).

FIRST USE 5-1-2001; IN COMMERCE 5-1-2001.

FOR: COMPUTER SOFTWARE PROGRAM DEVELOPED FOR THE MANAGEMENT AND ADMINISTRATION OF SURETY BOND CLAIMS OVER A

SER. NO. 78-117,350, FILED 3-25-2002.

KIMBERLY PERRY, EXAMINING ATTORNEY

Int. Cl.: 35

Prior U.S. Cls.: 100, 101 and 102

United States Patent and Trademark Office

Reg. No. 2,893,084

Registered Oct. 12, 2004

**SERVICE MARK
PRINCIPAL REGISTER**

POWERDIRECT

SACRAMENTO MUNICIPAL UTILITY DISTRICT
(CALIFORNIA MUNICIPAL CORPORATION)
6201 S STREET
SACRAMENTO, CA 958171899

FIRST USE 3-1-2002; IN COMMERCE 3-1-2002.

SER. NO. 78-117,758, FILED 3-27-2002.

FOR: ENERGY USAGE MANAGEMENT SERVICES VIA INTERNET-DIRECT BASED ELECTRICAL LOAD OFF-SITE MANAGEMENT, IN CLASS 35 (U.S. CLS. 100, 101 AND 102).

KENNETH D. BATTLE, EXAMINING ATTORNEY

Int. Cl.: 29

Prior U.S. Cl.: 46

United States Patent and Trademark Office

Reg. No. 2,893,085

Registered Oct. 12, 2004

**TRADEMARK
PRINCIPAL REGISTER**

MYGREENS

DOLE FOOD COMPANY, INC. (DELAWARE
CORPORATION)
ONE DOLE DRIVE
WESTLAKE VILLAGE, CA 91362

FIRST USE 5-0-2002; IN COMMERCE 5-0-2002.

SER. NO. 78-121,879, FILED 4-15-2002.

FOR: CUT AND PACKAGED FRESH VEGETA-
BLES, IN CLASS 29 (U.S. CL. 46).

MARY CRAWFORD, EXAMINING ATTORNEY

Int. Cl.: 41

Prior U.S. Cls.: 100, 101 and 107

United States Patent and Trademark Office

Reg. No. 2,893,086

Registered Oct. 12, 2004

SERVICE MARK
PRINCIPAL REGISTER



PORTNICK, JENNIFER O. (UNITED STATES
INDIVIDUAL)

100 RIDGEWOOD AVENUE
SAN FRANCISCO, CA 94112

FOR: PHYSICAL FITNESS CONSULTATION;
PHYSICAL FITNESS INSTRUCTION, IN CLASS 41
(U.S. CLS. 100, 101 AND 107).

FIRST USE 3-10-2002; IN COMMERCE 3-10-2002.

NO CLAIM IS MADE TO THE EXCLUSIVE
RIGHT TO USE "FITNESS", APART FROM THE
MARK AS SHOWN.

THE LIKENESS (OR, "PORTRAIT") IN THE
MARK IDENTIFIES A LIVING INDIVIDUAL
WHOSE CONSENT IS OF RECORD.

SER. NO. 78-122,982, FILED 4-19-2002.

CHERYL CLAYTON, EXAMINING ATTORNEY

Int. Cls.: 9 and 42

Prior U.S. Cls.: 21, 23, 26, 36, 38, 100 and 101

United States Patent and Trademark Office

Reg. No. 2,893,087

Registered Oct. 12, 2004

**TRADEMARK
SERVICE MARK
PRINCIPAL REGISTER**

DP CONNECT

OCE-TECHNOLOGIES B.V. (NETHERLANDS
COMPANY)
ST. URBANUSWEG 43
NL-5900 MA VENLO, NETHERLANDS

FOR: COMPUTERS; COMPUTER PERIPHERAL
DEVICES; RECORDING MEDIA, NAMELY BLANK
DISKS, CD-ROMS, TAPES AND MEMORY CARDS
FOR RECORDING DATA AND COMPUTER SOFT-
WARE; COMPUTER SOFTWARE USED TO CON-
TROL PRINTERS AND TO MANAGE
DOCUMENTS; DEVICES FOR DOCUMENT PRO-
CESSING AND SYSTEMS FOR ARCHIVING DOCU-
MENTS, NAMELY, SCANNERS AND CAMERAS;
PRINTERS; ARCHIVING SYSTEMS AND DEVICES,
NAMELY, COMPUTER SOFTWARE FOR STORING
AND OUT PUTTING ARCHIVED DATA, IN CLASS 9
(U.S. CLS. 21, 23, 26, 36 AND 38).

FOR: DESIGNING COMPUTER SOFTWARE FOR
OTHERS, NAMELY, COMPUTER SOFTWARE

USED FOR CONTROLLING PRINTERS, DEVICES
FOR DOCUMENT PROCESSING AND SYSTEMS
FOR ARCHIVING DOCUMENTS; TECHNICAL
CONSULTANCY WITH REGARD TO THE USE OF
COMPUTER SOFTWARE, OR PRINTING SYSTEMS,
OF DEVICES FOR DOCUMENT PROCESSING AND
OF SYSTEMS FOR ARCHIVING DOCUMENTS, IN
CLASS 42 (U.S. CLS. 100 AND 101).

PRIORITY CLAIMED UNDER SEC. 44(D) ON
ERPNTY TM OFC APPLICATION NO.
002438901, FILED 11-6-2001, REG. NO. 2438901, DA-
TED 7-4-2003, EXPIRES 11-6-2011.

SER. NO. 78-126,433, FILED 5-6-2002.

MARIA-VICTORIA SUAREZ, EXAMINING ATTOR-
NEY

Int. Cls.: 9, 38, 41 and 42

Prior U.S. Cls.: 21, 23, 26, 36, 38, 100, 101, 104 and 107

Reg. No. 2,893,088

United States Patent and Trademark Office

Registered Oct. 12, 2004

**TRADEMARK
SERVICE MARK
PRINCIPAL REGISTER**



NUCODA LTD. (UNITED KINGDOM CORPORATION)
COBALT BUILDING
19-20 NOEL STREET
LONDON, UNITED KINGDOM W1F 8GW

FOR: COMPUTER GRAPHICS SOFTWARE; COMPUTER PROGRAMS FOR PRODUCING COMPUTER GRAPHICS; COMPUTER SOFTWARE FOR THE PRODUCTION OF MOTION PICTURES AND TELEVISION PROGRAMS, NAMELY FOR EDITING, COMPOSITING, RETOUCHING, GRADING AND MASTERING OF SUCH MEDIA, IN CLASS 9 (U.S. CLS. 21, 23, 26, 36 AND 38).

FOR: DELIVERY OF MESSAGES BY ELECTRONIC MEDIA TRANSMISSION; DELIVERY OF MESSAGES BY AUDIOVISUAL MEDIA, VIA INTERNET TRANSMISSION, IN CLASS 38 (U.S. CLS. 100, 101 AND 104).

FOR: PROVIDING TELEVISION AND MOTION PICTURE FILM POST-PRODUCTION AND SPECIAL EFFECTS SERVICES FOR THE PURPOSE OF ENTERTAINMENT; PREPARATION OF SPECIAL EFFECTS FOR FILM AND TELEVISION; TRAINING IN THE OPERATION OF SOFTWARE SYSTEMS; PREPARATION OF SPECIAL EFFECTS FOR FILMS; PREPARATION OF SPECIAL EFFECTS FOR RADIO; PREPARATION OF SPECIAL EFFECTS FOR TELEVISION; PROVIDING AN ONLINE COMPUTER GAME; PRODUCTION OF VIDEO CASSETTES; PROVIDING A COMPUTER GAME THAT MAY BE ACCESSED NETWORK-WIDE BY NETWORK USERS, IN CLASS 41 (U.S. CLS. 100, 101 AND 107).

FOR: COMPUTER PROGRAMMING FOR OTHERS; DESIGNING AND IMPLEMENTING WEB SITES FOR OTHERS; COMPUTER PROJECT MANAGEMENT SERVICES; DESIGN OF COMPUTERS FOR OTHERS; DESIGN OF NEW PRODUCTS FOR OTHERS; PROVIDING COMPUTER CONSULTATION REGARDING THE REQUIREMENTS OF TELEVISION AND FILM PRODUCTION PROJECTS; ADVISORY SERVICES RELATING TO COMPUTER SOFTWARE USED FOR GRAPHICS; COMPUTER-AIDED DESIGN OF VIDEO GRAPHICS; COMPUTER SOFTWARE CONSULTANCY; COMPUTER SOFTWARE DESIGN FOR OTHERS; COMPUTER SOFTWARE DEVELOPMENT; COMPUTER SOFTWARE ENGINEERING FOR OTHERS; COMPUTER SOFTWARE PROGRAMMING SERVICES FOR OTHERS; RESEARCH IN THE FIELD OF COMPUTER SOFTWARE FOR OTHERS; CONSULTANCY RELATING TO COMPUTER SOFTWARE; CONSULTATION SERVICES RELATING TO COMPUTER SOFTWARE; CONSULTING SERVICES RELATING TO COMPUTER SOFTWARE; DESIGN OF GRAPHIC SOFTWARE FOR OTHERS; DEVELOPMENT OF COMPUTER SOFTWARE; DEVELOPMENT OF SOFTWARE, IN CLASS 42 (U.S. CLS. 100 AND 101).

PRIORITY CLAIMED UNDER SEC. 44(D) ON ERPN CMNTY TM OFC APPLICATION NO. 002587921, FILED 2-21-2002, REG. NO. 002587921, DATED 10-9-2003, EXPIRES 10-9-2013.

SER. NO. 78-131,692, FILED 5-29-2002.

SCOTT BALDWIN, EXAMINING ATTORNEY

Int. Cls.: 16, 25, 28 and 30

Prior U.S. Cls.: 2, 5, 22, 23, 29, 37, 38, 39, 46 and 50

United States Patent and Trademark Office

Reg. No. 2,893,089

Registered Oct. 12, 2004

TRADEMARK
PRINCIPAL REGISTER

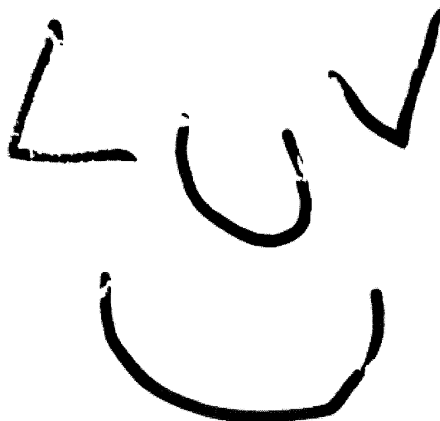

HALLAM, IAN (UNITED KINGDOM INDIVIDUAL)

C/O LUV-U LIMITED

3 MILL RISE, ROBERTS BRIDGE

EAST SUSSEX, UNITED KINGDOM TN32 5EG

FOR: GOODS MADE FROM PAPER AND CARDBOARD, NAMELY GREETING CARDS, STATIONERY, GIFT WRAPPING AND COMIC BOOKS, IN CLASS 16 (U.S. CLS. 2, 5, 22, 23, 29, 37, 38 AND 50).

FOR: CLOTHING, NAMELY FOOTWEAR, HEADWEAR, BLOUSES, T-SHIRTS, TROUSERS, TRACKSUITS, GLOVES, SCARVES, BASEBALL CAPS, IN CLASS 25 (U.S. CLS. 22 AND 39).

FOR: GAMES, NAMELY BOARD GAMES; PLAYTHINGS, NAMELY SOFT PLUSH TOYS AND DOLLS, IN CLASS 28 (U.S. CLS. 22, 23, 38 AND 50).

FOR: CONFECTIONERY AND SWEETS, NAMELY CHOCOLATE AND CANDY, IN CLASS 30 (U.S. CL. 46).

PRIORITY CLAIMED UNDER SEC. 44(D) ON ERPN CMNTY TM OFC APPLICATION NO. 002729481, FILED 5-28-2002, REG. NO. 2287069, DATED 11-30-2001, EXPIRES 11-30-2011.

SER. NO. 78-132,113, FILED 5-30-2002.

WILLIAM P. SHANAHAN, EXAMINING ATTORNEY

Int. Cl.: 36

Prior U.S. Cls.: 100, 101 and 102

United States Patent and Trademark Office

Reg. No. 2,893,090

Registered Oct. 12, 2004

**SERVICE MARK
PRINCIPAL REGISTER**

FUNDSTREAM

SUNGARD INSTITUTIONAL BROKERAGE INC.
(NEW YORK CORPORATION)
55 BROADWAY, 7TH FLOOR
NEW YORK, NY 10006

AND SETTING FINANCIAL TRANSACTIONS ON
BEHALF OF OTHERS, IN CLASS 36 (U.S. CLS. 100,
101 AND 102).

FOR: FINANCIAL SERVICES; NAMELY, MU-
TUAL FUND INVESTMENT MANAGEMENT SER-
VICES, MUTUAL FUND DISTRIBUTION
SERVICES, MUTUAL FUND ADMINISTRATION
SERVICES, STOCK BROKERAGE SERVICES,
CLEARANCE SERVICES, NAMELY, CLEARING

FIRST USE 9-4-2001; IN COMMERCE 9-4-2001.

SER. NO. 78-134,275, FILED 6-9-2002.

CAROL SPILS, EXAMINING ATTORNEY

Int. Cls.: 29, 30, 32 and 43

Prior U.S. Cls.: 45, 46, 48, 100 and 101

Reg. No. 2,893,091

United States Patent and Trademark Office

Registered Oct. 12, 2004

**TRADEMARK
SERVICE MARK
PRINCIPAL REGISTER**

GOING NATIVE

GOING NATIVE GROUP LIMITED, THE (UNITED KINGDOM CORPORATION)
BRAMHALL HOUSE
14 ACK LANE EAST
BRAMHALL, STOCKPORT, UNITED KINGDOM
SK7 2BY

FOR: MEAT, FISH, POULTRY AND GAME; MEAT EXTRACTS; PREPARED DRIED AND COOKED FRUIT AND VEGETABLES; JELLIES, JAMS; EGGS, MILK, AND MILK PRODUCTS EXCLUDING ICE CREAM, ICE MILK AND FROZEN YOGURT, EDIBLE OILS AND FATS; PREPARED MEALS CONSISTING PRIMARILY OF MEAT, FISH, POULTRY OR VEGETABLES; FRUIT OR POTATO-BASED SNACK FOODS; PREPARED SHELF STABLE, FRESH, REFRIGERATED AND FROZEN FOODS NAMELY READY TO USE, READY TO COOK, READY TO EAT, READY TO HEAT MEAT, POULTRY, GAME, MEAT EXTRACTS, PREPARED DRIED AND COOKED FRUITS AND VEGETABLES, JELLIES, JAMS, FRUIT SAUCES, NAMELY, APPLE SAUCE, CRANBERRY SAUCE; EGGS, MILK AND MILK PRODUCTS EXCLUDING ICE CREAM, ICE MILK AND FROZEN YOGURT AND PREPARED MEALS CONSISTING OF COMBINATIONS OF SOME OR ALL THE AFORESAID FOODS; SOUPS; MILK AND YOGURT BASED DRINKS; READY MEALS AND SNACK MEALS CONSISTING PRIMARILY OF MEAT, SEAFOOD, CHICKEN, VEGETABLES OR CHEESE, IN CLASS 29 (U.S. CL. 46).

FOR: COFFEE, TEA, COCOA, SUGAR, RICE, TAPIOCA, SAGE, ARTIFICIAL COFFEE, FLOUR AND PREPARATIONS MADE FROM CEREALS, NAMELY, CEREAL BASED SNACK FOOD, BREAK-

FAST CEREALS, FOOD BARS, BREAD; PASTRY AND CONFECTIONERY CHIPS FOR BAKING, FLAVORED ICES, ICE CREAM; HONEY, TREACLE; YEAST, BAKING POWDER; SALT; MUSTARD; PASTA OR RICE; RICE/CEREAL/WHEAT VEGETABLE BASED SNACK FOODS; VINEGAR; SAUCES USED AS CONDIMENTS; COOKING SAUCES; MARINADES; SALAD DRESSINGS; SNACK MEALS CONSISTING PRIMARILY OF RICE, NOODLES, PASTA, AND CHEESE; SORBETS; FROZEN YOGURT; SANDWICHES; SANDWICH WRAPS; ROLLS; PIZZA; STIR-FRY SAUCES, IN CLASS 30 (U.S. CL. 46).

FOR: BEERS; MINERAL AND AERATED WATERS AND OTHER NON-ALCOHOLIC DRINKS, NAMELY, SMOOTHIES, READY TO DRINK TEA AND COFFEE, FRUIT FLAVORED MINERAL WATERS, TABLE WATER, STILL WATER, SODA WATER, TONIC WATER, GINGER ALE, GINGER BEER, ISOTONIC BEVERAGES, LEMONADES, SELTZER WATER, FRUIT DRINKS AND FRUIT JUICES, CONCENTRATES, SYRUPS OR POWDERS USED IN THE PREPARATION OF SOFT DRINKS, IN CLASS 32 (U.S. CLS. 45, 46 AND 48).

FOR: RESTAURANT SERVICES; TAKE-OUT RESTAURANT SERVICES, IN CLASS 43 (U.S. CLS. 100 AND 101).

OWNER OF UNITED KINGDOM REG. NO. 2194412, DATED 4-21-2000, EXPIRES 4-14-2009.

SER. NO. 78-138,525, FILED 6-25-2002.

ZACHARY BELLO, EXAMINING ATTORNEY

Int. Cl.: 9

Prior U.S. Cls.: 21, 23, 26, 36 and 38

Reg. No. 2,893,092

United States Patent and Trademark Office

Registered Oct. 12, 2004

**TRADEMARK
PRINCIPAL REGISTER**

HARMONIZED SUBSCRIBER ACCESS

TAZZ NETWORKS, INC. (DELAWARE CORPORATION)
321 SOUTH MAIN STREET
SUITE 100
PROVIDENCE, RI 02903

FIRST USE 10-15-2003; IN COMMERCE 2-15-2004.

FOR: COMPUTER INFRASTRUCTURE SOFTWARE FOR USE IN ENABLING NETWORK OPERATORS TO DEPLOY, CONFIGURE, COMBINE, MAINTAIN AND UPGRADE COMPUTER HARDWARE AND OTHER COMPUTER NETWORK OPERATING SOFTWARE, IN CLASS 9 (U.S. CLS. 21, 23, 26, 36 AND 38).

NO CLAIM IS MADE TO THE EXCLUSIVE RIGHT TO USE SUBSCRIBER ACCESS, APART FROM THE MARK AS SHOWN.

SER. NO. 78-138,569, FILED 6-25-2002.

CAROLINE WOOD, EXAMINING ATTORNEY

Int. Cls.: 16 and 28

Prior U.S. Cls.: 2, 5, 22, 23, 29, 37, 38 and 50

Reg. No. 2,893,093

United States Patent and Trademark Office

Registered Oct. 12, 2004

**TRADEMARK
PRINCIPAL REGISTER**

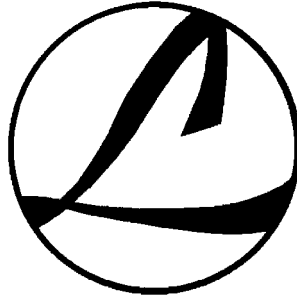

LEADER

GRATON EDITEUR SA (BELGIUM CORPORATION)
AVENUE DES COCCINELLES, 70
BRUSSELS, BELGIUM B-1170

FOR: WRITING PAPER, DRAWING PAPER, PRINTED LETTERHEAD STATIONERY, ENVELOPES, CARDBOARD, POSTERS AND POSTCARDS; BOOKS, NEWSPAPERS, PERIODICALS, MAGAZINES AND BROCHURES FEATURING CARTOONS; CARTOON STRIPS AND PRINTS; CALENDARS; LITHOGRAPHS, PHOTOGRAPHS; STATIONERY COVERS, NAMELY PROTECTIVE COVERS FOR SHEETS OF PAPER AND PAGES OF BOOKS AND THE LIKE; SCHOOL SUPPLIES, NAMELY PENCILS CASES, PENCIL SHARPENERS; GREETING CARDS; COMIC STRIPS; STATIONERY BOXES; DOCUMENT FILES; PLASTIC FILM FOR REPACKAGING NOT FOR COMMERCIAL OR INDUSTRIAL PURPOSES, IN CLASS 16 (U.S. CLS. 2, 5, 22, 23, 29, 37, 38 AND 50).

FOR: TOY SCALE MODEL VEHICLES; CARD GAMES, EQUIPMENT SOLD AS A UNIT FOR

PLAYING ACTION TYPE TARGET GAMES, HANDHELD UNIT FOR PLAYING ELECTRONIC VIDEO GAMES; RIDE-ON-TOYS; CHILDREN'S MULTIPLE ACTIVITY TOYS, TOY AND CRIB MOBILES, TOY ACTION FIGURES AND ACCESSORIES THEREFOR, TOY BOXES, DOLLS, DOLL ACCESSORIES, DOLL CLOTHING, DOLL COSTUMES, DOLL FURNITURE, DOLL HOUSE FURNISHINGS, DOLL HOUSES, IN CLASS 28 (U.S. CLS. 22, 23, 38 AND 50).

PRIORITY CLAIMED UNDER SEC. 44(D) ON BENELUX APPLICATION NO. 1012109, FILED 6-3-2002, REG. NO. 719330, DATED 7-2-2002, EXPIRES 7-2-2012.

THE MARK CONSISTS OF THE WORD LEADER IN SPECIAL FORM WITH A STYLIZED L ON A YELLOW BACKGROUND WITHIN A CIRCLE.

SER. NO. 78-140,440, FILED 7-1-2002.

MARY CRAWFORD, EXAMINING ATTORNEY

Int. Cl.: 30

Prior U.S. Cl.: 46

United States Patent and Trademark Office

Reg. No. 2,893,094

Registered Oct. 12, 2004

**TRADEMARK
PRINCIPAL REGISTER**

LICORICE SMACKERS

WAYMOUTH FARMS, INC. (MINNESOTA CORPORATION)
5300 BOONE AVENUE NORTH
NEW HOPE, MN 55428

NO CLAIM IS MADE TO THE EXCLUSIVE RIGHT TO USE "LICORICE", APART FROM THE MARK AS SHOWN.

FOR: CANDY, IN CLASS 30 (U.S. CL. 46).

SER. NO. 78-141,047, FILED 7-3-2002.

FIRST USE 9-18-2001; IN COMMERCE 9-21-2001.

SUSAN HAYASH, EXAMINING ATTORNEY

Int. Cl.: 25

Prior U.S. Cls.: 22 and 39

United States Patent and Trademark Office

Reg. No. 2,893,095

Registered Oct. 12, 2004

TRADEMARK
PRINCIPAL REGISTER



KOMEX INTERNATIONAL, INC. (CALIFORNIA CORPORATION)
850 EAST 62ND STREET
LOS ANGELES, CA 90001

FOR: CLOTHING, NAMELY JEANS, SHIRTS, SKIRTS, SHOES, IN CLASS 25 (U.S. CLS. 22 AND 39).

FIRST USE 11-1-1996; IN COMMERCE 11-1-1996.

NO CLAIM IS MADE TO THE EXCLUSIVE RIGHT TO USE IT'S FABULOUS, APART FROM THE MARK AS SHOWN.

THE STIPPLING IS FOR SHADING PURPOSES ONLY AND DOES NOT INDICATE COLOR.

THE LIKENESS (OR, "PORTRAIT") IN THE MARK DOES NOT IDENTIFY A LIVING INDIVIDUAL.

SER. NO. 78-143,730, FILED 7-14-2002.

PRISCILLA MILTON, EXAMINING ATTORNEY

Int. Cls.: 30, 35 and 43

Prior U.S. Cls.: 46, 100, 101 and 102

United States Patent and Trademark Office

Reg. No. 2,893,096

Registered Oct. 12, 2004

**TRADEMARK
SERVICE MARK
PRINCIPAL REGISTER**

BUTLERS IRISH

THE IRISH CHOCOLATE COMPANY LIMITED
(IRELAND COMPANY)
77 SIR JOHN ROGERSON'S QUAY
DUBLIN 2, IRELAND

FOR: CHOCOLATES; FUDGES; PEPPERMINT
CREAM FLAVORED CHOCOLATE; PEPPERMINT
CREAM CANDY; CONFECTIONERY, NAMELY,
COOKIES, CANDY, CANDY MINTS, CHOCOLATE,
CHOCOLATE TRUFFLES, CHOCOLATE CHIPS,
CHOCOLATE COVERED NUTS; BISCUITS; CAKES;
ICE CREAM; BREAKFAST CEREALS; SAUCES
USED AS CONDIMENTS; CHOCOLATE SPREADS;
CEREAL AND CHOCOLATE BASED SNACK
FOODS, IN CLASS 30 (U.S. CL. 46).

FOR: RETAIL STORE SERVICES FEATURING
FOOD AND DRINK PRODUCTS, IN CLASS 35 (U.S.
CLS. 100, 101 AND 102).

FOR: CAFES, RESTAURANTS, AND SNACK
BARS, IN CLASS 43 (U.S. CLS. 100 AND 101).

PRIORITY CLAIMED UNDER SEC. 44(D) ON
ERPNTY TM OFC APPLICATION NO.
2680213, FILED 4-30-2002, REG. NO. 2680213, DATED
12-5-2003, EXPIRES 4-30-2012.

NO CLAIM IS MADE TO THE EXCLUSIVE
RIGHT TO USE "IRISH", APART FROM THE MARK
AS SHOWN.

SER. NO. 78-143,870, FILED 7-15-2002.

PRISCILLA MILTON, EXAMINING ATTORNEY

Int. Cl.: 5

Prior U.S. Cls.: 6, 18, 44, 46, 51 and 52

United States Patent and Trademark Office

Reg. No. 2,893,097

Registered Oct. 12, 2004

TRADEMARK
PRINCIPAL REGISTER



KING PHARMACEUTICALS, INC. (TENNESSEE CORPORATION)
501 FIFTH STREET
BRISTOL, TN 37620

FOR: PRESCRIPTION PHARMACEUTICALS; NAMELY, CARDIOVASCULAR MEDICATIONS; ENDOCRINOLOGY MEDICATIONS; ANTI-INFECTIVE MEDICATIONS; CRITICAL CARE MEDICATIONS; NAMELY PREPARATIONS FOR THE TREATMENT OF INFECTIONS, ANTICOAGULANTS, AND ANESTHETICS; PEDIATRIC MEDICATIONS, NAMELY; ANTIBIOTICS, RESPIRATORY MEDICATIONS, OPHTHALMIC MEDICATIONS, GASTROINTESTINAL MEDICATIONS, AND ANTI-INFLAMMATORY MEDICA-

TIONS; GASTROINTESTINAL MEDICATIONS; ANTI-HEMATOSIS MEDICATIONS; OPHTHALMIC MEDICATIONS; ANTI-INFLAMMATORY MEDICATIONS; AND VACCINES, ANTIBIOTICS, NUTRITIONAL SUPPLEMENTS, AND PREPARATIONS FOR THE TREATMENT OF DISEASE IN SMALL AND LARGE ANIMALS INCLUDING PETS AND LIVESTOCK, IN CLASS 5 (U.S. CLS. 6, 18, 44, 46, 51 AND 52).

FIRST USE 1-10-1994; IN COMMERCE 1-20-1994.

SER. NO. 78-144,047, FILED 7-15-2002.

BARNEY CHARLON, EXAMINING ATTORNEY

Int. Cls.: 3, 5, 41 and 44

**Prior U.S. Cls.: 1, 4, 6, 18, 44, 46, 50, 51, 52, 100, 101
and 107**

Reg. No. 2,893,098

United States Patent and Trademark Office

Registered Oct. 12, 2004

**TRADEMARK
SERVICE MARK
PRINCIPAL REGISTER**

TOLBIOTICS

MADAUS S.R.L. (ITALY CORPORATION)
RIVIERA FRANCIA 3/A
PADOVA, ITALY 35127

FOR: DERMATOLOGICAL, COSMETIC AND PERSONAL CARE PRODUCTS, NAMELY BODY CREAM, HAND CREAM, NIGHT CREAM, SKIN CREAM, SKIN MOISTURIZER, MOUTHWASH, SUN BLOCK PREPARATIONS, SUN SCREEN PREPARATIONS, SUNTANNING PREPARATIONS, SOAPS, SHAMPOO AND HAIR LOTIONS; TOOTH-PASTE, IN CLASS 3 (U.S. CLS. 1, 4, 6, 50, 51 AND 52).

FOR: PHARMACEUTICAL PRODUCTS, NAMELY ACNE MEDICATIONS, ACNE TREATMENT PREPARATIONS, ALLERGY CAPSULES, ALLERGY MEDICATIONS, ALLERGY RELIEF MEDICATION, ALLERGY TABLETS, ANTI-INFLAMMATORIES, ANTI-BACTERIAL PHARMACEUTICALS, ANTIBIOTIC CREAMS, ANTIBIOTIC OINTMENTS, ANTIDOTES TO COUNTERACT POISONS, ANTIHISTAMINES, ANTIVIRALS, COUGH DROPS, COUGH EXPECTORANTS, COUGH LOZENGES, COUGH SYRUPS, COUGH TREATMENT PREPARATIONS, DECONGESTANT CAPSULES, DERMATOLOGICALS, DIARRHEA MEDICATION, DIETARY FOOD SUPPLEMENTS, DIETARY SUPPLEMENTS, FUNGAL MEDICATIONS, HERBAL SUPPLEMENTS, NASAL SPRAY PREPARATIONS,

NAUSEA TREATMENT PREPARATIONS, MEDICATED SUNBURN LOTIONS, VACCINE ADJUVANTS, VACCINES, VAGINAL PREPARATIONS, NAMELY ANTI-FUNGALS, VITAMIN SUPPLEMENTS, VITAMINS, WART REMOVING PREPARATIONS FOOD SUPPLEMENTS FOR DIETETIC AND MEDICAL USE; ALL PURPOSE DISINFECTANTS, IN CLASS 5 (U.S. CLS. 6, 18, 44, 46, 51 AND 52).

FOR: EDUCATIONAL AND FORMATION SERVICES IN THE MEDICAL-SCIENTIFIC FIELD, COURSES, CONFERENCES AND EDITORIAL ACTIVITIES REGARDING EDUCATION, FORMATION AND INFORMATION IN THE MEDICAL-SCIENTIFIC FIELD, IN CLASS 41 (U.S. CLS. 100, 101 AND 107).

FOR: PROVIDING MEDICAL INFORMATION, IN CLASS 44 (U.S. CLS. 100 AND 101).

PRIORITY CLAIMED UNDER SEC. 44(D) ON ERPN CMNTY TM OFC APPLICATION NO. 002748309, FILED 6-19-2002, REG. NO. 2748309, DATED 8-18-2003, EXPIRES 6-19-2012.

SER. NO. 78-145,593, FILED 7-19-2002.

SUE LAWRENCE, EXAMINING ATTORNEY

Int. Cls.: 9 and 37

Prior U.S. Cls.: 21, 23, 26, 36, 38, 100, 103 and 106

Reg. No. 2,893,099

United States Patent and Trademark Office

Registered Oct. 12, 2004

**TRADEMARK
SERVICE MARK
PRINCIPAL REGISTER**

VARIOSTREAM

OCE-TECHNOLOGIES B.V. (NETHERLANDS
COMPANY)
ST. URBANUSWEG 43
NL-5900 MA VENLO, NETHERLANDS

FOR: DATA PROCESSING APPARATUS, NAME-
LY, COMPUTERS, PRINTERS, BLANK DISCS AND
MEMORY CARDS FOR RECORDING DATA AND
COMPUTER OPERATING SOFTWARE THEREFOR;
ELECTRICAL AND OPTICAL APPARATUS AND
IMAGE PROCESSING DEVICES, NAMELY, PRIN-
TERS, SCANNERS AND DIGITAL CAMERAS AND
COMPUTER OPERATING SOFTWARE THEREFOR;
DEVICES FOR PROCESSING AND FINISHING
PRINTED MATERIAL AND DOCUMENTS, NAME-
LY, SORTERS AND HOLDERS, WINDERS AND
UNWINDERS FOR HOLDING AND FEEDING PA-
PER WHILE MAINTAINING TENSION, CUTTERS,
AND INSERTERS AND COMPUTER OPERATING
SOFTWARE THEREFOR, IN CLASS 9 (U.S. CLS. 21,
23, 26, 36 AND 38).

FOR: REPAIR AND MAINTENANCE OF DATA
PROCESSING APPARATUS, NAMELY, COMPU-

TERS, PRINTERS, BLANK DISCS AND MEMORY
CARDS FOR RECORDING DATA; REPAIR AND
MAINTENANCE OF ELECTRICAL AND OPTICAL
APPARATUS AND IMAGE PROCESSING DEVICES,
NAMELY, PRINTERS, SCANNERS AND DIGITAL
CAMERAS; REPAIR AND MAINTENANCE OF DE-
VICES FOR PROCESSING AND FINISHING PRIN-
TED MATERIAL, NAMELY, SORTERS AND
HOLDERS, WINDERS AND UNWINDERS FOR
HOLDING AND FEEDING PAPER WHILE MAIN-
TAINING TENSION, CUTTERS, AND INSERTERS,
IN CLASS 37 (U.S. CLS. 100, 103 AND 106).

PRIORITY CLAIMED UNDER SEC. 44(D) ON FED
REP GERMANY APPLICATION NO. 30205493.6,
FILED 2-1-2002, REG. NO. 30205493, DATED 4-18-
2002, EXPIRES 2-29-2012.

SER. NO. 78-146,120, FILED 7-22-2002.

LAURIEL DALIER, EXAMINING ATTORNEY

Int. Cl.: 36

Prior U.S. Cls.: 100, 101 and 102

United States Patent and Trademark Office

Reg. No. 2,893,100

Registered Oct. 12, 2004

**SERVICE MARK
PRINCIPAL REGISTER**

FIDUCIARY ASSET MANAGEMENT

FIDUCIARY ASSET MANAGEMENT, LLC (MISSOURI CORPORATION)
8112 MARYLAND AVENUE, SUITE 200
ST. LOUIS, MO 631053700

FOR: FUND INVESTMENT CONSULTATION, INVESTMENT CONSULTATION, INVESTMENT ADVICE, FUNDS INVESTMENT, FINANCIAL ANALYSIS AND CONSULTATION; PROVIDING INFORMATION ON THE TOPICS OF FUND INVESTMENT CONSULTATION, INVESTMENT CONSULTATION, INVESTMENT ADVICE, FUNDS INVESTMENT, FINANCIAL ANALYSIS AND CONSULTATION VIA A GLOBAL COMPUTER NETWORK, IN CLASS 36 (U.S. CLS. 100, 101 AND 102).

FIRST USE 10-3-1994; IN COMMERCE 10-3-1994.

NO CLAIM IS MADE TO THE EXCLUSIVE RIGHT TO USE NO CLAIM IS MADE TO THE EXCLUSIVE RIGHT TO USE "ASSET MANAGEMENT" APART FROM THE MARK AS SHOWN., APART FROM THE MARK AS SHOWN.

SEC. 2(F).

SER. NO. 78-148,116, FILED 7-26-2002.

MICHAEL WEBSTER, EXAMINING ATTORNEY

Int. Cls.: 38 and 45

Prior U.S. Cls.: 100, 101 and 104

United States Patent and Trademark Office

Reg. No. 2,893,101

Registered Oct. 12, 2004

**SERVICE MARK
PRINCIPAL REGISTER**



OPEN DREAMERS, LLC (DELAWARE LIMITED
LIABILITY COMPANY)
220 SOUTH LENOLA ROAD
APT.# D609
MAPLE SHADE, NJ 08052

FIRST USE 7-30-2002; IN COMMERCE 7-30-2002.

FOR: INTERACTIVE INTERNET WEBSITE FEATURING THE TRANSMISSION OF PERSONAL MESSAGES FOR THE PURPOSE OF PROVIDING ON-LINE DATING AND INTRODUCTION SERVICES, IN CLASS 38 (U.S. CLS. 100, 101 AND 104).

NO CLAIM IS MADE TO THE EXCLUSIVE RIGHT TO USE "BISEXUAL" AND ".COM", APART FROM THE MARK AS SHOWN.

FIRST USE 7-30-2002; IN COMMERCE 7-30-2002.

FOR: INTERACTIVE INTERNET WEBSITE FEATURING THE POSTING OF PERSONAL ADVERTISEMENTS AND THE POSTING OF PHOTOGRAPHS FOR THE PURPOSE OF PROVIDING ON-LINE DATING AND INTRODUCTION SERVICES, IN CLASS 45 (U.S. CLS. 100 AND 101).

THE MARK CONSISTS OF A LIGHT BLUE TRIANGLE ON TOP AND TO THE LEFT OF A PINK TRIANGLE WITH THE LETTER "B" WITH A WHITE DROP SHADOW IN THE CENTER OF THE LIGHT BLUE TRIANGLE AND THE LETTER "P" WITH A WHITE DROP SHADOW IN THE CENTER OF THE PINK TRIANGLE WITH THE WORD ".COM" BELOW AND TO THE RIGHT OF THE WORD "PLAYGROUND", ALL ON A WHITE BACKGROUND.

SER. NO. 78-152,684, FILED 8-9-2002.

DANIEL CAPSHAW, EXAMINING ATTORNEY

Int. Cl.: 41

Prior U.S. Cls.: 100, 101 and 107

United States Patent and Trademark Office

Reg. No. 2,893,102

Registered Oct. 12, 2004

**SERVICE MARK
PRINCIPAL REGISTER**

OTAKON

OTAKORP INC. (PENNSYLVANIA CORPORATION)
620 BISHOP PLACE
NORTHAMPTON, PA 19067

FIRST USE 8-1-1994; IN COMMERCE 8-1-1994.

SEC. 2(F) AS TO "OTAKON".

FOR: PROVIDING EDUCATIONAL CONFERENCES IN THE FIELDS OF JAPANESE/ASIAN ANIMATION, CULTURE, COMICS, MONGA, ART, MUSIC, VIDEO GAMES AND RELATED GRAPHICS AND AUDIO VISUAL EXPRESSIONS , IN CLASS 41 (U.S. CLS. 100, 101 AND 107).

SER. NO. 78-154,146, FILED 8-14-2002.

SCOTT OSLICK, EXAMINING ATTORNEY

Int. Cl.: 41

Prior U.S. Cls.: 100, 101 and 107

United States Patent and Trademark Office

Reg. No. 2,893,103

Registered Oct. 12, 2004

**SERVICE MARK
PRINCIPAL REGISTER**

MOUNTAIN MAGIC

GUNSTOCK AREA COMMISSION (NEW HAMPSHIRE CORPORATION)
P. O. BOX 1307
LACONIA, NH 032471307

FIRST USE 11-1-2001; IN COMMERCE 11-1-2001.

SER. NO. 78-154,319, FILED 8-14-2002.

FOR: SKI RESORT SERVICES, NAMELY SKI OR SNOWBOARD LESSONS, IN CLASS 41 (U.S. CLS. 100, 101 AND 107).

MARIA-VICTORIA SUAREZ, EXAMINING ATTORNEY

Int. Cl.: 41

Prior U.S. Cls.: 100, 101 and 107

United States Patent and Trademark Office

Reg. No. 2,893,104

Registered Oct. 12, 2004

**SERVICE MARK
PRINCIPAL REGISTER**

THE EGYPTIAN EVENT

THE PYRAMID SOCIETY (TEXAS CORPORATION)
4067 IRON WORKS PIKE
BUILDING C
LEXINGTON, KY 40511

FOR: EDUCATIONAL AND ENTERTAINMENT SERVICES; NAMELY, ORGANIZING AND CONDUCTING AN ANNUAL ARABIAN HORSE SHOW, IN CLASS 41 (U.S. CLS. 100, 101 AND 107).

FIRST USE 0-0-1981; IN COMMERCE 0-0-1981.

OWNER OF U.S. REG. NO. 972,104.

NO CLAIM IS MADE TO THE EXCLUSIVE RIGHT TO USE EVENT, APART FROM THE MARK AS SHOWN.

SEC. 2(F).

SER. NO. 78-155,386, FILED 8-19-2002.

SHARON MEIER, EXAMINING ATTORNEY

Int. Cls.: 10, 25 and 28

Prior U.S. Cls.: 22, 23, 26, 38, 39, 44 and 50

Reg. No. 2,893,105

United States Patent and Trademark Office

Registered Oct. 12, 2004

**TRADEMARK
PRINCIPAL REGISTER**

KINETOFOAM

WINDS ENTERPRISES LIMITED (HONG KONG CORPORATION)
ROOM 13, 3/F, BLOCK A
HI-TECH INDUSTRIAL CENTRE, 5-21 PAK TIN PAR STREET
TSUEN WAN, N.T., HONG KONG

FOR: ABDOMINAL BELTS; ARCH SUPPORTS FOR BOOTS AND SHOES; ELASTIC BANDAGES; SUPPORTIVE BANDAGES; ORTHOPAEDIC FOOTWEAR; PHYSICAL EXERCISE APPARATUS FOR MEDICAL PURPOSES; SHOULDER, ELBOW, KNEE, WRIST AND ANKLE SUPPORTS AND BRACES, IN CLASS 10 (U.S. CLS. 26, 39 AND 44).

FOR: CLOTHING, NAMELY, SHORTS, UNDERWEAR, UNDERPANTS, BRIEFS AND SOCKS; HEADWEAR; FOOTWEAR, IN CLASS 25 (U.S. CLS. 22 AND 39).

FOR: BODY PADS, BODY GUARDS AND BODY BRACES FOR THE PROTECTION OF SHOULDER, ELBOW, ARM AND WRIST, LEG, KNEE, ANKLE, FOOT AND HEAD FOR USE IN GYMNASTICS, BODY TRAINING, SPORTS BODY REHABILITATION, EXERCISE AND BODY TRAINING; IMPACT CUSHIONING MATERIAL FOR USE IN BODY PADS, BODY GUARDS, BODY BRACES, BODY CLOTHING, HEADGEAR AND FOOTWEAR FOR GYMNASTICS, SPORTS, BODY REHABILITATION, EXERCISE AND BODY TRAINING, IN CLASS 28 (U.S. CLS. 22, 23, 38 AND 50).

OWNER OF ERPN CMNTY TM OFC REG. NO. 002743250, DATED 9-11-2003, EXPIRES 6-21-2012.

SER. NO. 78-156,231, FILED 8-21-2002.

ZACHARY BELLO, EXAMINING ATTORNEY

Int. Cls.: 25 and 26

Prior U.S. Cls.: 22, 37, 39, 40, 42 and 50

Reg. No. 2,893,106

United States Patent and Trademark Office

Registered Oct. 12, 2004

**TRADEMARK
PRINCIPAL REGISTER**

noodlewear

NOODLES & COMPANY (DELAWARE CORPORATION)
2590 PEARL STREET
BOULDER, CO 80302

FOR: MEN'S, WOMEN'S AND CHILDREN'S CLOTHING, NAMELY, PANTS AND SLACKS, APRONS, BEACH COVERUPS, BOXER SHORTS, CAPS, CARDIGANS, GYM SHORTS, HEAD WEAR, INFANT WEAR, JACKETS, PAJAMAS, PULL-OVERS, SHIRTS, SHORTS, SLEEP WEAR, SWEAT PANTS, SWEAT SHIRTS, SWEAT SHORTS, SWEAT SUITS, SWEATERS, T-SHIRTS, TANK TOPS AND HALTER TOPS, TURTLENECKS, UNIFORMS,

VESTS AND WARM UP SUITS, IN CLASS 25 (U.S. CLS. 22 AND 39).

FIRST USE 5-30-2002; IN COMMERCE 5-30-2002.

FOR: BUTTONS FOR CLOTHING, IN CLASS 26 (U.S. CLS. 37, 39, 40, 42 AND 50).

FIRST USE 5-30-2002; IN COMMERCE 5-30-2002.

SER. NO. 78-157,429, FILED 8-23-2002.

KENNETH D. BATTLE, EXAMINING ATTORNEY

Int. Cl.: 33

Prior U.S. Cls.: 47 and 49

United States Patent and Trademark Office

Reg. No. 2,893,107

Registered Oct. 12, 2004

**TRADEMARK
PRINCIPAL REGISTER**

X WINERY

AMICUS CELLARS LLC (CALIFORNIA LTD
LIAB CO)
P.O. BOX 528
ST. HELENA, CA 94574

NO CLAIM IS MADE TO THE EXCLUSIVE
RIGHT TO USE "WINERY", APART FROM THE
MARK AS SHOWN.

FOR: WINE, IN CLASS 33 (U.S. CLS. 47 AND 49).

SER. NO. 78-158,598, FILED 8-28-2002.

FIRST USE 1-1-2002; IN COMMERCE 1-1-2002.

ANN E. SAPPENFIELD, EXAMINING ATTORNEY

Int. Cl.: 42

Prior U.S. Cls.: 100 and 101

United States Patent and Trademark Office

Reg. No. 2,893,108

Registered Oct. 12, 2004

**SERVICE MARK
PRINCIPAL REGISTER**

ADVISOR TOOLKIT

COMPUTER SCIENCE INNOVATIONS INC.
(FLORIDA CORPORATION)
1235 EVANS ROAD
MELBOURNE, FL 32904

FOR: COLLECTION OF ADVANCED SOFTWARE, BASED ON UNIQUE MATHEMATICAL ALGORITHMS, WHICH PERFORM DATA PREPARATION, KNOWLEDGE DISCOVERY, PATTERN RECOGNITION, CLUSTERING, CLASSIFICATION, INDUCTIVE LEARNING AND OTHER INTELLIGENT INFORMATION PROCESSING TASKS, USED FOR THE PURPOSE OF AD-

VANCED DATA MINING AND MODELING, IN CLASS 42 (U.S. CLS. 100 AND 101).

FIRST USE 1-0-1999; IN COMMERCE 1-0-2002.

NO CLAIM IS MADE TO THE EXCLUSIVE RIGHT TO USE "TOOLKIT", APART FROM THE MARK AS SHOWN.

SER. NO. 78-160,040, FILED 9-2-2002.

BRIAN NEVILLE, EXAMINING ATTORNEY

Int. Cl.: 43

Prior U.S. Cls.: 100 and 101

United States Patent and Trademark Office

Reg. No. 2,893,109

Registered Oct. 12, 2004

**SERVICE MARK
PRINCIPAL REGISTER**

SOPRA

DEPIERRO, JOHN (UNITED STATES INDIVIDUAL)
6 SADDLEBROOK DRIVE
HOHOKUS, NJ 07423

THE ENGLISH TRANSLATION OF THE WORD
"SOPRA" IN THE MARK IS "OVER" OR "ABOVE".

FOR: RESTAURANT AND BAR, IN CLASS 43
(U.S. CLS. 100 AND 101).

SER. NO. 78-161,231, FILED 9-5-2002.

FIRST USE 11-13-2001; IN COMMERCE 11-13-2001.

BARBARA GAYNOR, EXAMINING ATTORNEY

Int. Cl.: 3

Prior U.S. Cls.: 1, 4, 6, 50, 51 and 52

Reg. No. 2,893,110

United States Patent and Trademark Office

Registered Oct. 12, 2004

**TRADEMARK
PRINCIPAL REGISTER**

liquid lift

GRAHAM WEBB INTERNATIONAL, INC. (DE-
LAWARE CORPORATION)
5823 NEWTON DRIVE
CARLSBAD, CA 90017

NO CLAIM IS MADE TO THE EXCLUSIVE
RIGHT TO USE "LIQUID", APART FROM THE
MARK AS SHOWN.

FOR: HAIR ROOT AMPLIFIERS, NAMELY, HAIR
SPRAYS, IN CLASS 3 (U.S. CLS. 1, 4, 6, 50, 51 AND 52).

SER. NO. 78-166,044, FILED 9-19-2002.

FIRST USE 12-2-2002; IN COMMERCE 12-2-2002.

FLORENTINA BLANDU, EXAMINING ATTORNEY

Int. Cl.: 14

Prior U.S. Cls.: 2, 27, 28 and 50

United States Patent and Trademark Office

Reg. No. 2,893,111

Registered Oct. 12, 2004

**TRADEMARK
PRINCIPAL REGISTER**

ARNOLD & SON

THE BRITISH MASTERS SA (SWITZERLAND
CORPORATION)
AVENUE LEOPOLD-ROBERT 23
LA CHAUX-DE-FONDS, SWITZERLAND CH-2300

FOR: HOROLOGICAL AND CHRONOMETRIC
INSTRUMENTS, NAMELY, WATCHES, CHRON-
OMETERS, CHRONOGRAPHS, CHRONOSCOPES,
MARINE WATCHES, MARINE CHRONOMETERS ,
IN CLASS 14 (U.S. CLS. 2, 27, 28 AND 50).

FIRST USE 4-30-1997; IN COMMERCE 12-8-1998.

OWNER OF U.S. REG. NO. 2,007,546.

SEC. 2(F) AS TO "ARNOLD".

SER. NO. 78-167,683, FILED 9-25-2002.

WILLIAM BRECKENFELD, EXAMINING ATTOR-
NEY

Int. Cl.: 14

Prior U.S. Cls.: 2, 27, 28 and 50

United States Patent and Trademark Office

Reg. No. 2,893,112

Registered Oct. 12, 2004

TRADEMARK
PRINCIPAL REGISTER

ARNOLD
·1764·
&SON

THE BRITISH MASTERS SA (SWITZERLAND
CORPORATION)
AVENUE LEOPOLD-ROBERT 23
LA CHAUX-DE-FONDS, SWITZERLAND CH-2300

FOR: HOROLOGICAL AND CHRONOMETRIC
INSTRUMENTS, NAMELY WATCHES, CHRONOM-
ETERS, CHRONOGRAPHS, CHRONOSCOPES,
MARINE WATCHES, MARINE CHRONOMETERS,
IN CLASS 14 (U.S. CLS. 2, 27, 28 AND 50).

FIRST USE 4-30-1997; IN COMMERCE 12-8-1998.

OWNER OF U.S. REG. NO. 2,007,546.

SEC. 2(F) AS TO "ARNOLD".

SER. NO. 78-167,757, FILED 9-25-2002.

WILLIAM BRECKENFELD, EXAMINING ATTOR-
NEY

Int. Cl.: 11

Prior U.S. Cls.: 13, 21, 23, 31 and 34

United States Patent and Trademark Office

Reg. No. 2,893,113

Registered Oct. 12, 2004

**TRADEMARK
PRINCIPAL REGISTER**

ULTRA HEATWAVE

SEARS BRANDS, LLC (ILLINOIS LIMITED LIABILITY COMPANY)
3333 BEVERLY ROAD
B6-363B
HOFFMAN ESTATES, IL 60179

FOR: TEMPERATURE CONTROL FEATURE AS A COMPONENT PART IN MICROWAVE OVENS, NAMELY A COMBINATION OF THERMAL ENERGY AND A VARIABLE POWERED MICROWAVE

FOR COOKING FOOD, IN CLASS 11 (U.S. CLS. 13, 21, 23, 31 AND 34).

FIRST USE 4-1-2003; IN COMMERCE 4-1-2003.

OWNER OF U.S. REG. NO. 2,647,033.

SER. NO. 78-168,832, FILED 9-27-2002.

LAVERNE THOMPSON, EXAMINING ATTORNEY

Int. Cl.: 35

Prior U.S. Cls.: 100, 101 and 102

United States Patent and Trademark Office

Reg. No. 2,893,114

Registered Oct. 12, 2004

**SERVICE MARK
PRINCIPAL REGISTER**

AGResearch

GABRIEL, DAVID (UNITED STATES INDIVIDUAL)
6908 SAUCON VALLEY DRIVE
FORT WORTH, TX 76132

FOR: EXECUTIVE PLACEMENT RESEARCH FOR OTHERS; EMPLOYMENT RECRUITING AND PLACEMENT SERVICES FOR OTHERS; AND RESEARCH FOR OTHERS REGARDING COMPETITORS IN THE MARKET PLACE, NAMELY,

COMPETITIVE INTELLIGENCE, IN CLASS 35 (U.S. CLS. 100, 101 AND 102).

FIRST USE 7-10-2002; IN COMMERCE 7-10-2002.

SER. NO. 78-169,881, FILED 10-1-2002.

GLENN CLARK, EXAMINING ATTORNEY

Int. Cl.: 9

Prior U.S. Cls.: 21, 23, 26, 36 and 38

United States Patent and Trademark Office

Reg. No. 2,893,115

Registered Oct. 12, 2004

**TRADEMARK
PRINCIPAL REGISTER**

DIGISIX

GOSSEN FOTO- U. LICHTMEßTECHNIK
GMBH (FED REP GERMANY CORPORATION)
LINA-AMMON-STRASSE 22
NURNBERG, FED REP GERMANY 90471

PRIORITY CLAIMED UNDER SEC. 44(D) ON FED
REP GERMANY APPLICATION NO. 30218248.9,
FILED 4-11-2002, REG. NO. 30218248, DATED 4-26-
2002, EXPIRES 4-30-2012.

FOR: EXPOSURE METER FOR PHOTOGRAPHIC
DEVICES AND PURPOSES; EXPOSURE METER
FOR PHOTOGRAPHIC DEVICES AND PURPOSES,
IN CLASS 9 (U.S. CLS. 21, 23, 26, 36 AND 38).

SER. NO. 78-170,246, FILED 10-2-2002.

DARRYL SPRUILL, EXAMINING ATTORNEY

Int. Cl.: 5

Prior U.S. Cls.: 6, 18, 44, 46, 51 and 52

Reg. No. 2,893,116

United States Patent and Trademark Office

Registered Oct. 12, 2004

**TRADEMARK
PRINCIPAL REGISTER**

**Nature's
Breeze** 

OSCAR HOME CARE, INC. (CALIFORNIA COR-
PORATION)
4142 PACIFIC PRIVADO
ONTARIO, CA 91761

FIRST USE 8-7-2002; IN COMMERCE 8-7-2002.

SER. NO. 78-170,364, FILED 10-2-2002.

FOR: AIR DEODORANT, IN CLASS 5 (U.S. CLS. 6,
18, 44, 46, 51 AND 52).

DOMINIC J. FERRAIUOLO, EXAMINING ATTOR-
NEY

Int. Cl.: 12

Prior U.S. Cls.: 19, 21, 23, 31, 35 and 44

United States Patent and Trademark Office

Reg. No. 2,893,117

Registered Oct. 12, 2004

**TRADEMARK
PRINCIPAL REGISTER**

RHINELANDER BOAT COMPANY

SCHNELL, DAVID J. (UNITED STATES INDIVIDUAL)
PO BOX 29
BOULDER JUNCTION, WI 54512

NO CLAIM IS MADE TO THE EXCLUSIVE RIGHT TO USE BOAT COMPANY, APART FROM THE MARK AS SHOWN.

FOR: ROW BOATS, CANOES, ROWING SHELLS AND SCULLS, AND PARTS AND ACCESSORIES THEREFOR; NAMELY, PADDLES, OARS, BOAT SEATS, AND CANOE SEATS , IN CLASS 12 (U.S. CLS. 19, 21, 23, 31, 35 AND 44).

SER. NO. 78-170,828, FILED 10-3-2002.

FIRST USE 1-1-1996; IN COMMERCE 1-1-1996.

DOMINIC J. FERRAIUOLO, EXAMINING ATTORNEY

Int. Cl.: 9

Prior U.S. Cls.: 21, 23, 26, 36 and 38

Reg. No. 2,893,118

United States Patent and Trademark Office

Registered Oct. 12, 2004

**TRADEMARK
PRINCIPAL REGISTER**

SPIRITED GREEN

OCULAR SCIENCES, INC. (DELAWARE COR-
PORATION)
1855 GATEWAY BOULEVARD, SUITE 700
CONCORD, CA 94520

NO CLAIM IS MADE TO THE EXCLUSIVE
RIGHT TO USE GREEN, APART FROM THE MARK
AS SHOWN.

FOR: CONTACT LENSES, IN CLASS 9 (U.S. CLS.
21, 23, 26, 36 AND 38).

SER. NO. 78-173,074, FILED 10-10-2002.

FIRST USE 12-20-2002; IN COMMERCE 12-20-2002.

BRIAN BROWN, EXAMINING ATTORNEY

Int. Cl.: 16

Prior U.S. Cls.: 2, 5, 22, 23, 29, 37, 38 and 50

United States Patent and Trademark Office

Reg. No. 2,893,119

Registered Oct. 12, 2004

TRADEMARK
PRINCIPAL REGISTER



CASCARINO'S PIZZA EXPRESS, LTD. (NEW
YORK CORPORATION)
14-60 COLLEGE POINT BOULEVARD
COLLEGE POINT, NY 11356

FOR: PIZZA BOXES MADE OF CARDBOARD;
PAPER CARTONS FOR FOOD; PAPER NAPKINS;
PAPER PLACE MATS; PRINTED MENUS; PAPER
LABELS; COUPONS, IN CLASS 16 (U.S. CLS. 2, 5, 22,
23, 29, 37, 38 AND 50).

FIRST USE 4-1-2002; IN COMMERCE 4-1-2002.

OWNER OF U.S. REG. NO. 2,461,377.

NO CLAIM IS MADE TO THE EXCLUSIVE
RIGHT TO USE PIZZA EXPRESS, APART FROM
THE MARK AS SHOWN.

SER. NO. 78-173,100, FILED 10-10-2002.

AISHA CLARKE, EXAMINING ATTORNEY

Int. Cl.: 6

Prior U.S. Cls.: 2, 12, 13, 14, 23, 25 and 50

United States Patent and Trademark Office

Reg. No. 2,893,120

Registered Oct. 12, 2004

**TRADEMARK
PRINCIPAL REGISTER**

CYMAT SMARTMETAL

CYMAT CORP. (CANADA CORPORATION)
6320 DANVILLE ROAD
UNIT 2
MISSISSAUGA, ONTARIO, CANADA L5T 2L7

PRIORITY CLAIMED UNDER SEC. 44(D) ON
CANADA APPLICATION NO. 1152636, FILED 9-13-
2002, REG. NO. TMA589211, DATED 9-9-2003, EX-
PIRES 9-9-2018.

FOR: STABILIZED ALUMINUM FOAM IN THE
FORM OF BARS, PANELS AND SHAPES FOR USE
IN MANUFACTURING, IN CLASS 6 (U.S. CLS. 2, 12,
13, 14, 23, 25 AND 50).

SER. NO. 78-174,146, FILED 10-14-2002.

DARRYL SPRUILL, EXAMINING ATTORNEY

Int. Cl.: 18

Prior U.S. Cls.: 1, 2, 3, 22 and 41

United States Patent and Trademark Office

Reg. No. 2,893,121

Registered Oct. 12, 2004

TRADEMARK
PRINCIPAL REGISTER

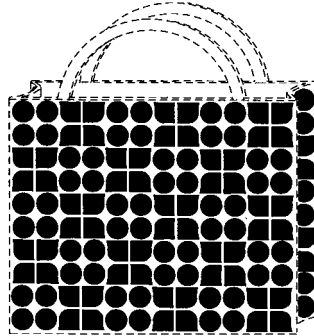

KATE SPADE, LLC (NEW YORK LIMITED LIABILITY COMPANY)
48 WEST 25TH STREET - 4TH FLOOR
NEW YORK, NY 10010

FOR: LUGGAGE, HANDBAGS, TOTE BAGS, DUFFEL BAGS, SACHELS, DIAPER BAGS, WALLETS, CREDIT CARD CASES, KEY CASES, BUSINESS CARD CASES, COSMETIC BAGS SOLD EMPTY, IN CLASS 18 (U.S. CLS. 1, 2, 3, 22 AND 41).

FIRST USE 7-0-2001; IN COMMERCE 7-0-2001.

NO CLAIM IS MADE TO THE EXCLUSIVE RIGHT TO USE THE OVERALL SHAPE OF THE

BAG AS SHOWN IN THE DRAWING BY BROKEN LINES, APART FROM THE MARK AS SHOWN.

THE MARK CONSISTS OF A REPETITIVE PATTERN OF A STYLIZED VERSION OF THE LETTERS "KS". THE MATERIAL IN THE DOTTED LINES IS USED TO SHOW POSITIONING OF THE MARK AND IS NOT PART OF THE MARK.

SEC. 2(F).

SER. NO. 78-174,847, FILED 10-16-2002.

TONI HICKEY, EXAMINING ATTORNEY

Int. Cl.: 9

Prior U.S. Cls.: 21, 23, 26, 36 and 38

Reg. No. 2,893,122

United States Patent and Trademark Office

Registered Oct. 12, 2004

**TRADEMARK
PRINCIPAL REGISTER**

WORXAUDIO

SARVIS, HUGH JR. (UNITED STATES INDIVIDUAL), DBA WORXAUDIO
620 SOUTH ELM STREET
SUITE 315
GREENSBORO, NC 27406

FIRST USE 6-0-2001; IN COMMERCE 6-0-2001.

SER. NO. 78-175,503, FILED 10-17-2002.

FOR: AUDIO SPEAKERS, IN CLASS 9 (U.S. CLS. 21, 23, 26, 36 AND 38).

MATTHEW PAPPAS, EXAMINING ATTORNEY

Int. Cl.: 7

Prior U.S. Cls.: 13, 19, 21, 23, 31, 34 and 35

United States Patent and Trademark Office

Reg. No. 2,893,123

Registered Oct. 12, 2004

**TRADEMARK
PRINCIPAL REGISTER**

SHUTTLELINE

UNAXIS BALZERS AG (LIECHTENSTEIN PUBLIC LIMITED LIABILITY COMPANY)
(NONE)
9496 BALZERS, LIECHTENSTEIN

FOR: PROCESS MODULES, NAMELY PLASMA REACTORS, WAFER PROCESSING MODULES, SEMICONDUCTOR WAFER PROCESS MODULES, SEMICONDUCTOR PROCESS MODULES KNOWN AS ETCH PROCESS MODULES, AND DEPOSITION PROCESS MODULES FOR SEMI-CONDUCTOR FABRICATION PROCESSING SUCH AS SPUTTERING, CHEMICAL VAPOR DEPOSITION, PLASMA ENHANCED CHEMICAL VAPOR DEPOSITION,

DRY ETCHING AND RAPID THERMAL ANNEALING, IN CLASS 7 (U.S. CLS. 13, 19, 21, 23, 31, 34 AND 35).

PRIORITY CLAIMED UNDER SEC. 44(D) ON LIECHTENSTEIN APPLICATION NO. 12649, FILED 9-24-2002, REG. NO. 12649, DATED 12-5-2002, EXPIRES 9-24-2012.

SER. NO. 78-178,075, FILED 10-24-2002.

LINDA ESTRADA, EXAMINING ATTORNEY

Int. Cl.: 7

Prior U.S. Cls.: 13, 19, 21, 23, 31, 34 and 35

United States Patent and Trademark Office

Reg. No. 2,893,124

Registered Oct. 12, 2004

**TRADEMARK
PRINCIPAL REGISTER**

VERSALINE

UNAXIS BALZERS AG (LIECHTENSTEIN PUBLIC LIMITED LIABILITY COMPANY)
9496 BALZERS, LIECHTENSTEIN

FOR: PROCESS MODULES, NAMELY PLASMA REACTORS, WAFER PROCESSING MODULES, SEMICONDUCTOR WAFER PROCESS MODULES, SEMICONDUCTOR PROCESS MODULES KNOWN AS ETCH PROCESS MODULES, AND DEPOSITION PROCESS MODULES FOR SEMI-CONDUCTOR FABRICATION PROCESSING SUCH AS SPUTTERING, CHEMICAL VAPOR DEPOSITION, PLASMA ENHANCED CHEMICAL VAPOR DEPOSITION,

DRY ETCHING AND RAPID THERMAL ANNEALING, IN CLASS 7 (U.S. CLS. 13, 19, 21, 23, 31, 34 AND 35).

PRIORITY CLAIMED UNDER SEC. 44(D) ON LIECHTENSTEIN APPLICATION NO. 12648, FILED 9-24-2002, REG. NO. 12648, DATED 12-5-2002, EXPIRES 9-24-2012.

SER. NO. 78-178,079, FILED 10-24-2002.

LINDA ESTRADA, EXAMINING ATTORNEY

Int. Cls.: 35 and 37

Prior U.S. Cls.: 100, 101, 102, 103 and 106

United States Patent and Trademark Office

Reg. No. 2,893,125

Registered Oct. 12, 2004

**SERVICE MARK
PRINCIPAL REGISTER**



PRECISION COMMUNICATION SERVICES, INC.
(FLORIDA CORPORATION)
7710 N. 30TH STREET
TAMPA, FL 33610

FOR: RETAIL SERVICES FEATURING TELEPHONES AND TELEPHONE EQUIPMENT AND PARTS AND ACCESSORIES THEREOF PROVIDED ONLINE AND BY WAY OF OTHER ADVERTISING MATERIALS, IN CLASS 35 (U.S. CLS. 100, 101 AND 102).

FIRST USE 1-1-1982; IN COMMERCE 1-1-1982.

FOR: MAINTENANCE AND REPAIR OF TELEPHONE EQUIPMENT AND PARTS AND ACCESSORIES THEREOF, IN CLASS 37 (U.S. CLS. 100, 103 AND 106).

FIRST USE 1-1-1982; IN COMMERCE 1-1-1982.

OWNER OF U.S. REG. NO. 2,125,836.

NO CLAIM IS MADE TO THE EXCLUSIVE RIGHT TO USE "PCS" AND "COMMUNICATIONS", APART FROM THE MARK AS SHOWN.

THE LINING IS A FEATURE OF THE MARK AND DOES NOT INDICATE COLOR.

SER. NO. 78-178,118, FILED 10-24-2002.

CAROL SPILS, EXAMINING ATTORNEY

Int. Cl.: 19

Prior U.S. Cls.: 1, 12, 33 and 50

United States Patent and Trademark Office

Reg. No. 2,893,126

Registered Oct. 12, 2004

**TRADEMARK
PRINCIPAL REGISTER**

ISO-STAR

NORTH AMERICAN REFRACTORIES CO. (OHIO
CORPORATION)
CHERRINGTON CORPORATE CENTER
400 FAIRWAY DRIVE
MOON TOWNSHIP, PA 15108

FIRST USE 10-1-2002; IN COMMERCE 10-1-2002.

SER. NO. 78-180,094, FILED 10-30-2002.

FOR: REFRACTORY SHAPES, IN CLASS 19 (U.S.
CLS. 1, 12, 33 AND 50).

GLENN CLARK, EXAMINING ATTORNEY

Int. Cl.: 41

Prior U.S. Cls.: 100, 101 and 107

United States Patent and Trademark Office

Reg. No. 2,893,127

Registered Oct. 12, 2004

SERVICE MARK
PRINCIPAL REGISTER



JACOB BURNS FILM CENTER, INC. (NEW YORK CORPORATION)
39 WASHINGTON AVENUE
PLEASANTVILLE, NY 10570

FOR: EDUCATIONAL SERVICES, NAMELY, WORKSHOPS, CLASSES AND SEMINARS IN THE FIELD OF VISUAL LITERACY, CREATIVE WRITING, STORY TELLING, FILM-MAKING AND MOVIE PRODUCTION; ENTERTAINMENT SERVICES, NAMELY, SCREENING FILMS AND MOVIES FOR STUDENTS, IN CLASS 41 (U.S. CLS. 100, 101 AND 107).

FIRST USE 10-31-2002; IN COMMERCE 10-31-2002.

NO CLAIM IS MADE TO THE EXCLUSIVE RIGHT TO USE "CINE" OR "FILM CENTER", APART FROM THE MARK AS SHOWN.

THE NAME(S), PORTRAIT (S), AND/OR SIGNATURE (S) SHOWN IN THE MARK DOES NOT IDENTIFY A PARTICULAR LIVING INDIVIDUAL.

THE ENGLISH TRANSLATION OF "CINE" IS "CINEMA".

SER. NO. 78-181,506, FILED 11-4-2002.

RUDY R. SINGLETON, EXAMINING ATTORNEY

Int. Cl.: 9

Prior U.S. Cls.: 21, 23, 26, 36 and 38

Reg. No. 2,893,128

United States Patent and Trademark Office

Registered Oct. 12, 2004

**TRADEMARK
PRINCIPAL REGISTER**

SMPP

SMS FORUM LIMITED (IRELAND LTD LIAB JT
ST CO)
GARDNER HOUSE
WILTON PLACE
DUBLIN, IRELAND

ENCE GUIDES, PROTOCOL SPECIFICATIONS AND
GUIDELINES IN THE FIELD OF TEXT AND WIRE-
LESS MESSAGING COMMUNICATION, IN CLASS 9
(U.S. CLS. 21, 23, 26, 36 AND 38).

FOR: MULTIMEDIA SOFTWARE RECORDED
ON CD-ROM DISCS CONTAINING DATA, INFOR-
MATION AND DOCUMENTATION REGARDING
TEXT MESSAGING COMMUNICATION AND PRO-
TOCOLS, AND WIRELESS MESSAGING COMMU-
NICATIONS AND PROTOCOLS; DOWNLOADABLE
ELECTRONIC PUBLICATIONS AND DOCUMEN-
TATION IN THE NATURE OF NEWSLETTERS,
NEWS ARTICLES, RESEARCH ARTICLES, REFER-

PRIORITY CLAIMED UNDER SEC. 44(D) ON
ERPN CMNTY TM OFC APPLICATION NO.
2703684, FILED 5-15-2002, REG. NO. 2703684, DATED
9-9-2003, EXPIRES 5-15-2012.

SER. NO. 78-181,852, FILED 11-5-2002.

CYNTHIA SLOAN, EXAMINING ATTORNEY

Int. Cls.: 35 and 40

Prior U.S. Cls.: 100, 101, 102, 103 and 106

United States Patent and Trademark Office

Reg. No. 2,893,129

Registered Oct. 12, 2004

**SERVICE MARK
PRINCIPAL REGISTER**

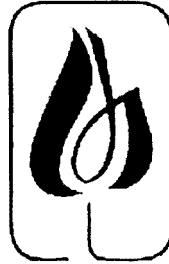

Liên Hương

LIEN HUONG UNIT (VIETNAM COMPANY)
111 PASTEUR, WARD 6, DISTRICT 3
HO CHI MINH CITY, VIETNAM

FOR: RETAIL FABRIC AND CLOTHING STORES,
IN CLASS 35 (U.S. CLS. 100, 101 AND 102).

FOR: CUTTING OF CLOTH, IN CLASS 40 (U.S.
CLS. 100, 103 AND 106).

OWNER OF VIETNAM REG. NO. 51385, DATED
12-12-2003, EXPIRES 9-11-2012.

THE NAME LIEN HUONG DOES NOT IDENTIFY
A LIVING INDIVIDUAL.

SER. NO. 78-183,060, FILED 11-8-2002.

MARIA-VICTORIA SUAREZ, EXAMINING ATTOR-
NEY

Int. Cl.: 9

Prior U.S. Cls.: 21, 23, 26, 36 and 38

Reg. No. 2,893,130

United States Patent and Trademark Office

Registered Oct. 12, 2004

**TRADEMARK
PRINCIPAL REGISTER**

PEAK PERFORMANCE LOCATED

TALAMONTI, PHILIP (UNITED STATES INDIVIDUAL)
174 PURPLE SLATE PLACE
THE WOODLANDS, TX 77381

FOR: ANALYSIS OF TUBES AND SHAFTS TO DETERMINE STATIC AND DYNAMIC CHARACTERISTICS, ESPECIALLY FOR SPORTING AND RECREATIONAL USES, INCLUDING GOLF AND

FISHING, IN CLASS 9 (U.S. CLS. 21, 23, 26, 36 AND 38).

FIRST USE 4-21-2002; IN COMMERCE 4-21-2002.

SER. NO. 78-186,166, FILED 11-18-2002.

DOMINIC J. FERRAIUOLO, EXAMINING ATTORNEY

Int. Cl.: 20

Prior U.S. Cls.: 2, 13, 22, 25, 32 and 50

Reg. No. 2,893,131

United States Patent and Trademark Office

Registered Oct. 12, 2004

**TRADEMARK
PRINCIPAL REGISTER**



HOWELL-WAKEFIELD CORPORATION (WIS-
CONSIN CORPORATION)

1500 WEST ST. PAUL AVENUE
MILWAUKEE, WI 53201

FOR: EDUCATIONAL FURNITURE, NAMELY,
CHAIRS, DESK-CHAIR COMBINATIONS, UNIT

DESKS, AND TABLET ARMCHAIRS, IN CLASS 20
(U.S. CLS. 2, 13, 22, 25, 32 AND 50).

FIRST USE 5-18-1988; IN COMMERCE 5-18-1988.

SER. NO. 78-189,126, FILED 11-26-2002.

RON FAIRBANKS, EXAMINING ATTORNEY

Int. Cl.: 25

Prior U.S. Cls.: 22 and 39

United States Patent and Trademark Office

Reg. No. 2,893,132

Registered Oct. 12, 2004

TRADEMARK
PRINCIPAL REGISTER



ALPHA UNLIMITED (PARTNERSHIP)
4019 VIA REBECCA
LANCASTER, CA 93536

FOR: FASHION APPAREL FOR MEN, WOMEN, JUNIORS, CHILDREN AND INFANTS, NAMELY EMBROIDERED SHIRTS, SHORTS, SWEATSHIRTS, SWEATPANTS, JEANS, JERSEYS, SKIRTS, DRESSES, WARM-UP SUITS; SWIMWEAR, NAMELY SWIMSUITS, BEACH COVER-UPS, SARONGS; OUTERWEAR, NAMELY JACKETS, SWEATERS, VESTS,

SUITS, SPORT COATS, COATS; HEADWEAR, NAMELY HEAD BANDS, EMBROIDERED BASEBALL CAPS, BANDANNAS; ACCESSORIES, NAMELY SCARVES, BELTS, TIES, GLOVES, IN CLASS 25 (U.S. CLS. 22 AND 39).

FIRST USE 3-19-2002; IN COMMERCE 4-16-2002.

SER. NO. 78-190,220, FILED 12-2-2002.

ROBIN CHOSID, EXAMINING ATTORNEY

Int. Cl.: 6

Prior U.S. Cls.: 2, 12, 13, 14, 23, 25 and 50

United States Patent and Trademark Office

Reg. No. 2,893,133

Registered Oct. 12, 2004

**TRADEMARK
PRINCIPAL REGISTER**

MDC INTELLIGENT STIRRUPS

COHEN, MARTIN, DAVID (UNITED STATES
INDIVIDUAL)
122 MONTEREY AVENUE
PACIFIC GROVE, CA 93950

NO CLAIM IS MADE TO THE EXCLUSIVE
RIGHT TO USE "STIRRUPS", APART FROM THE
MARK AS SHOWN.

FOR: ENGLISH RIDING STIRRUPS MADE OF
METAL, IN CLASS 6 (U.S. CLS. 2, 12, 13, 14, 23, 25
AND 50).

SER. NO. 78-190,248, FILED 12-2-2002.

FIRST USE 11-25-2002; IN COMMERCE 11-25-2002.

ROBIN CHOSID, EXAMINING ATTORNEY

Int. Cl.: 7

Prior U.S. Cls.: 13, 19, 21, 23, 31, 34 and 35

United States Patent and Trademark Office

Reg. No. 2,893,134

Registered Oct. 12, 2004

**TRADEMARK
PRINCIPAL REGISTER**

PRO LINE

HYDRO TEK SYSTEMS,INC (CALIFORNIA CORPORATION)
10418 ENTERPRISE DRIVE
REDLANDS, CA 92374

FIRST USE 12-20-1996; IN COMMERCE 1-1-1997.

SER. NO. 78-190,267, FILED 12-2-2002.

FOR: MACHINES-NAMELY COLD OR HOT WATER PORTABLE, TOWABLE, OR STATIONARY HIGH PRESSURE WASHERS, GAS OR ELECTRIC POWERED, IN CLASS 7 (U.S. CLS. 13, 19, 21, 23, 31, 34 AND 35).

APRIL L. RADEMACHER, EXAMINING ATTORNEY

Int. Cl.: 35

Prior U.S. Cls.: 100, 101 and 102

United States Patent and Trademark Office

Reg. No. 2,893,135

Registered Oct. 12, 2004

**SERVICE MARK
PRINCIPAL REGISTER**



Sino-American Pharmaceutical Professionals Association

SINO-AMERICAN PHARMACEUTICAL PROFESSIONALS ASSOCIATION (NEW YORK INCORPORATED ASSOCIATION)

3 MANDARIN LANE
WEST NYACK, NY 10994

FOR: ASSOCIATION SERVICES NAMELY, PROMOTING THE INTEREST OF THE PHARMACEUTICAL SCIENCE, THE BIOMEDICAL AND BIOTECHNOLOGY COMMUNITY, THE HEALTH PROFESSION, AND THE INTERESTS OF THE PUBLIC HEALTH, IN CLASS 35 (U.S. CLS. 100, 101 AND 102).

FIRST USE 8-1-1999; IN COMMERCE 8-1-1999.

NO CLAIM IS MADE TO THE EXCLUSIVE RIGHT TO USE THE CHINESE CHARACTERS,

WHICH TRANSLATED INTO ENGLISH MEAN SINO-AMERICAN PHARMACEUTICAL ASSOCIATION, APART FROM THE MARK AS SHOWN.

THE CHINESE CHARACTERS FIRST ROW FROM LEFT TO RIGHT TRANSLITERATE AS "MEI" MEANS "AMERICAN OR AMERICA" AND "ZHONG" MEANS "CHINESE, CHINA, OR SINO". SECOND ROW FROM LEFT TO RIGHT TRANSLITERATE AS "YAO" MEANS "PHARMACEUTICAL, OR PHARMACEUTICS" AND "XIE" MEANS "ASSOCIATION".

SER. NO. 78-191,575, FILED 12-5-2002.

JOHN HWANG, EXAMINING ATTORNEY

Int. Cl.: 38

Prior U.S. Cls.: 100, 101 and 104

United States Patent and Trademark Office

Reg. No. 2,893,136

Registered Oct. 12, 2004

**SERVICE MARK
PRINCIPAL REGISTER**



TENNESSEE INDEPENDENT TELECOMMUNI-
CATIONS GROUP, LLC (TENNESSEE LTD
LIAB CO)
211 COMMERCE STREET, SUITE 610
NASHVILLE, TN 37201

NO CLAIM IS MADE TO THE EXCLUSIVE
RIGHT TO USE "NETWORKS", APART FROM
THE MARK AS SHOWN.

FOR: TELECOMMUNICATIONS SERVICES,
NAMELY, PROVIDING FIBER OPTIC NETWORK
SERVICES, IN CLASS 38 (U.S. CLS. 100, 101 AND 104).

SER. NO. 78-193,532, FILED 12-11-2002.

FIRST USE 11-16-2001; IN COMMERCE 12-28-2001.

BRENDAN REGAN, EXAMINING ATTORNEY

Int. Cl.: 11

Prior U.S. Cls.: 13, 21, 23, 31 and 34

United States Patent and Trademark Office

Reg. No. 2,893,137

Registered Oct. 12, 2004

**TRADEMARK
PRINCIPAL REGISTER**

FLOATRON

FLOATRON, INC. (ARIZONA CORPORATION)
P.O. BOX 51000
PHOENIX, AZ 85076

FIRST USE 2-1-1989; IN COMMERCE 2-1-1989.

FOR: UNITS FOR PURIFYING, CONDITIONING
OR SOFTENING WATER UTILIZING ELECTRICAL
MEANS, IN CLASS 11 (U.S. CLS. 13, 21, 23, 31 AND
34).

SER. NO. 78-195,187, FILED 12-17-2002.

JOHN GARTNER, EXAMINING ATTORNEY

Int. Cls.: 5 and 10

Prior U.S. Cls.: 6, 18, 26, 39, 44, 46, 51 and 52

United States Patent and Trademark Office

Reg. No. 2,893,138

Registered Oct. 12, 2004

**TRADEMARK
PRINCIPAL REGISTER**

ZOLADEX SAFESYSTEM

ASTRAZENECA UK LIMITED (UNITED KING-
DOM LTD LIAB JT ST CO)
15 STANHOPE GATE
W1Y 6LN, UNITED KINGDOM

FOR: PHARMACEUTICAL PREPARATIONS
AND SUBSTANCES FOR USE IN CANCER THER-
APY, IN CLASS 5 (U.S. CLS. 6, 18, 44, 46, 51 AND 52).

FOR: MEDICAL APPARATUS AND INSTRU-
MENTS, NAMELY, MEDICAL DEVICES FOR SUB-
CUTANEOUS AND/OR INTRA-MUSCULAR INJEC-
TION OF PHARMACEUTICAL PREPARATIONS, IN
CLASS 10 (U.S. CLS. 26, 39 AND 44).

PRIORITY CLAIMED UNDER SEC. 44(D) ON
UNITED KINGDOM APPLICATION NO. 2316618,
FILED 11-25-2002, REG. NO. 2316618, DATED 5-16-
2003, EXPIRES 11-25-2012.

OWNER OF U.S. REG. NOS. 1,402,790 AND
1,624,402.

SER. NO. 78-195,770, FILED 12-18-2002.

BRENDAN REGAN, EXAMINING ATTORNEY

Int. Cl.: 31

Prior U.S. Cls.: 1 and 46

United States Patent and Trademark Office

Reg. No. 2,893,139

Registered Oct. 12, 2004

TRADEMARK
PRINCIPAL REGISTER

Sweet Bells 

JUNGPFLANZEN GRÜNEWALD GMBH (FED
REP GERMANY CORPORATION)
KOCHSTRASSE 6
SELM, FED REP GERMANY D-59379

FOR: NATURAL AGRICULTURAL PRODUCTS,
NAMELY, LIVE PLANTS AND NATURAL FLOW-
ERS, IN CLASS 31 (U.S. CLS. 1 AND 46).

PRIORITY CLAIMED UNDER SEC. 44(D) ON FED
REP GERMANY APPLICATION NO. 30257170.1,

FILED 11-21-2002, REG. NO. 30257170, DATED 3-13-
2003, EXPIRES 11-30-2012.

NO CLAIM IS MADE TO THE EXCLUSIVE
RIGHT TO USE SWEET BELLS, APART FROM
THE MARK AS SHOWN.

SER. NO. 78-196,690, FILED 12-20-2002.

HOWARD B. LEVINE, EXAMINING ATTORNEY

Int. Cls.: 16, 25, 32, 33, 35 and 43

Prior U.S. Cls.: 2, 5, 22, 23, 29, 37, 38, 39, 45, 46, 47, 48, 49, 50, 100, 101 and 102

Reg. No. 2,893,140

United States Patent and Trademark Office

Registered Oct. 12, 2004

**TRADEMARK
SERVICE MARK
PRINCIPAL REGISTER**

COOL ONE

FIB GMBH (SWITZERLAND CORPORATION)
WEIDENWEG 215
CH-3902 GLIS, SWITZERLAND

FOR: PRINTED PAPER SIGNS; PRINTED CARDBOARD SIGNS; POSTERS; PHOTOGRAPHS; GRAPHIC ART REPRODUCTIONS, IN CLASS 16 (U.S. CLS. 2, 5, 22, 23, 29, 37, 38 AND 50).

FOR: FOOTWEAR; HEADWEAR; CLOTHING, NAMELY, SPORT SHOES, TRACK SUITS, TRACK SUIT TROUSERS, T-SHIRTS, SWEAT SHIRTS, SWEAT PANTS, SWEAT SHORTS, SWEATERS, SWEATSOCKS, SWEAT BANDS, SPORT SHIRTS, UNDER SHIRTS, KNIT SHIRTS, POLO SHIRTS, GOLF SHIRTS, ATHLETIC SHOES, CAPS AND SPORT COATS, IN CLASS 25 (U.S. CLS. 22 AND 39).

FOR: DRINKING WATERS, MINERAL AND AERATED WATERS, IN CLASS 32 (U.S. CLS. 45, 46 AND 48).

FOR: ALCOHOLIC BEVERAGES, NAMELY, ALCOHOLIC FRUIT DRINKS AND JUICES; ALCOHOLIC TEA-BASED BEVERAGES, IN CLASS 33 (U.S. CLS. 47 AND 49).

FOR: DISSEMINATION OF ADVERTISING MATTER FOR OTHERS; PRODUCT DEMONSTRATION OF GOODS FOR OTHERS; DISTRIBUTION OF SAMPLES OF ALCOHOLIC FRUIT DRINKS AND FRUIT JUICES FOR OTHERS; ORGANIZING AND CONDUCTING EXHIBITIONS FOR THE PURPOSE OF PROMOTING THE GOODS AND SERVICES OF OTHERS IN THE BEVERAGE AND FOOD SERVICES INDUSTRIES, IN CLASS 35 (U.S. CLS. 100, 101 AND 102).

FOR: SERVICES OF PROVIDING FOOD AND DRINKS, NAMELY, OPERATING RESTAURANTS, SNACK-BARS, SELF-SERVICE RESTAURANTS, CANTEEN SERVICES, CAFES AND CAFETERIAS; PROVIDING TEMPORARY HOUSING ACCOMMODATIONS FOR OTHERS, IN CLASS 43 (U.S. CLS. 100 AND 101).

PRIORITY CLAIMED UNDER SEC. 44(D) ON SWITZERLAND APPLICATION NO. 05085/2002, FILED 8-6-2002, REG. NO. 505874, DATED 8-6-2002, EXPIRES 8-6-2012.

SER. NO. 78-197,475, FILED 12-23-2002.

CYNTHIA SLOAN, EXAMINING ATTORNEY

Int. Cls.: 16, 25, 32, 33, 35 and 43

Prior U.S. Cls.: 2, 5, 22, 23, 29, 37, 38, 39, 45, 46, 47, 48, 49, 50, 100, 101 and 102

Reg. No. 2,893,141

United States Patent and Trademark Office

Registered Oct. 12, 2004

**TRADEMARK
SERVICE MARK
PRINCIPAL REGISTER**



FIB GMBH (SWITZERLAND CORPORATION)
WEIDENWEG 215
CH-3902 GLIS, SWITZERLAND

FOR: PRINTED PAPER SIGNS; PRINTED CARDBOARD SIGNS; POSTERS; PHOTOGRAPHS; GRAPHIC ART REPRODUCTIONS, IN CLASS 16 (U.S. CLS. 2, 5, 22, 23, 29, 37, 38 AND 50).

FOR: FOOTWEAR; HEADWEAR; CLOTHING, NAMELY, SPORT SHOES, TRACK SUITS, TRACK SUIT TROUSERS, T-SHIRTS, SWEAT SHIRTS, SWEAT PANTS, SWEAT SHORTS, SWEATERS, SWEATSOCKS, SWEAT BANDS, SPORT SHIRTS, UNDER SHIRTS, KNIT SHIRTS, POLO SHIRTS, GOLF SHIRTS, ATHLETIC SHOES, CAPS AND SPORT COATS, IN CLASS 25 (U.S. CLS. 22 AND 39).

FOR: DRINKING WATERS, MINERAL AND AERATED WATERS, IN CLASS 32 (U.S. CLS. 45, 46 AND 48).

FOR: ALCOHOLIC BEVERAGES, NAMELY, ALCOHOLIC FRUIT DRINKS AND JUICES; ALCOHOLIC TEA-BASED BEVERAGES, IN CLASS 33 (U.S. CLS. 47 AND 49).

FOR: DISSEMINATION OF ADVERTISING MATTER FOR OTHERS; PRODUCT DEMONSTRATION OF GOODS FOR OTHERS; DISTRIBUTION OF SAMPLES OF ALCOHOLIC FRUIT DRINKS AND FRUIT JUICES FOR OTHERS; ORGANIZING AND CONDUCTING EXHIBITIONS FOR THE PURPOSE OF PROMOTING THE GOODS AND SERVICES OF OTHERS IN THE BEVERAGE AND FOOD SERVICE INDUSTRIES, IN CLASS 35 (U.S. CLS. 100, 101 AND 102).

FOR: SERVICES OF PROVIDING FOOD AND DRINKS, NAMELY, OPERATING RESTAURANTS, SNACK-BARS, SELF-SERVICE RESTAURANTS, CANTEEN SERVICES, CAFES AND CAFETERIAS; PROVIDING TEMPORARY HOUSING ACCOMMODATIONS FOR OTHERS, IN CLASS 43 (U.S. CLS. 100 AND 101).

PRIORITY CLAIMED UNDER SEC. 44(D) ON SWITZERLAND APPLICATION NO. 06852/2002, FILED 8-6-2002, REG. NO. 506232, DATED 8-6-2002, EXPIRES 8-6-2012.

SER. NO. 78-197,573, FILED 12-23-2002.

ANDREA K. NADELMAN, EXAMINING ATTORNEY

Int. Cl.: 41

Prior U.S. Cls.: 100, 101 and 107

United States Patent and Trademark Office

Reg. No. 2,893,142

Registered Oct. 12, 2004

**SERVICE MARK
PRINCIPAL REGISTER**

CIGAR CATERING

CIGARFLAVORS.COM, INC. (NEW YORK COR-
PORATION)
1070 MANOR RD
STATEN ISLAND, NY 10314

NO CLAIM IS MADE TO THE EXCLUSIVE
RIGHT TO USE "CATERING", APART FROM THE
MARK AS SHOWN.

FOR: ENTERTAINMENT IN THE NATURE OF
CIGAR ROLLING DEMONSTRATIONS FOR EN-
TERTAINMENT PURPOSES, IN CLASS 41 (U.S. CLS.
100, 101 AND 107).

SER. NO. 78-198,673, FILED 12-30-2002.

FIRST USE 7-21-2001; IN COMMERCE 7-21-2001.

ROBERT COGGINS, EXAMINING ATTORNEY

Int. Cl.: 41

Prior U.S. Cls.: 100, 101 and 107

United States Patent and Trademark Office

Reg. No. 2,893,143

Registered Oct. 12, 2004

**SERVICE MARK
PRINCIPAL REGISTER**

**TRULY MOVING PICTURES AWARD OF EXCELLENCE
HEARTLAND FILM FESTIVAL**

HEARTLAND FILM FESTIVAL, INC. (INDIANA
NON PROFIT CORPORATION)
200 S. MERIDIAN ST., SUITE 220
INDIANAPOLIS, IN 462251076

FOR: EDUCATIONAL AND ENTERTAINMENT
SERVICES, NAMELY, ORGANIZING AND CON-
DUCTING FILM FESTIVALS, IN CLASS 41 (U.S.
CLS. 100, 101 AND 107).

FIRST USE 9-1-2001; IN COMMERCE 9-1-2001.

OWNER OF U.S. REG. NOS. 2,092,804 AND
2,588,434.

NO CLAIM IS MADE TO THE EXCLUSIVE
RIGHT TO USE "MOVING PICTURE", "AWARD
OF EXCELLENCE" AND "FILM FESTIVAL",
APART FROM THE MARK AS SHOWN.

SER. NO. 78-198,979, FILED 12-31-2002.

JEFF DEFORD, EXAMINING ATTORNEY

Int. Cl.: 17

Prior U.S. Cls.: 1, 5, 12, 13, 35 and 50

United States Patent and Trademark Office

Reg. No. 2,893,144

Registered Oct. 12, 2004

**TRADEMARK
PRINCIPAL REGISTER**

ACTONBOND

ACTON TECHNOLOGIES, INC. (PENNSYLVANIA CORPORATION)
100 THOMPSON STREET
PITTSTON, PA 18640

FIRST USE 3-1-2002; IN COMMERCE 3-1-2002.

SER. NO. 78-201,035, FILED 1-8-2003.

FOR: SUPPORTED AND UNSUPPORTED ADHESIVE FILM FOR INDUSTRIAL OR COMMERCIAL USE, IN CLASS 17 (U.S. CLS. 1, 5, 12, 13, 35 AND 50).

MICHAEL SOUDERS, EXAMINING ATTORNEY

Int. Cl.: 9

Prior U.S. Cls.: 21, 23, 26, 36 and 38

Reg. No. 2,893,145

United States Patent and Trademark Office

Registered Oct. 12, 2004

**TRADEMARK
PRINCIPAL REGISTER**

ZONDERVAN

ZONDERVAN CORPORATION, THE (MICHIGAN CORPORATION)
5300 PATTERSON SOUTHEAST
GRAND RAPIDS, MI 49530

FIRST USE 7-31-2000; IN COMMERCE 7-31-2000.

OWNER OF U.S. REG. NO. 1,369,913.

FOR: PRE-RECORDED AUDIO TAPES, CD'S, VIDEOTAPES AND DVD'S ON A VARIETY OF TOPICS, NAMELY, FICTION AND NON-FICTION WITH RELIGIOUS AND SPIRITUAL THEMES , IN CLASS 9 (U.S. CLS. 21, 23, 26, 36 AND 38).

SER. NO. 78-201,500, FILED 1-9-2003.

DAVID C. REIHNER, EXAMINING ATTORNEY

Int. Cl.: 3

Prior U.S. Cls.: 1, 4, 6, 50, 51 and 52

United States Patent and Trademark Office

Reg. No. 2,893,146

Registered Oct. 12, 2004

**TRADEMARK
PRINCIPAL REGISTER**

CAPTURE R60/80

PARFUMS CHRISTIAN DIOR (FRANCE CORPORATION)
33 AVENUE HOCHÉ
75008 PARIS, FRANCE

FOR: SKIN CREAMS, EYE CREAMS, NIGHT CREAMS, WRINKLE REMOVING SKIN CARE PREPARATIONS, IN CLASS 3 (U.S. CLS. 1, 4, 6, 50, 51 AND 52).

PRIORITY CLAIMED UNDER SEC. 44(D) ON FRANCE APPLICATION NO. 02/3176966, FILED 7-

24-2002, REG. NO. 023176966, DATED 7-24-2002, EXPIRES 7-24-2012.

OWNER OF U.S. REG. NO. 1,805,712.

SER. NO. 78-201,595, FILED 1-9-2003.

ALEXANDER L. POWERS, EXAMINING ATTORNEY

Int. Cl.: 41

Prior U.S. Cls.: 100, 101 and 107

United States Patent and Trademark Office

Reg. No. 2,893,147

Registered Oct. 12, 2004

**SERVICE MARK
PRINCIPAL REGISTER**

AMA U.S. SUPERSPORT CHAMPIONSHIP

AMERICAN MOTORCYCLIST ASSOCIATION
(OHIO CORPORATION)
13515 YARMOUTH DRIVE
PICKERINGTON, OH 43147

OWNER OF U.S. REG. NOS. 2,063,162, 2,652,027
AND OTHERS.

FOR: ENTERTAINMENT IN THE NATURE OF
PROFESSIONAL MOTORCYCLE RACING EVENTS
AND FUNCTIONS; OFFICIATING AT PROFES-
SIONAL MOTORCYCLE RACING EVENTS; AND
RULE MAKING FOR PROFESSIONAL MOTOR-
CYCLE RACING, IN CLASS 41 (U.S. CLS. 100, 101
AND 107).

NO CLAIM IS MADE TO THE EXCLUSIVE
RIGHT TO USE "U.S. SUPERSPORT CHAMPION-
SHIP", APART FROM THE MARK AS SHOWN.

SER. NO. 78-202,434, FILED 1-13-2003.

FIRST USE 1-1-2003; IN COMMERCE 1-1-2003.

ROBERT COGGINS, EXAMINING ATTORNEY

Int. Cl.: 20

Prior U.S. Cls.: 2, 13, 22, 25, 32 and 50

United States Patent and Trademark Office

Reg. No. 2,893,148

Registered Oct. 12, 2004

**TRADEMARK
PRINCIPAL REGISTER**

GARASTOR

TAYLOR WOODROW DEVELOPMENTS LIMITED (UNITED KINGDOM LIMITED LIABILITY JOINT STOCK COMPANY)
2 PRINCES WAY
SOLIHULL
WEST MIDLANDS, UNITED KINGDOM B91 3ES

FOR: NON-METAL WATER STORAGE TANKS AND NON-METAL WATER DRAIN PIPES FOR USE IN THE CHANNELING AND COLLECTION OF FLOOD WATER AND PARTS AND ATTACH-

MENTS THEREFORE, IN CLASS 20 (U.S. CLS. 2, 13, 22, 25, 32 AND 50).

PRIORITY CLAIMED UNDER SEC. 44(D) ON UNITED KINGDOM APPLICATION NO. 2305338, FILED 7-16-2002, REG. NO. 2305338, DATED 7-16-2002, EXPIRES 7-16-2012.

SER. NO. 78-203,373, FILED 1-15-2003.

JEFF DEFORD, EXAMINING ATTORNEY

Int. Cl.: 41

Prior U.S. Cls.: 100, 101 and 107

United States Patent and Trademark Office

Reg. No. 2,893,149

Registered Oct. 12, 2004

**SERVICE MARK
PRINCIPAL REGISTER**

S P R U C E  E V E N T S

SPRUCE EVENT CONSULTING, INC. (ILLINOIS CORPORATION)

3918 NORTH SOUTHPORT AVENUE
CHICAGO, IL 60613

FOR: SPECIAL EVENT PLANNING CONSULTATION, IN CLASS 41 (U.S. CLS. 100, 101 AND 107).

FIRST USE 10-1-2002; IN COMMERCE 10-1-2002.

OWNER OF U.S. REG. NOS. 2,736,765 AND 2,750,418.

NO CLAIM IS MADE TO THE EXCLUSIVE RIGHT TO USE "EVENTS", APART FROM THE MARK AS SHOWN.

SER. NO. 78-203,396, FILED 1-15-2003.

GLENN CLARK, EXAMINING ATTORNEY

Int. Cls.: 12, 16, 26 and 35

Prior U.S. Cls.: 2, 5, 19, 21, 22, 23, 29, 31, 35, 37, 38,
39, 40, 42, 44, 50, 100, 101 and 102

Reg. No. 2,893,150

United States Patent and Trademark Office

Registered Oct. 12, 2004

TRADEMARK
SERVICE MARK
PRINCIPAL REGISTER



WOOD MANUFACTURING COMPANY, INC.
(ARKANSAS CORPORATION)
HIGHWAY 178 NORTH
P.O. BOX 179
FLIPPIN, AR 72634

FOR: BOATS AND STRUCTURAL PARTS
THEREFORE, IN CLASS 12 (U.S. CLS. 19, 21, 23, 31,
35 AND 44).

FIRST USE 7-2-1999; IN COMMERCE 7-2-1999.

FOR: BOAT DECALS, IN CLASS 16 (U.S. CLS. 2, 5,
22, 23, 29, 37, 38 AND 50).

FIRST USE 7-2-1999; IN COMMERCE 7-2-1999.

FOR: EMBROIDERED CLOTHING PATCHES, IN
CLASS 26 (U.S. CLS. 37, 39, 40, 42 AND 50).

FIRST USE 7-2-1999; IN COMMERCE 7-2-1999.

FOR: PROMOTING THE FISHING TOURNA-
MENTS OF OTHERS, IN CLASS 35 (U.S. CLS. 100,
101 AND 102).

FIRST USE 7-2-1999; IN COMMERCE 7-2-1999.

NO CLAIM IS MADE TO THE EXCLUSIVE
RIGHT TO USE "CUP", APART FROM THE MARK
AS SHOWN.

SER. NO. 78-203,531, FILED 1-15-2003.

HOWARD B. LEVINE, EXAMINING ATTORNEY

Int. Cl.: 35

Prior U.S. Cls.: 100, 101 and 102

United States Patent and Trademark Office

Reg. No. 2,893,151

Registered Oct. 12, 2004

**SERVICE MARK
PRINCIPAL REGISTER**

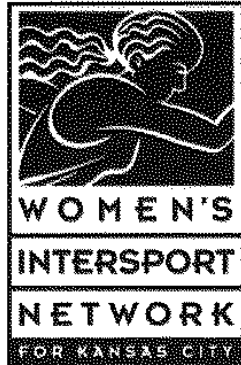

GREATER KANSAS CITY SPORTS COMMISSION, THE (MISSOURI NOTFOR PROFIT CORPORATION)
1308 PENNSYLVANIA AVE
KANSAS CITY, MO 64105

FOR: PROMOTING PUBLIC AWARENESS OF THE NEED FOR PARTICIPATION IN AND SUPPORT OF WOMEN'S SPORTS AND/OR PROMOTING WOMEN'S SPORTING EVENTS OF OTHERS, IN CLASS 35 (U.S. CLS. 100, 101 AND 102).

FIRST USE 2-28-2000; IN COMMERCE 2-28-2000.

NO CLAIM IS MADE TO THE EXCLUSIVE RIGHT TO USE "WOMEN'S" AND "NETWORK FOR KANSAS CITY", APART FROM THE MARK AS SHOWN.

THE MARK CONSISTS OF A DRAWING OF A WOMAN ATHLETE.

SER. NO. 78-203,577, FILED 1-15-2003.

HOWARD B. LEVINE, EXAMINING ATTORNEY

Int. Cl.: 11

Prior U.S. Cls.: 13, 21, 23, 31 and 34

United States Patent and Trademark Office

Reg. No. 2,893,152

Registered Oct. 12, 2004

**TRADEMARK
PRINCIPAL REGISTER**

HULA LA

WEST, ANNIKA, MARIE (UNITED STATES IN-
DIVIDUAL)
3225 BENDA PLACE
LOS ANGELES, CA 90068

FIRST USE 1-12-2002; IN COMMERCE 10-2-2002.

SER. NO. 78-203,581, FILED S.R. 1-15-2003 AM. P.R.
4-26-2004.

FOR: HAWAIIAN LAMP, IN CLASS 11 (U.S. CLS.
13, 21, 23, 31 AND 34).

HOWARD B. LEVINE, EXAMINING ATTORNEY

Int. Cl.: 9

Prior U.S. Cls.: 21, 23, 26, 36 and 38

Reg. No. 2,893,153

United States Patent and Trademark Office

Registered Oct. 12, 2004

**TRADEMARK
PRINCIPAL REGISTER**



DEKORRA OPTICS, LLC (WISCONSIN CORPORATION)
N5040 BEACH GARDEN RD
POYNETTE, WI 53955

NO CLAIM IS MADE TO THE EXCLUSIVE RIGHT TO USE "EASY DRAW", APART FROM THE MARK AS SHOWN.

FOR: COMPUTER GRAPHICS SOFTWARE, IN CLASS 9 (U.S. CLS. 21, 23, 26, 36 AND 38).

SER. NO. 78-203,739, FILED 1-15-2003.

FIRST USE 11-13-2002; IN COMMERCE 1-7-2003.

H. M. FISHER, EXAMINING ATTORNEY

Int. Cl.: 3

Prior U.S. Cls.: 1, 4, 6, 50, 51 and 52

United States Patent and Trademark Office

Reg. No. 2,893,154

Registered Oct. 12, 2004

**TRADEMARK
PRINCIPAL REGISTER**

PHYTOCYANE

CASTER (FRANCE CORPORATION)
35, AVENUE FRANKLIN ROOSEVELT
75008 PARIS, FRANCE

FOR: HAIR SHAMPOOS AND NON-MEDICATED
HAIR SERUM CONTAINED IN AMPOULES, IN-
TENDED TO PREVENT THINNING HAIR, IN
CLASS 3 (U.S. CLS. 1, 4, 6, 50, 51 AND 52).

FIRST USE 3-0-1992; IN COMMERCE 1-0-1994.

OWNER OF FRANCE REG. NO. 207629, DATED
10-14-1996, EXPIRES 10-14-2006.

OWNER OF U.S. REG. NO. 2,096,341.

SER. NO. 78-204,055, FILED 1-16-2003.

KARLA PERKINS, EXAMINING ATTORNEY

Int. Cl.: 41

Prior U.S. Cls.: 100, 101 and 107

United States Patent and Trademark Office

Reg. No. 2,893,155

Registered Oct. 12, 2004

**SERVICE MARK
PRINCIPAL REGISTER**

Health  Expo

HEALTH EDUCATION LIFESTYLE PROGRAMS,
INC. (CALIFORNIA CORPORATION)
445 HAWTHORNE RD.
COLFAX, CA 95713

NO CLAIM IS MADE TO THE EXCLUSIVE
RIGHT TO USE "HEALTH" AND "EXPO", APART
FROM THE MARK AS SHOWN.

FOR: ARRANGING AND CONDUCTING EDU-
CATIONAL CONFERENCES, NAMELY HEALTH
EDUCATION EXPOSITIONS, IN CLASS 41 (U.S.
CLS. 100, 101 AND 107).

SER. NO. 78-204,915, FILED 1-19-2003.

FIRST USE 7-9-1982; IN COMMERCE 7-9-1982.

STANLEY I. OSBORNE, EXAMINING ATTORNEY

Int. Cl.: 36

Prior U.S. Cls.: 100, 101 and 102

United States Patent and Trademark Office

Reg. No. 2,893,156

Registered Oct. 12, 2004

**SERVICE MARK
PRINCIPAL REGISTER**

F.N.B. WEALTH MANAGEMENT

FIRST NATIONAL BANKSHARES OF FLORIDA,
INC. (FLORIDA CORPORATION)
2150 GOODLETTE ROAD, NORTH
NAPLES, FL 34102

FOR: BANKING SERVICES; FINANCIAL SERVICES IN THE NATURE OF AN INVESTMENT SECURITY; FINANCIAL INFORMATION IN THE NATURE OF RATES OF EXCHANGE, FINANCIAL EXCHANGE, FINANCIAL FORECASTING AND FINANCIAL GUARANTEE AND SURETY; FINANCIAL INFORMATION PROVIDED BY ELECTRONIC MEANS; FINANCIAL MANAGEMENT; FINANCIAL PLANNING; FINANCIAL PORTFOLIO MANAGEMENT; FINANCIAL RESEARCH; FINANCIAL VALUATION OF PERSONAL PROPERTY AND REAL ESTATE; LOAN FINANCING; LEASE-PURCHASE FINANCING; FINANCING SERVICES; INVESTMENT SERVICES, NAMELY INVESTMENT BROKERAGE; CAPITAL INVESTMENT CONSULTATION; COMMODITY INVESTMENT ADVICE; FUND INVESTMENT CONSULTATION; INVESTMENT CONSULTATION; FINANCIAL INVESTMENT IN THE FIELD OF SECURITIES; FUNDS INVESTMENT; MUTUAL FUNDS INVESTMENT; REAL ESTATE INVESTMENT; COMMODITY INVESTMENT ADVICE; INVESTMENT ADVICE; INVESTMENT BROKERAGE; INVESTMENT CLUBS; CAPITAL INVESTMENT CONSULTATION; INVESTMENT MANAGEMENT; MAINTAINING ESCROW ACCOUNTS FOR INVESTMENTS; INVESTMENT OF FUNDS FOR OTHERS; INSURANCE SERVICES, NAMELY INSURANCE UNDERWRITING, BROKERAGE AND EXTENDED WARRANTY CONTRACTS IN THE FIELDS OF LIFE, HEALTH, ACCIDENT, FIRE, MARINE, MED-

ICAL AND PRE-PAID HEALTH CARE AND LEGAL SERVICES; INSURANCE ADMINISTRATION IN THE FIELD OF LIFE, HEALTH, ACCIDENT, FIRE, MARINE, MEDICAL AND PRE-PAID HEALTH CARE AND LEGAL SERVICES; INSURANCE AGENCIES IN THE FIELDS OF LIFE, HEALTH, ACCIDENT, FIRE, MARINE, MEDICAL AND PRE-PAID HEALTH CARE AND LEGAL SERVICES; APPRAISALS FOR INSURANCE CLAIMS OF PERSONAL PROPERTY AND REAL ESTATE; INSURANCE BROKERAGE, CONSULTATION, SUBROGATION AND ACTUARIAL SERVICES IN THE FIELDS OF LIFE, HEALTH, ACCIDENT, FIRE, MARINE, MEDICAL AND PRE-PAID HEALTH CARE AND LEGAL SERVICES; DEBIT CARD SERVICES; CREDIT CARD SERVICES; ELECTRONIC INTERACTIVE BANKING SERVICES; INTERNET BANKING SERVICES; SAFETY DEPOSIT BOX SERVICES; AND INFORMATION SERVICES FOR ALL FOR THE FOREGOING PROVIDED VIA A GLOBAL COMPUTER NETWORK, IN CLASS 36 (U.S. CLS. 100, 101 AND 102).

FIRST USE 1-0-2003; IN COMMERCE 1-0-2003.

OWNER OF U.S. REG. NOS. 2,308,321, 2,685,150, AND 2,690,885.

NO CLAIM IS MADE TO THE EXCLUSIVE RIGHT TO USE "WEALTH MANAGEMENT", APART FROM THE MARK AS SHOWN.

SER. NO. 78-205,295, FILED 1-21-2003.

ANN E. SAPPENFIELD, EXAMINING ATTORNEY

Int. Cl.: 9

Prior U.S. Cls.: 21, 23, 26, 36 and 38

United States Patent and Trademark Office

Reg. No. 2,893,157

Registered Oct. 12, 2004

**TRADEMARK
PRINCIPAL REGISTER**

TRUESTORE

AGERE SYSTEMS INC. (DELAWARE CORPORATION)
555 UNION BOULEVARD
ALLENTOWN, PA 18109

FIRST USE 8-21-2003; IN COMMERCE 8-21-2003.

SER. NO. 78-207,244, FILED 1-27-2003.

FOR: INTEGRATED CIRCUITS, IN CLASS 9 (U.S. CLS. 21, 23, 26, 36 AND 38).

NANCY CLARKE, EXAMINING ATTORNEY

Int. Cl.: 25

Prior U.S. Cls.: 22 and 39

United States Patent and Trademark Office

Reg. No. 2,893,158

Registered Oct. 12, 2004

TRADEMARK
PRINCIPAL REGISTER



PELLA PRODUCTS, INC. (IOWA CORPORATION)
835 BROADWAY
PELLA, IA 50219

FOR: CLOTHING, NAMELY PANTS, BIB OVERALLS, JACKETS, PARKAS, GLOVES, MITTENS AND HATS, IN CLASS 25 (U.S. CLS. 22 AND 39).

FIRST USE 1-15-2003; IN COMMERCE 1-15-2003.

NO CLAIM IS MADE TO THE EXCLUSIVE RIGHT TO USE "PELLA", "QUALITY APPAREL SINCE 1907", OR "PELLA IOWA, USA", APART FROM THE MARK AS SHOWN.

SER. NO. 78-207,489, FILED 1-27-2003.

STEVEN R. FINE, EXAMINING ATTORNEY

Int. Cl.: 35

Prior U.S. Cls.: 100, 101 and 102

United States Patent and Trademark Office

Reg. No. 2,893,159

Registered Oct. 12, 2004

SERVICE MARK
PRINCIPAL REGISTER



OMAHA STEAKS INTERNATIONAL, INC. (NE-
BRASKA CORPORATION)
11030 "O" STREET
OMAHA, NE 68137

FOR: RETAIL FOOD STORE SERVICES, IN
CLASS 35 (U.S. CLS. 100, 101 AND 102).

FIRST USE 12-19-2002; IN COMMERCE 12-19-2002.

OWNER OF U.S. REG. NOS. 1,674,686, 2,140,390
AND OTHERS.

NO CLAIM IS MADE TO THE EXCLUSIVE
RIGHT TO USE PREMIUM, QUALITY, STEAKS
AND STORES, APART FROM THE MARK AS
SHOWN.

THE COLORS BURGUNDY AND WHITE IS/ARE
CLAIMED AS A DISTINCTIVE FEATURE OF THE
MARK.

THE COLOR BURGUNDY APPEARS IN THE
TWO RECTANGULAR BOXES OF THE MARK AS
WELL AS IN THE WORDS PREMIUM HEARTLAND
QUALITY. THE COLOR WHITE APPEARS IN THE
BANNER PORTION OF THE MARK AS WELL AS IN
THE WORDS OMAHA STEAKS STORES.

SEC. 2(F) AS TO "OMAHA".

SER. NO. 78-207,757, FILED 1-28-2003.

ELISSA GARBER KON, EXAMINING ATTORNEY

Int. Cl.: 35

Prior U.S. Cls.: 100, 101 and 102

United States Patent and Trademark Office

Reg. No. 2,893,160

Registered Oct. 12, 2004

**SERVICE MARK
PRINCIPAL REGISTER**



PARAGON ASSET GROUP LLC (TEXAS LTD
LIAB CO)
915 FRANKLIN STREET, SUITE 4H
HOUSTON, TX 77002

FIRST USE 12-5-2002; IN COMMERCE 12-5-2002.

FOR: BUSINESS MANAGEMENT SERVICES FOR
COMPANIES INVESTING IN, OWNING, OR OPER-
ATING ASSETS USED IN THE PRODUCTION,
TRANSPORTATION, PROCESSING AND CONVER-
SION OF ENERGY, IN CLASS 35 (U.S. CLS. 100, 101
AND 102).

NO CLAIM IS MADE TO THE EXCLUSIVE
RIGHT TO USE ASSET GROUP LLC, APART FROM
THE MARK AS SHOWN.

SER. NO. 78-208,687, FILED 1-30-2003.

KARLA PERKINS, EXAMINING ATTORNEY

Int. Cl.: 12

Prior U.S. Cls.: 19, 21, 23, 31, 35 and 44

United States Patent and Trademark Office

Reg. No. 2,893,161

Registered Oct. 12, 2004

**TRADEMARK
PRINCIPAL REGISTER**

BODYBAR

AQUA FUN, INC. (ILLINOIS CORPORATION)
506 CLARK AVENUE
SCALES MOUND, IL 61075

AND OTHER ATTACHMENTS, IN CLASS 12 (U.S.
CLS. 19, 21, 23, 31, 35 AND 44).

FIRST USE 5-3-2001; IN COMMERCE 5-3-2001.

FOR: RAFT ACCESSORY IN THE NATURE OF
AN ATTACHMENT WHICH FITS ON THE EDGE OF
A RAFT FOR USE IN HOLDING CUPS, COOLERS

SER. NO. 78-209,633, FILED 1-31-2003.

PAULA MAYS, EXAMINING ATTORNEY

Int. Cl.: 36

Prior U.S. Cls.: 100, 101 and 102

United States Patent and Trademark Office

Reg. No. 2,893,162

Registered Oct. 12, 2004

**SERVICE MARK
PRINCIPAL REGISTER**

SHAREBUILDER BUILD YOUR FUTURE

NETSTOCK CORPORATION (WASHINGTON
CORPORATION)
1000 124TH AVENUE N.E.
BELLEVUE, WA 98005

FOR: BROKERAGE IN THE FIELD OF STOCKS,
NAMELY, FACILITATING THE PURCHASE AND
SALES OF EQUITIES VIA INTERNET, IN CLASS 36
(U.S. CLS. 100, 101 AND 102).

FIRST USE 1-29-2001; IN COMMERCE 1-29-2001.

OWNER OF U.S. REG. NO. 2,488,646.

SER. NO. 78-209,739, FILED 1-31-2003.

GEORGIA CARTY, EXAMINING ATTORNEY

Int. Cl.: 9

Prior U.S. Cls.: 21, 23, 26, 36 and 38

Reg. No. 2,893,163

United States Patent and Trademark Office

Registered Oct. 12, 2004

**TRADEMARK
PRINCIPAL REGISTER**

SHADOW NETWORKSPACE

CURATORS OF THE UNIVERSITY OF MISSOURI (MISSOURI CORPORATION)
227 UNIVERSITY HALL
COLUMBIA, MO 65211

FOR: SOFTWARE THAT ALLOWS SCHOOLS AND LEARNING COMMUNITIES TO ESTABLISH AN INTRANET WORK SPACE, FEATURING DISCUSSION BOARDS, E-MAIL, MESSENGER SYSTEMS AND WEB-BASED DOCUMENT VIEWERS AND EDITORS, IN CLASS 9 (U.S. CLS. 21, 23, 26, 36 AND 38).

FIRST USE 12-1-2000; IN COMMERCE 12-1-2000.

NO CLAIM IS MADE TO THE EXCLUSIVE RIGHT TO USE NETWORKSPACE, APART FROM THE MARK AS SHOWN.

SER. NO. 78-210,072, FILED 2-3-2003.

BRIAN BROWN, EXAMINING ATTORNEY

Int. Cl.: 2

Prior U.S. Cls.: 6, 11 and 16

United States Patent and Trademark Office

Reg. No. 2,893,164

Registered Oct. 12, 2004

**TRADEMARK
PRINCIPAL REGISTER**



POWCHEM CO.,LTD.

POWCHEM CO., LTD. (REPUBLIC OF KOREA
LIMITED LIABILITY COMPANY OF THE RE-
PUBLIC OF KOREA)

#681-2 SUNGGOK-DONG, DANWON-GU,
ANSAN-CITY, KYUNGKI-DO., REPUBLIC OF KOR-
EA

FOR: CHEMICAL RESISTING PAINTS; FIRE-
PROOF PAINTS; VARNISHES; PUTTIES FOR COAT-
ING; LACQUERS; WATERPROOF PAINTS;
BACTERICIDAL PAINTS; DISTEMPERS; ALUMI-
NUM PAINTS; AND ENAMELS IN THE NATURE
OF HOUSE PAINT, IN CLASS 2 (U.S. CLS. 6, 11 AND
16).

PRIORITY CLAIMED UNDER SEC. 44(D) ON
REPUBLIC OF KOREA APPLICATION NO.
200236125, FILED 8-7-2002, REG. NO. 574532, DATED
2-13-2004, EXPIRES 2-13-2014.

NO CLAIM IS MADE TO THE EXCLUSIVE
RIGHT TO USE "CO., LTD", APART FROM THE
MARK AS SHOWN.

SER. NO. 78-210,439, FILED 2-4-2003.

CHERYL CLAYTON, EXAMINING ATTORNEY

Int. Cl.: 25

Prior U.S. Cls.: 22 and 39

United States Patent and Trademark Office

Reg. No. 2,893,165

Registered Oct. 12, 2004

**TRADEMARK
PRINCIPAL REGISTER**

DELTA XI PHI MULTICULTURAL SORORITY, INC.

DELTA XI PHI MULTICULTURAL SORORITY,
INC. (ILLINOIS CORPORATION)
525 NORTH 20TH ST. APT. 214
MILWAUKEE, WI 93233

NO CLAIM IS MADE TO THE EXCLUSIVE
RIGHT TO USE "MULTICULTURAL SORORITY,
INC.", APART FROM THE MARK AS SHOWN.

FOR: CLOTHING, NAMELY, SHIRTS, T-SHIRTS,
PANTS, HEADWEAR, HATS, JACKETS, IN CLASS 25
(U.S. CLS. 22 AND 39).

SER. NO. 78-211,447, FILED 2-5-2003.

FIRST USE 4-20-1994; IN COMMERCE 4-20-1994.

CYNTHIA SLOAN, EXAMINING ATTORNEY

Int. Cls.: 1 and 31

Prior U.S. Cls.: 1, 5, 6, 10, 26 and 46

United States Patent and Trademark Office

Reg. No. 2,893,166

Registered Oct. 12, 2004

**TRADEMARK
PRINCIPAL REGISTER**

BANFE

BANFE SOIL & MULCH, INC. (NEW JERSEY CORPORATION)
145 BROADWAY
P.O. BOX 346
WESTVILLE, NJ 08093

FOR: POTTING SOIL, SOIL ADDITIVES, SOIL AMENDMENTS, SOIL CONDITIONERS, SOIL ENHANCERS, PREPARED SOILS, GROWING MEDIA, MANURE, GROWTH MEDIA, COMPOST, AND HUMUS, SOIL MADE FROM MUSHROOM GROWING MEDIA, AND SOIL MADE FROM LEAF WASTE, ALL FOR DOMESTIC, HORTICULTURAL, AGRICULTURAL AND PROFESSIONAL USE, IN CLASS 1 (U.S. CLS. 1, 5, 6, 10, 26 AND 46).

FIRST USE 3-31-1996; IN COMMERCE 3-31-1996.

FOR: LAWN AND GARDEN CARE PRODUCTS, SPECIFICALLY MULCH, BARK MULCH, HARDWOOD MULCH, CEDAR MULCH, COLORED MULCH, PLAYGROUND MULCH, TOP SOIL, ALL FOR DOMESTIC, HORTICULTURAL, AGRICULTURAL AND PROFESSIONAL USE, IN CLASS 31 (U.S. CLS. 1 AND 46).

FIRST USE 3-31-1996; IN COMMERCE 3-31-1996.

SEC. 2(F).

SER. NO. 78-211,744, FILED 2-6-2003.

JENNIFER KRISP, EXAMINING ATTORNEY

Int. Cl.: 37

Prior U.S. Cls.: 100, 103 and 106

United States Patent and Trademark Office

Reg. No. 2,893,167

Registered Oct. 12, 2004

SERVICE MARK
PRINCIPAL REGISTER

JUST SAFES

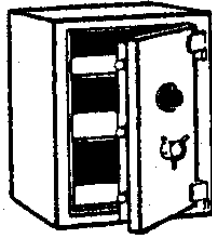

FERNANDEZ, ALBERTO (UNITED STATES IN-
DIVIDUAL)
446 CADENZA DRIVE
ORLANDO, FL 32807

NO CLAIM IS MADE TO THE EXCLUSIVE
RIGHT TO USE "SAFES", APART FROM THE
MARK AS SHOWN.

FOR: INSTALLATION, REPAIR AND MAINTEN-
ANCE OF SAFES, IN CLASS 37 (U.S. CLS. 100, 103
AND 106).

SER. NO. 78-212,722, FILED 2-10-2003.

FIRST USE 3-22-2001; IN COMMERCE 3-22-2001.

JAMES A. RAUEN, EXAMINING ATTORNEY

Int. Cl.: 42

Prior U.S. Cls.: 100 and 101

United States Patent and Trademark Office

Reg. No. 2,893,168

Registered Oct. 12, 2004

**SERVICE MARK
PRINCIPAL REGISTER**

LAW OFFICES OF SAM BERNSTEIN

LAW OFFICES OF SAM BERNSTEIN (MICHIGAN CORPORATION)
31100 NORTHWESTERN HWY.
FARMINGTON HILLS, MI 48334

FOR: LEGAL SERVICES, IN CLASS 42 (U.S. CLS. 100 AND 101).

FIRST USE 9-0-2000; IN COMMERCE 9-0-2000.

NO CLAIM IS MADE TO THE EXCLUSIVE RIGHT TO USE "LAW OFFICES", APART FROM THE MARK AS SHOWN.

THE NAME(S), PORTRAIT(S), AND/OR SIGNATURE(S) SHOWN IN THE MARK IDENTIFIES SAMUEL BERNSTEIN, WHOSE CONSENT(S) TO REGISTER IS SUBMITTED.

SER. NO. 78-216,322, FILED 2-19-2003.

ALLISON HOLTZ, EXAMINING ATTORNEY

Int. Cl.: 11

Prior U.S. Cls.: 13, 21, 23, 31 and 34

United States Patent and Trademark Office

Reg. No. 2,893,169

Registered Oct. 12, 2004

**TRADEMARK
PRINCIPAL REGISTER**

SILENT COMFORT

KAZ INCORPORATED (NEW YORK CORPORATION)
1775 BROADWAY, SUITE 2405
NEW YORK, NY 10019

FOR: PORTABLE ELECTRIC HEATERS AND AIR
FILTERS, IN CLASS 11 (U.S. CLS. 13, 21, 23, 31 AND
34).

FIRST USE 9-18-2000; IN COMMERCE 9-18-2000.

OWNER OF U.S. REG. NO. 2,191,271.

SER. NO. 78-216,441, FILED 2-19-2003.

HOWARD B. LEVINE, EXAMINING ATTORNEY

Int. Cl.: 7

Prior U.S. Cls.: 13, 19, 21, 23, 31, 34 and 35

United States Patent and Trademark Office

Reg. No. 2,893,170

Registered Oct. 12, 2004

**TRADEMARK
PRINCIPAL REGISTER**

FLUIDIC MUSCLE

FESTO AG & CO. (FED REP GERMANY KG)
RUITER STRASSE 82
ESSLINGEN, FED REP GERMANY D-73734

FOR: DRIVES OPERATED BY FLUID POWER,
NAMELY, PNEUMATIC AND HYDRAULIC AC-
TUATORS AND STRUCTURAL PARTS THERE-
FOR, EXCLUDING GEARS, IN CLASS 7 (U.S. CLS.
13, 19, 21, 23, 31, 34 AND 35).

OWNER OF FED REP GERMANY REG. NO.
39872209, DATED 1-11-1999, EXPIRES 12-31-2008.

NO CLAIM IS MADE TO THE EXCLUSIVE
RIGHT TO USE "FLUIDIC", APART FROM THE
MARK AS SHOWN.

SER. NO. 78-216,452, FILED 2-19-2003.

ANN LINNEHAN, EXAMINING ATTORNEY

Int. Cls.: 18 and 25

Prior U.S. Cls.: 1, 2, 3, 22, 39 and 41

United States Patent and Trademark Office

Reg. No. 2,893,171

Registered Oct. 12, 2004

**TRADEMARK
PRINCIPAL REGISTER**

SIDECAR

ALFRED DUNHILL LIMITED (UNITED KING-
DOM COMPANY)
30 DUKE STREET, ST. JAMES'S
LONDON, UNITED KINGDOM SW1Y 6DL

FOR: TRAVELING BAGS, UMBRELLAS, WALK-
ING STICKS, LUGGAGE, BAGS AND CASES,
NAMELY, CARRY ON BAGS, ALL PURPOSE ATH-
LETIC BAGS, FLIGHT BAGS, TOILETRY CASES
SOLD EMPTY; SHOOTING STICKS; BRIEFCASES,
ATTACHE CASES, DOCUMENT CASES; WALLETS,
HOLDALLS; POCHETTES, NAMELY, A HAND
HELD CARRYING CASE WITH COMPARTMENTS
FOR PENS, NOTEPADS, CALENDARS, MONEY,
CREDIT CARDS AND OTHER PERSONAL ITEMS;
SUIT BAGS, CREDIT CARD CASES; KEY CASES;
COIN PURSES, PARTS FOR ALL THE AFORESAID
GOODS, IN CLASS 18 (U.S. CLS. 1, 2, 3, 22 AND 41).

FOR: CLOTHING, NAMELY, JACKETS, SUITS,
SHIRTS, T-SHIRTS, POLO-SHIRTS, COATS,
SHORTS, TROUSERS, RAINWEAR, SWEATERS,
CARDIGANS, DRESSING GOWNS, SOCKS,
GLOVES, DRIVING GLOVES, BRACES, NAMELY,
SUSPENDERS; HEADWEAR, SCARVES, BELTS
AND TIES, IN CLASS 25 (U.S. CLS. 22 AND 39).

PRIORITY CLAIMED UNDER SEC. 44(D) ON
UNITED KINGDOM APPLICATION NO. 2317850,
FILED 12-5-2002, REG. NO. 2317850, DATED 7-18-
2003, EXPIRES 12-5-2012.

SER. NO. 78-217,408, FILED 2-21-2003.

CHERYL CLAYTON, EXAMINING ATTORNEY

Int. Cls.: 35 and 41

Prior U.S. Cls.: 100, 101, 102 and 107

United States Patent and Trademark Office

Reg. No. 2,893,172

Registered Oct. 12, 2004

SERVICE MARK
PRINCIPAL REGISTER

texcare

MESSE FRANKFURT GMBH (FED REP GERMA-
NY LIMITED LIABILITY JOINT STOCK COM-
PANY)

LUDWIG-ERHARD-ANLAGE 1
FRANKFURT AM MAIN, FED REP GERMANY
60327

FOR: PREPARING ADVERTISEMENTS FOR
OTHERS IN CONJUNCTION WITH ORGANIZING
FAIRS AND EXHIBITIONS; COOPERATIVE AD-
VERTISING AND MARKETING; BUSINESS MAN-
AGEMENT; PERSONNEL MANAGEMENT
CONSULTATION; ADMINISTRATION OF BUSI-
NESS PAYROLL FOR OTHERS; OFFICE SERVICES,
NAMELY, SECRETARIAL AND CLERICAL SERVI-
CES; RENTAL OF ADVERTISING SPACE; RENTAL
OF ADVERTISING DISPLAYS; PREPARING AD-
VERTISEMENTS FOR OTHERS, NAMELY, PRE-
PARING TRADE SHOW DISPLAYS AND
EXHIBITS; ORGANIZING FAIRS AND EXHIBI-
TIONS FOR COMMERCIAL AND ADVERTISING
PURPOSES IN THE FIELDS OF TEXTILE CLEAN-
ING, REFURBISHING, AND MAINTENANCE, IN
CLASS 35 (U.S. CLS. 100, 101 AND 102).

FIRST USE 1-1-1994; IN COMMERCE 1-1-1994.

FOR: EDUCATIONAL SERVICES, NAMELY,
CONDUCTING CLASSES, SEMINARS, AND CON-
FERENCES; ORGANIZING AND ARRANGING
CULTURAL AND EDUCATIONAL EXHIBITIONS,
IN CLASS 41 (U.S. CLS. 100, 101 AND 107).

FIRST USE 1-1-1994; IN COMMERCE 1-1-1994.

PRIORITY CLAIMED UNDER SEC. 44(D) ON FED
REP GERMANY APPLICATION NO. 30257105.1,
FILED 11-21-2002.

THE MARK CONSISTS OF THE LOWER CASE
LETTERS "TEXCARE" WITH A HORIZONTAL
SPACE RUNNING THROUGH THE CENTER OF
THE LETTER "X".

SER. NO. 78-217,726, FILED 2-21-2003.

ZACHARY BELLO, EXAMINING ATTORNEY

Int. Cl.: 7

Prior U.S. Cls.: 13, 19, 21, 23, 31, 34 and 35

United States Patent and Trademark Office

Reg. No. 2,893,173

Registered Oct. 12, 2004

**TRADEMARK
PRINCIPAL REGISTER**

CONE-HEAD

DYNAMIC MANUFACTURING CORPORATION
(MICHIGAN CORPORATION)
5059 W. WEIDMAN ROAD
WEIDMAN, MI 48893

FIRST USE 11-30-2001; IN COMMERCE 11-30-2001.

SER. NO. 78-218,103, FILED 2-24-2003.

FOR: POWER OPERATED WOOD REDUCING
TOOLS, NAMELY, CHIPPER AND SHREDDERS,
IN CLASS 7 (U.S. CLS. 13, 19, 21, 23, 31, 34 AND 35).

MARTHA FROMM, EXAMINING ATTORNEY

Int. Cl.: 3

Prior U.S. Cls.: 1, 4, 6, 50, 51 and 52

United States Patent and Trademark Office

Reg. No. 2,893,174

Registered Oct. 12, 2004

**TRADEMARK
PRINCIPAL REGISTER**

PHYTOKERATINE

CASTER (FRANCE CORPORATION)
35 AVENUE FRANKLIN ROOSEVELT
75008 PARIS, FRANCE

FOR: HAIR CARE PREPARATIONS, NAMELY,
LOTIONS WHICH FORM A PROTECTIVE SEAL
FOR THE HAIR, IN CLASS 3 (U.S. CLS. 1, 4, 6, 50, 51
AND 52).

FIRST USE 8-31-1997; IN COMMERCE 8-31-1997.

SEC. 2(F).

SER. NO. 78-218,750, FILED 2-25-2003.

VERNA BETH RIRIE, EXAMINING ATTORNEY

Int. Cl.: 5

Prior U.S. Cls.: 6, 18, 44, 46, 51 and 52

United States Patent and Trademark Office

Reg. No. 2,893,175

Registered Oct. 12, 2004

**TRADEMARK
PRINCIPAL REGISTER**

VETORYL

ARNOLDS VETERINARY PRODUCTS LIMITED
(UNITED KINGDOM CORPORATION)
UNIT 4 JAMAGE INDUSTRIAL ESTATE
JAMAGE ROAD STOKE-ON-TRENT
STAFFORDSHIRE, UNITED KINGDOM ST7 1XW

OWNER OF UNITED KINGDOM REG. NO.
1142130, DATED 10-17-1980, EXPIRES 10-17-2011.

SER. NO. 78-218,793, FILED 2-25-2003.

FOR: VETERINARY PREPARATIONS FOR THE
TREATMENT OF HYPERADRENOCORTICISM, IN
CLASS 5 (U.S. CLS. 6, 18, 44, 46, 51 AND 52).

APRIL L. RADEMACHER, EXAMINING ATTOR-
NEY

Int. Cls.: 9, 14 and 25

Prior U.S. Cls.: 2, 21, 22, 23, 26, 27, 28, 36, 38, 39 and 50

Reg. No. 2,893,176

United States Patent and Trademark Office

Registered Oct. 12, 2004

**TRADEMARK
PRINCIPAL REGISTER**

RAIDILLON

LE PLUS BEAU VIRAGE DU MONDE S.P.R.L.
(BELGIUM LIMITED LIABILITY JOINT
STOCK COMPANY)
AVENUE CLAIRE, 31
WATERLOO, BELGIUM B-1410

ARTICLES, NAMELY, COATS, JACKETS, PANTS,
FLIGHT SUITS AND RACING SUITS, NOT IN-
CLUDING PROTECTION SUITS; FOOTWEAR;
AND CAPS, IN CLASS 25 (U.S. CLS. 22 AND 39).

FOR: OPTICAL INSTRUMENTS, NAMELY, SPEC-
TACLES, SUNGLASSES; PIECES AND ACCESSOR-
IES FOR SPECTACLES, NAMELY, SPECTACLE
FRAMES, CASES AND OPTICAL GLASSES, IN
CLASS 9 (U.S. CLS. 21, 23, 26, 36 AND 38).

OWNER OF BENELUX REG. NO. 0696104, DATED
4-3-2001, EXPIRES 4-3-2011.

OWNER OF BENELUX REG. NO. 0715263, DATED
3-4-2002, EXPIRES 3-4-2012.

FOR: INGOTS OF PRECIOUS METALS AND
THEIR ALLOYS AND GOODS IN PRECIOUS ME-
TALS OR COATED THEREWITH, NAMELY, JEW-
ELRY, PRECIOUS STONES; AND HOROLOGICAL
AND CHRONOMETRIC INSTRUMENTS, IN CLASS
14 (U.S. CLS. 2, 27, 28 AND 50).

THE ENGLISH TRANSLATION OF THE WORD
RAIDILLON IN THE MARK IS ABRUPT PATH,
SHORT AND STEEP RISE IN A ROAD.

SER. NO. 78-218,971, FILED 2-26-2003.

FOR: ARTICLES OF CLOTHING, IN THE NAT-
URE OF LEATHER AND IMITATION LEATHER

MARK T. MULLEN, EXAMINING ATTORNEY

Int. Cl.: 14

Prior U.S. Cls.: 2, 27, 28 and 50

United States Patent and Trademark Office

Reg. No. 2,893,177

Registered Oct. 12, 2004

**TRADEMARK
PRINCIPAL REGISTER**

BELLA'ILLUSIONE

LOPRESTI, CYNTHIA (UNITED STATES INDIVIDUAL)
4375 WEST DESERT INN ROAD SUITE 315
LAS VEGAS, NV 89102

FOR: JEWELRY WITH SIMULATED GEMSTONES, NAMELY WHITE AND COLORED SIMULATED GEMSTONES, INCLUDING SIMULATED DIAMONDS, IN CLASS 14 (U.S. CLS. 2, 27, 28 AND 50).

FIRST USE 1-1-2002; IN COMMERCE 1-1-2002.

THE ENGLISH TRANSLATION OF "BELLA' ILLUSIONE" IS "BEAUTIFUL ILLUSION".

SER. NO. 78-220,081, FILED 2-28-2003.

MITCHELL FRONT, EXAMINING ATTORNEY

Int. Cl.: 36

Prior U.S. Cls.: 100, 101 and 102

United States Patent and Trademark Office

Reg. No. 2,893,178

Registered Oct. 12, 2004

**SERVICE MARK
PRINCIPAL REGISTER**



GLOBAL AFFILIATES, INC. (DELAWARE CORPORATION)
417 N. 8TH STREET, SUITE 502
PHILADELPHIA, PA 19123

FOR: ADMINISTRATION OF CORPORATE/ GROUP EMPLOYEE BENEFIT FITNESS CLUB MEMBERSHIP PROGRAMS, WHICH IS USED AT INDEPENDENTLY OWNED AND OPERATED FITNESS CLUBS , IN CLASS 36 (U.S. CLS. 100, 101 AND 102).

FIRST USE 9-1-2001, THE MARK WAS FIRST USED ANYWHERE IN A DIFFERENT FORM OTHER THAN THAT SOUGHT TO BE REGISTERED ON 02/01/1994.; IN COMMERCE 9-1-2001, THE MARK WAS FIRST USED IN

COMMERCE IN A DIFFERENT FORM OTHER THAN THAT SOUGHT TO BE REGISTERED ON 02/01/1994..

NO CLAIM IS MADE TO THE EXCLUSIVE RIGHT TO USE "FITNESS", APART FROM THE MARK AS SHOWN.

THE MARK CONSISTS OF A SWIRL/SEMI-OVAL AND A SOLID CIRCLE SUBSTITUTED FOR THE "O" IN THE WORD "GLOBALFIT".

SER. NO. 78-220,960, FILED 3-3-2003.

SAMUEL E. SHARPER JR., EXAMINING ATTORNEY

Int. Cls.: 41, 42 and 44

Prior U.S. Cls.: 100, 101 and 107

United States Patent and Trademark Office

Reg. No. 2,893,179

Registered Oct. 12, 2004

**SERVICE MARK
PRINCIPAL REGISTER**

LISTENING TO MOTHERS

MATERNITY CENTER ASSOCIATION (NEW YORK NOT-FOR-PROFIT CORPORATION)
281 PARK AVENUE SOUTH, FIFTH FLOOR
NEW YORK, NY 10010

FOR: EDUCATIONAL SERVICES, NAMELY, CONDUCTING PRESENTATIONS RELATING TO WOMEN'S MATERNITY EXPERIENCES AND DISTRIBUTING COURSE MATERIAL, NAMELY, REPORTS AND ARTICLES IN CONNECTION THEREWITH, IN CLASS 41 (U.S. CLS. 100, 101 AND 107).

FIRST USE 10-24-2002; IN COMMERCE 10-24-2002.

FOR: MEDICAL RESEARCH SERVICES, NAMELY CONDUCTING SURVEYS RELATING TO WO-

MEN'S MATERNITY EXPERIENCES, IN CLASS 42 (U.S. CLS. 100 AND 101).

FIRST USE 10-24-2002; IN COMMERCE 10-24-2002.

FOR: PROVIDING MEDICAL INFORMATION OVER THE INTERNET RELATING TO WOMEN'S MATERNITY EXPERIENCES, IN CLASS 44 (U.S. CLS. 100 AND 101).

FIRST USE 10-24-2002; IN COMMERCE 10-24-2002.

SER. NO. 78-221,505, FILED 3-4-2003.

SCOTT BALDWIN, EXAMINING ATTORNEY

Int. Cl.: 7

Prior U.S. Cls.: 13, 19, 21, 23, 31, 34 and 35

United States Patent and Trademark Office

Reg. No. 2,893,180

Registered Oct. 12, 2004

**TRADEMARK
PRINCIPAL REGISTER**

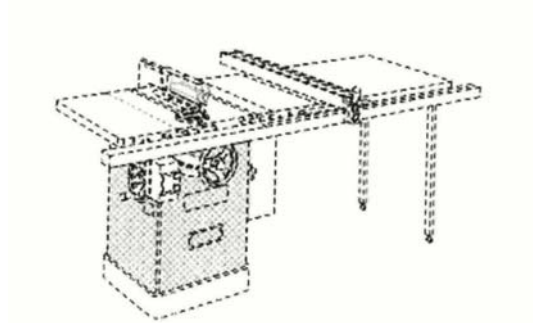

WMH TOOL GROUP, INC. (WASHINGTON CORPORATION)

300 HICKS ROAD
PALATINE, IL 60067

FOR: WOODWORKING AND METALWORKING MACHINES, NAMELY, POWER SAWS, BANDSAWS, CHOP SAWS, TABLESAWS, CABINET SAWS, PLANERS, JOINTERS, MOLDERS, JIGS, SHAPERS, MORTISERS, GRINDERS, ROUTERS, DRILLS, DRILL PRESSES, MILLING MACHINES, LATHES, SHEARS, SANDERS, AND STRUCTURAL PARTS THEREOF, SOLD AS A COMPLETE UNIT IN, IN CLASS 7 (U.S. CLS. 13, 19, 21, 23, 31, 34 AND 35).

FIRST USE 5-15-1996; IN COMMERCE 5-15-1996.

THE DRAWING IS LINED FOR THE COLOR WHITE.

THE MARK CONSISTS OF THE COLOR WHITE AS APPLIED TO THE EXTERIOR SURFACES OF THE GOODS AT THE RECTANGULAR BASE THEREOF EXCLUDING THE TOP SURFACE, WHEEL AND INSTRUMENTATION. THE DOTTED OUTLINE OF THE GOODS IS INTENDED TO SHOW THE POSITION OF THE MARK AND IS NOT A PART OF THE MARK.

SEC. 2(F).

SER. NO. 78-222,453, FILED 3-6-2003.

WILLIAM VERHOSEK, EXAMINING ATTORNEY

Int. Cls.: 9 and 45

Prior U.S. Cls.: 21, 23, 26, 36, 38, 100 and 101

Reg. No. 2,893,181

United States Patent and Trademark Office

Registered Oct. 12, 2004

**TRADEMARK
SERVICE MARK
PRINCIPAL REGISTER**

SiPass

SIEMENS BUILDING TECHNOLOGIES AG
(SWITZERLAND CORPORATION)

BELLERIVESTRASSE 36

CH-8008 ZURICH, SWITZERLAND

FOR: SECURITY SYSTEMS AND EQUIPMENT FOR PROTECTION AGAINST INTRUDERS AND UNAUTHORIZED ACCESS, NAMELY, ALARM, SIGNALING AND WARNING SYSTEMS COMPRISED OF ELECTRONIC STATE SENSORS FOR SENSING HEAT AND MOVEMENT, LIGHT AND INFRARED BARRIERS, NAMELY, LIGHT AND INFRARED MOTION DETECTORS, SIGNAL CONTROL CENTERS, NAMELY, ACCESS CONTROL MONITORING SYSTEMS; ALARM SIGNALING DEVICES, NAMELY, INTRUDER ALARMS; ANTI-THEFT SYSTEMS, FORCED ENTRY AND ARMED RAID PREVENTION SYSTEMS, COMPRISED OF, COMPUTER HARDWARE, COMPUTER SOFTWARE FOR MONITORING AND RECORDING UNAUTHORIZED OR FORCED ENTRY, ELECTRONIC SENSORS FOR SENSING HEAT OR MOVEMENT, ANTI-INTRUSION ALARMS, VIDEO AND PHOTOGRAPHIC CAMERAS, AUDIO AND VIDEO TRANSMITTERS, AUDIO AND VIDEO RECEIVERS, ALARMS AND WARNING SIGNAL TRANSMITTERS AND RECEIVERS, MAGNETIC CODED CARD READERS, BIOMETRICS READERS; ACCESS CONTROL SYSTEMS, COMPRISED OF COMPUTER HARDWARE, COMPUTER SOFTWARE FOR MONITORING AND RECORDING UNAUTHORIZED OR FORCED ENTRY, COMPUTER SOFTWARE FOR PATTERN RECOGNITION AND VERIFICATION, MAGNETIC CODED CARD READERS, BIOMETRICS READERS, ELECTRONIC SENSORS FOR SENSING HEAT OR MOVEMENT, ANTI-INTRUSION ALARMS, CAMERAS, AUDIO AND VIDEO TRANSMITTERS AND RECEIVERS, ALARM AND WARNING SIGNAL TRANSMIT-

TERS AND RECEIVERS; ATTENDANCE RECORDING, WORK TIME LOGGING AND TIME MANAGEMENT SYSTEMS, COMPRISED OF COMPUTER HARDWARE, COMPUTER SOFTWARE FOR MONITORING AND LOGGING EMPLOYEE TIME AND ATTENDANCE, COMPUTER SOFTWARE FOR PATTERN RECOGNITION AND VERIFICATION, MAGNETIC CODED CARD READERS, BIOMETRICS READERS; ELECTRONICALLY CONTROLLED OPENING AND CLOSING EQUIPMENT, NAMELY, COMPUTER HARDWARE AND COMPUTER SOFTWARE FOR MONITORING AND CONTROLLING OPENING AND CLOSING OF DOORS, ELECTRONIC CONTROL PANELS; EQUIPMENT FOR SURVEILLANCE AND CONTROL OF DOORS, NAMELY, COMPUTER HARDWARE AND COMPUTER SOFTWARE FOR MONITORING AND CONTROLLING DOORS, VIDEO AND PHOTOGRAPHIC CAMERAS; SIGNAL TRANSMISSION AND SIGNAL DISPLAY EQUIPMENT, NAMELY, AUDIO AND VIDEO TRANSMITTERS AND AUDIO AND VIDEO RECEIVERS; EQUIPMENT FOR EMERGENCY AND ALARM CONTROL CENTERS, NAMELY, COMMUNICATION COMPUTER HARDWARE; INTEGRAL ALARM INDICATION SYSTEMS AND MASTER ALARM INDICATION SYSTEMS, COMPRISED OF EQUIPMENT FOR THE RECORDING, PROCESSING AND EVALUATION OF SIGNALS IN THE AREAS OF INTRUSION ALARM, ACCESS CONTROL AND ATTENDANCE RECORDING, NAMELY, COMPUTER HARDWARE AND COMPUTER SOFTWARE FOR EVALUATING ALARMS SIGNALS; CLOSED-CIRCUIT TELEVISION SURVEILLANCE AND CLOSED-CIRCUIT TELEVISION CONTROL SYSTEMS, NAMELY, CLOSED-CIRCUIT TELEVISION AND CLOSED-CIRCUIT TELEVISIONS CAMERAS, RELATED COMPUTER HARDWARE, AUDIO AND VIDEO RECORDERS, AUDIO AND VIDEO TRANSMIT-

TERS AND RECEIVERS, AND COMPUTER SOFTWARE FOR MONITORING AND RECORDING DATA RECEIVED FROM CLOSED-CIRCUIT TELEVISION SURVEILLANCE AND CONTROL SYSTEMS; EQUIPMENT FOR ELECTRONIC CONTROL, SURVEILLANCE, REMOTE SURVEILLANCE AND ALARM VERIFICATION USING AUDIO AND VIDEO TECHNOLOGY AND TRANSMISSION AUDIO AND VIDEO SIGNALS, NAMELY, SIGNAL TRANSMITTERS AND RECEIVERS; COMBINATIONS OF THE AFOREMENTIONED SYSTEMS TO CREATE OVERALL SYSTEMS; COMPUTER OPERATING SOFTWARE FOR OPERATING FOR THE AFOREMENTIONED SYSTEMS; REPLACEMENT PARTS FOR ALL OF THE AFOREMENTIONED PRODUCTS, IN CLASS 9 (U.S. CLS. 21, 23, 26, 36 AND 38).

FOR: MONITORING SECURITY AND FIRE ALARM SYSTEMS AND NOTIFYING EMERGENCY AND ALARM CONTROL CENTERS AND STANDBY PERSONNEL BY MEANS OF COMPUTER TERMINALS, IN CLASS 45 (U.S. CLS. 100 AND 101).

PRIORITY CLAIMED UNDER SEC. 44(D) ON SWITZERLAND APPLICATION NO. 07838/2002, FILED 9-11-2002, REG. NO. 506598, DATED 1-21-2003, EXPIRES 9-11-2012.

THE MARK CONSISTS OF THE WORD SIPASS IN SPECIAL FORM.

SER. NO. 78-222,545, FILED 3-6-2003.

CYNTHIA SLOAN, EXAMINING ATTORNEY

Int. Cl.: 15

Prior U.S. Cls.: 2, 21 and 36

United States Patent and Trademark Office

Reg. No. 2,893,182

Registered Oct. 12, 2004

**TRADEMARK
PRINCIPAL REGISTER**

ROUNDBACK

KAMAN MUSIC CORPORATION (CONNECTI-
CUT CORPORATION)
1332 BLUE HILLS AVENUE
BLOOMFIELD, CT 06002

FOR: GUITARS, IN CLASS 15 (U.S. CLS. 2, 21 AND
36).

FIRST USE 6-0-1968; IN COMMERCE 6-0-1968.

OWNER OF U.S. REG. NO. 1,228,824.

SEC. 2(F).

SER. NO. 78-222,763, FILED 3-7-2003.

KATHLEEN M. VANSTON, EXAMINING ATTOR-
NEY

Int. Cls.: 25 and 35

Prior U.S. Cls.: 22, 39, 100, 101 and 102

United States Patent and Trademark Office

Reg. No. 2,893,183

Registered Oct. 12, 2004

TRADEMARK
SERVICE MARK
PRINCIPAL REGISTER

The logo for 'Usafrika' is written in a bold, black, cursive script. The letters are thick and connected, with a slightly irregular, hand-drawn appearance. The 'U' is the largest and most prominent letter, followed by 's', 'a', 'f', 'r', 'i', 'c', and 'a'.

ANPEZ USA, LLC (FLORIDA LIMITED LIABILITY JOINT STOCK COMPANY)

1540 S.W. 194TH TERRACE
PEMBROKE PINES, FL 33029

FOR: CLOTHING, NAMELY, JEANS, SKIRTS, BLOUSES, SWEATSHIRTS, T-SHIRTS, PANTS, JACKETS, SHIRTS, SHORTS AND SHORT PANTS, IN CLASS 25 (U.S. CLS. 22 AND 39).

FIRST USE 12-16-1996; IN COMMERCE 12-16-1996.

FOR: RETAIL STORE, RETAIL BOUTIQUE AND RETAIL DEPARTMENT STORE SERVICES IN THE FIELD OF CLOTHING; WHOLESALE DISTRIBUTORSHIP SERVICES IN THE FIELD OF CLOTHING, IN CLASS 35 (U.S. CLS. 100, 101 AND 102).

FIRST USE 12-16-1996; IN COMMERCE 12-16-1996.

SER. NO. 78-223,756, FILED 3-10-2003.

MARIA-VICTORIA SUAREZ, EXAMINING ATTORNEY

Int. Cls.: 5, 38, 41 and 44

Prior U.S. Cls.: 6, 18, 44, 46, 51, 52, 100, 101, 104 and 107

Reg. No. 2,893,184

United States Patent and Trademark Office

Registered Oct. 12, 2004

**TRADEMARK
SERVICE MARK
PRINCIPAL REGISTER**

You can only grow with your heart

SANOFI-SYNTHELABO (FRANCE CORPORATION)
174, AVENUE DE FRANCE
PARIS, FRANCE 75013

FOR: PHARMACEUTICAL PREPARATIONS FOR THE TREATMENT AND/OR PREVENTION OF CARDIOVASCULAR, THROMBOSIS, ONCOLOGICAL, CENTRAL NERVOUS SYSTEM, INSOMNIA, UROLOGY, SMOKING CESSATION AND OBESITY-RELATED ILLNESSES, IN CLASS 5 (U.S. CLS. 6, 18, 44, 46, 51 AND 52).

FOR: ELECTRONIC DELIVERY OF TEXT, IMAGES AND PHOTOGRAPHS VIA THE INTERNET; PROVIDING ONLINE CHAT ROOMS FOR TRANSMISSION OF MESSAGES AMONG COMPUTER USERS IN THE FIELD OF PHARMACEUTICAL AND MEDICAL DEVELOPMENTS, IN CLASS 38 (U.S. CLS. 100, 101 AND 104).

FOR: EDUCATIONAL SERVICES, NAMELY, CONDUCTING SEMINARS, WORKING GROUPS, STUDY GROUPS AND CONGRESSES, ALL IN THE

MEDICAL AND PHARMACEUTICAL FIELDS; PUBLISHING OF PERIODICALS, BOOKS, AND GUIDES IN THE FIELD OF MEDICINE, IN CLASS 41 (U.S. CLS. 100, 101 AND 107).

FOR: MEDICAL EVALUATION SERVICES, NAMELY, FUNCTIONAL ASSESSMENT PROGRAMS FOR PATIENTS RECEIVING MEDICAL TREATMENT FOR THE PURPOSE OF ASSESSING MEDICAL TREATMENT EFFECTIVENESS; PROVIDING MEDICAL AND PHARMACEUTICAL INFORMATION; PROVIDING AN ON-LINE COMPUTER DATABASE IN THE FIELD OF MEDICINE, IN CLASS 44 (U.S. CLS. 100 AND 101).

PRIORITY CLAIMED UNDER SEC. 44(D) ON FRANCE APPLICATION NO. 023195004, FILED 11-20-2002, REG. NO. 023195004, DATED 11-20-2002, EXPIRES 11-20-2012.

SER. NO. 78-224,080, FILED 3-11-2003.

SHARON MEIER, EXAMINING ATTORNEY

Int. Cl.: 21

Prior U.S. Cls.: 2, 13, 23, 29, 30, 33, 40 and 50

Reg. No. 2,893,185

United States Patent and Trademark Office

Registered Oct. 12, 2004

**TRADEMARK
PRINCIPAL REGISTER**



Cat Co-Pilot

BLASZAK, BENJAMIN D. (UNITED STATES IN-
DIVIDUAL)
761 OTTAWA DRIVE
TROY, MI 48085 AND
COSKI, JOHN E. (UNITED STATES INDIVIDUAL)
55 E. LONG LAKE ROAD, #374
TROY, MI 48085

FIRST USE 2-10-2003; IN COMMERCE 2-10-2003.

NO CLAIM IS MADE TO THE EXCLUSIVE
RIGHT TO USE "CAT", APART FROM THE MARK
AS SHOWN.

SER. NO. 78-224,206, FILED 3-11-2003.

FOR: CAT LITTER BOXES AND CONTAINERS,
IN CLASS 21 (U.S. CLS. 2, 13, 23, 29, 30, 33, 40 AND 50).

ALICIA COLLINS, EXAMINING ATTORNEY

Int. Cls.: 37, 40 and 42

Prior U.S. Cls.: 100, 101, 103 and 106

United States Patent and Trademark Office

Reg. No. 2,893,186

Registered Oct. 12, 2004

**SERVICE MARK
PRINCIPAL REGISTER**

NEPTUNO

NEPTUNO C.A. (VENEZUELA CORPORATION)
AV. SAN FELIPE, ENTRE 2DA TRANSV. Y JOSE
ANGEL LAMAS CENTRO COINASA, PISO 2, OFICI-
NA 26
LA CASTELLANA, CARACAS 1020, VENEZUELA

FOR: CONSTRUCTION OF TELECOMMUNICA-
TION TOWERS, NAMELY INSTALLATION OF TEL-
ECOMMUNICATION TOWERS, IN CLASS 37 (U.S.
CLS. 100, 103 AND 106).

FIRST USE 5-12-1972; IN COMMERCE 4-24-1997.

FOR: MANUFACTURE OF TELECOMMUNICA-
TION TOWERS TO THE SPECIFICATION OF OTH-
ERS, IN CLASS 40 (U.S. CLS. 100, 103 AND 106).

FIRST USE 5-12-1972; IN COMMERCE 4-24-1997.

FOR: TECHNICAL CONSULTATION, RE-
SEARCH, DESIGN FOR OTHERS, AND ENGINEER-
ING IN THE FIELD OF TELECOMMUNICATIONS,
IN CLASS 42 (U.S. CLS. 100 AND 101).

FIRST USE 5-12-1972; IN COMMERCE 4-24-1997.

SER. NO. 78-224,312, FILED 3-11-2003.

ALEX KEAM, EXAMINING ATTORNEY

Int. Cl.: 5

Prior U.S. Cls.: 6, 18, 44, 46, 51 and 52

United States Patent and Trademark Office

Reg. No. 2,893,187

Registered Oct. 12, 2004

**TRADEMARK
PRINCIPAL REGISTER**

ALPIOX

NOVARTIS AG (SWITZERLAND CORPORATION)
CH-4056
BASEL, SWITZERLAND

FOR: PHARMACEUTICAL PREPARATIONS FOR PREVENTION AND/OR TREATMENT OF DISORDERS OF THE NERVOUS SYSTEM, THE IMMUNE SYSTEM, THE CARDIOVASCULAR SYSTEM, THE RESPIRATORY SYSTEM, THE MUSCULOSKELETAL SYSTEM, THE GENITOURINARY SYSTEM, FOR THE TREATMENT OF INFLAMMATORY DISORDERS, FOR USE IN DERMATOLOGY, IN ON-

COLOGY, FOR USE IN THE GASTROENTEROLOGICAL AREA, AND THE PREVENTION AND TREATMENT OF OCULAR DISORDERS OR DISEASES, IN CLASS 5 (U.S. CLS. 6, 18, 44, 46, 51 AND 52).

OWNER OF SWITZERLAND REG. NO. 502477,
DATED 8-22-2002, EXPIRES 8-14-2012.

SER. NO. 78-225,137, FILED 3-13-2003.

MARY BOAGNI, EXAMINING ATTORNEY

Int. Cls.: 35 and 41

Prior U.S. Cls.: 100, 101, 102 and 107

United States Patent and Trademark Office

Reg. No. 2,893,188

Registered Oct. 12, 2004

**SERVICE MARK
PRINCIPAL REGISTER**

LOS ANGELES TEACHING FELLOWS

THE NEW TEACHER PROJECT (DELAWARE CORPORATION)

304 PARK AVENUE SOUTH, 11TH FLOOR
NEW YORK, NY 10010

FOR: EMPLOYMENT SERVICES, NAMELY, RECRUITING INDIVIDUALS TO TEACH CLASSES IN PRIMARY AND SECONDARY PUBLIC SCHOOLS IN THE FIELDS OF READING, WRITING, SPELLING, GRAMMAR, LANGUAGES, GEOGRAPHY, SOCIAL STUDIES, MATHEMATICS, SCIENCE, NUTRITION, HEALTH, PHYSICAL EDUCATION, COMPUTER AND INFORMATION TECHNOLOGY, MUSIC, ART, AND LITERATURE, IN CLASS 35 (U.S. CLS. 100, 101 AND 102).

FIRST USE 4-30-2002; IN COMMERCE 4-30-2002.

FOR: EDUCATIONAL SERVICES, NAMELY, TRAINING INDIVIDUALS TO TEACH CLASSES IN PRIMARY AND SECONDARY PUBLIC SCHOOLS IN THE FIELDS OF READING, WRITING, SPELLING, GRAMMAR, LANGUAGES, GEOGRAPHY, SOCIAL STUDIES, MATHEMATICS, SCIENCE, NUTRITION, HEALTH, PHYSICAL EDUCATION, COMPUTER AND INFORMATION TECHNOLOGY, MUSIC, ART, AND LITERATURE, IN CLASS 41 (U.S. CLS. 100, 101 AND 107).

FIRST USE 4-30-2002; IN COMMERCE 4-30-2002.

SEC. 2(F).

SER. NO. 78-226,547, FILED 3-17-2003.

CATHERINE CAIN, EXAMINING ATTORNEY

Int. Cls.: 35 and 41

Prior U.S. Cls.: 100, 101, 102 and 107

United States Patent and Trademark Office

Reg. No. 2,893,189

Registered Oct. 12, 2004

**SERVICE MARK
PRINCIPAL REGISTER**

NYC TEACHING FELLOWS

THE NEW TEACHER PROJECT (DELAWARE CORPORATION)

304 PARK AVENUE SOUTH, 11TH FLOOR
NEW YORK, NY 10010

FOR: EMPLOYMENT SERVICES, NAMELY, RECRUITING INDIVIDUALS TO TEACH CLASSES IN PRIMARY AND SECONDARY PUBLIC SCHOOLS IN THE FIELDS OF READING, WRITING, SPELLING, GRAMMAR, LANGUAGES, GEOGRAPHY, SOCIAL STUDIES, MATHEMATICS, SCIENCE, NUTRITION, HEALTH, PHYSICAL EDUCATION, COMPUTER AND INFORMATION TECHNOLOGY, MUSIC, ART, AND LITERATURE, IN CLASS 35 (U.S. CLS. 100, 101 AND 102).

FIRST USE 6-30-2000; IN COMMERCE 6-30-2000.

FOR: EDUCATIONAL SERVICES, NAMELY, TRAINING INDIVIDUALS TO TEACH CLASSES IN PRIMARY AND SECONDARY PUBLIC SCHOOLS IN THE FIELDS OF READING, WRITING, SPELLING, GRAMMAR, LANGUAGES, GEOGRAPHY, SOCIAL STUDIES, MATHEMATICS, SCIENCE, NUTRITION, HEALTH, PHYSICAL EDUCATION, COMPUTER AND INFORMATION TECHNOLOGY, MUSIC, ART, AND LITERATURE, IN CLASS 41 (U.S. CLS. 100, 101 AND 107).

FIRST USE 6-30-2000; IN COMMERCE 6-30-2000.

SEC. 2(F).

SER. NO. 78-226,570, FILED 3-17-2003.

JULIE WATSON, EXAMINING ATTORNEY

Int. Cl.: 16

Prior U.S. Cls.: 2, 5, 22, 23, 29, 37, 38 and 50

United States Patent and Trademark Office

Reg. No. 2,893,190

Registered Oct. 12, 2004

**TRADEMARK
PRINCIPAL REGISTER**

KEITH URBAN

URBAN, KEITH (AUSTRALIA INDIVIDUAL)
C/O ANSEL L. DAVIS, P.L.L.C
801 18TH AVENUE SOUTH SUITE 200
NASHVILLE, TN 37203

FOR: PAPER GOODS AND PRINTED MATTER,
NAMELY PHOTOGRAPHS, CALENDARS, NEWS-
LETTERS IN THE FIELD OF MUSIC, BUMPER
STICKERS AND STICKERS, IN CLASS 16 (U.S.
CLS. 2, 5, 22, 23, 29, 37, 38 AND 50).

FIRST USE 0-0-2000; IN COMMERCE 0-0-2000.

THE NAME KEITH URBAN IDENTIFIES A LIV-
ING INDIVIDUAL WHOSE CONSENT IS OF RE-
CORD.

SER. NO. 78-226,626, FILED 3-17-2003.

WON TEAK OH, EXAMINING ATTORNEY

Int. Cl.: 43

Prior U.S. Cls.: 100 and 101

Reg. No. 2,893,191

United States Patent and Trademark Office

Registered Oct. 12, 2004

SERVICE MARK
PRINCIPAL REGISTER



PARK HOSPITALITY LLC (DELAWARE LTD
LIAB JT ST CO)
1405 XENIUM LANE NORTH
PLYMOUTH, MN 554418254

FOR: HOTEL, MOTEL, RESORT LODGING AND
RESTAURANT SERVICES, IN CLASS 43 (U.S. CLS.
100 AND 101).

FIRST USE 4-1-2003; IN COMMERCE 4-1-2003.

OWNER OF U.S. REG. NOS. 1,488,851, 1,745,324
AND OTHERS.

NO CLAIM IS MADE TO THE EXCLUSIVE
RIGHT TO USE INN, APART FROM THE MARK
AS SHOWN.

THE MARK CONSISTS, IN PART, OF A HOR-
ZONTAL LINE BENEATH THE WORDING "PARK
INN", WHICH IS COMPRISED OF MULTIPLE CO-
LORED BLOCKS. THE FIRST SIXTEEN BLOCKS
REPEAT THE COLOR PATTERN RED, ORANGE,
GREEN, AND BLUE WITH THE BLOCK ADJACENT
TO AN ORANGE BLOCK, ADJACENT TO A GREEN
BLOCK, ADJACENT TO A BLUE BLOCK. THE
FINAL THREE BLOCKS ARE A RED BLOCK AD-
JACENT TO AN ORANGE BLOCK, ADJACENT TO
A GREEN BLOCK.

SER. NO. 78-226,722, FILED 3-18-2003.

JENNIFER CHICOSKI, EXAMINING ATTORNEY

Int. Cls.: 24 and 25

Prior U.S. Cls.: 22, 39, 42 and 50

United States Patent and Trademark Office

Reg. No. 2,893,192

Registered Oct. 12, 2004

**TRADEMARK
PRINCIPAL REGISTER**

COLIMAÇON

COLIMAÇON INTERNATIONAL INC. (CANADA CORPORATION)
503, 2E RUE
DAVELUYVILLE, QUEBEC, CANADA GOZ 1C0

FOR: RECEIVING BLANKETS; WASHCLOTHS; BLANKETS FOR INFANTS; BUNTING BLANKETS FOR INFANTS; TOWELS, IN CLASS 24 (U.S. CLS. 42 AND 50).

FIRST USE 1-1-1986; IN COMMERCE 1-1-1986.

FOR: INFANT CLOTHING, NAMELY ROMPERS, PLAYSUITS, WASH SUITS, OVERALLS, T-SHIRTS, TOPS, PANTS, SLEEPWEAR, SWEATER TOPS, DRESSES, BEACH ROBES, HATS, GOWNS, BOOTIES, CLOTH BIBS, SLEEPWEAR, NAMELY PAJAMAS, SLEEPERS AND NIGHTGOWNS; INFANT CLOTHING SETS, NAMELY OVERALLS AND SHIRTS, TOP AND PANTS, SHIRTS AND PANTS;

INFANT CLOTHING, NAMELY, SWEATER TOPS, SHIRTS, AND PANTS, IN CLASS 25 (U.S. CLS. 22 AND 39).

FIRST USE 1-1-1986; IN COMMERCE 1-1-1986.

PRIORITY CLAIMED UNDER SEC. 44(D) ON CANADA APPLICATION NO. 1,143,145, FILED 9-24-2002, REG. NO. TMA595413, DATED 11-21-2003, EXPIRES 11-21-2018.

OWNER OF U.S. REG. NO. 2,038,283.

THE FOREIGN WORDING IN THE MARK TRANSLATES INTO ENGLISH AS SNAIL.

SER. NO. 78-227,548, FILED 3-19-2003.

FRED MANDIR, EXAMINING ATTORNEY

Int. Cl.: 41

Prior U.S. Cls.: 100, 101 and 107

United States Patent and Trademark Office

Reg. No. 2,893,193

Registered Oct. 12, 2004

**SERVICE MARK
PRINCIPAL REGISTER**

STARS AND STRIPES

DEPARTMENT OF DEFENSE (UNITED STATES
FEDERAL AGENCY)
STARS AND STRIPES
529 14TH ST., NW SUITE 350
WASHINGTON, DC 200451301

FOR: DISTRIBUTION OF TELEVISION PROGRAMMING TO CABLE TELEVISION SYSTEMS; DISTRIBUTION OF TELEVISION PROGRAMS FOR OTHERS; ENTERTAINMENT IN THE NATURE OF TELEVISION PROGRAMS IN THE FIELD OF NEWS, DOCUMENTARIES, AND EDUCATION; ENTERTAINMENT NAMELY, PRODUCTION OF TELEVISION AND FILM DOCUMENTARIES AND NEWS; ENTERTAINMENT SERVICES, NAMELY, PROVIDING RADIO PROGRAMS IN THE FIELD OF NEWS AND ENTERTAINMENT; ENTERTAINMENT SERVICES, NAMELY, PROVIDING RADIO PROGRAMS IN THE FIELD OF NEWS AND ENTERTAINMENT VIA A GLOBAL COMPUTER NETWORK; ENTERTAINMENT SERVICES, NAMELY, PROVIDING A TELEVISION PROGRAM IN THE FIELD OF NEWS, DOCUMENTARIES, AND EDUCATION VIA A GLOBAL COMPUTER NETWORK; PRODUCTION OF

DOCUMENTARIES; ENTERTAINMENT, NAMELY A CONTINUING NEWS SHOW BROADCAST OVER TELEVISION, PDA, CELLULAR PHONES AND OTHER ELECTRONIC DEVICES, AUDIO AND VIDEO MEDIA; PRODUCTION OF RADIO AND TELEVISION NEWS AND DOCUMENTARY PROGRAMS; RADIO ENTERTAINMENT PRODUCTION; TELEVISION PROGRAM SYNDICATION; ON-LINE PUBLICATION OF NEWSPAPERS AND MAGAZINES; PUBLICATION OF NEWSPAPERS AND MAGAZINES; PROVIDING INFORMATION IN THE FIELD OF CURRENT EVENT AND MILITARY NEWS AND COMMENTARY, IN CLASS 41 (U.S. CLS. 100, 101 AND 107).

FIRST USE 0-0-1995; IN COMMERCE 0-0-1995.

OWNER OF U.S. REG. NOS. 2,641,505, 2,641,506, AND 2,697,201.

SER. NO. 78-227,654, FILED 3-19-2003.

G. MAYERSCHOFF, EXAMINING ATTORNEY

Int. Cls.: 6 and 8

Prior U.S. Cls.: 2, 12, 13, 14, 23, 25, 28, 44 and 50

United States Patent and Trademark Office

Reg. No. 2,893,194

Registered Oct. 12, 2004

**TRADEMARK
PRINCIPAL REGISTER**

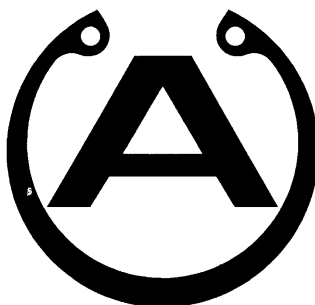

ANDERTON

CIRTEQ LIMITED (UNITED KINGDOM CORPORATION)
'HAYFIELD' COLNE ROAD
GLUSBURN, KEIGHLEY
WEST YORKSHIRE, UNITED KINGDOM BD20 8QP

FOR: CIRCLIPS; METAL RINGS, NAMELY SUPPORT RINGS, RINGS, RETAINING RINGS, SHIMS, METAL STANDS ALL FOR USE WITH CIRCLIPS, IN CLASS 6 (U.S. CLS. 2, 12, 13, 14, 23, 25 AND 50).

FIRST USE 1-1-1993; IN COMMERCE 1-1-1996.

FOR: CIRCLIP APPLICATORS; PLIERS AND HAND TOOLS, NAMELY PLIERS, ALL FOR USE

WITH CIRCLIPS, IN CLASS 8 (U.S. CLS. 23, 28 AND 44).

FIRST USE 1-1-1993; IN COMMERCE 1-1-1996.

PRIORITY CLAIMED UNDER SEC. 44(D) ON UNITED KINGDOM APPLICATION NO. 3017779, FILED 1-21-2003, REG. NO. 3017779, DATED 1-21-2003, EXPIRES 1-21-2013.

SER. NO. 78-228,057, FILED 3-20-2003.

JOHN DALIER, EXAMINING ATTORNEY

Int. Cl.: 43

Prior U.S. Cls.: 100 and 101

United States Patent and Trademark Office

Reg. No. 2,893,195

Registered Oct. 12, 2004

**SERVICE MARK
PRINCIPAL REGISTER**



TAYLOR, JOHN L., JR. (UNITED STATES INDIVIDUAL)
3399 PEACHTRE ROAD, N.E., SUITE 1700
ATLANTA, GA 303261148

FIRST USE 1-1-1994; IN COMMERCE 1-1-2000.

SER. NO. 78-228,470, FILED 3-21-2003.

FOR: NATURE, HUNTING, AND FISHING RESORT LODGE SERVICES, IN CLASS 43 (U.S. CLS. 100 AND 101).

MELVIN AXILBUND, EXAMINING ATTORNEY

Int. Cl.: 36

Prior U.S. Cls.: 100, 101 and 102

United States Patent and Trademark Office

Reg. No. 2,893,196

Registered Oct. 12, 2004

**SERVICE MARK
PRINCIPAL REGISTER**

TAX SAVERS

TAX SAVERS, INC. (NEW YORK CORPORATION)
30 GLENDALE TERRACE
ORCHARD PARK, NY 14127

FOR: TAX AND DEBT CONSOLIDATION SERVICES, NAMELY THE ARRANGEMENT AND NEGOTIATING OF RESOLUTIONS WITH TAXING AUTHORITIES AND CREDIT COMPANIES, IN CLASS 36 (U.S. CLS. 100, 101 AND 102).

FIRST USE 10-26-1999; IN COMMERCE 1-21-2000.

NO CLAIM IS MADE TO THE EXCLUSIVE RIGHT TO USE TAX, APART FROM THE MARK AS SHOWN.

SER. NO. 78-229,408, FILED 3-25-2003.

CATHERINE CAIN, EXAMINING ATTORNEY

Int. Cls.: 9 and 42

Prior U.S. Cls.: 21, 23, 26, 36, 38, 100 and 101

Reg. No. 2,893,197

United States Patent and Trademark Office

Registered Oct. 12, 2004

**TRADEMARK
SERVICE MARK
PRINCIPAL REGISTER**

MEANING BUS

ALBERT-INC. S.A. (SWITZERLAND CORPORATION)
RUE DU SIMPLON 25
LAUSANNE, SWITZERLAND 1006

FOR: DATA PROCESSING COMPUTER HARDWARE; COMPUTER SEARCH ENGINE SOFTWARE, NAMELY, SOFTWARE FOR SEARCHING DATABASES; COMPUTER HARDWARE AND SEARCH ENGINE SOFTWARE USED FOR DATA, IMAGE AND INFORMATION SEARCH, RETRIEVAL, INDEXING AND ORGANIZATION PERTAINING TO GOODS AND SERVICES AVAILABLE IN DATABASES, COMPUTER NETWORKS AND GLOBAL COMPUTER NETWORKS, NAMELY, THE INTERNET; COMPUTER SOFTWARE USED FOR QUERY PROCESSING OPTIMIZATION BY MEANS OF THE AFORESAID SOFTWARE, IN PARTICULAR FOR NATURAL LANGUAGE INTERPRETATION AND FOR COMPARISON WITH EXPERIENCE ACQUIRED FROM A DATABASE GROUPING SUCH QUERIES; COMPUTER SOFTWARE FOR INFORMATION CONTENT DEVELOPMENT, MANAGEMENT, ORGANIZATION AND INDEXING FOR INTRANETS, COMPUTER SITES AND COMPUTER NETWORKS; TEST COMPUTER SOFTWARE USED FOR ACQUIRING AN EXPERIENCE-BASED REFERENCE MODEL OF THE BEHAVIOR OF A PERSON AND/OR MACHINE PERTAINING TO THE FORMULATION OF SEARCH QUERIES, IN CLASS 9 (U.S. CLS. 21, 23, 26, 36 AND 38).

FOR: SCIENTIFIC AND TECHNOLOGICAL SERVICES AS WELL AS RESEARCH AND DESIGN SERVICES RELATING THERETO, PARTICULARLY COMPUTER AND SOFTWARE DESIGN AND DEVELOPMENT; CONSULTING RELATING TO INFORMATION TECHNOLOGY, STUDIES AND PROJECTS PERTAINING TO COMPUTER SOFTWARE FOR THIRD PARTIES; INFORMATION

TECHNOLOGY SERVICES, NAMELY DESIGN AND DEVELOPMENT OF COMPUTER SOFTWARE SEARCH ENGINES USED FOR DATA, IMAGE AND INFORMATION SEARCH, RETRIEVAL, INDEXING AND ORGANIZATION PERTAINING TO GOODS AND SERVICES AVAILABLE IN DATABASES, COMPUTER NETWORKS AND GLOBAL COMPUTER NETWORKS, NAMELY, THE INTERNET; CREATION AND DEVELOPMENT OF COMPUTER SOFTWARE IN THE NATURE OF INFORMATION INDEXES AVAILABLE ON INTRANETS, ON COMPUTER SITES AND ON COMPUTER NETWORKS, AND UPDATING OF THE STRUCTURE OF SUCH INDEXES FOR OTHERS; MAINTENANCE OF COMPUTER SOFTWARE AND PROGRAMS; TECHNICAL COMPUTER SOFTWARE RESEARCH, NAMELY, ELABORATION OF STUDIES AND PROJECTS FOR DEVELOPING, PRODUCING AND ADAPTING COMPUTER APPLICATIONS CONCERNING INFORMATION MANAGEMENT AND E-COMMERCE AND MAINTENANCE SERVICES FOR THE AFORESAID COMPUTER APPLICATIONS; INSTALLATION OF COMPUTER SOFTWARE FOR THIRD PARTIES AND TECHNICAL COMPUTER SUPPORT SERVICES, NAMELY TELEPHONE AND ON-SITE COMPUTER CONSULTATIONS IN CONNECTION WITH COMPUTER HARDWARE AND SOFTWARE OPERATION AND MAINTENANCE; UPDATING OF COMPUTER PROGRAMS FOR THIRD PARTIES, IN CLASS 42 (U.S. CLS. 100 AND 101).

PRIORITY CLAIMED UNDER SEC. 44(D) ON SWITZERLAND APPLICATION NO. 08532/2002, FILED 10-2-2002, REG. NO. 508197, DATED 4-23-2003, EXPIRES 10-2-2012.

SER. NO. 78-229,564, FILED 3-25-2003.

CHERYL CLAYTON, EXAMINING ATTORNEY

Int. Cl.: 35

Prior U.S. Cls.: 100, 101 and 102

United States Patent and Trademark Office

Reg. No. 2,893,198

Registered Oct. 12, 2004

**SERVICE MARK
PRINCIPAL REGISTER**

BROOKS.BUYS

RETAIL BRAND ALLIANCE, INC. (DELAWARE CORPORATION)
100 PHOENIX AVENUE
ENFIELD, CT 06082

FOR: RETAIL STORES SERVICES AND COMPUTERIZED ONLINE ORDERING AND RETAIL SERVICES VIA A COMPUTER NETWORK IN THE FIELD OF CONSUMER GOODS, NAMELY, SHIRTS, TOPS, SWEATERS, JACKETS, PANTS, SUITS, BOTTOMS, SOCKS, HATS AND CAPS, SHOES, SHORTS, COATS, NECKTIES, UNDERWEAR, VESTS, ROBES, HOSIERY, SKIRTS, DRESSES, LOUNGEWEAR, SCARVES, RAINWEAR, TROUSERS, ASCOTS, TIES, OUTER SHIRTS INCLUDING EVENING, DRESS, POLO, AND SPORTS SHIRTS, COLLARS, PAJAMAS, ROBES, SMOKING JACKETS, DRESSING GOWNS, MUFFLERS, GLOVES, HANDKERCHIEFS, HOSE, BELTS, SUSPENDERS, GARTERS, BOOTS, SLIPPERS, SHOES, OVERSHOES, BEACH WEAR, SWIMWEAR, FORMAL WEAR, HANDBAGS, TOTE BAGS, BACKPACKS, LUGGAGE, WALLETS, PURSES, KEY CASES, BRIEF CASES, DUFFLE BAGS, ALL-PURPOSE SPORT BAGS, BUSINESS CARD CASES,

CREDIT CARD CASES, BRIEFCASE-TYPE PORTFOLIOS, BILLFOLDS, ATTACHÉ CASES, KEY CASES, PASSPORT CASES, SUIT BAGS, WAIST AND FANNY PACKS, TRUNKS, TRAVEL BAGS, HAT BOXES FOR TRAVEL, KEY FOBS, LUGGAGE TAGS, OVERNIGHT BAGS AND CASES, COSMETIC, TOILETRY AND VANITY CASES SOLD EMPTY, UMBRELLAS, CANES, AND WALKING STICKS, COSMETICS AND JEWELRY, GOLF ACCESSORIES NAMELY GOLF EQUIPMENT INCLUDING GOLF BALLS, GOLF CLUBS, GOLF BAGS, GOLF SHOES, GOLF BALL WASHERS, GOLF CARTS, GOLF TEES, AND GOLF CLUB COVERS, IN CLASS 35 (U.S. CLS. 100, 101 AND 102).

FIRST USE 9-0-2001; IN COMMERCE 9-0-2001.

OWNER OF U.S. REG. NOS. 667,458, 1,835,798, AND 2,523,247.

SER. NO. 78-229,743, FILED 3-25-2003.

TRACY CROSS, EXAMINING ATTORNEY

Int. Cl.: 18

Prior U.S. Cls.: 1, 2, 3, 22 and 41

United States Patent and Trademark Office

Reg. No. 2,893,199

Registered Oct. 12, 2004

**TRADEMARK
PRINCIPAL REGISTER**

PLUME

HERMES INTERNATIONAL (FRANCE CORPORATION)
24, RUE DU FAUBOURG SAINT-HONORE
PARIS, FRANCE 75008

FOR: GOODS MADE OF LEATHER AND IMITATIONS OF LEATHER, NAMELY, BAGS, NAMELY, HANDBAGS, TRAVEL BAGS, RUCKSACKS; LEATHER PURSES, BUSINESS CARD CASES, WALLETTS, LEATHER KEY CASES, SUITCASES, BRIEFCASES AND LUGGAGE TRUNKS, IN CLASS 18 (U.S. CLS. 1, 2, 3, 22 AND 41).

PRIORITY CLAIMED UNDER SEC. 44(D) ON FRANCE APPLICATION NO. 03.3.214.126, FILED 3-10-2003, REG. NO. 033214126, DATED 3-10-2003, EXPIRES 3-10-2013.

THE ENGLISH TRANSLATION OF THE WORD PLUME IN THE MARK IS FEATHER.

SER. NO. 78-230,103, FILED 3-26-2003.

KATHERINE STOIDES, EXAMINING ATTORNEY

Int. Cl.: 3

Prior U.S. Cls.: 1, 4, 6, 50, 51 and 52

United States Patent and Trademark Office

Reg. No. 2,893,200

Registered Oct. 12, 2004

**TRADEMARK
PRINCIPAL REGISTER**

REVOLUTIONARY ANTI-AGING DAY

VICTORIA PRINCIPAL PRODUCTIONS, INC.
(CALIFORNIA CORPORATION)
9255 SUNSET BOULEVARD
LOS ANGELES, CA 90069

NO CLAIM IS MADE TO THE EXCLUSIVE
RIGHT TO USE "ANTI-AGING DAY", APART
FROM THE MARK AS SHOWN.

FOR: SKIN AND BODY CARE PREPARATIONS
NAMELY, SKIN MOISTURIZERS, SKIN LOTIONS,
SUN SCREEN PREPARATIONS, IN CLASS 3 (U.S.
CLS. 1, 4, 6, 50, 51 AND 52).

SER. NO. 78-230,476, FILED 3-26-2003.

FIRST USE 7-27-2003; IN COMMERCE 7-28-2003.

ELIZABETH J. WINTER, EXAMINING ATTORNEY

Int. Cls.: 7 and 11

Prior U.S. Cls.: 13, 19, 21, 23, 31, 34 and 35

United States Patent and Trademark Office

Reg. No. 2,893,201

Registered Oct. 12, 2004

**TRADEMARK
PRINCIPAL REGISTER**

AIRSCREEN

OHIO BLOW PIPE COMPANY (OHIO CORPORATION)
446 EAST 131ST STREET
CLEVELAND, OH 44108

FOR: MATERIALS HANDLING SYSTEMS COMPRISING MATERIAL CONVEYORS AND SEPARATING MACHINES FOR THE REMOVAL OF AIRBORNE WASTE MATERIALS FROM CONVEYING AIR, IN CLASS 7 (U.S. CLS. 13, 19, 21, 23, 31, 34 AND 35).

FIRST USE 4-22-1993; IN COMMERCE 4-22-1993.

FOR: AIR VENTILATION AND FILTERING SYSTEMS COMPRISING VENTILATING FANS AND

FAN BLOWERS FOR COMMERCIAL AND INDUSTRIAL USE FOR SEPARATING AIRBORNE WASTE MATERIALS FROM AIR, AND METAL DUCTS THEREFORE SOLD AS A UNIT, IN CLASS 11 (U.S. CLS. 13, 21, 23, 31 AND 34).

FIRST USE 4-22-1993; IN COMMERCE 4-22-1993.

OWNER OF U.S. REG. NO. 2,020,016.

SEC. 2(F).

SER. NO. 78-230,517, FILED 3-26-2003.

WANDA KAY PRICE, EXAMINING ATTORNEY

Int. Cl.: 36

Prior U.S. Cls.: 100, 101 and 102

United States Patent and Trademark Office

Reg. No. 2,893,202

Registered Oct. 12, 2004

SERVICE MARK
PRINCIPAL REGISTER



Accept No Boundaries

CHILDREN'S NEUROBIOLOGICAL SOLUTIONS
FOUNDATION, INC (DELAWARE CORPORATION)

1726 FRANCESCHI ROAD
SANTA BARBARA, CA 93103

FOR: CHARITABLE SERVICES, NAMELY, PROVIDING FUNDING FOR PEDIATRIC BRAIN REPAIR RESEARCH, IN CLASS 36 (U.S. CLS. 100, 101 AND 102).

FIRST USE 6-1-2001; IN COMMERCE 6-1-2001.

NO CLAIM IS MADE TO THE EXCLUSIVE RIGHT TO USE "CHILDREN'S", APART FROM THE MARK AS SHOWN.

THE STIPPLING IS FOR SHADING PURPOSES ONLY.

THE MARK CONSISTS OF "CHILDREN'S" AND "SOLUTIONS" ARE PANTONE 456U (OCHRE). THE DRAWING OF THE DNA DOUBLE HELIX IS A GRADATION OF PANTONE 456U (OCHRE) WHICH IS DARKER AT THE LEFT AND RIGHT SIDES, FADING TO WHITE AT THE CENTER. THE WORDS "NEUROBIOLOGICAL" AND "ACCEPT NO BOUNDARIES" AND THE VERTICAL RULE ARE PANTONE 432U (DARK GREY).

SER. NO. 78-230,528, FILED 3-26-2003.

JOHN E. MICHOS, EXAMINING ATTORNEY

Int. Cl.: 36

Prior U.S. Cls.: 100, 101 and 102

United States Patent and Trademark Office

Reg. No. 2,893,203

Registered Oct. 12, 2004

**SERVICE MARK
PRINCIPAL REGISTER**

THE PRASAD PROJECT

PRASAD PROJECT INC., THE (NEW YORK
CORPORATION)
465 BRICKMAN ROAD
HURLEYVILLE, NY 12747

NO CLAIM IS MADE TO THE EXCLUSIVE
RIGHT TO USE "PROJECT", APART FROM THE
MARK AS SHOWN.

FOR: CHARITABLE FUND RAISING, IN CLASS
36 (U.S. CLS. 100, 101 AND 102).

SEC. 2(F).

FIRST USE 11-30-1992; IN COMMERCE 11-30-1992.

SER. NO. 78-230,684, FILED 3-27-2003.

OWNER OF U.S. REG. NOS. 1,744,903 AND
2,742,771.

GLENN CLARK, EXAMINING ATTORNEY

Int. Cls.: 30 and 43

Prior U.S. Cls.: 46, 100 and 101

United States Patent and Trademark Office

Reg. No. 2,893,204

Registered Oct. 12, 2004

TRADEMARK
SERVICE MARK
PRINCIPAL REGISTER



SWEET DREAMS INTERNATIONAL, INC. (CANADA CORPORATION)
3520 BATHURST STREET
TORONTO, ONTARIO, CANADA M6A 2C6

FOR: READY-TO-DRINK COFFEE, COFFEE-BASED BEVERAGES CONTAINING MILK AND CANNED OR BOTTLED ICED COFFEE, IN CLASS 30 (U.S. CL. 46).

FIRST USE 9-18-2002; IN COMMERCE 9-18-2002.

FOR: RESTAURANT, CAFE AND COFFEE HOUSE SERVICES, IN CLASS 43 (U.S. CLS. 100 AND 101).

FIRST USE 9-18-2002; IN COMMERCE 9-18-2002.

NO CLAIM IS MADE TO THE EXCLUSIVE RIGHT TO USE "COFFEE SHOP", APART FROM THE MARK AS SHOWN.

THE NAME(S), PORTRAIT(S), AND/OR SIGNATURE(S) SHOWN IN THE MARK DOES NOT IDENTIFY A PARTICULAR LIVING INDIVIDUAL.

SER. NO. 78-230,940, FILED 3-27-2003.

ANDREW BENZMILLER, EXAMINING ATTORNEY

Int. Cl.: 6

Prior U.S. Cls.: 2, 12, 13, 14, 23, 25 and 50

Reg. No. 2,893,205

United States Patent and Trademark Office

Registered Oct. 12, 2004

**TRADEMARK
PRINCIPAL REGISTER**

STOP-STEP

CRAMER, INC. (MISSOURI CORPORATION)
1222 QUEBEC STREET
NORTH KANSAS CITY, MO 64116

FIRST USE 10-1-1949; IN COMMERCE 10-1-1949.

SER. NO. 78-230,975, FILED 3-27-2003.

FOR: METAL ROLLING LADDER WITH RE-
TRACTABLE CASTERS, IN CLASS 6 (U.S. CLS. 2,
12, 13, 14, 23, 25 AND 50).

CAROL SPILS, EXAMINING ATTORNEY

Int. Cl.: 5

Prior U.S. Cls.: 6, 18, 44, 46, 51 and 52

Reg. No. 2,893,206

United States Patent and Trademark Office

Registered Oct. 12, 2004

**TRADEMARK
PRINCIPAL REGISTER**

MITOCNOL

PHARMA NORD APS (DENMARK CORPORATION)
TINGLYKKE 4-6
6500 VOJENS, DENMARK

PRIORITY CLAIMED UNDER SEC. 44(D) ON
DENMARK APPLICATION NO. VA200203842,
FILED 9-27-2002, REG. NO. VR200203567, DATED
10-14-2002, EXPIRES 10-14-2012.

FOR: PHARMACEUTICAL PREPARATIONS
AND DIETETIC PREPARATIONS AND SUBSTANCES,
NAMESLY, DIETARY SUPPLEMENTS, NUTRITIONAL
SUPPLEMENTS AND VITAMINS, ALL WHICH
STRENGTHEN THE IMMUNE SYSTEM ,
IN CLASS 5 (U.S. CLS. 6, 18, 44, 46, 51 AND 52).

SER. NO. 78-230,981, FILED 3-27-2003.

GLENN CLARK, EXAMINING ATTORNEY

Int. Cl.: 9

Prior U.S. Cls.: 21, 23, 26, 36 and 38

Reg. No. 2,893,207

United States Patent and Trademark Office

Registered Oct. 12, 2004

**TRADEMARK
PRINCIPAL REGISTER**

SUPER GREEN KING

JOMAC CANADA INC. (CANADA CORPORATION)

10 BECHELER STREET

STANSTEAD QUEBEC, CANADA J0B 3E2

FOR: PROTECTIVE WORK GLOVES, IN CLASS 9
(U.S. CLS. 21, 23, 26, 36 AND 38).

FIRST USE 12-31-1985; IN COMMERCE 12-31-2001.

PRIORITY CLAIMED UNDER SEC. 44(D) ON
CANADA APPLICATION NO. 1172506, FILED 3-25-
2003.

NO CLAIM IS MADE TO THE EXCLUSIVE
RIGHT TO USE "GREEN", APART FROM THE
MARK AS SHOWN.

SER. NO. 78-231,146, FILED 3-28-2003.

TRACY FLETCHER, EXAMINING ATTORNEY

Int. Cl.: 9

Prior U.S. Cls.: 21, 23, 26, 36 and 38

United States Patent and Trademark Office

Reg. No. 2,893,208

Registered Oct. 12, 2004

**TRADEMARK
PRINCIPAL REGISTER**

JELLY TOUCH

AMERICAN COVERS, INC. (UTAH CORPORATION)
102 WEST 12200 SOUTH
DRAPER, UT 84020

FOR: COMPUTER MOUSE PADS, WRIST SUPPORTS FOR COMPUTER USERS, WRIST SUPPORTS FOR COMPUTER KEYBOARD USERS,

TELEPHONE HANDSET SUPPORT PADS, IN CLASS 9 (U.S. CLS. 21, 23, 26, 36 AND 38).

FIRST USE 1-0-2003; IN COMMERCE 1-0-2001.

SER. NO. 78-231,559, FILED 3-28-2003.

ROBIN CHOSID, EXAMINING ATTORNEY

Int. Cl.: 35

Prior U.S. Cls.: 100, 101 and 102

United States Patent and Trademark Office

Reg. No. 2,893,209

Registered Oct. 12, 2004

**SERVICE MARK
PRINCIPAL REGISTER**

MODULEMD

MEDNET SOLUTIONS L.L.C. (MICHIGAN LTD
LIAB CO)
2545 CAPITAL AVENUE SW, SUITE 205
BATTLE CREEK, MI 49015

THE MARK CONSISTS OF STANDARD CHAR-
ACTERS WITHOUT CLAIM TO ANY PARTICULAR
FONT, STYLE, SIZE, OR COLOR.

FOR: COMPUTER SERVICES, NAMELY, PRO-
VIDING AN ONLINE COMPUTER DATABASE IN
THE FIELD OF MEDICAL PRACTICE MANAGE-
MENT, IN CLASS 35 (U.S. CLS. 100, 101 AND 102).

SER. NO. 78-231,792, FILED 3-31-2003.

FIRST USE 3-7-2003; IN COMMERCE 3-7-2003.

TONJA GASKINS, EXAMINING ATTORNEY

Int. Cl.: 35

Prior U.S. Cls.: 100, 101 and 102

United States Patent and Trademark Office

Reg. No. 2,893,210

Registered Oct. 12, 2004

**SERVICE MARK
PRINCIPAL REGISTER**

CALDWELL

A. CALDWELL LIST CO., INC. (GEORGIA CORPORATION)
4350 GEORGETOWN SQUARE, SUITE 701
ATLANTA, GA 30338

FIRST USE 7-0-1985; IN COMMERCE 7-0-1985.

SEC. 2(F).

FOR: BUSINESS AND CONSUMER INFORMATION SERVICES, NAMELY, PREPARING, COMPILING, MAINTAINING AND RENTING INFORMATIONAL LISTS AND DIRECTORIES RELATING TO BUSINESS AND CONSUMERS FOR OTHERS, IN CLASS 35 (U.S. CLS. 100, 101 AND 102).

SER. NO. 78-231,794, FILED 3-31-2003.

CHERYL CLAYTON, EXAMINING ATTORNEY

Int. Cl.: 35

Prior U.S. Cls.: 100, 101 and 102

United States Patent and Trademark Office

Reg. No. 2,893,211

Registered Oct. 12, 2004

**SERVICE MARK
PRINCIPAL REGISTER**

PIT BULL

TIRE MART, INC. (MISSOURI CORPORATION)
1815 LOCUST STREET
ST. LOUIS, MO 63103

FOR: RETAIL STORE AND WHOLESALE DISTRIBUTORSHIP SERVICES IN THE FIELD OF TIRES, TUBES FOR TIRES AND CHAINS FOR TIRES FOR MOTOR VEHICLES, IN CLASS 35 (U.S. CLS. 100, 101 AND 102).

FIRST USE 1-1-2003; IN COMMERCE 1-1-2003.

OWNER OF U.S. REG. NOS. 2,007,072 AND 2,020,321.

SER. NO. 78-231,844, FILED 3-31-2003.

MICHAEL KAZAZIAN, EXAMINING ATTORNEY

Int. Cl.: 7

Prior U.S. Cls.: 13, 19, 21, 23, 31, 34 and 35

United States Patent and Trademark Office

Reg. No. 2,893,212

Registered Oct. 12, 2004

**TRADEMARK
PRINCIPAL REGISTER**

ALPINE BOLTER MINER

VOEST-ALPINE BERGTECHNIK GESELL-
SCHAFT M.B.H. (AUSTRIA LTD LIAB JT ST
CO)
ALPINESTRASSE 1
ZELTWEG, AUSTRIA A-8740

FOR: MINEWORKING AND MINING MA-
CHINES, NAMELY- TUNNELING MACHINES;
DRIVING MACHINES THAT DRIVE GALLERIES;
CUTTING MACHINES THAT CUT EARTH, ROCK,
AND MINERALS; MINE DEVELOPMENT MA-
CHINES; MINE PRODUCTION MACHINES; MINE-
WORKING MACHINES COMPRISING ANCHOR
BORING AND SETTING EQUIPMENT THAT
BORES HOLES IN MINES FOR ANCHORS AND
SETS ANCHORS THEREIN; MINEWORKING MA-
CHINES COMPRISING ANCHOR BORING AND
SETTING EQUIPMENT THAT BORES HOLES IN
MINES FOR ANCHORS AND SETS ANCHORS
THEREIN WHILE SIMULTANEOUSLY AND CON-
TINUOUSLY MINING; ANCHOR BORING AND
SETTING EQUIPMENT FOR MINEWORKING MA-
CHINES; CUTTING HEADS FOR MINEWORKING

MACHINES; CUTTING CYLINDERS FOR MINE-
WORKING MACHINES; BITS FOR MINEWORK-
ING MACHINES; AND CONVEYORS FOR
MINEWORKING MACHINES, IN CLASS 7 (U.S.
CLS. 13, 19, 21, 23, 31, 34 AND 35).

PRIORITY CLAIMED UNDER SEC. 44(D) ON
AUSTRIA APPLICATION NO. AM63702002, FILED
10-8-2002, REG. NO. 207942, DATED 1-15-2003, EX-
PIRES 1-15-2013.

OWNER OF U.S. REG. NO. 1,020,942.

NO CLAIM IS MADE TO THE EXCLUSIVE
RIGHT TO USE "BOLTER MINER", APART FROM
THE MARK AS SHOWN.

SER. NO. 78-232,089, FILED 3-31-2003.

WILLIAM BRECKENFELD, EXAMINING ATTOR-
NEY

Int. Cl.: 19

Prior U.S. Cls.: 1, 12, 33 and 50

United States Patent and Trademark Office

Reg. No. 2,893,213

Registered Oct. 12, 2004

**TRADEMARK
PRINCIPAL REGISTER**

ADESO

POLYGLASS S.P.A. (ITALY CORPORATION)
31040 NEGRISIA DI PONTE DI PIAVE
TREVISO, ITALY

ROOFING SHINGLES; ROOFING UNDERLAY-
MENTS, IN CLASS 19 (U.S. CLS. 1, 12, 33 AND 50).

FOR: WATERPROOF MEMBRANE FOR ABOVE-
GRADE USE, NAMELY, AS A ROOFING MEM-
BRANE AND FOR BELOW GRADE USE, NAMELY,
AS A NON-METAL FLASHING AROUND THE
FOUNDATION OF A BUILDING; NON-METAL

FIRST USE 9-0-2002; IN COMMERCE 9-0-2002.

SER. NO. 78-233,141, FILED 4-2-2003.

JENNIFER CHICOSKI, EXAMINING ATTORNEY

Int. Cl.: 20

Prior U.S. Cls.: 2, 13, 22, 25, 32 and 50

United States Patent and Trademark Office

Reg. No. 2,893,214

Registered Oct. 12, 2004

**TRADEMARK
PRINCIPAL REGISTER**

ANDES

ANDES INTERNATIONAL, INC. (COLORADO
CORPORATION)
4725 SOUTH NAUTILUS COURT
BOULDER, CO 80301

SEC. 2(F).

FOR: FURNITURE, IN CLASS 20 (U.S. CLS. 2, 13,
22, 25, 32 AND 50).

SER. NO. 78-233,617, FILED 4-3-2003.

FIRST USE 11-0-1987; IN COMMERCE 11-0-1987.

NANCY CLARKE, EXAMINING ATTORNEY

Int. Cl.: 43

Prior U.S. Cls.: 100 and 101

United States Patent and Trademark Office

Reg. No. 2,893,215

Registered Oct. 12, 2004

**SERVICE MARK
PRINCIPAL REGISTER**

COMFORT FOODS

PROJECT RENEWAL, INC. (NEW YORK CORPORATION)
8 EAST THIRD STREET
NEW YORK, NY 10003

FOR: PROVIDING FOOD AND ARRANGING PERMANENT AND TEMPORARY HOUSING TO MENTALLY ILL HOMELESS PERSONS; RESTAURANT SERVICES AND CATERING SERVICES RENDERED TO THE MENTALLY ILL, HOMELESS

PERSONS, THE ELDERLY AND THE HANDICAPPED, IN CLASS 43 (U.S. CLS. 100 AND 101).

FIRST USE 0-0-1998; IN COMMERCE 0-0-1998.

SER. NO. 78-234,024, FILED 4-4-2003.

AMY GEARIN, EXAMINING ATTORNEY

Int. Cl.: 35

Prior U.S. Cls.: 100, 101 and 102

United States Patent and Trademark Office

Reg. No. 2,893,216

Registered Oct. 12, 2004

SERVICE MARK
PRINCIPAL REGISTER



TEIXEIRA, EDWARD M. (UNITED STATES IN-
DIVIDUAL)
1022 MENDOCINO AVENUE
SANTA ROSA, CA 95401

NO CLAIM IS MADE TO THE EXCLUSIVE
RIGHT TO USE FINE JEWELRY, APART FROM
THE MARK AS SHOWN.

FOR: RETAIL STORE SERVICES FEATURING
FINE JEWELRY, IN CLASS 35 (U.S. CLS. 100, 101
AND 102).

SER. NO. 78-234,261, FILED 4-4-2003.

FIRST USE 1-1-1983; IN COMMERCE 1-1-1983.

PAULA MAHONEY, EXAMINING ATTORNEY

Int. Cls.: 3 and 4

Prior U.S. Cls.: 1, 4, 6, 15, 50, 51 and 52

United States Patent and Trademark Office

Reg. No. 2,893,217

Registered Oct. 12, 2004

**TRADEMARK
PRINCIPAL REGISTER**

Olylio

OLYCO DESIGN INC. (FLORIDA CORPORATION)
3700 SW 149TH TERRACE
MIRAMAR, FL 33027

FOR: SOAP IN THE FORM OF PETALS OR OTHER FORMS; PETALS OF SOAP; HAND AND BODY SOAPS; BATH GELS; LIQUID SOAP; SHAMPOO AND CONDITIONERS; LOTIONS AND CREAMS FOR THE SKIN, HAIR, AND FACE; BATH SALTS, IN CLASS 3 (U.S. CLS. 1, 4, 6, 50, 51 AND 52).

FIRST USE 8-23-2002; IN COMMERCE 8-23-2002.

FOR: CANDLES, NAMELY, SCENTED AND UNSCENTED CANDLES, FLOATING CANDLES, CANDLES WITH FORM, BEESWAX FOR USE IN THE MANUFACTURE OF CANDLES, IN CLASS 4 (U.S. CLS. 1, 6 AND 15).

FIRST USE 7-23-2002; IN COMMERCE 7-23-2002.

SER. NO. 78-234,404, FILED 4-6-2003.

GEORGIA CARTY, EXAMINING ATTORNEY

Int. Cls.: 35 and 43

Prior U.S. Cls.: 100, 101 and 102

United States Patent and Trademark Office

Reg. No. 2,893,218

Registered Oct. 12, 2004

**SERVICE MARK
PRINCIPAL REGISTER**

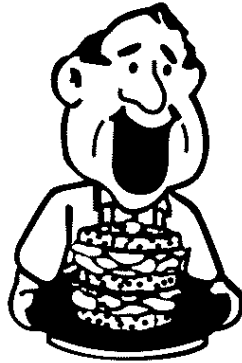

LB MANAGEMENT, INC. (PENNSYLVANIA
CORPORATION)
19 BALA AVENUE
BALA CYNWYD, PA 19004

FOR: RETAIL DELICATESSAN SERVICES, IN
CLASS 35 (U.S. CLS. 100, 101 AND 102).

FIRST USE 11-0-1993; IN COMMERCE 11-0-1993.

FOR: RESTAURANT SERVICES AND CATERING
, IN CLASS 43 (U.S. CLS. 100 AND 101).

FIRST USE 11-0-1993; IN COMMERCE 11-0-1993.

SER. NO. 78-235,307, FILED 4-8-2003.

ALLISON HOLTZ, EXAMINING ATTORNEY

Int. Cls.: 35 and 42

Prior U.S. Cls.: 100, 101 and 102

United States Patent and Trademark Office

Reg. No. 2,893,219

Registered Oct. 12, 2004

**SERVICE MARK
PRINCIPAL REGISTER**



TATTOO (CALIFORNIA CORPORATION)
1290 SUTTER STREET, SUITE 400
SAN FRANCISCO, CA 94109

FOR: BUSINESS SERVICES, NAMELY, CONSUMER BRAND AUDIT, STRATEGIC MARKETING CONSULTATION, COMMUNICATION STRATEGY AUDIT AND DEVELOPMENT, IN CLASS 35 (U.S. CLS. 100, 101 AND 102).

FIRST USE 10-0-1990; IN COMMERCE 10-0-1990.

FOR: PRODUCT DEVELOPMENT FOR OTHERS, AND PRODUCT DEVELOPMENT EVALUATION AND CONSULTATION, IN CLASS 42 (U.S. CLS. 100 AND 101).

FIRST USE 10-0-1990; IN COMMERCE 10-0-1990.

SER. NO. 78-235,568, FILED 4-9-2003.

WILLIAM BRECKENFELD, EXAMINING ATTORNEY

Int. Cls.: 9, 16 and 42

**Prior U.S. Cls.: 2, 5, 21, 22, 23, 26, 29, 36, 37, 38, 50,
100 and 101**

Reg. No. 2,893,220

United States Patent and Trademark Office

Registered Oct. 12, 2004

**TRADEMARK
SERVICE MARK
PRINCIPAL REGISTER**



NATIONAL STUDY OF SCHOOL EVALUATION
(D.C. CORPORATION)
1699 WOODFIELD ROAD
SCHAUMBURG, IL 60173

FOR: COMPUTER SOFTWARE TO COLLECT,
MANAGE, QUERY, ANALYZE, GRAPH OR RE-
PORT PERTINENT DATA AND INFORMATION
FOR EACH PHASE OF A SCHOOL IMPROVEMENT
PROCESS, IN CLASS 9 (U.S. CLS. 21, 23, 26, 36 AND
38).

FIRST USE 12-31-1995; IN COMMERCE 12-31-1999.

FOR: PRINTED REPORTS IN THE AREA OF
SCHOOL IMPROVEMENT PROCESSES, IN CLASS
16 (U.S. CLS. 2, 5, 22, 23, 29, 37, 38 AND 50).

FIRST USE 12-31-1995; IN COMMERCE 12-31-1997.

FOR: PROVIDING TEMPORARY USE OF NON-
DOWNLOADABLE SOFTWARE TO COLLECT,
MANAGE, QUERY, ANALYZE, GRAPH OR RE-
PORT PERTINENT DATA AND INFORMATION
FOR EACH PHASE OF A SCHOOL IMPROVEMENT
PROCESS, IN CLASS 42 (U.S. CLS. 100 AND 101).

FIRST USE 3-31-2003; IN COMMERCE 3-31-2003.

NO CLAIM IS MADE TO THE EXCLUSIVE
RIGHT TO USE "NATIONAL STUDY OF SCHOOL
EVALUATION", APART FROM THE MARK AS
SHOWN.

SER. NO. 78-236,161, FILED 4-10-2003.

ANN LINNEHAN, EXAMINING ATTORNEY

Int. Cls.: 13, 41, 42 and 45

Prior U.S. Cls.: 2, 9, 100, 101 and 107

Reg. No. 2,893,221

United States Patent and Trademark Office

Registered Oct. 12, 2004

**TRADEMARK
SERVICE MARK
PRINCIPAL REGISTER**



CORNER SHOT HOLDINGS, LLC (FLORIDA LIMITED LIABILITY JOINT STOCK COMPANY)
201 ALHAMBRA CIRCLE SUITE 801
CORAL GABLES, FL 33134

FOR: DEVICES THAT ENABLE FIREARMS TO SHOOT AROUND OBJECTS OR OBSTACLES, IN CLASS 13 (U.S. CLS. 2 AND 9).

FIRST USE 12-1-2001; IN COMMERCE 12-1-2001.

FOR: TRAINING SERVICES IN THE FIELDS OF SECURITY AND ANTI-TERRORISM, IN CLASS 41 (U.S. CLS. 100, 101 AND 107).

FIRST USE 12-1-2001; IN COMMERCE 12-1-2001.

FOR: DESIGN AND TESTING OF NEW PRODUCTS FOR OTHERS IN THE SECURITY AND ANTI-TERRORISM FIELDS; DESIGN FOR OTHERS IN THE FIELD OF SECURITY SYSTEMS AND ANTI-TERRORISM DEVICES; RESEARCH AND

DEVELOPMENT OF NEW PRODUCTS FOR OTHERS IN THE SECURITY AND ANTI-TERRORISM FIELDS; AND COMPUTER SYSTEMS ANALYSIS IN THE AREA OF SECURITY AND ANTI-TERRORISM, IN CLASS 42 (U.S. CLS. 100 AND 101).

FIRST USE 12-1-2001; IN COMMERCE 12-1-2001.

FOR: CONSULTING IN THE FIELDS OF SECURITY AND ANTI-TERRORISM; RESEARCH AND DEVELOPMENT AND PLANNING AND DESIGN OF SECURITY AND ANTI-TERRORISM PLANS AND PROCEDURES FOR OTHERS; AND REVIEW AND ANALYSIS OF OTHERS' SECURITY AND ANTI-TERRORISM PLANS AND PROCEDURES, IN CLASS 45 (U.S. CLS. 100 AND 101).

FIRST USE 12-1-2001; IN COMMERCE 12-1-2001.

SER. NO. 78-236,370, FILED 4-10-2003.

KELLEY WELLS, EXAMINING ATTORNEY

Int. Cl.: 35

Prior U.S. Cls.: 100, 101 and 102

United States Patent and Trademark Office

Reg. No. 2,893,222

Registered Oct. 12, 2004

**SERVICE MARK
PRINCIPAL REGISTER**

PERFUMELAND

PERFUMELAND (FLORIDA CORPORATION)
5157 INTERNATIONAL DRIVE
ORLANDO, FL 32819

FOR: ONLINE RETAIL STORE SERVICES FEATURING PERFUME AND FRAGRANCE PRODUCTS, COSMETIC PRODUCTS, HAIR AND SKIN CARE PRODUCTS, BATH AND BODY PRODUCTS AND AROMA THERAPY PRODUCTS; WHOLESALE ORDERING SERVICES IN THE FIELD OF PERFUME AND FRAGRANCE PRODUCTS, COS-

METIC PRODUCTS, HAIR AND SKIN CARE PRODUCTS, BATH AND BODY PRODUCTS AND AROMA THERAPY PRODUCTS, IN CLASS 35 (U.S. CLS. 100, 101 AND 102).

FIRST USE 5-25-1995; IN COMMERCE 5-25-1995.

SER. NO. 78-236,914, FILED 4-11-2003.

JOHN SCHUYLER YARD, EXAMINING ATTORNEY

Int. Cls.: 5 and 31

Prior U.S. Cls.: 1, 6, 18, 44, 46, 51 and 52

United States Patent and Trademark Office

Reg. No. 2,893,223

Registered Oct. 12, 2004

**TRADEMARK
PRINCIPAL REGISTER**

DenProDog

SDC SWEDENCARE AB (SWEDEN JOINT STOCK
COMPANY)
BJÖRKPLAN 6 K
KIRUNA, SWEDEN 981 42

FOR: FOOD SUPPLEMENTS FOR HEALTH CARE
AND MEDICAL PURPOSES, IN CLASS 5 (U.S. CLS. 6,
18, 44, 46, 51 AND 52).

FOR: FOODSTUFFS FOR ANIMALS; AND FOOD-
STUFFS FOR ANIMALS, NAMELY DRIED EDIBLE

ALGAE FOR ANIMALS, IN CLASS 31 (U.S. CLS. 1
AND 46).

PRIORITY CLAIMED UNDER SEC. 44(D) ON
SWEDEN APPLICATION NO. 200301947, FILED 3-
24-2003, REG. NO. 362446, DATED 8-8-2003, EXPIRES
8-8-2013.

SER. NO. 78-236,937, FILED 4-11-2003.

KAREN BRACEY, EXAMINING ATTORNEY

Int. Cl.: 9

Prior U.S. Cls.: 21, 23, 26, 36 and 38

Reg. No. 2,893,224

United States Patent and Trademark Office

Registered Oct. 12, 2004

**TRADEMARK
PRINCIPAL REGISTER**

FLEXJET

IOLINE CORPORATION (WASHINGTON COR-
PORATION)
14140 NE 200TH STREET
WOODINVILLE, WA 98072

FIRST USE 8-6-2002; IN COMMERCE 12-20-2002.

SER. NO. 78-237,034, FILED 4-11-2003.

FOR: INKJET PRINTER, IN CLASS 9 (U.S. CLS. 21,
23, 26, 36 AND 38).

GEOFFREY FOSDICK, EXAMINING ATTORNEY

Int. Cl.: 36

Prior U.S. Cls.: 100, 101 and 102

United States Patent and Trademark Office

Reg. No. 2,893,225

Registered Oct. 12, 2004

**SERVICE MARK
PRINCIPAL REGISTER**

PALOMAR VENTURES

PALOMAR VENTURES MANAGEMENT, LLC
(DELAWARE LIMITED LIABILITY JOINT
STOCK COMPANY)
18881 VON KARMAN AVENUE SUITE 960
IRVINE, CA 92612

FOR: CAPITAL INVESTMENT CONSULTATION,
PROVIDING WORKING CAPITAL AND VENTURE
CAPITAL SERVICES, NAMELY, PROVIDING FI-
NANCING TO EMERGING AND START UP COM-
PANIES, IN CLASS 36 (U.S. CLS. 100, 101 AND 102).

FIRST USE 4-0-1999; IN COMMERCE 4-0-1999.

NO CLAIM IS MADE TO THE EXCLUSIVE
RIGHT TO USE VENTURES, APART FROM THE
MARK AS SHOWN.

SER. NO. 78-237,049, FILED 4-11-2003.

JOHN SCHUYLER YARD, EXAMINING ATTOR-
NEY

Int. Cl.: 17

Prior U.S. Cls.: 1, 5, 12, 13, 35 and 50

United States Patent and Trademark Office

Reg. No. 2,893,226

Registered Oct. 12, 2004

**TRADEMARK
PRINCIPAL REGISTER**

FLATZIP

PLAST CORPORATION (JAPAN CORPORATION)
3-5 KUDANKITA, 1-CHOME CHIYODA-KU
TOKYO, JAPAN 102-0073

FOR: ADHESIVE TAPES FOR BAGS AND POUCHES FOR PACKING OR PACKING USE; ADHESIVE TAPES FOR CONTAINERS FOR PACKING OR PACKING USE, IN CLASS 17 (U.S. CLS. 1, 5, 12, 13, 35 AND 50).

PRIORITY CLAIMED UNDER SEC. 44(D) ON JAPAN APPLICATION NO. 2002-90947, FILED 10-28-2002, REG. NO. 4687044, DATED 6-27-2003, EXPIRES 6-27-2013.

SER. NO. 78-237,291, FILED 4-14-2003.

JEFF DEFORD, EXAMINING ATTORNEY

Int. Cl.: 35

Prior U.S. Cls.: 100, 101 and 102

United States Patent and Trademark Office

Reg. No. 2,893,227

Registered Oct. 12, 2004

**SERVICE MARK
PRINCIPAL REGISTER**

THE GONE FROM HOME NETWORK

CLEAR CHANNEL INTANGIBLES, INC. (DELA-
WARE CORPORATION)
200 EAST BASSE ROAD
SAN ANTONIO, TX 78209

FIRST USE 4-7-2003; IN COMMERCE 4-7-2003.

SER. NO. 78-237,531, FILED 4-14-2003.

FOR: BUSINESS MARKETING CONSULTING
SERVICES TO BUSINESS CLIENTS SERVING A
VARIETY OF INDUSTRIES, IN CLASS 35 (U.S.
CLS. 100, 101 AND 102).

CAROL SPILS, EXAMINING ATTORNEY

Int. Cl.: 5

Prior U.S. Cls.: 6, 18, 44, 46, 51 and 52

United States Patent and Trademark Office

Reg. No. 2,893,228

Registered Oct. 12, 2004

**TRADEMARK
PRINCIPAL REGISTER**

AIJIA

OSCAR HOME CARE, INC. (CALIFORNIA COR-
PORATION)
4142 PACIFIC PRIVADO
ONTARIO, CA 91761

FIRST USE 5-1-1996; IN COMMERCE 12-1-1999.

SER. NO. 78-237,668, FILED 4-14-2003.

FOR: AIR FRESHENERS, IN CLASS 5 (U.S. CLS. 6,
18, 44, 46, 51 AND 52).

INGRID C. EULIN, EXAMINING ATTORNEY

Int. Cl.: 5

Prior U.S. Cls.: 6, 18, 44, 46, 51 and 52

United States Patent and Trademark Office

Reg. No. 2,893,229

Registered Oct. 12, 2004

**TRADEMARK
PRINCIPAL REGISTER**

FIGHT RIGHT

OSCAR HOME CARE, INC. (CALIFORNIA COR-
PORATION)
4142 PACIFIC PRIVADO
ONTARIO, CA 91761

FIRST USE 2-8-2003; IN COMMERCE 2-8-2003.

SER. NO. 78-237,686, FILED 4-14-2003.

FOR: INSECTICIDES FOR AGRICULTURAL
AND DOMESTIC USE, IN CLASS 5 (U.S. CLS. 6, 18,
44, 46, 51 AND 52).

INGRID C. EULIN, EXAMINING ATTORNEY

Int. Cls.: 9, 16, 35 and 41

**Prior U.S. Cls.: 2, 5, 21, 22, 23, 26, 29, 36, 37, 38, 50,
100, 101, 102 and 107**

Reg. No. 2,893,230

United States Patent and Trademark Office

Registered Oct. 12, 2004

**TRADEMARK
SERVICE MARK
PRINCIPAL REGISTER**

ICSC

INTERNATIONAL COUNCIL OF SHOPPING
CENTERS (ILLINOIS CORPORATION)
1221 AVENUE OF THE AMERICAS
NEW YORK, NY 100201099

FOR: MOTION PICTURE FILMS, PRE-RECORDED
AUDIOCASSETTES AND PRE-RECORDED
VIDEOCASSETTES FEATURING INFORMATION
ON SHOPPING CENTERS, IN CLASS 9 (U.S. CLS.
21, 23, 26, 36 AND 38).

FIRST USE 1-31-1978; IN COMMERCE 1-31-1978.

FOR: NEWSPAPERS, BROCHURES, DIRECTOR-
IES, NEWSLETTERS, PRINTED REPORTS, SERIES
OF NON-FICTION BOOKS AND PRINTED COURSE
MATERIALS, ALL DEALING WITH SHOPPING
CENTERS AND RELATED ISSUES, IN CLASS 16
(U.S. CLS. 2, 5, 22, 23, 29, 37, 38 AND 50).

FIRST USE 1-31-1978; IN COMMERCE 1-31-1978.

FOR: ASSOCIATION SERVICES, NAMELY, PRO-
MOTING THE INTERESTS AND DEVELOPMENT
OF SHOPPING CENTERS IN THE UNITED STATES
AND ABROAD, IN CLASS 35 (U.S. CLS. 100, 101 AND
102).

FIRST USE 1-31-1978; IN COMMERCE 1-31-1978.

FOR: EDUCATIONAL SERVICES, NAMELY,
CONDUCTING CLASSROOM SEMINARS AND
CONFERENCES ON ISSUES RELATING TO SHOP-
PING CENTERS, IN CLASS 41 (U.S. CLS. 100, 101
AND 107).

FIRST USE 1-31-1978; IN COMMERCE 1-31-1978.

OWNER OF U.S. REG. NOS. 2,063,245 AND
2,531,881.

SER. NO. 78-237,848, FILED 4-15-2003.

MITCHELL FRONT, EXAMINING ATTORNEY

Int. Cl.: 9

Prior U.S. Cls.: 21, 23, 26, 36 and 38

Reg. No. 2,893,231

United States Patent and Trademark Office

Registered Oct. 12, 2004

**TRADEMARK
PRINCIPAL REGISTER**

MINION

PERSISTOR INSTRUMENTS, INC. (MASSACHU-
SETTS CORPORATION)
254-J SHORE ROAD
BOURNE, MA 02532

FOR: ELECTRONIC DEVICES CAPABLE OF PER-
FORMING FUNCTIONS INCLUDING ONE OR
MORE OF AUTOMATED CONTROL, DATA CAP-
TURE, DATA STORAGE, DATA TRANSFER AND
MANIPULATION, NAMELY DATA LOGGERS AND

CONTROLLERS, IN CLASS 9 (U.S. CLS. 21, 23, 26, 36
AND 38).

FIRST USE 4-3-2003; IN COMMERCE 4-3-2003.

SER. NO. 78-237,953, FILED 4-15-2003.

TRACY FLETCHER, EXAMINING ATTORNEY

Int. Cl.: 41

Prior U.S. Cls.: 100, 101 and 107

United States Patent and Trademark Office

Reg. No. 2,893,232

Registered Oct. 12, 2004

**SERVICE MARK
PRINCIPAL REGISTER**

MUSICIA

LIFE ENERGY PROCESS, INC. (CALIFORNIA
CORPORATION)
15030 VENTURA BOULEVARD, SUITE 908
SHERMAN OAKS, CA 91403

FOR: EDUCATIONAL SERVICES, NAMELY,
CONDUCTING WORKSHOPS AND SEMINARS IN
THE FIELD OF SELF-EXPRESSION AND PERSONAL

DEVELOPMENT, IN CLASS 41 (U.S. CLS. 100,
101 AND 107).

FIRST USE 0-0-2001; IN COMMERCE 0-0-2001.

SER. NO. 78-237,977, FILED 4-15-2003.

GEOFFREY FOSDICK, EXAMINING ATTORNEY

Int. Cl.: 39

Prior U.S. Cls.: 100 and 105

Reg. No. 2,893,233

United States Patent and Trademark Office

Registered Oct. 12, 2004

SERVICE MARK
PRINCIPAL REGISTER

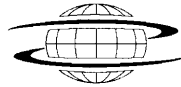

GLOBAL JET

GLOBAL JET CONCEPT S.A. (SWITZERLAND CORPORATION)
CHEMIN DES COQUELICOTS 16
VERNIER, SWITZERLAND 1214

FOR: AIR TRANSPORTATION OF GOODS, PASSENGERS AND TRAVELERS; ARRANGING FOR THE TRANSPORT OF GOODS, PASSENGERS AND TRAVELERS VIA AIR; BOOKING OF SEATS FOR TRAVEL; TRAVEL BOOKING AGENCIES; STORAGE AND HANDLING OF CARGO FOR OTHERS; ARRANGING TRAVEL TOURS FOR OTHERS; TRANSPORT BROKERAGE; TRAVEL AGENCY SERVICES, NAMELY, MAKING RESERVATIONS AND BOOKINGS FOR TRANSPORTATION; AMBULANCE TRANSPORT SERVICES; LEASING AND RENTAL OF AIRCRAFT; AIRCRAFT CHARTERING; ARRANGING AND BOOKING CHARTER FLIGHTS; AND CONSULTATION SERVICES RELATED TO THE FOREGOING; AIR TRANSPORTATION OF GOODS, PASSENGERS AND TRAVELERS; ARRANGING FOR THE TRANSPORT OF GOODS, PASSENGERS AND TRAVELERS VIA AIR; BOOKING OF SEATS FOR TRAVEL; TRAVEL BOOKING AGENCIES; STORAGE AND HANDLING OF CARGO FOR OTHERS; ARRANGING TRAVEL TOURS FOR OTHERS; TRANSPORT BROKERAGE; TRAVEL AGENCY SERVICES, NAMELY, MAKING RESERVATIONS AND BOOKINGS FOR TRANSPORTATION; AMBULANCE TRANSPORT SERVICES; LEASING AND RENTAL OF AIRCRAFT; AIRCRAFT CHARTERING; ARRANGING AND BOOKING CHARTER FLIGHTS; AND CON-

SULTATION SERVICES RELATED TO THE FOREGOING; AIR TRANSPORTATION OF GOODS, PASSENGERS AND TRAVELERS; ARRANGING FOR THE TRANSPORT OF GOODS, PASSENGERS AND TRAVELERS VIA AIR; BOOKING OF SEATS FOR TRAVEL; TRAVEL BOOKING AGENCIES; STORAGE AND HANDLING OF CARGO FOR OTHERS; ARRANGING TRAVEL TOURS FOR OTHERS; TRANSPORT BROKERAGE; TRAVEL AGENCY SERVICES, NAMELY, MAKING RESERVATIONS AND BOOKINGS FOR TRANSPORTATION; AMBULANCE TRANSPORT SERVICES; LEASING AND RENTAL OF AIRCRAFT; AIRCRAFT CHARTERING; ARRANGING AND BOOKING CHARTER FLIGHTS; AND CONSULTATION SERVICES RELATED TO THE FOREGOING, IN CLASS 39 (U.S. CLS. 100 AND 105).

FIRST USE 1-0-2002; IN COMMERCE 1-0-2002.

PRIORITY CLAIMED UNDER SEC. 44(D) ON SWITZERLAND APPLICATION NO. 088952002, FILED 10-15-2002, REG. NO. 505131, DATED 11-13-2002, EXPIRES 10-15-2012.

NO CLAIM IS MADE TO THE EXCLUSIVE RIGHT TO USE "JET", APART FROM THE MARK AS SHOWN.

SER. NO. 78-237,979, FILED 4-15-2003.

ANGELA M. MICHELI, EXAMINING ATTORNEY

Int. Cl.: 34

Prior U.S. Cls.: 2, 8, 9 and 17

United States Patent and Trademark Office

Reg. No. 2,893,234

Registered Oct. 12, 2004

**TRADEMARK
PRINCIPAL REGISTER**



THUNDER BAY (NC), INC. (NORTH CAROLINA
CORPORATION)
1103 DIXIE DRIVE
ROCKY MOUNT, NC 27804

THE MARK CONSISTS OF TWO GEESE IN
FLIGHT WITH AN OVAL IN THE BACKGROUND.

FOR: TOBACCO PRODUCTS, NAMELY LITTLE
CIGARS, IN CLASS 34 (U.S. CLS. 2, 8, 9 AND 17).

SER. NO. 78-238,101, FILED 4-15-2003.

FIRST USE 2-17-2003; IN COMMERCE 2-17-2003.

ODESSA BIBBINS, EXAMINING ATTORNEY

Int. Cls.: 9, 38 and 41

Prior U.S. Cls.: 21, 23, 26, 36, 38, 100, 101, 104 and 107

United States Patent and Trademark Office

Reg. No. 2,893,235

Registered Oct. 12, 2004

**TRADEMARK
SERVICE MARK
PRINCIPAL REGISTER**

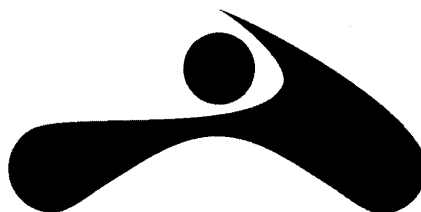

CAROLINE RECORDS, INC. (NEW YORK CORPORATION)
104 WEST 29TH STREET
NEW YORK, NY 10001

FOR: SOUND RECORDINGS AND DOWNLOADABLE SOUND RECORDINGS FEATURING MUSIC, COMEDY AND NARRATIVES; VISUAL RECORDINGS AND DOWNLOADABLE VISUAL RECORDINGS FEATURING MUSIC COMEDY AND NARRATIVES; DOWNLOADABLE ELECTRONIC PUBLICATIONS IN THE NATURE OF NEWSLETTERS IN THE FIELD OF MUSIC, IN CLASS 9 (U.S. CLS. 21, 23, 26, 36 AND 38).

FIRST USE 1-31-1993; IN COMMERCE 1-31-1993.

FOR: STREAMING OF AUDIO AND VISUAL MATERIAL ON THE INTERNET, IN CLASS 38 (U.S. CLS. 100, 101 AND 104).

FIRST USE 12-31-1996; IN COMMERCE 12-31-1996.

FOR: PROVIDING INFORMATION ON A GLOBAL COMPUTER NETWORK FEATURING INFORMATION ON MUSICAL ARTISTS AND THEIR BIOGRAPHIES, RECORDINGS AND TOUR SCHEDULES, IN CLASS 41 (U.S. CLS. 100, 101 AND 107).

FIRST USE 12-31-1996; IN COMMERCE 12-31-1996.

THE MARK CONSISTS OF THE LETTER "A" IN A STYLIZED FORM.

SER. NO. 78-238,172, FILED 4-15-2003.

VERNA BETH RIRIE, EXAMINING ATTORNEY

Int. Cl.: 40

Prior U.S. Cls.: 100, 103 and 106

United States Patent and Trademark Office

Reg. No. 2,893,236

Registered Oct. 12, 2004

**SERVICE MARK
PRINCIPAL REGISTER**

TOWER

VICKMOORE SCREEN PRINTING, INC. (FLOR-
IDA CORPORATION)
5115 WEST KNOX STREET
TAMPA, FL 33634

FIRST USE 0-0-2000; IN COMMERCE 0-0-2000.

SER. NO. 78-239,030, FILED 4-17-2003.

FOR: SCREEN PRINTING FOR OTHERS, IN
CLASS 40 (U.S. CLS. 100, 103 AND 106).

RICHARD WHITE, EXAMINING ATTORNEY

Int. Cl.: 42

Prior U.S. Cls.: 100 and 101

United States Patent and Trademark Office

Reg. No. 2,893,237

Registered Oct. 12, 2004

**SERVICE MARK
PRINCIPAL REGISTER**

EMCON

EMCON EMANATION CONTROL LIMITED (CANADA CORPORATION)
11 TRISTAN COURT
OTTAWA ONTARIO, CANADA K2E 8B9

FOR: CUSTOM DESIGN OF COMPUTERS AND COMPUTER PERIPHERALS IN THE FIELD OF INFORMATION SECURITY; AND ELECTROMAGNETIC ENGINEERING SERVICES IN THE ABOVE FIELD, IN CLASS 42 (U.S. CLS. 100 AND 101).

FIRST USE 12-31-1988; IN COMMERCE 12-31-1991.

PRIORITY CLAIMED UNDER SEC. 44(D) ON CANADA APPLICATION NO. 1166479, FILED 1-31-2003.

SER. NO. 78-239,466, FILED 4-18-2003.

STEVEN R. FOSTER, EXAMINING ATTORNEY

Int. Cl.: 42

Prior U.S. Cls.: 100 and 101

United States Patent and Trademark Office

Reg. No. 2,893,238

Registered Oct. 12, 2004

**SERVICE MARK
PRINCIPAL REGISTER**

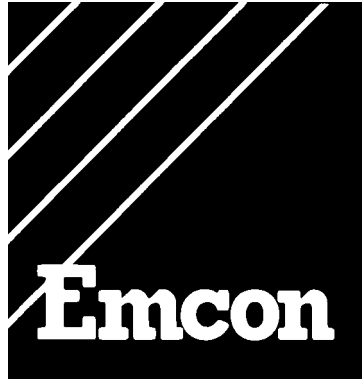

EMCON EMANATION CONTROL LIMITED (CANADA CORPORATION)
11 TRISTAN COURT
OTTAWA, CANADA K2E 8B9

FOR: CUSTOM DESIGN OF COMPUTERS AND COMPUTER PERIPHERALS IN THE FIELD OF INFORMATION SECURITY; AND ELECTROMAGNETIC ENGINEERING SERVICES IN THE ABOVE FIELD, IN CLASS 42 (U.S. CLS. 100 AND 101).

FIRST USE 12-31-1988; IN COMMERCE 12-31-1991.

PRIORITY CLAIMED UNDER SEC. 44(D) ON CANADA APPLICATION NO. 1166478, FILED 1-31-2003.

SER. NO. 78-239,477, FILED 4-18-2003.

STEVEN R. FOSTER, EXAMINING ATTORNEY

Int. Cls.: 29 and 30

Prior U.S. Cl.: 46

United States Patent and Trademark Office

Reg. No. 2,893,239

Registered Oct. 12, 2004

**TRADEMARK
PRINCIPAL REGISTER**

PEACEFUL PLANET

NUTRAMARKS, INC. (DELAWARE CORPORATION)
1500 KEARNS BOULEVARD, SUITE B-200
PARK CITY, UT 84060

FOR: SOY BASED SNACKS; SOY BASED POWDER USED AS A NUTRITIONAL INGREDIENT IN BAKING, IN CLASS 29 (U.S. CL. 46).

FIRST USE 9-1-1997; IN COMMERCE 9-1-1997.

FOR: PROCESSED CEREALS; PROCESSED GRAINS; CEREAL-BASED FOOD BAR AND SNACK FOODS; RICE-BASED FOOD BARS AND SNACK FOODS; WHEAT-BASED FOOD BARS AND SNACK

FOODS; GRAIN-BASED FOOD BARS AND SNACK FOODS; GRANOLA-BASED FOOD BARS AND SNACK FOODS; RICE BASED SNACKS; FLAVORED SHAKE DRINK MIXES; LIQUID AND POWDERED HERBAL FOOD BEVERAGE MIXES, IN CLASS 30 (U.S. CL. 46).

FIRST USE 9-1-1997; IN COMMERCE 9-1-1997.

SER. NO. 78-239,633, FILED 4-18-2003.

KARANENDRA S. CHHINA, EXAMINING ATTORNEY

Int. Cl.: 16

Prior U.S. Cls.: 2, 5, 22, 23, 29, 37, 38 and 50

United States Patent and Trademark Office

Reg. No. 2,893,240

Registered Oct. 12, 2004

**TRADEMARK
PRINCIPAL REGISTER**

THE STANDARDS EDGE

BOLIN COMMUNICATIONS (CALIFORNIA
SOLE PROPRIETORSHIP)
244 SUNNYSIDE AVENUE
PIEDMONT, CA 94611

NO CLAIM IS MADE TO THE EXCLUSIVE
RIGHT TO USE "STANDARDS", APART FROM
THE MARK AS SHOWN.

FOR: SERIES OF BOOKS COVERING ISSUES IN
STANDARDIZATION, IN CLASS 16 (U.S. CLS. 2, 5,
22, 23, 29, 37, 38 AND 50).

SER. NO. 78-239,814, FILED 4-19-2003.

FIRST USE 8-23-2002; IN COMMERCE 1-10-2003.

TRACY CROSS, EXAMINING ATTORNEY

Int. Cl.: 32

Prior U.S. Cls.: 45, 46 and 48

Reg. No. 2,893,241

United States Patent and Trademark Office

Registered Oct. 12, 2004

**TRADEMARK
PRINCIPAL REGISTER**

PRIGAT

GAT GIVAT CHAIM, COOPERATIVE SOCIETY
FOR PRESERVATION OF AGRICULTURAL
PRODUCTS LTD. (ISRAEL CORPORATION)
KIBBUTZ GIVAT CHAIM
KIBBUTZ GIVAT CHAIM, ISRAEL 38100

FOR: BEERS; MINERAL AND AERATED WA-
TERS; FRUIT DRINKS, FRUIT JUICES, FRUIT
NECTARS AND FRUIT-BASED SOFT DRINKS;
SYRUPS, FRUIT CONCENTRATES AND OTHER

PREPARATIONS FOR MAKING SOFT BEVERAGES
WITH FRUIT FLAVORING, IN CLASS 32 (U.S. CLS.
45, 46 AND 48).

FIRST USE 12-31-1976; IN COMMERCE 6-30-1999.

SER. NO. 78-239,847, FILED 4-20-2003.

MIDGE BUTLER, EXAMINING ATTORNEY

Int. Cl.: 42

Prior U.S. Cls.: 100 and 101

United States Patent and Trademark Office

Reg. No. 2,893,242

Registered Oct. 12, 2004

**SERVICE MARK
PRINCIPAL REGISTER**

FEMIDA

DUBOGRAEV, DMITRI I. (UNITED STATES IN-
DIVIDUAL)
910 17TH STREET, N.W., SUITE 800
WASHINGTON, DC 20006

FIRST USE 2-14-2003; IN COMMERCE 2-14-2003.

SER. NO. 78-239,873, FILED 4-21-2003.

FOR: LEGAL SERVICES, IN CLASS 42 (U.S. CLS.
100 AND 101).

DOMINICK J. SALEMI, EXAMINING ATTORNEY

Int. Cls.: 16, 35 and 41

Prior U.S. Cls.: 2, 5, 22, 23, 29, 37, 38, 50, 100, 101, 102 and 107

Reg. No. 2,893,243

United States Patent and Trademark Office

Registered Oct. 12, 2004

**TRADEMARK
SERVICE MARK
PRINCIPAL REGISTER**



THE DANNON INSTITUTE, INC. (DELAWARE NOT-FOR PROFIT CORPORATION)
120 WHITE PLAINS ROAD
TARRYTOWN, NY 10591

FOR: PUBLICATIONS, NAMELY, BOOKS, JOURNALS AND NEWSLETTERS PERTAINING TO THE FIELD OF NUTRITION AND HEALTH, IN CLASS 16 (U.S. CLS. 2, 5, 22, 23, 29, 37, 38 AND 50).

FIRST USE 4-30-2000; IN COMMERCE 4-30-2000.

FOR: PROMOTING PUBLIC AWARENESS OF THE NEED FOR CHILDREN'S NUTRITION EDUCATION, IN CLASS 35 (U.S. CLS. 100, 101 AND 102).

FIRST USE 4-30-2000; IN COMMERCE 4-30-2000.

FOR: PROVIDING EDUCATIONAL PROGRAMS IN THE FIELDS OF NUTRITION AND HEALTH AMONG RESEARCHERS AND MEDICAL PROFESSIONALS; PROVIDING INFORMATION ABOUT NUTRITION AND HEALTH EDUCATION VIA THE INTERNET; PROVIDING ONLINE PUBLICATIONS, NAMELY, NEWSLETTERS AND JOURNALS IN THE FIELD OF NUTRITION AND HEALTH; EDUCATIONAL RESEARCH ON THE

RELATIONSHIP BETWEEN NUTRITION AND HEALTH; DEVELOPMENT AND DISSEMINATION OF EDUCATIONAL MATERIALS OF OTHERS IN THE FIELD OF NUTRITION AND HEALTH, IN CLASS 41 (U.S. CLS. 100, 101 AND 107).

FIRST USE 4-30-2000; IN COMMERCE 4-30-2000.

THE MARK CONSISTS OF A BLACK OUTLINE, WITH A THICK BLACK BORDER AT THE BOTTOM WITHIN WHICH IS LOCATED THE WORDS "HEALTHY EATING", IN GOLD. THE WORD "CELEBRATE" IS IN GOLD. THE SPOON IS LIGHT BLUE ON A RED PLATE WITH A THIN BLACK INNER ARCuate LINE. THE BACKGROUND IS COMPOSED OF A CHECKERBOARD PATTERN OF ALTERNATING DARK AND LIGHT BLUE SQUARES, STARTING WITH A DARK BLUE SQUARE IN THE UPPER LEFT HAND CORNER. THE COLORS BLACK, RED, DARK BLUE, LIGHT BLUE AND GOLD ARE CLAIMED.

SER. NO. 78-239,925, FILED 4-21-2003.

HELEN BRYAN, EXAMINING ATTORNEY

Int. Cls.: 41 and 44

Prior U.S. Cls.: 100, 101 and 107

United States Patent and Trademark Office

Reg. No. 2,893,244

Registered Oct. 12, 2004

**SERVICE MARK
PRINCIPAL REGISTER**

NUTRITIONCLICK.COM

NUTRITION CLICK INC. (WASHINGTON CORPORATION)
17 GRAND VIEW LANE S.E.
BELLINGHAM, WA 982294828

FOR: EDUCATIONAL SERVICES, NAMELY, CONDUCTING ONLINE CLASSES IN THE FIELD OF NUTRITION; EDUCATIONAL SERVICES, NAMELY, CONDUCTING ONLINE PROFESSIONAL REVIEW CLASSES FOR DIETITIANS IN THE FIELD OF NUTRITION; EDUCATIONAL SERVICES, NAMELY, CONDUCTING EDUCATIONAL CLASSES IN THE FIELD OF HEALTH AND NUTRITION, IN CLASS 41 (U.S. CLS. 100, 101 AND 107).

FIRST USE 3-25-2003; IN COMMERCE 3-25-2003.

FOR: PROVIDING INFORMATION IN THE FIELD OF NUTRITION, NAMELY MENUS, RECIPES, GROCERY LISTS AND NUTRITION FACTS FOR PEOPLE WITH GLUCOSE INTOLERANCE, TYPE 1 AND TYPE 2 DIABETES, PRE-DIABETES AND GESTATIONAL DIABETES, IN CLASS 44 (U.S. CLS. 100 AND 101).

FIRST USE 3-25-2003; IN COMMERCE 3-25-2003.

SER. NO. 78-240,516, FILED 4-22-2003.

ANN LINNEHAN, EXAMINING ATTORNEY

Int. Cls.: 39 and 41

Prior U.S. Cls.: 100, 101, 105 and 107

United States Patent and Trademark Office

Reg. No. 2,893,245

Registered Oct. 12, 2004

**SERVICE MARK
PRINCIPAL REGISTER**

CHRISTIAN DISCOVERIES

EDUCATIONAL FIELD STUDIES, LLC (DELAWARE CORPORATION)
590 PETER JEFFERSON PARKWAY, SUITE 300
CHARLOTTESVILLE, VA 22911

FOR: TRAVEL SERVICES, NAMELY, ARRANGING AND CONDUCTING TRAVEL PROGRAMS IN EDUCATIONAL TRIPS, IN CLASS 39 (U.S. CLS. 100 AND 105).

FIRST USE 9-19-1997; IN COMMERCE 9-19-1997.

FOR: EDUCATIONAL SERVICES, NAMELY, ARRANGING AND CONDUCTING FIELD TRIPS, CLASSES, SEMINARS, WORKSHOPS IN A VARIETY OF SUBJECTS FROM A RELIGIOUS AND HISTORICAL PERSPECTIVE; DEVELOPMENT OF

EDUCATIONAL MATERIALS, STANDARD IN A CURRICULUM FOR THOSE IN A FIELD OF CHRISTIAN EDUCATION, IN CLASS 41 (U.S. CLS. 100, 101 AND 107).

FIRST USE 9-19-1997; IN COMMERCE 9-19-1997.

OWNER OF U.S. REG. NO. 2,327,591.

NO CLAIM IS MADE TO THE EXCLUSIVE RIGHT TO USE CHRISTIAN, APART FROM THE MARK AS SHOWN.

SER. NO. 78-240,677, FILED 4-22-2003.

NAAKWAMA ANKRAH, EXAMINING ATTORNEY

Int. Cl.: 33

Prior U.S. Cls.: 47 and 49

United States Patent and Trademark Office

Reg. No. 2,893,246

Registered Oct. 12, 2004

**TRADEMARK
PRINCIPAL REGISTER**

FALESCO

AZIENDA VINICOLA FALESCO S.R.L. (ITALY
LTD LIAB JT ST CO)
VIA SAN DOMENICO SAVIO, 28, FRAZIONE MON-
TERUBIAGLIO
CASTEL VISCARDO (TERNI), ITALY 05014

FIRST USE 0-0-1988; IN COMMERCE 0-0-1988.

SER. NO. 78-240,680, FILED 4-22-2003.

FOR: WINES, IN CLASS 33 (U.S. CLS. 47 AND 49).

CHERYL CLAYTON, EXAMINING ATTORNEY

Int. Cl.: 35

Prior U.S. Cls.: 100, 101 and 102

United States Patent and Trademark Office

Reg. No. 2,893,247

Registered Oct. 12, 2004

SERVICE MARK
PRINCIPAL REGISTER



KILBRIDE, GAYLA R. (UNITED STATES INDIVIDUAL)
7938 ELBOW LANE NORTH
ST. PETERSBURG, FL 33710

FOR: PROMOTING THE GOODS AND SERVICES OF OTHERS FROM WEB SITES OF INTERACTIVE TRAVEL MAPS BY PROVIDING POP-UP ADS AND HYPERTEXTLINKS TO THE WEB SITES OF OTHERS, IN CLASS 35 (U.S. CLS. 100, 101 AND 102).

FIRST USE 4-16-2003; IN COMMERCE 4-16-2003.

NO CLAIM IS MADE TO THE EXCLUSIVE RIGHT TO USE MAPS, APART FROM THE MARK AS SHOWN.

THE STIPPLING IN THE DRAWING IS FOR SHADING PURPOSES ONLY.

SER. NO. 78-240,868, FILED 4-22-2003.

MELVIN AXILBUND, EXAMINING ATTORNEY

Int. Cls.: 18 and 25

Prior U.S. Cls.: 1, 2, 3, 22, 39 and 41

United States Patent and Trademark Office

Reg. No. 2,893,248

Registered Oct. 12, 2004

**TRADEMARK
PRINCIPAL REGISTER**



WOLF, MARCUS (FED REP GERMANY INDIVIDUAL)
EMSSTRASSE 21
EMSBUEREN, FED REP GERMANY 48488

FOR: GOODS MADE OF LEATHER AND LEATHER IMITATIONS, NAMELY, HAND BAGS, ATTACHÉ CASES, PURSES, WALLETS, KEY CASES, TRUNKS FOR TRAVELING AND TRAVELING BAGS, UMBRELLAS; PARASOLS; WHIPS; HARNESSES; HORSE HALTERS; HORSE BLANKETS; SADDLE PADS; SADDLE GIRTHS; SADDLE BAGS; NOSE BAND COVERS; PROTECTIVE BOOTS FOR HORSES, NAMELY SCHOOLING BOOTS, TENDON BOOTS, LIGHTWEIGHT JUMPING BOOTS, BELL BOOTS, AND TRAVELING BOOTS; SADDLES; SADDLE ACCESSORIES, NAMELY, SADDLE BAGS, BRIDLES, SADDLE GIRTHS, HALTERS, REINS;

BRIDLE AND REINS ACCESSORIES NAMELY BROW BANDS, IN CLASS 18 (U.S. CLS. 1, 2, 3, 22 AND 41).

FOR: CLOTHING AND SPORTSWEAR - NAMELY, TROUSERS, BREECHES, PANTS, JACKETS, WAISTCOATS, MANTLES, COATS, SHIRTS, BLOUSES, PLASTRONS, NECKTIES, SKIRTS, GLOVES, AND CAPS, IN CLASS 25 (U.S. CLS. 22 AND 39).

OWNER OF FED REP GERMANY REG. NO. 30045350, DATED 2-5-2001, EXPIRES 2-5-2011.

SER. NO. 78-241,038, FILED 4-23-2003.

RUSS HERMAN, EXAMINING ATTORNEY

Int. Cl.: 5

Prior U.S. Cls.: 6, 18, 44, 46, 51 and 52

Reg. No. 2,893,249

United States Patent and Trademark Office

Registered Oct. 12, 2004

**TRADEMARK
PRINCIPAL REGISTER**

ATTENDS SHAPED PADS

PAPERPAK PRODUCTS, INC. (DELAWARE
CORPORATION)
545 TERRACE DRIVE
SAN DIMAS, CA 91773

FOR: INCONTINENCE PRODUCTS, NAMELY
ABSORBENT PADS AND LINERS, IN CLASS 5
(U.S. CLS. 6, 18, 44, 46, 51 AND 52).

FIRST USE 11-15-2002; IN COMMERCE 4-1-2003.

OWNER OF U.S. REG. NOS. 1,100,540, 2,645,355
AND OTHERS.

NO CLAIM IS MADE TO THE EXCLUSIVE
RIGHT TO USE "SHAPED PADS", APART FROM
THE MARK AS SHOWN.

SER. NO. 78-241,146, FILED 4-23-2003.

MICHAEL SOUDERS, EXAMINING ATTORNEY

Int. Cl.: 25

Prior U.S. Cls.: 22 and 39

United States Patent and Trademark Office

Reg. No. 2,893,250

Registered Oct. 12, 2004

**TRADEMARK
PRINCIPAL REGISTER**



V.F. CORPORATION (PENNSYLVANIA CORPORATION)
105 CORPORATE CENTER BLVD
GREENSBORO, NC 27408

FOR: MEN'S, WOMEN'S AND CHILDREN'S
TOPS, BOTTOMS, JEANS, JACKETS, VESTS, CAPS,
HATS, COVERALLS, UNDERWEAR, SLEEPWEAR,
HOSIERY, SOCKS, GLOVES, MITTENS, SHOES,
BOOTS, FOOTWEAR, BELTS, SKI WEAR, SNOW-
BOARD WEAR, SNOW PANTS, SNOW SUITS, LIN-
GERIE, LOUNGEWEAR, SKIRTS, SKORTS AND

DRESSES; CLOTH DIAPERS; CLOTH BIBS FOR
INFANTS AND CHILDREN; INFANT WEAR; LAB
COATS; UNIFORMS AND BANDANAS, IN CLASS
25 (U.S. CLS. 22 AND 39).

FIRST USE 1-1-1999; IN COMMERCE 1-1-1999.

OWNER OF U.S. REG. NO. 960,480.

SER. NO. 78-241,157, FILED 4-23-2003.

MELVIN AXILBUND, EXAMINING ATTORNEY

Int. Cl.: 5

Prior U.S. Cls.: 6, 18, 44, 46, 51 and 52

United States Patent and Trademark Office

Reg. No. 2,893,251

Registered Oct. 12, 2004

**TRADEMARK
PRINCIPAL REGISTER**

CHAFIDERM

STAN CHESTER (UNITED STATES INDIVIDUAL)
9301 CONGO ROAD
BENTON, AR 72015 AND
PATTI CHESTER (UNITED STATES INDIVIDUAL)
9301 CONGO ROAD
BENTON, AR 72015

FOR: OINTMENT FOR DIAPER RASH, IN CLASS
5 (U.S. CLS. 6, 18, 44, 46, 51 AND 52).

FIRST USE 7-1-1996; IN COMMERCE 7-1-1996.

SER. NO. 78-241,365, FILED 4-23-2003.

TRACY FLETCHER, EXAMINING ATTORNEY

Int. Cl.: 30

Prior U.S. Cl.: 46

United States Patent and Trademark Office

Reg. No. 2,893,252

Registered Oct. 12, 2004

**TRADEMARK
PRINCIPAL REGISTER**

GRANNY'S PRIDE

THE KROGER CO. OF MICHIGAN (MICHIGAN
CORPORATION)
18334 LAUREL PARK DRIVE NORTH
LIVONIA, MI 481522686

FIRST USE 3-0-2003; IN COMMERCE 3-0-2003.

SER. NO. 78-241,884, FILED 4-24-2003.

FOR: BREAD, IN CLASS 30 (U.S. CL. 46).

CYNTHIA SLOAN, EXAMINING ATTORNEY

Int. Cl.: 35

Prior U.S. Cls.: 100, 101 and 102

United States Patent and Trademark Office

Reg. No. 2,893,253

Registered Oct. 12, 2004

**SERVICE MARK
PRINCIPAL REGISTER**

METEOR

UDP, INC. (TEXAS CORPORATION)
2426 CEE GEE
SAN ANTONIO, TX 782176222

FOR: COMPUTERIZED BILLING AND REPORT-
ING SERVICES, NAMELY, COMPUTERIZED BILL-
ING RECORD PROCESSING, BILLING RECORD
REPORTING AND BILLING SERVICES, ALL FOR

THE TELECOMMUNICATIONS INDUSTRY , IN
CLASS 35 (U.S. CLS. 100, 101 AND 102).

FIRST USE 1-8-2003; IN COMMERCE 1-8-2003.

SER. NO. 78-242,045, FILED 4-25-2003.

YSA DEJESUS, EXAMINING ATTORNEY

Int. Cl.: 35

Prior U.S. Cls.: 100, 101 and 102

United States Patent and Trademark Office

Reg. No. 2,893,254

Registered Oct. 12, 2004

**SERVICE MARK
PRINCIPAL REGISTER**

COMET

UDP, INC. (TEXAS CORPORATION)
2426 CEE GEE
SAN ANTONIO, TX 782176222

FOR: COMPUTERIZED BILLING AND REPORT-
ING SERVICES, NAMELY, COMPUTERIZED BILL-
ING RECORD PRECESSING, BILLING RECORD
REPORTING AND BILLING SERVICES, ALL FOR

THE TELECOMMUNICATIONS INDUSTRY , IN
CLASS 35 (U.S. CLS. 100, 101 AND 102).

FIRST USE 1-8-2003; IN COMMERCE 1-8-2003.

SER. NO. 78-242,048, FILED 4-25-2003.

YSA DEJESUS, EXAMINING ATTORNEY

Int. Cl.: 35

Prior U.S. Cls.: 100, 101 and 102

Reg. No. 2,893,255

United States Patent and Trademark Office

Registered Oct. 12, 2004

**SERVICE MARK
PRINCIPAL REGISTER**



NCM ASSOCIATES, INC. (KANSAS CORPORATION)
SUITE 200
10551 BARKLEY
OVERLAND PARK, KS 66212

NO CLAIM IS MADE TO THE EXCLUSIVE
RIGHT TO USE "ASSOCIATES, INC." AND "SINCE
1947", APART FROM THE MARK AS SHOWN.

FOR: PROVIDING INFORMATION ABOUT AU-
TOMOTIVE DEALERSHIPS, IN CLASS 35 (U.S. CLS.
100, 101 AND 102).

SER. NO. 78-242,081, FILED 4-25-2003.

FIRST USE 1-1-2000; IN COMMERCE 1-1-2000.

YSA DEJESUS, EXAMINING ATTORNEY

Int. Cl.: 9

Prior U.S. Cls.: 21, 23, 26, 36 and 38

Reg. No. 2,893,256

United States Patent and Trademark Office

Registered Oct. 12, 2004

**TRADEMARK
PRINCIPAL REGISTER**

NOVA DEVELOPMENT

NOVA DEVELOPMENT CORPORATION (CALIFORNIA CORPORATION)
SUITE 2005
23801 CALABASAS ROAD
CALABASAS, CA 913021547

FOR: LINE OF COMPUTER SOFTWARE PRODUCTS FOR CONSUMER, HOME, AND BUSINESS USE, NAMELY, SOFTWARE TITLES IN THE FIELDS OF COMPUTER UTILITY PROGRAMS, DIGITAL MEDIA, LIFESTYLE AND PRODUCTIVITY, GRAPHICS, AND HOME OFFICE APPLICATIONS IN THE NATURE OF SPREADSHEETS WORD PROCESSING AND DATABASE MANAGE-

MENT PROGRAMS, IN CLASS 9 (U.S. CLS. 21, 23, 26, 36 AND 38).

FIRST USE 4-23-1985; IN COMMERCE 4-23-1985.

NO CLAIM IS MADE TO THE EXCLUSIVE RIGHT TO USE DEVELOPMENT, APART FROM THE MARK AS SHOWN.

SER. NO. 78-242,092, FILED 4-25-2003.

YSA DEJESUS, EXAMINING ATTORNEY

Int. Cl.: 9

Prior U.S. Cls.: 21, 23, 26, 36 and 38

Reg. No. 2,893,257

United States Patent and Trademark Office

Registered Oct. 12, 2004

**TRADEMARK
PRINCIPAL REGISTER**



NOVA
DEVELOPMENT

NOVA DEVELOPMENT CORPORATION (CALIFORNIA CORPORATION)
SUITE 2005
23801 CALABASAS ROAD
CALABASAS, CA 913021547

FOR: LINE OF COMPUTER SOFTWARE PRODUCTS FOR CONSUMER, HOME, AND BUSINESS USE, NAMELY, SOFTWARE TITLES IN THE FIELDS OF COMPUTER UTILITY PROGRAMS, DIGITAL MEDIA, LIFESTYLE AND PRODUCTIVITY, GRAPHICS, AND HOME OFFICE APPLICATIONS IN THE NATURE OF SPREADSHEETS WORD PROCESSING AND DATABASE MANAGE-

MENT PROGRAMS, IN CLASS 9 (U.S. CLS. 21, 23, 26, 36 AND 38).

FIRST USE 4-23-1985; IN COMMERCE 4-23-1985.

NO CLAIM IS MADE TO THE EXCLUSIVE RIGHT TO USE DEVELOPMENT, APART FROM THE MARK AS SHOWN.

SER. NO. 78-242,097, FILED 4-25-2003.

YSA DEJESUS, EXAMINING ATTORNEY

Int. Cl.: 35

Prior U.S. Cls.: 100, 101 and 102

United States Patent and Trademark Office

Reg. No. 2,893,258

Registered Oct. 12, 2004

SERVICE MARK
PRINCIPAL REGISTER



F.J.DESIGNS, INC. (OHIO CORPORATION)
2163 GREAT TRAILS DRIVE
WOOSTER, OH 44691

FOR: RETAIL AND ON-LINE STORE SERVICES FEATURING DECORATIVE MINIATURE WOODEN REPLICAS OF ARCHITECTURAL STRUCTURES, SHIPS, TRANSPORTATION VEHICLES AND ARCHITECTURAL AND LANDSCAPE ACCESSORIES SUCH AS FENCES, LAMPPOSTS, TREES, AND SHRUBS, AND A DISPLAY COMPRISING SCREENS, BRUSHES, TOOLS, AND WRITTEN COMMENTARY ABOUT THE HISTORY AND MANUFACTURE OF DECORATIVE MINIATURE

WOODEN REPLICAS, IN CLASS 35 (U.S. CLS. 100, 101 AND 102).

FIRST USE 11-1-2002; IN COMMERCE 11-1-2002.

OWNER OF U.S. REG. NOS. 1,777,900, 2,738,652 AND OTHERS.

THE MARK CONSISTS OF THE WORDS "THE JAY GROUP" IN TYPOGRAPHICAL STYLE AS SHOWN IN THE ATTACHMENT..

SER. NO. 78-242,207, FILED 4-25-2003.

YSA DEJESUS, EXAMINING ATTORNEY

Int. Cl.: 21

Prior U.S. Cls.: 2, 13, 23, 29, 30, 33, 40 and 50

Reg. No. 2,893,259

United States Patent and Trademark Office

Registered Oct. 12, 2004

**TRADEMARK
PRINCIPAL REGISTER**

BOEHM

HOME INTERIORS & GIFTS, INC. (TEXAS CORPORATION)
1649 FRANKFORD ROAD WEST
CARROLLTON, TX 752012980

FIRST USE 1-1-1950; IN COMMERCE 1-1-1950.

SEC. 2(F).

FOR: FIGURINES, SCULPTURES AND STATUETTES MADE OF CHINA AND PORCELAIN, IN CLASS 21 (U.S. CLS. 2, 13, 23, 29, 30, 33, 40 AND 50).

SER. NO. 78-242,382, FILED 4-25-2003.

LAURA KOVAISKY, EXAMINING ATTORNEY

Int. Cl.: 9

Prior U.S. Cls.: 21, 23, 26, 36 and 38

Reg. No. 2,893,260

United States Patent and Trademark Office

Registered Oct. 12, 2004

**TRADEMARK
PRINCIPAL REGISTER**

CREATIVE

CREATIVE TECHNOLOGY LTD. (SINGAPORE CORPORATION)
31 INTERNATIONAL BUSINESS PARK
CREATIVE RESOURCE
SINGAPORE, SINGAPORE 609921

FOR: COMPUTER HARDWARE; COMPUTER SOFTWARE TO CONTROL AND IMPROVE COMPUTER AND AUDIO EQUIPMENT SOUND QUALITY AND COMPUTER SOFTWARE FOR THE STORAGE, REPRODUCTION, TRANSMISSION AND EDITING OF SOUND, DATA, TEXT, IMAGES, AND VIDEO IN COMPUTER AUDIO COMPONENTS AND MULTIMEDIA APPLICATIONS; COMPUTER PERIPHERALS; DIGITAL AUDIO PLAYERS AND RECORDERS; DIGITAL VIDEO PLAYERS AND RECORDERS; DIGITAL IMAGE RECORDERS AND VIEWERS; ELECTRONIC AUDIO AND VIDEO COMPONENTS, NAMELY, SOUND SYSTEMS COMPRISED OF RECEIVERS, AMPLIFIERS, TUNERS,

SOUND MIXERS, EQUALIZERS, AUDIO AND VIDEO RECORDERS AND PLAYERS, AND RADIOS; NETWORK INTERFACE AND COMMUNICATION DEVICES, NAMELY, MODEMS, TELEPHONES, SWITCHES, ROUTERS, HUBS AND ADAPTERS; LOUDSPEAKERS; REMOTE CONTROLS; AND MANUALS DISTRIBUTED THEREWITH, IN CLASS 9 (U.S. CLS. 21, 23, 26, 36 AND 38).

FIRST USE 7-10-1992; IN COMMERCE 7-10-1992.

OWNER OF U.S. REG. NOS. 1,894,843 AND 1,905,352.

SER. NO. 78-242,660, FILED 4-28-2003.

LEIGH CAROLINE CASE, EXAMINING ATTORNEY

Int. Cls.: 36 and 41

Prior U.S. Cls.: 100, 101, 102 and 107

United States Patent and Trademark Office

Reg. No. 2,893,261

Registered Oct. 12, 2004

**SERVICE MARK
PRINCIPAL REGISTER**

THE BOX PROJECT

THE BOX PROJECT (CONNECTICUT CORPORATION)
PO BOX 435
PLAINVILLE, CT 06062

FOR: CHARITABLE FUND RAISING SERVICES, NAMELY, RECRUITING SPONSORS AND DONORS AND RAISING FUNDS IN THE UNITED STATES TO SUPPORT ACTIVITIES TO ENCOURAGE FAMILIES TO OVERCOME THE CYCLE OF POVERTY, IN CLASS 36 (U.S. CLS. 100, 101 AND 102).

FIRST USE 0-0-1968; IN COMMERCE 0-0-1968.

FOR: EDUCATIONAL SERVICES, NAMELY, MENTORING, CREATING AND PROVIDING EDUCATIONAL MATERIALS, AND DEVELOPING PROGRAMS IN THE FIELD OF LITERACY, CULTURAL ACTIVITIES AND ENLIGHTENMENT, MATHEMATICS, HISTORY AND GEOGRAPHY, IN CLASS 41 (U.S. CLS. 100, 101 AND 107).

FIRST USE 0-0-1968; IN COMMERCE 0-0-1968.

SER. NO. 78-243,004, FILED 4-28-2003.

MELVIN AXILBUND, EXAMINING ATTORNEY

Int. Cl.: 9

Prior U.S. Cls.: 21, 23, 26, 36 and 38

Reg. No. 2,893,262

United States Patent and Trademark Office

Registered Oct. 12, 2004

TRADEMARK
PRINCIPAL REGISTER

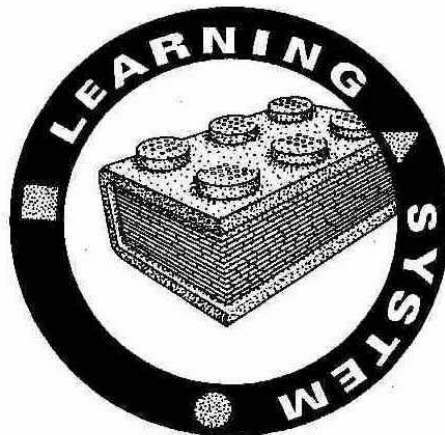

KIRKBI AG (SWITZERLAND CORPORATION)
NEUHOFSTRASSE 21 CH-6349
BAAR, SWITZERLAND

FOR: CHILDREN'S EDUCATIONAL SOFTWARE,
IN CLASS 9 (U.S. CLS. 21, 23, 26, 36 AND 38).

FIRST USE 0-0-2000; IN COMMERCE 0-0-2000.

OWNER OF U.S. REG. NOS. 2,175,247, 2,273,321
AND OTHERS.

NO CLAIM IS MADE TO THE EXCLUSIVE
RIGHT TO USE LEARNING SYSTEM, APART
FROM THE MARK AS SHOWN.

THE STIPPLING IN THE DRAWING IS FOR
SHADING PURPOSES ONLY.

SER. NO. 78-243,162, FILED 4-29-2003.

STEPHANIE DAVIS, EXAMINING ATTORNEY

Int. Cl.: 36

Prior U.S. Cls.: 100, 101 and 102

United States Patent and Trademark Office

Reg. No. 2,893,263

Registered Oct. 12, 2004

**SERVICE MARK
PRINCIPAL REGISTER**

JAZZ FOUNDATION OF AMERICA

JAZZ FOUNDATION OF AMERICA (NEW YORK CORPORATION)
322 WEST 48TH STREET
NEW YORK, NY 10036

FOR: CHARITABLE FUNDRAISING SERVICES TO RAISE FUNDS TO BENEFIT MUSICIANS IN NEED OF FINANCIAL SUPPORT, IN CLASS 36 (U.S. CLS. 100, 101 AND 102).

FIRST USE 0-0-1989; IN COMMERCE 0-0-1989.

NO CLAIM IS MADE TO THE EXCLUSIVE RIGHT TO USE "FOUNDATION", APART FROM THE MARK AS SHOWN.

SEC. 2(F).

SER. NO. 78-243,564, FILED 4-29-2003.

ALICIA COLLINS, EXAMINING ATTORNEY

Int. Cl.: 41

Prior U.S. Cls.: 100, 101 and 107

United States Patent and Trademark Office

Reg. No. 2,893,264

Registered Oct. 12, 2004

**SERVICE MARK
PRINCIPAL REGISTER**

ARBORLINKS

THE NATIONAL ARBOR DAY FOUNDATION
(NEBRASKA CORPORATION)
211 NORTH 12TH STREET SUITE 501
LINCOLN, NE 685081497

FOR: EDUCATIONAL SERVICES; NAMELY
CONDUCTING PROGRAMS IN THE FIELD OF
THE DEVELOPMENT AND MAINTENANCE OF
ENVIRONMENTALLY FRIENDLY GOLF COUR-
SES , IN CLASS 41 (U.S. CLS. 100, 101 AND 107).

FIRST USE 4-1-2001; IN COMMERCE 4-1-2001.

THE MARK CONSISTS OF STANDARD CHAR-
ACTERS WITHOUT CLAIM TO ANY PARTICULAR
FONT, STYLE, SIZE, OR COLOR.

SER. NO. 78-243,723, FILED 4-30-2003.

RICHARD WHITE, EXAMINING ATTORNEY

Int. Cl.: 25

Prior U.S. Cls.: 22 and 39

United States Patent and Trademark Office

Reg. No. 2,893,265

Registered Oct. 12, 2004

**TRADEMARK
PRINCIPAL REGISTER**



BEUNCO, INC. (ILLINOIS CORPORATION)
4718 EAST CRYSTAL LAKE AVENUE
CRYSTAL LAKE, IL 60014

CLOTHING, NAMELY, HATS, SHIRTS, PANTS,
JACKETS, VESTS AND SWEATERS, IN CLASS 25
(U.S. CLS. 22 AND 39).

FOR: MEN'S, WOMEN'S AND CHILDREN'S
CLOTHING, NAMELY, JEANS, SLACKS, CORDUR-
OYS AND BRIEFS; SHIRTS, NAMELY, LONG AND
SHORT SLEEVE, COLLAR, CREW AND SWEAT
SHIRTS; OUTERWEAR, NAMELY, HEAVY AND
LIGHT WEIGHT WINTER AND SUMMER JACK-
ETS AND COATS, SPORT COATS, SWEATERS AND
VESTS; SWIMWEAR AND SURF WEAR, NAMELY,
ROBES, BANDANAS, SWIMSUITS, SHIRTS, PANTS,
SHORTS, SUNHATS, SKI AND SNOWBOARD

FIRST USE 8-13-1999; IN COMMERCE 8-13-1999.

THE STIPLING CONTAINED IN THE ORIGI-
NAL DRAWING WAS INTENDED FOR SHADING
PURPOSES ONLY.

SER. NO. 78-243,797, FILED 4-30-2003.

CATHERINE FAINT, EXAMINING ATTORNEY

Prior U.S. Cl.: 200

United States Patent and Trademark Office

Reg. No. 2,893,266

Registered Oct. 12, 2004

COLLECTIVE MEMBERSHIP
PRINCIPAL REGISTER



LAWDOGS MOTORCYCLE CLUB (CONNECTI-
CUT CORPORATION)
1655 NORTH COLONY ROAD
MERIDEN, CT 06450

FOR: INDICATES MEMBERSHIP IN A SOCIAL
CLUB THAT PROVIDES HUMANITARIAN SERVI-
CES, IN CLASS 200 (U.S. CL. 200).

FIRST USE 1-1-2000; IN COMMERCE 1-1-2000.

NO CLAIM IS MADE TO THE EXCLUSIVE
RIGHT TO USE MC, APART FROM THE MARK
AS SHOWN.

THE COLOR GRAY IS A FEATURE OF THE
MARK. THE COLOR GRAY APPEARS INSIDE ALL
THE LETTERING AND ON THE DOG DESIGN.

SER. NO. 78-243,893, FILED 4-30-2003.

H. M. FISHER, EXAMINING ATTORNEY

Int. Cl.: 9

Prior U.S. Cls.: 21, 23, 26, 36 and 38

Reg. No. 2,893,267

United States Patent and Trademark Office

Registered Oct. 12, 2004

**TRADEMARK
PRINCIPAL REGISTER**

EATON

EATON CORPORATION (OHIO CORPORATION)
1111 SUPERIOR AVENUE
CLEVELAND, OH 44114

FOR: ELECTRICAL CONTROL APPARATUS, ELECTRICAL MACHINES, AND ELECTRICAL SUPPLIES, NAMELY; CONTROLLERS FOR DYNAMO-ELECTRIC MACHINES; STARTING, STOPPING, REVERSING, AND SPEED REGULATING APPARATUS FOR MOTORS; VOLTAGE AND CURRENT REGULATING APPARATUS FOR GENERATORS AND CONVERTERS, AND LIKE CONTROL APPARATUS FOR ROTARY CONVERTERS; ELECTRICAL PANELBOARDS AND SWITCHBOARDS; SOLENOIDS; SAFETY SWITCHES; DISCONNECT SWITCHES; METER SERVICE ENTRANCE AND BRANCH SERVICE SWITCHES; FLOAT, PRESSURE AND OTHER SPECIAL SWITCHES; INSULATING BASES AND SUPPORTS FOR SWITCHES AND THE LIKE; CONTROLLERS FOR VALVES REQUIRING ROTATING OF AN ELEMENT THEREOF; SOLENOID-OPERATED VALVES; FUSE PANELS; TERMINAL PLUGS; WIRING FIXTURES AND CONDUIT FITTINGS CONSISTING OF SWITCHES; SWITCH BOXES AND COVERS, ATTACHMENT PLUGS, TAPS, RECEPTACLES, LAMP SOCKETS, AND CORD CONNECTORS; SWITCH PANELS; CONTROL PANELS; LOAD CENTERS; METER CENTERS; PANEL BOARDS; SWITCH BOARDS; PUMP CONTROL PANELS; ELECTRICAL SWITCHGEAR; PUSH BUTTON SWITCHES; TOGGLE SWITCHES AND ILLUMINATED SWITCHES AND DISPLAYS; MOTOR STARTERS; SPEED CONTROLLERS AND REGULATORS; STARTERS AND SPEED REGULATORS FOR FIRE PUMPS, PRINTING PRESSES, PAPER MAKING MACHINES, OIL WELL DRILLERS AND PUMPS; CRANE, DERRICK AND HOIST CONTROLS; ELECTRICAL CONTROLS AND CIRCUIT CONTROLLERS OF THE ELECTRICAL AND ELECTRONIC TYPE FOR DIESEL LOCOMOTIVES; ELECTRIC WELDING CONTROLLERS; LOAD CELLS; CIRCUIT CONTROLLERS FOR ELECTRIC REFRIGERATORS, AND PROTECTIVE APPARATUS, NAMELY, OVERLOAD CIRCUIT BREAKERS,

PANELS, AND ENCLOSURES THEREFOR AND PARTS THEREOF; ELECTRICAL, ELECTRO-OPTICAL AND PHOTOELECTRIC SENSORS; AIRCRAFT COCKPIT AND TRIM CONTROLS; AUTOMOTIVE ROAD SPEED CONTROLS AND SPEED SENSING SWITCHES; TIMERS AND AUTOMATIC SEQUENCE CONTROLS FOR THE REGULATION OF DOMESTIC APPLIANCES AS A FUNCTION OF TIME AND/OR THROUGH A SERIES OF PERIODS OF A PROGRAM CYCLE; ELECTRONIC CONTROLS FOR MEASURING LIQUID LEVELS AND LIQUID TEMPERATURES; VOLTAGE CONTROLS; ELECTRIC VALVES; MOISTURE TESTERS AND METERS; TEMPERATURE CONTROL THERMOSTATS; BIMETAL THERMOSTATIC CONTROLS AND THERMOSTATICALLY CONTROLLED DAMPERS FOR WARM AIR REGISTERS; ZONE CONTROLS FOR HYDRAULIC HEATING AND COOLING APPARATUS; AIR CONDITIONING AND HEATING THERMOSTATIC CONTROLS; DC ADJUSTABLE SPEED CONTROLLED DRIVES; ADJUSTABLE FREQUENCY CONTROLS; AC MOTOR DRIVE APPARATUS AND CONTROLS; MULTIPLE MOTOR DRIVE APPARATUS AND CONTROLS; COUNTING INSTRUMENTS FOR MACHINES FOR COUNTING, READ-OUT AND/OR CONTROL FUNCTIONS—NAMELY, REVOLUTION AND STROKE COUNTERS, TOTALIZERS, RATE METERS, TACHOMETERS, NUMERICAL COUNTER WHEELS, TRANSDUCERS, ROTARY AND LINEAR CONTACTORS, ELECTRIC SWITCHES, SHAFT ENCODERS, MAGNETIC PICK-UPS, MAGNETIC AND INDUCTIVE PROXIMITY SENSORS, READ-OUT DISPLAYS, INPUT SIGNAL CONDITIONERS AND PROCESSORS; POWER SUPPLY CONTROLS; ELECTRONIC CONTROLS FOR PROCESSING DATA BETWEEN CONTROL CENTERS AND PLANT OPERATING APPARATUS; TERMINAL BLOCKS; FUSE BLOCKS; ELECTRICAL INTERLOCKS; THERMOSTATICALLY CONTROLLED ELECTRIC SWITCHES; SURFACE FINISH MEASURING APPARATUS; LEVEL INDICATORS; SCALES; ELECTRONIC LOAD CELLS; AUTOMATIC WEIGHING AND PROPORTIONING APPARATUS; LIQUID LEVEL

AND VACUUM SWITCHES; MANUALLY, MECHANICALLY AND MOTOR OPERATED SWITCHES; RHEOSTATS; RELAYS; CONTACTORS; RESISTORS; RECTIFIERS; TRANSFORMERS; AMPLIFIERS, INDUSTRIAL CIRCUIT CONTROLS OF THE ELECTRONIC, SEMI-CONDUCTIVE TYPE; TIMING CONTROLS OF THE INDUCTIVE, ELECTROPNEUMATIC, ELECTRONIC, SEMI-CONDUCTOR AND MOTOR DRIVEN TYPES; CONTROLS FOR ARTICLE AND MATERIAL HANDLING AND SORTING APPARATUS; SIGNAL AND INDICATING LIGHTS; ELECTRICAL CONTROL CENTERS; ELECTRICAL POWER DISTRIBUTION CENTERS; ELECTRICAL BUSWAYS; BUS DUCTS; WIREWAYS, NAMELY, ELECTRICAL WIRES; ELECTRICAL OUTLETS AND PLUGS; DIGITAL COMPUTER CONTROLS; ELEVATOR CONTROLS CONSISTING OF LIMIT SWITCHES, DOOR SWITCHES, TRANSFER SWITCHES AND FLOOR SELECTOR SWITCHES; MICROWAVE; WIRELESS COMMUNICATORS; REMOTE, ELECTRONIC AND ELECTROMECHANICAL PARTS AND ACCESSORIES FOR AUTOMOTIVE VEHICLES NAMELY, TRUNK RELEASE LOCKS, GAS DOOR LOCKS, POLLUTION CONTROL SOLENOIDS, TRANSMISSION SOLENOIDS, ELECTRONIC CHIMES, HEATED WINDSHIELD CONTROLS, AIR CONDITIONING SENSORS, HEADLIGHT CONTROLS, MIRROR CONTROLS, THROTTLE POSITION SOLENOIDS, TURBO WASTEGATE SOLENOIDS, REMOTE COMPASS SENSORS, SOLENOID ACTUATOR AIR VALVES, INSTRUMENT PANEL DISPLAYS, MEMORY SEAT CONTROLS, KEYLESS ENTRY MODULE, AND PULSE WIPE CONTROLS; ELECTRONIC AND/OR ELECTRICAL SYSTEM FOR MONITORING AND/OR CONTROL OPERATION, NAMELY, COMPUTERS, COMPUTER PROGRAMS, PARTS THEREFORE, AND ASSOCIATED INSTRUCTION MANUALS SUPPLIED THEREWITH; ELECTROMECHANICAL ACTUATORS; SOLID STATE CON-

TROLLERS; CONVEYOR CONTROLS; LIMIT SWITCHES; POSITIONING AND PROGRAMMABLE CONTROLS; SOLAR CONTROLS; ELECTRICAL TRANSMISSION SHIFT CONTROLS; ILLUMINATED KEYBOARDS; PROXIMITY SWITCHES; TRANSDUCERS; ELECTRIC OR ELECTRONICALLY OPERATED STEP UP OR REDUCTION CONTROLS; LIGHT BEAM CONTROLLED ELECTRICAL SWITCHES; AND ELECTRICAL POWER AMPLIFIERS; TRANSFORMERS, COMPONENTS AND PARTS THEREOF; ELECTRICAL PROTECTION AND COORDINATION APPARATUS; SURGE SUPPRESSORS; MOTOR PROTECTORS; INTRA-DEVICE COMMUNICATORS FOR CIRCUIT INTERRUPTERS AND CONTACTORS; VOLTAGE, CURRENT AND POWER ELECTRICAL METERING UNITS; VACUUM CIRCUIT INTERRUPTERS; MEDIUM AND LOW VOLTAGE ELECTRICAL SWITCHGEAR; ELECTRONIC MONITORING AND DISPLAY UNITS; ADJUSTABLE FREQUENCY MOTOR CONTROL DRIVES; TRANSFER SWITCHES AND CONTROLS; MICROPROCESSOR CONTROLLED, ELECTRONIC AND MECHANICAL CIRCUIT BREAKERS, TRIP UNITS; ELECTRICAL DISTRIBUTION EQUIPMENT, NAMELY, DISTRIBUTION TRANSFORMERS; POWER QUALITY METERS; POWER ANALYZERS; ENERGY MONITORS; POWER MONITORS; PROTECTIVE RELAYS; AND INFORMATION DISPLAYS, IN CLASS 9 (U.S. CLS. 21, 23, 26, 36 AND 38).

FIRST USE 6-20-1972; IN COMMERCE 6-20-1972.

OWNER OF U.S. REG. NOS. 1,216,476, 1,679,823 AND OTHERS.

SER. NO. 78-243,935, FILED 4-30-2003.

SOPHIA S. KIM, EXAMINING ATTORNEY

Int. Cls.: 35, 41 and 45

Prior U.S. Cls.: 100, 101, 102 and 107

United States Patent and Trademark Office

Reg. No. 2,893,268

Registered Oct. 12, 2004

**SERVICE MARK
PRINCIPAL REGISTER**

***An innovative approach
to enhancing your business
success into the 21st century...***

INNOVATIVE TECHNOLOGY PARTNERSHIPS,
LLC (NEW MEXICO LTD LIAB CO)
#2 SAN RAFAEL AVENUE, N.E.
ALBUQUERQUE, NM 871221167

FOR: BUSINESS CONSULTATION SERVICES NAMELY DEVELOPMENT, INTEGRATION AND IMPLEMENTATION OF BEST PRACTICE SOLUTIONS; VALUE ADDED RESELLER OF CUSTOMIZED TECHNOLOGY SOLUTIONS, NAMELY, COMMUNICATIONS, COMPUTER HARDWARE AND SOFTWARE, NETWORKS, AND LOGISTICS SUPPORT; CONDUCTING TAILORED TECHNOLOGY TRAINING SURVEYS; BUSINESS TRAINING NEEDS ASSESSMENT; BUSINESS RESEARCH AND SURVEYS; BUSINESS CONSULTATION; BUSINESS DEVELOPMENT SERVICES, NAMELY, PROVIDING STARTUP SUPPORT FOR BUSINESSES OF OTHERS; CONSULTING SERVICE TO BUSINESS, GOVERNMENT, EDUCATION, AND ASSOCIATIONS, NAMELY PROVIDING BUSINESS PLANNING, ORGANIZATIONAL ASSESSMENT, AND PLANNING, IN CLASS 35 (U.S. CLS. 100, 101 AND 102).

FIRST USE 11-1-1997; IN COMMERCE 1-24-1998.

FOR: CONDUCTING TRAINING PROGRAMS IN THE FIELD OF LEADERSHIP DEVELOPMENT AND TEAM BUILDING; DEVELOPMENT AND DISSEMINATION OF EDUCATIONAL MATERIALS OF OTHERS IN THE FIELDS OF LEADERSHIP, TEAM BUILDING, SECURITY, COMMUNICATIONS, COMPUTER HARDWARE AND SOFTWARE, NETWORKING, LOGISTICS, AND BUSINESS, GOVERNMENT, AND ASSOCIATION PLANNING, ORGANIZING, DEVELOPMENT,

STAFFING, TRAINING, DIRECTING AND COMMUNICATIONS; CONDUCTING TRAINING PROGRAMS IN THE FIELDS OF LEADERSHIP, TEAM BUILDING, SECURITY, COMMUNICATIONS, COMPUTER HARDWARE AND SOFTWARE, NETWORKING, LOGISTICS, AND BUSINESS, GOVERNMENT, AND ASSOCIATION PLANNING, ORGANIZING, DEVELOPMENT, STAFFING, TRAINING, DIRECTING AND COMMUNICATIONS; CONDUCTING TRAINING PROGRAMS FOR POLICE, DIGNITARY GUARDS AND SECURITY PERSONNEL IN THE FOLLOWING SUBJECT AREAS - PROFESSIONAL DRIVER AND VEHICLE OPERATOR SAFETY, GENERAL SAFETY, SURVEILLANCE, PROTECTION, COUNTER-TERRORISM, ANTI-TERRORISM, AND EMERGENCY SITUATION RECOGNITION, RESPONSE, EVASION, AND ESCAPE, IN CLASS 41 (U.S. CLS. 100, 101 AND 107).

FIRST USE 11-1-1997; IN COMMERCE 1-24-1998.

FOR: SECURITY SERVICES, NAMELY, TECHNICAL SURVEILLANCE, COUNTER-TERRORISM, ANTI-TERRORISM, SAFETY MANAGEMENT, PHYSICAL, CYBER, AND OPERATIONAL SECURITY ASSESSMENT, PLANNING, DEVELOPMENT, INTEGRATION AND IMPLEMENTATION, IN CLASS 45 (U.S. CLS. 100 AND 101).

FIRST USE 11-1-1997; IN COMMERCE 1-24-1998.

SER. NO. 78-244,125, FILED 4-30-2003.

DAWN FELDMAN, EXAMINING ATTORNEY

Int. Cl.: 35

Prior U.S. Cls.: 100, 101 and 102

United States Patent and Trademark Office

Reg. No. 2,893,269

Registered Oct. 12, 2004

SERVICE MARK
PRINCIPAL REGISTER



CALIFORNIA ASSOCIATION FOR HEALTHCARE QUALITY (CAHQ) (CALIFORNIA UNINC. ASSOCIATION)

P.O. BOX 70819
PASADENA, CA 911177819

FOR: ASSOCIATION SERVICES; NAMELY PROMOTING THE DELIVERY OF QUALITY HEALTHCARE AND PROMOTING THE INTERESTS OF THE HEALTHCARE INDUSTRY, ITS PROFESSIONALS, AND PATIENTS, IN CLASS 35 (U.S. CLS. 100, 101 AND 102).

FIRST USE 1-1-1992; IN COMMERCE 1-1-1992.

NO CLAIM IS MADE TO THE EXCLUSIVE RIGHT TO USE "CALIFORNIA ASSOCIATION FOR HEALTHCARE QUALITY 1977", APART FROM THE MARK AS SHOWN.

THE MARK CONSISTS OF A TRI-SPOKED WHEEL WITH THE UPPER LEFT 1/3 DISPLAYING AN ICONIC LAMP THAT SYMBOLIZES LIGHT OF QUALITY AS EMBODIED BY THE EARLY EFFORTS OF FLORENCE NIGHTINGALE, THE UPPER RIGHT 1/3 DISPLAYING AN ICONIC SCROLL AND FEATHER PEN INK POT THAT SYMBOLIZES LEARNING, IMPROVEMENT AND DOCUMENTATION, AND THE BOTTOM 1/3 DISPLAYING AN ICONIC CONCAVE MEDICAL CROSS THAT IS A TRADITIONAL SYMBOL OF MERCY, THREADED BY A STRAIGHT STAFF TO SYMBOLIZE SUPPORT AND CARE.

SER. NO. 78-244,399, FILED 5-1-2003.

ALEXANDER L. POWERS, EXAMINING ATTORNEY

Int. Cl.: 28

Prior U.S. Cls.: 22, 23, 38 and 50

Reg. No. 2,893,270

United States Patent and Trademark Office

Registered Oct. 12, 2004

**TRADEMARK
PRINCIPAL REGISTER**

DJ SKRIBBLE

SKRIBBLENO PRODUCTIONS, INC (NEW
YORK CORPORATION)
C/O TIN PAN APPLE 156 WEST 11TH STREET
NEW YORK, NY 10011

FOR: TOYS, NAMELY, TOYS FIGURES FEATUR-
ING AMPLIFIER FOR COMPACT MUSIC SYNTHE-
SIZERS; AND TOY FIGURES FEATURING MUSIC
SYNTHESIZERS AND AMPLIFERS; TOY FIGURES
FEATURING COMBINATION AUDIO PLAYER
AND AUDIO MIXER FOR USE WITH COMPACT
MUSIC SYNTHESIZER TO CREATE USER'S OWN

STYLE OF MUSIC, IN CLASS 28 (U.S. CLS. 22, 23, 38
AND 50).

FIRST USE 5-7-2003; IN COMMERCE 5-7-2003.

NO CLAIM IS MADE TO THE EXCLUSIVE
RIGHT TO USE "DJ", APART FROM THE MARK
AS SHOWN.

SER. NO. 78-244,401, FILED 5-1-2003.

SHARON MEIER, EXAMINING ATTORNEY

Int. Cl.: 3

Prior U.S. Cls.: 1, 4, 6, 50, 51 and 52

Reg. No. 2,893,271

United States Patent and Trademark Office

Registered Oct. 12, 2004

**TRADEMARK
PRINCIPAL REGISTER**

5 NINETY-FIVE

PROFOUND BEAUTY INC. (NEW YORK COR-
PORATION)
32-02 QUEENS BOULEVARD
LONG ISLAND CITY, NY 11101

FIRST USE 9-9-2003; IN COMMERCE 9-9-2003.

SER. NO. 78-244,479, FILED 5-1-2003.

FOR: HAIR CONDITIONER, IN CLASS 3 (U.S.
CLS. 1, 4, 6, 50, 51 AND 52).

JOHN SCHUYLER YARD, EXAMINING ATTOR-
NEY

Int. Cl.: 41

Prior U.S. Cls.: 100, 101 and 107

United States Patent and Trademark Office

Reg. No. 2,893,272

Registered Oct. 12, 2004

**SERVICE MARK
PRINCIPAL REGISTER**

SPACLUB

ZC INVESTMENTS, LLC (ARIZONA LTD LIAB
CO)
8600 EAST ROCKCLIFF ROAD
TUCSON, AZ 85750

FOR: EDUCATIONAL SERVICES, NAMELY,
CONDUCTING CLASSES, SEMINARS, CONFEREN-
CES, AND WORKSHOPS IN THE FIELDS OF NU-
TRITION, EXERCISE, BEAUTY, SKIN CARE,
PHYSICAL FITNESS, PHYSICAL TRAINING,
STRESS MANAGEMENT AND BEHAVIOR MODI-
FICATION, IN CLASS 41 (U.S. CLS. 100, 101 AND 107).

FIRST USE 6-30-1999; IN COMMERCE 6-30-1999.

OWNER OF U.S. REG. NOS. 2,498,670 AND
2,648,362.

SEC. 2(F).

SER. NO. 78-244,693, FILED 5-1-2003.

HOWARD SMIGA, EXAMINING ATTORNEY

Int. Cls.: 16, 21 and 25

**Prior U.S. Cls.: 2, 5, 13, 22, 23, 29, 30, 33, 37, 38, 39, 40
and 50**

United States Patent and Trademark Office

Reg. No. 2,893,273

Registered Oct. 12, 2004

**TRADEMARK
PRINCIPAL REGISTER**

LEAVE NO CHILD BEHIND

CHILDREN'S DEFENSE FUND (D.C. CORPORATION)

25 E STREET, N.W.
WASHINGTON, DC 20001

FOR: POSTERS (SEPTEMBER 1994) NOTE CARDS
(OCTOBER 1998) CALENDARS (JUNE 2, 2002), IN
CLASS 16 (U.S. CLS. 2, 5, 22, 23, 29, 37, 38 AND 50).

FIRST USE 9-0-1994; IN COMMERCE 9-0-1994.

FOR: WATER BOTTLES, NAMELY PLASTIC WATER
BOTTLES SOLD EMPTY, AND MUGS, IN
CLASS 21 (U.S. CLS. 2, 13, 23, 29, 30, 33, 40 AND 50).

FIRST USE 1-0-2000; IN COMMERCE 1-0-2000.

FOR: CLOTHING, NAMELY, SWEATSHIRTS, T-
SHIRTS AND BASEBALL CAPS, IN CLASS 25 (U.S.
CLS. 22 AND 39).

FIRST USE 4-0-1994; IN COMMERCE 4-0-1994.

OWNER OF U.S. REG. NO. 1,853,919.

SER. NO. 78-244,894, FILED 5-2-2003.

MARLENE BELL, EXAMINING ATTORNEY

Int. Cl.: 35

Prior U.S. Cls.: 100, 101 and 102

United States Patent and Trademark Office

Reg. No. 2,893,274

Registered Oct. 12, 2004

**SERVICE MARK
PRINCIPAL REGISTER**

DOMAIN SOLUTION CENTER

EMARKMONITOR INC. (DELAWARE CORPORATION)
ATTN: LEGAL
12438 W. BRIDGER STREET, SUITE 100
BOISE, ID 83713

FOR: BUSINESS INFORMATION MANAGEMENT IN THE FIELD OF INTELLECTUAL PROPERTY, NAMELY DOMAIN NAME PORTFOLIO MANAGEMENT, IN CLASS 35 (U.S. CLS. 100, 101 AND 102).

FIRST USE 9-23-2001; IN COMMERCE 9-23-2001.

NO CLAIM IS MADE TO THE EXCLUSIVE RIGHT TO USE DOMAIN AND CENTER, APART FROM THE MARK AS SHOWN.

SER. NO. 78-244,921, FILED 5-2-2003.

SOPHIA S. KIM, EXAMINING ATTORNEY

Int. Cl.: 9

Prior U.S. Cls.: 21, 23, 26, 36 and 38

United States Patent and Trademark Office

Reg. No. 2,893,275

Registered Oct. 12, 2004

**TRADEMARK
PRINCIPAL REGISTER**

A G S P

DAIWA CO., LTD. (JAPAN CORPORATION)
1-25, SHINMEI-CHO, 4-CHOME, OKAYA-SHI
NAGANO-KEN, JAPAN 394-0004

FOR: ELECTRIC NOTEBOOK COMPUTERS, VI-
DEO CAMERAS, INTEGRATED CIRCUIT CHIPS;
NOTEBOOK COMPUTERS, CELL PHONES, PRINT-
ING CIRCUITS, CIRCUIT BOARDS AND DIGITAL

CAMERAS, IN CLASS 9 (U.S. CLS. 21, 23, 26, 36 AND
38).

OWNER OF JAPAN REG. NO. 4642389, DATED 1-
31-2003, EXPIRES 1-31-2013.

SER. NO. 78-244,950, FILED 5-2-2003.

SOPHIA S. KIM, EXAMINING ATTORNEY

Int. Cls.: 25 and 41

Prior U.S. Cls.: 22, 39, 100, 101 and 107

United States Patent and Trademark Office

Reg. No. 2,893,276

Registered Oct. 12, 2004

**TRADEMARK
SERVICE MARK
PRINCIPAL REGISTER**

ROLLING THUNDER

JAMES J. BENDZICK AND LYNETTE M. BEND-
ZICK (PARTNERSHIP)
5865 KENYON BLVD.
FARIBAULT, MN 55021

FOR: CLOTHING, NAMELY, SHIRTS AND HATS
USED IN CONNECTION WITH THE PROMOTION
OF MONSTER TRUCK EVENTS, IN CLASS 25 (U.S.
CLS. 22 AND 39).

FIRST USE 7-3-2002; IN COMMERCE 7-3-2002.

FOR: ENTERTAINMENT SERVICES, NAMELY,
PARTICIPATING AND COMPETING IN MONSTER
TRUCK EVENTS, IN CLASS 41 (U.S. CLS. 100, 101
AND 107).

FIRST USE 12-28-2001; IN COMMERCE 12-28-2001.

SER. NO. 78-245,574, FILED 5-5-2003.

AMY GEARIN, EXAMINING ATTORNEY

Int. Cl.: 1

Prior U.S. Cls.: 1, 5, 6, 10, 26 and 46

United States Patent and Trademark Office

Reg. No. 2,893,277

Registered Oct. 12, 2004

**TRADEMARK
PRINCIPAL REGISTER**

NOCULATE

BRANDT CONSOLIDATED, INC (DELAWARE
CORPORATION)
ROUTE 125, BOX 277
PLEASANT PLAINS, IL 62677

FOR: SOIL AMENDMENTS, NAMELY, BENEFI-
CIAL BACTERIA, IN CLASS 1 (U.S. CLS. 1, 5, 6, 10, 26
AND 46).

FIRST USE 8-14-1997; IN COMMERCE 8-14-1997.

SEC. 2(F).

SER. NO. 78-246,412, FILED 5-6-2003.

CATHERINE FAINT, EXAMINING ATTORNEY

Int. Cls.: 3 and 4

Prior U.S. Cls.: 1, 4, 6, 15, 50, 51 and 52

Reg. No. 2,893,278

United States Patent and Trademark Office

Registered Oct. 12, 2004

**TRADEMARK
PRINCIPAL REGISTER**

EÇİN

OHIO CLINIC FOR AESTHETIC AND PLASTIC
SURGERY, INC. (OHIO CORPORATION)
30400 DETROIT ROAD
WESTLAKE, OH 44145

FOR: PERFUMERY, COSMETICS AND TOILET
PREPARATIONS, NAMELY FACIAL CLEANSERS,
BODY CLEANSERS, FACIAL TONERS, BODY DE-
FOLIANTS, BODY MOISTURIZERS, SUNSCREEN
AND FACIAL MASKS, IN CLASS 3 (U.S. CLS. 1, 4, 6,
50, 51 AND 52).

FIRST USE 2-1-2004; IN COMMERCE 2-1-2004.

FOR: CANDLES, IN CLASS 4 (U.S. CLS. 1, 6 AND
15).

FIRST USE 2-1-2004; IN COMMERCE 2-1-2004.

THE MARK CONSISTS OF STANDARD CHAR-
ACTERS WITHOUT CLAIM TO ANY PARTICULAR
FONT, STYLE, SIZE, OR COLOR.

SER. NO. 78-247,797, FILED 5-9-2003.

H. M. FISHER, EXAMINING ATTORNEY

Int. Cls.: 41, 42 and 44

Prior U.S. Cls.: 100, 101 and 107

United States Patent and Trademark Office

Reg. No. 2,893,279

Registered Oct. 12, 2004

**SERVICE MARK
PRINCIPAL REGISTER**

THE SEIZURE EXPERTS

GUMNIT, ROBERT J. (UNITED STATES INDIVIDUAL)
5775 WAYZATA BOULEVARD
MINNEAPOLIS, MN 55416

FOR: EDUCATIONAL SERVICES IN THE NATURE OF PROGRAMS AND WORKSHOPS TO INCREASE AWARENESS ABOUT EPILEPSY AND TO INFORM ABOUT DIAGNOSIS AND TREATMENT OF EPILEPSY, IN CLASS 41 (U.S. CLS. 100, 101 AND 107).

FIRST USE 8-27-1997; IN COMMERCE 9-3-1997.

FOR: MEDICAL RESEARCH SERVICES IN THE FIELD OF EPILEPSY, IN CLASS 42 (U.S. CLS. 100 AND 101).

FIRST USE 8-27-1997; IN COMMERCE 9-3-1997.

FOR: HEALTHCARE SERVICES IN THE FIELD OF EPILEPSY., IN CLASS 44 (U.S. CLS. 100 AND 101).

FIRST USE 8-27-1997; IN COMMERCE 9-3-1997.

OWNER OF U.S. REG. NO. 2,460,559.

SEC. 2(F).

SER. NO. 78-247,856, FILED 5-9-2003.

MARY ROSSMAN, EXAMINING ATTORNEY

Int. Cl.: 35

Prior U.S. Cls.: 100, 101 and 102

United States Patent and Trademark Office

Reg. No. 2,893,280

Registered Oct. 12, 2004

**SERVICE MARK
PRINCIPAL REGISTER**

GREETING CARDS THAT DELIVER

BENNETT BROTHERS, INC. (ILLINOIS CORPORATION)
30 EAST ADAMS ST.
CHICAGO, IL 60603

NO CLAIM IS MADE TO THE EXCLUSIVE RIGHT TO USE GREETING CARDS, APART FROM THE MARK AS SHOWN.

FOR: MAIL ORDER SERVICES FOR GENERAL MERCHANDISE, IN CLASS 35 (U.S. CLS. 100, 101 AND 102).

SER. NO. 78-247,983, FILED 5-9-2003.

FIRST USE 5-9-2003; IN COMMERCE 6-6-2003.

STEPHANIE DAVIS, EXAMINING ATTORNEY

Int. Cl.: 44

Prior U.S. Cls.: 100 and 101

United States Patent and Trademark Office

Reg. No. 2,893,281

Registered Oct. 12, 2004

**SERVICE MARK
PRINCIPAL REGISTER**

MYHEALTH@ANTHEM

ANTHEM INSURANCE COMPANIES, INC. (IN-
DIANA CORPORATION)
120 MONUMENT CIRCLE
INDIANAPOLIS, IN 46204

FOR: PROVIDING INFORMATION IN THE
FIELDS OF HEALTH AND MEDICINE FEATUR-
ING INFORMATION CONCERNING NUTRITION,
FITNESS AND LIFESTYLE, ILLNESS, DISEASE,
AND WELLNESS, VIA THE INTERNET, IN CLASS
44 (U.S. CLS. 100 AND 101).

FIRST USE 12-19-2001; IN COMMERCE 12-19-2001.

OWNER OF U.S. REG. NOS. 1,776,736, 2,751,535
AND OTHERS.

SER. NO. 78-248,043, FILED 5-9-2003.

STEVEN BERK, EXAMINING ATTORNEY

Int. Cl.: 41

Prior U.S. Cls.: 100, 101 and 107

Reg. No. 2,893,282

United States Patent and Trademark Office

Registered Oct. 12, 2004

**SERVICE MARK
PRINCIPAL REGISTER**

MEN IN SCRUBS

CRESSWELL, JOYCE J. (UNITED STATES INDIVIDUAL)
20000 NW WALKER RD.
BEAVERTON, OR 97006

FIRST USE 4-23-2002; IN COMMERCE 4-23-2002.

SER. NO. 78-248,100, FILED 5-9-2003.

FOR: EDUCATIONAL SERVICES, NAMELY, PROVIDING COURSES AND LECTURES IN THE FIELDS OF NURSING AND HEALTH CARE, IN CLASS 41 (U.S. CLS. 100, 101 AND 107).

MARC LEIPZIG, EXAMINING ATTORNEY

Int. Cl.: 9

Prior U.S. Cls.: 21, 23, 26, 36 and 38

Reg. No. 2,893,283

United States Patent and Trademark Office

Registered Oct. 12, 2004

**TRADEMARK
PRINCIPAL REGISTER**



INDUSTRIA BASICA, S.A. (ARGENTINA COR-
PORATION)
CASEROS
DR. A SABATTINI 5294
BUENOS AIRES B1678CQR, ARGENTINA

FIRST USE 1-8-2003; IN COMMERCE 3-10-2003.

SER. NO. 78-248,392, FILED 5-12-2003.

FOR: ELECTRICAL PARTS, NAMELY, CABLE
TRAYS, IN CLASS 9 (U.S. CLS. 21, 23, 26, 36 AND 38).

INGA ERVIN, EXAMINING ATTORNEY

Int. Cl.: 9

Prior U.S. Cls.: 21, 23, 26, 36 and 38

United States Patent and Trademark Office

Reg. No. 2,893,284

Registered Oct. 12, 2004

**TRADEMARK
PRINCIPAL REGISTER**

NEUROEXPLORER

KIRILLOV, ALEXANDRE B (UNITED STATES
INDIVIDUAL)
31 SURREY RD.
LITTLETON, MA 01460

FIRST USE 10-7-1998; IN COMMERCE 10-7-1998.

SER. NO. 78-248,803, FILED 5-12-2003.

FOR: COMPUTER SOFTWARE USED FOR DATA
ANALYSIS IN THE FIELD OF NEUROPHYSIOLO-
GY, IN CLASS 9 (U.S. CLS. 21, 23, 26, 36 AND 38).

CATHERINE FAINT, EXAMINING ATTORNEY

Int. Cl.: 42

Prior U.S. Cls.: 100 and 101

United States Patent and Trademark Office

Reg. No. 2,893,285

Registered Oct. 12, 2004

**SERVICE MARK
PRINCIPAL REGISTER**

ONELIST

JOHNSON SERVICES.COM, INC. (FLORIDA
CORPORATION)
548 DOLPHIN AVE SE
SAINT PETERSBURG, FL 33705

FIRST USE 12-19-2001; IN COMMERCE 5-1-2003.

SER. NO. 78-249,188, FILED 5-13-2003.

FOR: APPLICATION SERVICE PROVIDER (ASP)
FEATURING SOFTWARE FOR USE IN DATABASE
MANAGEMENT FOR REAL ESTATE AGENTS,
BUSINESS BROKERS AND RELATED PROFES-
SIONALS, IN CLASS 42 (U.S. CLS. 100 AND 101).

JANICE L. MCMORROW, EXAMINING ATTOR-
NEY

Int. Cl.: 35

Prior U.S. Cls.: 100, 101 and 102

United States Patent and Trademark Office

Reg. No. 2,893,286

Registered Oct. 12, 2004

**SERVICE MARK
PRINCIPAL REGISTER**

BIDOPTIMIZER

FINDWHAT.COM (NEVADA CORPORATION)
SUITE 500
5220 SUMMERLIN COMMONS BLVD.
FT. MYERS, FL 33907

FIRST USE 2-5-2003; IN COMMERCE 2-5-2003.

SER. NO. 78-249,667, FILED 5-14-2003.

FOR: BUSINESS MARKETING AND CONSULT-
ING SERVICES, IN CLASS 35 (U.S. CLS. 100, 101 AND
102).

YSA DEJESUS, EXAMINING ATTORNEY

Int. Cl.: 37

Prior U.S. Cls.: 100, 103 and 106

United States Patent and Trademark Office

Reg. No. 2,893,287

Registered Oct. 12, 2004

**SERVICE MARK
PRINCIPAL REGISTER**

PATRIOT COURT SYSTEMS

PATRIOT COURT SYSTEMS, INC. (TEXAS CORPORATION)
6926 PENNY COURT
HOUSTON, TX 77069

FOR: CONSTRUCTION SERVICES, NAMELY, CONSTRUCTION OF TENNIS COURTS, BASKETBALL COURTS, VOLLEYBALL COURTS, RACQUETBALL COURTS AND RUNNING TRACKS, IN CLASS 37 (U.S. CLS. 100, 103 AND 106).

FIRST USE 3-1-2001; IN COMMERCE 3-1-2001.

NO CLAIM IS MADE TO THE EXCLUSIVE RIGHT TO USE COURT SYSTEM, APART FROM THE MARK AS SHOWN.

SER. NO. 78-250,175, FILED 5-15-2003.

GLENN CLARK, EXAMINING ATTORNEY

Int. Cl.: 41

Prior U.S. Cls.: 100, 101 and 107

United States Patent and Trademark Office

Reg. No. 2,893,288

Registered Oct. 12, 2004

**SERVICE MARK
PRINCIPAL REGISTER**

BAM RACING

BAM RACING, LLC (MARYLAND LTD LIAB CO)
11881 VANCE DAVIS DRIVE
CHARLOTTE, NC 28269

NO CLAIM IS MADE TO THE EXCLUSIVE
RIGHT TO USE RACING, APART FROM THE
MARK AS SHOWN.

FOR: ENTERTAINMENT IN THE NATURE OF
PARTICIPATION IN AUTOMOBILE RACES, IN
CLASS 41 (U.S. CLS. 100, 101 AND 107).

SER. NO. 78-250,545, FILED 5-15-2003.

FIRST USE 12-31-1999; IN COMMERCE 12-31-1999.

RONALD AIKENS, EXAMINING ATTORNEY

Int. Cl.: 16

Prior U.S. Cls.: 2, 5, 22, 23, 29, 37, 38 and 50

United States Patent and Trademark Office

Reg. No. 2,893,289

Registered Oct. 12, 2004

**TRADEMARK
PRINCIPAL REGISTER**

ZOBMONDO!!

ZOBMONDO!! ENTERTAINMENT LLC (CALI-
FORNIA LTD LIAB CO)
1000 S. WESTGATE AVE. #202
LOS ANGELES, CA 90049

FIRST USE 11-25-2001; IN COMMERCE 11-25-2001.

OWNER OF U.S. REG. NO. 2,302,514.

FOR: PRINTED MATTER, NAMELY, CALEN-
DARS, STATIONERY, GREETING CARDS, AND
CARTOONS, NAMELY, CARTOON PRINTS, CAR-
TOON STRIPS AND NEWSPAPER CARTOONS;
BOOKS FEATURING COMEDY AND HUMOR, IN
CLASS 16 (U.S. CLS. 2, 5, 22, 23, 29, 37, 38 AND 50).

SER. NO. 78-250,563, FILED 5-15-2003.

HOWARD SMIGA, EXAMINING ATTORNEY

Int. Cl.: 25

Prior U.S. Cls.: 22 and 39

United States Patent and Trademark Office

Reg. No. 2,893,290

Registered Oct. 12, 2004

**TRADEMARK
PRINCIPAL REGISTER**

KARANINA

KARANINA, LLC (CALIFORNIA LTD LIAB CO)
5383 HOLLISTER DRIVE
SANTA BARBARA, CA 93111

SLACKS, SKIRTS, DRESSES, SWEATERS, JACKETS,
AND COATS , IN CLASS 25 (U.S. CLS. 22 AND 39).

FIRST USE 4-5-2003; IN COMMERCE 4-5-2003.

FOR: WOMEN'S CONTEMPORARY CLOTHING,
NAMELY, TOPS, BLOUSES, SHIRTS, T-SHIRTS,
HALTER TOPS, VESTS, BOTTOMS, PANTS,

SER. NO. 78-251,442, FILED 5-19-2003.

HEATHER THOMPSON, EXAMINING ATTORNEY

Int. Cls.: 25 and 28

Prior U.S. Cls.: 22, 23, 38, 39 and 50

United States Patent and Trademark Office

Reg. No. 2,893,291

Registered Oct. 12, 2004

**TRADEMARK
PRINCIPAL REGISTER**

AEROTOUR

BABOLAT VS (FRANCE JOINT STOCK COMPANY)

93 RUE ANDRE BOLLIER

LYON, FRANCE 69007

FOR: CLOTHING AND SPORTS CLOTHES FOR TENNIS, SQUASH AND BADMINTON, NAMELY, T-SHIRTS, SHORTS, POLO SHIRTS, SHIRTS, SWEAT-SHIRTS, TROUSERS, JACKETS, TRACK SUITS, SKIRTS, SOCKS, WRISTBANDS, SHOES, HEADBANDS; HEADGEAR, NAMELY, CAPS, HATS AND VISORS, IN CLASS 25 (U.S. CLS. 22 AND 39).

FOR: TENNIS, SQUASH AND BADMINTON RACKETS; BAGS FOR TENNIS, SQUASH AND BADMINTON RACKETS, IN CLASS 28 (U.S. CLS. 22, 23, 38 AND 50).

PRIORITY CLAIMED UNDER SEC. 44(D) ON FRANCE APPLICATION NO. 023197886, FILED 12-5-2002, REG. NO. 023197886, DATED 12-5-2002, EXPIRES 12-5-2012.

SER. NO. 78-251,572, FILED 5-19-2003.

HEATHER THOMPSON, EXAMINING ATTORNEY

Int. Cl.: 36

Prior U.S. Cls.: 100, 101 and 102

United States Patent and Trademark Office

Reg. No. 2,893,292

Registered Oct. 12, 2004

**SERVICE MARK
PRINCIPAL REGISTER**



KLINE, JONATHAN H. (UNITED STATES INDIVIDUAL)
2761 EXECUTIVE PARK DRIVE
WESTON, FL 33331

NO CLAIM IS MADE TO THE EXCLUSIVE RIGHT TO USE "TITLE COMPANY", APART FROM THE MARK AS SHOWN.

FOR: TITLE INSURANCE AGENCY, IN CLASS 36 (U.S. CLS. 100, 101 AND 102).

SER. NO. 78-251,742, FILED 5-19-2003.

FIRST USE 6-1-1996; IN COMMERCE 6-1-1996.

BARBARA GAYNOR, EXAMINING ATTORNEY

Int. Cl.: 25

Prior U.S. Cls.: 22 and 39

United States Patent and Trademark Office

Reg. No. 2,893,293

Registered Oct. 12, 2004

**TRADEMARK
PRINCIPAL REGISTER**

SENSOR POINT

MIZUNO KABUSHIKI KAISHA (MIZUNO CORPORATION) (JAPAN CORPORATION)
NO. 1-23 KITAHAMA 4-CHOME CHUO-KU
OSAKA, JAPAN

FIRST USE 5-15-2003; IN COMMERCE 5-15-2003.

SER. NO. 78-252,148, FILED 5-20-2003.

FOR: FOOTWEAR, NAMELY ATHLETIC FOOTWEAR, SPORTS SHOES, CASUAL SHOES, IN CLASS 25 (U.S. CLS. 22 AND 39).

JOSETTE BEVERLY, EXAMINING ATTORNEY

Int. Cls.: 3 and 5

Prior U.S. Cls.: 1, 4, 6, 18, 44, 46, 50, 51 and 52

United States Patent and Trademark Office

Reg. No. 2,893,294

Registered Oct. 12, 2004

**TRADEMARK
PRINCIPAL REGISTER**

MONTAGNE JEUNESSE LOVE EYES

CROY TRUST LIMITED (UNITED KINGDOM CORPORATION)
2ND FLOOR, 31 BROAD STREET, ST. HELIER
JERSEY, CHANNEL ISLANDS, UNITED KINGDOM
JE4 8XN

FOR: COSMETICS FOR USE ON AND AROUND THE EYES, NAMELY, EYE SHADOW, EYELINER, MASCARA, EYE GEL, EYE CREAMS, YE LOTIONS, EYE MAKE-UP REMOVER, FALSE EYELASHES, AND NON-MEDICATED PADS FOR MOISTENING, CLEANING, SOOTHING AND CARE OF THE EYES, IN CLASS 3 (U.S. CLS. 1, 4, 6, 50, 51 AND 52).

FOR: EYE WASHES AND NON-MEDICATED EYE DROPS, IN CLASS 5 (U.S. CLS. 6, 18, 44, 46, 51 AND 52).

PRIORITY CLAIMED UNDER SEC. 44(D) ON UNITED KINGDOM APPLICATION NO. 2329765, FILED 4-16-2003, REG. NO. 2329765, DATED 5-9-2003, EXPIRES 4-16-2013.

OWNER OF U.S. REG. NO. 1,824,048.

THE ENGLISH TRANSLATION OF THE WORD MONTAGNE JEUNESSE IN THE MARK IS YOUTH MOUNTAIN.

SER. NO. 78-252,451, FILED 5-21-2003.

RONALD MCMORROW, EXAMINING ATTORNEY

Int. Cl.: 15

Prior U.S. Cls.: 2, 21 and 36

United States Patent and Trademark Office

Reg. No. 2,893,295

Registered Oct. 12, 2004

**TRADEMARK
PRINCIPAL REGISTER**

FISITALIA

CI & EMME S.R.L. (ITALY LTD LIAB JT ST CO)
VIA CARSO N.8
CASTELFIDARDO (AN), ITALY 60022

FIRST USE 9-29-1997; IN COMMERCE 9-29-1997.

FOR: ACCORDIONS AND ACCORDION ACCES-
SORIES, NAMELY ACCORDION CARRYING
CASES AND ACCORDION SHOULDER STRAPS,
IN CLASS 15 (U.S. CLS. 2, 21 AND 36).

SER. NO. 78-253,094, FILED 5-22-2003.

BARNEY CHARLON, EXAMINING ATTORNEY

Int. Cl.: 42

Prior U.S. Cls.: 100 and 101

United States Patent and Trademark Office

Reg. No. 2,893,296

Registered Oct. 12, 2004

**SERVICE MARK
PRINCIPAL REGISTER**

NEW TECHNOLOGY, OLD SCHOOL SERVICE

MIDWEST TECHNOLOGY SERVICES, INC.
(KANSAS CORPORATION)
SUITE 226
6731 WEST 121ST
OVERLAND PARK, KS 66209

FIRST USE 1-1-2001; IN COMMERCE 1-1-2001.

SER. NO. 78-253,629, FILED 5-23-2003.

FOR: COMPUTER NETWORK DESIGN FOR
OTHERS, IN CLASS 42 (U.S. CLS. 100 AND 101).

PATRICIA EVANKO, EXAMINING ATTORNEY

Int. Cl.: 11

Prior U.S. Cls.: 13, 21, 23, 31 and 34

United States Patent and Trademark Office

Reg. No. 2,893,297

Registered Oct. 12, 2004

**TRADEMARK
PRINCIPAL REGISTER**

SAFE-T

FRANKE CONSUMER PRODUCTS, INC. (DELA-
WARE CORPORATION)
3050 CAMPUS DRIVE, SUITE 500
HATFIELD, PA 19440

FOR: SINK RIMS SOLD AS AN INTEGRAL
COMPONENT OF STAINLESS STEEL SINKS, IN
CLASS 11 (U.S. CLS. 13, 21, 23, 31 AND 34).

FIRST USE 12-0-2001; IN COMMERCE 12-0-2001.

SER. NO. 78-253,755, FILED 5-23-2003.

BRIAN NEVILLE, EXAMINING ATTORNEY

Int. Cl.: 35

Prior U.S. Cls.: 100, 101 and 102

United States Patent and Trademark Office

Reg. No. 2,893,298

Registered Oct. 12, 2004

SERVICE MARK
PRINCIPAL REGISTER



FRIENDLY PLANET TRADING CO. (PARTNER-
SHIP)
SUITE 105
175 SOUTH FRANKLIN STREET
JUNEAU, AK 99801

FIRST USE 12-1-2001; IN COMMERCE 12-1-2001.

SER. NO. 78-254,045, FILED 5-23-2003.

FOR: RETAIL SHOPS FEATURING INTERNA-
TIONALLY HANDCRAFTED GIFTS, IN CLASS 35
(U.S. CLS. 100, 101 AND 102).

BRIAN NEVILLE, EXAMINING ATTORNEY

Int. Cl.: 37

Prior U.S. Cls.: 100, 103 and 106

United States Patent and Trademark Office

Reg. No. 2,893,299

Registered Oct. 12, 2004

**SERVICE MARK
PRINCIPAL REGISTER**

COOL CARS

COOL CARS, INC. (KENTUCKY CORPORATION)
7514 PRESTON HIGHWAY
LOUISVILLE, KY 40219

FOR: AUTOMOBILE CUSTOMIZING SERVICES,
NAMELY, WINDOW TINTING AND INSTALLING
OF HYDRAULIC LIFTERS, SHOCK ABSORBERS,
AUTO ALARMS, SUNROOFS, NEON LICENSE
PLATES, AND UNDER CAR BODY LIGHTING, IN
CLASS 37 (U.S. CLS. 100, 103 AND 106).

FIRST USE 2-1-1994; IN COMMERCE 2-1-1994.

NO CLAIM IS MADE TO THE EXCLUSIVE
RIGHT TO USE "CARS", APART FROM THE MARK
AS SHOWN.

SER. NO. 78-254,096, FILED 5-24-2003.

MATTHEW PAPPAS, EXAMINING ATTORNEY

Int. Cl.: 9

Prior U.S. Cls.: 21, 23, 26, 36 and 38

United States Patent and Trademark Office

Reg. No. 2,893,300

Registered Oct. 12, 2004

**TRADEMARK
PRINCIPAL REGISTER**

NOTAFIT

GIESECKE & DEVRIENT GMBH (FED REP GER-
MANY CORPORATION)
PRINZREGENTENSTRASSE 159
MUNICH, FED REP GERMANY 81677

FOR: BANKNOTE PROCESSING DEVICES,
NAMELY ELECTRONIC, MAGNETIC OR OPTICAL
DETECTION UNITS FOR THE VERIFICATION OF
THE FITNESS AND QUALITY OF BANKNOTES , IN
CLASS 9 (U.S. CLS. 21, 23, 26, 36 AND 38).

PRIORITY CLAIMED UNDER SEC. 44(D) ON FED
REP GERMANY APPLICATION NO. 30262235.7/0,
FILED 12-19-2002, REG. NO. 30262235, DATED 1-31-
2003, EXPIRES 12-31-2012.

SER. NO. 78-254,527, FILED 5-27-2003.

MARY ROSSMAN, EXAMINING ATTORNEY

Int. Cl.: 35

Prior U.S. Cls.: 100, 101 and 102

United States Patent and Trademark Office

Reg. No. 2,893,301

Registered Oct. 12, 2004

**SERVICE MARK
PRINCIPAL REGISTER**

VMW PUBLIC RELATIONS, LLC

WOODS, VIVECA, M (NEW YORK LTD LIAB CO)
27 DIVISION STREET WEST
GREENWICH, CT 06830

NO CLAIM IS MADE TO THE EXCLUSIVE
RIGHT TO USE PUBLIC RELATIONS, APART
FROM THE MARK AS SHOWN.

FOR: PUBLIC RELATIONS, IN CLASS 35 (U.S.
CLS. 100, 101 AND 102).

SER. NO. 78-255,480, FILED 5-29-2003.

FIRST USE 5-15-2002; IN COMMERCE 5-15-2002.

HENRY S. ZAK, EXAMINING ATTORNEY

Int. Cls.: 9 and 42

Prior U.S. Cls.: 21, 23, 26, 36, 38, 100 and 101

United States Patent and Trademark Office

Reg. No. 2,893,302

Registered Oct. 12, 2004

**TRADEMARK
SERVICE MARK
PRINCIPAL REGISTER**

KPRS

KELLY REGISTRATION SYSTEMS, INC. (GEORGIA CORPORATION)
10115 HIGHWAY 142 NORTH
COVINGTON, GA 30014

FOR: COMPUTER SOFTWARE FOR USE IN THE REGISTRATION AND RENEWAL OF REGISTRATIONS OF GOVERNMENT-REGULATED PRODUCTS, IN CLASS 9 (U.S. CLS. 21, 23, 26, 36 AND 38).

FIRST USE 2-1-1994; IN COMMERCE 2-1-1994.

FOR: PROVIDING DATABASES FEATURING INFORMATION TO ASSIST GOVERNMENTAL ENTITIES, REGULATED BUSINESSES AND CONSUMERS OF REGULATED PRODUCTS IN

COMPLYING WITH GOVERNMENTAL LAWS AND REGULATIONS, IN CLASS 42 (U.S. CLS. 100 AND 101).

FIRST USE 2-1-1994; IN COMMERCE 2-1-1994.

OWNER OF U.S. REG. NOS. 2,334,938 AND 2,678,751.

SER. NO. 78-255,889, FILED 5-29-2003.

KEVON CHISOLM, EXAMINING ATTORNEY

Int. Cls.: 1, 3, 4, 5, 6, 8, 9, 10, 11, 16, 20, 21, 31 and 34

Prior U.S. Cls.: 1, 2, 4, 5, 6, 8, 9, 10, 12, 13, 14, 15, 17, 18, 21, 22, 23, 25, 26, 28, 29, 30, 31, 32, 33, 34, 36, 37, 38, 39, 40, 44, 46, 50, 51 and 52

Reg. No. 2,893,303

United States Patent and Trademark Office

Registered Oct. 12, 2004

**TRADEMARK
PRINCIPAL REGISTER**



SUPERVALU HOLDINGS, INC. (MISSOURI CORPORATION)
11840 VALLEY VIEW ROAD
EDEN PRAIRIE, MN 55344

FOR: WATER CONDITIONER PELLETS MADE OF SALT; MEAT TENDERIZER PREPARATIONS, IN CLASS 1 (U.S. CLS. 1, 5, 6, 10, 26 AND 46).

FIRST USE 5-0-1997; IN COMMERCE 5-0-1997.

FOR: AFTER SHAVES; ALOE VERA SKIN GELS; AMMONIA FOR CLEANING PURPOSES; BABY LOTIONS; BABY OILS; BABY POWDERS; BABY WIPE TRAVEL PACKS; LAUNDRY BLEACH; LAUNDRY BLEACH POWDERS; CLEANERS, NAMELY, GENERAL PURPOSE CLEANER ABRASIVES, GENERAL PURPOSE CLEANERS WITH BLEACH-TRIGGER, ALL PURPOSE LEMON CLEANERS, GLASS CLEANERS, PREWASH LAUNDRY CLEANERS, CLEANERS FOR COFFEE MAKERS; CONCENTRATE FABRIC SOFTENERS; COSMETIC PUFFS NOT BEING POWDER PUFFS; COTTON SWABS FOR COSMETIC PURPOSES; SCENTED DEODORANT ROLL ON; DETERGENTS, NAMELY, LAUNDRY DETERGENTS; DISH DETERGENTS; FABRIC SOFTENER SHEETS; LIQUID LAUNDRY DETERGENTS; HAIR CARE PRODUCTS, NAMELY, HAIR DETANGLERS, SHAMPOOS, BABY SHAMPOOS, KID'S SHAMPOOS, SHAMPOO DETANGLERS, CONDITIONERS; LIQUID BATH SOAPS; BODY LOTIONS; ANTIBACTERIAL LIQUID SKIN SOAPS; NAIL POLISH REMOVER; PETROLEUM JELLY FOR COSMETIC PURPOSES; PRESHAVE LOTIONS; SUN CARE PRODUCTS, NAMELY, SUN CARE LOTIONS; BODY POWDERS; DEODORANTS; MOUTHWASH; DENTURE CLEANING TABLETS, IN CLASS 3 (U.S. CLS. 1, 4, 6, 50, 51 AND 52).

FIRST USE 0-0-1997; IN COMMERCE 0-0-1997.

FOR: CHARCOAL BRIQUETTES; INSTANT LIGHT CHARCOAL BRIQUETTES; FIREPLACE LOGS; FIREPLACE FIRESTARTERS, IN CLASS 4 (U.S. CLS. 1, 6 AND 15).

FIRST USE 0-0-1993; IN COMMERCE 0-0-1993.

FOR: GAUZES; ACETAMINOPHEN; ACID CONTROLLER TABLETS; RUBBING ALCOHOL; LIQUID ALLERGY CAPSULES; ANTI-DIARRHEAL PREPARATIONS; ANTI PLAQUE DENTAL RINSES; ANTIBIOTIC OINTMENTS; ASPIRIN; CHILDREN'S ASPIRIN; BANDAGES, NAMELY, ADHESIVE BANDAGES, BANDAGES FOR SKIN WOUNDS; BLADDER CONTROL PADS; ADULT DIAPERS; CALAMINE LOTION; CALCIUM PRODUCTS, NAMELY, CALCIUM SUPPLEMENTS; CASTOR OIL FOR MEDICINAL PURPOSES, DIETARY SUPPLEMENTS, NAMELY, CHROMIUM PICOLINATE; PHARMACEUTICAL PREPARATIONS, NAMELY, CITRATE OF MAGNESIUM; ADULT COLD RELIEF TABLETS; CHILD COLD RELIEF TABLETS; INFANT COLD RELIEF SYRUPS; COUGH DROPS; COUGH SYRUPS; MEDICATED DIAPER RASH OINTMENTS; DIET CAPLETS; DIET DRINKS; VAGINAL PREPARATIONS, NAMELY, DOUCHES; ENEMA PREPARATIONS; EPINEPHRIN KITS FOR THE TREATMENT OF ANAPHYLATIC SHOCK CONSISTING PRIMARILY OF SYRINGES AND INJECTIBLE EPINEPHRINE; EPSOM SALT; BABY FORMULAS; DIETARY SUPPLEMENTS, NAMELY, GARLIC TABLETS; DIETARY SUPPLEMENTS, NAMELY, GINKGO BILBOA; DIETARY SUPPLEMENTS, NAMELY, GINSENG GELATIN; DIETARY SUPPLEMENTS, NAMELY, GLOCSAMINE CHONDROITIAN MAX; ANTACIDS; HEMORRHOID TREATMENT PREPARATIONS; HYDROGEN PEROXIDE FOR MEDICAL USE; IBUPROFEN TABLETS AND CAPSULES FOR USE AS ORAL ANALGESICS;

CHILDREN'S IBUPROFEN FOR USE AS AN ORAL ANALGESIC; INFANT IBUPROFEN DROPS FOR USE AS AN ORAL ANALGESIC; IODINE; DIETARY SUPPLEMENTS, NAMELY, IRON TABLETS; KAVA FOR USE AS A DIETARY SUPPLEMENT; PERSONAL LUBRICANTS; LAXATIVES; FEMININE HYGIENE PADS; DIETARY SUPPLEMENTS, NAMELY, MEMORY COMPLEX; MENSTRUAL RELIEF CAPLETS; MILK OF MAGNESIA; NAPROVEN SODIUM CAPSULES AND TABLETS FOR USE AS ORAL ANALGESICS; NASAL SPRAY PREPARATIONS; CHILDREN'S NON ASPIRIN TABLETS; NUTRITIONAL SUPPLEMENTS; DIETARY SUPPLEMENTS, NAMELY, PANAX GINSENG; PINK BISMUTH FOR PHARMACEUTICAL PURPOSES; PLASTIC STRIPS, NAMELY, ADHESIVE BANDAGES AND NASAL STRIPS; PREGNANCY TEST KITS FOR HOME USE; CONTACT LENS SOLUTIONS; DIETARY SUPPLEMENTS, NAMELY, SAW PALMETTO; DIETARY SUPPLEMENTS, NAMELY, SELENIUM; LICE TREATMENT PREPARATIONS; SLEEPING PILLS/TABLETS; DIETARY SUPPLEMENTS, NAMELY, SAINT JOHN'S WORT; SUPPOSITORIES; SUPPOSITORIES FOR INFANTS; TAMPONS; THROAT SPRAYS; VAPOR RUBS; VITAMINS, NAMELY, PRENATAL VITAMINS, CHILDREN'S VITAMINS; WITCH HAZEL; EYE DROPS; MINERAL OIL FOR PHARMACEUTICAL USE; MINOXIDIL; MEDICINAL PREPARATIONS TO RELIEVE DROWSINESS, IN CLASS 5 (U.S. CLS. 6, 18, 44, 46, 51 AND 52).

FIRST USE 0-0-1997; IN COMMERCE 0-0-1997.

FOR: ALUMINUM FOIL, IN CLASS 6 (U.S. CLS. 2, 12, 13, 14, 23, 25 AND 50).

FIRST USE 8-8-2002; IN COMMERCE 8-8-2002.

FOR: PLASTIC CUTLERY; UTILITY KNIVES; RAZOR BLADES; CHEESE SLICERS; EGG SLICERS; APPLE CORERS; NON-ELECTRIC CAN OPENERS; SCISSORS; NUT CRACKERS NOT OF PRECIOUS METAL; NON-ELECTRIC VEGETABLE PEELERS; PIZZA CUTTERS; PARING KNIVES; NUTCRACKERS AND PICKS NOT OF PRECIOUS METAL, IN CLASS 8 (U.S. CLS. 23, 28 AND 44).

FIRST USE 0-0-1996; IN COMMERCE 0-0-1996.

FOR: BATTERIES; PROTRACTORS; GRADUATED RULERS; GROUNDING ADAPTERS, NAMELY, CONVERTERS FOR ELECTRIC PLUGS; DISPOSABLE CAMERAS; MEASURING CUPS; MEASURING SPOONS; FOOD TIMERS; THERMOMETERS NOT FOR MEDICAL USE, IN CLASS 9 (U.S. CLS. 21, 23, 26, 36 AND 38).

FIRST USE 0-0-1998; IN COMMERCE 0-0-1998.

FOR: BLOOD GLUCOSE TESTS; DIABETIC PRODUCTS, NAMELY, GLUCOSE TESTERS, LANCES AND MONITORS, IN CLASS 10 (U.S. CLS. 26, 39 AND 44).

FIRST USE 10-13-2001; IN COMMERCE 10-13-2001.

FOR: ELECTRIC LIGHT BULBS; ELECTRIC NIGHT LIGHTS, IN CLASS 11 (U.S. CLS. 13, 21, 23, 31 AND 34).

FIRST USE 0-0-2000; IN COMMERCE 0-0-2000.

FOR: PLASTIC FOOD STORAGE BAGS FOR HOUSEHOLD USE; FREEZER BAGS; PAPER LUNCH BAGS; PLASTIC GARBAGE BAGS; TRASH BAGS; LAWN AND LEAF BAGS; TOILET PAPER; PAPER FILTERS FOR COFFEE MAKERS; DISPOSABLE DIAPERS; FACIAL TISSUES; PAPER NAPKINS; PAPER TOWELS; PLASTIC WRAP; DISPOSABLE TRAINING PANTS; WAX PAPER; SCHOOL SUPPLIES, NAMELY, ASSORTED PAPER, PENS, PENCILS, MECHANICAL PENCILS, BINDER CLIPS FOR HOLDING PAPER; ERASERS; PAPER CLIPS; PAPER HOLE PUNCHES; PENCIL SHARPENERS; PUSH PINS FOR CORKBOARDS; STAPLE REMOVERS; TAPE, NAMELY, ADHESIVE TAPE AND MASKING TAPE FOR HOUSEHOLD AND STATIONERY USE, IN CLASS 16 (U.S. CLS. 2, 5, 22, 23, 29, 37, 38 AND 50).

FIRST USE 4-20-2001; IN COMMERCE 4-20-2001.

FOR: DRINKING STRAWS; NON-METAL BAG CLOSURES; FITTED PLASTIC INSERTS FOR USE AS CONTAINER LINERS, IN CLASS 20 (U.S. CLS. 2, 13, 22, 25, 32 AND 50).

FIRST USE 3-0-2002; IN COMMERCE 3-0-2002.

FOR: COOKING UTENSILS, NAMELY, WIRE BASKETS, COOKING FORKS, DIPPERS; BASTING SPOONS; PASTRY BASTING BRUSHES; BASTERS; SERVING TONGS; PLASTIC BOWLS; BROOMS; CONTAINERS FOR FOOD; CUPS; PLASTIC CUPS; DENTAL FLOSS; CLEANING CLOTHS; MOPS; SPONGE MOPS; DUST MOP REFILLS; FOAM PLATES; FRUIT AND BUTTER BALLER; LATEX GLOVES FOR GENERAL USE; VINYL GLOVES FOR GENERAL USE; BAMBOO COOKING SKEWERS; HOUSEHOLD UTENSILS, NAMELY, SCRAPERS, SPATULAS, TURNERS; PIE DOUGH BLENDERS; ICE CREAM SCOOPS; CORK SCREWS; BOTTLE OPENERS; SLOTTED SPOONS; WOODEN MIXING SPOONS; VEGETABLE MASHERS; SOUP LADLES; FOOD SCOOPS; CORN COOKING SKEWERS; GRATERS; PAPER BOWLS; PAPER PLATES; ABRASIVE PADS FOR KITCHEN OR DOMESTIC PURPOSES; SPONGES, NAMELY, CLEANING SPONGES; TOOTHBRUSHES; POT SCRUBBERS; CORN SKEWERS; CLEANER PADS, IN CLASS 21 (U.S. CLS. 2, 13, 23, 29, 30, 33, 40 AND 50).

FIRST USE 0-0-1996; IN COMMERCE 0-0-1996.

FOR: CAT LITTER, IN CLASS 31 (U.S. CLS. 1 AND 46).

FIRST USE 3-31-2000; IN COMMERCE 3-31-2000.

FOR: CIGARETTE LIGHTERS NOT OF PRECIOUS METAL; MATCHBOOKS, IN CLASS 34 (U.S. CLS. 2, 8, 9 AND 17).

FIRST USE 2-28-2001; IN COMMERCE 2-28-2001.

SER. NO. 78-256,096, FILED 5-30-2003.

OWNER OF U.S. REG. NOS. 1,291,685 AND
1,846,413.

KATHY DE JONGE, EXAMINING ATTORNEY

Int. Cls.: 35 and 44

Prior U.S. Cls.: 100, 101 and 102

United States Patent and Trademark Office

Reg. No. 2,893,304

Registered Oct. 12, 2004

**SERVICE MARK
PRINCIPAL REGISTER**

WORKPLACE INSIGHTS

MINISTRY INSIGHTS INTERNATIONAL, INC.
(ARIZONA CORPORATION)
16020 N. 77TH STREET
SCOTTSDALE, AZ 85260

FOR: TESTING SERVICES FOR OTHERS, NAME-
LY, BEHAVIORAL TESTING SERVICES IN THE
FIELD OF EMPLOYMENT SELECTION, IN CLASS
35 (U.S. CLS. 100, 101 AND 102).

FIRST USE 3-0-2002; IN COMMERCE 3-0-2002.

FOR: TESTING SERVICES FOR OTHERS, NAME-
LY, BEHAVIORAL TESTING SERVICES IN THE
FIELDS OF COACHING, COUNSELING, TEAM
BUILDING, CONFLICT RESOLUTION, IDENTIFY-
ING INDIVIDUAL STRENGTHS, BEHAVIORS, AND

RELATIONSHIP BARRIERS, IN CLASS 44 (U.S. CLS.
100 AND 101).

FIRST USE 3-0-2002; IN COMMERCE 3-0-2002.

OWNER OF U.S. REG. NOS. 2,570,284 AND
2,582,414.

NO CLAIM IS MADE TO THE EXCLUSIVE
RIGHT TO USE "WORKPLACE" , APART FROM
THE MARK AS SHOWN.

SER. NO. 78-256,464, FILED 5-30-2003.

RON FAIRBANKS, EXAMINING ATTORNEY

Int. Cl.: 7

Prior U.S. Cls.: 13, 19, 21, 23, 31, 34 and 35

United States Patent and Trademark Office

Reg. No. 2,893,305

Registered Oct. 12, 2004

**TRADEMARK
PRINCIPAL REGISTER**

Z-BIT

J & S RENTAL TOOLS, INC. (LOUISIANA COR-
PORATION)
202 HOLSTEIN
YOUNGSVILLE, LA 70592

FIRST USE 11-30-1999; IN COMMERCE 11-30-1999.

SER. NO. 78-256,593, FILED 5-31-2003.

FOR: POWER-OPERATED DRILL USED TO
DRILL WELLS IN OIL AND GAS EXPLORATION,
IN CLASS 7 (U.S. CLS. 13, 19, 21, 23, 31, 34 AND 35).

MICHAEL SOUDERS, EXAMINING ATTORNEY

Int. Cl.: 35

Prior U.S. Cls.: 100, 101 and 102

United States Patent and Trademark Office

Reg. No. 2,893,306

Registered Oct. 12, 2004

**SERVICE MARK
PRINCIPAL REGISTER**

GOLDMINE'S NATIONAL RECORD SHOW

KRAUSE PUBLICATIONS, INC. (WISCONSIN
CORPORATION)
700 EAST STATE STREET
IOLA, WI 54990

FOR: ARRANGING AND CONDUCTING TRADESHOWS ON COLLECTIBLE RECORDS AND COMPACT DISCS AND POPULAR MUSIC HISTORY, IN CLASS 35 (U.S. CLS. 100, 101 AND 102).

FIRST USE 9-9-2000; IN COMMERCE 9-9-2000.

NO CLAIM IS MADE TO THE EXCLUSIVE RIGHT TO USE "NATIONAL RECORD SHOW", APART FROM THE MARK AS SHOWN.

SER. NO. 78-257,138, FILED 6-2-2003.

JAMES GRIFFIN, EXAMINING ATTORNEY

Int. Cl.: 42

Prior U.S. Cls.: 100 and 101

United States Patent and Trademark Office

Reg. No. 2,893,307

Registered Oct. 12, 2004

SERVICE MARK
PRINCIPAL REGISTER

The logo for Perkins Coie features the words "Perkins" and "Coie" stacked vertically. The text is in a serif font. To the right of the text is a graphic element consisting of a vertical line and a horizontal line that meet at a right angle, forming an L-shape that partially encloses the text.

PERKINS COIE LLP (WASHINGTON LIMITED
LIABILITY PARTNERSHIP)
SUITE 4800
1201 THIRD AVENUE
SEATTLE, WA 981013099

FOR: LEGAL SERVICES AND ADVICE; PROVID-
ING INFORMATION IN THE FIELD OF LAW VIA
THE INTERNET, IN CLASS 42 (U.S. CLS. 100 AND
101).

FIRST USE 5-1-2002; IN COMMERCE 5-1-2002.

OWNER OF U.S. REG. NOS. 1,825,410 AND
2,178,967.

THE MARK CONSISTS OF THE WORDS "PER-
KINS COIE," EACH WORD ON A SEPARATE LINE,
THE TWO WORDS BORDERED IN THE UPPER
RIGHT HAND CORNER BY PERPENDICULAR
LINES FORMING A RIGHT ANGLE.

SER. NO. 78-257,310, FILED 6-2-2003.

YONG KIM, EXAMINING ATTORNEY

Int. Cl.: 18

Prior U.S. Cls.: 1, 2, 3, 22 and 41

United States Patent and Trademark Office

Reg. No. 2,893,308

Registered Oct. 12, 2004

**TRADEMARK
PRINCIPAL REGISTER**



BOB BONDURANT SCHOOL OF HIGH PERFORMANCE DRIVING, INC. (ARIZONA CORPORATION)
20,000 SOUTH MARICOPA ROAD
CHANDLER, AZ 85226

FOR: TRAVEL BAGS AND BACKPACKS, IN CLASS 18 (U.S. CLS. 1, 2, 3, 22 AND 41).

FIRST USE 4-29-2003; IN COMMERCE 4-29-2003.

OWNER OF U.S. REG. NO. 2,144,186.

SER. NO. 78-257,603, FILED 6-3-2003.

STEPHANIE DAVIS, EXAMINING ATTORNEY

Int. Cl.: 13

Prior U.S. Cls.: 2 and 9

United States Patent and Trademark Office

Reg. No. 2,893,309

Registered Oct. 12, 2004

**TRADEMARK
PRINCIPAL REGISTER**

DIRECT IMPACT

ARMOR HOLDINGS, INC. (DELAWARE CORPORATION)
1400 MARSH LANDING PARKWAY SUITE 112
JACKSONVILLE, FL 32250

FIRST USE 4-3-2003; IN COMMERCE 4-3-2003.

SER. NO. 78-257,813, FILED 6-3-2003.

FOR: AMMUNITION, IN CLASS 13 (U.S. CLS. 2 AND 9).

APRIL L. RADEMACHER, EXAMINING ATTORNEY

Int. Cl.: 9

Prior U.S. Cls.: 21, 23, 26, 36 and 38

Reg. No. 2,893,310

United States Patent and Trademark Office

Registered Oct. 12, 2004

**TRADEMARK
PRINCIPAL REGISTER**

M A C R O  S Y S T E M

MACROSYSTEM DIGITAL VIDEO AG (FED REP
GERMANY CORPORATION)
SCHÖLLINGER FELD 28
58300 WETTER, FED REP GERMANY

FOR: ELECTRONIC DEVICES, NAMELY VIDEO
CAMERAS, VIDEO EDITING DEVICES AND VIDEO
RECORDERS FOR CREATING, EDITING, MIXING,
AND COUPLING OF PICTURES, TONE AND
SOUND DATA ON VIDEO TAPES AND DIGITAL
VERSATILE DISKS (DVDS); ELECTRONIC SUR-
VEILLANCE AND SECURITY SYSTEMS, NAMELY
VIDEO RECORDERS FOR SURVEILLANCE AND
SECURITY, MOTION DETECTORS, MOUNTINGS,
AND COMPONENT PARTS THERETO; AND COM-
PUTER SOFTWARE, NAMELY COMPUTER SOFT-
WARE FOR CREATING, EDITING, MIXING, AND
COUPLING OF PICTURES, TONE AND SOUND
DATA ON VIDEO TAPES AND DIGITAL VERSA-
TILE DISKS (DVDS), FOR ANALYZING MEDICAL

AND SCIENTIFIC VISUAL MATERIAL, VIDEO
RECORDING AND SIMULATION OF MEDICAL
PROCESSES AND PROCEDURES, FOR SURVEIL-
LANCE AND SECURITY APPLICATIONS, AND
FOR CONTROL OF LIGHTING USED FOR VIDEO
AND FILM RECORDING, AND SURVEILLANCE
AND SECURITY OF BUILDING FACILITIES AND
PROPERTY, IN CLASS 9 (U.S. CLS. 21, 23, 26, 36 AND
38).

FIRST USE 1-15-2002; IN COMMERCE 1-15-2002.

NO CLAIM IS MADE TO THE EXCLUSIVE
RIGHT TO USE "SYSTEM", APART FROM THE
MARK AS SHOWN.

SER. NO. 78-258,503, FILED 6-4-2003.

JOSETTE BEVERLY, EXAMINING ATTORNEY

Int. Cl.: 25

Prior U.S. Cls.: 22 and 39

United States Patent and Trademark Office

Reg. No. 2,893,311

Registered Oct. 12, 2004

TRADEMARK
PRINCIPAL REGISTER

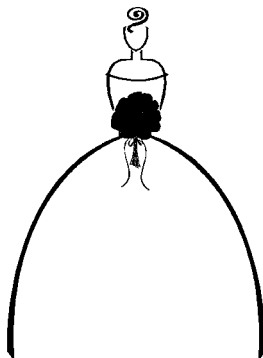

ZANITSCH, ALLISON MARIE (UNITED STATES
INDIVIDUAL)
1305 BOARDMAN-CANFIELD ROAD
BOARDMAN, OH 44512

FOR: BRIDE, BRIDESMAID, AND WEDDING
CLOTHING AND APPAREL, NAMELY, TANK
TOPS, SHORTS, PAJAMAS, TANK SETS, UNDER-
WEAR, PANTIES, GOLF SHIRTS, PANTS, T-SHIRTS,
BABY DOLL T'S, SWEATPANTS, SWEATSHIRTS,
HOODED ZIPPERED SWEATSHIRTS AND BOXER
SHORTS, HATS, VISORS, BASEBALL HATS, BUCK-
ET HATS, FISHING HATS, FLIP FLOPS, AND
SANDALS; CUSTOM EMBROIDERED CLOTHING
AND APPAREL FOR USE AS WEDDING PARTY

GIFTS, NAMELY, TANK TOPS, SHORTS, PAJAMAS,
TANK SETS, UNDERWEAR, PANTIES, GOLF
SHIRTS, PANTS, T-SHIRTS, BABY DOLL T'S,
SWEATPANTS, SWEATSHIRTS, HOODED ZIP-
PERED SWEATSHIRTS AND BOXER SHORTS,
HATS, VISORS, BASEBALL HATS, BUCKET HATS,
FISHING HATS, FLIP FLOPS, AND SANDALS , IN
CLASS 25 (U.S. CLS. 22 AND 39).

FIRST USE 9-1-2002; IN COMMERCE 10-1-2002.

SER. NO. 78-258,696, FILED 6-5-2003.

STANLEY I. OSBORNE, EXAMINING ATTORNEY

Int. Cls.: 25, 32 and 43

Prior U.S. Cls.: 22, 39, 45, 46, 48, 100 and 101

United States Patent and Trademark Office

Reg. No. 2,893,312

Registered Oct. 12, 2004

**TRADEMARK
SERVICE MARK
PRINCIPAL REGISTER**



SEAN DACEY, LLC (GEORGIA LTD LIAB CO)
4188 ROSWELL RD, NE
ATLANTA, GA 30342

FOR: CLOTHING, NAMELY, SHIRTS, PANTS,
CAPS, AND SHORTS, IN CLASS 25 (U.S. CLS. 22
AND 39).

FIRST USE 4-1-2000; IN COMMERCE 4-1-2000.

FOR: NON-ALCOHOLIC COCKTAIL MIXES,
NAMELY, MARGARITA AND DAIQUIRI MIXES;
AND NON-ALCOHOLIC COCKTAIL MIXES, IN
CLASS 32 (U.S. CLS. 45, 46 AND 48).

FIRST USE 4-1-2000; IN COMMERCE 4-1-2000.

FOR: CATERING SERVICES; RENTAL OF FOOD
SERVICE EQUIPMENT; CONSULTATION RELAT-
ING TO CATERING SERVICES, IN CLASS 43 (U.S.
CLS. 100 AND 101).

FIRST USE 4-1-2000; IN COMMERCE 4-1-2000.

SER. NO. 78-259,105, FILED 6-6-2003.

SHARON MEIER, EXAMINING ATTORNEY

Int. Cl.: 9

Prior U.S. Cls.: 21, 23, 26, 36 and 38

United States Patent and Trademark Office

Reg. No. 2,893,313

Registered Oct. 12, 2004

**TRADEMARK
PRINCIPAL REGISTER**

WINDAQ

DATAQ INSTRUMENTS, INC. (OHIO CORPORATION)
241 SPRINGSIDE DR
AKRON, OH 44333

TROL APPARATUS, AND FOR LIFE SCIENCES RESEARCH, IN CLASS 9 (U.S. CLS. 21, 23, 26, 36 AND 38).

FOR: COMPUTER SOFTWARE FOR USE IN COMPUTER-BASED DATA ACQUISITION, DISPLAY, AND RECORDING FOR MAINTENANCE, TROUBLESHOOTING AND TESTING DESIGN QUALIFICATIONS OF ELECTROMECHANICAL MACHINES EXCLUDING AIR POLLUTION CON-

FIRST USE 9-22-1992; IN COMMERCE 9-22-1992.

SER. NO. 78-259,242, FILED 6-6-2003.

LESLIE RICHARDS, EXAMINING ATTORNEY

Int. Cl.: 35

Prior U.S. Cls.: 100, 101 and 102

United States Patent and Trademark Office

Reg. No. 2,893,314

Registered Oct. 12, 2004

**SERVICE MARK
PRINCIPAL REGISTER**

OUR TALK IS CHEAP, OUR INFORMATION INVALUABLE

INFONE LLC (DELAWARE LTD LIAB CO)
11200 MURRAY SCHOLLS PLACE
BEAVERTON, OR 97007

FOR: PROVIDING TELEPHONE NUMBERS, PAGER NUMBERS, FACSIMILE NUMBERS, NAMES AND ADDRESSES, URL'S AND ELECTRONIC MAIL ADDRESSES; PROVIDING INFORMATION ABOUT PRODUCTS OR SERVICES ASSOCIATED WITH BUSINESSES AND BUSINESS NAMES; MAINTAINING COMPUTER DATABASE FILES CONTAINING INDIVIDUALS' AND/OR BUSINESSES' CUSTOMIZED COLLECTIONS OF COMMUNICATIONS INFORMATION SUCH AS ADDRESSES, TELEPHONE, PAGER AND FAX NUMBERS, E-MAIL ADDRESSES AND URL'S, CONTACT LISTS, AND CREDIT CARD NUMBERS; PROVIDING INFORMATION ABOUT AND MAKING REFERRALS

IN THE FIELD OF CONSUMER PRODUCTS AND SERVICES FOR RETAIL SERVICES CONCERNING PRODUCTS, SERVICES, EVENTS, ACTIVITIES, ATTRACTIONS AND FACILITIES IN PARTICULAR GEOGRAPHIC LOCATIONS; LOOKING UP AND PROVIDING INFORMATION ABOUT BUSINESSES CLOSEST TO TARGET GEOGRAPHICAL LOCATIONS; PROVIDING INFORMATION ABOUT THE GOODS AND SERVICES OF OTHERS VIA TELEPHONE; PROVIDING INFORMATION ABOUT CONSUMER PRODUCTS AND SERVICES, IN CLASS 35 (U.S. CLS. 100, 101 AND 102).

FIRST USE 6-11-2003; IN COMMERCE 6-11-2003.

SER. NO. 78-259,414, FILED 6-6-2003.

JOHN DALIER, EXAMINING ATTORNEY

Int. Cl.: 28

Prior U.S. Cls.: 22, 23, 38 and 50

United States Patent and Trademark Office

Reg. No. 2,893,315

Registered Oct. 12, 2004

**TRADEMARK
PRINCIPAL REGISTER**



NEWTON, SUSAN (UNITED STATES INDIVIDUAL)
3225 KELTON AVENUE
LOS ANGELES, CA 90034

FIRST USE 3-13-2002; IN COMMERCE 3-13-2002.

SER. NO. 78-259,545, FILED 6-6-2003.

FOR: GAME CARDS FOR PLAYING GAMES OF CHANCE, IN CLASS 28 (U.S. CLS. 22, 23, 38 AND 50).

KARANENDRA S. CHHINA, EXAMINING ATTORNEY

Int. Cl.: 38

Prior U.S. Cls.: 100, 101 and 104

United States Patent and Trademark Office

Reg. No. 2,893,316

Registered Oct. 12, 2004

**SERVICE MARK
PRINCIPAL REGISTER**

STARBACK

METRO ONE TELECOMMUNICATIONS, INC.
(OREGON CORPORATION)
11200 MURRAY SCHOLLS PLACE
BEAVERTON, OR 97007

FOR: TELECOMMUNICATIONS SERVICES, NAMELY, THE ELECTRONIC TRANSMISSION AND RECEPTION OF VOICE, DATA, AND A BROAD RANGE OF CONSUMER SERVICES; CONNECTING CALLERS TO DESIRED NUMBERS REQUESTED THROUGH DIRECTORY ASSISTANCE SERVICES VIA LIVE TELEPHONE OPERATORS; ESTABLISHING COMMUNICATION BETWEEN A USER AND A SYSTEM THAT IS REMOTE FROM THE USER; CONNECTING A USER WITH LIVE OPERATORS OR AUTOMATED MENUS AT ANY

TIME DURING A COMMUNICATION; AUTOMATICALLY CONNECTING A USER WITH LIVE OPERATORS OR AUTOMATED MENUS WHEN COMMUNICATION CANNOT BE COMPLETED; PROVIDING TELEPHONE NUMBERS CALLED TO A USER, IN CLASS 38 (U.S. CLS. 100, 101 AND 104).

FIRST USE 9-0-1993; IN COMMERCE 9-0-1993.

OWNER OF U.S. REG. NO. 1,923,993.

SER. NO. 78-259,590, FILED 6-6-2003.

ESTHER A. BORSUK, EXAMINING ATTORNEY

Int. Cl.: 36

Prior U.S. Cls.: 100, 101 and 102

United States Patent and Trademark Office

Reg. No. 2,893,317

Registered Oct. 12, 2004

**SERVICE MARK
PRINCIPAL REGISTER**

PROAPPRAISE

SHEPPARD, ROBERT (UNITED STATES INDIVIDUAL)
1514 COUNTY ROAD 101
NEW ALBANY, MS 38652

FIRST USE 1-5-2000; IN COMMERCE 1-5-2000.

SER. NO. 78-259,605, FILED 6-6-2003.

FOR: REAL ESTATE APPRAISAL, IN CLASS 36
(U.S. CLS. 100, 101 AND 102).

TINA L. SNAPP, EXAMINING ATTORNEY

Int. Cls.: 35 and 42

Prior U.S. Cls.: 100, 101 and 102

United States Patent and Trademark Office

Reg. No. 2,893,318

Registered Oct. 12, 2004

**SERVICE MARK
PRINCIPAL REGISTER**

INGENUITY

INGENUITY MARKETING SERVICES (CALIFORNIA SOLE PROPRIETORSHIP)
25852 MCBEAN PARKWAY, #126
VALENCIA, CA 91355

FOR: BUSINESS MARKETING CONSULTING SERVICES; ADVERTISING AND MARKETING SERVICES, NAMELY, DESIGNING AND IMPLEMENTING ADVERTISING AND MARKETING STRATEGIES FOR OTHERS; CONDUCTING MARKET AND BUSINESS RESEARCH AND STUDIES; ADVERTISING SERVICES, NAMELY, CREATING CORPORATE AND BRAND IDENTITY FOR OTHERS; PUBLIC RELATIONS AND EVENT MARKETING SERVICES, IN CLASS 35 (U.S. CLS. 100, 101 AND 102).

FIRST USE 1-3-2003; IN COMMERCE 2-7-2003.

FOR: LOGO AND PACKAGING DESIGN AND DEVELOPMENT FOR OTHERS; DISPLAY AND POINT OF PURCHASE DESIGN AND DEVELOPMENT FOR OTHERS; GRAPHIC ART DESIGN; GRAPHIC ILLUSTRATION SERVICES FOR OTHERS; COMPUTER SERVICES, NAMELY, DESIGNING WEBSITES FOR OTHERS, IN CLASS 42 (U.S. CLS. 100 AND 101).

FIRST USE 1-3-2003; IN COMMERCE 2-7-2003.

SER. NO. 78-259,635, FILED 6-7-2003.

INGA ERVIN, EXAMINING ATTORNEY

Int. Cl.: 9

Prior U.S. Cls.: 21, 23, 26, 36 and 38

Reg. No. 2,893,319

United States Patent and Trademark Office

Registered Oct. 12, 2004

**TRADEMARK
PRINCIPAL REGISTER**

PICTBRIDGE

CANON KABUSHIKI KAISHA (JAPAN CORPORATION)
30-2, SHIMOMARUKO 3-CHOME, OHTA-KU
TOKYO, JAPAN

FOR: INK-JET PRINTERS; LASER PRINTERS; COLOR PRINTERS FOR THERMAL PRINTING PAPERS; DYE SUBLIMATION THERMAL PRINTERS; LINE HEAD PRINTERS; PRINTERS FOR DIGITAL CAMERAS; PRINTERS FOR COMPUTERS; DIGITAL PHOTO PRINTING SYSTEMS IN THE NATURE OF KIOSKS COMPRISED OF A COMPUTER, MONITOR AND A PRINTER; PHOTO-DEVELOPING, PRINTING, ENLARGING MACHINES; DIGITAL CAMERAS; DIGITAL VIDEO CAMERAS; COMPUTER SOFTWARE FOR PRINTERS FOR PHOTO DEVELOPING; COMPUTER SOFTWARE FOR DIGITAL IMAGING; COMPUTER

SOFTWARE FOR DIGITAL PRINTING; INTEGRATED CIRCUITS; MOBILE PHONES; DVD PLAYERS; BLANK MAGNETIC OPTICAL DISCS; HARD DISC DRIVES; BLANK DATA STORAGE MEDIA UNITS, NAMELY, TAPES, DISKS, DISKETTES AND DIGITAL AUDIO TAPES, IN CLASS 9 (U.S. CLS. 21, 23, 26, 36 AND 38).

PRIORITY CLAIMED UNDER SEC. 44(D) ON JAPAN APPLICATION NO. 2003-004117, FILED 1-23-2003, REG. NO. 4713083, DATED 9-26-2003, EXPIRES 9-26-2013.

SER. NO. 78-259,853, FILED 6-9-2003.

SOPHIA S. KIM, EXAMINING ATTORNEY

Int. Cl.: 36

Prior U.S. Cls.: 100, 101 and 102

United States Patent and Trademark Office

Reg. No. 2,893,320

Registered Oct. 12, 2004

SERVICE MARK
PRINCIPAL REGISTER

HOMEfree

HOMEFREE USA LLC (WISCONSIN LTD LIAB
CO)
222 EAST COLLEGE AVENUE
APPLETON, WI 54911

FOR: FEE-BASED RESIDENTIAL PROPERTY
MANAGEMENT SERVICES, NAMELY, ASSISTING
PRIVATE HOMEOWNERS IN ASSESSING THE
CONDITION OF A HOME, AND IDENTIFYING,
PRIORITIZING AND COMPLETING REPAIR AND

MAINTENANCE NEEDS, IN CLASS 36 (U.S. CLS.
100, 101 AND 102).

FIRST USE 3-20-1997; IN COMMERCE 3-20-1997.

OWNER OF U.S. REG. NO. 2,464,911.

SER. NO. 78-259,861, FILED 6-9-2003.

SUSAN HAYASH, EXAMINING ATTORNEY

Int. Cl.: 29

Prior U.S. Cl.: 46

United States Patent and Trademark Office

Reg. No. 2,893,321

Registered Oct. 12, 2004

**TRADEMARK
PRINCIPAL REGISTER**



MANNI, ARMANDO (ITALY INDIVIDUAL)
SALITA DEL POGGIO LAURENTINO 19-I
00144 ROME, ITALY

FIRST USE 11-19-2002; IN COMMERCE 6-9-2003.

SER. NO. 78-259,986, FILED 6-9-2003.

FOR: EDIBLE OILS, IN CLASS 29 (U.S. CL. 46).

HOWARD SMIGA, EXAMINING ATTORNEY

Int. Cl.: 41

Prior U.S. Cls.: 100, 101 and 107

United States Patent and Trademark Office

Reg. No. 2,893,322

Registered Oct. 12, 2004

**SERVICE MARK
PRINCIPAL REGISTER**

JUNGLE JIM'S BUGS OF THE WORLD

KLINGER, JIM (UNITED STATES INDIVIDUAL)
P.O. BOX 1515
COPPELL, TX 75019

FOR: EDUCATION AND ENTERTAINMENT SERVICES, NAMELY, CONDUCTING PRESENTATIONS, EDUCATIONAL DEMONSTRATIONS AND EXHIBITIONS IN THE FIELD OF ARTHROPODS AND OTHER ANIMALS, IN CLASS 41 (U.S. CLS. 100, 101 AND 107).

FIRST USE 6-1-2000; IN COMMERCE 6-1-2000.

NO CLAIM IS MADE TO THE EXCLUSIVE RIGHT TO USE BUGS OF THE WORLD, APART FROM THE MARK AS SHOWN.

THE NAME "JUNGLE JIM" DOES NOT IDENTIFY A PARTICULAR LIVING INDIVIDUAL.

SER. NO. 78-260,173, FILED 6-9-2003.

TRACY CROSS, EXAMINING ATTORNEY

Int. Cl.: 36

Prior U.S. Cls.: 100, 101 and 102

United States Patent and Trademark Office

Reg. No. 2,893,323

Registered Oct. 12, 2004

**SERVICE MARK
PRINCIPAL REGISTER**

BENESYST

BENESYST, INC. (MINNESOTA CORPORATION)
SUITE 250
800 WASHINGTON AVENUE NORTH
MINNEAPOLIS, MN 55401

FOR: BENEFIT ADMINISTRATION SERVICES
FOR EMPLOYERS, NAMELY, ONLINE OR PAPER
BENEFIT ENROLLMENT MANAGEMENT, CON-
SOLIDATED BILLING ADMINISTRATION, VEN-
DOR MANAGEMENT, ELECTRONIC ELIGIBILITY
MANAGEMENT, FLEXIBLE BENEFIT ADMINIS-
TRATION, COBRA ADMINISTRATION, HEALTH
INSURANCE LAWS AND REGULATIONS COMPLI-

ANCE ADMINISTRATION, EMPLOYEE LEAVE,
RETIREMENT, AND SEVERANCE PLAN ADMIN-
ISTRATION, SHORT TERM DISABILITY PLAN
ADMINISTRATION, AND TRANSIT BENEFIT AD-
MINISTRATION, ALL FOR OTHERS, IN CLASS 36
(U.S. CLS. 100, 101 AND 102).

FIRST USE 0-0-1993; IN COMMERCE 0-0-1993.

SER. NO. 78-260,393, FILED 6-10-2003.

ANNE MADDEN, EXAMINING ATTORNEY

Int. Cl.: 9

Prior U.S. Cls.: 21, 23, 26, 36 and 38

Reg. No. 2,893,324

United States Patent and Trademark Office

Registered Oct. 12, 2004

**TRADEMARK
PRINCIPAL REGISTER**

TWELVE POUND BUTTOCK

HADDOCK, ROBERT WILLIAM (UNITED STATES INDIVIDUAL), DBA ROBERT JOSEPH BUTTOCK
SUITE 218
3300 UNIVERSITY BLVD.
WINTER PARK, FL 32792

FIRST USE 0-0-1996; IN COMMERCE 0-0-1996.

SER. NO. 78-260,410, FILED 6-10-2003.

FOR: SERIES OF SOUND AND VIDEO TAPE RECORDINGS FEATURING MUSIC, IN CLASS 9 (U.S. CLS. 21, 23, 26, 36 AND 38).

CAROLINE WOOD, EXAMINING ATTORNEY

Int. Cls.: 25 and 34

Prior U.S. Cls.: 2, 8, 9, 17, 22 and 39

United States Patent and Trademark Office

Reg. No. 2,893,325

Registered Oct. 12, 2004

**TRADEMARK
PRINCIPAL REGISTER**



ROYAL BLUNTS, INC. (CALIFORNIA CORPORATION)
121 ENTERPRISE COURT
CORONA, CA 92882

FOR: CLOTHING, NAMELY, HATS, BEENIES, JACKETS, SWEATERS, SWEAT SHIRTS, SWEAT PANTS, T-SHIRTS, POLO SHIRTS, BELTS, PANTS, JEANS, UNDERWEAR, BOXER SHORTS, BERMUDA SHORTS, SWIMMING TRUNKS, SOCKS AND SHOES, IN CLASS 25 (U.S. CLS. 22 AND 39).

FIRST USE 1-1-1997; IN COMMERCE 1-1-1997.

FOR: CIGARS, CIGARETTES, TOBACCO, TOBACCO LEAVES AND FLAVORED TOBACCO LEAVES IN THE FORM OF A SHEET FOR USE IN ROLLING CIGARS AND CIGARETTES AND CHEWING TOBACCO, IN CLASS 34 (U.S. CLS. 2, 8, 9 AND 17).

FIRST USE 1-1-1997; IN COMMERCE 1-1-1997.

SER. NO. 78-261,276, FILED 6-11-2003.

STEVEN R. FINE, EXAMINING ATTORNEY

Int. Cls.: 38, 41 and 42

Prior U.S. Cls.: 100, 101, 104 and 107

United States Patent and Trademark Office

Reg. No. 2,893,326

Registered Oct. 12, 2004

**SERVICE MARK
PRINCIPAL REGISTER**

CAMCONTACTS

CC NETWORK, INC. (UNITED KINGDOM CORPORATION)
TRIDENTTRUST CO. (B.V.I.)
LIMITED TRIDENT CHAMBERSPO BOX 146 ROAD
TOWN
TOROLA, UNITED KINGDOM

FOR: VIDEO TELECONFERENCING AND AUDIO TELECONFERENCING SERVICES RENDERED VIA THE GLOBAL COMPUTER NETWORK, PROVIDING ON-LINE CHAT ROOM SERVICES AND PROVIDING ON-LINE ELECTRONIC BULLETIN BOARDS FOR TRANSMISSION OF MESSAGES AMONG COMPUTER USERS CONCERNING INTERPERSONAL RELATIONSHIPS; PROVIDING MULTIPLE USER ACCESS TO A GLOBAL COMPUTER INFORMATION NETWORK, IN CLASS 38 (U.S. CLS. 100, 101 AND 104).

FIRST USE 11-1-1999; IN COMMERCE 11-1-2000.

FOR: ENTERTAINMENT SERVICES, NAMELY CONTINUING LIVE PERFORMANCES IN THE NATURE OF ADULT THEMED AND GENERAL-INTEREST VARIETY SHOWS DISTRIBUTED OVER THE GLOBAL COMPUTER NETWORK, IN CLASS 41 (U.S. CLS. 100, 101 AND 107).

FIRST USE 11-1-1999; IN COMMERCE 11-1-2000.

FOR: COMPUTER SOFTWARE DEVELOPMENT AND COMPUTER SOFTWARE DESIGN FOR OTHERS, IN CLASS 42 (U.S. CLS. 100 AND 101).

FIRST USE 11-1-1999; IN COMMERCE 11-1-2000.

SER. NO. 78-261,429, FILED 6-12-2003.

MARLENE BELL, EXAMINING ATTORNEY

Int. Cl.: 5

Prior U.S. Cls.: 6, 18, 44, 46, 51 and 52

United States Patent and Trademark Office

Reg. No. 2,893,327

Registered Oct. 12, 2004

**TRADEMARK
PRINCIPAL REGISTER**

GENECOLOR

BIOCYTEX (FRANCE CORPORATION)
140, CHEMIN DE L'ARMEE D'AFRIQUE
13010 MARSEILLE, FRANCE

FOR: REAGENT PRODUCT FOR LABORATORY
TO BE USED FOR IN VITRO DIAGNOSTIC, IN THE
FIELD OF HAEMOSTASIS AND BLOOD COAGU-
LATION, FOR HUMAN AND VETERINARY MED-
ICINE, IN CLASS 5 (U.S. CLS. 6, 18, 44, 46, 51 AND 52).

PRIORITY CLAIMED UNDER SEC. 44(D) ON
FRANCE APPLICATION NO. 023199141, FILED 12-
31-2002, REG. NO. 023199141, DATED 12-13-2002,
EXPIRES 12-13-2012.

SER. NO. 78-261,486, FILED 6-12-2003.

SUSAN STIGLITZ, EXAMINING ATTORNEY

Int. Cl.: 32

Prior U.S. Cls.: 45, 46 and 48

United States Patent and Trademark Office

Reg. No. 2,893,328

Registered Oct. 12, 2004

TRADEMARK
PRINCIPAL REGISTER

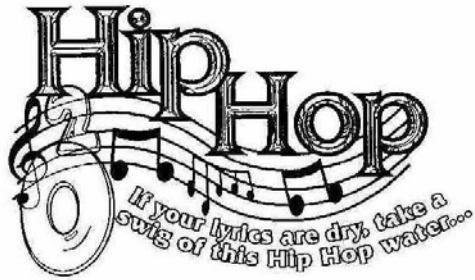

Always finish the rhyme @ HipHopH2O.com

MCKINNEY, BERNICE (UNITED STATES INDIVIDUAL)
7135 THEODORE
JENNINGS, MO 63136

FIRST USE 7-18-2003; IN COMMERCE 7-18-2003.

SER. NO. 78-261,733, FILED 6-12-2003.

FOR: BOTTLED WATER, IN CLASS 32 (U.S. CLS. 45, 46 AND 48).

CAROLYN CATALDO, EXAMINING ATTORNEY

Int. Cls.: 16 and 20

Prior U.S. Cls.: 2, 5, 13, 22, 23, 25, 29, 32, 37, 38 and 50

United States Patent and Trademark Office

Reg. No. 2,893,329

Registered Oct. 12, 2004

**TRADEMARK
PRINCIPAL REGISTER**

PIT BULL

TIRE MART, INC. (MISSOURI CORPORATION)
1815 LOCUST STREET
ST. LOUIS, MO 63103

FOR: ADHESIVE DECALS, ORNAMENTAL STICKERS, NEWSLETTERS IN THE FIELD OF VEHICLE TIRES, MAGAZINES IN THE FIELD OF VEHICLE TIRES, PERIODICALS IN THE FIELD OF VEHICLE TIRES, CALENDARS, ANNOUNCEMENT CARDS, BROCHURES IN THE FIELD OF VEHICLE TIRES, POSTERS, GREETING CARDS, PHOTOGRAPHS AND PHOTOGRAPH ALBUMS, STATIONERY, PENS, PENCILS, ADDRESS LABELS, BOOK BINDINGS, ART PICTURES AND ART PRINTS, PAPER BANNERS, PLASTIC SHOPPING BAGS,

AND PAPER BAGS, IN CLASS 16 (U.S. CLS. 2, 5, 22, 23, 29, 37, 38 AND 50).

FIRST USE 12-31-1994; IN COMMERCE 12-31-1994.

FOR: PLASTIC BANNERS, IN CLASS 20 (U.S. CLS. 2, 13, 22, 25, 32 AND 50).

FIRST USE 12-31-1994; IN COMMERCE 12-31-1994.

OWNER OF U.S. REG. NOS. 2,007,072 AND 2,020,321.

SER. NO. 78-261,738, FILED 6-12-2003.

MICHAEL KAZAZIAN, EXAMINING ATTORNEY

Int. Cl.: 43

Prior U.S. Cls.: 100 and 101

United States Patent and Trademark Office

Reg. No. 2,893,330

Registered Oct. 12, 2004

**SERVICE MARK
PRINCIPAL REGISTER**

HOPPING TURTLE

MANGINI, SCOTT J. (UNITED STATES INDIVIDUAL)
2707 CHARING ROAD
COLUMBUS, OH 43221 AND
BUCCILLA, MATTHEW J. (UNITED STATES INDIVIDUAL)
2707 CHARING ROAD
COLUMBUS, OH 43221

HOUSING ACCOMODATIONS, PROVIDING CAMPGROUND FACILITIES, AND LODGING FOR NATURE RETREATS, IN CLASS 43 (U.S. CLS. 100 AND 101).

FIRST USE 6-13-2003; IN COMMERCE 6-13-2003.

SER. NO. 78-262,372, FILED 6-13-2003.

FOR: TEMPORARY LODGING ACCOMODATIONS; NAMELY, ARRANGING TEMPORARY

CAROLYN CATALDO, EXAMINING ATTORNEY

Int. Cl.: 35

Prior U.S. Cls.: 100, 101 and 102

United States Patent and Trademark Office

Reg. No. 2,893,331

Registered Oct. 12, 2004

**SERVICE MARK
PRINCIPAL REGISTER**

CHOCTAW ARCHIVING

CHOCTAW NATION OF OKLAHOMA (OKLAHOMA FEDERALLY RECOGNIZED INDIAN TRIBE)
P.O. DRAWER 1210
DURANT, OK 747021210

FOR: RECORDS MANAGEMENT SERVICES, NAMELY DOCUMENT INDEXING, REPRODUCTION, TRACKING AND FILE MAINTENANCE FOR OTHERS, NOT BEING MEDICAL FILE MAINTENANCE; CONSULTING IN THE FIELD OF RECORDS MANAGEMENT, NOT BEING MEDICAL

FILE MAINTENANCE, IN CLASS 35 (U.S. CLS. 100, 101 AND 102).

FIRST USE 12-1-2002; IN COMMERCE 12-1-2002.

OWNER OF U.S. REG. NO. 2,711,510.

SER. NO. 78-262,428, FILED 6-13-2003.

KATHY DE JONGE, EXAMINING ATTORNEY

Int. Cl.: 25

Prior U.S. Cls.: 22 and 39

United States Patent and Trademark Office

Reg. No. 2,893,332

Registered Oct. 12, 2004

TRADEMARK
PRINCIPAL REGISTER



CAPITAL TAILORS, LLC (CALIFORNIA LTD
LIAB CO)
SUITE 420
701 E. THIRD STREET
LOS ANGELES, CA 90013

FOR: SHIRTS, T-SHIRTS, PANTS, TROUSERS,
JEANS, SWEATERS, SWEATSHIRTS, SWEAT SUITS,
JERSEYS, BLAZERS, SUITS, WAISTCOATS, RAIN-
COATS, CARDIGANS, COAT, GLOVES, SHOES,
SANDALS, BOOTS, SLIPPERS, SOCKS, BELTS,
BLOUSES, SKIRTS, DRESSES, STOCKINGS, BATH-
ROBES, NIGHTGOWNS, BATHING SUITS, SUN
SUITS, UNDERWEAR, TIES, NECKTIES, SCARVES,
PAJAMAS, CAPS AND HATS, IN CLASS 25 (U.S. CLS.
22 AND 39).

FIRST USE 6-1-2003; IN COMMERCE 6-1-2003.

NO CLAIM IS MADE TO THE EXCLUSIVE
RIGHT TO USE TAILORS, APART FROM THE
MARK AS SHOWN.

THE MARK CONSISTS OF THE WORD "CAPI-
TAL" IN A LARGER BOLD CURSIVE FONT SET
ABOVE THE SMALLER WORLD "TAILORS" WITH
TWO LINES EACH CONSISTING OF TWO RIGHT
ANGLES THAT FROM A BROKEN RECTANGLE
SURROUNDING SAID MARK.

SER. NO. 78-263,003, FILED 6-16-2003.

CHARLES L. JENKINS, EXAMINING ATTORNEY

Int. Cl.: 16

Prior U.S. Cls.: 2, 5, 22, 23, 29, 37, 38 and 50

United States Patent and Trademark Office

Reg. No. 2,893,333

Registered Oct. 12, 2004

**TRADEMARK
PRINCIPAL REGISTER**

AUTOBUZZ

NT MEDIA, LLC (DELAWARE LTD LIAB CO)
1201 EAST JEFFERSON STREET
PHOENIX, AZ 85034

FIRST USE 6-14-2001; IN COMMERCE 6-14-2001.

FOR: NEWSPAPER SECTIONS FEATURING INFORMATION ABOUT AND ADVERTISEMENTS FOR MOTOR VEHICLES, IN CLASS 16 (U.S. CLS. 2, 5, 22, 23, 29, 37, 38 AND 50).

SER. NO. 78-263,077, FILED 6-16-2003.

AMY GEARIN, EXAMINING ATTORNEY

Int. Cl.: 35

Prior U.S. Cls.: 100, 101 and 102

United States Patent and Trademark Office

Reg. No. 2,893,334

Registered Oct. 12, 2004

**SERVICE MARK
PRINCIPAL REGISTER**

RDP

PRACTICEWARES, INC. (DELAWARE CORPORATION)
7345 MISSION GORGE ROAD, SUITE E
SAN DIEGO, CA 92120

FOR: PROMOTING THE SALE OF PROFESSIONAL DENTAL SUPPLIES OF OTHERS BY CONDUCTING A REFERRAL PROGRAM THAT FINANCIALLY REWARDS CUSTOMERS OR OTHER INTERESTED PARTIES FOR THEIR RECOMMENDING NEW CUSTOMERS; RETAIL SERVICES BY DIRECT SOLICITATION BY INDEPENDENT SALES REPRESENTATIVES, TELEPHONE ORDER-TAKING SERVICES FOR OTHERS, MAIL-ORDER CATALOG SERVICES, AND INTERACTIVE RETAIL SERVICES RENDERED BY MEANS OF A GLOBAL COMPUTER INFORMATION NETWORK, ALL FEATURING DENTAL SUPPLIES OF OTHERS; MULTILEVEL BUSINESS

MARKETING CONSULTING SERVICES IN THE FIELD OF DENTAL SUPPLIES; PROMOTING THE SALE OF DENTAL SUPPLIES OF OTHERS THROUGH THE DISTRIBUTION OF PRINTED MATERIALS; DIRECT MARKETING ADVERTISING FOR OTHERS; PROMOTING THE GOODS AND SERVICES OF OTHERS BY PREPARING AND PLACING ADVERTISEMENTS IN AN ELECTRONIC MAGAZINE ACCESSED THROUGH A GLOBAL COMPUTER NETWORK, IN CLASS 35 (U.S. CLS. 100, 101 AND 102).

FIRST USE 4-30-2003; IN COMMERCE 4-30-2003.

SER. NO. 78-263,250, FILED 6-17-2003.

GLENN CLARK, EXAMINING ATTORNEY

Int. Cl.: 35

Prior U.S. Cls.: 100, 101 and 102

United States Patent and Trademark Office

Reg. No. 2,893,335

Registered Oct. 12, 2004

SERVICE MARK
PRINCIPAL REGISTER



E. THOMAS TITUS (OHIO CORPORATION)
1627 HENTHORNE DR., SUITE G
MAUMEE, OH 43537

FOR: ACCOUNTING SERVICES, NAMELY, AUDITS OF CLOSELY HELD BUSINESSES, EMPLOYEE BENEFIT PROGRAMS, NOT FOR PROFIT ORGANIZATIONS AND UNIONS; TAX PREPARATION AND CONSULTATION FOR BUSINESSES AND INDIVIDUALS, PAYROLL PREPARATION AND BOOKKEEPING, IN CLASS 35 (U.S. CLS. 100, 101 AND 102).

FIRST USE 9-30-2001; IN COMMERCE 9-30-2001.

NO CLAIM IS MADE TO THE EXCLUSIVE RIGHT TO USE INC. AND CERTIFIED PUBLIC ACCOUNTANTS, APART FROM THE MARK AS SHOWN.

SER. NO. 78-263,987, FILED 6-18-2003.

EDWARD NELSON, EXAMINING ATTORNEY

Int. Cl.: 35

Prior U.S. Cls.: 100, 101 and 102

United States Patent and Trademark Office

Reg. No. 2,893,336

Registered Oct. 12, 2004

**SERVICE MARK
PRINCIPAL REGISTER**

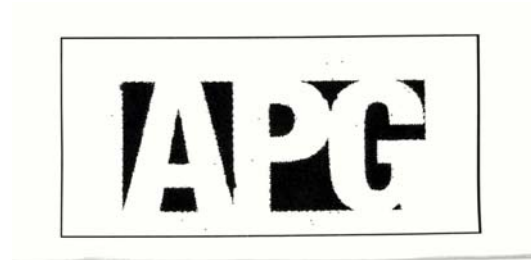

IDEX CORPORATION (DELAWARE CORPORATION)
SUITE 400
630 DUNDEE ROAD
DUNDEE, IL 60062

FIRST USE 1-30-2002; IN COMMERCE 1-30-2002.

SER. NO. 78-263,988, FILED 6-18-2003.

FOR: PROVIDING TRADE INFORMATION VIA
THE INTERNET REGARDING PUMPS, IN CLASS 35
(U.S. CLS. 100, 101 AND 102).

H. M. FISHER, EXAMINING ATTORNEY

Int. Cls.: 16 and 41

Prior U.S. Cls.: 2, 5, 22, 23, 29, 37, 38, 50, 100, 101 and 107

Reg. No. 2,893,337

United States Patent and Trademark Office

Registered Oct. 12, 2004

**TRADEMARK
SERVICE MARK
PRINCIPAL REGISTER**

XTREME VIDEO MAGAZINE

CMP MEDIA, LLC (DELAWARE LTD LIAB CO)
600 COMMUNITY DRIVE
MANHASSET, NY 11030

FORMATION AND COMPUTER TECHNOLOGIES,
IN CLASS 41 (U.S. CLS. 100, 101 AND 107).

FOR: PRINTED MATERIALS, NAMELY MAGAZINES IN THE FIELDS OF MULTIMEDIA, ENTERTAINMENT, INFORMATION AND COMPUTER TECHNOLOGIES, IN CLASS 16 (U.S. CLS. 2, 5, 22, 23, 29, 37, 38 AND 50).

FIRST USE 12-1-2003; IN COMMERCE 12-1-2003.

FIRST USE 12-1-2003; IN COMMERCE 12-1-2003.

NO CLAIM IS MADE TO THE EXCLUSIVE RIGHT TO USE "VIDEO MAGAZINE", APART FROM THE MARK AS SHOWN.

SER. NO. 78-264,759, FILED 6-19-2003.

FOR: PROVIDING ONLINE MAGAZINES IN THE FIELDS OF MULTIMEDIA, ENTERTAINMENT, IN-

JEAN IM, EXAMINING ATTORNEY

Int. Cls.: 37 and 42

Prior U.S. Cls.: 100, 101, 103 and 106

United States Patent and Trademark Office

Reg. No. 2,893,338

Registered Oct. 12, 2004

**SERVICE MARK
PRINCIPAL REGISTER**

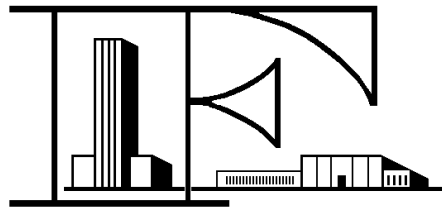

FORTUNATO SONS, INC. (NEW YORK CORPORATION)
630 JOHNSON AVENUE
BOHEMIA, NY 11716

FOR: BUILDING CONSTRUCTION, PLANNING AND MANAGEMENT, IN CLASS 37 (U.S. CLS. 100, 103 AND 106).

FIRST USE 4-0-1947; IN COMMERCE 4-0-1947.

FOR: ARCHITECTURAL DESIGN, IN CLASS 42 (U.S. CLS. 100 AND 101).

FIRST USE 4-0-1947; IN COMMERCE 4-0-1947.

SER. NO. 78-265,114, FILED 6-20-2003.

JOHN HWANG, EXAMINING ATTORNEY

Int. Cl.: 4

Prior U.S. Cls.: 1, 6 and 15

United States Patent and Trademark Office

Reg. No. 2,893,339

Registered Oct. 12, 2004

**TRADEMARK
PRINCIPAL REGISTER**

MR. LUBE N COOL

KIM LAUBE & COMPANY, INC. (CALIFORNIA
CORPORATION)
2221 STATHAM BLVD.
OXNARD, CA 93033

FIRST USE 7-15-1988; IN COMMERCE 7-15-1988.

SER. NO. 78-265,375, FILED 6-20-2003.

FOR: LUBRICANTS FOR ANIMAL GROOMING
TOOLS, IN CLASS 4 (U.S. CLS. 1, 6 AND 15).

KATHLEEN M. VANSTON, EXAMINING ATTOR-
NEY

Int. Cl.: 30

Prior U.S. Cl.: 46

United States Patent and Trademark Office

Reg. No. 2,893,340

Registered Oct. 12, 2004

**TRADEMARK
PRINCIPAL REGISTER**

TAXQUENA

DETERSOL S.A DE C.V. (MEXICO CORPORATION)

CARRETERA MEXICO P. NEGRAS 3240 ZONA INDUSTRIAL

SAN LUIS POTOSI, MEXICO 78090

FOR: HOT CHILI AND PEPPER SAUCES, IN CLASS 30 (U.S. CL. 46).

OWNER OF MEXICO REG. NO. 329209, DATED 2-24-1987, EXPIRES 2-24-2012.

THE WORD "TAXQUEÑA" IS TRANSLATED FROM SPANISH AS "A WOMAN FROM TAXCO".

SER. NO. 78-265,395, FILED 6-20-2003.

DOMINICK J. SALEMI, EXAMINING ATTORNEY

Int. Cls.: 35, 41 and 42

Prior U.S. Cls.: 100, 101, 102 and 107

United States Patent and Trademark Office

Reg. No. 2,893,341

Registered Oct. 12, 2004

**SERVICE MARK
PRINCIPAL REGISTER**

SIGMAX SOLUTIONS LLC

SIGMAX SOLUTIONS LLC (WISCONSIN LTD
LIAB CO)
19110 GLACIER PARKWAY
BROOKFIELD, WI 53045

FOR: BUSINESS CONSULTING SERVICES,
NAMELY, REVIEWING, EVALUATING, AND AD-
VISING MANUFACTURING AND SERVICE COM-
PANIES ON PROJECTS CENTERED AROUND
IMPROVING QUALITY AND SERVICE, IN CLASS
35 (U.S. CLS. 100, 101 AND 102).

FIRST USE 2-0-2001; IN COMMERCE 2-0-2001.

FOR: EDUCATIONAL SERVICES PROVIDED TO
MANUFACTURING AND SERVICE COMPANIES,
NAMELY PROVIDING CLASSES AND SEMINARS
IN THE FIELD OF QUALITY, SERVICE, AND
MANUFACTURING PROCESSES, IN CLASS 41
(U.S. CLS. 100, 101 AND 107).

FIRST USE 2-0-2001; IN COMMERCE 2-0-2001.

FOR: TECHNICAL CONSULTATION SERVICES
PROVIDED TO MANUFACTURING AND SERVICE
COMPANIES IN THE FIELD OF MANUFACTUR-
ING PROCESSES AND QUALITY ASSURANCE, IN
CLASS 42 (U.S. CLS. 100 AND 101).

FIRST USE 2-0-2001; IN COMMERCE 2-0-2001.

NO CLAIM IS MADE TO THE EXCLUSIVE
RIGHT TO USE "SOLUTIONS LLC", APART FROM
THE MARK AS SHOWN.

SER. NO. 78-265,653, FILED 6-23-2003.

DORITT L. CARROLL, EXAMINING ATTORNEY

Int. Cl.: 3

Prior U.S. Cls.: 1, 4, 6, 50, 51 and 52

Reg. No. 2,893,342

United States Patent and Trademark Office

Registered Oct. 12, 2004

**TRADEMARK
PRINCIPAL REGISTER**

EZFLOW

DANIEL, DAVID (UNITED STATES INDIVIDUAL)
920 WINDY RIDGE ROAD
CORONA, CA 92882 AND
HAILE, DANNY (UNITED STATES INDIVIDUAL)
12852 LARILYNN DRIVE
LA MIRANDA, CA 90638

FOR: PROFESSIONAL AND RETAIL BEAUTY PRODUCTS IN THE NATURE OF COSMETICS, NAMELY, HAND AND BODY LOTIONS, BODY WASH, NAIL PRIMER, NAIL ACRYLIC POWDERS,

ESSENTIAL OILS FOR PERSONAL USE, NAIL POLISH, ARTIFICIAL FINGERNAILS, NAIL CARE PREPARATIONS, NAIL CREAM, NAIL GLITTER AND NAIL TIPS, IN CLASS 3 (U.S. CLS. 1, 4, 6, 50, 51 AND 52).

FIRST USE 12-31-1986; IN COMMERCE 12-31-1986.

SER. NO. 78-266,106, FILED 6-23-2003.

NAAKWAMA ANKRAH, EXAMINING ATTORNEY

Int. Cl.: 32

Prior U.S. Cls.: 45, 46 and 48

United States Patent and Trademark Office

Reg. No. 2,893,343

Registered Oct. 12, 2004

**TRADEMARK
PRINCIPAL REGISTER**

CALPICO WATER

CALPIS CO., LTD. (JAPAN CORPORATION)
20-3, 2-CHOME, EBISU-NISHI, SHIBUYA-KU
TOKYO, JAPAN

FOR: SOFT DRINKS, IN CLASS 32 (U.S. CLS. 45, 46
AND 48).

FIRST USE 4-0-1992; IN COMMERCE 4-0-1992.

OWNER OF U.S. REG. NO. 1,000,780.

NO CLAIM IS MADE TO THE EXCLUSIVE
RIGHT TO USE "WATER", APART FROM THE
MARK AS SHOWN.

SER. NO. 78-266,179, FILED 6-24-2003.

JENNIFER KRISP, EXAMINING ATTORNEY

Int. Cl.: 41

Prior U.S. Cls.: 100, 101 and 107

United States Patent and Trademark Office

Reg. No. 2,893,344

Registered Oct. 12, 2004

**SERVICE MARK
PRINCIPAL REGISTER**

CODEWATCH

PRIMEDIA BUSINESS MAGAZINES & MEDIA
INC. (DELAWARE CORPORATION)
9800 METCALF
OVERLAND PARK, KS 66212

FIRST USE 6-23-2003; IN COMMERCE 6-23-2003.

SER. NO. 78-266,510, FILED 6-24-2003.

FOR: PROVIDING ONLINE NEWSLETTERS
CONCERNING THE PRINCIPAL ELECTRICAL
STANDARDS CODE, IN CLASS 41 (U.S. CLS. 100,
101 AND 107).

TONI HICKEY, EXAMINING ATTORNEY

Int. Cl.: 41

Prior U.S. Cls.: 100, 101 and 107

United States Patent and Trademark Office

Reg. No. 2,893,345

Registered Oct. 12, 2004

**SERVICE MARK
PRINCIPAL REGISTER**

FIN CLUB

AQUARIA, INC. (CALIFORNIA CORPORATION)
6100 CONDOR DRIVE
MOORPARK, CA 93020

FIRST USE 11-0-2003; IN COMMERCE 11-0-2003.

FOR: ENTERTAINMENT AND EDUCATIONAL SERVICES, NAMELY PROVIDING A WEB SITE FEATURING EDUCATIONAL AND ENTERTAINING INFORMATION IN THE FIELD OF AQUARIA AND FISHKEEPING AND CHILDREN'S GAMES AND PUZZLES, IN CLASS 41 (U.S. CLS. 100, 101 AND 107).

NO CLAIM IS MADE TO THE EXCLUSIVE RIGHT TO USE "CLUB", APART FROM THE MARK AS SHOWN.

SER. NO. 78-266,726, FILED 6-25-2003.

RUDY R. SINGLETON, EXAMINING ATTORNEY

Int. Cl.: 5

Prior U.S. Cls.: 6, 18, 44, 46, 51 and 52

United States Patent and Trademark Office

Reg. No. 2,893,346

Registered Oct. 12, 2004

**TRADEMARK
PRINCIPAL REGISTER**

BREATHECLEAR

NUTRITIONAL THERAPEUTICS, INC. (NEW
JERSEY CORPORATION)
90B ADAMS AVENUE
HAUPPAUGE, NY 11788

FIRST USE 8-0-2003; IN COMMERCE 8-0-2003.

SER. NO. 78-267,157, FILED 6-25-2003.

FOR: NUTRITIONAL SUPPLEMENTS, IN CLASS
5 (U.S. CLS. 6, 18, 44, 46, 51 AND 52).

VIVIAN MICZNIK FIRST, EXAMINING ATTOR-
NEY

Int. Cl.: 16

Prior U.S. Cls.: 2, 5, 22, 23, 29, 37, 38 and 50

United States Patent and Trademark Office

Reg. No. 2,893,347

Registered Oct. 12, 2004

**TRADEMARK
PRINCIPAL REGISTER**

MY FIRST SHARE

ONE SHARE OF STOCK, INC. (CALIFORNIA
CORPORATION)
BUILDING #1D
3450 THIRD STREET
SAN FRANCISCO, CA 94124

FOR: SINGLE SHARES OF STOCK IN UNFOL-
DED CERTIFICATE FORM AND FRAMED IN A
CUSTOMIZED PACKAGE WITH THE INTENT AS A
GIFT AND NOT INVESTMENT, IN CLASS 16 (U.S.
CLS. 2, 5, 22, 23, 29, 37, 38 AND 50).

FIRST USE 6-0-1996; IN COMMERCE 6-0-1996.

NO CLAIM IS MADE TO THE EXCLUSIVE
RIGHT TO USE SHARE, APART FROM THE MARK
AS SHOWN.

SER. NO. 78-267,477, FILED 6-26-2003.

ROBERT LORENZO, EXAMINING ATTORNEY

Int. Cl.: 31

Prior U.S. Cls.: 1 and 46

United States Patent and Trademark Office

Reg. No. 2,893,348

Registered Oct. 12, 2004

**TRADEMARK
PRINCIPAL REGISTER**

FRESHMAX

FRESHWAY SPECIALTY FOODS, INC. (CANADA CORPORATION)
11180 RIVER ROAD, UNIT 1130
RICHMOND BC V6X 1Z5, CANADA

FOR: FRESH FRUIT AND VEGETABLES, IN CLASS 31 (U.S. CLS. 1 AND 46).

OWNER OF CANADA REG. NO. TMA593,009, DATED 10-24-2003, EXPIRES 10-24-2018.

SER. NO. 78-268,253, FILED 6-27-2003.

BRIAN PINO, EXAMINING ATTORNEY

Int. Cls.: 9, 35 and 42

Prior U.S. Cls.: 21, 23, 26, 36, 38, 100, 101 and 102

United States Patent and Trademark Office

Reg. No. 2,893,349

Registered Oct. 12, 2004

**TRADEMARK
SERVICE MARK
PRINCIPAL REGISTER**

EMPACT SOLUTIONS

EMPACT SOLUTIONS, INC. (DELAWARE CORPORATION)
SUITE 400
373 PARK AVENUE SOUTH
NEW YORK, NY 10016

FOR: COMPUTER HARDWARE AND SOFTWARE FOR USE IN PERFORMING INDEPENDENT AUDIT AND ANALYSIS OF SERVICE QUALITY ACROSS INFORMATION TECHNOLOGY INFRASTRUCTURE, APPLICATIONS AND BUSINESS PROCESSES AND PRODUCING CUSTOMIZED WEB-BASED REPORTS THAT MAY BE DOWNLOADED FROM A GLOBAL COMPUTER NETWORK, IN CLASS 9 (U.S. CLS. 21, 23, 26, 36 AND 38).

FIRST USE 8-1-1999; IN COMMERCE 8-1-1999.

FOR: BUSINESS MANAGEMENT AND CONSULTATION IN THE FIELDS OF INFORMATION SYSTEMS AND APPLICATION MANAGEMENT TECHNOLOGIES; BUSINESS INFORMATION MANAGEMENT SUPPORT SERVICES, NAMELY, PROVIDING INDEPENDENT AUDIT AND ANALYSIS OF SERVICE QUALITY ACROSS INFORMATION TECHNOLOGY INFRASTRUCTURE,

APPLICATIONS AND BUSINESS PROCESSES, IN CLASS 35 (U.S. CLS. 100, 101 AND 102).

FIRST USE 8-1-1999; IN COMMERCE 8-1-1999.

FOR: PROVIDING TEMPORARY ACCESS TO ONLINE, SUBSCRIPTION-BASED, NON-DOWNLOADABLE SOFTWARE FOR USE IN PERFORMING INDEPENDENT AUDIT AND ANALYSIS OF SERVICE QUALITY ACROSS INFORMATION TECHNOLOGY INFRASTRUCTURE, APPLICATIONS AND BUSINESS PROCESSES AND PRODUCING CUSTOMIZED WEB-BASED REPORTS, IN CLASS 42 (U.S. CLS. 100 AND 101).

FIRST USE 8-1-1999; IN COMMERCE 8-1-1999.

NO CLAIM IS MADE TO THE EXCLUSIVE RIGHT TO USE "SOLUTIONS", APART FROM THE MARK AS SHOWN.

SER. NO. 78-269,147, FILED 7-1-2003.

DOMINICK J. SALEMI, EXAMINING ATTORNEY

Int. Cls.: 36 and 43

Prior U.S. Cls.: 100, 101 and 102

United States Patent and Trademark Office

Reg. No. 2,893,350

Registered Oct. 12, 2004

**SERVICE MARK
PRINCIPAL REGISTER**

VALUE PLACE

VALUE PLACE FRANCHISE SERVICES, LLC
(KANSAS LIMITED LIABILITY COMPANY)
8621 EAST 21ST STREET, SUITE 250
WICHITA, KS 67206

FOR: SHORT-TERM FURNISHED APARTMENT
RENTAL SERVICES, IN CLASS 36 (U.S. CLS. 100, 101
AND 102).

FIRST USE 10-1-2003; IN COMMERCE 10-1-2003.

FOR: RESIDENTIAL HOTELS AND EXTENDED-
STAY HOTELS, IN CLASS 43 (U.S. CLS. 100 AND 101).

FIRST USE 10-1-2003; IN COMMERCE 10-1-2003.

SER. NO. 78-269,847, FILED 7-2-2003.

RONALD MCMORROW, EXAMINING ATTORNEY

Int. Cl.: 35

Prior U.S. Cls.: 100, 101 and 102

United States Patent and Trademark Office

Reg. No. 2,893,351

Registered Oct. 12, 2004

**SERVICE MARK
PRINCIPAL REGISTER**

JAUNT

NORTH BAY MANAGEMENT ADVISORS, INC.
(CALIFORNIA CORPORATION)
3 LOCUST AVENUE
ROSS, CA 949570143

FIRST USE 7-1-2003; IN COMMERCE 7-1-2003.

SER. NO. 78-270,335, FILED 7-3-2003.

FOR: RETAIL STORE SERVICES FEATURING A
WIDE VARIETY OF CONSUMER GOODS, IN CLASS
35 (U.S. CLS. 100, 101 AND 102).

BRENDAN MCCAULEY, EXAMINING ATTORNEY

Int. Cl.: 9

Prior U.S. Cls.: 21, 23, 26, 36 and 38

United States Patent and Trademark Office

Reg. No. 2,893,352

Registered Oct. 12, 2004

**TRADEMARK
PRINCIPAL REGISTER**

LARA CROFT TOMB RAIDER: THE ELIXIR OF LIFE

CORE DESIGN LIMITED (UNITED KINGDOM CORPORATION)
2 ROUNDHOUSE ROAD, PRIDE PARK
DERBY, UNITED KINGDOM DE24 8JE

FOR: COMPUTER GAME SOFTWARE; COMPUTER GAMES DOWNLOADABLE FROM A REMOTE COMPUTER LOCATION OR RECORDED ON CD-ROMS, COMPACT DISCS, OR GAME CARTRIDGES; DOWNLOADABLE ELECTRONIC PUBLICATIONS IN THE NATURE OF NEWSLETTERS AND MAGAZINES FEATURING ACTION AND ADVENTURE GAMES; USER DOCUMENTATION SOLD AS A UNIT THEREWITH, IN CLASS 9 (U.S. CLS. 21, 23, 26, 36 AND 38).

PRIORITY CLAIMED UNDER SEC. 44(D) ON UNITED KINGDOM APPLICATION NO. 2335063, FILED 6-17-2003, REG. NO. 2335063, DATED 11-7-2003, EXPIRES 6-17-2013.

OWNER OF U.S. REG. NOS. 2,112,962, 2,717,626 AND OTHERS.

SER. NO. 78-272,080, FILED 7-9-2003.

JOHN DALIER, EXAMINING ATTORNEY

Int. Cls.: 16 and 21

**Prior U.S. Cls.: 2, 5, 13, 22, 23, 29, 30, 33, 37, 38, 40
and 50**

Reg. No. 2,893,353

United States Patent and Trademark Office

Registered Oct. 12, 2004

**TRADEMARK
PRINCIPAL REGISTER**

COOLTOUCH

POLESTAR JOWETTS LTD. (UNITED KINGDOM
CORPORATION)
EVANSTON AVENUE OFF KIRKSTALL ROAD
LEEDS, UNITED KINGDOM LS4 2HR

FOR: CARTONS OF PAPER OR BOARD; PRIN-
TED PAPER OR BOARD, IN CLASS 16 (U.S. CLS. 2, 5,
22, 23, 29, 37, 38 AND 50).

FOR: CARTONS, CONTAINERS, CARTONS AND
CONTAINERS OF PLASTIC MATERIAL AND CAR-
TONS AND CONTAINERS OF FOAM MATERIAL,
IN CLASS 21 (U.S. CLS. 2, 13, 23, 29, 30, 33, 40 AND 50).

PRIORITY CLAIMED UNDER SEC. 44(D) ON
UNITED KINGDOM APPLICATION NO. 2320804,
FILED 1-15-2003, REG. NO. 2320804, DATED 1-9-2004,
EXPIRES 1-15-2013.

PRIORITY CLAIMED UNDER SEC. 44(D) ON
UNITED KINGDOM APPLICATION NO. 2262520,
FILED 1-15-2003, REG. NO. 2262520, DATED 8-3-2001,
EXPIRES 1-15-2013.

SER. NO. 78-272,503, FILED 7-10-2003.

JEFF DEFORD, EXAMINING ATTORNEY

Int. Cl.: 29

Prior U.S. Cl.: 46

United States Patent and Trademark Office

Reg. No. 2,893,354

Registered Oct. 12, 2004

**TRADEMARK
PRINCIPAL REGISTER**



CENTEX MEAT COMPANY, LP (TEXAS LIMITED PARTNERSHIP)
P.O. BOX 670
TAYLOR, TX 76574

NO CLAIM IS MADE TO THE EXCLUSIVE RIGHT TO USE "BRAND", APART FROM THE MARK AS SHOWN.

FOR: MEATS; PORK; BEEF; PROCESSED MEATS, NAMELY, PORK, BEEF, BACON, FRANKFURTERS, SAUSAGE, AND HAM, IN CLASS 29 (U.S. CL. 46).

SER. NO. 78-272,540, FILED 7-10-2003.

FIRST USE 12-31-1947; IN COMMERCE 12-31-1965.

JOHN E. MICHOS, EXAMINING ATTORNEY

Int. Cl.: 19

Prior U.S. Cls.: 1, 12, 33 and 50

United States Patent and Trademark Office

Reg. No. 2,893,355

Registered Oct. 12, 2004

**TRADEMARK
PRINCIPAL REGISTER**



KRONOSPAN AG (SWITZERLAND JOINT
STOCK COMPANY)
6122
MENZNAU, SWITZERLAND

FOR: NON-METALLIC BUILDING MATERIALS,
NAMELY LAMINATE FLOORINGS MADE OF PAR-
TICLE BOARDS AND OF FIBRE BOARDS, IN
CLASS 19 (U.S. CLS. 1, 12, 33 AND 50).

PRIORITY CLAIMED UNDER SEC. 44(D) ON
SWITZERLAND APPLICATION NO. 016942003,

FILED 3-20-2003, REG. NO. 510386, DATED 5-14-
2003, EXPIRES 3-20-2013.

THE MARK CONSISTS OF THE WORDS "CRY-
STAL CLIC" WITH REPRESENTATIONS OF CRY-
STALS AND A LOCK WITHIN AN ARBITRARY
DESIGN.

SER. NO. 78-272,561, FILED 7-10-2003.

STEPHANIE DAVIS, EXAMINING ATTORNEY

Int. Cl.: 41

Prior U.S. Cls.: 100, 101 and 107

United States Patent and Trademark Office

Reg. No. 2,893,356

Registered Oct. 12, 2004

**SERVICE MARK
PRINCIPAL REGISTER**

CASINOTRUTH.COM

DURAN, MARCOS, A (DOMINICAN REP INDIVIDUAL)
APT 505
770 CLAUGHTON ISLAND DR
MIAMI, FL 33131

FOR: PROVIDING AN INTERACTIVE WEB SITE
IN THE FIELD OF COMPUTERIZED ON-LINE
GAMING AND CASINOS WHICH PUBLISHES INFORMATION, RATINGS, AND OPINIONS OF EDI-

TORS AND VISITORS CONCERNING ONLINE
CASINOS AND ONLINE GAMING SITES, IN CLASS
41 (U.S. CLS. 100, 101 AND 107).

FIRST USE 2-8-2002; IN COMMERCE 2-8-2002.

SER. NO. 78-273,567, FILED 7-12-2003.

DOMINICK J. SALEMI, EXAMINING ATTORNEY

Int. Cls.: 35, 42 and 44

Prior U.S. Cls.: 100, 101 and 102

United States Patent and Trademark Office

Reg. No. 2,893,357

Registered Oct. 12, 2004

**SERVICE MARK
PRINCIPAL REGISTER**

NATIONAL PEDORTHIC SERVICES

NATIONAL PEDORTHIC SERVICES, INC. (WISCONSIN CORPORATION)
7283 W. APPLETON AVE.
MILWAUKEE, WI 53216

FOR: RETAIL STORE SERVICES FEATURING ORTHOTIC, SHOES, STOCKINGS, AND BRACES FOR FEET AND LEGS, IN CLASS 35 (U.S. CLS. 100, 101 AND 102).

FIRST USE 2-0-1993; IN COMMERCE 2-0-1993.

FOR: DESIGN FOR OTHERS IN THE FIELD OF ORTHOTICS, SHOES, STOCKINGS AND BRACES FOR FEET AND LEGS, IN CLASS 42 (U.S. CLS. 100 AND 101).

FIRST USE 2-0-1991; IN COMMERCE 2-0-1993.

FOR: PEDORTHIC MEDICAL SERVICES; FITTING SERVICES FOR OTHERS OF ORTHOTICS, SHOES, STOCKINGS, AND BRACES FOR FEET AND LEGS, IN CLASS 44 (U.S. CLS. 100 AND 101).

FIRST USE 2-0-1991; IN COMMERCE 2-0-1993.

NO CLAIM IS MADE TO THE EXCLUSIVE RIGHT TO USE "PEDORTHIC SERVICES", APART FROM THE MARK AS SHOWN.

SEC. 2(F).

SER. NO. 78-273,593, FILED 7-13-2003.

BRENDAN MCCAULEY, EXAMINING ATTORNEY

Int. Cl.: 9

Prior U.S. Cls.: 21, 23, 26, 36 and 38

Reg. No. 2,893,358

United States Patent and Trademark Office

Registered Oct. 12, 2004

**TRADEMARK
PRINCIPAL REGISTER**

HYDRATRADE

SPARTAN TECHNOLOGIES LLC (NEW YORK
LTD LIAB CO)
SUITE 930
39 BROADWAY
NEW YORK, NY 10006

FIRST USE 6-30-2002; IN COMMERCE 8-31-2002.

SER. NO. 78-274,131, FILED 7-14-2003.

FOR: COMPUTER SOFTWARE PLATFORMS
FOR USE IN THE INSTITUTIONAL TRADING OF
EQUITIES EXCLUDING FIXED-INCOME SECURI-
TIES, IN CLASS 9 (U.S. CLS. 21, 23, 26, 36 AND 38).

NORA BUCHANAN WILL, EXAMINING ATTOR-
NEY

Int. Cl.: 43

Prior U.S. Cls.: 100 and 101

United States Patent and Trademark Office

Reg. No. 2,893,359

Registered Oct. 12, 2004

**SERVICE MARK
PRINCIPAL REGISTER**

KETTLE

KETTLE RESTAURANTS, INC. (TEXAS COR-
PORATION)
SUITE 128
350 OAKS TRAIL
GARLAND, TX 75043

FOR: RESTAURANT SERVICES, IN CLASS 43
(U.S. CLS. 100 AND 101).

FIRST USE 0-0-1968; IN COMMERCE 0-0-1968.

OWNER OF U.S. REG. NO. 868,262.

SER. NO. 78-274,403, FILED 7-15-2003.

CAROLYN CATALDO, EXAMINING ATTORNEY

Int. Cl.: 43

Prior U.S. Cls.: 100 and 101

United States Patent and Trademark Office

Reg. No. 2,893,360

Registered Oct. 12, 2004

**SERVICE MARK
PRINCIPAL REGISTER**



KETTLE RESTAURANTS, INC. (TEXAS CORPORATION)
SUITE 128
350 OAKS TRAIL
GARLAND, TX 75043

FOR: RESTAURANT SERVICES, IN CLASS 43
(U.S. CLS. 100 AND 101).

FIRST USE 2-0-2000; IN COMMERCE 2-0-2000.

OWNER OF U.S. REG. NO. 868,262.

SER. NO. 78-274,434, FILED 7-15-2003.

CAROLYN CATALDO, EXAMINING ATTORNEY

Int. Cls.: 25 and 41

Prior U.S. Cls.: 22, 39, 100, 101 and 107

United States Patent and Trademark Office

Reg. No. 2,893,361

Registered Oct. 12, 2004

**TRADEMARK
SERVICE MARK
PRINCIPAL REGISTER**

SENIOR OLYMPICS

UNITED STATES OLYMPIC COMMITTEE (UNI-
TED STATES CONGRESSIONALLY CHAR-
TERED CORPORATION)
ONE OLYMPIC PLAZA
COLORADO SPRINGS, CO 80909

FOR: CLOTHING, NAMELY T-SHIRTS AND
HATS, IN CLASS 25 (U.S. CLS. 22 AND 39).

FIRST USE 6-27-1990; IN COMMERCE 6-27-1990.

FOR: ORGANIZING AND CONDUCTING ATH-
LETIC COMPETITIONS AND DEMONSTRATIONS,
IN CLASS 41 (U.S. CLS. 100, 101 AND 107).

FIRST USE 6-27-1990; IN COMMERCE 6-27-1990.

OWNER OF U.S. REG. NOS. 968,566, 2,407,366 AND
OTHERS.

SEC. 2(F) AS TO "SENIOR".

SER. NO. 78-274,797, FILED 7-16-2003.

JEFFERY COWARD, EXAMINING ATTORNEY

Int. Cl.: 14

Prior U.S. Cls.: 2, 27, 28 and 50

United States Patent and Trademark Office

Reg. No. 2,893,362

Registered Oct. 12, 2004

**TRADEMARK
PRINCIPAL REGISTER**

TITOPEDRINI

TITO PEDRINI, G. G., INC. (NEW YORK COR-
PORATION)
SUITE 17D
48 PARK AVENUE
NEW YORK, NY 10022

THE NAME TITOPEDRINI IDENTIFIES A LIV-
ING INDIVIDUAL WHOSE CONSENT IS OF RE-
CORD.

FOR: JEWELRY, IN CLASS 14 (U.S. CLS. 2, 27, 28
AND 50).

SER. NO. 78-274,902, FILED 7-16-2003.

FIRST USE 7-31-2001; IN COMMERCE 7-31-2001.

CATHERINE CAIN, EXAMINING ATTORNEY

Int. Cls.: 3 and 24

Prior U.S. Cls.: 1, 4, 6, 42, 50, 51 and 52

United States Patent and Trademark Office

Reg. No. 2,893,363

Registered Oct. 12, 2004

**TRADEMARK
PRINCIPAL REGISTER**

PLUMERIA BAY

PLUMERIA BAY, INC. (HAWAII CORPORATION)
HC 1 BOX 5474
KEAAU, HI 96749

FOR: SKIN SOAP/HAIR SHAMPOO, IN CLASS 3
(U.S. CLS. 1, 4, 6, 50, 51 AND 52).

FIRST USE 11-1-2002; IN COMMERCE 11-1-2002.

FOR: COMFORTERS, IN CLASS 24 (U.S. CLS. 42
AND 50).

FIRST USE 4-20-2002; IN COMMERCE 4-20-2002.

SER. NO. 78-275,598, FILED 7-17-2003.

HOWARD B. LEVINE, EXAMINING ATTORNEY

Int. Cl.: 41

Prior U.S. Cls.: 100, 101 and 107

United States Patent and Trademark Office

Reg. No. 2,893,364

Registered Oct. 12, 2004

**SERVICE MARK
PRINCIPAL REGISTER**

FAST FIT 4 KIDS

FAST FIT 4 KIDS, INC. (CALIFORNIA CORPORATION)
4215 BISCAYNE STREET
CHINO, CA 91710

NO CLAIM IS MADE TO THE EXCLUSIVE RIGHT TO USE "FOR KIDS", APART FROM THE MARK AS SHOWN.

FOR: EDUCATIONAL SERVICES, NAMELY, WELLNESS AND EXERCISE INSTRUCTION FOR CHILDREN, IN CLASS 41 (U.S. CLS. 100, 101 AND 107).

SER. NO. 78-275,769, FILED 7-17-2003.

FIRST USE 2-1-2003; IN COMMERCE 2-1-2003.

ALEX KEAM, EXAMINING ATTORNEY

Int. Cl.: 25

Prior U.S. Cls.: 22 and 39

United States Patent and Trademark Office

Reg. No. 2,893,365

Registered Oct. 12, 2004

**TRADEMARK
PRINCIPAL REGISTER**

HUSTLERS UNITED H.U.

MARTIN, ISAIAH A. JR. (UNITED STATES INDIVIDUAL)
929 SOUTH 5TH STREET
PHILADELPHIA, PA 19147

FOR: HEAD CAPS, HEAD BANDS, TANK TOP SHIRTS, QUARTER LENGTH TEE SHIRTS, BUTTON FRONT SHIRTS, TOP BUTTON SHIRTS, KHAKI SHIRTS, MOCKNECK SHIRTS, CREWNECK SWEATERS, BUTTON FRONT SWEATERS, HOODED SWEATSHIRTS, FIVE POCKET JEAN SHORTS, FIVE POCKET JEAN PANTS, TWO POCKET SWEATPANTS, WARM-UP SWEATPANTS, LOW CUT SOCKS, QUARTER LENGTH SOCKS, HATS, WRIST BANDS, SHORT-SLEEVE TEE SHIRTS, LONG SLEEVE TEE SHIRTS, COLLAR SHIRTS, POLO SHIRTS, TURTLENECK SHIRTS, V-NECK SHIRTS, TURTLENECK SWEATERS, CREWNECK SWEATSHIRTS, ZIPPER FRONT HOODED SWEAT-

SHIRT, KHAKI SHORTS, KHAKI PANTS, THREE POCKET SWEATPANTS, ANKLE SOCKS, HIGH CUT SOCKS, UNDERWEAR BOXER BRIEFS, TRADITIONAL STYLE CANVASS UNDERWEAR BRIEFS, DOUBLE FLY UNDERWEAR BRIEFS, LEATHER JACKETS, SUEDE JACKETS, DENIM JACKETS, FULL ZIP JACKETS, HOODED JACKETS, BUTTON FRONT COATS, LEATHER COATS, BUTTON FRONT JACKETS, QUARTER ZIP JACKETS, RAIN COATS, ZIPPER FRONT COATS, SUEDE COATS, IN CLASS 25 (U.S. CLS. 22 AND 39).

FIRST USE 7-1-2003; IN COMMERCE 7-1-2003.

SER. NO. 78-276,574, FILED 7-21-2003.

DAVID C. REIHNER, EXAMINING ATTORNEY

Int. Cl.: 35

Prior U.S. Cls.: 100, 101 and 102

United States Patent and Trademark Office

Reg. No. 2,893,366

Registered Oct. 12, 2004

**SERVICE MARK
PRINCIPAL REGISTER**

EDEN HAND ARTS

CAREY-HARPER, RACHEL (UNITED STATES
INDIVIDUAL)
2 DR. LORDS ROAD
DENNIS, MA 02638

FOR: RETAIL STORE SERVICES IN THE FIELD
OF JEWELRY, POTTERY AND ART, IN CLASS 35
(U.S. CLS. 100, 101 AND 102).

FIRST USE 0-0-1970; IN COMMERCE 0-0-1970.

OWNER OF U.S. REG. NO. 2,459,387.

NO CLAIM IS MADE TO THE EXCLUSIVE
RIGHT TO USE HAND ARTS, APART FROM THE
MARK AS SHOWN.

SER. NO. 78-276,804, FILED 7-21-2003.

BRIAN BROWN, EXAMINING ATTORNEY

Int. Cl.: 14

Prior U.S. Cls.: 2, 27, 28 and 50

United States Patent and Trademark Office

Reg. No. 2,893,367

Registered Oct. 12, 2004

**TRADEMARK
PRINCIPAL REGISTER**

ROSDENTON

CHIAR HORNG INTERNATIONAL CO., LTD.
(TAIWAN CORPORATION)
2F, NO. 315, SUNG CHIANG ROAD
TAIPEI, TAIWAN 10001

FIRST USE 3-25-2002; IN COMMERCE 3-25-2002.

FOR: WATCHES; CLOCKS; HOROLOGICAL AND
CHRONOMETRIC INSTRUMENTS, NAMELY,
WRISTWATCHES; AND COMPONENT PARTS
THEREOF, IN CLASS 14 (U.S. CLS. 2, 27, 28 AND 50).

SER. NO. 78-277,242, FILED 7-22-2003.

AISHA CLARKE, EXAMINING ATTORNEY

Int. Cl.: 41

Prior U.S. Cls.: 100, 101 and 107

United States Patent and Trademark Office

Reg. No. 2,893,368

Registered Oct. 12, 2004

**SERVICE MARK
PRINCIPAL REGISTER**

URGE PRODUCTIONS

STEINMETZ, JEFF (UNITED STATES INDIVIDUAL)
3970 19TH STREET
SAN FRANCISCO, CA 94114

FOR: AUDIO RECORDING AND PRODUCTION, DISC JOCKEYS AND MUSICIANS FOR PARTIES AND SPECIAL EVENTS, COMPOSITION OF MUSIC FOR OTHERS AND MUSIC PRODUCTION SERVICES, IN CLASS 41 (U.S. CLS. 100, 101 AND 107).

FIRST USE 8-23-1994; IN COMMERCE 10-1-1994.

NO CLAIM IS MADE TO THE EXCLUSIVE RIGHT TO USE "PRODUCTIONS", APART FROM THE MARK AS SHOWN.

SER. NO. 78-277,587, FILED 7-23-2003.

KATHRYN COWARD, EXAMINING ATTORNEY

Int. Cl.: 42

Prior U.S. Cls.: 100 and 101

United States Patent and Trademark Office

Reg. No. 2,893,369

Registered Oct. 12, 2004

**SERVICE MARK
PRINCIPAL REGISTER**



KAPLAN KIRSCH ROCKWELL

KAPLAN KIRSCH & ROCKWELL LLP (PART-
NERSHIP)
SUITE 2300
1675 BROADWAY
DENVER, CO 80202

LAND USE, AND PUBLIC LANDS, IN CLASS 42 (U.S.
CLS. 100 AND 101).

FIRST USE 7-1-2003; IN COMMERCE 7-1-2003.

SER. NO. 78-279,233, FILED 7-25-2003.

FOR: LEGAL SERVICES CONCERNING ISSUES
RELATED TO AIRPORTS, THE ENVIRONMENT,

TRACY CROSS, EXAMINING ATTORNEY

Int. Cl.: 36

Prior U.S. Cls.: 100, 101 and 102

United States Patent and Trademark Office

Reg. No. 2,893,370

Registered Oct. 12, 2004

SERVICE MARK
PRINCIPAL REGISTER

CapitalOne

Mortgage

CAPITAL ONE FINANCIAL CORPORATION
(DELAWARE CORPORATION)
12061-0460/ANGELA ISABELL
11013 WEST BROAD STREET
GLEN ALLEN, VA 23060

FOR: FINANCIAL SERVICES, NAMELY MORT-
GAGE BANKING; HOME EQUITY LOANS, IN
CLASS 36 (U.S. CLS. 100, 101 AND 102).

FIRST USE 3-1-2003; IN COMMERCE 3-1-2003.

OWNER OF U.S. REG. NOS. 1,992,626, 2,075,171
AND OTHERS.

NO CLAIM IS MADE TO THE EXCLUSIVE
RIGHT TO USE "MORTGAGE", APART FROM
THE MARK AS SHOWN.

SER. NO. 78-280,001, FILED 7-29-2003.

VERNA BETH RIRIE, EXAMINING ATTORNEY

Int. Cl.: 41

Prior U.S. Cls.: 100, 101 and 107

United States Patent and Trademark Office

Reg. No. 2,893,371

Registered Oct. 12, 2004

**SERVICE MARK
PRINCIPAL REGISTER**

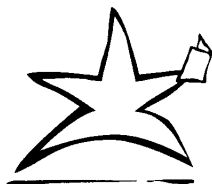

ALL-STAR KIDS
T U T O R I N G

ALL-STAR KIDS TUTORING, INC. (ARIZONA CORPORATION)
1717 W. NORTHERN, #200
PHOENIX, AZ 85021

NO CLAIM IS MADE TO THE EXCLUSIVE RIGHT TO USE "KIDS" AND "TUTORING", APART FROM THE MARK AS SHOWN.

FOR: EDUCATION AND ENTERTAINMENT, NAMELY, TUTORING ELEMENTARY SCHOOL AGE CHILDREN TO MASTER BASIC READING SKILLS, IN CLASS 41 (U.S. CLS. 100, 101 AND 107).

THE MARK CONSISTS OF A STARFISH HOLDING A BOOK.

FIRST USE 8-0-2002; IN COMMERCE 8-0-2002.

SER. NO. 78-280,500, FILED 7-29-2003.

OWNER OF U.S. REG. NOS. 2,697,594 AND 2,700,014.

JOHN GARTNER, EXAMINING ATTORNEY

Int. Cl.: 35

Prior U.S. Cls.: 100, 101 and 102

United States Patent and Trademark Office

Reg. No. 2,893,372

Registered Oct. 12, 2004

**SERVICE MARK
PRINCIPAL REGISTER**

NEW PRODUCT MOVERS

NEW PRODUCT MOVERS, LLC (KANSAS LTD
LIAB CO)
SUITE 400
10561 BARKLEY
OVERLAND PARK, KS 66212

FIRST USE 6-30-2003; IN COMMERCE 6-30-2003.

NO CLAIM IS MADE TO THE EXCLUSIVE
RIGHT TO USE NEW PRODUCT, APART FROM
THE MARK AS SHOWN.

FOR: PERSONNEL PLACEMENT AND RE-
CRUITMENT, NAMELY SUPPLYING PERSONNEL
TO OFFER SAMPLES OF MERCHANDISE OR PRO-
MOTIONAL OFFERS TO CONSUMERS IN STORES
CARRYING FOOD AND BEVERAGES, IN CLASS 35
(U.S. CLS. 100, 101 AND 102).

SER. NO. 78-280,729, FILED 7-30-2003.

MATTHEW KLINE, EXAMINING ATTORNEY

Int. Cl.: 44

Prior U.S. Cls.: 100 and 101

United States Patent and Trademark Office

Reg. No. 2,893,373

Registered Oct. 12, 2004

**SERVICE MARK
PRINCIPAL REGISTER**

THE BLUE HORN RANCH

BUCKEYE INTERNATIONAL, INC. (MISSOURI
CORPORATION)
2700 WAGNER PLACE
MARYLAND HEIGHTS, MO 630433471

NO CLAIM IS MADE TO THE EXCLUSIVE
RIGHT TO USE RANCH, APART FROM THE MARK
AS SHOWN.

FOR: BREEDING OF BLACK ANGUS CATTLE,
IN CLASS 44 (U.S. CLS. 100 AND 101).

SER. NO. 78-280,927, FILED 7-30-2003.

FIRST USE 11-1-2001; IN COMMERCE 11-1-2001.

JAMES GRIFFIN, EXAMINING ATTORNEY

Int. Cl.: 30

Prior U.S. Cl.: 46

United States Patent and Trademark Office

Reg. No. 2,893,374

Registered Oct. 12, 2004

**TRADEMARK
PRINCIPAL REGISTER**



CHRIS CAPELL (VIRGINIA LTD LIAB CO)
4819 BRIGGS ROAD
FAIRFAX, VA 22030

FOR: BARBECUE SEASONINGS, IN CLASS 30
(U.S. CL. 46).

FIRST USE 4-1-2002; IN COMMERCE 5-1-2002.

NO CLAIM IS MADE TO THE EXCLUSIVE
RIGHT TO USE "BARBECUE COMPANY", APART
FROM THE MARK AS SHOWN.

SER. NO. 78-281,223, FILED 7-31-2003.

FRED MANDIR, EXAMINING ATTORNEY

Int. Cl.: 5

Prior U.S. Cls.: 6, 18, 44, 46, 51 and 52

United States Patent and Trademark Office

Reg. No. 2,893,375

Registered Oct. 12, 2004

**TRADEMARK
PRINCIPAL REGISTER**

PLATINUM TRANQUILITY

PLATINUM PERFORMANCE INC. (CALIFORNIA CORPORATION)
UNIT 100, 67 COMMERCE DRIVE
BUELLTON, CA 93427

OWNER OF U.S. REG. NOS. 2,132,598, 2,476,090,
AND 2,737,157.

FOR: NUTRITIONAL SUPPLEMENTS FOR ANIMALS, IN CLASS 5 (U.S. CLS. 6, 18, 44, 46, 51 AND 52).

SER. NO. 78-281,500, FILED 7-31-2003.

FIRST USE 11-1-2002; IN COMMERCE 11-1-2002.

MARC LEIPZIG, EXAMINING ATTORNEY

Int. Cl.: 28

Prior U.S. Cls.: 22, 23, 38 and 50

United States Patent and Trademark Office

Reg. No. 2,893,376

Registered Oct. 12, 2004

**TRADEMARK
PRINCIPAL REGISTER**



GALILEO ENGINEERING SRL (ITALY LTD
LIAB CO)
VIA F. CAVALLOTTI 16
REGGIO EMILIA, ITALY

GINES, MAGNETOS, BRASSES, AXLES;
MINIATURE CAR MODELS FOR TOY CAR
TRACKS, IN CLASS 28 (U.S. CLS. 22, 23, 38 AND 50).

FOR: CASES FOR TOY VEHICLES; TOY MODEL
VEHICLES AND RELATED ACCESSORIES SOLD
AS UNITS; ELECTRONICALLY OPERATED TOY
MOTOR VEHICLES; TOY VEHICLES; TOY CAR
TRACKS; MINIATURE CAR MODELS AND ACCE-
SORIES THEREOF, NAMELY TIRES, GEARS, EN-

FIRST USE 1-31-1999; IN COMMERCE 1-31-1999.

SER. NO. 78-281,941, FILED 8-1-2003.

MICHAEL ENGEL, EXAMINING ATTORNEY

Int. Cl.: 9

Prior U.S. Cls.: 21, 23, 26, 36 and 38

Reg. No. 2,893,377

United States Patent and Trademark Office

Registered Oct. 12, 2004

**TRADEMARK
PRINCIPAL REGISTER**

PLANTRAX

PSMJ RESOURCES, INC. (MASSACHUSETTS
CORPORATION)
10 MIDLAND AVENUE
NEWTON, MA 02458

CONSTRUCTION FIELDS, IN CLASS 9 (U.S. CLS.
21, 23, 26, 36 AND 38).

FIRST USE 7-25-2003; IN COMMERCE 7-25-2003.

FOR: COMPUTER SOFTWARE FOR USE IN
PROJECT MANAGEMENT, NAMELY, FOR USE IN
THE ENGINEERING, ARCHITECTURAL AND

SER. NO. 78-282,153, FILED 8-1-2003.

MARC LEIPZIG, EXAMINING ATTORNEY

Int. Cl.: 5

Prior U.S. Cls.: 6, 18, 44, 46, 51 and 52

Reg. No. 2,893,378

United States Patent and Trademark Office

Registered Oct. 12, 2004

**TRADEMARK
PRINCIPAL REGISTER**

VARCERB

GLAXO GROUP LIMITED (UNITED KINGDOM CORPORATION)
GLAXO WELLCOME HOUSE
BERKELEY AVENUE, GREENFORD
MIDDLESEX UB6 0NN, UNITED KINGDOM

FOR: PHARMACEUTICAL PREPARATIONS FOR THE TREATMENT OF CANCER, INFECTIOUS DISEASES, PAIN, INFLAMMATION, SEPSIS, ALOPECIA AND OBESITY, AND FOR THE TREATMENT OF METABOLIC, MUSCULOSKELETAL, CARDIOVASCULAR, CARDIOPULMONARY, GENITOURINARY, RESPIRATORY, NEUROLOGICAL, GASTROINTESTINAL, HORMONAL, DERMATOLOGICAL AND PSYCHIATRIC RELATED DISEASES AND DISORDERS AND SKIN AND TISSUE REPAIR PREPARATIONS; PHARMACEUTICAL PREPARATIONS FOR THE TREATMENT OF CANCER, INFECTIOUS DISEASES, PAIN, INFLAMMA-

TION, SEPSIS, ALOPECIA AND OBESITY, AND FOR THE TREATMENT OF METABOLIC, MUSCULOSKELETAL, CARDIOVASCULAR, CARDIOPULMONARY, GENITOURINARY, RESPIRATORY, NEUROLOGICAL, GASTROINTESTINAL, HORMONAL, DERMATOLOGICAL AND PSYCHIATRIC RELATED DISEASES AND DISORDERS AND SKIN AND TISSUE REPAIR PREPARATIONS, IN CLASS 5 (U.S. CLS. 6, 18, 44, 46, 51 AND 52).

PRIORITY CLAIMED UNDER SEC. 44(D) ON UNITED KINGDOM APPLICATION NO. 2335928, FILED 6-25-2003, REG. NO. 2335928, DATED 6-25-2003, EXPIRES 6-25-2013.

SER. NO. 78-283,116, FILED 8-5-2003.

JASON TURNER, EXAMINING ATTORNEY

Int. Cl.: 5

Prior U.S. Cls.: 6, 18, 44, 46, 51 and 52

Reg. No. 2,893,379

United States Patent and Trademark Office

Registered Oct. 12, 2004

**TRADEMARK
PRINCIPAL REGISTER**

TYVERB

GLAXO GROUP LIMITED (UNITED KINGDOM CORPORATION)
GLAXO WELLCOME HOUSE, BERKELEY AVENUE, GREENFORD
MIDDLESEX UB6 0NN, UNITED KINGDOM

FOR: PHARMACEUTICAL PREPARATIONS FOR THE TREATMENT OF CANCER, INFECTIOUS DISEASES, PAIN, INFLAMMATION, SEPSIS, ALOPECIA AND OBESITY, AND FOR THE TREATMENT OF METABOLIC, MUSCULOSKELETAL, CARDIOVASCULAR, CARDIOPULMONARY, GENITOURINARY, RESPIRATORY, NEUROLOGICAL, GASTROINTESTINAL, HORMONAL, DERMATOLOGICAL AND PSYCHIATRIC RELATED DISEASES AND DISORDERS AND SKIN AND TISSUE REPAIR PREPARATIONS; PHARMACEUTICAL PREPARATIONS FOR THE TREATMENT OF CANCER, INFECTIOUS DISEASES, PAIN, INFLAMMA-

TION, SEPSIS, ALOPECIA AND OBESITY, AND FOR THE TREATMENT OF METABOLIC, MUSCULOSKELETAL, CARDIOVASCULAR, CARDIOPULMONARY, GENITOURINARY, RESPIRATORY, NEUROLOGICAL, GASTROINTESTINAL, HORMONAL, DERMATOLOGICAL AND PSYCHIATRIC RELATED DISEASES AND DISORDERS AND SKIN AND TISSUE REPAIR PREPARATIONS, IN CLASS 5 (U.S. CLS. 6, 18, 44, 46, 51 AND 52).

PRIORITY CLAIMED UNDER SEC. 44(D) ON UNITED KINGDOM APPLICATION NO. 2335929, FILED 6-25-2003, REG. NO. 2335929, DATED 6-25-2003, EXPIRES 6-25-2013.

SER. NO. 78-283,120, FILED 8-5-2003.

JASON TURNER, EXAMINING ATTORNEY

Int. Cl.: 1

Prior U.S. Cls.: 1, 5, 6, 10, 26 and 46

United States Patent and Trademark Office

Reg. No. 2,893,380

Registered Oct. 12, 2004

**TRADEMARK
PRINCIPAL REGISTER**

ENESTRA

PROMERUS LLC (DELAWARE CORPORATION)
9921 BRECKSVILLE ROAD
BRECKSVILLE, OH 44141

COMPONENTS, IN CLASS 1 (U.S. CLS. 1, 5, 6, 10, 26
AND 46).

FIRST USE 7-21-2003; IN COMMERCE 7-21-2003.

FOR: CHEMICALS, NAMELY POLYMERIZABLE
FORMULATIONS USED AS OPTICAL ENCAPSU-
LANTS IN THE MANUFACTURE OF ELECTRONIC

SER. NO. 78-283,461, FILED 8-5-2003.

GLENN CLARK, EXAMINING ATTORNEY

Int. Cl.: 28

Prior U.S. Cls.: 22, 23, 38 and 50

Reg. No. 2,893,381

United States Patent and Trademark Office

Registered Oct. 12, 2004

**TRADEMARK
PRINCIPAL REGISTER**

NEWGY

NEWGARDEN, JOSEPH E., JR. (UNITED STATES
INDIVIDUAL)
805 TEAL DRIVE
GALLATIN, TN 37066

FOR: TABLE TENNIS EQUIPMENT, NAMELY,
TABLE TENNIS BALL SERVING MACHINES AND
PARTS THEREFOR, ELECTRONIC TABLE TOP
TABLE TENNIS GAMES, TABLE TENNIS SERVING
MACHINE CARRYING CASES, NON-MOTORIZED
TABLE TENNIS SERVING MACHINE CARTS, TA-
BLE TENNIS SERVING MACHINE STANDS, TABLE
TENNIS BALL PICK UP AND RETRIEVAL DEVI-
CES, TABLE TENNIS BALL COLLECTION NETS;
ACCESSORIES FOR TABLE TENNIS EQUIPMENT,-
NAMELY, TABLE TENNIS BALLS, TABLE TENNIS

RACKETS, TABLE TENNIS RACKET CASES, RUB-
BER PADDLE SHEETS FOR TABLE TENNIS RACK-
ETS, BLADES FOR TABLE TENNIS RACKETS;
TABLE TENNIS TABLES, NETS FOR TABLE TEN-
NIS TABLES, TABLE TENNIS TABLE COVERS, IN
CLASS 28 (U.S. CLS. 22, 23, 38 AND 50).

FIRST USE 11-2-1988; IN COMMERCE 11-2-1988.

OWNER OF U.S. REG. NO. 1,276,361.

SER. NO. 78-284,008, FILED 8-6-2003.

JOHN SCHUYLER YARD, EXAMINING ATTOR-
NEY

Int. Cls.: 18, 20 and 25

Prior U.S. Cls.: 1, 2, 3, 13, 22, 25, 32, 39, 41 and 50

United States Patent and Trademark Office

Reg. No. 2,893,382

Registered Oct. 12, 2004

**TRADEMARK
PRINCIPAL REGISTER**

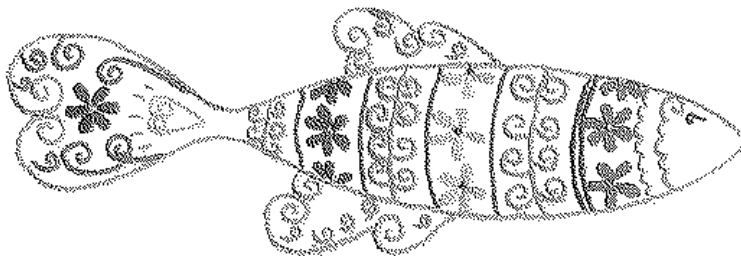

ZAZOU LIMITED (NEW YORK CORPORATION)
1060 FIFTH AVENUE, #5-A
NEW YORK, NY 10128

FOR: BAGS- SHOE BAGS FOR TRAVEL, PURSES,
BACKPACKS, BAGS FOR DOCUMENTS, JEWELRY
BAGS-SOLD EMPTY, LINGERIE BAGS, COSMETIC
BAGS-SOLD EMPTY, EYEGLOSS HOLDER BAGS,
IN CLASS 18 (U.S. CLS. 1, 2, 3, 22 AND 41).

FIRST USE 7-8-2003; IN COMMERCE 7-8-2003.

FOR: CLOTHES HANGERS-COVERED IN FAB-
RIC, IN CLASS 20 (U.S. CLS. 2, 13, 22, 25, 32 AND 50).

FIRST USE 7-8-2003; IN COMMERCE 7-8-2003.

FOR: CLOTHING- BLOUSES, JACKETS, PANTS,
LOUNGEWEAR, BEACH COVERUPS, IN CLASS 25
(U.S. CLS. 22 AND 39).

FIRST USE 7-8-2003; IN COMMERCE 7-8-2003.

SER. NO. 78-284,318, FILED 8-7-2003.

PAULA MAYS, EXAMINING ATTORNEY

Int. Cl.: 35

Prior U.S. Cls.: 100, 101 and 102

United States Patent and Trademark Office

Reg. No. 2,893,383

Registered Oct. 12, 2004

**SERVICE MARK
PRINCIPAL REGISTER**



BUZZTONE.COM, INC. (DELAWARE CORPORATION)
1801 AVENUE OF THE STARS 833
LOS ANGELES, CA 90067

FOR: ADVERTISING AGENCY SERVICES; PUBLIC RELATIONS SERVICES; PUBLICITY AGENCY SERVICES; DIRECT MARKETING ADVERTISING SERVICES FOR OTHERS, BUSINESS MARKETING CONSULTING SERVICES; MARKET RESEARCH, SALES PROMOTION SERVICES, NAMELY PROMOTING THE GOODS AND SERVICES FOR OTHERS THROUGH THE DISTRIBUTION OF PRINTED AND AUDIO PROMOTIONAL MATERIALS AND BY RENDERING SALES PROMOTIONAL ADVICE,

AND PREPARING ADVERTISING OF OTHERS, PURCHASE AND PROCUREMENT OF MEDIA ADVERTISING TIME FOR OTHERS, MARKET RESEARCH, NAMELY, PLANNING AND RESEARCH OF PRINT, RADIO, TELEVISION AND ELECTRONIC ADVERTISING MEDIA USE, IN CLASS 35 (U.S. CLS. 100, 101 AND 102).

FIRST USE 4-13-2000; IN COMMERCE 4-13-2000.

SER. NO. 78-284,638, FILED 8-7-2003.

THEODORE MCBRIDE, EXAMINING ATTORNEY

Int. Cls.: 1 and 9

Prior U.S. Cls.: 1, 5, 6, 10, 21, 23, 26, 36, 38 and 46

United States Patent and Trademark Office

Reg. No. 2,893,384

Registered Oct. 12, 2004

**TRADEMARK
PRINCIPAL REGISTER**



IMMUCOR, INC. (GEORGIA CORPORATION)
3130 GATEWAY DRIVE
NORCROSS, GA 30071

FOR: REAGENTS FOR USE IN VITRO FOR
DETECTING AND IDENTIFYING CELL AND SER-
UM COMPONENTS FOR HUMAN BLOOD, IN
CLASS 1 (U.S. CLS. 1, 5, 6, 10, 26 AND 46).

FIRST USE 4-24-2003; IN COMMERCE 4-24-2003.

FOR: NON-ELECTRONIC CALCULATORS FOR
USE IN DETERMINING DONATED BLOOD EX-

PIRATION DATES; AND LABORATORY INSTRU-
MENTS FOR ANALYZING BLOOD SAMPLES FOR
MEDICAL USE, IN CLASS 9 (U.S. CLS. 21, 23, 26, 36
AND 38).

FIRST USE 4-17-2003; IN COMMERCE 4-17-2003.

OWNER OF U.S. REG. NOS. 1,403,632 AND
1,943,860.

SER. NO. 78-285,182, FILED 8-8-2003.

CAROLYN GRAY, EXAMINING ATTORNEY

Int. Cl.: 3

Prior U.S. Cls.: 1, 4, 6, 50, 51 and 52

United States Patent and Trademark Office

Reg. No. 2,893,385

Registered Oct. 12, 2004

**TRADEMARK
PRINCIPAL REGISTER**

HYDRAJELLY

BEAUTE CREATEURS (SOCIETE ANONYME)
(FRANCE CORPORATION)
10 RUE DE LA PAIX
PARIS, FRANCE 75002

PRIORITY CLAIMED UNDER SEC. 44(D) ON
FRANCE APPLICATION NO. 033214007, FILED 3-7-
2003, REG. NO. 033214007, DATED 3-7-2003, EXPIRES
3-7-2013.

FOR: COSMETICS, NAMELY, NAIL VARNISH,
LIQUID FOUNDATION, TINTED SKIN CREAMS,
MAKE-UP, POWDER BLUSHER, LIPSTICK, MAS-
CARA, EYE SHADOW, COMPACT EYE-LINER PEN-
CIL, NAIL ENAMEL, IN CLASS 3 (U.S. CLS. 1, 4, 6, 50,
51 AND 52).

SER. NO. 78-285,467, FILED 8-11-2003.

RONALD AIKENS, EXAMINING ATTORNEY

Int. Cl.: 5

Prior U.S. Cls.: 6, 18, 44, 46, 51 and 52

Reg. No. 2,893,386

United States Patent and Trademark Office

Registered Oct. 12, 2004

**TRADEMARK
PRINCIPAL REGISTER**

ELAST

ACETO AGRICULTURAL CHEMICALS COR-
PORATION (NEW YORK CORPORATION)
ONE HOLLOW LANE
LAKE SUCCESS, NY 11042

FIRST USE 8-1-2003; IN COMMERCE 8-1-2003.

SER. NO. 78-285,859, FILED 8-11-2003.

FOR: FUNGICIDE FOR USE ON TREES, BOTH
FRUIT AND ORNAMENTAL, AND MAY BE USED
ON EDIBLE CROPS, IN CLASS 5 (U.S. CLS. 6, 18, 44,
46, 51 AND 52).

PAULA MAYS, EXAMINING ATTORNEY

Int. Cl.: 9

Prior U.S. Cls.: 21, 23, 26, 36 and 38

Reg. No. 2,893,387

United States Patent and Trademark Office

Registered Oct. 12, 2004

**TRADEMARK
PRINCIPAL REGISTER**

ENFINITY

SOLUTIONS BY COMPUTER, INC. (DELAWARE
CORPORATION)
191 CHESTNUT STREET
SPRINGFIELD, MA 01103

AND DATABASE MANAGEMENT, IN CLASS 9
(U.S. CLS. 21, 23, 26, 36 AND 38).

FIRST USE 7-8-2003; IN COMMERCE 7-8-2003.

FOR: COMPUTER PROGRAMS RECORDED ON
MAGNETIC MEDIA FOR USE IN RENTAL AND
RETAIL INVENTORY MANAGEMENT, RENTAL
AND RETAIL TRANSACTION MANAGEMENT

SER. NO. 78-286,419, FILED 8-12-2003.

JEFF DEFORD, EXAMINING ATTORNEY

Int. Cls.: 28 and 41

Prior U.S. Cls.: 22, 23, 38, 50, 100, 101 and 107

United States Patent and Trademark Office

Reg. No. 2,893,388

Registered Oct. 12, 2004

**TRADEMARK
SERVICE MARK
PRINCIPAL REGISTER**

BRIAN VICKERS

BRIAN VICKERS, LLC. (NORTH CAROLINA CORPORATION)
27 HIGH TECH BLVD.
THOMASVILLE, NC 27360

FOR: TOYS AND SPORTING ARTICLES, NAME-
LY SCALE SIZE COLLECTOR MODEL VEHICLES
AND MINIATURE TOY MODEL VEHICLES, IN
CLASS 28 (U.S. CLS. 22, 23, 38 AND 50).

FIRST USE 0-0-2002; IN COMMERCE 0-0-2002.

FOR: ENTERTAINMENT SERVICES IN THE
NATURE OF PARTICIPATING IN PROFESSIONAL

AUTO RACES AND RELATED EXHIBITIONS, IN
CLASS 41 (U.S. CLS. 100, 101 AND 107).

FIRST USE 0-0-2002; IN COMMERCE 0-0-2002.

THE NAME "BRIAN VICKERS" IDENTIFIES A
PARTICULAR LIVING INDIVIDUAL WHOSE CON-
SENT IS OF RECORD.

SER. NO. 78-286,434, FILED 8-12-2003.

CAROLYN CATALDO, EXAMINING ATTORNEY

Int. Cl.: 35

Prior U.S. Cls.: 100, 101 and 102

United States Patent and Trademark Office

Reg. No. 2,893,389

Registered Oct. 12, 2004

**SERVICE MARK
PRINCIPAL REGISTER**



MUSIC GORILLA, LLC (TEXAS CORPORATION)
12407 MOPAC EXPWY N. SUITE 100-312
AUSTIN, TX 78758

FOR: ENTERTAINMENT SERVICES, NAMELY,
PROVIDING AN ONLINE SHOWROOM FOR THE
GOODS OF OTHERS IN THE FIELD OF MUSIC, IN
CLASS 35 (U.S. CLS. 100, 101 AND 102).

FIRST USE 3-31-2003; IN COMMERCE 8-12-2003.

THE STIPPLING IS FOR SHADING PURPOSES
ONLY.

THE MARK CONSISTS OF THE WORDS MUSIC
"GORILLA". THE WORD MUSIC IS IN BLACK, THE
WORD "GORILLA" IS IN GRAY. THE "O" OF
"GORILLA" IS A PICTURE OF A GORILLA WITH
A TREBLE CLEF FOR THE BODY; BELOW THE
WORD "GORILLA" IS THE WORDS.

SER. NO. 78-286,514, FILED 8-12-2003.

PATRICIA EVANKO, EXAMINING ATTORNEY

Int. Cls.: 20 and 35

Prior U.S. Cls.: 2, 13, 22, 25, 32, 50, 100, 101 and 102

United States Patent and Trademark Office

Reg. No. 2,893,390

Registered Oct. 12, 2004

**TRADEMARK
SERVICE MARK
PRINCIPAL REGISTER**

GILSON GARDEN MARKETING

GILSON NAMES, LLC (MICHIGAN CORPORATION)

631 NORTH AVENUE, N.E.

GRAND RAPIDS, MI 49503

FOR: PRINTED MATTER, NAMELY, NON-METAL GARDEN PLANT STAKES; NON-METAL PLANT TAGS AND NON-METAL BENCH CARD TAGS, IN CLASS 20 (U.S. CLS. 2, 13, 22, 25, 32 AND 50).

FIRST USE 1-17-2003; IN COMMERCE 1-17-2003.

FOR: DIRECT MARKETING ADVERTISING FOR OTHERS IN THE HORTICULTURAL INDUSTRY, IN CLASS 35 (U.S. CLS. 100, 101 AND 102).

FIRST USE 1-17-2003; IN COMMERCE 1-17-2003.

NO CLAIM IS MADE TO THE EXCLUSIVE RIGHT TO USE "GARDEN MARKETING", APART FROM THE MARK AS SHOWN.

SER. NO. 78-286,639, FILED 8-13-2003.

SAMUEL E. SHARPER JR., EXAMINING ATTORNEY

Int. Cl.: 35

Prior U.S. Cls.: 100, 101 and 102

United States Patent and Trademark Office

Reg. No. 2,893,391

Registered Oct. 12, 2004

**SERVICE MARK
PRINCIPAL REGISTER**

BRANDS PEOPLE GET

DE HEER, CHRISTOPHER J. (UNITED STATES
INDIVIDUAL)
343 SOQUEL AVE., #510
SANTA CRUZ, CA 95062

FOR: ADVERTISING SERVICES, NAMELY,
CREATING CORPORATE AND BRAND IDENTITY
FOR OTHERS; AND BUSINESS MARKETING CON-

SULTING SERVICES , IN CLASS 35 (U.S. CLS. 100,
101 AND 102).

FIRST USE 8-12-2003; IN COMMERCE 8-12-2003.

SER. NO. 78-287,152, FILED 8-13-2003.

VERNA BETH RIRIE, EXAMINING ATTORNEY

Int. Cl.: 5

Prior U.S. Cls.: 6, 18, 44, 46, 51 and 52

United States Patent and Trademark Office

Reg. No. 2,893,392

Registered Oct. 12, 2004

**TRADEMARK
PRINCIPAL REGISTER**

POTENTSEA MME

GOLDBLATT, CHRISTOPHER, F. (UNITED STATES INDIVIDUAL)
484 B WASHINGTON ST. #320
MONTEREY, CA 93940

FIRST USE 1-1-2001; IN COMMERCE 8-14-2003.

SER. NO. 78-287,635, FILED 8-14-2003.

FOR: NUTRITIONAL VITAMINS AND MINERAL SUPPLEMENTS, IN CLASS 5 (U.S. CLS. 6, 18, 44, 46, 51 AND 52).

LINDA ESTRADA, EXAMINING ATTORNEY

Int. Cl.: 1

Prior U.S. Cls.: 1, 5, 6, 10, 26 and 46

Reg. No. 2,893,393

United States Patent and Trademark Office

Registered Oct. 12, 2004

**TRADEMARK
PRINCIPAL REGISTER**

E. CLONI

LUCIGEN CORPORATION (WISCONSIN CORPORATION)
2120 W. GREENVIEW DR. SUITE 9
MIDDLETON, WI 53562

FIRST USE 5-10-2001; IN COMMERCE 5-10-2001.

SER. NO. 78-287,973, FILED 8-15-2003.

FOR: REAGENTS FOR SCIENTIFIC OR MEDICAL RESEARCH USE, IN CLASS 1 (U.S. CLS. 1, 5, 6, 10, 26 AND 46).

DAWN FELDMAN, EXAMINING ATTORNEY

Int. Cl.: 35

Prior U.S. Cls.: 100, 101 and 102

United States Patent and Trademark Office

Reg. No. 2,893,394

Registered Oct. 12, 2004

**SERVICE MARK
PRINCIPAL REGISTER**

RIDE AMERICAN - EAT JAPANESE

TINSLEY, HARRY (UNITED STATES INDIVIDUAL)
220 EAST HIGH STREET
LEBANON, TN 37087

FIRST USE 7-1-1999; IN COMMERCE 7-1-1999.

SER. NO. 78-288,013, FILED 8-15-2003.

FOR: RETAIL STORE SERVICES FEATURING
MOTORCYCLE PARTS; DISTRIBUTORSHIPS IN
THE FIELD OF MOTORCYCLE PARTS, IN CLASS
35 (U.S. CLS. 100, 101 AND 102).

CATHERINE CAIN, EXAMINING ATTORNEY

Int. Cl.: 31

Prior U.S. Cls.: 1 and 46

United States Patent and Trademark Office

Reg. No. 2,893,395

Registered Oct. 12, 2004

**TRADEMARK
PRINCIPAL REGISTER**

ROZA'S

POHLMANS NURSERY PTY LTD (AUSTRALIA
LIMITED COMPANY)
REDBANK CREEK
GATTON, AUSTRALIA 4343

FOR: LIVE PLANTS, LIVE PEPPER PLANTS AND
SEEDLINGS, PLANT SEEDS, SEEDLINGS, LIVE
BEDDING PLANTS, LIVING HERBS, LIVE TREES,
LIVE SHRUBS, LIVE PLANTS FOR USE AS

GROUND COVERS, PLANT BULBS AND LIVE
FLOWERS, IN CLASS 31 (U.S. CLS. 1 AND 46).

OWNER OF AUSTRALIA REG. NO. 913998, DA-
TED 5-23-2002, EXPIRES 5-23-2012.

SER. NO. 78-288,230, FILED 8-15-2003.

ROBERT COGGINS, EXAMINING ATTORNEY

Int. Cl.: 31

Prior U.S. Cls.: 1 and 46

United States Patent and Trademark Office

Reg. No. 2,893,396

Registered Oct. 12, 2004

**TRADEMARK
PRINCIPAL REGISTER**

LUIGI'S

POHLMANS NURSERY PTY LTD (AUSTRALIA
LIMITED COMPANY)
REDBANK CREEK
GATTON, AUSTRALIA 4343

OWNER OF AUSTRALIA REG. NO. 913497, DA-
TED 5-21-2002, EXPIRES 5-21-2012.

FOR: LIVE PLANTS, LIVE TOMATO PLANTS
AND SEEDLINGS, PLANT SEEDS, SEEDLINGS,
LIVE BEDDING PLANTS, LIVING HERBS, LIVE
TREES, LIVE SHRUBS, LIVE PLANTS FOR USE AS
GROUND COVER, PLANT BULBS AND LIVE
FLOWERS, IN CLASS 31 (U.S. CLS. 1 AND 46).

SER. NO. 78-288,233, FILED 8-15-2003.

JOHN SCHUYLER YARD, EXAMINING ATTOR-
NEY

Int. Cl.: 41

Prior U.S. Cls.: 100, 101 and 107

United States Patent and Trademark Office

Reg. No. 2,893,397

Registered Oct. 12, 2004

SERVICE MARK
PRINCIPAL REGISTER

WANT IT. CREATE IT. LIVE IT.

BLACK, SCOTT V. (UNITED STATES INDIVIDUAL)
945 N. CLOVER LANE
RENO, NV 89408

FOR: EDUCATIONAL SERVICES, NAMELY, CONDUCTING CLASSES AND WORKSHOPS IN THE FIELD OF LEADERSHIP AND COMMUNICATION SKILLS AS WELL AS THE DISTRIBUTION OF

COURSE MATERIALS IN CONNECTION THEREWITH, IN CLASS 41 (U.S. CLS. 100, 101 AND 107).

FIRST USE 7-1-1998; IN COMMERCE 7-1-1998.

SER. NO. 78-288,310, FILED 8-16-2003.

KAREN BRACEY, EXAMINING ATTORNEY

Int. Cl.: 36

Prior U.S. Cls.: 100, 101 and 102

United States Patent and Trademark Office

Reg. No. 2,893,398

Registered Oct. 12, 2004

**SERVICE MARK
PRINCIPAL REGISTER**



FOREST INVESTMENT ASSOCIATES, INC.
(GEORGIA CORPORATION)
15 PIEDMONT CENTER, SUITE 1250
ATLANTA, GA 30305

FIRST USE 6-0-1986; IN COMMERCE 6-0-1986.

SER. NO. 78-288,605, FILED 8-18-2003.

FOR: INVESTMENT MANAGEMENT AND IN-
VESTMENT ADVISORY SERVICES, IN CLASS 36
(U.S. CLS. 100, 101 AND 102).

ANN LINNEHAN, EXAMINING ATTORNEY

Int. Cl.: 33

Prior U.S. Cls.: 47 and 49

United States Patent and Trademark Office

Reg. No. 2,893,399

Registered Oct. 12, 2004

**TRADEMARK
PRINCIPAL REGISTER**

MEDRED

DEHESA DE LOS LLANOS, S.L. (SPAIN CORPORATION)
CARRETERA PENAS DE SAN PEDRO, KM. 5,5
ALBACETE, SPAIN 02006

2003, REG. NO. 2553243, DATED 1-12-2004, EXPIRES
7-31-2013.

FOR: WINES, IN CLASS 33 (U.S. CLS. 47 AND 49).

SER. NO. 78-288,832, FILED 8-18-2003.

PRIORITY CLAIMED UNDER SEC. 44(D) ON
SPAIN APPLICATION NO. 2553243, FILED 7-31-

SOPHIA S. KIM, EXAMINING ATTORNEY

Int. Cl.: 41

Prior U.S. Cls.: 100, 101 and 107

United States Patent and Trademark Office

Reg. No. 2,893,400

Registered Oct. 12, 2004

**SERVICE MARK
PRINCIPAL REGISTER**

INTERNATIONAL LEAGUE

INTERNATIONAL LEAGUE OF PROFESSIONAL
BASEBALL CLUBS, INC. (VIRGINIA COR-
PORATION)
SUITE 202
55 S. HIGH STREET
DUBLIN, OH 43017

FOR: ENTERTAINMENT SERVICES IN THE
NATURE OF BASEBALL GAMES AND EXHIBI-
TIONS, IN CLASS 41 (U.S. CLS. 100, 101 AND 107).

FIRST USE 4-0-1886; IN COMMERCE 4-0-1886.

NO CLAIM IS MADE TO THE EXCLUSIVE
RIGHT TO USE "LEAGUE", APART FROM THE
MARK AS SHOWN.

SEC. 2(F).

SER. NO. 78-289,074, FILED 8-19-2003.

ZACHARY BELLO, EXAMINING ATTORNEY

Int. Cl.: 10

Prior U.S. Cls.: 26, 39 and 44

United States Patent and Trademark Office

Reg. No. 2,893,401

Registered Oct. 12, 2004

**TRADEMARK
PRINCIPAL REGISTER**

TROFIX

CENTERPULSE ORTHOPEDICS LTD. (SWITZER-
LAND CORPORATION)
ALTGASSE 44
BAAR, SWITZERLAND 6340

FOR: SURGICAL AND MEDICAL INSTRU-
MENTS AND APPARATUS, NAMELY, IMPLANTS
COMPOSED OF ARTIFICIAL MATERIAL FOR THE
TREATMENT OF FRACTURES IN THE REGION OF
THE TROCHANTER MAJOR , IN CLASS 10 (U.S.
CLS. 26, 39 AND 44).

PRIORITY CLAIMED UNDER SEC. 44(D) ON
SWITZERLAND APPLICATION NO. 04088/2003,
FILED 8-7-2003, REG. NO. 514080, DATED 8-7-2003,
EXPIRES 8-7-2013.

SER. NO. 78-289,181, FILED 8-19-2003.

VERNA BETH RIRIE, EXAMINING ATTORNEY

Int. Cl.: 41

Prior U.S. Cls.: 100, 101 and 107

United States Patent and Trademark Office

Reg. No. 2,893,402

Registered Oct. 12, 2004

**SERVICE MARK
PRINCIPAL REGISTER**

CASA DE ESPERANZA

CASA DE ESPERANZA (MINNESOTA CORPORATION)
PO BOX 75177
ST. PAUL, MN 55175

FOR: EDUCATIONAL SERVICES, NAMELY PROVIDING WORKSHOPS AND SEMINARS IN THE FIELD OF DOMESTIC VIOLENCE, AND DISTRIBUTING COURSE MATERIALS IN CONNECTION THEREWITH, IN CLASS 41 (U.S. CLS. 100, 101 AND 107).

FIRST USE 12-31-1982; IN COMMERCE 12-31-1982.

THE FOREIGN WORDING IN THE MARK TRANSLATES INTO ENGLISH AS "HOUSE OF HOPE".

SER. NO. 78-289,222, FILED 8-19-2003.

AISHA CLARKE, EXAMINING ATTORNEY

Int. Cl.: 16

Prior U.S. Cls.: 2, 5, 22, 23, 29, 37, 38 and 50

Reg. No. 2,893,403

United States Patent and Trademark Office

Registered Oct. 12, 2004

**TRADEMARK
PRINCIPAL REGISTER**

COMICSTICKS

MALONE-BURRELL, TERESA (TERRY) (UNITED STATES INDIVIDUAL)
7207 MONTEREY AVENUE
LITHONIA, GA 30058 AND
BURRELL, TYRONE, L. (UNITED STATES INDIVIDUAL)
7207 MONTEREY AVENUE
LITHONIA, GA 30058

FOR: STATIC CLING PLASTIC DECALS FEATURING ILLUSTRATED CARICATURES OF VARIOUS THEMES AND TOPICS ON STATIC CLING

PLASTIC FOR THE PURPOSE OF PROMOTIONS, SLOGANS, MESSAGES AND HUMOROUS COMMUNICATION THROUGH THE USE OF CARTOON CAPTION HEADERS, IN CLASS 16 (U.S. CLS. 2, 5, 22, 23, 29, 37, 38 AND 50).

FIRST USE 12-6-2000; IN COMMERCE 12-6-2000.

SER. NO. 78-289,516, FILED 8-19-2003.

TRACY CROSS, EXAMINING ATTORNEY

Int. Cl.: 16

Prior U.S. Cls.: 2, 5, 22, 23, 29, 37, 38 and 50

United States Patent and Trademark Office

Reg. No. 2,893,404

Registered Oct. 12, 2004

**TRADEMARK
PRINCIPAL REGISTER**

INTERNATIONAL EXPRESSIONS

LANGUAGE MASTERS INC (NEW HAMPSHIRE
CORPORATION)
3401 TUCKAWAY DRIVE
MOUNT AIRY, MD 21771

FIRST USE 8-1-2003; IN COMMERCE 8-1-2003.

SER. NO. 78-290,253, FILED 8-21-2003.

FOR: GREETING CARDS, IN CLASS 16 (U.S. CLS.
2, 5, 22, 23, 29, 37, 38 AND 50).

MARK T. MULLEN, EXAMINING ATTORNEY

Int. Cl.: 35

Prior U.S. Cls.: 100, 101 and 102

United States Patent and Trademark Office

Reg. No. 2,893,405

Registered Oct. 12, 2004

**SERVICE MARK
PRINCIPAL REGISTER**

340BETTER

TEXAS ASSOCIATION OF COMMUNITY
HEALTH CENTERS, INC. (TEXAS NON-PROF-
IT CORPORATION)
2301 S. CAPITAL OF TEXAS HIGHWAY
BUILDING H
AUSTIN, TX 78746

FOR: ADMINISTRATION OF A DISCOUNT PRO-
GRAM FOR ENABLING PARTICIPANTS TO OB-
TAIN DISCOUNTED PRICES ON

PHARMACEUTICAL GOODS AND SERVICES
THROUGH MEMBERSHIP OF THE PROGRAM, IN
CLASS 35 (U.S. CLS. 100, 101 AND 102).

FIRST USE 8-15-1999; IN COMMERCE 8-15-1999.

SER. NO. 78-290,281, FILED 8-21-2003.

MICHAEL KAZAZIAN, EXAMINING ATTORNEY

Int. Cl.: 36

Prior U.S. Cls.: 100, 101 and 102

United States Patent and Trademark Office

Reg. No. 2,893,406

Registered Oct. 12, 2004

**SERVICE MARK
PRINCIPAL REGISTER**

QUEEN CITY REALTY GROUP

BUGG PROPERTIES, LLC (NORTH CAROLINA
LTD LIAB CO)
1704 ROSEBANK LANE
CHARLOTTE, NC 28226

NO CLAIM IS MADE TO THE EXCLUSIVE
RIGHT TO USE REALTY GROUP, APART FROM
THE MARK AS SHOWN.

FOR: REAL ESTATE AGENCIES, IN CLASS 36
(U.S. CLS. 100, 101 AND 102).

SER. NO. 78-290,421, FILED 8-21-2003.

FIRST USE 8-4-2003; IN COMMERCE 8-4-2003.

KEVON CHISOLM, EXAMINING ATTORNEY

Int. Cl.: 38

Prior U.S. Cls.: 100, 101 and 104

United States Patent and Trademark Office

Reg. No. 2,893,407

Registered Oct. 12, 2004

**SERVICE MARK
PRINCIPAL REGISTER**

JUST SERVICE

JUST SERVICE, INC. (ILLINOIS CORPORATION)
2940 N. CLARK STREET
CHICAGO, IL 60657

FOR: PROVIDING A HIGH SPEED ACCESS TO
AREA NETWORKS AND THE INTERNET, IN
CLASS 38 (U.S. CLS. 100, 101 AND 104).

FIRST USE 8-9-1996; IN COMMERCE 8-9-1996.

OWNER OF U.S. REG. NOS. 2,668,865 AND
2,709,519.

NO CLAIM IS MADE TO THE EXCLUSIVE
RIGHT TO USE "SERVICE", APART FROM THE
MARK AS SHOWN.

SER. NO. 78-290,451, FILED 8-21-2003.

BRIDGETT SMITH, EXAMINING ATTORNEY

Int. Cl.: 35

Prior U.S. Cls.: 100, 101 and 102

United States Patent and Trademark Office

Reg. No. 2,893,408

Registered Oct. 12, 2004

**SERVICE MARK
PRINCIPAL REGISTER**

JUST SERVICE

JUST SERVICE, INC. (ILLINOIS CORPORATION)
2940 N. CLARK STREET
CHICAGO, IL 60657

FOR: BUSINESS CONSULTING SERVICES RE-
LATING TO MARKETING, SALES AND SERVICE
ON THE INTERNET, IN CLASS 35 (U.S. CLS. 100, 101
AND 102).

FIRST USE 8-9-1996; IN COMMERCE 8-9-1996.

OWNER OF U.S. REG. NOS. 2,668,865 AND
2,709,519.

NO CLAIM IS MADE TO THE EXCLUSIVE
RIGHT TO USE "SERVICE", APART FROM THE
MARK AS SHOWN.

SER. NO. 78-290,467, FILED 8-21-2003.

BRIDGETT SMITH, EXAMINING ATTORNEY

Int. Cl.: 30

Prior U.S. Cl.: 46

United States Patent and Trademark Office

Reg. No. 2,893,409

Registered Oct. 12, 2004

**TRADEMARK
PRINCIPAL REGISTER**



RAGUS HOLDINGS, INC. (DELAWARE CORPORATION)
SUITE 900
300 DELAWARE AVENUE
WILMINGTON, DE 19801

OWNER OF U.S. REG. NOS. 729,535, 914,123, AND 970,907.

FOR: SUGAR, POWDERED SUGAR, AND FLAVORED SUGAR, IN CLASS 30 (U.S. CL. 46).

SER. NO. 78-290,498, FILED 8-21-2003.

FIRST USE 6-25-2003; IN COMMERCE 6-25-2003.

PRISCILLA MILTON, EXAMINING ATTORNEY

Int. Cl.: 35

Prior U.S. Cls.: 100, 101 and 102

United States Patent and Trademark Office

Reg. No. 2,893,410

Registered Oct. 12, 2004

**SERVICE MARK
PRINCIPAL REGISTER**

PARTY ENGINEERING

EVENTSTYLE, INC. (NEW YORK CORPORATION)
135 WEST 20TH STREET SUITE 404
NEW YORK, NY 10011

FOR: PUBLIC RELATIONS; PROMOTING THE
SALE OF GOODS AND SERVICES OF OTHERS
THROUGH THE DISTRIBUTION OF PRINTED MA-

TERIAL AND PROMOTIONAL CONTESTS , IN
CLASS 35 (U.S. CLS. 100, 101 AND 102).

FIRST USE 3-0-2003; IN COMMERCE 3-0-2003.

SER. NO. 78-291,058, FILED 8-22-2003.

LINDA MICKLEBURGH, EXAMINING ATTORNEY

Int. Cls.: 37 and 42

Prior U.S. Cls.: 100, 101, 103 and 106

United States Patent and Trademark Office

Reg. No. 2,893,411

Registered Oct. 12, 2004

**SERVICE MARK
PRINCIPAL REGISTER**



BAKER COMMUNICATIONS, INC. (IOWA CORPORATION)
SUITE 190
6200 THORNTON AVENUE
DES MOINES, IA 50321

FOR: MAINTENANCE OF INFORMATION NETWORK SYSTEMS, NAMELY NETWORK SYSTEMS INCLUDING DATA NETWORKS, TELEPHONE SYSTEMS, AND DESKTOP FAXING APPLICATIONS, IN CLASS 37 (U.S. CLS. 100, 103 AND 106).

FIRST USE 4-1-2000; IN COMMERCE 4-1-2000.

FOR: COMPUTER SERVICES, NAMELY IMPLEMENTATION AND MANAGEMENT OF INFORMA-

TION NETWORK SYSTEMS, NAMELY NETWORK SYSTEMS INCLUDING DATA NETWORKS, TELEPHONE SYSTEMS, AND DESKTOP FAXING APPLICATIONS, IN CLASS 42 (U.S. CLS. 100 AND 101).

FIRST USE 4-1-2000; IN COMMERCE 4-1-2000.

NO CLAIM IS MADE TO THE EXCLUSIVE RIGHT TO USE "COMMUNICATIONS", APART FROM THE MARK AS SHOWN.

SER. NO. 78-291,111, FILED 8-22-2003.

KEVON CHISOLM, EXAMINING ATTORNEY

Int. Cl.: 38

Prior U.S. Cls.: 100, 101 and 104

United States Patent and Trademark Office

Reg. No. 2,893,412

Registered Oct. 12, 2004

**SERVICE MARK
PRINCIPAL REGISTER**



TDS TELECOMMUNICATIONS CORPORATION
(DELAWARE CORPORATION)
301 S. WESTFIELD
MADISON, WI 53717

FIRST USE 8-0-2002; IN COMMERCE 8-0-2002.

OWNER OF U.S. REG. NOS. 2,087,371, 2,258,553,
AND 2,271,412.

FOR: TELECOMMUNICATIONS SERVICES,
NAMELY, THE ELECTRONIC TRANSMISSION OF
DATA AND MESSAGES AND TELEPHONE COM-
MUNICATION SERVICES, IN CLASS 38 (U.S. CLS.
100, 101 AND 104).

SER. NO. 78-291,146, FILED 8-22-2003.

CATHERINE CAIN, EXAMINING ATTORNEY

Int. Cl.: 36

Prior U.S. Cls.: 100, 101 and 102

United States Patent and Trademark Office

Reg. No. 2,893,413

Registered Oct. 12, 2004

**SERVICE MARK
PRINCIPAL REGISTER**

AIG SMALL BUSINESS

AMERICAN INTERNATIONAL GROUP, INC.
(DELAWARE CORPORATION)
70 PINE STREET
NEW YORK, NY 10270

FOR: INSURANCE UNDERWRITING SERVICES,
NAMELY PROFESSIONAL LIABILITY, ERRORS
AND OMISSIONS, EXCESS LIABILITY, DIREC-
TORS AND OFFICERS, EMPLOYMENT LIABILITY,
AND PRODUCT LIABILITY INSURANCE; EM-
PLOYEE DEATH AND DISMEMBERMENT INSUR-
ANCE UNDERWRITING; EMPLOYEE VISION
CARE INSURANCE UNDERWRITING; BUSINESS
TRAVEL ACCIDENT INSURANCE UNDERWRIT-
ING; ENERGY EXCESS CASUALTY INSURANCE

UNDERWRITING, IN INTERNATIONAL CLASS
036., IN CLASS 36 (U.S. CLS. 100, 101 AND 102).

FIRST USE 8-31-2003; IN COMMERCE 8-31-2003.

OWNER OF U.S. REG. NOS. 1,151,229, 1,273,845
AND OTHERS.

NO CLAIM IS MADE TO THE EXCLUSIVE
RIGHT TO USE "SMALL BUSINESS", APART FROM
THE MARK AS SHOWN.

SER. NO. 78-291,611, FILED 8-25-2003.

CHERYL CLAYTON, EXAMINING ATTORNEY

Int. Cls.: 1 and 16

**Prior U.S. Cls.: 1, 2, 5, 6, 10, 22, 23, 26, 29, 37, 38, 46
and 50**

Reg. No. 2,893,414

United States Patent and Trademark Office

Registered Oct. 12, 2004

**TRADEMARK
PRINCIPAL REGISTER**

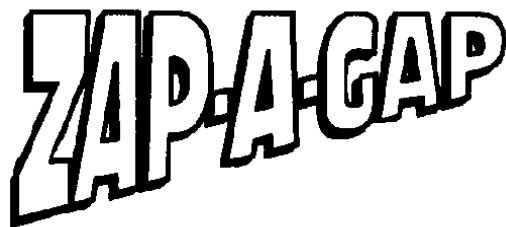

PACER TECHNOLOGY (CALIFORNIA COR-
PORATION)
9420 SANTA ANITA AVENUE
RANCHO CUCAMONGA, CA 91730

FOR: ADHESIVE BONDING AGENTS FOR
HOUSEHOLD USE, IN CLASS 16 (U.S. CLS. 2, 5, 22,
23, 29, 37, 38 AND 50).

FOR: ADHESIVE BONDING AGENTS FOR GEN-
ERAL INDUSTRIAL USE; ADHESIVE BONDING
AGENTS FOR USE BY HOBBYISTS; AND EPOXY
GLUE FOR GENERAL BONDING AND REPAIR
PURPOSES, IN CLASS 1 (U.S. CLS. 1, 5, 6, 10, 26 AND
46).

FIRST USE 3-27-1981; IN COMMERCE 3-31-1981.

SER. NO. 78-291,671, FILED 8-25-2003.

FIRST USE 3-27-1981; IN COMMERCE 3-31-1981.

JENNIFER CHICOSKI, EXAMINING ATTORNEY

Int. Cl.: 35

Prior U.S. Cls.: 100, 101 and 102

United States Patent and Trademark Office

Reg. No. 2,893,415

Registered Oct. 12, 2004

SERVICE MARK
PRINCIPAL REGISTER



The logo features the words "On the Run" in a bold, black, cursive script. A thick, black, wavy underline is positioned beneath the text, extending across its width.

EXXONMOBIL OIL CORPORATION (NEW
YORK CORPORATION)
5959 LAS COLINAS BOULEVARD
IRVING, TX 75039

FOR: RETAIL CONVENIENCE STORE SERVICES,
IN CLASS 35 (U.S. CLS. 100, 101 AND 102).

FIRST USE 12-11-2000; IN COMMERCE 3-20-2001.

OWNER OF U.S. REG. NOS. 2,110,223, 2,757,752
AND OTHERS.

THE MARK CONSISTS OF BLUE LETTERING
WITH A RED UNDERLINE ON A YELLOW BACK-
GROUND.

SER. NO. 78-291,683, FILED 8-25-2003.

EDWARD NELSON, EXAMINING ATTORNEY

Int. Cl.: 43

Prior U.S. Cls.: 100 and 101

United States Patent and Trademark Office

Reg. No. 2,893,416

Registered Oct. 12, 2004

**SERVICE MARK
PRINCIPAL REGISTER**

GIVE ME THE PINK STUFF

PIZZA SHOPPE FRANCHISING, INC. (MISSOURI
CORPORATION)
6640 N.W. #9 HIGHWAY
KANSAS CITY, MO 64151

FIRST USE 10-31-2001; IN COMMERCE 10-31-2001.

SER. NO. 78-292,215, FILED 8-26-2003.

FOR: RESTAURANT SERVICES, FEATURING
THE SALE OF PREPARED FOOD AND BEVERAGE
PRODUCTS FOR ON AND OFF PREMISE CON-
SUMPTION, IN CLASS 43 (U.S. CLS. 100 AND 101).

JEFF DEFORD, EXAMINING ATTORNEY

Int. Cl.: 43

Prior U.S. Cls.: 100 and 101

United States Patent and Trademark Office

Reg. No. 2,893,417

Registered Oct. 12, 2004

**SERVICE MARK
PRINCIPAL REGISTER**

WE SERVE TASTE ONE BITE AT A TIME

PIZZA SHOPPE FRANCHISING, INC. (MISSOURI
CORPORATION)
6640 N.W. #9 HIGHWAY
KANSAS CITY, MO 64151

FIRST USE 10-31-2001; IN COMMERCE 10-31-2001.

SER. NO. 78-292,222, FILED 8-26-2003.

FOR: RESTAURANT SERVICES, NAMELY, THE
SALE OF PREPARED FOOD AND BEVERAGE
PRODUCTS FOR ON AND OFF PREMISES CON-
SUMPTION, IN CLASS 43 (U.S. CLS. 100 AND 101).

JEFF DEFORD, EXAMINING ATTORNEY

Int. Cl.: 5

Prior U.S. Cls.: 6, 18, 44, 46, 51 and 52

United States Patent and Trademark Office

Reg. No. 2,893,418

Registered Oct. 12, 2004

**TRADEMARK
PRINCIPAL REGISTER**

PRAIRIE AIRE

WARBERG, KARI G. (UNITED STATES INDIVIDUAL)
4551 78TH AVE NW
NEW TOWN, ND 587639574

FIRST USE 8-1-2003; IN COMMERCE 8-25-2003.

SER. NO. 78-292,461, FILED 8-26-2003.

FOR: AIR FRESHENERS, NAMELY, LONG LASTING SCENT POUCHES THAT ABSORB ODORS AND NATURALLY FRESHEN THE AIR, IN CLASS 5 (U.S. CLS. 6, 18, 44, 46, 51 AND 52).

BILL DAWE, EXAMINING ATTORNEY

Int. Cl.: 44

Prior U.S. Cls.: 100 and 101

United States Patent and Trademark Office

Reg. No. 2,893,419

Registered Oct. 12, 2004

**SERVICE MARK
PRINCIPAL REGISTER**



OHIO CLINIC FOR AESTHETIC AND PLASTIC
SURGERY, INC. (OHIO CORPORATION)
30400 DETROIT ROAD
WESTLAKE, OH 44145

FOR: PROFESSIONAL MEDICAL SERVICES IN
THE FIELD OF PLASTIC, COSMETIC AND RECON-
STRUCTIVE SURGERY; SPA SERVICES PROVID-
ING BODY AND SKIN TREATMENTS, NAMELY
MASSAGES, APPLICATIONS OF LOTIONS AND
COMPOSITIONS INCLUDING SKIN LIGHTENERS,
SKIN MASKS, ANTIOXIDANT TREATMENTS,
SKIN PEELS, PREOPERATIVE SKIN CARE, POST-

OPERATIVE CAMOUFLAGE MAKE-UP, DEEP
CLEANSING FACIAL TREATMENTS, MANI-
CURES, PEDICURES, FACE AND BODY WAXING,
HAIR DESIGN, COLOR, PERMS AND FULL BODY
MASSAGE, IN CLASS 44 (U.S. CLS. 100 AND 101).

FIRST USE 6-30-1987; IN COMMERCE 6-30-1987.

SER. NO. 78-293,005, FILED 8-27-2003.

DAWN FELDMAN, EXAMINING ATTORNEY

Int. Cl.: 10

Prior U.S. Cls.: 26, 39 and 44

Reg. No. 2,893,420

United States Patent and Trademark Office

Registered Oct. 12, 2004

TRADEMARK
PRINCIPAL REGISTER



IMMUNIVEST CORPORATION (DELAWARE CORPORATION)
1105 NORTH MARKET STREET SUITE 1300
WILMINGTON, DE 19899

FOR: DIAGNOSTIC APPARATUS AND ACCESSORIES COMPRISING PRIMARILY A PLATFORM FOR SAMPLE CONTAINER; MAGNETS; SLIDE INCLUDING SAMPLE CHAMBER WITH FERROMAGNETIC GRID; PUMPS; PUMP TUBING; AND ALSO COMPRISING; ANTIBODY-MAGNETIC PARTICLE CONJUGATES; WASH SOLUTION; IMMUNOHISTOCHEMICAL DYES; ANTIBODY-ENZYME CONJUGATES; ALL SOLD AS A UNIT; FOR ISOLATING CELLS OR CELL SUBSETS FROM A MIXED CELL POPULATION IN A BIOLOGICAL

FLUID FOR EX VIVO ANALYSIS FOR MEDICAL DIAGNOSTIC USES, IN CLASS 10 (U.S. CLS. 26, 39 AND 44).

FIRST USE 2-27-2004; IN COMMERCE 2-27-2004.

OWNER OF U.S. REG. NO. 2,224,502.

NO CLAIM IS MADE TO THE EXCLUSIVE RIGHT TO USE "ANALYZER" , APART FROM THE MARK AS SHOWN.

SER. NO. 78-293,526, FILED 8-28-2003.

ESTHER BELENKER, EXAMINING ATTORNEY

Int. Cl.: 37

Prior U.S. Cls.: 100, 103 and 106

United States Patent and Trademark Office

Reg. No. 2,893,421

Registered Oct. 12, 2004

**SERVICE MARK
PRINCIPAL REGISTER**

WATCH HOSPITAL

JEWELRY HOSPITAL, INC. (TEXAS CORPORATION)
3321A BELL
AMARILLO, TX 791065023

NO CLAIM IS MADE TO THE EXCLUSIVE
RIGHT TO USE "WATCH" , APART FROM THE
MARK AS SHOWN.

FOR: WATCH REPAIRS, IN CLASS 37 (U.S. CLS.
100, 103 AND 106).

SER. NO. 78-294,300, FILED 8-29-2003.

FIRST USE 6-10-2002; IN COMMERCE 6-10-2002.

GLENN CLARK, EXAMINING ATTORNEY

Int. Cl.: 41

Prior U.S. Cls.: 100, 101 and 107

United States Patent and Trademark Office

Reg. No. 2,893,422

Registered Oct. 12, 2004

**SERVICE MARK
PRINCIPAL REGISTER**

WRITERS RISING UP

PRICE, VICKI PELLAR (UNITED STATES INDIVIDUAL)
16893 BAINBRIDGE DRIVE
EDEN PRAIRIE, MN 55347

FOR: EDUCATIONAL SERVICES, NAMELY, POETRY AND LITERARY CONTESTS, COMPETITIONS AND EVENTS FOR WRITERS TO SUBMIT AND PERFORM LITERARY INTERPRETATIONS RELATED TO PLACE, NATURAL HABITAT AND

WETLANDS, IN CLASS 41 (U.S. CLS. 100, 101 AND 107).

FIRST USE 5-10-2001; IN COMMERCE 5-10-2001.

SER. NO. 78-294,373, FILED S.R. 8-29-2003 AM. P.R. 4-14-2004.

STACY WAHLBERG, EXAMINING ATTORNEY

Int. Cl.: 30

Prior U.S. Cl.: 46

United States Patent and Trademark Office

Reg. No. 2,893,423

Registered Oct. 12, 2004

**TRADEMARK
PRINCIPAL REGISTER**

CAMBRIDGE & THAMES

ALLIED INTERNATIONAL CORPORATION
(VIRGINIA CORPORATION)
PO BOX 858
ASHBURN, VA 20146

FIRST USE 7-1-2002; IN COMMERCE 7-1-2002.

SER. NO. 78-294,708, FILED 9-2-2003.

FOR: CANDY, IN CLASS 30 (U.S. CL. 46).

CHERYL CLAYTON, EXAMINING ATTORNEY

Int. Cl.: 5

Prior U.S. Cls.: 6, 18, 44, 46, 51 and 52

United States Patent and Trademark Office

Reg. No. 2,893,424

Registered Oct. 12, 2004

**TRADEMARK
PRINCIPAL REGISTER**

PERFORMANCE BOOST

JAMBA JUICE COMPANY (CALIFORNIA COR-
PORATION)
1700 17TH STREET
SAN FRANCISCO, CA 941035136

FIRST USE 3-0-2000; IN COMMERCE 3-0-2000.

SER. NO. 78-294,999, FILED 9-2-2003.

FOR: FOOD SUPPLEMENTS; NUTRITIONAL
DRINKS FOR USE AS A MEAL REPLACEMENT,
IN CLASS 5 (U.S. CLS. 6, 18, 44, 46, 51 AND 52).

BRIDGETT SMITH, EXAMINING ATTORNEY

Int. Cl.: 5

Prior U.S. Cls.: 6, 18, 44, 46, 51 and 52

United States Patent and Trademark Office

Reg. No. 2,893,425

Registered Oct. 12, 2004

**TRADEMARK
PRINCIPAL REGISTER**

VIBRANT-C BOOST

JAMBA JUICE COMPANY (CALIFORNIA CORPORATION)
1700 17TH STREET
SAN FRANCISCO, CA 941035136

FOR: FOOD SUPPLEMENTS; NUTRITIONAL DRINKS FOR USE AS A MEAL REPLACEMENT, IN CLASS 5 (U.S. CLS. 6, 18, 44, 46, 51 AND 52).

FIRST USE 3-0-2000; IN COMMERCE 3-0-2000.

OWNER OF U.S. REG. NO. 2,087,566.

SER. NO. 78-295,032, FILED 9-2-2003.

BRIDGETT SMITH, EXAMINING ATTORNEY

Int. Cls.: 24 and 35

Prior U.S. Cls.: 42, 50, 100, 101 and 102

United States Patent and Trademark Office

Reg. No. 2,893,426

Registered Oct. 12, 2004

**TRADEMARK
SERVICE MARK
PRINCIPAL REGISTER**

TIMEOUT TOWELS

KOLOGY, KIMBERLY (UNITED STATES INDIVIDUAL)
P.O. BOX 1493
HARWICH, MA 02645

FOR: TEXTILES, NAMELY TOWELS FOR BATHING, SWIMMING, SUNBATHING, SPORTS AND RECREATION, IN CLASS 24 (U.S. CLS. 42 AND 50).

FIRST USE 4-1-2002; IN COMMERCE 4-1-2002.

FOR: RETAIL STORES FEATURING TOWELS, WHOLESALE STORES FEATURING TOWELS, MAIL ORDER CATALOG SERVICES FEATURING

TOWELS, COMPUTERIZED ON-LINE ORDERING SERVICES IN THE FIELD OF TOWELS, IN CLASS 35 (U.S. CLS. 100, 101 AND 102).

FIRST USE 4-1-2002; IN COMMERCE 4-1-2002.

NO CLAIM IS MADE TO THE EXCLUSIVE RIGHT TO USE "TOWELS", APART FROM THE MARK AS SHOWN.

SER. NO. 78-295,102, FILED 9-2-2003.

STEPHANIE DAVIS, EXAMINING ATTORNEY

Int. Cl.: 27

Prior U.S. Cls.: 19, 20, 37, 42 and 50

United States Patent and Trademark Office

Reg. No. 2,893,427

Registered Oct. 12, 2004

**TRADEMARK
PRINCIPAL REGISTER**

BARRIER ISLAND COLLECTION

JENNINGS, MARTIN (UNITED STATES INDIVIDUAL)
2829 PEACHTREE ROAD, N.E.
ATLANTA, GA 30305 AND
JENNINGS, KATHY T. (UNITED STATES INDIVIDUAL)
2829 PEACHTREE ROAD, N.E.
ATLANTA, GA 30305

FIRST USE 3-31-2003; IN COMMERCE 3-31-2003.

NO CLAIM IS MADE TO THE EXCLUSIVE RIGHT TO USE "COLLECTION", APART FROM THE MARK AS SHOWN.

SER. NO. 78-295,462, FILED 9-3-2003.

FOR: RUGS AND RUG RUNNERS, IN CLASS 27
(U.S. CLS. 19, 20, 37, 42 AND 50).

TONI HICKEY, EXAMINING ATTORNEY

Int. Cls.: 9 and 42

Prior U.S. Cls.: 21, 23, 26, 36, 38, 100 and 101

United States Patent and Trademark Office

Reg. No. 2,893,428

Registered Oct. 12, 2004

**TRADEMARK
SERVICE MARK
PRINCIPAL REGISTER**

KSTATION

IKNOW LLC (DELAWARE LTD LIAB CO)
100 OVERLOOK CENTER, 2ND FLOOR
PRINCETON, NJ 085407814

FOR: COMPUTER SOFTWARE, NAMELY, SOFTWARE FOR INFORMATION AND KNOWLEDGE MANAGEMENT, CONTENT MANAGEMENT, TAXONOMY MANAGEMENT, DATABASE MANAGEMENT, COLLABORATION, MESSAGING, GROUPWARE, PORTALS, TEXT PROCESSING AND TEXT ANALYSIS, DATA MINING, DATA MODELING, DATA VISUALIZATION, ANALYSIS OF DATA, SIMULATION, EXPERT SYSTEMS, AND/OR ARTIFICIAL INTELLIGENCE, SOLD AS A UNIT, IN CLASS 9 (U.S. CLS. 21, 23, 26, 36 AND 38).

FIRST USE 2-1-2003; IN COMMERCE 2-1-2003.

FOR: COMPUTER SERVICES, NAMELY, PROVIDING NON-DOWNLOADABLE COMPUTER

SOFTWARE, NAMELY, SOFTWARE FOR INFORMATION AND KNOWLEDGE MANAGEMENT, CONTENT MANAGEMENT, TAXONOMY MANAGEMENT, DATABASE MANAGEMENT, COLLABORATION, MESSAGING, GROUPWARE, PORTALS, TEXT PROCESSING AND TEXT ANALYSIS, DATA MINING, DATA MODELING, DATA VISUALIZATION, ANALYSIS OF DATA, SIMULATION, EXPERT SYSTEMS, ARTIFICIAL INTELLIGENCE, AND/OR RELATED SOFTWARE FUNCTIONALITY, FROM A HOSTED LOCATION TO END USERS ON THE INTERNET AND/OR ON CORPORATE INTRANETS, IN CLASS 42 (U.S. CLS. 100 AND 101).

FIRST USE 2-1-2003; IN COMMERCE 2-1-2003.

SER. NO. 78-295,699, FILED 9-3-2003.

ZACHARY BELLO, EXAMINING ATTORNEY

Int. Cl.: 42

Prior U.S. Cls.: 100 and 101

United States Patent and Trademark Office

Reg. No. 2,893,429

Registered Oct. 12, 2004

**SERVICE MARK
PRINCIPAL REGISTER**

PRICEFLO

PRICEFLO, INC. (DELAWARE CORPORATION)
2441 205TH STREET, SUITE C200C
TORRANCE, CA 90503

FOR: ONLINE SERVICES, NAMELY, PROVID-
ING SEARCH ENGINES AND DATABASES FOR
FACILITATING SEARCHING, SHOPPING AND
PURCHASING GOODS AND SERVICES OF OTH-

ERS VIA A GLOBAL COMPUTER NETWORK, IN
CLASS 42 (U.S. CLS. 100 AND 101).

FIRST USE 5-1-2003; IN COMMERCE 7-1-2003.

SER. NO. 78-295,783, FILED 9-3-2003.

AMY GEARIN, EXAMINING ATTORNEY

Int. Cl.: 35

Prior U.S. Cls.: 100, 101 and 102

United States Patent and Trademark Office

Reg. No. 2,893,430

Registered Oct. 12, 2004

**SERVICE MARK
PRINCIPAL REGISTER**

ZEPPELIN BEACH

SEDGWICK, MAYA R. (UNITED STATES INDIVIDUAL)
2716 GRANT ST.
BERKELEY, CA 94703

FIRST USE 5-3-2003; IN COMMERCE 5-3-2003.

SER. NO. 78-295,917, FILED 9-4-2003.

FOR: ON-LINE RETAIL SERVICES AND RETAIL STORE SERVICES IN THE FIELD OF ARTWORK, PHOTOS, AND AUDIO AND VIDEO RECORDINGS, IN CLASS 35 (U.S. CLS. 100, 101 AND 102).

ELLEN B. AWRICH, EXAMINING ATTORNEY

Int. Cls.: 4, 21 and 35

**Prior U.S. Cls.: 1, 2, 6, 13, 15, 23, 29, 30, 33, 40, 50,
100, 101 and 102**

Reg. No. 2,893,431

United States Patent and Trademark Office

Registered Oct. 12, 2004

**TRADEMARK
SERVICE MARK
PRINCIPAL REGISTER**

ILLUMINATIONS

ILLUMINATIONS.COM, INC. (DELAWARE CORPORATION)
1995 SOUTH MCDOWELL BOULEVARD
PETALUMA, CA 94954

FOR: CANDLES, IN CLASS 4 (U.S. CLS. 1, 6 AND 15).

FIRST USE 8-30-1996; IN COMMERCE 8-30-1996.

FOR: CANDLE HOLDERS MADE OF NON-PRECIOUS METAL, IN CLASS 21 (U.S. CLS. 2, 13, 23, 29, 30, 33, 40 AND 50).

FIRST USE 8-30-1996; IN COMMERCE 8-30-1996.

FOR: RETAIL STORE SERVICES, ONLINE RETAIL STORE SERVICES, AND MAIL ORDER CATALOG SERVICES FEATURING CANDLES, CANDLE HOLDERS AND ACCESSORIES, GIFT ITEMS, TABLETOP DECORATIONS, MIRRORS, FURNITURE, CRYSTAL, AND PICTURE FRAMES, IN CLASS 35 (U.S. CLS. 100, 101 AND 102).

FIRST USE 8-30-1996; IN COMMERCE 8-30-1996.

OWNER OF U.S. REG. NO. 2,165,202.

SER. NO. 78-296,412, FILED 9-5-2003.

GEOFFREY FOSDICK, EXAMINING ATTORNEY

Int. Cl.: 39

Prior U.S. Cls.: 100 and 105

United States Patent and Trademark Office

Reg. No. 2,893,432

Registered Oct. 12, 2004

**SERVICE MARK
PRINCIPAL REGISTER**

FEDEX IXF

FEDERAL EXPRESS CORPORATION (DELA-
WARE CORPORATION)
BUILDING B, 3RD FLOOR
3620 HACKS CROSS ROAD
MEMPHIS, TN 38125

FOR: PICK-UP, TRANSPORTATION AND DELIV-
ERY OF DOCUMENTS, PACKAGES AND FREIGHT
BY LAND AND AIR, IN CLASS 39 (U.S. CLS. 100
AND 105).

FIRST USE 7-31-2001; IN COMMERCE 7-31-2001.

OWNER OF U.S. REG. NOS. 1,311,503, 2,096,998
AND OTHERS.

SER. NO. 78-296,661, FILED 9-5-2003.

RAUL CORDOVA, EXAMINING ATTORNEY

Int. Cl.: 31

Prior U.S. Cls.: 1 and 46

United States Patent and Trademark Office

Reg. No. 2,893,433

Registered Oct. 12, 2004

**TRADEMARK
PRINCIPAL REGISTER**

WOOBIE'S DOG HOUSE BISCUITS

THOMAS, NATALIE (UNITED STATES INDIVIDUAL)
2510 - 150TH PLACE S.W.
LYNNWOOD, WA 98037

NO CLAIM IS MADE TO THE EXCLUSIVE RIGHT TO USE "BISCUITS" , APART FROM THE MARK AS SHOWN.

FOR: DOG BISCUITS, IN CLASS 31 (U.S. CLS. 1 AND 46).

SER. NO. 78-296,872, FILED 9-5-2003.

FIRST USE 1-1-2003; IN COMMERCE 3-31-2003.

KHANH LE, EXAMINING ATTORNEY

Int. Cl.: 42

Prior U.S. Cls.: 100 and 101

United States Patent and Trademark Office

Reg. No. 2,893,434

Registered Oct. 12, 2004

**SERVICE MARK
PRINCIPAL REGISTER**

EISERV

KUBRICHT, THEODORE, JOHN (UNITED
STATES INDIVIDUAL)
5925 STAR LANE
HOUSTON, TX 77057

FIRST USE 4-28-1999; IN COMMERCE 4-28-1999.

SER. NO. 78-297,007, FILED 9-7-2003.

FOR: ENGINEERING, IN CLASS 42 (U.S. CLS. 100
AND 101).

STEPHANIE DAVIS, EXAMINING ATTORNEY

Int. Cl.: 6

Prior U.S. Cls.: 2, 12, 13, 14, 23, 25 and 50

Reg. No. 2,893,435

United States Patent and Trademark Office

Registered Oct. 12, 2004

**TRADEMARK
PRINCIPAL REGISTER**

AWT

ACTION WINDOOR TECHNOLOGY, INC.
(TEXAS CORPORATION)
1312 W CROSBY ROAD
CARROLLTON, TX 75006

FIRST USE 10-5-1999; IN COMMERCE 10-5-1999.

SER. NO. 78-297,115, FILED 9-8-2003.

FOR: ALUMINUM WINDOWS FOR RESIDENTIAL USES, IN CLASS 6 (U.S. CLS. 2, 12, 13, 14, 23, 25 AND 50).

BRETT J. GOLDEN, EXAMINING ATTORNEY

Int. Cl.: 19

Prior U.S. Cls.: 1, 12, 33 and 50

United States Patent and Trademark Office

Reg. No. 2,893,436

Registered Oct. 12, 2004

**TRADEMARK
PRINCIPAL REGISTER**

AWT

ACTION WINDOOR TECHNOLOGY, INC.
(TEXAS CORPORATION)
1312 W CROSBY ROAD
CARROLLTON, TX 75006

FIRST USE 10-5-1999; IN COMMERCE 10-5-1999.

SER. NO. 78-297,129, FILED 9-8-2003.

FOR: VINYL WINDOWS FOR RESIDENTIAL
USES, IN CLASS 19 (U.S. CLS. 1, 12, 33 AND 50).

BRETT J. GOLDEN, EXAMINING ATTORNEY

Int. Cl.: 7

Prior U.S. Cls.: 13, 19, 21, 23, 31, 34 and 35

United States Patent and Trademark Office

Reg. No. 2,893,437

Registered Oct. 12, 2004

**TRADEMARK
PRINCIPAL REGISTER**

JET PRESS PLUS

HALM INDUSTRIES CO., INC. (NEW YORK
CORPORATION)
180 GLEN HEAD ROAD
GLEN HEAD, NY 115451995

FOR: COMMERCIAL OFFSET DOCUMENT
PRINTING PRESSES, IN CLASS 7 (U.S. CLS. 13, 19,
21, 23, 31, 34 AND 35).

FIRST USE 9-8-2003; IN COMMERCE 9-8-2003.

OWNER OF U.S. REG. NOS. 2,572,862, 2,577,470,
AND 2,687,843.

NO CLAIM IS MADE TO THE EXCLUSIVE
RIGHT TO USE "PRESS", APART FROM THE
MARK AS SHOWN.

SER. NO. 78-297,167, FILED 9-8-2003.

PRISCILLA MILTON, EXAMINING ATTORNEY

Int. Cl.: 35

Prior U.S. Cls.: 100, 101 and 102

United States Patent and Trademark Office

Reg. No. 2,893,438

Registered Oct. 12, 2004

**SERVICE MARK
PRINCIPAL REGISTER**

BALTIMORE DISPLAY INDUSTRIES

OUTPOST TRADING COMPANY, LLC (MARY-
LAND LIMITED LIABILITY CORPORATION)
1900 BAYARD STREET
BALTIMORE, MD 21230

FOR: RETAIL STORE SERVICES FEATURING
MANNEQUINS, INTERIOR FIXTURES, DISPLAY
SYSTEMS, MATERIALS AND SUPPLIES FOR USE
IN A RETAIL ENVIRONMENT, IN CLASS 35 (U.S.
CLS. 100, 101 AND 102).

FIRST USE 0-0-1946; IN COMMERCE 0-0-1946.

NO CLAIM IS MADE TO THE EXCLUSIVE
RIGHT TO USE DISPLAY INDUSTRIES, APART
FROM THE MARK AS SHOWN.

SEC. 2(F).

SER. NO. 78-297,434, FILED 9-8-2003.

ROBERT LORENZO, EXAMINING ATTORNEY

Int. Cl.: 16

Prior U.S. Cls.: 2, 5, 22, 23, 29, 37, 38 and 50

Reg. No. 2,893,439

United States Patent and Trademark Office

Registered Oct. 12, 2004

**TRADEMARK
PRINCIPAL REGISTER**

MICROMATE

VALLEY FORGE TAPE & LABEL CO., INC.
(PENNSYLVANIA CORPORATION)
119 SUMMIT DRIVE
EXTON, PA 193412889

CAL INDUSTRIES, IN CLASS 16 (U.S. CLS. 2, 5, 22, 23,
29, 37, 38 AND 50).

FIRST USE 5-1-2003; IN COMMERCE 5-1-2003.

FOR: GOODS ARE PRINTED SELF-ADHESIVE
LABELS WHICH CAN BE WRITTEN ON BY THE
USER, AND WHICH WILL BE APPLIED TO 1;5 ML
PLASTIC MICRO TUBES OR SIMILAR VESSELS
USED IN THE PHARMACEUTICAL AND BIOLOGI-

SER. NO. 78-297,500, FILED 9-8-2003.

MELVIN AXILBUND, EXAMINING ATTORNEY

Int. Cl.: 35

Prior U.S. Cls.: 100, 101 and 102

United States Patent and Trademark Office

Reg. No. 2,893,440

Registered Oct. 12, 2004

**SERVICE MARK
PRINCIPAL REGISTER**

ARCHERY COUNTRY

ARCHERY COUNTRY LLC (TEXAS CORPORATION)
8910 F-5 RESEARCH BLVD
AUSTIN, TX 78758

NO CLAIM IS MADE TO THE EXCLUSIVE
RIGHT TO USE "ARCHERY", APART FROM THE
MARK AS SHOWN.

FOR: RETAIL STORE SERVICES IN THE FIELD
OF ARCHERY AND HUNTING, IN CLASS 35 (U.S.
CLS. 100, 101 AND 102).

SER. NO. 78-297,963, FILED 9-9-2003.

FIRST USE 7-1-2003; IN COMMERCE 7-1-2003.

CHERYL CLAYTON, EXAMINING ATTORNEY

Int. Cl.: 9

Prior U.S. Cls.: 21, 23, 26, 36 and 38

United States Patent and Trademark Office

Reg. No. 2,893,441

Registered Oct. 12, 2004

**TRADEMARK
PRINCIPAL REGISTER**

MECOCOKEDCD.COM

BOSTON HEADJOINT CO. (NEW YORK CORPORATION), DBA DRELINGER HEADJOINT CO.

P. O. BOX 146
N. WHITE PLAINS, NY 10603

FOR: PRERECORDED MEDIA, NAMELY, COMPACT DISCS FEATURING MUSIC, IN CLASS 9 (U.S. CLS. 21, 23, 26, 36 AND 38).

FIRST USE 4-15-2002; IN COMMERCE 4-15-2002.

SER. NO. 78-298,798, FILED 9-10-2003.

TRACY CROSS, EXAMINING ATTORNEY

Prior U.S. Cl.: B

United States Patent and Trademark Office

Reg. No. 2,893,442

Registered Oct. 12, 2004

CERTIFICATION MARK
PRINCIPAL REGISTER



PPG INDUSTRIES OHIO, INC. (DELAWARE CORPORATION)
3800 WEST 143RD STREET
CLEVELAND, OH 44111

FOR: RESTORATION IN THE FIELD OF AUTOMOBILES, IN CLASS B (U.S. CL. B).

FIRST USE 12-1-2002; IN COMMERCE 12-1-2002.

NO CLAIM IS MADE TO THE EXCLUSIVE RIGHT TO USE CERTIFIED, NETWORK AND QUALITY RATED AUTO BODY REPAIR, APART FROM THE MARK AS SHOWN.

THE MARK AS USED BY PERSONS AUTHORIZED BY THE CERTIFIER, CERTIFIES THAT THE AUTOMOBILE REPAIR SHOPS DISPLAYING THIS MARK COMPLY WITH THE STANDARDS FOR AUTOMOBILE REPAIR AND RESTORATION ESTABLISHED BY THE OWNER OF THE MARK.

SER. NO. 78-298,814, FILED 9-10-2003.

JEFF DEFORD, EXAMINING ATTORNEY

Int. Cl.: 9

Prior U.S. Cls.: 21, 23, 26, 36 and 38

Reg. No. 2,893,443

United States Patent and Trademark Office

Registered Oct. 12, 2004

**TRADEMARK
PRINCIPAL REGISTER**

ROBOT

BOX OFFICE TICKETS, INC. (MARYLAND CORPORATION)
818 SW 3RD AVENUE PMB 213
PORTLAND, OR 972042405

FOR: COMPUTER SOFTWARE FOR THE REMOTE GENERATION OF TICKETS FOR EVENTS; COMPUTER HARDWARE, NAMELY, PRINTERS,

CREDIT CARD READERS AND BAR CODE SCANNERS, IN CLASS 9 (U.S. CLS. 21, 23, 26, 36 AND 38).

FIRST USE 12-1-2003; IN COMMERCE 12-1-2003.

SER. NO. 78-298,923, FILED 9-11-2003.

LESLEY LAMOTHE, EXAMINING ATTORNEY

Int. Cl.: 18

Prior U.S. Cls.: 1, 2, 3, 22 and 41

United States Patent and Trademark Office

Reg. No. 2,893,444

Registered Oct. 12, 2004

TRADEMARK
PRINCIPAL REGISTER



THE COLORADO SADDLERY COMPANY (COL-
ORADO CORPORATION)
1631 15TH STREET
DENVER, CO 80202

FOR: SADDLES, SADDLE BAGS, SADDLE
PACKS, PANNIERS FOR HORSES, BRIDLES FOR
HORSES, BREAST COLLARS, REINS, BREECH-
INGS, FEED BAGS FOR ANIMALS, PADS FOR
HORSE SADDLES, HORSE BLANKETS, STIRRUPS
OF LEATHER, WOOD, AND PLASTIC, BITS FOR
ANIMALS, HACKAMORES, NOSEBAND COVERS,
SLOBBER STRAPS, SPUR STRAPS, CURB STRAPS,
HORSE HALTERS, BOSELS, MARTINGALES, LATI-
GOES, CINCHES, BILLETS, BUCKING ROLLS, HOB-
BLES, MANE COVERS, CRUPPERS, HORN WRAPS,
WHIPS, BELL STRAPS, STALL GUARDS, BRIDLE
BRACKETS, TWITCHES, FLY MASKS FOR

HORSES, HOOF PICKS, NECK WRAPS, HOOF
GUARDS, SPLINT BOOTS, SKID BOOTS, HORSE
BOOTS, ANIMAL HIDES, LEATHER SOLD IN
BULK, HARNESS STRAPS, IN CLASS 18 (U.S. CLS.
1, 2, 3, 22 AND 41).

FIRST USE 0-0-1945; IN COMMERCE 0-0-1946.

NO CLAIM IS MADE TO THE EXCLUSIVE
RIGHT TO USE "SADDLERY", APART FROM THE
MARK AS SHOWN.

SEC. 2(F) AS TO "COLORADO" AND "DENVER".

SER. NO. 78-299,088, FILED 9-11-2003.

MICHAEL KEATING, EXAMINING ATTORNEY

Int. Cl.: 5

Prior U.S. Cls.: 6, 18, 44, 46, 51 and 52

United States Patent and Trademark Office

Reg. No. 2,893,445

Registered Oct. 12, 2004

**TRADEMARK
PRINCIPAL REGISTER**

PROCALYX

ALCON, INC. (SWITZERLAND CORPORATION)
BOSCH 69
CH-6331 HUNENBERG, SWITZERLAND

PRIORITY CLAIMED UNDER SEC. 44(D) ON
SWITZERLAND APPLICATION NO. 52621/2003,
FILED 7-23-2003, REG. NO. 513314, DATED 8-7-2003,
EXPIRES 7-23-2013.

FOR: OPHTHALMIC PHARMACEUTICAL PRE-
PARATION FOR THE TREATMENT OF DRY EYES,
IN CLASS 5 (U.S. CLS. 6, 18, 44, 46, 51 AND 52).

SER. NO. 78-299,297, FILED 9-11-2003.

CHERYL CLAYTON, EXAMINING ATTORNEY

Int. Cl.: 3

Prior U.S. Cls.: 1, 4, 6, 50, 51 and 52

United States Patent and Trademark Office

Reg. No. 2,893,446

Registered Oct. 12, 2004

TRADEMARK
PRINCIPAL REGISTER



BEAUTY HOLDING COMPANY, INC. (DELAWARE CORPORATION)
25 CHURCH STREET
HAMILTON, BERMUDA BM HM12

FOR: BABY OIL, POWDER AND SHAMPOO; NON-MEDICATED BATH SALTS; BEAUTY MASKS; BLUSHER; BODY GLITTER; BODY SPRAY; BREATH FRESHENER; BUBBLE BATH; COLOGNE; COSMETICS, NAMELY, COMPACTS AND PENCILS; COTTON PUFFS AND SWABS FOR COSMETIC PURPOSES AND PERSONAL USE; CREAMS, NAMELY, BODY, COLD, EYE, HAIR REMOVING, HAND, NIGHT, SHAVING, SKIN CLEANSING, SKIN AND VANISHING; PERSONAL DEODORANTS; EMERY BOARDS; ENAMEL FOR NAILS; ESSENTIAL OILS FOR PERSONAL USE; EYE SHADOW AND LINER; FACIAL SCRUBS; GELS, NAMELY, BATH, HAIR, SHAVING, SHOWER AND TOOTH; NON-MEDICATED HAIR CARE PREPARATIONS; HAIR CLEANING PREPARATIONS; HAIR CONDITIONER; HAIR SPRAY; INCENSE; NON-MEDICATED LIP BALM; LIP GLOSS; LIPSTICK; LOTIONS, NAMELY, SKIN, HAIR, FACIAL, BODY AND HAIR WAVING; MAKEUP, NAMELY, EYE, FACIAL AND FOUNDATION; MASCARA; MOUTHWASH; NAIL BUFFING PREPARATIONS; NAIL CARE PREPARATIONS; NAIL ENAMEL; NAIL GROOMING PRODUCTS, NAMELY, TIPS, GLUE, LACQUER AND GLITTER; NAIL HARD-

ENERS; NAIL POLISH; FALSE NAILS; OILS, NAMELY, BABY, BATH, BODY AND MASSAGE; PENCILS, NAMELY, COSMETIC, EYE AND EYEBROW; PERFUME; POTPOURRI; POWDER, NAMELY, BABY, BATH, BODY, FACE, TALCUM AND NON-MEDICATED FOOT; PRE-MOISTENED COSMETIC TISSUES, TOWELETTES AND WIPES; ROUGE; SACHETS; SHAMPOO, NAMELY, BABY AND HAIR; SKIN CLARIFIERS, CLEANSING CREAM, EMOLLIENTS, LIGHTENERS, LOTION, MOISTURIZER, SOAP AND TONERS; SOAP, NAMELY, DEODORANT, SKIN AND TOILET; LIQUID SOAPS FOR HANDS, FACE AND BODY; SUN BLOCK AND SCREEN PREPARATIONS; SUN TANNING PREPARATIONS; TOOTH PASTE, IN CLASS 3 (U.S. CLS. 1, 4, 6, 50, 51 AND 52).

FIRST USE 10-1-2002; IN COMMERCE 1-2-2003.

THE MARK CONSISTS OF STYLIZED LETTERING FOR THE WORDS BEE KISSED AND AN IMAGE OF A HONEY BEE SUPER IMPOSED ON A HONEY COMB PATTERN. APPLICANT DOES NOT CLAIM COLOR AS A FEATURE OF THE MARK.

SER. NO. 78-299,411, FILED 9-11-2003.

SOPHIA S. KIM, EXAMINING ATTORNEY

Int. Cl.: 36

Prior U.S. Cls.: 100, 101 and 102

United States Patent and Trademark Office

Reg. No. 2,893,447

Registered Oct. 12, 2004

**SERVICE MARK
PRINCIPAL REGISTER**

HUNTINGTON AT WORK

HUNTINGTON BANCSHARES INCORPORATED
(MARYLAND CORPORATION)
41 S. HIGH STREET
COLUMBUS, OH 43215

OWNER OF U.S. REG. NOS. 2,066,160, 2,475,384
AND OTHERS.

FOR: BANKING SERVICES, IN CLASS 36 (U.S.
CLS. 100, 101 AND 102).

SER. NO. 78-299,746, FILED 9-12-2003.

FIRST USE 5-19-2003; IN COMMERCE 5-19-2003.

DEZMONA MIZELLE, EXAMINING ATTORNEY

Int. Cl.: 6

Prior U.S. Cls.: 2, 12, 13, 14, 23, 25 and 50

United States Patent and Trademark Office

Reg. No. 2,893,448

Registered Oct. 12, 2004

**TRADEMARK
PRINCIPAL REGISTER**

C118

THOMAS & BETTS INTERNATIONAL, INC. (DE-
LAWARE CORPORATION)
250 LILLARD DRIVE
SPARKS, NV 89434

FIRST USE 12-31-1999; IN COMMERCE 12-31-1999.

SER. NO. 78-299,835, FILED 9-12-2003.

FOR: METAL CABLE CLAMPS; METAL PIPE
CLAMPS, IN CLASS 6 (U.S. CLS. 2, 12, 13, 14, 23, 25
AND 50).

PAULA MAHONEY, EXAMINING ATTORNEY

Int. Cls.: 2 and 16

Prior U.S. Cls.: 2, 5, 6, 11, 16, 22, 23, 29, 37, 38 and 50

United States Patent and Trademark Office

Reg. No. 2,893,449

Registered Oct. 12, 2004

**TRADEMARK
PRINCIPAL REGISTER**

*Decorative
Effects*

LF, LLC (DELAWARE LTD LIAB CO)
2601 ANNAND DRIVE, SUITE 17
WILMINGTON, DE 19808

FOR: PAINTS IN THE NATURE OF FAUX FINISHES, IN CLASS 2 (U.S. CLS. 6, 11 AND 16).

FIRST USE 2-14-1997; IN COMMERCE 2-14-1997.

FOR: INSTRUCTIONAL BOOKS AND BOOKLETS IN THE FIELD OF PAINTS AND FAUX FINISHES, SAMPLE CARDS AND COLOR CHIPS OF PAINTS

AND FAUX FINISHES, IN CLASS 16 (U.S. CLS. 2, 5, 22, 23, 29, 37, 38 AND 50).

FIRST USE 2-14-1997; IN COMMERCE 2-14-1997.

OWNER OF U.S. REG. NO. 2,153,208.

SEC. 2(F).

SER. NO. 78-300,197, FILED 9-15-2003.

ZACHARY BELLO, EXAMINING ATTORNEY

Int. Cl.: 9

Prior U.S. Cls.: 21, 23, 26, 36 and 38

United States Patent and Trademark Office

Reg. No. 2,893,450

Registered Oct. 12, 2004

**TRADEMARK
PRINCIPAL REGISTER**

QUANTISPECT

AMERSHAM PLC (UNITED KINGDOM CORPORATION)
AMERSHAM PLACE
LITTLE CHALFONT, UNITED KINGDOM HP7 9NA

FOR: COMPUTER PROGRAMS AND SOFTWARE
FOR USE IN RELATION TO MEDICAL AND DIAGNOSTIC IMAGING, IN CLASS 9 (U.S. CLS. 21, 23, 26, 36 AND 38).

PRIORITY CLAIMED UNDER SEC. 44(D) ON
UNITED KINGDOM APPLICATION NO. 2341127,
FILED 8-19-2003, REG. NO. 2341127, DATED 8-19-
2003, EXPIRES 8-19-2013.

SER. NO. 78-300,229, FILED 9-15-2003.

HOWARD SMIGA, EXAMINING ATTORNEY

Int. Cl.: 35

Prior U.S. Cls.: 100, 101 and 102

United States Patent and Trademark Office

Reg. No. 2,893,451

Registered Oct. 12, 2004

**SERVICE MARK
PRINCIPAL REGISTER**

THE AUSSIE OUTPOST

A.G.S. AUSTRALIAN GLOBAL SERVICES, INC.
(OHIO CORPORATION)
121 EAST MAIN STREET
LOUDONVILLE, OH 44842

FIRST USE 7-1-2003; IN COMMERCE 7-1-2003.

FOR: RETAIL STORE SERVICES AND ONLINE
MAIL ORDER SERVICES FOR AUSTRALIAN AND
ABORIGINAL MADE PRODUCTS, NAMELY
CLOTHING, FOOTWEAR, COATS, HATS, JEWEL-
RY, COLLECTIBLES, TOYS, BOOMERANGS, ART
WORK, RUGS, WOOL PRODUCTS, TOOLS, AND
HARDWARE, IN CLASS 35 (U.S. CLS. 100, 101 AND
102).

NO CLAIM IS MADE TO THE EXCLUSIVE
RIGHT TO USE "AUSSIE", APART FROM THE
MARK AS SHOWN.

SER. NO. 78-300,773, FILED 9-16-2003.

STEVEN BERK, EXAMINING ATTORNEY

Int. Cl.: 2

Prior U.S. Cls.: 6, 11 and 16

United States Patent and Trademark Office

Reg. No. 2,893,452

Registered Oct. 12, 2004

**TRADEMARK
PRINCIPAL REGISTER**

NANO-LOCK

PRINT-LOCK CORP. (NEVADA CORPORATION)
SUITE 2422
850 S. RANCHO DRIVE
LAS VEGAS, NV 89106

AND DIVERSION DETECTION , IN CLASS 2 (U.S.
CLS. 6, 11 AND 16).

FIRST USE 1-14-2004; IN COMMERCE 1-4-2004.

FOR: MULTI-COMPONENT MARKING SYSTEM
CONSISTING PRIMARILY OF TAGGANTS IN THE
NATURE OF COATINGS, INKS, OR COLORANTS
FOR MARKING GOODS FOR AUTHENTICATION

SER. NO. 78-300,863, FILED 9-16-2003.

MARC LEIPZIG, EXAMINING ATTORNEY

Int. Cl.: 42

Prior U.S. Cls.: 100 and 101

United States Patent and Trademark Office

Reg. No. 2,893,453

Registered Oct. 12, 2004

**SERVICE MARK
PRINCIPAL REGISTER**

HORNSBY LAW

HORNSBY, LAWRENCE (UNITED STATES IN-
DIVIDUAL)
1936 LEE ROAD, SUITE 100
WINTER PARK, FL 32789

FOR: LEGAL SERVICES IN THE FIELD OF
PERSONAL INJURY, WRONGFUL DEATH, WORK-
ER'S COMPENSATION AND MEDICAL MALPRAC-
TICE, IN CLASS 42 (U.S. CLS. 100 AND 101).

FIRST USE 1-1-2002; IN COMMERCE 11-0-2002.

NO CLAIM IS MADE TO THE EXCLUSIVE
RIGHT TO USE "LAW", APART FROM THE MARK
AS SHOWN.

SER. NO. 78-300,904, FILED 9-16-2003.

KENNETH D. BATTLE, EXAMINING ATTORNEY

Int. Cl.: 16

Prior U.S. Cls.: 2, 5, 22, 23, 29, 37, 38 and 50

United States Patent and Trademark Office

Reg. No. 2,893,454

Registered Oct. 12, 2004

**TRADEMARK
PRINCIPAL REGISTER**

CHANDLER CONNECTION

FREEDOM ARIZONA INFORMATION, INC. (CALIFORNIA CORPORATION)
17666 FITCH
IRVINE, CA 92614

FIRST USE 2-0-2001; IN COMMERCE 2-0-2001.

SER. NO. 78-301,184, FILED 9-16-2003.

FOR: NEWSPAPERS FOR GENERAL CIRCULATION, IN CLASS 16 (U.S. CLS. 2, 5, 22, 23, 29, 37, 38 AND 50).

ALEX KEAM, EXAMINING ATTORNEY

Int. Cls.: 16 and 21

**Prior U.S. Cls.: 2, 5, 13, 22, 23, 29, 30, 33, 37, 38, 40
and 50**

Reg. No. 2,893,455

United States Patent and Trademark Office

Registered Oct. 12, 2004

**TRADEMARK
PRINCIPAL REGISTER**



KIDSTAR LLC (COLORADO CORPORATION)
207 YUMA STREET
DENVER, CO 80223

FOR: CRAYONS PAPER PLACEMATS, IN CLASS
16 (U.S. CLS. 2, 5, 22, 23, 29, 37, 38 AND 50).

FIRST USE 5-1-1997; IN COMMERCE 5-1-1997.

FOR: PLASTIC CUPS, IN CLASS 21 (U.S. CLS. 2, 13,
23, 29, 30, 33, 40 AND 50).

FIRST USE 5-1-1997; IN COMMERCE 8-29-2001.

THE COLOR(S) BLUE APPEARS IN THE WORD
"KIDSTAR", THE COLOR BLUE OUTLINES THE
"STAR", THE COLOR YELLOW APPEARS IN THE
"STAR" ARE CLAIMED AS A FEATURE OF THE
MARK.

THE MARK CONSISTS OF THE WORD KIDSTAR
IN BLUE WITH A YELLOW STAR AT THE END.

SER. NO. 78-301,507, FILED 9-17-2003.

STEPHANIE DAVIS, EXAMINING ATTORNEY

Int. Cl.: 37

Prior U.S. Cls.: 100, 103 and 106

United States Patent and Trademark Office

Reg. No. 2,893,456

Registered Oct. 12, 2004

**SERVICE MARK
PRINCIPAL REGISTER**

TERMICON

TERMICON EXTERMINATORS, INC. (CALIFORNIA CORPORATION)
3831 ARDEN DRIVE
EL MONTE, CA 91731

FOR: TERMITE AND PEST CONTROL SERVICES;
VERMIN EXTERMINATION OTHER THAN FOR
AGRICULTURE, NAMELY EXTERMINATION OF

TERMITES AND WOOD DESTROYING ORGANISMS, IN CLASS 37 (U.S. CLS. 100, 103 AND 106).

FIRST USE 10-9-1996; IN COMMERCE 10-9-1996.

SER. NO. 78-301,515, FILED 9-17-2003.

STEVEN BERK, EXAMINING ATTORNEY

Int. Cl.: 9

Prior U.S. Cls.: 21, 23, 26, 36 and 38

Reg. No. 2,893,457

United States Patent and Trademark Office

Registered Oct. 12, 2004

**TRADEMARK
PRINCIPAL REGISTER**



INE S.P.A (ITALY SOCIETA PER AZIONI)
VIA FACCA 10
CITTADELLA, ITALY 35013

FIRST USE 0-0-1951; IN COMMERCE 7-24-2003.

SER. NO. 78-301,739, FILED 9-17-2003.

FOR: ELECTRODES FOR WELDING OF CAR-
BON AND LOW ALLOY STEELS, IN CLASS 9 (U.S.
CLS. 21, 23, 26, 36 AND 38).

GEOFFREY FOSDICK, EXAMINING ATTORNEY

Int. Cl.: 36

Prior U.S. Cls.: 100, 101 and 102

United States Patent and Trademark Office

Reg. No. 2,893,458

Registered Oct. 12, 2004

**SERVICE MARK
PRINCIPAL REGISTER**

PUTTING THE WORLD IN THE PALM OF YOUR HAND

NATIONAL FINANCIAL SERVICES GROUP INC
(DELAWARE CORPORATION)
GALLERIA 2/PH, 2 BRIDGE AVENUE
RED BANK, NJ 07701

FOR: FINANCIAL SERVICES, NAMELY ASSUMING FINANCIAL RISK OF OTHERS BY ENTERING INTO OPTIONS AND SWAPS, FINANCIAL ANALYSIS AND CONSULTATION, FINANCIAL FORECASTING, FINANCIAL INFORMATION PROVIDED BY ELECTRONIC MEANS, FINANCIAL INVESTMENT IN THE FIELD OF REAL ESTATE, SECURITIES, MORTGAGES, RIETS (REAL ESTATE INVESTMENT TRUSTS), CORPORATE AND MUNICIPAL BONDS AND INSURANCE, FINANCIAL MANAGEMENT, FINANCIAL PLANNING, FINANCIAL PORTFOLIO MANAGEMENT, FINANCIAL

RESEARCH, FINANCIAL SERVICES IN THE NATURE OF AN INVESTMENT SECURITY, FINANCIAL SERVICES IN THE FIELD OF MONEY LENDING, FINANCIAL SERVICES, NAMELY, INVESTMENT FUND TRANSFER AND TRANSACTION SERVICES, FINANCIAL STATEMENT PREPARATION AND ANALYSIS FOR BUSINESSES, FINANCIAL VALUATION OF PERSONAL PROPERTY AND REAL ESTATE, IN CLASS 36 (U.S. CLS. 100, 101 AND 102).

FIRST USE 3-1-2003; IN COMMERCE 3-1-2003.

SER. NO. 78-301,827, FILED 9-17-2003.

WILLIAM VERHOSEK, EXAMINING ATTORNEY

Int. Cl.: 14

Prior U.S. Cls.: 2, 27, 28 and 50

United States Patent and Trademark Office

Reg. No. 2,893,459

Registered Oct. 12, 2004

**TRADEMARK
PRINCIPAL REGISTER**

LVJ

PHOENIX JEWELRY MFG. INC. (FLORIDA
CORPORATION)
1499 NW 79 AVENUE
MIAMI, FL 33126

FIRST USE 9-19-2003; IN COMMERCE 9-19-2003.

SER. NO. 78-301,982, FILED 9-18-2003.

FOR: JEWELRY, IN CLASS 14 (U.S. CLS. 2, 27, 28
AND 50).

YONG KIM, EXAMINING ATTORNEY

Int. Cl.: 41

Prior U.S. Cls.: 100, 101 and 107

United States Patent and Trademark Office

Reg. No. 2,893,460

Registered Oct. 12, 2004

**SERVICE MARK
PRINCIPAL REGISTER**



AUSTIN CINEMA DRAFTHOUSE, INC. (TEXAS CORPORATION)
409 COLORADO ST.
SUITE B
AUSTIN, TX 78701

NO CLAIM IS MADE TO THE EXCLUSIVE RIGHT TO USE "ROADSHOW", APART FROM THE MARK AS SHOWN.

FOR: ENTERTAINMENT SERVICES, NAMELY, CINEMA THEATER SERVICES, IN CLASS 41 (U.S. CLS. 100, 101 AND 107).

SER. NO. 78-302,289, FILED 9-18-2003.

FIRST USE 5-1-2002; IN COMMERCE 5-1-2002.

BRETT J. GOLDEN, EXAMINING ATTORNEY

Int. Cl.: 35

Prior U.S. Cls.: 100, 101 and 102

United States Patent and Trademark Office

Reg. No. 2,893,461

Registered Oct. 12, 2004

**SERVICE MARK
PRINCIPAL REGISTER**



CAMPO ENTERPRISES LLC (KENTUCKY CORPORATION)
3110 FAIRVIEW DRIVE, SUITE 106
OWENSBORO, KY 42303

FOR: STRATEGIC SEARCH CONSULTING FIRM, RECRUITER, HEADHUNTER, STAFFING, AND PLACEMENT, NAMELY, EMPLOYMENT HIRING, RECRUITING, PLACEMENT, STAFFING, AND CAREER NETWORKING SERVICES, IN CLASS 35 (U.S. CLS. 100, 101 AND 102).

FIRST USE 5-21-2003; IN COMMERCE 5-21-2003.

NO CLAIM IS MADE TO THE EXCLUSIVE RIGHT TO USE "STRATEGIC HEALTHCARE SEARCH CONSULTANTS", APART FROM THE MARK AS SHOWN.

SER. NO. 78-302,438, FILED 9-18-2003.

BRIAN PINO, EXAMINING ATTORNEY

Int. Cl.: 41

Prior U.S. Cls.: 100, 101 and 107

United States Patent and Trademark Office

Reg. No. 2,893,462

Registered Oct. 12, 2004

**SERVICE MARK
PRINCIPAL REGISTER**

**NANOWORLD "...HARMONIZING THINGS SEEN AND NOT SEEN." -
S.A.G.**

LAVIANO, ANTHONY F. (UNITED STATES IN-
DIVIDUAL)
16651 LINDA TERRACE
PACIFIC PALISADES, CA 90272

NANOTECHNOLOGY, IN CLASS 41 (U.S. CLS. 100,
101 AND 107).

FIRST USE 1-0-2003; IN COMMERCE 8-12-2003.

FOR: EDUCATIONAL SERVICES, NAMELY,
CONDUCTING PRESENTATIONS, CONFERENCES,
SEMINARS, AND WORKSHOPS IN THE FIELD OF

SER. NO. 78-302,463, FILED 9-18-2003.

DOMINICK J. SALEMI, EXAMINING ATTORNEY

Int. Cl.: 9

Prior U.S. Cls.: 21, 23, 26, 36 and 38

Reg. No. 2,893,463

United States Patent and Trademark Office

Registered Oct. 12, 2004

**TRADEMARK
PRINCIPAL REGISTER**

MOBIO

CRYPTOLEX, INC. (DELAWARE CORPORATION)
1843 GROVE STREET, SUITE #2
BOULDER, CO 80302

FINANCIAL TRANSACTIONS, IN CLASS 9 (U.S. CLS. 21, 23, 26, 36 AND 38).

FIRST USE 5-5-2003; IN COMMERCE 5-5-2003.

FOR: COMPUTER HARDWARE, NAMELY, FINGERPRINT READER AND SOFTWARE FOR USE IN SECURITY, IDENTITY MANAGEMENT, AND

SER. NO. 78-302,669, FILED 9-19-2003.

JILL C. ALT, EXAMINING ATTORNEY

Int. Cl.: 9

Prior U.S. Cls.: 21, 23, 26, 36 and 38

Reg. No. 2,893,464

United States Patent and Trademark Office

Registered Oct. 12, 2004

**TRADEMARK
PRINCIPAL REGISTER**

HANDECODER

PROVISTAS, INCORPORATED (DELAWARE
CORPORATION)
12 DONGAN PLACE #203
NEW YORK, NY 100401592

FOR: COMPUTER SOFTWARE FOR FINDING
AND STORING PROCEDURE CODES AND FEES,
DIAGNOSIS CODES, AND COMPLIANT COMBINA-
TIONS OF THE CODES ACCORDING TO FEDERAL
REGULATION FOR USE IN MEDICAL CODING,

BILLING AND COMPLIANCE, IN CLASS 9 (U.S.
CLS. 21, 23, 26, 36 AND 38).

FIRST USE 9-12-2002; IN COMMERCE 12-2-2002.

SER. NO. 78-302,772, FILED 9-19-2003.

TONI HICKEY, EXAMINING ATTORNEY

Int. Cl.: 5

Prior U.S. Cls.: 6, 18, 44, 46, 51 and 52

United States Patent and Trademark Office

Reg. No. 2,893,465

Registered Oct. 12, 2004

**TRADEMARK
PRINCIPAL REGISTER**



PHD PRODUCTS, INC. (NEW YORK CORPORATION)
11 CLEARBROOK ROAD
ELMSFORD, NY 10523

OWNER OF U.S. REG. NOS. 2,115,323 AND
2,356,576.

FOR: PET FOOD SUPPLEMENTS, IN CLASS 5
(U.S. CLS. 6, 18, 44, 46, 51 AND 52).

SER. NO. 78-303,383, FILED 9-22-2003.

FIRST USE 12-31-1996; IN COMMERCE 12-31-1996.

TRACY FLETCHER, EXAMINING ATTORNEY

Int. Cl.: 35

Prior U.S. Cls.: 100, 101 and 102

United States Patent and Trademark Office

Reg. No. 2,893,466

Registered Oct. 12, 2004

**SERVICE MARK
PRINCIPAL REGISTER**

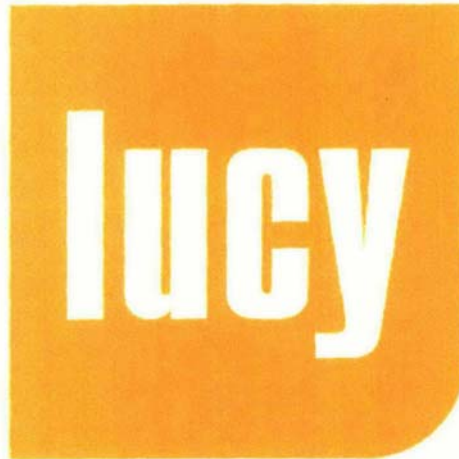

LUCY ACTIVEWEAR, INC. (DELAWARE CORPORATION)
3135 NW INDUSTRIAL STREET
PORTLAND, OR 97210

FOR: RETAIL STORE SERVICES FEATURING ATHLETIC CLOTHING AND SPORT BAGS, IN CLASS 35 (U.S. CLS. 100, 101 AND 102).

FIRST USE 12-18-2000; IN COMMERCE 12-18-2000.

OWNER OF U.S. REG. NOS. 2,701,054 AND 2,782,156.

THE COLOR(S) ORANGE IS/ARE CLAIMED AS A FEATURE OF THE MARK.

THE MARK CONSISTS OF A SQUARE WITH ONE ROUNDED CORNER IN THE COLOR ORANGE ON WHICH THE WORD LUCY APPEARS.

SER. NO. 78-303,736, FILED 9-22-2003.

H. M. FISHER, EXAMINING ATTORNEY

Int. Cl.: 29

Prior U.S. Cl.: 46

United States Patent and Trademark Office

Reg. No. 2,893,467

Registered Oct. 12, 2004

**TRADEMARK
PRINCIPAL REGISTER**

NOSHER'S DELIGHT

JACK TUCHTEN WHOLESALE PRODUCE, INC.
(ILLINOIS CORPORATION)
2404 S. WOLCOTT AVENUE, SUITE 31
CHICAGO, IL 60608

FIRST USE 12-31-1997; IN COMMERCE 6-13-2001.

SER. NO. 78-303,841, FILED 9-22-2003.

FOR: SNACK MIX CONSISTING PRIMARILY OF
DRIED MIXED FRUIT, IN CLASS 29 (U.S. CL. 46).

TONI HICKEY, EXAMINING ATTORNEY

Int. Cl.: 35

Prior U.S. Cls.: 100, 101 and 102

United States Patent and Trademark Office

Reg. No. 2,893,468

Registered Oct. 12, 2004

**SERVICE MARK
PRINCIPAL REGISTER**

TURQUOISE VILLAGE

PROMOTIONAL SALES, INC. (ARIZONA CORPORATION)
P.O. BOX 429
ZUNI, NM 87327

OWNER OF U.S. REG. NO. 2,642,499.

FOR: ON-LINE AND RETAIL STORE SERVICES
FEATURING ZUNI INDIAN JEWELRY, TURQUOISE
AND SILVER INDIAN JEWELRY, INDIAN
ART AND NATIVE AMERICAN CRAFTS, IN CLASS
35 (U.S. CLS. 100, 101 AND 102).

NO CLAIM IS MADE TO THE EXCLUSIVE
RIGHT TO USE "TURQUOISE", APART FROM
THE MARK AS SHOWN.

SER. NO. 78-303,862, FILED 9-22-2003.

FIRST USE 12-31-1978; IN COMMERCE 12-31-1978.

TONI HICKEY, EXAMINING ATTORNEY

Int. Cl.: 41

Prior U.S. Cls.: 100, 101 and 107

United States Patent and Trademark Office

Reg. No. 2,893,469

Registered Oct. 12, 2004

**TRADEMARK
PRINCIPAL REGISTER**

PICTURERITE

ADAMS, DENNY (UNITED STATES INDIVIDUAL)
70 KINDALL CIRCLE
PALM HARBOR, FL 34683

FIRST USE 1-1-2003; IN COMMERCE 1-1-2003.

SER. NO. 78-304,003, FILED 9-23-2003.

FOR: PHOTOGRAPHY SERVICES, IN CLASS 41
(U.S. CLS. 100, 101 AND 107).

MICHAEL WEBSTER, EXAMINING ATTORNEY

Int. Cls.: 43 and 44

Prior U.S. Cls.: 100 and 101

United States Patent and Trademark Office

Reg. No. 2,893,470

Registered Oct. 12, 2004

**SERVICE MARK
PRINCIPAL REGISTER**

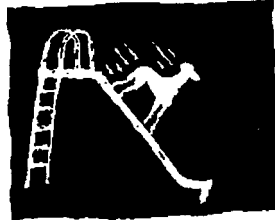

City Bark

K-9 KARE, LLC (COLORADO LTD LIAB CO)
370 KALAMATH STREET
DENVER, CO 80223

FOR: KENNEL SERVICES AND DOG DAY CARE,
IN CLASS 43 (U.S. CLS. 100 AND 101).

FIRST USE 9-1-2003; IN COMMERCE 9-1-2003.

FOR: PET SITTING AND ANIMAL GROOMING,
IN CLASS 44 (U.S. CLS. 100 AND 101).

FIRST USE 9-1-2003; IN COMMERCE 9-1-2003.

SER. NO. 78-304,135, FILED 9-23-2003.

SUSAN STIGLITZ, EXAMINING ATTORNEY

Int. Cls.: 25 and 41

Prior U.S. Cls.: 22, 39, 100, 101 and 107

Reg. No. 2,893,471

United States Patent and Trademark Office

Registered Oct. 12, 2004

**TRADEMARK
SERVICE MARK
PRINCIPAL REGISTER**

BONUS MOM

JANN BLACKSTONE-FORD (UNITED STATES
INDIVIDUAL)
5480 FAIRWAY COURT
DISCOVERY BAY, CA 94514

FOR: T-SHIRTS, CAPS, IN CLASS 25 (U.S. CLS. 22
AND 39).

FIRST USE 4-1-1993; IN COMMERCE 1-1-2002.

FOR: EDUCATIONAL WEBSITE FEATURING
AWARD PROGRAMS TO DEMONSTRATE EXCEL-

LENCE AND PROVIDE RECOGNITION AND IN-
CENTIVES IN THE FIELD OF CO-PARENTING
AFTER SEPARATION OR DIVORCE, IN CLASS 41
(U.S. CLS. 100, 101 AND 107).

FIRST USE 1-1-1999; IN COMMERCE 1-1-1999.

SER. NO. 78-304,138, FILED 9-23-2003.

JENNIFER CHICOSKI, EXAMINING ATTORNEY

Int. Cls.: 36 and 37

Prior U.S. Cls.: 100, 101, 102, 103 and 106

United States Patent and Trademark Office

Reg. No. 2,893,472

Registered Oct. 12, 2004

**SERVICE MARK
PRINCIPAL REGISTER**



CLUB ACQUISITION COMPANY (COLORADO
LTD LIAB CO)
2260 SOUTH XANADU WAY, SUITE 340
AURORA, CO 80014

FOR: RECREATIONAL REAL ESTATE MAN-
AGEMENT; RECREATIONAL REAL ESTATE
AGENCIES, IN CLASS 36 (U.S. CLS. 100, 101 AND
102).

FIRST USE 6-0-1999; IN COMMERCE 6-0-1999.

FOR: RECREATIONAL REAL ESTATE DEVEL-
OPMENT, IN CLASS 37 (U.S. CLS. 100, 103 AND 106).

FIRST USE 6-0-1999; IN COMMERCE 6-0-1999.

OWNER OF U.S. REG. NOS. 2,739,596 AND
2,741,055.

NO CLAIM IS MADE TO THE EXCLUSIVE
RIGHT TO USE "SAN FELIPE, BAJA, MEXICO",
APART FROM THE MARK AS SHOWN.

SER. NO. 78-304,335, FILED 9-23-2003.

RAUL CORDOVA, EXAMINING ATTORNEY

Int. Cl.: 30

Prior U.S. Cl.: 46

United States Patent and Trademark Office

Reg. No. 2,893,473

Registered Oct. 12, 2004

**TRADEMARK
PRINCIPAL REGISTER**

GRAFFITI ZOO

HUTCHISON, SHERRI DAWN (UNITED STATES
INDIVIDUAL)
303 CAMPBELL ROAD
COVINGTON, GA 30014

FIRST USE 6-1-1988; IN COMMERCE 6-1-2002.

SER. NO. 78-304,657, FILED 9-24-2003.

FOR: CHOCOLATE, IN CLASS 30 (U.S. CL. 46).

PRISCILLA MILTON, EXAMINING ATTORNEY

Int. Cl.: 43

Prior U.S. Cls.: 100 and 101

United States Patent and Trademark Office

Reg. No. 2,893,474

Registered Oct. 12, 2004

**SERVICE MARK
PRINCIPAL REGISTER**

HAVANA HARRY'S

HAVANA HARRYS I (FLORIDA CORPORATION)
4612 LEJEUNE ROAD
CORAL GABLES, FL 33146

THE NAME HAVANA HARRY'S DOES NOT
IDENTIFY A LIVING INDIVIDUAL.

FOR: RESTAURANT SERVICES, IN CLASS 43
(U.S. CLS. 100 AND 101).

SER. NO. 78-304,873, FILED 9-24-2003.

FIRST USE 12-16-1996; IN COMMERCE 12-16-1996.

SHAUNIA WALLACE, EXAMINING ATTORNEY

Int. Cl.: 35

Prior U.S. Cls.: 100, 101 and 102

United States Patent and Trademark Office

Reg. No. 2,893,475

Registered Oct. 12, 2004

**SERVICE MARK
PRINCIPAL REGISTER**



EMERALD COAST RV CENTER, INC. (FLORIDA CORPORATION)
6240 GULF BREEZE PARKWAY
GULF BREEZE, FL 32563

FOR: RECREATIONAL VEHICLE/RV DEALERSHIP SERVICES AND RETAIL STORE SERVICES FEATURING PARTS AND ACCESSORIES FOR RE-

CREATIONAL VEHICLES , IN CLASS 35 (U.S. CLS. 100, 101 AND 102).

FIRST USE 0-0-1992; IN COMMERCE 0-0-1992.

SER. NO. 78-305,433, FILED 9-25-2003.

LESLIE RICHARDS, EXAMINING ATTORNEY

Int. Cls.: 16, 41 and 42

Prior U.S. Cls.: 2, 5, 22, 23, 29, 37, 38, 50, 100, 101 and 107

Reg. No. 2,893,476

United States Patent and Trademark Office

Registered Oct. 12, 2004

**TRADEMARK
SERVICE MARK
PRINCIPAL REGISTER**

**PREVENTIVE STRATEGIES AND POSITIVE SOLUTIONS FOR THE
WORKPLACE**

JACKSON LEWIS, LLP (PARTNERSHIP)
59 MAIDEN LANE
NEW YORK, NY 10038

FOR: PRINTED PUBLICATIONS, NAMELY BOOKS, MANUALS, JOURNALS AND NEWSLETTERS, PRINTED TRAINING AND SEMINAR BOOKLETS, BROCHURES AND PAMPHLETS, ALL IN THE FIELD OF EMPLOYMENT AND LABOR LAW, IN CLASS 16 (U.S. CLS. 2, 5, 22, 23, 29, 37, 38 AND 50).

FIRST USE 1-1-2003; IN COMMERCE 1-1-2003.

FOR: EDUCATIONAL SERVICES, NAMELY CONDUCTING WORKSHOPS, SEMINARS, CONFERENCES, CLASSES AND CLINICS IN THE FIELD OF LABOR AND EMPLOYMENT LAW; ON-LINE

PUBLICATIONS IN THE FORM OF ELECTRONIC NEWSLETTERS, ARTICLES, AND JOURNALS IN THE FIELD OF EMPLOYMENT AND LABOR LAW, IN CLASS 41 (U.S. CLS. 100, 101 AND 107).

FIRST USE 1-1-2003; IN COMMERCE 1-1-2003.

FOR: LEGAL SERVICES; AND PROVIDING INFORMATION IN THE FIELD OF EMPLOYMENT AND LABOR LAW, IN CLASS 42 (U.S. CLS. 100 AND 101).

FIRST USE 1-1-2003; IN COMMERCE 1-1-2003.

SER. NO. 78-305,478, FILED 9-25-2003.

CURTIS FRENCH, EXAMINING ATTORNEY

Int. Cl.: 41

Prior U.S. Cls.: 100, 101 and 107

United States Patent and Trademark Office

Reg. No. 2,893,477

Registered Oct. 12, 2004

**SERVICE MARK
PRINCIPAL REGISTER**

FEEL BEAUTIFUL

JENNIFER LOOMIS PHOTOGRAPHY (WA-
SHINGTON CORPORATION)
1618 22ND AVENUE
SEATTLE, WA 98122

FIRST USE 1-21-2001; IN COMMERCE 1-21-2001.

SER. NO. 78-305,697, FILED 9-25-2003.

FOR: PHOTOGRAPHY SERVICES, NAMELY,
PHOTOGRAPHING PREGNANT WOMEN, IN
CLASS 41 (U.S. CLS. 100, 101 AND 107).

GLENN CLARK, EXAMINING ATTORNEY

Int. Cl.: 44

Prior U.S. Cls.: 100 and 101

United States Patent and Trademark Office

Reg. No. 2,893,478

Registered Oct. 12, 2004

**SERVICE MARK
PRINCIPAL REGISTER**



ILLINOIS BONE & JOINT INSTITUTE

ILLINOIS BONE AND JOINT INSTITUTE, LTD.
(ILLINOIS PROFESSIONAL SERVICE COR-
PORATION)
2454 DEMPSTER, SUITE 207
DES PLAINES, IL 60016

FIRST USE 7-1-2002; IN COMMERCE 7-1-2002.

NO CLAIM IS MADE TO THE EXCLUSIVE
RIGHT TO USE "ILLINOIS BONE AND JOINT
INSTITUTE", APART FROM THE MARK AS
SHOWN.

FOR: HEALTH CARE SERVICES IN THE FIELD
OF ORTHOPAEDICS, MEDICAL AND CLINICAL
SERVICES, IN THE FIELD OF PHYSICAL REHABI-
LITATION AND THERAPY, DIAGNOSTIC IMA-
GING AND EMERGENCY CARE SERVICES, IN
CLASS 44 (U.S. CLS. 100 AND 101).

SER. NO. 78-305,753, FILED 9-26-2003.

ALLISON HOLTZ, EXAMINING ATTORNEY

Int. Cl.: 36

Prior U.S. Cls.: 100, 101 and 102

United States Patent and Trademark Office

Reg. No. 2,893,479

Registered Oct. 12, 2004

**SERVICE MARK
PRINCIPAL REGISTER**



DUNHAM, TIMOTHY M. (UNITED STATES IN-
DIVIDUAL)
958 LEWISTON ROAD
TOPSHAM, ME 04087

FIRST USE 8-8-2003; IN COMMERCE 8-8-2003.

FOR: REAL ESTATE BROKERAGE, NAMELY
RESIDENTIAL AND COMMERCIAL REAL ESTATE
BROKERAGE, IN CLASS 36 (U.S. CLS. 100, 101 AND
102).

SER. NO. 78-305,858, FILED 9-26-2003.

PAULA MAYS, EXAMINING ATTORNEY

Int. Cl.: 35

Prior U.S. Cls.: 100, 101 and 102

United States Patent and Trademark Office

Reg. No. 2,893,480

Registered Oct. 12, 2004

**SERVICE MARK
PRINCIPAL REGISTER**

FRANSURVEY

JOHNSON FRANCHISE CONSULTING, INC.
(NEBRASKA CORPORATION)
2330 SOUTH 75TH STREET
LINCOLN, NE 68506

FOR: CONDUCTING BUSINESS RESEARCH
AND SURVEYS, NAMELY, CONDUCTING AN
ON-LINE SURVEY WHICH ACCUMULATES IN-
FORMATION FROM EXISTING FRANCHISEES
AND THEN DISSEMINATES THE INFORMATION

TO FRANCHISE COMPANIES AND TO PROSPEC-
TIVE FRANCHISEES, IN CLASS 35 (U.S. CLS. 100, 101
AND 102).

FIRST USE 7-15-2003; IN COMMERCE 7-15-2003.

SER. NO. 78-305,864, FILED 9-26-2003.

KATHRYN COWARD, EXAMINING ATTORNEY

Int. Cls.: 6 and 19

Prior U.S. Cls.: 1, 2, 12, 13, 14, 23, 25, 33 and 50

United States Patent and Trademark Office

Reg. No. 2,893,481

Registered Oct. 12, 2004

**TRADEMARK
PRINCIPAL REGISTER**

WILLIAMSBURG

THE COLONIAL WILLIAMSBURG FOUNDATION (VIRGINIA NON-STOCK CORPORATION)
POST OFFICE BOX 1776
WILLIAMSBURG, VA 23187

FOR: METAL HARDWARE, NAMELY, GATE STRAPS, HINGES AND LATCHES, IN CLASS 6 (U.S. CLS. 2, 12, 13, 14, 23, 25 AND 50).

FIRST USE 12-31-1989; IN COMMERCE 12-31-1989.

FOR: NON-METAL GATES AND FENCES, IN CLASS 19 (U.S. CLS. 1, 12, 33 AND 50).

FIRST USE 12-31-1989; IN COMMERCE 12-31-1989.

OWNER OF U.S. REG. NOS. 678,070, 2,625,351 AND OTHERS.

SEC. 2(F).

SER. NO. 78-306,059, FILED 9-26-2003.

APRIL L. RADEMACHER, EXAMINING ATTORNEY

Int. Cl.: 42

Prior U.S. Cls.: 100 and 101

United States Patent and Trademark Office

Reg. No. 2,893,482

Registered Oct. 12, 2004

**SERVICE MARK
PRINCIPAL REGISTER**



SPACE HOLDING CORP. (DELAWARE CORPORATION)
470 PARK AVENUE SOUTH-9TH FLOOR
NEW YORK, NY 10016

FOR: COMPUTER SERVICES, NAMELY PROVIDING ON-LINE INTERACTIVE AND NON-INTERACTIVE DATABASE INFORMATION, FEATURING NEWS, INFORMATION, AND DATA ALL CONCERNING SPACE AND PLANETARY EXPLORATION, THE GLOBAL SPACE INDUSTRY, SATELLITE MISSIONS, ASTRONOMY AND SCIENTIFIC DISCOVERIES RELATED TO THE UNIVERSE, UNEXPLAINED PHENOMENA AND

SCIENCE FICTION, IN CLASS 42 (U.S. CLS. 100 AND 101).

FIRST USE 10-0-2000; IN COMMERCE 10-0-2000.

NO CLAIM IS MADE TO THE EXCLUSIVE RIGHT TO USE ".COM", APART FROM THE MARK AS SHOWN.

SER. NO. 78-306,113, FILED 9-26-2003.

JACQUELINE A. LAVINE, EXAMINING ATTORNEY

Int. Cl.: 6

Prior U.S. Cls.: 2, 12, 13, 14, 23, 25 and 50

United States Patent and Trademark Office

Reg. No. 2,893,483

Registered Oct. 12, 2004

**TRADEMARK
PRINCIPAL REGISTER**

QUICK KIT

THE BOC GROUP, INC. (DELAWARE COR-
PORATION)
575 MOUNTAIN AVE.
MURRAY HILL, NJ 07974

NO CLAIM IS MADE TO THE EXCLUSIVE
RIGHT TO USE "KIT", APART FROM THE MARK
AS SHOWN.

FOR: COMMERCIAL CONTAINERS OF METAL
FOR TRANSPORTING SEMICONDUCTOR PRO-
CESSING EQUIPMENT, IN CLASS 6 (U.S. CLS. 2,
12, 13, 14, 23, 25 AND 50).

SER. NO. 78-307,061, FILED 9-30-2003.

FIRST USE 10-19-1999; IN COMMERCE 10-19-1999.

KIM SAITO, EXAMINING ATTORNEY

Int. Cl.: 9

Prior U.S. Cls.: 21, 23, 26, 36 and 38

Reg. No. 2,893,484

United States Patent and Trademark Office

Registered Oct. 12, 2004

**TRADEMARK
PRINCIPAL REGISTER**

FANSHOT

FANSHOT, LLC (OHIO LTD LIAB CO)
1178 JOYCE AVE.
COLUMBUS, OH 43219

FIRST USE 11-1-1999; IN COMMERCE 12-1-1999.

SER. NO. 78-307,415, FILED 9-30-2003.

FOR: DISPOSABLE CAMERAS AND FILM SOLD
AS A UNIT, IN CLASS 9 (U.S. CLS. 21, 23, 26, 36 AND
38).

MATTHEW KLINE, EXAMINING ATTORNEY

Int. Cl.: 35

Prior U.S. Cls.: 100, 101 and 102

United States Patent and Trademark Office

Reg. No. 2,893,485

Registered Oct. 12, 2004

**SERVICE MARK
PRINCIPAL REGISTER**

LONGREACH

LONGREACH EXPORT & INVESTMENT COM-
PANY, INC. (NORTH CAROLINA CORPORA-
TION)
13915 HASTINGS FARM ROAD
HUNTERSVILLE, NC 28078

FIRST USE 2-1-2002; IN COMMERCE 2-1-2002.

SER. NO. 78-307,430, FILED 9-30-2003.

FOR: IMPORT AND EXPORT AGENCIES FEA-
TURING MACHINE PARTS, IN CLASS 35 (U.S. CLS.
100, 101 AND 102).

ROBERT LORENZO, EXAMINING ATTORNEY

Int. Cl.: 9

Prior U.S. Cls.: 21, 23, 26, 36 and 38

Reg. No. 2,893,486

United States Patent and Trademark Office

Registered Oct. 12, 2004

**TRADEMARK
PRINCIPAL REGISTER**

PROLENDER

PROLENDER SOLUTIONS, INC. (CALIFORNIA
CORPORATION)
6050 SANTO ROAD, SUITE 160
SAN DIEGO, CA 92124

A LOCAL AREA NETWORK OR THE INTERNET ,
IN CLASS 9 (U.S. CLS. 21, 23, 26, 36 AND 38).

FIRST USE 0-0-2002; IN COMMERCE 0-0-2002.

FOR: COMPUTER SOFTWARE FOR MORTGAGE
LENDERS THAT AUTOMATES LOAN FILE PRO-
CESSING, MANAGEMENT AND REPORTING VIA

SER. NO. 78-307,770, FILED 9-30-2003.

JENNIFER CHICOSKI, EXAMINING ATTORNEY

Int. Cls.: 2 and 9

Prior U.S. Cls.: 6, 11, 16, 21, 23, 26, 36 and 38

United States Patent and Trademark Office

Reg. No. 2,893,487

Registered Oct. 12, 2004

**TRADEMARK
PRINCIPAL REGISTER**

MODERN TECHNOLOGY/OLD FASHIONED SERVICE

SUPERIOR PRINTING INK CO., INC. (NEW
YORK CORPORATION)
70 BETHUNE STREET
NEW YORK, NY 10014

FOR: PRINTING INKS, IN CLASS 2 (U.S. CLS. 6, 11
AND 16).

FIRST USE 10-28-1983; IN COMMERCE 10-28-1983.

FOR: SOFTWARE FOR USE IN COLOR MIXING
IN PRINTING PROCESSES, IN CLASS 9 (U.S. CLS. 21,
23, 26, 36 AND 38).

FIRST USE 1-1-2002; IN COMMERCE 1-1-2002.

SER. NO. 78-308,093, FILED 10-1-2003.

ANDREW BENZMILLER, EXAMINING ATTOR-
NEY

Int. Cl.: 25

Prior U.S. Cls.: 22 and 39

United States Patent and Trademark Office

Reg. No. 2,893,488

Registered Oct. 12, 2004

**TRADEMARK
PRINCIPAL REGISTER**

KIRRA

PACIFIC SUNWEAR OF CALIFORNIA (CALIFORNIA CORPORATION)
3450 EAST MIRALOMA AVENUE
ANAHEIM, CA 928062101

FOR: MEN, WOMEN AND CHILDREN'S APPAREL, NAMELY, HATS, CAPS, VISORS, HOODS, BERETS, HEAD BANDS, SWEAT BANDS, EAR MUFFS, GLOVES, MITTENS, WRIST BANDS, SUSPENDERS, BELTS, SOCKS, STOCKINGS, PANTY-HOSE, BODYSUITS, LEOTARDS, LEGGINGS, SWEAT SOCKS, THERMAL SOCKS, SHOES, SNEAKERS, GALOSHES, WADERS, BOOTS, SANDALS, SLIPPERS, KERCHIEFS, SCARVES, MUFFLERS, BANDANNAS, NECKERCHIEFS, VESTS, PAJAMAS, ROBES, KIMONOS, CAFTANS, SMOCKS, APRONS, BOXER SHORTS, BRIEFS, UNDERPANTS, CORSETS, CORSELETS, GIRDLES, BRASSIERES, BUSTIERS, CHEMISES, TEDDIES, CAMISOLES, SLIPS, NEGLIGEEES, PEIGNOIRS, SHIRTS, BLOUSES, KNIT TOPS, DRESSES, SKIRTS, JUMPSUITS, PANT SUITS, ROMPERS, SWIMMING TRUNKS, WET SUITS, THERMAL UNDERWEAR, UNDERSHIRTS, TUNICS, TANK TOPS, COTTON WOVEN SHIRTS, KNIT SHIRTS, POLO SHIRTS, T-SHIRTS, SWEAT

SHIRTS, CREW NECK SWEATERS, V-NECK SWEATERS, TURTLENECK SWEATERS, CARDIGANS, SUITS, JOGGING SUITS, SHORTS, SWEAT SHORTS, JEANS, PANTS, SLACKS, TROUSERS, SWEAT PANTS, SKI SUITS, SKI PANTS, SKI BIBS, CAPES, SHAWLS, BLAZERS, WAISTCOATS, RAIN COATS, OVERCOATS, TOP COATS, SPORT COATS, PARKAS, BOLERO JACKETS, JACKETS, WIND RESISTANT JACKETS, OUTER JACKETS, LEATHER JACKETS, SKI JACKETS, FLANNEL JACKETS, WOOL JACKETS, POLYESTER WOVEN SHIRTS, RAYON WOVEN SHIRTS, WOOL WOVEN SHIRTS, LEATHER COATS, ELASTIC WAIST SHORTS, FIXED WAIST SHORTS, DENIM SHORTS, AND DENIM JACKETS, IN CLASS 25 (U.S. CLS. 22 AND 39).

FIRST USE 8-15-1994; IN COMMERCE 8-15-1994.

OWNER OF U.S. REG. NO. 1,941,758.

SER. NO. 78-308,218, FILED 10-1-2003.

CAROLINE WEIMER, EXAMINING ATTORNEY

Int. Cl.: 6

Prior U.S. Cls.: 2, 12, 13, 14, 23, 25 and 50

United States Patent and Trademark Office

Reg. No. 2,893,489

Registered Oct. 12, 2004

**TRADEMARK
PRINCIPAL REGISTER**

HIBRITE

HILLE & MULLER GMBH (FED REP GERMANY
GMBH)
AM TRIPPELSBERG 48
DUSSELDORF, FED REP GERMANY 40589

FOR: COLD ROLLED STEEL STRIPS, IN CLASS 6
(U.S. CLS. 2, 12, 13, 14, 23, 25 AND 50).

OWNER OF FED REP GERMANY REG. NO.
39931500, DATED 7-30-1999, EXPIRES 6-30-2009.

SER. NO. 78-308,455, FILED 10-2-2003.

SHAUNIA WALLACE, EXAMINING ATTORNEY

Int. Cl.: 42

Prior U.S. Cls.: 100 and 101

United States Patent and Trademark Office

Reg. No. 2,893,490

Registered Oct. 12, 2004

**SERVICE MARK
PRINCIPAL REGISTER**

ARRESTING IMAGES

ARRESTING IMAGES, INC. (NEBRASKA CORPORATION)
P.O. BOX 927
WILBER, NE 68465

FIRST USE 6-10-2001; IN COMMERCE 6-10-2002.

SER. NO. 78-308,464, FILED 10-2-2003.

FOR: STOCK PHOTOGRAPHY SERVICES,
NAMELY, LEASING REPRODUCTION RIGHTS
OF PHOTOGRAPHS AND TRANSPARENCIES TO
OTHERS, IN CLASS 42 (U.S. CLS. 100 AND 101).

KEVON CHISOLM, EXAMINING ATTORNEY

Int. Cl.: 42

Prior U.S. Cls.: 100 and 101

United States Patent and Trademark Office

Reg. No. 2,893,491

Registered Oct. 12, 2004

**SERVICE MARK
PRINCIPAL REGISTER**

ACCELERATING THE SPEED OF BUSINESS

DATASYNAPSE, INC. (DELAWARE CORPORATION)
632 BROADWAY 5TH FLOOR
NEW YORK, NY 10012

FOR: CONSULTING SERVICES RELATED TO
IMPLEMENTATION, MAINTENANCE, MANAGEMENT,
AND/OR MONITORING OF GRID-BASED
COMPUTING PLATFORMS AND/OR GRID-BASED

COMPUTING APPLICATIONS, IN CLASS 42 (U.S.
CLS. 100 AND 101).

FIRST USE 6-30-2003; IN COMMERCE 6-30-2003.

SER. NO. 78-308,542, FILED 10-2-2003.

NAAKWAMA ANKRAH, EXAMINING ATTORNEY

Int. Cl.: 6

Prior U.S. Cls.: 2, 12, 13, 14, 23, 25 and 50

Reg. No. 2,893,492

United States Patent and Trademark Office

Registered Oct. 12, 2004

**TRADEMARK
PRINCIPAL REGISTER**

XP5

PMX INDUSTRIES, INC. (IOWA CORPORATION)
5300 WILLOW CREEK DRIVE SW
CEDAR RAPIDS, IA 52404

FIRST USE 7-2-2003; IN COMMERCE 7-2-2003.

OWNER OF U.S. REG. NO. 2,774,086.

FOR: HIGH PERFORMANCE COPPER ALLOY
PROVIDED IN THE FORM OF SHEETS AND STRIPS
FOR GENERAL INDUSTRIAL USE, IN CLASS 6
(U.S. CLS. 2, 12, 13, 14, 23, 25 AND 50).

SER. NO. 78-308,991, FILED 10-3-2003.

ROBERT COGGINS, EXAMINING ATTORNEY

Int. Cls.: 8, 25 and 41

Prior U.S. Cls.: 22, 23, 28, 39, 44, 100, 101 and 107

United States Patent and Trademark Office

Reg. No. 2,893,493

Registered Oct. 12, 2004

TRADEMARK
SERVICE MARK
PRINCIPAL REGISTER



C&S WILDLIFE SERVICES (ALABAMA LTD
LIAB CO)
PO BOX 790
SMITHS, AL 36877

FOR: OUTDOOR EQUIPMENT, NAMELY, SPORT
AND UTILITY KNIVES, IN CLASS 8 (U.S. CLS. 23, 28
AND 44).

FIRST USE 4-1-2003; IN COMMERCE 4-1-2003.

FOR: CLOTHING, NAMELY T-SHIRTS, SHIRTS,
CAPS AND HATS, IN CLASS 25 (U.S. CLS. 22 AND
39).

FIRST USE 9-1-2002; IN COMMERCE 9-1-2002.

FOR: ENTERTAINMENT SERVICES, NAMELY A
CONTINUING OUTDOOR ENTERTAINMENT
SHOW BROADCAST OVER TELEVISION, AUDIO
AND VIDEO MEDIA, IN CLASS 41 (U.S. CLS. 100, 101
AND 107).

FIRST USE 4-1-2003; IN COMMERCE 4-1-2003.

NO CLAIM IS MADE TO THE EXCLUSIVE
RIGHT TO USE MANAGEMENT, APART FROM
THE MARK AS SHOWN.

SER. NO. 78-309,028, FILED 10-3-2003.

FRED MANDIR, EXAMINING ATTORNEY

Int. Cls.: 35 and 43

Prior U.S. Cls.: 100, 101 and 102

United States Patent and Trademark Office

Reg. No. 2,893,494

Registered Oct. 12, 2004

**SERVICE MARK
PRINCIPAL REGISTER**



PETROPOLIS, INC. (GEORGIA CORPORATION)
112-F ATHENS WEST PARKWAY
ATHENS, GA 30606

FOR: RETAIL PET SUPPLY STORES, IN CLASS 35
(U.S. CLS. 100, 101 AND 102).

FIRST USE 9-1-2003; IN COMMERCE 9-1-2003.

FOR: DOG AND CAT DAY CARE AND KENNEL
SERVICES, IN CLASS 43 (U.S. CLS. 100 AND 101).

FIRST USE 9-1-2003; IN COMMERCE 9-1-2003.

SER. NO. 78-309,540, FILED 10-5-2003.

IRA J. GOODSaid, EXAMINING ATTORNEY

Int. Cl.: 33

Prior U.S. Cls.: 47 and 49

United States Patent and Trademark Office

Reg. No. 2,893,495

Registered Oct. 12, 2004

**TRADEMARK
PRINCIPAL REGISTER**



**MAPLE LEAF
DISTILLERS INC.**

MAPLE LEAF DISTILLERS INC. (CANADA CORPORATION)
251 SAULTEAUX CRESCENT
WINNIPEG, MANITOBA, CANADA R3J 3C7

NO CLAIM IS MADE TO THE EXCLUSIVE RIGHT TO USE "DISTILLERS INC.", APART FROM THE MARK AS SHOWN.

FOR: DISTILLED ALCOHOLIC BEVERAGES; LIQUORS AND LIQUEURS, IN CLASS 33 (U.S. CLS. 47 AND 49).

SER. NO. 78-309,576, FILED 10-6-2003.

FIRST USE 9-1-2002; IN COMMERCE 9-1-2002.

RON FAIRBANKS, EXAMINING ATTORNEY

Int. Cl.: 33

Prior U.S. Cls.: 47 and 49

United States Patent and Trademark Office

Reg. No. 2,893,496

Registered Oct. 12, 2004

**TRADEMARK
PRINCIPAL REGISTER**

MAPLE LEAF DISTILLERS INC.

MAPLE LEAF DISTILLERS INC. (CANADA CORPORATION)
251 SAULTEAUX CRESCENT
WINNIPEG, MANITOBA, CANADA R3J 3C7

FOR: DISTILLED ALCOHOLIC BEVERAGES; LIQUORS AND LIQUEURS, IN CLASS 33 (U.S. CLS. 47 AND 49).

FIRST USE 9-1-2002; IN COMMERCE 9-1-2002.

NO CLAIM IS MADE TO THE EXCLUSIVE RIGHT TO USE "DISTILLERS INC.", APART FROM THE MARK AS SHOWN.

SER. NO. 78-309,593, FILED 10-6-2003.

RON FAIRBANKS, EXAMINING ATTORNEY

Int. Cl.: 41

Prior U.S. Cls.: 100, 101 and 107

United States Patent and Trademark Office

Reg. No. 2,893,497

Registered Oct. 12, 2004

**SERVICE MARK
PRINCIPAL REGISTER**

DIAMOND HEART

DIAMOND HEART AND TRAINING INSTITUTE
(CALIFORNIA CORPORATION)
P.O. BOX 2747
BERKELEY, CA 94702

HUMAN POTENTIAL, IN CLASS 41 (U.S. CLS. 100,
101 AND 107).

FIRST USE 1-1-1988; IN COMMERCE 1-1-1988.

FOR: EDUCATIONAL SERVICES, NAMELY,
CONDUCTING SEMINARS AND WORKSHOPS IN
THE FIELD OF PERSONAL SPIRITUAL DEVELOP-
MENT AND ACTUALIZATION OF INDIVIDUAL

SER. NO. 78-310,036, FILED 10-6-2003.

NAAKWAMA ANKRAH, EXAMINING ATTORNEY

Int. Cl.: 29

Prior U.S. Cl.: 46

United States Patent and Trademark Office

Reg. No. 2,893,498

Registered Oct. 12, 2004

**TRADEMARK
PRINCIPAL REGISTER**

E-Z-REDI

JONMOR INVESTMENTS, INC. (DELAWARE
CORPORATION)
3411 SILVERSIDE AVE.
103 BAYNARD BUILDING
WILMINGTON, DE 19810

OWNER OF U.S. REG. NO. 757,849.

SER. NO. 78-310,107, FILED 10-7-2003.

FOR: MEAT, IN CLASS 29 (U.S. CL. 46).

FIRST USE 4-30-1962; IN COMMERCE 4-30-1962.

KATHRYN COWARD, EXAMINING ATTORNEY

Int. Cl.: 9

Prior U.S. Cls.: 21, 23, 26, 36 and 38

Reg. No. 2,893,499

United States Patent and Trademark Office

Registered Oct. 12, 2004

**TRADEMARK
PRINCIPAL REGISTER**



STARFIELD TECHNOLOGIES (ARIZONA CORPORATION)
14455 N. HAYDEN RD, STE 219
LEGAL DEPT.
SCOTTSDALE, AZ 85260

OWNER OF U.S. REG. NO. 2,821,786.

FOR: COMPUTER SOFTWARE FOR ANALYZING AND ENHANCING A WEB SITE TO INCREASE ITS RANKING ON ONE OR MORE SEARCH ENGINES ON A GLOBAL COMPUTER NETWORK, IN CLASS 9 (U.S. CLS. 21, 23, 26, 36 AND 38).

NO CLAIM IS MADE TO THE EXCLUSIVE RIGHT TO USE TRAFFIC, APART FROM THE MARK AS SHOWN.

SER. NO. 78-310,296, FILED 10-7-2003.

FIRST USE 9-8-2003; IN COMMERCE 9-8-2003.

MELVIN AXILBUND, EXAMINING ATTORNEY

Int. Cl.: 43

Prior U.S. Cls.: 100 and 101

United States Patent and Trademark Office

Reg. No. 2,893,500

Registered Oct. 12, 2004

**SERVICE MARK
PRINCIPAL REGISTER**



KELLER, JAMES C. (UNITED STATES INDIVIDUAL)
1808 EAST FREEMONT
TEMPE, AZ 85282

FIRST USE 8-1-1997; IN COMMERCE 8-1-1997.

SER. NO. 78-310,479, FILED 10-7-2003.

FOR: RESTAURANT AND BAR SERVICES, IN CLASS 43 (U.S. CLS. 100 AND 101).

JANICE L. MCMORROW, EXAMINING ATTORNEY

Int. Cl.: 24

Prior U.S. Cls.: 42 and 50

United States Patent and Trademark Office

Reg. No. 2,893,501

Registered Oct. 12, 2004

**TRADEMARK
PRINCIPAL REGISTER**

CONFORMCAMO

STANISLAWSKI, CRAIG, E (UNITED STATES
INDIVIDUAL)
312 E 8TH ST
WINONA, MN 55987

FIRST USE 10-4-2003; IN COMMERCE 10-7-2003.

SER. NO. 78-310,717, FILED 10-8-2003.

FOR: ADHESIVE TEXTILE CAMOUFLAGE FAB-
RIC, IN CLASS 24 (U.S. CLS. 42 AND 50).

ALICE BENMAMAN, EXAMINING ATTORNEY

Int. Cl.: 35

Prior U.S. Cls.: 100, 101 and 102

United States Patent and Trademark Office

Reg. No. 2,893,502

Registered Oct. 12, 2004

**SERVICE MARK
PRINCIPAL REGISTER**

TIME + PLUS

TIME PLUS, INC. (GEORGIA CORPORATION)
SUITE 650
500 COLONIAL CENTER PARKWAY
ROSWELL, GA 30076

OWNER OF U.S. REG. NOS. 1,872,278 AND
1,930,689.

FOR: PAYROLL PREPARATION; ADMINISTRATION
OF BUSINESS PAYROLL FOR OTHERS, IN
CLASS 35 (U.S. CLS. 100, 101 AND 102).

SER. NO. 78-310,723, FILED 10-8-2003.

FIRST USE 10-10-1989; IN COMMERCE 11-6-1989.

BARBARA A. LOUGHRAN, EXAMINING ATTORNEY

Int. Cl.: 35

Prior U.S. Cls.: 100, 101 and 102

United States Patent and Trademark Office

Reg. No. 2,893,503

Registered Oct. 12, 2004

**SERVICE MARK
PRINCIPAL REGISTER**

BRINGING E-COMMERCE INTO THE INBOX

TRANSACTIS, INC. (DELAWARE CORPORATION)
500 NORTH TOWER
4550 MONTGOMERY AVENUE
BETHESDA, MD 20814

FOR: ELECTRONIC ORDER FULFILLMENT SERVICES VIA ELECTRONIC MAIL AND GLOBAL COMPUTER NETWORK; MARKETING SERVICES, NAMELY CONDUCTING TARGETED MARKETING CAMPAIGNS FOR OTHERS IN THE NATURE OF CONTACTING CURRENT AND FORMER CUSTOMERS VIA ELECTRONIC MAIL; BUSINESS CONSULTING SERVICES IN THE FIELD OF ELECTRONIC COMMERCE AND DIRECT MAR-

KETING ADVERTISING; CONTENT DEVELOPMENT FOR ELECTRONIC COMMERCE AND DIRECT MARKETING ADVERTISING, NAMELY DESIGNING AND DEVELOPING ELECTRONIC MAIL ADVERTISING CAMPAIGNS, IN CLASS 35 (U.S. CLS. 100, 101 AND 102).

FIRST USE 9-12-2003; IN COMMERCE 9-12-2003.

SER. NO. 78-310,837, FILED 10-8-2003.

BARBARA A. LOUGHRAN, EXAMINING ATTORNEY

Int. Cl.: 35

Prior U.S. Cls.: 100, 101 and 102

United States Patent and Trademark Office

Reg. No. 2,893,504

Registered Oct. 12, 2004

**SERVICE MARK
PRINCIPAL REGISTER**

SPOOF-PROOF

TRANSACTIS, INC. (DELAWARE CORPORATION)
500 NORTH TOWER
4500 MONTGOMERY AVENUE
BETHESDA, MD 20814

FOR: ELECTRONIC ORDER FULFILLMENT SERVICES VIA ELECTRONIC MAIL AND GLOBAL COMPUTER NETWORK; MARKETING SERVICES, NAMELY CONDUCTING TARGETED MARKETING CAMPAIGNS FOR OTHERS IN THE NATURE OF CONTACTING CURRENT AND FORMER CUSTOMERS VIA ELECTRONIC MAIL; BUSINESS CONSULTING SERVICES IN THE FIELD OF ELECTRONIC COMMERCE AND DIRECT MAR-

KETING ADVERTISING; CONTENT DEVELOPMENT FOR ELECTRONIC COMMERCE AND DIRECT MARKETING ADVERTISING, NAMELY DESIGNING AND DEVELOPING ELECTRONIC MAIL ADVERTISING CAMPAIGNS, IN CLASS 35 (U.S. CLS. 100, 101 AND 102).

FIRST USE 9-12-2003; IN COMMERCE 9-12-2003.

SER. NO. 78-310,855, FILED 10-8-2003.

BARBARA A. LOUGHRAN, EXAMINING ATTORNEY

Int. Cl.: 36

Prior U.S. Cls.: 100, 101 and 102

United States Patent and Trademark Office

Reg. No. 2,893,505

Registered Oct. 12, 2004

**SERVICE MARK
PRINCIPAL REGISTER**

POWERCHECK

E-LOAN, INC. (DELAWARE CORPORATION)
5875 ARNOLD ROAD
DUBLIN, CA 94568

FIRST USE 12-15-2003; IN COMMERCE 12-15-2003.

SER. NO. 78-311,163, FILED 10-8-2003.

FOR: VEHICLE FINANCING, IN CLASS 36 (U.S.
CLS. 100, 101 AND 102).

LINDA POWELL, EXAMINING ATTORNEY

Int. Cl.: 38

Prior U.S. Cls.: 100, 101 and 104

United States Patent and Trademark Office

Reg. No. 2,893,506

Registered Oct. 12, 2004

**SERVICE MARK
PRINCIPAL REGISTER**

TOTAL TRAFFIC NETWORK

PREMIERE RADIO NETWORKS, INC. (DELA-
WARE CORPORATION)
200 EAST BASSE ROAD
SAN ANTONIO, TX 78209

FOR: RADIO AND TELEVISION BROADCAST-
ING SERVICES, IN CLASS 38 (U.S. CLS. 100, 101 AND
104).

FIRST USE 0-0-1997; IN COMMERCE 0-0-1997.

NO CLAIM IS MADE TO THE EXCLUSIVE
RIGHT TO USE TRAFFIC NETWORK, APART
FROM THE MARK AS SHOWN.

SER. NO. 78-311,230, FILED 10-8-2003.

JANICE L. MCMORROW, EXAMINING ATTOR-
NEY

Int. Cls.: 18 and 25

Prior U.S. Cls.: 1, 2, 3, 22, 39 and 41

United States Patent and Trademark Office

Reg. No. 2,893,507

Registered Oct. 12, 2004

**TRADEMARK
PRINCIPAL REGISTER**

SEPARATED FROM THE PACK

AZORA, L.L.C. (TEXAS LTD LIAB CO)
11020 AUDELIA ROAD, SUITE C-103
DALLAS, TX 752439021

FOR: BACKPACK SYSTEMS, NAMELY, BACK-
PACKS THAT FEATURE INTERCHANGEABLE
MODULAR CONTAINERS, IN CLASS 18 (U.S. CLS.
1, 2, 3, 22 AND 41).

FIRST USE 9-13-2003; IN COMMERCE 9-13-2003.

FOR: CLOTHING, NAMELY, SHIRTS, SHORTS,
PANTS, CLOTHING BELTS, HUNTING AND FISH-
ING VESTS, COATS, JACKETS, PARKAS, RAIN-
WEAR, GLOVES, SHOES, SOCKS, HIKING BOOTS,
HATS, AND SUN VISORS, IN CLASS 25 (U.S. CLS. 22
AND 39).

FIRST USE 9-13-2003; IN COMMERCE 9-13-2003.

SER. NO. 78-311,275, FILED 10-8-2003.

BRETT J. GOLDEN, EXAMINING ATTORNEY

Int. Cl.: 17

Prior U.S. Cls.: 1, 5, 12, 13, 35 and 50

Reg. No. 2,893,508

United States Patent and Trademark Office

Registered Oct. 12, 2004

**TRADEMARK
PRINCIPAL REGISTER**

MF8000

MAGNIFOAM DELAWARE, INC. (DELAWARE
CORPORATION)
8020 WHITEPINE ROAD
RICHMOND, VA 23237

FOR: FLAME RETARDANT SILICONE FOAM
FOR INDUSTRIAL, MASS TRANSIT, AND AERO-
SPACE APPLICATIONS; INSULATING MATERI-
ALS, NAMELY, GASKETS FOR ELECTRICAL
SYSTEMS AND TELECOMMUNICATION SYS-

TEMS, AND FOR OTHER GENERAL INDUSTRIAL
USES, IN CLASS 17 (U.S. CLS. 1, 5, 12, 13, 35 AND 50).

FIRST USE 11-1-2002; IN COMMERCE 7-31-2003.

SER. NO. 78-311,302, FILED 10-9-2003.

JENNIFER KRISP, EXAMINING ATTORNEY

Int. Cl.: 24

Prior U.S. Cls.: 42 and 50

United States Patent and Trademark Office

Reg. No. 2,893,509

Registered Oct. 12, 2004

**TRADEMARK
PRINCIPAL REGISTER**

PCOZY

HYMAN, RITA L. (UNITED STATES INDIVIDUAL)
13 OAKVIEW PLACE
VERNON, CT 06066

FIRST USE 3-1-2003; IN COMMERCE 3-1-2003.

SER. NO. 78-311,336, FILED 10-9-2003.

FOR: FITTED COVERS FOR COMMODOES MADE
OF FABRIC OR FABRIC SUBSTITUTE, IN CLASS 24
(U.S. CLS. 42 AND 50).

KATHERINE STOIDES, EXAMINING ATTORNEY

Int. Cl.: 28

Prior U.S. Cls.: 22, 23, 38 and 50

United States Patent and Trademark Office

Reg. No. 2,893,510

Registered Oct. 12, 2004

**TRADEMARK
PRINCIPAL REGISTER**

QUINTAGON

CARTER, MICHAEL, L. (UNITED STATES INDIVIDUAL)
2177 STOWMONT CT.
DUBLIN, OH 430169563

FIRST USE 10-1-2003; IN COMMERCE 2-10-2004.

SER. NO. 78-311,354, FILED 10-9-2003.

FOR: BOARD GAMES, IN CLASS 28 (U.S. CLS. 22, 23, 38 AND 50).

BARNEY CHARLON, EXAMINING ATTORNEY

Int. Cls.: 7 and 12

Prior U.S. Cls.: 13, 19, 21, 23, 31, 34, 35 and 44

United States Patent and Trademark Office

Reg. No. 2,893,511

Registered Oct. 12, 2004

**TRADEMARK
PRINCIPAL REGISTER**

ROUGHAGE MAXX

KUHN KNIGHT INC. (DELAWARE CORPORATION)
1501 WEST 7TH AVE
BRODHEAD, WI 53520

FOR: AGRICULTURAL MACHINES, NAMELY FEED MIXERS, SILAGE CUTTERS, SILAGE UNLOADERS, SILAGE UNLOADER FEEDERS, FODDER MIXER FEEDERS, BALE FEEDERS, AND SILAGE FEEDERS, IN CLASS 7 (U.S. CLS. 13, 19, 21, 23, 31, 34 AND 35).

FIRST USE 10-1-2003; IN COMMERCE 10-1-2003.

FOR: LAND VEHICLES, NAMELY MIXER WAGONS, MIXER TRUCKS, FEED DELIVERY VEHICLES, NAMELY, TRUCKS, IN CLASS 12 (U.S. CLS. 19, 21, 23, 31, 35 AND 44).

FIRST USE 10-1-2003; IN COMMERCE 10-1-2003.

NO CLAIM IS MADE TO THE EXCLUSIVE RIGHT TO USE "ROUGHAGE", APART FROM THE MARK AS SHOWN.

SER. NO. 78-311,419, FILED 10-9-2003.

SUSAN STIGLITZ, EXAMINING ATTORNEY

Int. Cl.: 35

Prior U.S. Cls.: 100, 101 and 102

United States Patent and Trademark Office

Reg. No. 2,893,512

Registered Oct. 12, 2004

**SERVICE MARK
PRINCIPAL REGISTER**

BEAUCOUP PRINT

BEAUCOUP PRINT LLC (NEW YORK LTD LIAB
CO)
SUITE #300
285 W. BROADWAY
NEW YORK, NY 10013

FIRST USE 10-1-2003; IN COMMERCE 10-1-2003.

NO CLAIM IS MADE TO THE EXCLUSIVE
RIGHT TO USE "PRINT", APART FROM THE
MARK AS SHOWN.

FOR: ADVERTISING AGENCY SERVICES,
NAMELY, PROMOTING THE GOODS AND SERVI-
CES OF OTHERS THROUGH THE DISTRIBUTION
OF PRINTED PROMOTIONAL MATERIALS AND
BY RENDERING SALES PROMOTIONAL ADVICE,
IN CLASS 35 (U.S. CLS. 100, 101 AND 102).

SER. NO. 78-311,489, FILED 10-9-2003.

CHRISIE B. KING, EXAMINING ATTORNEY

Int. Cl.: 5

Prior U.S. Cls.: 6, 18, 44, 46, 51 and 52

United States Patent and Trademark Office

Reg. No. 2,893,513

Registered Oct. 12, 2004

**TRADEMARK
PRINCIPAL REGISTER**

CAKE CANDLE FOR CARS

LUMI-LITE CANDLE COMPANY, INC. (OHIO
CORPORATION)
102 SUNDALE ROAD
NORWICH, OH 43767

NO CLAIM IS MADE TO THE EXCLUSIVE
RIGHT TO USE "FOR CARS", APART FROM THE
MARK AS SHOWN.

FOR: AIR FRESHENERS, IN CLASS 5 (U.S. CLS. 6,
18, 44, 46, 51 AND 52).

SER. NO. 78-311,511, FILED 10-9-2003.

FIRST USE 6-26-2003; IN COMMERCE 6-26-2003.

JENNIFER KRISP, EXAMINING ATTORNEY

Int. Cl.: 41

Prior U.S. Cls.: 100, 101 and 107

United States Patent and Trademark Office

Reg. No. 2,893,514

Registered Oct. 12, 2004

**SERVICE MARK
PRINCIPAL REGISTER**

ARE YOU LISTENING?

BMG SONGS, INC. (CALIFORNIA CORPORATION)
8750 WILSHIRE BOULEVARD
BEVERLY HILLS, CA 90211

FOR: PROVIDING MUSIC LIBRARIES FOR USE
BY PRODUCERS OF TELEVISION SHOWS, TELEVISION
ADVERTISEMENTS, MOTION PICTURES,
VIDEO RECORDINGS, IN-HOUSE PRODUCTIONS,
AND MULTI MEDIA APPLICATIONS; MUSIC PUB-

LISHING SERVICES, IN CLASS 41 (U.S. CLS. 100, 101
AND 107).

FIRST USE 8-31-2003; IN COMMERCE 8-31-2003.

SER. NO. 78-311,581, FILED 10-9-2003.

CHRISIE B. KING, EXAMINING ATTORNEY

Int. Cls.: 38 and 41

Prior U.S. Cls.: 100, 101, 104 and 107

United States Patent and Trademark Office

Reg. No. 2,893,515

Registered Oct. 12, 2004

**SERVICE MARK
PRINCIPAL REGISTER**

RADIO SAWA

BROADCASTING BOARD OF GOVERNORS
(UNITED STATES AGENCY OF THE UNITED
STATES GOVERNMENT)
330 INDEPENDENCE AVENUE
S.W. SUITE 3360
WASHINGTON, DC 20237

FOR: COMMUNICATION SERVICES, NAMELY,
INTERNATIONAL RADIO BROADCASTING SER-
VICES AND TRANSMITTING STREAMED SOUND
AND AUDIO-VISUAL MATERIAL VIA THE INTER-
NET, IN CLASS 38 (U.S. CLS. 100, 101 AND 104).

FIRST USE 3-22-2002; IN COMMERCE 3-22-2002.

FOR: NEWS AGENCIES, NAMELY, GATHERING
AND INTERNATIONAL DISSEMINATION OF
NEWS, NEWS REPORTING SERVICES; ENTER-
TAINMENT, NAMELY, PROVIDING PROGRAMS
IN THE FIELD OF LOCAL, NATIONAL AND IN-

TERNATIONAL NEWS, SPORTS, HEALTH, EDU-
CATION, ARTS, MUSIC, CULTURE, AND
CURRENT EVENTS VIA RADIO AND THE INTER-
NET; PRODUCTION OF INTERNATIONAL RADIO
PROGRAMS , IN CLASS 41 (U.S. CLS. 100, 101 AND
107).

FIRST USE 3-22-2002; IN COMMERCE 3-22-2002.

NO CLAIM IS MADE TO THE EXCLUSIVE
RIGHT TO USE "RADIO", APART FROM THE
MARK AS SHOWN.

THE FOREIGN WORDING IN THE MARK
TRANSLATES INTO ENGLISH AS TOGETHER.

SER. NO. 78-311,622, FILED 10-9-2003.

CHRISIE B. KING, EXAMINING ATTORNEY

Int. Cl.: 43

Prior U.S. Cls.: 100 and 101

United States Patent and Trademark Office

Reg. No. 2,893,516

Registered Oct. 12, 2004

**SERVICE MARK
PRINCIPAL REGISTER**



RAMMY'S SUB CONTRACTORS, INC. (ILLINOIS
CORPORATION)
834 S. WHEELING ROAD
WHEELING, IL 60090

FIRST USE 4-21-1998; IN COMMERCE 4-21-1998.

SER. NO. 78-311,822, FILED 10-9-2003.

FOR: RESTAURANT SERVICES, IN CLASS 43
(U.S. CLS. 100 AND 101).

TRICIA SONNEBORN, EXAMINING ATTORNEY

Int. Cl.: 5

Prior U.S. Cls.: 6, 18, 44, 46, 51 and 52

United States Patent and Trademark Office

Reg. No. 2,893,517

Registered Oct. 12, 2004

**TRADEMARK
PRINCIPAL REGISTER**

GET MOVING AGAIN PAIN FREE!

BAYER HEALTHCARE LLC (DELAWARE LTD
LIAB CO)
100 BAYER ROAD
PITTSBURGH, PA 15205

FIRST USE 5-1-2002; IN COMMERCE 9-2-2003.

SER. NO. 78-311,921, FILED 10-10-2003.

FOR: ANALGESIC CREAMS, ANALGESICS, AN-
ALGESIC PREPARATIONS AND PHARMACEUTI-
CALS, IN CLASS 5 (U.S. CLS. 6, 18, 44, 46, 51 AND 52).

JEFFREY S. MOLINOFF, EXAMINING ATTORNEY

Int. Cl.: 20

Prior U.S. Cls.: 2, 13, 22, 25, 32 and 50

United States Patent and Trademark Office

Reg. No. 2,893,518

Registered Oct. 12, 2004

**TRADEMARK
PRINCIPAL REGISTER**

HENREDON

HENREDON FURNITURE INDUSTRIES, INC.
(DELAWARE CORPORATION)
400 HENREDON ROAD
MORGANTON, NC 28655

OWNER OF U.S. REG. NOS. 503,630 AND 2,373,330.

FOR: FURNITURE, IN CLASS 20 (U.S. CLS. 2, 13,
22, 25, 32 AND 50).

SER. NO. 78-312,322, FILED 10-10-2003.

FIRST USE 7-25-1947; IN COMMERCE 7-25-1947.

KATHERINE STOIDES, EXAMINING ATTORNEY

Int. Cl.: 35

Prior U.S. Cls.: 100, 101 and 102

United States Patent and Trademark Office

Reg. No. 2,893,519

Registered Oct. 12, 2004

**SERVICE MARK
PRINCIPAL REGISTER**

411 IT

BELLSOUTH INTELLECTUAL PROPERTY COR-
PORATION (DELAWARE CORPORATION)
SUITE 901
824 MARKET STREET
WILMINGTON, DE 19801

FOR: TELEPHONE DIRECTORY INFORMATION
ASSISTANCE, INCLUDING CUSTOMER NAME
AND ADDRESS SERVICES, IN CLASS 35 (U.S. CLS.
100, 101 AND 102).

FIRST USE 1-28-2002; IN COMMERCE 1-28-2002.

NO CLAIM IS MADE TO THE EXCLUSIVE
RIGHT TO USE "411", APART FROM THE MARK
AS SHOWN.

SER. NO. 78-312,829, FILED 10-13-2003.

SUSAN STIGLITZ, EXAMINING ATTORNEY

Int. Cl.: 37

Prior U.S. Cls.: 100, 103 and 106

United States Patent and Trademark Office

Reg. No. 2,893,520

Registered Oct. 12, 2004

**SERVICE MARK
PRINCIPAL REGISTER**

PERMA-LATERAL

PERMA-LINER INDUSTRIES, INC. (DELAWARE
CORPORATION)
6196 126TH AVENUE NORTH
LARGO, FL 33773

FIRST USE 1-31-1999; IN COMMERCE 1-31-1999.

SER. NO. 78-313,115, FILED 10-14-2003.

FOR: INSTALLATION OF A LINING WITHIN
EXISTING, SMALL DIAMETER, SEWER LINES TO
REHABILITATE DAMAGED SEWER PIPES, IN
CLASS 37 (U.S. CLS. 100, 103 AND 106).

TONI HICKEY, EXAMINING ATTORNEY

Int. Cl.: 37

Prior U.S. Cls.: 100, 103 and 106

United States Patent and Trademark Office

Reg. No. 2,893,521

Registered Oct. 12, 2004

**SERVICE MARK
PRINCIPAL REGISTER**

PERMA-LINER

PERMA-LINER INDUSTRIES, INC. (DELAWARE
CORPORATION)
6196 126TH AVENUE NORTH
LARGO, FL 33773

FOR: INSTALLATION OF A LINING WITHIN
EXISTING SEWER OR STORM LINES TO REHABI-
LITATE DAMAGED AND DETERIORATED SEWER

AND STORM PIPES AND PIPELINES, IN CLASS 37
(U.S. CLS. 100, 103 AND 106).

FIRST USE 1-31-1999; IN COMMERCE 1-31-1999.

SER. NO. 78-313,134, FILED 10-14-2003.

TONI HICKEY, EXAMINING ATTORNEY

Int. Cl.: 37

Prior U.S. Cls.: 100, 103 and 106

United States Patent and Trademark Office

Reg. No. 2,893,522

Registered Oct. 12, 2004

**SERVICE MARK
PRINCIPAL REGISTER**

PERMA-MAIN

PERMA-LINER INDUSTRIES, INC. (DELAWARE
CORPORATION)
6196 126TH AVENUE NORTH
LARGO, FL 33773

FOR: INSTALLATION OF A LINING WITHIN
EXISTING MAINLINE SEWER AND STORM LINES
TO REHABILITATE DAMAGED SEWER AND

STORM PIPES AND PIPELINES, IN CLASS 37 (U.S.
CLS. 100, 103 AND 106).

FIRST USE 1-31-1999; IN COMMERCE 1-31-1999.

SER. NO. 78-313,156, FILED 10-14-2003.

TONI HICKEY, EXAMINING ATTORNEY

Int. Cl.: 1

Prior U.S. Cls.: 1, 5, 6, 10, 26 and 46

United States Patent and Trademark Office

Reg. No. 2,893,523

Registered Oct. 12, 2004

**TRADEMARK
PRINCIPAL REGISTER**

AMIMED

BIOCONCEPT (SWITZERLAND CORPORATION)
GEWERBESTRASSE 14
4123 ALLSCHWIL, SWITZERLAND

FIRST USE 3-5-1993; IN COMMERCE 3-5-1993.

FOR: CELL BIOLOGY PREPARATIONS, NAME-
LY, ANTIBODIES, CELL CULTURE REAGENTS
FOR SCIENTIFIC OR RESEARCH USE, IN CLASS 1
(U.S. CLS. 1, 5, 6, 10, 26 AND 46).

SER. NO. 78-313,229, FILED 10-14-2003.

CHERYL STEPLIGHT, EXAMINING ATTORNEY

Int. Cl.: 31

Prior U.S. Cls.: 1 and 46

United States Patent and Trademark Office

Reg. No. 2,893,524

Registered Oct. 12, 2004

**TRADEMARK
PRINCIPAL REGISTER**



KYORIN CO., LTD. (JAPAN CORPORATION)
9 MINAMI-MACHI
HIMEJI CITY, JAPAN 670-0912

THE FOREIGN WORDING IN THE MARK
TRANSLATES INTO ENGLISH AS LIGHT.

FOR: FISH FEED, IN CLASS 31 (U.S. CLS. 1 AND
46).

SER. NO. 78-313,318, FILED 10-14-2003.

FIRST USE 3-31-1985; IN COMMERCE 3-31-1985.

CHERYL STEPLIGHT, EXAMINING ATTORNEY

Int. Cl.: 35

Prior U.S. Cls.: 100, 101 and 102

United States Patent and Trademark Office

Reg. No. 2,893,525

Registered Oct. 12, 2004

**SERVICE MARK
PRINCIPAL REGISTER**

WHERE VALUE AND SELECTION COME HOME

HOME DECORATORS COLLECTION, INC. (DE-
LAWARE CORPORATION)
8920 PERSHALL ROAD
HAZELWOOD, MO 63042

FOR: MAIL ORDER CATALOG SERVICES FEATURING HOME FURNISHINGS, HOME DECOR, AND ACCESSORIES; ONLINE ORDERING SERVICES FEATURING HOME FURNISHINGS, HOME

DECOR, AND ACCESSORIES, IN CLASS 35 (U.S. CLS. 100, 101 AND 102).

FIRST USE 9-0-1991; IN COMMERCE 9-0-1991.

SER. NO. 78-313,398, FILED 10-14-2003.

M. E. BODSON, EXAMINING ATTORNEY

Int. Cl.: 41

Prior U.S. Cls.: 100, 101 and 107

United States Patent and Trademark Office

Reg. No. 2,893,526

Registered Oct. 12, 2004

**SERVICE MARK
PRINCIPAL REGISTER**

THE BEAUTIFUL LOSERS

THE BEAUTIFUL LOSERS, A PARTNERSHIP OF
BRETT BOYD AND RAJ RAMAYYA (PART-
NERSHIP)
305 REED BLVD.
MILL VALLEY, CA 94941

FIRST USE 10-24-1998; IN COMMERCE 9-14-2003.

SER. NO. 78-313,493, FILED 10-14-2003.

FOR: ENTERTAINMENT SERVICES, NAMELY
PROVIDING LIVE MUSIC PERFORMANCES, IN
CLASS 41 (U.S. CLS. 100, 101 AND 107).

DAWN HAN, EXAMINING ATTORNEY

Int. Cl.: 3

Prior U.S. Cls.: 1, 4, 6, 50, 51 and 52

United States Patent and Trademark Office

Reg. No. 2,893,527

Registered Oct. 12, 2004

**TRADEMARK
PRINCIPAL REGISTER**

DAILY LIGHT GUARD

AVEDA CORPORATION (DELAWARE CORPORATION)
4000 PHEASANT RIDGE DRIVE
MINNEAPOLIS, MN 55449

NO CLAIM IS MADE TO THE EXCLUSIVE RIGHT TO USE "DAILY", APART FROM THE MARK AS SHOWN.

FOR: NON-MEDICATED SKIN CARE PREPARATION AND SUNSCREEN, IN CLASS 3 (U.S. CLS. 1, 4, 6, 50, 51 AND 52).

SER. NO. 78-313,514, FILED 10-14-2003.

FIRST USE 7-19-1993; IN COMMERCE 7-19-1993.

CHERYL CLAYTON, EXAMINING ATTORNEY

Int. Cl.: 9

Prior U.S. Cls.: 21, 23, 26, 36 and 38

Reg. No. 2,893,528

United States Patent and Trademark Office

Registered Oct. 12, 2004

**TRADEMARK
PRINCIPAL REGISTER**

SAFE GUARD

LEXAR MEDIA, INC. (DELAWARE CORPORATION)
47421 BAYSIDE PARKWAY
FREMONT, CA 941113580

THEREWITH, IN CLASS 9 (U.S. CLS. 21, 23, 26, 36 AND 38).

FIRST USE 5-9-2003; IN COMMERCE 5-9-2003.

FOR: COMPUTER SOFTWARE TO PREVENT UNAUTHORIZED ACCESS TO COMPUTER FILES STORED ON REMOVABLE DATA STORAGE DEVICES AND USER DOCUMENTATION SOLD

SER. NO. 78-313,564, FILED 10-14-2003.

KIMBERLY PERRY, EXAMINING ATTORNEY

Int. Cl.: 16

Prior U.S. Cls.: 2, 5, 22, 23, 29, 37, 38 and 50

United States Patent and Trademark Office

Reg. No. 2,893,529

Registered Oct. 12, 2004

**TRADEMARK
PRINCIPAL REGISTER**

STRING BOOK-INIS

JOHNSON, PATRICIA, HARDIN (UNITED STATES INDIVIDUAL)
7690 ROAD 39
MANCOS, CO 81328

FOR: HAND CRAFTED BOOKMARKS WITH A FANCY GLASS OR WOODEN BEAD AT ONE END SECURELY KNOTTED ON A WAXED LINEN CORD/STRING AND A SILVER OR PEWTER CHARM SECURELY KNOTTED ON THE OPPOSITE END, IN CLASS 16 (U.S. CLS. 2, 5, 22, 23, 29, 37, 38 AND 50).

FIRST USE 7-1-2003; IN COMMERCE 8-1-2003.

NO CLAIM IS MADE TO THE EXCLUSIVE RIGHT TO USE "STRING", APART FROM THE MARK AS SHOWN.

SER. NO. 78-313,622, FILED 10-14-2003.

TONI HICKEY, EXAMINING ATTORNEY

Int. Cl.: 10

Prior U.S. Cls.: 26, 39 and 44

United States Patent and Trademark Office

Reg. No. 2,893,530

Registered Oct. 12, 2004

**TRADEMARK
PRINCIPAL REGISTER**

V-MARK

BIOPSY SCIENCES, LLC (FLORIDA CORPORATION)
300 SPOTTIS WOODS COURT
CLEARWATER, FL 33756

FIRST USE 2-9-2004; IN COMMERCE 2-9-2004.

SER. NO. 78-313,702, FILED 10-15-2003.

FOR: BREAST BIOPSY SITE MARKERS FOR USE
IN MEDICAL PROCEDURES, IN CLASS 10 (U.S.
CLS. 26, 39 AND 44).

JAMES GRIFFIN, EXAMINING ATTORNEY

Int. Cls.: 25 and 35

Prior U.S. Cls.: 22, 39, 100, 101 and 102

United States Patent and Trademark Office

Reg. No. 2,893,531

Registered Oct. 12, 2004

**TRADEMARK
SERVICE MARK
PRINCIPAL REGISTER**

REALSIZE FOR REAL WOMEN

KAYE, JONATHAN (UNITED STATES INDIVIDUAL)
4540 ENCINO AVENUE
ENCINO, CA 91316

FOR: CLOTHING, NAMELY, BATHING SUITS, BEACH COVER-UPS, BELTS, CAPS, HATS, DRESSES, PANTIES, PANTS, ROMPERS, SHIRTS, SHORT-ALLS, SHORTS, SKIRTS, SWEAT PANTS, SWEATERS, TOPS, VESTS, FOOTWEAR, IN CLASS 25 (U.S. CLS. 22 AND 39).

FIRST USE 4-0-2001; IN COMMERCE 4-0-2001.

FOR: RETAIL STORES AND ON-LINE RETAIL STORES FEATURING APPAREL, IN CLASS 35 (U.S. CLS. 100, 101 AND 102).

FIRST USE 4-0-2001; IN COMMERCE 4-0-2001.

OWNER OF U.S. REG. NOS. 2,495,812 AND 2,626,322.

SER. NO. 78-313,762, FILED 10-15-2003.

JANICE L. MCMORROW, EXAMINING ATTORNEY

Int. Cl.: 35

Prior U.S. Cls.: 100, 101 and 102

United States Patent and Trademark Office

Reg. No. 2,893,532

Registered Oct. 12, 2004

**SERVICE MARK
PRINCIPAL REGISTER**

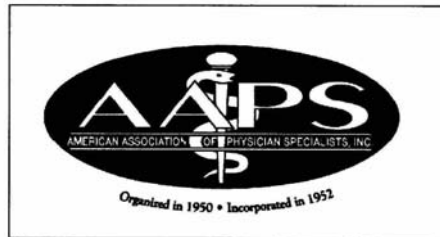

AMERICAN ASSOCIATION OF PHYSICIAN SPECIALISTS, INC. (MISSOURI CORPORATION)
SUITE 206
2296 HENDERSON MILL RD.
ATLANTA, GA 30345

FOR: ASSOCIATION SERVICES, NAMELY PROMOTING THE INTERESTS OF MEMBERS OF AMERICAN ASSOCIATION OF PHYSICIAN SPECIALISTS THROUGH THE ESTABLISHMENT OF CERTIFICATION BOARDS, PROGRAMS AND COMMUNICATION CONCERNING VARIOUS SPECIALITY FIELDS OF MEDICINE, IN CLASS 35 (U.S. CLS. 100, 101 AND 102).

FIRST USE 1-12-2001; IN COMMERCE 1-12-2001.

NO CLAIM IS MADE TO THE EXCLUSIVE RIGHT TO USE INC. AND ORGANIZED IN 1950 AND INCORPORATED IN 1952, APART FROM THE MARK AS SHOWN.

SER. NO. 78-314,411, FILED 10-16-2003.

DOMINIC J. FERRAIUOLO, EXAMINING ATTORNEY

Int. Cl.: 35

Prior U.S. Cls.: 100, 101 and 102

United States Patent and Trademark Office

Reg. No. 2,893,533

Registered Oct. 12, 2004

**SERVICE MARK
PRINCIPAL REGISTER**

MERCHANTS BAY

MERCHANTSBAY LLC (NEW JERSEY CORPORATION)
4 MARCY COURT
MT. LAUREL, NJ 08054

FOR: OPERATING ON-LINE MARKETPLACES
FOR SELLERS OF GOODS AND/OR SERVICES;
PROMOTING THE GOODS AND SERVICES OF
OTHERS BY PLACING ADVERTISEMENTS IN AN
ELECTRONIC MAGAZINE AND CATALOG AC-

CESSED THROUGH A GLOBAL COMPUTER NETWORK, IN CLASS 35 (U.S. CLS. 100, 101 AND 102).

FIRST USE 12-15-1995; IN COMMERCE 12-15-1995.

SER. NO. 78-314,419, FILED 10-16-2003.

IRENE D. WILLIAMS, EXAMINING ATTORNEY

Int. Cl.: 43

Prior U.S. Cls.: 100 and 101

United States Patent and Trademark Office

Reg. No. 2,893,534

Registered Oct. 12, 2004

**SERVICE MARK
PRINCIPAL REGISTER**

LIBERTY INN

ALIZA INC. (WASHINGTON CORPORATION)
C/O 119 NORTH COMMERCIAL
SUITE 180 POST OFFICE BOX 1151
BELLINGHAM, WA 98227

FOR: HOTEL AND MOTEL SERVICES, IN CLASS
43 (U.S. CLS. 100 AND 101).

FIRST USE 10-0-1998; IN COMMERCE 10-0-1998.

NO CLAIM IS MADE TO THE EXCLUSIVE
RIGHT TO USE THE WORD INN, APART FROM
THE MARK AS SHOWN.

SER. NO. 78-314,434, FILED 10-16-2003.

DOMINIC J. FERRAIUOLO, EXAMINING ATTOR-
NEY

Int. Cl.: 11

Prior U.S. Cls.: 13, 21, 23, 31 and 34

United States Patent and Trademark Office

Reg. No. 2,893,535

Registered Oct. 12, 2004

**TRADEMARK
PRINCIPAL REGISTER**

KENMORE

SEARS BRANDS, LLC (ILLINOIS LTD LIAB CO)
3333 BEVERLY ROAD
HOFFMAN ESTATES, IL 60179

FOR: REPAIR AND REPLACEMENT PARTS FOR HOME APPLIANCES, NAMELY, ELECTRIC CLOTHES DRYERS, GAS CLOTHES DRYERS, DOMESTIC AND COMMERCIAL COOKING OVENS, MICROWAVE OVENS, FREEZERS, REFRIGERATORS, GAS AND ELECTRIC STOVES, GAS AND ELECTRIC RANGES, AND GAS AND ELECTRIC COOKTOPS; HUMIDIFIERS; MICROWAVE OVENS; AIR COOLING APPARATUS, NAMELY, EVAPORATIVE COOLERS; NON-COIN OPERATED REFRIGERATED BEER DISPENSER AND COMPACT REFRIGERATORS; WATER HEATERS; WATER HEATING HEAT PUMPS; SOLAR WATER HEATING SYSTEMS; WATER SOFTENERS; COMBINATION HOT WATER HEATER AND DISPENSER FOR USE WITH A DOMESTIC SINK; FREEZERS; REFRIGERATORS; AIR CONDITIONERS AND DEHU-

MIDIFIERS; BARBEQUE GRILLS; RANGE HOODS; OVEN RANGE HOODS; CEILING FANS; GAS AND ELECTRIC WATER HEATERS FOR DOMESTIC USE; HOUSEHOLD AIR CLEANERS; FURNACES; WATER PURIFICATION UNITS; CENTRAL AIR CONDITIONERS; REPLACEMENT FILTERS FOR WATER PURIFICATION SYSTEMS; ICEMAKERS; REPLACEMENT AIR FILTERS FOR USE IN OVEN RANGES; BARBEQUE GRILL COVERS; TRASH COMPACTORS, IN CLASS 11 (U.S. CLS. 13, 21, 23, 31 AND 34).

FIRST USE 12-1-1945; IN COMMERCE 12-1-1945.

OWNER OF U.S. REG. NOS. 517,739, 2,475,811 AND OTHERS.

SER. NO. 78-314,709, FILED 10-16-2003.

LAVERNE THOMPSON, EXAMINING ATTORNEY

Int. Cl.: 19

Prior U.S. Cls.: 1, 12, 33 and 50

United States Patent and Trademark Office

Reg. No. 2,893,536

Registered Oct. 12, 2004

**TRADEMARK
PRINCIPAL REGISTER**

IRONTUFF

SOUTHWEST RECREATIONAL INDUSTRIES,
INC. (TEXAS CORPORATION)
P.O. BOX 589
701 LEANDER DRIVE
LEANDER, TX 78641

FOR: IMPACT ABSORBING FLOORING SURFACES, NAMELY, MULTI-USE POLYMERIC FLOORING; FLOORING UNDERLAYMENTS, NAMELY UNDERLAYING SHOCK ABSORBING PADS FOR USE WITH FLOOR COVERINGS; IMPACT ABSORBING GYMNASIUM FLOORING; IMPACT ABSORB-

ING WEIGHT ROOM FLOORING; IMPACT ABSORBING RECREATIONAL AND ATHLETIC FLOORING, IN CLASS 19 (U.S. CLS. 1, 12, 33 AND 50).

FIRST USE 10-3-2003; IN COMMERCE 10-3-2003.

SER. NO. 78-314,743, FILED 10-16-2003.

NORA BUCHANAN WILL, EXAMINING ATTORNEY

Int. Cl.: 9

Prior U.S. Cls.: 21, 23, 26, 36 and 38

United States Patent and Trademark Office

Reg. No. 2,893,537

Registered Oct. 12, 2004

**TRADEMARK
PRINCIPAL REGISTER**

SURROUNDSTAGE

BOSE CORPORATION (DELAWARE CORPORATION)
THE MOUNTAIN
FRAMINGHAM, MA 021102804

FIRST USE 8-31-2002; IN COMMERCE 8-31-2002.

SER. NO. 78-314,971, FILED 10-17-2003.

FOR: SIGNAL PROCESSING APPARATUS FOR
AUTOMOTIVE AUDIO SYSTEMS, IN CLASS 9 (U.S.
CLS. 21, 23, 26, 36 AND 38).

CAROLYN CATALDO, EXAMINING ATTORNEY

Int. Cl.: 9

Prior U.S. Cls.: 21, 23, 26, 36 and 38

United States Patent and Trademark Office

Reg. No. 2,893,538

Registered Oct. 12, 2004

**TRADEMARK
PRINCIPAL REGISTER**

TTP

BICRON ELECTRONICS COMPANY (CONNEC-
TICUT CORPORATION)
BARLOW STREET
CANAAN, CT 06018

FIRST USE 11-30-1968; IN COMMERCE 11-30-1968.

SER. NO. 78-314,975, FILED 10-17-2003.

FOR: TRANSFORMERS AND INDUCTORS AND
CONTROLS THEREFOR AND PARTS THEREOF, IN
CLASS 9 (U.S. CLS. 21, 23, 26, 36 AND 38).

CAROLYN CATALDO, EXAMINING ATTORNEY

Int. Cl.: 11

Prior U.S. Cls.: 13, 21, 23, 31 and 34

United States Patent and Trademark Office

Reg. No. 2,893,539

Registered Oct. 12, 2004

**TRADEMARK
PRINCIPAL REGISTER**

TRILINEA

PRECISION ARCHITECTURAL LIGHTING, INC.
(TEXAS CORPORATION)
4830 TIMBER CREEK DR.
HOUSTON, TX 77017

FIRST USE 6-25-2003; IN COMMERCE 6-25-2003.

SER. NO. 78-314,987, FILED 10-17-2003.

FOR: ELECTRIC LIGHTING FIXTURES, IN
CLASS 11 (U.S. CLS. 13, 21, 23, 31 AND 34).

KATHRYN COWARD, EXAMINING ATTORNEY

Int. Cl.: 10

Prior U.S. Cls.: 26, 39 and 44

United States Patent and Trademark Office

Reg. No. 2,893,540

Registered Oct. 12, 2004

**TRADEMARK
PRINCIPAL REGISTER**

TOEPIA

J&A USA, INC. (NEW YORK CORPORATION)
200 RODEO DRIVE
EDGEWOOD, NY 11717

FIRST USE 2-11-1999; IN COMMERCE 2-11-1999.

SER. NO. 78-315,166, FILED 10-17-2003.

FOR: WHIRLPOOL PEDICURE FOOT SPA SYSTEMS, NAMELY, ELECTRIC FOOT SPA MASSAGE APPARATUS, IN CLASS 10 (U.S. CLS. 26, 39 AND 44).

GLENN CLARK, EXAMINING ATTORNEY

Int. Cl.: 41

Prior U.S. Cls.: 100, 101 and 107

United States Patent and Trademark Office

Reg. No. 2,893,541

Registered Oct. 12, 2004

**SERVICE MARK
PRINCIPAL REGISTER**

SPEAKSHOP

STRACKBEIN, SALLY S. (UNITED STATES IN-
DIVIDUAL)
12020 SUNRISE VALLEY DR, #100
RESTON, VA 20191

FOR: EDUCATIONAL AND INSTRUCTIONAL
SERVICES IN THE NATURE OF SEMINARS,
WORKSHOPS, SPEECHES, PERSONAL COACHING
AND CONFERENCES, ALL RELATED TO EFFEC-
TIVE PUBLIC SPEAKING, EFFECTIVE COMMUNI-
CATION, EFFECTIVE PRESENTATIONS, SELF-

CONFIDENCE, LEADERSHIP ABILITIES AND
SELLING SKILLS; PUBLICATION OF INSTRUC-
TIONAL BOOKS, WORKBOOKS AND NEWSLET-
TERS, IN CLASS 41 (U.S. CLS. 100, 101 AND 107).

FIRST USE 10-16-2003; IN COMMERCE 10-18-2003.

SER. NO. 78-315,536, FILED 10-18-2003.

KAREN BRACEY, EXAMINING ATTORNEY

Int. Cl.: 19

Prior U.S. Cls.: 1, 12, 33 and 50

United States Patent and Trademark Office

Reg. No. 2,893,542

Registered Oct. 12, 2004

**TRADEMARK
PRINCIPAL REGISTER**

ASHTON HEIGHTS

VARIFORM, INC. (MISSOURI CORPORATION)
303 WEST MAJOR
KEARNEY, MO 64060

FIRST USE 12-15-2003; IN COMMERCE 12-15-2003.

FOR: VINYL SIDING PANELS FOR EXTERIOR
SURFACES OF MOBILE HOMES AND RESIDEN-
TIAL AND COMMERCIAL BUILDINGS, IN CLASS
19 (U.S. CLS. 1, 12, 33 AND 50).

SER. NO. 78-315,612, FILED 10-20-2003.

AMY ALFIERI, EXAMINING ATTORNEY

Int. Cl.: 9

Prior U.S. Cls.: 21, 23, 26, 36 and 38

Reg. No. 2,893,543

United States Patent and Trademark Office

Registered Oct. 12, 2004

**TRADEMARK
PRINCIPAL REGISTER**

MEX

KIDDE-FENWAL (MASSACHUSETTS CORPORATION)
400 MAIN ST.
ASHLAND, MA 01721

FIRST USE 1-1-1999; IN COMMERCE 1-1-1999.

SER. NO. 78-315,710, FILED 10-20-2003.

FOR: EXPLOSION SUPPRESSION EQUIPMENT,
NAMELY ATMOSPHERIC PRESSURE DETECTORS,
IN CLASS 9 (U.S. CLS. 21, 23, 26, 36 AND 38).

LESLEY LAMOTHE, EXAMINING ATTORNEY

Int. Cl.: 20

Prior U.S. Cls.: 2, 13, 22, 25, 32 and 50

United States Patent and Trademark Office

Reg. No. 2,893,544

Registered Oct. 12, 2004

**TRADEMARK
PRINCIPAL REGISTER**

CONCAVO

LTL WHOLESALE, INC. (PENNSYLVANIA CORPORATION), DBA LTL HOME PRODUCTS, INC.

125 ROUTE 61
SCHUYLKILL HAVEN, PA 179721026

FOR: SHELVING UNITS AND COMPONENT PARTS THEREOF, NAMELY, SHELVES AND

BRACKETS, IN CLASS 20 (U.S. CLS. 2, 13, 22, 25, 32 AND 50).

FIRST USE 5-31-2003; IN COMMERCE 5-31-2003.

SER. NO. 78-315,712, FILED 10-20-2003.

KENNETH D. BATTLE, EXAMINING ATTORNEY

Int. Cl.: 25

Prior U.S. Cls.: 22 and 39

United States Patent and Trademark Office

Reg. No. 2,893,545

Registered Oct. 12, 2004

**TRADEMARK
PRINCIPAL REGISTER**

SASSYBAX

SASSYBAX, LLC (CALIFORNIA LTD LIAB CO)
944 HARBOR CROSSING LN.
MARINA DEL REY, CA 90292

WEAR, SWIMSUITS, IN CLASS 25 (U.S. CLS. 22
AND 39).

FOR: INTIMATE APPAREL, NAMELY, BRAS-
SIERES, UNDERWEAR, UNDERGARMENTS, UN-
DERSHIRTS, SPORTS BRAS AND LINGERIE;
CLOTHING, NAMELY, SHIRTS, TANK TOPS, HAL-
TER TOPS, LOUNGEWEAR, PAJAMAS, SLEEP-

FIRST USE 8-8-2003; IN COMMERCE 8-8-2003.

SER. NO. 78-315,792, FILED 10-20-2003.

ELISSA GARBER KON, EXAMINING ATTORNEY

Int. Cl.: 8

Prior U.S. Cls.: 23, 28 and 44

United States Patent and Trademark Office

Reg. No. 2,893,546

Registered Oct. 12, 2004

**TRADEMARK
PRINCIPAL REGISTER**

GAMER

BENCHMADE KNIFE CO., INC. (OREGON CORPORATION)
300 BEAVERCREEK ROAD
OREGON CITY, OR 97045

FOR: KNIVES, NAMELY, FIXED BLADE KNIVES, COLLECTOR KNIVES, SPORT KNIVES, RESCUE KNIVES, UTILITY KNIVES, TACTICAL

KNIVES, CAMPING KNIVES, AND SURVIVAL KNIVES, IN CLASS 8 (U.S. CLS. 23, 28 AND 44).

FIRST USE 9-26-2003; IN COMMERCE 9-26-2003.

SER. NO. 78-315,878, FILED 10-20-2003.

ANNE MADDEN, EXAMINING ATTORNEY

Int. Cl.: 5

Prior U.S. Cls.: 6, 18, 44, 46, 51 and 52

United States Patent and Trademark Office

Reg. No. 2,893,547

Registered Oct. 12, 2004

**TRADEMARK
PRINCIPAL REGISTER**

HIOMEGA3

POLAR FOODS, INC. (CANADA CORPORATION)
P.O. BOX 293
FISHER BRANCH, CANADA R0C 0Z0

FIRST USE 10-17-2003; IN COMMERCE 10-17-2003.

SER. NO. 78-315,921, FILED 10-20-2003.

FOR: DIETARY AND FOOD SUPPLEMENTS
CONTAINING FLAX AND LINSEED OIL, IN CLASS
5 (U.S. CLS. 6, 18, 44, 46, 51 AND 52).

JENNIFER CHICOSKI, EXAMINING ATTORNEY

Int. Cl.: 5

Prior U.S. Cls.: 6, 18, 44, 46, 51 and 52

United States Patent and Trademark Office

Reg. No. 2,893,548

Registered Oct. 12, 2004

**TRADEMARK
PRINCIPAL REGISTER**

HIOMEGA

POLAR FOODS, INC. (CANADA CORPORATION)
P.O. BOX 293
FISHER BRANCH, CANADA R0C 0Z0

FIRST USE 10-17-2003; IN COMMERCE 10-17-2003.

SER. NO. 78-315,929, FILED 10-20-2003.

FOR: DIETARY AND FOOD SUPPLEMENT CON-
TAINING FLAX AND LINSEED OIL, IN CLASS 5
(U.S. CLS. 6, 18, 44, 46, 51 AND 52).

JENNIFER CHICOSKI, EXAMINING ATTORNEY

Int. Cl.: 8

Prior U.S. Cls.: 23, 28 and 44

United States Patent and Trademark Office

Reg. No. 2,893,549

Registered Oct. 12, 2004

**TRADEMARK
PRINCIPAL REGISTER**

AMBUSH

BENCHMADE KNIFE CO., INC. (OREGON CORPORATION)
300 BEAVERCREEK ROAD
OREGON CITY, OR 97045

FOR: KNIVES, NAMELY, POCKET KNIVES, COLLECTOR KNIVES, FOLDING KNIVES, SPORT KNIVES, RESCUE KNIVES, UTILITY KNIVES, TACTICAL KNIVES, FISHING KNIVES, HUNTING

KNIVES, CAMPING KNIVES, AND SURVIVAL KNIVES, IN CLASS 8 (U.S. CLS. 23, 28 AND 44).

FIRST USE 9-26-2003; IN COMMERCE 9-26-2003.

SER. NO. 78-315,960, FILED 10-20-2003.

SUSAN STIGLITZ, EXAMINING ATTORNEY

Int. Cl.: 30

Prior U.S. Cl.: 46

United States Patent and Trademark Office

Reg. No. 2,893,550

Registered Oct. 12, 2004

**TRADEMARK
PRINCIPAL REGISTER**

CORN GONE WRONG

KRAFT FOODS HOLDINGS, INC. (DELAWARE
CORPORATION)
THREE LAKES DRIVE
NORTHFIELD, IL 60093

NO CLAIM IS MADE TO THE EXCLUSIVE
RIGHT TO USE "CORN" , APART FROM THE
MARK AS SHOWN.

FOR: TOASTED CORN KERNELS, IN CLASS 30
(U.S. CL. 46).

SER. NO. 78-315,978, FILED 10-20-2003.

FIRST USE 6-30-2002; IN COMMERCE 6-30-2002.

SUSAN STIGLITZ, EXAMINING ATTORNEY

Int. Cl.: 43

Prior U.S. Cls.: 100 and 101

United States Patent and Trademark Office

Reg. No. 2,893,551

Registered Oct. 12, 2004

**SERVICE MARK
PRINCIPAL REGISTER**

IZZO'S ILLEGAL BURRITO

K & F RESTAURANT MANAGEMENT, LLC
(TEXAS LTD LIAB CO)
603 HUNTER'S WAY COURT
HOUSTON, TX 77024

NO CLAIM IS MADE TO THE EXCLUSIVE
RIGHT TO USE "BURRITO", APART FROM THE
MARK AS SHOWN.

FOR: RESTAURANT SERVICES, IN CLASS 43
(U.S. CLS. 100 AND 101).

SER. NO. 78-316,047, FILED 10-20-2003.

FIRST USE 7-23-2001; IN COMMERCE 7-23-2001.

STEPHANIE DAVIS, EXAMINING ATTORNEY

Int. Cl.: 41

Prior U.S. Cls.: 100, 101 and 107

United States Patent and Trademark Office

Reg. No. 2,893,552

Registered Oct. 12, 2004

**SERVICE MARK
PRINCIPAL REGISTER**

THE CONSTRUCTION COMIC

CIRICILLO, CARMEN (UNITED STATES INDIVIDUAL)
4484 GOLDEN LAKE DRIVE
SARASOTA, FL 34233

NO CLAIM IS MADE TO THE EXCLUSIVE RIGHT TO USE COMIC, APART FROM THE MARK AS SHOWN.

FOR: ENTERTAINMENT SERVICES, NAMELY STAND UP COMEDY AND PERFORMANCES, IN CLASS 41 (U.S. CLS. 100, 101 AND 107).

SER. NO. 78-316,385, FILED 10-21-2003.

FIRST USE 9-1-1991; IN COMMERCE 9-8-1992.

GRETTA YAO, EXAMINING ATTORNEY

Int. Cl.: 12

Prior U.S. Cls.: 19, 21, 23, 31, 35 and 44

Reg. No. 2,893,553

United States Patent and Trademark Office

Registered Oct. 12, 2004

**TRADEMARK
PRINCIPAL REGISTER**

ASPIRE

SUNRISE MEDICAL HHG INC. (CALIFORNIA
CORPORATION)
7477 EAST DRY CREEK PARKWAY
LONGMONT, CO 80503

FIRST USE 9-29-2003; IN COMMERCE 9-29-2003.

SER. NO. 78-316,401, FILED 10-21-2003.

FOR: WHEELCHAIRS, IN CLASS 12 (U.S. CLS. 19,
21, 23, 31, 35 AND 44).

DORITT L. CARROLL, EXAMINING ATTORNEY

Int. Cl.: 12

Prior U.S. Cls.: 19, 21, 23, 31, 35 and 44

United States Patent and Trademark Office

Reg. No. 2,893,554

Registered Oct. 12, 2004

**TRADEMARK
PRINCIPAL REGISTER**

IRIS

SUNRISE MEDICAL HHG INC. (CALIFORNIA
CORPORATION)
7477 EAST DRY CREEK PARKWAY
LONGMONT, CO 80503

FIRST USE 8-25-2003; IN COMMERCE 8-25-2003.

SER. NO. 78-316,428, FILED 10-21-2003.

FOR: WHEELCHAIRS, IN CLASS 12 (U.S. CLS. 19,
21, 23, 31, 35 AND 44).

ELLEN B. AWRICH, EXAMINING ATTORNEY

Int. Cl.: 10

Prior U.S. Cls.: 26, 39 and 44

United States Patent and Trademark Office

Reg. No. 2,893,555

Registered Oct. 12, 2004

**TRADEMARK
PRINCIPAL REGISTER**

DERMAFLOAT

SUNRISE MEDICAL HHG INC. (CALIFORNIA
CORPORATION)
7477 EAST DRY CREEK PARKWAY
LONGMONT, CO 80503

FIRST USE 9-10-2001; IN COMMERCE 9-10-2001.

SER. NO. 78-316,460, FILED 10-21-2003.

FOR: AIR MATTRESSES FOR MEDICAL PURPOSES INCLUDING AN INFLATOR, IN CLASS 10 (U.S. CLS. 26, 39 AND 44).

DORITT L. CARROLL, EXAMINING ATTORNEY

Int. Cl.: 14

Prior U.S. Cls.: 2, 27, 28 and 50

United States Patent and Trademark Office

Reg. No. 2,893,556

Registered Oct. 12, 2004

**TRADEMARK
PRINCIPAL REGISTER**

FOOD CHAINS

CULINARY CONNECTIONS (CALIFORNIA
SOLE PROPRIETORSHIP)
1248 BALBOA CIRCLE
CHULA VISTA, CA 91910

FIRST USE 10-21-2003; IN COMMERCE 10-21-2003.

SER. NO. 78-316,799, FILED 10-22-2003.

FOR: NECKLACES, IN CLASS 14 (U.S. CLS. 2, 27,
28 AND 50).

MITCHELL FRONT, EXAMINING ATTORNEY

Int. Cl.: 41

Prior U.S. Cls.: 100, 101 and 107

United States Patent and Trademark Office

Reg. No. 2,893,557

Registered Oct. 12, 2004

**SERVICE MARK
PRINCIPAL REGISTER**



HUTHWAITE, INC. (DELAWARE CORPORATION)
SUITE 100
22630 DAVIS DRIVE
STERLING, VA 20164

FIRST USE 8-5-2003; IN COMMERCE 8-5-2003.

OWNER OF U.S. REG. NO. 2,823,457.

FOR: EDUCATIONAL SERVICES, NAMELY, PROVIDING SALES TRAINING PROGRAMS AND SEMINARS; PROVIDING ON-LINE PUBLICATIONS, NAMELY, NEWSLETTERS, WHITE PAPERS AND ARTICLES IN THE FIELD OF SALES TRAINING SKILLS DEVELOPMENT, IN CLASS 41 (U.S. CLS. 100, 101 AND 107).

THE MARK CONSISTS OF A STYLIZED REPRESENTATION OF A BUILDING WITH THREE COLUMNS.

SER. NO. 78-316,857, FILED 10-22-2003.

SUSAN HAYASH, EXAMINING ATTORNEY

Int. Cl.: 25

Prior U.S. Cls.: 22 and 39

United States Patent and Trademark Office

Reg. No. 2,893,558

Registered Oct. 12, 2004

**TRADEMARK
PRINCIPAL REGISTER**

ROCKABILIA

INFINITY 1, INCORPORATED (MINNESOTA
CORPORATION)
1674 LAKE DRIVE WEST
CHANHASSEN, MN 55317

FIRST USE 0-0-1986; IN COMMERCE 0-0-1986.

SER. NO. 78-317,077, FILED 10-22-2003.

FOR: SHIRTS, BASEBALL CAPS, WRISTBANDS,
VISORS, BELTS, IN CLASS 25 (U.S. CLS. 22 AND 39).

SUSAN LESLIE DUBOIS, EXAMINING ATTORNEY

Int. Cl.: 20

Prior U.S. Cls.: 2, 13, 22, 25, 32 and 50

United States Patent and Trademark Office

Reg. No. 2,893,559

Registered Oct. 12, 2004

**TRADEMARK
PRINCIPAL REGISTER**

SLIDINGSUSAN

TOP DRAWER COMPONENTS, INC. (ARIZONA
CORPORATION)
5154 S. DELAWARE DR.
APACHE JUNCTION, AZ 85220

FIRST USE 8-8-2003; IN COMMERCE 8-8-2003.

SER. NO. 78-317,273, FILED 10-22-2003.

FOR: PREFABRICATED CABINET INSERTS
AND DRAWERS, IN CLASS 20 (U.S. CLS. 2, 13, 22,
25, 32 AND 50).

CHRISTOPHER ADKINS, EXAMINING ATTOR-
NEY

Int. Cl.: 44

Prior U.S. Cls.: 100 and 101

United States Patent and Trademark Office

Reg. No. 2,893,560

Registered Oct. 12, 2004

**SERVICE MARK
PRINCIPAL REGISTER**

OUR PLACE IS YOUR SPACE. BE YOU.

TROPITAN, INC. (MICHIGAN CORPORATION)
5152 COMMERCE ROAD
FLINT, MI 48507

FIRST USE 3-31-2003; IN COMMERCE 3-31-2003.

SER. NO. 78-317,449, FILED 10-23-2003.

FOR: TANNING SALON SERVICES, IN CLASS 44
(U.S. CLS. 100 AND 101).

STACY WAHLBERG, EXAMINING ATTORNEY

Int. Cl.: 44

Prior U.S. Cls.: 100 and 101

United States Patent and Trademark Office

Reg. No. 2,893,561

Registered Oct. 12, 2004

**SERVICE MARK
PRINCIPAL REGISTER**

GET YOUR TAN ON!

TROPITAN, INC. (MICHIGAN CORPORATION)
5152 COMMERCE ROAD
FLINT, MI 48507

FIRST USE 1-31-2000; IN COMMERCE 1-31-2000.

SER. NO. 78-317,462, FILED 10-23-2003.

FOR: TANNING SERVICES, IN CLASS 44 (U.S.
CLS. 100 AND 101).

DAWN HAN, EXAMINING ATTORNEY

Int. Cl.: 44

Prior U.S. Cls.: 100 and 101

United States Patent and Trademark Office

Reg. No. 2,893,562

Registered Oct. 12, 2004

**SERVICE MARK
PRINCIPAL REGISTER**

BE YOU. BE TAN.

TROPITAN, INC. (MICHIGAN CORPORATION)
5152 COMMERCE ROAD
FLINT, MI 48507

FIRST USE 10-22-2003; IN COMMERCE 10-22-2003.

SER. NO. 78-317,471, FILED 10-23-2003.

FOR: TANNING SERVICES, IN CLASS 44 (U.S.
CLS. 100 AND 101).

DAWN HAN, EXAMINING ATTORNEY

Int. Cl.: 28

Prior U.S. Cls.: 22, 23, 38 and 50

Reg. No. 2,893,563

United States Patent and Trademark Office

Registered Oct. 12, 2004

**TRADEMARK
PRINCIPAL REGISTER**



THE UNITED STATES PLAYING CARD COM-
PANY (DELAWARE CORPORATION)
4590 BEECH STREET
CINCINNATI, OH 452123497

OWNER OF U.S. REG. NOS. 256,622, 1,799,328 AND
OTHERS.

FOR: PLAYING CARDS, IN CLASS 28 (U.S. CLS.
22, 23, 38 AND 50).

SER. NO. 78-317,514, FILED 10-23-2003.

FIRST USE 4-15-2000; IN COMMERCE 4-15-2000.

DAWN HAN, EXAMINING ATTORNEY

Int. Cl.: 25

Prior U.S. Cls.: 22 and 39

United States Patent and Trademark Office

Reg. No. 2,893,564

Registered Oct. 12, 2004

**TRADEMARK
PRINCIPAL REGISTER**

HIDY NG

CO-WEAR INTERNATIONAL LTD. (HONG
KONG CORPORATION)
BLOCK A, 8TH FLOOR SHUI HONG IND.
BLDG.547-9 CASTLE PEAK ROAD
KWAI CHUNG, N.T., HONG KONG

FOR: CLOTHING, NAMELY, VESTS, PULL-
OVERS, CARDIGANS, SWEATERS, CAMISOLES,
SKIRTS, MINI SKIRTS, STOLES, BLOUSES,
SCARVES, SHAWLS AND BRAS IN INTERNATION-
AL CLASS 25, IN CLASS 25 (U.S. CLS. 22 AND 39).

FIRST USE 8-31-2003; IN COMMERCE 8-31-2003.

THE NAME SHOWN IN THE MARK IDENTIFIES
HIDY NG, WHOSE CONSENT TO REGISTER IS
SUBMITTED.

SER. NO. 78-317,543, FILED 10-23-2003.

FRED MANDIR, EXAMINING ATTORNEY

Int. Cl.: 42

Prior U.S. Cls.: 100 and 101

United States Patent and Trademark Office

Reg. No. 2,893,565

Registered Oct. 12, 2004

**SERVICE MARK
PRINCIPAL REGISTER**

CVIT

CARDIOVASCULAR IMAGING TECHNOLOGIES
L.L.C. (MISSOURI LTD LIAB CO)
SUITE 55
4320 WORNALL ROAD
KANSAS CITY, MO 64111

FIRST USE 8-22-2001; IN COMMERCE 8-22-2001.

SER. NO. 78-317,567, FILED 10-23-2003.

FOR: DEVELOPMENT OF COMPUTER HARD-
WARE AND SOFTWARE FOR THE MEDICAL
COMMUNITY, IN CLASS 42 (U.S. CLS. 100 AND 101).

GRETTA YAO, EXAMINING ATTORNEY

Int. Cl.: 29

Prior U.S. Cl.: 46

United States Patent and Trademark Office

Reg. No. 2,893,566

Registered Oct. 12, 2004

**TRADEMARK
PRINCIPAL REGISTER**

LA SQUISITA

LA SQUISITA FOOD CORP. (NEW YORK CORPORATION)
SUITE 2R
552 GRAMATAN AVENUE
MOUNT VERNON, NY 10552

FOR: CANNED GROCERY ITEMS, NAMELY, TOMATOES, OLIVES, EDIBLE OILS, SOUPS, BEANS, FISH, ARTICHOKEs, PEPPERS AND MUSHROOMS; CHEESES; DRY BEANS; SUNDRIED TOMATOES, IN CLASS 29 (U.S. CL. 46).

FIRST USE 1-1-1920; IN COMMERCE 1-1-1920.

OWNER OF U.S. REG. NO. 743,860.

THE FOREIGN WORDING IN THE MARK TRANSLATES INTO ENGLISH AS THE EXQUISITE.

SER. NO. 78-317,808, FILED 10-23-2003.

DAWN FELDMAN, EXAMINING ATTORNEY

Int. Cl.: 21

Prior U.S. Cls.: 2, 13, 23, 29, 30, 33, 40 and 50

United States Patent and Trademark Office

Reg. No. 2,893,567

Registered Oct. 12, 2004

**TRADEMARK
PRINCIPAL REGISTER**

FITS-ALL

CALIFORNIA QUALITY PLASTICS, INC. (CALI-
FORNIA CORPORATION)
2226 CASTLE HARBOR PLACE SOUTH
ONTARIO, CA 91761

FIRST USE 10-6-2002; IN COMMERCE 10-6-2002.

SER. NO. 78-317,887, FILED 10-23-2003.

FOR: BUILT-IN AND COUNTER-TOP CUP DIS-
PENSING UNIT, IN CLASS 21 (U.S. CLS. 2, 13, 23, 29,
30, 33, 40 AND 50).

MICHAEL HALL, EXAMINING ATTORNEY

Int. Cl.: 41

Prior U.S. Cls.: 100, 101 and 107

United States Patent and Trademark Office

Reg. No. 2,893,568

Registered Oct. 12, 2004

**SERVICE MARK
PRINCIPAL REGISTER**

VISIONARY UPSTARTS

CONDREN, MICHAEL (UNITED STATES INDIVIDUAL)
SUITE 2
233 WEST 122ND ST
NEW YORK, NY 10027

FOR: PERSONAL COACHING SERVICES IN THE FIELD OF SELF AWARENESS AND FULFILLMENT; CONDUCTING WORKSHOPS AND SEMI-

NARS IN PERSONAL AWARENESS , IN CLASS 41 (U.S. CLS. 100, 101 AND 107).

FIRST USE 5-1-2001; IN COMMERCE 8-1-2001.

SER. NO. 78-318,022, FILED 10-23-2003.

FRED MANDIR, EXAMINING ATTORNEY

Int. Cl.: 28

Prior U.S. Cls.: 22, 23, 38 and 50

Reg. No. 2,893,569

United States Patent and Trademark Office

Registered Oct. 12, 2004

**TRADEMARK
PRINCIPAL REGISTER**

MARGGABLES

ERSKI, THEODORE ISSAC (UNITED STATES
INDIVIDUAL)
8900 US HWY 14
CRYSTAL LAKE, IL 600122761

FOR: HOBBY CRAFT KIT COMPRISING 1/2 INCH
TO/AND/OR 1 1/2 INCH DIAMETER DISK-SHAPED
MAGNETS, 1/2 INCH TO/AND/OR 1 1/2 INCH
DIAMETER GLASS BEADS, 1/2 INCH TO/AND/OR
1 1/2 INCH DIAMETER DECORATIVE STICKERS
AND A BOTTLE OF SILICON ADHESIVE FOR THE

CREATION OF DECORATIVE MAGNETS, IN
CLASS 28 (U.S. CLS. 22, 23, 38 AND 50).

FIRST USE 3-5-2004; IN COMMERCE 3-5-2004.

SER. NO. 78-318,115, FILED 10-24-2003.

DANIELLE MATTESSICH, EXAMINING ATTOR-
NEY

Int. Cl.: 41

Prior U.S. Cls.: 100, 101 and 107

United States Patent and Trademark Office

Reg. No. 2,893,570

Registered Oct. 12, 2004

**SERVICE MARK
PRINCIPAL REGISTER**

OPEN FAIRWAYS

OPEN FAIRWAYS (COLORADO CORPORATION)
744 SYRACUSE STREET
DENVER, CO 80230

FOR: EDUCATIONAL SERVICES, NAMELY
CONDUCTING PROGRAMS FOR IMPROVING
THE LIVES OF AT RISK AND UNDER PRIVILEGED
CHILDREN THROUGH THE GAME OF GOLF;
GOLF INSTRUCTION SERVICES; ENTERTAIN-

MENT IN THE NATURE OF GOLF TOURNA-
MENTS, IN CLASS 41 (U.S. CLS. 100, 101 AND 107).

FIRST USE 6-0-2000; IN COMMERCE 6-0-2000.

SER. NO. 78-318,212, FILED 10-24-2003.

TRACY WHITAKER-BOWN, EXAMINING ATTOR-
NEY

Int. Cl.: 19

Prior U.S. Cls.: 1, 12, 33 and 50

United States Patent and Trademark Office

Reg. No. 2,893,571

Registered Oct. 12, 2004

**TRADEMARK
PRINCIPAL REGISTER**

MEDINA

TRINITY GLASS INTERNATIONAL, INC. (WA-
SHINGTON CORPORATION)
4617 192ND STREET EAST
TACOMA, WA 98446

FIRST USE 3-14-2003; IN COMMERCE 3-14-2003.

SER. NO. 78-318,251, FILED 10-24-2003.

FOR: FIBERGLASS DOORS, AND GLASS IN-
SERTS, TRANSOMS, AND SIDELIGHTS THERE-
FORE, IN CLASS 19 (U.S. CLS. 1, 12, 33 AND 50).

CAROLINE WOOD, EXAMINING ATTORNEY

Int. Cl.: 19

Prior U.S. Cls.: 1, 12, 33 and 50

United States Patent and Trademark Office

Reg. No. 2,893,572

Registered Oct. 12, 2004

**TRADEMARK
PRINCIPAL REGISTER**

PRESTON

TRINITY GLASS INTERNATIONAL, INC. (WA-
SHINGTON CORPORATION)
4617 192ND STREET EAST
TACOMA, WA 98446

FIRST USE 3-14-2003; IN COMMERCE 3-14-2003.

SER. NO. 78-318,253, FILED 10-24-2003.

FOR: FIBERGLASS DOORS, AND GLASS IN-
SERTS, TRANSOMS, AND SIDELIGHTS THERE-
FORE, IN CLASS 19 (U.S. CLS. 1, 12, 33 AND 50).

CAROLINE WOOD, EXAMINING ATTORNEY

Int. Cl.: 19

Prior U.S. Cls.: 1, 12, 33 and 50

United States Patent and Trademark Office

Reg. No. 2,893,573

Registered Oct. 12, 2004

**TRADEMARK
PRINCIPAL REGISTER**

SILVERDALE

TRINITY GLASS INTERNATIONAL, INC. (WA-
SHINGTON CORPORATION)
4617 192ND STREET EAST
TACOMA, WA 98446

FIRST USE 3-14-2003; IN COMMERCE 3-14-2003.

SER. NO. 78-318,255, FILED 10-24-2003.

FOR: FIBERGLASS DOORS, AND GLASS IN-
SERTS, TRANSOMS, AND SIDELIGHTS THERE-
FORE, IN CLASS 19 (U.S. CLS. 1, 12, 33 AND 50).

CAROLINE WOOD, EXAMINING ATTORNEY

Int. Cl.: 19

Prior U.S. Cls.: 1, 12, 33 and 50

United States Patent and Trademark Office

Reg. No. 2,893,574

Registered Oct. 12, 2004

**TRADEMARK
PRINCIPAL REGISTER**

LAKWOOD

TRINITY GLASS INTERNATIONAL, INC. (WA-
SHINGTON CORPORATION)
4617 192ND STREET EAST
TACOMA, WA 98446

FIRST USE 3-14-2003; IN COMMERCE 3-14-2003.

SER. NO. 78-318,258, FILED 10-24-2003.

FOR: FIBERGLASS DOORS, AND GLASS IN-
SERTS, TRANSOMS, AND SIDELIGHTS THERE-
FORE, IN CLASS 19 (U.S. CLS. 1, 12, 33 AND 50).

CAROLINE WOOD, EXAMINING ATTORNEY

Int. Cl.: 35

Prior U.S. Cls.: 100, 101 and 102

United States Patent and Trademark Office

Reg. No. 2,893,575

Registered Oct. 12, 2004

**SERVICE MARK
PRINCIPAL REGISTER**

NAIFA

NATIONAL ASSOCIATION OF INSURANCE
AND FINANCIAL ADVISORS (D.C. COR-
PORATION)
2901 TELESTAR COURT
FALLS CHURCH, VA 22042

FOR: ASSOCIATION SERVICES, NAMELY, PRO-
MOTING THE INTERESTS OF INSURANCE AND

FINANCIAL PROFESSIONALS, IN CLASS 35 (U.S.
CLS. 100, 101 AND 102).

FIRST USE 9-29-1999; IN COMMERCE 9-29-1999.

SER. NO. 78-318,373, FILED 10-24-2003.

ALEX KEAM, EXAMINING ATTORNEY

Int. Cl.: 42

Prior U.S. Cls.: 100 and 101

United States Patent and Trademark Office

Reg. No. 2,893,576

Registered Oct. 12, 2004

**SERVICE MARK
PRINCIPAL REGISTER**

FITCH, EVEN, TABIN & FLANNERY

FITCH, EVEN, TABIN & FLANNERY (PARTNER-
SHIP)
120 SOUTH LASALLE STREET, SUITE 1600
CHICAGO, IL 606033406

FIRST USE 12-31-1983; IN COMMERCE 12-31-1983.

SER. NO. 78-318,404, FILED 10-24-2003.

FOR: LEGAL SERVICES AND INTELLECTUAL
PROPERTY CONSULTATION, IN CLASS 42 (U.S.
CLS. 100 AND 101).

ALEX KEAM, EXAMINING ATTORNEY

Int. Cl.: 31

Prior U.S. Cls.: 1 and 46

United States Patent and Trademark Office

Reg. No. 2,893,577

Registered Oct. 12, 2004

**TRADEMARK
PRINCIPAL REGISTER**

LASTING PRIDE

OIL-DRI CORPORATION OF AMERICA (DELA-
WARE CORPORATION)
410 NORTH MICHIGAN AVENUE
CHICAGO, IL 60611

OWNER OF U.S. REG. NOS. 692,974, 1,539,488,
AND 2,330,220.

FOR: ABSORBENT IN THE FORM OF GROUND
CLAY USED AS ANIMAL LITTER, IN CLASS 31
(U.S. CLS. 1 AND 46).

SER. NO. 78-318,437, FILED 10-24-2003.

FIRST USE 1-31-1991; IN COMMERCE 1-31-1991.

ESTHER BELENKER, EXAMINING ATTORNEY

Int. Cl.: 41

Prior U.S. Cls.: 100, 101 and 107

Reg. No. 2,893,578

United States Patent and Trademark Office

Registered Oct. 12, 2004

**SERVICE MARK
PRINCIPAL REGISTER**

FURCON

ANTHROPOMORPHIC ARTS AND EDUCATION,
INC. (CALIFORNIA CORPORATION)
PMB 236, 105 SERRA WAY
MILPITAS, CA 95035

FIRST USE 5-28-1998; IN COMMERCE 5-28-1998.

SER. NO. 78-318,515, FILED 10-24-2003.

FOR: CONDUCTING EDUCATIONAL AND ENTERTAINMENT EXHIBITIONS IN THE FIELD OF ANTHROPOMORPHIC FANDOM, NAMELY A SUBSET OF SCIENCE FICTION FANDOM, IN CLASS 41 (U.S. CLS. 100, 101 AND 107).

DOMINIC J. FERRAIUOLO, EXAMINING ATTORNEY

Int. Cl.: 41

Prior U.S. Cls.: 100, 101 and 107

United States Patent and Trademark Office

Reg. No. 2,893,579

Registered Oct. 12, 2004

**SERVICE MARK
PRINCIPAL REGISTER**

FREEWIRE

THE CHRISTIAN SCIENCE PUBLISHING SOCIETY (MASSACHUSETTS TRUST)
ONE NORWAY STREET
BOSTON, MA 02115

FIRST USE 9-13-2003; IN COMMERCE 9-13-2003.

SER. NO. 78-318,751, FILED 10-27-2003.

FOR: NEWS SYNDICATION REPORTING, IN CLASS 41 (U.S. CLS. 100, 101 AND 107).

M. E. BODSON, EXAMINING ATTORNEY

Int. Cl.: 29

Prior U.S. Cl.: 46

United States Patent and Trademark Office

Reg. No. 2,893,580

Registered Oct. 12, 2004

**TRADEMARK
PRINCIPAL REGISTER**



CSC BRANDS LP (DELAWARE LIMITED PART-
NERSHIP)
CAMPBELL PLACE
CAMDEN, NJ 081031799

FOR: FROZEN PREPARED ENTREES CONSIST-
ING PRIMARILY OF ONE OR MORE OF THE
FOLLOWING- MEAT, POULTRY, FISH, EGGS, OR
VEGETABLES, IN CLASS 29 (U.S. CL. 46).

FIRST USE 5-31-2002; IN COMMERCE 5-31-2002.

OWNER OF U.S. REG. NOS. 657,519, 2,069,011 AND
OTHERS.

SER. NO. 78-318,766, FILED 10-27-2003.

CHARLES L. JENKINS, EXAMINING ATTORNEY

Int. Cls.: 16 and 35

Prior U.S. Cls.: 2, 5, 22, 23, 29, 37, 38, 50, 100, 101 and 102

Reg. No. 2,893,581

United States Patent and Trademark Office

Registered Oct. 12, 2004

**TRADEMARK
SERVICE MARK
PRINCIPAL REGISTER**

REAL PEOPLE WORKING FOR YOU

LAB SAFETY SUPPLY, INC. (WISCONSIN CORPORATION)
401 SOUTH WRIGHT ROAD
JANESVILLE, WI 535468729

FOR: CATALOGS IN THE FIELD OF EQUIPMENT AND SUPPLIES FOR FORESTRY, SURVEYING AND MAPPING, HORTICULTURE, SCIENCE AND LABORATORY, CIVIL/LANDSCAPE ENGINEERING, WEATHER AND TEMPERATURE, WILDLIFE MANAGEMENT, SAFETY, ENVIRONMENTAL STUDIES AND EDUCATION, AND FOR PERSONAL, ENVIRONMENTAL AND LABORATORY SAFETY, IN CLASS 16 (U.S. CLS. 2, 5, 22, 23, 29, 37, 38 AND 50).

FIRST USE 12-0-2002; IN COMMERCE 12-0-2002.

FOR: DISTRIBUTORSHIP SERVICES AND MAIL ORDER CATALOG SERVICES IN THE FIELD OF EQUIPMENT AND SUPPLIES FOR FORESTRY, SURVEYING AND MAPPING, HORTICULTURE, SCIENCE AND LABORATORY, CIVIL/LANDSCAPE

ENGINEERING, WEATHER AND TEMPERATURE, WILDLIFE MANAGEMENT, SAFETY, ENVIRONMENTAL STUDIES AND EDUCATION, AND FOR PERSONAL, ENVIRONMENTAL AND LABORATORY SAFETY; ON-LINE DISTRIBUTORSHIP SERVICES AND MAIL ORDER CATALOG SERVICES IN THE FIELD OF EQUIPMENT AND SUPPLIES FOR FORESTRY, SURVEYING AND MAPPING, HORTICULTURE, SCIENCE AND LABORATORY, CIVIL/LANDSCAPE ENGINEERING, WEATHER AND TEMPERATURE, WILDLIFE MANAGEMENT, SAFETY, ENVIRONMENTAL STUDIES AND EDUCATION, AND FOR PERSONAL, ENVIRONMENTAL AND LABORATORY SAFETY, IN CLASS 35 (U.S. CLS. 100, 101 AND 102).

FIRST USE 12-0-2002; IN COMMERCE 12-0-2002.

SER. NO. 78-318,791, FILED 10-27-2003.

JIM RINGLE, EXAMINING ATTORNEY

Int. Cls.: 16 and 35

Prior U.S. Cls.: 2, 5, 22, 23, 29, 37, 38, 50, 100, 101 and 102

United States Patent and Trademark Office

Reg. No. 2,893,582

Registered Oct. 12, 2004

**TRADEMARK
SERVICE MARK
PRINCIPAL REGISTER**

**HARD-WORKING SOLUTIONS DIRECT TO YOUR DOCK OR
DOORSTEP**

LAB SAFETY SUPPLY, INC. (WISCONSIN CORPORATION)
401 SOUTH WRIGHT ROAD
JANESVILLE, WI 535468729

FOR: MAIL ORDER CATALOGS IN THE FIELD OF AGRICULTURAL, HORTICULTURAL, GROUNDS MAINTENANCE, SAFETY, AND CONTRACTOR SUPPLIES, EQUIPMENT, AND CLOTHING, IN CLASS 16 (U.S. CLS. 2, 5, 22, 23, 29, 37, 38 AND 50).

FIRST USE 0-0-1996; IN COMMERCE 0-0-1996.

FOR: DISTRIBUTORSHIP AND MAIL ORDER CATALOG SERVICES IN THE FIELD OF AGRICULTURAL, HORTICULTURAL, GROUNDS MAINTENANCE, SAFETY, AND CONTRACTOR SUPPLIES, EQUIPMENT, AND CLOTHING, IN CLASS 35 (U.S. CLS. 100, 101 AND 102).

FIRST USE 0-0-1996; IN COMMERCE 0-0-1996.

SER. NO. 78-318,809, FILED 10-27-2003.

JIM RINGLE, EXAMINING ATTORNEY

Int. Cl.: 41

Prior U.S. Cls.: 100, 101 and 107

United States Patent and Trademark Office

Reg. No. 2,893,583

Registered Oct. 12, 2004

**SERVICE MARK
PRINCIPAL REGISTER**

TOSC

IHC HEALTH SERVICES, INC. (UTAH CORPORATION)
36 SOUTH STATE STREET, SUITE 2200
SALT LAKE CITY, UT 84111

FOR: EDUCATIONAL SERVICES, NAMELY, CONDUCTING COURSES, CLASSES, WORKSHOPS AND SEMINARS IN THE FIELD OF SPORTS MEDICINE AND PERFORMANCE, CONDITIONING, INJURY PREVENTION AND TREATMENT, NUTRI-

TION, PHYSICAL THERAPY AND PHYSICAL REHABILITATION, IN CLASS 41 (U.S. CLS. 100, 101 AND 107).

FIRST USE 6-1-1997; IN COMMERCE 6-1-1997.

SER. NO. 78-318,879, FILED 10-27-2003.

JIM RINGLE, EXAMINING ATTORNEY

Int. Cl.: 44

Prior U.S. Cls.: 100 and 101

United States Patent and Trademark Office

Reg. No. 2,893,584

Registered Oct. 12, 2004

**SERVICE MARK
PRINCIPAL REGISTER**

TOSC

IHC HEALTH SERVICES, INC. (UTAH CORPORATION)
36 SOUTH STATE STREET, SUITE 2200
SALT LAKE CITY, UT 84111

FOR: HOSPITAL, MEDICAL, HEALTH CARE,
PHYSICAL THERAPY AND PHYSICAL REHABILITATION SERVICES, IN CLASS 44 (U.S. CLS. 100 AND 101).

FIRST USE 6-1-1997; IN COMMERCE 6-1-1997.

SER. NO. 78-318,890, FILED 10-27-2003.

JIM RINGLE, EXAMINING ATTORNEY

Int. Cl.: 30

Prior U.S. Cl.: 46

United States Patent and Trademark Office

Reg. No. 2,893,585

Registered Oct. 12, 2004

**TRADEMARK
PRINCIPAL REGISTER**

SAVOURÉ

SAVOURE, INC. (OREGON CORPORATION)
201 W. BROADWAY
EUGENE, OR 97401

FOR: TEA, IN CLASS 30 (U.S. CL. 46).

FIRST USE 12-0-2000; IN COMMERCE 1-0-2001.

THE MARK IS PRESENTED WITHOUT ANY
CLAIM AS TO SPECIAL FORM.

THE FOREIGN WORDING IN THE MARK
TRANSLATES INTO ENGLISH AS "RELISH".

SER. NO. 78-318,894, FILED 10-27-2003.

ZHALEH DELANEY, EXAMINING ATTORNEY

Int. Cl.: 30

Prior U.S. Cl.: 46

United States Patent and Trademark Office

Reg. No. 2,893,586

Registered Oct. 12, 2004

**TRADEMARK
PRINCIPAL REGISTER**

TEA AS IT SHOULD BE

SAVOURE, INC. (OREGON CORPORATION)
201 W. BROADWAY
EUGENE, OR 97401

NO CLAIM IS MADE TO THE EXCLUSIVE
RIGHT TO USE "TEA", APART FROM THE MARK
AS SHOWN.

FOR: TEA, IN CLASS 30 (U.S. CL. 46).

SER. NO. 78-318,899, FILED 10-27-2003.

FIRST USE 12-0-2000; IN COMMERCE 1-0-2001.

ZHALEH DELANEY, EXAMINING ATTORNEY

Int. Cl.: 9

Prior U.S. Cls.: 21, 23, 26, 36 and 38

Reg. No. 2,893,587

United States Patent and Trademark Office

Registered Oct. 12, 2004

**TRADEMARK
PRINCIPAL REGISTER**

MENOPAUSE FLASHES

THE NORTH AMERICAN MENOPAUSE SOCIETY (OHIO CORPORATION)
5900 LANDERBROOK DRIVE, SUITE 195
MAYFIELD HEIGHTS, OH 44124

OWNER OF U.S. REG. NO. 2,663,452.

FOR: DOWNLOADABLE ELECTRONIC PUBLICATIONS IN THE NATURE OF NEWSLETTERS IN THE FIELD OF MENOPAUSE AND ISSUES RELATING TO MENOPAUSE, IN CLASS 9 (U.S. CLS. 21, 23, 26, 36 AND 38).

NO CLAIM IS MADE TO THE EXCLUSIVE RIGHT TO USE MENOPAUSE, APART FROM THE MARK AS SHOWN.

SER. NO. 78-318,908, FILED 10-27-2003.

FIRST USE 10-15-2003; IN COMMERCE 10-15-2003.

SUSAN HAYASH, EXAMINING ATTORNEY

Int. Cl.: 33

Prior U.S. Cls.: 47 and 49

United States Patent and Trademark Office

Reg. No. 2,893,588

Registered Oct. 12, 2004

**TRADEMARK
PRINCIPAL REGISTER**

CAIN CONCEPT

CAIN CELLARS, INC. (CALIFORNIA CORPORATION), DBA CAIN VINEYARD AND WINERY
3800 LANGTRY ROAD
ST. HELENA, CA 94574

FIRST USE 4-1-2000; IN COMMERCE 4-1-2000.

SER. NO. 78-318,994, FILED 10-27-2003.

FOR: WINE, IN CLASS 33 (U.S. CLS. 47 AND 49).

KELLEY WELLS, EXAMINING ATTORNEY

Int. Cl.: 31

Prior U.S. Cls.: 1 and 46

United States Patent and Trademark Office

Reg. No. 2,893,589

Registered Oct. 12, 2004

**TRADEMARK
PRINCIPAL REGISTER**

SEEDGUYS

FLICK, STEVE A. (UNITED STATES INDIVI-
DUAL)
1790 NW 50 ROAD
KINGSVILLE, MO 64061

FIRST USE 2-16-2002; IN COMMERCE 3-22-2003.

SER. NO. 78-319,004, FILED 10-27-2003.

FOR: AGRICULTURAL SEED, FLOWER SEED,
GRASS SEED, IN CLASS 31 (U.S. CLS. 1 AND 46).

MARY BOAGNI, EXAMINING ATTORNEY

Int. Cl.: 35

Prior U.S. Cls.: 100, 101 and 102

United States Patent and Trademark Office

Reg. No. 2,893,590

Registered Oct. 12, 2004

**SERVICE MARK
PRINCIPAL REGISTER**

LSS.COM

LAB SAFETY SUPPLY, INC. (WISCONSIN CORPORATION)
401 SOUTH WRIGHT ROAD
JANESVILLE, WI 535468729

FOR: ON-LINE DISTRIBUTORSHIP SERVICES AND MAIL ORDER CATALOG SERVICES IN THE FIELD OF EQUIPMENT AND SUPPLIES FOR PER-

SONAL, ENVIRONMENTAL, AND LABORATORY SAFETY, IN CLASS 35 (U.S. CLS. 100, 101 AND 102).

FIRST USE 7-0-2003; IN COMMERCE 7-0-2003.

SER. NO. 78-319,046, FILED 10-27-2003.

JIM RINGLE, EXAMINING ATTORNEY

Int. Cl.: 36

Prior U.S. Cls.: 100, 101 and 102

United States Patent and Trademark Office

Reg. No. 2,893,591

Registered Oct. 12, 2004

**SERVICE MARK
PRINCIPAL REGISTER**

ZIPAGENT

ZIPREALTY, INC. (CALIFORNIA CORPORATION)
SUITE 1555
2000 POWELL STREET
EMERYVILLE, CA 94608

FOR: REAL ESTATE AGENCIES, REAL ESTATE BROKERAGE SERVICES AND REAL ESTATE LISTINGS; PROVIDING REAL ESTATE AGENCY SERVICES, REAL ESTATE BROKERAGE SERVICES AND REAL ESTATE LISTINGS VIA A GLOBAL

COMPUTER NETWORK, IN CLASS 36 (U.S. CLS. 100, 101 AND 102).

FIRST USE 3-1-2001; IN COMMERCE 3-1-2001.

OWNER OF U.S. REG. NO. 2,507,682.

SER. NO. 78-319,223, FILED 10-27-2003.

RUDY R. SINGLETON, EXAMINING ATTORNEY

Int. Cl.: 36

Prior U.S. Cls.: 100, 101 and 102

United States Patent and Trademark Office

Reg. No. 2,893,592

Registered Oct. 12, 2004

**SERVICE MARK
PRINCIPAL REGISTER**

ZIPADVANTAGE

ZIPREALTY, INC. (CALIFORNIA CORPORATION)
SUITE 1555
2000 POWELL STREET
EMERYVILLE, CA 94608

FOR: REAL ESTATE AGENCIES, REAL ESTATE BROKERAGE SERVICES AND REAL ESTATE LISTINGS; PROVIDING REAL ESTATE AGENCY SERVICES, REAL ESTATE BROKERAGE SERVICES AND REAL ESTATE LISTINGS VIA A GLOBAL

COMPUTER NETWORK, IN CLASS 36 (U.S. CLS. 100, 101 AND 102).

FIRST USE 10-4-2000; IN COMMERCE 10-4-2000.

OWNER OF U.S. REG. NO. 2,507,682.

SER. NO. 78-319,230, FILED 10-27-2003.

RUDY R. SINGLETON, EXAMINING ATTORNEY

Int. Cl.: 36

Prior U.S. Cls.: 100, 101 and 102

United States Patent and Trademark Office

Reg. No. 2,893,593

Registered Oct. 12, 2004

**SERVICE MARK
PRINCIPAL REGISTER**

ZIPTIPS

ZIPREALTY, INC. (CALIFORNIA CORPORATION)
SUITE 1555
2000 POWELL STREET
EMERYVILLE, CA 94608

FOR: REAL ESTATE AGENCIES, REAL ESTATE BROKERAGE SERVICES AND REAL ESTATE LISTINGS; PROVIDING REAL ESTATE AGENCY SERVICES, REAL ESTATE BROKERAGE SERVICES AND REAL ESTATE LISTINGS VIA A GLOBAL

COMPUTER NETWORK, IN CLASS 36 (U.S. CLS. 100, 101 AND 102).

FIRST USE 8-29-1999; IN COMMERCE 8-29-1999.

OWNER OF U.S. REG. NO. 2,507,682.

SER. NO. 78-319,238, FILED 10-27-2003.

RUDY R. SINGLETON, EXAMINING ATTORNEY

Int. Cl.: 18

Prior U.S. Cls.: 1, 2, 3, 22 and 41

Reg. No. 2,893,594

United States Patent and Trademark Office

Registered Oct. 12, 2004

**TRADEMARK
PRINCIPAL REGISTER**

SOFTEE

CIRCLE Y SADDLES, INC. (TEXAS CORPORATION)
PO BOX 271
YOAKUM, TX 77995

STIRRUPS MADE OF LEATHER, STIRRUP STRAPS, SADDLE BAGS, SCABBARDS AND REINS ALL MADE OF LEATHER, IN CLASS 18 (U.S. CLS. 1, 2, 3, 22 AND 41).

FOR: SADDLES; SADDLERY; AND LEATHER HORSE AND HORSE BACK RIDING EQUIPMENT, TACK AND SUPPLIES, NAMELY RIGGING BELTS AND STRAPS, BRIDLES, HALTERS, HARNESSSES, SADDLE SKIRTS, CAVESONS, STRAPS AND BILLETS, BREAST STRAPS, GIRTHS, SEAT PADS,

FIRST USE 1-1-1994; IN COMMERCE 1-1-1994.

SER. NO. 78-319,265, FILED 10-27-2003.

BARNEY CHARLON, EXAMINING ATTORNEY

Int. Cl.: 35

Prior U.S. Cls.: 100, 101 and 102

United States Patent and Trademark Office

Reg. No. 2,893,595

Registered Oct. 12, 2004

**SERVICE MARK
PRINCIPAL REGISTER**

THE SMARTER WAY TO FIND A BETTER JOB

CAREERBUILDER, LLC (DELAWARE LTD LIAB
CO)
8420 W. BRYN MAWR, SUITE 600
CHICAGO, IL 60031

FIRST USE 12-26-2002; IN COMMERCE 12-26-2002.

SER. NO. 78-319,468, FILED 10-28-2003.

FOR: PROVIDING ON-LINE PERSONNEL RE-
CRUITMENT, PERSONNEL MANAGEMENT IN-
FORMATION AND JOB SEARCH INFORMATION,
IN CLASS 35 (U.S. CLS. 100, 101 AND 102).

MATTHEW PAPPAS, EXAMINING ATTORNEY

Int. Cl.: 19

Prior U.S. Cls.: 1, 12, 33 and 50

United States Patent and Trademark Office

Reg. No. 2,893,596

Registered Oct. 12, 2004

**TRADEMARK
PRINCIPAL REGISTER**

OPTIMA

TITAN AMERICA LLC (DELAWARE LTD LIAB
CO)
1151 AZALEA GARDEN ROAD
NORFOLK, VA 23502

FIRST USE 9-0-2002; IN COMMERCE 6-0-2003.

SER. NO. 78-319,655, FILED 10-28-2003.

FOR: CONCRETE, NAMELY SELF CONSOLI-
DATING CONCRETE, IN CLASS 19 (U.S. CLS. 1, 12,
33 AND 50).

TARAH HARDY, EXAMINING ATTORNEY

Int. Cl.: 9

Prior U.S. Cls.: 21, 23, 26, 36 and 38

Reg. No. 2,893,597

United States Patent and Trademark Office

Registered Oct. 12, 2004

**TRADEMARK
PRINCIPAL REGISTER**

TAMOSOFT

TAMOSOFT, INC. (BR.VIRGIN ISLANDS COR-
PORATION)
OFFICE 14, BLOCK B
LORDOS SEAFRONT CENTREPOTAMOS GERMA-
SOGIA
LIMASSOL, CYPRUS 4046

THE INTERNET AND LOCAL AREA NETWORKS,
IN CLASS 9 (U.S. CLS. 21, 23, 26, 36 AND 38).

FIRST USE 8-10-1998; IN COMMERCE 8-10-1998.

SER. NO. 78-319,675, FILED 10-28-2003.

FOR: COMPUTER SOFTWARE, NAMELY, SOFT-
WARE USED FOR SECURITY AND NETWORK
MONITORING FOR USE IN CONNECTION WITH

TARAH HARDY, EXAMINING ATTORNEY

Int. Cl.: 14

Prior U.S. Cls.: 2, 27, 28 and 50

United States Patent and Trademark Office

Reg. No. 2,893,598

Registered Oct. 12, 2004

**TRADEMARK
PRINCIPAL REGISTER**

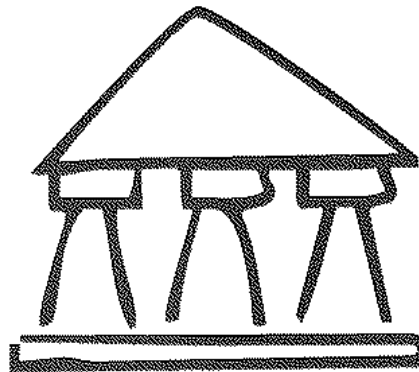

TEMPLE ST. CLAIR L.L.C. (DELAWARE LTD
LIAB CO)
594 BROADWAY, SUITE 306
NEW YORK, NY 10012

FIRST USE 9-18-2003; IN COMMERCE 9-18-2003.

SER. NO. 78-319,687, FILED 10-28-2003.

FOR: JEWELRY, IN CLASS 14 (U.S. CLS. 2, 27, 28
AND 50).

TARAH HARDY, EXAMINING ATTORNEY

Int. Cl.: 9

Prior U.S. Cls.: 21, 23, 26, 36 and 38

United States Patent and Trademark Office

Reg. No. 2,893,599

Registered Oct. 12, 2004

**TRADEMARK
PRINCIPAL REGISTER**

DORA THE EXPLORER

VIACOM INTERNATIONAL INC. (DELAWARE
CORPORATION)
1515 BROADWAY
NEW YORK, NY 10036

FOR: VIDEO GAME CARTRIDGES, VIDEO
GAMES RECORDED ON CD-ROM FOR USE IN
VIDEO GAME MACHINES AND COMPUTERS, IN
CLASS 9 (U.S. CLS. 21, 23, 26, 36 AND 38).

FIRST USE 8-2-2002; IN COMMERCE 8-2-2002.

OWNER OF U.S. REG. NOS. 2,493,373, 2,753,440
AND OTHERS.

SER. NO. 78-319,752, FILED 10-28-2003.

TARAH HARDY, EXAMINING ATTORNEY

Int. Cl.: 29

Prior U.S. Cl.: 46

United States Patent and Trademark Office

Reg. No. 2,893,600

Registered Oct. 12, 2004

**TRADEMARK
PRINCIPAL REGISTER**

CHICKEN TANGLERS

APPLEBEE'S INTERNATIONAL, INC. (DELA-
WARE CORPORATION)
4551 WEST 107TH STREET, SUITE 100
OVERLAND PARK, KS 66207

FOR: PREPARED ENTREES SERVED IN RES-
TAURANTS AND CONSISTING PRIMARILY OF
POULTRY, IN CLASS 29 (U.S. CL. 46).

FIRST USE 10-6-2003; IN COMMERCE 10-6-2003.

NO CLAIM IS MADE TO THE EXCLUSIVE
RIGHT TO USE "CHICKEN", APART FROM THE
MARK AS SHOWN.

SER. NO. 78-319,841, FILED 10-28-2003.

JOHN GARTNER, EXAMINING ATTORNEY

Int. Cl.: 10

Prior U.S. Cls.: 26, 39 and 44

United States Patent and Trademark Office

Reg. No. 2,893,601

Registered Oct. 12, 2004

**TRADEMARK
PRINCIPAL REGISTER**

SAFE-T-CENTESIS

ALLEGIANCE CORPORATION (DELAWARE
CORPORATION)
1430 WAUKEGAN ROAD, KB-1A
MCGAW PARK, IL 60085

FIRST USE 5-1-2003; IN COMMERCE 5-1-2003.

SER. NO. 78-320,154, FILED 10-29-2003.

FOR: DRAINAGE CATHETER DEVICES, IN
CLASS 10 (U.S. CLS. 26, 39 AND 44).

HOWARD SMIGA, EXAMINING ATTORNEY

Int. Cl.: 21

Prior U.S. Cls.: 2, 13, 23, 29, 30, 33, 40 and 50

United States Patent and Trademark Office

Reg. No. 2,893,602

Registered Oct. 12, 2004

**TRADEMARK
PRINCIPAL REGISTER**

HEARTS ON FIRE

HEARTS ON FIRE COMPANY (DELAWARE
CORPORATION)
SUITE 851
333 WASHINGTON STREET
BOSTON, MA 02108

FIRST USE 1-1-2000; IN COMMERCE 1-1-2000.

SER. NO. 78-320,285, FILED 10-29-2003.

FOR: PLASTIC WATER BOTTLES SOLD EMPTY,
IN CLASS 21 (U.S. CLS. 2, 13, 23, 29, 30, 33, 40 AND 50).

DANIEL CAPSHAW, EXAMINING ATTORNEY

Int. Cl.: 24

Prior U.S. Cls.: 42 and 50

United States Patent and Trademark Office

Reg. No. 2,893,603

Registered Oct. 12, 2004

**TRADEMARK
PRINCIPAL REGISTER**

HEARTS ON FIRE

HEARTS ON FIRE COMPANY (DELAWARE
CORPORATION)
SUITE 851
333 WASHINGTON STREET
BOSTON, MA 02108

FIRST USE 1-1-2000; IN COMMERCE 1-1-2000.

SER. NO. 78-320,306, FILED 10-29-2003.

FOR: TOWELS, NAMELY GOLF TOWELS AND
HAND TOWELS OF TEXTILE MATERIALS, IN
CLASS 24 (U.S. CLS. 42 AND 50).

DANIEL CAPSHAW, EXAMINING ATTORNEY

Int. Cl.: 25

Prior U.S. Cls.: 22 and 39

United States Patent and Trademark Office

Reg. No. 2,893,604

Registered Oct. 12, 2004

**TRADEMARK
PRINCIPAL REGISTER**

HEARTS ON FIRE

HEARTS ON FIRE COMPANY (DELAWARE
CORPORATION)
SUITE 851
333 WASHINGTON STREET
BOSTON, MA 02108

SWEATSHIRTS, JACKETS AND HATS, IN CLASS
25 (U.S. CLS. 22 AND 39).

FIRST USE 1-1-2000; IN COMMERCE 1-1-2000.

SER. NO. 78-320,332, FILED 10-29-2003.

FOR: CLOTHING, NAMELY, GOLF SHIRTS,
POLO-STYLE SHIRTS, T-SHIRTS, SWEATERS,

DANIEL CAPSHAW, EXAMINING ATTORNEY

Int. Cl.: 43

Prior U.S. Cls.: 100 and 101

United States Patent and Trademark Office

Reg. No. 2,893,605

Registered Oct. 12, 2004

**SERVICE MARK
PRINCIPAL REGISTER**

THE HEARTY BOYS

THE HEARTY BOYS CATERERS, INC. (ILLINOIS
CORPORATION)
3404 N. HALSTED ST.
CHICAGO, IL 60657

FIRST USE 3-29-1999; IN COMMERCE 3-29-1999.

SER. NO. 78-320,474, FILED 10-29-2003.

FOR: CAFES, CARRY-OUT RESTAURANTS, CA-
TERING, AND FOOD PREPARATION, IN CLASS 43
(U.S. CLS. 100 AND 101).

TRICIA SONNEBORN, EXAMINING ATTORNEY

Int. Cl.: 35

Prior U.S. Cls.: 100, 101 and 102

United States Patent and Trademark Office

Reg. No. 2,893,606

Registered Oct. 12, 2004

**SERVICE MARK
PRINCIPAL REGISTER**

MERCHANDISE INTELLIGENCE

COMPLEAT SPORTSWEAR, INC. (WASHING-
TON CORPORATION)
SUITE 222
6363 7TH AVE. SOUTH
SEATTLE, WA 98108

FOR: ADVERTISING SERVICES, NAMELY, PRO-
MOTING THE GOODS AND SERVICES OF OTHERS
BY AFFIXING TRADEMARKS, TRADE NAMES,
LOGOS AND SERVICE MARKS OF OTHERS TO A

WIDE VARIETY OF PROMOTIONAL PRODUCTS,
IN CLASS 35 (U.S. CLS. 100, 101 AND 102).

FIRST USE 10-1-2003; IN COMMERCE 10-1-2003.

SER. NO. 78-320,518, FILED 10-29-2003.

AISHA CLARKE, EXAMINING ATTORNEY

Int. Cl.: 9

Prior U.S. Cls.: 21, 23, 26, 36 and 38

United States Patent and Trademark Office

Reg. No. 2,893,607

Registered Oct. 12, 2004

**TRADEMARK
PRINCIPAL REGISTER**

MASTERCLIPS

INTERNATIONAL MICROCOMPUTER SOFTWARE, INC. (CALIFORNIA CORPORATION)
75 ROWLAND WAY
NOVATO, CA 94945

FIRST USE 1-15-1990; IN COMMERCE 1-15-1990.

SER. NO. 78-320,571, FILED 10-29-2003.

FOR: COMPUTER SOFTWARE AND USER GUIDES SOLD THEREWITH FEATURING STORED DESIGN IMAGES FOR USE IN ELECTRONIC CLIP ART, IN CLASS 9 (U.S. CLS. 21, 23, 26, 36 AND 38).

RENEE MCCRAY, EXAMINING ATTORNEY

Int. Cl.: 9

Prior U.S. Cls.: 21, 23, 26, 36 and 38

Reg. No. 2,893,608

United States Patent and Trademark Office

Registered Oct. 12, 2004

**TRADEMARK
PRINCIPAL REGISTER**

XPRESSARRAY

AMI SEMICONDUCTOR, INC. (DELAWARE
CORPORATION)
2300 BUCKSKIN ROAD
POCATELLO, ID 83201

FIRST USE 1-21-2002; IN COMMERCE 1-21-2002.

SER. NO. 78-320,968, FILED 10-30-2003.

FOR: SEMICONDUCTORS, MICROPROCES-
SORS, INTEGRATED CIRCUITS AND COMPUTER
SOFTWARE FOR INTEGRATED CIRCUIT DESIGN,
IN CLASS 9 (U.S. CLS. 21, 23, 26, 36 AND 38).

CIMMERIAN COLEMAN, EXAMINING ATTOR-
NEY

Int. Cl.: 19

Prior U.S. Cls.: 1, 12, 33 and 50

United States Patent and Trademark Office

Reg. No. 2,893,609

Registered Oct. 12, 2004

**TRADEMARK
PRINCIPAL REGISTER**

RIGIDMASTER

NAPCO, INC. (DELAWARE CORPORATION)
303 WEST MAJOR
KEARNEY, MO 64060

PONENT OF THE PANELS, IN CLASS 19 (U.S. CLS. 1,
12, 33 AND 50).

FIRST USE 12-15-2003; IN COMMERCE 12-15-2003.

FOR: ARCHITECTURAL GROOVE IN VINYL
SOFFIT PANELS TO ASSURE THAT PANELS LIE
FLAT AND RESIST SAGGING, SOLD AS A COM-

SER. NO. 78-320,974, FILED 10-30-2003.

MARY BOAGNI, EXAMINING ATTORNEY

Int. Cl.: 21

Prior U.S. Cls.: 2, 13, 23, 29, 30, 33, 40 and 50

United States Patent and Trademark Office

Reg. No. 2,893,610

Registered Oct. 12, 2004

**TRADEMARK
PRINCIPAL REGISTER**

MEALTIME BUDDIES

HALLMARK LICENSING, INC. (DELAWARE
CORPORATION)
2440 PERSHING ROAD
KANSAS CITY, MO 64108

FIRST USE 9-8-2003; IN COMMERCE 9-8-2003.

SER. NO. 78-321,000, FILED 10-30-2003.

FOR: PAPER PLATES, IN CLASS 21 (U.S. CLS. 2,
13, 23, 29, 30, 33, 40 AND 50).

LINDA E. BLOHM, EXAMINING ATTORNEY

Int. Cl.: 17

Prior U.S. Cls.: 1, 5, 12, 13, 35 and 50

United States Patent and Trademark Office

Reg. No. 2,893,611

Registered Oct. 12, 2004

**TRADEMARK
PRINCIPAL REGISTER**

RAUPEX

REHAU INCORPORATED (DELAWARE CORPORATION)
1501 EDWARDS FERRY ROAD
LEESBURG, VA 22075

FIRST USE 3-0-2001; IN COMMERCE 3-0-2001.

OWNER OF U.S. REG. NO. 2,064,607.

FOR: PLASTIC TUBING FOR USE WITH GLYCOL SOLUTION FOR TURF CONDITIONING; PLASTIC TUBING FOR THE TRANSFER OF INDUSTRIAL FLUIDS; PLASTIC TUBING FOR AIR DISTRIBUTION AND FIRE PROTECTION SYSTEMS, IN CLASS 17 (U.S. CLS. 1, 5, 12, 13, 35 AND 50).

SER. NO. 78-321,132, FILED 10-30-2003.

JENNIFER DIXON, EXAMINING ATTORNEY

Int. Cl.: 41

Prior U.S. Cls.: 100, 101 and 107

United States Patent and Trademark Office

Reg. No. 2,893,612

Registered Oct. 12, 2004

**SERVICE MARK
PRINCIPAL REGISTER**

**WISDOM TELLS US THAT CHANGE IS INEVITABLE. COMPASSION
TELLS US IT IS NECESSARY. POWER MAKES IT POSSIBLE.**

TRIBBLE CREATIVE GROUP, INC. (NORTH
CAROLINA CORPORATION)
SUITE 202
129 WEST TRADE STREET
CHARLOTTE, NC 28202

FOR: EDUCATIONAL SERVICES, NAMELY, DE-
VELOPING, ARRANGING AND CONDUCTING
CONFERENCES AND PROGRAMS ON ETHICS,
LEADERSHIP, RESPONSIBILITY AND SUSTAIN-

ABILITY IN THE FIELD OF BUSINESS AND PRIN-
TED MATERIALS DISTRIBUTED THEREWITH, IN
CLASS 41 (U.S. CLS. 100, 101 AND 107).

FIRST USE 3-14-2003; IN COMMERCE 3-14-2003.

SER. NO. 78-321,216, FILED 10-30-2003.

REBECCA GILBERT, EXAMINING ATTORNEY

Int. Cl.: 30

Prior U.S. Cl.: 46

United States Patent and Trademark Office

Reg. No. 2,893,613

Registered Oct. 12, 2004

**TRADEMARK
PRINCIPAL REGISTER**

WHEY LOW

VIVALAC INC. (MARYLAND CORPORATION)
131 BRINKWOOD ROAD
BROOKEVILLE, MD 20833

FIRST USE 3-29-2001; IN COMMERCE 3-29-2001.

SER. NO. 78-321,220, FILED 10-30-2003.

FOR: SUGAR SUBSTITUTE, IN CLASS 30 (U.S. CL.
46).

REBECCA GILBERT, EXAMINING ATTORNEY

Int. Cl.: 41

Prior U.S. Cls.: 100, 101 and 107

United States Patent and Trademark Office

Reg. No. 2,893,614

Registered Oct. 12, 2004

**SERVICE MARK
PRINCIPAL REGISTER**

BRINGING CHANGE TO A TURBULENT WORLD

TRIBBLE CREATIVE GROUP, INC. (NORTH
CAROLINA CORPORATION)
SUITE 202
129 WEST TRADE STREET
CHARLOTTE, NC 28202

FOR: EDUCATIONAL SERVICES, NAMELY, DE-
VELOPING, ARRANGING AND CONDUCTING
CONFERENCES AND PROGRAMS ON ETHICS,
LEADERSHIP, RESPONSIBILITY AND SUSTAIN-

ABILITY IN THE FIELD OF BUSINESS AND PRIN-
TED MATERIALS DISTRIBUTED THEREWITH, IN
CLASS 41 (U.S. CLS. 100, 101 AND 107).

FIRST USE 3-14-2003; IN COMMERCE 3-14-2003.

SER. NO. 78-321,222, FILED 10-30-2003.

REBECCA GILBERT, EXAMINING ATTORNEY

Int. Cl.: 41

Prior U.S. Cls.: 100, 101 and 107

United States Patent and Trademark Office

Reg. No. 2,893,615

Registered Oct. 12, 2004

**SERVICE MARK
PRINCIPAL REGISTER**

LOTTERYDNA

LOTTERYDNA WORLDWIDE LTD. CORP. (DE-
LAWARE CORPORATION)
P.O. BOX 4648
FT. LAUDERDALE, FL 33338

ING PREDICTIONS REGARDING FUTURE WIN-
NING NUMBERS, IN CLASS 41 (U.S. CLS. 100, 101
AND 107).

FOR: PROVIDING A WEB SITE ON A GLOBAL
COMPUTER NETWORK PROVIDING INFORMA-
TION IN THE LOTTERY FIELD; PROVIDING ON-
LINE SUBSCRIPTION SERVICES FEATURING
LOTTERY INFORMATION, NAMELY, WINNING
NUMBER SELECTION STRATEGIES AND PROVID-

FIRST USE 10-30-2002; IN COMMERCE 10-30-2002.

SER. NO. 78-321,451, FILED 10-31-2003.

MARK T. MULLEN, EXAMINING ATTORNEY

Int. Cls.: 16, 41 and 45

Prior U.S. Cls.: 2, 5, 22, 23, 29, 37, 38, 50, 100, 101 and 107

United States Patent and Trademark Office

Reg. No. 2,893,616

Registered Oct. 12, 2004

**TRADEMARK
SERVICE MARK
PRINCIPAL REGISTER**

DISCOVER THE CHAMPION IN YOU

LAKWOOD CHURCH (TEXAS NON-PROFIT CORPORATION)
PO BOX 23297
HOUSTON, TX 77228

FOR: INFORMATIONAL PUBLICATIONS AND EDUCATIONAL MATERIALS COVERING RELIGIOUS TOPICS, NAMELY, PAMPHLETS AND NEWSLETTERS, IN CLASS 16 (U.S. CLS. 2, 5, 22, 23, 29, 37, 38 AND 50).

FIRST USE 3-0-2001; IN COMMERCE 3-0-2001.

FOR: EDUCATIONAL SERVICES, NAMELY CONDUCTING CHURCH AND BIBLE SCHOOL CLASSES, SEMINARS, AND CONFERENCES IN THE FIELD OF RELIGIOUS SUBJECT MATTER; ENTERTAINMENT SERVICES IN THE NATURE OF

TELEVISION SHOWS FEATURING RELIGIOUS SUBJECT MATTER, IN CLASS 41 (U.S. CLS. 100, 101 AND 107).

FIRST USE 3-0-2001; IN COMMERCE 3-0-2001.

FOR: RELIGIOUS SERVICES, NAMELY MINISTERIAL SERVICES, EVANGELICAL SERVICES, PREACHING SERVICES, CONDUCTING RELIGIOUS SERVICES, PERSONAL RELIGIOUS COUNSELING, IN CLASS 45 (U.S. CLS. 100 AND 101).

FIRST USE 3-0-2001; IN COMMERCE 3-0-2001.

SER. NO. 78-321,691, FILED 10-31-2003.

ELIZABETH HUGHITT, EXAMINING ATTORNEY

Int. Cl.: 28

Prior U.S. Cls.: 22, 23, 38 and 50

United States Patent and Trademark Office

Reg. No. 2,893,617

Registered Oct. 12, 2004

**TRADEMARK
PRINCIPAL REGISTER**

MATHMATICS

TAYLOR, LAMONT (UNITED STATES INDIVIDUAL)
35 FIELD
IRVINE, CA 926203345

FIRST USE 10-1-2003; IN COMMERCE 10-24-2003.

SER. NO. 78-321,701, FILED 10-31-2003.

FOR: SNOWBOARDS, IN CLASS 28 (U.S. CLS. 22, 23, 38 AND 50).

RENEE MCCRAY, EXAMINING ATTORNEY

Int. Cl.: 9

Prior U.S. Cls.: 21, 23, 26, 36 and 38

Reg. No. 2,893,618

United States Patent and Trademark Office

Registered Oct. 12, 2004

**TRADEMARK
PRINCIPAL REGISTER**

IDT

INTEGRATED DEVICE TECHNOLOGY, INC.
(DELAWARE CORPORATION)
2975 STENDER WAY
SANTA CLARA, CA 95054

FOR: SEMICONDUCTORS, NAMELY SEMICONDUCTOR AND LOGIC DEVICES, INTEGRATED CIRCUITS, SEMICONDUCTOR ELECTRONIC MODULES, MICROPROCESSORS, AND MICROCONTROLLERS; AND SOFTWARE FOR USE IN THE DESIGN, APPLICATION, MANAGEMENT

AND SIMULATION OF SEMICONDUCTORS, IN CLASS 9 (U.S. CLS. 21, 23, 26, 36 AND 38).

FIRST USE 11-0-1983; IN COMMERCE 11-0-1983.

OWNER OF U.S. REG. NOS. 1,244,288, 2,300,863 AND OTHERS.

SER. NO. 78-321,845, FILED 10-31-2003.

MARGERY A. TIERNEY, EXAMINING ATTORNEY

Int. Cl.: 42

Prior U.S. Cls.: 100 and 101

United States Patent and Trademark Office

Reg. No. 2,893,619

Registered Oct. 12, 2004

**SERVICE MARK
PRINCIPAL REGISTER**

EZMATRIX

INDUSTRY SALES TAX SOLUTIONS, LLC
(PENNSYLVANIA LTD LIAB CO)
PMB 216 64 E. UWCHLAN AVENUE
EXTON, PA 19341

FIRST USE 10-31-2003; IN COMMERCE 10-31-2003.

SER. NO. 78-321,874, FILED 10-31-2003.

FOR: ON-LINE SERVICES PROVIDING ACCESS
TO DATABASES CONTAINING INFORMATION
RELATED TO TAXES, IN CLASS 42 (U.S. CLS. 100
AND 101).

MARGERY A. TIERNEY, EXAMINING ATTORNEY

Int. Cl.: 35

Prior U.S. Cls.: 100, 101 and 102

United States Patent and Trademark Office

Reg. No. 2,893,620

Registered Oct. 12, 2004

**SERVICE MARK
PRINCIPAL REGISTER**

**TURN II KEY
SOLUTION**

II KEY PLANNING GROUP, INC. (TEXAS CORPORATION)
SUITE 307
901 SONTERRA BLVD.
SAN ANTONIO, TX 78258

FOR: BUSINESS CONSULTING SERVICES RELATED TO MARKETING AND OPERATIONS SYSTEMS FOR LONG TERM CARE PLANNING PRACTICE IN THE FIELD OF LAW , IN CLASS 35 (U.S. CLS. 100, 101 AND 102).

FIRST USE 8-13-2003; IN COMMERCE 10-23-2003.

THE MARK CONSISTS OF STANDARD CHARACTERS WITHOUT CLAIM TO ANY PARTICULAR FONT, STYLE, SIZE, OR COLOR.

SER. NO. 78-321,974, FILED 11-2-2003.

MARGERY A. TIERNEY, EXAMINING ATTORNEY

Int. Cl.: 35

Prior U.S. Cls.: 100, 101 and 102

United States Patent and Trademark Office

Reg. No. 2,893,621

Registered Oct. 12, 2004

**SERVICE MARK
PRINCIPAL REGISTER**



II KEY PLANNING GROUP, INC. (TEXAS CORPORATION)
SUITE 307
901 SONTERRA BLVD.
SAN ANTONIO, TX 78258

FOR: BUSINESS CONSULTING SERVICES RELATED TO MARKETING AND OPERATIONS SYSTEMS FOR LONG TERM CARE PLANNING PRACTICE IN THE FIELD OF LAW , IN CLASS 35 (U.S. CLS. 100, 101 AND 102).

FIRST USE 8-13-2003; IN COMMERCE 9-9-2003.

NO CLAIM IS MADE TO THE EXCLUSIVE RIGHT TO USE PLANNING GROUP INC., APART FROM THE MARK AS SHOWN.

THE COLOR(S) BROWN AND BLACK IS/ARE CLAIMED AS A DISTINCTIVE FEATURE OF THE MARK.

THE MARK CONSISTS OF THE ROMAN NUMERALS II IN BROWN INTERTWINED WITH THE LEFT PART OF A STYLIZED CURSIVE BLACK K IN THE WORD KEY, TWO BROWN KEYS HANGING FROM THE BOTTOM RIGHT OF THE K, AND THE WORDS KEY, PLANNING, GROUP, AND INC. IN BLACK CAPITAL LETTERS.

SER. NO. 78-321,979, FILED 11-2-2003.

MARGERY A. TIERNEY, EXAMINING ATTORNEY

Int. Cl.: 21

Prior U.S. Cls.: 2, 13, 23, 29, 30, 33, 40 and 50

Reg. No. 2,893,622

United States Patent and Trademark Office

Registered Oct. 12, 2004

**TRADEMARK
PRINCIPAL REGISTER**

POP SOK

DECARLO, VICTORIA (UNITED STATES INDIVIDUAL)
432 GORDON AVENUE
ANGOLA, NY 14006

FOR: CYLINDRICAL FABRIC CONTAINER TO HOLD COMMON WATER AND SODA POP BOTTLES, IN CLASS 21 (U.S. CLS. 2, 13, 23, 29, 30, 33, 40 AND 50).

FIRST USE 9-11-2003; IN COMMERCE 10-5-2003.

THE MARK CONSISTS OF STANDARD CHARACTERS WITHOUT CLAIM TO ANY PARTICULAR FONT, STYLE, SIZE, OR COLOR.

NO CLAIM IS MADE TO THE EXCLUSIVE RIGHT TO USE "POP", APART FROM THE MARK AS SHOWN.

SER. NO. 78-322,017, FILED 11-2-2003.

MELVIN AXILBUND, EXAMINING ATTORNEY

Int. Cl.: 28

Prior U.S. Cls.: 22, 23, 38 and 50

United States Patent and Trademark Office

Reg. No. 2,893,623

Registered Oct. 12, 2004

**TRADEMARK
PRINCIPAL REGISTER**

TRAILBLAZER

L. L. BEAN, INC. (MAINE CORPORATION)
CASCO STREET
FREEPORT, ME 04033

THE MARK CONSISTS OF STANDARD CHAR-
ACTERS WITHOUT CLAIM TO ANY PARTICULAR
FONT, STYLE, SIZE, OR COLOR.

FOR: SNOW SHOES, IN CLASS 28 (U.S. CLS. 22, 23,
38 AND 50).

SER. NO. 78-322,309, FILED 11-3-2003.

FIRST USE 9-16-2003; IN COMMERCE 9-16-2003.

CAROLYN GRAY, EXAMINING ATTORNEY

Int. Cl.: 9

Prior U.S. Cls.: 21, 23, 26, 36 and 38

Reg. No. 2,893,624

United States Patent and Trademark Office

Registered Oct. 12, 2004

**TRADEMARK
PRINCIPAL REGISTER**

COBRA

SCHLAGE LOCK COMPANY (CALIFORNIA
CORPORATION)
SUITE 200
111 CONGRESSIONAL BOULEVARD
CARMEL, IN 46032

FOR: PROGRAMMABLE LOCKING SYSTEMS,
CONSISTING OF ELECTRONIC CYLINDRICAL
LOCKSETS AND KEYPADS, IN CLASS 9 (U.S. CLS.
21, 23, 26, 36 AND 38).

FIRST USE 3-0-2002; IN COMMERCE 4-0-2002.

THE MARK CONSISTS OF STANDARD CHAR-
ACTERS WITHOUT CLAIM TO ANY PARTICULAR
FONT, STYLE, SIZE, OR COLOR.

SER. NO. 78-322,653, FILED 11-4-2003.

JENNIFER KRISP, EXAMINING ATTORNEY

Int. Cl.: 42

Prior U.S. Cls.: 100 and 101

United States Patent and Trademark Office

Reg. No. 2,893,625

Registered Oct. 12, 2004

**SERVICE MARK
PRINCIPAL REGISTER**

ONIRACOM

ONIRACOM CORPORATION (CALIFORNIA
CORPORATION)
554 CORONEL PLACE #3
SANTA BARBARA, CA 93101

FOR: COMPUTER SERVICES, NAMELY, CREAT-
ING AND MAINTAINING WEBSITES FOR OTH-
ERS; AND HOSTING THE WEBSITES OF OTHERS
ON A COMPUTER SERVER VIA THE GLOBAL
COMPUTER NETWORK, IN CLASS 42 (U.S. CLS.
100 AND 101).

FIRST USE 7-1-2001; IN COMMERCE 7-1-2001.

THE MARK CONSISTS OF STANDARD CHAR-
ACTERS WITHOUT CLAIM TO ANY PARTICULAR
FONT, STYLE, SIZE, OR COLOR.

SER. NO. 78-322,865, FILED 11-4-2003.

CAROLYN GRAY, EXAMINING ATTORNEY

Int. Cl.: 16

Prior U.S. Cls.: 2, 5, 22, 23, 29, 37, 38 and 50

United States Patent and Trademark Office

Reg. No. 2,893,626

Registered Oct. 12, 2004

**TRADEMARK
PRINCIPAL REGISTER**

WHITE PEARL

LINZER PRODUCTS CORP. (NEW YORK COR-
PORATION)
248 WYANDANCH AVENUE
WYANDANCH, NY 11798

THE MARK CONSISTS OF STANDARD CHAR-
ACTERS WITHOUT CLAIM TO ANY PARTICULAR
FONT, STYLE, SIZE, OR COLOR.

FOR: PAINT APPLICATORS, IN CLASS 16 (U.S.
CLS. 2, 5, 22, 23, 29, 37, 38 AND 50).

SER. NO. 78-322,935, FILED 11-4-2003.

FIRST USE 0-0-1996; IN COMMERCE 0-0-1996.

CAROLYN GRAY, EXAMINING ATTORNEY

Int. Cl.: 42

Prior U.S. Cls.: 100 and 101

United States Patent and Trademark Office

Reg. No. 2,893,627

Registered Oct. 12, 2004

**SERVICE MARK
PRINCIPAL REGISTER**



ONIRACOM CORPORATION (CALIFORNIA CORPORATION)
554 CORONEL PLACE #3
SANTA BARBARA, CA 93101

FOR: COMPUTER SERVICES, NAMELY, CREATING AND MAINTAINING WEBSITES FOR OTHERS; AND HOSTING THE WEBSITES OF OTHERS ON A COMPUTER SERVER VIA THE GLOBAL COMPUTER NETWORK, IN CLASS 42 (U.S. CLS. 100 AND 101).

FIRST USE 5-17-2001; IN COMMERCE 6-1-2001.

THE MARK CONSISTS OF STYLIZED UPSIDE DOWN CAPITAL LETTER "J" WITHIN BRACKETS.

SER. NO. 78-322,940, FILED 11-4-2003.

CAROLYN GRAY, EXAMINING ATTORNEY

Int. Cl.: 36

Prior U.S. Cls.: 100, 101 and 102

United States Patent and Trademark Office

Reg. No. 2,893,628

Registered Oct. 12, 2004

**SERVICE MARK
PRINCIPAL REGISTER**

**NEW PROVIDENCE
ASSET MANAGEMENT**

NEW PROVIDENCE ASSET MANAGEMENT,
LLC (DELAWARE LIMITED LIABILITY COR-
PORATION)
70 EAST 55TH STREET
NEW YORK, NY 10022

FOR: FINANCIAL SERVICES, NAMELY, INVEST-
ING THE FUNDS OF OTHERS IN A PRIVATE
HEDGE FUND; INVESTMENT ADVISER SERVI-
CES; INVESTMENT MANAGEMENT SERVICES, IN
CLASS 36 (U.S. CLS. 100, 101 AND 102).

FIRST USE 5-31-2003; IN COMMERCE 5-31-2003.

THE MARK CONSISTS OF STANDARD CHAR-
ACTERS WITHOUT CLAIM TO ANY PARTICULAR
FONT, STYLE, SIZE, OR COLOR.

NO CLAIM IS MADE TO THE EXCLUSIVE
RIGHT TO USE ASSET MANAGEMENT, APART
FROM THE MARK AS SHOWN.

SER. NO. 78-323,001, FILED 11-4-2003.

YSA DEJESUS, EXAMINING ATTORNEY

Int. Cl.: 9

Prior U.S. Cls.: 21, 23, 26, 36 and 38

Reg. No. 2,893,629

United States Patent and Trademark Office

Registered Oct. 12, 2004

**TRADEMARK
PRINCIPAL REGISTER**

**Space Station
Manager**

OY MISTARIL AB (FINLAND CORPORATION)
ETELÄ HESPERIANKATU 4
HELSINKI, FINLAND 00100

THE MARK CONSISTS OF STANDARD CHAR-
ACTERS WITHOUT CLAIM TO ANY PARTICULAR
FONT, STYLE, SIZE, OR COLOR.

FOR: VIDEO GAME SOFTWARE, IN CLASS 9
(U.S. CLS. 21, 23, 26, 36 AND 38).

SER. NO. 78-323,223, FILED 11-5-2003.

FIRST USE 10-1-2002; IN COMMERCE 2-28-2003.

SUSAN LESLIE DUBOIS, EXAMINING ATTORNEY

Int. Cl.: 35

Prior U.S. Cls.: 100, 101 and 102

United States Patent and Trademark Office

Reg. No. 2,893,630

Registered Oct. 12, 2004

**SERVICE MARK
PRINCIPAL REGISTER**

10x10

INTEREP NATIONAL RADIO SALES, INC. (NEW
YORK CORPORATION)
100 PARK AVENUE FIFTH FLOOR
NEW YORK, NY 10017

FOR: ADVERTISING CONSULTING SERVICES
TO COMPANIES BUYING ADVERTISING IN ELEC-
TRONIC COMMUNICATIONS MEDIA, IN CLASS 35
(U.S. CLS. 100, 101 AND 102).

FIRST USE 2-5-2004; IN COMMERCE 2-5-2004.

THE MARK CONSISTS OF STANDARD CHAR-
ACTERS WITHOUT CLAIM TO ANY PARTICULAR
FONT, STYLE, SIZE, OR COLOR.

SER. NO. 78-323,477, FILED 11-5-2003.

MITCHELL FRONT, EXAMINING ATTORNEY

Int. Cl.: 14

Prior U.S. Cls.: 2, 27, 28 and 50

United States Patent and Trademark Office

Reg. No. 2,893,631

Registered Oct. 12, 2004

**TRADEMARK
PRINCIPAL REGISTER**

CHEER POWER

TCA CORPORATION (DELAWARE CORPORATION)
P.O. BOX 8657
BACLIFF, TX 77518

FOR: JEWELRY, NAMELY, CHARMS, IN CLASS
14 (U.S. CLS. 2, 27, 28 AND 50).

FIRST USE 9-30-1998; IN COMMERCE 9-30-1998.

THE MARK CONSISTS OF STANDARD CHARACTERS WITHOUT CLAIM TO ANY PARTICULAR FONT, STYLE, SIZE, OR COLOR.

OWNER OF U.S. REG. NO. 2,432,547.

SER. NO. 78-323,540, FILED 11-5-2003.

MICHAEL KEATING, EXAMINING ATTORNEY

Int. Cl.: 25

Prior U.S. Cls.: 22 and 39

United States Patent and Trademark Office

Reg. No. 2,893,632

Registered Oct. 12, 2004

**TRADEMARK
PRINCIPAL REGISTER**

FISHTAIL

VIEWPOINT INTERNATIONAL, INC. (DELA-
WARE CORPORATION)
222 PIEDMONT AVENUE
ATLANTA, GA 30308

THE MARK CONSISTS OF STANDARD CHAR-
ACTERS WITHOUT CLAIM TO ANY PARTICULAR
FONT, STYLE, SIZE, OR COLOR.

FOR: MEN'S PANTS, IN CLASS 25 (U.S. CLS. 22
AND 39).

SER. NO. 78-323,860, FILED 11-6-2003.

FIRST USE 4-1-2003; IN COMMERCE 9-1-2003.

JOHN LINCOSKI, EXAMINING ATTORNEY

Int. Cl.: 31

Prior U.S. Cls.: 1 and 46

United States Patent and Trademark Office

Reg. No. 2,893,633

Registered Oct. 12, 2004

**TRADEMARK
PRINCIPAL REGISTER**

**WE BRING MORE TO
THE TABLE**

SUPERIOR SALES, INC. (MICHIGAN CORPORATION)

P.O. BOX 159
2929 CORPORATE GROVE
HUDSONVILLE, MI 49426

FOR: FRESH FRUITS AND VEGETABLES FOR SALE TO WHOLESALE JOBBERS, DISTRIBUTORS AND CHAIN STORES, IN CLASS 31 (U.S. CLS. 1 AND 46).

FIRST USE 7-1-2003; IN COMMERCE 7-1-2003.

THE MARK CONSISTS OF STANDARD CHARACTERS WITHOUT CLAIM TO ANY PARTICULAR FONT, STYLE, SIZE, OR COLOR.

SER. NO. 78-323,896, FILED 11-6-2003.

ESTHER A. BORSUK, EXAMINING ATTORNEY

Int. Cl.: 30

Prior U.S. Cl.: 46

United States Patent and Trademark Office

Reg. No. 2,893,634

Registered Oct. 12, 2004

**TRADEMARK
PRINCIPAL REGISTER**

PLAYERS CHOICE

FUN CITY FOODS, INC. (NEVADA CORPORATION)
3211 SUNRISE AVENUE
LAS VEGAS, NV 89101

THE MARK CONSISTS OF STANDARD CHARACTERS WITHOUT CLAIM TO ANY PARTICULAR FONT, STYLE, SIZE, OR COLOR.

FOR: COOKIES, IN CLASS 30 (U.S. CL. 46).

SER. NO. 78-324,482, FILED 11-7-2003.

FIRST USE 10-5-1996; IN COMMERCE 10-15-1996.

MARY BOAGNI, EXAMINING ATTORNEY

Int. Cl.: 36

Prior U.S. Cls.: 100, 101 and 102

United States Patent and Trademark Office

Reg. No. 2,893,635

Registered Oct. 12, 2004

**SERVICE MARK
PRINCIPAL REGISTER**

**YOU'RE ALWAYS
FIRST WITH US**

FIRST NATIONAL OF NEBRASKA, INC. (NEBRASKA CORPORATION)
STOP CODE 3395 ATTN: ANITA KLANDERUD
1620 DODGE STREET
OMAHA, NE 681973395

FOR: BANKING SERVICES, IN CLASS 36 (U.S. CLS. 100, 101 AND 102).

FIRST USE 10-5-2003; IN COMMERCE 10-5-2003.

THE MARK CONSISTS OF STANDARD CHARACTERS WITHOUT CLAIM TO ANY PARTICULAR FONT, STYLE, SIZE, OR COLOR.

SER. NO. 78-324,599, FILED 11-7-2003.

WILLIAM VERHOSEK, EXAMINING ATTORNEY

Int. Cl.: 41

Prior U.S. Cls.: 100, 101 and 107

United States Patent and Trademark Office

Reg. No. 2,893,636

Registered Oct. 12, 2004

**SERVICE MARK
PRINCIPAL REGISTER**

BRITA LIVING

THE BRITA PRODUCTS COMPANY (DELA-
WARE CORPORATION)
1221 BROADWAY
OAKLAND, CA 94612

FOR: PROVIDING NEWSLETTERS VIA EMAIL
IN THE FIELDS OF HEALTH AND HEALTHY
LIFESTYLES, IN CLASS 41 (U.S. CLS. 100, 101 AND
107).

FIRST USE 3-0-2002; IN COMMERCE 3-0-2002.

THE MARK CONSISTS OF STANDARD CHAR-
ACTERS WITHOUT CLAIM TO ANY PARTICULAR
FONT, STYLE, SIZE, OR COLOR.

SER. NO. 78-324,730, FILED 11-7-2003.

ELIZABETH J. WINTER, EXAMINING ATTORNEY

Int. Cl.: 10

Prior U.S. Cls.: 26, 39 and 44

United States Patent and Trademark Office

Reg. No. 2,893,637

Registered Oct. 12, 2004

**TRADEMARK
PRINCIPAL REGISTER**

GUINOT

FINCHALE, LTD. (UNITED KINGDOM CORPORATION)
CHURCH'S HOUSE, LORD STREET
DOUGLAS, ISLE OF MAN, UNITED KINGDOM

FOR: FACIAL AND BODY TONING, FIRING, HYDRATING, SMOOTHING, REGENERATING, AND OXYGENATING MACHINES FOR COSMETIC PURPOSES, FOR USE ALONE OR WITH TOPICALLY APPLIED COSMETICS; ELECTRICAL MASSAGE APPARATUS, NAMELY SKIN AND FACE MASSAGERS; ELECTRONIC STIMULATORS FOR THE FACE AND SKIN; FACIAL TONING MACHINES FOR COSMETIC USE, NAMELY, ELECTRICAL MACHINES USED TO TREAT ACNE AND SKIN BLEMISHES, IN CLASS 10 (U.S. CLS. 26, 39 AND 44).

FIRST USE 4-0-1972; IN COMMERCE 4-0-1972.

THE MARK CONSISTS OF STANDARD CHARACTERS WITHOUT CLAIM TO ANY PARTICULAR FONT, STYLE, SIZE, OR COLOR.

OWNER OF U.S. REG. NOS. 1,285,719 AND 2,672,243.

SER. NO. 78-326,075, FILED 11-11-2003.

BRIAN PINO, EXAMINING ATTORNEY

Int. Cl.: 5

Prior U.S. Cls.: 6, 18, 44, 46, 51 and 52

United States Patent and Trademark Office

Reg. No. 2,893,638

Registered Oct. 12, 2004

**TRADEMARK
PRINCIPAL REGISTER**

SUPER RIPPED

NATURE'S BEST INC. (NEW YORK CORPORATION)

195 ENGINEERS ROAD
HAUPPAUGE, NY 11788

FOR: VITAMIN AND MINERAL SUPPLEMENTS,
IN CLASS 5 (U.S. CLS. 6, 18, 44, 46, 51 AND 52).

FIRST USE 9-15-1981; IN COMMERCE 9-15-1981.

THE MARK CONSISTS OF STANDARD CHARACTERS WITHOUT CLAIM TO ANY PARTICULAR FONT, STYLE, SIZE, OR COLOR.

OWNER OF U.S. REG. NO. 1,281,051.

SEC. 2(F).

SER. NO. 78-326,285, FILED 11-11-2003.

RICHARD A. STRASER, EXAMINING ATTORNEY

Int. Cl.: 20

Prior U.S. Cls.: 2, 13, 22, 25, 32 and 50

United States Patent and Trademark Office

Reg. No. 2,893,639

Registered Oct. 12, 2004

**TRADEMARK
PRINCIPAL REGISTER**

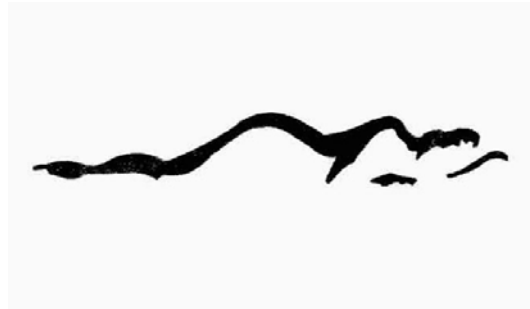

FOAMEX L.P. (DELAWARE LIMITED PART-
NERSHIP)
1000 COLUMBIA AVENUE
LINWOOD, PA 19061

FOR: SLEEP RELATED PRODUCTS, NAMELY,
MATTRESSES, MATTRESS TOPPERS, FUTONS
AND PILLOWS, IN CLASS 20 (U.S. CLS. 2, 13, 22, 25,
32 AND 50).

FIRST USE 10-0-2003; IN COMMERCE 10-0-2003.

THE MARK CONSISTS OF RECLINING FIGURE.

SER. NO. 78-326,939, FILED 11-12-2003.

ALEX KEAM, EXAMINING ATTORNEY

Int. Cl.: 7

Prior U.S. Cls.: 13, 19, 21, 23, 31, 34 and 35

United States Patent and Trademark Office

Reg. No. 2,893,640

Registered Oct. 12, 2004

**TRADEMARK
PRINCIPAL REGISTER**

FLEXPRESS

FISCHER & KRECKE GMBH & CO. (FED REP
GERMANY CORPORATION)
HAKENORT 47
BIELEFELD, FED REP GERMANY D-33609

FOR: HIGH SPEED FLEXOGRAPHIC PRINTING
MACHINES WITH VARIABLE REPEAT LENGTHS
FOR PRINTING PHOTOGRAPHIC QUALITY IMA-
GES ON CONTINUOUS WEBS USED FOR PACKA-
GING OF CONSUMER GOODS, IN CLASS 7 (U.S.
CLS. 13, 19, 21, 23, 31, 34 AND 35).

FIRST USE 3-21-2000; IN COMMERCE 8-20-2001.

THE MARK CONSISTS OF STANDARD CHAR-
ACTERS WITHOUT CLAIM TO ANY PARTICULAR
FONT, STYLE, SIZE, OR COLOR.

SER. NO. 78-328,077, FILED 11-14-2003.

MATTHEW KLINE, EXAMINING ATTORNEY

Int. Cl.: 3

Prior U.S. Cls.: 1, 4, 6, 50, 51 and 52

United States Patent and Trademark Office

Reg. No. 2,893,641

Registered Oct. 12, 2004

**TRADEMARK
PRINCIPAL REGISTER**

DIOR ME, DIOR ME NOT

PARFUMS CHRISTIAN DIOR (FRANCE CORPORATION)
33 AVENUE HOCHÉ
75008 PARIS, FRANCE

FOR: PERFUMERY, ESSENTIAL OILS FOR PERSONAL USE, COSMETICS, HAIR LOTIONS, IN CLASS 3 (U.S. CLS. 1, 4, 6, 50, 51 AND 52).

THE MARK CONSISTS OF STANDARD CHARACTERS WITHOUT CLAIM TO ANY PARTICULAR FONT, STYLE, SIZE, OR COLOR.

PRIORITY CLAIMED UNDER SEC. 44(D) ON FRANCE APPLICATION NO. FR033231012, FILED 6-6-2003, REG. NO. FR033231012, DATED 6-6-2003, EXPIRES 6-6-2013.

OWNER OF U.S. REG. NOS. 573,430, 1,485,855 AND OTHERS.

SER. NO. 78-336,209, FILED 12-4-2003.

BRIDGETT SMITH, EXAMINING ATTORNEY

Int. Cls.: 36 and 41

Prior U.S. Cls.: 100, 101, 102 and 107

United States Patent and Trademark Office

Reg. No. 2,893,642

Registered Oct. 12, 2004

**SERVICE MARK
PRINCIPAL REGISTER**

BLUE RIBBON DOWNS

BACKSTRETCH, L.L.C. (OKLAHOMA LTD LIAB
CO)
P.O. DRAWER 1210
DURANT, OK 747021210

FOR: PROVISION OF HORSE TRACK SERVICES,
NAMELY, ON-TRACK, OFF-TRACK AND INTER-
TRACK BETTING AND WAGERING SERVICES, IN
CLASS 36 (U.S. CLS. 100, 101 AND 102).

FIRST USE 0-0-1963; IN COMMERCE 0-0-1963.

FOR: ENTERTAINMENT SERVICES, NAMELY,
ORGANIZING AND CONDUCTING LIVE AND
SIMULCAST HORSE RACING; PROVISION OF
HORSE TRACK SERVICES, NAMELY CONDUCT-
ING HORSE RACES, ORGANIZING AND CON-
DUCTING PRE- AND POST-RACE ACTIVITIES,
NAMELY PROVIDING PARTY FACILITIES REN-
TAL SERVICES AT RACETRACKS FOR BUSINES-
SES AND ORGANIZATIONS; PROVIDING PRE-
AND POST-RACE ENTERTAINMENT SERVICES

IN THE NATURE OF LIVE MUSIC PERFORMAN-
CES AT RACETRACKS; PROVIDING PRE- AND
POST-RACE ENTERTAINMENT SERVICES IN THE
NATURE OF CAR SHOWS AND EXHIBITIONS AT
RACETRACKS; AND PROVIDING LIVE COMMEN-
TARY OF HORSE RACES, IN CLASS 41 (U.S. CLS.
100, 101 AND 107).

FIRST USE 0-0-1963; IN COMMERCE 0-0-1963.

THE MARK CONSISTS OF STANDARD CHAR-
ACTERS WITHOUT CLAIM TO ANY PARTICULAR
FONT, STYLE, SIZE, OR COLOR.

NO CLAIM IS MADE TO THE EXCLUSIVE
RIGHT TO USE "DOWNS", APART FROM THE
MARK AS SHOWN.

SER. NO. 78-336,636, FILED 12-4-2003.

KATHY DE JONGE, EXAMINING ATTORNEY

Int. Cl.: 35

Prior U.S. Cls.: 100, 101 and 102

United States Patent and Trademark Office

Reg. No. 2,893,643

Registered Oct. 12, 2004

**SERVICE MARK
PRINCIPAL REGISTER**

JAY C PLUS

THE KROGER CO. OF MICHIGAN (MICHIGAN
CORPORATION)
18334 LAUREL PARK DRIVE NORTH
LIVONIA, MI 481522686

THE MARK CONSISTS OF STANDARD CHAR-
ACTERS WITHOUT CLAIM TO ANY PARTICULAR
FONT, STYLE, SIZE, OR COLOR.

FOR: RETAIL GROCERY STORE SERVICES, IN
CLASS 35 (U.S. CLS. 100, 101 AND 102).

SER. NO. 78-360,320, FILED 1-30-2004.

FIRST USE 11-0-2002; IN COMMERCE 11-0-2002.

RICHARD WHITE, EXAMINING ATTORNEY

Int. Cl.: 14

Prior U.S. Cls.: 2, 27, 28 and 50

Reg. No. 2,893,644

United States Patent and Trademark Office

Registered Oct. 12, 2004

**TRADEMARK
PRINCIPAL REGISTER**

BIRTHVERSE

CINDY JAMES (VIRGINIA SOLE PROPRIETORSHIP), DBA HEAVENLY DESIGNS
118 BURNELL PLACE, SE
LEESBURG, VA 20175 AND
PUMPERNICKEL PRESS, LLC (VIRGINIA CORPORATION)
37251 EAST RICHARDSON LANE, UNIT D
PURCELLVILLE, VA 20132

FIRST USE 12-1-2003; IN COMMERCE 12-1-2003.

THE MARK CONSISTS OF STANDARD CHARACTERS WITHOUT CLAIM TO ANY PARTICULAR FONT, STYLE, SIZE, OR COLOR.

SER. NO. 78-361,390, FILED 2-2-2004.

FOR: BEADED BRACELETS , IN CLASS 14 (U.S. CLS. 2, 27, 28 AND 50).

KATHRYN COWARD, EXAMINING ATTORNEY

Int. Cl.: 9

Prior U.S. Cls.: 21, 23, 26, 36 and 38

United States Patent and Trademark Office

Reg. No. 2,893,645

Registered Oct. 12, 2004

**TRADEMARK
PRINCIPAL REGISTER**

DOZENS OF DIAMONDS

IGT (NEVADA CORPORATION)
9295 PROTOTYPE DRIVE
RENO, NV 895218986

FOR: GAMING MACHINES, NAMELY, SLOT MACHINES WITH OR WITHOUT VIDEO OUTPUT, VIDEO LOTTERY TERMINALS, GAMING MACHINES FOR PLAY OF AN INTERACTIVE, ELECTRONIC BINGO GAME, IN CLASS 9 (U.S. CLS. 21, 23, 26, 36 AND 38).

FIRST USE 12-1-1998; IN COMMERCE 9-22-1999.

THE MARK CONSISTS OF STANDARD CHARACTERS WITHOUT CLAIM TO ANY PARTICULAR FONT, STYLE, SIZE, OR COLOR.

OWNER OF U.S. REG. NOS. 2,029,173, 2,604,459 AND OTHERS.

SER. NO. 78-380,539, FILED 3-8-2004.

BRENDAN REGAN, EXAMINING ATTORNEY

Int. Cl.: 25

Prior U.S. Cls.: 22 and 39

United States Patent and Trademark Office

Reg. No. 2,893,646

Registered Oct. 12, 2004

**TRADEMARK
PRINCIPAL REGISTER**

XBOX

MICROSOFT CORPORATION (WASHINGTON
CORPORATION)
ONE MICROSOFT WAY
REDMOND, WA 980526399

FIRST USE 1-0-2001; IN COMMERCE 1-0-2001.

SER. NO. 78-975,142, FILED 9-19-2000.

FOR: SHIRTS, VESTS, SWEATSHIRTS, JACKETS,
CAPS, COATS AND SWEATERS, IN CLASS 25 (U.S.
CLS. 22 AND 39).

DOMINIC J. FERRAIUOLO, EXAMINING ATTOR-
NEY

Int. Cls.: 9, 16, 36, 41 and 42

**Prior U.S. Cls.: 2, 5, 21, 22, 23, 26, 29, 36, 37, 38, 50,
100, 101, 102 and 107**

Reg. No. 2,893,647

United States Patent and Trademark Office

Registered Oct. 12, 2004

**TRADEMARK
SERVICE MARK
PRINCIPAL REGISTER**



AMERICAN CENTER FOR LAW AND JUSTICE,
INC. (VIRGINIA CORPORATION)
P.O. BOX 64429
VIRGINIA BEACH, VA 23467

FOR: LEGAL AND EDUCATIONAL ELECTRONIC PUBLICATIONS, NAMELY, BOOKS, MAGAZINES, NEWSLETTERS, BROCHURES, PAMPHLETS, OUTLINES, FLYERS, LETTERS, AND LEAFLETS ON THE SUBJECT OF PUBLIC INTEREST LAW, CONSTITUTIONAL FREEDOMS WITH EMPHASIS ON FIRST AMENDMENT RIGHTS, NATIONAL SECURITY, HOMELAND SECURITY, PRINCIPLES OF JUSTICE, THE PROTECTION OF LIFE AND RELIGIOUS LIBERTY, CIVIL LIBERTIES, PRO-FAMILY AND PRO-LIFE ISSUES AND ON THE SUBJECTS OF THE RENDERING OF LEGAL SERVICES, ADVICE, AND COUNSELING OTHERS IN ALL OF THE FOREGOING, WHICH ARE RECORDED ON COMPUTER, DIGITAL AND TAPE MEDIA; DOWNLOADABLE ELECTRONIC PUBLICATIONS IN THE NATURE OF BOOKS, MAGAZINES, NEWSLETTERS, BROCHURES, PAMPHLETS, OUTLINES, FLYERS, LETTERS AND LEAFLETS ON THE SUBJECT OF PUBLIC INTEREST LAW, CONSTITUTIONAL FREEDOMS WITH EMPHASIS ON FIRST AMENDMENT RIGHTS, NATIONAL SECURITY, HOMELAND SECURITY, PRINCIPLES OF JUSTICE, THE PROTECTION OF LIFE AND RELIGIOUS LIBERTY, CIVIL LIBERTIES, PRO-FAMILY AND PRO-LIFE ISSUES AND ON THE SUBJECTS OF THE RENDERING OF LEGAL SERVICES, ADVICE, AND COUNSELING OTHERS IN ALL OF THE FOREGOING; PRERECORDED VIDEO TAPES AND CASSETTES, COMPACT DISCS AND DIGITAL VIDEO DISKS, AUDIO TAPES AND CASSETTES, ON THE SUBJECT OF PUBLIC INTEREST LAW, CONSTITUTIONAL FREEDOMS WITH EMPHASIS ON FIRST AMENDMENT RIGHTS, NATIONAL SECURITY, HOME-

LAND SECURITY, PRINCIPLES OF JUSTICE, THE PROTECTION OF LIFE AND RELIGIOUS LIBERTY, CIVIL LIBERTIES, PRO-FAMILY AND PRO-LIFE ISSUES AND ON THE SUBJECTS OF THE RENDERING OF LEGAL SERVICES, ADVICE, AND COUNSELING OTHERS IN ALL OF THE FOREGOING, IN CLASS 9 (U.S. CLS. 21, 23, 26, 36 AND 38).

FIRST USE 1-0-2003; IN COMMERCE 1-0-2003.

FOR: PRINTED LEGAL, INSTRUCTIONAL, TEACHING AND EDUCATIONAL MATERIALS AND PUBLICATIONS, NAMELY BOOKS, MAGAZINES, NEWSLETTERS, BROCHURES, PAMPHLETS, OUTLINES, FLYERS, LETTERS, LEAFLETS AND PRINTED LECTURES ON THE SUBJECT OF PUBLIC INTEREST LAW, CONSTITUTIONAL FREEDOMS WITH EMPHASIS ON FIRST AMENDMENT RIGHTS, NATIONAL SECURITY, HOMELAND SECURITY, PRINCIPLES OF JUSTICE, THE PROTECTION OF LIFE AND RELIGIOUS LIBERTY, CIVIL LIBERTIES, PRO-FAMILY AND PRO-LIFE ISSUES AND ON THE SUBJECTS OF THE RENDERING OF LEGAL SERVICES, ADVICE, AND COUNSELING OTHERS IN ALL OF THE FOREGOING, IN CLASS 16 (U.S. CLS. 2, 5, 22, 23, 29, 37, 38 AND 50).

FIRST USE 1-0-2003; IN COMMERCE 1-0-2003.

FOR: CHARITABLE FUNDRAISING SERVICES PROVIDED VIA THE INTERNET; AND CHARITABLE FUNDRAISING SERVICES, IN CLASS 36 (U.S. CLS. 100, 101 AND 102).

FIRST USE 1-0-2003; IN COMMERCE 1-0-2003.

FOR: COMPUTER SERVICES, NAMELY PROVIDING ON-LINE BOOKS, MAGAZINES, NEWSLETTERS, BROCHURES, PAMPHLETS, OUTLINES, FLYERS, LETTERS AND LEAFLETS ON THE SUB-

JECT OF PUBLIC INTEREST LAW, CONSTITUTIONAL FREEDOMS WITH EMPHASIS ON FIRST AMENDMENT RIGHTS, NATIONAL SECURITY, HOMELAND SECURITY, PRINCIPLES OF JUSTICE, THE PROTECTION OF LIFE AND RELIGIOUS LIBERTY, CIVIL LIBERTIES, PRO-FAMILY AND PRO-LIFE ISSUES AND ON THE SUBJECTS OF THE RENDERING OF LEGAL SERVICES, ADVICE, AND COUNSELING OTHERS IN ALL OF THE FOREGOING; ENTERTAINMENT SERVICES, NAMELY PROVIDING A RADIO PROGRAM IN THE FIELD OF PUBLIC INTEREST LAW, CONSTITUTIONAL FREEDOMS WITH EMPHASIS ON THE FIRST AMENDMENT RIGHTS, NATIONAL SECURITY, HOMELAND SECURITY, PRINCIPLES OF JUSTICE, THE PROTECTION OF LIFE AND RELIGIOUS LIBERTY, CIVIL LIBERTIES, PRO-FAMILY AND

PRO-LIFE ISSUES AND ON THE SUBJECTS OF THE RENDERING OF LEGAL SERVICES, ADVICE AND COUNSELING OTHERS IN ALL OF THE FOREGOING, IN CLASS 41 (U.S. CLS. 100, 101 AND 107).

FIRST USE 1-0-2003; IN COMMERCE 1-0-2003.

FOR: LEGAL SERVICES, IN CLASS 42 (U.S. CLS. 100 AND 101).

FIRST USE 1-0-2003; IN COMMERCE 1-0-2003.

SER. NO. 78-975,371, FILED 3-21-2003.

APRIL L. RADEMACHER, EXAMINING ATTORNEY

Int. Cl.: 9

Prior U.S. Cls.: 21, 23, 26, 36 and 38

Reg. No. 2,893,648

United States Patent and Trademark Office

Registered Oct. 12, 2004

**TRADEMARK
PRINCIPAL REGISTER**

FELONY RECORDS

SMITH, STEPHEN (UNITED STATES INDIVIDUAL)
9035 MOOR PARK RUN
DULUTH, GA 30097

NO CLAIM IS MADE TO THE EXCLUSIVE RIGHT TO USE RECORDS, APART FROM THE MARK AS SHOWN.

FOR: RECORDS, AUDIO TAPES, AND COMPACT DISCS FEATURING MUSIC RECORDINGS, IN CLASS 9 (U.S. CLS. 21, 23, 26, 36 AND 38).

SER. NO. 78-975,388, FILED 3-22-2002.

FIRST USE 3-1-2002; IN COMMERCE 4-1-2002.

SHARON MEIER, EXAMINING ATTORNEY

Int. Cls.: 29 and 32

Prior U.S. Cls.: 45, 46 and 48

United States Patent and Trademark Office

Reg. No. 2,893,649

Registered Oct. 12, 2004

**TRADEMARK
PRINCIPAL REGISTER**

NANA MAE'S

NANA MAE'S ORGANICS, LLC (CALIFORNIA
LTD LIAB CO)
P. O. BOX 2298
SEBASTOPOL, CA 95473

FOR: APPLESAUCE AND APPLESAUCE BLEN-
DED WITH OTHER FRUITS, IN CLASS 29 (U.S. CL.
46).

FIRST USE 4-2-1996; IN COMMERCE 6-12-2002.

FOR: FRUIT JUICE NAMELY APPLE JUICE,
APPLE JUICE BLENDED WITH OTHER FRUIT

JUICES, AND PEAR JUICE, IN CLASS 32 (U.S. CLS.
45, 46 AND 48).

FIRST USE 3-22-1996; IN COMMERCE 6-12-2002.

THE NAME OR NICKNAME, NANA MAE'S,
DOES NOT IDENTIFY A PARTICULAR LIVING
INDIVIDUAL.

SER. NO. 78-975,585, FILED 7-17-2003.

RICHARD A. STRASER, EXAMINING ATTORNEY

Int. Cl.: 16

Prior U.S. Cls.: 2, 5, 22, 23, 29, 37, 38, and 50

Reg. No. 2,893,653

United States Patent and Trademark Office

Registered Oct. 12, 2004

**TRADEMARK
PRINCIPAL REGISTER**



BEE WARE ENTERPRISES INC. (CANADA CORPORATION)
25 NORTHSIDE ROAD
UNIT D
OTTAWA, ONTARIO, CANADA K2H 8S1

FOR: PENCILS AND POSTERS, IN CLASS 16 (U.S. CLS. 2, 5, 22, 23, 29, 37, 38 AND 50).

FIRST USE 12-0-2003; IN COMMERCE 12-0-2003.

PRIORITY CLAIMED UNDER SEC. 44(D) ON CANADA APPLICATION NO. 819325, FILED 7-30-1996, REG. NO. TMA537,672, EXPIRES 11-23-2015.

NO CLAIM IS MADE TO THE EXCLUSIVE RIGHT TO USE "INTERNATIONAL", APART FROM THE MARK AS SHOWN.

SN 75-228,843, FILED 1-21-1997.

MICHAEL KAZAZIAN, EXAMINING ATTORNEY

Int. Cl.: 44

Prior U.S. Cls.: 100 and 101

United States Patent and Trademark Office

Reg. No. 2,893,654

Registered Oct. 12, 2004

**SERVICE MARK
PRINCIPAL REGISTER**

FORUM HEALTH

FORUM HEALTH (OHIO CORPORATION)
500 GYPSY LANE
YOUNGSTOWN, OH 44501

FOR: HEALTHCARE SERVICES, IN CLASS 44
(U.S. CLS. 100 AND 101).

FIRST USE 9-4-1997; IN COMMERCE 9-4-1997.

NO CLAIM IS MADE TO THE EXCLUSIVE
RIGHT TO USE "HEALTH" , APART FROM THE
MARK AS SHOWN.

SN 75-348,815, FILED 8-28-1997.

ALICE SUE CARRUTHERS, EXAMINING ATTOR-
NEY

Int. Cl.: 9

Prior U.S. Cls.: 21, 23, 26, 36, and 38

United States Patent and Trademark Office

Reg. No. 2,893,655

Registered Oct. 12, 2004

**TRADEMARK
PRINCIPAL REGISTER**

QUICK-FLEX

ACUITY BRANDS, INC. (DELAWARE COR-
PORATION)
1420 PEACHTREE STREET, NE
ATLANTA, GA 30309

FOR: FLEXIBLE ELECTRIC WIRING SYSTEMS
AND COMPONENTS NAMELY, FLEXIBLE
BRANCH CIRCUITS, ATTACHMENT PLUGS, RE-

CEPTACLES, CONNECTORS AND FITTINGS, IN
CLASS 9 (U.S. CLS. 21, 23, 26, 36 AND 38).

FIRST USE 7-0-1997; IN COMMERCE 7-0-1997.

SN 75-392,090, FILED 11-18-1997.

ESTHER A. BORSUK, EXAMINING ATTORNEY

Int. Cl.: 12

Prior U.S. Cls.: 19, 21, 23, 31, 35, and 44

United States Patent and Trademark Office

Reg. No. 2,893,656

Registered Oct. 12, 2004

**TRADEMARK
PRINCIPAL REGISTER**



FORMULA ONE LICENSING B.V. (NETHERLANDS PRIVATE LIMITED COMPANY)
KONINGSLAAN 34
1075 AD AMSTERDAM, NETHERLANDS

FOR: RACING CARS, AUTOMOBILES AND STRUCTURAL PARTS THEREOF; MOTORS AND ENGINES FOR LAND VEHICLES, IN CLASS 12 (U.S. CLS. 19, 21, 23, 31, 35 AND 44).

FIRST USE 1-0-1995; IN COMMERCE 9-30-2001.

PRIORITY CLAIMED UNDER SEC. 44(D) ON SOUTH AFRICA APPLICATION NO. 09713599, FILED 9-8-1997, DATED 0-0-0000.

OWNER OF U.S. REG. NOS. 2,117,160 AND 2,133,606.

SN 75-446,140, FILED 3-6-1998.

HENRY S. ZAK, EXAMINING ATTORNEY

Int. Cl.: 12

Prior U.S. Cls.: 19, 21, 23, 31, 35, and 44

United States Patent and Trademark Office

Reg. No. 2,893,657

Registered Oct. 12, 2004

**TRADEMARK
PRINCIPAL REGISTER**

XPRESS

SLP PERFORMANCE PARTS, INC. (NEW JER-
SEY CORPORATION)
1501 INDUSTRIAL WAY NORTH
TOMS RIVER, NJ 08755

FIRST USE 5-0-1999; IN COMMERCE 5-0-1999.

SN 75-518,315, FILED 7-13-1998.

FOR: LAND VEHICLES, NAMELY PICK-UP
TRUCKS, IN CLASS 12 (U.S. CLS. 19, 21, 23, 31, 35
AND 44).

KAREN BRACEY, EXAMINING ATTORNEY

Int. Cl.: 41

Prior U.S. Cls.: 100, 101, and 107

United States Patent and Trademark Office

Reg. No. 2,893,659

Registered Oct. 12, 2004

**SERVICE MARK
PRINCIPAL REGISTER**

MOLTEN BLUE PICTURES

STAUFFACHER, CARY (UNITED STATES INDIVIDUAL)
2649 N. CALIFORNIA AVE.
CHICAGO, IL 60647

NO CLAIM IS MADE TO THE EXCLUSIVE RIGHT TO USE "PICTURES", APART FROM THE MARK AS SHOWN.

FOR: SCRIPT WRITING SERVICES, IN CLASS 41 (U.S. CLS. 100, 101 AND 107).

SN 75-596,696, FILED 11-25-1998.

FIRST USE 1-0-2000; IN COMMERCE 1-0-2000.

ELIZABETH J. WINTER, EXAMINING ATTORNEY

Int. Cl.: 25

Prior U.S. Cls.: 22 and 39

United States Patent and Trademark Office

Reg. No. 2,893,661

Registered Oct. 12, 2004

**TRADEMARK
PRINCIPAL REGISTER**

LANGUAGE OF FLOWERS

FLAT CREEK MOUNTAIN, INC. (NORTH CAR-
OLINA CORPORATION)
P.O. BOX 8344
333 LOWER FLAT CREEK RD.
ASHEVILLE, NC 28814

FOR: SCARVES, IN CLASS 25 (U.S. CLS. 22 AND
39).

FIRST USE 2-12-2004; IN COMMERCE 2-12-2004.

OWNER OF U.S. REG. NO. 1,389,310.

SN 75-659,944, FILED 3-15-1999.

MARY BOAGNI, EXAMINING ATTORNEY

Int. Cl.: 9

Prior U.S. Cls.: 21, 23, 26, 36, and 38

United States Patent and Trademark Office

Reg. No. 2,893,662

Registered Oct. 12, 2004

**TRADEMARK
PRINCIPAL REGISTER**

EPAPER

ADOBE SYSTEMS INCORPORATED (DELA-
WARE CORPORATION)
345 PARK AVENUE
SAN JOSE, CA 95110

FOR: COMPUTER SOFTWARE, NAMELY, PAGE RECOGNITION AND RENDERING PROGRAMS USED TO CONVERT DATA INTO DIGITAL FILES FOR FILE-SHARING, STORAGE, ANNOTATION, TRANSFER, DISTRIBUTION, VIEWING AND PRINTING OF ELECTRONIC DOCUMENTS; COMPUTER SOFTWARE FOR USE WITH OPTICAL SCANNERS TO CONVERT DATA INTO DIGITAL FILES FOR STORAGE, ANNOTATION, TRANSFER, VIEWING, PRINTING AND DISTRIBUTION OF ELECTRONIC DOCUMENTS VIA E-MAIL OR A LOCAL OR GLOBAL COMPUTER NETWORK; COMPUTER SOFTWARE FOR USE IN PERFORMING ELECTRONIC BUSINESS TRANSACTIONS FOR THE SALE AND DISTRIBUTION OF ELEC-

TRONIC DATA, VIA A LOCAL OR GLOBAL COMPUTER NETWORK; COMPUTER SOFTWARE FOR DIGITAL RIGHTS MANAGEMENT, NAMELY, THE ENCRYPTION, ACCESS CONTROL, MONITORING AND PROTECTION OF THE CONTENTS OF ELECTRONIC DOCUMENTS; COMPUTER SOFTWARE USED FOR DESKTOP PUBLISHING, ELECTRONIC PUBLISHING, DIGITAL PUBLISHING AND PRINTING; AND INSTRUCTIONAL BOOKS AND MANUALS SOLD AS A UNIT THEREWITH, IN CLASS 9 (U.S. CLS. 21, 23, 26, 36 AND 38).

FIRST USE 11-1-1995; IN COMMERCE 5-1-1996.

OWNER OF U.S. REG. NO. 2,151,180.

SN 75-715,127, FILED 6-18-1999.

BRENDAN REGAN, EXAMINING ATTORNEY

Int. Cl.: 35

Prior U.S. Cls.: 100, 101, and 102

United States Patent and Trademark Office

Reg. No. 2,893,663

Registered Oct. 12, 2004

**SERVICE MARK
PRINCIPAL REGISTER**

LOVERBOY

LOVER'S LANE (MICHIGAN CORPORATION)
2020 N. WAYNE ROAD
WESTLAND, MI 48185

FOR: MAIL ORDER CATALOG SERVICES FEATURING INTIMATE APPAREL FOR MEN, ACTIVE WEAR FOR MEN, DAY WEAR APPAREL FOR MEN, SWIM WEAR, LEATHER WEAR, WARDROBE ACCESSORIES SUCH AS SHOES, BELTS,

HATS AND JEWELRY, IN CLASS 35 (U.S. CLS. 100, 101 AND 102).

FIRST USE 1-1-2000; IN COMMERCE 1-1-2000.

SN 75-743,454, FILED 7-6-1999.

WILLIAM BRECKENFELD, EXAMINING ATTORNEY

Int. Cl.: 25

Prior U.S. Cls.: 22 and 39

United States Patent and Trademark Office

Reg. No. 2,893,664

Registered Oct. 12, 2004

**TRADEMARK
PRINCIPAL REGISTER**

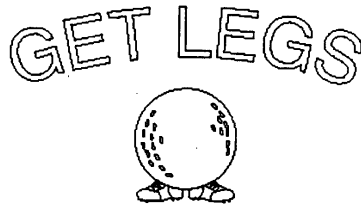

POWELL, DOUGLAS (UNITED STATES INDIVIDUAL)
7557 E LAGUNA AZUL AVE
MESA, AZ 85208

FIRST USE 1-1-2001; IN COMMERCE 7-18-2003.

SN 75-752,021, FILED 7-15-1999.

FOR: SHIRTS, PANTS, HATS, IN CLASS 25 (U.S. CLS. 22 AND 39).

MICHAEL BAIRD, EXAMINING ATTORNEY

Int. Cl.: 29

Prior U.S. Cl.: 46

United States Patent and Trademark Office

Reg. No. 2,893,665

Registered Oct. 12, 2004

**TRADEMARK
PRINCIPAL REGISTER**

OLIOVITA

SOL FRUT S.A. (ARGENTINA CORPORATION)
CHACABUCO 96, 2 PISO
1069 - CIUDAD DE BUENOS AIRES, ARGENTINA

FOR: EDIBLE OIL, COOKING OIL, EDIBLE FATS
AND COOKING FATS AND PACKAGED PROCES-
SED OLIVES, IN CANS OR BOTTLES OR POUCHES,
IN CLASS 29 (U.S. CL. 46).

FIRST USE 6-15-2004; IN COMMERCE 6-15-2004.

PRIORITY CLAIMED UNDER SEC. 44(D) ON
ARGENTINA APPLICATION NO. 2,201,112, FILED
2-4-1999, DATED 0-0-0000.

THE ENGLISH TRANSLATION OF "OLIOVITA"
IS "OIL OF LIFE" OR "OILLIFE".

SN 75-767,008, FILED 8-3-1999.

ELIZABETH HUGHITT, EXAMINING ATTORNEY

Int. Cl.: 35

Prior U.S. Cls.: 100, 101, and 102

United States Patent and Trademark Office

Reg. No. 2,893,666

Registered Oct. 12, 2004

**SERVICE MARK
PRINCIPAL REGISTER**

E-COOK

ZELBY INDUSTRIES, L.L.C. (RHODE ISLAND
LIMITED LIABILITY COMPANY)
100 MEDWAY STREET
PROVIDENCE, RI 02906

FOR: PROMOTING THE GOODS AND SERVICES
OF OTHERS BY PLACING ADVERTISEMENTS
AND PROMOTIONAL DISPLAYS IN AN ELECTRO-
NIC SITE ACCESSED THROUGH COMPUTER NET-
WORKS; ON-LINE COMPUTER SERVICES,
NAMELY, PROVIDING INFORMATION REGARD-
ING THE GOODS AND SERVICES OF OTHERS IN

THE NATURE OF A BUYER'S GUIDE; PROVIDING
ON-LINE RETAILING AND ON-LINE ORDERING
SERVICES IN THE FIELD OF A WIDE VARIETY OF
MERCHANDISE, IN CLASS 35 (U.S. CLS. 100, 101
AND 102).

FIRST USE 4-30-2004; IN COMMERCE 4-30-2004.

SN 75-775,026, FILED 9-3-1999.

DAVID H. STINE, EXAMINING ATTORNEY

Int. Cl.: 42

Prior U.S. Cls.: 100 and 101

United States Patent and Trademark Office

Reg. No. 2,893,667

Registered Oct. 12, 2004

**SERVICE MARK
PRINCIPAL REGISTER**

SEXBET.COM

NORTECH INVESTMENTS LTD (SEYCHELLES
CORPORATION)
P.O. BOX W1935
ST. JOHNS, ANTIGUA, WEST INDIES, SEY-
CHELLES

FOR: COMPUTER SERVICES, NAMELY, PRO-
VIDING DATABASES FEATURING GENERAL

AND LOCAL NEWS, IN CLASS 42 (U.S. CLS. 100
AND 101).

FIRST USE 2-0-2000; IN COMMERCE 2-0-2000.

SN 75-779,280, FILED 8-18-1999.

MICHAEL KEATING, EXAMINING ATTORNEY

Int. Cl.: 42

Prior U.S. Cls.: 100 and 101

United States Patent and Trademark Office

Reg. No. 2,893,668

Registered Oct. 12, 2004

**SERVICE MARK
PRINCIPAL REGISTER**

SEXBET

NORTECH INVESTMENTS LTD (SEYCHELLES
CORPORATION)
P.O. BOX W1935
ST. JOHNS, ANTIGUA, WEST INDIES, SEY-
CHELLES

FOR: COMPUTER SERVICES, NAMELY, PRO-
VIDING DATABASES FEATURING GENERAL

AND LOCAL NEWS, IN CLASS 42 (U.S. CLS. 100
AND 101).

FIRST USE 2-0-2001; IN COMMERCE 2-0-2001.

SN 75-779,281, FILED 8-18-1999.

MICHAEL KEATING, EXAMINING ATTORNEY

Int. Cl.: 35

Prior U.S. Cls.: 100, 101, and 102

United States Patent and Trademark Office

Reg. No. 2,893,669

Registered Oct. 12, 2004

**SERVICE MARK
PRINCIPAL REGISTER**

INDULGE

MYBASICS.COM, INC. (DELAWARE CORPORATION)
342 MADISON AVENUE
NEW YORK, NY 10173

FIRST USE 11-0-1999; IN COMMERCE 11-0-1999.

SN 75-793,550, FILED 9-7-1999.

FOR: PROVIDING ONLINE RETAIL STORE SERVICES, FEATURING FASHION, HEALTH, BEAUTY, AND STYLE PRODUCTS VIA A WEBSITE, IN CLASS 35 (U.S. CLS. 100, 101 AND 102).

ALICE SUE CARRUTHERS, EXAMINING ATTORNEY

Int. Cl.: 36

Prior U.S. Cls.: 100, 101, and 102

United States Patent and Trademark Office

Reg. No. 2,893,671

Registered Oct. 12, 2004

**SERVICE MARK
PRINCIPAL REGISTER**

MYTEXASBANK

TEXAS FIRST BANK (TEXAS STATE BANKING
ASSOCIATION (BANK))
5201 WEST WACO DRIVE
WACO, TX 76710

FIRST USE 10-29-1999; IN COMMERCE 10-29-1999.

SN 75-843,619, FILED 11-9-1999.

FOR: BANKING SERVICES FOR OTHERS, VIA A
GLOBAL COMPUTER NETWORK, IN CLASS 36
(U.S. CLS. 100, 101 AND 102).

DARRYL SPRUILL, EXAMINING ATTORNEY

Int. Cl.: 21

Prior U.S. Cls.: 2, 13, 23, 29, 30, 33, 40, and 50

United States Patent and Trademark Office

Reg. No. 2,893,672

Registered Oct. 12, 2004

**TRADEMARK
PRINCIPAL REGISTER**

CLEAN-PAK

JOHNSON DIVERSEY, INC. (DELAWARE CORPORATION)
8310-16TH STREET
STURTEVANT, WI 53177

FOR: DISPENSING SYSTEM FOR CLEANING AND SANITIZING SOLUTIONS, NAMELY, A DISPENSING SYSTEM CONSISTING OF ONE OR MORE OF THE FOLLOWING ITEMS - PROTEC-

TION SHIELD, BAG, IN CLASS 21 (U.S. CLS. 2, 13, 23, 29, 30, 33, 40 AND 50).

FIRST USE 9-0-2002; IN COMMERCE 5-13-2004.

SN 75-868,254, FILED 12-9-1999.

CYNTHIA SLOAN, EXAMINING ATTORNEY

Int. Cl.: 42

Prior U.S. Cls.: 100 and 101

United States Patent and Trademark Office

Reg. No. 2,893,673

Registered Oct. 12, 2004

**SERVICE MARK
PRINCIPAL REGISTER**

GENEDEX

ORIGENE, INC. (DELAWARE CORPORATION)
6 TAFT COURT, SUITE 300
ROCKVILLE, MD 20850

FIRST USE 6-10-2004; IN COMMERCE 6-10-2004.

SN 75-871,304, FILED 12-15-1999.

FOR: PROVIDING AN ONLINE COMPUTER DA-
TABASE FEATURING INFORMATION ABOUT
GENES, IN CLASS 42 (U.S. CLS. 100 AND 101).

GINNY ISAACSON, EXAMINING ATTORNEY

Int. Cl.: 25

Prior U.S. Cls.: 22 and 39

United States Patent and Trademark Office

Reg. No. 2,893,674

Registered Oct. 12, 2004

**TRADEMARK
PRINCIPAL REGISTER**

WAFFLE TRAINER

NIKE, INC. (OREGON CORPORATION)
ONE BOWERMAN DRIVE
BEAVERTON, OR 97005

FOR: ATHLETIC SHOES DESIGNED FOR RUNNING AND OTHER SPORTS REQUIRING RUNNING, IN CLASS 25 (U.S. CLS. 22 AND 39).

FIRST USE 12-31-1975; IN COMMERCE 12-31-1975.

OWNER OF U.S. REG. NOS. 1,129,000, 1,130,004, AND 1,276,233.

NO CLAIM IS MADE TO THE EXCLUSIVE RIGHT TO USE "TRAINER", APART FROM THE MARK AS SHOWN.

SEC. 2(F) AS TO "WAFFLE".

SN 75-883,317, FILED 12-30-1999.

BERYL GARDNER, EXAMINING ATTORNEY

Int. Cl.: 31

Prior U.S. Cls.: 1 and 46

United States Patent and Trademark Office

Reg. No. 2,893,676

Registered Oct. 12, 2004

**TRADEMARK
PRINCIPAL REGISTER**

FLAGSHIP

SMITH SEED SERVICES (PARTNERSHIP)
26878 POWERLINE ROAD
HALSEY, OR 97348

FIRST USE 7-8-2004; IN COMMERCE 7-8-2004.

SN 75-926,063, FILED 2-23-2000.

FOR: GRASS SEED FOR USE ON LAWNS SOLD
IN BULK, IN CLASS 31 (U.S. CLS. 1 AND 46).

ZHALEH DELANEY, EXAMINING ATTORNEY

Int. Cl.: 41

Prior U.S. Cls.: 100, 101, and 107

United States Patent and Trademark Office

Reg. No. 2,893,677

Registered Oct. 12, 2004

**SERVICE MARK
PRINCIPAL REGISTER**

DREXEL.COM

DREXEL UNIVERSITY (PENNSYLVANIA CORPORATION)
3141 CHESTNUT STREET
PHILADELPHIA, PA 19104

FOR: EDUCATIONAL SERVICES, NAMELY,
CONDUCTING DISTANCE LEARNING INSTRUCTION AT THE COLLEGE AND GRADUATE LEVELS, IN CLASS 41 (U.S. CLS. 100, 101 AND 107).

FIRST USE 6-20-2002; IN COMMERCE 6-20-2002.

OWNER OF U.S. REG. NOS. 2,118,379 AND 2,134,658.

SEC. 2(F) AS TO "DREXEL".

SN 75-933,438, FILED 3-1-2000.

INGRID C. EULIN, EXAMINING ATTORNEY

Int. Cl.: 21

Prior U.S. Cls.: 2, 13, 23, 29, 30, 33, 40, and 50

Reg. No. 2,893,680

United States Patent and Trademark Office

Registered Oct. 12, 2004

**TRADEMARK
PRINCIPAL REGISTER**

BIG DIPPERS

WINPAK PORTION PACKAGING, INC. (ILLI-
NOIS CORPORATION)
ONE SUMMIT SQUARE
RT. 413 & DOUBLEWOODS RD.
LANGHORNE, PA 190471084

FIRST USE 10-0-1999; IN COMMERCE 10-0-1999.

SN 76-003,535, FILED 3-18-2000.

FOR: FOOD PACKAGING MATERIALS, NAME-
LY, CUPS, IN CLASS 21 (U.S. CLS. 2, 13, 23, 29, 30, 33,
40 AND 50).

DARRYL SPRUILL, EXAMINING ATTORNEY

Int. Cl.: 21

Prior U.S. Cls.: 2, 13, 23, 29, 30, 33, 40, and 50

Reg. No. 2,893,681

United States Patent and Trademark Office

Registered Oct. 12, 2004

**TRADEMARK
PRINCIPAL REGISTER**

LIL' DIPPERS

WINPAK PORTION PACKAGING, INC. (ILLI-
NOIS CORPORATION)
ONE SUMMIT SQUARE
RT. 413 & DOUBLEWOODS RD.
LANGEHORNE, PA 190471084

FIRST USE 10-0-1999; IN COMMERCE 10-0-1999.

SN 76-003,536, FILED 3-18-2000.

FOR: FOOD PACKAGING MATERIALS, NAME-
LY, CUPS, IN CLASS 21 (U.S. CLS. 2, 13, 23, 29, 30, 33,
40 AND 50).

DARRYL SPRUILL, EXAMINING ATTORNEY

Int. Cl.: 14

Prior U.S. Cls.: 2, 27, 28, and 50

United States Patent and Trademark Office

Reg. No. 2,893,682

Registered Oct. 12, 2004

**TRADEMARK
PRINCIPAL REGISTER**

WATERGIRL

WOOD, ILONA J. (UNITED STATES INDIVIDUAL)
219 SACRAMENTO STREET
SANTA CRUZ, CA 95060

FIRST USE 6-0-2002; IN COMMERCE 6-0-2002.

SN 76-010,610, FILED 3-27-2000.

FOR: JEWELRY AND CHRONOGRAPHIC INSTRUMENTS, NAMELY, WATCHES, IN CLASS 14 (U.S. CLS. 2, 27, 28 AND 50).

AMY ALFIERI, EXAMINING ATTORNEY

Prior U.S. Cl.: B

United States Patent and Trademark Office

Reg. No. 2,893,684

Registered Oct. 12, 2004

**CERTIFICATION MARK
SERVICES
PRINCIPAL REGISTER**

CERTIFIEDFIRST

PPG INDUSTRIES OHIO, INC. (DELAWARE
CORPORATION)
3800 WEST 143RD STREET
CLEVELAND, OH 44111

FOR: RESTORATION IN THE FIELD OF AUTO-
MOBILES, IN CLASS B (U.S. CL. B).

FIRST USE 12-1-2002; IN COMMERCE 12-1-2002.

THE CERTIFICATION MARK, AS USED BY
AUTHORIZED PERSONS, CERTIFIES THAT TO BE
USED TO CERTIFY THAT AUTOMOBILE REPAIR
SHOPS OPERATED BY OTHERS COMPLY WITH
STANDARDS ESTABLISHED BY OWNER OF THE
MARK

SN 76-063,030, FILED 6-2-2000.

SONYA STEPHENS, EXAMINING ATTORNEY

Int. Cl.: 7

Prior U.S. Cls.: 13, 19, 21, 23, 31, 34, and 35

Reg. No. 2,893,686

United States Patent and Trademark Office

Registered Oct. 12, 2004

**TRADEMARK
PRINCIPAL REGISTER**

PIPE MASTER

TRI TOOL INC. (NEVADA CORPORATION)
3806 SECURITY PARK DRIVE
RANCHO CORDOVA, CA 957426990

NO CLAIM IS MADE TO THE EXCLUSIVE
RIGHT TO USE "PIPE", APART FROM THE MARK
AS SHOWN.

FOR: PORTABLE PIPE AND TUBE END SHAP-
ING MACHINE TOOLS, AND REPLACEMENT
PARTS THEREFOR, IN CLASS 7 (U.S. CLS. 13, 19,
21, 23, 31, 34 AND 35).

SN 76-069,634, FILED 6-15-2000.

FIRST USE 9-0-2001; IN COMMERCE 9-0-2001.

BRIAN NEVILLE, EXAMINING ATTORNEY

Int. Cl.: 35

Prior U.S. Cls.: 100, 101, and 102

United States Patent and Trademark Office

Reg. No. 2,893,689

Registered Oct. 12, 2004

**SERVICE MARK
PRINCIPAL REGISTER**

The logo for 'idea: integration' features the word 'idea:' in a bold, lowercase sans-serif font, with a colon. Above the 'a' in 'idea:' are three small, curved marks resembling a stylized smile or a set of teeth. To the right of 'idea:' is the word 'integration' in a lowercase sans-serif font, with a period at the end.

MODIS, INC. (FLORIDA CORPORATION)
1 INDEPENDENT DR.
JACKSONVILLE, FL 32202

FIRST USE 2-0-2004; IN COMMERCE 2-0-2004.

FOR: EMPLOYMENT STAFFING SERVICES IN
THE FIELD OF INFORMATION TECHNOLOGY, IN
CLASS 35 (U.S. CLS. 100, 101 AND 102).

SN 76-092,773, FILED 7-20-2000.

MICHAEL KAZAZIAN, EXAMINING ATTORNEY

Int. Cl.: 42

Prior U.S. Cls.: 100 and 101

United States Patent and Trademark Office

Reg. No. 2,893,690

Registered Oct. 12, 2004

**SERVICE MARK
PRINCIPAL REGISTER**

ENCOVER

ENCOVER, INC. (DELAWARE CORPORATION)
1390 SHOREBIRD WAY
MOUNTAIN VIEW, CA 94043

FOR: COMPUTER SOFTWARE DESIGN FOR
OTHERS; APPLICATION SERVICE PROVIDER
(ASP) FEATURING SOFTWARE IN THE FIELD OF
INTERNET SERVICE AGREEMENTS; APPLICA-
TION SERVICE PROVIDER (ASP), NAMELY, HOST-

ING COMPUTER SOFTWARE APPLICATIONS OF
OTHERS, IN CLASS 42 (U.S. CLS. 100 AND 101).

FIRST USE 3-28-2002; IN COMMERCE 3-28-2002.

SN 76-107,413, FILED 8-11-2000.

MARGERY A. TIERNEY, EXAMINING ATTORNEY

Int. Cl.: 35

Prior U.S. Cls.: 100, 101, and 102

United States Patent and Trademark Office

Reg. No. 2,893,691

Registered Oct. 12, 2004

**SERVICE MARK
PRINCIPAL REGISTER**

FELLOWES RESEARCH

FELLOWES RESEARCH GROUP, INC. (OHIO CORPORATION)
3299 WILLOWBROOK DR.
CLEVELAND, OH 44124

FOR: PREPARING BUSINESS REPORTS, BUSINESS MANAGEMENT CONSULTATION, BUSINESS ACQUISITION AND MERGER CONSULTATION, MARKET ANALYSIS, AND MARKET RESEARCH , IN CLASS 35 (U.S. CLS. 100, 101 AND 102).

FIRST USE 7-12-2000; IN COMMERCE 7-12-2000.

NO CLAIM IS MADE TO THE EXCLUSIVE RIGHT TO USE "RESEARCH", APART FROM THE MARK AS SHOWN.

SN 76-122,580, FILED 9-5-2000.

ROBERT LORENZO, EXAMINING ATTORNEY

Int. Cl.: 42

Prior U.S. Cls.: 100 and 101

United States Patent and Trademark Office

Reg. No. 2,893,692

Registered Oct. 12, 2004

SERVICE MARK
PRINCIPAL REGISTER



MAHA MASCHINENBAU HALDENWANG
GMBH & CO. KG (FED REP GERMANY
CORPORATION)
HOYEN 20
87490 HALDENWANG, FED REP GERMANY

FOR: CREATING DATA PROCESSING SOFTWARE FOR OTHERS; DEVELOPMENT OF CONTROL AND DISPLAY SOFTWARE FOR EQUIPMENT, NAMELY VEHICLE TESTING EQUIPMENT FOR OTHERS; TECHNICAL CONSULTING FOR CAR DEALERS AND CAR WORKSHOPS, IN CLASS 42 (U.S. CLS. 100 AND 101).

FIRST USE 11-30-1988; IN COMMERCE 11-30-1988.

NO CLAIM IS MADE TO THE EXCLUSIVE RIGHT TO USE "MASCHINENBAU HALDENWANG", APART FROM THE MARK AS SHOWN.

THE LINING IS A FEATURE OF THE MARK AND DOES NOT INDICATE COLOR OR SHADING.

THE ENGLISH TRANSLATION OF THE WORD "MASCHINENBAU" IN THE MARK IS "MECHANICAL ENGINEERING."

SN 76-124,831, FILED 9-8-2000.

ANN LINNEHAN, EXAMINING ATTORNEY

Int. Cl.: 35

Prior U.S. Cls.: 100, 101, and 102

United States Patent and Trademark Office

Reg. No. 2,893,693

Registered Oct. 12, 2004

**SERVICE MARK
PRINCIPAL REGISTER**



FORD MOTOR COMPANY (DELAWARE CORPORATION)
THE AMERICAN ROAD
DEARBORN, MI 48121

FOR: PROMOTING THE SALE OF GOODS AND SERVICES OF OTHERS THROUGH THE DISTRIBUTION OF PRINTED MATERIALS, AUDIO AND VIDEO TAPES, TELEVISION AND RADIO BROAD-

CASTS, AND PROMOTIONAL CONTESTS, IN CLASS 35 (U.S. CLS. 100, 101 AND 102).

FIRST USE 10-31-2002; IN COMMERCE 10-31-2002.

SN 76-125,044, FILED 9-8-2000.

MARK T. MULLEN, EXAMINING ATTORNEY

Int. Cl.: 35

Prior U.S. Cls.: 100, 101, and 102

United States Patent and Trademark Office

Reg. No. 2,893,694

Registered Oct. 12, 2004

**SERVICE MARK
PRINCIPAL REGISTER**

BIOBAR

AMERSHAM BIOSCIENCES AB (SWEDEN CORPORATION)
BJORKGATAN 30, SE-751 84
UPPSALA, SWEDEN

FOR: ONLINE RETAIL STORE SERVICES FEATURING FROZEN PRODUCTS, NAMELY, CHEMICAL REAGENTS FOR THE LIFE SCIENCE AND

BIOTECHNOLOGY INDUSTRY, IN CLASS 35 (U.S. CLS. 100, 101 AND 102).

FIRST USE 5-0-2000; IN COMMERCE 5-0-2000.

SN 76-128,293, FILED 9-13-2000.

DOUGLAS LEE, EXAMINING ATTORNEY

Int. Cl.: 41

Prior U.S. Cls.: 100, 101, and 107

United States Patent and Trademark Office

Reg. No. 2,893,697

Registered Oct. 12, 2004

**SERVICE MARK
PRINCIPAL REGISTER**

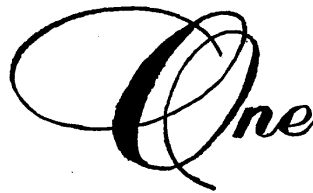

MANDALAY RESORT GROUP (NEVADA CORPORATION)
3950 LAS VEGAS BOULEVARD SOUTH
LAS VEGAS, NV 89119

FOR: CUSTOMER INCENTIVE AWARD PROGRAM, NAMELY, A CASINO CUSTOMER LOYALTY PROGRAM THAT PROVIDES CASINO

BENEFITS TO REWARD REPEAT CUSTOMERS, IN CLASS 41 (U.S. CLS. 100, 101 AND 107).

FIRST USE 11-8-2001; IN COMMERCE 11-8-2001.

SN 76-154,626, FILED 10-26-2000.

ARETHA MASTERSON, EXAMINING ATTORNEY

Int. Cl.: 25

Prior U.S. Cls.: 22 and 39

United States Patent and Trademark Office

Reg. No. 2,893,698

Registered Oct. 12, 2004

**TRADEMARK
PRINCIPAL REGISTER**

ALL BALLS RACING

POWER SPORT INDUSTRIES, INC. (PENNSYLVANIA CORPORATION)
704 EAST 4TH ST.
BOYERSTOWN, PA 19512

FOR: CLOTHING, NAMELY, SHIRTS, SKIRTS, SHORTS, PANTS, DRESSES, BUTTON DOWN SHIRTS, GOLF SHIRTS, SWEATERS, TANK TOPS, T-SHIRTS, SWEAT SHIRTS, SWEAT PANTS, JACKETS, UNDER GARMENTS, SOCKS, PAJAMAS,

HATS AND CAPS, FOR MEN, WOMEN AND CHILDREN, IN CLASS 25 (U.S. CLS. 22 AND 39).

FIRST USE 7-1-2001; IN COMMERCE 7-1-2001.

SN 76-166,813, FILED 11-16-2000.

TANYA AMOS, EXAMINING ATTORNEY

Int. Cl.: 9

Prior U.S. Cls.: 21, 23, 26, 36, and 38

United States Patent and Trademark Office

Reg. No. 2,893,700

Registered Oct. 12, 2004

**TRADEMARK
PRINCIPAL REGISTER**

HATTERAS NETWORKS

HATTERAS NETWORKS, INC. (DELAWARE
CORPORATION)
598 AIRPORT BOULEVARD
SUITE 700
MORRISVILLE, NC 27560

FIRST USE 11-1-2000; IN COMMERCE 11-19-2002.

FOR: COMPUTER HARDWARE, NETWORKING
HARDWARE FOR USE IN THE FIELD OF TELE-
COMMUNICATIONS AND DATA NETWORKING;
COMPUTER SOFTWARE FOR CONNECTING
COMPUTER NETWORK USERS OVER COMPUTER
NETWORKS, IN CLASS 9 (U.S. CLS. 21, 23, 26, 36
AND 38).

NO CLAIM IS MADE TO THE EXCLUSIVE
RIGHT TO USE "NETWORKS", APART FROM
THE MARK AS SHOWN.

SN 76-187,274, FILED 12-28-2000.

DAVID H. STINE, EXAMINING ATTORNEY

Int. Cl.: 35

Prior U.S. Cls.: 100, 101, and 102

United States Patent and Trademark Office

Reg. No. 2,893,701

Registered Oct. 12, 2004

**SERVICE MARK
PRINCIPAL REGISTER**

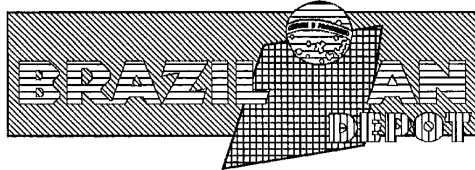

DE OLIVEIRA, DENISE (BRAZIL INDIVIDUAL)
700 SW 10TH STREET
DEERFIELD BEACH, FL 33441

FIRST USE 5-10-2001; IN COMMERCE 5-10-2001.

THE DRAWING IS LINED FOR THE COLORS
GREEN, BLUE, RED AND YELLOW.

FOR: RETAIL STORE FEATURING ETHNIC
FOOD, DESSERTS AND DRINKS, TYPICAL BRAZI-
LIAN SNACKS SUCH AS COXINHA-DE-GALINHA,
QUIBE, PAO-DE-QUEIJO, QUINDIM, ETC, FRUIT
JUICES, CANNED AND DRIED FRUITS AND VE-
GETABLES, CD'S, IN CLASS 35 (U.S. CLS. 100, 101
AND 102).

THE ENGLISH TRANSLATION OF "ORDEM E
PROGRESSO" IS "PROGRESS AND HARMONY".

SN 76-191,959, FILED 1-10-2001.

GEOFFREY FOSDICK, EXAMINING ATTORNEY

Int. Cl.: 30

Prior U.S. Cl.: 46

United States Patent and Trademark Office

Reg. No. 2,893,702

Registered Oct. 12, 2004

**TRADEMARK
PRINCIPAL REGISTER**

FAMOUS SQWISH CANDY FISH

PROMOTION IN MOTION, INC. (DELAWARE
CORPORATION)
3 REUTEN DRIVE
CLOSTER, NJ 07624

NO CLAIM IS MADE TO THE EXCLUSIVE
RIGHT TO USE "CANDY FISH", APART FROM
THE MARK AS SHOWN.

FOR: CANDY, IN CLASS 30 (U.S. CL. 46).

SN 76-197,860, FILED 1-22-2001.

FIRST USE 6-22-2001; IN COMMERCE 6-22-2001.

SUSAN LESLIE DUBOIS, EXAMINING ATTORNEY

Int. Cl.: 41

Prior U.S. Cls.: 100, 101, and 107

United States Patent and Trademark Office

Reg. No. 2,893,703

Registered Oct. 12, 2004

**SERVICE MARK
PRINCIPAL REGISTER**

METEOR STUDIOS

DISCOVERY COMMUNICATIONS, INC. (DELA-
WARE CORPORATION)
ONE DISCOVERY PLACE
SILVER SPRING, MD 20910

NO CLAIM IS MADE TO THE EXCLUSIVE
RIGHT TO USE "STUDIOS", APART FROM THE
MARK AS SHOWN.

FOR: TELEVISION PRODUCTION, ANIMATION
PRODUCTION SERVICES AND SPECIAL EFFECTS
ANIMATION SERVICES FOR FILM AND VIDEO, IN
CLASS 41 (U.S. CLS. 100, 101 AND 107).

SN 76-216,341, FILED 2-23-2001.

FIRST USE 1-31-2002; IN COMMERCE 1-31-2002.

MICHAEL BAIRD, EXAMINING ATTORNEY

Int. Cl.: 28

Prior U.S. Cls.: 22, 23, 38, and 50

United States Patent and Trademark Office

Reg. No. 2,893,704

Registered Oct. 12, 2004

**TRADEMARK
PRINCIPAL REGISTER**

FEMINA

ISOFEM CANADA (CANADA SOLE PROPRIETORSHIP)
P.O. BOX 114 STN. Q
TORONTO, ONTARIO, CANADA M4T 2L7

FOR: MANUALLY OPERATED EXERCISE EQUIPMENT, NAMELY, ISOMETRIC EXERCISE AIDS TO ASSIST IN STRENGTHENING PELVIC-FLOOR MUSCLES, IN CLASS 28 (U.S. CLS. 22, 23, 38 AND 50).

FIRST USE 1-1-2000; IN COMMERCE 1-1-2001.

PRIORITY CLAIMED UNDER SEC. 44(D) ON CANADA APPLICATION NO. 1090245, FILED 1-26-2001, REG. NO. TMA569717, EXPIRES 10-28-2017.

SN 76-216,592, FILED 2-26-2001.

SUSAN LESLIE DUBOIS, EXAMINING ATTORNEY

Int. Cl.: 36

Prior U.S. Cls.: 100, 101, and 102

United States Patent and Trademark Office

Reg. No. 2,893,705

Registered Oct. 12, 2004

**SERVICE MARK
PRINCIPAL REGISTER**

ST. REGIS

SHERATON CORPORATION, THE (DELAWARE
CORPORATION)
777 WESTCHESTER AVENUE
WHITE PLAINS, NY 10604

FOR: VACATION REAL ESTATE TIME-SHAR-
ING; REAL ESTATE SERVICES, NAMELY THE
LISTING AND MANAGEMENT OF CONDOMI-
NIUMS, IN CLASS 36 (U.S. CLS. 100, 101 AND 102).

FIRST USE 12-0-2003; IN COMMERCE 1-0-2004.

OWNER OF U.S. REG. NO. 1,897,870.

SN 76-218,453, FILED 3-1-2001.

RAUL CORDOVA, EXAMINING ATTORNEY

Int. Cl.: 10

Prior U.S. Cls.: 26, 39, and 44

United States Patent and Trademark Office

Reg. No. 2,893,706

Registered Oct. 12, 2004

**TRADEMARK
PRINCIPAL REGISTER**

HEPROTEC

EV3 INC. (DELAWARE CORPORATION)
4600 NATHAN LANE, SUITE 200
PLYMOUTH, MN 55442

FIRST USE 2-1-2002; IN COMMERCE 2-1-2002.

FOR: VASCULAR FILTRATION DEVICES,
NAMELY VASCULAR FILTERS AND VASCULAR
GUIDEWIRES, IN CLASS 10 (U.S. CLS. 26, 39 AND
44).

SN 76-220,607, FILED 3-5-2001.

JOHN DALIER, EXAMINING ATTORNEY

Int. Cl.: 4

Prior U.S. Cls.: 1, 6, and 15

United States Patent and Trademark Office

Reg. No. 2,893,707

Registered Oct. 12, 2004

**TRADEMARK
PRINCIPAL REGISTER**

SMITH & JOHNSON

ALLIED INTERNATIONAL INC. (VIRGINIA
CORPORATION)
45191 COLUMBIA PLACE
STERLING, VA 20166

FIRST USE 10-1-2001; IN COMMERCE 10-1-2001.

SN 76-222,397, FILED 3-12-2001.

FOR: SCENTED CANDLES, AROMATHERAPY
CANDLES, FLOATING CANDLES, BEES WAX CAN-
DLES AND TAPERED CANDLES, IN CLASS 4 (U.S.
CLS. 1, 6 AND 15).

SUSAN LESLIE DUBOIS, EXAMINING ATTORNEY

Int. Cl.: 29

Prior U.S. Cl.: 46

United States Patent and Trademark Office

Reg. No. 2,893,708

Registered Oct. 12, 2004

TRADEMARK
PRINCIPAL REGISTER



CLASSIC FOODS INC. (DELAWARE CORPORATION)
P.O. BOX 6376
ANAHEIM, CA 92816

95% FAT FREE", APART FROM THE MARK AS SHOWN.

FOR: POTATO SNACKS, IN CLASS 29 (U.S. CL. 46).

THE STIPPLING IS FOR SHADING PURPOSES ONLY.

FIRST USE 6-18-2004; IN COMMERCE 6-18-2004.

SN 76-233,763, FILED 4-2-2001.

NO CLAIM IS MADE TO THE EXCLUSIVE RIGHT TO USE "BAKED" AND "POTATO CRISPS

MARK T. MULLEN, EXAMINING ATTORNEY

Int. Cl.: 29

Prior U.S. Cl.: 46

United States Patent and Trademark Office

Reg. No. 2,893,709

Registered Oct. 12, 2004

**TRADEMARK
PRINCIPAL REGISTER**

LUCKY COW

MALAYSIA DAIRY INDUSTRIES PTE LTD. (SIN-
GAPORE CORPORATION)
2 DAVIDSON ROAD
, SINGAPORE 369941

FIRST USE 1-22-2004; IN COMMERCE 1-22-2004.

SN 76-245,620, FILED 4-23-2001.

FOR: MILK AND MILK PRODUCTS, NAMELY,
SWEETENED CONDENSED MILK, IN CLASS 29
(U.S. CL. 46).

MARK T. MULLEN, EXAMINING ATTORNEY

Int. Cl.: 31

Prior U.S. Cls.: 1 and 46

United States Patent and Trademark Office

Reg. No. 2,893,710

Registered Oct. 12, 2004

**TRADEMARK
PRINCIPAL REGISTER**

LES COLLINES

LES COLLINES, LLC (WASHINGTON LIMITED
LIABILITY COMPANY)
1244 FORREST LANE
WALLA WALLA, WA 99362

THE ENGLISH TRANSLATION OF "LES COL-
LINES" IN THE MARK IS "THE HILLS".

FOR: FRESH GRAPES, IN CLASS 31 (U.S. CLS. 1
AND 46).

SN 76-246,034, FILED 4-25-2001.

FIRST USE 9-15-2002; IN COMMERCE 9-15-2002.

INGRID C. EULIN, EXAMINING ATTORNEY

Int. Cl.: 17

Prior U.S. Cls.: 1, 5, 12, 13, 35, and 50

Reg. No. 2,893,711

United States Patent and Trademark Office

Registered Oct. 12, 2004

**TRADEMARK
PRINCIPAL REGISTER**

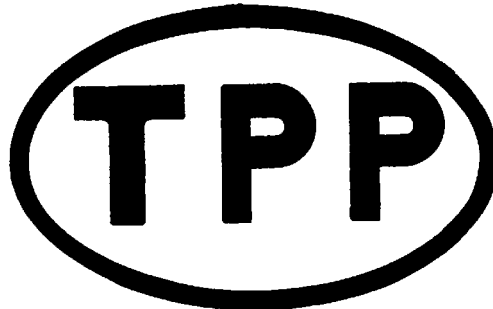

LOCKHEED MARTIN CORPORATION (MARY-
LAND CORPORATION)
6801 ROCKLEDGE DRIVE
BETHESDA, MD 20817

FOR: THERMAL INSULATION AND ABLATIVE
MATERIALS FOR USE IN HIGH TEMPERATURE
APPLICATIONS, NAMELY SPRAYABLE, TROWEL-
ABLE, BONDABLE AND MOLDABLE COATINGS
FOR USE IN THE AEROSPACE AND AVIATION

INDUSTRIES, IN CLASS 17 (U.S. CLS. 1, 5, 12, 13, 35
AND 50).

FIRST USE 6-1-2004; IN COMMERCE 6-1-2004.

SN 76-251,356, FILED 5-4-2001.

ELIZABETH HUGHITT, EXAMINING ATTORNEY

Int. Cl.: 33

Prior U.S. Cls.: 47 and 49

United States Patent and Trademark Office

Reg. No. 2,893,712

Registered Oct. 12, 2004

TRADEMARK
PRINCIPAL REGISTER

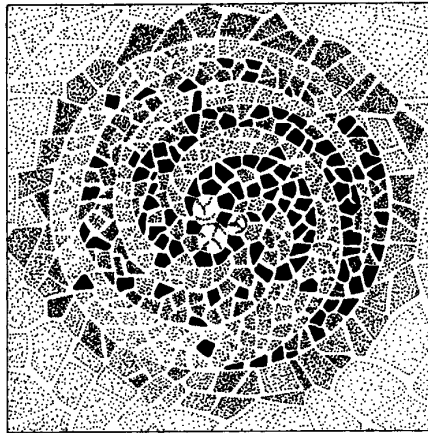

MIGUEL TORRES, S.A. (SPAIN JOINT STOCK
COMPANY)
COMERCIO 22
08720-VILAFRANCA DEL PENEDES (BARCELO-
NA), SPAIN

FOR: WINES, IN CLASS 33 (U.S. CLS. 47 AND 49).

FIRST USE 6-0-2002; IN COMMERCE 6-3-2004.

THE STIPLING IS A FEATURE OF THE MARK
AND DOES NOT INDICATE COLOR.

SN 76-260,252, FILED 5-21-2001.

ROBERT LORENZO, EXAMINING ATTORNEY

Int. Cl.: 35

Prior U.S. Cls.: 100, 101, and 102

United States Patent and Trademark Office

Reg. No. 2,893,713

Registered Oct. 12, 2004

**SERVICE MARK
PRINCIPAL REGISTER**

FACEPAGE

MATCHNET PLC (ENGLAND CORPORATION)
8383 WILSHIRE BLVD., SUITE 104
BEVERLY HILLS, CA 90211

FOR: PROMOTING THE GOODS AND SERVICES
OF OTHERS BY PREPARING AND PLACING AD-
VERTISEMENTS AND PROMOTIONAL DISPLAYS
VIA A GLOBAL COMPUTER NETWORK; DISSEMI-
NATION OF ADVERTISING OR PROMOTIONAL

MATERIALS TO OTHERS VIA THE INTERNET, IN
CLASS 35 (U.S. CLS. 100, 101 AND 102).

FIRST USE 5-25-2001; IN COMMERCE 5-25-2001.

SN 76-262,841, FILED 5-25-2001.

INGA ERVIN, EXAMINING ATTORNEY

Int. Cl.: 36

Prior U.S. Cls.: 100, 101, and 102

United States Patent and Trademark Office

Reg. No. 2,893,715

Registered Oct. 12, 2004

**SERVICE MARK
PRINCIPAL REGISTER**

CPR SOLUTION

THE TRUSTEE OF THE BIRGEN FAMILY
TRUST (CALIFORNIA LIVING REVOCABLE
TRUST)
C/O ROBERT M. BIRGEN TRUSTEE
21700 EAST COPLEY DRIVE, SUITE 120
DIAMOND BAR, CA 91765

FOR: FINANCIAL PLANNING SERVICES, ES-
TATE PLANNING SERVICES AND TAX PLANNING
SERVICES FOR OTHERS, IN CLASS 36 (U.S. CLS.
100, 101 AND 102).

FIRST USE 5-15-2002; IN COMMERCE 5-15-2002.

NO CLAIM IS MADE TO THE EXCLUSIVE
RIGHT TO USE "SOLUTION", APART FROM THE
MARK AS SHOWN.

SN 76-274,752, FILED 6-20-2001.

LINDA M. KING, EXAMINING ATTORNEY

Int. Cl.: 42

Prior U.S. Cls.: 100 and 101

United States Patent and Trademark Office

Reg. No. 2,893,716

Registered Oct. 12, 2004

**SERVICE MARK
PRINCIPAL REGISTER**

OLD PALM GOLF CLUB

WCI COMMUNITIES, INC. (DELAWARE CORPORATION)
24301 WALDEN CENTER DRIVE, SUITE 300
BONITA SPRINGS, FL 34134

NO CLAIM IS MADE TO THE EXCLUSIVE
RIGHT TO USE "GOLF CLUB", APART FROM
THE MARK AS SHOWN.

FOR: RESTAURANT SERVICES, IN CLASS 42
(U.S. CLS. 100 AND 101).

SN 76-290,402, FILED 7-25-2001.

FIRST USE 3-0-2004; IN COMMERCE 3-0-2004.

JIM RINGLE, EXAMINING ATTORNEY

Int. Cl.: 3

Prior U.S. Cls.: 1, 4, 6, 50, 51, and 52

United States Patent and Trademark Office

Reg. No. 2,893,717

Registered Oct. 12, 2004

TRADEMARK
PRINCIPAL REGISTER

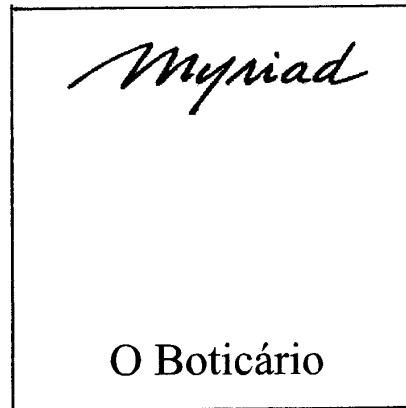

BOTICA COMERCIAL FARMACEUTICA LTDA.
(BRAZIL CORPORATION)
AV. RUI BARBOSA, 3450
83065-260 S. JOSE DOS PINHAIS PR, BRAZIL

THE ENGLISH TRANSLATION OF THE WORD
"O BOTICARIO" IN THE MARK IS "THE PHARMA-
CIST".

FOR: PERFUME, IN CLASS 3 (U.S. CLS. 1, 4, 6, 50,
51 AND 52).

SN 76-296,540, FILED 8-7-2001.

FIRST USE 12-16-1998; IN COMMERCE 12-16-2003.

REGINA DRUMMOND, EXAMINING ATTORNEY

Int. Cl.: 42

Prior U.S. Cls.: 100 and 101

United States Patent and Trademark Office

Reg. No. 2,893,718

Registered Oct. 12, 2004

**SERVICE MARK
PRINCIPAL REGISTER**

PLACEMENT DIAGRAM

BUILDERS SHOWCASE INTERIORS, INC. (CALIFORNIA CORPORATION)
9225 BROWN DEER ROAD
SAN DIEGO, CA 92121

NO CLAIM IS MADE TO THE EXCLUSIVE RIGHT TO USE "DIAGRAM", APART FROM THE MARK AS SHOWN.

FOR: ONLINE AND IN STORE ARCHITECTURAL AND INTERIOR DESIGN SERVICES IN THE FIELD OF HOMEBUILDING AND HOME REMODELING, IN CLASS 42 (U.S. CLS. 100 AND 101).

SN 76-297,259, FILED 8-8-2001.

FIRST USE 1-10-2001; IN COMMERCE 3-1-2001.

SUSAN LESLIE DUBOIS, EXAMINING ATTORNEY

Int. Cl.: 35

Prior U.S. Cls.: 100, 101, and 102

United States Patent and Trademark Office

Reg. No. 2,893,719

Registered Oct. 12, 2004

**SERVICE MARK
PRINCIPAL REGISTER**

WHERE HOME IS ON THE WAY

PACIFIC COAST FEATHER COMPANY (WA-
SHINGTON CORPORATION)
P.O. BOX 80385
SEATTLE, WA 98108

FOR: PROMOTING HOTEL AND MOTEL SERVI-
CES OF OTHERS BY MEANS OF A CUSTOMER
PROGRAM FEATURING A SELECTED LINE OF

BEDDING PRODUCTS , IN CLASS 35 (U.S. CLS. 100,
101 AND 102).

FIRST USE 5-1-2003; IN COMMERCE 5-1-2003.

SN 76-301,473, FILED 8-20-2001.

JERI J. FICKES, EXAMINING ATTORNEY

Int. Cl.: 42

Prior U.S. Cls.: 100 and 101

United States Patent and Trademark Office

Reg. No. 2,893,720

Registered Oct. 12, 2004

**SERVICE MARK
PRINCIPAL REGISTER**

OXIGENE THE VASCULAR TARGETING COMPANY

OXIGENE, INC. (DELAWARE CORPORATION)
321 ARSENAL STREET
WATERTOWN, MA 02472

FOR: CANCER RESEARCH; RESEARCH AND DEVELOPMENT OF BIOPHARMACEUTICAL PRODUCTS, NAMELY, VASCULAR TARGETING AGENTS AND CANCER THERAPIES; AND LICENSING OF INTELLECTUAL PROPERTY IN THE FIELD OF BIOPHARMACEUTICAL COMPOUNDS FOR VASCULAR TARGETING AGENTS AND CANCER THERAPIES, IN CLASS 42 (U.S. CLS. 100 AND 101).

FIRST USE 8-29-2001; IN COMMERCE 2-1-2002.

NO CLAIM IS MADE TO THE EXCLUSIVE RIGHT TO USE "THE VASCULAR TARGETING COMPANY", APART FROM THE MARK AS SHOWN.

SN 76-306,207, FILED 8-28-2001.

ALEXANDER L. POWERS, EXAMINING ATTORNEY

Int. Cl.: 11

Prior U.S. Cls.: 13, 21, 23, 31, and 34

United States Patent and Trademark Office

Reg. No. 2,893,721

Registered Oct. 12, 2004

**TRADEMARK
PRINCIPAL REGISTER**

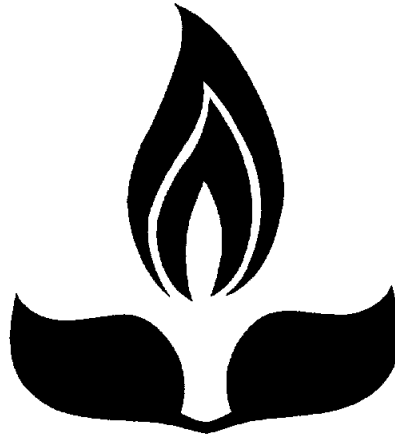

STATE INDUSTRIES, INC. (TENNESSEE CORPORATION)
500 LINDAHL PARKWAY
ASHLAND CITY, TN 37015

THE MARK CONSISTS OF A STYLIZED DEPICTION OF A FLAME ABOVE TWO LEAVES.

FOR: WATER HEATERS FOR DOMESTIC, COMMERCIAL AND INDUSTRIAL USE, IN CLASS 11 (U.S. CLS. 13, 21, 23, 31 AND 34).

SN 76-306,396, FILED 8-29-2001.

FIRST USE 1-0-2003; IN COMMERCE 1-0-2003.

JULIE WATSON, EXAMINING ATTORNEY

Int. Cl.: 20

Prior U.S. Cls.: 2, 13, 22, 25, 32, and 50

United States Patent and Trademark Office

Reg. No. 2,893,722

Registered Oct. 12, 2004

**TRADEMARK
PRINCIPAL REGISTER**

METRO MEDIA STORAGE

METRO INDUSTRIES, INC. (NEVADA CORPORATION)
651 NORTH WASHINGTON STREET
WILKES-BARRE, PA 18705

FOR: SHELVING SYSTEMS COMPRISING SHELVES AND ACCESSORIES, NAMELY, SHELF DIVIDERS, DIVIDER KITS, POSTS, ENCLOSURE PANELS, SHELF MARKERS, SHELF INLAYS, LABEL HOLDERS, HOOKS, HOOK CONNECTORS, CLAMPS, FOOT PLATES, LEVELING FEET AND SUPPORTS THEREOF, IN CLASS 20 (U.S. CLS. 2, 13, 22, 25, 32 AND 50).

FIRST USE 7-1-2002; IN COMMERCE 7-1-2002.

OWNER OF U.S. REG. NOS. 1,483,032, 1,483,039, AND 1,557,853.

NO CLAIM IS MADE TO THE EXCLUSIVE RIGHT TO USE "MEDIA STORAGE", APART FROM THE MARK AS SHOWN.

SN 76-306,990, FILED 8-30-2001.

LAURIEL DALIER, EXAMINING ATTORNEY

Int. Cl.: 20

Prior U.S. Cls.: 2, 13, 22, 25, 32, and 50

United States Patent and Trademark Office

Reg. No. 2,893,723

Registered Oct. 12, 2004

**TRADEMARK
PRINCIPAL REGISTER**

CUBANO

SUN ISLE CASUAL FURNITURE, LLC (NEW
JERSEY LIMITED LIABILITY COMPANY)
379 ALGONQUIN ROAD
FRANKLIN LAKES, NJ 07417

FIRST USE 12-0-2002; IN COMMERCE 12-0-2002.

SN 76-307,009, FILED 8-30-2001.

FOR: FURNITURE, NAMELY OUTDOOR FUR-
NITURE, IN CLASS 20 (U.S. CLS. 2, 13, 22, 25, 32 AND
50).

DAVID C. REIHNER, EXAMINING ATTORNEY

Int. Cl.: 9

Prior U.S. Cls.: 21, 23, 26, 36, and 38

United States Patent and Trademark Office

Reg. No. 2,893,724

Registered Oct. 12, 2004

**TRADEMARK
PRINCIPAL REGISTER**

EDUBYTE

BAXTER HEALTHCARE SA (SWITZERLAND
CORPORATION)
HERTISTRASSE 2
CH-8304 WALLISELLEN, SWITZERLAND

FOR: COMPUTER SOFTWARE IN THE FIELD OF
PROVIDING HEALTHCARE INFORMATION RE-
GARDING DRUGS TO AUTHORIZED USERS
OVER A GLOBAL OR REGIONAL INFORMATION
NETWORK BY ENABLING THEM TO ACCESS
RELEVANT DATA REPOSITORIES AND ALSO TO
COMMUNICATE WITH ONE ANOTHER, IN CLASS
9 (U.S. CLS. 21, 23, 26, 36 AND 38).

FIRST USE 2-8-2003; IN COMMERCE 2-8-2003.

PRIORITY CLAIMED UNDER SEC. 44(D) ON
CANADA APPLICATION NO. 1111013, FILED 7-27-
2001, DATED 0-0-0000.

SN 76-317,659, FILED 9-25-2001.

GEORGE LORENZO, EXAMINING ATTORNEY

Int. Cl.: 31

Prior U.S. Cls.: 1 and 46

United States Patent and Trademark Office

Reg. No. 2,893,725

Registered Oct. 12, 2004

TRADEMARK
PRINCIPAL REGISTER



DICARLO DISTRIBUTORS, INC. (NEW YORK
CORPORATION)
1630 NORTH OCEAN AVENUE
HOLTSVILLE, NY 11742

NO CLAIM IS MADE TO THE EXCLUSIVE
RIGHT TO USE "FARMS" AND "QUALITY FRUITS
& VEGETABLES", APART FROM THE MARK AS
SHOWN.

FOR: FRESH FRUITS AND VEGETABLES ONLY,
IN CLASS 31 (U.S. CLS. 1 AND 46).

SN 76-321,170, FILED 10-5-2001.

FIRST USE 7-1-2003; IN COMMERCE 7-1-2003.

SUSAN LESLIE DUBOIS, EXAMINING ATTORNEY

Int. Cl.: 37

Prior U.S. Cls.: 100, 103, and 106

United States Patent and Trademark Office

Reg. No. 2,893,726

Registered Oct. 12, 2004

**SERVICE MARK
PRINCIPAL REGISTER**

ANOTHER WILD GOOSE CHASE

WILD GOOSE CHASE INC. (ILLINOIS COR-
PORATION)
106 W. CALENDAR COURT
PMB 171
LAGRANGE, IL 60525

FOR: ANIMAL CONTROL SERVICES, NAMELY,
MOVING NUISANCE BIRDS FROM RESIDENTIAL
COMMERCIAL AND PUBLIC BUILDINGS AND

PROPERTY TO THEIR NATURAL HABITAT , IN
CLASS 37 (U.S. CLS. 100, 103 AND 106).

FIRST USE 4-0-2004; IN COMMERCE 4-0-2004.

SN 76-323,086, FILED 10-9-2001.

GEOFFREY FOSDICK, EXAMINING ATTORNEY

Int. Cl.: 36

Prior U.S. Cls.: 100, 101, and 102

United States Patent and Trademark Office

Reg. No. 2,893,728

Registered Oct. 12, 2004

**SERVICE MARK
PRINCIPAL REGISTER**

CONNECT 2 LEARN

MESIROW FINANCIAL HOLDINGS, INC. (DE-
LAWARE CORPORATION)
350 NORTH CLARK STREET
CHICAGO, IL 60610

FOR: FINANCIAL SERVICES, NAMELY, PRO-
VIDING AN INTERNET WEBSITE CONTAINING
INFORMATION RELATING TO FINANCIAL AND

INVESTMENT SERVICES , IN CLASS 36 (U.S. CLS.
100, 101 AND 102).

FIRST USE 11-0-2001; IN COMMERCE 11-0-2001.

SN 76-339,770, FILED 11-15-2001.

GEOFFREY FOSDICK, EXAMINING ATTORNEY

Int. Cl.: 9

Prior U.S. Cls.: 21, 23, 26, 36, and 38

United States Patent and Trademark Office

Reg. No. 2,893,730

Registered Oct. 12, 2004

**TRADEMARK
PRINCIPAL REGISTER**

ACCUVIEW ANTIALIASING

NVIDIA CORPORATION (DELAWARE CORPORATION)
2701 SAN TOMAS EXPRESSWAY
SANTA CLARA, CA 95050

NO CLAIM IS MADE TO THE EXCLUSIVE RIGHT TO USE "ANTIALIASING", APART FROM THE MARK AS SHOWN.

FOR: COMPUTER HARDWARE, NAMELY, INTEGRATED CIRCUITS, SEMICONDUCTORS AND CHIPSETS, IN CLASS 9 (U.S. CLS. 21, 23, 26, 36 AND 38).

SN 76-342,297, FILED 11-28-2001.

FIRST USE 3-0-2002; IN COMMERCE 3-0-2002.

KEVON CHISOLM, EXAMINING ATTORNEY

Int. Cl.: 35

Prior U.S. Cls.: 100, 101, and 102

United States Patent and Trademark Office

Reg. No. 2,893,731

Registered Oct. 12, 2004

**SERVICE MARK
PRINCIPAL REGISTER**



FAMILIES OF SEPTEMBER 11, INC. (DELA-
WARE CORPORATION)
1560 BROADWAY, SUITE 305
NEW YORK, NY 10036

FOR: GENERAL INFORMATION CLEARING
HOUSE; ASSOCIATION SERVICES, NAMELY, PRO-
MOTING THE INTERESTS OF SURVIVORS AND
FAMILY MEMBERS OF TERRORIST ATTACKS;
PROMOTING PUBLIC AWARENESS OF THE NEED

TO IMPROVE THE PREVENTION OF AND RE-
SPONSE TO TERRORISM, IN CLASS 35 (U.S. CLS.
100, 101 AND 102).

FIRST USE 12-4-2001; IN COMMERCE 12-4-2001.

SN 76-350,453, FILED 12-20-2001.

GEOFFREY FOSDICK, EXAMINING ATTORNEY

Int. Cl.: 30

Prior U.S. Cl.: 46

United States Patent and Trademark Office

Reg. No. 2,893,732

Registered Oct. 12, 2004

**TRADEMARK
PRINCIPAL REGISTER**

LIDIA'S REGIONAL ITALIAN FLAVORS

FELIDIA, INC. (NEW YORK CORPORATION)
243 E. 58TH STREET
NEW YORK, NY 10022

NO CLAIM IS MADE TO THE EXCLUSIVE
RIGHT TO USE "REGIONAL ITALIAN FLAVORS",
APART FROM THE MARK AS SHOWN.

FOR: SAUCES FOR USE ON FOOD, IN CLASS 30
(U.S. CL. 46).

SN 76-350,525, FILED 12-19-2001.

FIRST USE 9-1-1999; IN COMMERCE 9-1-1999.

OWNER OF U.S. REG. NO. 2,254,406.

GEOFFREY FOSDICK, EXAMINING ATTORNEY

Int. Cl.: 5

Prior U.S. Cls.: 6, 18, 44, 46, 51, and 52

United States Patent and Trademark Office

Reg. No. 2,893,733

Registered Oct. 12, 2004

**TRADEMARK
PRINCIPAL REGISTER**

TEAFLAVIN

NASHAI BIOTECH, LLC (TENNESSEE LIMITED
LIABILITY COMPANY)
5560 FRANKLIN PIKE CIRCLE
BRENTWOOD, TN 37027

FOR: DIETARY SUPPLEMENTS; VITAMINS; NU-
TRITIONALLY FORTIFIED BEVERAGES; MINER-
ALS; AND PHARMACEUTICAL PREPARATIONS
FOR USE IN THE TREATMENT OF CARDIOVAS-

CULAR CONDITIONS, IN CLASS 5 (U.S. CLS. 6, 18,
44, 46, 51 AND 52).

FIRST USE 6-0-2003; IN COMMERCE 6-0-2003.

SN 76-351,463, FILED 12-20-2001.

ALEXANDER L. POWERS, EXAMINING ATTOR-
NEY

Int. Cl.: 10

Prior U.S. Cls.: 26, 39, and 44

United States Patent and Trademark Office

Reg. No. 2,893,734

Registered Oct. 12, 2004

**TRADEMARK
PRINCIPAL REGISTER**

A LITTLE LITE GOES A LONG WAY

THE LITEBOOK COMPANY LTD. (CANADA
COMPANY)
233 - 5TH STREET S.E. # 107
MEDICINE HAT, AB T1A 0M 5, CANADA

FIRST USE 11-15-2002; IN COMMERCE 11-15-2002.

SN 76-351,845, FILED 12-21-2001.

FOR: HAND-HELD BRIGHT LIGHT DEVICE
THAT ASSISTS INDIVIDUALS IN AMELIORATING
THE EFFECTS OF LIGHT DEPRIVATION, IN CLASS
10 (U.S. CLS. 26, 39 AND 44).

BRIAN PINO, EXAMINING ATTORNEY

Int. Cl.: 29

Prior U.S. Cl.: 46

United States Patent and Trademark Office

Reg. No. 2,893,735

Registered Oct. 12, 2004

TRADEMARK
PRINCIPAL REGISTER



OCEAN BLUE INDUSTRIES, INC. (DELAWARE CORPORATION)
1510 WEST LOOP S.
HOUSTON, TX 77027

FOR: PROCESSED SEAFOOD, IN CLASS 29 (U.S. CL. 46).

FIRST USE 5-27-2004; IN COMMERCE 5-27-2004.

OWNER OF U.S. REG. NOS. 1,627,401 AND 1,629,314.

NO CLAIM IS MADE TO THE EXCLUSIVE RIGHT TO USE "GOURMET", APART FROM THE MARK AS SHOWN.

SN 76-352,143, FILED 12-21-2001.

DAWN FELDMAN, EXAMINING ATTORNEY

Int. Cl.: 41

Prior U.S. Cls.: 100, 101, and 107

United States Patent and Trademark Office

Reg. No. 2,893,736

Registered Oct. 12, 2004

**SERVICE MARK
PRINCIPAL REGISTER**

THE WILDERNESS AT FORTUNE BAY

BOIS FORTE BAND OF CHIPPEWA INDIANS
(MINNESOTA FEDERALLY RECOGNIZED
INDIAN TRIBE)
BOX 16
NETT LAKE, MN 55772

FIRST USE 5-28-2004; IN COMMERCE 5-28-2004.

OWNER OF U.S. REG. NOS. 2,272,337, 2,363,828,
AND OTHERS.

FOR: GOLF COURSES; GOLF CLUB SERVICES;
GOLF CADDIE SERVICES; ENTERTAINMENT IN
THE NATURE OF GOLF TOURNAMENTS, IN
CLASS 41 (U.S. CLS. 100, 101 AND 107).

SN 76-359,582, FILED 1-15-2002.

GEOFFREY FOSDICK, EXAMINING ATTORNEY

Int. Cl.: 16

Prior U.S. Cls.: 2, 5, 22, 23, 29, 37, 38, and 50

United States Patent and Trademark Office

Reg. No. 2,893,737

Registered Oct. 12, 2004

**TRADEMARK
PRINCIPAL REGISTER**

WELCOME TO MOTHERHOOD

MEREDITH CORPORATION (IOWA CORPORATION)
1716 LUCUST STREET
DES MOINES, IA 50309

NO CLAIM IS MADE TO THE EXCLUSIVE
RIGHT TO USE "MOTHERHOOD", APART FROM
THE MARK AS SHOWN.

FOR: MAGAZINES IN THE FIELD OF PARENT-
ING, IN CLASS 16 (U.S. CLS. 2, 5, 22, 23, 29, 37, 38 AND
50).

SN 76-359,648, FILED 1-16-2002.

FIRST USE 2-15-2003; IN COMMERCE 2-15-2003.

HOWARD B. LEVINE, EXAMINING ATTORNEY

Int. Cl.: 9

Prior U.S. Cls.: 21, 23, 26, 36, and 38

Reg. No. 2,893,738

United States Patent and Trademark Office

Registered Oct. 12, 2004

**TRADEMARK
PRINCIPAL REGISTER**

SOC-IT

MIPS TECHNOLOGIES, INC. (DELAWARE CORPORATION)
1225 CHARLESTON ROAD
MOUNTAIN VIEW, CA 94043

FOR: CONTROLLER CORES EMBODIED IN DOWNLOADABLE COMPUTER CODE FOR DESCRIBING SYSTEM AND MEMORY CONTROLLERS; COMPUTER SOFTWARE FOR USE IN THE DESIGN AND DEVELOPMENT OF COMPUTER HARDWARE AND INTEGRATED CIRCUITS, NAMELY, MEMORY AND SYSTEM CONTROLLERS; AND ELECTRONIC PUBLICATIONS, NAME-

LY, MANUALS, DATASHEETS, GUIDES AND PAMPHLETS RELATING TO COMPUTER TECHNOLOGY RECORDED ON COMPUTER MEDIA OR DOWNLOADABLE FROM A COMPUTER, IN CLASS 9 (U.S. CLS. 21, 23, 26, 36 AND 38).

FIRST USE 7-1-2002; IN COMMERCE 7-1-2002.

SN 76-365,866, FILED 2-1-2002.

CYNTHIA SLOAN, EXAMINING ATTORNEY

Int. Cl.: 3

Prior U.S. Cls.: 1, 4, 6, 50, 51, and 52

United States Patent and Trademark Office

Reg. No. 2,893,739

Registered Oct. 12, 2004

**TRADEMARK
PRINCIPAL REGISTER**

AFTER COFFEE MINT GLOSS

BONNE BELL, INC. (OHIO CORPORATION)
18519 DETROIT AVENUE
LAKEWOOD, OH 441073292

NO CLAIM IS MADE TO THE EXCLUSIVE
RIGHT TO USE "GLOSS", APART FROM THE
MARK AS SHOWN.

FOR: LIP COSMETICS, NAMELY LIP GLOSS, IN
CLASS 3 (U.S. CLS. 1, 4, 6, 50, 51 AND 52).

SN 76-371,352, FILED 2-15-2002.

FIRST USE 6-15-2002; IN COMMERCE 6-15-2002.

MARGERY A. TIERNEY, EXAMINING ATTORNEY

Int. Cl.: 9

Prior U.S. Cls.: 21, 23, 26, 36, and 38

United States Patent and Trademark Office

Reg. No. 2,893,740

Registered Oct. 12, 2004

TRADEMARK
PRINCIPAL REGISTER



KONAMI CORPORATION (JAPAN CORPORATION)
2-4-1, MARUNOUCHI
CHIYODA-KU, TOKYO, JAPAN

FOR: SLOT MACHINES; SLOT MACHINE SOFTWARES; COMPUTER PRODUCTS, NAMELY, COMPUTER GAME PROGRAMS; VIDEO GAME CARTRIDGES; VIDEO GAME CD-ROMS; VIDEO GAME MACHINES FOR USE WITH TELEVISIONS; VIDEO GAME PROGRAMS; VIDEO GAME PROGRAMS FOR USE WITH TELEVISION SETS; VIDEO GAME JOYSTICKS; COMPUTER GAME JOYSTICKS; VIDEO GAME CONTROLLERS; COMPUTER GAME CONTROLLERS; COMPUTER GAME TAPES, DISCS, CD-ROM, DIGITAL VERSATILE DISC-ROM, DIGITAL VERSATILE DISC-RAM, CARDS, ALL BEING MAGNETIC OR ENCODED AND FOR BEARING RECORDED DATA; COMPUTER GAME EQUIPMENT, NAMELY, HARDWARE AND FIRMWARE MEMORY DEVICE AND PLUG-

IN CARTRIDGES; PROGRAM MEMORY CARTRIDGES FOR ELECTRONIC AMUSEMENT MACHINES ADAPTED FOR USE WITH LIQUID CRYSTAL DISPLAYS; GAMING MACHINES AND GAME SOFTWARE USED THEREWITH; ARCADE GAMES; ARCADE GAME MACHINES FOR USE IN AMUSEMENT ARCADES; REPLACEMENT AND STRUCTURAL PARTS AND FITTINGS FOR ALL THE AFORESAID GOODS, IN CLASS 9 (U.S. CLS. 21, 23, 26, 36 AND 38).

FIRST USE 9-17-2001; IN COMMERCE 9-17-2001.

THE MARK CONSISTS OF THE WORDS "NINJA X NINJA" IN RED, WITH YELLOW LINING ON THE TOP AND GREEN LINING ON THE BOTTOM.

SN 76-372,282, FILED 2-20-2002.

CHERYL STEPLIGHT, EXAMINING ATTORNEY

Int. Cl.: 9

Prior U.S. Cls.: 21, 23, 26, 36, and 38

Reg. No. 2,893,741

United States Patent and Trademark Office

Registered Oct. 12, 2004

**TRADEMARK
PRINCIPAL REGISTER**

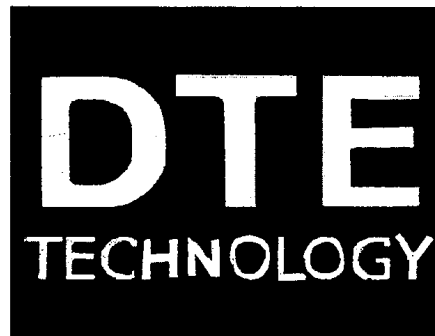

FOCUS ENHANCEMENTS, INC. (DELAWARE CORPORATION)
1370 DELL AVENUE
CAMPBELL, CA 95008

FOR: COMPUTER HARDWARE AND SOFTWARE FOR USE IN RECORDING AND PLAYING BACK DIGITAL VIDEO TO AND FROM HARD DRIVES AND FOR COMPUTER DISK CONTROL AND FILE FORMAT CONVERSION , IN CLASS 9 (U.S. CLS. 21, 23, 26, 36 AND 38).

FIRST USE 4-15-2004; IN COMMERCE 4-15-2004.

NO CLAIM IS MADE TO THE EXCLUSIVE RIGHT TO USE "TECHNOLOGY", APART FROM THE MARK AS SHOWN.

SN 76-379,203, FILED 3-5-2002.

HEATHER THOMPSON, EXAMINING ATTORNEY

Int. Cl.: 16

Prior U.S. Cls.: 2, 5, 22, 23, 29, 37, 38, and 50

United States Patent and Trademark Office

Reg. No. 2,893,742

Registered Oct. 12, 2004

**TRADEMARK
PRINCIPAL REGISTER**

KICKS WITH KIDS

DARBRO, MICHELLE (UNITED STATES INDIVIDUAL)
5311 SW 22 TERR.
DANIA BEACH, FL 33312

NO CLAIM IS MADE TO THE EXCLUSIVE RIGHT TO USE "KIDS", APART FROM THE MARK AS SHOWN.

FOR: BOOKS AND MANUALS IN THE FIELD OF MARTIAL ARTS, IN CLASS 16 (U.S. CLS. 2, 5, 22, 23, 29, 37, 38 AND 50).

SN 76-381,019, FILED 3-12-2002.

FIRST USE 3-18-2004; IN COMMERCE 3-18-2004.

ELIZABETH HUGHITT, EXAMINING ATTORNEY

Int. Cl.: 3

Prior U.S. Cls.: 1, 4, 6, 50, 51, and 52

United States Patent and Trademark Office

Reg. No. 2,893,743

Registered Oct. 12, 2004

**TRADEMARK
PRINCIPAL REGISTER**

FIBRO-SMILE

DENTAL ESSENTIALS INC. (CALIFORNIA CORPORATION)
4105 N. CLUBHOUSE DR.
SOMIS, CA 93066

FIRST USE 6-6-2001; IN COMMERCE 6-6-2001.

SN 76-389,075, FILED 3-29-2002.

FOR: TOOTHPASTE AND NON-MEDICATED MOUTHWASH, IN CLASS 3 (U.S. CLS. 1, 4, 6, 50, 51 AND 52).

PAUL F. GAST, EXAMINING ATTORNEY

Int. Cl.: 40

Prior U.S. Cls.: 100, 103, and 106

United States Patent and Trademark Office

Reg. No. 2,893,744

Registered Oct. 12, 2004

**SERVICE MARK
PRINCIPAL REGISTER**

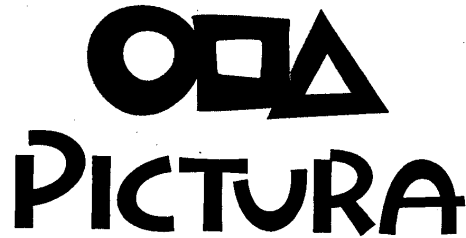

**ODA
PICTURA**

PHOTOLAB IMAGING CORP. (MINNESOTA
CORPORATION)
5900 OLSON MEMORIAL HIGHWAY
GOLDEN VALLEY, MN 55422

FOR: MANUFACTURE OF CUSTOM DIGITAL
DISPLAY GRAPHICS FOR COMMERCIAL USE;
NAMELY, TRADE SHOW DISPLAYS, POINT OF
PURCHASE DISPLAYS, VEHICLE GRAPHICS, IN-

DOOR AND OUTDOOR SIGNAGE AND BANNERS,
IN CLASS 40 (U.S. CLS. 100, 103 AND 106).

FIRST USE 4-11-2002; IN COMMERCE 4-11-2002.

SN 76-390,381, FILED 4-3-2002.

MICHAEL BAIRD, EXAMINING ATTORNEY

Int. Cl.: 41

Prior U.S. Cls.: 100, 101, and 107

United States Patent and Trademark Office

Reg. No. 2,893,745

Registered Oct. 12, 2004

**SERVICE MARK
PRINCIPAL REGISTER**

STUDIO DEVELOPMENTS

BUCKEYE COLOR LAB, INC. (OHIO CORPORATION)
5143 STONEHAM ROAD
NORTH CANTON, OH 44720

FOR: EDUCATIONAL SERVICES, NAMELY,
CONDUCTING PROGRAMS IN THE FIELD OF
PHOTOGRAPHY DIRECTED TO PROFESSIONAL
PHOTOGRAPHERS TO ASSIST THEM IN BETTER
UTILIZING THEIR OWN FACILITIES AND DIGI-

TAL DEVELOPMENT SERVICES OF OUTSIDE
LABS, IN CLASS 41 (U.S. CLS. 100, 101 AND 107).

FIRST USE 5-1-2002; IN COMMERCE 5-1-2002.

SN 76-390,596, FILED 4-1-2002.

SUSAN LESLIE DUBOIS, EXAMINING ATTORNEY

Int. Cl.: 35

Prior U.S. Cls.: 100, 101, and 102

United States Patent and Trademark Office

Reg. No. 2,893,746

Registered Oct. 12, 2004

**SERVICE MARK
PRINCIPAL REGISTER**

LIFESIGNS NETWORK

BLUWORLD INNOVATIONS, L.L.C. (FLORIDA
LIMITED LIABILITY CORPORATION)
5013 EDGEWATER DRIVE
ORLANDO, FL 32810

FOR: PROVIDING SPACE ON DECORATIVE
WATERFALL SCULPTURES FOR THE ADVER-
TISEMENT OF THE GOODS AND SERVICES OF
OTHERS; RENTAL OF ADVERTISING SPACE ON
DECORATIVE WATERFALL SCULPTURES FOR
OTHERS, IN CLASS 35 (U.S. CLS. 100, 101 AND 102).

FIRST USE 12-0-2002; IN COMMERCE 12-0-2002.

NO CLAIM IS MADE TO THE EXCLUSIVE
RIGHT TO USE "NETWORK", APART FROM THE
MARK AS SHOWN.

SN 76-391,020, FILED 4-4-2002.

ZHALEH DELANEY, EXAMINING ATTORNEY

Int. Cl.: 4

Prior U.S. Cls.: 1, 6, and 15

United States Patent and Trademark Office

Reg. No. 2,893,748

Registered Oct. 12, 2004

**TRADEMARK
PRINCIPAL REGISTER**



GOODLIFE (M) SDN BHD (MALAYSIA CORPORATION)

10 JALAN APOLLO U5/190

BANDAR PINGGIRAN SUBANGSEKSYEN 1, SUBANG 2SEKSYEN 1, SUBANG 2

40150 SHAH ALAM, SELANGOR DARUL EHSAN, MALAYSIA

FOR: LUBRICATING OILS FOR INDUSTRIAL AND HOUSEHOLD USE, IN CLASS 4 (U.S. CLS. 1, 6 AND 15).

FIRST USE 4-26-2004; IN COMMERCE 4-26-2004.

SN 76-401,484, FILED 4-29-2002.

FRED MANDIR, EXAMINING ATTORNEY

Int. Cl.: 35

Prior U.S. Cls.: 100, 101, and 102

United States Patent and Trademark Office

Reg. No. 2,893,749

Registered Oct. 12, 2004

**SERVICE MARK
PRINCIPAL REGISTER**

HEAR and KNOW

HEAR AND KNOW INCORPORATED (FLORIDA
CORPORATION)
4302 HEBRIDES COURT
BRADENTON, FL 34210

FIRST USE 4-12-2004; IN COMMERCE 4-12-2004.

SN 76-403,856, FILED 5-6-2002.

FOR: ONLINE RETAIL SERVICES FEATURING
COMPACT DISCS, IN CLASS 35 (U.S. CLS. 100, 101
AND 102).

MARGERY A. TIERNEY, EXAMINING ATTORNEY

Int. Cl.: 17

Prior U.S. Cls.: 1, 5, 12, 13, 35, and 50

United States Patent and Trademark Office

Reg. No. 2,893,750

Registered Oct. 12, 2004

**TRADEMARK
PRINCIPAL REGISTER**

TACJAC

MINNESOTA LABEL INCORPORATED (MINNE-
SOTA CORPORATION)
4260 CENTERVILLE ROAD
VADNAIS HEIGHTS, MN 55127

FOR: ADHESIVE BACKED LAMINATED POLY-
URETHANE LABELS HAVING PEEL-OFF REMO-
VABLE BACKINGS FOR APPLICATION TO

SUBSTRATE SURFACES, IN CLASS 17 (U.S. CLS. 1,
5, 12, 13, 35 AND 50).

FIRST USE 4-15-2002; IN COMMERCE 9-21-2002.

SN 76-415,736, FILED 5-28-2002.

BERYL GARDNER, EXAMINING ATTORNEY

Int. Cl.: 39

Prior U.S. Cls.: 100 and 105

United States Patent and Trademark Office

Reg. No. 2,893,751

Registered Oct. 12, 2004

**SERVICE MARK
PRINCIPAL REGISTER**

ALAMO COUNTRY

VANGUARD TRADEMARK HOLDINGS S.A.R.L.
(LUXEMBOURG PRIVATE LIMITED COMPAN-
NY)
200 SOUTH ANDREWS AVENUE
FT. LAUDERDALE, FL 33301

FOR: VEHICLE RENTAL AND RESERVATION
SERVICES; VEHICLE LEASING SERVICES, IN
CLASS 39 (U.S. CLS. 100 AND 105).

FIRST USE 8-0-2002; IN COMMERCE 8-0-2002.

OWNER OF U.S. REG. NOS. 1,097,722, 2,427,040,
AND 2,427,041.

SN 76-416,617, FILED 5-31-2002.

RONALD AIKENS, EXAMINING ATTORNEY

Int. Cl.: 32

Prior U.S. Cls.: 45, 46, and 48

United States Patent and Trademark Office

Reg. No. 2,893,752

Registered Oct. 12, 2004

**TRADEMARK
PRINCIPAL REGISTER**

RICOCHET

COOK, SHELLEY (CANADA INDIVIDUAL)
C/O 6 SECORD DRIVE
ST. CATHARINES, ONTARIO, CANADA L2N 1K8

PRIORITY CLAIMED UNDER SEC. 44(D) ON
CANADA APPLICATION NO. 1,129,088, FILED 1-25-
2002, REG. NO. TMA589676, EXPIRES 9-12-2018.

FOR: DRINKING WATER, BOTTLED WATER,
CARBONATED WATER, SPRING WATER, FIL-
TERED WATER, IN CLASS 32 (U.S. CLS. 45, 46
AND 48).

SN 76-420,682, FILED 6-14-2002.

FIRST USE 1-5-2003; IN COMMERCE 7-28-2003.

DAWN FELDMAN, EXAMINING ATTORNEY

Int. Cl.: 32

Prior U.S. Cls.: 45, 46, and 48

United States Patent and Trademark Office

Reg. No. 2,893,753

Registered Oct. 12, 2004

**TRADEMARK
PRINCIPAL REGISTER**

RICO)HET



COOK, SHELLEY (CANADA INDIVIDUAL)
C/O 6 SECORD DRIVE
ST. CATHARINES, ONTARIO, CANADA L2N 1K8

PRIORITY CLAIMED UNDER SEC. 44(D) ON
CANADA APPLICATION NO. 1,130,630, FILED 2-11-
2002, REG. NO. TMA589713, EXPIRES 9-12-2018.

FOR: DRINKING WATER, BOTTLED WATER,
CARBONATED WATER, SPRING WATER, FIL-
TERED WATER, IN CLASS 32 (U.S. CLS. 45, 46
AND 48).

SN 76-421,505, FILED 6-14-2002.

FIRST USE 1-5-2003; IN COMMERCE 7-28-2003.

DAWN FELDMAN, EXAMINING ATTORNEY

Int. Cl.: 9

Prior U.S. Cls.: 21, 23, 26, 36, and 38

United States Patent and Trademark Office

Reg. No. 2,893,754

Registered Oct. 12, 2004

**TRADEMARK
PRINCIPAL REGISTER**

WISE WAITER

NEWT, INC. (TEXAS CORPORATION)
14016 BROOKRIDGE DR.
DALLAS, TX 75240

NO CLAIM IS MADE TO THE EXCLUSIVE
RIGHT TO USE "WAITER", APART FROM THE
MARK AS SHOWN.

FOR: COMPUTER SOFTWARE FOR RESTAU-
RANT WAITERS TO RECORD CUSTOMERS' FOOD
ORDERS, IN CLASS 9 (U.S. CLS. 21, 23, 26, 36 AND
38).

SN 76-432,364, FILED 7-19-2002.

FIRST USE 5-2-2004; IN COMMERCE 5-2-2004.

H. M. FISHER, EXAMINING ATTORNEY

Int. Cl.: 31

Prior U.S. Cls.: 1 and 46

United States Patent and Trademark Office

Reg. No. 2,893,756

Registered Oct. 12, 2004

**TRADEMARK
PRINCIPAL REGISTER**

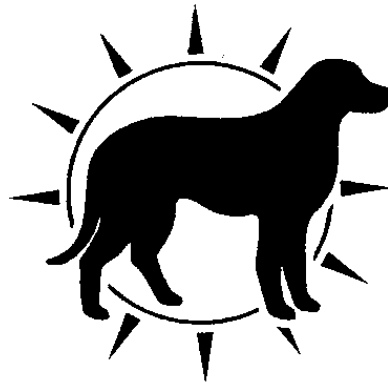

MARS, INCORPORATED (DELAWARE CORPORATION)
6885 ELM STREET
MCLEAN, VA 22101

FIRST USE 11-0-2002; IN COMMERCE 11-0-2002.

SN 76-442,597, FILED 8-15-2002.

FOR: PET FOOD, IN CLASS 31 (U.S. CLS. 1 AND 46).

DAWN FELDMAN, EXAMINING ATTORNEY

Int. Cl.: 9

Prior U.S. Cls.: 21, 23, 26, 36, and 38

United States Patent and Trademark Office

Reg. No. 2,893,759

Registered Oct. 12, 2004

**TRADEMARK
PRINCIPAL REGISTER**

VIRTUALITY

BOARDWALK TECHNOLOGY SERVICES, LLC
(MICHIGAN LTD LIAB CO)
900 WILSHIRE DRIVE, SUITE 385
TROY, MI 48084

FOR: COMPUTER SOFTWARE AND MANUALS
DISTRIBUTED THEREWITH FOR USE IN MAN-
AGEMENT AND OPERATIONS OF FINANCIAL
ADVISORY FIRMS, FEATURING COMPILING,
PROCESSING AND MANAGING INFORMATION
REGARDING CALENDAR AND TASK SCHEDUL-
ING, ACCOUNTS RECEIVABLE, INVENTORY, IN-

SURANCE, ADVISORY FEES, ACCOUNT AND
RECORDS INFORMATION, CORRESPONDENCE,
FINANCIAL PLANS, ASSET ALLOCATIONS, AND
COMPENSATION, IN CLASS 9 (U.S. CLS. 21, 23, 26, 36
AND 38).

FIRST USE 1-0-2002; IN COMMERCE 1-0-2002.

SN 76-447,537, FILED 9-5-2002.

RUSS HERMAN, EXAMINING ATTORNEY

Int. Cl.: 9

Prior U.S. Cls.: 21, 23, 26, 36, and 38

United States Patent and Trademark Office

Reg. No. 2,893,760

Registered Oct. 12, 2004

**TRADEMARK
PRINCIPAL REGISTER**

CLEAR-MESH

OMNILUX, INC. (DELAWARE CORPORATION)
130 WEST UNION STREET
PASADENA, CA 91103

NETWORK, IN CLASS 9 (U.S. CLS. 21, 23, 26, 36 AND
38).

FIRST USE 9-18-2002; IN COMMERCE 1-9-2003.

FOR: NETWORK MANAGEMENT SOFTWARE
PLATFORM WITH MANAGEMENT TOOLS TO
MONITOR AND CONTROL A REDUNDANT MESH

SN 76-452,086, FILED 9-24-2002.

CHERYL STEPLIGHT, EXAMINING ATTORNEY

Int. Cl.: 11

Prior U.S. Cls.: 13, 21, 23, 31, and 34

United States Patent and Trademark Office

Reg. No. 2,893,761

Registered Oct. 12, 2004

TRADEMARK
PRINCIPAL REGISTER



DESA IP, LLC (FLORIDA LTD LIAB CO)
1001 BRICKELL BAY DRIVE, 27TH FL.
C/O H.I.G. CAPITAL, LLC
MIAMI, FL 33131

FOR: ELECTRIC LIGHTING FIXTURES, IN
CLASS 11 (U.S. CLS. 13, 21, 23, 31 AND 34).

FIRST USE 2-1-2003; IN COMMERCE 2-1-2003.

NO CLAIM IS MADE TO THE EXCLUSIVE
RIGHT TO USE "CONTROLS 2 LIGHT GROUPS",
APART FROM THE MARK AS SHOWN.

THE LINING IS A FEATURE OF THE MARK
AND DOES NOT INDICATE COLOR.

SN 76-454,713, FILED 10-2-2002.

ALEX KEAM, EXAMINING ATTORNEY

Int. Cl.: 25

Prior U.S. Cls.: 22 and 39

United States Patent and Trademark Office

Reg. No. 2,893,762

Registered Oct. 12, 2004

TRADEMARK
PRINCIPAL REGISTER



HAGGAR WOMEN'S WEAR, LTD. (PARTNER-
SHIP)
TWO COLINAS CROSSING
11511 LUNA ROAD
DALLAS, TX 75234

THE MARK CONSISTS OF FIVE THREE-DIMEN-
SIONAL DICE-LIKE CUBES IN A ROW. EACH
CUBE FEATURES A LETTER ("W", " X", "R", "L",
"D"). THE LETTER "X" ON THE SECOND CUBE IS
SURROUNDED BY AN ASYMETRICAL SPLOTTCH".

FOR: WOMEN'S PANTS, SKIRTS, SHORTS AND
JACKETS, IN CLASS 25 (U.S. CLS. 22 AND 39).

SN 76-458,090, FILED 10-15-2002.

FIRST USE 11-15-2002; IN COMMERCE 11-15-2002.

THE STIPPLING IS FOR SHADING PURPOSES
ONLY.

HENRY S. ZAK, EXAMINING ATTORNEY

Int. Cl.: 30

Prior U.S. Cl.: 46

United States Patent and Trademark Office

Reg. No. 2,893,764

Registered Oct. 12, 2004

**TRADEMARK
PRINCIPAL REGISTER**

PIZZA PIE

ANNIE'S ENTERPRISES, INC. (VERMONT CORPORATION)
792 FOSTER HILL ROAD
NORTH CALAIS, VT 05650

NO CLAIM IS MADE TO THE EXCLUSIVE RIGHT TO USE "PIZZA" , APART FROM THE MARK AS SHOWN.

FOR: SAUCES; CONDIMENTS, NAMELY, SALAD DRESSINGS, IN CLASS 30 (U.S. CL. 46).

SN 76-465,778, FILED 11-12-2002.

FIRST USE 3-6-2003; IN COMMERCE 3-6-2003.

WANDA KAY PRICE, EXAMINING ATTORNEY

Int. Cl.: 9

Prior U.S. Cls.: 21, 23, 26, 36, and 38

United States Patent and Trademark Office

Reg. No. 2,893,765

Registered Oct. 12, 2004

**TRADEMARK
PRINCIPAL REGISTER**

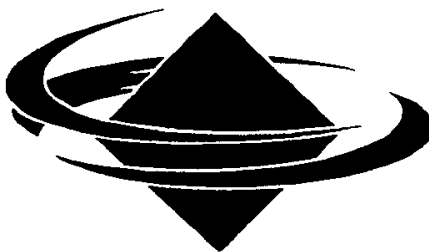

SAFETY MESSENGER, INC. (DELAWARE CORPORATION)
32 RIDGEROCK DRIVE
SIGNAL MOUNTAIN, TN 37377

FOR: CELLULAR AND RADIO FREQUENCY DATA TEXT MESSAGING EQUIPMENT, NAMELY, MODEMS, RADIO TRANSMITTERS, RECEIVERS AND ANTENNAS, SATELLITE POSITIONING AND NAVIGATIONAL RECEIVERS, LCD DISPLAY UNITS FOR TEXT MESSAGING; IN-VEHICLE DATA COMMUNICATIONS MODULES TO RECEIVE TEXT MESSAGES; MODEMS; RADIO TRANSMITTERS, RECEIVERS AND ANTENNAS; SATELLITE POSITIONING AND NAVIGATIONAL RECEIVERS; LCD DISPLAY UNITS FOR TEXT

MESSAGING; ROADSIDE RADIO FREQUENCY TRANSMITTERS; BROADCASTING AND RELAY EQUIPMENT FOR SENDING TEXT MESSAGES TO PASSING MOTORISTS, NAMELY, MODEMS, RADIO TRANSMITTERS, RECEIVERS AND ANTENNAS, SATELLITE POSITIONING AND NAVIGATIONAL RECEIVERS, LCD DISPLAY UNITS FOR TEXT MESSAGING, IN CLASS 9 (U.S. CLS. 21, 23, 26, 36 AND 38).

FIRST USE 3-12-2003; IN COMMERCE 3-12-2003.

SN 76-477,708, FILED 12-23-2002.

LINDA M. KING, EXAMINING ATTORNEY

Int. Cl.: 21

Prior U.S. Cls.: 2, 13, 23, 29, 30, 33, 40, and 50

United States Patent and Trademark Office

Reg. No. 2,893,766

Registered Oct. 12, 2004

**TRADEMARK
PRINCIPAL REGISTER**

STONEAGE

STONEAGE CERAMICS INTERNATIONAL
HONG KONG LTD. (HONG KONG COR-
PORATION)
19/F CENTRE POINT
181-185 GLOUCESTER ROAD
WANCHAI, HONG KONG

FOR: TABLEWARE AND TABLE ACCESSORIES
MADE OF PORCELAIN, STONEWARE, EARTHEN-
WARE AND GLASS, NAMELY, PLATES, CUPS,
MUGS, SAUCERS, BOWLS, CANDLESTICK HOLD-
ERS, AND VASES; SERVING PIECES MADE OF

PORCELAIN, STONEWARE, EARTHENWARE AND
GLASS, NAMELY, BOWLS, POT LIDS, SERVING
PLATTERS, MEAL TRAYS AND SERVING DISHES,
IN CLASS 21 (U.S. CLS. 2, 13, 23, 29, 30, 33, 40 AND 50).

FIRST USE 9-1-2001; IN COMMERCE 9-1-2001.

SN 76-481,613, FILED 1-10-2003.

ZACHARY BELLO, EXAMINING ATTORNEY

Int. Cl.: 9

Prior U.S. Cls.: 21, 23, 26, 36, and 38

United States Patent and Trademark Office

Reg. No. 2,893,767

Registered Oct. 12, 2004

**TRADEMARK
PRINCIPAL REGISTER**

QUICK BLOCK

UNIVERSAL SECURITY INSTRUMENTS, INC.
(MARYLAND CORPORATION)
7-A GWYNNS MILL COURT
OWINGS MILLS, MD 21117

NO CLAIM IS MADE TO THE EXCLUSIVE
RIGHT TO USE "BLOCK", APART FROM THE
MARK AS SHOWN.

FOR: ELECTRICAL WIRING DEVICES, NAMELY
GROUND FAULT CIRCUIT INTERRUPTERS, IN
CLASS 9 (U.S. CLS. 21, 23, 26, 36 AND 38).

SN 76-482,620, FILED 1-15-2003.

FIRST USE 5-1-2003; IN COMMERCE 5-1-2003.

CHERYL STEPLIGHT, EXAMINING ATTORNEY

Int. Cl.: 32

Prior U.S. Cls.: 45, 46, and 48

Reg. No. 2,893,768

United States Patent and Trademark Office

Registered Oct. 12, 2004

TRADEMARK
PRINCIPAL REGISTER



GREEN MOUNTAIN SPRINGS LTD. (NEW
YORK CORPORATION)
7703 BROADWAY AVENUE
HOLBROOK, NY 11741

FOR: NATURAL SPRING WATER, IN CLASS 32
(U.S. CLS. 45, 46 AND 48).

FIRST USE 1-0-2003; IN COMMERCE 1-0-2003.

NO CLAIM IS MADE TO THE EXCLUSIVE
RIGHT TO USE "SPRINGS" AND "NATURAL

SPRING WATER", APART FROM THE MARK AS
SHOWN.

THE STIPPLING SHOWN IN THE DRAWING IS A
FEATURE OF THE MARK AND NOT INTENDED
TO INDICATE COLOR.

SN 76-483,032, FILED 1-15-2003.

KAREN M. STRYZ, EXAMINING ATTORNEY

Int. Cl.: 27

Prior U.S. Cls.: 19, 20, 37, 42, and 50

United States Patent and Trademark Office

Reg. No. 2,893,769

Registered Oct. 12, 2004

**TRADEMARK
PRINCIPAL REGISTER**

ENTRY MATE

TECH-MATS, LLC (VIRGINIA LTD LIAB CO)
2840 HERSHBERGER ROAD, SUITE A
ROANOKE, VA 24017

FIRST USE 5-14-2003; IN COMMERCE 5-14-2003.

SN 76-488,649, FILED 2-10-2003.

FOR: DOOR MATS; FLOOR MATS WITH ADHE-
SIVE TOP SURFACES, IN CLASS 27 (U.S. CLS. 19, 20,
37, 42 AND 50).

BRENDAN MCCAULEY, EXAMINING ATTORNEY

Int. Cl.: 6

Prior U.S. Cls.: 2, 12, 13, 14, 23, 25, and 50

Reg. No. 2,893,770

United States Patent and Trademark Office

Registered Oct. 12, 2004

**TRADEMARK
PRINCIPAL REGISTER**

V-TEXBRICK

FEATHER LITE INNOVATIONS, INC. (OHIO
CORPORATION)
217 S. PIONEER BLVD.
SPRINGBORO, OH 45066

FIRST USE 4-30-2003; IN COMMERCE 4-30-2003.

SN 76-491,155, FILED 2-21-2003.

FOR: PRIMARILY METAL BUILDING MATERI-
ALS, NAMELY, CONCRETE CASTING FORMS, IN
CLASS 6 (U.S. CLS. 2, 12, 13, 14, 23, 25 AND 50).

VIVIAN MICZNIK FIRST, EXAMINING ATTOR-
NEY

Int. Cl.: 45

Prior U.S. Cls.: 100 and 101

United States Patent and Trademark Office

Reg. No. 2,893,771

Registered Oct. 12, 2004

**SERVICE MARK
PRINCIPAL REGISTER**

SA'KRED

SA'KRED, INC. (CALIFORNIA CORPORATION)
P.O. BOX 2296
MISSION VIEJO, CA 92690

GIIOUS PROGRAMS, IN CLASS 45 (U.S. CLS. 100
AND 101).

FOR: RELIGIOUS SERVICES, NAMELY, OPER-
ATING PLACES OF ASSEMBLY FOR PRAYER AND
WORSHIP; MINISTERIAL SERVICES, NAMELY,
PROVIDING RELIGIOUS WORSHIP SERVICES
AND CONDUCTING CHURCH SPONSORED RELI-

FIRST USE 1-1-2002; IN COMMERCE 1-1-2002.

SN 76-491,785, FILED 2-13-2003.

ALICE BENMAMAN, EXAMINING ATTORNEY

Int. Cl.: 9

Prior U.S. Cls.: 21, 23, 26, 36, and 38

Reg. No. 2,893,772

United States Patent and Trademark Office

Registered Oct. 12, 2004

**TRADEMARK
PRINCIPAL REGISTER**

CATOOL

AMARANTH NETWORKS, INC. (MASSACHU-
SETTS CORPORATION)
324 STILL RIVER ROAD
BOLTON, MA 01740

FOR: COMPUTER NETWORK SECURITY SOFT-
WARE; COMPUTER SOFTWARE FOR USE IN IM-
PLEMENTING E-MAIL ENCRYPTION, VIRTUAL
PRIVATE NETWORK (VPN) CONTROL, WIRELESS
ENCRYPTION, CERTIFICATE AUTHORITY (CA)

MANAGEMENT, AND FIREWALLS, IN CLASS 9
(U.S. CLS. 21, 23, 26, 36 AND 38).

FIRST USE 3-0-2004; IN COMMERCE 3-0-2004.

SN 76-492,180, FILED 2-24-2003.

PRISCILLA MILTON, EXAMINING ATTORNEY

Int. Cl.: 16

Prior U.S. Cls.: 2, 5, 22, 23, 29, 37, 38, and 50

United States Patent and Trademark Office

Reg. No. 2,893,773

Registered Oct. 12, 2004

**TRADEMARK
PRINCIPAL REGISTER**

A MORNING CUP OF

CRANE HILL PUBLISHERS, INC. (ALABAMA
CORPORATION)
3608 CLAIRMONT AVENUE
BIRMINGHAM, AL 35222

FIRST USE 5-1-2002; IN COMMERCE 10-1-2002.

SN 76-493,192, FILED 2-10-2003.

FOR: SERIES OF NON-FICTION BOOKS IN THE
FIELD OF MENTAL AND PHYSICAL WELL-
BEING, IN CLASS 16 (U.S. CLS. 2, 5, 22, 23, 29, 37, 38
AND 50).

ALEXANDER L. POWERS, EXAMINING ATTOR-
NEY

Int. Cl.: 20

Prior U.S. Cls.: 2, 13, 22, 25, 32, and 50

United States Patent and Trademark Office

Reg. No. 2,893,774

Registered Oct. 12, 2004

**TRADEMARK
PRINCIPAL REGISTER**

PET TENDER

SPENCE ENTERPRISES (PARTNERSHIP) , DBA
PET TENDER,
5620 SPINNAKER BAY DR.
LONG BEACH, CA 90803

FOR: DOG BED, IN CLASS 20 (U.S. CLS. 2, 13, 22,
25, 32 AND 50).

FIRST USE 4-18-2003; IN COMMERCE 12-3-2003.

NO CLAIM IS MADE TO THE EXCLUSIVE
RIGHT TO USE "PET", APART FROM THE MARK
AS SHOWN.

SN 76-493,293, FILED 2-27-2003.

JACQUELINE A. LAVINE, EXAMINING ATTOR-
NEY

Int. Cl.: 16

Prior U.S. Cls.: 2, 5, 22, 23, 29, 37, 38, and 50

United States Patent and Trademark Office

Reg. No. 2,893,775

Registered Oct. 12, 2004

**TRADEMARK
PRINCIPAL REGISTER**

IT'S GLUE NATURALLY

CLARENCE J. VENNE, L.L.C. (DELAWARE LTD
LIAB CO)
1425 HANFORD STREET
LEVITTOWN, PA 19057

FIRST USE 5-6-2003; IN COMMERCE 5-6-2003.

SN 76-494,493, FILED 3-4-2003.

FOR: GLUE FOR STATIONARY OR HOUSE-
HOLD USE, IN CLASS 16 (U.S. CLS. 2, 5, 22, 23, 29,
37, 38 AND 50).

ALEXANDER L. POWERS, EXAMINING ATTOR-
NEY

Int. Cl.: 10

Prior U.S. Cls.: 26, 39, and 44

United States Patent and Trademark Office

Reg. No. 2,893,776

Registered Oct. 12, 2004

**TRADEMARK
PRINCIPAL REGISTER**

OBTAPE

MENTOR CORPORATION (MINNESOTA CORPORATION)
201 MENTOR DRIVE
SANTA BARBARA, CA 93111

FOR: MEDICAL GOODS, NAMELY ARTIFICIAL
SUBURETHRAL SLING AND INSERTION TOOLS
FOR THE SURGICAL TREATMENT OF URINARY

INCONTINENCE, IN CLASS 10 (U.S. CLS. 26, 39 AND 44).

FIRST USE 10-9-2002; IN COMMERCE 10-9-2002.

SN 76-495,722, FILED 3-7-2003.

DAVID TAYLOR, EXAMINING ATTORNEY

Int. Cl.: 35

Prior U.S. Cls.: 100, 101, and 102

United States Patent and Trademark Office

Reg. No. 2,893,778

Registered Oct. 12, 2004

**SERVICE MARK
PRINCIPAL REGISTER**

STAFF NAVIGATOR

SEATONCORP. (ILLINOIS CORPORATION), DBA
STAFF MANAGEMENT,
358 WEST ONTARIO STREET
CHICAGO, IL 60611

NO CLAIM IS MADE TO THE EXCLUSIVE
RIGHT TO USE "STAFF", APART FROM THE
MARK AS SHOWN.

FOR: MANAGEMENT OF TEMPORARY STAFF-
ING PROVIDERS, IN CLASS 35 (U.S. CLS. 100, 101
AND 102).

SN 76-499,635, FILED 3-21-2003.

FIRST USE 5-1-2003; IN COMMERCE 5-1-2003.

ZHALEH DELANEY, EXAMINING ATTORNEY

Int. Cl.: 7

Prior U.S. Cls.: 13, 19, 21, 23, 31, 34, and 35

Reg. No. 2,893,779

United States Patent and Trademark Office

Registered Oct. 12, 2004

**TRADEMARK
PRINCIPAL REGISTER**

NUFLARE

TOSHIBA KIKAI KABUSHIKI KAISHA (JAPAN
CORPORATION)
2-11, GINZA, 4-CHOME, CHUO-KU
TOKYO 104-8141, JAPAN

MASK INSPECTION MACHINES, ULTRA HIGH
VACUUM PUMPS AND WAFER-HANDLING
CLUSTER TOOLS, IN CLASS 7 (U.S. CLS. 13, 19, 21,
23, 31, 34 AND 35).

FOR: SEMI-CONDUCTOR MANUFACTURING
APPARATUS, NAMELY, ELECTRON BEAM EXPO-
SURE MACHINES, EPITAXIAL REACTORS, CHE-
MICAL VAPOR DEPOSITION MACHINES,
PHYSICAL VAPOR DEPOSITION MACHINES,
PLASMA ETCHERS, ION IMPLANTERS, AND CHE-
MICAL MECHANICAL POLISHERS, CHEMICAL
VAPOR DEPOSITION PROCESSING CHAMBERS,

FIRST USE 0-0-2002; IN COMMERCE 0-0-2002.

SN 76-503,054, FILED 3-19-2003.

WILLIAM BRECKENFELD, EXAMINING ATTOR-
NEY

Int. Cl.: 41

Prior U.S. Cls.: 100, 101, and 107

United States Patent and Trademark Office

Reg. No. 2,893,780

Registered Oct. 12, 2004

**SERVICE MARK
PRINCIPAL REGISTER**

MEDIA CHOICE



MEDIA CHOICE, LLC (OHIO LTD LIAB CO)
155 TRI-COUNTY PARKWAY SUITE 111
SPRINGDALE, OH 45246

FIRST USE 5-1-2003; IN COMMERCE 5-1-2003.

SN 76-503,176, FILED 3-31-2003.

FOR: PRODUCTION OF VIDEO DISCS FOR OTHERS, IN CLASS 41 (U.S. CLS. 100, 101 AND 107).

DAVID TAYLOR, EXAMINING ATTORNEY

Int. Cl.: 41

Prior U.S. Cls.: 100, 101, and 107

United States Patent and Trademark Office

Reg. No. 2,893,781

Registered Oct. 12, 2004

**SERVICE MARK
PRINCIPAL REGISTER**

DVD2ME

MEDIA CHOICE, LLC (OHIO LTD LIAB CO)
155 TRI-COUNTY PARKWAY SUITE 111
SPRINGDALE, OH 45246

FIRST USE 3-25-2003; IN COMMERCE 3-25-2003.

SN 76-503,177, FILED 3-31-2003.

FOR: PRODUCTION OF VIDEO DISCS FOR OTHERS, IN CLASS 41 (U.S. CLS. 100, 101 AND 107).

DAVID TAYLOR, EXAMINING ATTORNEY

Int. Cl.: 30

Prior U.S. Cl.: 46

United States Patent and Trademark Office

Reg. No. 2,893,782

Registered Oct. 12, 2004

**TRADEMARK
PRINCIPAL REGISTER**

M-AZING

MARS, INCORPORATED (DELAWARE COR-
PORATION)
6885 ELM STREET
MCLEAN, VA 221013883

FIRST USE 7-0-2004; IN COMMERCE 7-0-2004.

SN 76-503,211, FILED 4-2-2003.

FOR: CONFECTIONERY, NAMELY, CANDY, IN
CLASS 30 (U.S. CL. 46).

GINA HAYES, EXAMINING ATTORNEY

Int. Cl.: 35

Prior U.S. Cls.: 100, 101, and 102

United States Patent and Trademark Office

Reg. No. 2,893,783

Registered Oct. 12, 2004

**SERVICE MARK
PRINCIPAL REGISTER**

HEALTHMATRIX

MARKET MEASURES/COZINT L.P. (NEW JERSEY LIMITED PARTNERSHIP)
120 EAGLE ROCK AVENUE
EAST HANOVER, NJ 07936

FOR: CONDUCTING MARKET RESEARCH IN THE FIELDS OF HEALTHCARE TREATMENT, DRUG THERAPY, PHARMACEUTICAL, BIOTECHNOLOGY, DIAGNOSTIC AND MEDICAL DEVICE PRODUCTS AND SERVICES, AND CONSUMER

BEHAVIOR AS IT RELATES THERETO, IN CLASS 35 (U.S. CLS. 100, 101 AND 102).

FIRST USE 5-0-2004; IN COMMERCE 5-0-2004.

SN 76-503,962, FILED 4-4-2003.

CHARLES JOYNER, EXAMINING ATTORNEY

Int. Cl.: 35

Prior U.S. Cls.: 100, 101, and 102

United States Patent and Trademark Office

Reg. No. 2,893,784

Registered Oct. 12, 2004

**SERVICE MARK
PRINCIPAL REGISTER**

ARE YOU FAN ENOUGH?

MBNA AMERICA BANK, NATIONAL ASSOCIATION (UNITED STATES BANKING ASSOCIATION)
RODNEY SQUARE
WILMINGTON, DE 19884

FOR: PROMOTING SPORTS COMPETITIONS AND/OR EVENTS OF OTHERS; PROMOTING THE SALE OF CREDIT CARD ACCOUNTS THROUGH THE ADMINISTRATION OF INCENTIVE AWARE PROGRAMS; AND PROMOTING THE SALE OF GOODS AND SERVICES OF OTHERS THROUGH THE DISTRIBUTION OF PRINTED MATERIAL

AND PROMOTIONAL CONTESTS, IN CLASS 35 (U.S. CLS. 100, 101 AND 102).

FIRST USE 5-31-2003; IN COMMERCE 5-31-2003.

OWNER OF U.S. REG. NOS. 1,362,384, 1,610,767, AND OTHERS.

SN 76-507,059, FILED 4-11-2003.

DAVID TAYLOR, EXAMINING ATTORNEY

Int. Cl.: 42

Prior U.S. Cls.: 100 and 101

United States Patent and Trademark Office

Reg. No. 2,893,785

Registered Oct. 12, 2004

**SERVICE MARK
PRINCIPAL REGISTER**

THE SALES LEVER

MLANS, INC. (NEW HAMPSHIRE CORPORATION)
38 BOYD ROAD
LONDONDERRY, NH 03053

SOFTWARE SYSTEMS FOR OTHERS, IN CLASS 42
(U.S. CLS. 100 AND 101).

FIRST USE 2-1-2004; IN COMMERCE 2-1-2004.

FOR: CONSULTING SERVICES IN THE FIELD
OF DESIGN, SELECTION, IMPLEMENTATION,
AND USE OF COMPUTER HARDWARE AND

SN 76-507,937, FILED 4-21-2003.

IRENE D. WILLIAMS, EXAMINING ATTORNEY

Int. Cl.: 20

Prior U.S. Cls.: 2, 13, 22, 25, 32, and 50

United States Patent and Trademark Office

Reg. No. 2,893,786

Registered Oct. 12, 2004

**TRADEMARK
PRINCIPAL REGISTER**

MAGNETAR

MOHON INTERNATIONAL, INC. (DELAWARE
CORPORATION)
1865 N. MARKET STREET
PARIS, TN 38242

FIRST USE 4-0-2003; IN COMMERCE 4-0-2003.

SN 76-509,132, FILED 4-24-2003.

FOR: LABORATORY FURNITURE, IN CLASS 20
(U.S. CLS. 2, 13, 22, 25, 32 AND 50).

JOSETTE BEVERLY, EXAMINING ATTORNEY

Int. Cl.: 6

Prior U.S. Cls.: 2, 12, 13, 14, 23, 25, and 50

Reg. No. 2,893,788

United States Patent and Trademark Office

Registered Oct. 12, 2004

**TRADEMARK
PRINCIPAL REGISTER**

BOND CLASSROOM SOLUTIONS

BOND BUILDING SYSTEMS, INC. (FLORIDA CORPORATION)
3811 PEMBROKE ROAD
HOLLYWOOD, FL 33021

FOR: STEEL BEAM SYSTEM COMPRISED OF HOLLOW RECTANGULAR STEEL BEAMS, STEEL CONNECTOR PLATES AND STEEL PEGS FABRICATED FOR SPECIFIC STRUCTURAL DESIGNS WHICH ARE USED FOR TEMPORARILY SUPPORTING STEEL MESH PANELS TO WHICH CONCRETE IS APPLIED ON BOTH SIDES TO FORM

STEEL REINFORCED CONCRETE WALLS, IN CLASS 6 (U.S. CLS. 2, 12, 13, 14, 23, 25 AND 50).

FIRST USE 1-1-2003; IN COMMERCE 1-1-2003.

NO CLAIM IS MADE TO THE EXCLUSIVE RIGHT TO USE "CLASSROOM SOLUTIONS", APART FROM THE MARK AS SHOWN.

SN 76-513,354, FILED 4-24-2003.

TRACY CROSS, EXAMINING ATTORNEY

Int. Cl.: 31

Prior U.S. Cls.: 1 and 46

United States Patent and Trademark Office

Reg. No. 2,893,789

Registered Oct. 12, 2004

**TRADEMARK
PRINCIPAL REGISTER**

MARADOL

MARIA ELENA RAMIREZ JAUREGUI (MEXICO
CORPORATION)
PROLONGACION COLON NO. 285
COLONIA OJO DE AGUA, SANTA ANITA
MUNICIPIO DE TLAQUEPAQUE, JALISCO, MEXI-
CO 45600

FIRST USE 1-26-2004; IN COMMERCE 1-26-2004.

SN 76-516,767, FILED 5-8-2003.

FOR: PAPAYA SEED, IN CLASS 31 (U.S. CLS. 1
AND 46).

FLORENTINA BLANDU, EXAMINING ATTORNEY

Int. Cl.: 3

Prior U.S. Cls.: 1, 4, 6, 50, 51, and 52

United States Patent and Trademark Office

Reg. No. 2,893,790

Registered Oct. 12, 2004

**TRADEMARK
PRINCIPAL REGISTER**

STEAL BACK TIME

LEONE, GIULIO A. (UNITED STATES INDIVIDUAL)
3060 N. ARLINGTON HTS. RD
ARLINGTON HEIGHTS, IL 60004

FOR: COSMETIC AND ANTI-AGING SKIN CARE PRODUCTS, NAMELY, ALPHA-HYDROXYACID SKIN CREAM, FACIAL CLEANSING LOTION

AND SKIN CREAM CONTAINING HYALURONIC ACID , IN CLASS 3 (U.S. CLS. 1, 4, 6, 50, 51 AND 52).

FIRST USE 2-0-2004; IN COMMERCE 2-0-2004.

SN 76-517,386, FILED 5-28-2003.

MITCHELL FRONT, EXAMINING ATTORNEY

Int. Cl.: 21

Prior U.S. Cls.: 2, 13, 23, 29, 30, 33, 40, and 50

United States Patent and Trademark Office

Reg. No. 2,893,791

Registered Oct. 12, 2004

**TRADEMARK
PRINCIPAL REGISTER**

BLACK SILK

THE OAK RUBBER COMPANY (OHIO CORPORATION)
4835 DARROW ROAD
STOW, OH 442244132

FOR: DISPOSABLE PLASTIC GLOVES FOR GENERAL USE; DISPOSABLE VINYL GLOVES FOR GENERAL USE; DISPOSABLE PLASTIC GLOVES FOR USE IN THE BEAUTY INDUSTRY; DISPOSABLE VINYL GLOVES FOR USE IN THE BEAUTY INDUSTRY, IN CLASS 21 (U.S. CLS. 2, 13, 23, 29, 30, 33, 40 AND 50).

FIRST USE 9-5-2003; IN COMMERCE 9-5-2003.

NO CLAIM IS MADE TO THE EXCLUSIVE RIGHT TO USE "BLACK", APART FROM THE MARK AS SHOWN.

SN 76-520,957, FILED 5-28-2003.

CATHERINE CAIN, EXAMINING ATTORNEY

Int. Cl.: 5

Prior U.S. Cls.: 6, 18, 44, 46, 51, and 52

United States Patent and Trademark Office

Reg. No. 2,893,792

Registered Oct. 12, 2004

**TRADEMARK
PRINCIPAL REGISTER**

REMEPRIN

LEINER HEALTH SERVICES CORP. (DELA-
WARE CORPORATION)
901 EAST 233RD STREET
CARSON, CA 90745

FIRST USE 1-0-2004; IN COMMERCE 1-0-2004.

SN 76-522,482, FILED 6-13-2003.

FOR: VITAMINS AND DIETARY FOOD SUPPLE-
MENTS, IN CLASS 5 (U.S. CLS. 6, 18, 44, 46, 51 AND
52).

ZHALEH DELANEY, EXAMINING ATTORNEY

Int. Cl.: 12

Prior U.S. Cls.: 19, 21, 23, 31, 35, and 44

United States Patent and Trademark Office

Reg. No. 2,893,793

Registered Oct. 12, 2004

**TRADEMARK
PRINCIPAL REGISTER**

KOOL STREET

MR. GASKET, INC. (DELAWARE CORPORATION)
10601 MEMPHIS AVENUE
CLEVELAND, OH 44144

FIRST USE 4-23-2004; IN COMMERCE 4-23-2004.

SN 76-527,123, FILED 7-2-2003.

FOR: AUTOMOTIVE PARTS, NAMELY AIR FILTERS FOR LAND VEHICLES, IN CLASS 12 (U.S. CLS. 19, 21, 23, 31, 35 AND 44).

DAVID TAYLOR, EXAMINING ATTORNEY

Int. Cl.: 10

Prior U.S. Cls.: 26, 39, and 44

United States Patent and Trademark Office

Reg. No. 2,893,794

Registered Oct. 12, 2004

**TRADEMARK
PRINCIPAL REGISTER**

THE FIRST WORD IN SINUS RELIEF

MED-SYSTEM INC. (WASHINGTON CORPORATION)
P.O. BOX 45634
MADISON, WI 53744

FIRST USE 8-0-2003; IN COMMERCE 9-0-2003.

SN 76-539,412, FILED 8-11-2003.

FOR: MEDICAL DEVICE USED TO OPEN AND
IRRIGATE NASAL PASSAGES, IN CLASS 10 (U.S.
CLS. 26, 39 AND 44).

DAVID TAYLOR, EXAMINING ATTORNEY

Int. Cl.: 19

Prior U.S. Cls.: 1, 12, 33, and 50

United States Patent and Trademark Office

Reg. No. 2,893,795

Registered Oct. 12, 2004

**TRADEMARK
PRINCIPAL REGISTER**

SAFETY SUITE

SAFETY SUITES, INC. (SOUTH DAKOTA CORPORATION)
103 OAK STREET
BUFFALO GAP, SD 57722

NO CLAIM IS MADE TO THE EXCLUSIVE RIGHT TO USE "SAFETY", APART FROM THE MARK AS SHOWN.

FOR: NON-METAL LIVESTOCK AND PET ENCLOSURES, NAMELY, TELESCOPING FENCING, PORTABLE CORRAL PANELS, AND ENCLOSURE GATES, IN CLASS 19 (U.S. CLS. 1, 12, 33 AND 50).

SN 76-975,037, FILED 5-6-2002.

FIRST USE 5-6-2003; IN COMMERCE 5-6-2003.

MARY BOAGNI, EXAMINING ATTORNEY

Int. Cl.: 16

Prior U.S. Cls.: 2, 5, 22, 23, 29, 37, 38, and 50

Reg. No. 2,893,796

United States Patent and Trademark Office

Registered Oct. 12, 2004

TRADEMARK
PRINCIPAL REGISTER



DNP AMERICA, LLC (NEW YORK LIMITED
LIABILITY COMPANY)
335 MADISON AVENUE
3RD FLOOR
NEW YORK, NY 10017

FOR: LOOSE-LEAF DIARIES AND AGENDA
BOOKS CONTAINING SPORTS-TEAM THEMED
INFORMATION, INCLUDING SCORE CARDS,
SCHEDULES, AUTOGRAPH PAGES, AND SOUVE-
NIRS; BINDERS; BLANK JOURNALS; PERSONAL
ORGANIZERS; PHOTOGRAPH ALBUMS; AND

PENS, IN CLASS 16 (U.S. CLS. 2, 5, 22, 23, 29, 37, 38
AND 50).

FIRST USE 5-6-2003; IN COMMERCE 5-6-2003.

NO CLAIM IS MADE TO THE EXCLUSIVE
RIGHT TO USE "GAME", APART FROM THE
MARK AS SHOWN.

SN 76-976,822, FILED 2-8-2002.

KIM SAITO, EXAMINING ATTORNEY

Int. Cl.: 16

Prior U.S. Cls.: 2, 5, 22, 23, 29, 37, 38, and 50

Reg. No. 2,893,797

United States Patent and Trademark Office

Registered Oct. 12, 2004

**TRADEMARK
PRINCIPAL REGISTER**

GAME BUDDY

DNP AMERICA, LLC (NEW YORK LIMITED
LIABILITY COMPANY)
335 MADISON AVENUE, 3RD FLOOR
NEW YORK, NY 10017

FIRST USE 5-6-2003; IN COMMERCE 5-6-2003.

FOR: LOOSE-LEAF DIARIES AND AGENDA
BOOKS CONTAINING SPORTS-TEAM THEMED
INFORMATION, INCLUDING SCORE CARDS,
SCHEDULES, AUTOGRAPH PAGES, AND SOUVE-
NIRS; BINDERS; BLANK JOURNALS; PERSONAL
ORGANIZERS; PHOTOGRAPH ALBUMS; AND
PENS, IN CLASS 16 (U.S. CLS. 2, 5, 22, 23, 29, 37, 38
AND 50).

NO CLAIM IS MADE TO THE EXCLUSIVE
RIGHT TO USE "GAME", APART FROM THE
MARK AS SHOWN.

SN 76-976,823, FILED 2-8-2002.

KIM SAITO, EXAMINING ATTORNEY

Int. Cl.: 38

Prior U.S. Cls.: 100, 101, and 104

United States Patent and Trademark Office

Reg. No. 2,893,798

Registered Oct. 12, 2004

**SERVICE MARK
PRINCIPAL REGISTER**

FUEL

BRIX GROUP, INC., THE (CALIFORNIA CORPORATION)
541 DIVISION STREET
CAMPBELL, CA 95008

FIRST USE 1-1-2003; IN COMMERCE 1-1-2003.

SN 76-976,932, FILED 1-28-2003.

FOR: PRE-PAID WIRELESS TELEPHONE CALLING SERVICES, IN CLASS 38 (U.S. CLS. 100, 101 AND 104).

CHRISTOPHER BUONGIORNO, EXAMINING ATTORNEY

Int. Cl.: 35

Prior U.S. Cls.: 100, 101, and 102

United States Patent and Trademark Office

Reg. No. 2,893,799

Registered Oct. 12, 2004

**SERVICE MARK
PRINCIPAL REGISTER**

WHATISFORLUNCHTODAY.COM

A. BROS., INC. (MARYLAND CORPORATION)
937 NORTH FREDERICK AVENUE
GAITHERSBURG, MD 20879

FOR: PROMOTING THE GOODS AND SERVICES
OF OTHERS BY PROVIDING THE END-USER
WITH THE NAME, ADDRESS, SERVICES, FOOD-
LISTINGS, AND SPECIALS GIVEN BY THE RES-
TAURANTS, FOOD SHOPS, FAST-FOOD CHINS,

DELIS, AND OTHER RELATED STORES OVER
THE INTERNET AT NO CHARGE TO THE END-
USERS, IN CLASS 35 (U.S. CLS. 100, 101 AND 102).

FIRST USE 6-9-2004; IN COMMERCE 6-9-2004.

SN 78-021,746, FILED 8-17-2000.

JOSETTE BEVERLY, EXAMINING ATTORNEY

Int. Cl.: 35

Prior U.S. Cls.: 100, 101, and 102

United States Patent and Trademark Office

Reg. No. 2,893,801

Registered Oct. 12, 2004

SERVICE MARK
PRINCIPAL REGISTER



ALBERTELLI, PETER, C. (UNITED STATES CORPORATION)
200 WEST 20TH STREET
SUITE 215
NEW YORK, NY 10011 AND
FLY-LIFE MUSIC, INC. (DELAWARE CORPORATION)
54 WEST 21ST STREET, SUITE 903
NEW YORK, NY 10010

FOR: BUSINESS MARKETING AND PROMOTIONAL SERVICES, NAMELY, PROMOTING, MARKETING, AND LICENSING THE ENTERTAINMENT SERVICES AND PRODUCTS OF OTHERS INVOLVED IN THE MUSIC, THEATRICAL, MOTION PICTURE, LIVE ENTERTAINMENT, MUSIC PUBLISHING, AND LITERARY FIELDS; ARRANGING FOR SPONSORS TO AFFILIATE THEIR GOODS AND SERVICES WITH LIVE PERFORMANCES OF ARTISTS; TALENT CONSULTATION AND MANAGEMENT SERVICES IN THE NATURE OF FINDING, SHOPPING, SIGNING AND GUIDING MUSICAL TALENT AND OVERSEEING RECORDING PROJECTS AND ARTIST DEVELOPMENT; LICENSING, PROMOTING, AND

MARKETING MERCHANDISE BEARING THE MARKS, NAMES AND/OR LOGOS OF ARTISTS, NAMELY CLOTHING AND APPAREL, PROGRAMS, POSTERS, BANDANAS, BUTTONS, GLOW LIGHTS, ARTIST PHOTOGRAPHS, FLASHLIGHTS, LIGHTERS, PENS, AND AUDIO AND VIDEO RECORDINGS; AND BUSINESS CONSULTATION SERVICES IN THE FIELD OF BUSINESS MARKETING AND PROMOTIONAL SERVICES IN THE MUSIC, THEATRICAL, MOTION PICTURE, LIVE ENTERTAINMENT, MUSIC PUBLISHING, AND LITERARY FIELDS, IN CLASS 35 (U.S. CLS. 100, 101 AND 102).

FIRST USE 12-1-2000; IN COMMERCE 12-1-2000.

NO CLAIM IS MADE TO THE EXCLUSIVE RIGHT TO USE "MUSIC", APART FROM THE MARK AS SHOWN.

SN 78-034,229, FILED 11-7-2000.

RON FAIRBANKS, EXAMINING ATTORNEY

Int. Cl.: 28

Prior U.S. Cls.: 22, 23, 38, and 50

United States Patent and Trademark Office

Reg. No. 2,893,802

Registered Oct. 12, 2004

**TRADEMARK
PRINCIPAL REGISTER**

SOLO IN THE SPOTLIGHT

MATTEL, INC. (DELAWARE CORPORATION)
333 CONTINENTAL BLVD.
EL SEGUNDO, CA 902455012

FIRST USE 4-1-1990; IN COMMERCE 4-1-1990.

SN 78-035,777, FILED 11-17-2000.

FOR: DOLLS, DOLL CLOTHING AND DOLL
ACCESSORIES, IN CLASS 28 (U.S. CLS. 22, 23, 38
AND 50).

JOHN GARTNER, EXAMINING ATTORNEY

Int. Cl.: 25

Prior U.S. Cls.: 22 and 39

United States Patent and Trademark Office

Reg. No. 2,893,803

Registered Oct. 12, 2004

**TRADEMARK
PRINCIPAL REGISTER**

TRANSFER

INTERNATIONAL NEWS, INC. (WASHINGTON
CORPORATION)
19226 70TH AVE. S.
KENT, WA 98032

FOR: APPAREL, NAMELY TOPS, BOTTOMS,
SHIRTS, PANTS, SHORTS, COATS, JACKETS,
SWEATERS, SWEAT SUITS, PONCHOS, VESTS,
OVERALLS, RAIN PANTS, RAIN COATS, FOOT-

WEAR, UNDERWEAR AND SWIMWEAR , IN
CLASS 25 (U.S. CLS. 22 AND 39).

FIRST USE 2-13-2003; IN COMMERCE 2-13-2003.

SN 78-039,711, FILED 12-18-2000.

MARIA-VICTORIA SUAREZ, EXAMINING ATTOR-
NEY

Int. Cl.: 3

Prior U.S. Cls.: 1, 4, 6, 50, 51, and 52

Reg. No. 2,893,804

United States Patent and Trademark Office

Registered Oct. 12, 2004

**TRADEMARK
PRINCIPAL REGISTER**

LUMIN8

AVON PRODUCTS, INC. (NEW YORK CORPORATION)
1251 AVENUE OF THE AMERICAS
NEW YORK, NY 10020

FOR: COSMETIC INGREDIENT COMPLEX USED AS A COMPONENT IN THE MANUFACTURE OF SKIN CREAMS, SKIN LOTIONS, SKIN GELS, SKIN CLEANSERS, SKIN TONICS, FACIAL MASKS, MAKEUP REMOVER AND PRE-MOISTENED COSMETIC WIPES IMPREGNATED WITH SKIN

CLEANSER, IN CLASS 3 (U.S. CLS. 1, 4, 6, 50, 51 AND 52).

FIRST USE 9-0-2001; IN COMMERCE 9-0-2001.

OWNER OF U.S. REG. NO. 2,350,822.

SN 78-053,239, FILED 3-15-2001.

MICHAEL WEBSTER, EXAMINING ATTORNEY

Int. Cl.: 35

Prior U.S. Cls.: 100, 101, and 102

United States Patent and Trademark Office

Reg. No. 2,893,805

Registered Oct. 12, 2004

**SERVICE MARK
PRINCIPAL REGISTER**

FRESH THINKING

UNGAR GROUP, INC., THE (ILLINOIS CORPORATION)
20 W. HUBBARD ST., 4TH FLOOR
CHICAGO, IL 60610

FOR: ADVERTISING FOR OTHERS, NAMELY, AN AD AGENCY; MARKETING, NAMELY, MARKETING STUDIES, PRODUCT PROMOTIONS AND MARKET EVALUATIONS; CREATIVE SERVICES, NAMELY, PREPARING AD COPY, AUDIO VISUAL PRESENTATIONS, SCRIPTS, ART WORK AND GRAPHICS FOR USE IN ADVERTISING; PROMOTIONS, NAMELY, PLANNING AND PROMOTING SPECIAL EVENTS, COUPON AND DISCOUNT PLAN PROGRAMS, PUBLIC RELATIONS COPY, INTERNET WEB SITE AND E-MAIL DESIGN AND IMPLEMENTATION, PRESS RELEASE COPY AND IMPLEMENTATION; INTEGRATED MARKETING

COMMUNICATIONS, NAMELY, PROVIDING COMPLETE ADVERTISING AND MARKETING PACKAGES OF VARIOUS COMBINATIONS OF ADVERTISING AND PROMOTIONAL SERVICES FOR NEW PRODUCTS AND SERVICES, NAMELY, PLANNING AND PROMOTING SPECIAL EVENTS, COUPON AND DISCOUNT PLAN PROGRAMS; BRANDING, NAMELY, CREATING SERVICE AND PRODUCT BRAND NAMES AND IDENTITIES FOR OTHERS; AND, GENERAL BUSINESS CONSULTING, IN CLASS 35 (U.S. CLS. 100, 101 AND 102).

FIRST USE 7-0-2002; IN COMMERCE 7-0-2002.

SN 78-067,370, FILED 6-5-2001.

EUGENIA MARTIN, EXAMINING ATTORNEY

Int. Cl.: 33

Prior U.S. Cls.: 47 and 49

United States Patent and Trademark Office

Reg. No. 2,893,806

Registered Oct. 12, 2004

**TRADEMARK
PRINCIPAL REGISTER**

JOLLY ROGER CARIBBEAN RUM

THREE-D SPIRITS, INC. (CALIFORNIA CORPORATION)
12 EAST WASHINGTON STREET
PETALUMA, CA 94952

NO CLAIM IS MADE TO THE EXCLUSIVE RIGHT TO USE "CARIBBEAN RUM", APART FROM THE MARK AS SHOWN.

FOR: DISTILLED SPIRITS; RUM, IN CLASS 33 (U.S. CLS. 47 AND 49).

SN 78-068,601, FILED 6-12-2001.

FIRST USE 6-29-2004; IN COMMERCE 6-29-2004.

JOSETTE BEVERLY, EXAMINING ATTORNEY

Int. Cl.: 25

Prior U.S. Cls.: 22 and 39

United States Patent and Trademark Office

Reg. No. 2,893,807

Registered Oct. 12, 2004

**TRADEMARK
PRINCIPAL REGISTER**

PARALLELE

P.B.F. (FRANCE CORPORATION)
1, RUE MONTMARTRE
PARIS, FRANCE 75001

THE ENGLISH TRANSLATION OF "PARAL-
LELE" IS "PARALLEL".

FOR: FOOTWEAR, NAMELY, BOOTS, BOOTEES,
SHOES, SANDALS AND SLIPPERS, IN CLASS 25
(U.S. CLS. 22 AND 39).

SN 78-077,882, FILED 8-7-2001.

FIRST USE 0-0-1996; IN COMMERCE 0-0-1996.

KARLA PERKINS, EXAMINING ATTORNEY

Int. Cl.: 28

Prior U.S. Cls.: 22, 23, 38, and 50

Reg. No. 2,893,808

United States Patent and Trademark Office

Registered Oct. 12, 2004

**TRADEMARK
PRINCIPAL REGISTER**

Grande Armée

MUSTAFA, SAM A. (UNITED STATES INDIVIDUAL)
11 COOLIGE PL
HALEDON, NJ 07508

FOR: GAME EQUIPMENT IN THE NATURE OF GAME BOOK MANUALS, IN CLASS 28 (U.S. CLS. 22, 23, 38 AND 50).

FIRST USE 11-8-2002; IN COMMERCE 11-8-2002.

THE MARK CONSISTS OF THE WORDS "GRANDE ARMEE" WRITTEN IN THE FRENCH STYLE, WITH AN ACCENT OVER THE SECOND "E" IN "ARMEE".

THE ENGLISH TRANSLATION OF "GRANDE ARMEE" IS "GREAT ARMY".

SN 78-078,402, FILED 8-9-2001.

CYNTHIA SLOAN, EXAMINING ATTORNEY

Int. Cl.: 25

Prior U.S. Cls.: 22 and 39

United States Patent and Trademark Office

Reg. No. 2,893,809

Registered Oct. 12, 2004

**TRADEMARK
PRINCIPAL REGISTER**

FORD MODELS

FORD MODELS, INC. (DELAWARE CORPORATION)
142 GREENE STREET
NEW YORK, NY 10012

FOR: T-SHIRTS, SWEATSHIRTS, SWEAT PANTS,
HATS, DRESSES, BLOUSES, SKIRTS, JACKETS,
PANTS, VESTS, VISORS, HOSIERY, SWIMSUITS,
IN CLASS 25 (U.S. CLS. 22 AND 39).

FIRST USE 12-6-2002; IN COMMERCE 12-6-2002.

OWNER OF U.S. REG. NOS. 1,296,761, 2,679,087,
AND 2,730,669.

SN 78-080,812, FILED 8-23-2001.

JOHN KELLY, EXAMINING ATTORNEY

Int. Cl.: 42

Prior U.S. Cls.: 100 and 101

United States Patent and Trademark Office

Reg. No. 2,893,810

Registered Oct. 12, 2004

**SERVICE MARK
PRINCIPAL REGISTER**

PICTONICS

XPLANE CORP. (MISSOURI CORPORATION)
809 GEYER AVENUE
ST. LOUIS, MO 63104

FIRST USE 7-22-2004; IN COMMERCE 7-22-2004.

SN 78-082,485, FILED 9-4-2001.

FOR: GRAPHIC ART AND TEXT DESIGN SER-
VICES, IN CLASS 42 (U.S. CLS. 100 AND 101).

JOHN GARTNER, EXAMINING ATTORNEY

Int. Cl.: 28

Prior U.S. Cls.: 22, 23, 38, and 50

United States Patent and Trademark Office

Reg. No. 2,893,811

Registered Oct. 12, 2004

**TRADEMARK
PRINCIPAL REGISTER**

FUNKY TRUNK

MATTEL, INC. (DELAWARE CORPORATION)
333 CONTINENTAL BLVD.
EL SEGUNDO, CA 902455012

NO CLAIM IS MADE TO THE EXCLUSIVE
RIGHT TO USE "TRUNK", APART FROM THE
MARK AS SHOWN.

FOR: TOYS, GAMES AND PLAYTHINGS, NAME-
LY, PLUSH TOYS, PLUSH TOY ACCESSORIES AND
PLUSH TOY PLAYSETS, SOLD TOGETHER AS A
UNIT, IN CLASS 28 (U.S. CLS. 22, 23, 38 AND 50).

SN 78-084,561, FILED 9-19-2001.

FIRST USE 9-27-2001; IN COMMERCE 9-27-2001.

STEVEN BERK, EXAMINING ATTORNEY

Int. Cl.: 21

Prior U.S. Cls.: 2, 13, 23, 29, 30, 33, 40, and 50

United States Patent and Trademark Office

Reg. No. 2,893,812

Registered Oct. 12, 2004

**TRADEMARK
PRINCIPAL REGISTER**

PIZZA TECHNO PLATE

METCALF, DARRELL (UNITED STATES INDIVIDUAL)
905 N. OAK AVE
FILLMORE, CA 93015 AND
GOODROW, MICHEAL (UNITED STATES INDIVIDUAL)
229 BEACH STREET
SANTA MONICA, CA 90405

FOR: SERVINGWARE FOR SERVING FOOD, NAMELY, A PIZZA-SERVING DEVICE THAT SUPPORTS A PORTION OF PIZZA, ALSO HAVING A FOLD-AS-YOU-EAT UTILITY THAT ALLOWS A USER TO FOLD SUCCESSIVE SEGMENTS OF THE DEVICE DOWNWARD AND AWAY FROM THE SUPPORTED PIZZA, EXPOSING SUCCESSIVE POR-

TIONS OF THE PIZZA IN A MANNER THAT FACILITATES EATING THE NEWLY EXPOSED PIZZA WITH MINIMAL TOUCHING OF THE FOOD, IN CLASS 21 (U.S. CLS. 2, 13, 23, 29, 30, 33, 40 AND 50).

FIRST USE 9-19-2002; IN COMMERCE 3-16-2004.

NO CLAIM IS MADE TO THE EXCLUSIVE RIGHT TO USE "PIZZA" AND "PLATE" , APART FROM THE MARK AS SHOWN.

SN 78-085,979, FILED 9-27-2001.

KARLA PERKINS, EXAMINING ATTORNEY

Int. Cl.: 28

Prior U.S. Cls.: 22, 23, 38, and 50

Reg. No. 2,893,814

United States Patent and Trademark Office

Registered Oct. 12, 2004

**TRADEMARK
PRINCIPAL REGISTER**



GIORDANO, LANIE (UNITED STATES INDIVIDUAL)
3418 ODLUM POINT
N.L.V., NV 89032

NO CLAIM IS MADE TO THE EXCLUSIVE RIGHT TO USE "SACK OR .NET ", APART FROM THE MARK AS SHOWN.

FOR: BEAN BAGS, IN CLASS 28 (U.S. CLS. 22, 23, 38 AND 50).

SN 78-097,345, FILED 12-8-2001.

FIRST USE 5-1-2002; IN COMMERCE 6-20-2002.

IRENE D. WILLIAMS, EXAMINING ATTORNEY

Int. Cl.: 20

Prior U.S. Cls.: 2, 13, 22, 25, 32, and 50

Reg. No. 2,893,815

United States Patent and Trademark Office

Registered Oct. 12, 2004

**TRADEMARK
PRINCIPAL REGISTER**

QUIXOTE

TMJ PROPERTIES, LLC (MINNESOTA LIMITED
LIABILITY COMPANY)
1213 MAIN STREET
HOPKINS, MN 55343

FIRST USE 10-31-2002; IN COMMERCE 10-31-2002.

SN 78-097,920, FILED 12-12-2001.

FOR: PILLOWS FOR USE WHEN TRAVELING, IN
CLASS 20 (U.S. CLS. 2, 13, 22, 25, 32 AND 50).

SCOTT BALDWIN, EXAMINING ATTORNEY

Int. Cl.: 5

Prior U.S. Cls.: 6, 18, 44, 46, 51, and 52

United States Patent and Trademark Office

Reg. No. 2,893,816

Registered Oct. 12, 2004

**TRADEMARK
PRINCIPAL REGISTER**

HEALTHY BABY

TARGET BRANDS, INC. (MINNESOTA CORPORATION)
1000 NICOLLET MALL
TPS-3165
MINNEAPOLIS, MN 554032467

NO CLAIM IS MADE TO THE EXCLUSIVE RIGHT TO USE "BABY", APART FROM THE MARK AS SHOWN.

FOR: INFANT FORMULA AND ELECTROLYTE REPLACEMENT SOLUTION, IN CLASS 5 (U.S. CLS. 6, 18, 44, 46, 51 AND 52).

SN 78-097,944, FILED 12-12-2001.

FIRST USE 5-0-2002; IN COMMERCE 5-0-2002.

JOHN KELLY, EXAMINING ATTORNEY

Int. Cl.: 9

Prior U.S. Cls.: 21, 23, 26, 36, and 38

United States Patent and Trademark Office

Reg. No. 2,893,817

Registered Oct. 12, 2004

**TRADEMARK
PRINCIPAL REGISTER**

KONRAD

SIEMENS MEDICAL SOLUTIONS USA, INC.
(DELAWARE CORPORATION)
4040 NELSON AVENUE
CONCORD, CA 94520

FIRST USE 4-30-2003; IN COMMERCE 4-30-2003.

SN 78-099,394, FILED 12-20-2001.

FOR: INVERSE PLANNING SOFTWARE FOR
IMRT RADIOTHERAPY TREATMENT PLANNING,
IN CLASS 9 (U.S. CLS. 21, 23, 26, 36 AND 38).

DAVID TAYLOR, EXAMINING ATTORNEY

Int. Cl.: 33

Prior U.S. Cls.: 47 and 49

United States Patent and Trademark Office

Reg. No. 2,893,818

Registered Oct. 12, 2004

**TRADEMARK
PRINCIPAL REGISTER**



AUTUMN MOON CELLARS

FELDER, RONALD C. (UNITED STATES INDIVIDUAL)
19 OXFORD AVENUE
MILL VALLEY, CA 94941

FOR: WINE, IN CLASS 33 (U.S. CLS. 47 AND 49).

FIRST USE 11-19-2003; IN COMMERCE 11-19-2003.

NO CLAIM IS MADE TO THE EXCLUSIVE RIGHT TO USE "CELLARS", APART FROM THE MARK AS SHOWN.

SN 78-107,844, FILED 2-9-2002.

CIMMERIAN COLEMAN, EXAMINING ATTORNEY

Int. Cl.: 5

Prior U.S. Cls.: 6, 18, 44, 46, 51, and 52

Reg. No. 2,893,819

United States Patent and Trademark Office

Registered Oct. 12, 2004

**TRADEMARK
PRINCIPAL REGISTER**

TRUVIEW

HSI SERVICE CORP. (DELAWARE CORPORATION)
220 CONTINENTAL DRIVE SUITE 115
NEWARK, DE 19713

FOR: MEDICAL DIAGNOSTIC TEST KITS FOR
INFECTIONS AND DISEASES AND NON-DISEASE
AND NON-INFECTIOUS CONDITIONS COMPRIS-
ING TEST STRIPS, DIAGNOSTIC PREPARATIONS
AND REAGENTS; PREGNANCY TEST KITS AND

OVULATION PREDICTION TEST KITS, ALL FOR
PROFESSIONAL USE, IN CLASS 5 (U.S. CLS. 6, 18, 44,
46, 51 AND 52).

FIRST USE 7-1-2002; IN COMMERCE 7-1-2002.

SN 78-113,280, FILED 3-7-2002.

IRENE D. WILLIAMS, EXAMINING ATTORNEY

Int. Cl.: 25

Prior U.S. Cls.: 22 and 39

United States Patent and Trademark Office

Reg. No. 2,893,820

Registered Oct. 12, 2004

**TRADEMARK
PRINCIPAL REGISTER**



RAVO, DAVID (UNITED STATES INDIVIDUAL)
P.O. BOX 49180
LOS ANGELES, CA 90049 AND
RAVO, AARON (UNITED STATES INDIVIDUAL)
P.O. BOX 49180
LOS ANGELES, CA 90049

SHOES, SOCKS, DRESSES, LEOTARDS, BANDAN-
NAS, HEADBANDS, SWEATBANDS, BELTS, UN-
DERGARMENTS, TIES, SKI-PANTS, SWEATERS,
SKI-BIBS, GLOVES, SKI-JACKETS; SWIM WEAR,
NAMELY, BATHING SUITS, BATHING TRUNKS,
AND BIKINIS, IN CLASS 25 (U.S. CLS. 22 AND 39).

FOR: MEN'S, WOMEN'S AND CHILDREN'S
CLOTHING, NAMELY T-SHIRTS, TANK TOPS,
JACKETS, JERSEYS, SHORTS, PANTS, SWEAT-
SHIRTS, SWEAT PANTS, HEAD WEAR, FOOT-
WEAR, SANDALS, SNEAKERS, BOOTS,

FIRST USE 1-16-2004; IN COMMERCE 1-16-2004.

SN 78-113,653, FILED 3-8-2002.

ESTHER A. BORSUK, EXAMINING ATTORNEY

Int. Cl.: 9

Prior U.S. Cls.: 21, 23, 26, 36, and 38

Reg. No. 2,893,821

United States Patent and Trademark Office

Registered Oct. 12, 2004

**TRADEMARK
PRINCIPAL REGISTER**

ULTRAMAN

TSUBURAYA PRODUCTIONS CO., LTD. (JAPAN
CORPORATION)
7-4-12 KINUTA SETAGAYA-KU
TOKYO, 157, JAPAN

FIRST USE 11-3-2003; IN COMMERCE 11-3-2003.

SN 78-117,189, FILED 3-25-2002.

FOR: PRERECORDED AUDIO AND VIDEO
TAPES FEATURING CHILDREN'S STORIES, MO-
TION PICTURE EXCERPTS, AND MOTION PIC-
TURE SOUNDTRACKS, IN CLASS 9 (U.S. CLS. 21, 23,
26, 36 AND 38).

CIMMERIAN COLEMAN, EXAMINING ATTOR-
NEY

Int. Cl.: 9

Prior U.S. Cls.: 21, 23, 26, 36, and 38

United States Patent and Trademark Office

Reg. No. 2,893,822

Registered Oct. 12, 2004

**TRADEMARK
PRINCIPAL REGISTER**

ULTRAMAN TIGA

TSUBURAYA PRODUCTIONS CO., LTD. (JAPAN
CORPORATION)
7-4-12 KINUTA SETAGAYA-KU
TOKYO, 157, JAPAN

FIRST USE 11-3-2003; IN COMMERCE 11-3-2003.

SN 78-117,192, FILED 3-25-2002.

FOR: PRERECORDED AUDIO AND VIDEO
TAPES FEATURING CHILDREN'S STORIES, MO-
TION PICTURE EXCERPTS, AND MOTION PIC-
TURE SOUNDTRACKS, IN CLASS 9 (U.S. CLS. 21, 23,
26, 36 AND 38).

CIMMERIAN COLEMAN, EXAMINING ATTOR-
NEY

Int. Cl.: 25

Prior U.S. Cls.: 22 and 39

United States Patent and Trademark Office

Reg. No. 2,893,823

Registered Oct. 12, 2004

TRADEMARK
PRINCIPAL REGISTER

The image shows the word "Origami" written in a highly stylized, cursive calligraphic font. The letters are interconnected, with long, sweeping lines that give it a fluid, artistic appearance. The 'O' is particularly large and loops around the 'r'. The 'i' has a long, thin tail that extends to the right.

LEONG, KEVIN (UNITED STATES INDIVIDUAL)
1186 BROADWAY
APT. 820
NEW YORK, NY 10001

FIRST USE 6-1-2004; IN COMMERCE 6-1-2004.

THE MARK CONSISTS OF THE WORD "ORIGAMI" IN CALLIGRAPHY FORM.

FOR: CLOTHING, NAMELY, TEE SHIRTS, SHIRTS, SWEATERS, PANTS, HATS AND MENSWEAR APPAREL, NAMELY, COATS, JACKETS, BELTS AND FOOTWEAR, IN CLASS 25 (U.S. CLS. 22 AND 39).

SN 78-118,835, FILED 4-2-2002.

STEVEN BERK, EXAMINING ATTORNEY

Int. Cl.: 35

Prior U.S. Cls.: 100, 101, and 102

United States Patent and Trademark Office

Reg. No. 2,893,824

Registered Oct. 12, 2004

**SERVICE MARK
PRINCIPAL REGISTER**

WE LIVE HERE TOO

CITGO PETROLEUM CORPORATION (DELA-
WARE CORPORATION)
POST OFFICE BOX 3758
TULSA, OK 741023758

FIRST USE 7-0-2002; IN COMMERCE 7-0-2002.

SN 78-119,346, FILED 4-3-2002.

FOR: RETAIL STORES FEATURING CONVENI-
ENCE STORE ITEMS AND GASOLINE, IN CLASS 35
(U.S. CLS. 100, 101 AND 102).

MARIA-VICTORIA SUAREZ, EXAMINING ATTOR-
NEY

Int. Cl.: 35

Prior U.S. Cls.: 100, 101, and 102

United States Patent and Trademark Office

Reg. No. 2,893,825

Registered Oct. 12, 2004

**SERVICE MARK
PRINCIPAL REGISTER**

WEBTALENT

SEVEN CS LEASING CORPORATION (MICHIGAN CORPORATION)
PO BOX 40659
DETROIT, MI 48240

FOR: FULL SERVICE INTERNET TALENT MANAGEMENT AND EMPLOYMENT AGENCY, NAMELY, PROVIDING TALENT AND MODELS OF ALL AGES AND ETHNICITIES TO CASTING DIRECTORS AND TALENT AGENTS WORLDWIDE; PROVIDING A WEBSITE THAT ALLOWS TALENT THROUGHOUT THE WORLD TO ADVERTISE THEIR SKILLS AND MODIFY THEIR PROFILES

TO CASTING DIRECTORS AND TALENT AGENTS AND ANY ENTITY IN NEED OF THEIR TALENT SERVICES AND PROVIDING INFORMATION ON JOB OPPORTUNITIES AND CASTING INFORMATION, IN CLASS 35 (U.S. CLS. 100, 101 AND 102).

FIRST USE 1-1-1997; IN COMMERCE 1-1-1997.

SN 78-119,752, FILED 4-5-2002.

MICHAEL BAIRD, EXAMINING ATTORNEY

Int. Cl.: 41

Prior U.S. Cls.: 100, 101, and 107

United States Patent and Trademark Office

Reg. No. 2,893,827

Registered Oct. 12, 2004

**SERVICE MARK
PRINCIPAL REGISTER**

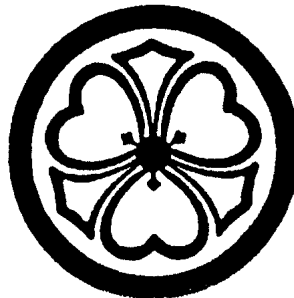

DEMURA, FUMIO (UNITED STATES INDIVIDUAL)
1429 N. BRISTOL
SANTA ANA, CA 92706

FIRST USE 10-0-2001; IN COMMERCE 10-0-2001.

SN 78-120,948, FILED 4-10-2002.

FOR: KARATE INSTRUCTION, NAMELY, CONDUCTING CLASSES AND SEMINARS IN THE FIELD OF KARATE; ENTERTAINMENT, NAMELY, CONDUCTING KARATE EXHIBITIONS, IN CLASS 41 (U.S. CLS. 100, 101 AND 107).

CIMMERIAN COLEMAN, EXAMINING ATTORNEY

Int. Cl.: 28

Prior U.S. Cls.: 22, 23, 38, and 50

United States Patent and Trademark Office

Reg. No. 2,893,829

Registered Oct. 12, 2004

**TRADEMARK
PRINCIPAL REGISTER**

NICK SPORTS

VIACOM INTERNATIONAL INC. (DELAWARE
CORPORATION)
1515 BROADWAY
NEW YORK, NY 10036

FOR: GAMES AND PLAYTHINGS, NAMELY,
CARD GAMES, DARTS, STAND ALONE VIDEO
GAME MACHINES UTILIZING CD ROM'S, STAND
ALONE VIDEO GAME MACHINES, STAND ALONE
AUDIO OUTPUT GAME MACHINES, AND BOARD
GAMES; SPORTING ARTICLES, NAMELY, GOLF
CLUBS, BASEBALLS, FOOTBALLS, PADDLE
BALLS, ACTIVITY BALLS, BASEBALL BATS; DEC-
ORATIONS FOR CHRISTMAS TREES, IN CLASS 28
(U.S. CLS. 22, 23, 38 AND 50).

FIRST USE 9-30-2002; IN COMMERCE 9-30-2002.

OWNER OF U.S. REG. NOS. 1,390,284, 2,102,209,
AND OTHERS.

NO CLAIM IS MADE TO THE EXCLUSIVE
RIGHT TO USE "SPORTS", APART FROM THE
MARK AS SHOWN.

SN 78-122,835, FILED 4-19-2002.

DAVID TAYLOR, EXAMINING ATTORNEY

Int. Cl.: 3

Prior U.S. Cls.: 1, 4, 6, 50, 51, and 52

United States Patent and Trademark Office

Reg. No. 2,893,830

Registered Oct. 12, 2004

**TRADEMARK
PRINCIPAL REGISTER**

HALF BAKED

PERFORMANCE BRANDS INC (FLORIDA COR-
PORATION)
959 SHOTGUN ROAD
SUNRISE, FL 33326

FIRST USE 10-10-2002; IN COMMERCE 10-10-2002.

SN 78-122,954, FILED 4-19-2002.

FOR: COSMETICS, NAMELY, SUN TAN ACCEL-
ERATOR LOTION, IN CLASS 3 (U.S. CLS. 1, 4, 6, 50, 51
AND 52).

SUELLEN HICKEY, EXAMINING ATTORNEY

Int. Cl.: 39

Prior U.S. Cls.: 100 and 105

United States Patent and Trademark Office

Reg. No. 2,893,831

Registered Oct. 12, 2004

**SERVICE MARK
PRINCIPAL REGISTER**



SIX CONTINENTS HOTELS, INC. (DELAWARE CORPORATION)
THREE RAVINIA DRIVE
ATLANTA, GA 303462149

NO CLAIM IS MADE TO THE EXCLUSIVE RIGHT TO USE "PIZZA" , APART FROM THE MARK AS SHOWN.

FOR: DELIVERY OF PIZZA, IN CLASS 39 (U.S. CLS. 100 AND 105).

SN 78-124,081, FILED 4-25-2002.

FIRST USE 7-0-2001; IN COMMERCE 7-0-2001.

CYNTHIA SLOAN, EXAMINING ATTORNEY

Int. Cl.: 28

Prior U.S. Cls.: 22, 23, 38, and 50

United States Patent and Trademark Office

Reg. No. 2,893,832

Registered Oct. 12, 2004

**TRADEMARK
PRINCIPAL REGISTER**

WARCRAFT III: REIGN OF CHAOS

DAVIDSON & ASSOCIATES, INC. (CALIFORNIA
CORPORATION)
6080 CENTER DRIVE 10TH FLOOR
LOS ANGELES, CA 90045

FOR: TOYS AND GAMES, NAMELY, ACTION
FIGURES AND ACTION FIGURES ACCESSORIES,
IN CLASS 28 (U.S. CLS. 22, 23, 38 AND 50).

FIRST USE 7-31-2002; IN COMMERCE 7-31-2002.

OWNER OF U.S. REG. NO. 1,947,586.

SN 78-124,347, FILED 4-26-2002.

FLORENTINA BLANDU, EXAMINING ATTORNEY

Int. Cl.: 5

Prior U.S. Cls.: 6, 18, 44, 46, 51, and 52

United States Patent and Trademark Office

Reg. No. 2,893,833

Registered Oct. 12, 2004

**TRADEMARK
PRINCIPAL REGISTER**

ERTACZO

JOHNSON & JOHNSON (NEW JERSEY CORPORATION)
ONE JOHNSON & JOHNSON PLAZA
NEW BRUNSWICK, NJ 089337001

FIRST USE 4-27-2004; IN COMMERCE 4-27-2004.

SN 78-125,990, FILED 5-3-2002.

FOR: PHARMACEUTICAL PREPARATION FOR
USE IN THE TREATMENT OF FUNGAL INFECTIONS,
IN CLASS 5 (U.S. CLS. 6, 18, 44, 46, 51 AND 52).

NANCY CLARKE, EXAMINING ATTORNEY

Int. Cl.: 30

Prior U.S. Cl.: 46

United States Patent and Trademark Office

Reg. No. 2,893,834

Registered Oct. 12, 2004

**TRADEMARK
PRINCIPAL REGISTER**



The logo consists of the word "SAROSO" in a bold, black, sans-serif font. The letter "A" is stylized as two overlapping raindrops: a larger one on top and a smaller one on the bottom, both pointing downwards. The rest of the letters are solid black.

FOOD SPECIALTIES GROUP, INC. (TEXAS CORPORATION)
8582 KATY FREEWAY, SUITE 119
HOUSTON, TX 77024

FOR: BEVERAGES WITH TEA AND CHOCOLATE BASES, NONE OF THE FOREGOING BEING VEGETABLE- OR DAIRY BASED, NAMELY, TEA, COCOA, COFFEE, ARTIFICIAL COFFEE; BAKING-POWDER, SAUCES; CONDIMENTS AND SPICES, NAMELY, BLACK PEPPER, WHITE PEPPER, CINNAMON POWDER, CLOVES, CUMIN, OREGANO, DRY CHIPOTLE PEPPERS FOR USE AS A SEASONING, PEPPER POWDER, GARLIC SALT, ONION

SALT, CELERY SALT AND SEASONING SALT, IN CLASS 30 (U.S. CL. 46).

FIRST USE 7-15-2002; IN COMMERCE 10-7-2003.

THE MARK CONSISTS OF THE WORDING "SAROSO" IN STYLIZED FORM, WITH A RAINDROP FORMING A PORTION OF THE LETTER "A" AND ANOTHER RAINDROP FORMING THE ENTIRE FIRST LETTER "A".

SN 78-125,993, FILED 5-3-2002.

NANCY CLARKE, EXAMINING ATTORNEY

Int. Cl.: 35

Prior U.S. Cls.: 100, 101, and 102

United States Patent and Trademark Office

Reg. No. 2,893,835

Registered Oct. 12, 2004

**SERVICE MARK
PRINCIPAL REGISTER**

HU-MANAGEMENT

BUSINESS INSIGHTS, INC. (CALIFORNIA CORPORATION)
2310 PEPPERWOOD AVENUE
LONG BEACH, CA 90815

FIRST USE 5-9-2002; IN COMMERCE 5-9-2002.

SN 78-126,749, FILED 5-7-2002.

FOR: BUSINESS CONSULTATION IN THE FIELD OF ANALYZING MANAGEMENT PRACTICES FOR COST EFFECTIVENESS, IN CLASS 35 (U.S. CLS. 100, 101 AND 102).

ANDREW BENZMILLER, EXAMINING ATTORNEY

Int. Cl.: 16

Prior U.S. Cls.: 2, 5, 22, 23, 29, 37, 38, and 50

United States Patent and Trademark Office

Reg. No. 2,893,836

Registered Oct. 12, 2004

**TRADEMARK
PRINCIPAL REGISTER**



WORLD TIMES, INC. (MASSACHUSETTS CORPORATION)
225 FRANKLIN STREET
BOSTON, MA 02110

FOR: PUBLICATIONS, NAMELY NEWSLETTERS, PRINTED REPORTS, RESEARCH REPORTS AND POLICY RECOMMENDATIONS IN THE FIELDS OF MOBILE INTERNET TECHNOLOGY AND THE MOBILE INTERNET INDUSTRY, IN CLASS 16 (U.S. CLS. 2, 5, 22, 23, 29, 37, 38 AND 50).

FIRST USE 5-13-2004; IN COMMERCE 5-13-2004.

NO CLAIM IS MADE TO THE EXCLUSIVE RIGHT TO USE "WIRELESS INTERNET INSTITUTE", APART FROM THE MARK AS SHOWN.

THE STIPPLING SHOWN IN THE DRAWING IS A FEATURE OF THE MARK AND IS NOT INTENDED TO INDICATE COLOR.

SN 78-129,342, FILED 5-16-2002.

DOMINIC J. FERRAIUOLO, EXAMINING ATTORNEY

Int. Cl.: 9

Prior U.S. Cls.: 21, 23, 26, 36, and 38

Reg. No. 2,893,837

United States Patent and Trademark Office

Registered Oct. 12, 2004

**TRADEMARK
PRINCIPAL REGISTER**

WIRELESS GENERATION

WIRELESS ACCESSORIES, LLC (NEVADA LIMITED LIABILITY COMPANY)
2288 WILHELMINA COURT NE
PALM BAY, FL 32905

FOR: CELLULAR TELEPHONE AND MOBILE COMPUTING DEVICE ACCESSORIES, NAMELY ANTENNAS, ANTENNA ADAPTERS, BATTERIES, BATTERY CHARGERS, HOUSINGS, CASINGS OR COVERS, CLIPS, CASES, FACEPLATES, CARRYING CASES FOR CELLULAR TELEPHONES AND MOBILE COMPUTING DEVICES; CAR KITS FOR THE ADAPTION OF PORTABLE AND WIRELESS COMMUNICATION DEVICES AND INSTRUMENTS FOR VEHICULAR USE; EARPHONES; HAND-FREE MI-

CROPHONES; PHONE HOLDERS; SPEAKERS; CAR CHARGERS; MODEM CABLES; DATA CABLES; ELECTRIC ADAPTOR CABLES; TELEPHONE CABLES, IN CLASS 9 (U.S. CLS. 21, 23, 26, 36 AND 38).

FIRST USE 5-0-2004; IN COMMERCE 5-0-2004.

NO CLAIM IS MADE TO THE EXCLUSIVE RIGHT TO USE "WIRELESS", APART FROM THE MARK AS SHOWN.

SN 78-131,088, FILED 5-24-2002.

DAVID TAYLOR, EXAMINING ATTORNEY

Int. Cl.: 9

Prior U.S. Cls.: 21, 23, 26, 36, and 38

Reg. No. 2,893,838

United States Patent and Trademark Office

Registered Oct. 12, 2004

**TRADEMARK
PRINCIPAL REGISTER**



PRETECT ELECTRONICS CORP. (CALIFORNIA CORPORATION)
40979 ENCYCLOPEDIA CIRCLE
FREMONT, CA 94538

LATILE FLASH MEMORY; PERSONAL DIGITAL ASSISTANT ACCESSORIES, NAMELY FLASH MEMORY CARDS; USB FLASH DISKS, IN CLASS 9 (U.S. CLS. 21, 23, 26, 36 AND 38).

FOR: PERSONAL COMPUTER CARD READERS; PERSONAL COMPUTER DATA STORAGE CARDS; MEMORY CARDS; FLASH MEMORY CARDS; FLASH CARD READERS; FLASH CARD ADAPTERS; COMPUTER FAX/MODEM CARDS; LOCAL AREA NETWORK CARDS; COMPACT GLOBAL POSITIONING SYSTEM CONSISTING OF NON-VO-

FIRST USE 5-22-2002; IN COMMERCE 1-2-2003.

SN 78-132,132, FILED 5-30-2002.

CYNTHIA SLOAN, EXAMINING ATTORNEY

Int. Cl.: 33

Prior U.S. Cls.: 47 and 49

United States Patent and Trademark Office

Reg. No. 2,893,839

Registered Oct. 12, 2004

**TRADEMARK
PRINCIPAL REGISTER**

COLIBRI RIDGE

ALEXANDER, JOHN (UNITED STATES INDIVIDUAL)
3100 CANNON COURT
DIAMOND SPRINGS, CA 95619

FOR: WINES, IN CLASS 33 (U.S. CLS. 47 AND 49).

FIRST USE 4-4-2002; IN COMMERCE 5-13-2004.

THE ENGLISH TRANSLATION OF "COLIBRI RIDGE" IS "HUMMINGBIRD RIDGE".

SN 78-132,723, FILED 6-3-2002.

JACQUELINE A. LAVINE, EXAMINING ATTORNEY

Int. Cl.: 9

Prior U.S. Cls.: 21, 23, 26, 36, and 38

Reg. No. 2,893,840

United States Patent and Trademark Office

Registered Oct. 12, 2004

**TRADEMARK
PRINCIPAL REGISTER**

SAVA

ADOBE SYSTEMS INCORPORATED (DELA-
WARE CORPORATION)
345 PARK AVENUE
SAN JOSE, CA 95110

DISCS, OPTICAL MEMORIES AND INTEGRATED
CIRCUIT MEMORIES SUCH AS ROMS, PROMS
AND EPROMS, IN CLASS 9 (U.S. CLS. 21, 23, 26, 36
AND 38).

FOR: COMPUTER SOFTWARE FOR CREATING
FONTS; TYPEFACE FONTS, TYPE FONTS, AND
TYPE DESIGNS OF ALPHANUMERIC CHARAC-
TERS AND TYPOGRAPHICAL SYMBOLS RECOR-
DED AS LATENT IMAGES IN MACHINE-
READABLE DATA STORAGE MEDIA, NAMELY,
MAGNETIC TAPE, MAGNETIC DISCS, COMPACT

FIRST USE 8-22-2003; IN COMMERCE 8-22-2003.

SN 78-134,494, FILED 6-10-2002.

NANCY CLARKE, EXAMINING ATTORNEY

Int. Cl.: 35

Prior U.S. Cls.: 100, 101, and 102

United States Patent and Trademark Office

Reg. No. 2,893,841

Registered Oct. 12, 2004

**SERVICE MARK
PRINCIPAL REGISTER**

CRAFTACULAR!

INNOVATION EVENT MANGEMENT, LP (PART-
NERSHIP)
P.O. BOX 1129
FREDERICKSBURG, TX 78624

FIRST USE 10-21-2002; IN COMMERCE 10-21-2002.

SN 78-134,753, FILED 6-11-2002.

FOR: PROMOTING, ARRANGING AND CON-
DUCTING TRADE SHOWS IN THE FIELD OF ARTS
AND CRAFTS, IN CLASS 35 (U.S. CLS. 100, 101 AND
102).

CYNTHIA SLOAN, EXAMINING ATTORNEY

Int. Cl.: 9

Prior U.S. Cls.: 21, 23, 26, 36, and 38

Reg. No. 2,893,843

United States Patent and Trademark Office

Registered Oct. 12, 2004

**TRADEMARK
PRINCIPAL REGISTER**

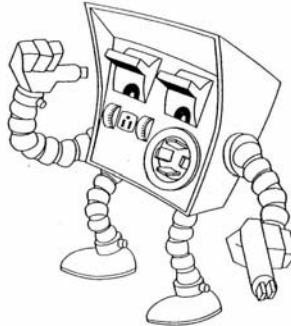

GEN-TRAN CORPORATION (GEORGIA CORPORATION)
88 MANSELL COURT
ROSWELL, GA 30076

FIRST USE 8-0-2003; IN COMMERCE 8-0-2003.

SN 78-142,318, FILED 7-9-2002.

FOR: ACCESSORIES FOR ELECTRICAL GENERATORS, NAMELY TRANSFER SWITCHES, POWER CORDS, POWER INLET BOXES AND WIRING DEVICES, IN CLASS 9 (U.S. CLS. 21, 23, 26, 36 AND 38).

WILLIAM P. SHANAHAN, EXAMINING ATTORNEY

Int. Cl.: 35

Prior U.S. Cls.: 100, 101, and 102

United States Patent and Trademark Office

Reg. No. 2,893,845

Registered Oct. 12, 2004

**SERVICE MARK
PRINCIPAL REGISTER**

WHERE BUSINESS SHOPS FOR SOLUTIONS

STAPLES THE OFFICE SUPERSTORE, INC. (DE-
LAWARE CORPORATION)
500 STAPLES DRIVE
FRAMINGHAM, MA 01702

FOR: RETAIL STORE SERVICES, MAIL ORDER
CATALOG SERVICES, AND COMPUTERIZED ON-
LINE RETAIL STORE SERVICES FEATURING OF-
FICE SUPPLIES, OFFICE EQUIPMENT,
INCLUDING COMPUTER HARDWARE, COPIERS

AND TELEPHONES, AND OFFICE FURNITURE, IN
CLASS 35 (U.S. CLS. 100, 101 AND 102).

FIRST USE 8-0-2002; IN COMMERCE 8-0-2002.

SN 78-148,558, FILED 7-29-2002.

KARLA PERKINS, EXAMINING ATTORNEY

Int. Cl.: 13

Prior U.S. Cls.: 2 and 9

United States Patent and Trademark Office

Reg. No. 2,893,846

Registered Oct. 12, 2004

**TRADEMARK
PRINCIPAL REGISTER**

24/7 EXPRESS SIGHTS

XS SIGHT SYSTEMS, INC. (TEXAS CORPORATION)
2401 LUDELLE STREET
FORT WORTH, TX 76105

NO CLAIM IS MADE TO THE EXCLUSIVE RIGHT TO USE "SIGHTS" , APART FROM THE MARK AS SHOWN.

FOR: GUN SIGHTS FOR FIREARMS, IN CLASS 13 (U.S. CLS. 2 AND 9).

SN 78-150,409, FILED 8-2-2002.

FIRST USE 5-15-2002; IN COMMERCE 5-15-2002.

PATRICIA EVANKO, EXAMINING ATTORNEY

Int. Cl.: 25

Prior U.S. Cls.: 22 and 39

United States Patent and Trademark Office

Reg. No. 2,893,847

Registered Oct. 12, 2004

**TRADEMARK
PRINCIPAL REGISTER**

DIVEEZ

DIVEEZ, INC. (FLORIDA CORPORATION)
15240 LAUREL LANE NORTH
PEMBROKE PINES, FL 33027

FIRST USE 3-18-2002; IN COMMERCE 3-18-2002.

SN 78-150,508, FILED 8-2-2002.

FOR: SHIRTS, HATS, SHORTS, PANTS, TANK
TOPS, SWEAT SHIRTS, T-SHIRTS, IN CLASS 25 (U.S.
CLS. 22 AND 39).

CIMMERIAN COLEMAN, EXAMINING ATTOR-
NEY

Int. Cl.: 29

Prior U.S. Cl.: 46

United States Patent and Trademark Office

Reg. No. 2,893,848

Registered Oct. 12, 2004

**TRADEMARK
PRINCIPAL REGISTER**

IT'S A GIRL

WILLIAMS, REGINALD F. JR. (UNITED STATES
INDIVIDUAL)
600 S SANDUSKY AVE
UPPER SANDUSKY, OH 43351

FIRST USE 5-21-2004; IN COMMERCE 5-21-2004.

SN 78-151,296, FILED 8-6-2002.

FOR: BEEF STICK AND BEEF JERKY, IN CLASS
29 (U.S. CL. 46).

JENNIFER KRISP, EXAMINING ATTORNEY

Int. Cl.: 9

Prior U.S. Cls.: 21, 23, 26, 36, and 38

Reg. No. 2,893,849

United States Patent and Trademark Office

Registered Oct. 12, 2004

**TRADEMARK
PRINCIPAL REGISTER**

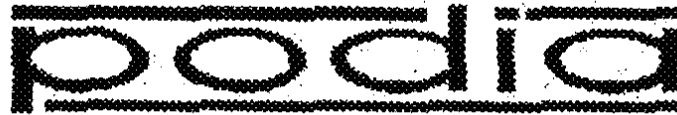

IAG MACAO COMMERCIAL OFFSHORE LIMITED (MACAO CORPORATION)
SUITE 1209, MACAU LANDMARK
555 AVENIDADA AMIZADE
AMIZADE, MACAO

FOR: LOUDSPEAKERS, LOUDSPEAKER CABINETS AND ENCLOSURES, AMPLIFIERS, GRAPHIC EQUALIZERS, AUDIO MIXERS, CD PLAYERS, MICROPHONES, TELEVISION RECEIVERS, VIDEO

TAPE RECORDERS; HI-FI EQUIPMENT, NAMELY AUDIO RECEIVERS AND SPEAKERS, IN CLASS 9 (U.S. CLS. 21, 23, 26, 36 AND 38).

FIRST USE 8-0-2002; IN COMMERCE 5-0-2004.

SN 78-152,210, FILED 8-8-2002.

ELISSA GARBER KON, EXAMINING ATTORNEY

Int. Cl.: 36

Prior U.S. Cls.: 100, 101, and 102

United States Patent and Trademark Office

Reg. No. 2,893,851

Registered Oct. 12, 2004

**SERVICE MARK
PRINCIPAL REGISTER**

PNEUTECH TRAILER

PNEUMATIC TECHNOLOGY, INC. (TEXAS CORPORATION)
99 TROPHY CLUB DRIVE, SUITE 342
TROPHY CLUB, TX 76262

NO CLAIM IS MADE TO THE EXCLUSIVE RIGHT TO USE "TRAILER", APART FROM THE MARK AS SHOWN.

FOR: BROKERAGE SERVICES IN THE FIELD OF PURCHASING AND RESELLING TANK TRAILERS AND PARTS AND ACCESSORIES THEREOF, IN CLASS 36 (U.S. CLS. 100, 101 AND 102).

SN 78-152,288, FILED 8-8-2002.

FIRST USE 5-0-2002; IN COMMERCE 5-0-2002.

BARBARA BROWN, EXAMINING ATTORNEY

Int. Cl.: 35

Prior U.S. Cls.: 100, 101, and 102

United States Patent and Trademark Office

Reg. No. 2,893,852

Registered Oct. 12, 2004

**SERVICE MARK
PRINCIPAL REGISTER**

PNEUTECH CONSULTING

PNEUMATIC TECHNOLOGY, INC. (TEXAS CORPORATION)
99 TROPHY CLUB DRIVE, SUITE 342
TROPHY CLUB, TX 76262

NO CLAIM IS MADE TO THE EXCLUSIVE RIGHT TO USE "CONSULTING", APART FROM THE MARK AS SHOWN.

FOR: BUSINESS CONSULTING SERVICES IN THE FIELD OF TRANSPORTATION OF PLASTICS, IN CLASS 35 (U.S. CLS. 100, 101 AND 102).

SN 78-152,294, FILED 8-8-2002.

FIRST USE 7-12-2004; IN COMMERCE 7-12-2004.

BARBARA BROWN, EXAMINING ATTORNEY

Int. Cl.: 7

Prior U.S. Cls.: 13, 19, 21, 23, 31, 34, and 35

United States Patent and Trademark Office

Reg. No. 2,893,853

Registered Oct. 12, 2004

**TRADEMARK
PRINCIPAL REGISTER**

PNEUTECH AIR-TO-AIR COOLER

PNEUMATIC TECHNOLOGY, INC. (TEXAS CORPORATION)
99 TROPHY CLUB DRIVE, SUITE 342
TROPHY CLUB, TX 76262

FOR: COOLING RADIATORS FOR USE IN UNLOADING BULK MATERIALS FROM TANK TRAILERS, IN CLASS 7 (U.S. CLS. 13, 19, 21, 23, 31, 34 AND 35).

FIRST USE 5-0-1997; IN COMMERCE 5-0-1997.

NO CLAIM IS MADE TO THE EXCLUSIVE RIGHT TO USE "AIR-TO-AIR COOLER", APART FROM THE MARK AS SHOWN.

SN 78-152,311, FILED 8-8-2002.

BARBARA BROWN, EXAMINING ATTORNEY

Int. Cl.: 7

Prior U.S. Cls.: 13, 19, 21, 23, 31, 34, and 35

United States Patent and Trademark Office

Reg. No. 2,893,854

Registered Oct. 12, 2004

**TRADEMARK
PRINCIPAL REGISTER**

PNEUTECH DRY COOL AIR-TO-AIR COOLER

PNEUMATIC TECHNOLOGY, INC. (TEXAS CORPORATION)
99 TROPHY CLUB DRIVE, SUITE 342
TROPHY CLUB, TX 76262

FOR: COOLING RADIATORS FOR USE IN UNLOADING BULK MATERIALS FROM TANK TRAILERS, IN CLASS 7 (U.S. CLS. 13, 19, 21, 23, 31, 34 AND 35).

FIRST USE 5-0-1997; IN COMMERCE 5-0-1997.

NO CLAIM IS MADE TO THE EXCLUSIVE RIGHT TO USE "COOL AIR-TO-AIR COOLER", APART FROM THE MARK AS SHOWN.

SN 78-152,315, FILED 8-8-2002.

BARBARA BROWN, EXAMINING ATTORNEY

Int. Cl.: 3

Prior U.S. Cls.: 1, 4, 6, 50, 51, and 52

United States Patent and Trademark Office

Reg. No. 2,893,855

Registered Oct. 12, 2004

**TRADEMARK
PRINCIPAL REGISTER**

COLOR ACCENTS

REVLON CONSUMER PRODUCTS CORPORATION (DELAWARE CORPORATION)
625 MADISON AVENUE
NEW YORK, NY 10022

NO CLAIM IS MADE TO THE EXCLUSIVE RIGHT TO USE "COLOR", APART FROM THE MARK AS SHOWN.

FOR: HAIR COLOR, HAIR COLORING PREPARATIONS AND NON-MEDICATED HAIR CARE PREPARATIONS, IN CLASS 3 (U.S. CLS. 1, 4, 6, 50, 51 AND 52).

SN 78-155,060, FILED 8-16-2002.

FIRST USE 1-31-2003; IN COMMERCE 1-31-2003.

JOHN DWYER, EXAMINING ATTORNEY

Int. Cl.: 41

Prior U.S. Cls.: 100, 101, and 107

United States Patent and Trademark Office

Reg. No. 2,893,856

Registered Oct. 12, 2004

**SERVICE MARK
PRINCIPAL REGISTER**

INTELLECTUAL LEADERSHIP SERIES

DESTINY HEALTH, INC. (MARYLAND CORPORATION)
6430 ROCKLEDGE DRIVE, SUITE 602
BETHESDA, MD 20817

FOR: EDUCATIONAL SERVICES, NAMELY, CONDUCTING CLASSES, SEMINARS, CONFERENCES, WORK SHOPS IN THE FIELD OF HEALTH INSURANCE, HEALTH MANAGEMENT, INVESTMENT ACCOUNTS, AND INVESTMENT MANAGEMENT, IN CLASS 41 (U.S. CLS. 100, 101 AND 107).

FIRST USE 2-17-2003; IN COMMERCE 2-17-2003.

NO CLAIM IS MADE TO THE EXCLUSIVE RIGHT TO USE "LEADERSHIP SERIES", APART FROM THE MARK AS SHOWN.

SN 78-155,448, FILED 8-19-2002.

ELLEN B. AWRICH, EXAMINING ATTORNEY

Int. Cl.: 41

Prior U.S. Cls.: 100, 101, and 107

United States Patent and Trademark Office

Reg. No. 2,893,857

Registered Oct. 12, 2004

**SERVICE MARK
PRINCIPAL REGISTER**



EG NORTON LLC (MINNESOTA LIMITED LIABILITY COMPANY)
6203 EAGLE LAKE DR.
MAPLE GROVE, MN 55369

FOR: PROVIDING FITNESS, EDUCATION, AND WELLNESS PROGRAMS IN THE NATURE OF CLASSES, SEMINARS, AND LECTURES ALL FOR TYPE I AND TYPE II DIABETICS AND THE GENERAL PUBLIC, AND PROVIDING LOG/TRACKING BOOKS IN CONNECTION THEREWITH, IN CLASS 41 (U.S. CLS. 100, 101 AND 107).

FIRST USE 3-2-2002; IN COMMERCE 6-1-2003.

NO CLAIM IS MADE TO THE EXCLUSIVE RIGHT TO USE "WELLNESS", "EXERCISE", "EDUCATION", APART FROM THE MARK AS SHOWN.

SN 78-159,369, FILED 8-29-2002.

DARRYL SPRUILL, EXAMINING ATTORNEY

Int. Cl.: 6

Prior U.S. Cls.: 2, 12, 13, 14, 23, 25, and 50

Reg. No. 2,893,858

United States Patent and Trademark Office

Registered Oct. 12, 2004

**TRADEMARK
PRINCIPAL REGISTER**

BRANDYWINE

NEWFREY LLC (DELAWARE LIMITED LIABILITY COMPANY)
TW-199
1207 DRUMMOND PLAZA
NEWARK, DE 19711

FIRST USE 5-31-2004; IN COMMERCE 5-31-2004.

SN 78-160,862, FILED 9-5-2002.

FOR: METAL DOOR HARDWARE, NAMELY, LOCKS, LATCHES, KNOBS, LEVERS AND HINGES, IN CLASS 6 (U.S. CLS. 2, 12, 13, 14, 23, 25 AND 50).

JOHN DWYER, EXAMINING ATTORNEY

Int. Cl.: 28

Prior U.S. Cls.: 22, 23, 38, and 50

United States Patent and Trademark Office

Reg. No. 2,893,859

Registered Oct. 12, 2004

**TRADEMARK
PRINCIPAL REGISTER**

WOLF ARMOR

MATTEL, INC. (DELAWARE CORPORATION)
333 CONTINENTAL BLVD.
EL SEGUNDO, CA 902455012

FIRST USE 2-13-2003; IN COMMERCE 2-13-2003.

FOR: TOYS, GAMES, AND PLAYTHINGS, NAME-
LY, TOY ACTION FIGURE AND ACCESSORIES
THEREFOR, IN CLASS 28 (U.S. CLS. 22, 23, 38 AND
50).

SN 78-161,367, FILED 9-6-2002.

KAREN BRACEY, EXAMINING ATTORNEY

Int. Cl.: 30

Prior U.S. Cl.: 46

United States Patent and Trademark Office

Reg. No. 2,893,860

Registered Oct. 12, 2004

**TRADEMARK
PRINCIPAL REGISTER**

SUMMIT HILL

FLAVOR & FOOD INGREDIENTS, INC. (NEW
JERSEY CORPORATION)
253 LACKLAND DRIVE EAST
MIDDLESEX, NJ 08846

FIRST USE 6-19-2003; IN COMMERCE 6-19-2003.

SN 78-161,905, FILED 9-9-2002.

FOR: FOOD FLAVORINGS, IN CLASS 30 (U.S. CL.
46).

JOHN DWYER, EXAMINING ATTORNEY

Int. Cl.: 16

Prior U.S. Cls.: 2, 5, 22, 23, 29, 37, 38, and 50

United States Patent and Trademark Office

Reg. No. 2,893,861

Registered Oct. 12, 2004

**TRADEMARK
PRINCIPAL REGISTER**

VP OF NO

XPLANE CORP. (MISSOURI CORPORATION)
809 GEYER AVENUE
ST. LOUIS, MO 63104

FIRST USE 6-0-2002; IN COMMERCE 6-0-2002.

SN 78-162,062, FILED 9-9-2002.

FOR: PRINTED VISUALS IN THE NATURE OF
INFORMATION GRAPHICS, IN CLASS 16 (U.S. CLS.
2, 5, 22, 23, 29, 37, 38 AND 50).

KATHY DE JONGE, EXAMINING ATTORNEY

Int. Cl.: 1

Prior U.S. Cls.: 1, 5, 6, 10, 26, and 46

United States Patent and Trademark Office

Reg. No. 2,893,862

Registered Oct. 12, 2004

**TRADEMARK
PRINCIPAL REGISTER**

DYNALYST

SUPERIOR MICROPOWDERS LLC (NEW MEX-
ICO CORPORATION)
3740 HAWKINS NE
ALBUQUERQUE, NM 87109

FOR: CATALYSTS AND CATALYST COMPOSI-
TIONS FOR USE IN FUEL CELLS, FUEL PROCES-
SORS, FUEL REFORMERS, BATTERIES,

CHEMICAL REFINING AND POLLUTION CON-
TROL, IN CLASS 1 (U.S. CLS. 1, 5, 6, 10, 26 AND 46).

FIRST USE 9-3-2003; IN COMMERCE 9-3-2003.

SN 78-162,647, FILED 9-10-2002.

TINA L. SNAPP, EXAMINING ATTORNEY

Int. Cl.: 33

Prior U.S. Cls.: 47 and 49

United States Patent and Trademark Office

Reg. No. 2,893,863

Registered Oct. 12, 2004

**TRADEMARK
PRINCIPAL REGISTER**

PARKERS ESTATE BLUE ASH ROAD

WINERY EXCHANGE, INC. (CALIFORNIA CORPORATION)
35 LEVERONI COURT, SUITE 100
NOVATO, CA 94949

NO CLAIM IS MADE TO THE EXCLUSIVE RIGHT TO USE "ESTATE" , APART FROM THE MARK AS SHOWN.

FOR: WINE, IN CLASS 33 (U.S. CLS. 47 AND 49).

SN 78-162,675, FILED 9-10-2002.

FIRST USE 11-0-2002; IN COMMERCE 11-0-2002.

TINA L. SNAPP, EXAMINING ATTORNEY

Int. Cl.: 25

Prior U.S. Cls.: 22 and 39

United States Patent and Trademark Office

Reg. No. 2,893,864

Registered Oct. 12, 2004

**TRADEMARK
PRINCIPAL REGISTER**

PARADISE GOLD

ATICO INTERNATIONAL USA, INC. (DELA-
WARE CORPORATION)
501 S. ANDREWS AVENUE
FORT LAUDERDALE, FL 33301

FIRST USE 7-24-2003; IN COMMERCE 12-1-2003.

SN 78-162,997, FILED 9-11-2002.

FOR: SUMMER APPAREL, NAMELY, MEN'S
SHIRTS, SARONGS, DRESSES, SHORTS, BEACH
SHOES, HATS, IN CLASS 25 (U.S. CLS. 22 AND 39).

VIVIAN MICZNIK FIRST, EXAMINING ATTOR-
NEY

Int. Cl.: 21

Prior U.S. Cls.: 2, 13, 23, 29, 30, 33, 40, and 50

United States Patent and Trademark Office

Reg. No. 2,893,865

Registered Oct. 12, 2004

**TRADEMARK
PRINCIPAL REGISTER**

EZ-DOSE-IT

CALIFORNIA TAN, INC. (DELAWARE COR-
PORATION)
10877 WILSHIRE BOULEVARD 12TH FLOOR
LOS ANGELES, CA 90024

FIRST USE 9-9-2002; IN COMMERCE 9-9-2002.

SN 78-163,415, FILED 9-12-2002.

FOR: CLEANING SUPPLIES, NAMELY CAR-
TRIDGE DISPENSERS FOR LIQUID SOAP AND
DETERGENT, IN CLASS 21 (U.S. CLS. 2, 13, 23, 29, 30,
33, 40 AND 50).

WON TEAK OH, EXAMINING ATTORNEY

Int. Cl.: 42

Prior U.S. Cls.: 100 and 101

United States Patent and Trademark Office

Reg. No. 2,893,866

Registered Oct. 12, 2004

**SERVICE MARK
PRINCIPAL REGISTER**



KNOWLEDGE INHERITED SYSTEMS LLC
(PENNSYLVANIA CORPORATION)
113 PAULINE DR
MONROEVILLE, PA 151461025

FOR: COMPUTER SOFTWARE DESIGN, DEVELOPMENT AND CONSULTING SERVICES SPECIALIZING IN DISTRIBUTED COMPUTING APPLICATIONS, FOR OTHERS, IN CLASS 42 (U.S. CLS. 100 AND 101).

FIRST USE 3-26-2004; IN COMMERCE 3-26-2004.

THE STIPPLING IS A FEATURE OF THE MARK.

THE MARK CONSISTS OF RED AND BLUE WAVE TO THE LEFT AND SAFFRON AND GREEN TO THE RIGHT WITH WHITE STRIPE. THE FUSION OF RED TO SAFFRON AND OF BLUE TO GREEN IS DISPLAYED BY STIPPLING.

SN 78-164,025, FILED 9-13-2002.

WILLIAM BRECKENFELD, EXAMINING ATTORNEY

Int. Cl.: 32

Prior U.S. Cls.: 45, 46, and 48

United States Patent and Trademark Office

Reg. No. 2,893,867

Registered Oct. 12, 2004

**TRADEMARK
PRINCIPAL REGISTER**

FLIP IT

DR PEPPER/SEVEN UP, INC. (DELAWARE COR-
PORATION)
5301 LEGACY DRIVE
PLANO, TX 75024

FIRST USE 11-30-2002; IN COMMERCE 11-30-2002.

SN 78-164,540, FILED 9-16-2002.

FOR: SOFT DRINKS, IN CLASS 32 (U.S. CLS. 45, 46
AND 48).

WILLIAM BRECKENFELD, EXAMINING ATTOR-
NEY

Int. Cl.: 36

Prior U.S. Cls.: 100, 101, and 102

United States Patent and Trademark Office

Reg. No. 2,893,868

Registered Oct. 12, 2004

**SERVICE MARK
PRINCIPAL REGISTER**

VERICLAIM

VERICLAIM, INC. (DELAWARE CORPORATION)
233 SOUTH WACKER DRIVE, SUITE 2420
CHICAGO, IL 60606

FIRST USE 11-0-2002; IN COMMERCE 11-0-2002.

SN 78-164,591, FILED 9-16-2002.

FOR: INSURANCE SERVICES, NAMELY,
CLAIMS ADMINISTRATION, CLAIMS ADJUSTMENT
AND LOSS ADJUSTING SERVICES, IN
CLASS 36 (U.S. CLS. 100, 101 AND 102).

ARETHA MASTERSON, EXAMINING ATTORNEY

Int. Cl.: 35

Prior U.S. Cls.: 100, 101, and 102

United States Patent and Trademark Office

Reg. No. 2,893,869

Registered Oct. 12, 2004

**SERVICE MARK
PRINCIPAL REGISTER**

IDENTITY COMMONS

COMMONS HOLDINGS, INC. (DELAWARE CORPORATION)
4104 24TH STREET #588
SAN FRANCISCO, CA 94114

FOR: ASSOCIATION SERVICES FOR BUILDERS AND USERS OF AN ELECTRONIC NETWORK WHICH PROMOTES THE RIGHTS OF INDIVIDUALS AND ORGANIZATIONS TO PROTECT AND CONTROL PRIVATE INFORMATION, IDENTITY AND RELATIONSHIPS, IN CLASS 35 (U.S. CLS. 100, 101 AND 102).

FIRST USE 8-31-2002; IN COMMERCE 8-31-2002.

NO CLAIM IS MADE TO THE EXCLUSIVE RIGHT TO USE "IDENTITY", APART FROM THE MARK AS SHOWN.

SN 78-164,642, FILED 9-16-2002.

MARIA-VICTORIA SUAREZ, EXAMINING ATTORNEY

Int. Cl.: 3

Prior U.S. Cls.: 1, 4, 6, 50, 51, and 52

United States Patent and Trademark Office

Reg. No. 2,893,870

Registered Oct. 12, 2004

**TRADEMARK
PRINCIPAL REGISTER**

BETACLEAN

THE DOW CHEMICAL COMPANY (DELAWARE
CORPORATION)
MIDLAND, MI 48674

FOR: INDUSTRIAL CLEANERS FOR GLASS,
PLASTICS, METAL AND SKIN FOR USE IN THE
MANUFACTURE AND REPAIR OF MOTORIZED
VEHICLES, IN CLASS 3 (U.S. CLS. 1, 4, 6, 50, 51 AND
52).

FIRST USE 10-30-2003; IN COMMERCE 10-30-2003.

OWNER OF U.S. REG. NOS. 797,672, 2,500,537,
AND OTHERS.

SN 78-165,682, FILED 9-19-2002.

PATRICIA EVANKO, EXAMINING ATTORNEY

Int. Cl.: 35

Prior U.S. Cls.: 100, 101, and 102

United States Patent and Trademark Office

Reg. No. 2,893,871

Registered Oct. 12, 2004

**SERVICE MARK
PRINCIPAL REGISTER**

SMOKER'S LOUNGE

DIVERSIFIED CONCEPTS MARKETING, INC.
(OHIO CORPORATION)
2824 WOODLAWN AVENUE, NW
CANTON, OH 44708

FOR: RETAIL STORE SERVICES, MAIL ORDER
SERVICES, TELEPHONE ORDER SERVICES AND
ONLINE CATALOG ORDER SERVICES FEATUR-
ING HOME ACCESSORIES, OFFICE ACCESSORIES,
NOVELTY ITEMS, ART REPRODUCTIONS AND

ANTIQUE REPRODUCTIONS, IN CLASS 35 (U.S.
CLS. 100, 101 AND 102).

FIRST USE 12-31-2000; IN COMMERCE 9-30-2003.

SN 78-165,936, FILED 9-19-2002.

HOWARD SMIGA, EXAMINING ATTORNEY

Int. Cl.: 7

Prior U.S. Cls.: 13, 19, 21, 23, 31, 34, and 35

Reg. No. 2,893,872

United States Patent and Trademark Office

Registered Oct. 12, 2004

**TRADEMARK
PRINCIPAL REGISTER**

MODA

BREVILLE PTY LTD (AUSTRALIA CORPORATION)
BUILDING 2, PORT AIR INDUSTRIAL ESTATE
1A HALE STREET
BOTANY, NEW SOUTH WALES, AUSTRALIA 2019

FIRST USE 10-0-2003; IN COMMERCE 12-0-2003.

SN 78-168,182, FILED 9-26-2002.

FOR: ELECTRIC MACHINES FOR FOOD PREPARATION, NAMELY BLENDERS, IN CLASS 7 (U.S. CLS. 13, 19, 21, 23, 31, 34 AND 35).

MICHAEL BAIRD, EXAMINING ATTORNEY

Int. Cl.: 42

Prior U.S. Cls.: 100 and 101

United States Patent and Trademark Office

Reg. No. 2,893,873

Registered Oct. 12, 2004

**SERVICE MARK
PRINCIPAL REGISTER**

4E-DOCTOR

COM NET, INC. (OHIO CORPORATION)
13888 COUNTY ROAD, 25A
WAPAKONETA, OH 45895

FOR: TECHNICAL COMPUTER SUPPORT SERVICES, NAMELY, COMPUTER CONSULTATION IN CONNECTION WITH THE OPERATION, UPGRAD-

ING AND MAINTENANCE OF COMPUTERS, IN CLASS 42 (U.S. CLS. 100 AND 101).

FIRST USE 1-0-2003; IN COMMERCE 1-0-2003.

SN 78-170,882, FILED 10-3-2002.

CHERYL CLAYTON, EXAMINING ATTORNEY

Int. Cl.: 10

Prior U.S. Cls.: 26, 39, and 44

Reg. No. 2,893,874

United States Patent and Trademark Office

Registered Oct. 12, 2004

TRADEMARK
PRINCIPAL REGISTER

3D Accu^{globe}tomo
XYZ Slice View Tomograph

J. MORITA MFG. CORP. (JAPAN CORPORATION)
680, HIGASHIHAMA MINAMI-CHO
FUSHIMI-KU, KYOTO-SHI
KYOTO, JAPAN

FOR: X-RAY APPARATUS FOR MEDICAL USE; X-RAY COMPUTERIZED TOMOGRAPHY SCANNERS FOR MEDICAL AND DENTAL USE, AND STRUCTURAL PARTS THEREOF; X-RAY GENERATORS; X-RAY ROTATION ARM SUPPORT PILLARS, BASE PLATES FOR FIXING IN PLACE THE ROTATION ARM SUPPORT PILLARS; ROTATION ARMS FOR SUPPORTING X-RAY GENERATORS AND X-RAY DETECTORS; X-RAY IMAGE DETECTORS, X-RAY IRRADIATION CONTROLLERS; SUPPORT DEVICES FOR PATIENT POSI-

TIONING, NAMELY, CHAIR AND HEAD POSITIONERS; AND ELECTRICAL CONTROLLERS, ALL FOR USE AS COMPONENTS FOR THE AFORESAID GOODS, IN CLASS 10 (U.S. CLS. 26, 39 AND 44).

FIRST USE 1-0-2003; IN COMMERCE 1-0-2004.

NO CLAIM IS MADE TO THE EXCLUSIVE RIGHT TO USE "3D" AND "SLICE VIEW TOMOGRAPH", APART FROM THE MARK AS SHOWN.

SN 78-171,691, FILED 10-7-2002.

JOHN GARTNER, EXAMINING ATTORNEY

Int. Cl.: 16

Prior U.S. Cls.: 2, 5, 22, 23, 29, 37, 38, and 50

United States Patent and Trademark Office

Reg. No. 2,893,875

Registered Oct. 12, 2004

**TRADEMARK
PRINCIPAL REGISTER**

HAPPILY EVER AFTERWORDS

HDG ENTERPRISES, LLC (VIRGINIA LIMITED
LIABILITY COMPANY)
20 NORTH 20TH STREET, SUITE A
RICHMOND, VA 23223

FOR: STATIONERY; STATIONERY BOXES; STA-
TIONERY FOLDERS; STATIONERY WRITING PA-
PER AND ENVELOPES; STATIONERY-TYPE
PORTFOLIOS; NAMELY, ALL SUCH MATERIAL
TO BE USED FOR COMMEMORATING, CELE-
BRATING OR REMEMBERING IMPORTANT

EVENTS, SUCH AS WEDDINGS AND ANNIVER-
SARIES, IN CLASS 16 (U.S. CLS. 2, 5, 22, 23, 29, 37, 38
AND 50).

FIRST USE 4-30-2004; IN COMMERCE 4-30-2004.

SN 78-172,183, FILED 10-8-2002.

JOSETTE BEVERLY, EXAMINING ATTORNEY

Int. Cl.: 24

Prior U.S. Cls.: 42 and 50

United States Patent and Trademark Office

Reg. No. 2,893,876

Registered Oct. 12, 2004

**TRADEMARK
PRINCIPAL REGISTER**

MOISTURE-BLOC

BI PROPERTIES I INC. (DELAWARE CORPORATION)
3330 WEST FRIENDLY AVENUE
GREENSBORO, NC 27410

FOR: TEXTILE FABRICS FOR USE IN THE
MANUFACTURE OF FURNISHINGS FOR HOME,
INDUSTRIAL AND COMMERCIAL USE; UPHOLSTERY
FABRICS FOR HOME, INDUSTRIAL AND
COMMERCIAL USE; TEXTILE FABRICS FOR USE

IN THE MANUFACTURE OF WALL COVERINGS
AND WALL PANELS, IN CLASS 24 (U.S. CLS. 42
AND 50).

FIRST USE 1-31-2003; IN COMMERCE 1-31-2003.

SN 78-172,242, FILED 10-8-2002.

BERYL GARDNER, EXAMINING ATTORNEY

Int. Cl.: 33

Prior U.S. Cls.: 47 and 49

United States Patent and Trademark Office

Reg. No. 2,893,877

Registered Oct. 12, 2004

**TRADEMARK
PRINCIPAL REGISTER**

TEQREMA

MAPLE LEAF DISTILLERS INC. (CANADA CORPORATION)
1251 SAULTEAUX CRESCENT
WINNIPEG, CANADA R3C 3J7

PRIORITY CLAIMED UNDER SEC. 44(D) ON
CANADA APPLICATION NO. 1154736, FILED 10-11-
2002, DATED 0-0-0000.

FOR: TEQUILA FRUIT FLAVORED CREAM LI-
QUEUR, IN CLASS 33 (U.S. CLS. 47 AND 49).

SN 78-173,362, FILED 10-11-2002.

FIRST USE 4-30-2003; IN COMMERCE 4-30-2003.

LINDA POWELL, EXAMINING ATTORNEY

Int. Cl.: 17

Prior U.S. Cls.: 1, 5, 12, 13, 35, and 50

Reg. No. 2,893,878

United States Patent and Trademark Office

Registered Oct. 12, 2004

**TRADEMARK
PRINCIPAL REGISTER**

ECHOTHERM

ELK PREMIUM BUILDING PRODUCTS, INC.
(DELAWARE CORPORATION)
14911 QUORUM DRIVE
SUITE 600
DALLAS, TX 75254

FIRST USE 12-0-2002; IN COMMERCE 12-0-2002.

SN 78-176,618, FILED 10-21-2002.

FOR: INSULATING COMPONENT FOR BUILD-
ING, NAMELY REFLECTIVE INSULATING RADI-
ANT BARRIERS AND THERMAL BARRIERS, IN
CLASS 17 (U.S. CLS. 1, 5, 12, 13, 35 AND 50).

ANDREW BENZMILLER, EXAMINING ATTOR-
NEY

Int. Cl.: 8

Prior U.S. Cls.: 23, 28, and 44

Reg. No. 2,893,879

United States Patent and Trademark Office

Registered Oct. 12, 2004

**TRADEMARK
PRINCIPAL REGISTER**



UNIONTOOLS, INC. (DELAWARE CORPORATION)
390 NATIONWIDE BOULEVARD
COLUMBUS, OH 432161930

FOR: HAND-OPERATED TOOLS; NAMELY, SCOOPS, SHOVELS, SPADES, SIDEWALK AND BARN FLOOR SCRAPERS, GARDEN TROWELS AND CULTIVATORS, POSTHOLE DIGGERS, SOIL AUGERS, RAKES, HOES, FORKS, HOOKS, TOOL HANDLES, VEGETATION KNIVES AND SHEARS, PRUNING TOOLS, PRUNING SAWS, LAWN WEEDERS, SOD LIFTERS, WEED CUTTERS, GRASS TRIMMERS, BULB PLANTERS, MATTOCKS, PICKS, WOOD-SPLITTING WEDGES, MAULS, HEA-

VY HAMMERS, SLEDGES, TAMPERS, CROW BARS, TAMPING BARS, WRECKING BARS, SNOW SHOVELS, AND SNOW PUSHERS, IN CLASS 8 (U.S. CLS. 23, 28 AND 44).

FIRST USE 12-0-2002; IN COMMERCE 12-0-2002.

NO CLAIM IS MADE TO THE EXCLUSIVE RIGHT TO USE "BRAND", APART FROM THE MARK AS SHOWN.

SN 78-179,691, FILED 10-29-2002.

VIVIAN MICZNIK FIRST, EXAMINING ATTORNEY

Int. Cl.: 35

Prior U.S. Cls.: 100, 101, and 102

United States Patent and Trademark Office

Reg. No. 2,893,880

Registered Oct. 12, 2004

**SERVICE MARK
PRINCIPAL REGISTER**

SUNGLASS GALAXY

HAGERTY, BRIAN, P (UNITED STATES INDIVIDUAL)
1702 E. WINTER DRIVE
PHOENIX, AZ 85020

FOR: RETAIL OUTLETS FEATURING EYEGLASSES, READING GLASSES, SUNGLASSES AND EYEWEAR ACCESSORIES, IN CLASS 35 (U.S. CLS. 100, 101 AND 102).

FIRST USE 5-1-1997; IN COMMERCE 12-13-2003.

NO CLAIM IS MADE TO THE EXCLUSIVE RIGHT TO USE "SUNGLASS", APART FROM THE MARK AS SHOWN.

SN 78-181,589, FILED 11-4-2002.

MARIA-VICTORIA SUAREZ, EXAMINING ATTORNEY

Int. Cl.: 3

Prior U.S. Cls.: 1, 4, 6, 50, 51, and 52

Reg. No. 2,893,881

United States Patent and Trademark Office

Registered Oct. 12, 2004

**TRADEMARK
PRINCIPAL REGISTER**

TEASE ZONE

DERMADOCTOR.COM, INC. (MISSOURI CORPORATION)
425 WASHINGTON STREET
KANSAS CITY, MO 64105

FIRST USE 6-30-2003; IN COMMERCE 6-30-2003.

SN 78-183,082, FILED 11-8-2002.

FOR: NON-MEDICATED SKIN CARE PREPARATIONS, NAMELY, A FACIAL OIL CONTROL GEL, IN CLASS 3 (U.S. CLS. 1, 4, 6, 50, 51 AND 52).

KIMBERLY PERRY, EXAMINING ATTORNEY

Int. Cl.: 41

Prior U.S. Cls.: 100, 101, and 107

United States Patent and Trademark Office

Reg. No. 2,893,882

Registered Oct. 12, 2004

**SERVICE MARK
PRINCIPAL REGISTER**



F-19 HOLDINGS, L.L.C. (DELAWARE CORPORATION)
950 PACIFIC AVENUE, SUITE 1250
TACOMA, WA 98402

NO CLAIM IS MADE TO THE EXCLUSIVE
RIGHT TO USE "FITNESS", APART FROM THE
MARK AS SHOWN.

FOR: HEALTH AND FITNESS CENTERS, NAME-
LY PROVIDING FITNESS AND EXERCISE FACIL-
ITIES, IN CLASS 41 (U.S. CLS. 100, 101 AND 107).

SN 78-183,653, FILED 11-11-2002.

FIRST USE 10-8-2002; IN COMMERCE 10-8-2002.

STEVEN BERK, EXAMINING ATTORNEY

Int. Cl.: 1

Prior U.S. Cls.: 1, 5, 6, 10, 26, and 46

United States Patent and Trademark Office

Reg. No. 2,893,883

Registered Oct. 12, 2004

**TRADEMARK
PRINCIPAL REGISTER**

AQUATIC BIOSCIENCE

AQUATIC BIOSCIENCE, LLC (CALIFORNIA
CORPORATION)
180 HOCKER LANE
FT. BRAGG, CA 95437

NO CLAIM IS MADE TO THE EXCLUSIVE
RIGHT TO USE "AQUATIC", APART FROM THE
MARK AS SHOWN.

FOR: WATER CLARIFYING COMPOUNDS FOR
PONDS, IN CLASS 1 (U.S. CLS. 1, 5, 6, 10, 26 AND 46).

SN 78-185,005, FILED 11-14-2002.

FIRST USE 1-15-2004; IN COMMERCE 1-15-2004.

ARETHA MASTERSON, EXAMINING ATTORNEY

Int. Cl.: 25

Prior U.S. Cls.: 22 and 39

United States Patent and Trademark Office

Reg. No. 2,893,885

Registered Oct. 12, 2004

**TRADEMARK
PRINCIPAL REGISTER**

NASTYRIDERS

WILES, WILLIAM A. (UNITED STATES INDIVIDUAL)
SPARKING EARTH PRODUCTS
2005 W. ROSE GARDEN LANE, BLDG. B
PHOENIX, AZ 85027

POLO SHIRTS; SCARVES; GOLF SHIRTS; NIGHT SHIRTS; BOXER SHORTS; T-SHIRTS; TANK TOPS; TEDDIES; TUBE TOPS; CLOTHING WRAPS, IN CLASS 25 (U.S. CLS. 22 AND 39).

FOR: APRONS; BANDANAS; HEAD BANDS; NECK BANDS; SWEAT BANDS; BEACH COVER-UPS; BLOUSES; BOXER SHORTS; DICKIES; GARTER BELTS; GYM SHORTS; HALTER TOPS; HATS; HEAD WEAR, NAMELY, SKULL CAPS, HEADWRAPS, DO RAGS, AND BANDANA HATS; JACKETS; LINGERIE; NECKERCHIEFS; NECKTIES;

FIRST USE 6-1-2003; IN COMMERCE 6-1-2003.

SN 78-185,751, FILED 11-15-2002.

CIMMERIAN COLEMAN, EXAMINING ATTORNEY

Int. Cl.: 36

Prior U.S. Cls.: 100, 101, and 102

United States Patent and Trademark Office

Reg. No. 2,893,886

Registered Oct. 12, 2004

**SERVICE MARK
PRINCIPAL REGISTER**

FIDELITY INVESTMENTS 529 COLLEGE REWARDS

FMR CORP. (DELAWARE CORPORATION)
82 DEVONSHIRE STREET
BOSTON, MA 02109

FOR: CREDIT CARD SERVICES FEATURING AN
INCENTIVE AWARD PROGRAM TO HELP FUND
EDUCATIONAL EXPENSES, IN CLASS 36 (U.S. CLS.
100, 101 AND 102).

FIRST USE 2-0-2003; IN COMMERCE 2-0-2003.

OWNER OF U.S. REG. NOS. 1,277,373, 1,481,037,
AND OTHERS.

NO CLAIM IS MADE TO THE EXCLUSIVE
RIGHT TO USE "INVESTMENTS 529 COLLEGE
REWARDS", APART FROM THE MARK AS
SHOWN.

SN 78-186,111, FILED 11-18-2002.

JOHN GARTNER, EXAMINING ATTORNEY

Int. Cl.: 36

Prior U.S. Cls.: 100, 101, and 102

United States Patent and Trademark Office

Reg. No. 2,893,887

Registered Oct. 12, 2004

**SERVICE MARK
PRINCIPAL REGISTER**

FIDELITY RETIREMENT PLAN MANAGER

FMR CORP. (DELAWARE CORPORATION)
82 DEVONSHIRE STREET
BOSTON, MA 02109

FOR: INVESTMENT MANAGEMENT SERVICES,
IN CLASS 36 (U.S. CLS. 100, 101 AND 102).

FIRST USE 3-0-2003; IN COMMERCE 3-0-2003.

OWNER OF U.S. REG. NOS. 1,277,373, 1,481,037,
AND OTHERS.

NO CLAIM IS MADE TO THE EXCLUSIVE
RIGHT TO USE "RETIREMENT PLAN MANAGER",
APART FROM THE MARK AS SHOWN.

SN 78-187,379, FILED 11-21-2002.

ROBIN CHOSID, EXAMINING ATTORNEY

Int. Cl.: 30

Prior U.S. Cl.: 46

United States Patent and Trademark Office

Reg. No. 2,893,888

Registered Oct. 12, 2004

**TRADEMARK
PRINCIPAL REGISTER**

THINADDICTIVES

VERSATILE INTERMARKET SOLUTIONS (V.I.S.)
INC. (CANADA CORPORATION)
258 LEBEAU BOULEVARD
VILLE ST-LAURENT, QUEBEC, CANADA H4N 1R4

FIRST USE 10-15-2002; IN COMMERCE 12-20-2002.

SN 78-187,664, FILED 11-21-2002.

FOR: BAKED GOODS, NAMELY, COOKIES, IN
CLASS 30 (U.S. CL. 46).

ARETHA MASTERSON, EXAMINING ATTORNEY

Int. Cl.: 36

Prior U.S. Cls.: 100, 101, and 102

United States Patent and Trademark Office

Reg. No. 2,893,889

Registered Oct. 12, 2004

**SERVICE MARK
PRINCIPAL REGISTER**

LIBERTY BANKERS LIFE INSURANCE COMPANY

LIBERTY BANKERS LIFE INSURANCE COMPA-
NY (IOWA CORPORATION)
1452 29TH STREET, SUITE 200
WEST DES MOINES, IA 502661307

FOR: LIFE INSURANCE AGENCY SERVICES, IN
CLASS 36 (U.S. CLS. 100, 101 AND 102).

FIRST USE 7-31-2001; IN COMMERCE 7-31-2001.

NO CLAIM IS MADE TO THE EXCLUSIVE
RIGHT TO USE "BANKERS LIFE INSURANCE
COMPANY", APART FROM THE MARK AS
SHOWN.

SN 78-187,852, FILED 11-22-2002.

TINA L. SNAPP, EXAMINING ATTORNEY

Int. Cl.: 10

Prior U.S. Cls.: 26, 39, and 44

Reg. No. 2,893,890

United States Patent and Trademark Office

Registered Oct. 12, 2004

**TRADEMARK
PRINCIPAL REGISTER**

NEWTEK

HYPOGUARD AMERICA LIMITED (UNITED
KINGDOM COMPANY)
5182 WEST 76TH STREET
MINNEAPOLIS, MN 55439

FIRST USE 3-25-2004; IN COMMERCE 3-25-2004.

SN 78-188,430, FILED 11-25-2002.

FOR: BLOOD GLUCOSE METER AND TEST
STRIPS THEREFOR, IN CLASS 10 (U.S. CLS. 26, 39
AND 44).

ELISSA GARBER KON, EXAMINING ATTORNEY

Int. Cl.: 37

Prior U.S. Cls.: 100, 103, and 106

United States Patent and Trademark Office

Reg. No. 2,893,891

Registered Oct. 12, 2004

SERVICE MARK
PRINCIPAL REGISTER



EXXON MOBIL CORPORATION (NEW JERSEY CORPORATION)
5959 LAS COLINAS BLVD.
IRVING, TX 750392298

FOR: CAR WASH SERVICES, IN CLASS 37 (U.S. CLS. 100, 103 AND 106).

FIRST USE 11-30-1998; IN COMMERCE 11-30-1998.

NO CLAIM IS MADE TO THE EXCLUSIVE RIGHT TO USE "WASH", APART FROM THE MARK AS SHOWN.

THE MARK CONSISTS OF THE STYLIZED WORDS "TIGER WASH" DISPLAYED ALONGSIDE A DETAILED LINE DRAWING OF A TIGER'S HEAD. THE TIGER APPEARS TO BE SHAKING WATER DROPLETS FROM HIS HEAD, AND LARGE BUBBLES APPEAR ON THE RIGHT AND LEFT SIDES OF THE MARK.

SN 78-188,466, FILED 11-25-2002.

ZHALEH DELANEY, EXAMINING ATTORNEY

Int. Cl.: 25

Prior U.S. Cls.: 22 and 39

United States Patent and Trademark Office

Reg. No. 2,893,892

Registered Oct. 12, 2004

**TRADEMARK
PRINCIPAL REGISTER**

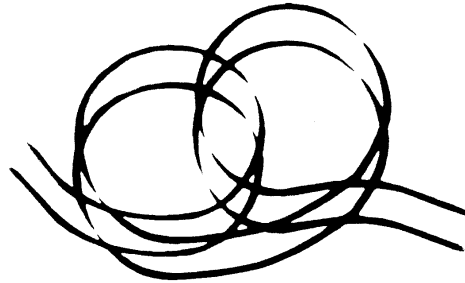

BRIAN KENDALL, LTD. (OHIO LIMITED LIABILITY JOINT STOCK COMPANY)
3791 ARABIAN COURT
COLUMBUS, OH 43221

FOR: CLOTHING, NAMELY, SHIRTS, HATS, JACKETS, AND SWEATSHIRTS, IN CLASS 25 (U.S. CLS. 22 AND 39).

FIRST USE 11-17-2002; IN COMMERCE 11-19-2002.

THE MARK CONSISTS OF A REPRESENTATION OF TIRE SKID MARKS THAT RESULT WHEN A RACECAR SPINS 360°, WHICH ACTION ALSO RESULTS IN A "BURNOUT" FOR HEATING THE TIRES. THE REPRESENTATION ALSO CAN BE REFERRED TO AS "DOUGHNUTS".

SN 78-188,982, FILED 11-26-2002.

KIMBERLY PERRY, EXAMINING ATTORNEY

Int. Cl.: 12

Prior U.S. Cls.: 19, 21, 23, 31, 35, and 44

United States Patent and Trademark Office

Reg. No. 2,893,893

Registered Oct. 12, 2004

**TRADEMARK
PRINCIPAL REGISTER**

PASSION FOR EXCELLENCE

BRIDGESTONE CORPORATION (JAPAN CORPORATION)
10-1, KYOBASHI 1-CHOME, CHUO-KU
TOKYO, JAPAN

FIRST USE 1-0-2004; IN COMMERCE 2-0-2004.

SN 78-189,226, FILED 11-26-2002.

FOR: TIRES; WHEELS FOR VEHICLES; INNER
TUBES AND RIMS, IN CLASS 12 (U.S. CLS. 19, 21, 23,
31, 35 AND 44).

SHARON MEIER, EXAMINING ATTORNEY

Int. Cl.: 25

Prior U.S. Cls.: 22 and 39

United States Patent and Trademark Office

Reg. No. 2,893,894

Registered Oct. 12, 2004

**TRADEMARK
PRINCIPAL REGISTER**



PALO CREATIVE, P.L.L. (OHIO LIMITED PART-
NERSHIP)
730 BEV ROAD, UNIT 1
BOARDMAN, OH 44512

NO CLAIM IS MADE TO THE EXCLUSIVE
RIGHT TO USE "2WEAR APPAREL", APART FROM
THE MARK AS SHOWN.

FOR: SHIRTS, SHORTS, HATS, PANTS, SWEAT-
SHIRTS, COATS FOR MEN, WOMEN AND CHIL-
DREN, IN CLASS 25 (U.S. CLS. 22 AND 39).

SN 78-189,860, FILED 11-29-2002.

FIRST USE 9-15-2001; IN COMMERCE 9-23-2002.

BARBARA BROWN, EXAMINING ATTORNEY

Int. Cl.: 35

Prior U.S. Cls.: 100, 101, and 102

United States Patent and Trademark Office

Reg. No. 2,893,895

Registered Oct. 12, 2004

**SERVICE MARK
PRINCIPAL REGISTER**

MANOR BORN

GEORGE, CATHLEEN M. (UNITED STATES IN-
DIVIDUAL)
1150 PAULSEN CT.
ST. HELENA, CA 94574

FOR: RETAIL STORE SERVICES FEATURING
FURNITURE, FURNISHINGS, BEDDING, TEX-
TILES, LINENS, HOME ACCESSORIES AND HOME
INTERIOR AND INTERIOR DESIGN PRODUCTS
IN THE NATURE OF LIGHTING FIXTURES AND

HOME FRAGRANCES, IN CLASS 35 (U.S. CLS. 100,
101 AND 102).

FIRST USE 11-30-2002; IN COMMERCE 11-30-2002.

SN 78-190,080, FILED 12-2-2002.

ZHALEH DELANEY, EXAMINING ATTORNEY

Int. Cl.: 21

Prior U.S. Cls.: 2, 13, 23, 29, 30, 33, 40, and 50

United States Patent and Trademark Office

Reg. No. 2,893,897

Registered Oct. 12, 2004

**TRADEMARK
PRINCIPAL REGISTER**

FlowerPower

FLOWERPOWER, INC. (CALIFORNIA CORPORATION)
1801 AVENUE OF THE STARS SUITE 446
LOS ANGELES, CA 90067

FIRST USE 12-19-2003; IN COMMERCE 12-19-2003.

SN 78-190,850, FILED 12-3-2002.

FOR: FLOWER HOLDERS FOR USE IN MOTOR VEHICLES, IN CLASS 21 (U.S. CLS. 2, 13, 23, 29, 30, 33, 40 AND 50).

JENNIFER MARTIN, EXAMINING ATTORNEY

Int. Cl.: 5

Prior U.S. Cls.: 6, 18, 44, 46, 51, and 52

United States Patent and Trademark Office

Reg. No. 2,893,898

Registered Oct. 12, 2004

**TRADEMARK
PRINCIPAL REGISTER**

CYCLE

SAMSON DISTRIBUTING INC. (FLORIDA CORPORATION)
9835-16 LAKE WORTH ROAD - SUITE #227
LAKE WORTH, FL 33467

FIRST USE 11-14-2003; IN COMMERCE 11-14-2003.

SN 78-190,911, FILED 12-3-2002.

FOR: NUTRITIONAL SUPPLEMENTS, IN CLASS
5 (U.S. CLS. 6, 18, 44, 46, 51 AND 52).

CYNTHIA SLOAN, EXAMINING ATTORNEY

Int. Cl.: 5

Prior U.S. Cls.: 6, 18, 44, 46, 51, and 52

United States Patent and Trademark Office

Reg. No. 2,893,899

Registered Oct. 12, 2004

**TRADEMARK
PRINCIPAL REGISTER**

PRO-STAT101

MEDICAL NUTRITION, INC. (NEW JERSEY
CORPORATION)
10 WEST FOREST AVENUE
ENGLEWOOD, NJ 07631

FIRST USE 6-0-2002; IN COMMERCE 6-0-2002.

SN 78-191,126, FILED 12-4-2002.

FOR: NUTRITIONAL SUPPLEMENTS, IN CLASS
5 (U.S. CLS. 6, 18, 44, 46, 51 AND 52).

BRENDAN REGAN, EXAMINING ATTORNEY

Int. Cl.: 25

Prior U.S. Cls.: 22 and 39

United States Patent and Trademark Office

Reg. No. 2,893,900

Registered Oct. 12, 2004

**TRADEMARK
PRINCIPAL REGISTER**

THEY MAGICALLY CHANGE COLOR

DYNASTY FOOTWEAR, LTD. (CALIFORNIA
LTD LIAB JT ST CO)
800 N. SEPULVEDA BLVD.
EL SEGUNDO, CA 90245

FIRST USE 8-30-2001; IN COMMERCE 8-30-2001.

SN 78-191,307, FILED 12-4-2002.

FOR: CLOTHING, NAMELY T-SHIRTS, SHIRTS,
SWEATSHIRTS, SHORTS, PANTS, COATS, JACKETS
AND SOCKS; FOOTWEAR AND HEADWEAR, IN
CLASS 25 (U.S. CLS. 22 AND 39).

WILLIAM BRECKENFELD, EXAMINING ATTOR-
NEY

Int. Cl.: 41

Prior U.S. Cls.: 100, 101, and 107

United States Patent and Trademark Office

Reg. No. 2,893,901

Registered Oct. 12, 2004

**SERVICE MARK
PRINCIPAL REGISTER**



SMITH, DONALD H (UNITED STATES INDIVIDUAL)
429 SOUTH MAIN ST. #1
ATTLEBORO, MA 02703

THE MARK CONSISTS OF A DESIGN OF A DRAGON ON A CLEF SYMBOL.

FOR: ENTERTAINMENT NAMELY, LIVE PERFORMANCES BY MUSICAL GROUP, IN CLASS 41 (U.S. CLS. 100, 101 AND 107).

SN 78-192,222, FILED 12-7-2002.

FIRST USE 6-16-2000; IN COMMERCE 6-16-2000.

BARBARA RUTLAND, EXAMINING ATTORNEY

Int. Cl.: 12

Prior U.S. Cls.: 19, 21, 23, 31, 35, and 44

Reg. No. 2,893,902

United States Patent and Trademark Office

Registered Oct. 12, 2004

**TRADEMARK
PRINCIPAL REGISTER**

METAL-SHIELD

CEQUENT TOWING PRODUCTS, INC. (DELA-
WARE CORPORATION)
47774 ANCHOR COURT
PLYMOUTH, MI 48170

FOR: VEHICLE TOWING APPARATUS AND
STRUCTURAL PARTS THEREFORE, NAMELY,
WEIGHT DISTRIBUTING HITCHES, FIFTH WHEEL
HITCHES, GOOSE NECK HITCHES, TRAILER
HITCH RECEIVERS, HITCH BARS, MOUNTS AND
BALLS, TOWING BARS, AND MECHANICAL
SWAY CONTROLS; BICYCLE CARRIERS; BICYCLE

CARRIER ADAPTERS; TRAILER HITCH MOUN-
TED CARGO CARRIERS; LUGGAGE CARRIERS;
TRAILOR HITCH TABLES AND PLATFORMS;
TRUCK BED EXTENDERS; AND BUMPER STEPS,
IN CLASS 12 (U.S. CLS. 19, 21, 23, 31, 35 AND 44).

FIRST USE 1-0-2003; IN COMMERCE 1-0-2003.

SN 78-193,805, FILED 12-12-2002.

ANN LINNEHAN, EXAMINING ATTORNEY

Int. Cl.: 9

Prior U.S. Cls.: 21, 23, 26, 36, and 38

Reg. No. 2,893,903

United States Patent and Trademark Office

Registered Oct. 12, 2004

**TRADEMARK
PRINCIPAL REGISTER**

CAPCAST

EKK INC. (MICHIGAN CORPORATION)
100 N. POND DRIVE
SUITE A
WALLED LAKE, MI 48390

FIRST USE 1-1-1997; IN COMMERCE 1-1-1997.

SN 78-196,086, FILED 12-19-2002.

FOR: COMPUTER SOFTWARE FOR METAL
CASTING SIMULATION PURPOSES, IN CLASS 9
(U.S. CLS. 21, 23, 26, 36 AND 38).

MICHAEL BAIRD, EXAMINING ATTORNEY

Int. Cl.: 9

Prior U.S. Cls.: 21, 23, 26, 36, and 38

Reg. No. 2,893,904

United States Patent and Trademark Office

Registered Oct. 12, 2004

**TRADEMARK
PRINCIPAL REGISTER**

PRISMPRO

VIPS, INC. (MARYLAND CORPORATION)
ONE WEST PENNSYLVANIA AVENUE
TOWSON, MD 21204

USER AND INSTRUCTION MANUALS DISTRIBUTED THEREWITH, IN CLASS 9 (U.S. CLS. 21, 23, 26, 36 AND 38).

FOR: COMPUTER SOFTWARE FOR USE BY HEALTHCARE PAYERS FOR CARE MANAGEMENT PURPOSES WITH A PRIMARY FOCUS ON EARLY IDENTIFICATION AND STRATIFICATION OF HIGH-COST, HIGH-DISEASE GROUPS, AND

FIRST USE 6-29-2004; IN COMMERCE 6-29-2004.

SN 78-197,365, FILED 12-23-2002.

JENNIFER KRISP, EXAMINING ATTORNEY

Int. Cl.: 41

Prior U.S. Cls.: 100, 101, and 107

Reg. No. 2,893,905

United States Patent and Trademark Office

Registered Oct. 12, 2004

**SERVICE MARK
PRINCIPAL REGISTER**

UNFAILING RELIABILITY FROM PEOPLE YOU RELY ON.

SWAGELOK COMPANY (OHIO CORPORATION)
29500 SOLON ROAD
SOLON, OH 44139

FOR: ARRANGING AND CONDUCTING OF TRAINING WORKSHOPS FOR INDUSTRIAL VALVES, FILTERS, FITTINGS, COUPLINGS, HOSES, TUBES, GAUGES, LUBRICANTS, SEALANTS, FLUID LEAK DETECTORS, MANIFOLDS, REGULATORS, CYLINDERS, WELD SYSTEMS AND HAND TOOLS USED IN RESEARCH AND IN THE INSTRUMENTATION, PHARMACEUTICAL, OIL AND GAS, POWER GENERATION, CHEMICAL, PETROCHEMICAL, SANITARY AND SEMICONDUCTOR INDUSTRIES; TRAINING IN THE USE AND OPERATION OF INDUSTRIAL VALVES, FILTERS, FITTINGS, COUPLINGS, HOSES, TUBES, GAUGES, LUBRICANTS, SEALANTS, FLUID LEAK DETECTORS, MANIFOLDS, REGULATORS, CYLINDERS, WELD SYSTEMS AND HAND TOOLS USED IN RESEARCH AND IN THE INSTRUMENTATION, PHARMACEUTICAL, OIL AND GAS, POWER GENERATION, CHEMICAL, PETROCHEMICAL, SANITARY AND SEMICONDUCTOR INDUSTRIES; VIDEOTAPE PRODUCTION IN THE FIELD OF INDUSTRIAL VALVES, FILTERS, FITTINGS,

COUPLINGS, HOSES, TUBES, GAUGES, LUBRICANTS, SEALANTS, FLUID LEAK DETECTORS, MANIFOLDS, REGULATORS, CYLINDERS, WELD SYSTEMS AND HAND TOOLS USED IN RESEARCH AND IN THE INSTRUMENTATION, PHARMACEUTICAL, OIL AND GAS, POWER GENERATION, CHEMICAL, PETROCHEMICAL, SANITARY AND SEMICONDUCTOR INDUSTRIES; PUBLICATION OF TRAINING MANUALS AND TEXT BOOKS IN THE FIELD OF INDUSTRIAL VALVES, FILTERS, FITTINGS, COUPLINGS, HOSES, TUBES, GAUGES, LUBRICANTS, SEALANTS, FLUID LEAK DETECTORS, MANIFOLDS, REGULATORS, CYLINDERS, WELD SYSTEMS AND HAND TOOLS USED IN RESEARCH AND IN THE INSTRUMENTATION, PHARMACEUTICAL, OIL AND GAS, POWER GENERATION, CHEMICAL, PETROCHEMICAL, SANITARY AND SEMICONDUCTOR INDUSTRIES, IN CLASS 41 (U.S. CLS. 100, 101 AND 107).

FIRST USE 6-7-2004; IN COMMERCE 6-7-2004.

SN 78-197,954, FILED 12-26-2002.

BRETT J. GOLDEN, EXAMINING ATTORNEY

Int. Cl.: 36

Prior U.S. Cls.: 100, 101, and 102

United States Patent and Trademark Office

Reg. No. 2,893,906

Registered Oct. 12, 2004

**SERVICE MARK
PRINCIPAL REGISTER**

ACCOUNT ASSURE

ALLIANCE DATA SYSTEMS CORPORATION
(DELAWARE CORPORATION)
17655 WATERVIEW PARKWAY
HOUSTON, TX 75252

FOR: FINANCIAL SERVICES IN THE FIELD OF
DEBT CANCELLATION AND DEBT SUSPENSION;
ELECTRONIC CREDIT CARD TRANSACTIONS;
CONSUMER CREDIT CARD SERVICES , IN CLASS
36 (U.S. CLS. 100, 101 AND 102).

FIRST USE 9-2-2003; IN COMMERCE 9-2-2003.

NO CLAIM IS MADE TO THE EXCLUSIVE
RIGHT TO USE "ACCOUNT", APART FROM THE
MARK AS SHOWN.

SN 78-203,097, FILED 1-14-2003.

KARLA PERKINS, EXAMINING ATTORNEY

Int. Cl.: 41

Prior U.S. Cls.: 100, 101, and 107

United States Patent and Trademark Office

Reg. No. 2,893,907

Registered Oct. 12, 2004

**SERVICE MARK
PRINCIPAL REGISTER**

4X MADE EASY

GLOBALTEC SOLUTIONS, LLP (PARTNERSHIP)
5010 ADDISON CIRCLE
ADDISON, TX 75001

FOR: EDUCATIONAL SERVICES, NAMELY,
CONDUCTING CLASSES AND SEMINARS IN THE
FIELD OF INVESTMENTS, AND DISTRIBUTING
COURSE MATERIALS, NAMELY, WORKBOOKS,
VIDEOTAPES, AND DIGITAL VIDEO DISCS, IN
CONNECTION THEREWITH, IN CLASS 41 (U.S.
CLS. 100, 101 AND 107).

FIRST USE 10-0-2002; IN COMMERCE 10-0-2002.

NO CLAIM IS MADE TO THE EXCLUSIVE
RIGHT TO USE "FOREX", APART FROM THE
MARK AS SHOWN.

SN 78-204,689, FILED 1-17-2003.

CIMMERIAN COLEMAN, EXAMINING ATTOR-
NEY

Int. Cl.: 1

Prior U.S. Cls.: 1, 5, 6, 10, 26, and 46

Reg. No. 2,893,908

United States Patent and Trademark Office

Registered Oct. 12, 2004

**TRADEMARK
PRINCIPAL REGISTER**

EXPO

LEBANON CHEMICAL CORPORATION (PENN-
SYLVANIA CORPORATION)
1600 EAST CUMBERLAND
LEBANON, PA 17042

FOR: INGREDIENTS, NAMELY, METHYLENE
UREA AND POTASSIUM SULFATE FOR FERTILI-
ZERS, AND FERTILIZERS ALL FOR HORTICUL-
TURAL USE AND FOR ORNAMENTAL DOMESTIC

AND COMMERCIAL USE, IN CLASS 1 (U.S. CLS. 1,
5, 6, 10, 26 AND 46).

FIRST USE 5-9-2001; IN COMMERCE 5-9-2001.

SN 78-205,897, FILED 1-22-2003.

ALICE BENMAMAN, EXAMINING ATTORNEY

Int. Cl.: 35

Prior U.S. Cls.: 100, 101, and 102

United States Patent and Trademark Office

Reg. No. 2,893,909

Registered Oct. 12, 2004

**SERVICE MARK
PRINCIPAL REGISTER**

AQUANTIVE

AQUANTIVE, INC. (WASHINGTON CORPORATION)
506 SECOND AVENUE, 9TH FLOOR
SEATTLE, WA 98104

FOR: ADVERTISING AGENCY SERVICES; BUSINESS AND ADVERTISING SERVICES, NAMELY, MEDIA PLANNING AND MEDIA BUYING FOR OTHERS AND CONDUCTING MARKETING RESEARCH AND ANALYSIS; DISSEMINATION OF ADVERTISING FOR OTHERS VIA AN ON-LINE ELECTRONIC COMMUNICATIONS NETWORK; MANAGING, TRACKING AND EVALUATING

MEDIA PLANNING, MEDIA BUYING AND THE SUCCESS OF MARKETING EFFORTS OF OTHERS; CONSULTING SERVICES IN THE FIELD OF ADVERTISING, IN CLASS 35 (U.S. CLS. 100, 101 AND 102).

FIRST USE 2-27-2003; IN COMMERCE 2-27-2003.

SN 78-206,323, FILED 1-23-2003.

THEODORE MCBRIDE, EXAMINING ATTORNEY

Int. Cl.: 35

Prior U.S. Cls.: 100, 101, and 102

United States Patent and Trademark Office

Reg. No. 2,893,910

Registered Oct. 12, 2004

SERVICE MARK
PRINCIPAL REGISTER



AMCOR SUNCLIPSE NORTH AMERICA (CALIFORNIA CORPORATION)
6600 VALLEY VIEW STREET
BUENA PARK, CA 90620

NO CLAIM IS MADE TO THE EXCLUSIVE RIGHT TO USE "ENGINEERED PACKAGING SOLUTIONS", APART FROM THE MARK AS SHOWN.

FOR: DISTRIBUTORSHIPS IN THE FIELD OF INDUSTRIAL PACKAGING AND EQUIPMENT, IN CLASS 35 (U.S. CLS. 100, 101 AND 102).

SN 78-207,066, FILED 1-24-2003.

FIRST USE 4-17-2003; IN COMMERCE 4-17-2003.

DAVID TAYLOR, EXAMINING ATTORNEY

Int. Cl.: 11

Prior U.S. Cls.: 13, 21, 23, 31, and 34

United States Patent and Trademark Office

Reg. No. 2,893,911

Registered Oct. 12, 2004

**TRADEMARK
PRINCIPAL REGISTER**

THE WILDERNESS

HUNTER FAN COMPANY (DELAWARE COR-
PORATION)
2500 FRISCO AVENUE
MEMPHIS, TN 38114

FIRST USE 4-30-2004; IN COMMERCE 4-30-2004.

SN 78-207,396, FILED 1-27-2003.

FOR: CEILING FANS AND ELECTRIC LIGHT-
ING FIXTURES, IN CLASS 11 (U.S. CLS. 13, 21, 23, 31
AND 34).

JOHN DWYER, EXAMINING ATTORNEY

Int. Cl.: 35

Prior U.S. Cls.: 100, 101, and 102

United States Patent and Trademark Office

Reg. No. 2,893,912

Registered Oct. 12, 2004

**SERVICE MARK
PRINCIPAL REGISTER**

ARTEMIS

MEDIA CONTACTS, S.A. (SPAIN CORPORATION)
AVENIDA GENERAL PERON, 38, PLANT 6
MADRID 28020, SPAIN

FOR: BUSINESS CONSULTING AND MARKETING STUDIES SERVICES, NAMELY, PROVIDING A COMPLETE ANALYSIS OF WEB SITE AND OFF-LINE DATA FOR BUSINESSES TO ASSESS THE EFFECTIVENESS OF WEB BASED ADVERTISING AND MARKETING INVESTMENTS, INCLUDING

ONLINE BANNER CAMPAIGNS, WEB SITE IMPROVEMENTS, AND DIRECT MAIL CAMPAIGNS, IN CLASS 35 (U.S. CLS. 100, 101 AND 102).

FIRST USE 9-12-2000; IN COMMERCE 9-12-2000.

SN 78-207,397, FILED 1-27-2003.

JOHN DWYER, EXAMINING ATTORNEY

Int. Cl.: 35

Prior U.S. Cls.: 100, 101, and 102

United States Patent and Trademark Office

Reg. No. 2,893,913

Registered Oct. 12, 2004

**SERVICE MARK
PRINCIPAL REGISTER**

LINKING FORECAST TO FUTURE

INFOMENTIS GROUP, LLC (GEORGIA LIMITED
LIABILITY COMPANY)
1750 FOUNDERS PARKWAY, SUITE 160
ALPHARETTA, GA 30004

FIRST USE 2-19-2003; IN COMMERCE 2-19-2003.

SN 78-207,422, FILED 1-27-2003.

FOR: BUSINESS CONSULTING SERVICES,
NAMELY, CONSULTING IN THE FIELDS OF
SALES AND SALES AND REVENUE FORECAST-
ING, IN CLASS 35 (U.S. CLS. 100, 101 AND 102).

CYNTHIA SLOAN, EXAMINING ATTORNEY

Int. Cl.: 9

Prior U.S. Cls.: 21, 23, 26, 36, and 38

United States Patent and Trademark Office

Reg. No. 2,893,914

Registered Oct. 12, 2004

**TRADEMARK
PRINCIPAL REGISTER**

MERLOT

DANA INNOVATIONS (CALIFORNIA COR-
PORATION)
212 AVENIDA FABRICANTE
SAN CLEMENTE, CA 92672

FIRST USE 5-1-2003; IN COMMERCE 5-1-2003.

SN 78-209,716, FILED 1-31-2003.

FOR: AUDIO PRODUCTS, NAMELY SPEAKERS,
IN CLASS 9 (U.S. CLS. 21, 23, 26, 36 AND 38).

PATRICIA EVANKO, EXAMINING ATTORNEY

Int. Cl.: 25

Prior U.S. Cls.: 22 and 39

United States Patent and Trademark Office

Reg. No. 2,893,915

Registered Oct. 12, 2004

**TRADEMARK
PRINCIPAL REGISTER**

ONE TRUE FIT

THE H. D. LEE COMPANY, INC. (DELAWARE
CORPORATION)
3411 SILVERSIDE RD
201 BAYNARD BLDG.
WILMINGTON, DE 19810

FOR: CLOTHING, NAMELY, NON-LEATHER
COATS, SHORTS, SHIRTS, BLAZERS, NON-LEA-

THE JACKET, SKIRTS, JEANS, AND PANTS, IN
CLASS 25 (U.S. CLS. 22 AND 39).

FIRST USE 6-6-2003; IN COMMERCE 6-6-2003.

SN 78-211,086, FILED 2-5-2003.

KAREN BRACEY, EXAMINING ATTORNEY

Int. Cl.: 16

Prior U.S. Cls.: 2, 5, 22, 23, 29, 37, 38, and 50

Reg. No. 2,893,916

United States Patent and Trademark Office

Registered Oct. 12, 2004

**TRADEMARK
PRINCIPAL REGISTER**

The PHARMACIST

GLOBAL MARQUEE MEDIA, INC. (PENNSYLVANIA CORPORATION)
1002 WHARTON CT.
NEWTOWN SQUARE, PA 19073

NO CLAIM IS MADE TO THE EXCLUSIVE RIGHT TO USE "PHARMACIST", APART FROM THE MARK AS SHOWN.

FOR: MAGAZINE FOR PHARMACISTS IN THE FIELD OF PHARMACY, IN CLASS 16 (U.S. CLS. 2, 5, 22, 23, 29, 37, 38 AND 50).

SN 78-211,701, FILED 2-6-2003.

FIRST USE 4-1-2003; IN COMMERCE 4-1-2003.

JOSETTE BEVERLY, EXAMINING ATTORNEY

Int. Cl.: 38

Prior U.S. Cls.: 100, 101, and 104

United States Patent and Trademark Office

Reg. No. 2,893,917

Registered Oct. 12, 2004

**SERVICE MARK
PRINCIPAL REGISTER**

TALK2MELIVE

HORNE, MARK J. (UNITED STATES INDIVIDUAL)
4810 N.E. 18TH TERRACE
FORT LAUDERDALE, FL 33308

FOR: TELECOMMUNICATION SERVICES ALLOWING THE USER TO MAKE A REAL TIME VOICE CALL THROUGH THE GLOBAL WORLD-

WIDE NETWORK TO ANY TELEPHONE, IN CLASS 38 (U.S. CLS. 100, 101 AND 104).

FIRST USE 7-1-2003; IN COMMERCE 7-1-2003.

SN 78-212,768, FILED 2-10-2003.

GINNY ISAACSON, EXAMINING ATTORNEY

Int. Cl.: 9

Prior U.S. Cls.: 21, 23, 26, 36, and 38

Reg. No. 2,893,920

United States Patent and Trademark Office

Registered Oct. 12, 2004

**TRADEMARK
PRINCIPAL REGISTER**

SYSTEMGLOBE

NIPPON DENKI KABUSHIKI KAISHA (JAPAN CORPORATION), DBA NEC CORPORATION, 7-1, SHIBA 5-CHOME MINATO-KU TOKYO, JAPAN

FOR: COMPUTER SOFTWARE FOR NETWORK MANAGEMENT; COMPUTER SOFTWARE FOR CONTROLLING, ADMINISTRATING AND MANAGING NETWORKS; NETWORK MANAGEMENT SOFTWARE FOR LOCAL AND GLOBAL COMPUTER NETWORKS AND FOR COMPUTER COMMUNICATION INFORMATION NETWORKS; COMPUTER SOFTWARE FOR COMPUTER AND COMMUNICATION MANAGEMENT AND CONTROL AND FOR PERIPHERAL COMPUTERS, EXTERNAL COMPUTERS AND COMMUNICATION DEVICES, APPARATUSES AND INSTALLATION LINKED WITH LOCAL AND GLOBAL COMMUNICATION INFORMATION NETWORKS; COMPUTER SOFTWARE FOR CONFIGURATION AND SYSTEM ADMINISTRATION OF DATA INFORMATION AND FOR VISUAL AND GRAPHIC REPRESENTATIONS AND CHARTS; COMPUTER SOFTWARE FOR USE IN CERTIFICATING PERSONAL INFORMATION FOR SECURITY AND SUPERVISING LOCAL AND GLOBAL COMPUTER AND COMMUNICATION INFORMATION NETWORKS; COMPUTER SOFTWARE FOR USE IN MANAGING, CONTROLLING AND MONITORING ELECTRONIC COMPUTERS AND COMPUTER PERIPHERALS INTERCONNECTED WITH LOCAL AND GLOBAL COMPUTER INFORMATION NETWORKS, FOR USE IN TRANSFERRING, DISSEMINATING AND RECOVERING OTHER COMPUTER SOFTWARE AND DATA INFORMATION ON LOCAL AND GLOBAL COMPUTER INFORMATION NETWORKS AND FOR USE IN CREATING GRAPHIC CHART BY UTILIZING DATA INFORMATION ON LOCAL AND GLOBAL COMPUTER INFORMATION NETWORKS; COMPUTER SOFTWARE FOR BUSINESS MANAGEMENT; COMPUTER SOFTWARE FOR DEVELOPING COMPUTER PROGRAMS; COMPUTER SOFTWARE FOR FACILITATING MANUFACTURE AND PRODUCTION OF

COMPUTER HARDWARE AND COMPUTER SOFTWARE; COMPUTER SOFTWARE FOR PRODUCTION PROCESS; COMPUTER SOFTWARE FOR SALES MANAGEMENT; COMPUTER SOFTWARE FOR CUSTOMER RELATIONSHIP MANAGEMENT; COMPUTER SOFTWARE FOR DATABASE MANAGEMENT; COMPUTER SOFTWARE FOR ORDER MANAGEMENT; COMPUTER SOFTWARE FOR USE IN BUSINESS WORKFLOW AUTOMATION; COMPUTER SOFTWARE FOR FINANCIAL MANAGEMENT; COMPUTER SOFTWARE FOR VIDEO GAMES; COMPUTER SOFTWARE FOR WORD PROCESSING; COMPUTER SOFTWARE FOR SPREAD SHEETS; COMPUTER SOFTWARE FOR SCHEDULE MANAGEMENT; COMPUTER SOFTWARE FOR E-MAIL; COMPUTER SOFTWARE FOR INTERNET ACCESS AND NAVIGATION; COMPUTER SOFTWARE FOR COMPILER PROGRAMS, DEBUGGER PROGRAMS AND UTILITY PROGRAMS FOR CREATING GRAPHICAL APPLICATIONS; COMPUTER SOFTWARE FOR WIRELESS COMMUNICATIONS; COMPUTER OPERATING SYSTEM SOFTWARE; COMPUTER SOFTWARE FOR ELECTRONIC PAGING; COMPUTER SOFTWARE FOR PROVIDING ELECTRONIC BULLETIN BOARDS AND INFORMATION SERVICES; COMPUTER SOFTWARE FOR BROWSING CONTENT ON GLOBAL COMPUTER NETWORKS; COMPUTER SOFTWARE USED FOR DOCUMENT MANAGEMENT; COMPUTER SOFTWARE FOR DESIGNING AND AUTHORIZING WEB PAGES; COMPUTER SOFTWARE FOR COMMERCIAL INTERACTION IN THE FIELD OF GLOBAL COMPUTER NETWORKS; OPERATING SYSTEM SOFTWARE AND APPLICATIONS SOFTWARE FOR RESOURCE ALLOCATION; COMPUTER SOFTWARE FOR COMMUNICATION MANAGEMENT; COMPUTER ALGORITHM SOFTWARE PROGRAMS FOR THE OPERATING AND CONTROL OF COMPUTERS; COMPUTER SOFTWARE FOR THE MANIPULATION OF DATA; COMPUTER SOFTWARE FOR ACCESSING AND USING A GLOBAL COMPUTER NETWORK; COMPUTER SOFTWARE FOR PROCESSING ONLINE ORDERS

PLACED TO ONLINE RETAIL ELECTRONIC COMMERCE WEB SITES; COMPUTER SOFTWARE FOR DEVELOPMENT TOOLS COMPUTER SOFTWARE FOR VOICE RECOGNITION; COMPUTER SOFTWARE FOR CREATING DOCUMENTS; SOFTWARE FOR USE IN OPERATING AND MAINTAINING COMPUTER SYSTEMS; COMPUTER ALGORITHM SOFTWARE FOR THE OPERATING AND CONTROL OF COMPUTERS; COMPUTER SOFTWARE FOR USE IN GENERATING STREAMING ADVERTISEMENTS ON THE WEB SITES OF OTHERS; COMPUTER SEARCH ENGINE SOFTWARE; COMPUTER SOFTWARE TO AUTOMATE DATA WAREHOUSING; COMPUTER SOFTWARE TO CONTROL AND IMPROVE COMPUTER PROCESSING SPEED; COMPUTER PROGRAMS FOR USE IN MANAGING PRODUCT DEVELOPMENT AND FOR MODELING AND ORGANIZING BUSINESS, ENGINEERING, AND MANUFACTURING PROJECTS; COMPUTER SOFTWARE FOR USE IN FINANCIAL MANAGEMENT; COMPUTER SOFTWARE FOR USE IN ACCOUNTING; COMPUTER SOFTWARE FOR USE IN PERSONNEL MANAGEMENT; COMPUTER SOFTWARE FOR USE IN PAYROLL; MIDDLEWARE FOR SUPPORTING APPLICATION SYSTEM CONSTRUCTION FOR USE IN DESIGNING AND DEVELOPING COMPUTER HARDWARE AND COMPUTER SOFTWARE PROGRAMS FOR OTHERS AND FOR USE IN DESIGNING AND DEVELOPING COMPUTER NETWORKS FOR OTHERS; COMPUTER SOFTWARE FOR USE IN DESIGNING AND DEVELOPING COMPUTER APPLICATION PROGRAMS FOR OTHERS; COMPUTER SOFTWARE FOR USE IN MANAGING AND CONTROLLING PRODUCTION SCHEDULE, SHIPPING SCHEDULE, PURCHASE OF MATERIALS, INVENTORIES AND ACCOUNTS; COMPUTER SOFTWARE FOR USE IN SEARCHING, RETRIEVING, CONFIGURATING, EDITING AND FORMATTING DATA INFORMATION STORED IN COMPUTER SERVERS AND COMPUTER PERIPHERALS INTERCONNECTED WITH LOCAL AND GLOBAL COMPUTER INFORMATION NETWORKS AND FOR USE IN PROVIDING USERS/CLIENTS WITH THE EDITED DATA INFORMATION VIA THE AFORESAID NETWORKS; COMPUTER SOFTWARE FOR ASSISTING DEVELOPERS IN CREATING PROGRAMS CODE FOR USE IN MULTIPLE APPLICATION PROGRAM; COMPUTER SOFTWARE FOR RUNNING DEVELOPMENT PROGRAMS AND APPLICATION PROGRAMS IN A COMMON DEVELOPMENT ENVIRONMENT; COMPUTER SOFTWARE FOR CONTROLLING THE DISPLAY OF TELEVISION PROGRAMS, OTHER DATA AND CONTENT DELIVERED OVER LOCAL AND GLOBAL COMPUTER INFORMATION NETWORKS; COMPUTER SOFTWARE FOR MANAGING COMMUNICATIONS AND DATA EXCHANGE BETWEEN HANDHELD COMPUTERS AND DESKTOP COMPUTERS; MAPPING SOFTWARE FOR USE IN AUTOMOBILES; COMPUTER SOFTWARE FOR SENDING AND RECEIVING TELEVISION AND GLOBAL COMMUNICATION NETWORK TRANSMISSIONS; COMPUTER SOFTWARE

DEVELOPED TO PROVIDE AUDIO, VIDEO AND MULTIMEDIA PROGRAMS SUCH AS MATERIAL FROM THE INTERNET; COMPUTER SOFTWARE FOR TRANSMISSION OF AUDIO DATA VIA TELEPHONE TRANSMISSION OR OTHER INTERACTIVE COMMUNICATION BETWEEN TWO REMOTE LOCATIONS; COMPUTER SOFTWARE FOR ALLOWING THE TRANSMISSION OF VARIOUS TYPES OF DATA AND ALSO FOR THE SIMULTANEOUS EDITING AND TRANSMISSION INFORMATION; COMPUTER SOFTWARE FOR LOCATING, RETRIEVING, AND RECEIVING TEXT, ELECTRONIC DOCUMENTS, GRAPHICS, AND AUDIOVISUAL INFORMATION ENTERPRISE-WIDE INTERNAL COMPUTER NETWORKS AND LOCAL, WIDE-AREA, AND GLOBAL COMPUTER NETWORKS; COMPUTER SOFTWARE FOR RECORDING, PROCESSING, RECEIVING, REPRODUCING, TRANSMITTING, MODIFYING, COMPRESSING, DECOMPRESSING, BROADCASTING, MERGING AND/OR ENHANCING SOUND, VIDEO IMAGES, GRAPHICS AND DATA, COMPUTER PERIPHERALS AND TERMINALS; COMPUTER SOFTWARE FOR USE IN MANAGING, CONTROLLING AND MONITORING ELECTRONIC COMPUTERS, COMPUTER HARDWARE AND COMPUTER PERIPHERALS OVER THE LOCAL AND GLOBAL COMPUTER INFORMATION NETWORKS, FOR USE IN SEARCHING, RETRIEVING AND ACCESSING TO DATA INFORMATION STORED IN ELECTRONIC COMPUTERS, COMPUTER HARDWARE AND COMPUTER PERIPHERALS INTERCONNECTED WITH THE LOCAL AND GLOBAL COMPUTER INFORMATION NETWORKS, FOR USE IN SECURELY TRANSFERRING DATA AND INFORMATION BETWEEN COMPUTER HARDWARE, AND FOR USE IN RECOVERING ELECTRONIC COMPUTERS, COMPUTER HARDWARE AND COMPUTER PERIPHERALS INTERCONNECTED WITH THE LOCAL AND GLOBAL COMPUTER INFORMATION NETWORKS; COMPUTER SOFTWARE FOR USE IN MANAGING AND CONTROLLING USERS' ACCESS TO THE DATABASE ON GLOBAL AND LOCAL COMPUTER INFORMATION NETWORKS; COMPUTER SOFTWARE FOR USE IN COMPUTER NETWORK MANAGEMENT FOR THE PURPOSE OF PROTECTING VARIOUS INFORMATION ON GLOBAL AND LOCAL COMPUTER INFORMATION NETWORKS FROM UNAUTHORIZED USERS' ACCESS; COMPUTER SOFTWARE FOR USE IN CREATING AND EDITING SECURITY INFORMATION; COMPUTER SOFTWARE FOR USE IN ESTABLISHING USERS' PASSWORDS; COMPUTER SOFTWARE FOR USE IN MONITORING USERS' ACCESS AND COLLECTING AND MAINTAINING INFORMATION ON USERS' ACCESS, IN CLASS 9 (U.S. CLS. 21, 23, 26, 36 AND 38).

FIRST USE 2-4-2004; IN COMMERCE 2-4-2004.

SN 78-216,837, FILED 2-20-2003.

JENNIFER KRISP, EXAMINING ATTORNEY

Int. Cl.: 24

Prior U.S. Cls.: 42 and 50

United States Patent and Trademark Office

Reg. No. 2,893,921

Registered Oct. 12, 2004

**TRADEMARK
PRINCIPAL REGISTER**

QUAKER ULTRA

QUAKER FABRIC CORPORATION OF FALL
RIVER (MASSACHUSETTS CORPORATION)
941 GRINNELL STREET
FALL RIVER, MA 02721

FOR: UPHOLSTERY FABRICS, IN CLASS 24 (U.S.
CLS. 42 AND 50).

FIRST USE 6-14-2004; IN COMMERCE 6-14-2004.

OWNER OF U.S. REG. NOS. 2,312,967 AND
2,400,428.

SN 78-218,141, FILED 2-24-2003.

ALICE SUE CARRUTHERS, EXAMINING ATTOR-
NEY

Int. Cl.: 21

Prior U.S. Cls.: 2, 13, 23, 29, 30, 33, 40, and 50

Reg. No. 2,893,922

United States Patent and Trademark Office

Registered Oct. 12, 2004

**TRADEMARK
PRINCIPAL REGISTER**

CASTALON

MEGAWARE INC., OF CALIFORNIA (DELA-
WARE CORPORATION)
3903 CALLE TECATE
CAMARILLO, CA 93012

ROASTER PANS, IN CLASS 21 (U.S. CLS. 2, 13, 23, 29,
30, 33, 40 AND 50).

FIRST USE 1-1-2004; IN COMMERCE 3-24-2004.

FOR: ALUMINUM COOKWARE, NAMELY, POTS
AND PANS, SAUCE PANS, DUTCH OVENS, FRY
PANS, WOK PANS, STOCK POTS, PASTA POTS AND

SN 78-221,377, FILED 3-4-2003.

KIMBERLY PERRY, EXAMINING ATTORNEY

Int. Cl.: 22

Prior U.S. Cls.: 1, 2, 7, 19, 22, 42, and 50

Reg. No. 2,893,923

United States Patent and Trademark Office

Registered Oct. 12, 2004

**TRADEMARK
PRINCIPAL REGISTER**

PERMASTRAND

MOHAWK BRANDS, INC. (DELAWARE COR-
PORATION)
300 DELAWARE AVE. SUITE 900
WILMINGTON, DE 19801

FIRST USE 9-5-2003; IN COMMERCE 9-5-2003.

SN 78-229,420, FILED 3-25-2003.

FOR: POLYPROPYLENE FIBER SOLD AS A
COMPONENT OF CARPET, IN CLASS 22 (U.S. CLS.
1, 2, 7, 19, 22, 42 AND 50).

DAVID TAYLOR, EXAMINING ATTORNEY

Int. Cl.: 10

Prior U.S. Cls.: 26, 39, and 44

United States Patent and Trademark Office

Reg. No. 2,893,924

Registered Oct. 12, 2004

**TRADEMARK
PRINCIPAL REGISTER**

NEUROFORM²

SCIMED LIFE SYSTEMS, INC. (MINNESOTA
CORPORATION)
ONE SCIMED PLACE
MAPLE GROVE, MN 55311

FIRST USE 7-0-2003; IN COMMERCE 7-0-2003.

SN 78-231,344, FILED 3-28-2003.

FOR: MEDICAL STENTS FOR NEUROVASCULAR APPLICATIONS, IN CLASS 10 (U.S. CLS. 26, 39 AND 44).

LINDA M. KING, EXAMINING ATTORNEY

Int. Cl.: 28

Prior U.S. Cls.: 22, 23, 38, and 50

United States Patent and Trademark Office

Reg. No. 2,893,926

Registered Oct. 12, 2004

**TRADEMARK
PRINCIPAL REGISTER**

BLACK BART LURES

BLACK BART INTERNATIONAL, LLC (FLORI-
DA LTD LIAB CO)
2300 E. MARKET STREET
AKRON, OH 44312

NO CLAIM IS MADE TO THE EXCLUSIVE
RIGHT TO USE "LURES", APART FROM THE
MARK AS SHOWN.

FOR: FISHING TACKLE, IN CLASS 28 (U.S. CLS.
22, 23, 38 AND 50).

SN 78-242,957, FILED 4-28-2003.

FIRST USE 10-1-2002; IN COMMERCE 10-1-2002.

HEATHER THOMPSON, EXAMINING ATTORNEY

Int. Cl.: 9

Prior U.S. Cls.: 21, 23, 26, 36, and 38

United States Patent and Trademark Office

Reg. No. 2,893,927

Registered Oct. 12, 2004

**TRADEMARK
PRINCIPAL REGISTER**

MOODY'S MORTGAGE METRICS

MIS QUALITY MANAGEMENT CORP. (DELA-
WARE CORPORATION)
501 SILVERSIDE ROAD; SUITE 20
WILMINGTON, DE 19809

FOR: SOFTWARE TO ASSESS AND RATE THE
PERFORMANCE OF LOANS AND LOAN-RELA-
TED TRANSACTIONS, IN CLASS 9 (U.S. CLS. 21,
23, 26, 36 AND 38).

FIRST USE 4-2-2003; IN COMMERCE 4-2-2003.

OWNER OF U.S. REG. NOS. 871,342 AND 871,497.

NO CLAIM IS MADE TO THE EXCLUSIVE
RIGHT TO USE "MORTGAGE", APART FROM
THE MARK AS SHOWN.

SN 78-247,742, FILED 5-9-2003.

JOHN KELLY, EXAMINING ATTORNEY

Int. Cl.: 9

Prior U.S. Cls.: 21, 23, 26, 36, and 38

United States Patent and Trademark Office

Reg. No. 2,893,928

Registered Oct. 12, 2004

**TRADEMARK
PRINCIPAL REGISTER**

PETAL

MARCOLIN U.S.A., INC. (DELAWARE COR-
PORATION)
1407 CORAL WAY
MIAMI, FL 33145

FIRST USE 7-11-2003; IN COMMERCE 7-11-2003.

SN 78-255,183, FILED 5-28-2003.

FOR: EYEGLASSES AND FRAMES, IN CLASS 9
(U.S. CLS. 21, 23, 26, 36 AND 38).

KIMBERLY PERRY, EXAMINING ATTORNEY

Int. Cl.: 36

Prior U.S. Cls.: 100, 101, and 102

United States Patent and Trademark Office

Reg. No. 2,893,929

Registered Oct. 12, 2004

**SERVICE MARK
PRINCIPAL REGISTER**

PREMIER XR ANNUITY

METROPOLITAN LIFE INSURANCE COMPANY
(NEW YORK CORPORATION)
200 PARK AVENUE
NEW YORK, NY 10166

NO CLAIM IS MADE TO THE EXCLUSIVE
RIGHT TO USE "ANNUITY", APART FROM THE
MARK AS SHOWN.

FOR: FINANCIAL AND INVESTMENT SERVI-
CES, NAMELY OFFERING, ADMINISTRATING
AND UNDERWRITING ANNUITY PLANS, IN
CLASS 36 (U.S. CLS. 100, 101 AND 102).

SN 78-260,424, FILED 6-10-2003.

FIRST USE 6-1-2003; IN COMMERCE 6-1-2003.

PATRICIA EVANKO, EXAMINING ATTORNEY

Int. Cl.: 36

Prior U.S. Cls.: 100, 101, and 102

Reg. No. 2,893,930

United States Patent and Trademark Office

Registered Oct. 12, 2004

SERVICE MARK
PRINCIPAL REGISTER



MONSANTO EMPLOYEES CREDIT UNION
(FLORIDA CORPORATION)
220 EAST NINE MILE ROAD
PENSACOLA, FL 32534

NO CLAIM IS MADE TO THE EXCLUSIVE
RIGHT TO USE "FEDERAL CREDIT UNION",
APART FROM THE MARK AS SHOWN.

FOR: CREDIT UNION SERVICES, IN CLASS 36
(U.S. CLS. 100, 101 AND 102).

SN 78-268,676, FILED 6-30-2003.

FIRST USE 5-13-2004; IN COMMERCE 5-13-2004.

DAVID TAYLOR, EXAMINING ATTORNEY

Int. Cl.: 41

Prior U.S. Cls.: 100, 101, and 107

United States Patent and Trademark Office

Reg. No. 2,893,933

Registered Oct. 12, 2004

**SERVICE MARK
PRINCIPAL REGISTER**

NORTHSTAR CASH

MINNESOTA STATE LOTTERY AGENCY (MIN-
NESOTA STATE AGENCY)
2645 LONG LAKE ROAD
ROSEVILLE, MN 55113

NO CLAIM IS MADE TO THE EXCLUSIVE
RIGHT TO USE "CASH", APART FROM THE MARK
AS SHOWN.

FOR: LOTTERY SERVICES, IN CLASS 41 (U.S.
CLS. 100, 101 AND 107).

SN 78-284,092, FILED 8-6-2003.

FIRST USE 10-7-2003; IN COMMERCE 10-7-2003.

FLORENTINA BLANDU, EXAMINING ATTORNEY

Int. Cl.: 35

Prior U.S. Cls.: 100, 101, and 102

United States Patent and Trademark Office

Reg. No. 2,893,934

Registered Oct. 12, 2004

**SERVICE MARK
SUPPLEMENTAL REGISTER**

INITIAL ETICKET OFFERING

GLOBAL ETICKET EXCHANGE LTD. (DELA-
WARE CORPORATION)
344 MAPLE AVENUE WEST
PMB 249
VIENNA, VA 22180

FOR: TICKET AGENCY SERVICES IN THE
FIELD OF SPORTING EVENTS, MUSICAL CON-
CERTS, THEATER AND OTHER ENTERTAIN-
MENT EVENTS; BUSINESS INFORMATION
SERVICES, FEATURING THE GATHERING, ANA-
LYZING AND PROVISION OF BIDDING, PUR-

CHASING AND SPENDING HABIT
INFORMATION OF TICKET PATRONS, MARKET-
ING AND DEMOGRAPHIC DATA TO OTHERS, IN
CLASS 35 (U.S. CLS. 100, 101 AND 102).

FIRST USE 6-29-2001; IN COMMERCE 6-29-2001.

SER. NO. 76-003,991, FILED P.R. 3-20-2000; AM. S.R.
8-31-2001.

ROBERT LORENZO, EXAMINING ATTORNEY

Int. Cl.: 9

Prior U.S. Cls.: 21, 23, 26, 36, and 38

United States Patent and Trademark Office

Reg. No. 2,893,937

Registered Oct. 12, 2004

**TRADEMARK
SUPPLEMENTAL REGISTER**

UP.TIME

1448280 ONTARIO INC. (CANADA CORPORATION)
1879 ORR ROAD
MISSISSAUGA, ONTARIO, CANADA L5J 3Z9

PRIORITY CLAIMED UNDER SEC. 44(D) ON
CANADA APPLICATION NO. 1081600, FILED 11-6-
2000, REG. NO. TMA611422, EXPIRES 5-28-2019.

FOR: COMPUTER SOFTWARE FOR MONITOR-
ING ONGOING COMPUTER PERFORMANCE AND
SERVER CAPACITY, IN CLASS 9 (U.S. CLS. 21, 23, 26,
36 AND 38).

SER. NO. 76-189,846, FILED P.R. 1-5-2001; AM. S.R.
10-10-2002.

FIRST USE 10-15-1999; IN COMMERCE 10-23-2001.

STEPHANIE DAVIS, EXAMINING ATTORNEY

Int. Cl.: 35

Prior U.S. Cls.: 100, 101, and 102

United States Patent and Trademark Office

Reg. No. 2,893,939

Registered Oct. 12, 2004

**SERVICE MARK
SUPPLEMENTAL REGISTER**

RECRUITMENT COUNSEL

KOWALSKI & ASSOCIATES, INC. (NEW YORK
CORPORATION)
885 THIRD AVENUE
NEW YORK, NY 10022

FIRST USE 6-0-2000; IN COMMERCE 6-0-2000.

SER. NO. 76-233,382, FILED P.R. 3-30-2001; AM. S.R.
4-7-2003.

FOR: LEGAL EMPLOYMENT RECRUITMENT
AND PLACEMENT SERVICES, IN CLASS 35 (U.S.
CLS. 100, 101 AND 102).

RUSS HERMAN, EXAMINING ATTORNEY

Int. Cl.: 35

Prior U.S. Cls.: 100, 101, and 102

United States Patent and Trademark Office

Reg. No. 2,893,941

Registered Oct. 12, 2004

**SERVICE MARK
SUPPLEMENTAL REGISTER**

EBLUEPRINT

LAKESIDE BLUEPRINT, INC. (OHIO CORPORATION)
4507 LORAIN AVENUE
CLEVELAND, OH 44102

FOR: PROVIDING INFORMATION, VIA A GLOBAL COMPUTER NETWORK, RELATING TO COPYING SERVICES, PRINTING SUPPLY SALES

AND PRINTER SALES, IN CLASS 35 (U.S. CLS. 100, 101 AND 102).

FIRST USE 3-1-2001; IN COMMERCE 3-1-2001.

SER. NO. 76-287,368, FILED P.R. 7-19-2001; AM. S.R. 3-27-2002.

WILLIAM VERHOSEK, EXAMINING ATTORNEY

Int. Cl.: 41

Prior U.S. Cls.: 100, 101, and 107

United States Patent and Trademark Office

Reg. No. 2,893,944

Registered Oct. 12, 2004

**SERVICE MARK
SUPPLEMENTAL REGISTER**

SMARTOPS

EMERSON PROCESS MANAGEMENT POWER &
WATER SOLUTIONS, INC. (DELAWARE COR-
PORATION)
200 BETA DRIVE
PITTSBURGH, PA 15238

FIRST USE 8-14-2001; IN COMMERCE 8-14-2001.

SER. NO. 76-330,920, FILED P.R. 10-29-2001; AM.
S.R. 7-29-2002.

FOR: TRAINING IN THE USE OF SYSTEMS AND
EQUIPMENT FOR CONTROLLING INDUSTRIAL
PROCESSES, IN CLASS 41 (U.S. CLS. 100, 101 AND
107).

STEPHANIE DAVIS, EXAMINING ATTORNEY

Int. Cl.: 35

Prior U.S. Cls.: 100, 101, and 102

United States Patent and Trademark Office

Reg. No. 2,893,945

Registered Oct. 12, 2004

**SERVICE MARK
SUPPLEMENTAL REGISTER**

DROP SHIP SOURCE DIRCTORY

WORLDWIDE BRANDS, INC. (FLORIDA COR-
PORATION)
16603 BAY CLUB DRIVE
CLERMONT, FL 34711

FOR: ON-LINE DIRECTORY FEATURING IN-
FORMATION ON WHOLESALE COMPANIES AND
THEIR PRODUCTS, IN CLASS 35 (U.S. CLS. 100, 101
AND 102).

FIRST USE 10-8-2000; IN COMMERCE 10-8-2000.

NO CLAIM IS MADE TO THE EXCLUSIVE
RIGHT TO USE "SOURCE DIRECTORY", APART
FROM THE MARK AS SHOWN.

SER. NO. 76-401,523, FILED P.R. 4-29-2002; AM. S.R.
1-6-2004.

SHAUNIA WALLACE, EXAMINING ATTORNEY

Int. Cl.: 31

Prior U.S. Cls.: 1 and 46

United States Patent and Trademark Office

Reg. No. 2,893,946

Registered Oct. 12, 2004

**TRADEMARK
SUPPLEMENTAL REGISTER**

TURF SCIENCE GENETICS

ALLIED SEED, L.L.C. (IDAHO LTD LIAB CO)
9311 HIGHWAY 45
NAMPA, ID 83686

FIRST USE 7-28-2003; IN COMMERCE 7-28-2003.

SER. NO. 76-441,585, FILED P.R. 8-14-2002; AM. S.R.
7-17-2004.

FOR: SEEDS FOR NON ARTIFICIAL PURPOSES,
NAMELY NON ARTIFICIAL TURF AND GRASS
SEEDS, IN CLASS 31 (U.S. CLS. 1 AND 46).

DAWN FELDMAN, EXAMINING ATTORNEY

Int. Cl.: 36

Prior U.S. Cls.: 100, 101, and 102

United States Patent and Trademark Office

Reg. No. 2,893,947

Registered Oct. 12, 2004

**SERVICE MARK
SUPPLEMENTAL REGISTER**

GMPA SCORE

LAZERSON, JEFFREY M. (UNITED STATES IN-
DIVIDUAL)
23681 BIRTCHEER, SUITE 2
LAKE FOREST, CA 92630

FIRST USE 6-12-2004; IN COMMERCE 6-12-2004.

SER. NO. 76-464,000, FILED P.R. 11-4-2002; AM. S.R.
6-17-2004.

FOR: MORTGAGE CREDIT EVALUATION SER-
VICES, IN CLASS 36 (U.S. CLS. 100, 101 AND 102).

BRIAN NEVILLE, EXAMINING ATTORNEY

Int. Cl.: 42

Prior U.S. Cls.: 100 and 101

United States Patent and Trademark Office

Reg. No. 2,893,949

Registered Oct. 12, 2004

**SERVICE MARK
SUPPLEMENTAL REGISTER**

NEW ENGLAND EQUESTRIAN CENTER

NEW ENGLAND EQUESTRIAN LAND MAN-
AGEMENT CONSERVATION CORPORATION
(MASSACHUSETTS CORPORATION)
991 BEARSDEN RD.
ATHOL, MA 013313451

FOR: LAND CONSERVATION SERVICES, NAME-
LY, PRESERVATION OF RIDING TRAILS AND
OPEN SPACE FOR USE IN EQUINE ACTIVITIES,
IN CLASS 42 (U.S. CLS. 100 AND 101).

FIRST USE 2-0-2001; IN COMMERCE 5-21-2001.

NO CLAIM IS MADE TO THE EXCLUSIVE
RIGHT TO USE "EQUESTRIAN CENTER", APART
FROM THE MARK AS SHOWN.

SER. NO. 76-471,055, FILED P.R. 12-2-2002; AM. S.R.
7-26-2004.

STEVEN R. FINE, EXAMINING ATTORNEY

Int. Cl.: 16

Prior U.S. Cls.: 2, 5, 22, 23, 29, 37, 38, and 50

United States Patent and Trademark Office

Reg. No. 2,893,950

Registered Oct. 12, 2004

**TRADEMARK
SUPPLEMENTAL REGISTER**

TRAINING & BEHAVIOR

BOWTIE, INC. (CALIFORNIA CORPORATION)
2401 BEVERLY BOULEVARD
LOS ANGELES, CA 90057

EST, IN CLASS 16 (U.S. CLS. 2, 5, 22, 23, 29, 37, 38 AND 50).

FIRST USE 5-29-2000; IN COMMERCE 5-29-2000.

FOR: PRINTED PUBLICATIONS, NAMELY, MAGAZINES, JOURNALS, BOOKS, NEWLETTERS AND PERIODICALS, ALL IN THE FIELD OF ANIMALS, CANINE SPECIES AND GENERAL INTER-

SER. NO. 76-473,351, FILED P.R. 12-2-2002; AM. S.R. 7-9-2004.

EDWARD NELSON, EXAMINING ATTORNEY

Int. Cl.: 16

Prior U.S. Cls.: 2, 5, 22, 23, 29, 37, 38, and 50

United States Patent and Trademark Office

Reg. No. 2,893,951

Registered Oct. 12, 2004

**TRADEMARK
SUPPLEMENTAL REGISTER**

TRAINING FOR OBEDIENCE

BOWTIE, INC. (CALIFORNIA CORPORATION)
2401 BEVERLY BOULEVARD
LOS ANGELES, CA 90057

EST. IN CLASS 16 (U.S. CLS. 2, 5, 22, 23, 29, 37, 38 AND 50).

FIRST USE 6-25-2002; IN COMMERCE 6-25-2002.

FOR: PRINTED PUBLICATIONS, NAMELY, MAGAZINES, JOURNALS, BOOKS, NEWLETTERS AND PERIODICALS, ALL IN THE FIELD OF ANIMALS, CANINE SPECIES AND GENERAL INTER-

SER. NO. 76-473,352, FILED P.R. 12-2-2002; AM. S.R. 7-9-2004.

EDWARD NELSON, EXAMINING ATTORNEY

Int. Cl.: 16

Prior U.S. Cls.: 2, 5, 22, 23, 29, 37, 38, and 50

United States Patent and Trademark Office

Reg. No. 2,893,952

Registered Oct. 12, 2004

**TRADEMARK
SUPPLEMENTAL REGISTER**

TRAINING YOUR PUPPY

BOWTIE, INC. (CALIFORNIA CORPORATION)
2401 BEVERLY BOULEVARD
LOS ANGELES, CA 90057

EST, IN CLASS 16 (U.S. CLS. 2, 5, 22, 23, 29, 37, 38 AND 50).

FIRST USE 6-5-2001; IN COMMERCE 6-5-2001.

FOR: PRINTED PUBLICATIONS, NAMELY, MAGAZINES, JOURNALS, BOOKS, NEWLETTERS AND PERIODICALS, ALL IN THE FIELD OF ANIMALS, CANINE SPECIES AND GENERAL INTER-

SER. NO. 76-473,355, FILED P.R. 12-2-2002; AM. S.R. 7-9-2004.

EDWARD NELSON, EXAMINING ATTORNEY

Int. Cl.: 35

Prior U.S. Cls.: 100, 101, and 102

United States Patent and Trademark Office

Reg. No. 2,893,953

Registered Oct. 12, 2004

**SERVICE MARK
SUPPLEMENTAL REGISTER**

POA COUNTRY STORE

PONY OF THE AMERICAS CLUB, INC. (IOWA
NON-PROFIT CORPORATION)
5240 ELMWOOD AVE.
INDIANAPOLIS, IN 46203

FOR: MAIL ORDER SERVICES FEATURING
CLOTHING, JEWELRY, PICTURE PRINTS, HATS,
VIDEOS, BOOKS, POSTERS AND PACKS, IN CLASS
35 (U.S. CLS. 100, 101 AND 102).

FIRST USE 9-1-2002; IN COMMERCE 9-1-2002.

NO CLAIM IS MADE TO THE EXCLUSIVE
RIGHT TO USE "STORE", APART FROM THE
MARK AS SHOWN.

SER. NO. 76-474,239, FILED P.R. 12-12-2002; AM.
S.R. 7-19-2004.

GEOFFREY FOSDICK, EXAMINING ATTORNEY

Int. Cl.: 41

Prior U.S. Cls.: 100, 101, and 107

United States Patent and Trademark Office

Reg. No. 2,893,954

Registered Oct. 12, 2004

**SERVICE MARK
SUPPLEMENTAL REGISTER**

AMERICAN SOCIETY OF PROFESSIONAL EDUCATION

AMERICAN SOCIETY OF PROFESSIONAL EDUCATION, INC. (NORTH CAROLINA CORPORATION)
1400 CRESCENT GREEN, SUITE 230
CARY, NC 27511

FOR: EDUCATIONAL SERVICES, NAMELY, CONDUCTING CLASSES AND SEMINARS IN THE FIELDS OF LAW, REAL ESTATE, FINANCE, MEDICAL CARE, HOSPITAL ADMINISTRATION AND GENERAL BUSINESS, AND DISTRIBUTING COURSE MATERIALS IN CONNECTION THEREWITH, IN CLASS 41 (U.S. CLS. 100, 101 AND 107).

FIRST USE 9-1-2002; IN COMMERCE 9-1-2002.

NO CLAIM IS MADE TO THE EXCLUSIVE RIGHT TO USE PROFESSIONAL EDUCATION, APART FROM THE MARK AS SHOWN.

SER. NO. 76-477,556, FILED P.R. 12-23-2002; AM. S.R. 8-2-2004.

ELLEN B. AWRICH, EXAMINING ATTORNEY

Int. Cl.: 41

Prior U.S. Cls.: 100, 101, and 107

United States Patent and Trademark Office

Reg. No. 2,893,955

Registered Oct. 12, 2004

**SERVICE MARK
SUPPLEMENTAL REGISTER**

THE WOMEN'S SUCCESS CONFERENCE

LIFE CHANGERS CHRISTIAN CENTER (MICHIGAN CORPORATION)
3000 W. MILLER RD.
LANSING, MI 48911

FOR: EDUCATIONAL SERVICES, NAMELY, CONDUCTING CLASSES, SEMINARS, CONFERENCES AND WORKSHOPS IN THE FIELD OF RELIGION, IN CLASS 41 (U.S. CLS. 100, 101 AND 107).

FIRST USE 5-1-1998; IN COMMERCE 5-1-1998.

SER. NO. 76-492,827, FILED P.R. 2-7-2003; AM. S.R. 5-17-2004.

INGA ERVIN, EXAMINING ATTORNEY

Int. Cl.: 12

Prior U.S. Cls.: 19, 21, 23, 31, 35, and 44

United States Patent and Trademark Office

Reg. No. 2,893,956

Registered Oct. 12, 2004

**TRADEMARK
SUPPLEMENTAL REGISTER**

VENTILATED NET SEAT

NISSAN JIDOSHA KABUSHIKI KAISHA (JAPAN
CORPORATION), TA NISSAN MOTOR CO.,
LTD.,
NO. 2 TAKARACHO, KANAGAWA-KU
YOKOHAMA-SHI, KANAGAWA-KEN, JAPAN

FOR: MOTOR VEHICLE SEATS, IN CLASS 12 (U.S.
CLS. 19, 21, 23, 31, 35 AND 44).

FIRST USE 4-17-2003; IN COMMERCE 4-17-2003.

NO CLAIM IS MADE TO THE EXCLUSIVE
RIGHT TO USE SEAT, APART FROM THE MARK
AS SHOWN.

SER. NO. 76-496,653, FILED P.R. 3-3-2003; AM. S.R.
12-5-2003.

BRIAN PINO, EXAMINING ATTORNEY

Int. Cl.: 16

Prior U.S. Cls.: 2, 5, 22, 23, 29, 37, 38, and 50

United States Patent and Trademark Office

Reg. No. 2,893,957

Registered Oct. 12, 2004

**TRADEMARK
SUPPLEMENTAL REGISTER**

THE INTERVENTION SOLUTION

HARCOURT, INC. (DELAWARE CORPORATION)
6277 SEA HARBOR DRIVE
ORLANDO, FL 32887

FOR: PRINTED PUBLICATIONS, NAMELY SERIES OF BOOKS FOR ELEMENTARY SCHOOL STUDENTS AND TEACHERS IN THE SUBJECT AREA

OF MATHEMATICS, IN CLASS 16 (U.S. CLS. 2, 5, 22, 23, 29, 37, 38 AND 50).

FIRST USE 2-14-2003; IN COMMERCE 2-14-2003.

SER. NO. 76-504,102, FILED P.R. 4-4-2003; AM. S.R. 12-29-2003.

SHARI SHEFFIELD, EXAMINING ATTORNEY

Int. Cl.: 42

Prior U.S. Cls.: 100 and 101

United States Patent and Trademark Office

Reg. No. 2,893,958

Registered Oct. 12, 2004

**SERVICE MARK
SUPPLEMENTAL REGISTER**

LAW VALUE CHAIN

HUBBARD & WELLS, INC. (DELAWARE CORPORATION), DBA HUBBARD ONE,
247 SOUTH STATE STREET
CHICAGO, IL 60604

FOR: DEVELOPMENT OF INFORMATION TECHNOLOGY FOR OTHERS, NAMELY FOR LAW FIRMS AND CORPORATE LEGAL DEPARTMENTS, FOR MANAGING, STRUCTURING, SEARCHING, LINKING, PROTECTING, DISPLAYING, PUBLISHING, CREATING, MANIPULATING, ARCHIVING AND INTEGRATING INFORMATION AND APPLICATION PROGRAMS, STORING, VIEWING, DISTRIBUTING, PRINTING AND MANAGING DOCUMENTS, ACCESSING OUTSIDE

CONTENT PROVIDERS VIA A GLOBAL COMPUTER NETWORK, AND FOR CONTENT MANAGEMENT, IN CLASS 42 (U.S. CLS. 100 AND 101).

FIRST USE 2-0-2003; IN COMMERCE 2-0-2003.

NO CLAIM IS MADE TO THE EXCLUSIVE RIGHT TO USE VALUE CHAIN, APART FROM THE MARK AS SHOWN.

SER. NO. 76-505,389, FILED P.R. 4-3-2003; AM. S.R. 6-17-2004.

MARTHA SANTOMARTINO, EXAMINING ATTORNEY

Int. Cl.: 36

Prior U.S. Cls.: 100, 101, and 102

United States Patent and Trademark Office

Reg. No. 2,893,959

Registered Oct. 12, 2004

**SERVICE MARK
SUPPLEMENTAL REGISTER**

SMALL COMMERCIAL LENDING MADE EASY

INTERBAY FUNDING, L.L.C. (DELAWARE LTD
LIAB CO)
4425 PONCE DE LEON BLVD.
FOURTH FLOOR
CORAL GABLES, FL 33146

FOR: FINANCIAL INFORMATION IN THE NAT-
URE OF LOANS AND LENDING; FINANCIAL
SERVICES IN THE FIELD OF MONEY LENDING ,
IN CLASS 36 (U.S. CLS. 100, 101 AND 102).

FIRST USE 2-28-2003; IN COMMERCE 2-28-2003.

NO CLAIM IS MADE TO THE EXCLUSIVE
RIGHT TO USE SMALL COMMERCIAL LENDING,
APART FROM THE MARK AS SHOWN.

SER. NO. 76-506,997, FILED P.R. 4-4-2003; AM. S.R.
6-22-2004.

SUSAN LESLIE DUBOIS, EXAMINING ATTORNEY

Int. Cl.: 16

Prior U.S. Cls.: 2, 5, 22, 23, 29, 37, 38, and 50

United States Patent and Trademark Office

Reg. No. 2,893,960

Registered Oct. 12, 2004

**TRADEMARK
SUPPLEMENTAL REGISTER**

Franchise Sales Desk Reference

FISHER & ZUCKER LLC (PENNSYLVANIA LTD
LIAB CO)
121 S. BROAD STREET, SUITE 1200
PHILADELPHIA, PA 19107

FIRST USE 9-1-2002; IN COMMERCE 9-1-2002.

SER. NO. 76-508,191, FILED P.R. 4-14-2003; AM. S.R.
3-25-2004.

FOR: FRANCHISE SALES COMPLIANCE MAN-
UALS IN PRINTED FORM, IN CLASS 16 (U.S. CLS. 2,
5, 22, 23, 29, 37, 38 AND 50).

RICHARD A. STRASER, EXAMINING ATTORNEY

Int. Cl.: 3

Prior U.S. Cls.: 1, 4, 6, 50, 51, and 52

United States Patent and Trademark Office

Reg. No. 2,893,961

Registered Oct. 12, 2004

**TRADEMARK
SUPPLEMENTAL REGISTER**

ORGANIC SPA COLLECTION

LEVLAD, INC. (CALIFORNIA CORPORATION)
9200 MASON AVENUE
CHATSWORTH, CA 91311

FOR: SHOWER AND BATH GEL, IN CLASS 3 (U.S.
CLS. 1, 4, 6, 50, 51 AND 52).

FIRST USE 4-14-2003; IN COMMERCE 4-25-2003.

NO CLAIM IS MADE TO THE EXCLUSIVE
RIGHT TO USE ORGANIC, APART FROM THE
MARK AS SHOWN.

SER. NO. 76-511,726, FILED P.R. 5-6-2003; AM. S.R.
5-11-2004.

SUSAN LESLIE DUBOIS, EXAMINING ATTORNEY

Int. Cl.: 14

Prior U.S. Cls.: 2, 27, 28, and 50

United States Patent and Trademark Office

Reg. No. 2,893,962

Registered Oct. 12, 2004

**TRADEMARK
SUPPLEMENTAL REGISTER**

THE SIBERIAN DIAMOND

FABRIKANT & SALANT DIAMOND COMPANY
LTD. (ISRAEL CORPORATION)
54 BEZALEL STREET
RAMAT GAN 52521, ISRAEL

FOR: PRECIOUS STONES, NAMELY, DIAMONDS, IN CLASS 14 (U.S. CLS. 2, 27, 28 AND 50).

FIRST USE 8-10-2003; IN COMMERCE 8-10-2003.

NO CLAIM IS MADE TO THE EXCLUSIVE RIGHT TO USE "DIAMOND", APART FROM THE MARK AS SHOWN.

SER. NO. 76-523,432, FILED P.R. 6-18-2003; AM. S.R. 7-6-2004.

RAUL CORDOVA, EXAMINING ATTORNEY

Int. Cl.: 5

Prior U.S. Cls.: 6, 18, 44, 46, 51, and 52

United States Patent and Trademark Office

Reg. No. 2,893,963

Registered Oct. 12, 2004

**TRADEMARK
SUPPLEMENTAL REGISTER**

HEARTBURN RELIEF 200

PHARMACEUTICAL FORMULATIONS, INC.
(DELAWARE CORPORATION)
460 PLAINFIELD AVENUE
P.O. BOX 1904
EDISON, NJ 088181904

FIRST USE 7-0-1998; IN COMMERCE 7-0-1998.

NO CLAIM IS MADE TO THE EXCLUSIVE
RIGHT TO USE HEARTBURN RELIEF 200, APART
FROM THE MARK AS SHOWN.

FOR: PHARMACEUTICAL PREPARATION FOR
THE TREATMENT AND PREVENTION OF HEART-
BURN AND ACID INDIGESTION, NAMELY, CIME-
TIDINE , IN CLASS 5 (U.S. CLS. 6, 18, 44, 46, 51 AND
52).

SER. NO. 76-530,492, FILED P.R. 6-30-2003; AM. S.R.
7-7-2004.

CAROLINE WEIMER, EXAMINING ATTORNEY

Int. Cl.: 35

Prior U.S. Cls.: 100, 101, and 102

United States Patent and Trademark Office

Reg. No. 2,893,964

Registered Oct. 12, 2004

**SERVICE MARK
SUPPLEMENTAL REGISTER**

REQUEST MAIL

KRAVCO COMPANY (PARTNERSHIP)
THE ATRIUM
234 MALL BOULEVARD
KING OF PRUSSIA, PA 194061528

FOR: MARKETING SERVICES FOR PROMOT-
ING THE GOODS AND SERVICES OF OTHERS
THROUGH ELECTRONIC MAIL AND HYPER-

LINKS TO THE WEB SITES OF OTHERS , IN CLASS
35 (U.S. CLS. 100, 101 AND 102).

FIRST USE 8-15-2003; IN COMMERCE 8-15-2003.

SER. NO. 76-531,240, FILED P.R. 7-11-2003; AM. S.R.
7-16-2004.

CAROLYN CATALDO, EXAMINING ATTORNEY

Int. Cl.: 36

Prior U.S. Cls.: 100, 101, and 102

United States Patent and Trademark Office

Reg. No. 2,893,965

Registered Oct. 12, 2004

**SERVICE MARK
SUPPLEMENTAL REGISTER**

HEALTH CARE BENEFITS ONLINE

NATIONAL ACCOUNT SERVICE COMPANY
LLC (DELAWARE LTD LIAB CO)
1200 ABERNATHY ROAD, SUITE 1000
ATLANTA, GA 30328

FOR: PROVIDING A WEBSITE FEATURING INFORMATION ON CUSTOMERS' HEALTH CARE BENEFITS ACCOUNTS, NAMELY, CLAIMS STATUS, ELIGIBILITY FOR COVERAGE, POLICY DEDUCTIBLES AND LIMITS, AND PARTICIPATING

HEALTH CARE PROVIDERS, IN CLASS 36 (U.S. CLS. 100, 101 AND 102).

FIRST USE 1-30-2001; IN COMMERCE 1-30-2001.

SER. NO. 76-534,477, FILED P.R. 8-4-2003; AM. S.R. 7-9-2004.

JOHN HWANG, EXAMINING ATTORNEY

Int. Cl.: 3

Prior U.S. Cls.: 1, 4, 6, 50, 51, and 52

Reg. No. 2,893,966

United States Patent and Trademark Office

Registered Oct. 12, 2004

**TRADEMARK
SUPPLEMENTAL REGISTER**

SPA 26

SEA OF LIFE SALES - AMERICA, LLC (NEW
JERSEY LTD LIAB CO)
83 EAST AVENUE, SUITE 104
NORWALK, CT 06851

FOR: SKIN, NAIL AND HAIR CARE PRODUCTS,
NAMELY, MINERAL MUD FACIAL CLEANSER,
FACIAL MUD MASKS, NON-MEDICATED MINER-
AL MUD FOR THE FACE, MOISTURIZING
CREAM, ANTI-AGING FACIAL CREAM, NON-
MEDICATED NATURAL MINERAL MUD FOR
THE BODY, NON-MEDICATED MINERAL BATH
CRYSTALS WITH ESSENTIAL OIL, NON-MEDICA-
TED MAGNESIUM CHLORIDE BATH CRYSTALS,
BODY LOTION FOR MASSAGE, MINERAL CRYST-
AL GLOW, NAMELY, SKIN EXFOLIANTS, MI-
NERAL SKIN ENHANCER, NAMELY, SKIN
MOISTURIZER, HAND CREAM, NON-MEDICA-
TED FOOT CREAM, EXFOLIATING GEL, NON-

MEDICATED NON-FOAMING MINERAL CRYSTALS FOR FOOT BATH, MINERAL MUD MASK FOR HANDS AND FEET, MOISTURIZING CREAM FOR HANDS, FEET AND BODY, NAIL AND CUTICLE REJUVENATOR, NAMELY NAIL BED STRENGTHENER AND CUTICLE HARDENER, MUD SHAMPOO, MUD HAIR CONDITIONER, HAIR AND SCALP MUD MASK, HAIR AND SCALP WATER, NAMELY, SCALP MOISTURIZER, AND HAIR AND SCALP MOISTURIZING CREAM, IN CLASS 3 (U.S. CLS. 1, 4, 6, 50, 51 AND 52).

FIRST USE 2-6-2003; IN COMMERCE 2-6-2003.

SER. NO. 76-534,754, FILED P.R. 8-5-2003; AM. S.R. 7-30-2004.

KATHY DE JONGE, EXAMINING ATTORNEY

Int. Cl.: 40

Prior U.S. Cls.: 100, 103, and 106

United States Patent and Trademark Office

Reg. No. 2,893,967

Registered Oct. 12, 2004

**SERVICE MARK
SUPPLEMENTAL REGISTER**

SIGNS & GRAPHICS NATIONWIDE

SIGNS BY TOMORROW - USA, INC. (MARY-
LAND CORPORATION)
6460 DOBBIN ROAD
COLUMBIA, MD 21045

FOR: MANUFACTURING SIGNS TO THE OR-
DER AND/OR SPECIFICATION OF OTHERS, IN
CLASS 40 (U.S. CLS. 100, 103 AND 106).

FIRST USE 6-0-2001; IN COMMERCE 6-0-2001.

OWNER OF U.S. REG. NO. 1,504,585.

NO CLAIM IS MADE TO THE EXCLUSIVE
RIGHT TO USE SIGNS & GRAPHICS, APART FROM
THE MARK AS SHOWN.

SER. NO. 76-539,524, FILED P.R. 8-22-2003; AM. S.R.
8-5-2004.

JOHN DWYER, EXAMINING ATTORNEY

Int. Cl.: 7

Prior U.S. Cls.: 13, 19, 21, 23, 31, 34, and 35

United States Patent and Trademark Office

Reg. No. 2,893,968

Registered Oct. 12, 2004

**TRADEMARK
SUPPLEMENTAL REGISTER**

NORTH AMERICAN PUMPS

NORTH AMERICAN PUMPS, LLC (TENNESSEE
LTD LIAB CO)
2593 BRACHTON
GERMANTOWN, TN 38139

FOR: CENTRIFUGAL PUMPS AND PUMPING
SYSTEM COMPRISED OF BOWL ASSEMBLY, COL-
UMN ASSEMBLY, SHAFTING, DISCHARGE HEAD
ASSEMBLY, BASEPLATES, MOTORS, GEAR
DRIVES AND ELECTRIC CONTROLS, IN CLASS 7
(U.S. CLS. 13, 19, 21, 23, 31, 34 AND 35).

FIRST USE 7-18-2003; IN COMMERCE 7-18-2003.

NO CLAIM IS MADE TO THE EXCLUSIVE
RIGHT TO USE PUMPS, APART FROM THE MARK
AS SHOWN.

SER. NO. 76-540,207, FILED P.R. 8-26-2003; AM. S.R.
7-9-2004.

ANN LINNEHAN, EXAMINING ATTORNEY

Int. Cl.: 37

Prior U.S. Cls.: 100, 103, and 106

United States Patent and Trademark Office

Reg. No. 2,893,969

Registered Oct. 12, 2004

**SERVICE MARK
SUPPLEMENTAL REGISTER**

BACHMAN AUTO GLASS

BRIGHTSTONE, INC. (ARIZONA CORPORATION)
P.O. BOX 17752
FOUNTAIN HILLS, AZ 85269

NO CLAIM IS MADE TO THE EXCLUSIVE
RIGHT TO USE AUTO GLASS, APART FROM THE
MARK AS SHOWN.

FOR: INSTALLATION AND REPAIR OF AUTO-
MOBILE GLASS, IN CLASS 37 (U.S. CLS. 100, 103
AND 106).

SER. NO. 76-541,160, FILED P.R. 8-18-2003; AM. S.R.
6-7-2004.

FIRST USE 8-1-2001; IN COMMERCE 8-1-2001.

THEODORE MCBRIDE, EXAMINING ATTORNEY

Int. Cl.: 16

Prior U.S. Cls.: 2, 5, 22, 23, 29, 37, 38, and 50

United States Patent and Trademark Office

Reg. No. 2,893,970

Registered Oct. 12, 2004

**TRADEMARK
SUPPLEMENTAL REGISTER**

DROPPIN' DIME

VIBE VENTURES LLC (DELAWARE LTD LIAB
CO)
11100 SANTA MONICA BOULEVARD, SUITE 1910
LOS ANGELES, CA 90025

FOR: MAGAZINE SECTION FEATURING IN-
FORMATION AND ADVICE ABOUT RECOMMEN-
DED NEW PRODUCTS, NEW SERVICES, AND NEW
TRENDS, IN CLASS 16 (U.S. CLS. 2, 5, 22, 23, 29, 37, 38
AND 50).

FIRST USE 2-0-2000; IN COMMERCE 2-0-2000.

SER. NO. 76-541,286, FILED P.R. 8-19-2003; AM. S.R.
7-8-2004.

WILLIAM BRECKENFELD, EXAMINING ATTOR-
NEY

Int. Cl.: 44

Prior U.S. Cls.: 100 and 101

United States Patent and Trademark Office

Reg. No. 2,893,971

Registered Oct. 12, 2004

**SERVICE MARK
SUPPLEMENTAL REGISTER**

FACIAL AESTHETIC CENTER OF EXCELLENCE

STEWART WANG, M.D., INC. (CALIFORNIA
CORPORATION)
1234 SOUTH GARFIELD AVENUE, SUITE 203
ALHAMBRA, CA 91801

FOR: MEDICAL SERVICES, IN CLASS 44 (U.S.
CLS. 100 AND 101).

FIRST USE 5-1-2003; IN COMMERCE 6-1-2003.

NO CLAIM IS MADE TO THE EXCLUSIVE
RIGHT TO USE CENTER, APART FROM THE
MARK AS SHOWN.

SER. NO. 76-543,221, FILED P.R. 9-8-2003; AM. S.R.
7-16-2004.

ANDREW BENZMILLER, EXAMINING ATTOR-
NEY

Int. Cl.: 33

Prior U.S. Cls.: 47 and 49

United States Patent and Trademark Office

Reg. No. 2,893,972

Registered Oct. 12, 2004

**TRADEMARK
SUPPLEMENTAL REGISTER**

BLUE AGAVE VODKA

CERDA, ENRIQUE FONSECA (MEXICO INDIVIDUAL)
VENEZUELA 425, COL. AMERICANA
CP 44600 GUADALAJARA, JALISCO, MEXICO

FOR: VODKA, IN CLASS 33 (U.S. CLS. 47 AND 49).

FIRST USE 10-10-2001; IN COMMERCE 10-10-2001.

THE MARK CONSISTS OF STANDARD CHARACTERS WITHOUT CLAIM TO ANY PARTICULAR FONT, STYLE, SIZE, OR COLOR.

NO CLAIM IS MADE TO THE EXCLUSIVE RIGHT TO USE "VODKA", APART FROM THE MARK AS SHOWN.

SER. NO. 76-560,680, FILED 11-18-2003.

GRETTA YAO, EXAMINING ATTORNEY

Int. Cl.: 29

Prior U.S. Cl.: 46

United States Patent and Trademark Office

Reg. No. 2,893,973

Registered Oct. 12, 2004

**TRADEMARK
SUPPLEMENTAL REGISTER**

YEREVAN

KAROUN DAIRIES, INC. (CALIFORNIA CORPORATION)
9027 GLENOAKS BLVD.
SUN VALLEY, CA 91352

THE MARK CONSISTS OF STANDARD CHARACTERS WITHOUT CLAIM TO ANY PARTICULAR FONT, STYLE, SIZE, OR COLOR.

FOR: DAIRY PRODUCTS EXCLUDING ICE CREAM, ICE MILK AND FROZEN YOGURT, IN CLASS 29 (U.S. CL. 46).

SER. NO. 76-568,129, FILED P.R. 12-29-2003; AM. S.R. 7-27-2004.

FIRST USE 1-1-2003; IN COMMERCE 1-1-2003.

IRA J. GOODSaid, EXAMINING ATTORNEY

Int. Cl.: 41

Prior U.S. Cls.: 100, 101, and 107

United States Patent and Trademark Office

Reg. No. 2,893,974

Registered Oct. 12, 2004

**SERVICE MARK
SUPPLEMENTAL REGISTER**

THE NEW YORK PILATES STUDIO

PILATES, INC. (MONTANA CORPORATION)
890 BROADWAY, SIXTH FLOOR
NEW YORK, NY 10003

FIRST USE 11-13-2000; IN COMMERCE 11-13-2000.

FOR: PROVIDING LESSONS, TRAINING, WORKSHOPS, SEMINARS, AND FACILITIES FOR EXERCISE AND PHYSICAL CONDITIONING; PHYSICAL EDUCATION SERVICES; PHYSICAL FITNESS CONSULTATION; TRAINING IN THE USE AND OPERATION OF EXERCISE EQUIPMENT; AND TEACHING IN THE FIELD OF PHYSICAL FITNESS, IN CLASS 41 (U.S. CLS. 100, 101 AND 107).

NO CLAIM IS MADE TO THE EXCLUSIVE RIGHT TO USE PILATES STUDIO, APART FROM THE MARK AS SHOWN.

SER. NO. 78-030,281, FILED P.R. 10-12-2000; AM. S.R. 7-7-2003.

KARLA PERKINS, EXAMINING ATTORNEY

Int. Cl.: 36

Prior U.S. Cls.: 100, 101, and 102

United States Patent and Trademark Office

Reg. No. 2,893,975

Registered Oct. 12, 2004

**SERVICE MARK
SUPPLEMENTAL REGISTER**

INDEPENDENT APPRAISAL COMP.

RODRIGUEZ, FELIPE L. (UNITED STATES IN-
DIVIDUAL)
480 WEST 33RD STREET HIALEAH FL. 33012
HIALEAH, FL 33012

FOR: REAL ESTATE APPRAISAL, IN CLASS 36
(U.S. CLS. 100, 101 AND 102).

FIRST USE 6-9-2003; IN COMMERCE 6-9-2003.

SER. NO. 78-040,842, FILED P.R. 12-28-2000; AM.
S.R. 7-14-2003.

KELLY BOULTON, EXAMINING ATTORNEY

Int. Cl.: 33

Prior U.S. Cls.: 47 and 49

United States Patent and Trademark Office

Reg. No. 2,893,976

Registered Oct. 12, 2004

**TRADEMARK
SUPPLEMENTAL REGISTER**

ECHTER NORDHÄUSER DOPPELKORN

NORDBRAND NORDHAUSEN GMBH (FED REP
GERMANY CORPORATION)

LUDWIG-ECKES-ALLEE 6

NIEDER OLM, FED REP GERMANY 55268

FOR: DISTILLED SPIRITS, NAMELY DOPPELK-
ORN, IN CLASS 33 (U.S. CLS. 47 AND 49).

OWNER OF FED REP GERMANY REG. NO.
DD647751, DATED 7-19-1991, EXPIRES 9-30-2010.

NO CLAIM IS MADE TO THE EXCLUSIVE
RIGHT TO USE ECHTER AND DOPPELKORN,
APART FROM THE MARK AS SHOWN.

THE ENGLISH TRANSLATION OF ECHTER IS
"GENUINE". THE ENGLISH TRANSLATION OF
KORN IS "GRAIN".

SER. NO. 78-159,541, FILED P.R. 8-30-2002; AM. S.R.
6-16-2004.

EDWARD NELSON, EXAMINING ATTORNEY

Int. Cl.: 35

Prior U.S. Cls.: 100, 101, and 102

United States Patent and Trademark Office

Reg. No. 2,893,978

Registered Oct. 12, 2004

**SERVICE MARK
SUPPLEMENTAL REGISTER**

CREW ONLY DISCOUNT GUIDE

SUNRISE GLOBAL MARKETING, INC. (FLORIDA CORPORATION)
7044 CAMINO DEGRAZIA #221
SAN DIEGO, CA 92111

FOR: PROMOTING THE GOODS AND SERVICE OF OTHERS BY PREPARING AND PLACING ADVERTISEMENTS DIRECTED TOWARDS CREW MEMBERS OF PLANES AND CRUISE SHIPS IN AN ELECTRONIC MAGAZINE ACCESSED THROUGH A GLOBAL COMPUTER NETWORK; PROMOTING THE SALE OF GOODS AND SERVICES OF OTHERS THROUGH THE DISTRIBUTION OF PRINTED MATERIAL FOR CREW MEMBER OF

PLANES AND CRUISE SHIPS, IN CLASS 35 (U.S. CLS. 100, 101 AND 102).

FIRST USE 1-0-2000; IN COMMERCE 1-0-2000.

NO CLAIM IS MADE TO THE EXCLUSIVE RIGHT TO USE DISCOUNT GUIDE, APART FROM THE MARK AS SHOWN.

SER. NO. 78-164,630, FILED P.R. 9-16-2002; AM. S.R. 8-3-2004.

MARIA-VICTORIA SUAREZ, EXAMINING ATTORNEY

Int. Cl.: 9

Prior U.S. Cls.: 21, 23, 26, 36, and 38

United States Patent and Trademark Office

Reg. No. 2,893,979

Registered Oct. 12, 2004

**TRADEMARK
SUPPLEMENTAL REGISTER**

PORTFOLIO COMPLIANCE MANAGER

BONDWAVE LLC (DELAWARE LIMITED LIABILITY CORPORATION)
1001 WARRENVILLE ROAD
LISLE, IL 60532

FOR: COMPUTER SOFTWARE FOR ANALYSIS OF PRESENT PORTFOLIO HOLDINGS IN VIEW OF SELECTED INVESTMENT CRITERIA, EVALUATION OF POTENTIAL PURCHASES AND SALES, AND THE PROVISION OF AN INTERFACE TO

OTHER MARKETPLACE PARTICIPANTS IN THE FIELD OF PURCHASE AND SALE OF SECURITIES, IN CLASS 9 (U.S. CLS. 21, 23, 26, 36 AND 38).

FIRST USE 9-1-2002; IN COMMERCE 9-1-2002.

SER. NO. 78-168,714, FILED P.R. 9-27-2002; AM. S.R. 7-7-2004.

STEVEN BERK, EXAMINING ATTORNEY

Int. Cl.: 9

Prior U.S. Cls.: 21, 23, 26, 36, and 38

United States Patent and Trademark Office

Reg. No. 2,893,980

Registered Oct. 12, 2004

**TRADEMARK
SUPPLEMENTAL REGISTER**

FAULT MAPPER

CHAUVIN ARNOUX, INC. (NEW HAMPSHIRE
CORPORATION)
15 FARADAY DRIVE
DOVER, NH 03820

FOR: ELECTRICAL AND ELECTRONIC TEST-
ING AND MEASURING INSTRUMENTS, NAMELY,
TIME DOMAIN REFLECTOMETERS, IN CLASS 9
(U.S. CLS. 21, 23, 26, 36 AND 38).

FIRST USE 9-0-2002; IN COMMERCE 6-0-2003.

SER. NO. 78-170,937, FILED P.R. 10-4-2002; AM. S.R.
7-9-2004.

JOHN GARTNER, EXAMINING ATTORNEY

Int. Cl.: 9

Prior U.S. Cls.: 21, 23, 26, 36, and 38

United States Patent and Trademark Office

Reg. No. 2,893,981

Registered Oct. 12, 2004

**TRADEMARK
SUPPLEMENTAL REGISTER**

DENIED CLAIMS MANAGEMENT SYSTEM

PRESSCOTT ASSOCIATES, LTD. (CONNECTI-
CUT CORPORATION)
21A ARTS CENTER COURT
AVON, CT 06001

FOR: COMPUTER SOFTWARE FOR TRACKING
AND MANAGING HEALTHCARE CLAIMS SUB-
MITTED FOR PAYMENT AND USER MANUAL
AND INSTRUCTIONAL GUIDES DISTRIBUTED
THEREWITH, IN CLASS 9 (U.S. CLS. 21, 23, 26, 36
AND 38).

FIRST USE 2-28-2000; IN COMMERCE 4-10-2000.

NO CLAIM IS MADE TO THE EXCLUSIVE
RIGHT TO USE "MANAGEMENT SYSTEM",
APART FROM THE MARK AS SHOWN.

SER. NO. 78-195,689, FILED P.R. 12-18-2002; AM.
S.R. 6-14-2004.

AMY LOHR, EXAMINING ATTORNEY

Int. Cl.: 40

Prior U.S. Cls.: 100, 103, and 106

United States Patent and Trademark Office

Reg. No. 2,893,983

Registered Oct. 12, 2004

**SERVICE MARK
SUPPLEMENTAL REGISTER**

ENVIRONMENTAL RECLAMATION SERVICES, INC.

ERS IMAGING SUPPLIES, INC. (PENNSYLVANIA CORPORATION)
2101 WEST 12TH STREET
ERIE, PA 165054839

FIRST USE 9-1-2003; IN COMMERCE 9-1-2003.

FOR: RECYCLING SERVICES FOR EMPTY LASER CARTRIDGES, EMPTY INKJET CARTRIDGES, CELL PHONES, AND OTHER ELECTRONIC PRODUCTS, IN CLASS 40 (U.S. CLS. 100, 103 AND 106).

SER. NO. 78-226,942, FILED P.R. 3-18-2003; AM. S.R. 8-6-2004.

J. TINGLEY, EXAMINING ATTORNEY

Int. Cl.: 31

Prior U.S. Cls.: 1 and 46

United States Patent and Trademark Office

Reg. No. 2,893,984

Registered Oct. 12, 2004

**TRADEMARK
SUPPLEMENTAL REGISTER**

SKRETTING

TROUW INTERNATIONAL B.V. (NETHER-
LANDS CORPORATION)
VEERSTRAAT 38
BOXMEER, NETHERLANDS 5831 JN

FOR: FOODSTUFFS FOR ANIMALS, IN CLASS 31
(U.S. CLS. 1 AND 46).

OWNER OF BENELUX REG. NO. 0716498, DATED
9-24-2002, EXPIRES 9-24-2012.

OWNER OF U.S. REG. NO. 2,801,204.

SER. NO. 78-230,268, FILED P.R. 3-26-2003; AM. S.R.
4-6-2004.

BARBARA A. LOUGHRAN, EXAMINING ATTOR-
NEY

Int. Cl.: 16

Prior U.S. Cls.: 2, 5, 22, 23, 29, 37, 38, and 50

United States Patent and Trademark Office

Reg. No. 2,893,985

Registered Oct. 12, 2004

**TRADEMARK
SUPPLEMENTAL REGISTER**

BUILDING SAFETY JOURNAL

INTERNATIONAL CODE COUNCIL (CALIFORNIA CORPORATION)
5360 SOUTH WORKMAN MILL ROAD
WHITTIER, CA 90601

FOR: PERIODICAL MAGAZINES AND NEWSLETTERS DIRECTED TO GOVERNMENT OFFICIALS, ARCHITECTS, ENGINEERS, AND OTHERS CONCERNED WITH CONSTRUCTION CODES, IN CLASS 16 (U.S. CLS. 2, 5, 22, 23, 29, 37, 38 AND 50).

FIRST USE 3-8-2003; IN COMMERCE 3-8-2003.

NO CLAIM IS MADE TO THE EXCLUSIVE RIGHT TO USE "JOURNAL", APART FROM THE MARK AS SHOWN.

SER. NO. 78-235,312, FILED P.R. 4-8-2003; AM. S.R. 11-10-2003.

ALLISON HOLTZ, EXAMINING ATTORNEY

Int. Cl.: 36

Prior U.S. Cls.: 100, 101, and 102

United States Patent and Trademark Office

Reg. No. 2,893,987

Registered Oct. 12, 2004

**SERVICE MARK
SUPPLEMENTAL REGISTER**

THE SEPTEMBER 11TH FUND

UNITED WAY OF NEW YORK CITY (NEW
YORK CORPORATION)
2 PARK AVENUE
NEW YORK, NY 10016 AND
NEW YORK COMMUNITY TRUST, THE (NEW
YORK CORPORATION)
2 PARK AVENUE
NEW YORK, NY 10016

FOR: ELEEMOSYNARY SERVICES IN THE
FIELD OF MONETARY DONATIONS FOR
HEALTH, WELFARE, EDUCATION AND OTHER
SOCIAL SERVICES; CHARITABLE FUNDRAISING
SERVICES, IN CLASS 36 (U.S. CLS. 100, 101 AND 102).

FIRST USE 9-12-2001; IN COMMERCE 9-12-2001.

NO CLAIM IS MADE TO THE EXCLUSIVE
RIGHT TO USE "FUND", APART FROM THE
MARK AS SHOWN.

SER. NO. 78-253,906, FILED P.R. 5-23-2003; AM. S.R.
6-9-2004.

WILLIAM BRECKENFELD, EXAMINING ATTOR-
NEY

Int. Cl.: 28

Prior U.S. Cls.: 22, 23, 38, and 50

United States Patent and Trademark Office

Reg. No. 2,893,988

Registered Oct. 12, 2004

**TRADEMARK
SUPPLEMENTAL REGISTER**

FRIDGE PIG

BETTA FIRE INVESTMENTS, INC. (CALIFORNIA CORPORATION)
12116 OTSEGO STREET
NORTH HOLLYWOOD, CA 91607

FOR: NOVELTY PLASTIC ELECTRONIC TOY PIG FIGURINE WHICH PLAYS FOOD AVERSION THERAPY AND OTHER VOICE MESSAGES, AND WHICH IS USED FOR THE RECORDING, TRANSMISSION OR REPRODUCTION OF THE SAME BY THE USER, IN CLASS 28 (U.S. CLS. 22, 23, 38 AND 50).

FIRST USE 6-5-2003; IN COMMERCE 6-5-2003.

NO CLAIM IS MADE TO THE EXCLUSIVE RIGHT TO USE "PIG", APART FROM THE MARK AS SHOWN.

SER. NO. 78-260,594, FILED P.R. 6-10-2003; AM. S.R. 6-14-2004.

ZHALEH DELANEY, EXAMINING ATTORNEY

Int. Cl.: 14

Prior U.S. Cls.: 2, 27, 28, and 50

United States Patent and Trademark Office

Reg. No. 2,893,989

Registered Oct. 12, 2004

TRADEMARK
SUPPLEMENTAL REGISTER

H. MOSER & Cie. SA

LANGE, JÜRGEN R. (SWITZERLAND INDIVIDUAL)

HERMANN-RORSCHACH-STRASSE 21

SCHAFFHAUSEN, SWITZERLAND 8200

FOR: WATCHES AND CLOCKS, NAMELY WRISTWATCHES, WALL CLOCKS, GRANDFATHER CLOCKS, POCKET WATCHES, IN CLASS 14 (U.S. CLS. 2, 27, 28 AND 50).

OWNER OF SWITZERLAND REG. NO. 495493, DATED 3-6-2002, EXPIRES 10-2-2011.

NO CLAIM IS MADE TO THE EXCLUSIVE RIGHT TO USE "CIE", APART FROM THE MARK AS SHOWN.

SER. NO. 78-261,230, FILED P.R. 6-11-2003; AM. S.R. 5-25-2004.

DAVID ELTON, EXAMINING ATTORNEY

Int. Cl.: 17

Prior U.S. Cls.: 1, 5, 12, 13, 35, and 50

United States Patent and Trademark Office

Reg. No. 2,893,990

Registered Oct. 12, 2004

**TRADEMARK
SUPPLEMENTAL REGISTER**

BAMBOOBARRIER

DEEP ROOT PARTNERS, L.P. (PARTNERSHIP)
SUITE 4
81 LANGTON STREET
SAN FRANCISCO, CA 94103

FIRST USE 5-12-1997; IN COMMERCE 5-12-1997.

SER. NO. 78-261,600, FILED P.R. 6-12-2003; AM. S.R.
6-15-2004.

FOR: PLASTIC SHEETS USED TO PREVENT THE
SPREAD OF INVASIVE PLANTS, IN CLASS 17 (U.S.
CLS. 1, 5, 12, 13, 35 AND 50).

BARBARA A. GOLD, EXAMINING ATTORNEY

Int. Cl.: 42

Prior U.S. Cls.: 100 and 101

United States Patent and Trademark Office

Reg. No. 2,893,991

Registered Oct. 12, 2004

**SERVICE MARK
SUPPLEMENTAL REGISTER**

LASSO TECHNOLOGIES

LASSO TECHNOLOGIES, INC. (NORTH CAROLINA CORPORATION)
9430 BRAEMAR TERRACE
CHARLOTTE, NC 28210

FOR: CONSULTING SERVICES IN THE FIELD OF DESIGN, SELECTION, IMPLEMENTATION AND USE OF COMPUTER HARDWARE AND SOFTWARE SYSTEMS FOR OTHERS; COMPUTER SOFTWARE DEVELOPMENT, IN CLASS 42 (U.S. CLS. 100 AND 101).

FIRST USE 1-10-2000; IN COMMERCE 7-5-2000.

NO CLAIM IS MADE TO THE EXCLUSIVE RIGHT TO USE "TECHNOLOGIES", APART FROM THE MARK AS SHOWN.

SER. NO. 78-266,468, FILED P.R. 6-24-2003; AM. S.R. 4-28-2004.

INGA ERVIN, EXAMINING ATTORNEY

Int. Cl.: 36

Prior U.S. Cls.: 100, 101, and 102

United States Patent and Trademark Office

Reg. No. 2,893,992

Registered Oct. 12, 2004

**SERVICE MARK
SUPPLEMENTAL REGISTER**

DIRECT DEALING

ESPEED, INC. (DELAWARE CORPORATION)
135 EAST 57TH STREET
NEW YORK, NY 10022

FOR: FINANCIAL SERVICES, NAMELY, TRANSACTING AND TRADING OF FINANCIAL INSTRUMENTS FOR OTHERS; PROVIDING AN ELECTRONIC FINANCIAL EXCHANGE FOR TRADING OF FINANCIAL INSTRUMENTS; PROVIDING A FINANCIAL TRADING NETWORK VIA AN ELECTRONIC PRIVATE INTRANET NETWORK AND GLOBAL COMPUTER NETWORK; PROVIDING FINANCIAL INFORMATION RELATING TO MARKET QUOTATIONS, AND TRADING

IN FINANCIAL INSTRUMENTS, NAMELY, BIDS, OFFERS, TRADES AND SIZES; AND PROVIDING INFORMATION RELATING TO FINANCIAL INSTRUMENTS, BROKERAGE, TRADING, INVESTMENTS, COMPANIES AND FINANCIAL MARKETS THROUGH A GLOBAL COMPUTER NETWORK, IN CLASS 36 (U.S. CLS. 100, 101 AND 102).

FIRST USE 1-0-2002; IN COMMERCE 5-0-2002.

SER. NO. 78-268,693, FILED P.R. 6-30-2003; AM. S.R. 7-9-2004.

JEFFERY COWARD, EXAMINING ATTORNEY

Int. Cl.: 9

Prior U.S. Cls.: 21, 23, 26, 36, and 38

Reg. No. 2,893,993

United States Patent and Trademark Office

Registered Oct. 12, 2004

**TRADEMARK
SUPPLEMENTAL REGISTER**

CADPRINT

OCE DISPLAY GRAPHICS SYSTEMS, INC. (DE-
LAWARE CORPORATION), DBA ONYX GRA-
PHICS CORPORATION,
2811 ORCHARD PARKWAY
SAN JOSE, CA 95134

FOR: COMPUTER SOFTWARE FOR USE WITH
IMAGE REPRODUCTION, NAMELY, CREATING,
FORMATING, PRINTING AND DISPLAYING CUS-

TOM IMAGES, IN CLASS 9 (U.S. CLS. 21, 23, 26, 36
AND 38).

FIRST USE 3-20-2003; IN COMMERCE 3-20-2003.

SER. NO. 78-270,961, FILED P.R. 7-7-2003; AM. S.R.
7-21-2004.

ZACHARY BELLO, EXAMINING ATTORNEY

Int. Cl.: 9

Prior U.S. Cls.: 21, 23, 26, 36, and 38

United States Patent and Trademark Office

Reg. No. 2,893,994

Registered Oct. 12, 2004

**TRADEMARK
SUPPLEMENTAL REGISTER**

JOBLOCK

BUTTON BUDDIES (CALIFORNIA CORPORATION), DBA EXAKTIME, INC.,
7916 WOODLEY AVE.
VAN NUYS, CA 91406

FOR: PORTABLE TIME CLOCK SYSTEMS COMPRISED OF HARDWARE AND SOFTWARE FOR TRACKING EMPLOYEES' AND SUBCONTRACTORS' TIME AT A SINGLE, OR MULTIPLE WORK

LOCATION, IN CLASS 9 (U.S. CLS. 21, 23, 26, 36 AND 38).

FIRST USE 5-1-2000; IN COMMERCE 11-1-2000.

SER. NO. 78-272,863, FILED P.R. 7-10-2003; AM. S.R. 3-26-2004.

CHERYL STEPLIGHT, EXAMINING ATTORNEY

Int. Cl.: 41

Prior U.S. Cls.: 100, 101, and 107

United States Patent and Trademark Office

Reg. No. 2,893,995

Registered Oct. 12, 2004

**SERVICE MARK
SUPPLEMENTAL REGISTER**

LIVE IN HOLLYWOOD

WESTERN INTERNATIONAL SYNDICATION
CORP. (CALIFORNIA CORPORATION)
SUITE 1050
12100 WILSHIRE BOULEVARD
LOS ANGELES, CA 90025

FIRST USE 9-0-2003; IN COMMERCE 9-0-2003.

SER. NO. 78-277,184, FILED P.R. 7-22-2003; AM. S.R.
7-16-2004.

FOR: ENTERTAINMENT SERVICES IN THE
NATURE OF A SERIES OF TELEVISION PRO-
GRAMS, IN CLASS 41 (U.S. CLS. 100, 101 AND 107).

MICHAEL ENGEL, EXAMINING ATTORNEY

Int. Cl.: 41

Prior U.S. Cls.: 100, 101, and 107

United States Patent and Trademark Office

Reg. No. 2,893,996

Registered Oct. 12, 2004

**SERVICE MARK
SUPPLEMENTAL REGISTER**

WORLD CONGRESS ON GASTROINTESTINAL CANCER

IMEDEX, INC. (GEORGIA CORPORATION)
710 TECHNOLOGY DRIVE
ALPHARETTA, GA 30005

FOR: EDUCATIONAL SERVICES, NAMELY,
CONDUCTING CLASSES, SEMINARS, CONFEREN-
CES AND WORKSHOPS IN THE FIELD OF GAS-
TROINTESTINAL CANCER FOR HEALTHCARE
PROFESSIONALS AND THE DISTRIBUTION OF
COURSE MATERIALS IN CONNECTION THERE-
WITH, IN CLASS 41 (U.S. CLS. 100, 101 AND 107).

FIRST USE 6-26-2003; IN COMMERCE 6-26-2003.

NO CLAIM IS MADE TO THE EXCLUSIVE
RIGHT TO USE "GASTROINTESTINAL CANCER",
APART FROM THE MARK AS SHOWN.

SER. NO. 78-279,864, FILED P.R. 7-28-2003; AM. S.R.
8-5-2004.

ROBERT LORENZO, EXAMINING ATTORNEY

Int. Cl.: 44

Prior U.S. Cls.: 100 and 101

United States Patent and Trademark Office

Reg. No. 2,893,997

Registered Oct. 12, 2004

**SERVICE MARK
SUPPLEMENTAL REGISTER**

DIGESTTEST

IDEAL HEALTH, INC. (NEVADA CORPORATION)
FIFTH FLOOR
100 MARKET STREET
PORTSMOUTH, NH 03801

FOR: MEDICAL SCREENING AND MONITORING SERVICES, NAMELY, PROVIDING DIAGNOSTIC TEST KITS FOR COLLECTING URINE SPECIMENS FROM PERSONS IN THEIR RESIDENCES WHO EXPERIENCE IMPAIRED DIGESTIVE FUNCTIONS, PARTICULARLY IMPAIRED PROTEIN DIGESTION OR GASTROINTESTINAL DISEASE, THE EVALUATION OF THE SPECIMENS AT DIAGNOSTIC CLINICS, THE PROVIDING OF NU-

TRITIONAL FOOD SUPPLEMENTS AND CUSTOMIZED EATING PLANS FOR PARTICIPANTS BASED ON THEIR CLINICAL TEST RESULTS, AND MONITORING THE RESULTS, IN CLASS 44 (U.S. CLS. 100 AND 101).

FIRST USE 10-14-2002; IN COMMERCE 10-14-2002.

OWNER OF U.S. REG. NO. 2,787,744.

SER. NO. 78-280,432, FILED 7-29-2003.

DAVID C. REIHNER, EXAMINING ATTORNEY

Int. Cl.: 25

Prior U.S. Cls.: 22 and 39

United States Patent and Trademark Office

Reg. No. 2,893,998

Registered Oct. 12, 2004

**TRADEMARK
SUPPLEMENTAL REGISTER**

CHIFFON SHAPERS

SARAMAR, L.L.C. (DELAWARE LTD LIAB CO)
10 SOUTH RIVERSIDE PLAZA
CHICAGO, IL 60606

FIRST USE 2-15-2004; IN COMMERCE 2-15-2004.

SER. NO. 78-280,728, FILED P.R. 7-30-2003; AM. S.R.
8-3-2004.

FOR: TANK TOPS AND GARMENTS THAT
SHAPE THE BODY, NAMELY BRIEFS AND THIGH
SHAPERS, IN CLASS 25 (U.S. CLS. 22 AND 39).

CYNTHIA SLOAN, EXAMINING ATTORNEY

Int. Cl.: 16

Prior U.S. Cls.: 2, 5, 22, 23, 29, 37, 38, and 50

United States Patent and Trademark Office

Reg. No. 2,894,000

Registered Oct. 12, 2004

**TRADEMARK
SUPPLEMENTAL REGISTER**

BUSINESS TO BUSINESS MARKETING CARDS

BUSINESS TO BUSINESS MARKETING CARDS,
INC. (FLORIDA CORPORATION)
18228 S.W. 3RD STREET
PEMBROKE PINES, FL 33029

FOR: GREETING CARDS FOR BUSINESS, IN
CLASS 16 (U.S. CLS. 2, 5, 22, 23, 29, 37, 38 AND 50).

FIRST USE 7-8-2003; IN COMMERCE 9-5-2003.

NO CLAIM IS MADE TO THE EXCLUSIVE
RIGHT TO USE "CARDS", APART FROM THE
MARK AS SHOWN.

SER. NO. 78-297,329, FILED P.R. 9-8-2003; AM. S.R.
7-20-2004.

TRACY CROSS, EXAMINING ATTORNEY

Int. Cl.: 16

Prior U.S. Cls.: 2, 5, 22, 23, 29, 37, 38, and 50

United States Patent and Trademark Office

Reg. No. 2,894,001

Registered Oct. 12, 2004

**TRADEMARK
SUPPLEMENTAL REGISTER**

FAMILY ISSUES MAGAZINE

FAMILY ISSUES MAGAZINE, INC. (ALABAMA
CORPORATION)
300 JENNIFER LANE
OXFORD, AL 36203

NO CLAIM IS MADE TO THE EXCLUSIVE
RIGHT TO USE "MAGAZINE", APART FROM THE
MARK AS SHOWN.

FOR: PRINTED GENERAL FEATURE MAGA-
ZINE IN THE FIELD OF FAMILY RELATED TO-
PICS, IN CLASS 16 (U.S. CLS. 2, 5, 22, 23, 29, 37, 38
AND 50).

SER. NO. 78-298,961, FILED P.R. 9-11-2003; AM. S.R.
8-2-2004.

FIRST USE 1-0-2004; IN COMMERCE 5-0-2004.

BRIAN PINO, EXAMINING ATTORNEY

Int. Cl.: 8

Prior U.S. Cls.: 23, 28, and 44

United States Patent and Trademark Office

Reg. No. 2,894,002

Registered Oct. 12, 2004

**TRADEMARK
SUPPLEMENTAL REGISTER**

RED WHEELS

STRYD, JACK T. (UNITED STATES INDIVIDUAL)

7907 BENT TREE RD.

KALAMAZOO, MI 49009

FOR: HAND-OPERATED SNOW REMOVAL
TOOL FOR INCLINED ROOFS IN THE NATURE
OF A POLE-MOUNTED SNOW LOOSENING

CROSSBAR AFFIXED TO A FLEXIBLE PLASTIC
SLIDE, IN CLASS 8 (U.S. CLS. 23, 28 AND 44).

FIRST USE 9-20-2003; IN COMMERCE 9-20-2003.

SER. NO. 78-303,128, FILED P.R. 9-20-2003; AM. S.R.
8-9-2004.

LINDA M. KING, EXAMINING ATTORNEY

Int. Cl.: 25

Prior U.S. Cls.: 22 and 39

United States Patent and Trademark Office

Reg. No. 2,894,003

Registered Oct. 12, 2004

TRADEMARK
SUPPLEMENTAL REGISTER



BAILEY, MICHAEL, W (UNITED STATES INDIVIDUAL)
1611 RED LEAF
SAN ANTONIO, TX 78232

FOR: BASEBALL CAPS, T-SHIRTS, IN CLASS 25
(U.S. CLS. 22 AND 39).

FIRST USE 10-14-2003; IN COMMERCE 1-9-2004.

NO CLAIM IS MADE TO THE EXCLUSIVE
RIGHT TO USE "MERCANTILE, INC." , APART
FROM THE MARK AS SHOWN.

SER. NO. 78-313,628, FILED P.R. 10-14-2003; AM.
S.R. 7-15-2004.

HEATHER THOMPSON, EXAMINING ATTORNEY

Int. Cl.: 10

Prior U.S. Cls.: 26, 39, and 44

United States Patent and Trademark Office

Reg. No. 2,894,004

Registered Oct. 12, 2004

**TRADEMARK
SUPPLEMENTAL REGISTER**

AUTO-FILL

VASCULAR SOLUTIONS, INC. (MINNESOTA
CORPORATION)
6464 SYCAMORE COURT
MINNEAPOLIS, MN 55369

FOR: MEDICAL EQUIPMENT, NAMELY, A SYR-
INGE DELIVERY SYSTEM COMPRISING BAR-
RELS, PLUNGERS, STOPPERS, GASKETS, BULBS,
PLUNGER SPRINGS, WASHERS, NEEDLES,
FLANGE CAPS AND TIP CAPS, IN CLASS 10 (U.S.
CLS. 26, 39 AND 44).

FIRST USE 5-3-2004; IN COMMERCE 5-3-2004.

THE MARK CONSISTS OF STANDARD CHAR-
ACTERS WITHOUT CLAIM TO ANY PARTICULAR
FONT, STYLE, SIZE, OR COLOR.

SER. NO. 78-329,341, FILED P.R. 11-18-2003; AM.
S.R. 7-12-2004.

RICHARD WHITE, EXAMINING ATTORNEY

Int. Cl.: 31

Prior U.S. Cls.: 1 and 46

United States Patent and Trademark Office

Reg. No. 2,894,005

Registered Oct. 12, 2004

**TRADEMARK
SUPPLEMENTAL REGISTER**

HONEY TRAIL MIX

SERGEANT'S PET CARE PRODUCTS, INC. (NE-
VADA CORPORATION)
SUITE 100
2637 S. 158TH PLAZA
OMAHA, NE 68130

FOR: EDIBLE PET TREATS AND PET FOOD, IN
CLASS 31 (U.S. CLS. 1 AND 46).

FIRST USE 9-20-2001; IN COMMERCE 9-20-2001.

THE MARK CONSISTS OF STANDARD CHAR-
ACTERS WITHOUT CLAIM TO ANY PARTICULAR
FONT, STYLE, SIZE, OR COLOR.

SER. NO. 78-336,818, FILED P.R. 12-5-2003; AM. S.R.
8-4-2004.

KATHY DE JONGE, EXAMINING ATTORNEY

Int. Cl.: 35

Prior U.S. Cls.: 100, 101, and 102

United States Patent and Trademark Office

Reg. No. 2,894,006

Registered Oct. 12, 2004

**SERVICE MARK
SUPPLEMENTAL REGISTER**

**SERVICE BRANDS
INTERNATIONAL**

SERVICE BRANDS INTERNATIONAL, LLC (MI-
CHIGAN LTD LIAB CO)
3948 RANCHERO DRIVE
ANN ARBOR, MI 481082775

FOR: FRANCHISING, NAMELY, OFFERING
TECHNICAL ASSISTANCE IN THE ESTABLISH-
MENT AND/OR OPERATION OF RESIDENTIAL
CLEANING, HOME REPAIR, DUCT CLEANING,
DRY CLEANING AND LAUNDRY BUSINESSES, IN
CLASS 35 (U.S. CLS. 100, 101 AND 102).

FIRST USE 3-19-2001; IN COMMERCE 3-19-2001.

THE MARK CONSISTS OF STANDARD CHAR-
ACTERS WITHOUT CLAIM TO ANY PARTICULAR
FONT, STYLE, SIZE, OR COLOR.

SER. NO. 78-342,849, FILED P.R. 12-18-2003; AM.
S.R. 7-27-2004.

JACQUELINE A. LAVINE, EXAMINING ATTOR-
NEY

Int. Cls.: 16, 25, 28, and 41

**Prior U.S. Cls.: 2, 5, 22, 23, 29, 37, 38, 39, 50, 100, 101,
and 107**

Reg. No. 2,893,650

United States Patent and Trademark Office

Registered Oct. 12, 2004

**TRADEMARK
SERVICE MARK
PRINCIPAL REGISTER**

ST. LOUIS RAMS

ST. LOUIS RAMS PARTNERSHIP (PARTNER-
SHIP)
1 RAMS WAY
ST. LOUIS, MO 63045

FOR: POSTERS, CALENDARS, TRADING
CARDS, BOOKS RELATING TO FOOTBALL, MA-
GAZINES RELATING TO FOOTBALL, NOTEPADS,
STICKERS, AND BUMPER STICKERS, IN CLASS 16
(U.S. CLS. 2, 5, 22, 23, 29, 37, 38 AND 50).

FIRST USE 8-1-1995; IN COMMERCE 8-1-1995.

FOR: MEN'S, WOMEN'S AND CHILDREN'S
CLOTHING, NAMELY FLEECE TOPS AND BOT-
TOMS, SHORTS, TANK TOPS, SWEATERS, PANTS,
JACKETS, TURTLENECKS, JUMPSUITS, JERSEYS,
WARM UP SUITS, SWIMWEAR, WIND RESISTANT
JACKETS, PARKAS, SLEEPWEAR, NAMELY PAJA-
MAS, GLOVES, SCARVES, APRONS, BOOTS AND
SNEAKERS, IN CLASS 25 (U.S. CLS. 22 AND 39).

FIRST USE 6-1-1995; IN COMMERCE 6-1-1995.

FOR: GOLF BAGS, GOLF BALLS, BOWLING
BAGS, FOOTBALLS, GOLF CLUB COVERS, EXER-
CISE EQUIPMENT, NAMELY GOLF CLUBS, IN
CLASS 28 (U.S. CLS. 22, 23, 38 AND 50).

FIRST USE 8-1-1995; IN COMMERCE 8-1-1995.

FOR: ENTERTAINMENT SERVICES, NAMELY
PROFESSIONAL FOOTBALL GAMES AND EXHIBI-
TIONS, IN CLASS 41 (U.S. CLS. 100, 101 AND 107).

FIRST USE 8-15-1995; IN COMMERCE 8-15-1995.

NO CLAIM IS MADE TO THE EXCLUSIVE
RIGHT TO USE ST. LOUIS, APART FROM THE
MARK AS SHOWN.

SN 74-706,358, FILED 4-26-1995.

JACQUELINE A. LAVINE, EXAMINING ATTOR-
NEY

Int. Cls.: 16, 25, 30, 41, and 42

Prior U.S. Cls.: 2, 5, 22, 23, 29, 37, 38, 39, 46, 50, 100, 101, and 107

Reg. No. 2,893,651

United States Patent and Trademark Office

Registered Oct. 12, 2004

**TRADEMARK
SERVICE MARK
PRINCIPAL REGISTER**



WILDHORSE SALOON ENTERTAINMENT VENTURES, INC. (TENNESSEE CORPORATION)
ONE GAYLORD DRIVE
NASHVILLE, TN 37214

FOR: PENCILS, MENUS, POSTCARDS, NOTE CARDS, STATIONERY AND WRITING PAPER, IN CLASS 16 (U.S. CLS. 2, 5, 22, 23, 29, 37, 38 AND 50).

FIRST USE 0-0-2003; IN COMMERCE 0-0-2003.

FOR: CLOTHING, NAMELY, MEN'S, WOMEN'S AND CHILDREN'S SHORTS, IN CLASS 25 (U.S. CLS. 22 AND 39).

FIRST USE 6-0-2003; IN COMMERCE 6-0-2003.

FOR: FOOD PRODUCTS NOT INCLUDED IN OTHER CLASSES, NAMELY, BARBEQUE SAUCES, KETCHUP, PREPARED MEALS NOT INCLUDED IN OTHER CLASSES, NAMELY, FISH, MEAT, POULTRY, AND VEGETABLE MEALS INCLUDING STUFFED PEPPERS; SANDWICHES, HAMBURGER SANDWICHES, HOT DOGS, PASTRIES, ICE CREAM, COFFEE, TEA, COCOA, SEASONINGS, SPICES, CONFECTIONERY AND PROCESSED GRAINS, IN CLASS 30 (U.S. CL. 46).

FIRST USE 0-0-2000; IN COMMERCE 0-0-2000.

FOR: ENTERTAINMENT SERVICES, NAMELY, AMUSEMENT ARCADE SERVICES; AMUSEMENT

CENTER SERVICES FEATURING VIDEO GAMES AND GAMBLING GAMES; PROVIDING CASINO FACILITIES; CASINO SERVICES; DANCE, BAND AND RODEO EVENT CONTESTS; BEAUTY PAGEANTS; FILM AND VIDEO THEATER AND RENTAL SERVICES; ATTRACTIONS IN THE NATURE OF LASER, LIGHT, MAGIC, PUPPET, ANIMAL AND/OR FASHION SHOWS; AMUSEMENT PARK RIDES, IN CLASS 41 (U.S. CLS. 100, 101 AND 107).

FIRST USE 0-0-2003; IN COMMERCE 0-0-2003.

FOR: BAR AND NIGHTCLUB SERVICES, CARRY-OUT RESTAURANT SERVICES, AND HOTEL SERVICES, IN CLASS 42 (U.S. CLS. 100 AND 101).

FIRST USE 0-0-2003; IN COMMERCE 0-0-2003.

OWNER OF U.S. REG. NO. 1,965,992.

NO CLAIM IS MADE TO THE EXCLUSIVE RIGHT TO USE "SALOON" IN CLASS 41, 42, APART FROM THE MARK AS SHOWN.

THE MARK IS NOT LINED FOR COLOR.

SN 75-178,029, FILED 10-7-1996.

MARY ROSSMAN, EXAMINING ATTORNEY

Int. Cls.: 16, 25, 30, 41, and 42

Prior U.S. Cls.: 2, 5, 22, 23, 29, 37, 38, 39, 46, 50, 100, 101, and 107

Reg. No. 2,893,652

United States Patent and Trademark Office

Registered Oct. 12, 2004

**TRADEMARK
SERVICE MARK
PRINCIPAL REGISTER**

WILDHORSE SALOON

WILDHORSE SALOON ENTERTAINMENT VENTURES, INC. (TENNESSEE CORPORATION)
ONE GAYLORD DRIVE
NASHVILLE, TN 37214

FOR: PENCILS, MENUS, POSTCARDS, NOTE CARDS, STATIONERY AND WRITING PAPER, IN CLASS 16 (U.S. CLS. 2, 5, 22, 23, 29, 37, 38 AND 50).

FIRST USE 0-0-2003; IN COMMERCE 0-0-2003.

FOR: CLOTHING, NAMELY, MEN'S, WOMEN'S AND CHILDREN'S SHORTS, IN CLASS 25 (U.S. CLS. 22 AND 39).

FIRST USE 6-0-2003; IN COMMERCE 6-3-2003.

FOR: FOOD PRODUCTS NOT INCLUDED IN OTHER CLASSES, NAMELY, BARBEQUE SAUCES, KETCHUP, PREPARED MEALS NOT INCLUDED IN OTHER CLASSES, NAMELY, FISH, MEAT, POULTRY, AND VEGETABLE MEALS INCLUDING STUFFED PEPPERS; SANDWICHES, HAMBURGER SANDWICHES, HOT DOGS, PASTRIES, ICE CREAM, COFFEE, TEA, COCOA, SEASONINGS, SPICES, CONFECTIONERY AND PROCESSED GRAINS, IN CLASS 30 (U.S. CL. 46).

FIRST USE 0-0-2000; IN COMMERCE 0-0-2000.

FOR: ENTERTAINMENT SERVICES, NAMELY, AMUSEMENT ARCADE SERVICES; AMUSEMENT CENTER SERVICES FEATURING VIDEO GAMES AND GAMBLING GAMES; PROVIDING CASINO FACILITIES; CASINO SERVICES; DANCE, BAND AND RODEO EVENT CONTESTS; BEAUTY PAGEANTS; FILM AND VIDEO THEATER AND RENTAL SERVICES; ATTRACTIONS IN THE NATURE OF LASER, LIGHT, MAGIC, PUPPET, ANIMAL AND/OR FASHION SHOWS; AMUSEMENT PARK RIDES, IN CLASS 41 (U.S. CLS. 100, 101 AND 107).

FIRST USE 0-0-2003; IN COMMERCE 0-0-2003.

FOR: BAR AND NIGHTCLUB SERVICES, CARRY-OUT RESTAURANT SERVICES, AND HOTEL SERVICES, IN CLASS 42 (U.S. CLS. 100 AND 101).

FIRST USE 0-0-2003; IN COMMERCE 0-0-2003.

OWNER OF U.S. REG. NO. 1,965,992 AND OTHERS.

NO CLAIM IS MADE TO THE EXCLUSIVE RIGHT TO USE "SALOON", APART FROM THE MARK AS SHOWN.

SN 75-189,000, FILED 9-19-1996.

MARY ROSSMAN, EXAMINING ATTORNEY

Int. Cls.: 2 and 3

Prior U.S. Cls.: 1, 4, 6, 11, 16, 50, 51, and 52

United States Patent and Trademark Office

Reg. No. 2,893,658

Registered Oct. 12, 2004

**TRADEMARK
PRINCIPAL REGISTER**

ECOLINE

CORTEC CORPORATION (MINNESOTA CORPORATION)
4119 WHITE BEAR PARKWAY
ST. PAUL, MN 55110

FOR: GEL-BASED RUST, SCALE AND OXIDE REMOVER FOR REMOVING RUST, SCALE, AND OXIDES FROM SURFACES, IN CLASS 2 (U.S. CLS. 6, 11 AND 16).

FIRST USE 11-17-1999; IN COMMERCE 11-17-1999.

FOR: CONTACT CLEANER USED TO CLEAN AND RESTORE CONNECTIONS ON ELECTRICAL EQUIPMENT, AIR CONDITIONING, AND REFRIGERATION UNITS; AEROSOL SPRAY FOR REMOVING ACTIVATED FLUXES AND OTHER IONIC CONTAMINANTS FROM CIRCUIT BOARDS, ELECTRICAL EQUIPMENT, AND ELECTRONIC EQUIPMENT; COMPRESSED GAS USED TO RE-

MOVE PARTICLES WHICH HAVE DEPOSITED ONTO SENSITIVE AREAS INCLUDING PRINTERS AND COPIERS, COMPUTERS, KEYBOARDS, AND ELECTRONIC, PHOTOGRAPHIC, OFFICE, AND VIDEO EQUIPMENT, CLEANING LENSES, AND ENERGIZED ELECTRICAL EQUIPMENT; AEROSOL SPRAY USED TO IDENTIFY THERMAL INTERMITTENT AND COOL LOCALIZED AREAS DURING SOLDERING OPERATIONS; GRAFFITI REMOVER FOR REMOVING INKS AND PAINTS FROM METAL, CONCRETE, AND WOOD, IN CLASS 3 (U.S. CLS. 1, 4, 6, 50, 51 AND 52).

FIRST USE 11-17-1999; IN COMMERCE 11-17-1999.

SN 75-571,029, FILED 10-14-1998.

LESLIE RICHARDS, EXAMINING ATTORNEY

Int. Cls.: 29 and 31

Prior U.S. Cls.: 1 and 46

United States Patent and Trademark Office

Reg. No. 2,893,660

Registered Oct. 12, 2004

**TRADEMARK
PRINCIPAL REGISTER**

GREENBACK

NEW ZEALAND MUSSEL INDUSTRY COUNCIL
LIMITED (NEW ZEALAND LIMITED LIABILITY COMPANY)
GRASSMERE HOUSE, 1 MAIN STREET
BLENHEIM, MARLBOROUGH, NEW ZEALAND

FOR: LIVE MUSSELS, IN CLASS 31 (U.S. CLS. 1 AND 46).

FIRST USE 6-15-2004; IN COMMERCE 6-15-2004.

FOR: PROCESSED MUSSELS, IN CLASS 29 (U.S. CL. 46).

SN 75-626,843, FILED 1-25-1999.

FIRST USE 11-17-2003; IN COMMERCE 11-17-2003.

ELLEN B. AWRICH, EXAMINING ATTORNEY

Int. Cls.: 18 and 25

Prior U.S. Cls.: 1, 2, 3, 22, 39, and 41

Reg. No. 2,893,670

United States Patent and Trademark Office

Registered Oct. 12, 2004

TRADEMARK
PRINCIPAL REGISTER

GENUINE BRAND
WHO.A.U
California

E. LAND LTD. (REPUBLIC OF KOREA CORPORATION)
19-8 CHANGJEON-DONG, MAPO-GU
SEOUL, REPUBLIC OF KOREA

FOR: COSMETIC CASES SOLD EMPTY; KNAPSACKS; BEACH BAGS; IMITATION LEATHER MADE OF POLYURETHANE SOLD IN BULK; KEY-CASES; TRAVELING BAGS; SCHOOL BAGS; WALLETS; UMBRELLAS; AND UMBRELLA COVERS, IN CLASS 18 (U.S. CLS. 1, 2, 3, 22 AND 41).

FIRST USE 2-1-2000; IN COMMERCE 2-1-2000.

FOR: SHOES AND CLOTHING, NAMELY, SLACKS, SKIRTS, JACKETS, JUMPERS, JEANS,

UNDERWEAR, SWEATERS, T-SHIRTS, OPEN-NECKED SHIRTS, ALOHA SHIRTS, AND SOCKS; SCARVES; AND CAPS AND HATS, IN CLASS 25 (U.S. CLS. 22 AND 39).

FIRST USE 2-1-2000; IN COMMERCE 2-1-2000.

NO CLAIM IS MADE TO THE EXCLUSIVE RIGHT TO USE "GENUINE BRAND" AND "CALIFORNIA", APART FROM THE MARK AS SHOWN.

SN 75-825,944, FILED 10-19-1999.

KIM SAITO, EXAMINING ATTORNEY

Int. Cls.: 25 and 41

Prior U.S. Cls.: 22, 39, 100, 101, and 107

Reg. No. 2,893,675

United States Patent and Trademark Office

Registered Oct. 12, 2004

**TRADEMARK
SERVICE MARK
PRINCIPAL REGISTER**

SPORTSKIDS.COM

REAL ESTATE SETTLEMENT CORPORATION
(CALIFORNIA CORPORATION)
2788 MONTE MAR TERRACE
LOS ANGELES, CA 90064

FOR: SWEATSHIRTS, T-SHIRTS, SHORTS, AND
SWEATPANTS, IN CLASS 25 (U.S. CLS. 22 AND 39).

FIRST USE 0-0-1999; IN COMMERCE 0-0-1999.

FOR: PROVIDING ON-LINE INFORMATION
FOR ATHLETIC COACHES, SCOUTS, PARENTS,
STUDENTS AND OTHERS TO CONSIDER COL-

LEGE AND RECRUITING OPPORTUNITIES, ACADEMIC REQUIREMENTS, PROFESSIONAL OPPORTUNITIES, ATHLETIC CAMPS, ATHLETIC TRAINING, AND OTHER ATHLETIC ACTIVITIES, IN CLASS 41 (U.S. CLS. 100, 101 AND 107).

FIRST USE 0-0-1999; IN COMMERCE 0-0-1999.

SN 75-924,742, FILED 2-14-2000.

ANDREW BENZMILLER, EXAMINING ATTORNEY

Int. Cls.: 10 and 40

Prior U.S. Cls.: 26, 39, 44, 100, 103, and 106

United States Patent and Trademark Office

Reg. No. 2,893,678

Registered Oct. 12, 2004

**TRADEMARK
SERVICE MARK
PRINCIPAL REGISTER**

IONFUSION

MOLECULAR METALLURGY, INC. (CALIFORNIA CORPORATION)
1770 GILLESPIE WAY
SUITE 107
EL CAJON, CA 92020

FOR: MEDICAL, SURGICAL AND DENTAL INSTRUMENTS, NAMELY, BLADES, SAWS, DRILLS, ROUTERS, FILES, CHISELS, NEEDLES, CUTTERS, KNIVES, CLIPS, CLAMPS, INSTRUMENT GUIDES, FORCEPS, DISSECTORS, SCISSORS, RASPS, SAW CAPTURES, BROACHES, RONGEURS, REAMERS, GRATERS, AND TRIMMERS; ARTIFICIAL JOINTS; MEDICAL IMPLANTS, NAMELY BONE IMPLANTS, ORTHOPEDIC JOINT IMPLANTS, SURGICAL IMPLANTS COMPRISING ARTIFICIAL MATERIAL, IN CLASS 10 (U.S. CLS. 26, 39 AND 44).

FIRST USE 1-31-2001; IN COMMERCE 1-31-2001.

FOR: MANUFACTURING SERVICES, NAMELY, APPLYING PROTECTIVE COATING TO METAL ITEMS, MEDICAL INSTRUMENTS AND SPORTING EQUIPMENT, IN CLASS 40 (U.S. CLS. 100, 103 AND 106).

FIRST USE 5-0-2000; IN COMMERCE 5-0-2000.

SN 75-981,431, FILED 9-22-2000.

MARY BOAGNI, EXAMINING ATTORNEY

Int. Cls.: 9 and 42

Prior U.S. Cls.: 21, 23, 26, 36, 38, 100, and 101

United States Patent and Trademark Office

Reg. No. 2,893,679

Registered Oct. 12, 2004

**TRADEMARK
SERVICE MARK
PRINCIPAL REGISTER**



BCSI INC. (DELAWARE CORPORATION), FORMERLY BROADWING COMMUNICATIONS SERVICES INC.),

201 EAST FOURTH STREET
CINCINNATI, OH 45202

FOR: PREPAID TELEPHONE CALLING CARDS, MAGNETICALLY ENCODED, IN CLASS 9 (U.S. CLS. 21, 23, 26, 36 AND 38).

FIRST USE 9-30-2001; IN COMMERCE 9-30-2001.

FOR: PROVIDING DESIGN OF CUSTOMIZED TELECOMMUNICATIONS NETWORKS FOR OTHERS (INCLUDING VOICE, DATA AND INTERNET) AS WELL AS CONSULTATION SERVICES IN THE AREA OF GLOBAL COMPUTER NETWORK EXPERTISE WHICH HELPS CUSTOMERS UNDER-

STAND HOW THE WIDE AREA NETWORK CONNECTS TO THEIR LOCAL AREA NETWORKS; AND INFORMATION TECHNOLOGY CONSULTING SERVICES IN THE AREA OF TELECOMMUNICATIONS, NAMELY, PROJECT MANAGEMENT AND ENGINEERING, SYSTEM ASSESSMENT AND TECHNOLOGY STRATEGY, SOFTWARE APPLICATION SELECTION AND INTEGRATION, ARCHITECTURE PLANNING AND DESIGN, IN CLASS 42 (U.S. CLS. 100 AND 101).

FIRST USE 6-30-2002; IN COMMERCE 6-30-2002.

SN 75-983,440, FILED 12-17-1999.

ESTHER A. BORSUK, EXAMINING ATTORNEY

Int. Cls.: 35 and 42

Prior U.S. Cls.: 100, 101, and 102

United States Patent and Trademark Office

Reg. No. 2,893,683

Registered Oct. 12, 2004

**SERVICE MARK
PRINCIPAL REGISTER**

GLOBAL IMAGE. LOCAL PRESENCE.

THE STANDARD REGISTER COMPANY (OHIO CORPORATION)
600 ALBANY STREET
DAYTON, OH 45408

FOR: COMPUTER SERVICES IN THE FIELD OF DOCUMENTS AND BUSINESS FORMS, NAMELY COMPUTERIZED DATABASE MANAGEMENT, DATA PROCESSING SERVICES; MANAGEMENT AND TRACKING OF ELECTRONIC FILES, ADVERTISING MATERIALS AND PROMOTIONAL MATERIALS; DISTRIBUTORSHIP SERVICES AND COMPUTERIZED ON-LINE ORDERING SERVICES IN THE FIELD OF BUSINESS FORMS, OFFICE SUPPLIES, COMPUTER SUPPLIES, MAINTENANCE SUPPLIES, REPAIR SUPPLIES, ADVERTISING MATERIALS AND PROMOTIONAL ITEMS; COMPUTERIZED TRACKING OF DOCUMENTS AND BUSINESS FORMS ORDERS; CONSULTING SERVICES RELATED TO ALL OF THE FOREGOING; AND BUSINESS CONSULTATION IN THE FIELDS OF BUSINESS FORMS, IN CLASS 35 (U.S. CLS. 100, 101 AND 102).

FIRST USE 5-0-2000; IN COMMERCE 5-0-2000.

FOR: COMPUTER SERVICES IN THE FIELD OF DOCUMENTS AND BUSINESS FORMS, NAMELY, DATA RECOVERY SERVICES; DATABASE DEVELOPMENT SERVICES; PROVIDING DATABASES AND ELECTRONIC LIBRARIES IN THE FIELD OF

DOCUMENTS AND BUSINESS FORMS, INCLUDING DOCUMENT DATA TRANSFER AND PHYSICAL CONVERSION FROM ONE FORM OF MEDIA TO ANOTHER; COMPUTER SERVICES, NAMELY, PROVIDING ON-LINE MAGAZINES IN THE FIELD OF ELECTRONIC COMMERCE; PROVIDING ON-LINE PUBLICATIONS, NAMELY CATALOGS, IN THE FIELD OF DOCUMENTS AND BUSINESS FORMS; UP-DATING OF COMPUTER SOFTWARE; COMPUTER DESIGN OF BUSINESS FORMS AND BUSINESS FORMS SYSTEMS, ADVERTISING AND PROMOTIONAL MATERIALS, LABELS, IDENTIFICATION LABELS AND TAGS, IDENTIFICATION CARDS, MEMBERSHIP CARDS, ACCESS CARDS, CONTROL CARDS, BUSINESS TRANSACTION CARDS AND PLASTIC CARDS FOR OTHERS; COMPUTER SYSTEMS ANALYSES; COMPUTER CONSULTATION SERVICES; COMPUTER PROGRAMMING FOR OTHERS; PRINTING SERVICES; AND COMPUTER SERVICES, NAMELY PROVIDING ON-LINE BULLETINS, ARTICLES AND NEWSLETTERS IN THE FIELDS OF BUSINESS FORMS AND E-COMMERCE, IN CLASS 42 (U.S. CLS. 100 AND 101).

FIRST USE 5-0-2000; IN COMMERCE 5-0-2000.

SN 76-041,057, FILED 5-4-2000.

HENRY S. ZAK, EXAMINING ATTORNEY

Int. Cls.: 35 and 42

Prior U.S. Cls.: 100, 101, and 102

United States Patent and Trademark Office

Reg. No. 2,893,685

Registered Oct. 12, 2004

**SERVICE MARK
PRINCIPAL REGISTER**

NUASIS

NUASIS CORPORATION (DELAWARE CORPORATION)
303 BRYANT STREET
MOUNTAIN VIEW, CA 94041

FOR: BUSINESS MANAGEMENT AND SUPPORT SERVICES, NAMELY, OUTSOURCING SERVICES FOR OTHERS IN THE FIELD OF SALES AND MARKETING, IN CLASS 35 (U.S. CLS. 100, 101 AND 102).

FIRST USE 5-8-2003; IN COMMERCE 5-8-2003.

FOR: COMPUTER SERVICES, NAMELY, HOSTING, MONITORING AND ADMINISTERING COMPUTER NETWORKS FOR OTHERS, IN CLASS 42 (U.S. CLS. 100 AND 101).

FIRST USE 5-8-2003; IN COMMERCE 5-8-2003.

SN 76-069,581, FILED 6-13-2000.

MITCHELL FRONT, EXAMINING ATTORNEY

Int. Cls.: 35, 36, and 42

Prior U.S. Cls.: 100, 101, and 102

United States Patent and Trademark Office

Reg. No. 2,893,687

Registered Oct. 12, 2004

**SERVICE MARK
PRINCIPAL REGISTER**



CFOKNOWS, LLC (NEW YORK CORPORATION)
10 SPRINGDALE LOCK
PITTSFORD, NY 14534

FOR: BUSINESS ADVISORY AND CONSULTING SERVICES IN THE FIELDS OF DATA WAREHOUSING, STRATEGIC SOURCING, IMPLEMENTATION OF ELECTRONIC PROCUREMENT SYSTEMS, SUPPLY CHAIN MANAGEMENT, PROCUREMENT INFRASTRUCTURE AND INFORMATION SYSTEMS RELATED TO THE PROCUREMENT FUNCTION OF COMPANIES, IN CLASS 35 (U.S. CLS. 100, 101 AND 102).

FIRST USE 3-1-2000; IN COMMERCE 6-1-2000.

FOR: FINANCIAL CONSULTING AND ADVISORY SERVICES, IN CLASS 36 (U.S. CLS. 100, 101 AND 102).

FIRST USE 3-1-2000; IN COMMERCE 6-1-2000.

FOR: DATA WAREHOUSING SERVICES FOR OTHERS, IN CLASS 42 (U.S. CLS. 100 AND 101).

FIRST USE 3-1-2000; IN COMMERCE 6-1-2000.

SN 76-081,107, FILED 6-30-2000.

MARY ROSSMAN, EXAMINING ATTORNEY

Int. Cls.: 35, 37, and 42

Prior U.S. Cls.: 100, 101, 102, 103, and 106

United States Patent and Trademark Office

Reg. No. 2,893,688

Registered Oct. 12, 2004

**SERVICE MARK
PRINCIPAL REGISTER**

WASHINGTON

WASHINGTON GROUP INTERNATIONAL, INC.
(OHIO CORPORATION)
720 PARK BOULEVARD
BOISE, ID 83729

FOR: COMMERCIAL AND INDUSTRIAL MANAGEMENT ASSISTANCE IN MINING OPERATIONS, IN CLASS 35 (U.S. CLS. 100, 101 AND 102).

FIRST USE 7-7-2000; IN COMMERCE 7-7-2000.

FOR: CONSTRUCTION SERVICES, NAMELY, PLANNING, DESIGN AND CUSTOM CONSTRUCTION OF RESIDENTIAL, COMMERCIAL AND INDUSTRIAL FACILITIES; CONSTRUCTION MANAGEMENT AND SUPERVISION; MINING EX-

TRACTION; MAINTENANCE OF MINING SITES, IN CLASS 37 (U.S. CLS. 100, 103 AND 106).

FIRST USE 7-7-2000; IN COMMERCE 7-7-2000.

FOR: ENGINEERING SERVICES; MINING EXPLORATION; TECHNICAL SUPERVISION AND INSPECTION IN THE FIELD OF GEOLOGICAL MINING; HAZARDOUS WASTE MANAGEMENT , IN CLASS 42 (U.S. CLS. 100 AND 101).

FIRST USE 7-7-2000; IN COMMERCE 7-7-2000.

SN 76-087,544, FILED 7-10-2000.

PAULA MAHONEY, EXAMINING ATTORNEY

Int. Cls.: 9, 36, and 41

Prior U.S. Cls.: 21, 23, 26, 36, 38, 100, 101, 102, and 107

Reg. No. 2,893,695

United States Patent and Trademark Office

Registered Oct. 12, 2004

**TRADEMARK
SERVICE MARK
PRINCIPAL REGISTER**

VOLIA

SIGMA VENTURES, INC. (DELAWARE CORPORATION)
123 N. POST OAK LANE, SUITE 410
HOUSTON, TX 77024

FOR: COMPUTER HARDWARE; WIRELESS COMPUTER HARDWARE FOR ACCESSING A COMPUTER NETWORK; COMPUTER NETWORK SYSTEMS COMPRISED OF COMPUTER HARDWARE AND OPERATING SYSTEM SOFTWARE USED IN THE FIELD OF TELECOMMUNICATIONS AND TELEPHONY; COMPUTER HARDWARE AND SOFTWARE FOR USE IN MANAGING AND OPERATING COMPUTER NETWORK SYSTEMS AND DESKTOP MANAGEMENT, IN CLASS 9 (U.S. CLS. 21, 23, 26, 36 AND 38).

FIRST USE 8-31-2003; IN COMMERCE 8-31-2003.

FOR: BANKING SERVICES; FINANCIAL INFORMATION PROVIDED BY ELECTRONIC MEANS; INVESTMENT, INSURANCE, MORTGAGE, REAL ESTATE, AND SECURITY BROKERAGE SERVICES; ELECTRONIC BROKERAGE SERVICES IN THE

FIELD OF STOCKS, COMMODITIES AND FUTURES; MONEY MANAGEMENT SERVICES, IN CLASS 36 (U.S. CLS. 100, 101 AND 102).

FIRST USE 8-31-2003; IN COMMERCE 8-31-2003.

FOR: DISTRIBUTION OF TELEVISION AND RADIO PROGRAMMING; PRODUCTION OF TELEVISION AND RADIO PROGRAMS; PROVIDING PRODUCTION OF DIGITAL MEDIA, NAMELY PRODUCTION OF TELEVISION AND RADIO SHOWS, MUSIC RECORDING PRODUCTION, MULTIMEDIA ENTERTAINMENT SOFTWARE PRODUCTION SERVICES; AND ENTERTAINMENT SERVICES, NAMELY, PROVIDING ONLINE COMPUTER GAMES AND MUSIC, IN CLASS 41 (U.S. CLS. 100, 101 AND 107).

FIRST USE 8-31-2003; IN COMMERCE 8-31-2003.

SN 76-152,188, FILED 10-23-2000.

SUE LAWRENCE, EXAMINING ATTORNEY

Int. Cls.: 29 and 30

Prior U.S. Cl.: 46

United States Patent and Trademark Office

Reg. No. 2,893,696

Registered Oct. 12, 2004

**TRADEMARK
PRINCIPAL REGISTER**

TASTE UP

MADHUR FOOD PRODUCTS, LTD. (INDIA
CORPORATION)
MADHUR COMPLEX, STADIUM CROSS ROAD
NAVRANGPURA, AHMEDABAD-380 009 GUJAR-
AT-, INDIA

FOR: INSTANT SOUP MIXES, PICKLES, SOUP,
POTATO CHIPS, AND BANANA CHIPS, IN CLASS 29
(U.S. CL. 46).

FIRST USE 6-28-2004; IN COMMERCE 6-28-2004.

FOR: SPICES, ICE CREAM POWDER MIXES AND
ICE CREAM, IN CLASS 30 (U.S. CL. 46).

FIRST USE 6-28-2004; IN COMMERCE 6-28-2004.

SN 76-152,710, FILED 10-25-2000.

CYNTHIA SLOAN, EXAMINING ATTORNEY

Int. Cls.: 12 and 28

Prior U.S. Cls.: 19, 21, 22, 23, 31, 35, 38, 44, and 50

United States Patent and Trademark Office

Reg. No. 2,893,699

Registered Oct. 12, 2004

**TRADEMARK
PRINCIPAL REGISTER**

HANGO

J. D COMPONENTS CO., LTD. (TAIWAN CORPORATION)
NO. 80, NAN DEE LANE, SHAN HSI VILL.
SHOU SHUI HSIANG
CHANG HUA HSIEN, TAIWAN

FOR: VEHICLES IN THIS CLASS, NAMELY, MOTORIZED SCOOTERS, MOTORIZED BICYCLES, NON-MOTORIZED BICYCLES, MOTORIZED TRICYCLES, NON-MOTORIZED TRICYCLES; ACCESSORIES FOR SCOOTERS, BICYCLES, AND TRICYCLES, NAMELY, GRIPS, HANDLE BARS, PEDALS, AND CLAMPS, IN CLASS 12 (U.S. CLS. 19, 21, 23, 31, 35 AND 44).

FIRST USE 12-0-2000; IN COMMERCE 1-11-2002.

FOR: TOYS, GAMES, AND PLAYTHINGS, NAMELY, NON-MOTORIZED SCOOTERS, TOY SCOOTERS, MODEL SCOOTERS, TOY BICYCLES,

MODEL BICYCLES, TOY TRICYCLES, MODEL TRICYCLES, ATHLETIC PADS FOR PROTECTING THE KNEE, WRIST, CHEST, SHOULDER, NECK, HAND, EAR, ELBOW, ARM, AND ANKLE; SPORTING AND GYMNASTIC GOODS, NAMELY, IN-LINE SKATES, ICE SKATES, ROLLER SKATES, SKATEBOARDS, TENNIS RACKETS, RACQUETBALL RACKETS, SQUASH RACKETS, GOLF CLUBS, BILLIARD CUES, HOCKEY STICKS; SPORTS EQUIPMENT BAGS; AND STATIONARY EXERCISE BICYCLES, IN CLASS 28 (U.S. CLS. 22, 23, 38 AND 50).

FIRST USE 12-0-2000; IN COMMERCE 1-11-2002.

SN 76-177,570, FILED 12-7-2000.

WON TEAK OH, EXAMINING ATTORNEY

Int. Cls.: 25 and 42

Prior U.S. Cls.: 22, 39, 100, and 101

United States Patent and Trademark Office

Reg. No. 2,893,714

Registered Oct. 12, 2004

TRADEMARK
SERVICE MARK
PRINCIPAL REGISTER

JERRBECK

DANSICKER, JAMIE (NEW YORK SOLE PROPRIETORSHIP), DBA JERRBECK,
1 UNION SQUARE SOUTH
APT. 14B
NEW YORK, NY 10003

FOR: CLOTHING, NAMELY, DRESSES, SWEATERS, COATS, JACKETS, SHIRTS, T-SHIRTS, BLOUSES, PULLOVERS, PANTS, SHORTS, SKIRTS, SUITS, HEADWEAR, SCARVES, BRASSIERES, HOSIERY, SOCKS AND FOOTWEAR FOR MEN AND WOMEN, IN CLASS 25 (U.S. CLS. 22 AND 39).

FIRST USE 10-26-2002; IN COMMERCE 10-26-2002.

FOR: CLOTHING DESIGN, IN CLASS 42 (U.S. CLS. 100 AND 101).

FIRST USE 10-26-2002; IN COMMERCE 10-26-2002.

THE NAME IN THE MARK DOES NOT IDENTIFY A PARTICULAR LIVING INDIVIDUAL.

SN 76-273,151, FILED 6-19-2001.

KIM SAITO, EXAMINING ATTORNEY

Int. Cls.: 29, 30, and 32

Prior U.S. Cls.: 45, 46, and 48

United States Patent and Trademark Office

Reg. No. 2,893,727

Registered Oct. 12, 2004

TRADEMARK
PRINCIPAL REGISTER



PANAMERICANA DE ALIMENTOS S.A. (COLOMBIA CORPORATION)
CARRERA 43 F # 18 - 110
MEDELLIN, ANTIOQUIA, COLOMBIA

FOR: COMPOTES, MARMALADES, PROCESSED FRUITS, NAMELY, FIGS, PINEAPPLES AND PEACHES, CANNED VEGETABLES, NAMELY, GREEN PEAS, CARROTS, MUSHROOM SALAD AND BEANS, IN CLASS 29 (U.S. CL. 46).

FIRST USE 0-0-1987; IN COMMERCE 0-0-1987.

FOR: HOT SAUCE, KETCHUP, BLACK SAUCE, MAYONNAISE DRESSING, WHITE FRUIT VINEGAR, IN CLASS 30 (U.S. CL. 46).

FIRST USE 0-0-1987; IN COMMERCE 0-0-1987.

FOR: FRUIT NECTARS, ESSENCES FOR THE MANUFACTURE OF LIQUEURS NOT IN THE

NATURE OF ESSENTIAL OILS, ESSENCES FOR THE PREPARATION OF MINERAL WATERS NOT IN THE NATURE OF ESSENTIAL OILS, ESSENCES FOR THE USE IN MAKING SOFT DRINKS NOT IN THE NATURE OF ESSENTIAL OILS, IN CLASS 32 (U.S. CLS. 45, 46 AND 48).

FIRST USE 0-0-1987; IN COMMERCE 0-0-1987.

NO CLAIM IS MADE TO THE EXCLUSIVE RIGHT TO USE "PANAMERICANA DE ALIMENTOS" AND "SINCE 1921", APART FROM THE MARK AS SHOWN.

THE ENGLISH TRANSLATION OF "DE ALIMENTOS" IS "FOOD PRODUCTS".

SN 76-336,731, FILED 11-13-2001.

MARK T. MULLEN, EXAMINING ATTORNEY

Int. Cls.: 36 and 41

Prior U.S. Cls.: 100, 101, 102, and 107

United States Patent and Trademark Office

Reg. No. 2,893,729

Registered Oct. 12, 2004

**SERVICE MARK
PRINCIPAL REGISTER**

ACTIVELY PROMOTING BEST PRACTICE PERFORMANCE

MIDWEST EMPLOYERS CASUALTY COMPANY,
A MEMBER COMPANY OF THE W.R. BERK-
LEY CORPORATION (DELAWARE COR-
PORATION)
13801 RIVERPORT DRIVE, SUITE 200
MARYLAND HEIGHTS, MO 63043

FOR: RISK MANAGEMENT SERVICES, INSUR-
ANCE UNDERWRITING IN THE FIELD OF WORK-
ER'S COMPENSATION, CONSULTATION IN THE
FIELD OF RISK MANAGEMENT, IN CLASS 36 (U.S.
CLS. 100, 101 AND 102).

FIRST USE 8-0-2001; IN COMMERCE 8-0-2001.

FOR: DEVELOPMENT AND DISSEMINATION
OF EDUCATIONAL MATERIALS IN THE FIELD
OF INSURANCE, IN CLASS 41 (U.S. CLS. 100, 101
AND 107).

FIRST USE 8-0-2001; IN COMMERCE 8-0-2001.

NO CLAIM IS MADE TO THE EXCLUSIVE
RIGHT TO USE "BEST PRACTICE PERFOR-
MANCE", APART FROM THE MARK AS SHOWN.

SN 76-340,167, FILED 11-20-2001.

WANDA KAY PRICE, EXAMINING ATTORNEY

Int. Cls.: 40 and 41

Prior U.S. Cls.: 100, 101, 103, 106, and 107

United States Patent and Trademark Office

Reg. No. 2,893,747

Registered Oct. 12, 2004

**SERVICE MARK
PRINCIPAL REGISTER**

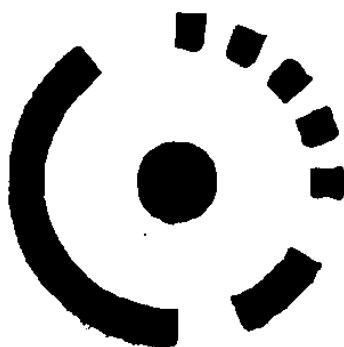

DIGITAL VIDEOSTREAM, LLC (CALIFORNIA
LIMITED LIABILITY CORPORATION)

2625 WEST OLIVE AVE.

BURBANK, CA 91505

FOR: FILM, VIDEO, AND DVD DUPLICATION
SERVICES; FILM, VIDEO, AND DVD MASTER
CONVERSION, DIGITAL COMPRESSION AND EN-
CODING SERVICES, IN CLASS 40 (U.S. CLS. 100, 103
AND 106).

FIRST USE 10-31-2001; IN COMMERCE 11-15-2001.

FOR: FILM, VIDEO, AND DVD POST PRODUC-
TION SERVICES, NAMELY EDITING; AND DIS-
TRIBUTION OF BROADCAST QUALITY MEDIA
NAMELY FILM, VIDEO AND AUDIO PROGRAM-
MING CONTENT VIA GLOBAL COMMUNICA-
TIONS NETWORK, DIGITAL LINE, FIBER OPTIC,
AND SATELLITE DELIVERY OF MEDIA WORLD-
WIDE, IN CLASS 41 (U.S. CLS. 100, 101 AND 107).

FIRST USE 10-31-2001; IN COMMERCE 11-15-2001.

SN 76-398,722, FILED 4-22-2002.

SHARI SHEFFIELD, EXAMINING ATTORNEY

Int. Cls.: 35 and 37

Prior U.S. Cls.: 100, 101, 102, 103, and 106

Reg. No. 2,893,755

United States Patent and Trademark Office

Registered Oct. 12, 2004

**SERVICE MARK
PRINCIPAL REGISTER**

YANMAR

YANMAR CO., LTD. (JAPAN CORPORATION)
1-32, CHAYAMACHI, KITA-KU
CORPORATE AFFAIRS DEPT
OSAKA, JAPAN 530-8311

FOR: PROVIDING CONSUMER INFORMATION ON MACHINERY, NAMELY, MOTORS AND ENGINES OF ALL KINDS, SHIPS, AIR-CONDITIONING APPARATUS, GENERATORS OF ELECTRICITY WITH WASTE HEAT UTILIZATION SYSTEMS, CONSTRUCTION MACHINES AND APPARATUS, AGRICULTURAL MACHINES, AGRICULTURAL IMPLEMENTS OTHER THAN HAND-OPERATED, GENERATORS OF ELECTRICITY, TRACTORS AND PARTS AND ACCESSORIES FOR THE FOREGOING; RETAIL OUTLETS FEATURING MACHINERY, NAMELY, MOTORS AND ENGINES OF ALL KINDS, SHIPS, AIR-CONDITIONING APPARATUS, GENERATORS OF ELECTRICITY WITH WASTE HEAT UTILIZATION SYSTEMS, CONSTRUCTION MACHINES AND APPARATUS, AGRICULTURE MACHINES, AGRICULTURE IMPLEMENTS OTHER THAN HAND-OPERATED, GENERATORS OF ELECTRICITY, TRACTORS AND PARTS AND ACCESSORIES FOR THE FOREGOING, IN CLASS 35 (U.S. CLS. 100, 101 AND 102).

FIRST USE 7-8-2002; IN COMMERCE 7-8-2002.

FOR: REPAIR AND MAINTENANCE OF MACHINERY, NAMELY, MOTORS AND ENGINES OF

ALL KINDS, SHIPS, AIR-CONDITIONING APPARATUS, GENERATORS OF ELECTRICITY WITH WASTE HEAT UTILIZATION SYSTEMS, CONSTRUCTION MACHINES AND APPARATUS, AGRICULTURAL MACHINES, AGRICULTURAL IMPLEMENTS OTHER THAN HAND-OPERATED, GENERATORS OF ELECTRICITY, TRACTORS AND PARTS AND ACCESSORIES FOR THE FOREGOING; PROVIDING INFORMATION ON REPAIR AND MAINTENANCE OF MACHINERY, NAMELY MOTORS AND ENGINES OF ALL KINDS, SHIPS, AIR-CONDITIONING APPARATUS, GENERATORS OF ELECTRICITY WITH WASTE HEAT UTILIZATION SYSTEMS, CONSTRUCTION MACHINES AND APPARATUS, AGRICULTURAL MACHINES, AGRICULTURAL IMPLEMENTS OTHER THAN HAND-OPERATED, GENERATORS OF ELECTRICITY, TRACTORS, AND PARTS AND ACCESSORIES FOR THE FOREGOING, IN CLASS 37 (U.S. CLS. 100, 103 AND 106).

FIRST USE 7-8-2002; IN COMMERCE 7-8-2002.

NO CLAIM IS MADE TO THE EXCLUSIVE RIGHT TO USE "YANMAR", APART FROM THE MARK AS SHOWN.

SN 76-432,916, FILED 7-2-2002.

MIDGE BUTLER, EXAMINING ATTORNEY

Int. Cls.: 16 and 35

Prior U.S. Cls.: 2, 5, 22, 23, 29, 37, 38, 50, 100, 101, and 102

Reg. No. 2,893,757

United States Patent and Trademark Office

Registered Oct. 12, 2004

**TRADEMARK
SERVICE MARK
PRINCIPAL REGISTER**

KARMA COACHING CARDS

KARMA COACHING CARDS INC. (CANADA CORPORATION)
881 HELMCKEN STREET
VANCOUVER, BRITISH COLUMBIA, CANADA V5Z 1B1

FOR: MOTIVATIONAL AND TASK-BASED COACHING CARDS IN THE FIELD OF PERSONAL GOALS, PERSONAL PRODUCTIVITY AND PERSONAL PERFORMANCE; DAILY PERSONAL JOURNALS, IN CLASS 16 (U.S. CLS. 2, 5, 22, 23, 29, 37, 38 AND 50).

FIRST USE 12-9-2003; IN COMMERCE 12-9-2003.

FOR: COMPUTER ON-LINE RETAIL BUSINESS SERVICES FEATURING MOTIVATIONAL AND TASK-BASED COACHING CARDS IN THE FIELD OF PERSONAL GOALS, PERSONAL PRODUCTIV-

ITY AND PERSONAL PERFORMANCE AND DAILY PERSONAL JOURNALS, IN CLASS 35 (U.S. CLS. 100, 101 AND 102).

FIRST USE 12-9-2003; IN COMMERCE 12-9-2003.

PRIORITY CLAIMED UNDER SEC. 44(D) ON CANADA APPLICATION NO. 1,134,054, FILED 3-12-2002, DATED 0-0-0000.

NO CLAIM IS MADE TO THE EXCLUSIVE RIGHT TO USE "COACHING CARDS", APART FROM THE MARK AS SHOWN.

SN 76-446,221, FILED 8-30-2002.

J. TINGLEY, EXAMINING ATTORNEY

Int. Cls.: 35 and 36

Prior U.S. Cls.: 100, 101, and 102

United States Patent and Trademark Office

Reg. No. 2,893,758

Registered Oct. 12, 2004

**SERVICE MARK
PRINCIPAL REGISTER**

IT'S ABOUT YOUR PAST... AND IT AFFECTS YOUR FUTURE.

TRILEGIANT CORPORATION (DELAWARE CORPORATION)
100 CONNECTICUT AVENUE
NORWALK, CT 06850

FOR: PROVIDING MEMBERS WITH INFORMATION ABOUT AND ACCESS TO THE SOCIAL SECURITY RECORDS, MEDICAL RECORDS AND DRIVING RECORDS OF THEMSELVES AND THEIR FAMILIES, BY MEANS OF THE INTERNET, IN CLASS 35 (U.S. CLS. 100, 101 AND 102).

FIRST USE 11-14-2002; IN COMMERCE 11-14-2002.

FOR: PROVIDING MEMBERS WITH INFORMATION ABOUT AND ACCESS TO CREDIT REPORTS AND FINANCIAL INFORMATION ON THEMSELVES AND THEIR FAMILIES, IN CLASS 36 (U.S. CLS. 100, 101 AND 102).

FIRST USE 11-14-2002; IN COMMERCE 11-14-2002.

SN 76-446,880, FILED 9-3-2002.

ANN LINNEHAN, EXAMINING ATTORNEY

Int. Cls.: 3 and 7

**Prior U.S. Cls.: 1, 4, 6, 13, 19, 21, 23, 31, 34, 35, 50, 51,
and 52**

Reg. No. 2,893,763

United States Patent and Trademark Office

Registered Oct. 12, 2004

**TRADEMARK
PRINCIPAL REGISTER**

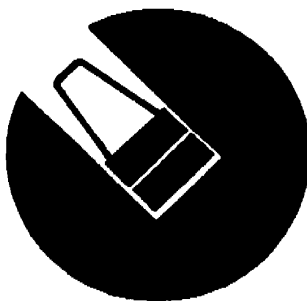

R.E. WHITTAKER COMPANY (PENNSYLVANIA
CORPORATION)
302 SOUTH CROTON AVENUE
NEW CASTLE, PA 16101

FOR: CARPET CLEANERS AND FLOOR CLEAN-
ING PREPARATIONS, IN CLASS 3 (U.S. CLS. 1, 4, 6,
50, 51 AND 52).

FIRST USE 10-0-2003; IN COMMERCE 10-0-2003.

FOR: ELECTRIC CARPET CLEANING MA-
CHINES AND FLOOR WASHING MACHINES, IN
CLASS 7 (U.S. CLS. 13, 19, 21, 23, 31, 34 AND 35).

FIRST USE 5-0-2003; IN COMMERCE 5-0-2003.

THE MARK CONSISTS OF A DESIGN OF A
CARPET CLEANING MACHINE CLEANING A CIR-
CLE-SHAPED FLOOR.

SN 76-461,878, FILED 10-28-2002.

KATHERINE STOIDES, EXAMINING ATTORNEY

Int. Cls.: 9 and 25

Prior U.S. Cls.: 21, 22, 23, 26, 36, 38, and 39

United States Patent and Trademark Office

Reg. No. 2,893,777

Registered Oct. 12, 2004

**TRADEMARK
PRINCIPAL REGISTER**

THROBACK RECORDS

SOUNDS 4 SITES, INC. (CALIFORNIA CORPORATION)
20604 ALAMINOS DRIVE
SAUGUS, CA 91350

FOR: MUSICAL SOUND RECORDINGS, NAME-
LY, PHONOGRAPH RECORDS, AUDIO MAGNETIC
TAPES, DIGITAL MAGNETIC TAPES, AUDIO COM-
PACT DISCS, CD-ROMS, DVD AND AUDIO-VISUAL
RECORDS IN ANALOG AND DIGITAL DISC CON-
FIGURATIONS, IN CLASS 9 (U.S. CLS. 21, 23, 26, 36
AND 38).

FIRST USE 11-0-2003; IN COMMERCE 11-0-2003.

FOR: CLOTHING FOR MEN, WOMEN AND
CHILDREN, NAMELY, T-SHIRTS, TANK TOPS,

SWEAT SHIRTS, JACKETS, HATS, VISORS, HEAD
BANDS, SCARVES, SHORTS, BOXER SHORTS,
SOCKS AND FOOTWEAR, IN CLASS 25 (U.S. CLS.
22 AND 39).

FIRST USE 12-0-2003; IN COMMERCE 12-0-2003.

NO CLAIM IS MADE TO THE EXCLUSIVE
RIGHT TO USE "RECORDS" , APART FROM THE
MARK AS SHOWN.

SN 76-496,084, FILED 3-10-2003.

JOHN DWYER, EXAMINING ATTORNEY

Int. Cls.: 35 and 41

Prior U.S. Cls.: 100, 101, 102, and 107

United States Patent and Trademark Office

Reg. No. 2,893,787

Registered Oct. 12, 2004

**SERVICE MARK
PRINCIPAL REGISTER**

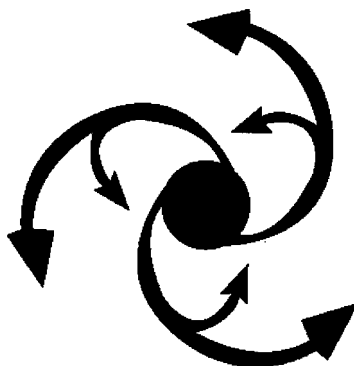

THE WILDWORKS GROUP (TEXAS CORPORATION)
2501 CEDAR SPRINGS
SUITE 200
DALLAS, TX 75201

FOR: BUSINESS MANAGEMENT CONSULTING SERVICES, NAMELY IN COLLABORATIVE STRATEGIC AND OPERATIONAL CONSULTING, IN CLASS 35 (U.S. CLS. 100, 101 AND 102).

FIRST USE 8-1-2002; IN COMMERCE 8-1-2002.

FOR: EDUCATIONAL SERVICES, NAMELY IN CONDUCTING TRAINING, WORKSHOPS, AND SEMINARS IN COLLABORATION, IN CLASS 41 (U.S. CLS. 100, 101 AND 107).

FIRST USE 8-1-2002; IN COMMERCE 8-1-2002.

SN 76-509,291, FILED 4-24-2003.

DAVID ELTON, EXAMINING ATTORNEY

Int. Cls.: 9 and 42

Prior U.S. Cls.: 21, 23, 26, 36, 38, 100, and 101

Reg. No. 2,893,800

United States Patent and Trademark Office

Registered Oct. 12, 2004

**TRADEMARK
SERVICE MARK
PRINCIPAL REGISTER**

ROVOR

ROVOR TECHNOLOGIES, INC. (CALIFORNIA CORPORATION)
259 PRAGUE STREET
SAN FRANCISCO, CA 94112

FOR: COMPUTER SOFTWARE FOR DIGITAL MUSIC AND VIDEO AND AUDIO PLAYBACK, RECORDING AND EDITING THAT MAY BE DOWNLOADED FROM A GLOBAL COMPUTER NETWORK; COMPUTER COMMUNICATIONS SOFTWARE FOR CONNECTING INTERNET MESSAGING, INSTANT MESSAGING, E-MAIL, AND BULLETIN BOARD HOSTING; COMPUTER SOFTWARE FOR USE IN ENTERING GAME SCORES AND GAME STATISTIC TRACKING; COMPUTER SOFTWARE FOR PERSONAL DIGITAL ASSISTANT COMPUTERS THAT CAN BE ACCESSED THROUGH A GLOBAL COMPUTER NETWORK; COMPUTER SOFTWARE FOR USE IN DATABASE MANAGEMENT, NAMELY, VIEWING, EDITING

AND NAVIGATING ELECTRONIC FILES, IN CLASS 9 (U.S. CLS. 21, 23, 26, 36 AND 38).

FIRST USE 7-28-1999; IN COMMERCE 8-16-2000.

FOR: COMPUTER CONSULTATION; COMPUTER SOFTWARE ENGINEERING; COMPUTER SOFTWARE DESIGN AND DEVELOPMENT FOR OTHERS; COMPUTER SYSTEMS ANALYSIS; COMPUTER SERVICES, NAMELY, DESIGNING AND IMPLEMENTING WEB SITES FOR OTHERS; HOSTING OF DIGITAL CONTENT ON THE INTERNET, IN CLASS 42 (U.S. CLS. 100 AND 101).

FIRST USE 7-28-1999; IN COMMERCE 8-16-2000.

SN 78-024,526, FILED 9-6-2000.

MARIA-VICTORIA SUAREZ, EXAMINING ATTORNEY

Int. Cls.: 9 and 42

Prior U.S. Cls.: 21, 23, 26, 36, 38, 100, and 101

United States Patent and Trademark Office

Reg. No. 2,893,813

Registered Oct. 12, 2004

**TRADEMARK
SERVICE MARK
PRINCIPAL REGISTER**

iTravelConnect

SITA ADVANCED TRAVEL SOLUTIONS LIMITED (UNITED KINGDOM LIMITED COMPANY)
WEYSIDE PARK
GODAMLING SURREY GU7 1XE, ENGLAND

FOR: COMPUTER SOFTWARE FOR APPLICATION AND DATABASE INTEGRATION, FOR CONNECTING GLOBAL COMPUTER NETWORKS, ALL IN THE FIELD OF GENERAL USE; AND INSTRUCTION MANUALS AND PUBLICATIONS IN ELECTRONIC FORMAT SOLD TOGETHER THEREWITH AS A UNIT, IN CLASS 9 (U.S. CLS. 21, 23, 26, 36 AND 38).

FIRST USE 6-0-2000; IN COMMERCE 6-0-2000.

FOR: COMPUTER PROGRAMMING FOR OTHERS; COMPUTER SYSTEMS ANALYSIS; TECHNICAL RESEARCH IN THE FIELD OF COMPUTER PROGRAMMING; CONSULTANCY SERVICES RE-

LATING TO THE DESIGN AND INSTALLATION OF COMPUTERS; CONSULTANCY SERVICES IN THE FIELD OF COMPUTER HARDWARE AND SOFTWARE; APPLICATION SOFTWARE INSTALLATION SERVICES; MAINTENANCE OF COMPUTER SOFTWARE; AND TECHNICAL SUPPORT, NAMELY, MONITORING OF NETWORK SYSTEMS, IN CLASS 42 (U.S. CLS. 100 AND 101).

FIRST USE 6-0-2000; IN COMMERCE 6-0-2000.

PRIORITY CLAIMED UNDER SEC. 44(D) ON ERPN CMNTY TM OFC APPLICATION NO. 2345296, FILED 8-20-2001, REG. NO. 2345296, EXPIRES 8-20-2011.

SN 78-091,484, FILED 11-2-2001.

KIMBERLY PERRY, EXAMINING ATTORNEY

Int. Cls.: 9 and 28

Prior U.S. Cls.: 21, 22, 23, 26, 36, 38, and 50

United States Patent and Trademark Office

Reg. No. 2,893,826

Registered Oct. 12, 2004

**TRADEMARK
PRINCIPAL REGISTER**

OUTDOOR ANTICS

WILD PLANET TOYS, INC. (CALIFORNIA CORPORATION)
225 BUSH STREET, 13TH FLOOR
SAN FRANCISCO, CA 94104

FOR: FLOATING WATERPROOF FM RADIO, SWIM MASKS AND SNORKELS, IN CLASS 9 (U.S. CLS. 21, 23, 26, 36 AND 38).

FIRST USE 10-0-2002; IN COMMERCE 1-0-2003.

FOR: OUTDOOR WATER SQUIRTING TOYS AND GAMES, NAMELY TOY PERISCOPES FOR USE UNDER WATER; ACTION SKILL GAMES FOR USE IN WATER CONSISTING OF A TIMER AND A SMALL TOY FISH LAUNCHED IN WATER; UNDERWATER TALKING TOYS; TOY FACE MASKS FOR SWIMMING; TOY FACE MASKS WITH LIGHTS FOR USE UNDERWATER; TOY SNORKELS; TOY SNORKELS WITH PERISCOPES; TOY

DIVE BALLS, CONSISTING OF BALLS WITH TAILS FOR USE IN WATER; TOY FLOATING WATERPROOF RADIO; TOY GLIDERS FOR USE UNDERWATER; DIVE AND SEARCH WATER GAMES, CONSISTING OF TOY MAGNETIC FISH AND MAGNETIC DIVE GLOVES; WATER PROJECTING, SQUIRTING AND FLOATING TOYS; PUMP ACTION WATER BLASTERS, IN CLASS 28 (U.S. CLS. 22, 23, 38 AND 50).

FIRST USE 10-0-2002; IN COMMERCE 1-0-2003.

NO CLAIM IS MADE TO THE EXCLUSIVE RIGHT TO USE "OUTDOOR", APART FROM THE MARK AS SHOWN.

SN 78-120,218, FILED 4-8-2002.

ALICE BENMAMAN, EXAMINING ATTORNEY

Int. Cls.: 18 and 25

Prior U.S. Cls.: 1, 2, 3, 22, 39, and 41

United States Patent and Trademark Office

Reg. No. 2,893,828

Registered Oct. 12, 2004

**TRADEMARK
PRINCIPAL REGISTER**

JUNIOR HEADQUARTERS

WEAR ME APPAREL CORP. (NEW YORK CORPORATION)
31 WEST 34TH STREET
NEW YORK, NY 10001

FOR: HANDBAGS, IN CLASS 18 (U.S. CLS. 1, 2, 3, 22 AND 41).

FIRST USE 6-14-2004; IN COMMERCE 6-14-2004.

FOR: CLOTHING AND ACCESSORIES, NAMELY, SHIRTS, KNITTED AND WOVEN TOPS, PANTS, SHORTS, DRESSES, SHOES, TIES, HATS, SCARVES, GLOVES, BELTS, OVERALLS, JEANS, SWEATERS, JACKETS, VESTS, SWEATSHIRTS, SWEATPANTS, SUSPENDERS, UNDERWEAR, SLEEPWEAR; WORKOUT GEAR, NAMELY SWEAT SUITS,

SWEATPANTS, SWEATSHIRTS, GYM SHORTS, SNEAKERS, LEG WARMERS, TIGHTS, TRACK SUITS, WRIST BANDS; OUTER WEAR, NAMELY SKI PANTS, COATS, EAR FLAPS, JACKETS, SKI MASKS, VESTS, AND RAINWEAR, IN CLASS 25 (U.S. CLS. 22 AND 39).

FIRST USE 6-14-2004; IN COMMERCE 6-14-2004.

NO CLAIM IS MADE TO THE EXCLUSIVE RIGHT TO USE "JUNIOR", APART FROM THE MARK AS SHOWN.

SN 78-121,468, FILED 4-12-2002.

ROBIN CHOSID, EXAMINING ATTORNEY

Int. Cls.: 3, 5, and 8

Prior U.S. Cls.: 1, 4, 6, 18, 23, 28, 44, 46, 50, 51, and 52

Reg. No. 2,893,842

United States Patent and Trademark Office

Registered Oct. 12, 2004

**TRADEMARK
PRINCIPAL REGISTER**

KIRAN

EAGLE DISTRIBUTORS INC. (CALIFORNIA CORPORATION)

2105 S. LOS ANGELES STREET

LOS ANGELES, CA 90011

FOR: SHAVING BALMS, CREAMS, GELS AND LOTIONS; SKIN LOTIONS, SOAPS AND TONERS; SHOE POLISH; PERSONAL DEODORANTS AND ANTIPERSPIRANTS; TOOTH PASTE, GEL AND POWDERS; NON-MEDICATED HAIR CARE PREPARATIONS, IN CLASS 3 (U.S. CLS. 1, 4, 6, 50, 51 AND 52).

FIRST USE 10-17-2002; IN COMMERCE 10-17-2002.

FOR: AIR FRESHENER; SHOE DEODORIZER; CAR AND TRUCK DEODORIZER, IN CLASS 5 (U.S. CLS. 6, 18, 44, 46, 51 AND 52).

FIRST USE 10-17-2002; IN COMMERCE 10-17-2002.

FOR: RAZORS, RAZOR BLADES, SCISSORS, NAIL CLIPPERS, IN CLASS 8 (U.S. CLS. 23, 28 AND 44).

FIRST USE 10-17-2002; IN COMMERCE 10-17-2002.

SN 78-137,947, FILED 6-22-2002.

CIMMERIAN COLEMAN, EXAMINING ATTORNEY

Int. Cls.: 3 and 4

Prior U.S. Cls.: 1, 4, 6, 15, 50, 51, and 52

United States Patent and Trademark Office

Reg. No. 2,893,844

Registered Oct. 12, 2004

**TRADEMARK
PRINCIPAL REGISTER**

PURE TIFFANY

TIFFANY (NJ) INC. (NEW JERSEY CORPORATION)
15 SYLVAN WAY
PARSIPPANY, NJ 07054

FOR: FRAGRANCE PRODUCTS, NAMELY, PERFUME, COLOGNE, TOILETTE WATER, BODY CREAM, AND BODY LOTION, IN CLASS 3 (U.S. CLS. 1, 4, 6, 50, 51 AND 52).

FIRST USE 2-0-2003; IN COMMERCE 2-0-2003.

FOR: SCENTED CANDLES, IN CLASS 4 (U.S. CLS. 1, 6 AND 15).

FIRST USE 12-0-2003; IN COMMERCE 12-0-2003.

OWNER OF U.S. REG. NOS. 1,228,409, 2,123,199, AND OTHERS.

SN 78-143,207, FILED 7-11-2002.

JACQUELINE A. LAVINE, EXAMINING ATTORNEY

Int. Cls.: 36 and 39

Prior U.S. Cls.: 100, 101, 102, and 105

United States Patent and Trademark Office

Reg. No. 2,893,850

Registered Oct. 12, 2004

**SERVICE MARK
PRINCIPAL REGISTER**

PNEUTECH

PNEUMATIC TECHNOLOGY, INC. (TEXAS CORPORATION)
99 TROPHY CLUB DRIVE, SUITE 342
TROPHY CLUB, TX 76262

FOR: BROKERAGE SERVICES IN THE FIELD OF PURCHASING AND RESELLING TANK TRAILERS AND PARTS AND ACCESSORIES THEREOF, IN CLASS 36 (U.S. CLS. 100, 101 AND 102).

FIRST USE 5-0-2002; IN COMMERCE 5-0-2002.

FOR: LEASING OF TANK TRAILERS AND PARTS AND ACCESSORIES THEREOF, IN CLASS 39 (U.S. CLS. 100 AND 105).

FIRST USE 5-0-2002; IN COMMERCE 5-0-2002.

SN 78-152,285, FILED 8-8-2002.

BARBARA BROWN, EXAMINING ATTORNEY

Int. Cls.: 3, 4, 11, and 21

**Prior U.S. Cls.: 1, 2, 4, 6, 13, 15, 21, 23, 29, 30, 31, 33,
34, 40, 50, 51, and 52**

Reg. No. 2,893,884

United States Patent and Trademark Office

Registered Oct. 12, 2004

**TRADEMARK
PRINCIPAL REGISTER**

ESSENCE OF GOOD LIVING

ENDAR CORPORATION (CALIFORNIA CORPORATION)
43195 BUSINESS PARK DRIVE
TEMECULA, CA 92590

FOR: HOME FRAGRANCE ITEMS, NAMELY, POTPOURRI, LIQUID POTPOURRI, INCENSE, FRAGRANCE OILS, POMANDERS, LIGHT BULB RINGS FOR CARRYING A FRAGRANCE, ROOM FRAGRANCES AND SACHETS, IN CLASS 3 (U.S. CLS. 1, 4, 6, 50, 51 AND 52).

FIRST USE 1-1-2003; IN COMMERCE 1-1-2003.

FOR: CANDLES, IN CLASS 4 (U.S. CLS. 1, 6 AND 15).

FIRST USE 1-1-2003; IN COMMERCE 1-1-2003.

FOR: ELECTRIC FRAGRANT OIL DISPENSER; ELECTRIC FRAGRANT OIL DISPENSER WITH NIGHT-LIGHT; LIGHT BULB RINGS AS LIGHTING ACCESSORIES, IN CLASS 11 (U.S. CLS. 13, 21, 23, 31 AND 34).

FIRST USE 1-1-2003; IN COMMERCE 1-1-2003.

FOR: CANDLE HOLDERS NOT OF PRECIOUS METAL, CANDLE RINGS FOR USE AS TABLE AND WALL DECORATIONS NOT OF PRECIOUS METAL; CERAMIC LIGHT BULB RINGS, IN CLASS 21 (U.S. CLS. 2, 13, 23, 29, 30, 33, 40 AND 50).

FIRST USE 1-1-2003; IN COMMERCE 1-1-2003.

SN 78-185,602, FILED 11-15-2002.

JENNIFER KRISP, EXAMINING ATTORNEY

Int. Cls.: 9 and 18

Prior U.S. Cls.: 1, 2, 3, 21, 22, 23, 26, 36, 38, and 41

United States Patent and Trademark Office

Reg. No. 2,893,896

Registered Oct. 12, 2004

**TRADEMARK
PRINCIPAL REGISTER**

TPRO

TRAVELPRO INTERNATIONAL, INC. (DELA-
WARE CORPORATION)
700 BANYAN TRAIL
BOCA RATON, FL 33431

FOR: COMPUTER CARRYING CASES, IN CLASS
9 (U.S. CLS. 21, 23, 26, 36 AND 38).

FIRST USE 1-0-2003; IN COMMERCE 1-0-2003.

FOR: LUGGAGE, TRAVEL BAGS, DUFFEL
BAGS, BACKPACKS, ROLLING TRAVEL BAGS
AND TOTES, IN CLASS 18 (U.S. CLS. 1, 2, 3, 22
AND 41).

FIRST USE 1-0-2003; IN COMMERCE 1-0-2003.

SN 78-190,668, FILED 12-3-2002.

GINNY ISAACSON, EXAMINING ATTORNEY

Int. Cls.: 16 and 41

Prior U.S. Cls.: 2, 5, 22, 23, 29, 37, 38, 50, 100, 101, and 107

Reg. No. 2,893,918

United States Patent and Trademark Office

Registered Oct. 12, 2004

**TRADEMARK
SERVICE MARK
PRINCIPAL REGISTER**

STUDYDOG

STUDYDOG, INC. (OREGON CORPORATION)
9720 S.W. NIMBUS AVENUE
BEAVERTON, OR 97034

FOR: PRINTED MATERIALS, NAMELY, BOOKS AND INSTRUCTIONAL MATERIALS IN THE FIELD OF EDUCATIONAL SUBJECTS SUCH AS READING, WRITING OR MATH, IN CLASS 16 (U.S. CLS. 2, 5, 22, 23, 29, 37, 38 AND 50).

FIRST USE 4-29-2003; IN COMMERCE 4-29-2003.

FOR: EDUCATIONAL SERVICES, NAMELY, ASSESSING AND REPORTING THE SKILL LEVELS OF STUDENTS ON-LINE, DEVELOPING A LEARNING PROFILE OF HOW THE STUDENT IS LIKELY

TO MORE READILY LEARN A SUBJECT, PROVIDING A RECOMMENDATION OF A TUTORIAL PROGRAM BASED UPON THE ASSESSMENT, PROVIDING INSTRUCTION IN EDUCATIONAL SUBJECT AREAS SUCH AS READING, WRITING AND MATH USING EDUCATIONAL CURRICULUM AND ON-LINE TUTORING, REPORTING THE PROGRESS OF A STUDENT ON-LINE TO INDIVIDUALS SUCH AS PARENTS, GUARDIANS AND TEACHERS, IN CLASS 41 (U.S. CLS. 100, 101 AND 107).

FIRST USE 4-29-2003; IN COMMERCE 4-29-2003.

SN 78-216,173, FILED 2-18-2003.

MICHAEL BAIRD, EXAMINING ATTORNEY

Int. Cls.: 16 and 41

Prior U.S. Cls.: 2, 5, 22, 23, 29, 37, 38, 50, 100, 101, and 107

Reg. No. 2,893,919

United States Patent and Trademark Office

Registered Oct. 12, 2004

**TRADEMARK
SERVICE MARK
PRINCIPAL REGISTER**



STUDYDOG, INC. (OREGON CORPORATION)
9720 S.W. NIMBUS AVENUE
BEAVERTON, OR 97034

FOR: PRINTED MATERIALS, NAMELY, BOOKS AND INSTRUCTIONAL MATERIALS IN THE FIELD OF EDUCATIONAL SUBJECTS SUCH AS READING, WRITING OR MATH, IN CLASS 16 (U.S. CLS. 2, 5, 22, 23, 29, 37, 38 AND 50).

FIRST USE 4-29-2003; IN COMMERCE 4-29-2003.

FOR: EDUCATIONAL SERVICES, NAMELY, ASSESSING AND REPORTING THE SKILL LEVELS OF STUDENTS ON-LINE, DEVELOPING A LEARNING PROFILE OF HOW THE STUDENT IS LIKELY

TO MORE READILY LEARN A SUBJECT, PROVIDING A RECOMMENDATION OF A TUTORIAL PROGRAM BASED UPON THE ASSESSMENT, PROVIDING INSTRUCTION IN EDUCATIONAL SUBJECT AREAS SUCH AS READING, WRITING AND MATH USING EDUCATIONAL CURRICULUM AND ON-LINE TUTORING, REPORTING THE PROGRESS OF A STUDENT ON-LINE TO INDIVIDUALS SUCH AS PARENTS, GUARDIANS AND TEACHERS, IN CLASS 41 (U.S. CLS. 100, 101 AND 107).

FIRST USE 4-29-2003; IN COMMERCE 4-29-2003.

SN 78-216,176, FILED 2-18-2003.

MICHAEL BAIRD, EXAMINING ATTORNEY

Int. Cls.: 30 and 43

Prior U.S. Cls.: 46, 100, and 101

United States Patent and Trademark Office

Reg. No. 2,893,925

Registered Oct. 12, 2004

**TRADEMARK
SERVICE MARK
PRINCIPAL REGISTER**

ONE HOT MAMA'S

CARB, STEVEN M (UNITED STATES INDIVIDUAL)
2 MILLWRIGHT DRIVE
HILTON HEAD, SC 29926

FOR: BARBECUE SAUCE, RIB SAUCE, CHICKEN WING SAUCE, MARINADES, SALAD DRESSINGS, SALSAS, SPICES; AND DRY RUBS, WET RUBS AND JERK RUBS, NAMELY, SEASONED COATINGS FOR MEAT, FISH AND POULTRY, IN CLASS 30 (U.S. CL. 46).

FIRST USE 5-1-2003; IN COMMERCE 5-1-2003.

FOR: RESTAURANT AND BAR SERVICES, IN CLASS 43 (U.S. CLS. 100 AND 101).

FIRST USE 5-1-2003; IN COMMERCE 5-1-2003.

SN 78-237,853, FILED 4-15-2003.

JOHN DWYER, EXAMINING ATTORNEY

Int. Cls.: 9 and 21

**Prior U.S. Cls.: 2, 13, 21, 23, 26, 29, 30, 33, 36, 38, 40,
and 50**

Reg. No. 2,893,931

United States Patent and Trademark Office

Registered Oct. 12, 2004

**TRADEMARK
PRINCIPAL REGISTER**

LIL' SPROUTS

MAGLA WORLDWIDE, LTD. (CAYMAN IS-
LANDS CORPORATION)
SUITE 1
2 STREET D-7, VILLA REAL DEV.
VEGA BAJA, PUERTO RICO 00693

FOR: GARDENING GLOVES, IN CLASS 21 (U.S.
CLS. 2, 13, 23, 29, 30, 33, 40 AND 50).

FIRST USE 6-0-2003; IN COMMERCE 6-0-2003.

FOR: PROTECTIVE WORK GLOVES, IN CLASS 9
(U.S. CLS. 21, 23, 26, 36 AND 38).

SN 78-281,627, FILED 7-31-2003.

FIRST USE 6-0-2003; IN COMMERCE 6-0-2003.

JOSETTE BEVERLY, EXAMINING ATTORNEY

Int. Cls.: 29 and 32

Prior U.S. Cls.: 45, 46, and 48

United States Patent and Trademark Office

Reg. No. 2,893,932

Registered Oct. 12, 2004

**TRADEMARK
PRINCIPAL REGISTER**

HAND PICKED GOODNESS

MOTT'S INC. (DELAWARE CORPORATION)
6 HIGH RIDGE PARK
STAMFORD, CT 06905

FOR: APPLESAUCE, IN CLASS 29 (U.S. CL. 46).

FIRST USE 11-30-2003; IN COMMERCE 11-30-2003.

FOR: FRUIT JUICES AND FRUIT-FLAVORED
DRINKS, IN CLASS 32 (U.S. CLS. 45, 46 AND 48).

FIRST USE 3-31-2004; IN COMMERCE 3-31-2004.

SN 78-281,681, FILED 7-31-2003.

JOSETTE BEVERLY, EXAMINING ATTORNEY

Int. Cls.: 7, 8, and 25

Prior U.S. Cls.: 13, 19, 21, 22, 23, 28, 31, 34, 35, 39, and 44

Reg. No. 2,893,935

United States Patent and Trademark Office

Registered Oct. 12, 2004

**TRADEMARK
SUPPLEMENTAL REGISTER**

JANSER

FIRMA MAXIMILIAN JANSER (FED REP GERMANY COMPANY)

BOBLINGER STRASSE 91

71139 EHNINGEN, FED REP GERMANY

FOR: MACHINES FOR THE TREATMENT OF FLOORS; MACHINES FOR THE REMOVAL OF FLOOR COVERINGS; MACHINES FOR THE INSTALLATION OF FLOOR COVERINGS; GRINDING MACHINES, GRINDING AND SANDING MACHINES FOR PARQUETRY, MILLING MACHINES; MACHINES, NAMELY, JOINT MILLERS, SAWING MACHINES FOR FLOOR COVERINGS, SAWS, DUST EXTRACTORS, VACUUM CLEANERS FOR GRINDING DUST, GROOVING MACHINES, WELDING GUNS, STRIPPERS FOR REMOVING FLOOR COVERINGS; MACHINES FOR THE OILING AND WAXING OF FLOOR COVERINGS; STIRRING MACHINES, NAMELY, STIRRING MACHINES FOR SUBFLOOR TREATMENT; MACHINES, NAMELY, MIXING STATIONS, CUTTING MACHINES, FOR CUTTING FLOOR COVERINGS AND TEXTILES; CLEANING MACHINES FOR CLEANING FLOORS; MACHINES, NAMELY, HAND GUN TACKERS AND ELECTRONIC AND PNEUMATIC STAPLERS, PNEUMATIC NAILERS, GLUING MACHINES, MACHINES, NAMELY POWER-OPERATED AGITATORS FOR TREATMENT OF SUBFLOORS, AIR COMPRESSORS, SCREWERS FOR LAYING FLOOR COVERINGS, ADHESIVE PISTOLS FOR LAYING FLOOR COVERINGS, WHIPPING MACHINES FOR CARPETS, MATS AND CARPET SKIRTINGS, FRINGING MACHINES, MEASURING AND CUTTING MACHINES FOR FLOOR COVERINGS, POWER OPERATED ROLL PATERNOSTERS FOR DISPLAYING AND STORING ROLLS OF FLOOR COVERINGS, AND SUPPORTS FOR ROLLS OF FLOOR COVERINGS, NAMELY METAL ROLL STANDS FOR DISPLAYING AND STORING FLOOR COVERINGS; REPLA-

CEMENT PARTS THEREFOR, IN CLASS 7 (U.S. CLS. 13, 19, 21, 23, 31, 34 AND 35).

FOR: HAND TOOLS FOR THE REMOVAL OF FLOOR COVERINGS, NAMELY, PULLING CLAWS, CUTTERS, FLOOR SCRAPERS, HANDSCRAPERS, SPATTLES, TROWELS, HAND GRINDERS, GRINDING STONES, SANDING STONES; HAND TOOLS FOR THE TREATMENT OF FLOORS AND THE INSTALLATION OF FLOOR COVERINGS; TOOLS FOR INTERIOR DECORATORS, FLOOR LAYERS, UPHOLSTERERS AND WALL DECORATORS, TROWELS, SCRAPERS, DOCTOR BLADES, SPATTLES, GRINDSTONES, PLANES, JOINTING PLANES, KNIVES, CARPET KNIVES, CUTTING KNIVES, BLADES, SCISSORS, SHEARS, SCRIBERS AND, PINCERS, TENSION JACKS FOR INSTALLING PARQUET AND LAMINATED FLOORS, ROLLS, ANGLES, PRESSURE ROLLERS FOR FLOOR COVERINGS AND WALL COVERINGS, HAMMERS, PARQUET SPACERS FOR SETTING THE DISTANCE TO THE WALL AND ADJUSTING THE TENSION OF FLOOR BOARDS; REPLACEMENT PARTS THEREFOR, IN CLASS 8 (U.S. CLS. 23, 28 AND 44).

FOR: WORKWEAR FOR MEN AND WOMEN, NAMELY, OVERALLS, TROUSERS, MULTI-TOOL WAIST COATS, JACKETS, VESTS, COATS, WORK GLOVES; FOOTWEAR, HEADGEAR, NAMELY, HATS AND CAPS; AND FOOTWEAR FOR WORK, NAMELY SHOES AND BOOTS, IN CLASS 25 (U.S. CLS. 22 AND 39).

OWNER OF FED REP GERMANY REG. NO. 39856394, DATED 11-20-1998, EXPIRES 9-30-2008.

SER. NO. 76-172,978, FILED P.R. 11-29-2000; AM. S.R. 8-18-2003.

HELEN BRYAN, EXAMINING ATTORNEY

Int. Cls.: 9, 35, and 42

Prior U.S. Cls.: 21, 23, 26, 36, 38, 100, 101, and 102

United States Patent and Trademark Office

Reg. No. 2,893,936

Registered Oct. 12, 2004

**TRADEMARK
SERVICE MARK
SUPPLEMENTAL REGISTER**

AUTODATA

AUTODATA SOLUTIONS COMPANY (CANADA
LIMITED LIABILITY COMPANY)
345 SASKATOON STREET
LONDON, ONTARIO N5W 4R4, CANADA

FOR: DOWNLOADABLE AND NON-DOWNLOADABLE COMPUTER SOFTWARE, RECORDED ON CDS, DVDS, AND DISKETTES, FOR USE TO PROVIDE DATA AND DATA CONTENT, NAMELY, VEHICLE PRICING, VEHICLE TECHNICAL SPECIFICATIONS, VEHICLE EQUIPMENT INFORMATION, VEHICLE OPTION INFORMATION, VEHICLE COLORS INFORMATION, VEHICLE TRIM INFORMATION, VEHICLE FEATURES INFORMATION, NEW AND USED VEHICLE VALUES INFORMATION, VEHICLE ACCESSORIES INFORMATION, INTERIOR AND EXTERIOR VEHICLE STILL AND VIDEO DIGITAL IMAGES, VEHICLE WARRANTY RULES, VEHICLE ORDERING RULES AND VEHICLE INCENTIVE INFORMATION, ALL FOR THE MARKETING, ORDERING AND LEASING OF VEHICLES AND FOR USE BY MANUFACTURERS, FLEET AND LEASING OPERATORS, DEALERSHIPS AND OTHER PARTIES IN THE AUTOMOTIVE FIELD, IN CLASS 9 (U.S. CLS. 21, 23, 26, 36 AND 38).

FIRST USE 12-0-1992; IN COMMERCE 12-0-1992.

FOR: PROVIDING AN ON-LINE COMPUTER DATABASE IN THE FIELD OF MARKETING, OR-

DERING AND LEASING OF VEHICLES, IN CLASS 35 (U.S. CLS. 100, 101 AND 102).

FIRST USE 12-0-1992; IN COMMERCE 12-0-1992.

FOR: PROVIDING TEMPORARY USE OF NON-DOWNLOADABLE SOFTWARE FOR ANALYZING PRICING AND COMPARING VEHICLES, ALL IN THE FIELDS OF VEHICLE AND AUTOMOTIVE PRODUCTS, VEHICLE EQUIPMENT, VEHICLE MARKETING, VEHICLE WARRANTY SPECIFICATIONS AND ORDERING AND LEASING OF VEHICLES; TECHNICAL SUPPORT SERVICES, NAMELY, TROUBLESHOOTING OF COMPUTER HARDWARE AND SOFTWARE PROBLEMS VIA GLOBAL COMPUTER NETWORKS, E-MAIL, MAIL, TELEPHONE AND ON SITE VISITS; PRODUCT DEVELOPMENT, NAMELY, SOFTWARE DEVELOPMENT, AND INSTALLATION OF COMPUTER SOFTWARE, ALL PROVIDED TO MANUFACTURERS, FLEET AND LEASING OPERATORS, DEALERSHIPS AND OTHER THIRD PARTIES IN THE AUTOMOTIVE FIELD, IN CLASS 42 (U.S. CLS. 100 AND 101).

FIRST USE 12-0-1992; IN COMMERCE 12-0-1992.

SER. NO. 76-185,673, FILED P.R. 12-20-2000; AM. S.R. 5-5-2003.

SONYA STEPHENS, EXAMINING ATTORNEY

Int. Cls.: 9 and 42

Prior U.S. Cls.: 21, 23, 26, 36, 38, 100, and 101

United States Patent and Trademark Office

Reg. No. 2,893,938

Registered Oct. 12, 2004

**TRADEMARK
SERVICE MARK
SUPPLEMENTAL REGISTER**

GoS

U4EA TECHNOLOGIES LIMITED (UNITED
KINGDOM CORPORATION)
UNIVERSITY GATE PARK ROW
BRISTOL, ENGLAND, UNITED KINGDOM BS1 5UB

FOR: COMPUTER SOFTWARE, NAMELY, SOFTWARE WHICH PROVIDES PACKET DELIVERY MECHANISMS FOR THE DIFFERENTIAL TREATMENT OF DATA IN DATA PACKET SYSTEMS, IN CLASS 9 (U.S. CLS. 21, 23, 26, 36 AND 38).

FOR: COMPUTER CONSULTATION SERVICES, NAMELY, CONSULTATION CONCERNING THE DIFFERENTIAL TREATMENT OF DATA PACKET SYSTEMS, IN CLASS 42 (U.S. CLS. 100 AND 101).

PRIORITY CLAIMED UNDER SEC. 44(D) ON ERPN CMNTY TM OFC APPLICATION NO. 1906239, FILED 10-2-2000, REG. NO. 001906239, EXPIRES 10-2-2010.

THE MARK CONSISTS OF THE LETTERS GOS, IN WHICH THE LETTERS G AND S ARE IN CAPITAL LETTERS AND THE LETTERS O IS IN LOWERCASE.

SER. NO. 76-232,836, FILED P.R. 3-23-2001; AM. S.R. 7-2-2004.

MONIQUE MILLER, EXAMINING ATTORNEY

Int. Cls.: 35, 36, and 42

Prior U.S. Cls.: 100, 101, and 102

United States Patent and Trademark Office

Reg. No. 2,893,940

Registered Oct. 12, 2004

**SERVICE MARK
SUPPLEMENTAL REGISTER**

APPRAISERSGIS.COM

A BOUND CORPORATION (CANADA CORPORATION)
174 NEWCASTLE BOULEVARD
MIRAMICHI
NEW BRUNSWICK, E1V 2J6, CANADA

FOR: PROVIDING INFORMATION, NAMELY, PROVIDING CENSUS, POPULATION, AND DEMOGRAPHIC INFORMATION, AND INFORMATION REGARDING THE SPENDING HABITS OF RESIDENTS WITHIN SPECIFIC MARKET AREAS IN AN INTERACTIVE DATABASE IN ORDER TO ALLOW INDIVIDUALS TO DETERMINE EXISTING AND POTENTIAL MARKETS BY CALCULATING INPUT DATA, IN CLASS 35 (U.S. CLS. 100, 101 AND 102).

FOR: PROVIDING A WEB BASED DATABASE FEATURING REAL ESTATE INFORMATION, NAMELY, PROPERTY SALES AND LEASE INFOR-

MATION, AND INFORMATION REGARDING REAL ESTATE SITES AND BUILDING IMPROVEMENTS THEREON, IN CLASS 36 (U.S. CLS. 100, 101 AND 102).

FOR: PROVIDING LINKS TO A DATABASE OF DIGITAL MAPS, SATELLITE IMAGES AND AERIAL PHOTOGRAPHS FOR THE PURPOSES OF PROVIDING SPATIAL OVERVIEWS, IN CLASS 42 (U.S. CLS. 100 AND 101).

OWNER OF CANADA REG. NO. TMA594858, DATED 11-17-2003, EXPIRES 11-17-2018.

SER. NO. 76-248,262, FILED P.R. 4-30-2001; AM. S.R. 7-26-2004.

KATHY DE JONGE, EXAMINING ATTORNEY

Int. Cls.: 9, 18, and 25

Prior U.S. Cls.: 1, 2, 3, 21, 22, 23, 26, 36, 38, 39, and 41

United States Patent and Trademark Office

Reg. No. 2,893,942

Registered Oct. 12, 2004

**TRADEMARK
SUPPLEMENTAL REGISTER**

RIDINGEAR

CREATIVE DESIGN INTERNATIONAL C.D.I.
INC. (CANADA CORPORATION)
6191 METROPOLITAN EST.
ST.-LEONARD, QUEBEC, CANADA H1P 1X7

FOR: BICYCLE HELMETS, MOTORCYCLE HELMETS, CATCHER'S HELMETS, PROTECTIVE HELMETS FOR USE WITH SKIS, SNOWBOARDS, SNOWMOBILES, SKATEBOARDS, AND SKATES; SAFETY GOGGLES, IN CLASS 9 (U.S. CLS. 21, 23, 26, 36 AND 38).

FIRST USE 1-0-2001; IN COMMERCE 1-0-2001.

FOR: LEATHER KEY CHAINS; TOTE BAGS, HIKING BAGS IN THE NATURE OF BACKPACKS AND WAIST PACKS, LUGGAGE; TOOL POUCHES, SOLD EMPTY; DRAWSTRING POUCHES, IN CLASS 18 (U.S. CLS. 1, 2, 3, 22 AND 41).

FIRST USE 1-0-2001; IN COMMERCE 1-0-2001.

FOR: JACKETS, PARKAS, BOMBER JACKETS, PANTS, DUFFLE COATS, LEGGINGS, LEG WARMERS, SNOW SUITS, VESTS, WETSUITS, COATS, PONCHOS, SHIRTS, BLOUSES, TURTLENECKS, TOPS, SHORTS, SKIRTS, JUMPERS, CAPES, SHAWLS, T-SHIRTS, SWEATSHIRTS, ROBES, LEOTARDS, TIGHTS, BODYSUITS, CULOTTES, GLOVES, MITTENS, HATS, CAPS, TUQUES, BONNETS, HEAD BANDS, NECK WARMERS, BOOTS, SOCKS, SWIMWEAR, IN CLASS 25 (U.S. CLS. 22 AND 39).

FIRST USE 1-0-2001; IN COMMERCE 1-0-2001.

PRIORITY CLAIMED UNDER SEC. 44(D) ON CANADA APPLICATION NO. 1090376, FILED 1-26-2001, REG. NO. TMA574010, EXPIRES 1-20-2018.

SER. NO. 76-290,320, FILED P.R. 7-26-2001; AM. S.R. 4-5-2002.

MARY ROSSMAN, EXAMINING ATTORNEY

Int. Cls.: 9, 12, and 16

**Prior U.S. Cls.: 2, 5, 19, 21, 22, 23, 26, 29, 31, 35, 36,
37, 38, 44, and 50**

Reg. No. 2,893,943

United States Patent and Trademark Office

Registered Oct. 12, 2004

**TRADEMARK
SUPPLEMENTAL REGISTER**



DAIMLERCHRYSLER AG (FED REP GERMANY
CORPORATION)
EPPLESTRASSE 225
70567 STUTTGART, FED REP GERMANY

FOR: ELECTRONIC MEASURING, CONTROL-
LING, REGULATING AND MONITORING DEVI-
CES FOR ELECTRIC POWER SUPPLY SYSTEMS IN
AUTOMOBILES, COMPRISING SENSORS, MICRO-
COMPUTERS, AND THEIR PARTS, WITH DATA
CARRIER PROGRAMS, ELECTRIC WIRES AND
CABLES MADE OF METAL OR GLASS FIBRE,
TRANSFORMERS, ELECTRIC MOTORS, STARTER
GENERATORS AND VOLTAGE CONVERTERS;
DATA BUSES FOR CONNECTING ELECTRONIC
EQUIPMENT IN AUTOMOBILES, NAMELY, BUS
INTERFACES, BUS PORTS AND BUS CONTROL-
LERS; ELECTRICAL DEVICES FOR PRODUCING,
TRANSFORMING, STORING, TRANSMITTING
AND DISTRIBUTING ELECTRICAL ENERGY IN
AUTOMOBILES, NAMELY, ALTERNATORS, GEN-
ERATORS, BATTERIES AND WIRING HARNESSSES;
COMPUTER SOFTWARE FOR MONITORING AND
CONTROLLING ELECTRIC POWER DISTRIBUTION
IN AUTOMOBILES; DATA MEMORY DEVI-
CES, NAMELY, COMPUTER DISCS, COMPUTER

CHIPS, MAGNETIC CODED CARDS, TAPES, DISCS
AND CD-ROMS; FUEL CELLS, IN CLASS 9 (U.S.
CLS. 21, 23, 26, 36 AND 38).

FOR: AUTOMOBILES AND THEIR STRUCTUR-
AL PARTS, IN CLASS 12 (U.S. CLS. 19, 21, 23, 31, 35
AND 44).

FOR: BOOKS, MAGAZINES, INSTRUCTIONAL
MANUALS, NEWSLETTERS, BROCHURES AND
BOOKLETS, ALL RELATING TO AUTOMOBILES
AND THE AUTOMOTIVE INDUSTRY, IN CLASS 16
(U.S. CLS. 2, 5, 22, 23, 29, 37, 38 AND 50).

PRIORITY CLAIMED UNDER SEC. 44(D) ON FED
REP GERMANY APPLICATION NO. 30109438.3/1,
FILED 2-12-2001, REG. NO. 30109438, EXPIRES 2-28-
2011.

THE STIPPLING IN THE DRAWING IS FOR
SHADING PURPOSES ONLY.

SER. NO. 76-298,473, FILED P.R. 8-10-2001; AM. S.R.
6-28-2004.

SHARI SHEFFIELD, EXAMINING ATTORNEY

Int. Cls.: 16 and 41

Prior U.S. Cls.: 2, 5, 22, 23, 29, 37, 38, 50, 100, 101, and 107

Reg. No. 2,893,948

United States Patent and Trademark Office

Registered Oct. 12, 2004

**TRADEMARK
SERVICE MARK
SUPPLEMENTAL REGISTER**

SPORTING DOGS

BOWTIE, INC. (CALIFORNIA CORPORATION)
2401 BEVERLY BOULEVARD
LOS ANGELES, CA 90057

FOR: PRINTED PUBLICATIONS, NAMELY, MAGAZINES, JOURNALS, BOOKS, NEWSLETTERS AND PERIODICALS, ALL IN THE FIELDS OF ANIMALS, CANINE SPECIES AND GENERAL INTEREST, IN CLASS 16 (U.S. CLS. 2, 5, 22, 23, 29, 37, 38 AND 50).

FIRST USE 7-11-2003; IN COMMERCE 7-11-2003.

FOR: COMPUTER SERVICES, NAMELY, PROVIDING ONLINE PUBLICATIONS AND INFORMA-

TION IN THE FIELDS OF ANIMALS, CANINE SPECIES AND GENERAL INTEREST, IN CLASS 41 (U.S. CLS. 100, 101 AND 107).

FIRST USE 7-11-2003; IN COMMERCE 7-11-2003.

OWNER OF U.S. REG. NOS. 1,278,017, 2,708,126, AND OTHERS.

SER. NO. 76-466,886, FILED P.R. 11-14-2002; AM. S.R. 6-25-2004.

LINDA MICKLEBURGH, EXAMINING ATTORNEY

Int. Cls.: 30, 32, 33, and 43

Prior U.S. Cls.: 45, 46, 47, 48, 49, 100, and 101

United States Patent and Trademark Office

Reg. No. 2,893,977

Registered Oct. 12, 2004

**TRADEMARK
SERVICE MARK
SUPPLEMENTAL REGISTER**

MORIMOTO

MORIDON GROUP, LLC (DELAWARE LIMITED
LIABILITY COMPANY)
40 EAST 88TH STREET
NEW YORK, NY 10128

FOR: SAUCES, IN CLASS 30 (U.S. CL. 46).

FIRST USE 11-15-2001; IN COMMERCE 11-15-2001.

FOR: BEER , IN CLASS 32 (U.S. CLS. 45, 46 AND
48).

FIRST USE 11-15-2001; IN COMMERCE 11-15-2001.

FOR: SAKE, IN CLASS 33 (U.S. CLS. 47 AND 49).

FIRST USE 11-15-2001; IN COMMERCE 11-15-2001.

FOR: RESTAURANT SERVICES AND CATERING
SERVICES, IN CLASS 43 (U.S. CLS. 100 AND 101).

FIRST USE 11-15-2001; IN COMMERCE 11-15-2001.

OWNER OF CANADA REG. NO. TMA554157,
DATED 11-21-2001, EXPIRES 11-21-2016.

OWNER OF U.S. REG. NO. 2,679,168.

SER. NO. 78-163,698, FILED P.R. 9-13-2002; AM. S.R.
5-3-2004.

STEVEN BERK, EXAMINING ATTORNEY

Int. Cls.: 35 and 41

Prior U.S. Cls.: 100, 101, 102, and 107

United States Patent and Trademark Office

Reg. No. 2,893,982

Registered Oct. 12, 2004

**SERVICE MARK
SUPPLEMENTAL REGISTER**

PORTABLE POWER CONFERENCE & EXPO

INTERNATIONAL DATA GROUP, INC. (MASSACHUSETTS CORPORATION)
5 SPEEN STREET
FRAMINGHAM, MA 01701

FOR: ARRANGING AND CONDUCTING TRADE SHOWS, EXPOSITIONS, AND EXHIBITIONS IN THE FIELDS OF COMPUTERS, COMPUTER SOFTWARE, HIGH TECHNOLOGY, AND INFORMATION TECHNOLOGY, IN CLASS 35 (U.S. CLS. 100, 101 AND 102).

FIRST USE 9-21-2003; IN COMMERCE 9-21-2003.

FOR: EDUCATIONAL SERVICES, NAMELY, ARRANGING AND CONDUCTING CONFERENCES,

SYMPOSIUMS, COLLOQUIUMS, BUSINESS SEMINARS, AND DISCUSSION GROUPS IN THE FIELDS OF COMPUTERS, COMPUTER SOFTWARE, HIGH TECHNOLOGY, AND INFORMATION TECHNOLOGY, IN CLASS 41 (U.S. CLS. 100, 101 AND 107).

FIRST USE 9-21-2003; IN COMMERCE 9-21-2003.

NO CLAIM IS MADE TO THE EXCLUSIVE RIGHT TO USE CONFERENCE & EXPO, APART FROM THE MARK AS SHOWN.

SER. NO. 78-211,094, FILED P.R. 2-5-2003; AM. S.R. 7-30-2004.

ELISSA GARBER KON, EXAMINING ATTORNEY

Int. Cls.: 30 and 43

Prior U.S. Cls.: 46, 100, and 101

United States Patent and Trademark Office

Reg. No. 2,893,986

Registered Oct. 12, 2004

TRADEMARK
SERVICE MARK
SUPPLEMENTAL REGISTER



DUNN BROS COFFEE FRANCHISING, INC.
(MINNESOTA CORPORATION)
SUITE 160
111 THIRD AVENUE SOUTH
MINNEAPOLIS, MN 55401

FOR: COFFEE, IN CLASS 30 (U.S. CL. 46).

FIRST USE 8-1-2002; IN COMMERCE 8-1-2002.

FOR: RESTAURANT SERVICES , IN CLASS 43
(U.S. CLS. 100 AND 101).

FIRST USE 8-1-2002; IN COMMERCE 8-1-2002.

SER. NO. 78-252,646, FILED P.R. 5-21-2003; AM. S.R.
4-20-2004.

LINDA MICKLEBURGH, EXAMINING ATTORNEY

Int. Cls.: 35 and 42

Prior U.S. Cls.: 100, 101, and 102

United States Patent and Trademark Office

Reg. No. 2,893,999

Registered Oct. 12, 2004

**SERVICE MARK
SUPPLEMENTAL REGISTER**

YOUR OFF-SITE PARALEGALS

MY CORPORATION BUSINESS SERVICES, INC.
(CALIFORNIA CORPORATION)
30141 AGOURA RD. #205
AGOURA HILLS, CA 91301

FOR: BUSINESS CONSULTATION; BUSINESS
RESEARCH SERVICES, IN CLASS 35 (U.S. CLS. 100,
101 AND 102).

FIRST USE 8-26-2003; IN COMMERCE 8-26-2003.

FOR: PROVIDING INTELLECTUAL PROPERTY
RESEARCH AND PUBLIC DOCUMENT FILING
SERVICES; PROVIDING INFORMATION IN THE
FIELD OF INTELLECTUAL PROPERTY VIA A

GLOBAL COMPUTER NETWORK, IN CLASS 42
(U.S. CLS. 100 AND 101).

FIRST USE 8-26-2003; IN COMMERCE 8-26-2003.

NO CLAIM IS MADE TO THE EXCLUSIVE
RIGHT TO USE PARALEGALS, APART FROM
THE MARK AS SHOWN.

SER. NO. 78-293,644, FILED P.R. 8-28-2003; AM. S.R.
3-31-2004.

PATRICIA EVANKO, EXAMINING ATTORNEY