

RI 9419

REPORT OF INVESTIGATIONS/1992

Gallium and Germanium Recovery From Domestic Sources

By D. D. Harbuck

UNITED STATES DEPARTMENT OF THE INTERIOR



BUREAU OF MINES

Report of Investigations 9419

Gallium and Germanium Recovery From Domestic Sources

By D. D. Harbuck

UNITED STATES DEPARTMENT OF THE INTERIOR
Manuel Lujan, Jr., Secretary

BUREAU OF MINES
T S Ary, Director

Library of Congress Cataloging in Publication Data:

Harbuck, D. D. (Donna D.)

Gallium and germanium recovery from domestic sources / by D.D. Harbuck.

p. cm. — (Report of investigations; 9419)

Includes bibliographical references (p. 25).

Supt. of Docs. no.: I 28.22:9419.

1. Gallium—Metallurgy. 2. Germanium—Metallurgy. 3. Leaching. 4. Solvent extraction. I. Title. II. Series: Report of investigations (United States. Bureau of Mines); 9419.

TN23.U43 [TN799.G3] 622 s—dc20 [669'.79] 92-6230 CIP

CONTENTS

	<i>Page</i>
Abstract	1
Introduction	2
Identifying domestic sources	2
Leaching of zinc residue	3
Background	3
Statistical determination of significant variables	3
Batch testing of significant variables	3
Improving germanium extraction from zinc residues	6
Germanium insolubility during roasting	6
Germanium insolubility during leaching	7
Methods for overcoming germanium insolubility	9
Leaching of germanium-gallium ore	10
Background	10
Results and discussion	10
Germanium extraction	11
Two-stage countercurrent leaching	11
Increasing germanium extraction	13
Gallium and germanium solvent extraction from H_2SO_4 solutions	14
Gallium solvent-extraction background	14
Germanium solvent-extraction background	14
Solution preparation and analysis	15
Initial solvent-extraction testing	15
Gallium solvent extraction	15
Iron versus gallium loading	15
OPAP and DEHPA	16
Rate and equilibrium analysis	17
Gallium loading	17
Gallium stripping	17
Ferric stripping	17
Continuous solvent extraction of gallium	17
System design	17
System operation	18
Strip liquor purification	18
Germanium solvent extraction	18
Effect of copper and iron	19
Synergism	20
Effect of acid concentration	20
Germanium stripping	20
Germanium rate and equilibrium analysis	21
Germanium loading	21
Germanium stripping	21
Iron scrubbing	21
Continuous solvent extraction of germanium	22
System design	22
System operation	22
Gallium and germanium coextraction	23
Experimental results	23
Industrial application	24
Summary	24
References	25

ILLUSTRATIONS

	<i>Page</i>
1. Stages of zinc processing	3
2. Effect of percent solids on metal extraction from zinc residue	4
3. Effect of H ₂ SO ₄ addition on metal extraction from zinc residue	4
4. Effect of leach time on metal extraction from zinc residue	4
5. Effect of temperature on metal extraction from zinc residue	4
6. Effect of adding SO ₂ to H ₂ SO ₄ leach on gallium and germanium extraction from zinc residue	5
7. Effect of H ₂ SO ₄ molarity on gallium and germanium extraction from zinc residue	5
8. Solubility of GeO ₂ in H ₂ SO ₄	5
9. XRD printouts of ZnO-GeO ₂ mixtures at 650°, 800°, and 950° C	6
10. XRD printouts of ZnO-SiO ₂ mixtures at 900°, 1,000°, and 1,100° C	7
11. Shift of 2θ quartz angle with increasing amounts of GeO ₂	7
12. SEM photograph of SiO ₂ -GeO ₂ solid solution	8
13. Effect of HF concentration on germanium extraction from H ₂ SO ₄ -leached residue	10
14. Effect of H ₂ SO ₄ concentration on metal extraction from gallium-germanium ore	11
15. Effect of leach temperature on metal extraction from gallium-germanium ore	12
16. Effect of leach time at various acid concentrations on metal extraction from gallium-germanium ore ..	12
17. Proposed two-stage leach system	13
18. Photomicrographs of gallium-germanium ore	13
19. Gallium and iron extraction from reduced and reoxidized solutions	16
20. Effect of pH on gallium extraction using the solvents OPAP and DEHPA	16
21. Gallium equilibrium loading and stripping on 0.3M OPAP	17
22. McCabe-Thiele analysis loading 0.32-g/L-Ga aqueous on 0.3M OPAP	17
23. McCabe-Thiele analysis stripping 0.32-g/L-Ga loaded organic using 1.5M H ₂ SO ₄	18
24. McCabe-Thiele analysis stripping ferric iron with 50 pct H ₃ PO ₄	18
25. Germanium equilibrium loading and stripping on 0.2M OPAP-30 pct LIX 63	21
26. McCabe-Thiele analysis of germanium-loading isotherm, 40-g/L-H ₂ SO ₄ solution	21
27. McCabe-Thiele analysis of germanium-loading isotherm, 60-g/L-H ₂ SO ₄ solution	22
28. McCabe-Thiele analysis stripping 0.3- or 0.6-g/L-Ge loaded organic using 75° C H ₂ O	22
29. McCabe-Thiele analysis stripping iron with 3M H ₂ SO ₄	22
30. Effect of multiple contacts in the coextraction of germanium and gallium from zinc processing liquors ..	24

TABLES

1. Analyses of potential gallium and germanium ores	2
2. Elemental analyses of studied materials	2
3. Results of statistically designed experiments	3
4. 2θ angles for SiO ₂ under various conditions	7
5. Typical analyses of leach solutions	8
6. Selectivity of silica gel for germanium	8
7. Effect of ZnSiO ₄ addition on gallium and germanium extraction	8
8. Effect of silica on germanium extraction	9
9. Effect of "weak acid" leach pH on subsequent germanium extraction from final zinc residue	9
10. Effect of acid concentration on metal extraction in two-stage leach	12
11. Effect of acid concentration on metal extraction in two-stage leach with varying percent solids	13
12. HF leaching of residue	14
13. Concentration of metals in leach filtrates	15
14. Solvent-extraction results testing various extractants	15
15. Solvent extraction of gallium and zinc from reduced leach solutions	16
16. Testing various organics for germanium selectivity	19
17. Germanium extraction with various organic combinations	19
18. Effect of copper and iron on germanium extraction	20

TABLES—Continued

	<i>Page</i>
19. Synergistic effect of OPAP-LIX 63 mixture	20
20. Effect of solution acidity on germanium extraction	20
21. Germanium stripping results testing various reagents	20
22. Effect of increasing water temperature on germanium stripping	21
23. Effect of recycling OPAP-LIX 63 extractant	23
24. Coextraction of gallium and germanium	23
25. Coextraction of gallium and germanium from zinc process solution	24

UNIT OF MEASURE ABBREVIATIONS USED IN THIS REPORT

°C	degree Celsius	min	minute
cm ³ /min	cubic centimeter per minute	mL	milliliter
deg	degree	mm	millimeter
g/L	gram per liter	μm	micrometer
h	hour	mol/L	mole per liter
L	liter	mol pct	mole percent
(lb/min)/st	pound per minute per standard (short) ton	pct	percent
lb/st	pound per standard (short) ton	vol pct	volume percent
M	molarity	wt pct	weight percent

GALLIUM AND GERMANIUM RECOVERY FROM DOMESTIC SOURCES

By D. D. Harbuck¹

ABSTRACT

To decrease reliance on foreign sources for the strategic and critical metals gallium and germanium, the U.S. Bureau of Mines identified and developed processing technology for two domestic sources of these metals: a Tennessee zinc residue and a Utah ore. Sulfuric acid (H_2SO_4) solutions were used to solubilize gallium and germanium in both sources. Statistically designed experiments showed that the most important parameter for high metal extraction from zinc residue was the H_2SO_4 concentration. At a concentration of $2.9M$ H_2SO_4 , 95 pct of the gallium was extracted, and at a concentration of $0.6M$ H_2SO_4 , 73 pct of the germanium was extracted. Controlled H_2SO_4 concentration was also the key for high metal extractions (97 pct Ga, 87 pct Ge) from the Utah ore. Such control was achieved using a two-stage countercurrent leach circuit. Testing showed that the insoluble germanium in both the residue and ore was tied up with silica. Several methods for overcoming this problem are given. To recover gallium and germanium from the leach solutions, the solvent extractants octylphenyl acid phosphate (OPAP) (for gallium) and LIX 63-OPAP (for germanium) were identified. These extractants were tested in separate, continuous, solvent-extraction circuits yielding a gallium recovery of 94 pct and a germanium recovery of more than 90 pct.

¹Supervisory chemical engineer, Salt Lake City Research Center, U.S. Bureau of Mines, Salt Lake City, UT.

INTRODUCTION

Gallium and germanium are assuming an increasingly important role in U.S. industry owing to their technological and strategic applications. The demand for these metals is expected to increase significantly during the next 10 years (1-2).² More than 95 pct of the gallium consumed in the United States is used in gallium arsenide devices, which have extensive electronic applications. These devices include light-emitting diodes, laser diodes, fiber optics, and semiconductors (3). Gallium arsenide superconductors, which enhance the speed of electron transfer, are potentially 25 times faster than conventional silicon devices (4-5). Because of the speed factor and its impermeability to high doses of radiation (6), gallium arsenide is finding increasing use in military radar systems and supercomputers.

The major uses for germanium are infrared optics, fiber-optics systems, detectors, and semiconductor devices, including transistors, diodes, and rectifiers (2). Infrared and fiber-optics systems have become useful in a wide variety of applications, including night vision, target acquisition, fire control, communication, surveillance, navigation, reconnaissance, tactical offense, strategic defense, and heat and/or infrared search and track (2). In most cases,

substitution for germanium cannot be made without a substantial loss in performance (2).

Although gallium and germanium are often together in nature, they are generally not found in concentrated forms. While trace amounts of gallium and germanium are identified in many minerals, they are not usually economically recoverable. Presently, gallium and germanium are produced almost exclusively as byproducts of the aluminum and zinc industries. Currently, more than 90 pct of the gallium and 50 pct of the germanium used in the United States is imported. A major focal point of this U.S. Bureau of Mines study was to identify potential domestic sources of gallium and germanium and to develop the necessary leaching and solvent extraction technology to recover these important metals. This work was done in support of the Bureau's program to decrease U.S. reliance on foreign sources for critical and strategic metals, such as gallium and germanium.

This report is divided into six sections: (1) identification of domestic sources, (2) leaching of a zinc residue, (3) leaching of a gallium-germanium ore, (4) gallium solvent extraction, (5) germanium solvent extraction, and (6) germanium and gallium coextraction.

IDENTIFYING DOMESTIC SOURCES

To decrease the U.S. dependence on foreign sources, more than 50 potential gallium and germanium ores and several residue byproducts were examined using inductively coupled plasma spectrophotometry (ICP), neutron activation analysis (NAA), and atomic absorption spectroscopy (AA). The results of this search are summarized in table 1.

Table 1.—Analyses of potential gallium and germanium ores, percent

	Ga	Ge
Ore:		
Southern Utah	0.04	0.09
Central Utah01	.01
48 various locations . . .	0	0
Residue:		
Zn—Tennessee32	.46
Zn—Missouri03	.03
Al02	.02

As seen, only one ore and one residue showed any significant amount of gallium or germanium. From

estimated reserves of these materials, each source has enough gallium and germanium to potentially supply the annual needs of the United States for many years; therefore, both of these sources were chosen for further study. Table 2 provides more detailed analyses of these two materials.

Table 2.—Elemental analyses of studied materials, percent

Element	Tennessee Zn residue	Southern Utah ore
Al	0.59	0.47
As	<.02	.79
Ca	4.13	2.2
Cd19	.01
Cu	1.05	.86
Fe	11.90	20.2
Ga32	.036
Ge46	.089
Pb	5.60	.94
S (free)	11.70	NA
Si	4.90	9.1
Zn	19.20	.44
NA	Not available.	

²Italic numbers in parentheses refer to items in the list of references at the end of this report.

X-ray diffraction (XRD) and scanning electron microscopy (SEM) revealed that the zinc residue contained zinc sulfide (ZnS), calcium sulfate ($CaSO_4$), lead sulfate ($PbSO_4$), silica (SiO_2), iron sulfide (FeS), zinc ferrate ($ZnFe_2O_4$), and free sulfur, while the ore was goethite

($FeOOH$), jarosite $KFe_3(SO_4)_2(OH)_6$, and SiO_2 . In both samples, the concentrations of gallium and germanium were so low and the particle sizes were so fine that SEM could not detect discrete germanium- or gallium-bearing minerals.

LEACHING OF ZINC RESIDUE

BACKGROUND

The Tennessee residue used in this study is the end product of the zinc process depicted in figure 1. There are four major operations in the process: (1) roasting of ZnS to calcine (ZnO); (2) "neutral" leaching of approximately 70 pct of the calcine in a pH 4.5 sulfuric acid (H_2SO_4) solution for 5 to 6 h to form a zinc sulfate ($ZnSO_4$) solution, which is further purified and sent to zinc electro-winning; (3) "weak acid" H_2SO_4 leaching at pH 1.5, 60° C, 2 to 3 h, of the "neutral" leach residue to dissolve the remaining zinc; and (4) neutralization to pH 4.5 of "weak acid" leach solution to precipitate impurities (this precipitate becomes zinc residue) from the $ZnSO_4$ solution before it proceeds to further purification and zinc electrowinning.

During roasting, sulfur dioxide (SO_2) gas is trapped and converted to H_2SO_4 . Because of the large amount of low-cost H_2SO_4 produced, it is the preferred acid for leaching gallium and germanium from zinc residue. Specific leach tests are described below.

STATISTICAL DETERMINATION OF SIGNIFICANT VARIABLES

To quickly identify the significant leach variables necessary for high gallium and germanium extraction from zinc residue, two factorially designed statistical tests (7-8) were set up to study the main and interactive effects of

H_2SO_4 and SO_2 addition, leach time, percent solids, and preleach roast temperature. The following ranges of conditions were tested: 400 to 2,000 lb/st H_2SO_4 , 0 to 25 cm^3/min SO_2 , 30 to 270 min leach time, 5 to 30 pct solids, and 300° to 900° C preleach roast temperature. Batch agitation leach tests, under various experimental conditions, were performed using standard laboratory hotplates, thermocouples, stirring devices, and glassware.

The major findings of these statistically designed tests are presented in table 3. The minimum significant factor (MIN) is the amount that an effect must exceed to be considered statistically significant. Negative numbers demonstrate that metal extraction decreased as the level of the corresponding variable increased. A complete discussion of the statistical analysis of factorial experiments can be found in many references (7-8).

Table 3.—Results of statistically designed experiments

Variable	Ga		Ge	
	Effect	MIN	Effect	MIN
Roast temperature . . .	-29.1	2.2	-4.1	2.2
Leach time	6	4.5	2.6	3.7
SO_2 addition	6.2	2.2	5.8	2.2
H_2SO_4 addition	69.3	4.5	12.2	3.7
Percent solids	3.3	4.5	-28.3	3.7
H_2SO_4 + pct solids . .	-7.4	4.5	-30.2	3.7
H_2SO_4 + leach time . .	13.3	4.5	2.6	3.7

MIN Minimum significant factor.

The results in table 3 indicate that the most important variables for high gallium and germanium extractions, respectively, were high H_2SO_4 addition and the interactive effect between H_2SO_4 addition and percent solids. This interactive relationship will be discussed in more detail later. Increasing the preleach roast temperature was detrimental to both gallium and germanium extraction; therefore, zinc residue was not roasted in further tests.

BATCH TESTING OF SIGNIFICANT VARIABLES

To better understand the effects of leach time, H_2SO_4 and SO_2 addition, and percent solids on gallium and germanium extraction, additional batch tests were performed to augment the statistical data obtained. Plots of metal (gallium, germanium, zinc, and iron) extraction versus

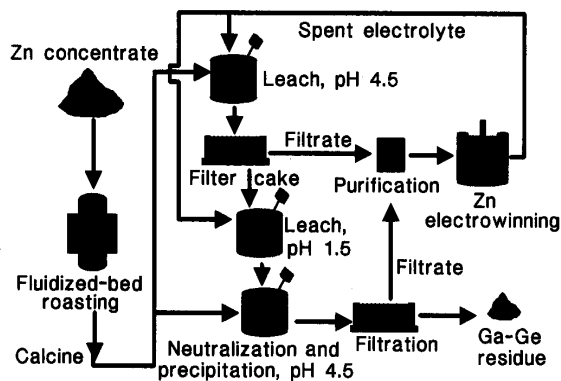

Figure 1.—Stages of zinc processing.

percent solids, H_2SO_4 addition, and leach time are presented in figures 2, 3, and 4, respectively. Main effects predicted by the statistical test are clearly confirmed. The dramatic decrease in germanium extraction with increasing percent solids is very apparent, as is the rise in gallium extraction as H_2SO_4 addition is increased. Leach time response is flat over the range studied.

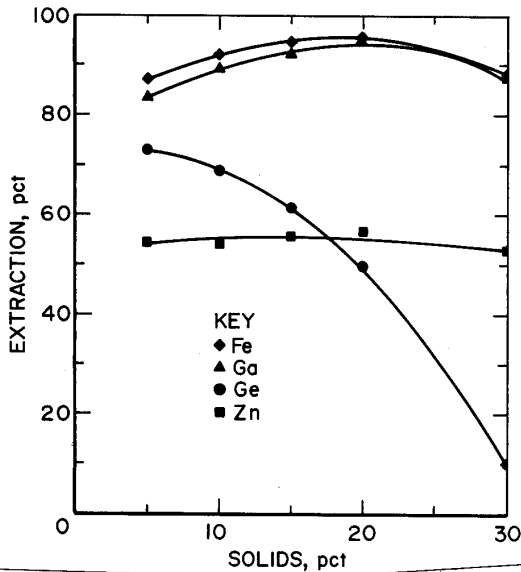

Figure 2.—Effect of percent solids on metal extraction from zinc residue (2,000 lb/st H_2SO_4 , 4.5 h, 80° C).

Experiments in the statistical designs were performed at 80° C. This temperature was verified using the following test conditions: 10 pct solids, 2,000 lb/st H_2SO_4 , and a 4.5-h leach time. From the plot of metal extraction versus leach temperature presented in figure 5, it is clear that 80° C is a valid operating temperature.

The effect of SO_2 addition is shown in figure 6. In these tests, residue was leached for 4 h at 80° C, 20 pct solids, with 200 to 1,600 lb/st H_2SO_4 . In one-half of the tests, SO_2 was added at a constant flow rate of 2.9 (lb/min)/st SO_2 . Approximately 90 pct of the gallium and 55 pct of the germanium were extracted when using

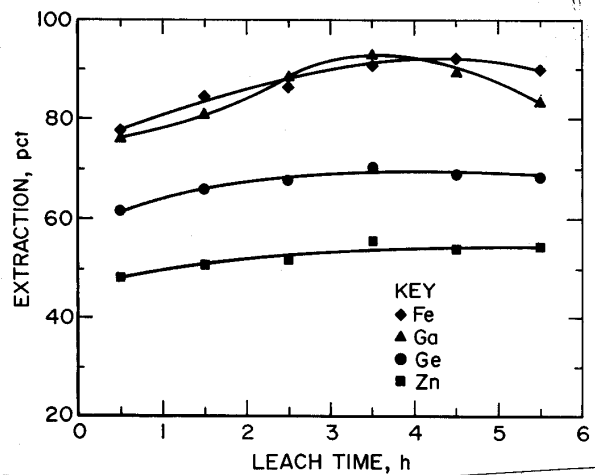

Figure 4.—Effect of leach time on metal extraction from zinc residue (2,000 lb/st H_2SO_4 , 80° C, 10 pct solids).

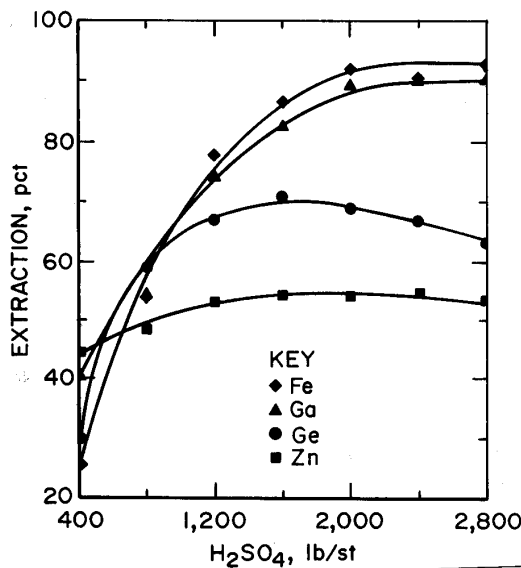

Figure 3.—Effect of H_2SO_4 addition on metal extraction from zinc residue (4.5 h, 80° C, 10 pct solids).

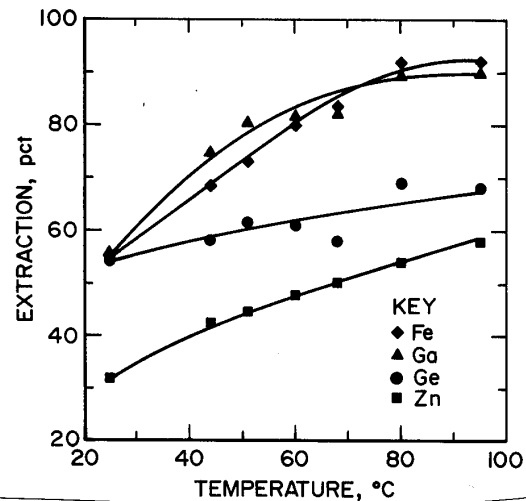

Figure 5.—Effect of temperature on metal extraction from zinc residue (2,000 lb/st H_2SO_4 , 4.5 h, 10 pct solids).

either 1,600 lb/st H_2SO_4 alone or 800 lb/st H_2SO_4 in combination with the SO_2 . Assuming that SO_2 converted to sulfurous acid, 800 lb/st sulfurous acid was added at these conditions, bringing the total acid content to approximately 1,600 lb/st. Therefore, any advantage gained by adding SO_2 could be achieved simply by increasing the amount of H_2SO_4 . Because H_2SO_4 is less expensive and poses less of a negative environmental impact, its use is preferred to SO_2 .

Perhaps the interactive effect between percent solids and H_2SO_4 addition can best be related as H_2SO_4 concentration. When data from various tests were plotted as extraction versus acid molarity (fig. 7), it is seen that as acid concentration increased, germanium extraction proceeded through a peak, then decreased significantly. Pugh (9) in studying the germanium dioxide (GeO_2)- H_2SO_4 system (fig. 8), found that as H_2SO_4 concentration increased, germanium concentration in solution decreased. He concluded that germanium sulfate is incapable of existence, a conclusion that has been substantiated through the years (10). Therefore, germanium must be precipitating from concentrated sulfate solutions as GeO_2 . This explanation matches the data obtained in this study. Although H_2SO_4 is needed to solubilize germanium in zinc residue, too much acid will precipitate germanium from solution.

Figure 7 reveals that a gallium extraction of 95 pct was attained at 2.9M H_2SO_4 , while germanium extraction reached a peak of 73 pct at 0.6M H_2SO_4 . Conditions for

simultaneously high gallium and germanium extraction were 10 pct solids, 2,000 lb/st H_2SO_4 , 4 h, and 80° C, yielding 89 pct Ga and 70 pct Ge extraction.

The problem remained that a large percentage of the germanium could not be extracted with H_2SO_4 , even at appropriate acid conditions. To effect total germanium extraction, further experimental work was required and is presented in the following section.

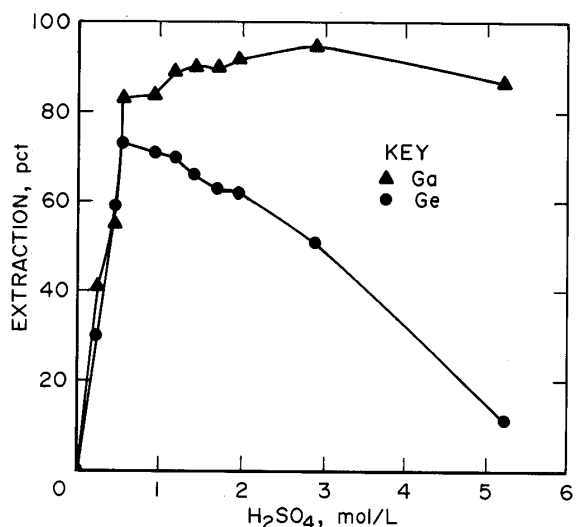

Figure 7.—Effect of H_2SO_4 molarity on gallium and germanium extraction from zinc residue (4 h, 80° C).

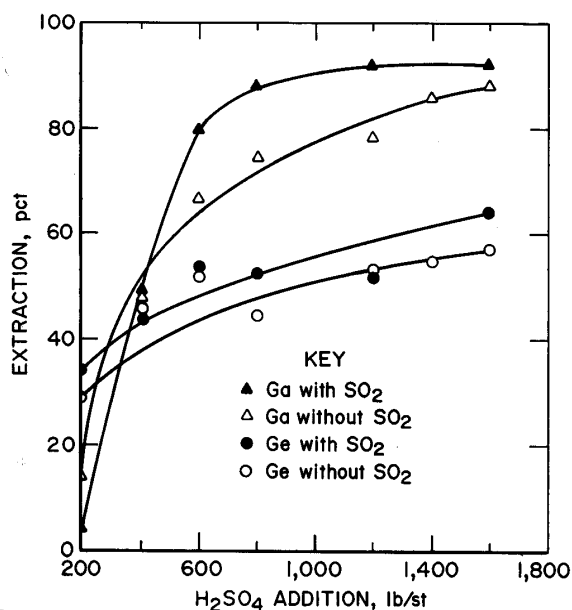

Figure 6.—Effect of adding SO_2 to H_2SO_4 leach on gallium and germanium extraction from zinc residue (4 h, 80° C, 20 pct solids).

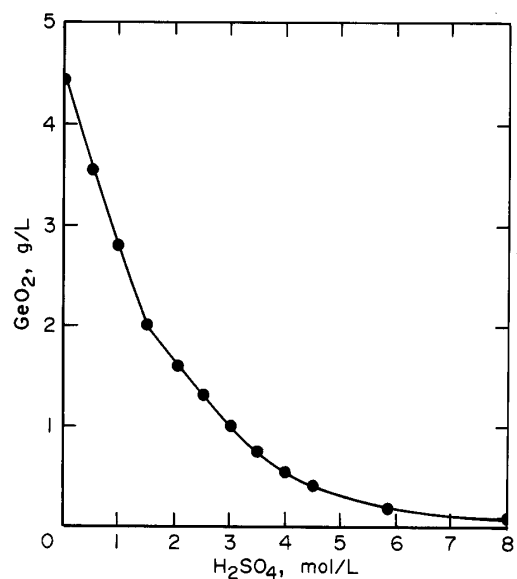

Figure 8.—Solubility of GeO_2 in H_2SO_4 .

IMPROVING GERMANIUM EXTRACTION FROM ZINC RESIDUES

A key to increasing germanium extraction is to identify the mineralogical form of germanium in the zinc residue. Unfortunately, as explained previously, this is very difficult to do. Another option would be to track germanium through the stages of the zinc process and theorize the changes it undergoes in each step. From figure 1, it would appear that germanium insolubility could occur either during the roasting or leaching procedures. Both of these possibilities are explored below.

Germanium Insolubility During Roasting

In hydrometallurgical zinc processing, zinc concentrates containing ZnS with minor amounts of iron, copper, lead, silica, gallium, and germanium are roasted at 900° to 1,100° C to convert sulfides to oxides. There is no unanimous opinion concerning the form of germanium in sphalerite. Researchers have suggested that germanium is present as the disulfide GeS₂ (11) or the monosulfide (12). One work maintains that a small amount of germanium metal can form a solid solution with ZnS (13). In any case, roasting the germanium compound most certainly converts it to GeO₂.

During the roast, it is proposed that GeO₂ reacts with both ZnO and SiO₂ according to reactions A and B, while ZnO combines with SiO₂ to form zinc silicate (Zn₂SiO₄), reaction C.

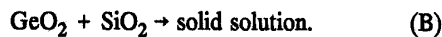
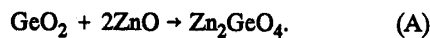

Umetsu and Tozawa (14) recently observed the formation of zinc germanium oxide (Zn₂GeO₄) in a ZnS-GeO₂ roast. In the current study, stoichiometric amounts of GeO₂ and ZnO were uniformly mixed and then roasted at 650° C for 12 h. This procedure was repeated for roasts at 800° and 950° C. An examination of the reaction products using XRD revealed the beginning formation of Zn₂GeO₄ at 800° C (fig. 9). By 950° C, a substantial amount of this compound was present.

A similar technique was used to verify reaction C. Stoichiometric amounts of SiO₂ and ZnO were uniformly mixed and roasted at 900°, 1,000°, and 1,100° C for 10 h. XRD analyses revealed that Zn₂SiO₄ began to form at 1,000° C, and by 1,100° C, a substantial amount was present (fig. 10).

In contrast, when SiO₂ and GeO₂ were heated together, a separate compound did not form. It is theorized that

GeO₂ substituted into the SiO₂ lattice to form a solid solution. Miller, Dachille, Shafer, and Roy (15) showed that up to 31 mol pct GeO₂ is soluble in α -SiO₂. They also demonstrated that as the amount of GeO₂ going into solution with SiO₂ increases, the 2 θ angles that correspond to the XRD peaks of SiO₂ shift downward. This phenomenon is better understood when the experimental results are plotted as in figure 11. A major XRD peak for SiO₂ occurs at a 2 θ angle of approximately 50.2°. As shown in figure 11, when 31 mol pct GeO₂ is in solid solution with SiO₂, the 2 θ angle shifts down to around 50°.

To verify the possibility of SiO₂-GeO₂ solid solution, SiO₂ and GeO₂ (30 mol pct) powders were mixed and then roasted at 650° C for 12 h. This procedure was repeated for roasts at 800°, 950°, and 1,100° C. Examining the products using XRD revealed that there were four prominent

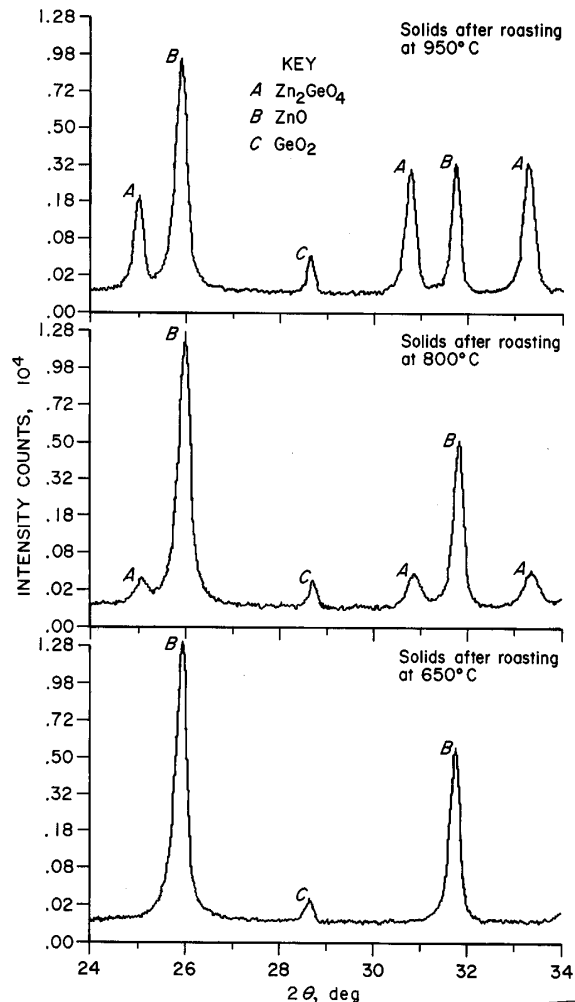

Figure 9.—XRD printouts of ZnO-GeO₂ mixtures at 650°, 800°, and 950° C.

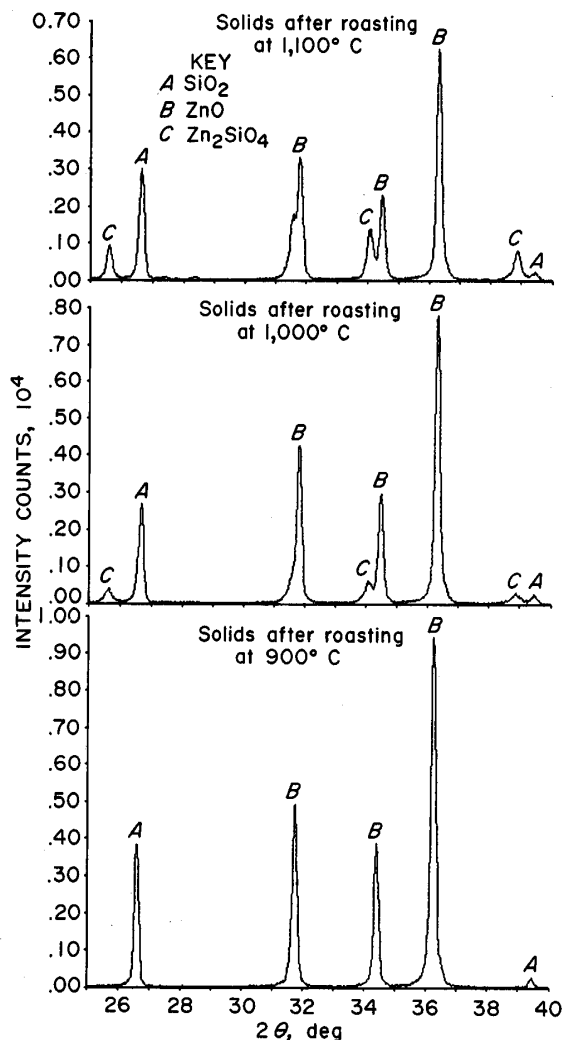

Figure 10.—XRD printouts of ZnO-SiO₂ mixtures at 900°, 1,000°, and 1,100° C.

2θ angles for SiO₂. Table 4 lists the angles obtained for each product. As the temperature of the mixtures increased, the SiO₂ 2θ angles shifted downward. Table 4 also reveals that as SiO₂ was heated, the 2θ angles naturally shifted downward. However, the shift seen with the SiO₂-GeO₂ mixture was much greater than with SiO₂ alone.

An even more dramatic proof of the existence of a SiO₂-GeO₂ solid solution was seen using SEM. Figure 12 is a photomicrograph of the SiO₂-GeO₂ mixture that was heated at 1,100° C. The dark, flat plates are SiO₂; the white botryoidal particles are GeO₂. A close look at the center area shows particles combined into a solid solution.

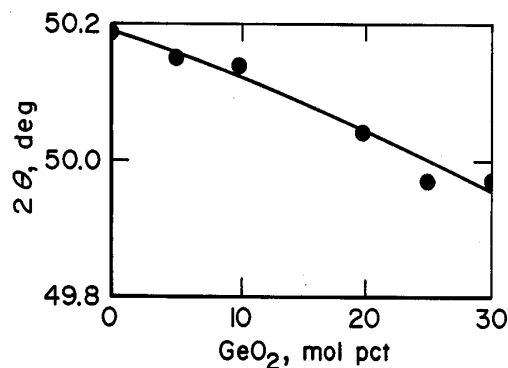

Figure 11.—Shift of 2θ quartz angle with increasing amounts of GeO₂.

Table 4.—2θ angles for SiO₂ under various conditions, degrees

(Four most prominent X-ray diffraction peaks)

Compound and test temperature, °C	1	2	3	4
SiO ₂ :				
25	26.710	50.155	59.965	20.925
1,100	26.650	50.108	59.965	20.875
SiO ₂ with 30 mol pct GeO ₂ :				
650	26.688	50.153	59.983	20.920
800	26.690	50.143	59.963	20.920
950	26.618	50.090	59.898	20.855
1,100	26.800	50.063	59.883	20.833

Any SiO₂-GeO₂ solid solution formed during roasting would be very refractory. It would pass unaffected through the leaching and neutralization steps of zinc processing and be carried along to the residue; thus, part of the germanium in the residue would not be solubilized during H₂SO₄ leaching.

Germanium Insolubility During Leaching

In the two-stage leach of the zinc process (see fig. 1), calcine is reacted in H₂SO₄ solutions to dissolve ZnO. Typical analyses for the "neutral" and "weak acid" leaches of the zinc process are given in table 5. As seen, most impurities, including germanium, are solubilized in the "weak acid" leach, indicating the dissolution of Zn₂GeO₄ at these conditions. (Zangieve, Kaloev, Bashkov, Burtakova, and Kubaloun (16) also conducted research verifying the solubility of Zn₂GeO₄ in H₂SO₄.) A small fraction of the calcine is not solubilized in either stage of the zinc leach process. This material is referred to as "gangue."

Table 5.—Typical analyses of leach solutions, grams per liter

	Neutral leach	Weak acid leach
Cd	1.2	1.4
Cu	<.5	1.7
Fe	<.2	4.3
Ga	0	.13
Ge01	.29
Zn	200	163

The dissolution of Zn_2SiO_4 was studied using the two-step leach process on commercially prepared material. Approximately 20 pct of the Zn_2SiO_4 dissolved in the "neutral" leach, while 97 pct of the remaining Zn_2SiO_4 was solubilized in the pH 1.5 "weak acid" leach. Matthew and Elsner extensively studied the leaching of zinc silicate ores with H_2SO_4 (17-18). They discovered that Zn_2SiO_4 dissolves to form $Si(OH)_4$ and $ZnSO_4$ according to reaction D at a pH of approximately 1.5 to 2.



The $Si(OH)_4$ subsequently polymerizes to produce polysilicic acid. With continued polymerization, the polymers attain colloidal dimensions. The stability of colloidal silica particles is dependent on such factors as pH, temperature, concentration, and ionic strength. Unstable colloidal particles aggregate to form silica gel.

It is postulated that in the "weak acid" leach, where both solubilized germanium and silica gel are present, a portion of the germanium becomes tied up with silica gel. Gruzdev and Vydrin (19) documented the affinity germanium has for silica. Miller, Dachille, Shafer, and Roy (15)

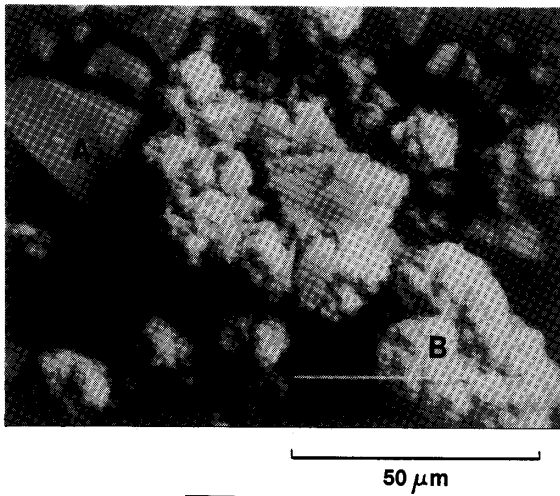

Figure 12.—SEM photograph of SiO_2-GeO_2 solid solution. (A = SiO_2 , B = GeO_2 , scale = 50 μm)

demonstrated how easily GeO_2 substitutes into the silica lattice, and Caletka and Kotas (20) observed that silica gel selectively adsorbs germanium from acidic solutions. In the present investigation, commercially prepared -3 mm silica gel was contacted with a pH 1.5 H_2SO_4 leach solution containing 0.44 g/L Ge as well as calcium, cadmium, copper, iron, zinc, and gallium. As seen in table 6, the silica gel selectively removed germanium from solution.

Table 6.—Selectivity of silica gel for germanium

Element	Removal by silica gel, pct
Ca	6.7
Cd	9.3
Cu	7.5
Fe	8.6
Ga	0
Ge	61.5
Zn	8.3

The hypothesis that germanium becomes tied up with silica in the "weak acid" leach was further verified by adding varying amounts of Zn_2SiO_4 to zinc calcine and leaching the mixture in the two-stage zinc leaching process. Less than 2 pct of the germanium was solubilized in the "neutral" leach. The slurry from the "weak acid" leach was filtered, and the solids were then leached five separate times in 20-pct- H_2SO_4 solutions (this procedure will subsequently be referred to as "intensive" leach) to ensure that all the soluble germanium was removed. Table 7 shows that as the amount of added Zn_2SiO_4 increased, the amount of soluble germanium in the "weak acid" leach residue decreased. When enough Zn_2SiO_4 was added to correspond to 10-wt-pct SiO_2 in the calcine, germanium extraction from the "weak acid" leach residue decreased to less than 38 pct. Gallium extractions are included to emphasize that only the germanium was rendered insoluble.

Table 7.—Effect of $ZnSiO_4$ addition on gallium and germanium extraction, percent

Zn calcine + Zn_2SiO_4 , wt pct SiO_2	Ga	Ge
0.6 (calcine as received) ..	97	82
1	97	76
3	96	56
5	96	55
10	97	<38

These results suggest that Zn_2SiO_4 dissolved to form silica gel, which removed germanium from solution. As additional evidence, the 10-wt-pct SiO_2 residue remaining after the "intensive" leach was completed was examined with both a standard laboratory microscope and a cross-polarized light microscope. Because silica gel is isotropic,

it is not visible in cross-polarized light. The residue could easily be seen using the standard microscope; however, under cross-polarized light, most of the residue was not visible, indicating the presence of silica gel.

This same residue was also examined using XRD. Because XRD is a technique used to identify crystalline solids, silica gel, being amorphous, should produce no XRD pattern. The XRD background pattern of the residue from the zinc calcine- Zn_2SiO_4 mixture drifted upward, and the compound peak heights were substantially diminished compared with the XRD pattern of the residue produced without the addition of Zn_2SiO_4 . This phenomenon indicates that the residue produced with Zn_2SiO_4 addition was less crystalline than the residue produced without Zn_2SiO_4 addition, further supporting the hypothesis that silica gel was formed.

In the zinc process, after the "weak acid" leach is completed, calcine is added to the slurry to precipitate impurities and raise the pH to approximately 5. The germanium in solution, which is not bound to silica gel, is precipitated with the other solubilized impurities. Testing showed that this precipitated germanium was readily soluble in H_2SO_4 solutions. The germanium that is bound to silica gel proceeds through this precipitation step unaffected and is carried along in the precipitate-gangue mixture.

In summary, using current leach practice, approximately 20 to 30 pct of the germanium reporting to the zinc residue is tied up with silica gel. Even under "intensive" H_2SO_4 leaching conditions, this germanium will not be solubilized.

In light of these results, of the two hypotheses presented on how germanium could become insoluble during zinc processing, the formation of silica gel is the most probable. With either theory, it is apparent that silica in the zinc concentrates is the problem. Possible solutions to this problem are presented in the next section.

Methods for Overcoming Germanium Insolubility

Potential alternatives for increasing germanium extraction from zinc residue were investigated. Methods tested, together with research results, included the following:

1. *Lower the silica content of zinc concentrates before they enter the roaster.* If less silica is present, then less Zn_2SiO_4 or SiO_2 - GeO_2 solid solution will form, and more of the germanium will be recoverable from subsequent process residues. Silica removal was explored using a Bureau column flotation system (21). ZnS concentrates containing 0.6 pct SiO_2 (obtained using traditional flotation cells) were reprocessed using column flotation to obtain concentrates containing 0.19 and 0.27 pct SiO_2 . More than 96 pct of the zinc was recovered and more than 70 pct of the calcium and magnesium were eliminated. The "clean" concentrates were then roasted at 1,000° C. The calcines

produced were leached by two-stage zinc process leaching methods. The residues from these leaches were then "intensively" leached to remove all soluble germanium. As seen in table 8, decreasing the SiO_2 content in the concentrates prior to roasting increased the amount of germanium that could be extracted from the subsequent zinc residues.

Table 8.—Effect of silica on germanium extraction

SiO_2 , pct	Ge extraction, pct
0.19	98.2
0.27	96.8
0.60	82.0

2. *Lower the temperature of the roast.* As shown in figure 10 and table 4, at lower roast temperatures, less Zn_2SiO_4 and SiO_2 - GeO_2 solid solutions were formed. If less Zn_2SiO_4 is present, less silica gel will form to insolubilize germanium. If less solid solution forms, more germanium can proceed through the zinc process in a soluble state. However, it must be remembered that the primary purpose of a high roast temperature is to oxidize ZnS to recover zinc. Lower temperatures could harm zinc extraction. Therefore, this alternative for increasing germanium extraction might not be acceptable to the zinc industry.

3. *Leach the insoluble germanium in the residue with hydrofluoric acid (HF).* It is well known that HF dissolves SiO_2 . Since the germanium is tied up with SiO_2 , leaching the final residue with HF will free the germanium. Figure 13 shows germanium extraction versus HF addition for zinc residue that had previously been leached with H_2SO_4 . As seen, leaching the H_2SO_4 -leached residue with 500 lb/st HF for 2 h at 80° C and 10 pct solids extracted 93 pct of the remaining germanium, bringing the total germanium extraction from approximately 70 to 98 pct.

4. *Modify the two-stage zinc leaching procedure.* Testing showed that silica gel formation in the "weak acid" leach was affected by solution pH. Table 9 demonstrates that as the pH of the "weak acid" leach decreased from 1.5 to 0, germanium extraction during subsequent leaching of the final zinc residue increased from 70 to 96 pct.

Table 9.—Effect of "weak acid" leach pH on subsequent germanium extraction from final zinc residue

pH	Ge extraction, pct
1.5	70
1.0	85
0.5	84
0.0	96

LEACHING OF GERMANIUM-GALLIUM ORE

BACKGROUND

The Apex Mine near St. George, UT, is the only ore body in the world that has been mined primarily for germanium and gallium within the last 20 years. From 1880 to 1945, copper was extracted from this unique property leaving behind unmined iron-rich minerals containing germanium and gallium. Geological studies of the site (22-23) have revealed that germanium is concentrated mainly in goethite, while gallium is found chiefly in jarosite. It is postulated that at some geological time, germanium and gallium substituted for iron in these minerals. Therefore, to extract germanium and gallium from the ore, it is necessary to solubilize the iron compounds.

Musto Explorations LTD, former owner of the mine, employed a three-stage countercurrent process using H_2SO_4 and SO_2 to leach approximately 80 pct of the germanium and 90 pct of the gallium from the ore (24). Researchers commissioned by Musto (25) determined that a reducing agent, such as SO_2 , must be present along with H_2SO_4 to attack goethite according to reaction E. Jarosite could be attacked by SO_2 alone according to reaction F.

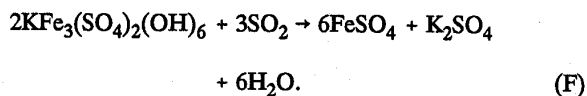
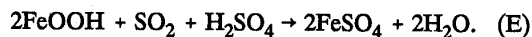

Jiang, Lee, Singh, Singh, and Torma (26) in their H_2SO_4 leaching studies of this ore also maintained that a reducing agent was needed for high germanium and gallium extractions. These researchers were able to leach approximately 95 pct of the gallium, but only up to 65 pct of the germanium.

Research reported in the previous section on H_2SO_4 leaching of germanium and gallium from zinc residues showed that although the addition of SO_2 increased extraction, the same effect could be achieved with increased H_2SO_4 concentration. Because germanium and gallium in both zinc residues and Apex ore are tied up in iron compounds, it was felt the previous research could be applicable to this ore.

According to reactions G and H, goethite and jarosite can be attacked with H_2SO_4 alone.

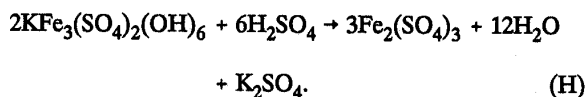
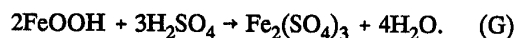

Comparing reaction E with G and F with H, it is seen that the addition of SO_2 reduces the total moles of leaching reagents needed to attack the iron compounds. However, because SO_2 is approximately six times more expensive than H_2SO_4 , the cost of reagents would be considerably less, and the overall leaching process would be simplified if only H_2SO_4 were used. In addition, SO_2 is difficult to handle and environmentally hazardous. Therefore, it was the goal of this research to study the extraction of germanium and gallium from Apex ore using only H_2SO_4 and eliminate the use of SO_2 .

RESULTS AND DISCUSSION

H_2SO_4 leaching of Apex ore was initially tested at 20 pct solids for 2 h at 80° C. Figure 14 shows the effect of increasing the initial solution H_2SO_4 concentration on germanium, gallium, and iron extraction. Since geological studies maintain that germanium and gallium are uniformly distributed in the iron lattices (22), and since goethite and jarosite are both ferric iron minerals, it was expected that the three extraction curves would follow each other

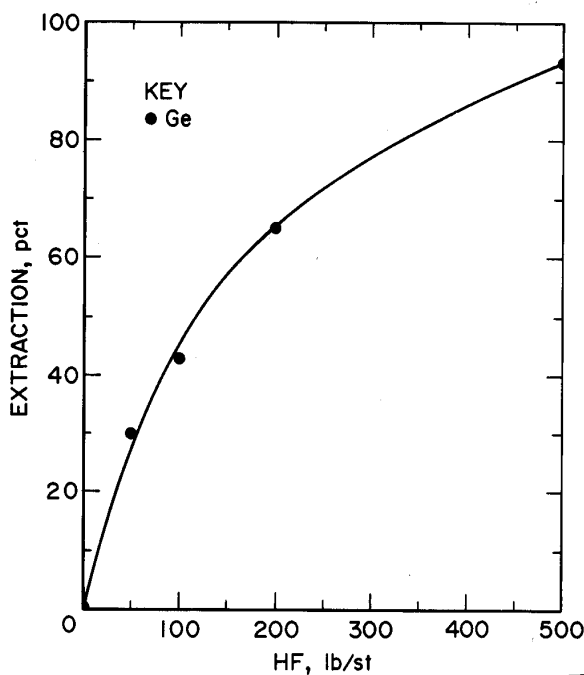

Figure 13.—Effect of HF concentration on germanium extraction from H_2SO_4 -leached residue (2 h, 80° C, 10 pct solids).

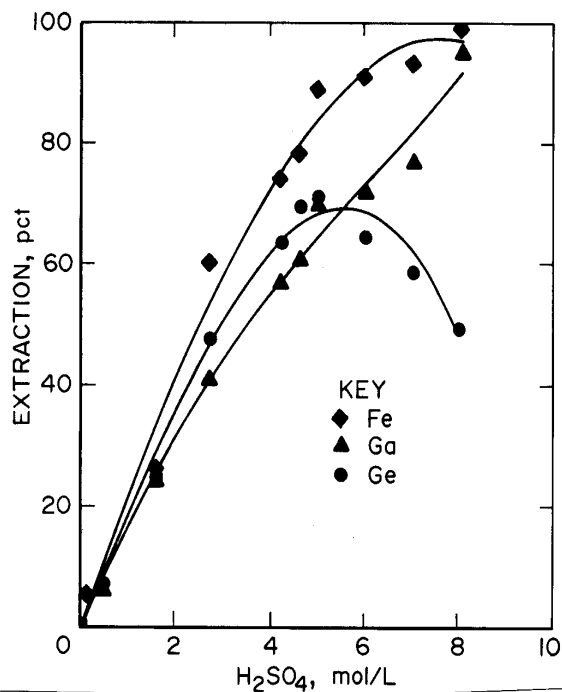

Figure 14.—Effect of H_2SO_4 concentration on metal extraction from gallium-germanium ore (2 h, 80° C, 20 pct solids).

fairly closely. As seen, gallium and iron extractions increased to more than 95 pct as the H_2SO_4 concentration increased, indicating the relatively high solubility of these metals. Germanium extraction, however, reached a peak of 71 pct using 5M H_2SO_4 . Above this point, germanium extraction decreased with increasing H_2SO_4 concentration, indicating the precipitation of solubilized germanium from the leach solution. This initial testing showed that while high gallium extraction from Apex ore was easily attainable by increasing the H_2SO_4 concentration in the leach liquor, germanium extraction warranted further investigation.

Germanium Extraction

From figure 14, it is apparent that in the leaching of Apex ore, germanium solubility decreased substantially in highly concentrated H_2SO_4 solutions. This same behavior was observed and explained previously for the leaching of germanium from zinc processing residues (see the "Batch Testing of Significant Variables" section). It is believed that the same mechanism applies here. When Apex ore is leached, H_2SO_4 attacks the goethite and frees the germanium. However, during the leach (and before complete dissolution of germanium from the ore) as the H_2SO_4 concentration becomes too high, part of the solubilized germanium precipitates as GeO_2 .

To avoid germanium precipitation during the leaching of Apex ore, the amount of H_2SO_4 in the leach solution must be controlled. If too much acid is added, germanium will begin precipitating from solution before the dissolution of germanium from the ore is complete. If not enough acid is added, germanium will not be freed from the goethite lattice. In either case, the end result is low germanium extraction.

To obtain high germanium extraction at the lowest possible H_2SO_4 concentration, other variables such as leach temperature and time were examined. The effect of increasing leach temperature from 25° to 100° C is shown in figure 15 for tests performed for 2 h with a 2.2M- H_2SO_4 solution. As seen, the highest germanium extractions were obtained at temperatures of 90° to 95° C.

Time tests were conducted at 90° C and 20 pct solids at three different acid concentrations: 2.6M, 5.3M, and 8.0M. The corresponding germanium and iron extraction curves are shown in figure 16. The highest germanium extraction of 85 pct was attained after 80 h using the 2.6M- H_2SO_4 leach solution. For comparison, germanium extractions with the 5.3M- and 8.0M- H_2SO_4 leach solutions decreased to 78 and 37 pct, respectively, after 72 h. More importantly, because germanium extraction continued to follow iron extraction in the 2.6M- H_2SO_4 test, it is clear that germanium was not precipitating from solution, as it clearly was in the 5.3M- and 8.0M- H_2SO_4 tests. Thus, the use of lower H_2SO_4 concentrations over longer leach times increased germanium extraction to 85 pct, a level 5 pct higher than that obtained in the system using both H_2SO_4 and SO_2 (24).

Two-Stage Countercurrent Leaching

Based on these results, a two-stage countercurrent leach system, as shown in figure 17, was proposed for extracting high amounts of both germanium and gallium from Apex ore.

In stage A, used acid from stage B contacts fresh ore for a relatively long leach time (at least 20 h) to extract high amounts of germanium. In stage B, fresh acid contacts previously leached ore for a shorter period of time (approximately one-third the time of stage A) to extract relatively high amounts of gallium. The acid concentration in stage B must be sufficiently high to extract most of the gallium. However, because of the countercurrent action, the acid concentration can be considerably less than shown in figure 14, i.e., 8M H_2SO_4 . Since most of the germanium would be solubilized in stage A, a high acid concentration in stage B would not adversely affect germanium extraction.

This system was tested using a leach time of 20 h in stage A and 6 h in stage B with a temperature of 90° C and 20 pct solids in each stage. The pulp density in

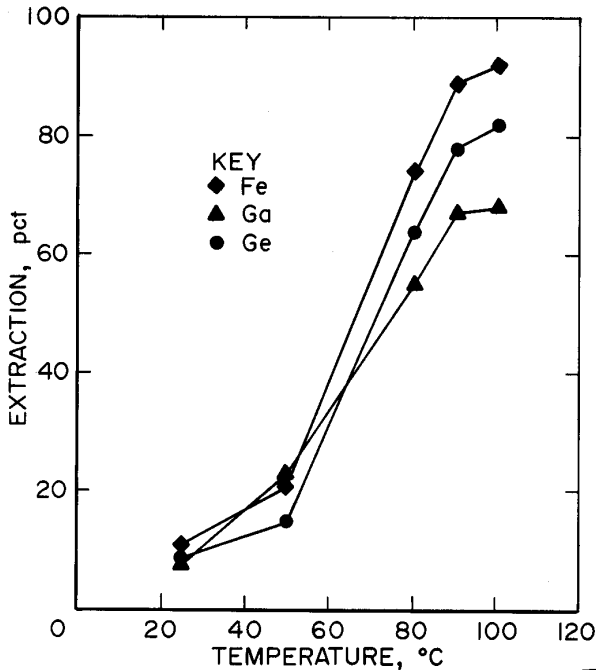

Figure 15.—Effect of leach temperature on metal extraction from gallium-germanium ore (2.2M H₂SO₄, 2 h).

stage B was based on the actual weight of dry solids remaining after the stage A leach. Varying amounts of H₂SO₄ were added to determine the optimal amount of acid needed for both high gallium and germanium extractions. The results shown in table 10 indicate that germanium extraction remained fairly constant as the initial acid concentration in stage A decreased from 3.2M to 1.9M. However, when the initial acid concentration in stage B decreased from 4.9M to 2.9M, gallium extraction dropped from 97 to 70 pct. Table 10 also lists the total amount of acid used on a pound-per-standard-ton basis. At 20 pct solids, at least 2,000 lb/st H₂SO₄ was required for both high gallium and germanium extraction.

Table 10.—Effect of acid concentration on metal extraction in two-stage leach

(Stages A and B - 20 pct solids)

Added H ₂ SO ₄ , lb/st	Initial molarity, M		Total extraction, pct	
	Stage A	Stage B	Ga	Ge
2,200	3.2	4.9	97	87
2,000	2.9	4.4	96	85
1,800	2.6	3.8	91	86
1,600	2.3	3.4	85	87
1,400	1.9	2.9	70	85

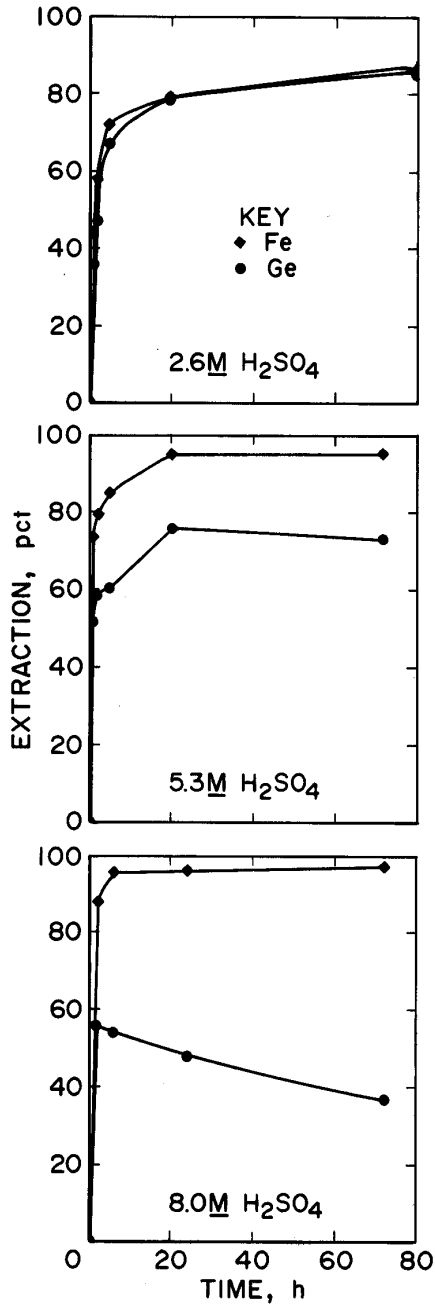

Figure 16.—Effect of leach time at various acid concentrations on metal extraction from gallium-germanium ore (90° C, 20 pct solids).

Increasing pulp density of the leach slurry was studied as a method to use acid more efficiently (less H₂SO₄ to maintain the same acid concentration). Table 11 shows the effect on metal extraction when the initial percent

solids in stages A and B were 25 and 30 pct, respectively. Increasing the pulp density of the two-stage leach did not significantly reduce the amount of acid needed (per ton of ore) to leach high amounts of gallium and germanium. However, increasing the pulp density did significantly increase the iron concentration in solution from an average of 55 g/L (with 20 pct solids) to 90 g/L Fe (with 30 pct solids), approaching iron saturation. To avoid this problem, the two-stage, 20-pct-solids leach is recommended. It should be realized that these tests show trends on a laboratory scale. To use the information on an industrial level, pilot-plant studies must be performed.

Table 11.—Effect of acid concentration on metal extraction in two-stage leach with varying percent solids

(Stage A - 25 pct solids, stage B - 30 pct solids)

Added H ₂ SO ₄ , lb/st	Initial molar- ity, <i>M</i>		Total extrac- tion, pct	
	Stage A	Stage B	Ga	Ge
1,500	2.9	6.0	91	81
1,300	2.5	5.0	67	79
1,100	2.0	4.2	57	77

Increasing Germanium Extraction

The highest germanium extraction attained, even under optimum two-stage leaching conditions, was 87 pct (see table 10). A key to increasing germanium extraction is understanding the mineralogy of the ore. In this study, microprobe studies were performed on the ore before and after leaching. Individual grains of the original and leached ore (residue) were scanned with the electron beam and analyzed for germanium, iron, and silicon. Figure 18 shows photomicrographs of germanium, iron, and silicon in the ore. As seen, although most of the germanium is with the iron, as predicted by geologists, a significant amount (approximately 10 to 20 pct) is also associated with silicon. Similar analyses of the residue showed the germanium was no longer associated with iron, but was found in solid solution in individual quartz (silica) grains. This information suggests that 10 to 15 pct of the germanium in Apex ore is tied up with silica and cannot be leached with H₂SO₄.

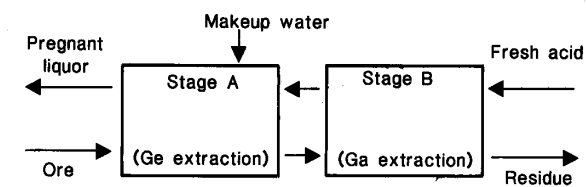

Figure 17.—Proposed two-stage leach system.

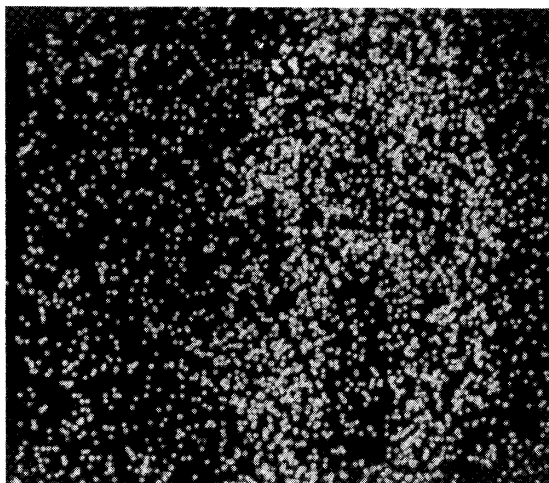

Figure 18.—Photomicrographs of gallium-germanium ore (X 300). White dots indicate germanium (top), iron (middle), and silicon (bottom).

Gruzdev and Vydrin (19) documented the affinity germanium has for silica. Miller, Dacheille, Shafer, and Roy (15) demonstrated how GeO_2 can substitute into the four-fold coordinated structures of silica. Therefore, it is theorized that in the formation of this deposit, some germanium substituted into silica grains. This theory was further verified by leaching the residue in an HF solution. Since HF attacks silica, leaching with HF should destroy the silica and solubilize the germanium. Table 12 shows that as the HF concentration in the leach solution increased, germanium solubility increased, resulting in a total of 99 pct of the germanium in Apex ore being extracted.

Because of the higher reagent cost and related environmental and safety problems associated with HF, recovering

the remaining 10 to 15 pct Ge with HF would probably not be an economical option.

Table 12.—HF leaching of residue

HF, pct	Total Ge extraction, pct ¹
0	85.0
1	87.7
5	92.3
10	93.1
20	98
30	99.1

¹After H_2SO_4 leach.

GALLIUM AND GERMANIUM SOLVENT EXTRACTION FROM H_2SO_4 SOLUTIONS

Leaching tests described in the previous research were performed to solubilize gallium and germanium. The next step toward metal recovery was the selective removal of these elements from solution. Traditional methods, such as chemical precipitation, are effective in some applications; however, these processes usually require many high-cost, complicated, and time-consuming steps (27). Other techniques, such as the use of resins, are being explored, but low loading capacity as well as high cost and strict separation conditions have limited their usefulness (28). The preferred method of gallium and germanium recovery from solutions is solvent extraction. Therefore, it was the goal of this research to identify or develop solvent extractants capable of recovering gallium and germanium from H_2SO_4 solutions.

GALLIUM SOLVENT-EXTRACTION BACKGROUND

A literature survey revealed that most of the research previously conducted on gallium solvent extraction concerned the recovery of gallium from basic sodium aluminate solutions produced in the Bayer process. U.S. patents such as 4,468,374; 4,135,917; 3,988,150; and 3,899,422 discuss these efforts.

Sheka, Chaus, and Mityureva (29) reviewed the extraction of gallium from hydrochloric acid (HCl) solutions with different organic extractants including ethers; ketones; esters; higher alcohols; and primary, secondary, and tertiary amines. Among these organic extractants, isopropyl ether and tri-n-butylphosphate (TBP) have received the most attention. Although processes employing isopropyl ether and TBP profess to selectively separate gallium, they require highly concentrated HCl solutions (7 to 9M), which shorten the life of the extractant (30-31).

Gallium solvent extraction from H_2SO_4 solutions using methyl isobutyl ketone (MIBK) has been researched, but this process extracted less than 0.5 pct of the gallium (32). Katsura and Abe (33) patented a process using versatic acid as the organic extractant in removing gallium from H_2SO_4 solutions. However, to obtain high gallium extractions, a pH of more than 3.5 was needed. To neutralize solutions to such a pH requires costly and time-consuming measures.

It has been reported that in an H_2SO_4 system di(2-ethylhexyl) phosphoric acid (DEHPA) can be used to extract gallium (25-26), but commercial production has not been attained. Musto Explorations (28), in St. George, UT, tried extracting gallium from an H_2SO_4 leach filtrate of Apex Mine ore using DEHPA; however, processing problems prevented the operation from becoming economically viable. A major obstacle in using DEHPA is that the pH of the leach filtrates, which ranges from 0 to 0.5, must be raised by neutralization to a range of 2 to 3 for high gallium extraction. Neutralization increases the cost and time required for processing.

GERMANIUM SOLVENT-EXTRACTION BACKGROUND

Various solvents, including carbon tetrachloride, chloroform, TBP, long-chain amines, alkylphosphoric acids, phosphinic acid, oxime, hydroxamic acids, and alkylpyrocatechol, have been proposed for the solvent extraction of germanium (34-35). Of these, only Kelex 100 (36) (beta-dodecyl 7-alkenyl-8-hydroxyquinoline) and LIX 63 (37) (19-hydroxyhexatriaconta-9,28 diene-18 oxime) have been mildly successful in extracting germanium from H_2SO_4 solutions. Kelex 100 effectively loads germanium from

acidic solutions; however, the rate of aqueous and organic disengagement is slow, and a harsh caustic is needed to strip germanium from the organic. LIX 63 is only effective with solutions containing high amounts of acid (more than 100 g/L), and again, strong caustic is needed to strip germanium from the organic. More importantly, patents for germanium solvent-extraction technology using these two solvents are owned by foreign companies that have been reluctant to lease the know-how to U.S. firms. It is clear that other extractants need to be found.

It was the goal of this research to identify effective solvent extractants for recovering gallium and germanium from H₂SO₄ leach solutions and to test the extractants in continuous, solvent-extraction circuits.

SOLUTION PREPARATION AND ANALYSIS

Four solutions were tested in this work: (1) synthetic solution A, produced by dissolving 99.99 pct pure GeO₂ in water and then adding H₂SO₄; (2 and 3) filtrates B and C, obtained by H₂SO₄ leaching of zinc residue at different conditions; and (4) filtrate D, produced by H₂SO₄ leaching of the Utah germanium-gallium ore. Table 13 shows the concentration of metals in each solution as determined by ICP and AA. Radioisotope tracers were used in this research for determining germanium extraction from these solutions.

Table 13.—Concentration of metals in leach filtrates, grams per liter

Element	Synthetic solution A	Zn residue filtrate		Apex ore filtrate D
		B	C	
As	0	<0.1	<0.1	2.3
Cd	0	.24	.17	<.1
Cu	0	2.10	1.06	3.5
Fe	0	18	11	81
Ga	0	.55	.32	.12
Ge	.24	.64	.32	.30
Zn	0	19	12	1.8

INITIAL SOLVENT-EXTRACTION TESTING

Nine different organic extractants were initially tested to determine their selectivity for extracting gallium and germanium from leach filtrate B: bis 2,4,4-trimethylpentyl phosphinic acid (Cyanex 272), DEHPA plus isodecanol (IDA), Kelex 100, LIX 63 plus IDA, octylphenyl acid phosphate (OPAP) plus IDA, 2-ethylhexyl phosphonic acid (PC88A), TBP, tri-octylphosphine oxide (TOPO) plus IDA, and tri-n-octylamine. Single-contact batch tests were conducted in separatory funnels on a wrist-action shaker for 30 min using aqueous-to-organic (A-O) volume ratios of 1:1 with kerosene as the diluent.

Table 14 shows that 0.3M OPAP plus 10 vol pct IDA in kerosene (this combination will subsequently be referred to as "OPAP") extracted the most gallium, while Kelex 100 extracted the most germanium. As explained previously, the use of Kelex 100 for germanium extraction is patented; however, the use of OPAP for gallium extraction is new and was, therefore, examined in more detail. Further testing for germanium solvent extraction is presented later.

Table 14.—Solvent-extraction results (percent) testing various extractants

Organic extractant ¹	Cd	Cu	Fe	Ga	Ge	Zn
Cyanex 272	1.2	0.7	7	5.6	1.6	0.8
DEHPA plus IDA	.5	1.1	21	0	.4	.6
Kelex 100	0	49	10	0	84	0
LIX 63 plus IDA	1.8	2	2.3	6	4	2.9
0.3M OPAP plus IDA	3.3	4	49.0	43.0	.4	3.9
PC88A	0	0	26	0	1.6	0
TBP	0	0	0	0	0	0
0.125M TOPO plus IDA	4.9	5	10	0	8	6.2
Tri-n-octylamine	0	0	0	0	0	0

¹10 vol pct except as noted.

GALLIUM SOLVENT EXTRACTION

In addition to OPAP, DEHPA was also included in a more detailed study for gallium extraction from H₂SO₄ solution. Although preliminary results using DEHPA were not encouraging, its use was not eliminated at this point because other researchers had found it to be successful in recovering gallium (25-26). In addition, DEHPA and OPAP are both organophosphate extractants with similar structures (38). The commercially prepared OPAP used in this study was obtained from Albright Wilsons Americas, and is reportedly a 60:40 mixture of monomer and dimer OPAP.

Iron Versus Gallium Loading

Zekel, Nosovshii, Rexnik, and Shpirt (30) found that when gallium was extracted from HCl solutions using TBP, any oxidized iron (ferric) in solution loaded preferentially to gallium. However, when iron was in the reduced state (ferrous), it did not load onto TBP. Tests using 0.3M OPAP showed that when solvent extraction was conducted immediately after the iron in the filtrate was reduced with metallic iron, reaction I, gallium extraction was high, and iron extraction was low.



However, when the solution was allowed to oxidize, the opposite occurred. It was theorized that ferric iron inhibited gallium loading onto OPAP, whereas with ferrous iron,

this problem does not exist. This assumption was verified by repeatedly contacting OPAP with reduced and oxidized leach solutions. Figure 19 shows that with a reduced solution, only small amounts of iron were loaded onto the OPAP, and gallium extraction remained high. When the solution was reoxidized, considerable amounts of iron loaded onto the OPAP on each contact, corresponding to decreased gallium loading; therefore, metallic iron was added to all filtrates to convert the ferric to ferrous iron to ensure high gallium loading onto OPAP.

An added advantage of reducing the solutions with iron is that copper is cemented out in the process, eliminating the need for copper removal at some later stage in the operation.

OPAP and DEHPA

Solvent extraction tests using OPAP and 10 vol pct DEHPA in kerosene were conducted using reduced leach filtrate C. Table 15 shows that one 30-min contact of filtrate with OPAP at an A-O ratio of 1:1 extracted 96 pct of the gallium and only 1 pct of the zinc. DEHPA alone extracted only 23 pct of the gallium in one contact. When the pH of the filtrate was increased by neutralization with sodium hydroxide (NaOH), gallium extraction using DEHPA increased. At pH 2.3, 81 pct of the gallium and 34 pct of the zinc were extracted after two contacts at an A-O ratio of 1:1; however, at pH 3.3, 68 pct of the gallium and 16 pct of the zinc were precipitated from solution.

Table 15.—Solvent extraction of gallium and zinc from reduced leach solutions, percent

Number of contacts	OPAP,		DEHPA								
	pH 0.5		pH 0.5		pH 1.1		pH 2.3		pH 3.3		
	Ga	Zn	Ga	Zn	Ga	Zn	Ga	Zn	Ga	Zn	
0 ...	0.0	0	0	0	0	0	0	0	0	68	16
1 ...	96	1	23	7	32	2	62	18	90	37	
2 ...	99.9	0	32	11	NA	NA	81	34	NA	NA	

NA Not available.

¹Precipitated.

Figure 20 demonstrates the effect of pH on gallium solvent extraction with OPAP. As seen, OPAP extracted more than 98 pct of the gallium even at a pH as low as 0 (corresponding to approximately 40 g/L H₂SO₄). As the pH dropped below 0, gallium extraction decreased dramatically. DEHPA, however, needed a pH of 2 to 3 to extract gallium. Therefore, the distinct advantage of OPAP is that the leach filtrate needs no neutralization and can be used as received. Because OPAP gave such excellent results, it was studied in more detail.

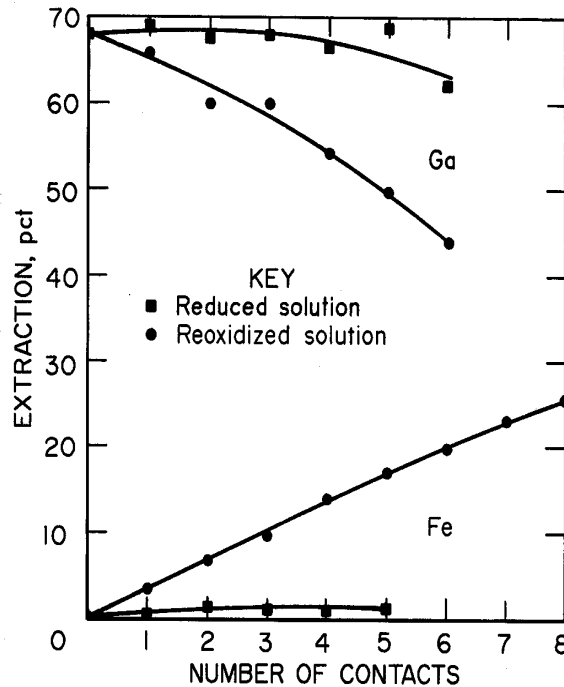

Figure 19.—Gallium and iron extraction from reduced and reoxidized solutions.

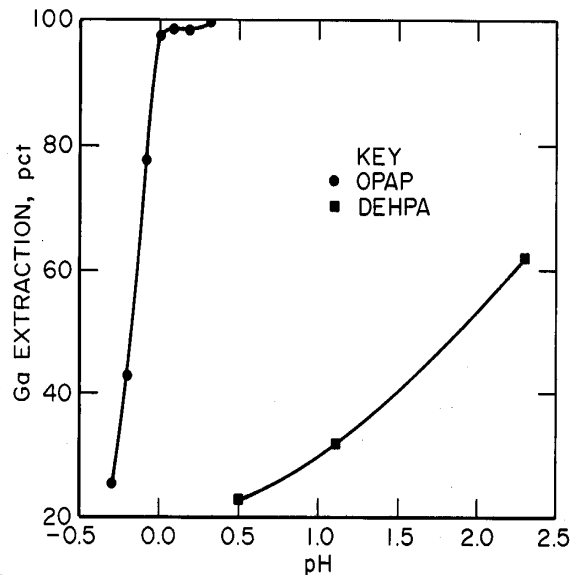

Figure 20.—Effect of pH on gallium extraction using the solvents OPAP and DEHPA.

Rate and Equilibrium Analysis

Rate and equilibrium analyses were conducted using OPAP to better understand its gallium loading and stripping properties.

Gallium Loading

Figure 21 shows that a contact time of 10 min was sufficient for gallium equilibrium loading onto OPAP. A McCabe-Thiele analysis of the gallium-loading isotherm for a 0.3M-OPAP organic and a 0.32-g/L-Ga filtrate showed that a loaded solvent containing 0.32 g/L Ga could be produced at an A-O ratio of 1:1 with four theoretical stages of mixing and separating (fig. 22).

Gallium Stripping

Batch solvent extraction tests conducted on a wrist-action shaker showed that gallium could be stripped from OPAP using 1 to 3M-H₂SO₄ solutions. Figure 21 reveals that stripping with a 1.5M-H₂SO₄ solution removed 98 pct of the gallium in 10 min. A McCabe-Thiele analysis of the equilibrium stripping isotherm for a 1.5M-H₂SO₄ strip solution and a 0.3M-OPAP organic containing 0.32 g/L Ga indicated that a strip liquor containing 1.3 g/L Ga could be produced at an A-O ratio of 1:4 with four theoretical stages (fig. 23).

Ferric Stripping

Even when extracting freshly reduced solution, a small amount of ferric iron was present and loaded onto the OPAP. An H₂SO₄ strip alone could not remove this ferric. Tests showed that a 50-pct-phosphoric acid (H₃PO₄), 50-pct-H₂O solution stripped 92 pct of the ferric from OPAP within 5 min. When the OPAP was reused, it extracted gallium nearly as well as fresh extractant. A McCabe-Thiele analysis (fig. 24) of the iron-stripping isotherm for a 50-pct-H₃PO₄ solution and a 0.3M-OPAP organic containing 0.53 g/L Fe showed that iron on the OPAP can be reduced from 0.53 to 0.02 g/L at an A-O ratio of 1:4 in three theoretical stages.

Continuous Solvent Extraction of Gallium

With this background information, it was possible to operate a continuous, gallium solvent-extraction circuit using OPAP for gallium loading and H₂SO₄ and H₃PO₄ for gallium and iron stripping.

System Design

A continuous system was constructed consisting of mixer-settlers arranged so that the organic was fed at the

top of the operation and cascaded down through the setup. The mixer-settlers were divided into three sections. Gallium was loaded in the highest section and stripped in the middle section. The lowest section was for ferric iron stripping. Mixer-settlers could be added or removed from each section as needed. Pumps and flowmeters made it possible to adjust the aqueous flows so proper A-O ratios and retention times could be maintained. To ensure that the iron in solution remained in the reduced state, an upflow column containing iron metal was inserted before the first mixer-settler. All solution entering the system passed through this iron reducer.

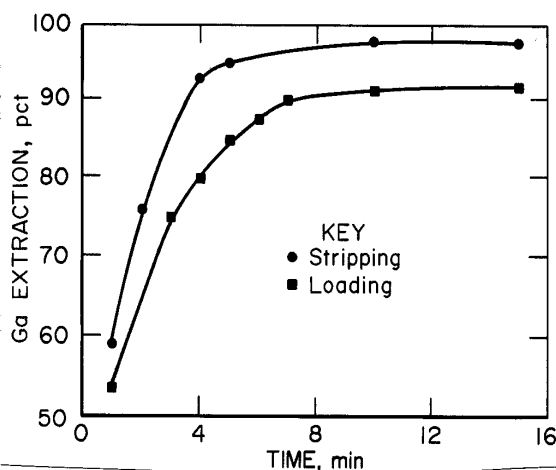

Figure 21.—Gallium equilibrium loading and stripping on 0.3M OPAP.

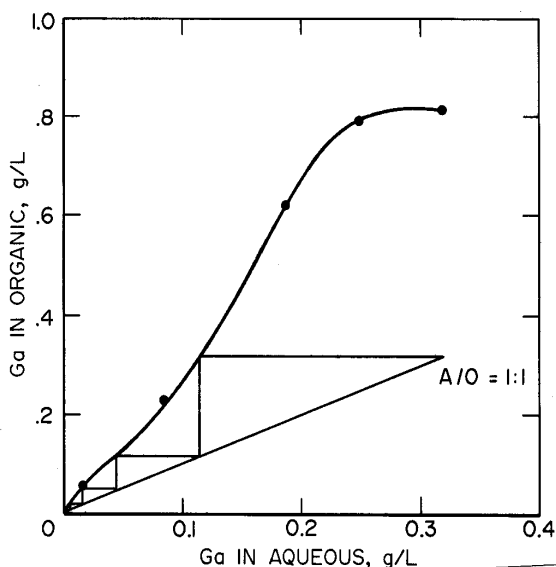

Figure 22.—McCabe-Thiele analysis loading 0.32-g/L-Ga aqueous on 0.3M OPAP. (A/O = aqueous-to-organic ratio)

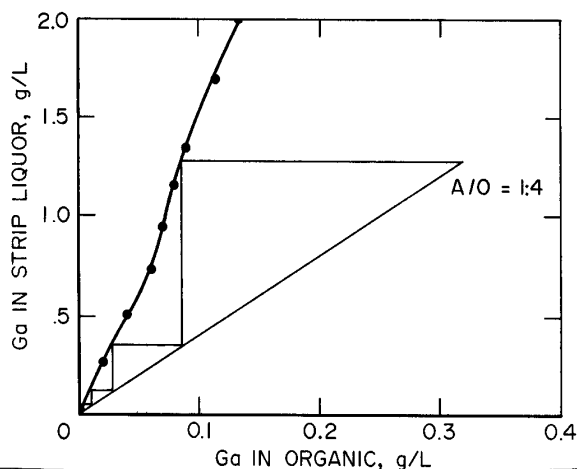

Figure 23.—McCabe-Thiele analysis stripping 0.32-g/L-Ga loaded organic using 1.5M H_2SO_4 . (A/O = aqueous-to-organic ratio)

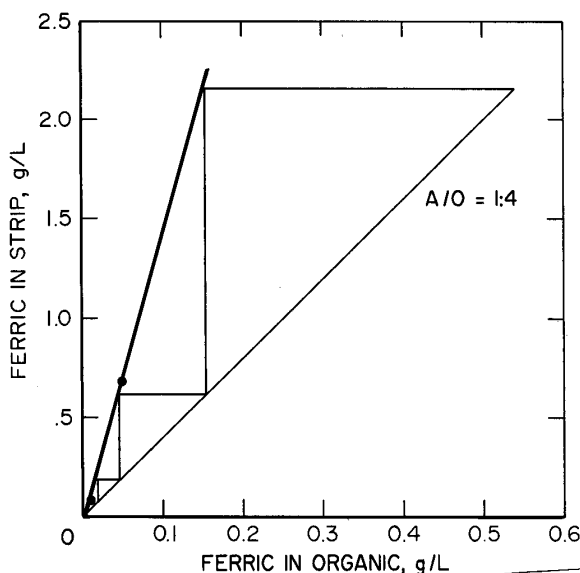

Figure 24.—McCabe-Thiele analysis stripping ferric iron with 50 pct H_3PO_4 . (Additional data point $x = 0.68$, $y = 7.09$; A/O = aqueous-to-organic ratio)

System Operation

The system was operated for maximum gallium recovery using conditions determined by the McCabe-Thiele analyses for leach filtrate C and for an organic containing 0.3M OPAP (figs. 21 through 24). The gallium-loading section contained four mixer-settlers and was operated at an A-O ratio of 1:1. Gallium stripping with 1.5M H_2SO_4 was conducted in four mixer-settlers at an A-O ratio of

1:4. A two-stage iron strip with 50 pct H_3PO_4 and an A-O ratio of 1:4 was used to keep ferric iron concentration on the OPAP below 0.5 g/L, thus allowing OPAP to function efficiently as it was recycled. Twelve liters of reduced leach filtrate containing 0.32 g/L Ga and 20 g/L Fe were pumped through the system in 32.4 h. Organic and aqueous flow rates were set to maintain a retention time of at least 10 min in each mixer of the loading section.

Operation of the system at these conditions resulted in a raffinate containing 0.02 g/L Ga and 20 g/L Fe. Organic loadings averaged, in grams per liter, 0.31 Ga and 0.36 Fe. The H_2SO_4 strip liquor averaged, in grams per liter, 1.07 Ga and 0.74 Fe. Gallium extraction from the leach filtrate averaged 95 pct; gallium recovery from the organic with the H_2SO_4 strip liquor averaged 94 pct. Operating the continuous system at these conditions concentrated the gallium by a factor of 3.3 (0.32 to 1.07 g/L). The rate of organic loss was 13.3 mL of organic extractant per liter of leach filtrate processed. The test was continued for an additional 20 h (7.9 L) with the H_3PO_4 strip removed. This was done to see how necessary this step was to the success of the operation. The gallium extraction dropped from 94 to 84 pct, while the iron concentration on the organic steadily increased from 0.4 to 0.79 g/L; thus, a H_3PO_4 strip was needed to maintain high gallium recovery.

Strip Liquor Purification

Although gallium recovery was high in the continuous system, the strip liquor contained too much iron to effectively precipitate a high-gallium product. Batch tests showed that by repeating the OPAP loading and stripping three times, 99.9 pct of the remaining iron was removed. When the liquor from the third and final strip was neutralized with ammonium hydroxide (NH_4OH), a product containing 40 pct Ga was precipitated. Such a product can be incorporated into traditional gallium purification systems.

GERMANIUM SOLVENT EXTRACTION

In a further effort to identify a germanium solvent extractant, 29 organic extractants, other than those listed in table 14, were tested for germanium selectivity using solution A spiked with either 100 or 10 g/L H_2SO_4 . In each test, 10 vol pct of liquid extractant was mixed with 90 vol pct kerosene. Where the extractant was a solid, the final concentration of the extractant in kerosene was 0.3M. Single-contact batch tests were conducted in separatory funnels on a wrist-action shaker for 30 min using A-O volume ratios of 1:1. The results in table 16 show that only Cyanex 301 (bis (2,4,4-trimethylpentyl) dithiophosphinic acid) extracted high amounts of germanium.

Table 16.—Testing various organics for germanium selectivity; extraction in percent

Organic extractant	H ₂ SO ₄ , g/L		Organic extractant	H ₂ SO ₄ , g/L	
	100	10		100	10
Adogen 283	1	0	JMT	9	7
Adogen 364	2	5	LIX 64N	2	2
Adogen 381	0	2	LIX 622	1	2
Adogen 464	9	11	LIX 860	1	1
Alamine 304	1	2	LIX 84	1	1
Alamine 308	0	2	LIX 984	0	3
Alamine 310	1	2	M-5640	0	0
Alamine 336	0	2	MEHPA	0	0
Aliquat 336	0	0	NeodecanoicPrine	0	0
Amberlite LA2 . .	1	2	Octyl-oxime	1	0
BC-150	0	0	P-5050	0	0
Cyanex 301	89	65	P-5100	1	0
Cyanex 302	0	0	Tri-octylamine . . .	0	3
Cyanex 923	1	1	Versatic acid	0	0
Cyanex 925	5	0			

The selectivity of Cyanex 301 for germanium was then tested using filtrate B, an actual leach solution containing 60 g/L H₂SO₄. As before, an A-O ratio of 1:1 and contact time of 30 min were used. Cyanex 301 extracted more than 80 pct of the germanium, but it also extracted 98 pct of the copper, 99 pct of the zinc, and more than 30 pct of the cadmium. Because Cyanex 301 was so nonselective for germanium, other possible extractants were sought.

Often when two extractants are mixed, a synergistic effect occurs whereby the combination of extractants is capable of extracting more of a metal than either organic alone. This was shown by Demopoulos and Gevert for extracting ferric iron (39) and by De Schepper, Commement, and Van Peteghem (40) for increasing germanium extraction by mixing Kelex 100 and LIX 26. In the current study, various extractants were grouped by twos and mixed with kerosene as the diluent. Each combination was then contacted with leach filtrate B for 30 min at an A-O ratio of 1:1. Select results in table 17 show that one combination, 0.3M OPAP and 10 pct LIX 63, extracted more than 40 pct of the germanium. Table 17 also shows the results when filtrate B was contacted with OPAP and LIX 63 alone. These results indicate that the OPAP-LIX 63 mixture had a synergistic effect on germanium extraction; therefore, work on this combination was expanded.

Effect of Copper and Iron

Because germanium extraction from an actual leach solution averaged only 40 pct when using the OPAP-LIX 63 mixture, methods to increase extraction were examined. LIX 63 was originally developed as a copper

extractant (41) and OPAP is known to extract ferric iron (see the "Iron Versus Gallium Loading" section); therefore, a series of tests was performed to determine the effect of aqueous copper and iron on germanium extraction when using the 0.3M-OPAP-10-pct-LIX 63 mixture. Table 18 shows that the highest germanium extraction was possible when the leach solution was free of copper and the iron was in the reduced state. These objectives can be accomplished by contacting the leach solution with metallic iron as shown in reactions I and J.

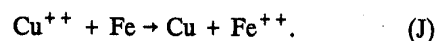
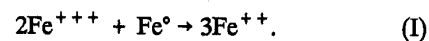

All further tests were performed using solutions contacted with metallic iron.

Table 17.—Germanium extraction with various organic combinations

Organic	Ge extraction, pct
10 pct DEHPA with—	
10 pct Adogen	8
10 pct JMT	9
10 pct LIX 64N	6
10 pct LIX 63	4
0.3M OPAP	0
0.3M OPAP with—	
10 pct Cyanex 272 . .	0
10 pct DEHPA	0
10 pct Kelex 100 . . .	85
10 pct LIX 63	49
10 pct TOPO	0

Table 18.—Effect of copper and iron on germanium extraction

	Ge extraction, pct
With Cu and—	
Fe ⁺⁺	72
Fe ⁺⁺⁺	41
Without Cu:	
Fe ⁺⁺	76
Fe ⁺⁺⁺	32

Synergism

Table 19 more clearly shows the synergistic effect obtained when various OPAP-LIX 63 combinations were used for germanium extraction. Filtrate C with 60 g/L free acid was used in these tests. As before, A-O ratios of 1:1 were used, and kerosene was the diluent. An organic with 10 pct LIX 63 extracted only 8.7 pct of the germanium; however, with a 0.3M-OPAP-10-pct-LIX 63 combination, germanium extraction increased to 57 pct. As another example, germanium extraction increased from 30 to 83 pct with the 0.2M-OPAP-30-pct-LIX 63 combination as compared with the 30-pct-LIX 63 organic.

Table 19.—Synergistic effect of OPAP-LIX 63 mixture; extraction in percent

Extractant	Ga	Ge
0.3M OPAP	77.7	0
10 pct LIX 63	0	8.7
10 pct LIX 63 and 0.3M OPAP	61.0	57.0
20 pct LIX 63	NA	21.0
20 pct LIX 63 and 0.3M OPAP	NA	80.5
30 pct LIX 63	0	30
30 pct LIX 63 and 0.2M OPAP	8	83
NA	Not available.	

Table 19 also demonstrates that the concentrations of LIX 63 and OPAP are important variables in obtaining high germanium extraction. By increasing the LIX 63 concentration from 10 to 20 pct in the 0.3M-OPAP organic, germanium extraction increased 23.5 pct.

An interesting phenomenon was observed in the data reported in table 19. The OPAP-LIX 63 mixture had the ability to coextract gallium along with germanium. A literature survey revealed that such a process has not previously been reported. Coextraction was pursued on a limited scale with some pertinent results given in a later section.

Effect of Acid Concentration

Table 20 shows the importance of solution acidity for germanium extraction with the OPAP-LIX 63 combination. As seen, germanium extraction increased with increasing free acid for both OPAP-LIX 63 combinations.

Table 20.—Effect of solution acidity on germanium extraction, percent

Free acid concentration, g/L	30 pct LIX 63- 0.2M OPAP	20 pct LIX 63- 0.3M OPAP
22.5	71.2	64.7
32.5	75.7	71.8
42.5	78.6	75.9
52.5	81.4	79.6
62.5	84.8	81.9

Germanium Stripping

Once the organic was loaded with germanium, a proper stripping agent was needed to make solvent extraction complete. Several possible reagents were tested to strip germanium from a loaded OPAP-LIX 63 organic mixture. Table 21 shows the results obtained using contact times of 1 h and A-O ratios of 1:1 to treat a loaded 0.3M-OPAP-10-pct-LIX 63 organic solvent.

Table 21.—Germanium stripping results (percent) testing various reagents

Reagent	Ge stripped
Distilled water	41.9
1 g/L FeSO ₄	38.5
10 pct HCl	19.5
1.0M H ₃ PO ₄	35.9
1.5M H ₂ SO ₄	28.4
1.0M Na ₂ CO ₃	12.0
0.5M NaOH	63.6
1.0M Na ₂ SO ₄	40.2

As anticipated, NaOH stripped a high percentage of the germanium; however, germanium stripping using distilled water was also surprisingly high. Because water is inexpensive and easy to handle, it was tested further. In particular, table 22 shows that increasing water temperature from 25° to 75° C increased germanium stripping from 41.9 to 73.9 pct.

With this background information, a study of continuous germanium solvent extraction was proposed using OPAP-LIX 63 for loading and hot water for stripping. For such an investigation, it was necessary to perform basic rate and equilibrium tests.

Table 22.—Effect of increasing water temperature on germanium stripping

Temperature, °C	Ge stripped, pct
25	41.9
60	64.6
75	73.9

Germanium Rate and Equilibrium Analysis

Rate and equilibrium analyses were conducted using a 0.2M-OPAP-30-pct-LIX 63 mixture for loading and 75° C water for stripping. Two samples of filtrate D were tested: one with the free acid adjusted to 40 g/L, the other with the free acid adjusted to 60 g/L. These tests were used to determine the number of loading and stripping stages as well as the retention time needed in a continuous, solvent-extraction operation.

Germanium Loading

Figure 25 shows equilibrium loading data obtained after one contact of aqueous with organic. A contact time of 20 min was deemed sufficient for loading germanium onto the extractant for a multicontact system.

Figure 26 shows a McCabe-Thiele analysis of the germanium-loading isotherm for a filtrate with 40 g/L free acid. As seen, a loaded solvent containing 0.3 g/L Ge could theoretically be produced at an A-O ratio of 1:1 using four mixer-settlers. When the 60-g/L-free acid

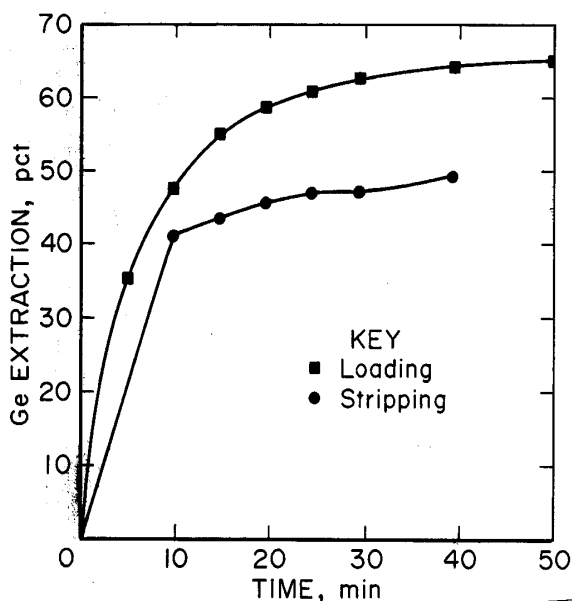

Figure 25.—Germanium equilibrium loading and stripping on 0.2M OPAP-30 pct LIX 63.

filtrate was tested, the McCabe-Thiele analysis of the germanium-loading isotherm (fig. 27) revealed that a loaded organic containing 0.6 g/L Ge could be obtained at an A-O ratio of 2:1 using four theoretical stages. Therefore, by increasing the free acid concentration in solution from 40 to 60 g/L, germanium concentration on the loaded organic would double.

Germanium Stripping

Stripping germanium from a loaded organic containing 0.3 g/L Ge with 75° C water reached equilibrium after a contact time of approximately 20 min, as seen in figure 25. A McCabe-Thiele analysis of the equilibrium stripping isotherm (fig. 28) indicated that an organic containing 0.3 g/L Ge could be stripped in three stages at an A-O ratio of 1:1 to produce a strip liquor containing 0.3 g/L Ge, while an organic containing 0.6 g/L Ge could be stripped in three stages at an A-O ratio of 1:1 to produce a strip liquor containing 0.6 g/L Ge.

Iron Scrubbing

Analysis of the organic after germanium loading and stripping revealed that up to 8 g/L Fe was present, even when the iron in the filtrate was maintained in the ferrous state. If the 8-g/L-Fe organic were recycled, this much iron would hinder germanium loading. To avoid this problem, iron scrubbing was studied. Rate and equilibrium

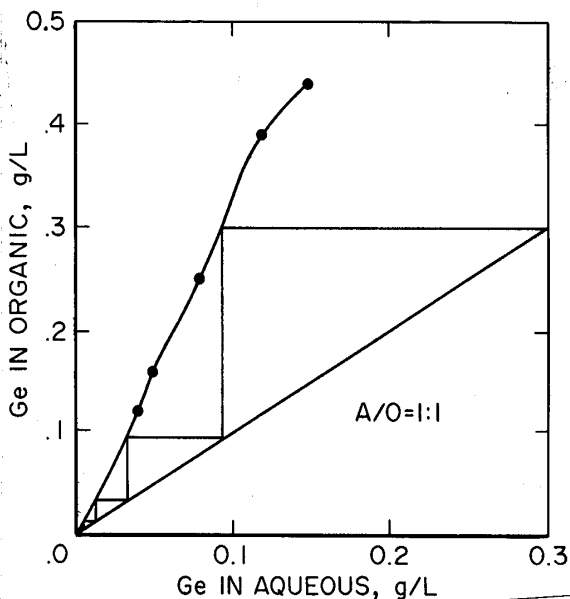

Figure 26.—McCabe-Thiele analysis of germanium-loading isotherm, 40-g/L-H₂SO₄ solution. (A/O = aqueous-to-organic ratio)

analyses for iron scrubbing were conducted using a loaded organic containing 7 g/L Fe and a 3M-H₂SO₄ scrub liquor. McCabe-Thiele analyses of the iron-scrubbing isotherm (fig. 29) showed that iron on the organic could be reduced from 7 to 2.4 g/L at an A-O ratio of 1:1 in two stages.

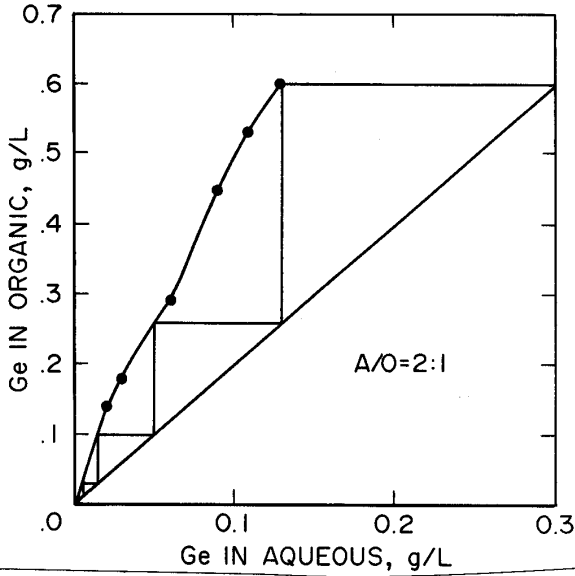

Figure 27.—McCabe-Thiele analysis of germanium-loading isotherm, 60-g/L-H₂SO₄ solution. (A/O = aqueous-to-organic ratio)

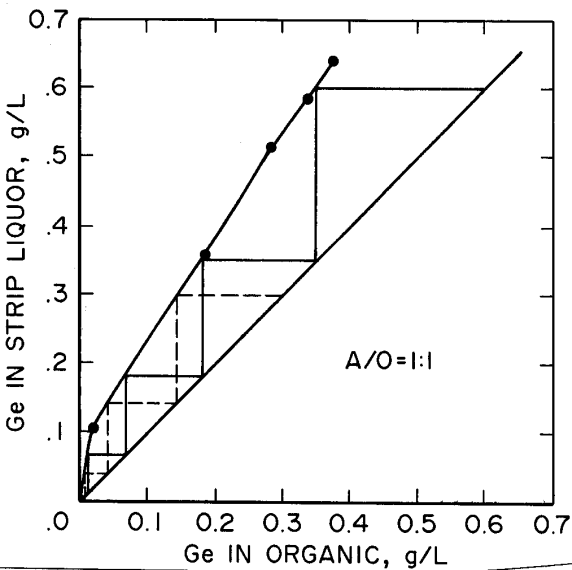

Figure 28.—McCabe-Thiele analysis stripping 0.3- or 0.6-g/L-Ge loaded organic using 75° C H₂O. (A/O = aqueous-to-organic ratio)

Continuous Solvent Extraction of Germanium

With this background information, it was possible to operate a continuous germanium solvent-extraction circuit using the OPAP-LIX 63 organic mixture for germanium loading, hot water for germanium stripping, and H₂SO₄ for iron scrubbing.

System Design

The continuous solvent-extraction circuit used for testing gallium solvent extraction was also used for testing germanium solvent extraction. For this work, the mixer-settlers were divided into three sections: germanium loading with four mixer-settlers, germanium stripping with four mixer-settlers, and iron scrubbing with two mixer-settlers. As before, to ensure that the iron in solution remained in the reduced state, an up-flow column containing metallic iron was inserted so that all solution entering the system passed through this column. The germanium-stripping stage was maintained at 75° C by circulating hot water through specially designed glass tubing placed in each settler.

System Operation

The continuous system was operated according to conditions determined by the McCabe-Thiele analyses for 0.2M-OPAP-30-pct-LIX 63 extractant combination.

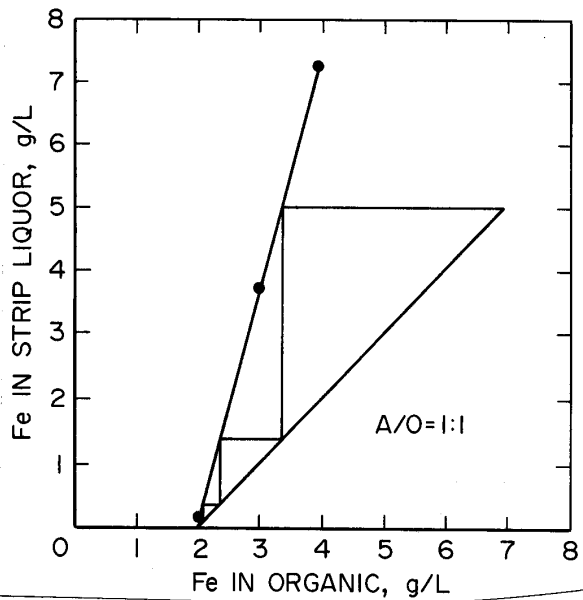

Figure 29.—McCabe-Thiele analysis stripping Iron with 3M H₂SO₄. (A/O = aqueous-to-organic ratio)

The operation parameters and results of each test, along with any variables tested, are given below.

Testing Leach Filtrate D Containing 40 g/L H₂SO₄

In these tests, germanium loading was operated at an A-O ratio of 1:1, as determined by the McCabe-Thiele analysis shown in figure 26. Germanium stripping with 75° C water was conducted at an A-O ratio of 1:1, as was the iron scrubbing with 3M H₂SO₄. Organic and aqueous flow rates were set to maintain a retention time of at least 20 min in each stage of the loading and stripping sections. In the first 30 h, the organic extractant was not recycled. Under these conditions, an average of 91 pct of the germanium loaded onto the extractant and 67 pct of this germanium was stripped from the organic extractant. When the organic was recycled, germanium loading stayed consistent at 88 pct, while germanium stripping increased to 77 pct.

The results using a 40-g/L-H₂SO₄ filtrate were encouraging; however, even under optimum conditions, the final strip liquor would have the same germanium concentration as the initial leach filtrate. One method of increasing the germanium concentration of the strip liquor would be to recycle the aqueous solution to load the organic to capacity and to recycle the aqueous during the stripping cycle to improve concentration ratios. In some operations, up to 90 pct of the aqueous is recycled. However, recycling increases operating costs and decreases the output rate. A better alternative would be to increase solution acidity so higher amounts of metal initially load onto the organic.

Testing Leach Filtrate D Containing 60 g/L H₂SO₄

In these tests, all conditions remained the same as described for the 40-g/L-H₂SO₄ solution tests except germanium loading was operated at an A-O ratio of 2:1, as shown in figure 27. In the first 20 h, the organic extractant was not recycled. Under these conditions, an average of 92 pct of the germanium loaded onto the extractant and 66 pct of this germanium was stripped from the organic extractant. These results are similar to those obtained using the 40-g/L-H₂SO₄ filtrate, but the highest germanium concentration in the strip liquor was 0.54 g/L, as opposed to a high of 0.24 g/L for the 40-g/L-H₂SO₄ solution.

The system was then operated for 24 h with the organic being recycled. Table 23 shows that germanium extraction remained relatively high at 85 to 90 pct, and the iron level remained consistently around 2.6 g/L. The fact that the amount of germanium stripped increased with each recycle indicates that an equilibrium amount of germanium remained on the organic, but did not affect subsequent germanium loading or stripping when the organic was recycled.

Table 23.—Effect of recycling
OPAP-LIX 63 extractant

Condition	Ge		Fe loading, g/L
	Loading, pct	Stripping, pct	
1st recycle . .	85	71	2.6
2d recycle . .	85	79	2.8
3d recycle . .	90	99	2.6

GALLIUM AND GERMANIUM COEXTRACTION

There is currently no available technology for the simultaneous solvent extraction and selective recovery of germanium and gallium from acidic solutions. This is significant because germanium and gallium often occur together in nature and can be leached using the same reagents. By extracting both metals at the same time, many processing steps could be eliminated.

EXPERIMENTAL RESULTS

Germanium and gallium coextraction was tested using OPAP-LIX 63 combinations in conjunction with filtrate B at A-O ratios of 1:1 and contact times of 1 h. The results in table 24 show that if the acid concentration of the aqueous and the strength of the extractant were properly controlled, appreciable amounts of both gallium and germanium could be extracted simultaneously.

Stripping the loaded organic with 75° C water at an A-O ratio of 1:1 removed 96 pct of the germanium. A

subsequent strip of the organic with 3M H₂SO₄ removed more than 95 pct of the gallium. More importantly, less than 1 pct of each metal contaminated the other.

Table 24.—Coextraction of gallium and germanium
(Solution free of Cu and Fe⁺⁺⁺)

Organic	Free acid, g/L	Extraction, pct	
		Ga	Ge
0.3M OPAP and			
10 pct LIX 63	40	58	55
Do.	60	57	61
Do.	80	28	69
Do.	100	26	77
0.2M OPAP and			
30 pct LIX 63	30	21	80
Do.	50	16	82
Do.	60	8	83

INDUSTRIAL APPLICATION

During the processing of certain zinc concentrates, germanium and gallium are solubilized in a pH 1.5 H_2SO_4 leach. These solutions typically contain more than 150 g/L Zn and approximately 0.13 g/L Ga and 0.29 g/L Ge. Coextraction using the 0.2M-OPAP-30-pct-LIX 63 mixture was tested on such a solution with the results shown in table 25. With just one contact of aqueous with organic, 60 pct of the gallium and 84 pct of the germanium were extracted. High germanium extraction from a pH 1.5 solution is quite significant. Table 25 also shows that when increasing amounts of H_2SO_4 were added to the solution, germanium extraction increased, while gallium extraction decreased.

Table 25.—Coextraction of gallium and germanium from zinc process solution, percent

Free acid, g/L	Ga	Ge
1.5	60	84
11.5	36	90
50.5	18	92

Results of multiple contacts of aqueous with organic are shown in figure 30. As seen, germanium and gallium continued to load without crowding one another off the organic. These results imply that an OPAP-LIX mixture

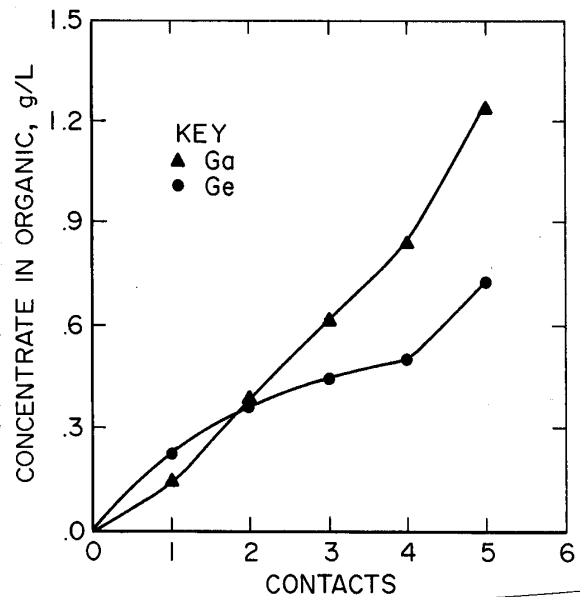

Figure 30.—Effect of multiple contacts in the coextraction of germanium and gallium from zinc processing liquors.

could be used to recover gallium and germanium during zinc processing, before these metals report to the waste residue. Such technology would greatly increase the supply of these critical metals.

SUMMARY

To decrease U.S. reliance on foreign sources of the strategic metals gallium and germanium, the Bureau has identified two potentially significant domestic supplies of these metals: a Tennessee zinc residue and a Utah ore. Leaching and solvent extraction techniques were studied for gallium and germanium recovery from both of these sources with the significant results summarized below:

1. For extracting high amounts of gallium and germanium from zinc residue, the following observations were noted:

- The most important operational parameter was shown to be the H_2SO_4 concentration.
- Conditions for simultaneously high gallium and germanium extraction were 10 pct solids, 2,000 lb/st H_2SO_4 , 4.5 h, and 80° C, yielding 89 pct Ga and 70 pct Ge extraction.
- Gallium extraction at ideal conditions approached 95 pct; however, germanium extraction of only 73 pct was achievable.

• It was postulated that germanium insolubility occurred during the leaching stages of zinc processing via the following mechanism: Minor amounts of Zn_2SiO_4 dissolve during calcine leaching to form silica gel and $ZnSO_4$. Silica gel selectively adsorbs germanium from solution, thus rendering it insoluble in H_2SO_4 leaches. Several potential alternatives exist to avoid this problem:

- a. Remove silica from the concentrates by column flotation.
 - b. Perform ZnS roasting at a lower temperature to avoid formation of Zn_2SiO_4 .
 - c. Leach the insoluble germanium with HF acid.
 - d. Decrease the pH of the "weak acid" leach to avoid losing germanium in silica gel formation.
- Each of these methods increased germanium extraction from zinc residue to more than 96 pct.

2. In leaching the Utah gallium and germanium ore, it was shown that H_2SO_4 alone could extract gallium and germanium without the use of a reducing agent such as

SO₂. Leaching studies showed that as the H₂SO₄ concentration increased, gallium extraction increased to more than 95 pct, while germanium extraction reached a peak of 71 pct before decreasing to less than 50 pct. It was hypothesized that at high acid concentrations, germanium precipitated from solution as GeO₂.

For optimum gallium and germanium extraction, a two-stage countercurrent leach system was devised to adequately control the solution acidity. At operating conditions of 2,000 lb/st H₂SO₄, 20 pct solids, and 90° C, 96 pct of the gallium and 85 pct of the germanium in the ore were extracted. Microprobe studies showed that approximately 10 to 15 pct of the germanium in Apex ore is in solid solution with silica and cannot be leached with H₂SO₄ or SO₂.

3. Gallium solvent extraction from H₂SO₄ filtrates was studied with the following conclusions being made:

- Solvent extraction with the organophosphate OPAP proved very successful for recovering more than 98 pct of the gallium from solutions with acid content as high as 40 g/L (approximately pH 0).

- Gallium extraction using OPAP was hindered when ferric iron was present in solution. Therefore, the iron in the filtrate was maintained in a reduced state by contacting the solution with metallic iron.

- Continuous gallium solvent extraction using a leach solution containing 0.32 g/L Ga and an organic containing 0.3M OPAP effectively loaded 95 pct of the gallium onto the organic. Stripping the organic with a 1.5M-H₂SO₄ solution recovered 94 pct of the gallium.

- A 50-pct-H₃PO₄ strip effectively reduced the amount of ferric iron remaining on the OPAP to less than 0.5 g/L, thus enabling the continuous system to maintain high gallium recoveries.

4. The investigation of germanium solvent extraction from H₂SO₄ solutions yielded the following results:

- Of the 60 potential extractants and combinations of extractants screened, the organic mixture of OPAP-LIX 63 was found to synergistically extract more than 40 pct of the germanium after one contact with actual leach solution.

- Germanium extraction increased to more than 80 pct when copper was removed from solution and iron was reduced to the ferrous state by contacting the leach solutions with metallic iron.

- Germanium was effectively stripped from the loaded organic using only 75° C water. Residual iron on the organic was reduced to acceptable levels using H₂SO₄ scrub solutions.

- A continuous germanium solvent-extraction circuit using OPAP-LIX 63 for germanium loading, 75° C water for germanium stripping, and H₂SO₄ for iron scrubbing extracted more than 90 pct of the germanium from leach solutions.

5. Research showed that the OPAP-LIX 63 organic combination was capable of extracting both gallium and germanium from H₂SO₄ solutions if the acid concentration of the aqueous and the strength of the extractant were properly controlled. More importantly, selective stripping with 75° C water stripped 96 pct of the germanium, while 3M H₂SO₄ removed 95 pct of the gallium.

REFERENCES³

1. Petkof, B. Gallium. Ch. in *Mineral Facts and Problems*, 1985 Edition. BuMines B 675, 1985, pp. 291-296.
2. Llewellyn, T. O. Germanium. Sec. in *BuMines Mineral Commodity Summaries 1989*, pp. 62-63.
3. Kramer, D. Gallium. Sec. in *BuMines Mineral Commodity Summaries 1989*, pp. 56-57.
4. *Wall Street Journal*. Silicon Successor? May 29, 1987, p. 1.
5. Brody, H. Ultrafast Chips at the Gate. *High Technol.*, v. 6, No. 3, 1986, pp. 28-35.
6. *Electronics*. GaAs-on-Silicon Wafers Are Set To Go Commercial. Oct. 15, 1987, pp. 47-48.
7. Murphy, T. D. Design and Analysis of Industrial Experiments. *Chem. Eng.*, v. 84, No. 12, 1977, pp. 168-182.
8. E. I. du Pont de Nemours & Co., Inc. (Wilmington, DE). *Strategy of Experimentation*. 1975, 70 pp.
9. Pugh, W. The Solubility of Germanium Dioxide in Acids and Alkalis. *J. Chem. Soc.*, v. 51, No. 6, 1929, pp. 1537-1541.
10. JCPDS International Centre for Diffraction Data (Swarthmore, PA). *Powder Diffraction File*. 1989, p. 246.
11. Brewer, F. M., J. O. Cox, and D. F. Morris. The Occurrence of Germanium in Blende. *Geochim. et Cosmochim. Acta*, v. 8, No. 3, 1955, p. 131.
12. Malevskiy, A. Y. Form of Germanium in Sphalerite. Ch. in *Geochemistry of Germanium*, ed. by J. Weber. Hutchinson and Ross, 1973, pp. 371-373.
13. Warren, H. V., and R. M. Thompson. Sphalerites From Western Canada. *Econ. Geol.*, v. 40, No. 5, 1945, p. 309.
14. Umetsu, Y., and K. Tozawa. Study on Behavior of Germanium in Electrolytic Zinc Production Process. *Metall. Rev. MMLJ*, v. 4, No. 1, 1987, pp. 66-81.
15. Miller, W. S., F. Dacheille, E. C. Shafer, and R. Roy. The System GeO₂-SiO₂. Ch. in *Geochemistry of Germanium*, ed. by J. Weber. Hutchinson and Ross, 1973, pp. 11-19.
16. Zangieve, Z. G., N. I. Kalojev, B. I. Bashkov, V. E. Burtakova, and L. M. Kubaloun. (Solubility of Zinc Germanate in Sulfuric Acid). *Zh. Neorg. Khim.*, v. 28, No. 10, 1983, pp. 2631-2633.
17. Matthew, I. G., and D. Elsner. The Hydrometallurgical Treatment of Zinc Silicate Ores. *Metall. Trans. B*, v. 8B, No. 1, 1977, pp. 73-84.
18. _____. The Processing of Zinc Silicate Ores—A Review. *Metall. Trans. B*, v. 8B, No. 1, 1977, pp. 85-91.

³A title enclosed in parentheses is a translation from the language in which the work was published.

19. Gruzdev, V. S., and V. M. Vydrin. Geochemical Features of Germanium in the Hydrothermal Process. *Dokl. Acad. Sci. USSR Earth Sci. Sect. (Engl. Transl.)*, v. 175, No. 2, 1967, pp. 188-190.
20. Caletka, R., and P. Kotas. Separation of Germanium From Some Elements by Adsorption on Silica Gel. *J. Radioanal. Chem.*, v. 21, No. 2, 1974, pp. 349-353.
21. Foot, D. G., Jr., J. D. McKay, and J. L. Huiatt. Column Flotation of Chromite and Fluorite Ores. *Can. Metall. Q.*, v. 25, No. 1, pp. 15-21, 1986.
22. Bernstein, L. R. Geology and Mineralogy of the Apex Germanium-Gallium Mine, Washington County, Utah. *U.S. Geol. Surv. Bull.* 1577, 1986, 9 pp.
23. Dutrizac, J. E., J. L. Jambor, and T. T. Chen. Host Minerals for the Gallium-Germanium Ores of the Apex Mine, Utah. *Econ. Geol.*, v. 81, No. 4, 1986, pp. 946-950.
24. Olsen, T. M., D. E. Voelker, and R. A. Smith. Gallium and Germanium Extraction From the Apex Mine Ore. Paper in Proceedings of Precious and Rare Metal Technologies (Albuquerque, NM, Apr. 6-8, 1988). *NM Inst. Min. and Tech.*, Socorro, NM, 1989, pp. 531-545.
25. Swinkels, G. M., and J. E. Litz. The Apex Project: Development of a Primary Gallium and Germanium Producer. *Soc. Min. Eng. AIME preprint* 86-153, 1986, 4 pp.
26. Jiang, H., K. Lee, A. J. Singh, A. K. Singh, and A. E. Torma. Kinetics of Gallium and Germanium Extraction From a Complex Ore by $H_2SO_4-Na_2S_2O_3$ Leachants. Paper in Proceedings of Precious and Rare Metal Technologies (Albuquerque, NM, Apr. 6-8, 1988). *NM Inst. Min. and Tech.*, Socorro, NM, 1989, pp. 547-565.
27. Davies, G. R., and G. T. Morgan. Determination of Germanium. *Analyst (London)*, v. 63, No. 744, 1938, p. 388.
28. Boateng, D. A., D. L. Ball, and G. M. Swinkels. Recovery of Germanium From Aqueous Solutions. *U.S. Pat.* 4,525,332, June 25, 1985.
29. Sheka, I. A., I. S. Chaus, and T. T. Mityureva. Methods of Preparation of Gallium. Ch. in *The Chemistry of Gallium*. Elsevier, 1966, pp. 225-230.
30. Zekel, L. A., M. D. Nosovshii, A. M. Rexnik, and M. Y. Shpirt. Extracting Gallium From Discard Solution of Germanium Plants. *Tsvetn. Met.*, v. 45, No. 5, 1972, p. 54.
31. Nagumo, T., and M. Murakoshi. Extraction of Gallium Using a Trialkyl Phosphate. *U.S. Pat.* 3,151,946, Oct. 6, 1964.
32. Rafaeloff, R. Separation of Gallium From Group III Elements, Germanium, Copper, Arsenic, and Iron. *Anal. Chem.*, v. 43, No. 2, 1971, pp. 272-274.
33. Katsura, T., and H. Abe. Solvent Extraction of Indium and/or Gallium. *U.S. Pat.* 3,920,450, Nov. 18, 1975.
34. Bauer, H., and K. Burschkies. *Organic Compounds of Germanium*. Berlin, v. 65B, No. 1, 1932, p. 960.
35. Cote, G., and D. Bauer. Liquid-Liquid Extraction of Germanium With Oxime Derivatives. *Hydrometallurgy*, v. 5, No. 2-3, 1980, pp. 149-160.
36. Bauer, D., G. Cote, P. Fossi, and B. Marchon. Process for Selective Liquid-Liquid Extraction of Germanium. *U.S. Pat.* 4,389,379, June 21, 1983.
37. De Schepper, A., and A. Van Peteghem. Liquid-Liquid Extraction of Germanium From Aqueous Solution Using Hydroxy-Oximes. *U.S. Pat.* 3,883,634, May 13, 1975.
38. U.S. Department of Energy. Uraniferous Phosphate Resources and Technology and Economics of Uranium Recovery From Phosphate Resources, United States and the Free World. *GJBX-110(79)*, 1979, p. 245.
39. Demopoulos, G. P., and D. L. Gevfert. Iron (III) Removal From Base-Metal Electrolyte Solutions by Solvent Extraction. *Hydrometallurgy*, v. 12, No. 3, 1984, p. 299.
40. De Schepper, A., M. Commement, and A. Van Peteghem. Process for Separating Germanium From an Aqueous Solution by Means of an Alphahydroxyoxime. *U.S. Pat.* 4,432,952, Feb. 21, 1984.
41. Ashbrook, A. W. Commercial Chelating Solvent Extraction Reagents: I. Purification and Isomer Separation of 2-hydroxyoximes. *J. Chromatog.*, v. 105, No. 1, 1975, p. 141.