

Bicycle Compliance Test Manual

**BUREAU OF
ENGINEERING SCIENCES**

DOCUMENT NO. 502496

DATED: MARCH 19, 1976

FRN JANUARY 28, 1976

**CONSUMER PRODUCT SAFETY COMMISSION
WASHINGTON, D.C.**



Bicycle Compliance Test Manual

REGULATORY DOCUMENTS

FRN July 16, 1974

FRN November 13, 1975

FRN January 28, 1976



MARCH 1976

KENNETH W. EDINGER

PRODUCT STANDARDS DIVISION
BUREAU OF ENGINEERING SCIENCES
CONSUMER PRODUCT SAFETY COMMISSION

ACKNOWLEDGEMENTS

Acknowledgement is hereby made to the National Bureau of Standards, Institute for Basic Standards, Mechanics and Optical Radiation Divisions, and the Bureau of Engineering Sciences Laboratory of the Consumer Product Safety Commission for research and development and product test information.

Assistance in technical writing, editing, organization and layout for the manual was provided by Edward T. Johnson & Associates, Washington, D.C.

TABLE OF CONTENTS

	page
Forward	ix
1.0 Scope	1
2.0 Applicable Documents	1
3.0 Test Equipment - General	1
4.0 Test Precautions	2
4.1 Environment	2
4.2 Safety	3
4.3 Equipment Calibration	3
5.0 Test Procedures	3
5.1 Visible Tests	3
5.2 Simple Tests	9
5.3 Brake Performance Test	13
5.4 Drive Chain Test	20
5.5 Wheel Tests	20
5.6 Handbrake Loading Test	21
5.7 Rocking Test	22
5.8 Footbrake Force Test	23
5.9 Handlebar Stem Test	25
5.10 Handlebar Stem-to-Fork Clamp	25
5.11 Handlebar Strength Test	26
5.12 Rim Test	27
5.13 Front Hub Retention Test	28
5.14 Fork Test	28
5.15 Fork and Frame Assembly	29
5.16 Seat Adjustment Clamps and Load Test	30
5.17 Reflector Mount and Alignment	30
5.18 Road Test	32
5.19 Sidewalk Bicycle Proof Test	32
5.20 Control Cable Pull Test	33
5.21 Temperature Tests	34
5.22 Operating Force Test	34

5.23	Retroreflective Tire Abrasion Test	35
5.24	Reflector Mechanical Impact Test	35
5.25	Reflector Moisture Test	36
5.26	Reflector and Retroreflective Tire Performance Tests	38
6.0	Tables	
7.0	Figures	
	References	
	Appendices	
A.1	Sidewalk Bicycle Exemption List	
A.2	NBS Long-range Reference Retroreflectance Instrument (LRRI)	
A.3	Sample Curve Fit Calculation	
	Drawings	
a.	Bicycle Handbrake Test Fixture	
b.	Bicycle Frame Test Fixture	

LIST OF TABLES

Table 1	Braking Test Data Sheet
Table 2	Structural Test Results
Table 3	Foot Brake Force Data

LIST OF FIGURES

1. General Compliance Test Flow Diagram
2. Load-Deflection Instrumentation Schematic
3. Excluded Area
4. Typical Handbrake Actuator Showing Grip Dimension
5. Chain Guard Requirements
6. Toe Clearance
7. Flow Diagram of Braking Test Procedure
8. Test Setup for Measurement of Coefficient of Friction
9. Velocity Timer Setup
10. Force Gage Assembly (see Handbrake Test Fixture Drawing, End of Manual)
11. Lever Clamp of Force Gage (prior to actuation)
12. Direction of Force Application (shall be applied along the line of action of the force gage, after actuation)
13. Force Gage Limit Stops and Switches
14. Handlebar Clamp (adjusted to allow the lever to bottom against the handlebar)
15. Ground Marker Gun Assembly
16. Schematic of Marker Gun Firing Circuit
17. Extension Lever Test Setup
18. Coaster Brake Test Setup
19. Bicycle Brake Performance Test Equipment-Installed
20. Braking Test Data and Sample Data Correction Calculations
21. Drive Chain Test Apparatus
22. Drive Chain Test Loading Fixture
23. Rear Hub Retention Test
24. Rear Hub Retention Test-Detail
25. Handbrake Loading Fixture
26. Handbrake Loading Fixture-Installed
27. Footbrake Force Test Fixture
28. Example of Pedal Force vs. Braking Force Graph
29. Handlebar Stem Test Fixture
30. Handlebar Stem Loading

31. Handlebar Stem-to-Fork Clamp Test
32. Handlebar Strength Test Fixture
33. Rim Test Fixture
34. Rim Test Fixture-Axle Coupling Detail
35. Fork Test Fixture
36. Typical Fork Test Load-Deflection Recordings
37. Typical Frame Test Load-Deflection Recordings
38. Frame Test Fixture
39. Frame Test-Front Fork Detail
40. Frame Test-Rear Fork Detail
41. Seat Clamp Test Vertical Loading
42. Seat Clamp Test Horizontal Loading
43. Reflection Mount and Alignment Test Arrangement
44. Representation of CIE Standard Observer and CIE Illuminant
45. Reflection Test Instrumentation Arrangement
46. Arrangement of Major Components-Top View
47. Optical Layout of Projector-Top View
48. Sample Carrier Arrangement
49. Section of Receiver
50. Alignment and Measurement Geometry
51. Sample Curve Fit Example

FORWARD

Bicycles have been declared number one on the Consumer Product Safety Commission (CPSC) Hazard Index. After considerable deliberation and study, a proposed Bicycle Safety Regulation was promulgated on May 10, 1973, and finalized on July 1, 1974. On November 13, 1975, the Bicycle Safety Regulation and its Amendments were finalized, and on January 28, 1976 the final bicycle regulation was promulgated in its entirety.

Any bicycle subject to the bicycle regulation shall meet its requirements in the condition to which it is offered for sale to consumers; any bicycle offered for sale to consumers in a disassembled or partially assembled condition shall meet these requirements after assembly according to the manufacturer's instructions. For the purpose of compliance with the bicycle regulation where the metric and English units are not equal due to the conversion process the less stringent requirement will prevail.

This test procedure document comprises all of the compliance tests that are specified in the Federal Register, January 28, 1976. The compliance tests are classified as visual, simple, and laboratory tests. Where deemed necessary, pictorial illustrations of test arrangements are shown. In some cases, drawings of the test equipment are included. Most of the material in this manual was developed under contract with the National Bureau of Standards (NBS). Refinements in test methods and test equipment may be made by the CPSC or its designate. The CPSC advises interested parties that its compliance test procedures, methods, and equipment are not unique to the requirements in the regulation in that there are approaches other than those herein that could have been chosen to perform the bicycle compliance testing.

This Bicycle Compliance Test Procedure integrates all of the test requirements specified in FR January 28, 1976 into a single document. Errors, if any, inadvertent omissions and the like will be corrected and revisions published as required. All parties are reminded that Part 1512, FR January 28, 1976 takes precedence over this document. A form is included in the back of the test manual for those who wish to receive revisions thereto.

1.0 SCOPE

The manual describes the test equipment, method, and procedure for performing those tests specified in FR January 28, 1976.

1.1 Test Purpose: The purpose of the test procedures described in this manual is utilization in compliance testing of bicycles that are regulated by the CPSC through implementation of FR January 28, 1976.

1.2 Test Flow: The test flow is as shown in Figure 1 and is based on a single test sample.

2.0 APPLICABLE DOCUMENTS

2.1 Requirements for Bicycles, Part 1512, Federal Register, Vol. 39, No. 137, July 16, 1974.

2.2 Requirements for Bicycles, Part 1512, Federal Register, Vol. 40, No. 220, November 13, 1975.

2.3 Requirements for Bicycles, Part 1512, Federal Register, Vol. 41, No. 19, January 28, 1976.

2.4 Marlowe, Donald E., The CPSC Road Test of Bicycle Braking Performance - Experimental Evaluation, NBSIR 75-755, National Bureau of Standards, Washington, D.C., August 1975.

2.5 Marlowe, Donald E., Structural Test Procedures for Bicycles, NBSIR 75-913, National Bureau of Standards, Washington, D.C., October 1975.

2.6 Marlowe, Donald E. A Procedure for Determining Bicycle Braking Performance, NBSIR 75-953, National Bureau of Standards, Washington, D.C., January 1976.

2.7 Mordfin, L., The CPSC Road Test of Bicycle Braking Performance - Kinetic and Error Analysis, NBSIR 75-786, National Bureau of Standards, Washington, D.C., October 1975.

3.0 TEST EQUIPMENT

The equipment used for these tests includes a universal testing machine with a 11100 N (2500 lbf) range which complies with the calibration requirements of ASTM E-4 [2], spring force gages with capacities of 450 N (100 lbf) and 900 N (200 lbf), a loading frame equipped with a load cell, deflectometer and an X-Y plotter, and several specialized test jigs which

will be described in conjunction with particular tests in later sections of this report. Also included are a force gage, handbrake loading assembly, an electronic timer for measurement of bicycle velocity, a ground position marker gun assembly and a level paved surface upon which to perform the tests.

3.1 Load-Deflection Recorder: This instrumentation is used for all tests which are conducted in the loading frame. The complete package includes and X-Y plotter, control box, load cell, and deflection transducer.

3.1.1 Operation: For operation and maintenance of the recorder, see the instruction manual provided with the recorder.

3.1.2 Load Channel: An electrical signal proportional to load is provided for recording on the Y-axis of the recorder. Load is sensed with 2200 N (500-lbf) capacity load cell. The load scale is adjusted to 220 N/cm of record (50 lbf/in of record) when the recorder multiplier switch is set at 1 mV/in and the push to calibrate button results in a deflection of 22.4 cm (8.80 in).

3.1.3 Deflection Channel: An electrical signal proportional to deflection is provided for recording on the X-axis of the recorder. Deflection is sensed with a displacement transducer having a maximum range of 10 cm (4 in). The deflection scale is adjusted to 0.25 cm per cm (0.25 in per in) of record when the recorder multiplier switch is set a 100 mV/in and the push-to-calibrate button results in a pen deflection of 19.2 cm (7.55 in).

3.1.4 Schematic: A schematic of the control box circuit, which includes the load and displacement transducers, is shown in Figure 2.

3.2 Loading Frame: A loading frame, designed to supplement the use of a testing machine, is used in several of these tests. Its use will be illustrated for several tests in later sections of this report. The loading frame provides attachment points for the bicycle parts and the loading actuator employed. The actuator used was a double acting hydraulic cylinder and power supply. Drawings of this load frame are provided.

4.0 TEST PRECAUTIONS

4.1 Environment

4.1.1 Brake Performance Test

4.1.1.1 The bicycle shall be ridden over a dry, clean, smooth paved test course free from protruding aggregate. The test course shall provide a coefficient of friction of less than 1.0 and shall have a slope of less than 1 percent.

4.1.1.2 The wind velocity shall be less than 11 km/h (7 mph).

4.1.2 All Other Tests

All other tests shall be performed in a clean environment under ambient conditions.

4.2 Safety: Bicycle test rider see page 3 Sect. 4.2 of Brake TP NBS 953

4.2.1 General: Standard safety precautions shall be observed for the protection of test personnel, observers, and test equipment.

4.2.2 Bicycle Test Rider:

(1) All riders shall be equipped with a riding helmet and clothing to limit the degree of injury should an accident occur during testing. Suitable clothing should include abrasion resistant pants, jacket, and gloves similar to that used by professional motorcycle riders.

(2) The rider shall become familiar with the performance characteristics of the test bicycle. The familiarization shall take place with the bicycle equipped for testing. Several test runs, similar to the performance test run, but at lesser speeds, shall be performed.

4.3 Equipment Calibration: All test equipment switch gages, electronics, etc., shall be calibrated prior to the initiation of each test.

5.0 TEST PROCEDURES

5.1 Visible Tests: These tests comprise compliance inspections that can be performed by observation only. With exception of sidewalk bicycle determination, inspection tools need not be used to perform these tests.

5.1.1 Definitions or Classifying Remarks:

- a) "Bicycle" - 2 wheeled vehicle, rear drive wheel, human powered.
- b) "Sidewalk Bicycle" - Seat height 635 mm (25") when seat in highest position.
- c) "Seat Height" - Seat surface and seat post centerline intersection to ground surface distance. Wheels must be aligned

and bicycle must be perpendicular to the ground.

d) "Track Bicycle" - Competitive machine with tubular tires, a single crank-to-wheel ratio with no free wheeling capability.

e) "One-of-a-Kind Bicycle" - use definition in Regulation.

5.1.2 Excluded Area (Sec. 1512.4 (g)): There shall be no protrusions in the area as shown in Figure 3.

5.1.3 Control Cable Ends (Sec. 1512.4 (i)): Shall have protective caps or treated to prevent unraveling.

5.1.4 Control Cable Abrasion (Sec. 1512 (j)): Control cables shall not abrade over fixed parts and shall enter and exit sheaths in line and in the direction of sheaths.

5.1.5 Brakes (Sec. 1512.5 (a)): Bicycles shall be equipped with front and rear wheel brakes or rear wheel brakes only.

5.1.6 Handlever Access for Handlebrakes (Sec. 1512.5(b)(2)): Shall have mechanisms located on handlebars and readily accessible to rider in normal riding position.

5.1.7 Attachment of Handbrakes to Frame (Sec. 1512.5 (b)(4)): Attachment by lockwasher, locknut or equivalent. Cable anchor bolt shall not cut cable strands.

5.1.8 Pad and Pad Holders for Handbrakes (Sec. 1512.5 (b)(6)):

a) Pads shall be replaceable and adjustable to engage braking surface without contact of tire or spokes.

b) Pad holders shall be securely attached to caliper assembly.

5.1.9 Handbrake - Hand Lever Location (Sec. 1512.5 (b)(8)):

a) Rear brake actuated by the right handlebar or as ordered by the customer.

b) Front brake actuated by left handlebar or as ordered by the customer.

c) Single hand lever must be located on right or left as ordered by the customer.

5.1.10 Footbrake Independent Operation (Sec. 1512.5 (c)(4)): Footbrake shall function independently of gear drive positions or adjustments.

5.1.11 Footbrakes Operating Force (Sec. 1512.5 (c)(2)):

- a) Footbrake force shall be opposite from drive force.
 - b) If brakes are separate from drive pedals, force is in same direction as drive.
- 5.1.12 Sidewalk Bicycles (Sec. 1512.5 (e)): Shall not have handbrakes only.
- 5.1.13 Handlebar Stem Insertion Mark (Sec. 1512.6 (a)): A permanent ring or mark for minimum insertion shall be visible.
- 5.1.14 Handlebar Ends (Sec. 1512.6 (d)): The handlebar ends shall be capped or otherwise covered.
- 5.1.15 Handlebar and Clamps (Sec. 1512.6 (e)): Determine if assembly instructions in manual contain:
- a) Warnings relative to stem-to-fork assembly and risk to rider from overtightening the stem bolt or other clamping device.
 - b) Simple, clear, and precise statement in the procedure to be followed for avoiding overtightening and damaging the stem-to-fork assembly.
- 5.1.16 Pedal Construction (Sec. 1512.7 (a)):
- a) Right and left hand symmetry required.
 - b) Tread shall be integral part of construction.
 - c) Tread material to be on top and bottom surfaces unless the pedal has a definite preferred position, then tread surface need only be on the surface presented to the rider's foot.
- 5.1.17 Toe Clips (Sec. 1512.7 (b)):
- a) Pedals intended to be used only with toe clips shall have toe clips securely attached and do not need tread surfaces.
 - b) Pedals designed for optional use of toe clips require tread surfaces.
- 5.1.18 Drive Chain (Sec. 1512.8): The drive chain shall operate over sprockets without catching or binding.
- 5.1.19 Derailleur Guard (Sec. 1512.9 (b)): A derailleur guard shall be located between the derailleur and the bicycle wheel on bicycles with more than single front and rear sprockets.
- 5.1.20 Tires (Sec. 1512.10):
- a) Manufacturer's inflation pressure shall be shown as molded

onto or into the sidewall of the tire and shall be in English using Arabic numerals

- b) Tubular sew-up, nonmolded wire-on tires and nonpneumatic tires are exempt from the above requirement.

5.1.21 Wheel Spokes (Sec. 1512.11 (a)): Check for missing wheel spokes.

5.1.22 Wheel Hub Locking Devices (Sec. 1512.12 (a)): Assure that wheels have positive lock device on frame (except sidewalk bicycles for Sec. 1512.12).

5.1.23 Quick Release Devices (Sec. 1512.12 (b)):

- a) Device shall be adjustable to allow setting lever position for tightness.
- b) Inspection shall indicate if lever is visible to rider in locked or unlocked position.
- c) Clamp action shall imboss frame or fork when locked.

5.1.24 Front Hubs (Sec. 1512.12 (c)): Inspect front hubs, except those with quick release devices, for positive retention feature (look for metal clip or similar device that holds axle to the fork).

5.1.25 Seat Post Mark (Sec. 1512.15 (b)): Check for seat post mark with seat in highest seat position to determine if present and of a permanent nature.

5.1.26 Seat Adjustment Clamps (Sec. 1512.15 (c)):

- a) Determine if seat clamps exist.
- b) Push normally in several directions to check for tightness (directions determined by normal use conditions).

5.1.27 Reflectors General (Sec. 1512.16):

- a) Determine if bicycle has front, rear, side, and pedal reflectors.
- b) Determine if bicycle has combination reflectors acting as one reflector. If so, see Simple Tests, Sec. 1512.16.

5.1.28 Front, Rear, and Pedal Reflectors Color (Sec. 1512.16 (a)):

- a) Front - colorless
- b) Pedal - colorless or amber
- c) Rear - red

5.1.29 Side Reflectors or Retroreflective Tire Sidewalls (Sec. 1512.16 (b) and (f)):

- a) Determine if bicycle has retroreflective tire sidewalls or reflectors mounted on the spokes of both wheels.
- b) Reflectors must be visible on each side of wheel and pose no problem to wheel adjustment.
- c) Reflectors shall be mounted within spoke cage or flat on spokes such that the angle between the optical axis and the normal to the plane of the wheel shall not exceed the angle of the spokes with the plane of the wheel.
- d) The side reflector shall be either colorless or amber for front wheels and colorless or red for rear wheels.

5.1.30 Front Reflectors (Sec. 1512.16 (c)):

- a) Reflector or mount shall not touch the ground plane when laid on the ground in any orientation.
- b) Reflectors and/or mounts shall have a distinct and preferred assembly method to insure passing the test in 1512.18 (m) pull and alignment test.

5.1.31 Rear Reflectors (Sec. 1512.16 (d)):

- a) Reflector or mount shall not touch the ground plane when laid on the ground in any orientation.
- b) Reflectors and/or mounts shall have a distinct and preferred assembly method to insure passing the test as in 1512.18 (m) pull and alignment test.

5.1.32 Pedal Reflectors (Sec. 1512.16 (e)):

- a) Pedal reflectors are not required for sidewalk bicycles.
- b) Check for reflectors on front and rear of pedals.
- c) Pedals must be recessed from edge of pedal so that a flat surface does not contact the reflector.

5.1.33 Retroreflective Tire Sidewalls (Sec. 1512.16 (h)): If retroreflective tire sidewalls are used in lieu of spoke mounted reflectors, retroreflective material must be a continuous circle.

5.1.34 Instruction Manual (Sec. 1512.19 (a)):

- a) Must be attached to frame or in packaging.

- b) Contents shall include operations and safety instructions describing operation of brakes and gears, cautions in wet weather, night operations, and safe on-off road operations.
- c) Contents shall include complete and proper maintenance instructions for brakes, control cables, bearing adjustments, wheel adjustments, lubrication, reflectors, tires, and handlebar and seat adjustments.
- d) Out of scope maintenance for the bicycle (as determined by the manufacturer) must be referenced in the manual as to the location of maintenance service.

5.1.35 Bicycles Less Than Fully Assembled and Adjusted (Sec. 1512.19 (b)): Displayed on any promotional display material and on shipping carton outside surface to indicate list of tools for assembly and adjustment and drawing of minimum leg length of a rider and method of how measurement is made.

5.1.36 Minimum Leg Length (Sec. 1512.19 (c)): The minimum leg length requirement must be readily understandable and based on one inch or greater clearance between top tube and ground plane distance and the crotch measurement of rider. Girls style frame shall be specified the same as above using boys style as basis.

5.1.37 Bicycles Introduced Into Interstate Commerce On or After May 11, 1976, to May 11, 1978 (Sec. 1512.19 (d)):

Assembled Bicycles:

- a) Display of a Hang Tag or other such label saying "Meets U.S. Consumer Product Safety Commission Regulations for Bicycles."
- b) Statement must be legible, easily seen, and in capital letters.
- c) No other words or symbols can be on the label.

Unassembled or Partially Assembled Condition

- a) Labeling statement "Meets U.S. Consumer Product Safety Commission Regulations for Bicycles" on carton.
- b) Statement must be legible, easily seen, and in capital letters.

5.1.38 Marking or Labeling on Bicycle (Sec. 1512.19 (e)):

- a) Must be securely affixed on or to the frame and cannot be removed without defacing or destroying the label or marking.
- b) The marking or label shall include the name of the manufacturer or private labeler, and the month and year of manufacture which is identifiable by the manufacturer or private labeler.
- c) Manufacture means completion of construction or assembly operations performed prior to shipping.

5.2 Simple Tests

5.2.1 Test Equipment

5.2.1.1 One 152 mm (6 in) Protractor

5.2.1.2 One 152 mm (6 in) Crescent Wrench

5.2.1.3 One 9.4 mm (3/8 in) Dia. x 76 mm (3 in) long Aluminum Rod

5.2.1.4 One 152 mm (6 in) Machinist's Scale

5.2.1.5 One 83 mm (3-1/4 in) Dia. x 254 mm (10 in) long Wooden Cylinder

5.2.1.6 One Retractable Tape Measure

5.2.1.7 One Inclinator

5.2.2 Test Procedures

5.2.2.1 Assembly (Sec. 1512.4 (a)): Determine if the unassembled bicycle has been manufactured such that mechanical skills required of the consumer for assembly shall not exceed those possessed by an adult of normal intelligence and ability.

5.2.2.2 Sharp Edges (Sec. 1512.4 (b)): There shall be no unfinished sheared metal edges or other sharp parts on bicycles that are, or may be, exposed to hands or legs; sheared metal edges that are not rolled shall be finished so as to remove any feathering of edges, or any burrs or spurs caused during the shearing process.

5.2.2.3 Protrusion Test (Sec. 1512.4 (e)):

- a) Locate all protrusions greater than 7.9 mm (5/16 in) with the test cylinder. Only the cylindrical surface shall be used.

- b) Using the following conditions determine if the protrusion is in violation of the Regulation. There shall be no exposed protrusions that do not have:
 - (1) The minor end dimension greater than 3.2 mm (1/8 in);
and
 - (2) The major end dimension greater than 12.7 mm (1/2 in) with radii greater than 6.3 mm (1/4 in).
- c) Capped exposed protrusions shall meet the above requirements.

5.2.2.4 Excluded Area (Sec. 1512.4 (g)): Control cables must be equal to or less than 0.25 inches dia. and clamp material must be equal to or less than 3/16 in. thick may be attached to the top tube, (see Figure 4).

5.2.2.5 Screw Length (Sec. 1512.4 (h)): Screw lengths shall be such that the threads of the internally threaded fastener are fully engaged by the screw (or the threads of the internally threaded fastener are engaged for a length of more than one screw diameter). Screw lengths that can come in contact with the test cylinder in Sec. 1512.18 (b) shall be limited to a maximum length of one major diameter of the screw beyond the internally threaded mating member and shall meet the requirements in Sec. 1512.4 (b). Screws that are exposed to any part of a rider's body in a normal riding position, however, shall be limited to a 3.2 mm (1/8 in) extension beyond the internally threaded mating member. Adjusting-type screws that meet the exposed protrusion requirements in Sec. 1512.4 (e) and that have no threaded ends exposed to a rider's body in the normal riding position are not required to be limited in length to one major diameter.

5.2.2.6 Grip Dimensions for Handbrakes (Sec. 1512.5 (b) (3)): The grip dimension (maximum outside dimension between the brake hand lever and the handlebars in the plane containing the centerlines of the handgrip and the hand brake lever) shall not exceed 89 mm (3 1/2 in) at any point between the pivot point of the lever and lever midpoint; the grip dimension for sidewalk bicycles shall not exceed 76 mm (3 in). The grip dimension may increase toward the open end of the lever but shall not increase by more than 12.7 mm (1/2 in) except for the last 12.7 mm (1/2 in) of the lever (see Figure 5).

5.2.2.7 Crank Differential (Sec. 1512.5 (c) (3)):

- a) Measure 60° or less crank differential between drive position and brake position.
- b) Take up play by applying a torque of no less than 13.6 N-m (10 ft-lb).

5.2.2.8 Sidewalk Bicycles - Seat Height Greater than 560 mm (22 in) (Sec. 1512.5 (e)): Bicycles whose seat height is higher than 560 mm (22 in) when the seat is in its lowest position shall have a foot brake meeting all footbrake requirements of 1512.5 (c).

5.2.2.9 Sidewalk Bicycles - Seat Height Less than 560 mm (22 in) (Sec. 1512.5 (e)):

- a) Sidewalk bicycles whose seat height is less than 560 mm (22 in) when the seat is in its lowest position shall have no free wheel feature and if there are no brakes.
- b) If there are no brakes, a permanent label on the bicycle identifying this condition shall be clearly visible from a distance of 3.0 m (10 feet) in daylight conditions and promotional display material and shipping cartons shall prominently display the words "No Brakes."

5.2.2.10 Handlebar Item Insertion Mark (Sec. 1512.6 (a)):

- a) The insertion mark shall be applied no less than 2 1/2 times the stem diameter from the stem bottom.
- b) The stem strength shall be maintained at 1 stem diameter from below the stem mark as determined by the Handlebar Stem Strength Test Sec. 1512.18 (g).

5.2.2.11 Handlebars (Sec. 1512.6 (c)):

- a) The inside dimension of the handlebar ends shall be equal to or greater than 356 mm (14 in) and equal to or less than 711 mm (28 in).
- b) Handlebar ends shall be symmetrically located with respect to the longitudinal axis of the bicycle and no more than 406 mm (16 in) above the seat surface when the seat is in its lowest position and the handlebar ends are in their highest position.

5.2.2.12 Chain Guard (Sec. 1512.9 (a)): For bicycles and sidewalk bicycles with single front and rear sprockets:

- a) Check for all requirements shown in Figure 5.
- b) The chain guard shall prevent entrapment of a 9.4 mm (3/8 in) dia. by 76 mm (3.0 in) long rod at chain/sprocket upper junction when inserted at any 45° angle from a line normal to the sprocket chain side.

5.2.2.13 Tires (Sec. 1512.10): Manufacturers inflation pressure that is molded onto or into sidewall of tire shall be equal to or greater than 3.2 mm (1/8 in) letter height.

5.2.2.14 Alignment of Wheels (Sec. 1512.11 (b)): Alignment of wheel shall be equal to or greater than 1.6 mm (1/16 in) clearance between rotated wheel and the frame or fork.

5.2.2.15 Seat Limit (Sec. 1512.15 (a)): No part of the seat; seat support or accessories shall be more than 125 mm (5 in) above seat surface where seat surface and seat post axis intersect.

5.2.2.16 Seat Post Mark (Sec. 1512.15 (b)): Seat Post mark for highest seat position shall be located at least 2 seat post diameters above shaft bottom. Examine seat post shaft for strength symmetry for a length of 1 shaft diameter below the mark.

5.2.2.17 Front and Rear Reflectors (Sec. 1512.16): The use of reflector combinations off the center plane of the bicycle (defined in Sec. 1512.18 (m) (2)) is acceptable if each reflector meets the requirements of this section and of Sec. 1512.18 (m) and (n) and the combination of reflectors has a clear field of view of $\pm 10^\circ$ vertically and $\pm 50^\circ$ horizontally. Sidewalk bicycles are not required to have reflectors.

- a) Side Reflectors Mounted on Wheels (Sec. 1512.16 (b)): The center of side wheel reflectors shall be located within 76 mm (3 in) of the rim.

5.2.2.18 Rear Reflector (Sec. 1512.16 (d)): Mount the reflector 76 mm (3 in) or more below seat surface intersection with seat mast on centerline with bicycle.

5.2.2.19 Pedal Ground Clearance (Sec. 1512.17 (c)):

- a) Remove training wheels, if required.
- b) With pedal in horizontal position and pedal crank in lowest position, tilt bicycle at least 25° from vertical for both sides.

c) Parts other than tires shall not contact the ground plane.

5.2.2.20 Toe Clearance (Sec. 1512.17 (d)): For bicycles not equipped with positive foot-retaining devices (such as toe clips) determine:

a) That the toe clearance "d" in Figure 6 is at least 89 mm (3 1/2 in) when the front wheel is turned in any position.

b) The least clearance measured shall meet this requirement.

5.2.2.21 Bicycles Introduced into Interstate Commerce on or After May 11, 1976 to May 11, 1978 (Sec. 1512.19 (d)):

Assembled Bicycles: Hang tag or label size and lettering to be at least 6.4 cm (2.5 in) x 17.8 cm (7 in) and at least 0.6 cm (1/4 in) high respectively.

Unassembled or Partially Assembled Condition: Labeling on carton in at least 1.3 cm (1/2 in) high capital letters conspicuously located on carton.

5.3 Brake Performance Test

5.3.1 Test Equipment

<u>Item No.</u>	<u>Description</u>
1.	Tire Inflation Pressure Gage, $7 \times 10^5 \text{N/m}^2$, (100 psi) capacity.
2.	122 cm (48 in) dividers.
3.	Scales-91 kg (200 lb) capacity.
4.	68.1 kg (150 lb) mass (rider dummy).
5.	Force gage - 900 N (200 lbf) capacity.
6.	Rear wheel loading fixture.
7.	Rear wheel locking pin.
8.	Electronic timer.
9.	Tape switch, 2 m (6 ft) length.
10.	12 volt rechargeable battery, (2), with charger.
11.	Force gage assembly with marker system firing switches.
12.	Force gage - 450 N (100 lbf) capacity, (2).
13.	Ground marker gun with marker loads.

14. Wiring for marker gun.
15. Extension lever stops.
16. Tape switch, 5 cm (2 in) length for actuating marker gun.
17. Firing switch for coaster brakes.
18. Riding helmet.
19. Riding gloves.
20. Riding coveralls.
21. Alcohol and cloth.
22. Camera.
23. Data sheet.

5.3.2 Equipment Check-Out

1) Coefficient of friction between the bicycle and test surface shall be measured as follows. A weight of 68.1 kg (150 lb) shall be placed on the bicycle seat. The weight distribution of the bicycle shall be determined by placing a platform scale or load cell weighing system under each wheel. The rear wheel of the bicycle shall be locked to prevent its rotation. A force gage shall be attached to the locked wheel near the tire-pavement interface. Steadily increasing forces are to be applied to the wheel in a direction parallel to the test surface until the wheel begins to slide on the surface. The coefficient of friction between the tire and pavement is the ratio of the maximum tractive force parallel to the surface to the load distributed onto the rear wheel.

2) Batteries for the ground marker system and velocity timer shall be fully charged at the start of testing.

3) Bicycle tires shall be inflated to the pressure recommended by the tire manufacturer and molded into the tire sidewall.

5.3.3 Test Procedure-Setup: Figure 7 outlines the test flow for this test.

5.3.3.1 Preliminary Checks and Measurements

- 1) Fully assemble the bicycle using the instructions provided by its manufacturer.
- 2) Adjust all brake and shift linkages in accordance with the instructions.
- 3) Inflate the tires to the maximum pressure recommended by their manufacturer.

- 4) Ride the bicycle to insure that all adjustments are properly made.
- 5) Measure the wheel base of the bicycle. This measurement is made from the center of the front axle to the center of the rear axle using the large calipers. Record the wheel base on the data sheet.
- 6) Weigh the test equipment. Record the weight.
- 7) Weigh the rider. Record the weight.
- 8) Affix a 68.1 kg (150 lb) mass to the bicycle seat.
- 9) With the bicycle level and upright, measure the ground force at the rear wheel. Record the weight.
- 10) Position the bicycle on the test pavement in the vicinity of the expected stopping tests.
- 11) Attach the force gage to the rear wheel of the bicycle near the ground. (Figure 8).
- 12) Lock the rear wheel to prevent its rotation (Figure 8). The front wheel must be free to rotate.
- 13) Using the force gage, apply steadily increasing loads to the wheel, parallel to the test pavement and in the plane of the wheel. Continue loading until the tire slides on the pavement. Record the maximum load (Table 1).
- 14) Compute the coefficient of friction for the particular tire-pavement combination as the ratio of the maximum applied force (Item 13) to the weight on the rear wheel (Item 9.)
- 15) Verify that the above coefficient of friction is less than 1.0 (1512.18 (d)(2)(v)(i)).
- 16) Remove the test mass from the bicycle.
- 17) Connect the external power plug to the electronic interval timer.
- 18) Connect the triggering tape switch to the battery (Figure 9).
- 19) Connect the battery package to the timer.
- 20) Position the triggering tape switch across the test pavement.

5.3.3.2 Test Equipment Setup

5.3.3.2.1 Caliper Brake System

5.3.3.2.1.1 Primary Brake System:

- 1) Remove all handgrips, wrapping tape, end plugs, etc., from the handlebars.
- 2) Position the force gage assembly on the handlebars and fasten with the friction clamp (Figure 10).
- 3) Attach the lever clamp to the brake lever such that the center of the clamp is 25 mm (1 in) from the lever end (Figure 11).
- 4) Adjust the position of the brake lever on the handlebar such that the line of action of the force gage will be straight when the lever is fully depressed (Figure 12).
- 5) Using the force gage assembly, apply 445 N (100 lbf) to the hand brake lever.
- 6) Adjust the stops (Figure 13) on the force gage assembly to limit the applied force to a maximum of 445 N (100 lbf).
- 7) If the clamp bottoms against the handlebar at a load of less than 445 N (100 lbf), adjust the position of the clamp on the lever to insure that the lever bottoms against the handlebar (Figure 14).
- 8) Remove the 445 N (100 lbf) load from the brake system.
- 9) Adjust the length of the force gage clamp linkage to insure that the brake system is fully unloaded and no braking forces are being applied to the braking system.
- 10) Install the ground marker gun on the front fork of the bicycle (Figure 15).
- 11) Strap or tape the ground marker system battery to the bicycle in any convenient location (Figure 10).
- 12) Connect the wiring to the battery, gun, and firing switches on the force gage assembly (Figure 16).

5.3.3.2.1.2 Extension Lever System:

- 1) Install the extension lever stops on the handlebar.

- 2) Adjust the position of the stops such that the maximum extension lever travel is limited by the stops at the top surface of the handlebar (Figure 17).
- 3) Install the ground marker gun on the front part of the bicycle (Figure 15).
- 4) Strap or tape the ground marker system battery to the bicycle in any convenient location (Figures 10 and 17).
- 5) Install the firing switch on the extension lever (Figure 17).
- 6) Connect the battery to the switch and gun (Figure 16).
- 7) Connect the ground wire from the gun to the battery.

5.3.3.2.2 Coaster Brake System:

- 1) Install the ground marker gun on the front fork of the bicycle (Figure 15).
- 2) Strap or tape the ground marker system battery to the bicycle in any convenient location (Figures 10 and 17).
- 3) Install the firing switch on the seat tube (Figure 18) such that the rearward motion of the chain causes the switch to close.
- 4) Connect the battery through the switch to the gun.
- 5) Connect the ground wire from the battery to the gun.

5.3.3.2.3 Caliper-Coaster Brake Combinations

To conduct tests on these systems, use procedures discussed above in sections 5.3.3.2.1 and 5.3.3.2.2 of the procedure. Both systems must be tested simultaneously.

5.3.3.3 Final Checks and Adjustments:

- 1) Test rider shall check all safety equipment. The rider shall wear a riding helmet and leather gloves plus a pair of durable coveralls or other riding attire.
- 2) The test rider shall become familiar with the behavior characteristics of the bicycle as it is equipped for the performance tests. This shall include several stops similar to those specified in the performance test but from lower speeds.

- 3) Adjust all brake system linkages and clearances in accordance with the manufacturer's instructions. This is the final adjustment which is permitted under the regulation (1512.18 (d) (2)).
- 4) Drag the bicycle forward and rearward over the test surface for a total distance of 8 cm (3 in) in each direction.
- 5) Repeat for a total of 6 tests.
- 6) Visually inspect the braking system after testing for loosening of the brake pads, pad holder, or cable and handlebar securing devices.
- 7) Remove the 68.1 kg (150 lb) mass from the bicycle.
- 8) Record the results (Table 1).

5.3.4 Test Procedure-Performance

All bicycles are to be tested in accordance with the Performance test (1512.18 (d)(2)(v)) of the regulation using the procedure as follows (Figure 19 shows a typical ready-for-testing bicycle):

- 1) Only the brake system under test shall be actuated.
- 2) The bicycle shall attain the specified ground speed while the rider is in the normal riding position.
- 3) The rider shall remain in the normal riding position throughout the test.
- 4) The bicycle must be moving in a straight line at the start of brake application.
- 5) The test run is invalid if at the commencement of the test, the measured test speed of the bicycle is not less than nor greater than the test speed required by this Part 1512 by 1.5 km/h (0.9 mph).
- 6) The stopping distances specified are based on a rider weight of at least 68.1 kg (150 lb) and a maximum rider and weight combination of 91 kg (200 lb). Greater stopping distances are allowable for heavier riders and test equipment weights at the rate of 0.30 m per 4.5 kg (1.0 ft per 10 lb).

- 7) A test run is invalid if front-wheel lockup occurs.
- 8) On bicycles equipped with handbrakes adjust the stops on the force gage assembly (Figure 13) or the extension lever (Figure 17) to limit the applied force to a maximum of 180 N (40 lbf).
- 9) Adjust the position of the firing switches (Figure 13) such that the marker guns fire upon first actuation of the brake lever.
- 10) Load the ground marker guns with the paint cartridges
- 11) Set the elapsed timer to zero.
- 12) Accelerate the bicycle to the test speed specified in FR January 28, 1976. Insure that the bicycle is traveling in a straight line at the test speed as it crosses the timing tape switch.
- 13) Using the brake system(s) under test, stop the bicycle as rapidly as possible while remaining seated on the bicycle.
- 14) Note the presence of front wheel lock up, if any.
- 15) Measure the stopping distance from the center of the rear-most ground mark along the original line of travel of the bicycle to the point opposite the center of the ground marker guns, disregarding changes in path which occur during the test. Record the distance (Table 1)
- 16) Record the elapsed time of the bicycle from the interval timer (Table 1)
- 17) Repeat steps 3 through 8 for a minimum of 4 tests. The stopping distance shall be determined by averaging the results of the four test runs.
- 18) Compute the bicycle speed and corrected stopping distance using the equations and following the example shown in Figure 20.

5.4 Drive Chain Test (Sec. 1512.8)

5.4.1 Test Equipment

The apparatus used for these tests is shown in Figure 21. The fixtures are mounted as shown in a universal testing machine having a loading range of 11,100 N (2,500 lbf) capacity. The detailed drawings of the test fixtures are available in 2.5.

5.4.2 Test Procedure

Suspend the chain grips (Figure 22) in the testing machine using the testing machine pull rods. Remove the drive chain from the bicycle and install it in the grips. Insert the chain onto the sprocket wheel such that the test section of the chain is on the axis of the testing machine and the chain is wrapped around the sprocket until the last link rests in the tooth adjacent to the hole through the sprocket. Then insert a light gage wire through the hole and wrap it around the chain or insert it through the hole in the last chain link (Figure 22). After placing the fly mesh screen around the specimen to contain all broken chain pieces, apply load until chain failure.

5.4.3 Test Criteria

The drive chain shall operate over the sprockets without catching or binding. The tensile strength of the drive chain shall be no less than 8,010 N (1,800 lbf) or 6,230 N (1,400 lbf) for sidewalk bicycles.

5.4.4 Test Results

Record test data in Table 2.

5.5 Wheel Tests (Sec. 1512.12)

5.5.1 Rear Wheels

5.5.1.1 Test Equipment

The equipment needed for this test is shown in Figure 23. This equipment includes a hydraulic ram and load cell for applying and measuring the load, the connectors needed to grip the bicycle frame and rear axle, and a reaction frame.

5.5.1.2 Test Procedure

Wheels shall be secured to the bicycle frame with a positive lock

device. Locking devices on threaded axles shall be tightened to the manufacturer's specifications.

For this test, remove the front wheel from the bicycle. Attach the test fixtures for holding the frame and axle to the bicycle (Figure 24). Attach the fixtures to the reaction frame and hydraulic ram such that the applied load is in the direction of the axle adjustment slot in the frame. Apply force gradually to the axle-frame coupling until 1,780 N (400 lbf) is reached or until the axle moves in the frame.

5.5.1.3 Criteria

There shall be no relative motion between the axle and the frame when a force of 1,780 N (400 lbf) is applied symmetrically to the axle for a period of 30 seconds in the direction of wheel removal.

5.5.1.4 Test Results

Record test data in Table 2.

5.5.2 Front Wheels

5.5.2.1 Test Equipment

Torque wrench.

5.5.2.2 Test Procedure

Apply torque to locking device in direction of removal of 17 N-m (12.5 ft-lb).

5.5.2.3 Test Criteria

Locking devices, except quick-release devices, shall withstand application of a torque in the direction of removal of 17 N-m (12.5 ft-lb).

5.5.2.4 Test Results

Record test data in Table 2.

5.6 Handbrake Loading Test (Sec. 1512.18 (d))

5.6.1 Test Equipment:

- 1) Force gage - 900 N (200 lbf) capacity.
- 2) Tire inflation pressure gage - 7×10^5 N/m² (100 psi) capacity.
- 3) Extension lever stops.
- 4) Force gage - 450 N (100 lbf) capacity, 2 (ref. 5.3.1)

5.6.2 Test Procedure

All bicycles equipped with handbrakes (primary and/or extension levers) are to be tested in accordance with the Handbrake Loading Test (Sec. 1512.18 (d)(2)(i)) of the Regulation using the procedure as follows:

- 1) Check tires for manufacturer's recommended pressure.
- 2) Using the force gage loading apparatus, apply load to the handbrake lever to a maximum of 445 N (100 lbf) or until the handbrake bottoms against the handlebar, whichever occurs first. Release the load. See Figures 25 and 26 for test fixture
- 3) Repeat for a total of ten tests.
- 4) Repeat steps 1 and 2 for the extension lever system, if any.
- 5) Visually inspect the braking system after testing for fractures, failures, or misalignments which result from the test.

5.6.3 Test Criteria

There shall be no visible fractures, failures, misalignments, and clearances not in compliance with the Regulation.

5.6.4 Test Results. Record the test results below.

Pass	Fail	Remarks
------	------	---------

5.7 Rocking Test

5.7.1 Test Equipment:

- 1) Tire Inflation pressure gage - 7×10^5 N/m² (100 psi) capacity.
- 2) 68.1 kg (150 lb) mass (rider dummy).
- 3) Rear wheel locking pin.
- 4) Force gage - 450 N (100 lbf) capacity, two.
- 5) Extension lever stops.

5.7.2 Test Procedure

All bicycles equipped with handbrakes (primary and/or extension lever) are to be tested in accordance with the Rocking Test (Sec. 1512.18 (d)(2)(iii)) of the Regulation using the procedure as follows:

- 1) Check tires for manufacturer's recommended pressure.
- 2) Test surface shall have a coefficient of friction of less than 1.0.

- 3) Affix a 68.1 kg (150 lb) mass to the bicycle seat.
- 4) Position the bicycle on the test surface.
- 5) Using the force gage loading apparatus, apply load to the handbrake lever to a maximum of 445 N (100 lbf) as in the loading test above (5.6.2, step 2).
- 6) Drag the bicycle forward and rearward over the test surface for a total distance of 8 cm (3 in) in each direction.
- 7) Repeat for a total of 6 tests.
- 8) Visually inspect the braking system after testing for loosening of the brake pads, pad holder, or cable and handlever securing devices.
- 9) Remove the 68.1 kg (150 lb) mass from the bicycle.

5.7.3 Test Criteria

There shall be no loosening of the brake pads, pad holders, or cable and handlever securing devices or any other functional brake component.

5.7.4 Test Results. Record the test results below.

Pass	Fail	Remarks

5.8 Footbrake Force Test (Sec. 1512.18 (e) and (f))

5.8.1 Test Equipment:

- 1) Footbrake force test fixture.
- 2) Six lead weights, 4.54 kg (10 lb) each.
- 3) Thin flexible tape 7.6 m (25 ft) in length (cloth or equivalent nonslip or nonstretch material)
- 4) Dynamometer.
- 5) Graph paper, 10 x 10 to the inch.
- 6) Sixty pound lead weight container.

5.8.2 Test Procedure

5.8.2.1 Mount the bicycle in the footbrake force test fixture which holds it in the upright position with the rear wheel off the ground (see Figure 26). Be sure all hardware has been tightened in accordance to manufacturer's instructions.

5.8.2.2 Load the pedal by placing weights in the container after it is attached to the pedal in the braking position with the crank arm parallel to the ground.

5.8.2.3 Attach one end of the tape material to the tire, and wrap it around the circumference of the tire at least two times. (Sew a loop in one end of the tape so that it may be tied to the wheel.)

5.8.2.4 Attach the other end to the dynamometer. Be sure the dynamometer reads zero. After the appropriate weight is carefully placed in the container, pull the dynamometer to the rear of the bicycle and horizontal to the ground plane. Do not jerk the tape. If this is done, the run is invalid.

5.8.2.5 Read the dynamometer between one-half and one full revolution of the tire, and record in Table 3.

5.8.2.6 Repeat steps 5.8.2.2 thru 5.8.2.5 three times.

5.8.2.7 Repeat this process for increments of pedal force from 89 N to 310 N (20 to 70 lbf) for bicycles and 44.5 N to 225 N (10 to 50 lbf) for sidewalk bicycles. The first weights shall be 89 N (20 lbf) and 44.5 N (10 lbf) for bicycles and sidewalk bicycles respectively. The weights shall be applied at 44.5 N (10 lbf) increments.

5.8.2.8 Average the data from each set of three runs and plot the brake force against the pedal force on graph paper. There should be six data points for bicycles and five for sidewalk bicycles.

5.8.2.9 To determine the best straight line for the data points obtained above use the best straight-line curve as obtained by using the least-squares curve fit method (see Appendix A-3).

5.8.2.10 Draw limit lines to indicate plus and minus 20 percent of the brake force, based on the measured brake load. See sample in Figure 28.

5.8.2.11 All measured data points, after averaging, must fall in shaded area, i.e., $\pm 20\%$ lines.

5.8.3 Test Criteria

5.8.3.1 Any one measured data point, after averaging, outside the shaded area ($\pm 20\%$ lines) in Figure 28 constitutes a test failure.

5.8.3.2 The braking force must be 178 N (40 lbf) or greater than

applied pedal force of 310 N (70 lbf).

5.8.3.3 Sidewalk bicycles shall have the ratio of applied pedal force to braking force of two-to-one or less.

5.8.4 Test Results

Record test data in Table 3.

5.9 Handlebar Stem Test (Sec. 1512.18 (g))

5.9.1 Test Equipment

Perform this test in a testing machine which complies with the requirements of ASTM designation E4-72. The apparatus used for this test is shown in Figure 29. This test fixture fulfills the requirements of paragraph 1512.18 (g)(1) and Figure 30 from the Regulation. A detailed drawing of this fixture is available in item 2.5.

5.9.2 Test Procedure

Remove the handlebar from the stem and insert a solid bar into the stem in its place. Retighten the handlebar clamp. Place the stem in the stem loading fixture at its minimum insertion mark and tighten the stem bolt. For stems which do not have a minimum insertion mark, measure the diameter of the stem and insert the stem into the fixture to a depth of 2.5 diameters. Apply gradually increasing loads in the testing machine through the loading yoke in a direction as shown in Figure 30 from the Regulation until a load of 2,000 N (450 lbf) is reached. Remove the stem from the fixture and check visually for cracks.

5.9.3 Test Criteria

No visible fractures shall result from this test.

5.9.4 Test Results

Record test data in Table 2.

5.10 Handlebar Stem to Fork Clamp (Sec. 1512.18 (h)(1))

5.10.1 Test Equipment

The apparatus used to conduct this test is shown in Figure 31. It includes a load bar clamped to the handlebar and a spring force gage attached to the load bar a measured distance from the stem clamp axis.

5.10.2 Test Procedure

Restrain the front fork from rotating by clamping it against a

stationary object. Clamp the load bar to the handlebar. Measure the distance from the stem axis to the loading point on the loading bar. Apply a gradually increasing load through the force gage until a torque on the clamp of 47.2 N-m (35 ft-lb) is reached or the stem begins to turn in the fork.

5.10.3 Test Criteria

There shall be no visible movement between the stem and fork when a torque of $47+3, -0$ N-m ($35+2, -0$ ft-lb) for bicycles and $20+3, -0$ N-m ($15+2, -0$ ft-lb) for sidewalk bicycles is applied to the handlebar about the stem-to-fork axis. There shall be no visible signs of damage to the stem-to-fork assembly or any component part thereof when disassembled.

5.10.4 Test Results

Record test data and any damage based on Sec. 1512.18 (h) in Table 2.

5.11 Handlebar Strength Test (Sec. 1512.18 (h)(2))

5.11.1 Test Equipment

The apparatus used to conduct this test is shown in Figure 32. It includes a fixture to hold the handlebar stem in the testing machine, and a loading jig to apply loads to the ends of the handlebar. The test is conducted in a testing machine for convenience only and can be done with the stem inserted in the bicycle. The detailed drawings of these test fixtures are available in item 2.5.

5.11.2 Test Procedure

Remove the stem from the bicycle, insert stem into the holding fixture, and tighten the stem clamp. Make adjustments to the fixture to level the portions of the handlebar near the ends where load will be applied. Place the fixture in a testing machine. Place the loading yoke on the handlebar ends and slowly apply load until 445 N (100 lbf) is reached, or an energy of 22.6 J (200 in-lb) is absorbed in handlebar bending, or the handlebar slips in the clamp.

5.11.3 Test Criteria

The handlebars shall support a force of no less than 445 N (100 lbf) or absorb no less than 22.6 J (200 in-lb) of energy through a maximum deflection of no more than 76 mm (3.0 in); the handlebar clamp shall

prevent rotational movement of the handlebars relative to the clamp, and there shall be no visible fractures.

5.11.4 Test Results

Record test data in Table 2.

5.12 Rim Test (Sec. 1512.18 (j))

5.12.1 Test Equipment

The test apparatus used in this test is shown in Figure 33. This equipment includes the masks for each tire size, a hydraulic ram to apply the load, a load cell and indicator to measure the load, a coupling for each bicycle axle, and a reaction frame. The mask rests on the frame and supports the rim through the tire around its entire circumference. A coupling which fits the threads of the axle and a chain (Figure 34) is used to connect the loading ram to the wheel.

5.12.2 Test Procedure

Test wheel rims in accordance with paragraph 1512.18 (j) of the Regulation. If both wheels of the bicycle are symmetric about the plane of the tire, only one is to be tested. If, however, the wheel hub is offset, as occurs when a multiple drive sprocket is used on the rear axle, test both wheels. For the wheel with the offset, apply load in the direction of the offset.

After the wheel to be tested is removed from the bicycle, inflate the tire to the pressure recommended by its manufacturer. Install the axle coupling, and place the wheel on the mask in the reaction frame with the mask supporting only the tire. Attach the chain to the loading ram and the axle coupling. Apply a gradually increasing load to 2,000 N (450 lbf). Hold this load for 30 seconds and remove. Then reinstall the wheel on the bicycle according to the manufacturer's instructions and test for alignment in accordance with paragraph 1512.11 of the Regulation which is 5.2.2.14.

5.12.3 Test Criteria

The wheel and tire assembly shall be inspected for compliance with the requirements of section 5.1.21 and shall be remounted on the bicycle according to the manufacturer's instructions and shall turn

freely without roughness and shall comply with the requirement of 5.2.2.14.

5.12.4 Test Results

Record test data in Table 2.

5.13 Front Hub Retention Test (Sec. 1512.18 (j)(3))

5.13.1 Test Equipment

5.13.1.1 Force gage

5.13.2 Test Procedure

Release front hub locking device. If threaded nuts and axles are used, open the nuts to at least 360° from a fingertight condition. Apply a separation force of at least 111 N (25 lbf) to the hub on a line along the slots in the fork ends.

5.13.3 Test Criteria

The front hub shall not separate from the fork; fenders, mudguards, struts, and brakes shall not be allowed to restrain the separation.

5.13.4 Test Results

Record test data below.

Torque (lbf)	Pass	Fail	Remarks
-----------------	------	------	---------

5.14 Fork Test

5.14.1 Test Equipment

The equipment needed for this test is shown in Figure 35. This fixture complies with the requirements of paragraph 1512.18 (k) (1) (1) and Figure 1 of the regulation. Also required for this test is a testing machine, a deflectometer and the X-Y plotter. A drawing of the apparatus used in the test is available from 2.5.

5.14.2 Test Procedure

After the results of the frame test are evaluated, remove the fork from the bicycle, and remove all bearings, hardened shoulders and any cable fittings. Install a hardened steel roller at the axle attachment

point (Figure 35). Place the fork in the fixture with the fork yoke hard against the V-block. Adjust the deflectometer to measure fork deflection. Connect the X-Y plotter to the load readout of the testing machine and to the deflectometer, and adjust the spans to a convenient value. Gradually increase loads through the roller wheel until a deflection of 64 mm (2.5 in) is reached. Compute the area under the force deflection curve to find the energy absorbed. (See Figures 37 and 38)

5.14.3 Criteria

Energy of at least 39.5 J (350 in-lb) shall be absorbed with a deflection in the direction of the force of no more than 64 mm (2 1/2 in).

5.14.4 Test Results

Record in Table 2.

5.15 Fork and Frame Assembly

5.15.1 Test Equipment

The equipment needed for this test is shown in Figure . It includes a reaction frame, load cell and deflectometer for measuring load and deflection, the X-Y plotter, and a hydraulic ram for applying the load.

5.15.2 Test Procedure

After the wheels are removed from the bicycle, remove the rear fender brackets. Insert the frame in the reaction frame as shown in Figures 38, 39 and 40. Shown in Figure 39 is the positioning of the deflectometer to measure frame deformations. As the load is applied using the hydraulic ram, make a plot of load versus deflection. Gradually apply load until a force of 890 N (200 lbf) is reached or 39.5 J (350 in-lb) of energy is absorbed in frame deflection, whichever results in the greater force (1512.18 (k) (2)). After the load is released, remove the frame from the test fixture and reinstall the front wheel on the bicycle, and make checks to determine if the steering of the bicycle is affected. See Frame Test Fixture drawing at end of manual.

5.15.4 Test Criteria

There shall be no visible evidence of fracture and no deformation of frame that significantly limits the steering angle over which the

front wheel can be turned.

5.15.4 Test Results

Record in Table 2.

5.16 Seat Adjustment and Clamps and Load

5.16.1 Test Equipment

For this test a 900 N (200 lbf) spring force gage was used as shown in Figure 41.

5.16.2 Test Procedure

With the bicycle frame restrained from movement by clamping its frame to the frame of a testing machine, apply 668 N (150 lbf) downward, 25 mm (1 in) from the seat front and then 25 mm (1 in) from the seat back so as to test the seat clamps in pitch. Then Apply a load of 222 N (50 lbf) horizontally at these same distances from the seat front and back so as to test the seat clamps in yaw (1512.18 (1) (1)) (Figures 41 and 42).

5.16.3 Test Criteria

No movement of the seat with respect to the seat post, or of the seat post with respect to the bicycle frame, shall have resulted from application of the forces specified.

5.16.4 Test Results

Record in Table 2.

5.17 Reflector Mount and Alignment

5.17.1 Test Equipment

The equipment required for this effort shall consist of a floor and wall containing a vertical and horizontal line respectively laying in the same plane, a sighting telescope and ring target capable of being leveled, and a front surface mirror assembled in a holder to afford orientation between the face of the reflector and the mirror. Further, a carpenters level is used to align the bicycle both in a vertical and horizontal position (see Figure 43).

5.17.2 Test Procedure

- 1) Place the telescope, which is affixed to a tripod, over the horizontal floor line. This is facilitated by an aid of a plumb bob aligned over the horizontal floor line. Level the

tripod with the leveling bubble and change focus to view the adjacent line on the wall. This aligns the telescope in direction.

- 2) Place the bicycle in its vertical plane so that the wheels are aligned over the horizontal line and the bicycle leveled vertically and horizontally.
- 3) Mount and adjust the front surface mirror with attached springs to the reflector so that the surface of the mirror is perpendicular to optical axis of the telescope. The reflector on the bicycle is placed a distance (d) from the telescope lens. This value is 1/2 the focal length of the attachment lens on the telescope.
- 4) Exert an 89 N (20 lbf) force to the reflector mount in three directions and note the reflection as observed through telescope as indicated on the target ring which is graduated in angular measurement in the form of concentric rings. At least one of those directions shall be selected to represent a force that would be expected in lifting the bicycle by grasping the reflector.

5.17.3 Test Criteria

- 1) During test: The optical axis of the reflector shall remain parallel within 15° to the line or intersection of the ground plane and the center plane of the bicycle defined as a plane containing both wheels and the centerlines of the down tube and seat mast.
- 2) Post test: The optical axis of the reflector shall remain parallel within 5° to the line or intersection of the ground plane and the center plane of the bicycle defined as a plane containing both wheels and the centerlines of the down tube and seat mast.

5.17.4 Test Results

Record test results below.

Reflector	During test (°)	Post Test (°)	Pass	Fail
Front				
Rear				

5.18 Road Test

5.18.1 Test Equipment

A 30 m (100 ft) course of wooden cleats fastened to a paved surface. The cleats shall be a full 25 mm (1.0 in) high by 51 mm (2.0 in) wide lumber with a 12 mm by 12 mm (1/2 in x 1/2 in) chamfer of 45° on the corners contacting the tires.

5.18.2 Test Procedure

The bicycle shall be ridden at least 6.4 km (4.0 mi) by a rider weighing at least 68.1 kg (150 lb) with the tires inflated to maximum recommended pressure. Travel shall include riding the bicycle five times over the cleated course at a speed of at least 24 km/hr (15 mph) with the rider firmly seated.

5.18.3 Test Criteria

The bicycle shall exhibit stable handling, turning, and steering characteristics without difficulty of operation. There shall be no system or component failure of the structure, brakes, or tires and there shall be no loosening or misalignment of the seat, handlebars, controls, or reflectors.

5.18.4 Test Results

Record test results below.

Pass	Fail	Remarks

5.19 Sidewalk Bicycle Proof Test

5.19.1 Test Equipment

- 1) 13.6 kg (30 lb) weight
- 2) Two 4.5 kg (10 lb) weights

5.19.2 Test Procedure

The bicycle shall be loaded with weights of 13.6 kg (30 lb) on the seat surface and 4.5 kg (10 lb) attached to the end of each handle grip for a total load of 22.7 kg (50 lb). The bicycle shall be lifted a distance of 0.3 m (1.0 ft) and dropped (while maintaining an upright posi-

tion) three times onto a paved surface. Following this and with weight removed, it shall be allowed to fall in any configuration and attitude from an upright position to the paved surface three times on each side.

5.19.3 Test Criteria

There shall be no fracture of wheels, frame, seat, handlebars, or fork during or resulting from this test.

5.19.4 Test Results

Record test data below.

Pass	Fail	Remarks

5.20 Control Cable Pull Test (Sec. 1512.18 (c))

5.20.1 Test Equipment

- 1) Chatillon Force Gage
- 2) Cable End Grip

5.20.2 Test Procedure

- 1) Apply a removal force of at least 67 N (15 lbf) to all protective caps.
- 2) Apply a removal force of at least 8.9 N (2.0 lbf) to all cable end caps.

5.20.3 Test Criteria

All protective caps and end-mounted devices that require forces less than those specified in Items 1 and 2 for removal are considered unacceptable and constitute a failure.

5.20.4 Test Results

Record test results fo all failure as follows:

End Cap Location	Removal Force, lbf
1	
2	
etc	

Protective Cap, Location

Removal Force, lbf

1

2

etc.

5.21 Temperature Tests (For Sec. See 5.21.2)

5.21.1 Test Equipment

Thermal oven (must hold 711 mm (28in) dia. tire)

5.21.2 Test Procedure

Place the test samples into a pre-heated oven under the conditions shown below.

Sample	Minimum Temperature		Time(min.)	Section
	°C	(°F)		
Brake Pad	121 [±] 3	(250 [±] 5)	30	1512.5 (b) (7)
Retroreflective Tire	50 [±] 3	(122 [±] 5)	30	1512.18 (h) (2)
Reflector	50 [±] 3	(122 [±] 5)	60	1512.18 (n) (i)

5.21.3 Criteria

Sample	Criteria
Brake Pad	Shall not melt or blister
Retroreflective Tire	Cannot be peeled or scraped away without removal of tire material
Reflector	No warpage

5.21.4 Test Results

Record test results as follows.

Sample	Pass	Fail	Remarks
Brake Pad			
Retroreflective Tire			
Reflector			

5.22 Operating Force Test (Sec. 1512.5 (b) (7))

5.22.1 Test Equipment

- 1) Chatillon Gage
- 2) Brake Pad Grip

5.22.2 Test Procedure

Apply a force of less than 44.5 N (10 lbf) to each handlever at a point 25 mm (1.0 in) from the open end of the handlever.

5.22.3 Test Criteria

Each brake pad must on each wheel contact the braking surface (rim) of the wheel when the load is applied.

5.22.4 Test Results

	Pass	Fail	Remarks
Front Wheel and Left Handlever			
Brake Pad No. 1			
Brake Pad No. 2			
Rear Wheel and Right Handlever			
Brake Pad No. 1			
Brake Pad No. 2			

Notes

For single lever actuation, all pads must meet the requirements when the force is applied to the lever in the normal operating direction.

5.23 Retroreflective Tire Abrasion Test (Sec. 1512.18 (h) (2))

5.23.1 Test Equipment

- 1) Steel Bristle Brush
- 2) Water

5.23.2 Test Procedure

- 1) Inflate the tire to manufacturer's recommended pressure.
- 2) Apply sufficient force using a wet steel brush to abrade the retroreflective tire material.

5.23.3 Test Criteria

Tire material must be removed along with the retroreflective material.

5.23.4 Test Results

Record test results as follows.

	Pass	Fail	Remarks
Front Wheel			
Rear Wheel			

5.24 Reflector Mechanical Impact Test (Sec. 1512.18 (n) (1) (ii))

5.24.1 Test Equipment

- 1) Reflector Holding Fixture
- 2) Polished Steel Ball, 13 mm (1/2 in) diameter
- 3) Perforated tube (cut to permit ball to be dropped from height of 0.76 m (30 in).

5.24.2 Test Procedure

- 1) Mount the reflector in the test fixture.
- 2) Install perforated tube
- 3) Center the tube over the reflector. Tube must be perpendicular to reflector center.
- 4) Drop ball from 0.76 m (30 in) in unrestricted free fall.

5.24.3 Test Criteria

The reflector must withstand the impact of the steel ball without degradation.

5.24.4 Test Results

Record test results below.

Reflector	Pass	Fail	Remarks
Front			
Rear			
Spoke (front)			
Spoke (rear)			

5.25 Reflector Moisture Test (Sec. 1512.18 (n) (1) (iii))

5.25.1 Test Equipment

- 1) Container capable of withstanding internal pressure of 17.2 KN/m³ (2.5 psi).
- 2) Tap water.
- 3) Water pressure gage.
- 4) Safety valve.

5.25.2 Test Procedure

- 1) Place the reflector in the container and seal.
- 2) Fill the container with water until a water pressure of 17.2 KN/m³ (2.5 psi) has been reached.
- 3) Hold this condition for 15 minutes.
- 4) Release the pressure and remove the reflector.

5.25.3 Test Criteria

There shall be no moisture within the confines of the reflector.

5.25.4 Test Results

Record the test results below.

Reflector	Pass	Fail	Remarks
front			
rear			
spoke (front)			
spoke (rear)			

5.26 Reflector and Retroreflective Tire Performance Tests (Sec. 1512.18 (n) and 1512.18 (o))

Two distinct types of retroreflective devices are specified in the Regulation.⁽²⁾ One, designated in the Regulation simply by the word "reflector" and herein to be called a "point retroreflector", is intended to be seen by the observer as a compact source of light. The photometric tests for these devices as specified in the Regulation are derived from SAE test procedures.⁽³⁾ The other type, designated by the words "retroreflective tire", is intended to be seen by the observer as a line source of light in a ring or crescent shape which he will associate with a bicycle wheel. The photometric tests for these devices is patterned after a Federal test method for reflective sheeting,⁽⁴⁾ with modifications to take into account that the reflector is a stripe.

The following sections provide instructions for persons testing the photometric performance of the reflective devices called for in the Regulation. Alignment and other tests will be covered elsewhere. Since the apparatus and procedures used in testing point retroreflectors and reflective tires are very similar, the instructions for both types will be combined with distinctions being made where needed. Since a background in photometry is seldom part of a scientific education, an effort has been made to make these instructions self-contained and complete enough to be understood by a technician with a background in general science. In particular, a special section (5.26.2.3) has been included which suggests practical ways to implement the measurements.

⁽²⁾ See Appendix for references in 5.26.

5.26.1 Definitions

A list of certain terms needed for describing the test procedures concisely, are given below. This list has been kept to a minimum, and the definitions are expressed in common language whenever possible. The definitions are written specifically for the conditions of retroreflector testing and should not be regarded as general definitions of photometric quantities. More complete terminology and more precise definitions can be found in other publications.^(5,6,7,8) Units are given in the international metric system (SI), in which distances are measured in meters (m). The corresponding units in the U. S. customary system, in which distances are expressed in feet (ft), are given in brackets [] beside each metric unit. Since the use of the U. S. customary system is to be discontinued in the future, it is advisable to use SI units whenever practical.

5.26.1.1 Photometric Terms

5.26.1.1.1 Light: Electromagnetic radiation regarded in terms of the way it is seen by a human observer. As light, the effectiveness of radiation from different parts of the spectrum varies.

5.26.1.1.2 CIE Standard Photometric Observer: Any instrument or observer which responds relatively to radiation from different parts of the spectrum according to the function $V(\lambda)$ (See Figure 44), where the wavelength, λ , is used to designate the position of radiation in the spectrum. This function represents the way a human observer relates the power radiated to the brightness observed for different parts of the spectrum. This function is used to quantitatively relate the amount of light to the amount of radiated power. Symbol: $V(\lambda)$

5.26.1.1.3 Luminous Intensity (of a source of radiation, in a given direction): The effective total strength of a source of light.

Symbol: I

Unit: Candels (cd) [Candle (c)]

5.26.1.1.4 Normal Illuminance (by a source, in a given direction, at a point): The amount of light which falls on a unit of area perpendicular to the direction the light is travelling.

Symbol: E_n

Unit: Lux (lx) [Foot candle (fc)]

Note 1: The normal illuminance E_n produced by a source of luminous intensity I at a distance D in meters (m) [feet (f)] can be calculated from the equation:

$$E_n = I/D^2$$

5.26.1.1.5 Coefficient of Luminous Intensity (of a point retroreflector, under specific conditions of illumination and observation): The ratio of the luminous intensity of a reflector to the normal illuminance at the location of the retroreflector.

Symbol: C.I.L.

Unit: Candela per incident lux (cd/lx) [candlepower per incident foot-candle (c/fc)].

Note 1: When reduced to simplest terms, the unit of CIL is the square meter (m^2) [square foot (f^2)].

Note 2: This term does not apply to retroreflective tires.

5.26.1.1.6 Coefficient of Luminous Intensity per Unit Length (of a retroreflecting stripe, under specific conditions of illumination and observation): The ratio of the luminous intensity per unit length of a reflecting stripe to the normal illuminance at the location of the retroreflector.

Symbol: C.I.L./L

Unit: Candela per meter per incident lux (cd/m · lx) [candlepower per foot per incident footcandle (c/f · fc)]

Note 1: When reduced to its simplest terms, the unit of C.I.L./L is the meter (m) [foot (ft)].

Note 2: The quantity "A" specified in the Regulation is 2π (6.28) times the average C.I.L./L of the retroreflective tire sidewall.

Note 3: This term does not apply to a point retroreflector.

5.26.1.1.7 CIE Illuminant "A": The relative distribution of power over the spectrum (see Figure 44) which comes from a small hole in a cavity at a temperature of 2,856°K. This standard relative spectral power distribution is used to specify the performance of bicycle reflectors since

it closely resembles the relative spectral power distribution of the radiation from an automobile headlamp.

Symbol: $S_A(\lambda)$

Unit: Watts per nanometer wavelength interval (W/nm)

Note 1: A table of $S_A(\lambda)$ is given in Table 4 of the Regulation⁽²⁾

5.26.1.2 Geometrical Terms (See Figure 45)

5.26.1.2.1 Retroreflector Center: A designated point near the center of the active area of a retroreflective device.

5.26.1.2.2 Source Aperture: The projection, onto a plane perpendicular to the incidence line, of the area from which the radiation emerges (exit window) from the device used to illuminate the reflector. In the usual projector, the source aperture is the projection lens aperture.

5.26.1.2.3 Incident Line: The line between the retroreflector center and the center of the source aperture.

5.26.1.2.4 Receptor Aperture: The projection, onto a plane perpendicular to the observation line of the sensitive area (entrance window) of the device with which the reflected radiation is observed. For visual observations, the receptor aperture is the pupil of the eye; for a photocell, it is the active area of the photocathode; and for a telephotometer, it is the aperture of the telescope or field lens.

5.26.1.2.5 Observation Line: The line between the retroreflector center and the center of the receptor aperture.

5.26.1.2.6 Observation Angle: The angle formed by the incident line and the observation line.

5.26.1.2.7 Observation Plane: The plane in which the observation angle lies.

5.26.1.2.8 Retroreflector Axis: A line which is fixed with respect to the retroreflective device and which is used for the determination of entrance angles.

5.26.1.2.9 Entrance Angle: The angle between the incident line and the retroreflector axis.

Note 1: For measuring point retroreflectors, the entrance angles are designated RIGHT, LEFT, UP, and DOWN according to the position of the

source with respect to the retroreflector axis as viewed from behind the retroreflector. Thus, in a "right" measurement, the retroreflector is illuminated from its right, and in an "up" measurement it is illuminated from its top.

Note 2: For measuring the retroreflective tire, the entrance plane and the observation plane coincide. For POSITIVE entrance angles, the retroreflector axis and the observation line are on opposite sides of the incident line, and for NEGATIVE entrance angles they are on the same side of the incident line. Thus "positive" and "up" represent the same relative orientation of the entrance angle, as do "negative" and "down."

5.26.1.2.10 Entrance Plane: A plane parallel to both the incident line and the retroreflector axis.

5.26.1.2.11 Reference Orientation Mark: A mark place on a reflective device to indicate its intended orientation.

5.26.1.2.12 Observation Distance: The distance from the receptor to the retroreflector center.

5.26.2 Test Equipment

5.26.2.1 Long-range Reference Retroreflectance Instrument (LRRI). See Appendix 2 for brief description of the instrument.

5.26.2.2 Conditions of Measurement

The conditions placed upon the instrumentation of the measurements are outlined in this section. Where appropriate, some background explanation underlying the need for the condition is given. In many cases, a preliminary evaluation of the retroreflector performance can be made without adhering strictly to the conditions in the Regulation. Because it may be difficult to obtain equipment which exactly meets the conditions given in the Regulation, reasonable alternatives are given at the end of some sections. This allows the tester some flexibility in implementing the measurements while still providing good assurance for obtaining a correct evaluation of the retroreflector.

5.26.2.2.1 Source

5.26.2.2.1.1 Source Aperture

- a) Point Reflector Test: A circle of 51 mm (2 in) diameter.

- b) **Retroreflective Tire Test:** A circle whose diameter is no more than 1/500 of the distance from the source to the retroreflector.

Background: Larger source and receptor apertures allow more light to be used in making the measurements, but an upper limit must be placed on these apertures in order that the variation of the C.I.L. with observation angle can be adequately resolved. The need for resolution is more critical at the smaller observation angles and is usually more critical for point reflectors than for retroreflective tires, since the point reflectors tend to reflect the light in a pattern which is more highly concentrated around the incident line.

Alternatives: A satisfactory measurement can usually be made with any shape source and receptor aperture at an observation distance, provided that the sum of the source aperture and the receptor aperture dimensions in the direction parallel to the plane of observation is less than $d/1,000$ for testing point retroreflectors and is less than $d/500$ for measuring retroreflective tires. Neither aperture should extend more than $d/500$ in the direction perpendicular to the plane of observation.

5.26.2.2.1.2 Spectral Power Distribution

Both Tests: The power distribution shall be that of a tungsten filament lamp operating at a color temperature of $2,856^{\circ}\text{K} \pm 10\%$

Background: A tungsten lamp has a color temperature of $2,856^{\circ}\text{K}$ when its light appears as closely as possible to be the color of CIE Illuminant "A". Because of the rather neutral emissive properties of tungsten, the radiation from such a lamp is very close to having the same spectral power distribution as CIE Illuminant "A". Meeting this condition closely is very important when measuring highly colored reflectors (e.g., amber or red), and is not very critical in measuring nearly colorless (e.g., silver, white, or clear) retroreflectors.

5.26.2.2.1.3 Uniformity of Normal Illuminance

- a) **Point Retroreflector Test:** No conditions.
b) **Retroreflective Tire Test:** The normal illuminance sampled

at angular intervals of 45° or less around the wire shall have a maximum deviation of 10% from the mean,

Background: Since the C.I.L./L of the tire sidewall sometimes varies considerably along the length of the retroreflecting stripe, the condition is imposed to provide for an accurate measurement of the average C.I.L./L for the entire sidewall.

Alternative 1: The luminous intensity can be measured with a photometer with a slow response while the wheel is spinning rapidly. This value can be used to calculate "A".

Alternative 2: The wheel can be turned slowly until its measured luminous intensity is a minimum. This minimum value can be used to calculate "A".

5.26.2.2.1.4 Size of Area Illuminated

Both Tests: No condition.

Background: Although no condition is placed on the size of the area illuminated, it should be reasonably small to reduce the possibility of errors due to light reflected from other objects in the laboratory, but should be large enough to assure uniform illumination of the reflector. A good rule of thumb is that the illuminated area should extend beyond the edge of the retroreflector about 1% of the observation distance.

5.26.2.2.2 Sample Holder

5.26.2.2.2.1 Accuracy of Entrance Angle

Both Tests: No direct condition. (A maximum deviation of 1° is implied by paragraph 1512.18 (n)(1)(vi) of the Regulation.)

Background: The measurement is not highly sensitive to entrance angle. If the entrance angle deviates less than $\pm 1^{\circ}$ from the specified value and the angle between the entrance plane and the observation plane deviates less than $\pm 2^{\circ}$ from the specified value, no significant error should result.

5.26.2.2.2.2 Rotation of Retroreflector

- a) **Point Retroreflector Test only:** If the retroreflector does not have preferred position with respect to rotation about its axis, the test mount must have provisions for rotating

the retroreflector about the retroreflector axis, with the center of rotation at the retroreflector center.

5.26.2.2.3 Receptor (Instrumental Measurement Only)

5.26.2.2.3.1 Receptor Aperture

- a) Point Retroreflector Test: Maximum dimensions of 13 mm (1/2 in) parallel to the observation plane and 25 mm (1 in) perpendicular to the observation plane.
- b) Retroreflective Tire Test: Must fall within a circle whose radius is 1/1,000 of the observation distance.

Background and Alternatives: See discussion of source aperture conditions in part 5.26.2.2.1.1 above.

5.26.2.2.3.2 Spectral Sensitivity

Both Tests: The spectral sensitivity must be that of the CIE Standard Observer.

Background: The object of this condition combined with condition 5.26.2.2.1.2 is to have the reflector evaluated as it would be seen by a CIE Standard Observer viewing it under CIE Illuminant "A"

Alternative: If the spectral power distribution condition 5.26.2.2.1.2 above cannot be met, a receptor can be used which is designed so that at each wavelength the product of its spectral sensitivity with the spectral power distribution is equal to $V(\lambda) \cdot S(\lambda)$.

5.26.2.2.3.3 Field of View

Both Tests: No conditions.

Background: For measuring retroreflective tires, the receptor should have uniform sensitivity over the part of its field of view occupied by the tire for the reasons given in 5.26.2.2.1.3. For both tests, the area of the field of view should include the entire active area of the retroreflector but should be limited as indicated in 5.26.2.2.1.4.

5.26.2.2.4 Test Layout

5.26.2.2.4.1 Observation Distance

- a) Point Retroreflector Test: 30.5 m (100 ft).
- b) Retroreflective Tire Test: At least 15 m (50 ft).

Background: Because of the large size of the wheel, the retroreflective

tire measurements become distorted if the observation distance is too short. With large lens "cat's eye" point retroreflectors, a large observation distance is needed to avoid getting inside a region where the light rays might converge to a focus. However, with point retroreflectors, which use small beads or small cube corners as retroreflecting elements, shorter distances can be used provided appropriate adjustments of the source and receptor apertures are made.

Alternative: For point retroreflector tests, observation distances as short as 10 m (32 ft) can be used provided the alternative conditions on the source and receptor apertures given in 5.26.2.2.1.1 are also met.

5.26.2.2.4.2 Accuracy of Observation Angle

Both Tests: No conditions.

Background: The observation angle " α " can be calculated from the observation distance " d " and the normal displacement " S " of the center of the receptor aperture from the incident line (see Figure 45) as

$$\alpha = \arctan (s/d)$$

At small entrance angles, the accuracy of setting the observation angle is critical. At 0.2° entrance angle, the percent error in measuring the C.I.L. is about the same size as the percent error in measuring α

5.26.2.2.4.3 Source-to-Retroreflector Distance

Both Tests: This distance should be nearly equal to the observation distance.

Background: The condition is not very critical. The source-to-retroreflector distance may depart from the observation distance by as much as 5% with no noticeable effect on the measurement.

5.26.2.3 Practical Suggestions for Implementing the Measurements

5.26.2.3.1 Receptor: This is probably the most critical component in the measurements, since the light levels to be measured are quite low. Buying a sensitive, stable telephotometer with $V(\lambda)$ correction from a reputable commercial instrument manufacturer is almost always the best route to follow. The instrument need not be elaborate, but if it is to be used for measuring retroreflective tires, be sure the field of view

is large enough to include the entire wheel at the desired observation distance. If a plain photocell photometer is used, it should be used with a baffle tube with apertures to restrict the direct field of view to the retroreflector.

5.26.2.3.2 Source: A slide projector makes a good source. The size of the illuminated area can be restricted by placing in the slide compartment a slide-sized metal plate with a chamfered hole in it. The bevelled side of the hole should face away from the lamp. An image of the hole is then focussed in a plane at the retroreflector test location.

If it is difficult to get the source and receptor close enough together to measure at 0.2° observation angle, a 45° - 90° totally reflecting glass prism can be used in front of either the source or receptor to deflect the light 90° making placement of these components easier. Distances and angles should be measured to the image of the source or receptor as seen through the prism.

Note: A mirror should not be used for this purpose since it will partially polarize the light.

5.26.3 Test Procedure

5.26.3.1 Measurement Procedure (Direct Instrumental)

Set up the test apparatus in the relative arrangement shown in Figure 45. (It is often convenient to rotate the arrangement in its entirety by 90° so that the source and receptor are side by side.) The source should be allowed to warm up for approximately 30 minutes at its operating voltage. For instrumental observations the photometer should be allowed to stabilize as instructed by the manufacturer, and for visual observations the observer should adapt to the dark for at least 10 minutes. The sample should be mounted, and areas which are not to be measured should be covered with a matte black material such as black cloth, black construction paper or flat black paint. Particular care should be taken to mask shiny metal surfaces such as those of wheel rims, spokes and reflector mounting hardware. Make the following determinations:

5.26.3.1.1 Normal Illuminance from the Source at the Retroreflector

5.26.3.1.1.1 Point Retroreflector Test: Move the retroreflector to one side. Move the receptor into the retroreflector position so that it is

aimed at the source and so that the center of the receptor aperture is located in the position of the retroreflector center. Obtain a reading E_g' from the receptor. Interpose an opaque disc whose diameter is approximately 1/50 of the observation distance at a point halfway between the source and the receptor in line with the source aperture center and the receptor aperture center in order to intercept light travelling directly from the source to the receptor. Obtain a reading E_g'' from the receptor. (If E_g'' is greater than 10% of E_g' , steps should be taken to reduce extraneous light.) The normal illuminance E_g is given by

$$E_g = E_g' = E_g''$$

Note: Because a ratio is always taken, the instrument readings, and, therefore, " E_g " need only be proportional to the normal illuminance.

5.26.3.1.1.2 Retroreflective Tire Test: Move the wheel to one side. With the receptor aperture centered at a point where the reflective sidewall would normally be, measure " E_g " using the procedure given in part 5.26.3.1.1.1. Repeat the measurement in at least seven other locations spaced evenly around the full circle where the reflector sidewall will be positioned for the test. The normal illuminance " E_g " to be used in calculating "A" is the average of all of the readings.

5.26.3.1.2 Specular Reflectance Test

5.26.3.1.2.1 Point Retroreflector Test: With the reflector in position to be measured, place a small piece of plane mirror (about 3 cm x 3 cm [1.2 in x 1.2 in]) against each exposed smooth plane surface on the retroreflector. If necessary, the entrance angle should be changed by a slight amount (less than 1°) so that the light reflected from the mirror does not strike the receptor. Look at the reflector from an observation angle of about 5° and make sure there are no reflections from shiny rounded surfaces. These appear as very bright images of the source and should be masked if they are not on the active retroreflecting surface.

5.26.3.1.2.2 Retroreflective Tire Test: With the wheel mounted in the test position observe it visually from an observation angle of about 5° and make sure that there are no images of the source reflected from shiny rounded surfaces.

5.26.3.1.3 Normal Illuminance From the Retroreflector

Both tests: With the retroreflector and the receptor positioned as in Figure 45, obtain a receptor reading E_T' . (Check to be sure that the entrance and observation angles are correct and that the receptor is aimed directly at the retroreflector.) Mask the active reflector area only with a matte black material and obtain a receptor reading E_T'' . The retroreflected normal illuminance is given by

$$E_T = E_T' - E_T''$$

5.26.3.1.4 Observation Distance

5.26.3.1.4.1 Point Retroreflector Test: Measure the observation distance "d" from the center of the receptor aperture to the point on the active area of the retroreflector which is nearest the receptor.

5.26.3.1.4.2 Retroreflective Tire Test Only: Measure the observation distance "d" from the center of the receptor aperture to the geometric center of the wheel.

5.26.3.1.5 Reflector Radius

5.26.3.1.5.1 Retroreflective Tire Test Only: Measure the minimum distance from the inner edge of the actively retroreflecting part of the sidewall to the center line of the axle. This should be measured in the same units as "d" in 5.26.3.1.4 above.

5.26.3.1.6 Repetition

Both tests: For each combination of entrance and observation angles, the measurement steps 5.26.3.1 through 5.26.3.1.5 should be repeated in order to avoid gross errors. If the values from each step agree well, use the averages in the computations in part 5.26.3.1.7 below.

5.26.3.1.7 Computation

5.26.3.1.7.1 Point Retroreflector Test: The C.I.L. of a point retroreflector for a given entrance and observation angle is calculated as:

$$C.I.L. = \frac{E_T}{E_T'} \times d^2.$$

These values of the C.I.L. should be compared with the appropriate entries in Tables 1 and 2 in the Regulation⁽²⁾ to determine compliance.

Note: The values given in the Regulation are in U.S. customary units. If "d" was measured in meters, the values computed above should be multiplied by 10.8 before comparing them to the values in the Regulation.

5.26.3.1.7.2 Retroreflective Tire Test: A quantity "A" for a given entrance and observation angle is calculated as:

$$A = \frac{E_r}{E_s} \times \frac{d^2}{r}$$

These values should be compared to the minimum values given in the appropriate column in Table 3 of the Regulation⁽²⁾ to determine compliance.

5.26.3.2 Spectral Correction: Measurements of a highly colored retro-reflector can be made more accurately by using a color correction filter. This is a filter whose spectral transmittance is approximately proportional to the spectral reflectance of the retroreflector. The luminous transmittance of the filter can be calculated from spectral transmittance measurements made on a spectrophotometer. Measurements of the normal illuminance E_{sf} with the filter placed in front of either the source or receptor aperture can be made using the procedure in step 5.26.3.1.1. A color correction factor "K" can be calculated as:

$$K = \frac{E_s}{E_{sf}} \times r$$

The value of the C.I.L. or of "A" as determined in 5.26.3.1.7 is multiplied by "K" to correct for small errors in spectral weighting. A very good color correction filter for plastic cube corner reflectors is a flat plate of the same plastic whose thickness is equal to the optical path length in the reflecting elements.

5.26.4 Criteria

5.26.4.1 Reflector Test: See Tables 1 and 2 of FR January 28, 1976.

5.26.4.2 Retroreflector Tire Test: The ratio "A" as defined in Sec. 1512.18 (o)(2)(iii) shall not be less than:

$$A = \frac{4\cos^2\theta}{1 + \left(\frac{\phi}{0.225}\right)^{3/2}}$$

where "A" is ratio in meters, θ is the entrance angle, and ϕ is the

observation angle in degrees. The criterion applies only for entrance angles from 0° to 40° and observation angles from 0.2° to 1.5°, and performance is not specified beyond this range. The values of "A" in Table 3 are obtained from the above formula by rounding up to two significant figures. Except in cases in which the performance of the reflector is seriously questionable, a reflector with "A" at least the value given in Table 3 at each of the six combinations of entrance and observation angle will be considered to satisfy this criteria.

5.26.5 Test Results: Record the test data as shown below.

5.26.5.1 Reflector

Observation Angle (degrees)	Entrance Angle (degrees)	Measured Value of A (m)	Minimum Required Value of A (m)	Pass	Fail

5.26.5.2 Retroreflector Tires

Observation Angle (degrees)	Entrance Angle (degrees)	Measured C.I.L. (candlepower instant foot candle)	Minimum Specified C.I.L. (candlepower instant foot candle)	Pass	Fail

REFERENCES

1. Mordecai Ezekial, Karl A. Fox, "Methods of Correlation and Regression Analysis", New York, John Wiley and Sons, 3rd edition, 1959
2. Title 16 - Commercial Practices; Chapter II - Consumer Product Safety Commission; Part 1500 - Hazardous Substances and Articles. Administration and Enforcement Regulations; Part 1512 - Requirements for Bicycles Federal Register, Vol. 41 - No. 19 - Wednesday, January 28, 1976.
3. SAE Standard J594-e; Reflex Reflectors; Society of Automotive Engineers (March 1970).
4. Federal Specifications L-S-300A; Sheetting and Tape, Reflective: Non-exposed Lens, Adhesive Backing (January 7, 1970).
5. International Lighting Vocabulary, Publication CIE N° 17 (E-1.1.) International Commission on Illumination (1970).
6. IES Lighting Handbook, Fifth Edition; Illuminating Engineering Society; New York, N.Y. (1972).
7. Federal Test Method Standard No. 141A, Method 6125; Luminance Factor of Retroreflective Materials, Instrumental Measurement (May 1, 1974).
8. International Commission on Illumination (CIE) - Draft of Publication on Retroreflectance (March 1974).

APPENDIX

A.1 Sidewalk Bicycle Exemption List

<u>Section</u>	<u>Description</u>
1512.5 (b) (1)	Stopping Distance
1512.5 (c) (1)	Stopping Distance
1512.5 (d)	Footbrakes and Handbrakes in Combination
1512.7 (c)	Pedal Reflectors
1512.11 (c)	Rims
1512.18 (j)	Rim Test
1512.12	Requirements for Wheel Hubs
1512.13	Requirements for Front Fork
1512.18 (k) (1)	Fork Test
1512.14	Requirements for Fork and Frame Assembly
1512.18 (k) (2)	Fork and Frame Assembly Test
1512.16	Requirements for Reflectors
1512.17 (a)	Road Test
1512.18 (d) (2) (v)	Performance Test Procedure
1512.18 (d) (vi)	Performance Test Criteria
1512.18 (e)	Footbrake Force and Performance Test - For modifications of test loads and conditions see Sec. 1512.18 (f)
1512.18 (j) (3)	Front Hub Retention Test
1512.18 (m)	Reflector Mount and Alignment Test
1512.18 (n)	Reflector Test
1512.18 (o)	Retroreflector Tire Test
1512.18 (p)	Road Test

A.2 NBS Long-range Reference Retroreflectance Instrument* (LRRI)

This instrument, located in photometric tunnel of the NBS Optical Radiation Section, is designed to test the photometric properties of retroreflectors under geometrical conditions similar to those under which retroreflectors are used. It will be used to provide standard retroreflectors to be used in calibrating retroreflectometers which are used by manufacturers and purchasers of retroreflectors and retroreflective materials. The instrument consists of three principal units: a projector, a sample carrier, and a receiver. These units, the general arrangement of which is shown in Fig. 46, have been specifically designed to reduce potential sources of systematic measurement error as much as possible, while at the same time providing sufficient flexibility in operation to investigate fully the characteristics of retroreflectors.

The projector, shown schematically in Fig. 47, contains a lamp with a tungsten ribbon filament which is run by a current regulated power supply. An image of this filament is projected onto and overfills a

*The support of the Consumer Product Safety Commission in developing this instrument is gratefully acknowledged.

circular aperture. An image of this illuminated aperture is projected onto the sample by one of several projection lenses, depending upon the size of the sample and its distance from the projector. The size of the projected spot of light is kept just slightly larger than the sample in order to minimize reflections from other objects in the range, and the projection optics have been carefully baffled to reduce scattered light from the projector. The spot of light is uniform to within a few percent. For measurements in which the uniformity of the irradiation of the sample is critical, the irradiance within the spot is mapped by scanning with a detector mounted on the sample carrier. A unique feature of this projector is the prism mounted just in front of the projection lens. This prism shifts the optic axis of the projected radiation to one side and changes its direction by 15° , allowing the receiver to move very close to the optic axis with an unobstructed view while still permitting adequate stray radiation baffles to be used in the projector.

The sample carrier, shown in Figure 48, is designed for automated sample handling and can be controlled by a computer. Horizontal and vertical motion of the sample carrier in a plane perpendicular to the length of the photometric tunnel by means of stepping motors allows samples and standards to be moved in and out of the spot of light, and also provides a means of scanning a photocell to map the irradiance in the spot of light. A third stepping motor rotates the sample carrier around a horizontal axis. These provide for the angular orientation of the sample in all possible directions. As an added convenience, one of the sample mounts has a manually adjustable rotation about an axis which is perpendicular to both of the other two axes. All axes of rotation intersect at a common point at the center of the sample.

The receiver, shown in Fig. 49 consists of a photocell corrected by filters to stimulate the response of the human eye. A baffle tube on the receiver and additional baffle screens located in the photometric range between the sample and the receiver prevent stray radiation reflected from the tunnel walls of the range from reaching the receiver. The receiver is mounted on a carrier on the same level above the range floor as the projector. The receiver mount is driven across the width of the photometric tunnel by means of a stepping motor, and it is rotated around a vertical axis by means of another stepping motor. These two motions provide for automatic adjustment of the angle of observation in a plane parallel to the tunnel floor. Measurements of individual retroreflectors are made relative to a standard retroreflector for convenience. However, in order to measure the standard retroreflector, the receiver must be moved to the sample position to measure the incident irradiance and then be returned over a distance of up to 30 meters to its customary position to measure the irradiance from the standard retroreflector. Therefore, a special digital current meter which is very insensitive to its location and orientation has been developed to measure the current from the detector.

In addition to the principal components outlined above, the instrumentation also includes auxiliary equipment such as mirrors, a surveying telescope, and a calibrated tape measure for alignment. To align the instrument, a right triangle is established which has one of its legs parallel to the receiver carrier track as shown in Figure 50. This triangle is determined by sighting a telescope in the sample carrier on its image in a mirror held against the rails of the sample carrier track. The long arm of the triangle is measured with the calibrated tape measure and the critical distance from the receiver to the sample at any angle is computed using the pythagorean theorem. The base observation angle, ϕ , is determined by reflecting light from a small mirror on the sample carrier first back onto the projector axis and then along the base line. This same mirror is used for initially setting the observation angle to zero.

The entire instrument is controlled by an NBS - developed Modular Interactive Data Acquisition System (MIDAS) which can be programmed by means of a punched paper tape or a minicomputer. With this instrument, accurately measured standard retroreflectors will be made available in order to provide for accurate and convenient retroreflectance measurements in the field.

This instrument was developed at the National Bureau of Standards by a spectrophotometry group, Radiometric Physics Section, Optical Radiation Division, Institution for Basic Standards, For further information, contact

Dr. William H. Venable, Jr.
 Room A-317, Metrology Building
 National Bureau of Standards
 Washington, D.C. 20234

Phone (301) 921-2553

A.3 Sample Curve Fit Calculation

<u>Pedal Force, Pounds (X)</u>	<u>Brake Force, Pounds (Y)</u>	<u>X·Y</u>	<u>X²</u>
20	25	500	400
40	40	1600	1600
60	58	3480	3600
80	80	6400	6400
$\Sigma = 200$	$\Sigma = 203$	$\Sigma = 11980$	$\Sigma = 12000$
$\bar{X} = 50$	$\bar{Y} = 50.75$		

$$b = \frac{\sum x \cdot y - \bar{y} \sum x}{\sum x^2 - \bar{x} \sum x}$$

$$b = 0.915$$

$$a = \bar{y} - b\bar{x}$$

$$a = 5.0$$

The least-squares curve fit is therefore

$$y = 5.0 + 0.915x$$

while the $\pm 20\%$ tolerance lines are

$$y = (1.0 \pm 0.2) (5.0 + 0.915 x) \quad \text{or}$$

$$y_1 = 4.0 + 0.732x$$

$$y_2 = 6.0 + 1.098x$$

See Figure 51 for sample graph of above.

Table 1. Braking Test Data Sheet

BRAKING TEST DATA SHEET

Prepare For Each Bicycle

- a) Bicycle Manufacturer _____
 Serial No. _____
 Model No. _____
- b) Test Data _____
- c) Rider _____
- d) Bicycle Information
 Wheel Size _____ in
 Max Gear Ratio _____
 Brake Type _____
 Brake Mfg. _____
 Frame Size _____ in
- e) Test Information
 Wheel Base _____ in
 Equip. Weight _____ lbf
 Rider Weight _____ lbf
- f) Loading Test
 Load on Force Gage _____ lbf
 Lever Hit Bar _____
 Pass-Fail _____
- g) Rocking Test
 Pass-Fail _____
- i) Coefficient of Friction
 Bicycle weight _____ lbf
 Force applied to
 wheel _____ lbf

h) Performance Test

Run No.	Elapsed Time for Speed Measurement	Direction of Run	Stopping Distance from	Distance Between Markers		Skidding
			Rear most Marker	L-R Coordination	Application of 40 lbf	
	sec		ft	ft	ft	

Table 2. Structural Test Results for Bicycles (Metric Units)^(a)

Bicycle No.	Drive Chain	Handlebar				Seat Clamp		Rear Hub Locking Device	Wheel Rim		Frame Test			Fork Test		
	Failure Load	Stem Clamp	Stem Strength	Strength		Pitch	Yaw		Front	Rear	Load	Defl	Energy	Load	Defl	Energy
	N	N	N	N	mm	N	N	N	N	N	N	mm	J	N	mm	J
REQUIREMENTS																
Bicycles	8010	47	2000	445	76	648	322	1780	2000	2000	890		39.5	64	39.5	
Sidewalk Bicycles	8230	20	1000	445	76	334	111	1780	2000	2000	890		39.5	64	39.5	

^(a) Record test data in Table in English units also.

Table 2a. Structural Compliance Test Results for Bicycles (English Units)

Bicycle No.	Drive Chain	Stem Clamp	Handlebar			Seat Clamp		Rear Hub Locking Device	Wheel Rim		Frametest			Fork Test		
	Failure Load		Stem Strength	Strength	Defl	Pitch	Yaw	Front	Rear	Load	Defl	Energy	Load	Defl	Energy	
	lbf	lbf-ft	lbf	lbf	in	lbf	lbf	lbf	lbf	lbf	lbf	in	in-lbf	lbf	in	in-lbf
REQUIREMENTS																
Bicycles	1800	35	450	100	<3.0	150	50	400	450	450	200		350		2.5	350
Sidewalk Bicycles	1400	15	225	100	<3.0	75	25	400	450	450	200		350		2.5	350

Table 3. Foot Brake Force Test Data

Pedal Load (lbf)	Braking Force (lbf)			Average (a) Braking Force (lbf)
	Run No.			
	1	2	3	
10 (sidewalk bicycles)				
20				
30				
40				
50				
60				
70				

(a) The average braking force (F_b) is determined by the following method:

$$F_b \text{ (ave)} = \frac{\text{Runs 1, 2, and 3}}{3}$$

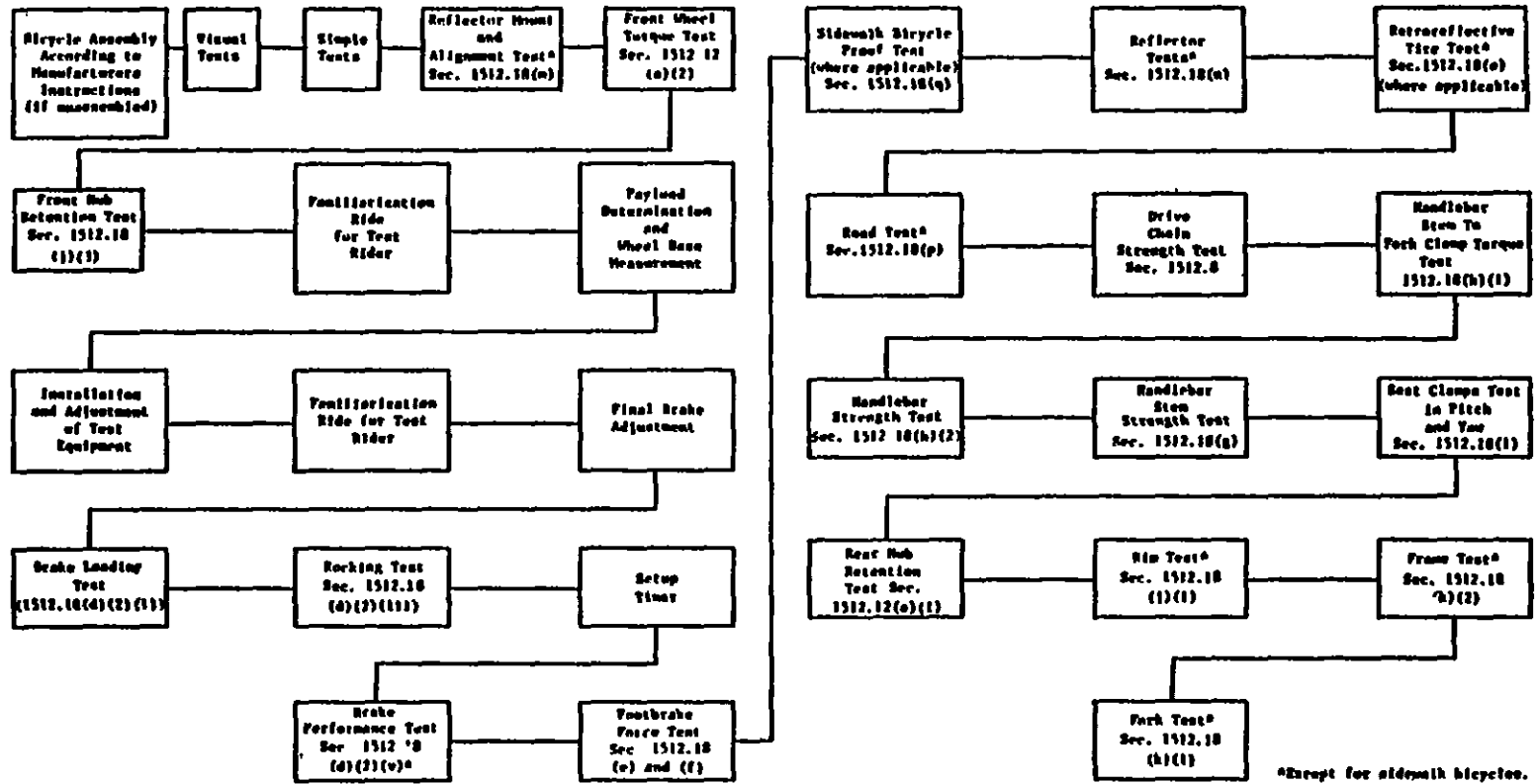

Figure 1. General Compliance Test Flow Diagram

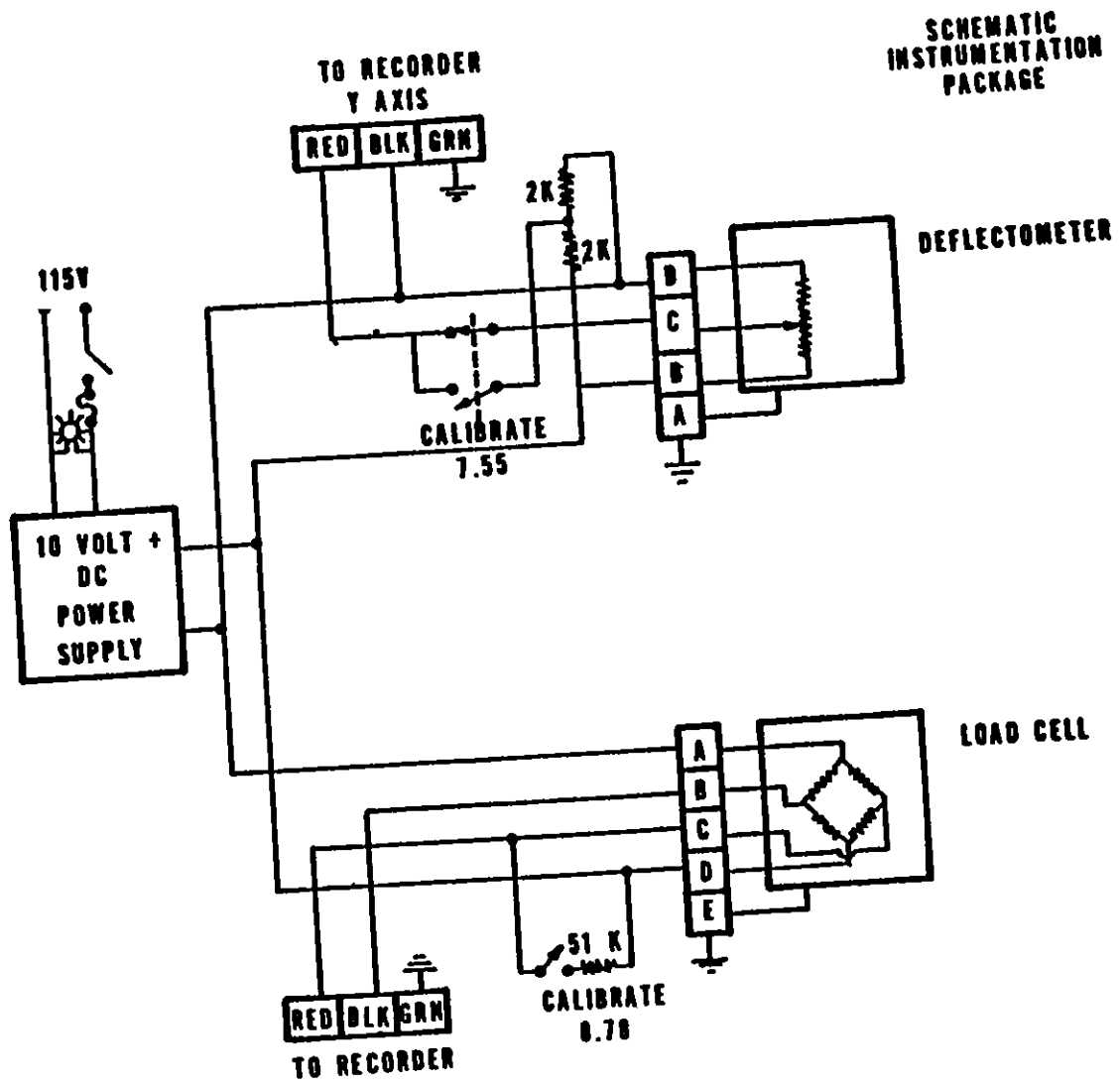

Figure 2. Load-Deflection Instrumentation Schematic

There shall be no protrusions in shaded area.

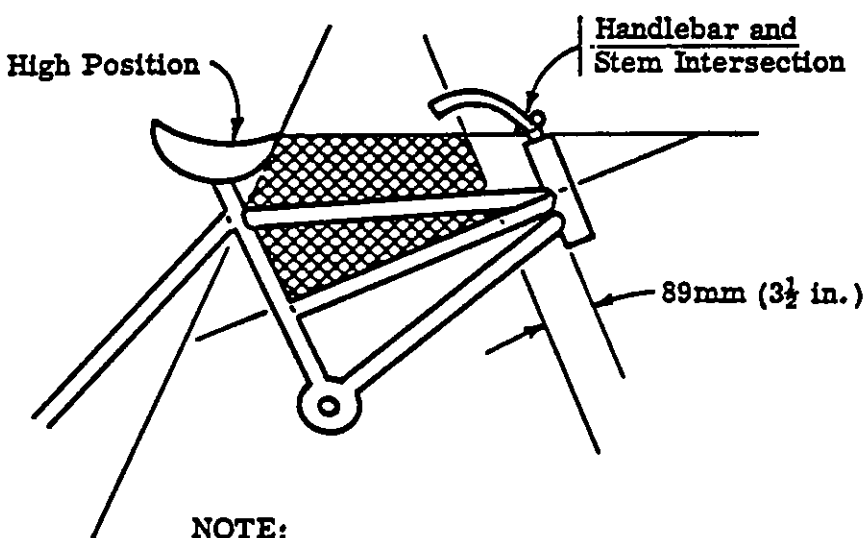

Figure 3. Excluded Area

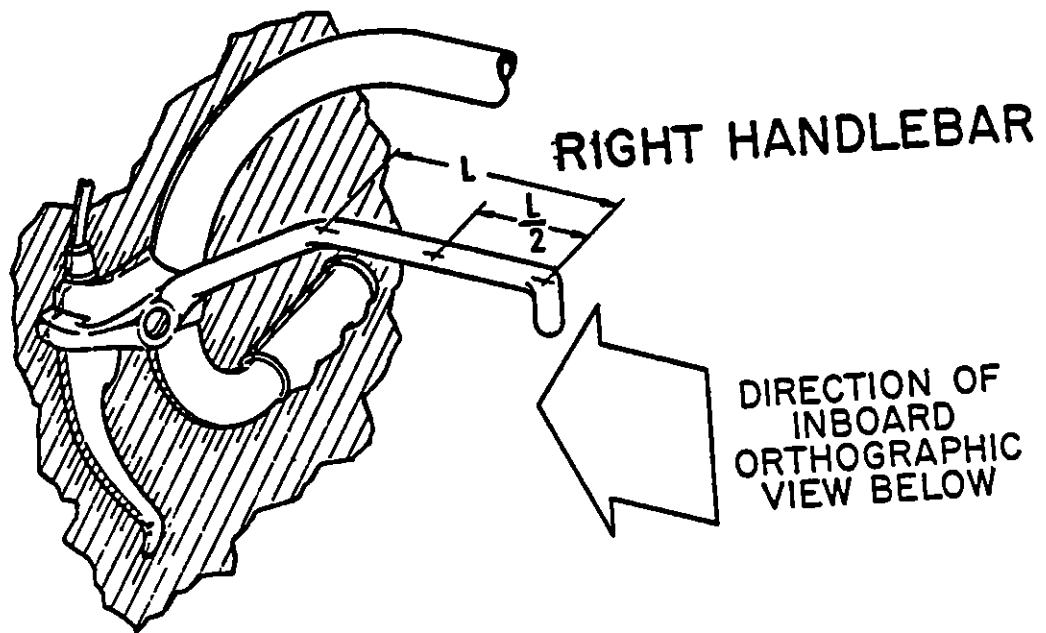

Figure 4. Typical Handbrake Actuator Showing Grip Dimension

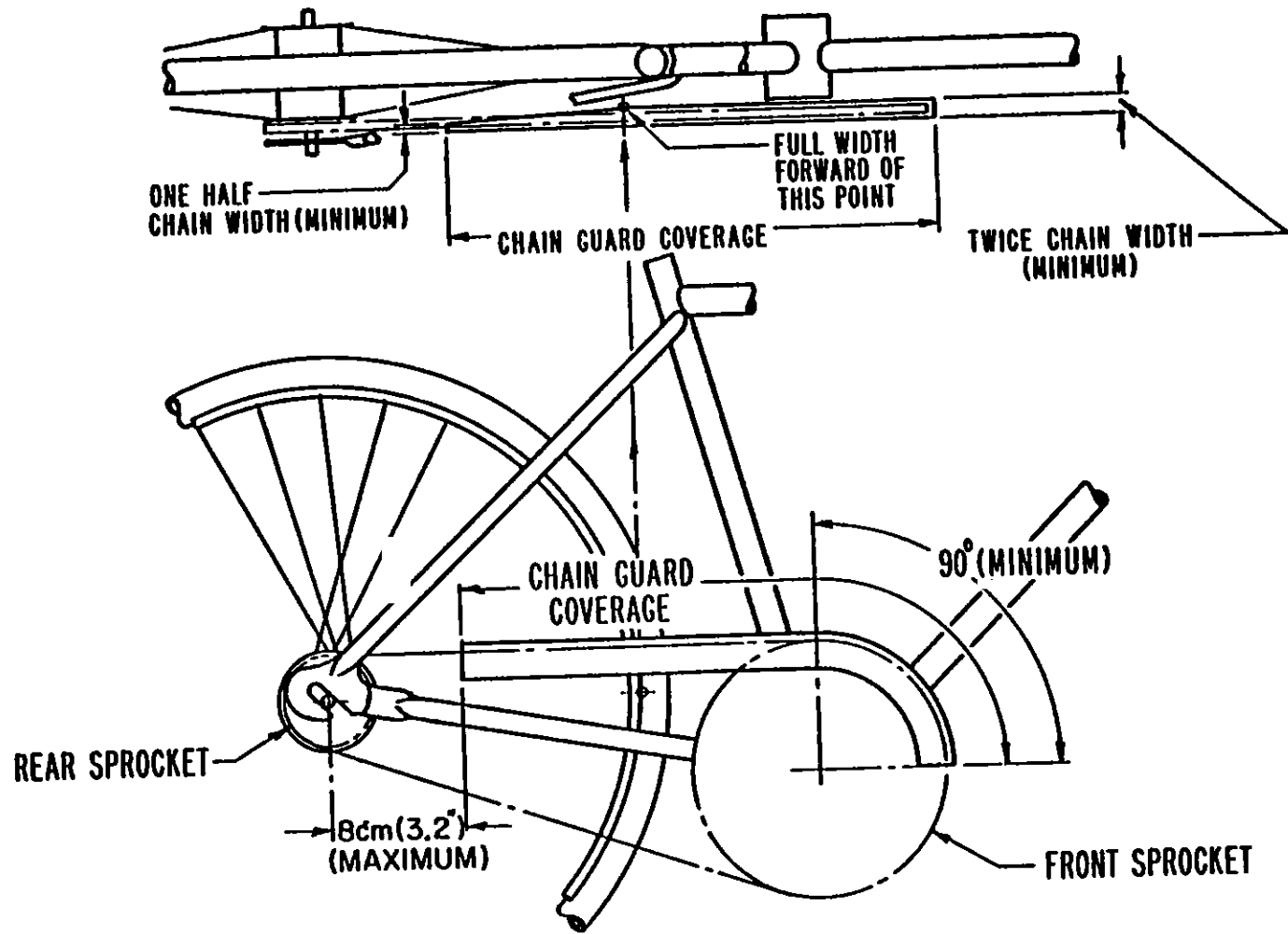

Figure 5. Chain Guard Requirements

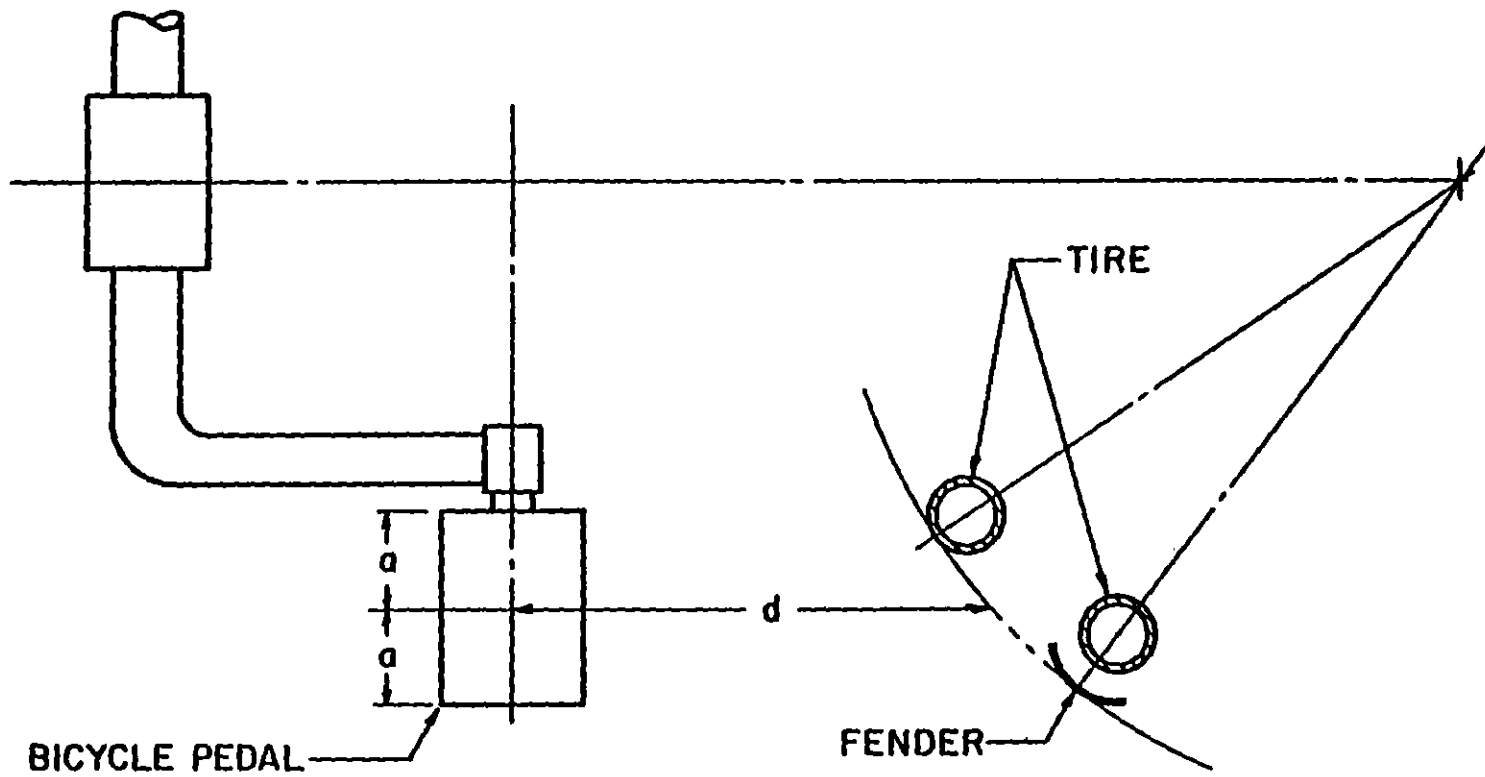

Figure 6. Toe Clearance

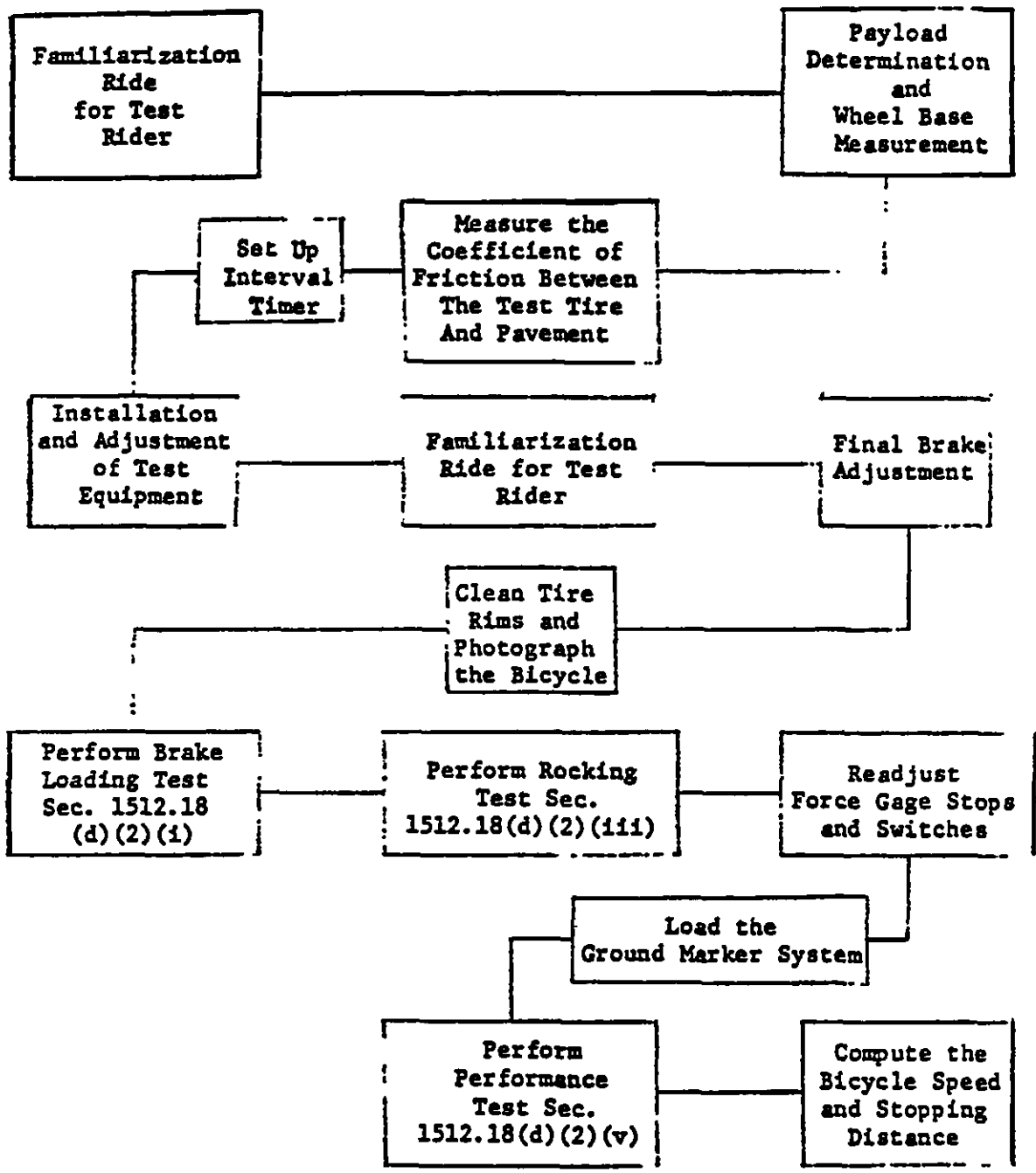

Figure 7. Flow Diagram of Braking Test Procedure

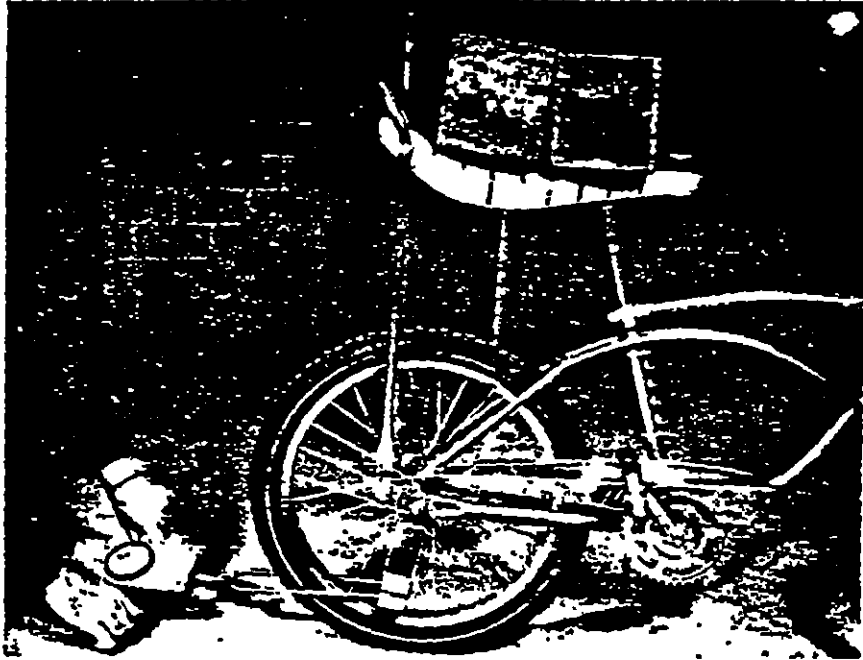

Figure 8. Test Setup for Measurement of Coefficient of Friction

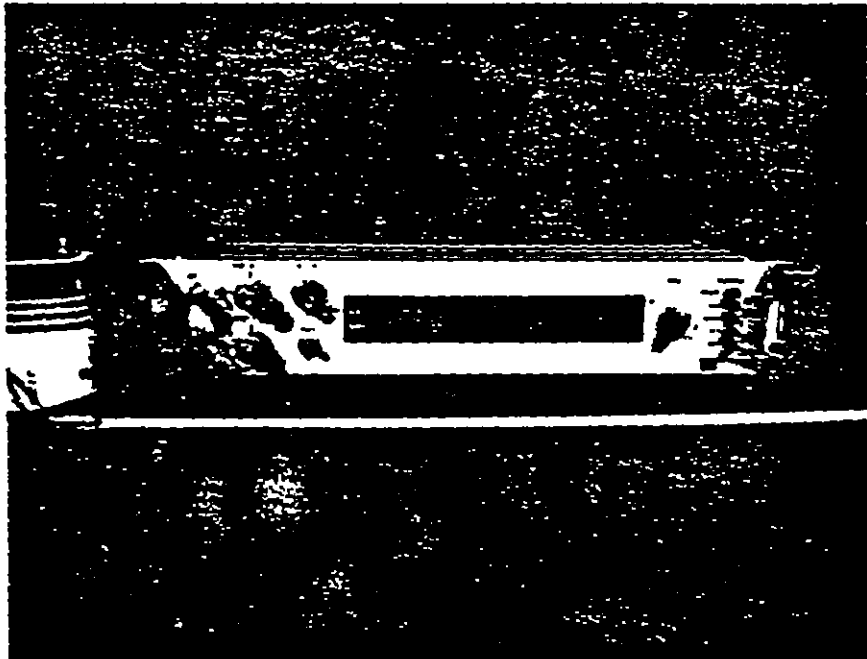

Figure 9. Velocity Timer Setup

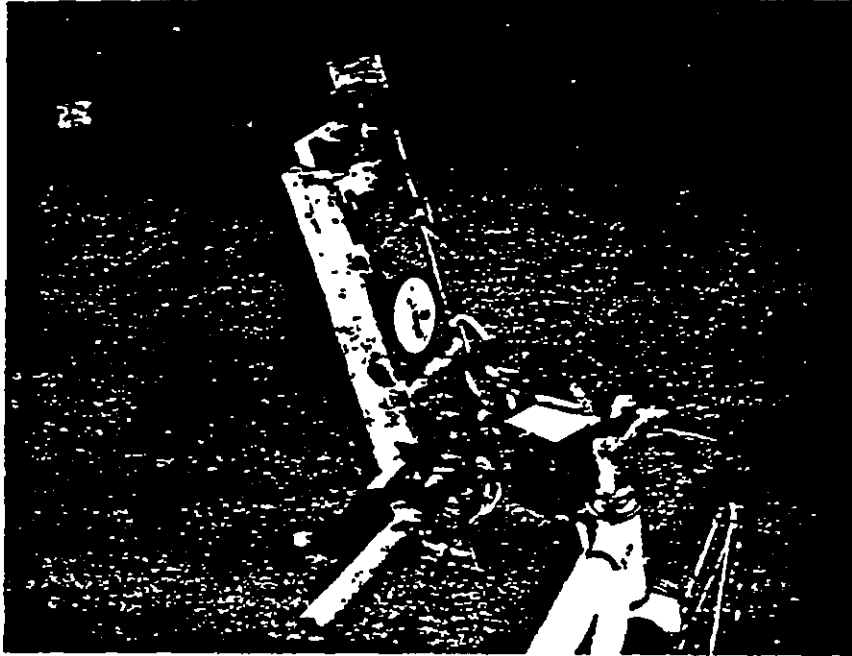

Figure 10. Force Gage Assembly (see Handbrake Test Fixture Drawing, End of Manual)

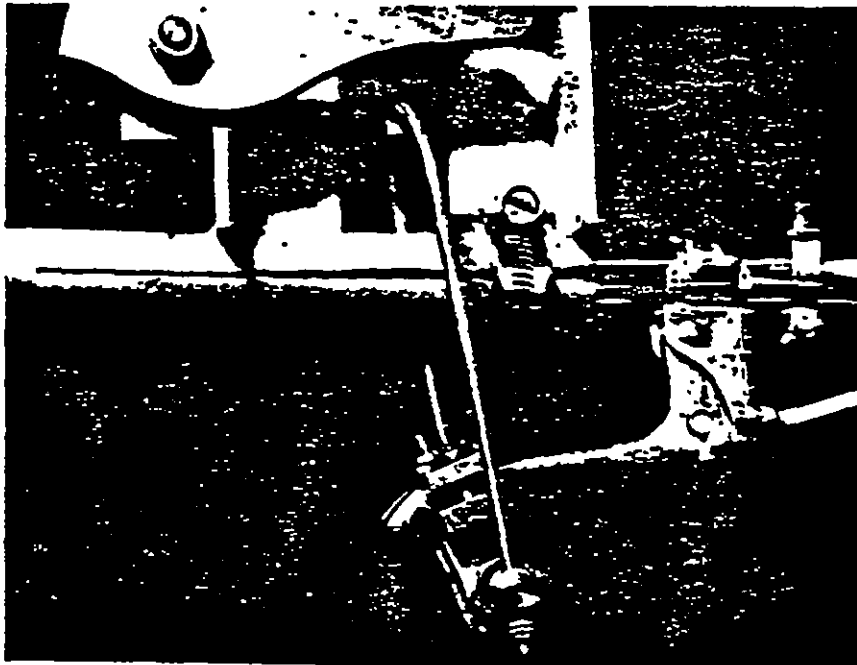

Figure 11. Lever Clamp of Force Gage (prior to actuation)

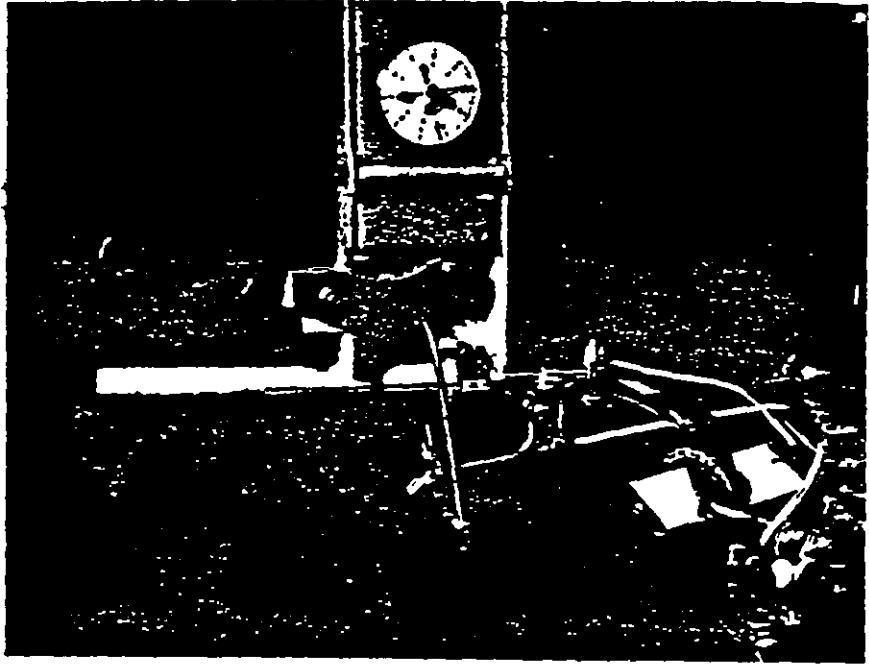

Figure 12. Direction of Force Application (shall be applied along the line of action of the force gage, after actuation)

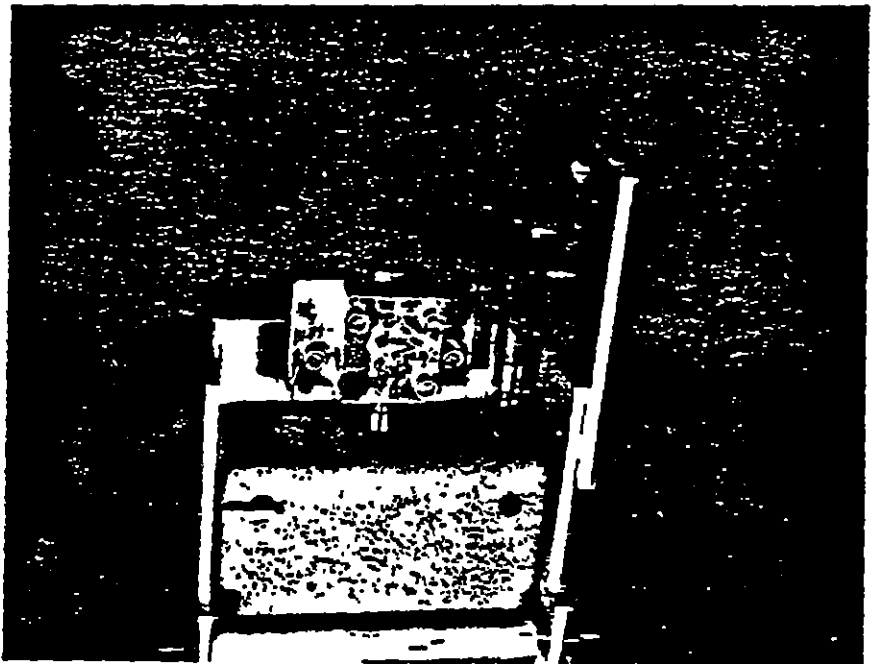

Figure 13. Force Gage Limit Stops and Switches

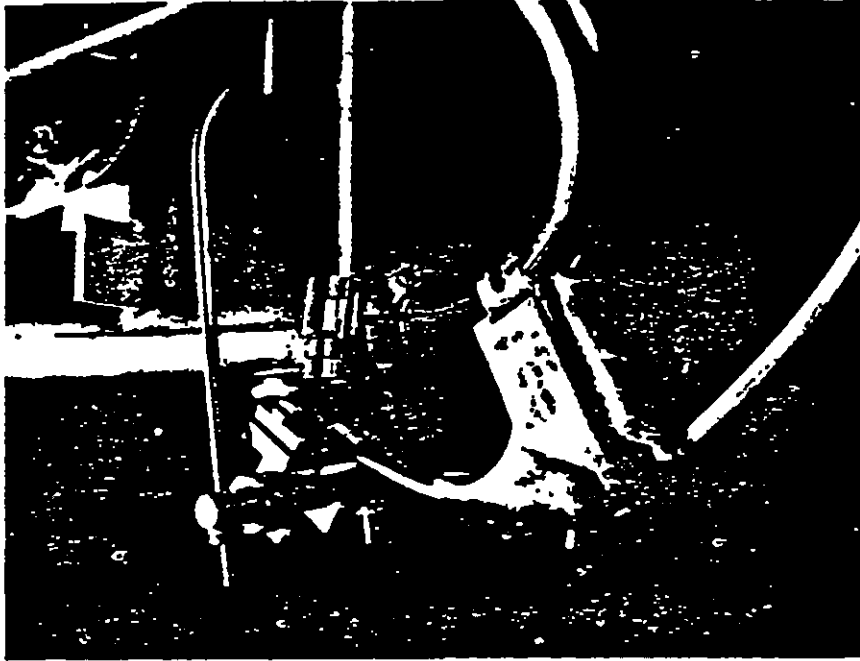

Figure 14. Handlebar Clamp (adjusted to allow the lever to bottom against the handlebar)

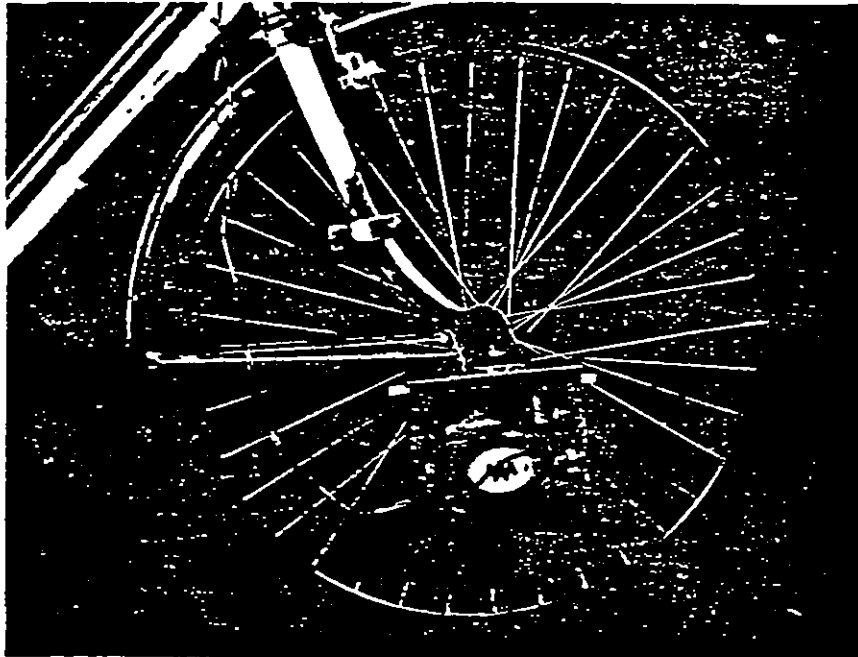

Figure 15. Ground Marker Gun Assembly

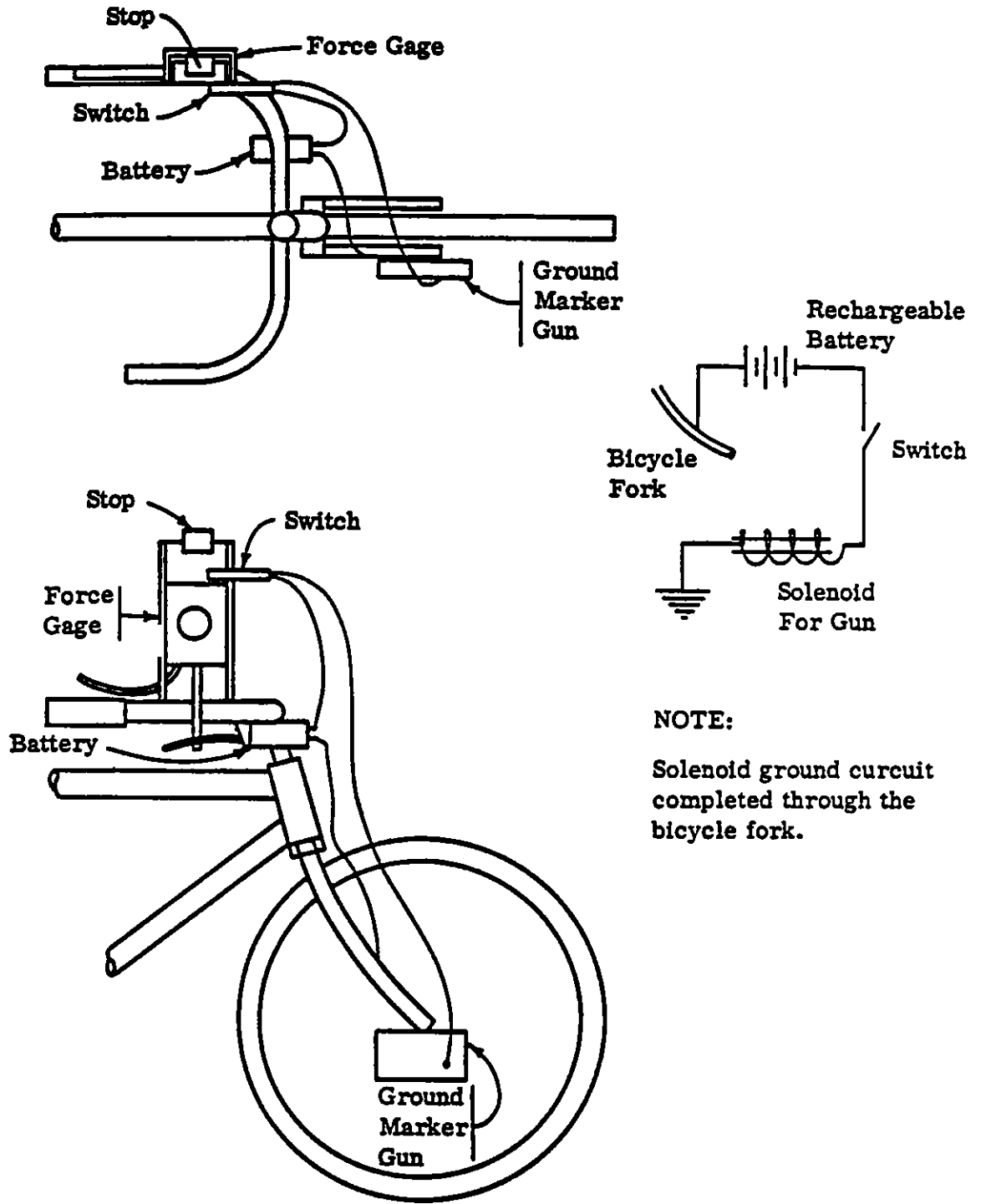

Figure 16. Schematic of Marker Gun Firing Circuit

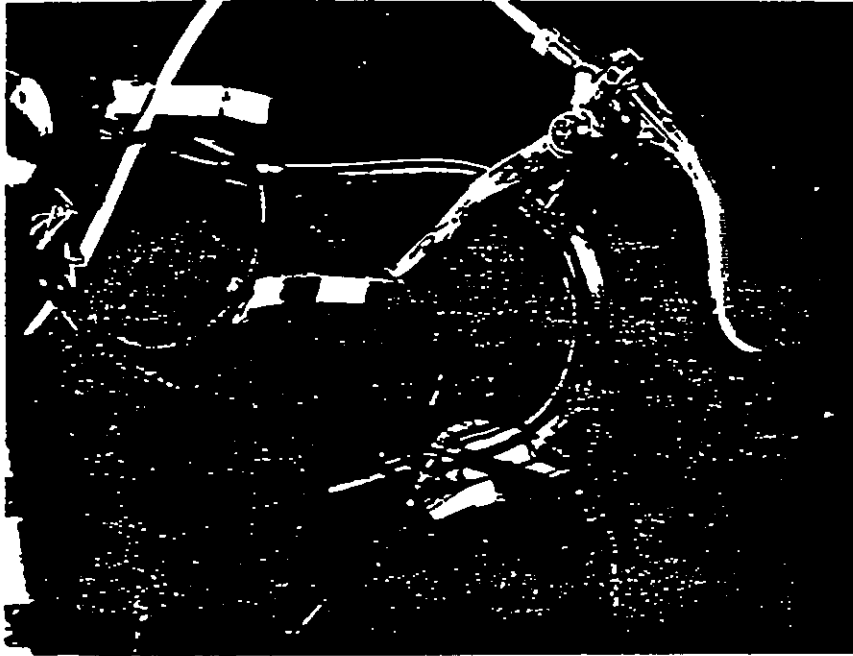

Figure 17. Extension Lever Test Setup

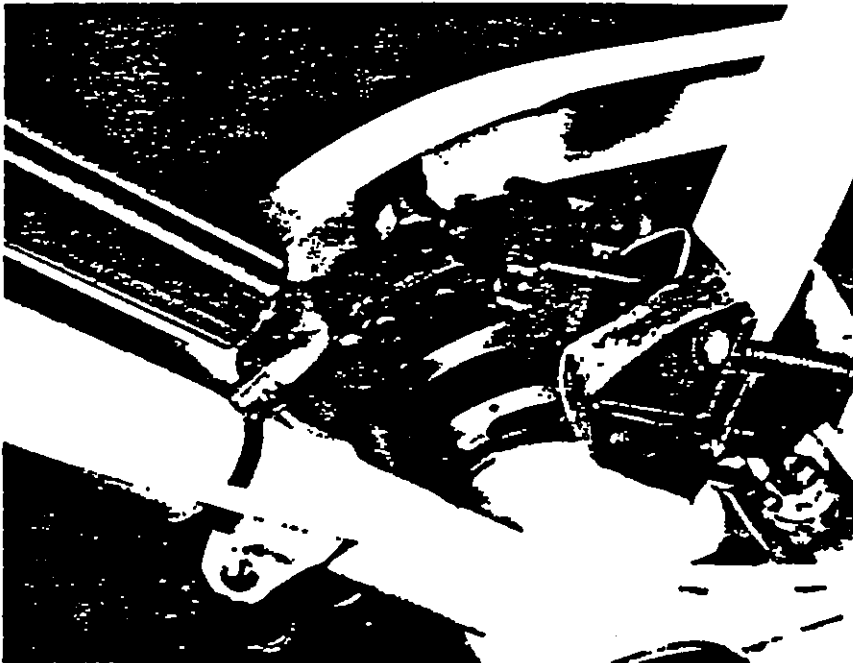

Figure 18. Coaster Brake Test Setup

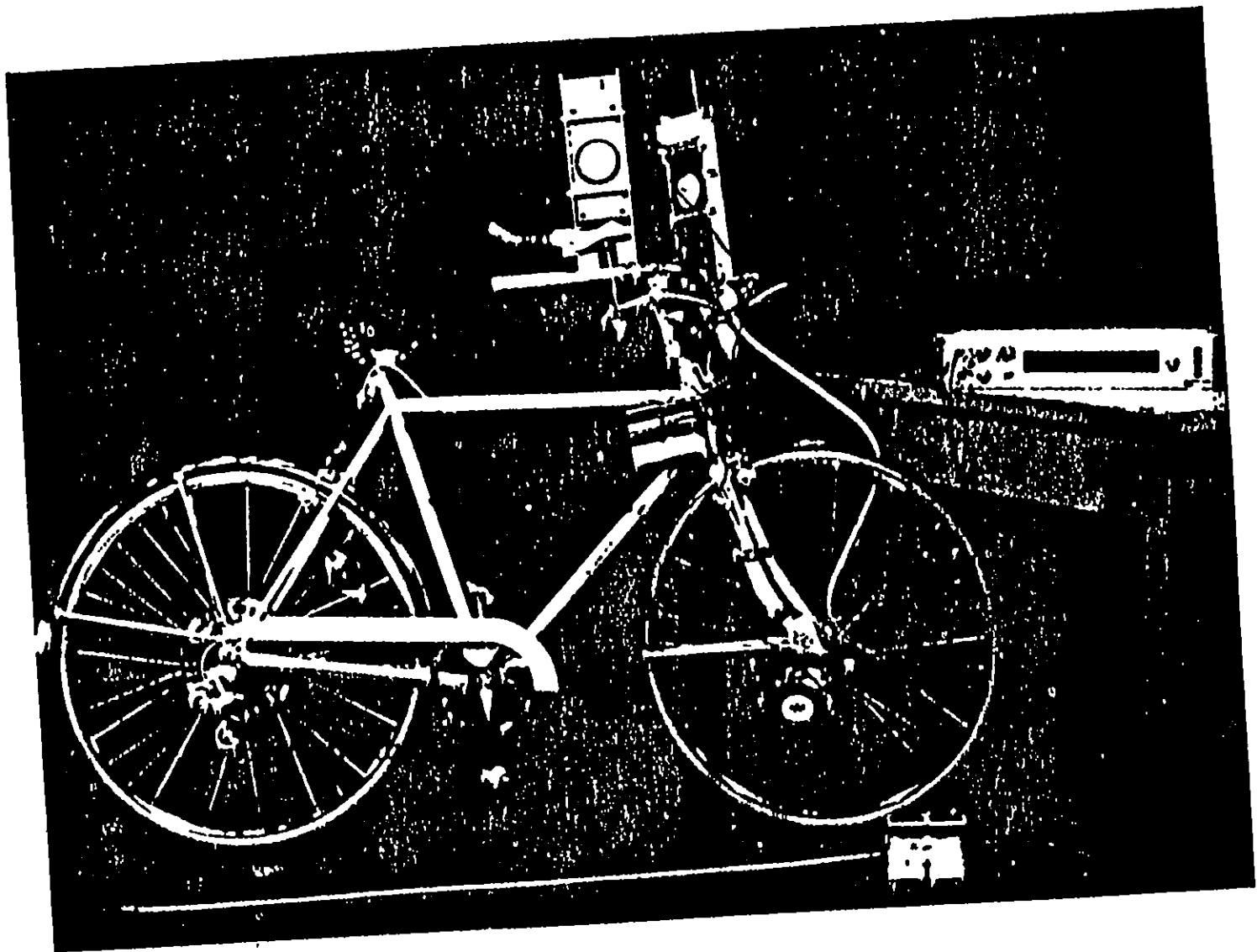

Figure 19. Bicycle Brake Performance Test Equipment-Installed

Figure 19. Bicycle Brake Performance Test Equipment-Installed

Bicycle Run No.	Speed Elapsed Time A	Wheel Base B	Measured Test Velocity C	Measured Stopping Distance D	Velocity Corrected Distance E	Bicycle Payload F	Load Corrected Distance G	Run Direction H	Average Distance I	Bicycle Manufacturer Serial No.
	sec	ft	ft/sec	ft	ft	lb	ft			

Specified Test Velocity, V_s = Velocity required for test, FR 1512, January 28, 1976

$$\text{Measured Test Velocity} = \frac{\text{Wheel Base}}{\text{Elapsed Time}} = V_m$$

$$\text{Velocity corrected} = \left(\frac{V_s}{V_m} \right)^2 \text{ Stopping Distance}$$

Load Corrected Distance = Velocity Corrected Distance + 0.30M/4.5 kg (+1 ft/10 lb) of Payload over 68.1 kg (150 lb).

Average Distance = Arithmetic Average of the Load Corrected Stopping Distance (col. G) computed for all tests in which valid Stopping Runs were made.

Figure 20. Braking Test Data and Sample Data Correction Calculations

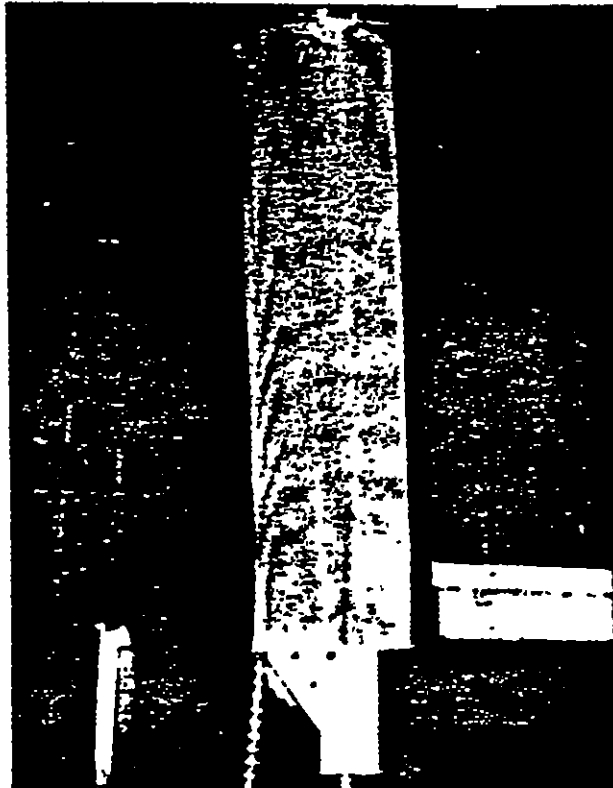

Figure 21. Drive Chain Test Apparatus

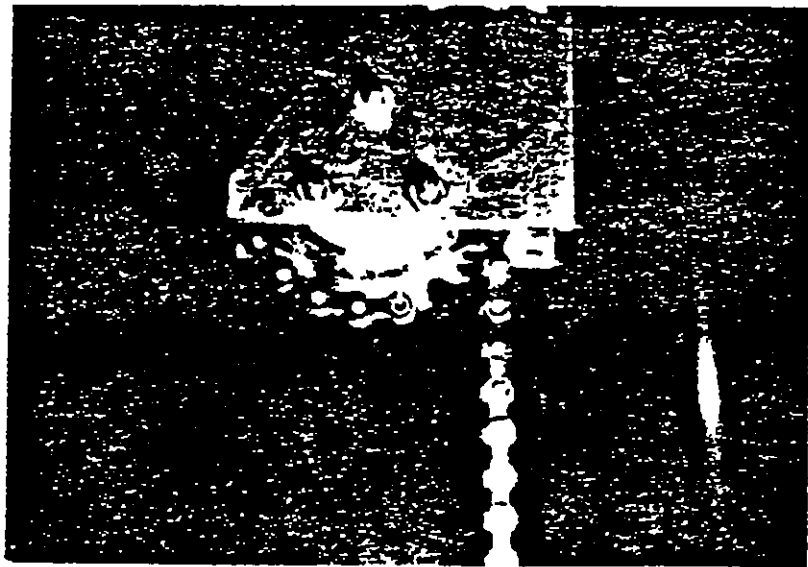

Figure 22. Drive Chain Test Loading Fixture

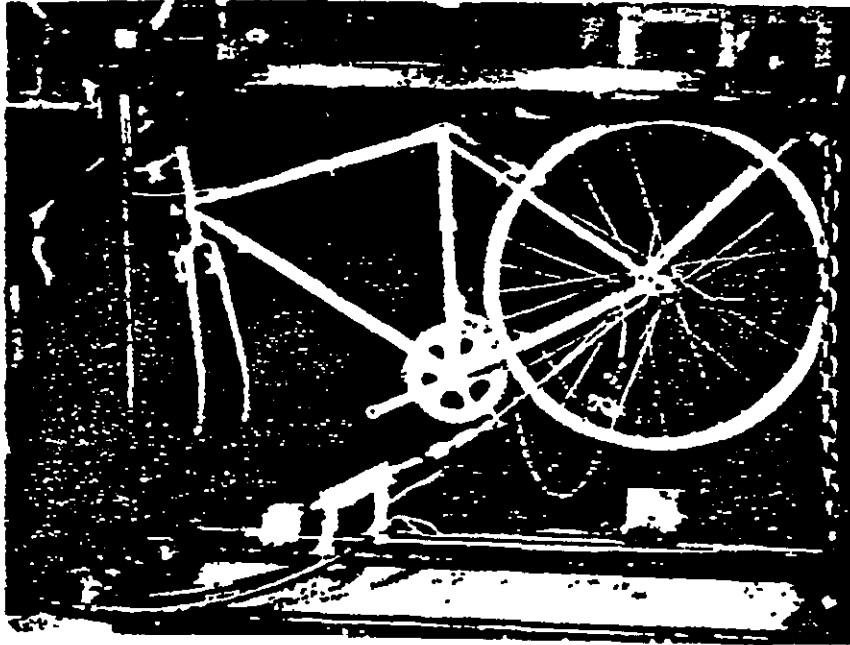

Figure 23. Rear Hub Retention Test

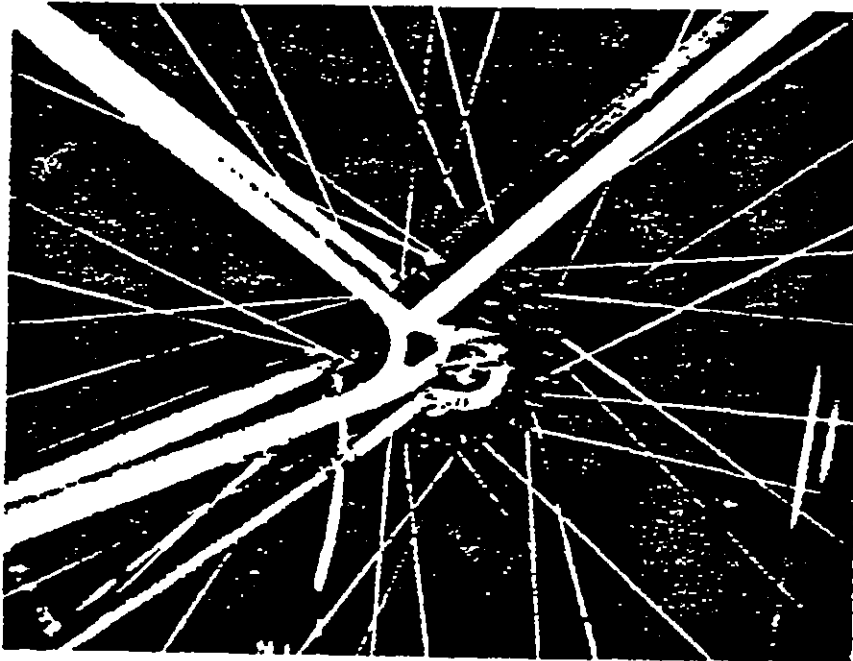

Figure 24. Rear Hub Retention Test-Detail

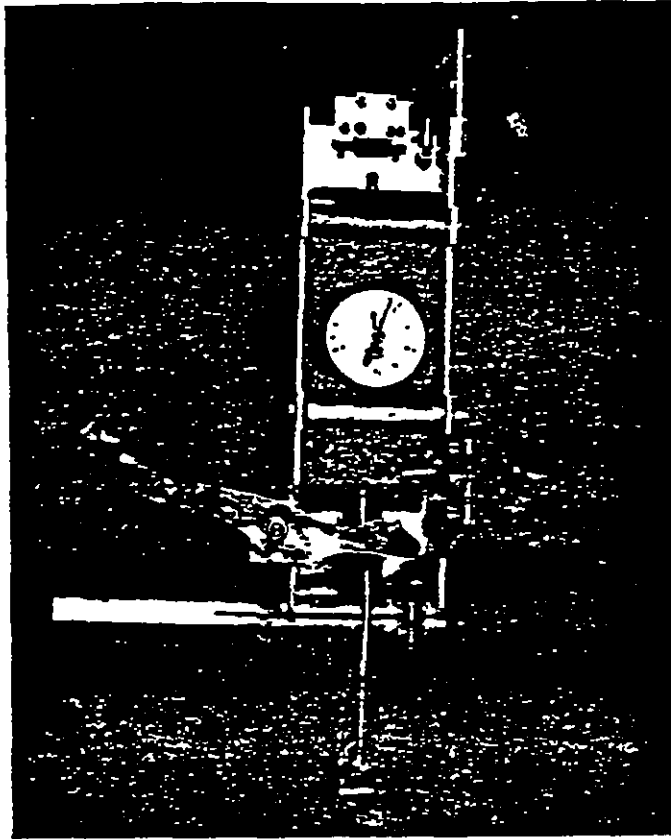

Figure 25. Handbrake Loading Fixture

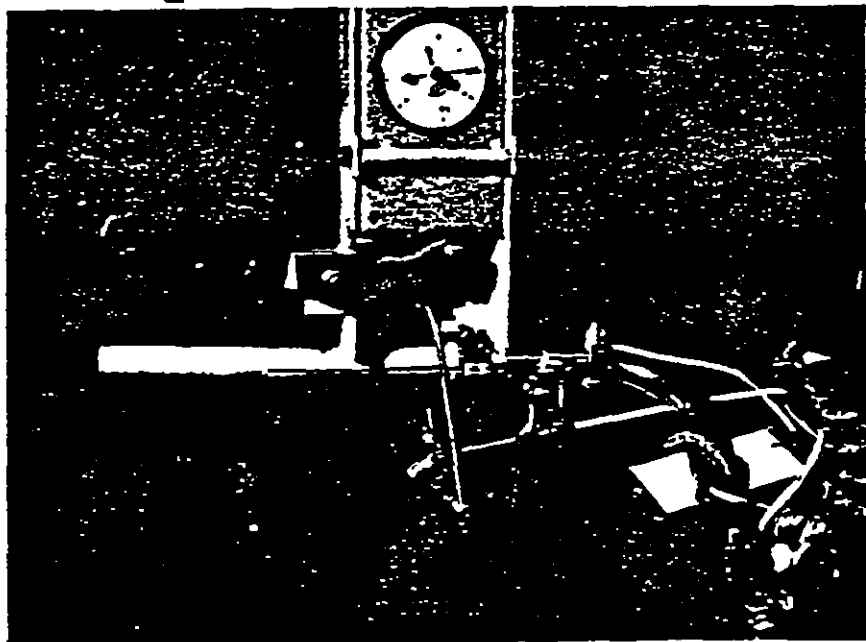

Figure 26. Handbrake Loading Fixture-Installed

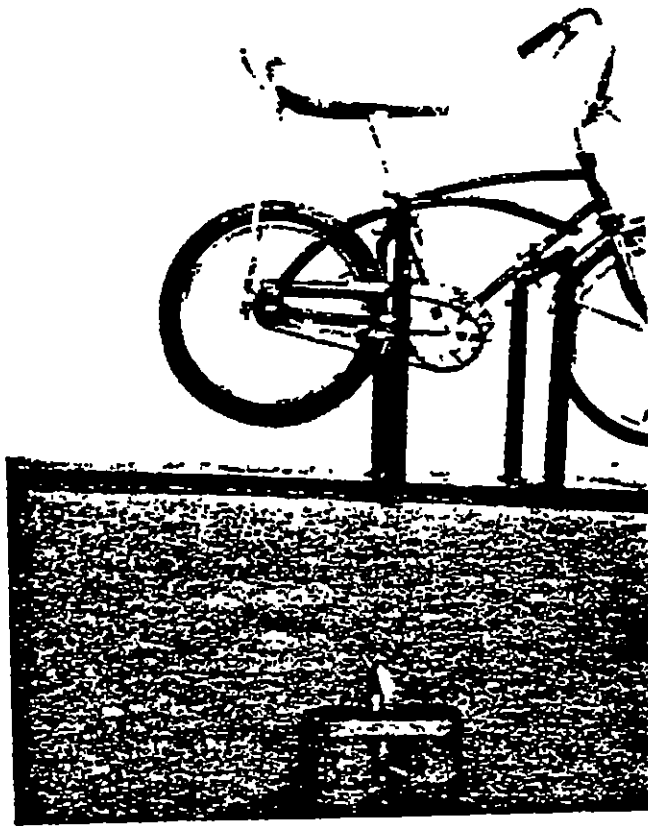

Figure 27. Footbrake Force Test Fixture

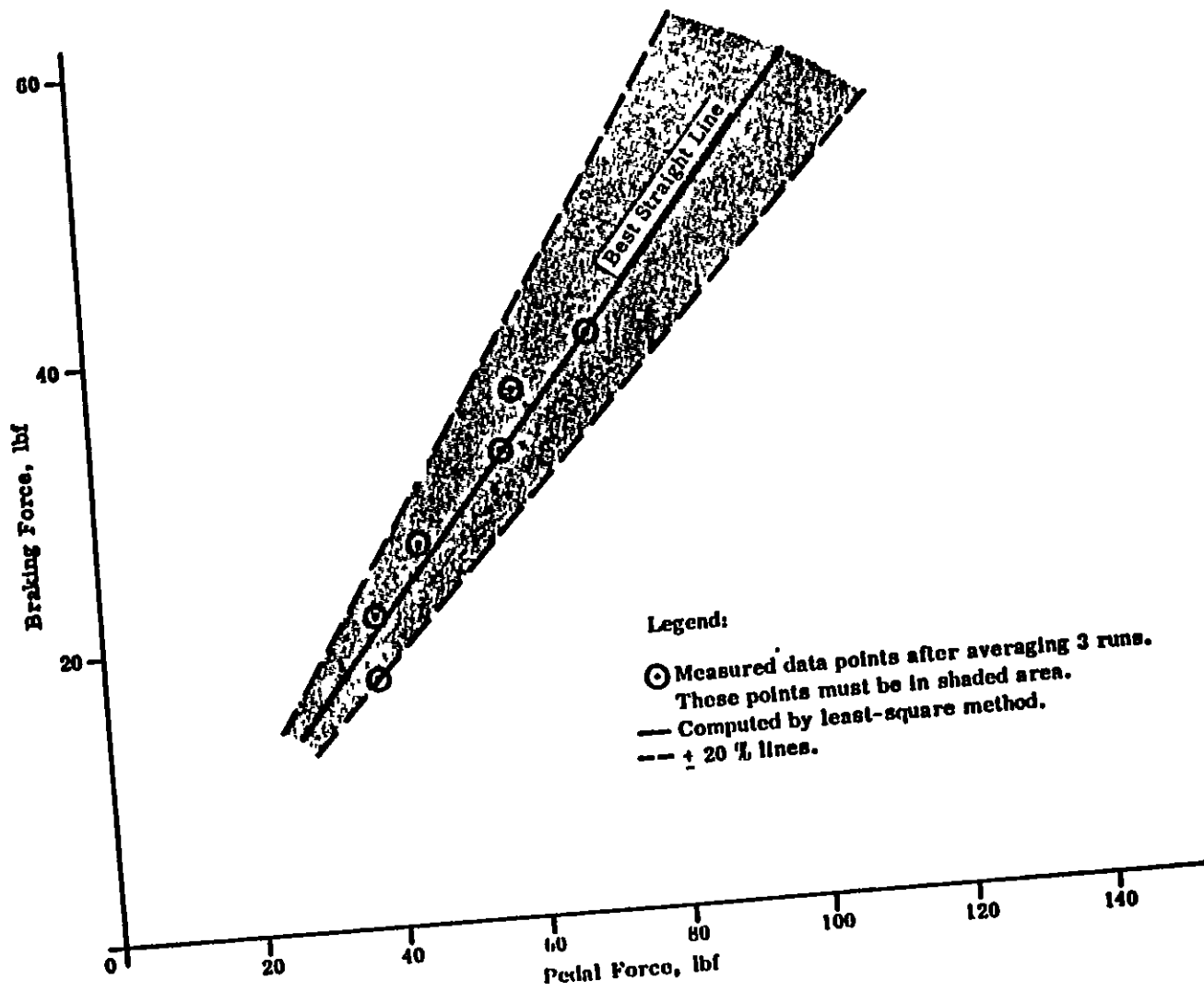

Figure 28. Example of Pedal Force vs. Braking Force Graph



Figure 29. Handlebar Stem Test Fixture

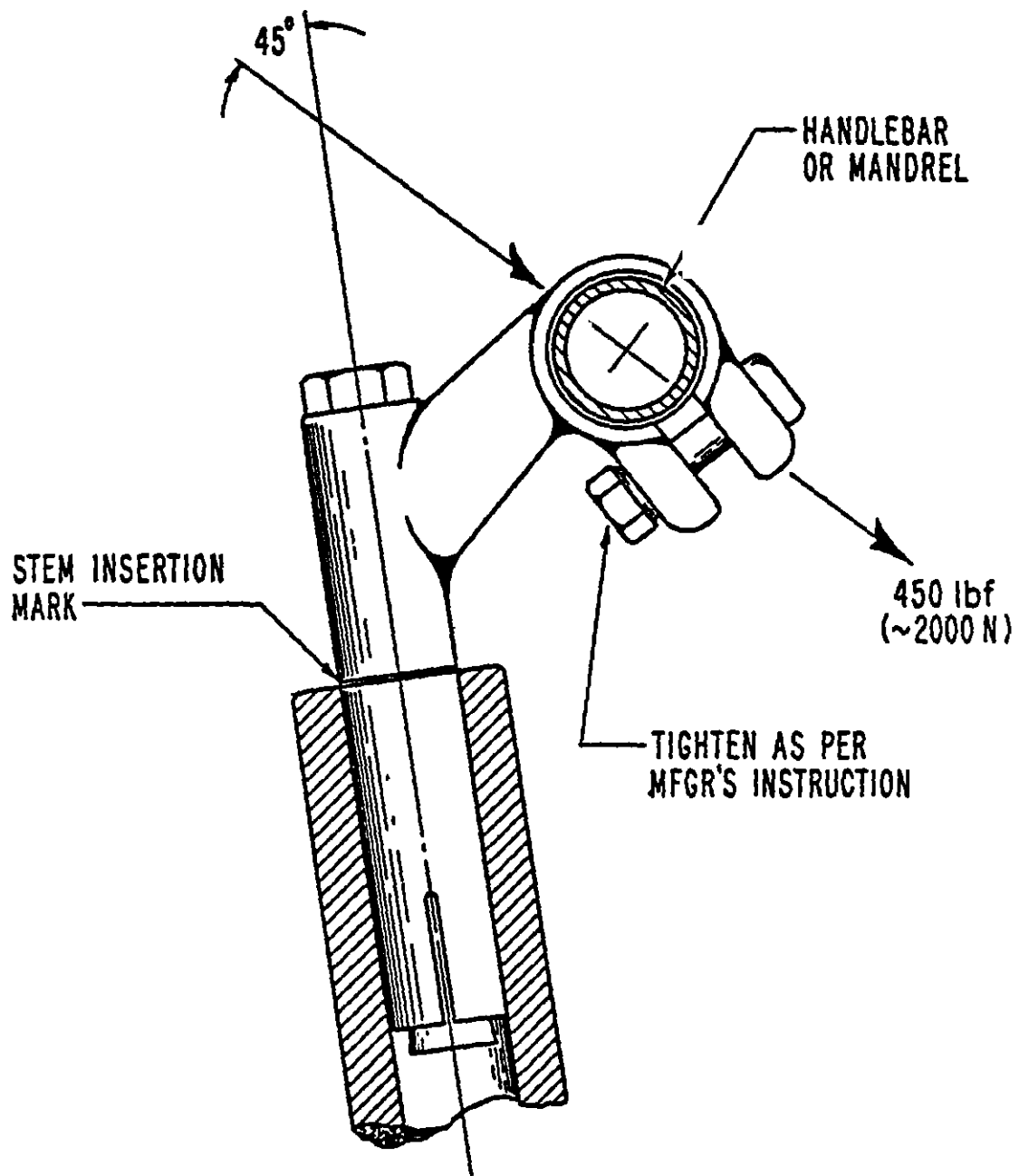

Figure 30. Handlebar Stem Loading

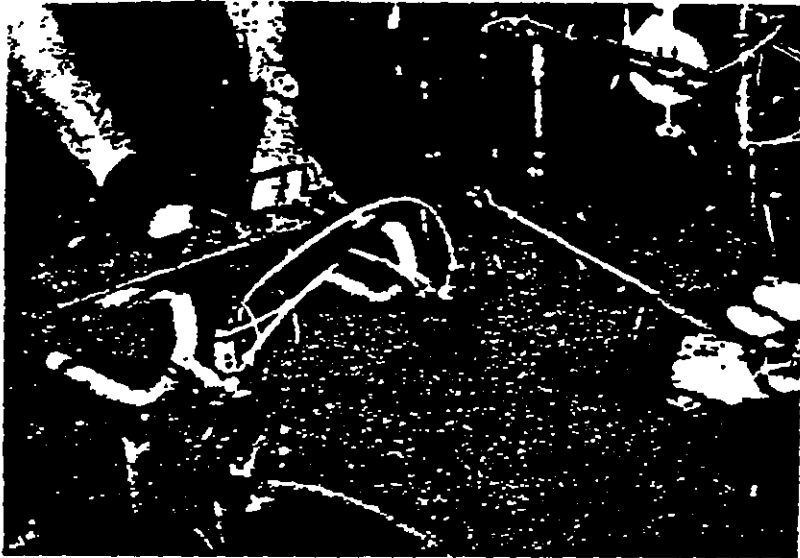

Figure 31. Handlebar Stem-to-Fork Clamp Test

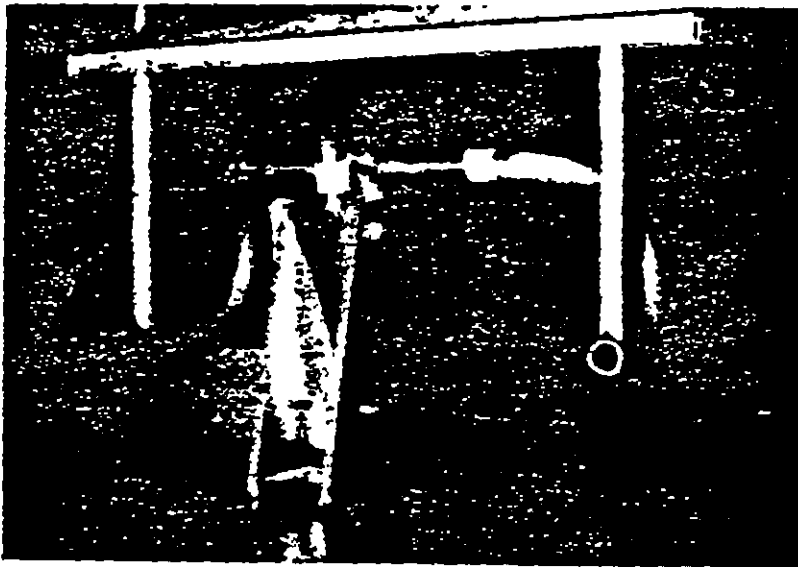

Figure 32. Handlebar Strength Test Fixture

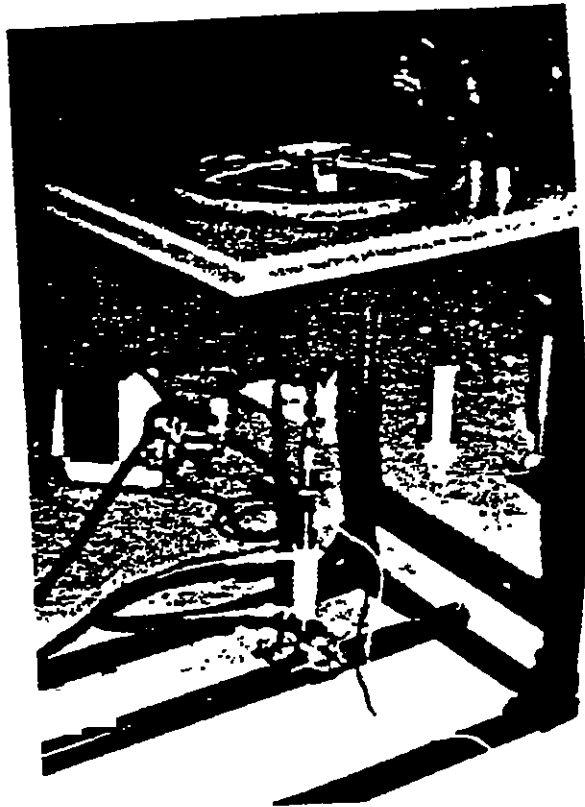

Figure 33. Rim Test Fixture

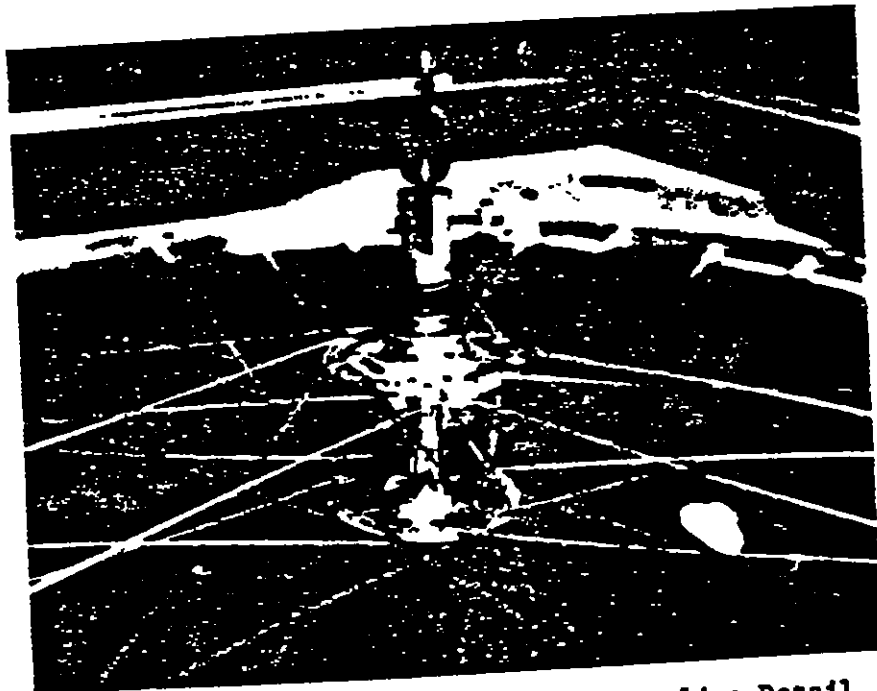

Figure 34. Rim Test Fixture-Axle Coupling Detail

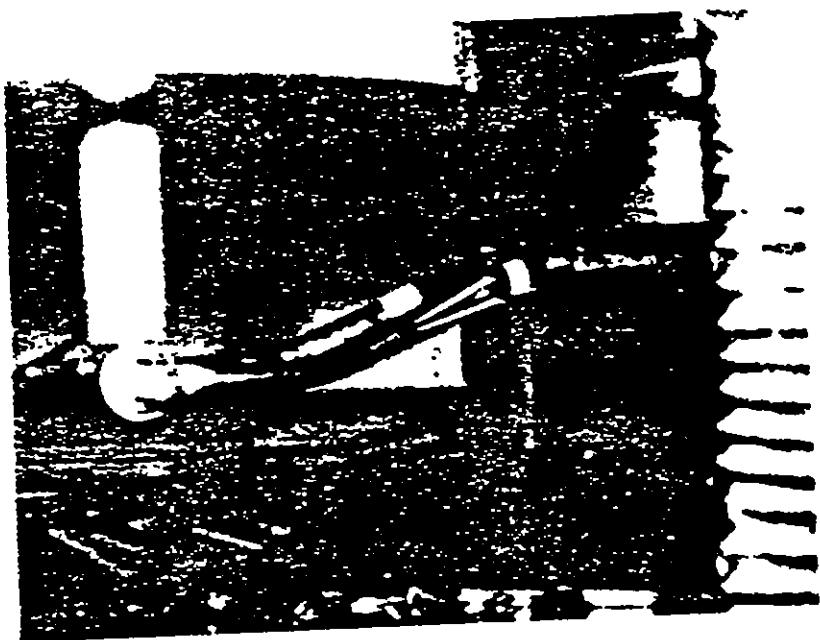

Figure 35. Fork Test Fixture

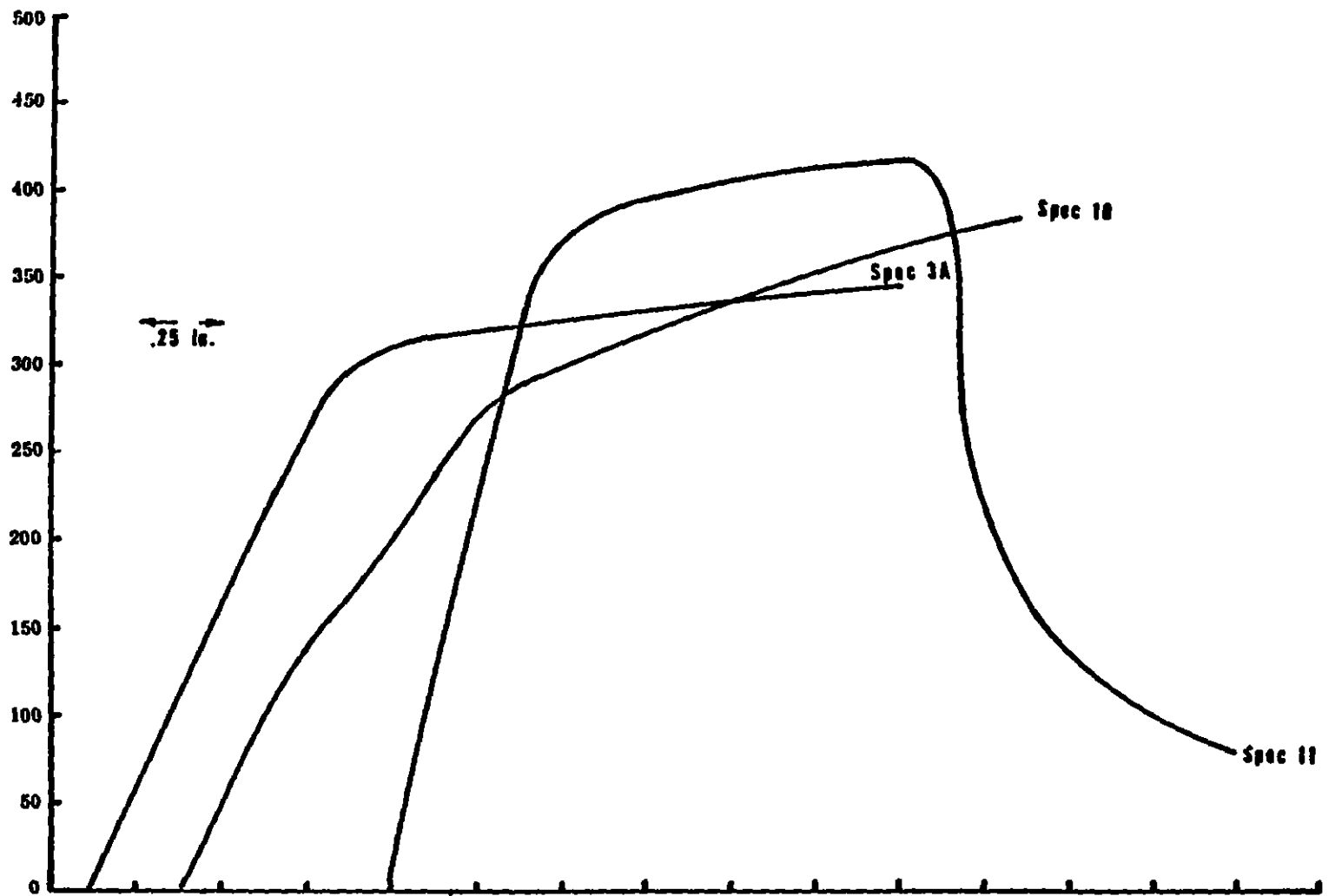

Figure 36. Typical Fork Test Load-Deflection Recordings

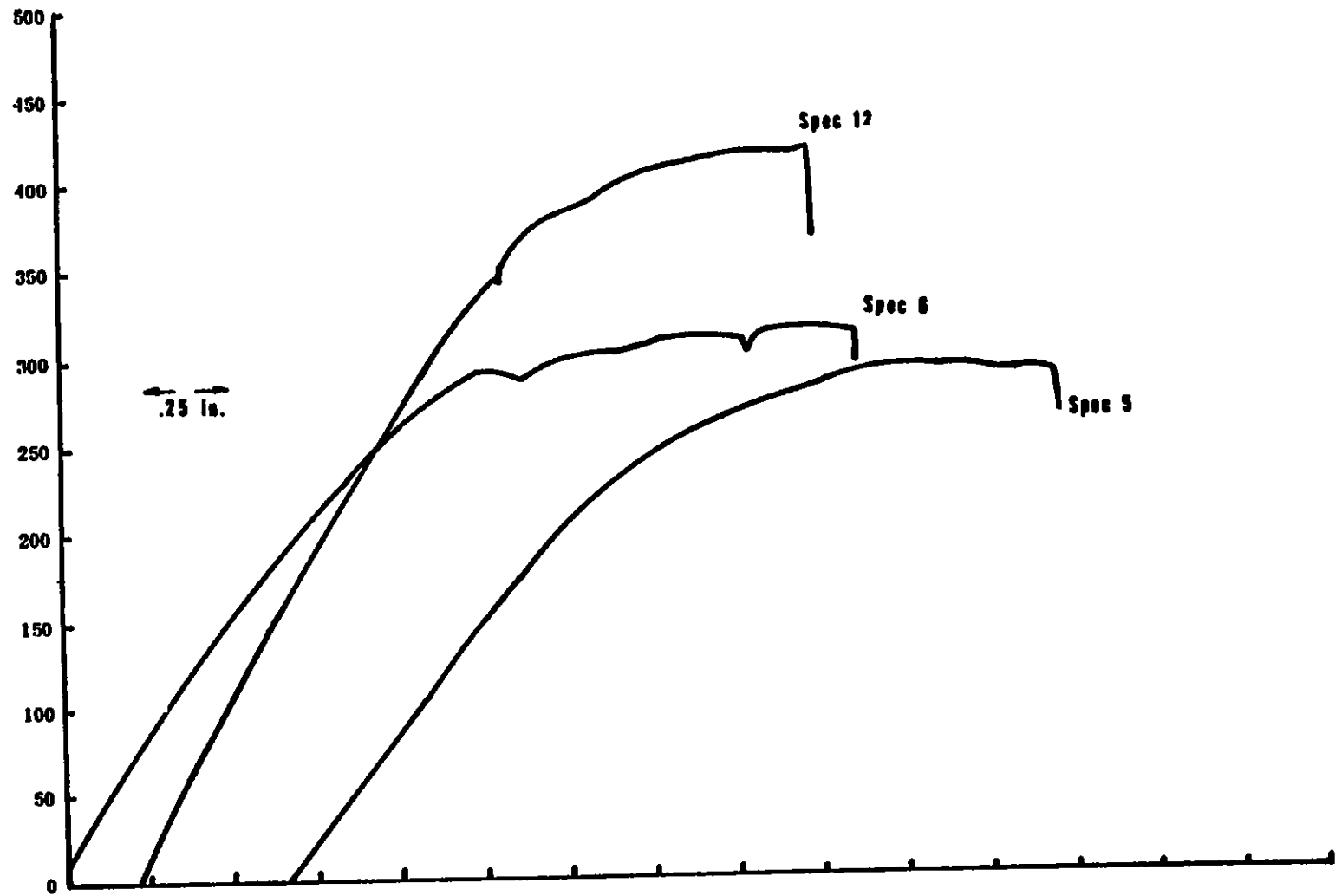

Figure 37. Typical Frame Test Load-Deflection Recordings

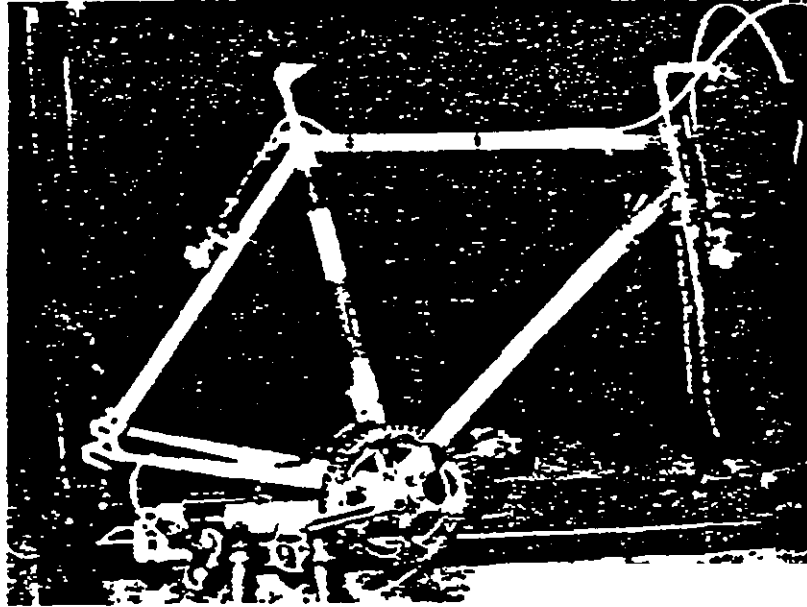

Figure 38. Frame Test Fixture

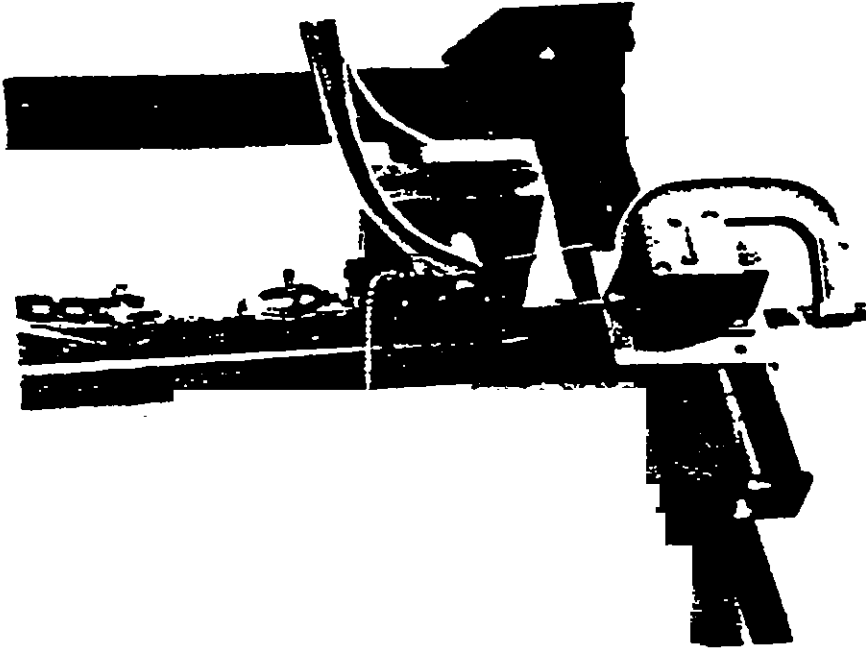

Figure 39. Frame Test-Front Fork Detail

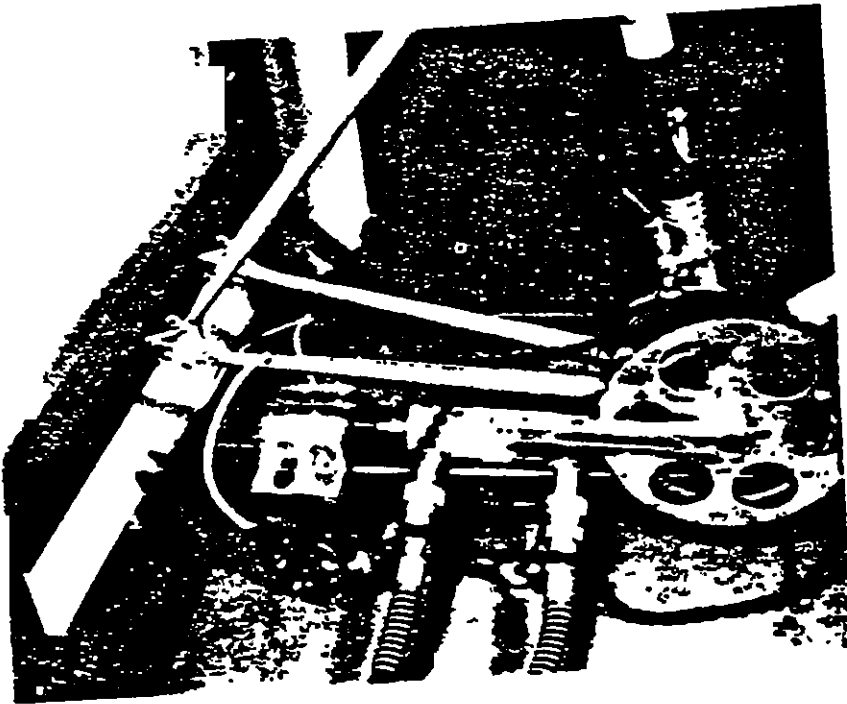

Figure 40. Frame Test-Rear Fork Detail



Figure 41. Seat Clamp Test-Vertical Loading

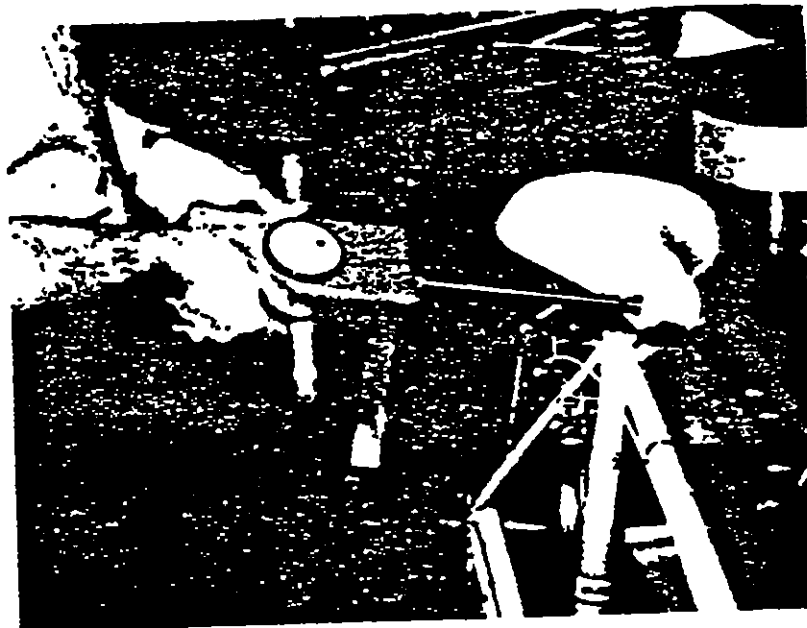

Figure 42. Seat Clamp Test-Horizontal Loading

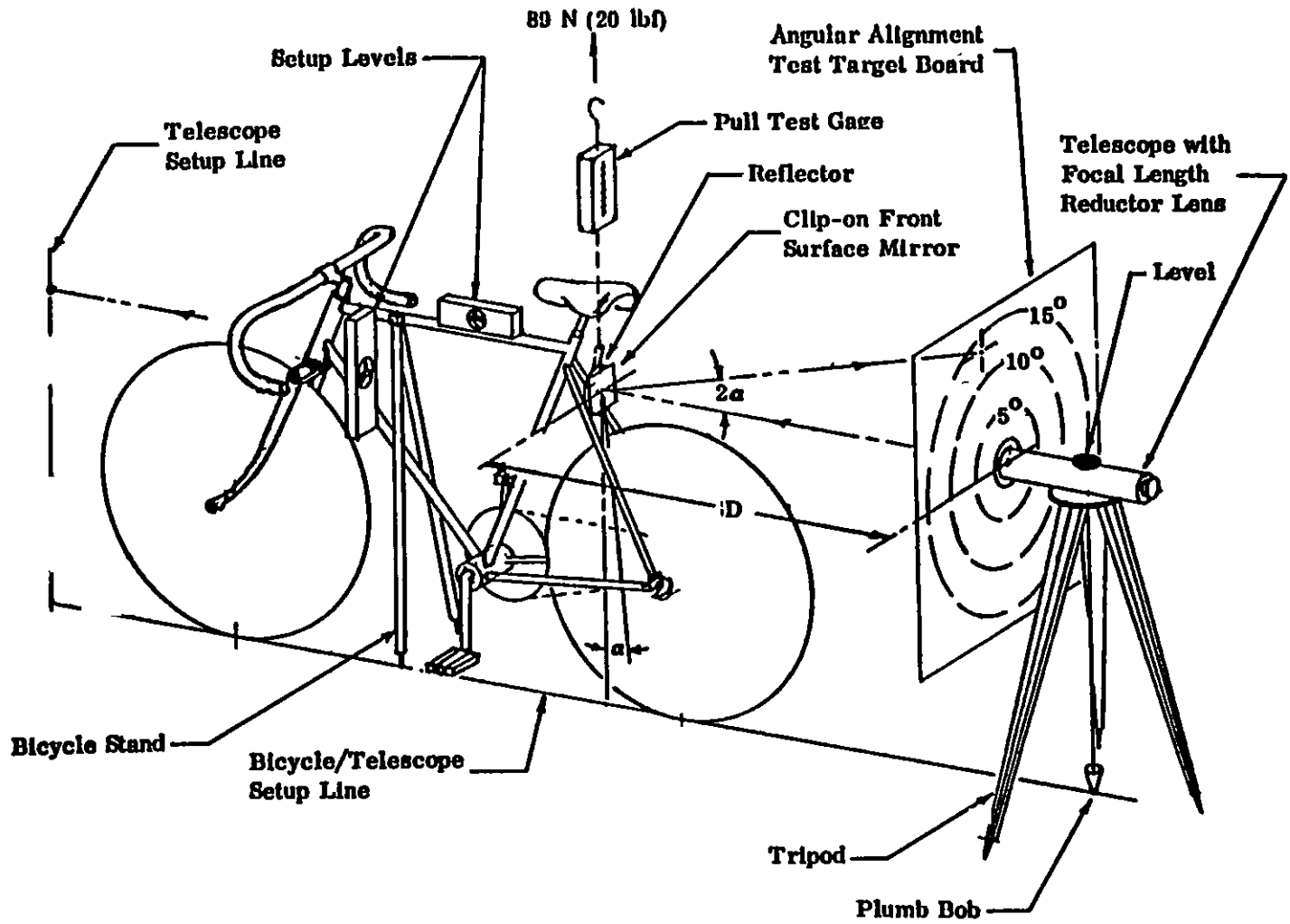

Figure 43. Reflection Mount and Alignment Test Arrangement

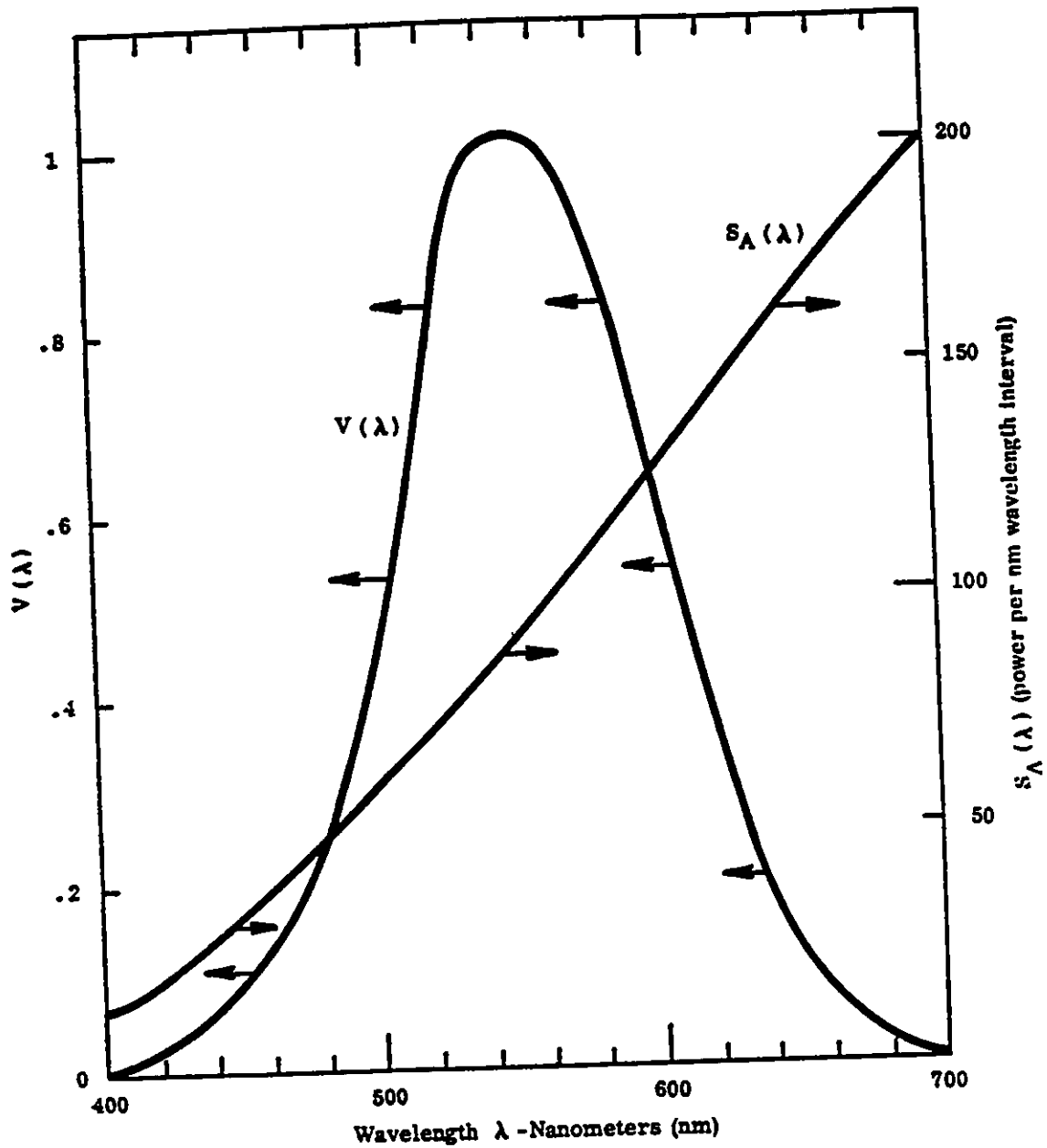

Figure 44. Representation of CIE Standard Observer and CIE Illuminant

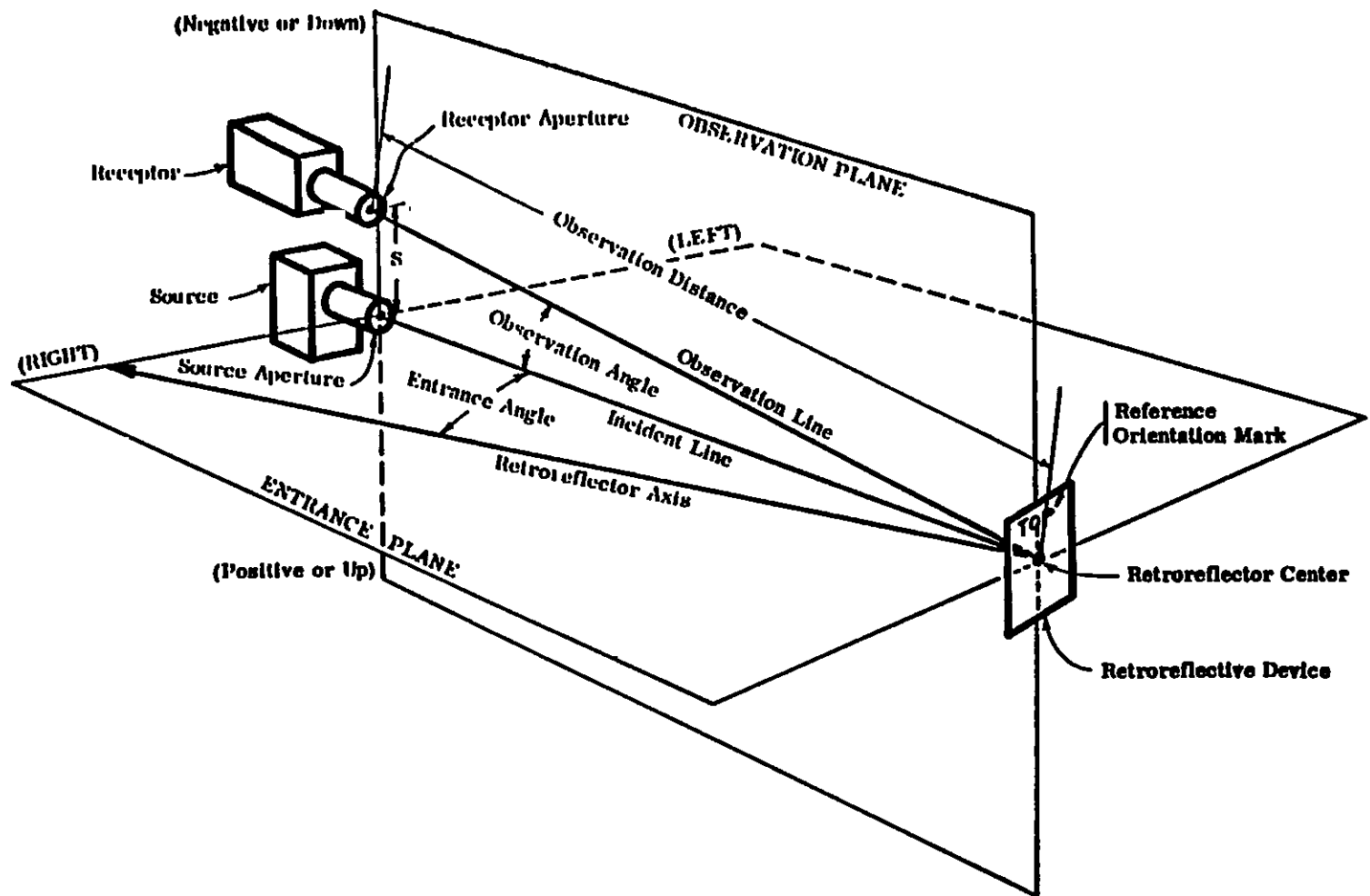

Figure 45. Reflection Test Instrumentation Arrangement

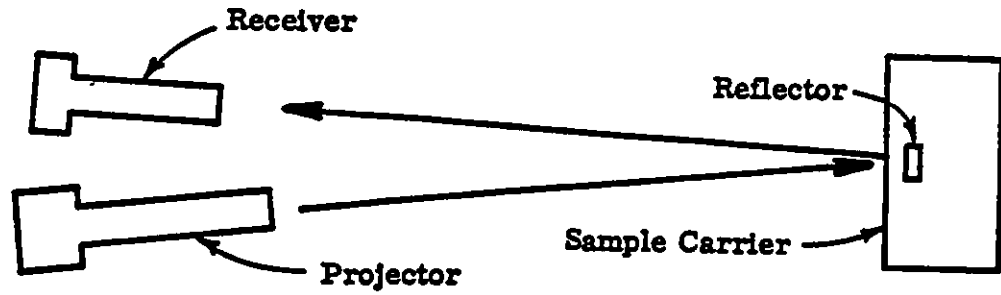

Figure 46. Arrangement of Major Components-Top View

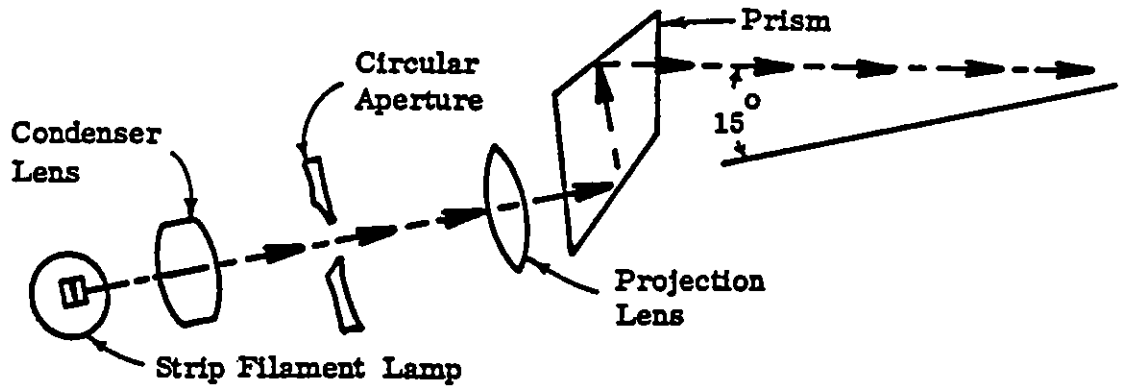

Figure 47. Optical Layout of Projector-Top View

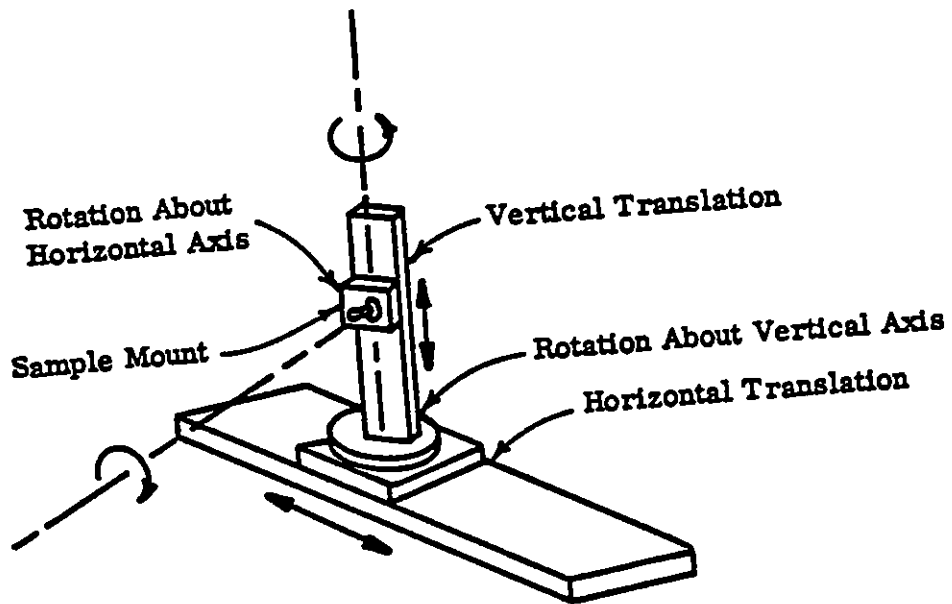

Figure 48. Sample Carrier Arrangement

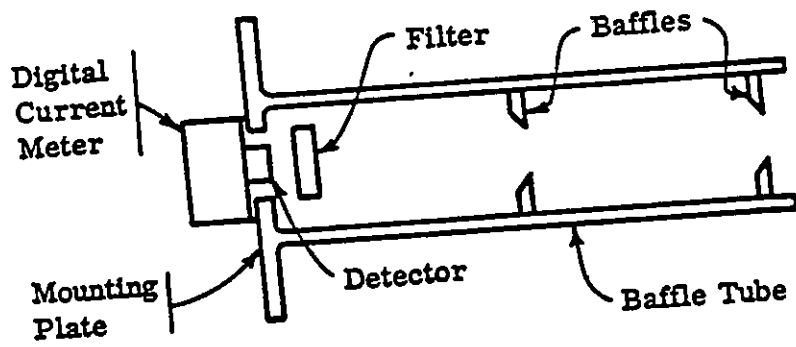

Figure 49. Section of Receiver

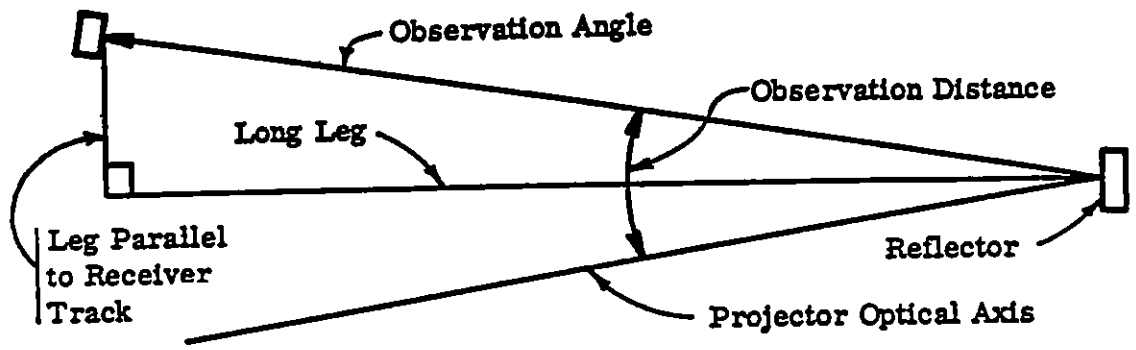

Figure 50. Alignment and Measurement Geometry

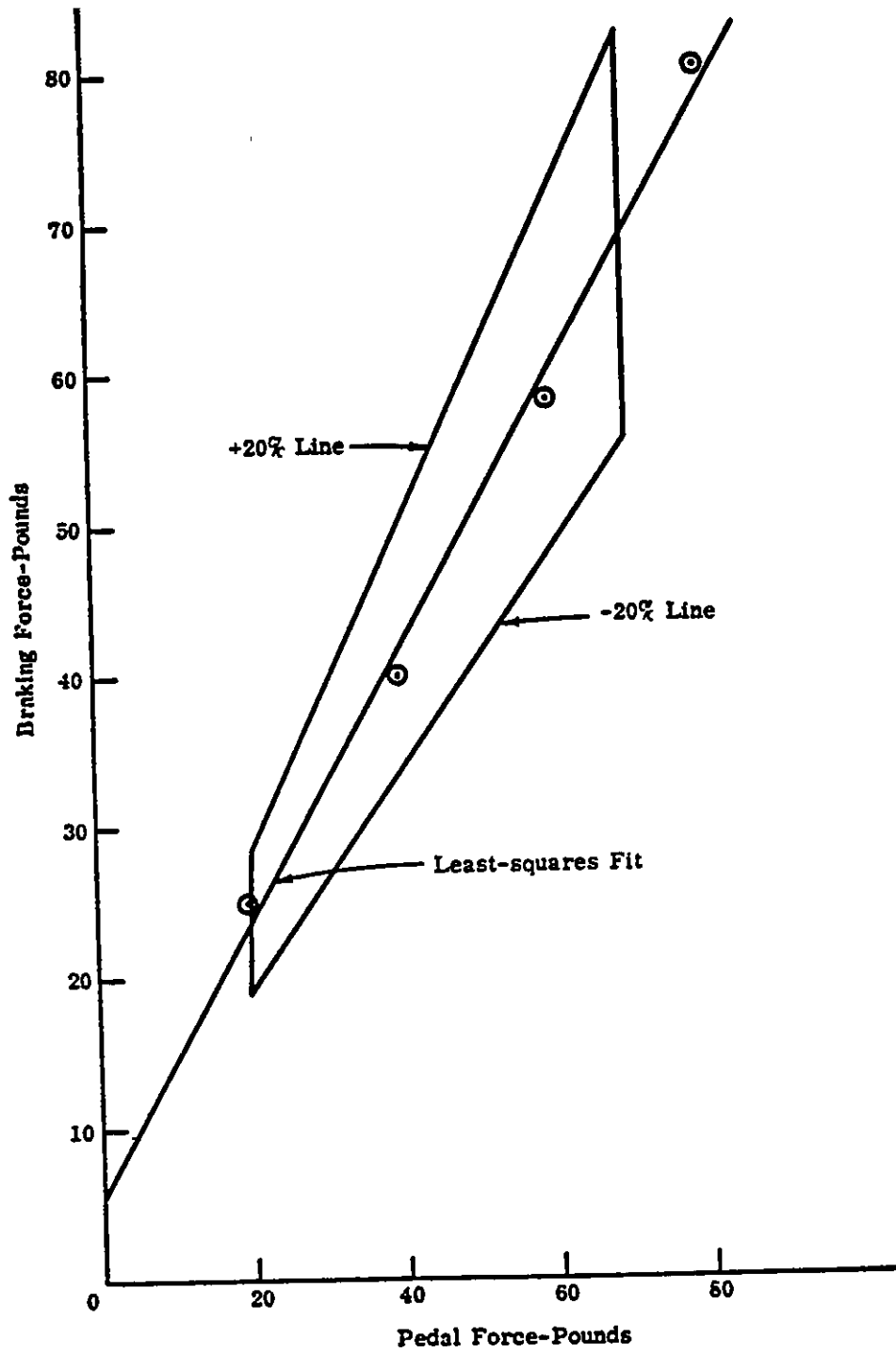

Figure 51. Sample Curve Fit Example

PLEASE PROVIDE YOUR NAME, ADDRESS AND TELEPHONE NUMBER AND WE WILL
SEND REVISIONS AS THEY BECOME AVAILABLE.

NAME _____

ADDRESS _____

TELEPHONE NUMBER _____

Send to: Consumer Product Safety Commission
 5401 Westbard Avenue
 Washington, D.C. 20207