

MCRP 3-40.3B
(Formerly MCRP 6-22C)

Radio Operator's Handbook



U.S. Marine Corps

PCN 144 00067 00

MCCDC (C 42)
10 Jul 2001

E R R A T U M

to

MCRP 3-40.3B

RADIO OPERATOR'S HANDBOOK

1. For administrative purposes, the publication short title has been reidentified. Change "MCRP 6-22C" to read: "MCRP 3-40.3B" of June 1999 wherever it appears in the Manual.

PCN 144 000067 80

DEPARTMENT OF THE NAVY
Headquarters United States Marine Corps
Washington, D.C. 20380-1775

2 June 1999

FOREWORD

Marine Corps Warfighting Publication (MCWP) 6-22, *Communications and Information Systems*, provides the doctrine and tactics, techniques, and procedures for the conduct of communications and information systems across the spectrum of Marine air-ground task force (MAGTF) operations. Marine Corps Reference Publication (MCRP) 6-22C, *Radio Operator's Handbook*, complements and expands upon this information by detailing doctrine, tactics, techniques, and procedures for operating single-channel high frequency (HF), very high frequency (VHF), and ultrahigh frequency (UHF) radios. The primary target audience for this publication is Marine Corps radio operators and other users of single-channel radios.

MCRP 6-22C describes—

- | Basic radio principles.
- | Single-channel radio.
- | Equipment sighting and grounding techniques.
- | Antennas.
- | Interference.
- | Radio operations under unusual conditions.
- | Electronic warfare.

MCRP 6-22C provides the requisite information needed by Marine radio operators to understand, plan, and execute successful single-channel radio operations in support of the MAGTF.

MCWP 6-22C supersedes FMFM 3-35, *Radio Operator's Handbook*, dated 26 September 1991.

Reviewed and approved this date.

BY DIRECTION OF THE COMMANDANT OF THE MARINE CORPS

J. E. RHODES
Lieutenant General, U.S. Marine Corps
Commanding General
Marine Corps Combat Development Command

DISTRIBUTION: 144 000067 00

Radio Operator's Handbook

Table of Contents

	Page
Chapter 1. Radio Principles	
Section I. Theory and Propagation	
Basic Components of Radio Equipment	1-2
Radio Waves	1-3
Radio Wave Propagation	1-6
Section II. Modulation and Single Side Band Transmission	
Modulation	1-14
Single Side Band Transmission	1-16
Chapter 2. Single-Channel Radio	
Single-Channel Radio Communications Equipment	2-1
High Frequency Radio	2-2
Very High Frequency Radio	2-6
Ultrahigh Frequency Radio	2-11
Data Communications	2-15
Chapter 3. Equipment Siting and Grounding Techniques	
High Frequency	3-1
Very High Frequency and Ultrahigh Frequency	3-3
Grounding Techniques	3-10
Data Communications	2-15
Chapter 4. Antennas	
High Frequency Antennas	4-1
Very High Frequency Antennas	4-6
Antenna Length	4-7

Chapter 5. Interference

Natural Interference	5-1
Manmade Interference	5-1
Poor Equipment Condition and Improper Usage	5-2
Frequency Interference and Intermodulation	5-2
Use of Unauthorized Frequencies	5-3
Frequency Reuse	5-3

Chapter 6. Radio Operations Under Unusual Conditions

Operations in Desert Areas	6-1
Operations in Jungle Areas	6-3
Operations in a Cold Weather Environment	6-5
Operations in Mountainous Areas	6-9
Operations in Special Environments	6-9

Chapter 7. Electronic Warfare

Electronic Attack Techniques	7-1
Electronic Protection Techniques	7-6
Electronic Warfare Support Techniques	7-10

Appendices

A Map Coordinates	A-1
B Time Zones	B-1
C Prowords	C-1
D Phonetic Alphabet	D-1
E Phonetic Numerals	E-1
F Prosigns	F-1
G Instructions for Preparing Field Messages	G-1
H Radio Log	H-1
I Metric System Conversion Table	I-1
J Authentication	J-1
K International Morse Code	K-1
L Frequency Prediction Means	L-1
M Position and Navigation Systems	M-1
N Size of Dipole and Inverted L Antennas	N-1
O Field Repair and Expedients	O-1
P Radio Operator's Checklist	P-1
Q Glossary	Q-1
R References and Related Publications	R-1

Chapter 1

Radio Principles

Communications and information systems (CIS) are any systems whose primary functions are to collect, process, or exchange information. The fundamental requirement is to provide the Marine air-ground task force (MAGTF) commander with a reliable, secure, fast, and flexible communications network.

Communications and information systems automate routine functions, thereby freeing commanders and staffs to focus on those aspects of command and control that require experience, judgment, and intuition.

These systems and the personnel who install, operate, and maintain them play a key role in the command and control of the MAGTF. Communications and information systems support the commander and every staff section in every phase of operations planning and execution.

These systems facilitate information flow throughout the MAGTF and provide shared situational awareness, informed decisionmaking, and rapid dissemination of decisions.

The success of the MAGTF in the modern battlespace depends on the effective employment of communications and information systems. Single-channel radio (SCR) is one of the most important components of MAGTF CIS.

Section I. Theory and Propagation

BASIC COMPONENTS OF RADIO EQUIPMENT

The radio equipment for communication between two stations and the path the signal follows through the air is called a radio link. A radio link consists of seven components: the transmitter, power supply, transmission lines, transmitting antenna, propagation path, receiving antenna, and receiver (see figure 1-1).

The transmitter generates a radio signal. The power supply (i.e., battery or generator) supplies power for the operating voltage of the radio. The transmission line delivers the signal from the transmitter to the antenna.

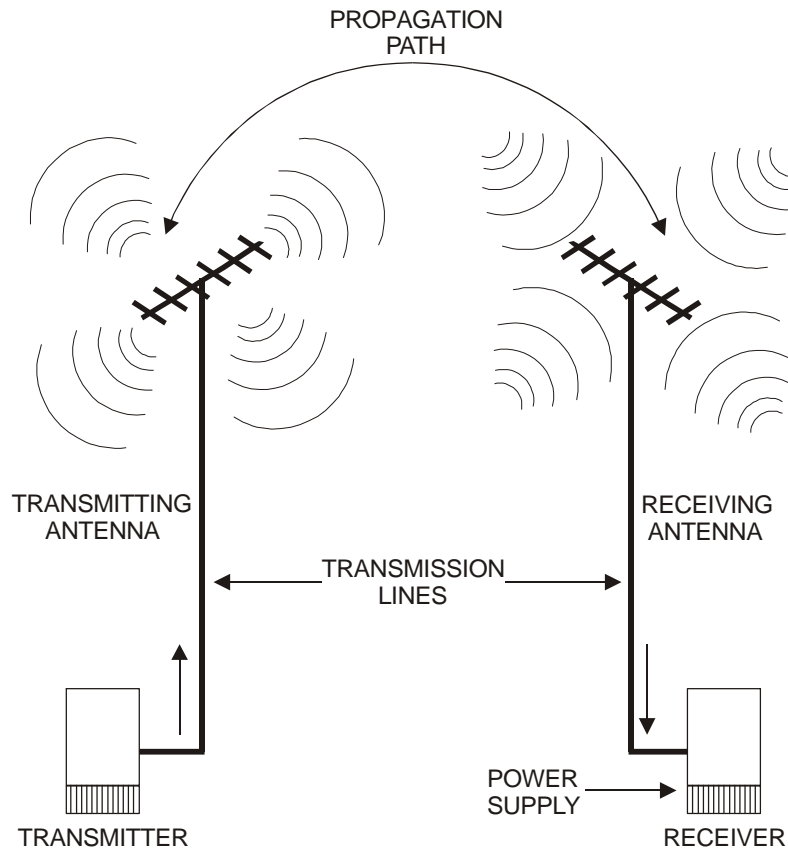

Figure 1-1. Radio Link.

The transmitting antenna sends the radio signal into space toward the receiving antenna. The path in space that the radio signal follows as it goes to the receiving antenna is the propagation path. The receiving antenna intercepts or receives the signal and sends it through a transmission line to the receiver. The receiver processes the radio signal so the human ear can hear it.

When transmitting, the radio operator aims to provide the strongest possible signal at the site of the receiving station. The best possible signal is that signal which will provide the greatest signal-to-noise ratio at the receiving antenna.

To transmit the best possible signal, select or determine the—

- 1 Optimum frequency.
- 1 Best antenna for that frequency based on the available space of the transmitting site.
- 1 Proper propagation path.

RADIO WAVES

Propagation Velocity (Speed)

Radio waves travel near the surface of the Earth and radiate skyward at various angles to the Earth's surface. These electromagnetic waves travel through space at the speed of light, approximately 300,000 kilometers (km) or 186,000 miles (mi) per second.

Wavelength

Wavelength is the distance between the crest of one wave and the crest of the next wave (see figure 1-2 on page 1-4). It can also be the length of one complete cycle of the waveform. It is also the distance traveled during one complete cycle. The length of the wave is always measured in meters.

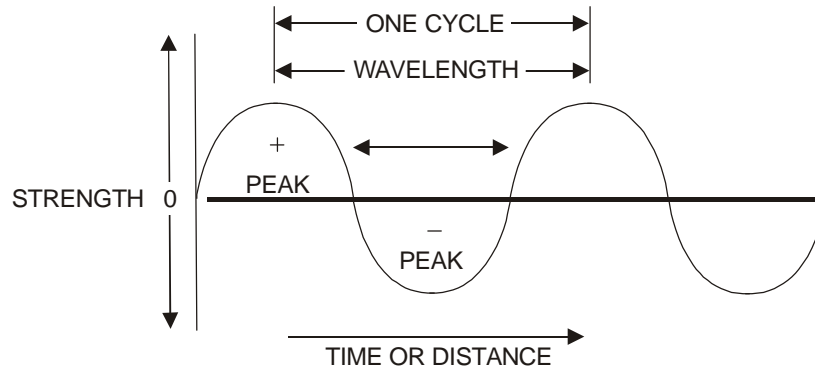

Figure 1-2. Radio Waves.

Radio Frequency

The frequency of a radio wave is the number of complete cycles that occur in one second. The longer the cycle, the longer the wavelength and the lower the frequency. The shorter the cycle, the shorter the wavelength and the higher the frequency. Frequency is measured and stated in units called hertz (Hz). One cycle per second is stated as 1 hertz. Because the frequency of a radio wave is very high, it is generally measured and stated in thousands of hertz (kilohertz [KHz]) or in millions of hertz (megahertz [MHz]). One KHz is equal to 1,000 cycles per second, and 1 MHz is equal to a million cycles per second. Sometimes frequencies are expressed in billions of hertz (gigahertz [GHz]). One GHz is equal to a billion cycles per second.

For practical purposes, the velocity of a radio wave is considered to be constant, regardless of the frequency or the amplitude of the transmitted wave. Therefore, to find the frequency when the wavelength is known, divide the velocity by the wavelength.

$$\text{Frequency (hertz)} = \frac{300 \text{ million (meters per second)}}{\text{Wavelength (meters)}}$$

To find the wavelength when the frequency is known, divide the velocity by the frequency.

$$\text{Wavelength (meters)} = \frac{300 \text{ million (meters per second)}}{\text{Frequency (hertz)}}$$

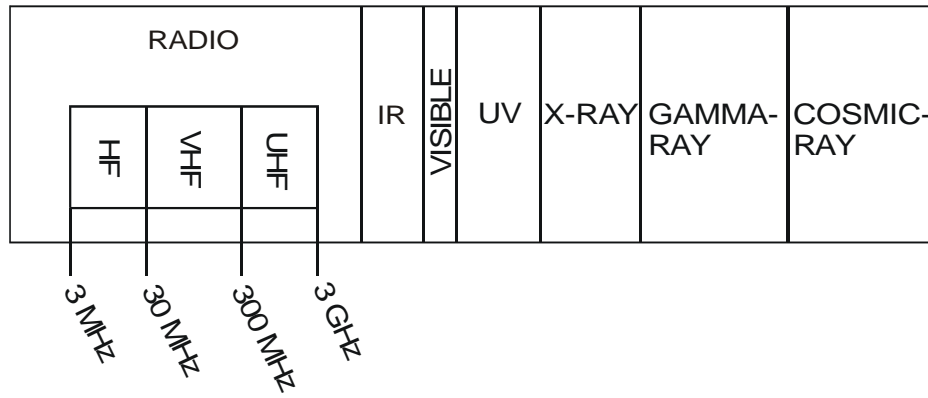

Figure 1-3. Electromagnetic Spectrum.

Within the radio frequency spectrum (see figure 1-3), radio frequencies are divided into groups or bands of frequencies. The radio frequency spectrum is part of the electromagnetic spectrum. Most tactical radio sets operate within a 2- to 400-MHz range within the frequency spectrum.

Each frequency band has certain characteristics. The ranges and power requirements shown in table 1-1 are for normal operating conditions (proper siting and antenna orientation and correct operating procedures). The ranges will change according to the condition of the propagation medium and the transmitter output power.

Table 1-1. Frequency Range Characteristics.

Band	Ground Wave Range	Sky Wave Range	Power Required
HF	0-50 miles	100-8000 miles	.5-5 kW
VHF	0-30 miles	50-150 miles	.5 or less kW
UHF	0-50 miles	N/A	.5 or less kW

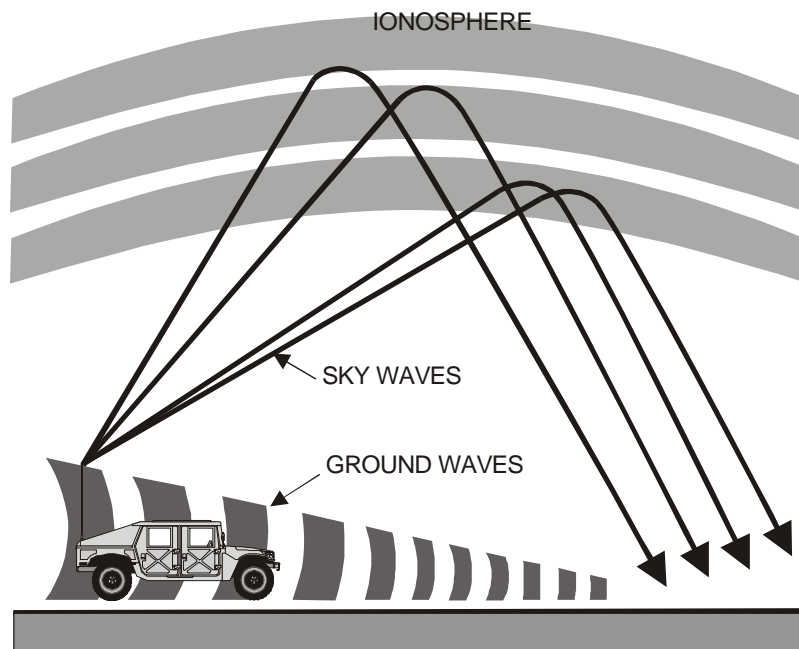

Figure 1-4. Principle Paths of Radio Waves.

RADIO WAVE PROPAGATION

There are two principal paths by which radio waves travel from a transmitter to the receiver (See figure 1-4): ground wave—which travels directly from the transmitter to the receiver and sky wave—which travels up to the ionosphere and is refracted (i.e., bent downward) back to the Earth. Short-distance, ultrahigh frequency (UHF), and upper very high frequency (VHF) transmissions are by ground waves. Long-distance, high frequency (HF) transmission is principally by sky waves. Single-channel radio sets can use ground wave or sky wave propagation for communications.

Ground Wave Propagation

Radio communications which use ground wave propagation do not use or depend on waves that are refracted from the ionosphere (i.e., sky waves). Ground wave propagation is affected by the electrical characteristics of the Earth and by the amount of diffraction (i.e., bending) of the

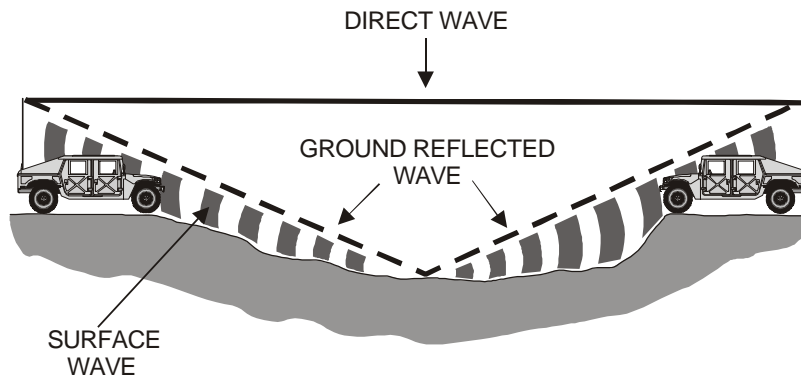

Figure 1-5. Ground Wave Propagation.

waves along the curvature of the Earth. The strength of the ground wave at the receiver depends on the power output and frequency of the transmitter, the shape and conductivity of Earth along the transmission path, and the local weather. The following paragraphs describe the components of a ground wave. See figure 1-5.

Direct Wave. The direct wave is that part of the radio wave which travels directly from the transmitting antenna to the receiving antenna. This part of the wave is limited to the line of sight (LOS) distance between the transmitting and receiving antennas, plus the small distance added by atmospheric refraction and diffraction of the wave around the curvature of the Earth. This distance can be extended by increasing the height of the transmitting antenna, the receiving antenna, or both.

Ground Reflected Wave. The ground reflected wave is that portion of the radio wave which reaches the receiving antenna after being reflected from the surface of the earth. Cancellation of the radio signal can occur when the ground reflected component and the direct wave component arrive at the receiving antenna at the same time and are 180° out of phase with each other.

Surface Wave. The surface wave, which follows the curvature of the Earth, is that part of the ground wave which is affected by the conductivity and dielectric constant of the Earth.

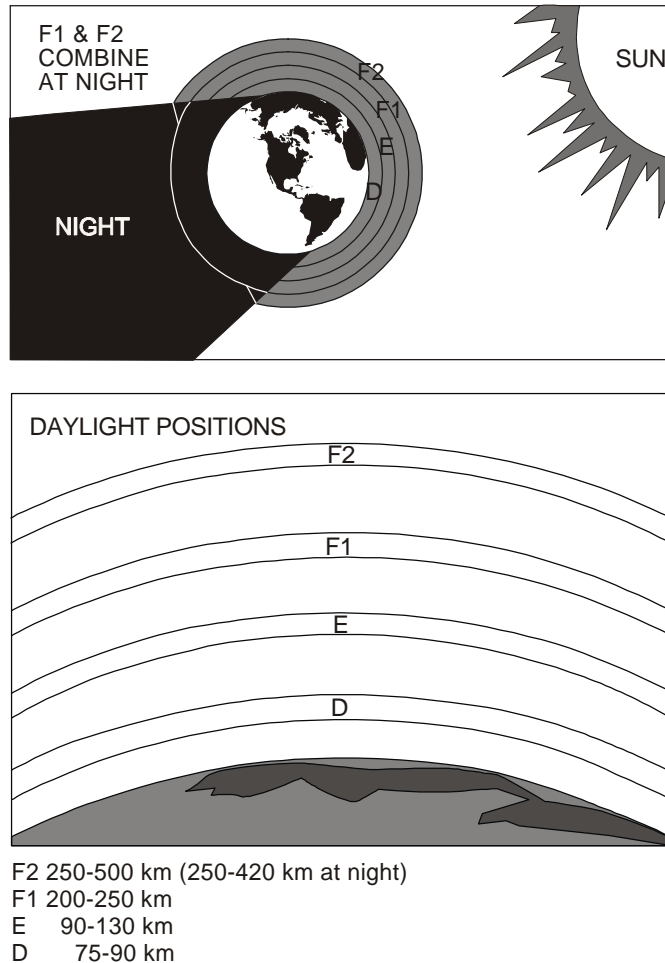

Figure 1-6. Layers of the Ionosphere.

Sky Wave Propagation

Radio communications that use sky wave propagation depend on the ionosphere to provide the signal path between the transmitting and receiving antennas.

Ionospheric Structure. The ionosphere has four layers (see fig. 1-6). In order of increasing heights and decreasing molecular densities, these layers are labeled D, E, F1, and F2. During the day, when the rays of the

Sun are directed toward that portion of the atmosphere, all four layers may be present. At night, the F1 and F2 layers seem to merge into a single F layer, and the D and E layers fade out. The actual number of layers, their height above the Earth, and their relative intensity of ionization varies constantly. The following are layers of the ionosphere:

- 1 D—exists only during daylight hours and has little effect in bending the paths of high frequency radio waves. The main effect of the D layer is to attenuate high frequency waves when the transmission path is in sunlit regions.
- 1 E—used during the day for high frequency radio transmission over intermediate distances (less than 2,400 km [1,500 mi]). At night, the intensity of the E layer decreases, and it becomes useless for radio transmission.
- 1 F—exists at heights up to 380 kilometers (240 mi) above the Earth and is ionized all the time. It has two well-defined layers (F1 and F2) during the day, and one layer (i.e., F) during the night. At night, the F layer remains at a height of about 260 kilometers (170 mi) and is useful for long-range radio communications (over 2,400 km [1,500 mi]). The F2 layer is the most useful of all layers for long-range radio communications, even though its degree of ionization varies appreciably from day to day.

Factors Affecting the Ionosphere. The movements of the Earth around the Sun and changes in the Sun's activity contribute to ionospheric variations. There are two main classes of variations: regular, which is predictable; and irregular, which occurs from abnormal behavior of the Sun.

Regular Variations of the Ionosphere. The regular variations are—

- 1 Daily—caused by the rotation of the Earth.
- 1 Seasonal—caused by the north and south progression of the Sun.
- 1 27-day—caused by the rotation of the Sun on its axis.
- 1 11-year—caused by the sunspot activity cycle going from maximum to minimum, back to maximum levels of intensity.

Irregular Variations of the Ionosphere. The current status of the four regular variations must be anticipated when planning a communications system. There are also unpredictable, irregular variations that must be considered. They have a degrading effect (at times blocking communications) which cannot be controlled or compensated for at present. Some irregular variations are—

- 1 Sporadic E. When it is excessively ionized, the E layer often blocks out the reflections back from the higher layers. It can also cause unexpected propagation of signals hundreds of miles beyond the normal range. This effect can occur at any time.
- 1 Sudden ionospheric disturbance (SID). A sudden ionospheric disturbance coincides with a bright solar eruption and causes abnormal ionization of the D layer. This effect causes total absorption of all frequencies above approximately 1 MHz. It can occur without warning during daylight hours and last from a few minutes to several hours. When SID occurs, receivers seem to go dead.
- 1 Ionospheric storms. During these storms, sky wave reception above approximately 1.5 MHz shows low intensity and is subject to a type of rapid blasting and fading called “flutter fading.” These storms may last from several hours to days and usually extend over the entire Earth.

Sunspots. Sunspots generate bursts of radiation that cause high levels of ionization. The more sunspots, the greater the ionization. During periods of low sunspot activity, frequencies above 20 MHz tend to be unusable because the E and F layers are too weakly ionized to reflect signals back to earth. At the peak of the sunspot cycle, however, it is not unusual to have worldwide propagation on frequencies above 30 MHz.

Frequency Characteristics in the Ionosphere. The range of long-distance radio transmission is determined primarily by the ionization density of each layer. The higher the frequency, the greater the ionization density required to reflect radio waves back to Earth. The upper (i.e., E and F) layers reflect the higher frequencies because they are the most highly ionized. The D layer, which is the least ionized, does not reflect frequencies above approximately 500 KHz. Thus, at any given time and for each

ionized layer, there is an upper frequency limit at which radio waves sent vertically upward are reflected back to Earth. This limit is called the critical frequency.

Radio waves directed vertically at frequencies higher than the critical frequency pass through the ionized layer out into space. All radio waves directed vertically into the ionosphere at frequencies lower than the critical frequency are reflected back to Earth. Radio waves used in communications are generally directed towards the ionosphere at some oblique angle, called the angle of incidence. Radio waves at frequencies above the critical frequency will be reflected back to Earth if transmitted at angles of incidence smaller than a certain angle, called the critical angle. At the critical angle and all angles larger than the critical angle the radio waves will pass through the ionosphere if the frequency is higher than the critical frequency. When the angle of transmission becomes smaller, the radio waves will be reflected back to Earth.

Transmission Paths. The distance from the transmitting antenna to the place where the sky waves first return to Earth is called the skip distance. The skip distance is dependent on the angle of incidence, the operating frequency, and the height and density of the ionosphere. The antenna height, in relation to the operating frequency, affects the angle that transmitted radio waves strike and penetrate the ionosphere and then return to Earth. This angle of incidence can be controlled to obtain the desired area of coverage. Lowering the antenna will increase the angle of transmission and provide broad and even signal patterns in a large area. The use of near-vertical transmission paths is known as near-vertical incidence sky wave (NVIS). Raising the antenna will lower the angle of incidence. Lowering the angle of incidence can produce a skip zone in which no usable signal can be received. This area is bounded by the outer edge of usable ground wave propagation and the point nearest the antenna at which the sky wave returns to Earth. In most communications situations, the skip zone is not a desirable condition. However, low angles of incidence make long-distance communications possible.

When a transmitted wave is reflected back to the surface of the Earth, part of its energy is absorbed by the Earth. The remainder of its energy is reflected back into the ionosphere to be reflected back again. This means

of transmission—by alternately reflecting the radio wave between the ionosphere and the Earth—is called hops, and it enables radio waves to be received at great distances from the point of origin.

Maximum Usable and Lowest Usable Frequencies. There is a maximum frequency at which a radio wave will return to Earth at a given distance when a given ionized layer and a transmitting antenna with a fixed angle of radiation is used. This frequency is called the maximum usable frequency (MUF). It is the monthly median of the daily highest frequency that is predicted for sky wave transmission over a particular path at a particular hour of the day. The MUF is always higher than the critical frequency because the angle of incidence is less than 90° . If the distance between the transmitter and the receiver is increased, the maximum usable frequency will also increase. Radio waves lose some of their energy through absorption by the D layer and the portion of the E layer of the ionosphere at certain transmission frequencies.

The total absorption is less and communications are more satisfactory as higher frequencies are used up to the level of the MUF. The absorption rate is greatest for frequencies ranging from approximately 500 KHz to 2 MHz during the day. At night, the absorption rate decreases for all frequencies. As the frequency of transmission over any sky wave path is decreased from high to low frequencies, a frequency will be reached at which the received signal just overrides the level of atmospheric and other radio noise interference. This is called the lowest useful frequency (LUF) because frequencies lower than the LUF are too weak for useful communications. The LUF also depends on the power output of the transmitter as well as the transmission distance. When the LUF is greater than the MUF, no sky wave transmission is possible.

Section II. Modulation and Single Side Band Transmission

Radio communications equipment is used primarily to transmit voice and data. Although sound can be converted to audio frequency electrical energy, it is not practical to transmit it in this energy form through the Earth's atmosphere by electromagnetic radiation. For example, efficient transmission of a 20-hertz audio signal would require an antenna almost 8,000 kilometers (5,000 mi) long. This would not apply when radio frequency electrical energy is used to carry the intelligence. When radio frequency electrical energy is used, great distances can be covered; efficient antennas for radio frequencies are of practical lengths; and antenna power losses are at reasonable levels.

The frequency of the radio wave affects its propagation characteristics. In the low frequency band (.03 to 3 MHz), the ground wave is very useful for communications over great distances. The ground wave signals are quite stable and show little seasonal variation. In the medium frequency band (.3 to 3.0 MHz), the range of the ground wave varies from about 24 kilometers (15 mi) at 3 MHz, to about 640 kilometers (400 mi) at the lowest frequencies of this band. Sky wave reception is possible during the day or night at any of the lower frequencies in this band. At night, the sky wave is receivable at distances up to 12,870 kilometers (8,000 mi). In the high frequency band (3 to 30 MHz), the range of the ground wave decreases as frequency increases, and the sky waves are greatly influenced by ionospheric considerations.

In the very high frequency band (30 to 300 MHz), there is no usable ground wave and only slight refraction of sky waves by the ionosphere at the lower frequencies. The direct wave provides communications if the transmitting and receiving antennas are elevated high enough above the surface of the Earth.

In the ultrahigh frequency band (300 to 3,000 MHz), the direct wave must be used for all transmissions. Communications are limited to a short distance beyond the horizon. Lack of static and fading in these bands makes line of sight reception very satisfactory. Antennas that are highly directional can be used to concentrate the beam of radio frequency (RF) energy, thus, increasing the signal intensity.

MODULATION

Both amplitude modulation (AM) and frequency modulation (FM) transmitters produce RF carriers. The carrier is a wave of constant amplitude, frequency, and phase which can be modulated by changing its amplitude, frequency, or phase. Thus, the RF carrier “carries” intelligence by being modulated. Modulation is the process of superimposing intelligence (voice or coded signals) on the carrier.

Amplitude Modulation

Amplitude modulation is the variation of the RF power output of a transmitter at an audio rate. In other words, the RF energy increases and decreases in power according to the audio frequencies superimposed on the carrier signal.

When audio frequency signals are superimposed on the radio frequency carrier signal, additional RF signals are generated. These additional frequencies are equal to the sum of, and the difference between the audio frequencies and the radio frequency used. For example, assume a 500-KHz carrier is modulated by a 1-KHz audio tone. Two new frequencies are developed, one at 501 KHz (the sum of 500 KHz and 1 KHz) and the other at 499 KHz (the difference between 500 KHz and 1 KHz). If a complex audio signal is used instead of a single tone, two new frequencies will be set up for each of the audio frequencies involved. The new frequencies resulting from superimposing an audio frequency (AF) signal on an RF signal are called side bands.

When the RF carrier is modulated by complex tones such as speech, each separate frequency component of the modulating signal produces its own upper and lower side band frequencies. The side band that contains the sum of the RF and AF signals is called the upper side band. The side band that contains the difference between the RF and AF signals is called the lower side band.

The space occupied by a carrier and its associated side bands in the radio frequency spectrum is called a channel. In amplitude modulation, the width of the channel (bandwidth) is equal to twice the highest

modulating frequency. For example, if a 5,000 KHz (5 MHz) carrier is modulated by a band of frequencies ranging from 200 to 5,000 cycles (.2 to 5 KHz), the upper side band extends from 5,000.2 to 5,005 KHz. The lower side band extends from 4,999.8 KHz to 4,995 KHz. Thus, the bandwidth is the difference between 5,005 KHz and 4,995 KHz, a total of 10 KHz.

Frequency Modulation

Frequency modulation is the process of varying the frequency (rather than the amplitude) of the carrier signal in accordance with the variations of the modulating signals. The amplitude or power of the FM carrier does not vary during modulation.

The frequency of the carrier signal when it is not modulated is called the center or rest frequency. When a modulating signal is applied to the carrier, the carrier signal will move up and down in frequency, away from the center or rest frequency.

The amplitude of the modulating signal determines how far away from the center frequency the carrier will move. This movement of the carrier is called deviation; how far the carrier moves is called the amount of deviation. During reception of the FM signal, the amount of deviation determines the loudness or volume of the signal.

The FM signal leaving the transmitting antenna is constant in amplitude but varies in frequency according to the audio signal. As the signal travels to the receiving antenna, it picks up natural and man-made electrical noises that cause amplitude variations in the signal. All of these undesirable amplitude variations are amplified as the signal passes through successive stages of the receiver until the signal reaches a part of the receiver called the limiter. The limiter is unique to FM receivers as is the discriminator.

The limiter eliminates the amplitude variations in the signal, then passes it on to the discriminator which is sensitive to variations in the frequency of the RF wave. The resultant constant amplitude, frequency-modulated signal is then processed by the discriminator circuit which changes the

frequency variations into corresponding voltage amplitude variations. These voltage variations reproduce the original modulating signal in a headset, loudspeaker, or teletypewriter. Frequency modulation is generally used by radiotelephone transmitters operating in the VHF and higher frequency bands.

SINGLE SIDE BAND TRANSMISSION

The intelligence of an AM signal is contained solely in the side bands. Each side band contains all the intelligence needed for communications. Therefore, one side band and the carrier signal can be eliminated. This is the principle on which single side band (SSB) communications is based. Although both side bands are generated within the modulation circuitry of the SSB radio set, the carrier and one side band are removed before any signal is transmitted.

The side band that is higher in frequency than the carrier is called the upper side band (USB). The side band that is lower in frequency than the carrier is called the lower side band (LSB). Either side band can be used for communications as long as both the transmitter and the receiver are adjusted to the same side band. Most SSB equipment operates in the USB mode. The transmission of only one side band leaves open that portion of the RF spectrum normally occupied by the other side band of an AM signal. This allows more emitters to be used within a given frequency range.

Single side band transmission is used in applications when it is desired to—

- 1 Obtain greater reliability.
- 1 Limit size and weight of equipment.
- 1 Increase effective output without increasing antenna voltage.
- 1 Operate a large number of radio sets without heterodyne interference (e.g., whistles and squeals) from radio frequency carriers.
- 1 Operate over long ranges without loss of intelligibility because of selective fading.

Chapter 2

Single-Channel Radio

SINGLE-CHANNEL RADIO COMMUNICATIONS EQUIPMENT

Single-channel radio is the principal means of communications support for MAGTF maneuver units. SCR communications equipment is easy to operate. The networks are easily established, rapidly reconfigured, and, most importantly, easily maintained on the move. SCR provides secure voice communications and supports limited data information exchange. SCR in the VHF and UHF bands is normally limited to line of sight. In the HF band, SCR can support long-range communications. SCR satellite communications (SATCOM) provides mobility, flexibility, and ease of operation with unlimited range. Limitations of SCR include susceptibility to enemy electronic warfare (i.e., cosite, terrain, and atmospheric interference); the requirement for close coordination and detailed planning (i.e., a need for common timing, frequency, and equipment); and limited spectrum availability. The latter is particularly critical in the case of SATCOM.

MAGTF SCR equipment is fielded in many configurations and includes hand-held, manpack, vehicle-mounted, bench-mounted, and sheltered radios. These radios operate in simplex and half-duplex modes. The most widely employed tactical radios provide integrated communications security (COMSEC) and jam resistance through frequency hopping. Tactical SCRs operate in the three military radio frequency bands shown in Table 2-1 on page 1-2.

Table 2-1. SCR Equipment.

Frequency Band	MAGTF SCR Equipment Used	Operating Frequency Range	Typical Application
HF	AN/PRC-104 AN/GRC-193 AN/MRC-138 AN/TSC-120	2-29.999 MHz	Radio line of sight and beyond/long range
VHF	AN/VRC-12 family: AN/PRC-68 AN/PRC-77 SINGARS family: AN/PRC-119 AN/VRC-88 (A, D) AN/VRC-89 (A, D) AN/VRC-90 (A, D) AN/VRC-91 (A, D) AN/VRC-92 (A, D) AN/GRC-213 AN/MRC-145	30-88 MHz	Radio line of sight and relay/retransmission
	AN/PRC-113 AN/VRC-83	116-150 MHz	Critical line of sight (ground to air)
UHF	AN/PRC-113 AN/VRC-83 AN/GRC-171	225-400 MHz	Critical line of sight (ground to air)
	AN/PSC-3 AN/PSC-5		SATCOM footprint

HIGH FREQUENCY RADIO

HF radio equipment is capable of both long- and short-range secure voice and data communications. Data communications capability is typically limited to rates of 2.4 kilobits per second (kbps). Data transmission requires modems specifically designed for operation in this band of the radio spectrum. The AN/PRC-104 is capable of remote operation by using the analog AN/GRA-39B radio remote control. See fig. 2-1.

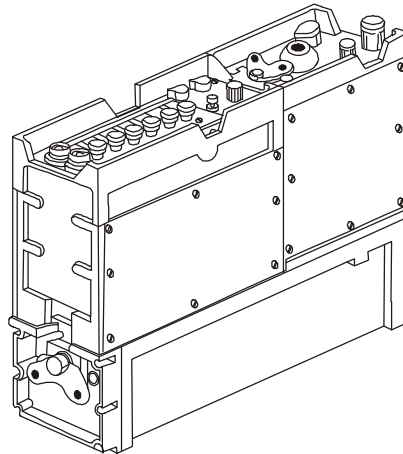

Figure 2-1. AN/PRC-104 HF Radio.

High frequency communications are capable of traveling around the world under the right conditions. This accounts for the large number of signals and noise in the receiver (e.g., thunderstorms). Conversely, the HF transmission may be intercepted and traced by the enemy who is many hundreds of miles away. VHF and UHF communications are normally limited to line of sight; therefore, their range is restricted. UHF transmissions may also be used in satellite communications, increasing ranges to thousands of miles.

High Frequency Radio Employment Considerations.

The primary advantage of using HF radio is its capability to provide long-range, over the horizon (OTH) communication. Successful data communications over the HF range depends on several factors: equipment siting, proper equipment grounding, types of antennas used, and other considerations such as tactical employment of radio equipment, path assessment and analysis, and frequency planning and assignment. When commercial data terminal equipment (DTE) is used, users employing HF radio equipment need to be aware of radio interference and potential shock hazards that can easily affect unprotected DTE. Whenever possible, HF radio equipment should be remoted from DTE.

High Frequency Radio Environmental Limitations

The primary limiting factors when using HF radios are frequency allocation and management and bandwidth availability. Frequency allocation and management is concerned with frequency, time of day, time of year, and location. The ability to reflect HF radio waves off the ionosphere to a distant location is in a constant state of flux because of activity in the ionosphere. The Sun's radiation causes disturbances in the ionosphere, with most changes taking place in what is known as the F layer (see chapter 1 for more details). Sunrise and sunset can be the most difficult times for HF communications. The F layer splits into two separate layers around sunrise and recombines into one layer around sunset. These splits affect transmission distances as the area "skipped over" increases and decreases. At times, solar storms can eliminate all HF communications. HF transmission paths must be constantly monitored to achieve a dependable HF link. HF radio data communications capabilities are limited by the bandwidth that is imposed by legal constraints and the physics of the spectrum. The bandwidth available in the HF spectrum limits the channel bandwidth, which limits data throughput.

High Frequency Propagation

There are two modes of propagation in HF: ground wave and sky wave. See figure 2-2.

Ground Wave. Ground wave propagation involves the transmission of a signal along the surface of the ground. The maximum ground wave range for most tactical HF communications is about 20 to 30 kilometers (12 to 22 miles) for manpack equipment and 80 to 100 kilometers for high-power vehicular and van equipment. The range may be decreased by heavy vegetation (e.g., Camp Lejeune), mountainous terrain (e.g., Camp Pendleton), or dry desert soil (e.g., Twenty-nine Palms). A ground wave circuit will generally be free of fading and may last for the entire 24-hour period without the need to change frequencies.

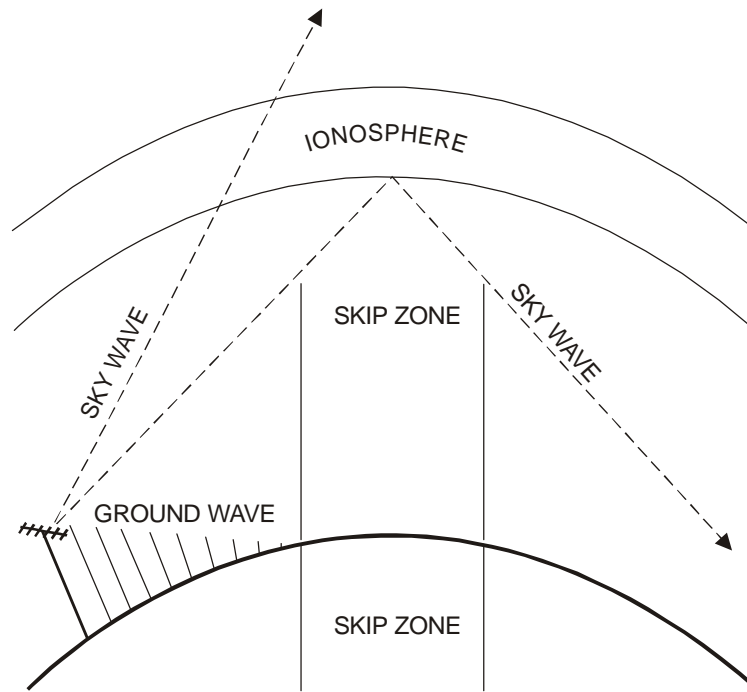

Figure 2-2. HF Propagation.

Sky Wave. Beyond this range, it is necessary to communicate by sky wave. Sky wave propagation involves the bending of the signal by the ionosphere. Frequencies are very important, as those above a certain value will not bend back to earth but will punch through the ionosphere into outer space. On the other hand, lower frequencies are noisier and become absorbed by the ionosphere. The reflective nature of the ionosphere will change when sunlight hits it each day. As a result, at least two frequencies are usually required during a 24-hour period: a low, night frequency and a higher, day frequency.

Skip Zone

A skip zone is where no signals will be received from a particular transmitter for a particular frequency. Skip zones are formed when the nearest point at which a sky wave is received is beyond the furthest point at which a ground wave is received. By using an antenna with a high

radiation take-off angle (i.e., the angle measured from the Earth's surface to horizon up to the direction of propagation towards the ionosphere), HF radio waves can be bounced off the ionosphere and come back to earth closer than they can with more commonly used antennas. This can cause the skip zone to disappear if the waves do not punch through.

The use of high radiation take-off angles is called near-vertical incident sky wave (NVIS) communications. The limit of the effective range of NVIS communications is usually about 300 miles. NVIS communications require a horizontally polarized antenna and are done over frequencies between 2 and 12 MHz. Launch angles can be changed by altering the antenna's height above ground, but for most tactical applications one-quarter wavelength above ground is sufficient. NVIS communications are particularly useful because they can be transmitted from moving vehicles. Used correctly, NVIS provides reliable, continuous communications beyond the range of HF ground wave and VHF and UHF line of sight. Multipath interference occurs when both the sky wave and the ground wave signals from the transmitter arrive at different times at the receiver. See figure 2-3. More detailed information on HF propagation and antennas may be found in MCRP 6-22D, *Antenna Handbook*.

VERY HIGH FREQUENCY RADIO

The primary MAGTF VHF radio is the single-channel ground and airborne radio system (SINCGARS). SINCGARS is a family of light-weight combat radios that serves as the primary means of communications for command and control and fire support on the battlefield. SINCGARS is the standard VHF-FM tactical radio for the Marine Corps, replacing the AN/PRC-77 and the AN/VRC-12 family. The system provides high security against threat electronic warfare (EW) by using frequency hopping with integrated COMSEC. It is capable of voice and data transmission (up to 16 kbps under optimum conditions and over limited distances) over the VHF-FM frequency range of 30 to 87.975 MHz. See MCRP 6-22A, *Talk II SINCGARS Multiservice Communications Procedures for the Single-Channel Ground and Airborne Radio System*, for more details.

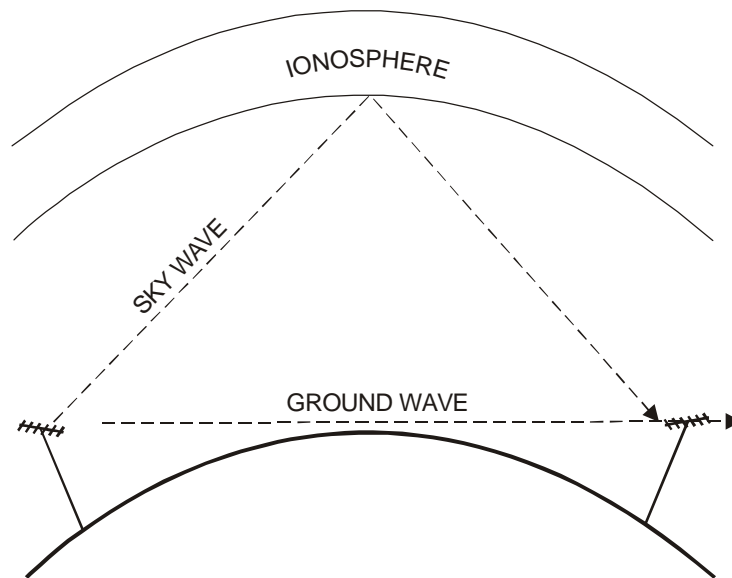

Figure 2-3. Multipath Interference.

There are seven different SINCGARS configurations available, depending on the requirements of the user. These configurations include the manpack AN/PRC-119 (see figure 2-4 on page 2-8), typically used in infantry operations, and vehicle-mounted variants. The radio provides voice communications ranges of up to 8 km for the manpack and 35 km for vehicular configurations. SINCGARS is capable of remote operation by using the analog AN/GRA-39B radio remote control, the digital HXX-57 wire-line ADAPTER, or the digital C-11561 (C)/U remote control unit (RCU).

The SINCGARS radio has undergone a systems improvement program (SIP). This radio is referred to as the SINCGARS SIP. The primary improvements relate to the data transmission capabilities of the system. A forward error correction appliqué was implemented in the receiver and/or transmitter, and a new packet data mode was created to better support packet networks. In addition, an improved channel access protocol was added, which optimizes data throughput performance while minimizing impact on voice communications on the same SINCGARS channel.

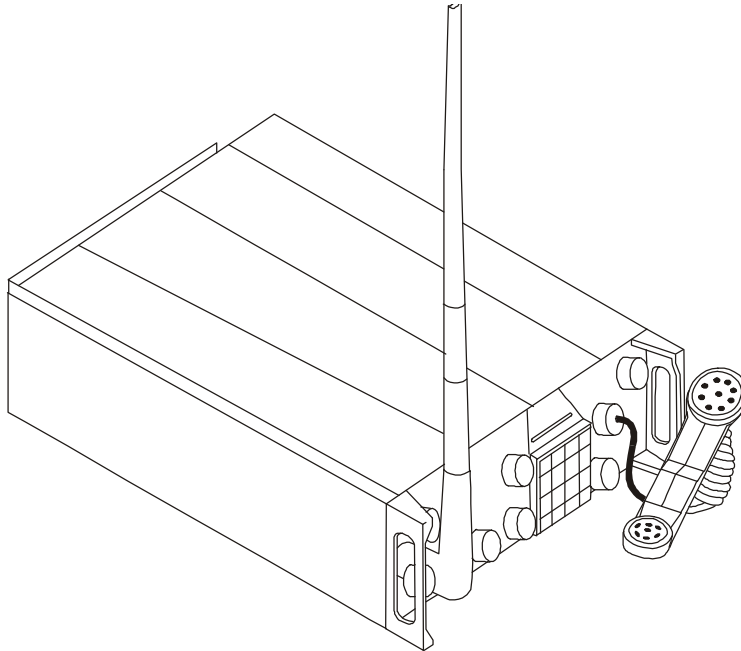

Figure 2-4. AN/PRC-119 SINCGARS Radio.

THE SINCGARS SIP radio is also available in a downsized version—the result of an advanced systems improvement program (ASIP). This radio is referred to as the SINCGARS ASIP. This radio will retain all the functionality of the full-size SIP radio but is half the size. It weighs 7.6 pounds (including the battery). The radio is interchangeable with previous SINCGARS versions, including the capability to be mounted in older vehicular adapter assemblies. A new feature of the SINCGARS ASIP provides a retransmission capability while operating in the packet data mode and will also employ a new, fast-channel access protocol for improved operations in shared voice or data nets.

The AN/ARC-210 multipurpose radio supports single-channel air-to-air, air-to-ground, and ground-to-air communications in tactical Navy and Marine Corps fixed- and rotary wing aircraft. It can transmit and receive VHF-FM, VHF-AM, and UHF signals. It is compatible with SINCGARS, HAVE QUICK, and HAVE QUICK II frequency hopping UHF radios, and it can accept 25 preset, single-channel frequencies. The AN/ARC-210 requires a TSEC/KY-58 encryption device to encrypt transmissions and decrypt received signals.

Hand-Held Very High Frequency Radios

Radio operators may have the opportunity to use various commercial off-the-shelf (COTS) VHF radios in the Fleet Marine Force (FMF). All of these radios have been open-purchased by the user units and are not part of the official Marine Corps table of equipment. Therefore, they have not been assigned a table of authorization material control number (TAMCN).

These hand-held radios are typically small, lightweight, battery-powered equipment which provides clear (and in some cases secure) voice communications on up to 100 different channels. Some models come with headsets and microphones. Hand-held radios are mostly used at the infantry-squad level or in maritime prepositioning force (MPF) offloads.

Very High Frequency Radio Employment Considerations

Operator maintenance of the radio equipment, antennas, cable assemblies, and equipment grounding as well as proper planning and selection are essential to reliable communications. Frequency separation, radio antenna separation, remote rekeying when using COMSEC, and power output are significant employment factors. SINCGARS may be limited to the single-channel mode when operating with some Navy ships. When SINCGARS is employed in the frequency hopping mode, the following operating factors need to be taken into account: hopset (i.e., frequency segment allocation), net sych time and mission date, antenna placement (cosite interference is more of a concern than in the single-channel operating mode), and power setting. SINCGARS radios configured for different hopsets that dial into the same numbered net will not be able to communicate. MCRP 6-22A provides detailed information on the employment of SINCGARS.

VHF SCR is the primary communications system for combat and combat support units while on the move. The predominant mode of operation is secure voice. However, use of VHF radio for data communications will increase with the fielding of tactical information systems at the battalion level and below. Small, hand-held VHF radios are used at the small-unit level in the MAGTF. These radios are often commercial items

that lack compatibility with SINCGARS and do not have integrated COMSEC. Their use should be governed accordingly.

Very High Frequency Radio Environmental Limitations

The primary limiting factors when using VHF radios are range and frequency availability. VHF radios can provide reliable communications for ranges of up to 10 miles, depending on the equipment operating constraints and the operating environment. Unit location must be considered when employing radios that operate in the VHF spectrum. Most circuits are limited to radio line of sight, known as four-thirds earth curvature. VHF radio signals essentially follow the curvature of the earth to a distance that is approximately one-third greater than the distance to the horizon. Foliage interferes with VHF signals and may reduce normal operating ranges to significantly less than 10 miles.

Very High Frequency Propagation

Radios in the SINCGARS family are the principal VHF transceivers used by the Marine Corps. The mode of communications used in this range is frequently referred to as frequency modulation. VHF will extend slightly beyond line of sight due to diffraction or bending of the signal by the atmosphere (see fig. 2-5). At frequencies in the 30-MHz range, VHF will often act like HF ground wave. The range of reliable communications is generally no more than 15 to 20 kilometers (9.3 to 12.4 mi) under normal field conditions for manpack equipment. Vehicle-mounted equipment may communicate farther because of higher transmitter power and better antennas.

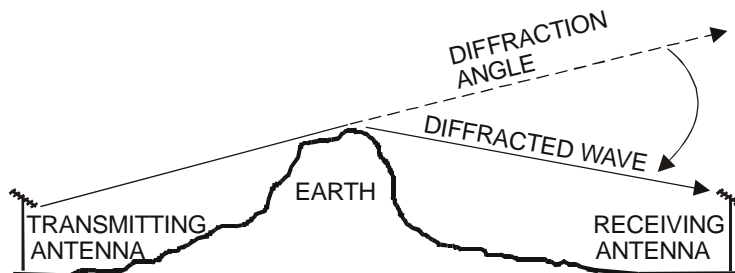

Figure 2-5. VHF Diffraction.

VHF LOS can also be plagued by multipath interference when the direct ray and a reflected ray traveling over a slightly longer path combine at the receiver antenna so that they periodically cancel or reinforce each other (see fig. 2-6). The signal fades in and out over a period of time as a result. Fading is not as great a problem with immobile equipment because corrective action can be taken, but fading can cause significant problems when one or more of the units are mobile.

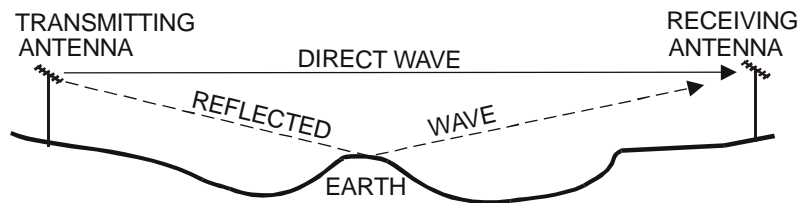

Figure 2-6. VHF LOS.

ULTRAHIGH FREQUENCY RADIO

Military UHF radio equipment operates in the 116 to 150 MHz upper-VHF frequency range and the 225 to 400 MHz military UHF radio spectrum. MAGTF UHF radio sets such as the AN/PRC-113 (see figure 2-7 on page 2-12) are capable of data communications at 16 kbps under optimal conditions. MAGTF ground and airborne UHF radios incorporate the HAVE QUICK Electronic Counter-Counter Measures capability and operate in single-channel and frequency hopping modes. The HAVE QUICK UHF radio is capable of remote operation by using the AN/GRA-39B or HYX-57.

Ultrahigh Frequency Radio Employment Considerations

UHF radios are used for forward air control (FAC) ground-to-air communication. Line of sight between radios is critical for reliable communications. Significant range differences are encountered between UHF radios employed for ground-to-air and ground-to-ground communications. Greater range is achieved when employed from ground-to-air because of the increased line of sight. When UHF radios are employed in

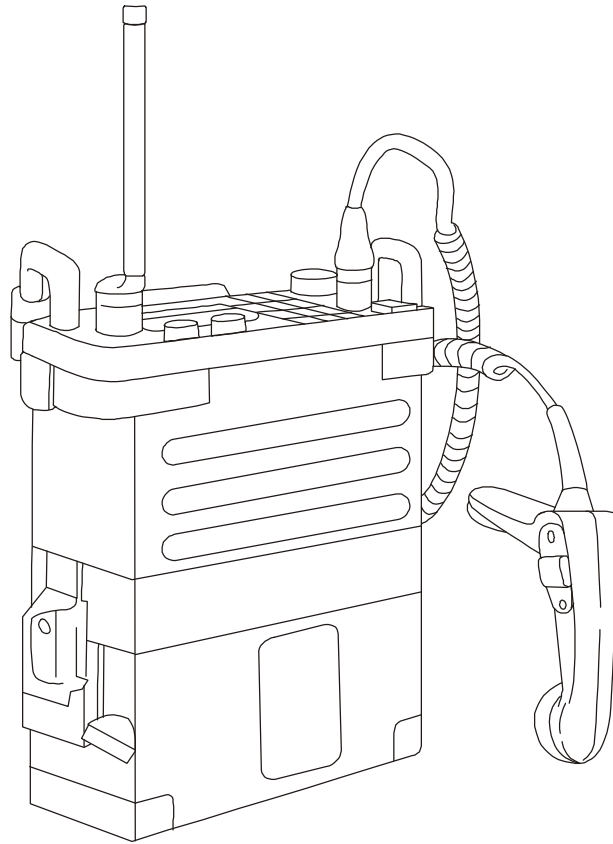

Figure 2-7. AN/PRC-113. UHF Radio.

the frequency hopping mode, the following operating factors must be understood for proper operation: hopset, time of day, antenna placement, and power setting.

Ultrahigh Frequency Radio Environmental Limitations

The primary limiting factor when using UHF radios is range (i.e., critical line of sight). Critical line of sight can be described as “what you see is what you get.” As long as the radio’s antenna has optical line of sight to another radio’s antenna, the two will be able to transmit and receive. For this reason, UHF radios are used primarily in air-to-ground communications.

Ultrahigh Frequency-Tactical Satellite

The AN/PSC-5 is a portable, battery-operated, half-duplex UHF transceiver. It is employed for long-range communications. It weighs approximately 14 pounds including antenna and batteries. The AN/PSC-5 provides two-way voice and data communications by satellite. It operates on the UHF frequency band of 225- to 400-MHz range. It provides 2,400 to 16,000-bits per second (bps) data rate, depending on mode setting. Only one operator is required to operate it. The United States Marine Corps UHF tactical SATCOM system supports and augments the high precedence command and control and common-user, single-channel requirements of a Marine air-ground task force and its major subordinate headquarters.

The space segments used by the AN/PSC-5 are the Fleet Satellite Communications, leased satellite communications, and UHF follow-on satellites. All the satellites are located in geosynchronous orbits and permit interconnections among mobile, ground terminals. The one-way distance to servicing satellites is approximately 25,000 miles, resulting in a round-trip propagation delay of approximately one-quarter of a second. The shape of the satellite footprints is roughly circular but elongated from north to south. This is caused by the angle at which the signal hits the Earth's surface and by the curvature of the Earth's surface.

Multiple-access schemes can operate either with fixed-channel assignments to the various users or with channels being assigned in varying fashion according to demand. The latter is called demand assigned multiple access (DAMA). With demand assignment, the user makes a channel request, and a channel is allocated after a brief time lag. The DAMA scheme of operation is employed on UHF-tactical satellite (TACSAT) to share available channels more efficiently. The radio systems are compatible with the KY-57 (wideband mode only), the KY-99 and ANDVT (narrowband mode only), and the KG-84C (wideband or narrowband) COMSEC equipment. This radio equipment is also capable of remote operations by using the AN/GRA-39B (narrowband mode) or HYX-57 (wide-band mode).

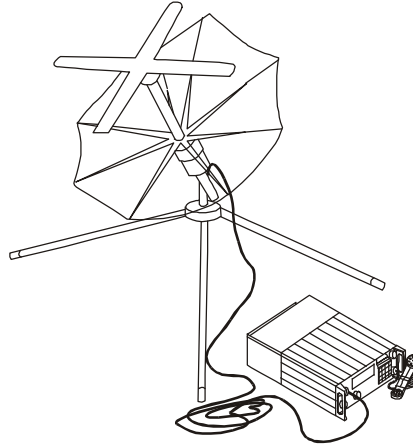

Figure 2-8. AN/PSC-5 UHF TACSAT Radio.

TACSAT Radio Employment Considerations. Because of TACSAT's limited availability, the MAGTF employs TACSAT primarily to support critical, long-range communications requirements (e.g., communications support for deep reconnaissance operations or connectivity to the tactical echelon of a MEU[SOC] when deployed ashore). The AN/PSC-5 is the primary DAMA-capable, TACSAT radio available to the MAGTF (see fig. 2-8). TACSAT limitations include the competition for available frequency resources and channel time on the satellite. If only narrow band channels are available, channel-data rates are limited to 2,400 bps. Channel congestion, noise, and network saturation will affect the information flow on satellite channels and will require a significant reduction in the data transmission rates to sustain data communications. Transmit power selection can be critical. Increasing the transmit power can decrease net effectiveness. Larger directional antennas provide increased signal gain, which increases the transmitted signal power. Antennas for these systems are lightweight and fragile and, therefore, require constant maintenance and inspection for proper operation. Satellites are shared resources. Exact frequency, bandwidth, and power of every carrier transmitted through the satellite is strictly controlled by a higher authority.

TACSAT Radio Environmental Limitations. The primary environmental limitations on TACSAT radios are signal propagation delay, location on the Earth, terrain masking, and weather effects. Timing between DTE can be a critical factor in SATCOM because the satellite, acting as a relay between radios, is about 25,000 miles away. There is

approximately a one-fourth second propagation delay between sending and receiving stations. This delay can interfere with systems that automatically retransmit if an acknowledgment is not received after a very short time-out period. As unit location changes, the “look angle” (i.e., angle above the horizon) to the satellite can affect net reliability. The orbit of a satellite allows it to cover a certain footprint on the earth. Satellites in equatorial orbit can cover large portions of the Earth, both north and south of the equator, but as the user moves closer to the Earth's poles, the TACSAT terminal may exceed the satellite footprint. This will cause intermittent or lost communications. Terrain can also have this effect by interfering with the satellite and TACSAT terminal line of sight. Thunderstorms, heavy snowstorms, and hail also affect satellite transmissions by damaging antennas and changing the electromagnetic environment.

Ultrahigh Frequency Propagation

UHF frequency propagation is used for ground-to-air, air-to-air, satellite, and tactical multi-channel communications. Communications are limited to LOS but may extend for more than 500 kilometers as long as the aircraft is high enough to be within LOS (see fig. 2-9). It is even possible for UHF communications ranges to a satellite to be more than 35,000 kilometers.

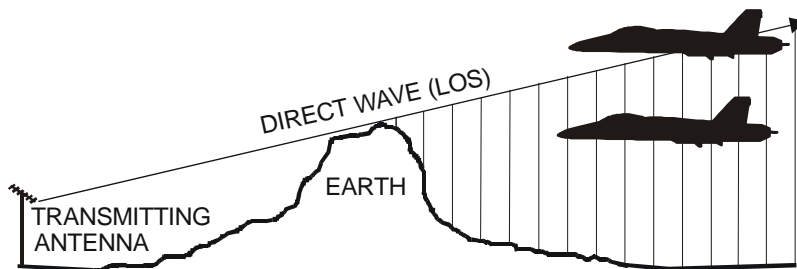

Figure 2-9. UHF LOS.

DATA COMMUNICATIONS

SCR can also transmit and receive data by using terminal devices such as the digital message system (DMS)—previously called and more commonly known as the digital communications terminal (DCT)—and the tactical communications interface module (TCIM). The DCT, data

automated communications terminal (DACT), and the TCIM are critical in enabling data communications at the tactical level over SCRs.

Digital Message System-AN/PSC-2

The DMS-AN/PSC-2 is a hand-held communications device that can be operated with either a standard military radio or telephone field wire equipment. The DMS is used to compose, edit, display, transmit, and receive information. By menu selection, formatted text, free text, and digitized map messages are transmitted over tactical communications equipment. DMS is being used directly for air support, fire support coordination, reconnaissance, medical evacuation, and other functions. DMS uses a burst transmission capability which reduces the vulnerability to enemy radio direction finding and jamming.

Data Automated Communications Terminal

The DACT is a small, tactical computer and communications terminal which gives users the capability to receive, process, and transmit various messages, to include text and symbology, used by tactical data systems. The DACT will effectively replace the DCT when it achieves full operational capability in FY 03, and it will provide much greater functionality below battalion levels. This will include an embedded global positioning system (GPS) receiver, the ability to share a common picture of the battlespace, automated data exchange, and MAGTF command, control, communications, computers, and intelligence (C4I) network connectivity. The DACT will be transportable by foot-mobile Marines and mounted in tactical or armored vehicles.

Tactical Communications Interface Module

The TCIM provides the communications link between the tactical computers of the communications and information systems within the MAGTF and the local and wide area networks, switched backbone (SBB), and radio nets. There are two versions of the TCIM card: an internal personal computer asynchronous transfer card to mount directly in the computer, and an external version with the card mounted in a portable chassis. TCIM software was developed for open-systems architectures. Small computer systems interfaces (SCSI) provide interoperability between the TCIM and other Marine Corps computers.

Chapter 3

Equipment Siting and Grounding Techniques

Two factors play an important role in equipment siting: optimum communications and camouflage. It is often difficult to find communications sites which are hidden from enemy view, fire, and direction finding and afford good communications connectivity. The ideal location for a radio antenna is as far away from cover as possible, such as a bare mountain top or in the middle of a large field. However, this goes against the commander's tactical requirement for troops and equipment to be camouflaged and concealed as much as possible. Therefore, planning the location of equipment must be detailed to achieve the best results. See Appendix A for a review on topographical maps and grid coordinates.

HIGH FREQUENCY

In the presence of hills (without large trees), the following guidelines for ground wave links should be used:

1. Locate HF antennas just below the top of the hill in the direction of desired communications. Often the signal will be greater below than on the top. This will also minimize interference and/or jamming from the opposite direction.
1. Move the antenna back from the hill if a hill is between the operator and the distant station with which the operator wishes to communicate. The signal strength can vary widely in the region immediately behind a hill. If it is necessary to set up behind a hill, then it may also be necessary to set up a variety of antennas located at different distances from the hilltop to see which one offers the best performance.

Long-distance, HF sky wave signals of more than several hundred kilometers are often best transmitted and received at angles just above the horizon level. Obstacles on the horizon will cause the signal to travel a

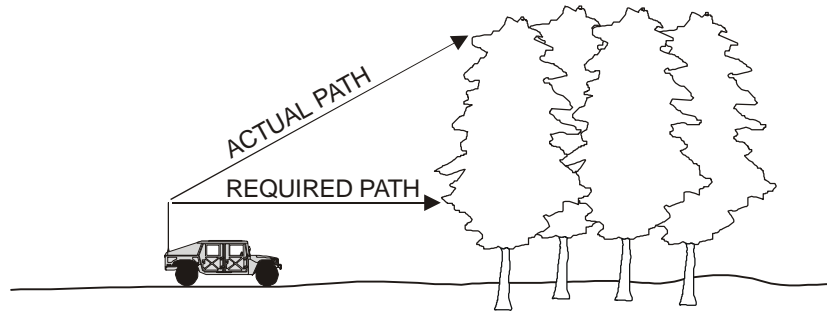

Figure 3-1. Low HF Horizon Angles.

higher path angle and may reduce the circuit reliability as a result (see fig. 3-1). Wire fences between the operator and the horizon will also lessen the chances of getting through (see fig. 3-2).

An HF ground wave signal will follow the terrain much better than higher frequency signals. It will be weakened by trees (more so when

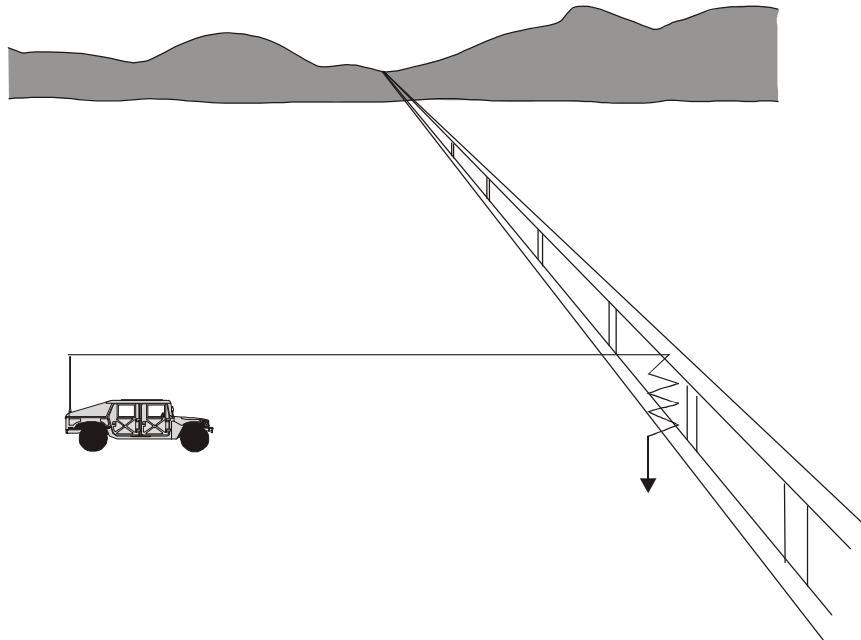

Figure 3-2. Effect of Wire Fences and Power Lines.

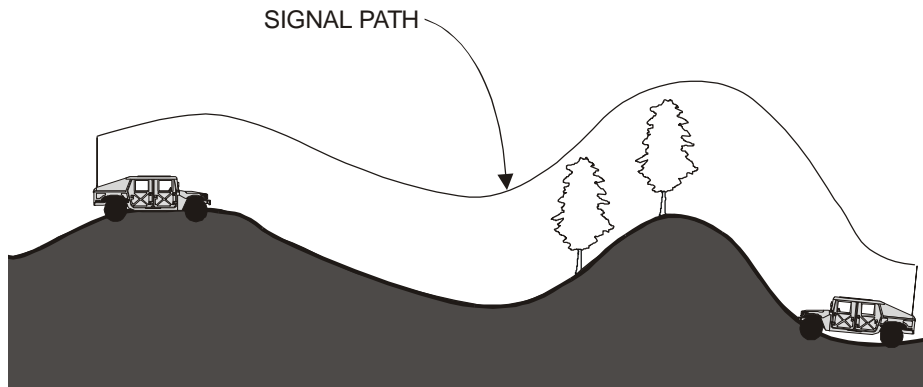

Figure 3-3. HF Ground Wave Path.

they have leaves) and rugged terrain, but the signal may still get through (see fig. 3-3).

VERY HIGH FREQUENCY AND ULTRAHIGH FREQUENCY

Obstacles such as trees, buildings, and hills between a transmitter and receiver will weaken the signal or stop it. Aircraft flying along the path will also interfere with reception (see fig. 3-4). A clear signal path

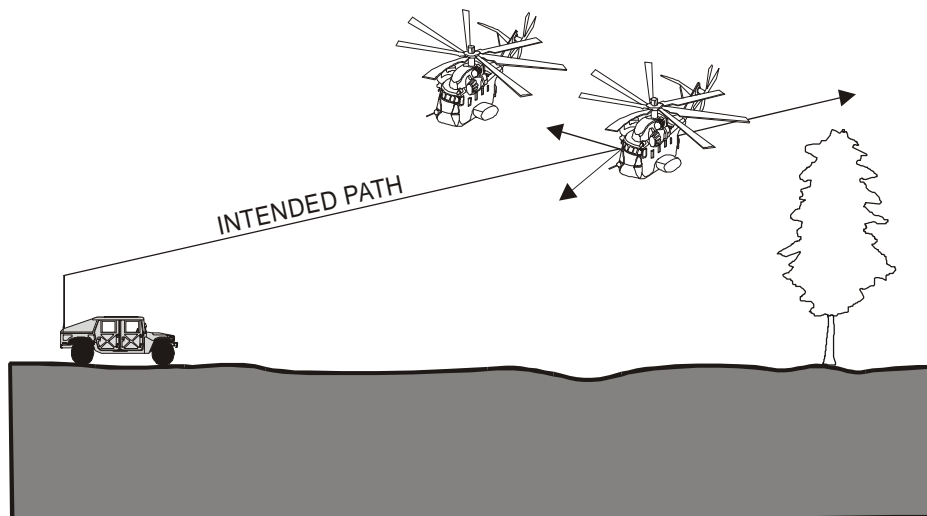

Figure 3-4. Aircraft Along Signal Path.

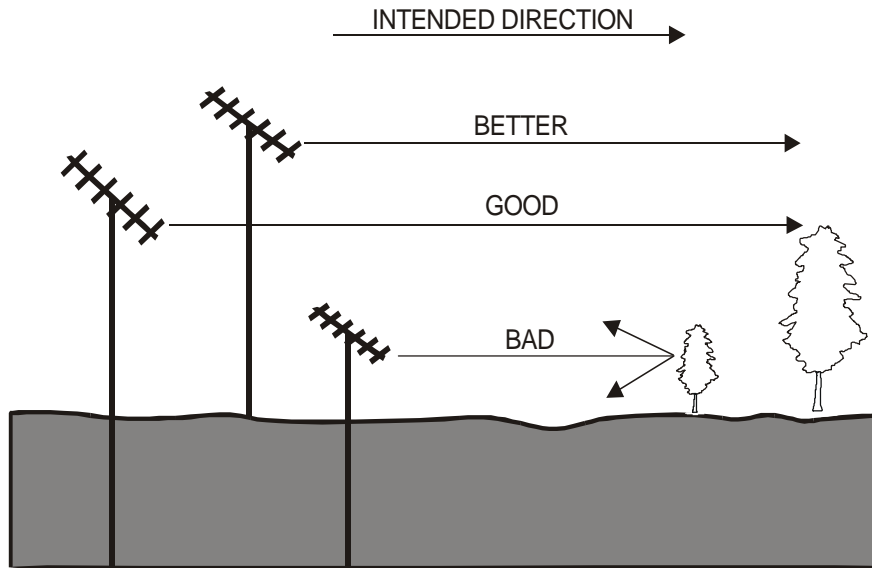

Figure 3-5. Antenna Obstacles.

between the transmitter and the intended receiver, especially for LOS communications, is preferred. The antenna must be positioned as high as possible to overcome obstacles, especially if communication is in the direction of trees or buildings (see fig. 3-5). Keep equipment as far back from obstacles in the direction of the signal path to prevent interference or damage to equipment.

In some situations, solid obstacles may actually improve a link by providing a sharper surface to diffract over or reflect from (see fig. 3-6).

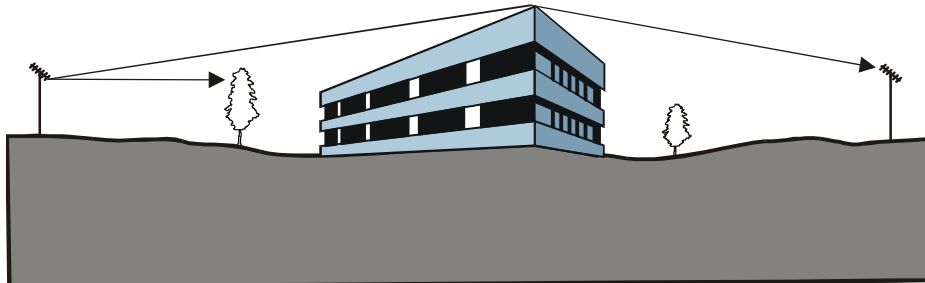

Figure 3-6. Diffraction Over Building.

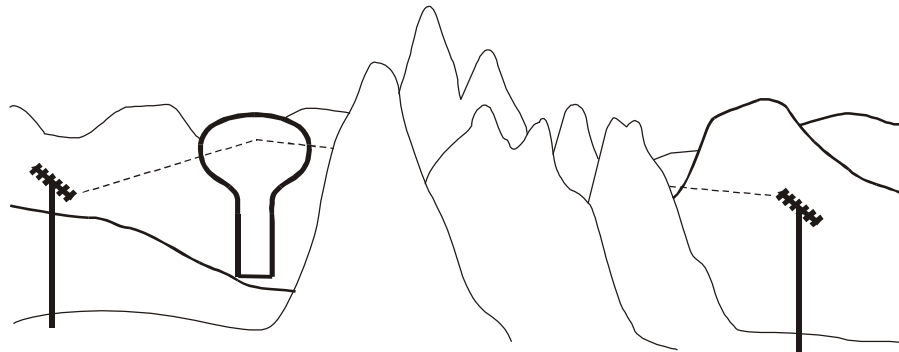

Figure 3-7. Reflection off Spherical Water Tower.

Under certain conditions, spherical water towers and walls of buildings (facing the proper direction) may enable communication around interfering terrain or vegetative obstacles (see fig. 3-7).

Transmitting over water allows VHF to go farther, but fading may occur. If communicating over water is unavoidable, and fading occurs, the signal may be improved by raising or lowering the antenna. The antenna may also be positioned so a hill or rise is between it and the water but not high enough to block the LOS to the other antenna (see fig. 3-8).

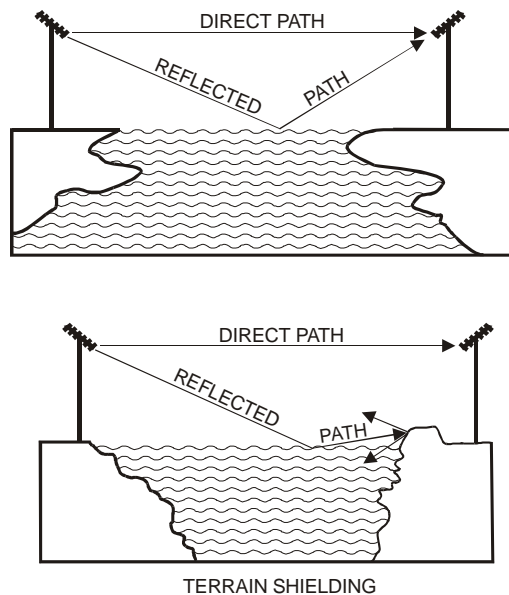

Figure 3-8. Multipath Fading and Terrain Shielding.

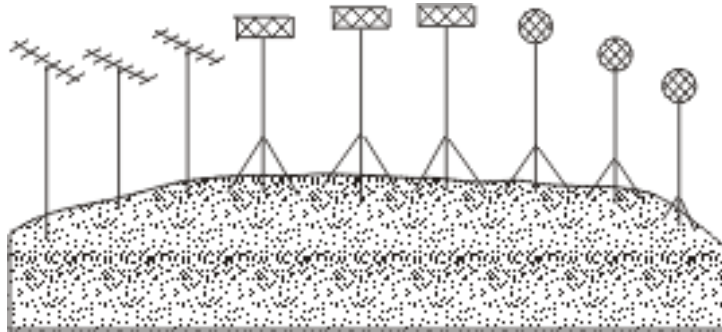

Figure 3-9. Ridge Line Antenna Farm.

Nothing is more compromising to a unit's location than an antenna farm stretched along a ridge line (see fig. 3-9). The enemy will realize that a major command post is nearby. The advantage of placing an antenna on a ridge line is the ability to talk in many directions without land being in the way. If communication is needed in only one direction—away from the enemy—put some terrain shielding between the antenna farm and the enemy (see figures 3-10 and 3-11). This way, the enemy won't be able to intercept communications or jam circuits as easily. However, it's not always necessary to talk from hilltop to hilltop. Talking from hillside to hillside or along the valley floor may be a better option in some instances. The enemy will certainly have a harder time locating a unit this way.

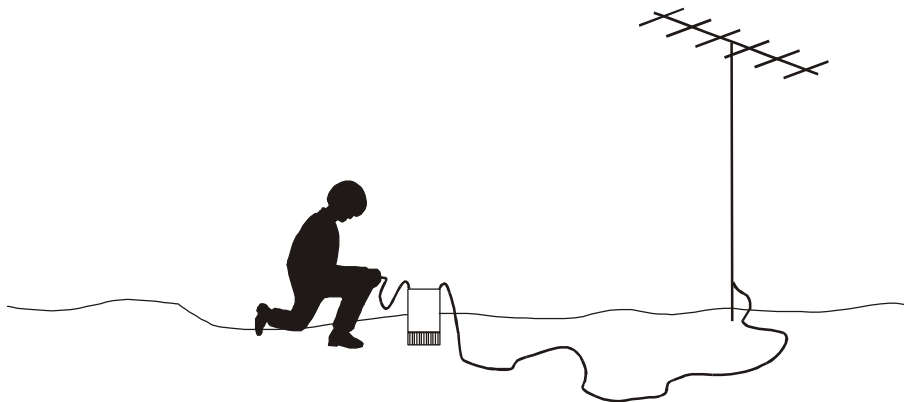

Figure 3-10. Low Antenna Profile.

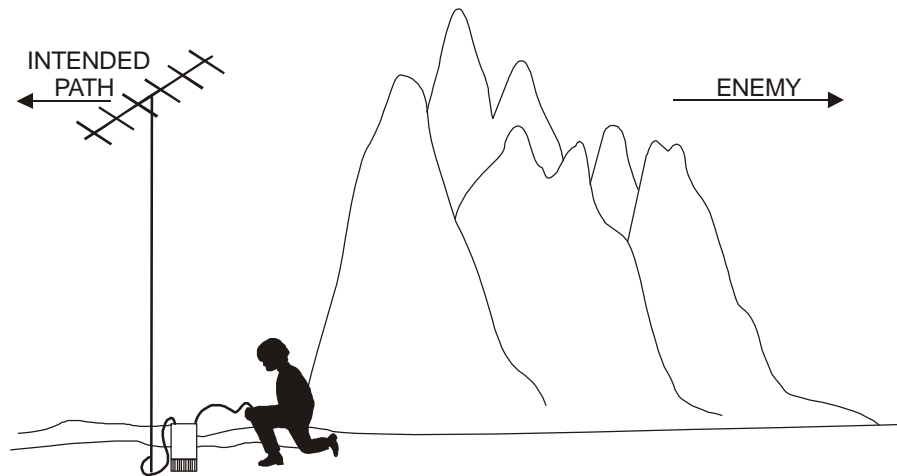

Figure 3-11. Terrain Shielding.

The body can act as an antenna and affect the quality of the radio signal, particularly backpack and hand-held VHF sets with short antennas. The effect of the body on signal strength depends on frequency, antenna length, and the position of the antenna or set relative to the operator's body (see fig. 3-12 on page 3-8).

Backpack Sets (AN/PRC-119)

Maximum radiation (i.e., best performance) is to the front when the set is on the operator's back with a 3-foot whip antenna. The operator should then try facing in the direction of distant communications. This effect is most noticeable at frequencies greater than 50 MHz.

When the set is on the ground, and the operator is very close to the set, maximum radiation will probably occur through the operator's body. If the operator is a couple of feet away, the operator may act as a reflector and either improve or interfere with the signal.

Hand-Held Sets (AN/PRC-68)

The antenna of the hand-held AN/PRC-68 is much smaller than the AN/PRC-119's, and the operator's body affects directional characteristics to



Figure 3-12. Direction of Best Communications.

a greater extent, particularly when the antenna is lowered. This radio will normally be in the front jacket pocket, and best performance is then over the back. The higher frequencies are strongly affected when the antenna is lowered. Holding the radio in hand a few inches away from the body will modify the radiation pattern and can substantially lower performance to the sides at the higher frequencies. The directional characteristics of the antenna-body combination can be used to some advantage in reducing interference arriving from directions other than that of the signal. Trial and error is necessary to make this judgment.

VHF Siting

Position the antenna to reflect the directive pattern away from the wall or fence in the intended direction of communication when using VHF antennas near a metal-walled building or high, metal fence. For frequencies between 30 and 50 MHz, the antenna should be placed approximately 2 meters (6.5 feet) away; between 50 and 88 MHz, no more than 1 meter (3.2 feet) away. Communications may be reduced if antennas are placed more than 2 meters from the radio. The distance may be varied a

foot or so in each direction, while receiving, to find the position where the signal is the strongest when setting up the equipment. If frequencies are changed later, the optimum position will have to be redetermined at that time by the same method.

UHF Siting

At UHF and (to a much lesser degree) VHF frequencies, if an operator cannot see a person, then they probably cannot communicate—especially in heavy vegetation. Often, the signal has to travel up to the tops of the trees and move along the treetops and down to the receiver (see fig. 3-13). This will weaken it considerably. In vegetation, the antenna should be positioned away from trees that are in the direction of the signal and erected as high as possible. Changing the location of the antenna is also an option. Both horizontal and vertical orientations may be used with the AS-4225 Parabolic Grid Antenna with UHF multi-channel (MUX) radio equipment. Horizontal polarization is usually better for passing through the trees, but if the signal is skimming over the tops of the trees (probably unnoticeable) or over water, then the polarization should be vertical (see fig. 3-14 on page 3-10).

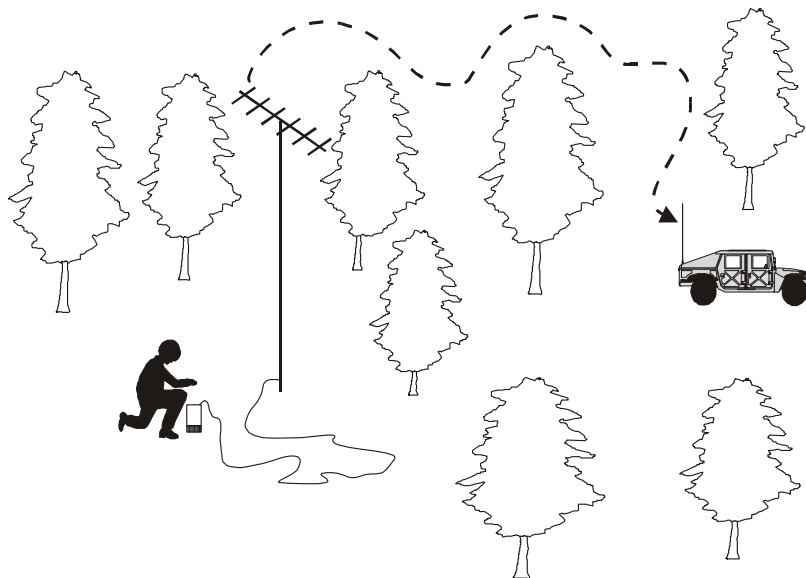

Figure 3-13. VHF Vegetative Propagation.

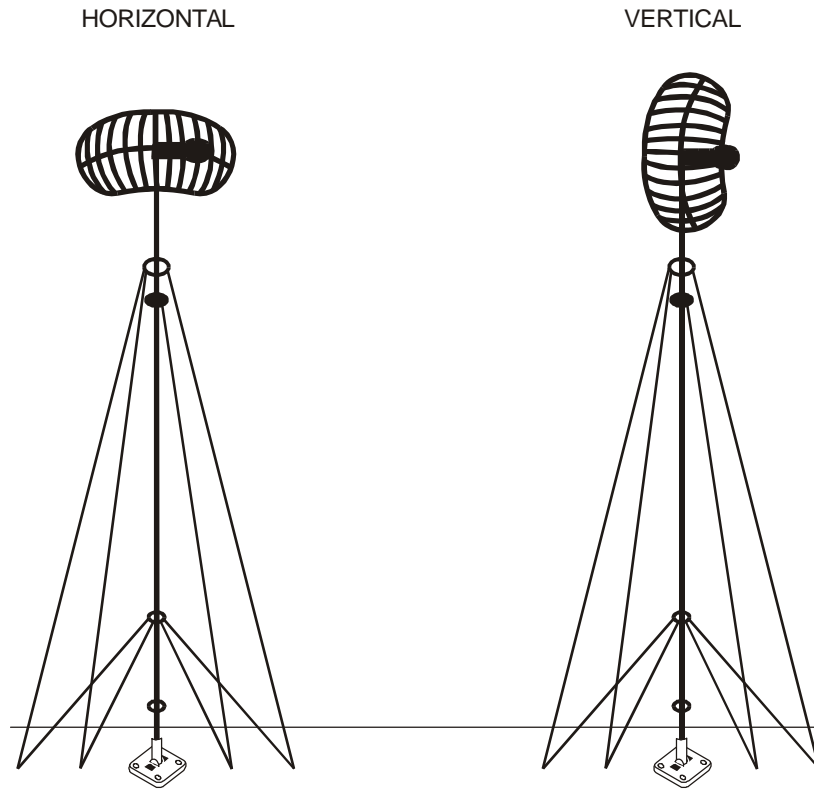

Figure 3-14. AS-4225 with AB-1356 Antenna Polarization.

GROUNDING TECHNIQUES

Poor grounding is probably the most important cause of a weak HF signal. Communication distances can easily be cut in half by improper grounding of the antenna. More importantly, the hazards involved with improper grounding coupled with high transmitter powers are bad burns, electrical shocks, or even death (see fig. 3-15).

Grounding prevents electrical shock to operator and improves signal strength, particularly in HF.

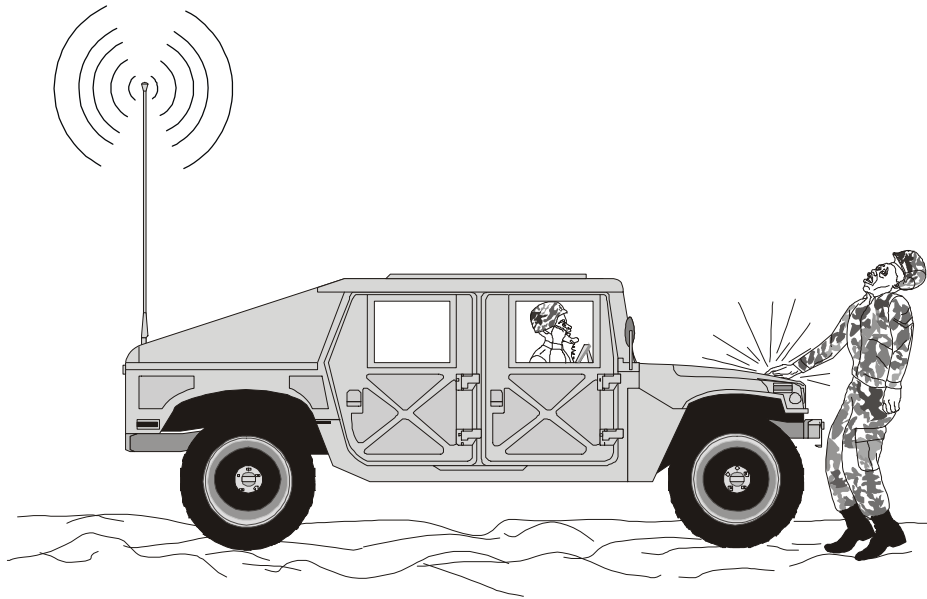

Figure 3-15. Shock Hazards of Ungrounded Equipment.

Ground Stake

The ground stake provided with the antenna should be driven deeply into the soil, making certain all connections are tight and clean. Soil moisture and salinity around the ground stake are very important for good grounding. If a dry or a damp location is available, choose the damp spot. If everything is bone dry, a couple of gallons of water poured around the stake may help. Adding a pound or two of salt from the mess tent to the soil around the stake before soaking it may help even more.

If a regulation ground stake is not available, there are many field-expedient means for grounding. The primary concern is to provide an electrical path from the equipment case, using braided copper or heavy gauge wire, to a buried metallic object that is in good contact with the ground. All cable connections and grounds should be free of grease, paint, or rust. Cables should be as short as possible.

Some useful grounds are—

- 1 Metal fence posts.
- 1 Steel reinforcing rods.

- | Metal pipes.
- | Metal plumbing (must not be connected to flammable liquid or gas).
- | Metal building frames.

Ground Radials

A ground radial system (i.e., counterpoise) is necessary to reduce the amount of power lost in the earth (see fig. 3-16). This is particularly important for HF whips, inverted As, and other vertical antennas. The radial system design is usually a compromise between performance, portability, and time to install the system. Ground radials help to establish a known reference point of electrical ground. Without them, electrical ground may be some distance beneath the Earth's surface. Known electrical ground is important not only for formation of the wavefront off the antenna, but it also affects launch angles from antennas.

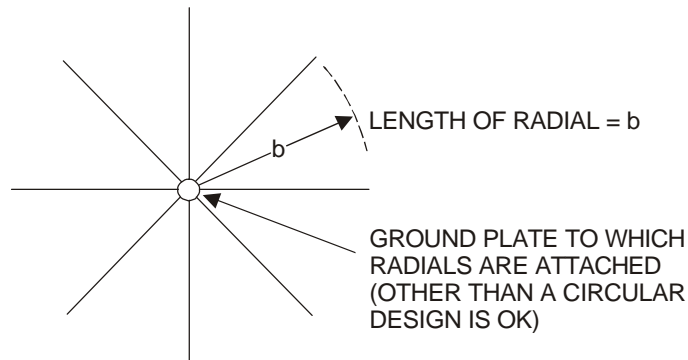

Figure 3-16. Radials.

Radials are attached metal-to-metal to a central point (a metal plate is often convenient). The radio frequency (RF) ground is attached to the central plate (Figure 3-17).

Wire diameter is not critical; select a diameter small enough to be lightweight and transportable, but large enough to prevent breakage. The largest number of radials to transport should be consistent with weight and bulkiness limitations. It is not necessary to make them greater than one-quarter wavelength at the lowest operating frequency.

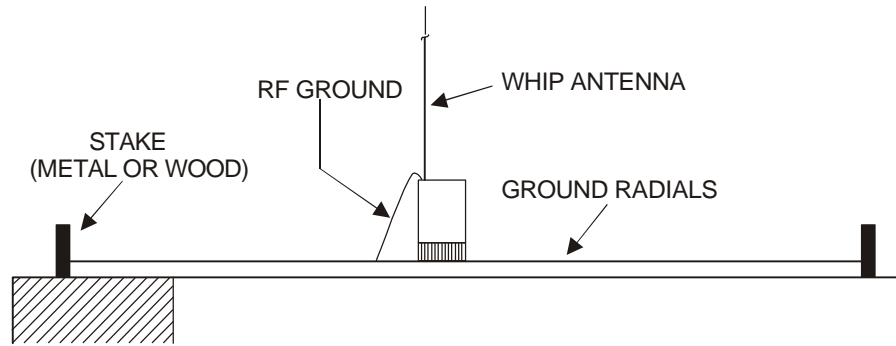

Figure 3-17. Equipment Configuration.

One-quarter wavelength = 74.9 meters
 frequency (MHz)

Suggested dimensions:

5 meters (15-foot whip): N (number of radials) = at least 30
 (one every 12°)
 b (length of radial) = 7 meters
 (23 feet)

10 meters (32-foot whip): N = at least 30
 b = 14 meters (46 feet)

If the site is semipermanent (i.e., several days or more), the number of radials should be increased to 100, and their length doubled.

Make radial systems for each antenna prior to an operation. Short stakes at the ends may be used to hold them in position when deploying. Ground all radials, where possible.

(reverse blank)

Chapter 4

Antennas

This chapter will discuss high frequency and very high frequency antennas. Antenna designs that work for HF sometimes work for VHF and vice versa. The main difference is size; HF antennas are considerably larger than VHF antennas. Ultrahigh frequency antennas are generally limited to whips. When determining the best antenna to employ with a circuit, consult MCRP 6-22D for more detailed information on antenna propagation characteristics, as well as construction considerations and procedures.

HIGH FREQUENCY ANTENNAS

Vertical Whip

A vertical whip antenna (i.e., whip) will most likely be used with an HF radio. The whip is particularly good for ground wave communications in many directions at one time, at distances of 20 to 30 kilometers. Unfortunately, while it is radiating in all directions at the same time, it is also picking up interference from all directions. It is useless if using sky wave over a distance of 100 kilometers, because of the high radiation angles required. (NOTE: Launch angles off vertically polarized whip antennas are maximum below 45° .) A vertical whip's performance by sky wave, however, improves with increased path distances.

A vehicle-mounted whip, tied down fairly close to the vehicle, may be efficiently employed in short- and intermediate-distance HF sky wave communications. A whip, tied back only a little, may be useful in long-distance HF sky wave applications.

Sloping Wire

If an HF circuit is only a single point-to-point ground link or a ground wave net with all other terminals being located in the same direction, a

sloping wire may be used, if available. The radiating length of the AT-984 “Fishreel” antenna (a 45-foot long, wire antenna which can be used with the AN/PRC-104) can be varied by either connecting or disconnecting the alligator clips. (Antenna length is measured from the radio equipment.) See Table 4-1 to determine how long an antenna should be cut to form an assigned frequency.

Table 4-1. Sloping Wire Antenna Lengths.

Frequency MHz	Length	
	(Feet)	(Meters)
5	45	13.7
9	25	7.6
12	15	4.6

The far end of the antenna should be connected to a rope with a weight, such as a stone or brick or other nonconducting material tied to the end. The weighted end should be thrown over a tree so that the antenna forms a 30° to 45° angle to the ground. Angles higher than 45° should be used for ground wave, and lower angles for sky wave. The high end should be opposite the direction of the intended receiver (see fig. 4-1).

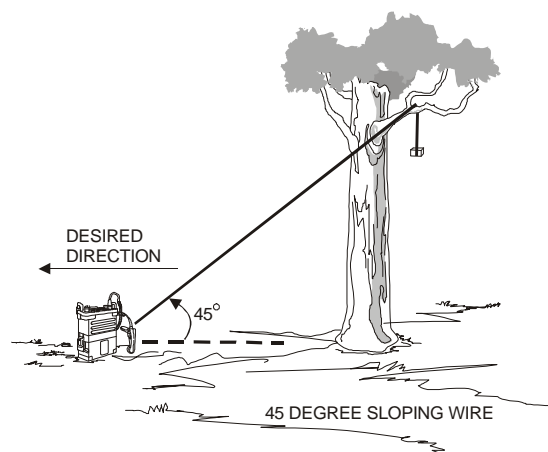

Figure 4-1. 45° Sloping Wire Antenna.

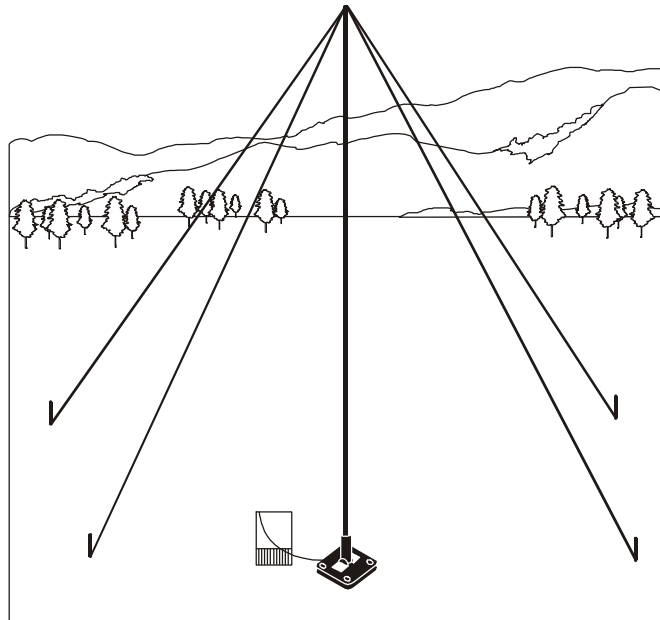

Figure 4-2. AS-2259.

AS-2259 Near-Vertical Incidence

Another HF antenna is the AS-2259 (see fig. 4-2). Although not suitable for frequencies under 3.5 MHz, this antenna can be used for both ground wave and sky wave. The AS-2259 will often enable an operator to communicate in a skip zone when a whip antenna will not. In addition, it can sometimes be used effectively to communicate by sky wave over a hill or mountain obstacle that would otherwise block a ground wave signal. More detailed information regarding HF NVIS antennas can be found in MCRP 6-22D.

Horizontal Half -Wave Dipole (Doublet)

The horizontal half-wave dipole (also known as the doublet) is frequently used for short to medium HF sky wave paths (up to about 1,500 kilometers). It is usually installed at one-quarter wavelength of the operating frequency above ground (see fig. 4-3 on page 4-4). The major drawback of this antenna is the unusually long length required (up to 71

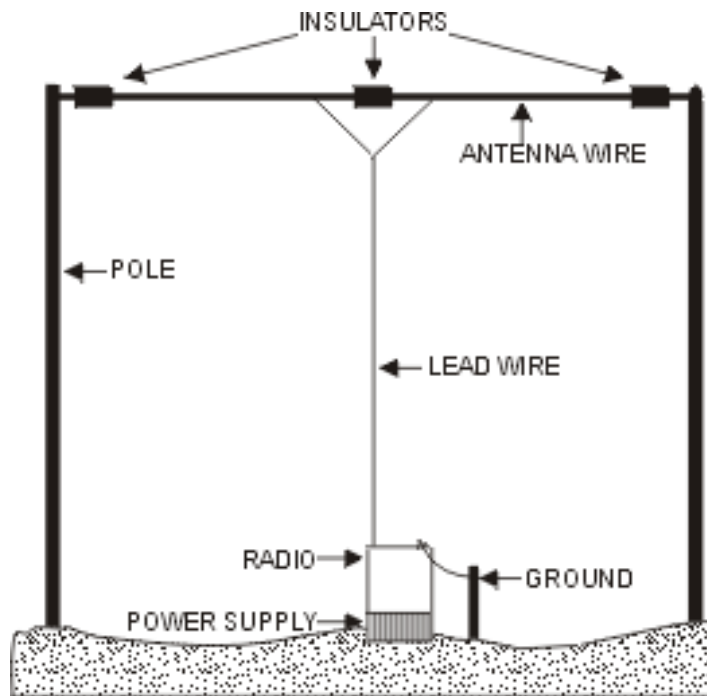

Figure 4-3. Doublet Antenna.

meters [233 feet] at 2 MHz). NOTE: A 2 percent or greater error in length means less efficiency and a loss of radiated power.

Inverted L

Inverted L antennas are useful for NVIS propagation (see fig. 4-4). Because of their construction, they also yield better ground wave radiation than whip antennas. Inverted L antennas can be effectively employed with a wider range of frequencies than can horizontal half-wave dipole antennas.

Antenna Enhancements

Several pieces of equipment which improve the capabilities of standard Marine Corps communications equipment are available from commercial sources. These items are not stocked in the Marine Corps supply system. They must be purchased directly from commercial sources.

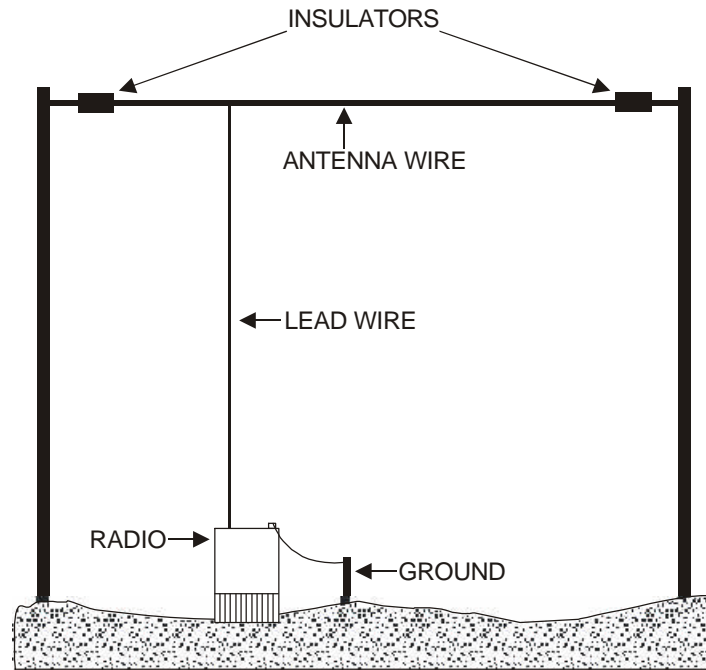

Figure 4-4. Inverted L.

They include—

- 1 Tilt whip adapter (TWA)—used with the vertical whip antennas issued with AN/MRC-138 radio. These antennas can be tilted to obtain the correct angles for NVIS communications. The TWA made for the AN/MRC-138 is one piece and has a simple design. When fitted with a TWA and only the top four sections of the AT-1011 antenna, the AN/MRC-138 can be operated on the move.
- 1 Whip loading coil (WLC)—used with the WTA for the AN/MRC-138. This device makes the antenna more efficient at lower frequencies.
- 1 Whip to wire adapter (WWA)—screws into the top one-inch-diameter section of the AT-1011, thus allowing the operator to use the one-inch-diameter section of the AT-1011 as the mast for field-expedient antennas.

- 1 Whip-base adapter (WBA)—allows the whip antennas for Army HF radios to be used with Marine Corps HF radios. The whip antennas for Army HF radios are of a different size than the whip antennas for Marine Corps HF radios.

For further information about commercial equipment which can improve the capabilities of Marine Corps radios, contact the G-6/S-6 sections of higher headquarters.

VERY HIGH FREQUENCY ANTENNAS

OE-254

This antenna is used with VHF-FM radios to increase the operating range beyond that of a normal whip. The two elements hanging down from the antenna form a ground-plane similar to the ground radials discussed in chapter 3. The effect is to act as an artificial ground and greatly increase the signal range. The antenna radiates in all directions at the same time. The OE-254's elements allow it to tune to frequencies between 30 and 88 MHz without manually adjusting either the ground-plane or radiating elements' length. Figure 4-5 illustrates the OE-254 antenna.

Vertical Whip

VHF whip antennas are usually limited in range from 15 to 20 miles. A whip antenna is omnidirectional; therefore, it has the potential to produce a great deal of radio-wave interference with the radios in the area. It is important when using a whip antenna or any antenna to keep maximum distance between antennas. Use of hills and other terrain features to block off unwanted signals will improve desired signal strength. When using whip antennas with backpack or hand-held equipment, body position may increase the transmitted and received signal. This is because the human body acts as an antenna. If experiencing communication problems, the operator should try facing in different directions to improve the reception of the signal.

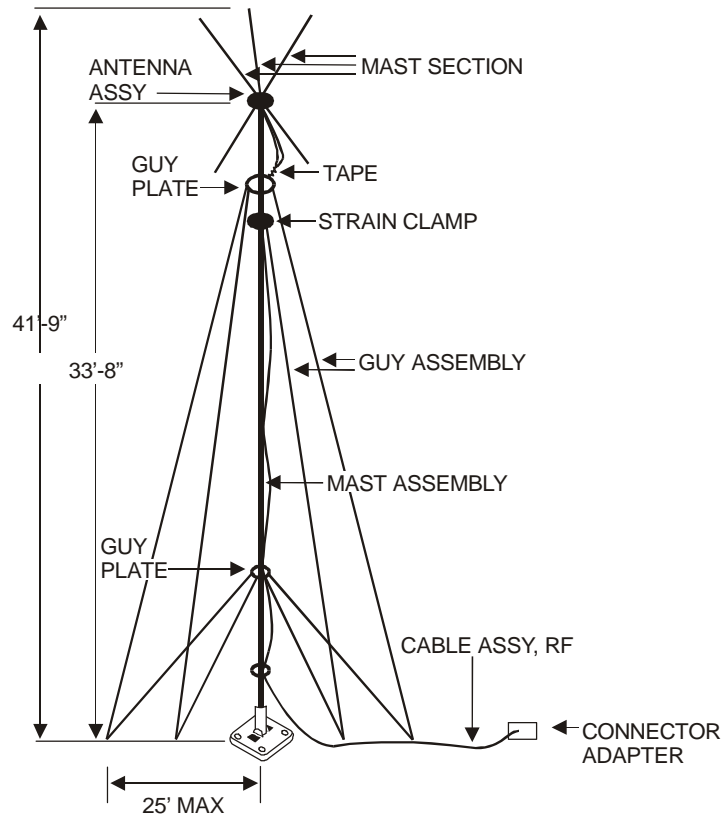

Figure 4-5. OE-254 Antenna.

ANTENNA LENGTH

The length of an antenna must be considered in two ways. It has both a physical and an electrical length, and the two are never the same. The reduced velocity of the wave on the antenna and a capacitive effect (known as end effect) make the antenna seem longer electrically than it is physically. The contributing factors are the ratio of the diameter of the antenna to its length and the capacitive effect of terminal equipment (e.g., insulators, clamps, etc.) used to support the antenna.

To calculate the physical length of an antenna, use a correction of 0.95 for frequencies between 3.0 and 50.0 MHz. The following figures are for a half-wave antenna.

$$\begin{aligned}\text{Length (meters)} &= 150 \times 0.95 / \text{Frequency in MHz} \\ &= 142.5 / \text{Frequency in MHz}\end{aligned}$$

$$\begin{aligned}\text{Length (feet)} &= 492 \times 0.95 / \text{Frequency in MHz} \\ &= 468 / \text{Frequency in MHz}\end{aligned}$$

The length of a long-wire antenna (one wavelength or longer) for harmonic operation is calculated by using the following formula:

$$\begin{aligned}\text{Length (meters)} &= 150(N-0.05) / \text{Frequency in MHz} \\ \text{Length (feet)} &= 492(N-0.05) / \text{Frequency in MHz}\end{aligned}$$

N = number of half-wave lengths in the total length of the antenna.

For example, if the number of half-wavelengths is 3 and the frequency in MHz is 7, then:

$$\begin{aligned}\text{Length (meters)} &= 150(N-0.05) / \text{Frequency in MHz} \\ &= 150(3-.05) / 7 \\ &= 150 \times 2.95 / 7 \\ &= 442.50 / 7 \\ &= 63.2 \text{ meters}\end{aligned}$$

Chapter 5

Interference

Radio frequency interference is always present in a military environment. It may come from a single source or a combination of many sources including natural or manmade frequency interference, poor equipment condition, improper equipment usage, frequency interference, use of unauthorized frequencies, and frequency reuse.

NATURAL INTERFERENCE

Natural radio noise has two principal sources: thunderstorms (atmospheric noise) and stars (galactic noise). It is especially noticeable at night when the lower frequencies propagate farther than in the daytime. The only way to reduce this type of interference is to use a directional antenna to prevent receiving the interference from all directions. However, this will not eliminate the noise coming from the direction of the received signal. Use of a higher frequency will also help, although if a sky wave circuit is used, care must be exercised not to pick the highest frequency at which the signal will be refracted to Earth by the ionosphere (i.e., the critical frequency).

MANMADE INTERFERENCE

Most manmade interference comes from electrical sources such as power generators, alarm systems, power lines, auto ignition, fluorescent lighting, faulty electrical relay contacts, and electrified railroads. Manmade interference also includes enemy jammers (see chapter 7). The key to combating this form of interference is to isolate communications equipment from manmade interference. The interference from known sources such as generators can be greatly reduced if an antenna is positioned so that an obstacle (e.g., a hill) is between it and the source. This must be done so that the same obstacle will not block the intended radio path. If the interference is not coming from the same direction as the intended signal, then a directional antenna should be used.

POOR EQUIPMENT CONDITION AND IMPROPER USAGE

The condition of radio equipment and how it is being used may result in interference. There are several steps that should be taken to lessen this possibility. These include making certain that shielded cables are used where required, ensuring connectors are properly connected to cables, and making sure that antennas within a group are as far apart as possible. All antenna leads (transmission lines), power lines, and telephone lines should be as short as possible when they are on the ground and should not cross. If lines do cross, they must cross at 90° angles to each other, and they must be separated from each other by standoffs. Lines threaded through the trees near an antenna serve as pipelines for interference to and from antennas. Finally, ensure that all radio equipment is grounded.

FREQUENCY INTERFERENCE AND INTERMODULATION

Frequency interference is one of the easiest communications problems to prevent, but it must be done by the CIS officer, CIS chief, and frequency manager during the development of the CIS plan. This type of interference is caused primarily by two radio transmitters using the same frequency, but it can also happen when different frequencies are used. Most of these problems can be eliminated by good frequency planning. However, if frequency interference does occur the following steps can be taken to improve communications:

- 1 Identify the source of the interference. If it is a VHF or HF ground wave transmission, it will probably be within the immediate area and will only occur when the offending transmitter is keyed. The other operator is probably transmitting on a different frequency and has no way of knowing that he is interfering with anyone else's ability to transmit.
- 1 Get the interfering operator to lower their transmitter power as long as it does not degrade their circuit.
- 1 Put as much distance as possible between the affected unit's equipment. This may involve using a hill or other object to block the signal.
- 1 Change to a directional antenna.

- | Remember that the receiver of interference may also cause someone else interference and, whenever possible, should lower his power and use a directional antenna.
- | Report interference to the CIS officer or CIS chief.

USE OF UNAUTHORIZED FREQUENCIES

There is one final source of frequency interference: the use of unauthorized frequencies. This practice is illegal and has the potential to disrupt a carefully engineered frequency plan, introduce interference to other frequencies and circuits, and prevent other units from fulfilling their mission. Radio operators should never use unauthorized frequencies.

FREQUENCY REUSE

There are not enough radio frequencies available for all radio operators to have their own channel. When HF propagation conditions are favorable, Marines may discover that their radio frequency is being used by foreign or United States military personnel in other countries. VHF FM frequencies often have to be reused within the same operation by more than one unit. The exercise frequency manager will try to make certain that users of the same frequency are as far away as possible from each other, but some units (United States Marine Corps and Army, in particular) will join at some stage in the operation. When this occurs, the first common, higher headquarters should be informed to settle the problem.

(reverse blank)

Chapter 6

Radio Operations Under Unusual Conditions

OPERATIONS IN DESERT AREAS

Capabilities and Limitations

SCR is usually the primary means of communications in the desert. It can be employed effectively in desert climate and terrain to provide the highly mobile means of communications demanded by widely dispersed forces. However, desert terrain provides poor electrical ground, and counterpoises are needed to improve operation.

Techniques for Operations

For the best operation in the desert, radio antennas should be located on the highest terrain available. Transmitters using whip antennas in the desert will lose one-fifth to one-third of their normal range because of the poor electrical grounding characteristics of desert terrain. For this reason, it is important to use complete antenna systems such as horizontal dipoles and vertical antennas with adequate counterpoises.

Equipment Considerations

Some SCRs automatically switch on their second blower fan if their internal temperature rises too high. Normally, this happens only in temperate climates when the radios are transmitting. This may disturb Marines unaccustomed to radio operation in the desert environment. Operation of the second fan, however, is quite normal. RF power amplifiers used in AM and SSB sets are liable to overheat severely and burn out. They should be turned on only when necessary (signal reception is not affected). Since the RF power amplifiers take approximately 90 seconds to reach the operating mode, the standing operating procedure (SOP) of units using the equipment should allow for delays in replying.

Dust affects communications equipment such as SSB/AM RF power amplifiers. Dust covers should be used whenever possible. Some receiver-transmitter units have ventilating ports and channels that can get clogged with dust. These must be checked regularly and kept clean to prevent overheating.

Batteries. Wet cell batteries do not hold their charge efficiently in intense heat. Electrolyte evaporates rapidly and should be checked weekly (more often, if warranted). Add distilled water as needed. Extra containers of distilled water should be carried in the vehicle. Maintenance of vehicle batteries, beyond adding water, must be done only by authorized motor-transport personnel according to applicable Marine Corps Orders and SOPs. Dry battery supplies must be increased, since hot weather causes batteries to fail more rapidly.

Electrical Insulation. Wind-blown sand and grit will damage electrical wire insulation over a period of time. All cables that are likely to be damaged should be protected with tape before insulation becomes worn. Sand will also find its way into parts of items such as “spaghetti cord” plugs, either preventing electrical contact or making it impossible to join the plugs. Carry a brush, such as an old toothbrush, and use it to clean such items before they are joined.

Condensation. In deserts with relatively high dew levels and high humidity, overnight condensation can occur wherever surfaces (such as metals exposed to air) are cooler than the air temperature. This condensation can affect electrical plugs, jacks, and connectors. All connectors likely to be affected by condensation should be taped to prevent moisture from contaminating the contacts. Plugs should be dried before inserting them into equipment jacks. Excessive moisture or dew should be dried from antenna connectors to prevent arcing.

Static Electricity. Static electricity is prevalent in the desert. It is caused by many factors, e.g., wind-blown dust particles. Extremely low humidity contributes to static discharges between charged particles. Poor grounding conditions exacerbate the problem. Be sure to tape all sharp edges (tips) of antennas to cut down on wind-caused static discharges and the accompanying noise. If you are operating from a fixed position,

ensure that equipment is properly grounded. Since static-caused noise diminishes with an increase in frequency, use the highest frequencies that are available and authorized.

Maintenance Improvement

In desert areas, the maintenance of SCRs becomes more difficult because of the large amounts of sand, dust, or dirt that enter the equipment. Radios equipped with servomechanisms are particularly affected. To reduce maintenance downtime, keep the radios in dustproof containers as much as possible. It is also important to keep air vent filters clean to allow cool air to circulate to prevent overheating. Preventive maintenance checks should be made frequently. Also, keep a close check on lubricated parts of the equipment. If dust and dirt mix with the lubricants, moving parts may be damaged.

OPERATIONS IN JUNGLE AREAS

Capabilities and Limitations

SCR communications in jungle areas must be carefully planned because the dense jungle growth significantly reduces the range of radio transmission. However, since SCR can be deployed in many configurations, especially manpacked, it is a valuable communications asset. Mobility is also an advantage of SCR. The capabilities and limitations of SCR must be carefully considered when used by forces in a jungle environment.

Climate and density of jungle growth limits SCR communications in jungle areas. The hot and humid climate increases the maintenance problems of keeping equipment operable. Thick jungle growth acts as a vertically polarized absorbing screen for RF energy that reduces transmission range. Therefore, increased emphasis on maintenance and antenna siting is necessary when operating in jungle areas.

Techniques for Operations

The main problem in establishing SCR communications in jungle areas is the siting of the antenna.

Apply the following techniques to improve communications in the jungle:

- | Antennas should be located in clearings on the edge farthest from the distant station and as high as possible.
- | Antenna cables and connectors should be kept off the ground to lessen the effects of moisture, fungus, and insects. This also applies to all power and telephone cables.
- | Complete antenna systems, such as ground planes and dipoles, are more effective than fractional wavelength whip antennas.
- | Vegetation must be cleared from antenna sites. If an antenna touches any foliage, especially wet foliage, the signal will be grounded.
- | Vegetation, particularly when wet, acts like a vertically polarized screen and absorbs much of a vertically polarized signal. Horizontally polarized antennas are preferred to vertically polarized antennas.

Maintenance Improvement

Because of moisture and fungus, the maintenance of SCR in tropical climates is more difficult than in temperate climates. The high relative humidity causes condensation to form on the equipment and encourages the growth of fungus. Operators and maintenance personnel should check the appropriate TMs for any special maintenance requirements. Some techniques for improving maintenance in jungle areas are—

- | Keep the equipment as dry as possible and in lighted areas to retard fungus growth.
- | Keep all air vents clear of obstructions so air can circulate to cool and dry the equipment.
- | Keep connectors, cables, and bare metal parts as free of fungus growth as possible. Use moisture fungusproofing paint (MFP) to protect equipment after repairs are made or when equipment is damaged or scratched.

High Frequency Expedient Antennas

Dismounted patrols and units of company size and below can greatly improve their ability to communicate in the jungle by using expedient antennas. While moving, they are generally restricted to using the short and long antennas which come with the radios. However, when they are not moving, these expedient antennas will allow them to broadcast farther and receive more clearly.

Note: An antenna that is not “tuned” or “cut” to the operating frequency is not as effective as the whips that are supplied with the radio.

Circuits inside the radio “load” the whips properly so that they are “tuned” to give maximum output. Whips are not as effective as a tuned doublet or tuned ground-plane, but the doublet or ground-plane must be tuned to the operating frequency.

OPERATIONS IN A COLD WEATHER ENVIRONMENT

Capabilities and Limitations

SCR equipment has certain capabilities and limitations that must be carefully considered when operating in extremely cold areas. However, in spite of significant limitations, SCR is the normal means of communications in such areas.

One of the most important capabilities of SCR in cold weather areas is its versatility. Vehicular-mounted radios can be moved relatively easily to almost any point where it is possible to install a command headquarters. Smaller, manpacked radios can be carried to any point accessible by foot or aircraft.

A limitation on radio communications that radio operators must expect in extremely cold areas is interference by ionospheric disturbances. These disturbances, known as ionospheric storms, have a definite degrading effect on sky wave propagation. Moreover, either the storms or the auroral (e.g., Northern Lights) activity can cause complete failure of radio communications. Some frequencies may be blocked out completely by static for extended periods of time during storm activity.

Fading, caused by changes in the density and height of the ionosphere, can also occur and may last from minutes to weeks. The occurrence of these disturbances is difficult to predict. When they occur, the use of alternate frequencies and a greater reliance on FM or other means of communications are required.

Techniques for Operations

Whenever possible, SCR for tactical operations in cold weather areas should be installed in vehicles to reduce the problem of transportation and shelter for operators. This will also help solve some of the grounding and antenna installation problems caused by the climate.

Because of permafrost and deep snow, it is difficult to establish good electrical grounding in extremely cold areas. The conductivity of frozen ground is often too low to provide good ground wave propagation. To improve ground wave operation, use a counterpoise to offset the degrading effects of poor electrical ground conductivity. Remember to install a counterpoise high enough above the ground so that it will not be covered by snow.

In general, antenna installation in arcticlike areas presents no serious difficulties. However, installing some antennas may take longer because of adverse working conditions. A few tips for installing antennas in extremely cold areas are—

- 1 Mast sections and antenna cables must be handled carefully since they become brittle in very low temperatures.
- 1 Antenna cables should be constructed overhead to prevent damage from heavy snow and frost, whenever possible. Nylon rope guys, if available, should be used in preference to cotton or hemp because nylon ropes do not readily absorb moisture and are less likely to freeze and break.
- 1 Antennas should have extra guy wires, supports, and anchor stakes to withstand heavy ice and wind loading.

Some Marine Corps radios that are adjusted to a particular frequency in a relatively warm place may drift off frequency when exposed to

extreme cold. Low battery voltage can also cause frequency drift. When possible, allow a radio to warm up several minutes before placing it into operation. Since extreme cold tends to lower output voltage of a dry battery, try warming the battery with body heat before operating the radio set. This minimizes frequency drift. Flakes or pellets of highly electrically charged snow are sometimes experienced in northern regions. When these particles strike the antenna, the resulting electrical discharge causes a high-pitched static roar that can blanket all frequencies. To overcome this static, antenna elements can be covered with polystyrene tape and shellac.

Maintenance Improvement

The maintenance of SCR equipment in extreme cold presents many difficulties. Radios must be protected from blowing snow, since snow will freeze to dials and knobs and blow into the wiring to cause shorts and grounds. Cords and cables must be handled carefully since they may lose their flexibility in extreme cold. All radio equipment and power units must be properly winterized. Check the appropriate technical manual (TM) for winterization procedures. A few tips for maintenance in arctic areas are discussed in the following paragraphs.

Power Units. As the temperature goes down, it becomes increasingly difficult to operate and maintain generators. They should be protected as much as possible from the weather.

Batteries. The effect of cold weather on wet and dry cell batteries depends upon the type and kind of battery, the load on the battery, the particular use of the battery, and the degree of exposure to cold temperatures.

Shock Damage. Damage may occur to vehicular SCR by the jolting of the vehicle. Most synthetic rubber shock mounts become stiff and brittle in extreme cold and fail to cushion equipment. Check the shock mounts frequently and change them, as required.

Winterization. Check the TMs for the SCR and power source to see if there are special precautions for operation in extremely cold climates.

For example, normal lubricants may solidify and permit damage or malfunctions. They must be replaced with the recommended arctic lubricants.

Microphones. Moisture from your breath may freeze on the perforated cover plate of your microphone. Use standard microphone covers to prevent this. If standard covers are not available, improvise a suitable cover from rubber or cellophane membranes or from rayon or nylon cloth.

Breathing and Sweating. A SCR generates heat when it is operated. When it is turned off, the air inside cools and contracts and draws cold air into the set from the outside. This is called breathing. When a radio breathes, and the still-hot parts come in contact with subzero air, the glass, plastic, and ceramic parts of the set may cool too rapidly and break.

When cold equipment is brought suddenly into contact with warm air, moisture will condense on the equipment parts. This is called sweating. Before cold equipment is brought into a heated area, it should be wrapped in a blanket or parka to ensure that it will warm gradually to reduce sweating. Equipment must be thoroughly dry before it is taken back out into the cold air or the moisture will freeze.

Vehicular-Mounted Radios. These radios present special problems during winter operations because of their continuous exposure to the elements. Proper starting procedures must be observed. The radio's power switch must be off prior to starting the vehicle; this is a particularly critical requirement when vehicles are slave started. If the radio is cold soaked from prolonged shutdown, frost may have collected inside the radio and could cause circuit arcing. Hence, time should be allowed for the vehicle heater to warm the radio sufficiently that any frost collected within the radio has a chance to thaw. This may take up to an hour. Once the radio has been turned on, it should warm up for approximately 15 minutes before transmitting or changing frequencies. This allows components to stabilize. If a vehicle is operated at a low idle with radios, heater, and lights on, the batteries may run down. Before increasing engine revolutions per minute to charge the batteries, radios should be turned off to avoid an excessive power surge. A light coat of silicon compound on

antenna mast connections helps to keep them from freezing together and becoming hard to dismantle.

OPERATIONS IN MOUNTAINOUS AREAS

Capabilities and Limitations

Operation of SCRs in mountainous areas has many of the same problems as in northern or cold weather areas. Also, the mountainous terrain makes the selection of transmission sites a critical task. In addition, the terrain restrictions encountered frequently make radio relay stations necessary for good communications.

Maintenance Improvement

Because of terrain obstacles, SCR transmissions will frequently have to be by line of sight. Also, the ground in mountainous areas is often a poor electrical conductor. Thus, a complete antenna system, such as a dipole or ground-plane antenna with a counterpoise, should be used. The maintenance procedures required in mountainous areas are very often the same as maintenance in northern or cold weather areas. The varied or seasonal temperature and climatic conditions in mountainous areas make flexible maintenance planning a necessity.

OPERATIONS IN SPECIAL ENVIRONMENTS

Urbanized Terrain

SCR communications in urbanized terrain poses special problems. Some problems are similar to those encountered in mountainous areas. There are problems of obstacles blocking transmission paths. There is the problem of poor electrical conductivity because of pavement surfaces. There is also the problem of commercial power-line interference. VHF radios are not as effective in urbanized terrain as they are in some other areas. The power output and operating frequencies of these VHF radios require a line of sight between antennas. Line of sight at street level is not always possible in built-up areas.

HF radios do not require or rely on line of sight as much as VHF radios because operating frequencies are lower, and power output is greater. The problem is that HF radios are not organic to small units. To overcome this, the VHF signals must be retransmitted.

Retransmission stations in aerial platforms can provide the most effective means if they are available. Organic retransmission is more likely to be used. The antenna should be hidden or blended in with surroundings. This will help prevent the enemy from using it as a landmark to “home in” his artillery bombardment. Antennas can be concealed by water towers, existing civilian antennas, or steeples.

The following steps should also be taken within urbanized terrain:

- 1 Park radio-equipped vehicles inside buildings for cover and concealment.
- 1 Dismount radio equipment and install it inside buildings (in basement, if available).
- 1 Place generators against buildings or under sheds to decrease noise and provide concealment (adequate ventilation must be provided to prevent heat buildup and subsequent failure of generator).

Nuclear, Biological, and Chemical Environment

One of the realities of fighting on the modern battlefield is the presence of nuclear weapons. The explosion of a nuclear weapon causes a tremendous blast, followed by intense heat and strong radiation. The ionization of the atmosphere by a nuclear explosion will have degrading effects on communications because of static and the disruption of the ionosphere.

Another effect of a nuclear explosion that is an even greater danger to radio communications is the electromagnetic pulse (EMP). EMP is a strong pulse of electromagnetic radiation, many times stronger than the static pulse generated by lightning. This pulse can enter the radio through the antenna system, power connections, and signal input connections. In the equipment, the pulse can break down circuit components such as transistors, diodes, and integrated circuits. It can melt capacitors, inductors, and transformers. EMP can destroy a radio.

Defensive measures against EMP call for proper maintenance, particularly the shielding of equipment. When the equipment is not in use, all antennas and cables should be removed to decrease the effect of EMP on the equipment. Effective grounding is necessary to reduce effect of EMP. EMP is a danger to SCR equipment, but contamination is a danger to Marines. Contamination from any portion of the nuclear, biological, and chemical (NBC) environment has adverse effects on both equipment and personnel.

(reverse blank)

Chapter 7

Electronic Warfare

Electronic warfare (EW) is the military action involving the use of electromagnetic energy (i.e., radio frequency waves) to attack personnel, facilities, or equipment with the intent of degrading, neutralizing, or destroying enemy combat capability. EW includes electronic attack (EA), electronic protection (EP), and electronic warfare support (ES).

EA includes actions taken to prevent or reduce the enemy's effective use of the electromagnetic spectrum and employment of weapons that use electromagnetic or directed energy. EP represents actions taken to protect personnel, facilities, and equipment from any effects of friendly or enemy employment of electronic warfare that degrade, neutralize, or destroy friendly combat capability. ES involves actions taken by, or under direct control of, an operational commander to search for, intercept, identify, and locate sources of intentional or unintentional radiated electromagnetic energy for the purpose of immediate threat recognition. Each radio operator must be aware of what the enemy will try to do. The enemy is well equipped to conduct EW, and the different techniques the enemy uses have specific purposes in the enemy's EW effort.

ELECTRONIC ATTACK TECHNIQUES

Enemy forces employ a large number of radio direction finder (RDF) sets and communications intelligence (COMINT) analysts to exploit friendly use of the electromagnetic spectrum. The enemy's goal is to locate and destroy as many command and control, fire support, and intelligence sites as possible during the first critical phase of the battle. When the enemy locates sites that the enemy cannot or does not want to destroy, these sites become prime targets for imitative electronic deception (IED) or jamming. Imitative electronic deception is the enemy's use of a compatible radio and a language expert to enter a friendly radio net. The enemy IED experts are very good at their jobs. If they are permitted to enter into a net, they will create much confusion for friendly forces.

Jamming is an effective way to disrupt control of the battle. All it takes is a transmitter, tuned to your frequency, with the same type of modulation and with enough power output to override the signal at your receiver.

There are many types of jamming signals that may be used against a radio operator. Some are very difficult to detect and some are impossible to detect. For this reason, an operator must always be alert to the probability of jamming and react accordingly when the radio has been silent for an inordinate amount of time. The radio operator should also be able to quickly identify the various types of jamming signals. These include—

- | Random noise.
- | Random pulse.
- | Stepped tones.
- | Wobbler.
- | Random keyed modulated continuous wave.
- | Tone.
- | Rotary.
- | Pulse.
- | Spark.
- | Recorded Sounds.
- | Gulls.
- | Sweep-through.

Capture Effect and Jamming Techniques

An inherent characteristic in FM communications is that a given station transmitting a signal will capture those receivers on the same frequency and in range for the receiver to detect the signal. This is the basis for netted communications for VHF FM radios. This FM capture effect is undesirable when receivers in a net are “captured” by a transmitter not in that net. This could be friendly interference or enemy interference. Friendly interference is usually unintentional whereas enemy interference is usually intentional.

Obvious Jamming

Radio operators are mostly aware of obvious interference (e.g., jamming) by an enemy, such as stepped tones (e.g., bagpipes), random-keyed Morse Code, pulses, and recorded sounds. The purpose of this type of jamming is to block out reception of friendly transmitted signals and to cause a nuisance to the receiving operator. An operator can usually detect when the enemy is using this type of jamming.

Subtle Jamming

This type of jamming is not obvious at all. With subtle jamming, no sound is heard from the receiver. The radio does not receive incoming friendly signals, yet everything seems normal to the operator.

Operator Actions

Radio operators must be able to determine whether or not their radios are being jammed. This is not always easy. Threat jammers may employ obvious or subtle jamming techniques. These techniques may consist of powerful unmodulated or noise-modulated carrier signals transmitted to the operator's receiver. Unmodulated jamming signals are characterized by a lack of noise. Noise-modulated jamming signals are characterized by obvious interference noises. If radio operators suspect that their radios are the targets of threat jamming, the following procedures will help them to make this determination.

Meaconing, Intrusion, Jamming, and Interference Report

If the radio operator suspects jamming or enemy intrusion on the net, then the radio operator should report it immediately to higher headquarters. Such information is vital for the protection and defense of radio communications.

Field meaconing, intrusion, jamming, and interference (MIJI) reports serve two purposes. First, initial MIJI reports facilitate battlefield evaluations of the enemy's actions or intentions and provide data for tactical countermeasures, as appropriate. Second, complete and accurate follow-up reports ensure MIJI incidents are documented and evaluated on a

national level, thus providing data for a continuing study of foreign electronic warfare capabilities and activities.

MIJI reports may be transmitted over nonsecure electronic means when secure communications are not available; however, the textual content of the MIJI report will be secured by an off-line (i.e., manual) system. Reports will be prepared in the format outlined in the following paragraphs. Brevity numbers pertinent to specific line item information are provided for some items. These brevity numbers must be encoded in the numeral cipher or authentication system prior to transmission. The two types of field MIJI reports are—

- 1 MIJI 1—an abbreviated initial report containing only those items of information necessary to inform headquarters of the incident and enable them to initiate evaluatory or retaliatory actions as appropriate.
- 1 MIJI 2—consists of 40 lines and is completed by higher headquarters.

The MIJI 1 Report. This report is forwarded through the chain of command to the combat operations center by the operator who is experiencing the MIJI incident. A separate report is submitted for each MIJI incident. The MIJI report includes—

- 1 Item 1—type report. When being transmitted over nonsecure communications means, the numerals 022 are encrypted as Item 1 of the MIJI 1 report. When being transmitted over secure communications means, the term MIJI 1 is used as Item 1 of the MIJI 1 report.
- 1 Item 2—type MIJI incident. When being transmitted over nonsecure communications means, the appropriate numeral preceding one of the items below is encrypted as Item 2 of the MIJI 1 report. When being transmitted over secure communications means, the appropriate term below is used as Item 2 of the MIJI 1 report.

- 1 Meaconing
- 2 Intrusion
- 3 Jamming
- 4 Interference

- | Item 3—type of equipment affected. When being transmitted over nonsecure communications means, the appropriate numeral preceding one of the terms below is encrypted as Item 3 of the MIJI 1 report. When being transmitted over secure communications means, the appropriate term below is used as Item 3 of the MIJI 1 report.
 - 1 Radio
 - 2 Radar
 - 3 Navigational aid
 - 4 Satellite
 - 5 Electro-optics

- | Item 4—Frequency or channel affected. When being transmitted over nonsecure communications means, the frequency or channel affected by the MIJI incident is encrypted as Item 4 of the MIJI 1 report. When being transmitted over secure communications means, the frequency or channel affected by the MIJI incident is Item 4 of the MIJI 1 report.

- | Item 5—victim designation and call sign of affected station operator. The complete call sign of the affected station operator is Item 5 of the MIJI 1 report over both secure and nonsecure communications means.

- | Item 6—coordinates of the affected station. When being transmitted over nonsecure communications means, the complete grid coordinates of the affected station are encrypted as Item 6 of the MIJI 1 report. When being transmitted over secure communications means, the complete grid coordinates of the affected station are Item 6 of the MIJI 1 report.

The MIJI 2 Report. This is a complete report containing all details of the MIJI incident. Due to the number of items which require encryption when the report is transmitted over a nonsecure circuit, it is recommended that the report be delivered by messenger whenever possible. The higher headquarters' operations officer, intelligence officer, or the electronic warfare officer is responsible for ensuring that a complete message report of the incident is submitted to the Joint Command and Control Warfare Center (JC2WC) within 24 hours of the incident.

ELECTRONIC PROTECTION TECHNIQUES

Communications security (COMSEC) is an integral part of electronic protection. COMSEC is the protection resulting from all measures designed to deny unauthorized persons information of value that might be derived from the possession and study of telecommunications or to mislead unauthorized persons in their interpretation of the results of such possession and study. COMSEC includes transmission, cryptographic, emission, and physical security.

The goal of COMSEC is to protect friendly communications from enemy exploitation while ensuring unimpeded use of the electromagnetic spectrum. The organization must be able to employ communications equipment effectively in the face of enemy efforts.

COMSEC requirements must be integrated into communications systems planning and must focus on providing secure communications without impairing reliability or responsiveness. Modern communications equipment includes features such as an integrated encryption capability and frequency hopping capability, which contribute to communications protection. However, the security of our communications depends on the proper operation of communications equipment and adherence to proper procedures.

Transmission security

Transmission security (TRANSEC) is that component of COMSEC that results from all measures designed to protect transmissions from interception and exploitation by means other than cryptanalysis. A message transmitted in the clear is the enemy's greatest source of information. After the enemy has intercepted your radio transmission, the enemy's language specialists will extract all possible intelligence from it. The enemy hopes to learn essential elements of friendly information (EEFI). Critical information that must be protected can be remembered by the key words SELDOM UP.

Each letter indicates a class of information as follows:

- | Strength—number of personnel, size of unit.
- | Equipment—type, quantity, condition.
- | Logistics—procedure for resupply, depots.
- | Disposition—where, what positions, map coordinates.
- | Organization—how, what, chain of command, forces structure.
- | Movement and morale—where, how, when and good or bad.
- | Units—type, designation.
- | Personalities—who, where.

Using TRANSEC is absolutely essential for the radio operator. When the radio must be used, keep transmission time to an absolute minimum (20 seconds absolute maximum: 15 seconds maximum preferred); preplan your messages to avoid compromising any essential element of information. If you must send EEFI items, use brevity lists, if possible, and also encrypt the message. These measures decrease your transmission, help prevent RDF, and deny the enemy valuable information. Included under transmission security are the authentication procedures that must be followed to protect against the enemy's IED. Every radio operator must be aware of the dangers of and guard against IED.

Strict radio discipline and adherence to authorized procedures are key to ensuring TRANSEC over SCR networks. SINCGARS radios should be operated in a frequency hopping mode to provide maximum protection against enemy EW capabilities. Other TRANSEC measures include—

- | Well-trained operators thoroughly familiar with proper communications procedures and equipment operation. (This includes all Marines who may operate SCR, not just CIS personnel.)
- | Avoidance of unauthorized transmission and testing and maximum use of data networks to minimize transmission time and opportunity for enemy direction finding.
- | Use of transmitter, antenna, and power combinations that produce minimum wave propagation and emission intensity consistent with reliable communications.

- | Strict adherence to authorized frequencies.
- | Use of authentication systems to protect against imitative deception on nonsecure nets.
- | Use of changing call signs and frequencies on nonsecure nets.
- | Prompt response to and reporting of enemy jamming. (Operators should continue to operate on assigned frequencies in a secure mode, unless otherwise directed by a competent authority, and should attempt to work through the interference.)
- | Strict adherence to all emission control (EMCON) restrictions and observance of radio silence.
- | Use of communications means that do not radiate in the electromagnetic spectrum such as messengers, visual and sound signaling, and local wire loops.
- | Use of terrain masking to shield transmission systems from enemy EW systems.
- | Remoting of transmitters and avoiding the clustering of antennas.

Cryptosecurity

Cryptosecurity deals with codes, key lists, and communications security devices. This is the third line of defense for the radio operator. If the radio operator uses a security device on the radio, the enemy will not get anything for the language specialists to work on. However, do not get a false sense of security. The need for emission control and transmission security still exists—probably more so—because, if the enemy can't get information, the enemy might attempt to destroy or jam your station. Also, it is very important for all radio operators to use only authorized codes and to realize that using homemade codes is dangerous. Homemade codes offer no protection at all. Their use is not authorized and is a serious violation of security.

This also includes trying to “talk around” a classified or sensitive piece of information. The enemy intelligence personnel are not fools, and trying something like “talking around” critical information does more harm than good. If critical information must be transmitted, it should be encrypted or sent by secure means. In a situation when it is not possible to send by a secure means or to encrypt a message that must be sent, the

possibility of what friendly forces will lose against what the enemy could gain must be weighed. Other factors, such as how fast the enemy could react to the information and what delaying the message for encryption could mean, must also be considered.

Emission Security

Emission security (TEMPEST) is the component of COMSEC that results from all measures taken to deny unauthorized persons information of value that might be derived from interception and analysis of compromising emanations from cryptosecurity equipment and telecommunications systems. The operation of communications and information systems may result in unintentional electromagnetic emissions. Although tactical equipment is designed to reduce the possibility of such emissions, COTS equipment is not. Unintentional emissions are extremely susceptible to interception and analysis and may disclose classified information. Commanders must follow applicable regulations providing guidance on control and suppression of such emissions.

Physical Security

Physical security is the COMSEC component that results from all physical measures necessary to safeguard classified equipment, material, and documents from access or observation by unauthorized persons. The access to classified cryptographic information must be tightly controlled. When a commander or designated representative has determined that an individual has a need to know and is eligible for access, then access to classified cryptographic information will be formally authorized. The authorization process must include an introduction to the unique nature of cryptographic information, its unusual sensitivity, the special security regulations governing its handling and protection, and the penalties prescribed for its disclosure. Reportable violations include—

- | Loss of material.
- | Unauthorized viewing.
- | Capture of individuals having access to COMSEC information.

Currently fielded COMSEC equipment is unclassified for external viewing when appropriate covers are in place and no keying material is visible. Consequently, the exposure of such equipment to casual viewing by uncleared personnel, whether by accident or as the result of operational necessity, does not constitute a reportable violation.

EP techniques are divided into two categories: preventive and remedial. Preventive EP are those procedures that can be used to avoid enemy EA attempts. Remedial EP apply to jamming only; there are no remedial measures once a unit has been intercepted, detected, or deceived.

ELECTRONIC WARFARE SUPPORT TECHNIQUES

Interception

The enemy is focused on intercepting your radio signal. To do this, all the enemy needs is a radio receiver that operates in the same mode and on the same frequency you are using to transmit. The mere fact that you are operating gives the enemy valuable information. It tells the enemy that you are in the area. By the number of stations operating on the same frequency, the enemy can estimate the size of the unit. If your net is operating in the clear, the enemy's language specialists can understand exactly what is said for even more information. When analyzing the traffic pattern, the enemy can figure out which station is the net control station (NCS) and identify the headquarters. Usually, in U.S. forces, the NCS is the radio used by the operations officer or section of the highest headquarters operating in the net. By further traffic analysis, the enemy can determine changes in the level of activity that could mean a movement or upcoming operation.

Radio Direction Finding

Interception is only one of the many dangers that the radio operator will face. After knowing friendly forces are in the area, the enemy will try to locate their position by using radio direction finding (RDF). A radio direction finder consists of a radio receiver, a directional antenna, and other specialized equipment. With RDF equipment, the approximate azimuth (i.e., bearing) to a transmitting radio can be determined. One

azimuth gives a general indication of direction. The intersection of two azimuths by different RDF stations is called a cut and gives a general indication of distance. The intersection of three or more azimuths is called a fix and gives a general location. The ideal fix is the exact intersection of three or more bearings. However, exact intersection is seldom achieved.

Terrain, weather, variations in radio wave propagation characteristics, the inherent RDF equipment, and operator inaccuracies, prevent an ideal fix. The fix that is obtained is called an actual fix. Although the actual fix may not be usable for immediate targeting purposes, it is more than enough for intelligence analysts to develop targeting data. Airborne direction finding is more accurate than ground-based direction finding but normally requires further analysis for targeting.

RDF ability to intercept electronics equipment emissions and determine a bearing depends on the power output of the targeting transmitter and its antenna radiation patterns. Experience indicates RDF accuracy of 500-meter (547-yard [yd]) circular error of probability (CEP) is considered a very good RDF fix. Normally, 50 percent of the CEPs are approximately 1,500 meters (1,640 yds) when the direction finder is located within 20 to 25 kilometers (12.4 to 15.5 mi) of the forward line of own troops (FLOT). Many threat forces will fire on a 1,500-meter (1,640-yd) CEP if they have sufficient massed artillery, and further analysis of terrain and radio intercept can reduce the target area or identify an important target.

(reverse blank)

Appendix A

Map Coordinates

Field coordinates are often expressed in universal transverse mercator grid coordinates and usually consist of 6-digit numbers. The typical map used by the radio operator is a 1 to 50,000 scale topographic map that has grid lines drawn on it, which are 1,000 meters (1 kilometer or klick) apart. (See fig. A-1.)

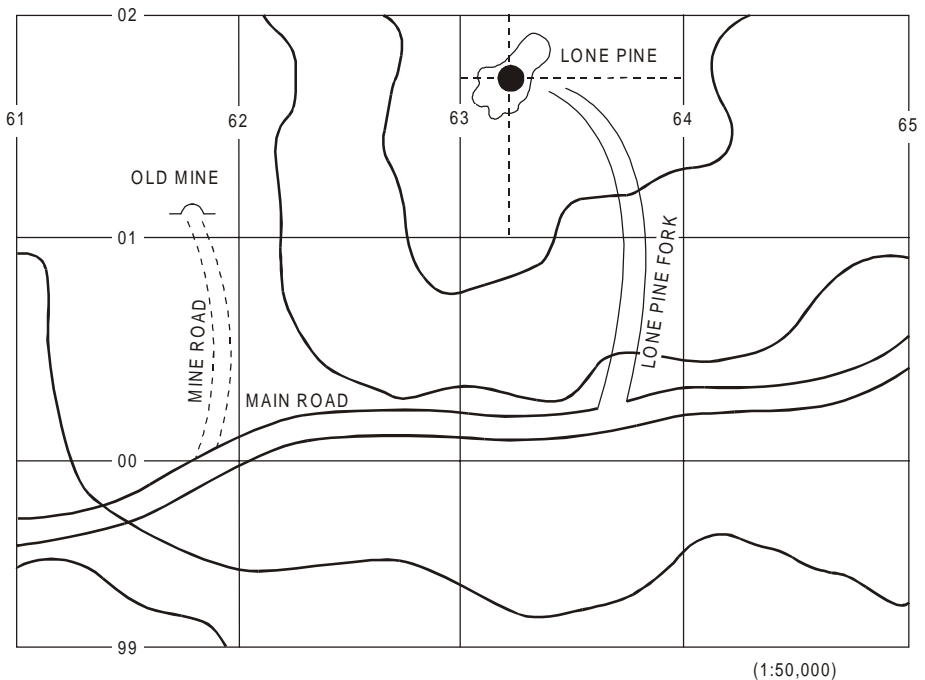

Figure A-1. Topographic Map.

To locate grid coordinate 632018, locate vertical line 63 (632018) in the figure and draw a vertical line 2/10 of the way (632018) between lines 63 and 64. Likewise, find horizontal line 01 (632018) and draw a

horizontal line 8/10 of the way (632018) between it and line 02. The two drawn lines intersect at Lone Pine.

Similarly, the intersection of the Lone Pine Fork with the Main Road in the figure would be represented as 638004, and the Old Mine would be 618012.

Although the use of the 6-digit number is generally sufficient for field use, a more exact coordinate will identify the 100,000 meter square and the grid zone designation to avoid confusion between different areas with identical grid line numbers.

A more detailed explanation of the complete coordinate may be found centered at the bottom of a 1 to 50,000 scale topographic map. The order in which the grids are read can be remembered by using the expression read-right-up.

Appendix B

Time Zones

The world is divided into 24 time zones, each one bearing a unique phonetic letter name (ROMEO, UNIFORM, etc.) or time zone number that must be applied to local time to arrive at the world standard time which is Coordinated Universal Time (UTC). This standard time is referred to in the Marine Corps as ZULU time. (See fig. B-1.) The time zones are roughly 15° apart in longitude.



Figure B-1. Standard Time Zones of the World.

ZULU TIME = LOCAL TIME - TIME ZONE NUMBER.

LOCAL TIME = ZULU TIME + TIME ZONE NUMBER.

If a Marine is in the UNIFORM time zone, (also referred to as the PLUS 8 zone), 8 hours must be added to the local time to get ZULU time. (See table B-1.) On the other hand, in the ROMEO or PLUS 5 time zone, 1300 ZULU would equate to 0800 local. During the summer, however, if a Marine is located in an area where daylight savings time is observed, one hour must be subtracted from the time zone number; i.e., the PLUS 8 zone becomes the PLUS 7 zone for local time purposes.

Table B-1. CONUS Time Zones.

Civilian Time Zone	Military Time Zone	ZULU	Local Time	ZULU Time
EDT	QUEBEC	+4	0800 Q	1200 Z
EST CDT	ROMEO	+5	0700 R	1200 Z
CST MDT	SIERRA	+6	0600 S	1200 Z
MST PDT	TANGO	+7	0500 T	1200 Z
PST	UNIFORM	+8	0400 U	1200 Z

AUTODIN communications (i.e., worldwide) ZULU time should be used in all messages. Within the operational area, however, local time is usually used. To avoid confusion, the time zone should always be stated e.g., 1100 LOCAL or 1900 ZULU.

Appendix C

Prowords

Word or Phrase	Meaning
ALL AFTER	I refer to the portion of the message that follows.
ALL BEFORE	I refer to the portion of the message that precedes.
BREAK	I hereby indicate the separation of the text from other portions of the message. Or: I have completed the text of the message, signature follows, etc. (When break-in is permitted, receiving operator may interrupt the transmitting operator to request retransmission of a portion of a message. This proword is the interruption sign.)
CORRECTION	An error has been made in this transmission (or message indicated). The correct version is _____. That which follows is a corrected version in answer to your request for verification.
DISREGARD THIS TRANSMISSION	This transmission is in error. Disregard it. (This proword shall not be used to cancel any message that has been completely transmitted and for which receipt or acknowledgment has been received.)
DO NOT ANSWER	Stations called are not to answer this call receipt for this message, or otherwise to transmit in connection with this transmission. When this proword is employed, the transmission shall be ended with the proword <i>OUT</i> .

Word or Phrase	Meaning
EXECUTE	Carry out the purpose of the message or signal to which this applies. To be used only with the executive method.
EXECUTE TO FOLLOW	Action on the message or signal which follows is to be carried out upon receipt of the proword <i>EXECUTE</i> . To be used only with the executive method.
EXEMPT	The addressee designations immediately following are exempted from the collective net call.
FIGURES	Numerals or numbers follow.
FLASH	Precedence <i>FLASH</i> .
FROM	The originator of this message is indicated by the address designation immediately following.
IMMEDIATE	Precedence <i>IMMEDIATE</i> .
INFO	The addressee designations immediately following are addressed for information.
IREADBACK	The following is my response to your instructions to read back.
ISAY AGAIN	I am repeating transmission (or portion) indicated.
ISPELL	I shall spell the next word phonetically.
I VERIFY	The following message (or portion) has been verified at your request and is repeated. To be used only as a reply to verify.
MESSAGE FOLLOWS	A message which requires recording is about to follow. (Transmitted immediately after the call.)

Word or Phrase	Meaning
NUMBER	Station serial number.
OUT	This is the end of my transmission to you. No response is necessary.
OVER	This is the end of my transmission to you and a response is necessary. Go ahead and transmit.
PRIORITY	Precedence <i>PRIORITY</i> .
READ BACK	Repeat this entire transmission back to me exactly as received.
RELAY TO	Transmit this message to all addressees or to the address designations immediately following.
ROGER	I have received your last transmission satisfactorily.
ROUTINE	Precedence <i>ROUTINE</i> .
SAY AGAIN	Repeat all of your last transmission. Followed by identification data means: "Say again (portion indicated)." ("Repeat" is not used because it is the signal for naval gunfire and artillery to fire.)
SIGNALS FOLLOW	The groups which follow are taken from signal book. (This proword need not be used on nets primarily employed for conveying signals. It is intended for use when tactical signals are passed on nontactical nets.)
SILENCE, SILENCE, SILENCE	Cease transmission immediately. (Silence will be maintained until instructed to resume. When an authentication system is in force, transmissions imposing silence are to be authenticated.)

Word or Phrase	Meaning
SILENCE LIFTED	Resume normal transmissions. (Silence can be lifted only by the station imposing it or by higher authority. When an authentication system is in force, transmissions lifting silence are to be authenticated.)
SPEAK SLOWER	Your transmission is too fast. Reduce speed of transmission.
THAT IS CORRECT	You are correct, or what you have transmitted is correct.
THIS IS	This transmission is from the station whose designation immediately follows.
TIME	That which immediately follows is the time or date-time group of the message.
TO	The addressees whose designations immediately follow are to take action on this message.
UNKNOWN STATION	The identity of the station with whom I am attempting to establish communications is unknown.
VERIFY	Verify entire message (or portion indicated) with the originator and send correct version. To be used only at the discretion of or by the addressee to which the questioned message was directed.
WAIT	I must pause for a few seconds.
WAIT OUT	I must pause longer than a few seconds.

Word or Phrase	Meaning
WILCO	I have received your message, understand it, and will comply. (To be used only by the addressee. Since the meaning of ROGER is included in that of WILCO, the two prowords are never used together.)
WORD AFTER	I refer to the word that follows.
WORD BEFORE	I refer to the word that precedes.
WORDS TWICE	Communication is difficult. Transmit(ing) each phrase (or each code group) twice. This proword may be used as an order, request, or as information.
WRONG	Your last transmission was incorrect. The correct version is.

Appendix D

Phonetic Alphabet

Letter	Word	Pronunciation
A	ALFA	AL FAH
B	BRAVO	BRAH VOH
C	CHARLIE	CHAR LEE
D	DELTA	DELL TAH
E	ECHO	ECK OH
F	FOXTROT	FOKS TROT
G	GOLF	GOLF
H	HOTEL	HOH TELL
I	INDIA	IN DEE AH
J	JULIETT	JEW LEE ETT
K	KILO	KEY LOH
L	LIMA	LEE MAH
M	MIKE	MIKE
N	NOVEMBER	NOVEMBER
O	OSCAR	OSS CAH
P	PAPA	PAH PAH
Q	QUEBEC	KEH BECK
R	ROMEO	ROW ME OH
S	SIERRA	SEE AIR RAH
T	TANGO	TANG GO

Letter	Word	Pronunciation
U	UNIFORM	YOU NEE FORM
V	VICTOR	VIK TAH
W	WHISKEY	WISS KEY
X	XRAY	ECKS RAY
Y	YANKEE	YANG KEY
Z	ZULU	ZOO LOO

Appendix E

Phonetic Numerals

Number	Pronunciation
---------------	----------------------

1	WUN
2	TOO
3	TREE
4	FOW-er
5	FIFE
6	SIX
7	SEV-en
8	AIT
9	NIN-er
0	ZERO

(reverse blank)

Appendix F

Prosigns

Prosign	Meaning
AA	All after.
AB	All before.
AR	End of transmission. No receipt required.
AS	I must pause for a few seconds.
AS AR	I must pause longer than a few seconds. Will call you back.
B	More to follow.
BT	Break.
C	Correct.
DE.....	This is.
EEEEEEEE	Error.
EEEEEEEE AR.....	This message is in error. Disregard it.
F.....	Do not answer.
FM	From.
G	Repeat this entire transmission back to me.
GR	Group count.
GRNC.....	The groups in this message have not been counted.
HM HM HM.....	Emergency silence sign-silence.

- IMI..... Repeat.
- INFO.....The address designations immediately following are addressed for information only.
- INT.....Interrogative.
- IX.....Action on the message or signal which follows is to be carried out upon receipt of execute.
- J..... Verify with originator and repeat.
- K.....This is the end of my transmission to you and a response is necessary.
- NR..... Numerals or numbers follow.
- O..... Immediate precedence.
- P..... Priority precedence.
- R.....Routine precedence.
- T.....Relay to.
- TO..... Action addressee.
- WA..... Word after.
- WB..... Word before.
- XMT..... Exempt.
- Y..... Emergency command precedence.
- Z.....Flash precedence.

Appendix G

Instructions for Preparing Field Messages

1. Place the protector insert under the message blanks to limit the number of copies produced. Retain one copy in the book as a file copy. Classify cover in accordance with contents (see fig. G-1).
2. Use BLOCK CAPITAL letters for all entries except the signature. Use necessary punctuation.
3. To assign precedence and classification use table on the next page.
4. If a classified message is to be transmitted, secure voice or in the clear, check appropriate block.
5. Show organization originating message in FM (from) block.
6. Show organization(s) for whom the message is intended in the TO block.
7. Block labeled date-time group is for communication personnel only.
8. Draft the message in brief but clear terms.
9. Message drafters are responsible for all message drafting functions to include the use of brevity codes.

PRECEDENCE TABLE

- Z - FLASH
- O- IMMEDIATE
- P - PRIORITY
- R - ROUTINE

SECURITY CLASSIFICATION TABLE

- TOPSEC - TOP SECRET
- SECRET - SECRET
- CONF - CONFIDENTIAL
- UNCLAS - UNCLASSIFIED

PROTECTOR INSERT
Place this under the last copy of each message written.

SAMPLE MESSAGE

PREC.	DTG	FM:	
TO:		INFO.	
BT	CLASS		
BT			
<input checked="" type="checkbox"/>	SEND SECURE VOICE	<input type="checkbox"/>	SEND CLEAR
		RELEASING OFFICER'S SIGNATURE	
TOR			TOD _____

Figure G-1. Sample Message.

Appendix H

Radio Log

Radio Circuit Log (Marine Corps)		
Circuit Bn TAC	Station Call A2C	Other stations
Net ID/Frequency 556	Net Control Station X4L	J4Z M2P
Operator PFC Jones, A	Net Call Sign S5F	
Supervisor Sgt. Smith, J	Page 01 of 10	Date 6 OCT 99

Time	Call	Transmission	End
0800Z	Assumed watch		
0801	B6D DE A2C A2C DE B30 A2C DE D5F	K K K	OVER
0804	B3D C3E D5F DE A2C	AR	OUT
0808	A2C DE B3D B3D DE A2C A2C DE B3D	K K P 231400Z SEP 99 C Files	OVER
0810	B3D DE A2C	AR	OUT
0812	B6D DE A2C	Abbreviated Calls Authorized AR	OUT
0815	C4E DE D5F	K	OVER
	DE E	K	
	DE F	MSG 0 231414Z SEP 99	
		FM D5F3	
		TO C4E3	
		BT	
		Classified (Use Actual Classification)	
		Report to CAR Dealer at 1000 Today for Liaison	
		BT	
		K	

(reverse blank)

Appendix I

Metric System Conversion Table

The basic unit of the metric system is the meter (m). The meter is 39.37 inches long. This is 3.37 inches longer than the English yard. Units that are multiples or fractional parts of the meter are designated by prefixes to the word “meter.”

1	millimeter (mm) = 0.001 meter or 1/1000 meter
1	centimeter (cm) = 0.01 meter or 1/100 meter
1	decimeter (dm) = 0.1 meter or 1/10 meter
1	decameter (dkm) = 10 meters
1	hectometer (hm) = 100 meters
1	kilometer (km) = 1000 meters

The Metric Measurement in Most Common Use

10	millimeters = 1 centimeter
10	centimeters = 1 decimeter
10	decimeters = 1 meter
1000	meters = 1 kilometer

To Convert

Length	Multiply by
Inches to centimeters	2.54
Feet to meters	0.3048
Yards to meters	0.9144
Miles to kilometers	1.609
Millimeters to inches	0.03937
Centimeters to inches	0.3937
Decimeters to inches	3.937
Decimeters to feet	0.328
Meters to inches	39.37

Meters to feet	3.28
Meters to yards	1.0936
Decameters to feet	32.8
Hectometers to feet	328.1
Kilometers to feet	3281
Kilometers to yards	1093.6
Kilometers to miles	0.62

Examples:

To change 90 kilometers to miles: $90 \times .62 = 55.8$ miles

To change 90 kilometers to feet: $90 \times 3281 = 295,290$ feet

To change 50 yards to meters: $50 \times 0.9144 = 45.72$ meters

Appendix J

Authentication

Authentication systems are provided to prevent unauthorized enemy stations from entering friendly radio nets to disrupt or confuse operations. The only authentication systems authorized are those approved for use by the National Security Agency. If a special or emergency requirement arises, notify the CIS officer (G-6/S-6).

INSTRUCTIONS

There are two methods of authentication that are authorized for use: challenge and reply authentication and transmission authentication. The operational distinction is that challenge and reply requires two-way communications, whereas transmission authentication does not.

Challenge and Reply Authentication

Challenge and reply authentication will be used whenever possible. The called party will always make the first challenge. Besides validating the authenticity of the calling station, this practice prevents an enemy operator from entering a net to obtain correct authentication responses for use in another net. The party making the call may counterchallenge the called party using a different challenge.

Note: In challenge and reply authentication, only the station responding is verified. Do not accept a challenge as an authentication.

When a caller desires authentication, he must invite a challenge by stating that he is prepared to authenticate.

Another challenge should be made if an incorrect reply is received, if a standby is requested, or if an unusual delay occurs between challenge and reply.

Users will occasionally misauthenticate because of such problems as having the wrong system, misreading the table, etc. The challenging station should attempt to pinpoint the difficulty and then rechallenge.

Never give the challenge and reply in the same transmission (self authentication).

Transmission Authentication

Transmission authentication is used to validate the authenticity of the message when it is impossible or impractical to use challenge and reply authentication (see table J-1).

For Instructional Purposes Only

Table J-1. Sample AKAC-874 Transmission Authentication.

	18	19	20	21	22	23
0	SD	IU	PY	UT	JG	LJ
2	FG	KG	AG	RG	YR	HF
4	VF	DY	KU	JM	RW	FS
6	HD	ML	DT	SC	DA	SA
8	RD	NB	MG	GR	LJ	QW
10	BJ	FR	SR	EF	MB	TP
12	JH	SP	PO	QS	VX	KU
14	TY	OL	RM	OL	FS	DR
16	DR	IJ	AO	MJ	HD	RT
18	JH	TL	KY	BG	UY	NY
20	SD	WM	SR	DE	GC	TR
22	MJ	AP	GH	FD	JG	OU
24	BN	PC	FI	KI	RW	TM

WHEN TO AUTHENTICATE

Transmission should be authenticated—

- | When any station suspects imitative deception on any circuit; e.g., when contacting a station following one or more unsuccessful attempts to contact that station.
- | When any station is challenged or requested to authenticate. This is not to be interpreted as requiring stations to break an imposed silence for the sole purpose of authenticating.
- | When directing radio silence, listening silence, or requiring a station to break an imposed silence.
- | When transmitting contact and amplifying reports in plain language.
- | When transmitting operating instructions that affect the military situation; e.g., closing down a station or watch, changing frequency other than normal scheduled changes, directing establishment of a special communication guard, requesting artillery fire support, directing relocation of units, etc.
- | When transmitting a plain language cancellation.
- | When making initial radio contact or resuming contact after prolonged interruptions.
- | When transmitting to a station that is under radio listening silence.
- | When authorized to transmit a classified message in the clear.
- | When forced, because of no response by the called station to send a message in the blind (transmission authentication).

Note: Authentication is not required when making initial contact after a scheduled call sign and frequency change since only bona fide stations will know their assigned call sign and frequency for the time period in use.

For detailed authentication instructions refer to the automated communications-electronics operations instructions.

(reverse blank)

Appendix K

International Morse Code

Dots and dashes are used in various distinctive combinations to represent the letters of the alphabet, the numerals from 0 to 9, and the prosigns (see fig K-1). The dots and dashes of the Morse Code are produced by keying a transmitter and causing it to transmit short and long signals. The dash is 3 times the length of the dot. The dots and dashes used for a letter are spaced from each other by a period of time equal in length to one dot. Letters are spaced from each other by a period of time equal to three dots. Words are spaced by a period of time equal to seven dots.

a. Letters

A	• —	J	• — — —	S	• • •
B	— • • •	K	— • —	T	—
C	— • — •	L	• — • •	U	• • —
D	— • •	M	— —	V	• • • —
E	•	N	— •	W	• — —
F	• • — •	O	— — —	X	— • • —
G	— — •	P	• — — •	Y	— • — —
H	• • • •	Q	— — • —	Z	— — • •
I	• •	R	• — •		

b. Figures

1	• — — — —	5	• • • • •	9	— — — — •
2	• • — — —	6	— • • • •	0	— — — — —
3	• • • — —	7	— — • • •		
4	• • • • —	8	— — — • •		

Figure K-1. Morse Code.

(reverse blank)

Appendix L

Frequency Prediction Means

Radio signals propagate from a transmitter to a receiver in different ways depending on the selected frequency of the radio. The two available resources for Marines to predict the best frequency to propagate over a given path are to use the Joint Spectrum Center (JSC) or the Marine Corps' system planning, engineering, and evaluation device (SPEED). See figure L-1 on page L-2.

JSC is a Department of Defense agency that is responsible for supplying the electromagnetic analysis to the uniformed services. Located in Annapolis, Maryland, JSC can perform a variety of propagation predictions on all ranges of frequencies. Once a quarter, JSC publishes a list of HF frequency predictions for selected paths that the Marine Corps has requested. A compilation of frequency predictions are held in the G-6 offices of the major subordinate commands within the Marine Corps.

The second method is SPEED. SPEED is computer software that allows communications system planners to do rapid analysis of radio signal propagation. The SPEED comes with electronic maps of the Earth which allow true line of sight data for the planners, as well as HF propagation prediction. SPEED is available down to the battalion level.

SPEED SUPPORTS...

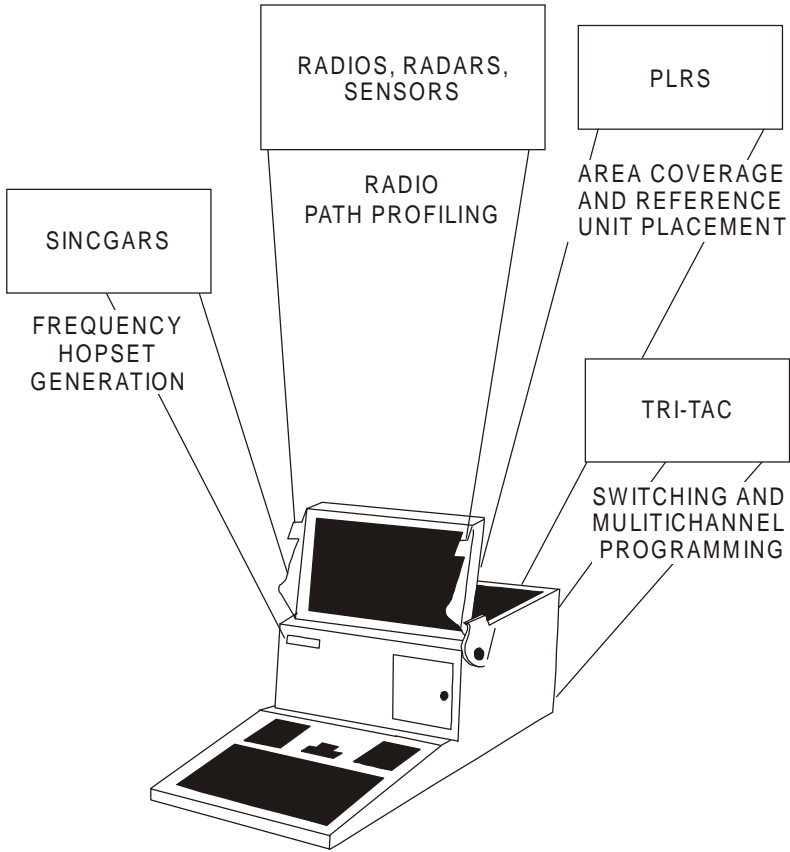

Figure L-1. SPEED.

Appendix M

Position and Navigation Systems

Global positioning system (GPS) and position location reporting system (PLRS) are new systems that radio operators may be required to operate.

GLOBAL POSITIONING SYSTEM

Global positioning system is a space-based navigation system designed to provide 24-hour continuous worldwide, all-weather precise position, and time measurement. The GPS consists of a space segment (satellite), control segment (monitors stations on Earth), and user segment (GPS receivers). The system operates by satellites sending out two signals on nonchanging frequencies. The GPS receiver receives the signals transmitted by the satellites and computes the users position. GPS (by being an all-weather, jam-resistant, continuous system) gives users highly accurate navigation; worldwide, three-dimensional position or location velocity; and time information. As a passive, receive-only system, GPS can be employed at the individual level in such nondescript terrain as jungles, mountain ranges, or deserts. (See fig. M-1 on page M-2.)

POSITION LOCATION REPORTING SYSTEM

PLRS is a system of UHF radios, signal and message processors, and user input and output devices configured as master stations and basic units that provide the user of the system with position navigation information and limited digital communications. PLRS works by the individual units in the network time sharing a single frequency band. As the master station records the arrival time of the signal bursts from each user unit at given locations, the range between sender and receiver can be computed. If units are beyond line of sight for the master station, then PLRS will automatically enable any user unit to serve as an automatic relay. The full PLRS performance can be provided over a 47- by 47-kilometer operating area. This operating area can be extended to a 300- by 300-kilometer area through the use of airborne relays provided by PLRS-equipped aircraft.

WHEN THE GPS IS COMPLETELY INSTALLED, AT LEAST FOUR SATELLITES WILL ALWAYS BE IN VIEW WORLDWIDE AND WILL CONTINUOUSLY TRANSMIT THEIR POSITION AND TIME OF TRANSMISSION.

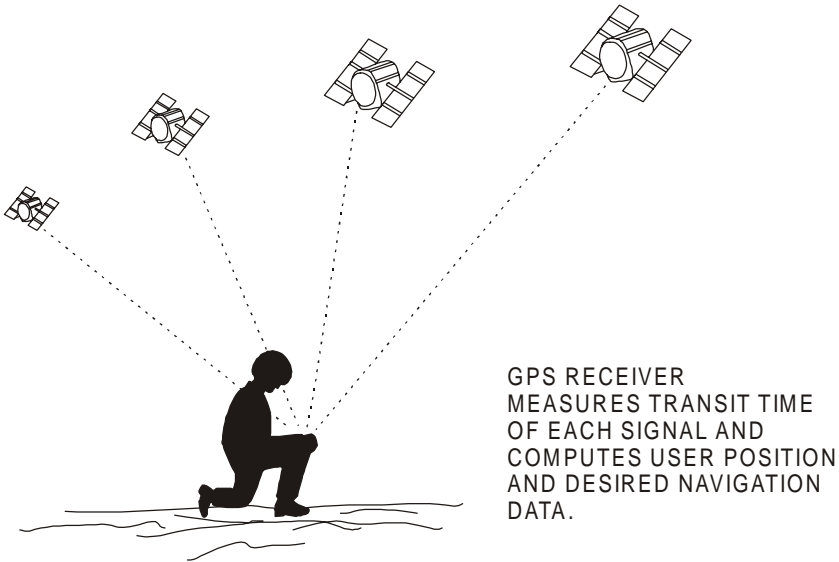

Figure M-1. Global Positioning System.

ENHANCED POSITION REPORTING SYSTEM

Enhanced position location reporting system (EPLRS) shares many characteristics with PLRS, but provides a significant increase in data communications capability over PLRS. Various data rates supporting a variety of broadcast and point-to-point modes are currently available. EPLRS will provide a dedicated data communications capability between regiment and battalion tactical data networks (TDNs) within the ground combat element, when fielded in FY-00. This network will also be extended to lower echelons throughout the MAGTF. EPLRS can also serve as a source for automated friendly position location information and navigation information in a hybrid community with PLRS, though data throughput is reduced.

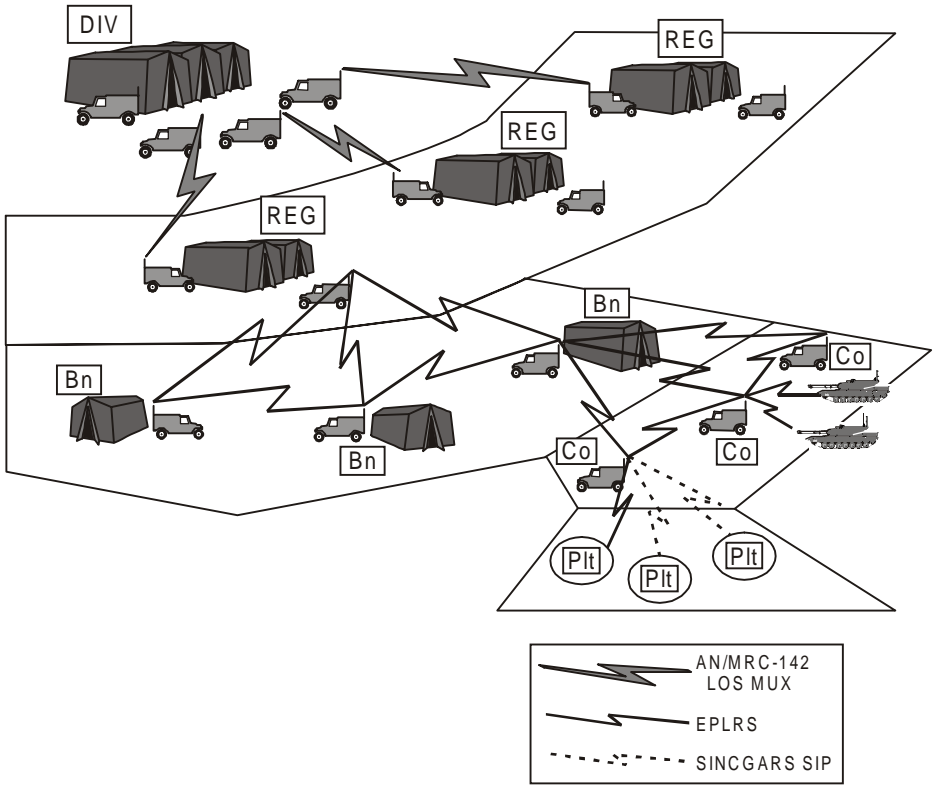

Figure M-2. EPLRS Concept of Employment.

Appendix N

Size of Dipole and Inverted L Antennas

ACCORDING TO WAVELENGTH MEASUREMENTS

Size of dipole and inverted L antennas according to wavelength measurements (in feet and inches).

Table N-1. Size of Antennas.

Frequency	1/2 Wavelength	1/4 Wavelength	1/8 Wavelength	2 1/2 Wavelength (MHz)
2.00	225 ft 6 in	112 ft 9 in	56 ft 4 1/2 in	1,127 ft 6 in
2.50	180 ft 4 3/4 in	90 ft 2 1/3 in	45 ft 1 in	901 ft 11 3/4 in
3.00	150 ft 4 in	75 ft 2 in	37 ft 7 in	751 ft 8 in
3.50	128 ft 10 1/4 in	64 ft 5 in	32 ft 2 in	644 ft 3 3/8 in
4.00	112 ft 9 in	56 ft 4 1/2 in	28 ft 2 1/2 in	563 ft 9 in
4.50	100 ft 2 2/3 in	50 ft 11/3 in	25 ft 2/3 in	501 ft 1 1/3 in
5.00	90 ft 2 1/3 in	45 ft 1 in	22 ft 6 2/3 in	450 ft 11 3/4 in
5.50	82 ft	41 ft	20 ft 6 in	410 ft
6.00	75 ft 2 in	37 ft 7 in	18 ft 9 1/2 in	375 ft 10 in
6.50	69 ft 4 2/3 in	34 ft 8 1/3 in	17 ft 4 in	346 ft 11 in
7.00	64 ft 5 in	32 ft 2 1/2 in	16 ft 1 1/4 in	322 ft 1 3/4 in
7.50	60 ft 1 2/3 in	30 ft 1 in	15 ft 1/3 in	300 ft 8 in
8.00	56 ft 4 1/2 in	28 ft 2 1/4 in	14 ft 1 in	281 ft 10 1/2 in
8.50	53 ft 3/4 in	26 ft 6 1/8 in	13 ft 3 1/8 in	265 ft 3 1/2 in
9.00	50 ft 1 1/3 in	25 ft 2/3 in	12 ft 1/3 in	250 ft 6 2/3 in
9.50	47 ft 5 2/3 in	23 ft 8 3/4 in	11 ft 10 1/3 in	237 ft 4 3/8 in

Table N-1. Size of Antennas (continued).

Frequency	1/2 Wavelength	1/4 Wavelength	1/8 Wavelength	2 1/2 Wavelength (MHz)
10.00	45 ft 1 in	22ft 62/3 in	11 ft 1/4 in	225 ft 6 in
10.50	42 ft 11 2/3 in	21 ft 5 3/4 in	10 ft 8 3/4 in	214 ft 9 1/8 in
11.00	41 ft	20 ft 6 in	10 ft 3 in	205 ft
11.50	39 ft 2 2/3 in	19 ft 7 1/2 in	9 ft 9 2/3 in	196 ft 1 in
12.00	37 ft 7 in	18 ft 9 1/2 in	9 ft 4 3/4 in	187 ft 11 in
12.50	36 ft 1 in	18 ft 1/2 in	9 ft 1/4 in	180 ft 4 3/4 in
13.00	34 ft 8 1/3 in	17 ft 4 in	8 ft 8 in	173 ft 5 1/2 in
13.50	33 ft 5 in	16 ft 8 1/2 in	8 ft 4 1/4 in	167 ft 3/8 in
14.00	32 ft 2 1/2 in	16 ft 1 1/4 in	8 ft 2/3 in	161 ft 3/4 in
14.50	31 ft 1 1/4 in	15 ft 6 2/3 in	7 ft 9 1/3 in	155 ft 6 1/4 in
15.00	30 ft 1 in	15 ft 1/3 in	7 ft 6 1/4 in	150 ft 4 in
15.50	29 ft 1 1/8 in	14 ft 6 1/2 in	7 ft 3 1/4 in	145 ft 5 7/8 in
16.00	28 ft 2 1/4 in	14 ft 1 1/8 in	7 ft 1/2 in	140 ft 11 1/4 in
16.50	27 ft 4 in	13 ft 8 in	6 ft 10 in	136 ft 8 in
17.00	26 ft 6 1/3 in	13 ft 3 1/8 in	6 ft 7 1/2 in	132 ft 7 3/4 in
17.50	25 ft 9 1/4 in	12ft 102/3in	6 ft 5 1/3 in	128 ft 10 1/4 in
18.00	25 ft 2/3 in	12ft 61/3in	6 ft 3 1/8 in	125 ft 3 1/2 in
18.50	24 ft 4 1/2 in	12ft 21/4in	6 ft 1 1/8 in	121 ft 10 3/4 in
19.00	23 ft 8 3/4 in	11ft 103/8in	5 ft 11 1/4 in	118 ft 8 1/8 in
19.50	23 ft 1 1/2 in	11ft 63/4 in	5 ft 9 3/8 in	115 ft 7 2/3 in
20.00	22 ft 6 1/2 in	11 ft 3 1/4 in	5 ft 7 2/8 in	112 ft 9 in
20.50	22 ft	11 ft	5 ft 6 in	110 ft
21.00	21 ft 5 3/4 in	10 ft 8 1/8 in	5 ft 4 3/8 in	107 ft 4 1/2 in
21.50	20 ft 11 3/4 in	10 ft 5 1/8 in	5 ft 3 in	104 ft 10 2/3 in
22.00	20 ft 6 in	10 ft 3 in	5 ft 1 1/2 in	102 ft 6 in
22.50	20 ft 1/2 in	10 ft 1/4 in	5 ft 1/8 in	100 ft 2 2/3 in

Table N-1. Size of Antennas (continued).

Frequency	1/2 Wavelength	1/4 Wavelength	1/8 Wavelength	2 1/2 Wavelength (MHz)
23.00	19 ft 7 1/3 in	5 ft 9 2/3 in	4 ft 10 1/8 in	98 ft 1/2 in
23.50	19 ft 2 1/4 in	9 ft 7 1/8 in	4 ft 9 in	95 ft 11 1/2 in
24.00	18 ft 9 1/2 in	9 ft 4 3/4 in	4 ft 8 3/8 in	93 ft 11 1/2 in
24.50	18 ft 5 in	9 ft 2 3/8 in	4 ft 7 1/4 in	92 ft 1/2 in
25.00	18 ft 1/2 in	9 ft 1/4 in	4 ft 6 1/8 in	90 ft 2 3/8 in
25.50	17 ft 8 1/4 in	8 ft 10 1/8 in	4 ft 5 in	88 ft 5 1/8 in
26.00	17 ft 4 1/8 in	8 ft 8 in	4 ft 4 in	85 ft 8 1/8 in
26.50	17 ft 1/4 in	8 ft 6 1/8 in	4 ft 3 in	85 ft 1 1/8 in
27.00	16 ft 8 3/8 in	8 ft 4 1/4 in	4 ft 2 1/8 in	83 ft 6 in
27.50	16 ft 4 3/4 in	8 ft 2 3/8 in	4 ft 1 1/8 in	81 ft 11 1/8 in
28.00	16 ft 1 1/4 in	8 ft 2/3 in	4 ft 1/3 in	80 ft 6 3/8 in
28.50	15 ft 9 1/8 in	7 ft 11 in	3 ft 11 1/2 in	79 ft 1 1/2 in
29.00	15 ft 6 2/3 in	7 ft 9 1/3 in	3 ft 10 2/3 in	77 ft 9 1/8 in
29.50	15 ft 3 1/2 in	7 ft 7 3/4 in	3 ft 10 in	76 ft 5 1/4 in
30.00	15 ft 3/8 in	7 ft 6 1/8 in	3 ft 9 in	75 ft 2 in

Appendix O

Field Repair and Expedients

Section I. Antenna Repair

Antennas are sometimes broken or damaged, causing either a communications failure or poor communications. If a spare is available, replace the damaged antenna. When there is no spare, you may have to construct an emergency antenna. The following paragraphs are suggestions on repairing antennas and antenna supports and on constructing and adjusting emergency antennas.

REPAIR TECHNIQUES

Whip Antennas

When a whip antenna is broken into two sections, the portion of the antenna that is broken off can be connected to the portion attached to the base by joining the sections as shown in figure O-1 on page O-2. Use the method illustrated in figure O-1A, when both parts of the broken whip are available and usable. Use the method shown in figure O-1B when the portion of the whip that was broken off is lost, or when the whip is badly damaged. To restore the antenna to its original length, add a piece of wire that is nearly the same length as the missing part of the whip. Then, lash the pole support securely to both sections of the antenna. Clean the two antenna sections thoroughly to ensure good contact before connecting them to the pole support. If possible, solder the connections.

Wire Antennas

Emergency repair of a wire antenna may involve the repair or replacement of the wire used as the antenna or transmission line; or, the repair or replacement of the assembly used to support the antenna.

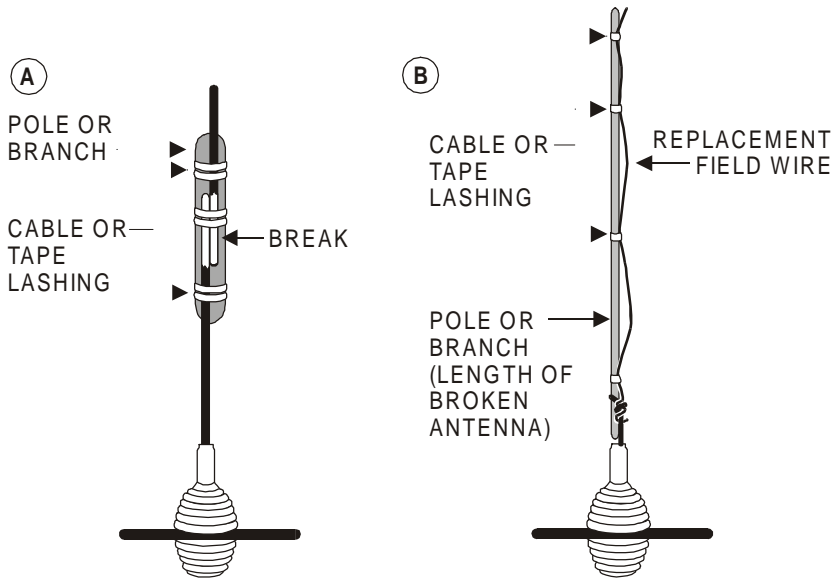

Figure O-1. Emergency Repair of Broken Whip.

When one or more wires of an antenna are broken, the antenna can be repaired by reconnecting the broken wires. To do this, lower the antenna to the ground, clean the ends of the wires, and twist the wires together. Whenever possible, solder the connection.

If the antenna is damaged beyond repair, construct a new one. Make sure that the lengths of the wires of the substitute antenna are the same length as the original.

Antenna supports may also require repair or replacement. A substitute item may be used in place of a damaged support and, if properly insulated, can be of any material of adequate strength. If the radiating element is not properly insulated, field antennas may be shorted to ground and rendered ineffective. Many commonly found items can be used as field expedient insulators. The best of these items are plastic or glass, to include plastic spoons, buttons, bottle necks, and plastic bags. Less effective than plastic or glass but better than no insulators at all are wood and rope, or both, in that order. The radiating element—the actual antenna wire—should touch only the antenna terminal and be physically

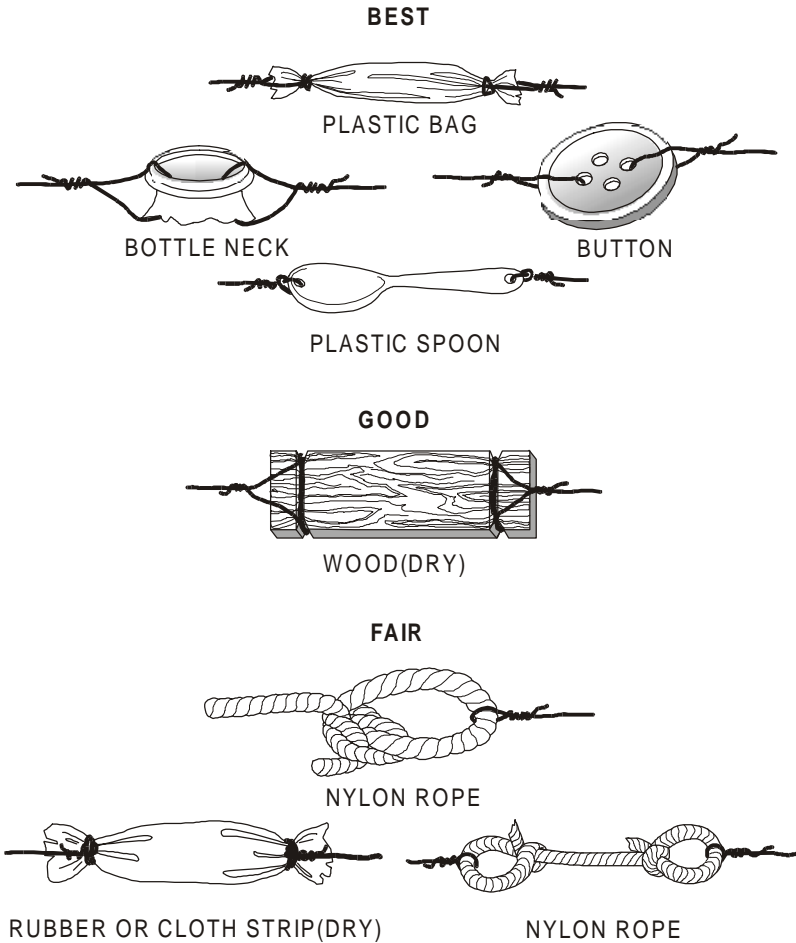

Figure O-2. Improved Insulators.

separated from all other objects, other than the supporting insulator. Figure O-2 shows various emergency insulators.

Guys

Lines used to stabilize the supports for an antenna are called guys. These lines are usually made of wire, manila rope, or nylon rope. If a rope breaks, it may be repaired by tying the two broken ends together. If the rope is too short after the tie is made, it can be lengthened by adding another piece of dry wood or cloth. If a guy wire breaks, it can be

replaced with another piece of wire. Figure O-3 shows a method of repairing a guy line with a spoon.

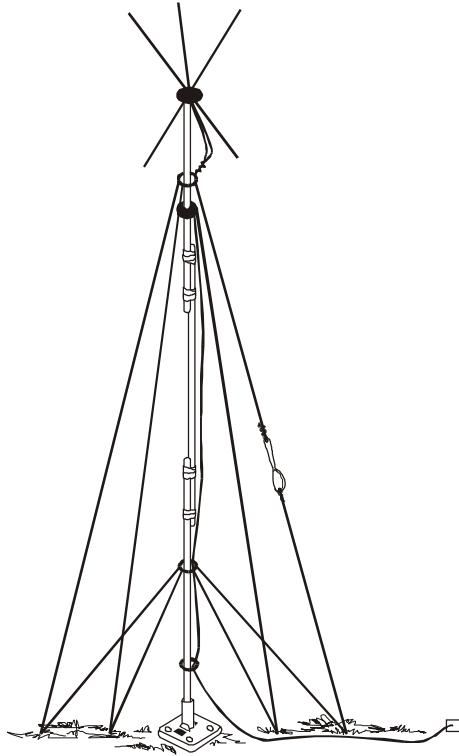

Figure O-3. Repaired Guy Lines and Masts.

Masts

Some antennas are supported by masts. If a mast breaks, it can be replaced with one of same length. If long poles are not available as replacements, short poles may be overlapped and lashed together with rope or wire to provide a pole of the required length. Figure O-3 shows a method of making an emergency repair to masts.

TIPS FOR CONSTRUCTION AND ADJUSTMENT

Constructing the Antenna

The best kinds of wire for antennas are copper and aluminum. In an emergency, however, use any type that is available.

The length of most antennas is critical. The emergency antenna should be the same length as the antenna it replaces.

Antennas supported by trees can usually survive heavy wind storms if the trunk of a tree or a strong branch is used as a support. To keep the antenna taut and to prevent it from breaking or stretching as the trees sway, attach a spring or old inner tube to one end of the antenna. Another technique is to pass a rope through a pulley or eyehook, attach the rope to the end of the antenna, and load the rope with a heavy weight to keep the antenna tightly drawn.

Guys used to hold antenna supports are made of rope or wire. To ensure that the guys made of wire will not affect the operation of the antenna, cut the wire into several short lengths and connect the pieces with insulators.

Adjusting the Antenna

An improvised antenna may change the performance of a radio set. Use the following methods to determine if the antenna is operating properly.

A distant station may be used to test the antenna. If the signal received from this station is strong, the antenna is operating satisfactorily. If the signal is weak, adjust the height and length of the antenna and the transmission line to receive the strongest signal at a given setting on the volume control of the receiver. This is the best method of tuning an antenna when transmission is dangerous or forbidden.

In some radio sets, the transmitter is used to adjust the antenna. First, set the controls of the transmitter in the proper position for normal operation; then, tune the system by adjusting the antenna height, the antenna

length, and the transmission line length to obtain the best transmission output.

Impedance-matching a load to its source is an important consideration in transmissions' systems. If the load and source are mismatched, part of the power is reflected back along the transmission line towards the source. This reflection not only prevents maximum power transfer, but can also be responsible for erroneous measurements of other parameters, or even cause circuit damage in high-power applications.

The power reflected from the load interferes with the incident (i.e., forward) power, causing standing waves of voltages and current to exist along the line. The ratio of standing-wave maxima to minima is directly related to the impedance mismatch of the load; therefore the standing-wave ratio (SWR) provides the means of determining impedance and mismatch.

WARNING

SERIOUS INJURY OR DEATH CAN RESULT FROM CONTACT WITH THE RADIATING ANTENNA OF A MEDIUM- OR HIGH-POWER TRANSMITTER. TURN THE TRANSMITTER OFF WHILE MAKING ADJUSTMENTS TO THE ANTENNA.

Section II. Field Expedient Antennas

SINGARS VHF radios provide the primary means of communications for Marine Corps forces around the world. The SINGARS radio operates in both single-channel and frequency hopping modes. It is important for CIS personnel to remember that when using the SINGARS radio in the frequency hopping mode, field expedient VHF antennas should not be used. CIS personnel should only use the whip antenna or the OE-254 antenna when operating in the frequency hopping mode.

HIGH FREQUENCY, FIELD EXPEDIENT OMNIDIRECTIONAL ANTENNAS

Vertical antennas are omnidirectional; i.e., they transmit and receive equally well in all directions. Most manpack portable radios use a vertical whip antenna. A vertical antenna can be improvised by using a metal pipe or rod of the correct length, held erect by means of guys. The lower end of the antenna should be insulated from the ground by placing it on insulating material. A vertical antenna may also be a wire, supported by a tree or a wooden pole (see fig. O-4). For short, vertical

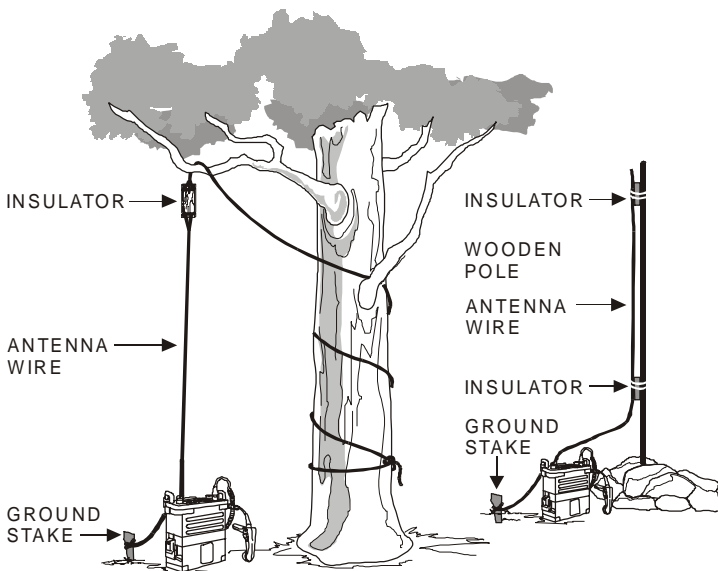

Figure O-4. Field Substitutes for Support of Vertical Wire Antennas.

antennas, the pole may be used without guys (if properly supported at the base). If the length of the vertical mast is not long enough to support the wire upright, it may be necessary to modify the connection at the top of the antenna.

End-Fed Half-Wave Antenna

An emergency, end-fed half-wave antenna can be constructed from available materials such as field wire, rope, and wooden insulators. The electrical length of this antenna is measured from the antenna terminal on the radio set to the far end of the antenna (see fig. O-5). Construct the antenna longer than necessary, then shorten it, as required, until best results are obtained. The ground terminal of the radio set should be connected to a good Earth ground for this antenna to function efficiently.

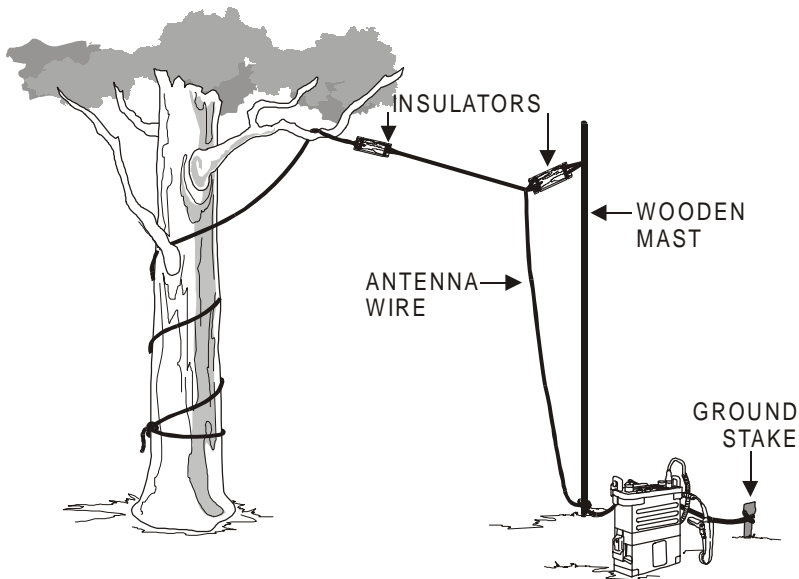

Figure O-5. End-Fed Half-Wave Antenna.

Center-Fed Doublet Antenna

The center-fed doublet is a half-wave antenna consisting of two, quarter-wavelength sections on each side of the center. Construction of an improvised doublet antenna for use with FM radios is shown in figure O-6.

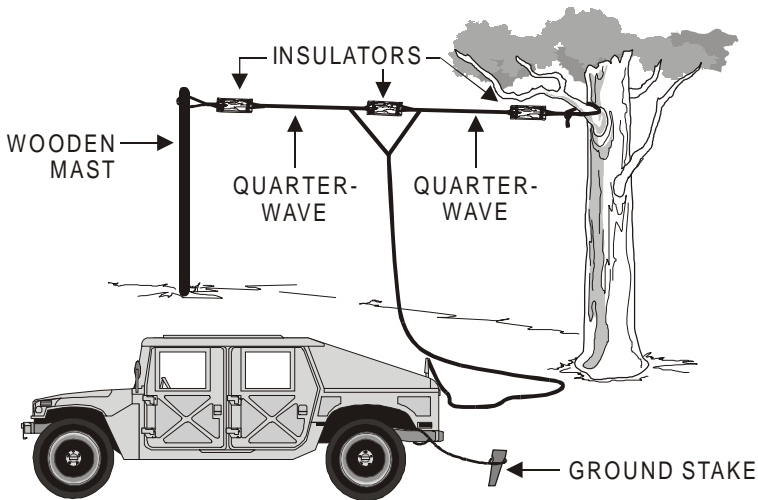

Figure O-6. Half-Wave Doublet Antenna.

Doublet antennas are directional broadside to their length, which makes the vertical doublet antenna essentially omnidirectional. This is because the radiation pattern is doughnut shaped. The horizontal doublet antenna is bidirectional.

The length of a half-wave antenna may be computed by using the formula in Chapter 4. Cut the wires as closely as possible to the correct length because the length of the antenna wires is important.

A transmission line is used for conducting electrical energy from one point to another, and it is used to transfer the output of a transmitter to an antenna. Although it is possible to connect an antenna directly to a transmitter, the antenna generally is located some distance away. In a vehicular installation, for example, the antenna is mounted outside, and the transmitter is inside the vehicle. A transmission line, therefore, is necessary as a connecting link.

Center-fed half-wave FM antennas can be supported entirely by pieces of wood. A horizontal antenna of this type is shown in figure O-7A; a vertical antenna in figure O-7B on page O-10. These antennas can be rotated to any position to obtain the best performance. If the antenna is erected vertically, the transmission line should be brought out horizontally from the antenna for a distance equal to at least one-half of the antenna's length before it is dropped down to the radio set.

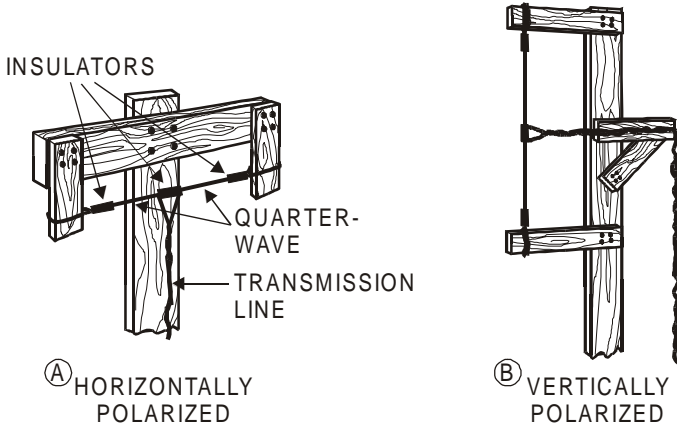

Figure O-7. Center-Fed Half-Wave Antenna.

A similar arrangement for a short, center-fed half-wave antenna is shown in figure O-8. The ends of this antenna are connected to a piece of dry wood, such as a bamboo pole, and the bend in the pole holds the antenna wire straight. Another pole, or bundle of poles, serves as the mast.

Figure O-9 shows an improvised vertical half-wave antenna. This technique is used primarily with FM radios. It is effective in heavily wooded

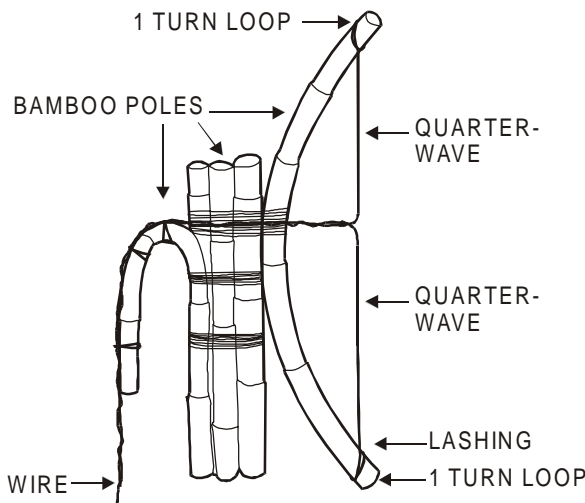

Figure O-8. Bent Bamboo Antenna.

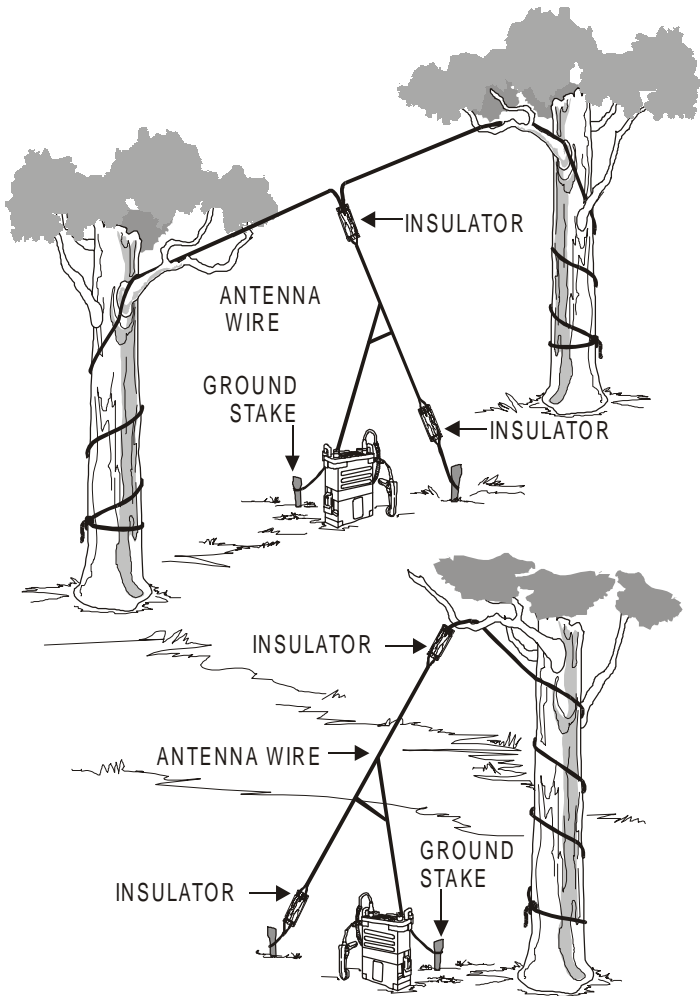

Figure O-9. Improvised Vertical Half-Wave Antennas.

areas to increase the range of portable radios. The top guy wire can be connected to a limb or passed over the limb and connected to the tree trunk or a stake.

HIGH FREQUENCY, FIELD EXPEDIENT DIRECTIONAL ANTENNAS

The vertical half-rhombic antenna (fig. O-10 on page O-12) and the long-wire antenna (fig. O-11 on page O-12) are two field expedient,

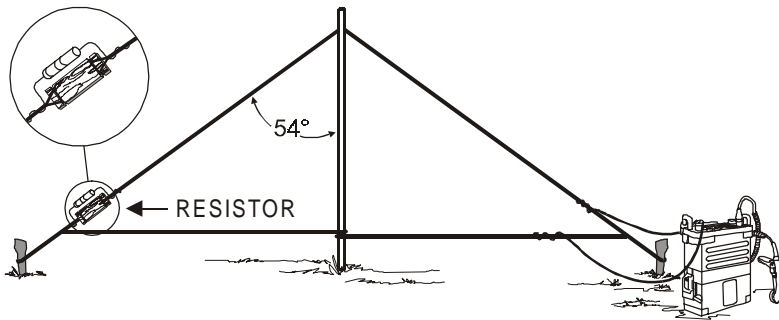

Figure O-10. Vertical Half-Rhombic Antenna.

directional antennas. These antennas consist of a single wire, preferably two or more wavelengths long, supported on poles at a height of 3 to 7 meters (10 to 20 feet) above the ground. The antennas will, however, operate satisfactorily as low as 1 meter (approximately 3 feet) above the ground. The far end of the wire is connected to ground through a noninductive resistor of 500 to 600 ohms. Use a resistor rated at least one-half the wattage output of the transmitter to ensure the resistor is not burned out by the output power of the transmitter. A reasonably good ground, such as a number of ground rods or a counterpoise, should be used at both ends of the antenna. The radiation pattern is directional. The antennas are used primarily for either transmitting or receiving high frequency signals.

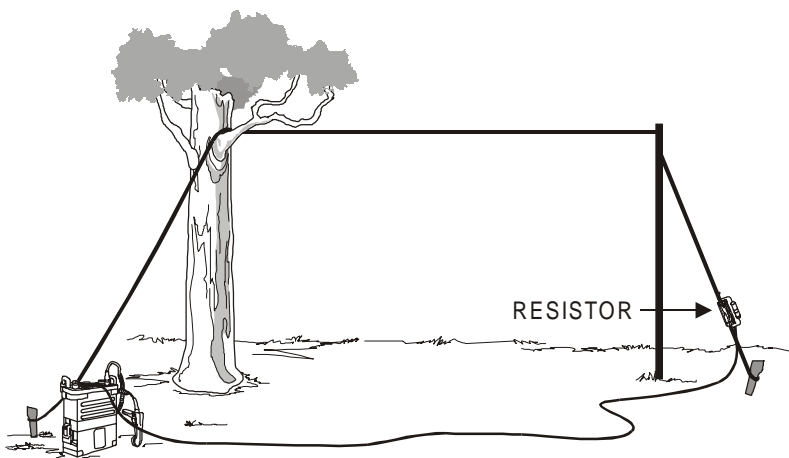

Figure O-11. Long-Wire Antenna.

The Vee antenna is another field expedient, directional antenna. It consists of two wires forming a Vee with the open area of the Vee pointing toward the desired direction of transmission or reception (see fig. O-12). To make construction easier, the legs may slope downward from the apex of the Vee (this is called a sloping Vee antenna [see fig. O-13 on page O-14]).

The angle between the legs varies with the length of the legs in order to achieve maximum performance.

When the antenna is used with more than one frequency or wavelength, use an apex angle that is midway between the extreme angles determined by the chart.

To make the antenna radiate in only one direction, add noninductive terminating resistors from the end of each leg (not at the apex) to ground.

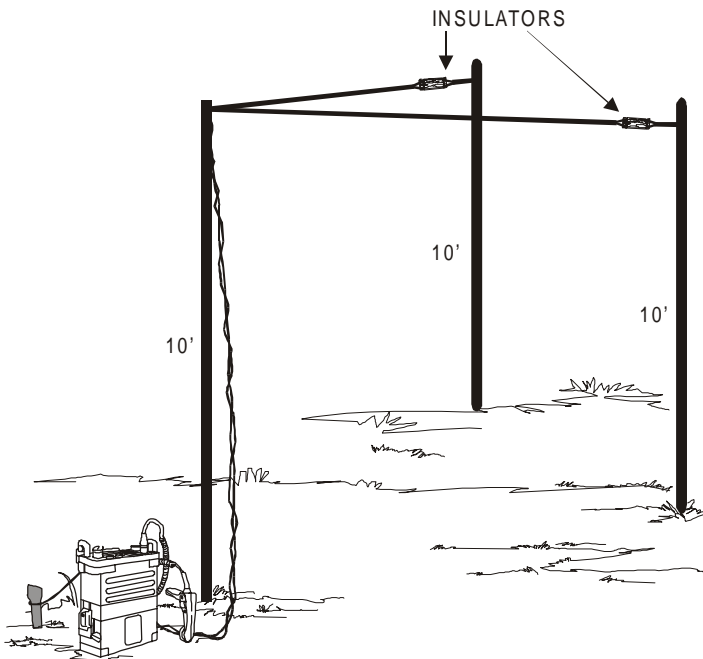

Figure O-12. Vee Antenna.

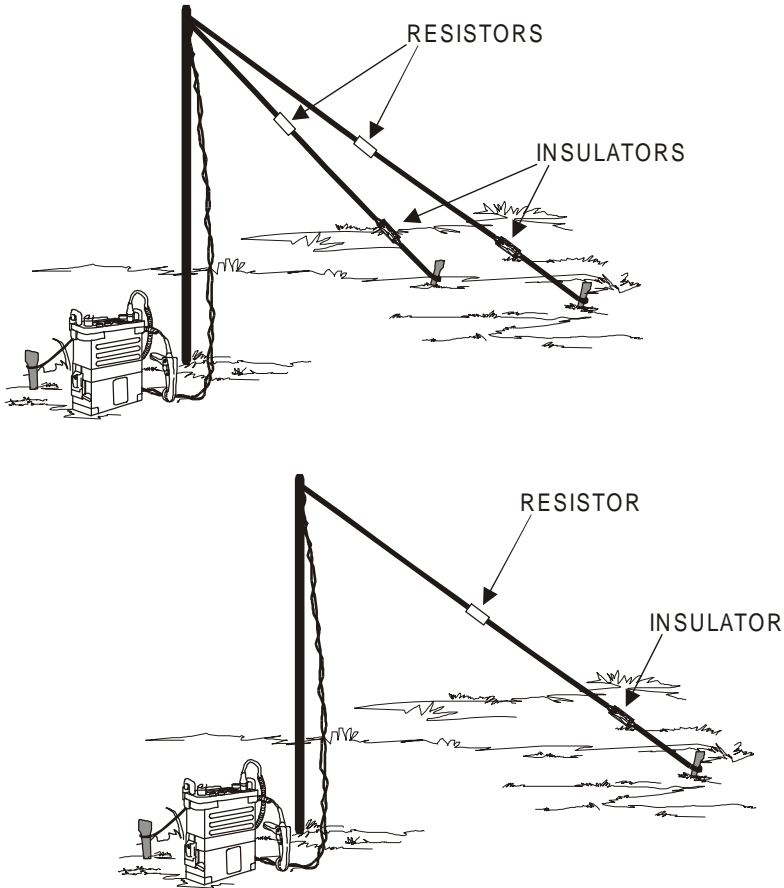

Figure O-13. Sloping Vee Antennas.

The resistors should be approximately 500 ohms and have a power rating at least one-half that of the output power of the transmitter being used. Without the resistors, the antenna radiates bidirectionally, both front and back.

The antenna must be fed by a balanced transmission line.

Use table O-1 to determine the angle and the length of the legs.

Table O-1. Leg Length for Vee Antennas.

Antenna Length (Wavelength)	Optimum Apex Angle (Degrees)
1	90
2	70
3	58
4	50
6	40
8	35
10	33

Appendix P

Radio Operator's Checklist

Before you operate any radio set, get the appropriate equipment technical manual (TM) and carefully study the operating instructions. Refer to the panel diagrams, connections diagrams, and the paragraphs covering the description of components during the preliminary starting procedure. Make sure that the proper cables are connected to the proper panel connectors, and that the controls are correctly set. Even the most experienced operators should check their preliminary procedures against the TM references from time to time to insure accuracy and avoid damaging the equipment. Use the operational checklist and the equipment performance checklist to determine what to do to remedy any problems encountered during starting procedures and operation.

STEPS IN OPERATING RADIO SETS

Radio sets issued to a unit vary in type according to the communications requirements of the unit. For example, some sets may be completely contained in one assembly, while others may consist of separate components that must be properly connected to assemble a complete radio set. The following steps are generally required in operating a radio set.

Check the Set for Completeness

Make sure that all the necessary components and accessories are on hand and ready for use. Refer to the equipment basic issue items list in the TM. Never operate the transmitter without the antenna attached.

Inspect the Condition of the Knobs, Dials, Switches, and Controls

Look for knobs, dials, switches, and controls that are loose on their shafts, bind when being operated, won't operate, or are damaged in any other way. Make corrections where possible or report the faulty

condition to the CIS officer or CIS chief. Make sure that all knobs and exterior parts are on the set. Immediately report any that are missing.

Check the Condition of Plugs, Receptacles, and Connectors

Do not attempt to connect the set for operation until you are sure that the plugs and connectors are clean and in good condition, and the receptacles to which they must be connected are also clean and in good condition.

Check the Connections Diagrams

The connections diagrams in the equipment TM show the type and number of cables required to interconnect the components of the radio set for each type of operation. The radio set may be damaged if cables are connected to the wrong receptacles.

If the connectors don't match, it is possible to physically damage the pins or sleeves of the connector.

If a cable is connected to a receptacle into which it fits but does not belong, it may cause serious electrical damage to the equipment and, in some cases, injury to the operator.

Make Sure of Dial, Switch, and Control Settings

Some radio sets can be seriously damaged if the switches, dials, and controls are not set to the required initial settings before applying power or making the initial timing adjustments. Before applying power, check the equipment TM to be sure you performed all preliminary starting procedures. Be sure radios installed in vehicles are turned off before starting the vehicle's engine to avoid damage to radio equipment.

Follow the Starting Procedure

The equipment TM covers, in detail, the proper procedure for starting the radio set. If there is a specific sequence for starting the set, it is described in the manual. Perform the operations in the proper sequence.

Apply Power

After the proper connections are made, and all switches are properly set, power may be applied to the set.

Allow the Set to Warm Up

Radio sets usually require a warm-up period when first applying power in order to stabilize the equipment. In some cases, it is possible to damage a set by attempting to operate a set without allowing a warm-up period. Most sets are protected against such damage, but it is foolish to risk damage to a radio set by trying to put it on the air before it is ready.

Tune to the Desired Frequency (Channel)

Tune the transmitter to the frequency of the desired channel according to the procedures in the equipment TM. Use the methods that are given in the TM to check for correct tuning.

Check the Set for Normal Operation

While the set is in operation, check the indicators frequently to be sure that the set is operating correctly. If anything unusual occurs during operation, investigate it immediately. When necessary, turn off the power to the set and refer to the operational checklist and the equipment performance checklist in the equipment manual. If the corrections given in the operational checklist and the equipment performance checklist will not correct the trouble, report the condition to the unit electronics maintenance shop. Make sure that the condition of the set and the action taken are properly recorded on the maintenance records.

Use the Proper Procedure to Turn Off the Set

After operation (or if the set is being turned off because of improper operation) make sure that the controls, switches, and dials are properly set (this may not be required on some radios). Proceed to shut down the components of the set in the sequence specified in the equipment manual. Simple radios may require nothing more than turning the power

switch to its OFF position, but more complex sets may require elaborate shutdown procedures.

Operating Hints

Use a handset or headset, rather than a loudspeaker, if the incoming signal is weak. Make sure that the microphone or handset is in good condition. Speak directly into the microphone; speak slowly and distinctly.

Make sure that the vehicle's battery voltage (if radio set is vehicular-mounted) is within the correct range. Keep the engine running to charge the battery. Move the set or the vehicle, if necessary, to improve reception.

Lack of communications or poor communications may be caused by—

- | Too great a distance between radio sets.
- | Poor choice of location (siting) at one or both ends of the circuit.
- | Terrain—hills or mountains.
- | Noise and interference.
- | Not enough transmitter power.
- | Defective equipment.
- | Improper adjustment of equipment.
- | Ineffective antenna.
- | Improper frequency assignment.

Poorly maintained equipment and improper operation can be just as effective in preventing communications as excessive distance or mountainous terrain. To avoid problems, observe the following precautions at all times:

- | Study the TMs for the equipment you are using. They provide complete operating instructions and maintenance procedures.
- | Keep your radio set clean and dry.
- | Handle your radio set carefully.

Appendix Q

Glossary

Section I. Acronyms

AC	alternating current
AF	audio frequency
AM	amplitude modulation
ASAP	as soon as possible
ASIP	advanced systems improvement program
bps	bits per second
C4I	command, control, communications, computers, and intelligence
CDT	Central Daylight Time
CEOI	communications-electronics operating instruction
CEP	circular error of probability
CIS	communications and information systems
cm	centimeter
COMINT	communications intelligence
COMSEC	communications security
CONUS	continental United States
COTS	commercial off-the-shelf equipment
CST	Central Standard Time
DACT	data automated communications terminal
DAMA	demand assigned multiple access
db	decibel
DC	direct current
DCT	digital communications terminal
dm	decimeter
dkm	dekameter
DMS	digital message system

DTE	data terminal equipment
DTG	date-time group
EA	electronic attack
EDT	Eastern Daylight Time
EEFI	essential elements of friendly information
EMCON	emission control
EMP	electromagnetic pulse
EP	electronic protection
EPLRS	enhanced position location reporting system
ES	electronic warfare support
EST	Eastern Standard Time
EW	electronic warfare
FAC	forward air controller
FLOT	forward line of own troops
FM	frequency modulation
FMF	Fleet Marine Force
FMFM	Fleet Marine Force manual
GHz	gigahertz
GPS	global positioning system
HF	high frequency
Hz	hertz
hm	hectometer
ID	identification
IED	imitative electromagnetic deception
IR	infrared
JC2WC	Joint Command and Control Warfare Center
JSC	Joint Spectrum Center
KHz	kilohertz
km	kilometer
kbps	kilobytes per second
kW	kilowatt

LOS line of sight
 LSB lower side band
 LUF lowest usable frequency

m meter
 MAGTF Marine air-ground task force
 MCRP Marine Corps reference publication
 MCWP Marine Corps warfighting publication
 MDT Mountain Daylight Time
 MEU(SOC) Marine expeditionary unit (special operations capable)
 MFP moisture fungusproofing paint
 MHz megahertz
 mi miles
 MIJI meaconing, intrusion, jamming, interference
 mm millimeter
 MPF maritime prepositioning force
 MST Mountain Standard Time
 MUF maximum usable frequency
 MUX multiplex

NBC nuclear, biological, and chemical
 NCS net control station
 NVIS near vertical incidence skywave

ohm a unit of electrical resistance (named for Georg Ohm)
 OTH over the horizon

prosign procedure sign
 proword procedure word
 PDT Pacific Daylight Time
 PLRS position location reporting system
 PST Pacific Standard Time

RCU remote control unit
 RDF radio direction finder
 RF radio frequency
 RFI radio frequency interference

SAA satellite access authorization
 SATCOM satellite communications

- SBB switched backbone
- SCR single channel radio
- SCSI small computer systems interfaces
- SHF super-high frequency
- SID sudden ionospheric disturbance
- SINCGARS single-channel ground and airborne radio system
- SIP systems improvement program
- SOP standing operating procedure
- SPEED system planning, engineering, and evaluation device
- SSB single side band
- SWR standing-wave ratio

- TACSAT tactical satellite
- TAMCN table of authorized materiel control number
- TCIM tactical communications interface module
- TDN tactical data network
- TEMPEST an unclassified name referring to the means used
to ensure computer security
- TM technical manual
- TOD time of day
- TRANSEC transmission security
- TWA tilt whip adaptor

- UHF ultrahigh frequency
- USB upper side band
- UTC Coordinated Universal Time
- UTM universal transverse mercator
- UV ultraviolet

- VHF very high frequency

- WBA whip-base adapter
- WLC whip loading coil
- WWA whip to wire adapter

- yd yard

Section II. Definitions

A

amplitude modulation (AM). Modulation in which the amplitude of the carrier wave is varied above and below its normal value in accordance with the intelligence of the signal being transmitted.

analog. A continuously variable signal which conveys information by the change of the value or magnitude of the signal. The signal can change in either amplitude, phase, frequency, or duration.

antenna gain. The effectiveness of a directional antenna as compared to a standard nondirection antenna. It is usually expressed as the ratio in decibels of standard antenna input power to directional antenna input power that will produce the same field strength in the desired direction. For a receiving antenna, the ratio of signal power values produced at the receiver input terminals is used. The more directional an antenna is, the higher is its gain.

authentication. A security measure designed to protect a communications system against acceptance of a fraudulent transmissions or simulation by establishing the validity of a transmission, message, or originator.

B

baseband. In a carrier (or subcarrier) wire or radio transmission system, the band of frequencies occupied by the signal before it modulates the carrier (or subcarrier) frequency to form the transmitted or radio signal.

black. The black designation is applied to all wire lines and equipment within a terminal or switching facility which handle encrypted traffic.

brevity code. A code which provides no security but which has as its sole purpose the shortening of messages rather than the concealment of their content.

bulk encryption. An application of on-line cryptographic operations where the encryption and decryption process is performed at designated points of technical interface within a communications system; input-output signals from various subscriber terminals thereby being cryptographically processed at these points. The operation is performed in bulk; i.e., two or more channels processed simultaneously by one crypto security device.

C

call sign. Any combination of characters or pronounceable words which identifies a communication facility, a command, an authority, an activity, or a unit; used primarily for establishing and maintaining communications.

carrier. (1) The radio wave produced by a transmitter when there is no modulating signal, or any other wave, recurring series of pulses, or direct current capable of being modulated. Also called carrier wave. (2) A wave generated locally at a receiver that, when combined with the sidebands of a suppressed carrier transmission and a suitable detector, produces the modulating wave.

communications security (COMSEC). The protection resulting from all measures designed to deny unauthorized persons information of value which might be derived from the possession and study of telecommunications, or to mislead unauthorized persons in their interpretation of the results of such possession and study. Communications security includes cryptosecurity, transmission security, emission security, and physical security of communications security materials and information.

critical frequency. The highest frequency at which a given wave at any given time will, if transmitted vertically, be refracted back to earth by a layer of the ionosphere.

cryptography. The art or science which pertains to the various means and methods for rendering plain text unintelligible, and reconverting unintelligible texts into intelligible language; application of that science by means other than cryptanalysis.

D

data. Representation of facts, concepts, or instructions in a formalized manner suitable for communication, interpretation, or processing by humans or by automatic means. Any representations such as characters or analog quantities to which meaning is or might be assigned.

date-time group (DTG). The date and time, expressed in digits and zone suffix, the message was prepared for transmission. (Expressed as six digits followed by the zone suffix; first pair of digits denotes the date, second pair the hours, third pair the minutes.)

decibel (dB). A unit used to express the magnitude of a change in signal or sound level. A change of three decibels is the change in power level of a pure sine wave that is just barely detectable by the human ear. The difference in decibels between two signals is 10 times the common logarithm of their ratio of powers or 20 times the common logarithm of their ratio of voltages or currents. One decibel is one-tenth of a bel.

digital. A signal having discrete states, usually two, such as the presence or absence of a voltage. The signal is given meaning by assigning numerical values or other information to the various possible combinations of the discrete states of the signal.

directed net. A net in which no station other than the net control station can communicate with any other station, except for the transmission of urgent messages, without first obtaining the permission of the net control station.

E

electromagnetic radiation. Radiation made up of oscillating electric and magnetic fields and propagated with the speed of light.

electronic warfare (EW). Any military action involving the use of electromagnetic and directed energy to control the electromagnetic spectrum or to attack the enemy. The three major subdivisions within electronic

warfare are: electronic attack, electronic protection, and electronic support measures.

F

free net. A net in which any station may communicate with any other station in the same net without first obtaining permission from the net control station to do so.

frequency. The number of complete cycles per unit of time for a periodic quantity such as alternating current, sound waves, or vibrating objects. Frequency is expressed in hertz, kilohertz, megahertz, and gigahertz.

frequency band. A continuous range of frequencies extending between two limiting frequencies.

Frequency hopping. A method of jumping from frequency to frequency in synchronization with one another in a random order at a rate of up to 100 times per second. Frequency hopping is the preferred method of communication with SINCGARS radios.

frequency modulation (FM). Frequency modulation is the process of varying the frequency (rather than the amplitude) of the carrier signal in accordance with the variations of the modulating signals. The amplitude or power of the FM carrier does not vary during modulation. A frequency modulation system is practically immune to atmospheric and man-made interference.

frequency spectrum designation. VLF (very low frequency): below 30 kHz (0.03 MHz). LF (low frequency): 30-300 kHz (0.03-0.3 MHz). MF (medium frequency): 300-3000 kHz (0.3-3 MHz). HF (high frequency): 3-30 MHz. VHF (very high frequency): 30-300 MHz. UHF (ultra high frequency): 300-3000 MHz. SHF (super high frequency): 3000-30,000 MHz (3-30 GHz). EHF (extremely high frequency): 30-300 GHz.

G

ground wave. A radio wave that is propagated over the earth and is ordinarily affected by the presence of the ground and the troposphere. The ground wave includes all of the components of a radio wave over the earth except ionospheric and tropospheric waves. The ground wave is refracted because of variations in the dielectric constant of the troposphere, including the condition known as a surface duct.

guard. To maintain a continuous receiver watch with transmitter ready for immediate use. A complete log is to be kept.

H

half-duplex—Refers to a mode of transmission in which communication between two terminals occurs in either direction, but in only one direction at a time. This is the typical mode of operation for tactical single-channel radios.

hertz (Hz). A unit of frequency equal to one cycle per second.

I

imitative communication deception (ICD). The introduction of radiation into enemy systems which imitate the enemy's emissions.

in the clear. In plain text. When cryptographic devices are not used to protect a transmitted signal.

ionosphere. A region in the earth's outer atmosphere where ions and electrons are present in quantities sufficient to affect the propagation of HF radio waves. It begins about 30 miles above the earth and extends above 250 miles, with the height depending on the season of year and the time of day. The chief layers of the ionosphere and their approximate heights are:

D layer—30 to 60 miles

E layer—60 to 90 miles

F layer—90 to 250 miles

J

jamming (electromagnetic). The deliberate radiation, reradiation, or reflection of electromagnetic energy for the purpose of preventing or reducing an enemy's effective use of the electromagnetic spectrum, and with the intent of degrading or neutralizing the enemy's combat capability.

L

line of sight (LOS). The straight unobstructed path between two points.

link. In communications, a general term used to indicate the existence of communications facilities between two points.

log. A chronological record of station events.

N

needline. A requirement to establish communications between two units or agencies.

net (communications). An organization of stations capable of direct communications on a common channel or frequency.

net call sign. A call sign which represents all stations within a net.

net control station. A communications station designated to control traffic and enforce circuit discipline within a given net. Also called NCS.

O

obstacle gain. The increase in signal strength obtained over a long radio communications path where a mountain obstacle or range of hills is located about halfway between transmitting and receiving antennas. This obstacle gain offsets some of the path losses normally expected.

operating signals. Three letter groups used as necessary in connections with operations or communications to convey orders, instructions, requests, reports, and information to facilitate communications.

P

precedence. In communications, a designation assigned to a message by the originator to indicate to communications personnel the relative order of handling and to the addressee the order in which the message is to be noted.

procedure sign (prosign). One or more letters or characters, or combination thereof, used to facilitate communications by conveying in a condensed standard form certain frequently used orders, instructions, requests, and information related to communications.

procedure word (proword). A word or phrase limited to radio telephone procedure used to facilitate communication by conveying information in a condensed standard form.

Propagation. A phenomenon by which any wave moves from one point to another.

pulse code modulation (PCM). The form of modulation in which the modulating signal is sampled, and the sample quantized and coded so that each element or information consists of different kinds and/or numbers of pulses and spaces.

pulse position modulation (PPM). A form of pulse modulation in which intelligence is conveyed by varying the time interval by which successive pulses are displayed from their normal times of occurrence.

push to talk operation. Voice communications on a circuit in one direction at a time in which operation of a switch is required prior to and during transmission.

R

radio frequency (RF). A frequency in which coherent electromagnetic radiation of energy is useful for communications purposes. The useful range is from approximately 10 kilohertz to 100,000 megahertz.

radio silence. A condition in which all or certain radio equipment capable of radiation is kept inoperative. (In combined or U.S. joint or intra Service communications the frequency bands and/or types of equipment affected will be specified.)

red. Designation applied to transmission lines, equipment, systems, and/or areas passing unencrypted signals.

S

satellite communications. Use of communication satellites, passive reflecting belts of dipoles or needles, or reflecting orbiting balloons to extend the range of radio communications by returning signals to earth from the orbiting objective, with or without amplification.

simplex. Refers to a mode of operation in which communication between two terminals can take place in only one direction.

skip distance. The minimum separation at which radio waves over a specified frequency can be transmitted at a specific time between two points on the earth by reflection from the regular ionized layers of the ionosphere.

skip zone. A region, in relation to a given transmitter, in which no signal would be predicted, either due to direct repetition or due to reflected waves.

sky wave. A radio wave that reaches the receiving location after refraction from the ionosphere.

T

tactical radio net. A functional radio net used by a commander for immediate and direct control of the fire and maneuver or movement of his subordinate units.

traffic. All transmitted and received messages.

transceiver. A radio transmitter and receiver combined in one unit and having switching arrangements such as to permit use of one or more circuit components for both transmitting and receiving.

transducer. A device that transfers or changes one type of energy into another form. An example is a loudspeaker, which changes electrical energy into acoustic (mechanical) energy.

Appendix R

References and Related Publications

Joint Publication (Joint Pub)

1-02 Department of Defense Dictionary of Military and Associated Terms

Marine Corps Doctrinal Publication (MCDP)

6 Command and Control

Marine Corps Warfighting Publications (MCWPs)

6-2 MAGTF Command and Control Operations (under development)

6-22 Communications and Information Systems

Marine Corps Reference Publications (MCRPs)

6-22A TALK II-SINCGARS Multiservice Communications Procedures for the Single-Channel Ground and Airborne Radio System

6-22B Multiservice Procedures for Spectrum Management in a Joint Environment

6-22D Antenna Handbook (under development)

Army Field Manuals (FMs)

11-32 Combat Net Radio Operations

24-11 Tactical Satellite Communications

24-18 Tactical Single-Channel Radio Communications Techniques

24-19 Radio Operator's Handbook

(reverse blank)