

MCWP 3-15.2
FM 7-90

Tactical Employment of Mortars



U.S. Marine Corps

PCN 143 000092 00

FM 7-90
9 OCTOBER 1992

By Order of the Secretary of the Army:

GORDON R. SULLIVAN
General, United States Army
Chief of Staff

Official:

MILTON H. HAMILTON
Administrative Assistant to the
Secretary of the Army
02075

DISTRIBUTION:

Active Army, ARNG, and USAR: To be distributed in accordance with DA Form 12-11E, Requirements for FM 7-90, Tactical Employment of Mortars (Qty rqr block no. 0801).

PREFACE

This publication serves as the doctrinal reference for the employment of mortar squads, sections, and platoons. It contains guidance on tactics, techniques, and procedures that mortar sections and platoons use to execute their part of the combat operations described in battalion-, squadron-, troop-, and company-level field manuals. This publication also contains guidance on how the mortar unit's fires and displacement are best planned and employed to sustain the commander's intent for fire support.

The target audience of this publication includes mortar squad, section, and platoon leaders, company and battalion commanders, battalion staff officers, and all others responsible for controlling and coordinating fire support during mounted or dismounted combined arms operations. This manual is also for use by training developers as a source document for the combat critical tasks and missions of mortar sections and platoons. Combat developers must use this manual as a source document when refining and revising operational concepts for infantry and cavalry mortar organizations. This publication serves as the primary reference for both resident and nonresident mortar tactical employment instruction presented to cadets, officer candidates, and both commissioned and noncommissioned officers.

This publication is not intended to be used alone. It is part of a set of doctrinal and training publications that together provide the depth and detail necessary to train and employ mortar units. Users must be familiar with the appropriate company-level and battalion-level maneuver manuals, FM 23-90 and FM 23-91, as well as mission-training plans and drill manuals for mortars.

This publication complies with the following international agreements:

STANAG 2020 Operational Situation Reports

STANAG 2022 Intelligence Reports

STANAG 3204 Aeromedical Evacuation

QSTAG 221 Target Numbering System

The proponent for this publication is US Army Infantry School. Send comments and recommendations on DA Form 2028 (Recommended Changes to Publications and Blank Forms) directly to the Commandant, US Army Infantry School, ATTN: ATSH-ATD, Fort Benning, GA 31905-5593.

Unless this publication states otherwise, masculine nouns and pronouns do not refer exclusively to men.

***FM 7-90**

Field Manual
NO. 7-90

HEADQUARTERS
DEPARTMENT OF THE ARMY
Washington, DC, 9 October 1992

<p>FM 7-90 MCWP 3-15.2</p>
<p>TACTICAL EMPLOYMENT OF MORTARS</p>

Table of Contents

PREFACE

**CHAPTER 1 - MORTAR SECTIONS AND PLATOONS ON THE
AIRLAND BATTLEFIELD**

- 1-1. Role of Mortars**
- 1-2. Tenets of Airland Battle**
- 1-3. Company- and Battalion-Level Battle**
- 1-4. Mortar Characteristics and Organizations**
- 1-5. Associated Organizations**

**CHAPTER 2 - COMMAND AND CONTROL OF MORTAR SECTIONS
AND PLATOONS**

- 2-1. Responsibilities of Key Personnel**

2-2. Troop-Leading Procedures

2-3. Combat Orders and Overlays

CHAPTER 3 - FIRE SUPPORT PLANNING AND COORDINATION

Section I - Mortar Support and Command Relationships

3-1. Command Relationships

3-2. Support Relationships

Section II - Fire Support Planning

3-3. Purpose of Indirect Fires

3-4. Effects of Indirect Fires

3-5. Fire Support Coordination Measures, Terms, and Techniques

3-6. Target Data Processing

3-7. Battalion Fire Support Plan

3-8. Battalion Target List and Overlay

3-9. Processing and Coordinating Calls For Mortar Fire

3-10. Ammunition Supply Rates

CHAPTER 4 - MORTARS IN SUPPORT OF OFFENSIVE OPERATIONS

4-1. Historical Example

4-2. Mortar Support During Offensive Operations

4-3. Types of Offensive Operations

4-4. Other Offensive Operations

4-5. Mortar Offensive Fire Support

4-6. Other Operations

CHAPTER 5 - MORTARS IN SUPPORT OF DEFENSIVE AND RETROGRADE OPERATIONS

5-1. Defensive Operations

5-2. Priority of Fires and Priority Targets

5-3. Mortar Defensive Fire Support Tasks

5-4. Retrograde Operations

5-5. Mortar Units Supporting Retrograde Operations

CHAPTER 6 - MORTAR PLATOON AND SECTION TACTICS, TECHNIQUES, AND PROCEDURES

Section I - Employment Techniques

6-1. Employment by Platoon

6-2. Employment by Section

6-3. Employment by Squad

Section II - Reconnaissance, Selection, and Occupation of Mortar Positions

6-4. Definition

6-5. Methods of Reconnaissance

6-6. Planning the Reconnaissance

6-7. Reconnaissance Party

6-8. Position Selection

6-9. Advance Party Operations

6-10. Occupation

6-11. Movement Briefing

6-12. Night Occupations

6-13. Types of Occupation

6-14. Deliberate Occupation

6-15. Hasty Occupation

6-16. Sustainment

Section III - Displacement Planning

6-17. Displacement Timing

6-18. Displacement Plans During Offense, Defense, and Retrograde Operations

Section IV - Displacement Techniques

6-19. Displacement by Platoon

6-20. Displacement by Sections

6-21. Displacement by Squad(s) or Section(-)

Section V - Movement

6-22. Independent Movement

6-23. Open Column

6-24. Closed Column

6-25. Infiltration

6-26. Terrain March

6-27. Movement Orders

6-28. Load Plans

6-29. Movement Preparation

6-30. Organization of the Platoon Column

6-31. March Discipline

6-32. Convoy Control Measures

6-33. Halts

6-34. March Column Contingencies

Section VI - Mortar Section and Platoon Firing Formations

6-35. Terrain Mortar Positioning

6-36. Parallel Formation

6-37. Lazy W Formation

6-38. Diamond Formation

6-39. Triangle Formation

6-40. Six-Mortar Star Formation

CHAPTER 7 - SURVIVABILITY TECHNIQUES AND DEFENSE OF A MORTAR FIRING POSITION

Section I - Threats to Mortar Survivability

7-1. Threats

7-2. Ground attack

7-3. Air Attack

7-4. Survivability Techniques

Section II - Dug-In Positions

7-5. Dismounted Mortars

7-6. FDC Bunkers

7-7. Mounted Mortars

7-8. Mortar Positions in a Strongpoint

7-9. High-Survivability Mortar Position

7-10. Additional Individual Protection

Section III - Other Survivability Techniques

7-11. Shoot and Hide Positions

- 7-12. Camouflage**
- 7-13. Firing Lowest Charge and Elevation**
- 7-14. Frequent Displacement**
- 7-15. Offset Registration**
- 7-16. Roving Gun**
- 7-17. Adjusting Rounds**
- 7-18. Use of Wire Communications**
- 7-19. Massing Fires**
- 7-20. Terrain Mortar Positioning**
- 7-21. Ground Defense Plan**
- 7-22. Coordination and Security Plan**
- 7-23. Defense Plan**
- 7-24. Conduct of the Defense**

CHAPTER 8 - SPECIAL CONSIDERATIONS FOR THE 60-mm MORTAR SECTION

- 8-1. Light Mortars on the Battlefield**
- 8-2. Organizations**
- 8-3. Responsibilities**
- 8-4. Employment Options**
- 8-5. Displacement**
- 8-6. Reconnaissance and Position Selection**
- 8-7. Types of Engagement**
- 8-8. Support and Command Relationships**
- 8-9. Support During Offensive Operations**

8-10. Support During a Movement to Contact

8-11. Support During a Hasty Attack

8-12. Support During a Deliberate Attack

8-13. Support During Defensive Operations

8-14. Rates of Fire

8-15. Load-Carrying Techniques

8-16. Load-Carrying Devices

CHAPTER 9 - COMBAT SERVICE SUPPORT

Section I - Trains

9-1. Field Trains

9-2. Combat Trains

9-3. Company Trains

9-4. Request for Support and Routine Supplies

Section II - Resupply

9-5. Resupply Operations

9-6. Resupply Techniques

9-7. In-Position Resupply

9-8. Prepositioning

9-9. Out of Position

9-10. Emergency Resupply

9-11. Basic Loads

9-12. Common Supplies

9-13. Miscellaneous Supplies

Section III - Maintenance

9-14. Vehicles

9-15. Weapons

9-16. Communications Equipment

9-17. Mortar Equipment

9-18. Recovery of Damaged Equipment

Section IV - Mortar Medical Support

9-19. Company Mortars

9-20. Battalion Mortars

9-21. Evacuation

9-22. Casualty and Strength Reporting

APPENDIX A - ORDERS, FORMATS, AND SUPPLEMENTS

APPENDIX B - TARGET EFFECTS PLANNING

APPENDIX C - MORTAR SMOKE OPERATIONS

APPENDIX D - CRATER ANALYSIS

APPENDIX E - OPERATIONS SECURITY

**APPENDIX F - FIRE WITHOUT AN FDC AND EMERGENCY
ENGAGEMENT TECHNIQUES**

APPENDIX G - SUSTAINED AND CONTINUOUS OPERATIONS

APPENDIX H - REPORTS

APPENDIX I - HELICOPTER OPERATIONS

APPENDIX J - MORTAR OPERATIONS ON URBANIZED TERRAIN

APPENDIX K - MORTAR ORGANIZATIONS

APPENDIX L - MORTAR AND ARTILLERY RADIO AND WIRE NETS

APPENDIX M - MORTAR PLATOON STANDING OPERATING PROCEDURES

GLOSSARY

REFERENCES

BLANK FORMS

AUTHORIZATION LETTER

<p>DISTRIBUTION RESTRICTION: Approved for public release; distribution is unlimited.</p>

*This publication supersedes FM 7-90, 11 June 1985.

CHAPTER 1

MORTAR SECTIONS AND PLATOONS ON THE AIRLAND BATTLEFIELD

All maneuver units require indirect fire to win. Mortar sections and platoons provide unique indirect fires that are organizationally responsive to the ground maneuver commander. Military history has repeatedly demonstrated the effectiveness of mortars. Their rapid, high-angle, plunging fires are invaluable against dug-in enemy troops and targets in defilade, which are not vulnerable to attack by direct fires. Although they are part of the total fire support system, mortar sections and platoons are not simply small artillery batteries. They play a unique and vital role on the AirLand Battlefield. By virtue of their organization at both company and battalion levels, they provide valuable and responsive fires that ease the combat tasks of company, battalion, and brigade commanders.

1-1. ROLE OF MORTARS

The primary role of mortars is to provide immediately available, responsive indirect fires that support the maneuver of the company or battalion, and that reinforce direct fires during close combat.

In the attack, effective maneuver requires a base of fire, both direct and indirect, to do the following:

- To establish the conditions for maneuver.
- To suppress the enemy.
- To fix him in place.
- To provide close supporting fires for the assault.

In the defense, this base of fire is used as follows:

- To force armored vehicles to button up.
- To breakup enemy troop concentrations.
- To reduce the enemy's mobility and canalize his assault forces into engagement areas.
- To deny him the advantage of defilade terrain and force him into areas covered by direct fire weapons.
- To break up the enemy combined arms team and destroy his synchronization.
- To protect the infantry against a close dismounted assault.

a. Mortar sections and platoons provide the commander with--

- (1) An organic indirect fire capability that is always present and always responsive to the maneuver commander regardless of the changing demands placed on any supporting field artillery.
- (2) Supporting fire that is immediately at hand and close to the company and battalion fight. The mortar section or platoon is aware of the local situation and ready to respond quickly without lengthy coordination.
- (3) Unique plunging fires that complement, but do not replace, the heavier fires of supporting field artillery, close air support, and naval gunfire.
- (4) Weapons whose high rate of fire and lethality fill the gap between the time field artillery fires shift to deeper targets, and the assault elements close onto the objective.
- (5) A solid base of fire upon which to anchor his maneuver to the critical point of enemy weakness.

b. Mortars allow the maneuver commander to quickly place killing indirect fires on the enemy, independent of whether he has been allocated supporting artillery. Heavy forces use carrier-mounted mortars to allow the mortar platoon to move cross-country at speeds compatible with the battalion task force. Light forces use wheeled vehicles or hand carry mortars into firing positions. Some companies have light mortars that can be manpacked across all terrain. All mortar sections and platoons exist to provide immediate, organizationally responsive fires that can be used to meet the rapid changes in the tactical situation on the AirLand Battlefield.

c. The three primary types of mortar fires are as follows:

- (1) **High explosive.** High-explosive rounds are used to suppress or kill enemy dismounted infantry, mortars, and other supporting weapons, and to interdict the movement of men, vehicles and supplies in the enemy's forward area. Bursting WP rounds are often mixed with high-explosive rounds to enhance their suppressive and destructive effects.
- (2) **Obscuration.** Obscuration rounds are used to conceal friendly forces as forces maneuver or assault, and to blind enemy supporting weapons. Obscuration can be used to isolate a portion of the enemy force while it is destroyed piecemeal. Some mortar rounds use bursting WP to achieve this obscuration; others employ more efficient technology. Bursting WP is also used to mark targets for engagement by other weapons, usually aircraft, and for signaling.
- (3) **Illumination.** Illumination rounds are used to reveal the location of enemy forces hidden by darkness. They allow the commander to confirm or deny the

presence of the enemy without revealing the location of friendly direct-fire weapons. Illumination fires are often coordinated with HE fires to both expose the enemy and to kill or suppress him.

1-2. TENETS OF AIRLAND BATTLE

Although mortars within infantry formations predate AirLand Battle, they embody the tenets of *initiative, depth, agility, and synchronization*.

a. **Initiative.** Mortars contribute to gaining the initiative from the enemy by providing immediate fires to destroy enemy forces and to disrupt his plans during both offensive and defensive combat. The speed at which mortar fires are brought to bear and the effectiveness of that fire prevent the enemy from gaining the initiative.

(1) Mortars are often used to deliver on-call immediate suppressive fires against camouflaged enemy weapons. Mortar sections and platoons can respond quickly with area fire that either destroys the weapon, obscures its field of fire, or suppresses its gunner. The friendly force thus retains the initiative to either close with the enemy and destroy him or to bypass and strike at another point. In the offense, mortar sections and platoons allow the battalion commander to weight the main effort and to shift, when needed. The commander can also use mortars to screen his movement or to designate targets on which to concentrate fires.

(2) Because each maneuver battalion has organic mortars, the brigade commander is free to mass his supporting artillery at the critical time and place to maintain the initiative. Mortars help regain the initiative during the defense by destroying or disrupting attacking forces, by screening and isolating enemy supporting elements, or by disclosing enemy movements. Mortar sections and platoons permit the battalion and brigade commanders to continue to bring indirect fires to bear on an assaulting enemy even while artillery shifts to attack enemy follow-on forces at a greater range.

b. **Depth.** Mortars add depth to the battlefield, or they can isolate a small portion from enemy observation and movement. They not only out-range most direct fire weapons but also reach enemy forces sheltered in defilade and within field fortifications. The high angle of mortar fires make them effective against enemy forces hidden in wadis, ravines, reverse slopes, thick jungle, or narrow streets and alleyways.

(1) At night, mortars extend the battlefield beyond the depth of normal vision. They can deliver unobserved preregistered fires to destroy the enemy themselves or they may illuminate the enemy for other weapons to engage. Mortar obscuration rounds limit the enemy's view of the battlefield and disrupt his coordinated actions. Mortars add depth to the battlefield by isolating a portion of the enemy's force, allowing its defeat in detail before other units can provide aid.

(2) Carrying their mortars, light raiding forces can move deep behind enemy formations to attack vulnerable points beyond the long-range fires of field artillery. The mortar's ability to deliver fires in any direction at short ranges provides responsive fire support throughout the depth of the friendly rear area. Suppressive fires from light and medium mortars allow the assaulting infantrymen to advance closer to their objective before these fires must be lifted or shifted. This not only conserves friendly combat power but also allows the field artillery to shift and attack enemy supporting weapons or formations deeper to the rear.

c. **Agility.** Mortar sections and platoons exemplify the tenet of agility. The mortar's light weight and simplicity allow infantrymen to move them rapidly and to engage targets quickly with a high volume of fire. Dismounted forces can carry medium and light mortars over all terrain, and light vehicles and helicopters can move heavy mortars easily. Mortars can fire from almost any ground upon which a man can stand. Mortar platoons can shift quickly from engaging multiple targets to massing their fires on a single enemy location. Also, infantry battalions fighting on restrictive terrain use the inherent agility of mortars to add combat power to small, dispersed units. The mortar's high angle of fire, 360-degree traverse, and multioption fuze allows the commander to move forces quickly about the battlefield without losing responsive and effective fires, regardless of the terrain.

d. **Synchronization.** Because mortar sections and platoons are organic parts of the maneuver battalion, their fires are more easily synchronized with the actions of the other members of the combined arms team to destroy the enemy. The synchronization of mortar fires with the fire of machine guns, TOWs, Dragons, and the small-arms weapons of the rifle platoons produces a greater combined effect on the enemy than the simple total of these fires.

(1) Mortar fires are a critical and irreplaceable element of the rifle company's maneuver. They either kill the enemy or suppress his fire, and thus allow the assaulting riflemen to close and kill him.

(2) Mortar fires alone cannot destroy enemy armor but contribute to the enemy's destruction through synchronized action. Long-range HE fires force enemy armor to button up and to reduce its speed of advance. HE and WP fires separate tanks from their dismounted infantry support, leaving them isolated and vulnerable to precision antitank weapons.

(3) Mortar illumination, synchronized with ground-mounted antitank weapons and AH-1 attack helicopters, reveals and destroys hidden enemy armored forces during darkness. Mortars also contribute to synchronization by providing marking rounds for CAS and attack helicopters. They also illuminate and suppress enemy defenders who can then be destroyed by direct fires and close assault forces.

(4) After the combined arms team wins the antiarmor battle, or is still fighting it around key engagement areas, friendly battalions face dismounted attacks by

Threat motorized infantry, day and night. The battalion commander uses mortar fires to dominate and destroy this enemy, while protecting and conserving the friendly force.

1-3. COMPANY- AND BATTALION-LEVEL BATTLE

Suppressing the enemy inhibits his fire and movement, while allowing friendly forces to gain a tactical mobility advantage. At the company- and battalion-level battle, mortar fire acts both as a killer of enemy forces and as an enhancer of friendly mobility.

- a. Field artillery assets at all levels are limited. For brigade and division commanders to concentrate offensive combat power at the critical point, they must decentralize elsewhere. Some maneuver units will always have less artillery support than others. Mortars compensate for this and reduce the degree of combat risk.
- b. Mortars unstress commanders at the next higher level from which they are organic. Since maneuver battalions have mortars, brigade commanders can divert field artillery fire support away from them for limited periods to win the critical fight elsewhere.
- c. Mortars contribute to the battalion's antiarmor battle by forcing the enemy to button up, obscuring his ability to employ supporting fires, and separating his dismounted infantry from their BMPs and accompanying tanks. The battalion's antiarmor fires become more effective when used against buttoned up enemy armor.
- d. Heavy mortars can penetrate buildings and destroy enemy field fortifications, preparing the way for the dismounted assault force.
- e. Mortars guarantee the battalion and company commanders the ability to cover friendly obstacles with indirect fire, regardless of the increasing calls for artillery fire against deep targets or the visibility on the battlefield.
- f. Mortar fire combines with the FPF of a company's machine guns to repulse the enemy's dismounted assault. This frees artillery to attack and destroy follow-on echelons, which are forced to slow down and deploy as the ground assault is committed. Mortars can use the protection of deep defilade to continue indirect fire support, even when subjected to intense counterfire.
- g. Mortars can fire directly overhead of friendly troops from close behind the forward elements. This allows combat power to be concentrated and synchronized on close terrain.

1-4. MORTAR CHARACTERISTICS AND ORGANIZATIONS

Simplicity, ruggedness, maneuverability, and effectiveness are the principle characteristics of mortars. This paragraph discusses the specific characteristics and

capabilities of US mortars, and current organization of these weapons into squads, sections, and platoons.

a. **Characteristics.** The US currently has five models of mortars. (See Table 1-1.) For detailed technical information on each mortar type, see FM 23-90 and the applicable TMs for each mortar.

WPN	AMMUNITION		METERS			RATES OF FIRE/NOTES
	MODEL	TYPE	MIN RANGE	MAX RANGE	DIA OF ILL	
60-mm M224	M720/M889	HE*	70	3,500 ⁽¹⁾	500	30 rounds per minute for 4 minutes ⁽²⁾ then 20 rounds per minute, sustained
	M722	WP**	70	3,500		
	M721	ILLUM***	200	3,500		
	M302A1	WP	35	1,830	300	
	M83A3	ILLUM	725	950		
	M49A4	HE	45	1,830		
81-mm M29A1	M374A2	HE	70	4,600		360
	M374A3	HE	73	4,790		
	M375A2	WP	73	4,595		
	M301A3	ILLUM	100	3,950		
81-mm M252	M821/M889	HE	80	5,800	650	30 rounds per minute for 2 minutes, then 15 rounds per minute, sustained
	M374A3	HE	73	4,790		
	M819	RP****	300	4,800		
	M375A2	WP	73	4,595		
	M853A1	ILLUM	300	5,060		
	M301A3	ILLUM	100	3,950		
107-mm M30	M329A2	HE	770	6,840	800	18 rounds per minute for 1 minute, then 9 rounds per minute for 5 minutes, then 3 rounds per minute, sustained
	M329A1	HE	920	5,650		
	M328A1	WP	770	5,650		
	M335A2	ILLUM	440	5,490		
120-mm M120	M57	HE	200	7,200	1,500	15 rounds per minute for 1 minute, then 4 rounds per minute, sustained
	M68	WP	200	7,200		
	M91	ILLUM	200	7,100		
	M933	HE (PD)	200	7,200		
	M934	HE(MDF)	200	7,200		
	M929	WP	200	7,200		
	M930	ILLUM	200	7,200		
	* HIGH EXPLOSIVE ** WHITE PHOSPHORUS *** ILLUMINATION **** RED PHOSPHORUS			(1) BIPOD-MOUNTED, CHARGE 4 (MAXIMUM RANGE HANDHELD IS 1,300 METERS) (2) CHARGE 2 AND OVER, 30 ROUNDS PER MINUTE CAN BE SUSTAINED WITH CHARGE 0 OR 1		

Table 1-1. Mortar characteristics.

(1) *Light mortar.* The 60-mm mortar, M224, provides air assault, airborne, ranger, and light infantry rifle companies with an effective, efficient, and flexible

weapon. The inherent limitations of a light mortar (short-range and small-explosive charge) can be minimized by careful planning and a thorough knowledge of its capabilities. The M224 can be employed in several different configurations. The lightest weighs about 18 pounds; the heaviest weighs about 45 pounds. Each round weighs about 4 pounds.

(2) **Medium mortars.** The 81-mm mortars, M29A1 and M252, are the current US medium mortars. The M252 is replacing the M29A1, but both will remain in the Army inventory for several years. Medium mortars offer a compromise between the light and heavy mortars. Their range and explosive power is greater than the M224, yet they are still light enough to be man-packed over long distances. The M29A1 weighs about 98 pounds. The M252 is slightly lighter, about 93 pounds. Both can be broken down into several smaller loads for easier carrying. Rounds for these mortars weigh about 15 pounds each.

(3) **Heavy mortars.** The 107-mm mortar, M30, and the 120-mm mortar, M120, are the current US heavy mortars. The M120 is replacing the M30, but both will remain in the US inventory for several years. The M30 is a rifled mortar, stabilizing its projectile by spinning it rapidly. The M120, like all other US mortars, fires fin-stabilized ammunition from a smooth bore. Although heavy mortars require trucks or tracked mortar carriers to move them, they are still much lighter than field artillery pieces. They outrange light and medium mortars, and their explosive power is much greater. The M30 weighs about 675 pounds. The M120 is much lighter at about 320 pounds. Rounds for the 107-mm mortar weigh about 28 pounds. Those for the 120-mm mortar weigh almost 33 pounds each.

b. Organization. The organization and equipment of mortar sections and platoons is based on approved TOE or MTOE. Because TOEs can change, current authorizations should be reviewed for more detailed information. Mortar sections or platoons are located in either the battalion's headquarters and headquarters company or combat support company, and in cavalry troops and rifle companies, depending on the TOE or MTOE. In most organizations, mortars are grouped under the leadership of a junior commissioned officer--these groupings are designated as platoons. Platoons consist of two to six squads, which are comprised of one mortar and its crew. All mortar platoons have personnel designated to man the FDC. Squads can be grouped into sections for command and control. Sections consist of two or more squads, which are normally under the supervision of a senior noncommissioned officer. The mortar sections in the airborne, air assault, and light infantry companies and the cavalry troop are not organized within a platoon and do not have designated FDC personnel. (See Appendix K for diagrams for mortar organizations.)

(1) Mechanized infantry and armor battalions are equipped with heavy mortars, either 107-mm or 120-mm (Figure 1-1). Both the mortar squads and the FDC personnel operate from tracked carriers, which offer protection from small-arms fire and shell fragments. TOEs differ in the number of mortar squads and FDCs within the mortar platoon. Mechanized infantry companies in some Reserve

Component battalions also have mortar platoons, which have 81-mm mortars in tracked mortar carriers.

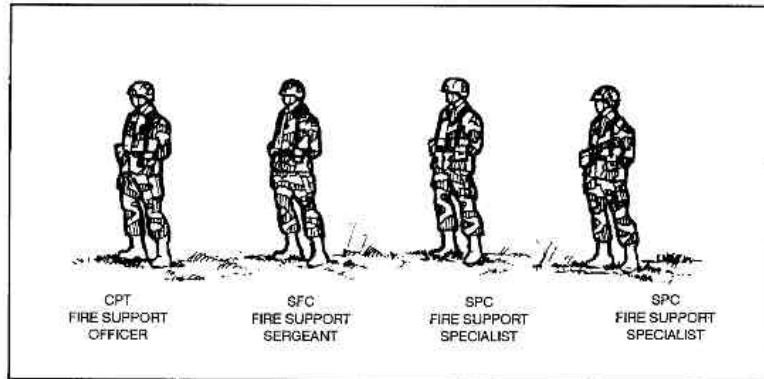

Figure 1-1. Typical battalion fire support section.

(2) Airborne, air assault, and light infantry battalions have mortar platoons at battalion and mortar sections at company levels. The mortar platoon at battalion level is equipped with 81-mm mortars. The mortar section at company level has the 60-mm mortar. The battalion mortar platoon is equipped with trucks and trailers, but the company's 60-mm mortars are hand carried.

(3) Some infantry battalions in the Reserve Component also have mortar platoons at both battalion and company levels. The mortar platoon at battalion level is equipped with either the 107-mm or 120-mm mortar. The company mortar platoon has 81-mm mortars. Both platoons are authorized trucks and trailers for movement.

(4) Ranger battalions are not authorized battalion-level mortars but do have a weapons platoon within each ranger rifle company. These weapons platoons are equipped with 60-mm mortars that they hand carry.

(5) Ground cavalry troops have heavy mortar sections equipped with either the 107-mm or 120-mm mortar, track-mounted. The difference between J- and H-series TOEs is the number of mortar squads for each troop. Cavalry mortar sections do not have dedicated FDC personnel.

(6) Motorized battalions have heavy mortar platoons within their combat support companies that are equipped with towed versions of the 120-mm mortar. Each mortar squad has a HMMWV as a prime mover.

1-5. ASSOCIATED ORGANIZATIONS

No element of the combined arms force operates independently. Each assists or coordinates with others. Several associated organizations work with mortar sections and platoons to maximize and coordinate the effects of mortar fire. There is a field artillery fire support coordinator at each echelon of command from company through brigade. At brigade level, he is the direct support artillery battalion commander. At battalion level and below, field artillery fire support coordinators are designated as FSOs.

a. A direct support field artillery battalion normally provides a fire support section (FSS) to each of its supported infantry, mechanized infantry, and tank battalions (Figure 1-1). The battalion FSO, a captain, is in charge of this section. He is the principal advisor to the maneuver commander on fire support matters and is the fire support coordinator for the battalion. In mechanized infantry and armor battalions, the FSS is equipped with a special tracked vehicle with radios that allow communications by both voice and digital transmissions. A key piece of communications equipment used by the FSS is the FIST-DMD. This is an enhanced version of the standard digital message device supplied to each FO team. Using the FIST-DMD, the FSO can operate in four separate digital radio nets, and accept input from laser designators. In infantry battalions, the FSS uses wheeled vehicles, and its digital communications nets may be limited.

b. Each infantry and armor maneuver company normally has a fire support team (FIST) (Figure 1-2). The FIST is led by a field artillery lieutenant, the company FSO, and has three two-man FO teams for each infantry company. The FO teams are normally attached, one to each rifle platoon, but they can be employed in other ways. In tank companies and armored cavalry troops, the FIST consists only of the FIST headquarters with no FO teams. The FO's functions are performed by leaders within the platoons. The FIST, and each FO team, is equipped with radios that can be man-packed. They also have a digital message device. In mechanized and armored battalions, the FIST has a FIST-V. In infantry and ranger battalions, the FIST may have a wheeled vehicle or he may operate dismounted.

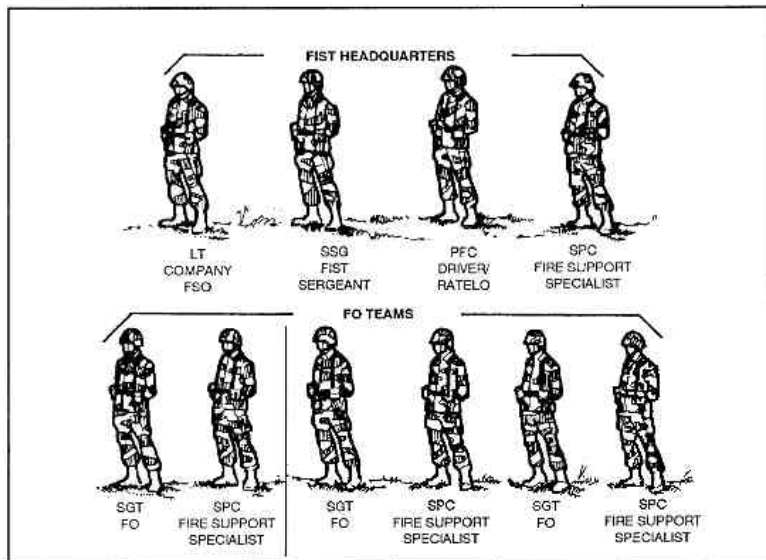

Figure 1-2. Typical infantry company fire support team.

c. Maneuver battalions may have one or more special lasing teams attached or supporting them (Figure 1-3). These teams are equipped with either the FIST-V or man-portable lasers that can be used to designate targets for aircraft or to provide terminal guidance for precision munitions such as Copperhead, Hellfire, or laser-guided bombs. The colt also calls for and adjusts conventional indirect fires, including mortar fires.

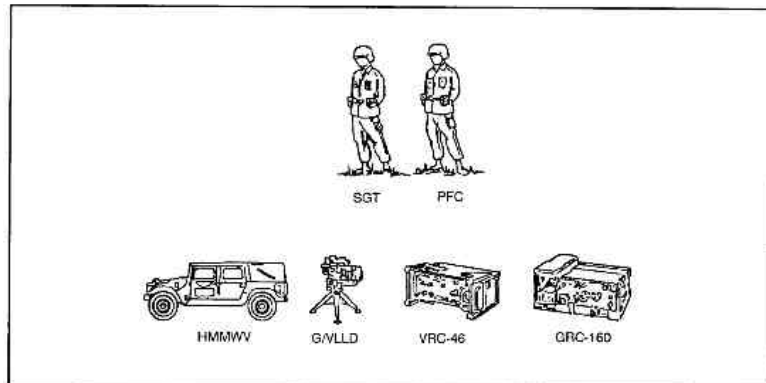

Figure 1-3. Typical combat observation lasing team.

d. If a maneuver battalion is operating near the coast, it may be supported by elements of the air and naval gunfire liaison company (ANGLICO) (Figure 1-4). The ANGLICO normally provides each battalion a supporting arms liaison team (SALT) consisting of one officer and six enlisted men. The SALT is capable of planning, requesting, coordinating, and controlling naval gunfire, and naval/marine air strikes. In the absence of a US Air Force TACP, the SALT can also control USAF close-air support. Each SALT is equipped with a wheeled vehicle, a radar bombing beacon, and sufficient radios to allow it to operate in the following nets:

- Naval gunfire support net.
- Brigade or battalion command net.
- Naval gunfire spot net.
- Tactical air request net.

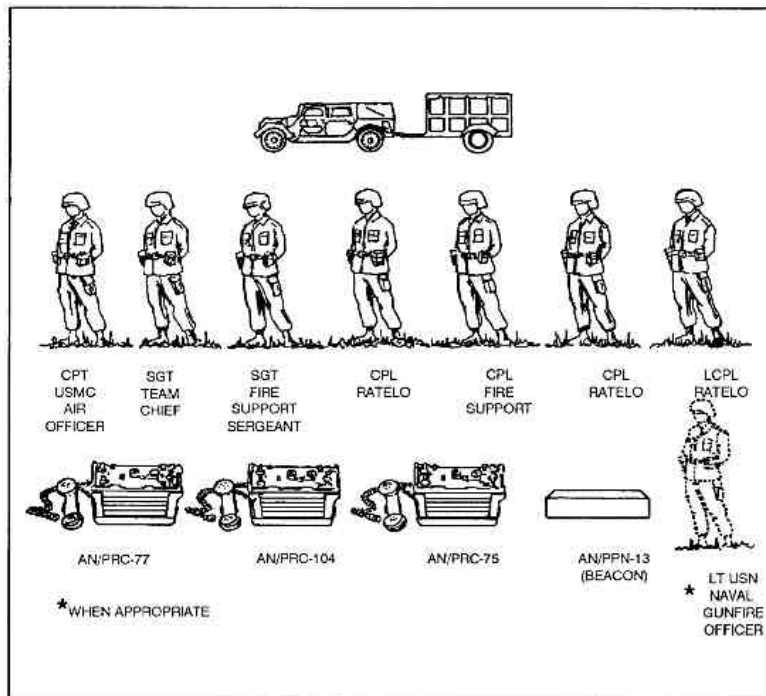

Figure 1-4. Typical supporting arms liaison team.

e. Each SALT has two firepower control teams (FCT). These teams perform much the same functions as the company-level FIST. They call for and adjust naval gunfire, and control naval close-air support. Each FCT is composed of one officer and five enlisted

men. The team has a wheeled vehicle and sufficient radios to operate in the following nets:

- Battalion or company command net.
- Naval gunfire spot net.
- Tactical air request net.

Each FCT also has a radar transponder (beacon) used to control beacon offset bombing missions. One FCT normally supports a company and may be attached to it (Figure 1-5).

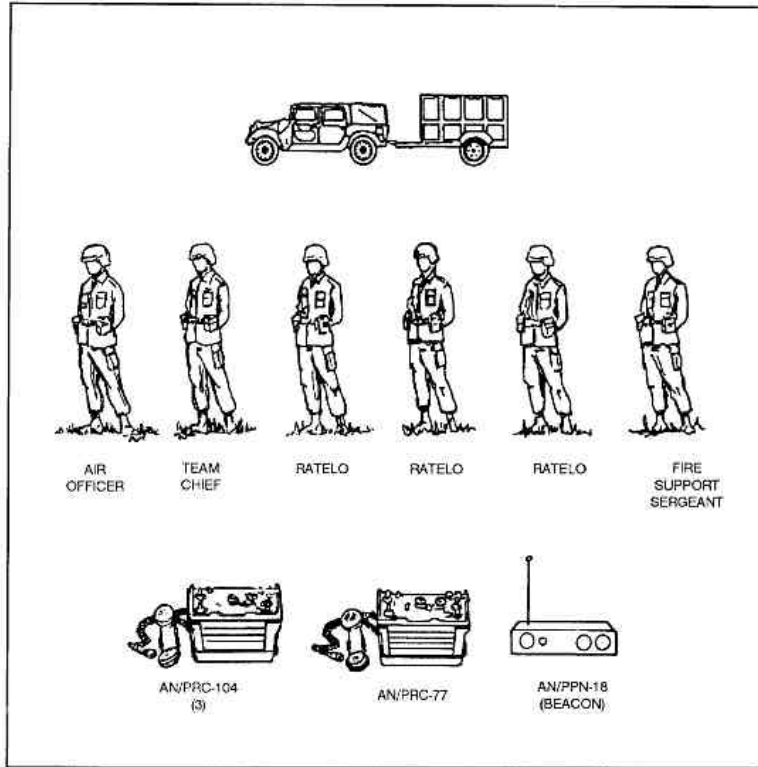

Figure 1-5. Typical firepower control team.

CHAPTER 2

COMMAND AND CONTROL OF MORTAR SECTIONS AND PLATOONS

This chapter discusses the responsibilities of mortar section and platoon leaders and other key personnel, the troop-leading procedures, and SOPs. The mortar leader's primary duty is mission accomplishment. He influences and directs his men to gain their confidence, respect, and cooperation in combat operations. His leadership involves an understanding of human behavior and the employment of mortars and mortar tactics. The mortar section or platoon leader is responsible for the discipline, training, welfare, and morale of his men as well as the maintenance of his equipment. At platoon and squad levels the leader sets the example. He leads from a position where he can control mortar fire, making decisions within his authority and executing command decisions.

2-1. RESPONSIBILITIES OF KEY PERSONNEL

Responsibilities of key personnel vary with the level of supervision. This paragraph discusses those responsibilities that directly affect the performance of mortar sections and platoons.

a. The battalion (or squadron) TF commander is responsible for the tactical employment of his mortar platoon. He cannot delegate this responsibility to any staff officer. The final decision, as well as the final responsibility, for the tactical employment of the mortar platoon rests with this commander. The battalion commander must delegate authority and foster a relationship of mutual trust, cooperation, and communication between him and the mortar platoon leader. Their relationship must be a special one that allows the platoon leader to anticipate requirements, to ask questions, and to provide feedback freely. For his mortar platoon to be effective, the commander must provide a clear idea of what he wants the mortar platoon's fire to do for the battalion. He must have detailed technical knowledge of the capabilities, limitations, and characteristics of mortars. Specific areas of his responsibility concerning the mortar platoon include--

- Tactical employment (missions, priority of fires, general locations, final approval of fire plans).
- Task organization (attachments and detachments, command and support relationships, communications).
- Logistical support (basic loads, types and mix of ammunition, priority of transportation and maintenance support, mess).

b. The battalion (or squadron) operations officer is the battalion commander's principal staff officer in matters concerning combat operations, plans, organization, and training. The nature of the operations officer's responsibilities requires a high degree of coordination with the mortar platoon leader. The battalion operations officer is responsible for expressing the commander's concept and guidance in both written and oral orders. As a member of the battalion commander's primary staff, the operations officer does not exercise command authority over the mortar platoon. He does, however, exercise a degree of control over the mortar platoon's actions. He has the authority to direct the platoon to accomplish specific missions or tasks within the framework of the battalion commander's intent. He does not exercise administrative or logistical control except as such action affects the platoon's accomplishment of the mission. Specific areas of responsibility concerning the mortar platoon include--

- (1) Preparing, authenticating, and publishing the battalion tactical SOP. The mortar platoon leader provides input to the appropriate sections of the battalion SOP. He then establishes an internal platoon SOP that adheres to the battalion's SOP, while addressing all issues of special concern to the platoon.
- (2) Preparing, coordinating, authenticating, and publishing operations plans and orders to include tactical movement orders; incorporating the mortar platoon leader's input to these plans and orders while they are being prepared.
- (3) Recommending priorities for critical resources. This includes establishing mortar ammunition basic loads by type and number of rounds, and the required and controlled mortar ammunition supply rate.
- (4) Recommending task organization to the commander and assigning specific missions to the mortar platoon.
- (5) Coordinating all combat support with maneuver; advising the commander and coordinating the fires and displacement of the mortar platoon with the actions of other units.

c. The battalion FSO is charged with doing whatever planning and coordination is necessary to execute the fire support plan and support the commander's intent. The battalion FSO and the mortar platoon leader have a unique relationship. They must both understand the battalion commander's intent for fires, and they must work closely to see that it is carried out. The battalion FSO must know mortar capabilities, limitations, and technical aspects. The mortar platoon leader must inform the battalion FSO of anything that affects the mortar platoon's ability to execute the commander's fire support plan. The battalion FSO recommends to the operations officer the appropriate unit to fire on each preplanned target. The mortar platoon leader must work closely with the battalion FSO to ensure mortar fires are planned on appropriate targets and delivered at the correct times. The battalion FSO is not in the mortar platoon leader's chain of command, but he anticipates requirements and passes orders, information, and instructions to the mortar platoon during the battle.

d. The headquarters (or combat support) company commander is a vital link in the chain of command between the battalion commander and the mortar platoon leader. He exercises all aspects of command over the mortar platoon. As a commander, he is responsible for--

- (1) The command and control of the mortar platoon, less OPCON during actual combat.
- (2) The safety and training, especially individual training, of the mortar platoon.
- (3) Health, welfare, morale, order, and discipline.
- (4) Administrative and financial actions associated with transfers, promotions, pay and allowances, and commendations.
- (5) Maintenance, logistical, and mess support for the mortar platoon.
- (6) Personnel and equipment status reporting.
- (7) Casualty reporting and handling.

e. The mortar platoon leader is primarily a combat leader. He is also the principal advisor to the battalion commander and battalion FSO on the tactical employment of mortars. He performs the following:

- (1) Recommends task organization, employment techniques, and positioning of the mortars to support the scheme of maneuver.
- (2) Assists in developing the fire support plan in conjunction with the company or battalion FSO; determines the best type and amount of mortar ammunition to fire, based on the factors of METT-T.
- (3) In accordance with the battalion OPORD and plan for fire support, develops his supporting platoon plan and reviews it with the FSO and operations officer. The amount of detail and time spent developing the supporting plan may vary, based on the situation.
- (4) Assists the operations officer in determining the RSR. If a CSR has been set, the mortar platoon leader may not exceed it without authorization. The platoon leader may need to recommend changes to the mortar platoon's mission based on the CSR.
- (5) Informs the commander, S3, and FSO of all significant range or ammunition limitations.
- (6) Designates reconnaissance and advance parties.

- (7) Selects and reconnoiters new positions and routes for the platoon; controls the movements of all elements of the platoon not attached or OPCON to other units.
- (8) Keeps abreast of the enemy situation and locations of friendly units to ensure the best use of ammunition and the safety of friendly troops.
- (9) Assigns missions and issues instructions and orders to subordinate leaders.
- (10) Supervises the execution of orders; ensures that priority targets are covered at all times; establishes the amount and type of ammunition set aside for priority targets.
- (11) Coordinates the fires and displacement of the mortar platoon with the action of other units; directs mortar section and platoon displacement.
- (12) Ensures security measures are enforced to increase the survivability of the platoon against the ground, air, and indirect fire attacks.
- (13) Lays mortars for firing, when required; verifies the direction of fire selected by the FDC.
- (14) Commands and controls the execution of the mortar platoon portion of the battalion fire support plan and coordinates the fires and displacements of the mortar sections.
- (15) Plans the platoon ground defense and maintains security while on the move or halted.
- (16) Submits ammunition and platoon status reports to the S3.
- (17) Relays intelligence information, SHELREPs, MORTREPs, and SPOTREPs to the S2.
- (18) Anticipates needs and ensures timely ammunition resupply, maintenance, and refuel requests are submitted to sustain combat operations.
- (19) Is responsible for the welfare of his men.
- (20) Is responsible for the training of the platoon to ensure technical and tactical proficiency, and combat lifesaver skills; cross trains personnel within the platoon on key tasks to ensure continuous operations.
- (21) Performs map spot and hasty survey operations.
- (22) Coordinates through the FSO with supporting artillery units for survey support, when possible.

- (23) Performs hasty crater analysis and reports the results.
- (24) Coordinates radar registration, when appropriate.
- (25) Establishes and maintains communications with supported companies and FISTs.
- (26) Becomes familiar and gains at least limited proficiency with field artillery fire support coordination and communications equipment such as the FIST -DMD and G/VLLD.
- (27) Enforces platoon safety precautions. He trains his platoon on the proper execution of all firing and misfire reduction procedures to minimize risk.
- (28) Keeps abreast of all changes to the enemy countermortar capability.

f. The mortar platoon sergeant is the principal assistant to the platoon leader and assists him in all matters pertaining to training and operation of the platoon. He assumes responsibilities of the platoon leader during his absence. In addition, he performs the following:

- (1) Inspects and supervises to ensure the platoon leader's orders are executed.
- (2) Leads the reconnaissance party and conducts reconnaissance of routes and positions, when required.
- (3) Supervises movements, as required. When the platoon is operating in two sections, he normally directly supervises one.
- (4) Supervises the preparation of the platoon ground defense.
- (5) Supervises camouflage, field hygiene, and sanitation.
- (6) Supervises the platoon's security and sleep plans.
- (7) Lays the mortars for firing, when required.
- (8) Ensures that situation maps are maintained in the FDC.
- (9) Ensures available meteorological data is applied to firing data, when appropriate.
- (10) Supervises the test firing and zeroing of weapons and boresighting of mortars.

- (11) Ensures communication nets are established and personnel use proper radiotelephone operating procedures.
- (12) Ensures platoon personnel are trained in their primary job assignments and cross trained to perform key functions within the FDC.
- (13) Ensures the required basic load and platoon equipment are on hand.
- (14) Monitors ammunition expenditures and ensures ammunition records are maintained.
- (15) Submits timely ammunition resupply requests.
- (16) Supervises ammunition prestockage, when used.
- (17) Ensures maintenance is actively supervised by subordinate leaders.
- (18) Coordinates and supervises POL resupply and maintenance support.
- (19) Coordinates and supervises vehicle recovery.
- (20) Requests fortification materials.
- (21) Coordinates resupply needs.
- (22) Adjusts personnel as needed and cross-levels personnel within mortar squads to maintain maximum firepower.
- (23) Conducts hasty crater analysis and submits SHELREPs and MORTREPs.
- (24) Ensures that aiming circles are declinated properly.
- (25) Ensures that all necessary safety, borescope, and pullover gauge inspections are performed and recorded.
- (26) Coordinates casualty evacuation.
- (27) Assists in the preparation of paragraph 4 of the platoon OPORD.

g. The section leader assumes the duties of the platoon sergeant during his absence. (See Chapter 8 for special considerations and duties of the light mortar section sergeant.) In addition, he performs the following:

- (1) Informs the platoon leader and platoon sergeant of ammunition status and of changes in the tactical situation.

- (2) Advises when displacements should be made because of range limitations.
- (3) Leads the reconnaissance or advance party, when directed.
- (4) Assists in vehicle placement.
- (5) Lays mortars for firing, when directed.
- (6) Controls FDC personnel. He ensures safe procedures are used in computing firing data and validates the computer safety check before issuing the FDC order.
- (7) Establishes and maintains situation maps. He marks all restrictive fire control measures on the map and ensures they are entered into the MBC or on the plotting board.
- (8) Relays intelligence information to the battalion FSO and platoon leader.
- (9) Supervises all fire missions. He examines target location relative to friendly units, fire control measures, and reference points. Based on the nature of the target, ammunition available, and command guidance, he decides if the mission should be fired, the number of mortars to fire, and the amount and type of ammunition to expend.
- (10) Issues the FDC order.
- (11) Checks the accuracy of computer operators and FDC records; ensures fires are correctly plotted.
- (12) Maintains ammunition records.
- (13) Reports ammunition status.
- (14) Recommends when re-registration should be conducted.
- (15) Determines and applies meteorological corrections for firing data.
- (16) Assumes control of a section during split-section operations.
- (17) Supervises the laying of communications wire in the mortar position.
- (18) Supervises the FDC sleep plan to ensure 24-hour operation.
- (19) Ensures FDC personnel use proper radiotelephone operating procedures.
- (20) Ensures FDC and gun crew personnel understand their role in defending the platoon position.

- (21) Ensures FDC and section vehicles are properly camouflaged.
- (22) Supervises the maintenance of vehicles and equipment.
- (23) Trains FDC personnel in FDC procedures and assists and trains squad leaders in FDC procedures.
- (24) Consolidates and submits NBC reports.
- (25) Supervises section and FDC NBC protective and decontamination measures.
- (26) Designates the duty mortar crew during continuous operations and ensures they are alert.

h. The mortar squad leader performs the following:

- (1) Controls squad movement.
- (2) Places the squad into position.
- (3) Ensures the mortar is properly laid.
- (4) Checks mask and overhead clearance.
- (5) Ensures the mortar position is camouflaged.
- (6) Ensures that proper deflection and elevation are indexed on the mortar sight.
- (7) Ensures the ammunition is properly prepared for firing and reports any ammunition discrepancies to the FDC.
- (8) Briefs his squad on the platoon leader's orders.
- (9) Informs his squad of any changes.
- (10) Conducts emergency fire missions without an FDC, when required.
- (11) Plots fires and determines firing data when operating separately from the section.
- (12) Supervises the preparation and manning of squad fighting positions.
- (13) Implements the squad sleep and security plans.
- (14) Ensures communication is maintained with the FDC.

- (15) Ensures the squad uses proper radiotelephone operating procedures.
- (16) Supervises the maintenance of personal weapons and squad equipment.
- (17) Supervises weapons test firing and mortar boresighting.
- (18) Ensures the ammunition and equipment are properly stored.
- (19) Informs FDC of any changes in ammunition status.
- (20) Is responsible for the training, welfare, and safety of squad members.
- (21) Trains squad members in individual and crew-related skills and cross trains to maintain technical proficiency at all times.
- (22) Submits NBC reports.
- (23) Supervises squad NBC protective and decontamination measures.

2-2. TROOP-LEADING PROCEDURES

Troop-leading procedures should be an instinctive familiar way of thinking for all leaders. The sequence of the individual procedures is not rigid. It is modified to meet the mission, situation, and available time. Some steps are done concurrently, while others may go on continuously throughout the operation. The procedures are time savers. The leader uses them in the order that is most efficient.

a. **Receive the Mission.** A mission may be received in the form of either a written or oral warning order, operation order, or fragmentary order. At times, a leader may deduce a change in mission, based on a change in the situation. The mortar platoon leader should attend the battalion OPOD.

- (1) Once an upcoming mission is identified, the leader takes action to begin preparing the unit. He conducts an initial METT-T analysis to determine the requirements for his warning order.
- (2) With the information available, the leader sets his time schedule by identifying the actions that must be done (time-critical tasks) to prepare for the operation. These preparatory actions are identified by a preliminary consideration of the information on the mission, enemy, terrain, and own troops. An initial reconnaissance (may be a map reconnaissance) is conducted to allow the leader to more fully understand the time requirements for the mission. He then develops his time schedule by starting at "mission time" and working backward to the current time (reverse planning). The mission time is normally the most critical time in the operation.

(3) The leader must ensure that all subordinate echelons have sufficient time for their own planning needs. A general rule of thumb for leaders at all levels is to use no more than one-third of the available time for planning and issuance of the OPORD. This will leave the rest of the available time for subordinate leaders to use for their planning and preparation. Establish a tentative time schedule, which may require adjustments as the procedures process continues.

b. **Issue a Warning Order.** Do not wait for more information. Issue the best warning order possible with the information at hand and update it as needed with additional warning orders. The warning order lets units prepare for combat as soon as possible after being alerted of an upcoming mission. This normally involves a number of standard actions that should be addressed by SOP. The warning order should address those items not covered in the SOP that must be done to prepare for the mission. The specific contents for each warning order will vary, based upon the unique tactical situation. (Appendix A provides an example warning order.)

c. **Make a Tentative Plan.** Tentative plans are the basis for the OPORD. The leader uses the commander's estimate of the situation to analyze METT-T information, develop and analyze a COA, compare courses of action, and make a decision that produces a tentative plan.

d. **Initiate Movement.** This can be done by having a subordinate leader move the section or platoon to an assembly area or firing position. The instructions for this move can be given in the warning order. The leader must ensure that all movements are coordinated with his headquarters and that security is maintained.

e. **Conduct Reconnaissance.** Reconnaissance is a continuous process during the procedures. The tentative plan should include time for reconnaissance. Plan and conduct reconnaissance to confirm or adjust the tentative plan. A thorough tentative plan helps the reconnaissance because specific guidance can be given to subordinates. In every tactical operation the leader requires additional information, and at the same time, he must deny the enemy information about his section or platoon.

f. **Complete the Plan.** The leader must be prepared to adjust his tentative plan based on the results of the reconnaissance. He may have to change COAs if the situation is not what he expected. In this case, one of the previously analyzed and discarded COAs may be adjusted to quickly finalize his new plan. Coordination continues with all supported agencies, higher headquarters, and adjacent units. This, along with his reconnaissance, gives the leader the information he needs to expand the tentative plan into a five-paragraph OPORD. (See OPORD format, Appendix A.)

g. **Issue the Order.** Preferably issue the order while viewing the avenues of approach/objective area. Make maximum use of visual aids (sketches and terrain models) to enhance the presentation of the order. When the leader issues the tentative plan before the leader's reconnaissance, he issues a FRAGO to finalize the plan before execution (see Appendix A).

h. **Supervise.** The best plan may fail if it is not managed right. Briefbacks, rehearsals, inspections, and continuous coordination of plans must be used to supervise and refine troop-leading procedures. Briefbacks and rehearsals are not the same; briefbacks focus on the planning process, and rehearsals focus on execution.

(1) **Precombat inspections.** During precombat inspections, check--

- Weapons and ammunition.
- Uniforms and equipment.
- Mission-essential equipment.
- Soldiers' knowledge and understanding of the mission and their specific responsibilities.
- Communications.
- Rations and water.
- Camouflage.

(2) **Rehearsals.** Rehearsals are always conducted. They are essential to ensure complete coordination and subordinate understanding. The mortar section or platoon must participate in the maneuver and fire support plan rehearsals held by the battalion. These rehearsals are critical to success. The warning order should provide subordinate leaders sufficient detail for them to schedule and conduct rehearsals of drills/SOPs before receiving the OPORD. Rehearsals conducted after the OPORD can then focus on mission specific tasks. Rehearsals are conducted as any other training exercise except the training area should be as much like the objective area as possible, including the same light and weather conditions. Rehearsals include holding soldier and leader briefbacks of individual tasks and using sand tables or sketches to talk through the execution of the plan. These are followed by walk-through exercises and then full-speed, blank-fire or live-fire rehearsals. The leader should establish the priority for rehearsals based on the available time. The priority of rehearsals, as COA development, flows from the decisive point of the operations. Some important tasks to rehearse are as follows:

- Execution of the battalion or company fire plan by phase or series. This cannot be done alone. The battalion staff and FSOs must participate along with the mortar platoon/section.
- Emergency occupation techniques. (See [Appendix F.](#))
- Visual and audio signals.
- Deliberate occupation of firing positions.
- Conduct of firing missions while in MOPP4.
- Reaction to countermortar fires.

(3) **Final Inspections.** The last requirement before an operation is to conduct an inspection to ensure the men and equipment are ready. This inspection can include (but is not limited to)--

- Rations.
- Water and water purification tablets.
- Vehicle (communications equipment, maintenance, fuel level, load plan, tools).
- Weapons (maintenance).
- Ammunition (amount, type, storage).
- Individual uniform and equipment (weapon, protective mask and nerve-agent antidote, helmet, flack vest, eye protection, bug repellent, earplugs, dog tags).
- Camouflage (personnel and equipment).
- Mission-essential equipment (mortar sights, night lights, extra batteries and bulbs, NBC equipment, aiming circle, compasses, chemical lights).
- Knowledge of the mission and individual responsibilities (displacement plan, fire plan).
- Knowledge of radio nets, frequencies, and call signs.
- Precomputed firing data.
- Knowledge of emergency signals and code words.
- Mortar ballistic computer setup and batteries.

Once the operation begins, the leader follows the plan. He should be ready to change his plan if the situation demands it.

2-3. COMBAT ORDERS AND OVERLAYS

Combat orders are written or oral, and leaders use them to transmit information and instructions to subordinates. The use of combat orders, expressed in standardized formats or containing essential elements, ensures that a leader conveys his instructions clearly, concisely, and completely. The detail of an order varies with the amount of time a leader has to prepare it. SOPs complement combat orders, allowing the leader to refer to them rather than issue the same instructions for tasks and situations that occur often. Three kinds of combat orders are: warning, operation, and fragmentary.

a. **Warning Order.** Leaders use warning orders to alert their sections of an impending mission and to provide initial instructions so that subordinates have a maximum amount of time to prepare for its execution. There is no prescribed format for a warning order, but by following the outline of the five-paragraph field order, leaders can simplify and standardize their orders. This helps when the leader is exhausted or under great stress. The warning order must provide any specific instructions not included in the SOP but which are important to preparation of the mission (such as changes to the composition of the on-board ammunition load). The platoon leader may issue it only to the platoon sergeant if time does not permit the gathering of other personnel. (See Appendix A for an example of a mortar platoon warning order.)

b. **Operation Order.** The OPORD supplies all-important information on WHO, WHAT, WHEN, HOW and most importantly, WHY. It outlines the commander's intent for fire support. The leader uses the OPORD to tell subordinates how he intends to fight the

battle. Leaders use the standard OPORD format to organize their thoughts in a logical sequence. This ensures that the platoon and squad know everything necessary to accomplish the mission. Consistent use of this standard format allows the leader to refine SOPs and to streamline his orders. (See Appendix A for an example of a mortar platoon OPORD.)

c. **Information Source for the OPORD.** The majority of the information needed for the platoon leader's OPORD comes directly from the battalion OPORD. The platoon leader can get additional information from the S2, the battalion FSO, and the S4. Some information he must determine himself during the analysis of his mission.

d. **Fragmentary Order.** The FRAGO is issued to make a change to an existing order. Therefore, FRAGOs address only those items from the OPORD that are changed. Since FRAGOs are normally used during the conduct of an operation, instructions should be brief and specific. Although there is no standard format for a FRAGO, the following mission-essential items are normally included:

- (1) Situation (enemy and friendly forces) includes a brief description of the enemy and friendly situations, and it should indicate the reason for the change in instructions.
- (2) Changes to the organization can include the attachment or detachment of the platoon, or part of it.
- (3) Orders to subordinate units should be issued by element. To avoid confusion, no element should be left out.
- (4) Fire support (if applicable) indicates any change in priorities or assets.
- (5) Coordinating instructions, as in the OPORD, should include all instructions that apply to one or more elements.

(See Appendix A for an example of a verbal mortar platoon FRAGO.)

e. **Operation Overlay.** An operation overlay is a tracing of the location, size, and scheme of maneuver and fires of friendly forces involved in an operation. Its purpose is to reduce the content and enhance the understanding of the written or oral order. The mortar platoon leader must ensure that information is transferred from the overlay onto the mortar ballistic computer and plotting board to ensure friendly units are not fired on. Normally, squad leaders will not be issued operation overlays. However, in conjunction with higher leader's orders, platoon and squad leaders should transfer the appropriate graphics to their maps. This allows them to plan their actions, based on a map reconnaissance deeper than the terrain may allow them to see. The overlay or transference should be simple, neat, and accurately drawn. It should include all control measures used during the operation and all other information that can be depicted

graphically. The section sergeant should keep a copy of the operation overlay in the FDC at all times, updating it as needed.

CHAPTER 3

FIRE SUPPORT PLANNING AND COORDINATION

Mortar fire is a key resource used by the commander to immediately influence the outcome of a battle. Mortars can deliver lethal and effective firepower almost anywhere within the company's or battalion's zone of action on short notice. In the offense, mortars are used to establish a base of fire to enable maneuver against the enemy. In the defense, mortars are used to break up and destroy the enemy's assault. However, rarely are there enough mortars or ammunition to allow the engagement of every target identified. Fire support planning and coordination are key to effective and efficient employment of mortar firers.

Mortar fire support planning is the continuous and concurrent process of analyzing, allocating, coordinating, and scheduling mortar fires. Integrating these fires with the maneuver plan optimizes the commander's combat power. Because mortars are organic to the companies and battalions, they provide immediate, responsive, reliable fire support to the commander. Mortar platoons and sections can be responsive and reliable only if their fires are planned, coordinated, and fully integrated into the scheme of maneuver.

Section I. MORTAR COMMAND AND SUPPORT RELATIONSHIPS

Mortar command and support relationships are the means by which commanders at battalion and company levels establish the framework within which they want the mortar platoon or section to operate. Commanders choose and convey to all concerned the command relationship that best supports their plan of fire support. Since the mortars are organic to the battalion, the battalion commander normally retains control at battalion level. He has the option to attach or even place the mortars under the operational control (OPCON) of a subordinate company, but he selects the support relationship that most clearly supports how he intends the mortars to support the operation. The commander must establish the appropriate support relationship and any specific priorities in addition to clearly articulating his plan for fire support. He may place the mortar platoon or section GS of the battalion with an established priority target(s), in GS of the battalion without established priorities of fire, or in direct support (DS) of a company or platoon. For example, the main effort company, the reconnaissance platoon, or the breaching team might have a mortar section in DS during some phase of an operation. The versatility of the mortar platoon or section, particularly in the heavy forces, is limited only by the imagination of the commander. For example, the commander may attach or place one section of his mortars in direct support of a rifle company while retaining one section in GS of the battalion.

3-1. COMMAND RELATIONSHIPS

Situations may occur when the mortar platoon cannot support the entire battalion while remaining under battalion control as an organic element, such as when a rifle company or platoon is given a mission that separates it from its battalion--for example:

- A raid or ambush.
- An advance, flank, or rear guard.
- A screen.
- A detachment left in contact.

In these situations, the commander may specify command relationships for mortars by either placing a mortar platoon or section OPCON to a maneuver element or by attaching it to that element. These command relationships carry with them inherent responsibilities that everyone involved in fire support must know. When a commander's intent cannot be adequately supported by a standard command relationship, a nonstandard one may be assigned. This is accomplished by issuing a separate mortar platoon or section mission statement, with explicit instructions on the command relationship desired.

a. **Operational Control.** OPCON is the authority delegated to a commander to direct forces provided him to accomplish specific missions, usually limited by function, time, or location (see FM 101-5-1).

(1) A commander who has OPCON controls the tactical employment, movement, and missions of the mortars. He plans and controls their fires. He is *not* responsible for logistic or administrative support. OPCON of the mortar platoon is given for a limited time or for a certain mission. Once the mission is accomplished, the mortar platoon reverts to battalion control.

(2) A mortar platoon or section that is OPCON to a company or troop establishes direct communications with that headquarters. Fire missions are passed on the battalion mortar fire direction net or on another net designated by the controlling headquarters.

(3) A company or platoon that has OPCON of the mortar platoon plans the platoon's fires and can further assign priority of fires and priority targets.

b. **Attachment.** This is the temporary placement of units or personnel in an organization. Subject to any limitations imposed by the attaching commander, the commander receiving the attachment exercises the same degree of command and control as he does over units organic to his command (see FM 101-5-1).

(1) A commander who has mortars attached is responsible for planning and employing their fires, as well as providing all classes of supply; MEDEVAC; vehicle recovery and administrative support. He specifies the general mortar

firing location and directs displacement. He is responsible for the security of the mortar element.

(2) Attachment is a restrictive command relationship. It ensures that mortar fires are immediately responsive to the new headquarters. However, it hinders the mortar platoon or sections in providing responsive fires to any other element of the battalion or squadron. It places a logistics burden on the headquarters receiving mortars as attachments. A commander with mortars attached must designate the priority of fires and priority targets.

(3) Attachment of mortar platoons and sections is not a normal command relationship. Some examples of when the attachment of mortars is appropriate are--

- (a) During unit movement over great distances or along multiple routes.
- (b) During dismounted infiltrations.
- (c) Company or platoon raids when the objective is out of range of normal supporting fires.
- (d) During the initial phase of an airborne operation until the battalion has completed its assembly and linkup.
- (e) During the initial phase of an air assault until the landing zone has been secured and the battalion headquarters can coordinate the actions of the companies.

3-2. SUPPORT RELATIONSHIPS

The commander specifies support relationships by assigning one of the two standard tactical missions for mortars--either GS (with or without priorities) or DS. These tactical missions carry with them inherent responsibilities that everyone who is involved in fire support must know. They describe in detail the fire support responsibilities of a mortar platoon or section. When a commander's intent cannot be adequately supported by a standard tactical mission, a nonstandard one may be assigned. This is done either by issuing a separate mortar platoon or section mission statement along with explicit instructions on each of the inherent responsibilities, or by assigning a standard tactical mission and explaining how it has been altered. (See Table 3-1 for the inherent responsibilities of each mortar standard tactical mission.)

MORTAR UNIT	WEIGHT PER ROUND (APPROX)*	QUANTITY PER CONTAINER	CUBIC VOL* PER CONTAINER	WEIGHT* PER CONTAINER	AMMO WEIGHT* PER THREE MIN PREP**
60-mm SEC (2 MORTARS)	4.5 LBS	8 EA	2.0 CU FT	86 LBS	600 LBS
81-mm, M29A1, PLT (3 MORTARS)	9.6 LBS	3 EA	1.4 CU FT	35 LBS	1,700 LBS
81-mm, M252, PLT (3 MORTARS)	9.5 LBS	3 EA	1.9 CU FT	45 LBS	1,800 LBS
107-mm SEC (3 MORTARS)	27.5 LBS	2 EA	1.5 CU FT	78.5 LBS	3,000 LBS
107-mm PLT (6 MORTARS)	27.5 LBS	2 EA	1.5 CU FT	78.5 LBS	6,000 LBS
120-mm SEC (3 MORTARS)	33.0 LBS	2 EA	2.0 CU FT	80.0 LBS	2,400 LBS
120-mm PLT (6 MORTARS)	33.0 LBS	2 EA	2.0 CU FT	80.0 LBS	4,800 LBS

*ALL WEIGHTS AND VOLUMES ARE ROUNDED OFF—ALL APPLY TO HE AMMUNITION.

**THREE MINUTES OF MAXIMUM RATE FIRE BY THE INDICATED FIRING UNIT, NOT FOR EACH MORTAR.

Table 3-1. Weight and bulk of packaged mortar ammunition.

a. **General Support (With Priority of Fires).** The assignment of priorities of fire allows the commander to retain overall control of the fires of his organic mortars but also makes them available to his subordinate commanders. When two or more observers are calling for fire at the same time, the mortar platoon leader has clear guidance as to whom the platoon should support first. The platoon also fires for nonpriority observers when priority fire missions are complete. The commander can alter the priority of fires at any time as the tactical situation changes.

(1) If given a GS mission with priorities of fire established, the mortar platoon leader must position at least one section of the platoon to cover the company or platoon with priority of fires. He should attempt to locate a position that permits coverage for the entire battalion.

(2) If providing priority of fires coverage to one company or platoon means a mortar platoon cannot provide coverage for all the other elements of the battalion, the platoon leader must inform the battalion commander and FSO.

(3) If the commander changes the company or platoon to which he allocates priority of fires, the mortar platoon or section may be forced to displace to provide coverage. If so, the mortar platoon leader must immediately notify the commander of his need to displace.

b. **General Support (With Priority Targets).** This is a standard tactical mission during which the delivery of fires on a specific target takes precedence over all other fires for the mortar section or platoon. The mortar platoon prepares for the engagement of such targets as much as possible. It lays its mortars on this target when not engaged in other fire missions. If any observer calls for the priority target to be fired, the mortar platoon does so immediately, even if engaged in another fire mission. Only the battalion commander can direct the platoon to cease firing on a priority target to engage in another fire mission. With the exception of the FPF (a special priority target), once a priority target mission is complete, the platoon immediately returns to firing other missions unless the order REPEAT is sent by the FO.

(1) The commander may designate a priority target as to type, location, or time sensitivity. The commander must give his FSO specific guidance as to when targets become priority targets and when they are no longer priority targets. He must also state the desired effects-on-target and any special ammunition to be used.

(2) A mortar platoon is normally assigned only one priority target at a time. A heavy mortar platoon can be assigned one priority target for each section. Under unusual circumstances, such as in a strongpoint defense, a section can be assigned more than one priority target. This may occur during execution of the battalion's close-in SEAD fires or during illumination missions. Multiple priority targets require close coordination between the mortar platoon leader and battalion FSO. The commander can alter priority targets as the tactical situation changes.

(3) The FPF is a special type of priority target. Normally, the FPF target is assigned to the company or platoon that is covering the most dangerous avenue of dismounted approach or covering the battalion's most vital sector. Most often this company or platoon also has priority of fire. This prevents conflict of missions. In some situations, however, one commander may have priority of fires while another has the FPF. This could occur when a security force has priority of fires initially, but the FPF target is assigned to a defending company. This requires close coordination between the battalion commander, S3, FSO, and mortar platoon leader. A specific amount of mortar ammunition is always designated, prepared, and set aside for use with the FPF target. This FPF ammunition may not be used on any other mission without specific authorization from the commander.

c. **General Support (Without Priorities Established).** A mortar platoon or section assigned a standard tactical mission of GS, but without priorities established, provides fires exclusively at the direction of the battalion (or company) headquarters. Assigning the GS mission without priorities of fire may be appropriate during--

- (1) Large-scale screening missions.
- (2) Closely phased deliberate attacks.

The GS mission provides mortar fires immediately responsive to the needs of the commander. A mortar platoon or section with this GS mission will be less responsive in attacking targets of opportunity since there is no direct communications link with the FISTs at company level. The GS mission is most effective against planned targets. General support (without priorities) is the most centralized of all standard tactical missions.

d. **Direct Support.** A mortar platoon assigned the standard tactical mission of DS is immediately responsive to the fire support needs of a particular maneuver company or some other element such as the reconnaissance platoon. The mortar platoon must establish effective communication with the supported commander. (For detailed descriptions of wire and radio communications nets, see Appendix L.) It must coordinate fire and movement with the battle plans of that commander. The difference between DS and GS with priority of fire is that a mortar platoon with a DS mission positions itself to conform to the *supported* commander's plans, even at the expense of the other commanders in the battalion. The essential feature of the DS mission is the one-on-one relationship between the mortar platoon and the supported commander. From the standpoint of battalion control, the DS mission is the most decentralized of the tactical missions. It is often used to place a mortar section in support of a rifle company. The commander that has a mortar platoon or section in DS can further assign priorities of fire and priority targets.

Section II. FIRE SUPPORT PLANNING

Indirect fires destroy, neutralize, or suppress the enemy. Fire support planning is necessary to ensure these fires strike the right place at the right time.

3-3. PURPOSE OF INDIRECT FIRES

Indirect fires are employed for three main purposes: close support, counterfire, and interdiction. They may also be used for deception.

a. Close support fires are targeted against enemy troops, weapons, or positions that are threatening or can threaten the friendly unit during either the attack or the defense. Providing close support fires is the most common mission given the mortar platoon or section. Because mortar fires are immediately available, they allow the battalion or company commander to rapidly multiply combat power effects and quickly shift fires about the battlefield. Close support mortar fires are the key to a successful maneuver at the platoon and company level--they can make the difference between success or failure in the defense. Close support mortar fires are normally requested and adjusted by platoon-level forward observers, but they may be initiated by any leader within the chain

of command. Examples of close support fires include illumination, screening, suppressive, marking, preparatory, and final protective fires.

b. Counterfires are used to attack enemy indirect fire weapons, observation posts, and artillery command and control facilities. Counterfire at long range is mainly the responsibility of the field artillery, but mortar sections and platoons provide close counterfire, especially against enemy mortars. Mortar counterfire is an immediate action taken to restore the freedom of action to the maneuver commander, before more powerful counterfire weapons can be brought to bear. Mortar fires are used to attack enemy mortars firing from reverse slopes and defilade positions that make them safe from low-angle artillery counterfire. Mortar smoke and WP rounds are used to obscure the view from enemy OPs, reducing the effectiveness of enemy indirect fire. During the defense of a strongpoint, mortar fires may be planned and integrated into the field artillery counterfire or the J-SEAD program. Their responsiveness, rapid rate of fire, and area target effects are used to suppress enemy gunners.

c. Interdiction fires are used to disrupt, delay, and destroy enemy forces that cannot fire their primary weapon system on friendly forces because of range limitations or intervening terrain. Field artillery cannon and missile battalions are responsible for most ground interdiction fires. Mortar sections and platoons fire limited, specific types of interdiction fires on likely or suspected enemy assault positions or assembly areas. As the advancing US forces close on an objective, mortar fires can be shifted from preparatory or suppressive fire (close support fires) to interdiction fires targeted on likely enemy withdrawal routes or suspected rally points. Normally, the benefits gained from unobserved mortar interdiction fire intended to harass the enemy do not outweigh the costs of ammunition expended and the increased danger of counterfire. Dismounted infantry, decisively engaged with an enemy on close terrain, can employ harassment and interdiction fire to its advantage. In some cases, when the enemy avenue of approach is canalized within deep defilade, such as a ravine or a street between high buildings, mortar interdiction fire may be the only way to attack him.

d. Deception fires are used to delude and confuse the enemy. Mortars can be used to fire false preparatory fires on enemy positions or landing zones. They can also be used to create deceptive smoke screens to focus the enemy in one location while friendly forces attack from another.

3-4. EFFECTS OF INDIRECT FIRES

The battalion or company commander must decide, and then clearly state, what effects he wants to achieve with mortar fire on a particular target. Four effects are: destruction, neutralization, suppression, and obscuration.

a. Destruction renders the enemy combat ineffective. Since only direct hits with HE rounds can destroy hardened targets, such as armored vehicles or bunkers, mortars are not often used against them to achieve destruction. Against soft targets, such as trucks or frame buildings, mortars can be used for destruction, but even then the amount of

ammunition expended is large. It requires about 30 percent casualties to render a unit combat ineffective. If the enemy infantry is exposed, mortar fires can easily achieve destruction on them. By themselves, mortars can rarely achieve destruction against a dug-in enemy. Only the 120-mm mortar is powerful enough to damage well-constructed field fortifications.

b. Neutralization knocks a target out of action temporarily. Against hardened targets, it is difficult to achieve neutralization with mortar fire. Against some targets it can be achieved, especially dismounted infantry or wheeled vehicles. Experience has shown that it takes about 10 percent casualties to neutralize a unit. A higher percentage may be required, depending on how experienced and strong the enemy is. Neutralization usually lasts no more than a few hours.

c. Suppression limits or prevents the enemy in the target area from firing back or performing other combat tasks. The effects of suppressive fires are immediate, but they last only as long as the fire continues. The key to any successful infantry assault is properly applying suppressive fires. A mortar platoon's high rate of fire and organizational responsiveness make it an excellent suppressor. Suppressive fires play a large role in generating combat power by infantry forces. The suppressive fires of mortars, along with other weapons, allow the infantry to close within range for a final assault. Effective suppressive fires increase infantry mobility. The more effective suppressive fires are, the less dependent infantrymen are on stealth, cover, and concealment. Mortar fires can continue to suppress the enemy until the assaulting forces are close enough to use their hand-carried weapons for suppression. Suppressive fires carry the assault over the last 200 meters and into the enemy's defensive position. At that point, the enemy either chooses to discontinue resistance by surrendering or withdrawing, or he is killed or wounded.

d. Obscuration interferes with the enemy's ability to observe the actions of friendly forces or prevents it altogether. Obscuration fires do not neutralize or suppress an enemy, since he can still employ his weapons, but reduces the effectiveness of enemy fire. Mortars can fire bursting WP rounds directly on an enemy position to both suppress and obscure, or they can fire either WP or smoke rounds to obscure observation. Mortar obscuration is effective for immediate response missions of limited scope and for short periods. The 81-mm (M252) and the 120-mm mortars have the most effective obscuration rounds.

3-5. FIRE SUPPORT COORDINATION MEASURES, TERMS, AND TECHNIQUES

To facilitate fire support coordination, maneuver commanders at battalion and higher echelons can direct the implementation of fire support coordinating measures. These measures are shown on maps, charts, and overlays. The measures are designed to reduce the requirements for coordination or to restrict firing into certain areas. Fire planners at all echelons use terminology peculiar to their task, and members of the mortar platoon must know the terms in order to provide the type of support required.

a. **Maneuver Control Measures.** Boundaries are the basic maneuver control measures used by commanders to designate the geographical area for which a particular unit is tactically responsible. They are normally designated along terrain features easily recognizable on the ground. They affect fire support in two ways as follows:

(1) They are *restrictive* in that no indirect fire support means can deliver fires or effects across the boundary unless those fires are coordinated with the force having responsibility for the area within that boundary.

(2) They are *permissive* in that the maneuver commander has complete freedom of fire and maneuver within his boundaries (unless otherwise restricted by higher headquarters). Many times, boundaries will reduce the need for other fire support coordinating measures.

b. **Fire Support Coordination Measures.** Fire support coordination measures are designed to make the rapid engagement of targets easy and, at the same time, provide safeguards for friendly forces. They ensure that fire support will not jeopardize troop safety, will interface with other fire support means, and will not disrupt adjacent unit operations. Graphic portrayal will be in black and will include, at a minimum, the abbreviation of the measure, the establishing headquarters, and the effective date-time group. Usually, coordinating measures are labeled at each end of a line or within the graphic, space permitting. There are two general classes of fire support coordination measures: permissive and restrictive.

(1) *Permissive measures* mean that requirements for coordination are reduced. They expedite attacks on targets.

(2) *Restrictive measures* provide safeguards for friendly forces. They indicate where firing is restricted or even prohibited. When these measures are employed, the graphic display will also contain the title or abbreviation of the measure, the establishing headquarters, and an effective date-time group. The mortar platoon leader must coordinate with the FSO/FIST to ensure that all restrictive fire control measures are known to all concerned personnel.

c. **Coordinated Fire Line.** The CFL is a permissive measure. Mortar fires can be delivered beyond the CFL without additional coordination. It is established by brigade or higher headquarters; however, it may be established by a battalion operating independently. In the example in Figure 3-1, the area that extends from the CFL forward to the end of the boundary can be attacked by all fire support means without coordinating with 2d Brigade. This includes attacks by mortar platoons in the brigades adjacent to 2d Brigade.

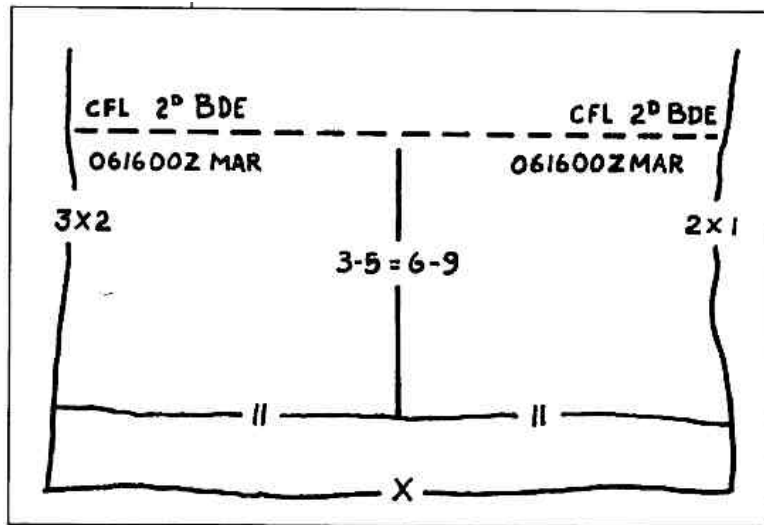

Figure 3-1. Example of a coordinated fire line.

d. **Fire Support Coordination Line.** A fire support coordination line (FSCL) is a permissive fire control measure that may be established by a corps within its area of operation to support its concept of the operation. The purpose of an FSCL is to allow the corps and its subordinate and supporting units (for example, Air Force) to expeditiously attack targets of opportunity beyond the FSCL.

e. **Free-Fire Area.** An FFA is a permissive fire control measure that defines an area into which mortars can fire without additional coordination.

f. **Restrictive Fire Line.** An RFL is a restrictive fire control measure often used during linkup operations. It is a line between converging friendly forces that prohibits fires or their effects across the line without coordination with the affected force. It is established on identifiable terrain by the common commander of the converging forces.

g. **Restrictive Fire Area.** The RFA is an area with specific restrictions and in which fires that exceed those restrictions will not be delivered without coordination with the establishing headquarters.

h. **No-Fire Area.** The NFA is an area into which no fires or their effects are allowed. It is established on identifiable terrain. It may be established in conjunction with a host nation to preclude damage or destruction to national asset, population center, or shrine. It also may be established to protect an element of tactical importance, such as a fuel storage area. Two exceptions to the no-fire rule exist as follows:

(1) When the establishing headquarters allows fires on a mission by mission basis.

(2) When a friendly force is engaged by an enemy located within the NFA and the commander returns fire to defend his forces. The amount of return fire should not exceed that sufficient to protect the force and continue the mission.

i. **Airspace Coordination Area.** An ACA is a block of airspace in the target area in which friendly aircraft are reasonably safe from friendly surface fires. It may be formal or informal. (See TC 90-7 for details on ACAs.)

j. **Fire Support Coordination Terms.** Fire support coordination terms are standardized. They mean exactly the same thing to artillerymen and mortarmen.

(1) **Targets.** The term target is the most fundamental term used in fire support planning. A target is personnel, materiel, or a piece of terrain that is designated and numbered for future reference attack. There are two broad categories of targets: targets of opportunity and planned targets.

(a) *Targets of opportunity.* A target that appears during combat, and against which no attack has been prearranged.

(b) *Planned target.* A target upon which fires are prearranged. The degree of prearrangement varies, but some before-action coordination has been done to facilitate its engagement. Planned targets may be further subdivided into scheduled, on-call, or priority targets.

- **Scheduled target.** A planned target to be fired IAW a time sequence. Targets can be scheduled for firing by time or by event. In scheduling by event, firing is keyed to the accomplishment of a maneuver phase, such as crossing the LD/LC in the offense. As a result, the FDC must monitor the command net in order to keep abreast of the progress of the maneuver force.
- **On-call target.** A planned target that has not been scheduled for attack at a specific time but may be attacked when requested. The on-call target requires less reaction time than a target of opportunity.
- **Priority target.** A target which when requested for attack takes priority over all other requests. Priority targets are designated by the maneuver commander, who provides specific guidance as to when the targets will become priority, munitions to use, accuracy, and desired effects.
- **Final protective fires.** The FPF is a special set of priority targets. It is a prearranged barrier of direct and indirect fire that prevents or stops the enemy from advancing.

This paragraph complies with QSTAG 221.

(2) **Target numbering system.** To designate targets for fire support operations, the Army adheres to the provisions of QSTAG 221. Target designators consists of two letters (the first letter is always A, K, Y, M, or W for US forces) followed by four numerals; for example, AB3002. This numbering system is used for each corps-size force.

(a) Target numbers serve as an index to all other information regarding a particular target, such as location, description, and size. Within a major force, normally at corps, a common target numbering system is used. Fire planners and fire support resources at all echelons, including the mortar platoon, are assigned blocks of target numbers for their use. Because target numbers are assigned in blocks to specific users, a target can be readily traced back to its originating source.

(b) The two-letter group denotes the originator of the target. Each Army headquarters allocates a first letter to each of its corps. The letters A, K, Y, W, or M may be reused by US armies as long as adjacent corps do not share the same letter.

(c) The second letter (A through Z) is assigned by corps down to brigade level.

(d) Standard blocks of numbers are assigned to each brigade:

<u>Numbers</u>	<u>Assigned To</u>
0001 through 1999	Brigade fire support cell.
2000 through 2999	FSO, lowest numbered maneuver battalion or squadron.
3000 through 3999	FSO, second lowest numbered maneuver battalion or squadron.
4000 through 4999	FSO, third lowest numbered maneuver battalion or squadron.
5000 through 6999	Additional FSOs.
7000 through 7999	FDC of the DS field artillery battalion.
8000 through 8999	Counterfire/counterbattery targets.
9000 through 9999	Toxic chemical targets.

(e) The battalion or squadron suballocates as follows:

<u>Numbers</u>	<u>Assigned To</u>
000 through 199	Battalion/squadron FSO.
200 through 299	FIST, A company/troop.
300 through 399	FIST, B company/troop.
400 through 499	FIST, C company/troop.
500 through 599	FIST, D company/troop.
600 through 699	Additional FISTs.
700 through 799	Battalion squadron mortar platoon(or section).
800 through 999	As required.

EXAMPLE: Assume that the battalion to which the mortar platoon is assigned is allocated target numbers 3000 to 3999. The mortar platoon's block of numbers would be 3700 to 3799. If the battalion is organic to the 2d brigade, the target numbers of the platoon would be B3700 to B3799. If the brigade is assigned to the lowest numbered division in the corps, the mortar platoon's block of numbers could be AB3700 to AB3799.

(f) Target numbers are usually established in the division or regimental tactical SOP. The numbers suballocated to brigades should be incorporated into the brigade, battalion/squadron, company/troop, and platoon SOPs.

(3) **Target symbols.** Standard symbols are used in the preparation of maps, charts, and overlays to identify targets by type.

(a) *Point target.* A point target is a target that is less than 200 meters wide. The symbol is shown in Figure 3-2.



TYPES OF TARGET	SYMBOL	DISCUSSION
POINT		A cross is used. It may be canted if several targets are in close proximity to each other or when the symbol might be confused as a grid intersection. The intersection of the lines represents the center of the target. The target list describes the nature of the target and other pertinent information.
LINEAR		This symbol is for those targets that are long and narrow (for example, roads and trench lines). Coordinates shown on the target list are for the center point. The target list also shows the length and attitude.
RECTANGULAR		These targets have both length and width. Coordinates shown on the target list are for the center point. The length and width shown on the target list represent the overall length and width of the target.
CIRCULAR		This symbol represents an area-type target. Coordinates shown on the target list are for the center point. The radius of the target is also included on the target list.
FINAL PROTECTIVE FIRE		The symbol for an FPF is similar to that for a linear target. It includes the target number, the designation FPF, and the unit to fire.

Figure 3-2. Target symbols.

(b) *Linear target.* A linear target is more than 200 meters but less than 600 meters long. Targets longer than 600 meters will require fire support assets other than mortars or must be further subdivided into multiple targets for attack. A linear target is designated on the target list by two grids or a center grid, length, and attitude.

(c) *Rectangular target.* A rectangular target is wider and longer than 200 meters. It is designated on the target list by four grids or a center grid, length, width, and attitude.

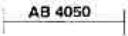
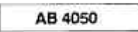
(d) *Circular target.* A target that is circular in nature or is vague as to its exact shape. It is designated by a center grid and a radius on the target list.

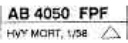
(e) *Final protective fires.* FPF are types of priority fires that are similar to linear targets. The symbol used includes the target number, the designation of the FPF, and the system/unit to deliver the fires.

(f) *Target reference point.* Maneuver elements use a TRP to orient direct-fire weapon systems. All TRPs should be dually identified in terms of the

direct-fire weapon system and the target numbering system. The symbol is the same as that for a standard target with a target number and a TRP letter. All TRPs should be plotted on the map and identified as a target. TRPs will be included on the target list and identified in the remarks section as TRPs.

(4) **Group of targets.** A group of targets consist of two or more targets upon which simultaneous fire is desired. It is graphically shown by circling the targets and identifying the group with a group designation number. The group designation number consists of the two letters assigned to the brigade and a sequence number inserted between the two letters. For example, if the brigade's target numbers begin with the letters AB, the first group of targets is designated A1B; the second group A2B. The fact that a group of targets has been formed does not preclude the attack of individual targets within the group. An artillery battalion is normally the lowest echelon capable of planning and executing a group of targets; however, mortar targets maybe included within a group of targets (Figure 3-3).

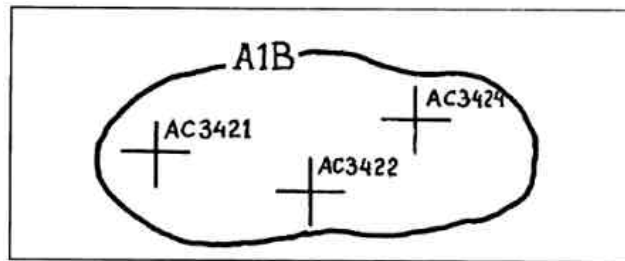

Figure 3-3. Series of targets.

(5) **Series of targets.** A series of targets consist of a number of targets or groups of targets planned to be fired on in a specific sequence to support a maneuver phase. The series is identified by a code name and all of the targets or groups of targets included in the series are enclosed by a line. The fact that a series has been formed does not preclude the attack of individual targets or groups of targets within the series. However, once the series has been initiated, all of the targets must be fired on in the predetermined sequence as provided by the target list or schedule for the series. The supporting DS artillery battalion is the lowest echelon that plans and designates a series of targets; however, mortars can fire in conjunction with a planned series of targets (Figure 3-4).

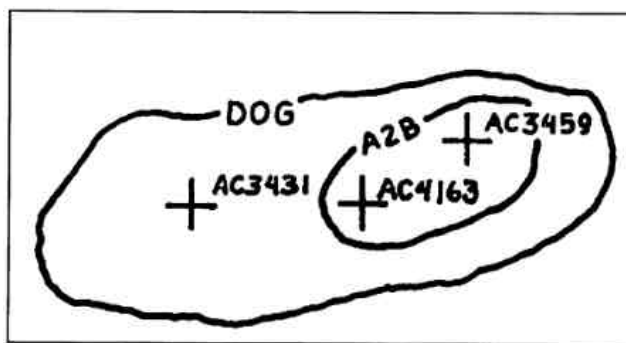

Figure 3-4. Group of targets.

(6) *Program of targets.* A program of targets is planned for a number of similar targets; for example, all enemy air defense targets, all observation posts, or all mortar targets. A particular program concentrates on one type of target. A program can be initiated on call, at a specified time, or when a particular event occurs. Once initiated, targets are fired IAW a predetermined time schedule. Programs of targets are not shown on charts, maps, or overlays. The DS artillery battalion is the lowest echelon that plans a program. Mortars can fire in conjunction with a program.

3-6. TARGET DATA PROCESSING

During bottom-up refinement of the top-down planning process, the forward observer in each infantry platoon identifies any additional targets as directed by the platoon leader. He then forwards his additional targets to the company FSO who further refines the fire plan to support the company commander's scheme of maneuver and his intent for fire support. The company commander forwards the list of additional targets to the battalion fire support element. A copy is also given to the company mortar platoon or section (Figure 3-5).

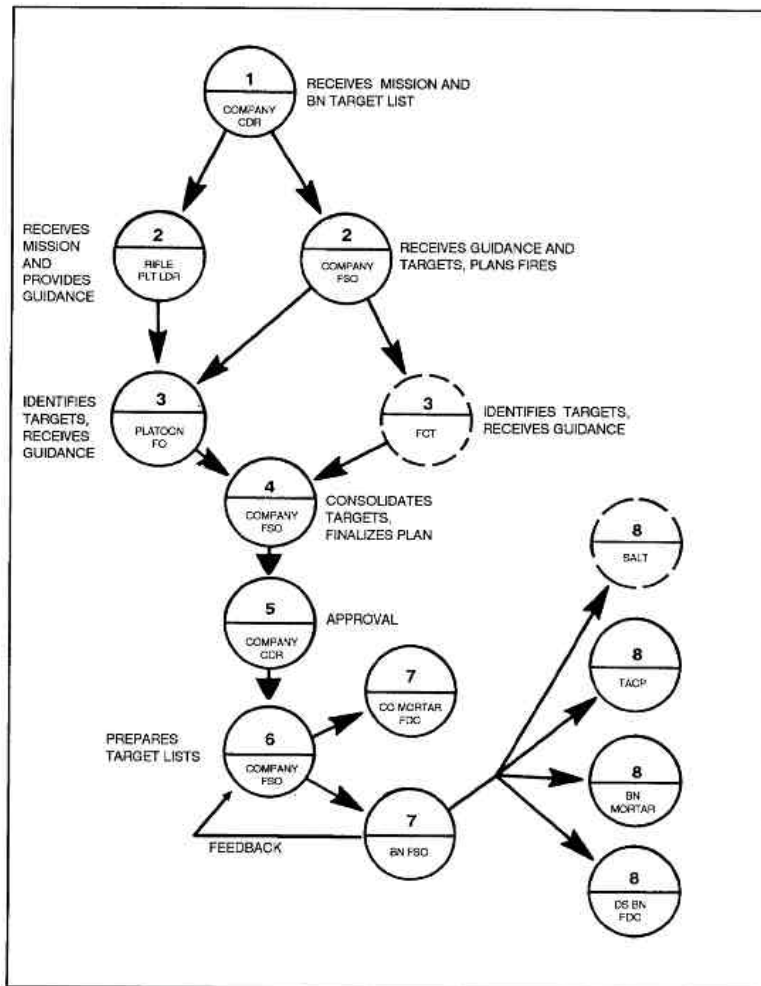

Figure 3-5. Company team fire support planning process.

- a. The battalion FSO analyzes each company's additional target list, resolves duplication by deleting redundant targets, adds any new targets provided by the battalion staff or external agencies, and produces a consolidated battalion target list and overlay (Figure 3-6).

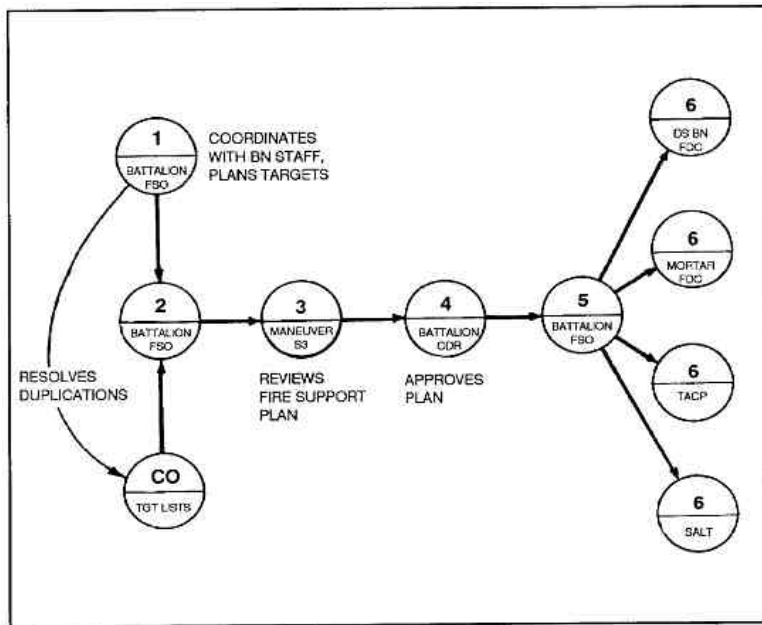

Figure 3-6. Battalion Squadron fire support planning process.

b. Based on the battalion commander's guidance, the FSO establishes a precedence of targets for engagement. He determines specific weapons and shell-fuze combinations to attack each planned target.

3-7. BATTALION FIRE SUPPORT PLAN

The battalion commander is responsible for the fire support plan. It is based on the commander's intent for fire support, developed by the battalion fire support officer, and reviewed by the battalion S3. It includes targets selected for engagement by the mortar platoons. The company commander is responsible for the company's fire support plan. It is developed by the FSO to support the company commander's plan for maneuver. A simple plan works best. The commander should give the mortar platoon a specific mission during each phase of an operation. The platoon's mission must be realistic and clearly understood by both the platoon and the observers who will be calling for fire.

a. The mortar platoon executes its portion of the fire support plan by engaging planned targets IAW schedules of fire provided by the FSO/FIST. It responds to calls for fire on planned targets and targets of opportunity originated by the company fire support teams, battalion FSO, or others. The mortar platoon has no formal fire planning responsibility, other than technical computation of firing data for planned mortar targets and ensuring

that the commander's guidance is met. However, the mortar platoon leader must be knowledgeable about fire support planning coordination.

b. To ensure the timely and accurate execution of the mortar platoon's portion of the fire support plan, the platoon leader must consider: support requirements, terrain and positioning of firing sections commensurate with the battalion's/company's scheme of maneuver, means by which he will command and

(1) Analyze the mortar targets given in the fire support plan to ensure that sufficient quantities of ammunition (by type) are available for firing against planned targets and targets of opportunity. This includes checking on the commander's intent to use smoke or illumination extensively.

(2) Select and reconnoiter firing positions that enable mission accomplishment, provide for the ability to mass fires, and provide essential characteristics of terrain favorable to mortar employment.

(3) Coordinate the use of terrain, the displacement plan, and resupply routes with the battalion S3 and support platoon leader, or the company commander and executive officer, as applicable.

(4) Coordinate required field artillery support, such as survey and meteorological data, with the battalion FSO/FIST to enhance first-round accuracy, and the ability to mass fires from separate firing section locations.

3-8. BATTALION TARGET LIST AND OVERLAY

The consolidated target list, overlay, and implementing instructions constitute the fire support plan for the battalion. A copy is provided to the mortar platoon for technical data processing. This enables each mortar platoon to precompute firing data for each planned target, thereby reducing response time. If multiple firing positions are planned, the sections can compute firing data from each firing position for each target.

a. The target overlay in the fire support plan shows targets planned to support the battalion's mission. The overlay shows any fire support coordinating measures that have been established, or that have been planned. Used in conjunction with the operations overlay, the target overlay is a quick reference for coordinating fires. Coordinating measures shown on the overlay should be transcribed onto firing charts in the FDCs to ensure compliance with any restrictions. The overlay, when transcribed on the operations map, keys the platoon to the status of individual targets in relation to friendly maneuver. The target overlay must be checked continuously against the maneuver graphics to ensure it supports the commander's plan.

(1) The battalion target overlay displays planned fires in relation to the scheme of maneuver or plan for the defense. This overlay provides a ready means for

resolving duplications, ensuring adequate coverage of the zone, and identifying targets that will require special coordination.

(2) A target overlay contains marginal information that identifies the overlay, references the applicable map sheet(s), and provides orienting data in the form of grid register marks.

(3) All planned targets to support the maneuver battalion operation are displayed on the target overlay.

b. The target list in the fire support plan is the basic document used to communicate planned target data. The target list provided to the mortar platoon contains all of the targets planned to support the operation, regardless of whether mortars or artillery are preferred to attack the target. Targets selected specifically for attack by the mortar platoon are designated in the remarks portion of the target list. If time does not permit the reproduction of the complete target list, an abbreviated target list is furnished that contains only those targets selected for engagement by the mortars. As a minimum, the target list given to the mortar platoon contains a target number, description, and location for each planned target. Special attention is given (in the remarks column) to a target list requiring extensive use of ammunition beyond basic load capabilities. For example, a 15-minute smoke screen for a river crossing operation is probably beyond basic load capabilities (Figure 3-7).

TARGET LIST WORK SHEET									
For use of this form, see FM 6-30 and appropriate agency's TARGET LIST									
LINE NO.	TARGET NO.	DESCRIPTION	LOCATION	ALTITUDE ft.	ALTITUDE m.	SIZE		SOUND ACCURACY ft.	REMARKS
						LENGTH ft.	WIDTH ft.		
1	AA 3411	82-MM MORTAR POSITION (TRENCH)	923435						MORTAR TOT ONLY
2	AA 3412	MESH FINE IN TRENCH LINE	918560		1600	400	50		HE PROX
3	AA 3413	AIRCRAFT LANDING STRIP	920450		4800	1200	200		GROUP A1A
4	AA 3414	SUP REGT CP	947343						50% W/P
5	AA 3415	FPP	875689	340	1650	200			ADJ W/ DELTA
6	AA 3416	ROAD JUNCTION	885670						TRP A3
7									
8									
9									
10									
18									
20									

Figure 3-7. Sample of a battalion target list.

(1) **Line number.** Line numbers can be designated corresponding to specific targets. Line numbers refer to a specific target without using its assigned target

number. Use of line numbers instead of target numbers is administrative in the processing of planned targets. They are never used in calling for the attack of targets.

(2) **Target number.** Each planned target is assigned a target number. Target numbers are assigned by the individual or agency that originates the target, and blocks of target numbers are provided for all fire planning agencies. A block of target numbers is given to each mortar platoon so the FDC personnel can assign a target number when an observer directs, RECORD AS TARGET, upon completion of a mission against a target of opportunity, or upon completion of a registration.

(3) **Description.** A target description for each planned target must be provided. Based upon the target description, targets are analyzed to select the most effective munition for engagement, the most effective means of engagement, and the quantity of ammunition required to suppress, neutralize, or destroy the target. The target description also aids in prioritizing targets for engagement.

(4) **Location.** The grid location of the center of each planned target must be provided. The target location furnished on the target list must be used to precompute data for planned targets. For linear, rectangular, and circular targets, locations provided on the target list are the grid coordinates for the center of the target.

(5) **Altitude.** This is the distance the target is above sea level, stated in meters. The mortar section FDC uses this information to make corrections to the firing data.

(6) **Attitude.** The attitude of a target is the direction (azimuth) from north in mils of a linear or rectangular target along its long axis. It is used with target length and width to enable the computation of data to provide a special sheaf, or the determination of multiple aiming points to engage the total target area (Figure 3-8).

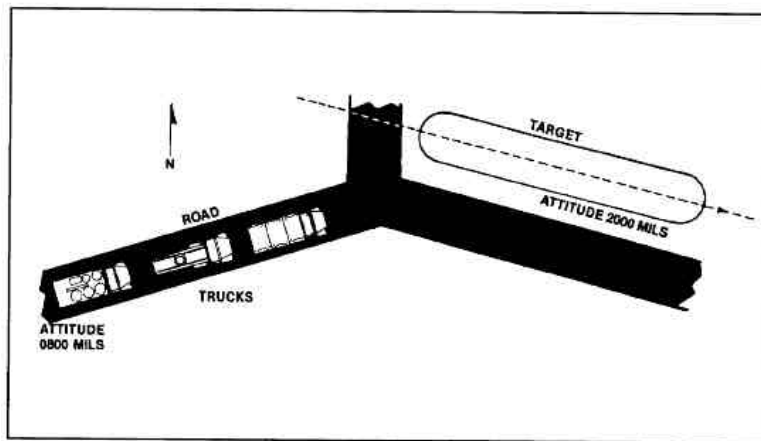

Figure 3-8. Target attitude.

(7) **Length.** The length of a target is determined along the long axis of a rectangular or linear target. Half of the length is applied to each side of the target's grid location corresponding to the attitude (azimuth) of the target.

(8) **Width.** The width of a target is determined along the short axis of a rectangular target. Half of the width is applied to each side of the target grid location at right angles to the attitude of the target.

(9) **Radius.** The radius of a target is provided to describe the overall size.

(10) **Source/accuracy.** The mortar platoon does not normally use any information contained in this column.

(11) **Remarks.** The remarks portion of the target list is used as follows:

- (a) To prescribe the quantity of ammunition (by shell/fuze type) to be expended upon a target.
- (b) To identify targets as part of a group, series, or program of targets.
- (c) To recommend or fix responsibility on a specific fire support resource to attack certain targets.
- (d) To schedule fire on specific targets by time or by event.
- (e) To designate priority targets.

(f) To specify the duration of smoke or illumination required for a specific target.

The remarks portion of a target list may also be used for information regarding a specific target that is not provided for in the target list format. Specifically, the size, shape, or orientation of a target can be provided in the remarks by referring to a target's attitude, length, width, or radius.

(12) **Transmission.** Target lists can be hand carried with the fire support plan or (with proper precautions) sent by electronic means.

c. In addition to the target overlay and target list, the battalion fire support plan will usually include some form of implementing instructions. If not written in the fire support plan, implementing instructions can be provided orally.

(1) The commander routinely makes decisions that affect the way the mortar operates. Through his analysis of the METT-T factors, the commander determines how he can best use the mortar platoon's firepower to accomplish the mission. He communicates his decisions by providing his intent for fire support to his S3, FSO, and mortar platoon leader. He also provides any other guidance he feels necessary. While not intended to be an all-inclusive list, the following are representative of the commander's guidance that affect mortar employment:

- (a) Ammunition constraints by type and quantity.
- (b) Priority of fire to designated subordinate companies or platoons.
- (c) Allocation of mortar fire to attack on-call priority targets.
- (d) Attack guidance, or the degree of damage required for particular targets (for example, suppress, neutralize, or destroy).
- (e) Establishment of fire support coordinating measures.
- (f) Anticipated changes in mortar employment (operational control, attached) to support future operations.
- (g) Communication constraints and special requirements.
- (h) Precedence of targets by type for engagement by various firing resources.
- (i) General designation of position to provide for attack of targets and survivability.
- (j) Instructions regarding moves.

(k) Coordination requirements.

(l) Special considerations for smoke, or illumination use, especially in MOUT.

(m) The enemy's capacity to fire countermortar fire.

(2) Implementing instructions for the mortar platoon might be from several sources. Although a written OPORD is seldom distributed at battalion level or below, the OPORD format is adhered to in oral presentations. As such, the mortar platoon leader pays particular attention to the execution paragraph with emphasis on the commander's intent, the scheme of maneuver, and plan for fires. Implementing instructions for targets can appear in the remarks column of the target list.

d. Implementing instructions are also provided in the form of schedules for firing. Schedules are prepared for firing a series, a program, a preparation, or a counterpreparation. Regardless of the type of schedule provided, they direct the firing of the mortar platoon onto designated targets at a specific time. The schedule designates the TOT and the amount of rounds to be fired, or it gives the TOT and the duration of fire (for example, TOT H-5, duration four minutes). The mortar platoon leader studies the schedule of fires closely to determine the ammunition required and the target shifts involved. The FSO plans a one-minute shift time for mortars. The platoon leader synchronizes his watch with the FSO, and keeps the platoon on the schedule. If the rounds scheduled for a certain period are not all fired by the shift time, the mortar squads check fire, shift, and stay with the schedule. Any targets not fired are reported to the FSO immediately (Figure 3-9).

LINE NO.	UNIT	UNIT	ROUNDS (per mortar)	TIME ON TARGET
1	BATTALION MORTAR PLATOON	AB2375 AB3427 AB2678 AB2352	36 (a) 12 (a) 45 (c) 36 (b)	H-19 to H-15 H-14 to H-10 H-11 to H-4 H-3 to H+6
REMARKS (a) High Explosive, Prox. (b) 50% Smoke, 50% HE Prox. (c) 50% High Explosive, Prox 50% HE Dly.				

Figure 3-9. Sample of a schedule of fires.

e. The fire support execution matrix is a graphical, easy to use way of assigning target responsibilities and allocating fire support resources to the battalion/squadron. The matrix

shows which targets are most critical to the battalion's success, and who is responsible for firing them. The matrix shows the allocation of priority targets and FPF. The matrix shows the mortar platoon's firing positions and the expected displacements by phase (Figure 3-10).

PRIORITY OF FIRES AND KEY TARGETS.					
PHASE LINE/ TRIGGER PT	PL /MACE	PL /BOW	PL /ARROW	PL /BLUE	OBJ A
TF					
TM/CO A			BB 3401	BB 0011 BB 0012	MORTAR PRIORITY
TM/CO B	BB 0001 BB 3003	BB 3001 MORTAR PRIORITY			
TM/CO C			BB 3010		
TM/CO D		BB 0007 BB 3002	BB 0013 BB 0009	BB 0015 GP B1B	FA PRIORITY
SCOUTS	BB 0029 BB 3004	BB 0017			
MORTARS	POS A1,A2	BB 3001 POS B1	POS B2, C1	BB 3111 POS C2	
FA ORGANIZATION FOR COMBAT		MORTAR POSITIONS		AMMUNITION AVAILABLE	
4-5 FA (155SP) DS TO 2 BDE		POS A1 123455 A2 124458 POS B1 1274556 B2 128452 POS C1 131500 C2 130495		12 BN 3 RDS DPICM 20 PLT 8 RDS HE 30 MIN ARTY SMOKE 20 MIN MORTAR SMOKE 30 MIN ARTY ILLUM 30 MIN MORTAR ILLUM	
FS COORD MEASURES		BDE CDR ATK GUIDANCE		TAC AIR	
CFL: PL BOW 0/0 CFL: PL ARROW/0/0 0/0 CFL: 0/0 CFL:				4 TF SORTIES 4 ACA* (8) 20-30 (SEE ACA OVERLAY)	
FASCAM		DEST ADA		HIGH PAY OFF TGTS	
TF ALLOCATION: 2 BDE 2 PLANNED: 195450 200444 199455 221456		NEUT RECON ELEMENTS SUPP AR, MECH PLTS		ZSU 32-4, SA 9, MRB's CRP (3 BMP, 1 BROM) ENGINEERS	
COC IS: A-, B-, C-, D-FSO WITH A-FSE BEING 0/0 BN FSE					
C DAY-1- FA DS BN CDR: H70_A FSO: A99_ FA FDC: H55_ E CF 2: 45.20 BDE FSCoord: E24_B FSO: B99_MORTAR FDC: U55_ O FD 1: 55.70 BDE FSO: J99_C FSO: J99_ I MORTAR: 32.60 BN FSO: Q99_D FSO: D99_OIC-O-NCIC-N-RATELO-R-					
COORDINATING INSTRUCTIONS: 1. TARGET ALLOCATION: A 3, B 3, C 2, D 4. 2. CUT OFF FOR TARGET SUBMISSION 052200 OCT. 3. SURVEY TARGETS FOR D, A, B, MORTAR FIRING POSITIONS. FSOs TAKE SURVEY TO NEXT LOCATION.					

Figure 3-10. Sample of a battalion fire support execution matrix.

f. The company fire support execution matrix is a tool used to aid in executing the battalion plan. The company FSO and mortar platoon or section leader develop the

matrix. It is designed for the key leaders in the company to understand and execute the fire support plan without the FSO (Figure 3-11).

COMPANY FIRE SUPPORT MATRIX

COMMANDER'S INTENT FOR FIRE SUPPORT: COMPANY OFFENSE

SMOKE ON BB 1001 TO COVER OUR INITIAL MOVEMENT ACROSS THE LD. FIRE GROUP B1B ON OBJ FOX AS 2d AND 3d PLATOONS CROSS PL BLUE. USE BB 3109 TO HELP BLOCK A COUNTERATTACK FROM HILL 333.

TGT #	GRID	DESCRIPTION	DECISION POINT	EXECUTION			
				PRIMARY	BACKUP		
BB 1001	123456	Smoke OP	When 1st Plt is ready to cross LD	1st Plt	FSO		
BB 1002 (Group B1B)	123567	Suspected Inf Squad	2d and 3d Plts cross PL Blue	CO Cdr	2d Plt		
BB 3108 (Group B1B)	135467	AT Position	2d and 3d Plts cross PL Blue	CO Cdr	2d Plt		
BB 3109	143335	Road Junction	If counteratk Bridge at 146578	2d Plt	3d Plt		
BB 2102	136324	Suspected AT Position	If receive fire from position	FSO	XO		
HIGH PAYOFF TARGETS - ALL AT-S POSITIONS							
ACTIONS UPON : XO MONITORS 4.2 MORTAR NET FOR FIRE SUPPORT COORDINATION. LOSS OF FSO : PLT LDERS SWITCH TO CF2 OR THE MORTAR NET TO FIRE MISSIONS.							
	PRIORITY OF FIRE				AMMUNITION AVAILABLE TO TF	CEOI DAY 05	
	Cross LD		Cross PL Blue			DAY 06	
	FA	MORT	FA	MORT		FA NET 31:10	45:10
CO	1st Plt	1st Plt	2d Plt	2d Plt	FA DPICW/HE 18 Bn 3 RDS	MT NET 56:00	
BN	A Co	B Co	A Co	B Co	FA Smk 25 min	MT FDC D34	W45
BDE	3-37		3-37		MT HE 22 Plt 8	FA FDC F7M33	H6178
					MT Smk 20 min	BN FSO K98	P72
COORDINATING INSTRUCTIONS:							
<ol style="list-style-type: none"> 1. SHOOT 4.2 MORTAR SMOKE ON BB 1001. 2. GROUP B1B TARGETS ARE ARTILLERY PRIORITY TARGETS. 3. SHOOT IMMEDIATELY ANY ZSU 23-4 OR SA 6 TARGETS. 							

Figure 3-11. Sample of a company fire support execution matrix.

3-9. PROCESSING AND COORDINATING CALLS FOR MORTAR FIRE

Wire communications are the most secure and reliable means of coordinating and calling for mortar fires. The mortar FDC always ties into the battalion or company wire net as soon as possible. The speed of modern combat demands the use of FM radio nets to call for and coordinate mortar fires. The organization and use of radio and telephone nets described in this paragraph give mortar leaders at company and battalion levels a description of the nets available for fire support planning and coordination with FISTs and FSOs, and for receiving calls for fire.

a. There are seven radio nets important to the mortar platoon leader. He does not routinely operate in all of them, but he can enter any of them to accomplish his mission. Some stations in the artillery-controlled nets may operate in the digital mode only. The mortar platoon leader cannot routinely operate in these nets. (See Appendix L for diagrams of these various radio and wire nets.)

(1) The DS artillery battalion command fire net is used by the artillery commander to control his batteries, and to pass tactical information. The battalion FSO operates in this net to conduct the fire planning. This net is used to pass target lists to the battalion FSO. The DS artillery battalion FDC is the NCS of this net. The mortar platoon leader may be directed to enter this net when fire plans are tightly controlled by brigade.

(2) The DS artillery battalion fire net is used by the FIST headquarters and FO to call for field artillery fire. No other information passes over this net. Three fire nets (F1, F2, F3) are normally authorized in a DS battalion, one for use by each firing battery and assigned for use by the FIST and FSO assigned to support a maneuver battalion. The DS field artillery battalion FDC will be the NCS for this net. The mortar platoon leader can monitor this net to keep informed when it is being operated in the voice mode.

(3) The company command net allows direct coordination between the platoon leaders (including mortar platoon or section leader), the company commander, and the company FSO. Although this net can be used to request mortar fire, it is the least desirable net to use. Calls for fire and observer's adjustments can quickly clog this important net. The company commander is the NCS for this net. The battalion mortar platoon leader may enter a company command net, especially if one of his mortar sections is attached or under OPCON of the company.

(4) The company fire control net is used by the company FSO to control actions of FO parties. It is also used by platoon leaders, platoon sergeants, and other non-field artillery observers to request artillery and mortar fire through the FIST. The FIST HQs is normally the NCS for the CFC net. When firing support planning and coordination must be over the FM radio (rather than face-to-face), this is the net used. It is also used for processing fire missions from either platoon FOs or non-field artillery observers. Stations operating this net are FOs, FIST

headquarters, and company mortars. The battalion FSO can (on occasion) enter this net to coordinate with the FIST chief.

(5) The primary net for processing and controlling fires of the battalion mortars is the battalion mortar fire direction net. Normally, the battalion mortar platoon leader, the FDC(s), FSO, and FOs operate within this net when requesting fires from the battalion mortars. In mechanized battalion mortar platoons, there are two fire direction nets: FD1 and FD2.

(6) The battalion mortar platoon always operates in the battalion command net. It operates in the administration/logistic net when necessary.

(7) The mortar platoon can conduct all of its coordination and fire control on the battalion wire net. Wire nets are always established when the battalion prepares defensive positions. They may also be established during night attacks.

(8) The radios in a battalion mortar platoon allow it to operate in many different nets, and pass information to any FM radio station in the battalion. By designating mortar squads within the platoon to monitor the lesser used nets, the mortar platoon keeps informed while retaining enough radios free to conduct fire coordination and execution.

(9) The company mortar platoon or section has fewer radios, and its radios nets are simpler.

b. There are three methods available to the company commander for controlling the forward observers' calls for fire. The company commander and company FSO determine, based on the experience of the FOs and the tactical situation, if the FOs are to send fire requests to the FIST headquarters (centralized control), directly to the mortar FDC (decentralized control), or if they will be predesignated. The company FSO monitors all calls for fire regardless of the method used.

(1) The *centralized* method is the most restrictive. It requires the FO to have his radio set on the CFC net. When a rifle platoon leader needs indirect fire, his FO calls the FIST HQs and submits a *target description* and *target location*. The company FSO determines if this request should be fired by the company mortars (if available), or sent to the battalion mortars or the supporting artillery. If the request is to be fired by company mortars, the company FSO may elect to give verbal authorization for the mortars to fire the mission or may establish that silence is consent to fire. The company mortars operate within the CFC net monitoring and processing the calls for fire pending authorization from the company FSO. If the FSO determines that the mission needs to be fired by battalion mortars, he directs the FO to switch to the battalion FD net and send his request. Once the FO completes his mission, he returns his radio from the fire net back to the CFC. This method allows the company FSO the most positive control

over the FOs, and prevents net overload. It is the slowest and least responsive method (Figure 3-12).

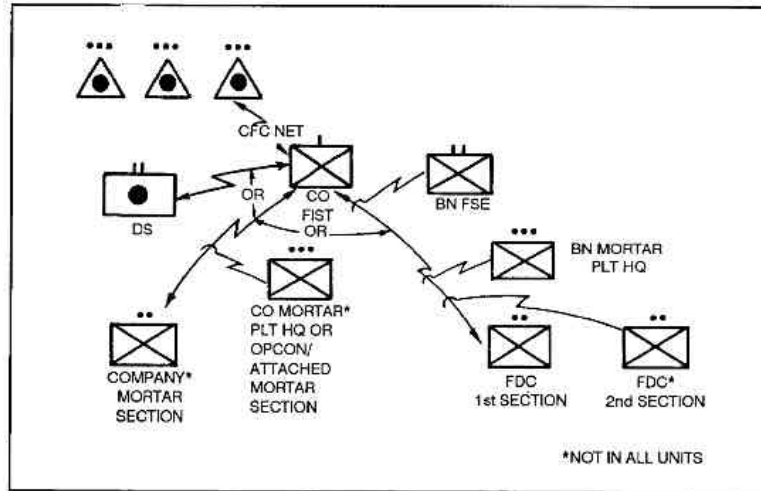

Figure 3-12. FM radio fire request to FIST headquarters (centralized control).

(2) In the *decentralized* method, the platoon FOs are allowed to call for fire from either the artillery or the mortars based on their own judgment. The FO does not have to contact FIST HQs before sending his call for fire, but the FIST HQs monitors all transmissions to ensure coordination of fires on target is accomplished. The FIST HQs can override any decision made by an FO and direct him to use another fire support means, a method of engagement, or to even cancel a mission. Anytime an FO is not engaged in a fire mission, he operates in the CFC net. The FO sends his request directly to the designated FDC on its fire control/direction net. The company FSO monitors each request and, in this situation, silence is consent. The battalion FSO monitors requests directed to the battalion mortars in the same way. When battalion mortars are being employed by platoon from one location, the second FDC section monitors the fire request and computes firing data for the platoon as a check on the controlling FDC section, when directed. When the sections are separated, the second FDC section monitors the fire request and computes firing data for its mortars. When a section or squad is attached or placed OPCON to a company, the section/squad operates in the company fire control net or as directed by the company commander. The advantage of this method is that it is highly responsive to each rifle platoon; however, to use this method requires highly trained FOs. It is difficult for the company FSO to control. The range of the platoon FO's radio may not be sufficient, and multiple FOs may overload a net (Figure 3-13).

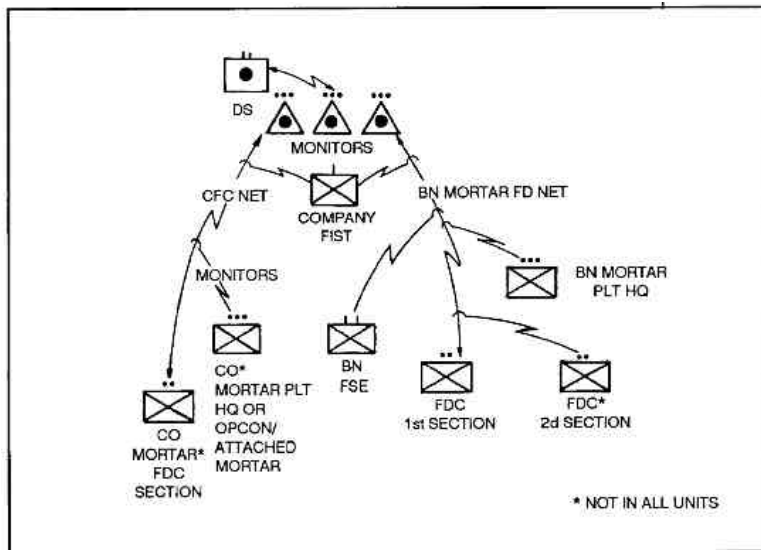

Figure 3-13. FM radio fire request to any FDC (decentralized control).

(3) In the *predesignated* method, the company FSO assigns one/any/all FOs a fire net in which to operate. This option includes provisions to assign two FOs to one net. Net assignment is dependent upon tactical considerations. Platoon FO can request as many missions as he desires and all nets are monitored by FIST HQs. If the FO requests the use of an asset other than his predesignated asset, he must coordinate with FIST HQs. If an FO is given a different asset for a particular mission, he will return to the original predesignated asset upon completion of the mission. Predesignation cannot last for the duration of an operation. This method is highly responsive, provides positive control by the FIST HQ, and prevents net overload (Figure 3-14).

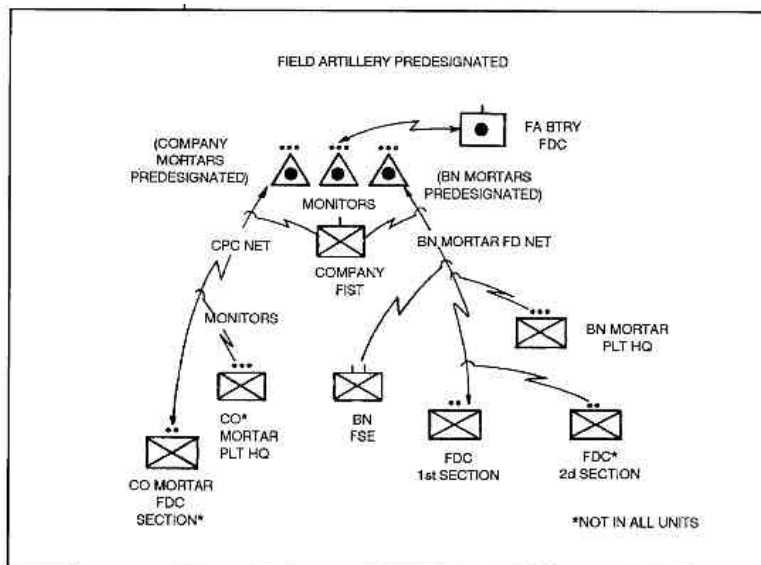

Figure 3-14. Pre-designated method.

c. FOs do not have to be under the same control options at the same time. The three methods of control by FOs must be tailored to the tactical situation. Normally, a combination of two or more methods are used. In tailoring the use of the three options for controlling the fire support assets and FOs, the commander considers the following items:

- (1) Decentralized control requires well-trained FOs.
- (2) The platoon requiring the most responsive support should get the mortars.
- (3) The platoon with the most difficult mission gets the assets that are effective against targets that he is expected to locate.
- (4) The FO that sees the farthest should be able to shoot the farthest.
- (5) Each FO must have access to a fire asset.
- (6) Personnel other than FOs can be designated to call for mortar fire.

3-10. AMMUNITION SUPPLY RATES

The expenditure of mortar ammunition must be controlled based on tactical priorities and ammunition availability. Tactical commanders provide this control by the use of ammunition allocations.

a. **Required Supply Rate.** The battalion or squadron operations officer computes or estimates the type and amount of mortar ammunition needed for a particular combat operation or phase. He then submits these RSRs to the brigade headquarters. The mortar platoon leader assists the operations officer in determining the RSRs. He uses historical records, rate-of-fire computations, or a combination of both. Once the RSR is determined, it is used to plan the transportation requirements for moving the mortar platoon's ammunition from the ATP to the firing location (see Table 3-1).

b. **Controlled Supply Rate.** Due to rapidly changing combat situations and problems that may arise in the logistical system, the actual ASR of mortar ammunition can be less than the RSR. If so, action must be taken to control expenditures. Each tactical commander, down to battalion level, announces a CSR of mortar ammunition, expressed in rounds (by type) per mortar per day. The mortar platoon or section leader considers the CSR during his planning and execution of fires. The CSR cannot be exceeded except in emergencies, and then only by the permission of the next higher commander. It is more combat effective to limit the number of mortar missions fired, firing enough rounds for each mission, than to ration rounds.

(1) When the CSR is small (10 to 20 rounds), the mortar missions should be limited to those that can be observed and can immediately affect friendly troops and operations.

(2) When the CSR is larger (20 to 100 rounds), mortar fire missions can include those that affect planned operations as well as some that involve planned fires without adjustment.

(3) Intense operations against a strong enemy force can generate an RSR of 100 to 300 rounds. If a CSR is imposed, the mortar platoon leader must periodically report his ammunition status to the operations officer and FSO.

CHAPTER 4

MORTARS IN SUPPORT OF OFFENSIVE OPERATIONS

Offensive operations carry the fight to the enemy. The main reason for attacking is to destroy enemy forces. The mortar platoon participates as part of a larger force in the conduct of offensive operations. Mortars are an integral part of any attack and can be used to do the following:

- **Neutralize, suppress, or destroy enemy forces.**
- **Deprive the enemy of resources or the use of decisive terrain.**
- **Fix the enemy in position.**
- **Deceive or divert the enemy.**
- **Provide screening or obscuration.**
- **Provide battlefield illumination.**

4-1. HISTORICAL EXAMPLE

An excellent example of the integrated use of mortars to support an infantry attack occurred during the operations of Company C, 39th Infantry Regiment, 9th Infantry Division at Cherbourg, France, in June 1944 (Figures 4-1 and 4-2.)

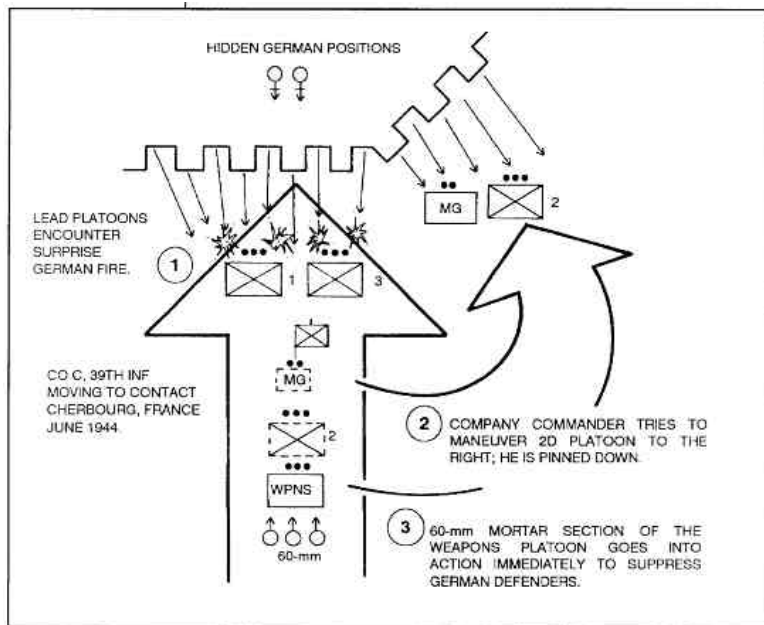

Figure 4-1. Initial actions of Co C, 39th Infantry.

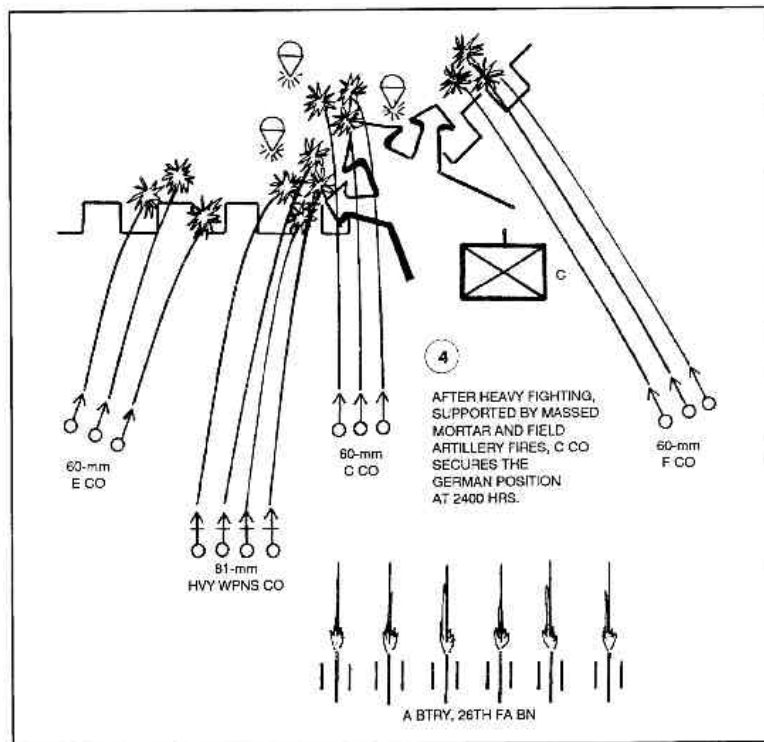

Figure 4-2. Subsequent actions of Co C, 39th Infantry.

- a. Company C was leading the 39th Regiment's advance, with its 1st and 3d platoons in front and 2d platoon trailing. Suddenly, the Germans opened fire with flak cannon and machine guns from hidden positions. The 1st and 3d platoons were pinned down, unable to move. At the same time, German mortars and artillery began to fall on the 2d platoon and the company command group.
- b. The company commander took the 2d platoon and a machine gun section with him and tried a sweeping maneuver to the right. He was unable to get any farther forward than the right flank of the 3d platoon. With all its rifle platoons pinned down by close and accurate enemy direct fire, the company was facing heavy casualties.
- c. Fortunately, the weapons platoon had placed its three 60-mm mortars into action and began to deliver fires on the German positions. The 81-mm mortar platoon of the heavy weapons company also assumed firing positions and began to adjust fire onto the enemy.

d. With the combined assistance of its own 60-mm mortar platoon, the 81-mm mortar platoon from Hvy Wpns Company, and the 60-mm mortar platoons of its sister E and F companies, and aided later by the 26th FA battalion, C Company riflemen were able to move forward again to close with the enemy. After several hours of bitter fighting, during which hundreds of mortar rounds were fired, the enemy broke. By 2400 hours the position was clear.

e. The commander later credited the immediate and accurate mortar fire from his weapons platoon with saving the company during those first critical moments. He said the combined fire of the battalion's other mortars and the field artillery "broke the back" of a determined enemy resistance. Because they were organic, the company's mortars were able to deliver fires faster and closer than the artillery. Their fires complemented and supplemented the heavier FA fires.

4-2. MORTAR SUPPORT DURING OFFENSIVE OPERATIONS

Offensive operations are characterized by movement and changing situations. Flexibility in fire support is required to provide continuous fires. The mortar platoon plans to conduct fires en route to the objective, on the objective, and beyond the objective (Figures 4-3 and 4-4).

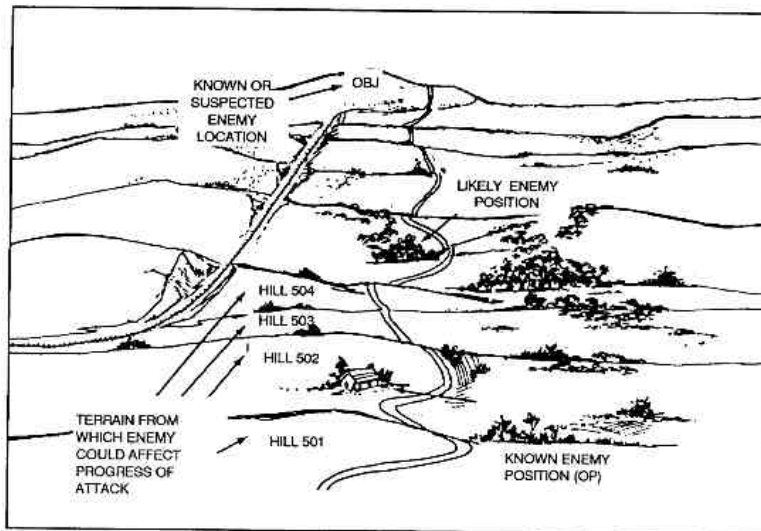

Figure 4-3. Planning fires en route to the objective.

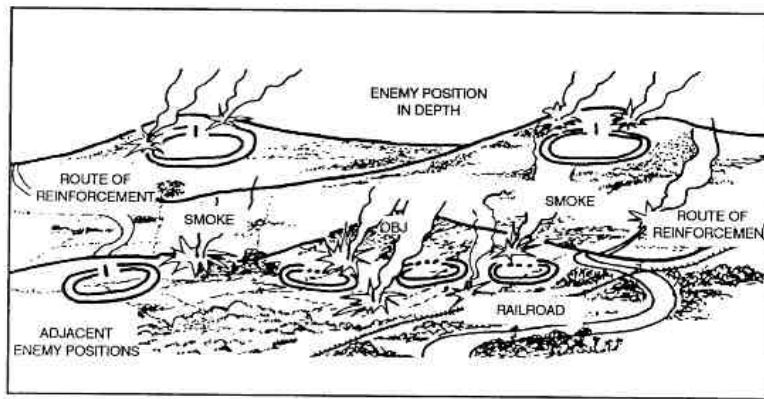

Figure 4-4. Fires on and beyond the objective.

- a. Mortars accomplish this by positioning near the LD using the one-half to two-thirds maximum range rule as a guide, and then moving forward. Having mortar firing positions in deep defilade is often more important than the one-half to two-thirds maximum range rule. If a good defilade position is located closer to the LD, it should be used.
- b. Mortars provide support during the attack to neutralize, suppress, or destroy the enemy while the assault element moves to the final coordination line, screens friendly movement by obscuring the enemy's vision, neutralizes resistance during the final assault, and isolates the objective.
- c. Mortars neutralize and suppress enemy defenses during the final phase of the attack by short, violent preparations targeted against frontline defenses and OPs. Mortar fires are lifted or shifted at the last possible moment before assault elements close on the enemy's position.
- d. Once an objective is seized, friendly forces consolidate and prepare to repulse enemy counterattacks or to reorganize with minimum loss of momentum to continue the attack. Mortars protect friendly troops during consolidation or reorganization by preventing enemy reinforcements from entering the objective area or by breaking up enemy counterattacks.

4-3. TYPES OF OFFENSIVE OPERATIONS

There are five major types of offensive operations that mortars can expect to support. In many ways, mortars support each type of operation in the same manner.

- a. **Movement to Contact.** Movement to contact gains or reestablishes contact with the enemy to further develop the tactical situation. The exact location of the enemy is usually not known.

(1) Mortars provide the maneuver commander the most responsive means of indirect fire support during a movement to contact. The displacement techniques used by a mortar platoon during this operation depend on the distance to be traveled, the likelihood of enemy contact, and or the maneuver commander's guidance. For example, if the objective in a movement to contact is distant, the entire mortar platoon can be directed to displace, moving close behind a maneuver element, depending on where enemy contact is expected. While the mortar platoon, section, section (-), or squad is displacing, it must be prepared to immediately engage targets using direct-lay, direct-alignment, or hip-shoot techniques of engagement.

(2) Fire planning on key terrain and likely enemy positions increases mortar responsiveness upon enemy contact. It must include possible targets en route to the march objective, on the march objective, and beyond. Once enemy contact is made, the mortar platoon leader quickly issues a FRAGO to support the maneuver element's hasty attack or bypass.

(3) Not only must the commander plan mortar fires, but he must also plan mortar movement. The mortar platoon can be attached, for movement, to a company near the front of the battalion march column or tactical formation. This will ensure that the mortars are close enough to the enemy to contribute responsive, immediate fires (See Figures 4-5 to 4-9 for examples of mortar platoons and sections moving within unit formations.)

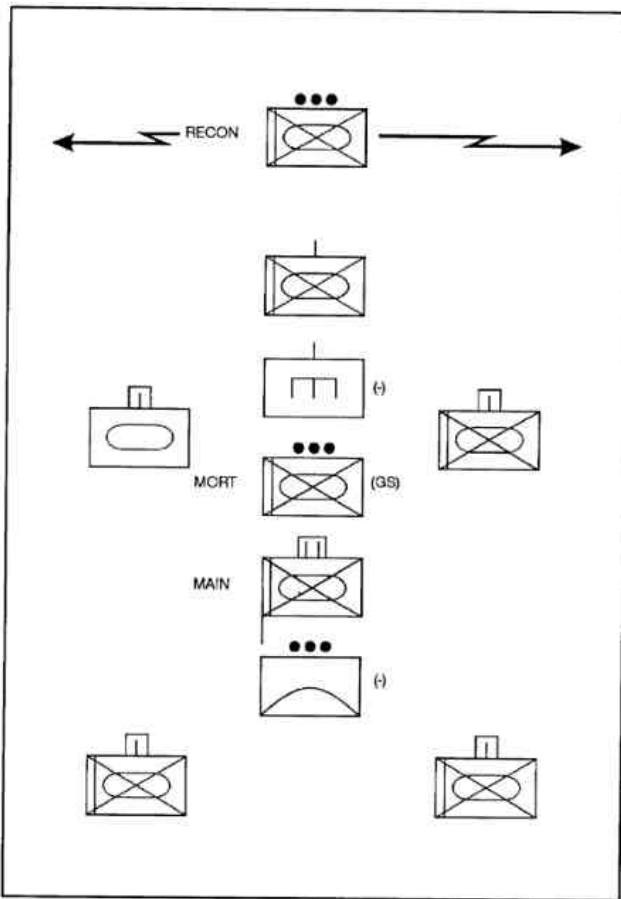

Figure 4-5. Position of battalion mortar platoon (GS) during mechanized task force movement to contact, box formation.

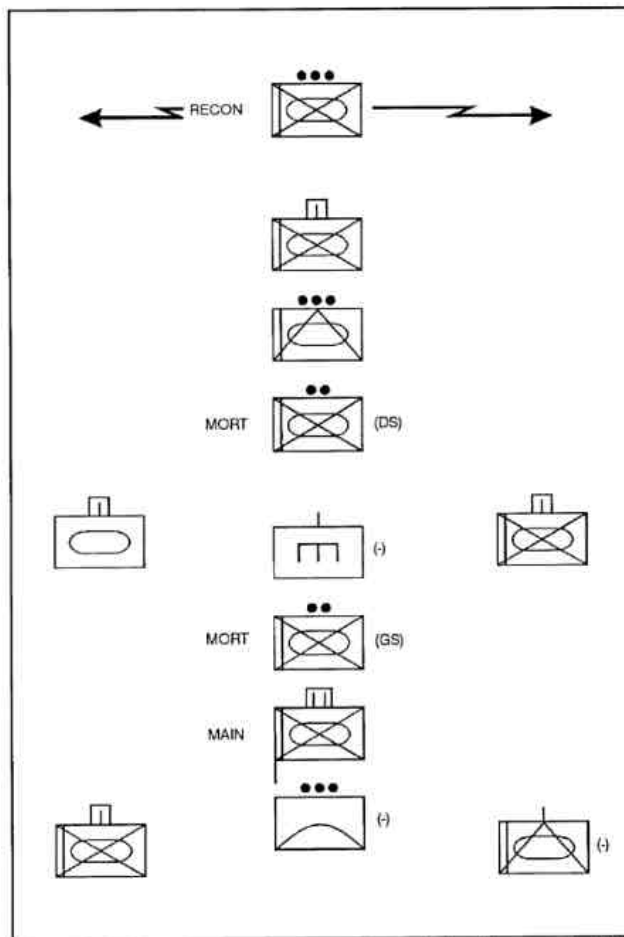

Figure 4-6. Position of battalion mortar platoon (GS) with one section DS during mechanized task force movement to contact.

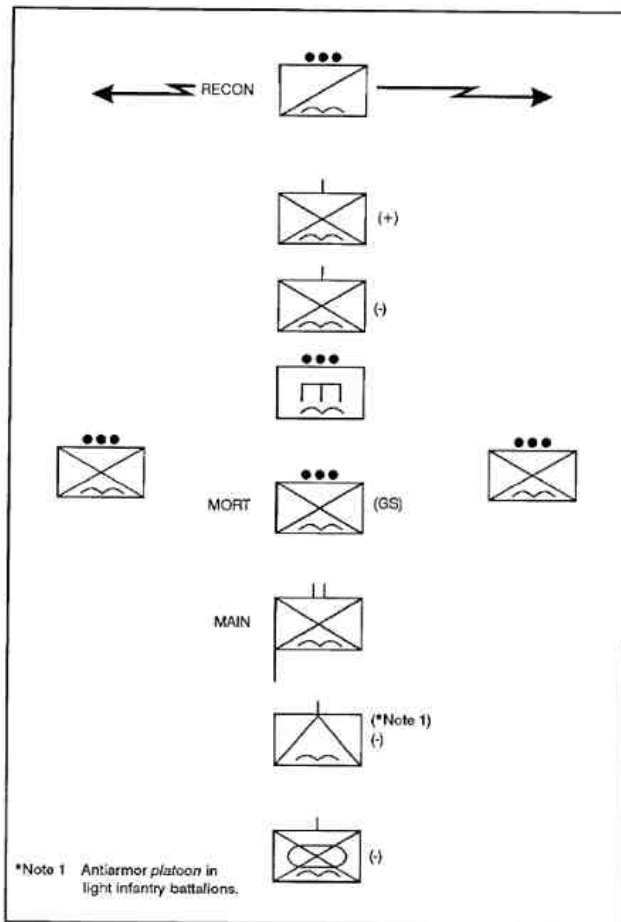

Figure 4-7. Position of battalion mortar platoon (GS) during infantry battalion movement to contact.

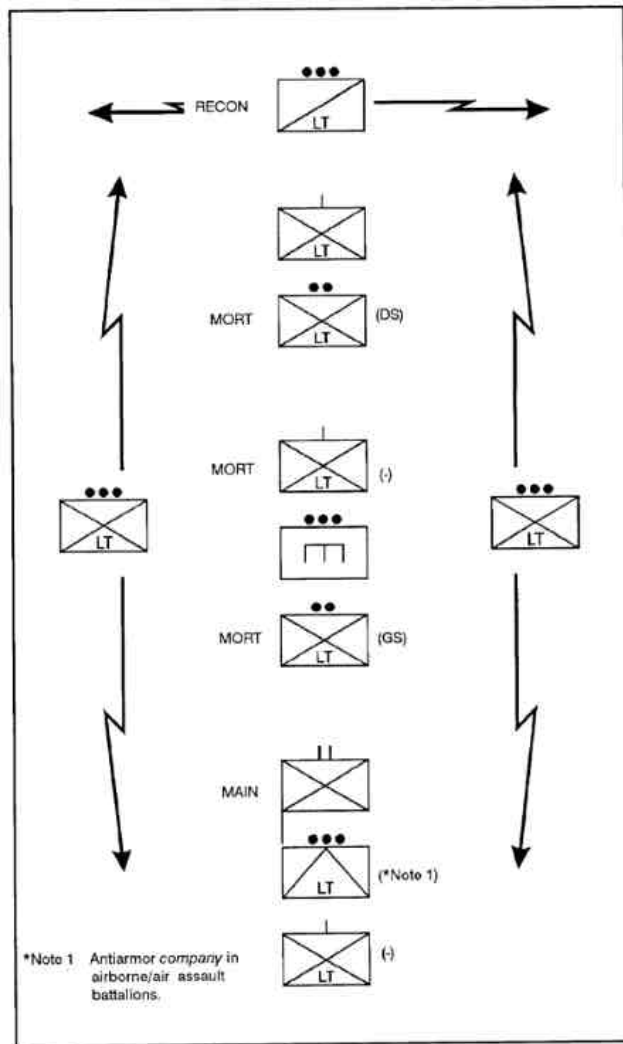

Figure 4-8. Position of battalion mortar platoon (GS) with one section DS during infantry battalion movement to contact.

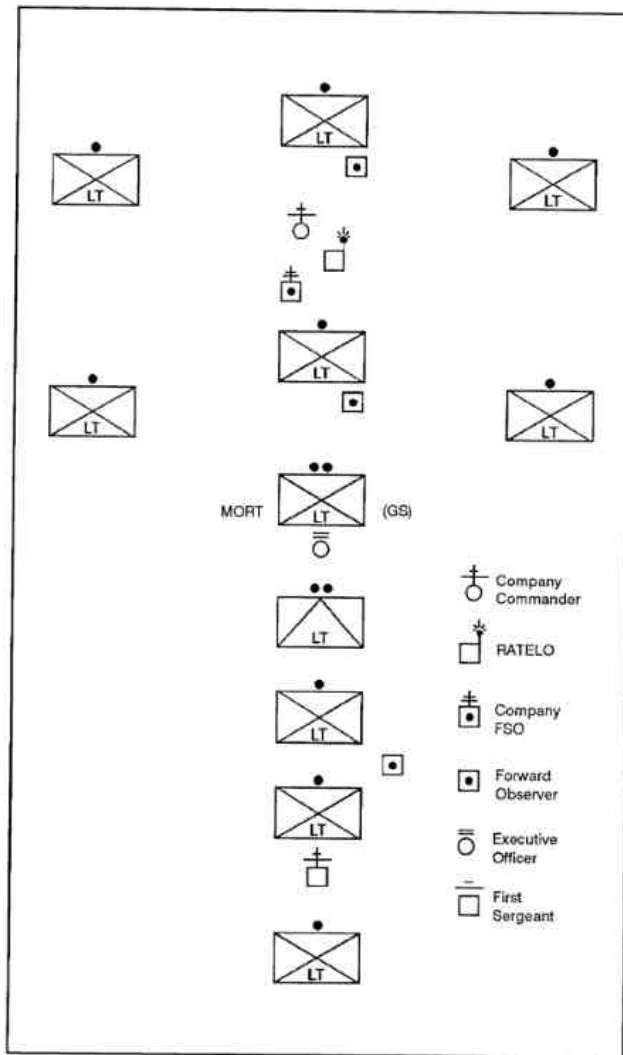

Figure 4-9. Position of company mortar section (GS) during company movement in column.

b. **Hasty Attack.** The hasty attack uses maximum firepower and rapid movement to maintain momentum. There is usually little or no time for planning additional fire support. Most targets engaged by mortars are targets of opportunity. However, planned

fires for the movement to contact or the defense increase mortar responsiveness when engaging enemy positions on or near planned targets.

(1) Once contact has occurred and the commander decides to attack, the mortar platoon leader issues fragmentary orders. He quickly positions any moving elements in defilade and provides maximum indirect fires. Properly positioned and employed, mortars aid the maneuver commander in maintaining the momentum of the attack.

(2) After a successful hasty attack, mortars must be resupplied quickly. This enables them to effectively support a continuation of the attack, to protect against a counterattack, or to transition to the defense. Any movement during this phase of the operation is conducted quickly to minimize the maneuver element's vulnerability to a counterattack.

c. **Deliberate Attack.** The deliberate attack requires more planning time, detailed intelligence, and a more detailed scheme of maneuver, including the plan for fire support.

(1) The mortar platoon is normally directed to deliver heavy, precisely timed fires on specific targets. Company mortars may be included in these fires or may be held for use against unplanned targets that appear. The platoon leader considers preparation of ammunition, registration, and resupply. Use of prestocked ammunition, where possible, allows the mortar platoon to save its basic/combat load for the continuing attack.

(2) One common form of maneuver during a deliberate attack is the penetration. The battalion must mass combat power against an isolated, narrow portion of the enemy front. Concentrated direct and indirect fires are used as the assaulting force closes on the enemy's forward defensive positions. At some point, the forward movement of the assault element masks the direct fires of supporting weapons. The mortar platoon's massed indirect fires keep the enemy suppressed while the rifle platoons assault to destroy him. The commander of the assaulting force controls this massed mortar fire and shifts it at the last minute onto the rear of the enemy defensive position, likely routes of withdrawal, support by fire positions, and likely counterattack routes. The mortar platoon leader must be prepared to fire large volumes of ammunition near friendly forces. This requires detailed planning and close supervision by mortar leaders at all levels. (See appendix B for detailed information on target effects planning.) Extraordinary amounts of HE ammunition are required to suppress or destroy defenders in properly prepared defensive positions.

(3) Mortars support the consolidation of the objective the same as in a hasty attack.

d. **Exploitation.** An exploitation follows a successful attack. It destroys the enemy's defenses and keeps him disorganized so he cannot resupply or regroup his forces. An exploitation requires rapid advance and violent action.

(1) In the exploitation, fragmentary orders are common. The operation may require changes in the direction of attack to ensure destruction of the enemy. There may be many small groups of enemy that are bypassed, which can pose a threat to the security of the mortar platoon. The mortar platoon provides its own security and may even be involved in taking and guarding PWs.

(4) Due to the speed with which an exploitation is conducted, mortars can be directed to move by platoon or section with, or just behind, the maneuver element. Many fire missions are conducted using direct-lay, direct-alignment, or hip-shoot techniques. Since exploitations occur deep behind enemy lines, the mortar platoon leader ensures that ammunition is conserved since resupply may be difficult.

e. **Pursuit.** The pursuit normally follows a successful exploitation. The primary difference is that it is oriented on the final destruction of retreating enemy units. The considerations for rapid movement, security, and resupply are much the same as in the exploitation.

4-4. OTHER OFFENSIVE OPERATIONS

Other offensive operations are limited objective, limited scale, or specially designed operations. They follow the basic considerations for hasty and deliberate attacks.

a. **Raid.** A raid is normally a platoon- or company-size operation into hostile territory to secure information, to confuse the enemy, to destroy his installations, or to liberate personnel. Company or battalion mortars can be attached or placed under OPCON. If the raid force is dismounted or moved by helicopter, mortarmen carry the mortars and ammunition. The commander can direct riflemen to carry one or two mortar rounds each.

b. **Reconnaissance in Force.** A reconnaissance in force is a limited objective attack by a strong force to obtain information; to discover or test the enemy's dispositions, strengths, weakness; and to force a reaction by his reserves or fire support elements. The commander ordering the mission must be prepared to extricate the force or to exploit its success.

(1) To the mortar platoon leader, a reconnaissance in force is conducted the same as a deliberate attack. Fire planning is detailed to increase responsiveness. The mortar platoon leader can adjust rapidly to changing situations that may include supporting the withdrawal of the force, a hasty defense, or an exploitation.

(2) Depending on the distance to be covered, mortars can be the maneuver commander's only means of indirect fire support. As such, platoon leaders position mortars to provide continuous fire support throughout the operation.

- (3) The sections or squads cover greater distances between displacements and should be prepared to engage targets using emergency techniques.

4-5. MORTAR OFFENSIVE FIRE SUPPORT

Commanders plan mortar fires on the terrain to be traversed and on the flanks to protect the force. If friendly forces make unexpected contact, immediate suppression missions may be fired. Mortar sections establish firing positions within forward assembly areas to protect against enemy spoiling attacks. Mortar fires are always planned from these assembly areas, though they may not be registered or prefired.

- a. Fires en route to the objective can be divided into the following phases:

(1) Short of the LD/LC.

- (a) Plan fires on checkpoints, passage points, release points, and attack positions to support movement to the LD/LC.
- (b) Plan targets to support in the event the enemy conducts a spoiling attack.

(2) From the LD/LC to the final coordination line (FCL).

- (a) Fire smoke and HE to obscure obstacle breaching operations and to suppress enemy fires.
- (b) Target mortar fires on friendly rally points, objective rally points, and assault positions to allow ease of adjustment from these known locations.

(3) From the FCL to the limit of advance.

- (a) Plan suppressive fires on the rear of enemy locations and along likely avenues of withdrawal.
- (b) Plan smoke and HE fires on likely enemy reserve positions and assembly areas.
- (c) Plan defensive fires on likely enemy counterattack routes and support positions.

- b. Preparatory fire is an intense volume of fire delivered in accordance with a time schedule to support an attack. It is normally divided into three phases. Fires may start at a prescribed time or be held on call until needed. The length of the preparation depends on ammunition levels (CSR) and the number of targets for attack. Mortars may not always have adequate range to fire at targets in all three phases. Therefore, the weapons are scheduled into the phase that is within their capabilities rather than being excluded from

the preparation. Commanders plan fires on the basis of the sustained rate of fire for each weapons system.

(1) **Phase I** provides for the early attack of enemy indirect fire support assets and observation capabilities. These targets are the slowest to recover. This degrades the enemy's ability to react with indirect fires and to gain intelligence about the friendly force. The battalion mortar platoon may play a major role in this phase of the preparatory fires. The brigade commander may have the FSCOORD position and mass the fires of the brigade's heavy mortars against enemy mortar units or reconnaissance elements. Mortars may contribute to the counterfire program to free artillery and to aid in J-SEAD programs.

(2) **Phase II** concentrates on identified CPs, communications positions, assembly areas, and reserves. The goal is degradation of the enemy's ability to reinforce his defense and to shift forces to counter the main attack. Mortar targets are based on weapons capabilities.

(3) **Phase III** concentrates on the forward portions of the enemy defensive area and targets that pose an immediate threat to attacking troops. The purpose of this phase is to suppress and obscure enemy direct fire systems until the assault force has closed with them. Mortar fires are most likely used during this phase, especially against enemy reverse-slope positions, which can only be reached by high-angle fire.

c. Fires on-call are preplanned targets fired on request not influenced by time schedules. On-call targets are planned to isolate all or part of the objective, to provide illumination during night attack if needed, and to disrupt an enemy counterattack.

d. Fires in support of consolidation and reorganization are planned to protect friendly units against enemy counterattack or reinforcement. Mortar fires on likely enemy withdrawal routes disrupt his organized retrograde operations.

4-6. OTHER OPERATIONS

Other types of operations include passage of lines, linkup, breakout from encirclement, and relief in place. They may occur during either offensive or defensive combat.

a. **Passage of Lines.** This occurs when one unit passes through the positions of another, as when elements of a covering force withdraw through MBA. A passage can be designated as a forward or rearward passage of lines. It can be conducted in offensive, defensive, or retrograde operations.

(1) Detailed reconnaissance and coordination ensure that the mortar platoon conducts the passage quickly and smoothly. Personnel can be overly concentrated, fires of the stationary unit can be masked temporarily, and the mortar platoon may not be able to react to enemy action. Direct and indirect fires of the stationary unit

are normally integrated into the fire support plan of the passing unit. Mortars and FIST can be collocated to provide coordinated and responsive support. Often mortars from the stationary unit provide fire support to the moving unit out to the limit of range. Particular attention is given to restrictive fire measures used to control these fires. The use of fire direction nets is also coordinated. The mortar platoon usually operates within the stationary platoon's fire direction nets. Call signs are exchanged and FDC personnel are informed that calls for fire can be received from the passing unit.

(2) The passing unit's mortars conduct a rearward passage of lines using appropriate displacement techniques until the maneuver element is within range of the stationary mortar platoon. The mortars can then move to and through the passage point either as a platoon or in sections.

(3) A mortar platoon normally conducts a forward passage when the maneuver element is just short of the stationary mortar platoon's maximum range. The passing mortars then begin displacement techniques to support their maneuver element with continuous fire.

b. Linkup. This is a meeting of friendly ground forces. Examples of a linkup include: when an advancing force reaches an objective previously seized by an airborne or airmobile force, when an encircled unit breaks out to rejoin friendly forces, or when converging maneuver forces meet.

(1) A linkup requires detailed restricted fire line (RFL), close coordination and detailed planning of movement, fires, control measures, and recognition signals. Ideally, an exchange of liaison officers takes place before the operation. Depending on the mission after the linkup, either force can be attached to the other or both can remain under control of the directing headquarters.

(2) To the mortar platoon leader, a linkup is conducted as a movement to contact if supporting a converging force or as a defense if supporting a stationary force. In either case, he ensures that all restrictive fire control measures are followed as the two forces converge.

c. Breakout From Encirclement. This is an offensive operation conducted by an encircled force. A breakout normally consists of an attack (penetration) by a rupture force to open a gap through enemy forces.

(1) Before a breakout attempt, all fire support assets are organized under centralized control, and fire support coordination is integrated into the breakout plan. Mortars in this situation may find themselves supporting the defense of the encircled perimeter and supporting either the diversionary or rupture attack. The ability to mass fires when needed may be critical to the success of the breakout attempt. Mortars have to remain flexible since they may be called on to provide deceptive and concentrated fires at the same time to aid in the penetration.

(2) Mortar platoons must exercise proper fire control to avoid depleting ammunition stores since resupply may be impossible.

d. **Relief in Place.** This is an operation in which a unit is replaced in combat by another unit. The incoming unit assumes responsibility for the combat mission and the assigned sector or zone of action of the replaced unit.

(1) Mortar sections and their FOs are relieved after the maneuver companies. The mortar platoon remains in position, ready to fire, until the relief is nearly completed. The mortar element being relieved passes on its range cards, target lists, and overlays to the incoming mortar platoon to ensure effective delivery of fires. Machine gun tripods and mortar base plates (if ground mounted), aiming posts, telephones, and wire lines can be left in place and exchanged. Authority to do so would be included in the relief order of the next higher commander. This simplifies the effort and lessens the time required to effect the relief.

(2) To ease occupation of the positions during hours of limited visibility, the incoming platoon leader conducts a reconnaissance during both daylight and darkness.

CHAPTER 5

MORTARS IN SUPPORT OF DEFENSIVE AND RETROGRADE OPERATIONS

Defensive operations retain ground, gain time, deny the enemy access to an area, and damage or defeat his attacking forces. A successful defense consists of reactive and offensive elements working together to deprive the enemy of the initiative. The mortar platoon participates in a defense as part of a larger force. Mortars provide the commander with the ability to strike out against the enemy, to regain his initiative and synchronization, and to counterattack by fire. They are an integral part of any defense and can be used for the following:

- **Deceive or divert enemy attention.**
- **Screen friendly maneuver.**
- **Obscure enemy observation and fires.**
- **Neutralize, suppress, or destroy enemy forces.**
- **Fix the enemy in position for a counterattack.**
- **Deprive the enemy of the use of defilade or decisive terrain.**
- **Illuminate the battlefield for more effective friendly fires.**
- **Harass the enemy and interdict his massing of assault forces.**

5-1. DEFENSIVE OPERATIONS

Defense is a coordinated effort by a force to defeat an attacker and to prevent him from achieving his objectives. The immediate purpose of the defense is to cause an enemy attack to fail. The defensive battlefield consists of three areas that are viewed by commanders when planning operations (Figure 5-1). The mortar platoon leader is not concerned with all three areas at the same time; however, he must understand the defensive framework. The mortar platoon leader can expect to be involved in one area at a time but may provide support in overlapping areas. (For details on the defensive framework see FM 7-20 and FM 71-2.)

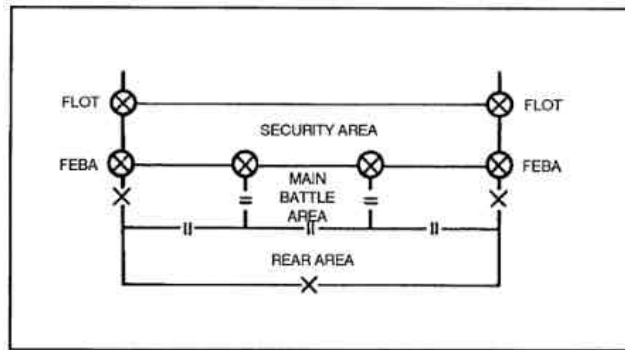

Figure 5-1. Three areas of defensive framework.

5-2. PRIORITY OF FIRES AND PRIORITY TARGETS

The commander routinely modifies indirect fire support by assigning priority of fires to one of his subordinate commanders or by establishing a sequence priorities of fires. These priorities of fires permit the rapid, flexible shifting of fires as the tactical situation develops. In the defense, priority of fires is normally given first to the company that can best place effective long-range fires on the enemy. As the enemy continues to advance, the priority of fires may be shifted to the company responsible for defending the most dangerous avenues of approach into the battalion's sector or battle position. If more than one company is positioned to cover the same avenue of approach (for example, around an engagement area), priority of fires should be given to the company or platoon that can best observe and place effective fire on the enemy forces that pose the greatest threat. As the battle develops, the priority of fires may be changed. To ensure that the most threatening enemy forces are fired on first, the commander must prioritize anticipated demands but may intervene to modify his guidance. The mortar platoon leader must stay in contact with the TOC and the battalion FSO to quickly change priorities of fires when needed.

a. **Priority of Fires.** Priority of fires are normally assigned to a forward security force, which may be the scout platoon, or to another maneuver force given a security or a counterreconnaissance mission. It can be subsequently assigned to weight a critical sector or battle position.

(1) The commander may shift the priority of fires to meet the threat, as required. He can assign priority of mortar fire to increase the effectiveness of direct fires. For example, the effectiveness of TOW and Dragon missiles can be increased by having mortar fire obscuring enemy overwatch elements, forcing enemy armor to button up, suppressing accompanying infantry, and canalizing the enemy.

(2) Priority of fires is assigned to a counterattacking force upon initiation of the counterattack.

b. Priority Targets. Priority targets are used to increase fire support responsiveness on specific targets or specific high threat areas. In addition to artillery priority targets that may be allocated to him, the battalion commander has one or two mortar priority targets he can allocate. The company commander has one priority target he can allocate. Only mortar platoons with six mortars can be allocated two priority targets, one for each section, and still provide adequate target coverage and results. Medium mortar platoons and light mortar sections cover only a single priority target. The company commander indicates his priority target in the REMARKS column of his target list. Anticipated changes of the priority target are indicated as ON-ORDER PRIORITY TARGETS on the same target list.

(1) The battalion commander and FSO must carefully consider priority targets before assigning them. Priority targets should lie in the sector of the company or platoon having priority of fires. This prevents any confusion if the mortar platoon receives several calls at the same time. If a conflict is possible (such as when the scout platoon has priority of fires, yet a priority target has been allocated to a rifle company), the commander, FSO, operations officer, and mortar platoon leader must coordinate to avoid confusion.

(2) Priority targets are not always fired on using HE ammunition. Illumination, smoke, or a mix of HE and WP can be used as the designated rounds to be fired. During darkness, one mortar within the section can be designated to fire illumination only.

(3) With the exception of FPF, priority targets have a predetermined amount of ammunition set aside to be fired on them. At the maximum rate of fire, the mortar section fires this ammunition immediately upon the observer's call for fire. The FDC then orders the section to repeat the mission, shift fires, or cease fire, based on the message from the observer.

c. Final Protective Fires. FPF are preplanned barriers of both direct and indirect fires designed to protect friendly troops from an enemy dismounted assault. They are the highest type of priority targets and take precedence over all other fire requests. The FPF differ from a standard priority target in that they are fired at the maximum rate of fire until the mortars are ordered to stop or until ammunition is depleted. Because mortar rounds are smaller than DS artillery rounds, they can be targeted closer to friendly forces and still be safe. Closer FPF are easier to integrate into direct-fire FPLs. The high rate of fire achievable by mortars creates effective barriers of fire. The allocation of FPF is identical to the allocation of priority targets (one for each battery and one for each mortar platoon). While firing FPF, mortar sections are not normally allowed to cease fire and displace due to countermortar fire. They must take precautions to avoid or withstand countermortar fire (see Chapter 7).

(1) A mechanized or armor battalion commander may direct the six-gun heavy mortar platoon to prepare 2 three-gun FPF. He should do this only if the terrain dictates the need for more FPF than he has been allocated and then only after

seeking additional artillery allocations. The heavy mortars should otherwise fire FPF as a platoon (see Table 5-1).

SIZE	TYPE	NUMBER OF MORTARS	APPROXIMATE	
			WIDTH (METERS)	DEPTH (METERS)
120-mm	M120	6 (platoon)	360	60
120-mm	M120	3 (section)	180	60
107-mm	M30	6 (platoon)	240	40
107-mm	M30	4 (platoon)	160	40
107-mm	M30	3 (section)	120	40
81-mm	M29A1	4 (platoon)	140	40
81-mm	M29A1	3 (section)	100	40
81-mm	M252	4 (platoon)	150	50
60-mm	M224	2 (section)	60	30

Table 5-1. Normal FPF dimensions for each number of mortars.

(2) The company commander is responsible for the precise location of the mortar FPF and FPF integration into the direct fire FPLs. The FDC plots and precomputes all firing data for the FPF as early as possible.

(3) The mortar FPF widths from Table 5-1 are neither precise or restrictive. The mortar sheaf can be opened or closed to cover the specific terrain on which the FPF is located. Table 5-1 is derived from data on the bursting diameter of mortar rounds, extracted from various sources. In the past, many publications have mistakenly used the term bursting *radius* while providing the actual distance of the bursting *diameter*. The bursting diameter of an HE round is twice the distance from the point of impact at which the round will reliably place one lethal fragment per square meter of target. The following mortar lethal bursting diameters are estimations since the type round, fuze, range, and target surface all affect the mortar's lethal bursting diameter:

- M120 (120-mm) mortar--60 meters.
- M30 (107-mm) mortar--40 meters.
- M252 (81-mm) mortar--38 meters.
- M29A1 (81-mm) mortar--35 meters.
- M224 (60-mm) mortar--30 meters (M720 round); 20 meters (M49A4 round).

(4) Artillery FPF are allocated to companies in the most critical defensive positions. Mortar FPF may be allocated to cover less critical avenues of approach that are in the same sector or in a different sector. Once allocated to a company,

that commander designates the precise FPF location where they can best augment the direct-fire weapons. Figure 5-2 shows how mortar FPF are positioned to integrate them into the direct-fire FPLs of the defender.

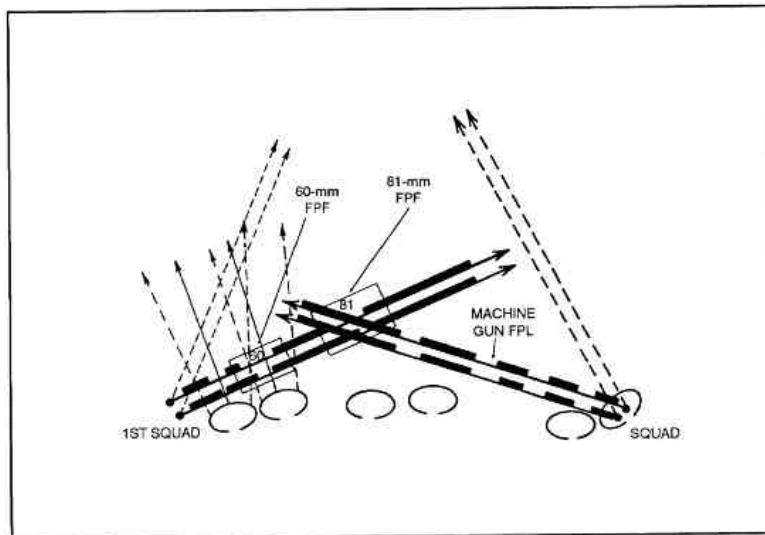

Figure 5-2. Positioning mortar final protective fires.

(5) Mortar FPF are always targeted on an avenue of likely dismounted attack. They can be any distance from the friendly position that fits into the ground commander's tactical situation but are always within the range of organic direct-fire weapons, normally within 100 to 400 meters of friendly troops. The importance of accurate defensive fires and the danger close situation means that each mortar firing the FPF must be individually adjusted into place normally using delay fuze settings and the creeping method of adjustment.

(6) The company commander may retain the authority to call for the mortar FPF to be fired, or he may delegate it to a platoon leader. If the decision is delegated to the forward platoon leader, he may direct his FO to transmit the request to fire the FPF directly to the FDC or through the company FSO. When the request is transmitted directly to the FDC, the rifle platoon leader informs the company commander. The mortar section or platoon leader always informs the commander when he initiates firing the FPF.

(7) The commander and mortar platoon leader must have alternate means of communication to call for the FPF. No one means of communication, radio, wire, or voice is sufficient--an alternate means must be established. In addition to

standard voice messages, the commander and mortar platoon leader should establish a simple visual pyrotechnic signal.

(8) Mortar FPF are fired only when needed. Once begun, FPF are fired until ordered terminated or until all mortar ammunition is gone. HE ammunition with PD fuzes is normally used in firing the FPF. When planning FPF, the mortar platoon leader decides how many rounds to prepare, based on ammunition available and the CSR, and sets them aside for use. This allows the mortars to quickly begin the FPF and maintain them without halting to prepare rounds when the call for fire is received. Additional rounds can be prepared during the firing of FPF if the ammunition requirement exceeds the quantity prepared.

5-3. MORTAR DEFENSIVE FIRE SUPPORT TASKS

In the defense, the mortar platoon leader must understand the intent of the defensive techniques the commander desires to employ. These techniques affect how the mortar platoon provides support, since specific actions and techniques vary depending on the characteristics of the defense.

a. Mortar fires are used in the defense against both mounted and dismounted enemy forces.

(1) Against a mounted attack, they are used to suppress--

- (a) Armored forces by using proximity-fuzed HE rounds to cause tanks and fighting vehicles to button up, reducing their effectiveness.
- (b) Antiarmor guided missile systems while friendly maneuver units are displacing.
- (c) Enemy direct-fire overwatch positions, mainly those of unprotected systems such as T-12 antitank guns.
- (d) Air defense vehicles.
- (e) Enemy mortars and AGS-30 automatic grenade launchers.

(2) Against a dismounted attack, they are used--

- (a) To engage dismounted enemy infantry beyond direct-fire weapon ranges.
- (b) To break up enemy troop concentrations.
- (c) To cover dead space in front of friendly positions.

(d) To reduce the enemy's mobility and to canalize his assault forces into engagement areas.

(e) To neutralize and destroy enemy forces attempting to breach friendly obstacles.

(f) To suppress and obscure enemy direct-fire support weapons, including laser weapons.

(g) To provide close-in FPF against the enemy's dismounted assault.

(h) To deny the enemy the use of a specified piece of terrain.

(i) To conceal friendly obstacles from the attacking force.

(3) Against both the mounted and dismounted attacks, mortar fire is used-

(a) To screen movement of friendly forces between firing positions.

(b) To isolate attacking enemy units.

(c) To illuminate areas where enemy forces are known or suspected to be, so they can be engaged with other weapons.

(d) To mark targets for attack by direct-fire weapons or aircraft.

b. Mortar fires are often used to support security forces. The security forces can be given priority of mortar fires, operational control of the mortar platoon (or section), or even attachment. The mortar fires are used to engage the advancing enemy at long ranges, to inflict casualties, to delay and disorganize his movements, and to assist the security force in breaking contact. If the mortar platoon or section moves forward of the main defensive positions to accomplish these tasks, the leader coordinates the subsequent rearward displacement. He confirms the timing of the displacement, changes in OPCON or fire priority, the routes of displacement, the passage point through the friendly barriers, recognition signals, and the plan for occupying the subsequent position.

c. Closely coordinated mortar fire can increase the effectiveness and survivability of antitank weapons significantly. The antitank company commander can be given priority of mortar fires or even OPCON of a mortar platoon or section. Antitank company commanders rarely have mortar squads attached to the company. The antitank company does not have a company FSO. An FSO or FO team can be task-organized. However, the mortar platoon leader and the antitank company commander must be prepared to coordinate and execute fires in support of antiarmor companies without a FIST. Since both sections and platoons are organic to the same battalion, this is easily accomplished. Mortar sections and platoons support the antiarmor battle in many ways.

(1) The HE fires force tank crews to button up. This reduces their field of view and their ability to detect friendly forces. Mortar rounds should be set to achieve airbursts to reduce the amount of dust and dirt thrown into the air. This interferes less with friendly direct fires.

(2) Mortar smoke rounds can be fired to isolate the lead element of an advancing enemy force from the main body. The antitank company can then attack this isolated element, free from enemy overmatching fires. Mortar smoke can be placed between the antitank company and the enemy to aid in the movement out of initial firing positions to subsequent ones. All commanders involved must coordinate the use of mortar smoke rounds. Also, the mortar platoon leader must be prepared to cease firing smoke rounds *immediately* if shifting winds move the smoke to an unfavorable area.

(3) Smoke and HE rounds can be used to complement the effects of antiarmor ambushes and to cover the withdrawal of the ambushing force.

d. The mortar platoon's or section's primary task during defensive operations is to provide immediate, close, and continuous HE fires to the defending force. This is especially critical during "defend to retain" missions. A mortar section will often be placed in DS of a company or platoon defending to retain a battle position or strongpoint.

e. Fires delivered before the enemy attack are designed to breakup the attack before it starts or to disorganize, delay, and weaken the attack. These fires are categorized as follows:

(1) ***Harassment and interdiction fires.*** Ammunition resupply constraints severely restrict the amount of harassment and interdiction fires mortar platoons or sections provide. In a high threat environment, harassment and interdiction fires can expose the mortar firing location to enemy target location and counterfire. Against a dismounted enemy on close terrain, mortar platoons may fire large amounts of harassment and interdiction fires to slow and disorganize the enemy as he concentrates forces and supplies to continue his offensive. Mortar harassing fire can severely limit the enemy in preparing battalion and regimental OPs and in laying wire lines. If the enemy must move men and supplies through a defile or across a ford, interdiction fire can severely hamper reinforcement and carving parties. Mortar harassment and interdiction fires are usually unobserved, and they require extensive coordination to ensure accuracy and safety. Some may be fired based on recurring patrol reports, aerial sightings, or sensor alerts. Close coordination with field artillery survey teams and target locating radars can greatly increase the effectiveness of mortar interdiction fires.

(2) ***Planned defensive targets and targets of opportunity.*** Defensive fires are planned on all known, likely, and suspected enemy locations. This does not mean that an unmanageable number of targets are planned. Known enemy locations are the first priority, followed by suspected and then likely. As enemy forces appear

near planned targets, mortar fire is delivered on them. Targets of opportunity that appear suddenly are engaged by shifting fires from planned targets.

(3) **Counterpreparation fires.** These are prearranged fires delivered when an enemy attack is imminent. Since the mortar's range is limited (compared to artillery), artillery fires most of the counterpreparation fires. Mortar platoons and sections may fire against enemy forces that are massing near friendly forward positions. Mortar smoke can be fired to obscure the view from suspected enemy OPs. Mortar illumination can be fired to confirm or deny the presence of enemy forces near defensive positions, while not revealing individual weapon's locations. Mortar platoons or sections may provide most, or all, of the countermortar fires since US mortars outrange most Threat mortars and can hit targets in deep defilade.

f. Once the enemy attack begins, mortar fires are delivered to break up the enemy's formations, to suppress and neutralize supporting weapons, and to destroy as much of the enemy force as possible. Targets in relationship to friendly defensive positions are planned as follows:

(1) In front of the position on all confirmed and suspected enemy locations, on likely avenues of approach, and on prominent terrain features that can be used by enemy overwatch elements.

(2) In front of friendly barriers and obstacles. These fires are often critical to the defense. Any obstacle not covered by both direct and indirect fires can be obscured and breached. High explosive with proximity settings can effectively prevent enemy dismounted forces from breaching an obstacle. Mortar fire is preferred for this task since it is always available to the battalion commander. Its use permits the field artillery to concentrate destructive fires against enemy formations backed up behind the obstacle.

(3) On top of the position so that if the enemy penetrates friendly defenses, effective fire can be delivered on him immediately. If the friendly forces are fighting from properly constructed fighting positions, the mortar fire from a proximity-fuzed round, can be placed directly on them to kill the exposed enemy. This is a combat emergency technique since some friendly casualties could still result. Mortar fires planned on friendly positions also aid immediate counterattacks.

(4) Behind friendly positions to provide flexibility to the defense if the enemy surprises the defender by attacking from the rear. They also aid the defender in blunting the enemy penetration, making the counterattack decisive.

g. Fire support for a counterattack is similar to that for the offense, except fire support priorities are divided between the forces still defending and the forces counterattacking.

Mortar platoons may have to provide all or most of the fire support to the defending forces while the artillery supports the counterattack.

5-4. RETROGRADE OPERATIONS

A retrograde operation is an organized movement to the rear or away from the enemy and must be approved by the next higher authority. It may be forced by enemy action or be voluntary. A retrograde operation is characterized by centralized planning and decentralized execution. Unlike the defense, the commander avoids decisive engagement to the extent that maneuver is restricted. A retrograde operation is designed to preserve the integrity of a force until the offense can be resumed. An inherent task is to inflict as much damage on enemy forces as the situation permits. Mortars participate in the retrograde by providing responsive indirect fire support to harass, delay, destroy, suppress, obscure, or illuminate the enemy. (Examples of the types of missions that mortars can expect to fire are listed in the defense section.) Also, the mortar platoon can screen the displacement of the rifle companies and provide deceptive fires to confuse the enemy as to the commander's intent to withdraw or delay.

5-5. MORTAR UNITS SUPPORTING RETROGRADE OPERATIONS

The mortar platoon supporting the delay or withdrawal provides the commander with a quick and effective means to support his maneuver. Mortar fire can be used to screen the movement of friendly units between positions and delay lines, or to suppress enemy weapons so the maneuver platoons can move to break contact without heavy enemy fire. Positioning of ammunition must be planned to allow for an increased use of smoke. Mortar fires may be used to deceive the enemy by maintaining a heavy volume of fire while friendly elements withdraw.

a. Three types of retrograde operations areas follows:

- In the *delay*, space is traded for time. Enemy contact is maintained, but decisive engagement is avoided.
- In the *withdrawal*, the friendly force deliberately disengages from the enemy and moves to the rear. Withdrawal usually follows a delay and can precede a retirement. A withdrawal can be made with or without enemy pressure.
- In the *retirement*, the friendly force is not in contact with the enemy and moves to a secure area.

b. In a delay or withdrawal, the mortar platoon plans its displacement so that it is in position to fire when needed. When and how to displace is based on how far the mortars are behind the forward units, how far to the rear those units will move, and the intensity of enemy contact. The platoon usually displaces by section.

c. In the withdrawal, the mortar platoon can be effective when employed in support of the security force. Employing mortars in split sections allows the mortars to be used in the deception plan and to support withdrawing maneuver elements. An effort must be made

to keep mortar fire at the same level during withdrawal to increase the effectiveness of the deception plan.

d. A section or squad can be attached or placed under OPCON of the security force or detachment in contact. If enemy pressure is great, the entire mortar platoon can be employed to support the disengagement.

CHAPTER 6

MORTAR PLATOON AND SECTION TACTICS, TECHNIQUES, AND PROCEDURES

This chapter presents some mortar platoon and section tactics, techniques, and procedures that have proven to be useful. A tactic or technique that has been successful in the past or is used often may not be appropriate under all conditions of METT-T. The mortar leader must analyze the situation and use his best judgment as to the appropriate course of action. Procedures are closely associated with existing items of equipment and allow less judgment in their execution. The leader must decide when it is appropriate to initiate or terminate a certain procedure. Tactics, techniques, and procedures can be successfully modified to meet the existing METT-T factors.

Section I. EMPLOYMENT TECHNIQUES

*The maneuver commander employs the mortar platoon based on his analysis of the mission, the enemy, the terrain and weather, and the troops and time available. There is no mortar employment option that is routine. Each has both advantages and disadvantages. The **battalion commander** has three options when considering how to use the battalion mortar platoon: by platoon, section, or squad(s). The **company commander** with a company mortar platoon has two options when considering how to use it: by platoon or squad(s). Company commanders with light mortar sections use them as a section, although a single mortar squad may be attached to a rifle platoon for a short time or a specific mission.*

6-1. EMPLOYMENT BY PLATOON

Under this employment option, the platoon operates from one or two firing positions and fires all mortars on each target, under the control of the platoon leader. Even when the mortar platoon is being used as a single firing unit, it can still fire multiple missions simultaneously. It can displace from its firing position either by echelon or as a complete platoon. Platoons with four or more mortars may occupy two separate firing positions. If these positions are up to 300 meters apart, it greatly decreases the enemy's chance of neutralizing them with countermortar fire (Figure 6-1). Generally, four-mortar platoons do not split up but occupy a single firing position. If the platoon occupies two positions, the distance between mortar sections is limited primarily by the ability to cover the target area, the terrain, the enemy threat, and limits in command and control (for example, wire or radio limitations). The key is that all mortars must be able to engage the platoons'

assigned targets. Separated firing positions, if used, must not be so far apart as to prevent the platoon leader from controlling them both. Separating the sections must not prevent massing the fires of the platoon on a single target.

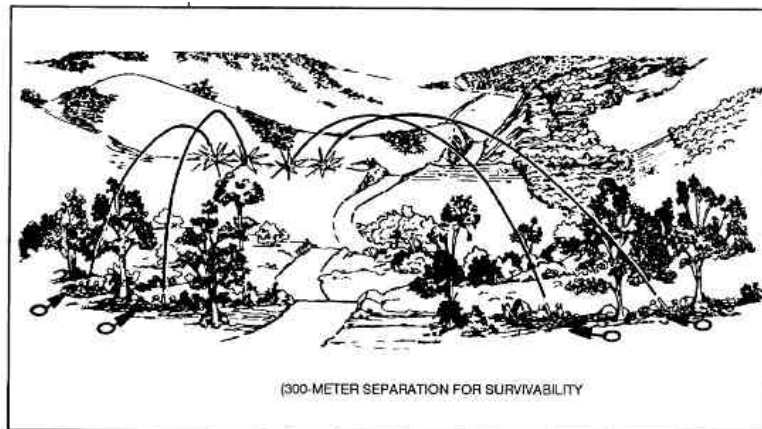

Figure 6-1. Firing locations (300-meter separation for survivability).

a. Massing fires requires the FDCs to compute data for each section on the same target. If speed is essential in engaging a certain target, the FDCs compute the fires of both sections on a single adjusting point. This produces a smaller, more concentrated sheaf in the target area. If a six-round, standard sheaf is required, the controlling FDC adjusts with the innermost mortar of one section onto the adjusting point and computes FFE data (Figure 6-2). The other section FDC plots an imaginary adjusting point at a distance of the bursting diameter, left or right of the fired adjusting point, and computes FFE data based on the imaginary adjusting point. Registration and meteorological data improve the accuracy for the nonadjusted section.

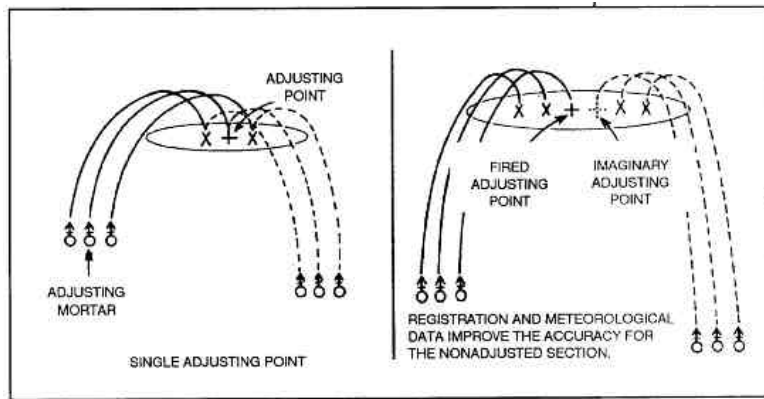

Figure 6-2. Six-mortar standard sheaf.

b. Both sections of the platoon can be located in the same area. This configuration increases the vulnerability of the platoon to being located and destroyed by enemy fire, but it enhances command and control of the platoon and local security.

c. When employed by platoon, one FDC is normally the controlling FDC for the platoon. The controlling FDC is the mortar fire direction net control station. When the sections are firing from the same location, the other FDC follows along or rests to provide for CONOPs. The controlling FDC issues the fire command designating the platoon, a section, or a squad deliver fire. It also identifies the type of ammunition and the number of rounds to be fired.

d. When the sections are separated, each FDC section prepares the firing data for its section. However, one FDC remains as the controlling FDC. If the fire mission requires only one or two mortars to be fired (for example, a smoke or illumination mission), the controlling FDC designates which mortars are to be fired.

6-2. EMPLOYMENT BY SECTION

Section employment places each section as a separate firing unit. Depending on the type of mortar platoon, a section may consist of two or three mortars. Each section acts semi-independently and covers its own targets or sector.

a. The mortar platoon is normally employed by section when it needs to cover wide frontages. Each section is positioned so it can provide fires within the area of responsibility of a part of the battalion. Depending on the range to the target and the separation of sections, more than one section may be able to mass fires on the same target. When employed by section, each section has an FDC or a computer.

b. The sections operate on the platoon's mortar fire direction net. The FIST FOs must request fire from a designated section using that section's call sign. If separate frequencies or wire lines are available, each section may operate on its own fire direction net.

c. The mortar platoon leader and the section sergeant control the displacement of each section. Displacement is coordinated with the movement of the part of the battalion or company that the section is supporting. Since both sections cannot cover the entire sector, they may be moving at the same time.

d. Section employment is more appropriate when the rifle companies operate over wide frontages or move along widely separated axis. It is difficult to control and to support logistically.

6-3. EMPLOYMENT BY SQUAD

Squad employment places one or more mortar squads on the battlefield as separate firing units. This usually supports special requirements such as--

- Security force operations.
- One mortar illumination mission(s).
- Roving mortar adjustment technique.
- Antiarmor ambush or other combat patrol.
- Withdrawals not under enemy pressure (as part of a DLIC).

a. When employed by squad, a fire direction computer from the FDC should accompany the squad. If more than one squad is employed in this manner, it may not be possible to place a fire direction computer with each squad. Therefore, squad leaders must be prepared to compute firing data.

b. An entire mortar platoon may be divided and employed by squads. This is the least desirable method of employment and is used only when the situation or terrain prevents adequate support if otherwise employed. Examples of when it may be necessary to employ the platoon by squads are as follows:

(1) When the supported maneuver element is required to cover a large front such as a battalion task force screening a division's flank.

(2) During rear area combat operations to provide security for critical installations.

These situations may not occur often. If adequate support can be provided by a section, employment by squads should be avoided. Employment by squads reduces the effects on a given target, increases command and control problems, and exposes the mortar squads to destruction by small enemy forces. It is also the most difficult option to support logistically. (Table 6-1.)

<u>EMPLOYMENT OPTION</u>	<u>ADVANTAGES</u>	<u>DISADVANTAGES</u>
Platoon: Intact (one location).	<p>Massing of fires simplified.</p> <p>Most responsive to the battalion commander.</p> <p>Platoon command and control problems are eased.</p> <p>Easiest to support logistically.</p> <p>FDCs can operate 24 hours.</p> <p>Only option for seriously understrength platoons.</p> <p>Most secure against ground attack.</p>	<p>Platoon more vulnerable to counterfire.</p> <p>Positioning may be limited by terrain.</p>
Platoon: Separated (two locations).	<p>Increased survivability against indirect fire.</p> <p>Less restricted by terrain.</p>	<p>Command and control requires more effort.</p> <p>Decreased survivability against ground attack.</p> <p>Possible increase in radio traffic.</p> <p>Massing of fires requires more effort.</p> <p>Logistics require more effort.</p>

Table 6-1. Summary of employment options.

<u>EMPLOYMENT OPTION</u>	<u>ADVANTAGES</u>	<u>DISADVANTAGES</u>
Sections:	<p>Increased survivability against indirect fire.</p> <p>Can cover larger front.</p>	<p>Decreased effects on target (fewer rounds per volley).</p> <p>Command and control more difficult.</p> <p>Logistics more difficult.</p> <p>Increased vulnerability to ground attack.</p> <p>Massing of fires more difficult.</p>
Squads:	<p>Greatest survivability against indirect fire.</p> <p>Cover even larger front.</p> <p>Responsive fire provided to small detachments.</p> <p>Deception efforts aided.</p>	<p>Decreased effects on target.</p> <p>Least responsive to the battalion commander.</p> <p>Most vulnerable to ground attack.</p> <p>Logistics support burden placed on the supported element.</p> <p>Massing of fires extremely difficult.</p> <p>Not enough FDC personnel to go with each squad.</p>

Table 6-1. Summary of employment options (continued).

c. If platoons must be employed by squads, each squad can be attached to the supported maneuver element. The attached squads normally operate on a radio net of the supported unit or as directed by the supported commander. Forward observers request fires from a designated squad using that squad's call sign.

d. If a target is within range of more than one squad, fires may be massed to engage that target. The massing of fires requires more effort due to mortar dispersion and the increased number of radio nets involved. It is neither fast nor accurate.

Section II. RECONNAISSANCE, SELECTION, AND OCCUPATION OF MORTAR POSITIONS

The tempo of the modern battle and the threat of enemy counterfire mean that mortar platoons and sections may have to move often. This frequent movement reduces responsiveness and requires greater reliance on emergency engagement missions. To reduce the time spent displacing, a mortar platoon must be able to do the reconnaissance, selection, occupation, and movement tasks quickly and efficiently. The key to a successful RSOP is frequent and effective training. Accurate position location is a critical element of the computation of firing data. Mortar positions should be verified by position location devices, graphical resection, or hasty survey. Map spotting is the least accurate method.

6-4. DEFINITION

Reconnaissance is the examination of terrain to determine its suitability for use in accomplishing the mortar platoon's mission. A continuous and aggressive reconnaissance is essential to timely and accurate fire support. The platoon leader must continually perform this reconnaissance and plan ahead to meet any contingency. He is given the general location of his new position, or he may select it himself and propose it to the commander.

6-5. METHODS OF RECONNAISSANCE

The three methods by which the platoon leader may conduct a reconnaissance are *map*, *air*, and *ground*. The best reconnaissance is one that uses a combination of all three.

a. **Map Reconnaissance.** Any reconnaissance begins with a map inspection. Potential positions and routes to the new position can be chosen. This method is fast and allows unsuitable routes to be eliminated. It also identifies possible ambush sites. In some combat situations, a map reconnaissance may be the only one possible. There are two major disadvantages to conducting only a map inspection:

- Terrain and other features may have changed--for example, a bridge shown on the map may no longer exist. Military load classifications of bridges are not listed on maps and must be physically inspected.
- The surface conditions of the route and position cannot be determined--for example, the soil texture may not support a mortar carrier or a mortar prime mover.

If available, aerial photographs should be used to supplement maps, because they are more recent, show more detail, and present a clearer picture of the current condition of the terrain to be crossed.

b. **Air Reconnaissance.** If time and resources are available, information gained from an air reconnaissance can be beneficial in selecting routes to be used and areas to be occupied. Although this is a fast method, true surface conditions can be indistinguishable or may appear distorted. The commander or platoon leader must be careful that his flight plan does not compromise the route or the new position area. This method may not be available to the platoon leader in all operations or theaters.

c. **Ground Reconnaissance.** The best method of reconnaissance is the ground reconnaissance since the suitability of routes can be physically examined. The true condition of the terrain is critical if the surface has been affected by enemy action (NBC attack) or weather conditions. The ground reconnaissance has the disadvantage of being the slowest method of reconnaissance.

6-6. PLANNING THE RECONNAISSANCE

To maximize its tactical benefit, the reconnaissance must be thoroughly planned before it is executed. As part of the planning phase for any operation order or RSOP, the factors of METT-T must be considered before any action is taken.

a. **Mission.** The mission is the governing factor in planning the RSOP. The platoon must perform its mission with minimal degradation as a result of tactical or survivability moves.

b. **Enemy Situation.** The current enemy situation must be thoroughly understood. The disposition, intentions, and capabilities of enemy forces must be analyzed before the RSOP, particularly their local capabilities as revealed in current combat information.

c. **Terrain and Weather.** The platoon leader must analyze the routes to be used by the platoon and the time and distance required to make the move. Moving the platoon over long, difficult routes requires well-planned, coordinated movement orders and detailed SOP. The effects of the weather on the terrain to be crossed must be analyzed to facilitate rapid movement. Weather affects visibility (fog, haze) and trafficability (ice, rain-softened ground).

d. **Troops.** The current troop strength must be considered. The mission may not change, but the troops available to accomplish it will. As the other factors of METT-T vary, so will the number of troops needed to perform the mission. Because of casualties and these varying conditions, adjustments must be made during the planning phase.

e. **Time.** The amount of time available for the RSOP will affect all phases of its accomplishment. The time factor will change because of events on the battlefield. Whether minutes or hours are allowed for the RSOP, adjustments must be made.

6-7. RECONNAISSANCE PARTY

The platoon leader or his designated representative performs the reconnaissance. The platoon sergeant and section sergeants should be able to perform a detailed ground reconnaissance. The reconnaissance party should be as small as possible while still able to accomplish the mission. The platoon leader, an NCO, and a driver normally compose the reconnaissance party.

6-8. POSITION SELECTION

With mission accomplishment being the most important factor, mortar firing positions are selected based on the following:

- Mission accomplishment.
- Tactical situation.
- Range.
- Target area coverage.
- Survivability.
- Overhead and mask clearance.
- Surface conditions.
- Communications.
- Routes.

a. **Mission Accomplishment.** Mission accomplishment is the most important factor. The position must permit the mortar section or platoon to accomplish its primary mission.

b. **Tactical Situation.** The platoon leader must understand the tactical situation, the supported unit's mission, and the location of friendly units, and potential enemy threats. By considering the tactical situation, the mortar platoon leader can ensure that the mortar platoon provides effective indirect fire support while maintaining security for the mortars.

c. **Range Criteria.** Maximum and minimum mortar ranges determine whether mortars can support from selected firing positions. Mortars should be able to fire at least one-half to two-thirds of their range to the front of the forward elements of the supported friendly force. These range criteria are only a guide, not inflexible rules. These may vary due to factors of METT-T or due to the commander's guidance. The mortars must be positioned far enough back so that fires can be placed directly in front of and behind the rifle platoon defensive positions. The longer ranges available from the M252 and M120 mortars do not mean platoons equipped with these weapons must be located further to the rear than those with the shorter-ranged M29A1 or M30 mortars. The added range allows the platoon leader flexibility in choosing firing positions. For example, he can fire out of deeper defilade and still cover the battalion (or company's) sector. Positions that place targets at the extreme edge of mortar range should be avoided, if possible.

d. **Target Area Coverage.** Mortar positions should give maximum coverage of the battalion or company frontage. To do this, the mortar platoon leader begins by

considering positions in the center of the sector. Positioning in the center of sector *does not* take precedence over the priority targets or priority of fires that a commander assigns to a specific mortar element. For example, if the mortars must be positioned on a flank to support the company with priority of fire, or a priority target, or because of terrain, then positioning in the center of sector becomes a secondary concern. The mortar platoon leader must choose an area that allows him to cover the company with priority of fires or his priority targets. He then chooses a firing position within that area that maximizes the fires he can provide for the rest of the battalion without reducing support to the priority company. If the priority of fires is planned to change, the mortar platoon leader must either choose a position from which he can cover both units, plan a displacement, or operate by section to cover the other unit.

e. **Survivability.** Mortar crews face many threats on the battlefield including NBC hazards, countermortar fire, and ground and air attacks. These must all be considered when a mortar position is selected. The position should facilitate both active and passive defense measures so it--

- Cannot be hit by direct or low-angle indirect fire (defilade) (Figure 6-3).
- Can be entered without enemy observation.
- Offers good cover and concealment.
- Avoids obvious avenues of approach from the FEBA.
- Has more than one entrance and exit route.
- Takes advantage of existing terrain features and natural obstacles.

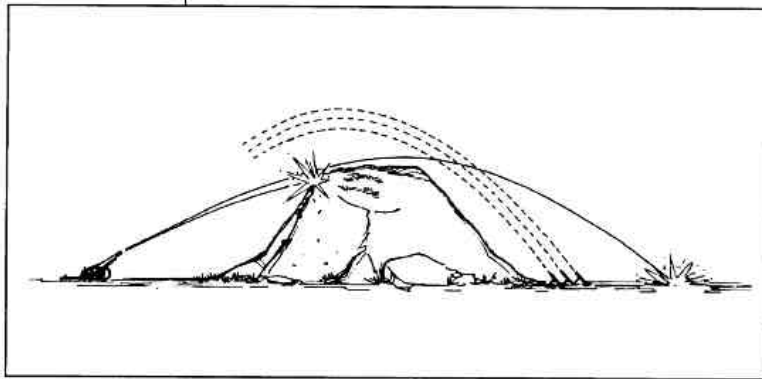

Figure 6-3. Defilade.

f. **Overhead and Mask Clearance.** (Figure 6-4.) Concealing and positioning the mortars should not interfere with their operation.

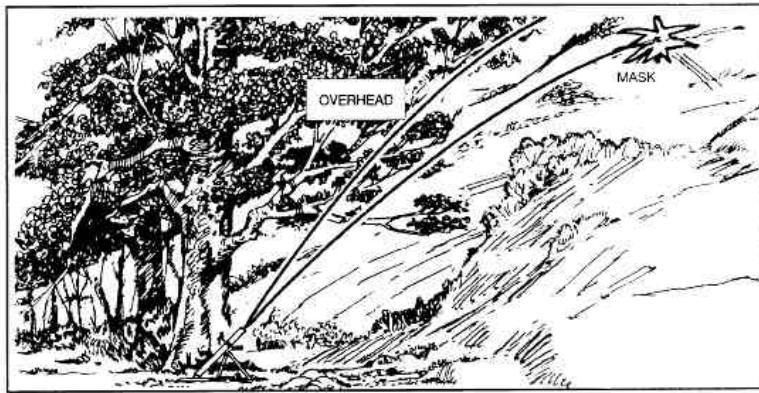

Figure 6-4. Overhead and mask clearance.

(1) Overhead interference is normally caused by trees or buildings. Overhead clearance is checked by putting the mortar into maximum elevation and looking up and along the side of the mortar to estimate a round's line of flight.

(2) Mask interference is to the front of the mortar and could be a hill, building, or tree. Mask clearance is checked by turning the mortar elevation down to the minimum and visually inspecting the clearance from the end of the mortar tube to the front.

(3) If clearance cannot be obtained through the mortar's full-range of elevation, then the FDC is notified of the minimum and maximum safe elevations allowed. The need for overhead and mask clearance must not prevent the mortar platoon leader from selecting positions in deep defilade. If the mission can be accomplished by selecting a firing position in deep defilade with a slightly restricted field of fire, in most cases, that position should be chosen.

g. **Surface Conditions.** The soil at each mortar position must be well drained and firm so that the mortar baseplates do not sink into the soil when the mortars are fired. If mortars are mounted on carriers, the soil must be firm for the carriers to remain stable when mortars are fired. When mortars must be fired on ground that is not stable, firing pads are constructed (see FM 5-103). When the ground is frozen, slots should be chopped into the earth for the baseplate spades, and extra time must be allotted to emplace mortars. When temperatures cycle repeatedly above and below freezing, personnel must ensure baseplates do not become frozen into the earth.

h. **Communications.** The mortar platoon must be able to communicate with the supported unit, and mortar squads must be able to communicate with the FDC.

(1) During reconnaissance, radio checks are made at the position to be occupied.

(2) Maximum effort must be made to protect the platoon from the direction-finding capabilities of the enemy. Direction antennas and maximum use of wire communications reduce the electronic signature of the platoon. If available, a DMD allows the mortar platoon to communicate with FOs through digital messages rather than by voice. This decreases the time needed to send messages.

i. **Routes.** Mortar positions should be close to access routes to speed resupply and displacement. Positioning close to access routes should not prevent concealment. After the reconnaissance has been conducted, an advance party is sent to the initial or next position. If time is limited, reconnaissance may be performed in conjunction with advance party operations.

6-9. ADVANCE PARTY OPERATIONS

The advance party includes a minimum of personnel and equipment needed to prepare a position for occupation. It accompanies the mortar platoon leader, or his representative, and begin preparations when he confirms the firing locations. For either a deliberate or a hasty occupation, a prearranged signal or procedure should be used to alert and assemble the advance party. The signal should be in the platoon SOP, which also lists the personnel, equipment, vehicles, and place of assembly.

a. The platoon leader determines the exact composition of the advance party on the basis of the tactical situation and assets available. Table 6-2 lists some assets needed for the advance party. This composition will not fit all mortar platoons and situations.

<u>PERSONNEL</u>	<u>EQUIPMENT</u>
Platoon leader, platoon sergeant, or section sergeant.	Vehicle with radio, map, compass, binoculars, chemical and nuclear detection equipment, and GPS if available.
FDC computer.	Map, grid sheet, overlay paper, coordinate scale, and protractor .
Radio telephone operator.	A declinated aiming circle, field telephone commo wire, minefield, and NBC warning signs.
Guide from each mortar squad.	M23 MBC, M16 plotting board, TFTs, and updated/weapon location data card.
	Marking stakes with tape and hammer.
	Axes, shovels, aiming posts with lights, and flashlights.

Table 6-2. Typical advance party personnel and equipment.

b. Table 6-3 lists the primary duties of advance party personnel. This table does not list all possible tasks to be performed, but it does serve as a starting point for advance party SOP. If a mortar accompanies the advance party, it can be laid and registered while the remainder of the platoon is moving.

<u>JOB</u>	<u>RECONNAISSANCE PHASE</u>	<u>SELECT/ORGANIZE PHASE</u>	<u>OCCUPATION PHASE</u>
Platoon Leader	Conduct map reconnaissance.	Select primary position for occupation.	Supervise and or direct occupation.
	Select primary and or alternate routes and checkpoints.	Determine azimuth of fire.	Reconfirm map location.
	Determine order of march.	Conduct hasty survey or map spot.	
	Brief key personnel and advance party.	Make plan for occupation.	
	Conduct ground reconnaissance.	Designate mortar, FDC, and aiming circle locations.	
Platoon Sergeant or Section Sergeant	Assist platoon leader on reconnaissance.	Plan defense.	Direct security defense.
	Assemble advance party.	Select vehicle positions (if necessary).	Lay mortars.
	Supervise security.	Supervise security sweep.	
		Set up and or orient aiming circle.	
		Determine initial deflection.	
	Brief guides on occupation plan.		

Table 6-3. Primary duties of advance party personnel.

<u>JOB</u>	<u>RECONNAISSANCE PHASE</u>	<u>SELECT/ORGANIZE PHASE</u>	<u>OCCUPATION PHASE</u>
Platoon Leader's Driver	Help in radio communication during security sweep.	Help in security sweep. Lay wire to aiming circle and FDC. Monitor NBC detection equipment. Position chemical agent detector upwind of selected position monitor.	Guide platoon from release point, if necessary. Guide vehicles into area, if necessary.
FDC Guide	Help in security measures.	Help in security sweep. Lay wire to FDC position. Record initial deflection, azimuth, and location. Initialize data base in M23 MBC. Reconnoiter route from release point to section position.	Meet section at release point, and guide it to assigned position.
Mortar Guides	Help with security during movement.	Help in security sweep. Prepare section position. Record initial deflection, and pass it to the squad leader upon occupation. Reconnoiter route from RP to section. Lay wire to the FDC.	Meet squad at release point, and guide it to assigned position. Align on azimuth of fire and give gunner initial direction.

Table 6-3. Primary duties of advance party personnel (continued).

c. In some instances, a complete mortar squad may be in the advance party. It should become the base mortar at the new firing position.

d. The equipment required to prepare a new position should be identified, maintained, located and loaded on prescribed vehicles.

e. The advance party also--

(1) Verifies and marks the route (with engineer tape, signs, lights, aiming posts, or road guides), as needed. If the tentative routes are determined to be unsuitable, the advance party leader contacts the remainder of the platoon and reports.

(2) Checks cover and concealment. This ensures that tentative routes and positions have the best cover and concealment.

(3) Locates and marks minefields and obstacles, as time allows. (See FM 20-32 for details on minefields marking.) It reports the discovery of minefields to the battalion TOC, and mortar leaders mark these areas on their maps. SOPs must prescribe actions taken when minefields are encountered.

(4) Uses NBC detection equipment during movement to detect contaminated areas. It reports the location of all contaminated areas. It marks the locations of contaminated areas on maps and alters the route of the displacing element.

(5) Determines and reports the time required to displace to the next position.

(6) Verifies tentative emergency occupation positions along the route selected during map reconnaissance. It informs the displacing element of any changes in the suitability of these positions.

f. After the reconnaissance, the advance party occupies the new mortar position. It prepares the position to the maximum extent possible before the main body arrives. The main body continues to improve the original position.

6-10. OCCUPATION

The advance party starts the occupation of the new firing position and works continuously until the main body arrives. Occupation by the main body is therefore a continuation of the actions by the advance party

a. The advance party starts the occupation by--

(1) Verifying the position location.

(2) Checking the position and surrounding areas for mines, NBC contamination, and enemy forces.

(3) Establishing local security and OPs.

(4) Marking mortar positions with stakes or lights (Figure 6-5).

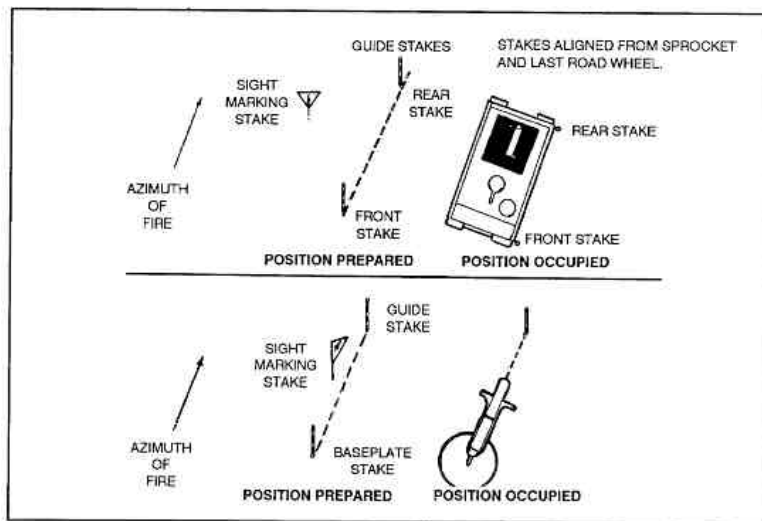

Figure 6-5. Marking positions.

(5) Setting up the aiming circle and determining the azimuth of fire. The advance party identifies the direction of fire with direction stakes.

(6) Completing a rough lay of the mortar positions, if time allows. This method is useful for night occupations. (Figure 6-6.)

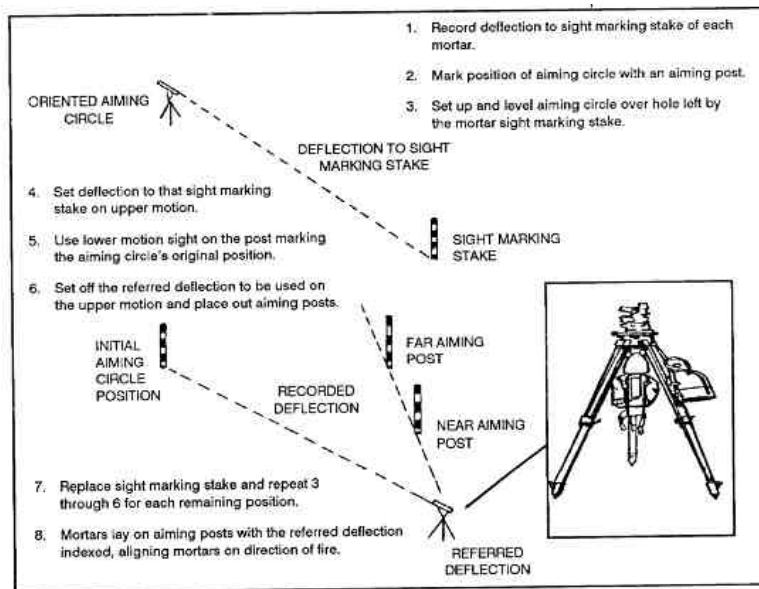

Figure 6-6. Rough lay of mortar position.

(7) Marking entrances to and exits from positions.

(8) Upon arrival, guiding the displacing element into position(s). The FDC is positioned near the middle of the formation to allow FDC members to announce fire commands to the mortars by voice, if necessary. However, wire is the primary means of communication between the FDC and mortars.

(9) Laying the mortars and wire. The MBCs or plotting boards should already be prepared.

(10) Determining and clearing mask and overhead obstructions.

(11) Improving security and defensive measures.

(12) Erecting camouflage or cutting and arranging it.

(13) Digging in the positions.

(14) Preparing alternate and supplementary positions, as time permits. It continually improves the positions until the mortars displace.

b. Before moving, the mortar platoon leader ensures that the following tasks are accomplished:

- (1) Headquarters is informed of the move.
- (2) The platoon position is inspected for documents, overlays, or anything else that may compromise security.
- (3) Obstacles and mines are retrieved.
- (4) Early warning devices (trip flares, platoon early warning system) are retrieved.
- (5) Communication wire is retrieved.
- (6) Personnel at the OPs are ordered to return to the position.
- (7) If carrier-mounted mortars were dismounted, they are remounted on the carriers.
- (8) Ammunition that cannot be moved is fired (if the tactical situation permits).
- (9) The MBC is initialized for the next firing position (if known).
- (10) Mortars are ordered out of action.
- (11) Time permitting, dug-in positions are filled in and camouflaged.

6-11. MOVEMENT BRIEFING

Before leaving to reconnoiter the new position, the platoon leader briefs key personnel on movement information.

a. As a minimum, the movement briefing should contain the following information:

- (1) ***Situation.***
 - Enemy situation: Rear area activity, major avenues of approach, air activity, and potential ambush sites.
 - Friendly situation: Changes in tactical missions and locations of friendly maneuver units and supporting artillery.
- (2) ***Mission.*** Changes in the mission of the maneuver unit.
- (3) ***Execution.***

- Concept of the operation. General location of the platoon positions, azimuth of fire, routes, order of march, location of SP and RP, and times.
- MOPP status.
- Areas of known chemical or nuclear contamination.

(4) **Administration and logistics.** When and where to feed personnel, priority for maintenance recovery, ammunition resupply, and refueling location.

(5) **Command and signal.**

- Command: Changes in the location of the CP and the location of the commander.
- Signal: Movement radio frequencies, net control restrictions, and signals for immediate actions at the halt and during movement.

b. After being briefed by the platoon leader, the FDC chief briefs the remaining key personnel on the following:

- Tactical situation.
- Routes to be used.
- Any anticipated problems.
- Movement (SP) time.

6-12. NIGHT OCCUPATIONS

Night occupations present special problems of command and control. The limited visibility makes almost every task associated with position occupation harder to accomplish. To conduct efficient night occupations of firing positions, the mortar platoon leader must establish a detailed SOP and train his platoon in its use.

a. The use of wire communications is more important at night than during daylight occupations. Wire ends must be clearly tagged to prevent confusion.

b. Guides must be thoroughly briefed and should pace the routes to and from the platoon's different elements before and after darkness. They should have filtered flashlights to guide the vehicles.

c. Color coding of individual squads or sections facilitates identification during night operations (for example, first squad-blue, second squad-red, third squad-yellow, and fourth squad-green).

d. Light discipline must be maintained. Chemical lights are useful during night occupations, but their use must be standardized and controlled.

6-13. TYPES OF OCCUPATION

The three types of occupation are deliberate, hasty, and emergency.

a. A *deliberate* occupation is one that has been planned and has the advance party precede the platoon to conduct extensive preparation of the new position. A deliberate occupation may take place during daylight hours following a daylight operation, at night after a daylight preparation, or at night following a nighttime preparation. Only the minimum number of vehicles and personnel should go forward. Too much activity during preparation risks compromise. When the tactical situation allows, a good procedure for deliberate occupations of a new position is to do the preparation before darkness and to move the sections by night. Deliberate nighttime occupation following a nighttime preparation is often necessary, but it can be time-consuming.

b. The *hasty* occupation is also planned. It differs from the deliberate occupation mainly in the amount of time available for preparation by the advance party. A hasty occupation may be necessary because of rapid combat operations or unforeseen circumstances. The advance party or the reconnaissance party may be able to accomplish some site preparation such as orienting the aiming circle and initializing the MBC.

c. An *emergency* occupation results when a call for fire is received while the platoon is making a tactical movement. It requires the mortar platoon or section to occupy the first available location without any prior site preparation (see Appendix G).

6-14. DELIBERATE OCCUPATION

A guide meets the platoon at a pickup point and leads the vehicle to the entrance of the position area. There the vehicle guides are waiting to lead the vehicles to their selected locations.

a. Each guide aligns his carrier on the azimuth of fire or leads the mortar squad vehicle to a position near the firing point, and gives the initial deflection to the gunner.

b. Previously laid wire lines are used to establish communications to the aiming circle operator and FDC.

c. The platoon sergeant implements the security and defense plan as personnel become available.

d. Other considerations for night occupations are as follows:

(1) Light discipline must be practiced. Proper preparation for a night occupation minimizes the need for lights. Vehicle blackout drive and blackout marker lights should be turned off as soon as the ground guide begins to lead the vehicle into position. During the laying process, only the aiming circle and the weapon being laid should have any night lights on.

(2) Noise discipline is most important, since noise can be heard at much greater distances at night.

(3) The time for occupation is increased.

(4) Each vehicle guide should know where his vehicle is in the order of march so the platoon can move smoothly into position without halting the column.

(5) Filtered flashlights are used to lead the vehicles.

e. Vehicles will not move *within* the position without a guide.

6-15. HASTY OCCUPATION

In a day or night hasty occupation, the platoon requires more time to occupy. This is because some preparatory tasks cannot be completed during the limited time available for the reconnaissance and selection phase. This may result in the following:

- Delay in getting the vehicles off the route of march.
- Laying by voice.
- Increased laying time, since guides might not have aligned the stakes on the azimuth of fire or obtained initial deflections.
- Increased FDC preparation time, because not all initial update/weapon location data will be available.

6-16. SUSTAINMENT

Once the occupation is completed and the platoon is ready to answer calls for fire, sustainment begins.

a. Sustaining actions are continuous and performed in the priority determined by the platoon leader. These actions include the following:

- Improve position defense plans.
- Improve camouflage.
- Bury or raise wire lines overhead.
- Harden positions.
- Perform maintenance.
- Rehearse.
- Cross train.
- Resupply.
- Complete position area survey.

b. Care must be taken in the way ammunition is resupplied and vehicles are refueled, particularly in tracked mortar platoons. These activities can reveal the location of the platoon. If possible, these tasks should be accomplished at night.

c. The advance party should always be prepared to leave at a moment's notice

Section III. DISPLACEMENT PLANNING

After he considers the scheme of maneuver and the commander's guidance, the mortar platoon leader develops a displacement plan based on his part of the fire plan. The displacement plan normally includes a map overlay that shows initial positions and subsequent positions. If time permits, the platoon leader selects and includes alternate and supplemental positions. The displacement plan also includes routes to be taken between positions and any pertinent control measures to support a specific operation or for a specific time (Figure 6-7).

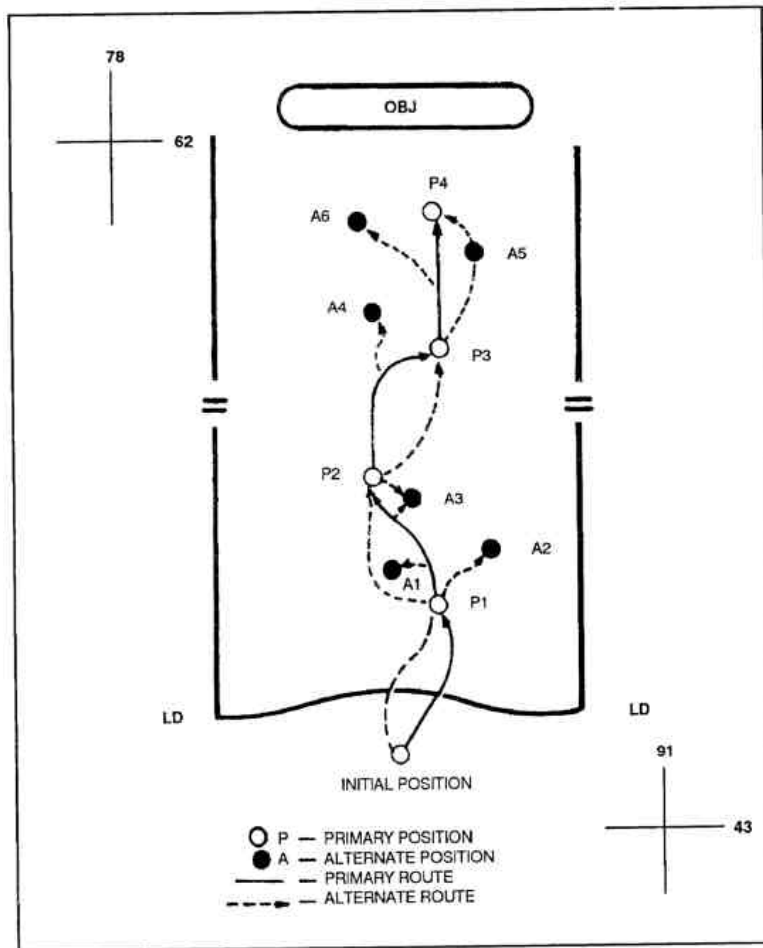

Figure 6-7. Example mortar displacement overlay.

6-17. DISPLACEMENT TIMING

The battalion or company commander controls the displacement of the mortar platoon in one of two ways:

a. He can direct the mortar platoon to displace only on order, which is the most restrictive way to control displacement. The battalion commander himself orders the platoon to displace or directs the operations officer or FSO to relay the order.

(1) The mortar platoon leader is responsible for keeping the battalion TOC informed of his status. At a minimum, he reports whenever his fires are falling beyond two-thirds of the maximum range in the offense or less than one-third of the range in the defense. These reports help the commander make timely decisions about mortar displacement. The platoon leader keeps himself informed of the combat situation so he can anticipate the order to displace and be prepared to execute it. If the mortar platoon leader feels he must displace, he informs the commander of the situation and requests permission.

(2) If the mortar platoon leader loses total communications with the TOC, he uses his best judgment about when to displace. He tries all possible means to reestablish communications with the TOC or its designated alternate.

(3) If he cannot reestablish contact, the mortar platoon leader changes to the command frequency of the company (or platoon) having the priority of mortar fires to reestablish his link to the battle. He must play an active role in keeping the lines of communication open to maintain effective fires.

b. He can direct the mortar platoon leader to displace whenever certain predetermined events occur. This is less restrictive for the mortar platoon leader, but it reduces the flexibility of the battalion or company commander

(1) An event-oriented displacement plan is established based on a time schedule, planned phases of an operation, the crossing of designated phase lines, or the receipt of code words signifying some event. Whatever events are chosen, the mortar platoon leader anticipates the one most likely to happen next and is ready to execute the displacement plan immediately. He monitors communications to learn when a specified event occurs. If he loses communications, he actively seeks information as to the course of the battle once communication is restored.

(2) When the situation changes and the platoon leader feels he must displace out of order with events, he informs the TOC and requests permission. If communications are lost, he makes a judgment. He always seeks to take whatever action is needed to keep the mortar platoon in range and in communication with the supported maneuver elements.

6-18. DISPLACEMENT PLANS DURING OFFENSE, DEFENSE, AND RETROGRADE OPERATIONS

The rapidly changing conditions of modern ground combat require the mortar leader to always be prepared to displace. Detailed displacement planning aids in providing immediately responsive fires.

a. To support *offensive* operations, a displacement plan must permit rapid displacement of the mortars and immediate fire support when needed. It must be flexible to allow for changes in the scheme of maneuver. The enemy situation, the distance to be covered, and the requirement for continuous fire support determine the number of mortars to be moved at one time and the displacement technique.

b. A *defensive* displacement plan has the same requirements as an offensive plan. Also, the platoon leader plans for extensive use of alternate and supplementary positions. He also anticipates future operations and plan displacements to assume the offense or to conduct a retrograde operation. (The same factors affecting the displacement in the offense apply to the defense.)

c. In *retrograde* operations, initial employment of mortars may be by platoon or section, depending on the situation and front to be covered. Displacement is planned to provide continuous mortar fire support throughout the operation. Plans should include designated locations for prestocking ammunition, when possible. Close coordination and communication with supported elements ensure that displacement is planned and timed to allow the mortars to move in advance of maneuver elements. Therefore, maneuver element's movements are covered, which prevents mortars from being left behind.

d. After a tentative displacement plan has been developed, the advance party conducts a reconnaissance to verify routes and positions. It then departs to perform actions that aid displacement and occupation by the displacing element. At the new position, the advance party prepares the position for occupation to the maximum extent possible until the displacing element arrives.

e. After the displacement plan is finalized, copies of the overlay are distributed to the commander or operations officer, the FSO, the platoon and section sergeant, or the FDC chief. This plan is used to help control the movement of mortars. As the tactical situation and mission change, the displacement plan is updated. Often these changes are the result of the reconnaissance.

Section IV. DISPLACEMENT TECHNIQUES

The maneuver commander's OPORD provides the mortar platoon leader the needed information and guidance for deciding which of the three techniques to employ. The displacement technique used for a particular operation depends on the factors of METT-T. They are as follows:

- Scheme of maneuver of supported unit.
- Enemy activity
- Trafficability of terrain.
- Number of sections/mortars in the platoon.
- Availability of supporting artillery.
- Time available.

6-19. DISPLACEMENT BY PLATOON

Displacement by platoon is used when there is little immediate likelihood of enemy contact or when artillery can provide adequate support during displacement. This technique requires the platoon to displace all of its mortars in one move. This is the fastest way to displace the platoon; however, the platoon cannot provide immediate responsive fire support while moving. If the platoon must fire during movement, it uses emergency techniques of engagement. Movements from the assembly area to the initial firing position are almost always by platoon.

6-20. DISPLACEMENT BY SECTIONS

This technique requires one section to remain in position while the other section moves. When the displacing section is in position and ready to fire, the remaining section displaces. Depending on the platoon's organization, each section displaces with a portion of the platoon FDC or with its organic FDC. Displacing by sections is accomplished when continuous fire support from the mortars is required. Since one section must be ready to provide fire support while the other section moves, this technique is slower than displacement by platoon. Displacement by sections is used more often by platoons with four or more mortars. Small platoons rarely form one-gun sections for displacement.

6-21. DISPLACEMENT BY SQUAD(S) OR SECTION(-)

This technique is similar to displacement by sections except less mortars are involved. It is usually employed by platoons or sections with two or three mortars. In two-mortar platoons/sections, displacement involves displacing one mortar while the other provides continuous support. In three-mortar platoons/sections, one or two mortars remain in place while one displaces.

- a. When mortars are in position and ready to fire, either one or both remaining mortars are displaced. When possible, part of the FDC is sent with the displacing squad(s), or a squad leader is sent with an M16 plotting board, who serves as the temporary FIX.
- b. When displacing by sections or squad(s), successive or alternate bounds can be used (Figure 6-8). Alternate bounds are normally used when displacement must be rapid in order to stay up with supported elements. Successive bounds are used when the maneuver element's movements are not so rapid such as in defensive or retrograde operations.

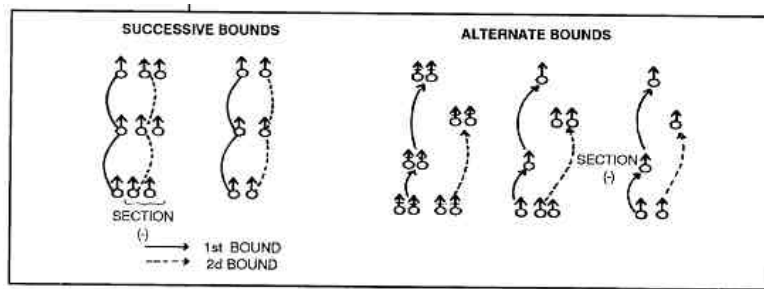

Figure 6-8. Types of bounds.

Section V. MOVEMENT

Because of their weight, heavy mortars are usually moved by vehicle. Medium mortars are both hand carried and moved by vehicles. The light mortars of the dismounted infantry company are usually hand carried. Mortar platoons or sections move independently or as part of a larger unit.

6-22. INDEPENDENT MOVEMENT

The mortar platoon normally moves as part of a larger group, but it may move independently for short distances.

- a. When moving dismounted, the mortar platoon employs the same dismounted movement techniques as other infantry squads: traveling, traveling overwatch, or bounding overwatch. Bounding overwatch is not often used because the mortar platoon or section does not normally seek to make dismounted contact with the enemy.
- b. When moving mounted, the mortar platoon leader has several options for moving the platoon in a tactical configuration. Each option has specific advantages and disadvantages. The platoon leader decides which method is best for the existing METT-T conditions.

6-23. OPEN COLUMN

The platoon uses the open column road movement for daylight movements when there is an adequate road network that is not overcrowded, when enemy detection is not likely, when time is an important factor, and when considerable travel distance is involved. Vehicle interval in an open column is about 100 meters.

- a. Advantages of this method are as follows:
 - Speed (the fastest method of march).
 - Flexible.

- Reduced driver fatigue.
- Improved vision on dusty roads.
- Fewer accidents.
- Ease in dispersing vehicles as a passive defense measure against an air attack.
- Less chance of the entire platoon being ambushed.

b. Disadvantages of this method are as follows:

- Greater column length requires more road space.
- Other traffic often becomes interspersed in the column.
- Communication within the column is complicated.
- Proper vehicle spacing is hard to maintain.

6-24. CLOSED COLUMN

For closed column movement, the vehicle interval is less than 100 meters. At night, each driver can observe the cat's-eyes of the blackout markers on the vehicle in front of him and maintain an interval of 20 to 50 meters. During daylight, the platoon uses closed column when maximum command and control is needed—for example, during limited visibility or when moving through built-up or congested areas.

a. Advantages of this method are as follows:

- Simplicity of command and control.
- Reduced column length.
- Concentration of defensive firepower.
- Full traffic capacity of the road can be used.

b. Disadvantages of this method are as follows:

- Column is vulnerable to enemy observation and attack.
- Quick dispersion is difficult.
- Strength and nature of the column are quickly apparent to enemy observers.
- Convoy speed is reduced.
- Driver fatigue increases.
- May cause congestion at point of arrival.

6-25. INFILTRATION

When the platoon moves by infiltration, it dispatches vehicles individually or in small groups without reference to a march table. This technique is time-consuming, and the vehicles are difficult to control. The platoon uses it when the enemy has good target acquisition means and quick reaction capabilities.

a. Advantages of this method are as follows:

- Least vulnerable to hostile observation.
- Ideal for covert operations.
- Provides passive defense against air and artillery attack.
- High speeds are possible.
- Deceives the enemy as to the size of the infiltrating force.
- Does not hinder cross traffic.

b. Disadvantages of this method are as follows:

- It is difficult to command and control.
- Individual vehicles may get lost.
- Small elements are more vulnerable to ground attack.
- It is time consuming.

6-26. TERRAIN MARCH

The terrain march is an off-road movement. A platoon or section using this type of movement should travel close to tree lines, along gullies, and close to hill masses. A terrain march should be conducted when enemy observation or interdiction by artillery fire or air attack is likely. A platoon may move safely on a road for some distance and change to a terrain march at a point where enemy observation becomes likely or vehicle congestion provides the enemy an inviting target.

a. Advantages of this method are:

- The strength and nature of a column are difficult to determine.
- Traffic is avoided.
- Passive defense against air and artillery attack is provided.

b. Disadvantages of this method are:

- Displacement time may be increased.
- Ground reconnaissance is required.
- Soil conditions may complicate movement.
- Improper movement leaves wheel or track marks to the new position.
- Extensive coordination is required to avoid traveling through other unit areas.

c. The platoon using the terrain march may move in open column, in closed column, or by infiltration. Also, it can displace either as a unit or by echelon. If the mortar platoon (or section) can move in a formation similar to a standard firing formation, this speeds emergency fire missions.

6-27. MOVEMENT ORDERS

The details given in a movement order depend on the time available, the tactical situation, and traffic conditions. The order may be supplemented by strip maps, sketches, and

march tables. The main items in a movement order are based on the commander's or platoon leader's reconnaissance.

a. Situation.

b. Mission.

c. Execution.

(1) Destination.

(2) Organization, to include order of march and composition of the column.

(3) Instructions to the main body, to include start point, checkpoints, designated rally points, release point, times for arrival at and clearance of these points, rate of march, route of march, order of march, and review of immediate actions to take in case of trouble.

d. General Instructions. These include restrictions on use of roads, maximum speed of march units, catch-up speeds, alternate routes, detours, use of lights, and any special instructions regarding march discipline or defense against air or ground attack.

e. Command and Communications Instructions. These include the use of radios, messengers, flags, whistle or horn signals, pyrotechnic signals, and arm-and-hand signals.

6-28. LOAD PLANS

A load plan prescribes efficient loading of personnel and equipment for movement. Each vehicle should have one. A good load plan ensures a squad will move into the new position with all its equipment and that the equipment most essential to the mission is loaded last. It should be recorded and graphically portrayed. All load plans between like sections within the same battalion should be identical.

6-29. MOVEMENT PREPARATION

When the command PREPARE TO MARCH ORDER is given, everything possible will be accomplished to quickly displace. However, these actions must not hamper the ability to continue to deliver fire. Actions may include, but are not limited to, the following:

- Stow squad and section equipment.
- Upload all ammunition.
- Stow camouflage nets.

6-30. ORGANIZATION OF THE PLATOON COLUMN

The organization of the platoon column varies according to the tactical situation, the threat, the position area to be occupied. The following points should be considered

- a. If feasible, there should be two air guards for each vehicle. One scans the sky forward of the vehicle while the other scans the sky rearward.
- b. Machine guns and light automatic weapons should be distributed evenly throughout the column. They should be aimed alternately to the left and right sides of the route of march.
- c. SOP should specify that some personnel fire on full automatic or three-round burst and that some personnel fire on semiautomatic to maintain continuous fire.
- d. The NBC detecting and monitoring equipment should be located with the lead vehicle of the convoy. The platoon could upgrade its MOPP level during movement.
- e. Unarmed or lightly armed vehicles should be positioned in the column where they can best be protected by more heavily armed vehicles.

6-31. MARCH DISCIPLINE

Officers and NCOs ride where they can best control the march. The senior person in each vehicle is responsible for ensuring that all orders concerning the march are carried out. Key personnel should disperse throughout the column to preclude loss of too many of these personnel as a result of enemy action. Also, each vehicle commander must watch for signs, markers, signals, and other traffic.

- a. The column must keep moving. The platoon leader should designate a soldier to pick up mission-essential personnel and equipment if a vehicle breaks down. In most cases, the driver stays with the vehicle. If the disabled vehicle cannot be repaired in a reasonable time or recovered by the platoon, the position and condition of the vehicle are reported to the commander for recovery.
- b. The objective of march discipline is to ensure full cooperation and effective teamwork by march personnel. Teamwork includes the following:
 - (1) Immediate and effective response to all signals.
 - (2) Prompt relaying of all signals.
 - (3) Obedience to traffic regulations and control personnel.
 - (4) Use of cover, concealment, camouflage, dispersion, blackout precautions, smoke, and other protective measures against air, armor, and NBC attack.

(5) Maintenance of the correct speeds, positioning, and between vehicles within the column.

(6) Ability to recognize route-marking signals and signs.

6-32. CONVOY CONTROL MEASURES

Predetermined signals should be established to aid in convoy control. Colored flags in daylight, and flashlights or chemical lights at night can aid in simple but important communications within the column.

a. The *start point* is normally a geographical feature identifiable on the ground and on a map. The first vehicle of the convoy must cross the start point at the specified start time. The commander or platoon leader determines the route to the start point and the time needed to get there. If the platoon displaces part of a battalion move, the *start point* is also the point at which the battalion assumes control of the marching element.

b. Normally, a *checkpoint* is a geographical feature identifiable on the ground and on a map. It is used in reporting progress along the route of march and may be used as a target when planning fires in defense of the convoy.

c. Normally, the *release point* is a geographical feature identifiable on the ground and on a map. The last vehicle of a convoy must cross the RP at the specified time. The platoon leader determines the route from the RP to the new position area. If the platoon displaces as part of a battalion move, the RP is also the point at which the platoon regains control of the marching element. The platoon leader may send a guide from the advance party to the release point to lead the squads into the new position area.

d. A *pickup point* is a location within the position where the guide meets the mortar squad and leads it into position.

e. Normally, a *rally point* is a geographical feature identifiable on the ground and on a map. It is used as a point of assembly and recovery from dispersion due to enemy attack. The designated rally point(s) should be located near or on the alternate route to the new position.

f. Marking the route aids in the move. A *route-marking detail* posts signs at those critical locations where elements of the march might make a wrong turn. (Details concerning traffic control and route marking are in FM 19-25 and FM 55-30.)

6-33. HALTS

Halts should be planned before movement begins. Unscheduled halts should be avoided, but when needed, they must be kept short.

a. During administrative marches, halts are made at regular intervals or at selected sites to rest personnel, to service the vehicles, and to check the loads. Normally, halts are not scheduled for short tactical marches.

b. Wooded areas, built-up areas, or winding sections of road should be selected as halting places during extended vehicle marches. These locations provide concealment and do not present a straight line of vehicles for attack by enemy aircraft. Platoons should avoid stopping near crossroads, railroads, and other easily identifiable reference points.

6-34. MARCH COLUMN CONTINGENCIES

A mortar platoon is vulnerable to enemy fire while moving.

a. **Immediate-Action Procedures.** Preplanned immediate actions can decrease vulnerability. In establishing immediate action procedures, the platoon leader should consider the following:

- (1) The enemy situation --what he expects to be attacked with.
- (2) His organic resources for countering the different types of attack.
- (3) The nonorganic support available for countering attacks.
- (4) The type of communications to be used with the immediate actions--flags, radio, arm-and-hand signals, and so forth.
- (5) How best to neutralize the attack.

b. **March Column Under Artillery Attack.** The immediate action in defense against hostile artillery fire is to move out of the danger zone, to report the situation to higher headquarters, and to continue the mission. If a platoon expects hostile artillery fire during the march, it can reduce its vulnerability by moving--

- By open column or infiltration.
- Under the cover of darkness or during other periods of reduced visibility.
- By terrain march.

c. **March Column Under Air Attack.** During an air attack all available personnel should engage the aircraft immediately. Following the example of the convoy commander, the column either increases speed and interval or halts. If the column halts, vehicles should disperse alternately off both sides of the road.

d. **Roadblock.** If a roadblock halts a platoon, the maximum amount of firepower available, including direct lay, should be placed immediately on and on both sides of the roadblock. If the roadblock cannot be neutralized, the platoon must try to disengage.

Upon disengaging, the platoon should meet at a designated rally point, render a SPOTREP, and resume its march by an alternate route.

Section VI. MORTAR SECTION AND PLATOON FIRING FORMATIONS

The mortar platoon or section leader must always consider METT-T factors when he decides the firing formation for his mortars. The main emphasis must be on mission accomplishment, but the factors of METT-T will also affect the choice of the firing formation. The platoon leader always considers the appropriate amount of dispersion, the need for position hardening and available camouflage and concealment.

6-35. TERRAIN MORTAR POSITIONING

When the threat of enemy counterfire and aerial attack is high, the platoon leader should consider dispersing the mortars over a larger area. He should maximize the use of natural cover and concealment offered by the local terrain. This type of dispersal, without regard to any set distance between mortars or effects on a parallel sheaf, is called *terrain mortar positioning*. This requires the computation of corrections by the FDC in order to fire a standard sheaf (Figure 6-9). The time required to compute these corrections decreases the responsiveness of the mortars from a given location, unless the terrain mortar position corrections (TMPCs) can be computed before occupation of the position. Since mortars move often, computing such corrections before occupation may be impossible. The modified version allows the platoon to use a form of terrain mortar positioning that does not decrease mortar responsiveness. A detailed discussion of terrain mortar positioning and how to complete DA Form 5424-R, Terrain Mortar Position/Special Corrections Worksheet, (Figure 6-10) can be found in FM 23-91. (A blank reproducible copy of this form is located in the Blank Forms section of this manual.)

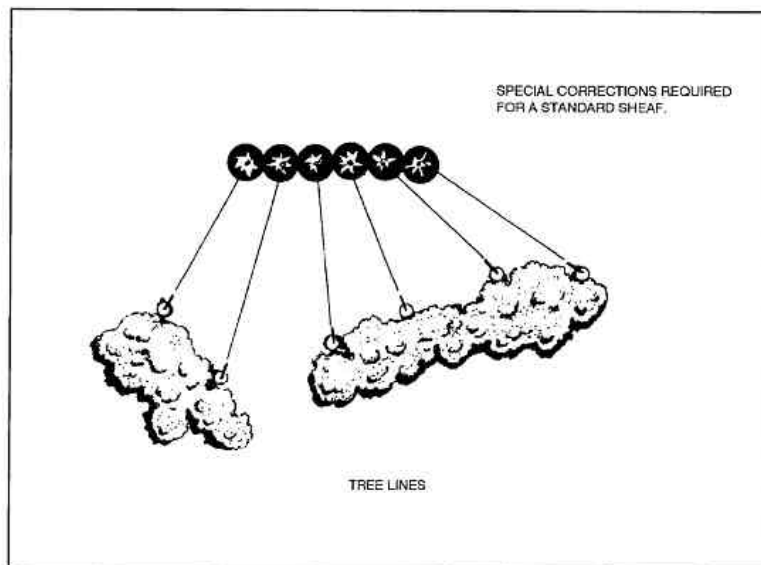

Figure 6-9. Terrain mortar positioning.

TERRAIN MORTAR POSITION/SPECIAL CORRECTIONS WORKSHEET									
SECTOR: LEFT <u>REAR</u> RIGHT		TRANSFER LIMITS					CHARGE ELEVATION OR <u>0900</u>		
CENTER DEFLECTION - 300m		DF	3000	2800	2600	DF	CENTER DEFLECTION - 300m		
CENTER RANGE - 3000M		CR	2500 (MAXIMUM)	4500	6500 (MAXIMUM)	CR	CENTER RANGE - 3000M		
① MORTAR NO	② CORRECT TO BULLET LINE NO.	③ POSITION LATERAL CORRECTION (L or R)	④ 100-YD BUL. CONVERSION TABLE PHYSICIAN'S RANGE	⑤ POSITION DEFLECTION CORRECTION (L or R)	⑥ POSITION RANGE CORRECTION (L or R)	⑦ CORRECTED RANGE (CR) PLUS CENTER RANGE	⑧ FINE SETTING	⑨ POSITION TIME CORRECTION (MINUTE PER CENTER RANGE)	
		≈ 3M	≈ 1m	≈ 1m	≈ 10M	≈ 10M	0.1, FB	0.1, FB	
1	1	L50	23	L12	-30	4470	32.5	-0.1	
2	2	L20	23	L5	-30	4470	32.5	-0.1	
3	3	0	23	0	0	4500	32.6	—	
4	4	0	23	0	+40	4540	32.8	+0.2	
5	5	R15	23	R3	+70	4570	32.9	+0.3	
6	6	R25	23	R6	+20	4520	32.7	+0.1	

LEGEND:
 100-Y: Number of rods required to make the scale of the round 100 meters for a specified range.
 F: Forward.
 B: Backward or Back.
 0.1, FB: Fine Setting Incentive.
 Corresponding to.
 In The Same.

DA Form 5424-R, May 85

Figure 6-10. Example of completed DA Form 5424-R.

6-36. PARALLEL FORMATION

The parallel formation has the mortars on line. The distance between mortar positions is the bursting diameter of HE ammunition for the particular mortar employed. The parallel formation is used to employ two or more mortars where the terrain allows dispersion of the mortars and maximum cover and concealment. A parallel sheaf is formed in the target when all mortars fire the same data. The parallel formation provides maximum coverage of a linear target. It does, however, present an easy linear target for enemy aircraft and artillery to engage and makes all-round security difficult to provide. This formation is one of the easiest to move into during a hasty occupation of a firing position since individual mortar placement is by SOP (Figure 6-11).

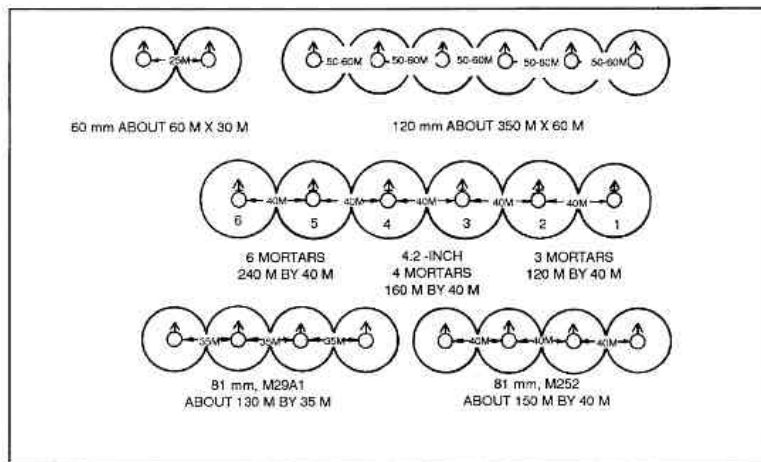

Figure 6-11. Target coverage from the parallel formation.

6-37. LAZY W FORMATION

The Lazy W formation lays the mortars on a modified line (Figure 6-12). It provides better flank security with almost the same target coverage as the parallel formation when all mortars fire the same data. The Lazy W is used when the terrain affords little cover and concealment. It adds depth to the sheaf, which is useful when engaging area targets.

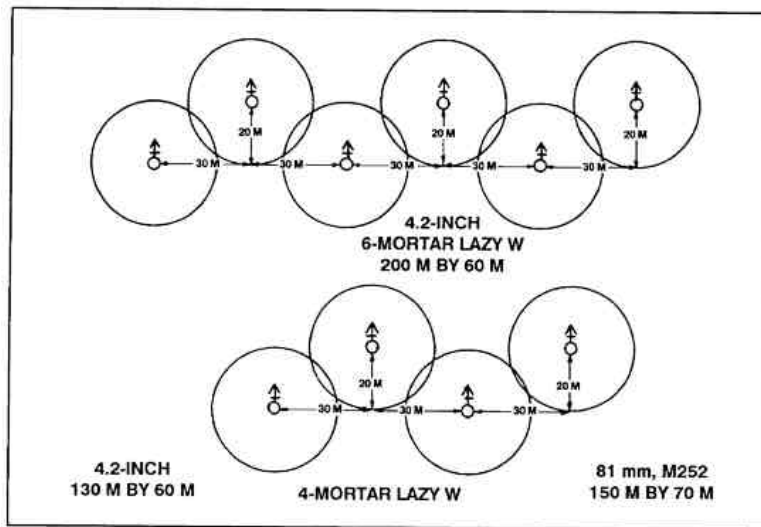

Figure 6-12. Lazy W formation.

6-38. DIAMOND FORMATION

The diamond formation allows a four-mortar platoon to fire in all directions with equal ease (Figure 6-13). It is used when 6400-mil coverage is required (for example, in support of encircled forces). It creates a tight, defensible position against ground attack and is excellent for use in restricted terrain. Special corrections, similar to those used in attitude missions, are required to fire a standard sheaf. Since the distance between mortars is decreased, the formation is more vulnerable to air attack and counterfire. The diamond formation is also useful in built-up area (Figure 6-14). By selecting the guns to fire, the FDC can create different sheaf patterns in the target area without computing time-consuming deflection and elevation corrections.

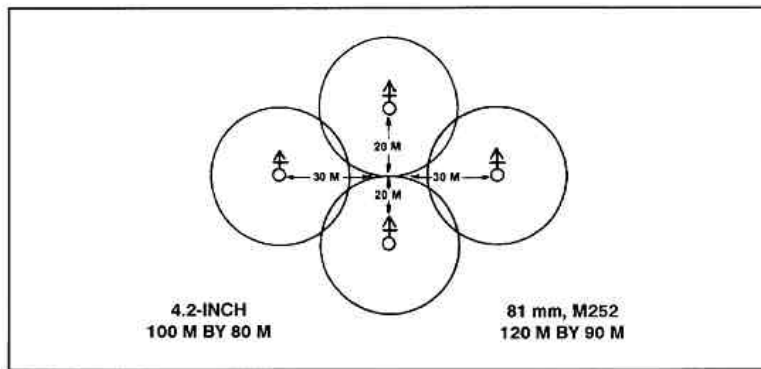

Figure 6-13. Diamond formation.

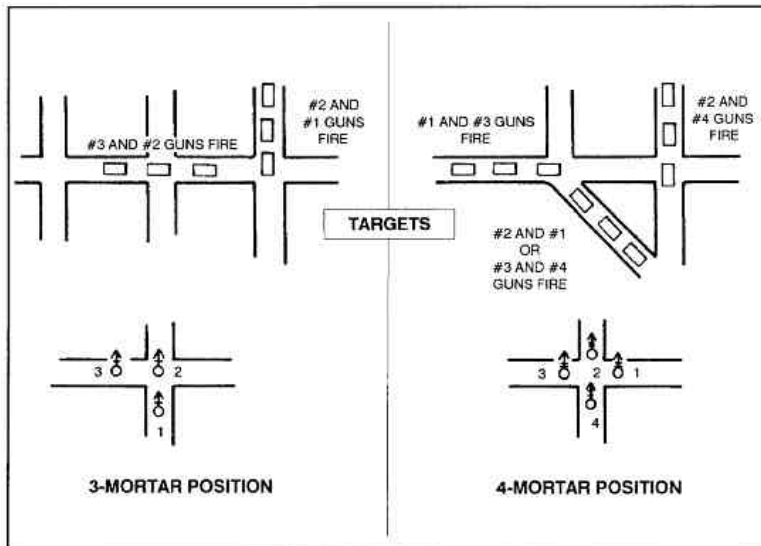

Figure 6-14. Diamond formation used in built-up areas.

6-39. TRIANGLE FORMATION

The triangle formation is a modification of the diamond formation in that only three mortars are used (Figure 6-15). It is used also when the 6400-mil coverage is required. This formation has the same advantages and disadvantages as the diamond formation.

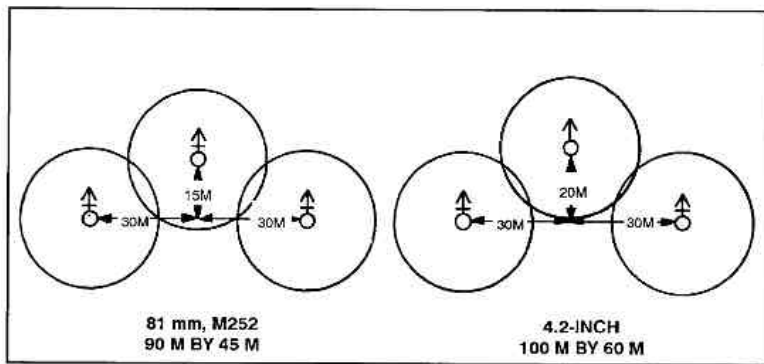

Figure 6-15. Triangle formation.

6-40. SIX-MORTAR STAR FORMATION

The star formation is used by a six-mortar platoon for the same reasons the diamond and triangle are used by smaller platoons—6400-mil coverage (Figure 6-16). This is a complicated formation to move the mortar platoon into, but it is the most compact and defensible. It is used in the strongpoint or perimeter defense.

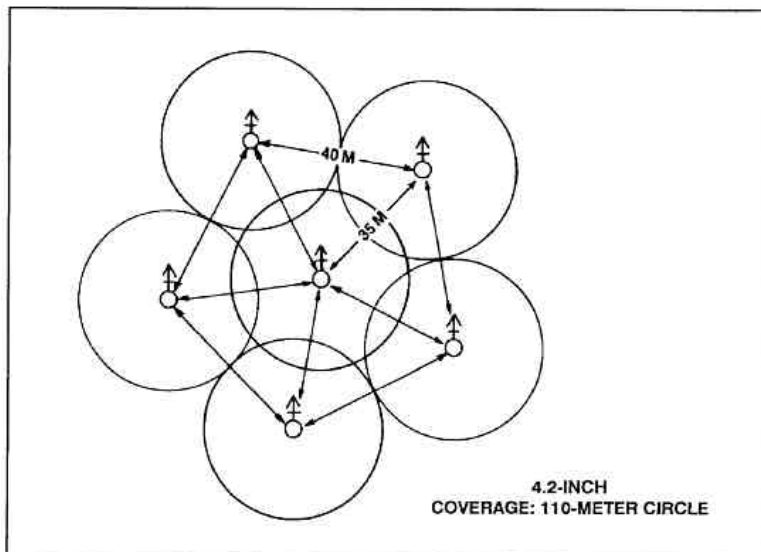

Figure 6-16. Six-mortar star formation.

NOTE: The platoon leader must understand and evaluate the trade-offs required in using the diamond, triangle, and star formations. The ability to provide 6400-mil coverage and increased defensibility is gained by decreasing platoon dispersion (increased vulnerability to counterfire). Corrections to fire standard parallel sheafs require more time for computation and thereby decrease responsiveness.

CHAPTER 7

SURVIVABILITY TECHNIQUES AND DEFENSE OF A MORTAR FIRING POSITION

Section I. THREATS TO MORTAR SURVIVABILITY

The mortar platoon leader must consider a number of threats. The greatest dangers to mortars are enemy counterfire, ground attacks, and air attacks.

7-1. THREATS

Mortar sections and platoons face an intense counterfire threat. Counterfire has the potential to reduce or degrade fire support from friendly mortars. Threat field artillery regiments often have an organic artillery reconnaissance battery or an organic target acquisition battalion. Radar, sound ranging, and reconnaissance methods are all used. Also, mortars can be located by radio direction-finding or other intelligence means. This large array of detection equipment, coupled with the huge amount of artillery available to many potential adversaries, presents a major threat to the survivability of US mortars.

a. Normally, mortars are not the first priority for enemy target acquisition systems. However, the mortar leader must assume the enemy will use them and take actions to neutralize friendly mortars.

(1) Visual observers with laser range finders can locate friendly mortar positions from up to 3 km away, with an error of less than 50 meters.

(2) Sound-ranging platoons can use simple acoustical sensors and sophisticated computer processors to determine the firing location of US mortars from as far away as 20 km. The accuracy of sound location varies but can locate firing mortars to about 100 meters.

(3) A widely used countermortar radar is the ARK-1. Mounted on a BMP chassis, the ARK-1 has a range of about 20 km. Its location error is small.

(4) Radio intercept/direction finding can rapidly identify and locate friendly radio transmitters. A successful intercept can result in countermortar fires within two to six minutes. Radio-direction finding can locate targets with an accuracy of 300 meters.

b. Many potential adversaries worldwide have recently begun a massive expansion in artillery and heavy mortar assets, combined with a parallel improvement in quality. Because of their size, range, and high-angle fire, mortars are the most likely indirect fire weapons to be used against US mortars.

c. The doctrine used by many potential adversaries calls for the massive use of indirect fire before an attack. US mortar platoons will be specifically targeted. As part of the battalion, they will receive heavy fire. Some armies plan to deliver up to 450 rounds on a company position as part of its 30-minute preparatory fires. The last few shells of the preparatory fire against mortars may be incendiary rounds. In addition to the common HE fragmentation rounds, some enemy weapons fire rounds that have enhanced blast effects or that release subprojectiles (flechettes). Exploding submunitions may also be used.

(1) Incendiary rounds are filled with thermite canisters in a WP matrix. When these rounds burst, they produce some fragmentation and dense smoke from the WP. The thermite canisters scatter and burn intensely, causing fires in exposed ammunition and fuel (Figure 7-1).

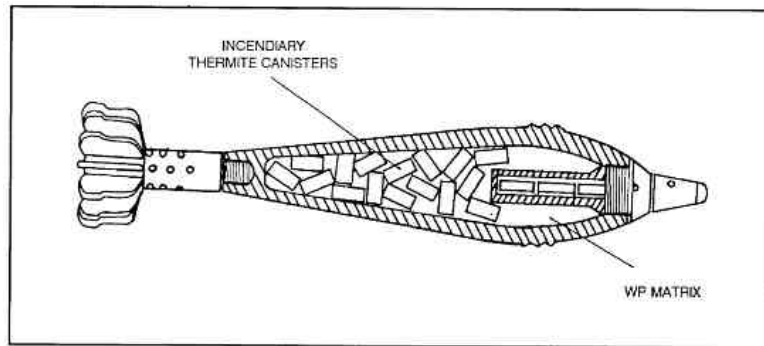

Figure 7-1. The 120-mm incendiary mortar round.

(2) Enhanced blast warheads are powerful but have little fragmentation. They are used to suppress and disrupt US tracked mortars, which are protected from fragments by their mortar carriers, and to crush field fortifications.

(3) Subprojectile warheads explode above the ground and scatter thousands of small, finned flechettes. These flechettes are deadly to unprotected personnel. There are two different sizes of flechettes, but each is effective against open mortar positions or carriers (Figure 7-2).

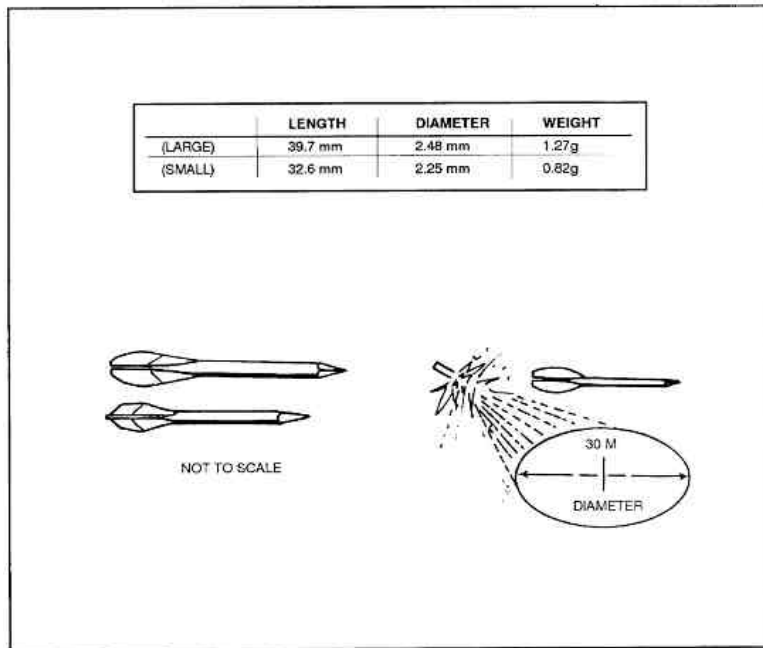

Figure 7-2. Flechette rounds, 152 mm.

7-2. GROUND ATTACK

When mortars support *offensive* operations, the greatest ground threat is chance contact with enemy forces that have been bypassed. When mortars support *defensive* operations, the greatest threats are enemy reconnaissance and main forces. Enemy reconnaissance teams may encounter mortars by chance contact or can be given the mission to locate mortar positions. Once reconnaissance teams encounter mortars, they may attack them or report their locations for destruction by indirect fire or by enemy ground forces. If mortars are located where enemy penetrations occur, they can be attacked by virtue of the enemy's momentum.

7-3. AIR ATTACK

Enemy aircraft pose a threat to mortars due to the difficulty in concealing mortar firing positions from aerial observation. Armed helicopters pose a major threat because of their standoff acquisition ability. Many armies in the world now have remotely piloted aircraft specifically used for reconnaissance.

a. The mortar platoon must hide itself from enemy aircraft through the use of passive air defense measures. These measures are described in FM 44-8 and must be part of normal OPSEC measures.

b. The mortar platoon usually does not engage in active air defense unless directly attacked by enemy aircraft, and then only in accordance with the air defense rules and procedures found in the air defense SOP. Individual small-arms weapons and machine guns provide a limited self-defense capability against enemy aircraft. (See FM 44-8 on techniques used to defend small units against enemy air attack.)

7-4. SURVIVABILITY TECHNIQUES

Crucial to evading counterfire is a sound mortar employment technique that considers this threat. The use of defilade and covered and concealed reverse-slope positions is the most effective survivability technique. Defilade is protection from hostile observation and fire provided by an obstacle such as a hill, ridge, or bank. It is important to mortars because of the difference in the trajectories of field guns, howitzers, rocket launchers, and mortars (Figure 7-3).

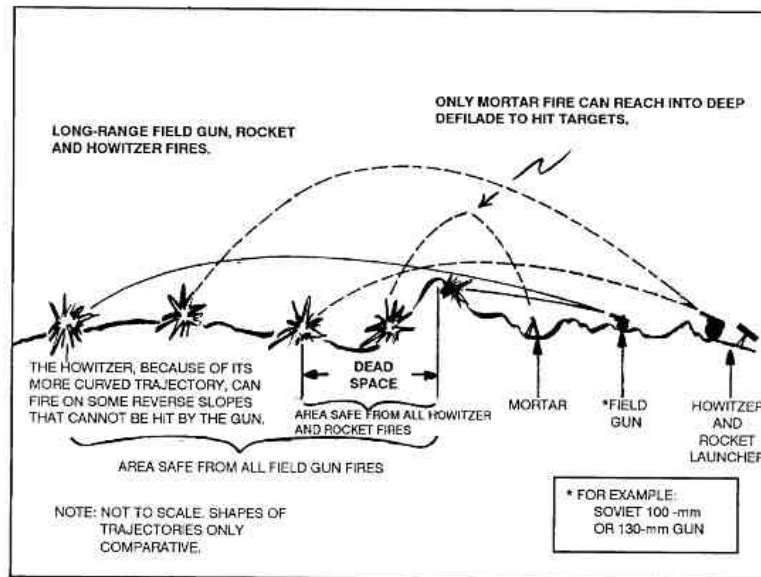

Figure 7-3. Example trajectories and dead space.

a. The flatter trajectory of field guns, howitzers, and rocket launchers creates a dead space behind large hill masses and tall buildings. US mortars can occupy positions in this area and be almost impervious to counterfire. Because of their high trajectories, US

mortars can still fire out of defilade to hit targets. Even deep defilade only partly reduces the maximum range of a mortar (Figure 7-4). Deep defilade protects mortar positions from field gun and howitzer fires but not from enemy mortar fires. However, to shoot into the dead space, enemy mortars must be moved close to friendly positions, making them vulnerable to counterfire.

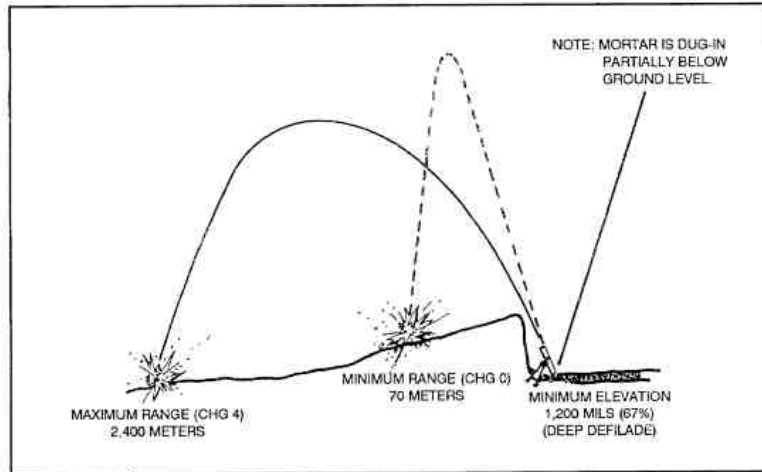

Figure 7-4. Example of range coverage from deep defilade (M224 60-mm mortar).

b. A geometric formula can be used to determine the exact extent of the dead space. However, the cotangent of the angle of fall (COT of fall) for the weapon firing must be known. For US-type mortars, this can be found in Table E, Supplementary Data, of the tabular firing tables (Figure 7-5).

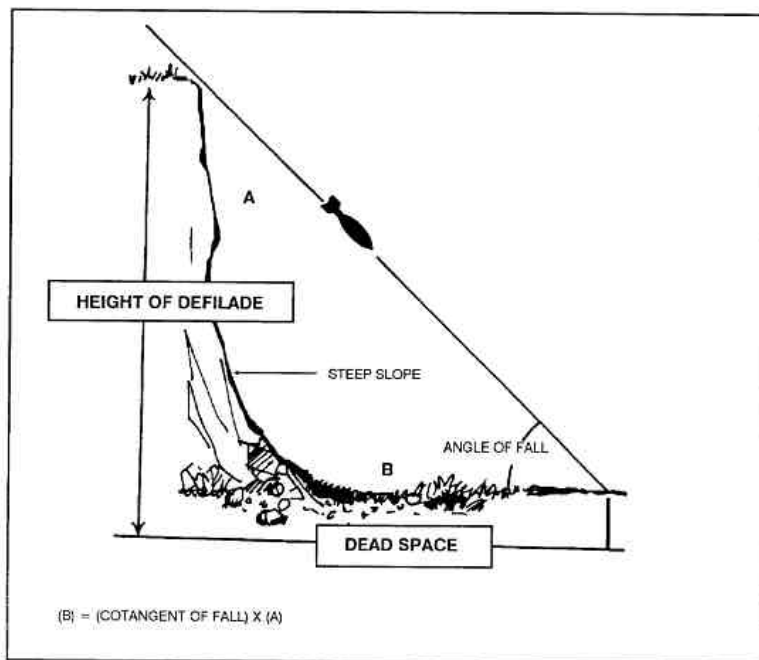

Figure 7-5. Geometric relationships.

c. The average angle of fall of howitzers is about 25 degrees, which equates to a COT of fall of about 2.0. Therefore, the dead space is about two times the height of the defilade. If a mortar position is chosen that has a minimum safe elevation of 900 mils, that position is safe from 122-mm and 152-mm howitzer rounds fired directly over the hill mass or ledge. The angle of fall of field guns is even lower; their dead space is much greater.

d. On flat terrain, deep defilade may be hard to find. On rolling or slightly broken terrain, it can usually be located. Deep defilade is easily located in mountainous terrain and built-up areas. Large buildings create huge amounts of dead space that can extend over several streets. The dead space created by a large building is about three times the height of the building for howitzers and about one-half the building height for mortar fires. (These distances are only guidelines.) The actual size of the dead space depends on the weapon, round, charge, range combination, and elevation difference between the weapon and the target.

NOTE: If the enemy fires artillery or rockets at an elevation of 800 mils, the dead space behind each building will be about equal to the height of the building.

e. If our mortars are close to a tall mass construction building and firing at near maximum elevation, they will be virtually impervious to frontal fires from one of the world's most effective counterbattery weapons, the BM-21 Multiple Rocket System. The BM-21 has a maximum firing elevation of about 885 mils. If the mortar position is within the building's dead space, the incoming rounds from that direction either will strike the building or pass over the mortars to strike behind them. (Figure 7-6.) US mortars should move as close to buildings as possible while maintaining clearance to fire over the building. If 81-mm mortars are firing at 1335 mils or higher elevation, the mortars should be back from the building a distance about one-quarter its height. A 4.2-inch mortar firing at 1065 mils elevation should be back from the building a distance about one-half the height. This positioning puts the mortars well within the building's dead space.

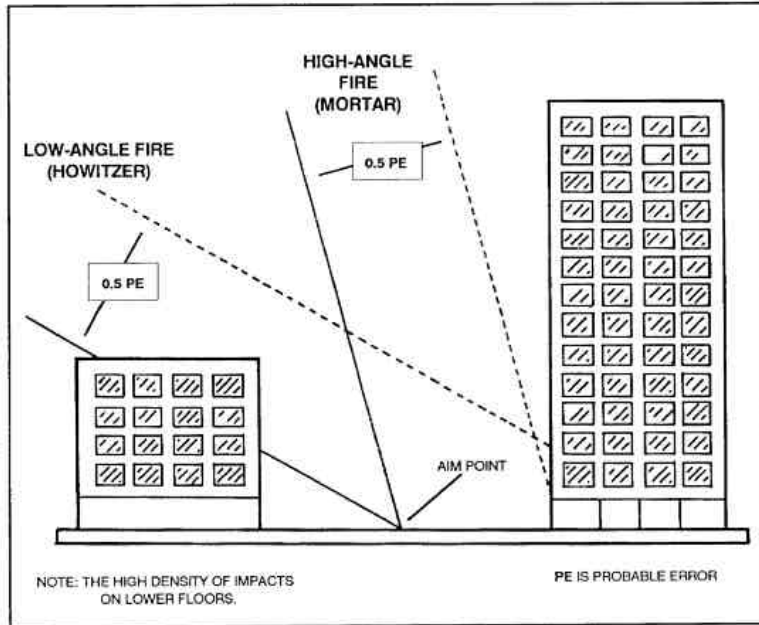

Figure 7-6. Expected locations of impact from high and low angles of fire.

f. Mortars should not be positioned close to buildings that have a large surface area made of glass because of the secondary fragment hazard. Short buildings close to the mortar position on any side do not provide much dead space in which to position mortars, but they will stop fragments from that side. If the open area the mortar is firing from is small and the adjacent walls will stop fragments, the incoming rounds have to be almost a direct hit to damage the mortar or crew.

g. Establishing mortar firing positions within the dead space created by a hill mass or building does not eliminate the enemy's ability to locate it. It does make it difficult for the enemy to place effective countermortar fire on the US position. Because of their high trajectory and powerful charges, US mortars can fire out of deep defilade against most targets in the battalion or company area.

Section II. DUG-IN POSITIONS

Mortars fight a complex, fluid, ever-changing battle. They may stop in a firing position only long enough to fire a few missions before displacing. Other times, they may occupy a good defilade firing position for several days. All infantry and mortar squads dig in during defensive operations and continue to improve their positions as long as they occupy them. If mortar platoons or sections defend from a strongpoint, they dig extensive fortifications to withstand a dismounted assault supported by heavy fire. Preparing hardened mortar positions takes much time and material. If completely accomplished by hand, preparing hardened mortar positions is a slow and fatiguing process. If engineer equipment is available to assist, protective positions can be built more quickly, which results in more rested and responsive mortar crews.

7-5. DISMOUNTED MORTARS

There is only one type of dismounted dug-in mortar position. It has variations as to the depth it is dug and its stage of construction. The standard dismounted dug-in mortar position has three stages of construction (Figure 7-7):

STAGE I-Gun pit.

STAGE II-Gun pit with personnel shelters.

STAGE III-Gun pit with personnel shelters and ammunition bunkers.

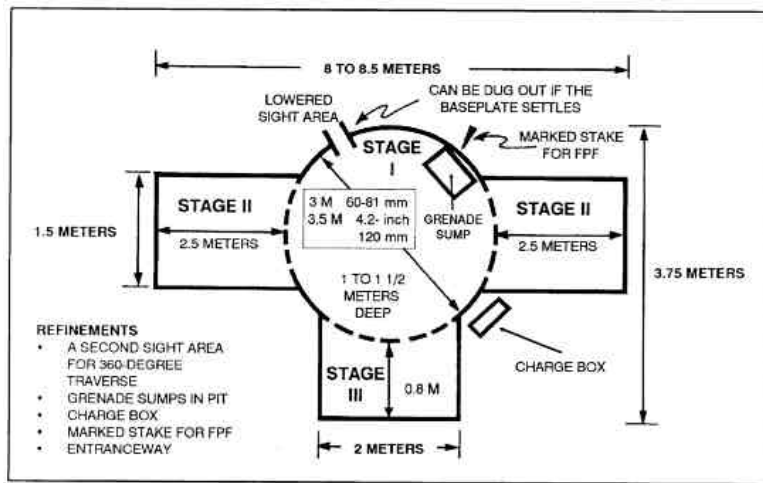

Figure 7-7. Mortar position (three stages of construction).

A dug-in position for the 81-mm/60-mm mortars is the same as for the 4.2-inch/120-mm mortars with only slight changes in dimensions. The standard mortar position must be constructed with a flat bottom. It can be constructed totally below, partly above, or completely above ground, depending on the time and material available and the composition of the ground at the intended position. The below-ground position offers the best protection.

a. **STAGE I.** After the position's general location is selected, the exact baseplate position is marked and construction begins. The mortar pit for 81-mm/60-mm mortars should be 3 M16-rifle lengths (about 3 meters) wide and a maximum of 1 1/2 M16-rifle lengths (1.5 meters) deep. All walls or parapets above ground must be at least 1 M16-rifle length (1 meter) thick for protection against small-arms fire and shell fragments. Sandbags, logs, 55-gallon drums, dirt-filled ammunition boxes, timber, or other materials can be used in constructing walls or parapets. The gunner must be able to see the aiming posts or the distant aiming point through all deflection and elevation settings. Construction for a heavy mortar pit is the same, except the pit diameter is 3 1/2 M16-rifle lengths (3 1/2 meters).

b. **STAGE II.** When time allows, increase protection by constructing personnel shelters with overhead cover. Construct the personnel shelters perpendicular to the principal direction of fire with firing ports positioned as determined by assigned small-arms sectors of fire. Build the shelters at the same depth (1.5 meters) as the pit, and 1 1/2 M16-rifle lengths (1.5 meters) wide, and 2 1/2 M16-rifle lengths (2.5 meters) long on opposite sides of the pit with a minimum of 1/2 an M16-rifle length (0.5 meters) of overhead cover. There should be a blast barrier of at least two sandbags in thickness separating the

personnel shelters from the mortar pit. The firing ports can be made using wooden ammunition boxes with the bottoms knocked out. Personnel should use sandbags to adjust the opening to the smallest usable size. Corrugated metal culvert halves covered with earth make excellent personnel shelters (Figure 7-8). Whatever design is selected, it should never support the weight of the overhead cover on sandbags. Use timber or some other structurally sound material.

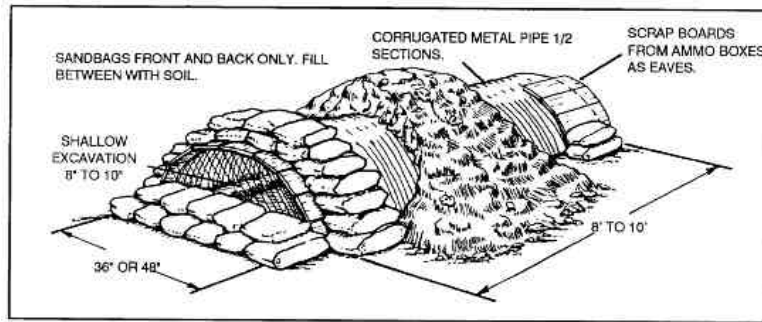

Figure 7-8. Corrugated metal culvert halves used as personnel shelter.

c. **STAGE III.** As position improvement continues, construct ammunition bunkers. A bunker should be two M16-rifle lengths (2 meters) wide, one ammunition box (length) deep, and two ammunition boxes (stacked on their sides) high (three for a 4.2-inch mortar position). The bunker is divided into four sections separated by the ammunition boxes stacked on their sides (Figure 7-9). Ammunition boxes form the floor on which the ammunition is stacked. U-shaped pickets or other suitable support material are placed across the stacked boxes, providing a base on which to place dirt-filled ammunition boxes to enclose the top of the bunker. All boxes are filled with dirt to increase stability and add protection. A canvas tarpaulin or plastic sheet available from the ammunition packing material should be placed on the top of the ammunition boxes, then covered with dirt and sandbags to form at least an 18-inch layer over the bunker. The tarpaulin should also drape over the opening to the bunker to protect the ammunition from dirt and moisture.

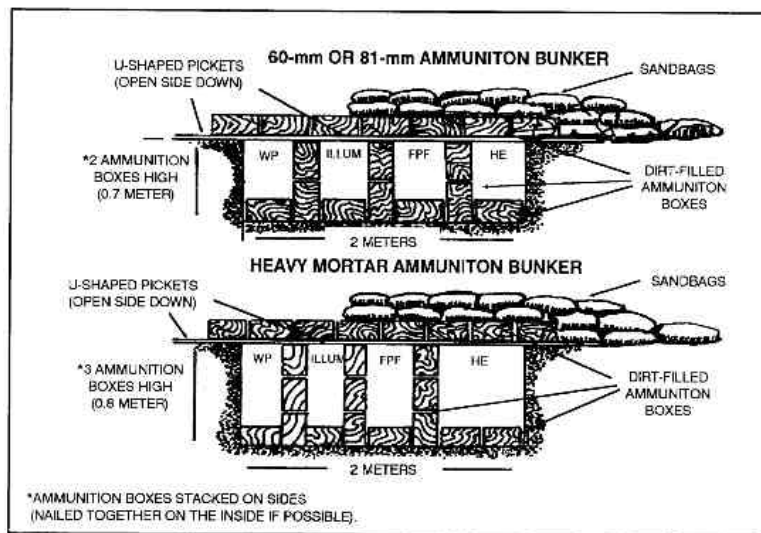

Figure 7-9. Ammunition storage area (front view).

The sandbags on top add protection and increase stability to the bunker and to reduce the danger of wooden splinters if a round impacts close by.

d. Once the mortar position is completed to STAGE III, personnel can add refinements.

- (1) Add another sight area to allow 360-degree traverse.
- (2) Dig grenade sumps (at least one) in the circular pit. They are dug against the wall of the pit, using the trench-style pit as shown in FM 7-8.
- (3) Add an entry with a 90-degree blast baffle. This can enter either the circular pit or one of the personnel shelters. Eventually, it should connect with a crawl trench toward the FDC.
- (4) Dig a hole, outside the circular pit, near the ammunition bunker for placing excess charges until disposal. Personnel should place an empty ammunition box in this hole; the cover will protect the excess charges from flash fires. Sandbags should be placed on the box lid when not placing charges into it (Figure 7-10).

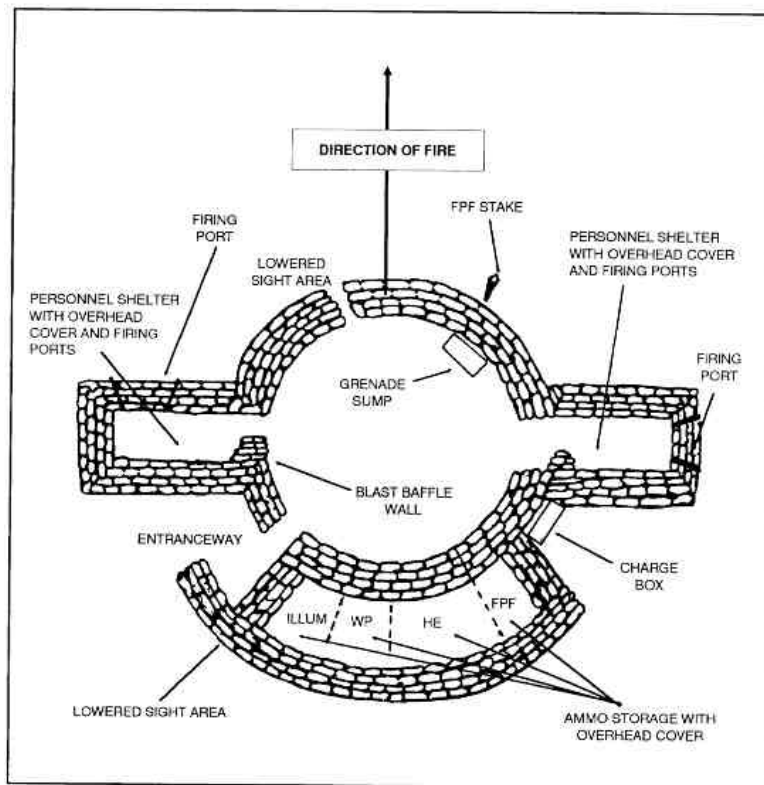

Figure 7-10. Completed dismantled mortar position (overhead view) with refinements.

(5) Place stakes around the rim of the circular pit corresponding to priority targets. Personnel mark the stake corresponding to the FPF with a distinctive mark; these stakes are for reference. Stakes are not as accurate as using aiming posts, but can be used if the aiming posts are disturbed or obscured. These stakes are useful for illumination targets, since precise lay of the mortar is not required. They can make the illumination mortar more responsive. Put the stakes in securely and do not disturb them.

(6) Install alternate wire lines from the mortar positions to the FDC and tag the alternate and primary lines.

(7) Sandbag the base of the aiming posts without disturbing them. This protects them from being blown over by enemy fire.

(8) Bury all communications wire at least 4 inches below the ground.

e. A STAGE III dismantled mortar position will take from 30 to 40 man-hours if it is dug by hand, depending on the type soil and the tools used. If engineer equipment can be used to make the initial pit and bunkers, this time can be shortened. Each mortar position will require approximately the following amount of fortification material (the exact amount depends on the depth of the excavation):

- 6,000 sandbags.
- 50 wooden ammunition boxes, or an equivalent amount of timber.
- 150 U-shaped pickets (72 inches long).

f. As time permits, personnel should add sandbag layers to increase protection. These sandbags must be properly supported. Poorly supported, overweight bunkers can collapse under enemy fire, killing or injuring the soldiers inside. (See FM 5-103 and FM 5-34 for guidance on support beams.)

7-6. FDC BUNKERS

There is no standard FDC bunker design. Any of several versions depicted in FM 5-103 is satisfactory. Figures 7-11 through 7-13 show various bunker designs and standards.

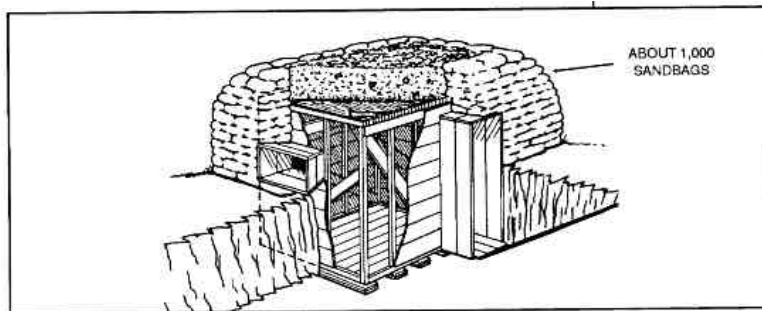

Figure 7-11. Cutaway view of a standard bunker.

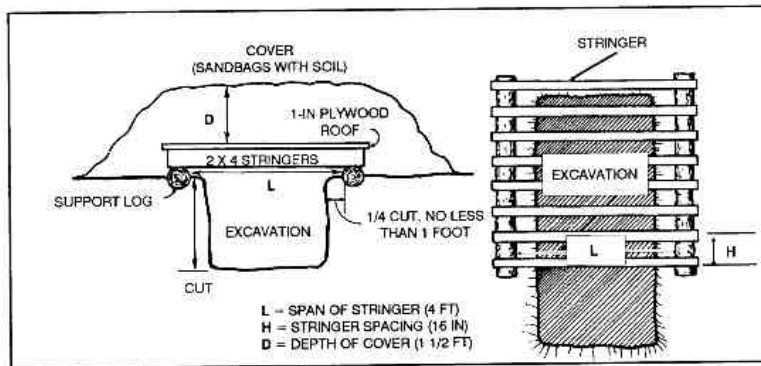

Figure 7-12. FDC position with overhead cover protection against fragments from a 120-mm mortar.

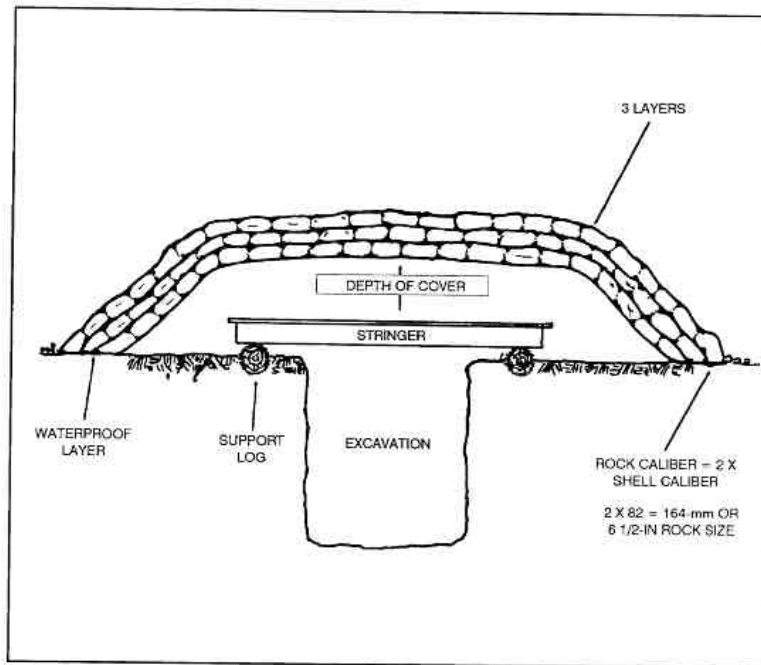

Figure 7-13. Stone layer added to overhead cover to defeat the delay fuze burst from an 82-mm mortar.

a. When constructing FDC bunkers, *always* do the following:

- (1) Ensure adequate shoring material is used.
- (2) Dig down as much as possible.
- (3) Maintain, repair, and improve positions continuously.
- (4) Inspect the safety of bunkers daily-after a heavy rain and after receiving enemy fires.
- (5) Revet excavations in sandy soil.
- (6) Interlock sandbags for double-wall construction and corners.
- (7) Fill sandbags to 75 percent.
- (8) Construct to proper engineering standards.

b. When constructing FDC bunkers, *never* do the following:

- (1) Fail to supervise construction.
- (2) Use sand or sandbags for structural support.
- (3) Forget to camouflage.
- (4) Drive vehicles within 6 feet of an excavation.
- (5) Overfill sandbags.
- (6) Omit lateral bracing on stringers.
- (7) Take shortcuts in construction safety.
- (8) Build above ground unless absolutely necessary.

7-7. MOUNTED MORTARS

Even though tracked mortar carriers provide protection against small-arms weapons and most shell fragments, they can be penetrated by heavy shellfire. To protect them, they should also be dug-in.

a. A protective position for a tracked mortar carrier is too large to be dug by hand; engineer equipment is normally required. Some work with hand tools is needed to finish the position.

b. A bulldozer or an SEE can build a hasty fighting position for a mortar carrier in about 25 minutes. This position must be 20 feet long, with entrance ways on both ends. It must be 10 feet wide and 6 feet deep. The carrier must be able to back into the position. The spoil should be spread out to avoid a distinct hump of fresh dirt, and the floor of the position should be level (Figure 7-14).

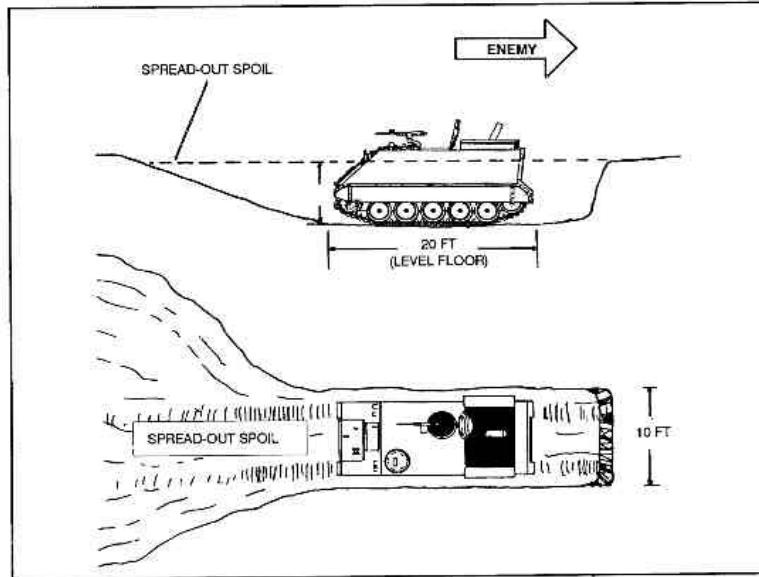

Figure 7-14. Hasty tracked mortar firing position.

c. As time permits, this hasty firing position can be improved. The sides can be widened slightly to allow movement around the track to perform maintenance. An ammunition bunker can be dug into one side of the position to store additional ammunition. In loose, sandy soil, the sides of the position must be revetted to prevent a cave-in.

7-8. MORTAR POSITIONS IN A STRONGPOINT

A strongpoint is a battle position fortified as strongly as possible to withstand direct assaults by dismounted infantry supported by heavy indirect fire. Mortars in a strongpoint must continue to provide close and continuous fires, even when under attack. All mortar positions must be completed to STAGE III. The FDC must be protected by earth and overhead cover. Ammunition storage areas, communications trenches, and wire lines must all be protected.

a. Even if the enemy masses fires against a strongpoint, mortars can survive and continue to fight if they are properly dug-in.

(1) In 1976, the German Infantry School fired artillery and mortars, with the intensity set by Soviet doctrine, on various field positions in which infantrymen were represented by mannequins. Results showed that troops prone in the open would suffer 100 percent casualties. Those in open fighting positions without overhead cover would suffer 30 percent casualties. Troops dug-in with overhead cover would expect fewer than 10 percent casualties, mostly by direct hits.

(2) During the entire month of February 1968, an average 1,100 rounds of enemy indirect fire fell daily on the USMC combat base at Khe Sahn, South Vietnam. This fire included 82-mm and 120-mm mortars, 100-mm and 130-mm field guns, 122-mm and 152-mm howitzers, and 122-mm rockets. The marines reported that this fire had little effect once they had prepared proper field fortifications. One rifle company reported that from 350 to 500 82-mm mortar rounds hit its position within two hours with only moderate damage.

b. From this recent combat experience against common weapons and from tests conducted by the US Army, some guidelines on protection levels have been developed:

(1) A minimum of 18 inches of earth is required to protect a position from fragmentation. This is not enough to protect against direct hits or near-misses.

(2) One strip of pierced steel planking (PSP) and three layers of well-compacted sandbags will protect against a direct hit from an 82-mm mortar round with a PD fuze.

(3) One layer of PSP and eight layers of well-compacted sandbags can protect against a direct hit from a 120-mm mortar round with a PD fuze.

(4) No reasonable amount of sandbags and PSP can protect a bunker against a direct hit by a 120-mm mortar round with a delay fuze. Heavy bunkers with timber supports and carefully constructed shielding material can minimize the damage done by a direct hit. They can also protect the occupants from fragments and near-misses.

(5) Without concrete or steel, no field fortifications can be built to withstand a direct hit from a 122-mm rocket or a 152-mm HE round with PD fuze. Even dud 152-mm rounds will penetrate about 4 feet of solid earth. However, properly constructed bunkers will protect against fragments and near-misses. (See FM 5-103 and FM 5-34 for more detailed information on constructing protective bunkers for the mortar FDC.)

7-9. HIGH-SURVIVABILITY MORTAR POSITION

With the exception of strongpoints, AirLand Battle doctrine does not envision remaining in static defensive positions and engaging in massive exchanges of indirect fire. However, battles during low- and mid-intensity conflicts in the past have resulted in just

such an exchange. During the Korean War, a high-survivability mortar position was developed and used successfully. This position protected a heavy mortar squad and allowed it to continue to fight, even during intense enemy countermortar fire.

a. The high-survivability mortar position requires from 150 to 300 man-hours to complete by hand, depending on the soil. If an SEE is used, this time is reduced greatly. If timbers are not available, dimensioned lumber or engineer U-shaped pickets can be used. (Refer to FM 5-103 for beam spacing and shoring guidance.)

b. Each high-survivability mortar position consists of two bunkers with a circular pit between them (Figure 7-15). The crew bunker holds the squad leader, the gunner and assistant gunner, and equipment for communication to the FDC and to platoon headquarters. The ammunition bunker holds the ammunition bearer and the ammunition. The gun pit and bunkers are sited so that the long axis of the emplacement is perpendicular to the primary direction of fire.

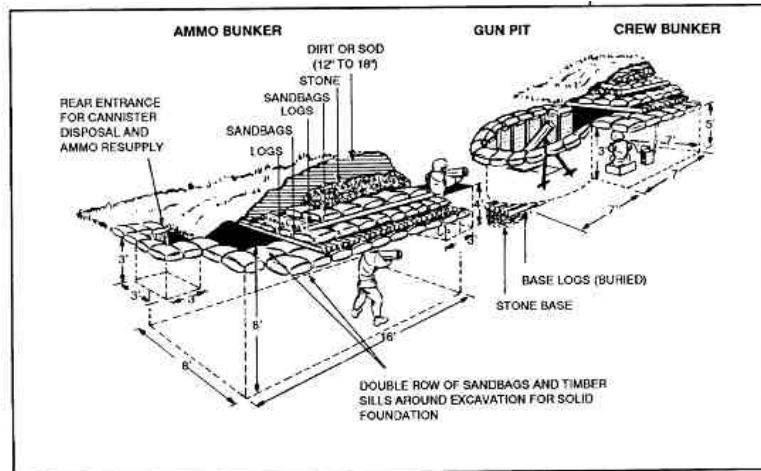

Figure 7-15. Cutaway view of heavy mortar, high-survivability position.

c. Material for construction is limited only by the ingenuity of the mortar crew and the items found in the surrounding area. Such items that can be used are logs, railroad rails or ties, planking, corrugated iron roofing, doors, woven straw mats, rice bags, sandbags, and stones. The gun pit is circular with a diameter of 8 feet. The pit is about 3 feet deep with a parapet around it. Beneath the baseplate, several layers of rock and logs are placed to ensure stability of the mortar during sustained fire and to prevent the baseplate's sinking.

d. The 180 degrees of the gun pit, facing the primary azimuth of fire, has logs 6 to 8 inches in diameter placed vertically behind the baseplate. This prevents the baseplate

from digging in or skidding back during prolonged firing. The sides of the pit can be strengthened with woven wire or branches. The gun pit has no overhead cover. However, a camouflage net can be draped on poles over the pit and removed before firing.

e. The crew bunker, a trapezoid about 7 feet long and 5 feet deep, is also the squad CP. It connects directly with the gun pit. The bunker widens out at the rear to provide space for the crew. This shape gives maximum protection. Telephone communication and some system of lighting for night firing are needed.

f. The rectangular ammunition bunker, larger than the crew bunker, measures 16 feet long. This bunker has a fire step with a 21/2-foot wide parapet between it and the gun pit. This allows the ammunition bearer to remain within the bunker, set charges and fuzes, and yet be able to pass the round to the assistant gunner for firing. The opening over the fire step is not covered, allowing the ammunition bearer to work freely between the gun pit and bunker. There is an entrance for ammunition and removal of empty ammunition containers at the rear of the bunker. Ammunition should be laid on dunnage and a sump dug if the position is wet or the drainage poor.

g. A minimum of 3 feet of logs, stone, and solidly compacted earth forms the overhead cover of a heavy-mortar, high-survivability position. No more than 4 feet of overhead cover can be used if the mortar is to have mask clearance when traversed to the right or left of its primary azimuth (Figure 7-16).

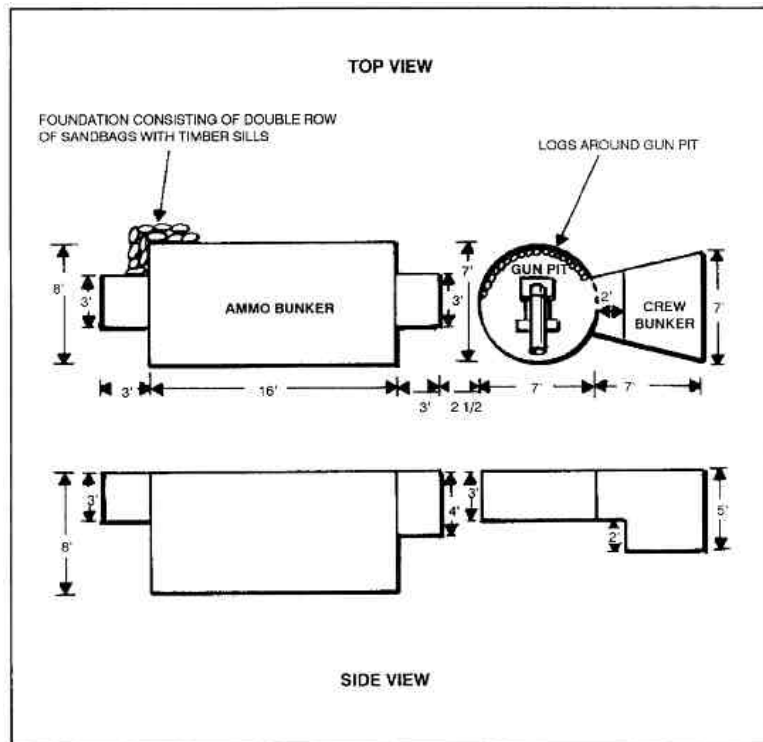

Figure 7-16. Dimensional drawing of heavy-mortar high-survivability position.

(1) The *first layer* consists of logs about 8 inches in diameter, laid closely together on a timber sill, and extending at least 18 inches beyond each side of the hole.

(2) The *second layer* consists of closely aligned and interlocked sandbags or mats, or any other covering such as dirt. More logs are then laid crosswise to the first layer of logs. Another layer of sandbags or earth is put on followed by a layer of stone. The top layer is packed earth with a layer of stone just beneath the surface. The entire position is covered with sod or other camouflage.

7-10. ADDITIONAL INDIVIDUAL PROTECTION

In addition to building protective positions, mortar leaders can increase the individual protection of platoon members.

- a. Properly selected defilade firing positions protect troops from enemy ground-mounted laser weapon systems. During movement, and anytime the mortar squad is exposed to the enemy, soldiers should wear their ballistic laser protective spectacles. The spectacles should not be used as a substitute for sunglasses. Excessive exposure to the sun's rays reduce their laser protective feature. Spectacles not only protect the eyes against laser light, but also protect them against small fragments that could blind soldiers. Most eye injuries are caused by small fragments of enemy shells, rocks, or debris thrown out by the explosion.
- b. The mortar leader must carefully consider the NBC threat and monitor the designated MOPP level. Protective garments and masks must be kept close to individuals, even though the bulk and weight of garments and masks make this inconvenient.
- c. Mortar squad and FDC members should always wear the Kevlar helmet and protective vest. The helmet and vest provide excellent protection from shell fragments. Although they cannot protect soldiers against flechettes, they reduce fragmentation casualties by 50 percent over unprotected troops. Those soldiers who are wounded while wearing the protective vest and helmet often suffer less serious injuries than they might have otherwise.
- d. The mortar platoon seldom has an aidman and ambulance attached. Therefore, all mortarmen should be taught to administer buddy aid to the seriously injured. An extra supply of compresses, cravats, air splints, and intravenous bags should be kept in the platoon to treat injured soldiers until evacuation.
- e. One of the greatest causes of casualties among mortar crews, after enemy counterfire, is burns from flaming ammunition propellant. Mortar propellant charges burn rapidly with extreme heat. All excess charges that accumulate in mortar positions must be stored. Ammunition that is prepared for firing should be stored in containers to reduce the spread of fire.

Section III. OTHER SURVIVABILITY TECHNIQUES

To support the commander's intent for mortar fires, the mortar section must survive the enemy's efforts to eliminate it. Survival requires the mortars to avoid detection as long as possible, confuse the enemy as to their true location and to defend themselves against enemy attacks.

7-11. SHOOT AND HIDE POSITIONS

Shoot positions are positions from which the mortars fire. *Hide* positions are located in a covered and concealed area and are occupied by the mortar crews when crews are not firing. The use of shoot and hide positions is an effective technique when covered and concealed firing positions are not available or when enemy counterfires are anticipated. For example, if the only place mortars can shoot from is on a roadway, a hide position adjacent to the road and under some trees, the position could be occupied by the crew

until receipt of a fire mission. Baseplates can be left in the shoot position, or stakes can be used to mark positions. Aiming posts and the aiming circle may be left set up.

7-12. CAMOUFLAGE

Camouflaging the position is accomplished during all stages of construction. Erecting camouflage netting, when available, should be accomplished before beginning construction to conceal the work effort.

7-13. FIRING LOWEST CHARGE AND ELEVATION

Firing the lowest charge and elevation reduces the chance of mortar rounds being detected by radar because of trajectory and time in flight. Also, responsiveness of fires is increased by reducing time of flight. Target effects must be considered since lower trajectories also mean less lethal area coverage (see Appendix B).

7-14. FREQUENT DISPLACEMENT

Frequent displacement enhances survivability from enemy counterfire but can degrade the ability of mortars to provide immediate massed fires. To aid continuous fire support, employment and displacement by section may be needed. The timing and number of moves are key to survival and should be based on the commander's guidance, the tactical situation, and the enemy target acquisition and counterfire Threat. Frequent displacement reduces the time available to properly prepare positions and increases crew fatigue.

7-15. OFFSET REGISTRATION

Offset registration reduces the vulnerability of the primary position when one mortar fires adjustment rounds (easily acquired) from offset locations. It requires accurate map spots or common survey control between the offset and primary locations to ensure accurate fires. It also increases command and control problems and relies on radio communications to transmit firing data.

7-16. ROVING GUN

A roving gun can conduct registrations and fire missions from a number of supplementary positions. This assists in concealing the platoon's primary position and in confusing the enemy as to the number of mortar sections or tubes employed. The platoon vacates deceptive firing positions upon completion of a specific mission, thus locations can be used that are easily identified on a map. This enhances the use of survey-accurate data without use of surveying assets, and it does not degrade the ability to mass fires from the primary position. However, any errors in location or direction can affect the FFE accuracy for the nonadjusting mortars.

7-17. ADJUSTING ROUNDS

Platoons can increase accuracy and reduce adjusting rounds in several ways. All reduce the threat from enemy target acquisition. A few of the means are as follows:

- Position-location devices such as a GPS or PADS.
- Registrations (abbreviated, regular).
- Computation of meteorological data corrections.
- Hasty survey from known points to eliminate map errors.
- Use of friendly artillery radar to accurately locate firing position (coordinate through fire support officer).

Although these techniques reduce vulnerability, increase effectiveness of fires, and conserve ammunition, they are time-consuming and may require support from artillery (survey teams, radar, MET data).

7-18. USE OF WIRE COMMUNICATIONS

Platoons can use wire in a static situation and when time allows; wire is recommended for all positions. It provides reliable communications while reducing the electronic signature that results from the use of radios. However, emplacing wire takes time and can be cut by enemy artillery, unless it is dug in.

7-19. MASSING FIRES

Massing the fires of several sections is a technique to overload enemy target acquisition means. It can also reduce the number of volleys needed on one target. Massing mortar fires can be difficult to control and may require increased radio communications. When possible, sections mass mortar fires by firing TOT missions.

7-20. TERRAIN MORTAR POSITIONING

To increase survivability on the battlefield, a mortar platoon must take full advantage of the natural cover and concealment afforded by the terrain and existing vegetation. When each mortar is positioned to fit the terrain without regard to standard formations, firing corrections are required to obtain a standard sheaf in the target area. These corrections compensate for the terrain positioning of the mortars. If each mortar fires the same deflection, charge, and elevation, the sheaf obtained would be a parallel sheaf. The corrections needed to achieve a standard sheaf are called terrain mortar position corrections (TMPC) (Figure 7-17).

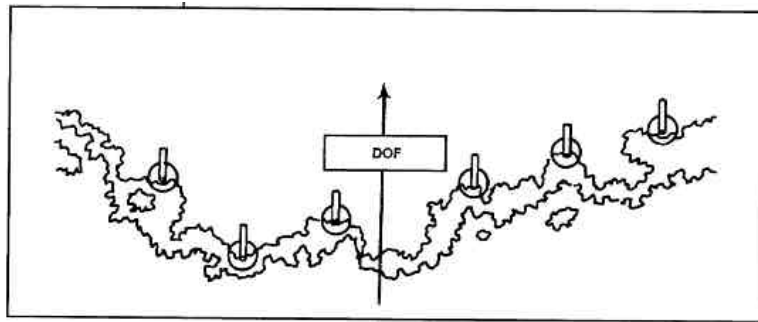

Figure 7-17. Positioning with respect to terrain.

a. **Piece Displacement.** To determine the position corrections for each mortar, the relative position of the mortars in the platoon area must be known. Piece displacement is the number of meters the piece is forward or behind and right or left of platoon center. It is measured on a line parallel (forward or behind) and perpendicular (right or left) to the azimuth of lay (Figure 7-18). Piece displacement can be determined by estimation, pacing, or hasty traverse.

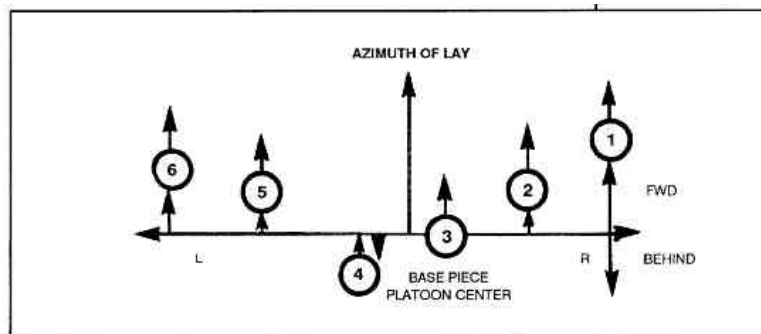

Figure 7-18. Piece displacement relative to base piece.

(1) The *estimation technique* is the least desirable method. Using this technique, the platoon leader or section chief estimates the displacement about the platoon center perpendicular to the azimuth of lay.

(2) The *pacing technique* provides accuracy in small open areas but is time-consuming. In using this technique, the platoon leader measures the lateral distance from the base piece and the distance forward or behind the base piece to each mortar.

(3) The *hasty traverse technique* is the most accurate and rapid technique for determining piece displacement. (See FM 23-91 for detailed discussion of the hasty traverse technique.)

b. **Terrain Mortar Position Corrections.** Mortar FDCs compute TMPCs before occupation of a position when possible, but TMPCs can be computed after occupation. TMPCs are applied to each mortar's firing data in order to achieve acceptable sheafs in the target area. They are computed and applied whenever a mortar platoon occupies a position that is wider than the width of the mortar system's standard sheaf or deeper than the bursting diameter of its HE ammunition.

c. **Hasty Terrain Mortar Positions.** When the advance party cannot conduct a reconnaissance of a mortar position due to time constraints or hasty occupation of a hip-shoot position, TMPCs cannot be computed before mortar crews occupy the position. Therefore, a modified technique of terrain mortar positioning can be used that still allows near-maximum use of the terrain. This provides cover and concealment for the platoon while placing acceptable sheaves on target (Figure 7-19).

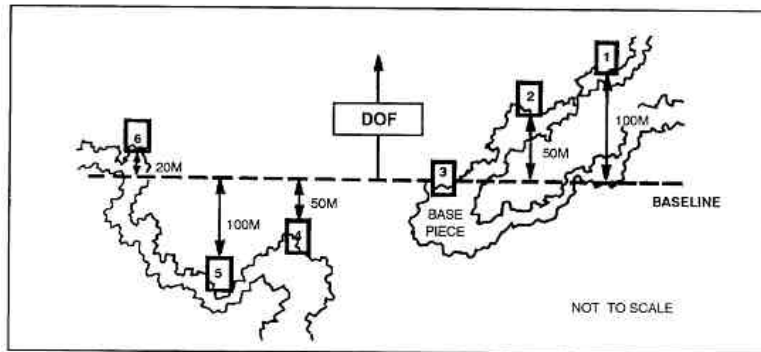

Figure 7-19. Hasty positioning with respect to terrain.

(1) To use the modified technique, the platoon occupies the position, conforming to the folds and treelines of the terrain. It maintains a lateral dispersion between mortars equal to the bursting diameter of an HE round of that mortar system.

(2) An imaginary line (baseline) is drawn through the base piece perpendicular to the direction of fire (azimuth of lay). From this line, the squad leader determines the distance to his mortar. Mortars, other than the base piece, will either be on line with, forward of, or behind the base piece. A squad member can measure the distance from the baseline while the squad leader lays or estimates the mortar. This distance is referred to as the *position range correction* and is recorded for future use by the squad leader. It is also given to the FDC for future use in computing TMPCs for the left and right sectors of fire. The squad leader applies

this position range correction to the command data. The FDC issues the correction for a fire mission in the same manner as described in applying normal TMPCs.

7-21. GROUND DEFENSE PLAN

The platoon leader ensures that the mortar platoon does everything possible for its own security. Regardless of where the mortar platoon, section, or squad is located, a defense of the position against a ground attack must be planned, organized, and implemented.

7-22. COORDINATION AND SECURITY PLAN

If necessary, the mortar platoon may have an infantry squad attached to enhance the mortar defense. Also, the mortar platoon can be positioned near a reserve company or nearby friendly forces that can assist in providing security. If the mortar platoon is positioned near a friendly company, it should be integrated into the defense. In this way, the company may be able to tailor security measures to assist the mortar platoon. Coordination includes the following:

- Location of primary, alternate, and supplementary positions.
- Sectors of fire.
- Location of dead space between the units and how to cover it.
- Visual and audible signals.
- Location of observation posts.
- Location and types of obstacles and how to cover them.
- Patrols to be conducted to include their size, type, time of departure and return, and routes.

7-23. DEFENSE PLAN

The mortar platoon leader's defense plan includes tasks that are accomplished based on a priority of work:

- Establish local security.
- Position and lay mortars.
- Establish FDC.
- Clear mask and overhead obstructions.
- Improve mortar positions.
- Emplace obstacles.

a. **Security Measures.** The platoon leader establishes security for his platoon so that the enemy cannot observe or surprise the platoon. He considers the company SOP, the orders received from his commander, the enemy situation, and terrain and visibility conditions.

(1) OPs are situated to provide early warning along enemy avenues of approach. They should be covered and concealed and have covered and concealed routes to

and from them. If available, the platoon employs sensors to provide early warning.

(2) The mortar platoon leader establishes security within the platoon's firing positions. This is accomplished by--

- Assigning sectors of observation and fire.
- Placing machine guns along most likely enemy approaches.
- Tying in with adjacent squads and other units, if applicable.
- Positioning observation posts.
- Emplacing obstacles.
- Conducting stand-to.

The mortar platoon leader must designate a set number of men to be alert at all times. The number will vary with the enemy situation, terrain, and visibility. Normally, at least one-fourth of the platoon should be alert at all times. When an attack is expected, the entire platoon is alert.

b. Positioning of Mortar Squads. When positioning mortars, the platoon leader ensures that mortars can provide effective indirect fire support. Normally, the mortar firing positions are also the positions from which squads defend. If time is available, squads can prepare supplementary positions to "round out" the defense. The platoon leader gives each squad primary and secondary sectors of fire, and the squad leader gives each individual primary and secondary sectors of fire. Sectors of fire should be planned so that adjacent sectors of fire are overlapping. Available machine guns and LAWs are included in the defense plan. Machine gun positions and sectors of fire should cover likely infantry avenues of approach and fire grazing fire across the platoon's front. Machine gun sectors of fire should overlap. Each machine gun is given primary and secondary sectors of fire. Its primary sector includes an FPL or a principal direction of fire.

c. Dug-In Positions. Platoons should always construct mortar positions. However, before the platoon leader decides to have his platoon dig positions, he must consider the trade-offs involved. When time and resources are devoted to digging positions, the ability to perform other tasks is reduced. For example, the mortar platoon cannot dig positions and displace frequently.

d. Obstacles. When time permits, the platoon improves the security of the mortar position by emplacing wire, other obstacles, and mines. The use of obstacles and mines must be authorized by, and coordinated with, the battalion TOC. (See FM 7-7 or FM 7-8.)

7-24. CONDUCT OF THE DEFENSE

By understanding the type of missions that the mortar platoon can be expected to perform and by knowing when and how the platoon may be attacked, the platoon leader can tailor

his defense based on his resources and the threat. During the defense, the platoon leader must--

- Supervise to ensure that security is maintained.
- Control and direct fire.
- Move soldiers within the position.
- Provide enough ammunition and equipment.
- Reorganize and reestablish the defense during lulls in battle.

CHAPTER 8

SPECIAL CONSIDERATIONS FOR THE 60-mm MORTAR SECTION

This chapter presents special considerations for the tactical employment of the 60-mm mortar section by airborne, air assault, light infantry, and ranger companies. It does not stand alone. It is dependent on the rest of this manual and FM 7-10.

8-1. LIGHT MORTARS ON THE BATTLEFIELD

The 60-mm mortar, M224, provides the mortar sections of the light infantry, air assault, airborne, and ranger infantry battalions an effective, efficient, and flexible weapon.

a. The rifle company commander depends on light mortars to supply close fire support, suppression, smoke, and illumination. Light mortars are the most responsive and versatile sources of indirect fire support available. Their maneuverability, high rate of fire, low minimum-range restrictions, lethality, and proximity to the commander ensure the versatility, reliability, and responsiveness needed in light infantry operations. Because of the demands placed on FA assets by counterfire, suppression, interdiction, and the employment of special munitions in nontraditional artillery roles, infantry leaders must plan and train well to ensure that light mortar sections provide the needed support in combat.

b. High-angle trajectories and multioption fuzes allow light mortars to effectively attack targets--

- In defilade on hilly, mountainous, or rolling terrain.
- Under jungle canopies.
- On marshy or snow-covered terrain.
- Behind buildings and on rooftops and top floors.

The short minimum range of the M224 makes the mortar well suited for close protective fires against an assaulting enemy, for block-to-block fighting in cities, and combat over close terrain with restricted visibility.

c. The light mortar section can be positioned between buildings, in confined areas, and on rough terrain. Light mortars are easy to conceal, can accompany raiding and counterattacking forces, can remain at the FEBA until the last moment, and can be moved with stealth. The location of the mortar section near the rifle platoons makes

communications by alternate means possible when conditions prevent radio contact with field artillery FDCs. The maneuverability of light mortars allows for sustained close fire support over the distances expected in light infantry combat.

d. Commanders increase the effect of their light mortars by--

- Stressing the constant integration of mortar fire into the fire support plan.
- Allocating manpower to help move and secure the mortars in rugged terrain.
- Stressing the value of mortars to the close infantry battle.
- Developing innovative ways to request and control mortar fires so that mortars can provide full support to the infantryman.
- Training their mortar's squads to deliver responsive, accurate fires at all times.
- Considering the timely resupply of mortar ammunition by including it in the plan for logistical support.

8-2. ORGANIZATION

The organization of the 60-mm mortar section in the rifle company is based on the company's TOE. The 60-mm mortar section is separate in the airborne, air assault, and light infantry rifle company. It is part of the weapons platoon in the ranger rifle company.

a. Light mortar sections consist of two squads, each consisting of one mortar and its crew. In the airborne, air assault, and light infantry rifle companies, the senior squad leader is the section leader. He is directly responsible to the company commander. (The organization of these mortar sections is shown in Figure 8-1.) No FDC personnel are in the airborne, air assault, or light infantry mortar sections. The mortar section sergeant coordinates closely with the company FIST chief to increase the effect of the section's fire.

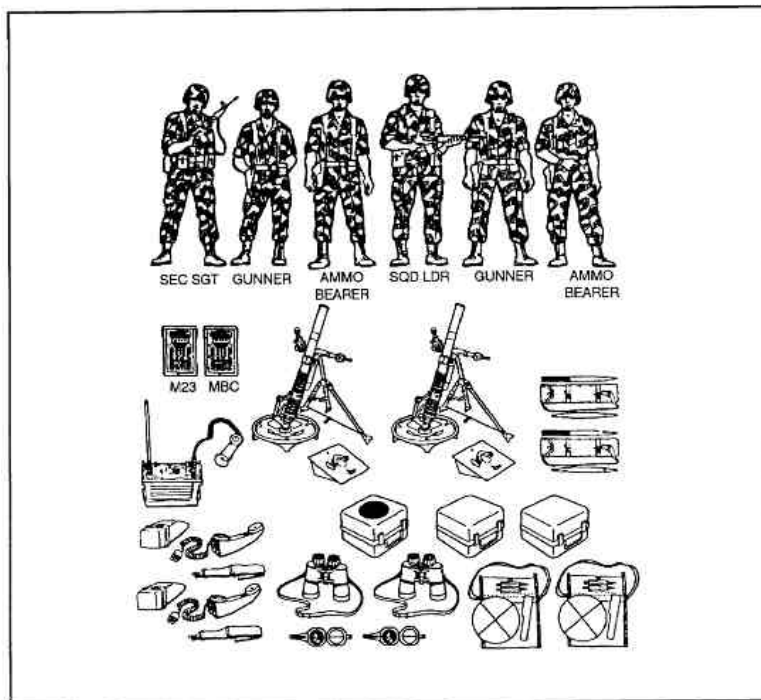

Figure 8-1. Equipment and organization.

b. Since there is no heavy or medium mortar platoon in the ranger battalion, the organic indirect fire support is provided by the 60-mm mortar section in the weapons platoon of each company. The ranger company's light mortar section has the same three-man squads as in the other infantry organizations. Also, it has a separate section sergeant and a single FDC computer. The FISTs in the ranger battalion are assigned rather than attached. This fosters a close relationship between the mortar section sergeant and the FIST.

c. The equipment carried by the mortar section allows the section to perform all the functions of an indirect fire team. Section members are armed for self-protection with M16 rifles (section sergeant and squad leader) or pistols (gunners and ammunition bearers). Each squad is equipped with a complete M224 mortar (baseplates, barrel, bipod, sight, and aiming stakes), fire control equipment (binoculars, M2 compass, MBC, and plotting board), and a TA-1 telephone. The section sergeant has a boresight device and a radio.

8-3. RESPONSIBILITIES

For the light mortar section to complete its tasks, the company commander and each member of the section are responsible for the following:

- a. The company commander is responsible for employment of the mortar section. He assigns missions and priority of fires, allocates priority targets, designates general firing locations, and approves fire plans. He determines the suitable command relationships. He plans for logistical support by determining the amount and type of ammunition, and its distribution and resupply. The commander must be concerned with ammunition resupply since a mortar section can fire 280 rounds of 60-mm mortar rounds in five minutes. At that rate, the ammunition supply of a company can drop rapidly.
- b. The ranger weapons platoon leader is the main advisor to both the company commander and the FIST chief on the tactical employment of the ranger company's mortar section. He recommends employment methods and positions the section to support the scheme of maneuver. He assists the commander and FIST chief in developing the company fire plan. He keeps them aware of the ammunition status and any range/mask problems. The weapons platoon leader leads the reconnaissance party, reconnoitering new positions and routes for the section based on the company commander's guidance and the enemy situation. He supervises the execution of orders and ensures that security measures are enforced to protect the section. The platoon leader lays the mortars for firing, when required.
- c. The mortar section sergeant in the airborne, air assault, and light infantry company is responsible for all the duties of a platoon leader. He also acts as the squad leader for one of the two mortar squads.
- d. The other mortar squad leader is responsible for the same duties as the section sergeant when operating as a separate squad. He acts as the section sergeant in the sergeant's absence.
- e. The specific duties of the gunner and ammunition bearer are described in FM 23-90. In the light mortar section, the ammunition bearer also acts as assistant gunner.

8-4. EMPLOYMENT OPTIONS

The maneuver commander employs the mortar section based on his METT-T analysis.

- a. The company commander has two options when considering how to employ the 60-mm mortar section--as a complete section or by squad.
 - (1) When the commander employs the mortars as a section, it operates from a single firing position under the control of the section sergeant. Both mortars engage the same target. The distance between mortars is 25 to 30 meters. This dispersion protects the section from enemy fire and ensures that the bursting radii of the rounds overlap. The section sergeant passes fire commands to the mortar squads by voice or over wire. To increase its responsiveness, the light mortar

section operates from a position near the rifle platoons. It engages targets as quickly as possible, often using fire without an FDC. If fire with an FDC is used, one of the two squads is designated by section SOP as the base squad. The section does not normally adjust the sheaf by firing. Once one mortar has been adjusted onto a target, the remaining mortar is laid parallel by reciprocal lay using the mortar sights (see FM 23-90).

(2) When the commander employs the mortar section by squad, he uses both squads as separate firing units. They may fire at the same target, but most often they engage different targets. Employment by squad may take place during the initial phases of airborne or air assault operations, or while supporting special needs:

- Reinforcing an element conducting a combat patrol
- Reinforcing the advance guard.
- Performing one-mortar illumination missions.
- Infiltrating the company along multiple routes.
- Supporting detachments left in contact.
- Displacing by bounds to give continuous support during movement by the company.

(3) Employment by squad is the less desirable method. It should be used as a temporary measure when METT-T factors prevent mission accomplishment by section employment. The 60-mm mortar lacks the destructive power of heavy mortars and FA. By concentrating fires, the section can achieve a greater measure of destructive power. The employment of separate mortar squads lessens the destructive power achieved by consolidating the section, but it does gain responsiveness to special situations. Squad employment also increases the problems common to ammunition distribution and resupply, as well as fire control. Employment by squads can reduce the company commander's span of control problems if the mortar squads are attached to platoons or a patrolling element.

(4) Under extreme circumstances, the commander may choose to leave one of the section's mortars behind and have more ammunition carried for the remaining mortar. This could occur during operations over deep snow, requiring the mortar section to use ahkios to transport its weapons and equipment. The six-man mortar section can pull only a single ahkio, which can carry up to 200 pounds. Operations on mountainous terrain can also cause the commander to choose to leave a mortar behind. During assault climbs or infiltration attacks over rough terrain, the efforts of all six mortarmen may be needed just to get a single mortar and its ammunition into a firing position.

b. The battalion commander always has the option of detaching the light mortar sections from the rifle companies and consolidating them under the command and control of the battalion mortar platoon.

(1) This might be done when the battalion's objective is a compact, well-defined area that can be covered completely from one or two mortar firing locations.

(2) Consolidating the battalion's mortars has several advantages:

- Fires can be massed and controlled by a single FDC.
- Ammunition resupply is much easier to control.
- Understrength mortar squads can be consolidated and rested.
- Displacement and transportation can be more easily controlled.
- Security against an enemy ground attack is increased.

(3) Consolidating the battalion's mortars has several disadvantages:

- It increases the chance that a large portion of the battalion's mortars will be destroyed by a single-enemy countermortar strike.
- It requires a larger firing position than normally needed.
- It may limit target coverage and flexibility of fire support.
- It deprives the rifle companies of organic mortar support to complement their direct fires and maneuver.
- It can cause a delay while the mortar sections are consolidated, and again when they return to their parent company.

c. Consolidation of the battalion's mortars, like almost all nonstandard task organizations, is highly dependent on specific METT-T conditions. It has inherent advantages and carries with it inherent risks. It should not be used routinely, but only after a careful analysis of the situation and the commander's desired outcome.

8-5. DISPLACEMENT

Based on the scheme of maneuver and the company commander's guidance, the mortar section sergeant prepares a displacement plan as part of his fire plan. The displacement plan must contain detailed instructions on the type and amount of ammunition to be carried with the section. The company's plan must have provided details on the displacement of the section's bulk ammunition load. The section leader briefs the section on the displacement plan. He orients the section on potential targets using a map, compass, and prominent terrain features. After having received new information, the section leader updates the earlier orientation given to the section, when possible.

a. To support offensive operations, the displacement plan must permit rapid displacement and emplacement, while ensuring the use of immediate fire support. The enemy situation, the distance and terrain to be covered, and the need for continuous fire support determine the displacement method used. However, the mortar section most often displaces as a complete section. The section may occupy successive positions while the company continues to advance. It also may identify likely firing positions and continue to move with the company until required to fire. Continuous orientation by all members of the section reduces the time to bring effective fire on the enemy.

b. The defensive displacement plan has the same needs as the offensive plan with some additions. Each member of the section is shown the route to be used and the exact location of alternate and supplementary locations. Use of prestocked firing positions, pre-laid wire for communication, and predetermined firing data are considered. All firing positions should be readied so the gunners can quickly lay the mortars. Also, careful map inspection and coordination between the rifle company and the supporting FA battalion should result in accurate map location of all firing positions. Two methods to speed the emplacement of the mortar section during defense displacement are as follows:

(1) The section sergeant reconnoiters subsequent firing positions and determines the locations of the mortar baseplates. He places a tent peg or stake into the ground at the intended location. Attached to this peg is 5 meters of engineer tape and another peg. The section sergeant runs this tape out and uses his M2 compass to orient the tape in the direction of fire. He then stakes the tape down. Depending on the time of day when the position will be occupied and the tactical situation, chemical lights can be placed at the far end of the tape to aid the gunner. Upon arrival, the mortar crew emplaces the baseplate at one end of the tape, sets the mortar sight on 3200 mils, sights on the light or along the tape, refers the sight to the section's SOP deflection (normally 2800 mils), and places out the aiming stakes. With practice, the mortar crew can emplace quickly during day or night.

(2) If possible, one mortar is carried to the firing location and emplaced using the M2 compass. The mortar crew places out an aiming post as if the mortar were going to occupy that position at that time. A stake is then driven into the ground at the rear of the baseplate, with a portion left visible. The mortar is moved to another position 25 to 30 meters away, and the procedure is repeated. The crew marks both the baseplate stakes and aiming stakes with white engineer tape or chemical lights. It also checks mask and overhead clearance at each location.

c. In retrograde operations, the mortar platoon leader plans displacement to provide continuous support. Close coordination and communication with the commander are needed to ensure that the mortars move at the proper time. Because of its mobility, the mortar section is an ideal supporting weapon to maintain in a firing position until the last of the rifle elements displace. The high rate of fire of the 60-mm mortar allows the section to suppress enemy dismounted assault elements so friendly forces can disengage.

d. The 60-mm mortar section normally displaces as a single element. It is always ready to fire from a hasty position.

8-6. RECONNAISSANCE AND POSITION SELECTION

Reconnaissance for mortars determines its use for mission accomplishment. Although ground and air reconnaissance can be used, the section sergeant normally performs a map reconnaissance. A detailed ground reconnaissance is the preferred method of locating positions for the mortar section, but lack of time and mobility may not allow it. The mortar section sergeant accompanies the commander on the leader's reconnaissance.

a. The general location of the mortar section is chosen by the company commander. He decides the location based on a careful consideration of the METT-T factors as well as:

(1) The need to provide maximum coverage of the company's area. He considers both minimum and maximum ranges of each type round. Positioning the mortar section near the center of the rifle company sector or battle position normally provides the best target coverage and flexibility.

(2) The need to place the mortars in defilade. This protects the mortar section from enemy direct and low-angle fires while still allowing it to support the company.

(3) The need to provide some measure of security for the mortar section. The section should be positioned near or with other elements of the company. The commander can position the mortars near the company CP, near the rearmost rifle platoon, with the company trains, or with the reserve force, if there is one.

(4) The need to provide for ease of ammunition resupply. The chosen position need not be directly on a route for resupply vehicles. However, if the position is near one, the resupply problem is eased if vehicles are used. Since the mortar ammunition is lightweight, resupply by a carrying party over short distances is possible.

b. Once the company commander designates the general location of the mortar section, the section sergeant reconnoiters and determines the precise location for each squad.

c. Once a section occupies a position and the mortars are laid, the section sergeant initializes the MBC or prepares an observed firing chart. Ready ammunition is unpacked, and communications are established. The mortars are left in temporary firing positions, and the emplacements are built to Stage I specifications. These positions are updated until they are at Stage III. Alternate and supplemental positions can be prepared or designated.

d. Communication with the mortar section is the key to effective employment. The section uses the single man-packed radio to monitor the company command net. The radio can be placed on the frequency used by the platoon having priority of fire. It can be used to enter the FIST fire control net but does not operate routinely in that net. Wire is the primary means of communication during long halts or defensive operations. The company commander ensures that the wire is quickly laid to the mortar section and that all platoons pass calls for fire to the mortars. Voice is the most common means of controlling the fires during fire without an FDC. Initial commands to move or fire may be passed to the section over the company command net but not long fire missions.

e. Advance party operations by the light mortar section are the exception rather than the rule. The size of the section and the simplicity of the weapon make a rapid and efficient emplacement possible without an advance party. When the section is expecting to move, mainly at night, and enough time exists to reconnoiter and prepare the new position, the

section sergeant does so. A set of direction and baseplate stakes, marked for easy identification, can help the crew in emplacement. Chemical lights of different colors can be useful, depending on the tactical situation.

8-7. TYPES OF ENGAGEMENT

The light mortar section must be prepared to engage targets using fire with or without an FDC.

a. Fire with an FDC increases the effect of the mortar section. The section sergeant sets up and operates an FDC when the mortar section occupies semipermanent positions or makes a long halt. The FDC influences the outcome of the battle by massing mortar fires, furnishing prearranged fires during reduced visibility, shifting fires, effecting time-on-target missions, lifting all fires, or furnishing fire support to other companies within range. Fire with an FDC may not always be possible. The mortar section can still be effective without using an FDC if the members are well trained in this method of fire.

b. Even though light infantry companies can employ the mortar without an FDC, they must not disregard the FDC method of employment. The section sergeant cross trains the other squad leader and gunners in FDC procedures. He establishes and employs an FDC whenever possible.

8-8. SUPPORT AND COMMAND RELATIONSHIPS

The mortar section can fire in support of any of the company's rifle platoons. The company commander sets priorities of fire and command relationships. He designates priority targets. Command relationships are limited to keeping the mortar section under the company commander's control or to attaching squads to the rifle platoons. The company commander can attach one mortar squad to a platoon while keeping the other mortar squad under his control—for example, when a platoon is sent out on a combat patrol.

8-9. SUPPORT DURING OFFENSIVE OPERATIONS

The mortar section is the only indirect fire support element that can accompany the rifle platoons as they move to the objective and begin the assault. The planning considerations outlined in Chapter 3 apply to the 60-mm mortar section sergeant's planning. The amount and type of ammunition available are considered first when using the light mortar in the attack.

a. The section sergeant and company commander consider how much ammunition is carried and who carries it. The mortar section can carry only a limited amount of ammunition. The approach load of mortarmen must be kept to a minimum. Extra pounds of personal equipment decrease the ammunition carried by the section. In World War II, the gunner of the 60-mm mortar squads carried the mortar tube and six rounds. Two other members of the squad carried 12 rounds each. This represents only one minute of fire at

the maximum rate for the 60-mm mortar. The company commander's options for carrying more mortar rounds are limited.

(1) Each member of the rifle platoons and company headquarters can carry one or two mortar rounds. This adds weight to the already heavy load of the riflemen and machine gunners, but it does ensure that mortar ammunition is available. This method is hard to control if the enemy opposition is intermittent but can be effective during a deliberate attack. As the rifle platoons pass through or near the proposed mortar firing position, they can drop their mortar rounds. A modification of this method was used in the Korean War when attacks were being made along or up steep ridge lines. The lead rifle platoons did not carry any mortar rounds. The mortar section moved second in the line of march, carrying as much ammunition as it could. The second and third rifle platoons, moving behind the mortars, carried one or two rounds on each man. When enemy contact was made, the leading platoon immediately began the assault, supported by the mortar section firing the ammunition it carried. As each succeeding rifle platoon passed the mortar position, it dropped its mortar rounds and joined the attack.

(2) The rifle company can have the mortar section carry as much ammunition as possible and rely on vehicles, aircraft, or battalion-carrying parties to resupply ammunition. This method works best when the advance is along a road net or over trafficable terrain. Organic vehicles may be used, or captured enemy equipment may be pressed into service. A method that saves time and effort is to have mortar ammunition broken out of its boxes either at the ammunition transfer point or unit trains. The individual canisters can then be placed into color-coded aviator kit bags and stockpiled for movement forward by the available transportation means. Using the kit bag eases loading, unloading, and transferring the ammunition. About 15 rounds of ammunition can be carried in each kit bag, making a load that can be handled easily by two men, or by one man in an emergency. In some areas of the world, labor service units provided by our allies can carry ammunition. In the lesser developed countries, indigenous pack animals may be available. If carrying parties or pack animals are used, the company XO and first sergeant must coordinate to ensure that guides and drivers/handlers are available and supervised.

b. Light infantry company offensive operations are characterized by dismounted movement, often over rugged terrain, and by rapidly changing situations. These operations require flexibility on the part of the mortar section. The value of the 60-mm mortar section in the offense does not lie in its volume of fire or its continuous fire support. The mortar section's best contribution to combat success is its immediate responsiveness to the company commander's orders, the speed at which it can be brought into action, and the effectiveness and accuracy of its multi-option fuze-equipped rounds. Due to the limited ammunition and destruction power of each round, commanders must consider when and at what the mortar should be fired. The company mortar section should be used to engage targets that appear suddenly and cannot be immediately engaged by other indirect support. Once effective battalion mortar or FA fire is brought

on the enemy, the company mortar section normally ceases fire to save ammunition. The commander must decide if increased fire is needed to destroy or neutralize the enemy. If so, he can direct the company mortar section to continue fire.

c. The lightweight M8 baseplate is used most often during offensive operations. In the attack or movement to contact, the larger M7 baseplate can be left at the trains location and brought forward later. The smaller M8 baseplate is lighter by 11 pounds, which allows the crew to carry three more rounds for each mortar. If a mortar squad is attached to a platoon conducting a combat patrol, the squad leader can choose to carry only the mortar cannon and the M8 baseplate. This is the lightest combination possible, weighing only 18 pounds. The mortar is then fired using the direct-lay, hand-held mode.

d. The mortar section normally moves as a section within the company formation. The chance of enemy contact determines whether the commander chooses the traveling, traveling overwatch, or bounding overwatch technique of movement.

(1) When the company is moving using the traveling or traveling overwatch technique, the mortar section moves either directly behind the company command group or directly behind the second rifle platoon in the line of march. The section sergeant monitors the company command radio net and continually orients the section members to the terrain. At halts, he moves forward to coordinate with the company commander and the FIST chief.

(2) If the company is moving in bounding overwatch, the mortar section is positioned directly behind the command group, and it moves with that element. The section sergeant estimates the range to the lead elements of the bounding platoon, and he is prepared to provide fire support from his location or to move to a better position. The company commander may attach one mortar squad to each of the two lead rifle platoons to assist them in overwatch.

e. Maintaining orientation is important for the mortar section when moving during limited visibility. The mortar section lacks night vision devices, and it relies on natural light or luminous markers to keep track of the element ahead. During limited visibility, the company commander may move with the lead platoon. The mortar section then moves behind the last squad of this platoon rather than with the commander. During short halts, the mortar section spreads out in prone positions behind cover. During longer halts, the mortars are set up, and a limited amount of ammunition is readied. Specified amounts of illumination ammunition (determined by SOP) can be carried ready-to-use. Also, fire without an FDC is difficult at night.

8-10. SUPPORT DURING A MOVEMENT TO CONTACT

The displacement method chosen during a movement to contact depends on the company commander's evaluation of the chance of enemy contact, distance to be traveled, and terrain being traversed. The mortars normally move as a section. If the terrain does not allow good observation, it may be best to attach the squads to the rifle platoons.

a. The commander may attach one of the mortar squads to the lead platoon. This allows quick response to enemy contact by the lead element, but it hampers the massing of fires by the section. When the company is acting as the advance guard and has a dedicated battery in DS, the company commander keeps the mortar section under his control. The section sergeant monitors the company command net and makes sure the section is in range of anticipated targets. The mortar section can supplement the fires of the dedicated battery by covering other priority targets as they become visible. In the movement to contact, light mortars are effective when firing HE and WP for suppression or WP for screening and obscuration.

b. The mortar section carries only a limited amount of ammunition during a movement to contact. The disadvantage is offset by the ability to bring immediate fire on the enemy. During World War II, the mortar section was most effective in the movement to contact when it followed close behind the lead elements, opened fire quickly, had effective first rounds, and fired about three or four rounds for each target. When the enemy offers intermittent resistance, the section is best used by attaching a mortar squad to each of the two forward platoons. This uses the quick response of the mortars to its fullest. If there is a greater resistance, the mortars are kept under the company commander's control and moved 75 to 100 meters behind the lead platoons. This provides quick response while making concentration of fire easier.

c. Communication between the lead platoon (that can see targets) and the mortar section is critical. There are several effective methods that have been used in combat to aid such communications:

(1) The mortar section sergeant can monitor the radio frequency of the lead platoon. If enemy resistance is encountered, the mortars immediately stop and conduct a hip shoot, firing the adjusting round forward of the friendly lead elements. This requires close monitoring of the lead platoon's location by the section sergeant who acts as the FDC. The platoon sends corrections to the mortars by radio. This method is used when the company commander expects the enemy resistance to be great. The mortar section is protected from the initial enemy fires by remaining slightly to the rear, yet staying close enough to fire quickly.

(2) The section sergeant can carry a roll of wire and a telephone or have a designated soldier to move with the mortar section and carry a wire dispenser. When enemy resistance is encountered, the mortars are emplaced, and the wire is connected to a telephone at the mortar position. The section sergeant (and wireman, if used) moves to a position where he can observe the enemy and adjust fires, unrolling the wire as he moves. Assault wire (MX-6894 or NIX-6895 combat assault rolls) is used for fast installation and light weight. Assault wire is thinner and not as strong as WD-1, but the 800-meter MX-6894 weighs 4 pounds as compared to 25 pounds for the same length of WD-1 wire on the MX-306. Standard WD-1 field wire is used either on the MX-306 doughnut roll or the CE-11.

(3) The mortar section can move behind the company command group until the lead element makes contact with the enemy. The section sergeant then leads the section forward to a position where they can fire using either direct alignment or direct lay. The company commander directs the section sergeant by voice command, arm-and-hand signals, radio, or messenger.

8-11. SUPPORT DURING A HASTY ATTACK

In the hasty attack, the commander develops the situation and uses immediate fire rapid maneuver to maintain momentum.

a. The targets engaged by the mortar section are mainly targets of opportunity, although the commander preplans targets, when possible. The company commander keeps the mortar section under his control. The section sergeant uses his judgment and initiative in the absence of orders to determine how best to support the company maneuver. He employs the section aggressively to support the assault elements as they close with the enemy.

b. Once the objective is seized, the mortar section is brought forward to a position from which to support the entire company. The mortar section prepares to fire against an enemy counterattack. The section sergeant acts decisively, using his best judgment and initiative to accomplish the commander's intent. The mortar section plays a key role in the defense against a counterattack. During the period after the seizure of the objective and before the assault force has reorganized, consolidated, and planned other fires, the company mortar section is the most responsive fire support means available. The section sergeant displaces the section forward to support the company, establishes fire control and communications, computes data and prepares to fire the section FPF, evaluates existing ammunition stocks, redistributes ammunition, coordinates resupply requests, and makes sure his squads prepare hasty defensive positions. He must do this with little guidance from the company commander.

8-12. SUPPORT DURING A DELIBERATE ATTACK

The deliberate attack is characterized by detailed planning, both for maneuver elements and fires. The commander uses the light mortar section to supplement scheduled fires of heavier indirect fire weapons. The flexibility of the light mortar is best suited for use against targets of opportunity encountered during the attack and for immediate screening missions.

a. Light mortars are included in the preparation fires when ammunition, positioning, and the enemy situation permit. The commander keeps in mind that mortar ammunition fired early can be hard to replace later. Mortars should provide fires on the objective to support the final assault, especially if the direct support artillery is 155 mm. This allows indirect fire suppression of the enemy until the assaulting forces close to within about 50 meters (minimum safe distance). Assaulting forces can get closer to the enemy under the cover of small caliber mortar fire than would be possible with fires from medium or heavy

artillery. A method that was used successfully in World War II was for the assaulting platoon to approach as close as possible to the objective while the mortars fired HE to suppress the enemy. On a prearranged signal by the assault force, the mortars switched to WP rounds and fired several in quick succession. The bursting WP rounds were the signal to the rifle platoon that the mortars were shifting their fires 50 to 100 meters beyond the objective. As soon as the last WP round had burst, the assault forces closed with the enemy. Not only do the WP rounds signal the shifting of fires, but also the smaller casualty-producing radius provides a margin of safety for the assault force. The psychological effect of the WP and the smoke produced combine to create confusion among the enemy during the critical moments when the friendly forces are exposed. This requires well-trained and practiced mortar crews, as well as close coordination between the mortar section and the assaulting force.

b. During a deliberate attack against a fortified position, the mortar section is best employed with the company's support element. Although 60-mm HE fires will not penetrate a properly constructed fortification with overhead cover, they force the enemy to remain inside his positions, limiting his observation. HE fires inflict casualties on troops in open trenches. By firing WP, the mortar section obscures enemy observation from adjacent positions and assists the assault element in gaining a foothold. After the assault element has made an entry into the fortified position, the mortar section moves forward with the support element. Follow-on elements from the company carry mortar ammunition as they move forward and through the support position.

c. During MOUT operations, the light mortar section is employed with the company's support element. The section provides the rifle platoons the firepower and obscuration needed to isolate a building or strongpoint while assault and security elements move forward to gain the initial foothold.

d. The 60-mm mortar is effective against enemy positions on urbanized terrain. Its high rate of fire and short minimum range allow the mortar section to mass fire on specific enemy positions in the restricted confines of city fighting. It is used to attack targets behind buildings that cannot be hit by low-angle artillery fire. The mortar section is used to obscure, neutralize, suppress, or illuminate targets. The multi-option fuze increases the mortar round's effectiveness, but the HE round, even employing the delay fuze setting, can penetrate only the upper floors of light buildings.

8-13. SUPPORT DURING DEFENSIVE OPERATIONS

The 60-mm mortar section provides the company commander organic indirect fire support that must be integrated into the company's overall defensive fire plan to be effective.

a. Planning.

- (1) The mortar section is used to engage the following:

(a) Dismounted enemy infantry, especially when it is covered from direct fire or concealed.

(b) Enemy armored vehicles, using HE rounds with proximity fuze settings. This causes the crew to button up, reducing the effectiveness of the vehicle while separating it from any accompanying dismounted infantry.

(c) Enemy long-range, direct-fire weapons that support the attack. The section engages these using a mixture of WP and HE rounds to suppress and screen.

(d) Assaulting enemy forces, using close defensive fires and FPF.

(e) Enemy mortars, especially light and medium mortars, with a combination of proximity and near-surface burst fuze settings.

(f) Enemy forces trying to breach friendly wire or mine obstacles.

(2) The M224 60-mm mortar fires the M83A3 illumination round to about 950 meters. The small size and limited burn time of the 60-mm illumination round make it more suitable for point illumination rather than area.

(3) The M302A1 WP round has a maximum range of about 1,600 meters. During the defense, its primary use is to screen enemy observation and fire. It can also be used to mark targets for air strikes. The round has a limited incendiary and casualty-producing effect.

b. Fire Support During the Defense.

(1) The company mortar section is employed as a section during defensive operations with priority of fires to a designated rifle platoon. The mortar section is assigned an FPF, which is integrated into the company's defensive fire plan to augment the fires of heavier weapons.

(2) The light mortar section should be emplaced in a defilade position near the company CP. It may collocate with the company reserve or the rearmost rifle platoon. Wire communications are established through the company CP with each rifle platoon and OPs. The section's second telephone can be connected to a wire line laid to the platoon having the priority of fires. This provides alternate communications if the primary wire is cut by artillery fire. Positions are dug in, and overhead cover is provided for both the ammunition and crew. Positions are camouflaged and wire lines are buried.

(3) The section sergeant acts as the FDC and closely coordinates with the FIST chief and the company commander to ensure effective integration of the section's

fires. The section sergeant locates and, if time permits, prepares an OP where he can control the fires of the section himself, if wire communication is lost. He monitors the company command radio net and can change to a platoon frequency or the FIST frequency, depending on the company commander's guidance.

(4) The mortar section's fires are not normally included in the defender's counterpreparation fires. Battalion mortars and field artillery should be used for this role. The company mortar section can be used to engage targets of opportunity, especially at night, or targets in close defilade positions. The light mortar section is used to fire as an immediate response to enemy direct fire weapons or against enemy mortars firing from positions near friendly lines. It is better to engage small enemy probes, breach teams, or reconnaissance patrols with indirect fire from the mortar section than to disclose the locations of friendly machine gun, SAW, or rifle positions.

(5) Once the enemy attacks, the company mortar section fires to break up his formations and to destroy his forces. Enemy elements assaulting the friendly positions and enemy crew-served weapons locations are primary targets. Fires from the 60-mm mortar are effective against enemy forces that have closed with friendly elements. The mortar section can still engage these targets by using near-surface burst and proximity-fuze settings or rounds fired directly onto dug-in friendly positions. This type mortar fire is effective against the enemy infantry outside while not harming friendly personnel inside a well-constructed bunker with overhead cover. The mortar section, firing from the reserve platoon's position, can support a counterattack or limit the enemy penetration. If the rifle company is counterattacking, the mortar section supports with fire from preplanned positions.

(6) The 60-mm mortar section can fire FPF that are about 70 meters wide and 35 meters deep. FPF are normally fired using impact or near-surface burst fuze settings. The mortar section has a single FPF assigned. Because of the light weight and small bursting radius of the mortar round, single mortar FPF have limited effectiveness. This does not preclude assigning of separate priority targets to each mortar squad. It means that such targets must be important enough to the commander to outweigh the need for FPF. The mortar section's FPF should be carefully integrated into the defensive fire plan of the company. It is most effective when the mortar section's FPF supplement the FPF of the battalion mortar platoon and the supporting field artillery. The accuracy and short minimum range of the M224 mean that the FPF can be close to friendly positions. (The M224 firing charge 0 has a maximum range probable error of only 3 meters.) Mortar FPF are always within small-arms range of friendly positions.

(7) The company commander must consider the section's ammunition status, the resupply rate, and the tactical situation when designating how much ammunition to keep in reserve for the FPF. The company SOP should set guidelines regarding the amount of ammunition to be fired at any one target. This is important since the

ammunition stockpiled can be expended rapidly. The company SOP clearly states who has the authority to call for the FPF to be fired and under what conditions.

c. Fire Support During Retrograde Operations.

(1) The mortar section sergeant coordinates closely with the company commander and the FIST chief to ensure that he understands the mortar section's role in the company retrograde fire support plan. Factors influencing the mission, employment, and movement of the 60-mm mortar section are as follows:

- (a) Whether the withdrawal will be conducted under pressure.
- (b) Whether DLIC, security forces, or the entire withdrawing force is to be supported.
- (c) Whether smoke screening is needed. The screen produced by the M224 mortar WP round is not as effective as that of the heavier mortars and field artillery. The mortar section should be used to obscure selected, critical areas or to add to the screen produced by other elements. It can be effective when used to screen the withdrawal of small elements such as OPs.
- (d) Whether ammunition and transportation assets will be available to support the mortar section. If ammunition can be stockpiled at progressively rearward positions and vehicles available can assist in section displacement, the 60-mm mortar section can maintain almost continuous fires as the company withdraws. Communication to control the displacement of the mortar section must be positive and timely.
- (e) The displacement schedule of the battalion mortars and supporting field artillery. If possible, the 60-mm mortar section should not displace at the same time as the battalion mortars.

(2) During retrograde, the mortar section is normally employed as a single element, but the commander may want to split the section, depending on his needs. If there are detachments left in contact, a mortar can be attached to the DLIC commander. The single squad is then used to continue the normal fires of the section and to aid the DLIC in breaking contact, if needed.

d. Fire Support During a Relief in Place.

(1) The company mortar section is the last element to be relieved. It stays in position, ready to fire, until all the maneuver elements are relieved. The section sergeant passes all target lists and FPF information to the relieving section. Ammunition, prestocked in a defensive location, is transferred to the relieving section. Baseplates and aiming stakes can be transferred, especially if the section

being relieved has well-prepared defensive positions. The relieving mortar section's base gun can be laid parallel with the guns of the relieved section by sight-to-sight reciprocal lay. Wire lines should be transferred to the relieving section.

(2) The mortar section can be required to continue to fire the missions associated with normal battlefield activity during the relief in place. If so, the two section sergeants coordinate to ensure a smooth transition of responsibility. The section sergeant of the relieved section should conduct a daylight reconnaissance of the route back to the company assembly area, as well as the section's location in the assembly area.

8-14. RATES OF FIRE

The 60-mm mortar section can quickly fire large amounts of ammunition. The M224 can fire 120 rounds in four minutes—a three-man crew can have 15 to 20 rounds in the air before the first round impacts. The high rate of fire is due to the simplicity of the mortar and its lightweight ammunition. The cooling fins at the base of the mortar allow the high rate of fire to be maintained for long periods. In the past, mortar crews, trying to produce and maintain a high rate of fire, have used the two-man loading method. This method should not be used; it increases the chances of double-loading the mortar and causing an in-bore premature detonation. A single loader can fire almost as fast with less chance of double-loading. If a high rate of fire is required and ammunition is available, the squad leader can assist the ammunition bearer in preparing rounds. With practice, they can establish a smooth flow of rounds.

8-15. LOAD-CARRYING TECHNIQUES

The load carried by the 60-mm mortar section has a direct effect on the section's ability to traverse terrain at the rate needed to move with other elements of the rifle company.

a. Since the mortar section is most effective when it is close to the point of enemy contact (although not under direct fire), the company commander and the section sergeant must monitor the section's load and keep it at the minimum required for the mission and tactical situation. Section members should carry only their minimum combat load in order to carry the mortar and enough ammunition. If transportation for the section's existence load is not available, the amount of ammunition and firepower of the section are reduced.

b. The M224 can be broken down into parts and hand carried. This, plus the flexibility in the choice of baseplates, allows the section sergeant to tailor the section's load to a specific mission and specific terrain.

(1) If the company is conducting an administrative road march, the section sergeant should request or coordinate to have the mortars and ammunition moved either by battalion or company vehicles. This conserves the strength of the section

members, allows members to carry their entire existence load, and provides the maximum protection to the ammunition, which can be kept in its packing boxes. The mortar section should move in the march column near the vehicle carrying the mortars. Care must be taken in transporting the mortars to ensure that nothing is lost or damaged, especially the sights. A section member can be detailed to ride with the mortars to ensure mortars are safe and delivered to the correct location.

(2) If the company is conducting a tactical road march or if vehicular transport is not available, the mortars should be carried using the three-man carry. The section sergeant and squad leader carry the radio, telephones, aiming stakes, sightunits, boresight, MBC, and plotting boards. They relieve the gunner and assistant gunner of their loads from time to time, allowing them to rest. Ammunition can either be carried on battalion vehicles or distributed among the crew members. To ease the strain, these loads should be rotated often.

(3) When the mortar crew is accompanying a patrol or is performing an airborne or air assault insertion, it may carry only the cannon with the M8 baseplate attached. This is the lightest combination possible (18 pounds), allowing the easiest portability. It requires that the mortar be employed in the direct-fire mode.

8-16. LOAD-CARRYING DEVICES

The heavy loads of equipment and ammunition carried by the mortar section can quickly exhaust soldiers moving over rugged terrain unless loads are distributed evenly and load-carrying equipment is properly used.

a. There are four pieces of standard Army equipment that can help the mortar section members transport the weapon and ammunition.

(1) The combat field pack, either the large or medium size, can be used with or without the metal pack frame. Either pack allows the soldier to carry his combat load and more ammunition. The 60-mm mortar rounds can be carried inside the pack or in the outside pockets. Individual rounds should be kept in their cylindrical packing container to protect both fuze and propellant charges from exposure and possible damage. Use of the pack frame with the field pack allows the greatest flexibility in load carrying. Some sections are equipped with newer packs that do not have an external metal frame. Mortar ammunition carried in these packs should be packed on top of all other items in the top portion of the pack.

(2) The pack frame can be used to carry heavy or bulky loads without the field pack by attaching the cargo shelf to the pack frame either at the middle or the bottom brace of the frame (Figures 8-2 and 8-3). Cargo tie-down straps are used to secure the load to the pack frame (Figure 8-4). The mortar, bipod, baseplates, and sightunits can also be secured to the frame by tie-down straps.

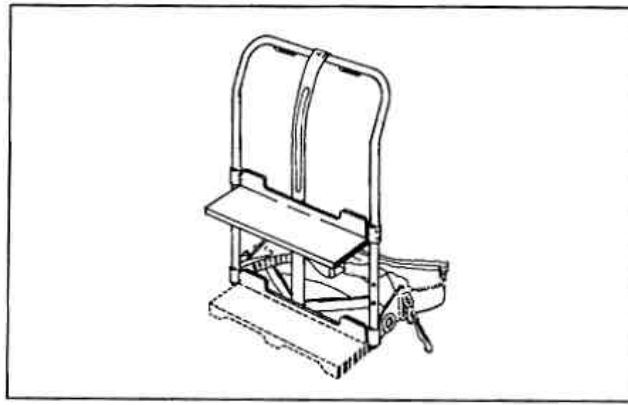

Figure 8-2. Attachment of the cargo shelf.

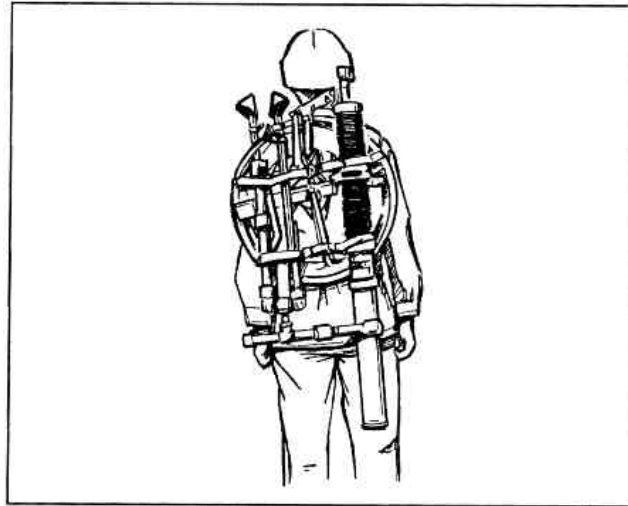

Figure 8-3. The 60-mm mortar carry-on backpack with frame.

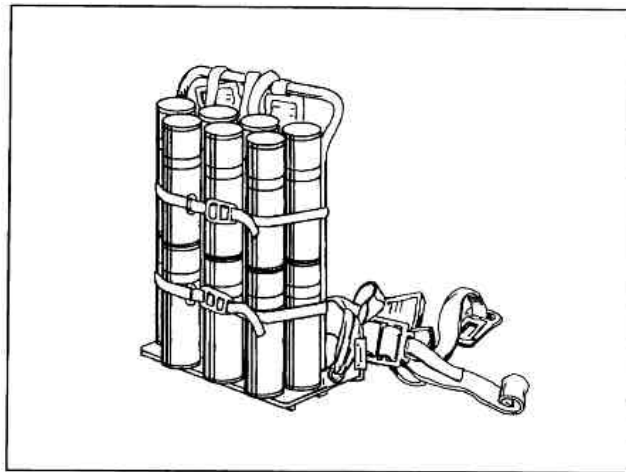

Figure 8-4. Cargo tie-down straps.

(3) The universal load-carrying sling (Figure 8-5) can be used to carry ammunition or the mortar. The sling is adjustable and can be shifted to the position needed to attach various loads. One sling can be used alone, or two slings can be combined, depending on the load. Not more than 35 pounds per sling should be carried. A method for using the sling to carry the 60-mm mortar ammunition containers is shown in Figure 8-6.

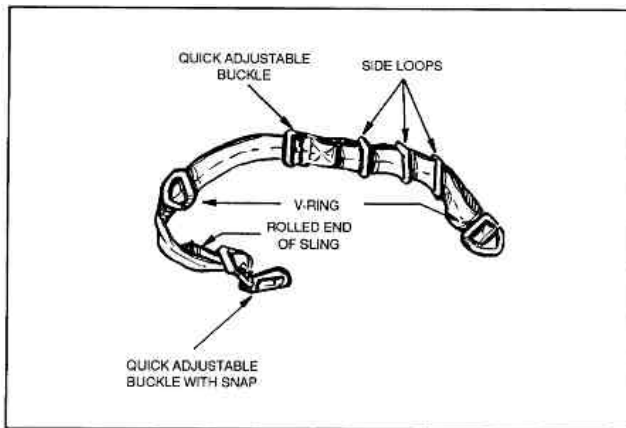

Figure 8-5. Universal load-carrying sling.

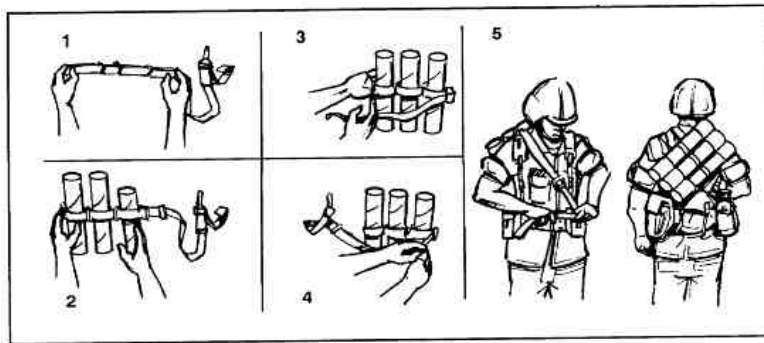

Figure 8-6. Carrying ammunition containers.

(4) The plywood packboard is an efficient means to carry heavy loads. When the packboard is used, 50 pounds can be carried easily, and more than 100 pounds can be transported for moderate distances. Irregular-shaped loads can be lashed onto the packboard with a rope. Standard loads, like fiber canisters, are secured using the quick-release straps (Figure 8-7).

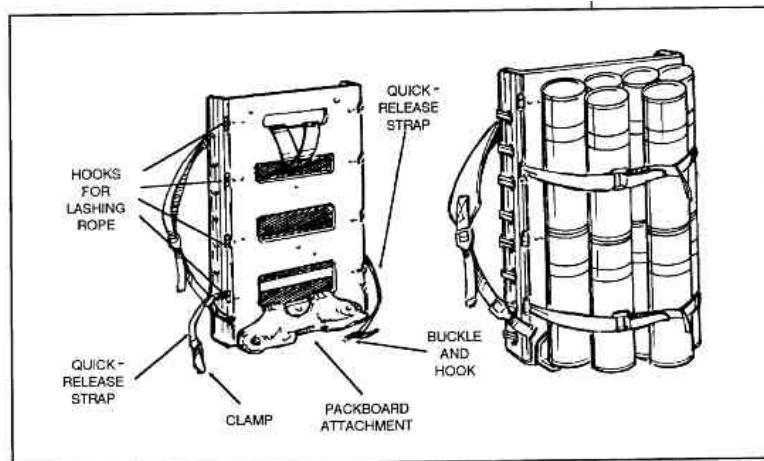

Figure 8-7. Typical packboard load.

b. The use of field-expedient, load-carrying methods is encouraged and only limited by the imagination of the soldiers and leaders involved. Five field-expedient methods of carrying loads that the mortar section can use are as follows:

(1) The nylon sling issued for carrying the M60 machine gun can be used to carry the M224 mortar. One end of the sling is formed into a loop, using the adjustable buckle. It is then looped around the cannon between the baseplate and the carrying handle. The other end is also looped and placed around the upper saddle. The mortar is carried across the body much like the M60 machine gun (Figure 8-8). Never loop the sling through the mortar's own carrying handle. The sling would then interfere with firing the mortar in the trigger-fire mode, and it would be difficult to remove during a fire mission.



Figure 8-8. Use of the M60 machine gun sling.

(2) The M60 machine gun sling can be modified by a direct-support canvas repair unit to make it even more useful as a carrying sling (Figure 8-9). A sewn canvas cup, slightly larger than the tube, can be attached to one end and slipped over the cannon muzzle during transport. It supports the mortar while also preventing dirt, leaves, and other debris from entering the bore and possibly causing a misfire. A sturdy metal hook (locally fabricated) can be placed on the other end of the sling and hooked onto the carrying handle. It will hold the mortar during transport and is easily removed when the mortar is placed into action.

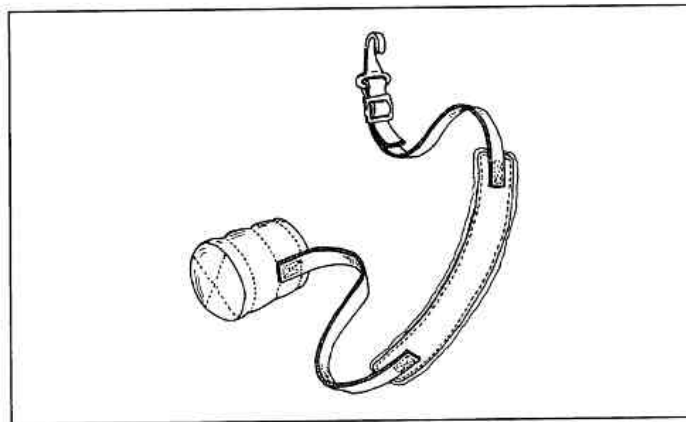

Figure 8-9. Modified M60 machine gun sling.

(3) A canvas repair unit can also fabricate a simple ammunition carrying vest. This type of vest, the M2A1 ammunition bag, was issued to World War II and Korean War 60-mm mortar crews, but it is no longer standard. The vest consists of a piece of sturdy canvas cut and sewn as indicated in Figure 8-10. Simple adjustment straps or ties secure the vest and ammunition. The hole for the head must be cut large enough to slip over the helmet and protective mask. The vest is worn over the combat load. Fiber containers of mortar ammunition are stacked horizontally both front and back.

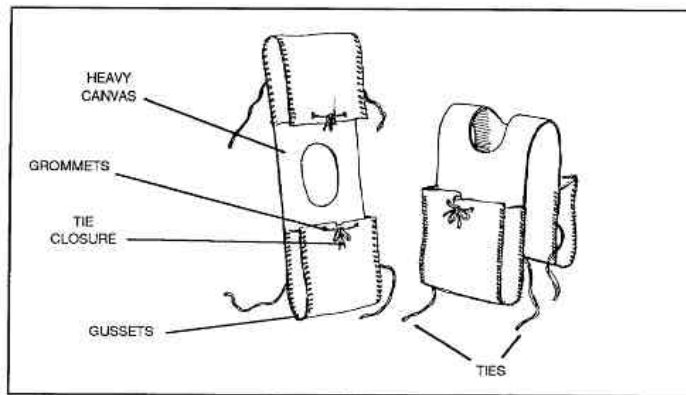

Figure 8-10. Locally fabricated load-carrying vest.

(4) One or two 60-mm mortar rounds can be carried in an empty Claymore mine bag. This method is good to use when other members of the company must carry other mortar rounds for the section. The bags can easily be taken off and dropped at the mortar position when needed. They can just as easily be handed back out again if the ammunition is not fired.

(5) For carrying mortar ammunition short distances, a standard Army litter can be used. A detail of two to four men can carry large amounts of mortar ammunition over rough terrain by lashing it to a litter and using universal slings to distribute the load (Figure 8-11). Using the sling frees the hands to carry weapons or negotiate obstacles. This method is useful in circumstances where an ammunition resupply vehicle can approach near the mortar section location, but large amounts of ammunition must still be carried the last few yards. Carrying the ammunition in one or two trips by using a litter reduces the time that the carrying party is exposed to enemy observation or fire. Medical personnel should not be used to transport ammunition since doing so violates their status as noncombatants.

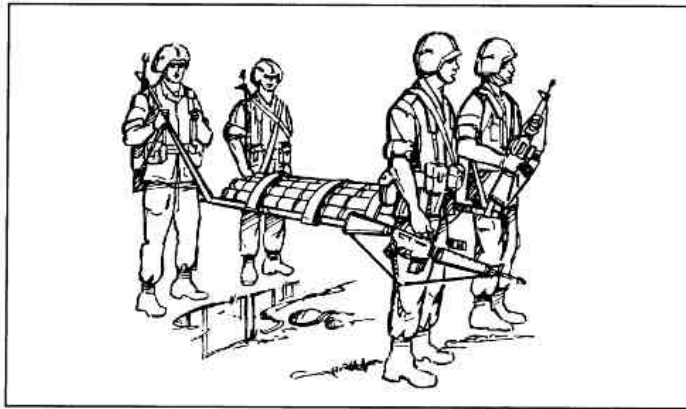

Figure 8-11. Use of litter and universal slings.

(6) The rapidly employable, lightweight litter referred to as the SKEDS litter can also be used to move mortar ammunition and equipment. One man can pull a fully loaded SKEDS litter out of a helicopter and over most types of terrain for short distances.

CHAPTER 9

COMBAT SERVICE SUPPORT

This chapter discusses the aspects of CSS that affect battalion mortars and company mortars in infantry and mechanized infantry mortar platoons. CSS includes the areas of administration and logistics. Essentially, CSS keeps mortar men mobile, fed, armed, clothed, maintained, and supplied for combat operations. Supplies usually required by the mortar platoon are ammunition, rations, petroleum, oil, lubricants, and repair parts. Such supplies are distributed to mortar platoons through field and combat trains.

Section I. TRAINS

Trains are groupings of CSS vehicles, equipment, and personnel at battalion level and below. Battalion trains are normally echeloned to provide responsive support. The result of this echelonment divides the battalion's CSS assets into field trains and combat trains.

9-1. FIELD TRAINS

The field trains are where most of the battalion's bulk-loaded ammunition, fuel, food, and other supplies are kept until delivered forward by LOGPAC (Figure 9-1).

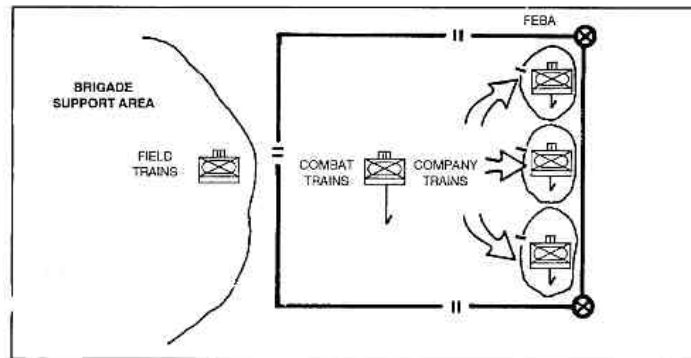

Figure 9-1. Field trains, combat trains, and company trains.

a. The field trains of a heavy task force consist of the battalion mess, maintenance platoon (minus), most of the fuel and ammunition vehicles from the support platoon, the

HHC CP, and the rifle company supply sections. The field trains of a light battalion consist of part of the support platoon, the HHC CP, and the rifle company supply sections.

b. The field trains are normally located about 20 to 30 km behind the FLOT, in the brigade support area (FM 7-20 or FM 71-2).

9-2. COMBAT TRAINS

Combat trains consist of the battalion S1, S4, the battalion aid station, some maintenance personnel and equipment, and some support platoon trucks loaded with fuel and ammunition (Figure 9-1).

9-3. COMPANY TRAINS

Company trains normally consist of the following:

- Company maintenance team/section (mechanized or armor).
- Company executive officer or first sergeant.
- Recovery vehicle (mechanized or armor).
- Company armorer.
- Company aidman with ambulance.

a. The first sergeant directly supervises the company trains. *The supply sergeant is the first sergeant's principal assistant and supervises the company's assets in the battalion field trains.*

b. The company trains are normally located between 1/2 and 1 km or one prominent terrain feature behind the company/team in a covered and concealed position (Figure 9-1). During MOUT, they may be as close as one block behind the forward positions.

c. The HHC trains must support the battalion mortars and the other HHC elements. They can be located anywhere within the battalion sector but normally not more than 5 km from the FLOT.

9-4. REQUESTS FOR SUPPORT AND ROUTINE SUPPLIES

Requesting support and routine supplies is a simple matter for the mortar platoon. The mortar platoon sergeant requests to the HHC company CP. The company XO or the first sergeant transmits the mortar platoon's requirements through the supply sergeant to the battalion S4 who directs the support platoon leader to ship supplies.

a. Maintenance and recovery support are requested the same way as supplies. The XO or first sergeant directs the company's maintenance assets to the platoon.

b. Company mortars send all requests for resupply and support through the company XO and first sergeant.

NOTE: Under the J-series TOE, the mechanized infantry battalion has only one echelon of mortars. The mortar platoon is under the headquarters company, which has no organic or attached maintenance section.

c. During the battle, the support will be limited to medical and maintenance activities. Emergency resupply is performed by the first sergeant. During the battle (defensive or offensive), the first sergeant continuously monitors the company command net and sends medical and maintenance support forward to the mortar platoon. He informs the combat trains on a continuing basis by radio or messenger.

d. The supply sergeant is responsible for obtaining and delivering most supplies to the company. He delivers small items and depends on the assets of the support platoon to deliver bulky or high-expenditure items. Priorities for delivery are established by the company commander, but the demands of combat will dictate that Class III, V, and IX supplies are the most critical.

Section II. RESUPPLY

This section covers LOGPACs, in and out of position supply techniques, supply priorities, and miscellaneous items.

9-5. RESUPPLY OPERATIONS

Resupply operations can be described as routine, emergency, and prestock. Each method is developed in the company SOP and rehearsed in training. The actual method selected will depend on the METT-T factors.

a. Routine resupply operations are the regular resupply of Classes I, III, V, and IX items; mail; and any other items requested. Routine resupply will take place at least daily. Periods of limited visibility are the best times to resupply. Class III should be resupplied at every opportunity. The LOGPAC technique is a simple, efficient way to accomplish routine resupply operations. The company team and battalion SOPs will specify the exact composition and march order of the LOGPAC. A LOGPAC is a centrally organized resupply convoy originating at task force field trains. The LOGPACs should contain all anticipated supplies required to sustain the mortar platoon for a specified time (usually 24 hours or until the next scheduled LOGPAC operation).

b. Company supply sergeants assemble the LOGPAC under the supervision of the support platoon leader or HHC commander in the battalion field trains. Replacements and soldiers released from the hospital are brought to the company on LOGPAC vehicles. Once the company LOGPAC is prepared for movement, the supply sergeant moves it as part of the task force resupply convoy led by the support platoon leader. In emergencies,

a LOGPAC can be dispatched individually to meet the first sergeant at a rendezvous point.

c. The task force LOGPAC convoy is met at the task force LRP by representatives from the combat trains and UMCP, company first sergeants, and the platoon sergeant from the mortar platoon. The first sergeant--

- Turns in routine reports to combat trains representatives.
- Turns in parts requisitions and the deadline status to the UMCP representative.
- Picks up routine correspondence.
- Awaits the LOGPAC.

d. The platoon sergeant or his representative meets the LOGPAC and guides the LOGPAC to the platoon resupply point.

9-6. RESUPPLY TECHNIQUES

The first sergeant establishes the mortar platoon's resupply point using the service-station (out-of-position) or tailgate (in-position) technique. The commander, or XO if delegated, decides on the technique to be employed and informs the first sergeant. The first sergeant briefs each LOGPAC vehicle driver on the resupply technique to be used. He also notifies the mortar platoon that it is ready. The commander directs the platoon to conduct resupply based on the tactical situation. Either of these techniques can be used for resupply, but the tailgate (in-position) technique is the most common.

9-7. IN-POSITION RESUPPLY

In-position resupply is a technique of bringing supplies directly to the mortar position. The resupply vehicle drives to each vehicle to refuel, or drops ammunition within the platoon's positions (Figure 9-2).

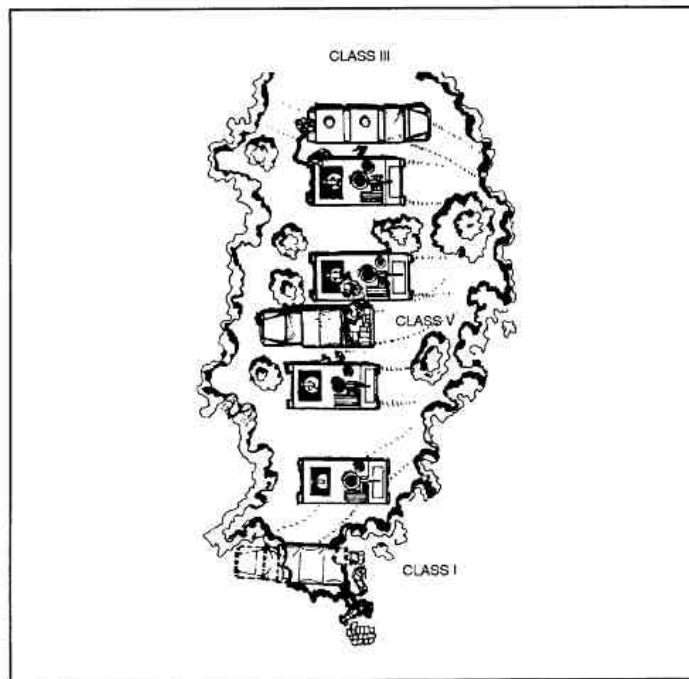

Figure 9-2. In-position resupply.

9-8. PREPOSITIONING

Prepositioning is a method of in-position resupply where supplies are placed on an unoccupied position to be used at a future time (Figure 9-3).

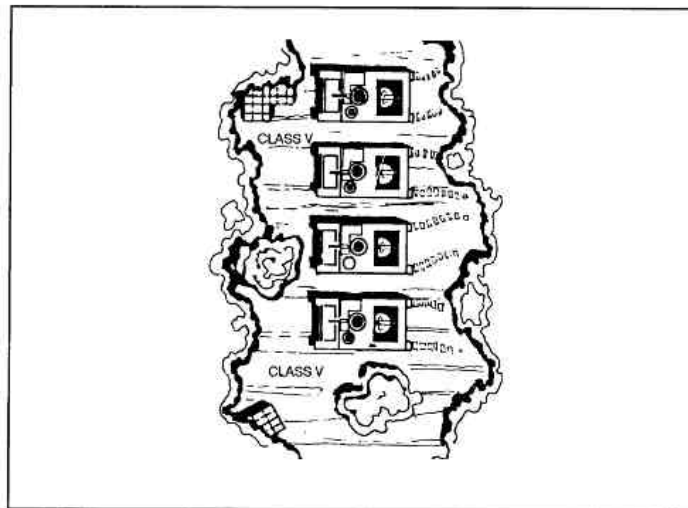

Figure 9-3. Prestocked ammunition.

a. Class V supplies are often prepositioned for the mortar platoon, especially in the defense. The location and amount of prepositioned ammunition must be carefully planned and each mortar squad leader informed. The platoon leader must verify the locations of the propositioning sites during his reconnaissance and rehearsals. When propositioning supplies, consider the following:

- (1) Covered and protected positions are needed for propositioned ammunition. If sufficient trailers are available, they can be used to preposition ammunition. The mortar carriers/prime movers can tow them from the preposition site to the next position.
- (2) Propositioning frees cargo vehicles to return and bring more ammunition forward.
- (3) The mortar platoon cannot guard preposition sites and, therefore, risks the capture or destruction of propositioned ammunition.
- (4) Propositioned ammunition must be far enough away from vehicles and individual fighting positions so its destruction will not cause friendly vehicle damage or personnel casualties, yet close enough to be loaded by hand.
- (5) Propositioned ammunition must be removed from its protective packing before it can be loaded or fired. This takes time and creates large amounts of residue.

Prying and cutting tools are needed to quickly open large amounts of ammunition boxes.

b. Considerations, which determine if prestocked is used, are normally made at battalion level. When a position that has been prestocked is occupied, the prestocked supplies are to be used first. Depending on the situation, this means that the mortar platoon immediately tops off the vehicle fuel tanks and fills up the on-board ammunition racks. Any remaining ammunition from the prestock supply is fired before any of the on-board ammunition is fired.

9-9. OUT OF POSITION

This resupply technique is the least preferred method, but there are times when it is unavoidable. It is used when the enemy situation or the terrain prevents movement of thin-skinned supply vehicles forward to the platoon's position.

a. When this method is used, individual vehicles move back to, or through, a centrally located rearm and refuel point. Based on the enemy situation, one vehicle per platoon, section, or even an entire platoon pull out of their positions, resupply, and return to their position. In this method-

- (1) Mortar vehicles enter the resupply point following one-way traffic flow.
- (2) Only vehicles requiring immediate unit or higher maintenance stop in the maintenance holding area before conducting resupply.
- (3) If WIA, KIA, and EPW have not already been evacuated, they are removed from the platoon vehicles when the vehicles stop at the refuel or rearm point.
- (4) Vehicles rearm and refuel moving through each point.
- (5) Crews rotate individually to feed, pick up mail, pick up supplies, and refill or exchange water cans.
- (6) When all vehicles have completed resupply, they move to the holding area where the platoon leader or platoon sergeant conducts a precombat inspection (time permitting).

NOTE: The medical evacuation vehicle is positioned an equal distance away from the refuel and rearm points. This decreases the distance traveled by litter teams and provides safety from fire or explosion for the casualties.

b. Before sending vehicles for resupply, mortars are ground mounted. If the platoon is required to displace before the return of the vehicles, the ground-mounted mortars and partial crews are cross loaded on the remaining vehicles and moved to the next position. The personnel sent back for resupply are briefed on the most likely contingency. They

must be able to use the platoon displacement plan to determine the location of the next position.

c. Transload is a modified version of out-of-position resupply (Figure 9-4). With this method, the platoon sends a portion of its vehicles back to the supply point, loads them up, and then returns to resupply the rest of the platoon.

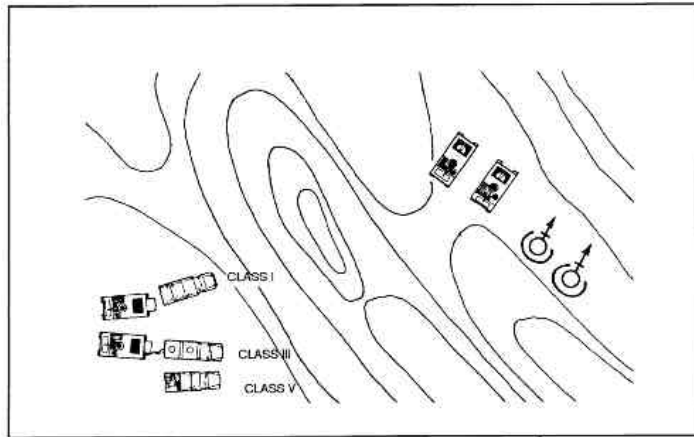

Figure 9-4. Transloading.

d. When transloading is the desired method, the platoon ground mounts its mortars (if mounted), and sends a man or two from each mortar with the empty carrier. With this method, all mortars can still fire with only minimum degradation due to missing personnel.

9-10. EMERGENCY RESUPPLY

Occasionally, the mortar platoon may have an urgent need for resupply that it cannot wait for a routine LOGPAC (normally a result of combat). Emergency resupply can involve any type of supplies, but ammunition and fuel are the most common. The support platoon normally keeps some mortar ammunition up-loaded and ready to move to the mortar platoon. Emergency resupply is often conducted while in contact with the enemy. Heavy combat may generate a need for ammunition several times in the course of a day.

9-11. BASIC LOADS

The commander normally prescribes a standard amount of supplies to be kept on hand. This is called a basic load. It is the amount of supplies he feels are necessary to sustain operations until initial resupply. It depends on the RSR and the length of time before resupply. It is limited by what can be transported, but not necessarily in a single lift.

Basic loads for the mortar platoon should be examined in detail by the platoon leader, reviewed by the S3 and S4, and approved by the battalion commander. Basic loads are divided into the combat load (carried on the mortar platoon's vehicles) and the bulk load (carried on support platoon trucks).

- a. The most common basic loads are Class I, Class II and IV, and Class III, batteries, and Class V.
- b. The Class V combat load is ammunition actually carried on board the mortar platoon's vehicles.
- c. The composition of a particular Class V basic load is METT-T dependent. Class V basic loads for mortars are constantly modified by the battalion commander based on that battalion's situation. (A sample basic load for mortars is shown in Table 9-1. It shows the load capability of both the combat vehicles and support assets. The basic load column lists an example of number and types of rounds. The combat load and bulk load columns only indicate total round capability since the actual ammunition mix in the combat load is situation dependent.)

Mechanized Infantry Mortars	Combat Load (rounds)	Bulk Load (rounds)	Basic Load (2) (rounds)
M125A2 Carrier (81-mm)	114 (1)	42	156
HE	--	--	110
WP with Fuze, PD	--	--	30
Illum with Fuze, MT	--	--	16
M106A2 Carrier (107-mm)	88 (1)	100	188
HE without Fuze	--	--	64
HE with Fuze	--	--	68
WP with Fuze, PD	--	--	40
Illum with Fuze, MT	--	--	16
Fuze, Proximity	--	--	68
Fuze, PD	--	--	5
Truck, Cargo, M998, HMMWV (120-mm)	39	121	160
HE with MOF	--	--	116
Smoke	--	--	30
Illum	--	--	14
Infantry Mortars	Combat Load (rounds)	Bulk Load (rounds)	Basic Load (rounds)
81-mm Mortar (3)	80 (1)	40	120
HE without Fuze	--	--	24
HE with Fuze	--	--	81
WP with Fuze	--	--	9
Illum with Fuze	--	--	6
Fuze, Proximity	--	--	25
Fuze, PD	--	--	5
107-mm Mortar (3)	50 (1)	110	160
HE without Fuze	--	--	54
HE with Fuze	--	--	60
WP with Fuze	--	--	30
Illum with Fuze	--	--	16

Table 9-1. Example of a Class V basic load for mortars.

Infantry Mortars	Combat Load (rounds)	Bulk Load (rounds)	Basic Load (rounds)
Fuze, Proximity	--	--	50
Fuze, PD	--	--	4
60-mm Mortar	240 (4) (1)	109	350 (2)
HE with MOF	156	72	228
WP	48	22	70
Illum	36	16	52

(1) Adapted from FM 101-10-1.
(2) Figures indicate number of rounds per mortar system.
(3) M988, Truck, Cargo, HMMWV.
(4) The light infantry company has no dedicated mortar vehicles. See Appendix F for considerations on carrying 60-mm mortar ammunition.

NOTE: Each 3/4-ton trailer can carry about 35 120-mm mortar rounds. The towed 120-mm has space to carry six additional rounds on the mortar trailer.

Table 9-1. Example of a Class V basic load for mortars (continued.)

d. Combat experiences in World War II and Korea have shown that an on-board mix of 70 percent HE, 20 percent WP or smoke, and 10 percent illumination ammunition is the most flexible. These percentages must be modified by the commander based on the ASR and the mission.

e. There may be times when amounts of ammunition delivered to the mortars will be controlled. This is called controlled supply rate (CSR). The CSR is designed to limit rounds per weapon per day. CSRs are imposed for two reasons: to conserve ammunition and to avoid an ammunition shortage for a designated tactical operation.

f. During fire support planning, consideration is given to ammunition requirements. This makes it essential for the mortar platoon leader or platoon sergeant to be present to advise what types and amounts of ammunition will be required. For example, if the mission is to be an illuminated attack at night, then additional illumination rounds must be brought forward to the mortar sites. If the mission is defense (day or night), sufficient HE and WP rounds must be on site. In either situation, the mortar platoon leader contacts the supported commanders and advises them of any ammunition constraints.

9-12. COMMON SUPPLIES

The HHC commander is responsible for ensuring that the mortar platoon has ample supplies of common use items. These are normally requested in bulk and divided into platoon-sized shipments.

a. The company XO or first sergeant orders rations (Class I) for the mortar platoon based on the strength of the platoon. Hot meals are prepared at a central location (battalion field trains) and trucked forward to the logistical release point. The mortar platoon sergeant or a platoon representative meets the vehicle and guides it to the feeding location. Field feeding of hot meals and the delivery of MREs can be accomplished in two ways:

(1) The food can be brought to the soldiers at their position. To maintain readiness, a feeding plan is necessary. Usually, half of the soldiers eat while the other half maintains security and preparedness to fire.

(2) The crews can be moved some distance away, usually several hundred meters, to where the food is served. In such cases, the feeding plan is critical to provide continuous support. Normally, no more than a third to one-half of the crews should be away from their positions at one time.

b. Crew-replaceable items are requested through the company XO or first sergeant for company and battalion mortar platoons.

(1) Repair parts are usually brought forward with Class I, III, and V resupply. Other repair parts required by company and battalion maintenance are either on hand, in the company's PLL, or requested as required.

(2) Mortar platoons can carry some of the repair parts in their carriers (for example, light bulbs, firing pins, and other crew-replaceable, expendable parts).

c. Petroleum, oil, lubricants (Class III) are delivered to the mortar platoon by battalion fuel trucks. The trucks are part of the battalion support platoon. The trucks deliver both fuel and required package products, such as engine oil, grease, and antifreeze. As with other supplies, fuel trucks resupply platoons as follows:

(1) ***In position.*** The fuel trucks drive up to the vehicle while it is in position and refuel it, going from one vehicle to the next.

(2) ***Out of position.*** This procedure requires the platoon's vehicles to travel to a fuel dispensing point and top off each vehicle, and then return to position. When this is done, the mortars, with ammunition, should be ground mounted or the platoon must accept the loss of firepower. The driver and vehicle commander should accompany the vehicle to the refuel point. The rest of the crew will man the firing positions.

d. When displacing, the platoon should be able to top off their vehicles from the manned LRP while en route to a new firing position (Figure 9-5).

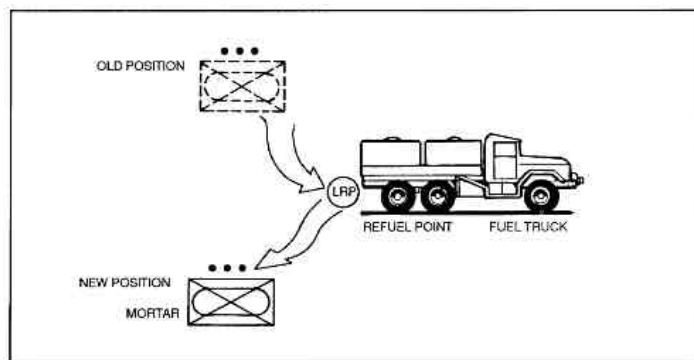

Figure 9-5. En route refueling at LRP.

9-13. MISCELLANEOUS SUPPLIES

Ordering the correct amount of needed supplies at the right time is a difficult task for the mortar leader and NCO. They must think ahead and not allow the platoon to run short of critical supplies that could effect mission accomplishment.

a. Batteries, other than vehicle batteries and rechargeable batteries, are controlled by the company communications section. Like ammunition, each platoon keeps a basic load of batteries, by type, on hand. Replacement batteries are requested and are delivered along with other supplies. The stockage, use, and reordering of batteries has become most important with the fielding of more modern devices such as NBC agent alarms and night vision devices.

b. Maps are requested the same as other supplies. Unclassified maps are obtained by the battalion S4 based on requirements established by the S2. They are distributed either through battalion supply channels or from the S2 to the company headquarters.

c. Sandbags and other barrier material fall into supply Class IV and are issued as needed or as required.

Section III. MAINTENANCE

Each company has a maintenance section assigned to it. This organization provides responsive, flexible support to the mortar platoon.

9-14. VEHICLES

When a vehicle is damaged or disabled, the platoon leader, platoon sergeant, or section sergeant requests maintenance support from the company XO or first sergeant.

a. When the request has been made, he tells the XO the problem and the location of the down vehicle. The XO or first sergeant will then ensure that the required support is dispatched. In some cases, particularly if there are a large number of disabled vehicles, the platoon may have to recover a vehicle with another like vehicle.

b. Each line company maintenance section (H-Series TOE), except the headquarters company's, has a recovery vehicle. Recovery support for the company mortars is provided by the battalion maintenance and service section or the recovery section of the battalion maintenance platoon (Figure 9-6).

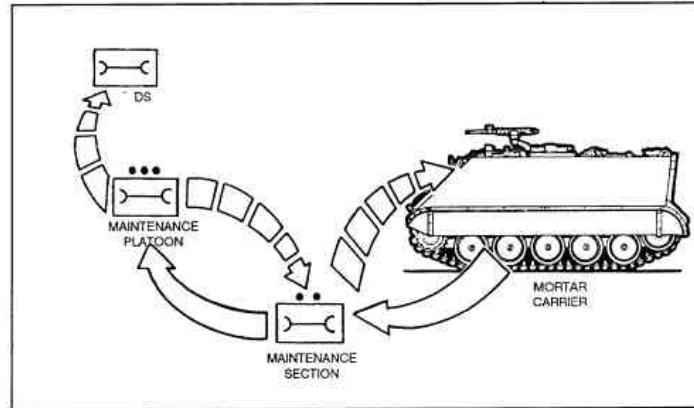

Figure 9-6. Maintenance flow.

9-15. WEAPONS

Damaged weapons are sent to the company armorer who is located in the company trains. Weapons are carried on platoon vehicles or on a returning supply vehicle.

The armorer can replace some parts on weapons, but major problems are handled by a DS maintenance unit. The DS unit maintains a weapons maintenance support team capable of going forward to the battalion and making some on-the-spot repairs. If the damaged weapon cannot be repaired by the support team, it will be evacuated to a GS unit.

9-16. COMMUNICATIONS EQUIPMENT

The FDC is the control center for company and battalion mortars. It should never be without reliable communications. Platoons leaders and sergeants replace inoperative radios in the FDC vehicle, or their own vehicles, with radios from the mortar carriers. The mortars can be directed by other means but not having communications with the parent or supported unit is unacceptable.

- a. Radios and other communications equipment that does not function are turned over to the battalion communications platoon. This equipment is either repaired or forwarded to the forward support battalion for repair. The mortar platoon can be issued another radio from the operational ready float, if one is available.
- b. Night vision equipment is also turned in to the battalion communications platoon for repair as are all items that require calibration (such as GPS, radiacmeters, or dosimeters) are turned in to the battalion maintenance platoon.
- c. When items are turned in to either the maintenance or communications platoon, a receipt (DA Form 2402, Exchange Tag) is used to show that the platoon turned in an item for repair or calibration. When the repaired item is returned, the exchange tag receipt is given back to the maintenance platoon (Figure 9-7).

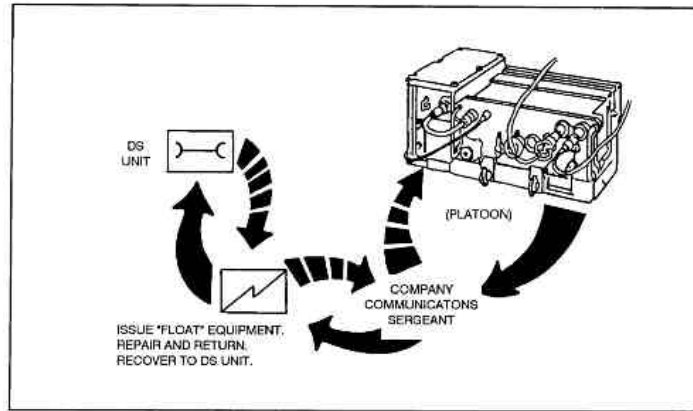

Figure 9-7. Communications equipment flow diagram.

9-17. MORTAR EQUIPMENT

For mortars, borescoping and pullover gaging is accomplished by DS maintenance. In combat, a weapons maintenance support team from the DS unit performs required checks. It can also replace worn or broken parts and has one spare mortar that can be issued for one that needs repair (Figure 9-8).

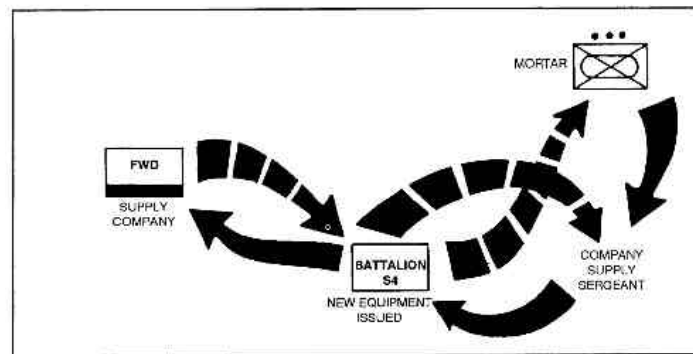

Figure 9-8. Equipment turn-in flow chart.

- a. When an aiming circle is damaged, it is turned in to the company supply sergeant and placed into maintenance channels to be repaired or a new one is requisitioned.
- b. Unserviceable mortar sights, plotting boards, and mortar ballistic computers are turned in to the the company supply sergeant who requests a replacement and issues it to the platoon.

9-18 RECOVERY OF DAMAGED EQUIPMENT

There are several ways that damaged or disabled equipment can be recovered.

- Using organic transportation.
- Using the supply truck on a return run.
- Requesting transportation from the battalion.

The most desirable method is to send damaged equipment back in an empty supply vehicle on its return run (for efficient use of assets).

Section IV. MORTAR MEDICAL SUPPORT

This section covers medical support for company and battalion mortar platoons, evacuation of casualties, priority of evacuation, and reporting casualties.

9-19. COMPANY MORTARS

Infantry companies are provided aidmen on the basis of one per rifle platoon and one senior aidman for each company headquarters. An evacuation section with an ambulance may be attached. Company mortar platoons receive medical support from the company headquarters or from a rifle platoon, depending on the situation. Casualties are

transported in empty supply vehicles or by requesting ambulance support from the company headquarters (Figure 9-9).

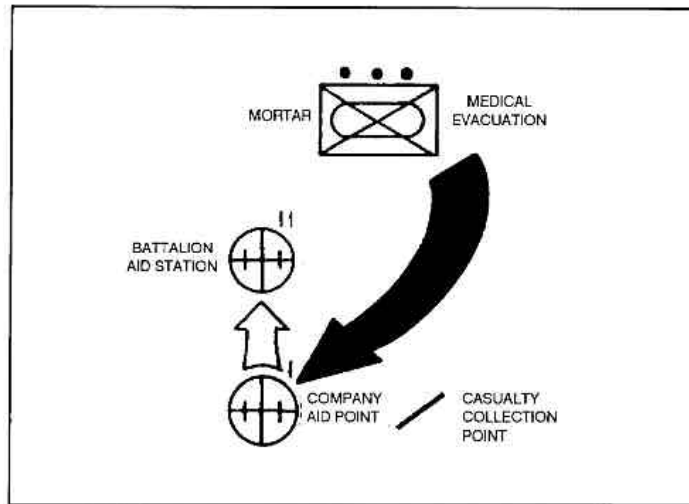

Figure 9-9. Medical flow diagram—company mortars.

9-20. BATTALION MORTARS

The battalion mortar platoon receives one medical aidman. Since CSC has no company aid station, the mortar platoon requests evacuation, on the administrative/logistics net, directly from the battalion aid station, located with the combat trains. Casualties can be backhauled on returning supply vehicles (Figure 9-10).

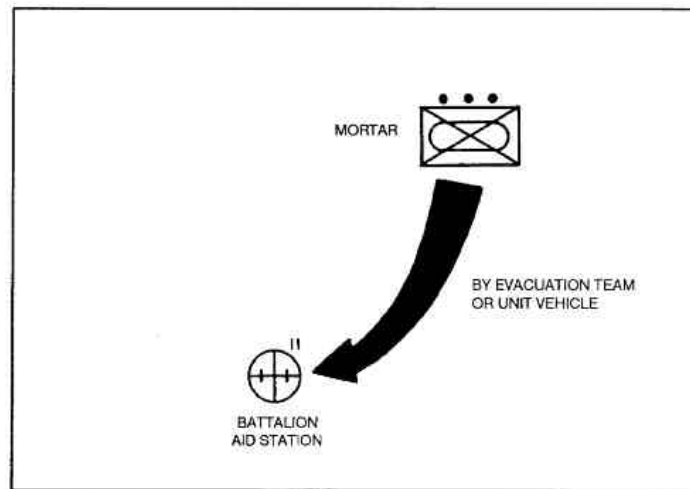

Figure 9-10. Medical flow diagram—battalion mortars.

NOTE: Battalion mortar platoons, organized under the J-series TOE, will receive no medical aidman. Casualties are given first aid by combat lifesavers from within the mortar platoon and evacuated to the battalion aid station.

9-21. EVACUATION

This paragraph complies with STANAG 3204.

When a casualty must be evacuated, and the only alternative is to request assistance, the evacuation request is made using the categories of precedence. The following categories of medical evacuation precedence conform to STANAG 3204. A patient's category of precedent is determined by the senior aidman or, if there is no aidman, by the senior officer or NCO present.

- a. **Priority I - Urgent.** Used for emergency cases that should be evacuated as soon as possible, and with a maximum of two hours, to save life, limb, or eyesight.
- b. **Priority IA - Urgent-Surgical.** Used for patients who must have surgical intervention to save their life and to stabilize them.
- c. **Priority II - Priority.** Used when the patient should be evacuated within four hours or his medical condition will deteriorate to an URGENT precedence.

d. **Priority III - Routine.** Requires evacuation, but condition is not expected to deteriorate seriously within 24 hours.

e. **Priority IV - Convenience.** Used when evacuation is a matter of medical convenience rather than necessity.

9-22. CASUALTY AND STRENGTH REPORTING

Casualty and strength reporting begins at squad level. Casualty reporting occurs as soon as possible after the event and is initiated by the squad leader verbally to the platoon sergeant. The platoon sergeant forwards the information to the first sergeant who collects the reports and forwards them to the administrative/logistic center. As the situation permits, the platoon sergeant completes a DA Form 1156, and DA Form 1155 for each casualty sustained. These are collected by the first sergeant who forwards them to the administrative/logistics center.

APPENDIX A

ORDERS, FORMATS, AND SUPPLEMENTS

The Army's authority for staff procedures and formatting orders is FM 101-5, and the formats contained herein are consistent with it. Although these formats are written, mortar platoon or section leaders will normally receive their orders verbally from the battalion or company commander and will give them verbally to their units. They will use target lists, operations overlays, terrain models, and execution matrixes to supplement the order.

A-1. WARNING ORDER

Warning orders give subordinates advance notice of operations that are to come. This gives them time to prepare. The order should be brief, but complete. Using the standard five-paragraph field order format helps ensure nothing is omitted. A sample format follows:

1. SITUATION.

Brief description of the enemy and friendly situations. Attachments and detachments to the unit.

2. MISSION.

Use the restated mission from the mission analysis.

3. EXECUTION.

- a. Special teams or task organization within the unit.
- b. Uniform and equipment common to all (changes from SOP).
- c. Special weapons, ammunition, or equipment (different from SOP).
- d. Special instructions to subordinates leaders.
- e. The tentative time schedule. It includes at least:
 - (1) Earliest expected time of move.

- (2) Time and place of OPORD.
- (3) Probable execution time.
- (4) Inspection times and items to be inspected different from SOP.
- (5) Rehearsal times and actions to be rehearsed.

f. Additional general instruction as needed or by SOP.

4. SERVICE SUPPORT.

- a. Fuel and ammunition.
- b. Trains location.
- c. MEDEVAC/casualty collection.
- d. Survey support.

5. COMMAND AND SIGNAL.

- a. Any changes to the normal chain of command.
- b. Any changes to the SOI or standard signals.
- c. Special communications requirements.

SAMPLE VERBAL WARNING ORDER

Situation. The enemy has fallen back to hasty defensive positions along the Orhbach Road. He is improving his fortifications. Our brigade is attacking to seize the high ground on the left of that line of hills. (Points out the terrain.) The TF will attack to seize Hill 408 (NB570255) 0600 hours.

Mission. We will provide fire support for the attack initially from a defilade position in the vicinity of the village of Unterstetten (NB565310).

Time of Operation. We must be ready to fire NLT 0545 hours. Move to SP at approximately 0300 hours.

Special and General Instructions. SFC Jones, meet the support platoon leader at the logistics release point (NB543328) in 30 minutes to lead the ammunition trucks to our current location. MOPP2 is in effect now. Begin NBC monitoring in 1 hour. We will not

be able to register, but the advance party will prepare our firing points. The advance party will depart here at 0200. It will be organized by the platoon SOP, except that I want SFC Smith to lead it. I have arranged to have an artillery survey crew with a PADS vehicle go with you. They will be here at midnight. They can only stay a short time before they must return. Radio listening silence is in effect at 2400 hours.

Time and Place OPORD Issued. I will issue the OPORD to you here at 2200 hours. While I am gone, I want the squads to rehearse emergency and deliberate position occupation. I want the FDC to rehearse hipshoots.

A-2. OPERATIONS ORDER

An OPORD gives the subordinate leaders the essential information needed to carry out an operation. OPORDs use a five-paragraph format (shown below) to organize thoughts and ensure completeness. They also help subordinate leaders understand and follow the order. Use a terrain model or sketch along with a map to explain the order.

TASK ORGANIZATION:

1st PLT(1)	2d PLT(+)	3d PLT
2 Antiarmor Tms	1/1st PLT	
Antiarmor SEC(-)	CO Control	
	60-mm SEC	

1. SITUATION.

(The company or battalion task organization for the mission is stated at the start of the OPORD so that the subordinates know what assets they will have during the operation.)

a. Enemy Situation.

- (1) Composition, disposition, and strength.
- (2) Recent activities.
- (3) Capabilities.
- (4) The enemy's most probable COA. A sketch or enemy overlay is normally included to clarify this description.

b. Friendly Situation.

- (1) Mission and concept for the battalion.
- (2) Mission for the unit on the left.
- (3) Mission for the unit on the right.
- (4) Mission for the unit to the front.
- (5) Mission for the unit to the rear or following.
- (6) Mission for the battalion reserve.
- (7) Mission for any units supporting the battalion if they impact on the mortar mission.

c. **Attachments and Detachments.** Changes to the task organization during the operation. For example, if the task organization changes during the consolidation phase of an attack, it would be indicated here.

2. MISSION.

The mission essential task(s) and purpose(s). It normally includes Who, What, When, Where, and Why. The where is described in terms of terrain features/grid coordinates. If objective names are used, they are secondary references and placed in parentheses.

3. EXECUTION.

a. **Concept of the Operation.** This paragraph describes how the leader intends to accomplish his mission. At company level, a maneuver and fires subparagraph will always be included. The operation overlay/concept sketch is referenced here.

- (1) **Maneuver.** The maneuver paragraph should be focused on the decisive action. At company level, a maneuver paragraph that outlines the missions to each platoon and or section and identifies the main effort normally, requires no additional clarification. If it should, the leader may clarify it in the concept of the operation paragraph (paragraph 3a).
- (2) **Fires.** This paragraph describes how the leader intends for the fires to support the maneuver. It normally states the purpose to be achieved by the fires, the priority of fires, and the allocation of any priority targets. A target list, fires execution matrix, or target overlay may be referenced here.
- (3) **Engineering.** Often, especially in defensive operations, this paragraph is required to clarify the concept for preparing fortifications. When the mortar platoon or section is supported by engineers, the leader states his guidance for employing these assets here. He may do this by stating his priority for the

engineer effort (survivability, countermobility, and mobility) and the priority for supporting the sections.

b. **Tasks to Sections or Squads.** This paragraph lists each of the section's tasks/limitations. Each subordinate unit will have a separate paragraph.

c. **Coordinating Instructions.** These are the tasks and limitations that apply to two or more subordinate units. If they do not apply to all the subordinate units, then those units that must comply are clearly stated.

4. SERVICE SUPPORT.

This paragraph provides the critical logistical information required to sustain the unit during the operation.

a. **General.** It provides current and future trains locations.

b. **Materiel and Services.** It may have a separate subparagraph for each class of supply, as required.

c. **Casualty Evacuation.**

d. **Miscellaneous.**

5. COMMAND AND SIGNAL.

a. **Command.** This paragraph states where the C2 facilities and key personnel will be located during the operation and adjustments to the unit SOP, such as a change to the succession of command or the standard wire plan.

b. **Signal.** It provides critical communication requirements such as radio listening silence in effect forward of the LD, signals for specific events or actions, emergency/visual signals for critical actions, and SOI information.

ACKNOWLEDGE. Use the message reference number.

ANNEXES

A-Intelligence/Intelligence Overlay(s).

B-Operation Overlay/Concept Sketches.

C-As required, such as road march, truck/boat movement, air assault, and river crossing.

EXAMPLE OF A VERBAL BATTALION MORTAR PLATOON OPERATION ORDER

1. SITUATION

a. **Enemy Forces.** Elements of the 283d Motorized Rifle Regiment have established defensive positions in our zone. Their most likely location is in a company-sized strongpoint in the vicinity of Hill 408 (NB570255). They are estimated at 80 percent strength and their morale is good. They are equipped with BMP-2 armored personnel carriers and T-80 tanks, and are capable of employing chemical weapons and countermortar fires. They will probably defend in their present position.

b. **Friendly Forces.** Task Force 2-79 IN attacks at 090600 Oct to seize Hill 408 (NB570255). 2d Bde attacks on the right at the same time to seize Hill 446 (NB605255). TF 2-77 attacks at the same time on our left to seize Hill 409 (NB543283). The 1-45 FA (DS) (155 SP) will support the brigade. 2-5 FA (8-inch SP) will be GSR to the 1-45 FA.

c. **Attachments and Detachments.** Two medics with a wheeled ambulance attached to the mortar platoon.

2. MISSION

We will support the TF attack by firing a 10-minute prep beginning at 090610 Oct to neutralize the enemy's machine guns and AT weapons, and to suppress fires from his forward positions. We will then prepare to fire an on-call screen mission to prevent the enemy OP on Hill 410 from observing the TF main effort, A Co. After that, we will respond to calls for fire to support the final assault and the consolidation on Hill 408.

3. EXECUTION

a. Concept of Operation.

Intent. It is my intent to support this attack by occupying our first firing position in the dark, using our standard advance party techniques. We will register the No. 3 mortar on a hill near the enemy position but not on it. When the 10-minute preparatory fires begin, each squad will fire five rounds (three HE, two WP) as fast as possible, leveling the mortar between rounds. After that, fire one round every 15 seconds until ordered to cease fire. We will immediately shift the tubes onto the deflection/elevation of the screen target. Once called, we will fire the screen for 25 minutes. This will use almost all of our remaining WP rounds. After the screen mission, we will immediately return to the preparatory fires data and prepare to fire suppression fires to support the final assault. I expect us to displace forward by section, keeping one section ready to fire at all times. We should be together again at the second firing position by noon. I intend to resupply there and prepare for our next mission.

(1) **Maneuver.** We will move from our present location at 090415 Oct in order to reach the SP located at grid NB553326 at 090420 Oct. Movement will be along route RED to the initial firing position vic NB569328. The platoon must be prepared to fire NLT 090600. Displacement to subsequent locations will be on order, by sections, Sergeant Jones's section will displace first. Each section will pass through passage point 3 en route to its first subsequent position. Subsequent positions, passage points, and routes are shown on the displacement plan overlay. Initially, we will move behind Team (Tm) B in the center of the battalion sector. Tm A is on the left and Tm Tank follows Tm A.

(2) **Fires.** Tm A has 155-howitzer priority of fires. Tm B has mortar priority of fires initially, then Tm A has priority when it takes the lead. Tm B has one priority target just past the LD. Any emergency fire missions are likely to be mixed HE and smoke missions to cover movements of the forward teams. The platoon will participate in the final stage of the preparation beginning at 0620, and then shift fires to the ridgeline running north, where we will fire the screen. We will then fire on-call fires during the battalion's consolidation and reorganization.

b. FDCs.

(1) Initial azimuth of lay is 3100 mils. The azimuth of lay for the second position is 2680 mils.

(2) Tm B's priority target is NB573310. Engage with two rounds HE and two rounds WP for each mortar. Be prepared to repeat that fire mission.

(3) There is no-fire area around the town of Unterweissenborn, see the overlay for its exact limits. Ensure this no-fire area is entered into the mortar ballistic computer.

(4) Prepare for split-section operations after occupying the initial firing position.

c. First Section. (May be given to squad level, if necessary.) Displace first from the initial position. Move to location two (see overlay). Report when you are ready to fire.

d. Second Section. (Omit if there are no specific instructions.)

e. Platoon Sergeant. Coordinate with the XO for traffic control measures during the passage of lines. Go with the second section.

f. Coordinating Instructions.

(1) Recon party departs 081800. Report to this location 10 minutes before departure. (Personnel and equipment specified by SOP.)

(2) MOPP2 is in effect now. Begin continuous monitoring at 090300 Oct.

- (3) Report arrival at all firing positions.
- (4) Report when ready to fire.
- (5) Report ammunition status at the end of the preparation.

4. SERVICE SUPPORT

- a. Controlled supply rate (CSR) is in force from 090001 Oct.
 - (1) HE - 45 rounds. (This does not include ammunition for the prep.)
 - (2) Illumination - 18 rounds.
 - (3) WP -20 rounds.
- b. We will prestock the prep ammunition (50 rounds per tube) in the initial firing position. The advance party will begin breaking this ammunition down. Fire prestocked ammunition first, or replace on-board ammunition as soon as possible. Depart the initial firing position with full ammunition racks.
- c. TF logistics release point is located at grid NB570346. Ammo trucks will be met there and brought to our positions. Expect a resupply of ammunition once we arrive at our final firing location.
- d. Company trains located at grid NB570330 behind Hill 502.
- e. Casualty collection point located at grid NB579340, near the old barn.
- f. EPW collection point located at grid NB577338, in the courtyard.
- g. Three-day supply of rations for each man are to be drawn before to 082330 Oct. Be sure all fuel and water cans are full.

5. COMMAND SIGNAL

a. Command.

- (1) I will initially be with the first section FDC, then I will recon subsequent positions.
- (2) If I become a casualty, MSG Miller will be in charge.
- (3) Chain of command:
Platoon Sergeant.
1st Section Sergeant.

2d Section Sergeant.
(Next ranking men in order.)

b. Signal.

- (1) SOI Index 8-15, Edition A in effect.
- (2) Emergency signal for lifting indirect fires is two red star clusters followed by one green star cluster.
- (3) Radio listening silence in effect from 090500 to 090630.

Annex A: Target list and overlay (omitted).

Annex B: Maneuver overlay.

Annex C: Displacement plan overlay (omitted, see Chapter 3).

ANNEX B: Overlay (example).

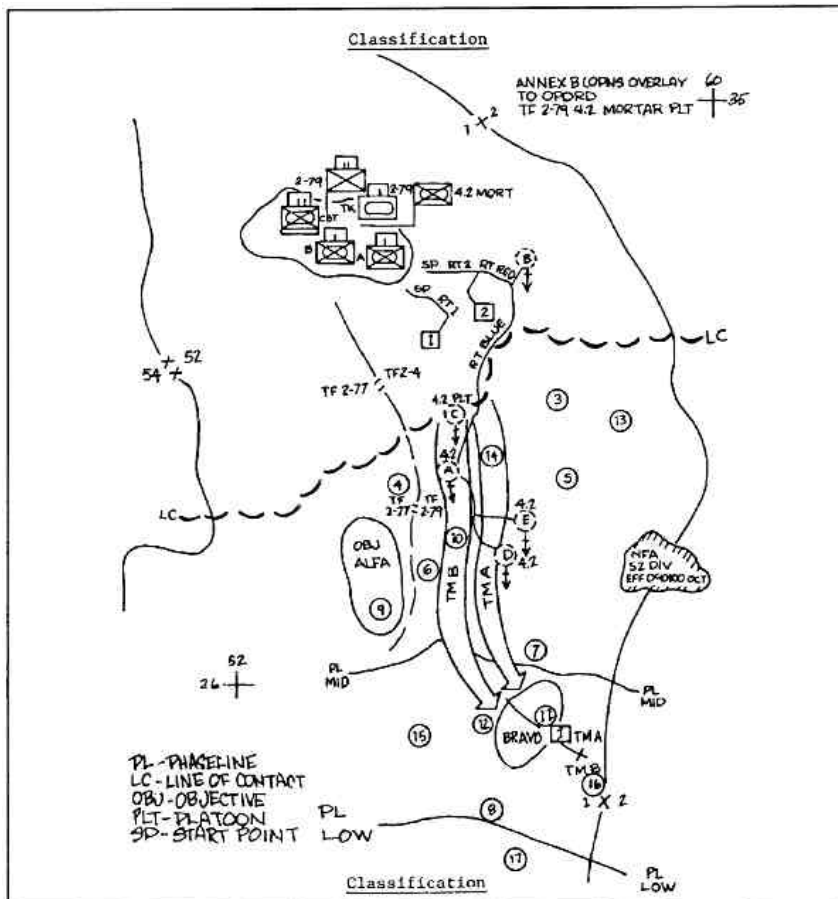

Figure A-1. Example of a maneuver overlay.

A-3. FRAGMENTARY ORDER

These provide timely changes to existing orders. Elements normally found in a complete order may be omitted when these elements have not changed, when they are not required to the mission, when they might delay transmission, or when they are unavailable or incomplete at the time of issue. Fragmentary orders are normally used to issue supplemental instructions or changes to a current OPORD while the operation is in progress.

SAMPLE VERBAL MORTAR PLATOON FRAGO

Situation. The TF attack has been successful. The TF has been ordered to continue the attack south toward the town of Malges. The enemy is delaying and seems to be consolidating in the vicinity of Malges.

Changes to Organization. None.

Orders to Subordinates. FDC No. 1 - The FSO is sending a new target list to your present location by way of messenger - stay there until he arrives. If he is not there by 1200 hours, displace to position Charlie. Report your new location to the FSO.

Section One - Continue to support from present position. Move to position Charlie when Section Two is ready to fire from there or no later than 1200 hours.

Section Two - Move to position Charlie immediately by way of the River Road. I will meet you there.

Platoon Sergeant - The S4 is sending ammunition to our location now. If it arrives in time, resupply Section One immediately. If not, take all the trucks to position Charlie and upload both sections there.

Fire Support. A Company now has priority of fires for mortars. Artillery priority of fires goes to B Company.

Coordinating Instructions. I will be with the FSO for 10 to 20 minutes. I will rejoin the platoon at position Charlie at 1230 hours.

A-4. SUPPLEMENTS TO ORDERS

Orders can be supplemented by overlays, concept sketches, execution matrixes, and operations schedules.

a. **Overlays.** Overlays are used to show both friendly and enemy information, such as indirect fire support, scheme of maneuver, logistic sites, and displacement plan. All this information can be combined on a single overlay unless this is confusing. Overlays are drawn to scale using the symbols shown in FM 101-5-1 (Figure A-2). Information shown on the overlay, except the mission statement, need not be repeated in the OPORD or FRAGO. Overlays can be combined with a written mission statement and an execution matrix (both written on the overlay) to produce a complete OPORD.

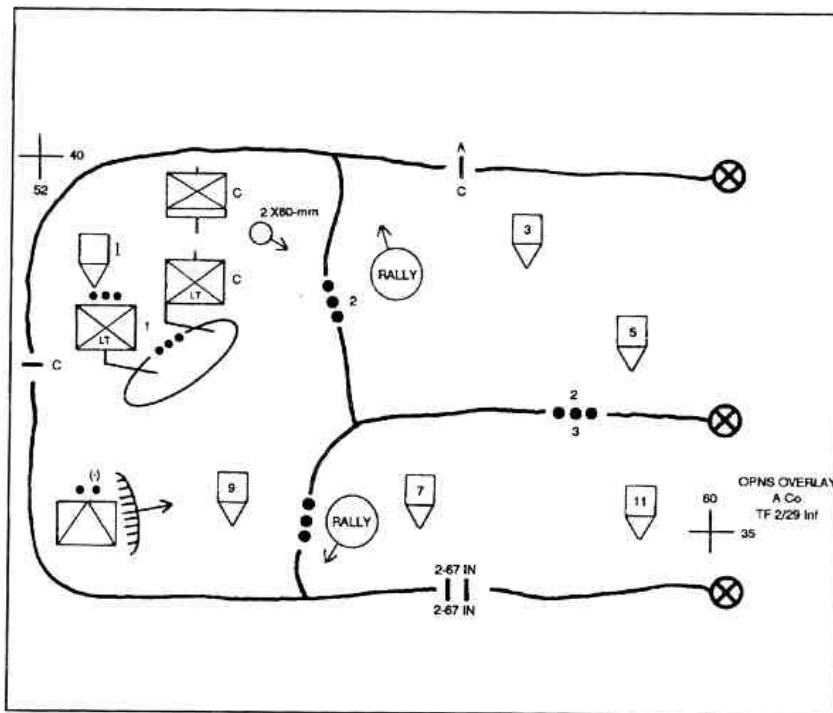

Figure A-2. Company operation overlay.

b. **Concept Sketch.** The company area of operations or objective area is often so small that on a 1:50,000 map, overlays are not sufficiently clear. The leader then makes a concept sketch or terrain model that accomplishes the same purpose. He begins by sketching the terrain of the area of operations or objective area. He does this by free-handing the dominant terrain features from the military map onto the sketch paper. Additional details of terrain and vegetation are added based on reconnaissance and a more detailed examination of the map. The enemy situation, the scheme of maneuver, fires, mobility/countermobility, or other pertinent data as desired are then superimposed. If possible, the synchronization of units in time and space is represented by using modified graphic symbols (explained by a legend) that show the order of occurrence.

c. **Execution Matrix.** An execution matrix shows the most critical tasks or events in a matrix format. The matrix is used to help the commander during the conduct of the mission, as well as to supplement the operations overlay and oral order. The execution

matrix does not replace the mission-type order that the commander gives to his subordinates; it assists their understanding of the mission.

d. **Operation Schedule.** An operation schedule (OPSKED) is a sequential list of events designated by numbers. An operation schedule is different from a brevity code in that each number is a cue for several events, even if the number is often a report as opposed to an order. For example, 2d Platoon reaches their support position and reports 101; the company FSO automatically calls for suppressive fires, and the 1st Platoon automatically begins movement to the assault position. Operation schedules can be used separately or in conjunction with execution matrixes.

APPENDIX B

TARGET EFFECTS PLANNING

Not only must fire support planners determine what targets to hit and when, but they must also decide how to attack each target. They must consider the complex relationship between the weapon fired, the round and fuze combination, the type of target, the terrain, and the effects desired. Because it is such a complex relationship, there are no definite rules. FSOs, mortar platoon and section leaders, and FDC chiefs should consider all the aspects of target effects when planning fires.

B-1. JOINT MUNITIONS EFFECTIVENESS MANUALS

The USAF publishes joint munitions effectiveness manuals (JMEMs) for all surface-to-surface weapons to include mortars. These manuals provide detailed data concerning the expected fraction of casualties to personnel targets or damage to materiel targets given the number and type of rounds fired. JMEMs are published for Army use as field manuals. FM 6-141-1 lists all current JMEMs. The data in JMEMs are taken from test firings, actual combat performance, and mathematical modeling.

- a. The JMEMs are normally classified "confidential." The battalion S1 can establish the classified documents account with the USAF to receive these manuals, and the S2 can store them when they are not being used.
- b. It takes some time to extract usable attack data from JMEMs. JMEMs should be used during training to develop SOPs and during deliberate planning rather than during actual calls for fire.
- c. The JMEMs provide effective data for many combinations of fuze/shell, target size, personnel posture, fortification, and terrain. They can be used to determine how many rounds to fire during each mission to cause a predetermined amount of enemy casualties. As a general guide, Figures B-1 through B-4 can be used, since they are based on extracts from JMEM data. These figures show the least amount of ammunition the mortar section or platoon should expend against platoon-sized targets attacking or defending on various terrain.

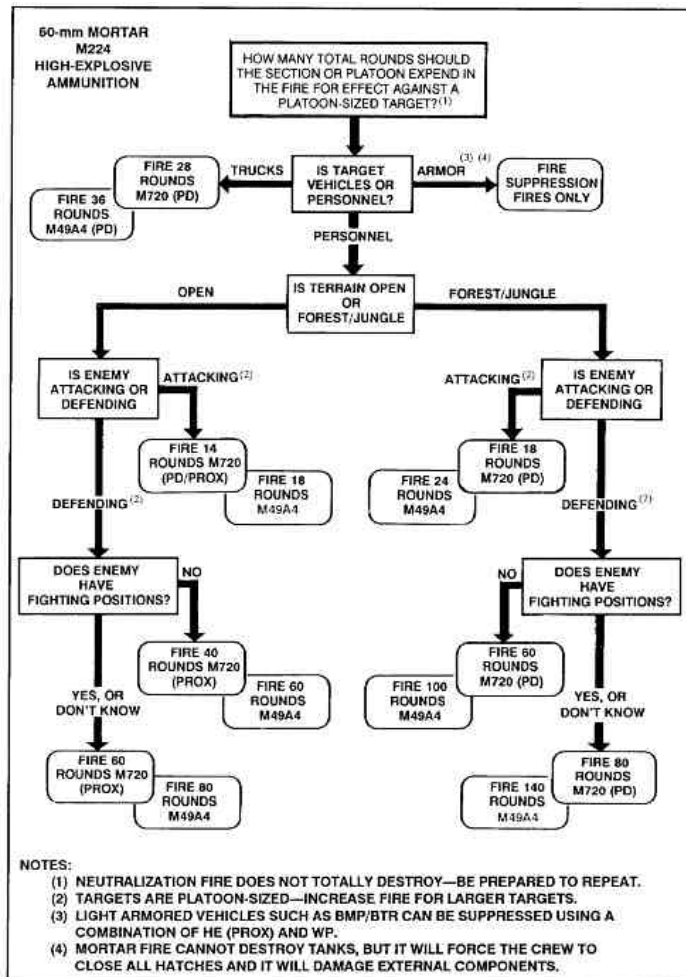

Figure B-I. Ammunition expenditure guide (60-mm).

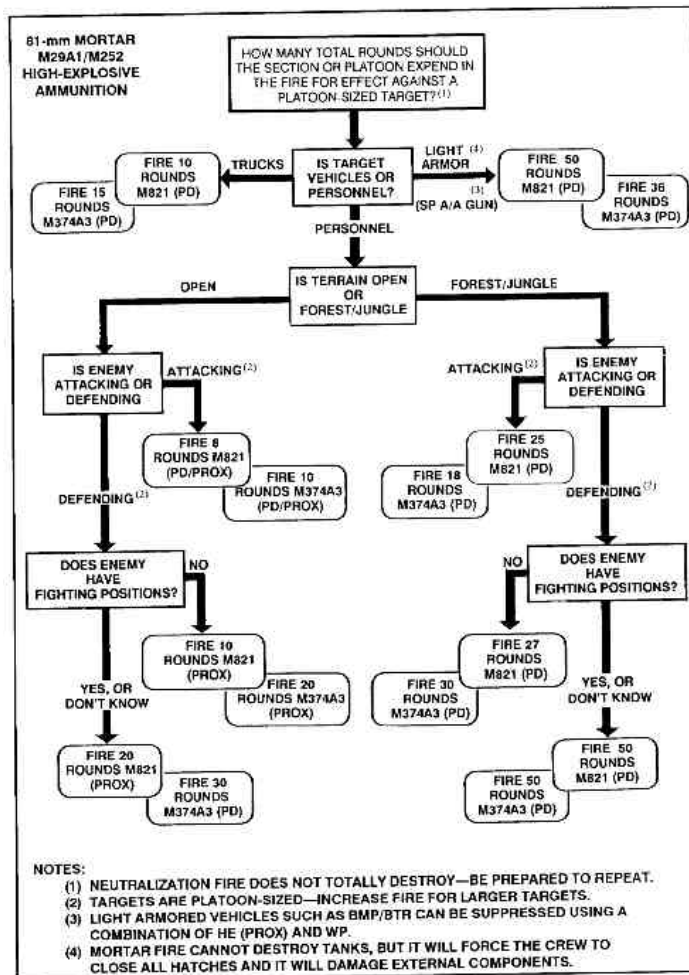

Figure B-2. Ammunition expenditure guide (81-mm).

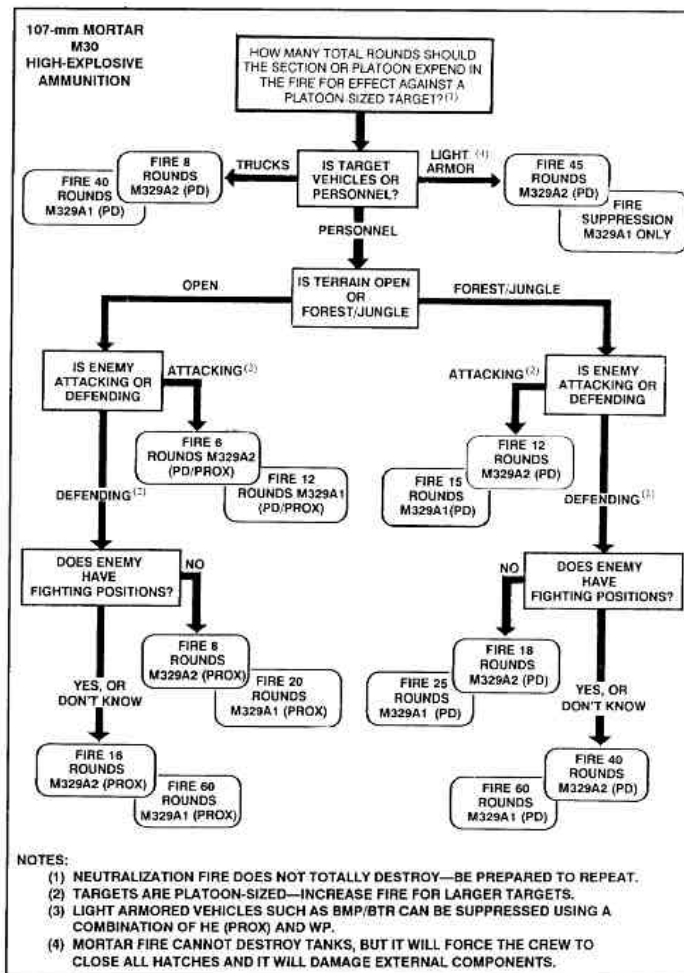

Figure B-3. Ammunition expenditure guide (4.2-inch).

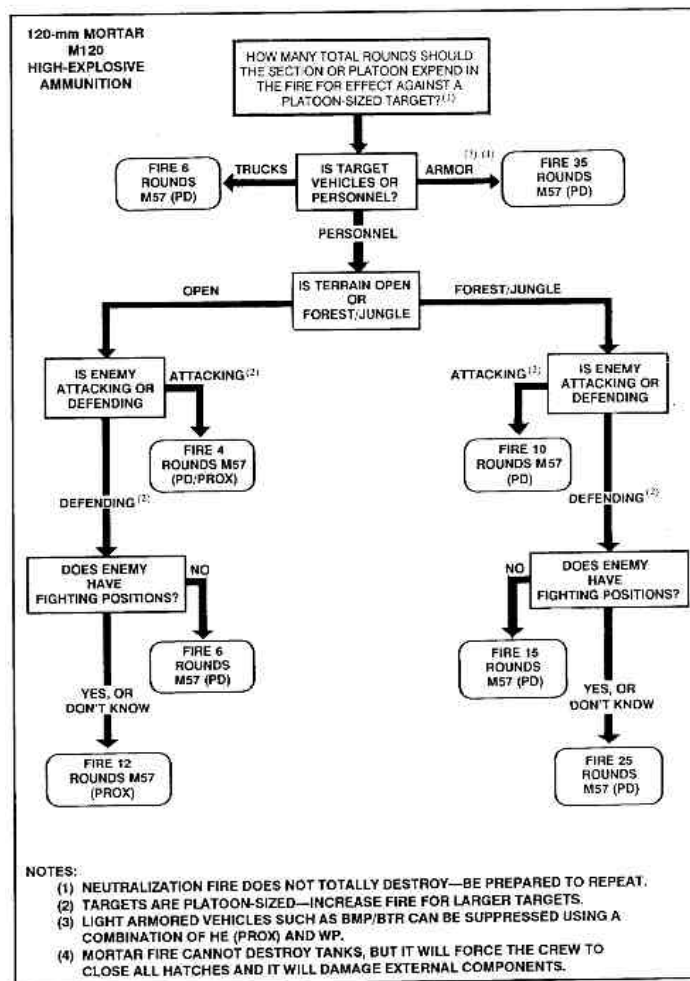

Figure B-4. Ammunition expenditure guide (120-mm).

B-2. HIGH-EXPLOSIVE AMMUNITION

When mortar rounds impact, they throw fragments in a pattern that is never truly circular and may even be irregular, based on the round's angle of fall, the slope of the terrain, and the type soil. However, for planning purposes, each mortar HE round is considered to

have a circular lethal bursting area. Figure B-5 shows a scale representation of the lethal bursting areas of mortar rounds.

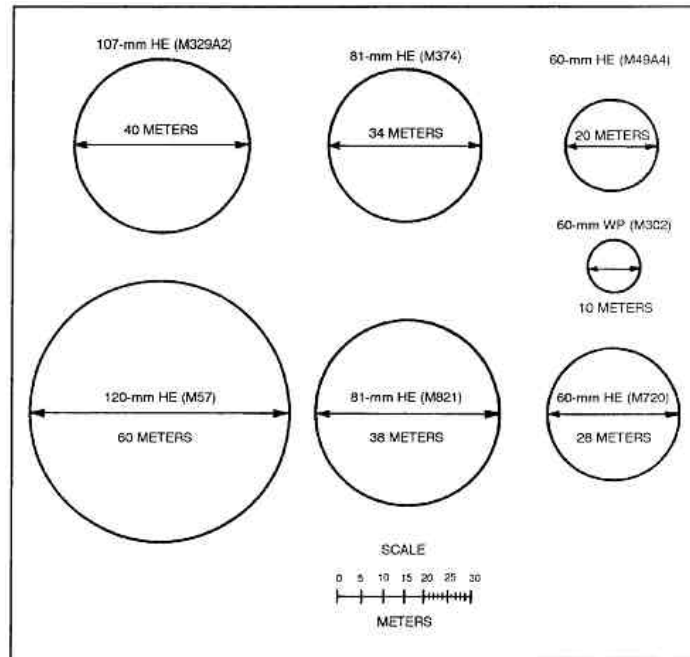

Figure B-5. Comparison of lethal bursting areas of US mortar rounds

B-3. FUZE SETTINGS

The decision as to what fuze setting to use depends on the position of the enemy.

- a. Exposed enemy troops that are standing up are best engaged with IMP or NSB fuze settings. The round explodes on, or near, the ground. Shell fragments travel outward perpendicular to the long axis of the standing target (Figure B-6).

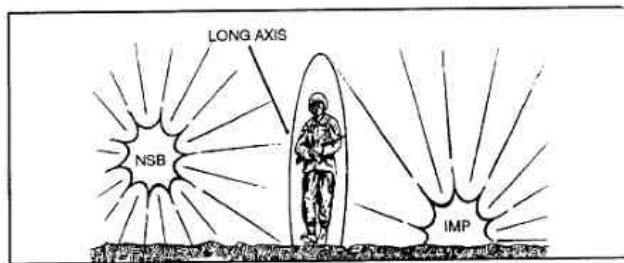

Figure B-6. Standing targets.

b. If exposed enemy troops are lying prone, the PRX fuze setting is most effective. The rounds explode high above the ground, and the fragments coming downward are once again traveling perpendicular to the long axis of the targets (Figure B-7).

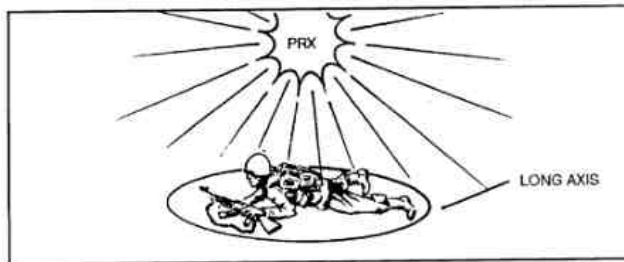

Figure B-7. Prone targets.

c. The PRX setting is also the most effective if the enemy is in open fighting positions, without overhead cover. Even PRX settings will not always produce effects if the positions are deep (Figure B-8).

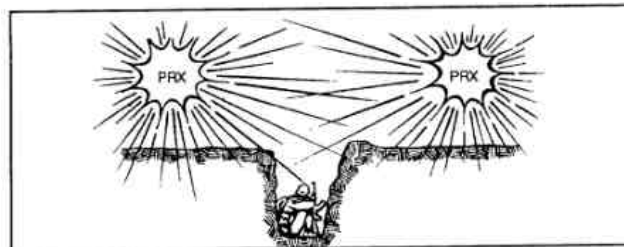

Figure B-8. Targets in open fighting positions.

d. The DLY fuze setting is most effective when the enemy is below triple canopy jungle or in fighting positions with overhead cover. Light mortars will have little effect against overhead cover; even medium mortars have limited effect. Heavy mortars can destroy a bunker with a hit or a near-miss (Figure B-9).

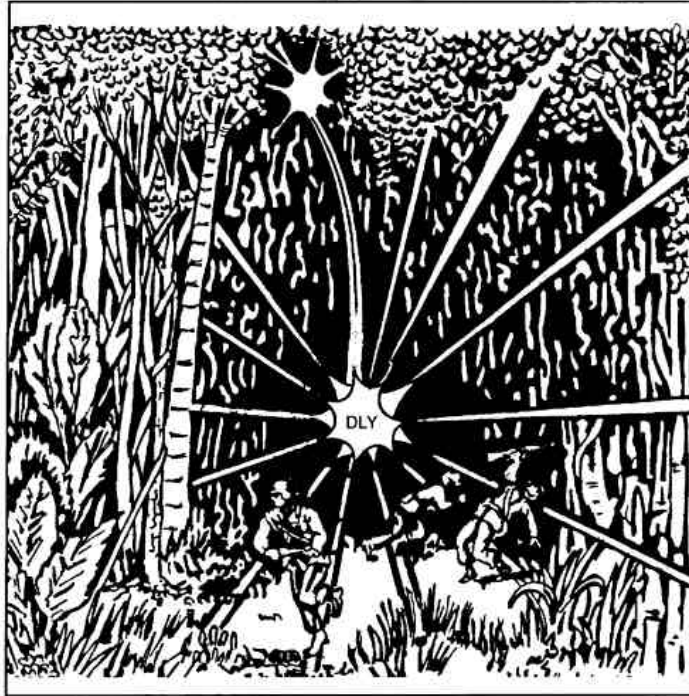

Figure B-9. Targets beneath triple canopy jungle.

e. Table B-1 gives information on the average lethal areas, in square meters, of mortar HE rounds against various targets. These figures can be used to develop the mortar ammunition RSR. Planners determine the size of the target or objective area, then divide the lethal areas of the mortar round into this figure to determine the number of rounds needed to cover the target with lethal fragments. This gives a rough idea of the least number of rounds needed to cover the target area once. JMEM data are used to further refine this number and to estimate the total number of rounds required.

MORTAR	SITUATION	IMP	PRX
60-mm MORTAR HE (M720) (NOTE 1) (1 ROUND)	STANDING ENEMY, OPEN TERRAIN	250	500
	PRONE ENEMY, OPEN TERRAIN	100	200
	CROUCHING ENEMY, OPEN POSITIONS (NOTE 2)	1	25
81-mm MORTAR HE (M374) (1 ROUND)	STANDING ENEMY, OPEN TERRAIN	700	900
	PRONE ENEMY, OPEN TERRAIN	300	600
	CROUCHING ENEMY, OPEN POSITIONS (NOTE 2)	5	30
107-mm MORTAR HE (M329A2) (1 ROUND)	STANDING ENEMY, OPEN TERRAIN	600	750
	PRONE ENEMY, OPEN TERRAIN	250	400
	CROUCHING ENEMY, OPEN POSITIONS (NOTE 2)	5	35
81-mm MORTAR HE (M374) (3 MORTARS/ 1 ROUND EACH)	STANDING ENEMY, OPEN TERRAIN	1000	1400
	PRONE ENEMY, OPEN TERRAIN	1000	1500
	CROUCHING ENEMY, OPEN POSITIONS (NOTE 2)	10	35
107-mm MORTAR HE (M329A2) (4 MORTARS/ 1 ROUND EACH)	STANDING ENEMY, OPEN TERRAIN	2400	2600
	PRONE ENEMY, OPEN TERRAIN	1000	1800
	CROUCHING ENEMY, OPEN POSITIONS (NOTE 2)	30	150
60-mm MORTAR HE (M720) (2 MORTARS/ 1 ROUND EACH)	STANDING ENEMY, OPEN TERRAIN	450	1000
	PRONE ENEMY, OPEN TERRAIN	200	450
	CROUCHING ENEMY, OPEN POSITIONS (NOTE 2)	5	30
120-mm MORTAR HE (M57) (1 ROUND)	STANDING ENEMY, OPEN TERRAIN	900	1100
	PRONE ENEMY, OPEN TERRAIN	350	600
120-mm MORTAR HE (M57) (3 MORTARS/ 1 ROUND EACH)	STANDING ENEMY, OPEN TERRAIN	2600	3000
	PRONE ENEMY, OPEN TERRAIN	1100	1800
NOTES:			
1. THE M49A4 HE ROUND, STANDARD B AMMUNITION FOR THE M224 MORTAR, IS ONLY 55 PERCENT AS EFFECTIVE AS THE NEWER M720 ROUND.			
2. AGAINST PERSONNEL IN OPEN POSITIONS, USE THE LOWEST ANGLE OF FALL POSSIBLE. IT GIVES TWICE THE COVERAGE OF THE STEEPEST ANGLE OF FALL.			

Table B-1. Approximate lethal areas (square meters), US mortars.

f. Against a standing, platoon-size enemy unit, a 60-mm mortar section that fires five rounds per mortar should inflict about 20 percent casualties. If the enemy is prone, these fires should inflict less than 10 percent casualties. This means that a light mortar section's FFE should seldom consist of any less than five rounds for each mortar, and often will require more.

g. Impact-fuzed rounds are normally the best for adjusting fire. If dense foliage prevents observation of the IMP-fuzed round, NSB or PRX settings will cause the round to

explode near the top of the trees where the burst can be better observed. If there is a combination of snow cover and fog in the target area, making adjusting rounds difficult to see, the DLY setting can be used for adjustments. This causes a plume of dirt or exposes the earth at the point of impact. The dark soil contrasts with the fog and snow, making adjustment easier.

B-4. EFFECTS OF TERRAIN ON HIGH-EXPLOSIVE FIRES

HE fires are the most common for destruction, neutralization, and suppression. Most mortar HE rounds can be fired with the M734 multi-option fuze. This fuze enables HE rounds to be detonated above the target surface, on the target surface, or after a short delay. Older ammunition that cannot use the multi-option fuze uses single- or dual-option fuzes to achieve almost the same effects. These effects vary depending on the ground, target, and size mortar fired.

a. Soft ground limits the effectiveness of surface-burst HE rounds for light, medium, and heavy mortars (light mortars being limited the most). One foot of soft ground, mud, or sand, or 3 feet of snow can reduce the effectiveness of surface-burst HE rounds by up to 80 percent. Light mortar rounds can land close (within a few yards) to a target on this type ground and still have no effect.

b. Hard, rocky soil and gravel actually increase the effectiveness of surface-burst HE rounds. The rock fragments are picked up and thrown by the blast, adding to the enemy's casualties (heavy mortars throw the most rock fragments).

c. Dense woods cause impact-fuzed HE rounds to detonate in the trees, producing airbursts. These airbursts can be dangerous to exposed troops since large wood splinters are added to the round's metal fragments. Wounds caused by large wooden splinters are often severe. Extremely dense woods, such as triple canopy jungle, cause most impact-fuzed HE rounds to detonate high in the trees without much of an effect at ground level.

B-5. EFFECTS OF COVER ON HIGH-EXPLOSIVE ROUNDS

Enemy forces will normally be either standing or prone. They may be in the open or protected by varying degrees of cover. Each of these changes the target effects of mortar fire.

a. Surprise mortar fire is always more effective than fire against an enemy that is warned and seeks cover. Recent studies have shown that a high casualty rate can be achieved with only two rounds against an enemy platoon standing in the open. The same studies required 10 to 15 rounds to duplicate the casualty rate when the platoon was warned by adjusting rounds and sought cover. If the enemy soldiers merely lay prone, they significantly reduce the effects of mortar fire. Mortar fire against standing enemy forces is almost twice as effective as fire against prone targets.

b. Proximity fire is usually more effective than surface-burst rounds against targets in the open. The effectiveness of mortar fire against a prone enemy is increased by about 40 percent by firing proximity-fuzed rounds rather than surface-burst rounds. The steeper the angle of the fall of the round, the more effective it is.

c. If the enemy is in open fighting positions without overhead cover, proximity-fuzed mortar rounds are about five times as effective as impact-fuzed rounds. When fired against troops in open fighting positions, proximity-fuzed rounds are only 10 percent as effective as they would be against an enemy in the open. For the greatest effectiveness against troops in open fighting positions, the charge with the lowest angle of fall should be chosen. It produces almost two times as much effect as the same round falling with the steepest angle.

d. If the enemy has prepared fighting positions with overhead cover, only impact-fuzed and delay-fuzed rounds will have much effect. Proximity-fuzed rounds can restrict the enemy's ability to move from position to position, but they will cause few, if any, casualties. Impact-fuzed rounds cause some blast and suppressive effect. Delay-fuzed rounds can penetrate and destroy a position but must achieve a direct hit. Only the 120-mm mortar with a delay-fuze setting can damage a Soviet-style strongpoint defense. Heavy bunkers cannot be destroyed by light or medium mortar rounds.

B-6. EFFECTS OF TERRAIN ON PROXIMITY-FUZED HIGH-EXPLOSIVE ROUNDS

The multioption fuze functions best over open, firm soil. Snow or sand can cause it to function low or on impact. Water or frozen ground can cause it to function early. If proximity-fuzed rounds are functioning high, they are still effective. The HOB can be reduced by using the NSB setting on the fuze. It cannot be increased except by choosing the steepest angle of fall possible.

a. Proximity-fuzed rounds fired over built-up areas can detonate if they pass close by the side of a large building. They can also function too high to be effective at street level. (Impact fuzes are the most effective in heavily built-up areas.)

b. In dense jungle or forest, proximity fuzes detonate too early and have little effect. Impact fuzes achieve airbursts in dense forests, and delay fuzes allow rounds to penetrate beneath the heavy canopy before exploding.

B-7. SUPPRESSIVE EFFECTS OF HIGH-EXPLOSIVE MORTAR ROUNDS

Suppression from mortar is not as easy to measure as the target effect. It is an effect produced in the mind of the enemy that prevents him from returning fire or carrying on his duties. Inexperienced or surprised soldiers are more easily suppressed than experienced, warned soldiers. Soldiers in the open are much more easily suppressed than those with overhead cover. Suppression is most effective when mortar fires first fall; as

they continue, their suppressive effects lessen. HE rounds are the most suppressive, but bursting WP mixed with HE has a great psychological effect on the enemy. Figure B-10 shows suppressive effects derived from live-fire studies and combat observations.

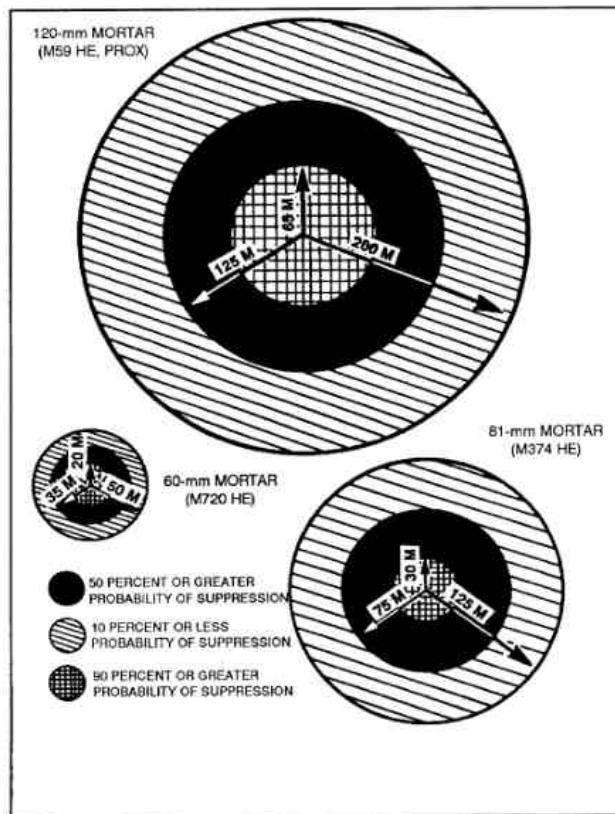

Figure B-10. Suppressive effects of US mortar rounds.

- a. If a 60-mm mortar round lands within 20 meters of a target, the target will probably be suppressed, if not hit.
- b. If a 60-mm mortar round lands within 35 meters of a target, there is a 50 percent chance it will be suppressed. Beyond 50 meters, little suppression takes place.
- c. If an 81-mm mortar round lands within 30 meters of a target, the target will probably be suppressed, if not hit.

- d. If an 81-mm mortar round lands within 75 meters of a target, there is a 50 percent chance that the target will be suppressed. Beyond 125 meters, little suppression takes place.
- e. If a heavy mortar round (proximity-fuzed) lands within 65 meters of a target, the target will probably be suppressed, if not hit.
- f. If a heavy mortar round (proximity-fuzed) lands within 125 meters of a target, there is a 50 percent chance the target will be suppressed. Beyond 200 meters, little suppression takes place. The 120-mm mortar round is better for suppression than the 107-mm, but both are excellent suppressive rounds.

B-8. EFFECTS OF MORTAR FIRE AGAINST VEHICLES

Mortar fires by themselves are not normally effective against vehicles, especially armored vehicles, but they can be most effective when combined with direct fires of antitank weapons. Mortar fires force the armored vehicle crewmen to button up, reducing their visibility and preventing them from firing the heavy machine guns mounted outside the vehicle. This allows dismounted infantry to approach closer, within range to use their handheld antiarmor weapons.

- a. Mortars are generally ineffective as a killer of tracked vehicles. The 120-mm heavy mortar has a moderate capability against BRDMs and BMPs. Mortar fragments from smaller mortars can damage exterior components of lightly armored scout vehicles, ATGM launchers, or self-propelled anti-aircraft guns and can reduce their effectiveness. Firepower or mobility kills are difficult to achieve without expending large amounts of mortar ammunition.
- b. Against moving heavily armored vehicles like tanks or BMPs, the best mortar fires can achieve is forcing the crew to button up. Against stationary tanks or BMPs, bursting WP rounds from medium and heavy mortars can be effective. These rounds must make almost a direct hit on the target to cause any damage.
- c. Point-detonating rounds are the most effective against trucks. Their low-angle fragments do the most damage to tires, wheels, and engines. Bursting WP rounds are also effective if mixed with the HE.

B-9. GUIDELINES FOR THE USE OF HIGH-EXPLOSIVE ROUNDS

The following guidelines are useful during the planning of mortar fires. As the battle progresses, the actual results should be reviewed and the guidelines modified.

- a. What is the enemy doing?
 - (1) If the enemy is unwarned, standing in the open, fire one impact-fuzed HE round from each mortar. Then fire the following rounds as proximity-fuzed.

(2) If the enemy is prone or crouching in open fighting positions, fire all rounds as proximity-fuzed.

(3) If the enemy's status is unknown, fire all proximity-fuzed rounds.

b. What is the ground in the target area like?

(1) If the ground in the target area is soft, swampy, or covered in deep snow, fire proximity-fuzed or near-surface burst rounds.

(2) On rocky and hard soil, fire a 50 percent mixture of proximity-fuzed and impact-fuzed rounds.

(3) If soil type is unknown, fire all proximity-fuzed rounds.

c. What is the vegetation in the target area like?

(1) If the target is within forest, fire point-detonating fuzes for all rounds.

(2) In extremely dense forest or jungle, fire point-detonating fuzes mixed with 50 percent delay fuzes.

d. What is the enemy position like?

(1) If the enemy is in bunkers, fire point-detonating rounds mixed with 50 percent delay fuzes.

(2) Do not depend on light or medium mortar fires to damage heavy bunkers or buildings.

(3) Expect heavy mortar fire to destroy some heavy bunkers and damage others, but also expect to fire large amounts of ammunition.

B-10. ILLUMINATION, SMOKE, AND WHITE PHOSPHORUS AMMUNITION

Illumination and obscuration missions are important functions for mortar platoons or sections. Atmospheric stability, wind velocity, and wind direction are the most important factors when planning target effects for smoke and WP mortar rounds. The terrain in the target area also effects smoke and WP rounds.

a. The bursting WP round provides a screening, incendiary, marking, and casualty-producing effect. It produces a localized, instantaneous smoke cloud by scattering burning WP particles.

b. The WP round is used mainly to produce immediate, close point obscuration. It can be used to screen the enemy's field of fire for short periods, which allows troops to

maneuver against him. The 60-mm WP round is not sufficient to produce a long-lasting, wide-area smoke screen, but the much larger WP round from the heavy mortar is.

c. The bursting WP round can be used to produce casualties among exposed enemy troops and to start fires. The casualty-producing radius of the WP round is much less than that of the HE round. Generally, more casualties can be produced by firing HE ammunition than by firing WP. However, the WP burst causes a significant psychological effect, especially when used against exposed troops. A few WP mixed into a fire mission of HE rounds may increase the suppressive effect of the fire.

d. The WP rounds can be used to mark targets, especially for attack by aircraft. Base-ejecting smoke rounds, such as the 81-mm M819 RP round, produce a dispersed smoke cloud, normally too indistinct for marking targets.

e. All bulk-filled WP ammunition needs special care when temperatures are high. The WP filler liquifies at temperatures of 100 degrees Fahrenheit. Since the WP does not fill all the space in the cartridge, the result is a hollow space in the upper part of the cartridge filler cavity. This causes the round to be unbalanced and, therefore, unstable in flight. WP ammunition should be protected from direct sunlight, if possible. When stored at high temperatures, it should be stacked with the fuze up. Keeping the WP ammunition under cover, digging ammunition bunkers, opening only as many rounds as needed, maintaining proper storage, and monitoring the ambient temperature will reduce the chances of firing unstable ammunition. In climates of extremely high temperatures, WP ammunition should be fired only if taken directly from vertical storage. This does not apply to the M252 mortar's base-ejecting RP smoke rounds. They need no special vertical storage.

f. The effects of atmospheric stability can determine whether mortar smoke is effective at all or, if effective, how much ammunition will be needed.

(1) During unstable conditions, mortar smoke and WP rounds are almost ineffective--the smoke does not spread but often climbs straight up and quickly dissipates.

(2) Under moderately unstable atmospheric conditions, base-ejecting smoke rounds are more effective than bursting WP rounds. The M819 RP round for the M252 mortar screens for over 2 1/2 minutes.

(3) Under stable conditions, both RP and WP rounds are effective. The higher the humidity, the better the screening effects of mortar rounds.

g. The M819 RP round loses up to 35 percent of its screening ability if the ground in the target area is covered with water or deep snow. During extremely cold and dry conditions over snow, up to four times the number of smoke rounds may be needed than expected to create an adequate screen. The higher the wind velocity, the more effective bursting WP rounds are, and the less effective burning smoke rounds become (Figure B-11).

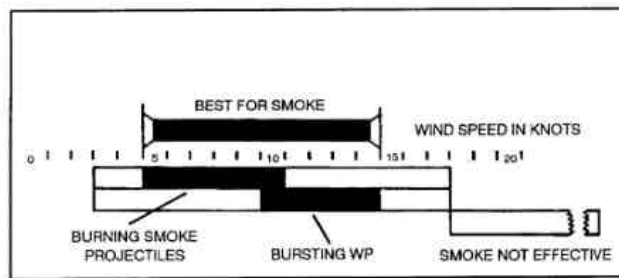

Figure B-11. Optimum wind speeds for mortar smoke and white phosphorus.

h. If the terrain in the target area is swampy, rain-soaked, or snow-covered, then burning smoke rounds may not be effective. These rounds produce smoke by ejecting felt wedges soaked in red phosphorus. These wedges then burn on the ground, producing a dense, long-lasting cloud. If the wedges fall into mud, water, or snow, they can be extinguished. Shallow water can reduce the smoke produced by these rounds by as much as 50 percent. Bursting WP rounds are affected little by the terrain in the target area, except that deep snow and cold temperatures can reduce the smoke cloud by about 25 percent.

i. Although bursting WP rounds are not designed to cause casualties, the fragments of the shell casing and bits of burning WP can cause injuries. Burning smoke rounds do not cause casualties and have little suppressive effect.

B-11. ILLUMINATION

Illumination rounds can be used to disclose enemy formations, to signal, or to mark targets. There are illumination rounds available for all mortars.

a. The 60-mm illumination round available now is the standard cartridge, illuminating, M83A3. This round has a fixed time of delay between firing and start of the illumination. The illumination lasts for about 25 seconds, and it provides moderate light over a square kilometer. The gunner must adjust the elevation to achieve height-of-burst changes for this round. The best results are achieved with practice. The maximum range of the illumination round is 950 meters. This range as well as the minimum range of 725 meters must be taken into account when planning illumination support.

b. The 60-mm illumination round does not provide the same degree of illumination as do the rounds of the heavier mortars and field artillery. However, it is sufficient for local, point illumination. The small size of the round can be an advantage where illumination is desired in an area but adjacent friendly forces do not want to be seen. The 60-mm illumination round can be used without degrading the night vision devices of adjacent units.

c. The new illumination round for the M224 and the M721 is ballistically matched with the M720 HE round. It is effective out to the full range of the mortar and produces improved illumination over the M83A3 round.

d. The medium and heavy mortars can provide excellent illumination over wide areas. The 120-mm mortar illumination round provides one million candlepower for 60 seconds.

B-12. SPECIAL ILLUMINATION TECHNIQUES

The following are three special illumination techniques that mortars have effectively used.

a. An illumination round fired extremely high over a general area will not always alert an enemy force that it is being observed. However, it will provide enough illumination to optimize the use of image intensification (starlight) scopes such as the AN/TVS-5 and the AN/TVS-4.

b. An illumination round fired to burn on the ground will prevent observation beyond the flare into the shadow. This is one method of countering enemy use of image intensification devices. A friendly force could move behind the flare with greater security.

c. An illumination round fired to burn on the ground can be used to mark targets during day or night. Illumination rounds have an advantage over WP as target markers during high winds. The smoke cloud from a WP round will quickly be blown downwind. The smoke from the burning illumination round will continue to originate from the same point, regardless of the wind.

B-13. SPECIAL CONSIDERATIONS WHEN USING THERMAL SIGHTS

Although illumination rounds may aid target acquisition when friendly forces are using image intensification devices, this is not so when thermal sights are used. As the illumination flares burn out and land on the ground, they remain as a distinct hot spot seen through thermal sights for several minutes. This may cause confusion, especially if the flare canisters are between the enemy and the friendly forces. WP rounds can also cause these hot spots that can make target identification difficult for gunners using thermal sights (tanks, BFV, TOW, or Dragon).

APPENDIX C

MORTAR SMOKE OPERATIONS

Smoke is used to increase the effectiveness of friendly operations by--

- Denying the enemy information by screening or obscuration.
- Reducing effectiveness of enemy target acquisition systems.
- Restricting nap-of-the earth and contour approaches for aircraft.
- Disrupting enemy movement, operations, and command and control.
- Deceiving the enemy as to the intent of friendly forces.

Technical information regarding ammunition and the employment of smoke is contained in applicable mortar field manuals and technical manuals. (Additional information about smoke operations can be found in FM 3-50 and TC 6-40.)

C-1. EMPLOYMENT OF SMOKE

Smoke operations has two general categories: *immediate* and *preplanned*. Immediate smoke missions are conducted with minimum planning, normally to counter some enemy action or anticipated enemy action of immediate concern to a commander. Immediate smoke is used to cover a small area and is of short duration. Preplanned smoke is planned in greater detail. It is often employed over a large area for a relatively long period. Mortars are mainly used to fire immediate smoke but can also participate in preplanned smoke missions. Preplanned smoke missions often require extensive logistical support due to large expenditures of smoke ammunition.

a. **Basic Applications on the Battlefield.** Smoke has four applications on the battlefield: obscuration, screening, deception, and signaling/marketing.

(1) **Obscuration smoke** is employed on or against the enemy to degrade his vision both within and beyond his location. Smoke delivered on an enemy ATGM position can prevent the system from acquiring or subsequently tracking targets, thereby reducing its effectiveness. Employment of obscuration smoke on an attacking armored force can cause it to vary its speed, to inadvertently change its axis of advance, to deploy prematurely, and force it to rely on less effective nonvisual means of command and control.

(2) **Screening smoke** is employed in friendly operational areas or in areas between friendly and enemy forces to degrade enemy ground and aerial observation, and to defeat or degrade enemy vision systems. Screening smoke

from mortars is used to conceal friendly ground maneuver, and breaching and recovery operations.

(3) *Deception smoke* is employed to create the illusion that some tactically significant event is occurring in order to confuse or mislead the enemy. Deceptive smoke from mortars can be used in river crossings, withdrawals, and air assault operations.

(4) *Signaling/markings smoke* is employed to relay prearranged communications on the battlefield and to mark unit locations. Occasionally, WP mortar rounds can be used to signal the end of a preparation on a target and the beginning of an assault. Marking smoke is used to identify targets, evacuation points, landmarks, and friendly unit positions.

b. **Employment of Smoke.** Normally, the battalion commander makes the decision of when to fire smoke missions. Several factors must be considered when employing smoke:

- Time required to fire the mission.
- Observation required while the smoke mission is conducted.
- Size of the area to be obscured.
- Characteristics of ammunition fuzes (Table C-1).
- Availability of ammunition.
- Length of time obscuration is desired.
- Effects of smoke on adjacent friendly units.
- Effects of smoke on friendly supporting fires.
- Capability of resupply.
- Weather conditions (see FM 23-91 for the effects of weather).
- Desirability of dual effect of obscuring and producing casualties by firing HE and WP.
- Closure rates (Table C-2).

DELIVERY SYSTEM	TYPE ROUND	TIME TO BUILD EFFECTIVE SMOKE	AVERAGE BURN TIME	AVERAGE OBSCURATION FRONTAGE FOR FIRING UNITS (METERS) WIND DIRECTION		
				CROSS	QUARTERING	HEAD/ TAIL
107-mm (4 mortars)	WP	30 sec	1 min	200	80	40
81-mm (3 mortars)	WP	30 sec	1 min	100	60	40

All rounds are fired as standard missions with parallel sheafs under favorable conditions.

Table C-1. Planning data for mortar smoke.

DISTANCE TRAVELED (METERS)	VEHICLE SPEED (KMH)					
	5	10	15	20	25	30
	TIME (MINUTES)					
3,000	36	18	12	9	7.2	6
2,500	30	15	10	7.5	6	5
2,000	24	12	8	6	4.8	4
1,500	18	9	6	4.5	3.6	3
1,000	12	6	4	3	2.4	2

Table C-2. Rates of closure.

(1) To obtain the best combination of smoke effects at the right time requires knowledge of a given type of round. Once all of the information is known about the type of smoke to use, the number of rounds must be decided to build the smoke and to maintain it.

(2) If HE and smoke are to be mixed, it maybe desirable to use two separate sources to deliver the rounds. For example, one section of the battalion mortars provides obscuration and the company mortars provide HE. This can increase the effect of the mission and can reduce the problems of the FIST FOs who are adjusting both types of rounds on one radio net. Detailed coordination is required for this type mission.

(3) Normally, the mortar platoon carries only a limited number of smoke rounds. This number and the capability of the load must be made known to commanders. Special requests for smoke or changes in smoke round allowances can be made, but they must be prepared in advance and submitted before the required mission.

C-2. SMOKE IN SUPPORT OF OFFENSIVE OPERATIONS

There are five specific ways that mortar smoke can be used in offensive operations.

a. **Blind Enemy Observers/Gunners.** This technique is effective when conducting a movement to contact or when enemy contact is likely. Mortars can fire smoke directly on all suspected or known enemy observer/gunner positions; or fire smoke between known or suspected enemy observer/gunner positions and the supported unit. The smoke cloud must be maintained in both until the attacking unit reaches its objective or passes the danger area.

b. **Screen an Attack.** This technique is used to cover a unit while moving forward in an attack. Maneuver is concealed by a smoke screen to the attacking unit's front. Ideally, the screen is maintained continuously along the axis of advance. It is terminated for mounted forces about 500 to 800 meters short of the objective to allow for maximum visibility

during the final assault. For dismounted forces, this distance is about 100 to 200 meters. By using this technique, a unit can move behind smoke without being effectively engaged. If necessary, the flanks or rear of the supported unit can also be screened.

c. **Conceal a Bypass.** There are two ways to conceal a bypass:

(1) Screen the bypassing unit while it is moving around the enemy. A smoke cloud is fired in front of the enemy position and on his left or right with mortar fire. When the smoke is in position, the bypassing unit moves around the screened flank towards its objective.

(2) Make the enemy believe he is the object of an attack. Mortars fire smoke and HE directly on the enemy position. With the smoke cloud in place, the bypassing unit moves around the enemy to its objective.

d. **Cover a Breaching Operation.** This technique is employed by mortars (or mortars and artillery) firing two smoke clouds at the same time. One cloud is fired directly on the enemy. The other is fired between the enemy position and the breaching force. Continuous smoke is maintained in both areas, because minefields are normally covered by direct and indirect fires.

e. **Obscure Vehicles From Enemy Direct Fire Gunners.** This technique is used to degrade the capability of enemy ATGM gunners. Once the vehicle commander realizes that his vehicle is being engaged by enemy missiles, he employs vehicle smoke or smoke hand grenades and directs his driver to take evasive action. To further degrade every gunner's vision, mortar smoke should also be requested. It can be fired on the enemy gunners or between them and friendly vehicles. This prevents enemy gunners from tracking vehicles and guiding missiles to the vehicles.

C-3. DEFENSIVE AND RETROGRADE USE OF SMOKE

There are five specific ways that mortar smoke can be used in support of defensive and retrograde operations.

a. **Force Enemy Infantry to Dismount From Mechanized Vehicles.** Ideally, this technique employs mortar and artillery smoke, HE ammunition, and scatterable mines or chemicals together. Smoke is fired to the front of the attacker. The smoke should be fired beyond the range of direct-fire weapons to give the defender more time to engage targets. Scatterable mines (if available) and HE are then fired into the smoke.

b. **Slow the Advance of Attacking Forces.** This technique causes the attacker to reduce his speed, thus slowing the momentum of his attack. It is employed by firing smoke across the front of the advancing enemy. HE rounds are also fired with smoke to make the enemy button up his tanks and personnel carriers. Vehicles are silhouetted as they emerge from the smoke, making them easier to track and destroy.

c. **Separate and Isolate Attacking Echelons.** This technique is employed by firing smoke between two echelons of an attacking enemy force (for example, between two battalion echelons of company size). The smoke visually separates the two echelons and prevents the second echelon from seeing the first being engaged. The second echelon is also slowed by the smoke. This gives the defender more time to fire at targets in the first echelon without being engaged by enemy in the second. It also provides the defender with easy targets as the second echelon emerges from the smoke.

d. **Cover Displacement.** This technique fires smoke in front of the defensive position so the supported unit can move without being observed. When the initial smoke screen begins to dissipate, more smoke is fired between the enemy and the displacing unit. Smoke is also fired on suspected enemy locations and routes.

e. **Expose Enemy Helicopters.** This technique makes enemy helicopters vulnerable to air defense systems, because smoke forces them to fly at higher altitudes. It may occur as a result of mortar smoke that has already been employed in fighting enemy ground forces. Also, smoke can be employed in a specific location (such as, a flank) to prevent enemy helicopters from attacking undetected by flying nap-of-the-earth. When helicopters fly above the smoke to engage their targets, they are engaged by air defense weapons.

APPENDIX D

CRATER ANALYSIS

Crater analysis is an important step toward defeating the enemy's countermortar effort. By conducting a simple analysis of the craters produced by enemy fire and by reporting the results, the mortar leader can provide valuable information about the enemy. Crater analysis is the responsibility of all mortar leaders. It is especially important during low-intensity conflict.

D-1. EQUIPMENT

Most of the equipment needed to conduct crater analysis is available in the mortar platoon or section. A key piece, the curvature template, must be constructed.

a. A *declinated aiming circle (or M2 compass)*, *stakes*, and *twine or communications wire* are used to obtain the direction from the crater to the weapon that fired the projectile.

b. A curvature template is used to measure the curvature of a fragment to determine the caliber of the shell (Figure D-1). The template can be constructed of heavy cardboard, acetate, wood, or other appropriate material.

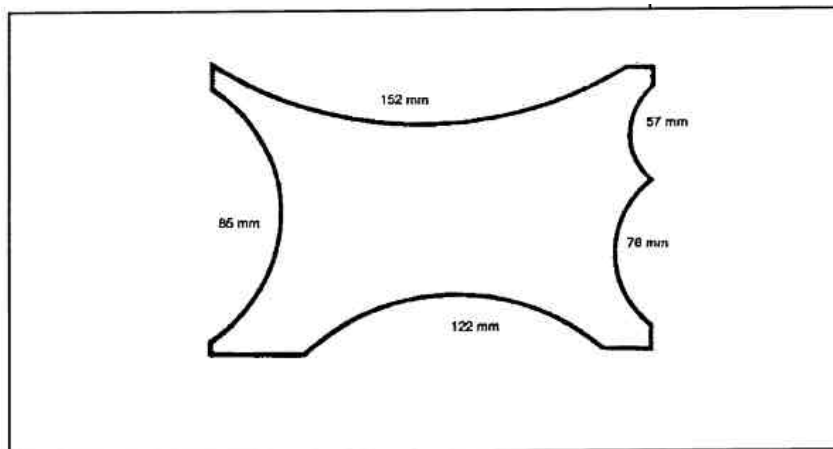

Figure D-1. Curvature template.

D-2. VALUE OF ANALYSIS

By studying shelling reports based on crater analysis, artillery experts at division artillery can--

- a. Confirm the existence of suspected enemy locations.
- b. Confirm the type of enemy artillery and obtain an approximate direction to it.
- c. Detect the presence of new types of enemy weapons, new calibers, or new ammunition manufacturing methods.

D-3. INSPECTION OF SHELLED AREAS

Shelled areas should be inspected as soon after the shelling. Craters that are exposed to the elements or are abused by personnel deteriorate quickly and lose their value as a source of information.

D-4. CRATER LOCATION

Craters must be located accurately for plotting on charts, maps, or aerial photographs. Deliberate survey is not essential; hasty survey techniques or map spotting usually suffices. Grid locations provided by GPS receivers are sufficiently accurate. Direction can be determined by using an aiming circle or a compass.

D-5. DETERMINATION OF DIRECTION

A clear pattern produced on the ground by the detonating shell indicates the direction from which the shell came.

- a. In determining direction, the mortar leader considers the following:
 - The effects of stones, vegetation, stumps, and roots in the path of the projectile.
 - Variations in density and type of soil.
 - The slope of the terrain at the point of impact.

From any group, use only the most clearly defined and typical craters.

- b. The direction from which a round was fired is often indicated by the marks made as it passes through trees, snow, or walls. Leaders must not overlook the possible deflection of the shell upon impact with these objects.
- c. Often, when an artillery round with a delay fuze is fired at low angle, it bounces or ricochets from the surface of the earth. In doing so, it creates a groove, called a *ricochet furrow*. Leaders must determine if the shell was deflected before or while making the furrow.

D-6. CRATER ANALYSIS PROCEDURES

The actual crater created by enemy fire is an excellent source of information to the artillery counterfire planners. The mortar platoon leader should conduct immediate crater analysis and report the results.

- a. The first step in crater analysis is to locate a usable crater for determining the direction to the hostile weapon. The crater should be clearly defined on the ground and reasonably fresh. Since the crater is the beginning point for plotting the direction to the enemy weapon, the mortar platoon leader determines the grid coordinates of the crater as an eight-digit grid or as precisely as time and method used allow. He determines the direction to the firing weapon by one of the methods described in the following paragraphs. He can collect shell fragments for identifying the type and caliber of the weapon.
- b. The projectile direction of flight is determined with reasonable accuracy from its crater or ricochet furrow. By accurately locating the crater and determining the direction of flight, the mortar leader can obtain the azimuth that will pass through or near the enemy position. He can determine the direction to an enemy battery from only one crater or ricochet furrow. However, plotting the intersection of the azimuths from at least three widely separated groups of craters is more accurate.
- c. Differences in angle of fall, projectile burst patterns, directions of flight, and time fuze settings can help to distinguish between enemy batteries.

NOTES:

1. Refer to FM 3-100 for guidance on friendly troop safety from the effects of craters contaminated with chemical agents.
2. Refer to STANAG 2002 in FM 3-100 for guidance in marking craters containing chemical, biological, or radiological contamination.
3. Refer to TC 6-50, The Field Artillery Cannon Battery, Appendix K for detailed explanations of the procedures used to measure the direction from a crater towards the enemy firing position.

D-7. LOW-ANGLE FUZE QUICK CRATERS (ARTILLERY)

The detonation of a low-angle artillery projectile causes an inner crater. The burst and momentum of the shell carry the effect forward and to the sides, forming an arrow that points to the rear (toward the weapon from which the round was fired). The fuze continues along the line of flight, creating a fuze furrow.

D-8. LOW-ANGLE FUZE DELAY CRATERS (ARTILLERY)

There are two types of fuze delay craters: ricochet furrow and mine action.

a. **Ricochet Furrow.** The projectile enters the ground and continues in a straight line for a few feet, causing a ricochet furrow. The projectile normally deflects upward; at the same time, it changes direction, usually to the right as the result of the spin of the projectile. The effect of the airburst can be noted on the ground. Directions obtained from ricochet craters are considered to be the most reliable.

b. **Mine Action.** A mine action crater occurs when a shell bursts beneath the ground. Occasionally, such a burst leaves a furrow that can be analyzed the same as the ricochet furrow. A mine action crater that does not have a furrow cannot be used to determine the direction to the weapon.

D-9. MORTAR SHELL CRATERS (HIGH ANGLE)

In typical mortar crater, the turf at the forward edge (the direction away from the hostile mortar) is undercut. The rear edge of the crater is shorn of vegetation and grooved by splinters. When fresh, the crater is covered with loose earth, which must be carefully removed to disclose the firm, burnt inner crater. The ground surrounding the crater is streaked by splinter grooves that radiate from the point of detonation. The ends of the splinter grooves on the rearward side are on an approximate straight line. This line is perpendicular to the line of flight if the crater is on level ground or on a slope with contours perpendicular to the plane of fire. A fuze tunnel is caused by the fuze burying itself at the bottom of the inner crater in front of the point of detonation.

D-10. ROCKET CRATERS

A crater resulting from a rocket impacting with a low or medium angle of fall is analyzed the same as a crater resulting from an artillery projectile armed with fuze quick. However, if the rocket impacts with a high angle of fall, the crater is analyzed the same as a crater resulting from a mortar round. The tail fins, rocket motor, body, and other parts of the rocket may be used to determine the caliber and type of rocket fired.

D-11. SHELL FRAGMENT ANALYSIS

An expert can identify a shell as to caliber, type, and nation of origin from shell fragments found in the shell crater.

D-12. SHELLING REPORTS

The division artillery is responsible for counterfire. Therefore, BOMREPs, SHELREPs, and MORTREPs should be forwarded quickly through fire support channels.

a. Regardless of how little information has been obtained, leaders must not hesitate to forward these reports. Fragmentary or incomplete information (a radio or telephone

report) is often valuable in supplementing or confirming existing information. This radio or telephone report may be followed by a written report.

b. Any usable fragments obtained from crater analysis should be tagged (shoe tag) and sent to the battalion S2. As a minimum, the tag must indicate the following:

- The location of the crater.
- The direction to the hostile weapon.
- The date-time group of the shelling.

APPENDIX E

OPERATIONS SECURITY

Actions taken to keep the enemy from learning about friendly dispositions, plans, intentions, and operations are called *operations security measures*. At the mortar platoon, section, and squad level, OPSEC measures include camouflage and concealment, physical security, noise and light discipline, and signal security.

Section I. CAMOUFLAGE, CONCEALMENT, AND PHYSICAL SECURITY

By wisely using camouflage and concealment, mortar platoons and squads can make it difficult for the enemy to detect and engage them with accurate fire. Physical security includes steps that the mortar platoons, sections, and squads take such as manning observation posts, conducting stand-to, and posting local security.

E-1. MORTAR CARRIER CAMOUFLAGE

Camouflage can be attached to the vehicle by communications wire or rope. It should be used to breakup outlines, especially the edges of the vehicle, to conceal its distinctive box-like shape. Camouflage materials must not obstruct the mortar's fire or movement. Both natural and man-made items may be used.

E-2. OBSERVATION POSTS

The mission to establish and man an OP is normally assigned to a section or squads. The OPs are designed to observe to the front or in the gaps between friendly positions. They provide early warning of the enemy's advance. When a platoon leader establishes an OP, he must explain in detail what he wants the OP personnel to do, what actions they take if the enemy is detected, and when and how they return to the platoon's position.

E-3. STAND-TO

Mortar platoons, sections, and squads must conduct stand-to.

a. Stand-to is a period of maximum preparedness at first light in the morning and at darkness in the evening. This ensures that the unit is ready for action and that every man adjusts to the changing light conditions. As a minimum, stand-to is conducted 30 minutes before and after BMNT and EENT.

b. The unit SOP should specify all the actions to be taken during stand-to, but they should include the following:

- Priority target ammunition is prepared and marked.
- Mortars are laid on priority targets.
- Illumination ammunition is prepared for use (EENT).
- The FDC has effective communications with FOs and headquarters.
- MBC is updated as necessary.
- Personnel are awake, dressed, and ready for combat.
- Vehicles are topped off with fuel and stocked with a basic load of ammunition.
- Weapons have been cleaned, serviced, and assembled, and ready for action.
- Radios are turned on and tested (briefly).
- Vehicles are loaded to the extent possible, less the deployed weapons, and ready for short-notice moves.

c. During evening stand-to preparations, the following steps should be taken:

- Place all vision block covers in positions.
- Test all panel control lights.
- Prepare all night vision goggles for operation.
- Turn off all internal vehicle lights.
- Place red or blue/green filters on flashlights.
- Check the aiming post lights and lay of the guns.
- Run the vehicle's engine sufficiently (if the tactical situation permits) to ensure batteries are charged so that when the platoon assumes silent watch all vehicles are ready.

E-4. SILENT WATCH

During limited visibility and lulls in the battle, observation must be maintained without exposing friendly positions to enemy detection. While doing this, the platoon can use silent watch, which is a defensive posture that minimizes all sounds that might be detected by the enemy. Silent watch enables friendly security elements to better hear noises made by the enemy. Mortar carrier engines are turned off, and radios are muted.

E-5. LOCAL SECURITY

Each mortar squad should be assigned an area of surveillance by the platoon or section leader. Dismounted security can be used separately or in conjunction with mounted security.

a. At night, the mortar carrier itself may compromise the platoon's position if proper steps are not taken.

b. When the area is dark enough, one member of each squad inspects the vehicle from the outside to ensure that there is no visible light emitted.

c. The squad members provide security by observing assigned sectors with the unaided eye, binoculars, and weapon nightsights. They listen for the enemy. Mechanized mortar crews must be alerted. They cannot hear over the vehicles' noise, and they are confined within the vehicles.

Section II. NOISE AND LIGHT DISCIPLINE

The best OPSEC measures can be wasted at night if a unit does not practice good noise and light discipline.

E-6. NOISE DISCIPLINE

Vehicle noises are the most likely to be detected by the enemy and the most difficult to control. Several techniques can be used to reduce the noise problem.

- a. Keep night movement to a minimum. The vehicle's engine and the tracks of the mortar carriers can be heard at a great distance.
- b. Turn the volume down on radio speakers and use headphones.
- c. Avoid unnecessary engine noises, such as idling engines at extreme speeds or moving rapidly.
- d. Use telephones to relay fire commands and data from the FDC to the mortars.
- e. Close ramps and hatches before dark, if possible. When they must be closed after dark, do not slam them shut.
- f. Sandbag generators to deaden noise.

E-7. LIGHT DISCIPLINE

The mortar platoon must exercise discipline in its use of lights and fires. FDCs should be blacked out. Flashlights and vehicle lights must be used sparingly. If fires are necessary, they should be kept small and hidden. If excess mortar propellant charges are burned, they should be burned in daylight rather than after dark.

Section III. ELECTRONIC AND COMMUNICATIONS SECURITY

Communications, especially radio communications, are an important part of mortar missions. Threat forces combine signal intelligence, direction-finding, jamming, deception, and destructive fires to attack opposing organizations and weapons systems. Effective use of these means can affect the mortar platoon's ability to accomplish its mission.

E-8. ELECTRONIC DEVICES

The enemy's direction-finding equipment can locate any radio that transmits in a forward area if there is line of sight between the direction finder and the radio. When a mortar platoon's radio is transmitting on lower power from defilade, the enemy's ability to locate the transmitter is significantly reduced and may even be defeated. Wire, directional antennas, and messengers also reduce the chance of detection. Communications security is of extreme importance to the FDC. It includes the following:

- a. Using authentication to ensure that other communication stations are friendly.
- b. Using only approved codes.
- c. Designating periods when all radio equipment is turned off.
- d. Restricting the use of radio transmitters when listening silence is in effect.
- e. Enforcing net discipline and radiotelephone procedures. All stations in a net must use authorized call signs and prowords; they must limit transmissions to official traffic.
- f. Selecting radio sites with a hill as a shield between them and the enemy.
- g. Using directional antennas, when possible.
- h. Using wire, when possible.

E-9. ANTENNAS

To overcome the enemy's direction-finding capability, leaders must use available antennas correctly. Field-expedient antennas can be employed to extend the range of radio equipment and to restrict transmission directions. When properly constructed, field-expedient antennas enhance the communications capacity of mortars operating in an electronic warfare environment.

- a. Keep the whip antenna vertical when transmitting. The antenna must not be grounded (in contact with a foreign object).
- b. Remote the transmitter (place it some distance away) from the FDC. This can be accomplished if mortars remain stationary for a time. The AN/GRA-39 radio set control group allows the operator to remote his radio up to 3.2 km away from the OP.
- c. Use the directional antenna for reducing a direction-finding threat. It is the most desirable antenna. However, some directional antennas are more efficient than others. While all field-expedient directional antennas radiate the majority of their power in the desired location, it is important to use hills and other terrain features to mask signals from the enemy. Use of a directional antenna requires a set location and knowledge of the receiving station's location. This technique can be useful for defensive situations or radio

nets between two fixed stations. For example, the battalion mortar platoon can use these antennas to maintain communications with the battalion command post.

E-10. ANTIJAMMING

Radio operators use antijamming procedures to reduce enemy jamming effects. The basic procedure is as follows:

STEP 1--Find out what is causing the interference. The operator cannot immediately assume his radio is being jammed, because jamming symptoms are often similar to other types of radio/radar interference. Removing the receiver antenna determines whether a signal is being generated internally by the receiver. If interference decreases with the antenna removed, then the interference is external and may be jamming.

STEP 2--Continue the operation. Unless ordered to shut down, continue normal radio operations once jamming has been identified so the enemy cannot learn the effect of his jamming.

STEP 3--Switch to a higher power.

STEP 4--Use another means of communication.

STEP 5--Re-relocate radios/antennas to minimize effects of the jamming signal.

STEP 6--Use a directional antenna.

STEP 7--Change to an alternate frequency, when authorized. Use only when as a last resort.

All operators must report jamming to their next higher headquarters. This report should be sent by another means of communication such as wire or messenger. A jamming report (MIJI report) format is included in the SOI.

APPENDIX F

FIRE WITHOUT AN FDC AND EMERGENCY ENGAGEMENT TECHNIQUES

Fire with an FDC increases the effectiveness of the mortar section. The section sets up and operates an FDC whenever it occupies semipermanent positions or makes a long halt. The FDC influences the outcome of the battle by massing mortar fires, by furnishing prearranged fires during reduced visibility, by lifting and shifting fires, by effecting time-on-target missions, or by providing fire support to other units within range. However, the mortar section must constantly be prepared to engage targets using fire without an FDC. Fire with an FDC is not always possible or desirable. The mortar section can be effective without using an FDC if the members are trained to do so.

F-1. DIRECT-ALIGNMENT METHOD

The direct-alignment method engages targets without an FDC. The squad leader or an FO positions himself on the gun-target line between the target and the mortar so that he can see both. Corrections are made with respect to the gun-target line rather than the observer-target line. The light mortar squad can often use direct-alignment effectively. (See FM 23-90 for a detailed explanation of the direct-alignment method of mortar fire control.)

F-2. DIRECT-LAY METHOD

The direct-lay method engages targets without the use of an FDC. The mortar squad leader controls the fire of his squad when directly engaging a target that can be seen from the mortar's position. He estimates the range to the target and determines the charge and elevation to fire. The gunner uses the burst-on-target method of adjusting subsequent rounds.

a. All mortar squads must be able to conduct direct-lay fires. Although light and medium mortar sections are the most likely to use it, heavy mortars also use direct-lay to attack targets that appear suddenly.

(1) Light and medium mortar sections may use direct-lay to support platoons conducting combat patrols or to provide immediate suppressive fires during surprise engagements. Bringing the light mortar section into action using direct-lay in the hand-held mode is faster than any other method.

(2) Heavy mortars use direct lay to engage targets from alternate or supplemental positions or targets that appear suddenly and require immediate attack.

b. The section's SOP should establish the amount of ammunition to be carried ready for use in direct-lay. The extra increments can be carried in an empty ammunition canister and safely stored for reattachment. The section SOP should also state the fuze setting for this ready ammunition. An impact (IMP) setting usually provides the easiest rounds, to adjust, but proximity (PRX) or near-surface burst (NSB) settings are the most effective for immediate suppression of enemy fire.

F-3. HIP-SHOOT MISSION

A hip-shoot mission is an emergency occupation of an unprepared firing position to respond to a call for fire received while the mortar section is moving. The two types of hip-shoot missions are *immediate suppression* and *adjust fire*. Normal procedures used to occupy a firing position and to lay the mortars are modified during a hip-shoot mission. The key to success in a hip shoot is the platoon leader or section sergeant. He must control the action closely. However, if he assumes too many key functions, too much time may be lost for the mission to be successful. The leader must know where he is at all times during movement. He should always look for possible hip-shoot positions by map and visual inspection.

a. When the platoon leader or section sergeant receives a call for fire, he--

(1) Ensures the call is authentic.

(2) Ensures FDC personnel monitored the call.

(3) Notifies the driver, if applicable.

(4) Signals the convoy, if applicable.

(5) Selects a firing position and passes the coordinates to the FDC personnel.

(6) Determines the best method to lay the mortars and announces it to the squad leaders.

The FDC determines the direction of fire and starts computing initial data.

b. Data must be passed quickly and efficiently. Radio is often the fastest and most efficient. Wire can be used if the platoon internal wire system is designed for rapid emplacement. In the absence of wire, use runners to obtain data as they become available. For example, as each nonadjusting mortar is emplaced, a runner moves to the aiming circle for his deflection. Another runner obtains the firing data from the FDC. On completion of the hip-shoot mission, the tactical situation dictates whether the section moves on or continues position improvement.

c. Few tactical activities require more teamwork than a hip-shoot. Everyone must know his job (drivers, gunners, computers, RATELOs) and do it automatically. If success depends on a leader shouting commands and directives to untrained personnel, the mission will fail.

d. Immediate suppression requires rounds in the target area as quickly as possible to minimize friendly casualties. Speed takes precedence over precise accuracy. When this type call for fire is received while moving, the mortar element positions itself and lays the guns rapidly using whatever means available.

F-4. ADJUST-FIRE MISSION

When an adjust-fire mission is received while moving, a conducted as follows:

a. The element leader moves into a suitable firing hip shoot is position and roughly aligns his vehicle on the direction of fire (as previously described for the immediate suppression mission). The squads pull into position in the directed formation and prepare to lay their mortars.

b. The element leader sets up and orients the aiming circle on the direction of fire determined by the FDC.

c. The base piece is laid using standard reciprocal-lay procedures and fires the first round at the charge and elevation directed by the FDC.

d. The base piece gunner levels up on the aiming circle and announces, "Base piece ready for recheck."

e. The aiming circle operator confirms the lay of the base piece and commands REFER TWO EIGHT ZERO ZERO (OR AS SOP OR FDC DIRECTS), PLACE OUT AIMING POSTS.

f. The base piece crewman places out aiming posts and continues to adjust under the direction of the FDC while the aiming circle operator resumes laying the remaining mortars.

g. After the mortars are laid, mortar squads place out aiming posts on the referred deflection and begin following the mission from that point on.

h. Both of the methods described for the immediate suppression hip shoot can be used to conduct an adjust-fire hip-shoot; however, the nature of adjust fire allows time to use an aiming circle for more accurate fires. The other methods are used when an aiming circle is not available.

APPENDIX G

SUSTAINED AND CONTINUOUS OPERATIONS

This appendix discusses methods for sustaining the mortar section's performance during prolonged combat. In any conflict, combat operations are continuous and are at a high pace. Mortar platoons and sections must fight without stopping for long periods. Under these conditions performance suffers. The mortar leader uses several methods to conserve and prolong his soldier's combat effectiveness.

G-1. TYPES OF OPERATIONS

Mortar platoons routinely conduct continuous operations and may be required to conduct sustained operations.

a. Continuous operations are possible by the mechanization of land combat forces and by technology that permits effective movement at night, in poor weather, and in other low-visibility conditions. Combat continues around the clock at the same level of high intensity for long periods. Armies now have the potential to fight without stopping. The reasons that battalions were forced to pause--darkness, resupply, regrouping--have been overcome by technological advances.

b. Sustained operations are used when the same soldiers and small units engage in continuous operations with no opportunity for the unit to stand down and little opportunity for the soldiers to catch more than a few minutes of sleep. Continuous operations do not always involve sustained operations if enough units or individuals within units are available to allow everyone to get adequate rest.

G-2. STRESS IN COMBAT

The confusion, stress, and lethality of the modern battlefield place a burden on the infantryman's endurance, courage, perseverance, and ability to perform in combat. Mortarmen conducting combat operations must perform complex collective and individual tasks without adequate sleep and under stress. Stress in combat is caused by the following:

a. **Fear.** All soldiers experience the fear of death or being wounded, or the fear of failing in the eyes of one's comrades.

b. **Limited Visibility and Low-Light Levels.** Smoke, darkness, fog, rain, snow, ice, and glare make it hard to see. The extended wear of night vision goggles, protective masks, or laser protective lenses causes stress.

c. **Disrupted Wake/Sleep Cycle.** A soldier's performance suffers during normal sleeping hours due to the disruption of the normal schedule.

d. **Decision Making.** Mental stress results from making vital decisions with little time and insufficient information. It is increased during times of great confusion and exposure to danger.

e. **Physical Fatigue.** Working the muscles faster than they can be supplied with oxygen and fuel can cause soldiers to function poorly without rest.

f. **Physical Discomfort.** Extreme cold, heat, wet, or thirst add greatly to the level of individual stress.

G-3. FATIGUE

As sustained operations continue, all soldiers begin to show effects of general fatigue and lack of sleep. Unless this is counteracted, mortar performance declines rapidly.

a. Mortar sections can conduct sustained operations for 24 to 48 hours, extending 72 hours to them when required. Extensive training and standardization, plus cohesion and esprit de corps, allow limited sustained operations beyond 72 hours. All units experience serious degradation of combat effectiveness that quickly rises after 72 hours. A rule of thumb is to expect a 25 percent degradation in performance for every 24 hours without sleep. Under the extreme demands of combat, units historically have conducted sustained operations for a maximum of 120 hours. The result was a total deterioration of combat effectiveness. Operations in MOPP4 cause faster degradation of combat effectiveness.

b. Though essential for endurance, sheer determination cannot offset the cumulative effects of sustained sleep loss. A unit that is subjected to extensive sustained operations requires a long period of rest and recuperation to regain combat effectiveness.

c. Continuous operations cause a slower, but no less serious, degradation of combat effectiveness. Whether a task is degraded by loss of sleep depends on many interacting and sometimes counteracting factors. Complicated tasks are more stimulating to the brain and require more training to master. A simple task requires less training to do but can be boring. A soldier needs a high level of arousal to perform a task well after sleep loss. The following three factors are interactive:

(1) *Task complexity or ambiguity.* The FDC computer operators perform the most complex tasks and are usually the first to show the effects of sleep loss. Simpler, clearer tasks are less affected by sleep loss; complicated or ambiguous tasks will suffer from fatigue and loss of sleep. This applies to both physical and mental

tasks. Simple lifting, digging, or marching can be stable. The fine hand-and-eye coordination needed to lay a mortar can suffer, and reasoning and problem-solving can be difficult.

(2) *State of arousal.* The extent to which the soldier's brain is aroused and active depends on both physical and mental stimulation. Noise, light, muscular movement, and speech keep the brain alert. Increased loss of sleep requires more stimulation to keep the brain awake. Too little or too much arousal can impair the soldier's performance. Combat operations are conducted at such a fast pace that a high state of arousal is maintained. However, even the most aroused soldiers are susceptible to *crashing*. This commonly occurs early during combat after as little as 24 hours of intense stress and sleeplessness. The body abruptly stops producing the high levels of adrenaline needed to sustain the initial activity. The result can be severe drowsiness, leading to near unconsciousness. Soldiers that are alert and aroused for 24 hours during the marshaling, loading, and insertion phase of an operation can be overcome by intense fatigue, which starts after dawn of the first day of combat. This effect can only be overcome by good leadership, motivation, and rest.

(3) *Level of training.* Extensive training delays the degradation of a task caused from lack of sleep. Training does not prevent lack of sleep from eventually affecting the performance of a task, but repetitive, stressful, realistic training can delay and moderate these effects. Good physical training prepares the soldier for sustained operations. It also allows him to recover quicker after a short rest than a soldier who is in poor physical condition. A good diet and healthful lifestyle prepares the soldier to cope with the physical stress of sustained operations.

d. Extensive Army studies on the effects of sustained operations on combat effectiveness show that the performance in all duty positions does not degrade the same. Performance in the FDC where there is a heavy load of mental tasks (determining, calculating, thinking, decision making) degrades faster than the performance in the mortar squad where tasks are mainly physical (firing, lifting, digging).

(1) Platoon and section leaders plan fires, integrate communications and plans, establish positions, and coordinate tactics. They show the effects of lack of sleep faster than the members of mortar squads.

(2) The FDC performs mentally demanding and complex tasks. Its ability to continue performing these tasks degrades severely over a period. For example, adjusting multiple missions can become difficult, and firing calculations are likely to be wrong as well as slow. Self-initiated tasks are especially likely to be forgotten.

(3) Long sustained combat degrades the fighting performance of all soldiers, teams, and units. The adverse factors affect everyone. If leaders at all levels perform without rest, they are likely to degrade faster than their troops.

(4) In addition to the degradation caused by fear, fatigue, and loss of sleep, there is a severe loss of effectiveness caused from operating in MOPP4. When soldiers are enclosed in full NBC protective gear, leadership judgment is degraded, communications are less effective, and information flow between units is reduced.

G-4. TECHNIQUES TO SUSTAIN OPERATIONS

To maintain effectiveness, soldiers must overcome adverse conditions. The rate of performance degradation must be slowed. Listed below are methods the mortar leader can use to slow degradation and to prepare to fight sustained operations.

- a. **Prepare Individual Soldiers.** Preventive measures are often more effective for keeping groups healthy and active. They include improving or maintaining good physical condition, balanced nutrition, good personal hygiene, and immunizations.
- b. **Provide Good Leadership.** Good leadership is the key to sustained unit performance. The leader must bring out the best efforts of his subordinates.
- c. **Set High Standards.** Success during sustained operations demands the highest standards of military expertise.
- d. **Develop Individual and Unit Confidence.** A confident, optimistic outlook resists stress and performance degradation.
- e. **Establish Good Communication Channels.** In combat, knowledge of the situation and the status of both enemy and friendly units sustains soldiers.
- f. **Cross Train.** Extensive cross training in the mortar platoon provides flexibility. Critical tasks, such as FDC and aiming circle operations, must be cross trained.
- g. **Develop Coping Skills.** All members must experience and learn to cope with adverse factors, especially stress and lack of sleep.
- h. **Develop Good Physical Fitness.** Whether moving heavy weapons, carrying large loads, or digging, physically fit soldiers can use their strength reserves to recover after only a brief rest.
- i. **Build Stamina.** Soldiers must develop aerobic fitness to work more and withstand the stress of sustained operations.
- j. **Practice Pacing While Extending Physical Limits.** All soldiers must be trained to pace themselves to work at their maximum range without degradation.
- k. **Foster a Spirit and Attitude of Winning.** In combat, winning depends on skill and dedication. Especially in sustained operations, a soldier who is dedicated demonstrates the extra strength needed to win.

1. Foster Cohesion, Esprit, Morale, and Commitment. Mutual trust based on personal face-to-face interaction is called *cohesion*. *Esprit de corps* is identifying with the unit and with its history and ideals--the company, battalion, division, and US Army. Cohesion holds units together; esprit keeps them dedicated to the mission.

m. **Guarantee and Encourage the Free Exercise of the Soldier's Faith.** Regardless of their religious background, most soldiers are reassured and calmed if the leader encourages and assists the battalion chaplain in his visits to the unit.

G-5. TECHNIQUES TO SUSTAIN COMBAT PERFORMANCE

Several techniques can be used to sustain combat performance:

- a. Share physical and mental burdens among all members of the unit.
- b. Rotate boring tasks often.
- c. Share tasks by assigning two or more soldiers to perform them.
- d. Cross-check all FDC calculations, sight settings, and map coordinates among other members of the unit.
- e. Avoid using strong artificial stimulants. The use of amphetamines or other strong stimulants has risks that outweigh the benefits. Most are habit-forming and, if used regularly, require progressively higher doses to maintain arousal. In combination with the other physical and emotional stresses of combat, they are likely to interfere with good judgment by making users nervous and suspicious of others. Prolonged high doses can cause paranoia with hallucinations and delusions.
- f. Learn to recognize signs of serious performance degradation in others. The least affected soldiers must perform the most important combat tasks.
- g. Learn to recognize signs of serious degradation in yourself. Leadership requires thinking, judging, calculating, determining, recognizing, distinguishing, and decision making. These abilities degrade quickly in sustained operations.

G-6. UNIT SLEEP PLAN

The platoon leader must ensure his platoon can conduct both sustained and continuous operations. The only way a platoon can conduct continuous operations over long periods is to ensure all soldiers and leaders get enough rest.

- a. The platoon leader and sergeant must devise and enforce a work-rest-sleep plan for the platoon. The section sergeants must enforce this plan. The plan must include provisions for leaders as well as soldiers to sleep. The plan should allow soldiers at least 4 hours of sleep each 24 hours, preferably uninterrupted and ideally between 2400 and 0600.

Priority for sleep should go to FDC personnel, drivers, and others whose judgment and decision making are critical to mission accomplishment. Even with an average of 4 hours of sleep a night, soldier performance will gradually degrade.

b. The continuity of sleep is also important. Soldiers should sleep in a quiet, safe place away from radios and conversations in order for sleep to be of the most value. Sleeping in a corner of the FDC amid the noise of radios, generators, and talking is of little value. Soldiers do not sleep deep enough to gain much restorative value.

c. Twelve-hour shifts are the most effective. Rotating shifts are difficult for most soldiers to adjust to and should be avoided.

d. The quality of sleep is important. Four hours of sleep in a protected, comfortable position at a comfortable temperature are much more helpful than a longer but uncomfortable period.

e. The effects of sleep deprivation are accumulative. If three soldiers do their part of a task at 50 percent effectiveness, the chances that the whole task will be accomplished correctly are less than 50 percent. In fact, it is about 12 percent ($.5 \times .5 \times .5 = .125$). Army studies on the effects of individual sleep deprivation on artillery FDC and gun crews show that seven hours of sleep for each man a day can maintain effectiveness indefinitely, five to six hours of sleep a day can maintain acceptable performance for 10 to 15 days, and four hours of sleep for each day maintain acceptable performance for only two to three days. Less than three hours of sleep a day is almost the same as not sleeping at all.

G-7. DUTY MORTAR CONCEPT

One method for allowing mortar crews to rest, which has proven useful in combat, is the designation of a duty mortar. One mortar crew is designated as being responsible for answering all initial calls for fire. This crew remains awake near its mortar during the entire tour of duty. The other crews can sleep without having anyone awake to respond immediately to fire missions. All mortars in the section must be laid on the priority target if one has been designated. A minimum amount of ammunition is prepared to fire the priority mission. Local security must still be established, and the FDC must have at least two people awake--a RATELO and an FDC computer. An easily initiated and effective signal for the whole mortar section to wake up and join in the fire mission must also be established. This may have to be a runner, since history has shown that exhausted mortar crews will not wake up, even when the mortar next to them begins to fire. After several days of sleep deprivation, the body will not respond to the sounds of outgoing fire.

APPENDIX H

REPORTS

In combat, reports give commanders and leaders information on which to base their plans and decisions. These reports must be accurate, timely, and complete. Standardized reporting procedures save time, promote completeness, and prevent confusion. Ways to transmit and safeguard reports vary and depend on the information being transmitted, the available equipment, the local requirements, the terrain, and the electronic-warfare Threat. Whatever the method of reporting, communications security must be enforced. Any report that contains information about friendly units will be either encoded or transmitted on secure communications means with approved codes.

H-1 SCHEDULED REPORTS

The mortar platoon submits both *scheduled* and *unscheduled* reports. Scheduled reports are normal recurring reports that higher headquarters expects to receive. Unscheduled reports are sent only when the situation calls for them. Reports, especially scheduled reports, do not have to be sent verbally. Sometimes a written report is more useful. The platoon or section leader uses DA Form 4004 to send written messages (Figure H-1). This book automatically makes a copy for the sender to retain.

MESSAGE FORM		PRECEDENCE		HOW SENT	SECURITY CLASSIFICATION
PAGE	OF	ACT	INFO		
1	1	RR	RR	MESSENGER	SECRET
FROM: MORTAR PLT, 1/125 TH INF					
TO: CDR, HHC 1/125 TH INF					
SUBJECT: TONIGHT'S LOGPAC					
SEND TONIGHT'S LOGPAC TO					
THE NEWLY DESIGNATED RP.					
PLT MOVE WILL BE COMPLETE					
BY 12:30 HRS.					
SIGNATURE & GRADE OF DRAFTER			DRAFTER TIME	DATE TIME GROUP	
				050820 JUN 89	
SIGNATURE & GRADE OF RELEASER				SECURITY CLASSIFICATION	
 GARY S. MOORE, 1 LT				SECRET	
DA FORM 4004					

Figure H-1. Example of a completed DA Form 4004, U. S. Army Message Books.

H-2. FIRING LOCATION REPORTS

The mortar platoon leader sends a firing location report to the TOC at least once every 24 hours or each time the platoon moves. The battalion or troop SOP may require this report more often. The higher headquarters establishes a set format for this report. The firing location report includes the following:

- a. Whether or not the platoon or section is laid and ready to fire.
- b. Grid location of platoon or sections.
- c. Mounting azimuth.
- d. Number of mortars able to fire.

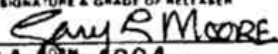
- e. Maximum range available from this firing location.
- f. Priority of mortar fires.
- g. Any limitations on fire from this location.

H-3. UNIT STATUS REPORTS

The battalion SOP normally specifies the personnel status and logistics status feeder reports required from the mortar platoon, and the format for these reports. It also specifies the reporting times and the period to be covered in each report (Figures H-2 and H-3).

ALPHA:	Reporting unit (separate entries for attached elements).
BRAVO:	Assigned strength.
CHARLIE:	Authorized strength.
DELTA:	Killed in action.
ECHO:	Wounded in action.
FOXTROT:	Missing in action.
GOLF:	Captured losses.
HOTEL:	Total daily losses.
INDIA:	Nonbattle losses.
JULIET:	Administrative losses.
NOTE: LIMA through QUEBEC not appropriate at company level.	
SIERRA:	Replacements.
TANGO:	Returned to duty.
UNIFORM:	PW captured.

Figure H-2. Example of a personnel status feeder report.

Line 1	REPORTING UNIT _____
Line 2	RATIONS _____ a. Quantity on hand. b. Quantity needed.
Line 3	FUEL _____ a. Quantity on hand. b. Quantity needed.
Line 4	AMMUNITION _____ a. HE 1. Quantity on hand. 2. Quantity needed. b. SMK 1. Quantity on hand. 2. Quantity needed. c. ILLUM 1. Quantity on hand. 2. Quantity needed. d. (Units continue the list to include commonly used types of ammunition.)
Line 5	WATER _____ a. Quantity on hand. b. Quantity needed.
Line 6	OTHER ITEMS NEEDED _____ a. ITEM 1. Quantity on hand. 2. Quantity needed. b. ITEM 1. Quantity on hand. 2. Quantity needed. c. (Units continue the list to include commonly used items not already listed).
Line 7	LOCATION AND DATE-TIME GROUP FOR DELIVERY _____

Figure H-3. Example of a logistics status feeder report.

H-4. AMMUNITION STATUS REPORT

The mortar platoon leader sends specific ammunition status reports to the operations officer and FSO. The operations officer and FSO use these reports to keep abreast of the mortar platoon's changing situation and to balance the mortar platoon's fire against those of the supporting artillery. If a CSR is in effect, the mortar platoon leader sends these type reports more often. The battalion SOP establishes the format and period for the ammunition status report.

H-5. UNSCHEDULED REPORTS

This paragraph complies with STANAGs 2022 and 2020.

Unscheduled reports are normally of a more urgent nature than scheduled reports. They are sent when the situation changes significantly or when an event occurs that calls for the report. Examples of unscheduled reports are SPOTREP, SITREP, SHELREP or MORTREP, and MIJIREP.

a. The platoon uses a SPOTREP to report enemy information. The SPOTREP format is set by a higher command, or the platoon submits a SPOTREP that conforms to STANAG 2022 and uses the memory aid SALUTE (Figure H-4).

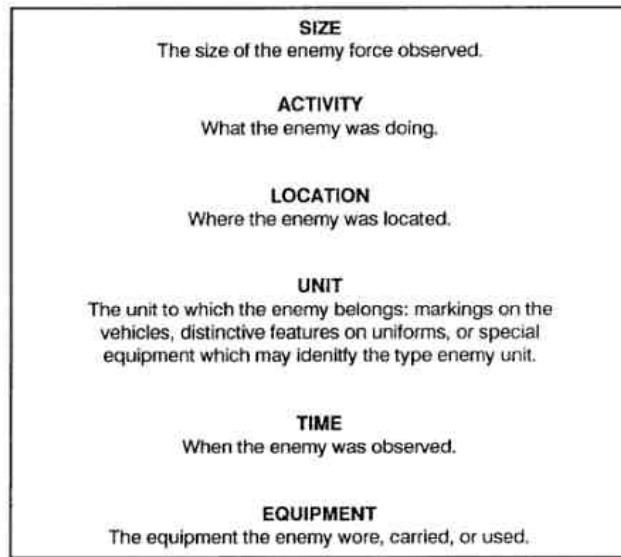

Figure H-4. Example of a spot report.

b. The platoon uses a SITREP to report the platoon's tactical situation for a specific period. The format and period for reporting is specified by the battalion SOP (Figure H-5) and conforms with STANAG 2020.

ALPHA:	Enemy activities and locations.
BRAVO:	Own situation and locations.
CHARLIE:	Administration.
DELTA:	General.
ECHO:	Commander's evaluation.

Figure H-5. Example of a situation report.

c. An ammunition incident report has no set format. The mortar platoon leader submits one when an incident occurs that involves mortar ammunition. Incidents such as misfires, hangfires, duds, premature detonation, fuze malfunctions, or problems with mortar propellant charges are all reported to the operations officer and FSO. If the incident is serious, firing that lot of ammunition is suspended if the combat situation permits (Figure H-6).

Line 1	UNIT REPORTING INCIDENT
Line 2	DATE/TIME GROUP OF INCIDENT
Line 3	LOCATION OF INCIDENT
Line 4	TYPE AMMUNITION INVOLVED
Line 5	MODEL NUMBER
Line 6	LOT NUMBER
Line 7	NATURE OF INCIDENT
Line 8	NAME OF INDIVIDUAL KNOWLEDGEABLE OF INCIDENT

Figure H-6. Example of an ammunition incident report.

d. The mortar platoon prepares and submits a SHELREP or MORTREP each time it receives incoming artillery or mortar rounds. This report is a vital step in the division's counterfire program. The platoon leader conducts crater analysis whenever he can to furnish further information for the SHELREP (Figure H-7).

ALPHA:	Unit callsign.
BRAVO:	Location of observer.
CHARLIE:	Azimuth to flash or sound.
DELTA:	Time shelling started.
ECHO:	Time shelling ended.
FOXTROT:	Location of shelled area.
GOLF:	Number, type, and caliber.
HOTEL:	Nature of fire (barrage, harassment, or registration).
INDIA:	Number of rounds.
JULIET:	Time of flash to bang.
KILO:	Damage.

Figure H-7. Example of a shelling report.

e. The mortar platoon should submit a MIJIREP whenever an incident occurs. The higher headquarters establishes the format for a MIJIREP. When the mortar leader observes the enemy using any directed-energy weapons, such as lasers, he should submit a MIJIREP.

APPENDIX I

HELICOPTER OPERATIONS

Helicopters can rapidly move mortar squads and ammunition directly to where they are needed. In emergency situations, helicopters can move large amounts of mortar ammunition across terrain unsuitable for trucks.

I-1. UTILITY HELICOPTERS

Utility helicopters are general-purpose aircraft that have limited carrying capability.

a. **UH-1 Iroquis (Huey).** The UH-1 Iroquis (Huey) cargo hook can handle up to 4,000 pounds. A ground guide is needed for a hovering pickup, since the air crew cannot see the cargo hook from inside. A typical external ammunition load for the UH-1 would be 100 to 110 rounds for the heavy mortar, about 350 rounds for the medium mortar, or 750 rounds for the light mortar.

b. **UH-60 Blackhawk.** The UH-60 Blackhawk can carry up to 14 combat-equipped troops internally or up to 8,000 pounds externally on the fixed-cargo hook. Although the crew chief can observe the load through a hatch and direct the pilot over the intercomm, a ground guide helps the pilot position the aircraft over the load. A typical external ammunition load for the UH-60 would be 200 to 220 rounds for the heavy mortar, 700 to 800 rounds for the medium mortar, or 1,500 rounds for the light mortar.

I-2. CARGO HELICOPTERS

Cargo helicopters can carry greater weights than utility helicopters. Because of their capacity, cargo helicopters often carry mixed loads of internal and external cargo.

a. **CH-47 Chinook.** The CH-47 Chinook "*C*" model has a maximum cargo hook capacity of 20,000 pounds; the "*D*" model can carry up to 26,000 pounds externally. The amount of load a cargo helicopter can carry depends on the model, the fuel on board, the distance to be flown, and atmospheric conditions.

(1) The CH-47C has only a single cargo hook below the center of the aircraft.

(2) The CH-47D has three cargo hooks: a center (main) hook and two additional hooks fore and aft of the main hook. When hooking a single load, soldiers use the main hook. They must coordinate closely with the aircrew as to which hooks to

use when carrying multiple loads. The planning figure for the fore and aft hooks is 10,000 pounds each.

b. **CH-54 Sky Crane.** The CH-54 Sky Crane is flown by Reserve Component units. There are two models of the CH-54: the "A" model can lift about 20,000 pounds; the "B" model can lift about 25,000 pounds.

I-3. RESPONSIBILITIES

Four different elements are normally involved in a mortar sling load mission: the maneuver unit headquarters requests the mission, the aviation unit provides the aircraft, the support platoon loads the cargo, and the mortar platoon receives the cargo. Sometimes, as during a unit relocation, the mortar platoon may prepare the loads itself. The responsibilities and functions of each element are discussed below.

a. The battalion, squadron, or company requesting the mission is responsible for--

- (1) Selecting, preparing, and controlling the landing site. (Pathfinders can be of great assistance in this area.)
- (2) Requisitioning all the equipment needed for sling-load operations, including slings, cargo bags, nets, and containers.
- (3) Storing, inspecting, and maintaining all sling-load equipment.
- (4) Providing enough trained ground crews for rigging and inspecting all the loads, guiding the helicopters, hooking up the loads, and clearing the aircraft for departure.
- (5) Securing and protecting sensitive items of supply and equipment.
- (6) Providing load derigging and disposition instructions to the mortar platoon.
- (7) Providing disposition instructions to the mortar platoon and aviation units for the return of slings, bags, cargo nets, and containers.

b. The aviation unit is responsible for--

- (1) Coordinating with the battalion and appointing a liaison officer who is familiar with the abilities and limitations of helicopters.
- (2) Advising the battalion of the limitations on the size and weight of acceptable loads before they are rigged.
- (3) Advising on the suitability of the selected pickup and landing sites.

(4) Assisting in the recovery and return of the slings, cargo bags, nets, and containers.

(5) Arranging for the aircraft to be at the landing site on schedule.

(6) Establishing safety procedures to ensure uniformity and understanding of duties and responsibilities between the ground crew and flight crew.

c. The battalion support platoon is normally responsible for all operations at the pickup site. These include marking, loading, rigging, and hooking up cargo.

d. The mortar platoon is responsible for--

(1) Selecting, preparing, marking, and controlling the landing site.

(2) Ensuring trained ground crews are available to guide the aircraft in and derig the load.

(3) Coordinating with the battalion S4 for the control and return of all air items.

(4) Preparing, coordinating, and inspecting backloads, such as slings and cargo bags, and having them ready for hookup or loading.

I-4. SITE SELECTION AND PREPARATION

Logistics and tactical considerations must be analyzed to ensure that the landing site is in the proper location to support the mission and that the area is accessible to the aircraft.

a. The size of the landing site depends on the number of landing points within it, the size of the landing points, and the dispersion required between the landing points as the tactical situation dictates. The minimum size of a landing point for each size helicopter is shown in Table I-1.

TYPE HELICOPTER	MINIMUM DIAMETER OF LANDING POINT
OH-6 OH-58	80 FEET (25 METERS)
UH-1	125 FEET (35 METERS)
UH-60	160 FEET (50 METERS)
CH-47 CH-53 CH-54	264 FEET (80 METERS)

Table I-1. Minimum landing point sizes.

b. Many considerations, such as helicopter type, unit proficiency, nature of loads, climatic conditions, and day or night operations, may apply to the size of the landing points used. With this information from the aviation unit, an 80-meter landing point should be prepared. The minimum recommended distance between landing points within the landing site, where no consideration is given in dispersion, is the same as the helicopter's minimum diameter. It is measured only from the center of one landing point to the center of the other.

c. The surface of the center of the landing point should be firm enough to allow a fully loaded vehicle to stop and start without sinking. All trees, brushes, stumps, or other obstacles that could cause damage to the main or tail rotor blades or to the underside of the aircraft must be cleared or marked. Any snow on a landing should be packed or removed to reveal any obstacles and to reduce the amount of loose snow blown over the area. A marker panel is essential to provide a visual reference for the pilot's depth perception in a snow-covered landing site and to reduce the effect of whiteout.

d. Ideally, the ground at the landing point should be level. Where a slope is present, it should be uniform. If the following criteria cannot be met, the use of the landing point must be confirmed by the aviation unit:

(1) During a daylight approach, the slope should not exceed 7 degrees (1 in 8) if the helicopter is to land. A greater slope may be acceptable for hover operations.

(2) During a night approach, a reverse slope as viewed from the approach path is not normally acceptable. Forward or lateral slopes should not exceed 3 degrees (1 in 19).

e. Often large helicopters do not fly in standard flight formations and are received one or two at a time. In such cases, the configuration in Figure I-1 is suggested. Each aircraft initially approaches and hovers, and is then guided to its cargo pickup point by the signalman.

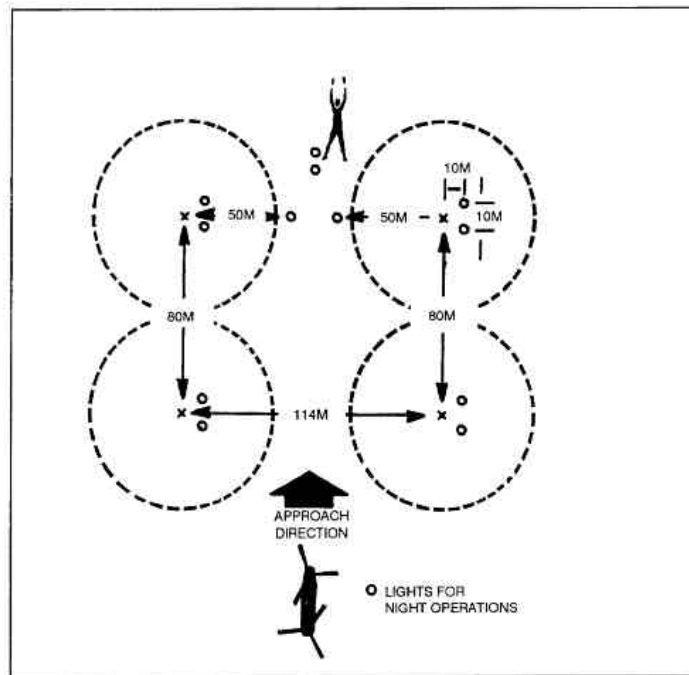

Figure I-1. Landing formation for large helicopters.

I-5. MARKING THE LANDING SITE

During daylight operations, the landing site can be marked with signal panels. Because the rotor wash from the helicopter might tear them from the ground and cause a hazard, they must be securely staked down. During daylight operations, the landing site can be marked with colored smoke or by the ground guide. The guide holds both arms straight up over his head or holds a folded VS-17 signal panel chest high.

- a. During night operations, the landing point for the lead aircraft is normally marked by amber beacon lights. The landing point for the lead aircraft, if aircraft are in formation, is marked with either an inverted "Y" or a "T" (Figure I-2). The aircraft touches down or hovers on the midpoint of the legs of the "Y" and to the left of the stern of the "T".

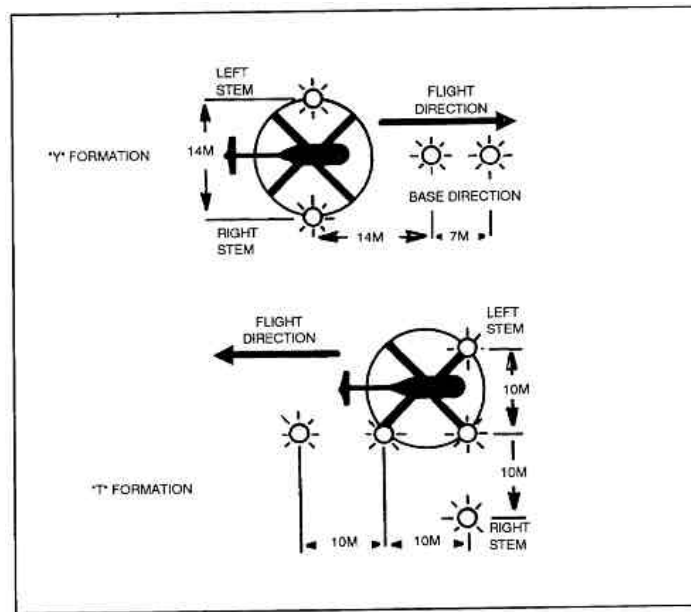

Figure 1-2. The "Y" and "T" formation for single landing site.

b. Chemical lights can also be used to mark the landing site. Depending on the size of the tube, the glow can last from 30 minutes to 12 hours. The chemical lights can be taped or tied into bundles on stakes and can be placed the same as the beacon lights. The chemical light comes in various sizes, intensity, and duration. Some chemical lights are infrared only. The various colors of chemical lights cannot be determined by pilots using night vision goggles.

c. During daylight helicopter operations, obstacles may be difficult to detect or impossible to remove. Wires, holes, stumps, or rocks should be marked with red panels or other clearly identifiable means. During night operations, red chemical lights can be used to mark all obstacles that cannot be removed. The mortar leader must exercise light discipline and not activate more lights than are needed. Excess lights can cause confusion. They should be buried or covered securely once they are no longer needed.

I-6. EXTERNAL CARGO CARRYING DEVICES

The mortar platoon must be able to rig and derig all of the common helicopter sling-load carrying devices. (See FM 55-450-1.)

a. **Sling Sets.** The two standard helicopter sling sets are the 10,000-pound and 25,000-pound capacity (Table I-2). The sling sets are similar. Each sling set comes in its own aviator kit bag. A complete 10,000- or 25,000-pound capacity sling set comes with four legs, which can be added or removed to modify the sling set. Some loads may have more or less than four hookup points. Adding legs does not increase the capacity. Removing legs does reduce the sling set's capacity by 25 percent for each leg removed.

ITEM	10,000-LB CAPACITY	25,000-LB CAPACITY
SLING ROPE COLOR	OLIVE DRAB	BLACK
SLING ROPE DIAMETER	7/8-INCH	1 1/4 INCHES
CLEVIS COLOR	DULL GRAY ALUMINUM	GOLD STEEL
NUMBER CHAIN LINKS	111 (APPROXIMATE)	88
WEIGHT	52 POUNDS	114 POUNDS

Table I-2. Visible differences between the 10,000- and 25,000-pound capacity sling set.

b. **Pallets and Pallet Slings.** One of the most efficient ways to deliver heavy or bulky supplies is by loading them securely to standard 40- x 48-inch pallets. Ammunition is often delivered from rear storage areas on pallets. Table I-3 shows examples of common mortar platoon ammunition loaded onto standard pallets. By using a pallet sling, palletized cargo can be moved directly to the mortar platoon by helicopter without having to reconfigure the load. The pallet sling used by the Army has a 4,000-pound carrying capacity and carries a standard 40- by 48-inch pallet (Figure I-3). The two models of the pallet sling are the MK 100 and MK 86. The major difference between the two models is that cargo on the MK 100 can be stacked from 48 to 70 inches; the MK 86 can be stacked from 29 to 40 inches (Figure I-3). Table I-4 shows the difference between the two models of pallet slings.

AMMO	TYPE	WT	RDS/PLT	SIZE OF PALLET		
				L	W	H
81-mm	CTG, HE (MORTAR)	2,008	108	42	53	45
107-mm (4.2)	CTG, HE (MORTAR)	2,048	48	44	32	49
60-mm	CTG, HE (MORTAR)	1,350	250	43	48	42
5.56-mm	CTG, BALL (RIFLE)	3,556	80,640	43	50	38
7.62-mm	CTG, LINKED (M60)	2,260	21,000	43	50	30
caliber .50	CTG, LINKED	3,700	9,600	40	50	39
		3,068	8,064	42	52	39

Table I-3. Example of ammunition pallet loads.

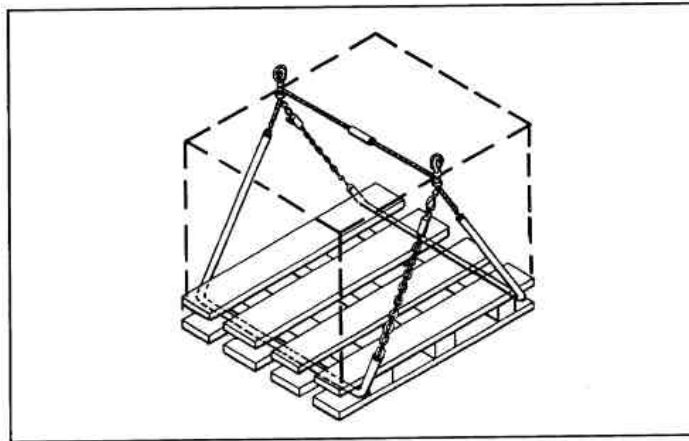

Figure I-3. Pallet sling.

MK	COLOR OF CODED TUBING	LOAD HEIGHT ON 40- \times 48-INCH PALLET (INCHES)	CAPACITY (POUNDS)	WEIGHT (POUNDS)
86	BLACK	29 TO 40	4,000	13
100	YELLOW	48 TO 70	4,000	15

Table I-4. Pallet sling models.

c. **A-22 Cargo Bag.** An A-22 cargo bag is used to transport any standard palletized load or loose cargo up to 2,200 pounds (Figure I-4). A-22 cargo bags can be rigged in multiples for moving large amounts of ammunition. The CH-47D can lift about 10 to 12 pallet-loaded A-22 cargo bags of medium or heavy mortar ammunition. It can carry about 15 pallet-loaded A-22 cargo bags of light mortar ammunition (Figure I-5).

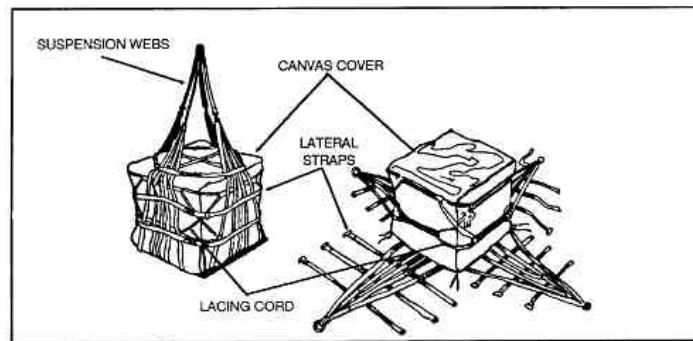

Figure I-4. Parts of the A-22 cargo bag.

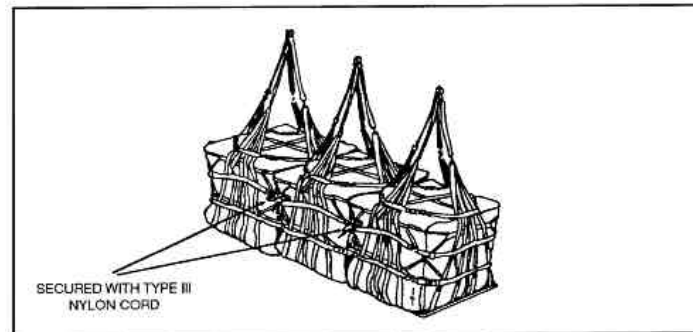

Figure I-5. Example of a load of Multiple A-22 cargo bags.

d. **Cargo Nets.** Two sizes of cargo nets are currently in the Army system--the 5,000- and 10,000-pound capacity cargo nets. These nets provide a means to externally transport ammunition or general cargo. The 5,000- and 10,000-pound nets are used in the same manner. Four sets of lifting legs are used with each net.

(1) *The 5,000-pound capacity net.* The 5,000-pound cargo net (Figure I-6) is octagon-shaped and measures 15 feet across the flat sides. The net is made of olive-drab nylon cord. The four hooks attach to the apex fitting. The apex fitting is then attached to the helicopter cargo hook.

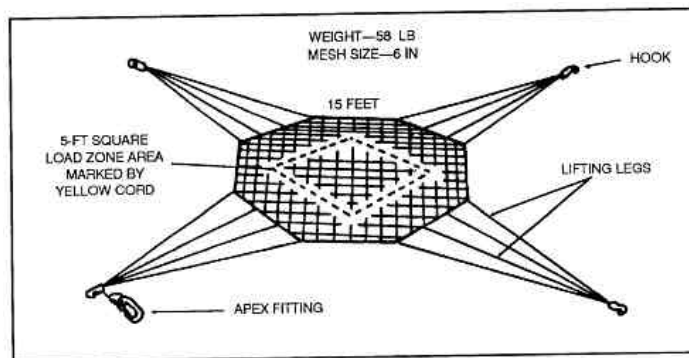

Figure I-6. The 5,000-pound capacity cargo net.

(2) *The 10,000-pound capacity net.* The 10,000-pound capacity net (Figure I-7) is made of black nylon cord. It is octagon-shaped, and it measures 18 feet across the flat sides. The load area is used as a guide to center the load on the net.

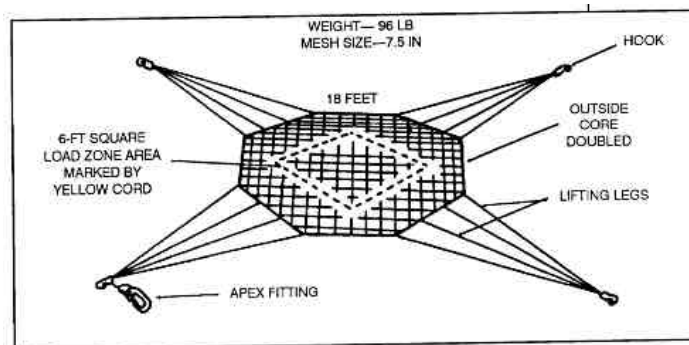

Figure I-7. The 10,000-pound capacity cargo net.

(3) *Typical sling combinations.* A typical mixed load can be rigged using more than one 5,000-pound capacity net. Each 5,000-pound cargo net apex ring is connected to one leg of the 25,000-pound cargo sling to make up a mixed sling load. If a 10,000-pound cargo net is used, two sling legs from a 25,000-pound sling set may need to be used. When using an aircraft equipped with multiple cargo hooks, several combinations of slings and nets can be used depending on the situation (Figure I-8).

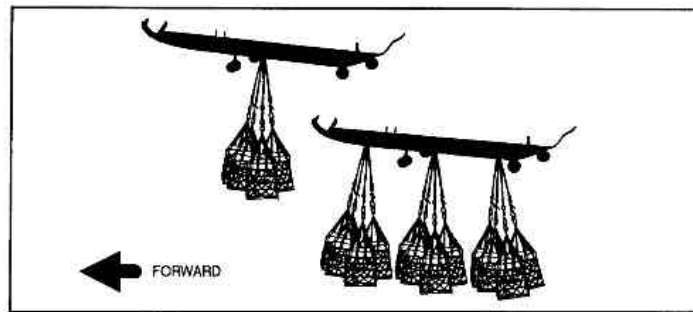

Figure I-8. Typical sling combinations.

e. **Extended Sling System.** The extended sling system improves the tactical efficiency and integrity of sling loads and the crew such as mortars, ammunition loads, and mortar crewmen.

(1) The extended sling system consists of one 6,250-pound capacity sling leg, from a 25,000-pound capacity sling set. The leg is connected to the apex fitting of a normally rigged cargo net.

(2) Using the extended sling, the aircraft lands next to the rigged load. A ground crewman crawls under the helicopter and connects the apex fitting to the aircraft cargo hook. The entire mortar crew boards the aircraft to include the hookup person. As the aircraft lifts off the ground, the aircrew member observes the load and directs the pilot over the top of the load. This system allows 100 percent of the equipment, crew, and accompanying ammunition to be transported in one lift. Also, all ground personnel can load onto the aircraft leaving no one on the ground. This system reduces aircraft lift requirements and ensures mortar crew integrity.

I-7. PLACEMENT OF LOADS FOR PICKUP

Loads for external pickup should be arranged for ease of pickup (Figure I-9). Loads should be placed on level ground away from obstacles and should be prearranged for the type of aircraft being used. When triple-hook nets or cargo loads are to be used, the loads must fit under the aircraft. The distance from one apex to the next should be less than 6 1/2 feet. It allows the loads to have some movement and not bind on each other when they are released separately (Figure I-10).

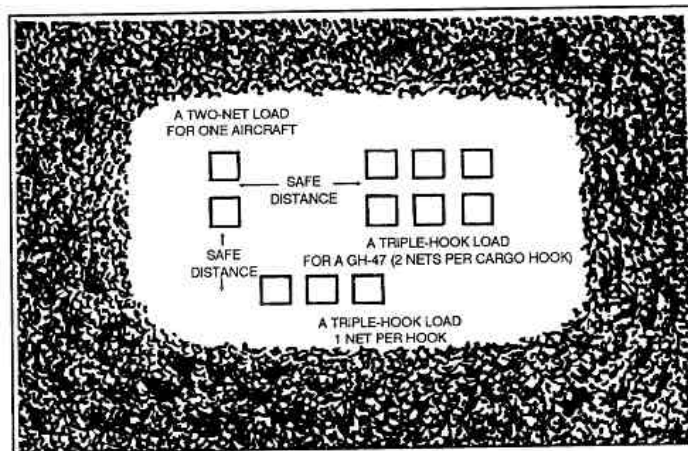

Figure 1-9. Suggested multiple pallet lift arrangement.

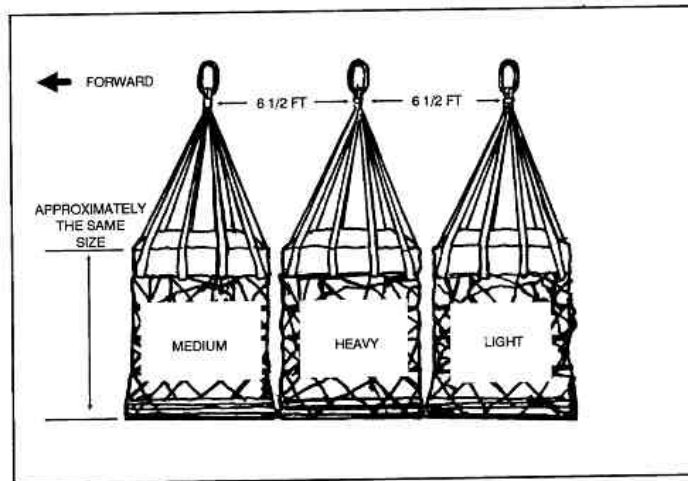

Figure 1-10. Distance between triple-hook net for loads.

CAUTION

SEE FM 55-450-1 FOR SAFETY CONSIDERATIONS, INCLUDING STATIC ELECTRICITY DISCHARGE DURING PICKUP OPERATIONS.

I-8. RIGGING SUPPLIES

Use the following information to order slings, nets, and spare parts for rigging supplies.

NSN	DESCRIPTION
1670-01-027-2902	Sling assembly, 10,000-pound Line No. T79003
8460-00-606-8366	Kit bag, flyer's*
1670-01-027-2900	Sling assembly, 25,000-pound Line No. T79009
1670-01-058-3811	Net, 5,000-pound Line No. N02776
1670-01-058-3810	Net, 10,000-pound Line No. N02708
080-00-108-1155	Transport case **
3990-00-360-0248	Assembly, load binder
4030-00-360-0304	Assembly, small clevis
4030-00-678-8562	Assembly, medium clevis
1670-00-090-5354	Assembly, large clevis
4020-00-240-2146	Cord, nylon, Type III, 550-pound BS
1670-00-360-0340	Fastener, quick-fit strap
8305-00-191-1101	Felt sheet, 1/2-inch thick and 60 inches wide
8135-00-664-6958	Padding, cellulose
8135-00-808-6446	Padding, cellulose
4020-00-231-2581	Rope, 3/8-inch
7510-00-266-5016	Tape, adhesive, 2-inch roll
1670-00-725-1437	Tie-down, strap, 5,000-pound, CGU-1B
8305-00-268-2411	Webbing, cotton, 80-pound, BS, 1/4-inch
8305-00-082-5752	Rope, nylon, tubular, 1/2-inch
4020-00-968-1357	Rope, fibrous, 1/2-inch
5825-00-917-3738	Light, beacon beanbag
1670-00-587-3421	Bag, cargo, A-22 Line B14181
1450-00-169-6927	Sling, pallet, MK86 Line S80670

1398-00-004-9175 Sling, pallet, MK100 Line S80738

*Used to store 10,000- and 25,000-pound capacity slings and 5,000-pound capacity cargo nets.

** Used to store 10,000-pound capacity cargo nets.

APPENDIX J

MORTAR OPERATIONS ON URBANIZED TERRAIN

Mortars are valuable in providing indirect fire support during military operations on urbanized terrain. Indirect fire by FA has often been unavailable to infantrymen and in city combat due to building mask and lack of effective observation. Mortars have some distinct advantages during MOUT. Their high rate of fire, steep angle of fall, and short minimum range give mortar sections the ability to mass considerable fire power on specific enemy positions in the tight confines of city fighting. The use of multioption fuzes and several types of rounds increases mortar fire versatility. Mortars can be used to obscure, neutralize, suppress, or illuminate during MOUT. (For further details on MOUT operations, see FM 90-10 and FM 90-10-1).

J-1 . POSITION SELECTION

The selection of mortar positions depends on the size of buildings, the size of the urban area, and the mission.

- a. The use of existing structures for hide positions is recommended (for example, garages, office buildings, or highway overpasses) to afford maximum protection and minimize the camouflage effort. By proper use of mask, survivability can be enhanced. If the mortar has to fire in excess of 885 mils to clear a frontal mask, the enemy counterbattery threat is reduced. These principles can be used in both the offense and the defense.
- b. Mortars should not be mounted directly on concrete; however, sandbags may be used as a buffer.
 - (1) Use two or three layers.
 - (2) Butt them against a curb or a wall.
 - (3) Extend them at least one sandbag width beyond the baseplate.
- c. Rubble may be used to make a parapet for firing positions.
- d. Mortars are usually not placed on top of buildings because lack of cover and mask makes them vulnerable. They should not be placed inside buildings with damaged roofs

unless the structure's ability has been checked. Overpressure can injure personnel, and the shock on the floor can weaken or collapse the structure.

J-2. COMMUNICATIONS

An increased use of wire, messenger, and visual signals will be required.

- a. Wire should be the primary means of communication used between the forward observers, fire support team, fire direction center, and mortars since elements are close to each other.
- b. FM radio transmissions in built-up areas are likely to be erratic. Structures reduce radio ranges; however, remoting of antennas to upper floors or roofs may improve communications and enhance operator survivability. Another applicable technique is the use of radio retransmissions. A practical solution is to use existing civilian systems to supplement the unit's capability.

J-3. MAGNETIC INTERFERENCE

In an urban environment, all magnetic instruments are affected by surrounding structural steel, electrical cables, and automobiles. Minimum distance guidelines for the use of the M2 aiming circle (FM 23-90) will be difficult to apply. To overcome this problem, obtain an azimuth to a distant aiming point. From this azimuth, the back azimuth of the direction of fire subtract. Index the difference on the red scale and manipulate the gun until the vertical crosshair of the sight is on the aiming point. Such features as the direction of a street maybe used instead of a distant aiming point.

J-4. AIMING POSTS

Posts may be placed vertically in dirt-filled cans or ammunition boxes if the frontal area is covered by concrete or asphalt. Natural aiming points, such as the edges of buildings or lampposts, may also be used.

J-5. HIGH-EXPLOSIVE AMMUNITION

During MOUT, mortar HE fires are more heavily used than any other type of indirect fire weapon. The most common and valuable use for mortars is often harassment and interdiction fires. One of their greatest contributions is interdicting supplies, evacuation efforts, and reinforcement in the enemy rear just behind his forward defensive positions. Although mortar fires are often targeted against roads and other open areas, the natural dispersion of indirect fires will result in many hits on buildings. Leaders must use care when planning mortar fires during MOUT to minimize collateral damage.

- a. High-explosive ammunition gives good results when used on lightly built structures within cities, particularly the 120-mm projectile. It does not perform well against reinforced concrete found in larger urban areas.

b. When using HE ammunition in urban fighting, point detonating fuzes should normally be used. The use of proximity fuzes should be avoided because the nature of built-up areas will cause proximity fuzes to function prematurely. Proximity fuzes, however, are useful in attacking targets such as OPs on tops of buildings.

c. During both World War II and recent Middle East conflicts, light mortar HE fires have been used extensively during MOUT to deny the use of streets, parks, and plazas to enemy personnel (Figure J-1).

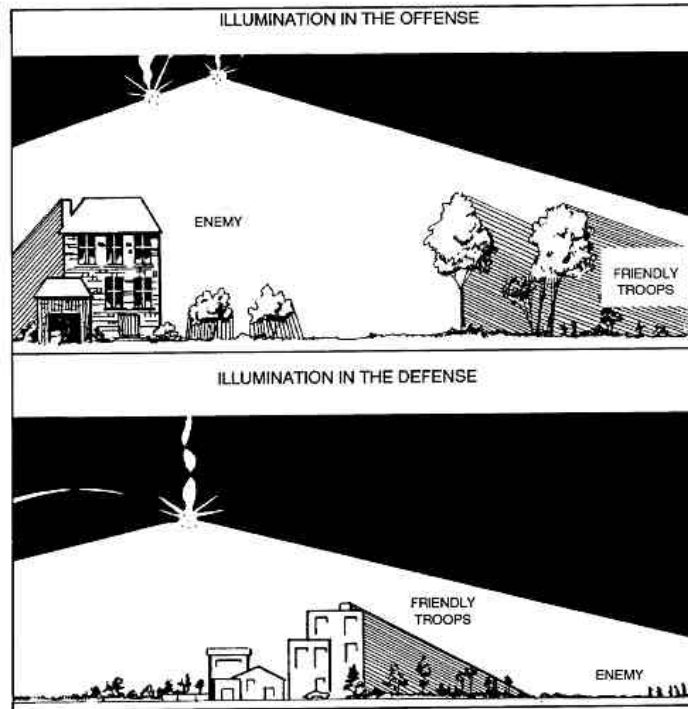

Figure J-1. Use of illumination fires during MOUT.

J-6. ILLUMINATION

In the offense, illuminating rounds are planned to burst above the objective to put enemy troops in the light. If the illumination is behind the objective, the enemy troops would be in the shadows rather than in the light. In the defense, illumination is planned to burst behind friendly troops to put them in the shadows and place the enemy troops in the light. Buildings reduce the effectiveness of the illumination by creating shadows. Continuous illumination requires close coordination between the FO and FDC to produce the proper

effect by bringing the illumination over the defensive positions as the enemy troops approach the buildings.

APPENDIX K

MORTAR ORGANIZATIONS

This appendix shows the organization of all current mortar units. Although care was taken to make these illustrations as accurate as possible, organizations and authorizations for mortar equipment can change. Readers should refer to tables of organization (TOE) and modified tables of organization and equipment (MTOE) for their particular unit to verify this information.

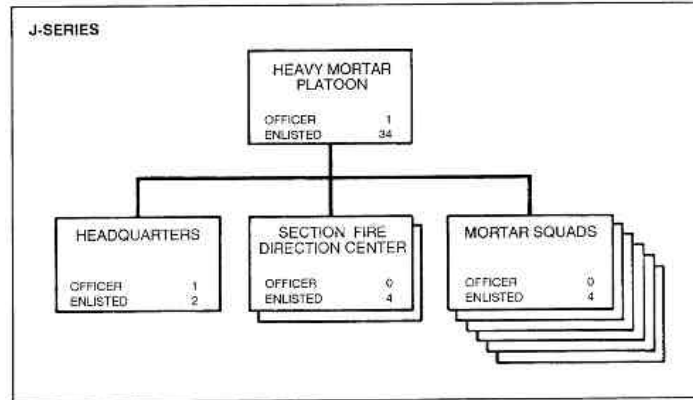

Figure K-1. Mechanized infantry and armor battalion heavy mortar platoon organizations.

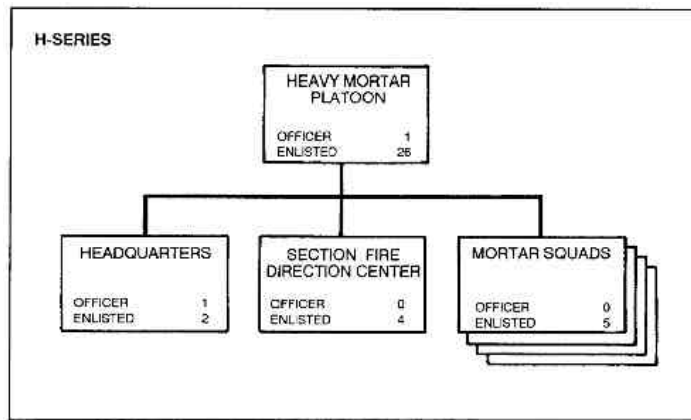

Figure K-1. Mechanized infantry and armor battalion heavy mortar platoon organizations (continued).

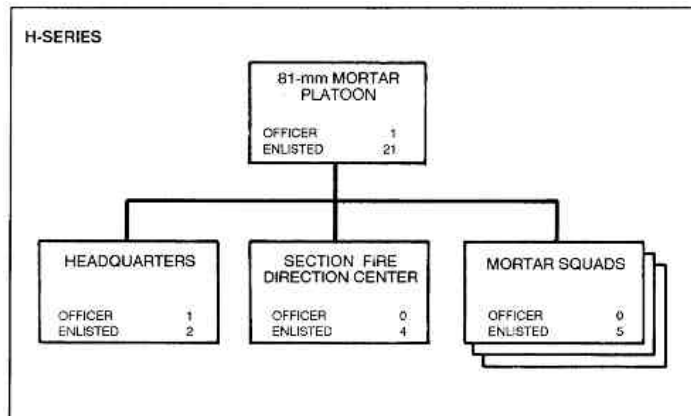

Figure K-2. Reserve Component mechanized infantry company mortar platoons.

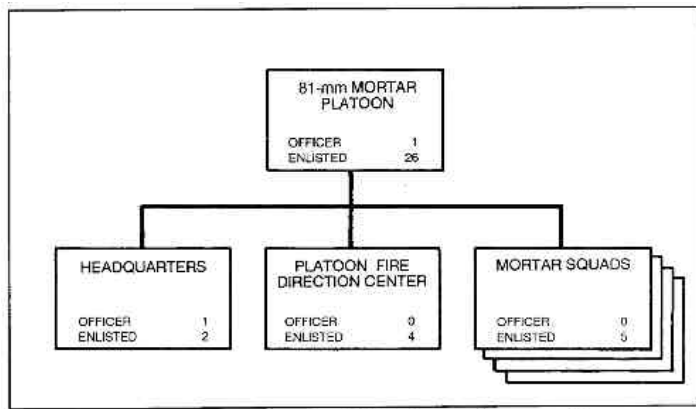

Figure K-3. Airborne, air assault, and light infantry medium mortar platoon.

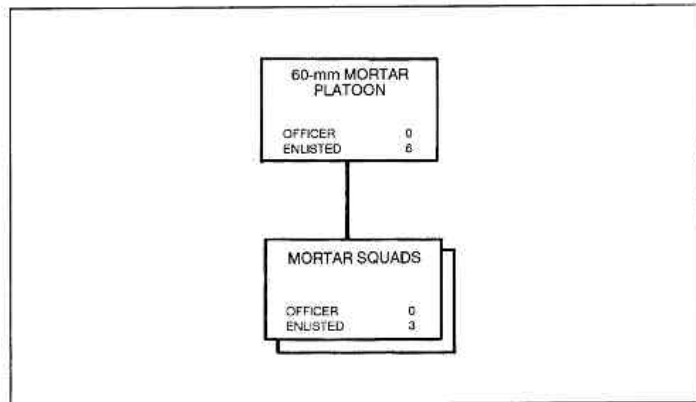

Figure K-4. Airborne, air assault, and light infantry mortar section.

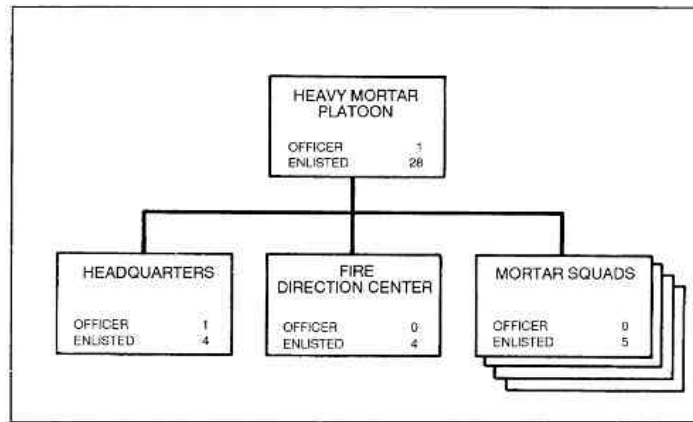

Figure K-5. Infantry battalion heavy mortar platoon.

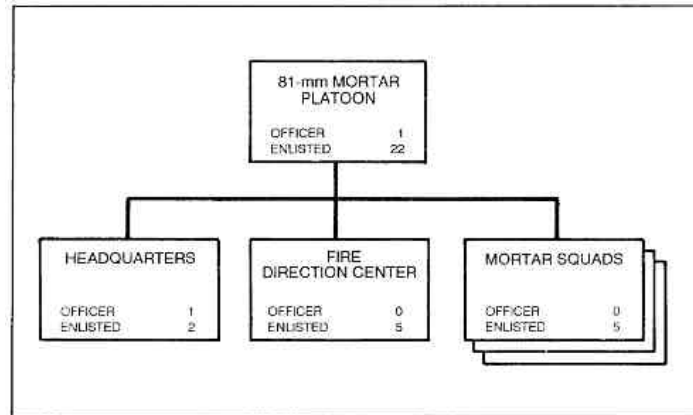

Figure K-6. Reserve Component infantry company mortar platoon.

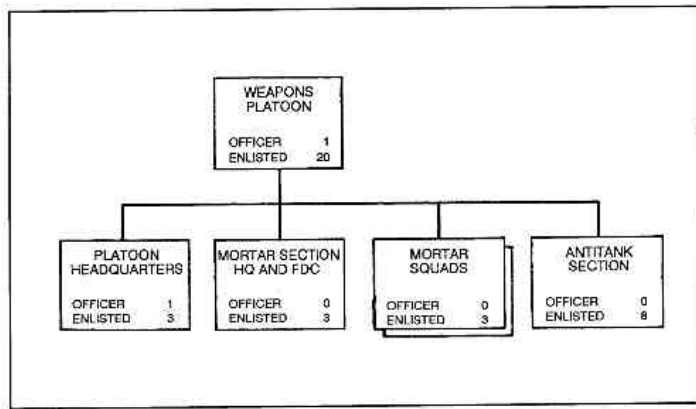

Figure K-7 Ranger rifle company weapons platoon.

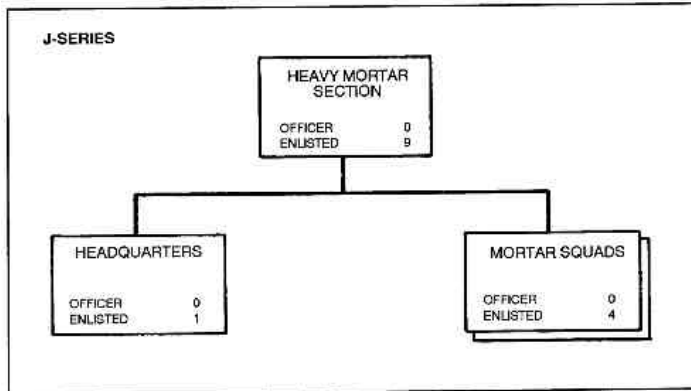

Figure K-8. Ground cavalry troop heavy mortar section.

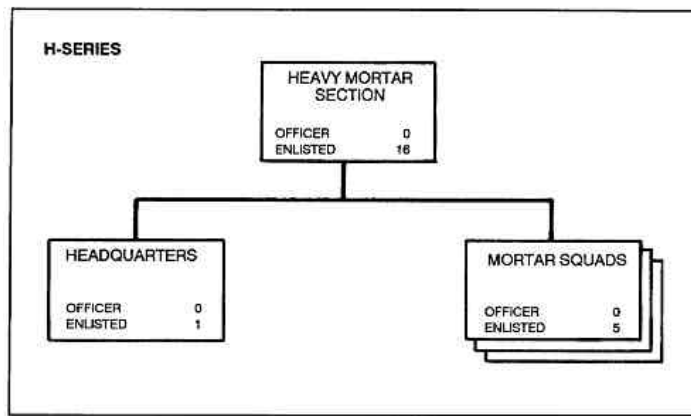

Figure K-8. Ground cavalry troop heavy mortar section (continued).

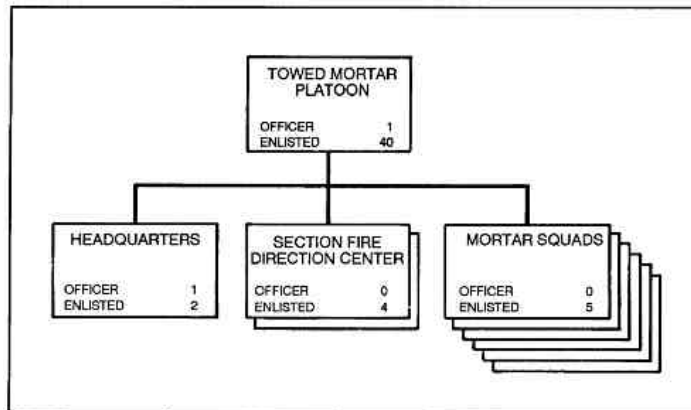

Figure K-9. Motorized battalion heavy mortar platoon.

APPENDIX L

MORTAR AND ARTILLERY RADIO AND WIRE NETS

This appendix depicts the net architecture of the most commonly used communication nets for both mortar and field artillery units. Because communication nets depend on the amounts of radio or telephones available, readers should consult the appropriate TOE or MTOE. Commanders can also modify nets depending on the tactical situation and mission.

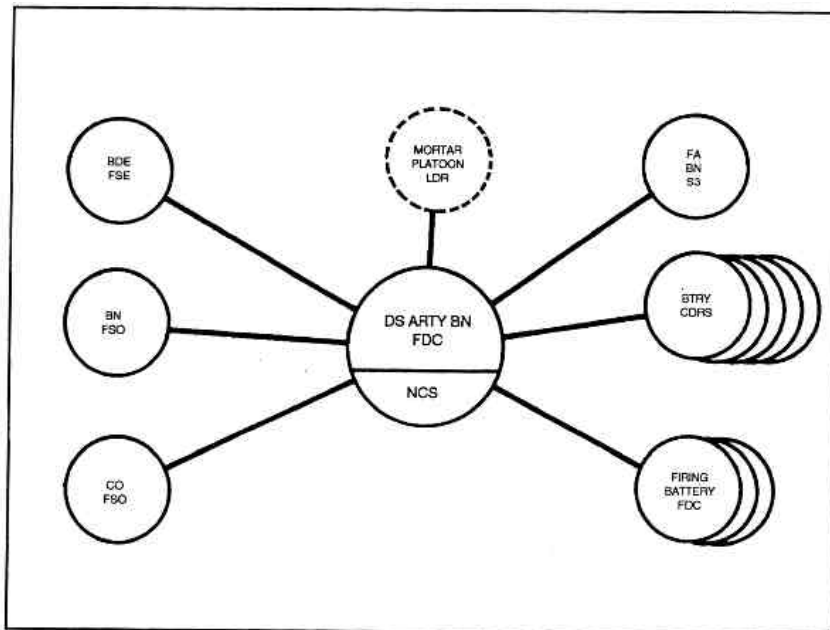

Figure L-1. Direct support FA battalion command fire net.

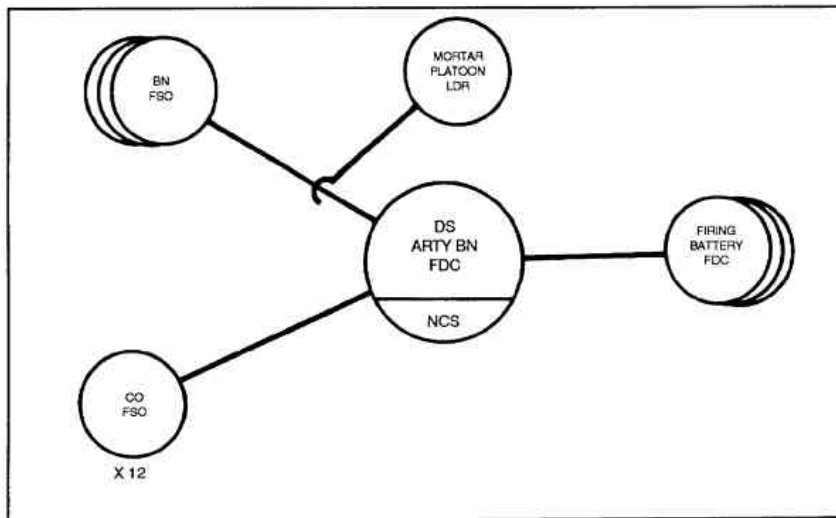

Figure L-2. Direct support artillery battalion fire net.

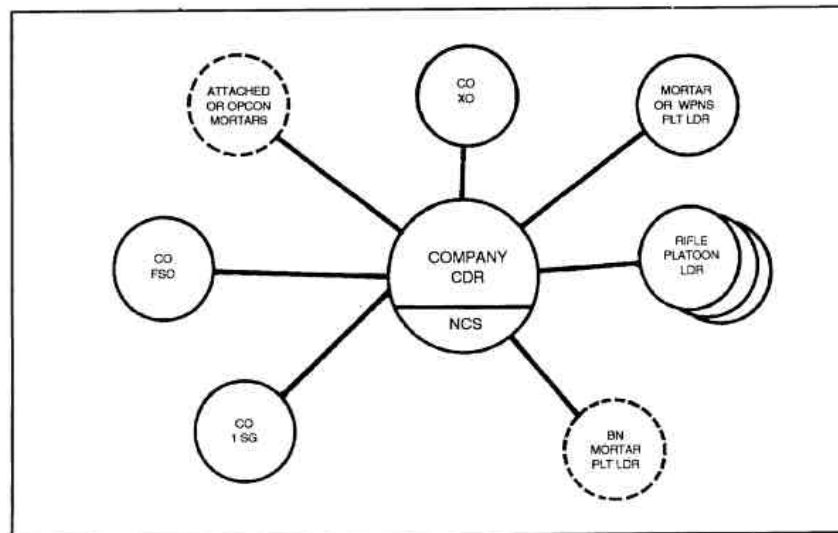

Figure L-3. Company command net.

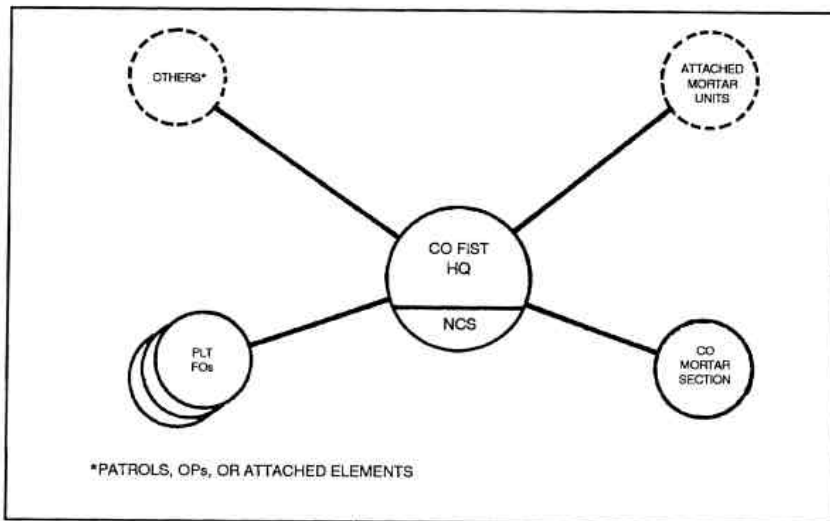

Figure L-4. Company fire control net.

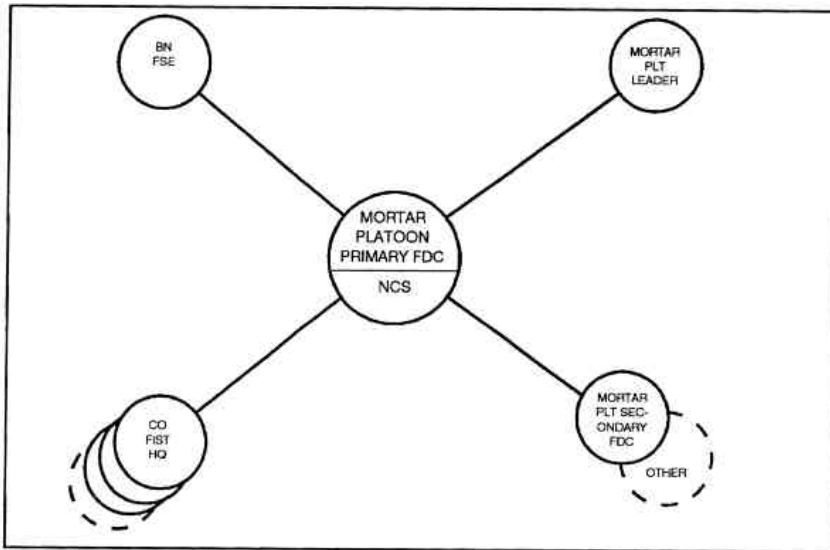

Figure L-5. Battalion mortar fire direction net (platoon in GS).

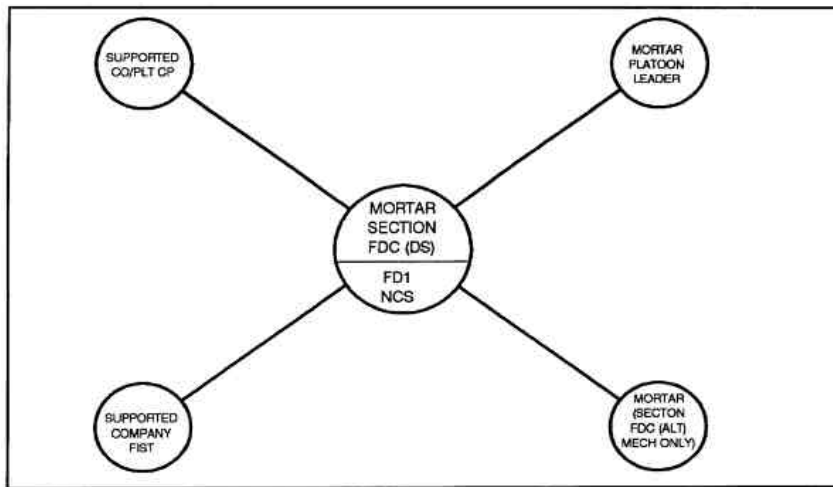

Figure L-6. Battalion Mortar Fire Direction Net (Platoon in DS).

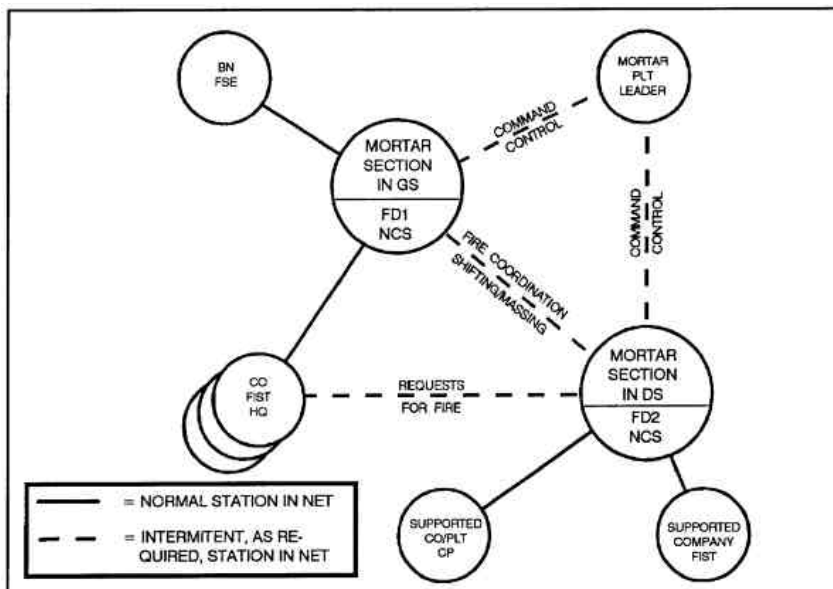

Figure L-7. Battalion mortar fire direction nets with one section DS and one section GS.

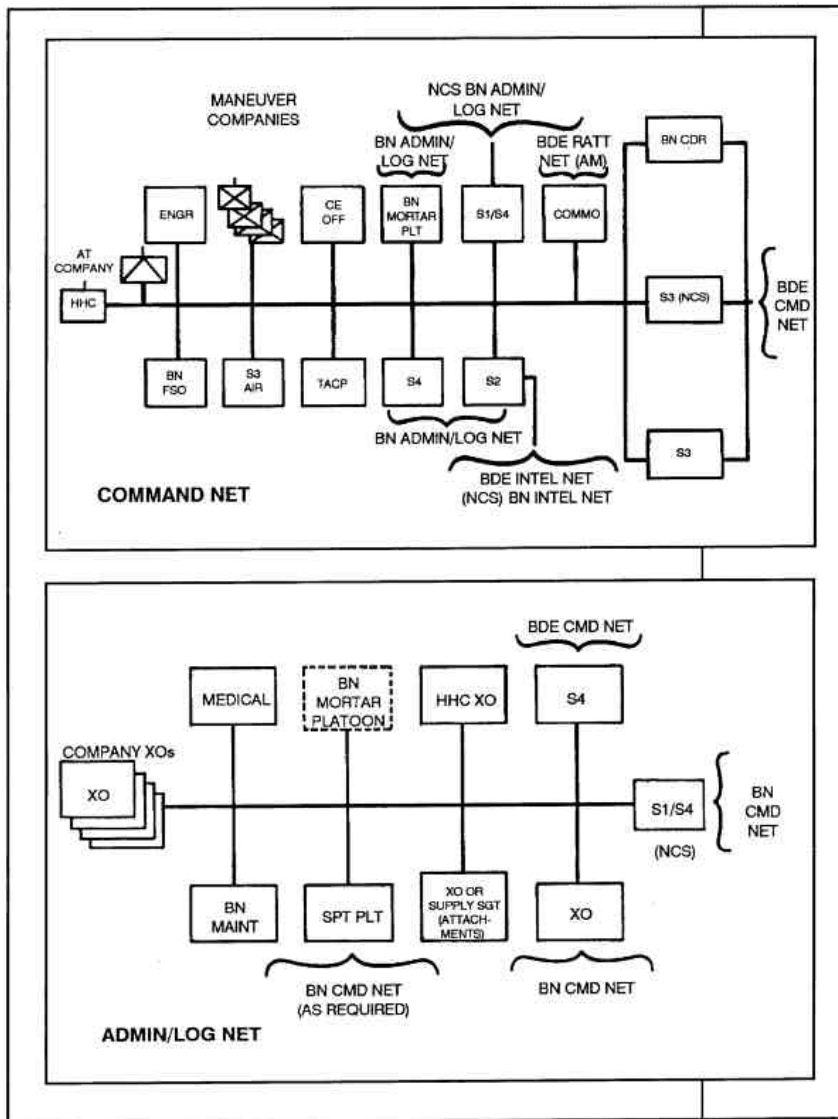

Figure L-8. Battalion command net and administrative/logistic net.

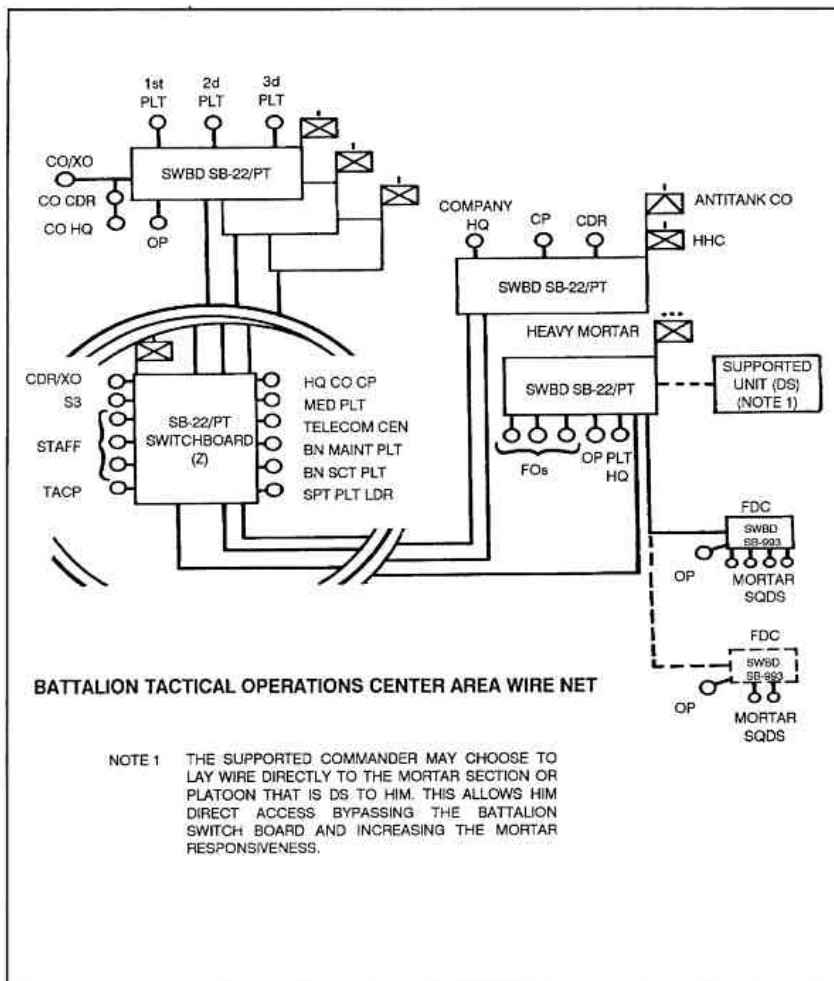

Figure L-9. Battalion wire net.

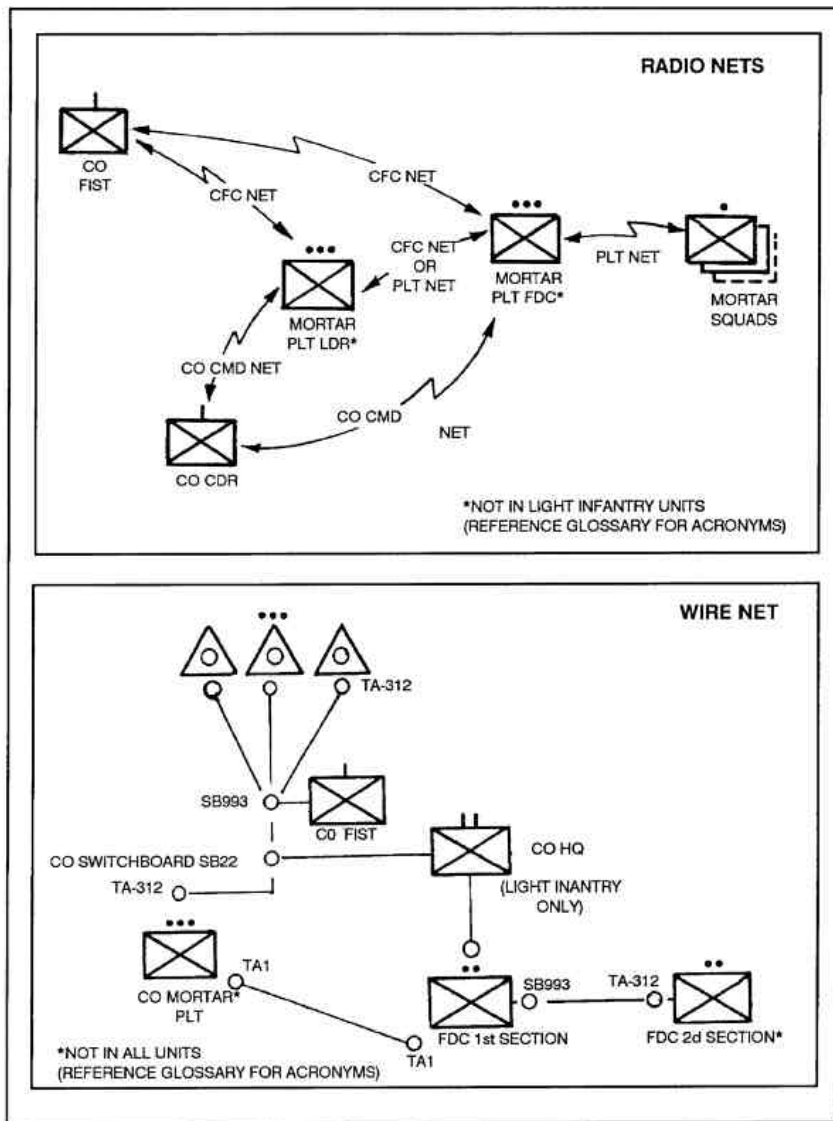

Figure L-10. Example of company mortar nets (radio and wire).

APPENDIX M

MORTAR PLATOON STANDING OPERATING PROCEDURES

The unit SOP is a set of instructions having the force of orders. It contains areas that lend themselves to standardization with no loss of effectiveness.

M-1. PURPOSE

SOPs facilitate and expedite operations by--

- Reducing the number, length, and frequency of combat orders.
- Simplifying the preparation and transmission of combat orders.
- Establishing priorities in the absence of specific instructions.
- Simplifying training.
- Promoting teamwork and understanding between the leaders and troops.
- Advising new arrivals or newly attached units of procedures followed in the organization.
- Reducing confusion and errors.

M-2. CONTENTS

Higher unit SOPs need not be restated in platoon and squad SOPs unless more detail is needed for actions to be accomplished at those levels. The mortar platoon SOP *must* comply with all parts of the company and battalion SOP. Virtually any item relating to the platoon can become a matter for the unit SOP. Many SOP items are derived from the personnel and equipment available to the organization. Other SOP items are a function of good tactics and techniques. Leaders can establish SOP items based on how they can operate most efficiently and best prepare their unit for combat. SOPs remain in effect unless modified by an order. If certain items continually need modification, they should not be a part of the SOP. Some examples of items to be discussed in the platoon SOP are:

- Higher unit SOPs.
- Uniform and protective equipment.
- Scheduled and unscheduled reports.
- Command and control.
- Procedures for organizing for combat. Chain of command.
- Responsibilities of the duty mortar crew.
- Emergency occupation. (See Appendix F.)

- Air defense and air guards.
- Combat service support, fueling, and feeding.
- Ammunition resupply, storage, and handling.
- Responsibilities of key personnel.
- Communications.
- Nuclear, biological, chemical protective operations.
- Advance party composition and duties.
- Straggler control.
- Handling of enemy prisoners of war.
- Road marches and convoy operations.
- Assembly area procedures.
- Limited visibility operations.
- Priority of work.
- Operation, warning, and fragmentary order formats.
- Occupation of firing positions.
- Stand-to alert procedures.
- Response to countermortar fires.
- Route and contaminated area marking.
- Casualty reporting.
- Safety precautions and hazard reporting.
- First aid and field sanitation.

M-3. FIRE DIRECTION CENTER

A special area of standardization by SOP is in FDC operations and fire commands. The mortar platoon leader and FDC chief must establish a clear and detailed SOP for operations within the FDC and for fire commands. The FDC requires technical proficiency and highly disciplined procedures that emphasize both time and motion efficiency. Wasted motion, unnecessary talking, clutter, and duplication of effort all result in lost time and errors during fire missions. The specific terminology for FDC orders and fire commands found in FM 23-91 must be taught and used during every fire mission. Cross-talk and the free flow of information must be encouraged in the FDC, but ambiguous talk and nonstandard terms detract from combat efficiency. Communications between the FDC and the gun squads, and within the gun squads, must be standardized. This saves time, prevents misunderstanding, and permits efficient personnel cross-leveling within the platoon.

TERRAIN MORTAR POSITION/SPECIAL CORRECTIONS WORKSHEET

SECTOR: LEFT, PRIMARY, RIGHT		TRANSFER LIMITS CENTER		RIGHT	CHARGE ELEVATION OR			
CENTER DEFLECTION + 200m		LEFT	RIGHT	DF	CENTER DEFLECTION - 200m			
CENTER RANGE + 200m		DF	RG	DF	RG	CENTER DEFLECTION - 200m		
(1) MORTAR NO.	(2) CORRECT TO BURST LINE NO.	(3) POSITION LATERAL CORRECTION (L or R)	(4) 100 R (MIL CONVERSION TABLE) CENTER RANGE	(5) POSITION DEFLECTION CORRECTION (L or R)	(6) POSITION RANGE CORRECTION (F = -) (B = +)	(7) CORRECTED RANGE PLUS CENTER RANGE	(8) FUZE SETTING	(9) POSITION TIME CORRECTION FS MINUS CENTER RANGE
		5 M	1 M	1 M	10 M	10 M	0.1 FSI	0.1 FSI
1								
2								
3								
4								
5								
6								

LEGEND:

100/R - Number of mills required to move the strike of the round 100 meters for a specified range.
 F - Forward.
 B - Behind or Back.
 0.1, FSI - Fuze Setting Increment.
 ~ - Corresponding To.
 ~ - To The Nearest.

GLOSSARY

AA assembly area

ACA airspace coordination area

AD air defense

AIMING POINT

a sharply defined point or object on which the aight of a mortar is aligned when it is laid for direction. There are two general types of aming point--distant and close-in.

ALO air liasion

ALTERNATE POSITION

a place located generally adjacent to the primary position from which a weapon, a unit, or an individual can perform the original task when the primary position becomes unsuitable.

AM amplitude modulation

ammo ammunition

ANGLICO air and naval gunfire liaison company

AO area of operation

approx approximately

ASR available supply rate

AT antitank

ATGM antitank guided missile

ATP ammunition transfer point

BACK AZIMUTH (RECIPROCAL BEARING)

the reverse or backward direction of an azimuth plus or minus degrees/3200 mils.

BASE LINE

an imaginary line passing through the base piece perpendicular to the azimuth of lay used to determine piece displacement relative to the base piece for use in computing hasty TMPCs.

Bde brigade

BMNT beginning morning nautical twilight

BMP Threat vehicle

bn battalion

BOMREP bombing report

btry battery

BURST LINE

lines drawn on the M16(M19) plotting board, representing the desired burst location of rounds to form a standard sheaf.

CAS close air support

CAV cavalry

cdr commander

CE Communication-Electronics

chg charge

CFC company fire control

CFL coordinated fire line

cmd command

co company

COA course of action

COLT combat observation lasting team

commo communication

CONOPS continuous operations

COT cotangent

counteratk counterattack

COUNTERFIRE

the attack of enemy indirect fire systems. It includes all activities to destroy or neutralize enemy mortars, artillery, rockets, missiles, and related units such as command and control, target acquisition, and ammunition stockpiles.

CP command post

CPL corporal

CPT captain

CSC combat support company

CSR controlled supply rate

CSS combat service support

cu cubic

DA Department of the Army

DAP distant aiming point

div division

DISPLACEMENT

to leave one position and occupy another. Forces may be laterally displaced to concentrate combat power in threatened areas.

DISTANT AIMING POINT

a point at least 1,500 meters from the mortars so that normal displacement in firing or traverse will not result in a horizontal angular change in direction of more than 1/2 mil. DAPs to the right or left flank are preferred to reduce the converging/diverging effect on the sheaf.

DIVARTY division artillery

DLIC detachment left in contact

DLY delay

DMD digital message device

DOF direction of fire

DPICM dual-purpose improved conventional munitions

DS direct support

ea each

EENT end evening nautical twilight

EMERGENCY OCCUPATION (HIP SHOOT)

occupation of a position from a convoy (displacement) without prior reconnaissance and immediately firing from this position.

enr engineer

EPW enemy prisoner of war

EW electronic warfare

FA field artillery

FCL final coordination line

FCT firepower control team

FD fire direction

FDC fire direction center

FEBA forward edge of the battle area

FFA free-fire area

FFE fire for effect

1SG first sergeant

FIST-V fire support team vehicle

FLOT forward line of own troops

FM field manual

FO forward observer

FPF final protective fire

FPL final protective line

FRAGO fragmentary order

FSCL fire support coordination line

FSCOORD fire support coordinator

FSE fire support element

FSO fire support officer

FSS fire support section

ft feet

GFF graphical firing fan

GLLD ground-laser locator designator

GPS global positioning system

G/VLLD ground-vehicular laser locator designator

GS general support

HASTY SURVEY

techniques used to establish rapid and sufficiently accurate direction or position data through simplified procedures with equipment from the TOE.

HE high-explosive

HHB headquarters and headquarters battery

HHC headquarters and headquarters company

HMMWV high-mobility, multipurpose wheeled vehicle

HOB height of burst

HQ headquarters

hvy heavy

IAW in accordance with

ILLUM illumination

IMP impact (fuze setting)

inf infantry

intell intelligence

intercomm intercommunication

INTSUM intelligence summary

J-SEAD joint suppression of enemy air defense

KIA killed in action

km kilometer

kmph kilometers per hour

LAW light antitank weapon

lb pound

LC line of contact

LD line of departure

ldr leader

LD light infantry division

log logistics

LOGPAC logistics package

LRP logistics release point

LT lieutenant

LZ landing zone

maint maintenance

mar march

MBA main battle area

MBC mortar ballistic computer

mech mechanized

med medical

MET meteorological

METT-T mission, enemy, terrain, troops, time

MHz megahertz

MLJIREP reports of meaconing, intrusion, jamming, and interference

min minute

mm millimeter

MOF multioption fuze

MOPP mission-oriented protection posture

mort mortar

MORTREP mortar shelling report

MOUT military operations in urbanized terrain

MRE meal, ready to eat

MRL multiple rocket launcher

MSG master sergeant

MT mechanical time

MTOE modified tables of organization and equipment

NBC nuclear, biological, chemical

NCO noncommissioned officer

NCOIC noncommissioned officer in charge

NCS net control station

NETT new equipment training team

NFA no-fire area

NIL not later than

No. number

NSB near-surface burst (fuze setting)

NSN national stock number

obj objective

OCOKA observation, cover and concealment, obstacles, key terrain, and avenues of approach

OP observation post

OPCON operational control

opn operation

OPORD operation order

OPSEC operation security

PADS position/azimuth determining system

para paragraph

PARALLEL SHEAF

a sheaf in which the *planes* of fire for all pieces *are parallel*. Regardless of the range, the bursts will be spaced laterally at the same intervals as the pieces.

PD point-detonating (a fuze setting)

PFC private first class

PIECE DISPLACEMENT

the distance of each mortar from the base piece in terms of right or left and forward or behind; the undesired movement of a weapon due to traversing or firing.

PL phase line

PLATOON/SECTION CENTER

the point over which the base piece is located. It is the chart location of the platoon/section and should be near the geographic center of all the mortars.

PLL prescribed load list

plt platoon

POL petroleum, oils and lubricants

PROX proximity (fuze setting)

prep preparation

PSG platoon sergeant

PSP pierced steel planking

PVT private

PW prisoner of war

PZ pickup zone

qty quantity

QSTAG Quadripartite Standardization Agreement

RATELO radiotelephone operation

RATT radio teletypewriter

rd rounds(s)

regt regiment

RFA restricted fire area

RFL restrictive fire line

RP release point

RSOP reconnaissance, selection, and occupation of position

RSR required supply rate

SALT support arms liaison team

SAW squad automatic weapon

sc scout

SEAD suppression of enemy air defense

SEE small emplacement excavator

sec second

SFC sergeant first class

SGT sergeant

SHELREP shelling report

SKEDS

a light weight plastic/Teflon coated litter used to evacuate casualties over short distances

SITREP situation report

smk smoke

SOI single operation instructions

SOP standard operating procedure

SP start point; specialist

SPC specialist

spt support

SPOTREP spot report

sqd squad

SSG staff sergeant

STANAG Standardization Agreement

STANDARD SHEAF

a sheaf in which the *planes* of fire for all peices *may not be parallel*, but the bursts will be spaced laterally at intervals equivalent to the *bursting diameter* of the system's high-explosive ammunition rounds.

STP soldier training publication

TAC Tactical Air Command (USAF)

TACP tactical air control party

TBD to be determined

TC training circular

TERRAIN MORTAR POSITION CORRECTIONS

precomputed corrections for each mortar that are applied to the command firing data to compensate for terrain positioning.

TF task force

TFT tabular firing table

tgt target

TM technical manual

tm team

TMPC terrain mortar position correction

TOC tactical operations center

TOE table of organization and equipment

TOT time on target

TOW tube-launched, optically tracked, wire guided

TRP target reference point

UMCP unit maintenance collection point

US United States

USAF United States Air Force

USMC United States Marine Corps

veh vehicle

VHF very high frequency

vic vicinity

vol volume

WIA wounded in action

WP white phosphorus

XO executive officer

z (time) zulu

References

Sources Used

These are the sources quoted or paraphrased in this publication.

Joint and Multiservice Publications

FM 101-60-1. (C) Joint Munitions Effectiveness Manual/Surface-to-Surface: Effectiveness Data for Mortar, 81-mm: M29 (U). 12 November 1986.

FM 101-60-17. Joint Munitions Effectiveness Manual/Surface to Surface: Basic Effectiveness Manual. 20 July 1976.

FM 101-60-31. (C) Joint Munitions Effectiveness Manual/Effectiveness Data for Mortar, 60-mm: M244 (U).

FM 101-60-70. (C) Joint Muntions Effectiveness Manual/Effectiveness Data for Mortar: 4.2-inch, M30 (U).

FM 101-61-3. (C) Joint Munitions Effectiveness Manual/Surface-to-Surface - Weapons/Munitions Application: Ammunition Reliability (U). 20 October 1978.

FM 101-62-1. (C) Joint Munitions Effectiveness Manual/Surface: Safe Distances for Fragmentary Munitions (U). 1 April 1987.

FM 101-62-2/1. (C) Lethal Area of Selected US Army, US Navy and US Marine Corps Surface-to-Surface Weapons Against Personnel and Materiel Targets. 23 October 1979.

FM 101-62-3. (C) Joint Munitions Effectiveness Manual/Surface-to-Surface: Manual of Fragmentation Data (U). 1 July 1982.

TC 90-7. Joint (Army/Air Force) Tactical Air Control Party/Fire Support Team (TACP/FIST) Close Air Support Operations. 29 September 1988.

Army Publications

FM 3-3. NBC Contamination Avoidance. 30 September 1986

FM 3-4. NBC Protection. 21 October 1985.

FM 3-5. NBC Decontamination. 24 June 1985.

FM 3-6. Field Behavior of NBC Agents (Including Smoke and Incendiaries). 3 November 1986.

FM 3-50. Deliberate Smoke Operations. 25 July 1984.

FM 3-100. NBC Operations. 17 September 1985.

FM 5-34. Enginner Field Data. 14 September 1987.

FM 5-102. Countermobility. 14 March 1985.

FM 5-103. Survivability. 10 June 1985.

FM 6-15. Field Meteorology. 30 August 1978.

FM 6-30. Observed Fire Procedures. 17 June 1985.

FM 6-141-2. (C) Field Artillery Target Analysis and Weapons Employment: Nonnuclear(U). 26 September 1980.

FM 7-85. Ranger Unit Operations. 9 June 1987.

FM 7-91. Tactical Employment of Antiarmor Platoons, Companies, and Battalions. 30 September 1987.

FM 9-6. Munition Support in the Theater of Operations. 1 September 1989.

FM 10-14. Unit Supply Operations (Manual Procedures). 27 December 1988.

FM 10-52-1. Commander's Handbook for Water Usage in Desert Operations. 2 May 1983.

FM 10-400. Quartermaster Airdrop and Airdrop Equipment Support Units. 2 November 1984.

FM 10-501. Airdrop of Supplies and Equipment: Rigging Containers. 23 May 1989.

FM 10-512. Airdrop of Supplies and Equipment: Rigging Typical Supply Loads. 31 August 1979.

FM 10-522. Airdrop of Supplies and Equipment: Rigging Potable Water. 3 June 1985.

FM 10-542. Airdrop of Supplies and Equipment: Rigging Loads for Special Operations. 7 October 1987.

FM 10-553. Airdrop of Supplies and Equipment: Rigging Ammunition. 4 December 1981.

FM 12-6. Personnel Doctrine. 23 August 1989.

FM 19-25. Military Police Traffic Operations. 30 September 1977.

FM 20-22. Vehicle Recovery Operations. 31 August 1984.

FM 20-32. Mine/Countermine Operations. 9 December 1985.

FM 21-10. Field Hygiene and Sanitation. 22 November 1988.

FM 21-11. First Aid for Soldiers. 27 October 1988.

FM 21-15. Care and Use of Individual Clothing and Equipment. 22 February 1985.

FM 21-26. Map Reading and Land Navigation. 30 September 1987.

FM 21-60. Visual Signals. 30 September 1987.

FM 22-6. Guard Duty. 17 September 1971

FM 22-9. Soldier Performance in Continuous Operations. 8 December 1983.

FM 23-25. Launcher and Cartridge, 84-mm, M136(AT4), HEAT. 22 November 1988.

FM 23-65. Browning Machinegun, Caliber .50 HB, M2. 19 May 1972.

FM 26-2. Management of Stress in Army Operations. 29 August 1986.

FM 27-10. The Law of Land Warfare. 18 July 1956.

FM 31-70. Basic Cold Weather Manual. 12 April 1968.

FM 55-9. Unit Air Movement Planning. 31 August 1981.

FM 55-30. Army Motor Transport Units and Operations. 14 March 1980.

FM 55-450-1. Army Helicopter External Load Operations. 3 October 1988.

FM 55-450-2. Army Helicopter Internal Load Operations. 24 August 1984.

FM 57-38. Pathfinder Operations. 9 October 1968.

FM 57-230. Advance Parachuting Techniques and Training. 13 September 1989.

FM 90-3 (HTF). Desert Operations. 19 August 1977.

FM 90-4. Air Assault Operations. 16 March 1987.

FM 90-5(HTF). Jungle Operations. 16 August 1982.

FM 90-6. Mountain Operations. 30 June 1980.

FM 90-8. Counterterrorism Operations. 29 August 1986.

FM 90-10(HTF). Military Operations on Urbanized Terrain (MOUT). 15 August 1979.

FM 90-10-1(HTF). An Infantryman's Guide to Urban Combat. 30 September 1982.

FM 90-13(HTF). River Crossing Operations. 1 November 1978.

FM 90-26. Airborne Operations. 18 December 1990.

FM 100-2-1. Soviet Army Operations and Tactics. 16 July 1984.

FM 100-2-2. Soviet Army Specialized Warfare and Rear Area Support. 16 July 1984.

FM 100-2-3. The Soviet Army Troops Organization and Equipment. 16 July 1984.

FM 100-5. Operations. 5 May 1986.

FM 100-26. The Air-Ground Operations System. 30 March 1973.

FM 101-5. Staff Organization and Operations. 25 May 1984.

FM 101-5-1. Operational Terms and Symbols. 21 October 1985.

Fm 101-10-1/1. Staff Officers Field Manual - Organizational, Technical, and Logistic Data (Volume 1). 7 October 1987.

FT 4.2-K-2. Mortar, 4.2-Inch, M30, Firing Cartridge, HE, M329A2. 30 June 1984.

FT 60-P-1. Mortar, 60-mm: M224, Firing Cartridge, HE, M720; Cartridge, HE, M49A24; Cartridge, HE, XM888; Cartridge, TP, M50A3; Cartridge, WP, M302A1 and Cartridge, Illuminating, M83A3. 22 March 1980.

STP 7-11BCHM14-SM-TG. Soldier's Manual, Skill Levels 1/2/4/4 and Trainer's Guide, CMF 11, Infantry. 30 September 1988.

STP 7-11C14-SM-TG. Soldier's Manual, Skill Levels 1/2/3/4 and Trainer's Guide, MOS 11C, Indirect Fire Infantry. 30 September 1988.

TC 6-40. Field Artillery, Manual Cannon Gunnery. 27 December 1988.

TC 6-50. The Field Artillery Cannon Battery. 29 September 1988.

TC 23-65-1. Browing Machine Gun, Caliber .50, Heavy Barrel, M2. 19 September 1984.

TM 5-725. Rigging. 3 October 1968.

TM 9-1010-223-10. Operator's Manual for Lightweight Company Mortar, 60-mm: M224. 18 December 1987.

TM 9-2350-261-10. Operator's Manual (Crew) for Carrier, Personnel, Full-Tracked: Armored, M113A2 Carrier, Command Post, Light: Tracked M577A2 Carrier, Mortar, 107-mm, Self-Propelled: M106A2 Carrier, Mortar: M125A2. 8 May 1984.

TM 9-3305. Principles of Artillery Weapons. 4 May 1981.

NATO STANDARDIZATION AGREEMENTS AND ALLIED PUBLICATIONS

STANAG 2002. Warning Signs for the Marking of Contaminated or Dangerous Land Areas, Complete Equipments, Supplies and Stores.

STANAG 2014. Operations Orders, Warning Orders, and Administrative/Logistics Orders.

STANAG 2020. Operational Situation Reports.

STANAG 2022. Intelligence Reports.

STANAG 2103. Reporting Nuclear Detonations, Biological and Chemical Attacks, and Predicting and Warning of Associated Hazards and Hazard Area-ATP-45.

STANAG 2868. Land Force Tactical Doctrine-ATP-35(A).

STANAG 3204. Aeromedical Evacuation.

DOCUMENTS NEEDED

These documents must be available to the intended users of this publication.

ARTEP 7-90-Drills. Drills for the Infantry Mortar Platoon, Section, and Squad. 14 February 1990.

DA Form 1155. Witness Statement on Individual. June 1966.

DA Form 1156. Casualty Feeder Report. June 1966.

DA Form 4004. Message Book. 1 February 1977.

DA Form 5424-R. Terrain Mortar Position/Special Corrections Worksheet. May 1985.

FM 3-50. Deliberate Smoke Operations. 25 July 1984.

FM 6-20. Fire Support in the AirLand Battle. 17 May 1988.

FM 6-20-40. Tactics Techniques, and Procedures for Fire Support for Brigade Operations (Heavy). 5 January 1990.

FM 6-20-50. Tactics Techniques, and Procedures for Fire Support for Brigade Operations (Light). 5 January 1990.

FM 6-141-1. Field Artillery Target Analysis and Weapons Employment: Nonnuclear. 15 February 1978.

FM 7-7. The Mechanized Infantry Platoon and Squad (APC). 15 March 1985.

FM 7-8. The Infantry Platoon and Squad (Infantry, Airborne, Air Assault, Ranger) (How to Fight). 31 December 1980.

FM 7-10. The Infantry Rifle Company. 14 December 1990.

FM 7-20. The Infantry Battalion. 28 December 1984.

FM 17-95. Cavalry Operations. 14 February 1986.

FM 17-97. Regimental Armored Cavalry Troop. 27 September 1988.

FM 23-90. Mortars. 19 September 1990.

FM 23-91. Mortar Gunnery. 7 October 1985.

FM 44-8. Small Unit Self-Defense Against Air Attack. 30 December 1981.

FM 71-2. The Tank and Mechanized Infantry Battalion Task Force. 27 September 1988.

TC 6-40. Field Artillery, Manual Cannon Gunnery. 27 December 1988.

READINGS RECOMMENDED

These sources contain relevant supplemental information.

FM 24-1 Combat Communications. 11 September 1985.

Nonmilitary Publication

RAND NOTE N-2984-A. Applying the National Training Center Experience: Artillery Targeting Accuracy; Goldsmith, Hodges, Burn: The Rand Corporation, 1700 Main Street, P.O. Box 2138, Santa Monica, CA 90406-2138. April 1990.