

Ocean Energy



U.S. DEPARTMENT OF THE INTERIOR
Minerals Management Service

TABLE OF CONTENTS

Teacher Guide	2
Related National Science Standards	3
Introduction to Ocean Energy	4
Petroleum & Natural Gas	5
Natural Oil and Gas Seeps	7
Methane Hydrates	8
Solar Energy	9
Wind Energy	10
Wave Energy	11
OTEC: Ocean Thermal Energy Conversion	12
Tidal Energy	13
Activity 1: Exploring Oil Seeps	14
Activity 2: Drilling for Oil in the Ocean	15
Activity 3: A Stationary Oil Rig	16
Activity 4: A Floating Oil Rig	17
Activity 5: Exploring Currents	18
Activity 6: Exploring Wave Energy	19
Activity 7: Exploring Wind Energy	20

Special thanks to the National Energy Education Development (NEED) Project for development of this booklet. For more information about NEED, go to www.NEED.org. Cover design by Will Waskes, MMS.

Teacher Guide

TO TEACH STUDENTS ABOUT THE MANY ENERGY RESOURCES IN, OVER, AND UNDER THE OCEAN, USING BACKGROUND INFORMATION, PRESENTATIONS, AND HANDS-ON ACTIVITIES.

BACKGROUND

The ocean environment has many energy resources, both renewable and nonrenewable. As new technologies are developed, ocean resources will be able to meet many of the Nation's energy needs.

TIME

Three to ten class periods, depending on the number of hands-on activities you choose to conduct.

MATERIALS

- Four copies of the backgrounder.
- Nine poster boards.
- The materials listed for each activity you choose to conduct on pages 16-22.

PROCEDURE

Step One—Preparation

- Divide the class into nine groups.
- Make four copies of the backgrounder and separate by the nine topics—Introduction to Ocean Energy, Petroleum & Natural Gas, Natural Oil Seeps, Methane Hydrates, Solar Energy, Wind Energy, Wave Energy, Ocean Thermal Energy Conversion, Tidal Energy.
- Gather materials for the activities you choose to conduct.

Step Two—Introduction of Activity (Day One)

Introduce the activity to the class. Explain to the students that they will be working in small groups to prepare a two-minute presentation on one aspect of ocean energy to teach to the class. Distribute the backgrounders to the groups. Give students the timeframe within which they are to accomplish their goals. If this will be a graded activity, explain the grading procedure. Have the students read their backgrounders. Answer any questions the students may have.

Step Three—Preparation of Presentations (Day Two)

Give the groups one class day to prepare their presentations. Encourage them to make posters for illustration.

Step Four—Presentations (Day Three)

Let's take the plunge—into the ocean of energy resources. Have each group make its presentation in turn.

Step Five—Hand-on Activities (Days Four—Ten)

Have the students conduct the hands-on activities you have chosen.

Related National Science Standards

(Intermediate Level)

- INT-B: 3.a Energy is a property of many substances and is associated with heat, light, electricity, mechanical motion, sound, nuclei, and the nature of a chemical.
- INT-B: 3.b Energy is transferred in many ways.
- INT-B: 3.g The sun is the major source of energy for changes on the earth's surface. The sun loses energy by emitting light. A tiny fraction of that light reaches earth, transferring energy from the sun to the earth. The sun's energy arrives as light with a range of wavelengths.
- INT-D: 1.b Water, which covers the majority of the earth's surface, circulates through the crust, oceans, and atmosphere in what is known as the water cycle.
- INT-D: 3.a Gravity governs the motion in the solar system. Gravity explains the phenomenon of the tides.
- INT-D: 3.b The sun is the major source of energy for phenomena on the earth's surface, such as the growth of plants, winds, ocean currents, and the water cycle.
- INT-E: 2.c Technological solutions are temporary and have side effects. Technologies cost, carry risks, and have benefits.
- INT-E: 2.f Perfectly designed solutions do not exist. All technological solutions have trade-offs, such as safety, cost, efficiency, and appearance. Risk is part of living in a highly technological world. Reducing risk often results in new technology.
- INT-E: 2.g Technological designs have constraints. Some constraints are unavoidable, such as properties of materials, or effects of weather and friction. Other constraints limit choices in design, such as environmental protection, human safety, and aesthetics.
- INT-F: 1.b Natural environments may contain substances that are harmful to human beings. Maintaining environmental health involves establishing or monitoring quality standards related to use of soil, water, and air.

Introduction to Ocean Energy

If you stand on the beach on a sunny day and look out at the ocean, you are surrounded by energy. You feel the radiant energy from the sun warming your skin. The energy in the wind blows your hair. The waves are constantly advancing and retreating. If you stand long enough, you will see the water level rise and fall with the tides. Powerful currents, unseen, move through the oceans. Energy is everywhere around you, just waiting to be harnessed.

Below the ocean, there are enormous energy resources, too. In many areas, large deposits of petroleum and natural gas are buried under the seabed. There are huge deposits of frozen crystals filled with methane, an energy-rich gas. The ocean is full of energy.



Oceans cover almost three-fourths of the earth's surface. The oceans and the land beneath them could provide all of the energy the world needs for years to come. Today, more than a fourth of the oil and gas produced in the United States comes from offshore areas.

The beach extends from the shore into the ocean on a **continental shelf** that gradually descends to a sharp drop, called the **continental slope**. This continental shelf can be as narrow as 20 kilometers or as wide as 400 kilometers. The water on the continental shelf is shallow, rarely more than 150 to 200 meters deep.

The continental shelf drops off at the continental slope, ending in **abyssal plains** that are three to five kilometers below sea level. Many of the plains are flat, while others have jagged mountain ridges, deep canyons, and valleys. The tops of some of these mountain ridges form islands where they extend above the water.

When most people think of the United States, a map of the country comes to mind. Everyone recognizes the outline of the USA. But our resources aren't confined to our land area. Our borders extend 200 miles into the water from our coastlines and encompass an area larger than the country itself. The underwater area claimed by the United States includes 3.9 billion acres; the land area of the country includes only 2.3 billion acres.

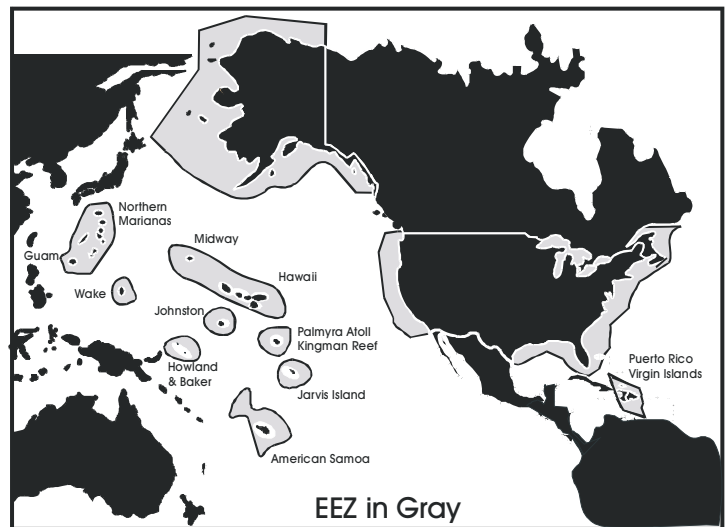

This large underwater area is called the **Exclusive Economic Zone (EEZ)**. In 1983, the President claimed all the area of the EEZ in the name of the United States. The Minerals Management Service of the U.S. Department of the Interior is responsible for protecting and developing its natural resources.

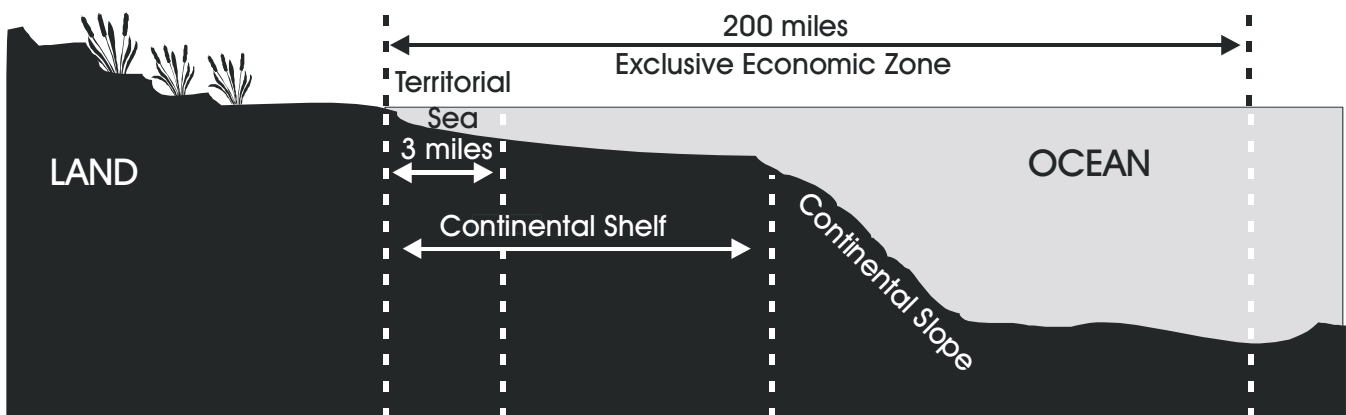

not drawn to scale

Petroleum and Natural Gas

Petroleum and natural gas deposits are found in sedimentary rock basins, where tiny sea plants and animals died millions of years ago. If the proper temperature and pressure were present, these plants and animals eventually turned into **hydrocarbons**. Oil and gas are made mostly of hydrogen and carbon—hydrocarbons. These hydrocarbons flowed into empty spaces in the surrounding rocks, called **traps**. Finally, an oil-soaked rock—much like a wet sponge—was formed. The traps were covered with a layer of solid rock, or a seal of salt or clay, that kept the oil and gas from escaping to the surface.

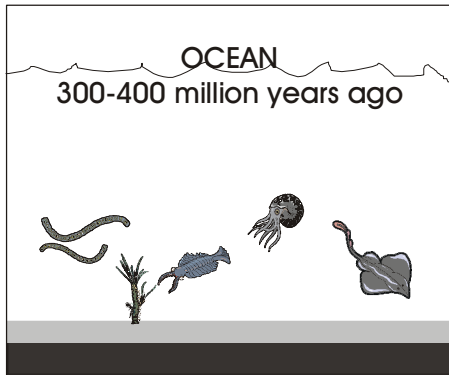

Tiny sea plants and animals died and were buried on the ocean floor. Over time, they were covered by layers of silt and sand.

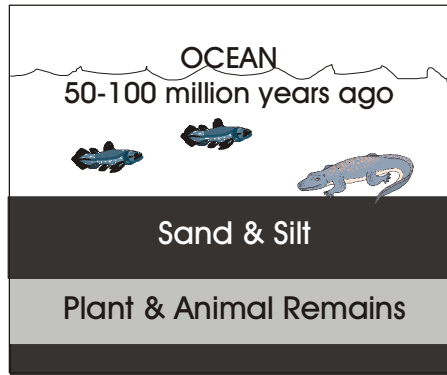

Over millions of years, the remains were buried deeper and deeper. The enormous heat and pressure turned them into oil and gas.

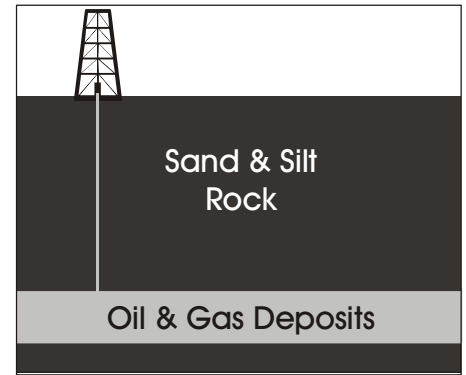

Today, we drill down through layers of sand, silt, and rock to reach the rock formations that contain oil and gas deposits.

Thirty basins in the EEZ have been found that could contain enormous oil and gas deposits. Some of these basins have been explored and are producing oil and gas at this time. Scientists estimate that 30 percent of U.S. gas and oil reserves are in these offshore basins.

Studies have been carried out on many of these basins to determine the amount of oil and gas in them and the environmental impacts of recovering them. Studies of the ocean currents and climate in potential drilling areas have also been done to find out the risks to drilling platforms. Test wells have been drilled in many areas.

The first offshore drilling was begun in 1897 from a pier in California. Early drilling was limited to areas where the water was less than 300 feet deep, but modern drilling rigs can operate to depths of a mile or more. Some drilling platforms stand on stilt-like legs that are imbedded in the ocean floor. These huge platforms hold all the drilling equipment,

as well as housing and storage areas for the work crews. Once the wells have been drilled, the platforms also hold the production equipment.

Floating platforms are used for drilling in deeper waters. These self-propelled vessels are anchored to the ocean bottom with huge cables. Once the wells have been drilled from these platforms, the production equipment is lowered to the ocean floor and sealed to the well casing to prevent leakage. Wells have been drilled in 10,000 feet of water using these floating rigs.

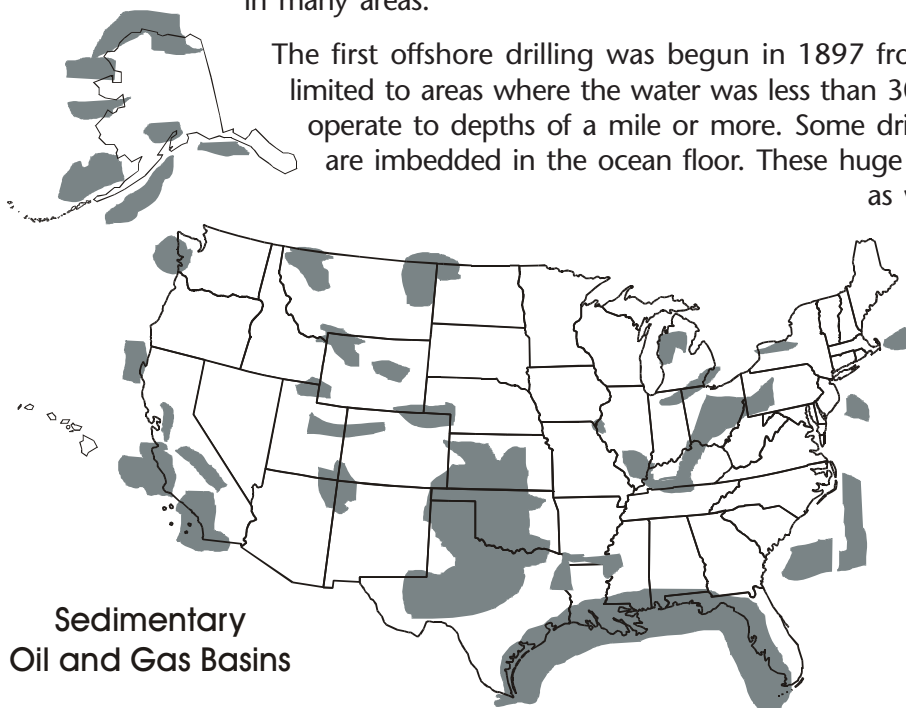

During every phase of development and production, precautions are taken to prevent pollution, spills, and significant changes to the ocean environment. All aspects of the operation, from waste disposal to hurricane safety measures, are regulated.

Since 1975, the offshore program has had a safety record of 99.99 percent—only about 0.001 percent of the oil produced has been spilled. During 1993, Hurricane Andrew passed through the Gulf of Mexico with winds of 140 mph and 35-foot waves and no major spills or injuries occurred.

In 1954, there were only 100 offshore wells drilled in the U.S. In 1978, four years after the first oil embargo, there were more than 1,200 new wells drilled.

Then, in 1990, President Bush excluded the Pacific Coast, the North Atlantic and North Aleutian areas, and parts of the Eastern Gulf of Mexico from drilling until the year 2000. In 1992, there were only 600 new wells drilled. In 1993, the energy picture changed and increased use of natural gas spurred the development of 800 new wells.

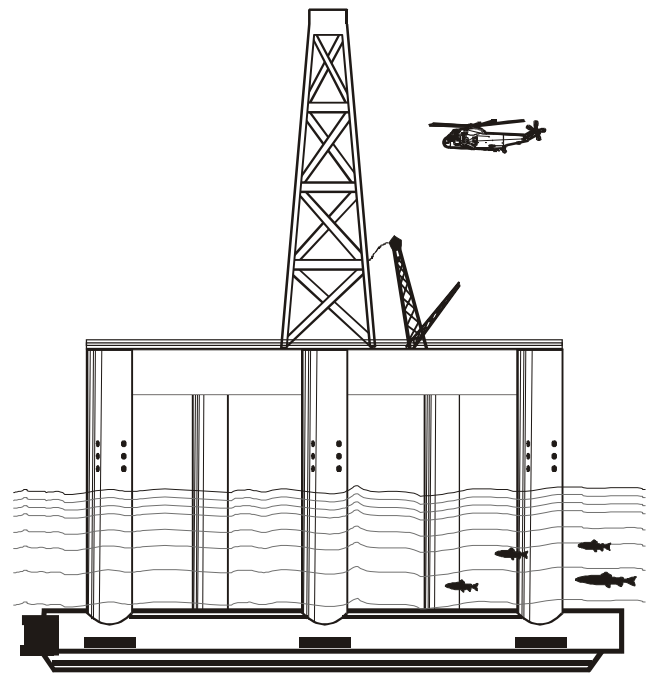

Semi-submersible Offshore Rig

Marine Life on Offshore Platforms

In the ocean off the California coast, there are 27 platforms producing oil and natural gas. These platforms provide an artificial habitat for more than 50 species of algae and invertebrates, many of which have potential uses in medicine and industry.

The Minerals Management Service has provided grants to the University of California at Santa Barbara (UCSB) and Louisiana State University (LSU) to investigate the use of the marine life growing on and around these oil platforms. The marine life will be investigated for compounds that might help wounds heal, reduce inflammation, and fight cancer. A compound from marine coral is being used today to treat bone fractures. Compounds from red algae have been discovered that imitate the anti-inflammatory actions of human hormones. One of the marine invertebrates may contain an important drug that can be used in the treatment of leukemia.

Researchers will also study the community and population ecology of the platforms. They will study the factors that affect the resident species, as well as the differences between natural populations and those around the platforms. The research will analyze marine life around platforms in the Santa Barbara Channel and the Gulf of Mexico without disturbing the naturally occurring reef systems. Many organisms, in fact, will be harvested as the platforms are cleaned. In some areas of southern California, mussels are already being harvested from oil platforms.

In December 1997, President Clinton extended the moratorium for another ten years. The oil and gas basins with the highest potential for development are included in this moratorium.

Today, there are more than 4,000 platforms in the Gulf of Mexico and off the coasts of California and Alaska, servicing thousands of wells. Offshore production supplies approximately 27 percent of the Nation's natural gas and 20 percent of its oil. Most of the active wells and proven reserves are in the Gulf of Mexico. Although there are no producing wells in other areas, there is believed to be significant petroleum in the Beaufort Sea off Alaska, as well as natural gas in the Eastern Gulf of Mexico and off the Atlantic Coast.

Although there is public concern about development of these areas right now, they offer great potential for the future. Today, the U.S. imports about two-thirds of the petroleum it consumes, much of it from politically unstable areas of the world. Consumption of natural gas continues to increase, too. In the future, we might need to develop offshore resources that are currently under restriction to meet our society's demand for energy.

Natural Oil and Gas Seeps

Millions of years ago, large deposits of petroleum and natural gas formed in basins along the coast of California. Over time, earthquakes caused cracks in the layers of rock that covered the deposits. The petroleum and natural gas began oozing through the cracks. This natural oozing of oil and gas is called a **seep**.

Natural seeps have occurred for thousands of years and are still occurring today. The petroleum and natural gas rise through the water to the surface. The natural gas eventually dissipates into the air, but the petroleum congeals into floating balls of sticky tar that are carried by ocean currents to local beaches, especially during the summer months.

The early explorer Juan Rodriquez Cabrillo, who arrived in the area in 1542, made a record of the oil floating on the ocean. The Chumash Tribe of Native Americans gathered the tar and used it for many tasks. They waterproofed woven bottles and mended cracks in bowls and other cooking vessels. They coated their sewing string and fishing spears and used the tar to make pipes and whistles. They also used the heavy tar to waterproof their ocean-going canoes so that they could travel and trade throughout the region.

In the 1880's, the Santa Barbara Area gained a reputation as a health resort, in large part because of the winds blowing over the seeps toward the town. People believed the oil and gas purified the atmosphere and helped cure many chronic diseases. Now we know these seeps are the largest source of air pollution in Santa Barbara County.

According to the California State Lands Commission, more than 1,200 natural seeps have been charted in the Santa Barbara Channel of California. It is estimated that 130-150 barrels of oil a day seep to the surface.

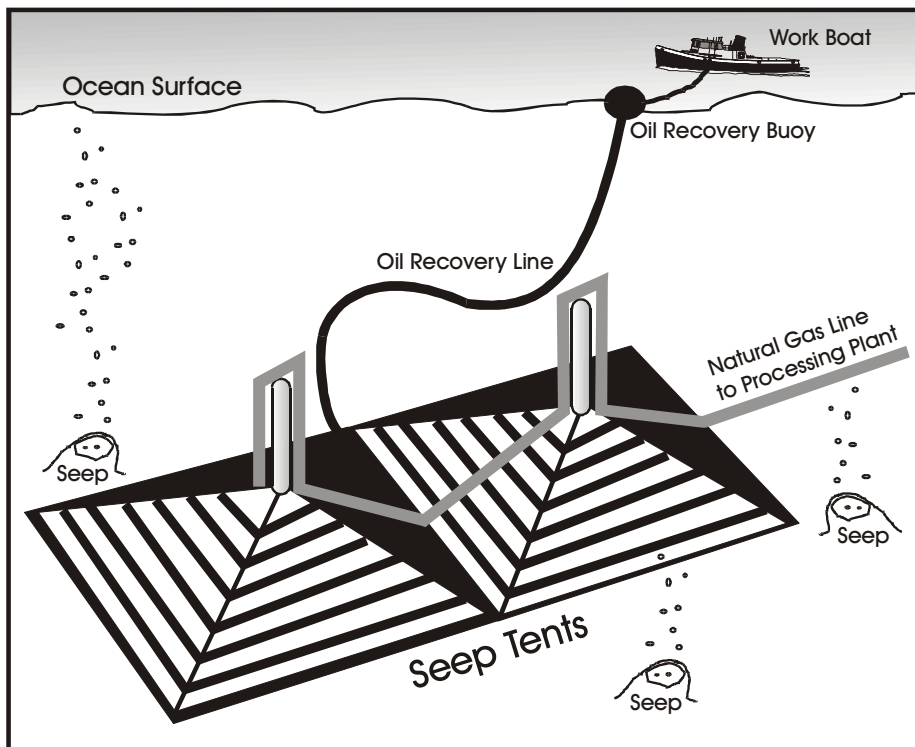
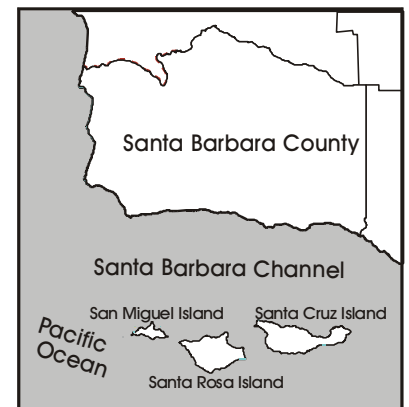
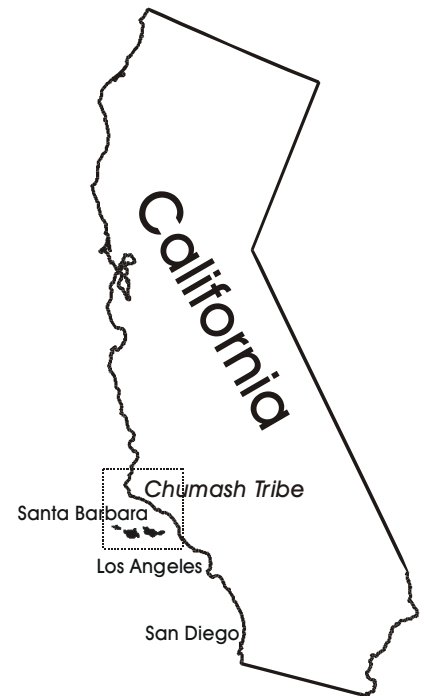

There are 42 gallons of oil per barrel, which equals more than two million gallons a year. In addition, five million cubic feet of natural gas seep through the ocean and into the air each day, or almost two trillion cubic feet per year.

In 1982, several oil companies built two steel pyramids, called tents, to capture the natural gas from one gigantic seep. These 50-foot high tents weigh 350 tons each and measure 100 feet on each side. They capture more than a half million cubic feet of seeping gas each day, an amount equal to the pollution from thousands of cars.

Methane Hydrates

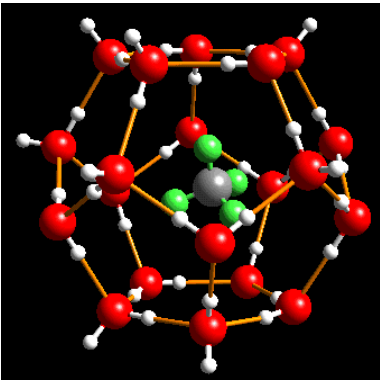

Methane is an energy-rich gas, the main component of natural gas. Buried in the sediments of the ocean floor is a reserve of methane so huge it could fuel the whole world. In the sediments, bacteria break down the remains of sea animals and plants. In the process, they produce methane gas. Methane is almost always a by-product of organic decay. Under the enormous pressures and cold temperatures at the bottom of the ocean, this methane gas dissolves. The molecules of methane become locked in a cage of water molecules to form crystals. These crystals look like ice, and they cement together the ocean sediments. In some places a solid layer of crystals—called **methane hydrate**—extends from the sea floor down hundreds of meters.

In addition to the methane trapped in crystals, scientists think that huge deposits of free methane gas are trapped beneath the hydrate layer. The methane in hydrates is very concentrated. The molecules of methane are packed together more closely in hydrates than in liquefied gas. Hydrates are the richest reservoirs of methane known to exist. Researchers estimate that there is more carbon trapped in hydrates than in all the fossil fuels—an enormous amount of energy.

Some of this methane is trapped in polar ice, but most is located in the waters off the East and West coasts, as well as Alaska. One deposit in a 30-by-100 mile area off the North Carolina coast holds enough methane to supply all the needs of the U.S. for 100 years. The challenge is to recover this methane safely and economically. We know that most of the hydrates are not hard to reach. They are located in ocean waters at depths of 1,000 to 3,000 meters. Drilling rigs in the Gulf of Mexico operate in much deeper water. Researchers think that it may be simple to free the methane from the crystals by reducing the pressure on them.

The Russians have used antifreeze to break down hydrates located on-shore in Siberia. Some researchers think that warm surface water could be piped to the bottom of a hydrate zone to melt it, while other pipes could vent the gas to the surface. Refining this technique, however, could take years of research. Perhaps the biggest question is the effect that removing the methane will have on the environment. When methane is removed from a hydrate, it loses its solidity and turns into mush. This could cause major landslides and other disturbances to the ocean floor.

Recovery efforts might also cause an increase in methane escaping into the atmosphere. Methane is a greenhouse gas and scientists think that methane from ocean hydrates has an impact on global climate. During the Ice Age, for example, sea levels dropped as the water became frozen on land.

As the sea level dropped, the pressure decreased, causing hydrates to melt and release huge amounts of methane into the air. Researchers think this caused a greenhouse effect that warmed the earth, moderating the temperatures.

In warmer periods, as glaciers and ice caps melted, the sea levels rose and increased the pressure on the hydrates. Less methane escaped into the atmosphere. This, in turn moderated the climate. Any wide-scale attempts to harvest methane from ocean hydrates will have to take into account the environmental impacts to the ocean floor and the atmosphere. Much research must be done before methane hydrate becomes a usable energy source for the future.

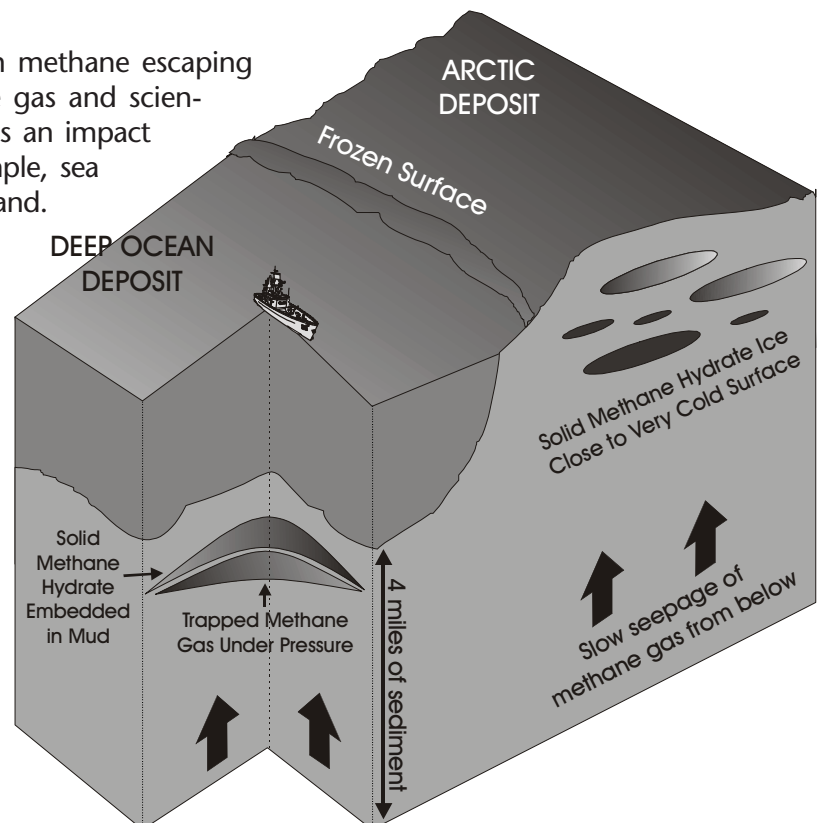

Solar Energy

Every day, the sun radiates an enormous amount of energy. This energy comes from within the sun itself. Like most stars, the sun is a big gas ball made mostly of hydrogen and helium. The sun produces energy in a process called nuclear fusion. The high pressure and temperature in the sun's core cause hydrogen atoms to split apart. Four hydrogen nuclei combine, or fuse, to form one helium atom, producing radiant energy in the process.

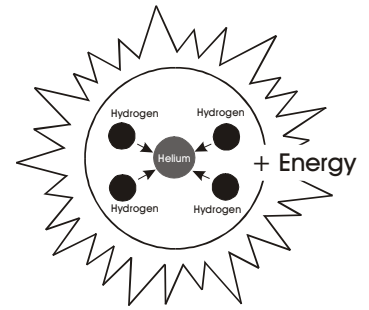

NUCLEAR FUSION

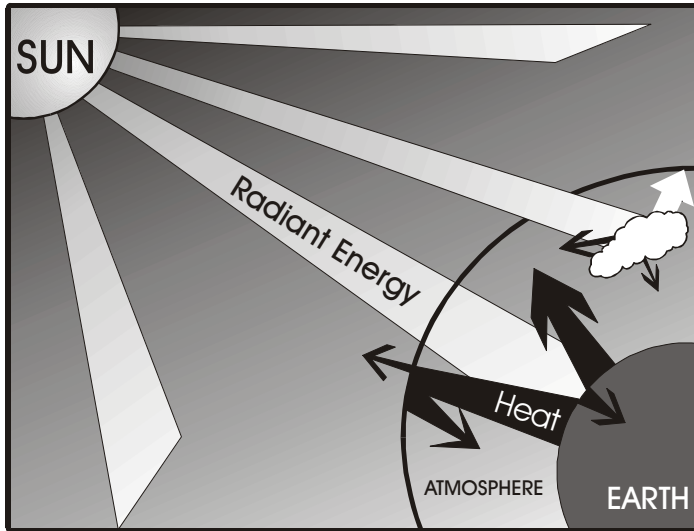

The sun radiates more energy in one second than the world has used since time began. Only a small portion of this energy strikes the earth, one part in two billion. Yet this amount of energy is enough to meet the world's needs, if it could be harnessed. About 15 percent of the radiant energy that reaches the earth is reflected back into space. Another 30 percent is used to evaporate water, which is lifted into the atmosphere and produces rainfall. The radiant energy is also absorbed by plants, landmasses, and the oceans.

Oceans cover more than 70 percent of the earth's surface and most of the ocean's energy comes from the sun. Only the tides—caused by the gravitational energy of the moon—and the geothermal energy under the oceans are not solar powered. Ocean currents, waves, and winds all are a result of the sun's radiant energy. Solar energy can also be used to produce electricity with photovoltaics.

Photovoltaic comes from the words photo (meaning light) and volt, a measurement of electricity. Photovoltaic cells are also called PV cells or solar cells. You are probably familiar with photovoltaic cells in solar-powered toys and calculators. The main disadvantage of PV cells is that they cannot produce electricity all the time.

Photovoltaic cells are made of two thin pieces of silicon, the substance that makes up sand. One piece of silicon has a small amount of boron added to it, which gives it a tendency to attract electrons. The other piece of silicon has a small amount of phosphorous to it, giving it an excess of free electrons. When the two pieces of silicon are placed together, an electric field forms between the layers. When the PV cell is placed in the sun, the radiant energy energizes the free electrons. If a circuit is made connecting the layers, electrons flow from the n-layer through a wire to the p-layer, producing electricity.

Compared to other ways of generating electricity, PV systems are expensive, but they are a good way to produce electricity in remote areas. Some offshore platforms have begun using PV systems to generate the electricity they need. One international energy company has designed solar systems to power radio communications, helicopter landing pad lights, and navigation warning lights on offshore platforms. Ocean buoys and other monitoring equipment also have PV cells as a power source.

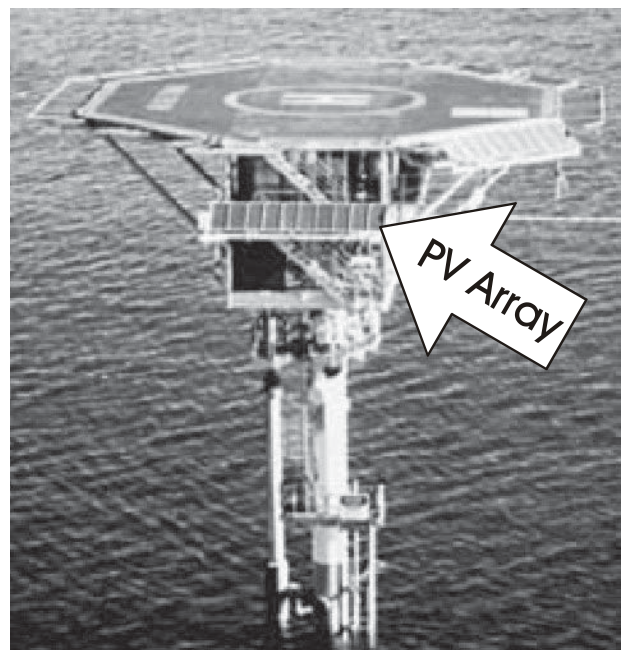

Wind Energy



Wind is air in motion. It is produced by the uneven heating of the earth's surface by the sun. Since the earth's surface is made of various land and water formations, it absorbs the sun's radiation unevenly. When the sun is shining during the day, the air over landmasses heats more quickly than the air over water. The warm air over the land expands and rises, and the heavier, cooler air over the water moves in to take its place, creating local winds. At night, the winds are reversed because the air over land cools more rapidly than the air over water. Similarly, the large atmospheric winds that circle the earth are created because the surface air near the equator is warmed more by the sun than the air over the North and South Poles.

Wind energy is mainly used to generate electricity. Windmills work by slowing down the speed of the wind. The wind flows over the airfoil-shaped blades causing lift, like the effect on airplane wings, causing them to turn. The blades are connected to a drive shaft that turns an electric generator to produce electricity. Wind turbines are being installed on offshore oil and gas platforms in many areas to generate power to operate the equipment.

For wind machines to be economical, there must be winds that blow consistently above 10-14 miles per hour. Many offshore areas have ideal wind conditions for wind machines. Denmark and the United Kingdom have installed large offshore wind parks to take advantage of the consistent winds. Several offshore parks are planned for the United States in the near future, including one in Nantucket Sound and one off Long Island, NY.

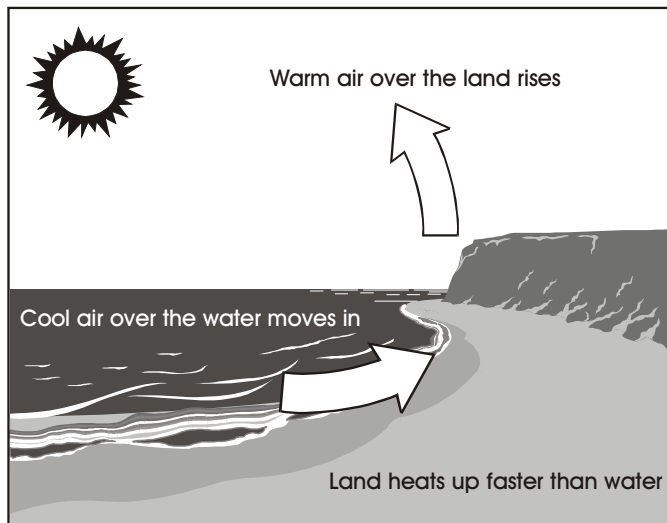

Cape Cod Wind Project

The first offshore wind park in the United States is planned for Nantucket Sound, five miles off the coast of Cape Cod, Massachusetts, in an area with optimal wind speed and direction. The wind park will consist of 170 wind turbines (each 260 feet tall with 164 foot blades) spread over a 25 square mile area of the sound. When the wind park is completed in 2005, the project will generate enough electricity to power more than a half million homes.

Developers plan to build the wind park on Horseshoe Shoal, a shallow area in the sound that is almost above sea level at low tide, making construction a relatively simple process that will not interfere with boat traffic. The turbines will be spaced about one-third of a mile apart and connected by undersea cables.

Not everyone in the area is excited about the project, however. The area is a tourist destination and many people are upset about the impact of building large wind towers in pristine waters that are used by pleasure boaters and commercial fishermen. The developers insist the towers will be nearly invisible from shore, but others believe they will be visible and offensive, especially at night with hundreds of navigation lights. To learn more about the pros and cons of this renewable energy project, you can go to www.capewind.org and www.saveoursound.org.



Wave Energy

Waves are caused by the wind blowing over the surface of the ocean. In many areas of the world, the wind blows with enough consistency and force to provide continuous waves. There is tremendous energy in the ocean waves. The total power of waves breaking on the world's coastlines is estimated at 2-3 million megawatts. The west coasts of the United States and Europe and the coasts of Japan and New Zealand are good sites for harnessing wave energy.

One way to harness wave energy is to bend or focus the waves into a narrow channel, increasing their power and size. The waves can then be channeled into a catch basin, like tidal plants, or used directly to spin turbines. There aren't any big commercial wave energy plants, but there are a few small ones. Small, on-shore sites have the best potential for the immediate future, especially if they can also be used to protect beaches and harbors. They could produce enough energy to power local communities. Japan, which must import almost all of its fuel, has an active wave-energy program.

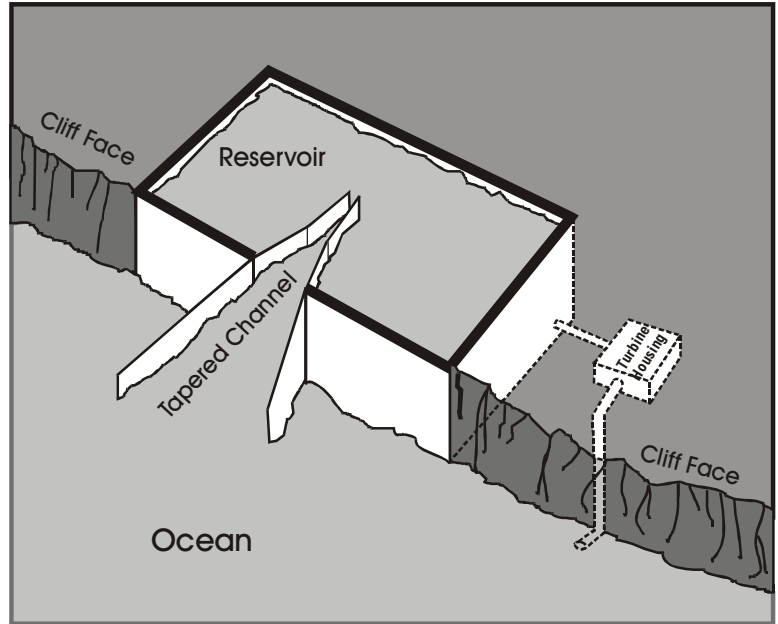

Another way to harness wave energy is with an Oscillating Water Column (OWC) that generates electricity from the wave-driven rise and fall of water in a cylindrical shaft or pipe. The rising and falling water drives air into and out of the top of the shaft, powering an air-driven turbine. In Norway, a demonstration tower that is built into a cliff produces electricity very economically using this method. The wail of the fast-spinning turbines, however, can be heard for miles.

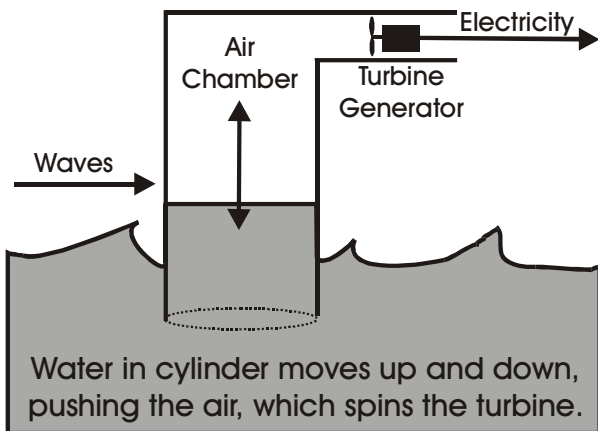
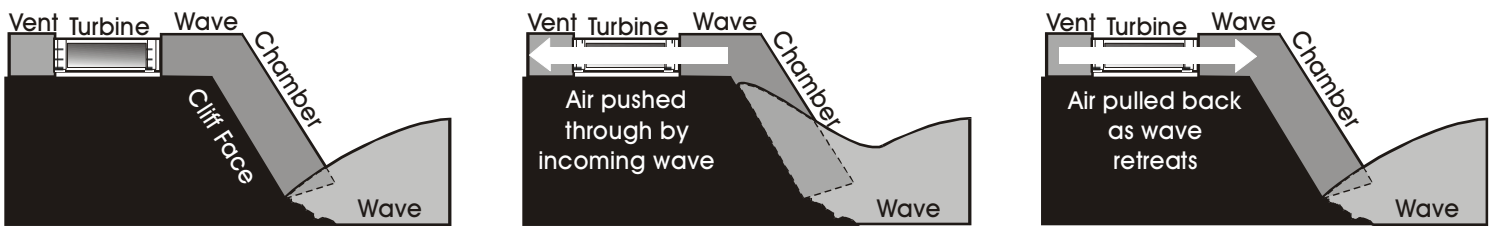

Float devices can generate electricity from the bobbing action of a floating object. The object can be mounted to a floating raft or to a device fixed on the ocean floor. These types of devices can power lights and whistles on buoys.

OTEC—Ocean Thermal Energy Conversion

The energy from the sun heats the surface water of the ocean. In tropical regions, the surface water can be 40 or more degrees warmer than the deep water. This temperature difference can be used to produce electricity. Ocean Thermal Energy Conversion (OTEC) has the potential to produce more energy than tidal, wave, and wind energy combined.

The OTEC systems can be open or closed. In a closed system, an evaporator turns warm surface water into steam under pressure. This steam spins a turbine generator to produce electricity. Water pumps bring cold deep water through pipes to a condenser on the surface. The cold water condenses the steam, and the closed cycle begins again. In an open system, the steam is turned into fresh water, and new surface water is added to the system. A transmission cable carries the electricity to the shore.

The OTEC systems must have a temperature difference of about 25 degrees Celsius to operate. This limits OTEC's use to tropical regions where the surface waters are very warm and there is deep cold water. Hawaii, with its tropical climate, has experimented with OTEC systems since the 1970's.

Today, there are several experimental OTEC plants, but no large operations. There are many challenges to widespread use. The OTEC systems are not very energy efficient. Pumping the water is a giant engineering challenge. In addition, the electricity must be transported to land. It will probably be 10 to 20 years before the technology is available to produce and transmit electricity economically from OTEC systems.

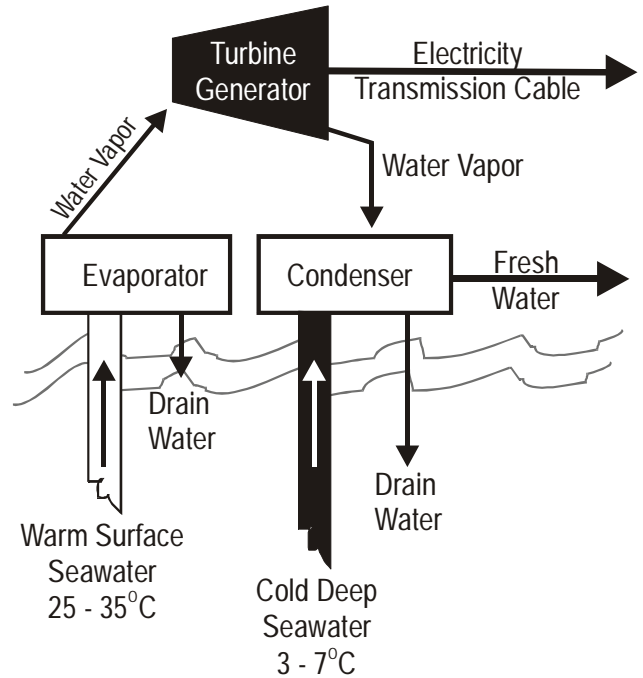

OTEC Floating Platform

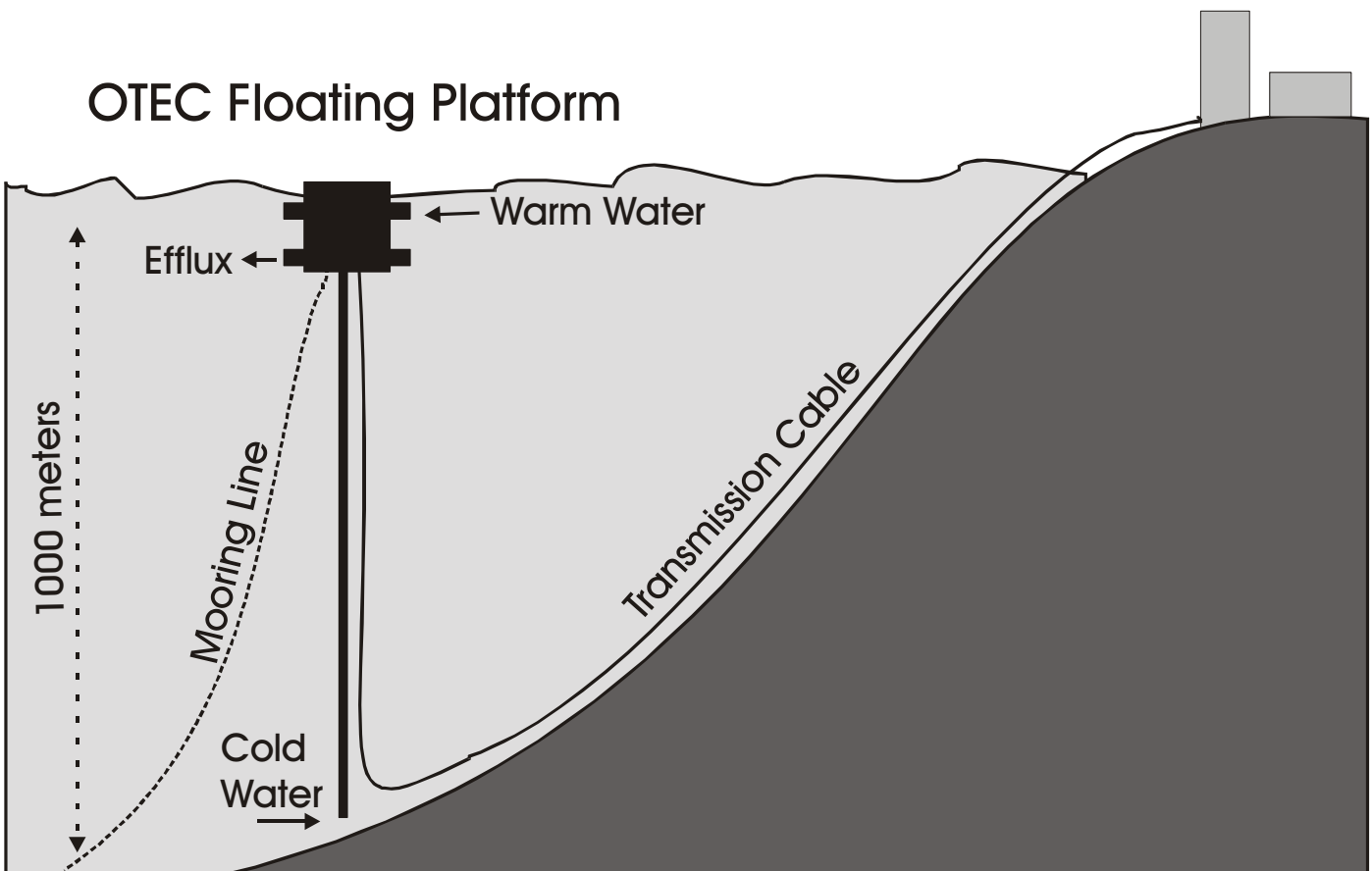

Tidal Energy

The tides rise and fall in eternal cycles. Tides are changes in the level of the oceans caused by the gravitational pull of the moon and sun, and the rotation of the earth. Nearshore water levels can vary up to 40 feet, depending on the season and local factors. Only about 20 locations have good inlets and a large enough tidal range—about 10 feet—to produce energy economically.

The generation of electricity from tides is similar to hydroelectric generation, except that tidal water flows in two directions. The simplest generating system for tidal plants involves a dam, known as a barrage, across an inlet. Sluice gates on the barrage allow the tidal basin to fill on the incoming high tides and to empty through the turbine system on the outgoing tide, known as the ebb tide. Flood-generating systems that generate power from the incoming tide are possible, but are less favored than ebb generating systems. Two-way generation systems, which generate electricity on both the incoming and ebb tides, are also possible.

The construction of a tidal barrage in an inlet can change the tidal level in the basin. It can also have an effect on the sedimentation and turbidity of the water within the basin. In addition, navigation and recreation can be affected. A higher tidal level can cause flooding of the shoreline, which can affect the local marine food chain. Potentially the largest disadvantage of tidal power is the effect a tidal station has on the plants and animals that live within an estuary. Since few tidal barrages have been built, very little is known about the full impact of tidal power systems on the local environment. In every case, it will depend on the local geography and marine ecosystem.

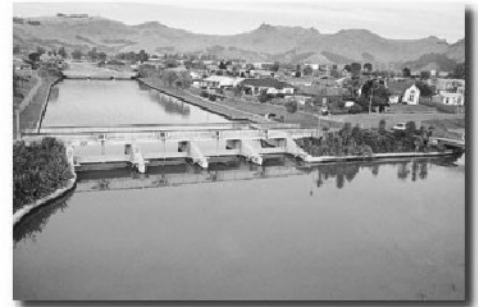

There are currently two commercial sized barrages in operation—a 240 MW turbine at La Rance, France, and a 16 MW plant at Annapolis Royal, Nova Scotia, Canada. Several other tidal power stations are being considered, including the Severn project in England. The United States has no tidal plants and only a few sites where tidal energy could be produced economically. France, England, Canada and Russia have much more potential. The keys are to lower construction costs, increase output, and protect the environment.

Tidal fences can also harness the energy in the tides. A tidal fence has vertical axis turbines mounted within a fence structure called a caisson that completely blocks a channel, forcing all of the water through it. Unlike barrage stations, tidal fences can be used in unconfined basins, such as in a channel between the mainland and a nearby offshore island, or between two islands. As a result, tidal fences have much less impact on the environment, because they do not require flooding the basin. They are also significantly cheaper to install. Tidal fences have the advantage of being able to generate electricity once each individual module is installed. Tidal fences are not free of environmental and economic impacts, however, since the caisson can disrupt the movement of large marine animals and shipping. A 55MW tidal fence is planned for the San Bernadino Strait in the Philippines.

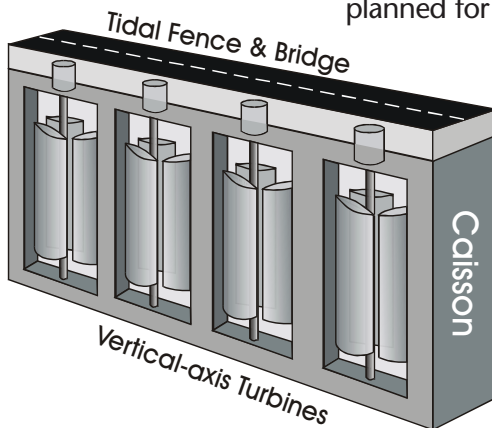

Tidal turbines are a new technology that can be used in many tidal areas. Tidal turbines are basically wind turbines that can be located wherever there is strong tidal flow, as well as in river estuaries. Since water is about 800 times as dense as air, tidal turbines will have to be much sturdier than wind turbines. They will be heavier and more expensive to build, but will be able to capture more energy.

Tidal Turbine

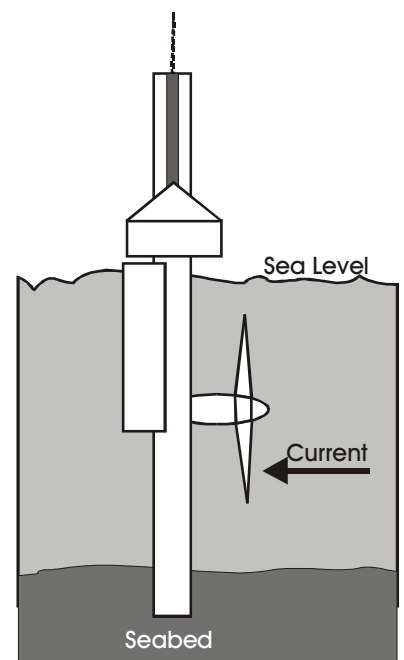

Activity 1: Exploring Oil Seeps

Materials:

- 1 large clear glass
- 1 small mixing bowl
- 2 ml (milliliters) of cooking oil
- 10 cm³ (cubic centimeters) of sand
- 30 cm³ (cubic centimeters) of soil
- 1 piece of clay
- water

Procedure:

- 1 Pour the sand into the bottom of the glass.
- 2 Pour the oil into the sand and add 1 ml of water.
- 3 Mix the soil with water until it is very wet, then pack tightly into the glass.
- 4 Flatten the clay into a circle as large as the opening of the glass.
- 5 Make a thin seal over the soil with the clay.
- 6 Fill the glass with water.
- 7 Observe the surface of the water to see how long it takes the oil to seep through the layers to the top of the water.

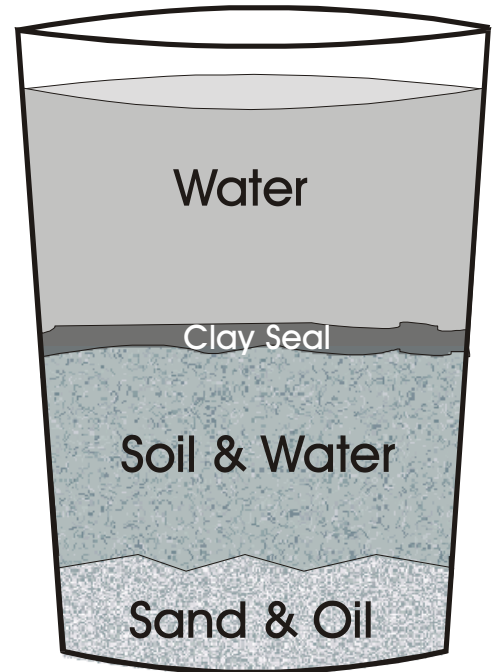

Results:

How long did it take for the oil to begin seeping to the top of the water?

Questions:

How long do you think it would take for all of the oil to seep to the top? How would you design an experiment to determine this?

Would the oil seep faster if you constantly agitated the glass?

Would a taller glass with more water (more pressure) affect the rate of seepage?

What effect would using saltwater have?

Activity 2: Drilling for Oil in the Ocean

Materials:

- 15 cm x 15 cm piece of foam board
- 4 sharpened pencils
- 2 clear plastic straws for each student
- 10-gallon aquarium
- 300 cm³ (cubic centimeters) of dark sand
- 1 large bag of light sand
- clear tape
- water

Procedure:

- 1 Pour the dark sand into the aquarium in three equal mounds.
- 2 Cover the bottom of the aquarium and the mounds of dark sand to a depth of 6 cm with light sand to resemble the ocean floor.
- 3 Carefully fill the aquarium to a depth of 20 cm with water, taking care not to disturb the sand.
- 4 Cut a 2 cm hole in the middle of the foam board.
- 5 Insert one sharpened pencil into each corner of the foam board, as legs for an oil rig.
- 6 Carefully place the rig in the water. The deck of the oil rig (foam board) should be slightly above water level.
- 7 Tape two straws together end to end so that the juncture is completely sealed to make a drill.
- 8 Try to strike oil by inserting your drill through the hole in the deck into the sand until it hits the bottom of the aquarium. Cover the end of the straw tightly with one finger and remove the straw.

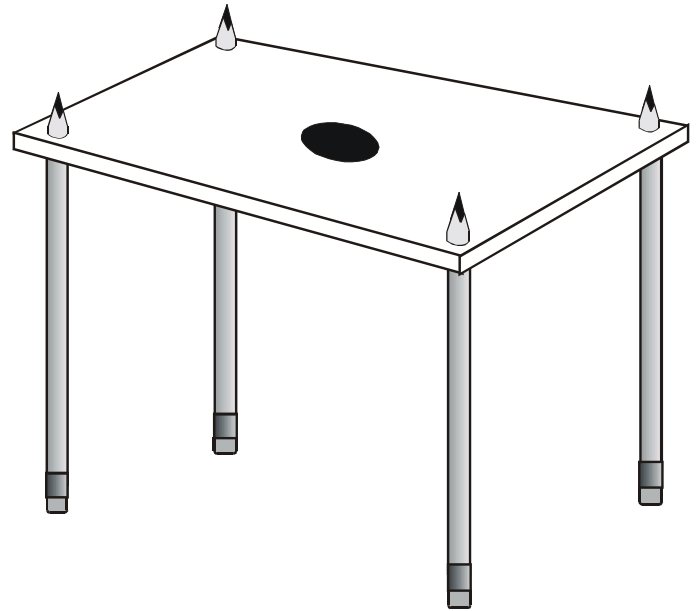

Results:

Is there any dark sand in the end of the straw? Did you strike oil?

Research Questions:

How do geologists determine where to look for oil under the ocean?

What are the challenges of finding and producing oil from offshore basins?

What would life be like working on an offshore oil rig?

Activity 3: A Stationary Oil Rig

Background:

An oil rig is built on shore, then floated out to the drilling site on huge barges. In shallow water, a rig rests on the ocean floor on long, hollow legs. While the rig is being towed to the site, the legs are filled with air. Once the rig reaches the site, valves in the legs are opened and the legs slowly fill with water, so that they sink to the bottom.

Materials:

10-gallon aquarium with water
15 cm x 15 cm piece of foam board
4 clear plastic straws
4 toothpicks
sharp knife
clay

Procedure:

- 1 Fill the aquarium with water to a depth of 15 cm.
- 2 Cut two 1-cm slits near the bottom of each straw with a sharp knife. The slits will act as water valves.
- 3 Make holes at the corners of the foam board and insert the ends of the straws without the slits.
- 4 Seal both ends of the straws with clay. Mold the clay on the bottoms into 2 cm x 2 cm square feet.
- 5 Float the platform in the aquarium.
- 6 Insert toothpicks in the slits in the straws to hold them open. (*Opening the valves in the legs of the rig*).
- 7 Break the seal of the clay at the top of the straws so that the air in the straws can escape.

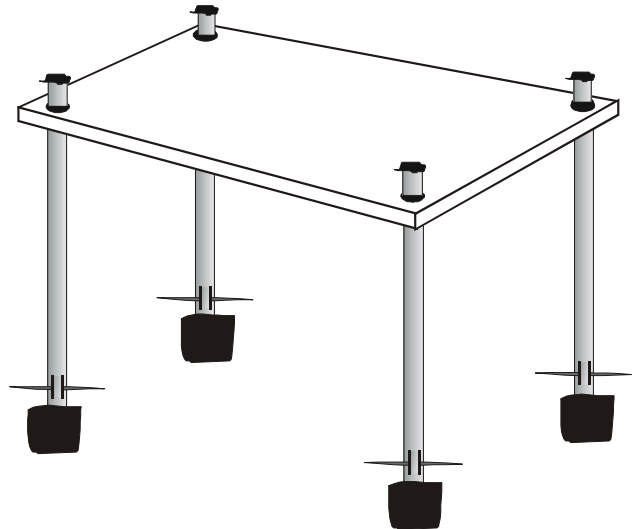

Results:

Describe the action of the rig as the straws filled with water.

Research Question:

What is the maximum depth of water in which a stationary rig could be used?

Activity 4: A Floating Oil Rig

Background:

When drilling in deep water, a floating rig is used. Air-filled tanks (called ballast tanks) support the rig, which is tethered to the bottom with cables.

Materials:

- 10-gallon aquarium with water
- 15 cm x 15 cm foam board
- 4 small empty glue bottles with twist-close tops
- 4 pieces of string or yarn 45 cm long
- 8 small weights such as sinkers
- sharp knife

Procedure:

- 1 Fill the aquarium with water to a depth of 20 cm.
- 2 Make two small holes near the bottom of each glue bottle.
- 3 Run a piece of string through the holes so that the string is hanging evenly from each bottle.
- 4 Attach the weights to the ends of string.
- 5 Remove the tops from the glue bottles.
- 6 Make holes in the foam board big enough for the necks of the glue bottles. Insert the bottles through the holes and replace the tops, closing them tightly.
- 7 Place the rig in the aquarium.
- 8 Spread out the weights on the bottom of the aquarium to secure the rig.
- 9 Adjust the water level in the aquarium if the weights don't reach the bottom.
- 10 Open the tops of the glue bottles.

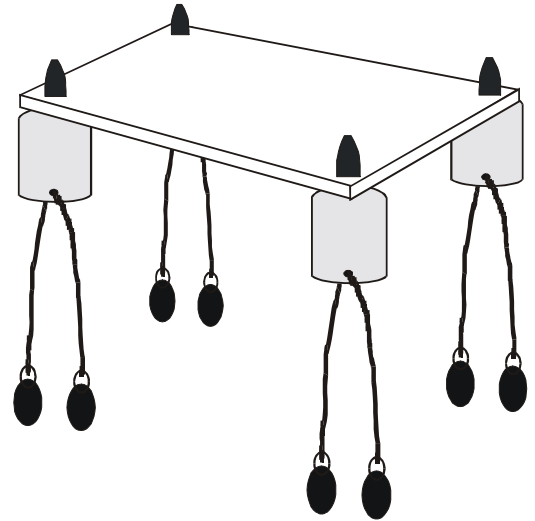

Results:

What happened when the tops of the glue bottles were opened?

Research Questions:

As more equipment is added to a floating rig, would you want more or less air in the ballast tanks?

What are some unique challenges to drilling in deep water?

Activity 5: Exploring Currents

Materials:

- 1 large glass beaker
- 2 ice cubes
- 4 drops of dark food coloring
- 1 bunsen burner with tripod, ring, and gauze mat
- water

Procedure:

- 1 Fill the beaker with water and place on the ring.
- 2 Put the ice cubes into the water.
- 3 Heat the water very slowly with the bunsen burner.
- 4 Add food coloring very carefully to the top of the water.
- 5 Observe the food coloring.

Results:

What happened to the food coloring?

Questions:

Which is denser—warm water or cold water?

How can you use this demonstration to explain how ocean currents are driven by the sun?

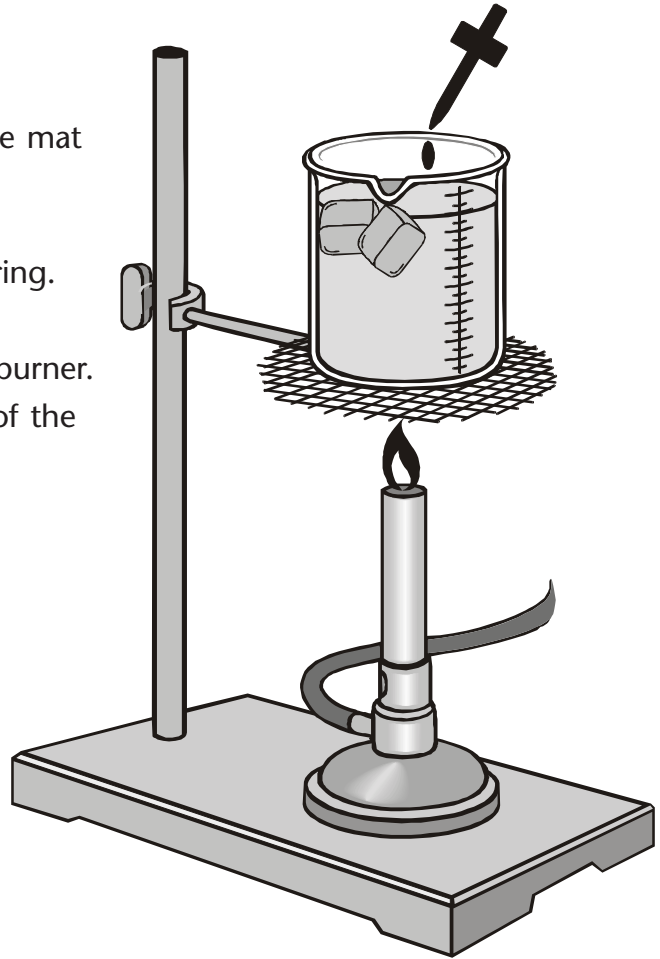

Activity 6: Exploring Wave Energy

Materials:

- 1 large deep pan
- 1 electric fan
- 1 drinking straw
- 1 piece of tissue paper (2 cm x 1/2 cm)
- tape
- water

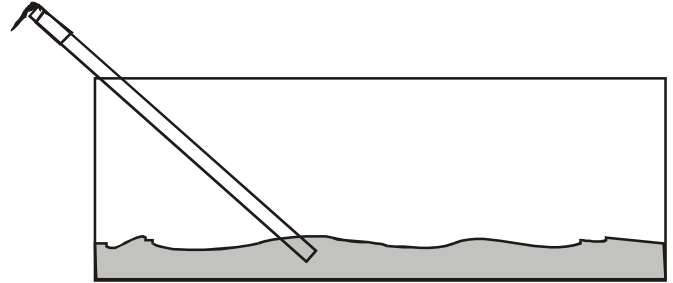

Procedure:

- 1 Tape one end of the tissue paper to the straw so that it hangs over one end of the straw.
- 2 Fill the pan to a depth of 2 cm with water.
- 3 Place the straw at an angle at one end of the pan, as shown in the diagram.
- 4 Use your hand to push the water in the pan into waves toward the straw.
- 5 Observe the tissue paper on the end of the straw.
- 6 Fill the pan almost to the top with water and remove the straw.
- 7 Turn on the fan and have it blow across the water.
- 8 Observe the top of the water.

Results:

What happened to the tissue paper on the end of the straw?

What effect did the fan have on the surface of the water?

Questions:

How can wave energy be harnessed using the concepts in this demonstration?

How does the sun produce wave energy?

Activity 7: Exploring Wind Energy

Materials:

- 1 unsharpened pencil with eraser
- 1 straight pin
- 1 piece of construction paper
- scissors
- electric fan
- marker

Procedure:

- 1 Cut a 20 cm x 20 cm square of construction paper.
- 2 Fold the paper from corner to corner, then open and fold opposite corners. Flatten the paper and mark the intersection with a dot.
- 3 Cut a little more than halfway up each crease.
- 4 Turn the paper over and place dots on the left points of each corner about 1 cm from the ends.
- 5 Stick the straight pin through the dot of each point in turn, then through the center dot and into the side of the pencil eraser. Make sure the pinwheel can spin freely on the straight pin.
- 6 Use the fan to provide wind power for the pinwheels. Explore the relative speed of the pinwheels at different distances from the fan and at different fan speeds.

Results:

How did the distance from the fan and the fan speed affect the rotation speed of the pinwheel?

Research Questions:

How do windmills produce electricity from wind power?

What are the advantages and disadvantages of wind machines?

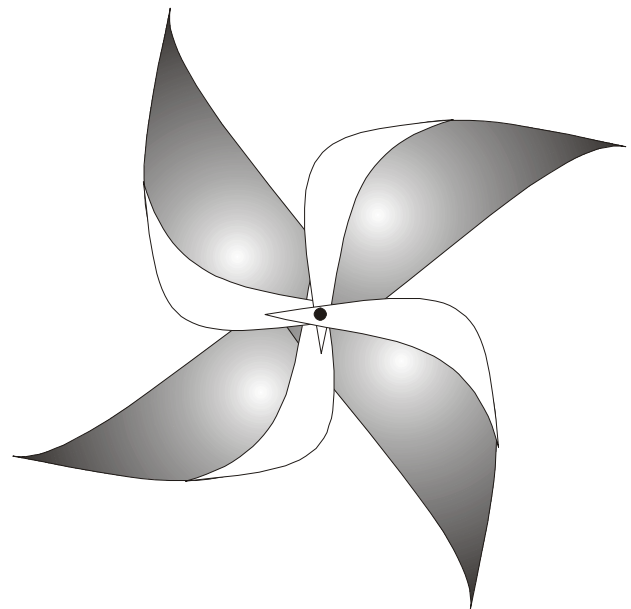
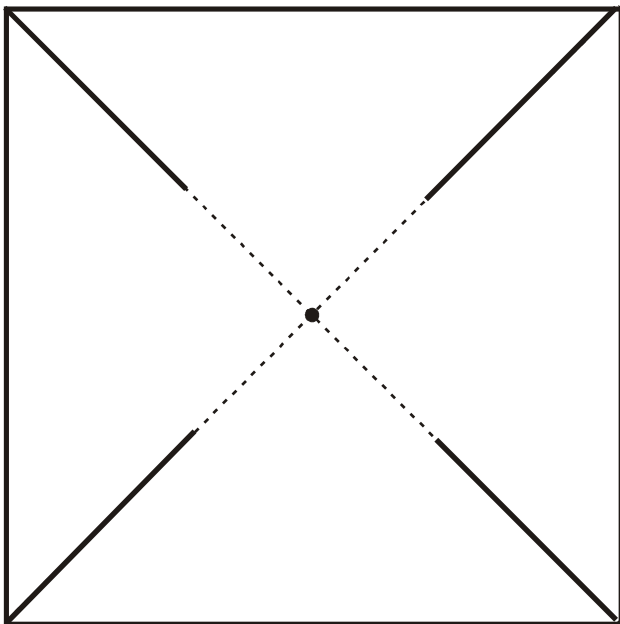



U. S. Department of the Interior
Minerals Management Service
Washington, D.C. 20240

www.mms.gov

