

**PREVENTING INJURIES CAUSED BY UNRECOGNIZED STONE MINE ROOF BEAM FAILURES
WITH A PRO-ACTIVE ROOF CONTROL PLAN**

**A.T. Iannacchione
L.J. Prosser
R. Grau
D.C. Oyler
D.R. Dolinar
T.E. Marshall
C.S. Compton
NIOSH
Pittsburgh, PA**

ABSTRACT

Unrecognized roof beam failures resulted in 69% of the falls of ground injuries occurring in underground U.S. stone mines from 1990 to 1996. Field investigations at 45 underground stone mines suggest that excessive beam sag or deflection is the principal unstable roof behavior characteristics associated with miner injuries. Laminated roof structures, common in most underground stone mines, allow the immediate roof to separate into distinct beams. The timely determination of roof beam deflection could provide stone miners with advanced knowledge of potentially hazardous roof. Existing methods to assess roof conditions consist of observational and monitoring techniques. Observational techniques include open drillholes, sounding, wedging, and borescopes. Monitoring techniques include scratch tools, extensometers, telltales, Miners Helpers, and Guardian Angels¹. Miners have difficulty utilizing these techniques because roof beams are located an average of 8 m (26.5 ft) above the miner's head in environments that are dark, dusty and noisy and these deflections are measured in millimeters of movement. To help mitigate the potential for falls of ground injuries to underground stone miners, the National Institute for Occupational Safety and Health (NIOSH) has developed the Roof Monitoring Safety System (RMSS) to aid in monitoring dangerous levels of roof beam deflection. If enough site-specific information is collected and placed on highly visible maps, individual mining operations could establish general guidelines for responding to specific roof beam deflection occurrences. This would help in implementing a pro-active, comprehensive roof control plan for reducing falls of ground injuries.

BACKGROUND

From 1990 to 1996, 16 states reported 92 injuries from falls of roof, rib or face in the more than 90 underground stone mines within the United States (Figure 1). Missouri, Pennsylvania, and Kentucky accounted for 48 % of the total number of injuries (Figure 2). Of this total, 11 miners have been fatally injured. Of the 11 fatalities 10 or 91 % were associated with unrecognized loose or failed rock within the roof beam. Additionally, unrecognized roof beam failures resulted in 69 % of the falls of ground injuries occurring in underground U.S. stone mines from 1990 to 1996. While this number is not large in magnitude, a work force of fewer than 2,000 miners makes for a very high fatal accident rate. The severity of the typical fall of ground injury is, in general, very high. Approximately 62 % of all roof, face, and rib fall injuries were designated by the Mine Safety and Health Administration (MSHA) as some kind of lost time accident. MSHA assigns each accident a severity value from 1 to 6. A 1 represents a fatality, a 2 a permanent disability, and 3 a lost time accident (Figure 3).

INTRODUCTION

The majority of underground stone mines operate in relatively thick limestone formations. Intact (solid) pieces of limestone are generally very strong, often having compressive strengths of 207 MPa (30,000 psi) and tensile strengths of 14

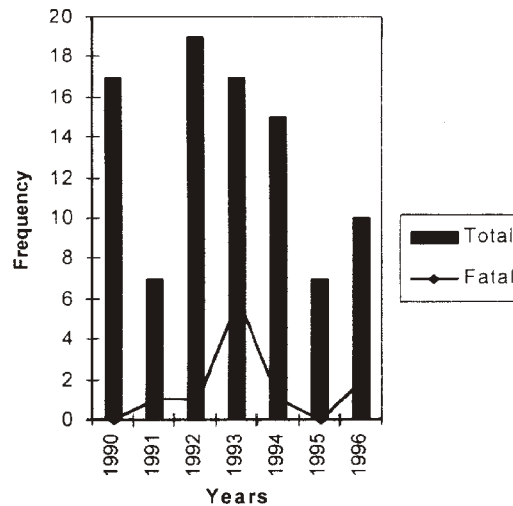

Figure 1 - Roof, face, and rib fall injuries in the underground stone industry.

MPa (2000 psi). Persistent horizontal bedding planes typically cause limestone roof rock members to separate into beams ranging from 0.15 m (0.5 ft) to 1 m (3 ft) thick which span large rooms, ranging from 6.1 m (20 ft) to 18.3 m (60 ft), and averaging 13.1 m (43 ft) in width (Figure 4). The deformation characteristic that affects roof beam stability is excessive deflection (Figure 5). If deflection or bending of the roof beams becomes excessive, roof failure can occur leading to injuries to miners. However, these beams can contain vertical and sub-vertical discontinuities (vertical joints or fractures and sub-vertical cross-beds planes) which sometimes affect local roof beam strength producing wedge or prism shaped failures (Figure 5).

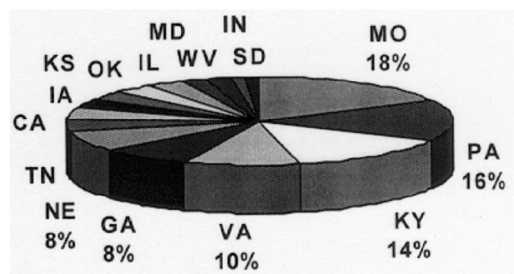

Figure 2 - Underground stone roof, face, and rib fall injuries by state from 1990 to 1996.

¹Reference to specific products does not imply endorsement by NIOSH.

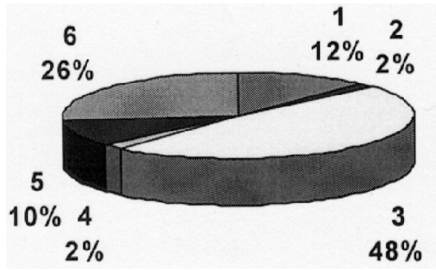

Figure 3 - Severity of roof, face, and rib fall accidents from 1990 to 1996.

If dangerous roof beam deflection values are known, they can be used as a clear indicator of roof instability (Parker, 1973). Undoubtedly there is a significant potential for roof monitoring to assist miners and mining operations in gathering quantitative as well as qualitative information. But for this technology to be fully implemented several technical problems must be overcome: 1) the factors which influence the variability in roof beam deflection and failure must be identified, 2) a simple, inexpensive method to monitor dangerous levels of roof beam deflection must be produced, and 3) guidelines for evaluating the output of these monitoring devices must be established.

CURRENT ROOF MONITORING TECHNOLOGY

Observing and monitoring rock deformations provides information for making critical mining decisions and potentially acts as a warning of impending hazardous conditions.

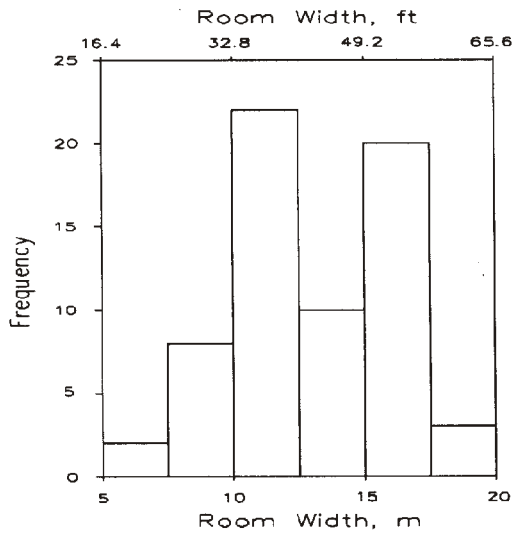

Figure 4 - Histogram of room widths for 65 underground stone mines.

Traditionally miners have sounded the rock, listening for the drummy sounds that signal loose rock. The act of drilling exploration, roof bolt, or blast holes can provide much information about the rock. If separations are present, the drill will often accelerate through these zones. Dust and water from

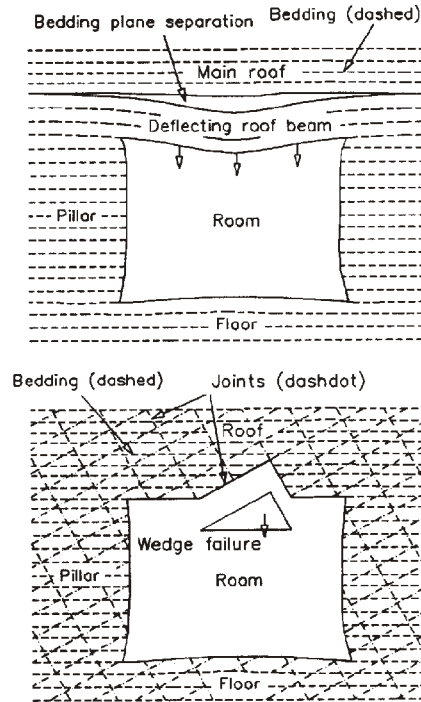

Figure 5 - Two different modes of roof rock failure that are common in underground stone mines.

adjacent fractures or drillholes indicates the occurrence of hidden rock fractures. Borescopes and borehole cameras have been used to observe fracture characteristics and roof lithology with increasing frequency as the quality and cost of these devices improves. Wedges inserted into angular fractures or horizontal bedding planes along the roof and ribs of the mine have been used to observe the movement of rock masses, i.e. if the wedge falls out, the rock mass is moving.

Observational techniques can be extended by monitoring the movement of the mine roof on some kind of regular basis. Monitors can be divided into two basic types: 1) roof-to-floor convergence monitors, and 2) roof and rib extensometer monitors. Because most stone mine development rooms average 7.1 m (23 ft) and bench rooms average 16.4 m (54 ft)

in height, roof-to-floor convergence monitors are difficult to install, maintain, and analyze. Roof and rib extensometers have enjoyed wider use than convergence monitors, however, they are difficult to read because of their location on the roof line or back.

In its simplest form, roof and rib extensometer monitoring can be accomplished with a scratch tool (Figure 6). This device can detect separations and provide an indication of loose rock layers or roof beam deflection. Information on the location and size of the separation can be marked on the roof and used to assess potential future roof degradation.



Figure 6 - Photograph of a scratch tool.

Extensometers permanently installed in drill holes have been used in underground mines to detect ground fall hazards for many years. Sonic probe extensometers have been widely used in the US, UK, and Australia. This commercial system allows for 20 permanent anchors up to a 6m (20ft) height. The probe is temporarily inserted when measurements are made. Home made mechanical extensometers have consisted of a top and bottom anchor, steel wire or rigid tubing, and some kind of micrometer or dial gauge. These devices have been used for decades in metal mines in Michigan, Missouri, and Idaho. For example, in the Missouri lead belt district a deflection rate of (0.007 in/month) is considered a good warning of strata failure. Extensometers have been used as real time hazard warning devices. Parker (1973) discussed an ingenious method to alert miners of strata movement by adding a warning light to an extensometer.

The most common commercially available mechanical extensometer monitoring devices are the Miners Helper, the Guardian Angel, and the Dual Height Telltale (Figure 7). These monitors generally have one or two anchors points which measure the overall separation of rock layers in the immediate

roof. If roof deflection is detected by the Miners Helper and the Guardian Angel a reflecting flag drops from the roof line, signaling the potential for imminent roof failure. In some cases this information has been used to indicate a need to add roof support, remove roof rock, or danger off affected areas.

Coal mines have used telltales for decades to warn miners of strata movement. The telltale is a rigid bar, possibly a roof bolt, anchored into the roof. A small section of rod protruding from the borehole is covered with three bands of reflective tape. The portion of the bar closest to the roof is generally green, followed downward by yellow and then red. The idea is that as the roof deflects downward the roof line can easily be seen to move through the green, yellow and finally red tape zones. Recently Bay Tech has produced an electronic telltale. In the United Kingdom, coal mines use telltales every 20 m (65 ft) with action bands from 0.4 to 2 cm (0.2 to 1 in). Between 1990 and 1995 falls of ground were reduced from 267 to 6, partially because of the use of telltales (Altounyan et. al, 1997).

OVERVIEW OF GROUND CONTROL PLANNING METHODS

Generally, underground mines use observational techniques, primarily visual inspection as a means of determining roof stability. Through the processes of blasting, drilling, and scaling additional knowledge related to roof conditions is gained. For example, a driller preparing to bolt notices a sudden increase in the penetration rate, realizes that possibly a gap or clay seam was encountered. Much of this "hands-on" information provides an overview of the general conditions related to roof stability. However, this base of knowledge can quickly deteriorate if that hands-on experience is lost through changes in employment or other circumstances. Many mines supplement visual inspections and knowledge gained through hands-on experience with various types of observational and monitoring techniques. Based on observations of and discussions with personnel at 48 mines, 49 observational and monitoring techniques beyond basic visual inspections were used at 26 different mines (Table I). This suggests that additional information is beneficial or needed to solve some classes of ground control problems.

Table I. Number of Mines Using Observational and Monitoring Techniques

Observation or monitor type	Sound- ing	Obser- vation hole	Wedge	Borescope	Scratch tool	Extensom eter	Miners Helper	Guardian Angel	Telltale
Number of Mines	9	11	5	6	4	2	7	4	1

To date, observational techniques are used more than monitoring techniques and accounted for 31 of the 48 mines or 65 % of the total. Drilling observational holes to detect conditions in the roof was the single most used technique with 11 of the 48 mines or 23 % of the total. The data also show that 11 of the 48 mines or 23 % of the total used or have available commercial mechanical monitors (Miners Helper or Guardian Angel). This relatively low number of overall usage, as well as the fact that 46 % of the mines use no additional monitoring methods, suggests apparent limitation to utilizing these methods. A comprehensive ground control plan not only includes the basic observational, visual and hands-on components, but also uses supplemental observational and monitoring techniques and regularly reads, analyzes and displays information gained from these efforts. When this type of information is logged or mapped it provides a documented history of ground conditions. This information can be analyzed and prepared by either consulting firms or with in-house expertise. The availability of this information at the time of a major ground fall or when unstable geologic conditions are encountered is extremely useful in deciding a course of action or alteration of the mining plan. Mines that follow these practices and that promote open communication and participation from everyone at the site are the mines with the most pro-active approaches towards ground control safety.

NIOSH'S ROOF MONITORING SAFETY SYSTEM

While there have been considerable advancements in roof monitoring, existing instruments have several limitations which are minimizing the impact of this technology on underground

stone mining. These limitations include: 1) difficulty in taking readings in high roof or back areas, 2) exposure to dangerous ground while reading the monitors, 3) complexity in making repetitive readings, 4) problems with making multiple measurements horizons with multiple anchors, 5) difficulty in seeing warning devices in the dusty and foggy production face areas, and 6) expense of most commercial monitors.

A new generation Roof Monitoring Safety System (RMSS) developed by NIOSH improves on the existing methods for determining roof stability. This electro-mechanical roof monitor includes the following features: 1) can be fabricated in most standard mine shops, 2)-is relatively inexpensive [single point RMSS costs less than \$40/unit to fabricate in-house], 3) reduces potential damage from face blast because of the in-hole positioning [this is true only of the single point RMSS], 4) compatible with existing commercial data measurement devices, 5) capability for monitor reading at ground level [allows miner to take readings away from potentially unstable roof conditions] 6) remotely monitored with either multimeter (Figure 8) or data acquisition systems (Figure 8), and 7) can accommodate as many as six anchor points [this is true only of the multipoint RMSS]. See Appendix A for more information on fabrication, installation, and data analysis of the single point RMSS.

Perhaps the greatest benefit of this new monitor is that the miner does not have to make readings in areas of questionable roof stability. After all, these instruments are most often deployed in areas where roof rock instabilities are suspected. Figure 9 illustrates the advantage of the electro-mechanical RMSS over other existing techniques.

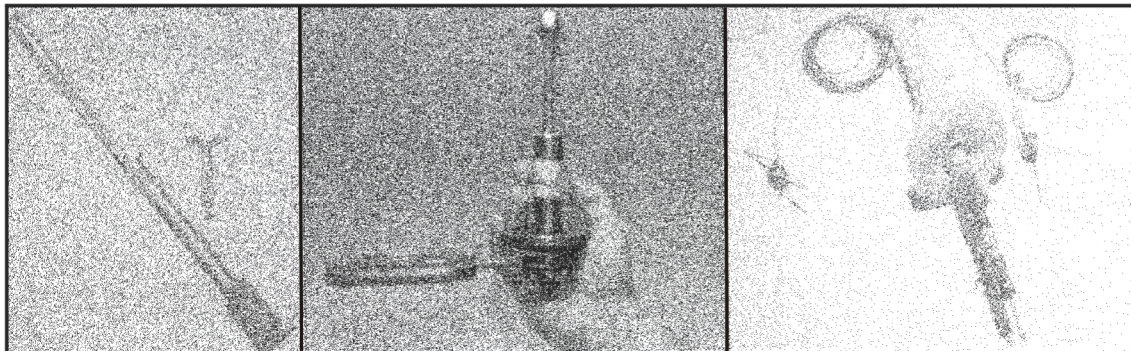

Figure 7 - Photograph of the commercially available Miners Helper, the Guardian Angel, and the RMT's Dual Height Telltale roof mechanical extensometer monitoring devices.

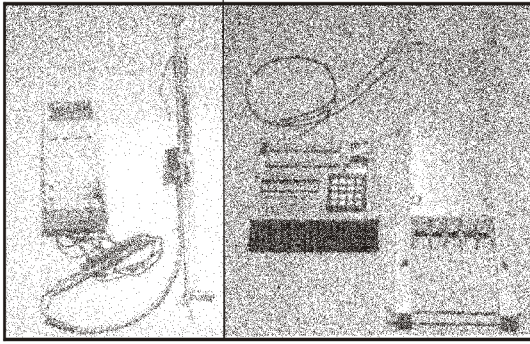

Figure 8 - Single-point RMSS with multimeter and multi-point RMSS with data acquisition.

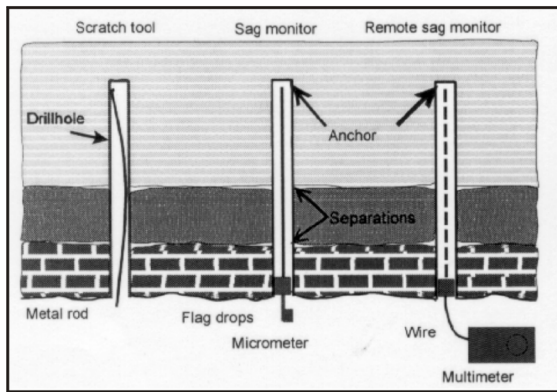

Figure 9 - Comparison of three roof monitoring techniques.

HOW DO ROOF MONITORS ASSESS STRATA STABILITY?

Every opening made in rock causes a redistribution of stresses in the adjacent strata. In bedded or layered sedimentary rock, the roof beams deflect into the opening immediately after excavation (Figure 10). A decay in the rate of deflection occurs as the stresses redistribute in response to the opening. Eventually, the beam deflection stabilizes (Figure 10). In most strata this initial deflection takes place very quickly. For example, NIOSH researchers have installed monitors in the face area a few days after a production blast and have not been able to detect this period of decelerating deflection. As time passes, these roof beams are subjected to natural and man-made processes such as dramatic humidity variations from changing environmental conditions, chemical alterations from strata water, tectonic stresses, additional mining adjacent to the opening, and heat from machinery. These processes initiate a period of instability which often continues until failure occurs. Generally, the rate of deflection increases steadily through this period. The entire length of this period can be minutes, days, or even years. For example, it is

not uncommon for the immediate roof beam to fail sometime between the blast and the time when miners first re-enter the face, in most cases a few hours. These beams are found draped over the rubble stone pile produced from the production blast. It is also not uncommon for beam failure to occur months or even years after the excavation has been formed. This period of quiet, between the decelerating and accelerating beam deflection periods, is the environmental condition which all miners desire to work under.

Roof beam deflection due to gravity loading can be estimated using standard formulas for deflection of beams or plates. For example, the maximum deflection (d) of a clamped, elastic beam is given by:

$$d_{\max} = \frac{\gamma(L)^4}{32E(t)^2}$$

where γ is the unit density of the limestone, E is the Modulus of Elasticity, L is the length of the beam in meters, and t is the thickness in meters. Figure 11 shows the effect varying beam lengths and thickness have on the maximum deflection of a 23.5 kN/m^3 (150 lb/ft^3), 41.4 GPa (6 Mpsi) fully intact beam of limestone. This deflection is, in general, very small and can take place quickly after an opening is excavated or much later as weathering processes aid in forming new, thinner beams. Tectonic processes can produce additional roof beam deflection by axially loading roof beams. Two-dimensional models have demonstrated how different levels of horizontal stresses may cause up to several centimeters of deflection prior to failure of roof beams (Iannacchione et. al, 1998). Vertical loading of roof beams from overlying or adjacent mining can load roof beams which in turn can accelerate deflection. In all of these examples, roof beam deflection is viewed as a precursor of failure and, if recognized early, could result in pro-active control solutions.

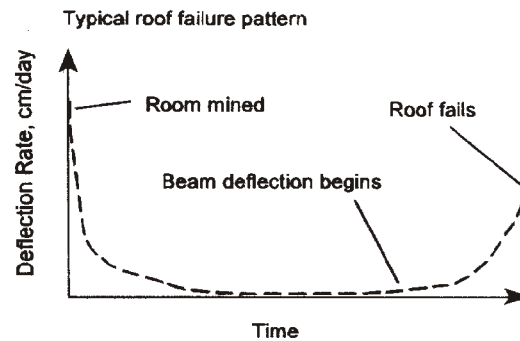

Figure 10 - Typical cycles experienced by failing stone roof beams. Note the periods of decelerating, quiet, and accelerating deflection rate.

A SITE SPECIFIC EXAMPLE OF A PRO-ACTIVE GROUND CONTROL PLAN

To further illustrate how information from roof monitors can help make safety decisions about the stability of mine roofs a site specific field test was performed and is discussed below. In 1996 the immediate roof at an operating stone mine began to fail approximately 90 m (300 ft) from the end of a previous directionally controlled roof fall. This original failure took on the appearance of a series of low-angled shear planes cutting or ripping the rock. The orientation of these planes was perpendicular to the orientation of the local horizontal stress field. Seven deflection monitors were quickly placed along the projected failure trend. Two of seven monitors used the 20-anchor point sonic probe; the other five were 3-anchor point prototypes of the RMSS.

Data collected from three of these monitors are shown in Figure 12. Monitor No. 7 collected deflection measurements for almost 70 days prior to total roof collapse. During this time, the roof deflected in three distinct phases. The first phase was marked by a slow but steady deflection in the lower roof beam. At approximately 40 days there was a sudden increase in the deflection of the beam. The third phase indicated that the beam deflection rate lessened, but ended in total roof failure. A total of approximately 5 cm (2 in) of roof deflection occurred prior to roof collapse. Data from monitor No. 3 showed a much different trend. Unlike monitor No. 7, this instrument was placed close to an existing failure; therefore, significant beam deflection could have already occurred. The area began to "cut or rip" on July 26, rapidly extending the zone of failed roof. The roof associated with monitor No. 3 went from stable to unstable in a matter of 5 hours.

Monitor No. 4 was purposely placed slightly away from the main failure trend. The magnitude of deflection measured from this instrument was 1/10 the magnitude of the instruments within the failure trend. However, these measurements did show that beam bending and associated shearing extended significant lateral distances on the order of 6 m (20 ft) from the fall's edge and 12 m (40 ft) from the center of the fall. This monitor also showed that while deflection was initiated in the lowest beam, beam separations quickly moved much higher in the roof.

This information proved extremely valuable to the mine. Several pro-active ground control strategies were implemented as a result of supplemental roof monitoring. Unstable roof areas were identified and personnel were restricted from entering. A new roof support plan was initiated that prohibited the progressive failure of the various roof beams. Roof monitoring was initiated in other areas of questionable stability. All of these actions had an extremely positive effect on the miners and regulators working at the site.

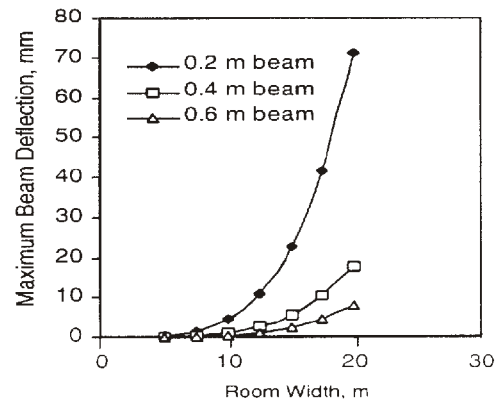

Figure 11 - Maximum deflection from gravity loading for various limestone beam geometries.

PROBLEMS, CRITICAL ISSUES, AND THE NEED FOR COOPERATION

RMSS technology has been utilized at 6 underground stone mines. Approximately 20 monitors have been fabricated, installed and are being read on a regular basis. These preliminary tests have revealed the following procedural questions: 1) how often should monitors be read, 2) where should monitors be placed within the entry, and 3) how should the data be analyzed? They have also revealed the importance of solving associated rock mechanics issues, such as: 1) what are critical deflection rates, 2) what geologic factors influence deflection magnitudes prior to a roof fall, and 3) at what locations in the roof does the failure initiate? The answers to these questions can provide the basis for recommendations/guidelines and can be used effectively and efficiently to improve the safety conditions for underground stone miners.

While much has been learned, more knowledge will be needed to help answer the question "when should monitoring techniques be used?" Because performance results are heavily dependent upon site specific conditions related to geologic, stress, and mining conditions, all monitoring data must be calibrated for site specific conditions. The solution to this problem demands a major research effort founded on a common goal and good communication. The best way to achieve this goal is to have Industry, labor, and government working together to gain the required data and knowledge.

SUMMARY AND CONCLUSIONS

This research is intended to serve as a catalyst to develop better engineering tools and strategies that will improve safety by better understanding roof behavior. An understanding of the complex behavior associated with roof instabilities is expected to provide a method for developing the "safest" decisions in

concert with the existing mining practice. Developing a pro-active roof control plan allows for a quick and timely response and ensures that every response is the one that is most appropriate in relation to existing conditions. Important characteristics associated with a pro-active roof control strategy are:

1. Visual and hands-on roof condition information is the basis of any roof control strategy,
2. Supplemental observational and monitoring techniques provide additional useful information,
3. Regularly recorded and charted information from basic and supplemental monitoring, placed on mine maps and shared with miners, fosters the development of a pro-active roof control plan.

There are currently many useful monitoring techniques available to underground stone mines. However, many of these techniques have certain operational problems and often lack adequate information to apply them at local mine sites. To help address these problems and to provide a better means of collecting and sharing roof deflection data, NIOSH has developed the RMSS. The RMSS has the following advantages: 1) local fabrication, 2) inexpensive, 3) placed in boreholes protected from blast damage, 4) read remotely, and 5) compatible with many kinds of data acquisition systems. Although a first step has been made here through the presentation of the RMSS, it is envisioned that improvements are possible and indeed likely. For example, both the single- and multiple-point RMSS can be incorporated into a mine-wide monitoring system. It is our hope that improvements to fabrication procedures/components and development of

computer software to assist in managing the large streams of data associated with mine-wide monitoring scenarios can be made.

Because hazardous roof beam deflection is dependent on site-specific geologic, stress, and mining characteristics; any roof monitoring technique must be calibrated for local conditions. The only way this can occur is if industry, mine workers, and government work together to gain the required data and knowledge. The use of the RMSS as well as other observational and monitoring techniques by the underground stone mines is expected to enhance miners' understanding of roof behavior and provide a tool for pro-active intervention when hazardous ground conditions exist. Knowledge gained through shared experiences will aid in developing innovative engineering techniques that will mitigate falls of ground and reduce the potential for injuries to mine workers.

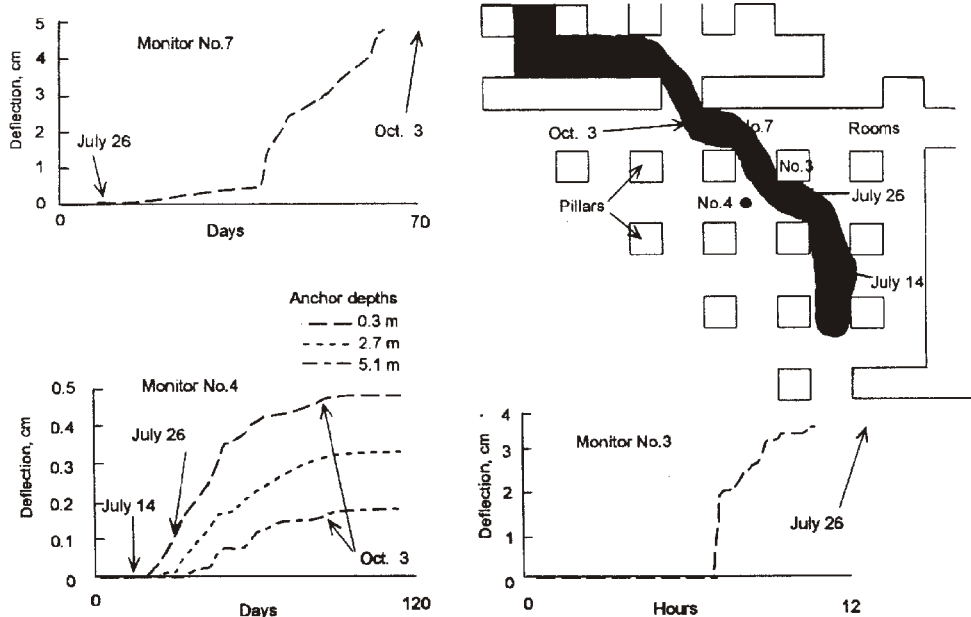

Figure 12. - Roof behavior associated with a large roof fall caused by high horizontal stresses monitor No. 7 was a 3-anchor point prototype of the RMSS and monitor No. 4 was a 20-anchor point sonic probe.

REFERENCES

- Anon, "Guidance on the use of rockbolts to support roadways in coal mines, HSE Books, 1996, 35 pp.
- Altounyan, P.F.R., D.N. Bigby, K.G. Hurt, and H.V. Peake, "Instrumentation and Procedures for Routine Monitoring of Reinforced Mine Roadways to Prevent Falls of Ground, 2nd Int. Conf. Of Safety in Mines Research Inst., 1997, New Delhi, India, pp. 759-766.
- Iannacchione, A.T., D. R. Dolinar, L. J. Prosser, T. E. Marshall, D. C. Oyler, and C. S. Compton, "Controlling Roof Beam Failures from High Horizontal Stresses in Underground Stone Mines", 17th Int. Conf. On Ground Control in Mining, Morgantown, WV, Aug. 4-6, 1998, pp. 102-112.
- Iannacchione, A.T., L. J. Prosser, T.E. Marshall, C.S. Compton, D. R. Dolinar, D. C. Oyler, and D.M. Pappas, "An Instruction Booklet for the Remote Monitoring Safety System (RMSS)," National Institute for Occupational Safety and Health Internal Publication, Dec. 10, 1997, 21 pp.
- Parker, J., "How Convergence Measurements Can Save Money", Engineering and Mining Journal, August, 1973, pp. 92-97.

APPENDIX A - SINGLE POINT RMSS FABRICATION, INSTALLATION, AND DATA ANALYSIS

An instruction booklet providing detailed information on how to fabricate, assemble, install, operate, and analyze data of the single point RMSS has been prepared (Iannacchione, et al., 1997). An advantage of the RMSS is that it can be fabricated from components available at most local suppliers (Figure 13). Parts include a potentiometer, spur gear, rack, stainless steel cable, 2-conductor electrical wire, washers, screws, nuts, angle assembly, 2-conductor electrical wire, cable and ring crimp connector, spring, rivets, metal banding, and aluminum tubing. It is also worth noting that the top-anchor can be inserted into the monitoring holes with insertion tools made of pipe 3/4 inch galvanized pipe or schedule 80 PVC with a 3/8 inch wide by 5/8 inch deep notch cut into the end of the rod (Figure 14).

Monitor installation takes about 20 minutes and requires an open 2-inch hole drilled into the roof to a depth of 14 feet or more. An electrical cable from monitor to a multimeter is installed with enough length so that readings can be made safely while on the floor. To read the RMSS, a multimeter or a data acquisition unit with high resolution and accuracy is required. The minimum meter resolution and accuracy acceptable for use with the RMSS are 1 ohm and 0.2%, respectively. The instruction manual provides examples of data sheets and graphs to record and analyze beam deflection with time. The two graphs consist of a Resistance Conversion Chart (Converts multimeter resistance readings to beam deflection) and a beam deflection graph (plot of deflection versus time).

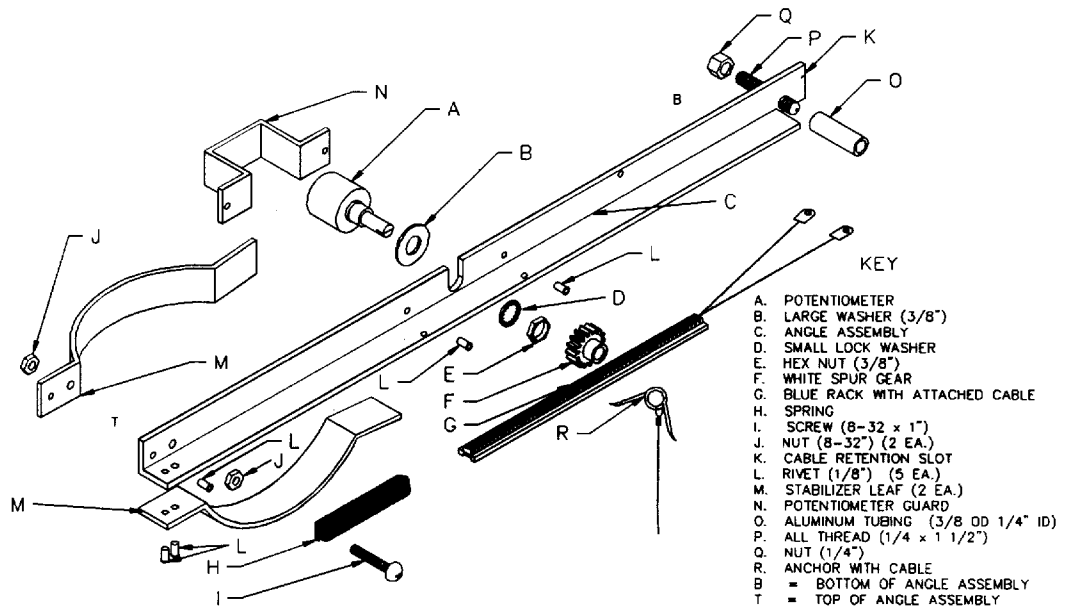

Figure 13 - Overall view of RMSS components.

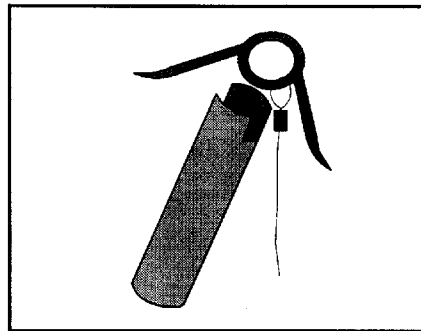

Figure 14 - Top-anchor being placed into insertion tool.