

RI 9432

REPORT OF INVESTIGATIONS/1992

Rock Mechanics Investigations at the Lucky Friday Mine

(In Three Parts)

1. Instrumentation of an Experimental Underhand Longwall Stope

**By T. J. Williams, J. K. Whyatt,
and M. E. Poad**

UNITED STATES DEPARTMENT OF THE INTERIOR



BUREAU OF MINES



Library of Congress Cataloging in Publication Data:

Rock mechanics investigations at the Lucky Friday Mine.

p. cm. — (Report of investigations; 9432)

Includes bibliographical references (p. 26).

Contents: 1. Instrumentation of an experimental underhand longwall stope / by T.J. Williams, J.K. Whyatt, and M.E. Poad—2. Evaluation of underhand backfill practice for rock burst control / by J.K. Whyatt, T.J. Williams, and M.P. Board—3. Calibration and validation of a stope-scale, finite-element model / by W.G. Pariseau, J.K. Whyatt, and T.J. McMahon.

1. Rock bursts—Idaho—Lucky Friday Mine. 2. Longwall mining—Idaho—Lucky Friday Mine. 3. Rock mechanics—Idaho—Lucky Friday Mine. I. Williams, Theodore Joseph, 1923- . II. Whyatt, J. K. (Jeff K.) III. Poad, M. E. IV. Series: Report of investigations (United States. Bureau of Mines); 9432.

TN23.U43 [TN317] 622 s—dc20 [622'.28] 90-15069 CIP

CONTENTS

	<i>Page</i>
Abstract	1
Introduction	2
Acknowledgments	2
Mine geology and stope design	2
Conventional stoping technology	2
LFUL experimental stope plan	4
Instrumentation plan	4
Fill behavior	5
Back safety	5
Support pressure and stope closure	6
Ramp stability	7
Rock mass response	7
Rock mass deformation	7
Change in stress	7
Extent of fractured rock	8
Project chronology	8
First instrumentation cycle	8
Development, 106 I-drift, and first 106 backstope round	8
First LFUL cut mining and instrumentation	9
Second through fourth LFUL cuts	13
Ramp	15
Second instrumentation cycle	20
Third instrumentation cycle	23
Discussion and conclusions	25
Fill performance	25
Ramp stability	25
Rock mass response	25
Mining method	25
References	26

ILLUSTRATIONS

1. Location of Lucky Friday Mine	3
2. LFUL geologic map	3
3. Schematic of cut-and-fill mining methods	3
4. Schematic of LFUL	5
5. Schematic showing sagmeter design and installation between mine floor and timber cap	6
6. Closure extensometer	7
7. Project timeline	8
8. Location of monitoring stations and excavation sequence for 106 and LFUL stopes	9
9. 106 I-drift fill reinforcement system	9
10. Location of monitoring stations and MPBX's in cut 1 of LFUL	10
11. Horizontal stope closure at monitoring stations in cut 1 prior to backfill placement	11
12. Response of MPBX-2 and MPBX-1 to cut excavation and location of MPBX's	12
13. Schematic of fill support system	13
14. Preparing Dywidag bolts for sandfill	14
15. Hanging chain link fencing for overhead protection	14
16. Response of pressure cells in cut 1 to mining in cut 2	14
17. Response of closure extensometers in cut 1 to mining in cut 2	15
18. Excavation sequence in 106 and LFUL stopes and response of closure extensometers in 106 stope to mining in LFUL stope	16

ILLUSTRATIONS—Continued

	<i>Page</i>
19. Location of ramp and ramp crosscut monitoring stations	17
20. Closure measured at ramp monitoring stations during mining	18
21. Location of monitoring stations in ramp crosscut and measured closure	19
22. Response of MPBX-R1	20
23. Response of pressure cells in cut 5 to mining in cuts 6 through 9	21
24. Location of stope monitoring stations and measured closure in cut 5 to mining in cuts 6 through 12	22
25. Gap above sandfill in cut 5	23
26. Response of closure extensometers and pressure cells in cut 10 to mining	24

TABLE

1. Instrument installation information	6
--	---

UNIT OF MEASURE ABBREVIATIONS USED IN THIS REPORT

ft	foot	psi	pound per square inch
in	inch	yd	yard
lb	pound	yd ³	cubic yard
pct	percent		

ROCK MECHANICS INVESTIGATIONS AT THE LUCKY FRIDAY MINE

(In Three Parts)

1. Instrumentation of an Experimental Underhand Longwall Stope

By T. J. Williams,¹ J. K. Whyatt,¹ and M. E. Poad²

ABSTRACT

Researchers at the U.S. Bureau of Mines monitored rock mass response to mining of an experimental underhand longwall stope in Hecla Mining Co.'s Lucky Friday Mine, Mullan, ID. This stope design, the Lucky Friday underhand longwall (LFUL), was proposed as a means of controlling rock bursting while also allowing increased mechanization of mining operations. Instruments were specifically manufactured to monitor three geomechanical factors (backfill performance, ramp stability, and rock mass response) that directly affect the success of stope design. Despite considerable difficulties with instrument installation and survival in the harsh mine environment, especially within the stope fill, sufficient information was collected to suggest that the LFUL method was successful in achieving project goals. This conclusion, in addition to favorable economic and operational evidence, led the mine to adopt the method throughout the mine. Indeed, this study and mining experience suggest that underhand longwall mining could be considered a feasible mining method for rock-burst-prone ground throughout the Coeur d'Alene District. Further Reports of Investigations (RI) in this series present in-depth analyses of the effects of backfill on rock bursting and calibration of a stope numerical model.

¹Mining engineer.

²Supervisory mining engineer.

Spokane Research Center, U.S. Bureau of Mines, Spokane, WA.

INTRODUCTION

The U.S. Bureau of Mines has sought to improve miner safety and productivity through the development of improved mining methods. One of these methods, underhand longwall cut-and-fill, was tested at the Lucky Friday Mine, Mullan, ID (fig. 1), under a cooperative agreement between the Bureau, Hecla Mining Co. of Coeur d'Alene, ID, and the University of Idaho, Moscow, ID.

This first RI in a three-part series covers instrumentation and evaluation of ground control performance during mining of the first 10 cuts of the experimental Lucky Friday underhand longwall (LFUL) stope. Other RI's in the series present detailed analyses of the effects of backfill practice on rock bursting (15),³ and calibration of a finite-element model to measured stope displacements (9).

ACKNOWLEDGMENTS

This investigation could not have been conducted without the close cooperation of the staff of Hecla Mining Co. and the College of Mines and Earth Resources, University of Idaho. Fred Brackebush, manager of mining research for Hecla (now president of Mine Systems Designs, Kellogg, ID), was instrumental in organizing research

efforts. Dave Cuvelier and Mike Werner, mining engineers, Hecla Mining Co., coordinated mine access. In addition, the contributions of Bureau of Mines staff, including Doug Scott, geologist, and Mark Board, mining engineer (now with Itasca Consulting Group), were invaluable to planning and monitoring the instrumented stope.

MINE GEOLOGY AND STOPE DESIGN

The LFUL test stope is located at the east end of the Lucky Friday vein between the 5100 and 5300 levels in the 5300-107 block. This block lies in the upper submember of the lower member of the Revett Formation, approximately 5,100 ft below the surface and 1,700 ft below sea level. The vein ranges from several inches to 14 ft thick and is nearly conformal to an anticline plunging 75° to the southeast. Because the vein itself dips steeply (70° to 90°) to the south and east, it comes in contact with progressively older rocks with depth (fig. 2). Some of the many faults and secondary folds in the anticline also intersect the vein.

The rock mass surrounding the vein is made up of beds of vitreous quartzite and sericitic quartzite from 12 to 36 in thick. Thin argillite beds are often found between quartzite beds. The vein itself contains massive galena, sphalerite, and tetrahedrite. Scott (10) provides an in-depth description of stope geology.

CONVENTIONAL STOPING TECHNOLOGY

The Coeur d'Alene District in northern Idaho has a long history and strongly established traditional methods of mining. The ore, which is typically found in steep, narrow veins throughout the district, is usually accessed through rectangular timbered shafts and extracted using the labor-intensive, overhand cut-and-fill method. The name is derived from the fact that a vein is divided into levels, usually 200 ft apart vertically, and each level is mined overhand from bottom to top. Access to the vein

on each level is through crosscuts from a lateral haulage drift paralleling the vein. Mining proceeds from the crosscuts by "raising up" into the vein, and a sequence of 200-ft-long horizontal cuts centered on the raise is then excavated. After a cut has been mined out, it is backfilled with sand or waste material, providing support for the wall rock and a floor for mining the next cut. Figure 3A illustrates a typical overhand stope with its raise, ore chute, backfill, and active stoping area.

One characteristic of the overhand stoping method is that it produces a pillar of rock as mining proceeds toward previously mined areas above. Eventually, the entire pillar is removed. As the pillar becomes smaller, stress levels increase until the pillar fails or is completely mined out. Failure may be violent or nonviolent, depending upon the brittleness of the pillar and the relative stiffnesses of the pillar and wall rock. A nonviolent failure is characterized by gradual fracturing and yielding, while violent failure is characterized by the release of seismic energy. When sufficient seismic energy is produced to damage mine openings, the failure is called a rock burst.

Rock bursts have become increasingly troublesome with depth (7) and pose major operational and safety problems for mining at current depths. They are especially common during excavation of the last portion of a pillar. Leighton (6) has provided a detailed description of ground conditions before and after a typical pillar burst at the nearby Galena Mine.

³Italic numbers in parentheses refer to items in the list of references at the end of this report.

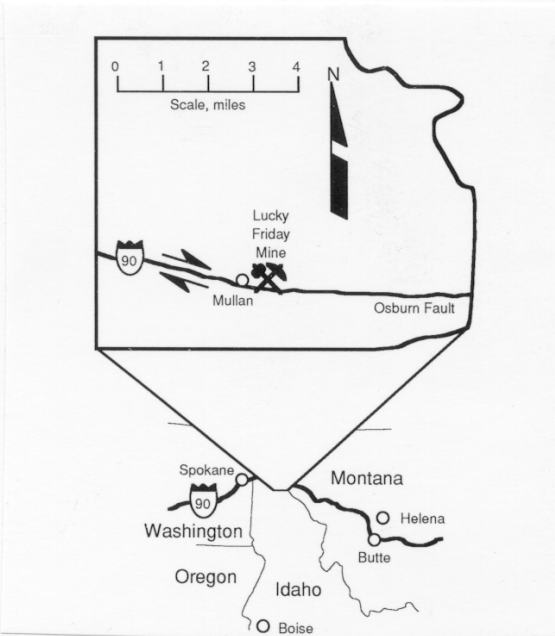

Figure 1.—Location of Lucky Friday Mine.

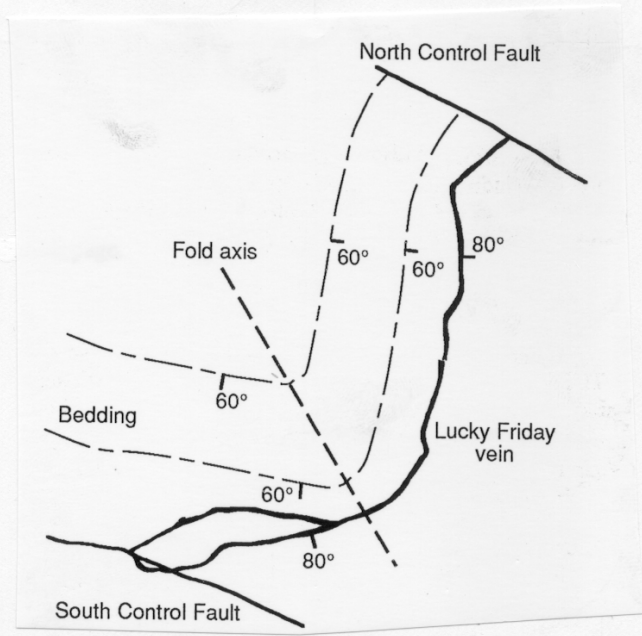
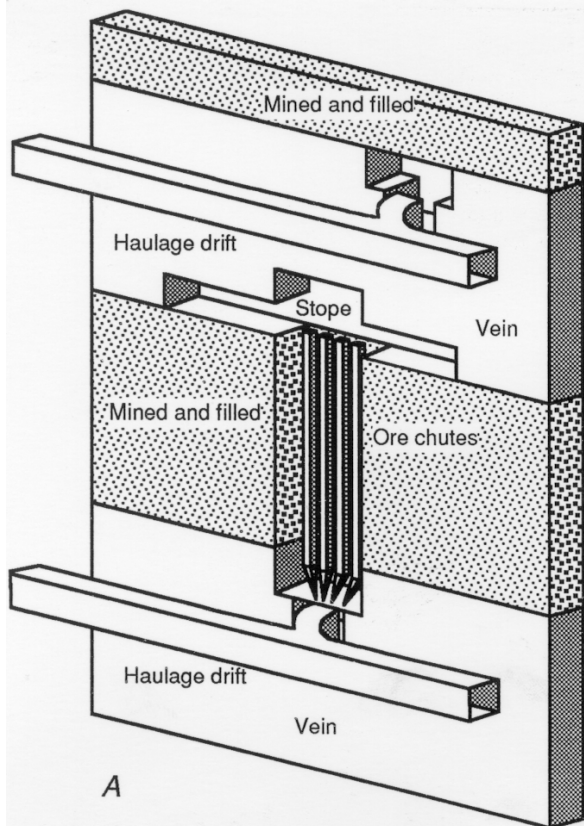
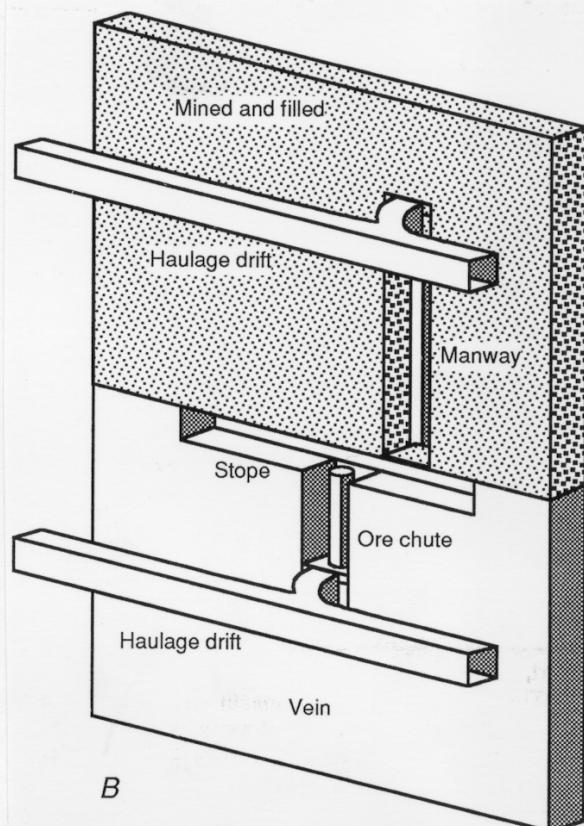

Figure 2.—LFUL geologic map.



A



B

Figure 3.—Schematic of cut-and-fill mining methods. A, Overhand; B, underhand.

Rock bursts have also been traced to sources other than pillars, including slip along faults and shear failure of highly stressed wall rock (5). Unfortunately, these mechanisms remain poorly understood (13).

LFUL EXPERIMENTAL STOPE PLAN

The underhand longwall method uses the principle of a single advancing face in conjunction with the underhand cut-and-fill method to reduce rock burst hazards. The South African High-Level Committee on Rock Bursts and Rock Falls recommended longwall mining as a means of reducing rock burst hazards associated with mining remnants (or sill pillars) as early as 1924 (4); this method is now standard practice in South Africa. Hecla Mining Co. has experimented with an underhand cut-and-fill method at its Star Mine in northern Idaho (1).

Underhand cut-and-fill stopeing is a method in which a block of ore is mined by cutting and filling in sequence from the top of the block to the bottom, rather than from the bottom to the top as in the overhand cut-and-fill method. Therefore, the intact vein forms the stope floor instead of the stope back. As in the overhand cut-and-fill method, the vein is accessed through crosscuts from laterals, and mining is conducted with a conventional drill, blast, and muck cycle. Figure 3B shows a typical underhand cut-and-fill stope with ore chutes and a filled area above the stope.

In the underhand longwall method, the open stope is backfilled following each cut with a reinforced, cement-stabilized fill material that provides a safe stope back or roof. Reinforcing members typically include wire mesh, timber, and rock bolts. Maintenance of a safe back is a critical issue, a point underscored by a tragic rock-burst-induced backfill collapse that killed four miners at the

Falconbridge Mine, Ontario, on June 20, 1984 (3). However, a well-designed fill back should have safety advantages over the burst-prone vein rock that it replaces. For instance, vein destressing (in which long blast holes drilled ahead of mining are fired to relieve stress concentrations) is often used to prevent bursting in the back, and the fractured rock that results can pose slabbing and caving hazards. Destressing the floor of an underhand stope avoids this problem entirely.

The LFUL stope uses conventional underhand cut-and-fill methods and a ramp system to provide access for mechanized mining equipment (11). Slushers are replaced with load-haul-dump equipment (LHD's), which in turn increase mucking efficiency sufficiently to allow stope lengths to be increased from 200 to 500 ft, thereby reducing the number of ramps required. Both 1/2- (in areas under 5 ft wide) and 1-yd³ LHD's can be used, depending on local vein width. In addition, all mining is organized on a single longwall to eliminate the formation of rock-burst-prone pillars. Figure 4 shows the resulting mining plan, as implemented in the experimental LFUL stope.

Each mining cut is about 10 ft high and extends approximately 250 ft along the vein to each side of the ramp. The declination of the ramp provides one turn adjacent to the ore body every 30 vertical feet. Crosscuts are driven from the turning point of the ramp to provide access for services and LHD's. Once a cut is complete, the stope and crosscut are filled with cemented fill. After the fill sets up, a new crosscut is driven from the ramp to the next stope level. Noyes, Johnson, and Lautenschlager (8) provide a detailed description of the method as it emerged during the development of the experimental LFUL stope.

INSTRUMENTATION PLAN

Three conditions were identified as crucial to successful implementation of the underhand longwall mining method. These were that:

1. The fill must provide a safe back and some regional support,
2. The ramp system must remain stable and operational throughout the life of the stope, and
3. The rock mass response to changing the mining method should not exacerbate, and should hopefully reduce, rock burst hazards, especially for rock bursts originating at the mining face.

An instrumentation plan was developed for the LFUL stope with the goal of monitoring conditions during mining

the first half of the stope block (about 100 vertical feet). Experience with prior instrumentation projects in the district suggested that electronic instruments would be vulnerable to the harsh conditions underground. Nonetheless, the need for remote monitoring of many instruments and the desirability of being able to read instruments automatically several times daily necessitated a largely electronic system. Therefore, the electronic instruments were treated with additional waterproofing and other protective measures and monitored with a computerized data acquisition system (14). Manually read instruments were installed in the ramp where they could be read on a regular basis by research staff. Stope seismicity was monitored by the mine's microseismic system (10).

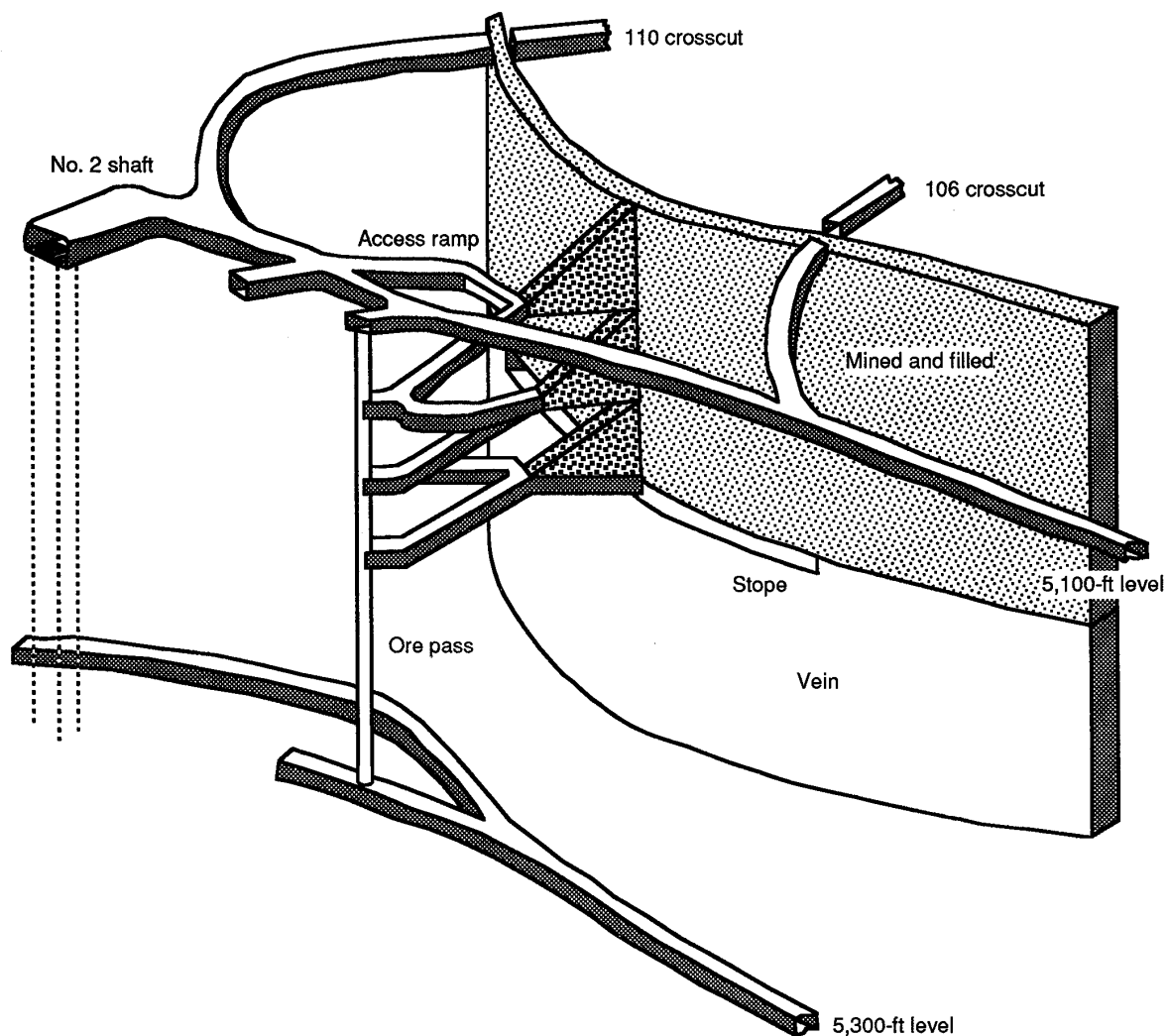

Figure 4.—Schematic of LFUL.

FILL BEHAVIOR

Information on the ability of the fill to provide a safe back and some regional support was sought from a package of instruments designed to monitor stope closure and fill behavior. As the safety of the back was a prime operational concern, and the back was regularly checked by mine staff, the bulk of the instrumentation effort was aimed at monitoring development of support pressure in the backfill, which received little or no attention from mine staff.

Back Safety

Safety practices used with overhead fill methods do not differ significantly from the routine used in overhand stopes. The back is inspected and loose material is removed (barred down) at the beginning of each shift, and reinforcement, including timber sets, is installed in hazardous areas.

One indication of a potentially dangerous back is the degree of fill sag. A large amount of sag suggests that the

fill (especially cemented fill) is failing and is being held in place only by reinforcement members. Because mining made maintaining a reference point on the floor difficult, a sagmeter (fig. 5) was designed to measure displacement of the fill back between the bottom of the fill and a fixed 10- by 10-in timber cap installed across the middle of the stope. Measurements are taken with a string potentiometer protected by a telescoping tube. The bottom end of the tube is attached to a plate in the sandfill, and the top end is attached to the timber cap. The potentiometer and cables are mounted in the top of the instrument, away from blasting.

These instruments were not found to be useful. The cemented fill fractured more quickly and discretely than expected. Subsequent lateral shifts along these fractures damaged the instruments and their readout cables. Such conditions were not properly anticipated when the sagmeters were designed. In addition, when the fill reinforcement system was redesigned, the timber caps were removed, eliminating the sagmeter's stable reference point. Thus, measurement of sag was abandoned and back conditions were judged entirely by on-the-spot observations.

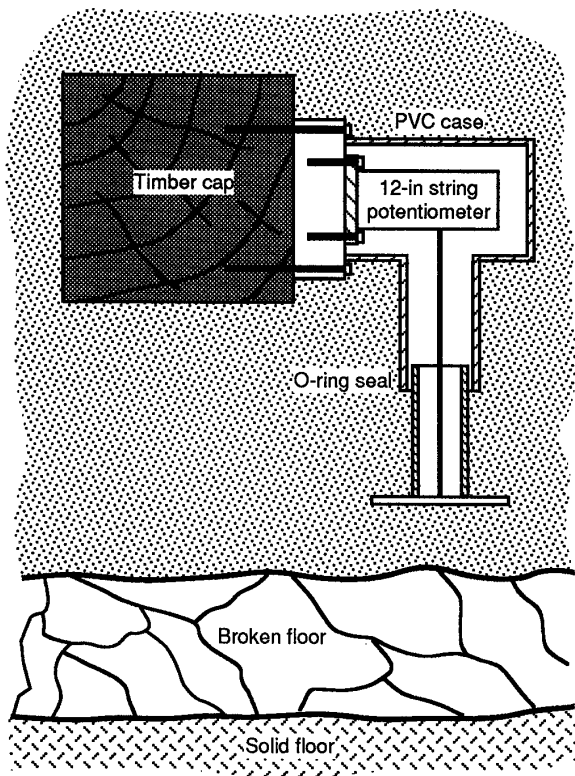

Figure 5.—Schematic showing sagmeter design and installation between mine floor and timber cap.

Support Pressure and Stope Closure

The performance of backfill as a ground support element lies in its ability to build up support pressure in opposition to stope closure. From this standpoint, the quality of a backfill system can be judged by how quickly pressure develops as a function of stope closure. Thus, the LFUL instrumentation package included both fill pressure and stope closure measurements. A previous Bureau investigation (1) showed that the lateral (cross stope) fill pressure was the only significant component and provided some important lessons on how to protect pressure cells.

Stope wall closure was monitored between pairs of reference points installed at stations in the first cut before and after fill placement to provide a complete history of closure to complement fill pressure measurements (table 1). Monitoring with a tape extensometer began with installation of grouted reference points 6 ft behind the face. Points mounted closer to the face were frequently blasted out. After a cut was completely mined out, electronic cross-stope closure extensometers (fig. 6) were installed at these same stations to monitor closure after backfill placement. They were built around a 24-in displacement potentiometer, which was protected with a 2-in-diam sealed plastic pipe. A plunger placed in one end of the pipe maintained contact with the opposite wall.

Table 1.—Instrument installation information

Instrument and location	Monitored excavation
Tape extensometer:	
LFUL, cut 1	LFUL, cut 1; 106, cuts 1 and 2.
Ramp	LFUL, cuts 1 to 10; 106, cuts 1 and 2.
Ramp crosscut	106, cuts 1 and 2.
MPBX-1 and MPBX-2:	
LFUL, cut 1	LFUL, cut 2; 106, cuts 1 and 2.
Ramp pillar	LFUL, cuts 1 to 3; 106, cuts 1 and 2.
Closure meters and pressure cells:	
Cut 1	LFUL, cuts 2 and 3.
Cut 5	LFUL, cuts 6 to 11.
Cut 10	LFUL, cuts 11 and 12.

Fracturing and movement of the cemented backfill apparently broke either the housing or cables of most of the closure extensometers, although some survived excavation of the following cut. During the project, the housing was upgraded from plastic to aluminum, and extra coils of cable were left near the closure extensometer to allow for cable movement. However, only marginal improvements in instrument survivability were realized.

Of the 13 closure extensometers installed in the fill, 10 survived through excavation of one cut, two survived

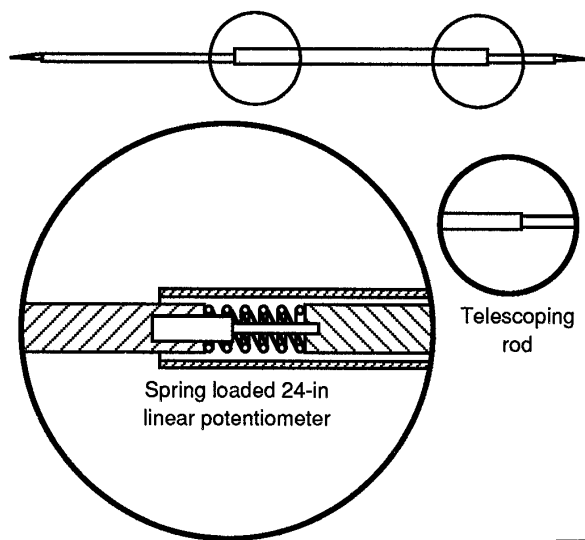

Figure 6.—Closure extensometer.

through two cuts, and one through three cuts. Thus, the instruments proved to be suitable for monitoring one or two cuts, but failed to monitor long-term stope closure.

Pressure measurements were made with Geokon⁴ hydraulic pressure cells installed with the closure extensometers at stations in the first cut. The cells were modified with additional moisture protection for the electronic transducers and cables. Proper orientation of the cells with the stope walls was ensured by attaching the cells to 6-in-square hog wire mounted in a frame of rock bolts driven into the loose muck on the floor. The stope was then filled with hydraulically placed cemented sandfill.

The pressure cells also proved to be suitable only for short-term monitoring. Of the 15 cells installed during the project, two failed almost immediately, and six more failed after excavation of the following cut. The seven remaining cells continued to function through mining two cuts, but none survived excavation of three cuts.

RAMP STABILITY

The ramp system provides the only access to the stope. Since a fully implemented longwall system concentrates mining on a single level, closing down a single ramp for repair disrupts as much as 20 pct of the mine's production. Thus, ramp stability is a key factor in preserving the economic viability of the underhand longwall system.

Two types of measurements indicate ramp instability: high rates of closure and an acceleration of those rates. Closure itself can result in narrowing of the ramp, thereby

⁴Reference to specific products does not imply endorsement by the U.S. Bureau of Mines.

blocking LHD access, while acceleration can indicate impending collapse of the pillar. Manual tape extensometers were used to measure closure rates, and an electronically read multipoint borehole extensometer (MPBX) was used to monitor rock deformation between the ramp and the stope to check for fracturing and impending failure of the pillar (table 1). These instruments were generally successful in providing information on ramp stability.

ROCK MASS RESPONSE

The rock mass responds to mining by fracturing at the skin of underground openings and by the global redistribution of stress. Stress redistribution often results in overstressing intact rock and/or creating discontinuities that may fail violently as a rock burst. It is this global behavior that is analyzed by stope models. Indices of rock burst hazard, such as the energy release rate, are drawn from the results of these models. Evidence of rock mass response to corroborate a stope model was sought by measuring rock mass deformation and stress changes in the rock mass with continued mining, and by observing the progression of rock fracturing ahead of mining.

Rock Mass Deformation

Rock mass deformation was monitored with Geokon two- and four-anchor MPBX's placed in several locations in the stope and ramp system. The first anchor of the two-anchor MPBX's and the second anchor of the four-anchor MPBX's were set at shallow depths (5 to 15 ft) to capture fracture zone deformations. The other anchors were set 25 to 50 ft in the rock and were expected to show small, elastic deformations if the rock mass remained intact.

Two MPBX's (MPBX-1 and MPBX-2) were installed in the stope walls prior to backfilling the first LFUL cut (table 1). MPBX-1 failed during placement of the backfill, probably from failure of instrument waterproofing. MPBX-2 failed after the second cut was completed; it also showed signs of water interference with electronic readings. In-stope MPBX installations were discontinued after this experience.

Change in Stress

Vibrating wire stressmeters were installed in the wall rock below the stope in an effort to detect mining-induced stress concentrations ahead of mining. These stresses lie beyond a zone of fractured rock that pushes stress into intact rock farther below the mining floor. Unfortunately, an unexpected reversal in the dip direction of the vein during the second cut brought mining through the stressmeter instrument wires. Attempts to repair the wires failed to provide valid instrument readings.

Extent of Fractured Rock

The extent of the fractured rock zone is not easily predicted. An attempt to determine the dimensions of the zone was made using a time-domain reflectometry (TDR) method. In this method, a cable grouted into a hole

drilled ahead of mining is monitored, and the location of breaks in the cable, presumably caused by rock fracturing, are pinpointed. Unfortunately, the grouting operation failed after the borehole was only one-third full. Whether this was the fault of the grouting equipment, the installation procedure, or raveling of the borehole is not known.

PROJECT CHRONOLOGY

A full interpretation of the many measurements obtained by the variety of instruments installed around the LFUL stope required careful consideration of ever-changing LFUL mine geometry. The following section presents a chronology of data collection, mining progress, and other pertinent information. Instruments were concentrated in the first, fifth, and tenth cuts of the LFUL stope. A summary timeline of mining activity and an outline of mining geometry are presented in figures 7 and 8 to complement the summary of instrument locations and excavations monitored given in table 1.

FIRST INSTRUMENTATION CYCLE

Development, 106 I-Drift, and First 106 Backstope Round

Standard development procedures were followed on the 5100 level, which serves several overhead stopes as well as the LFUL stope. An I-drift was mined from the crosscut for the 106 overhead stope, under which half of the LFUL stope was later developed. Excavation of the LFUL ramp was initiated in January 1985. After taking backstope

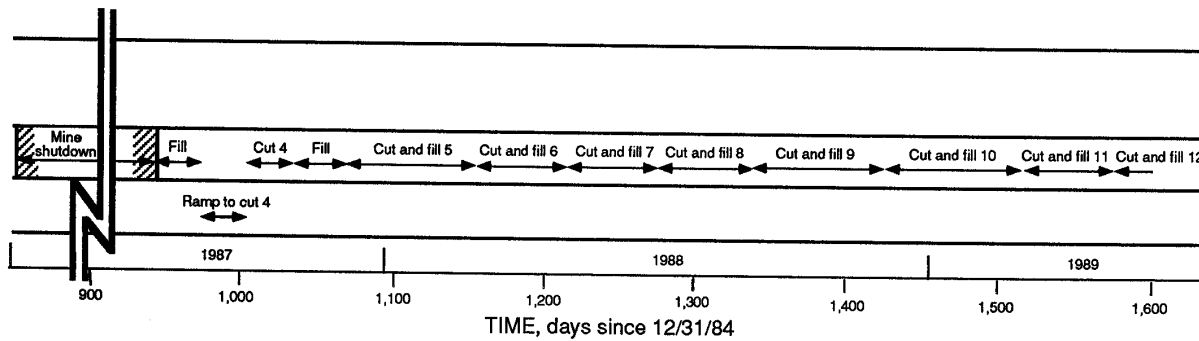
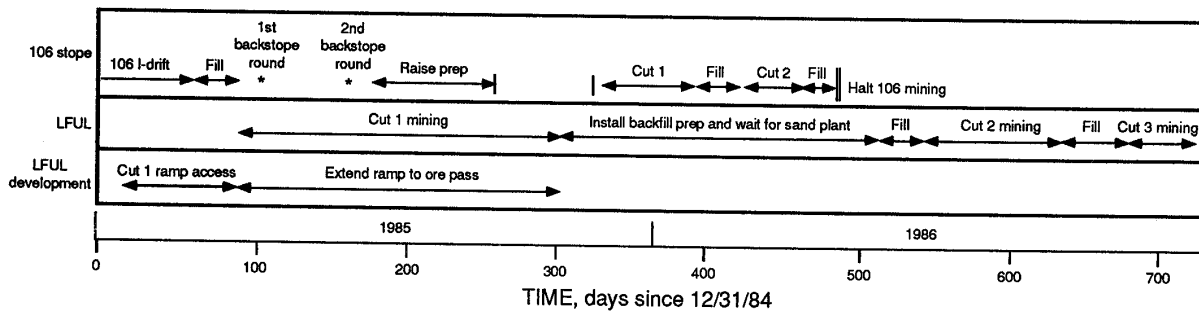

Figure 7.—Project timeline.

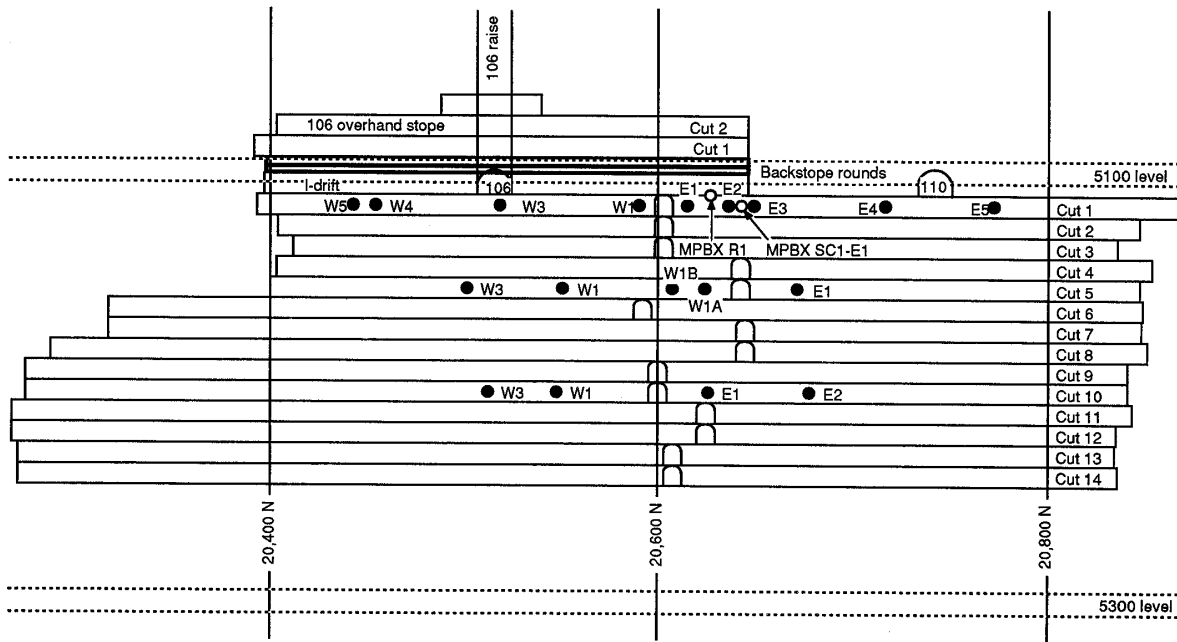

Figure 8.—Location of monitoring stations and excavation sequence for 106 and LFUL stopes.

rounds in 106, the I-drift was prepared to be backfilled as an underhand stope. Ten- by ten-inch caps were placed from wall to wall 3 ft off the floor, and wire mesh was hung at floor level from J-bolts and straps (fig. 9).

The I-drift was filled with 5 ft of cemented total mill tailings (called Garpenburg fill at the mine) with a cement-to-sand ratio of about 1:5 and a slurry density of about 70-pct solids. Laboratory tests were run to define the uniaxial strength and friction angle of the fill material. Samples of cemented fill tested after curing for 30 to 45 days showed uniaxial strengths from 300 to 800 psi, depending primarily on sampling location. Segregation and other problems hampered placement of a uniform fill mix.

First LFUL Cut Mining and Instrumentation

The LFUL ramp system reached the vein for the first LFUL cut on April 9, 1985. This cut was driven from the ramp as an I-drift east through the 110 block and as an underhand stope west under the backfilled 106 I-drift. The LFUL and the 106 stopes were mined simultaneously with only 5 ft of intervening fill. The first LFUL cut was completed in October 1985. Mining in the 5100-106 stope continued until April 11, 1986, when it was halted prior to mining the second LFUL cut. This left the 106 mining floor 40 ft above the back of the first LFUL cut.

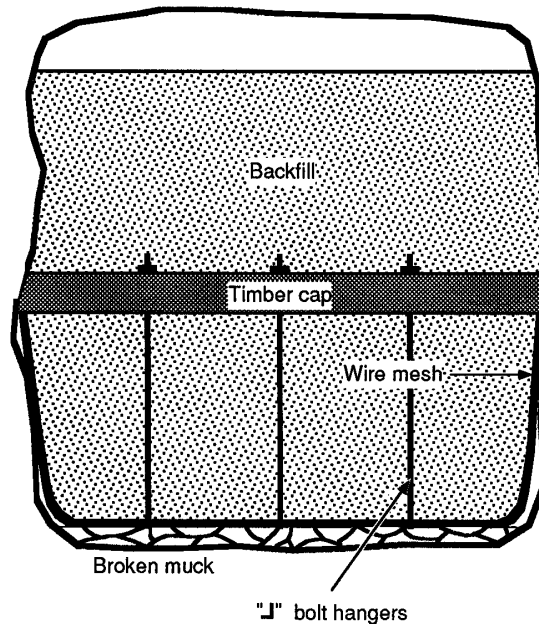

Figure 9.—106 I-drift fill reinforcement system.

Ore from the first cut was hauled to the 5100 level and dumped into rail cars until an ore pass to the 5300 level was completed in September 1985. The 5-ft-diam ore pass was excavated with standard raise boring equipment. However, the raise deteriorated rapidly and became a 10-by-15-ft oblong before it was stabilized with shotcrete. The 15-ft diam of the raise was perpendicular to the principal stress direction (12).

Figures 10 and 11 show data from manual tape extensometers taken from cut 1 of the LFUL stope during

completion of the cut and mining of cut 2 in the 5100-106 stope above. Jumps in the closure rate after initial stabilization were attributed to mining of various 106 stope cuts. Closure at location E2 was nearly double that at other locations. This result may be related to the presence of a minor fault that crosses the vein at E2, stress concentrations associated with the bend in the vein (fig. 11A), and the end-line of the 106 stope directly above.

As noted earlier, two MPBX's were placed in the walls of the first LFUL cut. Measurements showed that the

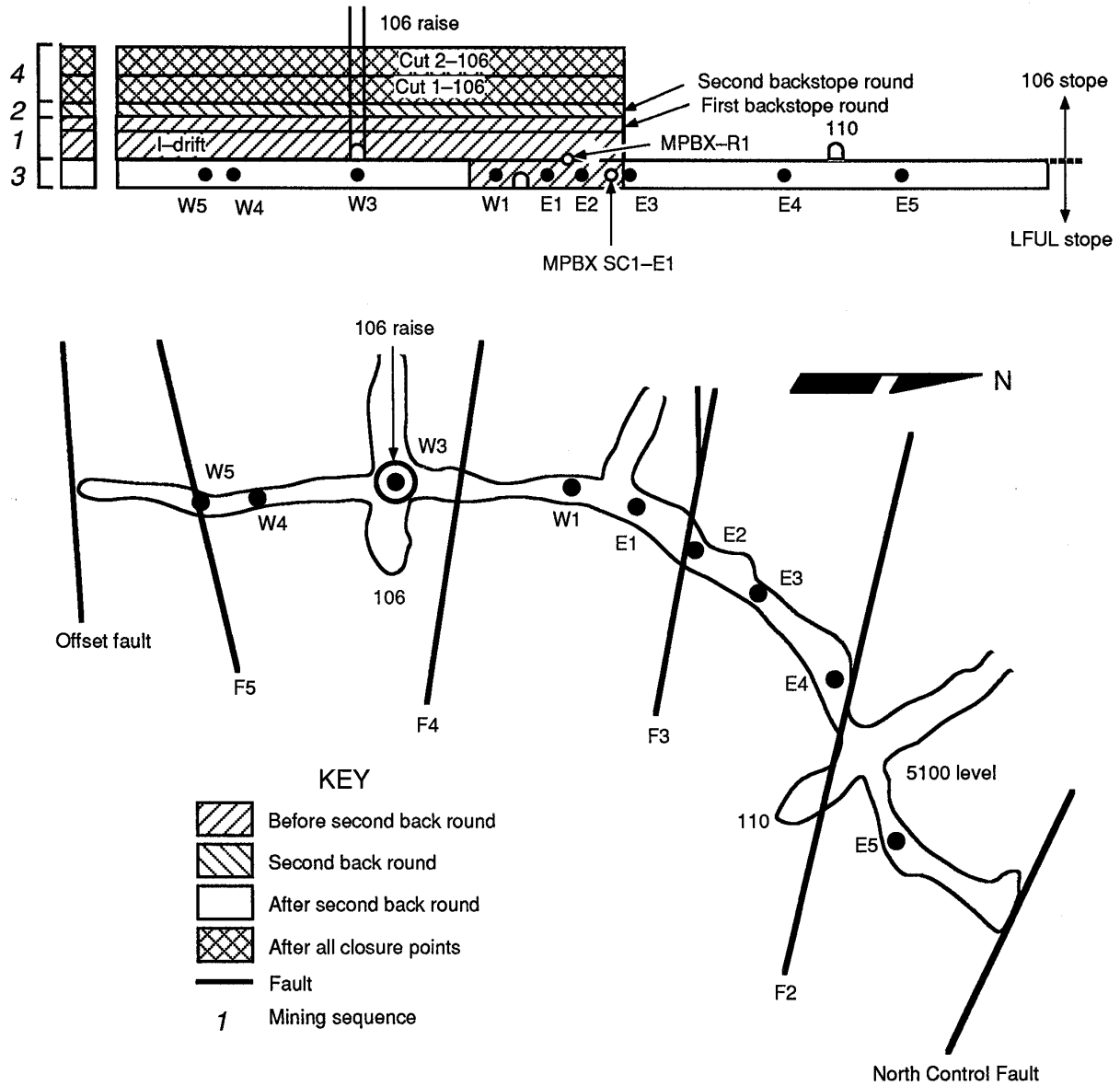

Figure 10.—Location of monitoring stations and MPBX's in cut 1 of LFUL.

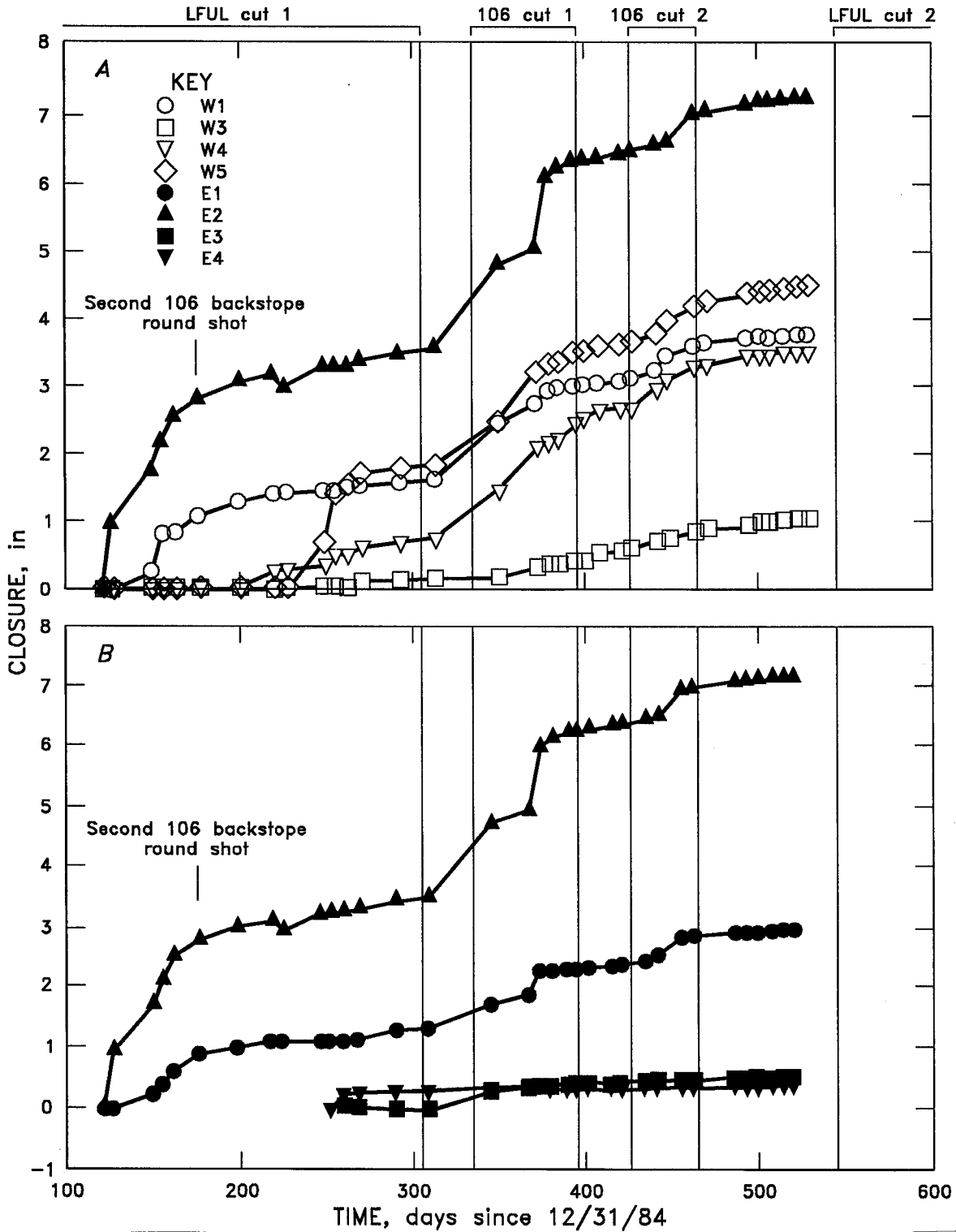

Figure 11.—Horizontal stope closure at monitoring stations in cut 1 prior to backfill placement. A, Stations west (W) of ramp; B, stations east (E) of ramp.

south wall was converging and fracturing more rapidly than the north wall (fig. 12) as cut 1 was finished. This phenomenon was visually evident and agreed with data collected by the mine-wide microseismic system (16), which indicated that most seismic activity and fracturing were occurring in the south wall. The seismicity pattern in the south wall did not appear during subsequent cuts, and an explanation for this pattern was never established.

The LFUL stope remained unfilled from October 1985 to June 1986 while mining continued in the 106 stope

above. The LFUL stope was prepared for sandfill placement by drilling holes in the wall at floor height, from which 1/2-in wire cable slings were installed from wall to wall (fig. 13). A wire mesh mat was laid over the cables. Engineers at Hecla Mining Co. (2) conducted pull tests of cable wedged into Split-Set rock bolts to evaluate the load-carrying capacity of the anchor. It was found that a typical cable held 8,000 lb of load before sliding out of the Split-Set anchor. Since actual loading direction in the LFUL stope is at an angle to, instead of parallel to, the Split-Set,

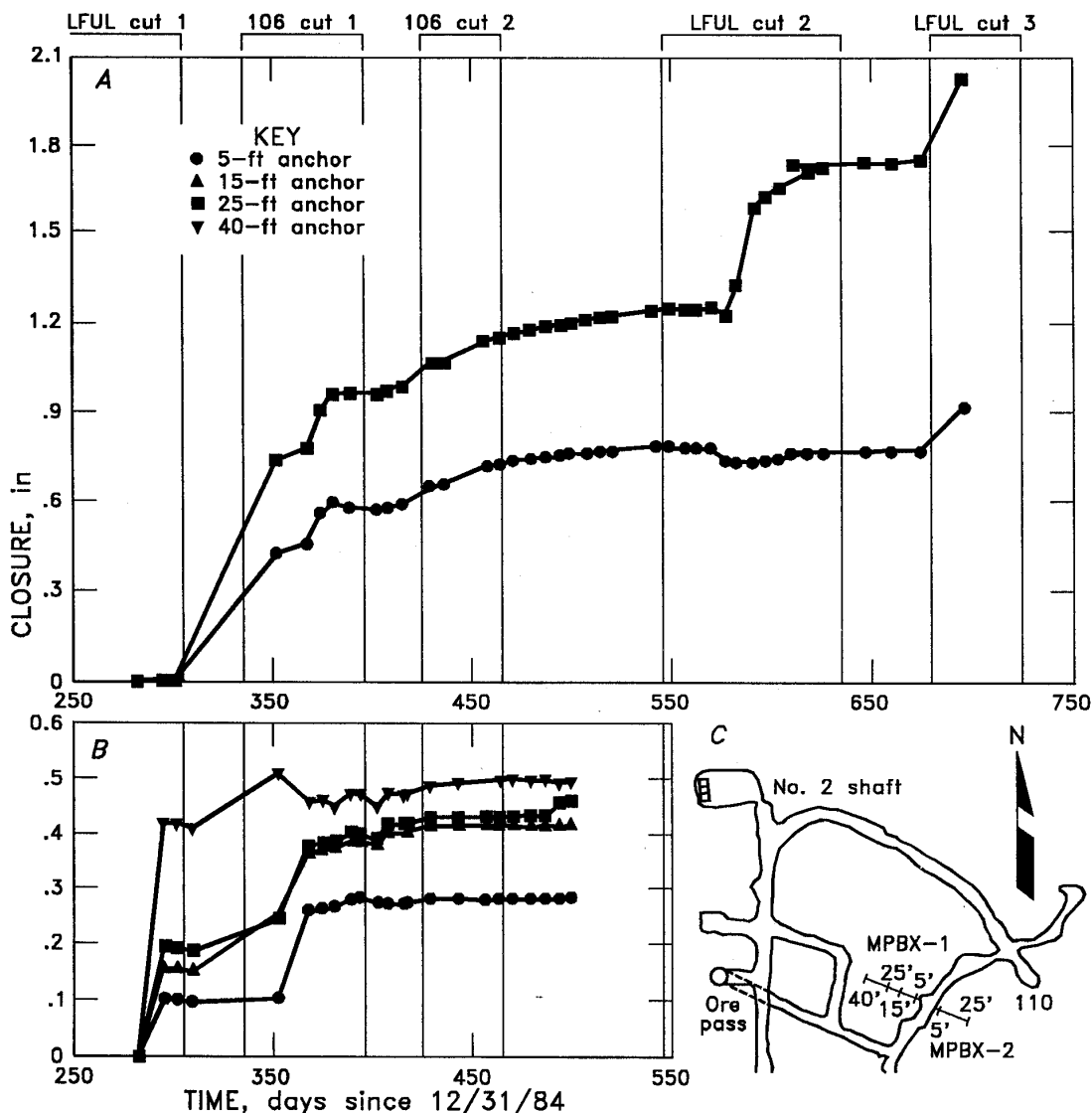

Figure 12.—Response of MPBX-2 (A) and MPBX-1 (B) to cut excavation. Location of MPBX's (C).

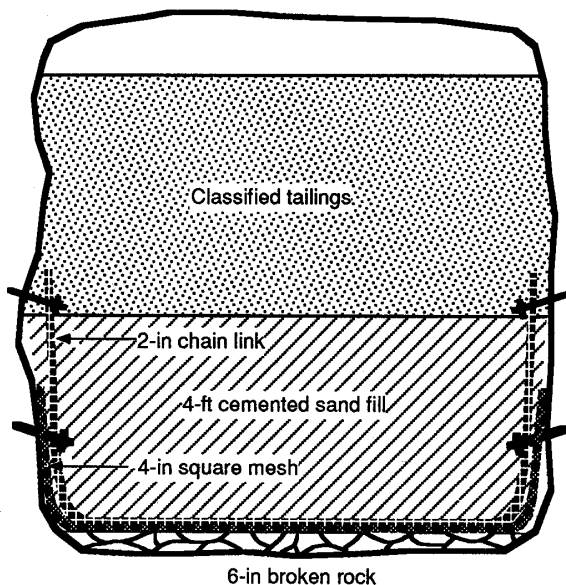

Figure 13.—Schematic of fill support system.

as was done in the pull test, actual load-carrying capacity would be higher.

Five pressure cells and five closure extensometers were installed along with fill reinforcement. Two additional closure extensometers were installed in the 106 raise prep, where they would not be subject to damage during backfilling.

The LFUL stope was eventually filled with 3 to 4 ft of cemented total mill tailings (Garpenburg fill) on the bottom, while the rest of the stope was filled with uncemented classified tailings. Despite the precautions taken to protect and waterproof instruments installed in this cut, MPBX-1, two of the five closure extensometers, and one of the five pressure cells were damaged during backfilling.

The great length of this cut required that filling be done in several stages behind several sandwalls. Variations in fill properties and height were observed. The irregular nature of the stope back and the 1-pct grade maintained for drainage made filling the stope entirely to the back impossible. Although no exact measurements were taken of the void, it was readily observed to be at least 1 ft high and could have been as high as 2 to 3 ft in places. This void would not appear in an overhand mining sequence. The consequences of such a space on rock bursting are examined in the second report of this series (15).

Second Through Fourth LFUL Cuts

Cuts 2 and 3 of the LFUL were mined between July 1986 and January 1987, and cut 2 was filled during this

period. The fill back in these cuts performed better than that in the I-drift, although some localized fill failures occurred.

A mine shutdown in January 1987 provided mine engineers with an opportunity to modify the fill reinforcement system by replacing cable slings with 6-ft-long Dywidag bolts. These bolts were installed vertically on 2- to 3-ft centers and behaved in a manner similar to rebar in concrete (fig. 14). The bottom end of each bolt was driven through wire mesh into loose muck on the floor. (The wire mesh was eventually eliminated in later cuts without any problems.) A nut and a plate were then placed on the top of the bolt to serve as an anchor in the fill. As the next cut was mined, the bottom ends of the bolts were exposed. At this time, a second set of plates and bolts were installed to tension the rebar and provide anchors for fencing. Fencing extended along the entire back and down the stope walls to within 1.5 ft of the bottom. Split-Set bolts were used to fasten the fencing to stope walls. The fencing protected miners from fly rock and localized rock bursts (fig. 15).

During the mine shutdown, the decision was made that all further mining on and below the 5300 level would use the LFUL method. Mining resumed in August 1987 with backfilling of cut 3, followed by excavation of cut 4. Cuts 2 through 4 were monitored by instruments installed in cut 1 and by two closure extensometers in the 106 raise.

Pressure cells monitored support pressure development as mining proceeded past each cell. Three of the four cells recorded substantial pressures when the mining face was 10 ft away horizontally; these pressures peaked when the face was 15 ft past and dropped off sharply with further mining, indicating fracture of the cemented fill (fig. 16). Fracturing was then confirmed by visual inspection. The fourth pressure cell (W3) was located in the upper uncemented portion of the fill. This cell showed a much smaller increase in pressure and no degradation of pressure as the underlying cemented fill fractured. The pressures measured in the cemented fill after fracturing were surprisingly similar to those measured in the uncemented fill.

Three of the pressure cells survived mining of the third cut. The two installed near the center of the stope showed increases of 40 to 70 psi, while the cell near the end of the stope showed increases of only 10 psi. This difference may have indicated a void at the top of the fill above the third cell, or greater closure towards the middle of the stope, as would be expected in an elastic rock mass.

MPBX-2 (fig. 12) showed that fractures between the stope wall and the 5-ft anchor were compressed while fractures between the 5-ft anchor and the 25-ft anchor opened. Apparently, the loose rib rock was subjected to confining pressures as fracturing rock expanded deeper in the wall.



Figure 14.—Preparing Dywidag bolts for sandfill.



Figure 15.—Hanging chain link fencing for overhead protection.

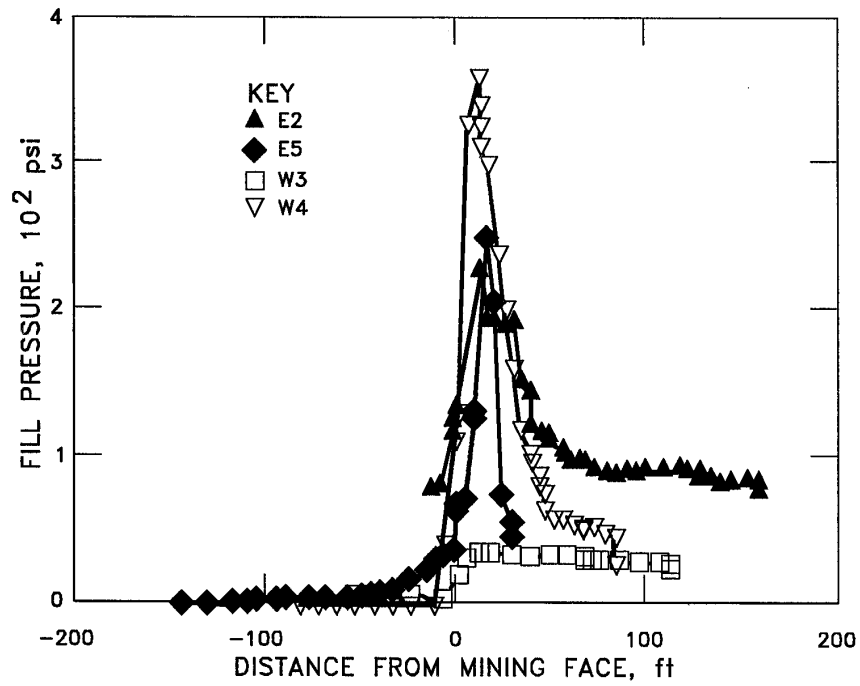

Figure 16.—Response of pressure cells in cut 1 to mining in cut 2.

Closure in the fill above mining clearly depended on the progress of mining in cut 2 (fig. 17). The closure extensometers in the 106 raise, which were farther removed from mining, showed a more gradual response (fig. 18).

Ramp

Instruments were installed in the ramp system to monitor ground stability yet not impede access by LHD's. Reference points for tape extensometers (fig. 19) were placed after every 40 to 50 ft of advance in the ramp spiral and at 20-ft intervals in the crosscuts connecting the ramp to the stope. In addition, an MPBX (MPBX-R1) was used to monitor the pillar between the ramp and the stope.

The reference points were monitored to provide information on initial stability, the effects of mining, and the influence of extending the ramp spiral below the existing ramp. The ore haulage section, which connected the stope to the ore pass, was the most sensitive part of the offset spiral ramp. Not only did the most traffic pass through it as ore was hauled from three successive cuts of the stope (30 ft of mining) to the ore pass, it also had a relatively small, 20-ft-thick floor pillar. Although ore haulage ceased

before a second haulage ramp was excavated in the next ramp spiral below, this section continues to be the sole means of stope access for the life of the stope. The offset spiral ramps connecting these haulage ramps alternated to the north and to the south, providing one ramp for every 60 ft of mining and, therefore, a 50-ft-thick floor pillar.

Reference points were installed at R1 to R9 in the main ramp spiral as it was driven for manual measurements of ramp closure. Measurements at R1 and R5 to R9 showed quick stabilization (fig. 20), but measurements at R4, and to a lesser extent, R2 and R3, showed significant amounts of closure prior to stabilization. Apparently, points at R2, R3, and R4 were located in a weaker portion of the rock mass, probably near a fault that runs through the ramp haulage section and the ore pass. This interpretation is supported by raveling of the ore pass adjacent to R4 encountered during stope development.

Since ore pass raveling was stabilized by applying a layer of shotcrete, the same approach was tried in the second ramp haulage section. Reference points at R8 and R9 were installed in this section along with a layer of shotcrete. Measurements showed reduced ramp closure in the shotcreted section, especially at R9.

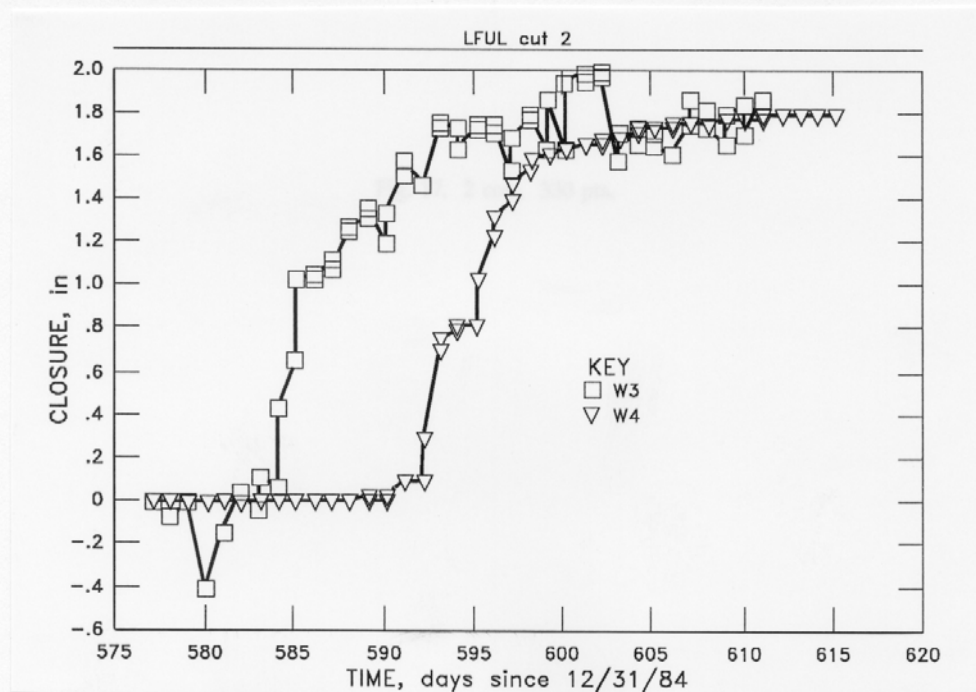

Figure 17.—Response of closure extensometers in cut 1 to mining in cut 2.

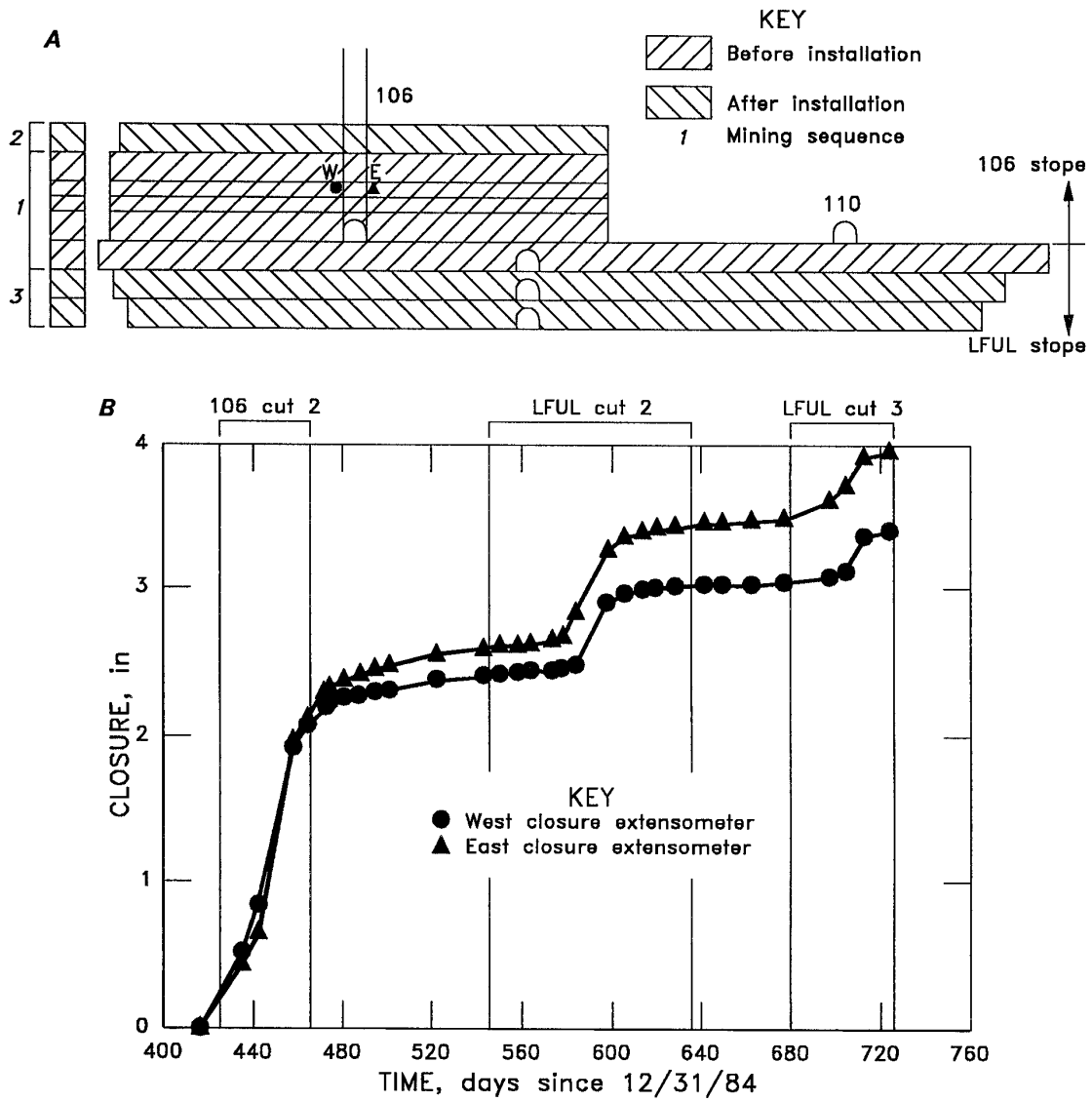

Figure 18.—Excavation sequence in 106 and LFUL stopes (A); response of closure extensometers in 106 stope to mining in LFUL stope (B).

Closure measurements were continued in the ramp after initial stabilization to check the response of the ramp to mining in the LFUL stope. In general, only the portions of the ramp nearest the stope (R2, R3, R6, R7, and R8) showed any change. This was especially evident for closure measurements in the second ramp spiral (R6, R7, and R8), which were quite small until mining reached cut 4, the first cut to use the second ramp spiral.

Overall, measured closure throughout the monitoring period was modest (<2 in), suggesting that the ramp was stable.

Three reference points at RX1, RX2, and RX3 were established in the crosscut between the spiral ramp and the vein to measure closure during mining of the first cut of the LFUL stope (fig. 21). RX2 was lost to a rock burst just after this cut was completed, but the remaining reference points were available for measuring crosscut closure associated with mining in the 106 stope above. These points were lost when the crosscut ramp was deepened to access the second cut of the LFUL stope.

MPBX-R1 was installed in the wall of the ramp near the LFUL stope just after excavation of the first cut of the LFUL stope. The purpose was to monitor the stability of the pillar between ramp and stope (fig. 22). Measurements were taken during mining in the 106 stope as well as the second and third cuts in the LFUL stope. The relative movement measured between anchors suggested minor inelastic deformation of rock between the 15-, 25-, and 40-ft anchors, which were nearest the stope, and between the collar (at the ramp wall) and the 5-ft anchor next to the ramp. The remaining portion of the pillar between the 5- and 15-ft anchors was very stable. The small magnitude of these displacements, less than 0.1 in, indicated a stable ramp pillar.

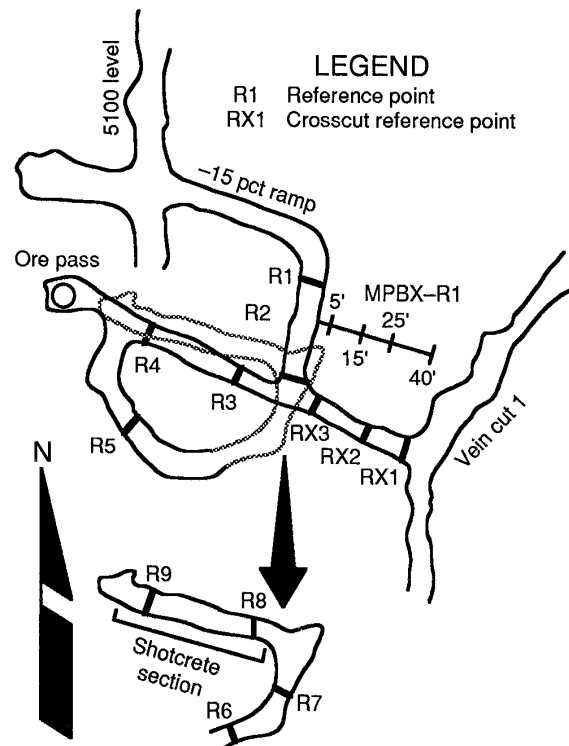

Figure 19.—Location of ramp (R1 to R4) and ramp crosscut (RX5 to RX9) monitoring stations.

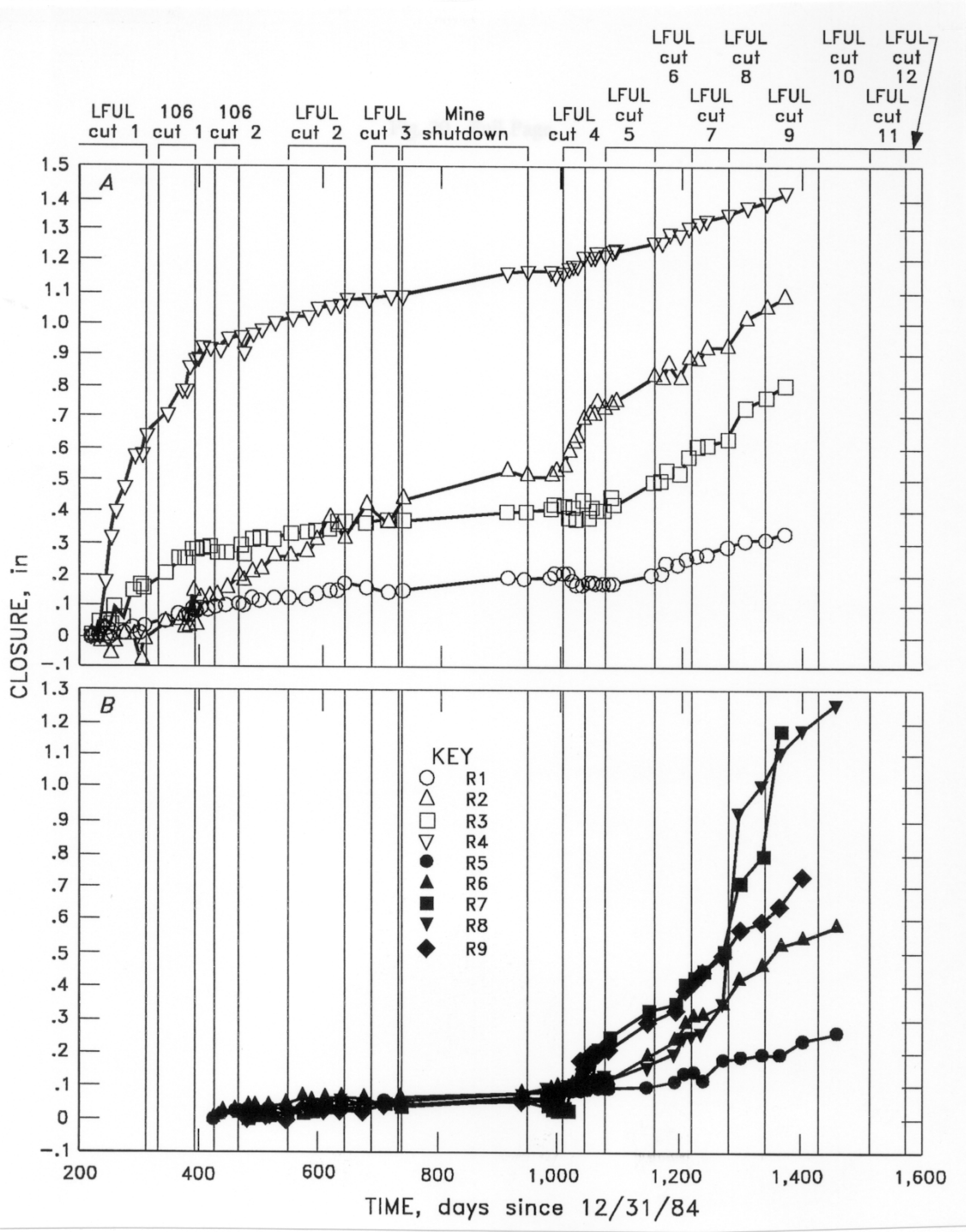

Figure 20.—Closure measured at ramp monitoring stations during mining. A, RX1 to RX4; B, RX5 to RX9.

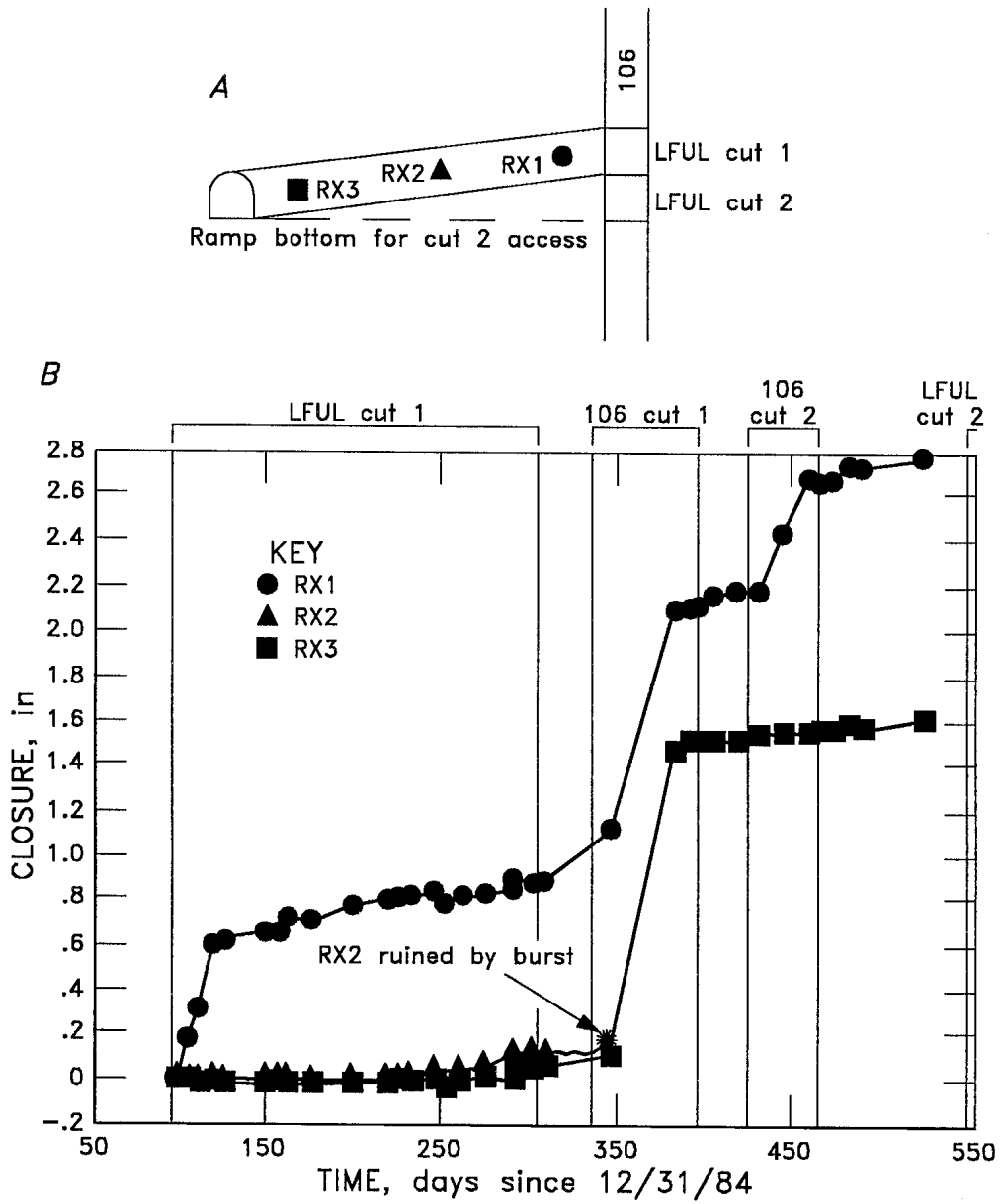

Figure 21.—Location of monitoring stations in ramp crosscut (A) and measured closure (B).

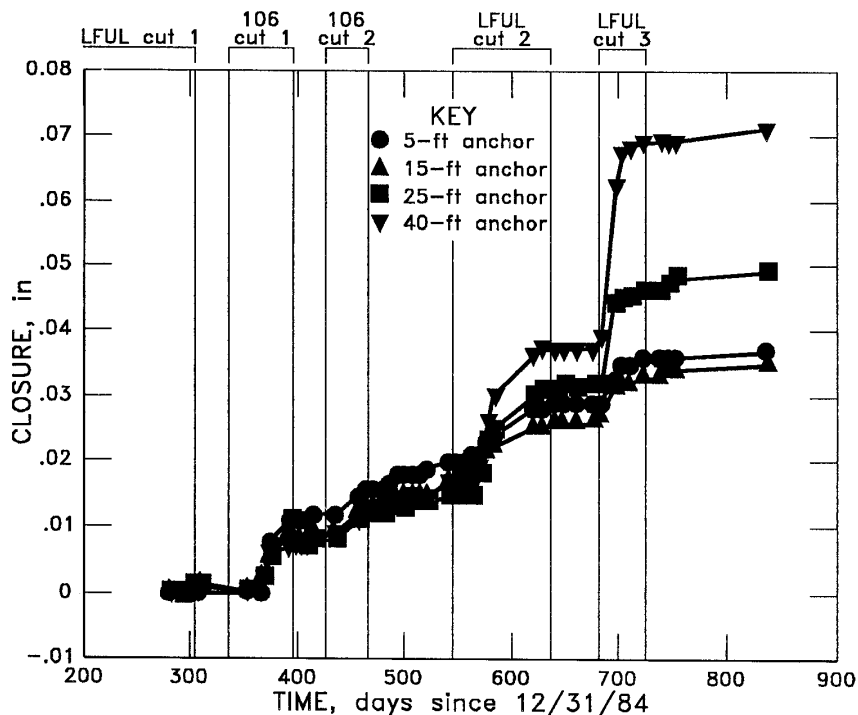

Figure 22.—Response of MPBX-R1.

SECOND INSTRUMENTATION CYCLE

The second set of four pairs of closure extensometers and pressure cells was installed in cut 5 of the LFUL stope along with the fill reinforcement. A lean cemented backfill was placed 6 to 7 ft high throughout the stope.

All four pressure cells (fig. 23) showed an increase in pressure between 300 and 400 psi during mining of cut 6, but failed to survive excavation of cut 7. Three of the four corresponding stope closure extensometers survived backfilling to record closure during mining of cut 6 (fig. 24). These instruments showed wide variations in the amount of stope closure between locations (1 to 3 in) and did not vary in concert with fill pressure measurements. This lack of correlation suggests that fill properties continued to vary widely within the stope.

The closure extensometer at W1 survived to monitor excavation of cuts 7 and 8, showing reduced, but still significant, closure with each cut. Visual inspection of backfill in the stope (possible through an unfilled portion of the ramp crosscut) just prior to excavation of cut 8 showed cut 5 fill was buckling up into the gap between stope fill levels (fig. 25). Two additional closure extensometers were installed at this time at locations W1A and W1B, between W1 and the ramp crosscut at cut 5. These closure extensometers survived mining of cut 8 through part of cut 11 and indicated continued closure at significant, but declining, rates with mining (fig. 24). These measurement readings reinforced the pattern of local variation in closure registered by the extensometers placed in cut 5 fill.

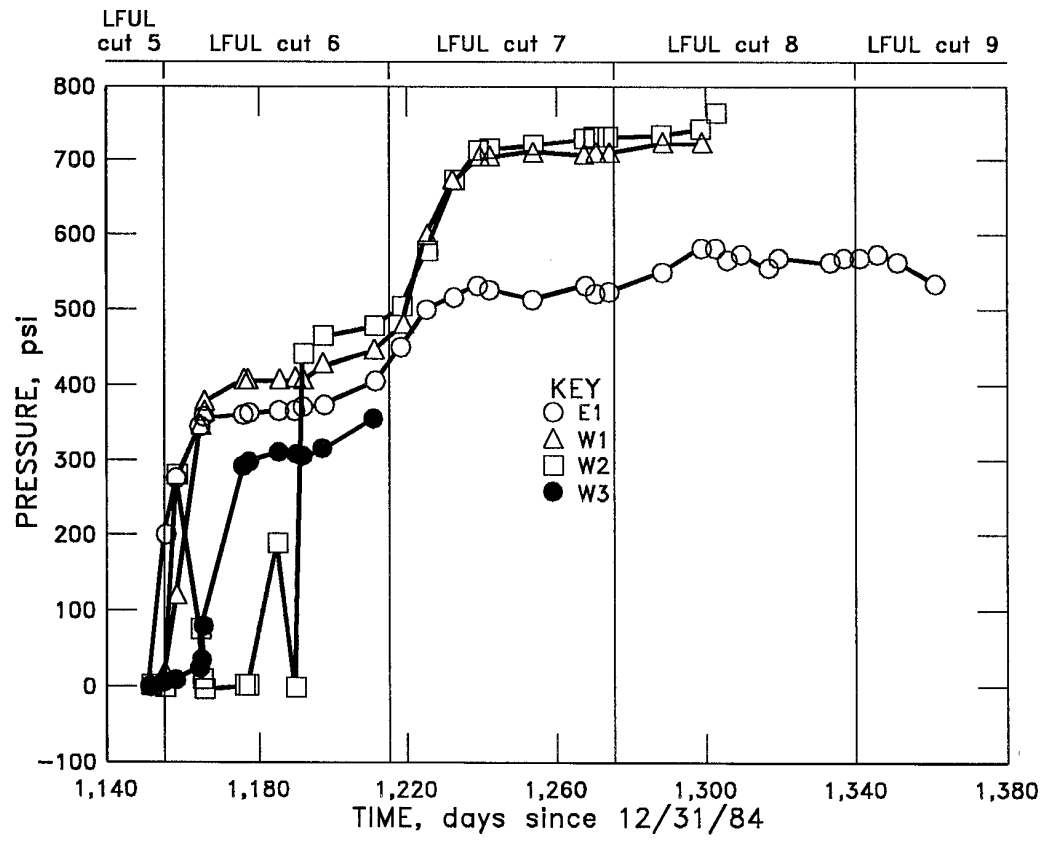

Figure 23.—Response of pressure cells in cut 5 to mining in cuts 6 through 9.

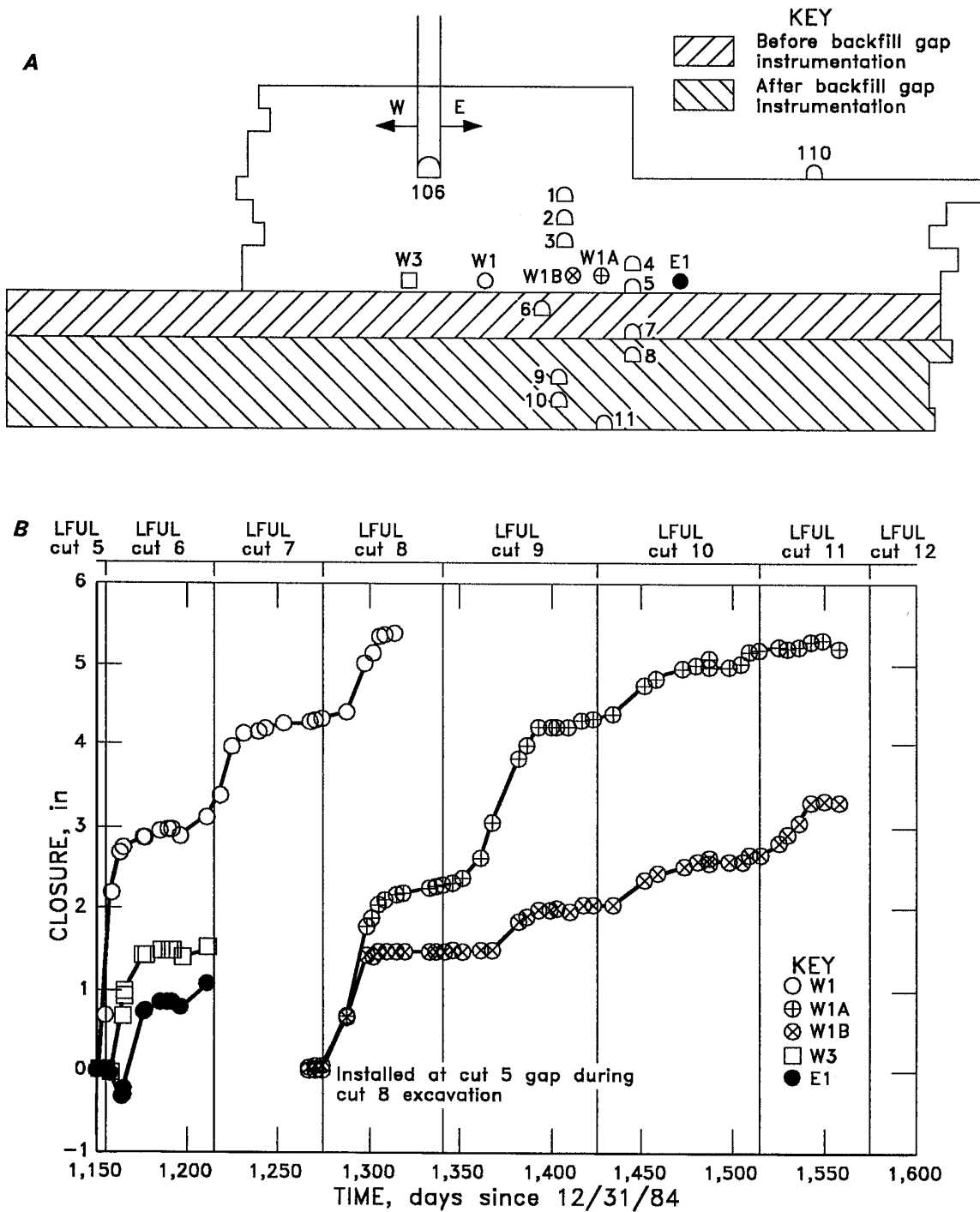

Figure 24.—Location of slope monitoring stations (A) and measured closure (B) in cut 5 to mining in cuts 6 through 12.

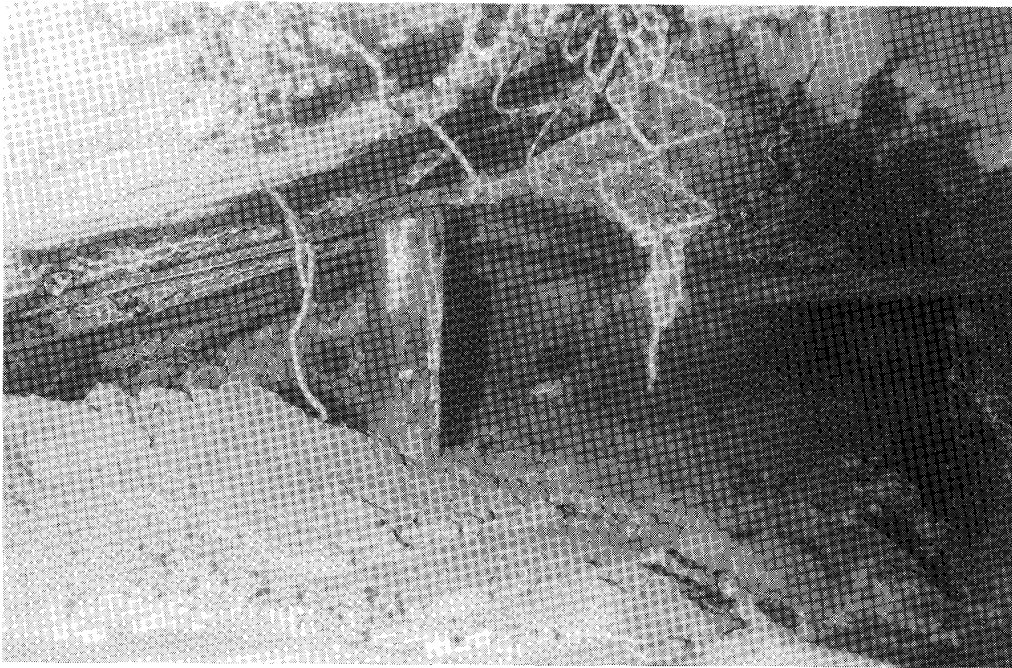

Figure 25.—Gap above sandfill in cut 5.

THIRD INSTRUMENTATION CYCLE

The final set of four closure extensometers and six pressure cells were installed in cut 10. The fill buckling and continued high rate of closure in cut 5 led researchers and mine staff to discuss ways to improve the speed at which support pressure could be generated in the fill. The easiest way appeared to be filling the stope as tight to the back as possible, hastening the attainment of fully confined conditions. With significant extra effort, miners were able to fill to within an average of 6 in of the back.

All the closure extensometers and five of the pressure cells survived backfilling operations to monitor mining of cut 11. The closure extensometers showed relatively

modest stope closures averaging less than 0.8 in. in response to mining of cut 11 (fig. 26A). The pressure cells (fig. 26B) showed generally impressive support pressures after excavation of cut 11. Four of the five pressure cells measured 600 to 1,000 psi. The lowest pressure, measured at W2A, registered nearly 300 psi, which was in line with the average pressure generated in cut 5 and may have been the result of a localized void. Thus, support pressure measured by all five cells averaged 800 psi. These instruments failed either during filling of cut 11 or early in the excavation of cut 12; pressure cell W1B measured a peak pressure of over 1,400 psi before it failed during excavation of cut 12.

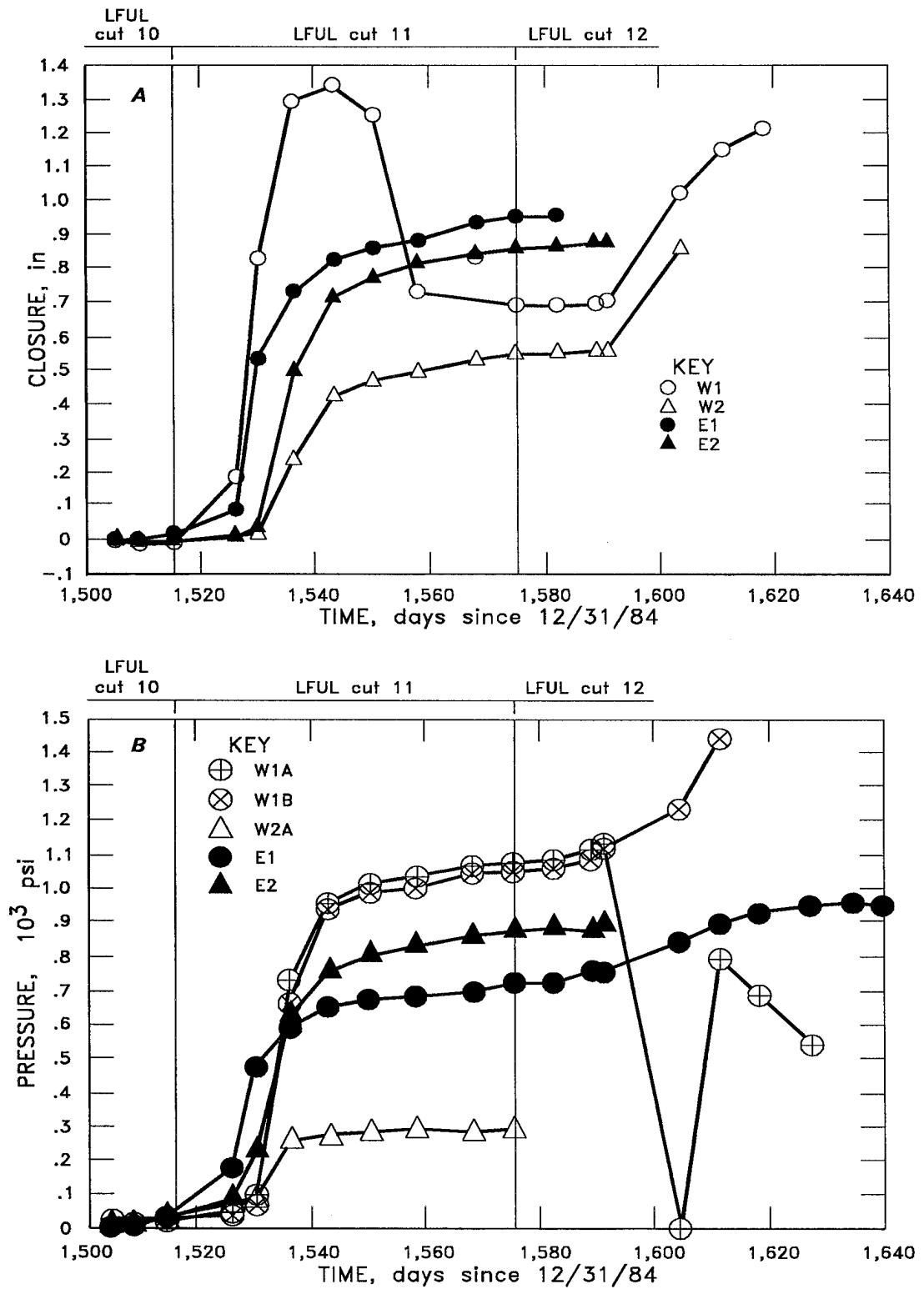

Figure 26.—Response of closure extensometers (A) and pressure cells (B) in cut 10 to mining.

DISCUSSION AND CONCLUSIONS

FILL PERFORMANCE

Although the survival rate for instruments installed in the fill was poor, enough instruments did survive to give good indications of fill performance. For instance, despite significant localized variations, closure after one additional cut averaged about 1.9 in for cut 1, 1.8 in for cut 5, and less than 0.8 in for cut 10. This decrease in closure appears to be in opposition to the tendency for greater closure as mining opens a larger area. The corresponding fill pressure and total load supported per foot of stope length after one additional cut improved also. The instruments showed that fill pressure increased from 40 psi in cut 1, to 350 psi in cut 5, and finally to 800 psi in cut 10. Adjusting for the portion of each cut actually filled, cut 1 (90 pct filled) produced about 52,000 lb of support force per foot of cut, cut 5 (60 pct filled) about 300,000 lb, and cut 10 (95 pct filled) more than 1,000,000 lb.

Thus, fill performance steadily improved through the life of this project. Continual improvement of the fill system reduced the number and severity of local fill failures, slowed stope closure, and increased the regional support pressure generated in the fill. Whyatt, Williams, and Board (15) present further analysis of LFUL backfill performance and the implications for rock bursting in part 2 of this series.

RAMP STABILITY

Instrument readings generally showed good ramp stability. The fracture zone ahead of mining appeared to stabilize quickly after excavation and did not propagate far into the ramp-stope pillar. However, some localized zones of weaker rock were encountered that significantly increased ramp closure and created ground control problems in the ore pass. The ground support measures undertaken were sufficient to stabilize these sections. The ramp should not be in danger unless support is neglected or zones of rock significantly weaker than those already encountered are intersected. Rock bursts still pose a threat in the ramp, as they do throughout the mine.

ROCK MASS RESPONSE

Monitoring the response of the rock mass was frustrated by instrument failures. Attempts to measure changes in stress and fracture zone development below the mining

front failed completely. The only direct measurements of rock mass response were obtained by MPBX-R1 installed in the ramp pillar and the two MPBX's installed in the stope. However, these instruments were located above the mining front. Thus, although they do provide some information on the depth of the fracture zone in stope and ramp walls, they do not describe the fracture and stress concentration zones ahead of mining.

However, some indirect information on the relative rock burst hazard associated with different backfill reinforcement designs can be gleaned from the stope closure data. Since the energy release rate is a known indicator of rock bursting and is a direct function of closure, improvements in backfill design that reduce closure do have a positive influence on the probability of rock burst occurrence. An analysis of this influence, emphasizing the role of gaps left in the fill between levels, is presented in part 2 of this series.

MINING METHOD

Geomechanical evaluation of a new mining method, especially in a geologically complex environment such as the Coeur d'Alene Mining District, is anything but straightforward. The effort to monitor the geomechanical performance of the experimental LFUL stope encountered serious problems because of difficulties during instrument installation and because most of the instruments failed. Nonetheless, some insights were gained regarding three geomechanical factors (backfill performance, ramp stability, and rock mass response) that directly affected stope performance. Surviving instruments, the analyses pursued in later parts of this series, and mining experience showed that the method did not suffer from serious problems in any of these areas.

This conclusion, and positive operational and economic considerations, have led to mine-wide adoption of the mining method. Indeed, this study and mining experience suggest that the underhand longwall method of mining could be considered a practical and economical mining method for rock-burst-prone ground throughout the Coeur d'Alene District. Mining this experimental stope is the culmination of years of research by Bureau investigators, cooperating companies in the mining industry, and academia. This effort has successfully adapted the underhand longwall cut-and-fill mining method to conditions in the Coeur d'Alene Mining District.

REFERENCES

1. Bush, D. D., W. Blake, and M. P. Board. Evaluation and Demonstration of Underhand Stopping To Control Rock Bursts (contract HO292013). BuMines OFR 62-85, 1982, 191 pp.
2. Cuvelier, D. (Hecla Mining Co.). Private communication, 1986.
3. Hedley, D. G. F., and R. J. Wetmiller. Rockbursts in Ontario Mines During 1984. Can. Cent. Miner. and Energy Technol., Elliot Lake, ON, CANMET Rep. MRL SP85-5, July 1985, 36 pp.
4. High-Level Committee on Rockbursts and Rockfalls. An Industry Guide to the Amelioration of the Hazards of Rockbursts and Rockfalls. Chamber of Mines of S. Afr., Johannesburg, S. Afr., 1977, 123 pp.
5. Jenkins, F. M., T. J. Williams, and C. J. Wideman. Analysis of Four Rockbursts in the Lucky Friday Mine, Mullan, Idaho, USA. Paper in International Deep Mining Conference: Technical Challenges in Deep Level Mining, ed. by D. A. J. Ross-Watt and P. D. K. Robinson (Johannesburg, S. Afr., Sept. 17-21, 1990). S. Afr. Inst. of Min. and Metall., Johannesburg, S. Afr., 1990, v. 2, pp. 1201-1212.
6. Leighton, F. A Case History of a Major Rock Burst. BuMines RI 8701, 1982, 14 pp.
7. McMahon, T. Rock Burst Research and the Coeur d'Alene District. BuMines IC 9186, 1988, 49 pp.
8. Noyes, R. R., G. R. Johnson, and S. D. Lautenschlager. Underhand Stopping at the Lucky Friday Mine. Pres. at 94th annu. meet., NW Min. Assoc. (Spokane, WA, Dec. 2, 1988). Paper No. 12, 8 pp.; available from J. K. Whyatt, Spokane Research Center, BuMines, Spokane, WA.
9. Pariseau, W. G., J. K. Whyatt, and T. J. McMahon. Rock Mechanics Investigations at the Lucky Friday Mine (In Three Parts):
3. Calibration and Validation of a Stope-Scale, Finite-Element Model. BuMines RI 9434, 1992, 16 pp.
10. Scott, D. F. Relationship of Geologic Features to Seismic Events, Lucky Friday Mine, Mullan, Idaho. Paper in Rockbursts and Seismicity in Mines. Proceedings of the 2nd International Symposium on Rockbursts and Seismicity in Mines (Minneapolis, MN, June 8-10, 1988), ed. by C. Fairhurst. A. A. Balkema, 1990, pp. 401-406.
11. Werner, M. A. The Lucky Friday Underhand Longwall Mining Method. Ph. D. dissertation, Univ. of ID, Moscow, ID, 1990, 132 pp.
12. Whyatt, J. K. Geomechanics of the Caladay Shaft. M. S. Thesis, Univ. of ID, Moscow, ID, 1986, 195 pp.
13. Whyatt, J. K., and M. P. Board. Numerical Exploration of Shear-Fracture-Related Rock Bursts Using a Strain-Softening Constitutive Law. BuMines RI 9350, 1991, 14 pp.
14. Whyatt, J. K., and E. L. Hardin. Microcomputer-Based Instrumentation System for Monitoring Ground Support in a Deep Mine Shaft. BuMines IC 9062, 1986, 88 pp.
15. Whyatt, J. K., T. J. Williams, and M. P. Board. Rock Mechanics Investigations at the Lucky Friday Mine (In Three Parts): 2. Evaluation of Underhand Backfill Practice for Rock Burst Control. BuMines RI 9433, 1992, 10 pp.
16. Williams, T. J., and D. J. Cuvelier. Report on a Field Trial of an Underhand Longwall Mining Method to Alleviate Rock Burst Hazards. Paper in Rockbursts and Seismicity in Mines. Proceedings of the 2nd International Symposium on Rockbursts and Seismicity in Mines (Minneapolis, MN, June 8-10, 1988), ed. by C. Fairhurst. A. A. Balkema, 1990, pp. 349-354.