

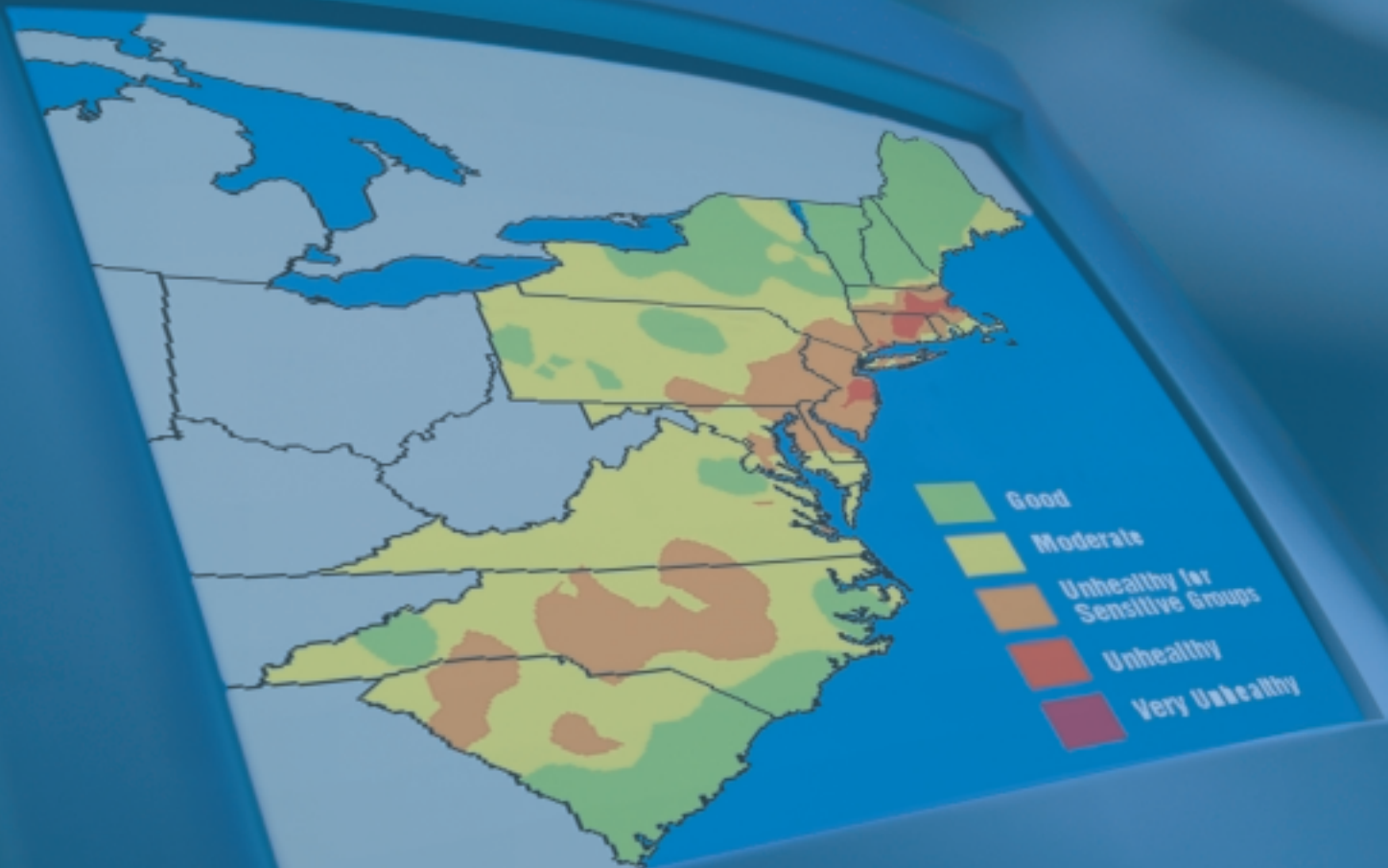

Ozone Monitoring, Mapping, and Public Outreach

Delivering Real-Time Ozone Information to Your Community



EMPACT

Environmental Monitoring for Public Access
& Community Tracking

Disclaimer

This document has been reviewed by the U.S. Environmental Protection Agency (EPA) and approved for publication. Mention of trade names or commercial products does not constitute endorsement or recommendation of their use.

Ozone Monitoring, Mapping, and Public Outreach

Delivering Real-Time Ozone Information to Your Community

**United States Environmental Protection Agency
National Risk Management Laboratory
Office of Research and Development
Cincinnati, Ohio 45268**



ACKNOWLEDGMENTS

The development of this handbook was managed by Scott Hedges (U.S. Environmental Protection Agency, National Risk Management Laboratory) with technical guidance from Richard Wayland (U.S. Environmental Protection Agency, Office of Air Quality, Planning and Standards). While developing this handbook, we sought the input of many individuals in air quality agencies across the country and within the U.S. Environmental Protection Agency. Gratitude is expressed to each person for their involvement and contributions.

Tad Aburn, Maryland Department of the Environment, Air Quality Planning Program

Lee Alter, Northeast States for Coordinated Air Use Management (NESCAUM)

Aaron Childs, City of Indianapolis Environment and Resource Management Division

Greg Cooper, New Jersey Department of Environmental Protection, Office of Air Quality Management

Laura DeGuire, Michigan Department of Environmental Quality, Air Quality Division

Phil Dickerson, U.S. Environmental Protection Agency, Office of Air Quality, Planning and Standards

Tim Dye, Sonoma Technology, Inc.

Chris Galilei, Ohio Environmental Protection Agency

Lisa Grosshandler, North Carolina Department of the Environment and Natural Resources, Division of Air Quality

Mike Koerber, Lake Michigan Air Directors Consortium (LADCO)

Thomas Monosmith, Michigan Department of Environmental Quality, Air Quality Division

Randy Mosier, Maryland Department of the Environment, Air Quality Planning Program

Mike Norcom, Mississippi Department of Environmental Quality

James Parks, Indiana Department of Environmental Management, Air Quality Division

Charles Pietarinen, New Jersey Department of Environmental Protection, Office of Air Quality Management

Scott Reynolds, South Carolina Department of Health and Environmental Control, Air Quality Analysis

Mike Rizzo, U.S. Environmental Protection Agency, Region 5

Liz Santa, Louisiana Department of Environmental Quality, Air Quality Division

Kerry Shearer, Sacramento Metropolitan Air Quality Management District

Dan White, Texas Natural Resource Conservation Commission

Neil Wheeler, MCNC Environmental Programs

CONTENTS

1. INTRODUCTION	1
2. HOW TO USE THIS HANDBOOK	5
3. OZONE MONITORING	7
3.1 Ozone Monitoring—An Overview	7
3.2 Siting Your Ozone Monitoring Network	10
3.3 Selecting Monitoring Equipment	13
3.4 Installing Monitoring Equipment	15
3.5 Calibrating Monitoring Equipment	18
3.6 Maintaining Your Monitoring Equipment and Ensuring Data Quality	20
3.7 Annual Network Review	24
4. DATA COLLECTION AND TRANSFER FOR OZONE MAPPING	25
4.1 Overview of the Automated Data Transfer System (ADTS)	25
4.2 Getting Ready to Use the ADTS for Data Collection and Transfer	28
4.3 Using the ADTS for Data Collection and Transfer	32
4.4 Operations at the Data Collection Center	41
5. MAKING OZONE MAPS	45
5.1 Understanding MapGen's Capabilities	45
5.2 Getting Started	46
5.3 Generating and Managing Maps	48
5.4 Advanced Features	61
5.5 Technical Support	61
6. COMMUNICATING INFORMATION ABOUT OZONE AND THE OZONE MAP	63
6.1 Creating an Outreach Plan for Ozone	63
6.2 Successful Ozone Outreach Programs	70
6.3 Guidelines for Presenting Information About Ozone to the Public	71
APPENDIX A	A-1
Tips on Configuring the Automatic Data Transfer System	
APPENDIX B	B-1
Instructions for Installing and Configuring Software	
APPENDIX C	C-1
Automated Data Quality Checks	

1. INTRODUCTION

Ozone, when it occurs at ground level, presents a serious air quality problem in many parts of the United States. Ozone is a major ingredient of smog, and when inhaled—even at very low levels—it can cause a number of respiratory health effects. People who live in communities with high ozone levels can use timely and accurate information to make informed decisions about how to protect their health from ozone exposure and when to take actions to reduce local ozone levels.

This handbook is designed to provide you with step-by-step instructions about how to provide this information to your community. It was developed by the U.S. Environmental Protection Agency’s (EPA’s) EMPACT program. EPA created EMPACT (Environmental Monitoring for Public Access and Community Tracking) in 1997, at President Clinton’s direction. The program takes advantage of new technologies that make it possible to provide environmental information to the public in near real time. EMPACT is working with the 86 largest metropolitan areas of the country to help communities in these areas:

- Collect, manage, and distribute time-relevant environmental information.
- Provide their residents with easy-to-understand information they can use in making informed, day-to-day decisions.

To help make EMPACT more effective, EPA is partnering with the National Oceanic and Atmospheric Administration and the U.S. Geological Survey. EPA will work closely with these federal agencies to help achieve nationwide consistency in measuring environmental data, managing the information, and delivering it to the public.

To date, environmental information projects have been initiated in 61 of the 86 EMPACT-designated metropolitan areas. These projects cover a wide range of environmental issues, such as groundwater contamination, ocean pollution, smog, ultraviolet radiation, and overall ecosystem quality. Some of these projects have been initiated directly by EPA. Others have been launched by EMPACT communities themselves. Local governments from any of the 86 EMPACT metropolitan areas are eligible to apply for EPA-funded Metro Grants to develop their own EMPACT projects.

The 86 EMPACT metropolitan areas are listed in the table at the end of this chapter.

Communities selected for Metro Grant awards are responsible for building their own time-relevant environmental monitoring and information delivery systems.

Ozone occurs both in the Earth’s upper atmosphere and at ground level. Ozone can be good or bad, depending on where it is found:

GOOD OZONE

Ozone occurs naturally in the Earth’s upper atmosphere—10 to 30 miles above the Earth’s surface—where it forms a protective barrier that shields people from the sun’s harmful ultraviolet rays. This barrier is sometimes called the “ozone layer.”

BAD OZONE

Because of pollution, ozone can also be found in the Earth’s lower atmosphere, at ground level. Ground-level ozone is a major ingredient of smog, and it can harm people’s health by damaging their lungs. Ground-level ozone can also damage crops and many common man-made materials, such as rubber, plastic, and paint.

To find out how to apply for a Metro Grant, visit the EMPACT Web site at <http://www.epa.gov/empact/apply.htm>.

One of the largest and most successful EMPACT projects is the Ozone Mapping Project, which creates maps that provide communities with real-time information about ozone pollution in an easy-to-understand pictorial format. The maps are created from hourly ozone data taken from monitoring networks in different regions of the country. They use color-coded contours to depict the level of health concern associated with different categories of ozone concentration. Shown below is a map that depicts peak ozone values in the northeastern United States on August 24, 1998.

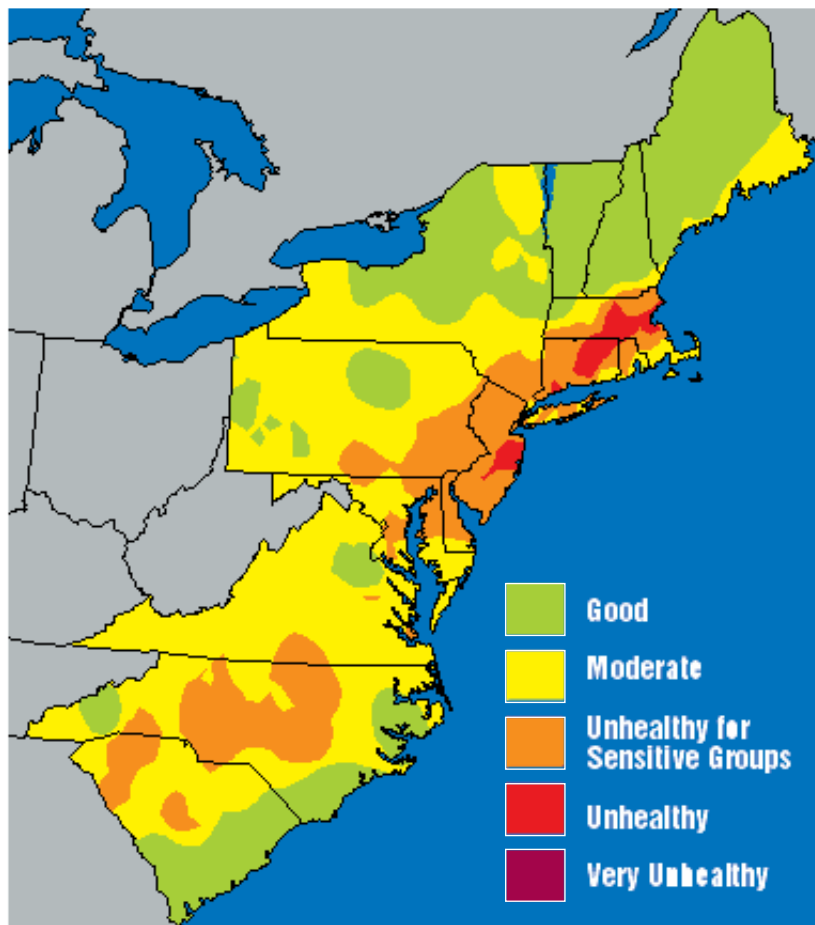

The Ozone Mapping Project is a cooperative effort of the EPA, State and local air pollution control agencies, and regional organizations, including the Northeast States for Coordinated Air Use Management (NESCAUM)(<http://www.nescaum.org>), the Mid-Atlantic Regional Air Management Association (MARAMA)(<http://www.marama.org>), and the Lake Michigan Air Directors Consortium (LADCO)(<http://www.ladco.org>). In 1998, EPA's Office of Air and Radiation assumed coordination of the project. The ozone maps are found on EPA's AIRNOW Web site—part of the Ozone Mapping Project (<http://www.epa.gov/airnow>). AIRNOW displays still-frame maps that show today's ozone levels, yesterday's peak ozone values, and tomorrow's ozone forecast,

as well as animated maps that depict the formation and movement of ozone throughout the day. The AIRNOW Web site also provides information about the health effects of ozone and links to state and local air pollution control agencies with real-time ozone data.

The number of cities served by the Ozone Mapping Project is growing but limited by available resources. The Technology Transfer and Support Division of the EPA Office of Research and Development's (ORD's) National Risk Management Laboratory initiated the development of this handbook to help interested communities learn more about the Ozone Mapping Project and to provide them with the technical information they need to develop and manage their own ozone monitoring, mapping, and information dissemination programs. ORD, working with the AIRNOW project lead from EPA's Office of Air Quality, Planning and Standards, produced the handbook to maximize EMPACT's investment in the project and minimize the resources needed to implement it in new cities. The handbook is also available in CD-ROM format.

Both print and CD-ROM versions of the handbook are available for direct online ordering from EPA's Office of Research and Development Technology Transfer Web site at <http://www.epa.gov/ttnrml/>. The handbook can be downloaded from EPA's Office of Air Quality Planning and Standards AIRNOW Web site at <http://www.epa.gov/airnow/>. You can also obtain a copy of the handbook by contacting the EMPACT program office at:

EMPACT Program
U.S. EPA (8722R)
401 M Street, SW
Washington, DC 20460
Phone: 202-564-6791
Fax: 202-565-1966

We hope that you find the handbook worthwhile, informative, and easy to use. We welcome your comments, and you can send them by e-mail from EMPACT's Web site at <http://www.epa.gov/empact/comment.htm>.

EMPACT Metropolitan Areas

Albany-Schenectady-Troy, NY
Albuquerque, NM
Allentown-Bethlehem-Easton, PA
Anchorage, AK
Atlanta, GA
Austin-San Marcos, TX
Bakersfield, CA
Billings, MT
Birmingham, AL
Boise, ID
Boston, MA-NH
Bridgeport, CT
Buffalo-Niagara Falls, NY
Burlington, VT
Charleston-North Charleston, SC
Charleston, WV
Charlotte-Gastonia-Rock Hill, NC-SC
Cheyenne, WY
Chicago-Gary-Kenosha, IL-IN-WI
Cincinnati-Hamilton, OH-KT-IN
Cleveland-Akron, OH
Columbus, OH
Dallas-Fort Worth, TX
Dayton-Springfield, OH
Denver-Boulder-Greeley, CO
Detroit-Ann Arbor-Flint, MI
El Paso, TX
Fargo-Moorhead, ND-MN
Fresno, CA
Grand Rapids-Muskegon-Holland, MI
Greensboro-Winston Salem-High Point, NC
Greenville-Spartanburg-Anderson, SC
Harrisburg-Lebanon-Carlisle, PA
Hartford, CA
Honolulu, HI
Houston-Galveston-Brazoria, TX
Indianapolis, IN
Jackson, MS
Jacksonville, FL
Kansas City, MO-KS
Knoxville, TN
Las Vegas, NV
Little Rock-North Little Rock, AR
Los Angeles-Riverside-Orange County, CA
Louisville, KY-IN
Memphis, TN-AR-MS
Miami-Fort Lauderdale, FL
Milwaukee-Racine, WI
Minneapolis-St. Paul, MN
Nashville, TN
New Orleans, LA
New York-Northern New Jersey-Long Island, NY-NJ-CT-PA
Norfolk-Virginia Beach-Newport News, VA-NC
Oklahoma City, OH
Omaha, NE-IA
Orlando, FL
Philadelphia-Wilmington-Atlantic City, PA-NJ-DE-MD
Phoenix-Mesa, AZ
Pittsburgh, PA
Portland, ME
Portland-Salem, OR-WA
Providence-Fall River-Warwick, RI-MA
Raleigh-Durham-Chapel Hill, NC
Richmond-Petersburg, VA
Rochester, NY
Sacramento-Yolo, CA
Salt Lake City-Ogden, UT
San Antonio, TX
San Diego, CA
San Francisco-Oakland-San Jose, CA
San Juan, PR
Scranton-Wilkes-Barre-Hazleton, PA
Seattle-Tacoma-Bremerton, WA
Sioux Falls, SD
Springfield, MA
St. Louis-E. St. Louis, MO-IL
Stockton-Lodi, CA
Syracuse, NY
Tampa-St. Petersburg-Clearwater, FL
Toledo, OH
Tucson, AZ
Tulsa, OK
Washington-Baltimore, DC-MD-VA-WV
West Palm Beach-Boca Raton, FL
Wichita, KS
Youngstown-Warren, OH

2. HOW TO USE THIS HANDBOOK

This handbook provides you with the information your community will need to develop an ozone monitoring, mapping, and outreach program. It contains detailed guidance about how to:

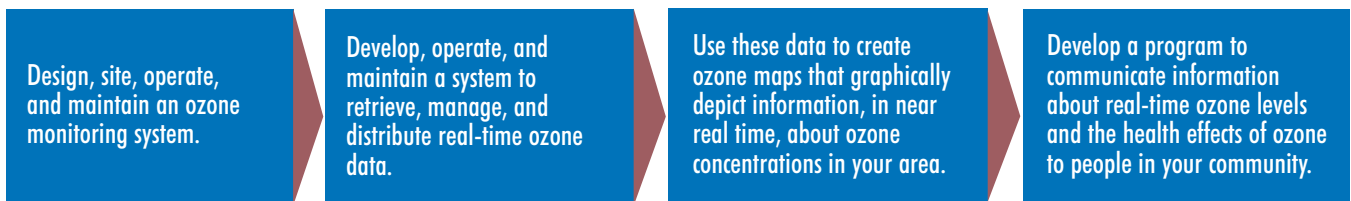

The handbook provides simple “how-to” instructions on each of these topics:

- **Chapter 3** explains how to implement an ozone monitoring program that will meet criteria established under the Clean Air Act for a National Air Monitoring Station and State/Local Air Monitoring Station (NAMS/SLAMS) monitoring network. It helps you plan and site your ozone monitoring network; select, install, and operate your monitoring equipment; and develop a preventive maintenance plan.
- **Chapter 4** provides you with the information you will need to operate the Automatic Data Transfer System (ADTS), which retrieves data from ozone monitors, converts the data from a participating agency’s format to a standard format, ensures the integrity of the data, and prepares it for ready-to-use mapping. This chapter helps you to obtain, install, configure, and operate the ADTS. It also provides guidance on how to conduct quality assurance checks on your ozone data. Appendices A and B provide step-by-step instructions on how to configure the ADTS and install supplemental software, and Appendix C contains a detailed description of data quality checks.
- **Chapter 5** offers a complete primer on MapGen, a software application developed by EPA that you can use to make maps that illustrate the concentration levels of ozone in your area. This chapter contains instructions on obtaining and installing the software, generating maps, using advanced features, troubleshooting, and obtaining technical support.
- **Chapter 6** outlines the steps involved in developing an ozone outreach plan and profiles examples of successful ozone outreach initiatives that have been implemented in EMPACT cities across the country. It also provides guidelines for communicating information about ozone and includes examples of information, written in an easily understandable, plain-English style, which you can incorporate into your own communication and outreach materials.

This handbook is designed both for decision-makers who may be considering whether to implement an ozone program in their communities and for technicians responsible for implementing an ozone program. Managers and decision-makers likely will find the initial sections of Chapters 3, 4, and 5 most helpful. The latter sections of these chapters are targeted primarily for technicians and provide detailed “how to” information. Chapter 6 is designed for managers and communication specialists.

The handbook also refers you to supplementary sources of information, such as Web sites, EPA technical guidance documents, and Internet news groups, where you can find additional guidance at a greater level of technical detail. Interspersed throughout the handbook are success stories and lessons learned from EMPACT cities that have already implemented their own ozone monitoring, data transfer, mapping, and outreach programs.

3. OZONE MONITORING

This chapter provides information about ozone monitoring, the first step in the process of generating real-time ground-level ozone information and making it available to residents in your area. The chapter begins with a broad overview of ozone monitoring (Section 3.1), then provides information about how to site, install, operate, and maintain an ozone monitoring network that complies with federal regulations (Sections 3.2 through 3.7). Throughout this chapter, you will find references to additional EPA guidance documents that provide detailed technical information about ozone monitoring.

Readers interested primarily in an overview of ozone monitoring may want to focus on the introductory information in Section 3.1. If you are responsible for actual design and implementation of a monitoring network, you should review Sections 3.2 through 3.7 for an introduction to the specific steps involved in developing and operating an ozone monitoring network and for information on where to find additional technical guidance.

3.1 OZONE MONITORING—AN OVERVIEW

Ground-level ozone is regulated under the Clean Air Act, the comprehensive federal law that regulates air emissions in the United States. Among other things, the Clean Air Act requires the U.S. EPA to set standards for “criteria pollutants”—six commonly occurring air pollutants, one of which is ground-level ozone. These standards, known as the National Ambient Air Quality Standards (NAAQS), are national targets for acceptable concentrations of each of the criteria pollutants. For each pollutant, EPA has developed two NAAQS standards:

- The “primary standard,” which is intended to protect public health.
- The “secondary standard,” which is intended to prevent damage to the environment and property.

A geographic area that meets the primary health-based NAAQS is called an attainment area. Areas that do not meet the primary standard are called nonattainment areas. More information about the Clean Air Act (including the full text of the law and a Plain English Guide to the Act) can be found at <http://www.epa.gov/epahome/laws.htm>.

The Clean Air Act requires each state to develop State Implementation Plans (SIPs). SIPs describe the programs a state will use to maintain good air quality in attainment areas and meet the NAAQS in nonattainment areas. For example, if a city or region is a nonattainment area for ozone, the SIP describes the programs that will be used to meet the primary NAAQS for ozone.

One of the elements of your state’s SIP is a network of monitors that measure concentrations of the six criteria pollutants, including ozone. An ozone monitoring network is an air quality surveillance system consisting of monitoring stations that measure ambient concentrations of ozone. The Clean Air Act places the responsibility on states to establish and operate these ozone monitoring networks and to report the data to EPA. EPA’s standards for ozone monitoring networks are found

in the Code of Federal Regulations (40 CFR Part 58 [National Primary and Secondary Ambient Air Quality Standards]). You can access and review these CFR sections from the Ambient Monitoring Technology Information Center (AMTIC) Web site at <http://www.epa.gov/ttn/amtic/codefed.html>.

Information provided by your ozone monitoring network is used for a number of purposes:

- To determine if your area is in compliance with the ozone NAAQS.
- For use in models that are used to develop strategies for controlling ozone levels in your area.
- To provide information to the public about local air quality. You can use ozone data to create ozone maps depicting today's ozone levels, yesterday's peak ozone values, and tomorrow's ozone forecast, as well as animated maps that illustrate the formation and movement of ozone throughout the day. These maps serve as effective tools for warning residents in your community when levels of ozone are unhealthy or expected to be unhealthy.

Under the State and Local Air Monitoring Stations network, three different subsystems are used to carry out ozone monitoring:

- *State and Local Air Monitoring Stations (SLAMS)*. SLAMS stations are used to demonstrate if an area is meeting the ozone NAAQS. A SLAMS system consists of a carefully planned network of fixed monitoring stations, with the network size and station distribution largely determined by the needs of state and local air pollution control agencies to meet their SIP requirements. EPA gives states and localities flexibility in determining the size of their SLAMS network based on their data needs and available resources. SLAMS network must be able to determine:
 - The highest concentration of ozone expected to occur in the area covered by the network.
 - Representative concentrations in areas of high population density.
 - The impact of significant sources or source categories on ambient pollution levels.
 - General background concentration levels.
 - The extent of regional pollutant transport among populated areas.
 - Impacts in more rural and remote areas (such as visibility impairment and effects on vegetation).
- *National Air Monitoring Stations (NAMS)*. NAMS are used to supply data for national policy and trend analyses and to provide the public with information about air quality in major metropolitan areas. NAMS are required in urban areas with populations greater than 200,000. NAMS monitoring stations are selected from a subset of the SLAMS network, and EPA requires a minimum of two NAMS monitors in

each of these metropolitan areas. There are two categories of NAMS monitoring stations:

- Stations located in areas of expected maximum ozone concentration.
 - Stations located in areas where poor air quality is combined with high population density. (These monitors are sometimes known as “maximum exposure monitors.”)
- *Photochemical Assessment Monitoring Stations (PAMS)*. PAMS are required to obtain more comprehensive and representative data about ozone air pollution in ozone nonattainment areas designated as serious, severe, or extreme. The table below shows how EPA designates a nonattainment area as serious, severe, or extreme. (The ozone design value for a site, shown in the right-hand column, is the 3-year average of the annual fourth-highest daily maximum 8-hour ozone concentration.)

Nonattainment Area Classification	Ozone Design Value
Serious	0.160 parts per million (ppm) to 0.180 ppm
Severe	0.180 ppm to 0.280 ppm
Extreme	0.280 ppm and higher

PAMS networks are used to monitor surface and upper-air meteorological conditions and ozone precursors. (See the box below for an explanation of ozone precursors.) Areas with fewer than 500,000 people must have at least two PAMS sites; areas with 500,000 to 1,000,000 people must have at least three sites; areas with 1,000,000 to 2,000,000 people must have at least four sites; and areas with more than 2,000,000 people must have at least five sites. EPA’s *Photochemical Assessment Monitoring Stations Implementation Manual* (available at <http://www.epa.gov/ttnamti1/pams.html>) provides detailed information about the number of PAMS required, station location guidance, and siting criteria. The specific types of PAMS monitoring sites are described in greater detail in Appendix D of 40 CFR Part 58.

Ozone Precursors

Ground-level ozone forms when various pollutants, such as volatile organic compounds and nitrogen oxides, mix in the air and react chemically in the presence of sunlight. These pollutants are known as **ozone precursors**. Common sources of volatile organic compounds (often referred to as VOCs) include motor vehicles, gas stations, chemical plants, and other industrial facilities. Solvents such as dry-cleaning fluid and chemicals used to clean industrial equipment are also sources of VOCs. Common sources of nitrogen oxides include motor vehicles, power plants, and other fuel-burning sources.

Because ozone levels increase significantly in the hotter parts of the year in most areas of the country, EPA requires that ozone monitoring at NAMS and SLAMS monitoring sites be conducted during “ozone season” only. EPA has designated ozone seasons for each state. These designations can be found in Appendix D of 40 CFR Part 58.

3.2 SITING YOUR OZONE MONITORING NETWORK

You will need to take a series of specific steps to establish and begin operating an ozone monitoring network. First, you will need to consider where to locate your ozone monitors. A well-designed ozone monitoring network would likely include monitoring stations at four key types of sites:

- Maximum population exposure sites
- Maximum downwind concentration sites
- Maximum emissions impact (maximum ozone precursor concentration) sites
- Upwind background sites

The chart below provides details about these sites:

Type of Site	Relevant Pollutants	Monitoring Objective	Notes
Maximum exposure	Ozone	Regulatory compliance	Required as part of the NAMS network. Designed to measure the highest ozone concentration in a heavily populated area.
Maximum downwind concentration	Ozone	Regulatory compliance	Required as part of the NAMS network. Designed to measure the maximum ozone concentration expected to occur in an urban area.
Maximum emissions	Ozone precursors (nitrogen oxides and VOCs)	Control strategy development	Designed to measure the concentration of nitrogen oxides and VOCs in proximity to a source. Data are used to model ozone formation.
Upwind background	Ozone and ozone precursors (nitrogen oxides and VOCs)	Control strategy development	Designed to measure the ozone and ozone precursor concentrations entering an urban area from an upwind source.

Locating Monitoring Sites

This subsection provides some basic information about how to locate monitoring sites and how to site monitors to avoid problems in the immediate vicinity of the monitor. For detailed guidance on siting ozone monitors, see *Guideline on Ozone Monitoring Site Selection* (available online at <http://www.epa.gov/ttn/amtic/cpreldoc.html>).

Locating Maximum Population Exposure Sites. You can use census or other population data to identify the areas with the highest populations. Ideally, the ozone monitor should be located in the highest population area likely to be exposed to high ozone concentrations. Be careful not to locate these monitors in areas where a local source of nitrogen oxide emissions, such as a highway or a fuel-combustion source, could affect monitor readings.

Locating Upwind and Downwind Maximum Concentration Sites. The prevailing wind direction is a key factor in determining where to locate upwind background and downwind maximum concentration sites. (See the diagram below illustrating a sample network design.) You can use models known as wind rose diagrams to help make these siting determinations. A program to construct wind roses is available from the Support Center for Regulatory Air Models (SCRAM) within EPA's Technology Transfer Network (TTN) at <http://www.epa.gov/ttn/scram>. In areas dominated by stagnant wind conditions (where winds average less than 1.5 meters/second), it may be difficult to determine the prevailing wind direction. In stagnant wind areas, upwind and downwind maximum concentration sites should be located not farther than 10 miles beyond the outermost portion of the urban fringe.

Wind rose plots alone, however, cannot determine the exact location of maximum ozone concentration downwind of an emission source. Saturation monitoring techniques are often used for this purpose. More information about these techniques can be found in EPA's *Photochemical Assessment Monitoring Stations Implementation Manual* at <http://www.epa.gov/ttnamt11/pams.html>.

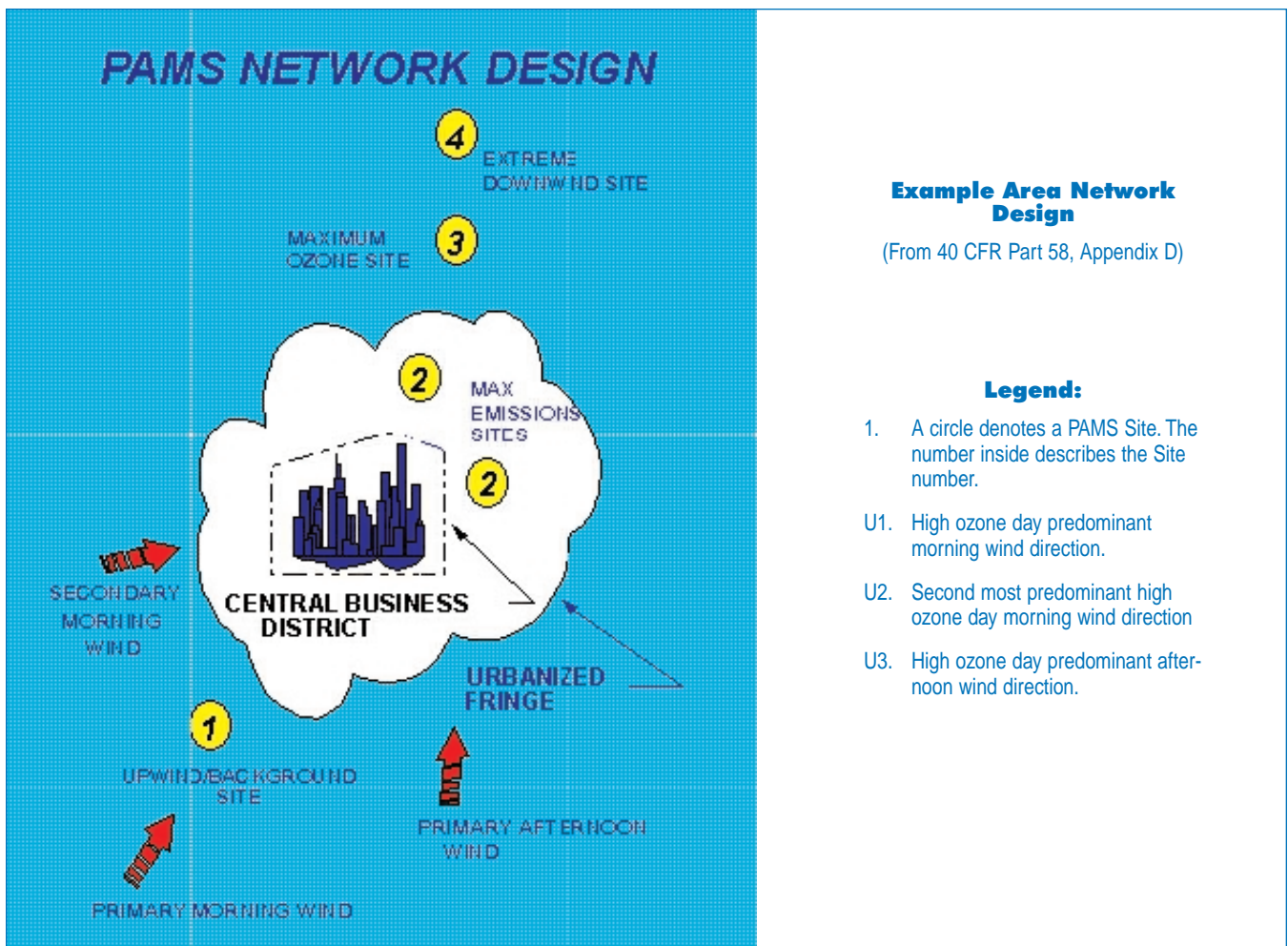

SPECIAL PURPOSE MONITORS

Obtaining Additional Data for Ozone Mapping and Outreach

To gather data on ambient ozone concentrations, the Clean Air Act requires states to establish an ozone monitoring network consisting of SLAMS and NAMS monitoring stations (and, where needed, PAMS stations).

In some cases, you may want to gather additional ozone data. When regular data gathering needs to be supplemented, Special Purpose Monitors (SPMs) are used. For example, some state and local agencies use SPMs to obtain additional information on where to locate permanent monitoring stations. SPMs are also used to focus air quality monitoring on a particular area of interest (often for studies intended to help learn more about a particular aspect of air pollution).

In addition, state and local agencies may install SPMs to supplement the data they use to map ground-level ozone concentrations in their area. These additional data are needed in some cases to ensure that the maps provided to the public are current and accurate.

Some state and local agencies that have considered installing SPMs have been concerned that these additional monitoring stations will generate data demonstrating that their region is a non-attainment area. Based on this concern, they may elect not to use SPMs. While EPA must consider all relevant, quality-checked data in reviewing compliance with NAAQS, the Agency recognizes that SPM data can play an important role in ozone monitoring and mapping. EPA does not expect to use data from ozone monitors that operate for no more than two years in judging compliance with the ozone map. Because SPMs can remain in one location for only a limited amount of time, their primary purpose is to determine how permanent monitors can be used to fill data gaps and where to locate permanent monitors to provide the best coverage for the ozone map and populated areas.

Surrogate or “dummy” monitors can also be used to facilitate ozone mapping in areas where information about local air quality is known but a permanent monitor does not exist. Communities should consult with the state and EPA air quality contacts to investigate this approach.

Here is how one agency has successfully used SPMs: The Indianapolis Environment Resources Management Division (ERMD), which handles air monitoring for Indianapolis and Marion County, Indiana, encountered difficulties in reducing ground-level ozone in the Indianapolis metropolitan area and in downwind areas to safer levels over the years. ERMD officials concluded that they needed to know if additional ozone was coming into their area from upwind sources.

To gather this information, the officials decided to use SPMs. They installed several stations in various upwind locations and began taking readings. When the results showed elevated ozone levels in these areas as well, ERMD was able to begin revising its ozone-reduction strategy. The agency is now working with organizations in the upwind areas on a regional approach to public education and regulatory enforcement designed to help both Indianapolis/Marion County and surrounding counties and states deal effectively with ground-level ozone.

Once you have identified the locations for your monitoring sites, you are ready to determine how and where to place your monitors at each site. You will need to consider the following factors when you install your monitors:

- *Height.* The monitor’s inlet probe should be placed 3 to 15 meters above ground level. Be sure to locate the probe at least 1 meter vertically and horizontally away from any supporting structure.

-
- *Airflow.* Obstructions such as buildings, trees, and nearby surfaces affect the flow of ozone and the mixing of pollutants. (Ozone may be destroyed on contact with these and other surfaces.) Airflow to the inlet probe must be unrestricted in a horizontal arc at least 270 degrees around the probe. The probe must be located so that the distance from the probe to any obstruction is twice the height that the obstruction protrudes above the probe. If the probe is located on the side of a building, a 180-degree clearance is required.
 - *Separation from roadways.* Because automobiles emit nitrogen oxides that affect ozone concentrations, you must place ozone monitors a minimum distance from roadways (10 meters to 250 meters, depending upon the average daily traffic flow). See Table 1 in Appendix E of 40 CFR Part 58 for specific separation distances between ozone monitors and roadways, based on daily traffic flow.
 - *Separation from trees.* Because trees and other vegetation can affect ozone levels, monitor probes should be placed at least 20 meters from the “drip line” of trees. (The “drip line” is the area where water dripping from a tree might fall.)

For detailed guidance on ozone monitor siting considerations, you can consult the following references:

- *Guideline on Ozone Monitoring Site Selection* (available online at <http://www.epa.gov/ttn/amtic/cpreldoc.html>).
- “Meteorological Considerations in Siting Photochemical Pollutant Monitors.” Chu, S. H. (1995). *Atmos. Environ.* 29, 2905-2913.

3.3 SELECTING MONITORING EQUIPMENT

The next step in developing your ozone monitoring network is to identify the equipment you need, ranging from extraction equipment and analyzers to data recording and transfer systems.

Analyzing Equipment

An ozone analyzer is a self-contained instrument designed to measure the concentration of ozone in a sample of ambient air. You will need to select analyzing equipment according to the technical needs of your monitoring program and your available resources.

Analyzers must also meet the reference method or equivalent method specified by EPA in Appendix D of 40 CFR Part 50. EPA requires the use of reference or equivalent methods to help assure that air quality measurements are accurate. The reference method measurement principles for ozone are also specified in Appendix D of 40 CFR Part 50. However, equivalent methods may have different measurement principles. Therefore, you should refer to the AMTIC Bulletin Board at <http://www.epa.gov/ttn/amtic>, where the EPA maintains a current list of all designated reference and equivalent methods.

Before you obtain an analyzer, you will need to verify that it meets the reference method or equivalent method requirements. Because manufacturers may have changed or modified analyzers without changing the model number, the model number alone does not necessarily indicate that an analyzer is covered under a designation. Also, any modification to a reference or equivalent method made by a user must be approved by EPA if the status as a reference or equivalent method is to be maintained.

Extraction Equipment

The probe used to extract a sample of ozone from the atmosphere for analysis must be made of suitable material. Extensive studies have shown that only Pyrex® and Teflon® are suitable for use in intake sampling lines for the reactive gases. EPA also has specified borosilicate glass and FEP Teflon® as the only acceptable probe materials for delivering test atmospheres used to determine reference or equivalent methods. Borosilicate glass, stainless steel, or its equivalent are acceptable probe materials for VOC monitoring at PAMS. (FEP Teflon® is not suitable as probe material because of VOC adsorption and desorption reactions.)

Your sampling probe will initially be inert. However, with use, reactive particulate matter will be deposited on the probe walls. Therefore, the residence time—the time that it takes for the sample gas to transfer from the inlet of the probe to the analyzer—is critical. In the presence of nitrogen oxides, ozone will show significant losses even in the most inert probe if the residence time is longer than 20 seconds. EPA requires that sampling probes for reactive gas monitors at SLAMS or NAMS have a sample residence time of less than 20 seconds.

Calibration Equipment

Calibration determines the relationship between the observed and the true values of the ozone concentration being measured. The accuracy and precision of data derived from air monitoring instruments depend on sound instrument calibration procedures. (*Accuracy* is the extent to which measurements represent their corresponding actual values, and *precision* is a measurement of the variability observed upon duplicate collection or repeated analysis) Your calibration system must include an ozone generator, an output port or manifold, a photometer (an instrument that measures the intensity of light), a source of zero air, and whatever other components are necessary to provide a stable ozone concentration output. Because ozone is highly reactive and can be destroyed upon contact with surfaces, all components between the ozone generator and the absorption cell must be made of glass, Teflon®, or other non-reactive material. Lines and interconnections should be kept as short as possible, and all surfaces must be clean.

Data Loggers

The analyzers you have set up at your monitoring sites will generate data that must be recorded and reported. A data logger is a computerized system that can be used to control and record the data from several instruments. The data logger unit incorporates software that provides a high level of flexibility for various applications. With a data logger system, you can interact with the software using either a keyboard or an interactive, command-oriented interface. Data loggers perform the following functions:

- Reviewing collected data
- Producing printed reports
- Controlling the analyzer and other instruments
- Setting up instrument operating parameters
- Performing diagnostic checks
- Setting up external events and alarms
- Defining external storage

A modem connection from the monitor to an off-site computer allows data logging (often from more than one monitor) to take place on a single computer. In addition to the modem, this system requires an off-site computer, data acquisition and processing software, and a data storage module. Once the data are delivered to the computer, they are filtered by specified acquisition parameters and stored in a file in the data acquisition system where further processing and reporting occurs.

3.4 INSTALLING MONITORING EQUIPMENT

The manufacturer that supplied your monitor should provide you with a complete manual with detailed equipment installation instructions. This section describes some of the basics of installation monitoring equipment. You will need to consult the manufacturer's manual, however, for complete step-by-step installation instructions.

When you install your ozone monitors, you will need to take the following basic steps:

Inspecting the Equipment

- When the shipment of the monitor is received, verify that the package contents are complete as ordered.
- Inspect the instrument for external physical damage due to shipping, such as scratched or dented panel surfaces and broken knobs or connectors.
- Remove the instrument cover and all interior foam packing and save (in case future shipments of the instrumentation are needed). Make note of how the foam packing was installed.

-
- Inspect the interior of the instrument for damage, such as broken components or loose circuit boards. Make sure that all of the circuit boards are completely secured. (Loose boards could short out the motherboard.) If no damage is evident, the monitor is ready for installation and operation. If any damage due to shipping is observed, contact the manufacturer for instructions on how to proceed.
 - If you discover that the instrument was damaged during shipping and it becomes necessary to return it to the manufacturer, repack it in the same way it was delivered.

Installing Monitors

Installing an ozone monitor consists of connecting the sample tubing to the sample gas inlet fitting and connecting the primary power and the recorder.

- The sample inlet line connection should be made with 1/4-inch outer diameter Teflon® tubing.
- The entrance of the sampling system should have provision for a water drop-out or other means of ensuring that rain cannot enter the system. Place this water drop-out as far as possible from any sources that could contaminate the sample.
- Because the analyzer is an optical instrument, it is possible that particulate in the gas sample could interfere with the ozone readings, although the sampling/referencing cyclic operation of the instrument is designed to eliminate such interference. In order to avoid frequent cleaning of the optics and flow handling components, installation of a Teflon® filter is recommended. A 0.5-micron Teflon® filter will not degrade the ozone concentration. However, if particulate matter builds up on the filter, the particulate matter will destroy some of the ozone in the sample. Be sure to change the filters regularly.
- Since the instrument's exhaust consists of ambient air with some ozone removed, ensure that the exhaust cannot re-enter the sample system.
- Install the monitor's electrical connections as indicated in the manual. The typical monitoring instrument is designed to operate on standard, single phase AC electrical power, 50-60 Hz, and 105-125 or 220-240 volts. Most instruments are supplied with a three-conductor power cable. If you are operating the instrument on a two-wire receptacle, a three-prong adapter plug should be used with the pigtail wire connected to the power outlet box or to a nearby electrical ground. (Operating the instrument without a proper third wire ground may be dangerous.)

Additional Equipment

The recording device, data acquisition equipment, and any monitoring equipment, calibration equipment, or other ancillary equipment should be installed according to the information supplied in the appropriate manuals.

Standard Operating Procedures

After you install your monitor, you should develop written Standard Operating Procedures that describe the operation of each portion of the monitoring site. Data collected using fully documented procedures have much higher credibility. Be sure to develop written Standard Operating Procedures whenever the procedure in question is repetitive or routine and will significantly affect data quality. *Guidance for the Preparation of Standard Operating Procedures for Quality-Related Documents* provides information about developing, documenting, and improving Standard Operating Procedures. It can be found on the Web at http://es.epa.gov/ncerqa/qa/qa_docs.html#g-.

Environmental Control for Monitoring Equipment

When you install your ozone monitor, you will need to control any possible physical influences that might affect sample stability, chemical reactions within the sampler, or the function of sampler components. These environmental controls will help ensure that you receive accurate data from your monitoring network. The table below summarizes these physical variables and the ways in which you can control them.

Variable	Method of Control
Instrument vibration	Design instrument housings, benches, etc. according to manufacturer's specifications. Use shock-absorbing feet for the monitor and a foam pad under analyzer. Attempt to find and isolate the source of the vibration. The pumps themselves can be fitted with foam or rubber feet to reduce vibration. If the pumps are downstream of the instruments, connect the pumps by way of tubing that will prevent the transfer of vibrations back to the instruments and/or the instrument rack.
Light	Shield instrumentation from natural or artificial light.
Electrical voltage	Ensure constant voltage to transformers or regulators. Separate power lines. Isolate high current drain equipment such as hi-vols, heating baths, and pumps from regulated circuits. The total amps to be drawn should be checked before another instrument is added.
Temperature	Regulate air conditioning system. Use 24-hour temperature recorder. Use electrical heating/cooling only.
Humidity	Regulate air conditioning system; use 24-hour recorder.

Securing Your Monitoring Site

Your monitoring equipment will need to operate unattended for prolonged periods. Standard security measures such as enclosures, fences, and lighting will help safeguard the equipment and prevent interference with its operation. To enclose the monitoring equipment, you might construct a shelter or use a trailer with appropriate power, telephone, and air conditioning systems.

Monitoring Site Checklist

Here's a list of things to check before operating your ozone monitoring site:

- Have the sampling manifold (if used) and inlet probe for the analyzer been checked for cleanliness?
- Has the shelter been inspected for weather leaks, safety, and security?
- Has the equipment been checked for missing parts or frayed electrical cords?
- Are the monitor exhausts positioned so that exhaust will not be drawn back into the inlet?
- Are field notebooks and checklists available at the site in a secure location?
- Have photographs or videotapes of the site been taken after set-up, for use in reviewing the layout of the monitoring site to ensure that conditions have not changed?

3.5 CALIBRATING MONITORING EQUIPMENT

To ensure the accuracy and precision of data derived from your air monitoring instruments, you will need to develop reliable instrument calibration procedures. This section describes two alternative calibration methods: primary calibration procedures and calibration using a transfer standard.

Primary Calibration Procedures

Dynamic calibration involves introducing gas samples of known concentrations into an instrument to adjust the instrument to a predetermined sensitivity and produce a calibration relationship. This calibration relationship is derived from the instrument's response to successive samples of different, known concentrations.

The photometer that you use for calibration must be dedicated exclusively to calibration and not used for ambient monitoring. Ozone analyzers are typically located at widely separated field sites. While a photometer and the photometric calibration procedure can be used at each field site to calibrate each analyzer, you may find it advantageous to locate a single photometer at a central laboratory where it can remain stationary, protected from the physical shocks of transportation, and available to be operated by an experienced analyst under optimum conditions. This single photometer can then serve as a common standard for all analyzers in a network. This central photometer would then be used to certify one or more ozone transfer standards that are carried to the field sites to calibrate the ozone monitors. For more information about ozone transfer standards, see *Standards for the Calibration of Ambient Air Monitoring Analyzers for Ozone*, available on the AMTIC Technical Guidance Documents Web site at <http://www.epa.gov/ttn/amtic/cpreldoc.html>.

You should conduct a visual inspection of the photometer system prior to use to verify that the system is in order, all connections are sound, gas flow is not restricted, and there are no leaks. Next, you should perform a linearity test of the photometer according to the manufacturer's instructions. Accuracy of the photometric calibration system can be verified by occasional comparison with ozone standards from other independent organizations, either directly or using transfer standards. Some portion of the ozone may be lost upon contact with the photometer cell walls and gas handling components. The magnitude of this loss must be determined and used to correct the calculated ozone concentration. This loss must not exceed 5 percent.

To calibrate ozone analyzers, take the following steps:

- Allow the photometer to warm up and stabilize.
- Verify that the flow rates through the photometer cell and into the output manifold are accurate.
- Open the two-way valve to allow measurement of zero air through the manifold.
- Adjust the ozone generator to produce the required amount of ozone.
- Actuate the two-way valve to allow the photometer to sample zero air until the cell is thoroughly flushed and record the stable measured value.
- Actuate the two-way valve to allow the photometer to sample the ozone concentration until the cell is thoroughly flushed and record the stable measured value.
- Record the temperature and pressure of the sample in the photometer cell.
- Calculate the ozone concentration.
- Obtain additional ozone concentration standards by repeating the steps above with different concentrations of ozone from the generator.

To learn more about calibration procedures, you can review *Technical Assistance Document for the Calibration of Ambient Ozone Monitors* (available at <http://www.epa.gov/ttn/amtic/cpreldoc.html>).

Calibration Transfer Standards

When the monitor to be calibrated is located at a remote monitoring site, it is often convenient to use a transfer standard rather than a primary standard calibration system. A transfer standard is defined as a transportable device or apparatus that, together with the associated operational procedures, can accurately reproduce pollutant concentration standards or produce accurate assays of pollutant concentrations which are quantitatively related to an authoritative master standard. The primary function of a transfer standard is to duplicate and distribute concentration standards to places where comparability to a primary standard is required.

Because of the nature of ozone, transfer standards must be capable of accurately reproducing standard concentrations in a flowing system. Ozone transfer standards are complex systems consisting of devices or equipment that generate or assay ozone concentrations. Ozone concentrations are needed to calibrate an ozone analyzer for ambient monitoring. Usually a number of such analyzers need to be calibrated, and they are located at various field sites which may be separated by appreciable distances. Also, these analyzers require recalibration at periodic intervals. Consequently, a large number of ozone standards will be required at various times and places. Ozone standards may also be needed to check the span or precision of these analyzers between calibrations.

Follow these procedures to calibrate ozone analyzers using transfer standards:

- Allow sufficient time for the ozone analyzer and the photometer or transfer standard to warm up and stabilize.
- Allow the analyzer to sample zero air until a stable response is obtained. Adjust the analyzer zero control to +5 percent of scale.
- Generate an ozone concentration standard of approximately 80 percent of the desired upper range of the ozone analyzer and allow the analyzer to sample this ozone concentration standard until a stable response is obtained.
- Adjust the ozone analyzer span control to obtain a convenient recorder or data logger response.
- Generate several other ozone concentration standards (at least five others are recommended) over the scale range of the ozone analyzer by adjusting the ozone source.
- Plot ozone analyzer responses versus the corresponding ozone concentrations and draw the calibration curve or calculate the appropriate response factor.

To learn more about the use of transfer standards, review the guide *Transfer Standards for Calibration of Ambient Air Monitoring Analyzers for Ozone* (available at <http://www.epa.gov/ttn/amtic/cpreldoc.html>).

3.6 MAINTAINING YOUR MONITORING EQUIPMENT AND ENSURING DATA QUALITY

Once you have installed and calibrated your ozone monitoring network, the process of monitoring ozone in your area can begin. At this point, you should be sure to develop procedures for checking the quality of your data and maintaining the monitoring equipment.

Quality Assurance

To help ensure that your data are valid, you will need to screen it for possible errors or anomalies. Statistical screening procedures can be applied to ambient air measurement data to identify data that may not be accurate.

Data validation entails accepting or rejecting monitoring data based on routine periodic analyzer checks. For example, you will need to check the analyzer span for excessive drift or changes in recorded data according to the manufacturer's specifications. If the span drift is equal to or greater than 25 percent, up to two weeks of monitoring data may be invalidated. To avoid this situation, you may want to perform span checks more often than the minimum recommended frequency of two weeks.

You should also monitor the hardcopy output from a data logger to detect signs of malfunctions, which may include:

- A straight trace (other than the minimum detectable) for several hours
- Excessive noise (noisy outputs may occur when analyzers are exposed to vibrations)
- A long steady increase or decrease in deflection
- A cyclic trace pattern with a definite time period, indicating a sensitivity to changes in temperature or parameters other than ozone concentration
- A trace below the zero baseline that may indicate a larger than normal drop in ambient room temperature or power line voltage
- Span drift equal to or greater than 25 percent

Data must be voided for any time interval during which the analyzer has malfunctioned.

In addition, the integrity of air samples may be compromised by faulty delivery systems such as the sampling interface. For information about quality control/quality assurance protocols set forth by the EPA, you can refer to AMTIC's QA/QC Web site (<http://www.epa.gov/ttn/amtic/qaqc.html>).

Equipment Maintenance

Each component of your monitoring equipment will have its own maintenance routine. In many cases, the equipment manual provided by the vendor will offer detailed maintenance procedures. The table below describes the essential equipment monitoring and maintenance activities you will need to follow.

Maintenance Issue	Acceptance Limits	Method of Measurement and Frequency	Corrective Action, If Needed
Shelter temperature	<ul style="list-style-type: none"> • Mean temperature between 22° and 28°C (72° and 82°F), daily fluctuations $\leq \pm 2^\circ\text{C}$ (4°F). 	<ul style="list-style-type: none"> • Check thermograph chart daily for excessive fluctuations. 	<ul style="list-style-type: none"> • Mark chart for the affected period of time. • Repair or adjust temperature control system.
Sample introduction system	<ul style="list-style-type: none"> • No moisture, foreign material, leaks, or obstructions; sample line connected to manifold. 	<ul style="list-style-type: none"> • Make weekly visual inspection. 	<ul style="list-style-type: none"> • Clean, repair, or replace as needed.
Recorder	<ul style="list-style-type: none"> • Adequate ink supply and chart paper. • Legible ink traces. • Correct settings of chart speed and range switches. • Correct time. 	<ul style="list-style-type: none"> • Make weekly visual inspections. 	<ul style="list-style-type: none"> • Replenish ink and chart paper supply. • Adjust recorder time to agree with clock; note on chart.
Data logger	<ul style="list-style-type: none"> • Complete data storage or hardcopy output. 	<ul style="list-style-type: none"> • Make weekly visual inspections. 	<ul style="list-style-type: none"> • Perform maintenance according to manufacturer's specifications.
Analyzer operational settings	<ul style="list-style-type: none"> • Flow and regulator indicators at proper settings. • Temperature indicators cycling or at proper levels. • Analyzer set in sample mode. • Zero and span controls locked. 	<ul style="list-style-type: none"> • Make weekly visual inspection. 	<ul style="list-style-type: none"> • Adjust or repair as needed.
Analyzer operational check	<ul style="list-style-type: none"> • Zero and span within tolerance limits as specified. 	<ul style="list-style-type: none"> • Check every two weeks. 	<ul style="list-style-type: none"> • Isolate source of error and repair. • After corrective action, re-calibrate analyzer.
Precision check	<ul style="list-style-type: none"> • Assess precision by repeated measurements. 	<ul style="list-style-type: none"> • Check every two weeks. 	<ul style="list-style-type: none"> • Calculate and report results of precision check.

Developing a Preventive Maintenance Plan

You should develop a preventive maintenance plan to ensure the equipment monitoring and maintenance procedures are consistently followed. Your preventive maintenance program should include:

- A short description of each maintenance procedure
- The schedule and frequency for performing each procedure
- A supply of critical spare parts on hand
- A list of maintenance contracts for instruments used in critical measurements
- Documentation showing that maintenance has been performed as required by the maintenance contract, the Quality Assurance Project Plan, or test plan

You must perform preventive maintenance periodically to maintain the integrity of the instrument. You should keep a log book with the instrument, since maintenance is performed according to total hours of “instrument on” time. The following steps are included in preventive maintenance procedures:

- Replace the ozone scrubber cartridge according to the procedures specified by the manufacturer in the operating manual for the analyzer (typically, every 125 hours of instrument operation). The exact life span of the ozone scrubber is directly proportional to the level and characteristics of the pollutants flowing through it. Most manufacturers recommend that you replace the ozone scrubber cartridge at regular intervals until you can determine an “average” life span based on your experience with actual operating conditions at each installation site.
- Clean the cooling fan filter to ensure an adequate air supply through the cooling fan at the back panel.

The table below lists checks that should be performed as corrective maintenance. (Procedures for performing the checks, acceptable values, and procedures for performing adjustments are included in the manufacturer’s operating manual.)

Type of Check	Recommended Frequency
Sample flow check	Every 24 hours, or on each day when an operator is in attendance
Span check	Every 168 hours of instrument operation
Recorder span check	Every 168 hours of instrument operation
Zero check	Every 168 hours of instrument operation
Control frequency check	Every 168 hours of instrument operation
Sample frequency check	Every 168 hours of instrument operation
Temperature check	Every 720 hours of instrument operation
Pressure check	Every 720 hours of instrument operation
System leak check	Every 168 hours of instrument operation
Solenoid valve leak check	Every 720 hours of instrument operation

To document the performance of these maintenance operations, site personnel should fill out and maintain data sheets as a permanent record of maintenance operations.

The manufacturer’s manual for each piece of instrumentation will provide a list of recommended spare parts that should be maintained either at the site or at a central location for easy replacement.

3.7 ANNUAL NETWORK REVIEW

EPA requires that you conduct an annual network review to determine:

- How well your network is achieving its required air monitoring objectives.
- Whether your network is meeting the needs of the data users.
- How the network might be modified to continue to meet its monitoring objectives and data needs.

Some possible modifications may include terminating existing monitoring stations, relocating stations, or adding new monitoring stations. (For a complete summary of the network review process, see EPA's *SLAMS/NAMS/PAMS Network Review Guidance* at <http://www.epa.gov/ttn/amtic/cpreldoc.html>.)

4. DATA COLLECTION AND TRANSFER FOR OZONE MAPPING

During ozone season, ozone monitors record ozone measurements around the clock, every day. Before monitoring station data reach you for mapping, the information is quickly passed through the Automatic Data Transfer System (ADTS), EPA's computer system set up for automated data retrieval, management, and distribution. Other data transfer and management systems are commercially available for ozone mapping; however, this handbook focuses on EPA's ADTS.

The ADTS enables you to provide data to EPA's central database, known as the Data Collection Center, as well as receive data from the Data Collection Center for mapmaking. If you are a staff member at a state or local agency operating ozone monitoring stations, you will probably want to obtain ADTS software and learn about the Internet protocol established for connecting to the system. This will enable your office to serve as one of the network exchange points for ozone data. Guidance on obtaining and installing the necessary software and on interacting with the ADTS for data exchange is provided after the overview section of this chapter. Throughout this chapter, we point you to other sources of help on the ADTS.

Readers interested primarily in an overview of the ADTS process may want to focus on the introductory information in Section 4.1 below. If you are responsible for or interested in implementing ADTS, you should carefully review the technical information presented in the sections on getting ready, using ADTS for data collection and transfer, and operations at the Data Collection Center (Sections 4.2 through 4.4).

4.1 OVERVIEW OF THE AUTOMATED DATA TRANSFER SYSTEM (ADTS)

In brief, here's how the ADTS works:

Throughout the United States, over 1300 monitoring stations collect ozone concentration data. You can view a map of the U.S. that shows the locations of these ozone monitors at <http://www.epa.gov/airsdata/mapview.htm>. These monitors collect ozone around the clock and then report the data as hourly averages. In general, the monitoring sites are maintained by state or local agencies that collect (or "poll") the data on a regular basis. Each participating agency collects the data in its State Host Computer, which is linked to a central database called the Data Collection Center (DCC). Together, all the State Host Computers and the DCC make up the ADTS network.

Each State Host Computer is set up to convert collected data to a standard format and then transfer the data to the DCC. At many agencies, the State Host Computer is configured to transfer data automatically; at some agencies, com-

puter equipment limitations require the data transfer to be carried out as a manual operation.

The DCC is located in North Carolina. It receives ozone monitoring data on a regular basis from sites around the country. The DCC's primary tasks are to:

- Manage and quality-check the data.
- Send out the collected data for use in ozone mapping.

In general, the DCC sends data for mapmaking through individual State Host Computers, which are set up to download ozone monitoring data from the DCC—either as a manual or automated process. From the State Host Computer, ozone monitoring data files make their way to your desktop for your use in developing ozone maps.

The schematic below shows how the ADTS operates.

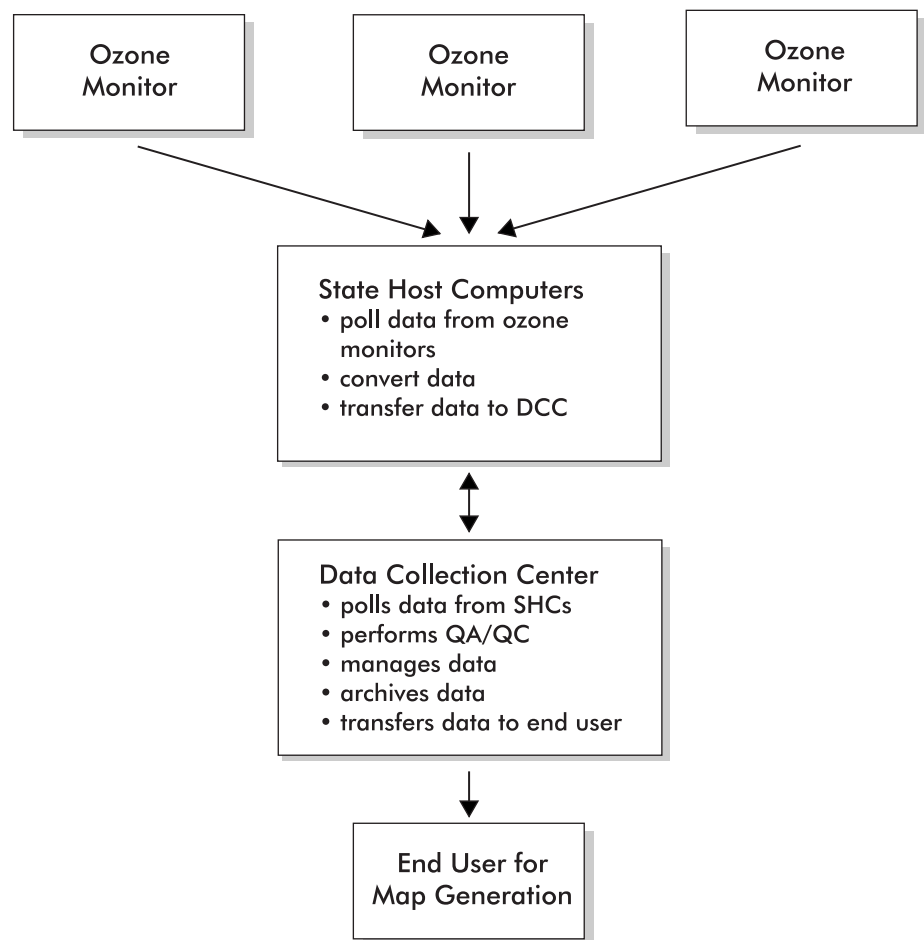

Data Flow within the ADTS

The ADTS collects and transfers ozone monitoring data so that the data are readily available for use in mapping and other ozone concentration studies. The ADTS requires each agency in the network to process and transfer its collected data according to a schedule that is specific to each state. Thus, when a state

agency decides when to poll its monitoring stations, it must consult its state schedule and allow sufficient time to complete the collection, processing, and transfer of data to the DCC.

Note!

Polling schedules for various states can be found at <http://tnwww.rtpnc.epa.gov/ozmap/>. You will need a password and user name to access this site. Please contact Phil Dickerson at dickerson.phil@epa.gov for a password and user name. When you reach the Ozone Mapping System (OMS) Web page, scroll to the section titled *New!* and click on the link called polling schedule table.

The table below shows the approximate times by which collected data moves through the system. As you can see, real-time ozone data are available to end users very quickly—usually in 1 to 2 hours.

State Host Computer Polls Ozone Monitor ^{1 2 3}	State Host Computer Must Process Data by	State Host Computer Must Transfer the Data to the DCC by	DCC Processes Data by	DCC Transfers Data to End User
8:00 a.m.	8:40 a.m.	8:45 a.m.	8:50 a.m.	9:20 a.m.
11:00 a.m.	11:40 a.m.	11:45 a.m.	11:50 a.m.	12:20 p.m.
1:00 p.m.	1:40 p.m.	1:45 p.m.	1:50 p.m.	2:20 p.m.
3:00 p.m.	3:40 p.m.	3:45 p.m.	3:50 p.m.	4:20 p.m.
5:00 p.m.	5:40 p.m.	5:45 p.m.	5:50 p.m.	6:20 p.m.
7:00 p.m.	7:40 p.m.	7:45 p.m.	7:50 p.m.	8:20 p.m.
9:00 p.m.	9:40 p.m.	9:45 p.m.	9:50 p.m.	10:20 p.m.

¹ Time at which polling of ozone monitors should begin.

² All times are in EDT.

³ The standard EPA convention for naming hourly data is to refer to hourly data by its starting time. For example, hourly data averaged from 11:00 a.m. to 11:59 a.m. would be reported as 11:00 a.m. data.

Here’s a more detailed explanation of how data move through the ADTS system:

- The agency collects data from a monitor at 8:00 a.m. and then every 2 hours between 11:00 a.m. and 9:00 p.m.
- The 8:00 a.m. poll contains all the previous day’s 24-hour observations (12:00 a.m. to 11:00 p.m.) and all hourly data for today (12:00 a.m. through 7:00 a.m.). Because this poll contains a complete data set for yesterday, actual 8-hour averages can be determined by the DCC for yesterday. This means that animations for the previous day can be created using actual data. (See Chapter 5 on making ozone maps.)
- The 11:00 a.m. poll contains 3 hours of hourly averaged data from 8:00 a.m., 9:00 a.m., and 10:00 a.m.
- The 1:00 p.m. poll contains 2 hours of averaged data for 11:00 a.m. and noon. The remaining polls will each also contain 2 hours of data.

Within 40 minutes of polling data from a monitor, an agency's State Host Computer converts and transfers the data to the DCC. For example, an agency polling data at 1:00 p.m. has until 1:40 p.m. to convert and transfer the data.

Upon receiving the data, the DCC quickly processes the data and transfers it back within 30 minutes on average. During this time, the DCC merges data, calculates peak data, performs automatic and manual quality assurance/quality control (QA/QC) checks, and transfers processed data (today's hourly and peak ozone data) to the end user for map generation.

Note!

The DCC collects and distributes forecast levels for those agencies and communities participating in the forecast program. This forecast data is posted to the EPA AIRNOW Web site (<http://www.epa.gov/airnow>).

This concludes the overview of the ADTS. If you are interested in technical details about the ADTS and how to access and use it to exchange ozone monitoring data, please read on.

4.2 GETTING READY TO USE THE ADTS FOR DATA COLLECTION AND TRANSFER

If you wish to set up a State Host Computer to connect to the ADTS, you will need to install special software that will enable you to use the system to transfer ozone monitoring station data to and from the DCC. Obtaining and installing the necessary software and then connecting and setting up operations with the automated system is relatively easy if you are familiar with the use of software applications and Internet technology. The guidance and reference information provided here will help you get started as an ADTS operator.

Before you obtain and install the software, however, you need to determine whether you have the necessary computer hardware, software, and connectivity resources to operate the ADTS. This section will help you make that determination so that you can upgrade your equipment if necessary. Then you will learn how to obtain and install the necessary software, and finally, how to configure your system to interact with the ADTS.

Assessing Your Computer Resources

Recognizing that the level of available computer equipment at state agencies across the country varies considerably, EPA has established three basic hardware, software, and connectivity options for interacting with the ADTS. Level 1 provides the highest level of performance because it accommodates the greatest level of automation in transferring data. Level 2, however, allows a level of performance high enough for most automated operations. Level 3 meets the minimum requirements for interacting with the ADTS; users with Level 3 computer resources are likely to encounter some limitations in using the system. EPA assumes that most agencies have computer arrangements that at least meet the requirements of Level 3. Depending on the level of performance you require, you may need to upgrade your system.

The attributes of the three performance levels are as follows:

Level 1: Computer systems operating at this level provide the highest degree of automation for data transfer functions. At this level, the State Host Computer is set up with a File Transfer Protocol (FTP) server to allow the DCC to initiate automatic data transfer.

Level 2: Computer systems operating at this level are able to initiate data transfer to the DCC by FTP, dial-up, or modem (backup). Many State Host Computers use Windows 95 FTP to upload/download data to and from the DCC. If you plan to have the DCC call your State Host Computer automatically, you will need to install FTP server software.

Also, if your agency plans to initiate data transfer, we strongly recommend that you use a dedicated, hard-wired Internet connection. Dial-up connections are unreliable—you may not be able to connect, the line may be busy, or the modem may not function properly. If you prefer dial-up, your software might not provide for automatic connections. If you do not have automatic connection software, we suggest that you use the Windows Dial-Up Networking software in combination with the free shareware Duncie (Dial-Up Networking Connection Enhancement). Both are discussed later in this chapter.

Level 3: Computer systems operating at this level provide performance sufficient for transferring files to the DCC by modem. Modems and communications software must support Kermit-Lite file transfers by modem. (See the description of Kermit-Lite software in the “Other Software” section below.)

The table below lists the equipment requirements for each performance level:

Level	Hardware	Software	Connectivity
Level 1 (Preferred)	133 MHz Pentium PC	Windows 95 (includes FTP client)	Network card or ISDN
	16 to 32 MB RAM	An FTP server	28.8 K baud modem
	100 MB free disk space		Direct Internet connection
	SVGA or EVGA video		Outside firewall or external access permitted
			Modem (backup)
Level 2	66 MHz 486 PC	DOS 6.22	14.4 K baud modem
	8 MB RAM	Windows 3.1 or Windows for Workgroups	Dial-up Internet connection
	100 MB free disk space	PPP/SLIP and FTP clients	Modem (backup)
	VGA video		
Level 3 (Minimum)	16 MHz 386 PC	DOS 3.2 or higher	2,400 baud modem
	1 MB RAM		Modem for Kermit-Lite
	20 MB free disk space		
	Monochrome monitor and card		

Obtaining and Installing ADTS and Other Software

Once you have determined that your computer system meets ADTS technical requirements, you can obtain, install, and configure the software and system as required transfer data. In addition to the ADTS software, you will need other applications, such as ClockerPro or Clocker, Kermit-Lite for MS-DOS, and data polling and conversion software. (See “Other Software” on page 32.) Using these software tools together allows you to poll data from monitoring stations, convert the data to the appropriate format, and transfer data to and from the DCC.

ADTS Software

The ADTS software allows you to transfer data to and from the DCC. Obtaining, installing, and configuring the ADTS software is straightforward. See the instructions below.

Obtaining and Updating ADTS Software

You can obtain the ADTS software (and updates) through the OMS Web site or by FTP. To download ADTS from the OMS Web site, you need a connection to the Internet and Internet browser software such as Microsoft Internet Explorer or Netscape Navigator.

You can find detailed instructions on how to obtain and install the ADTS software in *Installation and Operation of the Automatic Data Transfer System for State Host Computers* at <http://envpro.ncsc.org/oms/oms-docs.html>.

Configuring ADTS Software

Once you have installed the ADTS software, you can configure the files by following the guidance in the ADTS installation instructions file. You will also need to modify the ADTS configuration to conform with your polling and data conversion software. To do so, follow the instructions provided with your particular software as well as those in the ADTS installation instructions file. For assistance in configuring your polling and data conversion software, contact Phil Dickerson at dickerson.phil@epa.gov.

When you installed the ADTS software, various subdirectories were created under the *c:\oms* directory as described in *adts-shc.txt*. The table on the next page describes the files from these subdirectories that you will most likely use to configure and operate the ADTS software.

Directory	Files	Description
\bin	omscnvr.exe	Dummy data conversion program. Provides sample source code that shows you how to convert from AIRS (Aerometric Information Retrieval System) format to MapGen format.
\config	download.pif	Windows 95 program to download data from the DCC.
	downld31.pif	Windows 3.1 program to download data from the DCC.
	oms-env.bat	ADTS configuration script.
	mscustom.ini	Kermit-Lite initialization file.
	omscnvr.inp	Initialization file for the OMS data conversion program. Used only by agencies without polling software.
	shc31.dlk	Sample Clocker task schedule.
	shc95.dlk	Sample ClockerPro task schedule.
	spw.bat	Hidden DCC password file.
	upload.pif	Windows 95 program to upload data to the DCC.
	upld31.pif	Windows 3.1 program to upload data to the DCC.
\convert	omscnvr.bat	Contains most of the customization for your system.
	airs2oms.exe	Converts AIRS data format to OMS data format.
\data	\in	Incoming ozone data directory. Contains default directories by year.
	\out	Outgoing ozone data directory. Contains default directories by year.
	\work	Work directory for peak forecasts.
\transfer	upload.bat	ADTS master upload script.

To configure files, you can open and edit them with a text editor such as Notepad.

Appendix A contains tips about how to configure your system for forecast data. It also explains how to configure files such as *oms-env.bat*, *omscnvr.inp*, and *airs2oms.exe*.

Setting Up Your Password

To transfer data from a State Host Computer to the DCC, you will need to establish an FTP account with the DCC with an FTP password. You can obtain a password from Phil Dickerson at dickerson.phil@epa.gov.

After obtaining a password, you can add your password to *spw.bat* or *ws_ftp*. It is strongly recommended you use *ws_ftp* and not *spw.bat* to set up your password because *ws_ftp* encrypts passwords and makes them very secure. *ws_ftp* is available as a free download for U.S. federal, state, or local government employees at <http://www.ipswitch.com/support/versions/index.html>. Choose the product WS_FTP LE and download it. User documentation is available at http://www.ipswitch.com/support/ws_ftp_le_support.html.

After setting up your password, we recommend that you test your password by connecting to the DCC via FTP. To connect, the address is <http://stegy.rtpnc.epa.gov>, the FTP port is 21, and the USER ID is your three-character agency name. (See http://envpro.ncsc.org/oms/pub/SiteInfo/agency_codes.html.)

Polling and Data Conversion Software

Many agencies use polling software provided by outside vendors to obtain data from ozone monitoring stations. If your polling software does not include utilities for converting polled ozone data, the Ozone Mapping Project provides two software tools—*omsconvrt* and *airs2oms*—for converting standard AIRS (Aerometric Information Retrieval System) data files into the OMS standard format. Appendix A provides detailed information about how to obtain and install *omsconvrt* and *airs2oms*.

Other Software

ClockerPro and Clocker. ClockerPro and Clocker are personal/network program schedulers for Windows that are designed to schedule programs (or reminders)—such as the upload and download of data from the DCC—to run at specified times.

Kermit-Lite. You will need to install Kermit-Lite for MS-DOS, the communications software used by the ADTS as a backup method of file transfer. Kermit-Lite ensures that your data will be transferred if your other transfer protocol method (e.g., modem, Internet, or dial-up) should fail.

Connectivity Software. If your agency uses a dial-up network connection to initiate data transfer with the DCC, you may want to use Duncce 2.52 (Dial-Up Networking Connection Enhancement). Duncce allows for much easier dial-up networking than Win95 currently provides. Serv-U is a full-featured FTP server for Windows. If your agency wishes to have your State Host Computer data polled by the DCC, you can use Serve-U as your FTP server software.

Appendix B contains instructions for obtaining and installing ClockerPro, Clocker, Kermit-Lite, and Duncce 2.52.

4.3 USING THE ADTS FOR DATA COLLECTION AND TRANSFER

Now that you have installed and configured the software needed to connect with the ADTS, you are ready to learn how to use the ADTS system. Operating the ADTS is relatively easy if you are familiar with the use of software applications and Internet technology. If you have the appropriate computer resources (as described in Section 4.2), you can automate much of your system's interaction with the ADTS.

This section describes a four-step process for collecting and transferring ozone monitoring station data to and from the DCC. This section also provides information on maintaining and troubleshooting the system.

Collecting and Transferring Data

Using the ADTS to collect and transfer data involves the four steps shown below. The first time you perform these steps, you will need to be attentive to a variety of details involved in setting up the protocol for your State Host Computer. Once

you have established the appropriate protocol, however, implementing these steps should be quick and easy.



Step 1: Polling Data from Ozone Monitors

During ozone season, ozone monitoring stations typically operate around the clock and report hourly averaged ozone concentrations. If you are an operator of a State Host Computer, you should work in conjunction with the DCC to decide the most appropriate times for polling your monitoring stations for data using the ADTS. When deciding on polling times, you should consider your schedule for processing the data and transferring it to the DCC. (See the sample schedule provided in Section 4.1.) When developing your polling and transfer schedule, you may want to consult with Phil Dickerson at dickerson.phil@epa.gov.

Once you have established your polling schedule, use the polling software you installed to access the monitoring station data loggers. Consult the instructions provided with the software for information about operating your polling software.

To implement your polling software according to the schedule you developed, we recommend that you use the ClockerPro or Clocker personal/network program. If you have the necessary computer resources, these tools will enable your State Host Computer to automatically poll the data loggers at the specified polling times.

The polling software allows you to transfer polled data from ozone monitoring stations to your State Host Computer via a protocol transfer. You acquire the data by “calling” each monitor’s data logger at specified times throughout the day using a dedicated hard-wired Internet connection, a dial-up service, or a modem.

Place your polled data in your `c:\oms\data\in\{year}` directory.

Step 2: Converting the Data

After you poll data from monitoring stations, you must convert it to the correct format for use in creating ozone maps. This conversion is needed because ozone monitors record ozone measurements in the AIRS format, while MapGen only accepts the OMS format. Once you have configured your State Host Computer to run your conversion software, the data are automatically converted as they are received from the monitoring stations.

If you are using software supplied by an outside vendor, you should refer to that software’s instructions for information on operating data conversion software. (Your polling software may have come with conversion software.) If you are using the OMS conversion software, please contact EPA’s Phil Dickerson at dickerson.phil@epa.gov for user information.

Tip!

We strongly recommend that agencies bordering each other geographically collect data from the same monitoring station. If one agency is unable to collect data, the other can collect and transfer the data. For example, in northern Virginia, a few monitoring stations provide data to two different agencies. This redundancy allows one agency to supply the data when the other cannot.

ACCESSING YOUR OZONE DATA

We recommend that you use a dedicated hard-wired Internet connection to access data from your monitoring stations. Although this type of connection costs more than dial-up and modem connections, an Internet connection is more reliable and much more efficient. Dial-up and modem connections are less reliable because you may be unable to connect, the line may be busy, or the modem may not work. The following example illustrates the importance of using a dedicated hard-wired Internet connection: Suppose a state agency needs to collect data from 40 monitoring stations for the 1:00 p.m. poll and uses the dial-up method. If it takes you approximately 1 minute to connect to each monitor, you will need at least 40 minutes to collect data from 40 monitors. Thus, using dial-up service may not provide you with enough time to collect, convert, and transfer all the data files.

Step 3: Assigning QA/QC Criteria and Checking the Data

You can assign specific QA/QC criteria to your data for use by the DCC. You can also check your data before it goes to the DCC. The OMS Web site contains example quality assurance values that may be incorporated into the DCC software (<http://envpro.ncsc.org/oms/pub/SiteInfo/03-QC-Table.html>.) To assign specific QA/QC criteria, contact Phil Dickerson at dickerson.phil@epa.com.

You can review and check your data before sending it to the DCC. You can conduct a QA/QC on collected data according to an established written schedule. (See the sample schedule provided in Section 4.1.)

EPA encourages you to include a check on active and historical ozone monitoring station files as part of your QA/QC protocol. The active file lists monitoring sites expected to be operational this summer. The historical file lists ozone monitoring sites throughout the country that are known to have operated at one time or another (including currently active sites). It is important to check these files before data are transferred to the DCC to ensure that no monitoring sites are missing, coordinates are accurate, and priorities are set correctly. The files can be accessed at <http://envpro.ncsc.org/oms/OMS-docs.html>.

If you make changes to the active or historical file for a monitoring station, please document your changes and send the documentation to Ted Smith at smith_w@mcnc.org.

230210002, 45, 27, 54, 69, 33, 19,'GREENVILLE ',ME1-1
230252003, 44, 42, 20, 69, 39, 39,'SKOWHEGAN ',ME1-1
230313002, 43, 5, 0, 70, 45, 0,'FRISBEE SCHOOL, KITTERY MAINE ',NH1-1,ME1-2

Let's take a closer look at a station location file so you can see what needs to be covered when conducting QA/QC. Shown below is part of an active monitoring station file:

Notice that the file provides the geographic referencing information needed to plot the ozone data. Any errors in the latitude/longitude coordinates (e.g., 45, 27,

54, 69, 33, 19) will cause the data to be plotted in the wrong location when you generate an ozone map using MapGen.

Note!

We encourage agencies that border each other geographically to report data from the same monitoring station. (Note that dual reporting requires that neighboring agencies incorporate one another’s site and data files in their polling software.) As shown above for AIRS ID 230313002, this redundancy allows NH1-1 to supply the data to the DCC when ME1-2 is not available. For each station where redundancy occurs, agencies can specify a priority value that the DCC adds to the station location files. The priority is used to resolve duplicate station data. The higher the value, the higher the priority. If ME1-2 has primary priority and NH1-1 has secondary priority, the DCC specifies the codes as “NH1-1, ME1-2.” If ME1-2 fails to submit data for that site or reports missing data, then data from NH1-1 will be used.

Step 4: Transferring Data to and from the DCC

Data exchange from the agency’s State Host Computer to the DCC is accomplished in one of two transfer methods:

- The State Host Computer sends a data file to the DCC (agency initiated).
- DCC obtains the data file from the State Host Computer (DCC initiated).

The diagram below illustrates how data are exchanged via these two transfer methods.

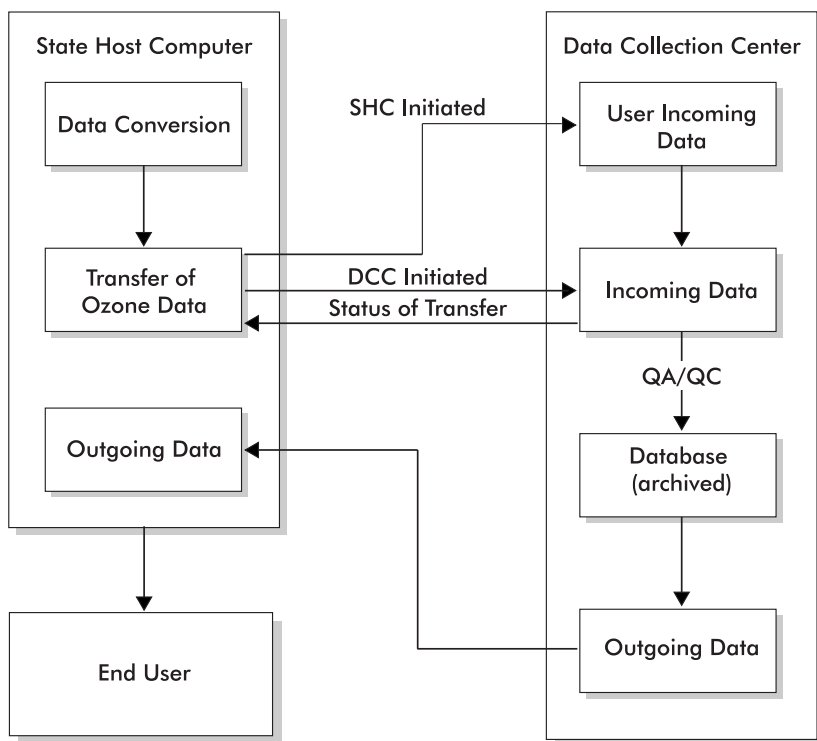

Because most agencies choose to initiate data transfer from their State Host Computer to the DCC, the process described below focuses on an agency-initiated exchange. For information on DCC-initiated data transfers, please refer to <http://envpro.ncsc.org/oms/oms-docs.html>. To transfer data to the DCC:

1. *Provide your agency user ID.* Before you can initiate a data transfer, your agency must establish a user's account on the DCC. (See the subsection on configuring the ADTS software in Section 4.2 for information about establishing a user's account.)
2. *Select a data file and send it to the DCC.* Sending the data places it on your user's incoming data directory on the DCC. For example, if an agency from Connecticut is identified by the user name CT1, the State Host Computer will deposit files in the CT1 user directory.

When the State Host Computer successfully transfers a data file to the DCC, the DCC sends an acknowledgment file to the sending computer for the 8:00 a.m. poll only. You can check the status of your last transfer (or transfer attempt) by reviewing the transfer log in `c:\oms\transfer\`. If you are using Windows FTP, check the file `transfer.log`. If you are using WS_FTP, check the file `xferlog.txt`.

3. *The DCC will obtain the file from the incoming directory.* On regular cycles, the DCC checks the user's incoming data directory and transfers data files to its incoming data directory. From here, files are merged, submitted to QA/QC, stored in a database, archived, and then released to the public.

To upload or download a data file to or from the DCC, follow the instructions below:

Uploading Data. To upload a data file (e.g., 071414.ct1) from your agency's State Host Computer to the DCC, double-click on `upload.pif` (Windows 95) or `upld31.pif` (Windows 3.1) in the `c:\oms\config` directory. To automatically schedule the upload, you can use ClockerPro or Clocker. Uploading transfers the data file from the `c:\oms\data\in\{year}` directory to the DCC user's incoming data directory.

Note!

The ADTS uses the `mmddhh.aaa` date/time naming convention for the data file being transferred to the DCC, where `mm` is the month, `dd` is the day, and `hh` is the hour when the file was created. The `aaa` is the three-character code for your agency. For example, if Vermont prepares a file for transmission at 2:25 p.m. (14:25) on June 20, the file name will be: `062014.vt1`. You should base your date/time stamp on the clock setting on the system doing the transfer, which can be in standard or daylight savings time, provided the DCC is made aware of which time scale you are using.

Submitting Forecast Data. Your state agency can submit site-specific forecasts as part of your routine ozone data file. (For more information about ozone forecasting, see the box below.) You need to submit forecast data via the ozone data file (with the 3:00 p.m. poll) or over the Web using a forecast transmission form. To submit forecasts using a data file, you will need to configure the ADTS software as discussed in the section on configuring ADTS. Once configured, the State Host Computer will insert a forecast packet in the data file being transferred to

the DCC. Some polling software programs insert a forecast packet into the file, so users of these software packages will not have to configure the ADTS software for forecasting.

If you plan to use the forecast packet, please follow the step-by-step instructions on the OMS Web site at <http://tnwww.rtpnc.epa.gov/ozmap/>. (You will need a user name and password to access this site. You can obtain a password and user name from Phil Dickerson at dickerson.phil@epa.gov. Once you reach the OMS Web site, scroll to the section titled *New!* and click on the link called *1999 Draft Forecast Plan*). Information on *The Ozone Forecast Map Plan for the Northeast States* also can be found at <http://www.nescaum.org>.

Ozone Forecasting

A number of air quality agencies have used ozone forecasts to warn the public about unhealthy levels of ozone and to encourage the public to take voluntary actions to reduce ozone concentrations in their area. For example, in California, the South Coast Air Quality Management District uses forecasts to predict maximum ozone concentrations for 40 subregions in the Los Angeles area.

Ozone forecasts are usually issued by air quality agencies and reported in local newspapers or on local television or radio stations. Forecasts are an important part of “ozone action day” programs—public health officials rely on ozone forecasts when they decide whether or not to call an “action day.” (See Chapter 6 for more information about ozone action days.)

To help air quality agencies develop and implement forecasting programs, EPA has developed a guidance document that provides:

- Information on how ozone forecasts are currently used.
- A summary and evaluation of methods currently used to forecast ozone levels.
- Step-by-step guidance that air quality agencies can follow in developing and operating an ozone forecasting program.

The guidance document—Guideline for Developing an Ozone Forecasting Program—is available from EPA’s Technology Transfer Network and can be downloaded from the Web at <http://www.epa.gov/tncaaa1/>.

Tip!

You should schedule your download an hour or two after a routine upload—at the end of the day, or early the next day—to ensure receipt of all available data. (See the example schedule provided in Section 4.1.)

Downloading Data. To download a data file from the DCC, double-click on *download.pif* (Windows 95) or *downld31.pif* (Windows 3.1) in the *c:\oms\config directory*. To automatically schedule the download, you can use ClockerPro or Clocker. Observation data (marked by .obs) and/or gridded data files (marked by .grd) will be transferred from the DCC’s outgoing data directory to the host computer’s *c:\oms\data\in\{year} directory*. (Observation data and gridded data are discussed in greater detail in Section 4.4.)

Readying Your System for Hourly Data Polling

Indianapolis Environment Resources Management Division

To gather the data needed to map changing levels of ozone during the day, air quality agencies and offices need to be able to poll data from their monitors frequently—typically, every 1 to 2 hours. These data are then reported to EPA and made available to the public via Web sites, telephone hotlines, and other outreach mechanisms.

Making the switch. While changing from daily data polling and transfer to the more frequent polling is not difficult, the experience of agencies that have upgraded their systems can be helpful. In 1998, the Indianapolis Environment Resources Management Division (ERMD), a city/county agency for Indianapolis and Marion County in Indiana, decided to move to frequent polling as part of their ozone public information initiative.

Upgrading hardware and software. Since ERMD did not need to add new monitors to gather the required data, the biggest change they had to make was obtaining and installing software capable of conducting the new polling regimen. To get the new system functioning smoothly, the agency needed to dedicate staff time to install and troubleshoot the software, contact the vendor for support, and test the system. In addition, ERMD decided to add another computer server at their office to handle the polling and data transfer functions.

Lessons learned. Communication is critical, ERMD staff noted. To change the software, conduct the data transfers, and implement new quality assurance procedures, they “reached out” to other state and regional air quality agencies that had undergone similar changes. Talking with these offices provided important insights that helped save time and resources. The office also communicated closely with EPA staff to ensure ERMD was able to move data to EPA’s Data Collection Center reliably.

Maintaining Your System

As with any application, staff resources are necessary to maintain your agency’s State Host Computer. This includes providing system support for your software, hardware, and security needs. Any staff member who is familiar with providing system support in general and with the ADTS software in particular should be able to maintain your State Host Computer.

Troubleshooting: Questions and Answers

This section contains information about common troubleshooting issues, presented in question-and-answer format.

Q: Is technical support available for agencies setting up a State Host Computer?

A: Yes. Additional documentation is available at <http://envpro.ncsc.org/oms/oms-docs.html>. You also can access a Web Bulletin Board system that allows you to post and respond to messages from members of the Technical

Workgroup at <http://ttnwww.rtpnc.epa.gov/ozmap/>. You will need a user name and password to access the Web board, which you can obtain from Phil Dickerson at dickerson.phil@epa.gov. When you reach the OMS Web page, scroll to the section titled *New!* and click on the link *Ozone Mapping Technical Site*. Scroll to the bottom of the new page and click on the link *Technical Workgroup Online Conference*. Enter your user name and password to enter the Web Bulletin Board system. If you are a new user of the Web Bulletin Board, you will need to create an account and password by clicking the *New Users* button.

Q: *Can I poll data more frequently than scheduled?*

A: Yes. You can collect data from the monitors as frequently as you want. You just need to configure the ADTS for the State Host Computer. Most states collect data every one or two hours and some collect it every five minutes. However, the data are processed by the DCC according to its set schedule.

Q: *If my agency has to perform manual polling, do we need to come in on evenings and weekends, or are alternatives available?*

A: Please contact Phil Dickerson at dickerson.phil@epa.gov for information.

Q: *What should I do if I miss a polling time for transferring data from the ozone monitor to the State Host Computer?*

A: You should complete the transfer as soon as possible and then transfer it to the DCC.

Q: *What should I do if I miss a polling time for transferring data from the State Host Computer to the DCC?*

A: If you miss one polling cycle, the missing data can be interpolated at the DCC. However, if you miss two or more hours of data, the data are marked as missing. You should still complete the transfer as soon as possible. You can also transfer the data in the morning along with the 8:00 a.m. poll, which contains all the previous day's observations.

Q: *What do I do when I can't log in or connect to the DCC using the ADTS software on the State Host Computer?*

A: Sometimes users enter an incorrect user ID or password. If you are unable to log in to the DCC but seem to connect, check the *oms-env.bat* and *spw.bat* files to make sure your user ID and password entries are correct and have no leading or trailing spaces in the entries.

If you cannot determine the cause of the failure, set *check=y* in the *oms-env.bat* file and run the system in *check mode*. This will allow you to test the system and ensure that it is working properly. You will be able to review your data prior to release, and the system will pause if it finds errors at the end of the script.

If you have a direct Internet connection and are having trouble connecting to the DCC, check with your network administrator to be sure the problem is

not related to a firewall at your site. Also, note that the DCC uses a firewall and you may not be allowed access if your Internet protocol address has changed (e.g., because you changed Internet Service Providers).

If you have difficulty connecting to your Internet Service Provider in a reasonable amount of time, you may wish to consider using ClockerPro or Clocker to schedule the connection 5 or 10 minutes before the ADTS is scheduled to transfer your data to the DCC. If you adopt this approach, remember to increase the time allowed for your connection to be idle before disconnecting.

In addition, the *oms-env.bat* file contains a debug feature that you can run. Set the debug variable to *Y*. You can also send the file to dickerson.phil@epa.gov for debugging and analysis.

Q: How do I know when the data file has been successfully transferred?

A: When the State Host Computer successfully transfers a data file to the DCC, the DCC will send an acknowledgment file to the sending computer for the first morning poll at 8:00 a.m. Acknowledgment files are not sent for other polling hours because of the large volume of e-mails that would be generated.

You can check the OMS transfer directory to check for any possible errors in transferring the data. If you are using Windows FTP, check the file *transfer.log*. If you are using WS_FTP, check the file *xferlog.txt*.

When the DCC initiates data transfer, it sends a delivery status file to the State Host Computer. If the DCC successfully connects to the State Host Computer and transfers data, it deposits an “okay” file on the host computer (e.g., *accede*). In the event that the State Host Computer transfer file is not found, the DCC deposits a “not found” file (e.g., *082114nf.ct1*) on the host computer.

Q: How will I be notified when new ADTS software is released?

A: You will be notified by e-mail. Each participant is automatically put on the e-mail list.

Q: Does the DCC calculate forecast data?

A: No. The agency sending the data is responsible for calculating the forecast data and submitting it to the DCC.

Q: How can an agency submit forecast data?

A: If you choose to participate in the forecast program, the agency can submit the forecast data via the ozone data file (with the 3:00 p.m. poll) or via a Web-based forecast submission form. After the data are submitted, the DCC will post it to the EPA AIRNOW Web site (<http://www.epa.gov/airnow>) for access by agencies and communities.

To submit forecast data via the Web or ozone data file, follow the step-by-step instructions in the OMS Web site at <http://ttnwww.rtpnc.epa.gov/ozmap/>. You will need a password and user name to access this site. You can obtain a password and user name from Phil Dickerson at dickerson.phil@epa.gov. When you reach the OMS Web site, scroll to the section titled *New!* and click

on the link called *1999 Draft Forecast Plan*. The *Ozone Forecast Map Plan for the Northeast States*, located at <http://www.nescaum.org>, contains additional information.

4.4 OPERATIONS AT THE DATA COLLECTION CENTER (DCC)

Now that your agency has established its State Host Computer and you are using the ADTS for data collection and transfer, you might be interested in knowing more about the DCC. The section provides general information about operations at the DCC in support of the ADTS.

The DCC, which is located at the Agency's computing center, functions as the only ozone data collection facility covering the United States. (Because operating a data collection system is quite complex, we strongly recommend that state agencies continue to use EPA's DCC as the central ozone data collection point.) Nonetheless, if you are interested in information on establishing and operating your own data collection system, see documentation at <http://envpro.ncsc.org/oms/oms-docs.html>.

This section describes the DCC's main functions, the types of data generated, formats used, the effect of the new ozone standards on DCC operations, and DCC's QA/QC program.

The DCC's Main Functions

The DCC's primary functions are to:

- Obtain ozone monitoring data from state agencies.
- Provide FTP and Kermit servers for State Host Computer-initiated data transfers.
- Maintain master station location and polling tables.
- Merge data from state agencies.
- Perform automated and manual QA/QC checks on incoming data.
- Compute daily peaks and 8-hour ozone averages.
- Manage and archive the collective database.
- Provide data for map generation.
- Transfer ozone monitoring station data.

Types of Data Generated by the DCC

State agencies report hourly data to the DCC. The DCC uses this information to generate different types of data, called data groups. These data groups include:

- Daily peaks based on forecasted 8-hour averages.

-
- Daily peaks based on actual 1-hour averages.
 - 8-hour averages derived from 1-hour averages.
 - 8-hour averages calculated from actual 1-hour averages.

For example, the DCC calculates actual 8-hour ozone concentrations once a day following the 8:00 a.m. polling of data files from State Host Computers. This allows the DCC to base yesterday's peak map on actual data. This also enables the DCC to keep a running record of the season's 8-hour ozone data.

Presentation of Forecast Data

The DCC places forecasts in an ozone forecast table on EPA's AIRNOW Web site at <http://www.epa.gov/airnow>. The table provides a categorical prediction of ozone levels for each participating metropolitan area. The forecast for each state is updated approximately 1 hour after the state agency begins collecting data from its monitoring sites.

Processed Data

The DCC uses two different types of indexes and data formats to display processed data. It is important to understand these indexes and formats to understand the data you will map.

Two different indexes are used to map the 8-hour and 1-hour values. The first index is the Air Quality Index (AQI) that shows 8-hour data in parts per billion. The second index normalizes these parts-per-billion values according to the AQI scale (0 to 500). (See Chapter 6 for more information about the AQI.)

The DCC can also create two types of ozone data formats: observation data (marked by the *.obs* file extension) and gridded data (marked by the *.grd* extension). Observation data from a State Host Computer contain various data points. Each point represents an hourly ozone measurement recorded by a monitoring station. The State Host Computer transfers these hourly data to the DCC. The DCC then calculates more data groups, such as 8-hour averages and daily peaks, from the hourly data. All these data groups are included in one file called the observation file. MapGen software can be used to display each of these data groups as maps that show, for example, still-frame and animation maps of hourly data.

Gridded data have generally undergone one more processing step than observation files. When an observation data group is saved as gridded data, the data group is projected onto a gridded data set. (Data groups are further explained in Chapter 5, Section 5.3.)

DCC's QA/QC of Data

The DCC ensures that the data you receive for mapping have been thoroughly quality-checked. The DCC uses both automated and manual data quality checks

before finalizing processed data. Among other things, the automated QA/QC program:

- Checks to see if the station locations reported by agencies are on the list of active monitoring station locations.
- Ensures that the files transferred from the State Host Computers conform to the OMS data format.
- Performs various data quality checks.

Before releasing data, the DCC staff perform manual QA/QC by creating maps and visually inspecting them. The DCC checks that the contour colors and ranges flow in categorical increments and accurately reflect changes in ozone concentrations. The DCC looks for such problems as:

- A questionable color range, such as a large red area with a green area inside, which may indicate a data discrepancy at the ozone monitor. (An area with “unhealthy” ozone levels is unlikely to surround an area with “good” ozone levels.)
- Gray areas on a map that identify missing data.

If anomalies on a map are large and cannot be resolved, or if large amounts of data are missing from the mapping domain, the data will not be released to the public.

Appendix C provides detailed information on how the DCC performs various automated data quality checks.

Developing a State-of-the-Art Ozone Data Transfer System

New Jersey Department of Environmental Protection

The way your system polls data from ozone monitors, checks the data, and distributes it plays a key role in the quality and usefulness of the resulting information. In New Jersey, the state's Department of Environmental Protection (DEP) has assembled an advanced system with several key features for collecting and transferring ozone data reliably and efficiently.

Polling data frequently. One of these features is frequent data polling. Like other states, New Jersey established a system of air quality monitors in the 1970s in response to the original Clean Air Act requirements. While other states' monitors typically poll their data at 1-hour intervals, New Jersey structured its system to poll by the minute. (New Jersey initially implemented this rapid reporting capability so that radiation releases from any of the state's nuclear power plants could be immediately detected.) To help transfer data reliably, the state uses both leased phone lines and dedicated Internet access lines. This helps prevent busy signals, line tie-ups, or other difficulties in sending and receiving data.

Publicizing the data. This near-constant data polling has allowed New Jersey DEP officials to track ozone levels closely throughout the day during the ozone season. This information is then made available to the public via frequent updates of the state's air quality Web site (located at <http://www.state.nj.us/dep/airmon>).

Customizing data management software. To manage the flow of all this information, the state needed specialized software for polling data, generating reports, and sending the data to the DCC. New Jersey DEP asked its software vendor to customize the company's regular, off-the-shelf product to include a user interface and capabilities tailored to New Jersey's system. Complementing this unique software is New Jersey's central computer system, which is based on UNIX, an operating system designed for stability and reliability. DEP officials report an extremely low amount of downtime.

Performing effective quality control. New Jersey has also developed a comprehensive quality assurance system. Quality reviews are built into the monitoring system, with software checks that highlight, for staff review, any data that fall outside New Jersey DEP-specified maximum fluctuations. Any information that is prepared for release to the public has similar warning flags built into the data transfer software. DEP programmers also have developed sophisticated graphing systems that allow ozone monitoring staff to quickly review nearly every piece of data coming from the monitors so they can pick up on problems almost immediately—a task that would otherwise be nearly impossible.

Lessons learned. DEP staff emphasize that air quality agencies should try to develop automated record keeping practices. In New Jersey, computers record information on every data transfer activity—from initial polling to the delivery of final data to the DCC. These files have proved invaluable, allowing DEP staff to identify and quickly correct any data difficulties that may occur.

5. MAKING OZONE MAPS

Now that your ozone monitoring network is in place and you have collected the resulting data, you can turn to the next step: preparing ozone maps to depict all this information. EPA has developed an easy-to-use, powerful application called MapGen that communities can use to make maps that illustrate the concentration levels of ozone and other data. MapGen will enable you to:

- Generate still-frame images of ozone concentrations, including yesterday's peak ozone concentrations, today's peak ozone concentrations, and snapshots of today's hourly data.
- Produce animated maps illustrating the movement of ground-level ozone over time.
- Customize your maps based on your data and outreach needs.

This chapter offers a complete primer on MapGen. It contains instructions on obtaining and installing the software, generating maps, using advanced features, troubleshooting, and obtaining technical support.

Readers interested primarily in an overview of MapGen's capabilities and features may want to focus on the introductory information in Section 5.1 below. If you are responsible for actual software installation and map generation, you should carefully review the technical information presented in the sections on getting started, generating and managing maps, advanced features, and technical support (Sections 5.2 through 5.5).

5.1 UNDERSTANDING MAPGEN'S CAPABILITIES

MapGen draws ozone maps in the following way: First, data from ozone monitors are input into MapGen. Then MapGen estimates ozone concentrations in areas where there are no actual ozone measurements (i.e., in the areas between monitors). The process of estimating ozone levels is called interpolation. Once ozone concentration data have been interpolated, MapGen automatically draws color contours that represent different levels of ozone in the mapping region. Each of the colors corresponds to the Air Quality Index (AQI) developed by EPA for ozone and other major air pollutants. (See Chapter 6 for more information about the AQI.) Five different color contours may appear on an ozone map. Each color denotes a different level of health concern for ozone.

The screen on page 46 shows one type of image you can compose using MapGen. This particular map depicts ozone levels in the northeastern United States on September 14, 1998.

Note!

The legend created by MapGen currently displays two shades of yellow for the contour associated with moderate air quality (as shown in the screen at right). In future releases of MapGen, the legend will be changed to display only one shade of yellow.

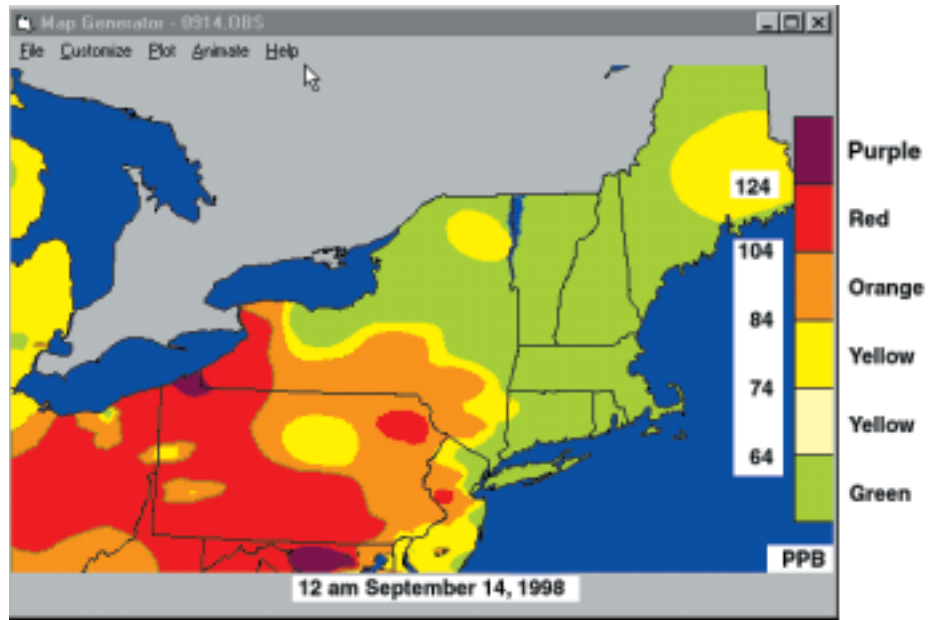

The map shows that ozone levels ranged from good to very unhealthy across the region. The table below shows the air quality descriptors and associated contour colors for 8-hour ozone data.

Contour Color	8-Hour Ozone Range (in parts per billion)	Air Quality Descriptor
Green	0–64	Good
Yellow	65–84	Moderate (upper end)
Orange	85–104	Unhealthy for sensitive groups
Red	105–124	Unhealthy
Purple	125–374	Very unhealthy

Once you become familiar with MapGen, you will be able to customize your maps. This will allow you to create different types of maps that can serve as effective public outreach and education tools. (For more information on the role the maps can play in public outreach on ozone, see Chapter 6.) You can also add additional layers of information—including meteorological, geological, and other pollutant data—to generate more comprehensive maps.

5.2 GETTING STARTED

MapGen was designed to be easy to obtain and install. The first step is to determine if you have the minimum computer hardware and software needed to run

MapGen. Once you are satisfied with your computer arrangement, you will need to follow a simple procedure to install MapGen (and update it, if needed).

Setting Up Your Computer

The following hardware, software, and Internet connection requirements are quite basic—most likely, your existing setup already meets these requirements. You will need:

- An IBM PC-compatible computer with a Pentium processor (133 MHz or greater)
- 16 megabytes of RAM (or greater)
- 100 megabytes of free disk space (more will be needed for large animations)
- A super VGA monitor and video card (24-bit or 32-bit color settings are recommended. Settings at or below 16-bit are inadequate for many of the colors used for mapping and for some data conversion programs.)
- Windows 95, Windows 98, or Windows NT 4.0

MapGen will work on older systems. For example, you can run the program on a 90 MHz Pentium computer. As with any software, however, the more processor power, memory, and free disk space your system has, the better MapGen's performance will be.

Because you will need to download MapGen from the Ozone Mapping System (OMS) Web site, you will need a connection to the Internet and Internet browser software such as Microsoft Internet Explorer or Netscape Navigator.

Obtaining and Installing MapGen

MapGen is obtained through the OMS Web site. To obtain and install the software, follow these steps:

1. Go to the OMS Web site at <http://envpro.ncsc.org/oms/#mapgen-reg>.
2. After registering to download MapGen, go to the “Download MapGen” page. Print out the installation instructions (the *mg980611.txt* file) and the *readme* file.
3. Download *mg980611.exe* to a directory on your computer.
4. Follow the installation instructions to install the downloaded file onto a directory on your computer. (We recommend that you accept the default directory, *C:\oms*, that the installation software creates.)
5. Once MapGen installation is complete, verify that the program is working by navigating to the *C:\oms* directory and double-clicking on *mapgen.exe*.

Updating MapGen

EPA periodically updates MapGen. If you previously installed MapGen, you may wish to replace it with the most current version. (Updated versions are posted on the OMS Web site.) To update MapGen:

1. Go to the Web site <ftp://envpro.ncsc.org/pub/oms/mapgen/>.
2. Click on the file *readme.upd* (installation instructions) for instructions on how to install the most recent version of MapGen.
3. Click on the file *update.bat*. (This is a script that installs the update.) Save this file to a directory on your computer.
4. Click on the self-extracting zip file containing the update files. This executable file is named according to its release date. For example, if a new release occurred on June 11, 1998, the new executable would be named *u990915.exe*. Save this file to a directory on your computer.
5. Go to the appropriate directory and double-click on *update.bat*. The file will unzip the installation files into the proper directories.

Once you have successfully installed or updated the MapGen software, you're ready to begin developing and customizing ozone maps.

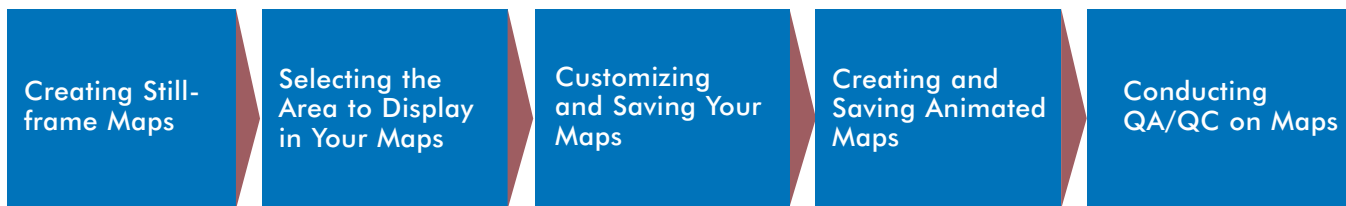

5.3 GENERATING AND MANAGING MAPS

This section presents instructions that will guide you through the process of creating, managing, and reviewing still-frame and animated maps using this simple, five-step process:

Because ozone monitoring data are typically delivered to you from the Data Collection Center (or a state agency) in ready-to-use format, you should be able to input ozone measurements into MapGen and immediately begin producing color maps.

STEP 1: CREATING STILL-FRAME MAPS

In this step, you will learn how to input ozone data into MapGen, choose the type of data to map, and display data to create a still-frame image.

Before you create your first maps, you will need to understand the difference between the two types of data you will receive from the Data Collection Center (or a state agency):

- Observation data (usually denoted by the *.obs* file extension)
- Gridded data (usually denoted by the *.grd* extension)

For the purposes of creating maps, the main thing you need to know about these two types of files is that gridded data have generally undergone one more processing step than observation data. When an observation data group is saved as gridded data, the data group is projected on and saved to a gridded data set. Once this has been done, the interpolation parameters and chosen data group cannot be adjusted.

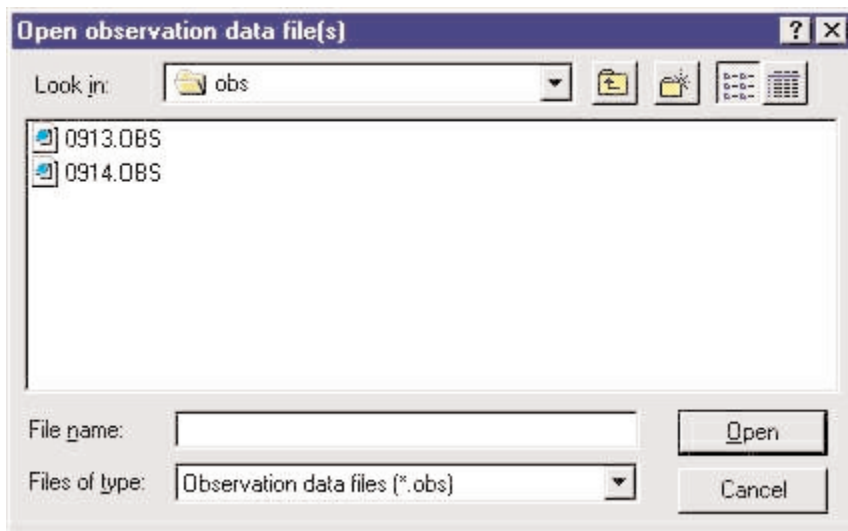

Let's start by creating a map using observation data.

Creating Maps Using Observation Data

1. Open MapGen by clicking on the *mapgen.exe* file in your *C:\oms* directory. MapGen will open up to a blank screen.
2. Go to the *File* menu and select *Open Observation Data*. Navigate to the directory in which the data are stored and select the data file you want to use. Open the data file.

Note!

If you received your data directly from the Data Collection Center, the data file will have an *.obs* extension (as shown in the screen above). For communities that receive data from a state or local agency, the data file may have an *.obs* extension or an extension unique to that agency (such as *.ME1* for a file from Maine).

3. Go to the *Plot* menu, where you will view the data groups in the files you opened. Select the data group you want for your map.

The name of each data group indicates what your ozone map will display. For example, in the screen shown on the next page, the user has selected a data group to create a map that shows daily peak ozone levels based on predicted 8-hour ozone level averages.

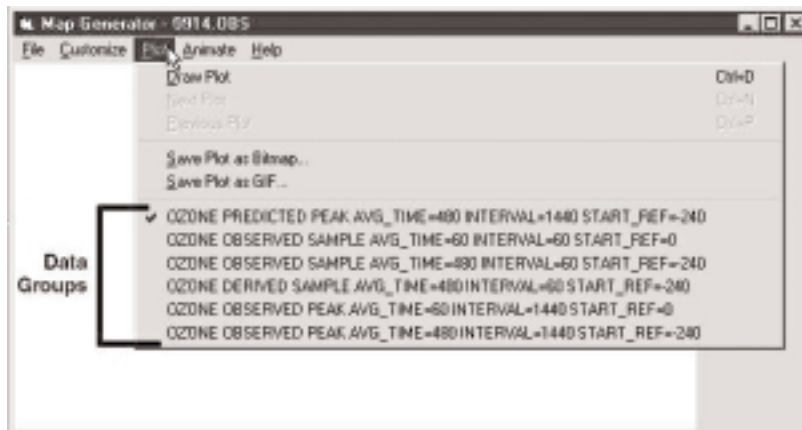

Here are a few other examples of data groups and what they will show in the maps you create:

- OZONE OBSERVED SAMPLE AVG_TIME=60 INTERVAL=60 START_REF=0

Displays actual 1-hour averages for each hour in the day in parts per billion (PPB). In keeping with the 8-hour ozone standard, 1-hour ozone values are displayed using MapGen's default 8-hour ranges as shown in the table in Section 5.1.

- OZONE DERIVED SAMPLE AVG_TIME=480 INTERVAL=60 START_REF=-240

Displays 8-hour averages derived from 1-hour averages in PPB. Ozone values are displayed using the default 8-hour ranges as shown in the table in Section 5.1.

- OZONE OBSERVED PEAK AVG_TIME=60 INTERVAL=1440 START_REF=0

Displays the daily peak based on actual 1-hour averages in PPB. Ozone values are displayed using the default 8-hour ranges as shown in the table in Section 5.1.

- AQI OZONE Data Groups

Displays the same type of maps for 1-hour, 8-hour, and daily peak ozone concentrations as described in the above data groups. However, ozone values are standardized to the Air Quality Index (AQI) scale. The AQI is explained in the section below on Adjusting Contours.

The illustration below and the table on the next page identify and explain the six parts of a data group name. This information will help you interpret the name of any data group—so you can choose the one you want for your map.

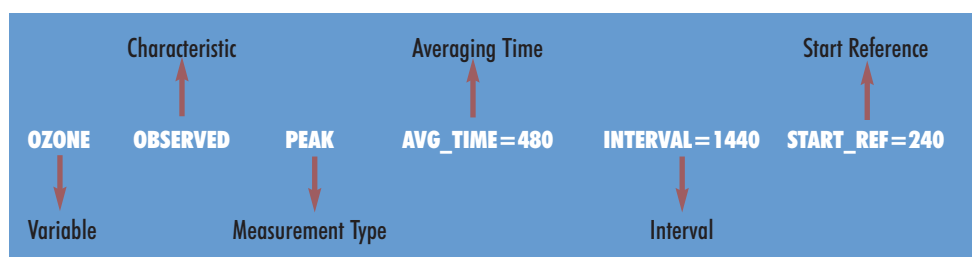

PARAMETER	EXPLANATION
Variable	The pollutant measured (for example, ozone)
Characteristic	The data are either observed, derived, or predicted
Measurement Type	Either sample or peak measurements
Averaging Time	The averaging time in minutes for the variable reported. For example: 60 (hourly averages), 480 (8-hour averages), or 1440 (daily averages)
Interval	The interval between values. For example: 60 (hourly) or 1440 (every 24 hours). Daily peaks have intervals of 1440 minutes.
Start Reference	The start time of a value in minutes. This can be designated as 0, -240, etc. A start reference of 0 indicates the starting time from when the ozone average is calculated. A start reference of -240 indicates that the ozone average is a mid-hour average. The average is calculated in the middle of the 8-hour period based on the four previous and four subsequent hours.

To learn more about data groups, refer to the *Map Generator System User Guide* at <http://envpro.ncsc.org/oms/oms-docs.html>.

4. After you have selected a data group, select *Draw Plot* to create a plot of the data group. (A “plot” is a still-frame image map.)

Remember that some data groups contain hourly ozone data. Here is how you can display still-frame, hourly images using these data groups: After using *Draw Plot* to create the first hourly map, use the *Next Plot* option to advance to the next hour of input data contained in that data group. Keep using *Next Plot* to display subsequent hourly maps until the *Next Plot* option has turned to gray in color. (When this occurs, there are no more data in the file.) You can also select *Previous Plot* to display the previous hour of input data for the selected data group. *Plot* menu options are shown below.

That’s it—you’ve created a map using observation data!

Creating Maps Using Gridded Data

With gridded data, *all the choices concerning data groups* have already been made—either by the Data Collection Center or by a MapGen user in a previous session. When you work with gridded data, all you need to do is open the file and display the still-frame image.

1. Open MapGen by clicking on the *mapgen.exe* file in your *C:\oms* directory. MapGen will open up to a blank screen.
2. Go to the File menu and select *Read Gridded Data*. Navigate to the directory in which the gridded data are stored and select a grid file. Open that file and your gridded data map will be displayed.

Congratulations on creating your first maps with MapGen! In Step 2, we’ll look at how you can adjust your maps to focus on specific regions.

Tip!

If you cannot view all the hourly maps contained in an hourly data file—and the *Next Plot* or *Previous Plot* options have turned to gray in color—make sure the *Time Span* menu item under the *Animate* menu is set correctly. The *Animation Start Time* should be set to the first step (first hour of input data) and the *Animation End Time* should be set to the last step (last hour of input data).

STEP 2: SELECTING THE AREA TO DISPLAY IN YOUR MAP

In this step, you will learn how to manipulate your still-frame image map to display ozone concentrations in a particular geographic area. As described below, this involves adjusting plot area parameters such as latitude and longitude. You then fine-tune the map view by adjusting its width and height.

Adjusting the Plot Area Displayed in the Map

1. Go to the *Customize* menu and choose *Select Plot Area and Projection Params* to open the *Select Plot Area* window displaying a view of your map. (See the screen below.) Notice that the current parameters for the map view are displayed in the bottom portion of the window.
2. Select the plot area you want by adjusting the map parameters. (See the screen on page 53.) The easiest way to do this is to left-click your mouse and then use the cursor to draw a box around the area you want to focus on. When you have selected the area you want, release the mouse button. MapGen will automatically recalculate the plot and parameter values shown at the bottom of the screen.

Tip!

To display a view of the entire United States, click the *Full U.S.* radio button and the plot area will be regenerated. If the north-east corner of the United States is cut off in the regenerated map, change the *Top-Right Corner Longitude* value to -58 to fix this problem.

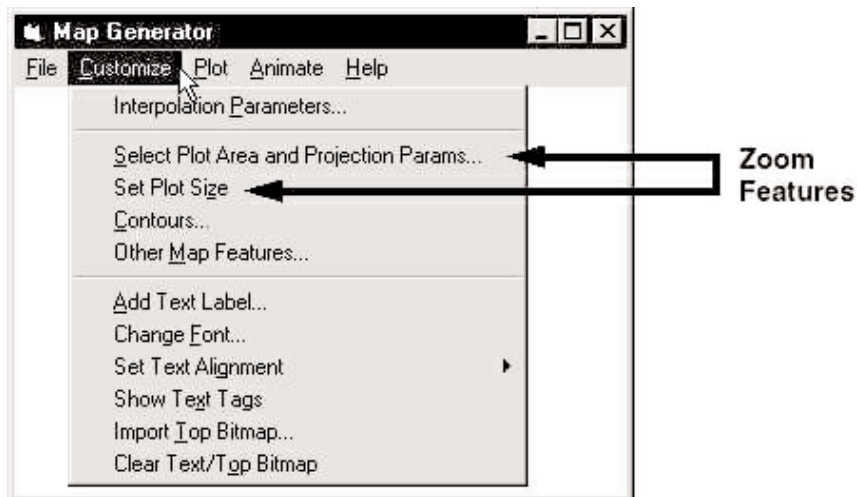

Alternatively, if you know the coordinates of the area you want to focus on, you can adjust your map by typing over the values in the *Latitude* and *Longitude* fields at the bottom of the screen. The view of your map shown will move one way or another, depending on the coordinate values you alter, as described below:

- *Bottom-Left Corner Coordinates:* Increase or decrease the latitude value to expand or contract the map southward. Increase or decrease the longitude value to expand or contract the map westward.
- *Top-Right Corner Coordinates:* Increase or decrease the latitude value to expand or contract the map northward. Increase or decrease the longitude value to expand or contract the map eastward.

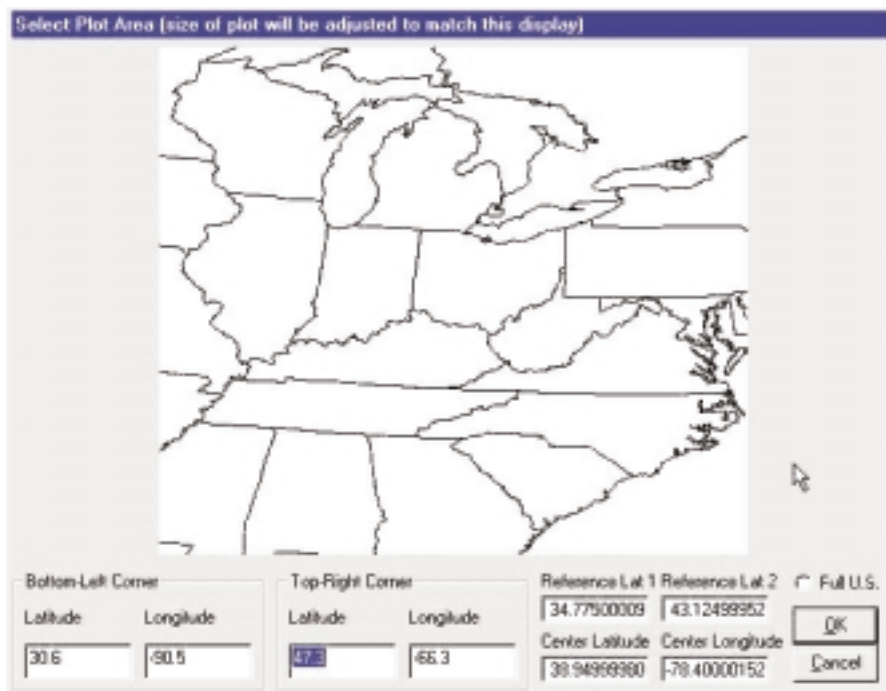

- *Center Coordinates:* MapGen automatically recalculates this when you change a corner coordinate. However, you can adjust the center coordinates to recenter the plot on the new coordinate(s) position.
- *Reference Coordinates:* MapGen automatically recalculates this when you change a corner coordinate. However, you can change the reference coordinates to recenter the map view at the center of the grid and reduce distortion.

If you are unfamiliar with reference coordinates and projections, we suggest that you let MapGen recalculate them automatically.

Regenerating the Map

1. Once you are satisfied with the plot area displayed, click on the *OK* button. Then, when prompted, click on the *OK* button in the *Confirm Clear Plot* pop-up window. (Alternatively, you can click on the *Cancel* button to continue adjusting the plot area displayed.) Selecting *OK* will return you to a blank screen.
2. At the blank screen, regenerate the map by clicking on the *Plot* menu and choosing *Draw Plot*.

Fine-Tuning the View of Your Map

1. Go to the *Customize* menu and choose *Set Plot Size*.
2. At the *Set Plot Size* window (shown at right), type over the current values in the *Width* field and the *Height* field to adjust the dimensions of the map.

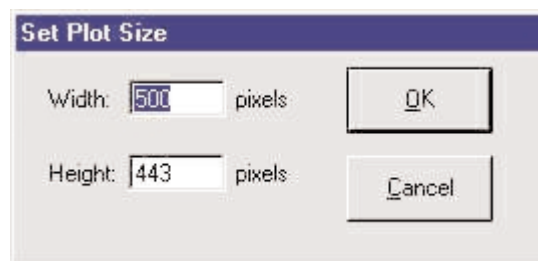

You've succeeded in showing a specific geographic area on your map! In Step 3, we'll work on customizing and saving your map.

STEP 3: CUSTOMIZING AND SAVING YOUR MAP

Now that you have generated an ozone map displaying a plot area of interest, you can customize your map in a variety of ways.

This section describes several customization features, shown in the screen below. These include interpolation, which allows you to change the default values programmed into MapGen for interpolating ozone levels between ozone monitoring stations, and contouring, which allows you to change the default values programmed into MapGen for the color, number, and ranges of different ozone contours.

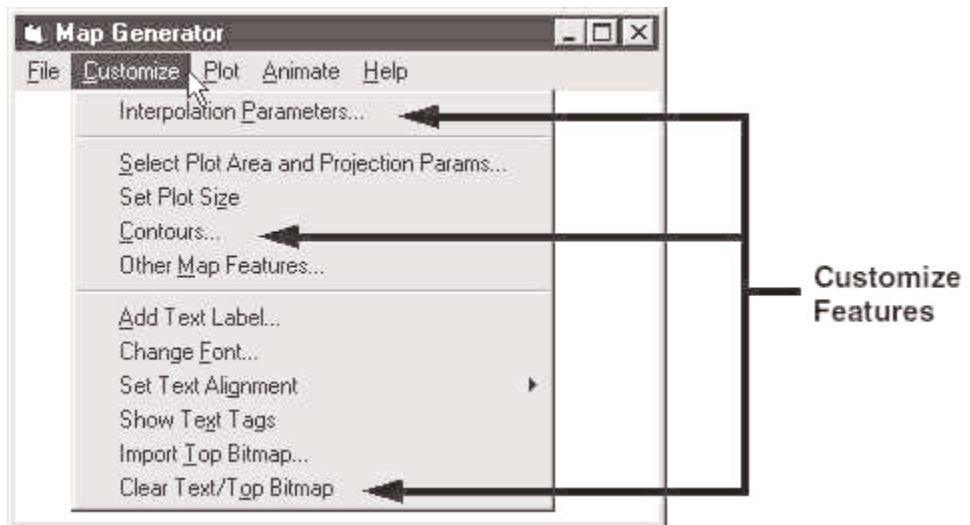

This section also shows you how to customize your map to show supporting information such as geographic features, identifying text, and images. After doing this, you can save your customization settings for use with other maps, and you can save your customized still-frame image map in a variety of formats.

Adjusting Interpolation Parameters

Interpolation is the process of estimating ozone concentrations in areas where ozone monitors do not exist. Estimated data measurements are derived from neighboring ozone monitors. Interpolation makes it possible to display ozone concentrations between ozone monitors.

We recommend that you use the default interpolation parameters, which have been thoroughly tested for generating appropriate estimated results. Changing the default settings has the potential to produce unrealistic results, especially if you are unfamiliar with the methods for estimating concentrations or with the typical behavior of ozone in a specific mapping region.

However, for some local analyses, you may want to adjust the interpolation parameters. For example, you may want to adjust the parameters to make the map's contours appear "smoother." We strongly recommend that you read further about interpolation methods at <http://envpro.ncsc.org/oms/oms-docs.html> by following the links to *Interpolation Documents and Map Generator System User Guide*. These documents will help you understand how to adjust interpolation parameters.

Adjusting Contours

Using predetermined breakpoints, MapGen automatically groups ozone data into different contour ranges keyed to health effects associated with particular ozone concentrations. Depending on the type of data group you are mapping, you may use the AQI 8-hour index (parts-per-billion scale) or the AQI common scale.

8-Hour Air Quality Index (parts-per-billion scale)

In keeping with the new 8-hour ozone standard, MapGen uses 8-hour ozone data, with parts per billion as the measurement unit, to determine the contour breakpoints. These default breakpoints are shown below. *It is strongly recommended that you do not change these contour ranges. Doing so can result in a misinterpretation of ozone concentration data. These settings are consistent with the new 8-hour ozone standard.* Nonetheless, if you wish to change the contours, please read the *Map Generator System User Guide* for further information. The following table shows the 8-hour index (parts-per-billion scale):

Contour Color	Health Descriptor	Breakpoint (parts per billion)	Range (parts per billion)
Green	Good	64	0–64
Yellow	Moderate	84	65–84
Orange	Unhealthy for sensitive groups	104	85–104
Red	Unhealthy	124	105–124
Purple	Very unhealthy	—	125+

AQI Common Scale

The AQI common scale standardizes pollutants such as ozone to a uniform scale (0 to 500) to convey a consistent health message across pollutants. The Data Collection Center calculates AQI 1-hour and 8-hour ozone data groups that are scaled to the common index for use in mapping. The table at the top of page 56 shows the AQI ranges for the 8-hour and 1-hour data measurements in parts per billion standardized to the AQI common scale.

Contour Color	AQI (Common Scale)	Equivalent AQI 8-Hour Ozone Concentration Range (parts per billion)	Equivalent AQI 1-Hour Ozone Concentration Range (parts per billion)	Air Quality Descriptor
Green	0–50	0–64	–9	Good
Yellow	51–100	65–84	–9	Moderate
Orange	101–150	85–104	125–164	Unhealthy for sensitive groups
Red	151–200	105–124	165–204	Unhealthy
Purple	200 +	125 +	205 +	Very unhealthy

The new 8-hour standard requires agencies to report the 8-hour ozone measurements. Using the new AQI 8-hour breakpoints will almost always result in a more health-protective index than the index based on 1-hour standard. However, a very small number of areas may have atypical air quality patterns that result in higher 1-hour averages than 8-hour averages. Only in these atypical areas—where the 1-hour index is more protective—are agencies required to report 1-hour data. For values above 125 parts per billion, agencies must report the highest value as determined for either the 8-hour or 1-hour value.

Customizing Your Map with Supporting Information

You are most likely to customize your ozone map by adding geographic features, other supporting information, and text or images to highlight particular features in the map.

Adding Geographic Features

1. Go to the *Customize* menu and select *Other Map Features* to access the Map Features window (shown below).

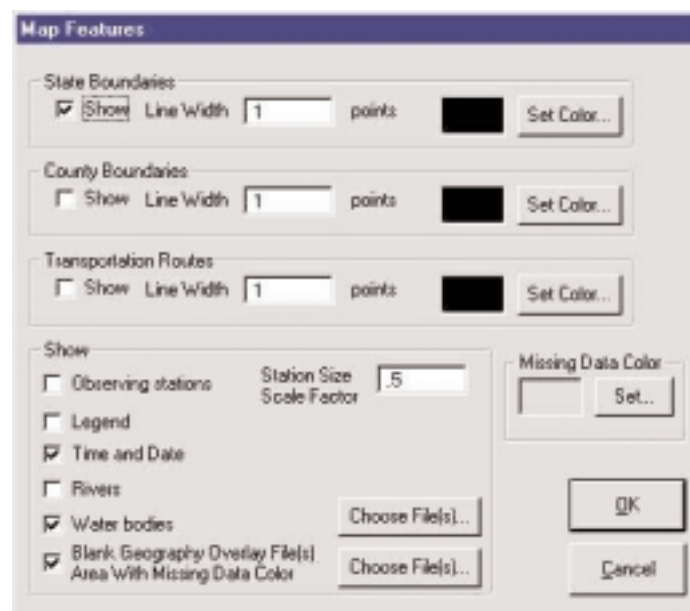

To select a feature for display in your ozone map, click on the *Show* box next to the option you want. You can also customize the display of these features as described below:

State Boundaries, County Boundaries, and Transportation Routes. These selections allow you to add state, county, and transportation lines to your map. You can set the width of these feature lines (specified in point sizes) by typing over the default setting. You also can set the color by clicking on the *Set Color* button.

Observing Stations. This selection plots ozone monitoring station locations on the map as triangles. You can scale the size of the icons as appropriate for your map.

Legend. This selection places a color scale legend on the right side of the map. The legend is based on either the default or the customized contours.

Time and Date. This selection adds to the map the time and date that data were collected.

Rivers. This selection plots rivers and other waterways on the map.

Water Bodies. This selection displays water bodies on the map. The *Choose File(s)* option allows you to select a file with a specific water body shape. In some cases, you may want to use a water body on your map as an overlay to focus the portrayal of ozone concentration information on an adjacent land area.

Blank Geography Overlay File(s) and Area with Missing Data Color. As with adding water bodies, these selections allow you to overlay areas in the larger frame of your map to focus attention on an adjacent area of interest. The *Choose File(s)* option allows you to select an appropriate shape from an overlay file. The files provide shape overlays for all 50 states, as well as areas of Canada and Mexico. *Area with Missing Data Color* allows you to choose a color for the overlay shape.

2. After selecting the map features you want and customizing their display, click on the *OK* button. Then refresh the map display by going to the *Plot* menu and selecting *Draw Plot*.

Adding Images and Text

Go to the *Customize* menu to add an image or text to your ozone map. For example, you might want to add an image to identify a unique geographic landmark or text to pinpoint the location of a city.

Import Top Bitmap. This selection allows you to place a custom bitmap image (*.bmp*) or graphic interchange format (GIF) onto your map. Some Windows meta files (usually denoted with a *.wmf* file extension) also can be imported and placed on the map.

Add Text Label. This selection accesses a window for entering text captions. After inputting your caption in the text field, click on the *OK* button. The caption will appear in the upper left-hand corner of the map display. From there, you can then move text to the desired location on the map.

Change Font. This selection allows you to change the typeface of the text labels.

Set Text Alignment. This selection allows you to align your text within the caption label block.

Show Text Tags. This selection allows you to select all text and bitmaps as one group on the map display. Once selected, you can move or delete them. You can individually select a caption or bitmap by left-clicking on your mouse, and then pointing at the desired selection.

Clear Text/Top Bitmap. This selection allows you to remove selected text or bitmap items from the map.

Saving Custom Settings and Still-Frame Image Maps

Once you have established your custom settings for a map, you can save the settings for use in a subsequent MapGen session. Also, you can save the still-frame image map you've created in any of several formats.

Saving Custom Settings

Go to the *File* menu and select one of the following:

Save Settings to Disk. This selection saves the current custom settings as an initialization file to a disk. (Such files are usually denoted by the *.ini* file extension.)

Load Settings from Disk. This selection allows you to select and display custom settings from a disk.

Save Current Settings as Defaults. This selection allows you to save the current user settings to a disk in MapGen's *.ini* file. Subsequent MapGen user sessions will default to those settings.

Return to Defaults. This selection allows you to reset all your custom settings to MapGen's "factory default" settings. With this selection, any customized settings that you have established will be deleted.

Saving Still-Frame Image Maps

To save a still-frame image as a bitmap file, or gridded data, go to the *Plot* or *File* menu as indicated below and select one of the following:

Save Plot as Bitmap (Plot menu). This selection saves the current still-frame image map as a pixellated image or bitmap. (Such files are usually denoted with a *.bmp* file extension.)

Save Plot as GIF (Plot menu). This selection saves the current plot as a GIF file (such files are usually denoted with a *.gif* file extension). The GIF option works only if your monitor is set to 256-color, 24-bit, or 32-bit and higher resolution. The GIF format enables you to easily incorporate your images onto Web pages.

Note!

If you are using Windows NT, your map may not convert to a GIF map. This is because the Windows NT and MapGen's ImageMagick convert programs conflict.

Save Gridded Data (*File* menu). This selection interpolates the open data file onto a grid, using the current interpolation parameter values, and then saves the interpolated data.

Now that you've mastered still-frame image maps, you're ready for animations!

STEP 4: CREATING AND SAVING ANIMATED MAPS

Another way to add supporting information to your ozone map is by animating the color ozone contours to portray changes in concentrations over time. For example, if you have sufficient data, you can use your map to show a "movie" of changes in ozone concentration over the course of an afternoon. In this step, you will learn how to create an animation for a particular time frame and then save the settings.

Getting Ready

1. Go to the *Plot* menu and select *Draw Plot* to display your ozone map.
2. Go to the *File* menu and select *Open Observation Data*. Then:
 - Navigate to the directory in which the data are stored and select the data file you want to use. Open the data file.
 - Go to the *Plot* menu, where you will view the data groups in the files you opened. Select an hourly data group for your animation.

Note!

You cannot create animations using data groups that have peak measurements.

3. Go to the *Customize* menu and choose *Select Plot Area* and *Project Params* to open the *Select Plot Area* window displaying your map. Select your plot parameters to cover the area that will include your animation, then regenerate and fine-tune your map (see Step 2: Selecting the Area to Display in Your Map).
4. Go to the *Customize* menu to customize your display **or** go to the *File* menu to load previously saved custom settings (see Step 3: Customizing and Saving Your Map).

Establishing the Time Span and Color Changes Portrayed

1. Go to the *Animate* menu and select *Time Span*. The window that appears allows you to choose what time period your animation will cover.

In the screen on page 60, for example, time span parameters are presented for a single observation file brought into MapGen. Because the *Animation Start Time* and the *Animation End Time* scroll bars are set at the extreme first and last steps, respectively, the window shows that the earliest ozone concentration

measurement recorded for this data group was taken at 12 a.m. on September 13, 1998, and the last was taken at 11 p.m. on September 13, 1998.

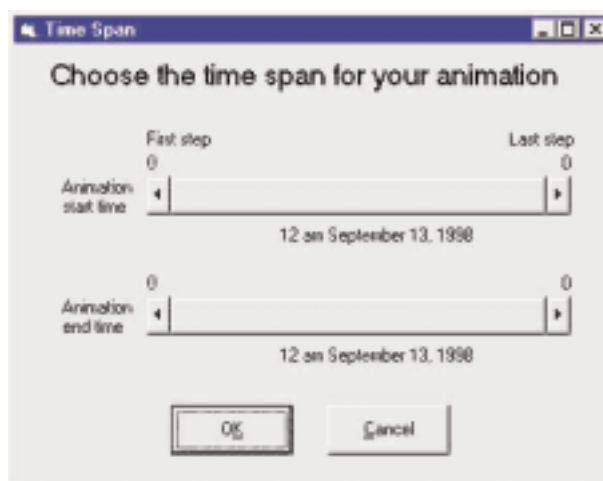

Note!

If you bring in two or more continuous observation files, the *Animation Start Time* (e.g., 12 a.m. on September 13, 1998) will be the date and time in the observation files of the earliest ozone measurement taken. The *Animation End Time* (e.g., 11 p.m. on September 14, 1998) will be the date and time in the observation files of the last ozone measurement taken. If you bring in two observation files that do not have a continuous time span, the time span window will appear with a range but there will be a gap in the data displayed.

2. Use the scroll bars in the *Time Span* window to specify a time period for your animation of ozone concentrations. When you are done, click on the *OK* button.
3. From the *Animate* menu, select *Frames/Hour* to set the number of frames to be shown in your animation per hour of ozone data. If you set the number at 1, your animation will show one image for each hour in the chosen time frame, running in chronological order. If you set the number at greater than 1, MapGen will create “in-between” frames by linearly interpolating data, which will make your animation flow more smoothly. A setting of 3 frames per hour is recommended for a smooth-running animation.
4. Again from the *Animate* menu, select *Animated GIF Settings* to control the speed of your animation by inserting delays and to specify whether your animation should continue to run by looping through the same data.

Playing, Saving, and Retrieving Your Animation

Now that you’ve established the settings for your animation, it’s time to show the “movie.” If you decide the animation effectively portrays important information, you might want to save it.

1. From the *Animate* menu, select *Animate* to view the animation “on the fly,” and then make adjustments as necessary.

-
2. Once you are satisfied with your animation, you can save the file by going to the *Animate* menu and selecting one of the following options:

Create Animation File. This selection creates and saves an animation file (such files are usually denoted by the *.ani* extension) to a disk.

Create Animated GIF File. This selection creates and saves a GIF animation file (such files are usually denoted by the *.gif* extension) to a disk.

Note!

An animation file can take up large amounts of disk space. Typically, about 312 Kilobytes (KB) of space must be available per 400x400-pixel frame of the animation. About 600 KB would be required for a 640x480-pixel frame. GIF animations can require even more disk space. About 200 KB to 6 Megabytes (MB) will be required for the animated GIF itself. Also, up to several hundred MB may be required while the image file is being created.

See the *Map Generator System User Guide* at <http://envpro.ncsc.org/oms/oms-docs.html> for further information on creating animated GIF files and on the use of a free animated GIF utility. (The current version of MapGen does not have the capability to generate MPEG video animations.)

3. To open and play an animation file saved to a disk, go to the *Animate* menu and select *Play Animation File*.

STEP 5: CONDUCTING QA/QC ON MAPS

It's always a good idea to review your map for data integrity. Detailed QA/QC considerations are covered in Section 4.3 of this handbook.

5.4 ADVANCED FEATURES

If you're interested in the following MapGen advanced features, additional information is available in the *Map Generator System User Guide* at <http://envpro.ncsc.org/oms/oms-docs.html>.

MapGen Scripting Language. You can automate map production using MapGen's scripting language. See the *User Guide's* section on writing and executing scripts.

ImageMagick Convert. MapGen uses the ImageMagick "Convert" program to convert bitmaps files to GIF format and to merge individual frames into animated GIF images. ImageMagick utilities also recognize over 40 image formats. See the *User Guide's* section on using and obtaining this software.

5.5 TECHNICAL SUPPORT

If you need additional help creating either still-frame image maps or animations, please refer first to MapGen's Help system. The *Help* menu includes entries such as *Beginner Tips* and *Map Generator Help*. (Selecting *Map Generator Help* opens the *Map Generator System User Guide* in HTML format.)

Technical support is also available via the Web. (See the box on page 62.)

Known MapGen Bugs

The current version of MapGen includes several known malfunctions that will be fixed in future releases of the software. For information about these bugs, see the *Map Generator System User Guide* at <http://envpro.ncsc.org/oms/oms-docs.html>.

Also, if you discover additional bugs in the software, please report them to the Web-based tracking system at <http://envpro.ncsc.org/products/ticket.html>. At the site, the Project—Subsystem you should select is *Ozone Mapping System—Other*. You also can report MapGen bugs by sending an e-mail to oms@ncsc.org or a fax to 919-248-9245.

Getting Help from EPA's WebBoard

The Online Ozone Conferencing and Discussion Resource

Real-time ozone monitoring and mapping systems can be complex, and, from time to time, difficulties may arise when implementing and operating them. Where can you go to get answers to your questions? EPA's WebBoard.

As ozone mapping has taken off in the past several years, state and local officials involved in ozone projects have faced—and tackled—many of the same issues you may now be confronting. WebBoard allows you to tap into their experience. Developed by EPA in 1998, the site offers informative question-and-answer sessions and discussions between anyone involved or interested in ozone monitoring and mapping. Have a question about merging ozone data from multiple agencies? Need help with MapGen's animations? Simply post your question on the WebBoard. You'll get responses from other EMPACT cities, EPA, state air quality officials, and others offering ideas or recommendations that can help you fix the problem and move ahead with your program.

WebBoard is divided into several areas. The feature area is the conference, where you can post questions on different topics and watch the replies flow back. In addition, the site contains a comprehensive search feature allowing you to check whether any of your questions have been addressed in previous postings. There also is a chat room hosting real-time discussions on anything related to ozone mapping. The more users, the better the information—so if you need to learn more about ozone monitoring or mapping, log on to WebBoard!

To access the WebBoard, you must log in to <http://tnwww.rtpnc.epa.gov/ozmap/>. You will also need a user name and password, which you can obtain by contacting Phil Dickerson at dickerson.phil@epa.gov. Once you have accessed the Web page, click on the link called Ozone Mapping System Online Conferencing & Chat to access the Web Board, where you can post and respond to messages about MapGen.

6. COMMUNICATING INFORMATION ABOUT OZONE AND THE OZONE MAP

As your community develops its ozone monitoring and real-time mapping systems, you will want to think about the best ways to communicate the information these systems will yield. This chapter of the handbook is designed to help you do so:

- It outlines the steps involved in developing an outreach plan and profiles examples of successful ozone outreach initiatives that have been implemented in EMPACT cities across the country.
- It also provides guidelines for communicating information about ozone and includes examples of information, written in an easily understandable, plain-English style, which you can incorporate into your own communication and outreach materials.

6.1 CREATING AN OUTREACH PLAN FOR OZONE

Outreach will be most effective if you plan it carefully, considering such issues as: Who do you want to reach? What information do you want to disseminate? What are the most effective mechanisms to reach people? Developing a plan ensures that you have considered all important elements of an outreach project before you begin. The plan itself provides a blueprint for action.

An outreach plan does not have to be lengthy or complicated. You can develop a plan simply by documenting your answers to each of the questions discussed below. This will provide you with a solid foundation for launching an outreach effort.

Your outreach plan will be most effective if you involve a variety of people in its development. Where possible, consider involving:

- A communications specialist or someone who has experience developing and implementing an outreach plan.
- Technical experts in the subject matter (both scientific and policy).
- Someone who represents the target audience, i.e., the people or groups you want to reach.
- Key individuals who will be involved in implementing the outreach plan.

As you develop your outreach plan, consider whether you would like to invite any organizations to partner with you in planning or implementing the outreach effort. Potential partners include trade associations, environmental organizations, community groups, health maintenance organizations (HMOs) and clinics, schools, day care centers, summer camps, local health departments, and other local or state agencies. Partners can participate in planning, product development

and review, and distribution. Partnerships can be valuable mechanisms for leveraging resources while enhancing the quality, credibility, and success of outreach efforts.

Developing an outreach plan is a creative and iterative process involving a number of interrelated steps, as described below. As you move through each of these steps, you might want to revisit and refine the decisions you made in earlier steps until you have an integrated, comprehensive, and achievable plan.

What Are Your Outreach Goals?

Defining your outreach goals is the first step in developing an outreach plan. Outreach goals should be clear, simple, action-oriented statements about what you hope to accomplish through outreach. Once you have established your goals, every other element of the plan should relate to those goals. Here are some sample goal statements that a community might develop for its ozone outreach effort:

- Have all local television stations include the ozone map in their weather reports during ozone season.
- Secure the participation of at least 50 percent of local businesses in “ozone action day” initiatives.
- Ensure that all local clinics and HMOs include articles about the health effects of ozone in their newsletters before and/or during the ozone season.

Who Are You Trying To Reach?

Identifying Your Audience(s)

The second step in developing an outreach plan is to clearly identify the target audience or audiences for your outreach effort. As illustrated in the sample goals above, outreach goals often define their target audiences. You might want to refine and add to your goals after you have specifically considered which audiences you want to reach.

Target audiences for an ozone outreach program might include, for example, the public, school children, educators, physicians, business leaders, environmentalists, journalists, and weather broadcasters. Some audiences, such as educators, journalists, and weather broadcasters, may serve as conduits to help disseminate information to other audiences you have identified, such as the public.

Consider whether you should divide the public into two or more audience categories. For example: Will you be providing different information to certain groups, such as the elderly, or parents? Does a significant portion of the public you are trying to reach have a different cultural or linguistic background from other members? If so, it likely will be most effective to consider these groups as separate audience categories.

Profiling Your Audience(s)

Outreach will be most effective if the type, content, and distribution of outreach products are specifically tailored to the characteristics of target audiences. Once you have identified your audiences, the next step is to develop a profile of their situations, interests, and concerns. This profile will help you identify the most effective ways of reaching the audience. For each target audience, consider:

- What is their current level of knowledge about ozone?
- What do you want them to know about ozone? What actions would you like them to take regarding ozone?
- What information is likely to be of greatest interest to the audience? What information will they likely want to know once they develop some awareness of ozone issues?
- How much time are they likely to give to receiving and assimilating the information?
- How does this group generally receive information?
- What professional, recreational, and domestic activities does this group typically engage in that might provide avenues for distributing outreach products? Are there any organizations or centers that represent or serve the audience and might be avenues for disseminating your outreach products?

Profiling an audience essentially involves putting yourself “in your audience’s shoes.” Ways to do this include consulting with individuals or organizations who represent or are members of the audience, consulting with colleagues who have successfully developed other outreach products for the audience, and using your imagination.

What Do You Want To Communicate?

The next step in planning is to think about what you want to communicate. In particular at this stage, think about the key points, or “messages,” you want to communicate. Messages are the “bottom line” information you want your audience to walk away with, even if they forget the details.

A message is usually phrased as a brief (often one-sentence) statement. For example:

- The ozone map provides you with real-time information about ozone levels in your community.
- You can take steps to protect your family’s health from ozone pollution.
- You can help reduce ozone levels in your community.

Outreach products often will have multiple related messages. Consider what messages you want to send to each target audience group. You may have different messages for different audiences.

What Outreach Products Will You Develop?

The next step in developing an outreach plan is to consider what types of outreach products will be most effective for reaching each target audience. There are many different types of outreach products in print, audiovisual, electronic, and event formats. The table below provides some examples.

Print	Audiovisual	Electronic	Events	Novelty Items
<ul style="list-style-type: none"> • Fact sheets • Brochures • Question-and-answer sheets • Newspaper and magazine articles • Editorials • Newsletters • Stuffers • Press releases • Educational curricula • Coloring books 	<ul style="list-style-type: none"> • Posters • Public service announcements • Cable television programs • Exhibits • Videos • Logos 	<ul style="list-style-type: none"> • Web pages • E-mail message 	<ul style="list-style-type: none"> • Press conferences • Speeches • Fairs • Community days • One-on-one meetings • Public meetings • Media interviews • Briefings 	<ul style="list-style-type: none"> • Banners • Bumper stickers • Mouse pads • Buttons

The audience profile information you assembled earlier will be helpful in selecting appropriate products. A communications professional can provide valuable guidance in choosing the most appropriate products to meet your goals within your resource and time constraints. Questions to consider when selecting products include:

- How much information does your audience really need to have? How much does your audience need to know now? The simplest, most effective, most straightforward product generally is most effective.
- Is the product likely to appeal to the target audience? How much time will it take to interact with the product? Is the audience likely to make that time?
- How easy and cost-effective will the product be to distribute or, in the case of an event, organize?
- How many people is this product likely to reach? For an event, how many people are likely to attend?
- What time frame is needed to develop and distribute the product?

- How much will it cost to develop the product? Do you have access to the talent and resources needed for development?
- What other related products are already available? Can you build on existing products?
- When will the material be out of date? (You probably will want to spend fewer resources on products with shorter lifetimes.)
- Would it be effective to have distinct phases of products over time? For example, a first phase of products designed to raise awareness, followed at a later date by a second phase of products to encourage changes in behavior.
- How newsworthy is the information? Information with inherent news value may be rapidly and widely disseminated by the media.

How Will Your Products Reach Your Audience?

Effective distribution is essential to the success of an outreach strategy. There are many avenues for distribution. The table below lists some examples.

EXAMPLES OF DISTRIBUTION AVENUES	
<ul style="list-style-type: none"> • Your mailing list • Partners' mailing list • Phone/Fax • E-mail • Internet • Journals or newsletters of partner organizations 	<ul style="list-style-type: none"> • TV • Radio • Print media • Hotline that distributes products upon request • Meetings, events, or locations (e.g., libraries, schools, clinics) where products are made available

You need to consider how each product will be distributed and determine who will be responsible for distribution. For some products, your organization might manage distribution. For others, you might rely on intermediaries (such as the media or physicians) or organizational partners who are willing to participate in the outreach effort. Consult with an experienced communications professional to obtain information about the resources and time required for the various distribution options. Some points to consider in selecting distribution channels include:

- How does the audience typically receive information?
- What distribution mechanisms has your organization used in the past for this audience? Were these mechanisms effective?
- Can you identify any partner organizations that might be willing to assist in the distribution?
- Can the media play a role in distribution?

-
- Will the mechanism you are considering really reach the intended audience? For example, the Internet can be an effective distribution mechanism, but certain groups may have limited access to it.
 - How many people is the product likely to reach through the distribution mechanism you are considering?
 - Are sufficient resources available to fund and implement distribution via the mechanisms of interest?

What Follow-up Mechanisms Will You Establish?

Successful outreach may generate requests for further information or concern about issues you have made the audience aware of. Consider whether and how you will handle this interest. The following questions can help you develop this part of your strategy:

- What types of reactions or concerns are audience members likely to have in response to the outreach information?
- Who will handle requests for additional information?
- Do you want to indicate on the outreach product where people can go for further information (e.g., provide a contact name, number, or address, or establish a hotline)?

What Is the Schedule for Implementation?

Once you have decided on your goals, audiences, messages, products, and distribution channels, you will need to develop an implementation schedule. For each product, consider how much time will be needed for development and distribution. Be sure to factor in sufficient time for product review. Wherever possible, build in time for testing and evaluation by members or representatives of the target audience in focus groups or individual sessions so that you can get feedback on whether you have effectively targeted your material for your audience. Section 6.3 provides guidelines for effectively presenting information about ozone to the public.

GETTING THE WORD OUT: NORTH CAROLINA'S AIR AWARENESS PROGRAM

North Carolina Department of Environment and Natural Resources, Division of Air Quality

One of the challenges of an ozone outreach effort is focusing the public's attention on the problem. In North Carolina, officials have implemented a comprehensive ozone outreach program—the Air Awareness Program—that has brought ozone to the public's attention and encouraged them to begin taking action. North Carolina created the Air Awareness Program in 1996 to help limit ozone levels in three of the state's largest metropolitan areas: Charlotte, Raleigh-Durham-Chapel Hill (the "Triad" area), and Winston-Salem-Greenville. Organizers in the state's Division of Air Quality (DAQ), which operates the program, have developed a multi-pronged approach to outreach to raise public awareness about ozone.

Holding Ozone Season Kick-Off Events. Each year, the DAQ begins its summer outreach with a series of ozone season kickoff events. In 1997, the program launched its outreach efforts in the Triad area with a rally at Durham Bulls Baseball Park before the start of a Bulls baseball game, complete with handouts for fans and a pre-game ozone weather report by a local television meteorologist. Also, before the start of each ozone season, the DAQ runs media-targeted special events to coach meteorologists, journalists, and other media professionals in how to report on ozone during ozone season.

Reaching Out to Schools. Educating school children is another important component of the Air Awareness program. DAQ staff frequently visit schools in the three target metropolitan areas to discuss ozone-related issues with students and offer teachers a series of classroom tools—from an "Air Adventures Puppet Show" to a computer-based "Air Jeopardy" game. Children are also encouraged to spread the word about ozone by talking with their parents about ozone's health effects and what families can do to help reduce summertime ozone levels.

Building Coalitions. Another strategy for raising public awareness about ozone is to build coalitions with businesses and other organizations willing to help reduce ground-level ozone. Program organizers seek out potential coalition members in the three target metropolitan areas, encouraging them to join the program and reach out to their employees to explain ozone and suggest steps they can take. At the end of each season, DAQ hosts an ozone awards night honoring those coalition members that developed the most innovative and effective public education efforts.

Getting Results. How well is the Air Awareness Program working? Surveys conducted in Charlotte before and after the ozone season in 1998 showed that the program had a measurable impact on public awareness about air pollution. For example, the percentage of survey respondents in the Charlotte area who said that air pollution was a problem increased from slightly more than half (56 percent) before the Air Awareness Program to about two-thirds (67 percent) after program implementation. Likewise, the percentage of people who said they took measures to reduce air pollution in their daily routines increased from 41 percent to 55 percent.

Lessons Learned. To be successful, DAQ staffers advise, it is important to consider these types of programs as year-round efforts, not just as projects that are limited to ozone. It takes time, they note, to plan events and recruit coalition members, and because schools are closed for much of the ozone season, outreach to kids needs to happen before peak ozone season, during the winter and spring. Even if budgets are tight, DAQ staff recommend that air quality agencies dedicate a full-time staffer to manage their ozone outreach programs all year long.

6.2 SUCCESSFUL OZONE OUTREACH PROGRAMS

Many innovative ozone outreach efforts have already been implemented in EMPACT cities around the country. These have included:

- Getting ozone maps on TV.
- Launching intensive campaigns to encourage broadcast and print media coverage during ozone season about ozone and its health effects.
- Developing Web sites that include ozone maps and other ozone-related information.
- Working with schools to provide information about ozone in science and health classes.
- Developing “ozone action day” programs aimed at encouraging people, businesses, and industries to take voluntary measures to help reduce ozone on days when ozone levels are high.
- Operating hotlines that provide recorded information about current and forecasted ozone levels.

TUNING IN TO OZONE

Sacramento Metropolitan Air Quality Management District

Getting ozone maps on television is one of the best ways to communicate information about ozone levels to a large number of people. The Sacramento Metropolitan Air Quality Management District (AQMD) has developed some winning strategies for getting their ozone maps broadcast on local television weather reports.

Depicting Ozone Graphically. For several years, television meteorologists covering Sacramento have broadcast short ozone forecasts for the next day without using any supporting maps. Despite these forecasts, the AQMD found that people did not always fully understand the health effects of ozone and the need to reduce it. AQMD planners decided to push for animated maps on weather broadcasts depicting the formation and movement of ground-level ozone. According to AQMD staff, seeing a map on TV showing your region covered with a blanket of orange or red—signifying high or unhealthy ozone levels—can be a powerful motivator.

Working with Weather Service Providers. Weather Service Providers (WSPs) are companies that supply weather data, images, and forecasts to TV stations, newspapers, and private industry. Generally, local television stations obtain information and images for their weather reports from WSPs. TV stations trust the products that WSPs supply. If WSPs pick up the ozone maps, station meteorologists are much more likely to use them. Before agreeing to use the maps, however, the WSPs need to be convinced that the information is worth providing, quality-checked, and consistently available. AQMD took on this challenge, focusing on the two main WSPs serving Sacramento area TV stations. AQMD staff provided the WSPs with fact sheets, developed working relationships with their meteorologists, and presented information on ozone maps at meetings attended by WSP staff. AQMD staff expect that at least one WSP will pick up the maps for the 1999 ozone season.

Recruiting Individual Stations. In addition to working with WSPs, AQMD also began reaching out to the individual local television stations. AQMD developed high resolution ozone maps, put them on their “Spare The Air” Web site (www.sparetheair.com), and began encouraging local meteorologists to use them. In the 1998 ozone season, this outreach method proved successful. Local station KCRA went to the Web site, downloaded the animated maps, modified them slightly to fit the station’s graphic style, and ran them on their weather broadcasts.

Lessons Learned. AQMD attributes its success in getting the ozone maps on television to the working relationships they developed with WSPs and local station meteorologists. In addition to pushing for broadcast of the maps, AQMD staff provided them with information on all types of air quality issues, made themselves available whenever television station staff needed anything for their weather-related news reports, and even tried to anticipate and respond to possible future feature story needs.

6.3 GUIDELINES FOR PRESENTING INFORMATION ABOUT OZONE TO THE PUBLIC

As you begin to implement your outreach plan and develop the products selected in the plan, you will want to make sure that these products present your messages and information as clearly and accurately as possible.

How Do You Present Technical Information to the Public?

Environmental topics are often technical in nature, and ozone is no exception. Nevertheless, this information can be conveyed in simple, clear terms to non-specialists, such as the public. Principles of effective writing for the public include avoiding jargon, translating technical terms into everyday language the public can easily understand, using the active voice, keeping sentences short, and using headings and other format devices to provide a very clear, well-organized structure. You may want to refer to the following Web sites for more ideas about how to write clearly and effectively for a general audience:

- The National Partnership for Reinventing Government has developed a guidance document, *Writing User-Friendly Documents*, that can be found on the Web at <http://www.plainlanguage.gov/>.
- The Web site of the American Bar Association has links to important online style manuals, dictionaries, and grammar primers (<http://www.abanet.org/lpm/writing/styl.html>).

As you develop communication materials for a specific audience, remember to consider what the audience members are already likely to know, what you want them to know, and what they are likely to understand. Then tailor your information accordingly. Provide only information that will be valuable and interesting to the target audience. For example, environmentalists in your community may be interested in why EPA revised the 1-hour ozone standard to an 8-hour standard. However, it’s not likely that school children will be engaged by this level of detail.

When developing outreach products, be sure to consider any special needs of the target audience. For example, if your community has a substantial number of people who speak little or no English, you will need to prepare communication materials in their native language.

The rest of this section contains examples of text about ozone, ozone monitoring and mapping, and the health and environmental effects of ozone. These examples, presented in a question-and-answer format, are written in a plain-English style designed to be easily understandable by the public. You can use this text as a model to stimulate ideas for your own outreach language or you can incorporate components of this text directly into your products.

The Nature Of Ozone Pollution

■ What is ozone?

Ozone is an odorless, colorless gas composed of three atoms of oxygen.

■ Is ozone good or bad for people's health and the environment?

Ozone occurs both in the Earth's upper atmosphere and at ground level. Ozone can be good or bad, depending on where it is found:

- *Good Ozone.* Ozone occurs naturally in the Earth's upper atmosphere—10 to 30 miles above the Earth's surface—where it forms a protective barrier that shields people from the sun's harmful ultraviolet rays. This barrier is sometimes called the "ozone layer."
- *Bad Ozone.* Because of pollution, ozone can also be found in the Earth's lower atmosphere, at ground level. Ground-level ozone is a major ingredient of smog, and it can harm people's health by damaging their lungs. It can also damage crops and many common man-made materials, such as rubber, plastic, and paint.

■ How is ground-level ozone formed?

Ground-level ozone is not emitted directly into the air but forms when two kinds of pollutants—volatile organic compounds and nitrogen oxides—mix in the air and react chemically in the presence of sunlight. Common sources of volatile organic compounds (often referred to as VOCs) include motor vehicles, gas stations, chemical plants, and other industrial facilities. Solvents such as dry-cleaning fluid and chemicals used to clean industrial equipment are also sources of VOCs. Common sources of nitrogen oxides include motor vehicles, power plants, and other fuel-burning sources.

■ Are there times of the year when ozone pollution is of particular concern?

Yes. In most parts of the United States, ozone pollution is likely to be a concern during the summer months, when the weather conditions needed to form ground-level ozone—lots of sun, hot temperatures—normally occur. Ozone pollution is usually at its worst during summer heat waves when air masses are stagnant.

■ **Are there times of the day when ozone pollution is a particular concern?**

Yes. Ozone levels vary during the day. They are highest during late afternoon and decrease rapidly at sunset.

The U.S. EPA's booklet *Ozone: Good Up High, Bad Nearby* (found on the Web at <http://www.epa.gov/oar/oaqps/gooduphigh>) contains additional information about both good and bad ozone.

The Health Effects of Ozone

■ **In what ways can ozone affect people's health?**

Ozone can affect people's health in many ways:

- *Ozone can irritate the respiratory system.* When this happens, you might start coughing, feel an irritation in your throat, and/or experience an uncomfortable sensation in your chest. These symptoms can last for a few hours after ozone exposure and may even become painful.
- *Ozone can reduce lung function.* When scientists refer to "lung function," they mean the volume of air that you draw in when you take a full breath and the speed at which you are able to blow out the air. Ozone can make it more difficult for you to breathe as deeply and vigorously as you normally would.
- *Ozone can aggravate asthma.* When ozone levels are high, more asthmatics have asthma attacks that require a doctor's attention or the use of additional asthma medication.
- *Ozone can aggravate chronic lung diseases,* such as emphysema and bronchitis.
- *Ozone can inflame and temporarily damage the lining of the lung.* Ozone damages the cells that line the air spaces in the lung. Within a few days, the damaged cells are replaced and the old cells are shed. If this kind of damage occurs repeatedly, the lung may change permanently in a way that could cause long-term health effects.

■ **When do I need to be concerned about ozone exposure?**

Most people only have to worry about ozone exposure when concentrations reach high or very high levels. Some groups of people are particularly sensitive to ozone, and members of these groups are likely to experience health effects before ozone concentrations reach high levels. However, when ozone levels are very high, everyone should be concerned about ozone exposure. In general, as ozone concentrations increase, more and more people experience health effects and the effects become more serious.

■ Who is sensitive to ozone?

People most sensitive to ozone include children, adults who are active outdoors, people with respiratory disease (such as asthma), and people with unusual susceptibility to ozone.

- *Children.* Active children are the group at highest risk from ozone exposure. Such children often spend a large part of their summer vacation outdoors, engaged in vigorous activities either in their neighborhood or at summer camp. Children are also more likely to have asthma or other respiratory illnesses. Asthma is the most common chronic disease for children and may be aggravated by ozone exposure.
- *Adults who are active outdoors.* Healthy adults who exercise or work outdoors are considered a “sensitive group” because they have a higher level of exposure to ozone than people who are less active outdoors.
- *People with respiratory diseases, such as asthma.* There is no evidence that ozone causes asthma or other chronic respiratory disease, but these diseases do make the lungs more vulnerable to the effects of ozone. Thus, individuals with these conditions will generally experience the effects of ozone earlier and at lower levels than less sensitive individuals.
- *People with unusual susceptibility to ozone.* Scientists don’t yet know why, but some healthy people are simply more sensitive to ozone than others. These individuals may experience more health effects from ozone exposure than the average person.

■ Are the elderly sensitive to ozone? What about people with heart disease?

Scientists have found little evidence to suggest that either the elderly or people with heart disease have heightened sensitivity to ozone. However, like other adults, elderly people will be at higher risk from ozone exposure if they suffer from respiratory disease, are active outdoors, or are unusually susceptible to ozone.

■ What can I do to avoid unhealthy exposure to ozone?

You can take a number of steps to protect yourself when ozone concentrations reach unhealthy levels. The chart on page 75 tells you what types of health effects may occur when ozone levels are considered good, moderate, unhealthy for sensitive groups, unhealthy, and very unhealthy. It also tells you what you can do to avoid these effects. (The example text on the Air Quality Index, beginning on page 77, contains additional text about communicating information about the health effects of ozone at different concentration levels.)

Ozone Level	Health Effects and Protective Actions
Good	<p>What are the possible health effects?</p> <ul style="list-style-type: none"> No health effects are expected.
Moderate	<p>What are the possible health effects?</p> <ul style="list-style-type: none"> Unusually sensitive individuals may experience respiratory effects from prolonged exposure to ozone during outdoor exertion. <p>What can I do to protect my health?</p> <ul style="list-style-type: none"> When ozone levels are in the “moderate” range, consider limiting prolonged outdoor exertion if you are unusually sensitive to ozone.
Unhealthy for Sensitive Groups	<p>What are the possible health effects?</p> <ul style="list-style-type: none"> If you are a member of a sensitive group,¹ you may experience respiratory symptoms (such as coughing or pain when taking a deep breath) and reduced lung function, which can cause some breathing discomfort. <p>What can I do to protect my health?</p> <ul style="list-style-type: none"> If you are a member of a sensitive group,¹ limit prolonged outdoor exertion. In general, you can protect your health by reducing how long or how strenuously you exert yourself outdoors and by planning outdoor activities when ozone levels are lower (usually in the early morning or evening). You can check with your State air agency to find out about current or predicted ozone levels in your location. This information on ozone levels is available on the Internet at http://www.epa.gov/airnow.
Unhealthy	<p>What are the possible health effects?</p> <ul style="list-style-type: none"> If you are a member of a sensitive group,¹ you have a higher chance of experiencing respiratory symptoms (such as aggravated cough or pain when taking a deep breath), and reduced lung function, which can cause some breathing difficulty. At this level, anyone could experience respiratory effects. <p>What can I do to protect my health?</p> <ul style="list-style-type: none"> If you are a member of a sensitive group,¹ avoid prolonged outdoor exertion. Everyone else—especially children—should limit prolonged outdoor exertion. Plan outdoor activities when ozone levels are lower (usually in the early morning or evening). You can check with your State air agency to find out about current or predicted ozone levels in your location. This information on ozone levels is available on the Internet at http://www.epa.gov/airnow.
Very Unhealthy	<p>What are the possible health effects?</p> <ul style="list-style-type: none"> Members of sensitive groups¹ will likely experience increasingly severe respiratory symptoms and impaired breathing. Many healthy people in the general population engaged in moderate exertion will experience some kind of effect. According to EPA estimates, approximately: <ul style="list-style-type: none"> Half will experience moderately reduced lung function. One-fifth will experience severely reduced lung function. 10 to 15 percent will experience moderate to severe respiratory symptoms (such as aggravated cough and pain when taking a deep breath). People with asthma or other respiratory conditions will be more severely affected, leading some to increase medication usage and seek medical attention at an emergency room or clinic. <p>What can I do to protect my health?</p> <ul style="list-style-type: none"> If you are a member of a sensitive group,¹ avoid outdoor activity altogether. Everyone else—especially children—should limit outdoor exertion and avoid heavy exertion altogether. Check with your State air agency to find out about current or predicted ozone levels in your location. This information on ozone levels is available on the Internet at http://www.epa.gov/airnow.

¹ Members of sensitive groups include children who are active outdoors; adults involved in moderate or strenuous outdoor activities; individuals with respiratory disease, such as asthma; and individuals with unusual susceptibility to ozone.

In general, your chances of being affected by ozone increase the longer you are active outdoors and the more strenuous the activity you engage in. Therefore, it is recommended that you limit outdoor activities as ozone levels rise to unhealthy levels. You can do this by limiting both the amount of time you are active outdoors and your activity level. For example, if you're involved in an activity that requires heavy exertion, such as running or heavy manual labor, you can reduce the time you spend on that activity or substitute another activity that requires less exertion. In addition, you can plan outdoor activities when ozone levels are lower, usually in the early morning or evening.

For additional, easy-to-understand information about the health effects of ozone, you can read EPA's booklet *Smog: Who Does It Hurt?* (found on the Web at <http://www.epa.gov/airnow/health>). EPA has also developed a fact sheet about ozone's health and environmental effects. It can be found on the Web at <http://tnwww.rtpnc.epa.gov/naaqsfm/o3health.htm>.

Ozone and the Clean Air Act

■ Are there federal laws that regulate ground-level ozone?

Yes. Ground-level ozone is regulated under the federal Clean Air Act, which is the comprehensive federal law that regulates air emissions in the United States. The Clean Air Act requires the U.S. EPA to set health-based standards for six commonly occurring air pollutants, including ozone. These standards are known as the National Ambient Air Quality Standards (NAAQS). The NAAQS can be defined as the levels of air quality that EPA has determined to be generally protective of people's health. The Clean Air Act requires each state to develop and implement a plan for meeting and maintaining the NAAQS for ozone and other major pollutants within their state.

You can find out more about the Clean Air Act and the NAAQS in EPA's *Plain English Guide to the Clean Air Act* (http://www.epa.gov/oar/oaqps/peg_caa/pegcaain.html.)

■ What is meant by the new 8-hour standard for ozone?

In 1997, EPA adopted new, more stringent standards for ozone, based on research that found that the original NAAQS for ozone, known as the 1-hour standard, was not adequately protective of human health. The 1-hour standard limited ozone levels to 0.12 parts per million averaged over a 1-hour period. The new standard, known as the 8-hour standard, requires that a community's ozone levels be no higher than 0.08 parts per million when averaged over an 8-hour period.

■ How are ground-level ozone levels measured?

Under the Clean Air Act, states are required to establish air monitoring networks—air quality surveillance systems that consist of a series of carefully placed monitoring stations. Each station measures the concentrations of important air pollutants, including ground-level ozone, in the immediate vicinity of the station. States are required to report the data gathered from the monitoring stations to the EPA.

The Ozone Map

■ What is the ozone map?

The ozone map is a tool designed to provide the public with easy-to-understand information about ozone levels in their community and throughout their region. The map uses color contours to show concentrations of ground-level ozone. The colors on the map change as the ozone concentrations change. The maps can show:

- Yesterday's actual ozone levels.
- Today's actual ozone levels.
- Forecasts of tomorrow's peak ozone levels.
- Animations that depict the formation and movement of ozone throughout the course of the day.

■ What do the map's colors mean?

The ozone map is color-coded to indicate the level of health concern associated with the ozone concentration. For example, green means ozone levels are "good," yellow means they are "moderate," orange means they are "unhealthy for sensitive groups," red means they are "unhealthy," and purple means they are "very unhealthy." Once you understand the color scheme, you can use the map to quickly determine whether ozone concentrations are reaching unhealthy levels in your area.

■ How is the ozone map created?

The map is created using specially designed computer software. Real-time, hourly ozone data provided by state and local air monitoring stations are input into the software, called MapGen. MapGen takes these ozone concentration data and automatically draws color contours coded to different levels of ozone concentrations.

■ Where can I see the ozone map?

In some areas of the U.S., the ozone map is shown on televised weather broadcasts and in local newspapers. For many areas of the country, the ozone map is available over the Internet on EPA's AIRNOW Web site (<http://www.epa.gov/airnow>). AIRNOW also contains facts about the health and environmental effects of air pollution, ideas about ways you can protect your health and actions you can take to reduce pollution, and links to state and local air pollution control agency Web sites with real-time air pollution data.

The Air Quality Index

■ What is the Air Quality Index?

The Air Quality Index (AQI) is a tool developed by EPA to provide people with timely and easy-to-understand information on local air quality and

whether it poses a health concern. It provides a simple, uniform system that can be used throughout the country for reporting levels of major pollutants regulated under the Clean Air Act. In addition to ground-level ozone, these pollutants include carbon monoxide, sulfur dioxide, particulate matter (soot, dust, particles), and nitrogen dioxide¹. You may sometimes hear the AQI referred to as the Pollutant Standards Index.

The AQI converts a measured pollutant concentration to a number on a scale of 0 to 500. The AQI value of 100 corresponds to the National Ambient Air Quality Standard established for the pollutant under the Clean Air Act. This is the level that EPA has determined to be generally protective of human health. The higher the index value, the greater the health concern.

■ What do the Air Quality Index health descriptors mean?

As shown below, the Air Quality Index scale has been divided into six categories, each corresponding to a different level of health concern. Each category is also associated with a color. (The same color scheme is used in the ozone map.)

Color	Air Quality Index Value	Health Descriptor
Green	0 to 50	Good
Yellow	51 to 100	Moderate
Orange	101 to 150	Unhealthy for Sensitive Groups
Red	151 to 200	Unhealthy
Purple	201 to 300	Very Unhealthy
Maroon	301 to 500	Hazardous

The level of health concern associated with each AQI category is summarized by a descriptor:

Good. When the AQI value for your community is between 0 and 50, air quality is considered satisfactory in your area.

Moderate. When the index value for your community is between 51 and 100, air quality is acceptable in your area. (However, people who are extremely sensitive to ozone may experience respiratory symptoms.)

Unhealthy for Sensitive Groups. Some people are particularly sensitive to the harmful effects of certain air pollutants. For example, people with asthma may be sensitive to sulfur dioxide and ozone, while people with heart disease may be sensitive to carbon monoxide. Some groups of people may be sensitive to more than one pollutant. When AQI values are between 101 and 150, members of sensitive groups may experience health effects. Members of the general public are not likely to be affected when the AQI is in this range.

¹ Lead is also considered a major air pollutant under the Clean Air Act. However, because all areas of the United States are currently attaining the NAAQS for lead, the AQI does not specifically address lead.

Unhealthy. When AQI values are between 151 and 200, everyone may begin to experience health effects. Members of sensitive groups may experience more serious health effects.

Very Unhealthy. AQI values between 201 and 300 trigger a health alert for everyone.

Hazardous. AQI values over 300 trigger health warnings of emergency conditions. AQI values over 300 rarely occur in the U.S.

■ **How is the Air Quality Index calculated?**

State and local air quality monitoring networks take measurements of levels of ozone, fine and coarse particulate matter, carbon monoxide, nitrogen dioxide, and sulfur dioxide several times a day. These raw measurements are then converted into corresponding AQI values using standard conversion scales developed by the EPA. For example, an ozone measurement of 0.08 parts per million, which happens to be National Ambient Air Quality Standard for ozone, would translate to an AQI value of 100.

Once the AQI values for the individual pollutants have been calculated, they are then used to calculate an overall single index value for the local area. The single AQI value is determined simply by taking the highest index value that was calculated for the individual air pollutants. This value becomes the AQI value reported in a community on a given day. For example, say that on July 12, your community has an AQI rating of 115 for ozone and 72 for carbon monoxide. The AQI value that will be reported that day for your community is 115. On days when the AQI for two or more pollutants is greater than 100, the pollutant with the highest index level is reported, but information on any other pollutant above 100 may also be reported.

■ **When and how is the Air Quality Index reported to the public?**

In metropolitan areas of the U.S. with populations over 350,000, state and local agencies are required to notify the public on days when the AQI for that area exceeds 100. They may also report the AQI levels for all pollutants that exceed 100. Even in areas where reporting is not required, EPA, state, and local officials may use the AQI as a public information tool to advise the public about how local air quality might affect their health, and what actions they can take to protect their health and improve air quality. You may see the AQI reported in your newspaper or on the Internet, or it may be broadcast on your local television or radio station. In some areas, AQI information is available on a recorded telephone message.

More information about the AQI is contained in EPA's brochure *Measuring Air Quality*. It can be found on the Web at <http://www.epa.gov/oar/oaqps/psi.html>.

Actions to Reduce Ground-Level Ozone

■ What can I do to reduce ozone pollution?

You can do a number of things to help prevent the formation of ground-level ozone. On days when ozone levels are high, you can take the following steps:

- Instead of driving, use mass transit, or walk or ride a bike—if these activities require moderate levels of exertion. (Keep in mind that because fitness levels vary widely among individuals, what is moderate exertion for one person may be heavy exertion for another.)
- Consider eating lunch at your desk rather than driving to a restaurant.
- Share rides.
- Make sure your car is well-tuned.
- Be careful not to spill gasoline when you fill the tank of your car or lawnmower.
- Refuel your car or lawnmower after dusk.
- Replace your gas-powered lawn mower with a manual or electric-powered unit.
- Don't mow the lawn or use an outdoor barbecue.
- Use water-based paints instead of oil-based paints.

ORGANIZING OZONE ACTION DAYS

Metropolitan Washington Council of Governments & the Baltimore Metropolitan Council

Air quality planners in many EMPACT areas have realized that unless the public begins to cut back voluntarily on activities that contribute to ozone formation—particularly on days when meteorologists predict high levels—their communities will face tough ozone-reduction measures down the line. But getting individuals to change their behavior can be difficult. Here’s how the Baltimore/Washington, D.C. region tackled this challenge.

Launching Ozone Action Days. The Metropolitan Washington Council of Governments and the Baltimore Metropolitan Council created the ENDZONE program (Partners to End Ground-Level Ozone) in 1994. From behavior modification surveys conducted previously, ENDZONE’s organizers knew area residents were concerned about air quality but didn’t know how they could help. In response, ENDZONE planners launched their Ozone Action Days program. Ozone action days, which have been initiated in a number of EMPACT areas, are designed to give individuals information about steps they can take to help reduce ground-level ozone when especially high ozone levels (called “Code Red” days) are forecast.

Recruiting Partners. ENDZONE’s Ozone Action Days strategy is based on recruiting high-profile industries, large retailers, and other businesses and organizations to commit to helping reduce ground-level ozone. There are two major benefits to this approach:

- Each partner educates their employees and customers on ground-level ozone and the concrete steps they can take when Code Red days are forecast. This approach enables the program to reach large numbers of individuals.
- The partners also initiate very public ozone reduction actions—often covered by the media—that in turn may influence many other individuals and organizations to follow suit.

Providing Tools to Partners. After recruiting over 400 local businesses and industries, ENDZONE staff provided the partners with extensive ozone outreach material and ideas. This gave partners the start they need to develop their own ozone outreach programs. For example, after educating their employees about ozone, International Paper went into the community to host an ozone workshop and partner with a local elementary school to teach kids about ozone. Amoco offered a \$4 rebate to customers for refueling after dark on Code Red days. And a local chamber of commerce placed articles in community newspapers all summer long about the need to change behavior when ozone levels are high.

Lessons Learned. What have organizers learned from this effort? Feedback from the partners has shown that the public has begun to understand what contributes to ground-level ozone. While people recognized that driving was an ozone-contributing activity, for example, many were unaware of how much ozone they could prevent by not operating lawnmowers and other lawn and garden power equipment. Ozone Action Days staff also learned to pick their behavior modification targets carefully. While boating is an important contributor to ground-level ozone, for example, efforts to reduce this activity during ozone incidents were unsuccessful—while people would forgo mowing the lawn on a hot summer’s day, boat owners typically were not willing to skip boating when the weather turned hot and muggy. In general, program organizers credit positive initial results on tying individual efforts to ozone incidents: when bad ozone levels are forecast, residents are motivated to take action. Still, organizers recognize that the kinds of changes needed won’t happen overnight. They caution that it is important to think about what changes will be needed 10 to 15 years from now and to structure an outreach program around long-term goals.

You can find out more about ENDZONE’s Ozone Action Days program at <http://www.endzone-partners.org/> and about other state and municipal ozone action days programs at <http://www.epa.gov/airnow/action.html>.

APPENDIX A

TIPS ON CONFIGURING THE AUTOMATIC DATA TRANSFER SYSTEM (ADTS)

This appendix contains tips on:

- Configuring your system for forecast data.
- Configuring files such as *oms-env.bat*, *omscnvr.inp*, and *airs2oms.exe*.

Forecast Data

Agencies and communities are strongly encouraged to participate in the EPA forecast program. By participating in this program, communities can receive ozone forecasts (for today and tomorrow) from the EPA AIRNOW Web site (<http://www.epa.gov/airnow>). If you choose to participate, your agency will be responsible for calculating the forecast data and submitting it via the ozone data file (with the 3:00 p.m. poll) or a Web-based forecast submission form. After the data are submitted, the Data Collection Center (DCC) will post it to EPA's AIRNOW Web site for access by agencies, communities, and individuals.

Please follow the step-by-step instructions in the Ozone Mapping System (OMS) Web site at <http://tnwww.rtpnc.epa.gov/ozmap/> for submitting forecast data via the Web or ozone data file. (You will need a password and user name, which you can obtain from Phil Dickerson at dickerson.phil@epa.gov. When you reach the OMS Web site, scroll to the section titled *New!* and click on the link called *1999 Draft Forecast Plan*). The *Ozone Forecast Map Plan for the Northeast States*, located at <http://www.nescaum.org>, contains additional information.

OMS-ENV.BAT

This file contains most of the customization for your system. Please see the installation instructions file *adts-shc.txt* for step-by-step instructions on configuring *oms-env.bat*. You will not need to modify *oms-env.bat* if you are using specific polling software listed in *adts-shc.txt*.

When you configure *oms-env.bat*, you will edit some lines of code. When you edit the code for SET AGENCY, you will enter your three-character agency ID (e.g., MA1). You can find list of agency IDs at http://envpro.ncsc.org/oms/pub/SiteInfo/agency_codes.html.

If you decide to submit data for your forecast via the ozone data file, you will need to configure *oms-bat.env* by editing the code for *SET FCST*. When you edit the code for *SET FCST*, you will determine whether you want forecasts to be calculated based on your ozone data. If *SET FCST* is set to *Y*, the Automatic Data Transfer System (ADTS) will insert a forecast packet in the file being transferred to the DCC. (Some polling software applications insert a forecast packet into the file, so the *FCST* variable should be set to *N*.)

OMSCNVRT.INP

This is the initialization file for the data conversion program and should be used by agencies without polling software. You can download this file from <ftp://envpro.ncsc.org/OMS/Utility/>. Please contact Phil Dickerson at dickerson.phil@epa.gov for information on obtaining and configuring this file.

AIRS2OMS.EXE

This file converts Aerometric Information Retrieval System (AIRS) data format to OMS data format and should be used by agencies without polling software. To obtain this program, download the *convert.exe* file from <ftp://envpro.ncsc.org/OMS/Utility/>. Save the file in the *c:\oms\convert* directory, double click on *convert.exe* to extract the *airs2oms* files, and then follow the installation instructions in *airs2oms.doc*. (The converter file is also distributed with MapGen, discussed in Chapter 5 of this handbook, and it will be placed in the *c:\oms\convert* directory when you install MapGen.)

APPENDIX B

INSTRUCTIONS FOR INSTALLING AND CONFIGURING SOFTWARE

This appendix contains instructions for installing and configuring ClockerPro and Clocker, Kermit-Lite, and connectivity software such as Dunce (Dial-up Networking Connection Software).

ClockerPro and Clocker

ClockerPro for Windows95 and Clocker for Windows 3.1 may be downloaded from: <http://www.winnovation.com/clocker.htm>. To install ClockerPro or Clocker:

1. Click on the file *clkpr311.zip* (for ClockerPro) or *clk2403.zip* (for Clocker) and save it to a temporary directory on your computer (such as *c:\tmp*).
2. Start your Web browser. Navigate to the location of *clkpr311.zip*.
3. Run *setup.exe* and follow the instructions provided.

For instructions on using ClockerPro or Clocker, select *Help* from the software's main screen. Sample schedules specific to Automatic Data Transfer System (ADTS) operation are provided in *c:\oms\config\shc95.clk* (for ClockerPro) and *c:\oms\config\shc31.clk* (for Clocker). You can open these from either program's *File\Open* menu. The polling times in these sample schedules do not reflect the currently recommended polling/upload times for each day and will need to be modified.

Kermit-Lite

Kermit-Lite for MS-DOS is the communications software used by the ADTS as a backup method of file transfer. The required initialization and script files have already been included in the ADTS software distribution. We suggest that you install the full Kermit for MS-DOS package to have access to the latest initialization and script files as well as documentation. Kermit-Lite for MS-DOS and Windows 3.x can be downloaded from <http://www.columbia.edu/kermit/mskermit.html>. Follow the installation instructions provided with Kermit-Lite and install it. Do not install the full Kermit-Lite package in the *c:\oms* directory. Doing so might overwrite files you have already configured for your computer.

Connectivity Software

For information on installing Dunce 2.52, see the instructions file *adts-shc.txt*. You can download Dunce 2.52 from <http://www.gf-inter.net/serv03.htm>.

Serv-U is available as shareware (registration is \$25) from <http://www.cat-soft.com/>.

APPENDIX C

AUTOMATED DATA QUALITY CHECKS

This appendix contains a detailed description of automated data quality checks that the Data Collection Center (DCC) performs on actual (observed) station data groups. These automated data quality checks:

1. Check for data that are out of range.
2. Check for data with unusual rates of changes.
3. Check how many hours of data are missing. Uses interpolation to estimate hourly values if only 1 hour is missing. If more than one hour is missing, the data is marked as missing and there is no attempt to estimate the data.
4. Assign quality control flags to each ozone value.

Quality assurance/quality control (QA/QC) flags enable whoever is reviewing the data to quickly identify problems and understand their source and severity. The flags are written to the observation file, where they can be reviewed by the DCC (and also by the end-user who has an observation file). The following table shows the correlation between flag type and data integrity.

Tip!

If you open an observation file, you will see that each monitoring station has two lines of data. The first line contains the ozone data values. The second line contains QA/QC flags directly beneath their respective ozone data values. The flags signify whether the data value is good, suspect, estimated, missing, or bad.

Level	Flag	Meaning
1	G	Good Data
2	K	Suspect Range or Sample Number
2	R	Suspect Rate of Change
3	E	Estimated
4	M	Missing (-999 will be used for the missing data value)
5	B	Bad (Severe Range or other problem)

5. Extrapolate a single missing value (i.e., estimate new values from missing or bad values).
6. Assign specific QA/QC criteria to the data. For example, for the Greenwich, CT, monitoring station, the proposed maximum allowed ozone level during 11:00 a.m. to 6:00 p.m. is 197 parts per billion. The QA/QC program checks to see if ozone data during this time fall within the allowable concentration. For further information on proposed quality assurance values that may be incorporated into the DCC software, see sample criteria at <http://envpro.ncsc.org/oms/pub/SiteInfo/03-QC-table.html>.
7. Generate a quality control report that summarizes the total amount of good, suspect, bad, and missing data by station. This report is reviewed every time a polling cycle is completed by a DCC staff member before the data are released to the public. Each “suspect” or “severe” flag set by the automated program is inspected in the context of surrounding data both in time and in space.

8. Document the level of QA/QC effort in the observation file. The observation file provides information on the level of QA/QC effort at the DCC:

- <qc_level>=0 means that no QA/QC was done.
- <qc_level>=1 means that the DCC performed an automated QA/QC check of the data.
- <qc_level>=2 means the staff reviewed the automated QA/QC.

Note!

The DCC performs a “mini-check” on forecast data, but the data are not flagged. Forecast data should be inspected before use.

