



## FAN SYSTEM UPGRADES

### Overview

Fan Systems, also known as air-handling systems, are the conduit for getting conditioned air (heating and cooling) to people occupying a building, and therefore directly impacting occupant comfort. Fan systems can be upgraded and adjusted to optimize the delivery of air in the most energy efficient way.

The heat flow diagram (Figure 1) illustrates how, in Fan System Upgrades, you can take advantage of the load reductions you have realized in other stages of an integrated approach. The resultant opportunities for reducing your air-handling system's energy consumption are now tremendous. Continuing with the integrated approach, you can realize a 50 to 85 percent reduction in fan power consumption.

Fan System Upgrades section will help you identify which components of your fan systems are most inefficient. “Best Ways to Save” and “Take Action”, will provide you with checklists for improving the operation of fan systems. “Best Opportunities” and “Additional Considerations” discuss the opportunities for improving energy performance of your fan systems through technology as well as operations. The appendix Fan System Survey provides instructions for recording the loads associated with your fan system.

**Figure 1: Heat Flow In Buildings**

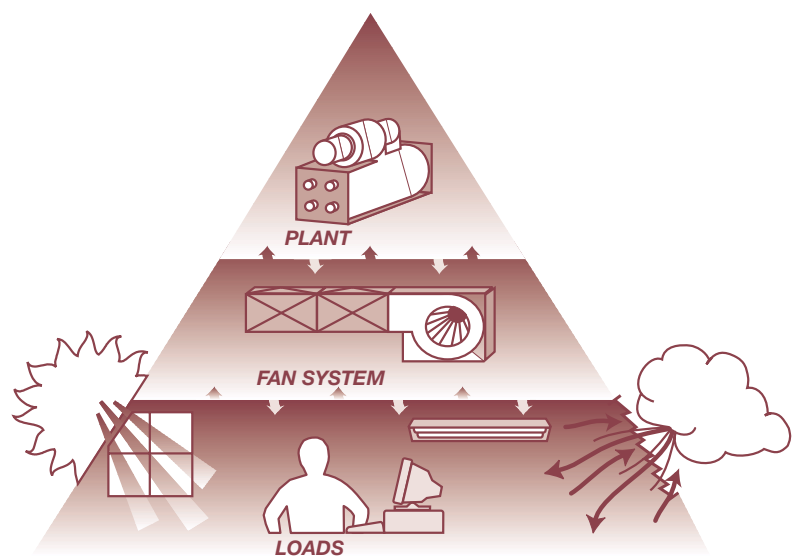

**Heat Flow In Buildings: Building Systems Interactions**

Figure 2 shows the interaction of heating, cooling, and electrical loads with the HVAC equipment. Arrows indicate heat flow pathways. Reducing heating, cooling, and electrical loads reduces the demand on HVAC equipment, thus saving energy.

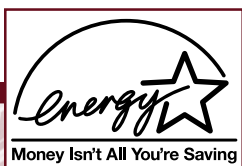

---

### Fan Systems Strategy

- Rightsize your cooling system to match reduced loads.
  - Take advantage of improvements in air-handling technology.
  - Install equipment that allows for more efficient operation, lower first cost, and lower maintenance costs.
- 

### **The Best Ways To Save**

- Fan system rightsizing
- Variable-speed drives
- Improved controls
- Energy-efficient motors
- Energy-efficient belts

If you are already planning to purchase replacement equipment, installing smaller components is less costly than replacing with larger equipment.

---

### Potential Savings

Potential energy savings from rightsizing, energy-efficient motors, and variable speed drives: 50–85%

Source: *Variable Air Volume Systems: Maximize Energy Efficiency and Profits*, EPA 430-R-95-002.

---

### **An Easy Target**

The fans that move the heated and cooled air through your building constitute eleven percent of the total energy consumed by your facility, as shown in Figure 2. Any reductions in their consumption can result in significant savings for you. A recent EPA study found that almost 60 percent of building fan systems were oversized by at least 10 percent, with an average oversizing of 60 percent. By rightsizing, you can save an average of 50 percent in fan system energy. Moreover, these savings are independent of any other improvements, such as installing energy-efficient motors.

### **Take Action!**

1. Use the Fan System Survey at the end of this chapter to determine the operating characteristics of your current fan system.
2. Enter survey data into a fan system software package to estimate potential savings and economic benefits.
3. Upgrade your fan system and begin saving money and energy, immediately.



**Figure 2: Typical Electrical Energy Consumption**

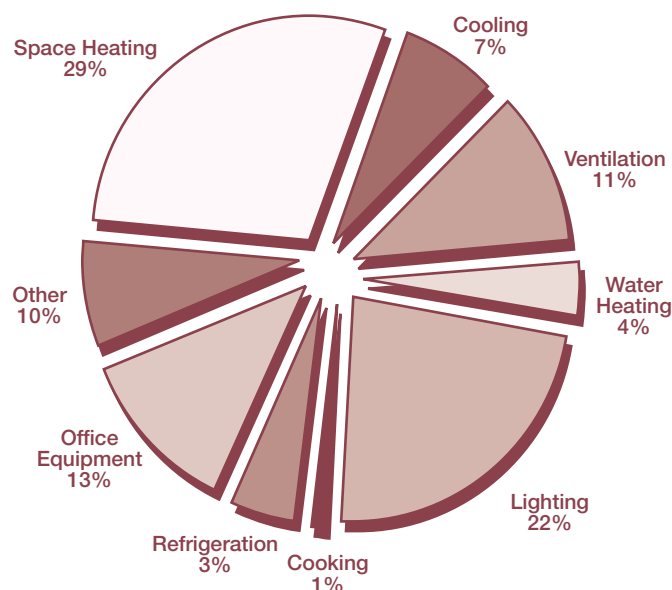

Source: U.S. Department of Energy, Energy Information Administration, Energy End Use Intensities in Commercial Buildings, Sept. 1994. DOE/EIA-05555(94)/2.

## Air-Handling Components

The major components in an air-handling system (AHS) are fans, coils, ducts, and dampers. These components must function well individually and together in order to ensure efficient operation as well as occupant comfort.

Each component performs a task critical to the proper operation of your system. Fans circulate the air and provide the pressure required to push it through ducts and across heating and /or cooling coils. Ducts convey the conditioned air throughout your building, distributing the air from the AHS to occupants and then returning it to the AHS to be conditioned and circulated again. Dampers control the flow and mix of returned and outside air through the ducts to the various parts of the building.

### Fans

Fans are the heart of your building's air-handling system. Like a heart that pumps blood through a body, they distribute throughout the building the conditioned (heated or cooled) air, that your occupants need. There are two main types of fans, centrifugal and axial.



**Centrifugal fans** (see Figure 3) are by far the most prevalent type of fan used in the HVAC industry today. They are usually cheaper than axial fans and simpler in construction, but generally do not achieve the same efficiency. Centrifugal fans consist of a rotating wheel, or impeller, mounted eccentrically inside a round housing. The impeller is electrically driven by a motor, which is usually connected via a belt drive.

**Figure 3: Centrifugal Fan**

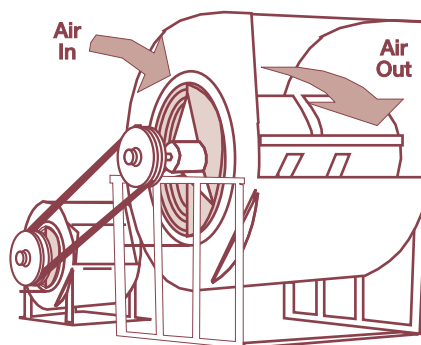

Axial fans (see Figure 4) consist of a cylindrical housing with the impeller mounted inside along the axis of the housing. In an axial fan, the impeller consists of blades mounted around a central hub similar to an airplane propeller. As with an airplane, the spinning blades force the air through the fan. Typically, axial fans are more efficient than centrifugal fans.

**Figure 4: Axial Fan**

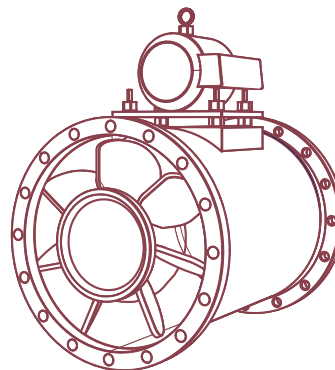

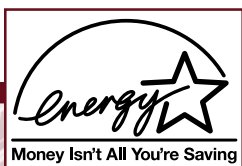

Axial fan motors can be mounted externally as on a centrifugal fan. They can also be belt driven. However, they are often driven by a motor directly coupled to the impeller mounted within the central hub.

### **Ducts**

Like the arteries and veins in your body, ducts convey the conditioned air from the air handling unit out through the building and return it back to be conditioned again. They are usually constructed of sheet metal, and are insulated.

Ductwork can either be round or rectangular. Rectangular duct is cheaper and more common than round duct, as it is generally easier to route, design, and install. Round duct, on the other hand, uses much less material, as it is the most efficient shape for a given cross-sectional area. It is also naturally stiffer than a rectangular duct having the same cross-sectional area. Round duct also creates less resistance as the air moves through it, reducing fan power requirements.

Duct insulation helps prevent the warming of your chilled air and the cooling of your heated air as it passes through the ducts. Ducts must be properly insulated to prevent excessive energy loss. Commercial building codes typically require 1 inch of insulation for ducts carrying hot or cold air. This requirement varies by jurisdiction, please consult your local energy and / or mechanical codes. Proper choice of insulation can also help reduce the transmission of fan and motor noise from your HVAC system to the working spaces inside your building.

### **Dampers**

Dampers serve to modulate the flow of air through the ducts to the various parts of the building, reducing or increasing the flow of air depending upon conditions. Dampers also serve to regulate the quantities of outside air allowed to enter the air handling unit and mix with return air for ventilation purposes. Dampers can be difficult to maintain and can affect occupant comfort as the space requirements change and as the air-handling system ages.

## **Air-Handling System Types**

Depending on the age and design requirements of your building, you might have one or more of the following systems:

- Constant volume systems
  - Reheat system
  - Dual-duct system
  - Multizone system
- VAV systems

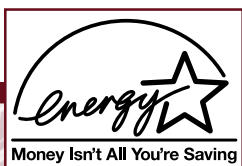

Compared to older systems, current air-handling systems offer much more efficient designs than may have originally been installed in your building. Today's VAV systems can handle changing load requirements by varying the amount of air circulated, as well as regulating the amount of cooled or heated air, to more accurately tailor energy consumption to the actual climate control needs of the building's occupants.

### **Constant Volume Systems**

Constant volume, also referred to as constant air volume, systems are installed in a large number of buildings. The simplest of all the systems discussed, they circulate a constant volume of conditioned air.

### **Reheat Systems**

In a reheat system, a constant amount of air is cooled and recirculated (see Figure 5). This amount of air is designed to be able to cool all parts of the building at peak cooling load. To cool at lighter loads or to heat the building, the circulated air, *which is still being cooled*, is reheated before being distributed to the various zones.

Reheat systems are very inefficient because the same air is being cooled and then reheated before it even reaches building occupants.

### **Dual-Duct Systems**

Often found in buildings constructed during the 1960s and 1970s, dual-duct systems are a relatively effective means of maintaining comfort, yet an extremely inefficient method of conditioning air.

**Figure 5: Constant Volume System With Reheat**

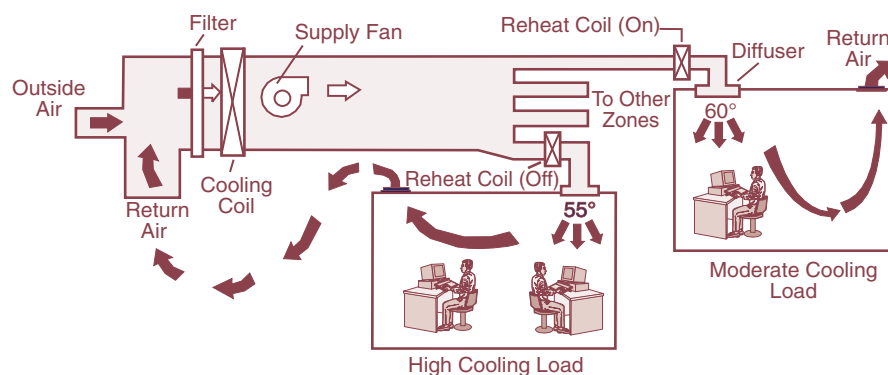

In this example, the room with the moderate cooling load is reheating its air from 55° to 60° F.

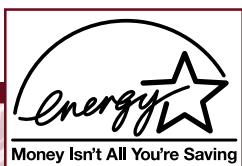

Dual-duct systems consist of two independent systems, one warm and one cool, which circulate air in parallel sets of ducts through all sections of the building. Hot and cold air are mixed in local mixing boxes in each zone or room and then fed into that area. Depending on the temperature needs of the area, the mixture of hot and cold air is adjusted until the desired temperature is reached. Unfortunately, with a dual-duct system, you must pay to cool, heat, and circulate a volume of air that is typically much larger than the actual volume required by your building.

### ***Multizone Systems***

Multizone systems are similar to dual-duct systems in that two streams of hot and cold air are mixed to produce a desired temperature. But, whereas dual-duct systems mix the air in individual boxes located at each area or room, multizone systems mix air in large mixing boxes near the fans. This conditioned air is then fed to each zone, with each zone, depending on its load, receiving air at a different temperature. As with dual-duct and reheat systems, multizone systems are quite inefficient because you must pay to heat and cool air simultaneously.

### ***Variable Air Volume Systems***

VAV systems vary the amount of circulated air in response to varying heating or cooling loads. This reduces fan power requirements, which saves energy and costs.

VAV systems work either by opening or closing dampers or by modulating the airflow through VAV fan-powered mixing boxes as loads in various zones of the building change (see Figure 6). If, for example, more cooling in an area is required, the damper to that area is opened wider, increasing the flow of cold air until the desired temperature is reached. Conversely in this same example, if an area is too cool, the damper is slowly closed, reducing the flow of cold air. Used in combination with VSDs, this reduction in flow results in a reduction in the fan power needed, saving energy. Because retrofitting an existing constant volume system to a VAV system allows your system to turn itself down in response to changing demand, it is a popular option for many building owners. Proper conversions to VAV systems include the removal of constant volume dampers and typically reduce fan horsepower requirements by 40 to 60 percent.



**Figure 6: VAV System**

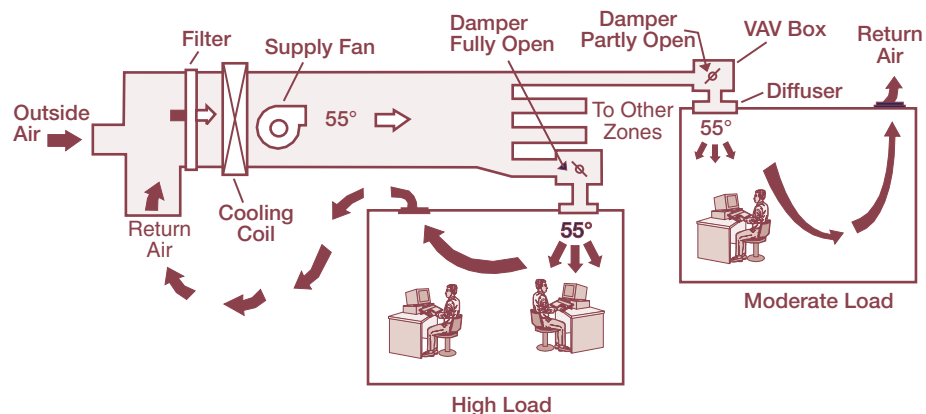

In a VAV system, dampers control the flow of chilled air to respond to changes in cooling load.

### *Thermally Powered VAVs*

Thermally powered VAV systems, like standard VAV systems, regulate the volume of air that a space (usually a room) receives based upon its temperature.

Thermally powered VAVs are ceiling-mounted diffusers, each with its own damper, that replace standard diffusers. With an internal “thermostat” and a small damper, they enhance the process of reducing airflow to a certain conditioned space when its temperature is below the setpoint and increasing airflow when the temperature in that space is too warm. In addition, thermally powered VAVs are now being produced with individual controls, a feature that provides a level of control comparable to that of a standard VAV system.

Thermally powered VAV systems also:

- Provide more comfort at less cost.
- Are a viable alternative to VAV fan-powered mixing boxes in terms of costs, benefits, and lessened disruption during retrofit construction.

## **Best Opportunities**

### ***Comparison: VAV Systems Vs. Constant Volume Systems***

The conversion of your older constant volume reheat, multizone, or dual-duct system to a modern, energy-efficient variable air volume system is a task to be undertaken with serious consideration and expert analysis. This would normally require the services of an engineering firm.





As discussed earlier, VAV systems are more energy-efficient than constant volume systems as VAV systems can reduce airflow in response to decreasing demand. You are also cooling only the amount of air that is required to meet demand, rather than meeting demand by simultaneously heating and cooling large volumes of air.

### ***Are Your Fans Oversized?***

If your fans are oversized, fan rightsizing can be profitable. It can be implemented separately or in combination with energy-efficient motors and VSDs. In general, rightsizing with an energy-efficient motor, energy-efficient belts, and a VSD is the best alternative.

### ***Advantages Of A Rightsized System***

A rightsized system saves you energy costs; however, there are other advantages to a rightsized system that you might not have thought of:

- *Lower First Costs*

As the capacity required from your fan system is reduced, your system can be more accurately tailored to the new air flow requirements. By installing smaller, more energy-efficient equipment that meets these requirements, first costs are also reduced.

- *Comfort*

If your fan system supplies too much air to your occupants, not only are you wasting energy, but you could also be affecting their comfort. Too much air can result in disturbing drafts, increased humidity, and noise.

- *Equipment Life*

Prolonged operation of an oversized motor with a VSD at very low speeds can reduce the useful life of motors and other equipment. Properly sized, smaller capacity equipment will be more suited to operation at reduced capacities.

### ***Rightsizing Your Fan System***

When rightsizing your fan system, the type of system in use—constant volume or VAV—will slightly affect the methods you use.

Regardless of whether you have a constant volume system or a VAV system, when reducing your fan airflows, make sure that you maintain the proper amount of outside air to ensure occupant health and comfort (see Stage Three—Other Load Reductions, Load Sources). Consult your local building codes for information about required outside air quantities.

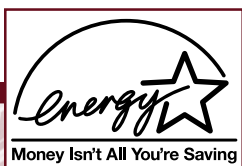

### *VAV Systems*

While VAV systems are more energy-efficient than constant volume systems, the potential for rightsizing may still exist. Your building engineer may be able to determine if your VAV fans are oversized by using one of three methods: measuring the fan motor current draw (amperage), checking the fan control vanes and dampers, or measuring fan system static pressure.

#### *Measuring Amperage*

1. Measure the fan motor amperage. For a VAV system, measure the amperage when your cooling system is operating under a peak load (a hot, humid day, for example).
2. Read the full-load amperage off the motor's nameplate or from the Operations & Maintenance manual.
3. Compare these two numbers. If the measured amperage is lower than 75 percent of the full-load amperage, the motor is oversized.

**Checking Vanes and Dampers** – Check the position of the fan control vanes or dampers when the cooling system is operating under a peak load (a hot, humid day, for example). If the vanes or dampers are closed more than 20 percent, the fan is oversized.

#### *Measuring Static Pressure*

1. Measure the static pressure of the main supply fan system on a hot, humid day. Make sure that all fan vanes and dampers are fully open, and that all VAV boxes are fully open.
2. Compare your static pressure reading with the static pressure setpoint. If the static pressure reading is less than the setpoint and the space in your building is sufficiently comfortable, the setpoint can be adjusted to the lower static pressure.

**Constant Volume Systems** – If it is not economically feasible to replace your constant volume system with a VAV, rightsizing your constant volume system is generally a profitable choice. However, in determining the potential for rightsizing, your building's engineer is typically limited to just one method—measuring fan system static pressure.

#### *Measuring Static Pressure*

1. Measure the main supply fan system static pressure on a hot, humid day. Make sure that all fan vanes and dampers are 100-percent open.
2. If the measured static pressure is greater than the design pressure (found in your building's mechanical drawings), your fan is probably supplying too much air and is a good candidate for rightsizing.

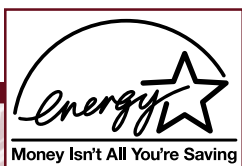

**Three Ways To Rightsize** – If you have assessed that your VAV or constant volume system is oversized, you can now rightsize it to match your building’s actual flow requirements. Rightsizing your fan system can be accomplished by installing larger pulleys (sheaves), adjusting static pressure, and/or replacing the fan’s motor with a smaller, energy-efficient motor.

- *Smaller, Energy-Efficient Motors*

Once you have rightsized the fan flow rate, your existing motor is probably too big for the brake horsepower required. Replace the existing, oversized motor with a smaller, energy-efficient motor that matches the load. For example, rightsizing a 75-hp standard efficiency motor to a 50-hp energy-efficient motor will reduce your motor energy consumption by about 33 percent.

- *Larger Pulleys*

Replacing an existing belt-driven pulley with a larger one will reduce its speed, saving energy costs. Reducing a fan’s speed by 20 percent reduces its energy consumption by 50 percent.

*Note: The new pulley should operate the fan at a reduced speed that matches peak load requirements.*

- *Static Pressure Adjustment (VAV Systems Only)*

Reducing static pressure in your VAV system reduces the fan horsepower consumption. By gradually reducing the static pressure setpoint to a level low enough to keep occupants comfortable, you will reduce energy consumption.

---

### **Example: VAV System Static Pressure Reduction**

A VAV fan system currently operating at a static pressure of 6 inches of water (gauge) is found to operate satisfactorily at 4 inches. This 33 percent reduction in static pressure with its accompanying reduction in flow will result in an energy savings of approximately 45 percent.

---

### *Estimating Potential Savings*

You can estimate the expected benefits of rightsizing by collecting data listed in the Fan Survey (see Appendix) and calculating savings from right-sizing your fan systems using a commercially available fan analysis software program.

### *Project Management Considerations*

The first consideration in rightsizing your fan system is to determine which components will be involved in the process. You have the choice of replacing pulleys, adjusting static pressure, installing smaller energy-efficient motors, or a combination of these.



*Note: Changes to one of these components will affect the others! Be sure to perform an analysis of the options and their effects on the system before proceeding to ensure an effective reduction.*

The engineer verifying the rightsizing potential will need the information you collected in the Fan Survey, as well as the types and efficiencies of the air-handling units, fans, and pulleys in your building.

If your company does not have a qualified engineer on staff, hire a consulting engineering firm to verify your choices.

Once the potential for rightsizing is verified, qualified personnel should implement the changes—a controls technician should adjust static pressure, an electrician should replace motors and drives, and HVAC technicians should replace fan pulleys and belts.

### **Variable-Speed Drives**

Variable-speed drives (VSDs) are an efficient and economical retrofit option and should be considered for all VAV systems. VSDs allow the motor speed of your equipment to vary depending on actual operating conditions, rather than operating at one speed. Varying the speed of your fans allows them to match more closely the actual load required. As indicated in Figure 7, reducing a fan's speed by 20 percent can reduce its energy requirements by nearly 50 percent. Installing a VSD on your fan motor allows the fan to automatically match this reduced capacity, slowing down in response to reduced demand, thereby saving energy.

A VSD is not actually a motor, but rather an electronic device that varies the frequency of the electricity to the motor. It is installed “upstream” of the motor, between the transformer and the motor.

A recent EPA study (*Variable Air Volume Systems Maximize Energy Efficiency and Profits*, EPA 430-R-95-002) showed that VSDs can greatly reduce the energy used by the same fan operating under similar airflow volumes and static pressure conditions. Overall, the study indicated that VSDs provided an average energy savings of 52 percent.



**Figure 7: VSDs Reduce Maximum Power Input**

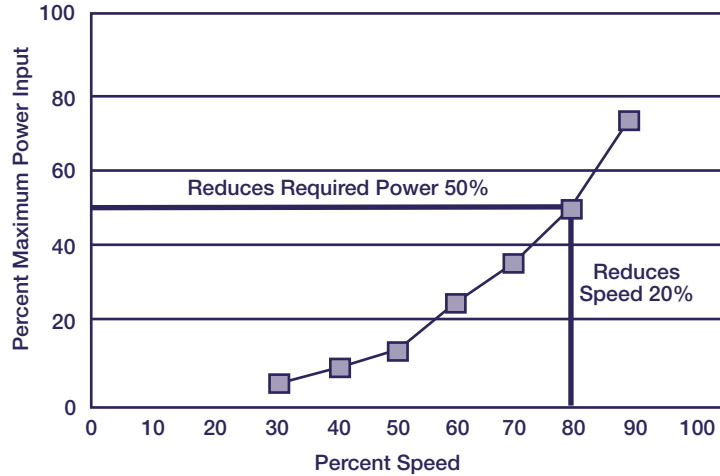

Source: Electric Power Research Institute.

VSDs make economic sense when installed on motors that operate many hours per year at fluctuating loads, and especially on larger motors.

**Table 1: VSDs: Installed Cost For Various Size Motors**

hp	Installed Cost
5	\$2,975
7.5	\$3,400
10	\$3,575
15	\$4,225
20	\$4,925
30	\$7,225
40	\$8,625
50	\$11,100
60	\$13,200
75	\$17,700
100	\$19,400

Source: Adapted from R.S. Means, *Electrical Cost Data*—1997 Edition.

### Controls

Modifying the *way* your system operates, not just the system itself or its components, can also save energy. By taking advantage of such concepts as economizer cooling and night precooling, you can significantly reduce your cooling costs.



### *Optimized Scheduling*

An optimum start and stop procedure for your system is a common-sense control philosophy that can result in significant energy savings. Normally, your system is set to automatically turn itself on and off based upon the expected occupant working hours.

For example, your cooling might come on at 6 A.M. and shut off at 7 P.M. Adjusting these times for varying seasons will reduce your energy costs. In the spring and fall seasons, where cooling is required but the peak temperatures are typically lower than the summer temperatures, you can set your system to come on later in the morning and shut off earlier in the day. Of course, you can also shut down your system on weekends.

### *Pressure Reset*

If you have installed a VSD on your fan system, pressure reset is a method by which you can increase your system's energy savings. Pressure and flow are related. Reducing pressure supplied by your fans also reduces the flow supplied, in turn reducing the power required. By reducing the duct pressure level when less air is required, instantaneous fan energy savings of 50 percent can be achieved above and beyond the application of a VSD. The desired setpoint can be found by gradually reducing the fan speed each day until the pressure is as low as possible, but occupant space is still comfortable. It is possible to have two or more pressure settings; for example, one for daytime and one for evening or one for summer and one for winter.

---

### **Case Study: Economizer Cooling**

The majority of conventional air-handling units are enabled to provide 100-percent outside air. However, at one 200,000-sf office building in a Boston suburb, it was noticed that air conditioning compressors in the rooftop units operated on sunny days even when outside air temperature was as low as 35° F. The reason was that solar-heated interior air had no way to escape from the building, so that the rooftop units, even with outside air dampers wide open, could not provide enough outside air to cool the building without mechanical refrigeration.

The solution was found by installing power exhausts in the rooftop units, which exhausted all indoor air outside when the building was in economizer cooling mode. Roughly 1,000 hours per year were found to have proper conditions for free cooling. After installation of the power exhausts, cooling compressors only operated when outside air temperature was above 55° F. The installation cost \$75,000 and paid for itself in under 4 years.

---

### *Economizer Cooling*

As discussed in Other Load Reductions, air-side economizers consist of a set of dampers, filters, and sometimes a fan on the supply air side of the air-handling system. The damper is controlled so that when outside air is cooler than return air, the outside-air damper opens, allowing the outside air to be drawn into the building. When it is hotter and more humid outside than the return air, the economizer damper closes to its minimum setting, which is the minimum amount of fresh air required according to ASHRAE standards (see Stage Three, Load Sources).

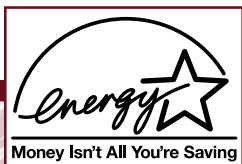

### ***Demand Ventilation***

Standard ventilation specifications are based on a certain volume of outside air in cubic feet per minute (cfm). ASHRAE 62-1999 specifies a minimum of 15 cfm per occupant. This ventilation level, however, should be understood as an average value to be applied to a whole building. In other words, if your building holds 3,000 people, your air-handling system should provide 15 cfm/person x 3,000 people = 45,000 cfm of outside air. This assumes that the occupants of your building are also equally distributed.

In some areas, such as cafeterias, auditoriums, conference rooms, and gymnasiums, the area could be empty during some portions of the day but full at others to the point that indoor air quality would suffer. For example, in a cafeteria at lunchtime, the air-handling system might not supply enough outside air to meet demand; conversely, for most of the day, the air-handling system is supplying outside air to an area with no people.

The solution to this problem is demand ventilation. By only supplying outside air when and where it is needed, you can ensure proper air quality while not wasting energy supplying the area with outside air during other parts of the day. A popular way to do this is by monitoring the concentration of CO<sub>2</sub> in the area. As mentioned before, CO<sub>2</sub> concentration is a good indicator of an area's population. As more people exhale, the concentration of CO<sub>2</sub> increases. By controlling the quantity of outside air based on a CO<sub>2</sub> setpoint, you can ventilate an area on a demand basis. When CO<sub>2</sub> concentration rises, dampers are opened and more outside air is allowed to flow into the area until the concentration decreases to acceptable levels. Keep in mind that CO<sub>2</sub> concentration rates do not indicate the levels of other potential VOCs contained within the space and that additional ventilation may be required in order to satisfy the acceptable indoor air quality requirements (consult your local building codes for proper ventilation rates).

### ***Energy-Efficient Motors***

Depending on their size, typical electrical motors are 75 percent to 95 percent efficient, with larger motors being more efficient than smaller ones. The remaining 5 percent to 25 percent of the wasted power is lost as heat to the surrounding area.

Energy-efficient motors are designed to convert a greater amount of electrical energy into useful work. After completing the other stages, you will have reduced the heating and cooling loads in your building, allowing for the installation of smaller motors that better match the reduced power requirements. By installing motors that are smaller *and* more efficient, you can save further energy costs.

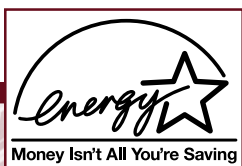

**Table 2: Comparison Of Standard Efficiency Motors And Energy-Efficient Motors**

(1,800 RPM Totally Enclosed Fan-Cooled Motor)

hp	Standard-Efficiency Motor	Energy-Efficient Motor
5	83.3	90.2
7.5	85.2	91.7
10	86.0	91.7
15	86.3	93.0
20	88.3	93.6
30	89.5	94.5
40	90.3	94.5
50	91.0	95.0
60	91.7	95.4
75	91.6	95.4
100	92.1	95.4

Note: Older standard-efficiency models have even lower efficiencies than those shown in this table.

Source: Adapted from California Energy Commission, Washington State Energy Office, U.S. Department of Energy, and E SOURCE, *Space Cooling Technology Atlas*.

### *Economic Benefits*

The savings realized by installing energy-efficient motors can be particularly attractive for equipment motors that run most or all of the day and have a higher capacity, such as a fan motor.

Energy-efficient motors achieve their efficiencies from improved internals (windings, stators, etc.). Higher efficiency means less waste heat is generated. While excessive heat shortens motor life over time, less heat prolongs lubricant life. Also, the higher thermal mass of energy-efficient motors allows them to tolerate heat better than standard motors. Altogether, energy-efficient motors generally last longer and require less maintenance than standard motors.

### *Considerations*

#### **Repair (Rewind) Vs. Replacement**

Occasionally, like any type of equipment under constant use, motors fail. When they do, many people make the assumption that they should replace the unit immediately rather than repair it. Although it is generally more economical to replace, rather than repair, a failed motor, this is not always the case. Rewinding a failed motor can be more cost effective if one or more of the following situations applies:

- The motor is larger than 125 hp.
- The motor operates less than 2,000 hours per year.
- The failed motor is an energy-efficient motor.





### **Premium Efficiency Vs. High Efficiency**

Many motor manufacturers have three lines of motors—standard efficiency, high efficiency, and premium efficiency. Adding to the confusion, many other manufacturers offer just two lines of motors, calling their standard efficiency motors “high efficiency” and their energy-efficient motors “premium efficiency.” Understanding this practice will help you choose the combination of motor efficiency and cost that best suits your specific needs.

### **Shaft Alignment**

In typical fan system configurations, the motor and the fan each have shafts, which are connected with a belt or belts and two pulleys. If the pulley faces are not square with each other, then the belt and shafts are not in alignment. Improperly aligned shafts can not only result in poor efficiency and higher operating costs, but also can lead to premature failure and increased maintenance costs. Whenever you replace or rewind a motor, be sure to pay close attention to the shaft alignment.

### **Energy-Efficient Belt Drives**

Belts are often used to transfer power from the motor to the fan system being driven. Standard V-belt drives can be found in the majority of belt applications. They are the lowest cost option of the belt family. The tradeoff, as usual, is reduced energy efficiency.

- V-belts, when new, can typically achieve efficiencies in the 90 to 95 percent range. A worn belt, however, can considerably reduce the efficiency by slippage caused by slackening and worn grip surfaces.
- Cogged V-belts are similar to standard V-belts, except that the normally flat underside has longitudinal grooves in it, allowing better grip and less slip than standard V-belts. They typically offer a 2 percent to 5 percent efficiency bonus.
- Synchronous belts combine toothed belts with grooved pulleys, minimizing slip and improving efficiency to a range of 97 percent to 99 percent.

### **Economic Benefits**

Drive belts should be a standard replacement part in your building’s maintenance program, requiring replacement every few months. Energy-efficient belts can easily be incorporated into your standard maintenance program, and the savings generated greatly outweigh the slight increase in cost per belt.

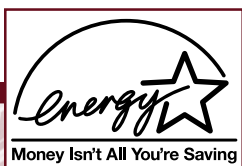

## Additional Considerations

### ***Ventilation Requirements***

As discussed in Other Load Reductions, building codes based on standards set by ASHRAE dictate minimum ventilation rates. Code-mandated rates have changed significantly over the years in response to events and new understanding about the impact of outside air, energy consumption, and occupant comfort.

### ***Testing, Adjusting, and Balancing Firms***

One issue to consider: After implementing some of the modifications outlined, your HVAC system will most likely exhibit different operating characteristics than before. Normally, the engineer or contractor who performed the work will be responsible for what is called the testing, adjusting, and balancing, or TAB, of the modified or new system. TAB involves analyzing the various flows of air, chilled water, hot water, steam, etc., and ensuring that distribution of heating and cooling throughout the building meets the required specifications as outlined in the contract documents. Recent developments in the building heating and cooling industry have led to the introduction of independent TAB firms. Under contract to the building manager, they serve as a third party to ensure accuracy of the TAB measurements and are worth retaining if further oversight is desired.

---

#### **Upgrading Of Fan System JC Penney Atlanta, GA**

The air distribution for one of JC Penney's 155,000-sf stores was provided by five air-handling units located in a penthouse equipment room. Two return fans, also located in the penthouse, vented air from the first and second floors through ductwork and back to the air-handling units. The air-handling units supplied conditioned air through ductwork to diffusers throughout the building. The fans operated at two speeds, high and low, each manually controlled with selector switches as well as on-off automatic-function switches. The fans usually operated at the high-speed setting, although they were cycled occasionally to conserve electricity. In an effort to reduce energy consumption, tests were conducted to determine the airflow from each of the fans while operating at high speed. Data collected indicated that the actual airflow for each air-handling unit was less than the design airflow; therefore the fans were larger than necessary for this facility. The testing also revealed that an accumulation of dirt on the cooling coils in air-handling units 1 and 2 was restricting air flow and wasting fan energy. The QuikFan software developed by EPA was used to estimate the energy savings potential of the various Stage Four upgrade options. Measurements of each fan motor indicated that the maximum load was less than the horsepower rating.

Another potential energy saver was minimization of the outside air brought into the building for ventilation. This air had to be heated or cooled, which required energy. By monitoring carbon dioxide levels in the building it was felt that the air intake could be safely reduced to the minimum quantity necessary.

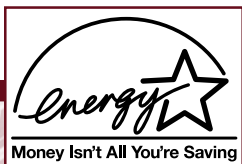

JC Penney decided to install variable-speed drives on the supply-air and return-air fans in the building to bring the fan capacity nearer the actual load and to install carbon dioxide sensors that would enable the system to minimize the intake of air. The large open areas in the store made it impractical to install variable air volume boxes that control the speed of the fan motors with pressure sensors. Space thermostats were therefore used to regulate fan speeds directly. Before installation of the variable-speed drives, the fans cycled on at maximum electrical consumption and then cycled off regularly. The variable-speed drives eliminated this inefficient constant cycling. Peak power use was therefore less than the maximum, with projected electric demand savings of 36 kW per month.

The total cost of installation of the variable-speed drives and the carbon dioxide sensors was \$17,000, which is projected to save 138,833 kWh of electricity at an annual savings of \$9,726. The payback for this upgrade of the fan system is 1.75 years, and the internal rate of return is 56.6 percent. JC Penney was therefore able to realize substantial annual savings with a relatively low investment, and the savings continue year after year.

## Summary

Fan Systems illustrates the many options that are available to you to save on your building's energy costs. To recap:

- Measure your loads.
- Rightsize your fan system to match actual loads.
- Install rightsized, energy-efficient motors where possible.
- Install VSDs where practical.
- Install energy-efficient belts.
- Investigate options available for improving the control of your fan system.

## Next Steps

1. Using the Fan System Survey provided in the Appendix, record information on your various fan systems and measure your loads.
2. Enter this data into a commercial fan sizing software program to estimate what you could save.
3. Using a qualified engineering firm, perform a more detailed assessment of your system to investigate further savings.



## Fan System Survey

Facility Name _____	Date _____
---------------------	------------

<i>Fan System Information</i>	<i>Motor Information</i>	<i>Operating Information</i>
-------------------------------	--------------------------	------------------------------

1	2	3	4	5	6	7	8	9	10	11
Name (ID)	Fan System Type	Operating Schedule	Fan Flow Control	System Duty Cycle	Nameplate Horsepower (hp)	Efficiency %	Horsepower @ 100% cfm (hp)	Installed Capacity (cfm)	Coil Load @ Peak (tons)	Fan Flow @ Peak (cfm)