

Appendix L

Technology Descriptions

L.1 Operation and Maintenance Practices

Sewer Testing and Inspection Techniques
Sewer Cleaning Techniques
Pollution Prevention
Monitoring, Reporting, and Public Notification

L.2 Collection System Controls

Maximizing Flow to Treatment Plant
Monitoring & Real-Time Control
Inflow Reduction
Sewer Separation
Sewer Rehabilitation
Service Lateral Rehabilitation
Manhole Rehabilitation

L.3 Storage Facilities

In-line Storage
Off-line Storage
On-site Storage

L.4 Treatment Technologies

Supplemental Treatment
Plant Modifications
Disinfection
Vortex Separators
Floatables Control

L.5 Low-Impact Development Techniques

Porous Pavement
Green Roofs
Bioretention
Water Conservation



TECHNOLOGY DESCRIPTION

OPERATION & MAINTENANCE

Sewer Testing and Inspection Techniques

Overview

Operations and maintenance practices, such as sewer testing and inspection, enhance sewer system performance. Specifically, testing and inspection practices ensure that new connections are made correctly, help locate and protect against unwanted inflow and infiltration (I/I), and assess the structural condition of the sewer system. Inspection techniques can also be useful in identifying locations where grease and debris accumulate or where roots intrude into the sewer, which can cause sewer blockages resulting in unexpected CSOs and SSOs. The keys to a successful sewer testing and inspection program are identification of potential or current problem locations; correction of the problem; and evaluation of the effectiveness of the corrective measures.

Sewer Testing Techniques

In general, sewer testing techniques are used to identify leaks which allow unwanted infiltration into the sewer system and determine the location of illicit connections and other sources of storm water inflow. Air testing and hydrostatic testing are used to identify leaks in the sewer system. Smoke testing is used to determine connectivity and to identify points where inflow to the sewer system can occur. These testing techniques are described in further detail below.

Air Testing

Air testing is used to determine if a particular section of sewer line has leaks that would allow unwanted groundwater to infiltrate into the system or sewage to exfiltrate into the surrounding soil. Plugs, such as inflatable stoppers, are placed at either end of the test section, and in all service connections to the section. The test section is pressurized with air. After the pressure is allowed to stabilize, it is monitored for a predetermined amount of time. The acceptable range of pressure drop and the duration of the test are based on the pipe material and diameter, detailed in American Society for Testing and Materials (ASTM)

standards. An unacceptable drop in the pressure indicates that the pipe has leaks that could lead to excessive infiltration. To isolate the leaks, air testing can be repeated on smaller sections of line.

Hydrostatic Testing

Hydrostatic testing is another technique used to detect and locate leaks in a sewer system. As with air testing, the sewer reach of interest is isolated using plugs. The test section is filled with standing water and the water level is monitored. A drop in the water level over time indicates the presence of leaks. The acceptable decrease in water level and the test duration are specified in ASTM standards based on pipe material.

Smoke Testing

Smoke testing is commonly used to detect sources of unwanted inflow such as down spouts, or driveway and yard drains. With each end of the sewer of interest plugged, smoke is introduced into the test section, usually via a manhole. Sources of inflow can then be identified when smoke escapes through them. This technique can also be used to identify cross connections between sanitary and storm sewer systems. The smoke can be tracked through the sewer system for a limited distance. The length of the sewer that can be tested at one time is dependent on a number of environmental factors affecting smoke dissipation, such as wind and the number of sewer and surface connections to the system.

Sewer Inspection Techniques

Sewer inspection is an important component of any maintenance program. Sewer inspections establish the current condition of sewer lines and identify potential problems. The most common sewer system inspection techniques are described in detail below.

Visual Inspection

Visual inspection, which is the most basic sewer

inspection technique, can include surface and internal inspections. In either case, the manhole cover is removed and an inspection of the manhole condition, as well as the flow characteristics in the pipe, is made. For smaller pipes, mirrors and lights can be used to inspect the first few feet of pipe upstream and downstream of each accessible manhole. For larger pipes, a maintenance crew member can enter the pipe to inspect the inside of the pipe.

Lamping

Lamping involves lowering a still camera into a maintenance shaft or manhole. The camera is lined up with the centerline of the junction of the manhole frame and the sewer. A picture is then taken down the pipe using a strobe-like flash. This method can typically be used to inspect the first 10-12 feet of the pipe upstream and downstream from the access point.

Camera Inspection

Camera inspection is slightly more comprehensive than lamping. In camera inspections, a still camera is mounted on a floatable raft that is released into a pipe. As it floats down in the sewer, the camera takes pictures of the pipe using a strobe-like flash. Camera inspections can be performed in any pipe that is large enough to accommodate the camera and raft device.

Closed-Circuit Television

Closed-circuit television (CCTV) is the most commonly used technique for inspecting the internal condition of a sewer (EPA 1999). A closed-circuit camera with a light is self-propelled or pulled down the pipe. As it moves, it records the interior of the pipe. The focus of the camera can be controlled remotely for a clear image of points of interest. The distance traveled is recorded so that the location of any irregularities can be noted. This technique can be used in lines with a diameter ranging from 4-inches to 48-inches (CSU 2001).

Sonar

Sonar is a newer technology available for inspecting sewer lines. Sonar is deployed in the same manner as CCTV cameras and, therefore, can be used in the same diameter pipes. Sonar works by emitting a pulse that is bounced off the walls of the sewer. The time it takes for the pulse to bounce back is a function of the wall geometry. This wall geometry can then be analyzed to develop an image of the interior of the pipe. At low frequencies, less than 200 kHz, the pulse can penetrate the walls and provide information on the structural condition of the pipe.

Sewer Scanner and Evaluation Technology

Sewer Scanner and Evaluation Technology (SSET) is an experimental sewer line inspection technology. A full digital picture of the interior of a pipe can be produced by using a probe with a 360 degree scanner.

Key Considerations

Sewer Testing Techniques

The location and elimination of leaks in a sewer system are the major concern of system operators (CSU 2001). An effective sewer testing and inspection program will identify existing leaks and prevent other leaks from developing. Key considerations, including advantages and disadvantages, in selecting appropriate testing and inspection techniques are detailed below.

Air Testing

Air testing tests the entire circumference of the pipe for leaks by exerting the same amount of pressure in all directions on the pipe. Air can leak through a smaller crack than wastewater, therefore air testing helps find vapor leaks which may attract roots. In addition, in areas with steep terrain, air tests are better than water tests because of excessive hydrostatic pressure created at the lower end of the sewer line (CSU 2001). However, air testing can be difficult to apply in areas that have numerous service lateral connections as each one must be individually plugged, and the test section must be taken out of service during air testing. Due to safety concerns, air testing can also only be used in 4-inch to 24-inch pipes. For example, pressure on a 24-inch plug, even during a low pressure test, is enough to cause an improperly installed plug to explode (Rinker Material 2002).

Hydrostatic Testing

Hydrostatic testing also requires that the test section be taken out of service during testing. Individual service lateral connections do not need to be plugged as long as the water level at which the test is conducted is below that of the lowest basement in the test area. However, if residential taps are not plugged, the service laterals will be included in the test area. Further, since the release of pressure due to a failure of a plug in the hydrostatic test is much lower than in an air test, it can be conducted in larger diameter pipes. The principle disadvantages of hydrostatic testing are the time, money, and water wasted in conducting these tests (CSU 2001).

Smoke Testing

Smoke testing does not require the test section to be removed from service. However, all floor and sink drains must be filled with water prior to introducing

smoke to the system. Use of smoke testing is best done when the groundwater levels are low (i.e., below the elevation of the pipe) so that any cracks will leak smoke. It is important to realize that the location of smoke on the ground surface does not necessarily reveal where the smoke is escaping underground, but rather the point of exit at the ground surface (CSU 2001).

Sewer Inspection Techniques

Logging and recording inspections is critical to ensuring their utility. Typically, each municipality will have a standard log sheet for recording observations made through any of the inspection techniques described below. In cases where old sewers are to be inspected, it may be important to clean the lines before inspection. Ideally, sewer line inspections will take place during low flow conditions. Key considerations for different inspection techniques are discussed below.

Visual Inspections

In conducting visual inspections of sewer interiors, the maintenance crew is required by law to have confined space entry training and to strictly follow confined space entry procedures. Safety concerns also arise when attempting visual inspections in sewers with access points more than 600 feet apart.

Lamping

Lamping does not require confined space entry. Additionally, little equipment and set-up time are needed. Inspection is only possible, however, in the areas clearly captured in the photograph. Further, lamping has limited use in small diameter sewers (CSU 2001).

Camera Inspection

Camera inspection is often a viable alternative to visual inspections in larger sewers when the access points are more than 900 feet apart. The main disadvantage of camera inspection, similar to lamping, is that the pictures are not comprehensive and portions of the pipe may be missed. Additionally, there must be flow in the pipe for the raft to float. If there is flow in the pipe usually the invert of the pipe cannot be seen and is not photographed. Therefore, this method of inspection does not fully capture the condition of the invert of the pipe.

Closed-Circuit Television

One of the primary advantages of CCTV over still-photography methods, such as lamping and camera inspections, is that the camera can be stopped and pulled back or forth for a more precise observation. A footage meter can also be used in conjunction with CCTV equipment to keep track of the location of any irregularities. CCTV, however, cannot capture pipe condition below the water. In addition, CCTV-based assessment is subjective and can be error prone as its

accuracy depends heavily on the skill and concentration of the operator.

Sonar Technology

Sonar technology is able to map the sewer condition both above and below the level of flow. The primary use for sonar equipment is to inspect and assess the structural condition of otherwise inaccessible or flooded sections of sewer lines. The disadvantage is that it requires more power and heavy equipment than the CCTV, and therefore tends to be more expensive.

Sewer Scanner and Evaluation Technology

Similar to sonar, SSET also offers the benefits of a more complete image of the pipe than CCTV, but this technology is still in the experimental phase. SSET does not identify all types of sewer defects, such as infiltration and corrosion, equally. Also, it is not possible to see laterals, and SSET is slow compared to CCTV (CERF 2000). It appears that comprehensive data on the condition of the pipeline can be determined by combining SSET with CCTV.

Cost

Costs for testing and inspection will vary based on location and technique used. CCTV is the most commonly used inspection technique and the costs are presented in Table 1.

Table 1. CCTV costs per linear foot, includes labor and equipment costs.

Location	CCTV ¹
Los Angeles, CA	\$0.57
Sacramento, CA	\$1.63
Santa Rosa, CA	\$0.27
Honolulu, HI	\$3.24
Boston, MA	\$1.89 - \$2.70
Laurel, MD	\$1.72
Albuquerque, NM	\$1.56
Charleston, SC	\$0.39
Fort Worth, TX	\$0.48
Fairfax County, VA	\$0.81
Norfolk, VA	\$1.62
Virginia Beach, VA	\$1.56 - \$1.73
Average	\$1.44

¹ Costs in 2002 dollars.

Implementation Examples

FORT WORTH, TX

Responsible Agency: City of Fort Worth

Population Served: 880,000

Service Area: 291 sq. mi.

Sewer System: 2,589 mi. of sewer

Sewer Maintenance and Service Program

The City of Fort Worth Water Department created a Preventative Maintenance Section and a Technical Service Section in 1998. The Preventative Maintenance Section was tasked with implementing a system-wide small diameter (less than 18 inches) sewer cleaning and inspection program. Larger pipes are cleaned and inspected by private contractors, due to technical logistics and the specialized equipment needed. The Sewer Maintenance Section handles

all other sewer maintenance activities such as cleaning blockages, and pipe installation and repair. The sewer system is divided into nine major drainage basins containing 167 subbasins. Each subbasin, along with its SSO and maintenance histories, is tracked in a Geographic Information System (GIS) database. Spatial analysis based on information from the GIS database and baseline performance criteria is used to prioritize the cleaning and inspection of the subbasins. Once a subbasin is selected for cleaning, approximately two-thirds of the cleaned lines are evaluated by CCTV. This information is used as part of the decision making process for determining whether or not further maintenance is needed. During 2001-2002, 176 miles of pipe were televised. The cost for inspection of small diameter sewers by city employees was \$0.48 per linear foot including labor and equipment.

Contact: Darrell Gadberry, City of Fort Worth Water Department, Field Operations Division

FAIRFAX COUNTY, VA

Responsible Agency: Fairfax County

Population Served: 835,000

Service Area: 234 sq. mi.

Sewer System: 3,100 mi. of sewer

Improved Sewer Maintenance Program

Fairfax County believes that improved record keeping, along with the reorganization and streamlining of their sewer maintenance program, has resulted in significant reductions in SSOs in recent years. By tracking the number of inspections and cleanings, as well as the number of overflows in each individual line, the county has established and prioritized inspection and cleaning schedules for

each line. This customized cleaning and inspection schedule, along with the resulting decrease in SSOs, led to a decrease in overall sewer maintenance costs. Inspection activities include visual inspection using a mirror attached to a pole, a portable camera, and CCTV. The sewers are then cleaned based on the regular schedule or sooner, as determined by the inspection results. In 2002, the cost of visual inspection and cleaning was \$0.87 per linear foot. The cost of CCTV inspection was \$0.78 per linear foot.

Contact: Ifty Khan, Fairfax County Department of Public Works & Environmental Services, Wastewater Collection Division

References

California State University (CSU), Sacramento, College of Engineering and Computer Science, Office of Water Programs. 2001. *Operation and Maintenance of Wastewater Collection Systems*. Vol. 1, 5th ed. Prepared for EPA Office of Water Programs, Municipal Permits and Operations Division. Sacramento, CA: CSU, Sacramento Foundation.

Civil Engineering Research Foundation (CERF). 2000. *Sewer Scanner & Evaluation Technology (SSET)*. Retrieved July 28, 2003. <http://www.cerf.org/ceitec/eval/ongoing/sset.htm>

EPA Office of Water. 1999. *Collection System O&M Fact Sheet: Sewer Cleaning and Inspection*. EPA 832-F-99-031.

Rinker Materials. 2002. *Information Series: Low Pressure Air Testing*. Retrieved July 28, 2003. <http://www.rinker.com/hydroconduit/infobriefs/i105.htm>

Inclusion of this technology description in this Report to Congress does not imply endorsement of this technology by EPA and does not suggest that this technology is appropriate in all situations. Use of this technology does not guarantee regulatory compliance. The technology description is solely informational in intent.



Sewer Cleaning Techniques

Overview

Operations and maintenance practices, such as sewer cleaning, enhance sewer system performance. Specifically, sewer cleaning can remove blockages caused by the deposition of solids and grease, as well as root intrusion. Sewer cleaning is important in maintaining sewer system capacity and can reduce the frequency and volume of CSOs and SSOs.

The three major techniques used to clean wastewater sewer systems are hydraulic, mechanical, and chemical. Some of the more widely used technologies in each of these categories are described below.

Hydraulic Cleaning Techniques

Jetting

Jetting involves aiming a high-pressure stream of water at the blockage or debris in the pipe. The shape of the nozzle can be changed depending on the surface in need of cleaning (CSU 2001). Jet cleaners can either be truck- or trailer-mounted. Jet cleaners are very efficient, require minimal staff, and are able to handle most types of sewers and blockages. Jetting is the most common hydraulic cleaning technique due to its comparatively low cost and effective cleaning results.

Balling

Balling involves inserting a rubber ball with a diameter slightly smaller than the interior diameter of the pipe into a sewer line. The ball is placed in the upstream end of the sewer line and reduces the area through which wastewater can pass, causing it to flow at a higher velocity. This increased velocity flow scours the interior of the pipe. Additional cleaning can also be achieved by threading the ball so that it spins as water flows past, scrubbing the interior of the pipe.

Kites

Kites are cone shaped devices that resemble a windsock and are used to hydraulically clean sewers. Kites work

similar to balling, increasing the velocity of the flow so that it scours the sewer line. They are made of a canvas material that traps and funnels the wastewater so that it is released as a high velocity stream. This wastewater stream works to break up deposits in the line.

Scoters

Scoters consist of a metal shield attached to a wheeled framework and are designed to be self-propelled. The shields are available in various sizes for use in different diameter pipes. Similar to the balling technique, the scooter blocks the flow in the pipe and forces it to go around the edges of the shield at a high velocity. The wheeled framework allows the scooter to be pushed by the wastewater built up behind it. The depth of wastewater behind the scooter is controlled by a spring system that adjusts the angle of the shield relative to the walls of the pipe. By adjusting the angle of the shield, the flow around the edges is either increased or decreased. The high velocity water flowing around the shield breaks up and moves debris down the pipe.

Flushing

There are two methods used in flushing sewers: manual flushing and self-flushing. Manual flushing involves introducing large volumes of low velocity water at the upstream end of the sewer. The large flow volume is capable of transporting floatables and low density, loose debris to the downstream manhole for removal, but not necessarily heavy or attached debris. This method is most effective when used in combination with a mechanical method such as rodding. Self-flushing techniques use the flow within the sewer for hydraulic cleaning. A gate or other device is used to store a volume of wastewater and then release it in a flood wave that washes deposits out of the sewer line.

Mechanical Cleaning Techniques

Rodding

Power rodding machines use an engine to force a

small diameter rod (less than one inch) through the sewer line. The rod turns as it passes through the pipe. Usually a cleaning attachment made of multiple small blades is located at the end of the rod. The attachment works to loosen and break up debris; it also cuts through roots that protrude into the interior of the pipe. In addition, power rodding can be used to thread cables for closed-circuit television (CCTV) inspection or bucket cleaning.

Bucket Machines

Bucket machines use a steel bucket that is pulled through the sewer along a cable threaded between two manholes. The front of the bucket has jaws that open and scrape the debris and deposits from the interior of the pipe capturing them in the bucket for removal. Bucket machines are available in a range of sizes to allow for cleaning of both small and large diameter pipes. The power of the equipment being used to pull the bucket determines the size of the pipe that can be cleaned with this method.

Chemical Grouting Techniques

Herbicides

Roots can inhibit flow, collect debris, and reduce the line's capacity. Herbicides are used to kill roots protruding into the sewer line and inhibit future root growth. Herbicides are typically applied by one of two methods: soaking the roots inside the sewer with a liquid solution for a short time period, or filling the sewer with a herbicidal foam. Chemical root control must be used in combination with some other cleaning technique to remove the roots killed by the herbicides.

Enzyme Additives

Enzyme additives can be used to break up scum, grease, and other accumulated organic matter. These additives can control odors in the sewer system as well as removing blockages. The additives usually come in a dry flaky form and are applied in small doses.

Key Considerations

Selection of the most appropriate sewer cleaning technique will need to be made on a site-specific basis. In general, hydraulic cleaning techniques tend to be simpler and more cost-effective in removing deposited solids when compared to other sewer cleaning techniques (CSU 2001). Mechanical techniques are typically used in areas where the volume, size, weight, or type of debris limit the effectiveness of hydraulic techniques. Chemicals can be helpful aids for cleaning and maintaining sewers, but most chemical applications are localized or used to enhance the effectiveness of other cleaning techniques. Specific

considerations for each of the aforementioned cleaning techniques are described below.

Applicability

Hydraulic Cleaning Techniques

Jetting

Jetting is most effective in cleaning flat, slow-flowing, smaller pipes (less than 15 inches in diameter). As the pipe diameter increases, the distance between the high velocity nozzle and the interior of the pipe increases, which decreases its cleaning potential. Jetting is often more effective in low flow pipes as the jets can easily penetrate shallow flow to clean the deposits in the invert of the pipe. Jetting must be used with caution in pipes with fixtures such as gauges and valves as they may be damaged by the jets. Basement backups can occur if the jetting hose is mistakenly fed into a service line, or if the volume of water introduced exceeds the capacity of the sewer line.

Balling

Balling is best suited for removing deposits of inorganic material and grease (CSU 2001). Balling can only be used in areas where sufficient hydraulic capacity is available to pressurize the water flowing around the ball without causing sewer backups, and it is most successful in 24-inch or smaller diameter pipes. It cannot be used in sewer lines that have large offsets, service connections, or roots protruding into the sewer line since the ball can get caught. The required frequency of balling varies from six months to three years (CSU 2001).

Kites

Kites clean in a manner similar to balling, but they are commonly used to clean larger diameter sewers. Kites require only a small amount of hydraulic pressure to create a cleansing velocity. Yet, they can only be used in areas where sufficient hydraulic capacity is available to pressurize the water flowing around the kite without causing sewer backups. Some accommodation for hydraulic capacity can be made by feeding the kite through the system at a faster rate. However, this faster rate may not allow for sufficient pressurization of the water flowing out of the end of the kite. A kite cannot be used in pipes with large offsets, which could cause the kite to become lodged in the line.

Scooters

Scooters are capable of removing large objects and heavy materials (i.e., brick, sand, gravel, and rocks). Scooters are considered more effective in larger lines, over 18 inches in diameter (CSU 2001). The operation of a scooter is quite simple, and the cost is often

considerably less than other cleaning operations. Since scooters depend on the build-up of water pressure, caution must be used where sewers are shallow or the danger of flooding homes or businesses exists. A scooter cannot be used in lines with protruding pipes or service lateral connections, and it may not be appropriate for lines with significant root intrusion, where it could become entangled.

Flushing

Flushing is most often used in conjunction with other mechanical techniques, especially rodding. Mechanical devices are used to cut roots and grease from the walls and joints of pipes. This is followed by flushing to remove the cut material. Flushing is not as effective as balling or jetting because sufficient velocities are not developed to remove grease, grit, or heavy debris. It is also important to note that the amount of water required to clean a line is dependent on the size, length, and slope of the line. Flushing is not a common practice due to poor results and large volumes of water required for cleaning, which ultimately flow to the wastewater treatment plant.

Mechanical Cleaning Techniques

Rodding

Rodding is one of the most widely used methods for cleaning sewers. Rodding is typically used to handle stubborn stoppages of roots, grease, and debris (CSU 2001). This method works best when applied in pipes with diameters of 12 inches or less. When used in larger diameter pipes, the rod tends to bend and coil up on itself. Rodding is most effective when it is applied in conjunction with some form of flushing because it works to loosen and break up debris, but rodding itself does not remove debris from the line. If the rod happens to break in the sewer line, retrieval and repair may be very difficult.

Bucket Machines

Bucket machines are most often used to clean a line after a pipe breaks or debris that cannot be removed by hydraulic cleaning techniques accumulates. They should not be used as a routine cleaning tool. Bucket machines are heavy, and set-up of the equipment is more time consuming than for other mechanical methods. In addition, if the sewer line is completely blocked, the pull cable cannot be threaded through the line, making this method ineffective. Bucket machines are costly to operate and maintain, and they can be potentially damaging to sewer pipes.

Chemical Cleaning Techniques

Herbicides

Proper application of chemical root control is essential in ensuring their effectiveness. Root control using chemicals is not as fast as cutting roots with a power rodder, however, it is more permanent. Effective chemical application can control roots in a sewer for two to five years (CSU 2001). It is important to take into consideration how the toxicity of the herbicide will affect the biological treatment process at the downstream wastewater treatment plant.

Enzyme Additives

The addition of enzyme additives to control grease and scum are effective under specified conditions in specific locations. Careful comparison of the results produced by the additives with those achieved via mechanical or hydraulic cleaning methods should be made to ensure that the most appropriate technique is selected.

Cost

Representative costs for various cleaning methods are summarized in Table 1. The relative effectiveness of the cleaning techniques is presented in Table 2.

Table 1. Cleaning costs per linear foot.

Municipality	Cleaning Method	Average Cost per Linear Foot ¹
Los Angeles, CA	Hydraulic - Jetting	\$0.27
	Mechanical - Rodding	\$0.41
	Mechanical - Manual Rodding	\$1.32
San Diego, CA	Overall Cleaning	\$0.54
Hammond, IN	Overall Cleaning	\$1.26
Afton, OH	Overall Cleaning	\$0.42
Sioux Falls, SD	Overall Cleaning	\$0.45
Fort Worth, TX	Overall Cleaning	\$0.61 - \$1.02
Fairfax, VA	Hydraulic - Jetting	\$0.44
	Mechanical - Rodding	\$0.86

¹ Costs include labor and equipment.

Table 2. Effectiveness of sewer cleaning techniques (CSU 2001).

Cleaning Technique	Maintenance Issue (Effectiveness scaled from 1=low to 5=high)				
	Emergency Stoppage	Grease	Roots	Sand, Grit, Debris	Odors
Jetting ¹	5	5	-	4	3
Balling	-	4	-	4	3
Kiting	-	4	-	4	3
Scooters	-	3	-	3	-
Flushing	-	-	-	-	2
Rodding	4	1	3	-	-
Bucket Machines	-	-	-	4	-
Chemicals	-	2	-	5	5
Microorganisms	-	4	-	-	-

¹ Effectiveness decreases as pipe diameter increases.

Implementation Examples

SIoux FALLS, SD

Sewer Cleaning and Maintenance

Responsible Agency: City of Sioux Falls
Population Served: 120,000
Service Area: 70 sq. mi.
Sewer System: 578 mi. of sewer

The City of Sioux Falls' sewer system consists of 578 miles of sanitary pipe. The pipes range in size from 6-66 inches in diameter. The sewer system is divided into 20 drainage basins, and the current maintenance program provides that the entire system is cleaned once every three years. Maintenance records are stored in an Oracle database that generates work orders by date and drainage basin. Sanitary sewer maintenance includes high pressure jetting, vacuuming

to remove loosened debris, and mechanical and chemical root control. Closed circuit televising (CCTV) is used to identify trouble spots, where more frequent cleaning is required than the scheduled three year intervals. In 2001, 372 miles of sewer (64 percent of the system) were cleaned and televised. The cost for these maintenance activities equates to \$236 per 5,280 feet (1 mile) of inch-diameter pipe. Using a ten-inch diameter pipe as an average, maintenance costs are about \$0.45 per linear foot.

Contact: Richard McKee, M.O.U. Public Works, Water Reclamation Division

FORT WORTH, TX

Sewer Cleaning Efforts

Responsible Agency: City of Fort Worth
Population Served: 880,000
Service Area: 291 sq. mi.
Sewer System: 2,589 mi. of sewer

The City of Fort Worth's sewer system consists of approximately 2,589 miles of pipe. The pipes range in size from 6-96 inches in diameter. Ninety percent of the system is composed of pipes with diameters of 18 inches or less. The city has established maintenance goals which include cleaning all sewers 18 inches or smaller once every eight years and all sewers larger than 18 inches once every 15 years. The cleaning and maintenance of the smaller diameter

pipes is conducted by city employees, while the cleaning of larger diameter pipes is outsourced due to technical logistics and the specialized equipment needed.

The sewer system is divided into nine major drainage basins containing 167 subbasins. Each subbasin, along with its SSO and maintenance histories, is contained in a Geographic Information System (GIS) database. Spatial analysis of the GIS database is compared to baseline performance indicators to prioritize the cleaning order of the subbasins. In 2001-2002, 1.15 million linear feet of pipe were cleaned by the city. The cost for city cleaning activities during this time, including labor and equipment, was \$0.61 per linear foot (in 2002 dollars) and the cost for cleaning of larger pipes by private contractors was \$1.02 per linear foot (in 2002 dollars).

Contact: Darrell Gadberry, City of Fort Worth, Water Department, Field Operations Division

References

Arbour, Rick, and Ken Kerri. 1998. *Collection Systems: Methods for Evaluating and Improving Performance*. Prepared for EPA, Office of Water Programs, Municipal Permits and Operations Division and developed under EPA Grant No. CX924908-01-0. Sacramento, CA: California State University, Sacramento Foundation.

California State University (CSU), Sacramento - College of Engineering and Computer Science, Office of Water Programs. 2001. *Operation and Maintenance of Wastewater Collection Systems*. Vol. 1, 5th ed. Prepared for EPA Office of Water Programs, Municipal Permits and Operations Division. Sacramento, CA: CSU, Sacramento Foundation.

EPA Office of Research and Development. 1998. *Sewer and Tank Sediment Flushing: Case Studies*. Prepared by Pisano, William C., et al. EPA 600-R-98-157.

EPA Office of Water. 1999. *Collection System O&M Fact Sheet: Sewer Cleaning and Inspection*. EPA 832-F-99-031.

Fan, Chi-Yuan, Richard Field, William C. Pisano, James Barsanto, James Joyce, and Harvey Sorenson. 2001. "Sewer and Tank Flushing for Sediment, Corrosion, and Pollution Control." *Journal of Water Resources Planning and Management*. May/June: 194-201.

Mitchell, Scott E. 2001. "Benchmarking Operations for Sewer Cleaning vs. Private Contractor - Cost Analyses, 1997-2001." Retrieved July 28, 2003. <http://www.ci.hammond.in.us/sewer/paper.html>

Inclusion of this technology description in this Report to Congress does not imply endorsement of this technology by EPA and does not suggest that this technology is appropriate in all situations. Use of this technology does not guarantee regulatory compliance. The technology description is solely informational in intent.



Pollution Prevention

Overview

Pollution prevention is defined as any practice that reduces the amount of pollutants, hazardous substances, or contaminants entering the waste stream (EPA 2002). Pollution prevention focuses on source control, seeking to reduce the pollutants generated by a particular process. It relies on individual action, and therefore, public education and awareness. A range of pollution prevention activities including best management practices (BMPs) for fats, oils, and grease; household hazardous waste; and commercial and industrial facilities are detailed below.

Fat, Oil, and Grease Control Programs

Fat, oil, and grease (FOG) are a by-product of many food items that are prepared in homes and restaurants. Often, when used for cooking, FOG is improperly disposed of by pouring it down a sink drain. FOG can also enter the sewer system when dishes are washed. Over time, FOG builds up in sewers, leads to blockages, and can cause combined and sanitary sewer overflows (CSOs and SSOs).

Nationally, EPA believes that FOG is one of the leading causes of SSOs contributing to approximately one out of every five SSOs. The best way to prevent these blockages is to keep FOG out of the sewer system. Education programs are important in ensuring residents, institutional, and commercial establishments, especially restaurants, are aware of their role in managing FOG. In addition, many municipalities have adopted regulations controlling the introduction of FOG into the sewer system.

In commercial areas, grease traps or interceptors are often used to remove FOG from wastewater before it enters the sewer system. Grease traps slow the flow of wastewater, allowing it to cool and FOG to float to the top of the trap. Baffles are located at the beginning and end of the trap to prevent FOG from escaping as shown in Figure 1. The size of the trap depends on the anticipated flow and the amount of FOG in the wastewater. Grease trap capacities range from small units (less than 10 gallons) located in the kitchen area to 5,000 gallon tanks installed underground outside the

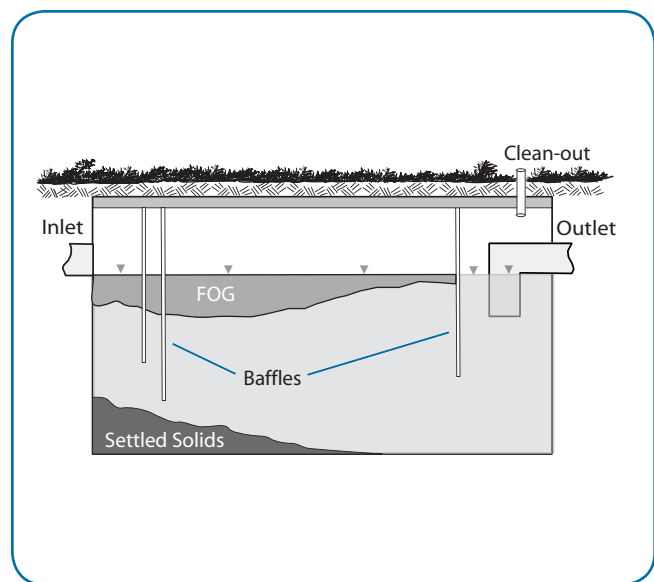

Figure 1. A schematic showing the collection of FOG by a grease trap located within a sewer line.

building (NCDPPEA 2002). Often, for restaurants, the size of the trap is determined by the number of seats.

Household Hazardous Waste Management

Household hazardous waste includes products that are corrosive, toxic, reactive, or flammable. Household hazardous waste management focuses on the proper application and disposal of these otherwise hazardous materials. Common household hazardous waste are paint thinners, auto batteries, pesticides, and oven cleaners.

Household hazardous waste collection programs highlight the importance of proper disposal of these materials and potential hazards resulting from improper disposal (i.e., pouring down kitchen sinks or storm drains and thus into the sewer system). Collection programs typically include schedules for home pick-up or drop-off points for the waste.

The inappropriate or excessive application of fertilizer and pesticide can allow large amounts of these chemicals to be washed off lawns and other landscaped areas during wet weather events. Fertilizer contains nitrogen and phosphorous that can contribute to the eutrophication of receiving waters. Pesticides contain chemicals that are toxic to aquatic life and can impact the biological processes used at the wastewater treatment plant. In areas served by combined sewers, runoff contaminated with fertilizer and pesticides may be discharged during a CSO event. Drain disposal of chemical remnants can also introduce the fertilizer or pesticide into the sewer system.

Integrated pest management (IPM) programs can be effective in limiting fertilizer and pesticide application. IPM programs teach residents the difference between insects that are beneficial and harmful to plants to avoid the over use of pesticides. For example, if one branch of an azalea bush is infected with an azalea lace bug, that branch can be cut out of the bush eliminating the pest and reducing the need for pesticide (NVPDC 1996). Further, IPM programs advocate using a diverse selection of native plants and maintaining a healthy plant bed by using organic compost instead of fertilizer.

Commercial and Industrial Waste Management

Commercial and industrial facilities can discharge large amounts of pollutants to sewer systems through direct disposal or storm water runoff (EPA 1999). Pollution prevention plans that incorporate storm water BMPs and water conservation measures can play an important role in reducing the pollutants discharged directly to the sewer system, as well as those washed-off commercial and industrial sites during wet weather events. BMPs for commercial and industrial sites can be used to control the volume or quality of storm water runoff. BMPs may include using temporary covers for outside storage areas, installing covered bays for vehicle maintenance, purchasing rain proof dumpsters, and adopting environmentally-friendly building and grounds maintenance practices. Water conservation measures at commercial and industrial facilities often include installing water efficient fixtures such as low-flow toilets and faucets and reusing or recycling cooling water. For more information on water conservation activities, refer to the “Water Conservation Technology Description” in Appendix B of the *Report to Congress on the Impacts and Controls of CSOs and SSOs*.

Key Considerations

Pollution prevention practices most often take the form of simple, individual actions which reduce the pollutants generated by a particular activity. Therefore, pollution prevention programs must be implemented with broad

participation in order for there to be a discernible reduction in pollutant loads discharged to sewer systems. Specific considerations for each of the pollution prevention practices described above are provided below.

Applicability

Fat, Oil, and Grease Control Programs

FOG is a common problem in both combined sewer systems (CSSs) and sanitary sewer system (SSSs). Numerous municipalities have invested in programs to educate customers about the proper handling and disposal of FOG. Education programs are most successful if they are tailored to a specific audience (i.e., residential, institutional, or commercial).

Education programs should make residents aware that FOG can block private laterals, in addition to municipal sewers, resulting in basement backups. Utility bill inserts, direct mailings, newspaper articles, and community events are ways to reach residential customers (NCDPPEA 2002). Outreach materials can include a “Do and Don’t” list such as the following:

Do:

- Collect FOG in a container and dispose of it with the trash
- Scrape grease and food from cooking/serving ware before washing
- Encourage neighbors and friends to help eliminate FOG from the sewers

Don’t:

- Pour FOG down the sink drain or toilet
- Put greasy waste or food down garbage disposals
- Place FOG wastes in the toilet

Education for commercial and institutional customers can take the form of workshops, mailings, and web information. Workshops provide a forum for disseminating information concerning environmental and health effects of FOG, BMPs for controlling FOG, and any municipal ordinances that pertain to FOG. Workshops can emphasize the important link between employee behavior and possible FOG blockages. If new ordinances are put into place, direct mailings can be used to inform those effected of their new responsibilities, as well as techniques for controlling FOG.

A vital part of any education program for commercial and institutional customers is discussion of grease trap design and maintenance. Grease traps do not remove all the FOG in the wastewater; proper design and regular maintenance is critical for effective grease trap performance. The effective separation of water and grease is based on four design criteria (NCDPPEA 2002):

- Sufficient volume to allow the wastewater to cool for separation
- Proper retention time for the FOG to separate from the wastewater
- Low turbulence to prevent FOG and solids from resuspending
- Adequate volume to handle the accumulation of FOG and solids between cleanings

Household Hazardous Waste Management

Programs that promote appropriate disposal of household hazardous waste and the proper application of fertilizers and pesticides can be instituted in any community.

Household hazardous waste collection programs provide information to residents about materials that are considered hazardous and provide opportunities for proper disposal. State or local governments can establish a network of regional, local, or mobile household hazardous waste collection facilities providing residents with multiple options for disposing of the waste (MPCA 2002). Municipalities may organize simple or elaborate drop off events that incorporate other environmental education programs.

The control of fertilizer and pesticide levels involves convincing residents, institutions, and municipal departments to adhere to handling and application techniques that limit pollutant runoff. Public education programs should emphasize that “more is not better,” and that the lowest effective dose listed on the label for any one application should always be used. Education programs can also include information on IPM and other alternative pest control measures. The caretakers of large parcels of urban land, including local park departments and other institutions, should be encouraged to demonstrate the responsible use of fertilizers and pesticides.

Commercial and Industrial Waste Management

The development and implementation of a pollution prevention plan can benefit almost any commercial or industrial facility. Pollution prevention plans can reduce operating costs and improve the facility’s public image, while reducing the quantity of pollutants generated. Technical assistance and incentives may also be used to encourage commercial and industrial facilities to participate.

Some states, regional agencies, and counties have developed programs to aid businesses in developing pollution prevention plans. These programs typically include a waste analysis to determine which portions of the commercial or industrial facility’s production could benefit from waste reduction measures and services to help implement the suggested measures.

Water conservation measures can be an important component of a pollution prevention plan helping to reduce the amount of water consumed by commercial and industrial operations. This in turn reduces the amount of water discharged to the sewer system. When establishing a water conservation plan, a facility should perform a water audit to survey its water use. The true cost of water usage can then be calculated by considering the water and sewer costs, on-site wastewater treatment costs, if any, and energy costs to heat or pump water. After water use is characterized, areas for improvement can be identified and prioritized. Changes in behavior, as well as the replacement or retrofit of equipment, can be used to implement more efficient water use practices.

Cost

Pollution prevention measures are site-specific, and it is therefore difficult to compare costs between programs. Tables 1 and 2 provide cost examples for pollution prevention practices. Table 2 specifically details commercial and industrial pollution prevention measures including potential cost savings.

Table 1. Example costs associated with pollution prevention programs.

Technology	Program	Typical Costs
Fats, Oil, Grease	Education Program	Raleigh, NC- Budgeted \$100,000 for program set-up and \$50,000 annually for implementation.
	Grease Trap/Interceptor	Wisconsin - Grease traps can cost \$750 per cubic foot or \$211,000 per structure. ²
Household Waste Management	Hazardous Household Waste Management	Jefferson County, KY - Operates a permanent collection facility for hazardous household materials. The annual operation budget is \$250,000 and they collect approximately 150,000 lbs. per year (\$3,333/ton or \$1.67/lb.). Greater Detroit Resource Recovery Authority - Collected 60 tons of waste in 1995 for \$223,000 (\$3,716/ton or \$1.86/lb.). ²
	Fertilizer and Pesticide Control	Lovinia, MI - Spent an average of \$80,918 annually for their hazardous household materials collection program from 1991- 1995. The average disposal cost was \$12.19/gallon. ² Prince William County, VA - Provides soil test kits to residents for \$10, which includes analysis for fertilizer needs. ²
	Waste Management	King County, WA - Operates the Industrial Materials Exchange, which helps businesses find markets for their surplus materials, wastes, and industrial by-products. The annual operating budget is \$250,000. Waste Reduction Partners of the Land-of-Sky Regional Council, Ashland, NC - Annual budget for 2001 was \$132,097. In 2001, the program diverted 10,609 tons of solid waste from landfills. ³

¹ EPA 1999, ²Ferguson, et al. 1997, ³ Land-of-Sky 2001

Table 2. Examples of commercial and industrial pollution prevention programs.

Company	State	Program	Activity	Capital Cost	Cost Savings/Yr.	Results
Air Products and Chemicals, Inc.	OH	Wastewater Discharge Reduction	Batch seal pot water is recovered and reused in continuous emulsion process	\$1,000	\$2,000	Reduced waste flow to sewer system by 56% annually.
Cooper Hand Tools	NC	Reuse Hazardous Waste Reduction	Concentrate chromic acid rinse water for reuse and recover nickel from nickel electroplating bath sludge	N/A	\$68,000	Reduced purchase of new chromic acid by 10,000 lbs. annually. Eliminated generation of 12 tons of hazardous waste annually.
Frigo Cheese Corporation	WI	Reuse	Salt whey recovery and reuse by evaporation	\$2,000	N/A	Not Available
Lockheed Martin	GA	Hazardous Waste Reduction	Minimized paint waste through improved planning	\$4,000	\$120,649	Reduced hazardous waste stream by 2,020 gallons annually.
Quality Metal Products/Sheet Metal Shop	CO	Hazardous Waste Reduction	Installed solvent recovery unit	\$14,700	\$13,000	Prevented formation of 375 gallons of hazardous liquid waste annually.
Small Engine Manufacturer	WI	Hazardous Waste Reduction	Replaced chlorinated solvents with aqueous cleaners for parts cleaning.	\$10,000	N/A	Not Available
Unilever Home and Personal Care, Inc.	GA	Water Conservation Plan	Reuse of cooling water and collected rainwater used in the manufacturing process.	N/A	\$20,000	Reduced wastewater effluent by 77%. No longer a Significant Industrial User in relation to pretreatment program.

Implementation Examples

RALEIGH, NC

Responsible Agency: City of Raleigh Department of Public Works

Population Served: ~315,000

Service Area: Not Available

Sewer System: 1,525 mi. of sewer

City of Raleigh's annual Water Fest; and developed informational brochures. The website contains information about grease and its affect on the sewer system including a "Do and Don't" list. The first newspaper advertisement run by the city is shown.

The city's efforts continue to educate the public on the proper disposal of grease. Currently, a video is being developed for civic groups and students. Public service announcements on grease management will air on community and network television stations. Press releases reminding citizens about the problems grease can cause in the sewer system will also continue. Also, water bills will contain informational inserts.

During 2001, the city experienced 51 SSO events, a 22 percent reduction from the previous year. The city attributes this reduction to the FOG education program and an aggressive sewer maintenance program. The "Can Can" Program operates on an annual budget of \$50,000; the start-up cost of the program was \$100,000.

Public Education "Can Can" Campaign

In 1999, the City of Raleigh passed an ordinance that made it unlawful to dispose of grease by pouring it into the sewer system. To educate the public about this ordinance and their responsibilities, the city launched the "Can Can" Campaign in 2000. The city developed a website; produced television and newspaper advertisements and radio spots; sponsored a poster contest during the



More information at <http://www.raleigh-nc.org/pubaffairs/cancan/index.htm>

DENTON COUNTY, TX

Responsible Agency: Upper Trinity Regional Water District

Population Served: ~158,000

Service Area: Not Available

Sewer System: Not Available

the district's customers with ways to dispose of their hazardous wastes in an environmental-friendly manner. The collected waste is then transported in a specially modified cargo trailer to a regional disposal facility. The trailer was purchased in 1998 using a grant from the Texas Commission on Environmental Quality. During collection events, residents can drop off batteries, used car oil, solvents, antifreeze, herbicides, pesticides, aerosols, mercury, and paint. Paint is the most disposed item. The district charges each city \$80 per participating household for disposal fees and administration costs. The first collection event was held in June 1999. In 1999, a total of 375 households handed in 51,468 pounds of material. The total cost for the participating cities was approximately \$26,250.

Household Hazardous Waste Collection

The Upper Trinity Regional Water District in the Dallas/Fort Worth area provides drinking water, wastewater, hazardous waste management, biosolids management, and non-potable water supply services. Approximately 13 cities have contracts with the district for the specific services they need. In 1998, a household hazardous waste collection program was established to provide

More information at <http://www.utrwd.com/HHW.HTM>

ORANGE COUNTY, CA

FOG Control Study

Responsible Agency: Orange County Sanitation District

Population Served: 2.4 million

Service Area: 470 sq. mi., 23 cities

Sewer System: 650 mi. of sanitary sewer

A two-phase FOG control study is currently being conducted by the Orange County Sanitation District. The first phase, completed in March 2003, consists of a set of 13 building blocks that can be used interchangeably to create FOG programs specific to local conditions. The building blocks are grouped into four categories: programmatic, best management practices, best available technologies, and regional and watershed. A summary of the

draft report that details the building blocks of a FOG control program is presented. The second phase is on-going and involves field studies and pilot tests of FOG control technologies.

Cost comparisons of the various technologies that will be pilot tested as part of the FOG control study are not currently available. The first phase of the study cost \$268,000. It is expected that another \$1 million will be spent on pilot tests and system characterization.

Contact: Adriana Renescu

Building blocks of Orange County Sanitation District's FOG control study.

Programmatic Building Blocks	Description
FOG Characterization	Characterization of local FOG conditions including the extent and nature of SSO problems; identification of current or potential "hot spots".
Ordinance	Provides the legal framework for implementing a FOG program; establishes monitoring requirements, enforcement conditions, and fees.
Monitoring and Enforcement	Ensures that FOG control requirements are being followed. <i>Enforcement:</i> penalize entities that fail to correctly implement FOG controls.
Fees and Incentives	Fees, often in the form of increased sewer fees, pay for the FOG program. Reduced fees may be used as an incentive if commercial and institutional establishments can prove they are successfully implementing controls.
Education and Outreach	Many different stakeholders contribute to the success of FOG programs, it is important to identify and target key partners. Also, it is necessary to take into consideration language barriers (multilingual programs are required).

Best Management Practices

Kitchen BMPs	Practices to reduce and eliminate residential FOG before it enters the sewer system.
Collection System Cleaning	Collection system cleaning and TV-monitoring should focus on areas in the sewer system where FOG is most problematic.

Best Available Technologies

Grease Interceptors	Grease interceptors located outside of buildings that have a minimum volume of 750 gallons.
Passive Grease Traps	Small collection devices with volumes less than 50 gallons, which are installed under sinks and must be cleaned manually.
Automatic Grease Traps	Automatic grease traps are self-cleaning.
Biological Additives and Services	Biological additives digest FOG and prevent it from blocking sewer lines or overloading traps.
Chemical Additives	Chemical additives break down FOG and have been found to be useful in solving lift station grease problems.

Regional and Watershed

Grease Disposal Practices and Alternatives	Once FOG controls have been put in place, there must be grease disposal mechanisms available to customers. Such disposal methods include converting grease into biofuels and feeding the waste into POTW digesters. Also, it is important to regulate haulers and disposal sites to avoid illicit dumping.
--	--

PRINCE WILLIAM COUNTY, VA

Horticulture and Water Quality Program

Responsible Agency: Prince William County Cooperative Extension

Since the early 1990s, the Prince William County Cooperative Extension has administered a water quality program that educates residents about the effects of over fertilizing their lawns and using too many pesticides. Residents are recruited using direct mailings and programs with civic and homeowner associations. Once a resident registers with the program, they complete a pre-program survey and attend educational seminars such as "Fall Fertilization" and "IPM Basics". Upon completing the program, a master gardener volunteer visits with the residents to ensure that they are implementing the IPM and fertilization practices correctly. Finally, the resident completes a post-program survey. To date, over 2,000 households have completed Prince William's turf care and management program. To determine the effectiveness of the program, Prince William compared 1996 survey results from 600 participating households pre- and post-program. Results of the survey is summarized below.

Turf care and management program participant responses.

Participant Activities	Pre-Program	Post-Program
Tested soil to determine fertilizer rates	17%	78%
Linked excessive nutrients to water quality problems	60%	86%
Considered IPM to be important	42%	62%
Followed a fall fertilization schedule	50%	82%

The survey results showed reductions in fertilizer and pesticide application. The average amount of nitrogen applied to lawns was reduced by 40 percent, pesticide and water use were reduced by 25 percent, and the volume of yard trimmings sent to the landfill was reduced by 25 percent. The program is facilitated by a part-time water quality technician and master gardener volunteers. Prince William County's operating cost for the program ranges between \$5,000-\$10,000 annually. Except for the \$10 soil test, the program is free for residents.

More information at <http://www.co.prince-william.va.us/vce/enr/enr.htm>

WINSTON-SALEM, NC

Ultrafiltration for Pollution Prevention

Responsible Agency: Sara Lee Knit Products Corporation

Sara Lee Knit Products Corporation produces an array of finished textiles, many of which include cotton material dyed with reactive dyestuff. Cotton dyeing produces large waste streams, composed

mostly of color and salt. The dyestuff has a low affinity to the cotton fabric, even with the help of the salts used to bind the color to the fabrics. Almost all of the salt and approximately half of the dye ends up in discharges to the sewer system.

To reduce the amount of chemicals purchased and wastewater generated, Sara Lee Knit Products investigated a pilot-scale ultrafiltration and nanofiltration system. The filtration system separates the salts from other impurities for reuse and generates a concentrated color waste stream that can be more efficiently treated. The pilot study revealed that the system removes most pollutants of concern while allowing sodium chloride to remain in the permeate. Also, the polymer treatment scheme applied to the filtrate was successful and economical.

Projections from the pilot study suggest that the facility, which generates 240,000 gallons per day of wastewater, would reduce its water use by 120,000 gallons per day and salt discharges by 26,000 pounds per day. The filtration system will remove an estimated 60 percent of the dyestuff and 50 percent of the salt typically discharged. The total capital cost for the filtration and treatment system would be \$990,000 with annual operating costs of \$180,000. Savings on salt purchases were estimated at \$335,000 annually. An additional annual savings of \$460,000 could be achieved using the color removal process.

Contact: Donald Brown, Sara Lee Knit Products Corporation

References

EPA Office of Prevention, Pesticides, and Toxic Substances. 2002. "Definitions National Prevention Pollution Policy." Retrieved November 22, 2002.
<http://www.epa.gov/p2/p2policy/definitions.htm>.

EPA Office of Water. 1999. *Combined Sewer Overflow Management Fact Sheet: Pollution Prevention*. EPA 832-F-99-038.

Ferguson, T. *et al.* 1997. "Rouge River National Wet Weather Demonstration Project: Cost Estimating Guidelines Best Management Practices and Engineering Controls." Retrieved December 9, 2002.
<http://www.rougeriver.com/pdfs/stormwater/sr10.pdf>.

Land-of-Sky Regional Council. 2001. "Waste Reduction Partners Annual Report 2001." December 10, 2002. (Retrieved July 10, 2003.)
http://www.landofsky.org/publications/annual_report2001/default.htm.

Minnesota Pollution Control Agency (MPCA). 2002. "Household Hazardous Waste." Retrieved November 25, 2002.
<http://www.pca.state.mn.us/waste/hhw.html#map>.

North Carolina Division of Pollution Prevention and Environmental Assistance (NCDPPEA). 2002. "Considerations for the Management of Discharge of Fats, Oil, and Grease (FOG) to the Sanitary Sewer Systems." Retrieved November 22, 2002.
<http://www.p2pays.org/ref/20/19024.pdf>.

Northern Virginia Planning District Commission (NVPDC). 1996. *Nonstructural Urban BMP Handbook*. Prepared for the Department of Conservation and Recreation/Division of Soil and Water Conservation. Annandale, VA: NVPDC Coastal and Chesapeake Bay Program.

Inclusion of this technology description in this Report to Congress does not imply endorsement of this technology by EPA and does not suggest that this technology is appropriate in all situations. Use of this technology does not guarantee regulatory compliance. The technology description is solely informational in intent.



TECHNOLOGY DESCRIPTION

OPERATION & MAINTENANCE

Monitoring, Reporting, and Public Notification

Overview

Operation and maintenance practices are intended to enhance sewer system performance and minimize or reduce the occurrence of CSOs and SSOs and the potential impacts they have on receiving waters. Monitoring, public notification, and reporting of CSOs and SSOs and their impacts do not directly accomplish these objectives, but they are essential to:

- Understand sewer system performance and impacts of CSOs and SSOs on receiving waters;
- Provide the potentially impacted public with information about overflow locations, specific events, and performance trends;
- Improve oversight by the National Pollutant Discharge Elimination System (NPDES) authority; and
- Improve operations and maintenance (O&M) program efficiency.

Monitoring Techniques

Monitoring of both the sewer system and receiving waters provides valuable information for the operation and maintenance of sewer systems and the control of CSOs and SSOs. Monitoring provides knowledge of:

- The hydraulic characteristics of a sewer system and how it responds to a range of rainfall events; and
- The degree of impact caused by CSOs and SSOs on receiving waters.

Results from monitoring programs can also be used to track improvements associated with control efforts. The basic components of a monitoring program include:

- Rainfall;
- Sewer system flows and overflow frequency, duration and magnitude; and
- Water quality in both CSOs and SSOs and receiving waters.

Techniques for monitoring each of these components are briefly described below. Additional guidance on monitoring can be found in *Combined Sewer CSOs and SSOs: Guidance for Monitoring and Modeling* (EPA 1999).

Rainfall

Precipitation is the primary cause of CSOs and a major contributor to SSOs. Consequently, rainfall measurements are an integral part of a monitoring program.

Monitoring rainfall is fairly simple and provides valuable information in assessing the response of a sewer system to various rainfall events. Advanced techniques that merge radar data with rain gage data are available and can provide better rainfall estimates than either radar or a rain gage can provide alone.

Sewer System Flow

Flow measurements in the sewer system provide essential information related to the magnitude, duration, and frequency of CSOs and SSOs. This information can be used to design structural controls and to better operate and maintain the system, all in an effort to reduce CSOs and SSOs. Flow measurements following construction of controls and improved O&M practices can be used to assess the performances of controls and track improvements. Techniques for measuring flow in sewer systems vary greatly in complexity, expense, and accuracy.

Manual methods are the simplest technique for measuring flow and are most useful for instantaneous flow measurement or for determining whether or not an overflow occurred during or between measurements. Manual methods can be labor intensive and do not provide continuous flow records.

Primary flow devices control flow in a portion of a pipe such that the flow rate can be calculated from flow depth. Relationships between depth and flow are

accurate as long as surcharging or backflow does not occur. Manual or automatic measurements of the depth can be made. Depth-sensing devices can be used to measure water depth behind a primary flow device to determine flow rates.

Velocity meters use ultrasonic or electromagnetic technology to sense the velocity of flow in the sewer system. The velocity measurement is combined with a depth measurement from a depth-sensing device to calculate flow rates. Velocity meters can be used without the need for a primary flow device and in situations where surcharging or backflow occurs.

Pressurized flow rates can be estimated from the length of time pumps are on and the specifications for the pumps. Alternatively, full pipe flow can be measured using orifices, venturi flow meters, flow nozzles, turbines, and ultrasonic, electromagnetic, and vortex shedding meters.

Water Quality

Monitoring water quality in both the sewer system and receiving waters provides essential information for:

- Characterizing CSOs and SSOs
- Assessing the attainment of water quality standards
- Defining baseline conditions
- Assessing the relative impacts of CSOs and SSOs on receiving water quality

Water quality monitoring programs can also be used to track improvements associated with control efforts.

Data characterizing the water quality in the sewer system and receiving waters during both dry and wet weather conditions is needed. The water quality data can be analyzed to identify pollutants of concern, their concentrations, and likely sources of such pollutants. Pollutant concentrations along with sewer system flows can be used to calculate pollutant loadings to the receiving waters.

In addition to pollutant characteristics, monitoring in the receiving waters may include:

- Biological assessment (including habitat assessment)
- Sediment monitoring (including metals and other toxics)
- Flow conditions

In many cases, the primary parameter of concern with respect to CSOs and SSOs will be pathogens,

represented by an indicator bacteria such as fecal coliform or *E. coli*. Observations of floatables, objectionable deposits, or algal growths may also provide relative measures of CSO and SSO impacts. Two distinct types of water quality samples can be collected:

- Grab samples: a discrete, individual sample representing the conditions at one location at the time the sample is taken.
- Composite samples: a combination of samples collected over a period of time from one location or combination of samples from more than one specific location.

Grab and composite samples can be collected using either manual or automatic sampling methods. Manual samples are collected by a trained individual using a hand-held container. Automated samplers can be programmed to collect multiple discrete samples as well as single or multiple composited samples. Many automated samplers can be connected to flow meters that will activate flow-weighted compositing programs, and some samplers are activated by inputs from rain gages.

A Quality Assurance Project Plan (QAPP) is an essential component of any monitoring program to ensure precise, accurate, and reliable data. EPA guidance for the development of a QAPP should be followed (EPA 2002c). The QAPP should address field sampling methods and protocols as well as laboratory analytical methods and quality assurance/quality control (QA/QC). Data management techniques and responsible personnel should also be addressed in a QAPP.

Public Notification

Public notification programs provide information to the potentially impacted community regarding the occurrence of CSO and SSO events and on-going efforts to control the discharges. The Nine Minimum Controls (NMC) outlined in EPA's CSO Control Policy specifically require implementation of a public notification program to ensure that the public receives adequate notification of CSO occurrence and CSO impacts. Public notification programs can assume a variety of forms, including posting temporary or permanent signs where CSOs and SSOs occur (Figure 1), coordinating with civic and environmental organizations, distributing fact sheets to the public and the media, and stenciling storm drains. Notices in newspapers are required to report occurrences of CSOs or SSOs in some states. Radio and TV announcements may be appropriate for CSOs or SSOs with unusually severe impacts. Distribution

of information on websites is another technique that is rapidly gaining wider use.

Posting Signs

Signs are one of the most common mechanisms used to communicate the potential hazard posed by CSO and SSO discharges. Signs can be posted in the area where the use is affected (e.g., along a beach front) or at select public places (e.g., a public information center at a park where recurrent SSOs have occurred). EPA specifically recommends posting at visible CSO outfalls and in locations where affected shoreline areas are accessible to the public. In addition to notifying the public of the potential risk of exposure to CSO or SSO discharges, signs may provide contact information for citizens interested in obtaining additional information or to submit concerns. Call centers may be established to receive sign-prompted calls.



Figure 1. CSO warning sign (King County, WA)

Coordinating with Civic Organizations

There are a number of ways that a municipality can involve public interest or civic and environmental groups in various aspects of programs to control CSOs and SSOs. One way is to involve the public in the process of evaluating technologies for controlling CSOs and SSOs. Involvement in assessing willingness to pay, determining the implementation schedule, and selecting or modifying the method of financing for the controls are other ways to involve these groups. Public meetings or hearings allow public interest or civic groups to officially comment or pose questions to the municipality regarding a control program.

For example, the State of Wisconsin organized a workgroup including representatives from state and local health departments and citizen groups with an interest in beach health. This group worked to gather data on beach use and potential sources of contamination. They also interviewed beachgoers and collected suggestions for improvement of beach health. As a result of this program, Wisconsin's 180 coastal beaches were categorized into high, medium, and low priority based on popularity and risk of contamination by sources including CSOs and SSOs. Higher priority beaches are tested more frequently, including 25 high-priority beaches that are tested five times per week. Every day, the high-priority beaches post one of three signs to advise beachgoers of water quality for that day – good, poor, or closed. In addition, bathers can also check a website to view daily water quality reports for all high-priority beaches along the Great Lakes.

Distributing Fact Sheets

Another method of outreach to the public is through the dissemination of fact sheets on CSOs and SSOs. Municipalities often use these fact sheets to describe what CSOs or SSOs are, address specific local issues, and discuss impacts to local water bodies. Local issues addressed in the fact sheets can include disconnecting downspouts from the sewer system, local monitoring programs, and system improvements that are planned or are being implemented to address CSOs and SSOs. Fact sheets can also be developed to target specific commercial or industrial sewer customers encouraging best management practices, explaining regulatory requirements, or highlighting important pollution prevention measures.

EPA's Office of Wastewater Management has also developed a series of outreach materials and fact sheets to help municipalities educate citizens on important wastewater issues. These materials are available online at: <http://cfpub.epa.gov/npdes/wastewatermonth.cfm>. The materials include space to insert local contact information for citizens to find more information. Local governments can inexpensively produce custom versions of the materials with their own addresses and phone numbers.

Stenciling Storm Drains

Storm drain stenciling is frequently used in separate storm sewer systems to educate the public that wastes disposed of in storm drains flow directly to receiving waters without treatment. Similarly, municipalities with CSSs can use storm drain stenciling as part of a public

education program (Figure 2). Stenciling the name of the water body to which the street inlet drains provides a concrete link to the public to the consequences of dumping or littering. Storm drain stenciling programs can also generate useful information for the municipality. Since cities often have more storm drain inlets than can be efficiently inspected by city staff, program volunteers may be asked to note drains that



Figure 2. Community education on the importance of storm drain stenciling (King County, WA)

are clogged with debris or show signs of dumping. The municipality can then target these drains for maintenance.

Reporting

An essential element of a proper O&M program is documentation of accurate and reliable records related to CSOs and SSOs. Reporting requirements related to CSO and SSO events are typically included in the NPDES permit issued to a wastewater utility. Current reporting requirements for CSOs and SSOs are not always consistent from state-to-state; however, reporting typically involves notifying the appropriate regulatory agencies in a timely manner after a CSO or SSO event. Several states require that the duration and frequency of every CSO event be reported in a discharge monitoring report and submitted on a monthly basis. Twenty-four hour oral reporting of SSO events is generally required, and must be followed by a written report within five days of the SSO event. States may also require an annual report estimating the volume of CSO or SSO discharged over the past year, identifying known or potential water quality impacts, and, in the case of SSOs, the cause of the spill. Several states compile information

on reported SSO events in databases or spreadsheets; at least two states, Michigan and Maryland, publish lists of reported CSO and SSO events on their websites.

The CSO Control Policy states that the municipality should submit to the NPDES permitting authority documentation on the implementation of the NMC. Documentation should include information that demonstrates:

- The alternatives considered for each minimum control
- The actions selected and the reasons for their selection
- The selected actions already implemented
- A schedule showing additional steps to be taken
- The effectiveness of the minimum controls in reducing/eliminating water quality impacts.

The *Guidance for Nine Minimum Controls* (EPA 1995) presents examples of the information that should be documented for the NMCs.

Key Considerations

Responsibility for monitoring, public notification, and reporting efforts is often shared by a number of agencies within a single jurisdiction. These can include:

- Wastewater utility operators
- City, county, or state health department
- City, county, or state environmental agencies
- Drinking water providers
- Public works departments

This potential overlap can lead to a duplication of efforts (e.g., multiple agencies monitoring water quality conditions in a single location). Good communication between these agencies can help ensure cost-effective data collection and a coordinated response to those CSO and SSO events with potential to impact the environment or human health. Other key considerations related specifically to monitoring, public notification, and reporting are discussed below.

Monitoring

Developing the extent of the monitoring program and selecting the most appropriate monitoring techniques will depend on site characteristics, budget constraints, and availability of trained personnel. The development of the monitoring program should be closely coordinated with the NPDES permitting authority to make sure that monitoring results will be acceptable and satisfy the regulatory requirements. Some specific considerations for monitoring rainfall, sewer system flow, and water quality are discussed below.

Rainfall

Rainfall conditions may vary significantly over a sewer system. Sufficient rain gages should be located to provide data representative of the entire study area. Rain gages should be located in open spaces away from trees or buildings that may shield the gage from rainfall. Installing the gages at ground level is preferred, rooftops are also an option. Police and fire stations and other public buildings are desirable locations as vandalism is prevented.

Sewer System Flow

Monitoring flows in sewer systems can be difficult because of surcharging, backflow, tidal flows, and the intermittent nature of CSOs and SSOs. Although some metering installations are designed to operate automatically, they are prone to clogging in sewer systems and should be checked as often as possible.

Monitoring locations should be selected to identify which structures in the sewer system limit hydraulic capacity and should target portions of the system that are most likely to have CSOs and SSOs or receive significant pollutant loadings. A representative range of land uses and basin sizes should be monitored. As many overflow outfall locations as possible should be monitored with an emphasis on discharges to sensitive areas. Flow measurement devices can be rotated between locations to obtain more comprehensive coverage of the sewer system.

For CSOs and SSOs dependent on rainfall, a sufficient number of storms should be monitored to accurately predict the sewer system's response to a range of rainfall conditions.

Water Quality

Flow-weighted composite samples should be collected from the sewer system or outfalls to determine the average pollutant concentration from an overflow event (also known as the event mean concentration or EMC). Discrete samples from the same location over the course of an overflow can help determine whether a pattern of pollutant concentration exists, such as a first-flush phenomenon. A range of rainfall events and receiving water conditions should be monitored.

In developing a water quality monitoring plan, the location and impacts of all sources of pollutant loadings should be considered, and monitoring locations should be selected to isolate the impacts from CSOs and SSOs as best as possible. Monitoring to characterize the pollutant loadings from sources other than CSOs and SSOs may be needed. Sensitive areas

should be given priority for monitoring, such as waters with drinking water intakes or recreational uses. The implementation of water quality monitoring programs should be a high priority at beaches or recreational areas directly or indirectly affected by CSOs and SSOs due to the increased risk of human contact with pollutants and pathogens. Finally, the safety and accessibility of monitoring locations should be given consideration.

One of the key considerations related to conventional water quality monitoring is the lag time between collecting water samples and providing the public with results. This lag is due to the time it takes (from 24 to 72 hours) to test for the presence of bacterial indicators of CSO or SSO contamination. During this time, pathogen levels, weather, and water conditions may change, and related environmental or human health risks may also change. This means that decisions regarding beach and recreational water postings, closings, and reopenings using bacterial indicators often reflect conditions as they were one to three days earlier (EPA 2002). Further, contaminants may no longer be present once test results are available and safe beaches may be posted needlessly. Recent studies of southern California beach closures showed that 70 percent of the postings of water quality exceedences last less than one day, meaning that water quality is likely to have already returned to acceptable levels by the time laboratory results are available and warning signs are posted (Leecaster and Weisberg 2001).

To address this time lag problem, a number of municipalities are using time-relevant water quality monitoring and receiving water quality models. These techniques seek to shorten analysis times, use quicker predictive methods, and communicate water quality information to the public on a timely (e.g., near-daily) basis so the public can make more informed decisions regarding recreational water use (EPA 2002). Specific activities undertaken to support these objectives include monitoring more frequently or at additional locations, using analytical methods that provide results sooner, using a predictive model to supplement monitoring, and improving public notification programs.

Public Notification

The principal advantage of a public notification program is the potential to reduce exposure of the general public to health risks associated with exposure to CSOs and SSOs. Well-designed public notification programs also offer wastewater utilities an opportunity to educate customers and seek assistance from the public in identifying problems,

such as dry weather CSOs and SSOs. It can be challenging, however, to interest and involve the public in municipal efforts to control CSOs and SSOs.

Public notification programs may be developed cooperatively with other agencies and organizations including city, county, or state health departments; shoreline owner associations; boating and fishing associations; or local planning and zoning authorities. Cooperative efforts can be a valuable mechanism for leveraging resources, as well as enhancing the quality, credibility, and success of public notification programs (EPA 2002). Experience shows that it may also be valuable for the wastewater utility to establish a relationship with the local media to help promote efforts to control CSO and SSO events, as well as to distribute time-relevant recreational water quality information. More extensive experience working with the local news media can also help ensure minimal misinterpretation regarding the occurrence of CSO and SSO events.

The public is often not interested in the details behind the monitoring project, but rather if the water body is safe to use. Therefore, it is important that information is disseminated in a clear and concise format so that the public can consider the relative risk associated with exposure to the water body. Unless beachgoers are informed about current water quality conditions in a particular area, they will be unable to make informed choices about destinations or how to avoid exposure to pollutants, if necessary.

Reporting

The timely reporting of CSO and SSO events is a regulatory requirement; therefore, penalties are assessed for failing to report. It is important to maintain regular communication with the regulatory authority to ensure that submissions comply with permit requirements and meet the expectations of the permitting authority.

As municipalities, NPDES permitting authorities, and the public undertake efforts to control CSOs and SSOs, consideration should be given to developing and reporting on performance measures such as:

- End-of-pipe measures that show trends in the discharge of CSOs and SSOs, such as reduction in

pollutant loadings and the frequency, duration, and magnitude of CSOs and SSOs;

- Receiving water measures that show trends in relevant water quality parameters, such as bacteria and dissolved oxygen concentrations; and
- Measures of the use of the receiving waters including beach closures, shellfish bed closures, and fish populations.
- Administrative measures that track programmatic activities;

Reporting on performance measures will allow municipalities, states, and EPA to demonstrate the benefits and long-term success of CSO and SSO control efforts.

Cost

The cost of monitoring will vary greatly based on the size and complexity of the sewer system and receiving waters, the number of CSO and SSO events that occur, and the techniques used. The costs of monitoring can be significant, especially for a large sewer system, a large number of outfalls, or frequent occurrences of CSO or SSO events. A small scale monitoring program may necessitate more conservative assumptions or result in more uncertainty when reporting on overflow events and when selecting and designing CSO or SSO controls. It should be noted that large sums of money spent on monitoring should be avoided if the additional data will not significantly enhance understanding of how a sewer system responds to a range of rainfall events, and to what extent receiving waters are impacted by CSOs and SSOs.

Analysis of water samples for the presence of indicator bacteria typically costs about \$35 per sample (EPA 2003). Bacteria data tend to be highly variable; therefore, samples may need to be collected in duplicate or triplicate from a single location. Additionally, if a CSO or SSO event occurs over an extended period of time, multiple samples may need to be collected over time.

EPA believes that, in general, costs for public notification programs should be nominal (EPA 1995), but will vary with the size of the potentially-impacted population. Costs for reporting should be nominal as well, if a well-designed O&M plan is carried out.

Implementation Examples

NARRAGANSETT BAY, RI

Responsible Agency: Rhode Island Department of Health
Population Served: 360,000

CSOs have historically caused use restrictions in large areas of the upper Narragansett Bay. There are several beach areas in the upper bay that are used by the public for swimming, diving, and water skiing. The

occurrence of recreational use in areas with use restrictions is a public health concern.

To address this public health issue, the Rhode Island Department of Health's (RIDOH's) Beaches Monitoring Project samples 23 sites in the upper bay. RIDOH conducts weekly beach monitoring from mid-May through mid-September to coincide with the summer beach season. Beaches are closed based on exceedances of bacterial water quality standards. RIDOH also closes beaches preemptively, without waiting for sampling results, if a CSO or SSO occurs near a beach. If a beach is closed because of high bacteria levels, it is resampled daily until bacteria levels fall below the water quality criteria. The beach is reopened if five consecutive samples are collected at least 24 hours apart that are at or below the bacterial water quality standard. Upon reopening, at least three samples are collected each week for three months. The public is notified of beach closures using the following procedures:

- Appropriate municipal and state officials are notified
- An advisory or closure notice is posted at the beach, as needed
- A press release is issued and the project website and hotline are updated with current conditions

Many of these sites sampled were found to display consistently poor water quality, exceeding the state bacteria standard more than 50 percent of the time.

More information at: <http://www.health.state.ri.us/environment/beaches/index.html>

KING COUNTY, WA

Responsible Agency: King County Wastewater Treatment Division
Population Served: 1.3 million
Service Area: 420 sq. mi.
Sewer System: 275 mi. of sewer

The King County Wastewater Treatment Division works jointly with the Seattle Public Utilities and the Seattle-King County Health Department in posting warning signs at CSO locations and undertaking public outreach. The Health Department maintains a CSO information line and website to answer any health concerns about CSOs or questions such as, "How long does water stay contaminated after a discharge?" In early 1999, King County and the City of Seattle posted signs near CSO outfalls. The signs warn people

not to swim or fish at these outfalls during or following rainstorms. The signs also include the phone number of the CSO Information Line operated by the Seattle-King County Health Department. The Health Department recommends that people not go in the water near these signs for 48 hours after a heavy rain.

Contact: Bob Swarmer, King County Wastewater Treatment Division

PITTSBURGH/ ALLEGHENY COUNTY, PA

Responsible Agency: Allegheny County Health Department

Population Served: 850,000

Service Area: 311 sq. mi.

Sewer System: 85 mi. of interceptor sewer

The Allegheny County Health Department (ACHD) implemented a public notification program designed to warn the public of possible river contamination as a result of CSO events, and advise limited contact while engaging in recreational activities on the river during periods immediately following wet weather events. The frequency and duration of the alerts varies depending on the amount of

rainfall. ACHD publishes river water advisories in local newspapers and produces public service announcements on local television stations to educate the public of the dangers attributable to the CSO discharges. When an alert is in effect, marinas, docks, and other sites along the rivers fly an orange-colored flag with black CSO lettering. Thirty-four sites participated in the program during the 2003 recreation season - seventeen on the Allegheny River, eight each on the Monongahela and Ohio Rivers, and one on the Youghiogheny River. The flags are lowered when "safe" levels have returned. The public can also call the river water advisory hotline or visit the ACHD website to obtain updates 24 hours a day.

Thirteen alerts were issued during the wet summer of 2002, lasting 83 days altogether or an average of six days each. By contrast, during the dry summer of 1999, 11 alerts were issued and lasted a total of 33 days or an average of three days each.

More information at <http://www.achd.net/>

BOSTON, MA

Responsible Agency: Charles River Watershed Association, Metropolitan District Commission, and Massachusetts Water Resources Authority

One of the monitoring objectives of the Charles River Basin/Boston Harbor Beaches Project was to develop a predictive model that would supplement the water quality monitoring program and provide quick, conservative estimates of bacteria levels at four Boston Harbor beaches. The four beaches are sampled seven times per week; rain gages have been installed close to the beaches.

Analysis of data collected at the beaches showed that the previous day's rainfall was a better predictor of water quality than the previous 24-hour bacteria measurement. Therefore, a simple rainfall model was developed for each of the beaches, and combined results from the rainfall model and bacteria monitoring are used to determine when to post the beaches. Beaches are reopened only when monitoring results indicate attainment of the bacterial water quality standard. The project uses several different types of public notification techniques to communicate the results of the monitoring program. These include:

- Availability of daily water quality conditions on the Metropolitan District Commission website
- A telephone hotline that provides updated water quality conditions for Boston Harbor beaches on a daily basis throughout the beach season
- Posters, water bottles, and brochures that explain and highlight the beach monitoring program
- Notification and other communications with the Massachusetts Department of Public Health and local boards of health

More information at <http://www.crwa.org>

References

- Allegheny County Health Department. "Topic: Water Pollution - Surface and Underground Sources of Water." Retrieved June 3, 2003. <http://trfn.clpgh.org/achd/sewage.html>.
- Bartram, J., and G. Rees, eds. 2000. *Monitoring Bathing Waters: A Practical Guide to the Design and Implementation of Assessments and Monitoring Programmes*. London and New York: E&FN SPON.
- Boehm, A.B., et. al. 2002. Decadal and shorter period variability and surf zone water quality at Huntington Beach, California. *Environmental Science and Technology*. 36:3885-3892.
- Citizens Environmental Research Institute (CERI). 1999. *Assessment Strategy for Evaluating the Environmental and Health Impacts of Sanitary Sewer CSOs and SSOs from Separate Sanitary Sewers*. EPA Cooperative Agreement CX-824848-01-1.
- EPA Office of Water. 1995. *Combined Sewer CSOs and SSOs: Guidance for Nine Minimum Controls*. EPA 832-B-95-003.
- EPA Office of Wastewater Management. 1999. *Combined Sewer CSOs and SSOs: Guidance for Monitoring and Modeling*. EPA 832-B-99-002.
- EPA Office of Water. 2001. *Report to Congress: Implementation and Enforcement of the Combined Sewer Overflow Control Policy*. EPA 833-R-01-003.
- EPA Office of Water. 2001a. *Source Water Protection Practices Bulletin: Managing Sanitary Sewer CSOs and SSOs and Combined Sewer CSOs and SSOs to Prevent Contamination of Drinking Water*. EPA 916-F-01-032.
- EPA Office of Research and Development and Office of Water. 2001. *National Coastal Condition Report*. EPA 620-R-01-005.
- EPA Office of Research and Development. 2002a. *Time-Relevant Beach and Recreational Water Quality Monitoring and Reporting*. EPA 625-R-02-0017.
- EPA Office of Water. 2002b. *National Beach Guidance and Required Performance Criteria for Grants*. EPA-823-B-02-004.
- EPA Office of Environmental Information. 2002c. *Guidance for Quality Assurance Project Plans (EPA QA/G-5)*. EPA 240-R-02-009.
- EPA Office of Water. 2003. Guidelines establishing test procedures for the analysis of pollutants; analytical methods for biological pollutants in ambient water: Final rule. *Federal Register* 68, no. 139, July 21, 2003.
- King County Department of Natural Resources and Parks Wastewater Treatment Division. "The CSO Control Program." Retrieved June 3, 2003. <http://www.dnr.metrokc.gov/wtd/cso/page02.htm>.
- King County Department of Natural Resources and Parks Wastewater Treatment Division. March 2002. "Regional Wastewater Services Plan - Water Quality Report." Retrieved October 1, 2003. <http://dnr.metrokc.gov/wtd/rwsp/documents/WQ2002.pdf>.
- King County Department of Natural Resources and Parks Wastewater Treatment Division. 2002. "2001/2002 Combined Sewer Overflow Report." Retrieved October 1, 2003. <http://dnr.metrokc.gov/WTD/cso/2001-02-intro.htm>.
- Leecaster, M.K., and S.B. Weisberg. 2001. Effect of sampling frequency on shoreline microbiology assessments. *Marine Pollution Bulletin* 42:1150-1154.
- Southern California Coastal Water Research Project (SCCWRP). 2003. "Research Plan 2003-2004." Retrieved July 7, 2003. <http://www.sccwrp.org/about/rspln2003-2004.html>.

Inclusion of this technology description in this Report to Congress does not imply endorsement of this technology by EPA and does not suggest that this technology is appropriate in all situations. Use of this technology does not guarantee regulatory compliance. The technology description is solely informational in intent.



TECHNOLOGY DESCRIPTION

Collection System Controls

Maximizing Flow to Treatment Plant

Overview

Maximizing the amount of wet weather flow transported to the wastewater treatment plant (WWTP) is a common technique for reducing the volume and frequency of CSO and SSO discharges. Maximizing the use of existing facilities to treat wet weather flows that would otherwise overflow without treatment is constructive in all circumstances. The various technologies available for maximizing the amount of flow conveyed to the WWTP include minimum measures that can be implemented without capital investment, and more capital intensive projects that require planning, design, and construction.

Maximizing flow to the WWTP is one of the nine minimum controls (NMC) established under EPA's 1994 CSO Control Policy. As an NMC, maximization of flow to the WWTP includes measures that do not require significant engineering studies or major construction. Simple modifications to existing facilities such as adjustment of regulators to divert more flow to the WWTP can be done rather inexpensively. The CSO Control Policy

also encourages municipalities to consider use of WWTP capacity for CSO control as part of developing a long-term control plan (LTCP). In doing so, municipalities may consider more capital intensive measures to maximize the wet weather flow delivered to the WWTP, including pump station enhancements and construction of relief sewers in areas with insufficient system capacity.

Many of the techniques for maximizing flow to the WWTP specifically referenced and expected for combined sewer systems (CSSs) have broad utility and can also be applied to sanitary sewer systems (SSSs). EPA recommends that the measures listed in Table 1 be considered as part of any effort to maximize flow to the WWTP (EPA 1995).

Effective implementation of controls to maximize flow to the WWTP requires a thorough understanding of the sewer system and how it functions during wet weather. This often includes a concurrent assessment of the sewer system and treatment plant operations to ensure that increased flows do not have adverse consequences, such as flooding within the system or at the WWTP, or upset of biological

Table 1. Considerations in maximizing flow to the WWTP.

Location	Measures
Sewer System	Determine the capacity of the major interceptor(s) and pumping station(s) that deliver flows to the treatment plant.
Treatment Plant	<p>Develop cost estimates for any planned physical modifications and any other additional operations and maintenance (O&M) costs at the treatment plant due to increased wet weather flow.</p> <p>Compare the current flows with the design capacity of the overall facility, as well as the capacity of individual unit processes. Identify the location of available excess capacity.</p> <p>Determine the ability of the facility to operate acceptably at incremental increases in wet weather flows and estimate the effect on the WWTP's compliance with the effluent limits in its permit. For example, increased flows may upset biological processes and decrease performance for an extended period after the wet weather flows have subsided.</p> <p>Determine whether inoperative or unused treatment facilities on the WWTP site can be used to store or treat wet weather flows.</p> <p>Analyze existing records to compare flows processed by the plant during wet weather events and dry periods and determine the relationships between performance and flow.</p>

treatment processes. This technology description is focused on the modifications and operational changes within the sewer system. Specific measures discussed include:

- Regulator adjustments
- Pump station operation and maintenance practices
- Sewer system operation and maintenance practices
- Conveyance capacity evaluations
- Real-time control and monitoring

Additional information on optimizing WWTP performance during periods of wet weather is presented in the “Plant Modifications Technology Description” in Appendix B of the 2003 *Report to Congress on the Impacts and Control of Combined Sewer Overflows and Sanitary Sewer Overflows*.

Regulator Adjustments

Simple modification to regulating devices in CSSs, such as weirs, can be useful in maximizing flow to the WWTP. Adding stop planks or raising brick/concrete weirs through the construction of either temporary or permanent structures, can increase the volume of wet weather flows stored in the CSS and eventually delivered to the WWTP for treatment. Such modifications should be made incrementally with careful observation of resultant changes in wet weather flow patterns in the CSS to prevent flooding.

Pump Station Operation and Maintenance Practices

Routine pump station O&M can also improve the conveyance of wet weather flows to the WWTP; this includes regular maintenance of pumps and accessories, as well as periodic cleaning of wet wells to remove grit, scum, and debris. Where emergency generators are provided, generators should be exercised weekly (NYSDEC 2003). Automatic transfer switches for transferring power from emergency generators or backup utility power feeds should be tested and exercised periodically. To be sure that all equipment is ready for service when wet weather arrives, regular maintenance of all equipment should be provided in accordance with the manufacturer’s recommendations. In addition to routine O&M, more detailed assessment of pump station performance can be made to ensure that the maximum flow is delivered to the WWTP. These include evaluating whether the pumps are currently able to achieve their rated pumping capacities and whether improved wet weather operating procedures would increase the flow volume delivered to the WWTP. Rehabilitation or replacement should be considered for pumps that are no longer able to achieve their rate pumping capacity. Wet weather operating

procedures can include adjustment to pump stations and their control systems to increase in-system storage during wet weather. For example, if the inlet sewer to the pumping station is not normally submerged and has available storage capacity, pump controls can be adjusted to allow the wet well level to rise above the feed pipe elevation, resulting in storage in the sewer system (NYSDEC 2003).

Sewer System Operation and Maintenance Practices

Operations and maintenance activities are necessary for sewer systems to function as designed and to deliver the maximum flow possible to the WWTP. Over time, sewer systems can deteriorate structurally or become clogged through the introduction of oil and grease and other obstructions into the sewers. Grit buildup reduces the hydraulic capacity of sewers and interceptors by reducing the cross-sectional area and increasing frictional resistance.

O&M practices include pollution prevention, sewer cleaning, monitoring, testing, inspection, and repair or rehabilitation. These activities enhance sewer system performance and are important for maintaining conveyance capacity. Some states include specific O&M requirements in NPDES permits for sewer systems in order to maximize the transport of wet weather flow to the WWTP for treatment. For additional information on proper O&M, see the series of O&M Technology Descriptions in Appendix B of the 2003 *Report to Congress on the Impacts and Control of Combined Sewer Overflows and Sanitary Sewer Overflows*.

Conveyance Capacity Evaluations

Quantifying sewer system transport capacity is valuable for communities seeking to maximize flow to their WWTPs. Evaluating transport capacity involves determining the maximum amount of flow that can be transported by the primary trunk sewers and interceptors without raising water elevations in these sewers to levels which increase the risk of basement or street flooding (Sherrill *et al.* 1997).

Models, varying from simple to complex, are commonly applied to rate a sewer system’s transport capacity. Historical information can be used to identify target water levels within the system that do not cause problems such as SSOs, basement backups, or street flooding. Transport capacity is determined through evaluation of modeled flows at flow rates less than or equal to the target water levels. Interceptor sewers and trunk lines are usually rated separately.

It is important to consider site-specific characteristics of the sewer system when evaluating conveyance capacity. Conveyance of flow through a sewer is dependent on the difference in water level from the upstream to the downstream end, pipe slope, sewer size (length, shape, and cross-sectional area), and roughness characteristics. Under ideal conditions, a single sewer pipe may be able to convey flow at its entire capacity. However, real-system boundary conditions such as river elevations, downstream sewer capacities, regulator capacities, and pump station wet well levels will affect the transport of flow (Sherrill *et al.* 1997).

The presence of bottlenecks in a sewer system is also an important consideration in conveyance capacity evaluations. Bottlenecks may occur at any point in the sewer system; they limit the amount of flow that can be transported to the WWTP for treatment during periods of high flow. Chronic bottlenecks typically occur as a result of insufficient interceptor capacity that causes flow to backup in connecting sewers. An example of a bottleneck resulting from insufficient interceptor capacity during a wet weather event is presented in Figure 1. As shown, the hydraulic response to the bottleneck is a decrease in flow velocity and an increase in water level. In acute situations, water levels increase until they rise above an overflow point (in this case the manhole rim) and an SSO occurs (ASCE 2000). Both velocity and water level return to normal once the high wet weather flow rates subside.

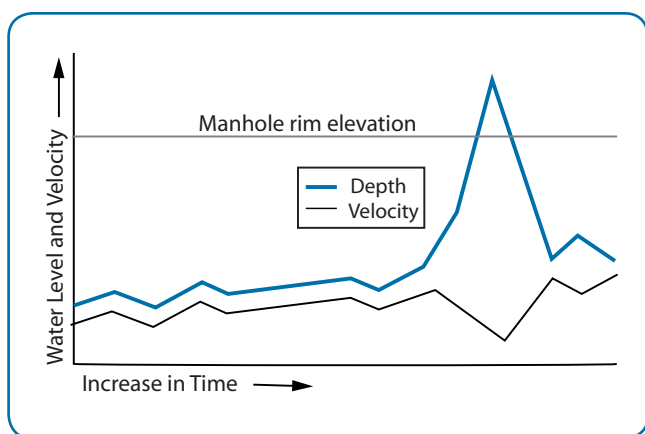

Figure 1. **Schematic showing water levels and velocity conditions at a manhole when a bottleneck occurs (ASCE 2000).**

Bottlenecks may also occur when the sewers delivering flow to the WWTP have less capacity than the individual unit processes at the plant. For example, if interceptors leading to the WWTP have a conveyance capacity of 50 MGD, yet unit processes (e.g., primary

treatment, secondary treatment, and disinfection) at the plant can treat 75 MGD, a hydraulic bottleneck exists in the sewer system. This bottleneck prevents the treatment capacity of the plant from being fully utilized. In order to maximize flow to the WWTP, bottlenecks need to be reduced or removed. Potential modifications include (Field *et al.* 1994):

- Increasing interceptor, pumping station, and/or trunk line transport capacity by replacing, rehabilitating, or adding parallel sewer components;
- Injecting polymers into the sewer system to reduce sewer roughness and increase carrying capacity in surcharged areas; and
- Improving operations and management procedures to remove obstructions.

Real-Time Control and Monitoring

Monitoring and the use of real-time control technologies can also assist in maximizing flows to the WWTP. An effective monitoring program that gathers information on rainfall, flow, and storage at major hydraulic control points enhances the overall understanding of system performance. In SSSs, enhanced monitoring information can be used operationally to identify blockages or rainfall induced SSOs. In CSSs, the linkage of real time flow, regulator, pump, and storage information can be used effectively to maximize use of the sewer system for storage and to maximize flow to the WWTP for treatment. Additional information on real-time control technologies is presented in the “Monitoring and Real-Time Control Technology Description” in Appendix B of the 2003 Report to Congress on the Impacts and Control of Combined Sewer Overflows and Sanitary Sewer Overflows.

Key Considerations

Applicability

Maximizing flow to the WWTP requires attention to both regulatory issues (e.g., NPDES permit requirements) and technical considerations (i.e., conveyance and treatment capacity). WWTPs are generally subject to EPA’s secondary treatment regulations. Secondary treatment requirements specify effluent concentration limits for biochemical oxygen demand (BOD) and total suspended solids (TSS), as well as a minimum removal percent (85 percent). These requirements are enforceable conditions in WWTP permits. The regulations provide some flexibility for WWTPs in communities receiving elevated flows (and more dilute influent) during wet weather by allowing for waivers of the

percent removal requirement. Waivers are not available, however, from effluent concentration limits (EPA 1995). Therefore, the optimal volume of wet weather flow transported to the plant may be constrained by provisions in existing discharge permits and the ability to modify provisions for increased flows during wet weather events.

Understanding the link between sewer system and WWTP operation can be the difference between effective treatment of wet weather flows and adverse environmental and financial consequences. Operational and structural modifications to maximize flow transport to the WWTP should only be made if the WWTP can accept the increased flows. Otherwise, consequences may include flooding the treatment plant and reducing treatment efficiency at the plant for extended periods of time. Likewise, changes in sewer system operation without a careful analysis of transport capacity could result in an increase in basement

backups or street flooding. For these reasons, both sewer system and WWTP capacity issues should be evaluated when implementing this control (see Table 1).

Cost

Maximization of flow to the WWTP can be a very cost-effective technique for controlling CSOs and SSOs. This control seeks to optimize use of existing sewer system and treatment plant capacity, which can lessen the need for construction of new facilities. The value of maximizing flow to the WWTP is dependent on the system-specific availability of underutilized conveyance and treatment capacity. Although some cost increases can be expected for WWTP operation, optimizing the use of existing facilities is likely to be more cost-effective than construction of structural controls at one or more upstream locations.

Implementation Examples

PHILADELPHIA, PA

Responsible Agency: Philadelphia Water Department

Population Served: 2.1 million

Service Area: Not Available

Sewer System: 1,600 mi. of combined sewer; 1,200 mi. of separate sanitary and storm sewer

Maximizing Conveyance Capacity

The first phase of the Philadelphia Water Department (PWD) CSO strategy focused on the implementation of the nine minimum controls (NMC), including increasing the transport of flow to the WWTP for treatment. To garner information for PWD's NMC program (and eventually the long term control plan), PWD instituted a \$6.5 million project to upgrade its comprehensive system flow monitoring network in its three drainage districts. This flow

monitoring program provided information to monitor system performance and enhance operation of the system through existing infrastructure (PWD 1997).

PWD also took steps to maximize flow to their wastewater treatment facilities in the second phase (capital improvement) of their CSO program. For example, analysis of the Northeast Drainage District Collector System, which conveys flow from almost half of the combined sewer area, showed that sewer operation modifications could significantly increase the volume of wet weather flow transported for treatment. Potential modifications included (1) reduction of hydraulic constraints in the system that limit the conveyance capacity of the sewers; and (2) modification of large sewers to provide additional wet weather flow storage and conveyance capacities.

PWD has implemented a range of projects to maximize conveyance to their treatment plants including adding a real-time control system, replacing pipes and raising dams at regulators, and cleaning and modifying the hydraulic control point regulators along the main level gravity sewers. A major goal of PWD's LTCP strategy also includes optimizing interceptor sewer system performance by maximizing the conveyance capacity of existing interceptors. Example projects are provided below.

- *Somerset Interceptor Conveyance Improvements:* Removal of grit, sediment, and debris from the interceptor enabled the full hydraulic capacity of the interceptor to be utilized, allowing for increased capture and representing an approximately 10 percent reduction in CSO volume. The project budget was \$300,000.
- *Cobbs Creek Low Level Control Projects:* Grit accumulation reduced the hydraulic capacity in an interceptor that conveys flow to the low-level pumping station. The grit was removed; flow was also rerouted with a 30-inch pipe, increasing the capacity from 11.8 MGD to 15 MGD. This project was completed at a cost of \$200,000.

More information at <http://www.phila.gov/water/>

DETROIT, MI

Responsible Agency: Detroit Water and Sewage Department

Population Served: 3 million

Service Area: 921 sq. mi.

Sewer System: 3,000 mi. of sewer

Assessing Transport Capacity

The WWTP for the City of Detroit receives wastewater via three interceptors. The city conducted an extensive study which rated its sewer system for both conveyance and storage of combined sewage. Rating the conveyance capacity involved determining the maximum amount of flow that can be transported by the primary trunk sewers and interceptors without raising water elevations in these sewers to levels that increase the risk of basement or street flooding. Historical information was used to

establish these water levels throughout the CSS. In addition, design data at specific locations were used, and detailed risk evaluations were conducted at specific locations in the system.

System rating included use of the Greater Detroit Regional Sewer System model to simulate flow throughout the sewer system for a range of storm events. Target water levels determined from the historic information were compared against the resulting water levels produced by the model. Flow rates, which predicted water levels equal to or less than target water levels, were used to establish the transport ratings. Trunk sewers and four interceptor sewers were rated separately (Sherrill *et al.* 1997).

More information at http://www.wadetrin.com/resources/pub_conf_collrate.pdf

BOSTON, MA

Responsible Agency: Massachusetts Water Resources Authority

Population Served: 2.5 million

Service Area: 228sq. mi.

Sewer System: Not Available

Elimination of Bottlenecks and System Optimization

Massachusetts Water Resources Authority's (MWRA) CSO plan was developed as part of an overall master plan that recommended interceptor system projects to eliminate bottlenecks that contribute to CSOs and to optimize existing facility operation during wet weather. Between 1988-2000, several transport-related projects were conducted to maximize wet weather flow conveyance to Deer Island Treatment Plant. This included rehabilitation of trunk sewers, improved pumping at Deer Island Treatment Plant, replacement of other pump stations within the collection system,

and construction of a new pumping station. This component of MWRA's CSO program provided reductions in CSO discharge from approximately 3.3 billion gallons (BG) annually in 1988 to approximately 1.0 BG in 2000 (MWRA 2000).

More recently, MWRA has begun work on the Braintree-Weymouth Relief Facilities Project. This project will expand and improve the Braintree-Weymouth System, which is MWRA's network of sewer pump stations, interceptors, and siphons that serves six Boston area communities. Wastewater generated by the six communities currently must pass through the Braintree-Weymouth pump station. The 54 MGD capacity at this pump station, however, is not sufficient to handle peak flows and presents a hydraulic bottleneck. The project will increase the Braintree-Weymouth System's peak flow capacity by approximately 19 MGD, streamlining the flow route from South Shore communities to the Nut Island Headworks and the Deer Island Treatment Plant. Specifically, the project includes constructing an intermediate pump station and a multi-use deep rock tunnel, replacing and rehabilitating the Braintree pump station, and adding new interceptors and siphons. The total project cost is estimated at \$150 million (MWRA 2001).

More information at <http://www.mwra.state.ma.us>

References

American Society of Civil Engineers (ASCE). 2000. *Protocols for Identifying Sanitary Sewer Overflows*. Prepared by Black & Veatch under EPA, Office of Wastewater Management Cooperative Agreement. EPA Cooperative Agreement #CX 826097-01-0. Reston, VA: ASCE.

EPA Office of Water. 1995. *Combined Sewer Overflows—Guidance for Nine Minimum Controls*. EPA 832-B-95-003.

Field, R., et al. 1994. *Optimization of CSO Storage and Treatment Systems*. Presented at “A Global Perspective for Reducing CSOs: Balancing Technologies, Costs, and Water Quality” Water Environment Federation (WEF) Specialty Conference, Louisville, Kentucky. July 10-13, 1994.

Massachusetts Water Resources Authority (MWRA). 2000. *MWRA Business Plan Strategy #17: Implement CSO Control Plan by FY09 - Draft*. v. 1.2. Retrieved September 1, 2003 <http://www.mwra.state.ma.us/org/busplan/17.pdf>

MWRA. 2001. *Facts about the Braintree-Weymouth Relief Facilities Project*. Boston, MA: Massachusetts Water Resources Authority. Retrieved September 4, 2003 <http://www.mwra.state.ma.us/03sewer/graphic/braintreeweyFS01.pdf>

NYSDEC. 2003. *Wet Weather Operating Practices for POTWs with Combined Sewers: “Technology Transfer Document.”* Retrieved September 1, 2003 http://www.dec.state.ny.us/website/dow/bwcp/ww_techtran.pdf

Philadelphia Water Department (PWD). 1997. *CSO Documentation Long Term Control Plan*. Submitted to: Pennsylvania Department of Environment Protection Bureau of Water Quality Management in partial fulfillment of NPDES Permit Nos. PA 0026689, 002662, 0026671 (January 27, 1997).

Sherrill, J.D., et al. 1997. *Rating and Optimization of Collection System Transport and Storage*. Presented at Water Environment Federation Technical and Exhibition Conference in Chicago, IL. October 18-22, 1997.

Inclusion of this technology description in this Report to Congress does not imply endorsement of this technology by EPA and does not suggest that this technology is appropriate in all situations. Use of this technology does not guarantee regulatory compliance. The technology description is solely informational in intent.

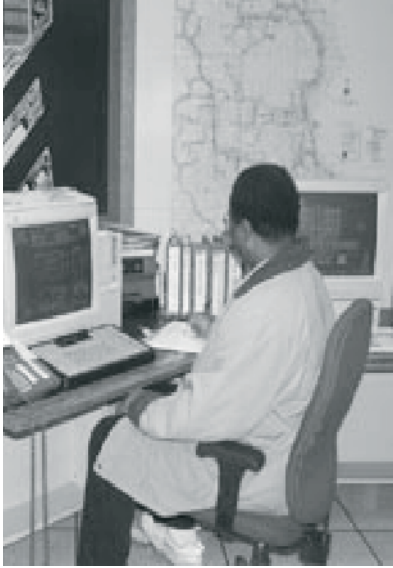

TECHNOLOGY DESCRIPTION

Collection System Controls

Monitoring & Real-Time Control

Overview

Effective monitoring programs enable evaluations of diurnal and day-to-day flow patterns as well as inflow and infiltration (I/I) in the system. Such programs also provide a basis to assess the need for, or effect of, maintenance efforts. Monitoring has the potential to provide insight into operational issues and problems, including the identification of CSO and SSO events, in a timely manner. Moreover, monitoring is valuable in establishing maintenance schedules, in developing hydraulic models for planning related to capital improvements, and for regulatory compliance.

In sanitary sewer systems (SSSs), enhanced monitoring information can be used operationally to identify blockages or capacity constrained areas of the system where wet weather SSOs may occur. The use of rainfall-derived infiltration and inflow (RDII) quantification methods can also serve as a predictive tool to control SSOs. In combined sewer systems (CSSs), the linkage of real-time flow, regulator, pump, and storage information can effectively maximize use of in-system and off-line storage facilities and maximize flow to the treatment plant. It should be noted that real-time control can also have substantial value in some SSSs (e.g., those sized for future growth or I/I). However, for practical as well as operational purposes, enhanced monitoring is discussed herein as an SSO control, and real-time control is discussed as a CSO control.

Enhanced Monitoring

Enhanced monitoring takes routine monitoring of system conditions a step further by using monitoring information to track patterns and guide operations and maintenance (O&M) decisions. Enhanced monitoring generally consists of a network of rain gages, flow meters, pump station, and storage measurement devices that are fully integrated into an information management system. The components of the information management system can include:

- Hardware to measure system conditions (i.e., rainfall, sewer flow, pumping rate, storage level, etc.);
- Software, a central processor, and work stations to house management programs and to track, analyze, and display system information;
- Reporting mechanisms for compliance purposes; and
- Established procedures to respond to problems as they are identified.

In practice, enhanced monitoring is typically applied systemwide as an SSO control. Abnormal wastewater flow patterns indicative of a blockage, pump station failure, or excessive I/I can be detected automatically. In sewer systems with enhanced monitoring programs (e.g., flow monitoring alarm systems), problematic conditions and blockages may be identified in advance so that prompt attention and repair may prevent SSOs from occurring. In cases where SSOs have already occurred due to blockage or power failure, early remote detection by an enhanced monitoring network can lead to a prompt response that minimizes the volume and duration of the overflow as well as any potential environmental and human health impacts. Enhanced monitoring can be an economical way to identify and track SSO events that were previously largely unpredictable.

RDII Quantification

During dry weather, flow in SSSs primarily consists of domestic, commercial, and industrial wastewater mixed with some groundwater infiltration. During periods of rainfall and snowmelt, however, dramatic increases in wastewater flows are often noted and can contribute to SSOs and increased treatment costs. The portion of sewer flow above normal dry weather flow is called RDII. Most communities served by SSSs are challenged to find effective means for predicting sewer system response to wet weather events; enhanced monitoring

programs often exceed their financial and staffing capabilities (WERF 1999).

RDII quantification methods are a tool for estimating the magnitude (frequency, location, and volume) of RDII and can inform efforts to improve sewer system performance. RDII quantification often precedes the development of enhanced monitoring programs

The Water Environment Research Federation (WERF) recently funded an extensive study that identified eight RDII hydrograph generation or RDII quantification categories (WERF 1999):

- Constant unit rate methods
- Percentage of rainfall volume (R-value) methods
- Percentage of streamflow methods
- Synthetic unit hydrograph methods
- Probabilistic methods (frequency analysis of peak RDII)
- Predictive equations based on rainfall/flow regression
- Predictive equations based on synthetic streamflow and basin characteristics
- RDII as a component of hydraulic software

These methods were tested under varying climatic and sewer operation conditions. With the goal of improved prediction and control of SSOs, the study found that no single RDII quantification method was universally applicable. Availability of data and experience of the research team were among the factors that influenced the usefulness of each method (WERF 1999).

A hydraulic (routing) analysis, which models the existing sewer system's ability to transport RDII, is recommended with RDII quantification to determine where SSOs will likely occur in the system. Once problems are characterized, RDII methods may also be used to evaluate and size appropriate control technologies and capacity relief scenarios. Because the same storms (including the same antecedent conditions and rainfall distributions) are unlikely to occur before and after controls are implemented, sewer system evaluations must rely on RDII quantifications (WERF 1999).

Real-Time Control

Real-time control seeks to optimize sewer system performance during wet weather events as flow and storage conditions change within the system. Many of the same information management system components described as part of enhanced monitoring are also required for real-time control. Real-time control is typically most applicable in CSSs, as these

systems tend to have substantial in-system storage in large pipes designed to transport excess wet weather flows. In addition to large pipes, CSSs may also have additional storage space (e.g., tunnels and tanks) that can be incorporated into a real-time control strategy. Maximizing system performance may lead to substantial savings in capital improvement programs if evaluated during the development of a long-term control plan (LTCP) (Field *et al.* 2000). Using feedback loops and rules to optimize storage, pumping, and treatment, real-time control technologies are capable of reducing the frequency, duration, and volume of CSOs through optimization of sewer system operations.

CSSs that use real-time control technology have system regulator elements such as weirs, gates, dams, valves, or pumps that can function in a real-time environment. Real-time control systems rely on monitoring data and use a customized software program to operate regulator elements without a significant time delay. Figure 1 shows a monitoring network used to operate a real-time control system.

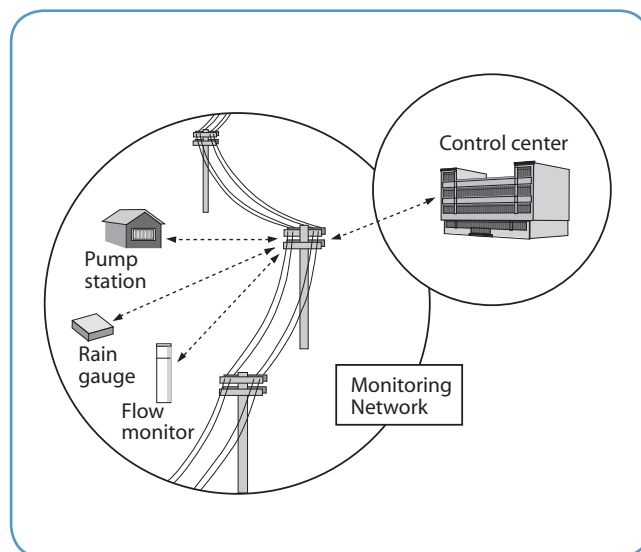

Figure 1. Schematic of a monitoring network.

The regulator elements function according to operating rules that are generally based on flow level, storage, or pumping rates monitored at points within the CSS. In a simple example, a regulator element can be controlled locally based on conditions that are monitored within the vicinity of that element. Alternatively, in a more complex example, global control of regulator elements would rely on a centralized control device that analyzes system-wide monitoring data. Centralized control systems can rely on either human operators or fully automated computer controls. Real-time control regulators that operate based on monitoring inputs are

referred to as reactive systems. Predictive systems, in contrast, include additional forecast data in the control process. Some predictive real-time control systems include a sewer system model as a component of the control device. In some instances, rainfall forecasts have been used successfully to optimize system operations in anticipation of rainfall.

Key Considerations

Applicability

The use of enhanced monitoring and real-time control is consistent with the goals and objectives of many O&M programs and EPA's 1994 CSO Control Policy. Enhanced monitoring and real-time control can be used to ensure that the public receives adequate notification of CSO and SSO events and potential impacts. Further, use of real-time control technologies for CSO control addresses two of the nine minimum controls (NMC). These are: maximizing use of the sewer system for storage; and maximizing flow to the wastewater treatment plant. In comparison, RDII quantification methods have lesser information requirements than enhanced monitoring techniques. RDII hydrograph generation methods can be used to predict RDII in different portions of an SSS and to evaluate source control scenarios, and in some cases, to develop enhanced monitoring programs.

Enhanced Monitoring

Sewer system monitoring is an essential component of an O&M program in most systems. An enhanced monitoring network utilizes fact-based knowledge to optimize sewer system performance. Enhanced monitoring can be used to determine the magnitude of the I/I and to better define locations where it is occurring. It can also provide direction for maintenance activities, detection of illicit storm water connections to the SSS, and in some cases, the detection of SSO events.

The size and complexity of the monitoring network usually depend on the size and complexity of the sewer system as well as financial considerations. In general, automated monitoring technologies are more applicable in larger systems, while simpler monitoring devices are better suited to smaller systems. In either case, the use of enhanced monitoring techniques can lead to better decisions on capital improvements required for wet weather control facilities.

Many municipalities have supervisory control and data acquisition (SCADA) systems already in place, which can be operated in an enhanced monitoring role if they are linked to broader information

technology management systems. The information collected by existing SCADA systems is often used locally rather than globally. Sharing relevant SCADA system information among many linked facilities as part of an information management system makes the information more meaningful; it also presents opportunities for detection of SSOs that would not otherwise exist.

RDII Quantification

Many communities do not have the resources necessary to implement enhanced monitoring programs. However, over-reliance on limited data and/or the rough interpretation of monitored flows can lead to oversimplification of RDII causes and implementation of inadequate control technologies. Selection of an appropriate technique for estimating RDII is critical. Usefulness of a given RDII quantification method depends on availability of data, experience of the analysis team, and purpose of the RDII evaluation (e.g., source control evaluation). Further, regardless of the RDII method selected, WERF (1999) found that testing on multiple storms is necessary to evaluate the true potential of the RDII quantification method for extrapolation or comparison with other wet weather events. Table 1 presents a number of factors that may confound the interpretation of monitoring data in SSSs.

Real-time Control

Real-time control, in general, works best for CSO communities with populations greater than 50,000. Local, rather than centralized, real-time control systems may be cost-effective for smaller CSO communities with limited control points. Real-time control tends to be more effective in areas with level, as opposed to steep, terrain where it is more practical to store wastewater in existing sewers. Further, a CSS that is already operating at or near capacity will not benefit from real-time control; systems which have capacity that is not being used effectively stand to gain more.

Real-time control has also proved useful for communities with both sanitary and combined sewers (e.g., Milwaukee, WI; Louisville, KY; and Quebec, Ontario, Canada). In such systems, real-time control is used to divert flows to and from storage systems during wet weather. For example, real-time control is used to prevent storage systems from filling entirely with combined sewage, reserving space for separate sewage. This is achieved by incorporating separate sewer volume predictions into the real-time operational strategies, where the goal is eliminating SSOs and minimizing CSOs (Schultz *et al.* 2001).

Table 1. Common interpretations of flow monitoring data (WERF 1999).

Monitoring Data Observation	Common Interpretation	Confounding Factors
Dry weather flow consistently higher than expected sanitary flow contribution	Infiltration through leaky pipes	<ul style="list-style-type: none"> Leakage from an adjacent lake or river directly into sanitary sewer Underground spring intercepted by the sanitary sewer Seasonal fluctuation in groundwater
Rapid, dramatic rise in flow coincides with rainfall initiation	Unauthorized direct connection of roof or yard drains	<ul style="list-style-type: none"> Leaking manhole lids or corbels in depressions that collect runoff Leaky pipes along stream banks Cross-connection with storm water systems Interconnection of the sanitary sewer with underground solution channels (common in karst topography)
Delayed and prolonged flow rise occurs after rain	Unauthorized connection of sump pumps or foundation drains to sanitary sewer	<ul style="list-style-type: none"> Granular backfill in the sanitary sewer trench acting as a french drain Seasonal fluctuation in groundwater; response may be rapid depending on soils and trenches
Flows rise proportionately to rainfall, but only up to an observable maximum	Direct connections with capacity restrictions	<ul style="list-style-type: none"> Further flow increases restricted by downstream blockages, backwater, or lift station capacity Further flow increases relieved by upstream overflows

Some advantages of real-time control include:

- Storage facilities can be dynamically operated and continuously optimized in response to changing conditions;
- Runoff and hydraulic models can be integrated into operating rules and control algorithms;
- System response can be predicted through use of rainfall forecast data and a local rain gage network with adequate spatial coverage; and
- Seasonal and spatial variation in rainfall and receiving water flows and volumes can be accounted for in the system.

Communities that do not experience much spatial or seasonal rainfall variation or that utilize receiving waters with a static assimilative capacity may not be able to take advantage of some these real-time control features.

Cost

The capital cost of implementing an enhanced monitoring or real-time control scheme depends on the quality and quantity of control, the measurement devices required for successful implementation, as well as any software needed to manage or process the data (Field *et al.* 2000). Monitoring and control schemes may not be sufficient as a stand-alone solution to completely control CSOs or SSOs; therefore, they should be evaluated as part of the solution. O&M costs are dependent on the characteristics of the system being monitored and include regular inspection of the monitors. In systems using real-time control, O&M costs also include mechanical maintenance of the regulator elements.

The initial costs of enhanced monitoring or real-time control can be significant and may be prohibitive for small communities. The monitoring costs, however, may be a fraction of the cost of large capital projects that would achieve similar levels of CSO and SSO reduction, such as construction of additional conveyance, storage, or treatment facilities.

Implementation Examples

SEATTLE, WA

Responsible Agency: Seattle Public Utilities

Population Served: 1.4 million

Service Area: 64 sq. mi.

Sewer System: 335 mi. sewer

Real-Time Sewer System Controls

Seattle was one of the first U.S. communities to implement and operate an advanced real-time control system. Seattle's system, called Computer Augmented Treatment and Disposal (CATAD), began operating in 1971. CATAD manages 13,120 acres of fully combined sewer area as well as 28,000 acres of partially-separated sewers. The network included 17 regulator structures and one major pumping station. CATAD has reduced CSO volume between 9 and

49 percent at different outfall locations. The actual reduction realized depends on the rainfall volume and patterns during each individual year.

The capital cost for CATAD was \$16.8 million, and O&M costs were approximately \$16 per acre (2002 dollars). Estimated costs for sewer separation or construction of additional storage capacity to achieve equivalent reductions in overflow volume range between \$127-\$760 million (2002 dollars). In the late 1980s, treatment plant computer hardware was upgraded, remote telemetry units at regulators and pump stations were replaced by programmable logic controllers, and operators' graphical displays were improved. Based on the success of the CATAD technology, Seattle implemented a new, predictive real-time control system that went online in early 1992. Rainfall prediction capabilities that utilized rain gage data and a runoff model were added at this time. A global optimization program was introduced that computed optimal flow and corresponding gate position for each regulator. Currently, the system's centralized computer hardware is being upgraded.

Contact: Bob Swarmer, King County Wastewater Treatment Division

MILWAUKEE, WI

Responsible Agency: Milwaukee Metropolitan Sewerage District

Population Served: 1.1 million

Service Area: 420 sq. mi.

Sewer System: 2,200 mi. of collector sewer;
310 mi. of intercepting and main sewer

Real-Time Sewer System Controls

In 1986, Milwaukee Metropolitan Sewerage District (MMSD) designed and installed real-time sewer system controls. The MMSD sewer system includes the Metropolitan Interceptor Sewer System (MIS) that collects flow from the local sewers; an Inline Storage System (ISS) that temporarily stores excess flows until treatment capacity is available, and a computer-based central control system. The MIS system collects wastewater from both sanitary and combined sewers and conveys flow to two wastewater treatment plants.

MMSD uses remote and local sensors to control intra-system flow diversions to both relief interceptors and temporary storage. Flows can be rerouted to avoid surcharging the system or to maximize treatment capacity during wet weather events. Routing is performed by adjusting diversion gates, which are controlled by monitoring multi-level sensors located at critical points in the MIS. Importantly, MMSD's real-time control system is used to prevent storage systems from filling entirely with combined sewage and to reserve space for the separate sanitary sewage. This is achieved by incorporating sanitary sewer volume predictions into the real-time operational strategies, where the goal is eliminating SSOs and minimizing CSOs. Precipitation and meteorological forecasts are used to calculate the storage volume that must be reserved for anticipated sanitary sewage flows.

MMSD's system was implemented to address chronic CSO and SSO problems cited in national and state court actions in the 1970s. In the mid-1970s, the city regularly experienced hundreds of SSOs and over 100 CSOs during wet weather; many homes in the sanitary sewer service area also faced sewage backups one or more times per year. MMSD has seen dramatic reductions in CSOs, SSOs, and backups in the last few decades. Furthermore, the real-time control system has provided much-needed flexibility in system operation, allowing MMSD to better accommodate variable precipitation patterns, growth patterns, and lake and groundwater levels (Schultz *et al.* 2001).

Contact: Nancy Schultz, CH2M Hill

QUEBEC, ONTARIO, CANADA

Responsible Agency: Quebec Urban Community

Population Served: 500,000

Service Area: 213 sq. mi.

Sewer System: Not Available

Real-Time Control System

In 1998-1999, the City of Quebec implemented a centralized, or global, optimal and predictive real-time control (GO RTC) system in its westerly sewer system. Quebec Urban Community's (QUC's) westerly catchment drains 82,000 acres and contains 41 miles of interceptor and 22 regulators; it is served by an 82 MGD treatment plant. The GO RTC equipment consists of five control stations, four

monitoring stations, thirteen rainfall stations, and one central control station (Colas *et al.* 2001). The GO RTC system improves the flow management of the westerly system by taking advantage of 3.7 million gallons of in-line storage as well as wet weather treatment capacity at the plant. Pressure flow conditions that occur in the system are also eliminated, thereby protecting downstream areas against basement backups. The cost of the western installation GO RTC system was approximately \$2 million. Operation costs are low because existing staff were trained to operate and maintain the system (Colas 2003).

In the late 1990s, EPA funded a demonstration study of three real-time control scenarios in the westerly QUC catchment (Field *et al.* 2000). Using modeling tools and rainfall data from the summer of 1998, Field *et al.* (2000) found that the automated central control system, eventually implemented as GO RTC, performed better as system complexity increased. Actual reductions in CSO volume have exceeded those predicted by Field *et al.* (2000)—i.e., reductions of 24-47 percent. Compared to simulations of past system configurations, CSO volumes were reduced by 60 percent in 1999, 75 percent in 2000, and 83 percent in 2001. At some sites, CSOs were eliminated. In other areas, where storage was limited, CSO frequency was reduced by more than 40 percent (Colas 2003).

Contact: H. Colas, BPR CSO

SAN DIEGO, CA

Responsible Agency: City of San Diego
Metropolitan Wastewater Department

Population Served: 1.3 million

Service Area: 310 sq. mi.

Sewer System: 2,300 mi. sewer

Flow Metering Alarm System

The City of San Diego MWWD installed a Flow Metering Alarm System (FMAS) in September 2000. FMAS uses flow meters to monitor wastewater flow conditions, which provides real-time event notification through the land-line telemetry system. Specifically, 92 alarmed flow meters provide coverage for 95 percent of MWWD's sewers with a diameter of 15 inches or greater. Flow meters are also used by MWWD to meter flows from San Diego and its 15 satellite agencies, collect data for sewer modeling, evaluate trunk

sewer capacities, and investigate I/I issues. MWWD hired a maintenance contractor to maintain all the flow meters in their system including those used for FMAS. In addition, MWWD created a new section of three to four staff (with supplemental help on nights and weekends) to monitor the sewer system, analyze data, and dispatch crews to investigate potential spills and/or minimize active SSOs.

The purpose of FMAS is to help prevent, detect, and minimize the impact of major SSOs in the MWWD system. An alarm signals when a FMAS meter experiences a 25 percent loss of flow. For some areas where the base flow is more consistent, the alarms can be set to activate when a 15 percent fluctuation in flow occurs. MWWD installed FMAS largely as a result of a large spill that occurred in February 2000 when the Alvarado Trunk Sewer was damaged during a winter storm, causing a 34 million gallon spill in an inaccessible canyon that went undetected for seven days. This spill forced beach closures, a highly undesirable situation for the City of San Diego and surrounding communities.

The FMAS has allowed MWWD to concentrate on specific areas of the SSS: trunk sewers where capacity is critical, remote areas, and sensitive areas including areas that would trigger beach closures. Although FMAS is principally used to detect major SSOs, it has also provided early warning of potential spills allowing crews to be dispatched in time to alleviate blockages. Over the past three years, MWWD has also considerably expanded its maintenance and cleaning program and is embarking on a 10-year capital improvement program to replace or rehabilitate structurally defective pipe, all in an effort to reduce future SSOs.

Contact: G. Hwang, City of San Diego Metropolitan Wastewater Division

ATLANTA, GA

Responsible Agency: Atlanta Department of Public Works

Population Served: 1.2 million

Service Area: 131.4 sq. mi.

Sewer System: 2,000 mi. of sanitary and combinedsewer

Automated Monitoring System

In 2002, Atlanta installed a web-based information system that automates data collection from flow meters and rain gages. One hundred twenty flow meters and 35 rain gages provide coverage of the city's entire sewer system and supply data to the information system. This system enables city staff to view pipe capacities, flow levels, and float positions (in the pumping stations) via the Internet. Alarms calibrated to the system activate when flow velocities or depths reach predefined critical levels, where the potential for SSO events is high.

Flow meters and rain gages have been used in the Atlanta sewer system for a number of years. In the past, field crews were required to collect the data, and it often took many weeks for the data to be analyzed. Without alarms or real-time data, the city was frequently faced with responding to spills after they had been reported by the public or detected by field crews. By automating data collection, the city is better able to analyze the data in a timely manner. Crews may be sent to investigate potential problems and act to prevent SSOs rather than respond to an overflow event.

In addition, the system has helped the city better allocate its resources and focus on sewer lines that need repair, areas where flow capacity is frequently exceeded, and sections where recurrent blockages occur. If grease build-up is identified as a chronic problem in a certain section of pipe, the crew that handles oil and grease issues will be dispatched to investigate (e.g., check grease traps). The city reports that businesses, such as restaurants, are more receptive to preventative operation and maintenance changes when shown evidence (provided by the monitoring data and CCTV) of the recurrent problem.

Contact: K. Toomer, Atlanta Department of Public Works

References

Colas, H., *et al.* 2001. *Operation and Performance of an Optimized Real time Control System for Wet Weather Pollution Control, Vulnerability of Water Quality in Intensively Developing Watersheds, Making the Case for High-Performance Integrated Control.* Presented at the University of Georgia, Athens, Georgia, May 14-16, 2001.

Colas, H. BPR CSO. E-mail correspondence with Limno-Tech, Inc., 2003. Washington, DC.

Field, R., Villeneuve, E., Stinson, M.K. 2000. "Get Real!" *Water Environment & Technology.* Vol. 12, No. 4: 64-67.

Hwang, G., City of San Diego Metropolitan Wastewater Division (MWW). Interview by Limno-Tech, Inc., February 2003. Washington, DC.

Schultz, N., *et al.* 2001. Milwaukee's Experience in Collection System Controls. Proceedings of WEF Speciality Conference, A Collection System Odyssey, Bellevue, Washington, July 2001.

Schultz, Nancy, CH2M Hill. E-mail correspondence with Limno-Tech, Inc., 2003. Washington, DC.

Stevens, Pat, ADS Environmental Services. Interview by Limno-Tech, Inc., January 2003. Washington, DC.

Swarmer, Bob, King County, WA Wastewater Treatment Division. Interview by Limno-Tech, Inc., December 2002. Washington, DC.

Toomer, K., Atlanta Department of Public Works. Interview by Limno-Tech, Inc., February 2003. Washington, DC.

Water Environment Research Foundation. 1999. *Using Flow Prediction Technologies to Control Sanitary Sewer Overflows.* Prepared by D. Bennett, *et al.* Project 97-CTS-8. Alexandria, VA: Water Environment Research Foundation.

Inclusion of this technology description in this Report to Congress does not imply endorsement of this technology by EPA and does not suggest that this technology is appropriate in all situations. Use of this technology does not guarantee regulatory compliance. The technology description is solely informational in intent.



TECHNOLOGY DESCRIPTION

Collection System Controls

Inflow Reduction

Overview

Inflow is the direct introduction of storm water into a sewer system; common sources include roof leaders, basement sump pumps, area drains in yards and driveways, foundation drains, cracked or broken manhole covers, and cross connections with a separate storm water system. Inflow occurs by design, through disrepair, and via illicit connections. Inflow reduction refers to techniques used to reduce the amount of storm water that enters a combined sewer system (CSS) or a sanitary sewer system (SSS).

This technology description focuses on inflow associated with direct connections of storm water sources to the sewer system. Much of the inflow to CSSs is intentional as these systems were designed to convey excess storm water away from dwellings and to reduce localized flooding. Inflow to SSSs is generally not by design and is often illicit. By reducing the volume of storm water entering a sewer system, inflow controls free conveyance capacity and available storage. This, in turn, aides in reducing the frequency, volume, and duration of wet weather CSO and SSO events. Inflow reduction is particularly applicable in areas where open land is available to receive redirected storm water for infiltration or detention, or where storm water can be diverted to surface waters either directly or via a separate storm water system.

Specific inflow reduction techniques that will be discussed in this technology description include disconnection of roof leaders; redirection of area drains, foundation drains, and basement sump pumps; and cross connection elimination.

Disconnection of Roof Leaders

Roof leaders or down-spouts convey rain that falls on residential and commercial roofs directly to the sewer system. The use of this practice in CSSs is usually intentional, and in some instances, required by local ordinance. Use of roof leaders to convey rainwater to an SSS is generally considered to be an illicit connection

in most, but not all, communities. In SSS areas, roof leaders may have been connected to the SSS by builders or homeowners to alleviate localized flooding associated with wet weather events. The disconnection of roof leaders from the sewer system and redirection to lawns, dry wells, or drain fields, where flows can infiltrate into the soil, reduces the amount of storm water entering the sewer system. Disconnection of roof leaders works best in residential areas where open land is available. City-wide surveys are often necessary to determine the extent of roof leader connections to the sewer system. This inflow reduction technique can be introduced as a voluntary effort or as a mandatory requirement. Guidance can be offered to individual homeowners on how to redirect the inflow from roof leaders, and it can be combined with other inflow reduction techniques such as area drain and basement sump pump redirection. Some communities have offered financial incentives to homeowners to disconnect roof leaders and have prequalified local contractors to provide this service.

Redirection of Area and Foundation Drains and Basement Sump Pumps

Many buildings have a system of area and foundation drains and basement sump pumps to alleviate drainage problems. As with roof leaders, area and foundation drains and basement sumps are typically connected to CSSs by design. In some parts of the country, both area drains and foundation drains are connected to the SSS by design, but in most instances they are considered to be illicit connections to the SSS. Flows from area and foundation drains and basement sumps can generally be redirected away from the sewer system to lawns, dry wells, drain fields, or an existing separate storm water system. However, redirection may require additional pumping. City-wide surveys often need to be conducted to determine where area drains and sump pumps are located, whether they discharge directly to the sewer system, and whether it is feasible to redirect them.

Elimination of Cross Connections

Cross connections are direct connections between an SSS and a separate storm water system. By definition, it is not possible to have a cross connection in a CSS. Cross connections most commonly occur where the sanitary service lateral from a home or commercial establishment is inappropriately connected to the storm water system. Cross connections also often exist as remnants of incomplete sewer separation projects. Detection and elimination of cross connections between separate sanitary and storm water systems can reduce inflow during wet weather events and reduce the concentration of bacteria, nutrients, and oxygen demanding substances contained in storm water discharges.

Key Considerations

Applicability

There are a number of different sewer testing and inspection approaches that are useful for locating sources of inflow. These include visual inspections, smoke testing, dye-water flooding, water sampling from manholes, interpretation of public complaints, and video inspection. The most appropriate technique will depend on suspected inflow sources and site-specific conditions. Additional information on techniques for locating sources of inflow is provided in the “Testing and Inspection Technology Description” in Appendix B of the *Report to Congress on the Impacts and Control of CSOs and SSOs*.

Inflow reduction can be an efficient way to reduce the volume of storm water delivered to both CSSs and SSSs, and can result in improved sewer system performance. Provided below are specific considerations for each of the inflow reduction techniques described above.

Disconnection of Roof Leaders

Disconnection of roof leaders is a relatively simple and low-cost technique for reducing inflow. It is more feasible in residential areas where houses are detached, yards are sufficiently large to accommodate increased overland flow and soils have relatively high infiltration rates. In order for a roof leader disconnection program to be successful the public must be educated about the benefits of disconnection and methods for implementing the program. This can be time-consuming and will most likely require some type of rebate program or other incentive for compliance. Communities who have experimented with voluntary disconnection programs found that approximately 20 percent of property owners are willing to participate (NBC 2000). In addition, because the effect per

individual roof leader is small, this program must be implemented with broad participation across entire neighborhoods in order for there to be a discernible reduction in sewer system flow.

Redirection of Area and Foundation Drains and Basement Sump Pumps

In general, area and foundation drains and sump pumps are a less common source of inflow than roof leaders, and their location may be harder to determine. The feasibility of redirecting drains and sump pumps depends on soil type, land slope, and the drainage conditions around the home or building. If a separate storm water system does not exist, then the excess rainwater must be conveyed to a distance far enough away and at a reverse slope from the building so that water is not allowed to migrate back into the building. Similar to the redirection of roof leaders, the volume controlled per individual drain or sump pump is small. Consequently, the program must be implemented with broad participation across neighborhoods in order for there to be a discernible reduction in sewer system flow. Implementation of this type of redirection program can be time-consuming and may necessitate use of a rebate program or other incentives for compliance.

Elimination of Cross Connections

Several methods exist for detecting and eliminating cross connections. Common sewer testing and inspection approaches are often appropriate for identifying storm water sources that were inappropriately connected to the SSS. In addition, there are a number of useful indicators for detecting connections between private building service laterals and the separate storm water system. These include inspections to determine the presence of unexpected dry weather flow in storm sewer lines, and finding biological indicators that denote the presence of human fecal matter in storm drain outfalls. Once cross connections are detected, excavation and correction are necessary. In addition to detection and elimination of existing cross connections, plans for new development should be carefully reviewed and inspections should be conducted during construction in order to prevent future cross connections from being placed.

Cost

The actual cost associated with implementation of an inflow reduction program varies considerably and is dependent on site-specific conditions. Disconnection of roof leaders and redirection of basement sump pumps can be quite economical under some circumstances. Disconnecting area and foundation drains typically requires

excavation around homes, and is therefore more expensive and disruptive than other inflow controls. Key parameters in determining the effectiveness of inflow reduction techniques are the infiltration rate of the soil in the area where flows will be redirected and the land area available to infiltrate the wet weather flow. Typical cost ranges for various techniques discussed in this technology description are presented in Table 1.

Table 1. Costs of inflow reduction activities

Technology	Cost
Disconnection of roof leaders	\$45-\$75 for individual homeowners
Redirection of area and foundation drains and basement sump pumps	Varies based on site-specific requirements. Sump pump redirection costs \$300-\$500 per home ^a
Cross connection elimination	Varies depending on location. Typical point repairs costs \$600-\$8,500 ^b

^a EPA 1999
^b Arbour and Kerri 1998

Implementation Examples

JOHNSON COUNTY, KS

Responsible Agency: Johnson County Wastewater (JCW)
Population Served: 500,000
Service Area: 20 sq. mi.
Sewer System: 1,700 mi. of sanitary sewer

Inflow Reduction Program

Wet weather SSOs were a frequent occurrence in Johnson County in the early 1980s. A comprehensive system-wide evaluation was conducted in 1983, which included smoke and dye-water testing of sewer lines, flow and rainfall monitoring, visual pipe inspections, and closed circuit television

inspections. The survey identified inflow as a major contributor to wet weather SSOs. JCW's response was to launch an inflow reduction and sewer system rehabilitation program. An ordinance was passed by the Johnson County Board of Commissioners that made it illegal for residents to make connections from surface or groundwater sources to the SSS. This ordinance provided JCW with the legal authority to require removal of unpermitted inflow sources, and to prohibit construction of new ones.

As part of the disconnection program, JCW initiated private property inspections to identify inflow sources and advise property owners on removal actions. Inspectors toured commercial and residential building interiors and grounds, and they gathered data on the location of foundation and area drains, roof leaders, and other apparent connections to the SSS. Sources suspected of contributing to storm water inflow were subjected to smoke and/or dye-water testing, and all unpermitted sources were scheduled for disconnection. As shown on the right, the most common sources of inflow were foundation drains, area drains, sump pumps, and roof leaders. JCW established informal fixed-price contracts with local contractors to complete the work. To help JCW prioritize its remedial efforts, a hydraulic model was developed with the data from the survey. The inflow reduction program was completed in 1994. The inflow reduction and sewer rehabilitation program resulted in significant reductions in capacity-related SSOs; wet weather flow rates in the sewer system were reduced by an average of 280 MGD during the 10-year, 6-hour storm. The total cost of the program was \$48.8 million, which includes \$11.2 million for the reduction of inflow from private property.

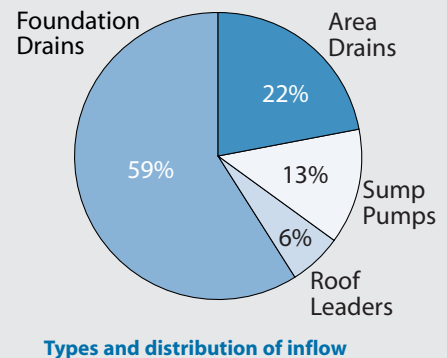

More information at http://cfpub2.epa.gov/clearinghouse/preview.cfm?RESOURCE_ID=253743

ROCKFORD, IL

Responsible Agency: The Rock River Water Reclamation District

Population Served: 250,000

Service Area: 80 sq. mi.

Sewer System: 1,100 mi. of sanitary sewer

Sewer System Evaluation Survey

The Rock River Water Reclamation District in Rockford conducted a survey of a portion of its service area that was experiencing SSOs during periods of heavy rainfall. The purpose of the survey was to determine the extent of inflow and to recommend a plan for mitigation

that included a cost-effectiveness analysis to justify the recommended work. Inflow sources were identified by smoke testing all sanitary sewers (approximately 77,000 linear feet) by dye-water testing storm systems adjacent to sanitary sewers, and with voluntary inspections of approximately 1,300 buildings for sources on private property. Infiltration and inflow (I/I) data were collected and analyzed in terms of location, pipe condition, flow rate, potential rehabilitation method, and cost. The relative cost-effectiveness calculations, using ratios of rehabilitation costs versus treatment-transport costs, provided the basis for rehabilitation recommendations. The primary sources of inflow identified were roof leaders, foundation drains, and sump pumps. This investigation identified 68 inflow sources that contributed an estimated 421 gallons per minute, based on a 5-year storm event (1.7 inches per hour). The investigation also determined that 75 percent of the I/I originated on private property.

Number of identified inflow sources.^a

Area	Number of Defective Sites	Inflow (Gallons Per Minute)
Cherry Valley	7	38.0
Dawson Avenue	26	167.6
Pepper Drive	35	147.8

^aWEF 1999

More information at <http://www.rwrwd.dst.il.us/>

SOUTH PORTLAND, ME

Responsible Agency: City of South Portland

Population Served: 23,200

Service Area: 12 sq. mi.

Sewer System: 16.6 mi. of combined sewer

Rebate Program to Reduce Inflow

The City of South Portland invested almost \$2.5 million between 1986 and 1995 to reduce wet weather inflow into their CSS. The program involved surveying 6,000 residential buildings. The survey identified approximately 380 roof leaders and 300 sump pumps that were connected to the CSS. Property owners were notified and offered the

following incentives to disconnect the inflow sources: \$75 for roof leader redirection and \$400 for sump pump redirection. At the program's completion in 1995, 64.5 percent of all known sources had been redirected. The program resulted in a reduction in CSO volume of 58 MG per year, a three percent reduction in annual flow to the local wastewater treatment plant, and fewer reported residential backups. The total cost of the rebate program was \$128,000. The inflow reduction program eliminated more than 420 gallons per year of storm water from the CSS for every dollar spent.

Contact: Dave Pineo, Engineering Department, City of South Portland

References

Arbour, Rick, and Ken Kerri. 1998. *Collection Systems: Methods for Evaluating and Improving Performance*. Prepared for EPA, Office of Water Programs, Municipal Permits and Operations Division and developed under EPA Grant No. CX924908-01-0. Sacramento, CA: California State University, Sacramento Foundation.

EPA Office of Water. September 1999. *Combined Sewer Overflow Technology Fact Sheet: Inflow Reduction*. EPA-F-99-035.

Narragansett Bay Commission (NBC). April 2000. *Stormwater Attenuation Study - Technical Memorandum No. 3, Evaluation of Alternatives*. Prepared by the Maguire Group Inc. Rhode Island: NBC.

Water Environment Federation (WEF). 1999. *Control of Infiltration and Inflow in Private Building Connections*. Alexandria, VA: WEF.

Inclusion of this technology description in this Report to Congress does not imply endorsement of this technology by EPA and does not suggest that this technology is appropriate in all situations. Use of this technology does not guarantee regulatory compliance. The technology description is solely informational in intent.



TECHNOLOGY DESCRIPTION

Collection System Controls

Sewer Separation

Overview

Sewer separation is the practice of separating the single pipe system of a combined sewer system (CSS) into separate systems for sanitary and storm water flows. Sewer separation, like other types of CSO control, is intended to reduce CSO volume, the number of CSO outfalls, or both. In practice, there are three distinct approaches to sewer separation:

- Full separation wherein new sanitary sewer lines are constructed with the existing CSS becoming a storm sewer system. This is probably the most widely used form of separation.
- Full separation wherein an entirely new storm sewer system is constructed with the existing CSS remaining as a sanitary sewer system. This form of separation is not often used because the capacity of the existing CSS was designed to accommodate storm runoff, which is more than what is required to accommodate sanitary flows.
- Partial separation wherein a new storm sewer system is constructed for street drainage, but roof leaders and basement sump pumps remain connected to the existing CSS allowing flow to enter the CSS during wet weather periods.

Full separation can be applied on a system-wide basis to eliminate the CSS. This approach is often practical only for communities with small areas served by combined sewers. Partial separation of select areas within the CSS is widely used in large and small CSO communities. In fact, a survey of readily available information in NPDES files indicates that sewer separation is the most widely used CSO control (EPA 2001). This suggests that most CSO communities opportunistically find portions of their CSS where separation is a cost-effective CSO control. Under these circumstances, separation is often implemented in conjunction with other public works projects, including road work and redevelopment.

Key Considerations

Sewer separation can be highly effective in controlling the discharge of untreated sewage to water bodies. Under ideal circumstances, full separation can eliminate CSO discharges. However, sewer separation on its own does not always lead to an overall reduction in pollutant loads or the attainment of water quality standards. Discharges of urban runoff from the newly separate storm sewer system often contain substantial pollutant loads that contribute to water quality problems. A comparison of average pollutant concentrations from a variety of sources is presented in Table 1. As shown, the pollutant concentrations in urban runoff can be quite high. From a management standpoint, the implementation of storm water controls is usually required following sewer separation in order to achieve the necessary pollutant load reductions for attainment of water quality standards.

Table 1. Typical pollutant concentrations.

Contaminant Source	BOD ₅ (mg/L)	TSS (mg/L)	Fecal Coliform (#/100mL)
Untreated wastewater	88 - 451 ^a	118 - 487 ^a	1,000,000 - 1,000,000,000 ^b
CSO ^c	4 - 699	4 - 4,420	1,100 - 1,645,000
Urban runoff ^d	0.41 - 370	0.5 - 4,800	1 - 5,230,000
Treated wastewater ^e (disinfected)	12 - 140	0.5 - 35	<200

^a AMSA 2003

^b NRC 1996

^c Chapter 4 of EPA's 2003 *Report to Congress on the Impacts and Control of CSOs and SSOs*

^d Pitt *et al.* 2003

^e EPA 2000

From a regulatory standpoint, implementation of sewer separation satisfies the requirements of the CSO Control Policy. However, the newly-created sanitary and storm water systems become subject to existing NPDES requirements for storm water and separate sanitary sewer systems.

Some CSO communities find that more cost-effective overall reductions in pollutant loads can be achieved with the implementation of other CSO controls such as storage and treatment, instead of sewer separation. Having the storm water collected and conveyed in a CSS does present some environmental advantages if most of the wet weather flow is given the minimum treatment required by the CSO Control Policy (i.e., the equivalent of primary treatment and disinfection, if necessary).

From both cost and design standpoints, it is often difficult to fully separate CSSs. The occurrence of occasional residual overflows is common in many CSSs that have been separated. The cost of full separation can be prohibitive, and some communities opt for partial separation for this reason. Several states require sewer separation to the extent necessary to eliminate CSOs under specific design storm conditions (i.e., the 2-year, 24-hour storm). This leaves a legacy of infrequent but substantial CSOs during large wet weather events or periods of snow melt. The difficulty in achieving full separation can leave a community with residual overflows that may be subject to potentially more stringent requirements for SSOs.

Applicability

A major benefit of sewer separation is that it has the potential to completely eliminate the CSOs and the unwanted discharge of raw sewage to receiving waters from an antiquated sewer system. Consequently, public health, water quality, ecological, and aesthetic benefits can be achieved through sewer separation. Another advantage of sewer separation is the reduction of wet weather flows to the wastewater treatment plant. Sewer separation diverts storm water to a separate storm water system during rainfall periods. The diversion of storm water reduces system-wide stress and frees up sewer system conveyance and wastewater treatment capacity. Sewer separation also offers a solution to localized flooding and basement backup problems caused by excess water entering the sewer system. Public health and aesthetic benefits accrue where public exposure to raw sewage in homes, businesses, and other public areas is reduced.

Cost

Sewer separation is expensive relative to other CSO controls, and full sewer separation is typically the most expensive CSO control alternative evaluated in most communities. Example unit costs for sewer separation are presented in Tables 2 and 3.

Table 2. Sewer separation costs per linear foot of CSS.

CSO Community	Cost per Linear Foot ^a
Detroit, MI: Rouge River Project ^b	\$175 - \$220
Syracuse, NY: Onondaga Lake Improvement Project ^c	\$490 for residential areas (estimate) \$610 for commercial areas

^aCosts are in 2002 dollars

^bIncludes removing existing pavement, laying a new sewer line, re-paving, and re-sodding

^cIncludes a 25 percent contingency for mobilization, bonds, permits, survey, stakeout, and drawings; does not include internal building plumbing modifications

Table 3. Sewer separation costs per acre of service area.

CSO Community	CSS Area (Acres)	Reported Costs ^a (Million)	Cost Per Acre
Seaford, DE	1,260	\$2.2	\$1,750
Skokie/ Wilmette, IL	6,784	\$213 ²	\$31,397
St. Paul, MN and surrounding areas	21,117	\$374	\$17,730
Portland, OR	N/A ^b	N/A	\$19,000
Providence, RI	180	\$14.6 ^c	\$81,000

^a Costs are in 2002 dollars

^b Not available

^c Estimated costs; community found other CSO controls to be more cost effective (NBC 2000)

Sewer separation can also be very disruptive. Disturbances caused by construction activities required to implement sewer separation are widespread and relatively long-lasting; and include digging up roads, altering traffic patterns, and potentially disrupting other utility services.

Implementation Examples

RANDOLPH, VT

Responsible Agency: Town of Randolph
Population Served: 2,270

Sewer Separation

Randolph, a town of approximately 2,270, is located on the White River in central Vermont. In 1990, the State of Vermont developed a CSO Control Policy that encouraged sewer separation. Compliance requires elimination of CSO discharges during any storm with precipitation less than 2.5 inches of rain over a 24-hour period. Randolph completed a sewer separation program during the mid-1990s that consisted of construction of a new separate storm water system throughout much of the downtown commercial district and adjacent residential areas. A total of 44 storm water catch basins were separated from the CSS, which was approximately 85 percent of the catch basins that were known or suspected to be connected.

Since completion of the main CSO abatement program in 1996, Randolph has continued to implement additional CSO control through separation of smaller combined sewer areas as part of road improvements under its capital improvement plan. This has resulted in the separation of six additional catch basins. Currently, the town has separated 95 percent of its combined sewers. Post-sewer separation monitoring has shown an 80 percent reduction in the duration of CSO events recorded at the CSO outfall located at the wastewater treatment facility. This reduction is based upon data collected from a 20-month period from 1998-2000 compared with data collected prior to CSO control. As of 1997, approximately \$2.66 million had been spent on the town's CSO abatement program.

Though significantly reduced, CSOs still occur, and Randolph plans to further its CSO abatement efforts through a plan that spans six years (2001-2006) at a projected cost of \$500,000. Planned projects include sewer line replacement and upgrades as well as continued sewer separation.

Contact: Joe Voci, Town of Randolph

SEAFORD, DE

Responsible Agency: City of Seaford
Population Served: 6,699
Service Area: Not Available
Sewer System: 22.7 mi. of sewer

City-wide Sewer Separation

The City of Seaford, a community of 5,900, is located in southwestern Delaware. In 2002, Seaford completed a major sewer separation program covering approximately 1.97 square miles. The goal of this program was to eliminate untreated CSO discharges into the Nanticoke River, a tributary of the Chesapeake Bay, during periods of wet weather. Compliance with Delaware and EPA regulations and water quality initiatives provided the driving force for this program. In addition, the program was designed to benefit city residents and recreational users of the Nanticoke River. Prior to sewer separation, Seaford's wastewater treatment plant was unable to process all the combined sewage captured by the CSS during wet weather events. This led to frequent discharges at four CSO outfalls located in downtown residential and commercial areas.

The initial plan to separate the combined sewers of Seaford was developed in 1984 with the objective of complete separation. Implementation of the entire program was scheduled in eight phases and took 18 years to complete, due to construction and financial constraints. The entire combined sewer area has been separated (approximately 40 percent of the city). Efforts to control the resulting storm water discharges to the Nanticoke River are currently underway. The cost of the sewer separation program was \$2.2 million.

Contact: Charles Anderson, City of Seaford

ST. PAUL, SOUTH ST. PAUL, AND MINNEAPOLIS, MN

Responsible Agency: Metropolitan Council Environmental Services Division (MCES) and the cities of St. Paul, South St. Paul, and Minneapolis

Population Served: 2.5 million

Service Area: 3,000 sq. mi.

Sewer System: 600 mi. of sewer

Full Sewer Separation

Working cooperatively under the Metropolitan Council's Environmental Services Division (MCES), the cities of St. Paul, South St. Paul, and Minneapolis completed a 10-year, \$331 million dollar sewer separation program in 1996 (MCES 1996). The goal of this program was to reduce the pollutant load delivered to the Mississippi River from CSO

discharges. Prior to sewer separation, the average volume of untreated CSO discharges from the metro areas was estimated at 4.6 BG per year, with discharges occurring on average once every three days. Separation of St. Paul, South St. Paul, and Minneapolis combined sewers began in 1985 as part of an on-going capital improvement program, with construction initially scheduled to be complete in 2025. Due to public demand, the Minnesota Legislature adopted an accelerated program aimed at completing the sewer separation by 1995. Implementation of the program resulted in the installation of 189 miles of separate storm sewers and 11.9 miles of new sanitary sewers. This amounted to separation of approximately 33 square miles of combined sewer areas: 6.66 square miles in Minneapolis, 24.53 square miles in St. Paul, and 1.8 square miles in South St. Paul. The disconnection of roof leaders was also an important component of the program as it was estimated that they contributed 20 percent of the CSO volume in St. Paul.

By design, the sewer separation program provided the opportunity to implement other municipal infrastructure improvements during construction. These included:

- Repair of existing sewers
- Disconnection of 21,900 residential rain leaders from the CSS
- Replacement of 3,500 lead water services with copper pipes
- Upgrade of other local utilities
- Installation of 8,200 new street lights
- Installation of handicapped-accessible ramps

As a result of sewer separation, water quality in the Mississippi River and other local waterbodies has improved. MCES noted lower fecal coliform bacteria levels in the river, the return of the pollution-sensitive Hexagenia Mayfly, and increases in fish populations. Sewer separation is believed to be the major reason for the decrease in fecal coliform levels from an average of 500 MPN/100 mL in 1976 to an average of 150 MPN/100 mL in 1995 in the waters below Minneapolis. The program also benefitted local waterfront development along the Mississippi River.

Contact Tim O'Donnell, Metropolitan Council

References

Association of Metropolitan Sewerage Agencies (AMSA). 2003. *The AMSA 2002 Financial Survey: A National Survey of Municipal Wastewater Management Financing and Trends*. Washington, DC.

EPA. 2001. *Report to Congress: Implementation and Enforcement of the Combined Sewer Overflow Control Policy*. EPA/833-R-01-003.

EPA Office of Water. 2000. *Progress in Water Quality: An Evaluation of the National Investment in Municipal Wastewater Treatment*. EPA-832-R-00-008.

Metropolitan Council Environmental Services (MCES). 1996. *Separating Combined Sewers to Improve and Protect Mississippi River Water Quality: A Ten-Year Commitment, Annual Progress Report to the Public - Year Ten*. St. Paul, MN: MCES and Cities of Minneapolis, St. Paul, South St. Paul.

The Narragansett Bay Commission (NBC). 2000. *Storm Water Attenuation Study: Technical Memorandum No.3 Evaluation Alternatives*. Prepared by MacGuire Group, Inc. Rhode Island: NBC.

National Research Council (NRC), Committee on the Use of Treated Municipal Wastewater Effluents and Sludge in the Production of Crops for Human Consumption. 1996. *Use of Reclaimed Water and Sludge in Food Crop Production*. The National Academies Press.

Pitt, R. *et al.* 2003. "The National Stormwater Quality Database (NSQD, version 1.0)." Retrieved August 6, 2003. Tuscaloosa, AL: University of Alabama. <http://www.eng.ua.edu/~rpitt/Research/ms4/Paper/Mainms4paper.html>

Inclusion of this technology description in this Report to Congress does not imply endorsement of this technology by EPA and does not suggest that this technology is appropriate in all situations. Use of this technology does not guarantee regulatory compliance. The technology description is solely informational in intent.



TECHNOLOGY DESCRIPTION

Collection System Controls

Sewer Rehabilitation

Overview

The structural integrity of many sewer system components has deteriorated from use and age. This gradual breakdown allows greater amounts of groundwater and storm water to infiltrate into the sewer system, which increases the hydraulic load, and in turn, reduces the system's ability to convey all flows to the treatment plant. During wet weather events, excessive infiltration can cause or contribute to CSOs and SSOs. There are many reasons why a system may deteriorate to the point where infiltration becomes a problem. These include (WEF 1999):

- Inadequate design and construction practices
- Inadequate or improper bedding material
- Root intrusion
- Pipe breakdown from chemical corrosion
- Traffic loadings
- Soil movement and settling
- Groundwater fluctuations
- Cracking and aging
- Inadequate installation and maintenance

Sewer rehabilitation helps restore and maintain the structural integrity of a sewer system, in part by reducing or mitigating the effects of infiltration. Specific sewer rehabilitation techniques discussed in this description include:

- Removing and replacing defective lines
- Shotcrete
- Trenchless methods

The presence of debris will limit the effectiveness of sewer rehabilitation efforts; therefore, before initiating sewer rehabilitation, it is essential to remove any debris or roots that may be present in the sewer line. When rehabilitating a sewer line, it is also important to consider rehabilitation of system components, such as manholes and service laterals, since these may also be subject to infiltration. More information on sewer cleaning and manhole and service

lateral rehabilitation is presented in additional technology descriptions included in Appendix B of *Report to Congress on the Impacts and Control of Combined Sewer Overflows and Sanitary Sewer Overflows*.

Removing and Replacing Defective Lines

In many cases, it is not practical or desirable to rehabilitate existing sewers. Removing and replacing part or all of a defective sewer is the most common and proven method for eliminating inflow and infiltration (I/I), as well as correcting other structural problems. Often called “dig-and-replace,” the original pipe is excavated and disconnected from the sewer system. The pipe is then removed and replaced with a new, often larger, pipe. Alternatively, a new pipe may also be positioned parallel to the existing sewer and connected to the sewer system.

Shotcrete

Shotcrete is a mix of cement, sand, and water that is applied to the walls of the sewer using air pressure. Shotcrete generally consists of 30 percent cement and 70 percent sand (Shotcrete 2001). A welded wire mesh screen is often constructed over the section to be rehabilitated to provide additional support for the shotcrete mixture. The screen is covered by at least one inch of shotcrete to create a smooth surface. To apply shotcrete, the sand and cement mixture is forced through a hose to a mixing chamber that contains water. The mixture is then “shot” into place using air pressure. Major structural problems can often be remedied using shotcrete (CSU 2001).

Trenchless Technologies

Trenchless sewer rehabilitation technologies use the existing sewer to support a new pipe or a liner. As the name implies, trenchless technology requires less surface interruption than to dig-and-replace a defective sewer line. Trenchless technologies include sliplining, cured-in-place pipe (CIPP), modified cross-section liners, and pipe bursting.

Sliplining

Sliplining involves placing a new, smaller diameter liner in the existing sewer. The new liner is then grouted to the existing pipe to improve structural integrity and prevent leaks (EPA 1999). The sliplining process can be continuous, segmented, or spiral wound. During continuous installation, the total length of lining is inserted at strategic locations. Segmented installation requires the pipe liner to be broken into portions and then assembled at access points in the sewer system. As shown in Figure 1, spiral wound lining is interlocked forming a spiral that is inserted into the pipe from a manhole or other access point. Sliplining may require access to the sewer line beyond that which a manhole can provide; an insertion pit may need to be created. Therefore, sliplining is not always a completely trenchless technology, but it is much less intrusive than traditional dig-and-replace methods (EPA 1999). Also, sliplining is not applicable in force mains.

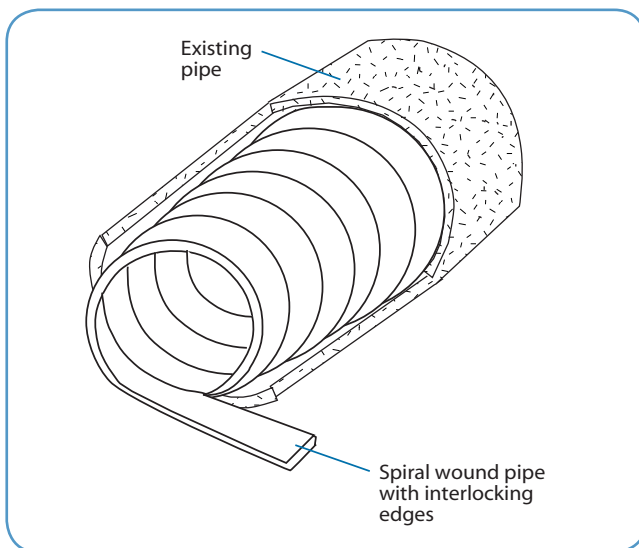

Figure 1. Schematic of a spiral wound lining.

Cured-in-Place Pipe

During CIPP rehabilitation, a flexible fabric liner coated with a thermosetting resin is inserted into the existing sewer and then cured (EPA 1999). The most common techniques for installing the liners are the winch-in-place and invert-in-place methods. In the former, a winch is used to pull the liner into place. The liner is then filled with air to push it against the existing pipe. When using the invert-in-place technique, the resin is applied to the inside of the liner. Water or air pressure is used to invert the liner so that the resin covered side “flips out” to meet the existing pipe. For both methods, heat is used to seal the liner to the pipe (EPA 1999). CIPP liners can be installed from existing

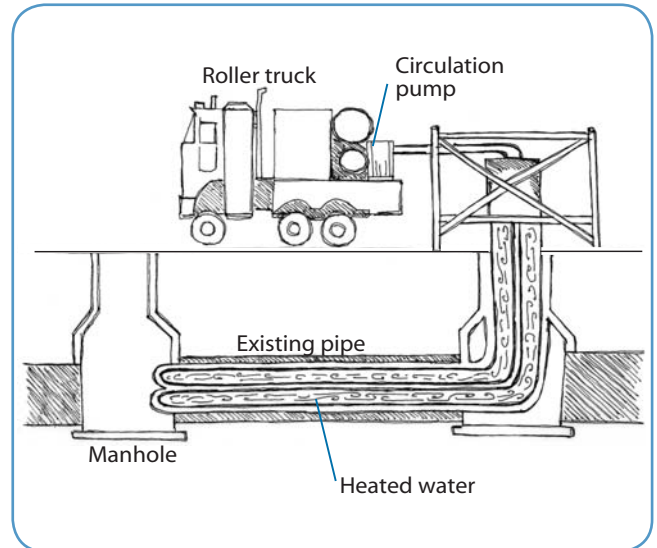

Figure 2. Schematic of a cured-in-place technique (O'Brien and Gere 2002)

manholes, making it a true trenchless technology, as shown in Figure 2.

Modified Cross Section Lining

Modified cross section lining rehabilitation methods modify the cross-sectional area of the liner to facilitate its installation. The three most common techniques are Swagelining™, deform and reform, and roll down. Swagelining™ uses heat and a chemical dye to reduce the size of the liner. After the liner is pulled through the pipe and allowed to cool, it returns to its original diameter. In the deform and reform method, a flexible pipe is deformed, often forming a U shape, and is then inserted into the existing pipe. The roll down technique minimizes the size of the liner using a series of rollers. Heat is used to reform the liner for both the deform and reform and rolldown methods (EPA 1999).

Pipe Bursting

Pipe bursting uses the existing pipe as a guide for an expansion head. A cable rod and winch pull the expansion head, which cracks the existing pipe by pushing it radially outwards. The new sewer line is pulled behind the expansion head, as shown in Figure 3. Expansion heads are either static or dynamic; the dynamic head provides additional pneumatic or hydraulic force to counter the pressure created by pulling the expansion head through the existing pipe (EPA 1999).

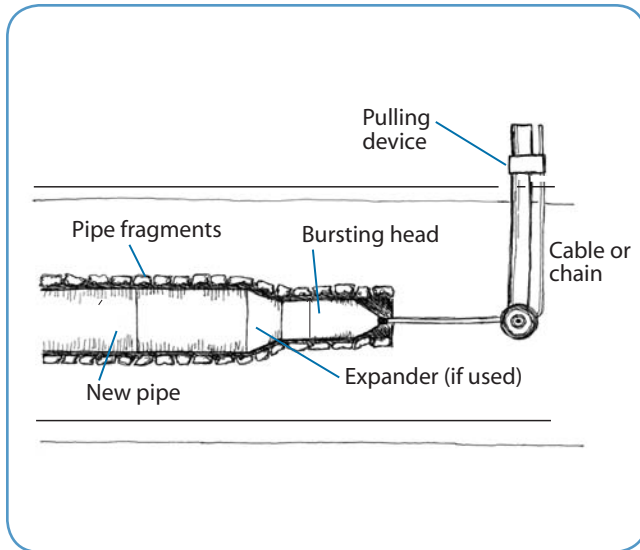

Figure 3. Schematic of pipe bursting technique.

Key Considerations

Applicability

In selecting a sewer rehabilitation technique, site-specific conditions, project goals, and sewer system characteristics should be evaluated. Inspection and evaluation of the current sewer condition are necessary before a sewer rehabilitation technique is chosen, as the condition of the sewer may favor specific techniques. Additional information on sewer inspection techniques is provided in the “Sewer Testing and Inspection Technology Description” located in Appendix B of *Report to Congress on the Impacts and Control of Combined Sewer Overflows and Sanitary Sewer Overflows*.

Removing and Replacing Defective Lines

Removing and replacing defective lines is the most commonly used rehabilitation technique when the sewer line is structurally deficient. Replacing defective lines results in a line segment design life that exceeds any other rehabilitation method. Also, in areas in need of increased conveyance capacity, complete replacement provides an opportunity for installation of a larger-diameter sewer (WEF 1999). Sewer replacement can be quite disruptive to automotive and pedestrian traffic, however. Construction times and service interruptions for replacement are typically lengthy compared to other rehabilitation methods. In addition, sewer flows must be rerouted during construction. Construction costs are also considerably higher for dig-and-replace than for other rehabilitation methods (EPA 1991).

Shotcrete

Shotcrete is often used to rehabilitate sewers with major structural problems. As with dig-and-replace, flow must be completely diverted during construction since equipment and personnel must access the pipe. Shotcrete may only be used in pipes with a diameter greater than 36 inches.

The advantages of using shotcrete include (CSU 2001):

- Rehabilitation can be accomplished using manholes to access the sewer system;
- Restoration of the original pipe strength; and
- Method is safer for crews than grouting and epoxy injections.

Disadvantages of shotcrete include (CSU 2001):

- A long curing time;
- Complete diversion of the flow during application; and
- Reduction in hydraulic capacity because the diameter of the sewer is reduced.

Trenchless Technologies

Trenchless technologies are especially well-suited to urban areas where the traffic disruption associated with large-scale excavation projects can be a significant obstacle to a project (WEF 1999). In addition, many sewers are located near other underground utilities in urban areas which can

Table 1. Sewer system characteristics for trenchless technologies (CSU 2001).

Method	Diameter Range (in.)	Maximum Installation (ft.)
<u>Grouting and Epoxy Injections</u>		
Remote Application		
Manual Application		Not Available
<u>Sliplining</u>		
Continuous	4-63	1,000
Segmented	12-158	5,600
Spiral wound	4-100	300
<u>CIPP</u>		
Invert-in-Place	4-54	500
Winch-in-Place	4-100	3,000
<u>Modified Cross Section Liners</u>		
Swagelining™	4-24	300
Deform and Reform	4-64	300
Rolldown	4-24	300
<u>Pipebursting</u>		
Pneumatic Head	2-24	475
Static Head	4-24	650

complicate traditional dig-and-replace methods; trenchless technologies avoid underground utilities.

Advantages of trenchless technologies include (EPA 1999):

- Reduced air pollution from construction equipment
- Fewer traffic detours
- Decreased construction noise
- Reduced vegetation disturbance
- Limited areas where safety concerns must be identified

Table 1 highlights conditions for which various trenchless technologies are most applicable. Trenchless technologies are not without limitations, however, and they are summarized in Table 2.

Table 2. Disadvantages of trenchless sewer rehabilitation technologies (EPA 1999).

Method	Disadvantage
Grouting and Epoxy Injections	<ul style="list-style-type: none"> • Utilize harsh chemicals that may be dangerous for installation crews • Will not prevent further pipe movement, and may crack if pipe shifts
Sliplining	<ul style="list-style-type: none"> • Requires an insertion pit • Reduces pipe diameter • Cannot be used with small diameter pipes
CIPP	<ul style="list-style-type: none"> • Curing can be difficult for long pipe sections • Requires diversion of flow • Resin can clump together • Reduces pipe diameter
Modified Cross Section Liners	<ul style="list-style-type: none"> • Liner may shrink after installation
Pipe Bursting	<ul style="list-style-type: none"> • Infiltration may occur between pipe and liner • Liner may not provide adequate structural support • Requires diversion of flow • Reduces pipe diameter
Pipe Bursting	<ul style="list-style-type: none"> • Insertion pit needed • Dynamic head may cause soil settling around the newly installed pipe • Requires diversion of flow • Not suitable for all pipe materials

Cost

Selection of a cost-effective sewer rehabilitation technique depends on the present condition of the sewer and other site-specific considerations. In general, grouting is the least expensive of the sewer rehabilitation methods presented. Further, trenchless sewer rehabilitation techniques are often less expensive than open-cut methods because the amount of excavation for the trenchless technology is minimal (EPA 1999). A representative range of costs for several trenchless technologies (CIPP, sliplining, and pipe bursting) is presented in Table 3; actual costs for sewer rehabilitation projects undertaken by a number of municipalities are summarized in Table 4. As shown in Table 4, there is considerable variation in the cost per foot for an individual technology; the diameter of the pipe drives much of this variation. Figure 4 illustrates the increase in cost of CIPP replacement as a function of increasing sewer diameter.

Table 3. Cost of selected trenchless technologies.

Technology	Cost (\$/foot)
CIPP	42-1200
Sliplining	10-560
Pipe Bursting	46-260

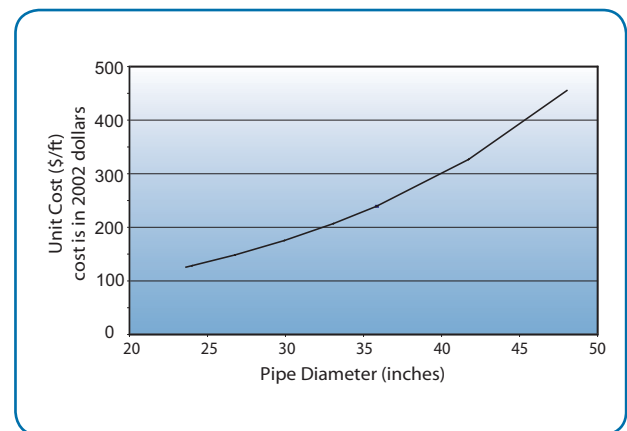

Figure 4. CIPP cost versus pipe diameter (Zhao et al. 2001).

Table 4. Costs of municipal sewer rehabilitation projects.

Municipality	Technology	Project Characteristics	Year Constructed	Costs ¹
Buffalo, NY	Shotcrete	Shotcrete was applied to 1,465 linear feet of the Military Road sewer that was over 50 years old. The pipe diameter tapered down from 53 to 48 inches.	1997	Approximate cost: \$280,552 or \$192 per foot
Indianapolis, IN	Shotcrete Trenchless	After sewer evaluation was performed a total of 12,495 feet for sewer have been rehabilitated using Shotcrete, CIPP, and sliplining.	1998-2002	\$4 million or \$317 per foot
St. Louis, MO	Open-Cut	1,560 feet of sewer were replaced, providing surcharge relief to upstream sewer system. Costs include all excavation, refill, and engineering costs.	2002	\$535,000 or \$343 per foot
Austin, TX	Open-Cut Trenchless	The Austin Clean Water Program is a comprehensive project to eliminate SSOs from the city's sanitary sewer system. The project will be complete by 2007.	2002 (construction started)	Cost for Crosstown Tunnel Service Area: \$44 million or \$530 per foot
Torrence, CA ²	Open-Cut Trenchless	8,400 feet of pipe was rehabilitated. 90 percent of the sewers were repaired using machine spiral wound PVC pipe liner. Open-cut methods were used for the remaining sewers.	2002	Total construction cost: \$530,000 Open-cut: \$191,000 or \$955 per foot Trenchless: \$339,000 or \$41 per foot
DuPage County, IL	Trenchless	U-liner to rehabilitate 24,000 feet of 8-inch and 4,000 feet of 10-inch VCP mains.	1994	8- to 12-inch U-Liner: \$34-\$44 per foot
Glendale, WI	Trenchless	U-Liner was used to repair 3,462 feet of eight to 10 inches pipes; CIPP was used for 1,966 feet of 15-inch pipes..	1999	8-to 10-inch U-Liner: \$29-\$33 per foot 15-18 inches CIPP: \$58-68 per foot
Muscatine, IA	Trenchless	CIPP method was used to rehabilitate 3,800 feet of 24- to 27-inch diameter pipes and 187 feet of 8-inch clay pipes.	2001	24-to 27-inch CIPP: \$67-\$103 per foot
South Fayette Township, PA	Grouting	Pilot program grouting a total of 2,788 feet was conducted. A total of 303 gallons of acrylmide grout was used.	1997	\$33,475 or \$12 per foot
Dallas, TX	Grouting	Approximately 10,000 feet of pipe were cleaned, tested, and sealed as part of a project to eliminate I/I.	2000	\$89,331 or \$9 per foot

¹ All costs are converted to 2002 dollars based on the ENR Construction Cost Index² Costs include traffic control, which increase the cost per linear foot; total construction cost was \$530,000 (Ringland 2003)

Implementation Examples

AUSTIN, TX

Responsible Agency: City of Austin Water and Wastewater Utility

Population Served: 1 million

Service Area: 364 sq. mi.

Sewer System: 2,262 mi. of sewer

Clean Water Program to Control SSOs

In April 1999, the City of Austin received an Administrative Order from EPA requiring it to eliminate SSOs by 2007. The order stemmed from a review of Austin's sewer system performance following a 170,000 gallon SSO to Bushy Creek, a tributary of the San Gabriel River. To comply with the order, the city created the Austin Clean Water Program. The order requires inspection of approximately 40 percent of the city's 2,200 mile sewer system, and, where appropriate, the rehabilitation of failing sewer lines. The project is broken

up into three areas, Crosstown Tunnel Service Area, Onion Creek Service Area, and Govalle Tunnel Service Area, which are being inspected and rehabilitated in a phased approach. To date, 500,000 linear feet have been rehabilitated using sliplining and open-cut methods.

The total cost estimate for the Austin Clean Water Program is \$150 million, which includes an I/I study and sewer system evaluation and rehabilitation projects in each service area. Estimated cost for the rehabilitation completed in the Crosstown Tunnel Service Area is approximately \$44 million or \$530 per linear foot.

More information at <http://www.ci.austin.tx.us/acwp/>

MIAMI, FL

Responsible Agency: Miami-Dade Water and Sewer Department

Population Served: 2.1 million

Service Area: Not Available

Sewer System: 2,441 mi. of gravity sanitary sewer

I/I and Rehabilitation Program

The Miami-Dade Water and Sewer Department (MDWASD) initiated an infiltration/inflow and rehabilitation (I/I & R) program in 1995 in response to an EPA consent decree. The I/I & R program established an ongoing sewer evaluation and rehabilitation schedule to preserve the sewer system's integrity and maintain acceptable levels of I/I. The I/I & R program includes sewer cleaning, CCTV

inspection, smoke testing, dye water flooding, and system rehabilitation.

Approximately 14.5 million feet of sanitary sewer have been inspected and rehabilitated. Sewer rehabilitation methods include dig-and-replace, sliplining, and grouting. Over 32,000 repairs have been completed, helping to reduce SSO volumes by 90 percent and I/I by an estimated 118 MGD since program inception. MDWASD believes the I/I & R program is working; for example, in June and July 2002, the area received more than 20 inches of rain, but the sewer system experienced no capacity-related SSOs. The total cost of the I/I & R program, since its inception, has been approximately \$174 million or \$12 per foot of sewer inspected or rehabilitated.

More information at <http://www.co.miami-dade.fl.us/wasd/>

COLUMBUS, OH

Responsible Agency: Department of Public Utilities, Division of Sewage and Drainage

Population Served: 1 million

Service Area: 219 sq. mi.

Sewer System: 4,000 mi. of sanitary and combined sewer

Sewer Inspection and Rehabilitation Program

In 1995, the City of Columbus initiated a sewer line inspection and rehabilitation program. To assure the quality of products used by contractors in the program, the city developed a list of approved rehabilitation technologies. When a new technology or product of interest emerges, the manufacturer may request to have their product added to the approved list. The city has developed a process to standardize the introduction of new products. The process requires that:

- The products meet and conform to American Society for Testing and Materials (ASTM) and other professionally recognized standard specifications.
- The products must have been used successfully by three municipalities over a minimum of three years.
- The city visits both construction sites and product manufacturing facilities to inspect operation and observe standard construction practices.
- The manufacturer provides information on the expected service life of the product with supporting data.

When a product is selected for preliminary review, it is installed in a small portion of the city's sewer system. The product's effectiveness is then monitored for three years. Once the product is judged effective, it can be placed on the list of approved technologies. The current list of approved technologies includes several CIPP products, sliplining, and shotcrete. These technologies have been utilized to repair numerous sections of structurally impaired combined sewers. The city has recently started rehabilitating sanitary sewers using the approved technologies.

Sewer rehabilitation is a priority for Columbus, and the program has been funded accordingly. The dollars spent on sewer rehabilitation between 1996 and 2001 are shown in the table on the right. Costs presented do not include construction, administration, and inspection costs.

Year	Construction Dollars Spent ¹ (Millions)
1996	\$6.5
1997	\$2.6
1998	\$5.9
1999	\$2.6
2000	\$6.8
2001	\$9.3

¹ All costs are converted to 2002 dollars based on the ENR Construction Cost Index

Contact: Miriam Siegfried, Department of Public Utilities, City of Columbus

HOUSTON, TX

Greater Houston Wastewater Program

Responsible Agency: City of Houston
Department of Public Works and Engineering

Population Served: 1.9 million

Service Area: 600 sq. mi.

Sewer System: 5,000 mi. of sanitary sewer

In 1987, the Texas Natural Resource Conservation Commission and EPA mandated that Houston eliminate the 200 known SSO points that were part of their sanitary sewer system by 1997. The first step the city took was to inspect over 27 million linear feet of sewer. The results of the inspections were used to rate each sewer segment. The rating took into account the severity of I/I, roots, concrete deterioration, and structural defects. The inspection program found that 50 percent of the inspected sewer segments were in need of rehabilitation or replacement.

To help prioritize the numerous rehabilitation projects, the city developed a numeric sewer rehabilitation rating system, which considered:

- Accessibility of the line
- Potential future capacity requirements
- Surrounding environment
- Cost

Prior to rehabilitation, a second analysis was performed to determine the most appropriate technique. The analysis considered:

- Current condition of the sewer line
- Maximum service capacity
- Hydraulics
- Site constraints

In areas that were fully built-out, with no future plans for redevelopment, trenchless technologies were generally used for sewer rehabilitation. Where trenchless technologies were utilized, a hydraulic analysis was performed to determine if reducing the inner diameter of pipe would cause capacity constraints that could lead to SSOs. For sewers where the use of trenchless technologies yielded an unacceptable reduction in pipe diameter, or areas where undeveloped land was still available, lines targeted for rehabilitation were typically replaced with a larger pipe to add additional capacity.

Technologies approved for use by the city included sliplining, cured-in-place pipe, pipe bursting, and limited use of modified cross-section liners. The city rehabilitates approximately 120 miles of sewers annually using trenchless technologies. The city committed to spend a total of \$300 million on sewer rehabilitation as part of the settlement with EPA.

Contact: Teresa Battenfield, City of Houston, Department of Public Works and Engineering

INDIANAPOLIS, IN

Combined Sewer Infrastructure Assessment

Responsible Agency: City of Indianapolis
Department of Public Works

Population Served: 800,000

Service Area: 58.4 sq. mi.

Sewer System: 82.2 mi. of combined sewer

The Indianapolis Combined Sewer Infrastructure Assessment Project investigated the integrity of approximately 50 miles of sewer with diameters of 60 inches or larger. The city used the study to identify sewers in need of immediate rehabilitation and to develop the basis for a more integrated Capital Improvement Program. This project was also important to the city in developing its CSO long-term control plan. The city wanted to maximize storage in the existing sewer system, but needed to be sure that the pipes

used to store flows were structurally sound. If a weak sewer pipe was stressed to the point of failure in using it for storage, the environmental impacts could be much larger than those attributed to a single CSO event. Approximately 253,000 feet of brick, concrete, and vitrified tile combined sewer were physically inspected and rated based on their structural integrity between 1994 and 1998. The study found that the majority of sewers were in good condition, identifying approximately 71,000 feet (28 percent of the assessed length) in need of rehabilitation. Since the Assessment Project was completed in 1998, a total of 12,495 feet of sewer have been rehabilitated. The city has used shotcrete, CIPP, and sliplining techniques to rehabilitate their large diameter combined sewers.

The total cost for the Assessment Project was \$1.1 million. An additional \$4 million or \$317 per foot has been invested in targeted sewer rehabilitation.

Contact: T.J. Short, Greeley and Hansen

References

EPA. 1991. *Sewer System Infrastructure Analysis and Rehabilitation*. EPA 625-6-91-010.

EPA. 1999. *Collection Systems O&M Fact Sheet: Trenchless Sewer Rehabilitation*. EPA 832-F-99-032.

California State University (CSU), Sacramento - College of Engineering and Computer Science, Office of Water Programs. 2001. *Operation and Maintenance of Wastewater Collection Systems*. Vol. 1, 5th ed. Prepared for EPA Office of Water Programs, Municipal Permits and Operations Division. Sacramento, CA: CSU, Sacramento Foundation.

National Research Council Canada (NRC). 2002. *Construction and Rehabilitation Costs for Buried Pipe with Focus on Trenchless Technologies*. Research Report No. 101. Ottawa, Canada: National Research Council Canada.

O'Brien & Gere. 2002. 'Wastewater Management: Trenchless Technologies.' Viewed December 17, 2002.

[http://www.obg.com/wastewater/pdf/Trenchless_Syr\(1\).pdf](http://www.obg.com/wastewater/pdf/Trenchless_Syr(1).pdf)

Shotcrete Technologies, Inc. 2001. "Shotcrete Tips and Tricks: Mix Design and Quality Control." Retrieved February 21, 2003.

<http://www.shotcretetechnologies.com/tips.html>

Ringland, David, City of Torrence. Interview with Limno-Tech, Inc., March 2003. Washington, DC.

Water Environment Federation (WEF). 1999. *Prevention and Control of Sewer System Overflows: WEF Manual of Practice No. FD-17*. Prepared by Gray, W. et al. Alexandria, VA: Water Environment Federation.

Zhao, J. Q. et al. 2001. *Guidelines for Condition Assessment and Rehabilitation of Large Sewers*. Ottawa, Canada: Institute for Research in Construction, National Research Council Canada. Report No. NRCC-45130.

Inclusion of this technology description in this Report to Congress does not imply endorsement of this technology by EPA and does not suggest that this technology is appropriate in all situations. Use of this technology does not guarantee regulatory compliance. The technology description is solely informational in intent.



Installing cured-in-place lining (Reynolds's Inc.)

TECHNOLOGY DESCRIPTION

Collection System Controls

Service Lateral Rehabilitation

Overview

Private building service laterals (herein referred to as “service laterals”) are the pipe or pipes used convey wastewater from individual buildings to the municipal sewer system. Typical service laterals are four to six inches in diameter, with lengths ranging from 15-100 feet. Service laterals are often thought of in two segments: the upper lateral, which includes the section of pipe between the building and private property boundary; and the lower lateral, which includes the section of pipe between the private property boundary and the municipal sewer system.

For many years, the effect of leaking service laterals was considered insignificant because it was assumed that most service connections were above the water table, and therefore, subject to infiltration only during periods of excessive rainfall or high groundwater levels (EPA 1991). More recent studies indicate that a significant component of the infiltration in any sewer system is the result of service lateral defects that contribute varying quantities of inflow and infiltration (I/I) to the sewer system. Many of these defects are traceable to poor design, pipe selection, and improper construction (WEF 1999). Further, fluctuating groundwater levels, variable soil characteristics and conditions, traffic, erosion, and washouts stress service lateral pipes and joints. As shown in Figure 1, the most common problems found in service laterals include:

- Improper connections
- Faulty pipe joints
- Root intrusion
- Failure of service lateral bedding or backfill to support the pipe
- Pipe material failure in aging service laterals
- Missing or broken cleanout caps

Service lateral testing is an important first step in any rehabilitation program. Testing is used to assess the structural condition of the service lateral and to help locate defects. Additional information on sewer testing practices is

provided in the “Sewer Testing and Inspection Technology Description” in Appendix B of *Report to Congress on the Impacts and Control of Combined Sewer Overflows and Sanitary Sewer Overflows*.

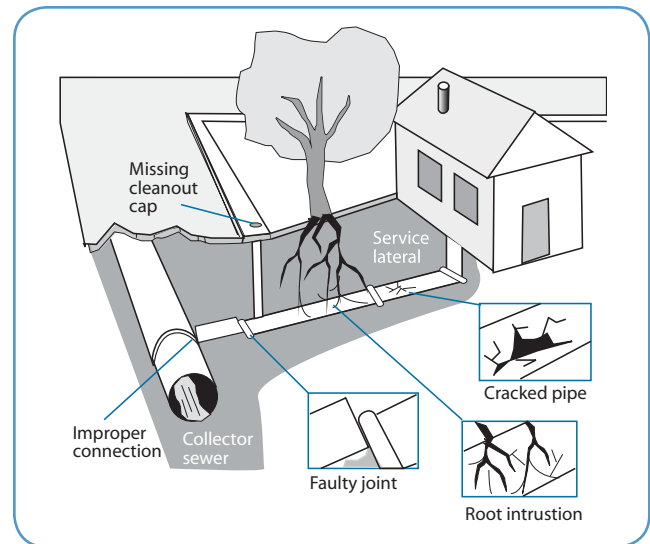

Figure 1. Common defects in service laterals.

There are a number of techniques available for repairing defective service laterals. These include:

- Removing and replacing defective service laterals
- Spot repairs
- Trenchless technologies
- Eliminating inflow sources

These four techniques are discussed in some detail below.

Removing and Replacing Defective Service Laterals

In many cases, it is not practical or desirable to rehabilitate existing sewers. Removing and replacing part or all of a defective service lateral is the most common and proven method for eliminating I/I from private property. A key factor to a successful program using remove and replace is

obtaining the private property owners' consent to access the property for construction.

Spot Repairs

Spot, or point, repairs are typically used to correct isolated or severe problems in relatively short portions of a service lateral. Spot repairs can also be made as an initial step in the use of other rehabilitation methods (NASSCO 1996). Spot repairs can be made using either open cut or trenchless technologies. The open-cut technique involves excavating and removing the defective section, and then installing new pipe with proper seals to ensure watertight connections to the existing service lateral and/or municipal sewer system. Trenchless technologies for spot repairs typically use epoxy or resin to fill defects; in general, their use is limited to service laterals with a diameter of six inches or more.

Trenchless Technologies

Trenchless service lateral rehabilitation uses the existing pipe to support a new pipe or a liner. Generally, the use of trenchless technology methods is neither as widespread nor extensive as open cut techniques for repairing service laterals (WEF 1999). As the name implies, trenchless technology requires less surface interruption than complete replacement of a defective line. Therefore, trenchless technologies show particular promise in areas where construction impacts on trees, shrubbery, and other landscaping materials would make open-cut service lateral repair costs prohibitive. Trenchless rehabilitation techniques include lining, cured-in-place pipe (CIPP), pipe bursting, grouting, and epoxy injections.

Lining Service Laterals

Lining service laterals is typically used to extend the life of an existing service lateral by increasing its strength and/or protecting it from corrosion or abrasion (NASSCO 1996). Lining involves sliding a flexible liner pipe of slightly smaller diameter into the existing lateral. The space between the liner and the existing service lateral is then grouted. Lining is most often used to rehabilitate extensively cracked laterals, especially those in unstable soil conditions. The most popular materials used to line sewers are polyolefins, reinforced thermosetting resins, and PVC (EPA 1991). The lateral must be thoroughly cleaned prior to lining. Typically, lining the service lateral requires excavating an entry point at both upstream and downstream ends to be able to insert and move the liner into position. Therefore, similar to remove and replace and open-cut spot repairs, lining service laterals requires private property access.

Cured-in-Place Pipe

The cured-in-place pipe (CIPP) process involves installing and curing a resin-saturated, flexible fabric liner inside the service lateral. The liner is installed using air or water inversion or a pull-in process. With water inversion, the lining is inverted using water pressure; air inversion uses air pressure to invert the liner. The pull-in process involves winching the liner into place and using an air bladder to "inflate" the liner. The liner is then cured by circulating low pressure hot water or steam. The lateral must be thoroughly cleaned prior to installing the CIPP, and areas with excessive infiltration must be sealed. Typically, installing CIPP liners requires excavating an entry point at either the upstream or downstream end. Therefore, installing CIPP liners may not require private property access.

Pipe Bursting

Pipe bursting replaces the existing lateral with a pipe of similar or larger diameter by fragmenting the existing pipe into the surrounding soil, thereby creating a cavity for the new pipe. Pipe bursting has been used in the gas industry for some time, but only more recently has been looked at for rehabilitating service laterals. Similar to lining a lateral, excavated entry points at both the upstream and downstream ends of the service lateral are required, which requires private property access.

Grouting and Epoxy Injections

Grouting and epoxy injections are most commonly used for sealing leaking joints in pipes that are otherwise structurally sound (NASSCO 1996). Small holes and radial cracks may also be sealed by grouting or epoxy injections. Grouts and epoxies are applied internally within a pipe and are a trenchless rehabilitation method.

Eliminating Inflow Sources

Service lateral cleanouts allow access to the lateral for routine maintenance. Often, the cap used to prevent storm water inflow into the service lateral at the cleanout is broken or missing. One study found that almost 25 percent of service lateral defects were related to missing or damaged cleanout caps (Rowe and Holmberg 1995). Replacing missing or defective cleanout caps can result in substantial reductions in inflow into the sewer system.

Although disconnecting inflow sources is not a repair of the service lateral per se, elimination of direct

connections of extraneous storm water is important. Other, often significant inflow sources include:

- Roof leaders
- Area, foundation, yard, patio, and driveway drains
- Basement sump pumps
- Cross-connections to separate storm sewers

Additional information on disconnecting inflow sources is provided in the “Inflow Reduction Technology Fact Sheet” in Appendix B of *Report to Congress on the Impacts and Control of Combined Sewer Overflows and Sanitary Sewer Overflows*.

Key Considerations

Applicability

Assigning responsibility for the repair or replacement of service laterals has often been cited as the biggest obstacle to correcting known defects. Notably, several studies highlighted significant problems in gaining access to private property until the municipality assumed full financial responsibility for the repair or replacement of service laterals (Curtis and Krustsch 1995; Paulson *et al.* 1984).

Removing and Replacing Defective Service Laterals

The removal and replacement of a service lateral is usually more expensive than other rehabilitation methods. Replacing a defective service lateral, however, ensures that the design capacity of the lateral is maintained, whereas rehabilitation may result in an unacceptable reduction in capacity. Construction activities associated with removal and replacement involve a greater risk of damage to or interruption of other utilities than most trenchless lateral rehabilitation techniques.

Spot Repairs

Spot repairs are often a cost-effective means of addressing minor defects in service laterals. While spot repairs eliminate infiltration at the location of the repair they are typically not an appropriate approach for rehabilitating a lateral with multiple defects. Without correcting all of the defects in a given lateral, groundwater will simply find another location to enter the pipe. Depending on the number and type of defects in a given lateral, it may be more cost-effective to address the infiltration by rehabilitating the entire length of the lateral.

Trenchless Technologies

Trenchless sewer rehabilitation techniques require substantially less construction work than traditional remove-and-replace methods (EPA 1999). However, with

the exception of pipe bursting, trenchless technologies reduce the lateral diameter, resulting in decreased capacity.

Lining Service Laterals

To date, there has been limited experience using liners to rehabilitate service laterals, although application is expected to increase (WEF 1999). In lining service laterals, particular attention must be paid to local plumbing codes, specifically, whether changes will be required to accommodate the reduced interior diameter of the lateral after it is lined.

Pipe Bursting

The primary advantage of pipe bursting is that the flow carrying capacity of the existing lateral does not have to be reduced; further, pipe bursting allows the new lateral to be up-sized, if needed. In addition, the amount of surface disruption associated with pipe bursting is less than that required for total lateral replacement. The soil type surrounding the existing lateral is an important variable when considering pipe bursting. In soils that are predominated by sand, the soil “relaxes” almost instantaneously onto the new pipe causing very slow progress. It is also important to ensure that no large boulders or rock formations are located in the path of the pipe bursting equipment. Finally, the forces exerted by the bursting equipment may adversely affect other pipes near the lateral being replaced. Unit replacement costs with pipe bursting are typically 20-40 percent lower than traditional open cut methods.

Cured-in-Place Pipe

The use of CIPP for rehabilitating laterals with diameters as small as four inches is common (NASSCO 1996). Unlike other types of lining, CIPP does not require grouting. Although the installation of a CIPP liner is rapid, the curing period can be extensive, and flow and groundwater infiltration in the lateral will need to be controlled during installation. CIPP also has relatively high set-up costs for small projects.

Grouting and Epoxy Injections

Grouting is relatively inexpensive. Grouting does not improve the structural strength of the lateral, and for that reason, should not be considered when the pipe is severely cracked, crushed, or badly broken (EPA 1991). Epoxy injections, although similar to grouting in most respects, provide the added benefit of improving somewhat the structural integrity of the rehabilitated pipe. Because epoxy is more viscous than grout, it cannot be pumped as far (WEF 1999). The service life of grout is an important consideration. The average service life of grouts is seven years (NASSCO 1996).

Grouting requires flow control, because the section being grouted cannot transport flow until the grout has cured. Therefore, it is also difficult to line service laterals if infiltration is present. Most coatings cannot be successfully applied to either water leaks or ponded water (NASSCO 1996). Large cracks, badly offset joints, and misaligned pipes may not be sealable using grouts or epoxies.

Eliminating Inflow Sources

Eliminating sources of inflow can be an efficient way to reduce the volume of storm water delivered to both combined and separate sanitary sewer systems. The feasibility of disconnecting inflow sources depends on the soil type, land slope, and drainage conditions around the home. Additionally, for an inflow disconnection program to be successful, the public must be educated about the benefits of and the methods for disconnecting sources. This can be time-consuming and will likely require some sort of rebate program or other incentive for compliance.

Cost

Often, very little specific data are available to compare the I/I contribution from service laterals with that from other sewer system components. Flow meters are rarely used to monitor individual service laterals for reasons including it is physically difficult to isolate service laterals from the sewer system for installing flow meters; placing flow meters in a service lateral requires significant and often expensive modifications; and the large number of service lateral

connections can make sampling representative locations costly. Rehabilitating service laterals, however, has proven to be a critical component of an I/I reduction program. Studies have found that service lateral rehabilitation can reduce the introduction of extraneous I/I into the sewer system from 45-87 percent (Rowe and Holmberg 1995; Curtis and Krustsch 1993; EPA 1985; Roberts 1979). Actual I/I reductions achieved, however, are dependent on a number of factors, and therefore the cost-effectiveness of lateral rehabilitation will vary from community to community.

Costs associated with the various techniques available for rehabilitating or replacing service laterals vary considerably and are driven by site-specific conditions. Table 1 presents the relative costs of the various techniques discussed in this technology description. For example, replacing a service lateral, either using open cut or pipe bursting techniques, is almost always more expensive than other rehabilitation alternatives. The exact cost of replacing the lateral, however, will be driven by the landscape and length of the lateral among other factors.

Table 1. Relative cost of various service rehabilitation costs.

Technique	Relative Cost
Removing and replacing service laterals	\$\$\$\$
Spot repairs	\$
Lining service laterals	\$\$
Pipe bursting	\$\$\$
Grouting and epoxy injections	\$\$
Eliminating inflow sources	\$\$

Implementation Examples

DARIEN, IL

Responsible Agency: DuPage County Public Works Division

Population Served: 585 single family homes

Hinsbrook Subdivision I/I Rehabilitation

In the early 1990s, the DuPage County Public Works Division initiated efforts to control I/I in the Hinsbrook Subdivision, which suffered from frequent SSOs. A study of the sewer system determined that 25-30 percent of the I/I was entering from the sewer system service laterals. Rehabilitation of the service laterals was necessary, but politically complicated as it involved coordinating three groups:

the Public Works Division of DuPage County, the Public Works Department of the City of Darien, and the property owners. DuPage County owns the SSS, while the City of Darien is responsible for storm water control in the subdivision, and property owners are responsible for the portion of the service lateral on their property.

Pipe bursting was used to rehabilitate the majority of the service laterals in the subdivision. Property owners were informed in advance of the replacement and given the option of hiring their own contractor or allowing the county to make the needed repairs. Only 35 homeowners chose to hire their own contractor. For the pipe bursting, a small pit was excavated at the foundation of each home. The pipe bursting head and new pipe were pulled with a winch from a pit located near the main pipe. The new service lateral was then connected to the house and the service main. Installation time averaged two hours limiting the time service was interrupted. Property owners who chose to have the county rehabilitate their service lateral paid the county \$966.

More information at <http://www.dupageco.org/publicworks/index.cfm>

MONTGOMERY, AL

Responsible Agency: Montgomery Water Works and Sanitary Sewer Board

Population Served: 225,000

Service Area: 150 sq. mi.

Sewer System: 1,098 mi. of sewer

I/I Tracking and Service Lateral Rehabilitation

Montgomery Water Works and Sanitary Sewer Board (MWWSSB) evaluated the condition of its sewer system in the early 1990s and discovered inflow sources could be cost-effectively eliminated in 86 percent of the system. Nearly 2.2 million linear feet of pipe were investigated in the first five years of the program. Of the 3,394 sewer system problems detected, 85 percent were service lateral problems; a defect was found in approximately every 700 feet of sewer inspected. Of

the 113 subbasins served by MWWSSB, 35 were smoke tested in the first six years of the program; 97 percent of the lateral defects identified have been repaired.

Lateral maintenance and repair has always been the responsibility of the property owner, who was notified when defects were discovered. Due to the number of defects identified, MWWSSB adopted a more aggressive maintenance and repair policy. Property owners initially received a 60-day notice of the lateral repair requirements. If they failed to respond to the initial notice, a 10-day notice was sent to the property owner. Finally, if the property owner had not responded to either notice, their water service was shut-off.

Lateral repairs necessary within the city street right-of-way are made by MWWSSB with consent and release of liability from the property owner. MWWSSB also replaces missing clean-out covers for a minimal cost with written permission from the property owner.

To help manage the numerous service lateral repairs, MWWSSB created a sewer maintenance database. The database includes information regarding when smoke testing was initiated, any defects found during testing, digital photos of the defect, when the first owner notice was generated, and any repairs that were performed.

The public notice process was implemented in the Fall of 1994; 65 percent of property owners responded after receiving the 60-day notice. The remaining property owners repaired their defects under threat of having their water service discontinued. In selected subbasins where service lateral rehabilitation is complete, a 42 percent reduction of I/I has been measured. It is estimated that the annual I/I volume in the MWWSSB service area has been reduced by 36 million gallons. The initial cost of establishing the I/I program was approximately \$150,000; MWWSSB annual program operation costs are \$207,000.

Contact: Danny Holmberg, Montgomery Water Works and Sanitary Sewer Board

ORLANDO, FL

Lateral Lining Program

Responsible Agency: City of Orlando Public Works Department, Wastewater Bureau

Population Served: 200,000

Service Area: 104 sq. mi.

Sewer System: 500 mi. of sanitary sewer

The City of Orlando Public Works Department (PWD) is responsible for the maintenance and repair of the city's sewer system. Service laterals in the sewer system are made from several different materials, including clay (45 percent), PVC (35 percent), and concrete (20 percent). PWD found that the clay and concrete pipes were particularly prone to I/I problems and that root intrusion was the most common defect in service laterals.

PWD began to excavate and replace laterals from the property line to the main sewer. Excavation was expensive and disturbed the local landscape and traffic patterns, frustrating residents. PWD looked into various trenchless technology options and selected CIPP liners installed using an air inversion system to rehabilitate laterals.

PWD only rehabilitates laterals from the property line to the main sewer. Lateral rehabilitation begins when city crews excavate the lateral at the property line. The crew then performs an initial inspection, and the proper length of liner is prepared and impregnated with resins. The liner is installed into the host pipe by inflating a bladder that forces the liner into the pipe and causes it to adhere to the walls of the host pipe. After a two-hour curing period, the bladder is deflated and removed. After a final inspection, the pipe is reconnected and the excavation site is resodded. It is estimated that this process takes four to five hours per lateral. It is believed that this system will help mitigate SSOs by controlling I/I into the system and will reduce service calls. The equipment for this program cost \$21,500, and it is estimated that rehabilitation will cost \$800 per lateral.

Contact: Ron Proulx, Public Works Department, City of Orlando

SAN LUIS OBISPO, CA

Voluntary Service Lateral Program

Responsible Agency: City of San Luis Obispo Utilities Department

Population Served: 44,613

Service Area: 10.7 sq. mi.

Sewer System: 130 mi. of combined sewer

The City of San Luis Obispo was experiencing I/I problems during their rainy season. At the time, the city treatment plant was suffering from wastewater flows that would increase from a daily average of 4.5 MGD to over 30 MGD during wet weather events, pushing the city's wastewater treatment facility over its design limit. A flow monitoring study of the city sewer system was conducted to identify the extent of I/I and its sources.

Flow monitoring data showed that a residential area served by sewers built between 1930 and 1965 was the major contributor of I/I. The city then video inspected the sewer mains to determine the locations of the I/I within this area. The inspection phase occurred from 1991-1994 and concluded that service laterals were the main source of the I/I. A small sample of laterals revealed that failures were mainly due to aging construction materials and failed mortar joints, particularly where laterals were constructed from orangeburg or clay pipe. Service lateral defects identified included root intrusion, misaligned joints, broken pipes, holes, and missing pipes. Based on these findings, the city adopted and implemented the Voluntary Sewer Lateral Rehabilitation Program (VSLRP) in 1997.

The VSLRP was developed to mutually benefit the city and homeowners. Homeowners who participate in the program received free lateral inspection, construction permits, technical advice, and a rebate of half the cost of the replacement or repair up to \$1,000 per property from the city. The lateral rehabilitation methods used by the city were removal and replacement, the most popular method, as well as trenchless rehabilitation methods of pipe bursting and lining.

More information at http://www.ci.san-luis-obispo.ca.us/utilities/vslrp_technical.asp

References

Curtis, N. M., and Krustsch, A.H. "Trying on Flow Reduction for Size." *Water Environment Technology*. 3 (No. 4): 48.

Curtis, N. M., and Krustsch, A.H. 1995. *Sewer Rehabilitation Using Trenchless Technology on Mainlines and Service Laterals*. Conference proceedings at Water Environment Federation WEFTEC, Anaheim, CA. October 1993.

EPA. 1985. *Demonstration of Service Lateral Testing and Rehabilitation Techniques*. Prepared by C. H. Steketee. EPA 600-2-85-131.

EPA. 1991. *Sewer System Infrastructure Analysis and Rehabilitation*. EPA 625-6-91-030.

EPA. 1999. *Collection Systems O&M Fact Sheet: Trenchless Sewer Rehabilitation*. EPA 832-F-99-032.

National Association of Sewer Service Companies (NASSCO). 1996. *Manual of Practices - Wastewater Collection Systems*. 2nd ed. Baltimore, MD: NASSCO.

Institute for Research in Construction, National Research Council Canada. 2002. *Construction and Rehabilitation Costs for Buried Pipe with a Focus on Trenchless Technologies*. Prepared by Jack Q. Zhao and Balvant Rajani. Research Report No. 101.

Paulson, R. I., *et al.* 1984. "Attacking Private Infiltration/Inflow Sources." *Public Works*. 115 (2):54-59

Roberts, G. C. 1979. "Expediting Sewer Studies." *Water Sewer Work*. 126 (No. 2): 52.

Rowe, R., *et al.* 1995. *Data Handling Procedures Expedite Sewer Evaluation and Repair of Service Laterals*. Proceedings of the National Conference on Sanitary Sewer Overflows, Washington, DC, April 1995.

Water Environment Federation (WEF). 1999. *Control of Infiltration and Inflow in Private Building Sewer Connections*. Alexandria, VA: WEF.

Inclusion of this technology description in this Report to Congress does not imply endorsement of this technology by EPA and does not suggest that this technology is appropriate in all situations. Use of this technology does not guarantee regulatory compliance. The technology description is solely informational in intent.

Broken manhole (Limno-Tech, Inc.).

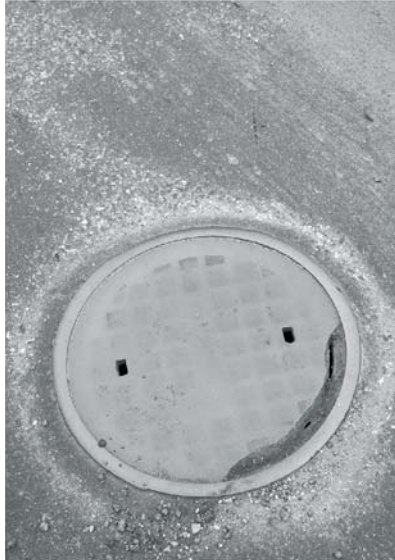

Manhole Rehabilitation

Overview

Manhole rehabilitation is one of several sewer system controls that can be implemented as part of an on-going maintenance or sewer rehabilitation program. Structurally defective manholes can be a source of significant infiltration and inflow (I/I) to a sewer system. Manhole rehabilitation is one way to reduce or eliminate I/I and preserve sewer system capacity for transporting wastewater. Manhole rehabilitation can range from spot repairs of structural components to complete manhole replacement. A typical manhole and its components are presented in Figure 1. Descriptions of manhole components and a summary of common defects are presented in Table 1.

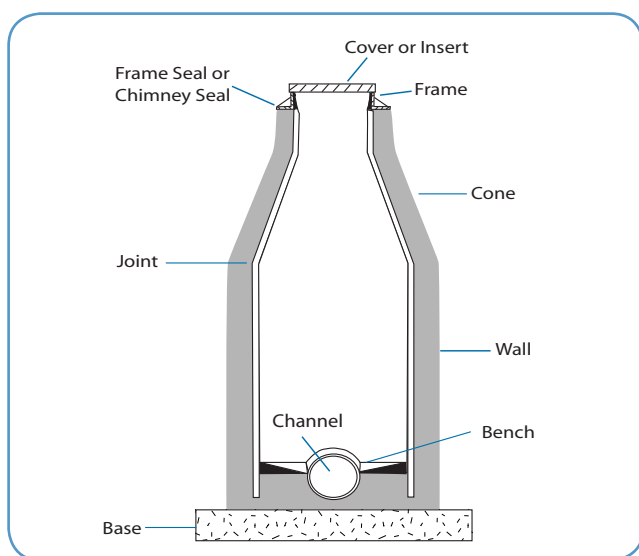

Figure 1. Schematic of a typical manhole

The most common manhole rehabilitation methods are: chemical grouting, spot repairs, coating systems, and structural reconstruction (ASCE 1997; NASSCO 1996). These methods are described in more detail below.

Chemical Grouting

Chemical grouting applications are used to fill and repair cracks and openings in manhole components,

primarily in the frame, chimney, and cone. There are a variety of grouts available including acrylamide, acrylate, acrylic, urethane gel, and urethane foam. The selection of a grout type should be based on site-specific considerations. A single grout or a combination of grout types may be used depending on the manhole's depth. The ideal ambient temperature for applying grout is about 40°F. Grouts need to be chemically stable; be resistant to acids, alkalis, and organics; have controlled reaction times; and have a 15 percent shrinkage control (ASCE 1997). For projects using a combination of grout types, urethane foam is typically used in the upper five feet of the manhole, while urethane gel or acrylamide are used for the lower section (ASCE 1997). Careful inspection of the grouting work and dye testing is recommended to ensure adequate sealing. The effectiveness of this method depends on soil conditions, groundwater table elevation, type of grouting mixture applied, pattern of injection, experience of the grout crew, and project quality control (ASCE 1997).

Spot Repair

Spot repairs include a variety of activities intended to restore damaged manhole components to a proper functional condition that prevents or minimizes I/I. Spot repairs may include: restoration or overhaul of specific components, or patch work depending on the degree of damage and the availability of replacement parts. The types of manhole I/I that can be addressed with spot repairs include surface water entering through holes in the manhole cover and the space between the manhole cover and frame, and subsurface water entering from under the manhole frame and chimney. Damaged manhole covers can be sealed by replacing them with a new watertight cover; sealing the existing cover with asphaltic mastic and plugging vent and pick hole plugs; installing watertight inserts under the existing manhole cover; or by installing rubber gaskets. Damaged frame-chimney joint areas can be sealed internally, without excavation, when frame alignment and chimney conditions permit.

Table 1. Summary of manhole components and common defects¹.

Component	Description	Typical Defects	Defect Result
Bench	Concrete or brick floor which directs incoming flows to the outlet piping and minimizes solids buildup. Includes bench/channel joint.	Cracked, loose, missing pieces, leaking channel/bench seal, deteriorated, or debris/deposition	Infiltration
Chimney	Narrow vertical section built from brick or from concrete adjusting rings that extends from the top of the cone to the frame and cover.	Cracked, broken, or deteriorated	Infiltration
Cone	Reducing section which tapers concentrically or eccentrically from the top wall joint to the chimney or the frame and cover.	Cracked, loose, missing mortar, leaking cone/wall joint, or deteriorated	Infiltration
Cover	Lid which provides access to the interior of the manhole.	Open vent or pick holes subject to ponding, bearing surface worn or deteriorated, poor fitting, cracked or broken, or missing	Inflow
Frame	The cast or ductile ring which supports the cover.	Bearing surface worn or deteriorated, no gasket for gasketed frames, cracked or broken, or frame offset from chimney	Infiltration and Inflow

¹ ASCE 1997

Coating Systems

Coating systems have been used successfully for manhole rehabilitation for over 20 years. The application of coating systems to the inner surface of the manhole protects concrete, steel, masonry, and fiberglass structures against chemical attack, abrasion, high temperatures, infiltration, and erosion. There are numerous coating systems available under various trade names, but in general they have similar basic components: rapid set patching, plugging, and coating compounds. The coating is applied in one or more layers to the manhole interior either by machine (spraying) or by hand. Surfaces that need coating require proper cleaning and preparation. If there is a potential for the presence of hydrogen sulfide, corrosion-resistant additives should be included in the coating mixture. Careful monitoring of cleaning, preparation, coating, and clean-up is important, as is testing for effectiveness after rehabilitation, using dye-water flooding, water exfiltration, or vacuum air testing.

Structural Reconstruction

Structural reconstruction is a rehabilitation method that completely restores the structural integrity of manhole walls through in-situ reconstruction methods. Structural reconstruction can be done with the following: poured-in-place concrete; prefabricated fiberglass, PVC rib-lock liner, prefabricated reinforced plastic mortar, spiral wound liner, cured-in-

place structural liners, prefabricated high-density polyethylene, and spray-applied systems (NASSCO 1996). Selection criteria for using this rehabilitation method include substantial structural degradation and life-cycle cost justifications. When completed, the wall should be a minimum of 36 inches in diameter and three inches thick. The use of Type II Portland cement mix and calcium aluminate or other special cement mixes or linings for corrosion resistance is generally recommended (ASCE 1997).

Key Considerations

The first step in selecting an appropriate manhole rehabilitation method is to conduct a thorough inspection of the manhole and its components. Selection of the appropriate method depends on several factors including:

- The type of problem to be remediated;
- Physical characteristics of the structure such as construction material, age, and condition of manhole;; and
- Location with respect to traffic and accessibility, risk of damage or injury associated with current condition, and cost/value in terms of rehabilitation performance (NASSCO 1996).

Applicability

Selection of an appropriate manhole rehabilitation technique is based on site-specific conditions. Chemical grouts are commonly used for rehabilitating manholes made of brick that are structurally sound. Spot repairs of manhole components are most appropriate for addressing minor defects. Coating systems are applicable for manholes with brick structures that show minimal or no evidence of movement or subsidence, since the coatings have minimal shear or tensile strength, and at sites not conducive to excavation or major reconstruction. Structural reconstruction is applicable for standard manhole dimensions (48-72 inches inner diameter) where substantial structural degradation has occurred. Structural reconstruction methods tend to be more expensive than other rehabilitation techniques.

Advantages

The primary advantage of manhole rehabilitation is a reduction in the capacity demanding I/I entering the sewer system through damaged manholes. Many municipalities have successfully implemented manhole rehabilitation programs as part of larger efforts aimed at reducing I/I and other extraneous flows into sewer systems. For manholes experiencing inflow from the surface, repairing or replacing individual components can be the most efficient and cost-effective rehabilitation method. For example, rubber gaskets are inexpensive and can effectively seal the cover without costly excavation. On a similar note, chemical grouting which seals cracks and voids along the manhole walls, is significantly less expensive than applying a coating system. Structural relining is often the most appropriate rehabilitation method for severely deteriorated manholes. An added benefit of structural relining is the renewal of manhole structural integrity and extended service life of the entire manhole.

Disadvantages

Manhole rehabilitation methods that require excavation can be significantly more expensive. For example, replacement of a manhole frame, rebuilding of a chimney and cone, and structural relining all require more extensive construction procedures including pavement replacement and surface restoration. Structural relining can reduce the diameter of the manhole and may entail higher initial costs. On the other hand, spot repairs or chemical grouting do not improve the structural integrity, and in some cases, may not be the most cost-effective long-term solution, especially for older manholes. In addition, the location of the manhole can entail significant safety risks for the work crew as some manholes are located in busy intersections and subject to considerable vehicle traffic.

Cost

The cost of rehabilitating individual manholes varies depending on the method selected and other site-specific conditions. A range of average costs for specific methods along with the anticipated useful life of the rehabilitated manhole or component are presented in Table 2. Selection of the most appropriate rehabilitation method often involves an assessment of cost and cost-effectiveness. If the amount of I/I controlled through manhole rehabilitation is known, then the cost of manhole rehabilitation can be compared directly with the cost of transporting and treating the I/I. When assessed in this manner, replacing or sealing of manhole covers is often cost-effective if substantial I/I enters the sewer system at manhole covers. However, in some situations, it may be more cost-effective to conduct a system-wide, comprehensive rehabilitation instead of assessing the need for repair or replacement of individual components. In addition to the volume of I/I removed, other important considerations include life-cycle cost, risk of failure, damage to surface from unrepaired manholes, disruption during construction, and life expectancy.

Table 2. Manhole rehabilitation costs and life expectancies.^a

Rehabilitation Method	Initial Cost Range (\$) ^b	Anticipated Life (Years)
Seal existing cover	20-50	8
Replace cover	120-240	50
Adjust frame		
with excavation	150-640	50
without excavation	150-200	25
Seal frame/applied seal	250-350	7
gasket (applied seal)	250-415	7
manufactured seal	250-415	25
Replace frame	415-685	50
Coating systems		
with corrosion protection	500-850	15
without corrosion protection	350-650	15
Chemical grouting	540-835	15
Structural lining	1,600-3,500	50
Replace manhole	2,400-5,500	50

^a Based on a standard 9-foot, 48-inch diameter manhole (ASCE 1997)

^b Costs are in 2002 dollars

Implementation Examples

PERKASIE BOROUGH, PA

Manhole Sealing

Responsible Agency: Perkasio Borough Authority

Population Served: 10,000

Service Area: 2.5 sq. mi.

Sewer System: 33.5 mi. of sanitary sewer

The Perkasio Borough Authority provides water and sewer services to Perkasio Borough and three neighboring communities in southeastern Pennsylvania. It is also one of six municipal members who have their sewage treated at a regional sewage treatment plant. In the early 1990s, the regional plant rated at 4 MGD was receiving 6-7 MGD of flow during wet weather. Concerned about the I/I, the Pennsylvania Department of Environmental Protection (DEP) implemented a moratorium on new sewer connections until I/I was substantially reduced.

Perkasio Borough found that manhole rehabilitation provided a simple, economical, and acceptable means to reduce I/I and get the moratorium on development lifted.

Perkasio Borough conducted a comprehensive study to determine the extent to which I/I contributed to high flow rates. As part of the study, flow monitoring was carried out at eight representative locations over a three month period which included extended dry periods, small to medium storm events, and three storms greater than one inch. The extent of I/I was determined through comparison of water use data with monitored flow data. Sewersheds were ranked from best to worst and prioritized for corrective action. A second flow monitoring effort was undertaken to determine the amount of I/I attributable specifically to manholes. Flow was measured in a sewershed serving 230 homes that had relatively new PVC piping. The flow monitoring showed that most of the inflow was entering the sewer system through manhole covers, frames, and connecting seals. Further, pilot tests showed that the installation of new seals would produce dramatic reductions in I/I. The evidence was so persuasive that the Pennsylvania DEP agreed that for every 3.2 seals installed, one new dwelling unit could be constructed in the service area. Perkasio Borough handles its own installations, and has found that the average cost-per-manhole is \$310 for components and installation. Installation of the seal is an economical and effective way to reduce I/I and has become a standard procedure for new manholes.

Contact Gary Winton, Perkasio Borough Authority

BROWARD COUNTY, FL

Manhole Rehabilitation

Responsible Agency: Broward County Southern Regional Sewer Authority

Population Served: 288,600

Service Area: 106 sq. mi.

Sewer System: 536 mi. of collection sewer

The Broward County Southern Regional Sewer Authority completed a comprehensive sewer system rehabilitation program in 1996. The rehabilitation program eliminated approximately 5.64 MGD of extraneous flow via 429 manholes repairs, 427

sewer line point repairs covering approximately 179,360 linear feet of lined or grouted main sewer line, and 314 private service lateral repairs. The sewer rehabilitation program reached its goal of eliminating 35 percent of the total system I/I. The construction cost for this project was \$6.9 million.

Manhole Rehabilitation Method	Number Completed
Cementitious liner	333
Realign manhole cover	59
Install cover inserts	58
Replace frame and cover	32
Install fiberglass liner	10

More information at <http://www.avantigrout.com/literature/casestudymiamil.pdf>

CINCINNATI, OH

Responsible Agency: Metropolitan Sewer District of Greater Cincinnati

Population Served: 800,000

Service Area: 400 sq. mi.

Sewer System: Over 3,000 mi. of sanitary and combined sewer

Manhole Rehabilitation Project

The Metropolitan Sewer District of Greater Cincinnati (MSD-GC) provides wastewater treatment services to more than 800,000 customers in Hamilton County, Ohio. Faced with I/I problems, MSD-GC conducted a demonstration project to evaluate various manhole rehabilitation products as part of a larger sewer system rehabilitation program. In 2001, over 35 different manhole rehabilitation products were installed and tested. The knowledge gained from the demonstration project allowed MSD-GC to develop specifications to maximize the success of future manhole rehabilitation efforts. These specifications involved the

development of guidelines on substrate preparation, material application, frost-line protection, testing and inspection, and contract warranty requirements. Manholes requiring rehabilitation of the invert (flow channel) were found to be more costly due to the need to plug and bypass flows.

Following the demonstration project, MSD-GC launched a project to evaluate the performance and cost of three particular manhole rehabilitation methods (i.e., cementitious coatings, spray-on epoxy coatings, and cured-in-place manhole liners). This project will result in the rehabilitation of 150-300 brick and concrete manholes per year, at an annual cost of approximately \$1 million. This project also allows MSD-GC to test the effectiveness of its current manhole rehabilitation specifications and to make necessary adjustments based on performance results. Initial post-rehabilitation flow monitoring data indicate improvement as a result of the manhole rehabilitation. The data show that cementitious coatings and spray-on epoxy are less effective than cured-in-place methods in reducing I/I.

Contact Ralph Johnstone, Metropolitan Sewer District of Greater Cincinnati

References

American Society of Civil Engineers (ASCE). 1997. *Manhole Inspection and Rehabilitation*. In *Manuals and Reports on Engineering Practice No. 92*. Prepared by the Committee on Manhole Rehabilitation of the Pipeline Division of the ASCE. New York, NY: ASCE.

EPA Office of Research and Development, Center for Environmental Research Information. 1991. *Handbook: Sewer System Infrastructure Analysis and Rehabilitation*. Cincinnati, OH: EPA Office of Research and Development. EPA/625/6-91/030.

Johnstone, Ralph. Interview by Limno-Tech, Inc., December 2002. Washington, D.C.

Larson, J.P., and C. Garcia-Marquez. 2000. *Broward County, Florida – Successful I/I Rehabilitation Programs*. Presented at the Water Environment Federation WEFTEC Conference, Anaheim, CA, 2000.

National Association of Sewer Service Companies (NASSCO). 1996. *Manual of Practices: Wastewater Collection Systems*. 2nd ed. Maitland, FL: NASSCO.

Metropolitan Sewer District of Greater Cincinnati (MSD-GC). "MSD Receives Trenchless Technology Award." Retrieved December 9, 2002. http://www.msdcg.org/news/archives/trenchless_tech_award/

Winton, Gary. Interview by Limno-Tech, Inc., March 2003. Washington, D.C.

Inclusion of this technology description in this Report to Congress does not imply endorsement of this technology by EPA and does not suggest that this technology is appropriate in all situations. Use of this technology does not guarantee regulatory compliance. The technology description is solely informational in intent.



In-Line Storage

Overview

Many sewer systems experience high flow rates during wet weather periods. The use of storage facilities to attenuate and store peak wet weather flows is widely implemented to reduce or eliminate CSOs and SSOs. In-line or in-system storage is the term used to describe facilities that depend on existing, available storage in the sewer system to control wet weather flows. In-line storage techniques include the use of flow regulators, in-line tanks or basins, and parallel relief sewers. Each of these types of in-line storage is described below.

Flow Regulators

Flow regulators are used to optimize in-line storage by damming or limiting flow in specific areas of the sewer system. Flow regulators can be grouped into two categories: fixed and adjustable.

Fixed regulators, as their name implies, are stationary and do not adjust to variations in flow. They are ideally located at key hydraulic control points. With fewer moving parts and sensors, fixed regulators tend to be less expensive to install, operate, and maintain than adjustable regulators. Fixed regulators include:

- Orifices
- Weirs
- Flow throttle valves
- Restricted outlets
- Vortex throttle valves

One specific type of fixed regulator is the vortex throttle valve shown in Figure 1. Low flows pass through vortex throttle valves without restriction. Once the flow reaches a pre-determined level, an air-filled vortex is automatically created that reduces the area through which flow can pass, damming the flow behind the valve (John Meunier/USFilter 2002). The vortex does not create a constriction. Trash and debris flow

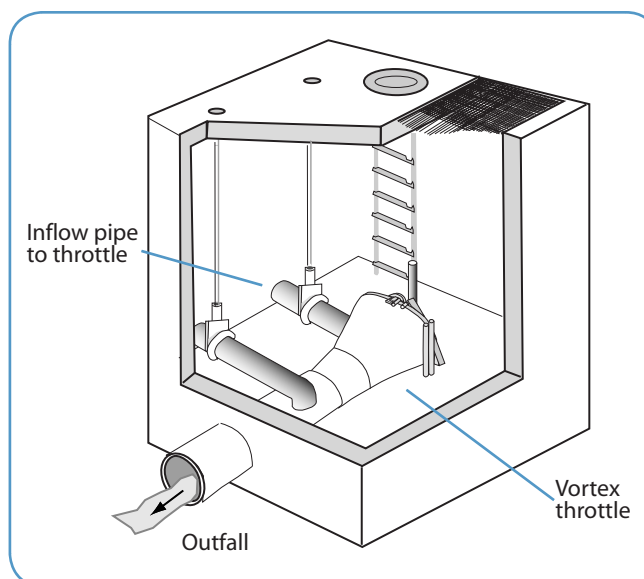

Figure 1. Schematic of a vortex throttle.

through the valve easily after excess flows subside (EPA 1993).

Adjustable regulators are more complex and can be operated in a dynamic mode. Consequently, they offer a greater potential to maximize the available in-system storage by reacting to the variable nature of flow in the sewer system (Moffa 1997). Adjustable regulators include:

- Inflatable dams
- Reverse-tainter gates
- Float-controlled gates
- Sluice-type gates
- Tilting plate regulators

An example of an adjustable regulator is the inflatable dam, shown in Figure 2. Inflatable dams are typically made of rubberized fabric and are inflated and deflated to control flow. Automatic sensors are often used to activate the dams. The dams can be filled with air,

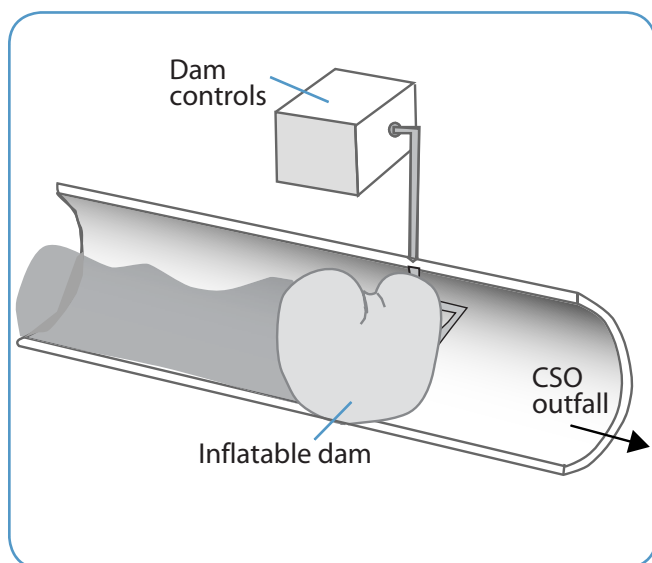

Figure 2. Schematic of an inflatable dam system.

water, or a combination of both. Air control is generally less costly, but water provides better control over dam shape (EPA 1993). With the dam inflated, flow can be stored in upstream pipes.

In-Line Storage Tanks or Basins

Storage tanks and basins constructed in-line within the sewer system can also be used to attenuate and store flows during wet weather periods. Dry weather flows pass directly through in-line storage tanks or basins. Storage within the in-line tanks or basins is typically governed by a flow regulator which limits flow exiting the facility during wet weather periods. The primary function of in-line storage structures is the attenuation of peak flows, not treatment. Flows exiting the storage structure are conveyed downstream for treatment. Therefore, unlike off-line retention basins and deep tunnel storage facilities, in-line tanks and basins are rarely equipped with disinfection, and may not have an outlet to discharge directly to a receiving water.

Parallel Relief Sewers

In-line capacity can also be created by installing relief sewers parallel to existing sewers, or by replacing older sewers with larger diameter pipes. The installation of parallel relief sewers, or larger pipes, is accomplished in the same manner as installing new pipes – using traditional open-cut construction methods or trenchless technologies. Trenchless technologies refer to several types of construction methods that minimize the environmental and surface impacts of sewer installation. More information on these techniques is provided in the “Sewer Rehabilitation Technology Description,” in Appendix B of the 2003 *Report to Congress on the Impacts and Control of CSOs and SSOs*.

Key Considerations

Applicability

Taking advantage of existing storage within the sewer system has broad application in CSSs and SSSs. It is regarded as a cost-effective way to reduce the frequency and volume of CSOs and SSOs, often without large capital investments. Maximization of storage in the sewer system is one of the NMC required of all CSO communities. EPA guidance describes maximization of storage as “making relatively simple modifications to the CSS to enable the system itself to store wet weather flow until downstream sewers and treatment facilities can handle them” (EPA 1995).

The physical condition of the sewer system must be considered when examining potential in-line storage. The amount of storage potentially available in the sewer system largely depends on the size or capacity of the pipes that will be used for storage, and the suitability of sites for installing regulating devices. The trunk sewers and many interceptors within CSSs are often designed to convey flows 5-10 times greater than average dry weather flows, and often provide some potential capacity for storage. Also, areas where the pipe slope is relatively flat often offer opportunities for storage.

An important component of successful in-line storage applications is proper operation and maintenance. By maintaining the initial condition of the sewer system (i.e., not allowing sediment build up within the pipes), the complete capacity of the sewer is available for storing and transporting excess wet weather flows. Similarly, CSO and SSO volumes can be reduced by removing obstructions that decrease the capacity of the sewer system. Larger objects often must be removed by hand, whereas sewer flushing can be used to remove smaller obstructions and sediment build up (EPA 1999). Additional sewer cleaning techniques are discussed in the “Sewer Cleaning Technology Description,” in Appendix B of the 2003 *Report to Congress on the Impacts and Controls of CSOs and SSOs*.

Certain factors limit the applicability of in-line storage; for example it can increase the possibility of basement backups and street flooding (EPA 1999). Basement backups occur when the level of the flow in the sewer is higher than the level of the connection between the service lateral and the building basement. Storing flow in existing pipes may exacerbate this condition because damming devices raise the level of the flow in the sewer system. Field surveys and investigations of sewer maps and as-built drawings are required in order to prevent the throttling back of flows to a degree that causes flooding and backups.

Use of in-line storage may also slow flows and allow sediment and other debris present in wastewater or urban runoff to settle out in the pipes. If allowed to accumulate, the sediment and debris can reduce available storage and conveyance capacity. Therefore, an important design consideration for in-system storage is to ensure that minimum flow velocities are provided to flush and transport solids to the wastewater treatment plant.

Advantages

Advantages of in-line storage include:

- Maximum utilization of existing capacity, which may reduce size or scope of other controls;
- Development of in-line storage in parallel relief or upsized sewers can be coupled with other sewer rehabilitation projects;
- Relatively inexpensive in comparison to other types of storage;
- Attenuates peak wet weather flows and equalizes loads to the treatment facility; and
- Reduces frequency and volume of CSOs and SSOs during light to moderate rainfall events.

Disadvantages

Disadvantages of in-line storage include:

- Provides little treatment of wet weather flows on its own;
- May be difficult to construct large storage volumes typically required for complete CSO control; and
- Increased potential for basement backups and street flooding.

Cost

The largest expenditure for most types of storage facilities is the construction of the actual storage volume. By taking advantage of underutilized capacity that may currently exist within the sewer system, costs are limited to flow regulators and other equipment needed to optimize the attenuation and storage of wet weather flows. The costs associated with construction of in-line storage range from approximately \$0.06 per gallon to more than \$1 per gallon. Cost information from a number of in-line storage applications is presented in Table 1 and 2.

The cost information shows that per gallon costs of storage developed using flow regulators are significantly less than storage developed through the installation of large diameter or parallel relief sewers.

Table 1. Summary of costs of inflatable dam installed in select communities.

Municipality	Technology	Characteristics	Year Constructed	Cost
Washington, DC	Inflatable Dam	<ul style="list-style-type: none"> • Total Storage = 36 MG • 2 dams in 8 locations throughout the system • Fully inflated under low pressure during dry weather 	1990	Construction Cost: \$2.2 million or \$0.06/gallon
Louisville, KY	Inflatable Dam	<ul style="list-style-type: none"> • Total Storage = 2.5 MG • Sneads Branch Relief Sewer collects wet weather flow from 11 CSOs 	2001	Construction Cost: \$1.07 million or \$0.43/gallon
Saginaw, MI	Flow Control Chamber with a Vortex Throttle	<ul style="list-style-type: none"> • Total Storage = 1.4 MG 	1986	Construction Cost: Less than \$290,000 or \$0.21/gallon
Philadelphia, PA	Inflatable Dam	<ul style="list-style-type: none"> • Total Storage = 16.3 MG • 3 large inflatable dams located in large sewers 11-15 ft. high • Can inflate in 15 minutes and deflate in 5 minutes 	Planned	Dam Cost: \$650,000 Civil Construction Cost: \$4.2 million Total Cost: \$4.8 million or \$0.29/gallon
Houston, TX	Parallel Relief Sewer	<ul style="list-style-type: none"> • Total Storage = ~ 0.64 MG • Diameter: 36 in., 18 in., and 15 in. • Length: over 6,000 ft. • Installed parallel to the existing system which was abandoned in place • Part of a plan to eliminate overflows from sewer system 	1995	Construction Cost: \$436,126 or \$0.68/gallon

Table 2. Summary of costs of in-line basins and relief sewers in communities.

Municipality	Technology	Characteristics	Year Constructed	Cost
Bangor, ME	In-line Basin	<ul style="list-style-type: none"> In-line storage tunnel Made from V-bottom precast box sections 		
		<p><i>Davis Brooke Storage Facility</i> Total Storage = 1.2 MG</p> <p><i>Barkersville Storage Facility</i> Total Storage = 1.4 MG</p>	1998	Construction Cost: \$1.4 million or \$1.17/gallon
			2002	Construction Cost: \$2 million or \$1.43/gallon
Houston, TX	Parallel Relief Sewer	<ul style="list-style-type: none"> Total Storage = ~ 0.64 MG Diameter: 36 in., 18 in., and 15 in. Length: over 6,000 ft. Installed parallel to the existing system which was abandoned in place Part of a plan to eliminate overflows from sewer system 	1995	Construction Cost: \$436,126 or \$0.68/gallon
Portland, OR	Parallel Relief Sewer	<ul style="list-style-type: none"> Total Storage = ~ 42 MG Conveyance pipe that is 6 ft. in diameter and a storage pipe that is 12 ft. in diameter Total length is 3.5 mi. 	2000	Design and Construction Cost: \$76 million or \$1.81/gallon
Syracuse, NY	In-line Basin	<ul style="list-style-type: none"> Total Storage = 5 MG Erie Boulevard Storage Facility Box culvert with sluice gate control Dimensions: 7.5 ft. wide, 10.5 ft. high, and 8,640 ft. long 	1970s; refurbished 2002	Approximate Cost of Refurbishment: \$2.6 million or \$0.53/gallon

Implementation Examples

BOSTON, MA

System Optimization Plan

Responsible Agency: Massachusetts Water Resources Authority

Population Served: 2.5 million

Service Area: 406 sq. mi.; 13 sq. mi. of combined sewers

Sewer System: 228 mi. of interceptor sewer

The Massachusetts Water Resources Authority (MWRA) provides sewer services for 43 communities in the Boston metropolitan area. The City of Boston and three surrounding communities have combined sewer areas. MWRA developed a system optimization plan in 1993, which included operational modifications and simple, low-cost structural changes to reduce CSO frequency. Structural alterations included repairing regulators, raising weir heights, and installing new weirs and regulators to increase storage within the sewer system. All 103 projects outlined in the system optimization plan have been completed. MWRA has since completed other system evaluations that have resulted in more simple structural alterations to reduce the occurrence of CSOs. As of 1997, MWRA had spent a total of \$3.1 million on structural alterations, which have reduced average annual CSO discharges by 400 MG. The typical capital costs for brick and mortar weirs, formed concrete weirs, and stop logs are \$3,650, \$13,525, and \$20,315, respectively.

More information at <http://www.mwra.state.ma.us/sewer/html/sewco.htm>

LOUISVILLE, KY

Responsible Agency: Louisville and Jefferson County Metropolitan Sewer District

Population Served: 600,000

Service Area: 205 sq. mi.

Sewer System: ~ 2,800 mi. of sewers

Snead Branch Relief Sewer Inflatable Dam

The Sneads Branch Relief Sewer is an 11 foot semi-elliptical tunnel that was built in 1951 to control flooding. The relief sewer receives no dry weather flow, which was one of the reasons it was selected for storage of wet weather events. An inflatable rubber dam was installed to maximize storage in the relief sewer; minimal tunnel modifications were necessary. During normal flow conditions, the dam is half inflated. During wet weather

events, it is inflated to full height. A water level sensor just above the dam activates the inflation. The relief sewer captures flow from 11 upstream CSOs, and it can store up to 2.5 MG of combined sewage. It is predicted that the inflatable dam will reduce the average annual CSO volume by 63 percent from 43 MG per year to 18 MG per year. The cost of the Sneads Branch Relief Sewer Inflatable Dam was \$1.07 million or \$0.43/gallon of storage.

Contact: Angela Akridge, Louisville and Jefferson Metropolitan Sewer District

PHILADELPHIA, PA

Responsible Agency: Philadelphia Water Department

Population Served: 2 million

Service Area: 335 sq. mi.

Sewer System: 1,600 mi. of combined sewers

Inflatable Dams

As part of Philadelphia's effort to control CSOs, the City Water Department plans to install three inflatable dams in large sewers that have available in-line storage. The dams will range from 11 to 15 feet high and will be automatically controlled for both dry and wet weather conditions. The three dams will enable 16.3 MG of flow that might otherwise discharge to local receiving waters to be stored in existing sewers, reducing CSO volumes by 650 MG per year.

The first inflatable dam, located in the city's main relief sewer, will be operational by the end of 2004. The associated civil work projects such as sewer rehabilitation have been completed for this project. When operating, the dam will have the ability to store up to 4 MG of combined sewage, and it is expected to reduce the number of CSO discharges to the Schuylkill River from 32 per year to four per year. Another inflatable dam will be installed in Rock Run during the summer of 2005. The total cost for the installation of the dams and sewer rehabilitation is approximately \$4.8 million, or \$0.29/gallon of storage.

More information at http://www.forester.net/sw_0011_innovative.html and <http://www.phila.gov/water/index.html>

SYRACUSE, NY

Erie Boulevard Storage System

Responsible Agency: Onondaga County
Department of Water Environment
Protection

Population Served: 400,000

Service Area: 13 sq. mi.; 11 sq. mi. of
combined sewer

Sewer System: 3,000 mi. of sewer

The Erie Boulevard Storage System was originally constructed in the 1970s as a separate storm water system. The facility is a box culvert that is 7.5 feet by 10.5 feet and 8,640 feet long. It has a storage volume of 5 MG, and an additional 1 MG of storage is available in ancillary conveyance pipes. It was retrofitted in 1985 with four sluice gates to facilitate the storage of combined sewage, and reduce CSO discharges to Onondaga Creek.

The original sluice gate control system was located within underground concrete vaults. Moisture and road salt severely damaged the control system requiring a facility upgrade. The upgrade was completed in July 2002, and included refurbishment of the sluice gates, construction of an above ground control center, and installation of a real-time control system. It is estimated that the Erie Boulevard Storage System will now capture 220 MG of wet weather flow annually. Upgrades to the Erie Boulevard Storage System cost \$2.6 million or \$0.52/gallon of storage.

More information at <http://www.lake.onondaga.ny.us/ol3113.htm>

PORTLAND, OR

Parallel Relief Sewers

Responsible Agency: City of Portland

Population Served: 500,000

Service Area: 133 sq. mi.

Sewer System: 2,256 mi. of sewer

In 1972, the City of Portland's CSS was estimated to release 10 BG of CSO annually into local receiving waters. In 1991, the city started a 20-year program to curb CSOs to the Willamette River by 94 percent, and to the Columbia Slough by over 99 percent. The plan includes actions to fully utilize storage in the existing sewer system by modifying 32 diversion structures.

The city has also invested in the construction of parallel relief sewers to store combined sewage that would otherwise be discharged to the Columbia Slough. Specifically, the city constructed 3.5 miles of six foot diameter conveyance pipe and a 12 foot diameter parallel relief sewer. It took three years to construct this relief sewer, which became operational in September 2000. It captures 100 percent of the overflows from the eight CSO outfalls in its drainage area and an average of 440 MG of combined sewage per year. The cost of the Columbia Slough Consolidation Conduit was approximately \$76 million or \$1.81/gallon of storage.

More information at <http://www.cleanriverworks.com/>

References

City of Portland, Oregon, Bureau of Environmental Services. 2002. "Action 4: Upgrading Portland's Eastside Sewer System." Retrieved October 2, 2002. <http://www.cleanrivers-pdx.org/pdf/action4.pdf>

Dahme, J. and J. Sullen. 2000. "Innovative Strategy Helps Philadelphia Manage Combined Sewer Overflows." Retrieved October 7, 2002. http://www.forester.net/sw_0011_innovative.html

District of Columbia Water and Sewer Authority. 2002. "Final Report: Combined Sewer System Long Term Control Plan." Retrieved October 9, 2002. <http://www.dcwasa.com/education/css/longtermcontrolplan.cfm>

EPA Office of Research and Development. 1993. *Manual: Combined Sewer Overflow Control*. EPA 625-R-93-007.

EPA Office of Water. 1995. CSO Guidance for Nine Minimum Controls. EPA-832-B-95-003.

EPA Office of Water. 1999. *Combined Sewer Overflow Technology Fact Sheet: Maximization of In-line Storage*. EPA 832-F-99-036.

Gray, W. et al. 1999. *Prevention and Control of Sewer System Overflows: WEF Manual of Practice No. FD-17*. Alexandria: Water Environment Federation.

John Meunier/USFilter. 2002. "CSO/Stormwater Management: Hydrovex Product Line." Retrieved December 9, 2002. http://www.johnmeunier.com/2002/en/products/pdf/hydrovex_line_card.pdf

Moffa, Peter. 1997. *Control and Treatment of Combined Sewer Overflows*. New York: Van Nostrand Reinhold.

Inclusion of this technology description in this Report to Congress does not imply endorsement of this technology by EPA and does not suggest that this technology is appropriate in all situations. Use of this technology does not guarantee regulatory compliance. The technology description is solely informational in intent.



TECHNOLOGY DESCRIPTION

STORAGE FACILITIES

Off-Line Storage

Overview

Many sewer systems experience high flow rates during wet weather periods. The use of storage facilities to store and attenuate peak wet weather flows is widely implemented to reduce or eliminate CSOs and SSOs. Off-line storage is the term used to describe facilities that store or treat excess wet weather flows in tanks, basins, tunnels, or other structures located adjacent to the sewer system. During dry weather, wastewater is passed around, not through, off-line storage facilities. During wet weather, flows are diverted from the sewer system to these off-line storage facilities by gravity drainage or with pumps. The stored wastewater is temporarily detained in the storage facility and returned to the sewer system once downstream conveyance and treatment capacity become available. Most off-line storage structures provide some treatment through settling, but their primary function is storage and the attenuation of peak flows. The use of off-line storage is usually considered to be a good option where in-line storage is insufficient or unavailable.

Near-Surface Storage Facilities

Near-surface storage facilities are typically located at key hydraulic control points. In CSSs, they are often located near a CSO outfall; in SSSs, they are often situated in areas where inflow and infiltration (I/I) problems are severe and difficult to otherwise control. A typical near-surface storage facility is a closed concrete structure with a simple design that is built at or near grade alongside a major interceptor. As shown in Figure 1, the basic components of near-surface storage facilities are:

- Basin or tank
- Flow regulating device to divert wet weather flows to the basin or tank
- Flow regulating device or pumps to drain the basin or tank
- Emergency relief or overflow point

Near-surface storage facilities in CSSs are sometimes designed for both storage and treatment. When designed and operated for these purposes, they can provide primary treatment or its equivalent including primary clarification, capture of solids and floatables, and disinfection of effluent, where necessary, to meet water quality standards (EPA 1994). Consequently, screens and disinfection equipment are sometimes added to those near-surface storage facilities designed to discharge directly to receiving waters.

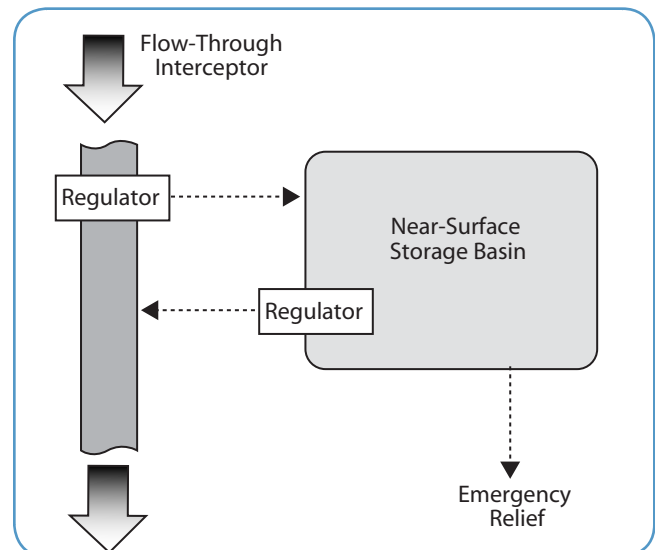

Figure 1. Basic components of near-surface storage facility.

An illustration of a more complex near-surface storage facility with multiple tanks that is designed to provide both storage and treatment is presented in Figure 2. As shown, screens are employed to remove floatables and coarse solids, and flows receive disinfection prior to discharge. Multiple tanks are used to enhance pollutant removal and facilitate maintenance activities. The benefits of using multiple tanks include:

- The “first flush” of pollutants can be retained in one or more of the tanks long enough to settle suspended solids, BOD, and nutrients, while the remainder of the flow is handled in subsequent compartments
- Allows portions of the facility to remain in service while maintenance is performed on other portions of the facility. The number of compartments used can vary from storm-to-storm according to the volume of excess wet weather flow generated, potentially reducing the area requiring maintenance after smaller storms, which in turn reduces costs

In a multiple tank configuration, excess wet weather flows can either pass through each compartment sequentially (i.e., the flow proceeds through chamber one, followed by chamber two, and then chamber three) or through each compartment simultaneously (i.e., there is flow in compartments one, two, and three at the same time). Both operational strategies are illustrated in Figure 2. However, near-surface storage facilities with multiple compartments are typically operated in a sequential manner. Specific advantages of sequential operation include:

- Tanks are only filled as the capacity of a preceding tank is exceeded; and
- Only that flow reaching the final tank is disinfected, saving on chemical costs.

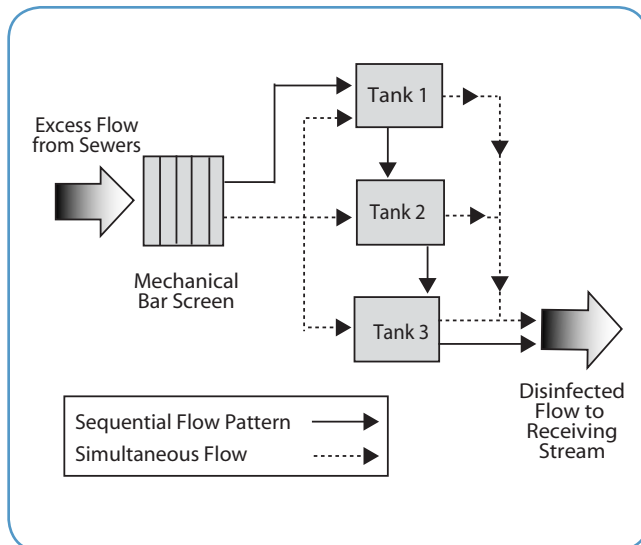

Figure 2. Flow paths for sequential and simultaneous storage facilities.

Deep Tunnels

Deep tunnel storage facilities are typically used where large storage volumes are required and opportunities

for near-surface storage are unavailable. Deep tunnels are primarily implemented as controls in CSSs, but have had some application in SSSs. As their name implies, deep tunnels are typically located 100-400 feet below ground. Tunnel diameters range from 10-50 feet, and many are several miles in length. Construction usually requires large tunnel boring machines. Most deep tunnels are built in hard rock, but some have been built in unconsolidated material. Lining the tunnel with concrete or other impermeable material to prevent infiltration and exfiltration is required in unconsolidated material, and is recommended for hard rock. Like near-surface storage facilities, stored flow is typically conveyed from deep tunnels to a wastewater treatment plant (WWTP) after wet weather events, as capacity becomes available.

An illustration of a deep tunnel, as constructed in Milwaukee, WI, is presented in Figure 3. The basic components of deep tunnels include:

- Storage tunnel;
- Flow regulating devices to divert wet weather flows to the tunnel;
- Coarse screening to protect tunnel facilities from large debris;
- Vertical drop shafts to convey wet weather flows to the tunnel;
- Pumps to drain and de-water the tunnel;
- Vent shafts to balance air pressure in the tunnel;
- Access shafts that give maintenance personnel access to the tunnel;
- Solids removal system for areas where grit may accumulate; and
- Odor control system, if necessary.

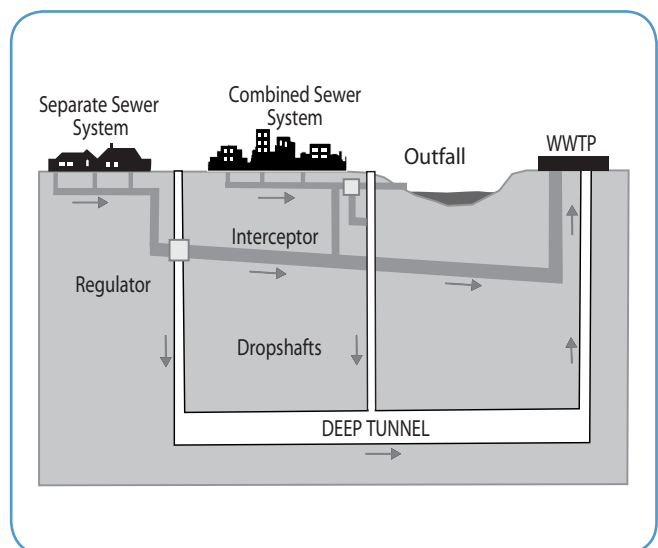

Figure 3. Deep tunnel storage (MMSD 2001).

Key Considerations

Applicability

Near-Surface Storage Facilities

Near-surface storage facilities have broad applicability and can be adapted to many different site-specific conditions by changing the basin size (volume), layout, proximity to the ground surface, inlet or outlet type, and, where required, disinfection mechanism. They are particularly applicable in areas where land is readily available and the disruption, due to construction, will be minimal. The adaptability of near-surface storage facilities has led to their use throughout the country. The flexibility of the basin design makes near-surface storage facilities practical for utilities, both large or small, in all climates.

Deep Tunnels

Deep tunnels provide an alternative to near-surface storage facilities where space constraints, potential construction impacts, and other issues make constructing near-surface facilities challenging. Deep tunnels can be constructed in a variety of mediums, but geotechnical exploration is needed to assess the suitability of subsurface conditions.

The major construction concerns are the structural integrity of the tunnel, infiltration of groundwater, and exfiltration of the stored flows. Tunneling in hard rock tends to be more economical because such tunnels need minimal, temporary, or permanent structural supports. Hard rock tunnels also require less lining to prevent infiltration and exfiltration (NBC 1998). When tunneling in soft rock or soil, the tunneling equipment is more expensive. Special equipment is needed to support the tunnel during construction to prevent the ground from collapsing. In addition, the cost of lining the tunnel can be greater because the lining is used to maintain the shape of the tunnel as well as to prevent infiltration.

Advantages

Near-Surface Storage Facilities

Advantages of near-surface storage facilities include:

- Structural design is simple compared to tunnels and supplemental treatment facilities;
- Construction and O&M costs are favorable relative to other structural approaches such as sewer separation (EPA 1999);
- Operation and response to intermittent and unpredictable wet weather events is automatic to a certain extent;

- Operators are allowed the flexibility of returning the stored wastewater flow to the treatment facility where it can receive full treatment; maximizing utilization of existing treatment facilities;
- Helps equalize the delivery of pollutants to the treatment plant, which tends to improve effluent quality at the treatment facility as well as treatment efficiency;
- Treatment of excess wet weather flows consistent with the CSO Control Policy can be achieved in CSSs; and
- Aesthetic benefits and other locally defined objectives can be realized with imaginative design. For example, Wayne County, MI, constructed two covered near-surface storage facilities that were landscaped with recreation facilities including soccer fields and basketball courts (Wayne County 2000).

Deep Tunnels

Advantages of deep tunnel storage include:

- Large volumes can be stored and transported while having a minimal effect on the existing surface features (EPA 1993);
- Disruptions that occur with the open-cut excavations associated with near-surface storage facilities can be avoided (EPA 1993); and
- Valuable surface land area is saved by building deep under the ground's surface.

Disadvantages

Near-Surface Storage Facilities

Disadvantages of near-surface storage facilities include:

- Costs can be substantial relative to non-structural controls such as I/I reduction;
- Land required for basins and tanks is often located in premium waterfront locations ;
- Construction activities are disruptive;
- On-going maintenance with attendant costs is required to keep facilities operating; and
- Solids and captured floatables must be removed and properly disposed to maintain storage capacity.

Deep Tunnels

Disadvantages of deep tunnel storage include:

- Difficult to map subsurface;
- Budget overruns can occur when boring does not proceed as planned;
- Tunnels may require substantial, on-going maintenance activities, including the disposal of built-up sediment deposits;

- Exfiltration from deep tunnels has the potential to adversely affect the quality of groundwater in adjacent aquifers; and
- Construction schedules for deep tunnels may be lengthy, allowing considerable time to pass between the initial investment and any measured water quality improvements.

Cost

The costs associated with construction of off-line storage facilities range from less than \$0.10 per gallon to \$4.61 per gallon. In general, costs for near-surface storage facilities were considerably less than those for deep tunnels. The average cost for deep tunnels was \$2.82 per gallon, while the average cost for near-surface storage was \$1.75 per gallon. Tables 1 and 2 present cost information for near-surface and deep tunnel storage facilities, respectively.

Table 1. Deep tunnel costs from select communities.

Municipality	Facility Name	Facility Characteristics	Year Initiated	Construction Cost ¹
Washington, DC		Total Storage = 194 MG 3 deep rock tunnels	To be constructed	\$761 million or \$3.92/gallon
Atlanta, GA	Intrenchment Creek	Total Storage = 34 MG 26 ft. diameter 9,293 ft. long	1985	\$42.2 million or \$1.24/gallon
Chicago, IL	TARP Project	Total Storage = 2.3 BG 109 mi. of deep rock tunnels 150-350 ft. below ground	1976 (Near completion)	\$2.51 billion or \$1.09/gallon
Rochester, NY		Total Storage = 175 MG	1993	\$690 million or \$3.94/gallon
Providence, RI		Total Storage = 56 MG 200-300 ft. below ground 26 ft. in diameter 13,500 ft long	2001 (Under construction)	\$258 million or \$4.61/gallon
Milwaukee, WI		Total Storage = 405 MG Depth up to 325 ft.	1994	\$866 million or \$2.13/gallon

¹ All costs are in 2002 dollars.

Table 2. Near-surface storage costs from select communities.

Municipality	Facility Name	Facility Characteristics	Year Initiated	Construction Cost ¹
Atlanta, GA	McDaniel CSO Facility	Underground basin Total Storage = 2 MG	1986	\$9.2 million or \$1.53/gallon
Chicago, IL	TARP Project	Three retention basins Total Storage = 15.7 BG	1976 (Under construction)	\$1.11 billion or \$0.07/gallon
Bangor, ME		Made from pre-cast concrete sections Total Storage = 1.2 MG	2000	\$2.5 million or \$2.08/gallon
Birmingham, MI		Two compartment retention basin Flow is simultaneous Total Storage = 5.5 MG	1997	\$14.4 million or \$2.61/gallon
Grand Rapids, MI	Market Avenue	Three compartment retention basin; flow is sequential Total Storage = 30.5 MG	1992	\$39 million or \$1.24/gallon
Fairport Harbor, OH	Retention Basin	Old oil tank converted for wet weather storage Total Storage = 3.2 MG	1994	\$3.1 million or \$0.97/gallon
Seattle, WA		Total Storage = 1.6 MG	1984	\$6.1 million or \$3.80/gallon
Richmond, VA	Shockoe Basin	Covered and uncovered retention basin Total Storage= 41 MG	~1988	\$70 million or \$1.73/gallon

¹ All costs are in 2002 dollars.

Implementation Examples

CHICAGO, IL

Responsible Agency: Metropolitan Water Reclamation District of Greater Chicago

Population Served: 5.1 million

Service Area: 873 sq. mi.

Sewer System: 4,300 total miles of sewer

Tunnel and Reservoir Plan (TARP)

Construction of Chicago's Tunnel and Reservoir Plan (TARP) began in 1976. The TARP contains both deep tunnels and a system of three large reservoirs that act as near-surface storage facilities. TARP has been implemented in two phases. The first phase focused on reducing CSOs. The second phase provides flood control benefits as well as further increases CSO capture. When completed, the TARP will have 18 BG of total storage between the three reservoirs and multiple deep tunnels. The three reservoirs hold 15.7 BG; the plan also includes 109 miles of deep rock tunnels, located 150-350 feet beneath the ground surface. One reservoir is

located on the site of an abandoned quarry. This siting reduces the amount of excavation needed for the reservoir, but does not eliminate it. The tunnels are lined to prevent infiltration and exfiltration. Pumping and treating the total volume stored in the TARP facilities will take two to three days. Since construction started, water quality in the Chicago area receiving waters has improved. Mass loadings of BOD₅, TSS, and volatile suspended solids have dropped by 13, 62, and 60 percent, respectively. Once the system is completed, tunnels in 2006 and reservoirs in 2014, it is believed that further water quality improvements will be observed. The total predicted cost of TARP is \$3.62 billion. The cost of the reservoirs is \$1.11 billion or \$0.07/gallon. The deep tunnels when completed, will cost \$2.51 billion or \$1.09/gallon.

More information at <http://www.mwrdgc.dst.il.us/plants/tarp.htm>

ATLANTA, GA

Responsible Agency: City of Atlanta
Department of Public Works

Population Served: 1.5 million

Service Area: 260 sq. mi.

Sewer System: 230 mi. of combined sewer and 1,970 mi. of separate sewer

Near-Surface Storage Facilities and Tunnels

Twenty percent of Atlanta's sewershed is composed of combined sewers, which includes the most highly developed area of downtown Atlanta. The city started to control CSOs in the mid-1980s, using a mix of near-surface storage facilities, deep tunnels, and sewer separation projects. The Intrenchment Creek Tunnel, which has a diameter of 26 feet and is 1.76 miles long, can store 30-34 MG of excess wet weather flows. It can be de-watered in one to two days, by sending the stored flows for physical and chemical treatment at the associated Intrenchment Creek

Treatment Facility. During a study performed from August 1999 to January 2000, fecal coliform levels in the effluent from the Intrenchment Creek Facility were below the water quality standard that requires a geometric mean of 1,000 MPN col/100 mL.

The city also maintains one near-surface storage facility at the McDaniel CSO Facility. This near-surface storage basin holds 2 MG of combined sewage. The combination of tunnel and near-surface storage creates a total storage volume of 36 MG. This storage has reduced the frequency of CSO events from 50-60 times per year to approximately 17 per year. The Intrenchment Creek CSO project cost was approximately \$42.2 million or \$1.24/gallon. The McDaniel CSO Facility was constructed for \$9.2 million or \$1.53/gallon.

More information at <http://www.atlantapublicworks.org>

PROVIDENCE, RI

Deep Tunnel Storage

Responsible Agency: Narragansett Bay Commission

Population Served: 360,000

Service Area: 110 sq. mi.

Sewer System: 89 mi. of interceptor sewer

The Combined Sewer Overflow Abatement Program being implemented by the Narragansett Bay Commission will reduce the frequency of CSO events from 71 to four per year. The plan includes sewer separation projects as well as construction of storage and treatment facilities. The project is divided into three phases. The main component of the first phase is a deep tunnel. The tunnel is 27 feet in diameter, 200-300 feet below the ground surface, and 2.5 miles long. The tunnel's storage volume is 56 MG, and it is designed to be de-watered within 24 hours. Phase I is expected to reduce CSO volume by 40 percent; the entire project is expected to reduce CSOs by 98 percent. Construction of Phase I started in 2002 and will be completed in 2009. Phase I will be followed by a two-year monitoring period to assess improvements in water quality as a result of the tunnel. The final completion date of the entire project is contingent on the success of Phase I. It is anticipated that the reduction in CSOs to Narragansett Bay will contribute to reductions in shellfish bed closures. The estimated construction cost for the deep tunnel is over \$258 million or \$4.61/gallon.

More information at <http://www.narrabay.com/CSO.asp>

BANGOR, ME

Kenduskeag East CSO Storage Facility

Responsible Agency: City of Bangor Sewer Division

Population Served: 33,000

Service Area: 6.4 sq. mi.

Sewer System: 33.21 mi. of sewer, 30 percent combined

Bangor began development of a CSO long-term control plan in 1992. Initially, the city separated a portion of its sewer system. The sewer separation projects were followed by the installation of three storage facilities, including the Kenduskeag East CSO Storage Facility. The 1.2 MG near-surface storage facility is located underneath an existing public parking lot. Stored flows are released back into the sewer system for treatment at the WWTP. The basin has a small on-line portion through which dry weather flows pass everyday. During a wet weather event, when levels rise to 3.5 feet in the on-line portion of the basin, wastewater spills over into the off-line portion. The off-line portion is comprised of five box section rows that are 360 feet long and 8 feet wide. The basin's flushing system utilizes stored flow to create waves that clean settled solids from the bottom of each section. The wastewater level in the basin is monitored electronically, and if the basin reaches capacity, the monitoring system opens control gates that allow for a controlled and measured CSO event. The construction cost of the storage tank was \$2.3 million or \$1.92/gallon.

More information at http://www.precast.org/pages/Solutions/Summer_2002/overflow_in_bangor.html

GRAND RAPIDS, MI

Market Ave. Near-Surface Storage Facility

Responsible Agency: Grand Rapids Public Works

Population Served: 261,000

Service Area: 750 sq. mi., 3.9 sq. mi. is combined

Sewer System: 850 mi. of sewer

The Grand Rapids wastewater service area includes the city of Grand Rapids and six other surrounding towns. The CSS area is small and consists of only a half percent of the entire service area. In the early 1990s, the city created a plan to deal with the excess wet weather flows from this area. Part of this plan was the Market Avenue near-surface storage facility. The design included a multi-stage basin with treatment facilities to control the 10-year, one-hour storm. The 30.5 MG basin has three compartments which are operated sequentially. The first compartment allows for primary settling and grit removal. Once this compartment is full, the second compartment begins to fill. The bottom of the second compartment is equipped with a floor wash system. If the second compartment reaches its capacity, the excess flow spills over into the third compartment where sodium hypochlorite is added for disinfection. The third compartment discharges the partially treated and disinfected flow to the Grand River. The near-surface storage facility came on-line in 1992. Since this time, there has been a noticeable decline in fecal coliform levels in the Grand River. As an example, in 1989, the annual geometric mean for fecal coliform was 500 MPN/100 mL, and in 1996, the value was 75 MPN/100 mL. The city believes the reduction can be attributed to the 90 percent reduction in discharges of untreated CSOs. The construction cost for the Market Avenue near-surface storage facility was \$39 million or \$1.24/gallon. Operation and maintenance costs are approximately \$40,000/year or \$0.001/gallon.

More information at <http://www.epa.gov/owm/mtb/csoretba.pdf>

FAIRPORT HARBOR, OH

Converted Surface Storage Facility

Responsible Agency: Lake County Regional Sewer District

Population Served: 3,180

Service Area: Not available

Sewer System: Separate sewer system

Fairport Harbor Village is a historic town located on Lake Erie in Ohio. The separate sewer system that serves the city receives considerable I/I, which can be linked to the system's aged clay pipes. In 1994, engineering investigations determined that 1.8 MG of storage was needed to contain the wet weather flows associated with a five-year design storm event. The original proposal to build a near-surface storage facility near a major overflow point was rejected largely on the basis of citizen complaints. An alternative industrial site with an aging oil storage tank built in the 1940s was viewed more favorably, and had the potential to provide 3.2 MG of storage. Further investigations demonstrated the feasibility of converting the oil tank into an off-line storage tank. It was also found that even with extensive rehabilitation, the tank would provide a savings of \$170,000-\$500,000 when compared to the construction of a new facility. Rehabilitation of the oil tank included the removal of lead-based paint, asbestos-covered exterior piping, crude oil sludge, and interior pipes. A majority of the vertical and horizontal welds were replaced to meet current standards. In addition to rehabilitation of the tank, a new 5 MGD pump station and a one mile long force main were installed to convey flows to the tank. The cost of the Fairport Harbor storage facility was \$3.1 million or \$0.97/gallon.

Contact: Phillip Shrout, CT Consultants

References

EPA Office of Research and Development. 1993. *Manual: Combined Sewer Overflow Control*. EPA 625-R-93-007.

EPA Office of Water. 1994. *Combined Sewer Overflow (CSO) Control Policy*. EPA-830-B-94-001.

EPA Office of Water. 1999. *Combined Sewer Overflow Technology Fact Sheet - Retention Basins*. EPA-832-F-99-042. <http://www.epa.gov/owm/mtb/csoretba.pdf>

Gray, W. *et al.* 1999. *Prevention and Control of Sewer System Overflows: WEF Manual of Practice No. FD-17*. Alexandria: Water Environment Federation.

Milwaukee Metropolitan Sewerage District. "Sewer Operations Under Different Weather Conditions." Retrieved September 20, 2002. <http://www.mmsd.com/deeptunnel/sewersystem.asp>

Narragansett Bay Commission. 1998. *Combined Sewer Overflow Abatement Program Concept Design Report Amendment*. Providence, RI: Narragansett Bay Commission.

Wayne County Department of Environment. "CSO Demonstration Projects." Retrieved September 17, 2002. <http://rougerivercom.readyhosting.com/cso/projects.html>

Inclusion of this technology description in this Report to Congress does not imply endorsement of this technology by EPA and does not suggest that this technology is appropriate in all situations. Use of this technology does not guarantee regulatory compliance. The technology description is solely informational in intent.



On-Site Storage

Overview

Many sewer systems experience high flow rates during wet weather periods. The use of storage facilities to attenuate and store peak wet weather flows is widely implemented to reduce or eliminate CSOs and SSOs. On-site storage, that is storage developed at the wastewater treatment facility, is often an effective control for managing excess wet weather flows in systems where sewer system conveyance capacity exceeds that of the treatment plant.

The two most common forms of on-site storage are flow equalization basins (FEBs) and converted abandoned treatment facilities. Flow equalization is used to overcome operational problems caused by flow rate variations, to improve the performance of downstream processes, and to reduce the size and cost of downstream facilities (Metcalf & Eddy 2003). FEBs are typically located downstream of screening and grit removal facilities, but they can be placed just before the headworks of the treatment plant. FEBs can be configured in two general ways. The FEB can be placed within the flow path, meaning that all flow reaching the treatment plant passes through the basin, or it can be placed outside the flow path, where wet weather flows that exceed plant design capacity are diverted into the basin. Both configurations are shown in Figure 1.

On-site storage capabilities may also be developed in abandoned treatment facilities such as: old clarifiers that have since been replaced; treatment lagoons or polishing ponds no longer needed after the construction of more modern treatment facilities; or pretreatment facilities at industrial sites near the treatment plant. Storing flows in abandoned facilities may require modification of the current wastewater flow path; a flow control device and piping may be needed to transport flows to and from the storage facility. It may be possible to retrofit existing piping for this purpose, otherwise new piping and a pump, if needed, will have to be installed.

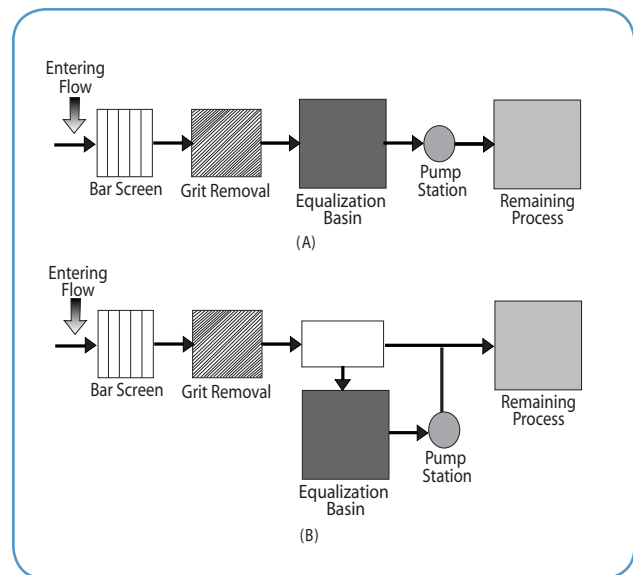

Figure 1. **Alternative locations for flow equalization basins (Metcalf & Eddy 2003).**

There are three primary design considerations related to on-site storage facilities: sizing and locating the facility, handling settled solids, and pumping systems to return stored flows for treatment. The best location for an on-site storage facility will vary with the characteristics of the sewer system, the wastewater, and the type of treatment required (Metcalf & Eddy 2003). The size of the storage facility will depend on the wet weather volume it is designed to hold, and the amount of land available at the treatment plant for construction, if needed.

On-site storage facilities must be designed to handle the solids present in the wastewater. For example, in Oklahoma the state design standards require storage facilities to be constructed with a minimum of two compartments (OKDEQ 2002). One compartment, which is lined with concrete or asphalt, is where the solids are allowed to settle. The other compartment holds overflow from the first, during moderate or large wet weather events. The

settled solids are washed back into the headworks of the treatment plant, allowing them to receive full treatment. Other facilities utilize mixing to prevent the deposition of solids. Mixing equipment requirements can be minimized by constructing on-site storage downstream of grit removal facilities. Examples of effective mixing mechanisms for storage facilities include tipping weirs and flushing gates. Aeration systems may be necessary if storage basins are susceptible to becoming oxygen-deprived and septic.

Variable or constant speed pumps may be used to return stored flows to the treatment plant. A constant speed pump will return flows at the same speed independent of the volume of flow stored, whereas a variable speed pump can be adjusted depending on the stored volume. A flow-measuring device should be installed to monitor the return of the stored flow.

While the volume of an on-site storage facility can be very large, there will be occasions when wet weather flows will exceed storage capacity. A mechanism to discharge flows that exceed facility capacity, with or without treatment, must be available.

Key Considerations

Applicability

On-site storage at the wastewater treatment plant can be a viable alternative for reducing or eliminating CSOs and SSOs. There are a number of important considerations that must be evaluated to determine the applicability of on-site storage at a given wastewater treatment plant. These include:

- Maximum flow that can be conveyed to the treatment plant;
- Maximum flow that can be treated with the existing treatment processes;
- Availability of land on site for the construction of a new FEB; and
- Location and volume of abandoned treatment facilities.

Advantages

On-site storage can play an important role in improving wet weather treatment plant operations. It provides operators with the ability to manage and store excess flows,

which helps maintain treatment efficiency and ensures that all flows reaching the plant receive the maximum treatment possible. Development of on-site storage can also facilitate operation and maintenance activities. If problems occur at on-site facilities, it is likely that they will be detected earlier, and that many of the tools required to make the needed repairs will already be at the treatment plant.

Constructing storage outside the bounds of the wastewater treatment plant typically requires an environmental site assessment. Site assessments are less likely to be required for on-site storage facilities because the storage is being placed in a location that has already been approved for such use. If an assessment is needed, the requirements may be less rigorous since environmental conditions at the wastewater treatment plant are known and may have already been investigated.

Disadvantages

There are limitations to on-site storage that must also be considered. Development of a large FEB uses space that might be needed for future plant expansion. Restored facilities, because of their age, may deteriorate faster than a new facility. The conveyance system or plant headworks may limit the amount of wet weather flow that can be brought to the treatment plant. The headworks can be expanded, but it can be costly to expand the conveyance system capacity. Finally, as with any storage facility, on-site storage has finite capacity which may not be sufficient to prevent CSOs and SSOs during extreme wet weather events.

Cost

The costs associated with the development of on-site storage facilities range from as little as \$0.01 per gallon to more than \$1.00 per gallon. These costs are, on average, considerably lower than the construction costs for typical near-surface storage facilities built outside the bounds of the treatment plant. Much of the cost savings derives from being able to site the storage facilities on land already owned by the utility. The following table presents cost information from a number of on-site storage applications.

Table 1. Summary of on-site storage costs.

Municipality	Technology	Characteristics	Year Initiated	Approximate Construction Cost ¹
Auburn, NY	Restored Storage	Total Storage = 0.2 MG Cleaned annually	1997	\$930,000 or \$4.65/gallon
Barlesville, OK	Flow Equalization Basin	Total Storage = 20 MG Sewer system also includes two other FEBs	1986	\$1.70 million or \$0.08/gallon
Cleveland, OH	Restored Storage	Total Storage = 6 MG Converted Imhoff Tanks	1985	\$18.3 million or \$3.05/gallon
Covington, LA	Flow Equalization Basin	Total Storage = 6 MG Cleaned annually	1997	\$1.22 million or \$0.20/gallon
Idabel, OK	Flow Equalization Basin	Total Storage = 10 MG	1999	\$450,000 or \$0.05/gallon
Lafayette, LA	Flow Equalization Basin	East WTPP: Total Storage = 3 MG	1999	\$1.6 million or \$0.53/gallon
		West WTPP: Total Storage = 3.5 MG	1999	\$1.9 million or \$0.54/gallon
Oakland, ME	Restored Storage	Total Storage = 0.2 MG FEB from a closed textile mill	1998	\$27,610 or \$0.14/gallons
South Paris, ME	Restored Storage	Total Storage = 1.5 MG Clarifiers from old tannery	1995	Annual Debt Service: \$110,000 or \$0.07/gallon
Tulsa, OK	Flow Equalization Basin	Total Storage = 13 MG	1994	\$3.81 million or \$0.35/gallon
Vinita, OK	Holding Ponds	Total Storage = 7MG Two holding ponds with capacity of 3.5 MG each	1996	\$94,000 or \$0.01/gallon

¹ All costs are in 2002 dollars.

² South Paris, ME, reported negligible construction costs associated with restoring their abandoned on-site facilities. The cost numbers presented reflect annual operation and maintenance for the facilities.

³ Vinita, OK, approximate construction cost does not include land or other facility improvement costs.

Implementation Examples

AUBURN, NY

Responsible Agency: City of Auburn
Department of Municipal Utilities
Population Served: 35,000
Service Area: Not Available
Sewer System: Not Available

Reusing Primary Treatment Facilities

In 1993, the City of Auburn began efforts to control both their CSOs and I/I within the separate sewer portion of their system. This included the conversion of primary settling tanks, originally built in the 1930s, into storage for wet weather events. When wet weather flows exceed the treatment plant's 25 MGD capacity, excess influent is directed to the settling tanks. Four tanks, with a combined capacity of approximately 158,000 gallons, serve as storage. When the capacity of the storage tanks is fully utilized, two additional tanks are used to provide high-rate disinfection and dechlorination before flows are discharged.

To modify the tanks, the primary sludge collectors were removed. A flushing system was then installed to wash the system after a wet weather event. Weirs were installed to permit flow between the tanks. Odors associated with the facility are minimized by returning the entire stored volume to the treatment plant within 24 hours of the wet weather event. Annually, the retrofitted primary settling tanks capture 5.8 MG of excess flow. The facility captures 76 percent of the possible overflows, which are returned to the plant for full treatment; the volume that does overflow receives primary treatment and disinfection. The conversion of the primary settling tanks into wet weather storage facilities cost \$930,000 or \$4.65/gallon.

Contact: Frank DeOrio, City of Auburn

CLEVELAND, OH

Responsible Agency: Northeast Ohio Regional
Sewer District (NEORS D)
Population Served: 500,000
Service Area: 355 sq. mi.
Sewer System: Not Available

Reusing Imhoff Tanks

In order to reduce CSO discharges, NEORS D refurbished old Imhoff tanks located at the Westerly wastewater treatment plant to store combined sewage. The Imhoff tanks required reconfiguration for CSO storage; in addition, sludge removal equipment, bar screens, flow control gates, and an effluent conduit and pump were installed. The tanks can store approximately 6 MG and the related interceptor can hold an additional 6 MG, for a total storage of approximately 12 MG. Volumes which exceed the

storage capacity are disinfected and then discharged. The conversion of the tanks was completed in 1985. The storage at the Westerly plant has helped reduce CSO discharges to the Edgewater State Park swimming beach on Lake Erie. The conversion of the Imhoff tanks into CSO storage facilities cost \$18.3 million or \$1.53/gallon.

Contact: Frank Greenland, Northeast Ohio Regional Sewer District

LAFAYETTE, LA

Responsible Agency: Lafayette Utilities System

Population Served: 37,500

Service Area: 38 sq. mi.

Sewer System: 650 mi. of separate sewer

Flow Equalization Basins

In the mid 1990s, the Lafayette Consolidated Government started to look at inflow and infiltration (I/I) problems prevalent in their sanitary sewer system. After surveying, rehabilitating, and maximizing flow to the treatment plants, the Utilities decided to construct FEBs at their East and South wastewater treatment plants. The FEBs were constructed as part of a larger project that included other plant upgrades. The East and South wastewater treatment

plants' FEBs can hold 3 MG and 3.5 MG, respectively. When flows exceed the maximum flow rate which can be handled by the plant, a portion of the flow is diverted to the FEB, to protect the treatment processes. Once the wet weather flows subside, the plants continue to operate at maximum capacity while the basins are drained. Emptying the FEBs can take one to three days. Since the FEBs have been in operation, hydraulic overload violations have been reduced from an average of six to nine annually to zero. The estimated cost for the East FEB was \$1.6 million or \$0.53/gallon. The estimated cost for the South FEB was \$1.9 million or \$0.54/gallon.

More information at <http://www.lus.org/site.php?pageID=2>

OAKLAND, ME

Responsible Agency: Oakland Public Works

Population Served: 6,000

Service Area: Not Available

Sewer System: 7 mi. of sewer

Restored Flow Equalization Basin

Oakland's sewer system consists mainly of combined sewers. The city has been implementing CSO controls since 1997. These efforts include separating a portion of the combined sewer system and other targeted inflow reduction activities. As a result, Oakland has been able to eliminate both of its CSO outfalls and transport all remaining wet weather flows to its wastewater treatment plant. Although the city had sufficient sewer system capacity to

transport these wet weather flows, it did not have treatment facilities capable of handling the peak wet weather flow. The city was able to utilize an FEB installed at the treatment plant for a nearby textile mill that had since ceased operation. The FEB was built in 1990 by the textile mill as part of their pretreatment program, but had sat unused since the mill closed shortly afterwards. Oakland is able to store 0.2 MG of excess wet weather flows in the basin, and then bleed it back to the wastewater plant for treatment as capacity becomes available. The FEB is available to the city year-round, but is mainly used during spring snow melts. To bring the FEB back into operation will cost approximately \$27,610 or \$0.14/gallon; operational costs are minimal.

Contact: Jim Fitch, Woodard and Curran

SOUTH PARIS, ME

Clarifiers from Old Tannery Storage

Responsible Agency: Paris Utility District
Population Served: 1,000
Service Area: Not Available
Sewer System: 16.3 mi. of combined sewer

The combined sewer system owned and operated by the Paris Utility District has one overflow point. Utilization of an unused pretreatment facility for storing excess wet weather flows has enabled the District to reduce the frequency of CSO events. The District's wastewater system was designed with pretreatment facilities for the two major industries in the city, a tannery and a cannery. The tannery pretreatment facility is considered part of the

South Paris wastewater treatment plant. The tannery closed in 1985. In the mid 1990s, the tannery pretreatment facility was brought back into service to store excess wet weather flows from the District's CSS and provide primary treatment during extreme events. The tannery facility provides a total storage volume of 1.5 MG. Costs for returning the tannery facility to service were minimal because the infrastructure was already in place; operation and maintenance costs are also quite small. The only true cost of the tannery storage is its portion of the facilities debt service for plant modifications, which costs approximately \$110,000 annually or \$0.07/gallon.

Contact: John Barlow, Paris Utility District

TULSA, OK

Flow Equalization Basins

Responsible Agency: Tulsa Public Works
Population Served: 85,000
Service Area: Not Available
Sewer System: 1,800 mi. of sewer

Tulsa's separate sanitary sewer system is divided into three major sewersheds, with a wastewater treatment plant located in each. Multiple sanitary sewer evaluations have been performed to help Tulsa establish a plan for controlling SSOs. SSO abatement efforts in the Northside Sewershed have facilitated on the attenuation of storage of excess wet weather flows. Tulsa has constructed three near-surface storage basins located remotely in the Northside Sewershed, and

one FEB located within the bounds of the wastewater treatment plant. The four basins together provide a total of 83.2 MG of storage, with the treatment plant FEB accounting for 13 MG. The treatment plant site is large enough to accommodate the FEB as well as all anticipated future additions to the plant. The Northside FEB is used when a large wet weather event overwhelms the capacity of the three upstream storage basins. The construction cost for the Northside FEB was approximately \$3.81 million or \$0.35/gallon.

More information at <http://www.cityoftulsa.org/Public+Works/wastewater/wastewater+treatment+process.htm>

References

Metcalf and Eddy, Inc. 2003. *Wastewater Engineering: Treatment, Disposal, and Reuse, 4th ed.* Boston: Irwin McGraw Hill.

Oklahoma Department of Environmental Quality (OKDEQ). 2002. "Title 252: Oklahoma Administrative Code Chapter 656 Water Pollution Control Facility Construction." Retrieved January 27, 2003. <http://www.deq.state.ok.us/rules/656-correction.pdf>

Inclusion of this technology description in this Report to Congress does not imply endorsement of this technology by EPA and does not suggest that this technology is appropriate in all situations. Use of this technology does not guarantee regulatory compliance. The technology description is solely informational in intent.



TECHNOLOGY DESCRIPTION

Treatment Technologies

Supplemental Treatment

Overview

When wet weather flow rates exceed available sewer system or treatment capacity, constructing supplemental treatment facilities may be a cost-effective alternative to expanding existing conveyance capacity or treatment facilities. Supplemental treatment facilities are designed solely to treat excess wet weather flows; the level of treatment provided is typically driven by regulatory requirements.

Supplemental treatment facilities can be located and configured in multiple ways, including:

- Providing treatment at established overflow locations by installing a small scale treatment process at or near a known CSO or SSO location. For example, a vortex separator with disinfection capabilities might be installed near a CSO outfall. The treated effluent would be discharged directly to a receiving water.
- Constructing a separate treatment facility upstream of the existing treatment plant. Such a facility would accept and treat excess wet weather flows that might otherwise result in untreated CSOs or SSOs from one or more locations in the sewer system; for example, a ballasted flocculation treatment process constructed in a capacity-constrained area of the sewer system. Effluent would be discharged directly to a receiving water from this facility.
- Adding parallel treatment process(es) at the existing treatment plant that would operate as necessary during wet weather. To be successful, this requires sufficient sewer system capacity to deliver wet weather flows to the existing treatment plant. Effluent from the parallel treatment process would be discharged directly or recombined with flows from existing treatment units prior to discharge.

For any of these configurations, the selection of a specific supplemental treatment technology will be driven by wet weather flow characteristics. Important characteristics to consider include:

- Frequency of wet weather events requiring supplemental treatment;
- Limited event duration, often lasting less than 24 hours;
- High flow rate and volume with potential peak wet weather flows of four to 20 times the average daily flow; and
- Weak influent pollutant concentrations, diluted by storm water inflow/infiltration (I/I).

These flow characteristics can pose technical challenges to efficient and effective treatment. Supplemental treatment facilities must be able to handle sudden increases in flow at unplanned times, have quick start-up time, or in the case of biological processes, quick acclimation time after extended periods of no flow (or low flow conditions), and provide adequate treatment despite significant variation in influent pollutant concentrations.

The technologies best suited for treating excess wet weather flows commonly involve physical or chemical processes rather than biological processes. The applicability of biological treatment processes is limited by factors including:

- Biological processes do not respond well to adverse, intense, and intermittent flow conditions typical of wet weather events.
- Rapid changes in the amount and quality of the influent reduce biological process treatment efficiency. In some cases, large hydraulic loads can wash out the microorganisms necessary for treatment.
- Microorganisms need a minimum level of food (i.e., organic matter) in the influent to survive. Therefore, it is often technologically and operationally difficult, if not impossible, to maintain a large enough microorganism population during dry weather or low flow periods, so that there is a sufficient population available for biological treatment of large wet weather flows.

Trickling filters are the biological treatment technology option considered most operationally feasible for treating excess wet weather flows. This is based on their ability to handle peak flow conditions with less likelihood of upset, relative to conventional activated sludge processes (WEF 1998). In a trickling filter system, microorganisms are maintained as a biological film attached to a fixed media. In contrast, microorganisms in an activated sludge process are suspended in a less stable, liquid media. Nonetheless, supplemental treatment facilities with any biological process must operate continuously with a minimum flow rate to maintain the biomass necessary for treatment of wet weather flows. During dry weather, effluent from biological supplemental treatment facilities is typically returned to the sewer system for further treatment and discharged at the wastewater treatment plant.

A number of physical and chemical treatment technologies are suited for use as supplemental treatment facilities handling excess wet weather flows. These include:

Primary clarification

Excess wet weather flows enter a large basin where the velocity of flow decreases, allowing solids to settle to the bottom of the tank and floatable materials (e.g., grease and debris) to rise. Mechanical equipment skims the floating material, while other mechanical devices collect and remove settled material from the bottom of the basin.

Screening

Excess wet weather flows are strained through a mesh of metal, plastic, ceramic, or cloth. Solids are collected on the surface of the screen where they are removed by mechanical scraping, a spray mechanism that washes solids off the screen, or by gravity. Various screen aperture sizes are available; solids removal efficiency decreases as the aperture increases.

Vortex separators

Vortex separators use centripetal force, inertia, and gravity to remove floatables, trash, and other settleable solids from excess wet weather flows. Additional information on vortex separators is presented in “Vortex Separators Technology Description” in Appendix B of the *Report to Congress on Impacts and Control of Combined Sewer Overflows and Sanitary Sewer Overflows*.

Ballasted flocculation

In ballasted flocculation or sedimentation, a metal salt coagulant is added to the excess wet weather flows to aggregate suspended solids. Then, fine-grained sand, or ballast, is added along with a polymer. The polymer

acts like glue which bonds the aggregated solids and sand. The process increases the particles’ size and mass which allows them to settle faster. The high dosages of flocculent may require pH adjustments.

Chemical flocculation

Similar to ballasted flocculation, chemical flocculation is a high-rate treatment process that adds metal salts and polymers to clump particles together. Depending on their density, the clumps will either sink to the bottom or float to the surface where they can be removed.

Deep bed filtration

A deep bed filter system consists of a series of large tanks (depths greater than 6 feet) filled with coarse medium (typically sand or anthracite). Excess wet weather flows are directed to the top of each tank and exit at the bottom of the tank. Pollutants can either attach to the filter media or become trapped in the interstitial space of the filter; the filter is later cleaned through backwashing. Chemical additives can be used to improve removal rates.

Key Considerations

Applicability

Supplemental treatment facilities are not intended to treat dry weather flows from combined or sanitary sewer systems, although biological facilities will need to be operated continually. The type and location of supplemental treatment facilities will be driven by site-specific considerations, which include:

- State and federal permit requirements and effluent limits;
- Characteristics of the excess wet weather flows;
- Land or space constraints;
- Capacity constraints within the existing sewer system or treatment facility;
- Anticipated population growth; and
- Financial resources.

For example, if available land is a constraint, a facility with a large “footprint” would not be appropriate. Alternatively, if the existing sewer system cannot convey all of the wet weather flow to the WWTP, a supplemental treatment facility upstream of the plant may be the most practical alternative.

It should be noted that primary clarification and trickling filter technologies can have a difficult time handling the highly variable flows associated with wet weather

events; these technologies may, therefore, require some type of flow equalization to operate efficiently. Adequate disinfection of treated excess wet weather flows is also a concern. High flow rates can result in reduced exposure to the disinfecting agent and reduced pathogen inactivation. Increased solid concentrations may also exist in treated wet weather flows, which can shield pathogens from exposure to the disinfectant. Specific wet weather considerations

related to disinfection technologies are discussed in more detail in the “Disinfection Technology Description” in Appendix B of the *Report to Congress on Impacts and Control of Combined Sewer Overflows and Sanitary Sewer Overflows*. The advantages and disadvantages of each of the aforementioned supplemental treatment processes are summarized in Table 1.

Table 1. Advantages and disadvantages of various supplemental treatment technologies.

Technology	Advantages	Disadvantages
Primary Clarification	<ul style="list-style-type: none"> • Little manual operation 	<ul style="list-style-type: none"> • Large “footprint” • Reduced retention and settling time (i.e., residence time) and possible short circuiting during high flow rates • Lack of removal of dissolved or soluble pollutants • Need for significant periodic maintenance requirements
Screening	<ul style="list-style-type: none"> • Small “footprint” • Little manual operation • High reliability with proper operations and maintenance (O&M) • Low energy consumption 	<ul style="list-style-type: none"> • Susceptible to clogging or poor solids removal • Require regular operator observation, especially microscreens • Prompt solids disposal required due to potential odor problems • Incomplete removal of solids from wastewater (coarse and fine screens generally only remove floatables and visible solids) • High cost for high performance microscreens
Vortex Separation	<ul style="list-style-type: none"> • Small “footprint” • Ability to handle high hydraulic loading rate • No moving parts (no mechanical maintenance) • Low construction cost 	<ul style="list-style-type: none"> • Inability to remove fine solids and dissolved or soluble pollutants • Loss of floatables to overflow during extremely high flows • Potential loss of foam and floatables in initial overflow • Manual cleaning needs for settled solids
Ballasted Flocculation	<ul style="list-style-type: none"> • Small “footprint” (typically 5-15 percent of the space required for conventional primary clarification) • Ability to handle high hydraulic loading rate(s) • Reduced capital cost relative to conventional clarification • Ability to treat rapidly varying flows • Ability to consistently achieve secondary treatment concentration standards for BOD and TSS 	<ul style="list-style-type: none"> • Limited ability to remove soluble pollutants • Increased operational cost relative to biological treatment or conventional clarification due to the cost of the chemicals and sludge disposal along with ballasted media
Chemical Flocculation	<ul style="list-style-type: none"> • Production of concentrated sludge, requiring no additional thickening equipment • Ability to handle high hydraulic loading rate • Ability to treat rapidly varying flows 	<ul style="list-style-type: none"> • Limited ability to remove soluble pollutants • Potential increase in sludge produced due to the addition of treatment chemicals • Increased operational costs relative to biological treatment or conventional clarification due to the cost of the chemicals
Deep Bed Filtration	<ul style="list-style-type: none"> • Ability to treat high and rapidly varying flows • Ability to consistently achieve secondary treatment concentration standards for BOD and TSS 	<ul style="list-style-type: none"> • High initial construction costs • Limited ability to remove soluble pollutants • Frequent backwash requirements to avoid clogging
Trickling Filters	<ul style="list-style-type: none"> • Small “footprint” • Ability to achieve all secondary treatment requirements • Rapid reduction of soluble BOD in wet weather flow • Ability to treat high and rapidly varying flows 	<ul style="list-style-type: none"> • Continuous operation required • Degraded removal efficiencies when excess biomass exists • High clogging potential • Regular operator supervision and maintenance requirements • Potential odor and snail population problems

Cost

Performance information for each of these technologies is presented in Table 2. Screening data are presented according to screen aperture size in millimeters. Typical performance for hydraulic loading capacity, BOD removal, and TSS removal is presented where available. The range in observed performance is largely due to changes in either hydraulic loading rates or influent characteristics (e.g., concentration, fraction of soluble pollutants). Where typical ranges were

not available, data for performance at a single location are provided with notation.

Capital cost information for each supplemental treatment technology is summarized in Table 3. Cost per gallon of capacity is provided where possible.

The capital costs for biological trickling filters are generally greater than capital costs for physical and chemical alternatives. In comparing daily operating costs, biological processes are typically significantly less expensive to operate

Table 2. Performance data summary for supplemental treatment technologies.

Technology	Source(s)	Hydraulic Capacity (gpd/ft ²)	BOD Removal (Percent)	TSS Removal (Percent)
Primary Clarification	Metcalf and Eddy 1991; NEIWPC 1998; WEF 1996	600-3,000	25-40	50-70
Screening	Metcalf and Eddy 1991			
Coarse (5-25 mm)		21,000-86,000	Not Available	15-30
Fine (0.1-5 mm)		150-1,400	Not Available	40-50
Micro (less than 0.1 mm)		150-1,400	Not Available	40-70
Vortex Separation	EPA 1996; Boner <i>et al.</i> 1995; WERF 2002	Up to and greater than 100,000	Up to 55 ^a	5-60
Ballasted Flocculation	Radick <i>et al.</i> 2001; Scruggs <i>et al.</i> 2001; Vick 2000; Poppe <i>et al.</i> 2001	Up to 90,000	65-80	70-95
Chemical Flocculation	Metcalf and Eddy 1991; Moffa 1997	Up to 20,000	40-80	60-90
Deep Bed Filtration	Ellard <i>et al.</i> 2002	Not Available	65 ^b	87 ^b
Trickling Filters (with settling) ^c	Metcalf and Eddy 1991; WEF 1998	Up to 11,000	40-90	Not Available

^a Based on two monitored events (Boner *et al.* 1995); limited data exist since BOD is not a common performance indicator for vortex separators.

^b Average performance based on pilot test data from Jefferson County, Alabama (Ellard *et al.* 2002).

^c High-rate trickling filters achieve 65-85 percent BOD removal. Related technologies, including rotating biological contactors and packed-bed reactors, use the same processes as trickling filters and have similar removal rates, advantages, and disadvantages.

because of the chemical costs associated with physical or chemical treatment. Supplemental biological treatment processes need to be operated continuously, however, so the actual annual operating costs for a biological supplemental process will likely be greater than for a physical or chemical supplemental process. For example, annual operation and maintenance (O&M) costs for a 10 MGD trickling filter facility are estimated at \$150,000 (EPA 2000). Assuming it operates 365 days per year, daily operating costs are \$411 per day. In comparison, annual O&M costs for a 10 mgd

ballasted flocculation facility are estimated at \$49,000 (Wendle 2002). Assuming this facility operates eight days per year (a conservative estimate based on an expected two to four events per year in Lower Paxton Township), daily operating costs are \$6,125 per day.

Table 3. Performance data summary for supplemental treatment technologies.

Technology	Source	Capacity (MGD)	Estimated Total Capital Cost ^a	Unit Cost ^a (Per Gallon/Day of Capacity)
Primary Clarification	Hufford 2001	78	\$11.0 million	\$0.14
Screening	EPA 1999	0.75-375	\$40,800-\$2.2 million	\$0.01-\$0.05
Vortex Separation	Sacramento 1999	1.8 - 16.2 ^b	\$10,000-\$50,000	\$0.01
Vortex Separation with Screening	Sacramento 1999	0.71-194	\$13,000-\$630,000	\$0.01-\$0.02
Ballasted Flocculation	Wendle 2002	15	\$5.5 million	\$0.37
	Hufford 2001	78	\$12.4 million	\$0.16
	WERF 2002	100	\$20.0 million	\$0.20
	Bremerton 2002	20	\$4.0 million ^c	\$0.20
Chemical Flocculation - Aluminum as Additive	Hewing <i>et.al.</i> 1995	Not Available	\$0.50 (cost per pound)	\$0.04 (per gallon treated) ^d
Chemical Flocculation - Ferrous Sulfate as Additive	Hewing <i>et.al.</i> 1995	Not Available	\$0.17 (cost per pound)	\$1.03 (per gallon treated) ^d
Deep Bed Filtration	Chandler 2001	360	\$55 million ^e	\$0.15
Trickling Filters	EPA 2000	1-100	\$760,000-\$63.4 million	\$0.63-\$0.76

^a Costs in 2002 dollars.

^b Vortex separator capacities are hydraulic capacities. Manufacturer recommended design capacities for optimal TSS removal are generally 25 percent of the hydraulic capacities.

^c Includes costs for a 20 MGD Ultraviolet (UV) disinfection process. Cost for ballasted flocculation alone was not available.

^d Capital costs for chemical feed mechanisms not available. Treatment costs include chemical costs and sludge handling costs. Ferrous sulfate generates larger sludge volumes than aluminum, significantly increasing treatment costs.

^e Includes costs for a 360 MGD UV disinfection process. Cost for deep bed filtration alone was not available.

Implementation Examples

JEFFERSON COUNTY, AL

Deep Bed Filter to Manage Peak Wet Weather Flows

Responsible Agency: Jefferson County Environmental Services
Population Served: 232,000
Service Area: Not Available
Sewer System: 3,100 mi. of sewer

Jefferson County's Village Creek Wastewater Treatment Plant receives an average daily flow of 40 MGD; peak flows exceed 400 MGD once per year on average. Exceedence of available 120 MGD of primary treatment and disinfection capacity at the treatment plant occurs an average 41 times per year (based on data from 1997-2001). Flows exceeding the 60 MGD of secondary capacity occur more frequently. Elevated wet weather flows have continuously exceeded treatment capacity for as long as six days. A combination of rainfall patterns, topography, geology, and sewer system

age have contributed to extreme peak wet weather flow issues for the county.

Under consent decree, Jefferson County will spend approximately \$200 million for the construction of a deep bed filter supplemental treatment facility. The deep bed filter facility will be constructed on a 450-acre site and will discharge through a separate outfall. Construction is scheduled for completion in late 2003. During pilot testing of the filter technology, the best effluent and longest filter runs were achieved with no chemical addition. Pilot testing performance showed average removals of 87 percent of TSS and 65 percent of BOD, on average.

To prevent filter clogging from high influent flow and solids loadings, new methods of operating and backwashing were developed during the pilot study. These methods are now patented or patent-pending.

Deep bed filter construction costs.

Component	Contract Cost (Million)
Influent tunnel (15 foot diameter)	\$17.0
Pump station (360 MGD)	\$46.0
Surge basins (20 basins, total capacity: 90 MG)	\$54.2
Deep bed filters plus UV disinfection (360 MGD) (22 filters, each at 1,167 ft ²)	\$55.0
24 megawatt generator building and equipment (primarily for pump station and UV operation)	\$22.0
Site work/access, road, and miscellaneous	\$14.3
Total:	\$208.4

Contact: Harry Chandler, Assistant Director of Environmental Services, Jefferson County

SYRACUSE, NY

Microscreens to Treat CSOs

Responsible Agency: Onondaga County Public Utilities

Microscreen performance data (EPA 1979).

Aperture (microns)	23	71	105
Hydraulic loading rate (gpd/ft ²)	2,500-11,000	4,000-18,000	16,000-95,000
Average influent TSS concentration (mg/L)	619	308	284
Average effluent TSS concentration (mg/L)	290	172	196
Average TSS removal (Percent)	58	45	32

The Syracuse demonstration program evaluated the treatment of CSOs with screening. Three screening units, ranging from an aperture size of 23 microns to 105 microns, were used in this program. The table on the left lists the hydraulic loading rates and average TSS removal efficiencies associated with each of these microscreens. These results show that as aperture increases, hydraulic loading rates also increase. As aperture increases, however, the TSS removal efficiencies decrease.

Contact: Rich Field, EPA Office of Research and Development, Edison, NJ

TACOMA, WA

Responsible Agency: City of Tacoma
Population Served: 258,000
Service Area: Not Available
Sewer System: 700 mi. of sewer

Ballasted Flocculation to Manage Wet Weather Flow

The City of Tacoma's Central Treatment Plant (CTP) receives flow from a separate sanitary sewer system serving a population of 208,000. The CTP has a hydraulic capacity of 103 MGD (primary plus disinfection), and a peak biological treatment capacity of 78 MGD. The sewer system can currently deliver up to 110 MGD to the CTP.

The CTP has reached the criterion specified in their permit that triggers a requirement to develop a plan for maintaining adequate capacity. The city plans to install a 78 MGD ballasted flocculation process at the CTP parallel to the existing processes. The ballasted flocculation process alone will cost approximately \$12.4 million. All related peak wet weather flow facility upgrades are estimated at \$50.7 million. In comparison, to expand the existing activated sludge processes by 78 MGD would cost an estimated \$130 million; this estimate does not include the cost for additional primary clarification capacity.

During pilot testing, the ballasted flocculation process reached acceptable performance levels within 10-15 minutes of start-up. Pilot testing performance data, collected over a nine-day period, indicate effluent TSS concentrations below 30 mg/L (with the exception of the first day) and percent removals for TSS ranging from 79-92 percent. Effluent BOD concentrations ranged from approximately 20-42 mg/L, and removal rates for BOD ranged from 63-73 percent (Tacoma 2000). The lower percent removals generally occurred during weaker influent conditions.

When the actual ballasted flocculation process is constructed and operated for wet weather treatment, effluent from the process will be separately disinfected and blended with disinfected biologically treated effluent prior to discharge. The blended effluent is expected to meet permitted effluent concentrations and removal efficiencies. The ballasted flocculation process is expected to operate a maximum of 5.5 days in a row, 8 days in a month, and 21 days per year (Tacoma 2001).

Contact: David Hufford, Division Manager, Environmental Services/Wastewater Management, City of Tacoma

BREMERTON, WA

Responsible Agency: City of Bremerton
Population Served: 37,000
Service Area: 5.2 sq. mi.
Sewer System: Not Available

Ballasted Flocculation to Treat CSOs

The City of Bremerton maintains a partially combined sewer system that provides service to approximately 37,000 people. The WWTP receives an average annual flow of 7.6 MGD and has a peak hydraulic capacity of 29.5 MGD. During periods of wet weather, however, flows in excess of 38 MGD have been delivered to the plant. Currently, Bremerton has 16 permitted CSO outfalls. As part of their CSO long term control plan, the city constructed the Pine Road Eastside CSO Treatment Facility. The CSO treatment facility was completed in December 2001.

The facility uses ballasted flocculation in combination with UV disinfection. Total construction costs were \$4 million. The CSO treatment facility also includes a 100,000 gallon storage tank that was constructed in 2000 for an additional \$400,000 (Bremerton 2002).

No performance data are currently available for the constructed facility (Bremerton 2002). Pilot testing performance showed a 71 percent removal of TSS, 63 percent removal of total BOD, and 46 percent removal of soluble BOD, on average. During pilot testing, the ballasted flocculation unit reached peak efficiency within 10 minutes of start-up.

Contact: John Poppe, Wastewater Manager, City of Bremerton

References

- Boner, M.C., *et al.* 1995. "Modified Vortex Separator and UV Disinfection for Combined Sewer Overflow Treatment." *Water Science and Technology*. Vol. 31(No. 3-4).
- Bremerton, City of 2002. "City of Bremerton Public Works and Utilities' Wastewater/CSO Update." Retrieved December 11, 2002.
http://www.cityofbremerton.com/content/ww_csoupdate.html.
- Chandler, Harry, Assistant Director of Environmental Services, Jefferson County. Interview by Limno-Tech, Inc., Birmingham, AL. Fall/Winter 2001.
- Ellard, Gregory, Meek, R., and H. Chandler. 2002. *Direct Filtration for Wet Weather Conditions*. Presented at Water Environment Federation Technical Exhibition and Conference (WEFTEC) Chicago, IL. September 29 - October 2, 2002.
- EPA. 1979. *Disinfection/Treatment of Combined Sewer Overflows - Syracuse, New York*. Prepared by O' Brien and Gere Engineers, Inc. EPA 600-2-79-134.
- EPA. 1996. *Assessment of Vortex Solids Separators for the Control and Treatment of Wet-Weather Flow*. EPA 832-B-96-006.
- EPA, Office of Water. 1999. *Combined Sewer Overflow Technology Fact Sheet: Screens*. EPA 832-F-99-040.
- EPA, Office of Water. 2000. *Wastewater Technology Fact Sheet: Trickling Filters*. EPA 832-F-00-014.
- Hewing, Albert, *et al.* 1995. "Reducing Plating Line Metal Waste." *Pollution Engineering*.
- Hufford, David, Division Manager, Environmental Services/Wastewater Management, City of Tacoma. Interview by Limno-Tech, Inc., October 2001. Tacoma, WA.
- Metcalf and Eddy, Inc. 1991. *Wastewater Engineering: Treatment, Disposal, and Reuse*. 3rd Ed. Boston: Irwin McGraw Hill.
- Moffa, P.E. (Ed.). 1997. *Control and Treatment of Combined Sewer Overflows*. 2nd ed. New York: Van Nostrand Reinhold.
- New England Interstate Water Pollution Control Commission (NEIWPC). 1998. *Technical Report #16: Guides for the Design of Wastewater Treatment Works*. Wilmington, MA: NEIWPC.
- Poppe, John, Wastewater Manager, City of Bremerton. 2002. Interview by Limno-Tech, Inc., Fall 2002. Washington, DC.
- Poppe, John, *et al.* 2001. "High-Rate Wet Weather Solution." *Public Works*. Vol. 132 (No. 8).
- Radick, Keith A. and Morgan, Marc A. October 2001. *Ballasted Flocculation: A Technology for Long Term CSO Control*. Presented at Water Environment Federation WEFTEC Conference Atlanta, GA. October 13 - 17, 2001.
- Sacramento, County of. 1999. *Stormwater Management Program: Investigation of Structural Control Measures for New Development*. Prepared by Larry Walker Associates, Inc. Retrieved December 12, 2002
www.sacstormwater.org/const/manuals/pdf/scm99_scm99.pdf
- Scruggs, Caroline and C. Wallis-Lage. 2001. *Ballasted Flocculation: A Wet-Weather Treatment Solution?* Presented at Water Environment Federation WEFTEC Conference Atlanta, GA. October 13 - 17, 2001.
- Tacoma, City of. 2000. *Ballasted Sedimentation Pilot Study Report and Feasibility Analysis, Central Wastewater Treatment Plant, City of Tacoma*. Prepared by Parametrix, Inc. Sumner, WA: Parametrix.
- Tacoma, City of. 2001. *Facilities Plan: Central Wastewater Treatment Plant, City of Tacoma - Draft Final Edits*. Prepared by Parametrix, Inc. Sumner, WA: Parametrix.
- Vick, Rebecca Chambers. 2000. "High-Rate Clarification Takes the Prize." *Pollution Engineering*. Vol. 32 (No. 10).
- Water Environment Federation (WEF). 1996. *Operation of Municipal Wastewater Treatment Plants, Manual of Practice No. 11*. 5th Ed, Vol. 2. Alexandria, VA: WEF.
- Water Environment Federation (WEF). 1988. *Design of Municipal Wastewater Treatment Plants, Manual of Practice No. 8*. 4th Ed., Vol. 2. Alexandria, VA: WEF.
- Water Environment Research Foundation (WERF). 2002. *Best Practices for the Treatment of Wet Weather Wastewater Flows*. Prepared by Brashear, Robert, *et al.* WERF Project No.00-CTS-6. Alexandria, VA: Water Environment Foundation; London, United Kingdom: IWA Publishing.
- Wendle, Jeff, CTE Engineering Services. Interview about Lower Paxton Township, PA by Limno-Tech, Inc., August 2001. Ann Arbor, MI.

Inclusion of this technology description in this Report to Congress does not imply endorsement of this technology by EPA and does not suggest that this technology is appropriate in all situations. Use of this technology does not guarantee regulatory compliance. The technology description is solely informational in intent.



Plant Modifications

Overview

Excess wet weather flows can cause sudden hydraulic surges and changes in pollutant loads that adversely affect the performance of wastewater treatment plants (WWTP). Excess wet weather flows can disrupt treatment processes and result in the discharge of untreated or partially treated sewage. As an alternative to constructing supplemental treatment units to handle excess wet weather flows, modifications of existing facilities may be sufficient to achieve the needed capacity and treatment efficiencies.

In general, these modifications involve either process control changes or physical reconfiguration of unit processes. Process control changes are operational; examples include the addition of chemicals to a clarifier to enhance settling and the modification of return sludge flow rates. Physical reconfiguration of unit processes involves actual modification of the internal components of a process. For example, a clarifier's internal components would be redesigned to improve its hydraulics and expand the range of flow and solids load it is able to handle. In addition to unit process modifications, system-wide or overall plant modifications can be used to improve performance with respect to treatment of excess wet weather flows; examples include flow distribution and real-time control.

A generalized schematic of a WWTP depicting typical unit processes and the associated sludge handling is shown in Figure 1. This technology description first describes unit process modifications and then overall plant modifications which can improve the ability of a WWTP to provide treatment for excess wet weather flows.

Unit Process Modifications

Clarification Processes

The performance of both primary and secondary clarifiers impacts the performance of biological secondary treatment units. The modifications described below pertain to both primary and secondary clarifiers, unless otherwise noted.

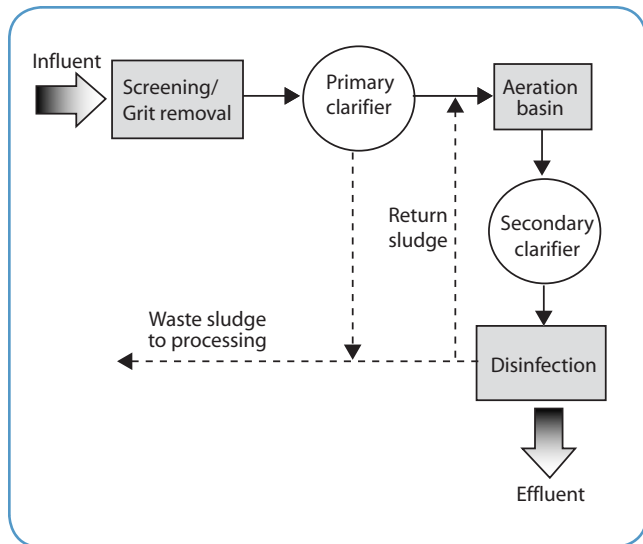

Figure 1. Schematic of a typical WWTP.

Chemical enhancement can improve solids removal in primary and secondary clarifiers. Two classes of chemicals used are coagulants and flocculants. Coagulants neutralize the charge associated with suspended solids in wastewater. This is important since most suspended solids in water are negatively charged and particles with the same charge repel each other. With the charges neutralized, the particles are able to stick together and form larger, heavier particles which settle faster. Flocculants (also referred to as coagulant aids) can help bridge and bind solids together, further increasing particle size, density, and settleability. Treatment plant operators may choose to use one or both types of chemicals depending on the wastewater characteristics, chemical costs, and other factors. Common coagulants include: aluminum sulfate (alum), polyaluminum chloride, ferric chloride, ferric sulfate, ferrous sulfate, calcium hydroxide carbonate (slaked lime), calcium oxide (quicklime), and sodium aluminate. The degree of clarification obtained when chemicals are added to untreated wastewater depends on the quantity of chemicals used, characteristics of the wastewater, and the care with which the process is

monitored and controlled. For any chemical application to be effective, the chemicals must adequately mix with the wastewater.

Baffles are most commonly used to interrupt or disperse density currents. Density currents travel at a higher velocity than surrounding waters and can carry solids through a clarifier and over its effluent weir, reducing effluent quality. The occurrence of density currents is also referred to as short-circuiting. These currents may exist in both circular and rectangular clarifiers, and may become more apparent and problematic during peak flows (NYSDEC 2001). Dye testing can be used to identify the existence of density currents and assist in determining the best baffle configuration. Baffles can be of any size and configured in multiple ways (e.g., placed in the top, middle, or bottom of the tank; constructed of one solid board or several boards with gaps in between). Various materials can be used to construct the baffle, including wood, fiberglass, plastic, and metal. In a rectangular clarifier, a baffle is a thin, vertical wall of material placed across the width of a clarifier. It may span up to the entire width and a portion of the depth of the clarifier. In a circular clarifier, baffles are commonly angled at 45-60 degrees along the perimeter of the clarifier wall, but they can also be placed perpendicular to the wall. Cross-section views of both placements in a circular clarifier are shown in Figure 2.

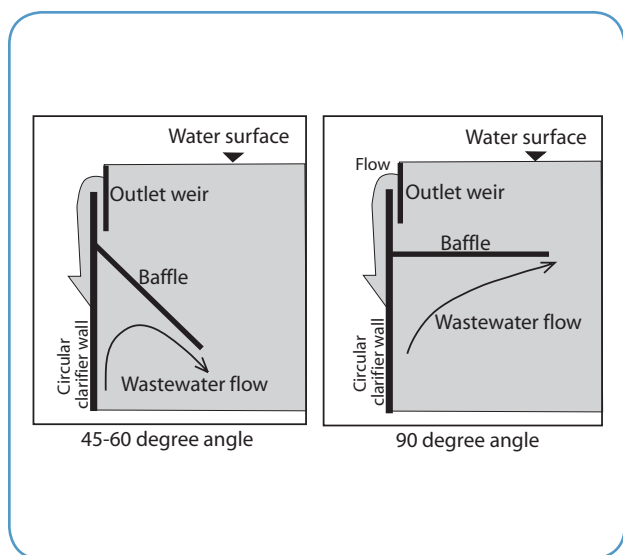

Figure 2. Example baffle replacement in circular clarifiers.

Lengthening weirs can reduce the loss of solids during periods of excess wet weather flow. For rectangular clarifiers, weirs can be lengthened by placing additional lateral weir troughs. In circular clarifiers with one peripheral effluent weir, weir lengths are normally

sufficient under average as well as peak flow conditions. For circular clarifiers with double-sided effluent weir troughs, eliminating identical V-notch spacing on outer and inner weirs can reduce solids loss during periods of excess wet weather flow. This can be accomplished by blocking alternating V-notches on the outer weir with plywood or other materials.

Biological Suspended Growth (Activated Sludge) Processes

Maintaining a concentration of biological solids in the activated sludge system higher than necessary for proper treatment will increase the potential for solids loss during peak flow periods. Operators should try to maintain the solids concentration that is necessary to ensure adequate treatment. The concentration of solids is managed primarily by controlling the total sludge mass in the system. Although long-term changes in total sludge mass must be made by adjusting the sludge wasting rate, short-term changes can be brought about by adjusting the return rate. Shifting the mode of operation to step feed or contact stabilization can be particularly effective, as described below.

Return sludge flow rate control is used to manage the sludge mass and detention time in the aeration basin of the activated sludge process. The return sludge flow is settled biomass that is removed from secondary clarifiers and recycled or returned back into the aeration basin (see Figure 1). It is necessary to return a portion of the secondary clarifier sludge to the aeration basin because the sludge contains the bacteria needed to maintain the biological treatment process. It is important to note that the rate at which the sludge is returned must be managed in accordance with influent conditions, sludge settling characteristics, and the dynamics of the biomass inventory which is continuously shifting between the clarifiers and the aeration basin. Understanding when to increase or decrease the return sludge flow can assist in maximizing secondary treatment capacity during periods of excess wet weather flow and improve effluent quality.

The step feed mode of operation introduces settled wastewater at several points in the aeration tank, as shown in Figure 3. Step feed mode can be used to handle increased organic loads by distributing them evenly across the aeration basin, but primarily provides more capability for handling hydraulic surges. To be effective, this approach generally requires three or more parallel channels in the aeration basin.

Contact stabilization is an operational modification in which the feed point is moved downstream in the

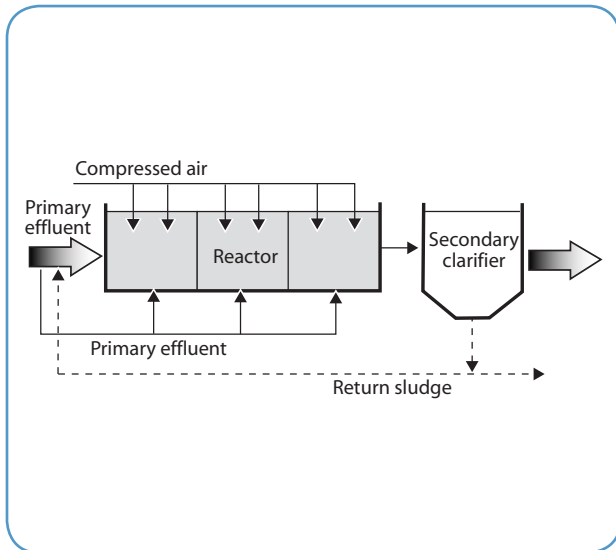

Figure 3. **Step feed mode of operation.**

aeration tank approximately one-half to two-thirds the length of the tank or into a separate tank. This configuration is shown in Figure 4. Return activated sludge is added to the basin inlet upstream of the feed point and aerated before being blended with influent. Similar to step feed, contact stabilization can reduce solids loss during hydraulic surge events. Solids in the reaeration basin are protected from the direct influent flow, thereby minimizing the potential for solids loss. Contact stabilization provides a relatively short detention time, which increases system stability.

Biological Fixed Film Processes

The biomass of fixed film processes, such as trickling filters and rotating biological contactors (RBCs), is not as easily washed out as the biomass of suspended growth processes. Nonetheless, their performance is impacted by excess wet weather flows. Techniques for improving the performance of fixed film processes under wet weather flow conditions are described below.

For trickling filters, recirculation of flow is commonly practiced to provide adequate wetting of the biological media. For RBCs, recirculation of sludge may be practiced to encourage some suspended growth and maintain dissolved oxygen and hydraulic loading. During peak flow periods, however, recirculation is generally not necessary and can be temporarily reduced or halted to allow increased capacity for peak flows.

Trickling filter flow distributors are used to spread wastewater influent evenly over the biological media. Distributor arms that are hydraulically driven may turn at excessive speeds during peak flow periods, but can be slowed by installing nozzles on the arms that discharge

in the opposite direction. The new nozzles can be capped to return the arm to normal speed during normal flow conditions. In practice, such changes are not made routinely.

Trickling filters are sometimes operated in series or sequentially. Pipes and pumping may be configured between units, however, such that during peak flow periods, the units could be converted to parallel operation allowing flows to pass through all filters simultaneously. This would increase the biological treatment capacity by reducing the hydraulic loading rate. Biochemical oxygen demand (BOD) removal efficiency may be reduced by placing the units in parallel operation; however, the reduced efficiency

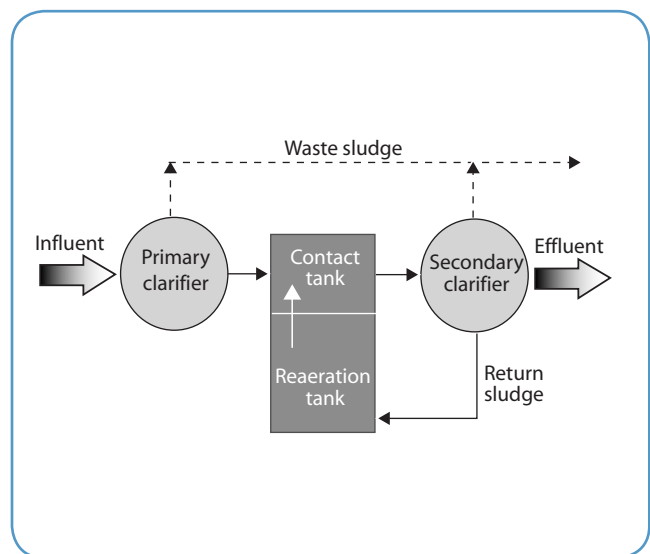

Figure 4. **Contact stabilizer mode of operation.**

would be offset somewhat by the fact that each unit will operate at or below design loading rates.

Chemical Disinfection Processes

During periods of excess wet weather flow, influent exposure time to chemical disinfectants may be insufficient for adequate disinfection. Key operational variables for optimizing performance of disinfection facilities include mixing and dosage. Poor disinfectant mixing or poor diffuser placement can significantly reduce effectiveness. For chlorine disinfection, it is possible to provide adequate disinfection at detention times of less than 15 minutes with the appropriate dosage (NYSDEC 2001). Determining the optimal dosage at high flows, however, requires some experimentation. Additional information on disinfecting wet weather flow is provided in the “Disinfection Technology Description” in Appendix

B of Report to Congress on the Impacts and Control of Combined Sewer Overflows and Sanitary Sewer Overflows.

Overall Plant Modifications

Flow Distribution and Control

Treatment facilities that have multiple treatment units used in a process must be able to control the distribution of flow. In general, uneven flow distribution can affect the hydraulic capacity in one or more of the treatment units, which can have a negative impact on performance (e.g., solids loss from a secondary clarifier) (NYSDEC 2001). Flow control can be incorporated into an existing facility through the addition of adjustable control weirs or appropriate valves.

Equal distribution of solids to the treatment processes, such as return sludge, is also important. Unless provided for in the design, equal distribution of solids to the treatment units may not occur coincidentally with the equal distribution of flow.

Sidestream Control

A sidestream is a liquid or sludge flow that is produced by a treatment process; wastewater treatment plants typically produce several sidestreams. Sidestreams are either handled separately from the wastewater flow, or returned to a specific unit process for additional treatment or to support operation. Controlling the timing and location of sidestream returns can prevent overload of the treatment facility. Specifically, consideration should be given to reducing or halting sidestream returns during peak wet weather flows (NYSDEC 2001).

Real-Time Automated and Remote Controls

Automated and remote operation controls, based on real-time system information, can improve preparation for and response to wet weather events. Real-time information from the sewer system can allow operators to anticipate the need for operational changes before excess wet weather flows reach the treatment facility, thereby optimizing the efficiency and effectiveness of mode shifts or operational changes. Additional information on the use of real-time control is provided in the “Monitoring and Real-Time Control Technology Description” in Appendix B of *Report to Congress on the Impacts and Control of Combined Sewer Overflows and Sanitary Sewer Overflows*.

At the treatment plant, automated or remote control systems optimize adjustments to gates, valves, and weir levels during wet weather events. Such real-time

controls have been shown to improve wet weather operations by reducing CSO events and maximizing sewer system storage capacity (Batzell 1994; Field *et al.* 2000). Real-time control within individual processes can also optimize unit process operation. For example, real-time information on dissolved oxygen concentrations in the aeration basin can optimize the performance of an activated sludge process.

Key Considerations

Applicability

A performance evaluation should be done prior to any plant modifications to determine whether it is feasible to obtain the needed capacity from the existing unit processes. Plant modifications are preferred over new construction since the cost of plant modifications is relatively small compared to new construction. Some of the recommended modifications for improving peak wet weather flow capacity, however, may result in increased effluent concentrations of BOD or other constituents. The ability to increase the capacity of existing processes must be balanced with the need to meet short- and long-term permit limits. In addition, modifications that require operator attention before and after a wet weather event may interrupt regular dry weather operations and potentially compromise the quality of treated effluent during dry weather.

Cost

In general, the costs for the modifications described above are low. Some modifications require only simple changes in operation and no additional treatment process units. Construction materials (e.g., lumber) for unit reconfiguration are typically simple and readily obtainable.

Material costs for density current baffles built in-house, for example, are quite low. In an article by the New York State Department of Environmental Conservation, the highest cost for a density current baffle reported was \$300 (NYSDEC 2002). Further, the addition of baffles can often be implemented by plant staff. Baffles commonly result in TSS reductions of 25-35 percent under average flow conditions and 40-50 percent under peak flow conditions (NEFCO 2002).

Of the potential modifications presented, chemical enhancement and real-time controls are expected to be the most expensive. Chemical enhancement represents an on-going cost that will vary depending on the chemicals used, and the frequency and volume of usage. Sludge volume and handling costs may also increase as a result of chemical addition. Nonetheless, chemical enhancement in primary

clarifiers has been demonstrated to improve TSS removal from the normal range of 50-70 percent to 80-90 percent.

Real-time control costs are summarized and presented in the *Monitoring and Real-Time Control Technology Description* in

Appendix B of the *Report to Congress on Impacts and Control of Combined Sewer Overflows and Sanitary Sewer Overflows*. Case studies for larger sewer systems indicated capital costs in millions of dollars. These systems represent highly sophisticated automated and predictive technology. Simpler

Implementation Examples

WASHINGTON COUNTY, NY

Responsible Agency: Washington County Sewer District #2

Population Served: 15,000

Service Area: 5.8 sq. mi.

Sewer System: 90 percent of combined sewer; 10 percent of sanitary sewer

Use of Contact Stabilization and Baffles

In March 1996, the NYSDEC and Washington County jointly conducted studies to investigate methods for increasing the wet weather treatment capacity of the existing secondary treatment process at the Sewer District #2 WWTP. The WWTP is an activated sludge facility designed to treat an average dry weather flow of 2.28 MGD. The actual dry weather flow averages 2.1 MGD. However, during wet weather, flow to the WWTP can exceed 15 MGD. Operators only allow 7.5 MGD to enter the plant in order to protect unit processes. Prior to the study, flow to the activated sludge process was further restricted to 5 MGD. During periods of wet weather, flows

entering the plant in excess of 5 MGD were bypassed around the activated sludge units and received only primary treatment and disinfection.

Two techniques for increasing secondary treatment capacity were investigated: operating the activated sludge process in contact stabilization mode; and evaluating primary and secondary clarifiers for short-circuiting. The studies found that the contact stabilization mode could treat a higher flow rate than conventional operation. Conventional operations failed to meet permit limits at flow rates greater than 7 MGD. The contact stabilization mode, however, was able to treat 7.5 MGD and meet permit limits.

Both the rectangular primary and circular secondary clarifiers exhibited short-circuiting. Baffle systems were designed for each, but installation was delayed for the secondary clarifier. The system initially installed in the primary clarifier was a seven-foot high, solid, mid-tank baffle that consisted of a used belt press supported by a wooden frame. The construction cost was less than \$50. After installation, testing showed no improvement in clarifier performance. The baffle was modified by cutting a six-inch opening every six inches. This configuration reduced the density currents and reduced effluent suspended solids by 10 percent (NYSDEC 2001). This also reduced the solids loading to the activated sludge process, improving overall treatment efficiency.

Contact: Joe McDowell, Washington County Sewer District

GRANVILLE, NY

Plant Modifications Increase Capacity

Responsible Agency: Village of Granville

Population Served: 2,646

Service Area: 1 sq. mi.

Sewer System: Not Available

The Village of Granville WWTP investigated methods for improving biological trickling filter and secondary clarifier performance during periods of wet weather. The WWTP experiences dramatic and prolonged peak flow events. Flows can rise quickly from a dry weather flow of 0.3 MGD to more than 3 MGD, and the elevated flows may last for up to a week. During periods of wet weather, the trickling filter distributor arm speed would increase and result in sloughing of biomass from the

filter media. Effluent quality was often degraded for a period of time beyond the wet weather event, as much of the biomass necessary for treatment was washed out.

During periods of high flow, the arm speed would increase from two revolutions per minute to more than seven revolutions per minute. Two retro nozzles (pointing in the opposite direction of existing nozzles) were installed on each trickling filter arm. The retro nozzles successfully slowed the arm speed to less than three revolutions per minute during periods of excess wet weather flow (greater than 2 MGD) (NYSDEC 2001). Excess sloughing and loss of biomass was reduced, resulting in higher effluent quality.

Suspended solids removal was problematic in the rectangular secondary clarifiers during both dry and wet weather periods. Extensive dye testing was conducted, and baffles were designed and installed. The initial baffle was installed at the one-third point in the tank. The baffle was solid at the top with staggered 2 x 8 lumber at the bottom. Dye test results after installation showed a 6 percent reduction in effluent solids. An additional baffle was designed and installed at the two-thirds point of the clarifier. This baffle was solid from top to bottom, but left a 14-inch opening at the bottom of the tank and a smaller area for flow at the top. With the second baffle, effluent solids concentrations were reduced by 19 percent (NYSDEC 2001).

Contact: Dan Williams, Village of Granville

CLATSKANIE, OR

Contact Stabilization Used for Treatment

Responsible Agency: Clatskanie People's Utility District

Population Served: 4,300

Service Area: 3.5 sq. mi.

Sewer System: Not Available

The Clatskanie WWTP is an activated sludge treatment facility that underwent a two-year full-scale performance evaluation of its wet weather treatment capabilities. High inflow and infiltration in its separate sanitary sewers resulted in the delivery of excess wet weather flows. During the evaluation, the plant was operated in the conventional mode during dry weather conditions. The average dry weather flow was 0.2 MGD and the peak dry weather flow was 0.5 MGD. During wet

weather flows, the activated sludge process was operated in contact stabilization mode. By switching operational modes during wet weather conditions, six to 12 times the average dry weather flow rate (approximately 1.25-2.3 MGD) was treated. For flows of up to 1.25 MGD, the mean suspended solids and BOD₅ effluent concentrations ranged from 2-24 mg/L and 6-11 mg/L, respectively. Removal efficiencies for wet weather flows ranging from 0.5-2.3 MGD were 71 percent and 73 percent for suspended solids and BOD₅, respectively (Benedict and Roelfs 1981).

References

Batzell, Russell W. 1994. "Computer Control of CSOs," *Civil Engineering*. Vol 64 (No.11): 58-59.

Benedict, A.H. and Roelfs, V.L. 1981. *Joint Dry/Wet Weather Treatment of Municipal Wastewater at Clatskanie, Oregon*. EPA-600/2-81-061, NTIS PB 81-187262.

Field, R., Villeneuve, E., and Stinson, M. K. 2000. "Get Real!" *Water Environment & Technology*. Vol 12 (No. 4): 64-68.

NEFCO, Inc. 2002. "Baffle Basics...A Brief Tutorial." Retrieved December 30, 2002.
<http://www.nefcoinc.com/torial.html>.

New York State Department of Environmental Conservation (NYSDEC). 2001. "Wet Weather Operating Practices for POTWs with Combined Sewers." Retrieved June 26, 2003.
http://www.dec.state.ny.us/website/dow/bwcp/ww_training.pdf

NYSDEC. 2002. "Clarifier Baffles Work." Retrieved December 30, 2002.
http://www.dec.state.ny.us/website/dow/bwcp/tt_baffles.pdf

Inclusion of this technology description in this Report to Congress does not imply endorsement of this technology by EPA and does not suggest that this technology is appropriate in all situations. Use of this technology does not guarantee regulatory compliance. The technology description is solely informational in intent.



TECHNOLOGY DESCRIPTION

Treatment Technologies

Disinfection

Overview

Disinfection of wastewater is necessary for the protection of public health. Therefore, municipal wastewater treatment processes are typically followed by a disinfection process that is designed specifically to inactivate bacteria, viruses, and other pathogens in the treated wastewater. The application of disinfection to CSOs and SSOs has been more limited, however, owing to uncertainties in process design, performance, and regulatory requirements. This technology description describes two processes that have been used to treat wet weather CSOs and SSOs: chlorine disinfection and ultraviolet (UV) light. Other technologies that have had more limited application in disinfecting CSOs and SSOs include ozonation, chlorine dioxide, peracetic acid, and electron beam irradiation. These will not be discussed in this fact sheet; more information is available in EPA's "Alternative Disinfection Methods" fact sheet (EPA 832-F-99-033).

Chlorine Disinfection

Chlorine disinfection involves the application of chlorine to wastewater to inactivate microorganisms. Wastewater disinfection most often employs gaseous chlorine. The gas is usually supplied in either 150-pound or 1-ton cylinders. When added to wastewater, gaseous chlorine undergoes hydrolysis and forms a mixture of hypochlorous acid (HOCl) and hydrochloric acid (HCl); some of the HOCl further dissociates to hypochlorite ion (OCl⁻). Hypochlorous acid and hypochlorite ion provide the majority of the disinfection. When ammonia is present, chloramines are also formed, although they are less potent as disinfectants.

Chlorine can also be applied in hypochlorite form. The chemistry of hypochlorination is very similar to gaseous chlorine in that the main agents of disinfection are hypochlorous acid and, to a lesser extent, hypochlorite ion. The two most commonly used hypochlorites are sodium hypochlorite, a clear, yellow

liquid, and calcium hypochlorite, a dry solid that comes in powder, granular, or tablet form.

Sodium hypochlorite, also known as bleach, is available in strengths ranging from 1-16 percent, but typically contains 12.5 percent available chlorine. Solutions of less than one percent strength can be generated electrochemically from salt brine solution, but must be done on-site. Calcium hypochlorite is a solid that contains 65-70 percent available chlorine. It is commonly used in tablet erosion systems, which pass a stream of water over the tablets and generate a solution of generally less than one percent available chlorine.

The performance of a chlorine disinfection system can be characterized in terms of the product of the chlorine concentration in milligrams per liter (mg/L) and the contact time in minutes, usually referred to as "CT." Disinfection efficiencies are usually fairly consistent for a given CT, and increase in proportion to increasing CT. Decreased contact time can therefore be offset by increased disinfectant concentration and vice versa.

Ultraviolet Light

Ultraviolet (UV) light disinfection involves the direct exposure of the wastewater stream to UV light, which alters genetic material in microbial cells and prevents them from reproducing. Germicidal wavelengths range from 200-320 nanometers (nm), with peak effectiveness at approximately 260 nm. In UV disinfection systems, a relatively thin film of wastewater flows past the UV lamps, and for a few seconds, the microorganisms are exposed to a dosage of UV energy.

Ultraviolet radiation is generated by striking an electric arc through mercury vapor contained in a lamp. Because ordinary glass absorbs UV light, the lamp is made of special UV light transmitting quartz, polymer, or silica. Factors that influence the level of radiation emitted from UV lamps include mercury vapor

pressure, chemical composition of the quartz sleeve, and electrical power input (Acher *et al.* 1997).

Low-pressure, low-intensity lamps have found the greatest application in disinfection of wastewater treatment plant effluents, primarily because they emit around 85 percent of their UV output at 254 nm, which is close to the most effective germicidal wavelength of around 260 nm. Due to their low-intensity, however, the number of lamps required is relatively large, which makes them impractical for high-rate applications such as disinfecting CSOs and SSOs. There is effectively no economy of scale in UV disinfection; much of the capital and operating costs are directly proportional to the number of bulbs, and the number of bulbs is directly proportional to the flow being disinfected. Medium-pressure, high-intensity lamps are becoming more widely available and have been shown to be more effective on lower-quality wastewaters such as CSO and SSO discharges. In addition, higher intensity means that fewer bulbs are required, which makes these systems more economical for CSO and SSO applications.

Ultraviolet disinfection technologies fall into two categories: closed systems and open channel systems. Closed system contact units consist of UV lamps encased in quartz around which wastewater flows. Open channel systems consist of submerged UV lamps either vertically or horizontally suspended in an open channel. Both systems are typically modular in design and are applicable to a wide range of flows.

To achieve inactivation, UV radiation must be absorbed into the microorganism. Therefore, anything that prevents UV light from reaching the microorganism will decrease the disinfection efficiency. Other factors that have been determined to affect disinfection efficiency include (EPA 1999):

- Chemical and biological films that develop on the surface of UV lamps
- Dissolved organics and inorganics in the wastewater, especially iron
- Clumping or aggregation of microorganisms
- Turbidity
- Color
- Incomplete exposure of wastewater to UV light

The effectiveness of UV disinfection is typically characterized by the UV dose. The dose is most often expressed in milliwatt-seconds per square centimeter ($\text{mW}\cdot\text{s}/\text{cm}^2$), and is defined as the product of the average intensity of UV energy emitted by the lamps (in mW/cm^2) and the exposure time (in seconds). UV dose

is analogous to the CT concept used to characterize chlorine disinfection and is of similar use in comparing results from studies.

Key Considerations

Applicability

Chlorine Disinfection

Chlorine is a fairly stable disinfectant that provides continuous disinfection. Chlorine disinfection often has significant space requirements; large tanks are usually required to allow for sufficient contact time between the chlorine and the wastewater. Chemical storage and the location of feed equipment must also be considered.

Chlorine reacts quickly with many constituents of wastewater including, but not limited to, pathogens, such that not all of the chlorine added is available for disinfection. The difference between the amount added and the residual concentration (that is, the concentration that persists long enough to provide disinfection) is called the “chlorine demand” (White 1999). The initial chlorine demand of the wastewater must be known to some extent so that enough chlorine can be added to satisfy initial demand and still provide a sufficient residual concentration.

Chlorine disinfection leaves residual chlorine in the treated wastewater, which is highly toxic to aquatic organisms. In addition, it may react with organics and inorganics in wastewater to form toxic compounds that can have long-term adverse effects on the receiving waters. For these reasons, residual chlorine levels are sometimes restricted by a facility’s discharge permit, and must be reduced by dechlorination. Dechlorination is typically done with either sulfur dioxide (a gas) or sodium bisulfite (a liquid).

Another effect of the chlorine disinfection process is the formation of disinfection by-products (DBPs), specifically halogenated organics such as total trihalomethanes (THMs) and haloacetic acids. DBPs form when natural organic matter reacts with free chlorine added for disinfection or free bromine that results from the chlorine disinfectant oxidizing bromide ions in the wastewater. DBP formation is affected by the type and concentration of natural organic matter, chlorine form and dose, time, bromide ion concentration, pH, organic nitrogen concentration, and temperature. The utility of chlorine for disinfection may be limited where DBPs are subject to regulatory limits. Removal of DBP precursors, modification of the

chlorine disinfection strategy, or changing disinfectants are typically used to lessen DBP formation.

UV Disinfection

UV disinfection requires no chemical storage and is very stable in this sense. Space requirements are relatively small due to short wastewater contact times and the lack of chemical storage.

Power consumption is an important consideration in UV applications. The process is energy-intensive compared to chemical methods. High-flow situations present high power demands, and will usually require an on-site generator, adding to the total construction and operating cost.

Advantages

Chlorine Disinfection

The primary advantage of gaseous chlorine is its low cost in relation to its overall effectiveness as a disinfectant. The technology is well-developed and straightforward to apply, and the chemical itself is widely available.

Hypochlorination acts in a similar fashion as gaseous chlorine and shares most of its advantages and disadvantages. It provides reliable inactivation of bacteria, it is widely available, and the technology is fully developed. Liquid sodium hypochlorite is usually somewhat more expensive than gas per pound of available chlorine.

UV Disinfection

UV disinfection is attractive for disinfection of CSOs and SSOs for several reasons. The disinfection process requires much shorter detention times than chemical methods, on the order of seconds as compared to 10 minutes or greater for chlorine. There are also no chemicals to transport, handle, or store, which appeases numerous concerns, including worker and public safety, environmental impacts, and degradation of chemical strength during storage. UV also does not form any known, potentially toxic byproducts, nor does it leave any toxic residuals.

Disadvantages

Chlorine Disinfection

Disadvantages of gaseous chlorine include poor inactivation of viruses and protozoan cysts and oocysts relative to bacteria, the formation of DBPs, and reactions with ammonia that result in combined chlorine residuals that are less effective disinfectants. These issues are especially important when treating CSOs and SSOs, since in many cases suspended solids

and ammonia levels are elevated in these flows. In addition, the hazards posed by leaking chlorine gas may make it infeasible for use at satellite locations, which could be in heavily populated areas. Fire and building codes may require scrubbers or other equipment to mitigate leaks.

Hypochlorination shares some disadvantages with gaseous chlorine, including lesser inactivation of viruses and protozoa, the formation of DBPs, and reactions with ammonia that lessen its effectiveness at a given residual concentration. Although liquid sodium hypochlorite is highly corrosive and must be handled with care, it is generally considered to pose less of a safety hazard than gaseous chlorine.

Solutions of sodium hypochlorite will decay in strength over time, especially at higher concentrations and temperatures. This can be a significant disadvantage for CSO and SSO facilities that are operated infrequently and which would require chemicals to be stored for potentially long periods of time. Decay rates can be attenuated by diluting the hypochlorite after delivery to 10 percent or even 5 percent, although this requires additional storage facilities. Calcium hypochlorite, used in tablet erosion systems, has a much longer shelf life than liquid sodium hypochlorite. Tablet erosion systems, however, may not be able to provide large enough volumes of chlorine solution with the short notice given by CSOs and SSOs during many wet weather events.

UV Disinfection

A major disadvantage of UV light disinfection of CSOs and SSOs has been its sensitivity to wastewater quality. Its efficiency is reduced by increased suspended solids and turbidity. The buildup of mineral deposits on the lamp sleeves also reduces effectiveness by reducing the applied dose of UV light. Recent advances are addressing these issues, however, by using higher intensity lamps and more effective self-cleaning mechanisms.

Cost

Chlorine Disinfection

Table 1 summarizes fecal coliform data for two chlorine disinfection facilities (more information on these facilities is provided in the case studies below): Washington, D.C., and Acacia Park in Oakland County, MI. The Washington, D.C., Northeast Boundary Swirl Facility (NEBSF) also tests for enterococci, and these results are also shown in Table 1. Samples at NEBSF are taken both in the disinfection chamber and at the river outfall.

The table shows the variability of performance that is often the case when treating CSOs and SSOs. A major operational issue is optimizing the addition of chlorine; the experience at these facilities and others has been that inadequate pathogen reduction is usually the result of insufficient chlorine levels. Achieving the desired chlorine level requires reliable flow measurement and knowledge of the strength of the chlorine solution.

Capital costs for construction of chlorine disinfection facilities are usually proportional to the peak design flow. The majority of the cost is in the construction of a basin that provides sufficient contact time (for example, 15 minutes); a smaller portion consists of equipment, such as feed pumps, mixers, and storage tanks. Analysis of construction costs of CSO detention and treatment facilities in the River Rouge area in southeast Michigan showed that the equipment portion of the chlorine disinfection costs were approximately three to four percent of the total project cost (Tetra Tech MPS 2002). These facilities generally included significant storage volume beyond what would be needed solely for chlorine disinfection, however. If the basin costs are adjusted to provide a 15-minute detention time, the costs for the facilities average around \$14,000 per MGD of peak flow. Reducing the detention time to 10 minutes, which is feasible if highly efficient chemical

mixing is provided, reduces this cost to about \$9,500 per MGD. Actual construction costs vary considerably because of site-specific conditions.

Ultraviolet Light

UV systems do not have as long a record as chlorine disinfection facilities in disinfecting CSOs and SSOs. Pilot studies have shown, however, that fecal coliform levels of 1,000 #/100 mL can be met consistently by medium-pressure, high-intensity units operating within their normal range of power usage (CDM 1997; Curtis and Blue 1999). In another study, *E. coli* levels of 126 #/100 mL were met by both low- and medium-pressure systems treating effluent from a physical/chemical process using alum as the coagulant (Matson *et al.* 2002). The desired *E. coli* level was not met when ferric chloride was used, however.

Capital costs for construction of UV disinfection facilities are not well known, due to a lack of data for this relatively new technology. As part of a CSO disinfection pilot study, capital costs for construction of UV disinfection facilities were projected by the US EPA Office of Research and Development. In this study, it is estimated that a UV disinfection facility that results in a four-log reduction in fecal coliform with a peak flow of 88 MGD will cost approximately \$27,600 per MGD of peak flow (EPA 2002).

Table 1. Pathogen removal performance for chlorine disinfection facilities.

Period	Number of Samples	Geometric Mean Fecal Coliform (#/100 mL)			Geometric Mean Enterococci (#/100mL)	
		Acacia Park	NEBSF		NEBSF	
			Disinfection Chamber	River	Disinfection Chamber	River
1997	13	5.4	--	--	--	--
1998	57	2,220	--	--	--	--
1999	31	2,430	--	--	--	--
Jan-Mar 2001	--	--	2,240	9,230	68	496
Apr-Jun 2001	--	--	6,620	26,500	1,700	23,800
Jul-Aug 2001	--	--	1,600	8,940	593	7,080

Implementation Examples

WASHINGTON, DC

Responsible Agency: District of Columbia Water and Sewer Authority

Population Served: 572,000

Service Area: 19.50 sq. mi.

Sewer System: 1,800 mi. of sanitary and combined sewer

Northeast Boundary Swirl Facility (NEBSF)

The District of Columbia Water and Sewer Authority (WASA) operates a sewer system that includes combined sewers serving approximately 12,478 acres. Among its existing CSO controls is the NEBSF, which provides treatment and disinfection for up to 400 MGD of CSO before discharging to the Anacostia River. The facility provides mechanical screening followed by three 57 foot diameter swirl concentrators. The effluent from the swirl concentrators flows to a mixing chamber where sodium hypochlorite is added, usually at a dose

of 5 mg/L. Sodium bisulfite is added at the end of the outfall for dechlorination, usually at a dose of 2 mg/L. Flows above 400 MGD receive no treatment and are discharged through the same outfall as treated flows.

Samples taken during CSO events at the mixing chamber and at the river outfall are analyzed for enterococcus and fecal coliform. Reported counts range from less than 10 MPN/100 mL to in excess of 250,000 MPN/100 mL. The high numbers are associated with events in excess of 400 MGD and represent a comingling of treated and untreated CSO.

Annual operating costs for the NEBSF are estimated to be about \$230,000. This is based on \$180,000 for labor and \$50,000 for chemicals. Labor includes two full-time operators, a part-time supervisor, and other part-time support for cleaning and maintenance. The facility discharges on average about 100 times per year, with an average total volume of approximately 1,500 MG.

Contact: Mohsin Siddique, CSO Control Program Manager, DC WASA

BIRMINGHAM, AL

Responsible Agency: Jefferson County Environmental Services Division

Population Served: 376,000

Service Area: Not Available

Sewer System: 3,100 mi. of sewer

UV Disinfection at Peak Flow WWTP

The Jefferson County Environmental Services Division owns and operates nine wastewater treatment facilities, collecting and treating wastewater from the City of Birmingham and some 20 neighboring municipalities. These nine plants, along with about 658 miles of separate sewers, serve an approximate population of 376,000 at an average daily flow of 97 MGD. The Village Creek WWTP has at times received peak flows greater than ten times its annual average flow (in excess of 400 MGD versus an average of 40 MGD). Currently, a 350 MGD peak excess flow treatment facility is under construction.

The Village Creek Peak Flow Wastewater Treatment Plant (PFWWTP) includes a pump station with 360 MGD capacity, 20 surge basins with surface aeration for mixing (total capacity of 90 MG), granular monomedia deep bed filters with 350 MGD capacity, UV disinfection, and a 24-megawatt generating facility (primarily to power the pump station and UV). The entire facility is scheduled to be completed in the summer of 2003.

The Village Creek PFWWTP uses a UV disinfection system with a total of 2,688 lamps and has a peak power requirement of 7,526 kW. The total installed cost of the UV facility at Village Creek is estimated to be \$13 million; the cost for the UV equipment is approximately \$10.7 million. Operating costs are not available.

Contact: Harry Chandler, Assistant Director, Environmental Services, Jefferson County

OAKLAND COUNTY, MI

Responsible Agency: Oakland County Drain Commissioner

Population Served: 4,500

Service Area: 1.28 sq. mi.

Sewer System: Not Available

Chlorine Disinfection at Acacia Park

The Office of the Oakland County Drain Commissioner (OCDC) currently operates three CSO retention basins in southeastern Michigan, all of which provide treatment and disinfection of flows that exceed their storage capacity. The Acacia Park CSO Retention Treatment Basin (RTB) is a 4 MG basin that serves a combined area of approximately 816 acres. Disinfection is by sodium hypochlorite, which is stored at about 6 percent to reduce the rate of degradation during storage. The feed system

is designed to provide a dose of 10 mg/L at a CSO flow rate of 426 MGD. The hypochlorite is fed at the discharge of the influent pumps, which provides sufficient mixing. Dechlorination is not currently provided at this facility.

Extensive monitoring of the basin performance was conducted during a three-year demonstration period from 1997-1999 (Johnson *et al.* 2000). The disinfection target was a fecal coliform count of less than 400 #/100 mL at a total residual chlorine (TRC) level of 1.0 mg/L. The purpose of the TRC goal is to ensure that a sufficient dose of chlorine is delivered to the basin.

Five of the nine events monitored had average TRC levels above 1.0 mg/L, and the fecal coliform target was met in four of these five events. The four events with average TRC levels less than 1.0 mg/L did not meet the fecal coliform target. Low TRC was generally attributed to sodium hypochlorite solutions being weaker than anticipated either because of degradation or inaccurate dilution of the chemical.

Annual operating costs for the Acacia Park facility are estimated to be \$120,000. This includes \$58,600 for labor, \$24,800 for energy and utilities, \$26,000 for chemicals, and \$10,500 for laboratory and other services. These costs reflect some additional expense associated with startup, testing, and performance evaluation. Over the three-year demonstration period, the facility captured approximately 60 percent of the flow it received; that is, treated overflows represented 40 percent of flow into the facility. The total volume of flow into the facility was estimated at 146 MG, with 88 MG retained and returned to the sewer system and 58 MG treated and discharged. Overflows occurred on average four to five times per year, and ranged in volume from 0.13-17 MG.

Contact: Dan Mitchell, Hubbell, Roth, and Clark, Michigan

BREMERTON, WA

Responsible Agency: City of Bremerton

Population Served: 40,000

Service Area: 10 sq. mi.

Sewer System: 250 mi. of sewer

UV Disinfection at CSO Treatment Facility

The City of Bremerton has recently constructed a CSO treatment facility that uses high-rate clarification, followed by UV disinfection, to treat flows up to 45 MGD. The facility uses a medium-pressure, high-intensity UV system that employs a total of 90 bulbs. A 500 kilowatt generator is located on site to supply power to the UV system as well as pumps, mixers, and other appurtenances.

The clarification system uses a polyaluminum chloride coagulant, which was selected over the equally effective ferric chloride to avoid UV interferences by residual iron. The primary reason for choosing UV over chlorination was to avoid the degradation of hypochlorite between discharge events, which are estimated to occur approximately 20 times per year. Bremerton installed a UV system at a cost of about \$600,000 to disinfect CSO discharges. The annual operation cost for the entire facility is estimated to be about \$50,000; UV power costs and bulb replacement are a portion of this.

Contact: John Poppe, Wastewater Division Manager, City of Bremerton

COLUMBUS, GA

Chlorine and UV Disinfection Demonstration Project

Responsible Agency: Columbus Water Works

Population Served: 186,000

Service Area: 95 sq. mi.

Sewer System: 8.1 mi. of combined sewer

Columbus Water Works (CWW) operates a sewer system and treatment plant that includes 5,200 acres of combined sewer service area. Pilot studies aimed at gathering more information for controlling CWW's CSOs grew, in part with the aid of an appropriation from Congress, into the Uptown Park Advanced Demonstration Facility (ADF). The ADF included vortex separators, compressed media filtration, and chemical and UV disinfection systems. Chemicals evaluated included sodium hypochlorite, chlorine dioxide and peracetic acid; vortex separators were used as contact chambers

for chemical disinfection. The UV system used medium pressure, high-intensity lamps.

The study demonstrated the challenges to chemical disinfection posed by the variation of chemical oxidant demand in CSO. In general, no direct relationships were observed between effluent fecal coliform concentrations and CT values based on disinfectant dose alone. Useful relationships were obtained, however, when CT values were normalized by both CSO ammonia concentration and the mass of chemical oxygen demand (COD) removed. The results were used to develop control algorithms for disinfectant dosing that are based on CSO influent conditions, rather than relying on residual chlorine measurements that can be difficult to obtain reliably under rapidly changing flow conditions.

UV disinfection performance was characterized by the inactivation of *E. coli*. The inactivation increased with increasing UV dose, which was calculated as the product of applied lamp power, UV percent transmittance, and contact time. UV transmittance of the filtered effluent was typically less than 60 percent, and at levels less than 40 percent, effluent bacteria increased by an order of magnitude (from hundreds to thousands). In contrast, the unfiltered CSO UV transmittance was as low as 20 percent.

Capital and operating costs were developed for an optimized treatment train consisting of screening and grit removal, vortex separation, filtration, and combined chemical and UV disinfection. UV and chlorine disinfection/dechlorination accounted for about 28 percent of the capital cost and 39 percent of the operating cost. Capital costs for a treatment system designed for 63 percent removal of TSS were estimated to be approximately \$10,000 per acre of combined sewer service area; annual operating costs were estimated to be about \$163 per acre. Designing the system for 80 percent removal of TSS increased the capital cost nearly threefold, with annual operating costs doubling.

Contact: Cliff Arnett, Columbus Water Works

References

Acher, A., *et al.* 1997. "Ecologically Friendly Wastewater Disinfection Techniques." *Water Research*. 31(6):1398-1404.

Camp, Dresser & McKee (CDM). 1997. "Spring Creek AWPCP Upgrade - CSO Disinfection Pilot Study - Final Report." Location: Publisher.

Curtis, M. and K. Blue. *City of Unalaska Ultraviolet Disinfection of a Primary Effluent*. Conference proceedings at Water Environment Federation WEFTEC New Orleans, LA, 1999.

EPA Office of Research and Development. 2002. CSO Disinfection Pilot Study: Spring Creek CSO Storage Facility Upgrade. EPA 600-R-04-077.

EPA Office of Water and Office of Ground Water and Drinking Water. 1999. *Alternative Disinfectants and Oxidants Guidance Manual*. EPA 815-R-98-009.

Johnson, C. E., *et al.* *Operating Experience with Large CSO Control Facilities*. Conference proceedings at Water Environment Federation WEFTEC Anaheim, CA, 2000.

Matson, B., *et al.* *Meeting SSO Requirements with a High Rate Process Train: Pilot Results Lead the Way*. Conference proceedings at Water Environment Federation WEFTEC Chicago, IL 2002.

Poppe, John. Wastewater Division Manager, City of Bremerton, WA. Interview by Limno-Tech, Inc., December 2002. Ann Arbor, MI.

Siddique, Mohsin. CSO Control Program Manager, District of Columbia Water and Sewer Authority. Interview by Limno-Tech, Inc, December 2002. Ann Arbor, MI.

Tetra Tech MPS. Interview by Limno-Tech, Inc., December 2002. Ann Arbor, MI.

White, G.C. 1999. *Handbook of Chlorination and Alternative Disinfectants*. 4th Ed. New York: Wiley and Sons, Inc.

Inclusion of this technology description in this Report to Congress does not imply endorsement of this technology by EPA and does not suggest that this technology is appropriate in all situations. Use of this technology does not guarantee regulatory compliance. The technology description is solely informational in intent.



Vortex Separators

Overview

Vortex separators are designed to concentrate and remove suspended solids and floatables from wastewater or storm water. Sometimes referred to as swirl concentrators, vortex separators use centripetal force, inertia, and gravity to provide treatment. The vortex design induces solids to settle out into a sump; floatables are captured by screens. In combined sewer systems (CSSs), vortex separators are used at hydraulic control points (regulators) to separate combined sewage into a small volume of concentrated sewage and solids, and a large volume of more dilute sewage and storm water runoff. The concentrated sewage is typically conveyed to a wastewater treatment plant (WWTP) for treatment, and the dilute mix is discharged directly to a receiving water. This discharge may or may not be disinfected. In storm water systems, vortex separators are used to capture solids and floatables at storm water outfalls. In storm water applications, captured material needs to be cleaned out and removed for disposal on a regular basis. In general, vortex separators are not used to provide treatment at remote locations in sanitary sewer systems (SSSs). The focus of this technology description is the use of vortex separators for controlling wet weather discharges from CSSs.

Vortex separators are flow-through structures that usually have one inlet and two outlets: one for concentrated sewage and solids, and one for more dilute sewage. Different vendors provide different design features to optimize liquid-solid separation and pollutant removal. Many vortex separators use screens and baffles to collect floatables. Floating sorbent materials are also used in some designs to capture oil and grease. The range of size and capacity of vortex separators is quite large.

A simple diagram of a vortex separator is shown in Figure 1. The basic operation of a vortex separator is as follows:

- Excess wet weather flow enters the separator tangentially through an inlet pipe.

- Velocity causes flow to move through the separator in a circular path, forming a vortex.
- Inertia, gravity, and centripetal forces cause the heavier solid particles to move to the center and bottom of the swirling flow. Clearer water rises and discharges through the outlet.
- The concentrated sewage, including heavier solids and debris, becomes underflow and is discharged through a foul sewer outlet at the bottom of the separator and routed to a WWTP.

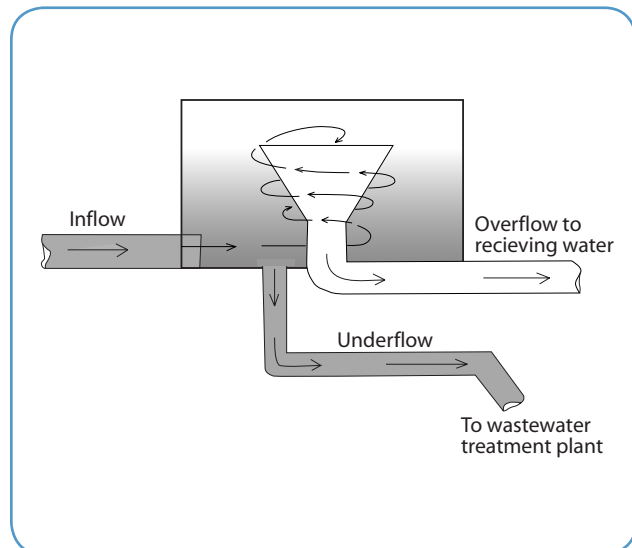

Figure 1. Simplified diagram of a vortex separator.

When the separator is full, the more dilute and clarified effluent is discharged through an overflow outlet at the top of the separator and conveyed to local receiving waters. At the end of an event, as excess wet weather flows subside and the water level in the separator drops below the level of the overflow outlet, the separator ceases to discharge to the receiving water.

Disinfection of the discharge from vortex separators is sometimes added for public health reasons (Boner *et al.* 1995). Sodium hypochlorite can be injected into

the separator basin, allowing the wet weather flows to be disinfected as the solids are removed. Chlorinated discharges may also need to be dechlorinated to prevent toxicity. Discharges from a vortex separator can also be treated using ultraviolet (UV) disinfection. If the separator design includes a sump to capture solids, the solids should be removed in advance of the next wet weather event. Some designs enable buoyant floatables to be skimmed from the dilute overflow and mixed with the underflow for conveyance to the treatment plant.

Key Considerations

Applicability

Vortex separators provide a modest level of treatment for a modest cost. In CSS, they can be used as a “stand-alone” CSO control, or in conjunction with other controls. When used on their own, they are useful in controlling suspended solids and floatables and in reducing pollutants associated with solids, such as metals bound to sediments. Their ability to reduce floatables in CSO discharges is valuable in situations where control of aesthetic impacts is important to the public. They have limited ability to reduce the strength of dissolved pollutants or bacteria unless disinfection is applied in conjunction with vortex separation. When used in combination with other CSO controls, the placement of vortex separators is important. Because they are designed to remove suspended solids and floatables, vortex separators should not be placed downstream of other facilities that perform the same function, such as sedimentation basins or netting systems.

Vortex separators are often retrofitted within CSSs to provide some level of treatment where none had existed before. Considerations in implementing vortex separators include:

- Vortex separators do not require a power source because the energy of the flowing water is used to separate the solids. Therefore, the utility of vortex separation technologies is diminished in situations where the velocity of wet weather flows is limited.
- Space requirements are minimal relative to storage units because they separate rather than store sewage.
- Units can range in diameter from 2 feet to more than 40 feet and are typically installed underground.
- Soil conditions and depth to bedrock at potential sites influence site suitability and construction costs.
- Vortex separators can be either pre-fabricated or built on-site. They can be constructed of concrete, high-density polyethylene (HDPE), aluminum, or stainless steel, depending on the manufacturer.

Advantages

The major advantage of vortex separators is their ability to remove suspended solids and floatables, which are the most visible and aesthetically displeasing components of CSO discharges. Vortex separators begin to separate out suspended solids and floatables as soon as inflow begins to move through the unit. Additional advantages include:

- Maintenance requirements are low. Vortex separators have no moving parts to wear out or break. They can be allowed to go dry between storms without affecting performance.
- Vortex separators have a high hydraulic loading capacity.
- Space requirements at implementation sites are low.

Disadvantages

The principal disadvantage in the use of vortex separators for CSO control is that they do not eliminate CSOs or reduce CSO volume; they just reduce the strength of the CSO discharge with respect to suspended solids, pollutants associated with suspended solids, and floatables. Other disadvantages include:

- Removal rates of fine solids and soluble pollutants are low or negligible in vortex separators.
- Disinfection is difficult because of the large volumes of excess wet weather flow received by vortex separators, short contact time for disinfection, and space and security requirements associated with disinfectants.
- Floatables may be lost during extremely high flows or in the initial overflow, when the surge of inflow could carry them around and over the baffles and weirs designed to remove them.
- Vortex separators with sumps require periodic cleaning to achieve optimal removal performance.

Cost

The performance of vortex separators with respect to pollutant removal is based on the difference in pollutant load, not volume, that is discharged to a receiving water over time, with and without a vortex separator. Performance is directly related to the nature of the solids and floatables in the influent wastewater, as well as the influent concentrations and loading rates. Qualitatively, vortex separators can be expected to provide “good” removal of heavier particles and floatables and “fair to poor” removal of lighter weight materials such as oil and grease, nutrients, and colloidal material (WERF 2002). Some common performance characteristics are as follows:

- Vortex separators perform better for concentrating larger or heavier suspended solids for treatment

than smaller or lighter suspended solids. Removal of dissolved solids or dissolved fractions of pollutants is negligible.

- Site specific design matched to particle size and settling velocity profiles of suspended solids is essential to optimize performance.
- Floatables capture decreases as hydraulic loading increases.

Available data for basic vortex separation suggest widely varying performance, with total suspended solids (TSS) removal ranging from five percent to 60 percent (EPA 1996; Boner *et. al.* 1995; WERF 2002). The higher removal rates are comparable to primary clarification, but can be achieved in a vortex separator that is one-fourth the volume and one-fifth the surface area of a conventional sedimentation basin (Boner *et. al.* 1995). TSS removal rates of up to 80 percent have been achieved when units are operated at one-fourth of the hydraulic capacity (Larry Walker Associates 1999). In a survey of vortex separator performance documented by Moffa (1997), removal efficiencies were shown to vary substantially from storm-to-storm, and from one facility to another.

Additional vortex separation performance information for other pollutants is as follows:

- BOD₅ removal rates have ranged from 20 percent and 79 percent in laboratory studies (Moffa 1997). Actual

BOD₅ removal rates for two storms in Columbus, GA, reached 55 percent (Boner *et. al.* 1995). Data for the Northeast Boundary Swirl Facility in Washington, D.C., indicate BOD₅ removal efficiencies of up to 28 percent (WERF 2002).

- Manufacturer laboratory tests show that vortex separators can remove 80 percent of oil and grease; however, no data are available for oil and grease removal rates under actual, full-scale operating conditions.
- UV disinfection of vortex discharges can achieve a 90-99 percent reduction in the concentration of fecal coliform bacteria (WERF 1994).

Costs for purchasing a basic vortex separator range from approximately \$8,000 for a 1.8 MGD unit to \$40,000 for a 16 MGD unit. Installation costs typically from 25-50 percent of the purchase costs (Larry Walker Associates 1999). A summary of products from various manufacturers with ranges in available hydraulic capacities and costs is presented in Table 1.

Maintenance costs for vortex separators vary depending on cleaning frequency, travel distances, and disposal costs for captured solids and floatables.

Table 1. Comparison of vortex separation products and costs.

Product (Manufacturer)	Available Hydraulic Capacity Sizes (MGD)	Purchase Costs
Continuous Deflective Separation (CDS Technologies)	0.7-193.8	\$9,600 - \$332,500
Downstream Defender (H. I. L. Technology, Inc.)	1.9-7.8	\$10,300 - \$26,000
V2B1 (Kistner Concrete)	1.8-16.3	\$8,000 - \$40,000
Vortechs Storm Water Treatment System (Vortechs)	1.0-16.2	\$10,500 - \$40,000

Implementation Examples

RANDOLPH, VT

Responsible Agency: Burlington Main Wastewater Treatment Facility

Population Served: 37,712

Service Area: Not Available

Sewer System: 100 mi. of sewer

Vortex Separator Used to Treat CSOs

The Burlington Main Wastewater Treatment Facility (WTF) treats municipal wastewater from the city's CSS and discharges treated flow through an outfall into Lake Champlain. The WTF also has a CSO treatment system on-site which includes vortex separation, mechanical screening, and disinfection; the system was installed in the early 1990s. The CSO treatment system is designed to handle wet weather instantaneous flows greater than 11 MGD, but not exceeding 86 MGD.

The vortex separation process, combined with the capacity of the treatment plant, is designed to provide a relatively high level of treatment for the "first flush" generated during the early stages of storm events that usually contains the highest pollutant concentrations. Chemical disinfectant is added to the CSO flow prior to and after treatment by the vortex separator. The concentrated underflow from the vortex separator, approximately 2 MGD, is diverted to the WTF for full treatment. During wet weather events when the instantaneous storm flow rate exceeds 75 MGD, ultrasonic sensors allow flows to bypass the vortex separator. According to self-monitoring reports from January 1995 through December 1999, the CSO system was activated an average of 32 times per year, 13 times on average during the "beach season" of June through August.

More information at <http://www.dpw.ci.burlington.vt.us/>

COLUMBUS, GA

Responsible Agency: Columbus Water Works

Population Served: 186,000

Service Area: 2,400 sq. mi.

Sewer System: Not Available

National Demonstration Project

The Columbus CSS extends over the old downtown area draining into the Chattahoochee River. Prior to CSO control, elevated levels of fecal coliform bacteria and visible sewage debris often plagued the Chattahoochee. Columbus began to implement CSO controls in 1995, including construction of two water resource facilities (WRFs). One of the WRFs, in Uptown Park, also serves as a national CSO technology testing facility used to demonstrate and evaluate alternative methods of CSO pollutant removal and disinfection.

A five year CSO testing program was conducted at the Uptown WRF to analyze the performance, operation and maintenance (O&M), costs, and applications of CSO treatment technologies, including vortex separators. At this facility, Columbus installed six vortex separators, each 32 feet in diameter, with a conical ring bottom where grit and concentrated solids are removed. All six vortex vessels start empty and fill with CSO flow as CSS capacity is exceeded. The vessels have no moving parts. The vortex vessels serve as storage for small events, pollutant reduction during medium events, and grit removal and chemical disinfection for all events. Chemical disinfectant is added once the vortex vessels are full. For loading rates of 5 gallons per minute per square foot (gpm/sf) of surface area, the vortex separators functioned similar to a primary clarifier. For loading rates above 5 gpm/sf, however, the removal of pollutants was reduced to zero except for grit and oil and grease. The study also found that the use of vortex separators in combination with media filters was an effective treatment method in terms of load reduction and cost. The annual O&M for the vortex separators is estimated at \$16,320, which is about 7 percent of the total O&M costs at the Uptown Park WRF. The capital cost of the vortex separators was \$4.8 million.

Contact: Cliff Arnett, Columbus Water Works

References

Boner, M. C., *et al.* 1995. "Modified Vortex Separator and UV Disinfection for Combined Sewer Overflow Treatment." *Water Science Technology*. 31: 263-274.

EPA Office of Wastewater Management, Municipal Support Division and National Risk Management Research Laboratory (Cincinnati) Water Supply and Water Resources Division. 1996. *Assessment of Vortex Solids Separators for the Control and Treatment of Wet-Weather Flow*. EPA 832-B-96-006.

Larry Walker Associates, Inc. 1999. "Investigation of Structural Control Measures for New Development. Prepared for the Sacramento Storm water Management Program." Retrieved December 12, 2002.
www.sacstormwater.org/const/manuals/pdf/scm99_scm99.pdf

Moffa, P.E. (Ed.). 1997. *Control and Treatment of Combined Sewer Overflows*. 2nd ed. New York, NY: Van Nostrand Reinhold.

Water Environment Research Federation (WERF). 1994. *Optimization of Vortex Separator Removal Efficiencies for CSO Treatment*. Prepared by Boner, M. C., *et al.* Alexandria, VA: WERF. Project 92-TCR-2.

WERF. 2002. *Best Practices for Treatment of Wet Weather Wastewater Flows*. Prepared by Brashnear, R., *et al.* Alexandria, VA: WERF. Project 00-CTS-6.

Inclusion of this technology description in this Report to Congress does not imply endorsement of this technology by EPA and does not suggest that this technology is appropriate in all situations. Use of this technology does not guarantee regulatory compliance. The technology description is solely informational in intent.



TECHNOLOGY DESCRIPTION

Treatment Technologies

Floatables Control

Overview

Solids and floatables are the trash, debris, and other visible materials that are discharged when sewers overflow. In sanitary sewer systems (SSSs), solids and floatables are generally limited to human waste and sanitary products that are flushed down a toilet. In combined sewers systems (CSSs), solids and floatables can also include litter and detritus that accumulates on streets and parking lots that are washed into storm drains during rainfall events. The presence of solids and floatables in receiving waters causes aesthetic impacts that can threaten wildlife, cause beach closures, and pollute recreational areas.

Floatables control technologies are principally applied in CSSs because of the recurring nature of CSOs. They are also used to control solids and floatables in urban storm water discharges from separate storm water systems. Floatables controls are most often designed to lessen aesthetic impacts that affect recreational uses. Water quality benefits from floatables controls, if they occur, are secondary. The CSO Control Policy recognized the importance of controlling solids and floatables by including it as part of the nine minimum controls. Floatables controls can be grouped into three categories:

- *Source controls* work to prevent solids and floatables from entering the sewer system.
- *Sewer system controls* work to keep solids and floatables in the sewer system, so that they can be collected and removed at strategic locations or transported to a wastewater treatment plant.
- *End-of-pipe controls* work to capture solids and floatables as they are discharged from the sewer system.

Source Controls

Source controls collect solids and floatables before they enter the sewer system. Two of the most common source controls are street sweeping and catch basin modifications. Street sweeping is a pollution prevention activity that removes litter, debris, dirt, and other

floatables materials from streets and other paved surfaces before it can be washed into a CSS during wet weather events. Paved surfaces can be swept using manual, mechanical, or vacuum sweepers (WEF 1999). The degree of floatables control achieved by street sweeping is influenced by the frequency of cleanings, local climate, and parked vehicle control (EPA 1999b).

Catch basins are the surface-level wells or chambers that serve as an entrance to CSSs and separate storm water systems for street runoff and overland flow. Catch basins are designed to trap grit and solids before they enter the sewer system (Moffa 1997). There are several modifications that can be made to catch basins to improve the capture of solids and floatables. Inlet grates installed at the entrance to the catch basin can reduce the amount of street litter and debris that enters the catch basin. If floatables enter the basin through these grates, they can be collected in colander-like structures called trash buckets installed beneath the grate. Other catch basin modifications, such as hoods and submerged outlets (Figure 1), modify the connection between the catch basin and the CSS to trap floatables

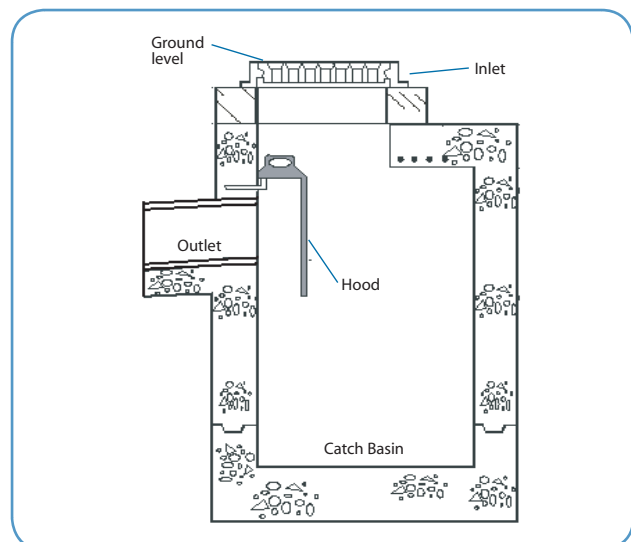

Figure 1. Typical hood design in a catch basin.

in the catch basin. Submerged outlets are located below the elevation of the sewer system and are connected by a riser pipe. Hoods are vertical cast iron baffles installed over the outlet pipe in the catch basin.

Collection System Controls

Collection system controls are designed to keep solids and floatables in the sewer system so that they can be collected and removed at strategic locations or transported to a wastewater treatment plant. Screens, baffles, and in-system netting are types of collection system controls.

Screens can be installed near CSO outfalls or at other strategic locations in the CSS. Screens trap floatables behind metal bars or mesh, allowing wastewater to pass through. Screen openings typically range in size from 0.1 inch to 6 inches. The type of screen and size of openings determine the amount and size of floatables captured (EPA 1999c). Major categories of screens include:

- Bar screens or trash racks with openings greater than 1 inch;
- Coarse screens with 0.25-1 inch openings; and
- Fine screens with 0.001-0.25 inch openings.

The nature and quantity of floatables in wet weather flows makes them likely to clog fine screens therefore their utility may be limited. Screens are usually set 0-30 degrees from vertical and may be cleaned manually or mechanically.

Baffles can be installed at flow regulators in CSSs or at outlets from storage facilities. Baffles are commonly made from concrete beams, steel plates, wood, or plastic, and, as shown in Figure 2, extend from the top of the sewer to just below the regulating weir. As flow rises in the CSS or storage facility, water passes under the baffle and over the regulator to the CSO outfall. Most floatables are trapped behind the baffle and remain in the CSS where they are transported to the treatment plant (EPA 1999a).

In-system netting is installed at strategic locations in the sewer system in concrete vaults, often near regulators in the outfall pipe. One or more nylon mesh bags are supported by a metal frame. Netting system design, including the aperture of the mesh nets, is based on the size and types of floatables targeted for capture and the anticipated volume of flow. Wet weather flows carry floatables into the nets, which are replaced periodically (EPA 1999a).

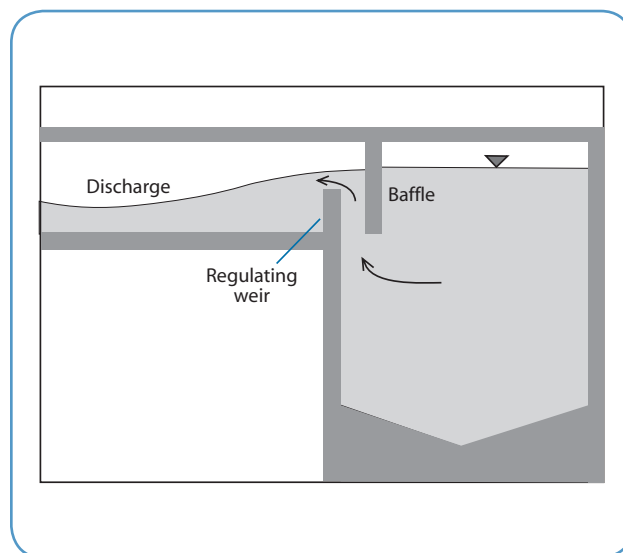

Figure 2. Baffle placement at a CSO regulator.

End-of-Pipe Controls

End-of-pipe controls use netting systems or containment booms and skimmer vessels to capture floatables in the receiving water after they have been discharged from the sewer system.

End-of-pipe netting systems consist of an in-water containment area that funnels CSO discharges through a series of nylon mesh bags attached to a modular pontoon structure. Also referred to as a floating netting system, nets are located a short distance from the CSO outfall, allowing the floatables to rise to the water surface after the discharge mixes with the receiving water (EPA 1999a). As with in-system nets, the size of the mesh net used will depend on the volume and type of floatables targeted for capture (EPA 1999a). After the nets become full, they are removed and disposed.

Containment booms can be located in a receiving water downstream of one or more CSO outfalls. The booms are floatation structures with a suspended curtain that captures buoyant materials. Booms are typically anchored to the shoreline and bottom of the waterbody. They may also be designed to absorb oils and grease. The size of the boom is determined by the volume of floatables expected from a design storm event. After a storm, floatables and other debris trapped by the boom will need to be removed with a vacuum truck, manually, or using a skimmer vessel (EPA 1999a).

Skimmer vessels are boats designed to gather floatables in lakes, harbors, or bays, and can be used in conjunction with containment booms. Skimmer vessels capture floatables using either a capture plate located at the bow of the boat that collects debris on a conveyor

belt system or by lowering large nets into the water. Skimmer vessels may require companion equipment to transport the debris for land disposal.

Key Considerations

Applicability

Source Controls

Street sweeping can be performed on any paved surface and is often already part of a municipality's standard activities. In colder climates, sweeping during the spring snow-melt reduces the road salt and sand load delivered to the CSS (EPA 2002). The optimal timing between street sweepings ranges from a few weeks to a month based on the amount of debris present on the street. The sediment removal efficiency of street sweeping as a function of the time between sweeps is illustrated in Figure 3.

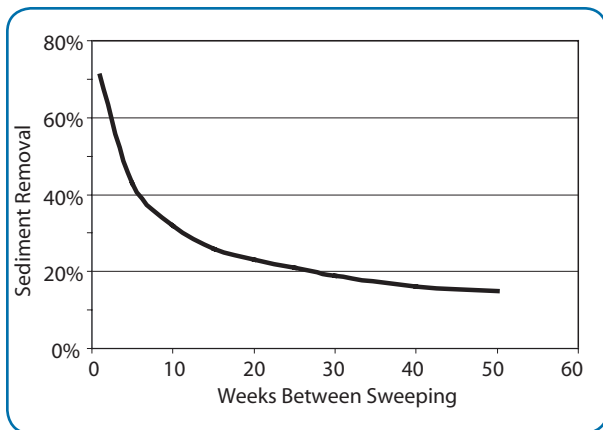

Figure 3. Cumulative sediment removal by street sweeping.

Catch basin modifications increase the capture of solids and floatables, which often necessitates more frequent maintenance. Without proper maintenance, catch basin performance can be compromised. The more solids and floatables that are collected and held in a catch basin, the less effective the basin becomes at trapping additional material. A catch basin filled with solids and floatables can have the unintended consequence of blocking the inlet to the sewer system. Catch basin cleaning frequencies vary greatly, with some municipalities performing maintenance annually and others scheduling catch basin cleaning once every five to six years. Often, individual basins are cleaned as specific needs arise, such as citizen complaints of localized street flooding. In general, a cleaning frequency of at least twice per year maintains the effectiveness of catch basins for pollutant removals (Moffa 1997). Manual and vacuum cleaning are two methods available to remove accumulated debris from catch basins (EPA 1999b).

Collection System Controls

Screens can be used effectively for CSO control because they capture a significant amount of the floatables contained in CSO discharges. Removal efficiencies are tied closely to the spacing between bars or mesh aperture and can range from 25-90 percent of the total solids. The effectiveness of screening is reduced significantly by the presence of oil and grease in the flow (EPA 1999a). Many screens are self-cleaning but regular maintenance is required to ensure their effectiveness. Finer screens have higher removal efficiencies, but are more susceptible to clogging and tearing and may require maintenance after every CSO event. Additional information on fine screens is presented in the "Supplemental Treatment Technology Description" included in Appendix B of the *Report to Congress on the Impacts and Control of Combined Sewer Overflows and Sanitary Sewer Overflows*.

The design of existing regulators or storage facilities will determine the effectiveness of baffles, as well as the cost to retrofit the structure. In some retrofits, the addition of baffles may restrict access to the regulators making maintenance more difficult. When a new structure is installed, baffles can be included in the design. Maintenance requirements for baffles are low compared to other floatables controls, requiring only occasional cleaning to remove debris and reduce odors.

In-line netting units are widely applicable and can be adapted to most CSSs (EPA 1999a). Access to in-system netting is important since the mesh bags must be inspected after each overflow event and changed when full. The frequency of bag changing depends on site-specific conditions, including the frequency and volume of CSO events and the volume of floatables in the discharges. Cities report changing the mesh bags between 12 to 36 times a year. Field tests indicate netting can provide removal efficiencies of up to 90 percent for floatables (EPA 1999a).

End-of-Pipe Controls

The nature of the receiving water influences the applicability of end-of-pipe controls. End-of-pipe netting systems are most suitable for lakes, estuaries, and tidal waters (EPA 1999a). Netting systems are sized based on the peak flow expected, the maximum flow velocity, and the quantity of floatables and other debris per million gallons of CSO. End-of-pipe netting systems require a minimum water depth of two feet and should not be located near heavily traveled waterways. As described in the discussion of in-line netting

systems, end-of-pipe systems have relatively high maintenance requirements.

Site conditions, such as receiving water velocity, should be considered when evaluating containment boom design, placement, and anchoring. Although booms float and can therefore accommodate some fluctuation in water level, high river velocities and winds may dislodge them. Furthermore, booms cannot be used during winter months in waters that are subject to freezing. Maintenance requirements for containment booms are moderate relative to other floatables controls; floatables trapped behind booms will need to be removed periodically.

Skimmer vessels are used to clean broad areas of open water. As a result, the floatables and other debris collected are likely to come from a variety of sources including CSOs, separate storm water systems, and upstream sources. Ice and high wind can impede

skimmer vessel navigation and the collection of floatables. It is also important to be aware of minimum depth and clearance height requirements specific to each vessel (EPA 1999a).

All end-of-pipe systems can create temporary unsightly conditions near CSO outfalls, and therefore, may be inappropriate in areas with waterfront development.

Cost

A summary of cost and maintenance considerations, as well as the relative capture efficiency, for each of the floatables control technologies is presented in Table 1. Representative costs from actual applications are presented in Table 2.

Table 1. Comparison of floatables control technologies.

Category	Technology	Capital Cost	Maintenance Requirements	Floatables Capture Efficiency
Source Controls	Street Sweeping	H ¹	M	L
	Catch Basin Modifications	L	M	M
Collection System Controls	Screens and Trash Racks	M	L	M
	Baffles	M	L	M
	In-System Netting	M	H	H
	End-of-Pipe Netting	M	H	H
End-of-Pipe Controls	Containment Booms	H	M	H
	Skimmer Vessels	H ¹	M	M

¹ Assumes program would require vehicle/vessel purchase.

Table 2. Cost comparison of floatable control technologies.

Category	Technology	Cost
Source Controls	Street Sweeping	<p>Costs depend on frequency of cleaning, volume of litter, enforcement of parking regulations, and other labor costs.¹</p> <p>Contracted street sweeping costs \$130-\$150 per curb mile.²</p> <p>Plymouth Township, MI, swept 511 miles of curb at a cost of \$68 per mile.²</p> <p>Vacuum sweeping trucks cost between \$150,000-\$200,000 depending on the material holding capacity. Maintenance costs range from \$12,500-\$15,000 per truck per year.¹</p>
Collection System Controls	Screens and Trash Racks	<p>Cost for screens depends on the size of the screen, the means of cleaning, construction materials, flow rate, and whether construction is new or a retrofit. Costs can range from \$40,000 to \$9 million per screen.⁴</p> <p>Seattle, WA, installed 25 MGD rotary screen for approximately \$1.7 million.⁴</p>
	Baffles	Steel or aluminum curtains are usually used for retrofits at an average cost of less than \$10,000 each. ³
	Catch Basin Modifications	<p>Costs range from \$65-\$100 per basin.¹</p> <p>Trash buckets can cost an average of \$100 per basin to install.³</p> <p>Contracted catch basin cleaning costs range from \$50-\$170 per hour.³</p>
	In-Line Netting	<p>Netting system costs range from \$75,000-\$300,000 per site.⁵</p> <p>Operations and maintenance (O&M) costs for changing full nets are \$1,000 per site.³</p>
End-of-Pipe Controls	End-of-Pipe Netting	Netting system costs range from \$25,000-\$300,000 per site. ⁵
	Containment Booms	<p>Installation costs for booms range from \$100,000-\$150,000 per site.³</p> <p>O&M costs for changing full nets are approximately \$1,000 per site.³</p>
	Skimmer Vessels	<p>Skimmer vessels cost between \$300,000-\$700,00 depending on vessel features.³</p> <p>O&M costs can range between \$75,000-\$125,000 per year per boat.³</p> <p>A pier conveyor to remove debris from the vessel can cost \$37,000.⁶</p>

¹ EPA 1999b² Ferguson 1997³ EPA 1999a⁴ EPA 1999c⁵ EPA 1999d⁶ Shenman 2003

Implementation Examples

PORTLAND, ME

Street Sweeping

Responsible Agency: City of Portland Public Works Department

Population Served: 190,000

Service Area: 17.7 sq. mi.

Sewer System: Not Available

The City of Portland Sweeping Program sweeping crews work five nights a week from late March to the beginning of December. During the sweeping season, the crews routinely sweep a total of 480 curb miles. The city tries to sweep each street at least once a month and twice a month if the street is more heavily trafficked. One section of town has daytime sweeping at the request of the area residents. A parking program is in effect in the downtown portion of the city and an odd/even parking program is used

in residential areas. The sweepers are effective in removing debris from the streets of Portland. It is estimated that during the spring street cleaning, up to 9,000 tons of sand and salt are caught before entering the sewer system.

The sweeping fleet consists of eight sweepers with an annual maintenance budget of \$125,000. The total annual budget of the program is \$412,000 or \$51,500 per sweeper.

More information at <http://www.ci.portland.me.us/publicworks/street.htm>

NEW YORK CITY, NY

City-Wide Floatables Study

Responsible Agency: New York City Department of Environmental Protection

Population Served: 7.6 million

Service Area: 297 sq. mi.

Sewer System: 4,200 mi. of combined sewer, 1,800 mi. of sanitary sewer

New York City studied street sweeping extensively in the early 1990s, as part of a city-wide effort to reduce CSO discharges of floatable material to New York Harbor (NYCDEP 1995). The study found that the primary sources of floatables were trees, littering, and spilled trash receptacles. Most debris was found within 3.5 feet of the curb. As shown in the table below, plastics were the most prevalent floatable material by volume.

Enhanced mechanical sweeping within a 450-acre study area (increased from two times per week to six times per week) produced a 42 percent reduction in floatables on an item count basis, and a 54 percent reduction on a weight basis. Using a city-wide model, it was estimated that street sweeping twice per week would reduce floatables loadings to New York Harbor by 29 percent from current levels, and that increasing the frequency to three times per week would bring the total reduction in floatables to 49 percent.

In addition to street sweeping, the city has implemented various other floatables control practices. The city also retrofitted numerous catch basins with hoods. NYCDEP has installed 23 containment booms near CSO outfalls. Once floatables are collected by the containment booms, they are removed using the city's fleet of skimmer vessels. The city operates four skimmers designed for smaller tributary streams and one designed for open water conditions. Some areas have also been equipped with end-of-pipe netting systems, including the Fresh Creek outfall, one of the city's largest. Studies have shown that the Fresh Creek net has a capture efficiency of 90-95 percent.

Program costs include \$6.5 million to purchase and engineer the containment booms/nets; \$6.8 million to purchase and operate the skimmer vessels; and \$6.7 million to purchase 41 catch basin cleaning trucks or \$164,000 per truck.

More information at <http://home.nyc.gov/html/dep/html/float.html>

Type of Material	Volume of Floatables (%)
Plastic	56
Glass	12
Metal	7
Styrene	7
Cloth	6
Paper	5
Wood	4
Misc	2
Rubber	1

NORTH BERGEN, NJ

Responsible Agency: North Bergen Municipal Utilities Authority

Population Served: 48,000

Service Area: 1.8 sq. mi.

Sewer System: Not Available

CSO Floatables Control Facilities

In 1999, North Bergen installed numerous solids and floatables control technologies, including a mechanical screen bar, four in-system netting systems, and five end-of-pipe netting systems. An Army surplus boom truck was purchased for net removal. A dump truck then transports the nets to the wastewater treatment plants, where the floatables are disposed of with the screenings taken from flows entering the plant. A portable vacuuming system is available to remove fine solids.

Replacement of the nets depends on the physical characteristics of the CSS upstream of the netting system. The in-line nets in relatively flat areas of the sewer system collect more silt and grit than those downstream of areas with steeper terrain. Changing the nets at a single location usually takes two hours, but can take up to four hours if the site must be vacuumed. The least active CSO facility is serviced four times a year, whereas the most active is serviced an average of once per month. A total of 90 tons of floatables were collected between 1999-2002.

The actual construction cost for the CSO facilities was \$3.3 million. Supporting equipment such as the boom truck and vacuum unit cost \$80,000; it is estimated that annual operation and maintenance costs are \$57,373.

Contact: Frank Bruno, Maintenance Supervisor, City of North Bergen

BALTIMORE, MD

Responsible Agency: Department of Public Works, Bureau of Water and Wastewater

Population Served: 1.8 million

Service Area: Not Available

Sewer System: 3,100 mi. of sewer

Keeping Inner Harbor Clean

Baltimore's Inner Harbor has become a symbol of success for waterfront revitalization efforts around the country. With more people visiting the harbor, it is important to remove the debris and trash discharged into the harbor from the city's CSS and separate storm water systems. In 1988, the

city purchased its first skimmer vessel and currently maintains a fleet of four boats. The original skimmers were made of machine steel, which have been refurbished using stainless steel because of the brackish nature of the harbor. The boats remove floatables, such as styrofoam cups and soda bottles, as well as large and unusual items, such as refrigerators. Once the floatables are collected, they are off loaded using a pier-conveyor into dumpsters for later disposal. Patrolling 25 miles of coastline, the skimmers collect approximately 394 tons of floatables per year. The city has seen marked improvement in the appearance of the water in Inner Harbor with the use of the skimmer vessels. Over the years, Baltimore has purchased skimmer vessels of varying capacity; costs for individual boats have ranged from \$200,000 to over \$500,000.



United Marine International, LLC

Contact: Tom Finnerty, Manager, Marine Operations in Baltimore Department of Public Works

References

EPA Office of Water. 1999a. *Combined Sewer Overflow Technology Fact Sheet: Floatables Control*. EPA 832-F-99-008.

EPA Office of Water. 1999b. *Combined Sewer Overflow Management Fact Sheet: Pollution Prevention*. EPA 832-F-99-038.

EPA Office of Water. 1999c. *Combined Sewer Overflow Technology Fact Sheet: Screens*. EPA 832-F-99-040.

EPA Office of Water. 1999d. *Combined Sewer Overflow Technology Fact Sheet: Netting System for Floatable Control*. EPA 832-F-99-037.

EPA. 2002. "Pollution Prevention/Good Housekeeping for Municipal Operations: Parking Lot and Street Cleaning." Retrieved December 9, 2002. http://cfpub.epa.gov/npdes/stormwater/menuofbmeps/poll_10.cfm

Ferguson, T. et al. 1997. "Rouge River National Wet Weather Demonstration Project: Cost Estimating Guidelines Best Management Practices and Engineering Controls." December 9, 2002. <http://www.rougeriver.com/pdfs/stormwater/sr10.pdf>

Moffa, P.E. (Ed.). 1997. *Control and Treatment of Combined Sewer Overflows*. 2nd ed. New York, NY: Van Nostrand Reinhold.

New York City Department of Environmental Protection (NYCDEP). 1995. *City-Wide Floatables Study*. Prepared by HydrQual, Inc. Mahwah, NJ: NYCDEP.

Shenman, Lou, President - United Marine International (UMI). Interview by Limno-Tech, Inc., 2003. Washington, DC.

Water Environment Federation (WEF). 1999. *Prevention and Control of Sewer System Overflows: Manual of Practice No. FD-17*. Edited by Gray, W. et al. Alexandria, VA: WEF.

Inclusion of this technology description in this Report to Congress does not imply endorsement of this technology by EPA and does not suggest that this technology is appropriate in all situations. Use of this technology does not guarantee regulatory compliance. The technology description is solely informational in intent.



TECHNOLOGY DESCRIPTION

LOW IMPACT DEVELOPMENT

Porous Pavement

Overview

Porous pavement is an infiltration system where storm water runoff is infiltrated into the ground through a permeable layer of pavement or other stabilized permeable surface (EPA 1999a). Porous pavement is considered a low impact development (LID) control intended to replicate pre-existing hydrologic site conditions through application of innovative land planning and engineering design. The use of porous pavement reduces or eliminates impervious surfaces, thus reducing the volume of storm water runoff and peak discharge volume generated on a site. This curtailment in storm water generation can keep storm water from entering combined sewer systems and taking up valuable conveyance and storage capacity. This in turn can lead to reductions in the volume or frequency of CSOs or stormwater discharges.

There are several types of porous pavement. Porous asphalt consists of an open-graded coarse aggregate that is bonded together by asphalt cement with enough interconnected voids and sufficient permeability to allow water to infiltrate through the medium and into the underlying soil quickly (EPA 1999b).

Porous concrete consists of uniform, open-graded, coarse aggregate and a lower water-to-cement ratio, which produces a pebbled, open surface that is roller compacted. Similar to porous asphalt, porous cement has interconnected voids that increase its permeability. Porous pavers are pre-fabricated units, rather than a medium, that come in two general types: block pavers and grass pavers. Block pavers consist of interlocking paving materials where the void areas are filled with pervious materials such as sand or grass (GSMM 2001). Grass pavers are mats of high strength plastic grids (often made of recycled materials) that are filled with gravel. An engineered aggregate material or a sand and soil mixture is installed beneath the grid and gravel that allows grass to grow through the gravel to the surface (TBS 2002). The grids function as mini-holding

ponds where storm water is collected and infiltrated into the ground.

Installation techniques for porous pavement vary depending on the type of porous pavement utilized. As shown in Figure 1, a typical porous pavement system consists of the following layers: (1) porous pavement; (2) gravel or coarse sand; (3) filter fabric; (4) reservoir consisting of 1.5-3 inch diameter stones; (5) gravel or sand layer; (6) optional filter fabric; and (7) undisturbed existing soil (EPA 1999b). The water storage capacity of the stone reservoir beneath the pavement can vary. Perforated overflow pipes may be installed near the top of the reservoir to drain excess storm water when the reservoir is full.

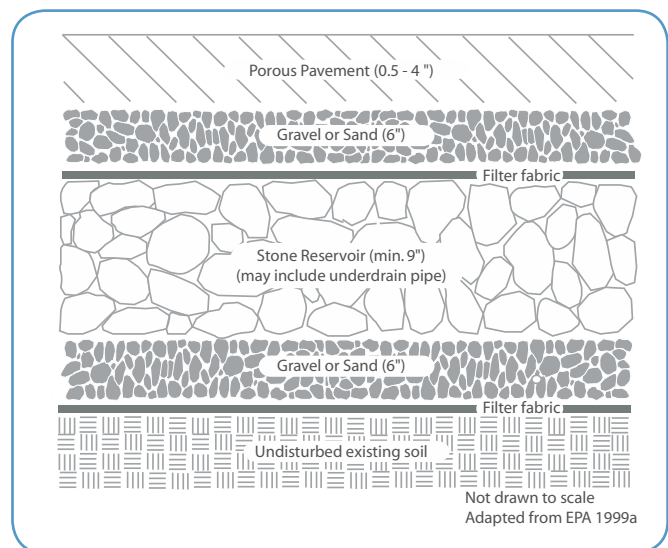

Figure 1. Porous pavement cross-section.

Key Considerations

Applicability

Porous pavement can be used in place of conventional impervious pavement under certain conditions. Typically,

porous pavement is most suitable for areas with sufficient soil permeability and low traffic volume. Porous pavement is a useful option in urban areas where little pervious surface exists, provided that the grade, subsoil, drainage characteristics, and groundwater conditions are suitable (EPA 1999b). Common applications include: parking lots, shoulders of airport runways, residential driveways, street parking lanes, recreational trails, golf cart and pedestrian paths, and emergency vehicle and fire access lanes. Use of this technology may be more limited in arid regions with high wind erosion and cold regions where sand can clog pores and road salt can contaminate groundwater. Also, they should not be installed in areas that generate highly contaminated runoff such as commercial nurseries, auto salvage yards, fueling stations, marinas, outdoor loading and unloading facilities, and vehicle washing facilities as the contaminants could infiltrate into the groundwater (SMRC 2002). The success of porous pavement applications depends on several key design criteria including site conditions, construction materials, and installation methods. These criteria are further described in Table 1.

Advantages

The primary advantage of porous pavement is a reduction in the volume of storm water runoff generated on site. By reducing runoff, porous pavement can reduce the need for storm water holding systems; allow the use of smaller, less expensive storm water collection systems; reduce the need for curbs, gutters, and inlets; maximize waste water

conveyance capacity in combined sewer systems; and reduce puddling and flooding. A secondary advantage of porous pavement is that it can remove both soluble and particulate pollutants such as total phosphorus, total nitrogen, and heavy metals via natural filtration through the underlying soil (GSMM 2001). By promoting pollutant treatment, porous pavements reduce the potential impact of storm water runoff on local receiving waters.

Disadvantages

A major disadvantage of porous pavement is its tendency to clog. This can occur as a result of improper design or construction, but it occurs most commonly from a lack of maintenance (WMI 1997). Proper maintenance includes periodic vacuum sweeping followed by high-pressure hosing to remove sediment from the pores (EPA 1999b). Once clogged, it is very difficult and expensive to rehabilitate porous pavement, often requiring complete replacement (EPA 1999a). Another disadvantage is the lack of expertise of pavement engineers and contractors with this technology. In addition, some building codes may not allow installation. Since not all soils are absorptive enough to provide proper drainage, selection of the technology must be based on site-specific considerations (TBS 2002). If the underlying soils are unable to dry out between storm events, anaerobic conditions may develop which can result in odors.

Table 1. Design criteria for porous pavement (EPA 1999b).

Design	Criterion Guidelines
Site Evaluation	<ul style="list-style-type: none"> • Take soil samples by boring to a depth of at least 4 feet below bottom of stone reservoir to check permeability, porosity, depth of seasonally high water table, and depth to bedrock • Not recommended on slopes greater than 5% and best with slopes closer to 0%. • Minimum depth to bedrock and seasonally high water table: 4 feet • Minimum infiltration rate of 3 feet below bottom of stone reservoir: 0.5 inches per hour • Minimum setback from water supply wells: 100 feet • Minimum setback from building foundations: 10 feet downgradient, 100 feet upgradient • Not recommended in areas where wind erosion supplies significant amounts of windblown sediment • Drainage area should be less than 15 acres
Traffic Conditions	<ul style="list-style-type: none"> • Use for low-volume automobile parking area and lightly used access roads • Avoid moderate to high traffic areas and significant truck traffic
Design Storage Volume	<ul style="list-style-type: none"> • Highly variable; depends upon regulatory requirements. Typically designed for storm water runoff volume produced in the drainage area by the 6-month, 24-hour storm event
Drainage Time for Design Storm	<ul style="list-style-type: none"> • Minimum: 12 hours • Maximum: 72 hours • Recommended: 24 hours
Construction	<ul style="list-style-type: none"> • Excavate and grade with light equipment with tracks or oversized tires to prevent soil compaction
Pretreatment	<ul style="list-style-type: none"> • Pretreatment, such as bioretention or vegetative swales, recommended for runoff with high levels of suspended solids

Cost

Porous pavement can initially cost more than traditional pavement. The overall cost-effectiveness varies depending on the site conditions, design requirements, and local installation and long-term maintenance costs. For porous asphalt and cement, the raw materials are the same as those utilized in conventional paving operations, but contractors may charge higher prices for jobs that involve unfamiliar formulas or techniques. For porous pavers, the cost can vary depending on the type utilized. Both grass pavers and block pavers require a high level of construction workmanship and expertise to ensure proper installation (GSMM 2001). The range of costs estimated for basic installation of porous pavement is summarized in Table 2.

Estimated cost for an average annual maintenance program for a porous pavement parking lot is approximately \$200 per acre per year (EPA 1999b). This cost estimate assumes four inspections each year with appropriate vacuum sweeping and jet hosing. Savings from reduced investments in storm sewer extensions and costs associated with storm drain systems (i.e. repair and maintenance) have the potential to offset the initial costs.

Table 2. **Estimated costs for installation.**

Paver System	Cost (Sq. Ft)	Life Span ¹
Traditional & Porous Asphalt	\$0.50 to \$1.00	20 yrs
Traditional & Porous Concrete	\$2.00 to \$6.50	20 yrs
Grass Pavers	\$1.50 to \$5.75	~20 yrs
Block Pavers	\$5.00 to \$10.00	~20 yrs

¹Actual values may vary as life span is site specific and maintenance dependent

Implementation Examples

RENTON, WA

Responsible Agency: University of Washington Center for Urban Water Resources

Porous Pavers Pilot Test

The University of Washington Center for Urban Water Resources undertook a pilot test of porous pavement in the King County Department of Public Works building parking lot in Renton, WA. Four types of porous pavement were installed in sections of the lot: (1) grass pavers with virtually no impervious surface, (2) plastic grid pavers with grass and gravel in-filling with 60 percent impervious surface, (3) concrete pavers with grass in-filling with 60 percent impervious surface, and (4) concrete block pavers with 90 percent impervious surface. There were sections of the parking lot that were unmodified and thus left as impervious surfaces (asphalt). Runoff volumes from the porous and impervious sections were monitored during several storm events in 1996 and in a follow-up evaluation in 2002. Monitoring during the 1996 study and the 2002 follow-up study showed that the impervious asphalt surface generated a significant amount of runoff for the majority of precipitation events. Whereas, minimal storm runoff was generated on the porous pavers as virtually all precipitation from the observed storms was infiltrated. Therefore, replacing asphalt with pervious pavement would decrease surface runoff and attenuate peak discharges. The study found no significant differences in the performance of different types of pavers. The follow-up study in 2002 demonstrated that the porous pavement systems were structurally functional after six years of daily use. The concrete pavers and block pavers were found to be particularly robust, while the grass and gravel pavers did undergo some minor wear.



Photo: University of Washington

Contact: Derek B. Booth, Center for Urban Water Resources Management, University of Washington

TAMPA, FL

Responsible Agency: Florida Aquarium

Florida Aquarium Storm Water Study

The 11.25 acre parking lot at the Florida Aquarium in Tampa, FL, was modified for a study that compared storm water runoff reduction rates from several different porous pavement applications including swales, asphalt pavement with swales, asphalt pavement without swales, and cement pavement with swales. Swales, which are areas of vegetation, were placed between the rows of parking stalls without reducing the total number of stalls. Results showed that for all rainfall events that produced flow, the basin with pervious paving and a swale reduced runoff by over 60 percent compared to asphalt pavement with no swale. Also, the area with porous pavement reduced the average amount of runoff by 41 percent compared to the other areas with swales and impervious pavement. Porous pavement was found to be more effective for small storms; for rainfall events less than 0.8 inch, the area with porous pavement and a swale had 80-90 percent less runoff than the asphalt pavement without a swale.

Contact: Betty Rushton, Southwest Florida Water Management District

KINSTON, NC

Responsible Agency: NC State University

Parking Lot Demonstration Project

A porous pavement parking lot was designed as a demonstration project, monitoring the amount of storm water runoff controlled by both block pavers and grass pavers. The parking lot was 9,340 square ft and was considered an ideal candidate because it was not a high traffic area, the *in situ* soil had sufficient capacity, and there was no indication of a seasonally high water table within five feet of the surface. Modular and grass pavers were installed in separate areas of the lot, and runoff volumes were monitored from June 1999 through July 2001. Monitoring results indicated that runoff from the concrete paver parking lot occurred only 11 out of the 48 wet weather events recorded (less than 25 percent of total storms during study period). In addition, rational method runoff coefficients for the permeable pavement used in this study were calculated. Rational method runoff coefficients (0-1.0) are a way of describing the amount of runoff generated during a wet weather event; a coefficient of 0 reflects maximum rainfall infiltration, whereas a coefficient of 1.0 reflects maximum runoff generation. The estimated runoff coefficient for the permeable pavement in this study ranged from 0.1-0.48, depending on method used and amount of precipitation recorded. The project cost was estimated to be 25 percent more than the cost of building a conventional asphalt parking lot.



Photo: North Carolina State University

Contact: Bill Hunt, North Carolina State University

References

Booth, D. B. and J. Leavitt, 1999. "Field Evaluation of Permeable Pavement Systems for Improved Storm Water Management". Journal of the American Planning Association. 65:314-325.

Booth, D.B. and Ben Brattebo, 2002. "Permeable Parking Lot Demonstration Project–The Six-Year Follow-Up". Draft submitted to Water Research.

EPA Office of Water. 2000. Low Impact Development (LID) A Literature Review. EPA-841-B-00-005.

EPA Office of Water. 1999a. Preliminary Date Summary of Urban Storm Water Best Management Practices. EPA-821-R-99-012.

EPA Office of Water. 1999b. Storm Water Technology Fact Sheet Porous Pavement. EPA 832-F-99-023.

Georgia Storm Water Management Manual (GSMM)(Volume 2). 2001.
<http://www.georgiastormwater.com>

Low Impact Development Center. "Permeable Paver Costs." Retrieved October 25, 2002. http://www.lid-stormwater.net/permeable_pavers/permpaver_costs.htm

Storm Water Manager's Resource Center (SMRC). "Storm Water Management Fact Sheet: Porous Pavement." October 25, 2002.
<http://www.stormwatercenter.net>

Tool Base Services (TBS). "Permeable Pavements" Retrieved October 25, 2002.
<http://www.toolbase.org/tertiaryT.asp?TrackID=&CategoryID=38&DocumentID=2160>

Watershed Management Institute (WMI), 1997. Operation, Maintenance, and Management of Storm Water Management Systems. Ingleside, MD.

Inclusion of this technology description in this Report to Congress does not imply endorsement of this technology by EPA and does not suggest that this technology is appropriate in all situations. Use of this technology does not guarantee regulatory compliance. The technology description is solely informational in intent.



TECHNOLOGY DESCRIPTION

LOW IMPACT DEVELOPMENT

Green Roofs

Overview

A green roof is a type of low impact development (LID) control that uses soil and plant growth for the purpose of rooftop runoff management. The rooftop vegetation and underlying soil serve to intercept storm water, delay runoff peaks, and reduce runoff discharge rates and volume. This can lead to reductions in the volume or occurrence of CSOs. A green roof is intended to minimize the impact of development on hydrologic site conditions through application of innovative building and engineering design. Green roof technology has been used in Europe for over 25 years and is gaining increased recognition in the United States. As shown in Figure 1, the series of engineered layers that make up a green roof, from bottom to top, typically include (GBS 2002):

- Waterproof membrane to protect the roof deck
- Root barrier to prevent roots from penetrating the waterproof membrane
- Optional insulation
- Drainage layer to direct excess water from the roof
- Filter fabric to keep fine soil from clogging the layers below
- Engineered soil substrate or growing medium
- Vegetation

There are two basic types of green roofs: intensive and extensive (Peck and Kuhn 2002). Factors to consider when choosing which type of green roof to install include: location, structural capacity of the building, budget, material availability, and client and/or tenant needs.

Intensive Green Roofs

Intensive green roofs, more commonly known as conventional roof gardens, can be landscaped environments developed for aesthetics and recreational uses. The landscaped roofs are likely to include garden-variety and food producing plants requiring high levels of management, though the degree of maintenance

can be reduced by using tolerant plants that would deal well with the micro-climate of the particular roof (Beckman *et al* 1997). As ten inches or more of soil depth is necessary for growing larger trees and shrubs, intensive green roofs can add as much as 80-150 pounds per square foot of load to the underlying structure (Sholz-Barth 2002) and often require an irrigation and drainage system. Food-producing plants are usually planted in containers rather than directly onto the rooftop. Intensive roofs are usually installed on flat roofs.

Extensive Green Roofs

In contrast to intensive green roofs, extensive green roofs (also called eco-roofs) are primarily utilized for their environmental benefits (Beckman 1997). This type of roof is composed of a continuous thin growing medium which sustains low-maintenance vegetation tolerant of local climatological conditions. Extensive roofs require little maintenance after the vegetation is established, typically within the first year or two after installation, and irrigation systems are generally

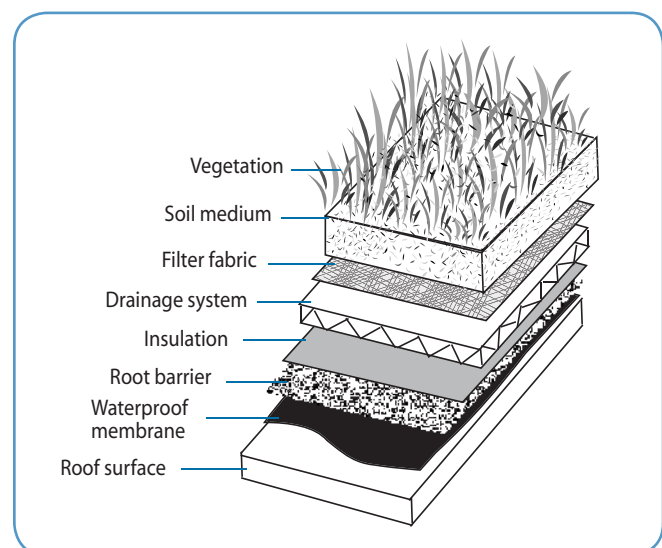

Figure 1. Typical layers of a green roof.

unnecessary. Suitable for large roofs, vegetated cover will extend across the entire roof and should only be accessed to perform periodic maintenance. The extensive green roof can be more readily retrofitted to an existing structure due to smaller loads, typically ranging between 15-50 pounds per square foot (Sholz-Barth 2001). In addition, extensive roofs can be installed on roofs with slopes up to about 25 percent (MUSS Manual 2001).

Design considerations for waterproofing, drainage, and soil type are important in any type of green roof. Common waterproofing options are rubber, modified bituminous membrane, polyvinyl chloride (PVC), rubberized asphalt, thermal polyolefins (TPO), and coal tar pitch (GBS 2002; Miller 2002). The two most common waterproofing materials are PVC and modified bituminous membranes (Miller 2002). To discourage roots from penetrating the waterproofing in intensive roof systems, a physical or chemical root barrier is usually installed over the protective layer. The key to moisture management and drainage is the use of absorptive growth media (Miller 2002). There are various drainage materials that can be used for moisture management including a synthetic sheet such as polystyrene or a granular drainage media. Depth of the drainage layer varies, depending on the level of runoff management desired and roof loading capacity. A geosynthetic filter mat is usually placed between the soil and drainage material to prevent the drainage system from becoming clogged with fine particles from the soil. Soils used for vegetated roofs are lighter in weight than typical soil mixes; they are usually 75 percent mineral aggregate and 25 percent organic material (MUSS Manual 2001).

Key Considerations

Applicability

Green roofs can be incorporated into new building design or retrofitted to existing buildings. Green roofs can be fitted to commercial buildings, multi-family homes, industrial structures, as well as single-family homes and garages. Depending on whether the system is intensive or extensive, green roofs can be installed on either flat or sloping roofs. Newly developed synthetic drainage materials have made green roofs feasible to install on most conventional flat roofs. The appropriate choice of vegetation is determined by substrate type, soil thickness, regional climate, and expected precipitation. Intensive and extensive green roofs have been successfully installed in cities with varying climatic conditions across the United States. Some factors that must be considered are the load-bearing capacity of the

roof deck, the moisture and root penetration resistance of the roof membrane, roof slope and shape, hydraulics, and wind shear. In regions of the country where snow is part of the expected annual precipitation, the maximum roof design loads must incorporate expected snow accumulation and drifting patterns.

Green roofs can be an important tool to reduce storm water runoff and subsequent CSOs in areas with dense development. Heavy development in urbanized areas may preclude the use of other space-intensive storm water management practices such as storm water management detention ponds and large infiltration systems. In these situations, green roofs may be a cost-effective technique for reducing storm water volumes. They can also be a component of an integrated runoff management program using a combination of low impact development practices.

Advantages

In a green roof system, storm water is released slowly over a period of several days rather than discharging immediately into a sewer system (Beckman *et al* 1997). Studies show that both extensive and intensive green roofs can absorb as much as 75 percent of the precipitation during a typical rainfall event (Sholz-Barth 2001), while runoff from low volume storms may be eliminated entirely. The choice of soil substrates and vegetation will determine the storm water retention capacity of the roof. When fully saturated, storm water runoff is filtered through the vegetative layer to a drainage outlet. The following formula estimates the potential gallons of precipitation captured based on acres of green roof area and average annual rainfall (City of Portland 2002):

$$\begin{aligned} &[(\text{Acres of Green Roof}) \times (43,560 \text{ foot}^2/\text{acre}) \times (144 \text{ inch}^2/\text{foot})^2 / \\ &(231 \text{ inch}^3/\text{gallon})] \times (60 \% \text{ of Annual Rainfall in Inches}) \\ &= \text{Gallons Rainfall Captured} \end{aligned}$$

The gallons of runoff potentially captured by green roofs in various cities can be calculated based on annual rainfall statistics and assuming 100 acres of vegetated roof cover. Table 1 shows hypothetical results for green roofs in Atlanta, GA; Chicago, IL; Philadelphia, PA; and Portland, OR. These results will vary depending on rainfall patterns and whether the rainfall was preceded by a dry period, which affects absorption.

An additional benefit to green roofs is they can filter airborne pollutants that are deposited via precipitation on the roof (i.e., nitrogen and particulate matter). They can also help counteract the “urban heat island effect,” created when the natural environment is replaced by pavement

and buildings; green roofs provide a cooling effect as the plants' foliage evaporate moisture via the process of evapotranspiration. In addition, green roofs can help

Table 1. Hypothetical gallons of storm water captured, assuming 100-acres of green roof cover.

City	Avg. Annual Rainfall (Inches)	Potential Gallons Captured (Millions)
Atlanta, GA	48	78
Chicago, IL	35	57
Philadelphia, PA	45	73
Portland, OR	37	60

reduce the roof temperature and insulate the building, as well as have aesthetic benefits. Vegetated covers can prolong the life of a roof by providing ultraviolet protection and reducing impacts resulting from extreme temperature fluctuations and high winds. The typical life-span of a green roof is about 40 years, significantly longer than a conventional roof. When used as accessible park-like building amenities, roof gardens can provide substantial aesthetic benefits. Where self-sufficient native vegetation tolerant of natural elements is used in green roofs, minimal maintenance is required.

Disadvantages

Potential disadvantages of green roofs include the difficulty of repairing possible leaks that are buried under the plant and soil substrate layers; additional structural support load requirements for substrate and vegetation layers; and cost considerations due to increased initial capital outlay. Roof slope can be a limiting factor as horizontal roofs will require a system that drains excess water from the root zones, while

sloped roofs may need erosion control measures. Also, maintenance costs may exceed those of a conventional roof. Buildings that are retrofitted with green roof covers are likely to incur more costs than a building that incorporates green roofs in its construction. For example, a building may need upgraded structural support for the added weight of the green roof.

Cost

The average cost of a green roof is estimated at \$10-\$25 per square foot compared to conventional roofs that cost \$3-\$20 per square foot (LIDC 2002; City of Portland 2002). Factors influencing cost include: the size of the installation; design complexity; local expertise and suppliers; type and depth of growing medium; selected vegetation and planting methods (seed, plug, or pot); and irrigation requirements.

Costs associated with intensive vegetated roofs tend to be higher compared to extensive roofs due to increased development and maintenance needs including more water, fertilizer, weeding, and clipping (Beckman *et al* 1997). Although green roofs may initially cost more than conventional roofs, the increase in membrane life-span and the decreased frequency of replacement make the green roof a cost-effective choice (City of Portland 2002). Costs of green roof installation may decrease with further development of the green roof market in the United States. In Europe, costs are typically one-fourth of those in the United States due to a more established green roof market.

Implementation Examples

PHILADELPHIA, PA

Responsible Agency: Fencing Academy of Philadelphia

Like many urban areas on the east coast, 90 percent of all rainfall in Philadelphia occurs during storms with 24-hour volumes of two inches or less. The 3,000 square foot extensive green roof was installed on the existing roof with the goal of replicating natural processes in detaining and treating a rainfall volume. The green roof was designed to reduce the peak runoff rate of a standard two year, 24-hour design storm. The overall depth of the green roof is three inches, featuring a synthetic under-drain layer; thin and lightweight growth media; and, vegetation selected for their hardiness and tolerance of the local climate. Perennial *Sedum* varieties create a meadow-like setting and require no irrigation or regular maintenance. The green roof weighs less than five pounds per square foot when dry, and approximately 17 pounds per square foot when saturated. The light weight allows installation on the existing conventional roof without the need for structural adjustments. The saturated infiltration capacity is 3.5 inches per hour. A pilot-scale test monitoring rainfall and runoff found that the green roof was able to detain 65% of the rainfall over a nine-month period. Runoff was negligible for storm events with less than 0.6 inch of rainfall. Based on typical costs of green roofs, the cost of the green roof at the Fencing Academy is estimated at \$18,000 or \$6/sq. ft.



Photo: Roofscapes, Inc.

Green Roof Demonstration Project



Photo: Roofscapes, Inc.

Contact: Charlie Miller, Roofscapes, Inc.

PORTLAND, OR

Responsible Agency: City of Portland Housing Authority and Portland Bureau of Environmental Services

The Housing Authority of Portland, in cooperation with the City of Portland's Bureau of Environmental Services (BES), installed an 8,500 square foot extensive green roof atop the 10-story Hamilton Apartment building. The type of vegetation used is hardy plants species such as *Sedum*, native wild flowers, and grasses. The Hamilton Apartment green roof system covers 60 percent of the total roof surface area and is comprised of two plots: the first is two inches thick and another is four inches thick. Storm events and runoff volumes are being monitored. During August 2001, a storm event was monitored for 9.5 hours by the BES. From a total measured rainfall of 1,485 gallons, 890 gallons ran off the two-inch plot and only 80 gallons ran off the four-inch plot. These runoff measurements do not take into consideration runoff generated from the remaining impervious areas of the roof (areas without green roof cover) that may be flowing into the green roof plots or directly into the drainage system. The estimated cost for the project was \$70,200.

The City of Portland acknowledges green roofs can play an important role in storm water management and have included them in their "Clean River Incentive and Discount Program," which is still under development. This program will offer incentives and discounts to commercial, industrial, institutional, and residential properties implementing storm water mitigation measures such as green roofs.



Photo: City of Portland Housing Authority

Contact: Tom Liptan, City of Portland Storm Water Specialist

CHICAGO, IL

City Hall Green Roof

Responsible Agency: City of Chicago

Twelve stories above ground, the demonstration green roof on Chicago's City Hall covers 20,300 of the 38,800 square foot roof surface area (one square city block). This roof was retrofitted as part of an urban heat island effect study initiated by EPA (City of Chicago 2002). The thickness of this green roof ranges from a 2.4 to 3.4-inches deep. Based on the structural capacity of the roof, it was determined that the roof could support an extensive system overall with intensive localized systems over the support columns. Given constraints such as snow load, the structural capacity for the roof was determined at an average of 30 pounds per square foot. The precipitation storage capacity was an average of one inch of rain. About 20,000 plants were used for the green roof, including those native to the Chicago region and tolerant of dry soil and sunny conditions. A drip-irrigation system, partially served by roof runoff collected in storage tanks, was installed as a supplemental water source for the plants during roof establishment and dry periods. Monitoring plant survival and environmental benefits related to energy and "urban heat island effect" is in process. Due to the expense of installing flow meters, storm water runoff is not being monitored at this site. The vegetated cover cost was \$500,000 of the entire re-roofing project cost, which totaled \$1.5 million.



Photo: City of Chicago

Contact: Mark Farina, City of Chicago

References

Beckman, S.; Jones, S.; Liburdy, K.; and Peters, C., *Greening Our Cities: An Analysis of the Benefits and Barriers Associated with Green Roofs*. Planning Workshop at Portland State University, 1997.
<http://www.greenroofs.com/Ecotrust%20Article.pdf>
<http://www.lsdg.net/EcoRoofs.pdf>

City of Chicago. "The components and design report of City Hall's Rooftop Garden." Retrieved December 2002.
<http://www.ci.chi.il.us/Environment/rooftopgarden/designpage.html>

City of Portland. "Ecoroof: Question and Answers" Retrieved December 2002.
http://www.cleanrivers-pdx.org/pdf/eco_questions.pdf

Green Building Services (GBS). "Green Rooftop Technology." Retrieved November 2002.
http://www.greenbuildingservices.com/green_resources/pdfs/ecoroofs.pdf

Low Impact Development Center (LIDC). "General Information on Green Roofs." Retrieved November 2002.
<http://www.lid-stormwater.net/intro/sitemap.htm#greenroofs>

Miller, Charlie. Interviewed by Limno-Tech, Inc. 2002.

Minnesota Urban Small Sites (MUSS). 2001. *BMP Manual: Storm Water Best Management Practices for Cold Climates*. Prepared for the Metropolitan Council Environmental Services by Barr Engineering Company.

Peck, Steven and Monica Kuhn. "Design Guidelines for Green Roofs." Retrieved October 18, 2002.
<http://www.cmhc-schl.gc.ca/en/imquaf/himu/loader.cfm?url=/commonspot/security/getfile.cfm&PageID=32570>

Sholz-Barth, Katrin. 2001. "Green Roofs: Stormwater Management from the Top Down." *Environmental Design & Construction Magazine*. Jan-Feb. 2001:1-11.

Inclusion of this technology description in this Report to Congress does not imply endorsement of this technology by EPA and does not suggest that this technology is appropriate in all situations. Use of this technology does not guarantee regulatory compliance. The technology description is solely informational in intent.



TECHNOLOGY DESCRIPTION

LOW IMPACT DEVELOPMENT

Bioretention

Overview

Bioretention is a soil and plant-based storm water management practice used to filter and infiltrate runoff from impervious areas such as streets, parking lots, and rooftops. Essentially, bioretention systems are engineered plant-based filters designed to mimic the infiltrative properties of naturally vegetated areas, which in turn can reduce the volume and frequency of CSOs. Bioretention is considered a low impact development (LID) practice and was developed in the early 1990s.

One of the unique qualities of bioretention is the flexibility of design themes. Bioretention systems can range in complexity depending on available funding, volume of runoff to be controlled, available land area, and the desired level of treatment. Bioretention systems can be used as a stand-alone practice (off-line) or connected to a storm drainage system (on-line). It is important to note that changes and improvements to a bioretention system design are continually being made as use of the practice becomes more developed.

On-line Bioretention System

A typical on-line bioretention system, as shown in Figure 1, includes components designed to capture, temporarily store, infiltrate, and treat storm water runoff. A graded surface conveys the runoff from impervious areas (i.e. roofs, driveways, parking lots) toward an optional grass buffer or swale. The grass buffer pretreats the runoff by reducing the runoff velocity, filtering particulates, and evenly distributing the incoming runoff. The rain garden, the main treatment component of an on-line bioretention system, is located in a depressed area that allows the runoff to pond and infiltrate, as well as evaporate from the surface. The rain garden is usually designed to hold up to six inches of standing water for one or two days, and consists of a mix of woody and herbaceous species planted in a soil mixture designed to optimize

percolation and pollutant removal. The best type of vegetation is native plant species that are tolerant of both wet and dry conditions. The planting soil should be two to four feet deep topped with an organic layer. This configuration allows the rain garden to maximize biological activity and enhance root growth. Factors affecting depth of the system include size of plants and depth to groundwater. Under the planting soil layer is a gravel layer that blankets an underdrain and serves to increase porosity of the system (Figure 1). The underdrain, a perforated pipe that collects and carries the runoff to the storm water system, ensures proper drainage for the plants and proper infiltration rates. Earlier bioretention system designs included a filter fabric between the soil and gravel layers, however this was found to cause premature clogging that led to infiltration problems. Replacing the filter fabric with a pea gravel diaphragm is an option. For storm flows exceeding the system's storage capacity, the excess

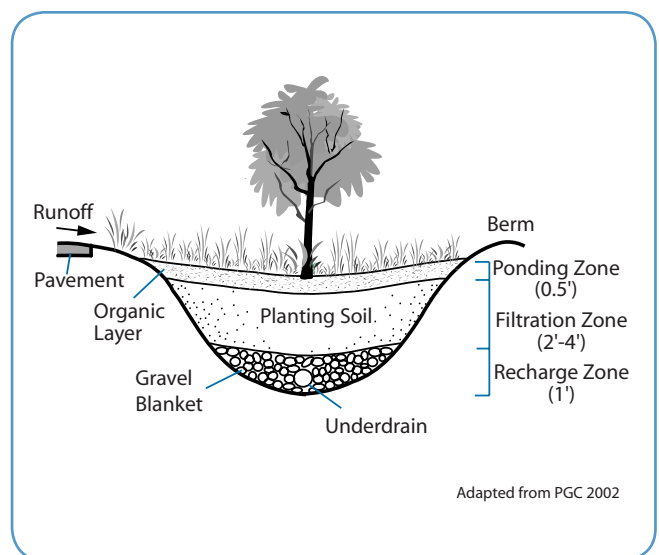

Figure 1. Cross-section of an on-line bioretention system.

Adapted from PGC 2002

runoff is allowed to flow over a grassy berm swale into an inlet pipe connected to the storm drain system. Other system designs allow the treated storm water to percolate back into the groundwater.

Off-line Bioretention Systems

Off-line bioretention systems possess similar general features to on-line systems, but are more simplistic and tend to be smaller in scale. One common design is where the bioretention areas (i.e. flower beds or other landscaping) are depressed so ponding and infiltration of storm water runoff can occur. Such designs do not include underdrains. Excess runoff overflows onto the adjacent surface areas. Another design is a bioretention “trap area” used in tree box areas, behind curbing, sidewalks, and pathways. With this technique, the paved surface is graded toward the adjoining grass areas to intercept runoff as it flows towards a drain or gutter (PGC 2002). Bioretention trap areas are common in urban areas with limited open space and high flow rates. In turn, tree boxes can be designed to serve as localized bioretention systems. This is done by creating a shallow ponding storage area by “dishing” mulch around the base of the tree or shrub (Figure 2).

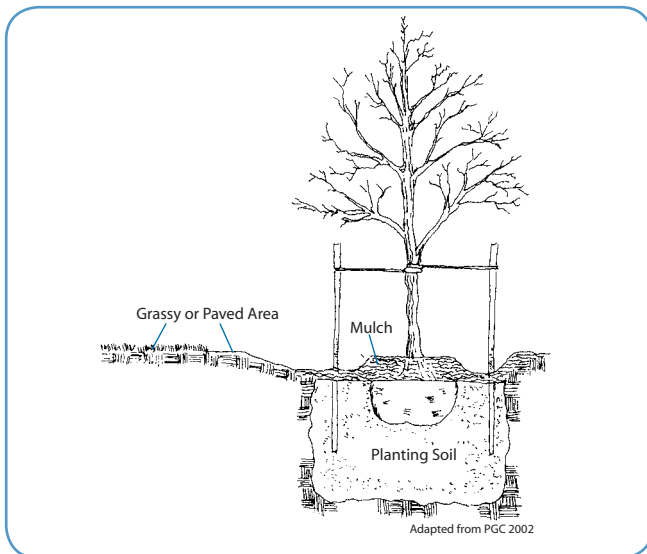

Figure 2. Schematic diagram of a tree-pit, which is a type of off-line bioretention system

Successful bioretention systems may also include soil amendments, which aim to improve health of the soil and its environmental functions. As a result of urban development, soils become compacted, which reduces soil porosity and ability to absorb water (ODEQ 2001). One type of soil amendment that can improve runoff absorption and treatment is the addition of compost. According to the Natural Resources Conservation Services (NRCS) hydrologic soils classification,

compacted urban soils are classified under Group D due to their limited ability to infiltrate runoff. Compost amendments can upgrade the compacted urban soils to Group B, soil with moderate infiltration rates, by increasing soil porosity (AACED 2002; City of Portland 2002). The soil is amended by spreading a layer of compost on the surface and tilling both the soil and compost to a total depth of 12 inches. The general soil to compost ratio rule is 2:1 by unit volume (ODEQ 2001).

Key Considerations

Applicability

Both on-line and off-line bioretention can be utilized in new developments or be retrofitted into developed areas. However, there is much more latitude to incorporate bioretention practices in new developments because there are fewer constraints regarding siting and sizing. In fact, good planning and design may result in an integrated site-wide bioretention system that decreases both initial project costs and long-term maintenance expenses. Bioretention practices are applicable in heavily urbanized areas such as commercial, residential, and industrial developments. For example, bioretention can be used as a storm water management technique in median strips, parking lots with or without curbs, traffic islands, sidewalks, and other impervious areas (EPA 1999).

The effectiveness of a bioretention system is a function of its infiltration and treatment ability and so the system must be sized to match the expected runoff. Miscalculating the capacity limits in the system design can lead to erosion and stabilization issues, particularly for on-line systems. The following criteria can be used to determine the suitability of bioretention:

- Drainage area - 0.25 to one acre per bioretention system (multiple systems may be required for larger areas);
- Space required - Approximately five percent of the impervious area that will contribute runoff; and
- Minimum depth to water table - No less than two feet between ground surface and seasonally high water table.

Typical maintenance activities for any bioretention system are re-mulching void areas; treating, removing, and replacing dead or diseased vegetation; watering plants until they are established; soil inspection and repair; and litter and debris removal.

Advantages

Bioretention reduces storm water runoff and can consequently help reduce the size and cost of storm water control facilities, and the volume and frequency of CSOs. Bioretention can be an effective LID retrofit, especially in urban areas with minimal open space and extensive impervious area. Bioretention systems have also shown promise in the removal of pollutants via physical and biological processes of adsorption, filtration, plant uptake, microbial activity, decomposition, sedimentation, and volatilization (EPA 1999). Types of pollutants removed include metals, phosphorus, hydrocarbons, suspended solids, nitrogen, organic matter, and oils (EPA 1999). Also, bioretention systems can reduce on-site flooding, improve groundwater recharge, help maintain stream baseflows, provide habitat, and have aesthetic value. On-line systems are most cost-effective when incorporated into the initial design or into the repair/reconstruction process of an area (i.e. parking lots). Off-line bioretention systems are cost-effective as retrofits in urban areas as they require little space and can be incorporated into existing urban landscapes.

Disadvantages

Functional problems of bioretention systems may arise such as clogging of the ponding area with sediment over time. Thus, pretreatment and regular maintenance are necessary components to the overall implementation. In many cases, maintenance tasks can be completed by a landscaping contractor. Systems with compost amendments require regular replacement of the compost. Additional soil amendments, such as lime or gypsum, may also be necessary to replenish nutritional deficiencies and correct unsuitable alkalinity levels (Chollak and Rosenfeld 1998).

Cost

The cost of a residential off-line bioretention system averages about \$3-\$4 per square foot, depending on the soil conditions and the density and types of plants used, whereas the cost of commercial, industrial, and institutional applications of bioretention systems range between \$10-\$40 per square foot, based on the need for control structures, curbing, storm drains, and underdrains (LID 2003). Landscaping costs required regardless of bioretention installation should be subtracted when determining the net cost of the bioretention system. As the size of bioretention systems can vary, so can the associated installation costs. In addition, in residential areas, storm water management controls become a part of each property owner's landscape, reducing the public burden to maintain large centralized facilities (LID 2003).

Retrofitting a site may entail additional costs (EPA 1999). The higher cost of a retrofit is attributed to the demolition of existing concrete, asphalt, and other structures and replacing fill material with planting soil. The costs of soil amendments are site specific as well. For a shallow (up to an 8-inch depth) compost amendment that incorporates in-site soil in a small area, the estimated cost is \$1-\$3 per square foot (LID 2002).

Bioretention has the potential for cost savings compared to other types of storm water drainage techniques, such as curbs and gutters. The operation and maintenance costs for a bioretention facility are comparable to that of typical landscaping. Additional costs beyond the normal landscaping fees will be site specific, but can include soil testing, planting soil installation, and soil amendment components.

Implementation Examples

MAPLEWOOD, MN

Responsible Agency: City of Maplewood

Rain Gardens in Residential Development

The City of Maplewood launched a storm water management project that implemented rain gardens instead of traditional curb and gutter systems in three neighborhoods. This decision was prompted by a combination of positive results of previously completed rain garden pilot projects, the need for road upgrades, and existing drainage problems in several neighborhoods. Considering bioretention as an environmentally friendly and aesthetically pleasing alternative, the city decided to focus on demonstration, education, and outreach to convey the benefits of using rain gardens for runoff management. Each bioretention system incorporated rain gardens and grass swales to collect runoff from streets and yards with a holding capacity of 0.5 inch of rain (85 percent of the local rainfall occurs during storms totaling 0.5 inch or less) (NSN 2001). The utilization of rain gardens in the neighborhoods was on a voluntary basis. However, the city offered incentives providing homeowners with plants, landscape plans, educational materials, and demonstrations free of charge. The three standard garden sizes offered were 12 foot by 24 foot, 10 foot by 20 foot, and 8 foot by 16 foot. At least 130 rain gardens are expected to be installed by the end of 2003. Within the project neighborhoods, the city is installing rain garden systems at schools, nature centers, and neighborhood parks. The city is providing necessary regrading or curb work to achieve the proper slope for each system. Volunteers for disabled or elderly residents wishing to participate in the program are being provided as well. Whether the residents utilize the gardens or not, all residents must pay an annual assessment to cover the costs of the projects.

This bioretention project costs 75-85 percent of the cost of traditional curb and gutter systems (NSN 2001). Each garden costs \$600-\$700 including excavation, rock infiltration sump, scarifying of the soils, bedding material, shredded wood mulch, and vegetation. Costs were kept low by recycling and using street material in lieu of gravel, by obtaining the plants from a local correctional facility green house program, and by having residents be responsible for the planting. Otherwise, the cost of each garden was estimated to be between \$1,200-\$1,500. The potential long-term savings are more difficult to quantify, but include reduced demand on the city's downstream storm sewer infrastructure.



Photo: City of Maplewood



Photo: City of Maplewood

Contact: Chris Cavett, Assistant City Engineer, City of Maplewood

PRINCE GEORGE'S COUNTY, MD

Responsible Agency: Prince George's
Department of Environmental Resources

Residential Rain Garden Program

An 80-acre residential development site in Prince George's County, MD, consisting of 199 homes on 10,000 square foot lots was designed featuring bioretention rain gardens. One to two rain gardens were built on each lot in the development. Each garden is 300-400 square feet in size and consists of ornamental grasses, mulch, shrubs, and trees. The rain gardens were implemented as means of storm water attenuation. The gardens control storm water quantity and quality by collecting runoff from driveways and rooftops for infiltration into the ground. Each garden generally includes a mulch layer underlain by a sandy loam or loamy sand planting media with a minimum depth of two feet. A one-foot sand layer was placed below the planting media to help store the runoff at sites with low porosity subsurface soils. Grassy swales were used to connect the rain gardens to storm drain inlets and provided additional quantity and quality management compared to a traditional curb and gutter system. Water was allowed to pool to a depth of six inches in the rain garden after each rain event. The basins provided a maximum of 48-hour storage onsite.

Analysis of the project costs showed the rain gardens were a cost-effective storm water management strategy. Each garden cost approximately \$500, which consisted of \$150 for excavation and \$350 for vegetation. The total cost of the project was \$100,000 compared to the projected cost of \$400,000 for a pond system which was the other storm water management alternative considered for the development. In addition, this allowed the developer to recover six lots that otherwise would have been used for the pond system. The area's naturally sandy soil was suitable for the sand base required in the rain garden profile, which kept the costs of the gardens down. Homeowners are responsible for replacing dead vegetation, regulating soil pH, removing filter clogs and excess sedimentation, keeping the storm water intake open, and repairing erosion damage. The overall savings to the developer from the use of bioretention was over \$4,000 per lot.



Photo: Prince George's County DER



Photo: Prince George's County DER

Contact: Larry Coffman, Prince George's County Department of Environmental Resources

WASHINGTON, DC

Bioretention System Retrofits

Responsible Agency: U.S. Navy

The Navy demonstrated LID effectiveness and applicability by installing a number of storm water retrofits, including both on-line and off-line bioretention systems, throughout the Washington Navy Yard (Lehner *et al.* 1999). These retrofits complement the Navy's effort to update the 150-year old separate storm sewer system. Video investigation, cleaning, and system modernization were conducted prior to the installation of ten pilot projects demonstrating the use of LID techniques in urban areas. Currently, the projects are undergoing monitoring and evaluation of maintenance requirements and pollution control effectiveness. Engineers designed the bioretention retrofits to treat the first one-half inch of rain, at a minimum. The two main retrofits were at the Willard Park and Dental Clinic parking lots, and cover a total of three acres of impervious surface. The Willard Park parking area incorporated the on-line bioretention retrofits in the replacement and repair of the parking lot. Bioretention was utilized to temporarily store and slowly release storm water to reduce the peak discharge. In an effort to maximize parking area, the bioretention systems were installed as strips between parking rows. Each unit is designed to treat 0.5 acre of impervious surface.

The Dental Clinic project is an example of implementing a combination of LID practices as part of a major reconstruction of the parking lot. Bioretention islands, sand filter gutter strips, and permeable pavers were installed between parking rows. Also, a tree box was installed within the property and soil amendments were made in some open space areas to increase infiltration capabilities of the soil.

Contact: Camille Destafney, Naval District Washington

References

Anne Arundel County Environmental Demonstration (AACED). "Revitalizing Compacted Soils." Retrieved November 11, 2002.
<http://www.srlt.org/compactsoils.shtml>

Chollak, Tracy and Paul Rosenfeld. 1998. *Guidelines for Landscaping with Compost-Amended Soils*. Prepared for City of Redmond Public Works.

City of Portland. 2002. *Storm Water Management Manual*. Environmental Services City of Portland Clean Water Works. Portland: City of Portland.

Coffman, Larry. Interview by Limno-Tech, Inc., 2002.

EPA. 1999. *Storm Water Technology Fact Sheet: Bioretention*. EPA 832-F-99-012.

Lehner, Peter, George Aponte Clark, Diane Cameron, Andrew Frank. 1999. *Storm water Strategies: Community Responses to Runoff Pollution*. New York: Natural Resources Defense Council.

Low Impact Development Center (LID) "Bioretention Cell Costs" Retrieved April 30, 2003.
http://www.lid-stormwater.net/bioretention/bio_costs.htm

Low Impact Development Center (LID) "Soil Amendment Costs." Retrieved November 21, 2002.
http://www.lid-stormwater.net/soilamend/soilamend_costs.htm

Nonpoint Source News-Notes. "Landscaped Rain Gardens Offer Stormwater Control." In *Notes on Watershed Management*. No. 66. October 2001. Retrieved November 14, 2002.
<http://notes.tetrattech-ffx.com/newsnotes.nsf>

Oregon Department of Environmental Quality (ODEQ). 2001. *Restoring Soil Health To Urbanized Lands: The Crucial Link between Waste Prevention, Land Use, Construction, Stormwater Management and Salmon Habitat Restoration*. Portland: Oregon Department of Environmental Quality.

Prince George's County Department of Environmental Resource, Programs and Planning Division (PGC) 2002. *The Bioretention Manual*. Prince George's County, MD: Department of Environmental Resource, Programs and Planning Division.

Inclusion of this technology description in this Report to Congress does not imply endorsement of this technology by EPA and does not suggest that this technology is appropriate in all situations. Use of this technology does not guarantee regulatory compliance. The technology description is solely informational in intent.



Water Conservation

Overview

Water conservation is the careful and efficient use of water in a manner that extends water supplies, conserves energy, and reduces water and wastewater treatment costs. As such, it is considered to be a low impact development (LID) control. With regard to CSO and SSO control, the reduced use of water through water conservation can decrease the total volume of dry weather sanitary sewage flowing through a sewer collection system. This produces an increase in conveyance and treatment capacity which then prevents some sewage from being discharged during periods when runoff, infiltration, and blockage exacerbate capacity constraints within wastewater collection systems.

Water conservation can be an important component of a program to control sewer overflows. It is not often a solution on its own, but can be effective when implemented in combination with other control methods.

There is a broad group of indoor and outdoor practices that reduces water consumption. Several of the important water conservation practices to reduce CSOs and SSOs are described below.

Water Efficient Fixtures and Appliances

Low-flow fixtures include low-flow toilets and urinals, showerheads, and faucets. Aerators, which break the flowing water into fine droplets by incorporating air without affecting wetting effectiveness, can be attached to showerheads and faucets to reduce water use. Self-closing and sensed faucets with automated water flow are available for commercial facilities (PNNL 2001). Installation of pressure-reducing valves can lower water consumption by reducing water flow and the likelihood of leaking pipes and faucets. Water efficient clothes and dish washers are also available. For example, high performance clothes washers can reduce water use from 35-55 to 18-25 gallons per load (PNNL 2001).

Water Recycling

Water recycling is the reuse of water for beneficial purposes (EPA 1998). Greywater, which is wastewater from sinks, kitchens, tubs, clothes and dish washers, can be reused for home gardening, lawn maintenance, cooling tower or boiler makeup water, landscaping, toilets, and exterior washing. More elaborate treated effluent recycling measures can also be implemented for residential, agricultural, and industrial uses.

Waterless Technology

Some available technologies eliminate the need for water for operation. Composting toilets treat domestic sewage (also food scraps, paper, lawn clippings, and grease) by composting and dehydration. This technology does not require hook-up to sewage or septic systems, and the end-product can be used as fertilizer. Waterless urinals use a liquid with a lower specific gravity than urine, such as barrier oil or other sealant liquid, that allows waste to pass through while an airlock cartridge in the base of the urine bowl prevents any malodor (GBS 2002).

Rain Harvesting

Rain harvesting is an interception practice that collects and stores roof runoff before it enters the sewer or storm water system. Typical components of a rain collecting system are a gutter or down spout; holding vessels (i.e., cisterns, rain barrels, or tanks); and a filter or screen (TWDB *et al.* 1997). Most often, harvested water is for home gardening or lawn care. More complex systems designed to collect water for in-home use require a water treatment system to settle, filter, and disinfect the water, as well as a gravity or pump system to transport the treated water (TWDB *et al.* 1997).

Key Considerations

Applicability

Water conservation makes sense for many reasons. One important reason is the contribution that water conservation can make to reducing the volume of CSO and SSO discharges. A few considerations regarding specific practices are discussed in the paragraphs below.

Water Efficient Fixtures and Appliances

Water efficient fixtures can be installed or retrofitted in residential, commercial, institutional, and recreational facilities. Buildings undergoing construction or remodeling have great potential for incorporating water-wise technologies, and most of these technologies are readily available in the U.S. Water efficient fixtures can be a practical and economical alternative for homes.

Toilets, showers, and faucets account for approximately 60% of all indoor residential water use (EPA 1995). In most instances, money saved from reduced water and sewer bills can offset installation costs over time, and the reduction of wastewater places less stress on sewer systems. Toilets in particular are one of the greatest residential water uses and have considerable water saving potential. By installing low-flow toilets, toilet water use can be reduced from more than 3.5 gallons to 1.6 or less gallons per flush (gpf). Low-flow toilets function similar to conventional toilets, and are therefore easy to substitute. Since low-flow toilets were first introduced in the 1980s, manufacturers have made significant improvements in toilet design, thus reducing the need to double flush, which was a source of customer dissatisfaction and a reduction in efficiency among earlier models (EPA 2002). In fact, current federal law requires that residential toilets manufactured after January 1, 1994, must use no more than 1.6 gpf; and that commercial toilets manufactured after January 1, 1997, must use no more than 1.6 gpf; and urinals must use no more than 1 gpf (FEMP 2002). Similar to low-flow toilets, low-flow showerheads conserve water by reducing water use from 4.5 to 2.5 gallons per minute (gpm) (EPA 1995). These showerheads are simple to install and relatively inexpensive, but flow can be reduced over time by scale buildup (EPA 1995). Various cities throughout the U.S. have established incentive programs, such as rebates, promoting the use of low-flow or water efficient technologies.

Water Recycling and Reuse

Water recycling and reuse have the potential to satisfy many household water needs and have numerous

potential applications. In general, water recycling provides a locally controlled water supply that can be developed in both residential and non-residential facilities. Benefits to users of greywater systems are reduced water and sewer bills due to lowered wastewater discharge and water usage. Reuse of greywater also can improve local water quality by reducing greywater pollution (i.e. organics) that may otherwise be discharged into local rivers and streams during sewer overflow events. The disadvantages are mainly in the costs of equipment and labor to install the system. For more complex systems, the economic payback period may extend beyond the life of the system. Periodic maintenance is required, and contaminants such as paint, bleach, and dye must not enter the system. Some local regulations may not be adapted for such systems. Sanitary engineers, inspectors, and boards of health may lack familiarity with such systems as well.

Cooling tower water recycling is most useful for commercial, institutional, and industrial facilities such as hospitals, factories, nuclear power plants, apartment buildings, and chemical plants. The recycling of cooling water reduces wastewater discharge, lowers water and sewer bills, and reduces the discharge of chemicals to wastewater collection systems. The operation of recirculating cooling towers in industrial buildings, however, can reduce production efficiency as the system pumps consume power. Regular maintenance is required to ensure efficient application of cooling tower technologies.

Waterless Technology

Technologies that eliminate the need for water all together are the ultimate water conservation tool. Composting toilets are particularly suitable for use in recreational facilities such as parks, although there are residential and commercial applications as well. The advantages include eliminating the need for potable water to flush the toilet and reduced sewer bills. Composting toilets, however, are not ideal in cold climates, can require some energy (i.e., ventilation and heating) to optimize composting, and need regular maintenance. Waterless urinals are another product line that conserve water. While suitable for commercial and other public facilities, their use can be limited because they are not always socially acceptable, and they require regular maintenance.

Institutions such as hospitals can benefit from ozonated laundering which provides disinfection but does not require detergent or rinsing. Ozone generation is power-intensive, requiring significant amounts

of electricity that may reduce its cost-effectiveness in certain applications. Also, ozone is reactive and corrosive and thus requires resistant material such as stainless steel (NSFC 1998).

Rain Harvesting

Important considerations for rain harvesting include age and type of roof, amount of canopy overhang, and availability of space to position rain barrels or other storage units. Rain harvesting costs vary depending on the complexity of the system. Rainwater yield varies with the size and texture of the catchment area. Systems can be custom designed and built or purchased as a package. Minimal costs are associated with simple systems consisting of a gutter and collection barrel serving a home. Applications of rain harvesting can be limited to certain geographical regions, as some western states have water laws that may impose restrictions on the practice of rain harvesting.

Cost

Important considerations in evaluating the effectiveness of water conservation technologies include determining if the water conservation savings offset the costs of implementing the technology; assessing the feasibility of the technology given local restrictions and building codes; size and complexity of installation; location (residential

vs. non-residential); and local water and sewer rates. Cost-effectiveness of specific technologies varies greatly depending on water use and geography. It is also important to consider the water conservation potential of combining the various technologies.

Among water efficient fixtures and appliances, low-flow showerheads and faucet aerators are almost always cost-effective due to the relative low cost and minimal labor required. Low-flow toilets also have widespread application, particularly in commercial and institutional settings, because the economic offset period can be relatively short. The cost-effectiveness of other technologies mentioned in this fact sheet, however, will be based on site-specific considerations. Major factors affecting the cost-effectiveness of water efficient landscaping include landscape area, type of vegetation, geography, and climate. The cost-effectiveness of rain harvesting is controlled by the amount of rainfall and storage capacity. For greywater systems, the cost-effectiveness will vary based on flow rate, water quality, temperature, local building regulations (TBS 2002), and size of the reuse system. Due to the various types of applications for cooling towers, cost-effectiveness calculations are system specific. The cost-effectiveness of waterless technology will be controlled by the availability of connections to water and sewer lines. Table 1 provides general estimates of the costs and benefits of each water conservation technology.

Table 1. Water conservation technology cost and performance¹.

Category	Technology	% Water Conserved ²	Approximate Cost (\$)	Life Span (yrs.)
Water Efficient Fixtures and Appliances	Ultra low-flow toilet	54-68%	\$200-300	15-25
	Low-flow showerhead	45%	\$23	2-10
	Faucet aerator	40%	\$13	1-3
	Clothes washer	49-55%	\$1000	12
Recycling/ Reuse	Residential greywater reuse	up to 54%	\$400-\$5000	Not Available
	Cooling tower	up to 90%	Not Available	Not Available
Waterless	Composting toilet	100%	\$1000-\$2000	Not Available
	Waterless urinal	100%	\$300-\$500	Not Available
Rain Harvesting	Rain barrels or cisterns	Varies	\$100-\$20,000	Not Available

¹These estimates are for illustrative purposes and may not be applicable to a given situation. Estimates are from various sources including PNNL 2001 and CUWCC 2002.

² Percentage of water saved when compared to conventional water use application (no conservation measures taken).

Implementation Examples

SIERRA VISTA, AZ

“Water Watch” Program

Responsible Agency: Sierra Vista Water Management Team

The City of Sierra Vista established a water management team in September 2000 to assess the public’s perception of local water issues, educate and involve the public on water management issues, provide incentive-based

conservation alternatives, identify and address new water conservation opportunities, and implement water conservation programs. The water conservation programs include a toilet rebate program to encourage residents to voluntarily install low-flow toilets, free in-home retrofits of high-use water fixtures, a leak detection program, an internal “Water Watch” program to monitor municipal water use, public education and surveying, and partnerships with the Chamber of Commerce to involve the business community. For the toilet rebate program, qualified participants received \$100 for each unit replaced with a limit of two units per household. Sierra Vista has approximately 13,400 homes built prior to 1987 that may have high-flow toilets and fixtures. Replacement of all high-flow fixtures could save the city up to 261 million gallons of water annually. The old high-flow fixtures collected by the city through this rebate program were crushed and used as road-base material for various city projects. For fiscal year 2002, 195 toilets were replaced through the rebate program saving two million gallons of water, while 110 homes were retrofitted with low-flow fixtures saving an additional 3.3 million gallons of water. The program provided homeowners the opportunity to have their high-flow fixtures modified with low-flow alternatives at no cost to the homeowner. Sierra Vista has also taken regulatory measures by adding the following code requirements:

- New commercial car washes must recycle 75% of their water
- Waterless urinals in all commercial facilities with urinals
- Turf limits for new golf courses and new developments
- Commercial landscapes must feature low water use plants from city-approved list
- New irrigation standards for steep slopes and medians
- Hot water recirculating pumps in new homes
- Independent water meters required for each multi-family unit

In addition, the “Water Watch” program involved internal monitoring and evaluation aimed at reducing water consumption in the city’s facilities. Monthly water invoices from the city’s use of water from its wells and from private water companies were checked for anomalies. Trained personnel also conducted inspections at virtually all of the city’s facilities, providing an inventory of water fixtures and identifying leaks and inefficiencies. The city was also involved in an internal retrofitting program where water fixtures were replaced with low-flow units. A study by the city showed the total acre-feet of water consumed between calendar year 2000 to 2001 decreased from 2.5 billion gallons to 2.3 billion gallons of water for Sierra Vista.

Contact: Patrick J. Bell, Environmental Services Manager, City of Sierra Vista

ALBUQUERQUE, NM

Water Recycling in Cooling System

Responsible Agency: U.S. Department of Energy

Sandia National Laboratory has established several water conservation programs within its facilities, one of which is located at the Compound Semiconductor Research Laboratory (CSRL). The CSRL replaced its cooling system used for its laser installations from a once-through water cooling system to a cooling loop cooling system. By reusing cooling water, CSRL is able to save five to ten million gallons of water per year based on normal usage. The water bill savings are estimated at \$10,000-\$30,000 per year. The project cost was \$200,000.

Contact: Darrell Rogers, Sandia National Laboratories

HOUSTON, TX

Responsible Agency: City of Houston and Houston Housing Authority Joint Water Conservation Project

Water Efficient Fixtures in Housing Project

Low-flow plumbing fixtures were installed in a 60-unit low income multifamily housing complex in Houston, owned and managed by the Housing Authority of the City of Houston (HACH). The average number of occupants per unit was 4.4. Devices installed in each unit included low-flow toilets (1.6 gpf), low-flow aerators on faucets (2.2 gpm), and new water meters for each unit. Faucet leaks were repaired, and tenants were educated on conservation techniques. The project resulted in a reduction in average monthly water consumption for the complex from 1.3 million gallons pre-installation to 367,000 gallons post-installation. Average monthly savings on water bills for the complex was \$6,834. Due to the success of the project, HACH (funded by HUD) has retrofitted four of its other low income housing developments.

Water use and bill comparison before and after project.

	Before	After
Water Use Comparison		
Avg Monthly Consumption	1,300,000 gals.	376,000 gals.
Avg Monthly Consumption/Unit	21,666 gals.	6,116 gals.
Avg Monthly Consumption/Person	4,924 gals.	1,390 gals.
Avg Consumption/Person/Day	146 gals.	46 gals.
Water Bill Comparison		
Avg Monthly Bill	\$8,644.00	\$1,810.00
Avg Monthly Bill/Unit	\$144.00	\$30.17

Contact: Pat Truesdale, City of Houston Public Works and Engineers Water Conservation Branch

HILLSBOROUGH COUNTY, FL

Responsible Agency: Hillsborough County Water Department

Water Conservation Program

Due to rapid urban growth on Florida's west coast, Hillsborough County's water resources were experiencing significant stress. To address this problem, the county established a comprehensive water conservation program. The program is composed of public education and regulatory, operational, and financial incentive/disincentive components. Examples of some of the program's projects include full-time enforcement of water use restrictions, rebates for water efficient devices, and educating communities on water conservation. The program has effectively reduced the per capita water consumption in the county from 146 to 105 gallons per person per day; well below the regional requirement of 130 gallons. The low-flow toilet rebate program that was started in 1994 replaced 75,200 fixtures, saving an estimated 1.7 MGD. The county also established a reclaimed water program where approximately 11 million gallons of reclaimed water are used by approximately 7,000 residential and commercial customers daily, and the numbers are growing. This program has helped reduce the need for groundwater withdrawals and wastewater discharges.

Contact: Norman Harcourt Davis IV, Water Conservation Manager, Hillsborough County Water Department

WASHINGTON, DC

Responsible Agency: DC Water and Sewer Authority (WASA)

In 2001, the DC Water and Sewer Authority undertook a study of the effectiveness of rain harvesting in controlling storm water runoff from rooftops within its combined sewer service area. Rooftops are a major type of impervious surface whose runoff can contribute to CSO events. Rain barrels were analyzed as a means for capturing storm water runoff from rooftops, thereby reducing flow in the combined sewer system. The 75-gallon rain barrels were installed at two types of homes (detached and rowhouse), each with distinct roof configurations, and were monitored over a nine-month period. For the study area, under a design rainfall of 0.19 inch, the study showed that approximately 27,521 gallons out of a total of 211,950 gallons of runoff generated would be controlled using rain barrels. Rain harvesting from roofs on rowhouses appeared to be more cost-effective than on detached homes. Calculations indicated that for a one million gallon reduction in storm water volume, rain barrels would need to be installed in 20 percent of the rowhouses at an estimated cost of \$1.7 million (MWCOG 2001).

Rain Harvesting Study



Photo: DC WASA

Contact: Phong Trieu, Peter Guillozet, John Galli, or Matt Smith, Metropolitan Washington Council of Governments

COLORADO SPRINGS, CO

Responsible Agency: U.S. Army



Photo: US Army

Water Reuse at Vehicle Wash

Fort Carson's Central Vehicle Wash Facility services approximately 4,000 military vehicles using recycled water and has been in operation for over 11 years. This facility is an example of a closed loop recycling water treatment system that consists of grit chambers, sand filters, oil skimmers, and aeration basins, and has a storage capacity of 9.6 million gallons. Grass carp were introduced in the aeration and stilling basins to control aquatic vegetation and to avoid use of algacides. On a given day, up to 491 vehicles can be washed, using 10 million gallons of water. As this treatment system is essentially self-sustaining, there is minimal impact on Fort Carson's sewage and industrial wastewater treatment systems. The yearly rainfall is usually sufficient to make-up for evaporation losses. Each year, the system conserves 150-200 million gallons of water. The facility was built at a cost of \$7 million.

Contact: Richard Pilatzke, Fort Carson

References

California Urban Water Conservation Council. "H₂Ouse." Retrieved October 16, 2002.
<http://www.h2ouse.net/action/index.cfm>

EPA Office of Water. "High Efficiency Toilets." Retrieved June 28, 2002.
<http://www.epa.gov/OW-OWM.html/water-efficiency/toilets.htm>

EPA Water Division Region 9. 1998. *Water Recycling and Reuse: The Environmental Benefits*. EPA 909-F-98-001.

EPA Office of Water. 1995. *Cleaner Water Through Conservation*. EPA 841-B-95-002.

Federal Energy Management Program. "Water-Conservation Best Management Practices." Retrieved October 10, 2002.
http://www.eren.doe.gov/femp/techassist/best_practices.html

Green Building Services. "Green Technology Brief: Water Conservation." Retrieved June 14, 2003.
<http://greenbuildingservices.com/images/PDF/WaterConWeb.pdf>

Metropolitan Washington Council of Governments (MWCOC). 2001. *Combined Sewer Overflow Rooftop Type Analysis and Rain Barrel Demonstration Project*. Prepared for The District of Columbia Water and Sewer Authority. Washington DC: Metropolitan Washington Council of Governments.

National Small Flows Clearinghouse (NSFC). 1998. *Environmental Technology Initiative Fact Sheet: Ozone Disinfection*. National Small Flows Clearinghouse Item #WWFSGN100. Morgantown, WV, West Virginia University.

Pacific Northwest National Laboratory (PNNL). 2001. *Market Assessment for Capturing Water Conservation Opportunities in the Federal Sector*. Prepared for the US Department of Energy Federal Energy Management Program. Richland, WA: Pacific Northwest National Laboratory.

Tool Base Services. "Water Conservation." Retrieved October 11, 2002.
<http://www.toolbase.org/secondaryT.asp?TrackID=&CategoryID=1002>

Texas Water Development Board (TWDB) and Center for Maximum Potential Building Services (CMPBS). 1997. *Texas Guide to Rainwater Harvesting*. Austin, TX: TWDB and CMPBS.

Inclusion of this technology description in this Report to Congress does not imply endorsement of this technology by EPA and does not suggest that this technology is appropriate in all situations. Use of this technology does not guarantee regulatory compliance. The technology description is solely informational in intent.