

---

**PAPERS AND PROCEEDINGS**  
of the  
**SURGEON GENERAL'S CONFERENCE ON**  
**AGRICULTURAL SAFETY AND HEALTH**

---

Edited by:

Melvin L. Myers, M.P.A.

Robert F. Herrick, Sc.D.

Stephen A. Olenchock, Ph.D.

John R. Myers, M.S.F.

John E. Parker, M.D.

David L. Hard, Ph.D.

Katherine Wilson, M.P.H.

---

Public Law 101-517

April 30 - May 3, 1991  
Des Moines, Iowa

Convened by

U.S. DEPARTMENT OF HEALTH AND HUMAN SERVICES  
Public Health Service  
Centers for Disease Control  
National Institute for Occupational Safety and Health

September 1992

## ***DISCLAIMER***

Sponsorship of this Conference and these *Papers and Proceedings* by the National Institute for Occupational Safety and Health (NIOSH) does not constitute endorsement of the views expressed or recommendations for use of any commercial product, commodity, or service mentioned. The opinions and conclusions expressed in the papers and abstracts are those of the authors and not necessarily those of NIOSH.

Recommendations are not to be considered as final statements of NIOSH policy or of any agency or individual who was involved. They are intended to be used in advancing the knowledge needed for improving worker safety and health.

This document is in the Public Domain and may be freely copied or reprinted. Copies of this and other NIOSH documents are available from:

Publication Dissemination, DSDTT  
National Institute for Occupational Safety and Health  
4676 Columbia Parkway  
Cincinnati, Ohio 45226  
**FAX (513) 533-8573**

U.S. Department of Commerce  
National Technical Information Services  
Springfield, VA 22161  
**NTIS PB 93-114890/\$77.00 or A/06**

Superintendent of Documents  
U.S. Government Printing Office  
Washington, DC 20402  
**GPO 017-033-00463-3**

**DHHS (NIOSH) PUBLICATION NUMBER 92-105**

**For information on other occupational safety and health problems, call:  
1-800-35-NIOSH**

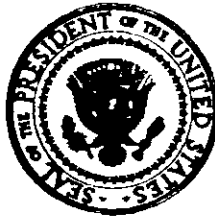

## National Farm Safety Week, 1991

*By the President of the United States of America*

### A Proclamation

The men and women who work in America's agricultural sector make a vital contribution to our Nation's well-being. By providing consumers with a variety of high-quality food and fiber at reasonable costs, they help to keep our work force strong and healthy and, in so doing, help to maintain the Nation's economic productivity and competitiveness. Because we count on farmers and ranchers for so much, both as individuals and as a Nation, it is fitting that we observe National Farm Safety Week—a concerted public awareness campaign aimed at promoting their health and safety.

Over the years much has been done to improve the safety of agricultural production. Advances in science and technology and increased attention to avoiding safety risks have made farms and ranches safer places to work. Moreover, dedicated professionals and volunteers have been working together to promote health and safety in rural communities. These efforts are reflected by a welcome downturn in farm accident rates.

Unfortunately, however, while important strides have been made in reducing the risks of farming and ranching, agricultural production remains one of our most hazardous industries, with an accident death rate that is more than four times the average of all industries. More must be done to reduce the toll of farm-related accidents.

Most accidents on the Nation's farms and ranches can be prevented by sensible measures that involve little extra time, effort, or expense. For example, farmers and ranchers can reduce their risk of serious injury and illness by following manufacturers' instructions on the use of chemicals and machinery and by utilizing protective apparel and safety equipment when the job calls for it. Children should be kept away from hazardous machinery, and all family members and employees should be trained in safety procedures and first aid.

For generations, the men and women who work on our Nation's farms and ranches have endured long hours of tough, physical labor. However, they have continually met the challenges of their vocation with determination and pride—and with unparalleled success. During National Farm Safety Week, let us resolve to make excellence in health and safety another one of America's great farming traditions.

NOW, THEREFORE, I, GEORGE BUSH, President of the United States of America, by virtue of the authority vested in me by the Constitution and laws of the United States, do hereby proclaim the week of September 15 through September 21, 1991, as National Farm Safety Week. I urge all who live and work on our Nation's farms and ranches to make the preservation of personal health and safety an integral part of their daily activities. I also urge them to protect their children, not only by instruction in safety habits, but also by setting an example of carefulness and by avoiding needless risks. I also call upon organizations that serve agricultural producers to strengthen their support for rural health and safety programs, and I encourage all Americans to observe this week with appropriate activities as we express our appreciation for the many contributions that men and women in agriculture make to our Nation.

IN WITNESS WHEREOF, I have hereunto set my hand this fifteenth day of April, in the year of our Lord nineteen hundred and ninety-one, and of the Independence of the United States of America the two hundred and fifteenth.

*George Bush*



## PREFACE

In 1990, the Congress established a national initiative in agricultural safety and health under Public Law 101-517. The Congress directed that this initiative, *when sustained over a period of time, would result in a significant and measurable impact on . . . health effects among rural Americans.*

As part of that initiative, the Congress appropriated funds for the National Institute for Occupational Safety and Health (NIOSH) to convene a Surgeon General's Conference on Agricultural Safety and Health. This Conference was held in 1991 and was chaired by Assistant Surgeon General J. Donald Millar, the Director of NIOSH. The purpose of this Conference was to raise consciousness, build coalitions, disseminate information, and encourage action to prevent injury and disease in agriculture. The Conference fulfilled this purpose and established a vision for improving the total quality of health and safety for agricultural workers and their families in America:

- ▶ *Raise Consciousness.* The Congress found that agricultural workers and their families experienced excessive rates of injuries, many kinds of cancers and lung diseases, and various health effects from exposures to agricultural chemicals. Their findings indicated significant disparities in the quality of health among agricultural workers and their families and a national need to improve the quality of their health. The Surgeon General's Conference reinforced this need, and the evidence was broadened into musculoskeletal problems, noise-induced hearing loss, dermatological conditions, stress, and infectious diseases. Furthermore, participants at the Conference emphasized the need to improve the health of agricultural workers and their families.
- ▶ *Build Coalitions.* The Surgeon General's Conference raised the consciousness of many officials in the fields of agriculture, education, labor, and public health at the national, state, and local levels. The need for a concerted effort was recognized by the participants. Over 500 people participated from 41 states and the Commonwealth of Puerto Rico as well as from other countries. As a result, a growing network of the participants are reaching out among themselves and to others to offer and to receive help.
- ▶ *Disseminate Information.* The most visible manifestation of information dissemination is these *Proceedings and Papers: Surgeon General's Conference on Agricultural Safety and Health* of that Conference, which will be distributed to participants and key prevention leaders at the national, state, and local levels across the nation.
- ▶ *Encourage Action.* The action that was overwhelmingly encouraged was to improve the health and safety of agricultural workers and their families. Moreover, the word, PREVENTION, came through loud and clear—over and over—at the Conference. This action, the improvement of agricultural safety and health through prevention, was identified with three views: as an action for the 1990's, with national leadership, and through people at the local level.

With the recognition of a need for improvement, the Congress, through its national initiative at NIOSH, launched a program for improving the health and safety of agricultural workers and their families. This program was comprised of:

- ▶ *A Survey.* The Congress directed NIOSH to undertake a Farm Family Health and Hazard Survey to develop more complete information on the circumstances of agricultural injury and disease problems. Based upon this information, informed priority-setting for prevention can be implemented and a baseline for measuring improvement can be established.
- ▶ *Research.* To insure that preventive actions are taken based upon scientific findings, including the etiology of the injuries and diseases, the Congress also directed NIOSH to conduct research both intramurally and through university-based Centers for Agricultural Health and Safety.
- ▶ *Intervention.* To actively promote and implement the research findings, the Congress directed NIOSH to establish a national Agricultural Health Promotion System in collaboration with county extension agents. The Congress also directed NIOSH to devise an early detection strategy to reduce the number of cancer deaths among farmers through Cancer Control Demonstration Projects for Farmers. In addition, funds were provided for the training of professionals in agricultural safety and health.
- ▶ *Surveillance.* To monitor results, the Congress directed NIOSH to establish an Agricultural Health Nurse Program in which rural hospitals would provide ongoing responsive (focused at intervention) surveillance to identify agriculture-related disease and injury problems through the support of nurses at rural hospitals.

In 1991, the Secretary of Health and Human Services issued a report, *Healthy People 2000*, which included national goals and objectives for improving the health of Americans. Three overarching goals emerged from this effort, each of which apply to agricultural workers and their families. These goals are: increase the span of healthy life for Americans, reduce health disparities among Americans, and achieve access to preventive health services for all Americans. Emerging from the purpose established by the Congress for a national initiative for agricultural safety and health from the goals of *Healthy People 2000*, and from the Surgeon General's Conference on Agricultural Safety and Health is a national vision for the 1990's for implementing the initiative:

*To continuously and measurably improve the safety and health of every working man and woman in American agriculture through the prevention of Leading Work-Related Diseases and Injuries consistent with the goals and objectives of 'Healthy People 2000.'* □

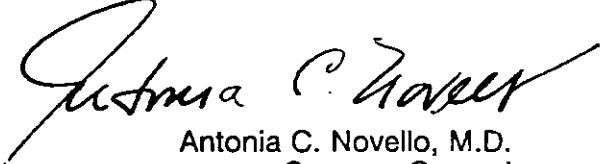

Antonia C. Novello, M.D.  
Surgeon General

## **FOREWORD**

The Surgeon General's Conference on Agricultural Safety and Health was convened by the National Institute for Occupational Safety and Health (NIOSH) in 1991. NIOSH was created in 1970 as a result of the passage of the Occupational Safety and Health Act. NIOSH is the national public health organization responsible for the occupational safety and health of all of the nation's workers. Moreover, NIOSH is a component of the Centers for Disease Control (CDC), The Nation's Prevention Agency.

In 1990, the Congress expressed concern that agricultural workers and their families experience a disproportionate share of injuries and diseases associated with numerous chemical, biological, and physical hazards. For example, agricultural workers have the second highest occupational fatality rate. They run a significantly higher risk of dying of certain types of cancer than persons in other occupations. The Congress also observed that inhalation of organic dusts from plant, soil, and animal sources, and from chemical and other substances, results in occupational health risks to agricultural workers.

The Congress, recognizing that agricultural workers continue to suffer high levels of injury and illness, directed NIOSH to lead a comprehensive national program and undertake a series of initiatives in surveillance, research, and intervention to prevent occupational injuries and diseases in agriculture. The Congress believed that NIOSH was in a unique position to lead a comprehensive national effort to prevent injury and disease in agriculture. The NIOSH initiative is intended to provide a balanced approach to substantially reduce the incidence of fatal and nonfatal traumatic injury, chronic injury, and occupational diseases among the 3.4 million agricultural workers in the United States. NIOSH expanded its research program to address the safety and health of workers in agriculture and awarded cooperative agreements to enhance the Institute's existing program in the areas of surveillance, research, and intervention.

The Congress also directed that NIOSH convene a Surgeon General's Conference on Agricultural Safety and Health. Held in 1991, its purpose was to raise consciousness, build coalitions, disseminate information, and encourage action to prevent injury and disease in rural areas. Several solutions for preventing diseases and injuries were presented and discussed at this Conference. The following is a summary of the Conference through the words of its participants, followed by a statement of the problem that emerged from the Conference, and a vision for the future of agricultural safety and health in America as well as a special mention of a particular, fully preventable agricultural injury—"an occupational obscenity"—which was repeatedly emphasized at the Conference.

### **CONFERENCE SUMMARY**

The general design of the Conference was to, first in plenary session, address its purpose, then provide direction through keynote speeches and questions, and pose some assumptions about the future of both the agricultural workforce and workplace. The titles

of the sessions and titles in this document corresponding to this part of the Conference are: *The Potential for a National Coalition, Looking Ahead to the Next Century, Questions to Guide the National Agenda, Medical Intervention Problems and Opportunities, and Issues That Affect the National Agenda.*

The Conference included five concurrent sessions dealing with the issues of surveillance, research, and intervention. The proceedings from these sessions are addressed in this document in the chapters entitled *Surveillance–Agriculture-Related Diseases, Injuries, and Hazards, Research–Chemical and Biological Hazards, Research–Mechanical and Physical Hazards, Intervention–Worker Protection from Environmental Hazards, Intervention–Safe Behaviors among Adults and Children.* Within each of these sessions, presentations of factual information were made, and discussions ensued from the perspectives of a range of interested parties.

Returning to plenary sessions, the chair of each concurrent session reported the results of deliberations in their session. In addition, a report was made on the issues raised at another conference held concurrently on migrant and seasonal labor. These reports are presented in the chapter entitled *Elements of a National Agenda.* The closing plenary session provided an opportunity for concluding remarks from a variety of participants who ranged from governmental to those representing farm organizations to a victim. These remarks are documented herein in the chapter entitled *Actions for the Future.*

The Conference included a poster and video tape session with 102 posters presented. The abstracts of the posters and titles of the video tapes are presented in the chapter entitled *Making Connections.*

Six unifying principles emerged from the Conference as operational concepts for the future. They are found in the words of 72 speakers at the Conference—these themes offer a verbal tour through these *Papers and Proceedings*:

► **CONTINUOUS IMPROVEMENT THROUGH PREVENTION.** The Congress has directed that a national initiative, of which this Conference was a part, be launched so that *when sustained over a period of time, would result in a significant and measurable impact on . . . health effects among rural Americans.* Augmenting this direction for continuous improvement, the Surgeon General's Conference consistently and in multiple ways demonstrated the need to prevent problems in order to improve the safety and health of agricultural workers and their families.

Senator Tom Harkin of Iowa asserted, ". . . we need to make "Prevention First" our motto for health care in the 90's." Dr. Thomas Dean of the National Rural Health Association challenged the Conference, ". . . to go forth in these deliberations with a sense of urgency and with an understanding that every day lives are lost because families are being devastated and futures are being ruined because of our failure in the past to build these coalitions."



Speaking to a paradigm for prevention, Dr. William Popendorf from The University of Iowa said, ". . . we face yet another challenge; how to translate them (parameters of health effects) into "agricultural hygiene," the industrial hygiene paradigm of "anticipation, recognition, evaluation, and control learned in general industry . . ." Jeffrey Human of the Office of Rural Health Policy encouraged the Conference to, ". . . confront conventional approaches and make new choices with limited funds, choices that help solve rural health problems."

Willis Eken of the Minnesota Farmers' Union contended, ". . . that it is something of a sham if the most effective tool for safer environmental protection regarding machinery is a law suit." Joseph Kinney of the National Safe Workplace Institute urged the Conference, ". . . to begin to get realistic about how you would like to see these issues addressed." Merlin Plagge of the Iowa Farm Bureau observed about OSHA standards that, ". . . knowing they exist has encouraged farmers to work for safer farmsteads."

► **RECOGNIZE THE NEEDS OF THE POPULATION AT RISK.** Fundamental to prevention is recognizing the needs of agricultural workers and their families, a population at disproportionately high risk of work-related disease and injury.

Dr. Myron Johnsrud of the U.S. Extension Service asserted, "A national strategy could rest on the belief that the most effective preventive efforts will emerge from a process that emphasizes identifying and characterizing problem areas and populations at risk." Relatedly, Dr. James Merchant of the Institute of Agricultural Medicine and Occupational Health at The University of Iowa reported, "Agricultural production is now changing dynamically, resulting in a substantial increase in farmers with non-farm jobs, greater involvement of women and seasonal workers, and involvement of children and recreational farmers in agricultural operations."

Dr. Leslie Whitener of the Economic Research Service at the U.S. Department of Agriculture defined this population: "The largest component (46 percent) of the agricultural work force in 1987 was made up of the 3.6 million people who did unpaid farmwork . . . the hired component of the agricultural work force will continue to grow in importance as hired workers increasingly replace family workers on farms and as the number of large, labor-intensive commercial farms continues to increase." Christopher Atchison of the Iowa Department of Public Health noted, "Because farming has traditionally been a family business, that it is not just the professional farmer, it is the farm family that is at risk for injury."

Cheryl Tevis from *Successful Farming Magazine* observed, ". . . that about half of farm women work outside the home." Todd Frazier from NIOSH expressed his viewpoint, "Because I am from a public health background and have always been interested in the population at risk, these demographics spell out to me a very serious challenge that we are facing when we look at projects that address the problems of farm families in generally rural areas."

Speaking of the migrant labor portion of the population, Roberta Ryder of the National Migrant Resource Program asked, "Is it really acceptable that such a large portion of our population be relegated to the edge for the duration of their lives?" Dr. Russell Currier from the Iowa Department of Public Health recognized two patterns of disease among agricultural workers, "Migrant farm workers experiencing human-host illnesses, often episodic and exacerbated by substandard living and employment conditions. All other farm workers experiencing sporadic, isolated illness that is most frequently zoonotic, vector-borne, or environmentally acquired in nature."

► **SURVEILLANCE TO MEASURE IMPROVEMENTS.** Part of prevention is the study of trends so as to measure progress. Surveillance is the means of doing so. Through surveillance, we can systematically and continually collect, analyze, and interpret data related to health and safety and direct prevention programs so as to control and, when possible, eliminate the occurrence of diseases and injuries.

With reference to John Donne's 16th century poem, Dr. William Halperin from NIOSH spoke to the role of surveillance as a guide to preventive action, "Surveillance in modern times is the equivalent of the tolling of the bells with the added commitment to investigation of the causation of morbidity and mortality and dissemination of data and analysis with the goal of prevention." Dr. John May from the New York Center for Agricultural Medicine and Health speaking to the use of sentinel events in surveillance relayed that, ". . . intervention should affect other workers by either addressing the hazardous exposure, by screening similarly exposed workers, or by insuring that at least adequate protection is provided to similarly exposed workers."

About surveillance and priorities, Dr. Dennis Murphy from Penn State University contended, "If we are going to let data guide us, we have to get to some specific categories to have some guidance." Dr. Henry Anderson from the Wisconsin Department of Health and Social Services reported, "We need to move away from the broad view to some specific, high-priority activities."

Regarding the role of the "helping" professions, Rodney Gilmore from the North Dakota State Department of Public Health related, "We learned that in order to keep a good surveillance system going, you must keep direct and frequent contact with the medical facilities and with the providers who are giving you the information." Dr. Eugene Freund from NIOSH suggested, "Inasmuch as the nurses, through their interactions with providers, can do case surveillance, they can help with the recognition of problems that may not be identified in the community."

► **RESEARCH TO FIND ROOT CAUSES.** A principle that emerged at the Conference was to base actions on facts. Research is a way of finding the facts, and through research, we work to understand the causes of work-related diseases, injuries, and hazards; detect their vulnerabilities to prevention; and discover, assess, and improve measures to reduce them. Dr. Lorann Stallones from Colorado State University reported, "National policy guidance is needed in order to provide focus for targeting proper areas of research and to define the scope of research to be performed within priority areas."

Regarding high technology, Dr. Ronald Eckoff of the Iowa Department of Public Health introduced two speakers saying that they, ". . . will reveal changes in the agricultural work place as it is affected by new and different crops and by biotechnology." Dr. Daniel Kugler from the Office of Agricultural Materials at the U.S. Department of Agriculture noted, ". . . that agriculture, indeed, is a very high-tech business." Dr. Jane Rissler from the National Wildlife Federation challenged the Conference with, "I hope that this presentation will provoke a wide-ranging consideration and evaluation of the potential impacts of biotechnology on farm worker health." Regarding noise-induced hearing loss, Dr. Matthew Marvel from the Oneonta Health Center observed that, "We also might find some high-technology solutions like using sound cancellation."

The occupational problems faced by farmers were seen to be numerous, significant, and preventable. Dr. Susanna Von Essen from the University of Nebraska summarized the problems with lung diseases on the farm, "The presence of inflammation is a common theme in these disorders." Other problems were addressed by Dr. Linda Rosenstock from the University of Washington when she maintained that, "On the basis of this study and the accumulating evidence in the medical literature, we feel that even episodes of acute organophosphate poisoning can cause permanent neurologic dysfunction." Dr. Aaron Blair from the National Cancer Institute observed, "A critical role for suppression of immune responsiveness by pesticides has been demonstrated for infectious disease and maybe for other diseases."

The injury problem was addressed by Dr. Sverker Høglund from the Swedish Farmers Safety and Preventive Health Association who explained that, "Machine design may be related to hazards of two kinds. One is accidents causing acute injuries. The other is chronic injuries or illnesses because of long-term, unfavorable effects on the body during work operations." Murray Madsen from Deere and Company observed that, "Sometimes equipment is in mint condition; other times it is not, or modified, or built from scratch in a local shop." Dr. Thomas Bean from Ohio State University reported that, "In either case, the majority of studies indicated that farm equipment was the single factor most associated with on-farm injury." John Crowley from the Equipment Manufacturers Institute urged that, "Behavioral research is needed to guide engineers on how equipment can be designed for safer operation and maintenance."

Dr. Susan Gerberich from the University of Minnesota maintained that, "A major barrier to progress in the prevention of agricultural injuries has not only been a lack of knowledge about the magnitude of the problem but also a lack of knowledge about specific causes or risk factors due to the lack of analytical studies." Penn Peters of the U.S. Forest Service stated that, "A high-priority research area is in the injuries that result from a felled tree having hit another tree, which includes hangup fell, broken limbs or tops, and butt rebound."

Regarding the hazards of overhead electrical lines, Robert McLymore from North Carolina State University remarked, "That moment of carelessness may end up with that piece of equipment getting in contact with that line. We know how electricity kills." Governor Robert Ray, Chairman of the National Advisory Committee on Rural Health

## Foreword

Policy, observed that, "the suicide rate for farmers is now 30 to 40 percent above the national non-farm rate."

Dr. David Cochran of the Occupational Safety and Health Administration recounted a conversation, "She was telling me that the top occupational category suffering from tendinitis in the state of Washington is farmworkers." Regarding greenhouse workers, Dr. John Coumbis of the Agency for Toxic Substance and Disease Registry related that, ". . . you find some of the reports of back pain in roughly a third of the work force, pain in multiple joints in 19 percent, pain of the upper extremities in 11 percent of the workers, lower extremities in 8 percent, and neck pain in 2 percent."

► **RESPECT PEOPLE WHILE CONTROLLING THE PROBLEMS.** Another principle that emerged overwhelmingly at the conference was respect for people, and also consistent with our Conference theme of *A National Coalition for Local Action*, our intervention must be based upon such respect.

Speaking to this theme through a video message, Secretary Louis Sullivan of Health and Human Services stated, "The key to making those strategies effective—the critical, vital factor that will determine our success in lowering the risks of agricultural work—is local initiatives and efforts." Assistant Surgeon General William Roper declared, "As the theme of this meeting, *National Coalition for Local Action*, clearly portends, the foundation of our public health system, as it functions in agriculture and other sectors, must be the local public health agency."

Dr. James Dosman from the University of Saskatchewan recommended, ". . . the establishment of health and safety committees at the local level, organized by target populations, for the purpose of identifying issues, facilitating programming, and achieving results." Referring to agricultural workers, Ellen Widess' Children's Advocacy Institute contended, "Unless we also deal with those economic realities of their lives and their limited choices, we will fail in our efforts to improve health and safety."

Regarding networking and community involvement, Dr. Dean Stueland from the National Farm Medicine Center related, "We need to close the loop between what is happening on the farm and what is happening in medicine so that people understand each other." Wayne Sprick of the National Young Farmer Educational Association said, "The FFA chapters and those younger people are looking for opportunities to conduct community-service types of projects." Robert Graham with the National Vocational Agriculture Teachers' Association commented, "We encourage students to sit down and do a community review by interviewing resource people with organizations, such as the community health organizations, the district representatives of OSHA and NIOSH, the Farm Bureaus, and National Grange Affiliates." Valerie Wilk from the Farmworker Justice Fund reported, "In a number of the workshops there were very concrete examples of groups who had worked in coalition, either within their community or statewide, on particular health and safety issues: workers' compensation or field sanitation."

Gene Graham with the W.K. Kellogg Foundation challenged the Conference, ". . . (how can we) develop meaningful opportunities for enfranchisement, access to the institutions of society, and the much needed occupational safety and health interventions for migrant and seasonal workers?" Craig Merrilees with the Consumer Pesticide Project contended, "Health and safety improvements come only when people are organized and when they are able to control their own destiny." Thomas Seymour from the Occupational Safety and Health Administration observed, "In the OSHA history of writing rules, regulations and enforcement, we have found that the people who are interested in trying to correct these problems need to be on board and in support of the process."

Regarding the issue of training, Cynthia Douglass from the Occupational Safety and Health Administration conveyed, "The answer lies in education, training, and increasing awareness of those hazards and how they can be reduced." Malanie Zavala from the University of California-Davis pointed out that, ". . . a lot of these people come here without an excellent education, and this is going to make a difference as to what they can understand in terms of reading—not so much in terms of spoken language, I think, but in terms of things that they are going to have to read."

On children and women, Marilyn Adams of Farm Safety for "Just Kids" proposed, "My experience with the youth tells me that they are our best bridge to the farm family. If you take this one step further and train farm women in tractor safety, chemical safety, rescue, and the other aspects of farming along with the youth, Dad and Grandpa will not have a chance after we start rocking the boat and making waves." Surgeon General Antonia Novello declared, "As a woman, I totally agree with the philosophy of Marilyn Adams' group, Farm Safety for "Just Kids," who say that the one person on a farm who can play the most pivotal role in educating farmers and farm children about the dangers of working on a farm is the woman." Nineteen-year-old Mark Timm from the National FFA Organization related, "Not only does America need its young, but young people need your help, support, guidance, and leadership." Dr. Walter Armbruster of the Farm Foundation observed, "We also know that reaching adults through youth is a very effective channel for modifying adult behavior."

► **UNDERSTAND "THE SYSTEM" IN ORDER TO CONTROL THE PROBLEMS.** A general principle that emerged was to develop win-win situations by understanding the system, recognizing people as part of the system, and intervening early in that system in its design.

Dr. Rice Leach, Chief of Staff to the Surgeon General, in speaking to a 'win-win' strategy conveyed it succinctly, ". . . I submit that the purpose of this endeavor or our mission is to prepare the next generation to live in harmony with nature." Judith Heffernan of the University of Missouri-Columbia remarked, "There is a social movement afoot that looks at environmental and food safety and a whole host of issues that are . . . put together, and so pesticide usage and water quality—and you know the litany—we have heard much of it here." Dr. Robert Pinger from Ball State University reported, "Integrated Pest Management is the use of the safest and most appropriate

combination of methods (physical, chemical, and biological) to control vector populations."

Dr. Kelley Donham from the University of Iowa reported, "One of the items that came out of the group was a call for a sustainable human resource in agriculture. This was based on an analogy to the sustainable agriculture movement from a natural resources conservation perspective." Larry Belmont from the Idaho Panhandle Health District 1 stated, "Our next best alternative is to develop new solutions or new systems of service to cover those areas."

Recognizing human behavior as an important part of the system, Dr. Robert Aherin from the University of Illinois propounded, "This theory has proven that intention is strongly correlated to one's behavior and behavioral intentions are formed by two basic determinants, one personal in nature and the other reflecting social influence." Assistant Surgeon General Michael McGinnis offered an avenue for prevention by noting that, ". . . the prominent role of behavior in health threats is not novel or unique, some of the lessons that can be gleaned from other public health areas may be germane to the kinds of approaches that we seek to establish for agricultural health and safety." In contrast, Dr. Pamela Elkind from Eastern Washington University contended, "This assumption, simply stated, is that to make agriculture safe for the farm families and workers, it is necessary to motivate them to protect themselves from health and safety hazards . . . I shall attempt to demonstrate to you that these assumptions lack validity."

Regarding design, Dr. David Pratt of the New York Center for Agricultural Medicine and Health reported, "Intervention strategies are most effective when they are applied early in the process." Dr. Gary Erisman, a private farmer, declared, ". . . design is the most critical stage for the prevention of hazards and hazardous products." Ray Crammond, consulting engineer, said of design, "I think the biggest problem is people who ignore the human input." Rollin Schnieder from the University of Nebraska stated, "You have to realize that a lot of the equipment that we have in agriculture is not totally designed." Professor Stephan Konz from Kansas State University maintained, "Designing out the problem is the best approach because it is a permanent solution." Dr. Richard Fenske from the University of Washington said, ". . . there are many opportunities, if we are creative, to reduce the hazard before we ever have to worry about personal protective equipment." Dale Baker from J.I. Case Company challenged the Conference, "Is anyone going to invest the time and effort to develop new designs unless there is, in fact, a demand?"

## **THE PROBLEM: DISEASE AND INJURY**

To help establish priorities for the field of occupational safety and health, NIOSH in 1983 developed a list of 10 Leading Work-Related Diseases and Injuries and proposed national strategies to prevent each of them. NIOSH invited leading experts to improve

and elaborate on these strategies at two national symposia held in 1985 and 1986.<sup>1</sup> The initial list was based upon three criteria: the scope of the problem, the severity of the problem in the individual case, and the vulnerability of the problem to prevention. More recently, infectious diseases have also emerged as a significant problem in occupational safety and health.<sup>2</sup>

The problem is disease and injury, our common enemy. We have seen how this enemy attacks American agricultural workers and their families. Recognized at this Conference were a number of The Leading Work-Related Diseases and Injuries:

1. Occupational Lung Diseases – farmers’ lung, asthma, hog lung, silo fillers’ disease, etc.
2. Musculoskeletal Injuries – milkers’ knee, tractor drivers’ syndrome, tendinitis, repetitive motion trauma, etc.
3. Occupational Cancers – skin, bladder, and brain cancer, leukemia, etc.
4. Severe Occupational Traumatic Injuries – machine-related fatalities, electrocutions, suffocations, suicides, amputations, eye injuries, etc.
5. Occupational Cardiovascular Diseases – heat stroke.
6. Disorders of Reproduction – miscarriages, infertility, etc.
7. Neurotoxic Disorders – dementia, neurologic dysfunction, etc.
8. Noise-Induced Hearing Loss
9. Dermatological Conditions – burns, lacerations, dermatitis, etc.
10. Psychological Disorders – depression, stress, etc.
11. Infectious Diseases – zoonosis, tuberculosis, etc.

## **A VISION FOR THE FUTURE**

In 1990, the Congress directed NIOSH to lead a comprehensive national program to prevent occupational injuries and diseases in agriculture. NIOSH gains its authority for responding to this direction from the Occupational Safety and Health Act of 1970, which

---

<sup>1</sup> *Proposed National Strategies for the Prevention of Leading Work-Related Diseases and Injuries*. Part 1 in 1986 and Part 2 in 1988, Published by the Association of Schools of Public Health under a Cooperative Agreement with the National Institute for Occupational Safety and Health.

<sup>2</sup> For an example related to agricultural workers see: Centers for Disease Control. "Prevention and Control of Tuberculosis in Migrant Farm Workers: Recommendations of the Advisory Council for the Elimination of Tuberculosis," *MMWR* 1992;41 (No. RR-10).

## Foreword

established the national goal "to assure so far as possible every working man and woman in the Nation safe and healthful working conditions and to preserve our human resources."

NIOSH is charged in the Act to undertake scientific activities that will enable the goal to be won. In response to this charge, NIOSH identifies those populations at highest risk, defines risk factors that guide our efforts to reduce those risks, and provides information to whomever has the ability to act in preventing the problem.

The Surgeon General's Conference of 1991 has established a national commitment to the continuous improvement of safety and health among agricultural workers and their families. It is a "Total Quality" commitment! As a result of the Conference, the Surgeon General has identified a VISION for a national program for agricultural safety and health in America:

*To continuously and measurably improve the safety and health of every working man and woman in American agriculture through the prevention of Leading Work-Related Diseases and Injuries consistent with the goals and objectives of 'Healthy People 2000.'*

In 1991, the U.S. Public Health Service published a report, *Healthy People 2000: National Health Promotion and Disease Prevention Objectives*. This document is a statement of national opportunities. This report is not intended as a statement of Federal standards and requirements, but as a product of a national effort that involved over 10,000 people. The Surgeon General addressed three overarching goals from this report in the *Preface*. These goals are buttressed by specific and substantive objectives, which are aimed at guiding decisions about programs, resource allocations, and professional and personal commitments.

The objectives enumerated in *Healthy People 2000* deal with **Health Status, Risk Reduction, Services and Protection, and Surveillance**. The Health Status Objectives address the problem of disease and injury, the Risk Reduction Objectives address the control of the causes of the disease and injury problem. The Services and Protection Objectives relate to the processes that require improvement so that risk can be reduced. The Surveillance Objectives address the process of diagnosing and reporting information about health status, risk reduction, and services and protection so as to better guide and focus our intervention to control disease and injury.

With the vision of the future in mind, *FarmSafe 2000* is a program commitment to *Healthy People 2000*. Consistent with this commitment, we have listed, as illustrative examples, 11 Health Status Objectives for the year 2000 that correspond with the



problem, the 10 Leading Work-Related Diseases and Injuries plus infectious diseases.<sup>3</sup> Each objective represents a significant improvement in health status over an existing baseline by the year 2000.

1. Occupational Lung Diseases – Reduce asthma morbidity, as measured by a reduction in asthma hospitalizations to no more than 160 per 100,000 people (11.1).
2. Musculoskeletal Injuries – Reduce cumulative trauma disorders to an incidence of no more than 60 cases per 100,000 full-time workers (10.3).
3. Occupational Cancers – Reverse the rise in cancer deaths to achieve a rate of no more than 130 per 100,000 people (16.1).
4. Severe Occupational Traumatic Injuries – Reduce work-related injuries resulting in medical treatment, lost time from work, or restricted work activity to no more than 6 cases per 100 full-time agricultural workers (10.2c).
5. Occupational Cardiovascular Diseases – Reduce stroke deaths to no more than 20 per 100,000 people (15.1).
6. Disorders of Reproduction – Reduce the prevalence of infertility to no more than 6.5 percent (5.3).
7. Neurotoxic Disorders – Reduce nonfatal poisoning to no more than 88 emergency department treatments per 100,000 people (9.8).
8. Noise-Induced Hearing Loss – Reduce significant hearing impairment to a prevalence of no more than 82 per 1,000 people (17.6).
9. Dermatological Conditions – Reduce occupational skin disorders or diseases to an incidence of no more than 55 per 100,000 full-time workers (10.4).
10. Psychological Disorders – Reduce suicides to no more than 10.5 per 100,000 people (6.1).
11. Infectious Diseases – Reduce tuberculosis to an incidence of no more than 3.5 cases per 100,000 people (20.4).

Another Health Status Objective, which would be classified under Severe Occupational Traumatic Injuries, is to reduce deaths from work-related injuries to no more than 4 per 100,000 full-time agricultural workers. There was an annual average of 6 deaths per 100,000 for the period, 1983 to 1987. The next issue that I will discuss relates directly to this objective.

---

<sup>3</sup> Each Objective is parenthetically followed by an identifying number. This number uniquely identifies each Objective within the document: U.S. Department of Health and Human Services, Public Health Service. *Healthy People 2000: National Health Promotion and Disease Prevention Objectives*. 1990; DHHS Publication No. (PHS) 91-50212, Washington, DC: Government Printing Office.

## AN "OCCUPATIONAL OBSCENITY"

One final issue that was raised at the Conference cannot go without special mention. Amidst expressions of anguish and pleas for reason, there was an overwhelming interest in a particular issue, namely the need to reduce the risk of fatalities related to tractor roll-overs.

Deaths from tractor roll-overs are the leading cause of traumatic fatalities on the farm. There is no acceptable excuse for the persistence of this problem as deaths from tractor roll-overs are fully preventable. The problem justifies the term, "occupational obscenity." Twenty-seven speakers at the Conference addressed this problem. Categorized by the six principles that emerged as unifying concepts at the Conference, here is what they said:

### ► CONTINUOUS IMPROVEMENT THROUGH PREVENTION.

*A good example of the need for such a model is the prevention of tractor roll-over deaths through the application of roll-over protective structures (ROPS) on both new and older tractors. The epidemiological evidence for the very significant risk posed by tractors without ROPS is clear . . . The data available from Sweden, which mandated such a program, makes it equally clear that ROPS can prevent almost all tractor roll-over deaths. An important question for this conference is whether an American intervention model can be developed that can produce a significant reduction of tractor roll-over deaths and injuries. A second question, with much broader ramifications, is, "If we cannot develop a U.S. model for a proven intervention on the single most important cause of agricultural mortality, how can we succeed in addressing less dramatic yet still important causes of agricultural diseases and injuries?"*

— Dr. James A. Merchant  
Director, Institute of Agricultural Medicine and Occupational Health  
The University of Iowa

*In Sweden in 1959 the law was put forward concerning safety frames (ROPS) in new tractors. It was also decided that employed agricultural workers were not allowed to work in tractors lacking such frames. Self-employed farmers and family members for many years were excluded from this law and could use old tractors without frames in farm work. A new tractor, of course, had this device. In 1983 the law was extended to include family farmers. It was later decided that even old tractors had to have frames if they were to be used in agricultural work. The effect on fatalities due to tractor turn-over since the year of legislation was striking. It is obvious that this action from the authorities, unpopular as it might have been, has had quite a significant effect in preventing severe accidents.*

— Dr. Sverker Hoglund  
Director, Swedish Farmers Safety and Preventive Health Association  
Stockholm, Sweden

### ► RECOGNIZE THE NEEDS OF THE POPULATION AT RISK.

*Even though the land is so flat, we still have a tendency to have tractor roll-overs in the eastern part of the state . . . Tractor roll-overs are still a major source of fatalities in the state.* — Rodney Gilmore  
Injury Control Program Manager  
North Dakota State Department of Public Health

*Bob Aherin said something about ROPS that really interested me. He said to identify the farmers with high risk exposure and to identify appropriate intervention strategies . . . As a farmer, this makes much more sense to me than suggesting that all farmers should put ROPS on all tractors.*

*We need to start somewhere and give the farmer a realistic picture of the high-risk exposure with all tractors with end loaders or whatever the highest risk is . . . I heard Wes Buchele address the issue of retrofits. By all means, guarding for the older equipment needs to be made accessible and marketed. It is my personal feeling that dealers should not resell equipment without all protective shields. They have a responsibility to their customers to market the proper shielding for their own products.*

— Marilyn Adams  
President, Farm Safety for "Just Kids"

*Farm children have been injured and killed for years. I was too young to remember a tragic tractor roll-over accident that claimed the life of our neighbor's son. Years later I remember finding the yellowed and brittle newspaper articles about it that my mother had saved. On looking back, I think that that accident may have had a lot to do with the fact that my brothers were not expected to function as hired hands at a young age . . . When asked, "If cost were not a consideration, would you use roll-over protection?" 89 percent said they would; 96 percent would use safety shielding; and 50 percent would use day care. These figures may be slightly high. We all know it is good to have good intentions.*

— Cheryl Tevis  
Senior Farm Issue Editor  
Successful Farming Magazine

*We have had a great deal of discussion, in this session, about ROPS. We have all seen the slide, many times, of the success of ROPS in Sweden. In 1985, we had a commitment by the North American tractor manufacturers to make ROPS standard on all tractors. With a few exceptions of tractors that are being imported into this country and those that are for orchard applications, all tractors since that time are equipped with ROPS. By 1970, ROPS in this country became available on virtually all major manufacturers' product lines. There was no demand for them. Therefore, we have a significant number of tractors in operation in the U.S. that were built in that interval between 1970 and 1985 that are not equipped with ROPS. I would suggest, in gross terms, that there are about a million tractors that are equipped with ROPS or that have ROPS built into the cab. About a million tractors that are out there could have a ROPS installed on them but do not. Another million tractors that are in use were built prior to this introduction of ROPS and here installation of ROPS becomes a real technological issue. Now we should look at those two issues separately.*

*In putting ROPS onto tractors that were built prior to 1970, there are some significant technical issues. Will the tractor structure survive an impact with this ROPS attached? The structure was not built for that kind of use. New frames could be designed, possibly, to accommodate the design by sharing the load forward to the transmission housing. There is now a need to develop that new structure. There were many applications for those old tractors where implements were attached to the same location that we would attach this ROPS structure. If you destroy that, you have destroyed the utility of that tractor. There is also the issue of the economics of putting those ROPS on old tractors. If there is to be a program of that nature, it is going to have to start with the development of some public policy change that will create that demand. Is anyone going to invest the time and effort to develop new designs unless there is, in fact, a demand?*

*The issue for tractors built in the interval between 1970 and 1985 where a ROPS can be installed becomes an issue of how to create an environment where the public demands those ROPS. They are available. A demand undoubtedly could bring down the cost that was mentioned earlier. Until there is a demand, there will not be any initiative that will cause that to happen. It is the chicken and the egg situation. If you could decrease the cost, maybe you could increase the demand. You*

*cannot decrease the cost, however, until there is a demand. We are now again looking at what is a public policy issue of how you create that demand. I would say to you that my brother is aware of the issues of ROPS and tractor overturns. But fatal tractor overturns are a rare event (a farmer is far more likely to be killed in a car accident than a tractor overturn). Virtually all farmers are aware of the issue of fatal tractor overturns in the same sense that farmers (and the general public) are aware of the issue of cigarette smoking causing cancer.*

— L. Dale Baker  
Product Safety Engineer  
J.I. Case Company

► SURVEILLANCE TO MEASURE IMPROVEMENTS.

*For many conditions we are at different surveillance stages in this scheme. For one condition that we have heard much about, that of farm fatalities due to tractor roll-over, we have identified the problem, we largely know the scope of the problem, and we know what needs to be done to target interventions.*

— Dr. Henry A. Anderson  
Chief, Section of Environmental Epidemiology  
Wisconsin Department of Health and Social Services

*For example, in 1958, Sweden instituted a law that any new tractor that was produced had to have roll-over protection. In the years thereafter, surveillance data indicate a decline in roll-over fatalities. In 1978 Sweden instituted another law that any tractor in use had to have roll-over protection, and the problem was eradicated.*

— Dr. William E. Halperin  
Associate Director for Surveillance  
Division of Surveillance, Hazard Evaluations, and Field Studies  
National Institute for Occupational Safety and Health

*The Olmstead Agricultural Trauma Study provided the basis for the Regional Rural Injury Study, currently being conducted in a five-state region: Minnesota, Wisconsin, North Dakota, South Dakota, and Nebraska. Data collection covers a twelve-month period of time for over 4,000 rural households, utilizing computer-assisted telephone interviews. This effort will enable the identification of injury rates for each state and the region as well as multiple analytic substudies, including tractor-roll-overs and animal-human injuries. The project also includes application of the results to the development of intervention strategies, to be achieved by convening nationally recognized experts and the regional participants in the Agricultural Injury Intervention Strategy Workshop.*

— Dr. Susan Goodwin Gerberich  
Division of Environmental and Occupational Health  
School of Public Health, University of Minnesota, Minneapolis, Minnesota

*We will look at safety risk factors, injuries, ergonomics, roll-overs, power-take-off's, and secondary occupations.*

— Todd M. Frazier  
Chief, Surveillance Branch  
Division of Surveillance, Hazard Evaluations, and Field Studies  
National Institute for Occupational Safety and Health

*They (nurses) can identify that as a problem and trigger efforts to prevent it from happening again. Since they will be located in their own regions, they will often be able to identify all cases of a given condition, tractor roll-overs or power take-off injuries. They can identify the scope of those problems, use that information to target intervention efforts, and after intervention efforts, evaluate how effective they have been . . . The Extension service have people who know how to retrofit tractors with roll-over protection, if that is something someone wants to do.*

— Dr. Eugene Freund  
Medical Officer, Surveillance Branch  
Division of Surveillance, Hazard Evaluations, and Field Studies  
National Institute for Occupational Safety and Health

► RESEARCH TO FIND ROOT CAUSES.

*Farm equipment accounted for 40 to 60 percent of deaths and injuries in the majority of studies, followed very closely by livestock injuries and falls. Numerous types of farm machinery have been implicated in all studies. Since the majority of farm machinery is associated with tractors, it stands to reason that injuries "involving" tractors were the most common type of machinery-related trauma. Tractor over-turns, it appeared, were involved in the majority of agricultural fatalities. Many studies indicated that youth and the elderly were most often associated as an at-risk population . . . The studies varied, though, when you compared those using statistics from government agencies that were not gathering the appropriate and associated data with youth . . .*

*The opportunity presents itself to include some homespun theory. This happens to be a theory of mine: on family farms, older tractors and equipment are often reserved for general duty while newer pieces of machinery are delegated to more production types of tasks. The general duty may be more hazardous than the normal production tasks on farms. As a result, general duty is often done by the youth or the elderly. The typical farmer, the principal operator, is using the newer machinery to plow and till the field, etc., while the older machinery may be relegated to cutting the fence rows or ditch banks and stationary operations that may be more hazardous than doing field-related operations. As a result, when you combine the inexperience of youth and the diminished capacity that comes with aging (because the elderly or youth usually do this general duty) with the inherent danger of the equipment, you have an increased potential for trauma . . . Research on roll-over protection on older tractors should continue.*

— Dr. Thomas L. Bean  
Safety Leader, Ohio Cooperative Extension Service  
Ohio State University

*Dr. Bean stressed the need to install ROPS on farm tractors . . . "ROPS is a proven intervention strategy. Why can we not implement it?" Is the problem the cost, the infrastructure, the regulation, or the legal system?*

— Penn A. Peters  
Project Leader  
U.S. Forest Service

*In the late 1950's and early 1960's, extensive research and development work was done by the industry to establish the efficacy of ROPS designs for the kinds of tractor overturns that can occur in normal farming and road transport. Manufacturers began supplying ROPS commercially in the late 1960's. The experience in both the United States and Europe has proven ROPS to be an effective safety device.*

*There is a need for additional research on small tractors' ROPS. The standard "protective zone" around the tractor operator, which controls the size of the ROPS envelope, was defined on the basis of the ergonomic data that existed in the 1950's and 1960's. The zone remains essentially unchanged today. The Equipment Manufacturers Institute (EMI) sponsored a literature review of the different protective zones used for the design of several kinds of vehicles, including aircraft, automobiles, racing cars, farm equipment, construction equipment, and mining equipment. This study, which was performed by Triodyne, Inc. of Skokie, Illinois, has been completed. Publication will be through both the Society of Automotive Engineers (SAE) and the American Society of Agricultural Engineers (ASAE) before the end of 1991. The basic conclusion of the Triodyne study was that it did not appear, from the kinds of systems that are in place, that sufficient research had been done that could serve as the basis for making the protective zone of a ROPS, as specified by current standards, for smaller for small tractors. Small tractors are often used in low overhead clearance settings—in vineyards, orchards, storage buildings, and machine sheds.*

*The higher the profile of a ROPS relative to an overhead object such as a tree branch, the greater the likelihood that a farmer will not want to equip a tractor with ROPS or, if there is one on a tractor, to keep it in place. Clearly, there is potential safety value in making the ROPS as compact as possible without compromising protection in the event of a tip-over. As Murray Madsen mentioned in his presentation, one approach to addressing this situation is to make ROPS that can be raised or lowered. They telescope or fold down for temporary use in the lowered position under low clearance conditions. There are some companies that have such ROPS on the market today. Industry's research capabilities concerning ROPS are limited to mechanical and structural aspects. There is little more to be done there with the exception of the small tractor ROPS.*

*Accident data identify tractor roll-overs as the leading cause of machinery-related death on the farm. Therefore, perhaps the most pressing challenge for behavioral researchers and health professionals is to find an effective way to ensure, short of compulsory measures such as regulation, that ROPS are installed and kept on tractors. EMI believes that behavioral research in this area holds promise of effecting a substantial reduction in roll-over injury and fatality rates. The starting point for such research, we submit, may be recognition that over one million of the approximately 3.6 million agricultural tractors in use today in the United States do have ROPS on them. There are over one million farmers who chose to equip their tractors with ROPS when they purchased them. The question should be asked how these farmers arrived at their decision to equip the tractors with ROPS. Was it because of the Occupational Safety and Health Administration's (OSHA) rule? Was it because manufacturers were able to package the ROPS in a cab that was noise-insulated and isolated from vibration of the tractor? It provided air conditioning, heating, and stereo; i.e., it was made so attractive in other respects that the farmer was willing to pay for the ROPS cab.*

*Or were there other factors? The key to getting ROPS on the over-2.5 million tractors that do not now have them may indeed be found by examining the factors in the decisions of the approximately one million farmers who did decide to equip their tractors with ROPS. The third essential criterion is that a safety device must not by its presence, introduce different risks that would not exist without it. Murray Madsen referred to a study that showed that some accidents occurred because of an operator presence-type device.*

*I am reminded of a situation that existed several years ago when OSHA, with all good intent, promulgated its ROPS rule for agriculture. As it turned out, there were some small tractors that had backhoes mounted to the three-point hitch, with a separate seat for the operator affixed to the backhoe frame behind the tractor. Without the ROPS there was not any problem. It was discovered that when a ROPS was installed on a tractor with the threepoint-hitch-mounted backhoe, a crush point between the elevating backhoe boom and the rigid ROPS structure was created. A number of fatalities occurred because of that condition. The solution was to do away with the three-point-hitch-mounted backhoe or redesign the ROPS or both. A combination of these measures was implemented through various field rework programs to eliminate the hazard. When tractor ROPS were being developed, manufacturers' test programs included actual roll-overs of tractors with experimental ROPS designs at different attitudes and speeds. There is a need, in many cases, to verify that a new safety feature will be acceptable to the farmer.*

— John H. Crowley  
Director of Safety Programs  
Equipment Manufacturers Institute

*It has been learned in recent times that attitude measures do not correspond with behavioral criterions. The early attitudinal studies would evaluate a very general behavioral statement. An example of this would be when evaluating the potential purchase of ROPS on a tractor a subject*

might be asked to evaluate a statement such as, "Roll-over protective structures are \_\_\_\_\_." A more appropriate evaluative statement for predicting ROPS purchasing behavior would be to ask farmers their attitude toward buying roll-over protective structures. The attitude question would look as follows: "My buying a roll-over protective structure in the next two years for one of my non-ROPS equipped tractors is \_\_\_\_\_." The attitudinal question must match the corresponding behavioral criterion in terms of 1) action, 2) target, 3) context, and 4) time. In the previous example the action was "my buying," the target was "ROPS for one of my (the subject) non-ROPS equipped tractors," the context was "general," and time was "within the next two years."

In summary, there may be a substantial difference between people's attitudes toward objects (in this example, ROPS) and people's attitudes toward behaviors associated with objects (in this example, buying ROPS). To predict behavior, this distinction is crucial. An example of an issue that might benefit from Theory of Reasoned Action type of analysis would be the installing of ROPS on tractors. Tractor roll-overs are a major factor in farm work-related deaths. It is well known that if a tractor has a ROPS it almost eliminates the death potential in a tractor roll-over incident. But only about 30 percent of the farm tractors in the United States have a ROPS. Thus, at issue is what it would take to persuade farm tractor owners to install a ROPS on non-ROPS tractors. There have been significant educational programs to promote the purchase of ROPS among farm tractor owners. But there has been no significant increase in the retrofitting of ROPS on non-ROPS equipped tractors. If an analysis was conducted among US farm tractor operators utilizing the Theory of Reasoned Action, one could learn what intervention initiatives would be necessary to effect a significant change in this behavior. For example, it could be learned how much if anything farmers would be willing to spend for a ROPS, their general perception of the need for ROPS on their tractors, tractor use problems that they may encounter with ROPS, and so on. This type of information would provide focus for initiatives to deal with this issue rather than using the traditional "shotgun" approach of trying anything and seeing if it works.

— Dr. Robert Aherin  
Professor, Department of Agricultural Engineering  
University of Illinois

#### ► RESPECT PEOPLE WHILE CONTROLLING THE PROBLEMS.

Again, economic realities make choices very difficult. Take for example, ROPS protection. Most farmers know the dangers and would willingly retrofit their tractors, but there is economic reality.

— Ellen G. Widess  
Director of Health and Safety Policy, Children's Advocacy Institute  
Center for Public Interest Law

"I think I am going to invest in (it) whatever it costs," although I did hear myself saying to my husband last night, "Honey, we have got to buy roll-over bars." That is on the agenda. But we, with other income, can probably do that; but I know people who are borrowing money to put bread on the table.

— Judith Bortner Heffernan  
Executive Director of Heartland Network for Town and Rural Ministries  
University of Missouri-Columbia

I heard one presenter say that her family was going to buy the roll-over protective device for their tractor. I encourage her to follow through on this commitment.

— Dr. Rice C. Leach  
Chief of Staff, Office of the Surgeon General

When we looked at the tractor roll-over problem with Marshfield, we decided that there was no need for further research on the problem. What we decided we needed was a way to help farmers who wanted to retrofit older tractors with roll bars or other roll-over protective devices to find those

## Foreword

*"ROPS," as they are called. So we asked Marshfield to develop and publish a catalog of all American manufacturers of "ROPS," all products they produce and what make of tractor, model of tractor, and year of tractor they will build. Then Marshfield sent the catalog to all extension agents in the country, so it is available where it is needed. Producing that catalog is not the best step we could take as a society. As we have seen in the slide on the Swedish experience, the best step we could take would be to require "ROPS." But as an Office, it was the best we could do.*

— Jeffrey Human  
Director, Office of Rural Health Policy  
U.S. Public Health Service

*We have also seen ROPS development and the recent development of retractable or foldable ROPS for those essential applications where you must go into a building that is shorter — not as tall as your tractor's ROPS. I would also say to those of you who wonder about ROPS that since 1985 virtually every tractor produced has been sold with a ROPS on it or right at the fingertips. Since 1970, virtually every tractor could have a ROPS put on it, and some have since 1960. Consider, for example, how to convince the owner of a 30-year-old tractor worth, at most, \$1,000, to put a \$500 ROPS on it. The University of Illinois, NIOSH, and the University of Iowa are doing research to help find some of those kinds of answers. A ROPS that provides protection and still meets the needs of users under limbs, vines, and rafters holds promise. It is likely that this kind of roll-over protection will produce more acceptable designs for the user. Perhaps it may not produce as much protection as users have become accustomed to with larger or more conventional roll-over protective structures. Is there an opportunity for validating acceptable ROPS for more compact tractors?*

— Murray Madsen  
Product Safety Engineer for Agricultural Equipment  
Deere and Company

*There are also recommendations aimed at reducing specific hazards, such as the danger of injury or death in tractor roll-over or from moving machinery parts . . . OSHA also reviews existing standards that apply to agriculture, such as the ROPS standard. We look at whether these standards should be modified to reflect changing conditions in the United States, in the world, and in the industry. We need your help, though, on reviewing and modifying these standards, if we are to have good, common-sense safety standards. In another area, a member of our staff has been comparing the new standard on ROPS for tractors and other vehicles, which was adopted by SAE, to the existing OSHA standard. We have received design and test data from American tractor manufacturers and others. We have made a preliminary conclusion that the new SAE standard is equal to or exceeds the current OSHA standard and, therefore, is acceptable to the agency. A final decision on this will be made shortly. Hopefully, this will make it easier for American farm equipment manufacturers to compete in the European market.*

— Cynthia Douglass  
Deputy Assistant Secretary of Labor  
U.S. Occupational Safety and Health Administration

### ► UNDERSTAND "THE SYSTEM" IN ORDER TO CONTROL THE PROBLEMS.

*Look no further than the agriculture-implement lobby here today. This lobby has blocked roll-over protection in this country for 30 years with knee-jerk, protective, self-interested arguments that continue to allow farmworkers to die in this country, out of their narrow interest. That is wrong. The reason that it happened is not because we have not done enough scientific research to document the problem.*

— Craig Merrilees  
Director, Consumer Pesticide Project



*ROPS for tractors and tractor seat-belt use could prevent the majority of tractor-related deaths. Virtually all new tractors sold in the United States have ROPS . . . Because of the relatively long life of tractors, most agricultural tractors in use do not have ROPS in place. Nearly half of the approximately 400 tractor-related deaths that occur each year in this nation involve roll-overs. How do we ensure that the older tractors and machines without these modern safety features get retrofitted with modern safety features when feasible or get taken out of use? The issue of how such updating and retrofitting is practical presents a significant challenge . . . Although more research and more data are needed to direct intervention, we know certain health and safety precautions work; ROPS work.*

— Dr. Myron D. Johnsrud  
Administrator, Extension Service  
U.S. Department of Agriculture

*Perhaps the best example of passive controls is ROPS.*

— Dr. David S. Pratt  
Director, New York Center for Agricultural Medicine and Health  
Cooperstown, NY

*There are some issues, the ROPS issue is the most typical one, that we can approach from a national perspective.*

— Dr. Dennis Murphy  
Professor, Penn State University

*The committee divided itself into working groups to develop suggestions and recommendations in the areas of training, and also in the needs for standards like ROPS and machine guarding. In 1972, the full committee recommended its first standard. They recommended that we do a ROPS rule for farm tractors. The first agricultural standard that OSHA issued under its normal rule-making was the ROPS standard. We proposed that back in 1975, we finalized it in 1975, and it became effective in October, 1976. It dealt with all farm tractors made after October, 1976; they had to be equipped with the ROPS. The standard is based on the ASAE Standard, J11-94. The complete text of that Standard was put into the OSHA standard.*

*Even though tractors were required to have ROPS, we continue to see deaths of tractor operators from roll-overs. We have seen seat belts cut off or cut out; seat belts were not used in several roll-over deaths. Obviously, we have not seen the results that the Swedes have achieved with their standardization efforts. OSHA wants to see its standard evaluated. We want to see this standard looked at very thoroughly to see why it is not working. What can we do to modify it, to make it work, to become more effective? We know that seat belts are considered by many farmers and farmworkers as a hassle in hooking and unhooking, especially when you have to get off the tractor a number of times. The new ASAE Standard, J21-9.4, is a revision of this effort. We have said publicly that the standard is acceptable in meeting our ROPS standard that we require here. We have done that administratively. The International Standards Organization (ISO) is also involved in writing standards for ROPS, and the ISO Standards 5700 and 34-63 are additional new ROPS standards. Our ROPS standard is not as stringent as theirs. In our opinion, if you have a ROPS design that meets all the tests of the ISO Standards, that will be acceptable in meeting the OSHA Standard as well.*

— Thomas H. Seymour  
Fire Protection Engineer, Directorate of Safety Standards  
U.S. Occupational Safety and Health Administration

*Due to engineering advances in the last three decades, farm equipment manufacturers have incorporated more safety devices on their equipment. Integral rotary shields for power take-off shafts and roll-over protective structures for tractors have been two major accomplishments in making farm machinery more user-safe. Since tractor roll-overs are involved in a large portion of agricultural fatalities, elimination of this type of incident alone would cause the death rate on*

## Foreword

*American farms to plunge. But farmers themselves must make the commitment to run a safe operation. When they see the dangers and learn the advantage, safety happens. In Nebraska, for example, university safety experts have conducted 450 tractor roll-over demonstrations since 1970 to convince farmers of the dangers. About 23,000 young people were trained in tractor safety. There have been two known fatalities in this group. The national average for a group that size would be five deaths.*

— Merlin Plagge  
President, Iowa Farm Bureau

In conclusion, I wish to thank CAPT Melvin L. Myers for his hard work in planning and managing both the Surgeon General's Conference on Agricultural Safety and Health and the production of these *Papers and Proceedings*. I also wish to thank the rapporteurs, CAPT Robert F. Herrick, CAPT Stephen A. Olenchock, Mr. John R. Myers, CDR John E. Parker, and Dr. David L. Hard, who assisted with the concurrent sessions and the editing of the papers presented at those sessions.

I wish to thank Ms. Katherine Wilson who coordinated the poster and video tape session and reviewed the abstracts from those posters for this publication. Many others who helped to make this Conference a success are named in the acknowledgements of this document.

But most of all, it was the work of the 540 participants at this Conference who made it a success through honest engagement with the issues and interaction with others. Their names are listed by their respective state near the end of this document. My thanks to all for making this Conference a splendid success in our national movement to improve the safety and health of agricultural workers and their families.□

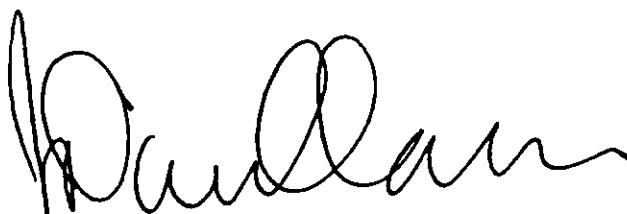

J. Donald Millar, M.D., D.T.P.H. (Lond.)  
Assistant Surgeon General  
Director, National Institute  
for Occupational Safety and Health

## THE PLANNING COMMITTEE

Melvin L. Myers, M.P.A. – Chair  
Office of the Director  
NIOSH, CDC  
1600 Clifton Rd, NE  
Atlanta, GA 30333

Lawrence J. Doemeny, Ph.D.  
Division of Physical Sciences and  
Engineering, NIOSH, CDC  
5555 Ridge Ave  
Cincinnati, OH 45226

Russell E. Savage, Ph.D.  
Division of Biomedical and  
Behavioral Science, NIOSH, CDC  
4676 Columbia Pkwy  
Cincinnati, OH 45213

Robert W. Mason, Ph.D.  
Division of Standards  
Development and Technology  
Transfer, NIOSH, CDC  
4676 Columbia Pkwy  
Cincinnati, OH 45213

Pantelis G. Rentos, Ph.D.  
Division of Training and  
Manpower Development  
NIOSH, CDC  
4676 Columbia Pkwy  
Cincinnati, OH 45213

Robert F. Herrick, Sc.D.  
Division of Surveillance, Hazard  
Evaluation, and Field Studies  
NIOSH, CDC  
5555 Ridge Ave  
Cincinnati, OH 45226

Stephen A. Olenchock, Ph.D.  
Division of Respiratory Disease  
Studies, NIOSH, CDC  
944 Chestnut Ridge Rd  
Morgantown, WV 26505

John R. Myers, M.S.F.  
Division of Safety Research  
NIOSH, CDC  
944 Chestnut Ridge Rd  
Morgantown, WV 26505

Paul Burlack  
Division of Injury Control  
NCEHC, CDC  
2858 Woodcock Blvd  
Chamblee, GA 30341

Katherine Wilson, M.P.H.  
Division for Chronic Disease  
Control and Community  
Intervention, NCCDPHP, CDC  
3005 Chamblee-Tucker Rd  
Chamblee, GA 30341

John J. Coumbis, M.D.  
Oak Ridge Fellow, ATSDR  
1600 Clifton Rd, NE  
Atlanta, GA 30333

William H. Gimson  
Financial Management Office  
OPS, CDC  
255 E Paces Ferry Rd  
Atlanta, GA 30305

Robert A. Wright  
Office of Vital and Health  
Statistics Systems, NCHS, CDC  
6525 Belcrest Rd  
Hyattsville, MD 20782

Stephen M. Ostroff, M.D.  
Division of Bacterial and Mycotic  
Diseases, NCID, CDC  
1600 Clifton Rd, NE  
Atlanta, GA 30333

The Planning Committee

— ADVISORS TO THE PLANNING COMMITTEE —

John E. Parker, M.D.  
Division of Safety Research  
NIOSH, CDC  
944 Chestnut Ridge Rd  
Morgantown, WV 26505

David L. Hard, Ph.D.  
Division of Safety Research  
NIOSH, CDC  
944 Chestnut Ridge Rd  
Morgantown, WV 26505

Stephen Mallinger  
OSHA, US Department of Labor  
Rm N3653  
200 Constitution Ave, NW  
Washington, DC 20210

Bradley K. Rein, P.E.  
Extension Service, USDA  
Rm 3346, South  
14th and Industrial Ave, SW  
Washington, DC 20250

Cathy J. Wasem, RN, MN  
Office of Rural Health Policy  
Health Resources and Services  
Administration  
5600 Fishers Ln, Rm 14-22  
Rockville, MD 20857

Dushanka V. Kleinman, D.D.S.  
Office of the Surgeon General  
USPHS, Rm 710G  
200 Independence Ave, SW  
Washington, DC 20201

Jeffrey H. Lancashire  
Office of the Director  
NIOSH, CDC  
1600 Clifton Rd, NE  
Atlanta, GA 30333

Vivian K. Morgan  
Division of Standards  
Development and Technology  
Transfer, NIOSH, CDC  
4676 Columbia Pkwy  
Cincinnati, OH 45213

Todd M. Frazier, Sc.M.  
Division of Surveillance, Hazard  
Evaluation, and Field Studies  
NIOSH, CDC  
5555 Ridge Ave  
Cincinnati, OH 45226

Ann M. Cronin  
Office of the Director  
NIOSH, CDC  
1600 Clifton Rd, NE  
Atlanta, GA 30333

## ACKNOWLEDGEMENTS

Convening and holding the Surgeon General's Conference on Agricultural Safety and Health was a team effort as was preparing these *Papers and Proceedings*. In addition to the planning committee and their advisors, the presenters, the panel moderators and rapporteurs, and panel members, we wish to thank the following staff to the Surgeon General, NIOSH staff, and editorial advisors for their diligent work for this Conference and for their help in the preparation of this document:

For their willing and timely assistance from the Office of the Surgeon General, Dushanka V. Kleinman, D.D.S., who served as the principle liaison within the Office, Rice C. Leach, M.D., who maintained an open door for resolving the most pressing problems, and for assisting the Surgeon General, Elizabeth P. Schmidt, Theresa Hyatt, and Margaret Garikes.

For their attention to detail and quality from NIOSH, Kimberly L. Barth for her diligent work in assembling and preparing much of the information that proceeded the conference and that is in this document including coordinating its changes; Elizabeth H. Dryden who coordinated with commitment and diplomacy the staff and the logistics of the conference with the contractor; Trevia K. Pereira for her early assistance to the planning committee; René L. Ross for her willing help in formatting the abstracts and appendixes of this document; Amy A. Huston, Julie A. Wasil, and Judy L. James for their assistance in making the many editorial changes during the progress of this document; Ann M. Cronin, Mary B. Griffin, Richie D. Dickerson, Kay Basile, Terry L. Stewart, Terri L. Sims, Kami L. Townsend, and Lunette K. Utter, who helped with the logistics at the Conference; Janice M. Huy, Vivian K. Morgan, and Charlene B. Maloney for their professionalism in preparing and showing the Conference exhibit.

For their assistance as editorial advisors from NIOSH, Newell E. Tozzer, Charlene B. Maloney, Shirley M. Carr, William E. Halperin, M.D., and Richard A. Lemen, Ph.D. For their added assistance as editorial advisors, Henry A. Anderson, M.D., Ph.D., Kelley J. Donham, D.V.M., Lorann Stallones, Ph.D., David S. Pratt, M.D., Walter J. Armbruster, Ph.D., Rice C. Leach, M.D., Cathy J. Wasem, RN, MN, and Valerie A. Wilk, M.S.

And for her superb work as the contractor for this conference, Rosita Bachmann and to her associates.□



## TABLE OF CONTENTS

- iii National Farm Safety Week, 1991: A Proclamation  
*By the President of the United States of America*
- v Preface *By Antonia C. Novello, M.D.*
- vii Foreword *By J. Donald Millar, M.D.*
- xxvii The Planning Committee
- xxix Acknowledgements
- xxxi Table of Contents

- 
- 1 Welcome from the Chair of the Conference *By J. Donald Millar, M.D.*
- 2 Welcome to Des Moines *By John P. Dorrian*
- 3 Welcome to Iowa *By Christopher G. Atchison, M.P.A.*

### THE POTENTIAL FOR A NATIONAL COALITION

*Moderator: Antonia C. Novello, M.D.*

- 
- 7 Raising Safety and Health Consciousness among Farmers and Farmworkers  
*By Ellen G. Widess, J.D.*
- 17 Building Coalitions for Preventing Injury and Disease in Agriculture  
*By Thomas M. Dean, M.D.*
- 22 Disseminating Safety and Health Information through Education  
*By J. Michael McGinnis, M.D.*
- 28 Encouraging Action in Preventing Injury and Disease in Agriculture  
*By Louis W. Sullivan, M.D.*
- 30 Surgeon General Conferences: A Model for the Future  
*By Antonia C. Novello, M.D.*

Table of Contents

**LOOKING AHEAD TO THE NEXT CENTURY** *Moderator: J. Donald Millar, M.D.*

---

- 35 Remarks by the Chair of the Conference *By J. Donald Millar, M.D.*
- 36 Healthy People 2000 and Agriculture *By Senator Tom Harkin*
- 43 Building Infrastructures for Prevention *By William L. Roper, M.D.*
- 48 Charge to the Conference *By Antonia C. Novello, M.D.*

**QUESTIONS TO GUIDE THE NATIONAL AGENDA** *Moderator: Mark Timm*

---

- 55 Remarks by the National FFA President *By Mark Timm*
- 59 The Role of Public Policy in Agricultural Safety and Health  
*By Joseph A. Kinney, M.P.A.*
- 67 Surveillance for Agricultural Safety and Health *By William E. Halperin, M.D.*
- 73 Research for Agricultural Safety and Health *By James A. Merchant, M.D.*
- 86 Intervention for Agricultural Safety and Health *By Myron D. Johnsrud, Ph.D.*

**MEDICAL INTERVENTION PROBLEMS AND OPPORTUNITIES**

---

- 93 Rural Health Policy *By Jeffrey Human, M.A.*
- 97 Medical Intervention Problems and Opportunities in Rural Areas  
*By Governor Robert D. Ray*

**ISSUES THAT AFFECT THE NATIONAL AGENDA**

---

*Moderator: Ronald D. Eckoff, M.D.*

- 105 Introductory Remarks *By Ronald D. Eckoff, M.D.*
- 107 The Agricultural Workforce *By Leslie A. Whitener, Ph.D.*
- 123 Attitudes and Risk Behavior in Agriculture *By Pamela D. Elkind, Ph.D.*
- 129 Industrial Crops of the Future *By Daniel E. Kugler, Ph.D.*
- 134 Biotechnology and Agriculture *By Jane Rissler, Ph.D.*



**PROPOSALS FOR A NATIONAL AGENDA**

---

**1. Surveillance – Agriculture-Related Diseases, Injuries, and Hazards**

*Moderator: Henry A. Anderson, M.D.*

*Rapporteur: Robert F. Herrick, Ph.D.*

- 143 Surveillance: A Physician’s Viewpoint *By John J. May, M.D.*
- 151 Chemical Hazards *By Linda Rosenstock, M.D.*
- 157 Respiratory Diseases *By James A. Dosman, M.D.*
- 161 Surveillance of Injuries in Agriculture *By Susan G. Gerberich, Ph.D., et. al.*
- 179 Musculoskeletal Disorders and Hazards *By John J. Coumbis, M.D.*
- 184 A Government Perspective I *By Todd M. Frazier, Sc.M.*
- 189 A Government Perspective II *By Eugene Freund, Jr., M.D.*
- 192 A Consumers’ Perspective *By Craig Merrilees, B.A.*
- 199 An Agricultural Safety Perspective *By Dennis J. Murphy, Ph.D.*

**2. Research – Chemical and Biological Hazards**

*Moderator: Kelley J. Donham, D.V.M.*

*Rapporteur: Stephen A. Olenchock, Ph.D.*

- 204 Airborne Dusts *By Susanna Von Essen, M.D.*
- 216 Infectious Diseases *By Russell W. Currier, D.V.M.*
- 229 An Overview of Potential Health Hazards among Farmers from Use of Pesticides  
*By Aaron Blair, Ph.D.*
- 243 Gases, Liquids, Vapors, and Drugs *By William Pependorf, Ph.D.*
- 255 The Migrant Workers’ Perspective *By E. Roberta Ryder, B.A.*
- 261 A Foundation’s Perspective *By Gene F. Graham, M.S.*
- 267 A Clinical Perspective *By Dean T. Stueland, M.D.*

### **3. Research – Mechanical and Physical Hazards**

*Moderator: Lorann Stallones, Ph.D.*

*Rapporteur: John R. Myers, M.S.F.*

- 
- |     |                                |                                    |
|-----|--------------------------------|------------------------------------|
| 274 | Farm Machinery and Vehicles    | <i>By Thomas L. Bean, Ph.D.</i>    |
| 278 | Musculoskeletal Hazards        | <i>By David Cochran, Ph.D.</i>     |
| 285 | Electrical Power               | <i>By Robert L. McLymore, M.S.</i> |
| 293 | Noise and Stress               | <i>By Matthew Marvel, M.D.</i>     |
| 299 | Technology Transfer            | <i>By Murray Madsen, P.E.</i>      |
| 308 | The Manufacturers' Perspective | <i>By John H. Crowley, M.B.A.</i>  |
| 317 | A Forestry Perspective         | <i>By Penn A. Peters, P.E.</i>     |
| 321 | A Regulatory Perspective       | <i>By Thomas H. Seymour, P.E.</i>  |

### **4. Intervention – Agricultural Workers' Protection from Hazards**

*Moderator: David S. Pratt, M.D.*

*Rapporteur: John E. Parker, M.D.*

- 
- |     |   |                                     |
|-----|---|-------------------------------------|
| 327 | Farming Methods and Systems Analysis    | <i>By Gary Erisman, Ph.D.</i>       |
| 334 | Ergonomics                              | <i>By Stephan Konz, Ph.D.</i>       |
| 340 | Personal Protective Equipment           | <i>By Richard A. Fenske, Ph.D.</i>  |
| 351 | Machine Design                          | <i>By Sverker Hoglund, M.D.</i>     |
| 357 | Vector Control                          | <i>By Robert R. Pinger, Ph.D.</i>   |
| 365 | A Consulting Engineer's Perspective     | <i>By Ray H. Crammond, P.E.</i>     |
| 372 | An Extension Specialist's Perspective   | <i>By Rollin D. Schnieder, M.S.</i> |
| 378 | An Agricultural Engineering Perspective | <i>By L. Dale Baker, P.E.</i>       |

## 5. Intervention – Safe Behaviors among Adults and Children

*Moderator: Walter J. Armbruster, Ph.D.*

*Rapporteur: David L. Hard, Ph.D.*

- 383 Health Education *By Rodney Gilmore, B.S., B.A.*
- 391 Vocational Agriculture *By Robert Graham, M.S.*
- 397 The Mass Media and Agriculture *By Cheryl Tevis, M.A.*
- 405 Multilingual Training *By Malanie Zavala, B.S.*
- 412 County Health Education *By Larry Belmont, M.P.H.*
- 419 A Rural Sociologist's Perspective *By Judith Bortner Heffernan, M.A.*
- 432 Young Farmers' Perspective *By Wayne Sprick*
- 437 Farm Family Behavior Perspective *By Robert Aherin, Ph.D.*

## ELEMENTS OF A NATIONAL AGENDA

*Moderator: Richard A. Lemen, Ph.D.*

- 
- 445 Surveillance – Agriculture-Related Diseases, Injuries, and Hazards  
*By Henry A. Anderson, M.D.*
- 448 Research – Chemical and Biological Hazards *By Kelley J. Donham, D.V.M.*
- 453 Research – Physical and Mechanical Hazards *By Lorann Stallones, Ph.D.*
- 457 Intervention – Agricultural Workers' Protection from Hazards  
*By David S. Pratt, M.D.*
- 462 Intervention – Safe Behaviors among Adults and Children  
*By Walter J. Armbruster, Ph.D.*
- 466 Report on Migrant and Seasonal Farmworkers *By Valerie A. Wilk, M.S.*

Table of Contents

**ACTIONS FOR THE FUTURE**

*Moderator: Rice C. Leach, M.D.*

- 471 Outstanding FFA Poster *By Rice C. Leach, M.D.*
- 472 OSHA Initiatives in Agricultural Safety and Health *By Cynthia Douglass*
- 479 Sustainable Agriculture and Safety *By Willis R. Eken*
- 485 The Farm Bureau's Continuing Commitment *By Merlin Plagge*
- 489 A Victim's Perspective of the Conference *By Marilyn Adams*
- 492 Conference Summary *By Rice C. Leach, M.D.*

**MAKING CONNECTIONS**

*Coordinator: Katherine Wilson, M.P.H.*

*Co-coordinator: Ann M. Cronin*

- 498 Poster Abstracts
- 582 FFA Poster Abstracts
- 597 Video Presenters

**PARTICIPANTS**

- 601 National Participants
- 620 International Participants

**APPENDIX**

- 621 Acronyms
- 625 Metric System of Weights and Measures
- 627 The Surgeon General's Conferences on Occupational Health *By Anne Mather*
- 629 Excerpts from *Diseases of Workers* *By Bernardino Ramazzini*

- 637 INDEX

## WELCOME FROM THE CHAIR OF THE CONFERENCE

By J. Donald Millar, M.D.

Director, National Institute for Occupational Safety and Health  
Assistant Surgeon General of the United States Public Health Service

---

I am very delighted and proud to welcome you to this Surgeon General's Conference on Agricultural Safety and Health. The nickname is "FarmSafe 2000," and the theme is "a national coalition for local action."

Now all of this is by way of saying that everybody here is interested in preventing the unnecessary wastage of life, limb, and health that is associated with the oldest and noblest occupation—agriculture. Beyond that common interest, we are a very diverse group.

I would wager that some of you never heard, for instance, of NIOSH, the National Institute for Occupational Safety and Health, before this meeting. That is not unexpected, because most of the professional life of NIOSH has been devoted to the problems of smokestack industries—manufacturing, mining, and other occupations—but that is very rapidly changing in this rapidly changing world of ours.

We were created by the Occupational Safety and Health Act of 1970, which sought to "assure safe and healthful working conditions for every working man and woman." So we are obliged at this point in our national history to turn our attention to all problems that create unsafe and unhealthful working conditions for men and women.

That Act created two organizations you may have heard of OSHA and NIOSH;

both are quite different organizations; both are in different parts of the Federal Government, and you will hear from leaders of both during this week.

OSHA is located in the Department of Labor and has responsibility, among other things, for promulgating and enforcing occupational standards.

NIOSH is in the Public Health Service, the Department of Health and Human Services, and is expected to exercise scientific leadership in this field. So we are expected to produce and disseminate scientific information that enables the prevention of occupational diseases and injuries.

Among the things we do best is to convene people, such as at this conference, to bring people together so that they are able to share with each other useful scientific information, which can permit the practice of prevention in every setting where it can be done. So we were very eager when the Surgeon General called on us to sponsor this conference—the first of its kind in agricultural safety and health that has ever been convened.□

Dr. J. Donald Millar: And now it is my distinct pleasure to introduce the convener of this Conference, the Surgeon General of the United States Public Health Service. She is the first woman and the first Puerto Rican to hold the position of Surgeon General. She is a dynamic and vivacious leader in the war against death and disease. I give you the fourteenth Surgeon General of the United States, Dr. Antonia C. Novello:

## WELCOME TO DES MOINES, IOWA

By John P. Dorrian  
Mayor, City of Des Moines

Dr. Antonia C. Novello: Thank you Dr. Millar. Ladies and Gentlemen—I welcome you to the Surgeon General's Conference on Agricultural Safety and Health, the tenth Surgeon General's Conference on Occupational Health, and the first one in 50 years. The last one was convened in 1941, but I will speak further on that history later. I would now like to introduce Mr. Dorrian, the mayor of Des Moines, Iowa. It is a great pleasure for me to be able to introduce him. He is a lifelong resident of Des Moines, and he has served in the city government since 1983. Following service as mayor pro tem, he was elected mayor in 1987. We also know that he currently serves as the Executive Director of the Central Iowa Building Trades. Among his many public service activities, he currently serves on the Governor's Committee of Partnership for Economic Progress. Ladies and Gentleman, I would like to welcome Mr. Dorrian:

Thank you very much. On behalf of myself and all the other members of the Des Moines City Council, I want to welcome you to the City of Des Moines, and a very special welcome to Dr. Novello. Thank you for that nice introduction.

We are extremely proud of our city, and we hope that if it is your first visit to Des Moines you will be pleasantly surprised. If it has been awhile since you have been to the City of Des Moines, then you have seen some good changes take place.

We are the capital city of the State of Iowa, and as the stewards of the capital city, we try to prepare the city well for everyone's visit. We have spent a lot of dollars on the Skywalk System, for example. The weather is pretty good today, but there are days when people really appreciate that Skywalk System. Several miles of it now exist, and it is very expensive to erect, but there is a purpose in mind.

Sometimes it snows in Iowa, and sometimes it gets extremely warm with a little bit of humidity. So we need our Skywalk System. We have a lot of neat things that we hope

you are able to take in while you are here. We even have a horse track running out there; I do not know if any of you are familiar with that or not, but for every dollar that is bet out there my property taxes may not go up—if you have it in your heart to support the horse racing. I have not been out there myself much, but we have a lot of other neat things—the botanical center and the zoo, the libraries, the Governor's Mansion and the Capital Building.

We just have a lot of attractions. We like to keep all these things going, and that is where you can help, if you would have it in your heart to do so. We hope that you will find a place to spend a dollar or two while you are here in our city. But really, we do hope that you have a good conference. I have to apologize because I have to leave. We do hope that you have a good conference, and again, a very special welcome to you to the capital city of Des Moines, Iowa. We are extremely proud to have all of you with us.

We do hope that you have a good conference. Enjoy yourself and come back often. Thank you.□

## WELCOME TO IOWA

*By Christopher G. Atchison*  
Director, Iowa Department of Public Health

Dr. Antonia C. Novello: Governor Branstad was unable to attend the conference today. So, I would like to introduce Christopher G. Atchison, the Assistant Director of the Illinois Department of Public Health, who is here to speak in his behalf. Mr. Atchison has served as the Assistant Director of the Illinois Department of Health since 1987. As Assistant Director, he has been responsible for program development, legislative action and executive implementation of agency programs. He has also served as a chair of the Governor's Interagency AIDS Task Force and was involved in the establishment of the Center for Rural Health. In addition, as a member of the Illinois Public Health Association, he recently worked on a task force to restructure public health in Illinois according to the future of public health reported by the Institute of Medicine. Mr. Atchison has just been appointed as director of the Iowa Department of Public Health and his welcome to us today marks his maiden speech to this state. Please welcome Mr. Atchison:

Thank you, Dr. Novello. Before I officially welcome you on behalf of Governor Branstad to Iowa, I want to acknowledge the work that Dr. J. Donald Millar, who opened this conference and is the Assistant Surgeon General and Chair of this conference, put into organizing this great event. On behalf of the people of Iowa, we thank you for bringing this conference here.

Mayor Dorrian has already welcomed you to Des Moines. On behalf of Governor Terry Branstad and the Iowa Department of Public Health, I want to welcome you to Iowa and to the Surgeon General's Conference on Agricultural Safety and Health.

We, of course, believe it is quite appropriate for this conference to be held in Iowa, a leading agricultural state. Each year Iowa farmers produce more than \$9 billion in crops and livestock. Twenty-five percent of America's pork and eight percent of the nation's grain-fed beef are raised in Iowa. Among the states, Iowa ranks second in the value of agricultural exports, and in 1988, Iowa ranked first in the nation in the production of red meat.

I am pleased to welcome such a broad-based group of individuals to this conference. Represented here today are individuals from 40 states and several foreign countries, evidence that agricultural safety and health is an issue that is not only national but international in scope. Your attendance here demonstrates your commitment to agricultural safety and health.

Though everyone here today may know that agriculture is one of the most hazardous occupations there is, according to the Year 2000 Health Status Objectives, farmworkers suffered 14 injuries per 100,000 during the years 1983 through 1987. The national goal would be 6 in all occupations. So, you can see agricultural injuries are high even in the statistics that we know.

The health objectives further state that agricultural worker deaths may be underestimated because many farm work forces have fewer than 11 workers and are, therefore, not identified by national data systems. The National Safety Council has estimated a rate as high as 52.1 deaths per 100,000 agricultural workers.

## Opening Remarks

Until now, the hazards have been undercounted and largely ignored and underfunded, but that is changing as we can see when we look at the stated purposes of this conference—to raise consciousness, build coalitions, disseminate information, and encourage action to prevent injury and disease related to agriculture—certainly all very worthwhile goals.

Nationally, we are beginning to develop surveillance systems that document the kinds of injuries that are occurring and where they are occurring—efforts that are just beginning to develop interventions and strategies, which will help prevent those injuries and fatalities.

In Iowa, we recently finished the first year of a surveillance program to collect information about agricultural injuries and fatalities, the Sentinel Project Researching Agricultural Injury Notification Systems, which we simplified to called SPRAINS. SPRAINS is the only statewide surveillance program currently in existence, and we have been astounded by some of the figures we have gathered.

We know that there are currently about 116,000 full- and part-time agricultural workers in the state; and there were over 2,000 injuries and over 83 fatalities recorded in 1990. Eleven of these fatalities were children under the age of 15. Of the total fatalities, 51 percent were in the less-than-20-year-old age group and the over-65 age group.

In any other occupation, these people would not be working. However, in agriculture-related occupations, workers span the ages from childhood to the senior years; and apparently young workers and seniors are most vulnerable to fatal injuries.

We must note, because farming has traditionally been a family business, that it is not just the professional farmer, it is the farm family that is at risk for injury. Our statistics show that 70 percent of all injuries are suffered by farm family members—spouses, children, grandpas and grandmas helping out.

The major causes or vectors of injury fall into three groups. Number one is machinery. Number two is animal-related. Number three is falls and slips. Where do the injuries occur? Everywhere from the barn to the pasture. At least in Iowa, no clear pattern has emerged.

Iowa is developing interventions and strategies by building broadbased collaborative efforts. Among the organizations involved in these collaborative ventures are State government, academia, farm organizations, and community-based organizations.

The Governor has appointed a task force to look at our health and safety objectives for the year 2000. The purpose of this task force is to adopt objectives and measures that will guide the planning and allocation of resources throughout the decade, resulting in:

1. Increasing the span of life in Iowa.
2. Reducing health disparities among Iowans.
3. Achieving access to prevention services for all Iowans by the year 2000.

Recently I had the pleasure of meeting with Dr. Richard Remington, who chaired the Institute of Medicine's commission on the future of public health, and the Governor has appointed him the chair of our Year 2000 effort. Dr. Remington and



I hope to build this planning process into the development of programs and projects across all agencies and communities, which are involved in the public health system in Iowa.

We must note, because farming has traditionally been a family business, that it is not just the professional farmer, it is the farm family that is at risk for injury.

Another major collaborative effort, the Iowa Center for Agricultural Safety and Health, ICASH, brings together key organizations concerned with agricultural health and safety. ICASH is a partnership of the University of Iowa, Iowa State University, the Iowa Department of Public Health, and the Iowa Department of Agriculture and Land Stewardship. Its mission is to coordinate the state's resources and to establish programs to improve the health and safety of farm families, farm workers, and the agricultural community.

Some exciting projects ICASH has undertaken include the following:

1. The expansion of the Iowa Agricultural Health and Safety Service Project to a statewide network of hospitals. This project provides comprehensive occupational health and safety services.
2. The development of an illness and injury prevention program for livestock confinement operators.
3. A health and safety program for school classrooms and rural youth groups.
4. Sponsorship of a community-based project to increase awareness of farm machinery hazards.
5. The dissemination of information collected by the statewide agricultural injury surveillance program.

Another collaborative effort is Work Safe Iowa. Work Safe Iowa has established an occupational medicine and associate program at the University of Iowa with the goal of promoting occupational safety and health through education and consultation. The program was designed to assist community hospitals in implementing and strengthening their occupational medicine clinics and related outreach services. In addition, the community hospitals serve as a vehicle to integrate Work Safe Iowa services into local communities.

The Iowa Center for Rural Health and its advisory committee represent another collaborative effort. The Center for Rural Health, located within the Office of Health Planning at the Iowa Department of Public Health, acts as a focal point for the state's efforts in preserving quality health care in Iowa's rural areas. The Center and its broadbased advisory committee strive to identify health needs, build rural coalitions, provide technical assistance to rural areas, administer grants for rural projects, and act as an advocate and information resource with respect to rural health issues.

The Occupational Health and Safety Nurses Program at the Iowa Department of Public Health is the tie between the state and the communities. This program builds on existing rural health programs and links the Health Department to rural health areas.

## Opening Remarks

Yet another community-based program is the Farm Family Risk Assessment and Education Program that is targeted at farm youth. It includes a farm family "safety-walkabout" training program where families learn to recognize existing farm hazards and receive assistance in changing the farm workplace into a safe environment.

Finally, we know that if all prevention interventions have failed, we must turn to Emergency Medical Services (EMS). In Iowa, EMS is a community-based program, and 75 percent of the medical providers are volunteers.

Medical treatment begins at the scene of an injury or illness and can make the critical difference between life and death. EMS has become an even more critical issue to rural Iowa over the last decade, as our population has aged and access to health care has become a pressing concern.

In the movie *Field of Dreams*, Iowa was memorialized when someone asked the hero, "Is this heaven?" and the hero responds, "No, this is Iowa." You and I know that Iowa is not heaven; it is close, but it is not heaven, as our agricultural injury and fatality numbers certainly prove. That is why we must work toward making Iowa and the nation a safe and healthy place to live and work.

Remember, even in the movie *Field of Dreams*, an injury to a farm family member was almost a tragedy. Helping prevent those injuries is our goal and our challenge at this conference.

Once again, on behalf of Governor Branstad and the people of Iowa, welcome to Des Moines and to this conference and to this opportunity to move preventable injury programming out of the big cities and into rural America.□

## RAISING SAFETY AND HEALTH CONSCIOUSNESS AMONG FARMERS AND FARM WORKERS

By Ellen G. Widess, J.D.

Director of Health and Safety Policy, Children's Advocacy Institute  
Center for Public Interest Law

Dr. Antonia C. Novello: Now, we know that in 1990 this conference was authorized by Congress with four purposes, which Mr. Atchison mentioned. The first topic is going to be addressed by Professor Ellen Widess, and she will speak to us on the first topic, which is raising consciousness. Professor Widess brings a breadth of experience to our conference that ranges from managing pesticide regulatory programs to protecting the safety and health of children. Professor Widess received a law degree from the University of California at Berkeley in 1974. Ms. Widess then served on the faculty post until 1978, when she became Chief of the California State Pesticide Regulatory Program within the Division of Occupational Health. From 1984 to 1986, she managed the Workers' Compensation Program for the University of California at Berkeley and later, from 1986 to 1988, managed a similar program for the Texas Department of Agriculture. Also, while in Texas, from 1986 to 1988, Professor Widess directed the pesticide regulatory program for the Department of Agriculture. Last year, she was an adjunct professor of the University of Texas School of Law where she taught, with specific emphasis, on Toxic Torts and Occupational Health. Ellen Widess has come to us today from the Children's Advocacy Institute in San Francisco, where she is Director of Health and Safety Policy. She will speak at this moment on the topic, *Raising Safety and Health Consciousness Among Farmers and Farm Workers*. Professor Widess:

I am very, very pleased to be here. When I was first asked to speak in the place of our new Secretary of Labor, Lynn Martin, I thought it was my fantasy come true. After working for the OSHA Program, I long had a fantasy of wanting to be the Secretary of Labor.

Particularly after toiling, as Dr. Novello has indicated to you, for many years in these various lives trying to address the problems of farmers and farm workers' safety and health, I thought this would be a fabulous chance to clear up the jurisdictional confusion many of us have noted and to determine who protects agricultural workers, who should regulate pesticides and with what standards, and who, in fact, has responsibility for farm safety.

That fantasy lasted only a few moments. Then I came to my senses. It dawned on

me that were I really the Secretary of Labor, I would have to deliver.

I might, in fact, make a few friends, but no doubt I would make more than an enemy or two and be saddled with all the constraints of government. As one who has been a regulator for many years, I am delighted to come today to this conference as an advocate, openly advocating, for the interests of children, who are our future generation.

I am reminded by the line from my old boss, Jim Hightower, former Agricultural Commissioner of Texas, "Ain't nothing in the middle of the road but dotted lines and dead armadillos." I hope today to be a little bit provocative, because I think it is time we got out of the middle of the road. This conference is an extremely hopeful

beginning of a more promising future in this much-needed work.

As Dr. Novello has indicated, I have had a checkered life. I would like to give you some perspective from my work, both in and out of regulatory life. I have worked for OSHA in one life and then for an agricultural department, retreating at various periods to academia—scarred from the regulatory battles—to come back and take stock of what have we accomplished in this regulatory arena.

What were our successes? What are more viable options? What have been the various creative solutions that we have devised?

### **CONSCIOUSNESS-RAISING AMONG FARMERS AND FARM WORKERS**

I had the dubious honor of attempting to regulate pesticides in Texas, which is to most sane people pretty much a mission impossible. This is to try to somehow meet the needs of farmers while also protecting workers, consumers, and the environment. That is a very tough bill. I think we took a number of very creative approaches to that mission, including passing the nation's only right-to-know law.

Though this law was billed as the "farmworker right-to-know law," it clearly provided critical information about pesticides and their health effects to thousands of farmers and farm families in Texas. The children often were applying pesticides where groundwater (and drinking water supply) came from contaminated well waters. They were affected by drift just as farm workers were.

During those years, we also sought to change consciousness, not only among

workers, but among the public who demanded blemish-free produce. We developed a model organic farming program, which would not only reorient farmers to reduce their chemical inputs, but also change consumer consciousness and provide farmers with the technical assistance they needed and the economic assistance.

I think that is one of the messages that I want to convey today. We have to deal not only with the health and safety data we have—we have plenty of data—but we also have to deal in terms of raising consciousness among the populations of both farmers and farm workers. We have to realize that we deal with certain economic imperatives, some realities in agriculture.

Unless we also deal with those economic realities of their lives and their limited choices, we will fail in our efforts to improve health and safety. We have learned this in the industrial world, and we should apply that lesson as well in the agricultural world.

Unless we also deal with those economic realities of their lives and their limited choices, we will fail in our efforts to improve health and safety.

Also, in my time in Texas, we focused (unusual for an agricultural department), on building and supporting a rural health program. As we sought to protect farm workers, we realized that we had to deal more basically with the overriding needs of all rural Texans: farmers, farm families, farm workers and their families, and their overriding, haunting lack of rural medical care in Texas.

It leads the nation with the highest rate of hospital closings, no OB-GYNs in most rural counties to deliver babies, dwindling emergency room facilities for farm injuries, and few physicians trained in agricultural medicine or pesticide-poisoning treatment. So, all our efforts to promote agricultural safety and health and provide crop sheets and good training materials on pesticides would have little chance of success in the frontiers of rural Texas.

I was fortunate to work with a national coalition, The National Coalition of Agricultural Safety and Health (NCASH), and the National Rural Health Association, because in working for worker and farmer protection, we realized that is one part of a very looming and serious national rural health problem.

We realized that we must deal directly with the basic needs of farmer, farm workers, and their families and redirect state policies to meet these needs. Our efforts to promote agricultural health and safety were part of a much larger political and economic problem of the powerlessness of farmers and farmworkers in the country.

Now to my current role with the Children's Advocacy Institute, which provides a voice for children's well-being in California and the nation. I see this as a continuum.

If we are not taking care of our children and protecting future generations, we are a doomed society. And dealing with children is yet another face of rural poverty, disenfranchisement, and lack of access to basic health care.

An example is a recent epidemiological study by the California Department of Health Services of cancer clusters in McFarland, a rural town in the heart of

the rich San Joaquin agricultural valley. State epidemiologists were unable to correlate the cancers with specific pesticide use. So in a sense, it was a negative study. However, that study uncovered some other realities, including the most horrifying statistics about malnutrition, lack of immunization, and lack of primary health care for farmworkers and rural poor, conditions that characterize the Third World. We tend not to believe these conditions exist in rural America.

To best address how to raise health and safety consciousness of farmers and farmworkers we must do several things:

- ▶ First, we have to understand the unique nature of this work force and the common grounds and the differences. My thesis is that there is much more that these two worlds share in common than they differ on. Basically they share powerlessness and disenfranchisement in this country, economic and political powerlessness. That is reflected in the lack of resources, research, jurisdictional clarity, health and safety standards, training materials, and many other things that other speakers will address throughout this conference.

My thesis is that we need to build on that common ground. If we do not get to the essential root causes of that powerlessness and turn that around and empower farmers, farm workers, and their communities, we will ultimately fail in our efforts to improve health and safety. I will discuss some of the areas in common in a moment.

- ▶ Second, I think we need to look at the lessons that hopefully we have learned from the industrial workers' struggle for health and safety and examine what has worked and whether that can be translated

to the agricultural work force. Obviously, it is a different work force. We do not have workers who work continually in steel mills or petrochemical plants.

We have rather independent, entrepreneurial farmers who are not used to regulation as are industrial employers. However, there is a lot of commonality even in that. I think the key issues there are the collective action that has led to the improvement of health and safety for industrial workers.

Just as our conference theme is "a national problem, local solutions," we need to look at what is nationally needed and a national minimum standard.

Improvements such as the asbestos standard or the cotton dust standard, or the right-to-know law for industrial workers, have not had to be fought out at every shop floor in every factory. There has been some national *minimum* standard of care, of humanity, of morality.

Then, there has been the opportunity on the shop floor for local initiatives for workers by unions to do even better. Just as our conference theme is "a national problem, local solutions," we need to look at what is nationally needed and a national minimum standard. We can not expect farmers and farmworkers to be fighting that out for themselves every day.

► Finally, we need to seek ways to empower and ways that lead to local solutions. We have learned that for industrial workers as well. People have to have a stake in their own health and safety. Solutions

have to fit local needs and use local talents and resources.

In agricultural, even more than industrial workforces, a uniform national standard or prescription simply will not work. It will not work for the populations we are dealing with and the problems they face.

## WORKABLE SOLUTIONS

I also want to encourage that we look for simple solutions and be very realistic about what has worked and what has not. A good example is in the area of farmworker protection.

There is a tendency to talk and move toward increasingly more sophisticated personal protective equipment for farmworkers to enable them to enter treated fields. We already know a lot about problems in using this equipment. These are problems such as heat stress, availability of protective equipment, maintenance of it, worker attitudes, and the general impossibility of having that scheme work.

We also have seen another example of the development of the field sanitation standard, which took about 17 years to provide, something as basic as toilets and water in the field. When you see that it has taken 17 years to get toilets in the fields and then you imagine the most complicated and sophisticated personal protective equipment and worrying about the nightmare of enforcement, you really have to think:

Is that the way we ought to be going?

Is there not another solution?

Can we not instead look for another way to farm, a way to use less toxic

substances that may not require those kinds of protective measures that are difficult to enforce and use?

There, too, we have a lot of issues in common. We have the real cost to farmers, farmworkers, and their families for cheap food in this country. Those costs are measured in the mangled bodies and in the statistics that we have heard and will hear. They are measured in the acute poisonings, which are grossly under-reported because workers are afraid of being deported or retaliated against, or have no idea of their rights.

Moreover, we have no uniform national data base for reporting those illnesses and injuries. We have chronic risks that are yet to be measured, which are incalculable, whose long-term social costs, if we were to do a fair cost benefit analysis, would outweigh the benefits of using some of the most toxic pesticides.

In any case, there is the basis of a common fight, and allies, and alliances. Even unholy one alliances, unimagined strange bed-fellows might come together on some of these issues.

Let me elaborate a bit more on the issue of the unique agricultural work force. We are told constantly that agriculture is different from the industrial work force and obviously that is true. There are, in fact, real differences that are cultural, racial, and often those of class between farmers and farmworkers.

Farmers, based on the farm studies that have been conducted in Iowa and New York, indicate high concern about health and safety and even fairly sophisticated understanding about those risks. There is also a serious and healthy antipathy for

regulation. Farmworkers, on the other hand, are obviously a lot less educated about those risks. They frequently have even fewer economic options and great fear of exercising their right to protection on the job.

Those may be the differences, but should they divide the two populations? I think that there is much more that they share in common. Both farmers and farmworkers form the hidden, invisible work force of America.

Agriculture has steadily become the most dangerous occupation. It comprises less than 3 percent of the work force, yet has over 14 percent of work-related deaths. There is a staggering lifetime risk of occupational death for farmworkers; the nonfatal injuries are equally depressing.

Yet there is depressing news, even with non-reporting, of the degree of injury among farmworkers. We have in a 1987 Federal Government report, over 280,000 handicapped migrant and seasonal farmworkers and 60,000 handicapped dependents, with one-third of those estimated to be work-related.

Children comprise a large percent of those injuries attributed to both farmers and farmworkers. And as Chris Atchison has mentioned, an equally disturbing factor of the ill-health is the high injury rate suffered by our elderly. No, there is no retirement in agriculture. No one can look forward to early retirement.

It apparently is true that you cannot even look forward to a childhood in agriculture. Children are truly the invisible workers. In my new incarnation, I am going to work hard on that because I think there is a sense, not only among farmworkers and

farmers but in the morality of this country, that we can not visit these same tragedies on our children. Even if we, as adults, are willing to take those risks or have no other options, we can not do this to our children. We want a better life for our future generations.

It certainly is true that both farmworkers and farmers want better lives, but both have few options. Child labor is not a matter of choice; it is a question of economic necessity both for farmworkers and farm families.

Marilyn Adams, who will be speaking later, eloquently captured this in a recent video, *Danger, Children at Risk*, which highlighted child labor in several different sectors including children of farmworkers and farmers. She said:

*You would never hire a 10 or 12 year-old to work on your farm, but you let your own child work, because you have to. You can not afford to hire one.*

Many farmworkers are also driven by economic necessity, the piece-rate system that characterizes much of corporate agriculture in America. There are children in the fields working side-by-side with their parents. Though the health and safety standards do not adequately protect children, they work in the fields to help families make a living.

On the farmer's side, we know that agriculture is the most dangerous work. Again, economic realities make choices very difficult. Take for example, ROPS (roll-over protective structures) protection. Most farmers know the dangers and would willingly retrofit their tractors, but there is economic reality.

Farmers have to choose between continuing survival and retrofitting or paying the mortgage on the farm. Taking the little bit of money that is left over these days in the struggling farm economy to pay for safety equipment to protect themselves and their children is a difficult choice.

The point is that hazards do not recognize the lines between farmers and farmworkers. The safety and health hazards cross over those lines. A good example of that is the issue of parathion and whether it should continue to be used. The EPA has indicated that it may finally act to discontinue parathion's use.

This is not a mystery pesticide. There is a well-developed body of literature on parathion as the most documented cause of worker death and the cause of a very high percentage of children's deaths in children six and under. Despite the known risks, we have continued to use parathion for over 25 years. Yet the hazards are not only visited on farmworkers and their children, but also on farmers and surrounding communities.

In California, a recent study demonstrated that parathion was deposited by fog in the San Joaquin Valley. It drifted significant distances away from the original site of application; affected other farmers' crops; and contaminated the soil, the drinking water, and other rural communities. The point is that parathion is not just a hazard that affects farmworkers, but is also a hazard to farmers and their families.

Finally, in terms of this work force that faces such political and economic powerlessness, we face a problem of our trying to turn this around and raise consciousness. Either we have people who are unaware of the risks, and we have to edu-



cate them, or they know them but are absolutely unable to do anything about them because of economic reality.

Again, we look at industrial workers' fights for safety and health and we see a stark contrast. Farming is unlike industry, where the costs of safety and health are eventually borne by the industry and factored into the cost of production.

We have not chosen, in this country, to factor safety and health into the costs of preparing our food. The costs, essentially, are borne by farmers, farmworkers, and their families.

Further, we have farmers and farmworkers who are fairly remote and isolated, spread out all over the country. They may be migrants or they may be non-citizens. All in all, we have no basis for real political constituency or clout. Neither farmers nor farmworkers are validated citizens. Though they feed the nation, they are generally left out hungry.

## LESSONS LEARNED

Now let us look at the lessons that we have learned from our history of fighting for occupational safety and health in industry.

As I mentioned, the first lesson to apply to the agricultural work force is that we have to give people a stake in improving their own safety and health. The first critical step is to give people information because information is obviously the basis for awareness, for consciousness.

But even more important, information such as crop sheets, safety information sheets, pamphlets, videos, training programs, etc., will not do without giving people the pow-

er to act on that information, on that knowledge. For industrial workers, the fight for health and safety is best when there is collective, unified action.

Generally it comes from unionized work forces that have some economic power, are not afraid, and have independent means to have their own health and safety professionals advocate for others beyond themselves. That collective force for industrial workers has been the key ingredient of political and economic power to push government and industry. Not that this has been an easy fight, we have many examples where workers have had to be the "canaries."

What about the fight for knowledge? That may worry some of you, and maybe it should because the fight for knowledge and the raising of consciousness definitely means increasing demands. One option might be more regulation. I think we need to look very carefully at what will work, is needed, and is most effective.

The lesson that we have learned from occupational safety and health in the industrial world is that often the most effective safety and health programs do not require or depend on complete regulation. We maybe do not need police officers everywhere in every work force. Given this economic climate, we simply do not have the governmental resources, nor will we ever. We have to come up with something that is effective and relevant.

What I am suggesting in terms of raising health and safety consciousness is to give people the information and tools to allow them to make their own decisions and to allow them to come up with their own solutions. In industry that has meant selling certain minimum standards—for exam-

ple, machine guarding or carcinogen standards. Many workers have been able to bargain or even more than that to affect bottom line.

In agriculture that means setting of some minimum safety and health standards that could then allow the dissemination of information to unleash local wisdom, resources, and initiatives. These kinds of alliances might come up with new ideas—for example, re-examining our pesticide policy, our agricultural policy, or our attitudes and policies about child labor.

I am excited about the new OSHA initiative and the direction it is taking in terms of giving people more information and consultation, which is the first step. The next step is the power to act on it.

## A TALE OF TWO CITIES

I would like to close with a tale of two cities—two different cases that I would like to present, which have to do with the meaning and success of empowerment.

The first case involves a pesticide poisoning of a large crew in the Salinas Valley of California in 1978. Now this was not a case of the small farm that, I think, is described most commonly in this conference. This was a fairly typical corporate agricultural operation that is common in California and in other states. This is a different and very important agricultural model, because no one is ultimately responsible for worker protection.

In this case, there was an absentee landowner, a farm manager, a marketing cooperative who hired an irrigator, a pesticide applicator, and finally, a crew leader to bring in labor. No one talked to each

other. No one had any idea how the whole thing fit together.

As a result, a large crew of workers, including a matriarch, her father of 70, her two children under 12, a sister in her first trimester of pregnancy, and a host of other workers, entered a field that had been sprayed only 6 hours before with two of the most toxic pesticides, Phosdrin and Phosphamidon. There is a legal reentry of 48 hours.

These workers were in the fields, by mistake, through no one's conscious endangerment or recklessness. An inevitable mistake happened because of the nature of that kind of agriculture.

What happened? The workers became severely poisoned, but no one knew the signs and symptoms of pesticide poisoning. Even the crew leader was sick, but kept on working. Because the workers were dependent on what they could make per bushel of cauliflower, they kept on working. This happened even though one worker was unconscious, others were vomiting, and many were severely sick.

The aftermath of this case is important in terms of a lesson that we can learn about raising health and safety consciousness among workers. The workers were severely poisoned and the recovery was much longer than anyone expected. The pesticide poisoning taught us a lesson, again by workers being "canaries," of the effects of organophosphate poisoning and the slow regeneration of cholinesterase.

The children working in the fields had most severe and persistent symptoms, and even a year later were describing symptoms of sweating and nightmares from their exposures.

One of the most important things that saved these workers and made a real difference was that the workers were protected and kept out of further re-exposure to pesticides. In this case, there was immediate assistance by rural legal assistance people who taught the workers about their rights, who taught and empowered them to take advantage of programs that are available to all other workers. These are programs such as workers' compensation and unemployment insurance.

These rights, incidentally, are not granted to all farmworkers in all states, but were extended in California. That made the difference. Those workers did not have to go back to work immediately, which would have exacerbated their health effects.

The medical care has to be characterized as some of the finest in this country. The immediacy of care, knowledge about pesticide poisoning and tracking of the workers was impeccable. While a fortunate occurrence for those workers, this is, unfortunately, not a common one.

And finally, the workers who were poisoned in this episode were trained about the effects of pesticide poisoning. The next time they were in a field that had been sprayed and they began to experience the symptoms of organic phosphate poisoning—pin-point pupils, nausea, dizziness, and so forth—they left the fields.

They realized what was happening to them and could stop it. They did not need an OSHA or an agriculture inspector on the fields. They were their own protectors.

Other lessons that we learned from that case, that are important to translate more generically, were the obvious importance of good rural health care, the necessity to

train workers about the health risks and how to protect themselves, empowerment, and economic power in order to use that knowledge—giving them the chance, for example, to be out on workers' compensation in order to recover.

One regulatory change that shifted the balance was the posting of fields. There was a realization that you can not always depend on perfect knowledge. In this case, even the crew leader did not know the fields had been sprayed and everyone walked in equally ignorant. Mistakes happen.

Eleven years later, another large crew of 80 workers similarly walked into a field long before the legal reentry period. They had never been trained in pesticide poisoning and were not fortunate enough to have fields posted.

Ironically the applicator, in this case, was a relative of the farm manager; he himself was affected. The farmer also bore another serious loss, because his crops could not be sold. Unwilling to take the risk of having crops with over-residues, all of that produce was withdrawn.

So, there were losses, serious medical, personal losses for the farm workers in terms of their health. Economic losses were suffered by those farm workers because they too were working piece-rate. When they had to stop because they were poisoned, they lost their day's work.

The *Tampa Register* reported on a woman who said she kept on working although she knew it was dangerous because she had bills to pay. That was simply a fact of life. She refused incidentally to give her full name for fear of losing her job. This is,

again, an economic reality of the life of farm workers.

The lesson is we have 11 years later an inevitable risk, one that could have been predicted—the same pesticide and same lack of training. Most importantly, this farmworker crew had been trained about the signs and symptoms of pesticide poisoning. Thus they were aware and protected the next time they were forced to reenter a treated field before the legal reentry interval.

That leads me to the lesson that we learned in passing the right-to-know law for farmworkers and farmers. This law was initially fought by farmers who felt it was an unnecessary, burdensome regulation that would have a serious economic impact on agriculture with no measurable benefit.

Many farmers came to believe the law and training program had benefits for farmers and their families as well. The reality is that both farmworkers and farmers have a right and a need to know about the effects of pesticides. Those hazards are visited in both worlds.

We found that by requiring that farmers give workers crop sheets about the various pesticides registered for different crops, we nourished the beginning of an awareness, in farmworkers, about the risks that they had to take. There are choices they have to make for themselves and their families.

More surprising and encouraging, it also changed the consciousness of farmers. When they saw a list of pesticides ranging from the most toxic to least toxic pesticides available to be used on a particular crop, farmers realized they had choices.

The choices are not only to protect their workers but to protect their families as well. Their families were often applying the pesticides and it was their ground water. They were uniformly concerned about protection of the water and the protection of future generations.

I am still haunted by the images in the video that I have mentioned, *Danger: Kids at Risk*. It points out very clearly that children, from both farmworker and farm families, are at peril and that we have really denied them a future. It is a huge and, I think, an unacceptable sacrifice that farmers and farmworkers have had to make.

One of the speakers in this video ends with a message that is very powerful. We need it if we are to be successful in raising consciousness of both these populations. It is a message told by a teacher who works with migrant children, but it applies equally to children of farm families. It is this: You must tell the children,

*You are important. You are American citizens and entitled to something important.*

We must fight for the future of our children; otherwise we will fail as parents, as communities, and as a society.

I also listened to the "Farmers' Hotline," which was developed by the Texas Department of Agriculture to help farmers and their families on the brink of suicide, depressed about economic conditions beyond their control. It is time that we stopped blaming the victims, farmers and farmworkers, and stopped allowing them to blame themselves. We must provide them the means to protect themselves.□

## BUILDING COALITIONS FOR PREVENTING INJURY AND DISEASE IN AGRICULTURE

By Thomas Dean, M.D.  
President, National Rural Health Association

Dr. Antonia C. Novello: Our next speaker is going to be Dr. Thomas Dean, and he has distinguished himself in the field of rural health. He served in the U.S. Public Health Service as part of the National Health Service Corps, from 1975 to 1983, and he received a commendation medal. Dr. Dean's years with the Public Health Service were served as staff physician and later as a medical director of the Frontier Medical Services in Hyden, Kentucky. In 1978, he returned to his home state of South Dakota in Wessington Springs, to serve as medical director at Tri County Health Care. He has remained there as medical director since leaving the public health service. He is active in many professional activities in South Dakota, and he is on the Executive Committee, since 1987, of the National Rural Health Association. He currently serves as its president. Let me introduce Dr. Thomas Dean, to describe the second purpose of this conference, *Building Coalitions For Preventing Injury and Decease in Agriculture*. Dr. Dean:

Thank you. It certainly is an honor to be invited to speak to this distinguished group. However, when I was asked to address the group regarding coalitions, I wondered if I was really the one. That is not, certainly, my area of expertise.

I am a country doctor who has been in a small town in South Dakota for about 13 years. I am not a political organizer or an expert in conflict resolution and certainly not an expert in any of the various technical aspects of agricultural safety.

On the other hand, I do know something about agricultural injuries. I grew up on a farm and as I was looking back on some of these experiences, I recalled at least four times when I personally survived potentially fatal agricultural injuries. Certainly it brings home the significance of this issue.

I remember the time when, as a teenager, we were cutting silage, and I was driving down the road with a fully-loaded silage wagon, as fast as the old "M" Farmhall

would go. The tractor began to drift to the right, and I turned to the left.

The tractor continued to go to the right and pretty soon we were off the road and ended up crossways in the ditch; I hit the embankment so hard that it broke the front end out from underneath the tractor. A pin had fallen out of the steering column, and how I avoided rolling over, I have no idea.

I remember another time when we were going to a local horse show, and we had to go out in the pasture to catch one of the horses. My dad and I went out and caught the horse, and I was walking home leading the horse when all of a sudden something spooked this young colt. He took off and, without me being totally aware of what was going on, pulled the coil of rope tight around my hand.

Pretty soon I was down on my face sailing through the grass behind this horse. Fortunately it rained that morning and so it was not too bad until the horse decided to

## The Potential for a National Coalition

go between the fence and a tree; the two were only about 18 inches apart. For reasons that I do not completely understand, just before the horse pulled me between the fence and the tree he stopped.

At that point my father caught up, and things were okay. It really does, I think, bring home the fact that these are real issues. I do not believe I was particularly wild, and I do not think our farm was any more dangerous than the average one. I suspect anyone who has grown up in an environment like that probably could relate similar sorts of experiences.

So, as I look back, trying to think what I could contribute to this group, I would hope that maybe I can bring some perspective, some understanding of farmers and farm communities, some firsthand experience as I have just mentioned about the importance of the issue. Finally, I think I can offer some experiences with a coalition that has experienced some success, namely the National Rural Health Association (NRHA), which truly is a coalition of some very disparate organizations and interests.

I think the success that our association has had can be attributed in large part to the fact that it is a coalition. Certainly all of the people that we represent have their own professional organizations who are able to speak and, in many ways, active in speaking for their interests. But NRHA has enjoyed a considerable amount of success simply because we were able to bring together a group of people with very diverse backgrounds and interests and focus on a single issue. That, in turn, has given credibility to the arguments and the efforts that I think have really paid off and have helped to produce some movement

for the betterment of health services in rural areas.

Recently we have become affiliated with the National Coalition for Agricultural Safety and Health, NCASH, which several speakers have already mentioned. I would mention just a brief commercial.

There is a brochure, a little flyer, that will be out at the front desk, which describes NCASH and also tomorrow evening, at 6:00 in the Council Bluffs Room, there will be a reception for anyone interested in closer involvement with the National Coalition for Agricultural Safety and Health. If any of you are interested in getting more information, Gary Kukulka from the NRHA staff is here, as well as David Pratt and Kelley Donham, who have both been very involved in this effort. They can certainly give you further details about the activities of NCASH.

But, to get back to the issue of coalition building, the question is, Why is it that we are focused on coalitions? What is it about the problems that we are facing today, which brings us in this direction?

I certainly believe that it is a well-placed emphasis, and I believe it is well-placed because of the nature of the barriers that we face. Certainly our barriers are not lack of knowledge.

We, no doubt, can use more knowledge, but we have a great deal of information about the problems we face. It is not lack of skills.

We have a great many skilled, dedicated people who have been concerned about these issues for some time. These skills can be improved, but that is not the barrier that blocks us.

Even resources or lack of resources is not the major barrier. We can always use more resources but we have substantial resources, if we can mobilize them. I think our biggest problem is the coordination, direction and implementation of the things that we already know.

It is not what to do. Our question is really how to do it. That is how the issue and the significance of coalitions evolved.

The dictionary defines a coalition as:

*a temporary alliance of factions for some specific purpose.*

I think that clearly is the goal that we are trying to accomplish. I do not know that it needs to be temporary, but we certainly need to bring together the disparate factions that are involved in these issues.

Examining what brings about an effective coalition, I think there are at least four characteristics and probably others:

1. There needs to be a **unifying issue**. Clearly we have that. I think the fact that this size of group would come together testifies to the fact that this is a powerful issue.
2. We need a **desire to bring about change** and, with that, a **willingness to compromise** on some of our own personal agendas in order to accomplish a larger goal.
3. We need to have some appreciation or some feeling that, in fact, **action and change are possible**. Coalitions do not hang together in stalemates, but if we have the sense that real change and improvement can come about, coalitions can be extremely effective.

4. Certainly by far the most important issue in any effective coalition is that we have **effective and energetic leadership**. That is why we are here today.

We certainly face a tremendous diversity of challenges and a tremendous variety of different problems, but if we are going to make progress, we really need to have the leadership to bring about a vision of where we want to get to. I think an analogy is the process of assembling a jigsaw puzzle. We have all the pieces, but unless we can come up with a vision, the big picture that is on the front of the box, it is not likely that we are going to be very effective at pulling together our activities.

That is what this conference is designed to focus on and certainly the main thing that we hope will come out of it. I believe the Surgeon General and her staff at NIOSH deserve tremendous credit and our thanks for putting this process in motion.

In trying to understand this situation a little more, I would like to spend a couple of minutes looking at a somewhat analogous situation that NRHA has been involved in over the last several years. During that time, in our concern about maintaining health services in rural communities, it has become increasingly apparent that the preservation of rural health services and the development of the communities in which they exist go hand in hand. Certainly if the community is not coordinated and working, the health services will not be coordinated and working.

One of the things that has come out of this realization is several projects around the country that focus on improving health services through community organization. The one that I would like to quote from is referred to as the Community Health Ser-

ices Development model, which was a project funded by the Kellogg Foundation, and currently active in the State of Washington.

The goal was to help communities whose health services were deteriorating by focusing on and organizing the strengths of the community itself. They went into communities where, in many cases, the health services were falling apart, and they have come out with a number of fairly striking successes, at least on the preliminary evaluation.

The particular report that I am going to cite now was published as a working paper from the WAMI Rural Research Project—their working paper #11. Anyway, in reviewing their successes, they looked at six elements, which were predictors of success.

1. Clearly, the **quality of local leadership.**
2. **The breadth of involvement of local stakeholders.** Certainly ownership of this issue and local involvement are critical if we are going to have any kind of effective response.
3. **Community commitment.** Their conclusion was that in many cases a situation of helplessness and a culture of dependence had evolved, which really effectively neutralized any response to efforts and unless that attitude could be overcome, success was very unlikely.
4. **Teamwork within the community.**
5. **Comprehensive, complete and honest identification of problems within the system.**

6. **Availability of concurrent education in order to provide the necessary skills to respond.**

I would say that the situation that we face and that will be addressed in this conference is quite analogous to that. Certainly all of those issues are relevant. Appreciation of their existence and their presence will predict the success of any coalitions that we evolve.

Self-reliance and self-determination are bedrock values of rural people, but unfortunately over time many of these have atrophied as outside problems have led to a sense of frustration and helplessness. We need to convince rural people that this energy can be rekindled, and we have to show them that even in this complex world they have a critical role and that what they do really does make a difference.

I would challenge you to go forth in these deliberations with a sense of urgency and with an understanding that every day lives are lost because families are being devastated and futures are being ruined because of our failure in the past to build these coalitions.

As we focus on the development of coalitions, I would say that we really need to look in two different directions.

► We need to build the coalitions within the professional community. We have a diverse group of professionals that are involved in these concerns—the safety professionals, public health professionals, and the medical community.



We have to put our professional egos aside and certainly, speaking as a physician, I know that there are many professional egos involved. My profession clearly has more than its share.

► Second, and probably more importantly, we need to build the bridges between the professional community and the people on the farms. They need to understand that there is real concern and that there is help available and that what they have to contribute is important.

I would certainly echo the concerns that we must not depend on regulation. If there is any group that hates regulation more than doctors, it is farmers; and absolutely the quickest way to wreck any program, or at least to reduce cooperation among the participants, would be to provide increased regulation.

In final analysis, I would say that the effectiveness of anything we do will be determined by our own honest desire to improve the lot of the people that we are dealing with. It will depend extensively on our ability to put aside our own egos and professional pride to be sure that we can work together and move toward the improvement that we are seeking.

Coalition building is not just the best way, it really is the only way. I would challenge you to go forth in these deliberations with a sense of urgency and with an understanding that every day lives are lost because families are being devastated and futures are being ruined because of our failure in the past to build these coalitions.□

## DISSEMINATING SAFETY AND HEALTH INFORMATION THROUGH EDUCATION

By J. Michael McGinnis, M.D.  
Deputy Assistant Secretary for Health  
Director, Office of Disease Prevention and Health Promotion  
Assistant Surgeon General

Dr. Antonia C. Novello: Now I would like to introduce Dr. J. Michael McGinnis. I am very pleased that he is going to address this conference. Dr. McGinnis serves as Deputy Assistant Secretary for Health, and holds the rank of Assistant Surgeon General. He has served as the Director of the Office of Disease Prevention and Health Promotion since 1977. Dr. McGinnis is a Fellow of the American College of Epidemiology and the American College of Preventive Medicine, and has held faculty appointments at Duke University and George Washington University. His contributions include the initiation and development of *Healthy People: The Surgeon General's Report on Health Promotion and Disease Prevention*, *Healthy People 2000: National Health Promotion and Disease Prevention Objectives*, and the *Dietary Guidelines for Americans*, which was jointly issued by the U.S. Department of Health and Human Services and the U.S. Department of Agriculture. In addition, he has collaborated with the National Institute for Occupational Safety and Health in the mid-1980s on the project, *The Future of Work and Health*. In 1988, he also developed *The Surgeon General's Report on Nutrition and Health*. It is with great honor that I introduce Dr. McGinnis to speak on the third purpose of this conference, *Disseminating Safety and Health Information Through Education*. Dr. McGinnis:

Thank you very much, Dr. Novello. I would like to begin by commending Surgeon General Novello for her leadership in sponsoring this conference. She has often said that she must be the Surgeon General of all the people, and has certainly followed that up by addressing issues that are important to all Americans, and especially to those Americans who have been disadvantaged. I think that this Surgeon General's Conference on Agricultural Safety and Health is indicative of that leadership and both Surgeon General Novello and Assistant Surgeon General Millar deserve our thanks in that regard.

I would like to thank you for inviting me to join you at this very important conference. Farming remains one of the most hazardous occupations in our nation. The annual death rate for farmworkers in America is five times as high as the com-

bined death rate for all other workers. Every day nearly 500 agricultural workers in America suffer disabling injuries, and almost half of these injuries result in permanent impairment.

Since these troubling statistics are affected by a number of factors, the health and safety of agricultural workers is especially vulnerable. One of the major problems stems from the decentralized nature of the workforce.

Because farmers live in rural areas and have traditionally worked independently, their health and safety needs have not been adequately addressed. Furthermore, because many farm work forces have fewer than 11 workers, they are not identified by national data systems and their burden of suffering therefore may be underestimated.

A second factor is the issue of economic disincentives. Because there is no simple way to spread the economic risk as large corporations or other industries can do, the costs of implementing many safety measures are passed directly on to farmers.

The final factor involves those health problems that adversely affect agricultural workers. Though trauma is the most prominent health problem for farmworkers, respiratory diseases, other sequelae of pesticide toxicity, certain cancers, dermatitis, noise-related hearing loss, and stress-related mental disorders are all problems that agricultural workers must face. Though these health problems are extremely diverse in the way they affect individual farmers and their families, they do have a major commonality.

Fortunately, because the prominent role of behavior in health threats is not novel or unique, some of the lessons that can be gleaned from other public health areas may be germane to the kinds of approaches that we seek to establish for agricultural health and safety.

Behavior plays a prominent role in both the onset and the management of many occupational injuries and diseases. Therefore, motivating behavior change must be a part of any approach to the solutions that we seek. Fortunately, because the prominent role of behavior in health threats is not novel or unique, some of the lessons that can be gleaned from other public health areas may be germane to the kinds of approaches that we seek to establish for agricultural health and safety.

In my comments today, I would like to echo many of the themes that were raised by Ms. Widess and Dr. Dean by illustrating some examples of how those themes can play out by virtue of successes from other public health sectors in which public education and behavior change have proved to be a very important tools. I would like to share with you examples of the impact of behavioral factors on a number of our leading health problems.

Several years ago, the Carter Center of Emory University, in collaboration with the Centers for Disease Control, undertook a project called *Closing the Gap*, which examined the burden of a variety of the leading killers in our society. It found that behavioral factors played a significant role in 55 percent of heart disease deaths, 60 percent of cancer deaths, and 70 percent of motor vehicle deaths.

In fact, across all causes of death, and in comparison to genetic factors, environmental factors, and factors related to the lack of access to appropriate treatment facilities, behavior contributed to almost one-half of all premature deaths from all causes in our society. The leading causes are by now well known to all of us, as a result of the work of Surgeon General Novello and her predecessors.

Of the 2.1 million deaths each year in our society, tobacco accounts for approximately 400,000 deaths each year. The impact of factors related to the imbalance between diet and activity accounts for another 300,000 to 400,000 deaths.

Alcohol contributes to 100,000 deaths each year, including 20,000 deaths related to alcohol's impact on motor vehicle operation. It is clear by these numbers that behavioral choices have an enormous im-

pact on our society's health profile, including the health profile of agricultural workers in our country.

The good news is that we have made a great deal of progress in the past several decades. Tobacco use among males, for example, has declined from 54 percent in 1964 (at the time the first Surgeon General's report on tobacco and health was released) down to approximately 30 percent today, almost half of what it was when the campaign against tobacco was initiated.

The changes with respect to diet are less dramatic. Though the average percentage of calories for dietary fat intake is still as high as 36 percent, there has been a dramatic shift away from saturated fat consumption, resulting in risk reduction for heart disease.

Finally, we have also seen progress in the area of alcohol. Cirrhosis rates are down, and alcohol-related motor vehicle fatalities have declined. There is greater awareness of the problems related to alcohol, and I suspect that the awareness will accelerate as a result of the special focus and attention that Surgeon General Novello has drawn to that issue.

These kinds of changes are not serendipitous; they are the result of specific and targeted campaigns. Some of these campaigns have been local in nature and very carefully controlled. I would like to share with you two important examples of community mobilization to reduce behavioral risks, which improved the health prospects of those communities.

Both examples were carefully controlled studies offering a scientific approach, and both focused on cardiovascular disease

prevention through targeting multiple risks simultaneously. These kinds of multiple risk factor interventions can also be applied to improving the health of our agricultural workers.

The Stanford Five-City Project addressed coronary heart disease risks, such as smoking, dietary habits, and blood pressure control. The campaign used a comprehensive mass media intervention strategy—television, radio, and newspapers—in combination with direct education provided in classes, community-level contests, and school-based programs. As a result, reduction in coronary heart disease risk in the experimental cities was nearly 20 percent greater than the secular trends of the control cities.

The other example, the North Karelia Study in Finland, used environmental change (i.e., by increasing the availability of low-fat foods and designing non-smoking areas) in addition to mass media and direct education. As a result, the overall coronary heart disease mortality in the target populations was reduced by almost 25 percent.

In addition to these carefully controlled experiments of a community wide nature, there have been some large-scale national campaigns that have had a tremendous impact on the entire nation. The Surgeon General's campaign against tobacco, initiated by Terry Luther, SG, in 1964, is perhaps the most prominent example of a successful national campaign.

Other examples include the initiation of the National High Blood Pressure Education Program in 1972 and the initiation in the early 1980s of the National Cholesterol Education Program, both by our National Heart, Lung, and Blood

Institute. Programs growing out of grass-roots efforts have also had a tremendous impact on behavioral change.

For example, Mothers Against Drunk Driving (MADD) has provided important impetus in efforts to reduce the terrible tragedy of alcohol-related automobile fatalities among our young people. Consequently, we have seen some real gains in overcoming the problems related to motor vehicles and alcohol.

Indeed, all of these efforts mobilized every aspect of community life—schools, community organizations, voluntary organizations, professional societies, and worksites—in a coalition to address those problems. As Don Millar would point out, occupationally based programs have also contributed substantially to making the major inroads that we have seen against high blood pressure and tobacco smoking, as well as alcohol.

As a result, coronary heart disease mortality has declined by about 40 percent in the last 15 years, stroke mortality has declined by 55 percent, and auto fatality rates among children have declined by 22 percent in the last ten years alone. These are striking examples of success stories: success of public education efforts, with their roots at the community level. Due to these accomplishments, overall childhood and adult mortality rates have decreased.

Specifically in 1980, the Surgeon General targeted a 20 percent reduction in childhood mortality and a 25 percent reduction in adult mortality to be accomplished over the decade of the 1980's, by 1990. Both of these goals have been met, and done so largely through public education efforts.

What have we learned from these efforts that might be useful to the dissemination of agricultural health and safety information? First and foremost, we have learned that the dissemination of information alone is not enough. Knowledge is power, but education alone will not accomplish the task.

In order to succeed, we need to change the entire environment, including the physical environment as well as the social environment. The social environment contributes to shaping people's perspectives and therefore their risks.

We heard from Ms. Widess about the importance of the regulatory processes in insuring that we have provided a safe environment for farmworkers with respect to pesticide use. We heard from Dr. Dean about the importance of safety standards as well as public education efforts. Each of these are critical to success, and each was used in the successful public education campaigns launched to reduce cardiovascular risk. For example, non-smoking areas mandated through clean air laws passed at the local level have given tremendous impetus to our gains against tobacco.

The provision of lower-fat food changes, not a regulatory measure, but a very important environmentally oriented initiative on the part of industry, has helped people to make changes that are important to their daily lives. The engineering and availability of better auto passenger restraints has allowed the improvements that we have seen with respect to use of seat belts, in particular for our children, and has allowed the consequent improvements in mortality in that regard.

It is clear that the approach must be balanced between health protection on the

one hand and health promotion on the other. It is crucial to remember, however, that health promotion can make a tremendous difference. I would like to spend my last few minutes, therefore, talking about health promotion.

The health promotion sciences are not tremendously well-developed, but we do know that prior to behavior change, there must be changes in knowledge, in attitudes, and in beliefs. For changes in knowledge and in attitudes to occur, we need messages that are credible, that are reinforced from a variety of perspectives, and that are sustained over time. In other words, we need to know the facts, we need to build coalitions, and we need to stay with it.

Credibility of a campaign comes from improving data sources, from deepening the analysis of those data, and from involving leadership, such as your involvement with the Surgeon General in this public health effort on improving agricultural safety and health.

I would like to give special emphasis to the issue of data sources, because they are so vital to insuring that the messages that we give are credible. We heard from Mr. Atchison earlier of the discrepancies that exist in our current data sources.

When we know that some estimates describe 14 deaths per 100,000 agricultural workers, whereas others indicate that there may be as many as 50 deaths per 100,000 agricultural workers, it is evident that we need to have better data on which to shape our policies and programs. Improving data systems, especially for agricultural workers, needs to be a priority for the future.

We also clearly need to recruit allies to help us disseminate the information. We need to involve schools, employers, retailers, and the media. We need to involve farm equipment manufacturers and community leaders. The establishment of solid, locally based coalitions is critical to gains in agricultural safety and health, just as they have been critical to the gains that we have seen in other areas of public health in recent decades.

Even knowledge, attitudes, and changes therein, while necessary, may not be sufficient to accomplish the kinds of gains that we would like to see. People also need to believe that these issues are directly and personally relevant to themselves.

The message needs to be brought home. Whether it is brought home to families through children in school settings or whether it is brought home to people through interactions with health providers taking a more careful history of individual risk, it is clear that we need to find ways to make these risks more relevant to the individuals who are at greatest risk.

It is no accident that the biggest gains in public health recently have been made in areas where individual risks have been defined in the form of a number (e.g., cholesterol level or a blood pressure reading). It should be entirely possible to develop a health hazard appraisal instrument that can be used to better characterize the risk of individual farm settings, and we need to work on new ideas.

In summary, know the facts, build coalitions, stay with it, and bring it home. It is a tested formula. It has worked, and it can work in agricultural safety and health.

*Healthy People 2000* is a statement of national goals and objectives for the year 2000, and I am delighted, Mr. Atchison, that you have taken this on in a very substantial way here in Iowa. Richard Remington is going to provide tremendous leadership, and we will profit throughout the nation in the kind of model that you will be developing here in Iowa.

*Healthy People 2000* envisions the year 2000 with nearly a third fewer farm injuries and deaths than currently occur, but it also envisions as a means to achieving these goals, greater commitment on the part of our health providers, schools, manufacturers, and states to the problem of agricultural safety and health.

It envisions greater national attention to the issue. It envisions a situation in which we can provide an example to the world for improvements in agricultural safety and health, just as we have provided an example to the global community in improvements against cardiovascular disease. I believe that it is a vision that can be attained in this Surgeon General's Conference on Agricultural Safety and Health as an important step to forming the coalition that can make it happen.□

## ENCOURAGING ACTION IN PREVENTING INJURY AND DISEASE IN AGRICULTURE — A Video Message —

By *Louis W. Sullivan, M.D.*  
Secretary of Health and Human Services

Dr. Antonia C. Novello: Dr. Louis Sullivan, our Secretary of Health, was going to come to this meeting, but because of scheduling - you would not believe how many places we have to go when we are in jobs like this, and he has to be in many more than anyone can ever dream of - he could not make it; but, he sent a video message for you all, and I would like to show that for you:

Hello, I am Dr. Louis Sullivan, Secretary of Health and Human Services. Thank you for inviting me to participate in your conference—I regret that my schedule did not allow me to attend.

It is fitting to hold this conference in Des Moines. For many years, Iowa has been at the forefront of efforts to improve agricultural safety.

This state has produced many national leaders in rural health. In fact, Former Iowa Governor Robert Ray is currently an advisor to me as chair of the National Advisory Committee on Rural Health.

The seriousness of agricultural injury and disease demands national attention.

The advances in technology during the past few decades have given today's agricultural workers a tremendous advantage unimagined by the workers of yesteryear. But those advances have come at a price: the technology that increases productivity

tenfold can also be a powerful, tragic threat to health and well-being.

The seriousness of agricultural injury and disease demands national attention. Successful improvements, however, will be rooted solidly in local initiatives. Your theme—"A National Coalition for Local Action"—establishes the ideal framework for addressing the problems of agricultural occupational hazards.

Agricultural workers have one of the highest rates of occupational fatality in the country. Although they represent only two percent of the nation's work force, they rank fourth highest in the number of work-related traumatic fatalities.

The risks of agricultural work do not fall equally across all types of work, nor among the workers themselves. For example, loggers have an especially high risk of death with more than 200 deaths per 100,000 workers, a rate nearly 30 times the general private-sector fatality rate.



There is also a clear disparity among population groups. Hispanic and black agricultural workers face an occupational fatality rating 20 to 30 percent higher than white populations. Other minorities are more than twice as likely to die while working at an agricultural job than in another profession.

The key to making those strategies effective—the critical, vital factor that will determine our success in lowering the risks of agricultural work—is local initiatives and efforts.

However, the very definition of *occupational hazards* means that it is possible to reduce many of the risks involved. Our first and strongest attack on occupational hazards should be prevention. Improved working conditions, use of safety devices, and more extensive educational efforts will lower job-related fatalities.

It is estimated that tractors are involved in more than three-quarters of agriculture-related deaths, most of which occur as a result of tractor rollovers. Roll bars and other preventive structures can be very effective in limiting death and injury to tractor operators, but often such safety measures are not used.

To encourage farmers to use preventive structures, the Marshfield Center, an Health and Human Services (HHS)-funded rural health research center in Marshfield, Wisconsin, has published a guide to give farmers information on where to find roll bars and how to use them to minimize the risks of injury in rollovers.

Efforts to reduce job-related exposure to chemicals should also be more effective. It is estimated that 20,000 people suffer pesticide poisoning each year. Often other economical alternatives—such as crop rotation and biological pest control—can significantly reduce the risks of exposure.

The key to making those strategies effective—the critical, vital factor that will determine our success in lowering the risks of agricultural work—is local initiatives and efforts.

This conference is already a milestone in developing efforts to save lives and preserve health. By thinking nationally and acting locally, we can make agricultural work in America safer and healthier for everyone.□

## **SURGEON GENERAL CONFERENCES: A MODEL FOR THE FUTURE**

*By Antonia C. Novello, M.D.*

Surgeon General of the United States Public Health Service

---

Thank you. As they said in the movie "Field of Dreams," "We have built it, and they have come." I would like to thank Dr. Millar, Mel Myers, and the rest of NIOSH, as well as the people of Iowa for helping organize this event. I am honored to be the first Surgeon General to hold a Conference on Occupational Health in 50 years.

I imagine the last Conference was probably set up much differently than this one. I am sure it was much more of a "low key" affair, without all the new communications technology that has come along in the last several years. Of course, the last Surgeon General's Conference was not even videotaped, so it is possible that back then the Public Health Corps' Commissioned Officers could probably get away with not wearing their uniforms, since no one would find out!

At any rate, it is about time we had another one of these Conferences. And it is my hope that we do not have to wait another 50 years to have the next one, because I am not real sure what my schedule will look like at that time.

The last Conference was held in the year 1941, the same year the United States entered World War II. Fifty years later,

we finally have the opportunity to hold another Conference—just after we have ended the Persian Gulf War. However, in between those two wars, *another* war has raged continuously for those of us in the Public Health Service. The war against disease and injury.

### **WHY THIS CONFERENCE IS IMPORTANT TO ME**

Ever since I became Surgeon General, it has been written and said many times that I will have a lot of difficulty trying to be like Dr. Koop. That is OK, because I would never be able to grow a beard like him. It is also OK, because it is my desire to set my *own* agenda as Surgeon General.

Although Dr. Koop was very successful in redefining the role of Surgeon General by bringing a lot of visibility to public health priorities—priorities, which I will continue to pursue—it is my prerogative to establish new priorities as well. Today's Conference on Agricultural Safety and Health marks a perfect occasion for me to do that.

In addition to being frequently compared with Dr. Koop, a lot has been made of the fact that I am the first woman and Hispanic to hold this position. I can not lie to you—I am both! However, as a woman and

a Hispanic, there are aspects about this conference, which are very important to me.

As a woman—as well as a pediatrician—it greatly concerns me that women and children are so often the victims of farm injuries and fatalities. These injuries and fatalities occur because farming is frequently a family occupation, where everyone participates.

As a woman, I totally agree with the philosophy of Marilyn Adams' group Farm Safety for "Just Kids," who say that the one person on a farm who can play the most pivotal role in educating farmers and farm children about the dangers of working on a farm is the woman. She can most easily influence her husband and her children—either in a nice way, or if necessary, in a not so nice way! In tomorrow's "Charge to the Conference," I will more strongly express my concerns about the dangers to farm children.

These are my concerns as a woman. As a Hispanic, I am well aware of the safety and health problems of the migrant worker, many of whom are also Hispanic:

- Out of the 50 States in this country, 48 of them rely heavily on migrant workers for help during the peak harvest seasons.
- These workers have very poor access to health care facilities and infant mortality is very high, estimated to be 50 per 1000.

- Due to water shortages on many of these desert—area farms, these workers are often forced to drink irrigation water, which may be contaminated with farm chemicals or infectious agents.
- Crop dusting planes often swoop down from the sky and spray toxic pesticides onto fields where many of these migrant workers are forced to sleep. Many chemicals are known to cause problems such as sterility and miscarriage.
- Finally, injuries and illnesses to these workers are grossly under—reported to safety and health officials, primarily due to:
  1. Language barriers.
  2. Fear of job—loss.
  3. An overall lack of worker education.

As a woman, I totally agree with the philosophy of Marilyn Adams' group Farm Safety for "Just Kids," who say that the one person on a farm who can play the most pivotal role in educating farmers and farm children about the dangers of working on a farm is the woman.

We must take more initiative in educating these workers. It is a situation we are continuing to learn more about all the time, as shown by Dr. Sullivan's comments we just heard about Black farm workers and their high risk of tuberculosis.

Therefore, safety and health among migrant workers, women, and children are all issues that I care about, not only as your Surgeon General, but as a woman and Hispanic. This is why this Conference is so important.

### **BACKGROUND ON THE SURGEON GENERAL'S CONFERENCE ON OCCUPATIONAL HEALTH**

I will now provide a little history on the Surgeon General's Conference on Occupational Health. This is the 10th Conference in U.S. history. The first conference was held on May 20, 1925 by the Surgeon General of that period, Dr. Hugh S. Cumming, who called a Conference to discuss the problem of tetraethyl lead—a deadly occupational poison. Attending that first Conference were industrialists, chemists, labor representatives, and physicians.

Surgeon General Cumming held another Conference in 1926, in which the first cooperative agreement on toxic substances was reached. A third Conference, on the health hazards of radium dial painting, was held in 1928, and six more were held over the course of the next 13 years (Other Conferences dealt with: methanol; carbon tetrachloride and similar volatile chlorinated liquid hydrocarbons; carbon tetrachloride fire extinguishers; aniline oil; carbon disulfide; benzol; occupational cancer; and chronic mercurial poisoning in the hatting industry—better known as the "mad hatter" syndrome).

### **CHARACTERISTICS OF THIS CONFERENCE**

Dr. Alice Hamilton, the famous industrial hygiene pioneer and the first U.S. physician to devote her career to occupational safety and health, was so encouraged by these Conferences that she wrote:

*it was to me both surprising and heartening to see men of such widely separated backgrounds and interests... meet in a spirit of reasonableness and genuine desire to get at the real facts and deal practically with the problem.*

That is true today, as well. I look around the room and see people from many points on the spectrum of society, and this is why the theme of the Conference is called "A National Coalition for Local Action."

Safety and health issues in agriculture must be handled differently than safety and health issues in other occupational fields. Although people involved in the production of food and fiber are the largest single occupational group in the U.S., they are also a very isolated group. Not only because they live in rural areas far away from the noise and chaos of the urban environment, but also because they are isolated when it comes to protecting themselves.

There is no *internal* voice among the farm community to represent them, and there is no *external* voice to represent them either. This is something the farm community has in common with the children of the United States; children have no voice among

themselves to represent them, and no external group to speak for them either.

Children, like farmers, are isolated. This is why I chose to be a pediatrician.

So, it is important that we address the problems of the farming community beginning at the local level, although this is a national problem. This is certainly a unique approach to solving a public health problem, and I am hopeful this is only the beginning.

Actually, there is a precedent for this Conference. In September 1988, a Conference was held by a group, which ultimately became NCASH—the National Coalition for Agricultural Safety and Health. That Conference focused on four main objectives:

- Summarizing research and health and safety programs.
- Integrating the viewpoints of farmers and farm workers, the private sector, and public institutions.
- Identifying service needs and policy issues for the family farm.
- Communicating the results to legislators, policy makers, federal/State agencies, farm groups, farm families, and the general public.

That 1988 Conference is how the "National Coalition for Local Action" began. Without their hard work, it is unlikely we could have ever pulled this event off.

Three people in particular deserve special recognition for their involvement with NCASH: Mr. Carrol Bolen, with Pioneer H-Bred and the Executive Director of the Iowa 4-H Foundation, Ms. Lu Jean Cole, the Director for Community Investment for Pioneer H-Bred, and Mr. Tom Urban, Chairman and President of Pioneer Hi-Bred International, Inc. Could Mr. Bolen, Ms. Cole, and Mr. Urban please stand and be recognized?

### CONCLUDING REMARKS

In Puerto Rico where I grew up, farming was the dominant way of life for many generations—as it was here in America. Puerto Rico is much different now. A program known as "Operation Bootstrap" restructured and revitalized the Puerto Rican economy, transforming it from an agricultural economy to a manufacturing economy.

Although farming is no longer the major way of life in Puerto Rico, there are still parts of Puerto Rico where farming still exists, just as there are parts of the United States where farming is still a major industry. Iowa is certainly one of those places.

Although the farming population has decreased over the years\*, these are still the people who we rely on for our food. The 1989 Bureau of Labor Statistics reports that the injury and illness rate in the agriculture, forestry, and fishing industry is estimated to be about 11 injuries and illnesses per 100 full-time workers, making it the third most hazardous industry in the country. With the number of farms and

## The Potential for a National Coalition

farm workers declining, this high injury and illness rate is particularly alarming because it poses a threat to the backbone of food production in America.

The key to success for this "National Coalition for Local Action" we are building here is communication. There are many different representatives involved in this building process: farmers, physicians, chemical company representatives, farm machinery manufacturers, as well as representatives from government and academic institutions.

Naturally, there is going to be a great many philosophical differences between these groups. What we need to do is not dwell negatively on the things we disagree on, and instead focus positively on the things we *do* agree on, and build from there.

Only then, will this local action serve the national purpose. This is our "Field of Dreams." If we build it, they will come.□

---

\*The number of farms in Iowa shrunk from 119,000 in 1980 to 105,000 in 1989 (according to the 1990 Statistical Abstract of the United States). Accordingly, farm employment has also dwindled in the last decade. In 1980, the farm employment population stood at approximately 3.7 million in the U.S. By 1988, that number decreased to 2.9 million.

## REMARKS BY THE CHAIR OF THE CONFERENCE

By *J. Donald Millar, M.D.*  
Director, National Institute for Occupational Safety and Health  
Assistant Surgeon General

The National Institute for Occupational Safety and Health, part of the Centers for Disease Control, and I am very, very delighted to welcome you again to this Surgeon General's Conference for Agricultural Safety and Health. Is it not a great day in Iowa! It is beautiful out there. And just think how fortunate all the farmers of Iowa are that they get to spend the day outside today. It is wonderful!

I want to thank you again for coming. Is there anybody here from Amesworth or thereabouts? My wife and I drove over and we had a little automobile problem there or about there, and the good folk at the Amesworth Amoco Station were very helpful to us. So I just wanted to say thank you. Any of you from that area drop by and tell them that here is one very grateful Public Health Service officer who appreciates their help.

It is really good to be here. You know, this is the heartland, not only geographically, but in many ways philosophically, because here amidst the good people in the center of our country who still pursue farming as a primary occupation is the reservoir of many traditional American values—things that have made this country the great nation that it is; all the more reason why we should be here again, the second day of the conference, focusing on how to make their quality of life even better and more productive.

I would like you to, at this point, look in your program, if you have it, at page 27;

there begins a full 18 pages of names of people who have made this conference possible. At your leisure look through; as you recognize these people during your time here just say thank you to them personally. There are lots of folks represented, from many walks of life; many from NIOSH, many from outside of NIOSH. It is to them that we owe the success of this conference.

There are two people there whose names you will not see. One is Dr. James Merchant, from the University of Iowa, who has demonstrated great national leadership in this field and who, along with Dr. Pratt, came to Atlanta one day and encouraged this meeting and many other things related to agricultural safety and health. We appreciate that leadership, and we are glad to be responsive to it. The other is one of our speakers this morning, Senator Harkin, who provided legislative encouragement for us to convene in this session.

So you will want to remember these people with gratitude for having initiated—having helped us all to initiate—this conference. The three speakers that I am pleased to introduce this morning all have roots in traditional agricultural states—people who have a good feel for the land. Whether or not they, themselves, may have ever operated behind a plow or on a tractor or whatever, each of them brings to this a sense of the appreciation of human worth that I think is so important in public health.□

## HEALTHY PEOPLE 2000 AND AGRICULTURE

*By Tom Harkin*  
U.S. Senator, State of Iowa

Dr. J. Donald Millar: I would like to introduce Senator Tom Harkin, a senator from the State of Iowa. Last fall, in Iowa City, he and I shared a platform at the annual meeting there for occupational medicine. Senator Harkin's father was a coal miner. His mother was an immigrant from Yugoslavia. He worked his way through school here in Iowa and then served as a pilot in the U.S. Navy from 1962 to 1967. In 1970, he was appointed as a staff assistant to the U.S. House Select Committee on U.S. Involvement in Southeast Asia. In 1972, he received his law degree from Catholic University in Washington, D.C., and was elected a U.S. Congressman from Iowa in 1974. Through the years, he has pursued what I think is a very fascinating practice, and that is a series of workdays on which he works a full day side-by-side with an Iowan. Last fall he worked his 100th such day, and it was on an Iowa farm. He was elected U.S. Senator in 1984 and again, as you know, was re-elected in 1990. On both the House and Senate Agriculture Committees, he has been an outspoken advocate for America's farm families. Since 1989 he has chaired the Senate Appropriations Subcommittee on Labor, Human Services, and Education on which, again, he has advocated improved agricultural safety and health. As his record shows, he has been able to effectively represent citizens from both major parties while becoming known as a man who has the courage of his convictions. I present to you Senator Harkin:

Thanks, Dr. Millar, for that generous introduction. But I am not sure I deserve all that praise.

It kind of reminds me of what Mark Twain once said. He said,

*You'll go to heaven for your charity,  
unless you go somewhere else for your  
exaggeration.*

I would like to thank the Centers for Disease Control (CDC) for inviting me to speak here this morning. I am honored to share the stage with such world-class health care leaders, like Dr. Millar, who is fighting for the safety of working people all over America; and Dr. Novello, the Surgeon General, who tells it like it is and gets the job done.

I have been very impressed with your work and your leadership, Dr. Novello. And of course, Dr. Roper, who is leading the fight

toward preventing and curing disease with great leadership at CDC. You and those that work for you are making it possible for us to meet the health care challenges facing this nation.

It is good to be home. I am proud to see Iowa host such an important conference. I see a lot of familiar faces out there today.

Well, I will not speak to you too long this morning. Here in Iowa, we do not waste time with a lot of words. We say what we mean, and get on with it.

I am here today because there is a crisis in rural America: a real crisis. It goes beyond droughts and low commodity prices, beyond floods and infestation. It strikes at the heart of the American farmer.

It is a crisis about how we protect the people who put food in our homes and what we can do to help them. Quite



frankly, our farmers are dying. Not just here in Iowa, but everywhere, in farms and fields all over this country.

We are here today to say American farm families should not have the second highest fatality rates in the nation. That 170,000 disabling farm injuries each year is a national tragedy. And that 300 children killed on farms each year is a national disgrace.

Last year in Iowa alone, 83 people died on farms. 16 of them children. Over 2,000 more were injured, including 439 children.

What we learn here this week, what we take back to our towns and hospitals and community centers, may save thousands of lives.

Use what you learn here this week to fight to make our farms safer places. And never stop searching for answers. The stakes are too high to settle for anything less.

The work certainly will not end here at this conference. But the discussion must begin here. It is a discussion that needs to start by asking the simple question, WHY?

- Why are so many farmers and their children losing their hands, their fingers, and their lives performing routine chores every day?
- Why are farmers and their kids sick so often, afflicted by acute illness?
- Why do cancer, chronic lung disease, arthritis, and hearing loss cripple so many farm families?
- Why cannot most farmers get a drink of water after a long, hard day without worrying about contamination?

- Why cannot many farmers afford basic health care and hospital expenses once they are sick?
- And why cannot we prevent it all from happening in the first place?

It is not our place to ask why it took so long for this discussion to start. That will not solve anything.

Dwelling on the failed policies of the past will not keep a young child out of a grain elevator today. It will not teach farmers planting beans or corn about the dangers of pesticides.

You know, it is funny that we call them farmers. Just "farmers." Because they are so much more than that. Sure, they farm.

They plant, and seed the harvest; they buy combines, sell crops, fix broken tractors, tend sick animals, and help bring life into the world. They are meteorologists, soil experts, businessmen and women, carpenters, mechanics, and laborers. And they perform a hundred separate tasks each day in a hundred different locations.

Farmers are working longer days, with more mechanization, bigger machines, and more complex machines. Bigger farms have collapsed planting seasons. Farmers rush to get everything done. Their windows for harvest are smaller. They work harder and faster. Is it any wonder that safety needs to be talked about?

There are those that look at this kind of farm work and say:

*We cannot do anything. Our money can be better spent in other places. Studying farm injuries and farm safety is a waste of time.*

Well, tell that to Richard Zeman. Richard is an Iowa farmer. He lives in Bode, Iowa with his family. He has always lived in Bode.

He was born and raised on the same farm that he is on now. One September afternoon 14 years ago, Richard was chopping silage with one of those big choppers that shoots the debris into a wagon behind it.

Richard's brother was following in the wagon. Richard was going along, and some weeds got caught in the chopper. He stepped out of his tractor, leaving it still running, circled around front, and stomped down on the weeds to pull them out.

But something happened that Richard had not planned. The chopper started to move again. It took the weeds, and caught Richard's pant leg with them. He struggled to get free, but the machine pulled him in. By the time his brother pulled him out seven minutes later, Richard's right leg was nearly severed from the knee down.

He survived. But here he was, 34 years old, five kids, and forced to wear a fake leg the rest of his life. Let me tell you, it is pretty hard to farm with a false leg.

But Richard still farms today. Sure, he moves slower. He cannot play the softball and volleyball he used to, but he gets by okay. That is, as long as the back spasms for which he has had two operations do not cause him too much pain, or his leg stem does not blister too much.

Richard says that if there had been some education then, or if he had heard a brief word or two about safety, he would have thought twice. He probably would not have done what he did. And he would have his leg. In fact, he would probably be

playing third base for the local softball team.

How many Richard Zemans are there out there? I know you are probably thinking,

*Sure Harkin, we know that happened. But that was a long time ago. Things like that do not happen anymore.*

Well, sure, and I say let me tell you another story. Let me tell you about my friend Marilyn Adams.

Marilyn is an Iowa farmer. She and her husband, Darrell, have been farming the same land in Earlham for many years. Marilyn's son, Keith, loved the farm.

He always helped his dad in the fields and around the barn. Of course, he also loved going to church, and riding his bike, and playing down at the pond. He had a pet frog. And he planned on being a minister, even at age 11.

Then one fall afternoon in 1986, Keith went out to help his dad. While his father was out working in the field, Keith worked on the grain wagon closer to the house.

After a while, Keith's dad came back with a load of grain. He called Keith's name but got no answer. He looked around and could not find his son anywhere. Eventually, something caught his eye. Mr. Adams went closer to the grain wagon to look around.

He found his 11-year-old boy suffocated at the bottom of the wagon. To this day, the Adamses do not know how Keith fell in. The grain just sucked him to the bottom, like a whirlpool.

Marilyn Adams was distraught, as you might imagine. A year went by, and while still hurt, she realized not enough was being done to promote safety to kids on farms. In October, 1987, she formed Farm Safety for "Just Kids," an education program to teach kids about farm safety.

A month ago, I went on a farm safety tour in Union, Iowa, at the Martin family farm, Reginal and Melody. They have three kids. There was something very special about the tour.

Mr. Martin did not show me around. His two boys did—Bryce and Paul, both less than 10 years old. They had both been through the "Just Kids" program and knew all the dangerous places to stay away from.

So when people tell me that we cannot do anything to make our farms safer places, I say they are wrong. Too many of my friends have been hurt for us to turn our backs.

We can do more, and we must do more, and as long as I am in Washington, that is what I am going to fight for. And you can count on it.

I am in kind of a unique position. Three years ago, I took over as chairman of the Senate subcommittee that funds health programs in this country. Until then, there had never been a focus on farm safety.

Well, we changed all that. In 1990, we got \$11.5 million for the Centers for Disease Control to begin a farm health and safety initiative program. We increased that amount to \$19.5 million in the 1991 bill, and we hope to increase it more for next year.

I am happy to say that \$2.2 million has gone to the University of Iowa, Iowa State University, the Iowa State Department of Health, and to a network of 14 Iowa hospitals where they battle against farm disease and disability every day.

The farm safety program is made up of three parts. The first part focuses on identifying problems. The second part focuses on research. And the third part focuses on prevention and early intervention. We have seen early intervention work outside our farms and fields in other areas of society.

We know, for instance, that a woman given prenatal care while pregnant is 90 percent likely to have a healthy baby. If we help that poor kid with Head Start, WIC, and school lunch programs, the child is more likely to stay healthy, to stay in school, and to go on to become a productive citizen.

That is why Marilyn Adams' program is such a good idea. It reaches kids during that stage when it is so easy for them to learn. So they can recognize health hazards and can teach others about them.

Early intervention and prevention works in other places, too. Let me tell you about a few projects.

At Mercy Hospital here in Des Moines, for instance, we have started a cancer screening project for farmers, so cancer is detected early. Research has found that farmers have higher rates of leukemia, Hodgkin's disease, and lymphoma, as well as cancer of the lip, skin, stomach, prostate, and brain. We know that pesticide toxicity causes many more problems.

You will hear a lot about cancer and chronic disease over the next few days.

We do not understand all the problems and causes, but we have learned a lot. Through projects like those at Mercy Hospital, we can detect cancer early.

And through community outreach programs, we can educate farmers to the dangers when we discover them—community outreach programs like the Nurses in Rural Hospitals program, another project we started in order to get public health nurses into communities and rural hospitals and Parent-Teacher Association (PTA) meetings and everywhere that they will make a difference.

These nurses go out and look for injuries in farm communities. They are trained to recognize trends in medical histories, and to educate farm families to different risks.

The project just started. Currently, we have these nurses in many states throughout the country. And we will be increasing that amount.

We have also got to continue our efforts to provide farmers like Richard Zeman with safety tips, so they think twice before doing certain things. We know that taking shields off equipment can be dangerous, but many farmers do so because they interfere with cleaning. We know that it is not safe to go near moving parts on a machine, but many take the risk to save time, or they just miss the danger.

We know that kids should not go in a grain bin when the elevator is running. There are dangers on tractors and around other machines. Heck, when I was a kid, I used to ride on the fender of the tractor all the time. We just did not know it was dangerous.

Well, it is, and more people need to be reminded that saving time may mean risking lives. Above all, we need to stop people from thinking that farm injuries are just "part of the job." That is kind of like a traffic cop accepting a traffic accident as "part of the job," or a construction worker accepting a fall from a tall building as "part of the job."

There are things that can and must be done to prevent illness, disease, and disability, and not only on our farms and in our rural communities. Early intervention and prevention must reach into all aspects of American society in every city and town.

You know, we spend more than \$700 billion on health care in this country—and we are not getting our money's worth. We do not need to spend more on health care. We just need to spend it better.

Experts say that over half of that amount is spent on preventable illnesses. Yet, of the more than \$700 billion, only a small fraction is spent on prevention.

Well, my mother taught me the same thing your mother taught you: an ounce of prevention is worth a pound of cure. If that is true, then what is a pound of prevention worth? Everybody is talking about how to patch and fix and mend people, and that is important. But it is also important to talk about how to prevent injury, disease, and disability in the first place.

Well, my mother taught me the same thing your mother taught you: an ounce of prevention is worth a pound of cure.

Imagine if Americans took care of their cars like they take care of their bodies. What would you say if I bought a new car, drove it off the lot, never checked the oil, never checked the water, never tuned it up. Just drove.

And then, one day the engine seizes, I call the mechanic, he tells me that I need a new engine, so I say, okay, just put one in. You would think I was a little crazy.

Fact is, most of us spend more to maintain our cars than we do to maintain our bodies. Most people put more effort into watering their lawns to prevent browning than they do into taking care of their health to prevent costly and life-threatening illness later. Any farmer will tell you that you fix the fence before the horse escapes, not after.

Earlier this year, I introduced seven bills—called "Prevention First" to focus our attention on prevention and get rid of some of the anomalies in our system. I would like to talk about a few of these anomalies on both sides of life.

#### • MAMMOGRAMS

- 1 in 9 will develop breast cancer in their lifetime.
- Of those, 1 in 4 will die.
- 500 alone will die in Iowa this year.
- ▶ Anomaly:
- Spend \$15,000 for mastectomies.
- Spend up to \$50,000 for chemotherapy.
- Too often a woman dies.

- But we will not spend \$75 for mammograms.

#### I HAD TWO SISTERS DIE.

#### • LOW BIRTHWEIGHT BABIES

- Spend \$2,000 to care for them; gladly pay it.
- ▶ Anomaly:
- But we will not spend less than \$500 for 9 months for prenatal care.

#### • LEAD POISONING

- Thought problem was gone
- ▶ Anomaly:
- 28-month old Wisconsin boy died—calcium depleted.
- Will not spend \$7 billion to treat problems.

#### • CENTERS FOR DISEASE CONTROL

- Need to commit more to research.
- ▶ Anomaly:
- Spent more on military research in last 27 months.

On our farms, in our factories, in our schoolyards and boardrooms, we need to make "Prevention First" our motto for health care in the 90's.

On our farms, in our factories, in our schoolyards and boardrooms, we need to make "Prevention First" our motto for

## Looking Ahead to the Next Century

health care in the 90's. We will not solve every problem in the first year.

For some problems, we may never find a solution. But we can save a lot of lives and a lot of money.

I am counting on you first, to learn, then to educate. Take what you learn here back to farmers and hospitals in every community. Get the word out. Talk to people.

Because when you come down to it, we are the ones that will make a difference. And we will stop this crisis before there are more tragedies on our farms.

Above all, let us help protect the most valuable product that comes off our farms: our children. Let us teach them right so their children do not experience any of the problems we see today.

There is a lot of work to do. And we have got to start now. I want to see America where farmers do not have to accept injury and illness and disease as "part of the job."

As long as I am privileged to work for you in Washington, that is the kind of America I will be fighting for. And you can count on it!□

## BUILDING INFRASTRUCTURES FOR PREVENTION

By William L. Roper, M.D., M.P.H.  
Director, Centers for Disease Control

Dr. J. Donald Millar: I am sure that nobody will appreciate that kind of attitude more than the next speaker, my boss, Dr. William L. Roper, who is the Director for the Centers for Disease Control, which is the nation's prevention agency. As Director of CDC since 1990, Dr. Roper has shown, again, true national leadership in emphasizing that this country must have prevention in order to deal with many aspects of the health care problem. Dr. Roper served in a variety of positions before coming to CDC in 1990. He received his medical degree from the University of Alabama School of Medicine, in 1974, and subsequently a Master of Public Health from that university in 1981. He completed a residency in pediatrics at the University of Colorado Medical Center in 1977. He has served as a local health officer, a county health officer in Alabama, and also later as assistant state health officer. During that period, he also served in several faculty positions at the University of Alabama. From 1982 to 1983, he was a White House Fellow in the White House Office of Policy Development, with responsibility for health policy. He then served as special assistant to the President for health policy—that is the President of the United States—until 1986, when he served as administrator of the Health Care Financing Administration, the agency that is responsible for Medicare and Medicaid. From 1986 to 1989, Dr. Roper served as Deputy Assistant to the President for all domestic policy and as Director of the White House Office of Policy Development. In the time that he has been Director of CDC, it has been very clear to all of us there that Dr. Roper is a man who is moved by human misery and who seeks always to act decisively to help. I am very happy to present Dr. William Roper:

Senator Harkin, I am speaking for myself and all of the Centers for Disease Control (CDC) and especially the National Institute for Occupational Safety and Health (NIOSH) in saying we are honored to be in your home state for this important conference. Iowa has already given a great deal towards focusing national attention on the health needs of farmers, farm workers, and their families, and paving a way to attend to these needs.

Back in the fall of 1988, Des Moines hosted what turned out to be the seminal conference on this topic, "Agricultural Occupational and Environmental Health: Policy Strategies for the Future." It resulted in the creation of the National Coalition for Agricultural Safety and Health, and a "Report to the Nation," which summarized the findings and recommendations of the conference. An Iowan, Jim Merchant of the coalition, with several of his colleagues,

presented this report to my predecessor at CDC and now my boss, Jim Mason, in December of that year.

The presentation and report were persuasive. A CDC work group, headed by Don Millar, was quickly formed and plans for action followed. For the enactment of these plans we have to thank Iowa's Senator Harkin, who provided the political leadership in Washington to fund CDC's plans. So we gratefully recognize Iowa's profound role in bringing us to this point, and on into a better future, which we are here this week to help create.

As you know, CDC is the nation's prevention agency, so with the theme of my presentation today, "Building Infrastructures for Prevention," I would also like to recognize another Iowan important to public health, Dr. Richard Remington. He chaired an Institute of Medicine (IOM)

committee to study *The Future of Public Health*.

The findings and recommendations of his committee, published in a 1988 IOM report under the same title, represent a lucid appraisal of the state of our public health infrastructure and what is needed. I believe it will prove influential for all of us in this field and hopefully it will receive some attention outside the field as well.

However, the building of infrastructures has undoubtedly had as great a role as wars in history. The construction of first, railways, and then highways, and the shore-to-shore electrification and communications programs all have had revolutionary, long-term effects. The greatness of this country owes much to these achievements.

Likewise, the building of the current public health infrastructure has had profound impact. I define this infrastructure as the system of individuals and institutions that, when working effectively together, promote and protect the health of the people.

This infrastructure is made up of people, materials, strategies, and facilities. Among a host of achievements, our public health infrastructure has led to generally sanitary conditions in our cities and towns, progress in cleaning our air and water, the control of a host of communicable diseases, and an overall reduction in smoking.

What we are hearing these days, however, is that our progress in public health has to some extent lost its footing and missed a few steps. Having addressed the most public crises of yesteryear, we are finding ourselves challenged by an enormous range of scientifically and socially complicated problems for which public outrage and political will are far from automatic.

The public health concerns in agriculture make a case in point. You will be hearing many statistics of injury and disease over the course of this conference. The public health needs of those living and working on farms have been largely neglected. It is not surprising.

When the general public thinks of life on the farm, it conjures up a wholesome, perhaps hard but also idyllic picture of self-sufficiency and freedom from urban stressors and pollution.

The statistics, from CDC and others, have only recently been collected. The government policies and media attention are still largely focused on the medical care side of the equation; we are providing incentives for health care practitioners to work in rural areas, and reporting about the financial straits and closings of rural hospitals. There has been little prevention activity or interest.

Social factors concerning farm populations and their constituency groups have been equally important. The coalition's 1988 report cited the character of independence among people of farm populations, their sense of responsibility, and consequently a lack of organization or unions to represent farm families and workers. I understand there has been growing concern among farmers about toxins but I suspect injuries have always been, and are still, considered by many to be a condition of the way of life.

I would add to this the admirable trait of farmers to make the most of what they have, such as old equipment, making it last. Given also the financial rigors, it follows that farm constituency groups have pursued issues of economics and freedom



from restrictive regulations, rather than health.

In the past, when leaders in public health considered agriculture, they might have reasoned that the EPA is responsible for the safe use of agricultural chemicals and the Agricultural Extension Service has safety responsibility, and not pursued the subject further.

As the theme of this meeting, "National Coalition for Local Action," clearly portends, the foundation of our public health system, as it functions in agriculture and other sectors, must be the local public health agency.

This brings me back to "building infrastructures." Dr. Remington's IOM committee defined the mission of public health as "fulfilling society's interest in assuring conditions in which [all] people can be healthy." There are various infrastructures in agriculture that have a role in pursuing this mission.

Not only are USDA, EPA, and DOL needed, there is need for contributions from the public education system, rural hospitals, academic centers, agriculture-related businesses, volunteers, and community-based organizations such as Marilyn Adams' Farm Safety for "Just Kids." All of the individuals and institutions that have or could have involvement are needed, working effectively together towards our public health mission.

But it is time now that the public health agency become centrally involved with all of these partners. Surveillance, epidemiology, environmental and industrial hygiene,

safety engineering, these are public health prevention disciplines. The responsibility for leadership in assuring healthy conditions of life for our citizens lies with us.

In this context, I am going to emphasize in the rest of my remarks a view of our public health system and how it will have to be strengthened, or some important aspects of how to build an infrastructure for prevention. The hope is that, working with you in the Agricultural Extension Service, the FFA, and in other organizations active and concerned in this area, we can build an infrastructure able to assure that agriculture's workers and families can be healthy. Not that public health agencies—federal, state, or local—are going to "take over," but that we will together build the system, the infrastructure, successfully to meet the problems of farm safety and health.

As the theme of this meeting, "National Coalition for Local Action," clearly portends, the foundation of our public health system, as it functions in agriculture and other sectors, must be the local public health agency. Most of the opportunity to enhance health occurs locally.

Yet, as CDC found in working with the National Association of County Health Officials (NACHO) to inventory local health units, even state agencies are generally once removed from communities. In our survey, we found that only 17 percent of county health departments were actually an arm of the state health department, and 41 percent reported themselves totally independent.

The CDC-NACHO study also brought us an important understanding of the resources available to local health departments outside of metropolitan areas. The re-

sources at the local health department are insufficient.

About half of the jurisdictions with a population of fewer than 50,000 have a local health officer who is a physician. A small majority of these jurisdictions have a full-time health officer.

They may have a handful of employees, most commonly including a clerical position, a registered nurse, and an engineer or sanitarian, in that order. The budgets of these local health departments range from tens of thousands to a few hundred thousand dollars. Included in these budgets are Medicaid reimbursements for personal health care.

Here we begin to see the picture of a local, rural health department where perhaps a single public health nurse is trying to meet a range of competing demands, including personal health needs such as immunizations, tuberculosis control, child health, and sexually transmitted disease control; environmental health demands such as safe water supply and sewage; and other functions such as food and milk control.

What resources can this lone rural nurse, with a clerical assistant, bring to bear on occupational safety and health on the farm, for example? According to the CDC-NACHO study, four out of five local health departments in jurisdictions with populations of fewer than 50,000 report, in effect, "none."

What is the answer then, if this foundation of the public health system, the local health department, may not be equipped to expand its activity to address the problems of the 90's—injury control, occupational and environmental issues, chronic dis-

eases, smoking and nutrition, to name a few? The answer is not only enhancing resources quantitatively, but directing them to the rising demands, and where there is need or opportunity, capturing resources and assistance existing outside of the health department and even outside of government (raising coalitions).

In a word, what is needed at all levels of the public health system is "leadership." Leadership will build infrastructures for prevention. See *agricultural safety and health* as a reason for strengthening this nation's public health system.

We have various complementary means of leadership by which to accomplish our end. First among these is advocacy to ensure that we have the resources and participation we need.

Without articulate communication of our mission and the challenges that stand in its way, public health will not achieve the prominence required. Advocacy is an opportunity for public health in agriculture because of the insight and eloquence of many of the participants here today. However, public health advocacy must be unrelenting and, I emphasize, must occur at all levels.

In democracy, the most powerful advocacy swells from the community up. Local health departments should assume the community leadership role—setting forth the health agenda, building the necessary networks and alliances, mobilizing support, putting together public and private resources for common health purposes. It is the job of the rest of us in public health, whether we be state or Federal or outside of either, to encourage and empower these community agencies to take on their leadership.

If infrastructure is comprised of people, materials, strategies and facilities, the highest priority among these must be the people, the public health work force. After advocacy, human resources are important—public health is primarily people, not technology.

I would hope all of you here will join in supporting public health education, particularly of students of health professions. Taking the training of physicians for example, 99 percent of the curriculum in our medical schools today teaches curative medicine, not prevention.

In building infrastructures for prevention, we ought to think of our children as the most important infrastructure of all! We will always be striving to make our communities safer and more healthful. But raising generations with enough awareness to live healthy lives among the hazards around us and the hazards of choice is something we can and should achieve.

Building infrastructures requires advocacy, training, education . . . three other aspects in urgent need of attention are information, funding, and management and policy development. In bringing public health to agriculture, we are beginning in the right direction.

The information is needed at all levels, from the community to the nation. We are working with several states, including Iowa, to obtain this information and make it available. The use of our funds in this program, and the management and policy making involved, are directed to build infrastructures for prevention.

Looking forward, where we demonstrate success. This may sound very optimistic. The agricultural program CDC is leading is relatively small and much of the work is ahead of us. We have our first egg, and we are already counting flocks of chickens. However, we are expecting this program to grow.

We have this coalition we are building. We have, and this is what I have been trying to convey about building infrastructures for prevention, a great deal of opportunity before us. In whatever capacity we find ourselves, we can exert leadership to build a public health system of public and private means that serves our agricultural work force and their families.

In their report, the Committee for the Study of the Future of Public Health referenced de Toqueville as identifying an American political tendency to "organize actions around specific issues." The point being made was that issue-specific political groundswells can build or fragment our public health system. A general consensus on the mission and organization of our public health system is needed behind such groundswells if we are going to build a system to serve, for the long-term, a whole country of healthy people.

We have ourselves here just such an issue as De Toqueville was referring to in the 19th century. We have recognized that there is "a problem out on the farm," and we have begun to assemble our forces. Let us use the opportunity we have created to build a public health system that will work.□

## A CHARGE TO THE CONFERENCE

By *Antonia C. Novello, M.D., M.P.H.*  
Surgeon General of the U.S. Public Health Service

Dr. J. Donald Millar: Well, what you did not read in USA Today yesterday, you are about to see through the miracle of video communications:

A Video Introduction: *Good Science and Good Sense*—That is the motto of Dr. Antonia Novello, who in March 1990 became the first woman and the first Hispanic to become Surgeon General of the United States Public Health Service. The road to success for Dr. Novello began in her hometown of Fajardo, Puerto Rico, the center of a region long known for its production of sugar. After receiving her B.S. and M.D. from the University of Puerto Rico, Dr. Novello moved on to the University of Michigan in Ann Arbor, where she served her pediatric internship and residency. She also completed her subspecialty training in pediatric nephrology at Michigan, and later at Georgetown University, and then went on to earn a Masters in Public Health from the Johns Hopkins University. After several years working in the private practice of pediatrics and nephrology, Dr. Novello entered the Public Health Service with the National Institutes of Health, where she eventually became Deputy Director of Child Health and Human Development. Dr. Novello has served on several major public health committees and organizations over the years and has received a long list of prestigious awards in the process. Since her historic appointment as Surgeon General, Dr. Novello has made issues such as childhood immunization, pediatric AIDS, and childhood injuries among the top priorities on her agenda as the nation's number one public health spokesperson. Dr. Antonia Novello . . . the 14th Surgeon General of the United States:

— Edited and narrated by Jeffrey H. Lancashire

Greetings. I am glad to be here with you this morning as I welcome you to the Surgeon General's Conference on Agricultural Safety and Health.

As the Surgeon General of this country, I represent all of the citizens of this Nation. But as a pediatrician, I am especially concerned about the health of our Nation's children, for they are our most important resource and they represent our future.

The theme of this conference—*FarmSafe 2000, A National Coalition for Local Action*—is a serious topic. One that I know we have all placed on the top of our agendas.

As Surgeon General, I never thought that much would be focused on the subject of injuries—but because they are one of the leading causes of death in this country for all age groups, I will continue to speak out

about them whenever and whenever possible.

It seems somehow fitting, then, that I have just returned from addressing the Third National Injury Control Conference in Denver, at which a national agenda for injury control was drafted, and from a symposium on trauma in Texas, where four states came together to work on the prevention of head, neck, and spine injuries.

I am concerned about the health of our Nation's children. The more I talk about their health, the more I must tell you that it is very important for parents to recognize the dangers that their children face with regard to injuries.

We know that politically, children have no voice and therefore no power, yet they comprise one-quarter of the U.S. popula-

tion today, or about 64 million. As citizens of the Nation, we must assess, help, plan, and then act—it is our duty to build a stronger foundation for our young people and for their parents. We must speak for those who cannot speak for themselves—for those who are not with us today—it is their right to live full and rewarding lives, and it is our responsibility to do all that we can to make those lives the best they can be. As I said:

- Injuries are the leading cause of death in children today, with non-fatal injuries out numbering fatal injuries. Annually, injuries claim the lives of over 22,000 children between the ages of 0-19.
- Each year, an estimated 600,000 children are hospitalized and almost 16 million more are seen in emergency rooms for their injuries.
- The toll of injuries on the young is devastating; they suffer more deaths from injuries from the first year of life through the age of 19, than from all diseases combined.
- Injuries are also the leading cause of disability, with more than 30,000 children suffering permanent disabilities each year.

While the effects of such disabilities on children's development, daily living, and future productivity are great, the financial, emotional, and social effects on the family are enormous. Sadly enough, the number of reported injuries suffered by our children has not really changed much over the past twenty years.

If we, at least acknowledge that injuries occur and can be prevented—then maybe

injuries as a public health problem in this United States whether in farm country or in some Eastern State neighborhoods will receive the attention, focus, and resources commensurate with their magnitude.

The picture is worse for parents who are farmers where additional hazards are faced by their children. For example:

- Over 24,000 children are estimated to be injured each year on farms; 5000 of them suffering serious injuries.
- One out of five of all deaths occurring on farms are for children under the age of 16.
- A Cornell University study shows that children on farms under 14 years old were more than three times as likely to be injured, when compared to others working on the farm.
- Similarly, a Mayo Clinic study found that there were two ages where farm children were most vulnerable to injury; age four, because kids could go anywhere on their own, and were not scared of anything—and the other dangerous age was 14, when children—especially boys—began to take on major farming chores.
- Sixty-five percent of farm boys drive tractors before the age of 12. By law, they are permitted to drive a tractor down the highway. If the tractor flips over or is struck by another car, and the child is injured or killed—this is not reported as a workplace accident.
- The long-term emotional toll and injuries are enormous: A 1984 Wisconsin study placed the cost for a serious farm injury at \$140,000 and the total hospital

and rehabilitation costs for farm injuries were estimated to be about \$2.5 billion dollars.

All of us here today know that we have many problems that we must deal with. The realities we face vary from lives lost to long-term disabilities. As we heard yesterday:

- Agriculture is among the Nation's most hazardous occupations.
- We know that death rates, hover around 50 deaths per 100,000 workers, while the annual death rate for all other industries combined is only 11 deaths per 100,000.
- We know that in 1986, 1600 agricultural deaths occurred, including approximately 300 children that were killed while engaged in farm-related activities.
- We know that about 170,000 disabling farm injuries occur each year, and about half of all that survive them are permanently disabled.
- We also know that farms and other agricultural operations are predominantly small businesses.
- We also know that agricultural work is typically conducted in remote areas away from emergency medical or specialized diagnostic services.
- We know that agricultural equipment is typically over 15 years old, still in wide use and frequently does not include safety technology that would protect the operator.

You may say, why are injuries such a problem in this country? Well, I believe several reasons apply here.

► First, the term "accidents" still connotes randomness, unpredictability, and preventability. These connotations prevent institutions, the public, and educators from approaching injury prevention in a scientific manner.

Injuries need to be visualized as a problem of public health—allowing for us to deal with them the same way we approach disease and subsequent disease prevention wherever they may occur.

► Second, I believe there is a lack of interest and knowledge of the field by the general public, as well as by some law makers. People in the rest of the United States might not realize that injuries that happen in farm country have an effect on the country as a whole.

► And third, but not least, there is a general lack of morbidity and mortality data, which hinders prevention efforts that sometimes can be most effective.

Obviously, we need to come together to work this problem through. It is not just a problem that happens in farm country, it is a problem that happens everywhere. We as united citizens must bring it to the forefront. For example:

- The U.S. Department of Agriculture reports that there are 13.1 million persons in the United States that derive some of their income from farming, and an additional 6 million dependents.

These workers and their families experience a disproportionate share of inju-

ries and diseases associated with numerous chemical, biological, and physical hazards.

### **Occupational Lung Diseases**

In 1988, agriculture had the sixth highest work-related lung disease rate in this country. Types of lung diseases ranged from: allergic, to asthma and acute responses to toxic or irritating grain fumigants.

### **Musculoskeletal Disorders**

Another disease entity that is prevalent is degenerative musculoskeletal disorders. They result from chronic exposure to farm machinery vibrating, or to repetitive trauma associated with farm work. The most noticeable for these are reported as low back pain, hip arthrosis, and degenerative arthritis of the knee and upper extremities.

Migrant workers are typically involved in work that involves frequent hand and wrist movements, awkward working positions, and a dependence on manual lifting, which may be conducive to carpal tunnel syndrome and low back injuries.

### **Occupational Cancer**

Regarding cancer, epidemiological studies of farmers have uncovered consistent excesses of hematologic cancers, including leukemia, Hodgkin's disease, non-Hodgkin's lymphoma, and multiple myeloma, as well as cancers of the lip, skin, stomach, prostate, and brain.

Causative agricultural exposures have not been conclusively identified, but agents of concern include nitrates, pesticides, viruses, antigenic stimulants, and various fuels, oils, and solvents.

Excess cancers of the lip and skin are linked to increased exposure to the sun's ultraviolet radiation.

### **Severe Traumatic Injuries**

Severe occupational traumatic injuries usually occur suddenly on the job and are either fatal or require immediate medical care. These injuries affect, in substantial numbers, children under the age of 16 and the elderly 65 and older.

Machinery, especially farm tractors, are a major cause of death to agricultural workers. Others result from inadequate farm building design and livestock handling.

Of the estimated 1,500 machinery-related deaths annually among all occupations, more than half involve farm equipment.

### **Cardiovascular Diseases**

Another serious disease associated with agriculture is heat stroke. Agricultural workers are at the highest risk of developing this compared to all other workers, including miners and construction workers.

One associated risk factor is the lack of available drinking water, which affects at least one-fifth of labor-intensive farmwork nationwide.

### **Reproductive Disorders**

Workplace exposures can adversely affect the male and female reproductive systems, and as a consequence interfere with fetal development, and children's health. Pesticides may cause reproductive failure in either men or women, genetic damage, or miscarriage.

Moreover, the nature of agricultural work and the physiological changes of pregnancy put the pregnant farmworker at increased risk of health problems for both herself and her baby.

### **Neurotoxic Disorders**

Neurotoxic disorders present problems for the farmers as well. Approximately 10,000 people in this country suffer acute poisoning by organophosphate insecticides annually. These pesticides affect the nervous system, and up to not, the long-term neurologic consequences are known.

### **Noise-Induced Hearing Loss**

Regarding noise, noise-induced hearing loss is a well-documented result of exposure to farm machinery noise, especially tractor noise. Approximately 323,000 agricultural workers are exposed to potentially hazardous noise levels. Such hearing loss has been found to affect a quarter of younger farmers and fully one-half of older ones.

Significant numbers of those affected have been found to develop a communication handicap by age 30.

### **Dermatological Conditions**

Epidemiological data indicate that dermatological conditions caused by ultraviolet radiation, plant materials, soils, fertilizers, pesticides, and agents causing zoonotic infection are very common among United States farm workers.

In 1984, these disorders comprised over two-thirds of the occupational illnesses among crop production workers.

Skin disorders in this group were over five times more common than among all private sector employees combined, and nearly three times that of manufacturing employees.

### **Psychological Disorders**

Additionally, farmers, farm family members, and other rural inhabitants are not exempted from stress-related psychological disorders, especially depression.

Some of these psychological disorders appear to be related to isolation, economic hardship, weather conditions, or labor status.

### **Infectious Diseases**

In addition, some infectious diseases, which are agriculture-related, vary from one part of the country to another. Some others, such as those related to poor sanitation, like dysentery, hepatitis, typhoid fever, and intestinal ailments, are commonly spread by using the same eating and drinking utensils, drinking non-potable water, and from fecal-oral contaminating due to the lack of toilet and handwashing facilities.

Others, like parasitic infections — estimated to be 20 times that of either the general U.S. population or even other rural or poor urban populations, are epidemic among migrant farm workers.

Such is also the case for tuberculosis. For migrant workers, this is an occupational problem, and not an imported disease. The disease is 3,000 times more prevalent among black migrants than the general population as a whole.



So now that I have disseminated the information, and you are aware of the problem, what do we do?

First, and most importantly, parents who farm need to know what the dangers are. Second, parents must then educate their children about these dangers. Ignorance—like knowledge can remain forever.

The country is ready and the time is ripe to move the national agenda forward regarding injury control. The key to any success we might realize, however, lies in our ability to come together, first at the local level, and then at the Federal level.

And this is why we are here today—to explore what is needed to facilitate and promote this common goal, and work together in making it a reality.

In order to accomplish this, we need to return to some of the basic aspects of public health and management.

- We must work to raise the consciousness of the public and alert the community leaders about critical issues.
- We must also build coalitions—partnerships between health, education, environment, labor, and agriculture communities.

We must begin to disseminate the appropriate information, and we must as a consequence of such information, encourage action to prevent injuries.

Ultimately, my goal is to motivate all of you to reduce agriculture-related diseases and injuries, by prevention.

If we are to be successful in this endeavor, we must tackle the problem head on.

My wish is that this Conference will set a milestone in saving lives and preserving health. To accomplish this, Dr. Millar and I hope to convene a follow-up conference in the near future to develop a national strategy for the prevention of agricultural-related diseases and injuries.

But until then I must tell you that it is my belief that in agricultural safety and health, prevention begins and ends with the family, and so, the family should be one of our main targets as we fulfill the charge I have given to this Conference.

The key to any success we might realize, however, lies in our ability to come together, first at the local level, and then at the Federal level.

There was a famous 19th century Puerto Rican literary figure, Eugenio Maria de Hostos, who considered the family to be the cornerstone of society. He said:

*. . . as members of a family, we are so closely bound to it by gratitude that we recognize its effects from the cradle to the grave. If we are born, we owe it to the family; if we grow up, it is through the protection of the family; if we are educated, it is the work of the family; when we are with the family we work for it, away from it we long for it; we are happy in the family and for its sake; if we are unfortunate, we regret it for the sake of the family; ill, we fear death for its sake, and in dying, we long for it.*

With all this in mind, your deliberations here will set the stage for the work that needs to be done in this field. You have the responsibility of building a firm foun-

dition for our future actions in the coming decade. Your networking and coalition building will set the partnerships that need to be maintained.

This may be the tenth Surgeon General's conference on occupational safety and health, but this is just the beginning of our work together.

Appropriately enough, today, May 1st, is traditionally viewed in agriculture as a "day of fertility." Hopefully, today will mark the day for our National Coalition for Local Action to grow stronger. I trust that will be the case.

We know that changes do not come easy—they take commitment, partnership, and dedication.

It is apparent to me that this group is serious about injuries, and their impact on the lives of all our citizens.

It also seems to me that we know what to do and how to do it. Now we, together, must do it.

Only when this is done will this local action serve the national purpose. Friends, this is our "Field of Dreams." If we build it, they will come. I know we can, I know we will.

Thank you, and God Bless.□

## REMARKS BY THE NATIONAL FFA PRESIDENT

By Mark Timm  
President, National FFA Organization

Dr. J. Donald Millar: One of the great things about this conference to me is that there are so many young people here. We are very, very pleased with that aspect, and oftentimes in public health meetings there are not a lot of young people around. It seems to me that we have not made prevention and public health all that attractive to young people. But this is a field that compels the imagination of youth as well as the rest of us. So it is a great pleasure for me, at this point in the conference, to introduce you to a young national leader, Mark Timm, who is the national president, FFA. Mark is president for 1990-91. He is 19 years old, and he serves over 387,000 FFA members in over 7,600 local chapters nationwide, including the District of Columbia, Puerto Rico, and the U.S. Virgin Islands. These FFA members are preparing for careers in the science, business, and technology of agriculture. Mr. Timm was State FFA president in Indiana last year and is a National FFA scholarship recipient. He is currently on a one-year leave of absence from Purdue University—my wife and I drove through West Lafayette just two days ago—where he is studying sales and marketing with sights on working for an agricultural company in the future. During his year as FFA president, he will travel more than 200,000 miles, making hundreds of appearances on behalf of the FFA. It is my very great pleasure to introduce Mark to you:

### OPENING REMARKS

Good morning, and thank you for that kind introduction, Dr. Millar.

It is a pleasure to be here. I have a background similar to that of many people who have taken this podium. Senator Harkin stood up here and said he was from a small town.

Well, I am also from a small town, the town of Fillmore, Indiana, a rural community. Sometimes when I am talking across the country, in cities such as Los Angeles, Oklahoma City, Iowa City, talking about a small town, I say, "You know Fillmore is so small that when you drive into Fillmore there is no need for a turn signal because everybody knows where you are going anyway."

I think it is one of the few places in the country that you can dial the wrong number and still talk for thirty minutes. Many

of you can probably relate to what I am talking about.

But, I am from a rural community, and I can stand up here, as many have, and relate to you story after story of my experiences with working with agriculture—the experiences of discing a 100-acre field at the age of 10, or planting at the age of 11, or maybe even driving a grain truck with 7½ tons of grain at the age of 14.

I will be honest with you: at that point in my life I did not give it a second thought.

By the same token, most of you involved in agriculture know that it is a way of life, and it is a respected way of life. I feel that the objectives being accomplished here and the directions that we are heading are definitely right.

Dr. Millar, you talked about my involvement in the FFA. The FFA is the nation's largest intercurricular student youth orga-

## Questions to Guide the National Agenda

nization—nearly 400,000 FFA members nationwide. And serving as national president is a tremendous honor. It is a great opportunity, but it is even a greater responsibility, because, as the speakers have stood up here and talked about the role of youth in America there are not very many opportunities for youth to speak out and speak to adults.

I have been given the chance to represent a large portion of the youth in America and the youth in agriculture. It gives me great delight to see the young people in our organization out here. I do not know if you have had the chance to notice, but there is more than just my jacket running around here. There are seven chapters from all across this country.

Dr. Roper talked about leadership. Well, our organization is based on agriculture. That is the backbone of this organization.

But, equally important, our students are interested in developing their leadership, their personal, and their academic skills, through agriculture. We are teaching them not only to be stewards of the land but to be the future leaders of our communities, of our state, of our country, and eventually even of our world.

I would like to share with you some of the leadership that we are showing in the area of safety. We have a National Chapter Safety Award Program.

This year, at our National Convention, we honored over 150 chapters for outstanding accomplishments in the area of safety. Thirty-six chapters received gold recognition, and out of those 36, seven were chosen to attend this conference. Those seven chapters are going to be putting on poster

displays tomorrow afternoon in the poster display demonstration.

I want to share with you, just to highlight some of the safety areas that we work on or that we address as an organization, because, you see, our primary goal as a national safety award program is just like the goal that your theme states. It is a national coalition for local action.

This year, at our National Convention, we honored over 150 chapters for outstanding accomplishments in the area of safety.

It is a national award program centered at the local level. What we do is assess the needs of the community. The chapter assesses the needs of the community, and some of those needs that we address are National Farm Safety Week; Farm Safety for Just Kids, which you have heard about; chemical safety for farmers; water quality testing; and all-terrain vehicle (ATV) and three-wheeler seminars.

Chapters even address areas such as boating safety; holiday awareness programs such as the testing of candy on Halloween; fire-prevention safety; home safety, farm machinery operations, and hazardous grain hauling; chain-saw safety; restricted use for pesticides; CPR classes and substance abuse awareness. So, we are touching several areas in safety, focusing primarily on agriculture, which is our backbone, but also other areas of safety.

Not only do we have our National Safety Award Program, but we also are infusing safety into our curriculum—agricultural education. We have initiated programs in areas such as food safety and environmen-

tal safety. As a matter of fact, one of our most recent programs was food safety—a \$300,000 project that business has picked up and is willing to sponsor, and we plan to start developing the actual curriculum this summer.

We will be writing the curriculum and will be spreading it across the country, with 400 workshops, trying to educate our teachers of agriculture education and the home economic teachers about food safety, all the way from the production of food to the processing of the food. So we are covering a wide range, a wide spectrum, of food safety. We will educate teachers on food safety, then they will educate the people that make it count, and that is the young people in America.

I would like to close on my statements about the FFA and our role in safety by quoting what one of the chapters that are represented here—the Stockton Chapter of Missouri—said in their safety award application:

*Health is not everything,  
but you're dead without it.*

#### **[REMARKS AFTER THE FIRST SPEAKER]**

The rest of this session will frame the work of the conference around three activities: surveillance, research, and intervention. Each of the three following speakers will pose questions related to each of these activities, which will be addressed by five concurrent sessions.

One session will address surveillance; two will address research; and two will address intervention. These five concurrent sessions will convene this afternoon. The five sessions are:

1. Surveillance—Agriculture-related Disease, Injuries, and Hazards.
2. Research—Biological and Chemical Hazards.
3. Research—Physical and Mechanical Hazards.
4. Intervention—Agricultural Workers' Protection from Hazards.
5. Intervention—Safe Behaviors among Adults and Children.

A presentation panel will deliver talks on a variety of issues. Tomorrow, after a morning plenary session, a concurrent session will reconvene to hear discussion panels comment on today's presentations. The concurrent session will reconvene again after lunch tomorrow, to hear public comment and to address the points to be reported back to the full conference on Friday morning.

#### **[REMARKS AT THE CONCLUSION OF THE SESSION]**

Before we conclude, I would like to thank them for giving me the opportunity to come here, and I would also like to say that, as the population of the rural community declines, so does our membership in the FFA, the organization that I represent. However, our urban membership has drastically increased, so we are involving a much more diverse group of young people interested in agriculture.

I get the chance, as I travel across the country, to represent youth in agriculture, and I want to share with you one quick story before we conclude. That is, a special place that I have found off the coast of

## Questions to Guide the National Agenda

Alaska. It is a special place called the Diomedes Islands.

Why it is so special is because the International Date Line is found to run right down between the Diomedes Islands. Not only that, but one side of the islands is owned by the Soviet Union and the other side is owned by the United States.

Not only does America need its young, but young people need your help, support, guidance, and leadership.

So you can sit on one side of the island and look across and it would be the 28th of the month, and on the other side of the island it would be the 29th. On a clear day, when you look across these islands, not only would you see another perspective on life, since the Soviets value the posses-

sions they have and we as Americans value freedom—but on a clear day you can even see tomorrow.

If you really think about that—the ability to see into the future—I wish I had the ability to see in the future right now because, let me tell you, I see a tremendously bright future in this industry of agriculture.

I am proud to say that I am a part of agriculture and proud to be here representing this organization, representing youth in agriculture. With that, I would like to leave you with one final statement on behalf of the youth, and that is that America needs youth because youth represents the future of the state of this country and of the existence of everybody. Not only does America need its young, but young people need your help, support, guidance, and leadership.□

## THE ROLE OF PUBLIC POLICY IN AGRICULTURAL SAFETY AND HEALTH

Joseph A. Kinney, M.P.A.  
Executive Director, National Safe Workplace Institute

Mr. Mark Timm: Our first speaker this morning is Mr. Joseph A. Kinney, Executive Director of the National Safe Workplace Institute, located in Chicago. Mr. Kinney spent his youth and entire professional career closely linked to agriculture. He grew up in Kansas working on farms and ranches and was deeply involved in breeding Charlette cattle when he was a college student at Illinois State University. Mr. Kinney holds a Purple Heart from service in Vietnam. He later spent five years working on agriculture in the United States Senate, and an additional five years as staff director for the committee on agriculture in the National Governor's Association. He spent a significant amount of time living and working with farm families in several states, including Idaho, North Carolina, Minnesota, Alaska, and California. He holds graduate degrees from the Maximal School of Citizenship and Public Affairs, and from the University of Pennsylvania. In 1987, Mr. Kinney founded the National Safe Workplace Institute, which is a not-for-profit organization devoted to making occupational safety and health a higher priority for the private and public sectors. Both Mr. Kinney's background and his interest in safety uniquely qualifies him to speak on the topic, *The Role of Public Policy in Agricultural Safety and Health*. Mr. Kinney:

Good morning. It is really a privilege for me to be here today to address the Surgeon General's Conference and to discuss the role of public policy in agricultural safety and health.

As you have just heard, I have had two careers. My first career was in agriculture. In fact, about 10 years ago or so I had the opportunity to address an agribusiness audience in Dallas, and one of the old ranchers in the audience got up and made a little speech and at the end of it he said, "And son, how long you been involved in agriculture?" I said, "Sir, 30 years. Next question, please." So, you know, I feel like I've been around it a fair bit of my life, since I was about 32 when I spoke in Dallas.

Throughout my life, I have developed a deep appreciation for the role that our farmers and ranchers play in the production of the food and fiber of this country. They clearly are our backbone. Without

them, we would have nothing. In fact, if you look at our economies and compare them with many of the economies in the industrialized world, one of the real strengths we have is our efficiency in food and fiber production. It is because of people like Mark. We all really owe them a lot.

As Mark said, I spent a lot of time living and learning from farmers and ranchers. I have cured tobacco in Harnett County, North Carolina. I used to be involved in all aspects of grain and livestock production in Illinois. Certainly I have baled my share of hay in Kansas. I have tended ranges in Wind River, in Wyoming.

My least favorite job was culling potatoes in Idaho. But I took those jobs because working in Washington, you tend to be sort of isolated and insulated from reality, and so when I would meet an interesting farmer I would ask him, "Well, can I come and

work for you for a week and learn what you do?" That is how I did it.

I actually was injured once. I had a very severe laceration to my left leg and was stitched by a "vet." When we design our surveillance systems, it is clear that we have got to include veterinarians because I was stitched by a vet. I have got a lot of ugly scars, but it is the ugliest. But it was a very valuable experience because it taught me that farmers like to rely on their own community. I would be very surprised if there is not some resistance to NIOSH.

► Certainly one of the things that I learned in my years in Washington was that the agricultural community is strongly resistant to OSHA. I think that will have to change. Clearly, farmers are a unique group. Farmers tend to work until the job is done. They do not know a 9-to-5 day. But it is also clear that agriculture defies easy generalization.

Throughout my life, and I am 42 now, there have been two consistent themes. The first is that our farms and ranches tend to grow in size, almost year by year. The little house on the prairie, near where I grew up in Kansas, now looks a lot more like Dallas.

► The second theme is that we are spending a lot of money—a significant amount of money—on supporting farm incomes from the Federal treasury. I think that is very important to understand, because I know farmers—and we will talk a little bit about this today—want to resist any kind of intrusions by external forces. But what farmers need to understand—and rural people need to understand—is that there is a significant public investment in what they do and, therefore, there is a significant

public interest in their health and well-being.

My interest in occupational safety and health stemmed from the death of my brother, Paul, from a scaffold collapse in Colorado. Since I have been involved, I have had a peripheral interest in agricultural safety. At the Institute, we have written about it. We have talked about it a little bit. We are doing a rather comprehensive analysis of options for public involvement on job safety. I will touch a little bit on that today.

Frankly, there would be more public involvement if it were not for the farm lobby.

You have heard plenty about the size and magnitude of this problem. You know, the National Safety Council puts out data and, based on this data, agriculture has had persistently high levels of injury relative to other regulated areas. I guess the lesson we could learn from that is that the free market and, perhaps, many educational approaches are not working. We need to look more aggressively to other approaches.

Frankly, there would be more public involvement if it were not for the farm lobby. Having met with many farm organizations, I can tell you that at least in the past they have resisted involvement. I think that is going to change. In fact, I think we will begin to see more public involvement in these issues in the near future. I mean involvement beyond the sort of touchy-feely things of education and beyond research issues. There are any number of areas that we could see develop.



I would like to show you a couple of transparencies that I put together here so we can get a sense of who is involved and what is involved. Farmers like to talk about target prices. People in public health like to talk about target groups.

When we look at this issue, we need to understand that there is more involved than the men and women who own and operate farm enterprises. There are children. There are farmworkers. There are all different categories of people.

Sector	Dollars Spent Per Worker
Agriculture	\$0.30
Mining Workers Covered by OSHA	\$181.68 \$4.34
U.S. Department of Agriculture's Commitment to Agricultural Safety and Health, FY 1991:	
▶ Extension Service—distributed on a formula basis with \$19,000 to each state:	\$970,000
▶ Competitive Grant Program:	\$1,000,000
Source: Prof. William Field, Purdue University.	

Figure 1. Federal Dollars (Fiscal Year 1987) Spent on Occupational Safety and Health.

Now, potentially there are all sorts of laws that could be applied in this area—child labor laws, criminal prosecutions for not only fatalities and homicides, but batteries and injuries. There is obviously the possibility of citations. Right now there is a rider on the appropriations bill that keeps OSHA from inspecting injuries or fatalities on farms. Of course, there is Workers' Compensation, and, finally, there are injury lawsuits.

To this point the public involvement has largely been limited to research and education migrant protection, and health servic-

es. Of course, there is the sanitation standard. But the involvement of both states and the Federal Government has been quite limited.

1. Surveillance	\$5,745,816
▶ Farm Family Health and Hazard Survey.	
▶ Occupational Health and Safety Surveillance Through Health Departments.	
2. Research	\$6,217,817
▶ Applied Preventive Research.	
▶ Education and Training Programs.	
3. Intervention	\$6,676,367
▶ Cooperative Agreement Program for Agricultural Health Promotion Systems.	
▶ Demonstration Cancer Control Projects for Farmers.	
Source: NIOSH.	

Figure 2. National Institute for Occupational Safety and Health—Agricultural Safety and Health Program.

In fact, if we look at Figure 1, we can see that these data are a little old; but, I am told by the producer of it, Bill Field of Purdue University, that the data really have not changed that much. As you can see, occupational safety and health expenditures equal about thirty cents per farmer. Perhaps that is what they think their lives are worth, but we spend a substantial amount of money, for miners, and a small amount of money for regular industrial workers.

The Agriculture Department's commitment is now essentially limited to a \$975,000 fund distributed equally to states. Perhaps we are going to hear that the U.S. Department of Agriculture (USDA) is also going to spend a million dollars in competitive grants that will be committed by the end of this fiscal year.

Questions to Guide the National Agenda

Figure 2 shows NIOSH programs that are multi-year programs. It looks like a lot of money. NIOSH spends \$18-\$19 million dollars. In reality, it is quite little.

In Figure 3 what we wanted to measure, in terms of budgetary expenditures, is the commitment that we have to occupational safety and health in America. Total federal workplace health spending involves the budgets for NIOSH, for the Occupational Safety and Health Administration (OSHA), and for the Mine Safety and Health Administration (MSHA).

In 1981, we spent one dollar out of each \$1,579 of the Federal budget for these programs—not very much. By 1991, that amount of money had dropped to just a one dollar out of each \$2,408.

Fiscal Year	Total Workplace Health Spending	Amount Required to Keep Pace with Inflation <sup>1</sup>	How Many Federal Dollars Spent for Each Dollar Spent on Workplace Health <sup>2</sup>
1981	\$4,294	n/a	\$1,579
1983	\$4,165	\$4,854	\$1,941
1985	\$4,356	\$5,234	\$2,172
1987	\$4,524	\$5,493	\$2,219
1989	\$4,807	\$987	\$2,212
1991*	\$5,447	\$6,512	\$2,408

\* Estimate.  
<sup>1</sup> Inflation data based on calendar years; 1991 figure is an estimate.  
<sup>2</sup> Another way of expressing this statistic: Number of federal dollars spent for every single dollar spent on the combined budgets of OSHA, MSHA, and NIOSH.  
 Sources: Inflation Data—Bureau of Labor Statistics. Budget Figures—Office of Management and Budget. Compiled by the National Safe Workplace Institute.

Figure 3. Workplace Safety and Health Regulatory, Research, and Education Spending—Adjusted for Inflation and as a Share of Federal Budget, Selected Years (in millions).

What this chart represents to me is a diminished and decreasing commitment to workplace safety relative to other budget

priorities. There is no way around that. We have also looked at this and you know, we have looked at occupational health versus EPA; we have looked at this versus the National Institutes of Health and a lot of other measurements. Clearly, our commitment to occupational health in this country—workplace health—is going down.

Now in Figure 4, we looked at workplace health compared to the national defense.

Fiscal Year	Total Workplace Health*	National Defense	Ratio
1981	\$429.4	\$157,513	366.9
1983	416.5	209,903	504.0
1985	435.6	252,748	580.2
1987	452.4	281,999	623.3
1989	480.7	290,361	604.0
1991**	544.7	298,910 ***	548.8

\* Includes combined budgets of the Occupational Safety and Health Administration, Mine Safety and Health Administration, and National Institute for Occupational Safety and Health.  
 \*\* Estimate  
 \*\*\* Pre-Desert Storm  
 Source: Office of Management and Budget. Compiled by the National Safe Workplace Institute.

Figure 4. Comparison of Total Workplace Health Spending Versus National Defense Spending, Selected Years (in hundreds of millions of dollars).

In 1981, as you can see, we valued our national defense 367 times more than we valued the health and safety of workers in America. That is what these data say to me. By 1987, the ratio had grown to 623 times. In 1991, it dropped to 548 times. But, of course, that was before Desert Storm. No one seems to know what is going to happen to the defense budget. I think we are going to have to add somewhere in the neighborhood of \$40 billion plus. So, the 548 times figure will be much closer to 600 and something.

In fact, if you look on Figure 5, at workplace health spending compared to farm income stabilization, in 1981 we supported farm income 23 times more than we supported workplace health.

Please do not misunderstand what I am saying. I have worked hard on the farm bills of 1973, 1977, and 1981, and I certainly know all the arguments for target prices and price support loans and all the various USDA programs. I think they are very valuable. These are income transfers to farmers. Clearly, the dollar amounts fluctuate up and down depending on what commodity prices are doing, but nevertheless it is interesting to compare price supports and workplace health spending.

Fiscal Year	Total Workplace Health*	Farm Income Stabilization	Ratio
1981	\$429.4	\$ 9,783	22.8
1983	416.5	14,344	34.4
1985	435.6	21,323	49.0
1987	452.4	29,606	65.4
1989	480.7	14,817	30.8
1991**	544.7	9,761	17.9

\*Includes combined budgets of the Occupational Safety and Health Administration, Mine Safety and Health Administration, and National Institute for Occupational Safety and Health.  
 \*\*Estimate.

Source: Office of Management and Budget.  
 Compiled by the National Safe Workplace Institute.

**Figure 5.** Comparison of Total Workplace Health Spending Versus Farm Income Stabilization Spending, Selected Years (in hundreds of millions of dollars).

Figure 6 compares total workplace health spending to agricultural research and services of selected years, basically every other year from 1981 to 1991.

As you can see, the agricultural research and services budget is growing at a faster rate than workplace health. I was having breakfast this morning with some of my

extension friends and they were telling me how poorly the USDA agriculture research budget has been doing. My friends, you have been doing much better than NIOSH, OSHA, and MSHA, as you can clearly see in this Figure 6.

What these figures suggest to me, at least at a superficial level, is that there may be more room to do more things at USDA. Of course, that raises a significant question I hope will be worked out in the next year or two. The question is how we might best coordinate and work together. I think there is room for both agencies to be involved in this area. In fact, I think they already are. The Extension Safety programs go back a hundred years—a long, long time.

Fiscal Year	Total Workplace Health*	Agriculture Research & Services	Ratio
1981	\$429.4	\$1,540	3.6
1983	\$416.5	\$1,578	3.8
1985	\$435.6	\$1,813	4.2
1987	\$452.4	\$1,864	4.1
1989	\$480.7	\$1,964	4.1
1991**	\$544.7	\$2,404	4.4

\*Includes combined budgets of the Occupational Safety and Health Administration, Mine Safety and Health Administration, and National Institute for Occupational Safety and Health.  
 \*\*Estimate.

Source: Office of Management and Budget.  
 Compiled by the National Safe Workplace Institute.

**Figure 6.** Comparison of Total Workplace Health Spending Versus Agriculture Research and Services, Selected Years (in hundreds of millions of dollars).

The next figure, Figure 7, is what my four-year-old son would call a "big nasty." These are the kinds of public sanctions that can be taken against job-safety violators.

► First, if you look at the economic literature, the most costly part of OSHA's involvement with business is not in fines,

but clearly in the inspection process. There are many studies on that.

- ▶ Second, there are civil penalties, and they were recently increased by a substantial magnitude.
- ▶ Third, there are criminal penalties. There is legislation in the Congress now to increase the amount of time we can spend in jail for knowingly and willfully tolerating workplace conditions that result in the death of a worker. The government has recently put one person in jail, under the OSHA Act. It was a South Dakota contractor and the incident involved excavation fatalities. I have no idea how many people die in excavation fatalities on farms and ranches, but I am sure it is a substantial number.
- ▶ Fourth is Workers' Compensation premium increases.
- ▶ Fifth is a seldom-used tool, unfortunately. Hopefully, it will be used more in the future. It is simply an injunction to stop people from doing what they are doing.
- ▶ Sixth is the loss of eligibility to participate in public programs. The most recent example is that of a construction company called S.A. Healey, a Chicago company that had a bad safety record with many violations.

So far, they have lost a \$78 million contract in Los Angeles on which they are the low bidder in, because of their safety record. They lost a \$37 million contract in Milwaukee, where they were the low bidder, because of their safety record. They are the low bidder in an approximately \$200 million contract in another New Eng-

land state where my organization is actively trying to knock them out.

- |  |
|--|
| <ol style="list-style-type: none"><li>1. <b>Potential target groups:</b><ul style="list-style-type: none"><li>▶ Farmers.</li><li>▶ Farm Families (spouse, children).</li><li>▶ Farm Children engaged in farm work.</li><li>▶ Farm Workers, Permanent, Full-Time, Year-Round.</li><li>▶ Farm Workers, Permanent, Part-Time, Year-Round.</li><li>▶ Farm Workers, Seasonal, Part- or Full-Time.</li><li>▶ Migrants.</li></ul></li><li>2. <b>Applicable laws:</b><ul style="list-style-type: none"><li>▶ Child labor laws.</li><li>▶ Federal criminal prosecution: homicide, willful violation.</li><li>▶ State homicide or battery prosecution.</li><li>▶ Citations for violations by the Occupational Safety and Health Administration or corresponding state agency.</li><li>▶ Workers' Compensation.</li><li>▶ Injury law suits.</li></ul></li></ol> <p style="text-align: center;">— Compiled by the National Safe Workplace Institute.</p> |
|--|

Figure 7. Target Groups and Laws that Could Be Used To Regulate Agriculture Safety and Health.

One of the possibilities that we could see, frankly, in the agricultural area, is the possibility of cross-compliance. One of the models that we might look at in terms of public intervention and farm safety would be a farm safety audit.

If farmers did not pass their audits or make corrections within a specified period of time, they could lose eligibility for price support programs, soil-conservation programs, farm loan programs, farmers' home programs—whatever programs exist, and there are plenty of them.

Another area where I think we will see some intervention, very soon, of a criminal nature is children on farm equipment. Mark Timm talked about his involvement as a youth.

I could tell the same stories. One is a recent event; a 21-month-old was killed while helping his father when he fell under the wheel of a tractor that his six-year-old sister was driving. According to Bill Field, at Purdue, the fact that 300 kids die each year on farms—kids below the age of 15—is supported by a similar study at the University of Tennessee.

In recent years, we have documented three-year-olds who were killed in Nebraska and Texas who were actually classified as industrial deaths. Let me say one thing. This 300 number may be substantially larger in proportion to population than the numbers of 15-year-olds who are killed—murdered—in big cities because of drugs. If that does not make your blood boil, I think you should go out and have your temperature checked.

There is no way that anybody with half a conscience, looking at these numbers and looking at these stories, can sit and not say that this is not potential child labor abuse. We have been responding to increasing inquiries from prosecutors in various cities who have been looking into bringing child labor abuse charges in farm accidents. It has not happened, but I am certain that it will happen in the next few years.

Sunday there was a story on CNN—maybe many of you saw it—about a guy named Dominguez in Miami who is going to jail because his kid did not have a seat belt fastened. In fact, the kid was sitting in his mamma's lap, if I remember the story correctly. They had a crash, and the kid was

killed. So the father is being prosecuted. Frankly, there is not a dime's worth of difference, in my view, between the Dominguez in Miami and the man in Visalia, California.

The last area where I think there is going to be some involvement, as shown in Figure 8, has always been a dynamic area. There are only 12 states in the United States where farmworkers are recognized as workers under workers' compensation.

Coverage	States
<b>Same as other Workers</b>	Arizona, California, Colorado, Connecticut, Hawaii, Louisiana, Massachusetts, Montana, New Hampshire, New Jersey, Ohio, and Oregon (12).
<b>Voluntary</b>	Alabama, Arkansas, Idaho, Indiana, Kansas, Kentucky, Mississippi, Nebraska, Nevada, New Mexico, North Dakota, Rhode Island, South Carolina, and Tennessee (14).
<b>Limited</b>	Alaska, Delaware, Florida, Georgia, Illinois, Iowa, Maine, Maryland, Michigan, Minnesota, Missouri, New York, North Carolina, Oklahoma, Pennsylvania, South Dakota, Texas, Utah, Vermont, Virginia, Washington, West Virginia, Wisconsin, and Wyoming (24)
—Compiled by the National Safe Workplace Institute with the Assistance of the Farmworker Justice Fund.	

Figure 8. Workers' Compensation Coverage of Agricultural Workers.

Workers' compensation is a no-fault injury program. When you create workers' compensation programs, you can not sue your employer for injury. Voluntary really means no program. I am sure—I do not have any studies but I am sure—that the vast majority of farmers in those states have no workers' compensation insurance. Are there any studies on this subject that you know of?

About how many farmers have workers' compensation insurance in the states where it is voluntary? It would be a good study to do. In these other states—24 states—it is limited, like in Georgia. Farmers who work for the Department of Corrections are covered, but all other farmers are excluded. There are all sorts of different restrictions. We have all the data. We have analyzed the laws. That is the story!

Let me say that what we are now recommending to farmworkers who are injured, especially in the states with voluntary programs where there is no compensation coverage, is to sue. Sue the living "Bejesus" out of the farmer for whom you work.

This is the only way that we are going to get the attention of people in states where workers compensation is limited and farmers are not covered—sue. It is only recourse the injured have.

What has happened historically? To use the terms of economists, the economics of these injuries have been externalized. Who pays for injury in the case of the farmworker or migrant?

I can tell you who pays for it. It is the families. It is the local public charities. It is the public hospitals. It is not the farmer. And, of course, if the farmer can external

ize the cost and risk to other forces in society, it is rational for that farmer to do so.

I am not going to sit up here and just tell you exactly what is going to happen when and where. I do not know. But, believe me, it is moving toward public interventions. I hope what that says to each and every one of you out here is that you need to begin to get realistic about how you would like to see these issues addressed.

Our country spends more per capita for the education of the young than any other nation, save Switzerland. We spend lots of money to prepare young people for life. Cities help educate farm kids.

There is also public investment in human lives, and we need to do more to protect those lives in agriculture. I am sorry if some of you people feel, as my son probably would feel, that I have come and been the "big nasty" here today, but I think that it is time that we begin to look at this and realize that we have got to do something about farm safety.□

## SURVEILLANCE FOR AGRICULTURAL SAFETY AND HEALTH

*William E. Halperin, M.D.*

National Institute for Occupational Safety and Health

Mr. Mark Timm: Our next speaker is Dr. William Halperin. He is the Associate Director for Surveillance, Division of Surveillance, Hazard Evaluation, and Technical Assistance, at NIOSH in Cincinnati. Dr. Halperin received his Master's in Public Health and M.D. from Harvard. In 1975 he became an Epidemic Intelligence Officer at the Centers for Disease Control. In 1979 he became the Chief of Industrywide Studies Branch at NIOSH. Dr. Halperin has served on numerous professional and expert committees. He currently serves on the Committee on Risk Assessment Methodology at the National Research Council. Dr. Halperin has published over 100 scientific papers, editorials, and letters to editors. His epidemiological investigations include herbicides, dioxin, and biotechnology. He was a co-author on perhaps the most popular paper in occupational health in the last 10 years—the *Sentinel Health Event: A Framework for Occupational Health Surveillance and Education*. That leads to Dr. William Halperin's topic today, *Surveillance for Agricultural Safety and Health*. Dr. Halperin:

Public health surveillance is central to the process of disease prevention. Surveillance systems are vital tools in targeting the resources of the public health system and in evaluating program effectiveness.

The Institute of Medicine report *The Future of Public Health*<sup>1</sup> found the core functions of public health to be assessment, policy development, and assurance of the availability of services. Surveillance is intrinsic to the assessment function and essential for proper policy development and assurance of service availability.

An ongoing national dialogue is needed on the role of public health education in training future public health professionals; graduates of schools of public health are acknowledging the need for more books and course materials designed to prepare students for public health practice. State and local public health agencies, in particular, have recognized this need as they recruit and hire new professional staff. There is growing recognition of the role of surveillance conducted by agencies of

government as well as by industry and labor to advance the mission of public health—"to fulfill society's interest in assuring conditions in which people can be healthy."<sup>2</sup>

Although surveillance is an essential element of the practice of public health, the subject is rarely taught in schools of public health or fully discussed in textbooks of public health or of epidemiology. This gap reflects the diverging cultures of public health between schools of public health and public health practitioners, a divergence recently addressed in a report of the Institute of Medicine, *The Future of Public Health*.

The essence of the motivation for public health was captured by the 16th century poet John Donne, who unfortunately came to the wrong conclusion about surveillance. Donne wrote:

*No man is an island, entire of itself; every man is a piece of the continent, a part of the main. If a clod be washed away by the sea, Europe is the less, as well as if a*

*promontory were, as well as if a man or of their friend's or of their own were: any man's death diminishes me, because I am involved in mankind, and therefore never send to know for whom the bell tolls; it tolls for thee.*

The public health sentiment is captured in the following line:

*Any man's death diminishes me, because I am involved in mankind.*

This is not a matter of epidemiology or the technology of public health, but rather a matter of the philosophy that motivates public health action.

The antithesis of surveillance is captured in the following line: "Therefore, never send to know for whom the bell tolls." In earlier times, church bells were rung when people died. Currently we have a need for similar information to connect us to the burden of morbidity and mortality and to call forth public health practitioners so that deaths and morbid events can be investigated and recurrences prevented.

Surveillance in modern times is the equivalent of the tolling of the bells with the added commitment to investigation of the causation of morbidity and mortality and dissemination of data and analysis with the goal of prevention. Surveillance, as defined by Alexander Langmuir, the father of modern public health surveillance, and the founder of the Epidemic Intelligence Service of the Centers for Disease Control, "means the continued watchfulness over the distribution and trends of incidence through the systematic collection, consolidation, and evaluation of morbidity and mortality reports and other relevant data"<sup>3,4</sup> for the purposes of prevention of disease or injury.

It is worth lingering over some of the key words in this definition. "Continued watchfulness" implies that the surveillance process continues over time, rather than being a one-time survey or epidemiologic study. Repeated surveys from which trends can be discerned are consistent with surveillance. "Collection, consolidation, and evaluation" should differentiate surveillance as a process from the important, but different enterprise of registering cases in a disease register, such as a cancer registry, if this registry does not include analysis of the data and dissemination of the results.

"Other relevant data" allows for collection of information on risk factors for disease, health or safety hazards, etc., or preventive interventions, such as immunization, rather than limiting surveillance to collection solely of data on disease. To differentiate surveillance from other useful collection of data, such as marketing surveys for a product, "for the purposes of prevention of injury and disease" should be added to Dr. Langmuir's definition.

Surveillance should not be so definitively defined that in-depth investigation of individual or sentinel cases is excluded. A "sentinel health event" represents a failure of prevention, such as a maternal death or an industrial injury.<sup>5</sup>

## **THE ROLE OF SURVEILLANCE IN PUBLIC HEALTH PRACTICE**

The practice of public health can be defined as the logical application of methods of problem recognition, evaluation, and intervention for the purpose of prevention of disease and injury in populations. A working definition of epidemiology should reflect both the traditional broad notion that epidemiology is "the study of the distribution and determinants of disease



frequency in man,"<sup>6</sup> which encompasses interest in epidemic and endemic diseases, as well the inclusion of the supplemental views of theoretical epidemiology. Theoretical or modern epidemiology focuses much more on the use of very sophisticated analytic methodology for understanding the relationship of risk factor and disease, particularly of endemic disease, rather than on the description of epidemics.<sup>7</sup>

Surveillance in modern times is the equivalent of the tolling of the bells with the added commitment to investigation of the causation of morbidity and mortality and dissemination of data and analysis with the goal of prevention.

A useful model that specifies the role of surveillance in the practice of public health has been developed by Greenwald,<sup>8</sup> and further elaborated by Layde,<sup>9</sup> and modified here to describe the role of surveillance in the prevention of occupational injury and disease.

- The first step in public health is the recognition of a problem; a related goal is tracking the trends of a problem as its incidence increases.

Sam Milham provides an example from the analysis of death certificates for industry and occupation.<sup>10</sup> Usual industry and occupation is entered onto every death certificate; however, only in some states is it coded in order to be machine readable. From 1979 to 1987, about 2.9 million deaths were coded for industry and occupation in approximately 23 states.

In comparison to data purposefully collected for a research study, information from death certificates on industry and occupation and even cause of death will be collected without quality control, by minimally trained observers, and will inevitably contain errors. However, surveillance data, often collected for administrative purposes and secondarily used for disease prevention, is inexpensive and readily available.

Milham and colleagues found that farmers had a substantial excess in the proportion of deaths due to electrocutions. When the deaths were investigated, they found that many were due to contacting electric utility lines with portable aluminum irrigation pipe. While the association of electrocution and aluminum piping must have been evident to the sphere of people involved with each incident, the problem was only brought to the attention of the public health community by the analysis of minimal information available from death certificates, and the dissemination of results for the purpose of prevention.

Data from the Annual Survey of the Bureau of Labor Statistics<sup>11</sup> provide an example of tracking an occupational health problem as its incidence changes. The Annual Survey collects data from a sample of logs of injuries and illnesses kept by employers.

These data demonstrate an upturn in the numbers of cases of repeated trauma. Surveillance has done its job by disseminating information on this apparent epidemic to those with a need to know for the purpose of prevention. The related role of epidemiologic research necessary to determine the reality and etiology of this apparent epidemic should be evident.

- The second step in the process of public health is the definition of the scope of a problem. Two examples reflect the value of ongoing collection of data in this endeavor and the usefulness of periodic surveys.

The first example concerns the surveillance of lead poisoning. In 16 states, laboratories report to the state health department if samples submitted for blood lead determination in adults are in excess of a state standard. This information provides a crude estimate for the burden of occupational lead poisoning for the United States, currently about 17,000 reports each year.<sup>12</sup>

A second example of the role of surveillance in providing an estimate of the scope of a problem comes from survey information periodically collected by the National Center for Health Statistics, Centers for Disease Control.<sup>13</sup> From 1983 to 1987, successive periodic surveys provided information from approximately 2700 white, male farmers.

Farmers report 2.7 cases of skin cancer per hundred farmers. Nonfarmers report less than one case of skin cancer per hundred people.

Farmers have three-fold the amount of skin cancer than do nonfarmers. Thus, the periodic survey provides a crude estimate of the scope of the excess of skin cancer in farmers, in contrast to a research study that would likely include confirmation of each case, and which would estimate in substantially greater detail the exposure of the farmers, and would likely be designed to provide information on etiology or perhaps use of preventive measures.

- The third step in the public health process is to conduct etiologic research to determine the cause of a disease. This step consists of an epidemiologic study, not surveillance. For example, an epidemiologic study might be conducted to determine the differential exposure of cases of eosinophilia-myalgia syndrome as compared to controls without the disease. It does not require the ongoing collection of information about cases; rather, it requires more detailed information about cases occurring during the research period.

- Once an etiologic agent or exposure is identified, the fourth step in the public health process is the design of an intervention that will prevent transmission of the infectious agent, exposure to a chemical hazard, etc. Examples of intervention include immunization, withdrawal of a food contaminant, provision of a ventilation system, etc. This is not surveillance.

- The fifth step involves a trial of the proposed intervention system in an experimental situation where a limited number of important factors are carefully controlled. This type of public health experiment does not involve surveillance.

- Successful interventions in the controlled laboratory environment sometimes do not withstand the more rugged environment of the field test, the sixth step in the practice of public health. Surveillance can play a role in selection of field sites for testing.

- The seventh step in the public health process is targeting scarce preventive resources in order to maximize their effectiveness. A classic example comes from the eradication of smallpox.<sup>14</sup> While the burden of smallpox was reduced by mass immunization, smallpox persisted because

there were sufficient unimmunized to sustain transmission. A turning point in efforts to eradicate smallpox came with the use of intensive surveillance for cases and the targeting of immunization to the contacts of cases.

Similarly, greater success in cancer prevention might be obtained if screening programs for breast cancer and cervical cancer were targeted to high-risk populations. Another example of the use of surveillance for targeting also comes from the surveillance of elevated blood lead based upon laboratory reports. Multiple elevated results from a single worksite almost insure that the work environment is in need of amelioration.<sup>15</sup>

- The eighth step in the practice of public health is the evaluation of the effectiveness of the public health intervention. Tracking the trends of disease is one mechanism for evaluating the effectiveness of intervention.

For example, in 1958, Sweden instituted a law that any new tractor that was produced had to have rollover protection.<sup>16</sup> In the years thereafter, surveillance data indicate a decline in rollover fatalities. In 1978 Sweden instituted another law that any tractor in use had to have rollover protection, and the problem was eradicated.

## REFERENCES

1. Institute of Medicine, *The Future of Public Health*. National Academy Press, Washington, 1988.
2. Public Health Service, U.S. Department of Health and Human Services, *Healthy People 2000*. National Health Promotion and Disease Prevention Objectives, Washington, D.C., 1991.
3. Langmuir A. The Surveillance of Communicable Diseases of National Importance. *New England Journal of Medicine*. 268:182-191.
4. Langmuir, A. William Farr: Founder of Modern Concepts of Surveillance. *International Journal of Epidemiology*. 5:13-18, 1976.

## CONCLUSION

There are four goals for surveillance. These include:

1. The identification of new occupational health problems.
2. The estimation of the scope or magnitude of the problem.
3. The delineation of the trend in incidence of the illness, disease, or hazard.
4. The targeting of opportunities for prevention.

Surveillance is a powerful tool in many parts of the complex continuum of practices that constitutes the public-health problem-solving process.

Epidemiologists have much to owe to the modern father of surveillance and field epidemiology, Alexander Langmuir, who in his wisdom commented, "Good surveillance does not necessarily ensure the making of the right decisions, but it reduces the chances of wrong ones."<sup>3</sup>□

## Questions to Guide the National Agenda

5. Rutstein, D., Mullan, R., Frazier, T., Halperin, W., Melius, J., Sestito, J.: The Sentinel Health Event (Occupational): A Framework for Occupational Health Surveillance and Education, *JAPHA* 73:1054-1062, 1983.
6. MacMahon Brian, Pugh Thomas. *Epidemiology: Principles and Methods*. Little, Brown and Company, Boston, 1970.
7. Miettinen Olli. *Theoretical Epidemiology: Principles of Occurrence Research in Medicine*. John Wiley and Sons, New York, 1985.
8. Greenwald P, Cullen JW, McKenna JW. Cancer Prevention and Control: From Research through Applications. *JNCI* 79:389-400, 1978.
9. Layde P. Beyond Surveillance: Methodologic Considerations in Analytic Studies of Agricultural Injuries. *American Journal of Industrial Medicine*. 18:193-200, 1990.
10. Helgerson, SD., Milham, S. Farm Workers Electrocuted When Irrigation Pipes Contact Powerlines. *Public Health Reports*. 1985 May-June; 100 (3):325-8.
11. Personal Communication. T. Frazier. NIOSH. Cincinnati, Ohio, 2/91.
12. Personal Communication. Paul Seligman. NIOSH. Cincinnati, Ohio, 2/91.
13. Brackbill, R., Behrens, V., Cameron, L. Prevalence of Conditions among Farmers 1983-1987. in press.
14. Foege, WH, Millar, JD, Lane, JM. Selective Epidemiologic Control in Smallpox Eradication. *Am J Epidemiol* 1971 Oct; 94(4):311-5.
15. Seligman, P., Halperin, W.: Targeting of Workplace Inspections for Lead. *American Journal of Industrial Medicine* 20:381-390, 1991.
16. Thelin, A. Epilogue: Agricultural Occupational and Environmental Health Policy Strategies for the Future. *AJIM* 18:523-526, 1990.

## RESEARCH FOR AGRICULTURAL SAFETY AND HEALTH

*James A. Merchant, M.D., Dr.P.H.*  
Professor, Preventive and Internal Medicine  
Director, Institute of Agricultural Medicine and Occupational Health  
The University of Iowa

Mr. Mark Timm: Our next speaker is Dr. James A. Merchant, Director of Agricultural Medicine and Occupational Health at the University of Iowa. Dr. Merchant received his B.S. from Iowa State University, his M.D. from the University of Iowa, and his Doctor of Public Health in epidemiology from the University of North Carolina. In 1968, he became an Epidemic Intelligence Officer at the Centers for Disease Control with an assignment to the North Carolina Board of Health. After this assignment, he served as Assistant Professor in Medicine at the University of North Carolina. In 1975, Dr. Merchant became Director of the Division of Respiratory Disease Studies at NIOSH. In 1981, he became and currently is Professor of Preventive and Internal Medicine at the University of Iowa. Dr. Merchant has published broadly in pulmonary medicine and epidemiology. His early work was in associating cotton dust exposure with byssinosis. He has published broadly on different lung diseases, which include problems with vegetable dusts and other organic dusts in agriculture, farmers' lung, and asthma. Dr. Merchant is active in professional organizations and in chairing and serving on expert committees at both the national and the international levels. Allow me to introduce to you Dr. James Merchant to speak on *Research for Agricultural Safety and Health*. Dr. Merchant:

### ABSTRACT

In identifying research priorities for agricultural health and safety, one must first define the populations at risk. In agriculture, those at risk greatly exceed the number of farmers who report sole or primary employment from agriculture. Agricultural production is now changing dynamically, resulting in a substantial increase in farmers with non-farm jobs, greater involvement of women and seasonal workers, and involvement of children and recreational farmers in agricultural operations. All are exposed to some degree to multiple farm hazards—farm machinery, livestock, chemicals, organic dusts, and a wide variety of biological hazards. Priorities for research in agricultural safety and health include disease and injury surveillance; epidemiological investigations of morbidity, mortality and risk factors; studies of toxicological effects and mechanisms of disease; and the opportunity for meaningful intervention for disease and injury prevention. Those engaged in this research must also recognize the influence of poverty, limited access to health care, and limited insurance coverage among many living and working in rural areas. As the result of the national initiative in agricultural and environmental health, federal, state and foundation funding is now available to address these research priorities. The challenge is to maintain and cultivate these research opportunities through targeted research designed to advance our understanding and prevention of diseases and injuries among those with agricultural exposures.

### THE POPULATION AT RISK

The population at risk to farming exposures is not known with precision. In 1980, some 2 million Americans reported prima-

ry employment in farming; 3.1 million reported some farm income; there were 2.7 million hired to do farm labor; and there were an additional 6 million farm-family members, some of whom did farm

work. But the number of full-time farmers is being reduced as agriculture moves dynamically to larger numbers of corporate farming operations, with greater numbers of part-time farmers and farmers with off-farm jobs, and more farm wives employed in both farm and off-farm jobs, while significant farm work is contributed by children under the age of 18.

A state-wide survey of Kentucky farms found 26 percent of farm men had off-farm jobs, 15 percent of farm women had off-farm jobs, and 23 percent with both farm men and women holding off-farm jobs.<sup>1</sup> Women's role in agricultural production has been largely ignored in the occupational literature, yet the proportion of women participating in the agricultural workforce has risen steadily from 11 percent in 1940 to 46 percent in 1980.<sup>2</sup>

In the University of Iowa Farm Family Survey of 1988 that included Iowa, Washington and New York states, 25-40 percent of women (depending on the state) were employed full-time in farming, and 45-55 percent were employed part-time in farming. Only 11-30 percent reported doing no farm work.<sup>3</sup> In addition, 3549 percent of the farm women surveyed were employed in off-farm work. Thus, many farm men face two work exposures (farm and off-farm job) while many farm women face three (farm, off-farm job, and home).

In addition to the occupational risks posed by the off-farm jobs, there is a significant additional risk of travel to and from the off-farm job on rural roadways, often under poor driving conditions. As 64 percent of the nation's 48,700 motor vehicle deaths in 1988 occurred in rural areas, travel to and from work poses an additional occupational risk, which has often been

ignored in occupational health and safety research.<sup>4</sup>

There is even less information on the numbers of children at risk to agricultural operations. In the University of Iowa Farm Family Survey, the proportion of farms reporting children regularly doing farm work ranged from 18 percent (New York) to 23 percent (Iowa).<sup>3</sup> It is recognized, however, that the number of children at risk to agricultural operations is much larger, as they are often exposed to farm machinery, buildings, and livestock while not engaged in routine farm work.

Migrant farmers are the most fluid population at risk in agriculture. The numbers at risk are not adequately defined, but it is known that migrant farmers assume some of the highest risks from exposure to agricultural chemicals, long hours, and some exposure to agricultural machinery, in addition to poor living conditions, limited—if any—insurance or health care, and often an additional risk of extensive travel over the harvest season.

Migrant farmers are especially challenging to study, as they are highly mobile, have variable exposures, and are a difficult population on which to obtain valid data because of language and legal barriers. Migrant farmers are, nevertheless, a very high priority for research because of their extensive exposures and other risks to health.

An additional population at risk in agriculture is the weekend or recreational farmer who typically farms a few acres using older farm machinery, often has some livestock, and often uses the same farm chemicals as full-time farmers. The number of weekend farmers is not known, but is increasing as

urban areas encroach on adjacent farm land.

Thus, the total population at risk to agricultural exposures is large, but the number is unclear—while the number of full-time farm workers appears to be decreasing, the total population at risk to agricultural operations may not be, given the diversity of multiple work roles of farm men, women, children, and migrant workers. Currently, there is no uniformity in classification of farm men, women, and children in regard to farm work and off-farm work. Clearly, development of such a classification would be useful for assessment of agriculture - related diseases and injuries among those living in rural America.

Therefore, four research priorities are:

1. To determine the distribution of farm men, women, and children and the total population at risk in agriculture.
2. To develop the best standard classification of farm men, women, and children, by on-farm and off-farm employment, that will provide the most relevant classification for health surveillance and epidemiological assessment.
3. To assess what additional occupational morbidity and mortality is attributable to off-farm work and to travel to and from off-farm work, and what the interactive effects of these multiple risks on disease and injury incidence are.
4. To determine, especially among migrant farm workers, what non-farming morbidity and mortality is attributable to living conditions, limited availability of health care delivery, and extended travel and what the interactions of these

factors and the multiple risks they face in agricultural work are.

These questions will be high priorities for the NIOSH Farm Family Health and Hazard Survey and should also be priorities for others engaged in health and injury surveillance and epidemiological studies of agricultural workers.

## **RESEARCH METHODS**

Research approaches to agricultural safety and health may be divided into five broad research methodologies:

1. Basic Research (Toxicology and Mechanisms).
2. Disease and Injury Surveillance (Information Systems).
3. Epidemiological Studies.
4. Demonstration and Education Research (Intervention Studies).
5. Health Services Research.

### **Basic Research**

Basic research is essential for adequate development of prevention strategies for agricultural safety and health. While this is less true for injuries, there is still a great need for basic research on the toxicology and mechanisms by which various agricultural exposures cause adverse health effects.

► One clear need for greater basic research is in the area of toxicological testing of agricultural chemicals, especially older pesticides that have not yet been tested for acute and chronic toxicity. This

is a subset of a larger testing issue faced by the National Toxicology Program.

- At a National Institute of Environmental Health Sciences Conference on Agricultural Chemical Utilization and Human Health, the need for further chemical testing to address organ function, perinatal toxicity, immunotoxicity, and chronic and delayed effects including cancer and delayed nervous system manifestations (and testing of combinations of chemicals) was strongly recommended.

- ▶ A second area where basic research needs to play an important role is in the emerging area of agricultural biotechnology. Genetically engineered microorganisms promise substantial benefits for food production throughout the world.

Potential benefits include new crop varieties that will benefit the grower through lower input costs and increased productivity, the food processor through production of higher-quality and consistent products, and ultimately the consumer through production of more appealing and nutritious foods. Use of biotechnology in agriculture has potentially significant implications for agricultural safety and health.

Two potentially lowered risks that may accrue through use of agricultural biotechnology include:

1. Reduced use or replacement of agricultural chemicals now known to be harmful to human health.
2. Reduced field exposures to crop production, especially to farm machinery, which is known to be the single greatest risk in farming.

Biotechnology is currently being regulated by EPA through the Federal Insecticide, Fungicide, and Rodenticide Act (FIFRA; 7 U.S.C. 136-136y) and regulation adopted in 1984 (49 Federal Register 40659), the Toxic Substances Control Act (TSCA; 5 U.S.C. 2601-2929), and by the USDA through provisions of the Plant Pest Act (7 U.S.C. 150aa-jj) and regulations adopted in June of 1987 (CFR Part 330).

- While regulation of this emerging technology provides some assurance that appropriate testing will be done, from a public health perspective it is essential that necessary testing for adverse effects on plants and animals be conducted in the laboratory and in small field experiments.

Experience to date suggests that the use of biotechnology in agriculture will not be associated with unpredictable exposures that cannot be addressed using appropriate work practices.<sup>5</sup>

### Disease and Injury Surveillance

The development of disease and injury surveillance or information systems is a very high priority for the advancement of agricultural safety and health research. As surveillance is covered by another speaker, I will confine my comments to those information systems especially important to epidemiological research. These information systems fall in two categories—those dealing with health effects (injuries and diseases) and those dealing with exposures (cohorts with specific exposures or systems defining exposures to which human or animal populations may be linked).

- Information systems that are especially useful in epidemiology are specific disease and injury registries. Often existing cancer registration data is available from state or



hospital data. Use of these information systems is an inexpensive and powerful epidemiologic tool.

Through the State Health Registry of Iowa at the University of Iowa, we are now able to register birth defect and cancer incidence. An Alzheimer's Disease Registry has also been developed for some counties, and a Rural Injury Surveillance System is now under development.

These health effect registries are especially useful as they allow systematic collection of large numbers of specific types of birth defects, cancers, or injuries that can then be studied quantitatively through the use of case control studies. This approach has been used effectively in the assessment of risk factors for a variety of specific types of cancer.

The same approach is now being applied to birth defects, which have an added advantage of having a much shorter latency (hence more accessible and valid data). In the case of injuries, there is no latency and the circumstances of injury are usually clear. This will allow the injury registry to collect more data at the time of the event and thus reduce the time and cost of case control studies.

### **Epidemiological Studies**

- A significant problem in assessment of surveillance and epidemiological data is the lack of adequate exposure data. The development of exposure registries is, therefore, especially attractive.

For instance, large cohorts of pesticide applicators who must be licensed to do their work now provide an especially important opportunity for epidemiological research through record linkage to cancer

and birth defect registries. Data on the sale of certain farm chemicals provide another type of exposure registry. Another type may be derived from widespread testing of drinking water for nitrates and pesticides.

While these exposure registries usually provide evidence of exposure to certain agricultural chemicals, epidemiological research requires much more detail in terms of the types and amounts of specific chemical use, the time-frames of use, the type of application, and the use (and non-use) of protective equipment. These types of data must almost always be collected retrospectively, but could be collected prospectively in a small cohort or in a sample of a larger cohort.

Collection of representative exposure data is also essential in cross-sectional studies of injuries and health effects. These data are necessary in order to derive exposure response relationships, which are essential to the development of guidelines for reduction of exposures and the prevention of diseases and injuries.

- There are very few trained industrial hygienists specializing in agriculture. The need for these skills in the collection and interpretation of environmental data is critical to advance agricultural health and safety research.

### **Demonstration and Education Research**

Closely related to epidemiological research is the area of demonstration and education research that utilizes intervention studies. While epidemiological research may clearly show an excess in a certain type of cancer, birth defect, respiratory disease or specific type of injury, a valid model for

intervention may not be available or may be difficult to implement.

The traditional intervention model in occupational safety and health is that of regulation, which has seen some significant successes, such as the reduction of respiratory disease through the regulation of coal mine dust and cotton dust. Occupational safety and health regulation has, however, been greatly diminished over the past decade, and agriculture has traditionally not been a regulated industry.

If we cannot develop a U.S. model for a proven intervention on the single most important cause of agricultural mortality, how can we succeed in addressing less dramatic yet still important causes of agricultural diseases and injuries?

As a result, more innovative intervention methods for disease and injury prevention are needed in agricultural safety and health. A good example of the need for such a model is the prevention of tractor roll-over deaths through the application of roll-over protective structures (ROPS) on both new and older tractors.

The epidemiological evidence for the very significant risk posed by tractors without ROPS is clear. The data available from Sweden, which mandated such a program, makes it equally clear that ROPS can prevent almost all tractor roll-over deaths.

• An important question for this conference is whether an American intervention model can be developed that can produce a significant reduction of tractor roll-over deaths and injuries. A second question, with much broader ramifications, is, "If we

cannot develop a U.S. model for a proven intervention on the single most important cause of agricultural mortality, how can we succeed in addressing less dramatic yet still important causes of agricultural diseases and injuries?"

### Health Services Research

An observation made by Dr. James A. Dosman in his summary of the research workshops prior to the conference, "Agricultural Occupational and Environmental Health: Policy Strategies for the Future," was the following:

*It is striking that the organized scientific documentation of specific health risks is occurring at a time when changing rural economic resources and family and rural community infrastructures are leaving few community resources to alter specific risk patterns. Thus, the assessment and presentation of health and family-life deficiencies must be viewed in a climate of economic adjustment, rural population decline, and loss of personal, financial, and social control by individuals and families. However, one must realize that whereas all these changes are occurring simultaneously, unacceptable injury, death, and dysfunction are occurring on the farms and in rural areas. This conundrum describes a widening gap in diagnostic and preventive health services, and in family support services, between rural dwellers and city dwellers.<sup>6</sup>*

While this paper is not intended to address the very broad field of health services research, this quotation points out that there are significant differences between rural populations and their urban counterparts, which must be taken into account in conducting epidemiological research. In nearly every parameter of health—disease

and injury incidence, availability of health care, and related social services—people living in rural areas have less favorable statistics than their urban counterparts.<sup>7</sup> Especially vulnerable are migrant agricultural workers who are at triple jeopardy—poor, rural and uninsured.

- These social service and health-care delivery factors clearly influence the incidence of rural injuries and diseases and point up the importance of interaction and collaboration between those engaged in agricultural health and safety research with rural sociologists and those engaged in rural health care delivery research.

## **AGRICULTURAL DISEASE AND INJURY RESEARCH PRIORITIES**

### **Injury Morbidity and Mortality**

Available data on the risk of injury and traumatic death consistently reflect a higher injury risk to those living in rural compared to urban areas, with a mortality rate for unintentional injuries twice that of urban areas.<sup>8</sup> This excess is attributable to several factors, including increased mortality from motor and non-motor vehicle deaths arising from higher speeds on poorer roads, less seat belt use, more use of high-risk utility vehicles, and poorer access to trauma care. At particular risk to rural injury are farmers, their family members, and hired and migrant laborers.

In addition to the several factors that place rural residents at increased risk are added the occupational risks of farming. The National Safety Council estimated deaths among farm residents to be 56.2 per 100,000, 30.1 of which were motor-vehicle-related, 20.1 work-related (18.1 in farm work), 8.0 home-related, and 4.0 public non-motor vehicle deaths.<sup>4</sup> The trend in

agricultural mortality over the past ten years has shown relatively little improvement and remains higher than that of mining and construction.

NIOSH, through its National Traumatic Occupational Fatalities (NTOF) database, reports 20.7 deaths per 100,000 agricultural workers, versus 7.9 deaths per 100,000 for the general private - sector workforce.<sup>9</sup> Results of epidemiological studies and newly developed surveillance systems suggest these national estimates may significantly underestimate both deaths and farm-related injuries.

The Iowa Department of Public Health farm injury surveillance program (SPRAINS) reported 83 deaths for 1990 based on voluntary reports from health-care providers.<sup>10</sup> As this was the initial year of reporting, it is thought that this number is incomplete; yet this number of deaths is over 60 percent higher than previous estimates of farm deaths in Iowa. Epidemiological studies draw our attention to the importance of farm machinery in fatalities and severe injuries, to higher rates of injury among children and the aged, and to the substantial numbers of intentional deaths (suicides and homicides).<sup>11</sup>

While it is clear that traumatic injuries and deaths are epidemic on American farms, we still lack national and state-based information systems (surveillance), a reasonable understanding of risk factors, and an adequate characterization of hazards of farming associated with injury morbidity and mortality. Therefore, three research priorities in the area of traumatic injuries are:

1. Development of national and state-based information systems, which will

## Questions to Guide the National Agenda

provide essential injury and injury mortality incidence data by type of injury (ICD-9 codes), cause of injury (E-codes), place of injury and demographic information on the injured party.

2. From surveillance data or large epidemiological studies, case control studies of specific farm injuries, which will allow much better understanding of risk factors associated with the injury.
3. A much better environmental assessment of farm machinery, farm buildings, livestock operations, on and off-road vehicles, agricultural chemical use and storage, and available prevention measures. This assessment is essential to epidemiological surveys and case-control studies

### Respiratory Health Effects

Farmers and other agricultural workers are exposed to a number of respiratory hazards, the most common of which is organic dust. Additional exposures, which are known to be important include several agricultural chemicals, toxic gases from livestock confinement facilities, toxic and immunogenic constituents of microorganisms, feed additives such as antibiotics, and infestations of insects, which may produce lung disease.<sup>12, 13</sup>

A common denominator in these exposures is a significant exposure to organic dust, which has been shown by many epidemiological studies to result in acute symptoms of airway inflammation, heightened airway reactivity and asthma, and acute changes in lung function. Pulmonary edema followed by bronchiolitis obliterans and hypersensitivity pneumonitis are relatively uncommon but well-known pulmonary conditions arising from certain agricultural exposures.

In some agricultural populations with long exposure to organic dust, fixed airway obstruction has been observed. Despite recent interest in this area, there are significant research gaps including the following:

1. There is little surveillance data and incomplete epidemiological data on respiratory diseases in several agricultural populations. Disease patterns and risk factors are still incompletely understood in the animal confinement and grain handling and processing industries, and from exposures to agricultural chemicals such as anhydrous ammonia.
2. There is a very great need for the development of dose-response data for agricultural exposures in order to allow fuller development of prevention strategies.
3. There is a need to more fully explore certain environmental factors, such as exposure to storage mites and the toxic products of certain microorganisms, in both the laboratory and through field studies.

### Cancer

Epidemiological studies reported a decade ago initially raised questions about an association between soft-tissue sarcoma and lymphoma and exposure to acetic acid herbicides and chlorophenols. Since then, over 20 additional cohort and case-control studies have addressed this issue. The results of these studies are not consistent, but excess deaths from non-Hodgkin's lymphoma, multiple myeloma and leukemia have shown more consistent positive associations.

In addition, excesses of lung, stomach and prostate cancer have been observed in cohort studies of manufactures and applicators.<sup>14</sup> Other potential risk factors for cancer incidence include viruses, and dietary and other factors as possible contributors to cancer incidence among agricultural workers.<sup>15</sup> A number of methodological issues pose difficulties in interpreting these findings and indicate priorities for research in this area:

1. There is a uniform need for better environmental characterization of agricultural chemical exposures through the development of valid and inexpensive environmental exposure protocols.
2. Use of exposure registries linked with cancer registries promises to provide important additional data on cancer risk among agricultural workers.
3. Improved epidemiological methods to assess and validate previous agricultural and other exposures are needed for adequate analysis and evaluation of cancer data.

### **Reproductive Health Effects**

Concern about possible adverse reproductive health effects arises from toxicological testing showing some agricultural chemicals to be teratogenic, from widespread use of some of these chemicals, and from some case reports suggesting associations between certain adverse reproductive effects and agricultural exposures.<sup>16,17</sup> The reports on dibromochloropropane (DBCP) on male reproductive function have provided an important example of the toxic effects of this pesticide, an exposure, which now continues in some developing countries.<sup>18</sup>

Assessment of adverse reproductive effects has a significant methodological advantage over assessment of cancer incidence in that the latency from the time of exposure to the time of the reproductive effect is much shorter than that for cancer, which is generally 20 or more years. The lack of birth defect information systems has greatly hampered evaluation of birth defects in association with environmental exposures. Priorities for research in this area fall in two areas:

1. Additional systematic toxicological testing of agricultural chemicals and commonly used combinations of chemicals for adverse reproductive effects.
2. Further development of birth defect registries and linkage of these information systems with exposure registries, and through the development of case-control studies with adequate exposure data.

### **Neurological Health Effects**

Recent reviews of the neurotoxic effects of pesticide exposure have focused on chronic neuropsychological sequelae from exposures to organophosphate pesticides.<sup>19,20</sup> While the early (immediate and delayed) neurotoxic effects are well-described for organophosphate intoxication, until recently little attention had been given to evaluation of possible chronic effects.

However, as the result of several case studies and clusters of adverse behavioral and neurological findings, the World Health Organization (WHO) and the United Nations Development Programme (UNDP) are coordinating a ten-country European, prospective epidemiological study on the neurotoxic effects of low-level exposure to organophosphorus pesticides.

## Questions to Guide the National Agenda

This study includes both pesticide formulators and agricultural workers. Additional studies of three types are needed:

1. A replicate of the European study through the use of recently developed and standardized tests of neuro-psychological function and extensive characterization of exposures to organophosphate pesticides;
2. Well-controlled follow-up studies of workers who have documented cases of acute organophosphate intoxication for possible chronic neuropsychological effects; and
3. Greater attention to neurotoxic effects of agricultural chemicals through toxicological testing.

### Repetitive Trauma

Trauma research in agricultural populations has focused almost entirely on acute traumatic injury and death. Yet repetitive trauma is known to be a much more significant problem than acute trauma in most industries.

There is reason to suspect that significant repetitive trauma may occur as the result of vibration and repetitive tasks in the use of farm machinery and other farming operations. A recent case-control study of hip joint arthrosis among Swedish farmers found a relative risk for this condition between 2.1 and 3.2, varying by length of time in farming.<sup>21</sup>

There is also reason to believe that long hours of work on agricultural machinery may induce significant muscle fatigue, which may, in turn, contribute to the risk to acute injury. Repetitive trauma has not been systematically studied among farming

populations, but should be a research priority:

1. Surveys of farming populations to assess acute injuries or other health effects should also include assessment of repetitive trauma conditions, especially those involving the back, hip and knee.
2. Collaboration between agricultural engineers and biomechanical engineers should focus on ergonomic factors that may contribute to repetitive injuries and how these factors may be mitigated.

### Dermatitis

Dermatitis is a condition endemic in farming. Data from the Bureau of Labor Statistics (BLS) indicate a five-fold greater incidence of dermatitis among farm workers compared to workers in general industry. Because of the limitations in BLS data for agricultural workers, these findings may represent a significant underestimation of dermatitis in this working population. A recent survey of California grape and tomato workers found a high cumulative incidence of dermatitis, suggesting that dermatitis is a frequent and recurrent problem among these farm workers.<sup>22</sup>

1. There is a need for systematic dermatological surveys of farm workers with attention given to criteria for classification of dermatological conditions, to the sensitivity and specificity of questionnaires, and to the correlation between questionnaire and exam results.
2. There is a great need for environmental evaluation and measurement of dermatological irritants and sensitizers.

3. Development and evaluation of intervention programs to prevent dermatitis among farm workers are further research needs.

### Noise-Induced Hearing Loss

Several studies have now reported bilateral high-frequency hearing loss to be quite prevalent among farmers.<sup>23</sup> Of particular concern is the frequency with which this abnormality is observed among farmers under the age of 30. This strongly suggests that noise is the cause of this injury. Indeed, farm machinery and chain saws are known to generate noise levels above recommended limits. A further finding has been that relatively few farmers use hearing protection. Therefore, research priorities here include:

1. Systematic industrial hygiene surveys to characterize farming operations where noise levels exceed recommended levels.
2. Development and evaluation of intervention programs to provide adequate hearing protection to those engaged in these farming operations.

### THE NATIONAL AGRICULTURAL AND ENVIRONMENTAL HEALTH INITIATIVE

Since the publication of *Agriculture At Risk: A Report to the Nation*, which summarized the recommendations arising from the national public policy conference, "Agricultural Occupational and Environmental Health: Policy Strategies for the Future," and the dissemination activities of the NCASH, there is a new level of awareness of the magnitude and severity of disease and injury among American agricultural workers. Significant credit for initiation of and support for this effort is due to several

agricultural industries and foundations, to the interest and support of several state and federal agencies, to the efforts of the National Rural Health Association, to the work of many university faculty who participated in the conferences and briefings, and to the commitment of many members of the U.S. Congress and several state legislatures.

As a result, and for the first time, a healthy dialogue has involved all parties to these important issues. Significant resources are now available through federal appropriations and some state appropriations to mount this national research and intervention initiative. This research effort is just beginning. The challenge ahead is to maintain this momentum and build upon these gains.

### CONCLUSIONS

1. The high risk of disease and injury arising from agricultural exposures has now been recognized and has now been placed on the national public health agenda.
2. Adequate resources and incentives have been provided to address the multiple research priorities. These resources must be maintained and cultivated.
3. A healthy dialogue has promoted the involvement of most parties. Greater efforts are needed to involve full representation of children, women, migrants, and the rural poor.
4. The challenge ahead is to prioritize, implement, and publish research findings and translate this research into meaningful prevention and health delivery programs. □

## Questions to Guide the National Agenda

### REFERENCES

1. Coughenour CM and Swanson L. Work Statuses and Occupations of Men and Women in Farm Families and the Structure of Farms, *Rural Sociology*. 48(1):23-43, 1983.
2. Fassinger PAD and Schwarzseller HK. The Work of Farm Women: A Midwestern Study, *Research in Rural Sociology and Development*. (1):37-60, 1984.
3. Ungar RL. *Farm Women at Risk: Work Roles and Agricultural Exposures*. Thesis, Department of Preventive Medicine and Environmental Health, The University of Iowa, 1990.
4. National Safety Council. *Accident Facts, 1988 Edition*. National Safety Council, Chicago, Ill, 1988.
5. Glass DJ. Agricultural Biotechnology: Occupational Health and Regulatory Issues in *Occupational Medicine: State of the Art Reviews*. 6(2):301-309, 1991.
6. Dosman JA. Technical Workshop Report: Working Group I: Occupational Health and Safety Strategies for Agriculture, *American Journal of Industrial Medicine*. 18:353-356, 1990.
7. Summer L. *Limited Access: Health Care for the Rural Poor*. Center on Budget and Policy Priorities, Washington D.C., 1991.
8. Baker SP, O'Neill B. and Karpf R. *The Injury Fact Book*. Lexington, Mass.: Lexington Books, 1984.
9. Myers JR. National Surveillance of Occupational Fatalities in Agriculture, *American Journal of Industrial Medicine*. 18(2):163-168, 1990.
10. Currier R. Iowa Department of Public Health, Personal Communication, 1991.
11. Stallones L. Surveillance of Fatal and Non-Fatal Farm Injuries in Kentucky, *American Journal of Industrial Medicine*. 18(2):223-234, 1990.
12. Merchant JA. Agricultural Respiratory Diseases, *Seminars in Respiratory Medicine*. Thieme, Inc., No.3, 7:211-224, New York, 1986.
13. Merchant JA. Agricultural Exposures of Organic Dusts. *Occupational Medicine: State of the Art Reviews*. 2(23) April-June:409-425, 1987.
14. Blair A and Zahm SH. Herbicides and Cancer: A Review and Discussion of Methodologic Issues, *Recent Results in Cancer Research*. 120:132-145, 1991.
15. Pearce N and Reif JS. Epidemiologic Studies of Cancer in Agricultural Workers, *American Journal of Industrial Medicine*. 18(2):133-148, 1990.
16. Schwartz DA and LoGerfo JP. Limb Reduction Defects in the Agricultural Setting, *American Journal of Public Health*. 78:654-659, 1988.
17. Gordon JE and Shy CM. Agricultural Chemical Use and Congenital Cleft Lip and/or Palate, *Archives Environmental Health*. 36(5):213-221, 1981.
18. Whorton D. Dibromochloropropane Health Effects, Chapter 48 in *Environmental and Occupational Medicine*. WN Rom (Ed). Little, Brown and Company, Boston, 1983.



19. Rosenstock L, Daniell W, Barnhart S., Schwartz D, and Demers PA. Chronic Neuropsychological Sequelae of Occupational Exposure to Organophosphate Insecticides, *American Journal of Industrial Medicine*. 18(2): 321-326, 1990.
20. Davies JE. Neurotoxic Concerns of Human Pesticide Exposures, *American Journal of Industrial Medicine*. 18(2):327-332, 1990.
21. Thelin A. Hip Joint Arthrosis: An Occupational Disorder Among Farmers, *American Journal of Industrial Medicine*. 18(2):339-344, 1990.
22. Schenker MB and McCurdy SA. Occupational Health Among Migrant and Seasonal Farmworkers: The Specific Case of Dermatitis, *American Journal of Industrial Medicine*. 18(2):345-352, 1990.
23. May JJ, Marvel M, Regan M, Marvel LH, and Pratt DS. Noise-Induced Hearing Loss in Randomly Selected New York Dairy Farmers, *American Journal of Industrial Medicine*. 18(2):333-338, 1990.

## INTERVENTION FOR AGRICULTURAL SAFETY AND HEALTH

*Myron D. Johnsrud, Ph.D.*  
Administrator, Extension Service  
United States Department of Agriculture

Mr. Mark Timm: From Washington, D.C., our next speaker is Dr. Myron Johnsrud, Administrator of the USDA Extension Service. Dr. Johnsrud holds a master's and doctor's degree in administration from the University of Wisconsin and farmed for a number of years in North Dakota. He directed the North Dakota State University Cooperative Extension Service for 12 years. He served as chairman of the Great Plains Agricultural Council, and served on the Board of Directors of the Prairie Public Television Corporation and on the Board of Trustees of the National 4-H Council. Since 1986, Dr. Johnsrud has directed the U.S. Department of Agriculture's Extension Service. In this position, he is responsible for a \$15 million program and \$370 million of federal allocations to the land grant universities for cooperative extension service programs. He is responsible for a major program for redirecting the Extension Service, in partnership with the Cooperative Extension Service, a national network in the 50 states and territories, and more than 3,100 countries. The redirection focuses on current and critical issues of the nation. Dr. Myron Johnsrud will speak to us this morning on the critical issue of *Intervention for Agricultural Safety and Health*. Dr. Johnsrud:

### INTRODUCTION

*"The health of the people is really the foundation upon which all their happiness and all their powers as a state depend."*

Benjamin Disraeli, prime minister of Britain, made that statement in a speech over 100 years ago, and it is still right to the point today. Safety, too, which we link closely with health, has long been essential to civilization. *Salus populi suprema lex* ("The people's safety is the highest law") was a legal and political maxim of ancient Rome.

The need for surveillance and research to guide injury control efforts in agricultural safety and health presents many challenges that have been identified by the previous speakers. However, we must ask ourselves how society will judge our success in solving the problems of agricultural injuries. I believe that society will judge our success by how effective our intervention methods

are in protecting agricultural workers and helping create the change in their behavior necessary for their success. Intervention countermeasures will rely upon the knowledge gained from research and surveillance programs to implement effective solutions to agricultural health and safety problems.

What makes agricultural production one of the most hazardous occupations in the United States? As we attempt to prevent and reduce the incidence of fatal and serious accidents and chronic illness on our farms and ranches, do we know what areas to focus on for the most success?

How do we keep agricultural safety and health from being overlooked when addressing other issues that confront agriculture, such as the environment, animal welfare, or energy? How wide is our scope—does it stop at the farm gate or timber mill? Or, does it include many segments of food, feed, and fiber processing?

These are just a few of the questions confronting us today in the important issue of agricultural safety and health. This morning I want first to present a brief history and the current status of intervention efforts. Second, I will pose questions to guide the concurrent session on developing intervention strategies for various targeted audiences, approaches to intervention, and the need for collaboration. Third, I will suggest some areas that I see as the pressure points, injuries, and fatalities of highest priority and the places where we have the best chance to intervene successfully.

### **CURRENT STATUS OF INTERVENTION**

Voluntary safety efforts have had much success. Agriculture has the most extensive community of voluntary safety professionals of any industry in the United States. What was probably the first farm safety effort began in 1933, when the Sixth Annual Rock River Valley Safety Conference meeting at Fort Atkinson, Wisconsin organized a farm safety section.

In 1937 the National Safety Council held a meeting of an agricultural section. Its first farm conference took place in 1947. An organized professional effort to prevent farm accidents began in the Cooperative Extension system early in the 1940's with appointment of a full-time Extension farm safety specialist by the University of Wisconsin.

A coalition of farm safety professionals representing agricultural equipment manufacturers, the Farm Bureau, insurance companies, and the Cooperative Extension System chartered the National Institute for Farm Safety in 1961 to provide a forum for the exchange of research results, surveillance data, and effective intervention methods. Much of the success in reducing the

occupational injuries experienced by agriculture over the past 50 years is due to the accomplishments of these professionals working cooperatively through organizations such as the National Institute for Farm Safety and the safety committees and standards committees of the American Society of Agricultural Engineers (ASAE).

We cannot ignore the fact, however, that the rate of decline in agricultural fatalities and injuries is much slower than that experienced by mining and construction, the other two most hazardous industries in this nation. Except for this fact, we would not be here today. Because of it and the efforts of such organizations as NCASH, the Congress has recognized the need to commit additional resources to research, surveillance, education, and intervention programs.

Most of the new programs are being administered by NIOSH. In administering these programs, NIOSH has recognized the value of supporting existing programs. An example of this is NIOSH's intervention program Agricultural Safety and Health Promotion Systems, which is providing funding to enhance educational safety programs through the Cooperative Extension System in 15 states.

Two new NIOSH programs crucial to developing intervention include establishing two new centers in Iowa and California for agricultural research and education and supporting occupational health and safety nurses in agricultural communities. These programs exemplify, too, the key questions we must ask ourselves in developing strategies for intervention programs.

1. How do we implement promising and innovative new programs such as nursing services in agricultural communities

## Questions to Guide the National Agenda

so that they complement existing intervention programs?

2. How do we foster programs that utilize the existing infrastructure of organizations, such as the Cooperative Extension System and the National Safety Council, to enhance our ability to make the most effective use of resources available for intervention programs?

What is the current status of safety features on farm equipment? New farm equipment being sold today has the latest state-of-the-art safety technology. When machines are used and maintained properly, injuries and deaths from machinery-related accidents can drop dramatically. ROPS for tractors and tractor seat-belt use could prevent the majority of tractor-related deaths. Virtually all new tractors sold in the United States have ROPS.

Because of the relatively long life of tractors, most agricultural tractors in use do not have ROPS in place. Nearly half of the approximately 400 tractor-related deaths that occur each year in this nation involve rollovers. How do we ensure that the older tractors and machines without these modern safety features get retrofitted with modern safety features when feasible or get taken out of use? The issue of how such updating and retrofitting is practical presents a significant challenge.

I encourage us not to focus solely on tractor fatalities, though they have become a focus of considerable media attention. They account for only a small percentage of nonfatal injuries on farms, compared with traumatic injuries from other causes and chronic occupational illnesses. Engineering and safety standards have long been the primary method of injury control.

Many manufacturers of agricultural equipment rely heavily upon the voluntary standards of ASAE in equipment design when no mandated standards exist. The development and issuance of technical standards by ASAE has contributed strongly to intervention for many years.

New standards and updates related to safety are constantly needed. What intervention programs do we need to ensure that the vast array of small manufacturers of farm equipment are aware of and comply with both mandatory and voluntary standards?

Unlike the situation in many other industries, the autonomy of the agricultural workplace can render many safety standards useless as safety features are discarded or overridden. How will this problem be overcome?

## DEVELOPING INTERVENTION STRATEGIES

### Characteristics of Target Audiences

How wide a net do we cast for our targets? Do we include forestry and logging? Food, feed, and fiber processing? Textile mills? Workers at fast-food chains? Food safety in general, which means all of us who eat?

As a first level of how wide we cast our net, let us focus on the 3.32 million persons who work on the nation's farms and ranches. Nearly half of these people are self-employed farm operators. The balance are unpaid workers (family), agricultural service employees, and workers hired directly by farm operators.

What methods would work best for reaching farmers? A recent study in New York State found that farmers and farm-

workers, while acknowledging the need for health and safety, did not have time to attend meetings.

Radio, general farm magazines, and conversations with others are prime information sources. The Cooperative Extension Service received a very high rating as a source of health and safety information.

A sizable share of the farm population is children. Accidents are the primary cause of death among children less than 15 years old in the United States as a whole and in farming. About 23,000 farm children are injured on farms each year. Why are these injuries occurring?

Partly, it is the generally risky nature of the farm environment and the fact that it is both home and office for farmers and for their spouses and children. Often, the economic realities of farming create a dependence on children for labor. Frequently, either there is no adequate child care for them off the farm or it is too costly for farm families. These problems exist for both the farm-operator family and the migrant-labor family.

In a recent national survey, farmers reported that they allowed their young children (aged 6-9 years) to ride on a tractor, and as many as 29 percent of 7-9 year-olds were driving the tractor. Between ages 7 and 15, farm children were performing a wide range of farm operations with tractors.

When asked about risks of such behavior, farm parents surveyed saw a low accident-risk level for their children when they were riding on a tractor the parent was operating or when the children were operating the tractor. As great as a 40 percent reduction in the farm fatalities to children

may be possible if children do not ride on tractors.

Studies of the cognitive physical limitations of children at various stages up through 15 years of age indicate that they are being put at risk through farm activities that they are asked to perform.

I have yet to see a farm safety awareness or education program that did not stress the danger of extra riders on tractors. This poses some important questions that need to be applied to all agricultural safety and health problems.

Why are our safety warnings going unheeded? Are we reaching and involving our targeted audiences sufficiently to develop effective education and awareness programs that change behavior? What will be the most effective combination of engineering controls, awareness, education, regulation, and enforcement to find solutions to each problem?

Studies of the cognitive physical limitations of children at various stages up through 15 years of age indicate that they are being put at risk through farm activities that they are asked to perform. Their parents do not understand that risk potential. How do we direct our educational efforts at these target populations? Helping farmers understand the developmental limitations of their children could significantly reduce child accidents and deaths on farms.

Another target population is the estimated 3 million migrant and seasonal farmworkers from many different ethnic groups. Children are about one-third of this population.

No comprehensive baseline health data exist for them. Some of their health problems and hazards are well documented. Others require much more investigation and research. Their need for a wide variety of education and social services is enormous. What are the unique demographic, cultural, and language problems that must be overcome to provide effective intervention programs for this targeted audience?

The average age of U.S. farm operators is 52, with 21 percent of farm operators 65 or older. Farm workers aged 65 and over have two to three times the injury rate of other age groups. Older workers are more vulnerable to injury due to decreases in sensory capabilities (hearing, vision, smell).

They also may be suffering from several chronic occupational illnesses that have high incidence rates among farmers. This target audience offers unique challenges for effective intervention programs that reduce their risk of traumatic injury and prevent increasing the severity of existing health problems.

What intervention programs are needed by audiences who have experienced an injury? Approximately 600,000 farmers have a disability that impedes their ability to perform essential farming tasks. This group is also at high risk to further injury.

Expanding upon several pilot programs, USDA's Extension Service, in cooperation with the National Easter Seal Society and other nonprofit disability organizations, recently launched an innovative program to help farmers with disabilities continue farming.

Extension agents, disability experts, rural professionals, and volunteers will offer

such services as identification and referral of farmers with disabilities, on-the-farm technical assistance for modification of the workplace, and, agriculture-based education to prevent further injury and disability. Accident victims can be a powerful influence in creating behavioral change. How can we more effectively involve these individuals and the grassroots organizations they have created, such as Farm Safety for Just Kids?

Should we target groups that are not employed in agriculture or live on farms but may become victims of farm injuries? What are the risks to individuals that visit or provide services to farms?

Approximately 40 percent of the fatalities that occur in confined-space agricultural accidents are attempted rescuers of farm accident victims. The Cooperative Extension System has trained more than 17,000 professionals in farm accident extrication procedure and nonprofessionals in first-on-the-scene emergency response procedures. These programs are crucial to reducing the risk of injury to the rescuer, reducing the severity of the injury to the victim, and emphasizing the value of injury prevention.

### **Approaches to Intervention**

Various approaches to intervention have been applied to agriculture. What do we know about the effectiveness of injury control strategies in the agricultural workplace? What new method emanating from the public health approach and human factors engineering will be required to solve these problems? How do we educate to achieve behavioral changes toward better agricultural safety and health? Many educational programs are in place.

We have our own, ranging from training of persons who will be using restricted-use pesticides to courses that instruct youth (14-15 years old) in operating tractors safely. Of the more than 23,000 Nebraska youth that have completed the tractor certification training program conducted by the University of Nebraska Cooperative Extension Service, only two have died in tractor-related accidents.

A national strategy could rest on the belief that the most effective preventive efforts will emerge from a process that emphasizes identifying and characterizing problem areas and populations at risk.

How do we educate people to change accident-causing or otherwise risky behavior? Simple identification of a public problem such as agricultural safety and health is not enough to allow the design and development of successful remedial programs.

Building meaningful people-involvement into problem identification, program development, and program delivery is essential. Failure to involve the real stakeholders (the farmers and farmworkers) dooms even the most outstanding programs to failure. The era of unshared decisionmaking is generally behind us.

### **Need for Collaboration**

What is required? The attention, effort, and cooperation of individuals and organizations at every level of society, from this conference to our offices at home. Should there be a national coalition to plan and to coordinate intervention programs? A

national strategy could rest on the belief that the most effective preventive efforts will emerge from a process that emphasizes identifying and characterizing problem areas and populations at risk.

The collaborative efforts of engineers, ergonomists, safety professionals, industrial hygienists, and experts in biomechanics and the behavioral sciences are needed to address the most compelling problem areas by studying what makes up workplace systems and the process, tasks, and tools involved. They must identify potential causal mechanisms, opportunities for intervention, and possible prevention strategies.

How will automatic ("passive") protection be used more in agriculture? Passive protection is generally more effective than "active" measures requiring effort by each worker.

Engineering controls are available for many known hazards but have not been systematically applied and evaluated. "Passive" measures of prevention could involve worker protective-system ventures into the realm of intelligent microenvironments that feature sensors, microprocessors, adaptive protective mechanisms, and display and imaging technology to protect, inform, and warn workers for hazardous conditions at their onset.

How do we ensure that the safety and health of the agricultural worker is not sacrificed for the sake of other issues? In considering common issues, such as selective harvesting versus clearcutting in the forests, we need to be aware that selective harvesting may be better for the environment but that it places the logger at a greater risk of injury than occurs in clearcutting using modern equipment. Can we engineer machines that allow selective

harvesting and that protect the workers using them?

We must apply a systems approach that identifies the multiple benefits and feasibility of intervention methods. For example, closed-container mixing systems for pesticides not only protect the applicator from exposure to pesticides, but can also prevent ground water contamination and reduce the possibility of mixing errors. Communication of multiple benefits can be an effective means of creating a change in behavior.

### **FUTURE FOCUS**

Let us look at success stories in agricultural safety and health. What data do we have on them? We know they exist. Probably one of the greatest shortcomings of existing educational farm-safety programs is the lack of scientific evaluations of their effectiveness. We must conduct more comprehensive evaluations. We need more than simple, generalized descriptors—beyond age and sex of the victim, the time of year of accident, and its severity—for us to develop innovative engineering or educational countermeasures.

Although more research and more data are needed to direct intervention, we know certain health and safety precautions work; ROPS work. Educational programs by the Extension System and others in health, hygiene, and pesticide use all have their successes in reaching our target audiences.

Where do we need to go? We need to focus on injuries that often result in death or severe disability because of their impact on the family and the economic and social costs to society. We need to find workable solutions to tractor fatalities and to reduce and eliminate them, if possible.

Tractor-related injuries are about one-third to one-half of all fatal farm injuries. This figure has changed little in 20 years. We also know that the youth and the aged were involved in a significant portion of total tractor injuries. We need to reach these target groups more effectively.

Injuries that occur with high frequency and may be easily prevented should receive high priority, even if less severe in nature. For occupational illnesses, we can increase educational efforts in the use of common methods of worker protection from hazards and in the use of protective equipment and clothing. Some types of clothing and equipment, for example, can reduce exposure to many harmful agents. We need feasible engineering controls to reduce vibrations, noise exposure, air contaminants, and other harmful agents. We need to stop the decay of basic health services available in rural areas and to reverse this trend.

I have raised many questions for your consideration both now and after you return home. Your presence here today is testimony to the momentum building to address this issue.

I think that we can find the answers to solving these problems through the collaborative efforts of all of you. We can act on measures that we know work now and search for more effective intervention countermeasures. Safety and health are the right of every person involved in agriculture. I wish us success in solving our agricultural health and safety problems.□



## RURAL HEALTH POLICY

By Jeffrey Human, M.A.  
Director, Office of Rural Health Policy  
U.S. Public Health Service

Has this not been a terrific conference so far? We have outstanding attendance. We have had one excellent speaker after another. The commitment to improve agricultural safety and health has also been striking in these presentations.

Groups like the National Coalition for Agricultural Safety and Health and the Farm Foundation have been working extra hours to form consensus on the national agenda we need to develop. This is a time of hope.

One of the most interesting things about several of the presentations so far was the emphasis on the movie *Field of Dreams*, and its use as a metaphor of hope. I asked a city dweller last evening what movies urbanites relate to these days. "Well," he said, "I'd include *Deathwish*, *Taxi*, *Mean Streets*, and *Escape from New York*." I think there is more hope in the country.

This morning's *Des Moines Register* ran a nice story on Dr. Novello's speech, which I thought was a high point of the meeting. What an anachronism to call her the "Surgeon General."

Her message makes it clear that she is both the "Pediatrician General" and the "Family Medicine General." And that is what we need in rural health. Yesterday, everybody had a different ranking for agriculture as a dangerous occupation. It was first, second, third, and fourth within an hour.

Chris Atchison, and this morning, Dr. Bill Halperin seemed to me to have the best idea. Let us set up and run farm health and safety surveillance systems in all states as they do in Iowa. Let us keep track of injuries and deaths and let us export this record-keeping to the other states, so we can keep track on a national basis and so that we can intervene for prevention. We also need to educate the nation's public on the nature and extent of the dangers of farm work to get the assistance we need.

It is very fitting that this meeting should be in Des Moines. It was in this city, in 1984, that the *Des Moines Register* won the Pulitzer Prize for a series of articles entitled "A Harvest of Harm." Those articles argued, persuasively, that agriculture has become our most dangerous occupation.

It was in Des Moines and Iowa City, in 1988, that Jim Merchant and Kelley Donham held a conference on agricultural health and safety; the conference led to the publication of *Agriculture at Risk: A Report to the Nation*, a report that has brought the issues we are talking about today to the nation and to the Congress.

The 1988 conference also led to the formation of the National Coalition for Agricultural Safety and Health—a coalition that is continuing to keep these issues in the forefront of national efforts to improve rural health; a coalition that has now integrated its work with the National Rural Health Association; a coalition whose work at

raising consciousness made this meeting possible.

Iowa's leaders have been very influential in other rural health endeavors. In the mid-1980's, the administrators of small rural hospitals detailed the problems they were experiencing to the Congress. Don Dunn and Art Spies (who is with us today) of the Iowa Hospital Association, were among the chief spokespersons of the movement.

The Iowa Congressional Delegation has been as united as any in the country in rural health advocacy. Senators Harkin and Grassley helped build a Senate Rural Health Caucus of 65 of the 100 members of the Senate, and they have delivered better-funded programs and new programs through the Senate Appropriations Committee, on which they serve. Former Iowa Congressman Tom Tauka was the first co-chairman of the House Rural Health Care Coalition, which now has 165 of the 435 members of the House, including all of Iowa's Congressmen.

There is one other Iowa leader we should speak of, but he is our next speaker. I will get to him soon.

I am supposed to say something about the Office of Rural Health Policy, which I direct. We act as a voice of the rural constituency in the Department of Health and Human Services and coordinate its rural activities. So I come to meetings like this as much to listen as to speak.

Our primary responsibility is policy, but we also run some programs. For example, this year we will be making around 38 grants to states to help them establish or enlarge state Offices of Rural Health. These offices work like our federal offices but at the state level.

I think they can be very effective in representing rural constituencies in the state capitals, in working with communities and their health providers to solve local problems, and in working with the farm community on health and safety issues.

This year, we will be making anywhere from 60 to 200 grants for local innovative health services programs or programs that support health professionals through education, telecommunications, or similar means. We expect several agricultural health and safety proposals.

We fund seven rural health research centers nationwide. All of them have some involvement in agricultural health and safety and one center—the Marshfield Medical Foundation—has agricultural health and safety as its principal emphasis.

We heard about one of their projects yesterday from Secretary Sullivan. It illustrates the practical applied research I ask for from each center.

When we looked at the tractor-rollover problem with Marshfield, we decided that there was no need for further research on the problem. What we decided we needed was a way to help farmers who wanted to retrofit older tractors with roll bars or other rollover protective devices to find those "ROPS," as they are called.

So we asked Marshfield to develop and publish a catalog of all American manufacturers of "ROPS," all products they produce and what make of tractor, model of tractor, and year of tractor they will build. Then Marshfield sent the catalog to all extension agents in the country, so it is available where it is needed.

Producing that catalog is not the best step we could take as a society. As we have seen in the slide on the Swedish experience, the best step we could take would be to require "ROPS." But as an Office, it was the best we could do.

We fund a national information center on rural health. It is a part of the U.S. Department of Agriculture and is within their National Agriculture Library. So if you want some rural health information, call 1-800-633-7701.

The nice thing is that you can also get agricultural information or rural economic development at this same number. Add \$24.95 and postage, and we will include all the hits of *Boxcar Willie*. That is 1-800-633-7701. Offer is not valid in Mexico or Canada.

My own office is also a sort of information clearinghouse. In my presentations, I try to share ideas on the things that are happening in the states and communities and in Washington that affect rural health.

Thus, I talk around the country about the problems of rural health and about the potential solutions. For example, I tell state officials that they should train more nurses because we have a national rural nurse shortage. If they ask where to get the money, I suggest they cut back on training so many lawyers at taxpayer expense.

If we are short of nurses, we are short of essential health services for our people. If we grow short of lawyers, however, what are we short of? Essential lawsuits?

Certainly with a few less lawyers we might have fewer malpractice suits. Seriously, let us confront conventional approaches and

make new choices with limited funds, choices that help solve rural health problems.

I tell people in other states about the package of programs offered to local subscribers by the University of Iowa's Institute of Agricultural Medicine and Agricultural Health. I do not have time to tell you the specifics today, but I will mention three features of the program, which is based on a Swedish model.

1. It is hospital based and contributes to the viability of rural hospitals. That is important because 10 percent of all of America's rural hospitals closed their doors during the 1980's.
2. The program includes continuing medical education for physicians. A 1979 survey showed that 70 percent of all medical schools offered no instruction in agricultural medicine. The other 30 percent offered an average of four hours of instruction during four years of medical school. The young physician new to an agricultural community may be baffled by pulmonary and cardiac conditions caused by agricultural dusts or chemicals. Ellen Widess' stories yesterday play out over and over again, and many times with worse endings when we do not prepare our physicians properly.
3. The program trains farm families to be responsible for their own health and safety. For example, they are shown how to make animal confinement houses safe for themselves and the animals. For more information, see Jim Merchant or Kelley Donham or David Pratt, who know more about these and other similar programs than I do.

I want to tell you about one last program. It is called "Stress Country Style," and it is in Illinois. A network of health workers throughout the state are available to help farm families. Farmers call an 800 number, and help comes to them. There is no stigma because the encounter is private at the farm. Counseling is offered. Referral to mental health or debt consolidation or one of 100 other programs is offered. Oklahoma and Iowa have similar programs.

Seriously, let us confront conventional approaches and make new choices with limited funds, choices that help solve rural health problems.

We need more innovative stress reduction programs like these. In Ontario between 1979 and 1982, 95 of the 273 farm deaths were suicides, and the farm suicide rate has been documented to be high in this

country as well. Mental health must be an important part of our national strategy.

Incidentally, we need to place a special emphasis on teenagers when we look at mental health in the farm community. A survey by the University of Minnesota's Extension Service and the Medical School indicated that 5 of every 100 rural adolescents surveyed has attempted suicide within the past month.

Nationally, the figure was 2 of 1,000. This was in the early 1980's during the height of the farm crisis, but other studies have shown pervasive high levels of depression among rural adolescents.

I should also mention that our office provides staffing for the National Advisory Committee on Rural Health. I have left some brochures about our office at the registration desk. If there are none left, call 1-800-633-7701, and they will have us send you one.□

## MEDICAL INTERVENTION PROBLEMS AND OPPORTUNITIES IN RURAL AREAS

By Governor Robert D. Ray  
Chairman, National Advisory Committee on Rural Health Policy

Mr. Jeffrey Human: My last assigned task is to introduce our next speaker. My honest impression is that Bob Ray is a real enigma. This is a guy who was elected to five terms as Governor of Iowa, and then found a life after politics on his own. He did not lose an election—he quit. There was no scandal. He just left the political life. He wanted to try something new. This is almost unprecedented in American politics. Then Bob went out and got jobs on his own and made a mark. He ran a successful insurance company, and now he is president of Blue Cross and Blue Shield of Iowa, with a million subscribers. He is not some absentee figurehead president either. A top official of Blue Cross nationwide tells me he has personally turned the program around in this state. Secretary Sullivan told us yesterday that Bob Ray is one of his advisors. Well, he should be, because Bob is chairman of the National Advisory Committee on Rural Health. That committee has provided Secretary Sullivan and the Congress with a series of challenging recommendations on rural health that have led to changes. For example, the Outreach program I told you about is partially a result of a recommendation of the committee. There is a great revival of interest in national health reform. There are many competing proposals. One of the best and most influential, based on universal insurance coverage, is from the National Leadership Commission on Health Care. The Commission's members read like a *Who's Who* in American health policy. The chairman is, of course, Bob Ray. Bob Ray also was a U.S. Delegate to the United Nations and former chairman of the Indochinese Refugee Panel, providing leadership in efforts to resettle Vietnamese and Cambodian refugees. Bob is a graduate of Drake University's Law School, and he has a lot of honorary degrees and distinctions. Those of us who work with him and for him with the National Advisory Committee on Rural Health have discovered more important things about Bob. We have found him to be intelligent, funny, caring, realistic, charming, articulate, and an excellent leader. He is one of the best listeners I have ever met. He knows more about health care than most of us. It is a pleasure to introduce one of America's great leaders, Robert D. Ray:

Jeff, thank you. Thank you very much. I just learned a great deal about Jeff Human. I have always admired him and his talent and his ability and I have watched him in Washington, knowing that he is not just a bureaucrat. He is a person with tremendous compassion and understanding of people, their needs, and their problems.

Jeff, what I did not know about you is how flexible you can be. You have talked to us about education; you have talked to us about tractors; you have talked to us about Federal programs; you have talked to us about *Boxcar Willie*; and you have talked to us about me. I am here to tell you that

I am sure thankful I do not practice law anymore.

I am not sure I should have been invited to speak to you today at all because I am not sure of my own commitments. There is probably no one who is working harder or who believes more that we should hold down health care costs than I.

Earlier this year, I was in an automobile accident and was taken to the emergency room. I was laying there flat on the slab and looking up, and two white spotlights were shining down on me. It was very, very warm and very comfortable.

I felt pretty good about that, but then I looked kind of from one side to the other, and I saw these green things running around. There were doctors standing here and there. Once in awhile one would lean over and look at me, and I would look at him. The funny thing about it is that never one time did I look up and say, "How much is it going to cost, Doctor?"

And so there are conflicts within all of us. We want the best health care system possible. We do not always want to pay for it. We believe that there are ways in which we can cut and save—but not on the service that we get.

So, it is very difficult when we talk about what is needed and what is doable. If at first blush you think it is just overwhelming and impossible, you would quit.

Then when you realize that things do happen—maybe slowly, but they do happen. There is always change going around. Maybe the change will inure to a system that we want to change. That is the reason it has been exciting to me to work with Jeff Human and the people in Washington and DHHS.

Some of the business people and the major leaders of this country are trying to do something about health care. We have long learned that you can not do something about cost alone because if you control cost, you reduce access.

You cannot do something about quality of care alone, even though that, by itself, might reduce health care costs 30 or 40 percent, because it costs money to do certain things.

You cannot just provide more access for everybody without affecting costs and qual-

ity. So we have to deal with all of those aspects of health care and the health care delivery system together.

I think that it is awfully easy for us in the rural areas to be neglected because we do not have the votes they have in the big states: California, how many congressmen do they now have? New York?

It has been very impressive, what has happened in Congress over the last several years. Jeff already mentioned how many members belong to the House Coalition on Rural Health. So, a lot of good things have happened, and our advisory committee, I think, has had some influence, some impact, and I am pleased to be associated with them.

I am pleased that the Surgeon General decided that we should have this conference and that our senators endorsed it, and Tom Harkin helped to get it here in the State of Iowa. There is no better place we could have a conference on rural health than right here in the State of Iowa. I think we ought to have one of these every 50 years.

An awful lot has happened to change the landscape of American health care during this past 50 years. Advances in technology and the proliferation of medical specialties allow us to live longer and healthier lives. That is good. But unfortunately, farm families, farm workers, and rural farming communities do not share equally in all of this achievement with our neighbors in urban areas.

This conference is very timely, and I am pleased that it is here in the State of Iowa. And I want to thank the Surgeon General for being here.

There are so many people that I would like to acknowledge on the federal level, on the state level, and on the regional level—our Senators, Congressmen, Dr. Donham and Dr. Merchant, and the list goes on and on. I am going to save you—spare you—the time that it will take to do that.

Let it suffice to say, I truly appreciate what you are doing because this is important—not just to those people who live on farms, but even those who live in small towns; it is important to every one of us. I will get back to that.

The diverse groups of people like yourself who focus specifically on rural health at this conference give us a unique chance to build and strengthen active, vital, rural health networks. It offers the opportunity to develop links between the researchers and the health professionals, between health professionals and extension agents, between extension agents and surveillance experts, and between surveillance experts and researchers. The list goes on and on; you get the picture.

We just finished a rather tasty meal. You have probably had better; you have undoubtedly had worse, but by most standards, let me tell you, there are people in this world who have never, ever had a meal that good. Let me give you some food for thought.

Just stop and pause and reflect for a moment with me about who produced that food. I am not talking about the culinary part, the chef's part, but about the people who provided the labor and the risk and the sacrifice that we enjoyed at noon: we are spoiled. We in this country try to decrease the calories that we eat, while the rest of the world measures growth and

progress by the increase in calories their people eat.

Our farmers only get a very small fraction of what we spend for food. They get 4 cents for the wheat that goes into a loaf of bread, which costs roughly a dollar and a quarter. They get 5 cents for the corn that goes into a 7-ounce box of corn flakes, which sells for a dollar and a quarter.

We in this country spend a smaller percent of personal income on food than any other civilized country. You people pay, on the average, 11.9 percent of your personal income for food. It was 18 percent in 1959. It has been reduced.

Yet, in other countries, like the European countries, they are paying around 17 percent; Japan, 19 percent; the Soviet Union, 28 percent; India, 54 percent; China, 48 percent. We have a bargain.

Look at what is happening in the Soviet Union. During our lifetime we have grown up knowing about two superpowers—one the United States of America and the other the Soviet Union.

Today the Soviet people stand in lines for hours. You see them on television. You can watch them—waiting for a little piece of bread that they cannot even afford.

Add to that the fact that the suicide rate for farmers is now 30 to 40 percent above the national non-farm rate.

We are fortunate, yet we take it all for granted. Our farmers produced the food that the chef prepared for us today, but they did it accepting some risk: the possi-

bility of an untimely death or serious injury or acute or chronic illness—all of that—while they were growing the food and raising it.

## RURAL STATISTICS

Earlier at this conference, if I understand correctly, you heard some alarming statistics. Let me briefly reiterate what I think some of them were.

Although farmers and farmworkers comprise only 3 percent of the work force, they suffered 14 percent of work-related deaths, according to National Safety Council figures. Agriculture, as you heard just a moment ago, precedes mining now as the most hazardous occupation.

Unlike mining, where the death rates have been decreasing, agriculture mortality rates have remained consistently high during this past decade. The fatality rate in farm work is five times the average for all U.S. industry—five times.

Researchers have discovered that midwestern farmers have a higher-than-normal chance of dying of leukemia. The cause is uncertain. Some experts fear an unusual incidence of leukemia is linked to the use of modern pesticides in raising corn.

A serious new hazard known as "hog lung" is also one of the by-products of the modern system of raising hogs in confinement. In a half-dozen or more of our cities, water supplies contain greater than acceptable amounts of pesticides and other synthetic organic chemicals.

Millions of rural poor people are risking health problems because of substantially substandard diets. That problem is attributed to the pride of rural poor who are

unwilling to accept food stamps and other assistance. These numbers do not even take into account all the children who die each year in farm-related activities.

In addition to deaths, there are 130,000 to 170,000 disabling farm injuries every year. These injuries entail an enormous hospital rehabilitation cost, and nearly half of all survivors of serious farm trauma are permanently impaired. Add to that the fact that the suicide rate for farmers is now 30 to 40 percent above the national non-farm rate.

Jeff just gave you some other information about that fact. He mentioned that I had served as a representative to the United Nations. When I was there, I found myself frequently talking to those of other countries, and especially Africans, who no longer could produce enough food for their own people.

They had joined a crowd of socialized countries, and soon learned that they just could not produce food like they used to. They liked talking to me because they knew that I came from the State of Iowa, one of the best farm states in the country, in the world.

We spent hours talking about how our farmers could produce food better than anybody in the world. I believe that we could help them. We used to talk about how we might do that.

One day I was telling them about how wonderful our farmers were and how well they could produce food. Then, the very next day, I picked up the *New York Times* and there on the front page was a dateline story from Spencer, Iowa; and this is a quote, "More suicides on Iowa farms." I just hoped that my friends I talked to the



day before did not read that. But it was and it is a fact of life. It is a shocking fact of life.

I have just given you a few statistics that I think indicate the importance of your getting together today for this conference. Let me turn our attention to the big issue of rural health care and rural health care delivery.

### **RURAL POVERTY**

Many of you are undoubtedly familiar with the agricultural, occupational, and environmental health conference that was held here in Des Moines a couple of years ago. That conference report was called *Agriculture at Risk*.

It described the need for occupational health and safety services. It discussed the challenges facing the rural health care system, challenges like failing rural hospitals, pay disparities between urban and rural physicians, difficulties in retaining both rural health providers and patients, and the need for a strong emergency medical services system. Although the public's image of rural America is one of picturesque countrysides and healthy lifestyles, this image belies the reality of life in much of rural America. These are hard times for many rural communities, the result of both economic and demographic trends.

For example, the rural poverty rate increased steadily during the 1980's and for the first time is now higher than the urban rate. Rural residents are much more likely than urban residents to have no health insurance coverage at all—public or private.

Rural residents are plagued by chronic disease, higher rates of infant mortality, and dramatically higher rates of injury-

related mortality. Some of these figures reflect the corn prices of the 1980's. You probably are not surprised to hear that the number of farm foreclosures reached 650,000 between 1981 and 1987.

You may not know that rural America also lost over 500,000 manufacturing jobs at the same time. It is estimated that for every seven farms that have been lost, one rural business has closed.

The rural population increased in the 1970's. The 1980's saw a dramatic shift. Growth was stagnant at best and some midwestern communities lost population, Iowa being one of them. All of you know we are going to lose a Congressman. We do not want to lose that Congressman; we have no choice.

These economic and demographic trends together with changes in the delivery and financing of health care have taken a huge toll on the rural health care systems, especially the rural hospitals. Ten percent of all U.S. rural hospitals closed during the 1980's, and it was estimated that about 25 percent of those still serving patients were in serious trouble.

With greater rural poverty has also come a rise in uncompensated care provided at rural hospitals. Under Medicare's prospective payment system, rural hospitals, since 1983, have been paid at a lower rate than urban hospitals, as much as 25 percent lower. This has been devastating to many rural hospitals because Medicare patients represent an exceptionally high percentage of their patients.

One of the first recommendations that the National Advisory Committee on Rural Health made to Secretary Sullivan was to establish a single national standardized

payment for Medicare hospital reimbursements. I am pleased to be able to say that Secretary Sullivan has been successful in seeking a higher annual update for rural hospitals. The Congress has now legislated a phase-out of the rural-urban differential in Medicare payments.

In 1989, the Federal Government implemented the Rural Hospital Transition Grant Program to address rural hospital vitality. Under this program about 180 new grants were made to rural hospitals each year for the past two years. Hospitals can receive up to \$50,000 a year to help them with strategic planning and implementation of programs to help them with that change in rural health care needs and practices.

Iowa has fared very well under this program. Twenty-three of these grants were awarded to Iowa hospitals in 1990. That totals \$819,000 and represents 10 percent of all the federal funds awarded.

The second program that the Federal Government is implementing right now is the EACH/PEACH Program. EACH means Essential Access to Community Hospitals. PEACH means Primary Care Hospitals. The Congress authorized this program in 1989 to provide financial incentives for rural hospitals to downsize and to focus on providing primary care and limited inpatient services and emergency care.

The program also encourages these primary care hospitals to form networks anchored by larger full-service, essential-access community hospitals. Seven states will receive funding this year to develop networks in primary care in essential-access community hospitals.

## RURAL HEALTH PERSONNEL

Another rural health issue receiving a lot of attention is the shortage of rural health personnel. To maintain a rural health system, we have to have physicians, nurses, emergency medical service helpers, and other health personnel.

Rural counties have only one-third as many physicians per capita as the nation at large. In these counties, 20 percent of physicians are over the age of 65 and, obviously, are going to retire very soon. Communities also have problems recruiting and retaining physicians. Right now 165 Iowa communities are looking for doctors. Rural communities particularly find it difficult to recruit and retain registered nurses, physical therapists, occupational therapists, x-ray technologists, and other health professionals critical to health care systems.

Some recent federal efforts may help address a few of these problems. The National Health Service Corps was re-authorized last year. Its funding was increased. This program places physicians, nurse practitioners and physician assistants in the underserved areas. In recent years, about 70 percent of the placements have been in rural areas.

A Medicare bonus was implemented two years ago for physicians practicing in rural underserved areas. The bonus was increased just recently to 10 percent.

That represents just a very small incentive, but given the substantially lower rate that many rural physicians receive as compared to urban physicians, it is at least a step in the right direction. Both of these provi-

sions, I might add, were recommended by the National Advisory Committee for Rural Health.

Congress has also mandated a new Medicare physician payment system. Under this payment system, primary care physicians are going to be reimbursed at higher levels than they currently receive, and that ought to help.

At the same time, we should not overlook the issue of rural emergency medical services. In Iowa there are more than 400 ambulance services and approximately 10,000 trained personnel. Seventy percent of these people are unpaid volunteers, and most all of them are in the rural areas. The difficulties of recruiting and retaining these dedicated individuals who have other jobs, spend long hours in training, and donate their time free to an important health service are, I think, rather obvious.

Rural volunteer ambulance services also struggle to purchase equipment. An ambulance, fully stocked, is going to cost \$70,000 and rarely is there money from government to pay for that.

So they have their chili suppers and their chicken barbecues just to raise the money for an ambulance. That, actually, is where most of the money comes from. It seems kind of strange to think that the emergency services upon which we depend so heavily, particularly in rural areas—services that treat farm injuries, heart attacks, highway traffic accidents—are actually provided by volunteers.

## **RURAL MENTAL HEALTH**

Now, the third and last rural health issue I want to mention is rural mental health. As I said a moment ago, the farm crisis of the

1980's caused incredible stress for rural individuals and families, but the accompanying drop in land values and tax bases made it increasingly difficult for rural communities to finance mental health services.

As we look at ways to strengthen our rural health care system, we have to make sure that mental health services are a part of that system. Mental health personnel are also trained for rural practice. Iowa State University, for example, has recently been awarded a \$4.5 million grant to establish a center for family research in rural mental health.

Right now Iowa has about \$24 million in rural health related federal grants, employing a variety of programs.

Mercy Hospital here in Des Moines, for example, has received \$750,000 for a cancer screening and control program for farm families in 35 Iowa counties.

## **CONCLUSION**

Well, what is the sum and substance of it all? I think, notwithstanding the problems and all the difficulties, we can be somewhat encouraged by the recent progress in both rural health and in agricultural health and safety. Make no doubt about it, we have a long, long way to go.

Public policy items all have their life span on the national agenda. The challenge that we face is to keep rural health and agricultural health and safety issues on that agenda long enough so that we can make and see a very substantial difference.

If we can do that, we are going to see that the time and the effort and the money were all well spent to ensure a future for our rural areas. This conference is unique

## Medical Intervention Problems and Opportunities

because of the range of the players that it has brought together.

I would suggest that we have a second conference; in fact, I already did before the Surgeon General left. I think I am not speaking out of school—she said she agrees. We really ought to have one.

I think it would be nice if we had it before 50 years, because I would like to come back. I would like to see what we have done between now and next year or the next year or whatever time that conference is set for.

The last Surgeon General's Occupational Health Conference resulted in something maybe very important, the elimination of mercurial poisoning in the hatting industry. We do not have much hatting industry anymore. In contrast, this conference has the potential to lead to dramatic decreases in agricultural deaths as well as advances in preventing and treating agriculturally related diseases and injuries.

To wrap it up, I would like to just share a quotation from the newsletter of the Center of Rural Affairs, Walthill, Nebraska. It puts what you are doing here in a broader context of rural development and, in a sense, summarizes what I think this conference is about. I am going to quote:

"Good rural development conserves the best in people; the resources they live from, the values that nourish them, and the institutions that sustain them. We need not try to prevent change but to shape it in ways that conserve our future."

I would add to that, the health and future of our rural farmers, farmworkers, and the farm community. If we succeed at doing that, every one of us will benefit. I appreciate so much you being here, because that is what you are here for, to do exactly what that quote says. Thank you very much.□

## INTRODUCTORY REMARKS

By *Ronald D. Eckoff, M.D.*  
Director, Division of Family and Community Health  
Iowa Department of Public Health

Dr. Richard A. Lemen: To lead this panel this morning is Dr. Ronald Eckoff, a physician who is currently the Director of the Division of Family and Community Health with the Iowa Department of Public Health. Dr. Eckoff is a native of Michigan, having trained in both undergraduate and medical school at the University of Michigan. He holds a Master in Public Health degree from Harvard University. He has been active within the Iowa State Health Department, and I was looking at his resumé and noticed that somewhat—like locusts, I suppose—every 20 years he has been asked to be the Acting Director or Acting Commissioner of the Iowa Department of Public Health. He has a very good background in public health, and he will be leading the discussion today. I would like, at this time, to present to you Dr. Ronald Eckoff of the Iowa State Department of Public Health. Dr. Eckoff:

Thank you. I want to add my welcome to Iowa to the welcomes you have already heard from others in Iowa. I should give you a little warning. Some people have come to Iowa and said what a nice state it is, what a pretty state it is.

My warning is, I came here in the Commission Corps of the Public Health Service 26 years ago, on a two-year assignment with no intention of staying, and I am still here. So, we do not want you to leave the conference early, but if you do not want to get trapped into staying here, maybe as soon as the conference is over, you will want to get out of the state.

Chris Atchison talked the day before yesterday about some of the things that are going on in the Iowa Department of Public Health in relation to agricultural safety and health. So I will not repeat those things. But I would mention that when you go to the poster sessions this afternoon, if my counting is somewhere near correct, there are 101 posters there.

Five are from the Iowa Department of Public Health about our activities. There

are another 22 or 23 from other agencies and organizations in Iowa: Iowa State University, the University of Iowa, the Lung Association, the Easter Seal Society, county extension, and others. So I would certainly encourage you to view those sessions this afternoon.

As I have listened to other people and as I have talked to people here, I have come to the conclusion that everybody at this conference either is currently engaged in farming, grew up on a farm, spent a lot of time visiting their grandparents' farm when they were kids, or at least liked to visit farms or go to the petting zoo section of the zoo.

I did grow up on a farm, but I am here to tell you that I did not do any of those dangerous things that some of the other speakers have talked about. I did not drive a combine at a young age, or a grain truck, or anything like that.

Of course the fact that I grew up on a fruit farm in Michigan, and we raised apples and pears and that sort of thing, not corn and soybeans, might have had something

## Issues That Affect the National Agenda

to do with that. I will not mention to you the kinds of things that I might have done that were dangerous.

This morning's session we shift gears just a little bit and talk about some issues that affect agricultural health and safety. We have been talking more specifically about some of the dangers and the activities, and now we are going to talk about issues that affect agricultural safety and health.

Our first two speakers will address the agricultural work force and the behavior of its members. Then the second two speakers will reveal changes in the agricultural work place as it is affected by new and different crops and by biotechnology. Biotechnology is certainly a word we hear used a great deal these days.□

## THE AGRICULTURAL WORK FORCE: PATTERNS AND TRENDS

By *Leslie A. Whitener, Ph.D.*  
Economic Research Service  
U.S. Department of Agriculture

Dr. Ronald D. Eckoff: Dr. Leslie Whitener is a sociologist and Head of the Agricultural Labor Section, Economic Research Service, U.S. Department of Agriculture. Dr. Whitener holds M.A. and Ph.D. degrees in Sociology from The American University in Washington, D.C., with specializations in the sociology of work and advanced statistics. She has over 15 years of experience in farm labor research and has authored or co-authored more than 50 papers, monographs, book chapters, and journal articles relating to the agricultural and rural labor force. Specific studies have focused on the problems and needs of migrant farmworkers, the effects of Food Stamp and Federal employment programs on hired farmworkers, and labor market conditions facing farmers who seek off-farm jobs. Dr. Whitener's presentation focuses on patterns and trends in the U.S. agricultural work force and their implications for farm safety issues. Dr. Whitener:

### INTRODUCTION

Major changes have occurred in American agriculture during the last 40 years, which have affected the way we think about farms and the nation's farmworkers. Farms have become fewer and larger and agricultural production has become increasingly concentrated on the bigger farms.

The greater availability of machinery, chemicals, water, improved seed and live-stock, and public financing have led to a greater substitution of capital for labor. As a result, the number of agricultural workers has declined by over 70 percent since 1950 and the activities and working conditions of U.S. farm workers have changed dramatically.

Some of these changes have raised serious questions about the health and safety of agricultural workers. Agriculture continues

to have one of the highest "accident" rates of any major industry group—a fact you will undoubtedly hear repeated throughout this conference. According to the Bureau of Labor Statistics, for example, the incidence rate of workplace injuries and illnesses for agricultural production workers (12.2 injuries per 100 full-time workers in 1989) is exceeded only by construction and some manufacturing industries.\*<sup>1</sup>

Other data sources show even higher injury and illness rates for agriculture. My comments today will help to provide a context for understanding some of the farm safety and health issues raised in this conference. To that end, my presentation focuses on the changing structure of American farms and on the demographic and employment characteristics of the people who work on those farms.

I will concentrate on three major points that have important implications for cur-

\*The incidence rates for agricultural production workers do not include workers on farms with less than 11 employees.

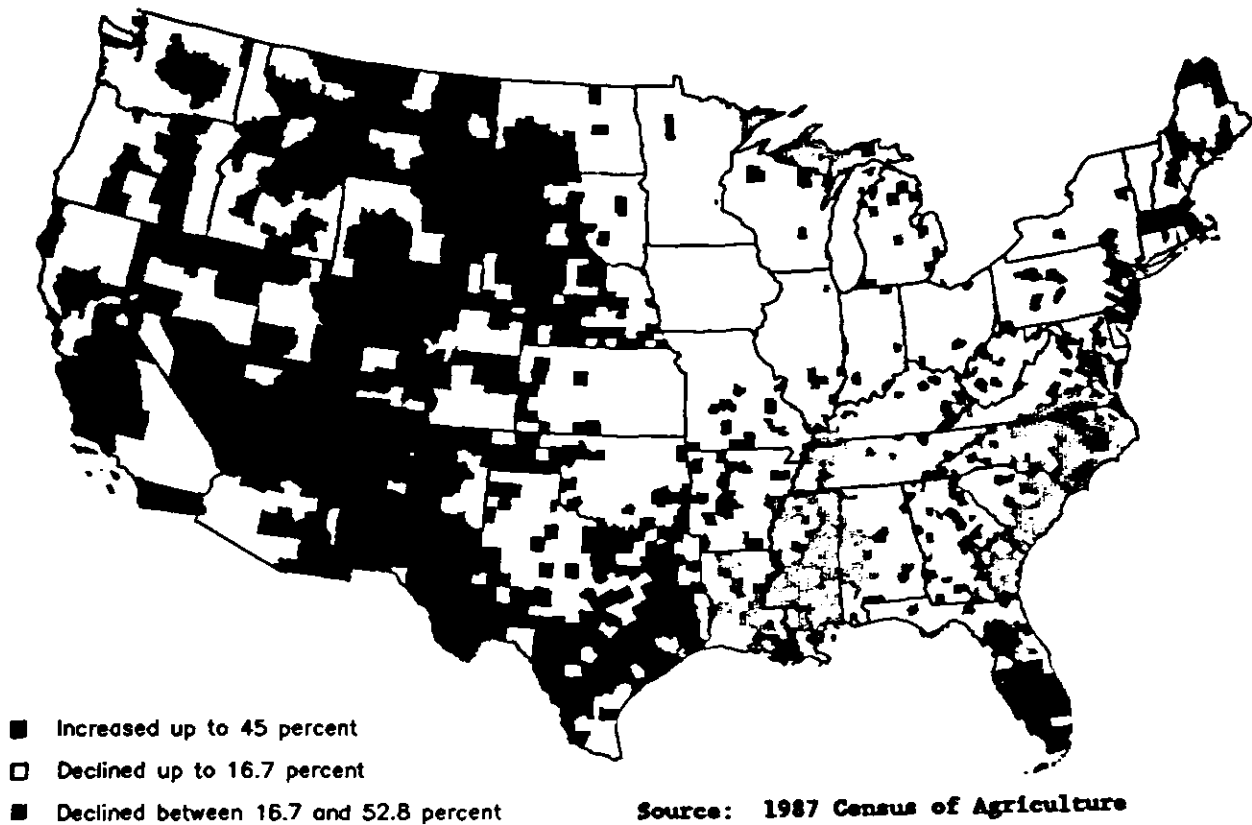

**Figure 1.** Change in Farm Numbers, 1982-87. *Two-thirds of the Nation's counties lost farms; the heaviest losses were in the eastern half of the Nation.*

rent and future agricultural safety and health issues.

► First, U.S. agriculture has changed dramatically over time; farming and the nature of farmwork are very different today than they were in the 1950's.

► Second, the agricultural work force is a diverse group of workers who perform a wide variety of activities on the farm. This diversity complicates generalizations about farm safety problems and solutions.

► Third, all is not what it seems, and many of our long-held tenets about farming and

farmworkers are no longer relevant or have been based on stereotypic images that were never true. These new ideas and patterns suggest caution when projecting farm labor trends to the future.

### CHANGES IN FARM STRUCTURE

Perhaps the most notable change in agriculture over the last four decades has been the decrease in the number of farms. Farm numbers declined by over 3 million between 1950 and 1987, falling to about 2.1 million farms in 1987.<sup>2</sup> Yet, these declines have not occurred consistently across the country (Figure 1).



Between 1982 and 1987, for example, the largest declines in farm numbers occurred along the South Atlantic coast and the Mississippi Delta. During this period, the slow-growing economy of the rural South encouraged many poor, part-time farmers to leave farming for higher-paying non-farm jobs. Many small farms were consolidated into larger operations.

The Corn Belt, Lake States, and most of the Northeast also showed declines in farm numbers but at slower rates of loss. While the farm recession of the early 1980's undoubtedly affected major farm production states, the effects appear to be less serious than expected.

During 1982-87, the period immediately following the farm recession, much more change occurred in regions not usually associated with major agricultural production. Figure 1 shows little shading in the midwest, and there is little indication of severe decline in these states.<sup>3</sup> The recession apparently resulted more in financial restructuring than in farm loss in these areas.

In contrast to these patterns of decline, farm numbers increased in many parts of the United States, particularly in the Western States and in southern Florida. The increase in farms may be a reflection of rapid population and employment growth in these areas during the mid-to late 1980's. Farm increases, particularly in the West, were also due to division of farms into smaller units as partnerships dissolved or as older operators retired and divided their farms among heirs.

Farm numbers will continue to decline in the 1990's, but at a slower rate than was experienced during much of the post-World War II period. By the year 2000, the number is expected to drop by about 6 percent—substantially below the 11 percent decline seen during the 1980's.<sup>4</sup>

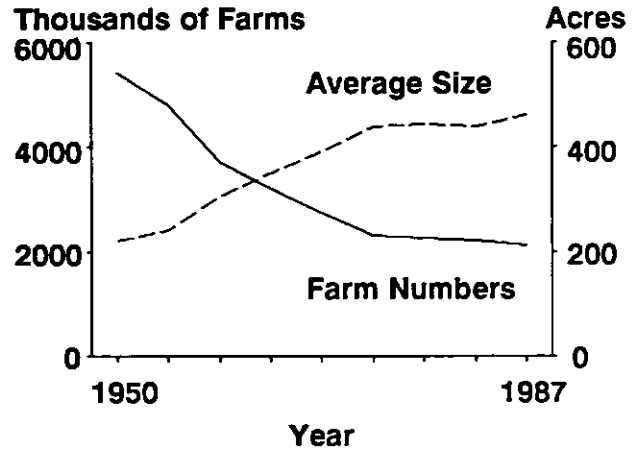

Source: Census of Agriculture, selected years.

Figure 2. Change in Farm Numbers and Size, 1950-87.

As the number of farms decreased, average farm size increased, forming what some have called the "Iron Cross of Agriculture" (Figure 2).<sup>5</sup> Farm size averaged 216 acres in 1950 but increased to over twice that size (462 acres) by 1987.\*\* There will be more large farms at the turn of the century than there are today, and by the year 2000 the largest 1 percent of farms is expected to account for half of all farm production.<sup>6</sup>

*As the number of farms decreased, average farm size increased, forming what some have called the "Iron Cross of Agriculture."*

\*\* Note that the rates of increase in farm size have consistently declined since the 1950's, and the trend toward larger farm size may be stabilizing.<sup>3</sup>

The current trend toward fewer and larger farms is due to many factors, including technological development, economies of scale, tax laws, price instability, differences in operators' managerial ability, capital requirements, credit availability, foreign trade arrangements, and Government programs and regulations.<sup>7</sup>

### PATTERNS OF LABOR USE ON U.S. FARMS

What do these structural changes mean for labor use on U.S. farms? Changing farm structure has transformed labor requirements on U.S. farms. Capital substitutions of machinery, chemicals, water, and fertilizer for labor resulted in a substantial drop in the need for the number of workers in agriculture. In 1989, the number of hours of labor required in agriculture was about one-third of its 1950 level.<sup>8</sup>

Feed, seed, and livestock purchases increased over 80 percent since 1950. The use of agricultural chemicals, including fertilizer, lime, and pesticides, increased by over 500 percent. During the same period, farm output and worker productivity increased dramatically. In 1950, the average farmworker supplied farm products for about 16 people; by 1989, the number had risen to 98 people.<sup>8</sup>

As a result, the agricultural work force, including both family and hired workers, declined by over 70 percent between 1950 and 1989 (Figure 3). Farm operators and their unpaid family members continue to provide the major portion of labor in agriculture.

However, hired workers have gradually replaced some family workers on farms. In 1950, hired workers comprised about 23

percent of annual average employment; by 1989, the proportion had increased to 35 percent.

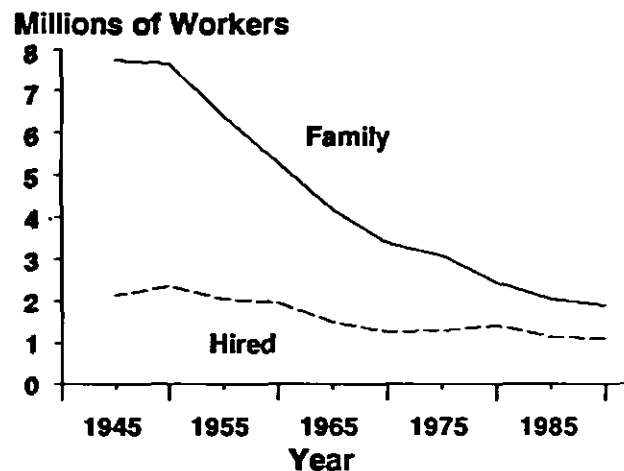

Source: USDA, NASS Farm Survey.

Figure 3. Farm Employment Trends, 1945-90.

The amount and type of labor used on farms is related to the size of the farm operation, the commodities produced, and the geographic location of farms.<sup>9</sup> Less than half (about 954,000) of the nation's 2 million farms employed hired or contract workers in 1987.<sup>2</sup>

Small part-time farms, particularly those involved in grain or livestock production, are more likely to rely on family labor. Larger farms, especially those producing fruits and vegetables, tend to have labor needs in excess of the capacities of the families who farm them. A closer examination of farms by three size categories provides a useful perspective on patterns of farm labor use (Figure 4).

### Small Part-Time Farms

Almost two-thirds of the nation's farms are small, part-time operations with annual product sales of less than \$25,000. For

most of these farmers, farming is a secondary occupation, and off-farm income has become increasingly important to their economic survival.

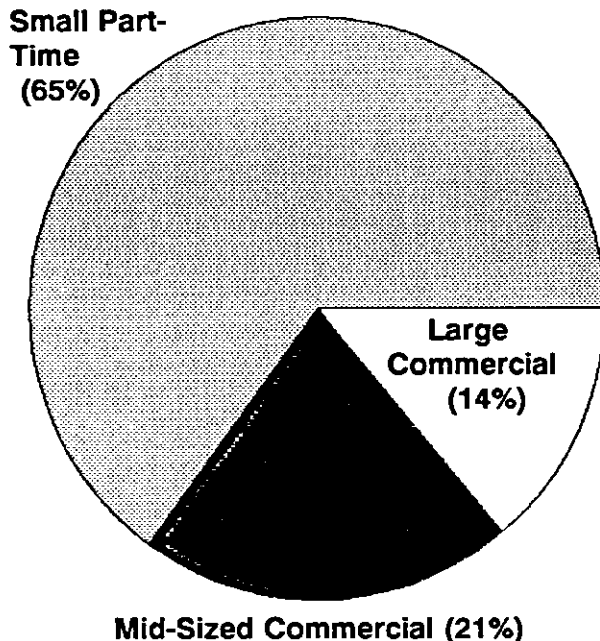

Source: 1987 Census of Agriculture.  
**Figure 4. Farm Size Based on Cash Value of Sales, 1987.**

These farms are generally small, owner-operated farms, largely dependent on family members for labor supply. Over two-thirds did not use any hired or contract labor in 1987, and the remainder averaged less than \$5,000 in labor expenses per farm.<sup>9</sup> Most are involved in grain and livestock production and are disproportionately located in the southern half of the United States. Between 1982 and 1987, these small part-time farms accounted for half of the national loss in farms.

### Mid-Size Commercial Farms

About one-fifth of U.S. farms are mid-size commercial farms with annual product

sales of \$25,000-99,999. Mid-size commercial farms are largely producers of cash grains, cotton, and cattle—agricultural products, which do not require large amounts of hired labor per farm. The 1982-87 loss in the number of farms was heavily concentrated among mid-size commercial farms.

This group suffered the largest rate of decline all the farm size categories, losing 12.5 percent of its farms. Operators of mid-size farms are under considerable financial pressure to either enlarge their farming operations to a more viable commercial size or to scale back to a smaller part-time size of operation. Consolidation of mid-size farms into larger units has been a major source of the growth of large commercial farms over the two past decades.

### Large Commercial Farms

Large commercial farms, those with annual sales over \$100,000, have grown in number over time and comprised about 14 percent of all U.S. farms in 1987. Agricultural production and hired farm labor use are becoming increasingly concentrated on these larger farms.

The largest 2 percent of commercial farms (with cash sales of \$500,000 and over) accounted for over half (54 percent) of the total expenditures for hired labor in 1987. These farms tend to specialize in vegetables, melons, fruits, tree nuts, and specialty crops. The production and harvest of these crops has not been widely mechanized and continues to require large amounts of hired labor during critical periods.

These large farms are concentrated geographically. California, Texas, and

Florida, together with four other states (Washington, Wisconsin, North Carolina, and Pennsylvania) accounted for almost half of all hired labor expenditures in 1987. Hired farmworkers will become increasingly important to agricultural production as these labor-intensive farms continue to grow in number.

Patterns of change by farm sales class suggest continued movement toward a bifurcated or dual structure of agriculture. One group represents a small number of large, capital and labor-intensive commercial farms that produce a growing share of the nation's food and fiber.

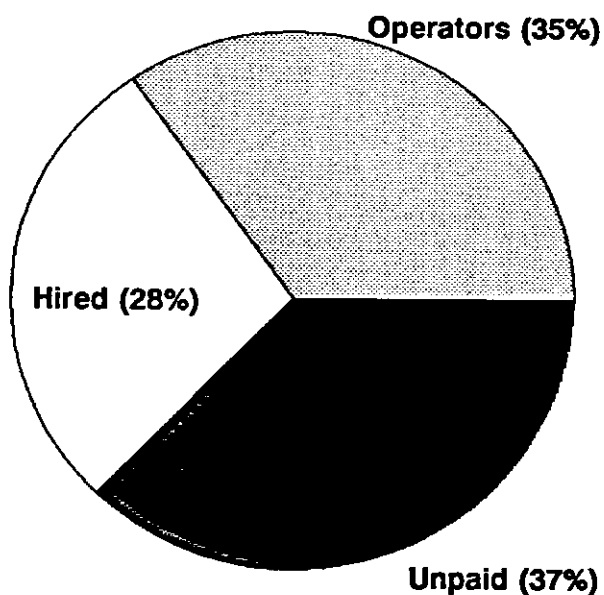

Source: Agricultural Work Force Survey.

Figure 5. Components of the Agricultural Work Force, 1987.

The second component represents a large number of small, owner-operated farms that are largely dependent on off-farm income and use few hired workers. Although comprising the majority of farms, these small part-time farms account for only a small portion of total production,

and many exist primarily as a means of preserving a rural lifestyle for operators and their families.<sup>3</sup>

### THE AGRICULTURAL WORK FORCE: A PORTRAIT OF DIVERSITY

Who are the nation's farmworkers? Data from the U.S. Department of Agriculture's (USDA) Agricultural Work Force Survey indicate that almost 7.7 million persons 14 years of age and older were employed on U.S. farms as farm operators, hired farmworkers, and unpaid farmworkers in 1987.<sup>11</sup> Over 1 million persons performed more than one of these three activities. For example, some farmers operated their own farm but also hired themselves out for wages to other farmers.

To avoid double-counting individuals in more than one category, individuals were grouped by their major farmwork occupation, the activity in which they spent the most time during the year. By this definition, there were approximately 2.7 million farm operators (35 percent), nearly 2.2 million hired farmworkers (28 percent), and almost 2.9 million unpaid farmworkers (37 percent) (Figure 5).

These data help to define an agricultural work force that is subject to potential risk from farm accidents, illnesses, and injuries because they work on farms. However, several groups are excluded from this population at potential risk, including children working on farms. The Fair Labor Standards Act allows children to legally work on farms under certain conditions.<sup>\*\*\*</sup>

The Agricultural Work Force Survey did not collect information on the number of children under 14 who worked on the nation's farms. We do know, however,

that about 1.2 million children under 14 years of age resided in farm operator households; it is likely that many of these children helped out with farm chores.

Another 800,000 children lived in households headed by hired farmworkers; some may have worked along with their parents.<sup>12</sup> There is no direct evidence from the survey to suggest how many of these children actually worked on farms.

The Agricultural Work Force Survey also did not count two other groups of hired farmworkers—foreign workers who legally enter the United States to do temporary farmwork and undocumented foreign workers who enter this country illegally to do hired farmwork.

These hired workers were probably not included in the survey data because they returned home before data collection in December or because they tended to avoid contact with Federal enumerators. These two groups are discussed in more detail later in this paper.

A look at the numbers and characteristics of the different components of the agricultural work force reveals the considerable diversity among these workers and points up the difficulties of generalizing farm occupations.

## Farm Operators

About 2.8 million people operated a farm that they owned, rented, or leased at some time during 1987, according to USDA's Agricultural Work Force Survey.<sup>13</sup> Two or more persons (such as a husband and wife or partners) could operate one farm, and both would be included as farm operators under this definition.

Most of the farm operators were white (97 percent), male (77 percent) and middle-aged (median age of 47 years). Farm operators on average had relatively high levels of formal education. Eight out of ten operators had completed high school and three out of ten had some college education.

Farm operators averaged 235 days operating a farm in 1987. About 58 percent worked 250 days or more operating a farm, while only 11 percent worked fewer than 25 days. In addition, almost half did some non-farm work during the year and non-farm work provided an important source of income. Those who did non-farm work averaged 213 days of work in non-farm activities with average annual non-farm earnings of \$15,882.

## Unpaid Workers

Unpaid farmworkers are those who do any amount of farmwork without receiving cash

\*\*\*The Fair Labor Standards Act limits the employment of minors in agriculture according to age and occupational activity. Children 14-15 years old may work on farms outside school hours in non-hazardous occupations in agriculture. Children aged 12-13 years may work outside school hours in any nonhazardous farm job with written parental consent or on the same farm where their parents are employed. Children 10-11 years of age may work outside school hours in any nonhazardous farm job, with written parental consent only on farms where none of the employees are legally entitled to the Federal minimum wage; a special waiver may be obtained from the U.S. Department of Labor. Children of farm owners or operators may be employed by their parents at any time and in any occupation on a farm owned or operated by their parents.<sup>10</sup>

wages or salary, or receive only a token cash allowance, or do farmwork for room and board or payment-in-kind. The largest component (46 percent) of the agricultural work force in 1987 was made up of the 3.6 million people who did unpaid farmwork.

The majority of these workers were white (95 percent), male (66 percent), and young (median age of 31 years). They had relatively high levels of education; 77 percent had completed high school and 37 percent had some college.<sup>13</sup>

The largest component (46 percent) of the agricultural work force in 1987 was made up of the 3.6 million people who did unpaid farmwork.

Most of these unpaid workers did not reside in farm operator households. However, the 34 percent of unpaid workers who did live in farm operator households generally worked more days at their farm activities. They averaged 101 days of unpaid farmwork compared to only 30 days for those not living in farm operator households.

Almost 70 percent of unpaid farmworkers did some non-farm work during the year. They averaged 211 days of non-farm work and 40 days of unpaid farmwork and earned an average of \$13,900 from non-farm work during the year.

### Hired Workers

The nation's hired farmworkers originate from three different sources of labor: domestic workers (including those hired directly and those employed through crew leaders or farm labor contractors), foreign

nationals brought into the country under the H-2A Program, and undocumented foreign workers.

### 1. Domestic Hired Farmworkers

The number of hired farmworkers has decreased by almost 40 percent, falling from a high of 4.2 million workers in 1950 to about 2.5 million in 1987.<sup>13</sup> Most of these losses occurred in the 1950's and 1960's, largely as a result of the adoption of new production and marketing technology on farms, including labor-reducing machines and higher-yielding crops and livestock.

During the 1970's, however, hired worker displacement slowed considerably as large-scale mechanization and technological innovations with large labor displacement potential leveled off. Between 1970 and 1987, the number of hired farmworkers stabilized at 2.5 to 2.6 million annually, after years of continuous decline.<sup>14</sup>

On average, hired farmworkers are young and male, with relatively low levels of education. More than 40 percent of hired workers 25 years of age and over had not completed high school compared with only 15 percent of the U.S. labor force 25 years and over. The educational disadvantage was even more pronounced for minorities.

Because of the seasonal nature of agriculture, hired farmwork is frequently unstable, sporadic, and of short duration. In 1987, the average hired farmworker spent 112 days doing farmwork. However, there was considerable variation in days worked. More than half (55 percent) worked fewer than 75 days during the year. Only one-fifth were year-round workers who worked more than 250 days during the year (Figure 6).

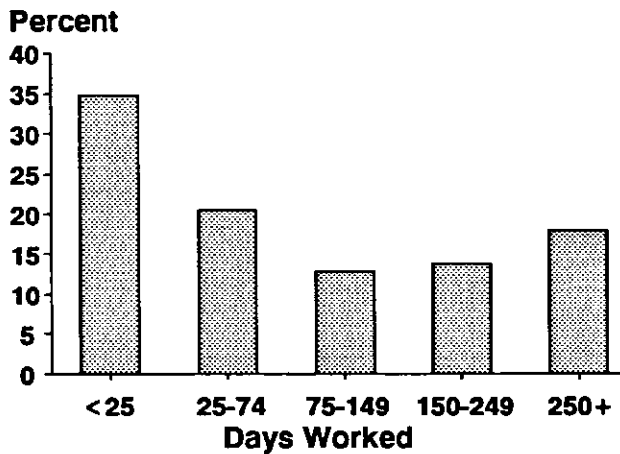

Source: 1987 Agricultural Work Force Survey.

Figure 6. Hired Farmworkers by Days of Farmwork, 1987.

Hired farmworkers were paid an average of \$4.87 per hour for farmwork in 1987. This low wage and the seasonal employment combined to make hired farmworker earnings among the lowest of all occupational groups in the United States. Hired farmworkers earned an average of \$6,663 from both farm and non-farm jobs in 1987, accounting for only 41 percent of the \$16,250<sup>15</sup> earned by the average nonagricultural private sector workers.

However, the nation's hired farmworkers are a diverse labor force, and a picture of the average farmworker can be misleading. Popular image depicts hired farmworkers as a large, undifferentiated group of low-income workers with little education and few skills, who harvest the nation's fruits and vegetables mostly in California and Florida. Yet hired farmwork comprises a wide range of activities performed all over the United States.<sup>12</sup> For example, hired farmworkers:

- Cut sugarcane in Florida.
- Strip and bale tobacco in Kentucky.

- Herd sheep in Idaho.
- Operate a combine in Kansas.
- Milk cows in Vermont.
- Shear Christmas trees in Michigan.
- Stock catfish ponds in Florida.
- Serve as farm managers in Oregon.

Hired farmworkers not only perform widely different activities, but they work for a variety of reasons. Hired farmworkers include household heads, who do hired farmwork on a regular or year-round basis and whose families depend on their farm earnings for economic support, as well as non-farm workers who do seasonal farmwork to supplement their non-farm earnings.

Also included is a large group of students, housekeepers, and others not in the labor force most of the year, but who do a few days or weeks of farmwork during the year. Some of these workers are earning extra spending money while others contribute necessary earnings to the family income.<sup>16</sup>

## 2. Migrant Farmworkers

Migrant farmworkers provide a necessary supplement to local labor when demand exceeds the supply of farmworkers living in a local areas. After almost 50 years of Congressional hearings, countless Federal task forces, poignant documentaries and books, and national media coverage of the socioeconomic problems of migrant farmworkers, we still wrestle not only with the question of how to help these workers, but also how to count them.

Data collection is complicated by the wide variation in definitions and measurement procedures used by Federal agencies and others concerned with migrants, as well as with difficulties in counting a transient population. As a result, population counts

range widely from a low of around 200,000 reported by USDA in the mid-1980's to as many as 1.6 million migrants and their dependents reported.<sup>17</sup>

Little statistical information is available on the travel patterns or routes followed by migrants as they harvest the Nation's crops. Common perception suggests the existence of three major migrant streams, one each on the east and west coasts, and one in mid-continent. However, the uniformity of migrant travel patterns has not been well-documented leading one farm labor expert to observe that:

*The maps of migratory streams—Atlantic, Pacific, and Mid-continent—which in the past were so prominent and still are to be seen now and again, embodied more flows of imagination than of people.<sup>18</sup>*

Figure 7 illustrates the commonly perceived image of three major migrant streams. Figure 8 shows the more likely patterns. In 1977, David Lillisand et al. conducted a survey for the Legal Services Corporation across the county to determine the state of origin, last state of employment, and next state of destination for migrants in various states.<sup>19</sup>

While the data do show three broad patterns of migratory travel consistent with the common image, they also indicate considerable deviation from three major streams. The study concluded that if patterns of migrant travel existed at all, they were much more complex than

the commonly perceived image of three streams.

### 3. Foreign Workers

Foreign workers leave their home countries to work in U.S. agriculture because there are more jobs and higher wages here. Lack of education, work experience, or language fluency do not hinder foreign workers as much in agriculture as in many other types of jobs. As a result, many U.S. farm employers have come to rely on foreign workers as a ready source of labor.

► **Temporary Foreign Workers.** Some foreign nationals are legally admitted to the United States to do hired farmwork under the H-2A Temporary Foreign Worker Certification Program. This program, administered by the U.S. Department of Labor, permits foreign workers to enter the United States to do farmwork when there are not enough available qualified domestic workers to do the work and when the employment of

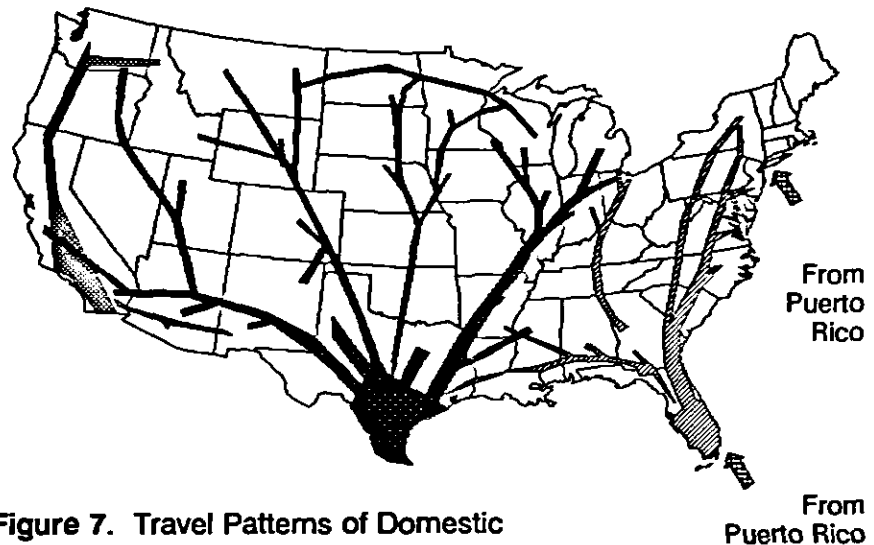

Figure 7. Travel Patterns of Domestic Seasonal Migratory Agricultural Workers.

— Source: Migrant Health Program, U.S. Public Health Service.



foreign workers will not adversely affect the wages or working conditions of similarly employed U.S. farmworkers.

About 26,000 farm jobs were certified for foreign workers under the H-2A program in 1989. Due to their small numbers, H-2A workers have little effect on the national farm labor market. However, they do account for a significant portion of the labor force in some production areas, particularly Florida sugarcane, and eastern and northeastern apples.

► **Undocumented Foreign Workers.** Illegal aliens have a much greater effect on the U.S. farm labor market because of their large numbers than do legally admitted foreign workers. There is little reliable statistical information on the numbers and characteristics of these workers. Deriving a reliable count is problematic because of the migratory nature of this illegal work force and because many of these workers will not participate in surveys for fear of revealing their illegal status.

Experienced observers of the farm labor market during the mid-1980's believed that undocumented workers accounted for about 10-15 percent of all hired farmworkers, with higher proportions in the labor-intensive fruit and vegetable sector.<sup>20</sup> Farm labor experts now believe this figure to be much higher.

Concern over the large number of unauthorized workers coming to the United States led to the passage of the Immigration Reform and Control Act (IRCA) of 1986. The Act was designed to reduce the flow of undocumented workers by imposing fines and jail terms on employers who hired them.

At the same time, IRCA offered legal U.S. residence status to qualifying undocumented workers who had resided

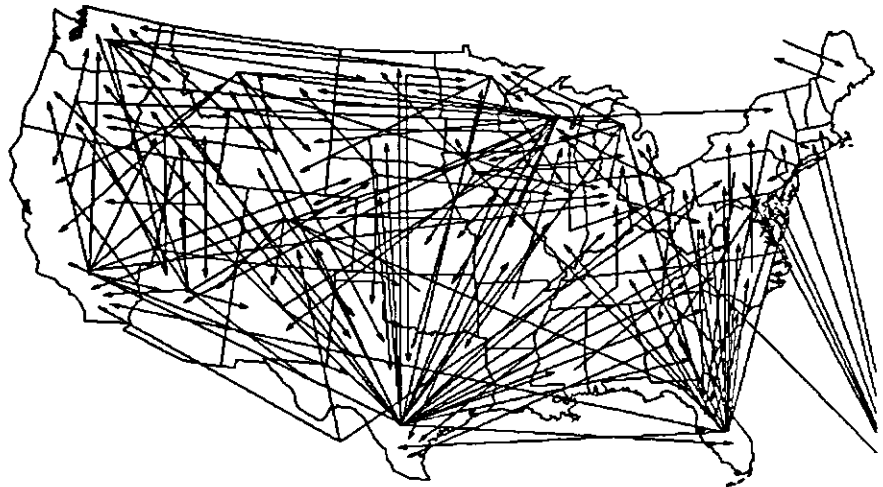

Figure 8. Farm Labor Migration Patterns.<sup>19</sup>

— Source: Lillisand et al. in a study prepared in 1977 for the Legal Services Corporation.

continuously in the United States since before January 1, 1982. Over 1.7 million persons were approved for resident status.

Many of these people are experienced farmworkers and may choose to continue to work in agriculture. IRCA also established a Special Agricultural Worker (SAW) program for producers of perishable commodities.

This program allows undocumented workers who previously worked in seasonal agricultural services to apply for legal

resident status. About 1.3 million persons applied, and a high approval rate is expected.

IRCA could have important implications for the supply, demand, working conditions, and wage structure of both illegal and U.S. hired agricultural workers in the future. The absence of reliable statistical information on illegal aliens creates difficulties for estimating the effect of immigration reform on agriculture.

...the hired component of the agricultural work force will continue to grow in importance as hired workers increasingly replace family workers on farms and as the number of large, labor-intensive commercial farms continues to increase.

However, it is likely that many of the farms affected by immigration reform will be those that hire large numbers of seasonal farmworkers. Vegetable, melon, fruit and tree nut, and horticultural specialty farms are generally the least mechanized and require a large number of workers for short periods of time. These farms are generally concentrated on the Pacific Coast, in the Southwest, the Northeast, in Florida, and around the Great Lakes.<sup>9,21</sup>

## OUTLOOK FOR THE FUTURE

Patterns of farm labor use have changed dramatically over the past four decades and definite employment trends emerged in the seventies and eighties. What do these trends suggest for farm labor requirements in the future?

It is likely that the trend toward fewer and larger farms will continue in the near future, although the rate of change is expected to be slower than during the 1970's and 1980's. Also, the hired component of the agricultural work force will continue to grow in importance as hired workers increasingly replace family workers on farms and as the number of large, labor-intensive commercial farms continues to increase.

If current trends in farm inputs persist, we will see increased use of agricultural pesticides, fertilizers, and pesticides. Mechanization of the harvest of some fruits and vegetables is possible in the near future, but labor reductions are not likely to be as great as those of the 1950's or 1960's.

For tree fruits and nuts, extensive replanting of trees is often required for machine harvesting, and costs for replanting and lost productive years are often difficult to justify. For some fruits and vegetables, such as strawberries and asparagus, the technology needed to machine harvest efficiently with minimal product damage has not yet been developed.<sup>16</sup>

The 1990 Food, Agriculture, Conservation, and Trade Act of 1990 directs the Secretary of Commerce to include questions relating to agricultural accidents and farm safety in the 1992 Census of Agriculture.

Several factors will help determine patterns of farm labor use in the future, including technology development, international trade, farm programs, immigration policy, and relative prices of major farm

inputs. Recently enacted immigration reform legislation has not yet been empirically evaluated and could have important effects on farm labor supply, demand, and wages.

Also, negotiations are currently underway between Mexico and the United States concerning removal of trade barriers between the two countries. A Mexican free trade agreement has the potential to affect movement of jobs and workers across the border.

## **SUMMARY AND IMPLICATIONS**

My comments today point to three major conclusions:

► First, changes in the structure of farming have dramatically affected the numbers, activities, and working conditions of the agricultural labor force.

Farming and the nature of farms are very different today. The trend toward fewer and larger farms has reduced the number of family workers but increased the average farm's hired labor requirement.

Operators and hired workers must have a variety of skills to perform farm tasks, ranging from heavy equipment operator to chemical applicator.<sup>22</sup> Length and intensity of farm work days exhibit high variation, and the number of hours worked per day is often dictated by weather conditions.

The use of agricultural chemicals on the farm has increased dramatically since the 1950's, and technological developments have placed a wide variety of complex machinery on U.S. farms. The changing nature of agricultural work has led to increased concern about the health and safety of agricultural workers.

► Second, the agricultural work force is comprised of diverse workers with different demographic characteristics, skills, and experience, who work on a variety of farms in a multiplicity of farm activities throughout the country. Components of the agricultural work force include farm operators, unpaid workers, domestic hired farmworkers, legal and illegal foreign workers, migrants, and children. This diversity complicates generalizations about farm safety problems and solutions.

► Third, many of our long-held beliefs about farming and farmworkers are no longer relevant or have been based on stereotypic images that were never true:

1. Despite long-term declining trends in farm numbers, some areas of the country, particularly the West, are experiencing increases in the number of farms.
2. The majority of U.S. farmers are part-time farmers and have a principal occupation other than farming. For whatever reason, farming is a second job, and many work only a few days in farm activities.
3. Employment of hired farm workers is highly concentrated on the large commercial farms, and 2 percent of the biggest farms accounted for over half of all labor expenditures.
4. While the number of hired farmworkers has declined over the last 40 years, most of the decrease was in the early 1950's and 1960's. During the 1970's and 1980's, the number of workers stabilized.
5. While many hired farmworkers are involved in the harvest of fruits and

vegetables, farmworkers also do such diverse activities as shearing sheep, pruning Christmas trees, stocking cat-fish ponds, and baling tobacco.

These findings suggest that we should not become complacent about long-term patterns and trends in farm employment. However, continued monitoring of farm labor conditions is dependent on adequate data collection on all components of the agricultural work force.

While we collect comprehensive information on agricultural production levels, value of sales, and costs of production, little data are available on the characteristics, wages, and working conditions of agricultural workers. More detailed farm labor information at the local level is needed to help assess the impact of farm labor policies and programs, including those related to agricultural safety and health, on the employment and working conditions of the nation's farmworkers.

Passage of the most recent Farm Bill may help to improve our data collection efforts in this area. The 1990 Food, Agriculture, Conservation, and Trade Act of 1990 directs the Secretary of Commerce to include questions relating to agricultural accidents and farm safety in the 1992 Census of Agriculture. The Bureau of the Census is currently pre-testing a series of questions to collect these data in the next Census.

At the same time, the Farm Bill also authorizes the Secretary of Agriculture to make grants for the establishment of farm safety education programs for farmworkers, timber harvesters, and farm families.

These grants, coordinated with state offices of rural health and the U.S. Department of Health and Human Services, are to provide information on such topics as the reduction of occupational injury and death rates, exposure to farm chemicals, occupational rehabilitation of farmers with physical disabilities, and farm accident rescue procedures.

The changing nature of agricultural work has led to increased concern about the health and safety of agricultural workers.

While funding for these grants has not yet been appropriated, the mechanism is in place to improve our farm safety educational efforts. These two legislative components of the 1990 Farm Act recognize growing National concern over agricultural safety and health issues and provide the potential to improve our data collection and expand our educational efforts to help reduce accidents, illnesses, and deaths on the nation's farms.□

## REFERENCES

1. U.S. Department of Labor. *Survey of Occupational Injuries and Illnesses, 1989*. Summary 91-1. Washington, D.C.: Bureau of Labor Statistics. January, 1991.
2. U.S. Department of Commerce, Bureau of the Census. *1987 Census of Agriculture*. Volume 1, Geographic Area Series, United States Summary and State Data, 1989.
3. Brooks, Nora L., Judith Z. Kalbacher, and Donn A. Reimund. *Farm Structural Trends in the 1980's*. AIB No. 605. Washington, D.C.: U.S. Department of Agriculture, Economic Research Service, 1990.
4. Carlin, Thomas A. and Donn A. Reimund. *Changes in Farm Structure*. Paper presented at the Annual Agricultural Outlook Conference, Washington, D.C., 1990.
5. Friedland, William H. The Labor Force in U.S. Agriculture, in Lawrence Busch and William B. Lacy, *Food Security in the United States*. Boulder, Co.: Westview Press, 1984, pp 143-181.
6. Smith, Matthew G., Clark Edwards, and Neal Peterson. How Many Farms? Projecting U.S. Farm Numbers and Sizes, *Rural Development Perspectives*. Vol. 3, Issue 3. June, 1987.
7. Schertz, Lyle P., et al. *Another Revolution in U.S. Farming?* AER No. 441. Washington, D.C.: U.S. Department of Agriculture, Economic Research Service, 1979.
8. U.S. Department of Agriculture. *Production and Efficiency Statistics, 1989*. Washington, D.C.: Economic Research Service, 1991.
9. Oliveira, Victor J. *Hired and Contract Labor in U.S. Agriculture, 1987: A Regional Assessment of Structure*. Washington, D.C.: U.S. Department of Agriculture, Economic Research Service, forthcoming 1991.
10. Runyan, Jack L. *A Summary of Federal Laws and Regulations Affecting Agricultural Employers*. AIB No. 550. Washington D.C.: U.S. Department of Agriculture, Economic Research Service, 1989.
11. Oliveira, Victor J. *The Agricultural Work Force of 1987*. AER No. 609. Washington, D.C.: U.S. Department of Agriculture, Economic Research Service, 1989.
12. Oliveira, Victor J. and E. Jane Cox. *Characteristics of Agricultural Work Force Households, 1987*. AIB No. 612. Washington, D.C.: U.S. Department of Agriculture, Economic Research Service, 1990.
13. U.S. Department of Agriculture. *The Agricultural Work Force Survey of 1987*. Economic Research Service, 1987.
14. Oliveira, Victor J. *Trends in the Hired Farm Work Force, 1945-87*. AIB No. 561. Washington, D.C.: U.S. Department of Agriculture, Economic Research Service, 1989.
15. U.S. Department of Labor. *Employment and Earnings*. Washington, D.C.: Bureau of Labor Statistics. January, 1987.
16. Whitener, Leslie A. and Rafiq Munir. Hired Farm Labor, pp 102-112 in Barse, Joseph R. (ed.), *Seven Farm Input Industries*. Agricultural Economic Report No. 635. Washington, D.C.: U.S. Department of Agriculture, Economic Research Service. Washington, DC, 1990.

## Issues That Affect the National Agenda

17. Whitener, Leslie A. *Migrant Farmworkers: Characteristics and Trends*, in *Out of Sight, Out of Mind: An Update on Migrant Farmworker Issues in Today's Agricultural Labor Market*. National Governors' Association, 1985.
18. Holt, James, et al. *Toward the Definition and Measurement of Farm Employment*, in *Proceedings of Workshop on Agricultural and Rural Data*. Jointly sponsored by the American Agricultural Economics Association and the U.S. Department of Agriculture, 1977.
19. Lillesand, David, Linda Kravitz, and Joan McClellan. *An Estimate of the Number of Migrant and Seasonal Farmworkers in the United States and the Commonwealth of Puerto Rico*. Washington, D.C.: Legal Services Corporation, 1977.
20. Coltrane, Robert. *Immigration Reform and Agricultural Labor*. AER No. 510. Washington, D.C.: U.S. Department of Agriculture, Economic Research Service, 1984.
21. Duffield, James, Mitchell J. Morehart, and Robert Coltrane. *Labor Expenditures Help Determine Farms Affected by Immigration Reform*. AIB No. 557. Washington, D.C.: U.S. Department of Agriculture, Economic Research Service, 1989.
22. Daberkow, Stan G. and Conrad F. Fritsch. *Agricultural Workplace Safety: A Perspective on Research Needs*, *American Journal of Agricultural Economics*. 61 (4), 1979, pp 824-835.

## ATTITUDES AND RISK BEHAVIOR

By Pamela D. Elkind, Ph.D.  
Professor, Department of Sociology  
Eastern Washington University

Dr. Ronald D. Eckoff: Our next presentation will be by Dr. Pamela Elkind on attitudes and risk behavior. Dr. Elkind has a bachelor's degree in sociology from Boston University, a master's degree in sociology from Boston University, and a Ph.D. in sociology from Northeastern University with joint course work at Tufts University. Her special areas of work have been environment and energy, social impact assessment, medical sociology, rural communities, and research methods. Dr. Elkind has held a variety of research and consulting positions and for the past ten years has been at Eastern Washington University in the Department of Sociology where she is a professor of medical sociology, environmental sociology, and a research specialist. Dr. Elkind will be presenting this morning in relation to *Attitudes and Risk Behavior*. Dr. Elkind:

Thank you. Good morning. I have been asked to speak to you today about behavioral attitudes related to hazardous farm activities. To speak to this subject, three questions should be asked.

- ▶ Firstly, why consider agricultural attitudes?
- ▶ Secondly, what are the relevant attitudes?
- ▶ Thirdly, how are these attitudes related to farm health and safety practices?

These are the questions we will consider today.

### AGRICULTURAL ATTITUDES

The first question I shall address is, Why consider agricultural attitudes? As in this extraordinary conference, farm health and safety is receiving attention in the early 90's. Coalitions of concerned citizens and organizations are becoming common. OSHA is developing regulations. NIOSH is funding large projects. Kellogg is initiating special innovation projects.

Popular magazines are covering the risks of agriculture. Programs and projects that deal with the safety of farm populations are being conceptualized.

Within the framework of the various projects, there appears to be an important assumption. This assumption, simply stated, is that to make agriculture safe for the farm families and workers, it is necessary to motivate them to protect themselves from health and safety hazards.

The assumption further suggests that the way to accomplish this is to educate them about the dangers and possible negative outcomes of hazards. It is assumed that armed with the statistics and the knowledge of the means of protection, the agriculturalist will change behaviors, ultimately diminishing injuries and casualties. I shall attempt to demonstrate to you that these assumptions lack validity.

Principal persons in 206 farm families were interviewed in the State of Washington, in 1988 and 1989. The data were gathered as one of four subgroups in an analysis of farm hazards sponsored by the University

of Iowa, Institute of Agricultural Health and Occupational Medicine. Many of you have referred to this as the NCASH study.

This assumption, simply stated, is that to make agriculture safe for the farm families and workers, it is necessary to motivate them to protect themselves from health and safety hazards...I shall attempt to demonstrate to you that these assumptions lack validity.

There is a good deal of similarity between the four states, data sets, but today we will speak of Washington State. Respondents were asked to compare farming to other occupations in terms of occupational hazards, including health effects and injuries. In our Washington State sample, 80 percent of those questioned believed that farming is at least as dangerous as other occupations, and there is no significant correlation between perceptions of farm safety and gender, occupational longevity, age, education, or outside occupational status. This leads us to conclude that there is a generalized agreement across all categories in the farm population that agriculture is hazardous.

However, the knowledge that farming is dangerous does not necessarily affect the attitudes of the respondents (Figure 1). When asked if they were more concerned about farm safety and health than economic issues, as, for example, farm product prices, only 21 percent were more concerned about health and safety.

Furthermore, when later in the interview we asked if the health hazards in farming are great enough for them to discourage their children from farming, only 6 percent

of the sample replied yes (Figure 2). In fact, those who felt farming was most dangerous were more likely not to discourage their children from farming.

	Number of Responses	Percent
Yes	43	20.9
No	140	45.5
Equally Concerned	53	25.7

Figure 1. More Concerned About Health and Safety Than Farm Product Prices.

There is the greatest likelihood that a farm family knows agriculture is dangerous in terms of health and injury, yet parents believe it is an appropriate occupation for their children and are more concerned over the economics of agriculture than anything else.

	Number of Responses	Percent
Yes	11	6.3
No	164	93.7

Figure 2. The Health Hazards in Farming Are Great Enough That You Could Discourage Your Children from Farming.

In an interview, it is difficult to evaluate behavior, since only reported behavior is measured. Yet, some elements may be scrutinized. Respondents were asked about the precautions they take when dealing with agri-chemicals, tractors, machinery, or with grains, feed, and bedding material.

They were asked to choose from among lists of choices, which range from staying



downwind and washing one's hands to wearing protective devices and using machine or vehicle safety equipment. Though many of the safety approaches would appear to take little effort, 18 percent did none of these.

Conversely, 82 percent of the sample take some safety precaution, and there is no significant difference in their behavior with respect to the degree they consider agriculture hazardous. Some families practice a good deal of safety. About 40 percent of the sample reported that they regularly practice 5 percent to 10 percent of the safety precautions. Again, there was no significant difference between these behaviors when correlated with diverse perceptions of farm hazards.

This analysis suggests to us that:

- ▶ First, based on the sample of Washington State farm families surveyed, there is a good deal of knowledge about farm hazards in the population. Farmers perceive agriculture as dangerous.
- ▶ Second, we might conclude that the attitudes about the importance of those hazards with respect one's own life differ from the knowledge of the hazards. In fact, when weighed against the family's economic well-being or a child's future in agriculture, the hazards are overlooked.
- ▶ Third, behaviors of taking precautions tend to be unrelated to the knowledge of hazards. Farmers who regularly take many safety precautions do not say that farming is any more or any less dangerous than those who do nothing to protect their families and workers.

Thus, I will argue, based on the Washington State sample, that knowledge

about farm-based safety and health hazards is unrelated to deep-seated values and attitudes about what is important in farm life, and it is ultimately unrelated to the behaviors found in farm families with respect to safety practices. I will further argue that if knowledge is, in fact, not related to the reported attitudes and behaviors, one cannot conclude that change in the knowledge about safety will yield change in safety precautionary behavior. There are, I might add, some number of intervening variables within the attitudinal structures of farm families that require understanding in order to discover in what way behavioral changes might take place to increase farm safety practices.

## RELEVANT ATTITUDES

Next, we should discuss what the relevant attitudes are that we might consider. Research since the 1930's has demonstrated a consistent value orientation pervasive in rural farm regions. The value set is known as agrarianism. It appears to partially emanate from Thomas Jefferson's anti-Federalist thinking as appropriated from Aristotle, Locke, and Montesquieu.

The pattern is derived from farmers' backgrounds in the class struggles of the 18th century European estate system.

- Agrarianism suggests that rural life is natural and healthy rather than artificial or evil.
- The ownership of land makes the farmer self-reliant and independent.
- Agriculture is nationally important.
- Thus, farming is a virtuous occupation.

The sense of equality and independence in agriculture points to a positive benefit of democracy, and farmers tend to be fierce defenders of democracy.

Sociologists defined rural life, early in the century, as having an habitual character and an even flow. Life rested upon deeply felt and emotional relationships rooted in the steady rhythms of uninterrupted habit.

The intimate relations between persons were based upon their individuality and wholeness. The traditional lifestyle was comprised of friendship groups, neighborliness, and blood relations.

The attitudes of persons involved in 20th century agricultural production result from a lifestyle structured around conflicting values; traditional agrarian and contemporary market values clash.

The social values and ideas had their points of reference within these social groups and organizations. Farm-based economic independence and social equality foster the sharing of problems and activities by collectives engaged in land-based living over time.

However, the deepest problems of modern life derive from the claim of the individual to preserve the autonomy and individuality of existence in the face of overwhelming social forces, of historical heritage, of existence, of external culture, and of the technique and technology of life. Farmers experience these problems more than other groups. Agrarian values stress autonomy and individuality, but agriculture necessitates a great deal of interaction within

the economic and political institutions of the society.

Agriculture is a scientific endeavor requiring a great deal of educational background reinforced by practical experience. It involves a knowledge base in agronomy, economic projection, and fiscal management training, personnel management training, and a solid knowledge of both the marketplace and government regulatory policy.

Farming today, at every level, is involved with local, state and federal governments in, for example, subsidies, tax adjustments, and regulations of both crop output and farm practices. Technological development necessitates a constantly changing body of regulation in agriculture.

The agricultural lifestyles, attitudes, and behaviors today are the outcome of the opposing forces of traditional agrarianism against the economic realities of a highly technical, rapidly changing society. The attitudes of persons involved in 20th century agricultural production result from a lifestyle structured around conflicting values; traditional agrarian and contemporary market values clash. The result is a shared pattern of living and thinking, which differs from both the old farm ways and the highly urbanized, post-industrial society.

## **SAFETY AND HEALTH PRACTICE**

Finally, let us consider how these attitudes are related to farm health and safety practices. There is a paucity of research on the question, but I shall use a few of the available studies to suggest some answers.

According to Worwick, everything we know about accidents leads us to the conclusion

that faulty habits and attitudes are the prime accident producers.<sup>1</sup>

Murphy, hypothesizing that those farmers who hold different attitudes about health and safety from other farmers would have different accident records, looked at the diversity of attitudes and accidents in Pennsylvania.<sup>2</sup> Using a semantic differential procedure contrasting attitudes in about 500 farmers, he found no significant difference between the attitudes of persons working where accidents had occurred in the previous five years, and those of accident-free farmers. In fact, no differences in safety attitudes or occurrences were found between farmers, when they were grouped by such demographic and structural variables as farm size, number of workers, type of farm, level of education, or hours worked on the farm.

He concludes that other factors are likely to be more related to farm accidents than safety attitudes. His suggestion is that the pressures exerted by society and the low value actually placed upon safety in the decision process is likely to cause more risk behavior and, ultimately, accidents.

Napier, et al., conducted an extension-based analysis of farm risks in the state of Ohio.<sup>3</sup> Their statistically based research also indicated that there were no significant demographic or structural variables that would account for the accident rate differentials on farms in Ohio. Further, they considered a farmer's accident background and decided that social learning or experience with hazards does not make a significant difference in accident rates, since people may or may not repeat their mistakes.

Farm family attitudes may be related to economic well-being, as the Washington

study suggests. They may revolve around the problems of agricultural productivity and the various costs surrounding preventive measures; however, the attitudes and ultimately behaviors could also be connected to a range of risk-taking personality characteristics and coping mechanisms.

They are also likely to be related to an occupational culture. An excellent example of occupational culture could be considered that of mine workers. Yount found very definite work culture characteristics in risk behavior associated with mine workers.<sup>4</sup>

The manner in which they treated hazards, the interaction with respect to fear, and discourse while in social settings all demonstrated risk-taking and hazard--coping mechanisms shared by the work culture. These characteristics and attitudes are influenced by the environment of their daily work, and they influence their everyday behaviors. Similar feelings and findings are likely to be found in farmworkers.

Other elements such as ethnic or gender culture may also be related to attitudes. For example, a NIOSH/OSHA safety training story comes to mind. An Hispanic male working with hazardous materials was ordered to wear protective clothing: shoes, mask, and gloves. He wore all of these items except the gloves.

When ordered continuously to wear the gloves for his own protection, he finally responded that yellow gloves remind him of his mother washing dishes. As a strong male, he could not force himself to wear the gloves. When black gloves replaced the yellow ones, the problem was solved. In the case of this worker, there were personality characteristics associated with

the cultural statement of masculinity that were outstanding. These stories are pervasive in the occupational safety domain.

What characteristics and attitudes are at play when engineers monitoring construction sites or hazardous waste sites and educated not to enter sealed tunnels beyond four feet continuously take flashlights and go into these areas? They have read the statistics, and they are well-educated persons. If asked, they respond that they have been doing it for years, or it is the only way to get the job done, or they shrug and laugh, according to one OSHA-trained supervisor.

Do each of you use seat belts? I am sure you have read the studies. And how many of you smoke cigarettes despite warnings?

Much as Murphy, Napier, et al., Aherin and others—many others—are suggesting, in order to reduce farm hazards, it will be necessary to undertake a good deal more investigation into the forces behind the formation of attitudinal behavior and farm communities.<sup>235</sup>

The various dimensions of risk-taking behavior and their attitudinal components tend to be at the very heart of this problem. Only through a thorough comprehension of these behavioral dynamics will policy-makers and change agents design successful interventions, which are likely to alter risk-taking in order to reduce farm injuries and health hazards.□

## REFERENCES

1. Worwick, W. *Safety Education: Man, His Machines and His Environment*. New Jersey: Prentice Hall, 1975.
2. Murphy, Dennis. Farm Safety Attitudes and Accident Involvement, *Accident Analysis and Prevention*. Vol. 13, No. 4:331-337. London: Pergamon Press, 1981.
3. Napier, T. L, W.R. Goe, and R.R. Pugh. *Incidence and predictive factors associated with farm accidents in Ohio*. Ohio Extension Service document, 1987.
4. Yount, Kristen R. Work-emergent behaviors and traits: the segregation of energy workers in boomtowns. *Differential Impacts of Rural Resource Development*, Pamela D. Elkind (ed.) Boulder: Westview Press, 1986, pp 119-144.
5. Aherin, Robert A. Understanding and Predicting the Safety Behavior of Farmers, Paper presented at the American Society of Agricultural Engineers Conference, Chicago, 1985.

## INDUSTRIAL CROPS OF THE FUTURE

By Daniel E. Kugler, Ph.D.  
Director, Office of Agricultural Materials  
U.S. Department of Agriculture

Dr. Ronald D. Eckoff: We shift gears a little bit again now. Instead of talking so much about the workers, we're going to talk about some other things that are happening that relate. Our next presentation will be by Dr. Daniel Kugler, regarding industrial crops of the future. Dr. Kugler has a Ph.D. in Agricultural Economics from Michigan State University and works for the United States Department of Agriculture. He led economic and policy studies for soil and water conservation programs with special emphasis on the economic impacts of variable cost sharing and soil depletion on the adoption of conservation practices. In 1986, he joined the Cooperative State Research Service in Washington, D.C., to start up and manage the Department's Kenaf Development Program, a program designed to remove barriers preventing the commercialization of this non-wood fiber plant for manufacture of newsprint. In 1989, he was appointed director for the Office of Agricultural Materials, where he oversees research, development and commercialization of a number of crops, which provide new raw materials and chemical feedstocks to industry. Dr. Kugler will speak, this morning, on the topic, *Industrial Crops of the Future*. Dr. Kugler:

First, I want to thank the organizers for the opportunity to come here to Iowa and address this important conference in the area of issues, which affect the national agenda. It is always important to keep informed of changes that will affect the agricultural industry, which is so important to our country.

Specifically, I want to offer to you a glimpse of an area of agriculture that many of you know nothing about or, at most, may not think about on a day-to-day basis. It is an area that we refer to as industrial crops or agricultural materials—these being crops or materials, which provide non-food, non-feed materials to industry for use in processing and product manufacture and marketing. These materials generally do not enter the food chain either for human consumption or as animal feeds, although there are some notable exceptions in pharmaceuticals and in the area of some by-product meals that are used for animal feeds.

I thought that the best way to illustrate this area would be to provide you seven examples of industrial crops of the future. They have a variety of potentials. Some of them are commercializable now; some next week; some of them may require the remainder of this decade before they can come to the marketplace.

You will find that a number of them are surprisingly common. Others, as I have mentioned before, you may have never seen or heard of before.

### ASPEN, SOUTHERN PINE

The first crop is the very beautiful aspen tree. Many of you may be familiar with it. This tree is an excellent source of wood fibers and is harvested mainly from the northern United States and from forest plantations in Canada.

The fiber from this tree is very well suited for the manufacture of dry-formed composites. Aspen, in a dry, refined form—very

coarsely refined— resembles shredded wheat.

When you take it and blend it with synthetic fibers such as glass or polyester and add thermal-setting resins, you can create an air-laid, non-woven mat. This particular kind of mat can then be put into a heated compression mold to make a variety of shapes of various angles and depths that can be used in a wide variety of products with which you are very familiar.

Common applications include interior car door panels, dashboards, and the head liner that is over the top of you when you sit in your automobile. So, the next time you're rolling down the window in your car, underneath that vinyl or leather panel there may be an aspen tree.

### **CORN, WHEAT, RICE, OR POTATO STARCH**

The second example is pretty familiar to you folks here in Iowa. Corn is very abundant and well known as a food source in our diets. However, there is more to do with corn than to just eat it.

Corn is a principal source of starch, which is being extensively explored by government, universities, and industry to make degradable thermoplastics or starch polymers. Here in the United States alone we manufacture, on an annual basis, some 60 billion pounds of plastics from petrochemical sources.

There are technologies available right now that can put up to 40 percent starch—and it can be from wheat, potato or other sources—into various kinds of plastic film such as grocery bags and trash can liners. There are other technologies that are in

development that will put 85 percent to 95 percent starch into these kinds of plastic materials and use it to make a variety of molded products.

There is one effort that we believe is very significant—the Department of Agriculture and Department of Defense have joined hands with several universities and a major private company to produce degradable starch products, which will satisfy the Marine Plastic Pollution and Research Control Act of 1987. That particular act of Congress requires the Navy to cease the disposing of plastics at sea by the end of 1992, unless they are fully degradable in the marine environment. This is a very, very busy project. It is a very challenging and, we believe, achievable opportunity.

### **INDUSTRIAL RAPESEED AND CRAMBE**

For the next industrial material, you will see a very beautiful slide of a crop in the state of Idaho. It is industrial rape seed. Many of you may know a cousin of this crop, called canola. The canola variety vegetable oil is sold in your supermarket under the Puritan label, from Proctor and Gamble.

The industrial variety of rape seed, however, retains a high content of erucic acid, and that erucic acid can be used to manufacture a number of functional fluids, plastics, and nylons. I have several examples of things we are doing with high erucic acid rape seed.

We have been working with some companies and universities to produce an automatic transmission fluid supplement, which is made from the derivatives of rape seed oil. Tests have shown at this point, when compared to standard factory-fill

fluids, that with this particular kind of supplement, wear is reduced 50 percent, oxidative breakdown is reduced 24 percent, and that pentane insolubles are reduced some 60 percent.

In another product, we are producing cutting fluids from rape seed oil. The cutting fluids show longer use. They show extended tool life. In addition to that, there are no halogenated fluids produced, which require hazardous waste disposal.

One other very significant product, which has been made from crambe oil, another crop source of erucic acid, is nylon 1313. Crambe, indeed, is a crop of the future and nylon 1313 is a product of the future because it is very lightweight, has very low water absorption characteristics and shows exceptional dimensional stability. We expect in the near future that nylon 1313 will be used in a variety of aircraft and marine applications.

## **GUAYULE**

My fourth example is another very interesting crop. Guayule is native to the southwestern United States and northern Mexico.

It is a perennial shrub that reaches maturity at about three to five years of age. We extract natural rubber and resins and a variety of other chemical feedstocks from the plant's stems, branches, and roots.

The advanced varieties of this particular plant have about 10 percent high molecular weight rubber, which is very similar to and comparable in performance with the Hevea rubber, which we import mainly from Malaysia, Thailand, and Indonesia. We are currently 100 percent import dependent for our nation's rubber supply,

and it costs us a billion dollars a year in export dollars.

Right now we are manufacturing tires made from guayule natural rubber, which will go on the Navy's F18 and A4 aircraft at a Goodyear plant in Virginia. We are also manufacturing light truck tires, which will be used for testing by the Army at a Firestone facility in Illinois. These are very important strides forward in developing a domestic rubber industry.

In addition to the natural rubber in this particular plant, there are some very interesting resins. The most notable one can be used to produce a strippable coating for preservation of machine parts and mothballing aircraft. We are currently seeking work with the Air Force to test out this particular coating.

## **KENAF**

The fifth example is another industrial crop that many of you may know if you have an ornamental hibiscus plant in your yard at home. This is a hibiscus grown for its industrial fibers, called kenaf. It is an annual plant of tropical and semitropical origin, native to east central Africa.

In the cotton belt of the United States, this crop will grow 12 to 20 feet tall and produce six to ten tons of dry matter per acre. The fibers of this particular plant are very interesting. There are two fibers in the plant: a bark and an inside core. They make a very natural mixture for manufacture of newsprint.

The outer fibers are long and tough and strong. The inner fibers are short and flat and make good filler and surfaces. When you take the entire plant and thermo-mechanically pulp it, you make a very high

quality pulp that makes a very high quality newsprint, which has been accepted by the newsprint industry as a real commodity.

Currently in the state of Texas, there are plans to build a \$50 million newsprint mill based on kenaf. We hope to see those plans activated this year and to see newsprint in production by the end of 1992 or early 1993.

In addition to newsprint, there are a variety of other products made from kenaf fibers, which show premier. These are composites, packaging, poultry litter, high-grade specialty papers, absorbants and soil amendments.

### **PACIFIC YEW TREE**

The next example of an industrial crop is the Taxus plant, an ornamental yew used as a landscaping shrub all over the country. Bark of the Pacific yew tree and needles and twigs of ornamental Taxus shrubs yield a complex natural chemical called taxol.

According to the National Cancer Institute, taxol is the most important anticancer drug in 15 years and is in the last stage of cancer. The Department of Agriculture has organized an effort to establish immediate, medium and long-term supplies of the tree bark and shrub clippings for extraction of the drug. Agriculture will help provide the renewable raw material for this life-saving drug.

### **SOY BEAN**

The last example, like corn, is another very familiar agricultural plant. But also like corn, there is more to do with soybeans than eat or feed it.

Printer's ink using soybean oil has been under development since the early 1980's and inks with 30 percent soybean oil are in use. Notably, *The Gazette* in Cedar Rapids, Iowa, under the leadership of Joe Hladky, Publisher and Chair of the American Newspaper Publishers Association Technical Committee for Inks, is the pioneer in daily commercial use.

In March 1991, the Department of Agriculture announced a 100 percent soybean oil ink that is completely compatible with newspaper presses. This formulation removes all the petroleum from the ink and shows low rub-off, lower cost, and more environmentally soundness in terms of degradation and recycling of old newsprint. If all newspaper ink were made with soybean oil, it would require 40 million bushels.

### **RENEWABLE MATERIALS**

We are talking about renewable materials from agriculture, and I stress the word "materials." We are looking to make polymers, functional fluids, composites, structural materials, natural fiber products, and pharmaceuticals—all of which are extremely important to the health of our business and industry in this country.

Why do we do this? There is a variety of reasons. There are some very obvious balance-of-trade implications here, where we can reduce the imports of certain commodities, in particular petroleum and rubber. There are opportunities to turn around and export things that we currently import.

There are very obvious areas in which we can improve the competitiveness of our country by utilizing the excess productive capacities of our farmland to produce new



crops or to use some of the crops that we are currently producing in excess. All of this, of course, is designed to spur rural economic development, increase our domestic production and add value to our agricultural materials at home, send them to the international market place.

In addition to that, we are trying to alter the image, to some extent, of agriculture, and to let this country and the world know that agriculture, indeed, is a very high-tech business.

In the area of leadership, one of the things we would like to be able to do in this country is to be a leader in technology development. One thing we have done an excellent job on in this country, for years and years, is research.

We are the pre-eminent research country in the world, but the honest truth is, we have not done a very good job of taking those research results and moving them into the marketplace by doing value-added work. Many other countries come here, take our research discoveries and inventions home with them, make the products and then deliver them back to us. There is no need for that. We can do much of that here in our own country.

How are we going at this? The Office of Agricultural Materials is a very small office. We are working very closely with industry, very closely with academia, and very closely with state and federal government to do something that Washington calls "precompetitive generic technology development." We are trying to enable commercialization, that is, to bridge the gap that currently exists between the research bench and the marketplace.

In addition to that, we are trying to alter the image, to some extent, of agriculture, and to let this country and the world know that agriculture, indeed, is a very high-tech business. We are every bit as sophisticated as and have scientific talent on a par with those that are conducting research on supercomputers, high-performance ceramics, etc.

To close, let us look at this slide that shows the official seal of the United States Department of Agriculture. It has an animal-drawn plow in the front and some shocks of corn in the back. Focus your attention at the statement at the very bottom, where it says:

*Agriculture is the foundation  
of business and commerce.*

Industrial crops and many other crops can be and are strengthening and enhancing that foundation.□

## BIOTECHNOLOGY AND AGRICULTURE

By Jane Rissler, Ph.D.  
Biotechnology Specialist  
National Wildlife Federation

Dr. Ronald D. Eckoff: Our final presenter this morning is Dr. Jane Rissler, who will be speaking about biotechnology and agriculture. Dr. Rissler received her Ph.D. degree in plant pathology from Cornell University and conducted post-doctoral research in fungal physiology at the Boyce-Thompson Institute for Plant Research. She has taught and conducted research in the university setting for a number of years. Since 1983, Dr. Rissler has been engaged in biotechnology science and regulatory policy work. From 1983 to 1988, she was at the Environmental Protection Agency where she was involved in the formulation and implementation of biotechnology policies. She served as a science advisor for and a project manager of the Pile Technology Project that operated under the Toxic Substances Control Act and was a special assistant in biotechnology to the EPA Assistant Administrator for Pesticides and Toxic Substances. In those position, she helped to develop EPA biotechnology regulatory policy and coordinated EPA's activities in the development of the Federal regulatory framework for biotechnology. She currently is a biotechnology specialist with The National Wildlife Federation. As part of her work in the National Wildlife Federation's National Biotechnology Policy Center, she has recently authored or co-authored several documents: *Biotechnology's Bitter Harvest*, *Herbicide Tolerant Crops and the Threat to Sustainable Agriculture*, *Natural Resources and Environment*, *Biotechnology and Pest Control: Quick Fix Versus Sustainable Agriculture* published in the *Global Pesticide Monitor*. She is the co-editor of the *Gene Exchange* a National Wildlife Federation Newsletter that provides a public voice on genetic engineering. This morning, Dr. Rissler will discuss *Biotechnology and Agriculture*. Dr. Rissler:

### INTRODUCTION

I was asked to come here today to talk with you about potential farm worker health issues raised by the use of biotechnology products in agriculture. In fulfilling that request, I will briefly explain the technology, where it is likely to be heading in the next decade, and some concerns for worker safety that may arise from the technology. I appreciate the opportunity to provoke discussion of biotechnology and agricultural worker health issues and hope that worker safety experts will consider and evaluate these issues as the technology is developing and before its widespread use.

Before I begin, however, I would like to tell you of my biases that are relevant to

this talk. I represent a major environmental group, the National Wildlife Federation, the country's largest conservation, education, and environmental advocacy organization, with over 5.8 million members and supporters and 50 affiliated state groups.

Four years ago the Federation established the National Biotechnology Center, to try to prevent the environmental and human health consequences associated with other technologies, such as the synthetic chemical, fossil fuel, and nuclear technologies. The Center's objectives are to minimize the risks of this new technology and to ensure that the public has a role in the regulation and development of the technology.

I am here, not as a proponent of agricultural biotechnology, but as a skeptic—a skeptic who fears that the technology poses significant risk and uncertainty. Furthermore, from a vantage point of studying the industry for nearly eight years, I seriously question whether biotechnology should or can assume a major role in answering the environmental, human health, and productivity problems facing U.S. agriculture.

### WHAT IS BIOTECHNOLOGY?

Broadly speaking, biotechnology refers to the use of living organisms as products or processes for humanity. People have used organisms for food and drink (e.g., yogurt, bread, wine, cheese) for millennia. From early agriculturalists to 20th century plant and animal breeders, humans have manipulated living organisms to improve food and fiber production.

I am here, not as a proponent of agricultural biotechnology, but as a skeptic—a skeptic who fears that the technology poses significant risk and uncertainty.

Advances in molecular biology in the last three decades allow human beings to manipulate organisms in dramatically different ways than are possible with traditional breeding methods. Many of these methods have been developed out of basic research in the 1960's and 1970's and have been adapted in the last 15-20 years to produce commercial products.

These methods, along with the products and processes developed using them, constitute modern biotechnology. The terms are not used precisely or consistently. Sometimes the term biotechnology

is used to characterize a small subset of techniques, that is, genetic engineering, gene splicing, or recombinant DNA techniques. Other times it is used in varying degrees to include other techniques.

### A Powerful Technology

This is a powerful technology—a technology in its infancy. As an illustration, I use the words from a promotional piece from Monsanto, a company that made a huge investment in biotechnology:

*A new science destined to take [hu]mankind into technology as a scientific milestone comparable to the realization of atomic energy or the development of semiconductors and powerful computers.<sup>1</sup>*

The power of the genetic engineering—gene splicing—techniques comes from the capacity to combine genes from a wide array of organisms: mouse genes in tobacco plants, human genes in bacteria, or chicken genes in potatoes. Traditional breeding techniques are dramatically more limited in the range of possible gene combinations. Only closely related organisms can be interbred by traditional means. By combining genes from widely disparate organisms, genetic engineers will create a variety of genetically novel organisms impossible by traditional means.

### Expected Products

Using genetic engineering techniques, cell and tissue cultures, and other modern techniques, the industry promises transformations in the way food and fiber are produced and processed in this country. Among the products already on the market and that we can expect to see in the near

future or within a decade or two are the following:

1. Genetically engineered food (grain, fruit, vegetables, oil) and fiber crops—for example, genes from insects, chickens, mice, fish, bacteria, viruses, and unrelated plants have already been splices into crops; these crops have been field tested in the last two years.
2. Food and food supplements from genetically engineered microorganisms—cheese, yogurt, alcoholic beverages—for examples, a cheese enzyme produced by bacteria containing a cow gene is already in wide commercial use and tryptophan, a food supplement derived from genetically engineered bacteria, was on the market; it was removed because nearly 30 people died and hundreds more became ill with eosinophilia myalgia syndrome as a result of consuming the product; whether the genetic engineering contributed to the toxicity is not yet known.<sup>2</sup>
3. Genetically engineered food animals—cows, pigs, chickens, fish—carp with a trout growth hormone gene are being tested in ponds in Alabama; pigs and cows containing human genes have been produced.
4. Genetically engineered hormones, antibiotics, vaccines—among the products thus far developed, bovine growth hormone, derived from genetically engineered microorganisms, is being used to enhance milk production; a recombinant vaccine against pseudorabies is already on the market; a recombinant rabies vaccine is being tested in wild animals in Virginia and Pennsylvania.

5. Genetically engineered microorganisms to control plant diseases and enhance crop growth—several recombinant microbes have already been field tested.
6. New uses of crops and animals to produce commercially valuable chemicals—cows producing drugs in milk; tobacco plants producing anti-cancer proteins.

While this list is incomplete,<sup>3</sup> it gives an idea of the power of a technology still in its infancy.

### BIOTECHNOLOGY COMPANIES

The following are companies that are farthest along—as measured by their progress in field testing genetically engineered plants and microorganisms—in developing novel organisms for use in agriculture:

- Monsanto
- DuPont
- Calgene
- Upjohn
- Crop Genetics International
- Northrup King
- Agrigenetics Advanced Sciences
- Agracetus
- Amoco Technology
- Boyce Thompson Institute
- Wistar Institute
- Dekalb Plant Genetics
- Campbell Institute for Research and Technology.
- Ciba-Geigy
- Sandoz
- BioTechnica
- Pioneer HiBred
- Rohm and Haas
- Cannors Seed
- Rogers NK Seed
- Frito-Lay

### WHAT FARM WORKER HEALTH ISSUES ARE RAISED BY AGRICULTURAL BIOTECHNOLOGY?

Based on industry predictions about the nature and pace of agricultural biotechnology, it is obvious that farm workers will

be exposed to genetically engineered organisms: micro-organisms, viruses, plants, animals.

I hope that this presentation will provoke a wide-ranging consideration and evaluation of the potential impacts of biotechnology on farm worker health.

Keeping in mind that this is a new technology, one based on a highly artificial manipulation of living things, one that poses significant unknowns and uncertainties, it is time to begin discussing the agricultural worker-health ramifications of biotechnology. The organizers of this conference, is placing this talk on its agenda, recognized this need. I hope that this presentation will provoke a wide-ranging consideration and evaluation of the potential impacts of biotechnology on farm worker health.

The experiences that we have to draw on to initiate this discussion come from genetic engineering research laboratories,<sup>4</sup> the pharmaceutical industry where genetically engineered organisms have been used for some time, and industries and agriculture based on traditionally developed microorganisms, plants, and animals.

A complete discussion of risk<sup>5</sup> would require consideration of both hazards and exposure. This talk is limited to an attempt to identify potential farm worker health hazards that may develop from a large commercial agricultural biotechnology industry. I have not attempted to describe exposure beyond general statements indicating that more farm workers are likely to be exposed to

increased numbers of living organisms—both genetically engineered and conventionally bred ones—and their products.

The list of potential hazards I offer may be incomplete; I welcome suggestions. Some are more speculative than others. As the hazards are evaluated by experts, some will be judged as more problematic than others. Some concerns are the same that one would expect with non-engineered organisms.

## POTENTIAL BIOLOGICAL HAZARDS

### Opportunistic Pathogens<sup>6</sup>

Several factors point to the potential for increased problems for genetically engineered organisms that are opportunistic human pathogens. Developers may engineer microorganisms whose opportunism is unknown. Scientists may unknowingly engineer an opportunistic pathogen for one of two reasons.

► First, they are working with organisms about which little, including opportunism, is known. Splicing genes into an organism requires little or no information about the organism's ecological or pathogenicity traits.

► Second, engineers may have some information on the organism's ecological characteristics but, because of isolation between scientific disciplines, the scientists may not know that the same organism has been classified as opportunistic (or even frank pathogens) by human health experts.<sup>7</sup> The organism may, in fact, have different taxonomic designations in two different disciplines.

1. Farmers and farm workers, as a population engaged in one of the nation's two most hazardous jobs (the other is mining), may often be unhealthy and highly stressed as a result of their occupation<sup>8</sup>—and more susceptible than the population at large to opportunistic infection.
2. In addition to their occupational stress, the farm worker population is likely to show an increase in the number of immunosuppressed or compromised persons as a result of the epidemic of acquired immune deficiency syndrome (AIDS) and related diseases. Persons with suppressed or compromised immune systems are generally more susceptible to infection by opportunistic pathogens.

One example of an opportunistic pathogen that already is the subject of biotechnology research and development is the vaccinia virus—the virus originally used to immunize the human population against smallpox. The vaccinia virus has long been known to cause, though rarely, disease and death, including encephalitis,<sup>9</sup> in immunocompromised/suppressed persons. Recently, three persons infected with AIDS reportedly died after being inoculated with a vaccinia virus.<sup>10</sup>

Work is underway to genetically engineer vaccinia virus to make vaccines against a number of animal diseases, including rabies and rinderpest. To create these vaccines, one or a few genes is taken from the rabies or rinderpest virus and spliced into the vaccinia virus. The genetically engineered vaccinia virus then is used to inoculate animals to prevent rabies or rinderpest from developing.

## FRANK PATHOGENS<sup>11</sup>

Generally, we expect that companies will not use and regulators will not permit the use of genetically engineered human pathogens in agriculture. However, a problem arises because of the potential for splicing genes into poorly characterized organisms, some of which may be human pathogens. As noted above, scientists may engineer organisms about which they know little in terms of ecological or pathogenicity traits.

Another question that may arise is whether genetic engineering could transform a non-pathogen into an opportunistic or frank pathogen. Because pathogenicity is generally a complex trait controlled by many genes, it is not likely that splicing in one or a few genes could create a pathogen. On the other hand, there are instances where engineering an organism that is closely related to a pathogen, i.e., already possesses most of the characteristics of a pathogen, might change that organism into a pathogen.<sup>12</sup>

## ENDOTOXINS<sup>13</sup>

Greater use of gram-negative bacteria (e.g., pseudomonads and rhizobia) in biotechnology applications may increase the incidence of respiratory problems among farm workers. Some scientists have hypothesized that the endotoxin portion of the gram-negative cell wall may be responsible for the respiratory disorders associated with a number of agricultural industries: grain and silage handling, pork and poultry production in confined facilities, composting, and poultry processing.<sup>14</sup>

## **ALLERGENS<sup>15</sup>**

Allergens, which incite a hypersensitive reaction, include substances produced by plants, animals, and microbes. If biotechnology achieves even a portion of the success promised by its proponents, there will be an increase in the agricultural use of living and novel organisms—and their products.

Consequently, we may see an increased incidence of hypersensitivity—due to greater exposures to living organisms, in general, and due specifically perhaps to changes caused by genetic engineering. Genetic engineering may introduce new allergens, for example, by producing expected secondary metabolites in microorganisms. Foreign genes in crops may produce new allergens in the plants and their pollen.

## **ANTIBIOTIC RESISTANCE**

Many novel organisms are genetically engineered to resist one or more antibiotics. This is a trait added, not to improve the organism, but to confirm that gene splicing has been successful. Splicing in antibiotic resistance is part of standard genetic engineering methodology. The worker health issue that arises is the extent to which the unintentional ingestion of antibiotic-resistant microbes could result in the subsequent transfer of antibiotic resistance to gut microflora and eventually to pathogens.<sup>16</sup>

Transfer of antibiotic resistance to pathogens could make them resistant to therapeutic control by the drugs to which they are resistant. Thus far, most drug resistances used in genetic engineering in this country are antibiotics not widely used clinically.

## **UNEXPECTED/UNKNOWN HAZARDS**

This is a category of hazards whose definition will only be known in retrospect. Generally, what I am proposing is that there may be unexpected and as yet unknown hazards associated with this highly artificial technology—perhaps a new illness or an old one unexpectedly associated with genetically engineered organisms.

Already genetic engineering has produced unexpected effects. Three examples are:

1. Naked DNA from human cancer cells can unexpectedly trigger tumors when the DNA is applied to abraded skin. It was previously thought that DNA had to be transported into target cells by a carrier.<sup>17</sup>
2. Human or bovine growth hormone genes spliced into pigs gave the expected result—leaner pigs. However, the genetically engineered pigs also displayed unexpected deleterious effects: arthritis, gastric ulcers, weak muscles, and lethargy.<sup>18</sup>
3. Experiments with petunias, genetically engineered to alter pigment production in flowers, showed "results . . . completely different from those the scientists expected."<sup>19</sup> Not only was the actual frequency of nonpigmented flowers ten times greater than expected, but the flower pigmentation responses to environmental conditions were totally unexpected.

## **POTENTIAL CHEMICAL HAZARDS**

One of first agricultural biotechnology products to reach the market will be crops engineered to resist herbicides, that is,

crops created so farmers can apply more of certain herbicides to obtain weed control and not harm plants. Some of the herbicides for which plants are being engineered for resistance are 2, 4-D, bromoxynil, glufosinate, glyphosate, and sulfonyleurea. Increased use of certain herbicides, particularly those like 2, 4-D and bromoxynil, which are known or suspected to be human health hazards, poses risks to workers who apply them or are otherwise exposed.<sup>20</sup>

On the other hand, a potential improvement in farm worker safety may come from genetic engineering for pest resistance, such as splicing insect toxin genes into plants. Pest-resistant crops may provide at least a short-term decrease in the use of dangerous insecticides and fungicides.

#### **WHAT SHOULD BE DONE TO ENSURE WORKER SAFETY IN AGRICULTURAL BIOTECHNOLOGY?**

Four actions will go a long way toward enduring the safety of farm workers exposed to agricultural biotechnology products.

1. Evaluate risks. Public and occupational health experts should begin to evaluate the risks that a growing agricultural biotechnology industry poses to farmers and farm workers.
2. Use only no- or low-risk organisms, ones that are well-characterized and thoroughly evaluated, for potential human health hazards. Only these should be approved for agricultural use.

3. Reduce exposure to biotechnology products. Standard approaches, such as worker protection equipment, procedure, and training, should be adopted to reduce worker exposure to biotechnology products.
4. Initiate and maintain medical surveillance. The case for surveillance is best made in a report from a Centers for Disease Control/National Institute for Occupational Safety and Health (CDC/NIOSH) *Ad Hoc* working group on medical surveillance for industrial applications of biotechnology.<sup>21</sup>

Uncertainty provides the strongest argument for maintaining medical surveillance over workers engaged in industrial applications of biotechnology. As is the case for any newly developed technology, there is a lack of information concerning the nature or severity of any acute or chronic health hazards, which might be associated with the industrial applications of this technology. The CDC/NIOSH working group is of the opinion that medical surveillance of biotechnology workers constitutes prudent medical practice. Such surveillance should be aimed at the early detection of sentinel disease events.

The detection of any occupational illness caused by recombinant organisms or their products will have important biological and public health consequences and should be actively sought.□



## REFERENCES AND NOTES

1. "Out Front in Biotech," *Monsanto Magazine*, Fall 1986.
2. "L-Tryptophan Puzzle Takes New Twist," *Science*, August 31, 1990, page 988.
3. See *The Gene Exchange*, Volumes 1 and 2, National Wildlife Federation, Washington, DC, 1990-1991, for additional information on many of these organisms and products.
4. In the 1970's the major risk associated with the new genetic engineering technologies was the potential for disease among laboratory researchers and the public. Conferences were held and experiments were conducted to evaluate the human health risks (see for example, *Risk Assessment of recombinant DNA Experimentation with Escherichia coli K12*, Proceedings from a Workshop at Falmouth, MA, published in *The Journal of Infectious Diseases*, Volume 137, Number 5, May 1978). Since that time, in the absence of epidemics attributable to recombinant DNA, the fears have largely dissipated. However, as far as we know, there have been no extensive, systematic studies monitoring the health of recombinant DNA researchers—recent disturbing report may cause a reconsideration of the safety of some aspects of genetic engineering research. See, for examples, "Some DNA Lab Work Raises Cancer Risks," *BioWorld Today*, October 12, 1990, page 1; "Cancer Deaths Probed at Pasteur Institute," *Science*, June 27, 1986, page 1597.
5. To understand the complexities and limitations in fully describing the human health risks of some biotechnology products, see "The Toxicology of Genetically Engineered Microorganisms" by L.S. Katz and J.K. Marquis, pages 51-63 in *Risk Assessment in Genetic Engineering*, M. Levin and H. Strauss, eds., McGraw-Hill, New York, 1990.
6. Pathogens that do not cause disease in healthy individuals but may do so in certain unhealthy or stressed persons.
7. "Plant-associated bacteria as human pathogens: disciplinary insularity, ambilateral harmfulness, and epistemological primacy" by M.P. Starr, *Annals of Internal Medicine* 90: 708-710, 1979.
8. See, for example, *Agriculture at Risk: A Report to the Nation* by the National Coalition for Agricultural Safety and Health, Institute of Agricultural Medicine and Occupational Health, Iowa City, IA, 1989.
9. "Vaccine Technology: Developmental Strategies," *Bio/Technology*, Volume 5, page 1038-1040, October 1987; "Smallpox, Vaccinia, and Cowpox" by A.R. Rao, pages 1672-1686 in *Medical Microbiology and Infectious Diseases*, edited by A.I. Braunde. W.B. Saunders, Philadelphia, 1981.
10. "Deaths of 3 Patients Not Included in Report About AIDS Experiment," *New York Times*, April 14, 1991.
11. Outright pathogens; pathogens that cause disease in healthy persons.
12. See "Phenotypic Properties of Source Microorganisms and Their Genetically Modified Derivatives," pages 99-112 in National Research Council, *Field Testing Genetically Modified Organisms: Framework for Decisions*, National Academy Press, Washington, DC, 1989, for a discussion of the potential effects of genetic engineering on pathogenicity.
13. Components of the cell walls of gram-negative bacteria.

## Issues That Affect the National Agenda

14. See discussion and references in "Inhaled Endotoxin and Decreased Spirometric Values" by R.M. Castellan, S.A. Olenchock, K.B. Kinsley, and J.L. Hankinson, *The New England Journal of Medicine* 317: 605-610, 1987.
15. Substances which induce hypersensitivity/allergy. Hypersensitivity in humans is a specific and deleterious reaction to a substance that does not, in similar amounts, affect other persons.
16. See, for example, "Emergence of Antibiotic-Resistant Bacteria in the Intestinal Flora of Farm Inhabitants," by S.B. Levy, *Journal of Infectious Diseases* 137: 688-690, 1978.
17. "Some DNA Lab Work Raises Cancer Risks," *BioWorld Today*, October 12, 1990, page 1.
18. "Gene-Watchers' Feast Served Up in Toronto: Putting Foreign Genes into Domestic Animals," *Science* October 7, 1988, pages 32-33.
19. "Jumping Genes Confound German Scientists" by D. MacKenzie, *New Scientist*, December 15, 1990, page 18. See also "The German Experience Gained with Field Testing of Genetically Modified Plants" by P. Lange, pages 161-164 in *Biological Monitoring of Genetically Engineered Plants and Microbes*, Proceedings of an International Symposium, Kiawah Island, 1990.
20. *Biotechnology's Bitter Harvest: Herbicide-Tolerant Crops and the Threat to Sustainable Agriculture* by R. Goldberg, J. Rissler, H. Shand, and C. Hassebrook, 1990, Biotechnology Working Group, Washington, DC.
21. "Medical Surveillance of Biotechnology Workers: Report of the CDC/NIOSH *Ad Hoc* Working Group on Medical Surveillance for Industrial Applications of Biotechnology" by P.J. Landrigan, M.L. Cohen, W. Dowdel, L.J. Elliott, and W.E. Halperin, *Recombinant DNA Technical Bulletin* 5:133-138, 1982.

## SURVEILLANCE: A PHYSICIAN'S VIEWPOINT

By John J. May, M.D.

Director, Bassett Farm Safety and Health Project  
New York Center for Agricultural Medicine and Health

The title of my talk today is *A Physician's Viewpoint*, which is a nice title. For a while I thought maybe I would just talk about the Chicago Cubs. Then a couple of weeks ago, I thought perhaps I would expound about the Internal Revenue Service for a while. Actually, what I will try to do today is present a physician's point of view—a practicing physician's point of view—regarding our role in the surveillance of agricultural health and safety problems.

I will try to build upon Dr. Halperin's very excellent discussion of surveillance this morning, focusing in particular on the potential contribution of the rural physician. Next, I will review some of the likely obstacles or roadblocks that, at least in my mind, might prevent effective physician surveillance. Finally, I will try to suggest some ways of using existing resources to enhance physician surveillance.

I will try to define a couple of terms. The first term is surveillance, which refers to the collection, collation, analysis, and dissemination of data for purposes of program planning, implementation, and evaluation.

For my purposes, when I talk about physicians, I am referring not only to medical doctors and doctors of osteopathy but also to registered nurses, to nurse practitioners, to physician's assistants, to anyone who is involved in the delivery of primary care in a rural setting.

By "health department," I am referring to any body that processes the information that is reported to it and who collects and analyzes surveillance data.

By "farmer," I am referring to a broad group: anybody who does physical work in agriculture.

How is it that the physician gets involved in this scheme of surveillance, which was so nicely outlined earlier this morning? Well, of the methods that were described earlier, you will recall that some are based upon examination of large, existing, data bases, looking for evidence of **trends in morbidity and mortality**. Some are based upon **recognition of excess hazard**, possibly using some of the data that has been collected over the years by NIOSH or by OSHA.

### SENTINEL HEALTH EVENTS

Dr. Halperin also mentioned the recognition of individual cases or sentinel health events. This is where, in my view, the practicing physician can contribute to surveillance. The sentinel events are occurrences that have been determined to be of public health significance. Dr. Halperin described many of the other characteristics of the ideal sentinel event.

The recognition of a sentinel event is important, both for the individual case and for others experiencing similar risk. An appropriate response to a sentinel event

may involve an intervention aimed at the index case, which, hopefully, can reverse the problem or at least prevent further morbidity.

...the intervention should affect other workers by either addressing the hazardous exposure, by screening similarly exposed workers, or by insuring that at least adequate protection is provided to similarly exposed workers.

Additionally, the intervention should affect other workers by either addressing the hazardous exposure, by screening similarly exposed workers, or by insuring that at least adequate protection is provided to similarly exposed workers. These events can be detected in several ways.

### **Screening programs**

Screening of specific worker populations can occur in various settings. A lot of this is done by employers both under duress from OSHA and on their own. It can be done through an occupational health clinic. If such screening uncovers evidence of occupational disease in a worker, this event should trigger a careful analysis and possibly an intervention.

### **Reporting programs**

Alternatively, sentinel cases may be picked up in reporting programs, which may require reports from physicians or, in some cases, laboratories. Examples of this might include patients who turn up with clinical evidence of occupational asthma, or situations in which blood samples are determined to have elevated lead levels. In most states, such situations are reported to the department of health. Often this is a

legal requirement for the practitioner. The value of this kind of case identification was demonstrated very nicely in a number of Dr. Halperin's examples earlier today.

### **PROBLEMS IN PHYSICIAN REPORTING OF OCCUPATIONAL SENTINEL EVENTS**

For the next few moments, I would like to review some of the potential problems associated with the surveillance of sentinel events, both in theory and in terms of applying it to the agricultural setting.

It is widely acknowledged that this type of surveillance leads to the detection of only a significant minority of cases. This is most clearly seen in the infectious disease experience.

Here is a study from Vermont that looks at the typical or passive mode of reporting and compares it to an active approach in which physicians were contacted on a weekly basis. You can see that with the customary model, the passive model, only about half as many cases of hepatitis, measles, rubella, and Salmonella were reported when compared to the more active approach.

If we look at occupational health, the news is not really any better. One example is physician-generated reports of occupational disease in Maryland from 1981 through 1983.

There were 17 clinics in the Baltimore area that were doing a substantial amount of occupational health as part of their practice. There were 16 board-certified occupational physicians in Maryland, and there were at least 143 worksite clinics in operation in the state.

In 1982, 279 cases in total were reported. Twenty-three percent of these were reported by one physician, and 62 percent were reported by another physician. So, 85 percent of all the case reports in Maryland in 1982 came from two physicians.

Obviously, there are some potential problems with the reporting of sentinel events in that the afferent limb of the reflex here is certainly not flawless.

There is another set of problems relating to the other side, the efferent part of the reflex. The public health body, which is the recipient of these notifications, must have the personnel, the interest, and the funding to provide an appropriate analysis and response to these notifications. But look at what we know about the effectiveness of this interaction.

This is from a 1985 survey of the health departments of 50 states as well as the health department of New York City and Washington, D.C. You can see that about 60 percent of the departments mandated physician reporting of selected occupational illnesses.

Lead poisoning was the most commonly required reportable condition, yet only five of these health departments had developed criteria for evaluating reports of lead poisoning. Eighteen departments indicated routine or periodic efforts to obtain additional details on reported cases. Only 10 departments used the case report, so only about one-third of those who mandated reporting used the case reporting in any of their interventional activities, only seven departments had ever published a summary of information from case reports, and no department reported having evaluated its surveillance program to determine the rate of reporting.

So, it is clear that the surveillance of occupational sentinel events is a complex activity. It is not currently being done optimally by any of the participants.

## **PROBLEMS IN PHYSICIAN REPORTING OF AGRICULTURAL SENTINEL EVENTS:**

### **Physical and Farmer Interaction**

Now, let us look at some of the potential challenges involved in applying this model to agricultural health and safety. The physician and farmer interaction is not always a many-splendored thing. First of all, some farmers feel that they do not have the funding or the time required to see their physicians on a regular basis.

A second issue is the farmer's perception of the physician's expertise regarding agricultural health problems. If I tried to assure an audience of farmers that their physician could consistently recognize occupational hazards and could always advise them reliably on the proper treatment and prevention, my statements might be received by the farmers with an element of skepticism.

### **Physician Recognition of Sentinel Events**

This leads us into the second aspect of the issue of reporting, and that has to do with physicians. My observations over the last 10 years are that physicians, in general, tend to have relatively limited sophistication with regard to agricultural medicine. There are a variety of occupational problems, which have been outlined by Dr. Novello and a number of other speakers, that can affect farmers.

Some of these are clearly job-related, and others are probably job-related. Many physicians would have difficulty diagnosing some of these conditions and would seldom relate others to the farmer's occupation.

### **Physician Reporting of Sentinel Events**

If we assume that the farmer does come to see the physician and that the physician correctly diagnoses the problem, does it get reported? This relates to the physician's awareness of the responsibility to report as well as their interest in doing the reporting.

I cannot show you any data on the level of this interest. As a practicing physician, I can assure you that when things get relatively busy, the interest in reporting is limited.

### **Public Health Response to Sentinel Events**

Now, a final challenge in the physician reporting of agricultural sentinel events, in my mind, has to do with the need for a mutually productive interaction between the reporting physician and the health department. Reliable reporting will continue only if it is clearly beneficial to either the physician or to his patient.

Yet these departments have limited resources. Even if there is sufficient interest at the health department level, it is unlikely that most health departments have the expertise in agricultural medicine to mount an effective response to this kind of information.

For the past 10 minutes I have outlined a series of problems and roadblocks involved in this issue that make it seem that the likelihood of effective physician surveil-

lance is somewhere between slim and none. I believe, however, this is an effective activity that can be made to work, and there are resources available that can be applied to the task.

### **RESOURCES**

The National Coalition for Agricultural Safety and Health (NCASH) was formed, following the meeting in Des Moines and Iowa City. This group has successfully worked to secure funding to begin some of the efforts that we are seeing today.

NIOSH certainly had contributed to this field prior to the beginning of the NCASH endeavor. Since then, it has received funding needed to begin a more organized attack on these problems. Now, through NIOSH, there is a wealth of experience with occupational problems, although not specifically with agricultural problems.

The recently designated NIOSH centers should be able to provide consultation and educational support that is specifically aimed at agricultural issues. As you know, these are located in Iowa and California.

Another NIOSH-initiated program is the Rural Nurse Sentinel Program, which I suspect Dr. Freund will expand upon tomorrow. Briefly, this is a program that proposes to locate specially trained occupational nurses in rural regions where they will interact with rural physicians and others to form a network for surveillance purposes.

In addition to NIOSH-funded programs, there are a handful of other groups around the country that have a particular interest and expertise in agricultural medicine. In New York we have been working in this field for about 10 years. We were preceded in this by the group from Marshfield,

Wisconsin. In other places in the country, there certainly are a number of interested individuals who have considerable experience working with farmers and farmworkers.

Certainly, a number of the land-grant universities have developed expertise in engineering and safety issues, and, in some cases, this has expanded into the area of health and health education. An example of this would be Bill Field at Purdue, whose interest in rehabilitation of injured farmers has resulted in his acquiring a knowledge of rehabilitation medicine that makes most of us physicians envious.

Some occupational medicine groups have become increasingly interested in this field and clearly have become resources. Our previous speaker and her program in Seattle are certainly an example of this. In general, however, I think that agricultural problems are not an area of expertise or even of particular interest for many occupational physicians.

## **POSSIBLE SOLUTIONS**

Let me see if I can spend a few minutes proposing ways in which some of these resources might be used to help us get around the various obstacles that I described a few minutes ago.

### **Physician and Farmer Interactions**

The physician and farmer interaction is a difficult problem, and it certainly needs to be addressed. Currently physicians are not viewed as being particularly knowledgeable with regard to agricultural problems, nor are they affordable or convenient to the farmers.

Some of these issues can be improved, certainly with aggressive efforts at continuing medical education. As you heard at lunchtime, here in Iowa interested physicians within a community may sometimes enter a program in which they receive intensive training in agricultural health problems at the center. Such individuals then become local resources.

Educational efforts by physicians can go a long way towards building bridges between farmers and physicians. Jim Hartye has developed an innovative approach at his clinic in North Carolina.

Periodic health screening events are scheduled for the farm community. When these people come in for free spirometry or free blood pressure checks or free cholesterol checks, these are coupled with discussions of safety practices, protective equipment, etc.

Mary Lee Hill, from our group, will present a poster later this week demonstrating the effectiveness of a similar program. A proposal for this type of approach was recently discussed by the American Academy of Family Practice.

The experience that we have had in New York is that educational programs are a very effective way to reach out to the farm community. For this reason, we never decline an invitation to speak to a farm group, whether it be large or small. We have an educational booth that spends a lot of time on the road going to various farm shows and programs. We design the programs that accompany this booth to be interactive in some way.

Frequently, there is some sort of a come-on with free hearing testing or free respiratory testing. The main point is to

obtain a teachable moment with this group and spend some time educating.

These kinds of contacts with farmers and their families have enabled us to learn a lot. It also, at the same time, has strengthened our relations with the agricultural community in New York and has enabled us to gain some recognition with the community as having some experience and expertise in agricultural health problems.

Now the local practitioner is unlikely to have the time, interest, or expertise to approach farmer education in this way. However, if one were supported in this effort with teaching materials, with examples of acceptable protective equipment, as well as a basic understanding of this material, these efforts might prove not only possible but actually productive, not only in terms of educating but in terms of altering the relationship that currently exists between physicians and farmers.

In the waiting room of a rural clinic in Sweden that is run by a physician, with a particular interest in agricultural medicine, prominently displayed are various types of protective equipment as well as instructions. He provided fairly sophisticated discussions of ergonomics for his patients. I think these kinds of effort go a long way to building bridges with the farm community.

### **Physician Recognition of Sentinel Events**

The problems in physician recognition relate to the level of sophistication that the physician has regarding occupational and specifically agricultural health problems. The potentially large number of events, many not clinically certain or absolutely related to work, clearly poses a problem for these physicians. Here again, aggres-

sive, continuing medical education is part of the answer.

In addition, I think the number of reportable events must be limited to a few. These should be defined for epidemiologic rather than clinical purposes. For example, if we agree that farmer's lung is an appropriate target for surveillance, we would not require that a case demonstrate repeated recurrences, antibody positivity, and a predominance of lymphocytes in the bronchoalveolar lavage fluid.

Rather, we would want to hear about any febrile reactions with myalgias or cough that occur following dusty work. The determination of whether this is farmer's lung, or organic dust toxicity, or simply pneumonia would be made later on by a different part of that reflex loop. A form that we use in the Occupational Health Network in New York allows for a substantial amount of uncertainty regarding the clinical diagnosis.

Nevertheless, these people get on the records and it is possible at a later date to sort out how certain we were and how good the evidence was that this was a bona fide case. So I think that although physicians have a need to be quite certain, epidemiologists are more comfortable with less certainty. Physicians have to be educated to this difference, if they are going to report these cases.

### **Physician Reporting of Sentinel Events**

Physician interest in reporting agricultural or any illness is going to be affected by the level of antipathy felt towards the local health department. In my home state of New York, this is considerable, and the easiest way to infuriate a New York physician is to send him a letter that says, "Dear Provider, The New York State Department



of Health now requires that you do the following." There is no way to enforce these kinds of laws, and so I do not think it is a productive way to approach the physicians.

Interest in reporting is further moderated by the amount of time and effort needed to do so as well as by the natural reluctance to get wrapped up in what is sometimes a quagmire of workmen's compensation. If the health department hopes to receive reports, the system must be readily accessible, user friendly, and perceived as beneficial either to the physician or to her patient. A system like the Poison Control Center Network, which provides consultation and support to the physician, will attract a lot more interest than simply another annoying letter from the health department.

Active surveillance has repeatedly been shown to be more effective and well-received by physicians.

Once again, I will use an example from the infectious disease literature. This is a study from Rochester, New York.

They divided the physicians into three groups. Some received a weekly phone call, some received a weekly post card, and most just performed passive surveillance as is typical.

Not surprisingly, there was substantially more response in the telephone group than in the post card group. There was better response in the post card group than in the passive group. So the message is that active surveillance is better, and I think NIOSH, recognizing this, has initiated the nurse surveillance program, which I mentioned earlier.

## Public Health Response to Sentinel Events

Now, the final series of roadblocks, as I see them, are at the level of the health department. We have already seen that health departments often have poor, if any, response to the cases of commonly reported occupational illness. The response to agricultural illness is likely to be worse, since it's unlikely that the department will have any experience, much less expertise, in the area.

It is not likely that agricultural problems will be able to compete in a busy, urban-based, overworked, and underfunded health department. What is the solution to this particular set of problems?

I would propose that the health department ought not to be directly involved in the feedback part of this loop. Ideally, this would best be done by a group, which is interested in and knowledgeable about agricultural problems—a group that could offer the "poison control center"-type of approach with support and consultation for the referring physician. Ideally, industrial hygiene and agricultural engineering consultation would be offered to the physician's patient.

Who can provide these kinds of services for the health department? In some cases, it might be a medical school. In general, however, I think most medical centers' lukewarm approach to occupational health, abysmal records in rural health, and lack of appreciation of agricultural medicine make it likely that we should look elsewhere for help.

The resource, which I would favor, is the existing NIOSH program for Centers for Agricultural Research, Education, Disease

## **Surveillance – Agriculture-Related Diseases, Injuries and Hazards**

and Injury Prevention. Expansion of this program on a regional basis throughout the country would enable education of physicians so frequently mentioned in the last few minutes. These centers would interact to support the nurse sentinels, provide user friendly feedback and support to practicing physicians, and help bridge the gap between the farm community and the medical establishment.

In summary, I believe that the practicing rural physician can definitely make a valuable contribution to the detection of occupational sentinel events in farmers. There are particular problems, or potential

problems, that are related to the ability of health departments to coordinate responses to these reports, related to the competence of physicians in agricultural medicine, and related to the farmers' perception of the physician relative to the farm workplace.

I believe that there are potential solutions to these problems and that many of these might best be approached by the use of regional centers for agricultural health and safety, which could provide education, consultation, and support services to practicing physicians and farmers.□

## CHEMICAL HAZARDS

By Linda Rosenstock, M.D.  
Director of Occupational Medicine  
University of Washington

Dr. Henry A. Anderson: So, let me introduce Dr. Linda Rosenstock who is Director of Occupational Medicine at the University of Washington. She has done considerable research and has been very active dealing with chemicals—actually all occupational exposures—and today is going to specifically address chemical exposures as they occur in the agricultural setting. Dr. Rosenstock:

There are two things that I would like to highlight during this discussion about pesticide health effects. The first is to consider how surveillance can be used to prompt further investigation and research, particularly looking at the interface between surveillance and research.

The second is to use this opportunity to talk specifically about a class of pesticides—the organophosphate pesticides—because of their significant acute toxicity and because of their potential for chronic toxicity.

As we try to break new ground and broaden our concern for farmers and farmworkers to include community effects of exposures, we will need to investigate the whole spectrum of the dose-response curve. I will provide evidence of long-term neurologic consequences of the highest levels of exposures, which are those that follow serious acute poisoning.

I want to raise for consideration the potential for long-term, chronic neurologic effects from lower levels of exposures to pesticides in the unpoisoned worker. This could happen by directly applying or handling the pesticides and even, perhaps, in the indirect exposures seen in the community setting.

### SURVEILLANCE

My colleagues and I at the University of Washington first became involved in pesticide health-effects research in clinical evaluation of patients. Our primary goal at the Occupational Medicine Clinic is to attempt to define a patient's medical condition and then to try to determine whether or not it is work-related.

One such patient was a farmworker who had spent all of his adult life in farm labor. He was living east of the mountains near some of our largest apple orchards. He was referred because of concerns by his physician, who had known him well for a number of years. Following an episode two years before we saw him, he developed a number of new, now chronic, health problems.

At the time we saw him, the patient complained of persistent headache, memory loss, confusion, and generalized fatigue. These symptoms followed soon after a significant pesticide poisoning two years earlier.

He had been involved in a full day of working behind a chemical sprayer, sustaining significant skin absorption of an organophosphate pesticide, and was over-

come and soon hospitalized with what was a moderately severe pesticide poisoning. He never successfully returned to work after that episode.

He tried to go to work one week later and just could not. It was at this time that his family and his physician documented a significant change in his general mental status.

The patient had one previous significant pesticide poisoning five years before this latter episode, from which he recovered well except for some continuing complaints of new, mild headaches.

On physical examination, we found evidence of disorientations and problems with memory. Clinically, he looked similar to elderly patients who present with dementing disorders such as Alzheimer's disease. Full neuropsychological tests documented in a more objective fashion significant abnormalities in a wide array of neurologic functions consistent with an organic brain syndrome or chronic encephalopathy.

On the basis of this information, we confirmed that he had a significant dementia-type illness. Important questions still remained. What caused this illness? Was it related to work?

There were certainly several features that made us think it was not traditional Alzheimer's disease. Not only was he a bit young to present this level of abnormality from the disease, but it had come on rather suddenly. Clearly, the temporal relation to the pesticide poisoning was remarkable.

With that in mind, we decided to turn to the medical literature for assistance. Over the last few decades, there have been many suggestions of the potential for chronic neurologic problems to follow acute

poisonings. Little formal epidemiologic research has been done.

## **ORGANOPHOSPHATE PESTICIDES**

Our lack of knowledge is perhaps surprising given the extent of pesticide exposures and intoxications. Current estimates from the World Health Organization (WHO) are that around the world there are about three million severe pesticide poisonings a year.

Organophosphate pesticides are the leading cause of intoxications in most areas. Only about one-third of the poisonings are occupational. Two-thirds of these are accidental, including suicide.

It is estimated that the annual poisoning fatality rate on a global basis is about 220,000. People who get occupationally poisoned, as expected, have a lower fatality-to-case ratio than those who sustain intentional and unintentional nonoccupational poisoning.

It is estimated that 99 percent of fatal poisonings occur in the developing world. It has also been estimated that about 5,000 to 10,000 serious poisonings occur each year in the United States.

Much is known about the early effects that will follow acute organophosphate pesticide intoxication. In addition to the acute syndrome there are a few others, which may follow by days or perhaps weeks.

The question, though, that I would like to address and give you some information about is whether or not high-level, acute, single doses of organophosphate exposure can lead to chronic central nervous system neurologic deficits.

In order to look at this question, we had an opportunity to perform a study in Leon, Nicaragua. Leon is the center of an agricultural region in Nicaragua. A very active

and reasonably well-validated pesticide registry has been in place there for about 4 years.

**Table I. Neuropsychological Performance of Poisoned and Comparison Charts.**

TEST	Mean Test Score (SD)*		Estimate of Difference of Means (95% CI) <sup>†</sup>	
	Poisoned n = 36	Not Poisoned n = 36		
<b>LANGUAGE</b>				
WAIS-R Vocabulary	25.2 (12.1)	28.7 (9.4)	3.4	(-1.1,8.0)
<b>ATTENTION</b>				
Verbal WAIS-R Digit Span <sup>1++</sup>	4.6 (2.1)	6.3 (3.2)	1.7	(0.6,2.9)‡
Visual Digit Vigilance (seconds)	305 (135)	256 (91)	60.3	(18.9,101.9)‡
<b>MEMORY</b>				
Verbal REY Auditory Verbal Learning <sup>2</sup>	7.9 (2.9)	8.8 (2.7)	0.9	(-0.2,2.0)
Visual Benton Visual Retention Test <sup>++</sup>	4.6 (2.4)	6.1 (2.2)	1.5	(0.6,2.5)‡
<b>VISUO-MOTOR</b>				
Speed Digital Symbol <sup>++</sup>	19.2 (12.5)	25.4 (11.9)	6.1	(1.6,10.6)‡
Sequencing Trail A (seconds) Problem Solving	81.0 (33.0)	63.3 (26.7)	20.6	(7.7,33.5)‡
Block Design	7.7 (7.3)	14.7 (9.2)	6.9	(3.7,10.2)‡
<b>MOTOR</b>				
Steadiness Pursuit Aiming II <sup>++</sup>	75.9 (33.6)	94.4 (29.9)	18.4	(7.3,29.6)‡
Reaction Simple Reaction Time (milliseconds) <sup>++</sup>	340 (111)	308 (50)	32	(-2.0,66)
Dexterity Santa Ana Dexterity Test (dominant hand) <sup>++</sup>	31.7 (6.5)	35.6 (7.0)	4.2	(1.3, 7.0)‡
Speed Finger Tapping (dominant hand)	46.3 5.9	47.3 (6.4)	1.1	(-1.9,4.0)
<b>AFFECT/SYMPTOMS</b>				
Brief Symptom Inventory <sup>3</sup>	20.6 (10.7)	18.8 (9.8)	1.8	(-2.9,6.5)
Questionnaire 16	7.2 (4.0)	4.7 (3.8)	2.5	(1.0,4.1)‡

\* = Test results represent raw scores (numbers of incorrect responses) unless other units are specified.

† = Positive value for Estimate of Means (and 95% CI) indicates worse performance by poisoned cohort relative to comparison cohort. Estimate is based on paired t-test. Estimate may differ from value obtained by subtracting sample means in instances where full paired data were not available.

++ = Component of WHO Neuropsychological Core Test Battery (11).

‡ = p<0.01 by paired t-test.

<sup>1</sup> Digit Span (total recalled: forward and backward).

SD = standard deviation

<sup>2</sup> Rey Auditory Verbal Learning (number correct after distraction, Trial VI).

CI = confidence interval

<sup>3</sup> Brief Symptom Inventory (Positive Symptom Total).

— Adapted from Rosenstock L et al. Chronic Nervous Effects of Acute Organophosphate Intoxication, *The Lancet*. 338: 223-227, 1991.

For example, in one region over a several-month period in 1987, there were close to 300 reported cases. Most were occupational cases of poisoning and two-thirds of these were hospitalized.

Some conditions of pesticide use in Nicaragua are worth noting by a look at some photographs. A common reason for occupational poisonings is malfunction of backpack sprayers. These are made of plastic and there often are not replacement parts available. Skin absorption is hastened in the hot climate. A breakdown of equipment in league with skin absorption can lead rapidly to serious overexposures.

Another photo shows a warning label on a container; the label that gives a warning is in English. This is not very helpful in a Spanish-speaking country where only about half the population in the rural area is even literate.

I will now review briefly how we undertook the study and what our main results have been. We were able to identify 36 men who had been hospitalized in the main hospital in this region with moderate to severe organophosphate pesticide poisoning. We studied them, on average, about two years after the poisoning episode.

A community comparison group was composed by matching to each poisoned individual someone of the same age and sex who was either a close friend or a sibling and who worked in the same community. By doing this kind of design, which is a retrospective, cohort, matched-pair design, we had a comparison group that was significantly exposed to pesticides. What was different was that this group had never been medically treated for a poisoning.

Neuropsychological functioning was assessed by a test battery, which evaluated a

wide array of neurological functions including motor testing, visual perception and processing, testing of memory and language abilities, and affect.

Table I shows the characteristics of these populations. There was good matching of our community (never poisoned) and our poisoned group.

**Table II. Characteristics of Poisoned and Comparison Cohorts.**

	Poisoned (N = 36)	Not Poisoned (N = 36)
Mean age in years (±S.D.)	27.6 (±9.5)	27.8 (±9.3)
Number with no formal education	17 (47%)	12 (34%)
Number who consumed any ethanol in past month	13 (36%)	16 (44%)
Number with heavy ethanol consumption past month*	5 (14%)	6 (17%)

\* Defined as drinking more than 10 bottles of beer or 10 one-half bottles (500 cc) of rum in past month.

— Adapted from Rosenstock L et al. Chronic Nervous Effects of Acute Organophosphate Intoxication, *The Lancet*. 338: 223-227, 1991.

They are almost identical in age. About 70 percent of the comparison cohort has also worked with pesticides. A large number also gave complaints that were consistent with pesticide poisoning, but they had not been hospitalized for these episodes.

The poisoned group performed worse than the non-poisoned comparison group for all outcomes studied (Table II).

In one set of tests, which is a World Health Organization (WHO) standardized, neuropsychological battery, the poisoned group had statistically significant worse performance on five out of six subtests. We also did some additional tests. The same pattern holds.

On the basis of this study and the accumulating evidence in the medical literature, we feel that even episodes of acute organophosphate poisoning can cause permanent neurologic dysfunction.

We cannot in this study tease out as much precision as we would like to compare the contribution of cumulative pesticide exposure to the overall effect. Any analysis we did, looking at why the poisoned group did worse, suggested that it was the actual

episode of acute poisoning that contributed as the main factor to these differences in performance rather than other measures of pesticide exposure. On the basis of this study and the accumulating evidence in the medical literature, we feel that even episodes of acute organophosphate poisoning can cause permanent neurologic dysfunction.

Although we concluded that it was likely that the patient first presented in this discussion had sustained a work-related organic brain syndrome, much remains unknown about organophosphates and chronic neurologic sequelae. Further study is needed to try to replicate our findings and explore the effects of specific chemicals within the organophosphate group, the role of other factors interacting with these chemicals, and the clinical significance of the observed neuropsychologic disturbances.□

## QUESTIONS

**Dr. James A. Dosman:** Linda, thanks a lot. I really enjoyed your talk. As scientists we never pay attention to one case, but, as you know, clinical observation is the first step in epidemiology. About two years ago a man came to me who said that he was perfectly healthy until one afternoon when he was spraying with (inaudible); it is a carbamate.

When he went out in the morning, the wind was still. Then the wind came up and it blew over him. When he got in at noon he felt so weak that he could not get to the house. Eventually he did. He lay there for two or three days; he seemed to recover. Since that time, he has been unable to do anything. He has felt depressed. He cannot make decisions. He cannot be effective. I would like to ask you, do you think, on the basis of the work that you have carried out, that this kind of mental reaction is possible following one overdose?

**Dr. Linda Rosenstock:** I think it is a good question. Using the word "possible" makes it a little easier to answer. If I were asked, again using this legal standard, if there is a greater than 50 percent likelihood, I would have more trouble saying yes.

I think the case reports in the medical literature suggest that there may be significant anxiety and depression following exposures. The question is how much exposure and what the mechanism is. Unfortunately, I think the conventional wisdom has been to say people just get traumatized and we are looking only at a psychological reaction. They are anxious and it has nothing to do with the effects, directly, of the chemicals.

## Surveillance – Agriculture-Related Diseases, Injuries and Hazards

In our study, we were actually surprised. We expected to find differences in psychiatric performance. In other words, there is increased anxiety and depression in the previously poisoned group, which I went over quickly.

In our study, we found no such differences. That made it easier for us to say everything else was real. If we found differences, then a lot of critics would say, *"Well, you are only measuring problems with memory because people are depressed; if you are depressed you do not concentrate as well because you are distracted."* It made it easier for us to defend our results.

But I still think, despite our negative findings in that regard, that the medical literature suggests that results like this can happen. I think they are worthy of further investigation. It is too easy to write off all of these people who have these complaints and say that they, all of a sudden, got a little crazy when they were not crazy before.

Dr. Henry Anderson: I think we all want to keep in mind that we are going to be hearing examples. What we are challenged with is, what data systems or what surveillance currently exists that can assist in the identification of the cases so that it can interface with follow-up research? We have one of the key chemical exposures. I think we are all aware that there are multiple chemical exposures that go on in the agricultural setting. One of the key ones is the organophosphate poisoning. We think in terms of the continuum that Bill presented. We have laboratory testing to measure effect. Whether it is an adverse effect is still being argued. We have exposure assessment techniques. We have disease outcomes ranging from fatality to acute poisonings. The challenge is, "How can surveillance assist in a better understanding of the other parameters that relate to these types of exposures?"



## RESPIRATORY DISEASES

By James A. Dosman, M.D.  
Director, Center of Agricultural Medicine  
University of Saskatchewan

### SUMMARY

The structuring of health surveillance programs for widely dispersed agricultural populations is difficult because of the multiplicity of exposures and health effects. There is also the difficulty with reaching and communicating with widely dispersed populations.

In order to accomplish this objective, a cooperative approach between government, industry, the community, and individuals is necessary. In order to achieve successful "rural family life enhancement," a high degree of local ownership and leadership in the program is essential.

The problems of structuring health surveillance programs for widely dispersed populations that do not fit traditional labor-management structures for industry are numerous. Nonetheless, the significant issues relating to health and well-being—involving high rates of death, disability, and accidents; respiratory difficulties as the result of dust, microbe, and chemical exposure; possible enhanced cancer risks as a result of environmental exposures; hearing loss as a result of unquantified and uncontrolled noise levels; skin problems as a result of exposure to dusts, chemicals, microbes, and other substances; and stress and psychiatric problems as a result of isolation, economic difficulties, and inter-generational family problems—all demand a coordinated occupational health program.

On the organizational level, structuring such programs is difficult as farmers and other agricultural workers are widely dispersed, do not belong to single organizations or companies, and are thus difficult to reach for health surveillance, early identification, and an educational-preventive perspective.

### THE TOOLS OF HEALTH SURVEILLANCE

In this model, no one organization may be responsible for, or effectively deal with, occupational health and well-being questions. In order to achieve success, cooperation is required between government, industry, the community, and individuals. This paper describes certain approaches at each of these four levels.

...we recommend the establishment of health and safety committees at the local level, organized by target populations, for the purpose of identifying issues, facilitating programming, and achieving results.

### GOVERNMENT

Governmental agencies can exercise considerable influence on health surveillance by moral leadership, regulatory approaches, and information retrieval and distribution. In Canada, for example, Labour

Canada, a regulatory agency for workers that is involved in the cereal grain industry, requires that dust levels be maintained at no greater than 10 mg/m<sup>3</sup> time-weighted over an 8-hour day, and that workers be given the opportunity for questionnaire assessment and pulmonary function testing every 3 years. As part of this program, Labour Canada requires receipt of dust level and medical information.

The latter requirement has contributed to compliance and interest in the program on the part of industry and labor. It has provided scientific information that is being utilized to estimate longitudinal effects of grain dust exposures on human health. Thus, the regulatory process appears to be accomplishing a number of goals:

1. Reduction and regulation of environmental dust levels.
2. Compliance of industry and workers in providing for, and being involved in, a periodic human health assessment program.
3. The utilization of information from this program in scientific research, that in

turn may assist in re-evaluating dust level regulations.

In some ways, this program may be considered a model of the manner by which government may stimulate action at several levels.

## INDUSTRY

Where concentrations of agricultural workers exist, as in the grain transport and storage industry, industry may play a leading role in promoting good health amongst its workers. Utilizing the Canadian grain industry as an example, compliance among companies in initiating dust removal equipment in grain facilities has been relatively good. Table I indicates that out of a total of 2,048 dust samples obtained in grain facilities in Canada in the early 1980's, only 19.8 percent of the samples obtained by Labour Canada, and 17.2 percent of the samples obtained by the companies themselves, exceeded the recommended maximum dust exposure limit of 10 mg/m<sup>3</sup>.

An additional dimension to the provision of health surveillance services for these workers is taking place in Canada in the Province of Saskatchewan. In this province, all grain companies have gone beyond the legal requirements of Labour Canada and are providing sufficient resources for a more comprehensive approach to health surveillance that goes beyond the minimum respiratory requirements of the regulatory agency.

Such additional services include, in addition to respiratory testing, one-to-one nurse counselling involving lifestyle management

Table I. Number of Dust Samples Obtained in Canadian Grain Elevator Facilities.

	<5 mg/m <sup>3</sup>		>5 mg/m <sup>3</sup>		>10 mg/m <sup>3</sup>	
	n	%	n	%	n	%
Labour Canada*	341	64.8	185	35.2	104	19.8
Companies**	1008	66.2	514	33.8	261	17.2

Samples Collected:

\* 1980-1984, n = 526

\*\* 1978-1986, n = 1,552

Total = 2,078

- Reprinted from: McDuffie HH, Pahwa P, Dosman JA. Respiratory Health Status of 3,098 Canadian Grain Workers Studied Longitudinally, *American Journal Industrial Hygiene*. (in press) 1991.

(smoking and other issues), use of personal protective devices, back care, stress, and a variety of other occupational health questions. In our experience, the workers have responded positively to this initiative.

## **COMMUNITY**

The provision of health surveillance to widely dispersed farmers and their families must, by necessity, involve the community. In Saskatchewan, in the model being utilized, a widely dispersed approach is taken to occupational safety and health through the Agricultural Health and Safety Network of the University of Saskatchewan.

In this approach, individual rural municipalities, the local unit of self-government, enroll their resident farm families in the Agricultural Health and Safety Network for the promotion of better health and farming practice. Since its commencement three years ago, 10 percent of the rural municipalities in the province have enrolled their farm families in this network, comprising about 7,000 persons. Once enrolled in the network, individual farm families receive preventive materials on various topics relating to good healthy farm practice annually.

In addition, health surveillance services, such as respiratory testing and seminars on safe dust management, the use of personal protective devices, and other issues, are provided. Recently, as part of this program, seminars on safe chemical management have been offered, and a hearing conservation survey took place in one municipality.

This program is financed by individual subscriptions from the municipalities, amounting to 1/10th of one mill of taxation per year. The relation between the Center for

Agricultural Medicine, which promotes the program, and individual farm families is through elected rural Municipal Councils. While it is too early to determine the effectiveness of this approach to health surveillance, it appears to offer potential.

## **THE INDIVIDUAL**

The most successful approach to good work, health, and lifestyle practice is through an educated and motivated individual. Farm families are scattered widely geographically. With farm work practices being ingrained over many years, the process of education remains the most important and useful means of making gains.

The basis of the approach through the Agricultural Health and Safety Network is to achieve an educated and motivated individual. Yearly provision of materials, the provision of stickers for farm implements identifying individuals as members of the Agricultural Health and Safety Network, and tailored educational sessions are important in this process. In addition, information and material developed within the geographic area in question that is useful to, and identified with, the type of farm practice, social issues, and family life of the region, are important.

## **RURAL FAMILY LIFE ENHANCEMENT**

The goal of health surveillance in the agricultural industry should be a broadly based approach to a multiplicity of issues that go beyond the workplace *per se* and result in an enhanced quality of life for persons who live in rural areas, the majority of whom are involved in agriculture and its related industries. In order to accomplish these goals, a combined, coordinated approach between government, industry, community organizations, and individuals is essential.

## **Surveillance – Agriculture-Related Diseases, Injuries and Hazards**

**Underlying this cooperative approach is the necessity of local ownership of and leadership for programs that are undertaken. Specifically, we recommend the estab-**

**lishment of health and safety committees at the local level, organized by target populations, for the purpose of identifying issues, facilitating programming, and achieving results.□**

## **SURVEILLANCE OF INJURIES IN AGRICULTURE**

*By Susan Goodwin Gerberich, Ph.D.*

Division of Environmental and Occupational Health,  
School of Public Health, University of Minnesota, Minneapolis, Minnesota

*Robert W. Gibson, Ph.D.*

Division of Environmental and Occupational Health,  
School of Public Health, University of Minnesota, Minneapolis, Minnesota, and  
Department of Behavioral Sciences, School of Medicine, University of Minnesota, Duluth, Minnesota

*Paul D. Gunderson, Ph.D.*

National Farm Medicine Center, Marshfield Medical Research Foundation, Marshfield, Wisconsin

*L. Joseph Melton III, M.D., M.P.H.*

Department of Medical Statistics and  
Epidemiology, Mayo Clinic/Mayo Medical School, Rochester, Minnesota

*L. Ronald French, Ph.D.*

Chronic Disease and Environmental Epidemiology Section  
Minnesota Department of Health, Minneapolis, Minnesota

*Colleen M. Renier, B.S.*

Department of Behavioral Sciences, School of Medicine, University of Minnesota, Duluth, Minnesota

*John A. True, M.S.*

Department of Agricultural Engineering, University of Minnesota, Minneapolis, Minnesota

*W. Peter Carr, M.P.H.*

Division of Environmental and Occupational Health, School of Public Health  
University of Minnesota, Minneapolis, Minnesota

---

### **ABSTRACT**

There has been no comprehensive data system to identify the magnitude of the injury problem in the rural farming community or the potential risk factors that may be associated with this problem. Serious discrepancies among the existing data sources, pertinent to occupational morbidity and mortality, limit identification of the true magnitude of the problem. Based on a recent National Academy of Sciences report, it has been documented that fatal as well as non-fatal occupationally related injuries have been greatly undercounted. In part, these discrepancies in mortality and morbidity data are due to variations in definitions, the worker populations included, methods of case ascertainment, and the data sources utilized.

Fatality rates identified for agriculture have ranked among the highest for many years. However, given the overall discrepancies among the data systems and the reporting limitations for agriculture, these would appear to be extremely conservative estimates. A major barrier to progress in the prevention of agricultural injuries has not only been a lack of knowledge about the magnitude of the problem but also a lack of knowledge about specific causes or risk factors

due to the lack of analytical studies. This paper includes an historical perspective of surveillance and its importance to the problem of injuries in the agricultural community. Special emphasis is placed upon the data sources and methodological approaches that have been used in agricultural surveillance, including advantages and limitations.

Among the agricultural injury surveillance efforts that will be discussed are two major population-based efforts, conducted by a multi-disciplinary team, using a methodology that can also serve as a model for long-term surveillance efforts at the state, regional and national levels. These efforts are the Olmsted Agricultural Trauma Study (OATS) and the Regional Rural Injury Study (RRIS):

1. The overall purpose of OATS was to identify the magnitude and characteristics of the injury problem among all farms in Olmsted County, Minnesota, using a telephone interview methodology, validated through medical records. Data pertinent to the household members, characteristics of the farm operation, and injury events (farming and non-farming related; intentional and unintentional) were collected. In concert with this effort, a case-control study to facilitate identification of risk factors, an inter- and intra-rater reliability study of E-coding, and a follow-up pilot investigation of machinery-related injury events were also conducted. Specific findings, including injury rates, characteristics of the injuries and injury events, and risk factors, are presented with regard to implications for surveillance.
2. OATS provided the basis for the Regional Rural Injury Study (RRIS), currently being conducted in a five-state region: Minnesota, Wisconsin, North Dakota, South Dakota, and Nebraska. Data collection covers a twelve-month period of time for over 4000 rural households, utilizing computer-assisted telephone interviews (CATI). This effort will enable the identification of injury rates for each state and the region as well as multiple analytic substudies, including tractor-rollovers and animal-human injuries. The project also includes application of the results to the development of intervention strategies, to be achieved by convening nationally recognized experts and the regional participants in the Agricultural Injury Intervention Strategy Workshop.

## INTRODUCTION

There has been no comprehensive data system to identify the magnitude of the injury problem in the rural farming community or the potential risk factors that may be associated with this problem that can enable progress in the prevention of agricultural injuries. Serious discrepancies among existing data sources limit identification of the true magnitude of occupational morbidity and mortality. For example, the fatality rates identified for agriculture have ranked among the highest for many years, but a recent National Academy of Sciences report,<sup>1</sup> documented that fatal as well as non-fatal occupationally-

related injuries have been greatly undercounted.

Another major barrier to progress in the prevention of agricultural injuries has been a deficiency in knowledge about specific causes or risk factors due to the lack of analytical studies. This paper includes an historical perspective of surveillance and its importance to the problem of injuries in the agricultural community. Special emphasis is placed upon the data sources and methodological approaches that have been used in agricultural surveillance, including advantages and limitations.

## **SURVEILLANCE: AN HISTORICAL PERSPECTIVE**

Surveillance is a French word originally meaning, "keeping a close watch over an individual or group of individuals in order to detect any subversive *tendencies*."<sup>2</sup> Current dictionary definitions, e.g., "vigilant supervision," "spylike watching," or "watch or observation kept over a person, especially one under suspicion or a prisoner,"<sup>3</sup> continue this negative connotation. This historical perspective provides a basis for the negative perception of "surveillance" in the general population that can seriously affect data collection efforts.

Surveillance of disease evolved in the 17th century when fear of plague epidemics resulted in efforts to document the impact of morbidity and mortality. Subsequently, surveillance efforts have been utilized to monitor acute disease outbreaks and to ascertain potential relationships between working environments and certain health conditions in Europe.<sup>2</sup> However, it was not until the 19th century that surveillance had evolved as a "means of collection and interpretation of data related to environmental and health monitoring processes for the definition of appropriate action, for prevention and health care."<sup>2</sup>

A surveillance effort comparable to those that were developed in Europe and focused on disease entities did not emerge in the United States until 1900; full national mortality coverage was not attained until 1933.

## **INJURY SURVEILLANCE**

Of great importance is the fact that, although injuries have been identified as a persistent problem over time, there have

been no adequate comprehensive surveillance systems established.<sup>4</sup> In particular, occupational injuries, which constitute an important part of the injury problem in the United States, have not received attention commensurate with the magnitude of the problem. Agriculturally related injuries have received even less attention since about 95 percent of all farming operations, by virtue of their size, do not fall under the jurisdiction of the Occupational Safety and Health Administration's, or other agencies' recording and reporting requirements.<sup>5,6</sup>

## **Occupational Injury Surveillance**

Serious discrepancies among the existing data sources pertinent to occupational morbidity and mortality limit identification of the true magnitude of the problem. In 1989, the National Safety Council estimated that there were 10,400 occupationally related fatalities.<sup>7</sup> The Bureau of Labor Statistics: (BLS) reported 3,300 for the same year.<sup>8</sup> A third source of occupational fatality data is the National Traumatic Occupational Fatality (NTOF) data base at NIOSH, based on death certificates specifically coded with the "injury-at-work" designation. Through this source, it was estimated that approximately 7,000 work-related fatalities occurred each year during the period between 1980 and 1985.<sup>9</sup>

Similar discrepancies are identified for non-fatal occupational injuries. In 1989, the National Safety Council estimated that there were 1.7 million disabling injuries.<sup>7</sup> During the same year, the Bureau of Labor Statistics estimated that approximately 6.2 million work-related injuries occurred, with 2.9 million of those involving lost work days.<sup>8</sup> Another source of data is based on a sample of approximately 66 emergency rooms from the

United States Consumer Products Safety Commission's (CPSC) National Electronic Injury Surveillance System (NEISS). From an unpublished NIOSH report based on these data, it was estimated that over 3.8 million occupational injuries of varying severity and outcome are treated every year in all U.S. emergency departments. In part, these discrepancies in morbidity as well as mortality data are due to variations in definitions, the worker populations that have been included, different methods of case ascertainment, and the various data sources that have been utilized.<sup>10</sup>

### Agricultural Injury Surveillance

Fatality rates identified for agriculture have ranked among the highest across all occupations for many years. Based on National Safety Council data for 1989,<sup>7</sup> agriculture accounted for a rate of 40 deaths per 100,000 workers, compared with 9 deaths per 100,000 workers for all occupations. National morbidity rates in agriculture have been elusive due to the lack of adequate population-based data for non-fatal events.

However, the data suggest a major problem among farm residents.<sup>5, 11-15</sup> In 1989, an estimated 120,000 disabling injuries occurred in agricultural work, with 70,000 of these involving farm residents.<sup>7</sup> Given the discrepancies among the various data systems and the reporting limitations for agriculture, the estimates identified would appear to be extremely conservative.

A major barrier to progress in the prevention of agricultural injuries has been not only a lack of knowledge about the magnitude of the problem but also a deficiency in knowledge about the specific causes or risk factors due to the lack of analytical studies.<sup>15, 16</sup> Through ongoing, systematic data collection, with consequent analysis

and interpretation, epidemiologic surveillance (Figure 1) enables the identification of the magnitude of the morbidity and mortality problem, injury epidemics, new injury problems, and potential risk factors.

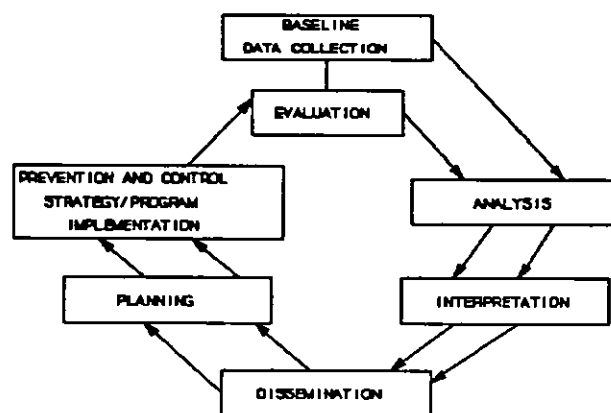

Figure 1. Surveillance of Injuries in Agriculture.

Of particular importance is that it can provide a scientific basis for analytic research to identify specific risk factors that are critical to the development of intervention strategies for the prevention and control of agricultural injuries. The integrity of a surveillance system is reliant upon regular evaluation and modification, as appropriate, with specific attention to validity and reliability measures. Finally, the surveillance system provides for ongoing evaluation of specific prevention and control activities so that alterations can be implemented, if necessary, along the way.

### ELEMENTS OF SURVEILLANCE

Meaningful injury surveillance requires data that will allow the calculation of population-based morbidity and mortality rates. This requires complete numerator and denominator data for the population from which the data are drawn.



A serious deficiency in many of the surveillance efforts that have been initiated is the inability to identify adequate denominator data.<sup>6,15,17-19</sup> Not only is it essential to identify the total numbers of people at risk but also the various demographic characteristics of that population (e.g., age, gender, education, socioeconomic status, length and types of exposures, experience, and behavioral characteristics).

Of further importance is the collection of exposure data that address the farming operation, including the sizes and types of operations, the animals involved, and the machinery, equipment, and chemicals that are in use. Basic to the numerator is a clearly established definition of injury that may be very broad or may focus on specific types and severity of injuries, sources and locations of injuries that occur to the entire population or, perhaps, to certain subpopulations, and whether the injuries are intentional or unintentional.<sup>19</sup>

These elements are all integral to an injury definition. Utilization of an active versus passive system of reporting will enhance the likelihood of identifying complete numerator data.<sup>20,21</sup> Of further importance is consideration of the specific time period for which the data are to be collected, the relevant data analysis to be conducted, and dissemination and utilization of the results.<sup>15,22</sup>

Based on recommendations published from a National Academy of Sciences Committee,<sup>4,23</sup> there are essential data elements for injury surveillance (Table I). These include time of the event; place of occurrence; demographic characteristics of the injured person; characteristics of the injury, including the body part affected, type and severity; the agent causing the event, as well as the source and mechanism of the event, and the circumstances surrounding the injury event; medical care provided;

**Table I. Essential Data Elements for Injury Surveillance.**

---

<p><b>INJURY CASE ELEMENTS</b></p> <ul style="list-style-type: none"> <li>• TIME OF EVENT</li> <li>• PLACE OF OCCURRENCE</li> <li>• DEMOGRAPHIC CHARACTERISTICS OF THE INJURED PERSON (e.g., age, gender, education, socioeconomic status, occupation)</li> <li>• CHARACTERISTIC OF THE INJURY (including body location affected, type of injury, severity)</li> <li>• AGENT CAUSING THE EVENT (e.g., mechanical, chemical, electrical energy)</li> <li>• SOURCE OF THE EVENT (e.g., machinery, tractor, gun, animal)</li> <li>• MECHANISM OF THE EVENT (e.g., fall, struck by/against)</li> <li>• CIRCUMSTANCES SURROUNDING THE INJURY EVENT (actively involved, equipment failure, weather, surface, or other environmental conditions)</li> <li>• MEDICAL/HEALTH CARE PROVIDED TO THE INJURED PERSON</li> <li>• HEALTH OUTCOME OF THE EVENT (e.g., complete recovery, persistent disability involving limitation of activities)</li> </ul> <p>* Necessary to facilitate International Classification of Diseases (ICD) External Cause Coding (E-coding).</p>
---

Adapted from Ing, 1985; Committee on Trauma Research, Commission on Life Sciences, Natural Research Council and the National Institute of Medicine, 1985.

and overall health outcome. Inclusion of appropriately coded severity levels is particularly important in determining the overall magnitude.<sup>24,25</sup>

A major barrier to progress in the prevention of agricultural injuries has not only been a lack of knowledge about the magnitude of the problem but also a lack of knowledge about specific causes or risk factors due to the lack of analytical studies.

Identification of the agent, source and mechanism of the injury event, together with the circumstances surrounding the event, is crucial to External Cause Coding, or E-coding, using the International Classification of Diseases (ICD) codes and modifications specific to agricultural injuries.<sup>15,26</sup> The use of E-codes provides the critical link between the source and the nature of an injury, which enables targeting for more comprehensive analytic studies to identify specific risk factors and, subsequently, to develop relevant prevention and control programs; it also facilitates comparisons across data sets. The fact that intervention at the source of the injury event has been the most successful in the prevention and control of injuries highlights this element as integral.<sup>26</sup>

The items that have been identified provide only the very basic elements of a surveillance system. More comprehensive systems can be implemented with the recognition that as more items are included, the system becomes more expensive and it is more difficult to ensure consistency and quality of the data.<sup>19</sup>

## **SURVEILLANCE OF AGRICULTURALLY RELATED INJURIES**

### **Advantages and Limitations of Surveillance Efforts**

A *variety* of efforts in the surveillance of agriculturally related injuries have been undertaken to ascertain the magnitude of the problem, with varying degrees of success. The data sources for these efforts are presented in Table II (at the end of this paper), with elaboration on the advantages and limitations of each of these sources. For example, death certificates, which are utilized in agricultural fatality surveillance, are easily accessible. Yet there are many limitations, including the persistent lack of attention by those who complete these certificates to indicating that the event occurred at work. As a single source for surveillance, fatalities account for an extremely small proportion of the total problem.<sup>15</sup>

The Occupational Safety and Health Administration (OSHA) is extremely limited as a data source, given that about 95 percent of farms are not covered by this system; Federal appropriations do not enable enforcement of OSHA regulations among farms employing ten people or less. For a variety of reasons, there has also been underreporting of both morbidity and mortality data through the BLS.<sup>1</sup> Workers' Compensation data also are limited by virtue of a small proportion of farmers covered by this system.

Another very large national system, the Fatal Accident Reporting System (FARS), which is operated by the National Highway Traffic Safety Administration (NHTSA), enables identification of non-truck farm vehicle fatalities that occur on roadways.<sup>27</sup> However, it is not possible to identify the

specific type of vehicles involved through this system.

Newspaper clipping services have been used by several investigators<sup>4,12</sup> in various efforts and, while this source has serious limitations, it can facilitate recognition of emerging as well as persistent injury problems. To a limited degree, it can also detect fatal events that are not readily accessed through death certificate data.

While hospital records may enable identification of specific diagnoses and treatments, there are also many limitations in using these records for surveillance. These include the problem of confidentiality, as well as inadequate information on the circumstances surrounding the event and the long-term consequences, together with a bias toward the more severe injuries.<sup>19</sup> Of particular importance is the fact that only a small proportion of injuries related to farm operations result in hospitalizations and, with extremely rare exceptions, the hospital record sources are not population-based<sup>15</sup>.

The records from emergency departments, outpatient facilities, and from primary care practitioners have even greater limitations, including accessibility, unless they are linked into a major data base. Operation of such data bases is extremely difficult and, consequently, very rare. The denominator is a major problem for these data sources, as well. While there are a few success stories, linking multiple data sources is extremely complex and not recommended.<sup>19</sup>

Data from a combination of some of the above sources have also been used with varying success.<sup>19, 28-30</sup> In Minnesota, a feasibility effort in establishing injury surveillance was initiated to link multiple

existing data sets, ranging from hospital-based data to agency-based data, including highway crash events.<sup>19</sup> Many limitations were identified. These included:

1. Issues of confidentiality, which prevented access to personal identifiers in some cases, preventing detection of duplication of cases.
2. Quality and quantity of data elements, affected by varying injury definitions, data elements included, methodologies and a combination of active and passive reporting.
3. The inability to calculate rates other than for mortality, which accounted for only 0.3 percent of the total injury problem.

Finally, there is the potential for ongoing surveillance using in-person and telephone-based interviews or mailed questionnaires, each with advantages and limitations. In general, the quality of data do not vary greatly between in-person and telephone interviews, given the same interview content.<sup>31</sup> However, the in-person interview is much more expensive. While mailed questionnaires can provide ease of contact, the quantity and quality of information and the potential for lower response rates can be a problem.

## **POPULATION-BASED SURVEILLANCE OF AGRICULTURAL INJURIES IN THE UPPER MIDWEST**

Olmsted Agricultural Trauma Study (OATS): Given the limitations that have been identified and that there has been no comprehensive data system to identify the true magnitude of the injury problem in the agricultural community or the variables that might be associated with this problem,

a major project was undertaken in Minnesota in 1986 by a multidisciplinary team of investigators. The purpose of this population-based effort, known as the OATS,<sup>15</sup> was to determine the magnitude of the injury problem, using a methodology that could serve as the basis for long-term surveillance efforts at the state, regional, and national levels.

OATS, which served as the basis for the current regional five-state effort, was implemented in Olmsted County, Minnesota due to the ability to validate telephone interview-based injury data using the Mayo Clinic's comprehensive Rochester Epidemiology Project.<sup>15,32</sup> This internationally recognized unique data base contains health care records for virtually all residents in the county.

### Definition of Terms

Two basic issues our research team dealt with, initially, were the elusive definition of a farm and the definition of an injury. The definition of a farm was based on the USDA's Master Sampling Frame; their definition is "an operation with annual sales of \$1,000 or more of agricultural products."

An injury event was defined as one, which restricted normal activities for at least four hours, involved a loss of consciousness, loss of awareness, or amnesia for any length of time, or required professional health care, or any combination of these three.

This included both farming and non-farming activity-related injuries classified either as intentional or unintentional. The injury definition was based on experience in previous research endeavors and is compatible with definitions used by the NCHS.<sup>15</sup>

### Data Sources

The sources of data included both telephone interviews and medical record review. Demographic and exposure data were collected from both male and female heads of household by trained telephone interviewers, using specially designed, pre-tested data collection instruments. The female head of household was the preferred respondent for demographic information on the family and whether or not any family members, workers, or visitors had been injured during the designated one-year time frame.

The male head of household was the preferred respondent for the farming operation exposure information. Injured persons were interviewed, directly, to obtain information concerning the injury events, with the exception of children under the age of 18, in which case the female head of household was asked to respond pertaining to their injuries.

The injury data collected included type, severity, source, mechanism, and contributing factors. Injury events reported through the telephone interviews were validated by review of the health care records in the Mayo Clinic medical records linkage system.<sup>15,32</sup>

### Selected Results and Discussion

Among the total eligible farms in the county (n=892), there was an overall participation rate of 82 percent, with 75 percent completing all components of the interview. The distribution of the farm household members by age and gender revealed nearly identical mean ages for males and females (34.7 and 34.6, respectively).

Examples of the exposure data that were collected included the types of farming

operations, which enabled calculation of specific injury rates. For example, the rates for farming and non-farming activity-related injury events per 100 farms per year were 16.0 and 21.6, respectively. Similarly, the injury event rates per 100 farm residents for farming and non-farming related activities were 4.6 and 6.2, respectively.

The fact that non-farming injury rates exceeded the farming-related rates is of particular interest. Consideration of the total injury picture is essential to address the overall impact of injuries on the farming operation and potential intervention strategies that might ultimately be implemented.

The age- and gender-specific rates provided further information. It is important to note that the conclusions drawn from any such data can vary with the use of different denominators. For non-farmwork related injuries, among males (whose overall rate was 6.3 injury events/100 persons), those less than 14 years of age (8.8/100) and 14-24 years of age (11.9/100) had the highest rates; among females (whose overall rate was 5.1 injury events/100 persons), the highest rates occurred in those age groups less than 14 years (5.2/100), 14-24 years (7.0/100), and 25-44 years (5.6/100).

In contrast, when considering the farmwork-related injury events per 100 farm residents, the older age groups emerged as being primarily involved. Among males (whose overall rate was 6.5/100), the highest rates were shown in the 25-44 (12.3/100) and 45-64 (7.6/100) year age groups; among females (whose overall rate was 1.5/100), the highest rate was in the 45-64 year age group (2.6/100).

In order to target groups for potential intervention efforts, it is also critical to consider the total exposure time with regard to farming-related injuries. Given this information, a very different pattern was demonstrated, whereby the children and younger adults were shown to be at greatest risk.

Among the males, the highest injury rate per 100,000 hours worked per year was in the age group involving those less than 14 years of age (8.3); the next highest rate was among those 25-44 years of age (4.7). Among females, the highest rate was found in the 15-24 year age group (6.0), followed by the 45-64 year age group (2.8).

To identify potential risk factors, the sources of the injury events were documented for both the farming and non-farming related injuries. The primary sources of the farming operation-related injuries were machinery (23 percent), animals (18 percent), general farm sources (16 percent), and tractors (12 percent), while sports and recreational sources (38 percent), vehicles other than farm machinery (12 percent), and home activity sources (12 percent) were primarily involved in the non-farming related injury events. These data, together with other comprehensive data that have been collected, provide a basis for identifying potential risk factors that might be investigated through specifically designed analytic efforts and serve as a springboard for development of prevention and control strategies.

Descriptive information pertinent to the injury can also be generated from this type of effort. The three major types of farmwork-related injuries were sprains and strains (27 percent), contusions (17 percent), and fractures (14 percent). Similar types of non-farmwork related injuries

were also identified: sprains and strains (28 percent), lacerations (18 percent), and fractures (17 percent).

Of particular relevance are the proportions of injury cases that required hospitalization—8 percent of the farmwork-related injuries and 10 percent of the non-farmwork related injuries. As indicated previously, this finding has implications pertinent to the limitations imposed when only hospital-based surveillance is used.

Consideration of restricted activity must also be taken into account when assessing the total impact on the farming operation. The fact that a large proportion of injured individuals were actually restricted for a week or more as a result of either a farming-related injury (21 percent) or a non-farming related injury (24 percent) is very important when looking at the overall impact. Moreover, a large proportion, when interviewed, still had some type of persistent problem, including some permanent disabilities (farming and non-farming related injuries, 27 percent and 25 percent, respectively).

These findings constitute only a very small proportion of the total analyses, but give an indication of the possibility of identifying the extent of the problem in a comprehensive manner. OATS data were also used as a basis for conducting sub-studies, including analytic efforts, to further address the agricultural injury problem. These efforts included a case control study to identify human and environmental risk factors for farming-related injuries.<sup>33</sup>

In addition, a pilot on-site investigation of machinery-related injury events was conducted by a team of engineers and epidemiologists to identify factors for consideration in subsequent engineering studies.<sup>34</sup> A sub-study of inter- and intra-rater

reliability in the assignment of ICD E-codes provided a further contribution to the use of this system for classifying farming and non-farming-related injuries.<sup>36</sup>

### Regional Rural Injury Study

The research design that was evaluated in OATS served as a basis for the current Regional Rural Injury Study (RRIS),<sup>35</sup> involving Minnesota, Wisconsin, North Dakota, South Dakota, and Nebraska. This new project has been designed to serve as a national model for conducting surveillance in agricultural populations. In addition to its value as a comprehensive surveillance system, the five-state RRIS also provides a basis for specific analytic studies, as well as the potential for ongoing surveillance that can facilitate evaluation of specific intervention efforts.

In the RRIS, data were collected from 4,201 households, identified through a stratified random sampling process, using the USDA Master Sampling Frame. These data were collected in two phases to cover a 12 month period (January 01-June 30, and July 01–December 31, 1990) To accomplish this, the data collection instruments designed for OATS were converted to a computer-assisted telephone interview (CATI) system, which facilitates the interviewing and the data management and analyses.

The interviewing has been completed and initial analyses have been implemented. The final analyses will include age- and gender-specific rates for farmwork and non-farmwork related injuries in the region and for each state. Rates adjusted according to hours worked on the farm will also be calculated.

Analyses, including types of injuries, body parts affected, and relevant sources and

mechanisms, are integral to this effort. Other more comprehensive and analytical analyses will be conducted on a variety of substudies, including case-control studies focused on animal-human injuries and tractor rollovers.

This effort will also result in a workshop in July 1992, at which time the regional participants as well as other experts and the investigators involved will meet to develop state action plans for the prevention of agricultural injuries. Data generated from the RRIS will be used as the basis for development of prevention and control strategies in the five-state region that may also be applied at the national level.

**SUMMARY**

This presentation has provided a background on the surveillance of injuries and specifically with regard to agricultural injuries. The need for ongoing, systematic data collection, not only to identify the magnitude of the problem but also to provide a basis for analytic studies, is clear.

Identification of specific risk factors will facilitate more appropriate planning and implementation of strategies. Finally, application of surveillance to monitor the effects of prevention and control programs that have been implemented will enable evaluation of their efficacy and identify necessary modifications to ensure optimal reduction of agricultural injuries.□

**TABLE II. Data Sources Utilized in Agricultural Injury Surveillance: Advantages and Limitations**

DATA SOURCES	AGENCIES/ AUTHORS	ADVANTAGES	LIMITATIONS
Occupational Safety and Health Administration	<ul style="list-style-type: none"> <li>• Bureau of Labor Statistics</li> </ul>		<ul style="list-style-type: none"> <li>• Approximately 95% of all farms are not covered under OSHA, i.e., those with 10 or less employees.</li> </ul>
Workers' Compensation			<ul style="list-style-type: none"> <li>• Limited proportion of farms included.</li> </ul>
Fatal Accident Reporting System (FARS)	<ul style="list-style-type: none"> <li>• National Highway Traffic Safety Administration</li> <li>• Gerberich, Robertson, Gibson et al, 1991<sup>27</sup></li> </ul>	<ul style="list-style-type: none"> <li>• Detects roadway farm vehicle-related fatalities.</li> </ul>	<ul style="list-style-type: none"> <li>• Off-roadway vehicle events not included.</li> <li>• No identification of specific type of vehicle.</li> </ul>

Surveillance – Agriculture-Related Diseases, Injuries and Hazards

DATA SOURCES	AGENCIES/ AUTHORS	ADVANTAGES	LIMITATIONS
<p><b>Death Certificates</b></p>	<ul style="list-style-type: none"> <li>• Welsch et al., 1989<sup>12</sup></li> <li>• Gunderson, et al., 1990<sup>5</sup></li>   <li>• National Institute for Occupational Safety and Health—National Traumatic Occupational Fatalities (NTOF), Myers, 1990<sup>36</sup></li> </ul>	<ul style="list-style-type: none"> <li>• Easily accessible.</li> <li>• Includes intentional and unintentional events.</li> </ul>	<ul style="list-style-type: none"> <li>• Fatality rate less than 1/100 or 1% assuming no more than one farmer per farm.</li> <li>• Extremely difficult to assess accurate count—occupation, frequently misclassified.</li> <li>• Information inadequate on death certificate relevant to primary/secondary causes of death.</li> <li>• "at work" box infrequently checked.</li> <li>• Source/mechanism of injury information limited and/or missing.</li>   <li>• Excludes individuals under 16 years of age.</li> <li>• All limitations, identified above, apply.</li> </ul>
<p><b>Newspaper Clipping Services—National/State Newspaper Clipping Services</b></p>	<ul style="list-style-type: none"> <li>• Welsch et al., 1989<sup>12</sup></li> <li>• Gunderson et al., 1990<sup>5</sup></li> </ul>	<ul style="list-style-type: none"> <li>• May facilitate recognition of emerging as well as persistent injury problems.</li> <li>• Authors included death certificates for verification.</li> <li>• Detects fatal events not readily accessed through death certificate data</li> </ul>	<ul style="list-style-type: none"> <li>• Identifies agricultural-related fatalities and catastrophic injuries.</li> <li>• 50% of fatalities may be missed as well as a large proportion of non-fatal injuries.</li> <li>• Reporting is biased according to gender/other variables.</li> </ul>



DATA SOURCES	AGENCIES/ AUTHORS	ADVANTAGES	LIMITATIONS
<b>Hospital Records</b>	<ul style="list-style-type: none"> <li>• Gerberich et al., 1989, 1990, 1991 (Used to validate telephone interview)<sup>15, 18</sup></li> </ul>	<ul style="list-style-type: none"> <li>• Identification of specific diagnosis and treatment.</li> </ul>	<ul style="list-style-type: none"> <li>• Confidentiality makes records difficult to access.</li> <li>• Bias—only most severe injury cases included.</li> <li>• Inadequate data on circumstances of event.</li> <li>• Non population-based.</li> <li>• Oriented toward diagnosis, treatment and, possibly, rehabilitation.</li> <li>• Long-term consequences not identifiable.</li> <li>• very few persons are hospitalized; only 8% of all farming-related injury cases.</li> <li>• Miss those who die before reaching hospital or are transferred elsewhere.</li> <li>• Biased due to type of insurance, if any.</li> </ul>
<b>Hospital Records—</b> All hospitals (n=25) in 15 county sample	<ul style="list-style-type: none"> <li>• Fuortes et al., 1990<sup>37</sup></li> </ul>	<ul style="list-style-type: none"> <li>• Active system employed.</li> </ul>	<ul style="list-style-type: none"> <li>• Selection of sample not identified.</li> <li>• Occupation-related injuries only.</li> <li>• Procedures regarding confidentiality not identified—cases were followed up by investigators with no apparent consent procedures.</li> <li>• No indication of participation rate of either hospitals or patients.</li> </ul>
<b>Emergency Room Cases</b> U.S. Consumer Product Safety Commission (CPSC), National Electronic Injury Surveillance System (NEISS)	<ul style="list-style-type: none"> <li>• McKnight, 1984<sup>38</sup></li> </ul>	<ul style="list-style-type: none"> <li>• Provides national estimates.</li> </ul>	<ul style="list-style-type: none"> <li>• Product-related injuries only .</li> <li>• Sample of emergency rooms is not representative of those in the United States.</li> <li>• Identification of manufacturer not released.</li> </ul>
<b>Emergency Room Cases</b> Part of project to develop systems for continuous and periodic injury surveillance	<ul style="list-style-type: none"> <li>• Jansson, 1987<sup>39</sup></li> <li>• Jansson and Svanstrom, 1989<sup>40</sup></li> </ul>	<ul style="list-style-type: none"> <li>• May facilitate recognition of emerging as well as persistent problems.</li> </ul>	<ul style="list-style-type: none"> <li>• Descriptive data on injured cases only</li> <li>• No exposure data collected.</li> </ul>

Surveillance - Agriculture-Related Diseases, Injuries and Hazards

DATA SOURCES	AGENCIES/ AUTHORS	ADVANTAGES	LIMITATIONS
<b>Emergency Room and Urgent Care Cases</b>	<ul style="list-style-type: none"> <li>• Stueland et al., 1991<sup>41</sup></li> </ul>	<ul style="list-style-type: none"> <li>• May facilitate recognition of emerging as well as persistent injury problems</li> </ul>	<ul style="list-style-type: none"> <li>• Descriptive data on injured cases only</li> <li>• No exposure data collected.</li> </ul>
<b>Outpatient Facilities</b>		<ul style="list-style-type: none"> <li>• Potential to detect greater range of severity.</li> </ul>	<ul style="list-style-type: none"> <li>• Diagnosis may not be ascertained initially.</li> <li>• No denominator information.</li> </ul>
<b>Primary Care Practitioners</b>		<ul style="list-style-type: none"> <li>• Potential to detect greater range of severity.</li> </ul>	<ul style="list-style-type: none"> <li>• No denominator information (age/gender composition is overestimated, Eylonbosch and Noah, 1988).<sup>2</sup></li> <li>• Typically a passive system.</li> <li>• Quality of classification underestimated.</li> </ul>
<b>In-Person Interviews</b>	<ul style="list-style-type: none"> <li>• National Safety Council</li> </ul>	<ul style="list-style-type: none"> <li>• Contact reportedly every three months—minimized recall bias.</li> </ul>	<ul style="list-style-type: none"> <li>• Sample selection unclear</li> <li>• Use of local volunteer interviewers.</li> </ul>
<b>Telephone-Based Interviews—Olmsted Agricultural Trauma Study (OATS); Provided basis for Regional Rural Injury Study and Subsequent Surveillance (validation with medical records)</b>	<ul style="list-style-type: none"> <li>• Gerberich et al., 1991<sup>15</sup></li> </ul>	<ul style="list-style-type: none"> <li>• Population-based, enabling.</li> <li>• Utilized U.S. Department of Agriculture's (USDA) Master Sampling Frame to identify all farms in Olmsted County.</li> <li>• Ensured qualification as an operating farm during period of study.</li> <li>• Collected demographic and farm exposure injury data on all participating farms in the county.</li> <li>• Overall participation rate = 82%, full interview participation = 75%.</li> <li>• Provided a basis for the following multiple sub-studies, including:               <ol style="list-style-type: none"> <li>1) Case-Control Study of Farmwork-Related Injuries.</li> <li>2) E-Coding Study.</li> <li>3) Follow-up site visit, machinery-related studies.</li> </ol> </li> </ul>	<ul style="list-style-type: none"> <li>• Confidentiality of records necessitates access through USDA office resources only.</li> </ul>

DATA SOURCES	AGENCIES/ AUTHORS	ADVANTAGES	LIMITATIONS
<p><b>Telephone-Based Interviews-Regional Rural Injury Study (RRIS) Provides a basis for national surveillance</b></p>	<ul style="list-style-type: none"> <li>• Gerberich et al., 1989-1992<sup>35</sup></li> </ul>	<ul style="list-style-type: none"> <li>• Population-based, enabling identification of specific rates.</li> <li>• Utilized USDA Master Sampling Frame to select stratified random sample of farms in five states.</li> <li>• Ensured qualification as an operating farm during period of study.</li> <li>• Collected demographic and farm exposure injury data on participating farms in five states.</li> <li>• Participation Rate-78%.</li> <li>• Data are entered directed into the Computer Assisted Telephone Interview (CATI) system, enabling efficient monitoring, data management, and analysis.</li> <li>• Provides a basis for multiple studies, including the following:               <ol style="list-style-type: none"> <li>1) Case-control study of tractor rollovers.</li> <li>2) Case-control study of animal related injuries.</li> </ol> </li> </ul>	<ul style="list-style-type: none"> <li>• Confidentiality of records necessitates access through USDA office resources only.</li> </ul>
<p><b>Mailed Questionnaires</b> 545 dairy farms in Otsego County</p>	<ul style="list-style-type: none"> <li>• Stallones, 1986<sup>42</sup></li> </ul>	<ul style="list-style-type: none"> <li>• Ease of contact.</li> </ul>	<ul style="list-style-type: none"> <li>• Response rate 45%</li> <li>• Self-selected sample.</li> </ul>
<p><b>Mailed Questionnaires</b></p>	<ul style="list-style-type: none"> <li>• Fuortes et al., 1990<sup>37</sup></li> </ul>	<ul style="list-style-type: none"> <li>• Ease of contact.</li> </ul>	<ul style="list-style-type: none"> <li>• Response rate 41%.</li> <li>• Biased populations of hospitalized individuals.</li> <li>• Identification of occupation relatedness and event characteristics in medical records are notoriously poor.</li> <li>• No control for days of hospitalization.</li> <li>• High potential for misclassification.</li> </ul>

## REFERENCES

1. Pollack, ES, Keimig, DG: *Counting Injuries and Illnesses in the Workplace: Proposals for a Better System*. Washington, D.C.: National Academy Press, 1987.
2. Eylenbosch, WJ and Noah, ND Editors: *Surveillance in Health and Disease*, Commission of the European Communities, New York: Oxford University Press, 1988.
3. *Webster's New Twentieth Century Dictionary*, Second Edition, New York: Simon and Schuster, 1979.
4. Committee on Trauma Research, Commission on Life Sciences, National Research Council, and the Institute of Medicine: *Injury In America: A Continuing Public Health Problem*, Washington, D.C.: National Academy Press, 1985.
5. Gunderson, PD, Gerberich, SG, Gibson, RW, Adlis, S, Carr, WP, Erdman, AG, Elkington, JM, French, LR, Melton, LJ III, and True, JA: Injury surveillance in agriculture, *American Journal of Industrial Medicine* 18:169-178, 1990.
6. Panel on Occupational Injury Prevention, Draft Position Paper on Occupational Injury, June 3, 1991. - Presented at the Third National Injury Control Conference, Denver, Colorado, April 1991.
7. National Safety Council: *Accident Facts*. Chicago: National Safety Council, 1990.
8. Bureau of Labor Statistics, United States Department of Labor: Occupational injuries and illnesses in the United States by industry, 1989, Washington: Bureau of Labor Statistics 1990.
9. Bell, CA, Stout, NA, Bender, TR, Conroy, CS, Crouse, WE, Meyers, JR: Fatal occupational injuries in the United States, 1980 through 1985. *Journal of American Medical Association* 263 (22): 3047-3054, 1990.
10. Kraus, JF: Fatal and nonfatal injuries in occupational settings: A review, *Annual Reviews of Public Health* 6: 403-418, 1985.
11. Rivara, FP: Fatal and nonfatal farm injuries to children and adolescents in the United States, *Pediatrics*. 76(4): 567-573, 1985.
12. Welsch, A, Gerberich, SG, Gunderson, PD: A unique approach to surveillance of severe and catastrophic injuries: An agricultural case study, *Proceedings: Public Health Conference on Records and Statistics*, National Center for Health Statistics, USDHHS, PHS, CDC, July 1989; pp. 474-480.
13. Stallones, L: Surveillance of fatal and non-fatal farm injuries in Kentucky. *American Journal of Industrial Medicine* 18: 223-234, 1989.
14. Gunderson, PD, Gerberich, SG, Gibson, RW, Melton, LJ III, French, LR, Renier, CM, Erdman, AG, True, JA, Carr, WP, and Elkington, JM: An analysis of variables potentially associated with trauma in the agricultural community, *Proceedings: First World Conference on Accident and Injury Prevention* Stockholm, Sweden, September 1989.
15. Gerberich, SG, Gibson, RW, Gunderson, PD, French, LR, Melton, LJ, III, Erdman, AG, Smith, P, True, JA, Carr, WP, Elkington, JM, Renier, CM and Andreassen, LR: *The Olmsted Agricultural Trauma Study (OATS): A Population-Based Effort*, Report to the Centers for Disease Control, 1991.
16. Layde, PM: Beyond surveillance: Methodologic considerations in analytic studies of agricultural injuries, *American Journal of Industrial Medicine* 18: 193-200, 1990.

17. Gerberich, SG, Gibson, RW, and Carr, WP: *Minnesota Injury Prevention and Control Program I*. (Comprehensive review of the surveillance literature and documentation of all data sets pertinent to injury in Minnesota; initial evaluation of suitability for surveillance) Minneapolis: Report to the Minnesota Department of Health, 1987.
18. Gerberich, SG, Gibson, RW, Gunderson, PD, Melton, W III, French, LR, Renier, CM, Erdman, AG, True, JA, Carr, WP, and Elkington, JM: Validity of trauma reporting in the agricultural community, *Journal of Occupational Accidents* 12: 200, 1990.
19. Gerberich, SG, Gibson, RW, San Juan, L, and Carr, WP: *Minnesota Injury Prevention and Control Program II*. (Comprehensive feasibility analysis of Minnesota injury data sets for use in surveillance of injuries), Minneapolis: Report to the Minnesota Department of Health, 1990.
20. Vogt, RT, Larue, D, Klaucke, DN, Jillson, DA: Comparison of an active and passive surveillance system of primary care providers for hepatitis, measles, rubella, and salmonellosis in Vermont, *American Journal of Public Health*, 73: 795-797, 1983.
21. Thacker, SB, Redmond, S, Rothenberg, RB, Spitz, SB, Choi, K, and White, MC: A controlled trial of disease surveillance strategies, *American Journal of Preventive Medicine* 2(6): 345-350, 1986.
22. Thacker, SB and Berkelman, RL: Public health surveillance in the United States, *Epidemiologic Reviews* 10: 164-190, 1988.
23. Ing, RT: Surveillance in injury prevention, *Public Health Reports* 100(6): 586-588, 1985.
24. Robertson, LS: *Injuries: Causes, Control, Strategies, and Public Policy*, Lexington, Massachusetts: Lexington Books, Incorporated, 1984.
25. National Injury Prevention and Control Committee (NIPCC): Injury Prevention: Meeting the Challenge, *American Journal of Preventive Medicine*, Volume 5 (Number 3), New York: Oxford University Press, 1989.
26. French, LR, Carr, WP, Gerberich, SG, Gunderson, PD, Gibson, RW, Melton, LJ III, and Elkington, JM: Reliability of "E"-coding farm-related injuries using the International Classification of Diseases, Ninth Revision (ICD-9) and a modified version of ICD-9, *American Journal of Epidemiology* 130(4): 826, October 1989.
27. Gerberich, SG, Robertson, LS, Gibson, RW, and Renier, CM: An epidemiological study of roadway fatalities related to farm vehicles, In review, 1991.
28. Melius, JM, Sestito, JP, and Seligman, PJ: IX. Occupational disease surveillance with existing data sources, in Baker, EL, Editor: Surveillance in Occupational Safety and Health, *American Journal of Public Health* Supplement; 79:46-52, 1989.
29. Baker, EL, Editor: Surveillance in Occupational Safety and Health, *American Journal of Public Health* Supplement; 79:1-63, 1989.
30. Marine, WM, Garrett, C, Keefer, SM, Vancil, R, Hoffman, McKenzie, L: *Occupational Injury Deaths in Colorado 1982-1987*. Denver, Colorado: Colorado Department of Health, 1990.
31. Thornberry, OT: An experimental comparison of telephone and personal health interview surveys, Data Evaluation and Methods Research, Series 2, Number 106, United States Department of Health and

## Surveillance – Agriculture-Related Diseases, Injuries and Hazards

Human Services (USDHHS) Publication Number Public Health Service (PHS) 87-1380, Hyattsville, Maryland: USDHHS, PHS, National Center for Health Statistics, August 1987.

32. Gerberich, SG, Gibson, RW, Gunderson, PD, Melton, LJ III, French, LR, Renier, CM, Erdman, AG, True, JA, Carr, WP, and Elkington, JM: Validity of trauma reporting in the agricultural community, *Proceedings: Occupational Accident Prevention Conference, Stockholm, Sweden, September 1989.*
33. Elkington, JM: A Case-Control Study of Farmwork Related Injuries in Olmsted County, Minnesota, Doctoral Thesis, Minneapolis, Minnesota: University of Minnesota, December 1990.
34. Kolstad, OC, Erdman, AG, Elkington, JM, True, JA, Gerberich, SG, Gunderson, PD, Gibson, RW, Carr, WP, and Renier, CM: Hazard analysis of farm equipment, *Proceedings: American Society of Agricultural Engineers Annual Meeting Chicago: December 1990.*
35. Gerberich, SG, Gibson, RW, Gunderson, PD, French, LR, Martin, FB, True, JA, Shutske, J, Carr, WP, Renier, CM, and Stasch, BD: Regional Rural Injury Study, Funded Grant—Centers for Disease Control, 1989-1992.
36. Myers, JR: National surveillance of occupational fatalities in agriculture. *American Journal of Industrial Medicine* 18:163-168, 1990.
37. Fuortes, LJ, Merchant, JH, Van Lier, SF, Burmeister, LF and Muldoon, J: 1983 occupational injury hospital admissions in Iowa: A comparison of the agricultural and nonagricultural sectors, *American Journal of Industrial Medicine*, 18: 211-222, 1990.
38. McKnight, RH, Hetzel, GH: Annual trends in farm tractor and machinery deaths, 1975-1981, Paper number 84-5507. St. Joseph, Missouri: American Society of Agricultural Engineers, 1984.
39. Jansson, B: The yield of systems for continuous and periodic injury surveillance in emergency care with emphasis on farm-work-related accidents, *Scandinavian Journal of Social Medicine* 15: 247-252, 1987.
40. Jansson, B and Svanstrom, L: Evaluation of a system for injury surveillance in Swedish emergency care, *Scandinavian Journal of Social Medicine* 17: 7-11, 1989.
41. Stueland, D, Lee, B, and Layde, PM: Surveillance of agricultural injuries in Central Wisconsin: Epidemiologic Characteristics, *Journal of Rural Health* 7(1): 63-71, 1991.
42. Stallones, L: Reported frequency of dairy farm associated health hazards, Otsego County, New York, 1982-1983, *American Journal of Preventive Medicine*, 2: 198-191, 1986.

---

Reprints: Susan Goodwin Gerberich, Ph.D., Division of Environmental and Occupational Health, School of Public Health, University of Minnesota, Box 807-UMHC-420 Delaware Street S.E., Minneapolis, Minnesota 55455, Telephone: 612-625-5934, Fax: 612-626-0650.

## MUSCULOSKELETAL DISORDERS AND HAZARDS

By John J. Coumbis, M.D.  
Oak Ridge Fellow  
Agency for Toxic Substance and Disease Registry

---

There have been numerous and, in my opinion, quite excellent presentations on the basic principles of surveillance, and I will try in my talk not to repeat them too much as I think they were made quite clear.

What might be of particular interest to you is how you get started. In the previous presentations some very elaborate studies were spoken about. You should not feel that you necessarily need to have the world of resources or help from the most technical government agency. The study that I am going to present is one that I did during my training in occupational medicine, my master's thesis. It concerns health effects in greenhouses.

How many of you have ever been in a greenhouse? May I have a show of hands? That is good. Does anybody own a home greenhouse? Well, there will be more of you next time we have a conference.

The first record of a greenhouse dates back to ancient Greece half a century before Christ, the Gardens of Adonis. But there was a physician of a famous Roman named Tiberius Caesar who also made quite a milestone when he prescribed a cucumber a day for Caesar. Caesar in turn told his gardener, "You have to provide me with a cucumber a day." So, this fellow did, indeed, model a greenhouse and was able to produce a cucumber a day, from what I have read. History looks favorably upon the gardener who, is nameless, and

the physician is fortunate in that his name has been lost.

But the modern greenhouse is founded on technologies that are drawn from agricultural/engineering sciences. It is a very specialized environment that produces homeostatic conditions that are favorable for the growth of plants.

Well, you might say, Why study greenhouses? That is usually the question I am asked when I talk about my master's thesis. This audience already has a handle on that to some degree.

In the greenhouse you find an unusual ensemble of physical and chemical hazards, each of which have been identified elsewhere as a human health hazard. The second reason would be to safeguard the health of thousands of greenhouse workers and address the public health concerns surrounding environmental hazards for those who live around greenhouses.

I am a city boy: grew up in Flushing, New York. Greenhouses can be found in New York City and can be found in other communities, and very often there are questions that come up about, well, am I at risk of being contaminated via the greenhouse chemicals? What of the washoff? That is another subject, but I just wanted to make mention of it, because I think it is a very important issue. It is, also, one that concerns the Agency for Toxic Substances and Disease Registry.

I should mention that what I intend to do is show you that you can do a very informative study without a lot of money and resources, but you should take advantage of those that are free, and there is a network of clinics called the American Occupational Environmental Clinics. I believe that the Iowa City Medical School is a member of that. In fact, they have the only other program, besides the University of Kentucky, where the word "occupational" appears in the name of the Department of Preventive Medicine.

Let us go on and talk about the greenhouse industry. The 1988 figures, which are released in a recent USDA publication, would suggest that it is a greater than \$7 billion industry and is one that is growing. I believe that there is a great market for greenhouse vegetables in the future as different chemicals become more restricted, because so many fewer chemicals are needed to produce food in an enclosed environment.

## DEMOGRAPHICS

The number of farms has jumped considerably from 1982 to 1987, as well as the actual size of the greenhouse capacity. Most important of all, though, this study is about people—people who love flowers, people who grow their own food. We want to make sure that they are healthy.

The objectives of this study were to determine the demographics of greenhouse workers, to ascertain the nature of greenhouse work, to identify the materials as well as an understanding of how they were used, and to survey the workers themselves for self-reported health effects. I am really grateful to Dr. Dosman, who pointed out that surveys are a useful tool in surveillance studies.

I would like to point out that there were eight greenhouses that participated in this study. Only one declined. There were 62 workers out of 92 potential workers that were there. So, it is a very high participation rate.

The workers in their 20's and their 30's, together, made up 61 percent of the work force. This is a very young work force. The females outnumbered the males three to one. Females were very well represented, being highest at either extreme of age.

Now, what is an important thing to know about this? Is it a good job? Is it a bad job? That is generally a function of how long people stay.

When you add up those who worked less than a year and those who worked one year and two years, that is already 55 percent of the work force. I found that 64 percent of the workers with less than two years of exposure were less than 30 years of age. Those with more than five years of experience, they were not represented at all in the population less than 30.

What I am trying to bring across is the point that a lot of information can be derived just by defining the characteristics of the work force. Here you have an industry with primarily young people, primarily female, and with a very high turnover. That, in and of itself, suggests that there is probably something wrong there.

Well, let us go into the greenhouse, and we will talk about what is to be found there. I am very fortunate that I did not do the study in the summertime because the temperatures would have been outrageously high. The other problem is that greenhouse work is very seasonal. There is not much going on in terms of growth of new plants.



In the greenhouse you have lots of water. It is a very hot and humid environment. Water not only comes from hoses, but through water conduits. You also have the same sort of conduits that go into ceramic cylindrical structures that are placed right inside the bed so that erosion does not occur.

A feature that is only found in the most modern greenhouses is a water modification area, where different nutrients or a diverse ensemble of chemicals can be added. That water mixture, in turn, is distributed widely throughout the greenhouse.

A primary mechanism of cooling the greenhouse is by circulating tremendous volumes of air. In the more modern greenhouse, the top of the glass houses will open according to a temperature sensor. If the wind becomes too great, it shuts down so that the entire door will not be torn off.

Many greenhouses have a heating device that I presume works with propane or some sort of natural gas. These have the potential to produce large amounts of carbon monoxide, but I am not aware of any reports of carbon monoxide poisoning, but certainly where you have such an instrument there is that potential.

Another means of heating a greenhouse is through pipes that go underneath the planting beds. They transfer hot water. This is a better system because it distributes the heat to the roots of the plant; they grow much faster. The heat sources are generally provided by coal stoves, which is the least expensive form of fuel.

A crude air conditioner has strips of cardboard-like material. They are sprayed

with water, and air is blown in, which produces cooling by evaporation.

You might ask, Why am I telling you all these things? Well, the reason is that I want to impress upon you that you have got to know these things if you are going to be able to communicate with the greenhouse operators and workers. This is the basic premise that transcends occupational/environmental medicine.

Asbestos is no longer used as a construction material in greenhouses, but it is still a part of old greenhouse (planting bed) construction. In fact, if they wanted to dispose of it, it would be quite an expensive process. The asbestos does not weather, but the edges of it do get destroyed through use and, of course, release dust.

Well, not only plants grow in greenhouses, algae does too. Also, around the greenhouse you see a tremendous growth of other plants, which were not intended.

A surveillance technique used by the greenhouse operator is a specialized fly paper. Based on what will be stuck on the paper, the farmer will know when to use chemicals to control pests. The advantage is that, because it is ongoing, you can make early intervention and you do not have to do prophylactic or periodic spraying with different chemicals.

Steam is used to sterilize soil, and chemicals—particularly dibromochloropropane, which is an extremely hazardous chemical—have been used. Of course, if no one follows this population, it would be very hard to find out if there were any side effects from that chemical.

Other kinds of material are used. One is called Perlmix. It is a mixture of peat, perlite, and vermiculite. Each of those substances carries its own health problems.

Workers are exposed to tremendous volumes of this material on a regular basis. One worker took the process outdoors as a means of mitigating exposures.

## ERGONOMICS

Let us get into some of the hard-core problems of ergonomics. A worker will prepare either flat trays or different kinds of potting material or fill the pots with the potting material.

The workers take small immature plants, called plugs, and place them in larger trays. It is a series of transplantations and is very labor-intensive. It is quite difficult to pick them up. It is a pinching maneuver.

I found a loose electrical line on a vaporizer. I am sure that it would be recognized as a severe electrical hazard, even by non-electricians. I also saw an electrical wire just strung across the top of the vaporizer and an unenclosed electrical box.

... you find some of the reports of back pain in roughly a third of the work force, pain in multiple joints in 19 percent, pain of the upper extremities in 11 percent of the workers, lower extremities in 8 percent, and neck pain in 2 percent.

Pathways were not level, which was from the constant accumulation of the potting materials. It is not just the potting materials, but it is all the other chemicals that

have been used. Residues will also persist there.

Ideally, if the grower had enough funds, he would make the whole floor cement. That way it is much easier to keep clean.

Pipes that I saw, which were in the way of workers, can be corrected with modern tables that are commercially available. They place the heating pipes up just underneath the level of the table. The height of the table is also critical.

Imagine a woman who has just started her shift. She is going to manipulate every plant on the table all the way down its length, most likely without even taking a break. That is a lot of stuff to move. The table is wide, and later, she will be stretching out further over it. That, of course, is not a very natural position to assume, and it predisposes workers to back problems and shoulder and neck pains.

A different greenhouse that I saw had three or four different levels, if you count the hanging baskets above. Hanging baskets are wonderful because they increase the space without having to add extra tables, but you are working over your head when you have to manipulate those plants. The metal line that held them up was barbed so that the plants would remain in place and not slide.

I saw a cutting tool that a worker was operating. It did not have a particularly good ergonomic design because he had to extend his wrist. Fortunately it did not require a whole lot of pressure to cut the plants.

Pinching of flowers (by fingers) is done for two reasons. One is to make older plants of equal height so that they will fit in a box or wherever they are putting them.

It is also done in a process called disbudding, where you will have different buds and either you will remove the center one or you will remove the peripheral ones. Imagine doing a whole row of plants. That is a tremendous volume.

### **FREQUENCY OF MUSCULOSKELETAL SYMPTOMS**

Now, those that reported any form of musculoskeletal pain were 31 workers, which was half the work force. Approximately half of those were taking analgesics. I did not differentiate between prescription and nonprescription. I found reports of back pain in roughly a third of the work force, pain in multiple joints in 19 percent, pain of the upper extremities in 11 percent of the workers, lower extremities in 8 percent, and neck pain in 2 percent.

I would like to hold off here because this is where the musculoskeletal portion ends. The other components were respiratory; related to skin changes; mouth, throat, and nose irritation; certainly all the respiratory findings are also quite striking. But considering the late hour I think we can end it right here.

The take-home point is that this is a study that was done. The costs were the transportation from one place to another and the film used and, perhaps, some xeroxing for the surveys. A lot of information can be derived about an industry in a local area without terrifically big resources.

Thank you very much. I hope you all enjoyed the session.□

## A GOVERNMENT PERSPECTIVE I

By Todd M. Frazier, Sc.M.

Chief, Surveillance Branch

Division of Surveillance, Hazard Evaluation and Field Studies  
National Institute for Occupational Safety and Health

It is presumptuous of me to talk about the government's perspective. My first disclaimer is that much of what you will hear here today is my interpretation of the government's perspective. I want to talk about three aspects of the government perspective: the challenge that we received, the response that we have given to date, and some ideas that we have gleaned from the conference during the past few days.

### THE CHALLENGE

First, I would like to talk about the challenge. The challenge came to us in 1988, as a result of attendance at the National Coalition for Agricultural Safety and Health (NCASH) meeting and the subsequent publication of *Agriculture at Risk*, the NCASH report. Specifically, the challenge appeared as a legislated initiative designed to promote surveillance, research, and interventions. The specific challenge was to the National Institute for Occupational Safety and Health (NIOSH) to conduct a National Occupational Hazard Survey for Agriculture and to survey agricultural workers exposed to certain risk factors.

The second challenge was from the appropriation language in two programs that comprise the surveillance component. I will talk about one; Dr. Freund will talk about another of the NIOSH agriculture initiatives.

The third challenge is something that we have been aware of for some time and periodically read about in such scientific journals as *American Demographics* or its parent publication, *The Wall Street Journal*. On the 24th of April, the *Journal* carried this article, front page, left-hand side, "Iowa Towns Shriveled as Young People Head for the Cities." They were talking about Alden, Iowa.

From my reading of the map, that is a little town probably about 50 or 60 miles or so north of Des Moines. It is a town in which the young people are leaving and the old people are staying behind to farm and to run the town. The article gives some very interesting demographics about the State of Iowa, demographics that may apply to other agricultural states.

I will just give you a couple of these. The new data from the 1990 census show that 29 of Iowa's 99 counties had more deaths than births, a natural decrease. During the 5 years that preceded 1990, only four counties reported natural decreases. So, here in Iowa, they have gone from 5 counties to 29 counties with a natural decrease.

Natural decrease is an unusual demographic phenomenon. Most of us think in terms of continued growth of a country and a natural increase about 1 percent, but here we have a natural decrease. The median age of Iowa's

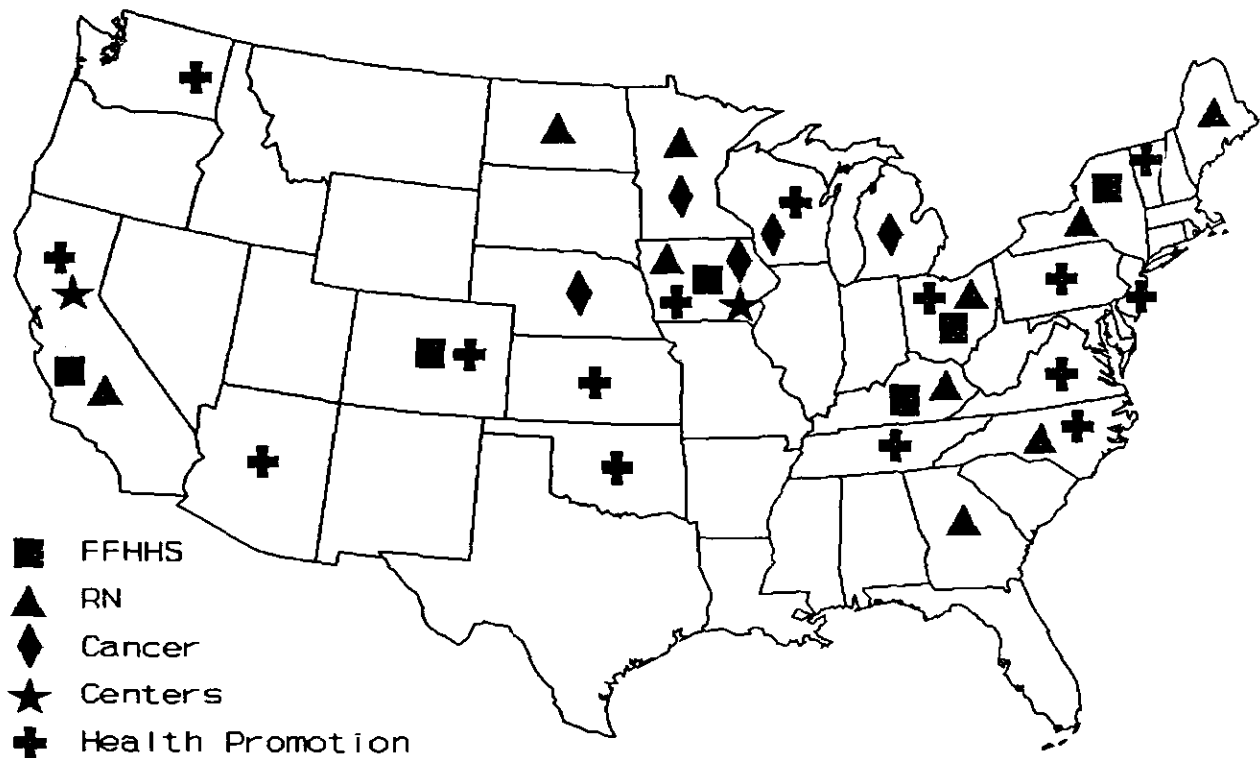

Figure 1. FY-91 NIOSH Agricultural Initiative Programs.

population increased from 30 in 1980 to more than 33 in 1989.

Read on. The situation is so bad that 3 years ago Iowa became only the second state in the nation where the number of people over 75 was greater than the number under 5. I will let you guess at the other state. If you guess Florida, you are right.

Now, the demographic challenge goes on. The flight of young people and middle-aged people from Iowa's rural towns has spawned a sub-crisis of its own: an aging population of people who not only have no doctors nearby but no young relatives or neighbors to look after their health or even do their marketing if they are sick.

Because I am from a public health background and have always been interested in the population at risk, these demographics spell out to me a very serious challenge that we are facing when we look at projects that address the problems of farm families in generally rural areas. With that background, I would like to go on to tell you a little bit about the response to some of these challenges.

The response from NIOSH is broad. It includes surveillance, research, and intervention. Our particular interest here today is in the surveillance component. I would be remiss, however, if I did not remind you that we are part of this triad that uses surveillance signals to trigger either research or intervention. The same surveillance systems may be useful later on to

evaluate the effectiveness of these intervention stratagems.

Figure 1 shows a map of the total NIOSH agricultural initiative FY-1991 funding. The different codes show the different types of programs being funded by NIOSH. I will speak about the Farm Family Health and Hazard Survey (FFHHS); Dr. Freund about the nurses in rural communities.

There are cancer projects in four states. There are two centers of excellence, and, I believe, 15 health promotion states.

You can see how there is a clustering in certain states. That provides an opportunity for collaboration or a symbiotic relationship between these projects. You will also note there are parts of the country that have nothing.

Now, a few words about FFHHS. The purpose of this descriptive survey is, first of all, to describe the health status of farm families and to recognize work-related hazards—chemical, physical, biological hazards.

In doing this, we are borrowing some of the techniques used by our colleagues in the National Center for Health Statistics (NCHS). They are expert in survey design, questionnaire development, training of interviewers. We are also borrowing from our own experience with the National Occupational Hazards Survey, the National Occupational Exposure Survey, and the recognition of work-related hazards.

We have, in effect, two groups working on this project. One group is concerned with the health effects. That group is headed up by Ms. Nina Lulich. Her colleague on the hazard side, Dr. Alice Greife, heads the hazard section of our unit. We have now decentralized to a point where we

have the specialists working with the states that we have funded.

In late FY-1990, we awarded six cooperative agreements. I am sure that some of you in the room know what a cooperative agreement is because you have been awarded one. It is positioned between a grant and a contract. It allows our staff to work very closely with the awardee's staff.

We feel that it is an excellent way to begin to build the kind of infrastructure and continuing collaboration that we have been hearing about in this conference. The average award was \$194,000 per year with the expected duration of 5 years.

The awards went through the competitive process and were awarded to two health departments and four university-based awardees, spanning from the east to the west coast of this country. We are busy working with these people now.

They have all visited Cincinnati, and we are about to undertake a series of visits to each site. We are also preparing our OMB packages for clearance with the questionnaire part of the surveys.

As you might expect, these are quite diverse surveys. Agriculture has a long tradition of being state-based. We see this in the strength of the land-grant university system. We see it in the county extension agent system. We felt that it was important to build on the existing infrastructure.

We had a hard decision to make whether to try to do a national survey with limited resources or to do a state-based survey in states where there was the capability, the interest, and the likelihood of carrying surveillance findings on into research, intervention, and, ultimately, prevention.

We elected to do state-based surveys. Given that construct, it is not surprising that we encounter many variables that are state-determined. For example, some states elected to look at a particular commodity.

Other states, in terms of the geographic coverage, elected to go to a subset of counties rather than statewide. In one or two states, there was a demographic slice, and they elected to look at a sample of young and old farmworkers—the very young and very old.

This is both a disease and injury survey. There is no question that injuries are a very important part of the farm family's assessment of their hazards. They see this every day on their own farm; they see it with their neighbors. Injuries predominate.

That is reflected in many of the proposals. We are looking at injury patterns. We are doing this in collaboration with our colleagues in the Division of Safety Research in Morgantown.

In addition, we are looking at disease components. Here again we are collaborating with the Division of Respiratory Disease Studies in Morgantown. Dr. Castellano has been a faithful and valuable contributor to this aspect of it. Beyond that, we are trying to look at a wide spectrum of disease and also look at the hazards, the physical, chemical, and biological hazards that cause these diseases or injuries.

This is an attempt to show in matrix form a summary of health interview and examination topics that were elected by the six states. I should point out that we were insistent on one or two topics.

We want a good demographic base. We felt we should have consistency in age, sex, and race types of questions. That presents very little problem.

We are all used to using the kind of questions the Census and NCHS use to get that kind of information. Beyond that, we wanted to look at medical access.

What are the barriers to medical care? Do people have health insurance? If they have it, how did they get it?

Many of these people are self-employed. Does the health insurance come as a result of one, or maybe both, adult members of a family taking employment off the farm in order to be eligible for health insurance? These are questions that I think are particularly important in juxtaposition with the *Wall Street Journal* article I referred to, which made the point about the breakdown of the medical care delivery system in rural America. The barrier—the economic barrier—may not be the problem. It may be that there is nobody in practice; there is no hospital. These are things we need to find out.

Injuries are being recorded. We are also interested in musculoskeletal, respiratory, dermatologic, mental health, neurologic, cancer, spirometry testing, and hearing and audiometric testing. These are the types of things that are being built into surveys using what we call modules.

We developed these suggested patterns or models. States are picking up on one or more modules and putting these in their survey proposal. The proposal will then be packaged for OMB review and approval.

Hazards are next. Borrowing from our experience with the National Occupational

Exposure and Hazard Surveys, we are working toward an on-site walk-through in much the same way we would walk through an industry or industrial setting. We are looking at pesticides. We will do some sampling. We will look at chronic trauma. We will look at safety risk factors, injuries, ergonomics, rollovers, PTO's, and secondary occupations.

We need the information on secondary occupation for a number of reasons. One I cited was health insurance. The other is a bit more along the lines of traditional industrial hygiene interests. If a person has an off-farm job that has certain hazards that may result in a disease, we want to know about that job. We want to know the potential for those hazards. Otherwise, we may attribute that particular disease to something that is being done on the farm. It is very important to look at the relationship between off-farm and farm employment.

**[REMARKS FOLLOWING NEXT SPEAKER]**

Mr. Todd M. Frazier: One thing about a conference like this is that you are hit with so many thoughts and ideas that it is hard to put them all together in any meaningful way. I am not going to attempt to do that for even a small part of this conference.

I went back through my notes last night and picked out words—words that, if you forced me to, I could attribute to a speaker but right now they are just words. They are words that I am going to take home from this conference to see if what we are

doing somehow addresses the concerns we have heard from people at the Surgeon's General's Conference.

Here are some of the words. Of course, "change." Times are changing. For most of us in NIOSH it went from a smokestack to haystack type of change (i.e., change in the direction of our own organization).

"Cooperation, communication, education"—in many different forms, we have heard that. "Infrastructure"—we are dealing with that. That is why we are here in many respects. "Children." "Women." "Older farmers." "Disabled farmers." "Target groups." "Exposure assessment." "Weaving the ideas of industrial hygiene into agricultural aspects." "Shortage of rural health care personnel." "Stress."

Back to the *Wall Street Journal*. Here is a man whose kids are leaving the farm. He says:

*"We expected to live here forever. Be surrounded by our family. We planned on it, but things change; and I'm seeing that all change is not for the better. Things aren't going to work out the way I thought they would."*

So here is a 70-year-old man who is going to farm whether he likes it or not.

You have farmer-provider interaction. You have that phrase I do not want to forget. John May used it, "teachable moment."

Then, I have to say this. Did you read the paper this morning about that old guy that pitched his seventh no-hitter? So, if we build it, they will come.□



## A GOVERNMENT PERSPECTIVE II

By Eugene Freund, Jr., M.D.  
Chief, Surveillance Branch

Division of Surveillance, Hazard Evaluation and Field Studies  
National Institute for Occupational Safety and Health

Over the past two days I have been sitting in the audience and hearing talks from people who are able to report vast experiences with agriculture and farming. So it is with some trepidation that I got up here. I reminded myself, "Hey, Gene, you have more than 35 years of experience as an end-user of agricultural products and that is it." But I do know what it is like, briefly, to be a practicing physician, seeing agricultural injuries, and—when I recognize them—illnesses. Frequently, I did not know where to go for preventive as opposed to curative or palliative help.

Nurses have a long history of public health care. They are in immunization programs, in tuberculosis control, women, infant, and children programs, STD programs—virtually all aspects of public health. What I want to do now, with these few minutes, is describe what we are doing. We are calling it the Nurses' Project, which will extend that model of public health nursing into the agricultural-occupational arena. I will try to fit this program into what I have heard from other talks.

It is still developing. It is already a program that will act locally and, I believe, has national impact.

May I go to that first slide with the map of our projects (Figure 1). The Nurses' Project is the green triangles. I think I will center the world on Iowa today and do an Iowa-centered perspective. You can see

that we have the Nurses' Project located in Iowa, Minnesota, and North Dakota. New projects have just been awarded starting in July in Ohio and Kentucky. The project is also in California, Georgia, New York, Maine, and North Carolina.

Each project has three to five nurses. They will be, for the most part, regionally located. That varies from state to state. They are all in state health departments, but they will be based in districts, counties, or quadrants of the state, depending on the state and its population and the differences that each applicant engineered into its programs.

The important part is that each of these nurses is expected to become involved with the target communities. That means getting to know health-care providers of all types, getting involved with the Extension Service, land-grant universities, educational institutions, the Farm Bureau, the Grange, or whatever is important in taking care of the health and safety of the population, which they will be helping.

I think of the program as providing a public health infrastructure. It does that with three functions. Two of them are part of the surveillance, intervention, and research triad—surveillance and intervention. Those are enabled by what I expect to be the nurses' ability to forge links between their efforts, their health department's efforts, and other efforts and resources from

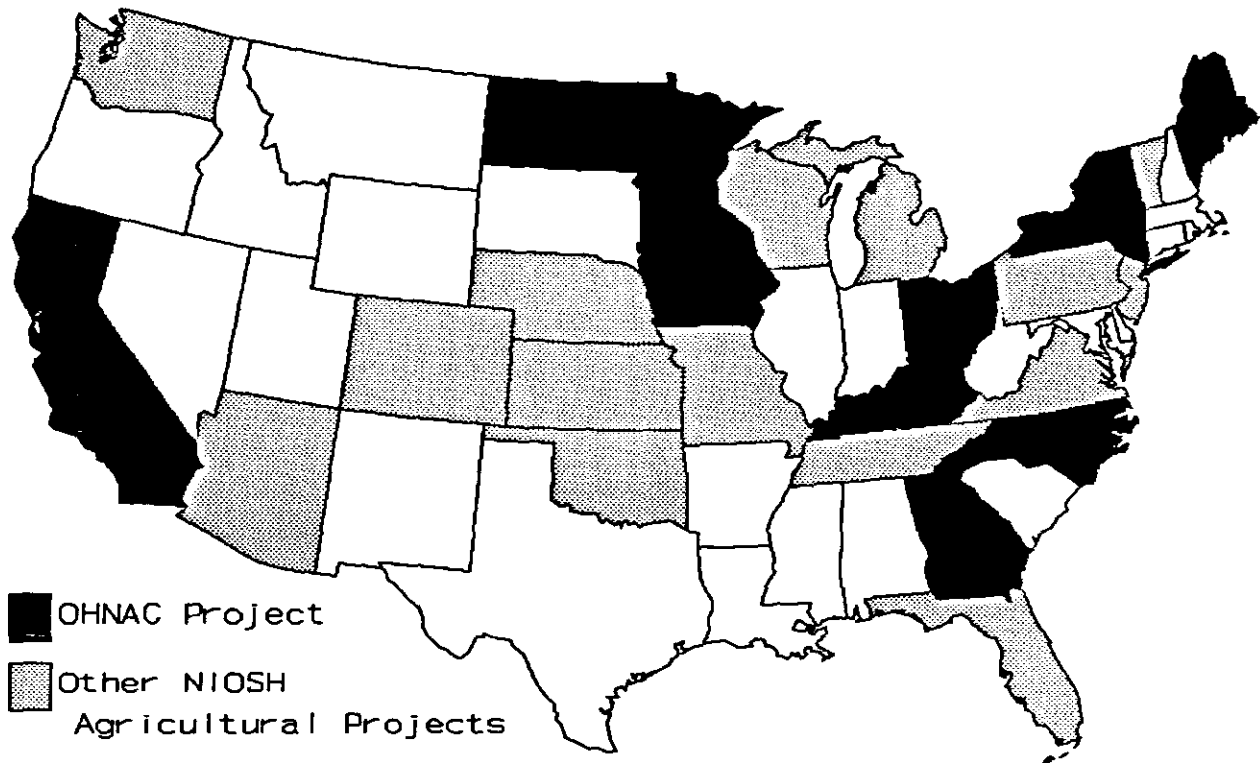

Figure 1. States with NIOSH Projects.

NIOSH projects, such as the Farm Family Health and Hazard Survey (FFHHS) that Todd just described, to all the groups I have mentioned, extension, educational groups, and the like.

I want to use Bill Halperin’s surveillance topology from yesterday to help think through the surveillance aspects of this program. Inasmuch as the nurses, through their interactions with providers, can do case surveillance, they can help with the recognition of problems that may not be identified in the community.

For example, they may hear from a physician about a case of diagnosed or suspected organic dust toxic syndrome. They can identify that as a problem and trigger ef-

forts to prevent it from happening again. Since they will be located in their own regions, they will often be able to identify all cases of a given condition, tractor roll-overs or power take-off injuries. They can identify the scope of those problems, use that information to target intervention efforts, and after intervention efforts, evaluate how effective they have been.

The case surveillance also can work for targeting efforts in and of itself. An identified case of a sentinel event, which should not happen, such as a child injured from falling off a tractor on a farm, could trigger educational campaigns, press releases, on whatever would be appropriate in the community. This is active surveillance for these conditions because they will be there.

The other function is intervention. There are a number of ways to intervene.

Some are education (not just by going to schools and talking, which is something the nurses could do); giving presentations (sometimes it is very helpful to have someone who is a health professional provide that information); and also working with the already considerable efforts of the Extension Service. Another intervention is educating providers by giving them lists of reportable or desired reportable conditions or putting them in touch with contacts in the academic community, or referral sources that they are aware of.

Another educational intervention, which I think has the potential to be very powerful, is the dissemination of surveillance and research results. If they can show a community that these problems are real and happening to their neighbors, I think they can have an impact on people's behavior. Again, they can be links to other resources.

The Extension service have people who know how to retrofit tractors with rollover protection, if that is something someone wants to do. We at NIOSH have quite a lot of expertise in doing health hazard evaluations. That is an intervention that, when appropriate, could be performed.

By having some utility to providers in the community—and this brings things full circle—they can have an influence on sur-

veillance. If you are asked to contribute to surveillance, you as a provider or an individual in the community are asked to contribute to something you perceive as useful. You, therefore, are going to be more likely to contribute.

That is the outline of the infrastructure, which with variations through our 10 cooperative agreement partners is being implemented. We have got a number of challenges ahead of us. We have work to do in terms of defining the most appropriate target conditions for this project.

I think injury clearly has much potential. Physicians are able to identify it. Some of the work on illness remains to be seen.

I believe that there are physicians and other providers out there who, as I have done, would—with a structure to support them in their interest in doing public health efforts—be eager to report. They would be eager to get their patients and their communities plugged into a public health system to prevent illness and injury.

There is plenty of work to be done in designing interventions. Of course, evaluating and identifying are the most successful elements of the varied projects that are part of this program. All these tasks need to be taken in concert with those at the local level that these people will be working with, the farmers, the Extension Service, the providers. All of these have a stake and a potential contribution.□

## THE CONSUMERS' PERSPECTIVE

By *Craig Merrilees, B.A.*  
Director, Consumer Pesticide Project

Thank you very much, and thanks to NIOSH and to the Surgeon General for inviting consumer and environmental speakers here today. We appreciate the pluralistic way you have approached "coalition building," the theme of this conference.

I have been inspired by many of the folks I have met at this conference during the past couple of days, and cannot help but notice that your tone is upbeat. Many of the participants are activists. You are considering new approaches.

We all know these have not been the best of times for occupational safety and health, so coalition building has become even more important. It is essential for making progress and improvement in the workplace, particularly on the farm.

I want to tell you about some of my background and orientation. I work closely with the National Toxics Campaign. This is a federation of over 1,000 grass-roots environmental activist organizations. Most of these people are angry. They are unhappy.

They feel that environmental policy is out of their control. They are demanding that industry and government be more accountable to the community and workers. Most of the members are women. Many of them are directly concerned about environmental occupational issues in agriculture.

On a personal level, I have been involved in these issues from four perspectives:

1. **Public health:** I am a former county health commissioner and took a great interest in farmworker safety and health when I served in that position. Also, I helped establish a neighborhood-based health maintenance organization to deliver affordable, high-quality health care services.
2. I am heavily involved in environmental policy and politics right now. I recently finished work on the 1990 Farm Bill and other legislation.
3. I have members of my family that are still surviving on a farm—God knows how—in Ohio. They are trying to grow corn and soy beans for a living. They will not be in business much longer for reasons that I am going to explain. I am deeply concerned about the future of family farming in this country and the way in which smaller-scale agriculture is being destroyed by Federal policies that have brought about tremendous changes on the farm—and not necessarily for the better—from an occupational or an environmental perspective.
4. Finally, I have worked as a journalist. I investigated many stories about occupational hazards and environmental scandals.

I will begin talking about coalition building and about some practical experience that our organization, the National Toxics Campaign, has had in building coalitions and in promoting what we call "source reduction," removing of fundamental problems. In this case we are removing pesticides by utilizing consumer and environmental pressure, along with cooperation from farmers and industry people, to eliminate use of the most dangerous classes of pesticides.

However, first I want to quickly talk about the structure and the politics of agriculture in this country, how that bears on health and safety issues. If you were here earlier, you heard that there are some interesting trends under way. We have an increasing number of large capital-intensive farms. We have a decline in small family farms.

If you had a chance to analyze some of the data we heard earlier, you would have found that by the end of the day we will have lost 50 family farms in this country; 125,000 farms will be gone by the end of this decade. That is a sentinel event.

Something is wrong in the country. Something fundamentally dangerous is under way, particularly if you happen to live on a farm or if you live in a community region or city like Des Moines. I was walking the streets last night. You can see the consequence of that policy in the boarded-up stores and empty office buildings.

The third element is a direct link between the intensification of agriculture, a policy that has been promoted by the U.S. Department of Agriculture (USDA) and indirectly by the Congress and the Administration, and the increased use of chemicals in agriculture, at a rate of 500 percent since World War II. That has a direct bearing

on occupational safety and health problems.

Yields are up. Incomes are down. Is that not strange? People work hard, they produce more, and they get paid less to do it. Ask any farmer in the Midwest.

Ask any farmworker in California. They have not reaped many of the benefits from increasing productivity. Those benefits should have included improvement in occupational safety and health.

Health and safety improvements come only when people are organized and when they are able to control their own destiny.

If you were to compare, for example, the budget the USDA is advocating for biotechnology versus their budget for low-input sustainable agriculture, you would get a clear picture of where the priorities are in this country. They are wrong and detrimental for farmers and farmworkers.

I think if we have learned anything in the past, it is that health and safety problems are influenced by these policies. Health and safety improvements come only when people are organized and when they are able to control their own destiny. I want you to look at some priorities that the USDA is currently pursuing.

Just look at the way the U.S. Government is promoting the development of herbicide-tolerant plants. This is serious issue that has been ignored in terms of the health and safety effects.

We know that farmers who work with certain classes of pesticides have

non-Hodgkin's lymphoma at five and six times the rate of those who do not. We do not know exactly why, but we think it has something to do with pesticides.

Do you not think it is curious, then, that the USDA is currently promoting programs to increase the use of these herbicides by promoting and subsidizing the development of herbicide-tolerant potatoes? They are doing some of these experiments in California. The pesticide that they are using is 2-4D.

The same thing could be said for bromoxy-tolerant cotton, or atrazine, which is responsible for extensive ground-water pollution. There are 40 states now that have serious ground water pollution, much of it caused by atrazine.

Why is the USDA working so hard to promote atrazine-tolerant canola? Some of the work is being done in Canada. I can guarantee you, however, it will not be long before the USDA is petitioning to encourage our farmers to use those products here.

Farmers are the ones who drink more contaminated water than those of us that live in the cities. Farmers are the ones who are exposed more to pesticides and other hazards.

I want to have some dialogue with you about how some of my people view science and research. A lot of my activist friends have, I believe, false hopes in scientific research.

The victims, as they call themselves, demand the EPA come in and ATSDR come in. Their basic position is, "We are sick. We are being poisoned. We know this is happening. We want you to document it."

You come in. You spend thousands, sometimes millions of dollars. Then you come up with negative associations or no associations whatsoever between the exposure and any negative outcomes. Folks walk away disgruntled and angry.

They think there is a conspiracy or cover-up. This is wrong. I think our people are increasingly wondering whether this is a good use of resources.

I think they are going to be questioning whether we should be doing this kind of epidemiological research. I say this, knowing that their naivetè has led them to believe that scientists can prove and document environmental damage to people when, in fact, it is much more elusive. It may require a different approach than scientific proof obtained through epidemiological studies.

I also think there is some naivetè on the part of researchers and academics who believe that somehow, if we could simply document facts, things will change. They believe somehow political leaders will be influenced by facts and rational arguments. This is not how things change in this country.

I would challenge anyone here to give me an example where facts and rational arguments alone persevered in the face of strong, powerful corporate interests. The facts and scientific evidence were available long before OSHA set lead standards, mercury standards, asbestos standards, and benzene standards. That evidence was clear for decades before the Congress and the Administration even saw fit to establish OSHA! Every single sentinel health improvement in this country came because two things were present:

1. There was scientific research to show it; but that was never the determining factor.
2. People were organized where they worked. They had political power. They built coalitions. They made change.

Those are the ways that changes have happened and health outcomes have been improved in this country. Therefore, I think it calls for all of us to have a much closer relationship with workers and their organizations.

Look no further than the agriculture-implement lobby here today. This lobby has blocked rollover protection in this country for 30 years with knee-jerk, protective, self-interested arguments that continue to allow farmworkers to die in this country, out of their narrow interest.

That is wrong. The reason that it happened is not because we have not done enough scientific research to document the problem.

What kind of research can make a difference? I think we have a phenomenal amount of talent here. People are doing all sorts of interesting studies. People are beginning to reach out to ATSDR. OSHA is maybe waking up from a deep sleep and a very depressed situation that they encountered after being savaged during the Reagan and the Bush years.

I think there are good examples where universities are trying to work with people who are facing these problems firsthand. Some of the extension folks are doing that. Look at the excellent work done by Don Villarejo at the University of California at Davis.

We have to ask if money is being wasted on research. I question, for example, whether money in my state was well-spent to try to look into the problems of the cancer cluster at McFarlane. What we found is that there were an excess number of cancers and too many kids that had cancer, according to the statistics. We ended up spending millions of dollars to research that problem, however.

The one fact that the research turned up was that most of the people there have terrible health care because they are poor. They do not have good quality primary health care and that may have something to do with the outcomes that were generating cancer.

It may; it may not. What we found is that 70 percent of the people who live in that community do not have any decent health care. That is the most profound finding we discovered.

It leads us to the conclusion that more communities should be demanding services. They should be demanding changes in the health care delivery system so that they receive more services and put less emphasis on empirical scientific studies that try to prove slight elevations in certain rates are occurring in their community. That is what we are thinking about.

We recognize that environmental solutions will require good scientific research: epidemiology and surveillance. In many cases, the science is already finished. We are going to be focusing on eliminating hazards that are known, that are understood.

We know that parathion is a dangerous chemical. We have known that for 30 years. We know that it kills people. We know that there is no reason for it to be

used. There are safer substitutes that are out there.

There are different ways to organize agriculture that can produce the results we need in terms of productivity without using that pesticide. There are people in this country who will pay a lawyer \$300 an hour to work around the clock to lobby EPA to keep that product in the marketplace. No matter how many studies you do and how many deaths you document, it is going to keep being sold despite the scientific evidence.

Therefore, our campaign is going to focus on getting rid of that pesticide. We are going to focus on the acutely toxic pesticides, the ones with strong neurotoxicity, the ones that are potent carcinogens. There is no reason for those pesticides to be on the market and to be used.

We are going to be emphasizing the need for new technology. We are going to be exposing the hidden cost of using these products. There is no reason that these costs have to be socialized in this country when the folks who benefit do not socialize their profits.

I will talk about a strategy we have developed that may be of interest to you in terms of how to achieve these reductions. You know that we failed in California when we proposed that all of the B2 carcinogenic pesticides—those that EPA says are probable human carcinogens—be phased out over an 8-year time period. That was considered to be an extreme proposal.

It was opposed by the Farm Bureau. It was supported by family farmers. The Farm Bureau and the major chemical companies worked together in a coalition to defeat that proposal.

What we have done in California is to promote more dialogue with people that could make a difference, the farmers that are growing the fruits and vegetables. Fruit and vegetable production has doubled in past decades.

That means there are going to be more farmworkers out there, more exposure. With the kind of intensification we are using, there will be more exposure to dangerous pesticides.

We went to the farmers. We went to the supermarket industry.

We said to the farmers, "How would you like to receive a slight premium for the fruits and vegetables that you grow, if you could grow them with fewer and safer pesticides? Not necessarily entirely without pesticides right off the bat, but those of you that can move into an organic system or a regimen of pesticide reduction, do it. We will support you. We will lobby for you. We will try to get your products carried in the stores. Those of you who could reduce your use of the B2 carcinogens and provide lettuce grown without DBCP's, we want to support you.

We went to the supermarket industry. We said, "How would you folks like to be able to sell a product that has a unique environmental distinction and that provides you with a marketing niche?" This is an industry that is viciously competitive, where executives live or die over fractions of a tenth of market share. Some of these executives were interested in experimenting with pesticide reduction. The environmental and consumer groups also were interested. They want to see change happen. It is not happening now in government.



Finally, the farmworker organizations, as well, were obviously concerned about this. Probably the most important reason agriculture has done so poorly in terms of occupational safety and health is because there are practically no unions there. And I think the single strongest correlation between mediocre safety and health outcomes has to do with the lack of organization within that industry.

We did work a little bit with farmworkers, together with farmers, supermarkets, and consumers. What we did is arrange a deal that benefited everyone.

Not long ago, we had 1,200 supermarkets that represented \$10 billion worth of purchasing power in the country who went on record that USDA EPA, FDA, the California Department of Food and Agriculture, and other organizations have spent too much of their time defending the status quo. They said, "We are on record calling for the phase-out of all B2 carcinogens." Period. End of discussion.

We are going to be favoring growers who can provide us supplies of fruits and vegetables without pesticides that are acutely neurotoxic, eliminating pesticides that lack any practical analytical detection method. They took a very progressive policy.

They were immediately attacked by the USDA, by the FDA, and by the EPA as unnecessarily alarmist, threatening the integrity of people's confidence in the food supply. The Administration wanted the rest of the industry to continue mimicking their mantra, which is that "We have the world's safest food supply; the food supply is safe; do not worry, be happy; do not worry about the people who work on a daily basis with these pesticides. Trust us.

The system will protect you and the environment."

That position is wrong. That position has to change. It is a dinosaur position. It is one that is based on defending the status quo; eventually those people will lose out.

In the meantime, we have built an interesting coalition with supermarket executives. They are not a liberal bunch, on the whole. They do have an economic advantage in promoting this, which we are happy to support.

We think that is a great thing. To the extent that we can use market forces to encourage these things, we are going to do that.

Certainly the farmers are happy to see that they can demand and receive a small premium. That is the kind of coalition that we have attempted to build.

The National Toxics Campaign has promoted some similar approaches in more traditional industry. One of them is replacing TCE (trichloroethylene) solvent with detergent compounds for washing circuit boards.

Before we negotiated we spent our time beating up some of the major electronics firms. They refused to acknowledge that there were safer alternatives that would not cause some of the occupational and environmental problems that TCE was causing. After a certain amount of head banging, and a certain amount of rational argument, and a certain amount of objective studies, things got to the negotiations point. Now, IBM and other major industry leaders have replaced TCE solvents with

more benign detergent compounds to wash their circuit boards.

The same things happen with refineries. We lost a chemical plant yesterday that killed eight people. Refinery work is one of the most dangerous occupations in the country, after agriculture, of course. We have fought a major battle with Chevron's Richmond refinery that has released tons of benzene and other chemicals every year into a black neighborhood.

That is now going to end. It did not end, however, because the government made it happen. It happened because we used third-party pressure to make it happen.

In fact, the government was giving Chevron a permit every year to dump that benzene into the air and dump heavy metals into the water. That is something that the government was willing to tolerate, but we were not.

I believe what it is going to come down to is this: we want to work with you. We want to see interesting, provocative research. We hope that it is going to be oriented towards helping farmworkers and helping farmers and moving it down to that level.

Too much of our research has tended to benefit people that already have the resources to do their research. We need research that can help the folks who are working in the granaries and the mills, the folks who are picking those fruits and vegetables, and the farmers who are struggling to make a living in these difficult times for family farmers. We would like to work with you to make sure that your research is appreciated and that it does the most good for the most people.□

## AN AGRICULTURAL SAFETY PERSPECTIVE

By Dennis Murphy, Ph.D.  
Professor, Penn State University

---

The first thing I want to say is that, being an agricultural person, my opinions are unbiased. Everything I am going to tell you is completely unbiased. I did not realize what a miracle person I was, growing up on a farm and being happy. I did not realize I was so abused.

I thought I had a relatively happy childhood. I continue to know a lot of people who are pretty happy about being out on a farm. I am probably confused, but I thought that our life expectancy was increasing instead of going down. I thought people were still dying to get into this country instead of out of it.

I was not asked to make a presentation *per se*. Rather, I was asked to get up and respond to other presentations. I think that has been called a "rebuttable," or something like that.

Dr. Herrick said "don't worry about actually preparing something." Since I do not pay attention to a lot of things, I went ahead and prepared something.

I am glad that I did because I have not heard many people talking about the concepts of dealing with surveillance issues. Very few people have talked about that.

We have had actual research studies presented, which is one thing. That is fine. This does not mean that all positions and all the things that have been talked about

are not important. They are not the things that I consider important issues in surveillance of agricultural safety and health hazards and problems.

I am going to get to the categories of specific exposure groups because we have talked about descriptive statistics. We are finally getting beyond descriptive statistics. Some of the papers presented earlier have illustrated this.

In the last two, three, or four years, public health has gotten more interested in agricultural safety and health issues, and particularly in certain aspects of them. I keep reading papers that are just discovering that there is a problem out there. We keep discovering the same problem over and over and over.

There are a whole bunch of new people here again. I am afraid that in the next couple of years we are going to keep reading a lot of papers that are saying the same thing over and over again.

The descriptive stuff is out there and has been for 20 or 30 years now. I strongly encourage you to get beyond that. If that is all that you can do, you are not going to contribute very much to literature.

### STANDARD TERMINOLOGY

We talked about the standard terminology. What I keep hearing here through the use of agricultural statistics, is that we are

either the first, second, third, or fourth most hazardous industry. We heard all of those numbers within an hour and a half the other day. That is because we define things in different ways.

If we are going to let data guide us, we have to get to some specific categories to have some guidance.

One of the things we talked about earlier was that 300 kids are killed every year on the farm. If you go back and look at the original study, those really were children and adolescents. I have not heard the work "adolescents" used at all at this conference. That statistic included adolescents through the age of 18. It was all fatalities on the farm.

It was not agricultural work. Yet everybody uses agricultural work as a justification for getting into this area. A lot of those fatalities were hunting accidents and other leisure types of things. This 300 number is firmly entrenched and everybody uses that number.

They fail to mention that it involves adolescents, not just children. Nobody identifies that it is not just farm work fatalities included in that statistic.

There is much to do in straightening out our language. I am not sure that the public health people are really addressing this issue.

Category-specific exposure data is an issue. I think it is very important. We have heard about exposure assessment. We are moving in that direction. I know that the family farm health surveillance program is dealing with this.

What I would caution is that it is not total exposure that is important. If we are going to do something meaningful, we have to get down into categories. Not all exposures are equal. The quality of exposure is not necessarily equal when you get into tractors, or into age groups, or into other machinery or respiratory hazards.

If we are going to let data guide us, we have to get to some specific categories to have some guidance. Otherwise, we are throwing away money, effort, and a lot of time on something that may or may not exist.

The same is true with categories. The "children" category is one of the best examples. Again, we have heard much about children and about the elderly. Thus far, "children," at this conference, means everyone 19 and under, 18 and under. We just had 17 and under; 16 has not been mentioned yet, but 15 and 14 have been mentioned. So, what is the "children" category?

I do not think it is as important whether it is 14, 16, or 18. It is important that we all should use the same thing. When you look in the literature, it is all different. Everybody has a different group. It is hard to understand and communicate with each other exactly what the problem is with children because they are all different age categories.

The same thing is happening with the elderly. We have 55, 60, and 65 for most of the elderly categories. It is not helping us to have these different categories.

We have the same problem with other categories. Sometimes machinery includes tractors and sometimes it does not. That makes a big difference on the farm when you are talking about statistics, whether

you are including tractors in agricultural machinery. I am suggesting that we need to take time to work on some of these kinds of things before we rush out and do something that might prove to be inappropriate or ineffective.

Another issue is useful categories. From the beginning, we have known that there are more injuries among kids during the summer months than there are during the school year.

That makes a lot of common sense to me. They are out there during the summer months. The rest of the time, they are in school. Their exposure is lower and obviously they are hurt less often.

There is data that says that tractors are involved in injuries at certain times of the year. That is because they are being used more at some times of the year than others. These are common sense things that I am hoping the public health researchers are not going to go back and tell us again.

Data is already there. It has been there for a long time. We need to define groups and categories and come to some agreement on what those are.

I am not saying that what I do is the right thing. It is just that we all should get together and come to some kind of agreement on these kinds of issues.

#### **DATA AND NONFATAL DIFFERENCES**

Another issue is the fatality and nonfatality descriptions. They are different. This is combined with the priorities issue. What are our priorities, long-term or short? I find myself in a difficult position because I have to argue something in order to get it identified as a issue.

When we talk about fatalities, the picture is clear. You may not realize it but there is a very clear picture of the fatalities on farms, fatalities associated with farm work and with farm worksites.

If we are concerned about doing something, about saving somebody's life next week, next month, or this year, we need to work on that. We need to let that give us some guidance.

If we are taking a longer view, we look at nonfatal injuries because they involve a different group of exposures, different kinds of agents. So, we approach things and we do some things differently.

#### **LONG-TERM AND SHORT-TERM VIEWS**

Much of the discussion during this conference has been about pesticides and chemicals. The public health system is obviously knowledgeable and concerned about chronic health effects, whether from pesticides or respiratory or other kinds of things.

When we talk about those issues from my perspective, those are quality-of-life issues. I am worried about keeping the poor guy alive to begin with.

I may not be right, but I think that is an issue. We do not talk about it as an issue. We are jumping on all kinds of bandwagons and talking about things that affect people 15 or 20 years down the road; that is important.

That is why I have difficulty talking about this because I am not trying to argue against being concerned about long-term effects. Given the real world and limited resources to put into anything, if we are going to prioritize, and if we are going to

use data to help do that sort of thing, I think this is an issue we have to discuss.

### **DEATH CERTIFICATES**

Another issue that I think has been clearly identified is death certificates. Death certificates are not a very good measure of what is going on.

They are a starting point. That is about all. You can follow up to get better information, especially in terms of whether the injury was occupationally related.

### **OUT-OF-FIELD LITERATURE**

The next issue I have is the awareness and availability of out-of-field literature. This goes back to some of the earlier comments. We already know to a large extent what the acute problem is.

I will not say we know so much about the long-term, about the pesticides, and long-term effects from that perspective. From the short-term perspective, that information is already known. You need to look beyond the public health literature, however, to find it.

There is the National Institute for Farm Safety literature. There is the American Society of Agricultural Engineers literature. There is the Agricultural Division of the National Safety Council.

There are other groups that have been doing things for a long time that sometimes have been published and sometimes not. A lot of the people in these groups do not publish in refereed journals because that is not their purpose or mission.

You can scan medical journals and think that you are going to find out what is going on in agriculture. To a large extent, it is

past history. There is literature out there but you need to try to find it. Then we will not keep saying that there are no studies, there is no documentation, there is nothing. That is not true.

### **LOCAL DATA**

The last thing I see as an issue is that educational and intervention efforts need more localized data if we are going to do something that is meaningful. There is a purpose for state and national surveillance. I understand and strongly support that. I am involved with it. When it comes to doing something about the problem, the national data in particular is not going to guide us very well.

We need local level data to help guide us, not just national data.

There are some issues, the ROPS issue is the most typical one, that we can approach from a national perspective. That is just one part of the problem. There are dozens and dozens of problems out there. When used on a local level, one to one, or with small groups of farm people, they see right away that what you are talking about is not a problem in their area.

I tried to talk about respiratory hazards to a group of poultry and potato farmers. I was using the Iowa information, I said "Iowa has done a lot of great things. This is the information that is coming from there." They said, "That doesn't mean anything to us; that is in Iowa."

I then spent the next half hour, instead of talking about respiratory hazards and what they can do to protect themselves, talking about how a hog in Pennsylvania is the

same as a hog in Iowa. They did not believe that what I was using was relevant to them, the types of diseases they get.

Again, this is for the people who are newer in this area who do not have a working knowledge of farms and a working know-

ledge of the culture and values of farm people. You do not need to understand that you will be going off on some tangents that are not going to be productive. We need to get down to local levels. We need local level data to help guide us, not just national data.□

## AIRBORNE DUSTS

By Susanna Von Essen, M.D.  
Assistant Professor of Medicine, University of Nebraska

---

### OVERVIEW

Exposure to airborne dusts has long been known to cause illness. Ramazzini wrote that measurers and sifters of grain were at risk for respiratory problems and irritation of the eyes in his book *De morbis artificum*, published in 1713.<sup>1</sup>

Hypersensitivity pneumonitis (HP) in farmers was formally described in modern times by Campbell, in the year 1932. He recognized the relationship between exposure to spoiled hay and a febrile illness with cough and an interstitial pattern on chest X-ray.

HP is a disease about which much is known. A variety of etiologic agents and measures for treatment and prevention have been identified. However, a great deal still remains to be learned about this disease.

Organic dust toxic syndrome (ODTS), originally called pulmonary mycotoxicosis, is a disorder that was first recognized in the 1970's in dairy farmers after heavy exposure to moldy silage.<sup>3</sup> The disorder was called "silo unloaders' syndrome" when it was recognized that the symptoms likely were not caused by fungal poisoning.<sup>4</sup>

A similar illness, originally called grain fever, was seen after exposure to dust from stored grain.<sup>5</sup> ODTS shares many features with acute hypersensitivity pneumonitis but

is without clearly identified long-term sequelae.

Most studies have shown that chronic bronchitis is more common among farmers than in the general population.<sup>6-11</sup> The majority of farmers with chronic bronchitis have a history of exposure to grain dust, which has been linked to this problem in grain workers,<sup>12</sup> or of work in animal confinement units. However, not all researchers agree that exposure to airborne dust places farmers at increased risk for chronic bronchitis.<sup>13</sup>

Exposure to grain dust causes cough, chest tightness, and dyspnea in some individuals.<sup>14-17</sup> The environment of swine confinement units causes cough, chest tightness and dyspnea acutely in many individuals who are without chronic symptoms.<sup>18-25</sup> It is unclear if there is a relationship between repeated exposures to airborne dust followed by symptoms suggesting acute airway inflammation and the subsequent development of chronic bronchitis.

It has long been known that individuals with asthma become more symptomatic after exposure to airborne dusts. Charles Thackrah, a British physician, described a relationship between asthma and inhalation of corn dust in a book published in 1832.<sup>26</sup> A variety of organic dusts have been associated with the onset of asthma symptoms.<sup>27-34</sup> Whether exposure to these dusts can actually cause asthma remains controversial.



Eye, throat, and nasal symptoms, termed mucous membrane irritation, are experienced after exposure to airborne dusts, including grain dust, as well as to the environment of dairy barns and swine confinement units. Mucous membrane irritation symptoms have been mentioned but not described in great detail.<sup>35</sup>

### **HYPERSENSITIVITY PNEUMONITIS**

Hypersensitivity pneumonitis is the best characterized of the disorders described after airborne dust exposure in the agricultural setting.<sup>36</sup> Acute HP is an immunologic reaction to antigens present in organic dust. It has the following clinical features: fever, chills, muscle aches, a dry cough, and malaise experienced four to eight hours after exposure to a causative antigen.

Laboratory and X-ray findings include hypoxemia, leukocytosis, infiltrates on chest X-ray, and restriction and a low diffusing capacity for carbon monoxide (DLCO) on pulmonary function testing. The symptoms usually improve over 12-24 hours. Repeated exposures to the offending antigen may lead to further attacks. A small number of the individuals at risk for this disease actually develop HP. At this time, there is no predictor for susceptibility to this disorder.

Occasionally, HP presents as a subacute process, lasting for weeks. The course of this illness can be shortened using systemic corticosteroids. Rarely, HP leads to pulmonary fibrosis and respiratory failure.

At this time, it is not possible to identify those individuals with HP who are at risk for pulmonary fibrosis. There are no firm recommendations for surveillance programs, using pulmonary function testing

or other means, for identifying those who are likely to have this outcome with continued exposure to the offending antigens.

The cause of HP is known to be repeated exposure to antigens from a variety of substances, including the microorganisms *Faeni rectivirulga* (previously known as *Micropolyspora faeni*), *Thermoactinomyces* and *Aspergillus spp.* and others that are found in spoiled hay and grain as well as in silage. Avian proteins, including those from chickens, and wheat weevils have also been implicated as causes for HP.

The dairy farm is an environment where HP is common. However, this problem is also seen in other agricultural settings, including farms where grain is stored in drying bins, in poultry houses, and in mushroom growing facilities. Estimates of prevalence of HP, or farmer's lung, on dairy farms range from 1/1,000 to 2 to 4/10,000.<sup>37,38</sup> Epidemiologic studies remain to be done to determine the prevalence of this problem in other farm settings.

Epidemiologic studies are complicated by a lack of definitive means of making a retrospective diagnosis. Many farmers do not seek medical care for episodes of HP, so that there is no supportive information available from medical records.

Serum allergic precipitins identify individuals who have been exposed to antigens that can cause HP, but do not point to the subjects who have the disease. Serum allergic precipitins may have become negative after a bout of HP experienced in the remote past. Open lung biopsy reveals characteristic findings in the presence of the disease, but should not be performed routinely for this problem.

Additional difficulties are posed by the similarity between the clinical picture of acute HP and that of ODTS.<sup>37-39</sup> In absence of a clear history of repeated episodes of illness and supportive laboratory and X-ray information, it is often impossible to determine which disorder is or was present.

Recently, a study was published that indicated that use of corticosteroids shortens the course of subacute HP.<sup>40</sup> However, there is no agreement on the dose and duration of treatment required.

There is some evidence that episodes of HP may be prevented by the use of dust masks or full-face respirators.<sup>41</sup> In spite of being aware of the potential benefit of wearing protective devices, farmers often fail to do so.

Reasons given include lack of comfort as well as excessive expense. There is a need for better designed devices to reduce exposure to airborne dust as well as formal testing of the efficacy of these products. In addition, it is possible, though still unproven, that improved ventilation in farm structures will decrease the risk for HP.

## ORGANIC DUST TOXIC SYNDROME

ODTS is a febrile illness associated with myalgias, malaise, dry cough, chest tightness, and headache, which begin 4-12 hours after exposure of large amounts of organic dust.<sup>3-5, 38, 42-53</sup> Common causes of ODTS include uncapping of silos on dairy farms, cleaning of grain bins and moving moldy grain. Recently, it was also described as being common in swine confinement workers.<sup>34</sup> It is possible that it will be identified in other farm settings as well.

The exact incidence of ODTS is unknown, because of difficulties similar to those for HP in making a retrospective diagnosis. Results of previous studies conducted in Scandinavia indicate that the incidence of ODTS ranges from 10 to 190/10,000.<sup>54</sup> A more complete understanding of the epidemiology of ODTS, as well as other disorders caused by airborne dust, has been hampered by a lack of validated questionnaires tailored for use in the farm environment. A recently published questionnaire designed specifically for evaluating organic dust exposure likely will help solve this problem.<sup>55</sup>

ODTS may occur without prior sensitization, which is required for HP. Laboratory findings are notable for the presence of leukocytosis but an absence of hypoxemia, restriction, and a reduced DLCO on pulmonary function tests and infiltrates on chest X-ray. However, there is a need for more specific diagnostic tests indicating the presence of this disorder.

Farmers with ODTS have been studied with bronchoscopy and bronchoalveolar lavage, revealing neutrophilic airway inflammation.<sup>46, 52</sup> A neutrophilic lower respiratory tract inflammation is also seen in acute HP.<sup>56</sup>

However, the mediators of inflammation present in the lung, or systemically, have not been identified. Organic dust toxic syndrome typically resolves in 24 hours, but may last 2-5 days. Therefore, it can cause significant morbidity and time lost from work. Corticosteroids have been used as treatment in several patients with ODTS, but little is known about their efficacy in this disorder.<sup>57</sup>

There have been no sequelae described for ODTS, unlike for HP. However, farmers

with bronchial hyperactivity often attribute the onset of their asthma to an organic ODTs-like episode occurring after an abnormally severe dust exposure. Others date the onset of their chronic bronchitis or an increased susceptibility to having respiratory symptoms back to an episode which may have been ODTs.

A small study published recently did not definitively establish a connection between airway disease and a history of ODTs.<sup>58</sup> More work needs to be done to determine if a relationship exists between ODTs and chronic pulmonary disease.

Farmers are often told to wear dust masks to prevent ODTs when heavy exposure to airborne organic dust is anticipated. However, there are no studies published that attempt to answer the question of whether or not ODTs can be prevented by wearing dust masks. Again, improved ventilation may reduce the amount of airborne dust present and, therefore, might decrease the risk for developing ODTs.<sup>59-61</sup>

The component(s) of airborne organic dust that causes ODTs remains controversial. There is strong evidence that endotoxin causes ODTs, as it is present in high levels in the environments where ODTs is common.<sup>62-68</sup> In the laboratory setting, endotoxin has been shown to cause fever and neutrophil influx into the lung.<sup>66,69</sup> However, there has been a study suggesting that the risk for ODTs did not correlate well with endotoxin levels.<sup>70</sup> Since ODTs is often reported after exposure to moldy organic material, mycotoxins must also be considered as potential causes of ODTs.<sup>71</sup>

Tannins are polyphenols present in various plant materials. Work done with tannins found in cotton bract has demonstrated their ability to cause neutrophilic lower

respiratory tract inflammation, raising a question of their potential contribution of the inflammatory changes seen in ODTs.<sup>72</sup>

## CHRONIC BRONCHITIS

Chronic bronchitis, defined as bringing up phlegm on most days for at least three months per year for at least two consecutive years, has been shown to be more common in farmers than in the general population.<sup>6,7</sup> In several studies, a two- or three-fold difference is demonstrated. The healthy worker effect may help lower the number of farmers with chronic bronchitis after airborne dust exposure as well as other pulmonary disorders, leading to an underestimation of the problem.

Extensive epidemiologic work done with subjects exposed to airborne grain dust has indicated that this likely is a factor in the causation of chronic bronchitis in farmers.<sup>2, 12, 73</sup> However, their airborne dust exposures are more heterogeneous than those of grainworkers, creating difficulties when attempts are made to determine the precise cause of the airway inflammation.

At this time, it is not possible to identify those individuals who are at risk for the development of chronic bronchitis caused by inhalation of airborne dust. The role of airway hyperactivity as a predictor of chronic bronchitis remains controversial. Other tests, such as measuring the group-specific component, may prove useful in the future.<sup>74</sup>

Many farmers have exposures to airborne dust in animal confinement units as well as from working with grain. Recent studies conducted in Iowa swine confinement workers indicate that up to 25 percent of these individuals suffer from chronic bronchitis.<sup>75</sup>

Gases present in confinement units, including ammonia and hydrogen sulfide, may contribute to the symptoms observed.<sup>12, 19, 24</sup> The airborne dust in swine confinement units is heterogenous, consisting of feed particles, animal dander, bacteria, and endotoxin.<sup>26</sup> Identifying a component of hog dust which is particularly noxious is difficult.

Poultry farmers also appear to have respiratory risks, similar in symptoms to those of the swine confinement workers.<sup>77</sup> Dust, endotoxin, and ammonia have also been implicated as a cause.

Pulmonary function tests performed on farmers with chronic bronchitis do not reveal the presence of severe obstruction in most individuals unless they are cigarette smokers. However, farmers in swine confinement units do have small decreases in FEV1 and FVC values over a workshift.

Confinement units are a relatively new innovation in farming, so no individuals have had a lifetime of exposure to airborne dust and fumes in this setting. It remains to be seen if significant airway obstruction develops in farmers who have been exposed to this environment for their entire working life.

Cigarette smoking is the most common cause of chronic bronchitis. It is likely, but not definitively proven, that exposure to grain dust or the swine confinement environment in addition to cigarette smoke works additively to cause airway obstruction.<sup>20, 24, 78</sup> The mechanisms of this interaction are unknown.

Several forms of pharmacologic treatment have been approved for use in chronic bronchitis, including inhaled corticosteroids

and ipratropium bromide. It has not been demonstrated whether or not these drugs are useful for the treatment of chronic bronchitis caused by organic dust.

The components of airborne dust that cause chronic bronchitis are largely unknown. It may be speculated that endotoxin, mycotoxins and tannin play a role. Plant lectins have been isolated from grain dust.<sup>81</sup> Lectins cause lymphocyte proliferation, which could contribute to elevated airway immunoglobulin levels seen in individuals acutely exposed to grain dust.<sup>82</sup>

Most of the work done in the laboratory looking at the effects of inflammatory dust has been done with grain dust extracts.<sup>83</sup> Repeated inhalation challenge of rabbits with grain dust extracts causes lower respiratory tract infiltration with macrophages.

Macrophages are known to release a variety of mediators of inflammation, which could play a role in the development of chronic bronchitis.<sup>84</sup> Neutrophils, present in increased numbers in the airway of many individuals with chronic bronchitis, could function in a similar way.<sup>84</sup>

## ACUTE BRONCHITIS

The acute pulmonary effects seen after airborne dust exposure include dyspnea, chest tightness, and a cough, which may or may not be productive of sputum. In the non-atopic subject, these symptoms are consistent with acute bronchitis. This has been described in grain farmers as well as in swine confinement workers.

A preliminary study done in grain farmers during harvest using bronchoscopy with

BAL revealed evidence of airway inflammation without changes in spirometry.<sup>85</sup> One study has described signs of lower respiratory tract inflammation in swine confinement workers by also using bronchoscopy with bronchoalveolar lavage.<sup>86</sup>

Farmers symptomatic after other types of occupational airborne dust exposure have not been studied in this way. It might be useful to better characterize any changes in the lower respiratory tract in order to find therapy specific for these problems. Therapies that could be used prophylactically would be optimal.

The components of airborne dust that cause acute pulmonary effects have not been identified. Endotoxin is again suspected to play an important role. However, it has been shown that giving an inhalation challenge of grain dust extract to guinea pigs causes greater acute neutrophilic lower respiratory tract inflammation than a challenge with endotoxin alone, given in an amount equivalent to that present in the grain dust extract (unpublished data).

When added to cultures of bronchial epithelial cells, grain dust extracts also cause cell death and the release of neutrophil chemotactic factors.<sup>87</sup> Whether or not these observations help explain the presence of acute pulmonary symptoms after airborne dust exposure in the farm setting remains unknown.

## **ASTHMA**

Exacerbation of asthma by airborne dust is a well-described phenomenon, both as a response to specific allergens and as a nonspecific reaction.<sup>34, 88, 89</sup> A host of substances present in the farm setting contain antigens that trigger asthma. These

include animal dander, pollen, storage mites, and grain. There is no consensus, however, regarding the ability of these substances to cause asthma in the farm setting in a subject who has no previous exposure to them.

A host of substances present in the farm setting contain antigens that trigger asthma.

Ethical considerations complicate studies designed to answer the question raised above. Specific antigen challenges, using extracts made from airborne dusts, can be given in the laboratory in order to help determine the cause of asthma in farmers suspected of having occupational causes for their bronchospasm.

There is some evidence that farmers have increased bronchial reactivity presumably related to airborne dust exposures.<sup>25,90</sup> More work remains to be done relating bronchial reactivity to acute and chronic respiratory symptoms in farmers.

## **MUCOUS MEMBRANE INFLAMMATION**

Symptoms of eye and nasal irritation as well as dry throat are common after exposure to airborne dust. This is a common reaction to airborne dust in subjects with allergic rhinitis. However, symptoms of mucous membrane irritation are also seen in individuals without a history of atopy.

With some grain dusts, the offending agent appears to be a part of the plant, which causes mechanical irritation. However, endotoxin and mycotoxins must also be

considered as possible causes for this problem.

The presence of inflammation is a common theme in these disorders.

It has not been demonstrated that wearing respirators commonly in use in the farm settings reduces incidences of these complaints. Also, no pharmacologic therapy has been found for these symptoms. Attempts should be made to find agents that prevent as well as treat the symptoms.

Little work has been done in the laboratory to further define the problems described. It has been shown that aerosol challenge of human volunteers with grain sorghum dust extract causes an influx of neutrophils into the nose, as demonstrated with nasal lavage.<sup>21</sup>

## REFERENCES

1. Ramazzini B. *De Morbus Artificum*. pp. 1-360, Modena, 1700.
2. Campbell JM. Acute symptoms following work with hay. *Brit Med J* 1932; 2:1143.
3. Emanuel DA, Wenzel FJ, Lawton BR. Pulmonary mycotoxicosis. *Chest* 1975; 67:293-297.
4. May JJ, Stallones L, Darrow D, Pratt DS. Organic dust toxicity (pulmonary mycotoxicosis) associated with silo unloading. *Thorax* 1986; 41:919-923.
5. DoPico GA, Flaherty D, Bhansali P, Chavaje N. Grain fever syndrome induced by inhalation of airborne grain dust. *J Aller Clin Immunol* 1982; 69:435-443.
6. Warren CPW, Manfreda J. Respiratory symptoms in Manitoba farmers: association with grain and hay handling. *CMA J* 1980; 122:1259-1264.
7. Husman K, Koskenvuo M, Kaprio J, Terho EO, Vohlonen I. Role of environment in the development of chronic bronchitis. *Eur J Respir Dis* 1987; 71:57-63.
8. Iversen M, Dahl R, Korsgaard J, Hallas T, Jensen EJ. Respiratory symptoms in Danish farmers: an epidemiological study of risk factors. *Thorax* 1988; 43:872-877.

## SUMMARY

A variety of disorders are associated with exposure to airborne dust in the farm setting. These include hypersensitivity pneumonitis, organic dust toxic syndrome, chronic bronchitis, acute pulmonary symptoms, asthma, and mucous membrane irritation. Better ways of preventing these problems must be found, through the use of protective devices and agricultural engineering innovations, as well as perhaps by pharmacologic means.

The presence of inflammation is a common theme in these disorders. Researchers are faced with a variety of challenges in better defining the inflammatory changes. In particular, the causative components in the airborne dust and the mediators of inflammation must be better described so that specific therapies can be identified.□

9. Terho EO, Husman K, Vohlonen I. Prevalence and incidence of chronic bronchitis and farmer's lung with respect to age, sex, atopy and smoking. *Eur J Respir Dis* 1987; 71:19-28.
10. Dosman JA, Graham BL, Hall D, Van Loon P, Bhasin P, Froh F. Respiratory symptoms and pulmonary function in farmers. *J Occupational Med* 1987; 29:38-43.
11. Vohlonen I, Tupi K, Terho EO, Husman K. Prevalence and incidence of chronic bronchitis and farmer's lung with respect to the geographical location of the farm and to the work of farmers. *Eur J Respir Dis* 1987; 71:37-46.
12. Manfreda J, Cheang M, Warren CPW. Chronic respiratory disorders related to farming and exposure to grain dust in a rural adult community. *Am J Industrial Med* 1989; 15:7-19.
13. Manfreda J, Nelson N, Cherniack RM. Prevalence of respiratory abnormalities in a rural and an urban community. *Am Rev Respir Dis* 1978; 117:215-226.
14. Warren CPW, Manfreda J. Respiratory symptoms in grain farmers: A brief report. In: *Occupational Pulmonary Disease*. Dosman JA, Cotton DJ, eds. New York: Academic Press, 1980.
15. DoPico GA, Reddan W, Anderson S, Flaherty D, Smalley E. Acute effects of grain dust exposure during a work shift. *Am Rev Respir Dis* 1983; 128:399-404.
16. Fonn S, Groeneveld H, DeBeer M, Becklake MR. Subjective and objective assessment of exposure to grain dust in relation to lung function change over a working week. In: *Progress in Occupational Epidemiology*. Hogstedt C, Reuterwall C, eds., Elsevier Science Publishers, 1988.
17. Dosman JA, Cockcroft DW. *Principles of Health and Safety in Agriculture*. CRC Press, Inc., Boca Raton, Florida, 1989.
18. Donham KJ, Rubino M, Thedell TD, Kammermeyer J. Potential health hazards to agricultural workers in swine confinement buildings. *J Occupational Med* 1977; 19:383-387.
19. Donham KJ, Zavala DC, Merchant J. Acute effects of the work environment on pulmonary functions of swine confinement workers. *Am J Industrial Med* 1984; 5:367-375.
20. Haglind P, Rylander R. Occupational exposure and lung function measurements among workers in swine confinement buildings. *J Occupational Med* 1987; 29:904-907.
21. Wilhelmsson J, Bryngelsson I-L, Ohlson C-G. Respiratory symptoms among Swedish swine producers. *Am J Industrial Med* 1989; 15:311-318.
22. Donham K, Haglind P, Rylander R, Peterson Y. Environmental and health studies of workers in Swedish swine buildings. In: *Principles of Health and Safety in Agriculture*. Dosman JA, Cockcroft DW, eds. Florida: CRC Press, Inc. 1989.
23. Holness DL, Nethercott JR. Respiratory status and environmental exposure of hog confinement and control farmers in Ontario. In: *Principles of Health and Safety in Agriculture*. Dosman JA, Cockcroft DW, eds. Florida: CRC Press, Inc. 1989.
24. Merchant JA, Donham KJ. Health risks from animal confinement units. In: *Principles of Health and Safety in Agriculture*. Dosman JA, Cockcroft DW eds. Florida: CRC Press, Inc., 1989.

## Research – Chemical and Biological Hazards

25. Iversen M, Pedersen B. Relation between respiratory symptoms, type of farmer, and lung function disorders in farmers. *Thorax* 1991; 46:919-923.
26. Thackrah CT. The effects of arts, trades and professions and civic states and habits of living, on health and longevity. In: *The Life, Work and Times of Charles Turner Thackrah*. Meiklejohn AL, London 1957.
27. Duke WW. Soy bean as a possible important source of allergy. 11th Annual Meeting of the Association for the Study of Allergy, Milwaukee, WI, 1933.
28. Davies RJ, Green M, Schofield NMCC. Recurrent nocturnal asthma after exposure to grain dust. *Am Rev Respir Dis* 1976; 114:1011-1019.
29. Peters GA. Bronchial asthma due to soybean allergy. *Ann Allergy* 29: 270-272.
30. Bush RK, Cohen M. Immediate and late onset asthma from occupational exposure to soybean dust. *Clin Allergy* 1977; 7:369-373.
31. Harries MG, Cromwell O. Occupational asthma caused by allergy to pigs' urine. *Brit Med J* 1982; 284:867.
32. Anto JM, Sunyer J, Rodriguez-Roisin R, Suarez-Cervera M, Vazquez L. Community outbreaks of asthma associated with inhalation of soybean dust. *NEJM* 1989; 320:1097-1102.
33. Blainey AD, Toppind MD, Ollier S, Davies RJ. Allergic respiratory disease in grain workers: The role of storage mites. *J Allergy Clin Immunol* 1989; 84:296-303.
34. Chan-Yeung M. A clinician's approach to determine the diagnosis, prognosis and therapy of occupational asthma. *Med Clinics of North America* 1990; 74:811-822.
35. Rylander R. Epilogue. *Am J Industrial Med* 1990; 17:147-148.
36. Seaton A, Morgan WKC. Hypersensitivity pneumonitis. In *Occupational Lung Diseases*, W.B. Saunders, Philadelphia, 1984, 564-608.
37. Marx JJ, Guernsey J, Emanuel DA, Merchant JA, Morgan DP, Kryda M. Cohort studies of immunologic lung disease among Wisconsin dairy farmers. *Am J Industrial Med* 1990; 18:263-268.
38. Malmberg P, Rask-Andersen A. Natural and adaptive immune reactions to inhaled microorganisms in the lungs of farmers. *Scand J Work Environ Health* 1988; 14:68-71.
39. Richerson HB, Bernstein IL, Fink JN, Hunninghake GW, Novey HS, Reed CE, Salvaggio JE, Schuyler MR, Schwartz JH, Stechschulte DJ. Guidelines for the clinical evaluation of hypersensitivity pneumonitis. *J Allergy Clin Immunol* 1983; 84:839-844.
40. Kokkarinen J, Tukiainen H, Terho EO, Husman K. Corticosteroid treatment in farmer's lung. *Am Rev Respir Dis* 1990; 141:A311.
41. Hendrick J, Marshall R, Faux JA, Krall JM. Protective value of dust respirators in extrinsic allergic alveolitis: clinical assessment using inhalation provocation tests. *Thorax* 1981; 36:917-921.
42. Pratt DS, May JJ. Feed-associated respiratory illness in farmers. *Arch Environ Health* 1984; 39:43-48.



43. Emauel DA, Marx J, Ault B, Treuhaft M, Roberts R, Kryda M. Pulmonary mycotoxicosis revisited. *Am J Industrial Med* 1986; 10:305-306.
44. May JJ, Stallones L, Darrow D, Pratt D. Organic dust toxicity (pulmonary mycotoxicosis) associated with silo unloading. *Thorax* 1986; 41:919-923.
45. May JJ, Pratt DS, Stallones L, Morey PR, Olenchock SA, Deep IW, Bennett GA. A study of silo unloading: The work environment and its physiologic effects. *Am J Industrial Med* 1986; 10:318.
46. Lecours R, Laviolette M, Cormier Y. Bronchoalveolar lavage in pulmonary mycotoxicosis (organic dust toxic syndrome). *Thorax* 1986; 41:924-926.
47. Brinton WT, Vastibinder EE, Greene JW, Marx JJ, Hutcheson RH, Schaffner W. An outbreak of organic dust toxic syndrome in a college fraternity. *JAMA* 1987; 258:1210-1212.
48. Malmberg P, Rask-Andersen A, Palmgren U, Hoglund S, Kolmodin-Hedman B, Stalenheim G. Exposure to microorganisms, febrile and airway-obstructive symptoms, immune status and lung function of Swedish farmers. *Scand J Work Environ Health* 1985; 11:287-293.
49. May JJ, Pratt DS, Stallones L, Morey PR, Olenchock SA, Deep IW, Benent GA. A study of dust generated during silo opening and its physiologic effects on workers. In: *Principles of Health and Safety in Agriculture*. JA Dosman, DW Cockcroft, eds. CRC Press, Inc. Florida, 1989, 76-79.
50. Malmberg P, Rask-Andersen A, Hoglund S, Kolmodin-Hedman B, Guernsey JR. Incidence of organic dust toxic syndrome and allergic alveolitis in Swedish farmers. *Int Arch Allergy Appl Immunol* 1988; 87:47-54.
51. Rask-Andersen A. Organic dust toxic syndrome among farmers. *Brit J Industrial Med* 1989; 46:233-238.
52. Husman K, Terho EO, Notkola V, Nuutinen J. Organic dust toxic syndrome among Finnish farmers. *Am J Industrial Med* 1990; 17:79-80.
53. Von Essen S, Robbins RA, Thompson AB, Rennard SI. Organic dust toxic syndrome: An acute febrile reaction to organic dust exposure distinct from hypersensitivity pneumonitis. *Clin Toxicology* 1990; 28:389-420.
54. Malmberg P, Rask-Andersen A, Hoglund S, Kolmodin-Hedman B, Guernsey JR. Incidence of organic dust toxic syndrome and allergic alveolitis in Swedish farmers. In: *Arch Allergy Appl Immunol* 1988; 87:47-54.
55. Rylander R, Peterson Y, Donham KJ. Questionnaire evaluating organic dust exposure. *Am J Industrial Med* 1990; 17:121-126.
56. Fournier E, Tonnel AB, Gosset P, Wallaert B, Ameisen JC, Voisin C. Early neutrophil alveolitis after antigen inhalation in hypersensitivity pneumonitis. *Chest* 1985; 88:563-566.
57. Emanuel DA, Marx JJ, Ault B, Roberts RC, Kryda MJ, Treuhaft MW. Organic dust toxic syndrome (pulmonary mycotoxicosis) a review of the experience in central Wisconsin. In: *Principles of Health and Safety in Agriculture*. Dosman JA, Cockcroft DW, eds., Boca Raton, Florida: CRC Press, 1989:72-75.
58. May JJ, Marvel LH, Pragg DS, Coppolo DP. Organic dust toxic syndrome: A follow-up study. *Am J Industrial Med* 1990 17:111-113.

## Research – Chemical and Biological Hazards

59. Clark S. Report on prevention and control. *Am J Industrial Med* 1986; 10:267-273.
60. Hoglünd S. Prevention of respiratory problems in agriculture. *Am J Industrial Med* 1986; 10:245-247.
61. Watson RD. Prevention of dust exposure. *Am J Industrial Med* 1986; 10:229-243.
62. Olenchock SA, Lenhart SW, Mull JC. Occupational exposure to airborne endotoxins during poultry processing. *J Toxic Environ Health* 1982; 9:339-349.
63. Clark S, Rylander R, Larsson L. Airborne bacteria, endotoxin and fungi in dust in poultry and swine confinement buildings. *Am Ind Hyg Assoc J* 1983; 44:537-541.
64. Lundholm M, Palmgren U, Malmberg P. Exposure to endotoxin in the farm environment. *Am J of Industrial Med* 1986; 10:314-315.
65. Donham, KJ. Hazardous agents in agricultural dusts and methods of evaluation. *Am J Industrial Med* 1986; 10:205-220.
66. Brigham, KL, Meyrick B. Endotoxin and lung injury. *Am Rev Respir Dis* 1986; 133:913-927.
67. Rylander R. Role of endotoxins in the pathogenesis of respiratory disorders. *Eur J Respir Dis* 1987; 154:136-144.
68. Olenchock SA, May JJ, Pratt DS, Piacitelli LA, Parker JE. Presence of Endotoxin in Different Agricultural Environments. *Am J Industrial Med* 1990; 18:279-284.
69. Hudson AR, Kilburn KH, Halprin GM, McKenzie WN. Granulocyte recruitment to airway exposed to endotoxin aerosols. *Am Rev Respir Dis* 1977; 115:89-95.
70. Rask-Anderson A, Malmberg P, Lundholm M. Endotoxin levels in farming: absence of symptoms despite high exposure levels. *Br J Industrial Med* 1989; 46:412-416.
71. Sorenson WG. Mycotoxins as potential occupational hazards. *J Industrial Microbiol* 1990; 31:205-211.
72. Laque DE, Hempel SL, Schroeder MA, Hyatt RE, Rohrbach MS. Evaluation of the contribution of tannin to the acute pulmonary inflammatory response against inhaled cotton mill dust. *Am J Path* 1988; 133:163-172.
73. Warren CPW, Manfreda J. Respiratory symptoms in Manitoba farmers: association with grain and hay handling. *CMA J* 1980; 122:1259-1264.
74. Horne SL, Cockcroft DW, Dosman JA. Possible protective effect against chronic obstructive airway disease by the GC2 allele. *Hum Hered* 1990; 40:173-176.
75. Donham KJ, Merchant JA, Lassise D, Pependorf WJ, Burmeister LF. Preventing respiratory disease in swine confinement workers: intervention through applied epidemiology, education and consultation. *Am J Industrial Med* 1990; 18:241-261.
76. Donham KJ, Scallon LJ, Pependorf W, Treuhaft MW, Roberts R. Characterization of dust collected from swine confinement buildings. *Am Ind Hyg Assoc J* 1986; 47:404-410.

77. Leistikow B, Pettit W, Donham K, Merchant J, Pependorf W. Respiratory risks in poultry farmers. In: *Principles of Health and Safety in Agriculture*. Dosman JA, Cockcroft DW, eds., CRC Press, Inc., Boca Raton, Florida 1989; 62-65.
78. Dopico GA, Reddan W, Tsiatis A, Peters ME, Rankin J. Epidemiologic study of clinical and physiologic parameters in grain handlers of Northern United States. *Am Rev Respir Dis* 1984; 130:759-765.
79. Chen Y, Horne SL, McDuffie HH, Dosman JA. Combined effect of grain farming and smoking on the prevalence of chronic bronchitis. *Am Rev Respir Dis* 1991; 143:A99.
80. Cotton DJ, Graham BL, Li KYR et al. Effects of grain dust exposure and smoking on respiratory symptoms and lung function. *J Occup Med* 1983; 25:131-141.
81. Olenchock SA, Lewis DM, Mull JC. Composition of extracts of airborne grain dusts: Lectins and lymphocyte mitogens. *Environ Health Perspec* 1986; 66:119-123.
82. Thompson AB, Von Essen SG, Robbins RA, Sears KK, Linder J, Rennard SI. Grain dust exposure is associated with alveolar inflammation. *Am Rev Respir Dis* 1987; 135:A236.
83. Von Essen SG, Robbins RA, Thompson AB, Ertl RF, Linder J, Rennard S. Mechanisms of neutrophil recruitment to the lung by grain dust exposure. *Am Rev Respir Dis* 1988; 138:921-927.
84. Sibley Yves, Reynolds, HY. Macrophages and polymorphonuclear neutrophils in lung defense and injury. *Am Rev Respir Dis* 1990; 141:471-501.
85. Von Essen SG, Thompson AB, Robbins RA, Jones KK, Dobry CA, Rennard SI. Lower respiratory tract inflammation in grain farmers. *Am J Industrial Med* 1990; 17:75-76.
86. Pedersen B, Iversen M, Dahl R. Bronchoalveolar lavage of pig farmers. *Am J Industrial Med* 1990; 17:118-118.
87. Von Essen SG, O'Neill DP, Robbins RA, Koyama S, Rennard SI. Grain sorghum dust extract causes epithelial cell cytotoxicity. *SEP-SEPCR*, London, England, September 1990.
88. Grammar LC, Patterson R, Zeiss CR. Guidelines for the immunologic evaluation of occupational lung disease. *J Allerg Clin Immunol*, 1989; 84:805-814.
89. Smith, AB, Castellan RM, Lewis D, Matte T. Guidelines for the epidemiologic assessment of occupational asthma. *J Allerg Clin Immunol* 1989; 84:794-804.
90. Iversen M, Dahl R, Jensen EJ, Korsgaard J, Hallas T. Lung function and bronchial reactivity in farmers. *Thorax* 1989; 44:645-649.
91. Von Essen SG, McGranaghan S, Cirian D, O'Neill D, Spurzem JR, Rennard SI. Inhalation of grain sorghum dust extract causes respiratory tract inflammation in human volunteers. *Am Rev Respir Dis* 1991; 143:A105.

## INFECTIOUS DISEASES

By *Russell W. Currier, D.V.M.*

Bureau Chief of Environmental Epidemiology and Chronic Diseases  
Iowa Department of Public Health

---

### INTRODUCTION

The infectious diseases associated with farming and agricultural practices are broad in terms of diversity and—owing to general health improvements and significance of reductions of livestock zoonotic diseases—minimal in terms of morbidity. Nevertheless, there are continuing infectious disease problems, mostly sporadic in nature and occasionally episodic, that affect agricultural workers and occasionally, via the food chain, their urban counterparts.

Many excellent disease-specific reviews are available to interested parties for further study.<sup>1,2</sup> This review, while not comprehensive in nature, is offered to define the scope of current problems as reported and investigated by public health workers and health care givers. Much of this information was obtained through a recent survey of state epidemiologists and related staff.<sup>3</sup>

The review will be divided into four major groups of infectious conditions by nature of source or form of transmission: interpersonal illness, food-borne illness, environmental and vector-borne disease, and zoonoses (not covered in the aforementioned groups). Comment on improved management of these conditions and exposures will be provided, as well as recommendations for improved prevention and control, including research needs to address these problems more effectively.

### INTERPERSONAL ILLNESS

This category focuses almost exclusively on migrant farm workers (MFWs) and will be confined primarily to human-host illness. Tuberculosis and sexually transmitted diseases (STDs) are both problems in migrant worker populations.

California reports a recent outbreak of chancroid in a migrant camp in Orange County.<sup>4</sup> STD problems were the fourth most prevalent problem at two migrant health clinics in Maryland.<sup>5</sup>

Tuberculosis (TB) remains a serious public as well as personal health problem in MFWs. Ciesielski and colleagues<sup>6</sup> reported on a large random-sample population-based 1988 study of farm workers (n=543) in three North Carolina counties and demonstrated that skin-test positivity ranged from 33 percent in Hispanics to 54 percent in US-born blacks and 76 percent in Haitians. Active tuberculosis disease occurred in 3.6 percent of US-born blacks (300 times the average U.S. rate) and 0.47 percent of Hispanics.

This investigation indicates that TB among MFWs is an occupational problem, not an imported one. Among black American migrant farm workers, risk factors associated with farm work and years of such work were far more important than age, gender, and history of familial TB. These investigators offer strategies to control tuberculosis among MFWs, including:

1. Adhere to recommendations of the Strategic Plan for Elimination of Tuberculosis in the U.S. and TB Among Foreign-born Persons Entering the United States.<sup>7,8</sup>
2. In states with large migrant populations, establish a separate registry, e.g. Florida's special registry.
3. Increase funding for migrant health-care centers.
4. To avoid false negatives, consider use of recall antigens when administering skin tests among high-risk groups.
5. Regulate labor contracts more closely.
6. Occupational Safety and Health Administration (OSHA) should promulgate regulations addressing TB control.

During August 1990, the Wisconsin Department of Health investigated an outbreak of gastrointestinal illness affecting an undisclosed number among approximately 1,000 MFWs and their families residing in 40 camps in 3 counties.<sup>9</sup> Some infections were due to *Giardia* and appeared to spread through migrant day care centers (DCC).

Initial infection is postulated to originate from exposure to contaminated water from a sewer back-up into the shower of the residence of the index case. Known symptomatic cases totaled 21. Other cases of illness in this population were due to *Shigella flexneri* 1 and 2 and, owing to limitations of obtaining accurate history and limited microbiological studies of food and water, the exact chain of infection could not be established.

Enterically transmitted viral and bacterial diseases among MFWs do occur at about 10 times the rate of the general population. This can be attributed to a variety of factors, but primarily to poor water and toilet hygiene.

Outbreaks subsequently can affect consumers of the produce. In August 1990, an outbreak of *Salmonella javiana* in Minnesota was associated with the consumption of contaminated raw tomatoes from a South Carolina distributor.

Mary Proctor, an epidemiologist with the Wisconsin Division of Health, has reviewed the literature and cites reports implicating hepatitis A with frozen raspberries and fresh lettuce.<sup>11</sup> *Shigella* infections have also been implicated in commercially distributed lettuce which were thought to be contaminated at the harvest site.

In 1979, Iowa and several other states with Amish settlements sustained polio transmission in these agri-populations; no transmission to surrounding communities was reported.<sup>12</sup> More recently, rubella has been reported in Amish settlements in Tennessee.<sup>13</sup>

In addition to the diseases mentioned, a variety of personal health problems in MFWs and their families are also reported; these problems are influenced by substandard living and working conditions, and include parasitic infections, urinary tract infections, gynecological problems, respiratory infections, and pediatric infections.<sup>14,15</sup> Migrant and farm workers also have a higher percentage of children not immunized against vaccine-preventable diseases.<sup>16</sup>

## FOOD-BORNE ILLNESS

Improvements in food processing and packaging, coupled with livestock disease control programs, have reduced many zoonotic diseases formerly affecting consumers.<sup>17</sup> Examples include tuberculosis, brucellosis, and trichinosis. Since a great deal of this reduction has been effected through improved processing and pasteurization, many pathogens continue to infect farm workers who consume produce without adequate safeguards or preparation.

Unpasteurized milk is a vehicle that still infects large numbers of farmers and their guests. Potter and Currier have summarized the hazards of raw milk, but episodes continue to occur.<sup>18, 19</sup>

A report by Blazer describes an outbreak of *Campylobacter* infection in a fraternity group which visited a member's farm family.<sup>20</sup> In this outbreak, 22 of 25 students (88 percent) who consumed raw milk for the first time became infected; two who had not consumed raw milk were not infected.

Residents of the farm were not affected by virtue of long-term raw milk consumption, and had elevated levels of *Campylobacter*. Jejuni-specific serum antibodies provided apparent immunity to symptomatic infection. Numerous episodes and case reports exist in the literature of *Campylobacter* outbreaks in children and visitors touring farms and dairies where unpasteurized milk consumption resulted in infection.

*Salmonella* infections have also been associated with numerous episodes where raw or inadequately pasteurized milk was consumed. It is reasonable to assume that families and workers on dairy farms ex-

perience related illness, although less frequently from raw milk.

In 1987, Vogt reported a case of listeriosis in a 76-year-old female who lived on a dairy farm. Blood culture isolated *L. monocytogenes*.<sup>21</sup> Isolates subsequently obtained from two cows and the bulk tank were identical to the patient's, as characterized by isoenzyme typing and ribosomal RNA typing.

The patient regularly consumed raw milk from her farm on her cereal each morning but consumed no other food products from her farm. In addition, North Dakota health officials are currently investigating a case of *E. coli* 0157:H7 transmitted through raw milk to a farm patient.<sup>22</sup>

In the past 5 years, eggs have been implicated in numerous cases and episodes of gastroenteritis due to *Salmonella enteritidis*.<sup>23</sup> The role eggs play and the extent to which they cause salmonellosis in farm workers are unclear.

Brief reports and unpublished investigations have implicated ungraded farm eggs in "home-made ice cream" in transmitting salmonellosis.<sup>24</sup> These incidents may attest to the lack of understanding farm workers and families have concerning basic food hygiene, and may contribute directly or indirectly to the larger problem.

Trichinosis continues to decline in the United States, but in any given year the rate of cases may double or triple as influenced by one or two community episodes. A large outbreak affecting 15 of 25 individuals from four related farm families in Nebraska was investigated in 1973.<sup>25</sup> Source of infection was uncooked pork-beef sausage from two pigs and one

beef animal; these animals were raised in open lots or pastures on the farms and were slaughtered on the premises.

Again, there was an apparent lack of concern for trichinosis owing to tradition. During 1990, 90 cases of trichinosis in central Iowa were traced to raw pork consumption from a locally procured carcass attesting to the disease's continued presence in swine.<sup>26</sup> In many states, expanded garbage feeding practices, although well regulated, may serve to enhance transmission to pigs.

Overall, food-transmitted illness to farmers is isolated, sporadic and perhaps not always recognized. It points to the need for educating these producers about risks, food sanitation, and desirability of consuming adequately processed, pasteurized, or cooked food. It is conceivable that elderly persons on farms, very young children, and farmers with coexistent health problems would be at increased risk of infection or its complications.

## ENVIRONMENTAL AND VECTOR-BORNE ILLNESS

Farmers and farm workers pursue their activities in a diverse environment of landscapes, buildings and livestock collections. Vector-borne disease does present occasional risks to farm workers in outdoor settings.

Sylvatic plague, Rocky Mountain Spotted fever, Colorado tick fever, and tularemia (tick and deer fly transmitted) are infrequently transmitted to farm and ranch workers during ordinary work activities. Oregon and Utah report recent isolated cases of arthropod-borne tularemia in farm and ranch workers.<sup>27, 28</sup>

More recently, Lyme disease is being recognized in some farm workers in upper Midwest states. Concern exists not only for exposure to deer ticks in field settings, but also exposure to infected cattle.

In a Wisconsin study (to be published later), of 246 dairy workers tested using CDC ELISA, 21 (8.5 percent) had significant *B. burgdorferi* antibody levels, while 6 (4.9 percent) of the 123 crop farmers were seropositive ( $p < 0.2$ ).<sup>9</sup> Concern exists for the role of spirochetes in cattle urine splash as a means of Lyme transmission. Additional studies are planned.

In another Wisconsin seroprevalence survey conducted in 1987 at the Marshfield Clinic on asymptomatic residents of north central Wisconsin, the seropositivity rate for farmers was 32 percent versus 16 percent in non-farmers.<sup>29</sup> Obviously, farm workers are at increased risk from Lyme disease where vectors and conditions favor its presence, and it should to be included in differential diagnoses.

Malaria is of greater concern, especially since this disease had been eliminated from the United States in the 1940's. California reports increased activity relating to MFWs. A summary of the California experience from its state morbidity report is provided verbatim:

Since 1950, California has experienced 16 episodes of introduced autochthonous malaria (malaria acquired by mosquito transmission in an area where malaria does not occur regularly) accounting for 120 cases, all due to *P. vivax*. Ten counties have been the sites of exposure with 7 in the Sacramento Valley and adjacent Sierra Foothills (Butte, El Dorado, Glenn, Nevada, Sacramento, Sutter, and Yolo), 2 in the San Joaquin Valley (Fresno and

Kings) and San Diego County along the state's southernmost coast. Only 2 counties have experienced more than 1 episode, Sutter (4 episodes), and San Diego (4 episodes).

The confirmed or presumptive sources of introduction were an army veteran just returned from Korea and agricultural workers from India (4 episodes) or Mexico (8 episodes). In 3 introductions, the source cases were uncertain but most likely from India or Mexico. Transmission of malaria occurred from May to September, with 3 anopheline species being the likely vectors (*An. freeborni* and *An. punctipennis* in the central valley and *An. hermsi* in San Diego County).

The largest of these outbreaks was in 1952 when 35 cases occurred in a group of Campfire Girls exposed in Nevada County. The second and third largest episodes were in 1986 and 1988 involving 27 and 30 cases, respectively, in San Diego County. The remaining 13 introductions resulted in 1 to 5 cases each.

Since 1986 there have been several important changes in the epidemiology of introduced malaria in California. The incidence of introductions has risen sharply; 9 (56 percent) of the 16 introduced episodes since 1950 have occurred in the last 4 years. Before 1986 all episodes (7) had occurred in Sacramento County northward and in 5 (71 percent), the source(s) of introduction were associated with immigrants recently arrived from northern India.

Since 1986, activity has shifted with 6 of the 9 (67 percent) introductions occurring south of Sacramento County and 8 of 9 (89 percent) being associated with MFWs from Mexico. Until 1986 all outbreaks of

mosquito-transmitted malaria had involved only permanent California residents. Since 1986, the great majority of cases (59/71) have occurred in migrant workers though local residents have also been involved in all outbreaks.

Paralleling these trends in the epidemiology of introduced malaria in California has been a sharp rise in the incidence of malaria in Mexico and the number of imported malaria cases in persons entering the State from that country. Malaria cases reported in Mexico have risen steadily from 25,774 in 1980 to 166,271 in 1988 (>6 fold increase) while the number of California malaria cases reported in travelers and immigrants from Mexico has risen steadily from 12 in 1980 to 83 and 81, respectively, in 1988 and 1989 (>6 fold increase).

The episodes of local mosquito transmitted vivax malaria since 1986 (particularly in San Diego County) have features in common which include:

1. Remotely located encampments.
2. Inadequate shelters for MFWs residing in areas with *Anopheles* mosquito vectors capable of transmitting malaria.
3. The reluctance of MFWs to seek medical care because of limited access and concerns about being identified as undocumented aliens.

Once a parasitemic individual introduces malaria in such settings, these factors allow substantial transmission of malaria to evolve before outbreak foci can be identified and control measures instituted.

Mosquito transmitted viral encephalitis also presents risks to farm workers and



rural residents. St. Louis encephalitis (SLE) and western equine encephalitis (WEE) are transmitted by vector mosquitoes that breed in field irrigation run-off pools. During 1989, California reported 29 confirmed cases of SLE but no cases of WEE.<sup>31</sup> While specific occupation was not recorded, cases tended to be older, live closer to fields, and were more likely to be outdoors in the evenings (when mosquitoes are active) prior to illness when compared to cases of viral CNS disease who were seronegative for SLE.

Other environmental exposures focus on fungal diseases. Histoplasmosis is frequently diagnosed in farm personnel cleaning up litter and debris from poultry houses, sheds, and barns.

A recent outbreak occurred in Iowa during a family reunion, when attendees retreated to a seldom-used barn to seek refuge from a thunderstorm. Old debris and the presence of droppings from birds gaining access through broken windows provided a milieu for the fungus to flourish, and when disrupted by guests, resulted in 10 cases of histoplasmosis among 25 guests exposed to the barn.<sup>32</sup>

Coccidioidomycosis, or valley fever, is endemic in arid rural areas of western states, particularly California. The ratio of infections that cause clinical disease is very small; children and adolescents display milder illness than adults, and African-Americans, Latinos, and Filipinos tend to have more serious disease when it occurs.

New residents in endemic areas are more apt to become ill than permanent residents. Roberto reports that immigrants, especially Philippine natives from coccid-free areas of the world who are employed in farming in the Central Valley of

California, may develop severe illness and chronic complications.<sup>4</sup>

Injury incidental to farming activities often results in cellulitis and at least suggests the need for tetanus-toxoid immunization among adult farm workers—a group that may not be current on vaccine history. Kansas reports three recent adult cases of tetanus in rural/farm individuals.<sup>33</sup>

In Iowa, the special class of farm injury relating to inadvertent syringe needle sticks incidental to livestock health programs was studied in 1990.<sup>34</sup> A total of 28 exposures were recorded; 10 involved sticks to legs or feet and 18 sustained injury to hand, wrist, or arm. One involved anaphylactic reaction to blood drawn from a vein. Hospitalization was required for another case of cellulitis of the leg from a syringe stick.

While most of these exposures resulted in cellulitis, it is also worth noting that animal vaccines often contain very irritating adjuvants that enhance tissue injury. There is a definite need for a compendium of patient-management guidelines for individuals with syringe stick exposures to veterinary injectables.

In summary of this segment, environmental contaminants do play a role in infectious disease of farm workers. Frequently infections secondary to injury from a variety of sources are the mechanism of transmission.

Arthropods also serve to expose farm-ranch workers to disease agents, but are geographically localized and generally sporadic-to-rare in incidence. Systemic fungal diseases also occur, are often episodic, and primarily affect new residents or nonresident workers in agriculture settings.

## NON-VECTOR-BORNE ZONOSSES

This is a broad, diverse group of disease-causing organisms. Tuberculosis due to *M. bovis* is functionally eliminated from domestic livestock, and does not present a threat to farm workers or related personnel.

Nevertheless it should be noted that certain wild or exotic species (e.g., bison, feral swine, and non-human primates) may still be infected and potentially serve as reservoirs for reinfecting cattle.<sup>35</sup> This reality speaks to the need for ongoing surveillance programs to monitor potential introductions.

Also of concern is the increased commerce in wild exotic animals that may be infected. During the past 3 years an eastern Iowa family unsuccessfully managed and finally depopulated their llama herd due to *M. bovis* infection.

Brucellosis has been greatly reduced these past 40 years through livestock control programs.<sup>36</sup> Total U.S. cases for 1989 were 95.<sup>17</sup>

Earlier employment of the milk ring test that monitors producing dairy herds has eliminated "undulant fever" in mostly farm-family consumers of raw milk; pasteurization assured safe milk for consumers even before herd eradication schemes were successful. During the 1970's and early 1980's, swine brucellosis was eradicated and cattle brucellosis eliminated in all but a few southern states.

Wild animal foci of brucellosis also exist, e.g., among bison, elk (Yellowstone National Park), and feral swine.<sup>37</sup> It appears that most recent brucellosis cases remain confined to packing-house workers

and international travelers exposed to contaminated foods. Farm workers are rarely still infected from handling aborted feti and placental membranes from infected cows.

Standard febrile agglutinin tests are available to diagnosticians who are evaluating farm workers with fevers of unknown origin. Serology and often blood culture are of critical importance to early diagnosis and, thus, effective treatment of this disease.

Exacerbation of earlier infections still occurs, often decades later, especially in older farmers infected with *B. suis*. Other infections may result from *B. abortus*, Strain 19 vaccine from inadvertent syringe sticks, and splash in the eye.

These events still occur and call for prophylactic treatment with tetracycline or one of its analogues and streptomycin.<sup>38</sup> The exact number of human brucellosis cases by occupational category is not conveniently available.

Leptospirosis cases for 1989 totaled 93, reflecting sporadic incidence except for Hawaii, which contributed 69 cases to the total.<sup>17</sup> Over the past five years (1986-1990), there have been 192 cases of leptospirosis reported in Hawaii, including five fatalities.

For this period, 18.75 percent of the cases were in agricultural occupations, while 20.8 percent of the cases had agricultural exposure and 9.9 percent had agriculture-related exposures (gardening, yard work).<sup>38</sup> Again, as in brucellosis, serology is critical to establishing the diagnosis and optimal treatment.

Tularemia, as noted earlier, when transmitted by arthropods can result in transmission to farmers. Rare and isolated cases of pneumonic tularemia from grain dust aerosols presumably contaminated with rodent excreta have been recently recorded from Iowa and Oregon.<sup>39</sup> Here, too, appropriate cultures and especially serology are critical to diagnosis and effective treatment.

Chlamydial bacterial infections (psittacosis) are occasionally recognized in farm workers incidental to exposure to pigeons and domestic fowl, especially turkeys. Interestingly, turkey psittacosis may result in explosive outbreaks in poultry-plant workers after stress of transport and slaughtering processes creates infectious aerosols. Rarely is illness recognized in personnel at the turkey grower-sites of infected flocks.

Q fever, anthrax, erysipelas, and other bacterial zoonoses are very infrequently diagnosed in farm workers nationally. Sporadic cases of Q fever have been reported from Arizona in personnel handling aborted feti and bagging sheep manure for commercial sale as fertilizer.<sup>41</sup>

Parasitic zoonoses are an eclectic group of minor problems. *Giardia* infections have resulted from servicing irrigation systems in Utah.<sup>28</sup> Echinococcosis, introduced to western sheep-raising states by immigrant shepherds, has been eliminated.

Beef cattle infected with cysticerci from *Taenia saginata* continue to be recognized by federal meat inspection service. The occasional recognition of "measly beef" at slaughter speaks to the need of adequate toilet facilities for MFWs in feedlots and cattle production operations.

There are no known cases of recent transmission of these tape helminths to farm personnel (or consumers). Anecdotal cases of cryptosporidiosis have occurred in farm personnel and are of minor significance to immunocompetent individuals.<sup>42</sup>

Viral zoonoses, especially rabies, continue to result in exposures to farm workers. Cattle pose special risks, are highly susceptible to rabies, and are rarely immunized for the disease. When cattle are unwittingly cared for during clinical rabies, extensive exposure to saliva may occur and prompt need for immunoprophylaxis. This is especially true for registered breeding-cattle that often are valued at multiples of market price.

During January 1991 in Iowa, a registered beef bull with rabies and a dairy cow with the disease used in an ovum transplant program resulted in 26 farm workers' and veterinarians' being administered vaccine boosters or full immunoprophylaxis.<sup>43</sup> During the period 1985-1989, laboratory diagnoses of cattle rabies in the U.S. ranged from 150-200 cases.<sup>44</sup>

An earlier Illinois study estimates a ratio of one farm worker's being prophylaxed for each case of cattle rabies.<sup>45</sup> The last recognized case of rabies in a farm worker from cattle exposure occurred in California in 1939.<sup>46</sup>

The real significance of cattle rabies is the uncertainty and anxiety of exposure that prompt farm workers to receive costly—and probably unnecessary—immunoprophylaxis. In Iowa, cats—especially rural and farm cats—are serious vectors of human exposure since these animals frequently exhibit furious behavior and are prone to bite. Farm family members are the single

largest occupational group exposed to this species.<sup>47</sup>

Other viral zoonoses exist that occasionally infect farmers, including orf and swine influenza. Specific surveillance information is unavailable and precludes meaningful comment. Other retroviruses and lentiviruses infect a broad range of animals maintained on farms, e.g. bovine leukemia, feline leukemia, etc. Their role in any human illness is conjectural at this time and remains to be demonstrated if it exists.

## COMMENT

Infectious diseases unique or incidental to agricultural activity can be conveniently divided into migrant-worker-related illness and a variety of zoonoses. In the former category, many of these MFW illnesses—often episodic—are human host infections that may relate to country of origin (e.g., malaria and echinococcosis) or to substandard living or working conditions (e.g., tuberculosis and *Shigella* dysentery).

All these illnesses pose risks to the non-agricultural community through personal contact and potential contamination of foods or environments. For these reasons, as well as for humanitarian considerations, migrant farm workers need resources of improved medical care, education, and adequate living and working accommodations to reduce their burden of morbidity and suffering.

The second category mentioned above is infectious disease incidental to farm environmental exposures, primarily zoonoses. Since their occurrence is often sporadic and generally infrequent, problems of recognition and optimal management are obvious.

Clearly they are underdiagnosed and underreported. Primary care givers should improve diagnostic acumen through more active consultation with infectious disease specialists and increased use of microbiologic studies, especially serology.

## RECOMMENDATIONS

1. Migrant worker health concerns are paramount, as noted in this review. Clearly OSHA should exercise more authority in this sector of agricultural activity to assure adequate living and working standards for migrant and non-migrant or permanent employees.
2. Migrant worker health clinics are now networked, which facilitates follow-up of diagnostic and treatment services, particularly tuberculosis. States with large migrant populations should maintain a separate TB registry such as Florida's. All states should adhere, as much as practical, to CDC published guidelines for TB control in general and foreign-born cases in particular.
3. USDA should improve regulation of food production and harvesting to assure field sanitation measures are adequate to assure wholesome product. Indirectly, this would increase incentives for producers to provide improved working conditions for both domestic employees and MFWs.
4. Where not already accomplished, state and local health agencies should establish regulatory standards and inspection services addressing minimal living and health-care accommodations for MFWs, including day care centers.
5. State-federal minority health programs should also include components targeted to MFWs.

6. Conference of State and Territorial Epidemiologists and CDC should require "occupation" on all investigative surveillance reports. Summaries should include categories of farm workers, farm service personnel and MFWs.

7. Enhanced recognition of agriculturally related infections through increased utilization of serology is needed. This educational role can be best instituted by state health agencies and laboratories.

8. Since many agricultural disease problems are localized or exist in specific regions (e.g., leptospirosis in Hawaii), federal research grants to study these problems should be targeted to state-level health agencies. This is currently being done by CDC for Lyme disease. Examples of possible research projects include<sup>42</sup>

a. What is the potential for transmission of enteric pathogens such as *Salmonella*, *Yersinia*, and *Campylobacter* between animals and animal caretakers?

b. What is the role of urine shedding, if any, in Lyme disease transmission between cattle and humans?

c. What is the character of viral shedding of rabies in cattle and horses (to facilitate meaningful quarantine or observation periods)?

d. What is the role of stray and rural farm cats in terms of health risks, e.g., rabies, toxoplasmosis, and visceral larva migrans?

9. Federal agencies which license injectable veterinary biologics (USDA) and drugs (FDA) should require manufacturers to distribute specific management guidance

to all poison control centers concerning accidental exposures.

10. In at least one state, there has been an increasing trend of using treated sewage effluent for irrigation of crops.<sup>43</sup> Outbreaks of gastrointestinal illness have occurred in Israel from this practice. Specific surveillance studies of enteric illness in personnel exposed through employment or food consumption of produce from this practice would be indicated.

11. Indirectly, infectious disease in farm workers and family members may be adversely influenced by several psychological and economic factors. Many individuals who live on farms are less able to afford health care due to lack of health insurance. Most are self-employed without sick leave and workers' compensation, as noted. Also, the availability of health care may be limited or difficult to access. Sociological and epidemiology studies are needed to put these issues and concerns in perspective to reduce morbidity and its attendant cost.<sup>45</sup>

12. State-federal regulation of commerce in exotic and wild animals should be increased to assess presence of infectious diseases or vectors among livestock that may adversely affect domestic livestock and their handlers, ultimately including the consumer. Economic studies are needed to determine feasibility of indemnity payments for depopulation programs.

13. Enhanced research on farming practices that increase the risk of food-microbial contamination and/or may enhance risk of human exposure to infectious diseases should be implemented. Positive developments should be published for the agricultural community.

## SUMMARY

Infectious disease remains a serious problem in U.S. agriculture in two distinct populations:

- Migrant farm workers experiencing human-host illnesses, often episodic and exacerbated by substandard living and employment conditions.
- All other farm workers experiencing sporadic, isolated illness that is most frequently zoonotic, vector-borne, or environmentally acquired in nature.

Both populations may present risk of exposure to the non-farm population through personal contact, indirect exposure (environment or vector), or contamination of food produce. Obvious innovations and technologies exist to improve disease recognition, management, and control for both groups specifically, and non-farm individuals generally. The broad and varied scope of this problem is presented, including areas that should be targeted for additional research or enhanced program support.□

## REFERENCES

1. American Public Health Association, *Control of Communicable Diseases in Man*. Benenson AS ed, 15th Ed; 1990.
2. Amer Vet Med Association, Zoonoses Updates (published compilation), *JAVMA*. Amer Vet Med Ass'n, Schaumburg IL; 1990.
3. Currier RW. Iowa Department of Public Health, Des Moines IA; March 1991.
4. Roberto RR. Personal communication. California Department of Health Services, Berkeley CA; April 1991.
5. Armstrong CW. Personal communication. Virginia Department of Health, Richmond VA; April 1991.
6. Ciesielski SD, Seed JR, Esposito DH, and Hunter N. The epidemiology of tuberculosis among North Carolina migrant farm workers. *JAMA* 265: 1715-1719; April 3, 1991.
7. Centers for Disease Control. A strategic plan for the elimination of tuberculosis in the United States. *MMWR*. 1989; 38: S-3.
8. Centers for Disease Control. Tuberculosis among foreign-born persons entering the United States: recommendations of the Advisory Committee for Elimination of Tuberculosis. *MMWR*. 1990; 39(No. RR18).
9. Davis JP. Personal communication. Wisconsin Division of Health, Madison WI. March 1991.
10. Proctor M. Unpublished investigation. Wisconsin Division of Health, Madison WI. 1990.
11. Proctor M. Internal agency report. Wisconsin Division of Health, Madison WI. 1990.
12. Centers for Disease Control: *Poliomyelitis Surveillance Summary 1979*, Issued April 1981.
13. Hutchins R. Personal communication. Tennessee Department of Health, Nashville TN. April 1991.

14. Stevens GA. Testimony prepared for the Occupational Safety and Health Administration on Proposed Field Sanitation Standards. Delmarva Rural Ministries. July 1984.
15. Federal Register, 29 CFR Field Sanitation; Final Rule Vol 52, No 84, p 16049-16096. May 1, 1987.
16. McChesney TC. Personal communication. Arkansas Department of Health, Little Rock AR. April 1991.
17. Centers for Disease Control. Summary of notifiable diseases, United States, 1989. *MMWR*. 1989; 38 ( 54 ) .
18. Potter ME, Kaufman AF, Blake PA, and Feldman RA. Unpasteurized milk: The hazards of a health fetish. *JAMA*. 252:1048-2052. Oct 1984.
19. Currier RW. Raw milk and human gastroenteric disease: problems resulting from sale of legalized raw milk. *J of Pub Health Policy* 2:226-234, Sept 1981.
20. Blazer MD, Sazie E, Williams LP. The influence of immunity on raw milk-associated *Campylobacter* infection. *JAMA*. 257: 43-46. Jan 1987 .
21. Vogt RL, et al. Linking environmental and human strains of *Listeria monocytogenes* with isoenzyme and ribosomal RNA typing. *Eur J Epidemiol* 0392-2990:p 229-230. June 1990.
22. Shirely LA. Personal communication. North Dakota Department of Health. April 1991.
23. St Louis ME, Morse DL, Potter ME, et al. The emergence of grade A eggs as a major source of *Salmonella enteritidis* infections. *JAMA*. 259: 2103-2107. 1988.
24. Gunn RA and Markakis G. Salmonellosis associated with homemade ice cream. *JAMA* 240:1885-1886. 1978.
25. Currier RW, Rapp WF, Juranek DD. A community outbreak of trichinosis in Nebraska: report of an epidemiologic investigation. *Nebraska Medical Journal*. Jan-Feb, 1982.
26. Centers for Disease Control. *Trichinella spiralis* infection - United States, 1990. *MMWR*. 1991; 40 : 57-60.
27. Williams LP. Personal communication. Oregon Department of Health, Portland OR. April 1991.
28. Staff Epidemiologist. Personal communication. Utah Department of Health, Salt Lake City UT. April 1991.
29. Marx J. Unpublished data. Marshfield Clinic, Marshfield WI. April 1991.
30. California Morbidity. Mosquito-transmitted malaria in California: 1988-1989. Part 2 of 2. Nr 52, Jan 5, 1990. (Publ by Calif Department of Health Services.)
31. California Morbidity. Arboviral disease surveillance - California, 1989. Nr 21/22. June 1, 1990.
32. Fuortes L. Unpublished data. College of Medicine, Univ of Iowa, Iowa City IA. April 1991.
33. Wood C. Unpublished data. Kansas Department of Health and Environment, Topeka KS. April 1991.
34. Currier RW. Farm injury surveillance (SPRAINS Program) - unpublished data. Iowa Department of Public Health, Des Moines IA. Feb 1991.

Research – Chemical and Biological Hazards

35. Thoen CO. Zoonoses Update: Tuberculosis. *JAVMA* (Publ collection of Zoonoses Updates.) 132-135. 1990.
36. Currier RW. Zoonoses Update: Brucellosis. *JAVMA* (Publ collection of Zoonoses Updates.) p 25-27. 1990.
37. Music S. Personal communication. Wyoming Department of Health, Cheyenne WY. March 1991.
38. Sasaki DM. Personal communication. Hawaii Department of Health, Honolulu HI. April 1991.
39. Williams LP. Personal communication. Oregon Department of Health, Portland OR. April 1991.
40. Durfee PT, Pullen MM, Currier RW and Parker RL. Human psittacosis associated with commercial processing of turkeys. *JAVMA* 167: 804-808. Nov 1, 1975.
41. Doll J. Personal communication. Arizona Department of Health, Phoenix, AZ, April 1991.
42. Smith KA. Personal communication. Ohio Department of Health, Columbus, OH, April 1991.
43. Iowa Department of Public Health. Bovine rabies in Iowa. *Iowa Disease Bulletin*. Feb 1991.
44. Centers for Disease Control. *Rabies surveillance – 1988*. Issued Aug 1989.
45. Martin RJ. Personal communication. Illinois Department of Health, Springfield, IL, April 1991.
46. Baer G. Personal communication. Centers for Disease Control, Atlanta, GA., 1990.
47. Currier RW. Unpublished data. Iowa Department of Public Health, Des Moines IA. 1990. 48. Sewell CM. Personal communication. New Mexico Health and Environment Department, Sante Fe NM. March 1991.



## AN OVERVIEW OF POTENTIAL HEALTH HAZARDS AMONG FARMERS FROM USE OF PESTICIDES

By Aaron Blair, Ph.D.  
Occupational Studies Section  
National Cancer Institute

---

Beginning in the mid-1940's, pesticides have become an increasingly important weapon in the attempt to control troublesome agricultural pests. Consequently, agriculture has become a major consumer of pesticides and now accounts for about 65 percent of the total domestic use.<sup>1</sup> Pesticide use varies by the crops and livestock raised, but a majority of farmers report application of some.

In a 1982 survey, approximately 75 percent of the farmers with crops and 70 percent with livestock used pesticides.<sup>2</sup> With 2 million farmers, 6 million additional farm family members, and nearly 3 million hired farm workers, there is a large number of persons with potential contact with pesticides through agricultural use.<sup>3</sup>

Use of pesticides has been an integral component of the agricultural revolution, which over the past 50 years has greatly increased yields. Losses that would occur without the use of pesticides are difficult to estimate, but they could be sizable.<sup>4</sup>

Despite efforts to tailor the toxicologic properties of pesticides to specific pests, the fundamental similarity of all organisms at the subcellular level raises concerns about potential pesticide exposure of a large segment of the population.

Although we should not lose sight of the benefits pesticides provide, the purpose of

this review is to evaluate the potential for, and evidence of, adverse health outcomes from pesticide exposure in humans. Acute effects have been well established, and the major focus of this presentation will be on chronic effects.

### ACUTE EFFECTS

Effects from acute exposure to pesticides are well established, but statistics on injury and death from acute exposures are incomplete for the United States as a whole. Some results indicate that the number of fatalities fell between the 1950's and the 1970's.<sup>5</sup> Based on extrapolation from a survey of a small number of hospitals, EPA estimated that there were fewer than 3,000 annual admissions to hospitals for pesticide poisoning.<sup>6</sup>

In California, however, where physicians are required by law to report suspected pesticide poisonings to the Department of Food and Agriculture, approximately 2,000 poisonings have been reported annually in recent years.<sup>7</sup> About 50 percent of these were from occupational exposures.

More effective reporting systems are needed before the magnitude of adverse health conditions from acute exposures can be well monitored. Assessments in agriculture should include migrant workers, farm laborers, and dependents of farmers, as well as farm operators.

## CHRONIC EFFECTS

Of growing concern are chronic health outcomes that do not occur immediately after exposure, including carcinogenic, developmental, immunological, reproductive, and neurological effects.<sup>4,9</sup> The lengthy interval between exposure and chronic effects makes risk assessment for these outcomes more difficult to evaluate than acute effects.

As testing procedures have improved, concern has increased over long-term health effects from pesticides. Today significant efforts are devoted toward experimental and epidemiologic evaluation of pesticides. The quantity and quality of the data available, however, vary by disease outcome.

Establishment of a formal testing program by the National Cancer Institute (NCI) in 1968 and continued by the National Toxicology Program (NTP) in 1978 gave carcinogenicity screening of chemicals, of which pesticides were an important concern, an early start. This experimental effort stimulated epidemiologic investigation of pesticides and cancer.

The availability of cancer registries also enhanced opportunities for cancer research by providing a readily available source of well-diagnosed cases. Registries for other chronic disease endpoints are only beginning to be established. Since we lack some of these resources, the occurrence of non-malignant chronic disease from pesticide exposure has not been evaluated as thoroughly.

## CARCINOGENIC EFFECTS

Some 47 pesticides have been evaluated in the NCI-NTP bioassay program (Table I).<sup>10</sup>

Information from other sources is available, but is not considered here because study protocols sometimes deviate from the preferred model and because the purpose of this paper is to provide an indication of hazards presented by pesticides and not to provide a comprehensive review of all available data.

In the NCI-NTP assays, six pesticides, or 13 percent (chlordecone, dichlorvos, aminotrizole, sulfallate, dibromochloropropane (DBCP), and EDB) were positive in both sexes in mice and rats. Another 10 (21 percent) were positive in both sexes of one species (chlordane, chlorobenzilate, dieldrin, heptachlor, tetrachlorvinphos, toxaphene, nitrofen, captan, chlorthalonil, and dichloropropene). Five (11 percent) were positive in one sex of at least one species (aldrin, dicofol, piperonyl sulphoxide, chloramben, and trifluralin). For 19 (40 percent) there was no evidence of carcinogenicity in any sex/species group and seven (15 percent) provided inadequate or equivocal evidence for carcinogenicity.

Several of the pesticides positive in bioassays are no longer on the market, or their use is severely restricted, but others are widely used. The 16 chemicals positive in both sexes in at least one species include organochlorine and organophosphate insecticides, herbicides, fungicides, and fumigants, suggesting that no chemical class of pesticides can be considered problem free.

Pesticides are selected for testing for various reasons, including suspicion of carcinogenicity. With 45 percent of the pesticides tested showing some evidence of carcinogenicity, the concern about chronic human exposure would seem well founded.

**Table I. Results of Carcinogenicity Testing of Pesticides from the National Toxicology Program of Bioassays in Mice and Rats (modified from reference 10).**

	MICE		RATS			MICE		RATS	
	<u>M</u>	<u>F</u>	<u>M</u>	<u>F</u>		<u>M</u>	<u>F</u>	<u>M</u>	<u>F</u>
	▼	▼	▼	▼		▼	▼	▼	▼
<b>INSECTICIDES</b>					<b>HERBICIDES</b>				
Aldicarb	-	-	-	-	Aminotriazole	+	+	+	+
Aldrin	+	-	E	E	Chlorambene	+	-	-	-
Azinphosmethyl	-	-	E	E	Fluometuron	E	-	-	-
Chlordane	+	+	-	-	Monuron	-	-	+	-
Chlordecone	+	+	+	+	Nitrofen	+	+	E	+
Chlorobenzilate	+	+	E	E	Sulfallate	+	+	+	+
Coumaphos	-	-	-	-	Trifluralin	-	+	-	-
Diazinon	-	-	-	-	<b>FUNGICIDES</b>				
Dichlorvos	+	+	+	+	Anilazine	-	-	-	-
Dicofol	+	-	-	-	Captan	+	+	-	-
Dieldren	+	+	-	-	Chlorthalonil	-	-	+	+
Dimethoate	-	-	-	-	Fenaminosulf	-	-	-	-
Dioxathion	-	-	-	-	O-Phenylpheno-l	-	-	-	-
Endosulphan	l	-	l	-	Pentachloro-				
Endrin	-	-	-	-	nitrobenzene	-	-	-	-
Fenthion	E	-	-	-	Triphenyltin-OH	-	-	-	-
Heptachlor	+	+	-	-	<b>FUMIGANTS</b>				
Lindane	-	-	-	-	DBCP	+	+	+	+
Malathion	-	-	-	-	Dichloropropene	l	+	+	+
Maloxon	-	-	-	-	EDB	+	+	+	+
Methoxychlor	-	-	-	-					
Methyl parathion	-	-	-	-	E = Equivocal				
Mexacarbate	-	-	-	-	l = Inadequate evidence				
Parathion	-	-	E	E	M = Male				
Phosphamidon	-	-	E	E	F = Female				
Photodieldrin	-	-	-	-					
Piperonyl butoxide	-	-	-	-					
Piperonyl sulphoxide	+	-	-	-					
Tetrachlorvinphos	+	+	-	+					
Toxaphene	+	+	E	E					

Pesticides may exert their carcinogenic effects through several mechanisms, including mutation, inhibition of gap-junctional cellular communication, peroxisome proliferation, and other promotional activities.<sup>11</sup> In an evaluation of genetic damage from 65 pesticides in 14

*in vivo* and *in vitro* tests, the nine chemicals were found to be active in most assays. These included organophosphate insecticides (acephate, demeton, monocrotophos, and trichlorfon), phthalimide fungicides (captan and folpet), and thio-

carbamate herbicides (diallate, sulfallate, and triallate).<sup>12</sup>

Another group of 26 chemicals were positive in some tests, but were generally less active than the nine chemicals above. Pesticides in this group included phenoxy herbicides (2,4-D and 2,4-DB); organophosphate insecticides (azinphos-methyl, crotoxyphos, disulfoton, and methyl parathion); ethylenebisdithiocarbamate fungicides (manzeb, maneb, mancozeb, and zineb); and pyrethroid insecticides (allethrin, chrysanthemic acid, and ethyl chrysanthemate). Thirty pesticides gave no evidence of genetic toxicity.

Some pesticides may influence the carcinogenic process in an epigenetic manner. For example, inhibition of intercellular communication can disrupt development or promote cancer.<sup>13</sup>

Broad occupational surveys from around the world have noted rather consistent excesses of leukemia, non-Hodgkin's lymphoma, multiple myeloma, soft-tissue sarcoma, and cancers of the brain, skin, lip, stomach, and prostate among farmers.

A number of pesticides have been shown to inhibit gap junction intercellular communication including DDT, dieldrin, chlordane, heptachlor, Kepone, mirex, and endrin.<sup>14</sup> Several of these pesticides have been shown to have a promotional effect on liver carcinogenesis in the rat.<sup>11</sup>

Peroxisome proliferation and the resultant increased generation of hydrogen peroxide represent another possible non-genotoxic carcinogenic mechanism. Phenoxy acid

herbicides appear to be peroxisome proliferators in several rodent species.<sup>11</sup> Much of the epidemiologic data available on the carcinogenicity of pesticides comes from studies of persons employed in agriculture.

Broad occupational surveys from around the world have noted rather consistent excesses of leukemia, non-Hodgkin's lymphoma, multiple myeloma, soft-tissue sarcoma, and cancers of the brain, skin, lip, stomach, and prostate among farmers.<sup>15-17</sup> These excesses occur against a background of lower overall mortality, particularly for heart disease and other cancers including lung, colon, bladder, kidney, esophagus, and liver. This pattern of low mortality from most causes of death, but excesses for a few cancers, suggests a role for work-related factors.

The low prevalence of smoking among farmers is probably related to their more favorable rates for heart disease and cancers of the lung, esophagus, and bladder.<sup>15</sup> High levels of physical fitness may contribute to their lower rates of colon cancer and heart disease.<sup>17</sup>

Case-control and other studies provide further evidence that farmers are at higher risk for selected cancers than the general population. In a recent survey of the literature,<sup>17</sup> excesses among farmers were seen in 12 of 13 studies of leukemia, 12 of 15 studies of Hodgkin's disease, 14 of 19 studies of multiple myeloma, 18 of 29 studies of non-Hodgkin's lymphoma, three of three studies of lip cancer, three of three studies of skin cancer, five of seven studies of brain cancer, three of five studies of soft-tissue sarcoma, six of six studies of stomach cancer, and two of three studies of prostate cancer.

The excesses for specific cancers among farmers may have broad public health implications, since several of the high-rate tumors appear to be increasing in the general population of many developed countries.<sup>18</sup> Of special interest are the rising rates for multiple myeloma, non-Hodgkin's lymphoma, melanoma, and cancer of the brain.

In England and Wales<sup>19</sup> and the United States<sup>20</sup>, prostate cancer has also been increasing. Changes in diagnosis and reporting may account for some of the increase for these tumors.<sup>20,21</sup>

The rising rates for non-Hodgkin's lymphoma, multiple myeloma, and leukemia in agricultural areas of the central United States, however, is a further indication of the possible involvement of agricultural exposures. Excesses of cancer of the brain and lymphatic and hematopoietic system have also been observed in rural farm populations in Quebec.<sup>62</sup>

Risks were correlated with pesticide usage and were observed among women, as well as men, raising the possibility of effects from nonoccupational exposure. The specific agricultural factors that might account for the cancers excessive among farmers have not been definitively identified, but a number of etiologic clues exist.

Exposures of interest include pesticides, fertilizers, fuels and engine exhausts, organic and inorganic dusts, solvents, ultraviolet light, and zoonotic viruses.<sup>3</sup> Many, perhaps even most, of the members of the general population may also have contact with some of these substances. Studies of farmers may, therefore, provide explanations for the rising incidence of certain cancers among the general population.

Although farmers come into contact with a variety of potentially hazardous substances, pesticides have received the most attention in epidemiologic studies, possibly because several pesticides are carcinogenic in bioassays.<sup>10</sup> Early epidemiologic investigations evaluated cancer risks associated with pesticide exposure in general.

The International Agency for Research on Cancer (IARC) in a recent deliberation concluded that exposures occurring during the application of insecticides were probably carcinogenic in man.<sup>22</sup> Cohort studies of applicators and manufacturers of insecticides have tended to show excesses of cancers of the lung and the lymphatic and hematopoietic system, although some investigations show deficits.<sup>10,11</sup>

In these studies it was not possible to determine the specific chemicals accounting for these excesses, but most subjects were employed during a time when organochlorine insecticides were the chemicals used predominately. Although many epidemiologic studies have evaluated cancer risks among farmers and other pesticide-exposed workers,<sup>17</sup> only recently have there been attempts to assess risks from exposure to specific pesticides.<sup>23</sup>

Among those studies that have, soft-tissue sarcoma, Hodgkin's disease, non-Hodgkin's lymphoma, leukemia, and lung cancer have been associated with DDT;<sup>22,24-28</sup> non-Hodgkin's lymphoma with organophosphates;<sup>25</sup> soft-tissue sarcoma with a variety of animal insecticides<sup>24</sup>; leukemia with crotoxyphos, dichlorvos, famphur, pyrethrins, methoxychlor, and nicotine<sup>26</sup>; and non-Hodgkin's lymphoma<sup>25,29-33</sup> and soft-tissue sarcoma<sup>34-38</sup> with phenoxyacid herbicides. A potential problem for other cancers is suggested by an important study of workers engaged in the production of 2,4,5-

Table II. Pesticide Effects on the Immune System (modified from reference 39).

<u>Pesticide</u>	<u>Species</u>	<u>Summary of Effects</u>
<b>► ORQANOPHOSPHATES</b>		
<b>Methylparathion</b> .....	Rabbit	Thymus atrophy and reduced DTH response.
	Mouse	Decreased host resistance to infection <i>Salmonella typhimurium</i> .
<b>Parathion</b> .....	Mouse	Altered colony forming activities of bone marrow stem cells.
<b>Malathion</b> .....	Mouse	Suppression of CTL response <i>in vitro</i> .
<b>► ORQANOCHLORINES</b>		
<b>DDT</b> .....	Rabbit	Thymus atrophy and reduced DTH response.
<b>Mirex</b> .....	Chicken	Decreased IgG levels.
<b>Hexachlorobenzene</b> ..	Mouse	Increased sensitivity to endotoxin and malaria challenge.
	Rat	Increased humoral immune responses to tetanus toxoid and delayed-type hypersensitivity to ovalbumin.
<b>Dieldrin</b> .....	Mouse	Decreased AFC response and increased susceptibility to viral infection.
<b>Chlordane</b> .....	Mouse	Decreased contact hypersensitivity after <i>in utero</i> exposure.
	Mouse	Suppression of AFC responses and T-cell activity in a MLC reaction following <i>in vitro</i> exposure.
<b>► CHLOROPHENOXY COMPOUNDS</b>		
<b>Pentachlorophenol</b> ...	Mouse	Decreased host resistance to virus-induced tumor metastases.
<b>2,4-D</b> .....	Mouse	Enhanced T- and B-cell responses following dermal application.
<b>► CARBAMATES</b>		
<b>Carbofuran</b> .....	Rabbit	Reduced DTH response.
	Mouse	Decreased host resistance to <i>Salmonella typhimurium</i> infection.
<b>Aldicarb</b> .....	Mouse	Decreased AFC response to sheep erythrocytes.
	Human	Increased response to <i>Candida</i> antigen, increased number of lymphocytes expressing CD8 markers and decreased CD4+/CD8+ cell ratio.
	Mouse	No alterations in AFC response, B- or T-lymphocyte mitogenesis, host resistance to influenza virus infection, CTL response or percentages of T-cells, T-cell subpopulations or B-cells.
DTH = delayed-type hypersensitivity. CTL = cytotoxic T lymphocytes. AFC = antibody-forming cells. MLC = mixed lymphocyte culture.		

trichlorophenol and derivative herbicides, products contaminated with 2,3,7,8-tetrachlorodibenzo-p-dioxin.<sup>38</sup> In this report, 20 years after first exposure, a significant 50 percent excess of total cancer occurred among workers employed for more than one year while no excess occurred among

those employed for less than one year.

Risks were elevated for soft-tissue sarcomas and cancers of the esophagus, stomach, intestines, larynx, lung, and prostate. In the 20-year latency category, lung cancer increased with duration of exposure

with standardized mortality ratios (SMRs) of 96, 126, 146, and 156 for duration of exposure categories of < 1 year, 1 to < 5 years, 5 to < 15 years, and 15 or more years, respectively.

## IMMUNOLOGIC EFFECTS

Pesticides have immune effects that are of interest in their own right, but they may also be an important mechanism in carcinogenesis. A critical role for suppression of immune responsiveness by pesticides has been demonstrated for infectious disease and maybe for other diseases.<sup>39</sup>

Pesticides have displayed a variety of effects on the immune system (Table II), including suppression of cytotoxic T lymphocyte (CTL) response by malathion, thymus atrophy and delayed-type hypersensitivity (DTH) response by methylparathion and DDT, decreased antibody-forming cells (AFC) responses from dieldrin and chlordane, enhanced T- and B-cell responses by 2,4-D, and reduced DTH and host resistance by carbofuran. As with carcinogenicity, immunologic effects are observed from pesticides in various chemical classes (organochlorines, organophosphates, carbamates, and phenoxyacids). *In vitro* studies of human leukocyte functions have also shown inhibition of blastogenic stimulation<sup>41</sup>.

Lymphocyte PHA stimulation was reduced 10 percent by carbamates, 11 to 18 percent by organophosphates, and 11 to 17 percent by organochlorines. Contact dermatitis and allergic chemical dermatitis are well-recognized health effects from pesticide exposure and can occur from exposure to various insecticides, fungicides, and fumigants.<sup>42,42</sup>

Immunologic evaluations of pesticide exposure in humans are in their infancy. Effects observed in animals are not always seen in human studies.<sup>40</sup> For example, altered numbers of T-cells and a decreased ratio of CD4/CD8 T-cells were found in women exposed to aldicarb-contaminated drinking water.<sup>43</sup> In investigations of aldicarb in mice, one noted an inverse dose-related suppression of antibody response,<sup>44</sup> while the another study did not.<sup>45</sup>

A critical role for suppression of immune responsiveness by pesticides has been demonstrated for infectious disease and maybe for other diseases.

There is also the possibility of a linkage between immunologic effects from pesticide exposure and cancer. It is well documented that patients with naturally occurring or medically induced immunodeficiencies experience striking excesses of non-Hodgkin's lymphoma.<sup>46-50</sup>

In addition, excesses of leukemia and stomach cancer have been observed among persons with primary immunodeficiency syndromes, while increases of soft-tissue sarcoma, melanoma of the skin, and squamous carcinomas of the skin and lip have been observed in renal transplant patients.<sup>49,50</sup> The fact that several of the tumors excessive among farmers (e.g., non-Hodgkin's lymphoma, leukemia, skin, lip, and stomach) also occur among immunodepressed patients could be a coincidence, but it may suggest that effects on the immune system play a role in farming-related cancers.

Epidemiologic investigations of alterations of the immune system are difficult because

of large interindividual variability and the confounding effects from infections, drug use and other factors that influence immune responses. Alterations in immune responses may also be short lived.

Monitoring of the immune system over an extended period may be necessary to determine the relevance of any alterations to subsequent disease risk. Consequently, it may be necessary to rely primarily upon experimental investigations in the near future. Thomas, *et al.*,<sup>40</sup> note two important criteria in extrapolating experimental results to humans.

► First, the pharmacologic pattern for the pesticide should be the same in humans as in the animal model. This is difficult to achieve because information on absorption, distribution, biotransformation and excretion for the chemical of interest is rarely available in both humans and the animal model.

► Second, the human end point of interest must be appropriate for the species selected.

## NEUROTOXIC EFFECTS

The nervous system of the pest is the target for many pesticides, so the fact that there are acute neurotoxic effects in humans is not surprising. Anecdotal case reports and epidemiologic studies also suggest that some neurologic symptoms may persist for years.<sup>51</sup>

Chronic effects observed include tremors, anorexia, anemia, muscular weakness, hyperexcitability, EEG pattern changes, insomnia, irritability, convulsions, headache, dizziness, and depression. These occur from various insecticide class-

es including organochlorines, organophosphates, and carbamates.<sup>52</sup>

Many of the above symptoms developed among workers with prolonged exposure to Kepone (chlordecone) in the Hopewell incident.<sup>53</sup> The symptoms gradually disappeared over an 18-month period, but symptoms persisted after several years in seven of the 23 most severely affected patients.<sup>53</sup>

Less information is available concerning neurotoxic effects from herbicide exposure. Neuromuscular rigidity has been observed in rats after phenoxyacid exposure (2,4-D and MCPA)<sup>54,55</sup> and peripheral nerve conduction velocities were slowed among workers engaged in the manufacture of 2,4-D and 2,4,5-T.<sup>56</sup>

Other nervous system conditions may be associated with pesticide exposure. A case report of Guillain-Barré syndrome noted recent skin exposure to the cotton defoliant, merphos.<sup>57</sup>

An association with spraying of pesticides was reported in a case-control study of idiopathic Parkinson's disease.<sup>58</sup> Risk of Parkinson's disease was also associated with longer duration farming and exposure to pesticides in a study in Hong Kong.<sup>59</sup>

In another case-control study, however, it was associated with a rural residence and drinking well water, but not with use of pesticides.<sup>60</sup> The subjective end points noted in most human studies of neurologic conditions make epidemiologic investigations difficult.

Evaluation of these end points is generally not possible in animals. Closing the gap between the two approaches is critical for a thorough evaluation of neurotoxic effects of chronic pesticide exposure.



## REPRODUCTIVE EFFECTS

Mattison *et al.* classify reproductive toxicants as direct-acting or indirect-acting.<sup>64</sup> Direct-acting toxicants may resemble a biologically important molecule and function as agonists or antagonists in the reproductive process.

They may also have direct effects because of their chemical reactivity. Most chemically-reactive substances are cytotoxic, carcinogenic, or mutagenic.

Indirect-acting reproductive toxicants include chemicals that must be metabolized to produce effects, those that interfere with critical enzyme systems, or those that enhance or suppress secretion or clearance of critical control chemicals. Some chemicals may act both directly and indirectly. For example, activities for organochlorine insecticides are suspected to act directly through estrogen receptors and indirectly through prohormone hepatic induction.

Reproductive effects of specific pesticides have recently been reviewed by Mattison *et al.*, 1990.<sup>64</sup> Adverse outcomes in experimental and/or epidemiologic investigations have been reported for DBCP, chlordecone, ethylene dibromide, and carbaryl in males and DDT, chlordecone, lindane, organophosphates, and carbamates among females.

Effects among males have included disruption of spermatogenesis by DBCP, reduced sperm motility and viability by chlordecone, abnormal sperm morphology and sterility by ethylene dibromide, and sperm abnormalities by carbaryl. In animals, studies have noted reduced egg shell thicknesses from DDT, reduced egg production and number of offspring from chlordecone,

increased estrone metabolisms by liver microsomal enzymes by lindane, reduced egg production by organophosphates, and reduced fertility by carbamates.

## CONCLUSIONS

Experimental and epidemiologic investigations indicate that pesticides can cause a variety of adverse effects including carcinogenicity, immunotoxicity, neurotoxicity, and reproductive toxicity. From this brief review several points stand out.

- ▶ First, the carcinogenicity of pesticides has been more thoroughly evaluated than other toxic effects and approximately 45 percent of the chemicals tested had an effect in at least one sex of one species in NCI-NTP bioassays. If this experience is relevant to other end points, the potential for any type of adverse outcome from pesticide exposure could be considerable.
- ▶ Second, the specific pesticides that are positive in the various toxicologic tests do not appear to be restricted to a few chemical classes. Effects are noted from insecticides (organochlorines, organophosphates, carbamates, and pyrethrins), herbicides, and fungicides.
- ▶ Third, adverse outcomes have been noted in epidemiologic, as well as experimental investigations, indicating that humans are also at risk.

## RECOMMENDATIONS

1. Given the evidence for adverse health outcomes from pesticides, enhanced efforts are needed to control exposures in agriculture and elsewhere.

2. More thorough evaluations (experimental and epidemiologic) are needed to more fully characterize the potential adverse effects that may occur from pesticide exposures.

3. Epidemiologic investigations must focus on exposures to specific pesticides. This will require detailed exposure assessment procedures to characterize the type and intensity of exposures.

4. Studies of farm populations should receive a high priority given the widespread use of pesticides in agriculture and the potential for exposure among

farmers and farmer laborers, and their dependents.

Retrospective designs can be used to address specific questions, but prospective studies should also be initiated. Prospective investigations provide the opportunity to obtain information on exposure as it occurs, which would eliminate the potential for response bias and would minimize exposure misclassification. Once exposures are well characterized, prospective designs can also be used to evaluate a number of adverse health outcomes, a highly efficient approach in these times of funding limitations.□

## REFERENCES

1. Eichers T, Andrienas PA, Anderson TW. Farmers' Use of Pesticides in 1976. U.S. Department of Agriculture. Agricultural Economic Report No. 418. Washington, D.C., 1978.
2. Duffy M. Pesticide Use and Practices, 1982. U.S. Department of Agriculture. Agriculture Information Bull. No. 462. Economic Research Service. U.S. Government Printing Office, Washington, D.C., 1982.
3. National Coalition for Agricultural Safety and Health. *Agriculture at Risk. A Report to the Nation.* Institute of Agricultural Medicine and Occupational Health, University of Iowa, Iowa City, Iowa, 1989.
4. Ware GW. *Pesticides: Chemical Tools.* Freeman and Co., New York, NY. 1983.
5. Hayes WJ Jr, Vaughan WK. Mortality from pesticides in the United States in 1973 and 1974. *Toxicol Appl Pharmacol* 42: 235-252, 1977.
6. EPA (Environmental Protection Agency). National study of hospital admitted pesticide poisonings. Washington, D.C. 1976.
7. Edmiston S, Maddy K. Summary of illnesses and injuries reported in California by physicians in 1986 as potentially related to pesticides. *Vet Hum Toxicol* 29: 391-397, 1987.
8. Sharp DS, Eskenazi B, Harrison R, Callas P, Smith AH. Delayed health hazards of pesticide exposure. *Ann Rev Public Health* 7: 441-471, 1986.
9. Baker SR, Wilkinson CF (Eds). The Effects of Pesticides on Human Health. *Adv Modern Environ Toxicol* Vol XVIII. Princeton Sci Publ Co, Inc. Princeton, NJ, 1990.
10. Hoover RN, Blair A. *Cancer and pesticides.* (In press).
11. Blair A, Axelson O, Franklin C, Paynter OE, Pearce N, Stevenson D, Trosko JE, Vainio H, Williams G, Woods J, Zahm SH. Carcinogenic effects of pesticides. In: *The Effects of Pesticides on Human Health.* (Eds.) Baker SR, Wilkinson CF. *Adv Modern Environ Toxicol* Vol XVIII. Princeton Sci Publ Co, Inc. Princeton, NJ: 201-260, 1990.

12. Garrett NE, Stack HF, Waters MD. Evaluation of the genetic activity profiles of 65 pesticides. *Mutation Res* 168: 301-325, 1986.
13. Trosko JE. A new paradigm is needed in toxicology evaluation. *Environ Health Perspect* 6: 767-769, 1984.
14. Trosko JE, Chang CC. Nongenotoxic mechanism in carcinogenesis: Role of inhibited intercellular communication. In: *New Directions in the Qualitative and Quantitative Aspects of Carcinogen Risk Assessment*. (Eds.) Hart RW, Setlow RB. Banbury Rep. 31. Cold Spring Harbor, NY: 139-170, 1988.
15. Blair A, Malmer H, Cantor KP, Burmeister L, Wiklund K. Cancer among farmers: A review. *Scand J Work Environ Health* 11: 397-407, 1985.
16. Pearce N, Reif JS. Epidemiologic studies of cancer in agricultural workers. *Am J Ind Med* 18: 133-142, 1990.
17. Blair A, Zahm SH. Cancer among farmers. In: *Health Hazards of Farming*. Occupational Medicine - State of the Art Reviews. (Eds.) Cordes DH, Rea DF. Hanley and Belfus, Inc. Philadelphia, PA. (In press).
18. Davis DL, Hoel D, Fox J, Lopez A. International trends in cancer mortality in France, West Germany, Italy, Japan, England and Wales, and USA. *Lancet* 336: 474-481, 1990.
19. Office of Census and Population Surveys. *Reviews of the National Cancer Registration System* (Series MBA, No. 17). London: HM Stationery Office, 1990.
20. Devesa SS, Silverman DT, Young JL, Pollack ES, Brown CC, Horm JW, Percy CL, Myers MH, McKay Fw, Fraumeni JF Jr. Cancer incidence and mortality trends among whites in the United States, 1947-84. *JNCI* 79: 701-770, 1987.
21. Doll R, Peto R. The causes of cancer: Quantitative estimates of avoidable risks of cancer in the United States today. *JNCI* 66: 1191-1308, 1981.
22. IARC (International Agency for Research on Cancer): IARC Monographs on the Evaluation of the Carcinogenic Risk of Chemicals to Humans. *Occupational Exposure in Insecticide Application and Some Pesticides*, Vol. 53. Lyon, France. (In press).
23. Axelson O. Pesticides and cancer risks in agriculture. *Med oncol Tumor Pharmacother* 4: 207-217, 1987.
24. Zahm SH, Blair A, Holmes FF, Boysen CD, Robel RJ. A case-referent study of soft-tissue sarcoma and Hodgkin's disease - farming and insecticide use. *Scand J Work Environ Health* 14: 224-230, 1988.
25. Zahm SH, Weisenburger DD, Babbitt PA, Saal RC, Vaught JB, Cantor KP, Blair A. A case-control study of non-Hodgkin's lymphoma and the herbicide 2,4-dichlorophenoxyacetic acid (2,4-D) in eastern Nebraska. *Epidemiology* 1:349-356, 1990.
26. Brown LM, Blair A, Gibson R, Everett GD, Cantor KP, Schuman LM, Burmeister LF, Van Lier SF, Dick F. Pesticide exposures and other agricultural risk factors for leukemia among men in Iowa and Minnesota. *Cancer Res* 50: 6585-6591, 1990.
27. Woods JS, Polissar L, Severson RK, Heuser LS, Rulander BG. Soft tissue sarcoma and non-Hodgkin's lymphoma in relation to phenoxyherbicide and chlorinated phenol exposure in western Washington. *JNCI* 78: 899-910, 1987.

## Research – Chemical and Biological Hazards

28. Flodin U, Frederiksson M, Persson B, Axelson O. Chronic lymphatic leukemia and engine exhausts, fresh wood, and DDT: A case-referent study. *Br J Ind Med* 45: 33-38, 1988.
29. Hoar SK, Blair A, Holmes FF, Boysen CD, Robel RJ, Hoover RN, Fraumeni JF Jr. Agricultural herbicide use and risk of lymphoma and soft-tissue sarcoma. *JAMA* 256: 1141-1147, 1986.
30. Hardell L, Eriksson M, Lenner P, Lungren E. Malignant lymphoma and exposure to chemicals, especially organic solvents, chlorophenols, and phenoxy acids: A case-control study. *Br J Cancer* 43: 169-176, 1981.
31. Persson B, Dahlander A, Fredriksson M, Brage HN, Ohlson CG, Axelson O. Malignant lymphoma and occupational exposures. *Br J Ind Med* 46: 516-520, 1989.
32. Wigle DT, Semenciw RM, Wilkins K, Riedel D, Ritter L, Morrison HI, Mao Y. Mortality study of Canadian male farm operators: Non-Hodgkin's lymphoma mortality and agricultural practices in Saskatchewan. *JNCI* 82: 575-582, 1990 .
33. Bond GG, Wetterstroem NH, Roush GJ, McLaren EA, Lipps TE, Cook RR. Cause-specific mortality among employees engaged in the manufacture, formulation, or packaging of 2,4-dichlorophenoxyacetic acid and related salts. *Br J Ind Med* 45: 98-105, 1988.
34. Hardell L, Sandstrom A. Case-control study: soft-tissue sarcoma and exposure to phenoxyacetic acids and chlorophenols. *Br J Cancer* 39: 711-717, 1979.
35. Eriksson M, Hardell L, Berg NO, Moller T, Axelson O. Soft tissue sarcomas and exposure to chemical substances: A case referent study. *Br J Ind Med* 38: 27-33, 1981.
36. Vineis P, Terracini B, Ciccone G, Cignetti A, Colombo E, Bonna A, Maffi L, Pisa R, Ricci P, Zanini E, Comba P. Phenoxy herbicides and soft-tissue sarcomas in female rice weeders: A population-based case-referent study. *Scand J Work Environment Health* 13: 9-17, 1986.
37. Lynge E. A follow-up study of cancer incidence among workers in manufacture of phenoxy herbicides in Denmark. *Br J Cancer* 52: 259-270, 1985.
38. Fingerhut MA, Halperin WE, Marlow DA, Piacitelli LA, Honchar PA, Sweeney MH, Greife AL, Dill PA, Steenland R, Suruda AJ. Cancer mortality in workers exposed to 2,3,7,8-tetrachlorodibenz-p-dioxin. *N Engl J Med* 324: 212-218, 1991.
39. Thomas PT, Busse WW, Kerkvliet NI, Luster MI, Munson AE, Murray M, Roberts D, Robinson M, Silkworth J, Sjoblad R, Smialowicz R. Immunologic effects. In: *The Effects of Pesticides on Human Health*. (Eds.) Baker SR, Wilkinson CF. Adv Modern Environ Toxicol Vol XVIII. Princeton Sci Publ Co, Inc. Princeton, NJ: 261-295, 1990.
40. Thomas PT, Faith RE. Adult and prenatal toxicity induced by halogenated aromatic hydrocarbons. In: *Immunotoxicology and Immunopharmacology*. (Eds.) Dean J, Luster M, Munson A, and Amos H. Raven Press, New York, NY, 1985.
41. Lee TP, Moscati R, Park BH. Effects of pesticides on human leukocyte functions. *Res Comm Chem Pathol Pharmacol* 23:597-609, 1979.
42. Sullivan JB Jr. Immunological alterations and chemical exposure. *Clinical Tax* 27: 311-343, 1989.

43. Fiore M, Ander CHA, Hong R, Golubjatnikov R, Seiser JE, Nordstrom D, Hanrahan L, Belluck D. Chronic exposure to aldicarb-contaminated groundwater and human immune function. *Environ Res* 41: 633-645, 1986.
44. Olson LJ, Erickson BJ, Hinsdill RD, Wyman JA, Porter WP, Binning LK, Bidgood RC, Nordheim EV. Aldicarb immunomodulation in mice: An inverse dose-response to parts per billion levels in drinking water. *Arch Environ Contam Toxicol* 16: 433-439, 1987.
45. Thomas PT, Ratajczak HV, Eisenberg WC, Furedi-Machacek M, Ketels KV, Barbera PW. Evaluation of host resistance and immunity in mice exposed to the carbamate pesticide aldicarb. *Fundam Appl Toxicol* 9: 82-89, 1987.
46. Hoover R, Fraumeni JF Jr. Risk of cancer in renal transplant recipients. *Lancet* 2: 55-57, 1973.
47. Filipovich AH, Spector BD, Kersey J. Immunodeficiency in humans as a risk factor in the development of malignancy. *Prev Med* 9: 252-259, 1980.
48. Blohme I, Brynner H. Malignant disease in renal transplant patients. *Transplantation* 39: 23-25, 1985.
49. Penn I. Immunosuppression and skin cancer. *Clin Plast Surg* 7: 361, 1980.
50. Kinlen L, Doll R, Peto J. The incidence of tumors in human transplant recipients. *Transplant Proc* 15: 1039-1042, 1983.
51. Ecobichon DJ, Davies JE, Doull J, Ehrich M, Joy R, McHillan D, MacPhail R, Reiter LW, Slikker W Jr, and Tilson H. Neurotoxic effects of pesticides. In: *The Effects of Pesticides on Human Health*. (Eds.) Baker SR, Wilkinson CF. Adv Modern Environ Toxicol Vol XVIII. Princeton Sci Publ Co, Inc. Princeton, NJ: 131-199, 1990.
52. Taylor JR, Selhorst JB, Houff SA, Martinez AJ. Chlordecone intoxication in man. I. Chemical observations. *Neurology* 28: 626-630, 1978.
53. Taylor JR. Neurological manifestations in humans exposed to chlordecone: Follow-up results. *Neurotoxicology* 6: 231-236, 1985.
54. Squib RE, Tilson HA, Mitchell CL. Neurobehavioral assessment of 2,4-dichlorophenoxyacetic acid (2,4-D) in rats. *Neurobehav. Toxicol Teratol* 5: 331-335, 1983.
55. Elo H, Ylitalo P. Distribution of 2-methyl-4 chlorophenoxyacetic acid and 2,4-dichlorophenoxyacetic acid in male rats: Evidence for the involvement of the central nervous system in their toxicity. *Toxicol Appl Pharmacol* 51: 439-446, 1979.
56. Singer R, Moses M, Valciukas J, Lilis R, Selikoff IJ. Nerve conduction velocity studies of workers employed in the manufacture of phenoxy herbicides. *Environ Res* 29: 297-311, 1982.
57. Fisher JR. Guillain-Barré syndrome following organophosphate poisoning. *JAMA* 238: 1950-1951, 1977.
58. Golbe LI, Farrell TM, Davis PH. Follow-up study of early life protective and risk factors in Parkinson's disease. *Movement Disorders* 5: 66-70, 1990.
59. Ho SC, Woo J, Lee CM. Epidemiologic study of Parkinson's disease in Hong Kong. *Neurology* 39: 1314-1318, 1989.

Research – Chemical and Biological Hazards

60. Koller W, Vetere-Overfield B, Gray C, Alexander C, Chin T, Dolezal J, Hassanein R, Tanner C. Environmental risk factors in Parkinson's disease. *Neurology* 40: 1218-1221, 1990.
61. Mattison DR, Bogumil RJ, Chapin R, Hatch M, Hendricks A, Jarrell J, LaBarbera A, Schrader SM, Selevan S. Reproductive effects of pesticides. In: *The Effects of Pesticides on Human Health*. (Eds.) Baker SR, Wilkinson CF. Adv Modern Environ Toxicol Vol XVIII. Princeton Sci Publ Co, Inc. Princeton, NJ: 1297-1389, 1990.
62. Godon D, Lajoie P, Thouez J, Nadeau D. Pesticides et cancers en milieu rural agricole au Quebec: Interpretation géographique. *Soc Sci Med* 29: 819-833, 1989.

## GASES, VAPORS, LIQUIDS, AND DRUGS

By William Pependorf, Ph.D., C.I.H.  
Institute of Agricultural Medicine, University of Iowa

### INTRODUCTION

A wide range of gaseous and liquid hazards exists in agriculture (Table I).<sup>1,2</sup> Virtually all of the gaseous hazards from which we can anticipate health effects exist in one form or another in general industry.

While we know of their existence in agriculture, only a few of these hazards have been surveyed in farm settings. We do not know how frequently (on the average) farmers are exposed to individual agents. We do not know the range of concentrations of such exposures. We do not know the extent of the health effects except for the occasional severe case report or fatality.

And if we really did know these parameters, we face yet another challenge; how to translate them into "agricultural

hygiene," the industrial hygiene paradigm of "anticipation, recognition, evaluation, and control" learned in general industry over the past 50 years. As we begin to apply this paradigm, another challenge is to understand the limitations of rote transferral of this paradigm from general industry to agriculture without also understanding its nature and its culture.

This presentation will begin with a review of some of these agents, their sources on the farm, and some of the limitations of the traditional hierarchy of controlling these hazards either at their source, along the pathway of the exposure route, or at the receiver (in this case the farmer or farm worker). A discussion of health effects will be minimized except for agents that are by-and-large unique to agriculture.

Table I. Typical Toxic Agricultural Liquids, Gases, and Vapors.

Ammonia .....	from urine, urea, and anhydrous
Carbon dioxide .....	animal respiration and combustion
Carbon monoxide .....	combustion sources
Hydrogen sulfide .....	manure gas
Nitrogen dioxide .....	from fresh silage
Oxygen Depletion .....	asphyxiation in confined spaces
Pesticides .....	primarily dermal absorption hazards except fumigants
Welding .....	fumes and gases
Fuel storage .....	leaks and fires
Fuel and waste oil .....	skin cancers and dermatitis
Liquified Propane [LP] gas .....	fires
Liquified anhydrous ammonia .....	dermal injury

## DEFINITIONS

I feel obliged to define a few terms and concepts ingrained into industrial hygiene folklore. The first (Figure 1) is the paradigm of anticipation, recognition, evaluation, and control. Historically, this process began with the recognition of adverse health effects existent within a working population.

- **Anticipation** is the prospective application of dose-response knowledge generated either in the laboratory or in other industries.
- **Recognition** requires the commitment of farmers, interested farm groups, and governmental agencies to survey both the farming environment and the health status of farmers.
- **Evaluation** must develop new ways to interpret surveillance data from the farm setting for the agricultural population.
- **Control** includes not only "hazard communication" but also modified sources and interruptions in the pathways of exposure before the farmer, with or without personal protection, is dosed.

Figure 1. The Agricultural Hygiene Paradigm.

Today, we can anticipate (and hopefully avoid) adverse health effects based on toxicology or prior experiences in other work settings. To evaluate the degree of risk, we have developed a system of "performance based" exposure limits guidelines (guidelines called Threshold Limit Values [TLVs] and their regulatory equivalents called Permissible Exposure Limits [PELs]), the goal of which is to prevent

adverse health effects by keeping exposures and doses to acceptable low levels without specifying the method or "work practices" to achieve those levels.

The second is a concept that adverse health effects are the culmination of an often-complex chain of events beginning with the agent emanating into the working environment from a sometimes nebulous source and traveling through a physical pathway to create either an airborne, dermal, or even oral dose; the dose is generally dependant upon the duration of exposure and the degree of personal protection being used by the worker; the agent may act at the site of contact or be absorbed into the body and be transported to some biological target organ where it acts toxicologically to create a clinically identifiable effect.

Over the years, a hierarchy of control options has been inculcated into the profession whereby controlling the source is the preferred option, controlling the pathway between the source and worker is the second option, and controlling the receiver is the third and least preferred option. Hygienists believe that respirators or other forms of personal protective equipment are not a quick cure-all, contrary to popular belief. And even when they are recommended, good practice dictates (and OSHA now requires) that the respirator should be selected based on the measured level of exposure.

## GASES AND VAPORS

The following history of silo gas is representative of the fragmented progression of anticipation, recognition, evaluation, and control of a potentially common agricultural health hazard.



Occupational hazards associated with silo gas were first reported in 1914 via case studies of four fatalities of farmers working in and among their freshly filled silos. Their deaths were attributed to carbon dioxide (CO<sub>2</sub>).<sup>3</sup>

It was not until the 1950's (30 to 40 years later) that investigations revealed the presence and importance of nitrogen dioxide (NO<sub>2</sub>).<sup>4,6</sup> The major portion of toxic NO<sub>2</sub> appears to be produced from organic nitrates, aggravated by the addition of heavy nitrate fertilizer and/or drought conditions.<sup>6</sup>

The process of NO<sub>2</sub> production begins within hours of ensilage, peaks in three to seven days, but may last for up to two weeks. Levels of NO<sub>2</sub> as high as 200 ppm have been reported seven days after filling;<sup>6,7</sup> this is well over its current TLV of 3 ppm (with a 5 ppm STEL).

Our broad understanding of the magnitude and frequency of this hazard is limited by a lack of systematic environmental surveillance and poor reporting of farm injuries and fatalities. Our understanding of its overall impact on the health of farmers is further limited by the difficulty in diagnosing nonfatal cases of the disease due to the multiple and usually latent phases of its clinical manifestations.<sup>8-10</sup> Thus, the severe and fatal cases of silo fillers' disease that are reported probably represent the tip of the proverbial iceberg.

A few systematic surveys have recently been made of chronic gaseous hazards in modern semi-enclosed animal production buildings. Mulhausen<sup>11</sup> found that air quality in poultry barns frequently exceeded exposure limits of 25 ppm for ammonia (NH<sub>3</sub>) during fall and winter and

sometimes even exceeded its STEL of 35 ppm; H<sub>2</sub>S was undetected. Donham

*et al.*<sup>12,13</sup> surveyed similar swine barns and found 50 percent exceeded the TLC for ammonia; many of these buildings also exceeded the TLC for CO<sub>2</sub>, H<sub>2</sub>S, and CO (from un-vented space heaters).

Source: urine (urea)-wet floors, slats, gutters, etc.	
Anticipated Health Hazards:	
Irritating to eyes, nose, trachea (wet body parts) .....	10-15 ppm
TLV = recommended exposure limit (for gas) .....	25 ppm
Absorbed into an aerosol may provoke bronchitis, asthma, or other pulmonary effects .....	<20 ppm

Figure 2. Ammonia (NH<sub>3</sub>).

At these concentrations, ammonia by itself would only be a strong irritant to the eyes, nose, and throat. However, in both poultry and swine farm settings, it may be important to consider the simultaneous presence of both ammonia and organic dust aerosols at levels often in excess of 5 mg/m<sup>3</sup>. The hypothesis here is that the pulmonary damage caused by ammonia could be considerably greater if the gas were adsorbed onto a respirable-sized aerosol (Figure 2).

In addition to hydrogen sulfide, mercaptans and organic acids (such as methyl and ethyl-mercaptan, carbonyl-sulfide, skatole, and propionic, butyric, and valeric acids) have been identified in the gases emanating from the anaerobic decay of manure typically stored in a pit under most

hog and some dairy barns.<sup>14-15</sup> It should be acknowledged that under normal barn conditions, hydrogen sulfide is not at levels of great health concern (Figure 3).<sup>12,13</sup>

Source: anaerobic manure digestion	
Anticipated Health Hazards:	
Threshold of odor detection	..... 0.1-0.2 ppm
Offensive odor	..... 3-5 ppm
TLV = recommended exposure limit	..... 10 ppm
Olfactory paralysis (cannot be smelled)	..... 25-100 ppm
Serious eye injury (gas eye)	..... 50-100 ppm
Bronchitis (dry cough)	..... 100-150 ppm
Pneumonitis and pulmonary edema	..... 200-500 ppm
Rapid respiratory arrest (death)	.. >1000 ppm

Figure 3. Hydrogen Sulfide (H<sub>2</sub>S).

However, when the manure is agitated prior to pump-out to be returned to the fields as fertilizer, it is rapidly released into the air above the frothing liquid.<sup>15-19</sup> During agitation, the author has measured levels of H<sub>2</sub>S as high as 300 ppm at pig breathing height and 1500 ppm in the pit (Figure 4).

- |                    |                  |
|--------------------|------------------|
| • Methyl-mercaptan | • Propionic acid |
| • Ethyl-mercaptan  | • Butyric acid   |
| • Carbonyl-sulfide | • Valeric acid   |
| • Skatole          |                  |

Figure 4. Mercaptans and Organic Acids Associated with Hydrogen Sulfide from Manure.

Manure gas deaths often involve multiple victims during futile rescue attempts.<sup>17,20</sup> As was the case with silo gas, manure gas deaths even as recently as 1989 are

sometimes mis-diagnosed as asphyxiation from methane.<sup>20</sup>

Control of agricultural respiratory hazards should rely first on reduction at the source, second on ventilation or some other physical barrier to its movement, and third on personal protection. Control of the source of most of the above agents will require further research before the process of gas generation is sufficiently understood to be reduced or avoided.

High rates of ventilation of farm shops or animal confinement building is often resisted by operators who prefer to conserve heat in cold winter climates, and if too much ventilation were installed without consideration of make-up air requirements, high levels of CO could be drawn back down heater exhaust vents (Figure 5).

Source: improperly adjusted heaters or no make-up air	
Anticipated Health Hazards:	
TLV = recommended exposure limit	..... 50 ppm
Induces spontaneous abortions in swine	..... 100-150 ppm
Asphyxiation dependent upon duration of exposure	..... (2-3 hours at 500 ppm) <15 mins >2000 ppm

Figure 5. Carbon Monoxide (CO).

As in any other industry, the use of respirators should be considered a temporary and supplemental protection. In agriculture there are no trained persons available to assist in the selection, fit, or maintenance of respirators. Thus, when purchased at all, respirators are selected

without knowledge of measured levels of exposure and often without even the benefit of an adequate "work practices" evaluation as shall be discussed below.

## LIQUIDS

Pesticides are formulated as solids (such as granules and wettable powders), liquids, and gases and vapors (mostly fumigants). Pesticides can present a hazard to applicators,<sup>21-23</sup> to harvesters re-entering a sprayed field,<sup>24, 25</sup> and to rural residents via air, water, and even food contamination.<sup>26-28</sup>

Toxicologically, the major field-use pesticides can be broken down into six major chemical groups shown in Table II. Most of these agricultural chemicals present dermal hazards either from absorption directly through intact skin and/or from dermatitis. Some of these insecticides are also used indoors, especially in greenhouses where exposure is often higher.<sup>29</sup>

There are two additional groups of non-field agricultural chemicals: one is fumigants (such as phosphine [usually aluminum phosphide or Phostoxin] or a volatile organic like carbon disulfide or ethylene dichloride) used in produce storage areas, and the other is disinfectants (such as chlorine, quaternary ammonia compounds, organic iodides, and cresol-based compounds) used in indoor animal production facilities.<sup>2</sup> Certain of these chemicals present respiratory hazards particularly when used in combinations; other of these liquid chemicals present a risk of contact or an allergic dermatitis.<sup>30</sup>

**Table II. Major Groups of Field-Use Agricultural Pesticides.**

	<u>Common Commercial Names</u>
<b>INSECTICIDES</b>	
Organophosphates .....	Counter, Parathion, Guthion, Lorsban, Rabon
Carbamate .....	Temik, Furidan, Lannate, Sevin
Organochlorines .....	Dieldrin, Lindane, Chlordane
<b>HERBICIDES</b>	
Phenoxy-aliphatic acids .....	2,4-D, 2,4,5-T, Trioxone
Bipyridyls .....	Paraquat, Diquat
Triazines .....	Atrazine, Blasex, AAtrex
<b>OTHER/MISCELLANEOUS</b>	
Thiocarbamates (fungicides) ..	Thiram, AAtack, Mabam, Maneb, Zineb
Arsenicals (herbicides) .....	Paris Green, Cacodylic acid
Acentanilides (herbicides) .....	Alachlor, Lasso, Ramrod
Dicarboximides (fungicides) ...	Difolitan, Captan
Dinitrotoluidine (herbicides) ...	Amex, Prowl, Treflan

While a review of pesticide toxicities is being presented separately, they are presented here because they demonstrate an approach to anticipation, recognition, evaluation, and control quite different from general industry. Some level of anticipation was available from the time of registration, but much of that interest was directed toward consumers rather than users who are exposed at much higher levels.

Given that starting point, it is unfortunate that the recognition of hazards to users has often been a protracted process, in some ways no better than the history of many chemicals used in general industry. However, evaluation of exposure, when it finally started to be conducted, was not site nor user specific but was conducted in response to more recent EPA pesticide registration requirements.

EPA then promulgated what amounts to a "use practices standard" in the form of

label instructions, which specify the ways the chemical can be safely and legally used. The implication is that if all users follow these instructions, exposure will be sufficiently low to prevent adverse health effects. This process contrasts sharply with general industry where employers are expected to "assure a workplace free from recognized hazards."

Controls under these circumstances have also differed from general industry. It can be argued that the registration process is itself a form of controlling the source, screening out chemicals deemed too hazardous for agricultural use and restricting certain others to "licensed users."

In that sense, a form of hazard communication was adopted by agriculture a little before general industry. However, the EPA registration and labelling process has yet to address the machinery controlling the pathway of exposure.

When it comes to personal protection, control has for a long time been misdirected at airborne versus the dermal route of exposure; and those respiratory controls which are specified, were established without a decision logic common to general industry for over 30 years<sup>31,32</sup>. I am happy to report that EPA is currently developing a respirator selection decision logic at least consistent with a "use practices standard."

One might ask why a "use practices standard" versus a "performance standard" approach used in agriculture. The one asking the question must not be a farmer.

Even if the administrative and support structure were in place to conduct on-site monitoring at each farm or "place of employment," the activities, working en-

vironments, and chemical exposure levels in most agricultural settings vary sufficiently by season, day, and even by hour as to make such measurements moot, which is not to say that measurements and even performance standards have no place in agriculture.

For instance, work in animal production facilities is amenable to the application of traditional TLVs, environmental monitoring, and respirator selection criteria. "Use practice standards" have their own limitations; they must account for many variables, thus often making them overly restrictive conducive to low compliance. It remains a challenge for the future to define the conditions favoring either form of standard or to determine if either is even adequate.

The other category of agricultural chemicals is fertilizers. Anhydrous ammonia is the most heavily used fertilizer in production agriculture. Anhydrous ammonia is hazardous to the skin and especially to the eyes because it is highly hygroscopic, highly caustic, and extremely cold (-28°F under pressure).

Almost any eye contact with this chemical will result in permanent blindness.<sup>33</sup> Inhaling high concentrations of ammonia can result in severe damage to the upper respiratory tract, resulting in bronchiectasis as a possible sequela.<sup>34</sup>

Most of the occupational injuries from anhydrous ammonia occur because of faulty couplings, bleeder valves, shut-off valves, broken hoses, or plugged applicator tips. In addition to an established program of preventive maintenance, a pro-active hazard communication for both commercial and private applicators is essential to establish consistent wearing of eye protec-

**Table III. Skin Conditions of Agricultural Workers (adapted from reference 2).**

<u>Classification of Skin Condition</u>	<u>Agents (examples)</u>
Irritant contact dermatitis .....	ammonia fertilizers animal feed additives vegetable crops and bulb plants insecticides, herbicides, and fumigants
Allergic contact dermatitis .....	herbicides and insecticides antibiotic feed additives plants
Photo-contact dermatitis .....	creosota feed additive plants containing furocoumarins
Sun-induced dermatoses .....	sunlight
Infectious dermatoses .....	cattle, swine, and sheep
Heat-induced dermatoses .....	moist and hot environments
Arthropod-induced dermatoses .....	chiggers, bees, and wasps

tion and ensuring the availability of clean water to flush eyes and skin in case of contact.

In addition to their fire hazard and intrinsic toxicity, many of the liquids involved in agriculture can produce dermatitis (Table III). Compared to other occupational groups, farmers have a proportionately higher prevalence of skin diseases.<sup>35,36</sup>

Irritant contact dermatitis is perhaps the most common type of agricultural dermatoses.<sup>35-39</sup> Irritant substances are ubiquitous and include ammonia fertilizers, several pesticides, soaps, petroleum products, and solvents. Avoidance schemes must include work practices to eliminate or reduce exposure to the most irritative substances and/or the use of personal protection equipment.

Allergic contact dermatitis is typified by poison ivy or poison oak reactions. These are exquisite sensitizers as are certain

herbicides and pesticides.<sup>2</sup> These reactions are more difficult to control, because susceptible farmers are exquisitely sensitive to very small amounts of offending liquids.

## VETERINARY DRUGS

Veterinary drugs are broadly divided into two classes of biologicals and antibiotics (Table IV). Biologicals are made from living products to enhance the immunity of an animal to a specific infectious disease or diseases.

Users of biologicals are at risk of either accidental inoculation or splashing the product into the eyes, mucous membrane, or broken skin. Users at risk include not only veterinarians and their assistants, but also farmers, ranchers, and their employees, except for certain diseases for which a government-regulated control program is in effect (e.g., brucellosis, rabies, pseudorabies).<sup>2</sup>

The most frequent reports of occupational illnesses associated with biologicals involve veterinarians, whether splashing brucellosis strain 19 in their eyes or accidental inoculating themselves. Symptoms may include infection, inflammation, severe localized swelling and pain, and/or an allergic reaction. The infection mimics the acute infection seen from acquisition of the disease directly from either cattle or swine. Disability may last for days to weeks in the worst cases.<sup>40</sup>

**Table IV. Veterinary Drugs Potentially Hazardous to Users.**

---

**Biologicals**

Brucellosis strain 19  
Newcastle disease vaccine  
Contagious ecthyma (orf) vaccine  
Jhone's disease bacterin  
*Escherichia coli* bacterins  
Erysipelas vaccines

**Antibiotics**

Penicillin  
Tetracycline  
Sulfamethazine  
Erythromycin  
Virginiamycin

---

Other products that have been associated with occupational illnesses include Newcastle disease vaccine, contagious ecthyma vaccine, Jhone's disease bacterin, *Escherichia coli* bacterins, and erysipelas vaccines. Newcastle disease and contagious ecthyma (orf) vaccines are live products used in chickens and sheep, respectively.

Workers may contaminate their eyes with Newcastle vaccine as it is being applied inside poultry buildings via a nebulizer, resulting in a moderate conjunctivitis with influenza-like systemic symptoms. Orf vaccine can cause the same pox-like lesions at the site of inoculation as a naturally acquired infection.

Both of these diseases are self-limited and disability will only last for a few days, unless the orf lesions are numerous.<sup>41, 42</sup> Injuries induced by the bacterins for Jhone's and *E. Coli*, and by most erysipelas

vaccines are limited to the inflammatory response induced by the adjuvants.

Control of these hazards again resides largely in "use practice standards," good animal handling techniques and facilities to prevent the uncontrolled and untimely movements of stressed animals.<sup>43</sup> The use of pneumatic syringes, lock-on needle hubs, and multiple dose syringes will also help reduce injuries.

Eye protection is indicated in many instances. A full-face respirator is recommended while aerosolizing vaccines such as Newcastle, but the other components of a full respirator program are rarely instituted.

Antibiotics are products derived or synthesized from living organisms, mainly mold species of the genus *streptomyces*. Antibiotics are used to treat infectious diseases therapeutically or to improve the rate of gain and feed efficiency in cattle, swine, and poultry.

Again not only veterinarians but also livestock producers and feed manufacturers and formulators are exposed to these agents via aerosols of antibiotic-containing feeds within livestock buildings or via aerosols or direct contact while preparing feeds either on the farm or in feed manufacturing plants. The two main occupational hazards are allergic reactions and the development of antibiotic-resistant infections.

The main products used as feed additives include penicillin, tetracycline, sulfamethazine, erythromycin, and virginiamycin. These same products plus many more are used therapeutically. Penicillin is the primary agent that may induce an allergic reaction manifest in the form of a skin reaction from direct contact, or

possibly a systemic reaction from inhalation or inoculation.

A variety of these agents may induce development of resistant organisms in the gut flora of exposed individuals. In one case, a severe resistant salmonellosis was traced to animal contact by people who were treated with antibiotics for a condition unrelated to salmonella.<sup>4</sup>

Again the importance of antibiotics as an agricultural health hazard is unknown either in terms the frequency or the magnitude of exposure levels or health effects. It seems that the evaluation of risk from antibiotics is amenable to air sampling and the development of "performance" oriented exposure guidelines.

Control should strive toward removing as feed additives those antibiotics used for humans and rotating the use of those still added. Other prudent control measures where antibiotics are used include enclosing feed formulating, grinding, mixing, and storing operations, and utilizing general dust control procedures in small feeding operations, supplemented by dust masks.

## CONCLUSIONS

The industrial hygiene paradigm of "anticipation, recognition, evaluation, and control" can, in principle, be applied to agriculture with the following translations:

1. Anticipation of health and safety hazards in agriculture can be accomplished with the prospective application of dose-response knowledge generated either in the laboratory or in other industries.
2. Recognizing health and safety hazards in agriculture requires the interest and

commitment of farmers, farmer groups, local community organizations, manufacturers, and governmental agencies to survey both the farming environment and the health status of farmers.

3. Evaluation of health and safety hazards in agriculture can in most cases use existing surveillance technologies, but new ways must be developed to interpret surveillance data from settings for farmers.

4. Controlling health and safety hazards in agriculture must go beyond "hazard communication" to modify the sources and interrupt the pathways of exposure before the farmer, with or without personal protection, is dosed.

Organizationally, the hazards from gases, liquids, vapors, and veterinary drugs are not uncontrollable. By and large, we can anticipate the health effects of individual agents, and we know how to measure both the agents and their effects in a population.

We have not utilized these skills in agriculture as yet, probably both because of the cost of surveillance studies in such a scattered and diverse population and because of the perception that "agriculture" was not interested in someone intervening in their affairs. We are at the dawn of the age where the interest and funds are being put into agricultural health and safety.

I hope that in our rush to study and improve the statistics upon which future preventive health and safety decisions will be made, we do not lose sight of agriculture as way of life. Kelley Donham and I recently have been referring to agricultural hygiene as the application on farms of industrial hygiene principles learned in general industry.<sup>2</sup>

We like to think (with tongue in cheek) that agricultural hygiene is a growing opportunity. The open question is, is it going to be easier to train industrial hygienists about farming than it will be to train farmers to be agricultural hygienists?□

## REFERENCES

1. W. Pependorf, K.J. Donham, D.N. Easton, and J. Silk. A synopsis of Agricultural Respiratory Hazards. *American Industrial Hygiene Association Journal*. 46(3): 154-161, (1985).
2. W. Pependorf and K.J. Donham: Agricultural Hygiene. Chapter 19 in *Patty's Industrial Hygiene*. 4th Edition, pages 575-608, J. Wiley & Son, NY 1991.
3. E.R. Hayhusrt and E. Scott, Four Cases of Sudden Death in a Silo. *JAMA* 63:1570-1572, (1914).
4. R.R. Grayson, Silage Gas Poisoning: Nitrogen Dioxide Pneumonia, a New Disease in Agricultural Workers. *Ann. Int. Med.*, 45:393-408, (1956).
5. T. Lowry and L.M. Schuman. Silo-filler's Disease: A Syndrome Caused by Nitrogen Dioxide. *JAMA* 162:153-160 (1956).
6. W.H. Peterson, R.H. Burris, S. Rameshchandra, and H.N. Little. Production of Toxic Gas (Nitrogen Dioxides) in Silage Making. *Agric and Food Chem*, 6:121-126, (1958).
7. B.T. Commins, F.J. Raveney, and M.W. Jesson. Toxic Gases in Tower Silos." *Ann. Occupational Hygiene* 14:275-283, (1971).
8. R.J. Ramirez and A.R. Dowell. Silo Filler's Disease: Nitrogen dioxide-induced Lung Injury. Long-term Follow-up and Review of the Literature. *Ann. Intern. Med.* 74:569-576, (1971).
9. E.G. Scott and W.B. Hunt. Silo-filler's Disease. *Chest* 63:701-706, (1973).
10. E.D. Horvath, G.A. do Pico, and R.A. Barbee et al. Nitrogen dioxide-induced pulmonary disease. *Journal of Occupational Medicine*. 20:103-110, (1978).
11. J.R. Mulhausen, E.E. McJilotn, P.T. Redig, K.A. Janni. Aspergillus and Other Human Respiratory Disease Agents in Turkey Confinement Houses. *American Industrial Hygiene Association Journal*. 48(11):894-899, (1987).
12. K.J. Donham, M. Rubino, T.D. Thedell, J. Kammermeyer, Potential Health Hazards to Agricultural Workers in Swine Confinement Buildings. *Journal of Occupational Medicine*. 19(6):383-387, (1977).
13. K.J. Donham, M. Rubino, T.D. Thedell, J. Kammermeyer. Ambient Levels of Selected Gases Inside Swine Confinement Buildings. *American Industrial Hygiene Association Journal*. 46:658-661, (1985).
14. J.A. Merkel, T.E. Hazen, and J.R. Miner. Identification of Gases in a Confinement Swine Building Environment. *Trans. ASAE*. 12:310-315 (1969).
15. W.C. Banwart and J.M. Brenner. Identification of Sulfur Gases Evolved from Animal Manures. *Journal of Environmental Quality*. 4(3):363-366, (1975).



16. D.L. Morses, M.A. Woodbury. Death Caused by Fermenting Manure. *Journal of the American Medical Association*. 245(1):63-64, (1981).
17. K.J. Donham, L.W. Knapp, R. Monson, K. Gustafson. Acute Toxic Exposure to Gases From Liquid Manure. *Journal of Occupational Medicine*. 24(2):142-145, (1982).
18. S.R. Hagley, D. L. South. Fatal Inhalation Of Liquid Manure Gas. *Medical Journal of Australia*. 2:459-460, (1983).
19. A. Phelps. The Hidden Hazard. *Hog Farm Management*. 25(4):38-39, 1988.
20. Anonymous. Fatalities Attributed to Methane Asphyxia in Manure Waste Pits - Ohio, Michigan, 1989. *MMWR*, 38(33):583-586, (1989).
21. H.N. Nigg and J.H. Stamper. Exposure of Spray Applicators and Mixer-Loaders to Chlorobenzilate Miticide in Florida Citrus Groves. *Arch. Environmental Contamination Toxicology*. 12:477-482, (1983).
22. J.M. Devine, G.B. Kinoshita, R.P. Peterson and G. L. Picard. Farm Worker Exposure to Terbufos [phosphorodithioic acid] during Planting Operations of Corn. *Arch. Environmental Contamination Toxicology*. 15:113-119, (1986).
23. W. Pependorf. Mechanisms of Clothing Exposure and Dermal Dosing during Spray Application. In: *Performance of Protective Clothing: Second Symposium*. ed. by S.Z. Mandorf, R. Sager, and A.P. Nielsen. Amer. Soc. for Testing and Materials. Phil. PA, 611-624, (1988).
24. W. Pependorf and J.T. Leffingwell. Regulating OP Pesticide Residues for Farmworker Protection. *Residues Reviews*. 82:125-201, (1982).
25. H.N. Nigg, J.H. Stamper, R.M. Queen. The Development And Use Of A Universal Model to Predict Tree Crop Harvester Pesticide Exposure. *American Industrial Hygiene Association Journal*. 45(3):182-186, (1984).
26. J. Maybank, K. Yoskida, and R. Grover. Spray drift from agricultural pesticide applications. *J. Air Pollution Control Association*. 28:1009-1014, (1978).
27. National Research Council. *Regulating Pesticides in Food*, National Academy Press, Washington, DC, (1987).
28. D. Fairchild. *Ground Water Quality and Agricultural Practices*. Lewis Publishers, Inc., Chelsea, MI (1987).
29. J.H. Stamper, H.N. Nigg, W.D. Mahon, A.P. Nielsen, M.D. Royer. Pesticide Exposure to Greenhouse Foggers. *Chemosphere*. 17(5):1007-1023, (1988).
30. R.L. Zuehlke. Common cutaneous problems in agricultural work. In: *Proceedings of Conference on Agricultural Health and Safety*. Society of Occupational and Environmental Health, Environmental Sciences Laboratory, 100th Street and Fifth Avenue, NY, pp. 54-67, (1975).
31. F.A. Patty. *Industrial Hygiene and Toxicology*. 2nd Edition. Pages 352-354, Interscience Publishers, NY (1958).
32. N.J. Bollinger and R.H. Schutz. *Guide to Industrial Respiratory Protection*. DHHS (NIOSH) Publ. 87-116, (1987).

## Research - Chemical and Biological Hazards

33. S. Helmers, F.H. Top, and L.W. Knapp. Ammonia Injuries in Agriculture. *J. Iowa Med. Society*. 61(5):271-280 (1971).
34. I. Kass, N. Zamel, C.A. Dobry, and M. Holzer. Bronchiectasis following ammonia burns of the respiratory tract: A review of two cases. *Chest*, 62:282-285, (1972).
35. D. Hogan and P. Lane. Dermatologic Disorders in Agriculture. *Occupational Medicine: State of the Art Reviews*, 1:285-300, (1986).
36. C.L. Wand. The Problem of Skin Diseases in Industry. Washington D.C., Office of Occupational Safety and Health Statistics, U.S. Department of Labor, U.S. Government Printing Office, (1978).
37. R.M. Caplan. Cutaneous hazards posed by agricultural chemicals. *Journal of the Iowa Medical Society*, 59(4):295-299, (1969).
38. D. Burrown. Contact dermatitis in animal feed mill workers. *British Journal of Dermatology*, 92:167-170, (1975).
39. R.D. Peachey. Skin hazards in farming. *British Journal of Dermatology*, 105(Supp.21):45-50, (1981).
40. W.W. Spink. The Significance of Bacterial Hypersensitivity in Human Brucellosis; Studies on Infection due to Strain 19. *Brucella Abortus*. 47:861-873, (1957).
41. A.H. Keeney and M.C. Hunter. Human infection with Newcastle virus of fowls. *Archives of Ophthalmology*. 44:573-580, (1950).
42. U.W. Leavell, Jr., M.S. McNamara, R. Muelling, et al. Orf-Report of 19 human cases with clinical and pathological observations. *JAMA*, 204:109-116, (1968).
43. T. Grandin. *Animal Handling and Farm Animal Behavior*. *Veterinary Clinics of North America: Food Animal Practice*, 3:324-336, (1987).
44. R.W. Lyons, C.L. Samples, H.N. DeSilva et al. An Epidemic of Resistant Salmonella in a Nursery-Animal-to-Human Spread. *JAMA* 243:546-547, (1980).

## MIGRANT WORKERS' PERSPECTIVE

By E. Roberta Ryder, B.A.

Executive Director, National Migrant Resource Program, Inc.

---

I am coming to you from Buffalo, New York, where I have been for six days participating in the National Migrant Conference, which is a joint group with migrant education, migrant health, migrant head-start, and migrant labor. So, I am running a little ragged here in my throat, and I ask you to bear with me for just a little while.

### NATIONAL MIGRANT HEALTH PROGRAM

I am going to give you a brief synopsis of the organization that I work with because I think there are some resources there that some of you might be interested in. The National Migrant Resource Program is located in Austin, Texas. It has been there for almost 20 years.

We act as a resource not just to migrant health centers but to any other interested parties around the country. We are a private, non-profit corporation. We have a newsletter, a directory, and a number of publications, perhaps the most exciting of which is one that was just completed by Dr. (inaudible) who is an epidemiologist with Mercer University in Georgia.

I am going to read you one sentence out of this report. It is an analysis of migrant farmworkers in the midwestern stream. He says, "The results of this study are significant, shocking, and convincing. The findings are based on a sample of migrant and seasonal farmworkers living and

working in the U.S., yet their demographic patterns, socioeconomic conditions, lifestyle characteristics, and disease categories reflect agrarian third-world conditions rather than those of the most powerful and affluent nation in the world."

This monograph is available for all of you if you want to contact me. Our name is listed in the back of the roster of participants.

I come from a farming background. I am the daughter of a farmer, and I am also the ex-wife of a farmer.

I have been a health center administrator and worked with migrant farmworkers since I got out of college in 1972. I would also like to let you know that we are doing—if any of you have an interest in it we would like to hear from you—some work with EPA on expert meetings on the topics of children and pesticides and on biological monitoring alternatives.

### COMMENTS ON PAPERS

I am going to go directly to the presentations that were made yesterday. I would like to state that of the four, some of them were more directly applicable to migrant farmworkers than others. Even the one that was least directly applicable, i.e., Dr. Popendorf's presentation on gases, liquids, vapors, and veterinary drugs, contained significant concepts that are very valuable when applied to the field of mi-

grant health. I speak particularly of his paradigm of anticipation, recognition, evaluation, and control.

The other concept that he presented was that adverse health effects are the culmination of an often complex chain of events beginning with a nebulous source and traveling through a physical pathway. This concept is very important, especially if you think for the moment of the father of a farmworker family, say 50 years old, who comes into a clinic with chronic headaches, gastric problems, or dermatitis.

We cannot figure out what the problem is. How do we determine what series of events or exposures led him to this state? After 40 years of exposure, traveling in maybe one or two streams, a multiplicity of states, and working with a range of crops that go from apples to mushrooms to zucchini — what kinds of exposures has he had? Certainly the case is complex beyond that of the grower, the farmer, who stays on one farm, one piece of property, over a 40- to 60-year span of time.

We do not know what the chronic effects of low-level continuous exposure are, but because we do not know, we sometimes hide our heads in the sand and pretend that they are not problems, much like we did with cigarette smoking 20 years ago. Good judgment and common sense advised us that smoking was not healthy.

To touch on Dr. Pendorf's theory, we could anticipate potential problems, we could recognize the questionability of putting such a substance in our bodies, but yet for economic and political reasons we got stuck on evaluation before we could move on to control. Are we going to wait until we can prove, irrefutably, that exposure to chemical and biological substances is

hazardous to the health of farmworkers, farmers, and consumers before we use this God-given good judgment and anticipate or recognize the danger and take action?

You might wonder why I mentioned the consumer here. Those of us who work in migrant health believe that the migrant farmworker and the farmer are, in essence, the "canaries." Do you all know what I mean by that concept? The indicator of risks that are shared with the consumer.

I speak here not only of chemical hazards but of biological exposure. A colleague of mine testified before a joint session of the Congress in the early years when we were trying to promulgate the field sanitation regulations which, by the way, were only finally passed in 1987. He said, "Just tell me, sir, exactly what amount of fecal matter present on a strawberry is a tolerable level."

All of the presentations touched on issues which are of significant impact to farmworkers. I would like to run through that list briefly with you at this time.

We spoke of infectious diseases for which farmworkers are at high risk, because of their working and crowded living conditions. TB, STD, HIV, parasites, gastroenteritis, Salmonella, Shigella, hepatitis A, UTI's, and respiratory infections—all of them very clearly problems that we see in the farmworker population. One of the reasons that I referred you to Dr. (inaudible) study is that he does an analysis of the frequency of these diagnoses in this study.

Dr. Von Essen spoke to us of airborne dust. Certainly hypersensitivity pneumonitis is less of a problem with the migrant farmworker population, since only

small numbers of them work in dairy or grain operations. I have a foster child who lives with me and is 20 years old. I have known Danny since he was three, and I had him in day care in southwest Michigan.

He is the child of a farmworker family that is home-based in the Little Rock or Batesville, Arkansas area. When they are not migrating north, they work in the poultry industry. Danny, at the tender age of 20, has chronic bronchitis from having been in and out of the poultry settings and the freezers of the processing plant. This is clearly a problem, but in less significant numbers than the larger portion of the population that works primarily in fruits and vegetables.

I would like to draw attention to the fact that for farmworkers, we are talking about chemical and biological exposures, but there are a number of other hazards that people often do not think about as being agriculturally or occupationally related. For example, automobile accidents with farmworkers who are traveling 1,200 miles up and down the stream in cars that I would not drive 200 miles in are significantly related to occupational employment.

I would like to go to Dr. Blair's presentation. It is most exciting to me in that it takes a very honest approach to the difficulties in assessing the chronic effects of acute exposure. Certainly clusters of cancer among farmers which cannot be explained for other reasons are alarming enough to motivate us to anticipate and recognize the problem so that we can then control it. Let us not get bogged down in the assessment, or we will lose all of our canaries.

What are the solutions? Certainly there are some laws on the books which need to be fully implemented. I had originally jotted down the word "enforced," and I crossed that out and used the word "implemented," because, quite frankly, our enforcement is not working.

We have people here from OSHA. Someone asked me a question just before the conference started as to how things were going with OSHA in Texas. Enforcement does not happen.

Specifically, the laws that are on the books include such things as field sanitation, use of child safety restraints in automobiles, minimum wage, and re-entry times, but these are not always observed. Then there are other laws that have yet to be promulgated.

I speak specifically here of the loopholes in current laws, which exempt migrant and seasonal farmworkers and farmers from basic worker protection standards afforded to all other workers and child labor laws which do the same. There is movement towards promulgating both of those at this time. One of my colleagues, Dr. Paul Monahan who is sitting in the back row, has information on each of those. The group within migrant health that takes a strong advocacy role is the migrant clinicians' network, and I believe he has copies of the position papers on both of those laws.

Currently worker protection standards within the Environmental Protection Agency are bogged down in a political morass where they have been for years. They need to get out of the red border status and be promulgated.

Once this is achieved, they merit careful, independent, academic evaluation from professionals like yourself with an eye to modifications. Let us push now to get them on the books because if we try to inject modifications at this time into the political process, I am afraid we will never have the standards.

Is it really acceptable that such a large portion of our population be relegated to the edge for the duration of their lives?

Unfortunately, laws alone are not going to improve conditions for farmworkers. I would like to propose to you that farmworkers and farmers are literally in the same field—or boat as you might say—not only when it comes to exposures, but economically and politically.

It is very clearly recognized that farm and farmworker families have lived their lives on the edge between survival and destitution for at least the last 10 years. Many farm families have lost that struggle through suicide and bankruptcy. We do not see, visibly, tangibly, the demise occurring in the numbers of the farmworker population because there has always been another family to take the place of one that settles out. So we can not quantify it for farmworkers the way we can for farmers.

The theory of the hierarchy of need tells us that safety, shelter, and nourishment are the three basic needs of any human, and that without assurance of them, self-actualization will not occur. Is it really acceptable that such a large portion of our

population be relegated to the edge for the duration of their lives?

Sometimes the farmworker's plight is erroneously blamed on the farmer or on the laziness of the farmworker. So who do we blame for the farmer's plight?

I blame the ignorance, selfishness and greed of the consumer and all of the middlemen in the food production system. Perhaps where humanitarianism and altruism are not strong enough to create change, consumer self-concern may.

We can certainly look at the examples of Alar in the Pacific Northwest, the consumer reaction, and the practice of its use among growers. We can look at the European Economic Community and the purchase of beef with steroids. We can look at the safe tuna model for examples of where consumer pressure has certainly brought about change. We know that it is a powerful entity.

## RECOMMENDATIONS

I have 10 recommendations:

1. I would like to suggest that it is very important that we continue to mainstream farmer and farmworker issues, especially in arenas such as these, and I would like to volunteer to be one of several linkages that can help to bring participants— participation of migrant farmworkers themselves to sit and be a part of your negotiations. Not all farmworkers are monolingual, and several of them are very outspoken in English as well as Spanish.
2. Enforce protection standards where they exist.
3. Promulgate laws where necessary.

4. Educate both farmers and farmworkers as to the risks that they face.
5. Educate the consumer and the general public.
6. The academic world needs to feel free to speak out about the risks, even where proof does not exist. Let good judgment prevail.
7. Promote economic market changes that assure that farmers and farmworkers receive a decent wage or profit for their work, because truly it is the economic market that drives the situation. In this manner, both farmers and farmworkers can be pushed back from the edge where they currently teeter.
8. Recognize the difference between farm families and huge, multi-level, diversified agribusiness, which is making a profit, and decide where our values lie and promulgate and implement legislation accordingly.
9. Anticipate that the Free Trade Agreement between the United States and Mexico is going to blow us all out of the water, at least for the first five years, and then recognize that the short-run, political solutions and protections must be put in place in order to protect not only the farmer and the farmworker but the consumer, in that we do not control the use of toxic substances in Mexico.
10. Just as it took Surgeon General Koop's audacity to challenge the economic and political bastions of the tobacco industry and to state that cigarettes smoking is hazardous to our health, so too can Dr. Novello have the audacity, as a pediatrician and a woman and, I dare say probably a mother, to speak out on behalf of the hazards faced by our farming community.□

## QUESTIONS

**Anonymous:** You used the term "blow us out of the water," on the Free Trade Agreement. Could you clarify that?

**Roberta Ryder:** The question is, What do I mean by "blow us out of the water" on the Free Trade Agreement? I have a sense that the long-term benefits of the Free Trade Agreement are going to be of significant value to this country and so, therefore, I personally am not opposed to it, but when you look at the fact that the production of a watermelon, for example, basically costs the same in Mexico as it does in the United States with the exception of the labor factor, what we are going to find is that the importation of agriculture into the United States will be far more prevalent than it is right now.

We will also find that some of the larger, healthier farms are going to actually move into Mexico, and there will be others who cannot sustain that kind of change that will go under. That is the impact on the farm.

For the farmworker, what we are going to find is that there are a number of second-generation agricultural farmworkers that have been here in the United States traveling along all of the streams, that are truly America's working poor. They are not a welfare population, and they are not going to have work. That is going to be a burden on American society just as it is in our inner city areas where we have large welfare populations.

I do not think that it is going to have a significant impact on the cost of produce for us as the consumer, but I do think that it will actually cut, pull the rug out from under our feet on, any of the consumer safety protections that have been put in place to control the use of certain substances because, in Mexico, things

## Research – Chemical and Biological Hazards

like DDT are still being used quite frequently without any control at all. We are going to be consuming that produce.

Anonymous: To come back to the local level, how do we educate our migrant workers on all these things that are going on... (inaudible).

Roberta Ryder: The only way that I know of is through outreach. Our clinics have gone from being very basic, simple, community-level organizations to somewhat more sophisticated—nicer buildings, better trained doctors, and in the process, what we find is that we are not reaching the farmworkers.

As our health centers have become more and more a part of the industry and our highly trained physicians sit in the clinic and wait for the patients to come to them, we are reaching smaller and smaller numbers of the total population. We know—and dollar resources are clearly the issue here—that the only way to reach them is through outreach, through use of lay rich people, employment of the best and the brightest of the migrant farmworkers themselves, and through paraprofessionals and mid-level practitioners to go out into the labor camps and the housing, the colonias in the Valley of Texas, and take care of the basic level things. I am speaking in health, because that is the field that I am most familiar with, but I think you can apply that to education whether it is health education or safety education.

Anonymous: Can you get that through, say, migrant clinics?

Roberta Ryder: You definitely can. Migrant clinics have the expertise and the know-how. They have the models. Right now what they are lacking is the resources, and they are committed to health education and worker protection status.

Anonymous: Do you have a list of migrant clinics?

Roberta Ryder: The question is, "Do I have a list of migrant clinics?" I have a directory that is produced out of our office in Austin, Texas, and that is available free of charge. It includes all of the grantees funded through the Federal Department of Health and Human Services and each of their satellites, including names of the health professionals that work in them and the services that are provided. Included in that directory is also a list of pediatricians around the country who are members of the American Academy of Pediatrics who provide services to farmworkers on a volunteer basis.



## A FOUNDATION'S PERSPECTIVE

By *Gene F. Graham, M.S.*  
Assistant Program Director, W.K. Kellogg Foundation

Dr. Kelley J. Donham: The next speaker is a person who I had the privilege of meeting just a little over a year ago, he revealed to me this morning that he got an infection once from one of his animals and since that time I think he has become quite a leader and promoter, very much so, in the whole area of agricultural health and safety. Gene Graham was born on a farm. I guess you have to have that stamp of approval, almost, to be here. If we keep this up, we are going to have so many people up here doing this stuff and not farming maybe we will not have to worry about those problems anymore, but . . . we need to keep in mind and perspective who we are working for and what we are trying to do. Anyway, Gene was born on a dairy farm in Michigan, a little ways north of Lansing. His project, perhaps more of a hobby than an actual economic unit on the farm, was pure-bred sheep. Gene went to Michigan State University and got a degree in education and specifically agribusiness and natural resources education and went to work in real life in a high school, in Laingsburg, Michigan, as an agricultural instructor, until 1989. He then went to work for the Kellogg Foundation in Battle Creek. Starting about one year ago, Gene was the stimulant to get an agricultural health and safety initiative going within Kellogg, which has helped to move this whole process along in a very big way. So, without further ado, I would like to introduce Gene Graham:

I do not know whether to say thank you to Kelley Donham or not. This morning I was asked to give a foundation's perspective on the papers and presentations that were made yesterday. As Kelley has suggested, it probably is easier for me to give a layperson's perspective.

In a sense, I hope to give a community perspective, and quite frankly, a perspective of a young midwestern farm youth and one from my involvement in agriculture as a farmer. In fact, I continue to farm today and had the opportunity in 1989 to purchase a farm in Michigan and continue to be involved there.

Although my bias and experience and exposure to the issues of agricultural health and safety clearly lie on the safety side, I will talk about that in just a minute. I first want to clear up Kelley's story. As Kelley mentioned, one day while shearing sheep on the farm, I contracted orf virus.

It was the first time that I had come to grips with some of the relationships between agriculture and health, although I had read about and understood, at least at a very rudimentary level, some of the potential that health issues in agriculture pose.

I think, though, that what stirred me more was a series of experiences as I grew up in a very rural community, as Kelley said, not far from Michigan's capital, in Ingham County, Michigan. I think about two very good friends, Ron and Steve, who, in separate tractor accidents, were either killed while working on a farm or while driving a farm tractor down the road.

One, in fact, was struck by a car and killed. I also think about Gary, who, as a sophomore in high school, had a full chopper box roll onto him. He lost his left leg just above the knee.

I think about Sarah, in probably the most devastating experience that I could ever imagine, who walked too close to a sickle bar mower and lost both her feet. Somehow, in the miracle of what has gone on in health care in this country, Sarah had both feet successfully reattached. As one of the presenters alluded to yesterday, when you are in some of those situations, you do not look up at the doctor and say, "How much is it going to cost?"

Also, when I was a graduate student at Michigan State University, I remember very specifically, a good friend got stuck by a needle with animal vaccine, for the third time in his young life, and died within just a few hours of that experience. I think about five members of a family, in an accident that many of you heard about in Michigan's Upper Peninsula, where one after another each individual attempted a rescue from an underground manure pit and all five lost their lives.

Just last year, in the school district where I grew up, in a small rural community, the local people went through the pain of one suffocation/asphyxiation in an upright grain silo and a second accident where a young man lost his legs and a big share of his future as the result of a sweep auger in the bottom of a grain bin. So, all of these experiences wear and bear on my mind as I think about these issues and what we heard about yesterday.

With respect to a foundation's perspective, the foundation that I represent is not one that is very typical or traditional. It is one that says as its motto, "The application of knowledge to the problems of people." So that does not qualify me very well to stand today and reflect about the presentations that were made yesterday.

For the Kellogg Foundation, it is an issue of the complimentary relationship between research and community intervention, where each bears directly on the other. It is a fundamental and naive belief that models and demonstrations can be established which will, at some point, affect policy even at a very local or regional level. It is the application of knowledge for community intervention.

A foundation can only bring limited resources to this or any other important issue. It cannot do work by itself. In fact, foundations have no role except to contribute some pieces to the equation of research, surveillance, education, and intervention.

For the Kellogg Foundation in Battle Creek, Michigan, this work represents an opportunity to bring financial resources, networking, and an expectation of innovation. In our particular initiative, the expectations include collaborative, comprehensive, responsive, intensive, continuous, cost-effective (however that can be measured), creative, and effective programs at a community level.

## **COMBINED FACTORS OF RISK**

As I reflect on the presentations which were made yesterday, I will only talk about where I see some potential next steps in relationship to what I heard. First, I would address an issue that was raised regarding combined factors of risk. The context of this issue could include factors outside of agriculture, such as cigarette smoking, which complicates our understanding of agricultural risk for exposure to the lungs.

Another example which was given yesterday was the case of two pesticides and what equations are appropriate, and what

do the results of the equations really mean? Have we got that figured out in a scientific and meaningful way?

A final example that I would give, and I think this may be a midwestern perspective, is the combination of wood smoke and a livestock confinement building. These are conditions and circumstances which exist on farms today. These are things at a community level which are very relevant; that young people and adults, in rural communities, who work and live on farms and tend to get exposed to more than one pesticide, to more than one type of animal confinement, to more than one risk must face a combination of occupationally and non-occupationally related risks.

### **ADDITIONAL STUDIES**

Secondly, I want to comment on the suggestion of additional studies. Yesterday Dr. Blair suggested a study of farmers. He said, perhaps a massive study which would be long-term in nature, of 100,000 farmers.

I said to myself, Who? Who are we in American agriculture? What 100,000 farmers are we?

The question generates out of my concern for a regional and locally diverse agriculture. Clearly, American agriculture is a regionally diverse agriculture. We all understand that fact. Moreover, the context of any one particular region is based on farming systems and farming practices, which are locally diverse.

In fact, as I move to that and think about exposure to risk, farming practices and farming systems come back again to the forefront and cause me to reflect in a second way, by thinking about a reduction

of exposure to risk. Certainly our rural neighbors knew 30 years ago that when one generation on the farm grew up severely asthmatic, they had to design and develop different ways to harvest and feed forage on our community dairy farms.

These are things at a community level which are very relevant; that young people and adults, in rural communities, who work and live on farms and tend to get exposed to more than one pesticide, to more than one type of animal confinement, to more than one risk must face a combination of occupationally and non-occupationally related risks.

Today, I think that we need to refocus on those efforts, and how we reduce risk in a meaningful way with respect to forage and grain handling, feeding systems, and milking systems. Why is it that some of us went to milking parlors as opposed to staying with our stall or stanchion barns? The examples, in the context of any regional production system and the diversity of local production strategies and production techniques, are all there.

### **ECONOMIC INCENTIVE**

A third factor, one with which I was especially impressed this morning as I listened and reflected in the plenary session, is one of economic incentive. As we think about the very traditional models of prevention and assistance in agricultural health and safety, we historically depended on enforcement, education, and engineering. I am still convinced, even as I read the policy statements and voluntary equipment standards proposed in this country, that there must be economic in-

centives in order for agricultural producers to change practice and in order for them to be able to provide leadership for their workers to change practice.

## **ETHNIC AND CULTURAL DIVERSITY**

The fourth area that I raise as a concern is the ethnic and cultural diversity of the prospective target population. This morning I listened as Dr. Pamela Elkind talked about the worker acceptance levels of yellow gloves versus black gloves.

I was saddened, as two of my fellow conference participants looked at each other in disbelief as to say, "This is silly," and I said to myself that it does not seem silly to me. On Saturday morning, while I am watching cartoons, I put on my yellow house work gloves and polish my shoes, because I do not want shoe polish all over my hands.

The issue of cultural sensitivity is relevant though. I do not wear those yellow gloves in front of anybody else.

I want to challenge you all about how it is that we can develop meaningful opportunities for enfranchisement, access to the institutions of society, and the much needed occupational safety and health interventions for migrant and seasonal workers.

It seems to me that there are learning style differences, cultural sensitivities, a need for the reduction of cultural barriers, and need of a more comprehensive understanding of the referent values and attitudes for various cultural populations involved in American agriculture. Traditionally these

groups have been, at best, slighted and, at worst, alienated. I am terrifically disappointed that with the exception of Bobbi Ryder and a few others who are here, very few migrant and seasonal workers or workers' representatives are present.

I am saddened that this meeting was scheduled on top of a national meeting which deals more specifically with the issues of migrant and seasonal labor. I want to challenge you all about how it is that we can develop meaningful opportunities for enfranchisement, access to the institutions of society, and the much needed occupational safety and health interventions for migrant and seasonal workers. At a very philosophical level, in this great American experiment and interesting American fabric, we have a great opportunity.

Some would say that we are not up to this challenge, yet we, as Americans, have established so many new ideas and institutions in our desire to find better ways. I would point to the Land Grant system, which established that technical and scientific education was important for the whole populace, as opposed to only the wealthy or the gentry in this country.

I would point to the whole system of public school education, which has a fundamentally different meaning in this country than in others and, in the development of, and now our transition away from, the one-room schoolhouse. I say to myself and to you, let us not lose our perspective or sight of our opportunity for innovation in this area.

In fact, let me restate this challenge differently. Less than 50 percent of the participants in this meeting represent those issues concerning non-owner operators,

those who either are unpaid workers or who are paid what are clearly substandard wages and live in substandard conditions across the country, then we have done a less than adequate job in identifying the issues. There must be enfranchisement of all people in this country involved in agricultural production, or we will not have addressed the issues of agricultural health and safety in an adequate and meaningful way.

### **LESSONS FROM OTHER INTERVENTIONS**

Fifth, I would say that there are lessons from other safety and health interventions, lessons which I did not hear referenced enough and which I am still curious about. These include seat belts, child restraints, helmets, and smoking laws.

Please do not misunderstand me. I am not an advocate of additional levels of regulation, but I do think that there needs to be a balance between research, regulation, surveillance, education and behavioral change, and improved service delivery. I strongly believe that there are models from the progress made in the areas of cigarette smoking, in helmet use, in seat belt use, and as was raised yesterday by Dr. Pependorf, in the process and sequence of industrial hygiene, and how science can be applied to American agriculture.

### **SURVEILLANCE SYSTEMS**

Finally, and in closing, a sixth area that I would raise is that of surveillance systems. I continue to be very frustrated about our lack of a comprehensive and unified surveillance system. This is especially challenging for someone who is a relatively new entrant, as an individual, into the field

of agricultural safety and health. I have been very frustrated while working with others to conceptualize systems that will eventually serve populations at the local level.

It is very clear to me that in a society that is losing its grasp on the availability of resources and on where we should put resources, we will have the opportunity to invest only in those programs and places where we know interventions are effective. Presently, we do not even have a system of baseline surveillance data that is uniformly agreed upon.

Even so, I hold out hope. I hold out hope for evolution in the NIOSH or other related programs as was mentioned yesterday, in the surveillance system that is being developed here in Iowa. I hold out hope for what others have done on a state-by-state basis, and for what more traditional safety organizations have done to document injury in agriculture in this country.

I am convinced that we have not achieved even the very basic goal of accurate injury and illness data yet. We need to continue to work towards this goal so that we can measure the eventual effectiveness of interventions.

Well, that brings me to the closure of my remarks. For me the priority is community intervention. Yesterday was a phenomenal experience for me to again listen as some of the health issues in agriculture were raised, issues which it is difficult to become familiar with, based on their chronic nature as opposed to their traumatic nature.

In sharing a closing thought, it seems to me that as a nation we are more con-

cerned than ever about the protection of the resource base upon which American agriculture is built. As evidenced by some of the speakers in this morning's plenary session, we have developed a greater concern for the issues of land and water management as reflected in agriculture.

These concerns cross all levels: local, state, regional, and national. As I reflect on the issues of sustainability, and I believe that this renewed importance on the wise use

and protection of our resource base is important, I ask myself, can the challenge posed by the greater protection of all workers in American agriculture, and in the prevention of occupationally related injury and illness merit any less attention, as an issue for the sustainability of our great agricultural system? My answer, and hopefully, our common answer must be that the protection of human resources in agriculture is an area of critical importance.□

## A CLINICAL PERSPECTIVE

By *Dean T. Stueland, M.D.*  
Medical Director, National Farm Medicine Center

---

I am going to come at this primarily from the point of view of a clinician and with that I would like to make two quick comments to Bobbi Ryder. One of the things about someone who spends first six days in Buffalo and then three days here in Des Moines is that she cannot be accused of exactly seeking the garden spots of the country.

The second thing is you have a sore throat and headaches. Why do you not take two aspirin? If you take good care of your cold, it will be over in seven days; if you do not, it will last a week.

I have three parts to my presentation. The first is some of the difficulties that I believe a clinician in practice experiences when trying to deal with the farming population and, specifically, some issues that were discussed yesterday. Second, I want to look at some of the specific things that were in each of the presentations. Third, I want to make some short recommendations.

### DIFFICULTIES IN CLINICAL PRACTICE

As a physician, one of the real issues clearly is what I would call a cultural gap between the clinicians and most of their clients, or patients in this case. We often have to learn, so to speak, a language that is different from what we would ordinarily speak.

As an example, I can even report—and it is nice of Kelley to speak as well as he did of the Marshfield Center—but I can give a report of my own colleagues having some difficulty in confusing silo gas exposure—that is, nitrogen dioxide—from organic toxic dust syndrome or hypersensitivity pneumonitis. The point, of course, as was pointed out well yesterday, is they occur at two completely different times.

They both can occur in silos. They have different settings. Prognostically they are worlds apart. But, in point of fact, when a physician sees someone short of breath who has just been in a silo, he says, "Well, I suspect this is silo gas exposure," when, of course, especially if it is in the spring, it is not.

The same thing might go on when we get to talk about more specific exposures. I know one of the things that we think we should do is encourage patients, that is the farmers in this case, to know the exposures that they have endured and be able to speak to them with some intelligence, and I think that is very good.

On the other hand, I can tell you as a practicing clinician, everybody has all kinds of strange exposures which they believe they have incurred, and it is often difficult to sort out fact and fancy. Although these are worthwhile recommendations, it just is not as easy as it may seem.

Another thing we often talk about is the age of machinery and its poor repair. But we need to recognize that change in farming practices actually occurs quite rapidly and so those of us who left the farm at say 18 or 20 have to recognize that things are being done significantly differently now than they were then.

This is especially true if we deal with the issue of chemicals. I think if you look at, for example, the information on the back of a pesticide bag and so on, it is all there. It strikes me about as useless as a PDR and nobody gives you any idea what is important and what is unimportant; the information is basically confusing.

Finally, I want to point out that I think there is some sort of a feeling that farmer and farm groups are in some sense not particularly cooperative. I think we all recognize they want to work and want to get back to work.

There is always a tendency in any society to blame the victim, and that is clearly the case here as well—and especially, as we've pointed out already, certain sub-groups are especially difficult in the sense of not being able to communicate to us well. For example, migrant families have already been spoken of, and likewise certain secluded groups that tend to be in agriculture.

Locally we have such groups as Amish; obviously they speak English with us. For example, as was pointed out in Dr. Currier's discussion, they may not have the simple vaccinations that we expect most people to have had.

Second, I want to speak about difficulties, for the physician, in some of the diagnostic methods. When you go through, for

example, some infectious disease, you will see references to serologic methods.

Serologic studies are very good in telling you what has transformed from previously negative to positive and they give you some indication of what is occurring in the population, but in terms of a specific patient, you usually only get a diagnosis after the fact. So if we can develop diagnostic studies that are more specific to disease, we certainly can aid the clinician a great deal.

In that regard, I would like to comment on the issue of pesticides and viruses and the relationship to cancers that are well recognized. There is probably not a great deal of difference from a clinician's point of view as to the etiology of the cancer, unless we know something about preclinical diagnosis or screening methods and can make recommendations in that regard.

Clearly, recommendations with regard to screening at least certain populations have been fairly effective. If we can make those sorts of recommendations—that is, who should be screened, how often, and by what method, or if there are some preclinical diagnostic methods, who is at risk—I think we have come a long way.

As I have said, the diagnosis of the cancer probably is not a particularly difficult issue for the clinician, as treatment protocols are well publicized. The issue of preclinical diagnosis remains an issue which may have social as well as medical implications.

Third, I think you have to recognize that most practicing clinicians do not have a great deal of public health or preventive medicine orientation. We are taught, and I probably more than most as I practice primarily emergency medicine, how to deal



with things on an acute basis. We have a very strong fix in terms of how to treat and the need to treat. That is a real problem.

It is relevant, for example, if you look at such things as control of hypertension or control of cholesterol. Here you have a number and an intervention that you can follow.

It fits very well into the treatment model because you can pick a disease by definition, have an effective treatment, and perhaps alter the patient's risk. But for most of these things that we are talking about, that is not true.

The issues then with regard to prevention and exposure are sometimes dissatisfying to both the physician and the patient who find that there is no delivery of what they consider to be health care even though treatment may be very effective.

In that regard, I would just like to say a couple of words about surveillance. I think that many times it is useful to have clinical cooperation with surveillance methods. I want to just suggest that there are three things that one needs to recognize in terms of deriving cooperation from physicians in surveillance methods.

- ▶ First, we clinicians are very good at saying we are busy. Believe it! If you do not believe it, just ask our families. So, you have got to come on—even if it isn't true—and say, "I understand you are busy."

- ▶ Second, it is looked at as an intrusion. Since there is a perception that there is already too much intrusion, you need to make the point that that is not the intent.

- ▶ Third, if you point out that this is likely to be useful, then it is going to go a long

way. Of course, in point of fact, I think most clinicians are very interested in providing very good useful information to help prevent problems. I think most clinicians are found to be fairly cooperative.

- ▶ Fourth is the issue of knowledge base. It is important to remember that when we talk about medical practice, we emphasize the word "practice." Over a period of time one develops a skill of being able to recognize and do certain things particularly well and other things less well.

Even with a well-developed left brain, there is only a certain amount of information that can stay anywhere near the forefront. Even in a rural practice, the agricultural illnesses are going to be only a small portion of the overall practice. So something needs to be done to keep that information in the forefront.

We had here yesterday four very good experts who spoke very well, and very clearly, and very lucidly to the issues that were raised. But for a particular physician in a typical family practice, these are all going to be blurred together and have to be dealt with simultaneously. There need to be some ways to get this information to the clinician in ways that are more palatable.

One of the things people talk a great deal about are data and information banks. I have not particularly observed that my colleagues are very quick in researching those for care of a specific patient.

As an example, I just want to talk briefly about the issue of cellulitis related to needle sticks or puncture wounds, which may occur in barns or areas where antibiotics are used frequently. There are

several people who will speak to the observation that the bacteria that are contaminating those wounds, when they develop infection, are multiply resistant—much different from the usual bacteria that clinicians have been told to expect in a skin infection. As far as I can see, we do not yet have a science to predict what those bacteria are going to be nor what antibiotics should be given to treat such an infection.

Finally, in terms of problems, it makes no sense to speak to the issue of agricultural problems in medical practice without speaking to the issue of the whole rural health care delivery problem, itself. Clearly, at the present time, the infrastructure is being challenged in many ways.

As was alluded to yesterday, rural hospitals are being significantly threatened. Someone suggested that 25 percent are in difficult straits. That is after 10 percent have already left the practice. Although we understand the need to reformat and downsize, I think it is also important to remember that at the present time, and I want to emphasize "the present time," hospitals are usually the key to the medical community. Hospitals do not necessarily have to be the basis for a rural medical community, but that does mean we are going to talk about a different model.

The rural health practitioner generally feels that he has a lack of support, that he has difficulty probably with his professional life and education, and that the working poor are a particularly difficult problem in terms of finances. Rural populations in general have more than their share of working poor, as has already been pointed out in this session. Agricultural groups probably have even a higher representation.

## ISSUES RAISED IN THE PRESENTATIONS

Next, I would like to speak to specific issues that I think were raised in each of the four talks, and hope here I will be a bit more provocative.

The first difficulty is talking about the differentiation between hypersensitivity pneumonitis and toxic organic dust syndrome. The differential diagnosis is clearly important prognostically and perhaps even clinically, but it is actually, I think, much more difficult than it appears. If one knows a specific allergen that is expected in a specific region, then a very useful test, of course, is the presence or absence of that precipitant. At least that tells you whether that specific patient is at risk.

On the other hand, the differentiations based on a chest x-ray, which I think many times can be clinically quite subtle, or arterial blood gases which usually are borderline, can be very difficult. So, when you are trying to tell the patient whether this is an important exposure or not, whether the prognosis is difficult or not, I find it is not as easy as it would appear. I guess I would appreciate it if Dr. Von Essen could speak to that a little bit at the end.

There is also an issue of acute and chronic bronchitis. Although we recognize that such things as buildings, particularly confinement buildings, are a risk, it is unclear to me what difference that makes in terms of clinical practice except from prevention. I am unsure if you know of specific antibiotics or specific treatment or prevention protocols that would apply in a particular exposure.

Finally, I agree with the point that there seems to be a relationship between organic toxic dust syndrome and asthma; at least many people seem to feel that is true from an empirical or episodic point-of-view, but I am not sure if there is exactly science or statistics to support that, and I am not sure if that is a clinically relevant issue or not.

Next I want to speak to some of the infectious disease issues. First, I want to commend Dr. Currier for stressing the problem of the migrant farmworker who has the whole family at risk because of living conditions.

I might point out that it would be unwise to speak of sexually transmitted disease as occupational exposure. But that does stress the importance of recognizing the whole family and the environment as part of the agricultural business. The risks are not just that of work but also of the living environment. This, of course, applies in a large measure to the non-migrant farmer as well.

I believe food-borne illnesses are primarily an issue in the rural environment in general. I think it is an increasing problem, and I am not sure if you have specific suggestions in that regard or not. Clearly one issue is knowledge. For example, the physician assistant with whom I work can regularly diagnose giardiasis because we see it so frequently. Again, it is not necessarily an agricultural problem; it seems to be rural in general.

I also appreciate the emphasis on populations at risk, especially the elderly and the children. I want to emphasize with regard to the infectious diseases that the new practices lead to new problems, or sometimes resurfacing of old problems. It is good to keep before the clinician how

things are changing in agricultural practice, because it is going to change in their practice as well.

Next, I want to discuss pesticides. It is probably appropriate that the discussion of acute pesticide exposure was largely ignored because it is probably better recognized in practice anyway. At any rate, it is actually, from a statistical point of view, not a big part of anyone's particular practice; I am not making any points about that.

With regards to chronic effects, I would like to ask for more information. First is in regard to neurologic symptoms. It seems to me that in a clinical practice, one hears this issue asked about a great deal, not only by the agricultural worker or family but the people across the fence from them.

Please remember, that even in the most rural of communities, close to half of the people are just rural dwellers and not agricultural farmers or workers. Neurologic symptoms tend to be vague. They tend to be similar, whatever the cause. There seem to be ineffective interventions, and the prognosis seems to be very difficult to ascertain. So any further information that we can get in that regard, and especially good diagnostic studies, I think would be very helpful.

With regard to cancer, I concur with by Dr. Blair, also alluded to earlier, that the farmer may well be the "canary" or the test animal for cancer in our society. We are seeing an increase in many cancers, and so this is very relevant information.

I think the idea of synergism between chemicals is basically a given. For example, there is the farming practice of

applying two herbicides for a specific weed where it is recognized that plants are developing resistance. If they need to use synergism against the pests, I suspect that synergism applies to the unfortunate victims as well.

Finally, looking at the issue of gases and vapors, one of the difficulties that I have as a clinician is obtaining good, adequate measurements. That is not necessarily because of the fact that there are not good industrial hygiene methods, but we have to appeal to people like those in Iowa to turn out these people much more quickly and with an agricultural background. Clearly we need that kind of consultation.

We need to close the loop between what is happening on the farm and what is happening in medicine so that people understand each other.

A specific problem is the allergic responses to some of these substances such as pesticides, antibiotics, or whatever chemical you wish. Both farmers and clinicians need to recognize that many of these are sensitizers, so the chemical that has not been a problem in the past may become one in the future; at least clinically that appears to be the case. Otherwise, the farmer and clinician tend to dismiss the idea that a particular chemical may be the problem.

Second, I want to speak to the issue of antibiotics again. My bias is that a big part of the problem with feeding antibiotics to animals is not residual antibiotics in the animal, but the change of the local environment in which the animal is present. Perhaps these antibiotics may

be an allergen, especially for the farmer, and not necessarily for the person ingesting the food.

I think it is good that Dr. Popenдорf pointed out that the manure gas is, for example, something that needs to be understood much better by clinicians. For example, the case in the Upper Peninsula of Michigan to which Mr. Graham referred was reported in some sources as methane poisoning. Although methane was undoubtedly present, I agree with Dr. Popenдорf that the most likely agent was hydrogen sulfide.

The relevance is in emergency medical practice. Hydrogen sulfide, if you are going to treat it, should be treated with the nitrates in the cyanide kit; whereas if you are dealing with methane, it is primarily an issue of oxygenation and ventilation, which does not necessarily need specific treatment.

## RECOMMENDATIONS

Finally, I would like to close with just five recommendations.

1. We need to work to help the clinician and, therefore, the farmer on specific diagnostic methods and treatment methods for agricultural problems. If there are specific treatments that should be different for different types of agricultural exposure, we need to know those.
2. We need to look much better at the issue of promulgation of this information as reference works. We need to close the loop between what is happening on the farm and what is happening in medicine so that people understand each other. Because of the distance typically between

the clinician and the farmer, that will not happen without specific efforts.

3. We need to increase the status of such entities as state and local health departments and industrial hygiene and provide adequate resources for them to respond to the clinical needs of farmers.

4. We need to deal with the issue of the rural medical infrastructure in general. If the rural medical infrastructure is in difficulty, then these agricultural health problems cannot be addressed well.

5. One of the things that I find personally important—and I think many of my colleagues would agree—is the positive aspects of medical practice in the rural, and especially agricultural, communities. The patients generally are very appreciative of the care they get. They are very willing to go into rehabilitation. In fact, most clinicians complain that rural patients want to go back to work before they are well.□

## FARM MACHINERY AND VEHICLES

By Thomas L. Bean, Ph.D.  
Safety Leader, Ohio Cooperative Extension Service  
Ohio State University

Preparation for this presentation included the review of literature, accident reports, unintentional injury data, and technical and professional papers from the United States and foreign countries. One of the earliest was a 1931 study by J.R. Jewell from the Cooperative Extension Service, University of Nebraska. After such an extensive review, it is appropriate to provide a broad, general brush to this topic and indicate the most significant items that stood out as general findings, which seemed to run as a thread or recurring theme in much of the literature.

### AGRICULTURE, A HAZARDOUS OCCUPATION

The most obvious finding was that agriculture, based upon statistical studies, was usually classified as a hazardous industry or occupation. Most early studies concentrated on on-farm injuries as occupational in nature. In either case, the majority of studies indicated that farm equipment was the single factor most associated with on-farm injury.

Farm equipment accounted for 40 to 60 percent of deaths and injuries in the majority of studies, followed very closely by livestock injuries and falls. Numerous types of farm machinery have been implicated in all studies. Since the majority of farm machinery is associated with tractors, it stands to reason that injuries "in-

volving" tractors were the most common type of machinery-related trauma.

Tractor over-turns, it appeared, were involved in the majority of agricultural fatalities. Many studies indicated that youth and the elderly were most often associated as an at-risk population. The studies varied, though, when you compared those using statistics from government agencies that were not gathering the appropriate and associated data with youth.

In either case, the majority of studies indicated that farm equipment was the single factor most associated with on-farm injury.

Injury data for youth under a certain age was often excluded from the data base. Many studies conducted by those of us in the field have included unintentional injuries, which have occurred in the lower-age group, and recognize the associated problems.

### GENERAL DUTY

The opportunity presents itself to include some homespun theory. This happens to be a theory of mine: on family farms, older tractors and equipment are often reserved for general duty while newer

pieces of machinery are delegated to more production types of tasks. The general duty may be more hazardous than the normal production tasks on farms.

As a result, general duty is often done by the youth or the elderly. The typical farmer, the principal operator, is using the newer machinery to plow and till the field, etc., while the older machinery may be relegated to cutting the fence rows or ditch banks and stationary operations that may be more hazardous than doing field-related operations. As a result, when you combine the inexperience of youth and the diminished capacity that comes with aging (because the elderly or youth usually do this general duty) with the inherent danger of the equipment, you have an increased potential for trauma.

## HIGHWAY HAZARDS

Few studies have centered on farm machinery and the hazards associated with highway travel. This is an area that needs additional study.

A recent study by *Farm Journal* surveyed 100 of their readers. Those readers indicated that traveling on roads to reach the field was one of their primary safety concerns. Of concern to these readers were faded slow-moving-vehicle (SMV) emblems, implements without brakes or lights, no turn signals, no clear differentiation between the turn signal and the flashers, and no stops or pins to hold the equipment in transport. Some equipment is held in transport by the hydraulics.

There is also a problem of farm vehicles being exempted from state motor vehicle laws. These exemptions are based on agriculture being a protected class, similar to the farm exemption by OSHA. The

protection agriculture is given as a protected class varies from state to state.

A review of state laws will reveal that a farm tractor is usually well-defined, which means that many state legislatures can recognize a farm tractor. However, when you explore legislative definition of implements of husbandry, farm machinery, farm wagons, farm trailers, or special vehicles (another term in many state laws for such farm equipment), you discover a gray area. The typical legislature fails to define them.

Exemptions are set by definition or the lack of definition. This is the problem. It is a learning activity that needs to be conducted with state legislatures.

Farm vehicles—varying, again, from state to state—may be exempt from registration. They may be exempt from any kind of inspection, adequate lighting requirements, braking requirements, or other requirements, which are normally associated with other types of vehicles.

As an example, if you study the West Virginia laws, you will find that farm vehicles may be exempt from braking requirements. If you do not have to have brakes, you are exempt. As for a driver's license, most states exempt agricultural vehicles and, therefore, the people that run them, from any kind of licensing requirement.

Age or physical condition does not make any difference. They are exempt by definition. It is a problem.

An eight-year-old can operate a farm vehicle on roadways. Yet all other drivers may need a driver's license to operate motorcycles, cars, buses, trucks, etc. This is not so for farm machinery. This is a sample of

the many other exemptions caused because agriculture is a protected class.

## STUDIES IN OHIO

Some of the studies that we are doing in Ohio, I will briefly present to you. We have a project now with a special agricultural population, the Amish.

### Buggy Safety

If you were to view Ohio highway safety statistics, you would find there are three classes of agricultural highway accidents. One is tractors, the second one is farm machinery, and the third one is buggy accidents. Are buggy accidents part of the agricultural problem?

The answer is probably, because the Amish really only use buggies for two things:

1. To do some activity concerning the farm.
2. To go to church.

So buggies can be a potential agricultural problem. We are embarking now on an effort to work with Amish youth in their schools on safe buggy operation.

### Highway Safety

We are conducting a second project in cooperation with our Highway Safety Office. In the fall, we will be conducting a survey of 1,200 farms in an effort to get the farmers' perceptions of the hazards of operating agricultural equipment on the state and county highways in Ohio:

1. What type of equipment is actually being operated on the roadways?

2. What are the conditions under which farm machinery is moved on the roadways?

3. What are the major problems with operating farm equipment on roadways?

4. What is the road worthiness of farm equipment?

## RECOMMENDATIONS

Although there are many that could be made, the following are some recommendations for research and action.

1. We need to continue efforts in research on human sensors and automatic shut-offs. If a person is too close to the tractor in a given situation, it should not start or continue to operate.

2. Research on roll-over protection on older tractors should continue.

3. There should be aggressive inclusion of safety in all of ASAE and other standards.

4. There should be research conducted on the lighting and marking of agricultural equipment.

5. There should be some consideration for a uniform motor vehicle code on farm tractors and machinery used on the highways, including set definitions of types of agricultural equipment. This would provide a model for states to consider in future legislation.

6. There should be continued studies on agricultural safety educational techniques that work.□



## REFERENCES

1. Jewell, JR; *Farm and Home Accidents: Their Cause and Prevention*. Extension Circular 5578, University of Nebraska (1931).
2. Ottey, Audra and Charlene Finch; "Farm Journal Survey Shows Road Travel Tops List of Safety Concerns." *Farm Journal*, Volume 115, Number 3, February 1991.

## QUESTIONS

John Hahn: I am with the Iowa Division of Labor. Regarding the ROPS, the rollover protection on the tractors, I have heard no mention about the need to use a seat belt or a safety harness to keep from being thrown out of the tractor on to the ground where you can be crushed by the crush-proof cage as it rolls over.

Dr. Thomas Bean: Definitely that is a problem. We—I say we—a lot of us know that that is a problem. I can go to any farming group, and I ask how many have rollover protective structures—either cabs or poles—and get a good many hands. Then I ask the next question, "How many use their seat belt?" You will probably find zero or very few. We realize that it needs to be addressed as a behavioral problem. Farmers tell me the reason is because they get off and on their tractor so many times. Something has to be designed or implemented or there has to be education about what is acceptable to that group as far as belting them in on the tractor. Often I try to use the example of highway safety and ask them, "Do you use it when you ride on the highway, at least?" Still the answer is very, very low.

John Hahn: With seat belts on things like tractors—I once looked into seat belts on forklifts, and there is a big controversy on forklifts, and there is something that they call the fly swatter effect. That is, when you fall off an elevation on a forklift, is it better to be fastened in there so that when you hit, your head goes bump, bump, bump against the pavement, or is it better to be unrestrained? There probably is some of that in agriculture also.

(inaudible): I am back. One thing on your comment on the forklift. Generally, other construction equipment works with a seat belt. What some companies have done to keep the guy's head from being pounded into the ground is just to take metal screening or expanded metal and put it on the side and that way he can just cut his head up once against the screening when he goes.

John Hahn: I was talking about forklifts. I just might add, I know that there are a lot of problems on the issue of seat belts, when you put a screen or that type of thing on. I know it is more of an issue in logging than it is, maybe, in farming, but the idea is that once you put that screen in, you have now taken that person, and if he has the seat belt on, he can become a human pincushion. The point I was trying to make is, this whole issue of seat belts is a very tough one because, depending on what industry you are working in, there were a lot of complaints when NIOSH talked to OSHA and recommended seat belts on skidders in logging. The main complaint we had was you had screening devices on those skidders to provide something like a cage for that person while he is in the skidder. When it rolls or rolls over or while he is moving through the woods, if sticks, and that kind of thing comes in through that mesh, he cannot get out of the way if he has his seat belt on. I have not heard that complaint yet from farmers, but at the same time, these are the types of issues that you have to learn to resolve when you start talking about the use of seat belts on this type of equipment. There are other factors that we have to be aware of and we cannot make just a blanket statement that seat belts are the best until we start getting some good information and look at some of the other types of alternatives, such as possibly a seat bar. We are not sure what is going to work.

(inaudible): I just have a comment on the seat bar versus seat belts. In Canada, log skidders are being equipped with seat bars, and it looks like they are getting very popular.

## MUSCULOSKELETAL HAZARDS

By David Cochran, Ph.D.

Industrial Engineer, U.S. Occupational Safety and Health Administration

---

Good afternoon. I feel a little out of water in that my specialty is not in agriculture. I have been asked to talk about ergonomics, musculoskeletal disorders, and agriculture.

As I started thinking about the agricultural environment, I realized that I see it as a hostile environment. It is about as hostile an environment as we have in this country. We have chemical and dust hazards, machines that can take your bodily parts rather easily, slips and falls, amputations, death, noise, and temperature hazards, including cold stress and heat stress. We also have whole body and segmental or limb vibration, explosions, and infectious diseases. Lastly, on my list, we have musculoskeletal hazards.

Quite honestly, I think most of you and most people in agriculture do not consider musculoskeletal disorders or musculoskeletal hazards very much. If you do, you think of back injuries. Back injuries probably are far and away the biggest problem that my discipline, which is ergonomics, deals with.

There are, however, cumulative trauma disorders of other sorts. I consider back injuries cumulative trauma. In many cases it is a one-instance injury, but in most cases we strongly believe that they are cumulative. The more times you lift excessive weight, the more times you stress your back or strain it, the more likely it is that

you will have a back injury. It is a cumulative problem.

In addition, we have problems of the upper extremities. I am going to go into that in a minute. I thought, that problem is probably not present in agriculture.

I was talking to a friend of mine, Barbara Silverstein, who was with the University of Michigan and is now in the state of Washington. She was telling me that the top occupational category suffering from tendinitis in the state of Washington is farmworkers. They do not have the foggiest idea why or where it is occurring.

Ergonomics and cumulative trauma do exist in agriculture, and probably a lot more than we realize.

### CUMULATIVE TRAUMA DISORDERS

Now, being a professor I have to educate a bit, just in case you do not know some of the things that I think are important. I am going to talk about some of the cumulative trauma disorders. These can be of the upper extremity or the lower extremity—not necessarily concentrating on the back.

#### Tendon-related Disorders

First, tendon-related disorders usually occur by overuse of, or stretching of, or excessive forces exerted by these tendons. The most common is tendinitis, inflammation of the tendon tissues. Another very

common illness is tenosynovitis, separate or concomitant inflammation of the tendon and its sheath.

I normally think of it as the sheath. I do not know how good your anatomy is, but we have tendons. Tendons really are cables in the body. Around those, in strategic locations, we have soft tissue that protects the tendons, called sheaths. They are a lubricated tissue. As the tendon slides around a corner or moves past bones, it is protected by the tendon sheath.

When the sheath becomes inflamed, it is normally called synovitis. Sometimes when the tendon is involved it is tenosynovitis. This is common in normal manufacturing operations. It probably is common in farming or in agriculture, but we do not have much data.

### **Carpal Tunnel Syndrome**

Second, carpal tunnel syndrome gets all the press. It is a problem in the wrist. One of the nice things about this one is that all the reporters are suffering from this. Since they are suffering from it, they write about it. There is nothing like having an interest in your own preservation.

Carpal tunnel syndrome is indicated by a numbness or tingling on the palm side of the first two fingers, part of the third finger, and the thumb. It is the damage to the median nerve that goes through the carpal tunnel.

The carpal tunnel is in the wrist. It is bordered on three sides by bones and on the fourth side by a strong ligament. None of these give very much. So when you use your tendons a lot, you get tendinitis or tenosynovitis. When you do that, things swell.

When they swell in a confined space, they compress on each other. You get a circular problem in that the more they swell, the more they are damaged, the more they want to swell, the more they are damaged, and it keeps going around and around. It gets worse and worse.

The best thing to do is quit doing whatever you were doing that made it happen. It is like the dentist I went to one day. I said, "You know, my teeth hurt when I do like this," and he said, "Well, do not do that." It is the same way with carpal tunnel syndrome and all of these things.

If you back off and do not do whatever is causing it as much, frequently it goes away, and you do not have to end up in very expensive surgery. You do not have to end up disabled.

### **Raynaud's Syndrome**

Third, Raynaud's syndrome, or occupational white finger, is a shut-down of the circulatory system. It is caused by exposure to vibration in the hands. I am not familiar with this disorder in the feet, but it might happen there. So segmental vibration or arm and hand vibration can bring this on.

I have not driven many tractors, but the ones I have driven vibrate. Old tractors are the only ones I have ever driven, because I do that kind of work you are talking about. I have a farm. I am a city boy, but I bought a farm. I have an old Ford tractor, and it does vibrate. There is a lot of vibration out there.

There is also non-occupationally caused Raynaud's syndrome. Some people get it without being exposed to vibration; mostly it is women who acquire it this way.

Let me go back—there are just a few of the agriculture-related cumulative trauma disorders. There are twenty-some repetitive motion related disorders of the upper extremities. There is rotator cuff, pronator teres syndrome, cubital tunnel syndrome, and epicondylitis. These are just examples. Do not get the idea that there are just a few of these disorders.

What do you do about cumulative trauma? First, I am getting the cart before the horse, but you have got to work on what is causing it, and so you work on the tools and the work station. Normally I deal with a fixed work station, and in agriculture that is not necessarily true. So the problem is more difficult to deal with.

We work on the methods: how people do their job, how they do the tasks. I put training and monitoring in there. It is hard to deal with changing behavior; because I do not have a lot of faith in training if it is easier to do something one way than the other.

I do not think we have a problem with work pace in agriculture, certainly not in the farming part of agriculture, maybe in other places. I am going to skip idle time; that is production-line-oriented.

## **RISK FACTORS**

There are six risk factors that we look for in cumulative trauma.

### **Repetition**

First is repetition, high repetition. If you are doing something highly repetitive over and over again, it tends to cause these problems. Repetition is rampant in things like processing of fish, meat packing, and luggage making.

Is high repetition present in farming? I do not know. I do not think anybody knows. My guess is that repetition is not where the major problem is.

At the other side of the curve, statically maintaining muscles causes problems. Statically loading muscles causes them to be exerted. They build up metabolic by-products. A lot of the time the circulation is cut off so that nutrients are brought into the muscles and the by-products are not carried off and you get rapid fatigue. Very static operations are a problem and very dynamic or repetitive operations are a problem.

### **High Force**

The next factor, high force, is probably present in spades in agriculture, especially in maintenance-type things. Farmers and agricultural workers are notorious for ignoring good sense and picking up things they should not pick up. They exert high forces.

Things that require pinch grasp go along with that. Anytime you start using the tips of your fingers to exert force, you are not mechanically effective. It puts the body at a bigger disadvantage than normal.

So we have pinch grasp, we have static grasp, and what I call a press grasp, anytime you are pressing with hands. In industry when you are boxing things or when you are folding boxes or you are pressing down on tape, you start getting incidences of carpal tunnel syndrome. Those motions tend to be highly repetitive and with a press at the end of them.

Gloves cause problems. Gloves cause people to overexert for two reasons: they interfere with the grasp, and they interfere

with the feedback, so people tend to over-grasp. Gloves are worn a lot in agricultural work.

## **Posture**

First, let us talk about shoulder posture. Anytime you are reaching down and behind or you are putting your elbow up in the air, you are doing something that a meatpacking company I have dealt with calls winging of the elbows. When they look at any kind of a task, they look for that. That causes problems with the tendons and the nerves.

Repeated inward and outward rotations, especially when you are going from the maximum of one to the other, is called pronation and supination. Inward and outward. Think about rotating the forearm. If you do that frequently, it causes problems such as cumulative trauma disorders.

When tasks are highly repetitive or are highly forceful and involve bending the wrist, they cause the tendons to wrap around a corner. They are pressing against those soft tissues that are supposed to lubricate their movement. Sometimes they press against the median nerve and do damage. We want to keep the wrist in a neutral posture as much as possible.

## **Mechanical Stress Concentrations Anywhere on the Skin**

If you have somebody who has to maintain a pressure on the hand or anywhere else, it is a problem. Resting their arms on sharp edges or lack of a good armrest can cause nerve damage. It can cause circulatory or circulation damage.

If they use their hand as a hammer, like banging hubcaps on, banging things loose with the palm of their hand or the base of their hand, this causes nerve and circulation damage. Mechanical stress concentrations anywhere on the skin can cause problems.

A lot of the tools we use—pliers, screwdrivers, things like that—press right in the palm of the hand where you have the tendons and the nerves running, and they do damage.

## **Vibration**

There are probably people in this audience who know a lot more about vibration than I do. We have whole-body vibration, and we have segmental vibration. Dealing with each is different.

The frequencies that cause problems are different. As far as I can tell in reading the literature, there is no good number as to what is excessive and what is not. There are some guidelines.

NIOSH put out a publication on this within the last year.<sup>1</sup> It is pretty good, but as far as I could tell there is no magic number that says, "When you start exceeding this number, you have got problems."

## **Cold**

Now, when you throw in cold with any of these other factors, it accentuates it. When you throw in vibration with any of these other factors, it accentuates it. If you put cold in the environment and you get cold hands or cold muscles and tendons, it accentuates the problem. If you are doing some of these things and your body is vibrating, it accentuates the problem.

If any of you are familiar with industrial hygiene or familiar with chemical hazards, you know that OSHA sets permissible exposure limits (PEL's). Those are based on single-chemical exposures or single-agent exposures.

She was telling me that the top occupational category suffering from tendinitis in the state of Washington is farmworkers.

No one knows what the combined presence of toluene, gasoline, and carbon monoxide does to you and at what concentrations that combination is a problem.

The same thing in ergonomics occurs. We have repetition here. We have force. We have posture. We have mechanical stresses. We have cold and vibration. All of these things combine in some way to cause problems.

One of the main questions I get is, "How many repetitions are too many reps? How much force is too much force?" We do not know because the problem is almost always in combination with something else. You cannot isolate them. We know that almost no force is required if the repetitions are high enough, because we have people that sign for the deaf that get carpal tunnel syndrome.

This is far and away the easiest to read and best book on cumulative trauma of the upper extremity.<sup>2</sup> It was originally put out by NIOSH, and it is now available from Taylor and Francis for about \$23. There is an 800 number. They are located in Philadelphia.

## WORK DESIGN

It seems to me in agriculture that we have a problem of work design. We have the task that people are doing. We have the machinery and equipment they are using. We have the products that they are producing and the products that they are using. All of these combine to be potential problems.

One of the things that I am interested in is packaging. Things that people use on the farm are packaged in anywhere from 5- to 100-pound quantities. I have seen people picking up 50-pound containers or 100-pound containers and standing in precarious situations and pouring them into hoppers or whatever.

It is no surprise that we have back injuries. It is no surprise that we have slips, trips, and falls. In fact, if these were in regular industry—if I were not working for OSHA at the moment—I would say, "OSHA might shut them down." It is hazardous.

## RESEARCH NEEDS

I could not find data or anybody who knew of any data out there relating to cumulative trauma disorders, and there is not much relating to back injuries in agriculture, which I see as the number one research need. We have a dearth of data.

My understanding is NIOSH is beginning to act on this and that there are several programs. I think there are about three programs that may start to collect more data. I will admit that I may be ignorant of some of the data that has already been collected.

1. From my point of view, we need to determine the nature and the extent of the

problem. We also need reporting. It is my understanding that most farmers have never heard of an OSHA-200 log.

2. We are going to need epidemiological studies.

3. We are going to need studies on packaging and how to repackage things.

4. We need studies of what are the high-incidence tasks out there. Now some of them you know, but I would venture to say that if we ever arrive at cumulative data, if it is out there, we will find some tasks we do not know about now.

5. We also need to research what can be done in machine and equipment design to minimize cumulative trauma disorders, if that is what is causing them.

6. We need to figure out what the costs and the benefits are.

7. Lastly, and not necessarily least important, we have to come up with things that are acceptable to the people doing the work.

You know as well as I do that there is no more independent group than farmers. Maybe truck drivers challenge them, but farmers are very independent. You put guards on machinery, you do things that are supposed to be for their benefit, and they blow it off. We have to come up with solutions that are acceptable to this community. □

## REFERENCE

Putz-Anderson, Vern; *Cumulative Trauma Disorders: A Manual for Musculoskeletal Diseases of the Upper Limbs*. New York: Taylor & Francis, 1988.

## QUESTIONS

Ronald Schuler: I am from the University of Wisconsin, Madison. Dr. Cochran, have you heard of milker's knee, and is that a cumulative disorder?

Dr. David Cochran: I have heard of it. I am not familiar with it. My guess is yes, but I do not know. Tom, do you know?

Dr. Thomas Bean: It is very similar to miner's knee. It is a bursitis, an inflammation of the bursa of the joints, because of the constant bending, and the repetition, and the force as you are kneeling against the ground.

Dr. Wesley F. Buchele: I am Wes Buchele from Iowa State University, retired. Dr. Cochran gave a list of things you ought to conduct research on. I would like to add to that list, if I might, putting a screen over a wagon to permit people from sinking in the grain when they happen to be on grain. I happen to be one that thinks we should put extra seats on the tractor, with seat belts, because people are going to ride tractors and are going to have more than one person on the tractor. Therefore, we ought to start taking care of the problem as they do in Europe. I also think that we should think about putting floor boards on tractors to eliminate people being run over by tractors, which they are from time to time—run over by either a front wheel or a back wheel. We no longer put planters and cultivators in that area. I think we also ought to put a seat bar like on a ferris wheel or on forklifts. They have taken care of the forklift problem by putting a

## Research – Mechanical and Physical Hazards

seat bar on the skid steer loaders. We should have seat bars on tractors. We should also promote the use of guards by retrofitting. I think that we need to retrofit roll bars on tractors, guards on power take-off shafts, and guards on augers.

**Mark Veazie:** I am from the Johns Hopkins Injury Prevention Center. Dr. Cochran, have you done or are you aware of any assessments that have been done on cumulative trauma risk with manual harvesting typical of migrant and seasonal farm work?

**Dr. David Cochran:** I am not aware of any, but there may be.



## ELECTRICAL POWER

By Robert McLymore  
Extension Safety Specialist, North Carolina State University

Dr. Glen Hetzel contributed a lot to this presentation, as well as some of my other colleagues. In the event that I did not call you to get some background information, do not feel bad. When they have the panel presentation tomorrow, you can answer some questions.

Electrical safety areas of concern are electrical wire components, electrical wiring systems, overcurrent protection, ground-fault interrupters, and grounding. These terms may not be important to you now. Maybe as you think in terms of what you do at your home, these terms can have some significance.

### ELECTRICAL WIRING SYSTEM

The reason why I am talking about electrical wiring components is that we need to know where power is coming in on an operation.

We know that it is coming in several places—at the service entry riser and the meter. You may have a meter on your home. Think about it. There are meters on farms.

Farming is not like that picture that you saw—that poster—where you see them out in the fields smiling, laughing, carrying on, and having fun. It is much more. There is power somewhere on that farm: overhead power; there is underground power coming to that farm. It all has to go through a certain code.

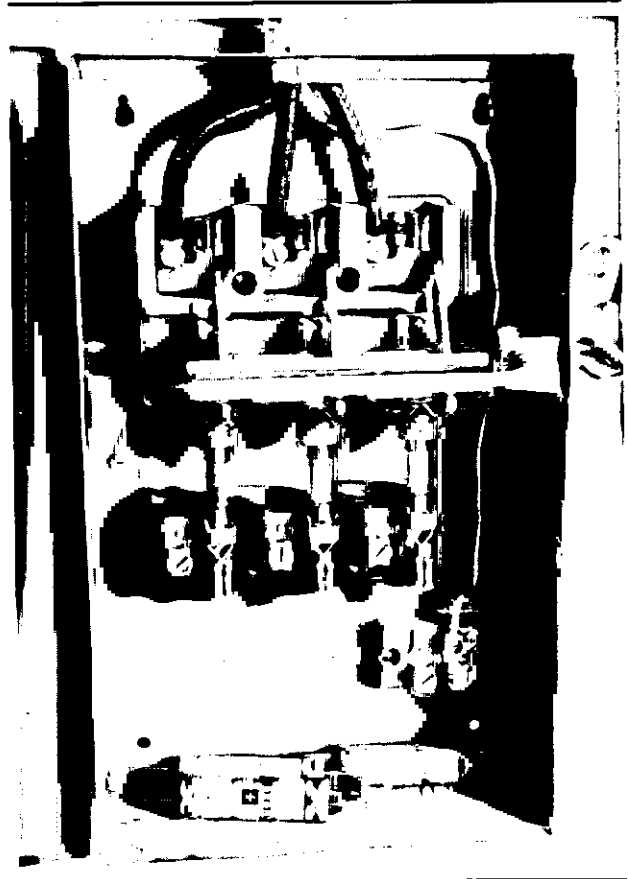

Figure 1. An Example of a Wiring Box.

For these components, you should only have licensed electricians install that electric wiring, and it has to be inspected. This may be what one of those wiring boxes looks like (Figure 1).

You have never opened one up, have you?  
You have never opened your fuse box up

at home, have you? It does not look like that. It has circuit breakers in it, has it not? This assures that the wiring will meet the requirements of the National Electric Code (NEC), as well as local safety codes, which may be in your home or in your state.

There are requirements for agricultural buildings in Article 547 of the NEC that specifies the type of materials to use for safety and protection is the environment in which this wire is contained. Dusty or damp conditions exist in agricultural buildings, which may create explosive atmospheres or corrosive conditions for electrical metal fixtures and equipment.

Did you ever think about that? These things, in themselves, may be explosive. That explosion may be in the form of a fire. That is what those conditions may be.

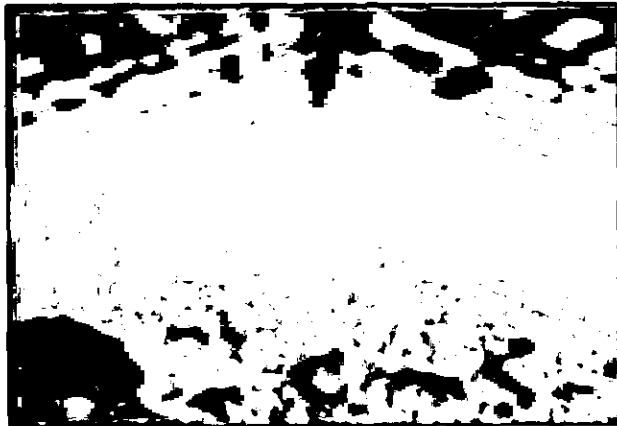

Figure 2. The Atmosphere of a Chicken Barn.

How many of you know about poultry. You ate it today at lunchtime. Was it good? Those are dusty, damp, dirty conditions—if you did not catch it in the last slide, that is what dust looks like when it is in suspension in the air (Figure 2).

This is what dust looks like when it is coming out of that vent that is adding air into that house (Figure 3). It is collecting particulate matter. Will that dust burn? Is it truly just dirt, or is there partially dry material in with that material?

## OVERCURRENT PROTECTION

The next part is overcurrent protection. There are specific types of overcurrent devices. You have the plug, the cartridge fuses, and the breakers.

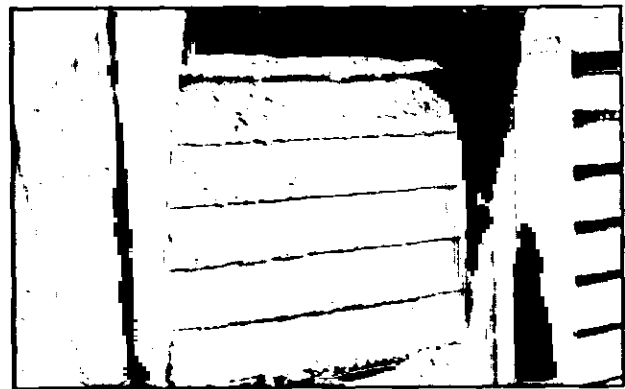

Figure 3. Dust on an air vent from a Chicken Barn.

## Fuses

This is what they look like (Figure 4). There is the fuse (right, center in Figure 4). You have seen this type at home before, a screw-in fuses.

That is another type of cartridge fuse (also in Figure 4). Some are delayed so that when a surge of power goes through them—too much electricity—they are delayed. They protect the conducting wire.

You are probably more familiar with breakers in a box at home (Figure 5). The fuses and breakers are installed to protect the circuit, not the appliance.

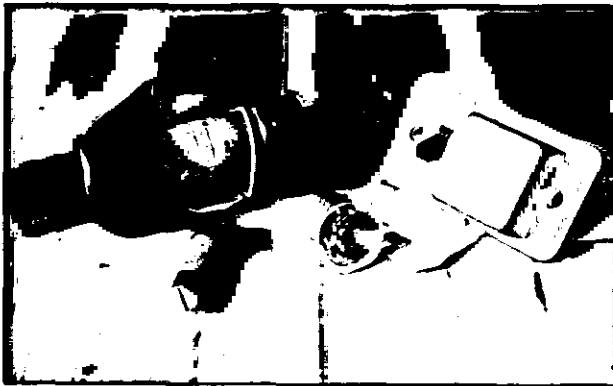

Figure 4. Examples of Fuses.

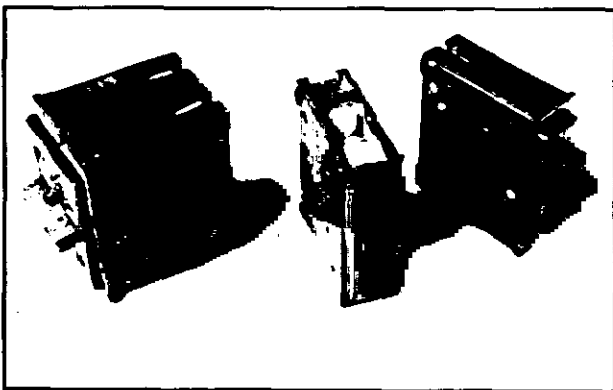

Figure 5. Examples of Breakers.

There are special fuses that are available to protect the electrical equipment, and it is important that we realize that overcurrent devices are sized to carry no more current than the circuit wire is rated to carry. Is that important to you? Is it important to that farmer?

Yes, it is important because he has some expensive equipment that he is using, and overcurrent protection is needed to protect it. What about for his own personal life?

Think about you and the overcurrent devices that may be in your home.

You have wires like this that are made to carry a specific amount of electricity. If contact is made with a live part, will the overcurrent device trip and protect human life? No.

Well, I used to work at a funeral home, so I have seen it, too. The human body will receive a lethal shock if the current that flows through the body is 0.01 amperes or greater. A fuse or breaker will not provide protection to the human body. The wire protected by the proper size of the fuse or breaker will not allow the temperature of the wire to exceed safe operating conditions and cause what we have on some farms—explosions in bins and fires where material may be stored, like hay or dry feed.

### GROUND-FAULT INTERRUPTER

The ground-fault circuit interrupter (GFCI). Are you familiar with that term? Do you know about it? You have seen it a lot? You buy devices, appliances, that have GFCI's on them. It is the most recent device that is used and designed to protect human life from shock.

It is designed to detect minute amounts of current, 0.005 amperes or greater leakage, from the circuit. It is supposed to trip the circuit off.

The overcurrent power and the conventional tripper turn the circuit off when there is a current flow that is in excess of the rated value of the breaker. The GFCI may be a separate device or it may be incorporated within a breaker. It is designed to give protection from that lethal

shock in a fraction of a second. It can be used on any 120-volt circuit.

It is also required in places at home by NEC. These places are in the kitchen, in the bathroom, in the garage, and exterior sockets on the house.

How many of you use extension cords outside to, perhaps, vacuum the car? Has the circuit ever tripped off for you when you were outside? Be thankful that they invented the GFCI. You would not be here at this conference without its protection.

Think about farmers. Are they always in dry locations when they are utilizing some of their appliances, some of their tools, like a skill saw or maybe a hand grinder?

There is one particular person who was using his welder when it was raining. He could not work outside, but he had some welding work that he needed to do.

He did not want to use the welder inside his shop because it was too small, too tight of an area, and there would be too many welding fumes. He laid down a piece of sheet metal; he pulled out the piece of equipment he was going to do some welding on, and he hooked it up to the welder.

The coroner tells us what happened to him next. He was shocked and killed. It was raining. There was the metal. There was the electrical appliance, with the electrical source coming in through the welder, and the welder was not properly grounded.

There are three types of and locations for these devices. We will find that these GFCI can be at a distribution box to protect the entire circuit or they can be at

a receptacle box. They can also be in an extension cord.

## GROUNDING

Do you see the third leg (Figure 6)? These are designed to give you continuity, to give you the grounding so that you do have a proper ground in that extension cord. That term "third-wire" ground and bonding should be understood for safety.

Electrical bonding means to connect all metal parts in the building together and that this be connected to the system of the ground.

The proper grounding of the system helps prevent stray voltage, which is a term that a lot of my colleagues know about. It is not voltage that wanders around aimlessly saying, "I am looking for a victim." It is voltage in itself that is not going to a proper ground. It provides a low resistance path for the neutral current to go to the ground.

That third-wire ground is the conductor in the wiring system that extends from the ground to the main distribution panel to the electric device and looks similar to that (shown in Figure 6). That is what is plugged in for your hot side and cold side. That is the ground that goes in. This is what it looks like on the other side, on the male side.

That is the female receptacle and the male receptacle (Figure 7). That is why bonding is so important—I talk about it twice because a lot of injuries and deaths could be avoided if the electrical bonding process was followed.

The last slides I have are getting more back to the topic of what to do from an



Figure 6. Example of Three-wire Receptacles.

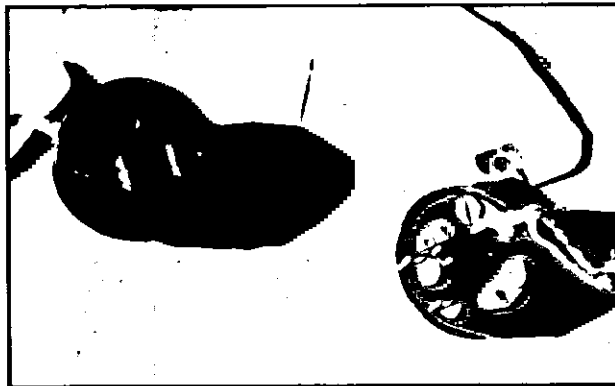

Figure 7. Male and Female Receptacles.

agricultural perspective, or even from just regular people's perspective.

### GENERIC PROBLEMS

When you start thinking about your uses of electricity, there are generic problems I see that may arise on the farm.

#### Wire Damage

One is damaged wire resulting from crushing or cutting incidences where wire can be

enclosed in a conduit material or exposed. In Figure 8, you see wire that is encased - either a metal case-like conduit or in the hard rubber, plastic, or the other material that you have that wire comes in.

When you are working around a farmplace, you are using a lot of equipment. Farmers are using equipment that backs onto it.

#### Two-Prong Adapters

These are what I call pseudo-outlets (Figure 9). These are two-prong plugs. The significance of these two-pronged plugs is that there are two-prong adapters being used with various equipment that requires that third wire ground, that third leg, so they can properly ground the electricity that is flowing through.



Figure 8. Examples of Wiring.

How many of you have remodeled your homes lately, or done anything inside the home where you changed a light fixture or maybe have changed a wall socket? They sell what I would term pseudo-outlets for you.

They were originally designed for two wire and replaced with a cover for a third wire

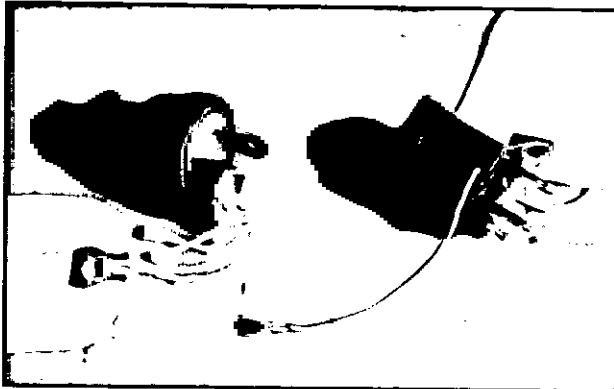

Figure 9. Two-prong Plug and Adaptor.

ground. It looks like it is grounded properly, but it is not. This is what it may look like (Figure 10). You have them there. Who is to say that has just been put into a two-prong outlet or through the wall socket. Assume it is not grounded unless you look behind it.

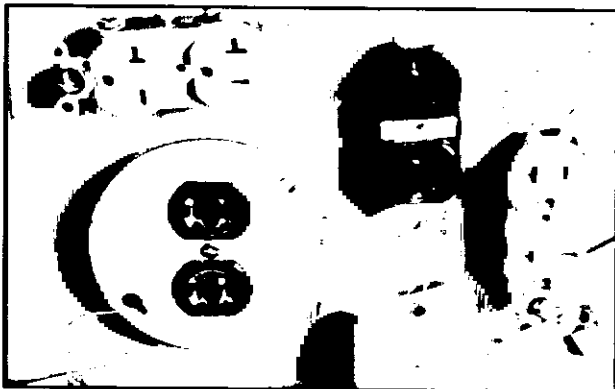

Figure 10. A Three-prong Receptacle.

Do you know whether or not it has been grounded properly? Can you tell? Can you walk up to and look at the socket and tell that it has been grounded?

That is why those 250 fatalities occur. Some of them did it before, some of them

did not. This is a term which is not a scientific term, but I like it. Have you heard of a term called "shade tree mechanics?" This is what I call the "jack-leg" wire mechanic. That means that he is not following codes for the types of materials he uses. This is a faulty method of installation.

There is a hot wire that goes through the wire. There is a hot side and there is a cold side. You can hook the hot side through the switch and the cold side through the switch so the wire is running through the white side.

When you shut it off, the switch goes off, but it is still hot. You start working on that socket. You start taking it out of the wall to repair it; it is still connected. The power is still flowing through it. Was it installed using NEC codes?

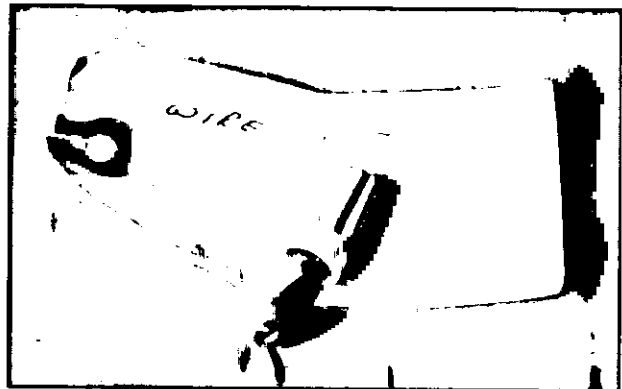

Figure 11. A Wire Nut.

### Wire Nuts

Some people, when they replace their wire nuts, do not necessarily use the wire cover on the nuts (Figure 11). They may use plastic. They may use tape. They may squeeze them together. But it may call for the wire cover, the wire nut, the yellow cap

to go over that wire where that connection has been made.

A lot of jack-leg wiring will go on like this. You have a conduit box there designed to carry only so many connectors inside. They are rated because of the amount of heat that is given off by each connector. They build up additional heat inside.

This situation is an excellent point for a fire to occur, unsuspectedly, for the wiring itself to degrade from the heat, causing it to touch the metal casing and the metal conduit around it. A person could then touch it and die.

### **Overhead Wires**

I would be remiss without talking about what we traditionally think about on the farm where we have equipment that is being pulled around: getting in contact with overhead wires. There are labels. There are safety shields and warnings in place to help people to avoid that situation.

Most people, farmers and agriculture workers, do try to obey this. Sometimes, however, they get too busy, and they forget for a few moments. That moment of carelessness may end up with that piece of equipment getting in contact with that line. We know how electricity kills. It is going to go through what is grounded the most.

A cartoon character can live through it. The human body cannot.

### **CONCLUSION**

#### **Inspections Need to be Made**

In conclusion, I would like to offer the following. Inspections need to be made on

the farm. They need to be made on a scheduled basis and immediately when things are damaged. These inspections will reveal problems before they become life-threatening situations.

Those conduits, if they are bent, need to be checked. How many times have you put down an electric cord and said, "Well, I am only going to use this temporarily here; get some power to do this little function."

#### **NEC Codes Should be Followed**

Five years later you still have that same electric cord in place. Think about it at home. You have an electric cord you have been using someplace, have you not?

That moment of carelessness may end up with that piece of equipment getting in contact with that line. We know how electricity kills.

The NEC should be followed. It helps everyone on that farmstead or that place. They can have some assurance that there is some safety, that they know that it is supposed to be working like this. You know what kills a lot of people—things that "were supposed to be," (and were not) and sometimes we do not find out until after the fact.

#### **Safety Procedures Adopted**

There are safety procedures that should be adopted. First, if you are going to do your own work, you need to have someone there who can check it over before you start using it. What happens with people

doing their own work is that they are always trying to save on budgets.

Other problems are putting things up and not checking to make sure that they have been wired or that they have been grounded properly. Maybe someone cut down on the materials that are being used because he or she is just going to add some power to a particular room or building on the farm.

I have seen places where you have wires extended over here, hanging down—a light

bulb extended hanging down from the rafter. That in itself is an accident waiting to happen. They can be avoided.

We are trying to get codes followed, inspections made, and safety procedures adopted. When you work with electricity outside, make sure that you do not use equipment unless it has been properly grounded with that third wire. Make sure that everything has been bonded together so that it is properly grounded. Only then can we address this problem effectively.□



## NOISE AND STRESS

By *Matthew Marvel, M.D.*  
Attending Physician, Oneonta Health Center

---

It is indeed a privilege to speak to this dedicated and distinguished group. I appreciate being invited to speak here.

The topic of my talk today is noise and stress. Let me preview a little bit what I am going to talk about.

In a few words, I am going to be talking about noise and its potential to cause stress. I am not going to talk about stress to any great extent. Most of my expertise is in the area of noise and noise-induced hearing loss in farmers.

I am going to discuss those topics. For those of you who are not familiar with the subject, I am going to define noise and what constitutes dangerous noise.

I will be reviewing OSHA guidelines governing noise exposure, show some sample farm-equipment sound levels, and review the characteristics of noise-induced hearing loss. I am going to give an overview of studies that examined hearing loss in farmers and finish with suggestions for future research.

### NOISE AND STRESS

First, a few words about noise and stress. Can noise cause stress? Yes. For example, if this microphone were to start having feedback, I think both you and I would start to have stress after a little while. There are ample studies in animals that

have documented the ability of noise to cause stress-related physiological changes.

In humans, noisy jobs have been associated with higher rates of various diseases. Noise can cause stress by interfering with communication, disturbing concentration, and acting as a noxious stimulus leading to activation of neurohumoral mechanisms.

Noise results in elevated blood pressure, heart rate, and respiratory rate, as well as affecting other systems. All these contribute to increased levels of fatigue and, ultimately, injuries.

### DANGEROUS NOISE

Noise is loosely defined as an undesirable sound. It is a subjective definition and one that is a matter of taste. For example, one man's noise is another man's music.

Potentially hazardous noise, on the other hand, can be simply defined as something greater than 85 decibels and is independent of the source. It is a function of the intensity, as measured in decibels, and of the duration of the sound.

This governs industrial workers and not, for the most part, farmworkers. It can be used as a guideline and should be used for farmworkers. After all, a hundred decibels in a factory is no different than a hundred decibels in a barn or in a field.

Where I am from, Ostego County in New York. Various types of equipment operate above this 85-decibel level. A cab added to a tractor can have a protective effect, on lowering the exposure to sound.

Chain saws are loud. Some people might find surprising their including chain saws on this slide, but in my part of the country particularly they are widely used on the farms, in wooded areas for clearing and for cutting firewood.

We have heard, at various times in the talks this week, how engineering is improving things for farmers. That is true in the area of sound production as well. Newer equipment is engineered to be quieter, but there is a lot of older equipment still in use. A survey of upstate New York found that the average age of tractors in use on farms is about 20 years. There is quite a bit of equipment out there being used that has not benefitted from this improved engineering.

### **NOISE-INDUCED HEARING LOSS**

Noise-induced hearing loss can be either permanent (PTS stands for permanent threshold shift) or temporary (TTS refers to temporary threshold shift). Established noise-induced hearing loss is permanent, but moderate exposures to noise may cause temporary threshold shifts.

Repeated temporary threshold shifts may become permanent. Noise-induced hearing loss is sensorineural. In noise-induced loss, opposed to conductive types of losses that are due to middle ear disease, there is actual damage to the neurological structures of the inner ear. It tends to be bilateral but may often be directional, as some of the studies have shown. In addition, noise-induced hearing loss presents initially

at higher frequencies, with a characteristic loss that occurs at 4,000 Hz. This is commonly called the noise notch.

This has implications for hearing conservation measures as well. Noise-induced hearing loss develops more rapidly at the higher frequencies, and speech comprehension is affected. Consonants are heard at the higher frequencies, whereas vowels tend to be in the lower frequencies.

It once was thought that speech was mostly a phenomenon that occurred between 500 and 3,000 Hz. The work of Alice Suter and others, however, has shown that accurate speech comprehension requires the perception of higher frequencies and that we need to be looking at those as well.<sup>1</sup>

### **STUDIES OF HEARING LOSS**

I would like to now turn to the overview of some of the studies on hearing loss in farmers. It is not a large body of evidence at this point, compared to a lot of other fields.

Again, I am going to give an overview of the different published studies from the scientific literature covering hearing loss in farmers. The first reported study was by Glorig in 1957, who reported the results of hearing tests done on visitors to the 1954 Wisconsin State Fair.<sup>2</sup>

He found that farmers aged 50 to 69 had significantly more hearing loss in the 2,000 to 6,000 Hz range than office workers of the same ages. The frequencies affected pointed to noise-induced hearing loss as the culprit.

Lierle and Reger reported, in 1958, on the adverse effects of tractor noise on the hearing of farmers.<sup>3</sup>

The next reports did not appear until the mid-1970's, when Karlovich tested the hearing of an unselected rural population in Wisconsin<sup>4</sup>, and Townsend studied a similar group in rural central Michigan.<sup>5</sup> Townsend used a mobile van to visit rural communities over an 8-week period and tested over 1,300 adults.

The purpose of the study was to depict a profile of hearing sensitivity of rural mid-western adults. His findings were that, on the average, hearing loss was greater than could be expected by aging alone.

There was no significant difference in hearing, however, between those with a history of industrial work and those without. He concluded that in addition to occupational noise exposure another noise exposure, perhaps recreational such as one gets during hunting, boating, or the use of snowmobiles, seemed to be a prime contributor.

Thelin re-examined what Glorig had found from the 1954 study to see if the discrepancy between the hearing of older farmers and office workers could still be shown and if there had been a change, and to determine if younger farmers were also at risk. The sites were the 1979 Missouri Farmer's Association Agri-Fair and the 1982 Shelter Insurance Health Fair.<sup>6</sup>

He tested 161 farmers and 75 non-farmers at the Agri-Fair and 130 office workers. His findings were that older farmers were still at risk for high-frequency hearing loss as were younger farmers, which Glorig had not found. Like Townsend, however, he also found a higher rate of hearing loss in non-farmers at the Agri-Fair. The non-farmers' hearing was not as bad as the farmers' but was worse than the office workers.

Karlovich, in 1988, published reports of his testing of 812 visitors over a 5-year period to the Wisconsin Farm Progress Days.<sup>7</sup> The purpose of this study was to re-evaluate the prevalence and characteristics of noise-induced hearing loss in a rural population. The findings were similar to the overall trends that Glorig had found in the 1950's.

Males continued to acquire noise-induced hearing loss sufficient to affect their ability to communicate. It was seen as early as age 20. One out of four of the males had the beginnings of a communication handicap by age 30; one-half of them had a communication handicap by the age of 50.

Again, both farmers and non-farmers demonstrated noise-induced hearing loss, suggesting a non-occupational source of noise like firearms use. Only 25 percent of noise-exposed males reported consistent use of hearing-protective devices.

Broste, et al., in a 1989 publication, examined an even younger group for evidence of noise-induced hearing loss.<sup>8</sup> He studied 872 high school students from Wisconsin to determine whether students engaged in farming had evidence for more hearing loss than their non-farming peers. He found that about twice as many students involved in farming had evidence of early noise-induced hearing loss as compared to non-farmers.

Less than one out of ten of the students, however, used hearing protection. The left ear was more severely affected, and for the first time in this series of studies, precautions were taken to exclude or to try to control for temporary threshold shifts.

I have a study that is due for publication this year. It will be appearing in the *Amer-*

*ican Journal of Industrial Medicine.*<sup>9</sup> We tested 49 randomly selected, full-time dairy farmers from Ostego County, New York.

Ours is the first study to examine a random selection like this. We also tested 49 age- and sex-matched rural non-farmers. The purpose of our study was to assess the prevalence and nature of hearing loss in this population.

Like Broste, we controlled for temporary threshold shifts, but we used hospital-based equipment. We found an alarming rate of hearing loss in the farmers, while the non-farmers had losses not far from what one might see due to the effects of aging alone. High-frequency ranges (HFA), is an average of the frequencies at 3,000, 4,000, and 6,000 Hz.

Sixty-seven percent of the farmers had abnormal hearing as opposed to 37 percent of the non-farmers, at the high-frequency ranges. The PTA<sub>4</sub>, which measured the mid-frequency ranges of 500, 1000, 2000 and 3,000 Hz, showed somewhat lower levels, but still a big difference. The farmers had a 37 percent rate of hearing loss, whereas the non-farmers had 12 percent.

As to the results of the subjects who were younger than the mean age of 43 years. At the higher frequencies, where we would expect to find noise-induced hearing loss, we saw lower average thresholds for the farmers.

We also found that the left ear was more severely affected, as did Broste. Through correlation regression analysis of the data, we were able to support our hypothesis that the differences found were due to farm noise exposure.

I am aware of one other study that is going to be published this year. The preliminary reports were presented at a hearing conservation conference in San Antonio. This is by {;alle, who is from northern Iowa.<sup>11</sup>

Looking at the troubles that some of the studies have had in separating occupational noise exposure from recreational, he sought to select a group of 30 farmers who had only occupational noise exposure. He compared them to a group of age-matched non-farmers who had no significant noise exposure. There were three groupings—age 30, age 40, and age 50.

The 30-year-olds had no significant difference at any of the frequencies tested. The 40-year-olds had significant differences in the 3,000 to 8,000 Hz range, again where you might expect noise exposure to start showing. The 50-year-old group had significant differences at all frequencies tested. I was pleased to find that his audiometric data looked similar to what I showed you on those two graphs. Our results look similar.

The cumulative summary of the findings, then, showed that farmers have higher-than-expected rates of hearing loss. This is true in all studies.

The rates exceed those of the general population, and loss starts in the teen years or before. Farm noise appears to be a major factor.

In addition, non-occupational noise may be contributing, as Thelin, Karlovich, and Townsend have reported. This is also something very important to recognize and address. If you are only working on occupational noise exposure and people are still losing their hearing while hunting, you are not gaining much.

That summarizes the studies that have been done to date. Despite the evidence, some people still have not heard the message. Therefore, more work needs to be done.

## FUTURE RESEARCH

What are the areas for future research? First of all, we have barely scratched the surface of this problem. There is plenty of room for more research. The number of studies so far is still small, and it is a large and diverse industry with many different risks.

We also might find some high-technology solutions like using sound cancellation.

We ought to be testing other regions of the country, other types of farming practices, and other types of farmers.

Research should be done for more effective methods of hearing conservation and education. We should be doing dosimetry studies to better define noise risks. I was pleased in looking through the pamphlet showing the poster sessions. It looks like somebody is presenting something on that.

We need more research on the possible synergistic effects between noise and certain agents like carbon monoxide. We need some more research into engineering advancements, greater developments for quieter equipment at the source, ways to improve barriers to sound transmission like tractor cabs. This is needed not only for improved new ones, but perhaps more economical ones that farmers could retrofit.

We also might find some high-technology solutions like using sound cancellation. Improvements could be made in hearing protective devices, to improve the fit, the comfort and convenience and, consequently, the likelihood that farmers would wear them.

It would be nice to be able to better predict the risk of noise-induced hearing loss from noise exposure levels and early audiometric changes. Naturally, it would be good to see more basic science research into the anatomic, physiologic, and genetic bases for presbycusis and noise-induced hearing loss.

In conclusion, through research, let us continue to look for ways to better describe the nature of the problem so that through the spread of this knowledge those at risk for noise-induced hearing loss may see the ways to prevent it.□

## REFERENCES

1. Suter, Lempert B and J Franks; "Real-ear Attenuation of Earmuffs in Normal-hearing and Hearing-impaired Individuals." *Journal of the Acoustical Society of America*. 87 (5): 2114-2117, 1990.
2. Glorig, A; "Some medical implications of the 1954 Wisconsin state fair hearing survey." *Trans American Academy Ophthalmology Otolaryngology* 61:160-171, 1957.
3. Lierle, DM and SN Reger; "The effect of tractor noise on the auditory sensitivity of tractor operators." *Ann Otol Rhinol Laryngol* 67:372-388, 1958.

## Research – Mechanical and Physical Hazards

4. Karlovich, RS, and TL Wiley; "Spectral and Temporal Parameters of Contralateral Signals Altering Temporary Threshold Shift." *Journal of Speech and Hearing Research*, Vol. 17, No. 1, pp. 41-50, 1974.
5. Townsend, TH, FH Bess, and WA Fishbeck; "Hearing Sensitivity in Rural Michigan." *American Industrial Hygiene Association Journal*, Vol. 36, No. 1, pp. 63-68.
6. Thelin, JW, DJ Johseph, WE David, DE Baker, MC Hosokawa; "High frequency hearing loss in male farmers of Missouri." *Public Health Rep* 98:268-273, 1983.
7. Karlovich RS, TL Wiley, T Tweed, DV Jensen; "Hearing Sensitivity in Farmers." *Public Health Reports*, Vol. 103, No. 1, pp. 61-71, 1988.
8. Broste, SK, DA Hansen, RL Strand, DT Stueland; "Hearing loss among high school farm students." *American Journal Public Health*. May: 79(5): 619-22, 1989.
9. Marvel, ME, DS Pratt DS, LH Marvel, M Regan, JJ May; "Occupational hearing loss in New York dairy farmers." *American Journal of Industrial Medicine*, 20(4): 517-31, 1991.
10. Plakke, BL, and E Dare; "Occupational hearing loss in farmers." *Public Health Rep* 107:188-192, 1992.

## TECHNOLOGY TRANSFER

*By Murray Madsen*

Product Safety Engineer for Agricultural Equipment  
Deere and Company

---

There are opportunities for inventions, discoveries, innovations, and improvements that will help reduce the traumatic and acute injuries that occur in agriculture. These opportunities exist in both hardware and software technology, and I contend their impact can be achieved more fully and in a more timely manner through better technology transfer. I will explain that as we go.

- By hardware, I mean the sheet metal, machines, parts, and gears.
- By software, I mean the safety signs, safety messages and operator's manuals, promotional brochures, posters, human factors interfaced with the machine, and much more.
- By technology transfer I am talking about not only what moves the information going from here to there, but also the process that drives it, how the information gets delivered from point A to point B.

We are engaged in this conference to help protect the men, women, and children who come in contact with agriculture. I am especially interested, of course, in that part of agriculture that relates to agricultural machinery such as farm tractors.

I am also talking about the things that plow the fields and turn the soil. I am going to run through some of these quite

rapidly to give you a flavor for modern production agricultural equipment. They are the plows that turn the soil; the planters and tractors, combines and other harvesters; the mowers; the windrowers; the loaders; the manure spreaders, wagons, and much more.

That is a grain drill, a minimum-till grain drill, and a corn planter. You might notice there (on the planter) the dry chemical transfer system Deere and Company developed with American Cyanamid, the "lock and load" system.

That is a spectrum of some agricultural tractors, one at closer range. A combine is shown in wheat as well as corn. There is a cotton picker, for those of you from the south and west, and you from Arkansas may be more familiar with cotton strippers. You see a self-propelled forage harvester, a rotary cutter, a rotary mower or mower conditioner, a windrower, and front-end loader with a large, round bale.

There is a product that probably no one stands behind, a manure spreader. You see a cotton stripper, hay equipment, all-materials transport utility hauler (which distinguishes it from an ATV or all-terrain vehicle), self-propelled high-cycle sprayer, and a blank slide that gets me on to the important part of my conversation with you today.

I have a very strong preference for prevention before injuries happen, for the leverage of design over safe practice control. I recognize, however, the need for a compatible blend.

I am delighted that you are here. I wish that more people could be. I am also extremely impressed with the attendance at this conference and encouraged about the steep learning curve that all of us are on for these few days that we are together.

My plan is to move from the broad perspectives to suggestions for improved technology transfer. I plan to give you some kinds of research that I believe are appropriate and necessary. I will close with three general directions.

## **BROAD PERSPECTIVES**

You have all seen the FFA signposts that declare, "Agriculture is more than farming." It is technically farms, dairies, nurseries, orchards, vineyards, cranberry bogs, hatcheries, and more, that produce crops from artichokes to zucchini and livestock from Angus to zebra. Agriculture is done in fields, buildings, and under water. It includes agricultural services such as veterinary care, farm management, landscaping, tillage, and crop protection.

Agriculture includes tree farms, tracts, nurseries, and those engaged in gathering forest products. And it includes commercial fishing, hatcheries, preserves, and commercial hunting and trapping. While our typical "mind's eye" picture may run to the serene dairy in Delaware or to the cotton of California, that is only part of the real picture.

Yes, there are household products used on farms. There are hand tools, grinders,

welders, saws, drills, motors, mills, and much more. There are ATV's, trucks, crawler tractors, and punch presses. My remarks focus on agricultural field and farmstead or farmyard equipment, typically on wheels or mounted to tractors that have wheels.

Many farms have a full line of modern production machinery. Others use tractors and machines that are 50 or more years old. Sometimes equipment is in mint condition; other times it is not, or modified, or built from scratch in a local shop.

In all cases, new equipment must be compatible with the old. A great deal has been accomplished through the voluntary standard system, such as the American Society of Agricultural Engineers (ASAE), to achieve the essential level of interchangeability and compatibility.

Each day technology and our understanding of it—how to use it; how product users will interface with it—increases. It leads to improved products—products with greater productivity, products with less cost, and products with improved safety. All of those are happening now.

We are on the brink of future technology that will dwarf the revolutions of the 20th century. Semiconductors and the associated inventions have led to innovative new products, like computers, and to improvements in others, like radios. Mechanization, electronics, and biotechnology must be considered the technological revolutions of this century. Perhaps photonics, the gathering and processing of information transmitted by means of light, will join them.

I wish that I had the ability to predict what the next inventions will be. But who



knows what they will be or where they will come from? Perhaps one can only do it in a somewhat Buck Rogers' fashion. Most likely we would be in error in timing or content, but we will do some of that for a little fun as we go.

We have seen innovations in agricultural equipment, the modern sound-guard body with its noise reduction, its vibration isolation, and its fatigue-reducing aspects. We have also seen roll-over protective structure (ROPS) development and the recent development of retractable or foldable ROPS for those essential applications where you must go into a building that is shorter — not as tall as your tractor's ROPS.

I would also say to those of you who wonder about ROPS that since 1985 virtually every tractor produced has been sold with a ROPS on it or right at the fingertips. Since 1970, virtually every tractor could have a ROPS put on it, and some have since 1960.

In addition, we have open-throat designs on large round balers. We have service tether systems on cotton pickers for doing the essential maintenance and cleaning functions that are appropriate for that machine.

Improvements have been prevalent as we talk about modern implement-to-tractor driveline guarding; the controls, the steering, and the brake systems; the guarding on the exterior for thrown objects and blade contact; and improvements in the area of lighting and marking. Not revolutionary, perhaps innovative, all of these changes have made an improvement in the level of safety that is being provided, and we are, indeed, making the best better.

While some may tend to associate technology transfer only with hardware, it is also appropriate to realize that technology exists in product safety software as well. That includes the safety signs, the safety messages, the human factor. Most often there is the need to deliver a compatible blend of both hardware and software.

I do not, in any way, intend to imply that we should stop doing or not do research that discovers why things work and new information. I think that is a valuable aspect of learning that we should never lose. I also believe that there will be safety impacts of any research that is not specifically aimed at safety.

For example, reduced through-put combine harvesters may reduce the entanglement potential and keep the operator away from moving machinery parts. Improved monitoring and sensing may keep the operator in the relatively protected environs of the operator station instead of out where he or she is more vulnerable.

Essentially everyone who is on the receiving end of new information about a technology is participating in technology transfer. It is not only the "what" but the "how," the product and the process, the deliverable and how it is delivered.

### **The Technology Transfer Process**

We need to do more to improve the technology transfer process. U.S. government, universities, non-profit research organizations, industries, and others encompass an astonishing array of research capabilities. To be of greatest value, technology must be put to use. To measure its value, we must look at how well we ultimately transfer it.

Not since the Smith-Lever Act of 1914, which established the Cooperative Extension Service, has there been such interest in increasing technology transfer. It is obviously not a one-way proposition limited to dialogue between industry and the Federal government research community.

It is more than that, and it is not a simple task. It seems to me that one of the things we ought to do is understand who is doing what in the area of safety research in various parts and regions of this country.

Sometimes equipment is in mint condition; other times it is not, or modified, or built from scratch in a local shop.

Many companies supplement their research and development on a scale not seen in the past and establish aggressive links and liaisons with the external environment. All of this serves to unite the research community with those who really must deliver a product that is attractive to the user.

Research and development expenditures are expected to be \$155 billion for 1991, according to a Battelle Report. About half of that is being spent by industry and the other half, slightly less, being spent by Federal government. Industry will focus on electronics, composite materials, communications, advanced machinery, and energy-efficient products.

Defense, Energy, and Health and Human Services will dominate Federal research and development with over 90 percent of their half of the total. The same Battelle Report suggests that all agencies will be improving and enhancing their technology transfer effort.

Interest in agriculture is building. The funding looks like it is there. We are here. Our ability to transfer the technology, to transfer the research, to transfer the information needs to be built. One part of that will be the need to deliver technology, which "understands" the needs and the application. So I direct the next portion of my remarks to the needs.

### The Needs

Much has been said about the National Safety Council (NSC) injury statistics. We need representative data that can be dissected and provided in a meaningful way.

That needs to be on the national agenda. The now-outdated NSC Farm Accidents surveys, conducted overlapping both ends of the 1970's decade, encompassed 127,000 farm family members and 57,000 full- and part-time workers.

The rough conclusion from those surveys still used today is an estimate that one-third of the agricultural injuries can be associated with machinery. A parallel kind of estimate is that roughly half of the agricultural fatalities are associated with machinery.

Looking at some other data, the seven state surveys that were done with support and help of NIOSH delivered a 60 percent response rate and 5,079 returns. On aggregate, approximately 11 percent of those returns reported an accident during the past 12 months.

If one looks at the composite information from these surveys, tractors and machinery total about 30 percent or one-third. Animals are second at 16.9 percent, and following that are falls on surfaces.

A 1985 study in Arkansas showed farm machinery to be involved in about 38 percent of all injuries and about 80 percent were to farm family members. Here is something you should note: three of ten, 30 percent occurred while working off the farm.

Based on narrative descriptions for the most recent injuries, these ten narratives describe roughly 80 percent of the experience reported in those NIOSH-supported and state-run surveys. Livestock handling topped the list at 19.4 percent, machinery at 13.4 percent, and falls or slips from ladders, equipment, elevated platforms, at 12.2 percent.

This information gives you a feel for the severity and kind of injuries that are being experienced. The most frequent injuries, all of the types that we have seen in this kind of survey, have severity toward the lesser severity end of the scale. On the other end of the scale are the fatalities.

NSC estimates work deaths, and divides them among agriculture and the other seven standard industrial classifications. NIOSH, BLS, and NCHS also monitor fatal occupational injuries. There is considerable disparity in the numbers as well as in how to categorize them. The 1980 to 1985 average for non-transport fatalities on farms puts machinery at 45.6 percent of those fatalities and firearms and drownings a distant second and third at around 12 percent each.

As noted in virtually any discussion of farm fatalities, tractors are associated with about two-thirds of the machinery-related deaths or about one-third of the deaths in agriculture. The dominant tractor accident scenario is an overturn, which may contribute to over 50 percent of the tractor fatalities.

Thus, tractor overturns are about one-half of two-thirds of one-half the agricultural-related deaths, approximately 15 percent of all agricultural deaths.

Another 25 percent are related to deaths when someone falls into the path of a tractor. Sometimes operators fall while the tractor is in motion, or they get off before it stops, or they start it in gear from the ground, or one of the riders falls off.

It is unacceptable to have a rider on a tractor with or without a cab. About 5 percent of tractor deaths are reported to involve the power take-off (PTO). This category is somewhat suspect since, presumably, there is a PTO-driven piece of equipment attached to it at the time.

In addition to overturns, and runovers, PTO entanglements, and the other things, the "other" category for tractors includes things like contact with overhead electrical powerlines and road transport collisions. Imagine yourself driving down the rural country roads of Iowa, perhaps just recently attending the Surgeon General's Conference in Des Moines, "tooling" down a farm-to-market road—perhaps graveled-at your regular road traffic speed then cresting a knoll behind a tractor-implement combination. The results can be startling. In some cases it does not make a difference whether there are lights on that equipment or not.

In other cases such as in turns, or when there is good visibility ahead, or at night, better lighting and marking could and should be developed.

There is a potential for research in tractors. When we talk about cresting-the-knoll, perhaps there is room for over-the-horizon detection or for moni-

toring from above that can deliver the kinds of warnings necessary to avoid collisions.

We want to make sure in all of this that we are addressing the right problem. For example, is it really the lack of lights, or the lack of good enough lights, or the lack of the right color, or the right position? Maybe more effort should be devoted to improving the connections so that they are more likely to get connected.

Consider a product which is hooked and unhooked dozens of times a day. Will it get reconnected? Will it get reconnected on products that never, or seldom, venture onto a roadway? When they do, will it still work?

Research may discover a way to multiplex information, control signals, and control power so that it is no extra effort to get the safety value at the same time that you get the desired productivity.

The lighting and marking issue is still an open one and some of you may be interested in pursuing in more detail the kind of research that is being launched at Ohio State University on lighting and marking for equipment. Research is necessary in some cases.

In other places we need to apply more of what we know. We just looked at the more frequent yet less severe farm machinery injury picture, and we looked at the most severe injury death. It is likely there are similar kinds of injuries in between—in the middle ground.

It is also likely that there are more severe, but less frequent kinds of injuries in that middle ground. We would generally call them entanglements.

Entanglements occur in the belts, chains, and gears that run auxiliary drive systems like cooling fans for engines. They occur as we transfer power from one part of the machine to another part of the machine:

1. In the crop gathering, or picking, or intake mechanisms.
2. In the parts that thresh, or transfer, or clean the material that is flowing through the machine.
3. In the discharge.
4. At the tractor PTO.
5. Along the PTO drive line.

Professionals like those in the NSC Agriculture Division and the National Institute for Farm Safety would likely divide these kinds of entanglements into three major categories of concern: those areas where we gather the crop, those where we are transferring power around the machine, and those where we are processing the crop.

A proposed revision to the ASAE standard for agricultural equipment includes a specification for an automatic means to stop the crop-gathering mechanisms and the intake mechanisms of self-propelled agricultural machines. This would be before potential entanglement of the operator, not after. Typical applications have been an operator-presence seat switch on combines and the service tether system that I showed you earlier on cotton pickers.

In responding to suggestions for those kinds of systems, the Ontario Implementation Committee rejected the usefulness of interlocking safety cut-off switches as a means for accident prevention. This com-

mittee claimed to be aware that some accidents have occurred because of the presence of those kinds of systems. When investigating emergency stop systems for that PTO drive line, they could not resolve the differences between the "invitation" for many to risk entanglement and the potential to lessen the severity of some accidents.

Research may discover the way to protect maintenance personnel and bystanders from that programmed, unmanned machine that swarms through the wheat field and vacuums up heads of wheat, flowing centimeters off the ground.

We may also find a way to detect and respond to the presence of a person who should not be in a protected zone. Perhaps the beginnings for that have already been laid at the University of Illinois with work on the capacitance of discharge systems. Maybe it starts with the radar, obstacle avoidance work in the auto industry.

Part of why we are here at this conference includes this kind of visioning. What is needed relative to nanotechnology where those micromachines with engines one-third the width of a human hair will be released to swarm across the field and devour preselected bugs from a population of pests?

Perhaps we need a more sophisticated ability to anticipate and successfully avoid tractor overturns, like the work at Penn State University, or to alter collision courses. Clearly, an early understanding of the application will lead to research that is more readily available.

Having identified some needs, it is important to also consider how those needs will be met in the real world where the opera-

tor must interface with the machine; where human factors become the field of expertise; where work, the man, the environment, and the machine come together surrounding the task.

We must be cognizant of the somewhat limited ability we have to modify the man successfully; the relative leverage of changing the machine, if that is possible and appropriate; and not forget the ability to adjust the task.

Some would say that accidents can be attributed to unsafe actions of operators. Therefore, we ought to focus our research on those behaviors and how to modify or eliminate them.

Others would say that the machine's design dictates how the operator will behave. Therefore, we ought to design the machine to not allow errors, to make it difficult to err, to not invite unsafe behaviors or to not accommodate unsafe behaviors, and to encourage safe ones.

There are, more likely, opportunities in between than at either end of these polarized points of view. I believe it is important to understand that those possibilities exist and not to forget the option of modifying the task.

Research is needed to accommodate the physical and behavioral aspects of the people in and around farm machines. I do not, however, advocate identifying any of what you might call generic or typical operator safety behaviors. Identifying new concepts in education and solidifying those guiding principles for educational training, in general, seems to be fertile ground.

It may relate to the positioning of incentives. It may also relate to cognitive risk

avoidance versus situations where the rewards are greater for risk-taking.

Perhaps it springboards from some of the work on injury control strategies and farmworker behavior which will be published by ASAE between Penn State and the University of Illinois. Where do we go when the weight of what is being published today questions the ability of safety signs to alter—to measurably alter—behavior?

I want to express a few things of importance to you, somewhat slowly and carefully, because a good friend of mine asked me to do it that way. If you will breathe deeply with me and reflect a moment—the current engineering design community, myself included, as well as students and teachers needs capabilities and tools to better incorporate human factors into what we do.

Research on how to build those capabilities and the tools themselves are needed for our organization's development and for curriculums. How does safety become the cultural value that permeates all that each of us does? After all, are we not safer than the people out there? What are the skills needed to excel in hazard recognition during the earliest stages of design? Can such skills be learned? What is a capable process for identifying and communicating safety research issues?

How do we rationally evaluate alternatives, none of which are without safety risks? What is the measure of safety improvement at a stage when we are comparing conceptual alternatives, when we have no injury experience?

We are learning more each day about the attractiveness of safety in the user's mind and in the user's perspective. How do we

keep the momentum going? How do we tap that latent potential demand? How do we serve those safety needs and wants of our customers? All this could benefit from more research.

Consider, for example, how to convince the owner of a 30-year-old tractor worth, at most, \$1,000, to put a \$500 ROPS on it. The University of Illinois, NIOSH, and the University of Iowa are doing research to help find some of those kinds of answers. A ROPS that provides protection and still meets the needs of users under limbs, vines, and rafters holds promise.

It is likely that this kind of roll over protection will produce more acceptable designs for the user. Perhaps it may not produce as much protection as users have become accustomed to with larger or more conventional roll over protective structures. Is there an opportunity for validating acceptable ROPS for more compact tractors?

In general, research has evolved from centers isolated from commercial considerations to centers in touch with the application, in touch with the network, and with the people who must deliver. My final comment is about better technology transfer. It is for the researchers to participate in the safety network or, as Dr. Røper called it, the infrastructure.

Researchers must learn the needs, find the funding, know what is being done, share the findings, gain application insights, gather and synthesize information, learn, establish contacts, and establish conduits. All of these help promote the results of the research, to participate in sustained improvement with those engaged in agriculture.

## **GENERAL DIRECTIONS**

I hope to have whetted your research appetite and to have given you perspectives. Now to boil my sense for direction down to three points:

1. **Overturn protection, refurbished guarding, and proven effective educational training relative to products in use.**
2. **Integrated approaches to hazard control, primarily aimed at entanglements, which blend the latest injury prevention**

**hardware and software, particularly software as it relates to behaviors.**

3. **New technologies for sensing, anticipating, and responding to the potential for an injury. This is not only in the sense of hardware. I mean it in the sense of the users and their abilities. And I mean it in the sense of those who are striving to prevent the first or the next injury from happening.□**

## THE MANUFACTURERS' PERSPECTIVE

By Mr. John H. Crowley, M.B.A.  
Director of Safety Programs, Equipment Manufacturers Institute

---

The Equipment Manufacturers Institute, or "EMI," is the principal association in the USA for manufacturers of farm equipment. My remarks will be in two parts.

- First, I will give an overview of farm machinery safety research needs as identified by EMI member companies.
- Second, I will address some of the points raised yesterday in the plenary sessions, particularly the questions that Dr. Myron Johnsrud suggested for discussion in these sessions. One on these was "Where do we focus our resources to be of most success?"

Allow me to preface my remarks with a word on the role of surveillance as it relates to injuries involving farm equipment. Surveillance is said to be important to provide the foundation and direction for both research and intervention.

Manufacturers already know quite a lot about how accidents involving their products happen from information available to them. They have a good sense of the relative magnitude of product-related accidents in terms of the frequency and severity of injury that can result from them.

Nevertheless, better injury data, expressed quantitatively, which should be forthcoming from the current NIOSH-sponsored initiative, are needed to identify problems at the regional and national levels, to establish prioritized objectives, and to mea-

sure progress. Manufacturers need better data on the association, if any, between machinery and cumulative trauma disorder, noise-induced hearing loss, and illness related to the handling and application of pesticides.

### RESEARCH NEEDS

The industry has identified several areas for additional safety and ergonomic research. Two years ago, EMI's Agricultural Safety Committee looked at the accident and injury data base, the product-related safety standards, and the innovative work that Murray Madsen described in his presentation that individual companies are doing. The committee developed a questionnaire to survey equipment manufacturers throughout the industry to find out where they thought additional research was needed.

The responses fell into two groupings. One was safety-related research that was thought to be appropriate for public support.

The other concerned items for which industry concluded it had the necessary expertise itself to carry out. I would like to revisit the results of this survey with you.

The survey identified eight areas that were deemed to merit public support. I will present them in no particular order.



## Behavioral Research

Not surprisingly, in view of much that has already been said by others at this conference, the industry identified a need for research into behavior of equipment users. Manufacturers' experience based on in-depth evaluations of numerous accidents indicated that the manner of use of equipment was a significant factor in accidental injury. The equipment manufacturer's view is that there is a need for basic research aimed at developing a better understanding of behavior with respect to safety and risk-taking in the agricultural environment.

Behavioral research is needed to guide engineers on how equipment can be designed for safer operation and maintenance. It must also be designed for developing effective educational and training programs and other measures aimed at inducing fundamental, lasting behavioral changes.

Behavioral research is needed to guide engineers on how equipment can be designed for safer operation and maintenance.

EMI was familiar at the time of the survey with the work of Dr. Dennis Murphy of The Pennsylvania State University and Dr. Robert Aherin of the University of Illinois in examining attitudes, underlying cultural beliefs, and other factors as possible determinants of behavior.

J.I. Case, a member of EMI, has sponsored a literature review, which is being done by Drs. Murphy and Aherin. This work is nearly complete, and the results will be

provided to J. I. Case in a few weeks. Case has asked the American Society of Agricultural Engineers (ASAE) to publish the results. We understand that publication may occur by the end of July, 1991. The study will look into four elements:

1. A review of the characteristics of farming and farm-accident statistics.
2. Injury- control strategies.
3. Approaches to modifying safety behaviors.
4. Effective ways of communicating the safety message.

EMI has received proposals from several organizations in response to a Request for Proposal (RFP) it issued to do additional work in the area of behavior. The proposals are being evaluated, and EMI will seek other sponsors to help fund this particular research project. Broad sponsorship by both private- and public-sector entities is being encouraged.

## Injury Data Collection

The second area identified for public support was agricultural injury data collection. The industry strongly supports the work of NIOSH to develop a uniform national reporting system and database.

For our purposes, better data is needed on the relationship of machinery characteristics to such things as hearing loss, effects of whole-body vibration, and the significance of such factors as age, fatigue, and environmental variables. EMI encourages public-sector research in these areas.

### **Lighting and Marking of Equipment**

The third area is the lighting and the marking of agricultural field equipment. Dr. Thomas Bean of Ohio State University spoke on this subject. We concur in his view that additional work of a research nature is needed. EMI has issued a RFP for research on the effectiveness of current lighting and marking systems for agricultural equipment.

Five responses were received. These have been evaluated and a study contractor selected. The study contractor will look at alternative ways of effectively identifying slow-moving vehicles, extremity lighting and marking of equipment that travels on roads and highways, and turning indications.

The system now in use in agriculture to indicate turning is somewhat different than the system for motor vehicles. The significance, if any, of the differences will be evaluated.

The study will also look at the adequacy and effectiveness of the slow-moving vehicle emblem and reflectors as specified in the standards of the ASAE. The project will include both simulation and field evaluation using subjects.

There is a need for additional funding for the lighting and marking research study. The cost of the study is about \$220,000. It is 75 percent funded now and we are looking for additional sponsors for the remaining 25 percent.

### **Protection During Chemical Handling**

The fourth area identified in the industry survey concerned protection when handling agricultural chemicals. The focus is on

equipment for handling and mixing and transfer of chemicals from original containers to field application machinery.

Development of a standardized "closed" system for the mixing and transfer of pesticides would provide increased worker protection, guard against damage to the environment from accidental spills and possibly eliminate the need to dispose of excess mixture. EMI and the National Agricultural Chemical Association have undertaken a joint effort to develop such a system. We are not sure that additional research is needed at this particular point. It appears to be more a question of engineering development and standardization.

### **Air Filtration Systems**

The fifth area is air filtration systems that can effectively reduce the hazard of exposure to pesticide vapors, dusts, and aerosols. Tractor cabs now have effective filtration systems for most particulate matter. Additional research is required to determine whether a reliable system is feasible to reduce to acceptable levels concentrations of fine pesticide dusts, aerosols, vapors, and gases.

ASAE has begun a study on this question. It is also being looked at by the International Organization for Standards (ISO). EMI is participating in both the ASAE and ISO initiatives.

### **Whole Body Vibration Reduction**

Sixth, the industry identified improving tractor seat design to limit whole-body vibration as important. The industry has not done any work in this area through EMI. However, some individual companies are looking at it. Manufacturers look

to human factors specialists for guidance here.

### **Hazardous Atmospheres Detectors**

Seventh, devices to detect hazardous atmospheres are needed. Reports abound concerning suffocations and toxic exposures in confined space environments such as manure reception pits and silos. There is a need for a reliable, inexpensive, and easy-to-use device for on-farm use in confined spaces where oxygen deficiency or toxic gases are present. EMI looks to the public health sector, which has the expertise and the funding, to take the lead in addressing this research need.

### **Broaden Research Sponsorship**

Lastly, "research" could be conducted to identify effective ways to gain the interest and support of entities outside the agricultural health and safety community to help sponsor the eight kinds of research that I have just described.

### **INDUSTRY-BASED RESEARCH**

Next, I will discuss certain safety-related areas identified in the EMI survey that the industry believes it can do either through the Institute or as individual manufacturers. These are areas for which industry believes it has sufficient expertise and resources to do the work itself, with some exceptions. There were three such areas identified by the survey:

1. Small tractor roll-over protection structures (ROPS) and seat belts.
2. Safety systems and devices.
3. Product safety signs.

### **ROPS for Small Tractors**

The first of these was ROPS for small farm tractors. In the late 1950's and early 1960's, extensive research and development work was done by the industry to establish the efficacy of ROPS designs for the kinds of tractor overturns that can occur in normal farming and road transport.

Manufacturers began supplying ROPS commercially in the late 1960's. The experience in both the United States and Europe has proven ROPS to be an effective safety device.

There is a need for additional research on small tractors' ROPS. The standard "protective zone" around the tractor operator, which controls the size of the ROPS envelope, was defined on the basis of the ergonomic data that existed in the 1950's and 1960's. The zone remains essentially unchanged today.

EMI sponsored a literature review of the different protective zones used for the design of several kinds of vehicles, including aircraft, automobiles, racing cars, farm equipment, construction equipment, and mining equipment. This study, which was performed by Triodyne, Inc. of Skokie, Illinois, has been completed. Publication will be through both the Society of Automotive Engineers (SAE) and ASAE before the end of 1991.

The basic conclusion of the Triodyne study was that it did not appear, from the kinds of systems that are in place, that sufficient research had been done that could serve as the basis for making the protective zone of a ROPS, as specified by current standards, for smaller small tractors. Small tractors are often used in low overhead clearance

settings—in vineyards, orchards, storage buildings, and machine sheds.

The higher the profile of a ROPS relative to an overhead object such as a tree branch, the greater the likelihood that a farmer will not want to equip a tractor with ROPS or, if there is one on a tractor, to keep it in place. Clearly, there is potential safety value in making the ROPS as compact as possible without compromising protection in the event of a tip-over.

As Murray Madsen mentioned in his presentation, one approach to addressing this situation is to make ROPS that can be raised or lowered. They telescope or fold down for temporary use in the lowered position under low clearance conditions. There are some companies that have such ROPS on the market today.

Industry's research capabilities concerning ROPS are limited to mechanical and structural aspects. There is little more to be done there with the exception of the small tractor ROPS.

Accident data identify tractor roll-overs as the leading cause of machinery-related death on the farm. Therefore, perhaps the most pressing challenge for behavioral researchers and health professionals is to find an effective way to ensure, short of compulsory measures such as regulation, that ROPS are installed and kept on tractors.

EMI believes that behavioral research in this area holds promise of effecting a substantial reduction in roll-over injury and fatality rates. The starting point for such research, we submit, may be recognition that over one million of the approximately 3.6 million agricultural tractors in use today in the United States do have ROPS

on them. There are over one million farmers who chose to equip their tractors with ROPS when they purchased them.

The question should be asked how these farmers arrived at their decision to equip the tractors with ROPS. Was it because of the OSHA rule? Was it because manufacturers were able to package the ROPS in a cab that was noise-insulated and isolated from vibration of the tractor? It provided air conditioning, heating, and stereo; i.e., it was made so attractive in other respects that the farmer was willing to pay for the ROPS cab.

Or were there other factors? The key to getting ROPS on the over-2.5 million tractors that do not now have them may indeed be found by examining the factors in the decisions of the approximately one million farmers who did decide to equip their tractors with ROPS.

### **Safety Systems and Devices**

The second area identified for further industry research was safety systems and devices. There was some discussion about safety systems and devices yesterday, specifically, the concepts of interlocks for barrier-type guards and operator restraint devices.

I would like to identify the criteria that manufacturers use for evaluating concepts or proposals for safety systems and devices, or for that matter most engineering design concepts. There are five such criteria.

1. The first criterion is that a design concept must be technologically feasible. The archives of the U.S. Patent Office contain millions of concepts, inventions, and ideas.

Many have proven to be successful. Many others have not. Much more is needed than mere technological feasibility as demonstrated by the existence of a patent. This is where the other criteria come in.

2. The second criterion is effectiveness. A safety device or system must be effective. There are two necessary qualities for effectiveness.

► First, the system or device must substantially reduce or eliminate the hazard. The tractor ROPS is incontrovertibly effective in this respect. In contrast, there is a type of device with which most of us probably are familiar, the ubiquitous, audible back-up alarm used on heavy equipment. OSHA requires back-up alarms on construction equipment such as front-end loaders, forklifts, and dump trucks that have bi-directional movement while working.

The alarms "beep" every time the machine goes backward. There is much evidence that workers quickly become desensitized to the audible back-up alarm. They hear it going on and off all the time.

If there are several pieces of construction equipment with back-up alarms working on a site it can become difficult to distinguish the back-up alarm of one machine from that of another. The effectiveness of audible back-up alarms is generally recognized to be questionable. Alternative approaches to addressing the hazard of moving machinery in the presence of workers are being investigated.

► The other necessary element for effectiveness is that a device be reliable when called upon to perform its function. I will ask rhetorically, how many of us would buy an automobile if the dealer said: "The

brakes will perform 999 times out of 1,000 when you apply them, but one time out of a thousand they are not going to work."

A type of device that has been proposed for use in agriculture is the electrical-proximity-warning indicator. This is an electronic device that is supposed to sense electromagnetic field or capacitance around energized overhead power lines. It either signals an alarm or deactivates a mobile machine before it gets too close to the lines.

Tests sponsored by the U.S. Mine Safety and Health Administration (MSHA) revealed that when such a device was installed on cranes it gave both false positive and false negative indications. No one has yet been able to perfect a device that will accurately and reliably detect a hazardous electrical field when one is present and will activate only under the hazardous condition. EMI encourages further research and would welcome the discovery of an effective electrical proximity warning device that could be used on tall farm equipment such as portable grain augers.

► The third essential criterion is that a safety device must not by its presence, introduce different risks that would not exist without it. Murray Madsen referred to a study that showed that some accidents occurred because of an operator presence-type device.

I am reminded of a situation that existed several years ago when OSHA, with all good intent, promulgated its ROPS rule for agriculture. As it turned out, there were some small tractors that had backhoes mounted to the three-point hitch, with a separate seat for the operator affixed to the backhoe frame behind the tractor.

Without the ROPS there was not any problem. It was discovered that when a ROPS was installed on a tractor with the three-point-hitch-mounted backhoe, a crush point between the elevating backhoe boom and the rigid ROPS structure was created. A number of fatalities occurred because of that condition.

The solution was to do away with the three-point-hitch-mounted backhoe or redesign the ROPS or both. A combination of these measures was implemented through various field rework programs to eliminate the hazard.

► The fourth requirement is for a safety system or device to be economically feasible. As we have heard from others at this conference, there are strong economic disincentives to safety in American agriculture.

In the mid-1970's, when OSHA promulgated the tractor ROPS and the guarding and shielding regulations, both original equipment manufacturers and independent suppliers of these safety devices produced them in large quantities in the expectation that there would be a substantial increase in demand. Unfortunately, the demand was not there.

On the other hand, as I have mentioned, the ROPS-equipped tractor cab was attractive to the purchaser. Companies do attempt to establish the economic feasibility or salability of products and safety devices before putting them on the market; this is not always easy to do.

► Lastly, a purported safety system or device must be functionally practical. Even if the other requirements I have mentioned are met, the safety device cannot unduly interfere with the basic function

of the machinery. This requirement is found in the ASAE Safety Standards and in the OSHA safety rule for agriculture.

Consider the intake guard of the portable grain auger. The function of a portable grain auger is to move grain from ground level to the top of a grain storage structure and dump it in. The bottom end of the auger, into which the grain flows, has a guard around the inlet opening, that is in the form of a rigid wire mesh cage or screen.

Portable grain auger manufacturers, based on the results of extensive experiments with various kinds of grain, determined the optimum size of the wire mesh openings. The size of the openings in the guard is specified in an ASAE standard.

In determining the optimum size, industry engineers were aware that if the openings were made too small the guards would plug up. The auger would no longer move grain. If that were to happen, farmers would be inclined to take off the guards, thereby totally exposing the very hazard that the guard was intended to cover.

It was known when the standard was written that the openings were not small enough to prevent passage of a small hand or foot through them and into the moving machinery. Thus, it was found to be necessary to have a portable grain auger intake guard that struck a balance between the compelling need to preserve function and safety. In doing this, the intake guard necessarily provided less-than-perfect protection.

There is evidence of a predisposition on the part of people to be unwilling to accept inconvenience in the interest of safety. Recall the 1974 automobiles with the man-

datory interlocking seat belts. The cars could be started only if the seat belts had been fastened.

A political decision was made to drop the requirement because many consumers became enraged when they found that the safety feature caused inconvenience and sometimes interfered with function. One can conjecture that, to the extent that awareness on a personal level of the importance of safety can be increased, there will be greater acceptance by the individual, in the interest of safety, of perceived impairment of function. Industry hopes that behavioral scientists can provide insights and contribute to the development of strategies to bring about changes in farmers' attitudes and beliefs, strategies that may be necessary before meaningful, lasting changes in safety behavior can be effected.

Research and development work on safety systems and devices is done by individual companies, not through EMI. Manufacturers subject the safety designs that they eventually put on the market to rigorous evaluation.

When tractor ROPS were being developed, manufacturers' test programs included actual roll overs of tractors with experimental ROPS designs at different attitudes and speeds. There is a need, in many cases, to verify that a new safety feature will be acceptable to the farmer.

Manufacturers conduct pilot studies in which designs are placed on a number of machines. They are provided to select groups of farmers to determine whether they are acceptable to the customer under a variety of usage conditions.

## **Product Safety Signs**

The third and last area for industry research identified by the survey was product safety signs. The Institute is represented on the committee of the American National Standards Institute (ANSI) to develop a new approach to hazard pictorials and safety signs. Soon national standards reflecting that committee's work will be issued. Much of the recent innovation in safety signage is already embodied in ASAE Standard S441 - Safety Signs.

The ANSI standards will provide additional information including a methodology for measuring the effectiveness of hazard pictorials on signs. The designation of the standard covering the design and testing of hazard pictorials will be ANSI Z535.3.

The methodology contained in ANSI Z535.3 calls for an approach using subjects to evaluate the effectiveness of hazard pictorials in terms of two criteria: recognition of the hazard depicted in the pictorial and the intensity of the impression the pictorial makes on the subject. Industry successfully used the draft ANSI Z535.3 methodology to test a number of pictorials, which subsequently were put into production on new farm equipment.

## **CONCLUSION**

I will conclude my remarks by addressing some of the points that were raised in the session yesterday. Dr. Thomas Bean discussed farm machinery and vehicle safety.

He gave an insightful review of the literature and his own interpretation of injury data that indicated that agriculture was classified as one of the most hazardous industries. Tractor overturns were the

most serious equipment-related type of accident.

Older tractors were often used for general utility work, and youth and the elderly had especially high injury and death rates. Information available to the industry lends support to the observations made by Dr. Bean.

We noted that four of Dr. Bean's six recommendations had to do with farm machinery. Among these was the recommendation that research be conducted on human sensors, automatic shutoffs, and means to effectuate the installation and use of ROPS on older tractors.

Dr. Bean also called for aggressive inclusion of safety in all ASAE standards and research on improved lighting and marking of agricultural machinery on roads. EMI concurs with these recommendations, which are consistent with current industry safety programs.

The question was raised yesterday regarding the efficacy of putting "seat bars," or restraining devices similar to those used on skid-steer loaders, on tractors. The skid-steer loader safety standard, SAE J1388, calls for a means to prevent the lift arms from lowering when the operator is entering or leaving the machine.

As a point of clarification, the kinds of devices discussed yesterday were not necessarily intended to be an operator restraint device, but a device of the kind called for by SAE Standard J1388. There are several approaches used in the industry to meet the SAE requirement. Some companies have interlocking switches in the seats. One company uses an interlocking gate at the front entry point; another uses an interlocking safety belt.

It was said yesterday that in Canada, log skidders were being equipped with seat bars. There is research and development being done in Canada on an operator restraint system for log skidders.

EMI has been following this very closely. The understanding that we have from the Canadian Research Institute is that a device may be made available for production use toward the end of 1991.

This concludes my remarks on the subject of safety-related research needs and programs for farm equipment. I wish I could tell you about the many "intervention" type programs of the Institute, such as our cooperative programs with equipment dealers to promote equipment safety at the community level. This will be a subject for another time.□



## A FORESTRY PERSPECTIVE

By Penn A. Peters, P.E.  
U.S. Forest Service, Morgantown, WV

---

My purpose in being on this panel is to present a forestry perspective on agricultural safety. The hazards to the farmer in the woodlot are similar to those of the professional logger. My remarks will consist of an introduction to logging safety, a response to the technical panel, notable quotes heard at this conference, and recommended future directions.

### AN INTRODUCTION TO LOGGING SAFETY

Dr. Louis Sullivan introduced logging safety in his introductory remarks when he quoted the logging fatality rate as 200 per 100,000 workers, the highest of any occupation. The national average for all occupations is eight fatalities per 100,000 workers.

Approximately two-thirds of the logging fatalities occurred while the worker was felling trees with a chainsaw or was in the felling area (OSHA, 1988). Over 100 loggers and about 30 farmers die each year in the United States while felling trees. In addition, some farm tractor accidents undoubtedly are caused by attempting to transport logs or trees unsafely; these, though, are reported as tractor accidents. The connection with forestry does not appear in the statistics.

NIOSH lumps the principal factors contributing to a felling fatality into a single category, "struck by" accidents.<sup>1</sup> Based on

OSHA fatality reports, in 26 percent of the deaths, a hangup fell on the victim.<sup>2</sup>

- A hangup occurs when a felled tree hangs in the crown of another tree. A gust of wind, vibration from mechanical equipment, or the falling of another tree can dislodge a hangup. Many fellers have been killed by a falling tree that had a hangup only minutes earlier.

- Another major factor is working too close to the feller. Often a co-worker will walk into the area as the tree falls.

- A third cause is the crown of a falling tree either breaking or pulling a tree directly behind it, which strikes the feller from behind. Poor felling technique accounted for 15 percent of fatalities.

Examples of poor techniques include felling a tree with a hangup in it, failing to put in a notch cut to control the direction of fall, or not following a notch cut immediately with a back cut to fell the tree.

Snags were involved in 25 percent of the cases and were the principal factor in 8 percent of them. Snags have no root system and easily break in pieces when struck by another tree.

Butt rebound, another cause, occurs when the bole of a falling tree strikes the top of a neighbor tree causing the butt to rebound toward the feller.

Broken limbs or tops occur when a tree with a large crown hits another tree, causing the top or limbs to be broken off and thrown back at the feller. In one fatality, the top 25 feet of a black cherry tree, weighing approximately 50 pounds, was thrown 65 feet. It struck the feller, who presumably was standing in a safe place 20 feet behind the felled stump.

The situation in logging safety has been summarized as:

- Loggers and farmers do not recognize the hazards.
- Compliance with the proposed OSHA logging rules would reduce injuries.<sup>3</sup> However, the rules do not effectively address the problems of butt rebound, broken limbs or tops, or being struck from behind.
- Hardwood partial cuts are dangerous; 56 percent of felling fatalities are related to a felled tree hitting another tree. Hardwoods are involved in many injuries.
- The harvesting trends of more use of hardwoods, more use of partial cuts, and more snags left standing will make logging more dangerous.
- Use of a hazard recognition procedure before felling each tree would reduce injuries.
- Research should be conducted on the dangerous reactions that occur when a felled tree strikes another tree.
- Injury investigations frequently fail to report critical research information such as tree species, heights, diameters, and separation distances.

## **RESPONSE TO THE TECHNICAL PANEL**

The presentations of the technical panel were impressive. Most of the agriculture safety problems have a counterpart in forestry. Some of the successful intervention strategies that have been used in agriculture perhaps can be used in forestry and vice versa.

Dr. Bean stressed the need to install Roll-over Protective Structures (ROPS) on farm tractors and to evaluate highway travel hazards of agricultural vehicles. The forest industry had a serious problem hauling tree-length southern pine, resulting in a 20-foot overhang on some trucks.

Dr. Cochren discussed cumulative trauma injuries. A forestry example was the disease called "white finger." This is caused by poor circulation and traced to vibration of early chainsaw designs. The problem was solved by engineering design.

Mr. McLymore discussed electrical hazards. A common electrical hazard in forestry occurs when a falling tree or piece of logging equipment contacts a high power line.

Dr. Marvel compared hearing loss of farmers with that of similar people who did not work on a farm. Similar comparisons should be done in forestry. One application could compare the accident experience of loggers who have had safety training with similar loggers who have not.

Mr. Madsen spoke on technology trends, including smarter machines, automatic control, computers in machinery and safety devices, and proximity detectors. Proximity detectors may have an application in for-

estry to indicate when someone has walked into a felling area.

### **NOTABLE QUOTES HEARD AT THIS CONFERENCE**

- "Prevention is the key." Certainly this is true of logging injuries; some you would almost not want to recover from.
- "One logger out of five experiences a lost-time work injury in a year." An amazing statistic!
- "Logging fatality rate is 200 per 100,000 workers." Twenty-five times the national average.
- "Develop the infrastructure for prevention." Who determines the effective intervention strategy, and who implements it?
- "Build coalitions." Coalitions are needed for political and financial support of organizations and programs. Coalitions also are needed to attack safety problems effectively. Using the felling safety problem as an example, organizations that can contribute to solving the problem include the U. S. Forest Service Research, NIOSH, OSHA, insurance companies, logging companies, trade organizations, universities, and consultants. Cooperation exists among these organizations in the form of information sharing. Building of cooperative working relationships, however, to make a concerted attack on a problem is difficult.
- "Injuries are assumed to be unpredictable." Most injuries are predictable. They occur over and over again, only to different people.
- "We blame the victim." There is almost always some failure on the part of the victim. If nothing else, he or she failed to recognize the hazard. Have we given workers the information. They need to recognize the hazard?
- "ROPS is a proven intervention strategy. Why can we not implement it?" Is the problem the cost, the infrastructure, the regulation, or the legal system?
- "Do we include logging in the agricultural safety and health program?" That is a good question. Logging injury statistics are included in some farming injury statistics, making farming look more dangerous than it is. This may be an argument for including logging statistics. On the other hand, information targeted to reach farmers is unlikely to reach loggers, and vice versa.
- "We see what we look for." How often do we overemphasize a minor problem area because of personal interest or because it fits our skills and fail to see a significant problem area?

### **RECOMMENDED FUTURE DIRECTIONS**

Detailed accident surveillance data should be used to identify problem areas and to set priorities for safety research and programs. NIOSH is progressing in this area. Expert opinion can be used to confirm the problem areas that have been identified.

For example, NIOSH has identified "struck by" injuries as a major logging injury type. Experts confirm the problem and know that it occurs most often in the act of felling trees. The experts typically are people who work with groups of loggers or farmers, or are association professionals.

Research by qualified researchers with knowledge of the industry should be conducted on the causes and potential cures. A high-priority research area is in the injuries that result from a felled tree having hit another tree, which includes hangup fell, broken limbs or tops, and butt rebound.

A high-priority research area is in the injuries that result from a felled tree having hit another tree, which includes hangup fell, broken limbs or tops, and butt rebound.

The research would identify timber stand conditions and geometry that result in felling injuries. It would develop means

for loggers and farmers to recognize the hazards. Injury investigations could contribute to an excellent database.

For example, the OSHA logging fatality investigation summaries (1988) were adequate to identify causes of "struck by" accidents, but failed to report information (tree species, diameters, heights, and separation distances) in several cases that would help identify potential cures. Training of injury investigators would be useful here.

Intervention strategies should be devised based on the results of research. A number of pilot intervention programs should be funded. The programs should be tracked by research studies or surveillance data in order to identify successful pilots as models for large-scale funding and national implementation.□

## REFERENCES

1. Peters, Penn A; "Logging Fatalities and Injuries Due to Felling Trees." ASAE Pap. No. 907536. St. Joseph, MI: *Am. Soc. Agric. Eng.* p. 21, 1990.
2. Cole, William; "Selected Occupational Fatalities Related to Logging as Found in Reports of OSHA Fatality/Catastrophe Investigations." Occupational Safety and Health Administration. Washington, DC. p. 157, 1988. Available from: NTIS, 5285 Port Royal Road, Springfield, VA 22161, PB 89-142-954.
3. Smith, Frank, Jr. "Logging Operations: Notice of Proposed Rulemaking." Occupational Safety and Health Administration. *Fed. Reg.* 54(83): 18798-18817.

## A REGULATORY PERSPECTIVE

By *Thomas H. Seymour, P.E.*

Fire Protection Engineer, Occupational Safety and Health Administration

---

I have some overheads I would like to show you so that you can see some of the things that the Occupational Safety and Health Administration (OSHA) has done. To pick up on what Mr. Peters just talked about, the OSHA has been compiling data to report the various sorts of the fatality investigations that our field staff have made over the years (e.g., logging). We have about 16 of those reports now. We are continuing to write those on various subject matters like industrial trucks.

OSHA has had its ups and downs in the agricultural arena. When we had our initial standards published, there were a number of standards that involved agriculture. The way the Occupational Safety and Health Act was written, we were to utilize national consensus standards in our initial set of standards.

In those days of President Nixon, his people wanted us to issue those standards as promptly as possible. We attempted to do just that.

Looking at the input from the agricultural community, there were only four standards that they had been actively involved in. These standards were issued in May of 1971. There were these four areas:

1. We had temporary labor camps, which is one of the 1910 standards.

2. Next was anhydrous ammonia. We used the ANSI K61 Standard for handling anhydrous ammonia on farms.
3. Pulp-wood logging is next. Farmers, especially in the northeast, would do this kind of work in the off-season winter months—to make some extra money. So pulp wood logging was also covered.
4. The slow-moving vehicle emblem from the American Society of Agricultural Engineers (ASAE) was one of the other standards that we used as part of the ANSI sign and tag standard.

OSHA was aware of the death and injury rates among farmers, at least as the National Safety Council described them in the early 1970's. We were trying to develop what we considered a balanced program for agriculture. We were looking for outreach efforts and training of agricultural workers and farmers.

### **AGRICULTURAL ADVISORY COMMITTEE**

In order to effect this kind of effort, the agency formed an Agricultural Advisory Committee. Our Assistant Secretary was in charge of the standards office back in those days.

We formed the Agricultural Advisory Committee in 1972. You can see in Figure 1 that Rollin Schnieder was the initial Chairman of the Committee. Gary

Erisman, who was one of the speakers here this week, was also on the Committee.

The tripartite arrangement was that we had professional, state, and Federal representatives. There were employer/employee representatives, and there were representatives from the West Coast, the Midwest, and the East Coast (Figure 1). We tried to get a broad representation of agricultural interests into our committee activities.

### Roll-over Protection

The committee divided itself into working groups to develop suggestions and recommendations in the areas of training, and also in the needs for standards like ROPS and machine guarding. In 1972, the full committee recommended its first standard. They recommended that we do a roll-over protective structure (ROPS) rule for farm tractors.

The first agricultural standard that OSHA issued under its normal rule-making was

---

EMPLOYEE			
Rubin Contreras McMinrville, OR	Robert H. Discoe Paxton, NE	John C. Ramirez King City, CA	Peter A. Andrade Western Food Processing Division Burlingame, CA
EMPLOYER			
Will Gill, Jr. Will Gill & Sons Madera, CA	Joseph H. Price Texas Cotton Ginners' Association Dallas, TX	Richard V. Thornton Grower, Shipper Vegetable Association Salinas, CA	J.S. (Alice) Van Mert Hampton, IA
STATE		FEDERAL	
Glenn J. Hertzler Commissioner of Agriculture Cheyenne, WY	James Wiles Administrator, Workmen's Compensation Board Salem, OR	Dr. Jon R. May National Institute for Occupational Safety and Health Rockville, MD	Robert O. Gilden Extension Service U.S. Department of Agriculture Washington, DC
PROFESSIONAL			
Chairman: Fr. Rollin D. Schnieder University of Nebraska Lincoln, NE	Dr. John G. Erisman Illinois State University Normal, IL	Dr. Mayland Hayes, Jr. Vanderbilt University School of Medicine Nashville, TN	

---

Figure 1. Standards Advisory Committee on Agriculture.

the ROPS standard. We proposed that back in 1975, we finalized it in 1975, and it became effective in October 1976.

It dealt with all farm tractors made after October, 1976; they had to be equipped with the ROPS. The standard is based on the ASAE Standard, J11-94. The complete text of that Standard was put into the OSHA standard.

Even though tractors were required to have ROPS, we continue to see deaths of tractor operators from roll-overs. We have seen seat belts cut off or cut out; seat belts were not used in several roll-over deaths. Obviously, we have not seen the results that the Swedes have achieved with their standardization efforts.

OSHA wants to see its standard evaluated. We want to see this standard looked at very thoroughly to see why it is not working.

What can we do to modify it, to make it work, to become more effective? We know that seat belts are considered by many farmers and farmworkers as a hassle in hooking and unhooking, especially when you have to get off the tractor a number of times.

What other means can we use in lieu of seat belts to keep the person inside the ROPS area? How can training be made more effective? What are the weaknesses of our standard? These are some of the things that we need to look at and evaluate.

The new ASAE Standard, J21-9.4, is a revision of this effort. We have said publicly that the standard is acceptable in meeting our ROPS standard that we re-

quire here. We have done that administratively.

The International Standards Organization (ISO) is also involved in writing standards for ROPS, and the ISO Standards 5700 and 34-63 are additional new ROPS standards. Our ROPS standard is not as stringent as theirs.

In our opinion, if you have a ROPS design that meets all the tests of the ISO Standards, that will be acceptable in meeting the OSHA Standard as well. However, the seat belt requirements of the ISO Standard are not quite as stringent as our Agricultural Engineer's Standard at OSHA.

### Machine Guarding

In 1973, the full committee went on to recommend that we propose a standard for machine guarding. This standard was finalized and became effective in March 1976, and became fully effective in June 1977.

This standard is also not working the way we had hoped. We need to refine ways of evaluating this Standard to see why it is not working. We have seen some power take-off (PTO) guards that are hinge-operated. Those seem to be working much better than those that you unbolt and bolt back on again.

We need to make guards—to use a term from the computer age—"user friendly," especially those on equipment that one has to get into frequently. Then, it will not be a hassle to move the guard off or move it out of position so you can make the adjustment and then put it back into place.

Augers are another area where we have serious problems. We are looking for

some practical solutions for a variety of farm machinery which people are still getting caught in and ground up by.

### **Publications**

The full committee also looked into training and guidelines. They thought those items should be part of the overall outreach effort of the agency. The committee formed a publications group and came up with a list of things that needed to be done in the form of slides, tapes, publications, and even training films for ranchers, farmworkers, and ranch hands.

The publications were to be printed for those with low reading comprehension. Another set was printed for normal reading level for farmworkers and ranchers. Also, we had Spanish-language translation that we wanted to do for the agricultural community.

We got involved in this and entered into a contract with Purdue University's Agricultural School to help develop these publications. We were off to what I thought was a good start.

### **THE APPROPRIATIONS RIDER**

Several U.S. Senators and others from the farm-belt states, however, began to severely criticize the agency for its standards effort and its outreach effort. We got raked over the coals.

The low-reading-comprehension booklet was a target for criticism. OSHA made a valiant effort to explain what we were trying to do. We hoped that the Advisory Committee was going to be one of our entrées to get the word out to the farm community.

We obviously did not have the kinds of coalitions and liaisons that we needed. The criticisms got to be blistering politically. As we were getting some of the booklets to press, the political pressure mounted against the effort.

Reason no longer prevailed. We came to a complete halt. OSHA withdrew their effort, and the critics continued to howl about OSHA.

The Agriculture Committee continued to work on other subjects like electrical and personal protective equipment, even field sanitation and transportation of farmworkers. No action was ever taken on any of these Agriculture Committee suggestions.

In Fiscal Year 1977, the Congress slapped a restriction or rider on the appropriations. The intent was to stop OSHA from carrying out its mandates under the Occupational Safety and Health Act. The Congress passed a law and told us to do it; they came back and told us they did not like the way we were doing it. They told us to stop doing it.

They did not want us doing more in this area, farms with 10 or fewer workers. Therefore, that rider said no enforcement, no standards-making, no investigations of fatalities or complaints would be allowed, nor would money be spent for these kinds of efforts.

The rider stopped OSHA, and that rider is still in the appropriation bill every year up to today. The Farm Bureau and other major organizations in the agricultural community are advocates for that rider.



The Congress put it on. We think that the Congress needs to be the one to take it off.

### **OSHA IN THE 1980'S**

Let us take a look at the decade of the 1980's. Little action was taken by OSHA in the agricultural area during the 1980's. OSHA defines agriculture covered by Part 1928 to be those operations involved in planting, raising, and harvesting crops; animal husbandry including feedlots; aquaculture; cotton ginning; and others such as on-farm storage for grain handling. This is when a farmer is going to store several seasons of grain in his own storage facilities. That is considered part of our definition of farming under Part 1928.

#### **Logging**

We do not consider logging operations to be an agricultural area. We have a proposed rule to address those kinds of hazards.

#### **Hazard Communication**

OSHA issued two standards during the 1980's to add to Part 1928. Both were Federally court-mandated. OSHA was directed to issue both these standards which apply to farms with 11 or more workers.

The first one was hazard communication. This is one standard that applies to all workplaces that OSHA covers today, except for farms with 10 or fewer workers. These farms are the only ones that are not protected by the standard.

#### **Field Sanitation**

The next one was field sanitation. We went through the long, laborious steps to get the standard issued, a lot of agony. There was a lot of interaction in the Federal courts.

There was a strong desire by certain elements in the agricultural community to see this standard promulgated. They were successful, through the court system, at getting it into place.

### **OSHA IN THE 1990's**

Where are we heading in the 1990's? OSHA continues to support NIOSH in its injury surveillance efforts, the injury prevention and control research, Fatal Accident Circumstances and Epidemiology (FACE) investigations by NIOSH, and the hazard alerts NIOSH has done like the oxygen-limiting silo problem. More needs to be done in this area on real problems on the farm and on the ranches.

OSHA wants to see its existing standards, like ROPS and farmstead machinery guarding, fully evaluated. What works? What does not work? Why does it not work? How can we make it so that it is effective?

We want to see a better injury and trauma data-gathering system. We want to analyze these data to help us better understand what are the causes of deaths and serious injuries on farms and ranches.

OSHA has about 5,000 slides that can be put into slide programs that are available to NIOSH and USDA. These are also available to our consultation program that we have in all 50 states. These were made during the 1970's, before the rider on the

appropriation bill, to help as outreach efforts.

To date, our consultation people have not had a rush of requests from the agricultural industry or community and the farmers and ranchers to conduct on-site consultation visits. Obviously, we need to find ways to reach those people. We have not found those ways yet.

In the OSHA history of writing rules, regulations and enforcement, we have found that the people who are interested in trying to correct these problems need to be on board and in support of the process.

We need to find ways to evaluate injury intervention strategies to promote those that are found to be effective and work. We need to have the farmers and ranchers actually involved in helping with the evaluation.

In the OSHA history of writing rules, regulations and enforcement, we have found that the people who are interested in trying to correct these problems need to be on board and in support of the process. They need to find that these kinds of solutions work. Then, we can carry the message to the non-believers or the "stick-in-the-mud" types who need to be pulled along a little harder.

OSHA is looking forward to the day when the Congress no longer considers riders on its appropriation bill to be necessary. OSHA hopes to be a full-fledged partner in the outreach and consultation efforts that help the farm community, the agricultural community generally, with assistance so that the injury and trauma problems can be brought to a much more acceptable level.

We want to see this assistance given in all 50 states, territories, and the Commonwealth of Puerto Rico to reduce trauma and tragedies.□

## FARMING METHODS AND SYSTEMS ANALYSIS

By Gary Erisman, Ph.D., C.S.P.  
Private Farmer

Dr. David S. Pratt: The first speaker today is—I am very pleased, harkening back to some of the comments we heard this morning—someone who is involved as a stakeholder and a person directly involved in agricultural production. Gary Erisman was born and raised on a family farm in Stanford, Illinois. He got a bachelor's degree and master's degree, both from Illinois State University, one in agricultural education and the other in traffic and safety education. He went on to receive a Ph.D. in health and safety from the University of Illinois in Urbana, and then has gone on to become a Certified Safety Professional. He has had numerous experiences and has taught and been involved in occupational safety and health at the university level for a number of years. At the present time, and since 1980, he is an active farmer and also serves as a safety consultant in farming.

Dr. Erisman:

As I view it, my primary task as lead-off man for this session is to establish a perspective on the topic. It has been concluded for many years that accidents are a particular problem to those engaged in farming.<sup>1</sup> This conclusion has resulted from intuition and the use of epidemiology, the scientific method of studying epidemics in a particular population.

### PROBLEMS WITH THE EPIDEMIOLOGY APPROACH

Epidemiology is a staple method of investigative evaluations of health problems. However, there are some problems with epidemiology when used to investigate accidents.

1. In epidemics, the agent (germ) is usually a constant, a single, identifiable organism with predictable properties. That finding is not true with accidents.<sup>2,3</sup> For example, all cases of chicken pox result from one organism. However, not all tractor accidents result from the same organism (tractor). Tractors vary in size, weight, ballast, age, etc.

2. Little can be done to change the germ. In epidemiology, most success has been achieved by reducing the human's susceptibility to disease through vaccination, administration of drugs, or education. However, data has consistently shown the most success in preventing accidents is achieved through changing the agent or environment through redesign.<sup>4,5,6</sup>
3. In epidemiology, the illness must manifest itself. It is an "after the fact" method of problem solving. When compared with alternative methods, it is an inefficiency.
4. Perhaps the biggest problem with epidemiological studies of accidents is that they rarely tell us the most crucial information. Epidemiological studies answer the questions "who," "what," "where," "when." They do not answer "why."<sup>13</sup>

We have to resort to other techniques to answer the latter question. For example, we may find 70 percent of all farm accidents in Iowa occur between the months April and October.

However, that may be because of chance alone; that is the time span during which most farming activities are conducted.

When we pool data from different states, it produces even more uninterpretable data; April has a different significance to farm activities in Iowa than it does to farms in Georgia.

The output of such studies is data, which serves as the basis of conjecture. It is little basis for scientific, effective counter-measure development.

Epidemiological studies of accident problems already in existence are of value to isolate problem areas that justify more in-depth investigation.

### **THE SYSTEMS APPROACH**

A more proactive, modern technique to use with accident and injury control is referred to as the systems approach. It is the approach to accident control that has been used with considerable success in areas such as highway transportation systems, air travel and traffic control, and the space program.

We need to define some terms as we go along. I will use the systems method to try to establish a perspective on farm accidents. A system is defined as an orderly arrangement of components that act and interact to perform some task or function within a given environment.<sup>7</sup>

1. Note that a system is defined according to some task or function it is to perform. Examples include the digestive system of a human, the postal system, or an air traffic control system.
2. A system is made up of components that act or interact (the components are

related); each component affects the function of other components, and ultimately, the output of the system.

When using the systems approach, the first consideration is to identify the purpose of the system. What is the system supposed to achieve? What is the system's output to be?

The second consideration is the development of a thorough understanding of how the system functions. How do the components or activities relate to each other? What happens to the system if one component fails? For example, it would be impossible for a physician to competently practice medicine unless he or she knows the systems of the body, the components of the systems, and how the systems interrelate. Extending this example, it is impossible to effectively use the systems analysis technique, without first gaining a thorough knowledge of the system in question.

Systems are designed and maintained on a two-priority basis. The first priority of a systems designer is to produce a system that will do the job for which it is intended. The second priority is to determine if the system will work within an acceptable degree of safety.

Systems can be evaluated using two types of criteria, systems criteria and human criteria.<sup>7</sup> I would like to use these two criteria in an evaluation of our American farming system.

### **Systems Criteria**

Following the procedure set out, I must ask the question, "What is the purpose of the U.S. farming system?" From a national perspective, the purpose is to insure a reliable supply of food and fiber for our

citizens and other people abroad. It can be argued that America's greatest natural resource is its capacity as a food factory. The climate, soil types, water supply, technology, distribution system, economic system, and creativeness of the farmers and workers, when put together, comprise the best collection of agricultural resources (components) in the world.

1. Each farmer in Japan produces enough food to supply himself and 3 others; in Russia, 11 others. But each American farmer produces enough to support himself and 114 others.<sup>8</sup>
2. The reliability of the American food machine is so high, it is largely taken for granted in this country. We have *never* known the starvation experience of European, Russian, and Asian countries during and after World War II. Nor do we know the famine that exists in a host of countries today.
3. Americans spend a smaller percent of their disposable personal income for food than in any other country in the world.<sup>9</sup>
4. American agriculture is big business. It makes up about 18 percent of all the nation's jobs (20 million jobs). However, only 19 percent of that 18 percent (3.8 million) are actually involved in farm production—farmers, hired labor, and workers in forestry, fisheries, and agricultural services.
5. The American production system has evolved from the hunter-gatherer system of our Native Americans, through slash and burn systems, largely through nomadic systems, and through the subsistence form of farming that predominated well into the 1950's.

Since then, economic demands have brought a major shift from subsistence farming to a specialized, commercialized form that predominates today.

6. U.S. farmers produce a variety of commodities for domestic and export markets. The 1987 Census of Agriculture lists more than 200 different commodities produced in the U.S. If a single word were chosen to describe U.S. production, the best word would be "diverse".<sup>9</sup>
7. Each commodity produced represents a specific subsystem with specific operations equipment, timetables, labor, and marketing demands.

In addition, a majority of farms still combine two or more subsystems—one superimposed on the other—that usually have synergistic effects. Examples are hog-corn farms; cattle, corn, bean farms; etc. Each farm represents a unique subsystem of activities and risks, with no two exactly alike. Perhaps the greatest strength of the overall system is the creativity of the components; each farmer tries to build a better mousetrap.

It is important, at this point, to make a distinction between the system's purpose from a national perspective, and the purpose of the system from the producer's perspective. From the farmer's perspective, the purpose of the system is a means of earning a living, or supplementing income.

True, there are many secondary motives—pride of ownership, a way of life, perpetuation of the heritage, etc. But the primary purpose, to earn a living, should never be allowed to become obscured.

1. Farmers seek to bring about an optimum mix of land, labor, and capital inputs to maximize output, which is ultimately measured in dollars.

This technique of mixing inputs is the basis of doing business in America. It is referred to as entrepreneurship, "the ability of one to organize, manage, and assume the risk of a business or enterprise" (dictionary). Thus, to enter farming is to voluntarily expose ourselves to risks, economic and personal. There is evidence to suggest that people psychologically differ in their willingness to expose themselves to risk.<sup>10</sup>

That does not make them "bad" people. It adapts them to the demands of the job others could not perform successfully or happily. Other occupational groups of this type would include such people as astronauts, pilots, stock and real estate brokers, athletes, police officers, and fire fighters.

2. The most telling single statistic that depicts the system's performance for producers was released by the USDA recently.

In the middle 1970's, \$0.34 of every food dollar was returned to the farm level. Today, that figure has been reduced to \$0.24. The margin of profit per unit of operation continues to shrink. There is only one way to maintain or increase profitability under those conditions, operate or produce more units.

Usually, for one operator to increase in size, another must shrink. This may sound like Darwinism, but it is not that simple. A farmer may be extremely efficient.

With no opportunity to expand, however, i.e., no additional land to rent, he can be economically reduced to the point that his

primary income must shift to off-farm sources. The enterprise is taken up by another, who remains economically viable. The result is that the big get bigger. There are more and more part-time farmers. The middle-sized operations continue to disappear.<sup>9</sup>

3. The trend in farm size leads to another finding with implications for safety.

The trend toward fewer, larger farms has reduced the number of family workers, but it has increased the average farm's hired-labor requirements.

Today, 50 percent of the hours worked on farms are worked by farm operators; 16 percent by unpaid farm workers, such as family members; and 34 percent by hired farm workers.<sup>9</sup> The trend toward fewer, larger farms has reduced the number of family workers, but it has increased the average farm's hired-labor requirements.

4. The trend toward fewer, larger farms in not necessarily a healthy one either for those engaged in farming or those dependent on the U.S. food system.

There is a point where concerns about quantity override concerns about quality. For example, one operator may operate more acres, but may do a poorer job per acre. Yields per unit may begin to dip a bit. These events are insidious and sometimes hard to measure.

The ultimate result is a detrimental effect on total system output. The system, in total, reaches a point of diminishing returns. It is not a situation of the operator's choosing, making, or desire. It is some-

thing the economic system is imposing on them. It is an event that ultimately will have to be addressed.

To summarize, based on an evaluation of systems criteria, the U.S. food production system is found to be extremely productive. It is also found to be changing toward fewer, larger components, which, in turn, threaten continued capacity to increase production.

### Human Criteria

A second group of criteria can be used to evaluate systems. They are referred to as human criteria, and as identified by McCormick and Sanders,<sup>7</sup> are made up of 4 subcriteria.

1. *Human Performance Measures* elements such as individual demands on sensory, mental, and motor activities.

It is obvious, due to increased mechanization and specialization, that physical demands on farmers and other workers are being reduced. It is equally obvious, due to economic demands, that mental stresses are being increased.

The luxury of being able to survive a season of bad weather or inaccurate business decisions no longer exists for some operators. It resembles playing in a poker game with increasingly high stakes. Each year more and more producers find they have their whole stack of chips in the pot. There is no acceptable alternative to being correct. That is stress!

2. *Physiological Criteria* indicators of the effects of the work load on people.

Examples might include blood pressure, heart rate, respiration rates, chronic health

problems, and others. I am unaware of studies that have attempted to compare the fitness to work of today's farmers and other workers with those of the past. I would postulate farmers today are less physically fit as a group than those 20 years ago.

- The average age of an American farmer today exceeds 50 years of age.
  - Farm work has become more erratic. The subsistence farms of the 1950's required work every day year around. Today, with specialization, the *physical* demands are much more seasonal. Nevertheless, farmers today try to operate units that fully use their capacity (equipment). This trend tends to produce more pronounced periods of underwork and overwork. Partially offsetting are contributions from industry that reduce physiological demands, i.e., air-conditioned cabs, power assists, etc. Nevertheless, farming still remains among the most physically demanding of all forms of work.
3. *Subjective Criteria*: This critically important area refers to people's evaluation of the system.

Thus, design is the most critical stage for the prevention of hazards and hazardous products.

It is often inaccurate. However, it is the perspective that drives decisions. From a national perspective, farming may appear to have the characteristics of farming 30 years ago. The public perception is often that of the farm when they left it. Little

public understanding of the true dynamics of modern farming exists.<sup>9</sup>

By contrast, those directly involved in farming are acutely aware of the realities of modern activities. The opinion of many is that it is not as much fun, nor as enjoyable as it used to be. It is approached more as a cold-blooded, demanding, unfor- giving business.

4. *Accident Frequency*: It should be noted that accidents are just one of several criteria used to evaluate a system.

The value of any system is contrasted with the cost to operate it. That statement may sound insensitive. It is an accurate as- sessment of the way the world works.

When viewed in the systems concept, an accident represents one form of system failure. When the system breaks down, output is reduced or stopped. Systems are designed to minimize or eliminate break- downs in any form.

Farming ranks at or near the top of the list of accidental deaths per 100,000 workers exposed to risks.<sup>10</sup> These findings have been documented by more than one source.

Translated into system terms, this docu- ments a system that breaks down more fre- quently because of a specific reason (inju- ries) than most other systems. Further, it documents that consequences of this sys- tems failure are more serious than others. The breakdown involves a death or serious injury.

The question is, "Why?" That is a question for which we do not have a definite scien- tific answer. In my evaluation, we have a great number of opinions, conjecture, and

over-generalization. We do not have de- fendable data. That finding is the direct result of the inadequacy of the epidemiological methods primarily used to study the problem.

## HAZARD EVOLUTION

Perhaps the greatest single value of the use of the systems approach is the preven- tion of the problem before the problem manifests itself in the form of an injury. I will discuss one example of its use.

When we view the development of any device, i.e., hammer, screwdriver, or trac- tor, we find that in each stage of move- ment, an opportunity for degradation from design criteria exists. Examples are incor- rect assembly, repair, and wear.

It has long been recognized that the safety of a device can be no better than it is found to be at the design stage. Thus, design is the most critical stage for the prevention of hazards and hazardous prod- ucts.<sup>5,6,7</sup>

When products are found to have prevent- able hazards resulting from design inade- quacies, it suggests that two further evalua- tions are in order:

1. The academic preparation of the engi- neers and the content of the curricula through which engineers are or have been prepared, and
2. The degree to which administrative environments encourage or reward contributions toward sound systems and human factors design.



## SUMMARY

The U.S. production system is a model of productivity when viewed from the outside. Economic trends have left much to be desired to producers and others who work in the system and make the system work.

Accident frequencies suggest a high frequency of system breakdowns that must be addressed. System approaches should be used to evaluate why these breakdowns are occurring. What system modifications can be made to reduce the system failure rate?□

## REFERENCES

1. National Safety Council. *Accident Facts - 1990 Edition*. Chicago: The Council, 1990.
2. Halsey, Maxwell; Editor. *Accident Prevention*. American Public Health Association. New York: McGraw-Hill, 1961.
3. Jacobs, Herbert, et al. *Behavioral Approaches to Accident Research*. New York: Association for the Aid of Crippled Children, 1961.
4. Klein, David and Julian Waller. *Causation, Culpability, and Deterrence in Highway Crashes*. U.S. Department of Transportation. Washington, D.C.: Superintendent of Documents, 1970.
5. Marshall, Gilbert. *Safety Engineering*. Monterey, California: Brooks/Cole Engineering, 1982.
6. Waller, Julian. *Injury Control*. Lexington, Massachusetts: D.C. Heath, 1985.
7. McCormick, Ernest, J and Mack S. Saunders. *Human Factors in Engineering and Design*. 5th Edition. New York: McGraw-Hill, 1982.
8. Meyer, Don. McLean County Cooperative Extension Service, University of Illinois, 1991.
9. *Americans in Agriculture - 1990 Yearbook of Agriculture*. Washington, D.C.: United States Department of Agriculture, 1990.
10. Erisman, J. Gary. "The Relationship Between Emotional Immaturity and Accident Involvement of Illinois Male Farm Operators." *Research Report No. 7*, Safety and Driver Education Laboratory, Champaign-Urbana: University of Illinois, 1971.
11. Master, David. *Conceptual Aspects of Human Factors*. Baltimore: John Hopkins University Press, 1989.

## ERGONOMICS

By Professor Stephan Konz  
Department of Industrial Engineering, Kansas State University

Dr. David S. Pratt: We have another presentation that I think is going to shed some important light on agriculture from a perspective that we, unfortunately, seldom hear from very much, and that is ergonomics. Dr. Steve Konz is going to speak next. He received his Ph.D. in Industrial Engineering from the University of Illinois. He has been at Kansas State University since 1964. He has been a prolific writer and contributed to the scientific literature with over 170 publications, and he has a book that is very popular, *Work Design: Industrial Ergonomics*, which is currently in its third edition and was just recently re-offered in 1990, and it is used at more than 25 American universities. We are, indeed, delighted to have Dr. Konz with us today to talk about *Ergonomics*. Dr. Konz:

### SUMMARY

Ergonomics deals with the interaction of man and machine in a physical and social environment. For agricultural safety, two ergonomic recommendations are:

1. Focus on unsafe conditions, not unsafe acts.
2. Redesign rather than use training or warnings.

### ERGONOMICS

#### Overview

The word *ergonomics* was coined by Professor Murrell in Wales in 1949 from the Greek words *erg* (work) and *nomos* (laws, rules).<sup>1</sup> Thus, it referred to the study of work. Over the years, the meaning has broadened to the study of the interaction of people and their environment. The work environment is just one possible environment.

One aspect of ergonomics that has received considerable attention is the study of the characteristics of the individual person. When focused on a person's dimen-

sions and strengths, this is called anthropometry. When focused on the cardiovascular and muscular systems, this is called work physiology.

Information flows from the man to the machine through controls. Information flows from the machine to the man through displays.

Thus, it was logical that much of the early work in ergonomics focused on controls and displays. Note that displays include not only instruments (active displays) but also letters and number arrangements such as text, tables, and graphs (passive displays).

The man and machine are in a physical environment (visual, noise, climate, chemical). Therefore, ergonomists also study these variables.

Most ergonomists attention has been focused on the visual environment. Ergonomists' interest in noise and climate (temperature, humidity) has focused on the degradation of performance due to noise and climate.

Finally, this activity occurs in a social and organizational milieu. The person interacts not only with machines but with other people. This area presents many challenges as people are much more difficult to modify than machines.

One of the basic philosophies of ergonomics is the primacy of people over machines. The idea is to adjust the machine, not the man.

This is in contrast to a common engineering philosophy of designing a machine, then assuming the personnel department will be able to find someone to be able to run the machine. Thus:

- Adjust the machine to the man, not the man to the machine.

An alternative statement is:

- Adjust the procedure to the person, not the person to the procedure.

### **PROFESSIONAL BACKGROUND OF ERGONOMISTS**

As might be imagined, the professional background of ergonomists is very diverse. As a very broad split, ergonomists are divided into those interested in product design and those interested in occupational ergonomics.

The ergonomists interested in product design, however, usually are not designers or engineers but staff consultants to designers. Very commonly, they will have a background in psychology— usually a M.S. or Ph.D.

The ergonomists interested in occupational ergonomics include consultants. More commonly, they include industrial engi-

neers, medical practitioners, and safety specialists. These occupational ergonomists tend to have a small amount of training in ergonomics (50 to 100 classroom hours) grafted onto a basic specialty such as industrial engineering, industrial hygiene, occupational medicine, etc.

The occupational ergonomists tend to have BS degrees. (During the 1950's and 1960's, ergonomics was the province of the Ph.D. In the 1970's, it changed from a science to a technology. Ergonomics knowledge was obtained by those with M.S. and B.S. degrees. In the 1990's, training materials are beginning to appear for blue-collar workers.)

There are many professional homes for occupational ergonomists in the USA. The largest ergonomics society, the Human Factors Society (HFS), has "technical interest groups" for Safety (582 members as of January 1, 1990) and Industrial Ergonomics (506 members). They are the second and fourth largest of the seventeen interest groups in the HFS.

The Institute of Industrial Engineers has an Ergonomics Division of about 1,050 members. The International Foundation for Industrial Ergonomics and Safety has about 300 at their annual meetings. There is considerable interest in ergonomics in other organizations (National Safety Council, American Society of Biomechanics, etc.).

Ergonomics is widespread outside the USA. There are 18 countries that have an ergonomics society belonging to the International Ergonomics Association (IEA), as well as some countries that have not yet joined the IEA. Total membership is about 15,000.

## AGRICULTURAL SAFETY AND HEALTH CHALLENGES

As a broad generalization, safety and health problems can be divided into three categories:

1. **Injury:** An accident causes an injury. The time frame is short—a "sudden event." An example would be a hand mangled in a power takeoff or a burn from a grass fire. It enters government statistics for deaths, lost worktime, medical treatment other than first aid, loss of consciousness, restriction of work or motion, or transfer to another job.
2. **Cumulative trauma:** The body (muscles, ligaments, joints) suffers "insults" over a time period usually measured in months or years. Examples would be carpal tunnel syndrome, back injuries, or hearing loss. In general, the problem is due to a "physical" agent (weight, noise, vibration) or motion of the human body itself. In government records, cumulative trauma (also called repetitive strain, occupational over-use syndrome) is considered an illness. Back problems, however, are considered injuries.
3. **Illness:** An organ of the body is injured, generally by a chemical or a biological agent. The time period is variable, with times of minutes (acute) for skin irritants and allergies to years (chronic) for silicosis and occupational cancers.

Note that the present government statistics do not have this division into three categories. Present statistics are divided into injuries and illnesses.

Most of the cumulative trauma problems are in the illness category although back problems are considered injuries. Figure 2

shows how cumulative trauma has become a larger percent of reported illnesses.

Table I gives, for agriculture, injury and illness statistics for 1988 (last data available). A key point is that, although cumulative trauma is increasing in importance among illnesses, total injury cases (per 100 workers) are about 20 times more frequent than total illness cases.

## ERGONOMICS FOR AGRICULTURE

As pointed out in the previous section, the major problem of safety and health is safety. Although ergonomics has a broader orientation than just safety, two ergonomics concepts will be discussed in relation to safety.

Table I. Injury and illness statistics per 100 full-time workers for agriculture in 1988.<sup>2</sup>

	Agricultural		Forestry
	Production	Services	
	▼	▼	▼
<b>Injury</b>			
Total cases	11.7	9.2	11.9
Lost workday cases	6.1	5.0	6.3
Non-fatal cases with-			
out lost workdays	5.6	4.2	5.5
Lost workdays	108	91	136
<b>Illness</b>			
Total cases	0.54	0.45	0.47

Focus on unsafe conditions, not unsafe acts. Most accidents and injuries can be considered to be a result of either unsafe acts or unsafe conditions. For example:

- A farmer is injured when a tractor tips over on a slope. The injury could be considered to be from the tractor having a

McCarthy et al.<sup>4</sup>, after reviewing 400 papers, reported that there is very little evidence that warnings work—that is, change behavior. Any cigarette smoker emphasizes this point. There are literally thousands of warnings about the dangers of smoking. Yet, people continue to smoke. The acronym Present, Read, Understand, Memory, Act, Effective (PRUMAE) points out some of the challenges.

**P (Present):** The warning must be present. If the warning is in an instruction manual, which has not been seen, the warning cannot work. If the warning originally was a label on a machine, but the label is gone, there is no warning.

**R (Read):** The next problem is to get the warning read. People find many excuses not to start reading material. (If all else fails, read the instructions.) If they start, they often skip many parts of the text. We are surrounded by a barrage of messages in newspapers, TV, billboards, etc., and learn to filter them out. Most injuries concern rare events so there is no reinforcement from not following the warning. (Remember how in "Peter and the Wolf," Peter ignored repeated warnings about the wolf and nothing happened to him for a long time until the last time.) Try to make the warning "stand out" of the background.

**U (Understand, comprehend):** The reader may not understand the warning language (e.g., a Mexican reading English). Even if the reader "knows" the language, the words may be "too big." Pictographs are an attempt to reduce this problem. Unfortunately, some of them are as intelligible as written Chinese. That is, pictographs are another language that you may not understand. Understandability can be improved with grammar and layout of the message. The warning can be divided into four statements: signal, hazard, consequence, instruction. For example: "DANGER, HIGH VOLTAGE WIRES CAN KILL, STAY AWAY"; or "WARNING, CONTAMINATED WATER, ILLNESS MAY RESULT, DO NOT DRINK." The "hazard" statement is the most important. The "Signal" word and the "Consequences" may be redundant information to informed users.

**M (Memory):** Once motivated to input the information to the brain, the person now must commit it to long-term memory. Then, upon need, retrieve it. Easier said than done.

**A (Act):** Upon retrieving the information from the brain, the person now must translate this into action. An important point is the cost of compliance. For example, complying with a warning "Don't use broken door" was 94 percent if another door was adjacent, 6 percent when another door was 50 ft. away, and 0 percent when another door was 200 ft. away. Reducing the cost of compliance (reducing the cost/benefit ratio) should improve compliance.

**E (Effective):** The person then needs the necessary ability to do the desired behavior and then the skill and training to do it effectively.

For a warning to work, all six steps must succeed.

**Box 1. Warnings.**

high center of gravity or from an unsafe act of the farmer (farmer makes too sharp of a turn).

- A farmer is injured on a power takeoff. The injury could be considered due to an inadequate guard or an unsafe act (farmer fails to maintain the guard).
- A farmer falls from the second floor of a barn. The injury could be considered due to an inadequate railing or an unsafe act (farmer tripping over tools on the floor near the edge).

To reduce future accidents and injuries, the best approach is to consider all accidents as due to unsafe conditions. That is, the "machine" is at fault. The "machine" should adjust to the "man," not the converse. If the man had "problems," then the "machine" or procedure should adjust, not the man.

Psychologically, the "machine is at fault" approach results in a positive approach to solving the problem. If a "man is at fault" approach is used (i.e., the accident was due to an unsafe act), the problems of changing human behavior seem so overwhelming that often nothing is done.

There is a need for research on how to get people not to commit unsafe acts. Why do people do things that they know are unsafe? And, an even more difficult problem, how can their behavior be changed?

### **FOCUS ON DESIGN RATHER THAN USE TRAINING OR WARNINGS**

A safety challenge can be reduced by warnings, training, or design. For example, a farmer could fall into a silo. One possibility is to warn the farmer against falling into the silo. The second possibility is to

train the farmer not to fall into the silo. The third possibility is to redesign the procedure or machine to prevent falls.

#### **• Warnings**

Box 1 discusses warnings in more detail.<sup>3</sup> The key point is that warnings do not work well. Many things have to occur for the warning to work.

Another problem with a warning is that it is a temporary solution, not a permanent solution. That is, each person exposed to the danger must be warned and the warning must be repeated over time, or it is forgotten.

#### **• Training**

Training can be effective, but it is expensive since everyone exposed to the danger must be trained. It is difficult to give training to "visitors" and "bystanders." Another problem of training is that it is temporary and must be repeated over time, or it is forgotten.

#### **• Design**

Designing out the problem is the best approach because it is a permanent solution. For the silo problem, design solutions might be a safety harness or railings.

It may help acceptance of design solutions to focus on the annual capital cost rather than the initial capital cost. For example, railings may cost \$500 but then last 25 years. Give the cost as \$20 per year rather than \$500.□

## REFERENCES

1. Konz, S. *The Rise of Ergonomics, Proceedings of the Int. Ergonomics and Safety Conference*. Cincinnati, London: Taylor and Francis, 1989.
2. *Occupational Injuries and Illnesses in the United States by Industry, 1988 (Bulletin 2366)*. Bureau of Labor Statistics: Washington, Supt. of Documents, August 1990.
3. Konz, S. *Work Design: Industrial Ergonomics*. 3rd edition, Scottsdale, AZ: Publishing Horizons, 1990.
4. McCarthy, R., Finnegan, J., Krumm-Scott, S. and McCarthy, G., *Product Information Presentation, User Behavior, and Safety. Proceedings of the Human Factors Society*. 84—85, 1984.

## PERSONAL PROTECTIVE EQUIPMENT

By Richard A. Fenske, Ph.D., M.P.H.  
Associate Professor, Industrial Hygiene Program  
University of Washington

Dr. David S. Pratt: The next speaker is Dr. Richard Fenske. Dr. Fenske received both his Master's in Public Health and his Ph.D. from the School of Public Health at the University of California at Berkeley. Following his preparation there, he spent six years on the faculty at Rutgers University in New Jersey and worked with the Agricultural Experiment Station in New Jersey. Recently, and I must say to the lament of the agricultural community of New Jersey, Richard has left and is now with the University of Washington, School of Public Health and Community Medicine. Dr. Fenske is going to talk about *Personal Protective Equipment*. Dr. Fenske:

I am going to talk about—and I was a little daunted by being the only person to talk about a subject this broad—personal protective equipment. I have done research in this area, but as all of us who do research know, we know a lot more about the particular problems that we have studied than the general issues that might be raised by all of the farming activities in the United States.

As a result, this talk is going to focus more or less on applicators and, perhaps, field workers and their exposure to pesticides and the use of protective equipment under those circumstances as opposed to, say, the use of such equipment in silos or in swine confinement and all the other kinds of activities that are involved.

The pesticide application problem and the residue problem with harvesters tend to be, in some sense, generic—not that there are not differences across the regions. The processes have some similarities, and we are able to make some general statements about the use of personal protective equipment during these kinds of activities.

### WORKER PROTECTION STRATEGIES IN THE AGRICULTURAL WORKPLACE

I am going to start out by discussing a lot of options other than personal protective equipment. In industrial hygiene and in occupational health in general, we tend to talk about controls of exposure or hazards in terms of a hierarchy that involves engineering, administrative controls, and personal protective equipment.

This hierarchy is actually explicitly addressed in the Occupational Safety and Health Act, and this point has already been made earlier—that the best solution is to engineer the hazard out of the process, if we can do that. Increasingly, regulators have turned to personal protective equipment because given the kinds of risk assessments that are being produced for pesticide applicators and field workers, under current practices, it would appear that many compounds could not be registered if we were not using personal protective equipment.

I am going to be a little bit critical of this point of view, but at the same time sympathetic to the dilemmas that are faced by regulators and by farmers who have a



pressing need for certain chemicals to be registered at the present time. Let us go through these options before we get into our main subject.

### **Engineering Controls**

Regarding engineering controls: we have already had some examples of closed mixing and loading systems. I think this is an understandable concept. If we can avoid direct contact of the worker with chemicals, we are going to reduce the hazard.

We can have applications conducted with closed tractor cabs. If these types of systems are used properly, they do tend to reduce exposure among the workers. We can also have changes in the way in which we conduct the applications.

Quite a bit of research is going on in the way of agricultural engineering, attempting to get more of the material on the target and less as drift and on areas of the environment where we are not interested in having the compound. We can also make innovations in formulation.

Microencapsulation comes to mind as a good example of a formulation technology that gets the active ingredient out there, but in a much less hazardous form. So there are many opportunities, if we are creative, to reduce the hazard before we ever have to worry about personal protective equipment.

### **Administrative Controls**

In terms of administrative controls, I think one that is given a lot of lip service but, I know from my own experience, does not get much funding is integrated pest management. That is selective use of agricultural chemicals and the use of other kinds

of pest management processes. This, obviously, reduces the hazard of chemical exposure.

I might add to this list alternative cultivation practices. One of the interesting points in the earlier talk had to do with the evolution of farming practices, from subsistence to specialization. With that specialization comes the need to use increased amounts of chemicals, given monocultural agricultural systems.

I think a lot of farmers actually are taking a second look at this. Mixed cultivation, rotation of crops and such, is a means of reducing the use of chemicals. It is cost-effective in some cases, and it certainly reduces the hazard.

So there are many opportunities, if we are creative, to reduce the hazard before we ever have to worry about personal protective equipment.

Product substitution: EPA is trying to find safer substitutes for the kinds of compounds that we use in the agricultural work place, but given the review process and the complexities of the regulatory process, we know this is very difficult. Also, at this stage in the game, to create a new chemical, a chemical manufacturer has to invest literally tens of millions of dollars prior to that compound coming onto the marketplace.

It is a very risky game at this stage for chemical manufacturers, and we have seen a thinning out of the industry. A number of agricultural chemical companies have disappeared from the scene in the last five

to ten years because of this kind of pressure.

Of course we have worker education and training, something I think is being discussed quite a bit in this (conference). We are going to talk a little bit more about how important that is for personal protective equipment. It is a control that can be exerted to reduce hazards that can be quite effective. Of course, when you are talking about agricultural field workers, people who enter fields that have been treated and may come into contact with the residues, we do have a formal administrative control called a re-entry interval. I believe, EPA is changing the name of the reentry interval to restricted entry—a period of time during which no one is allowed into a field so as to allow residues to decay to an acceptable level as judged by a risk assessment process.

### Personal Protective Equipment

Our third and, one should say, final resort: In general in industrial hygiene, it is considered that personal protective equipment is the final resort and also a temporary resort.

No one may consider that temporary may mean years of time to bring a new engineering control into the marketplace to avoid the use of these things, but I think philosophically we need to treat personal protective equipment as a stop-gap measure, however necessary it may be today, and try to look beyond the use of this equipment to some process that does not require the need for this equipment.

The first question to ask about personal protective equipment is, "Can we make equipment that does the job?" I think the

answer is—with American ingenuity behind us—yes, we can. We have seen it done.

For workers conducting some mechanical operations on the moon, their protective equipment is doing a very good job of protecting them from absolutely nothing. In this sense that is profound, for without these suits there would be a hazard, indeed.

We put these same kind of suits on workers right here on earth. If you can imagine yourself working for eight hours a day under these circumstances, I think you can immediately see some of the problems associated with protective clothing. Cumbersome, etc. We will detail some of these.

Now, in the agricultural work place, unfortunately a farmer's view of farm work is this. I point out this fellow who is dressed like a true westerner. This is a picture in South Dakota. (Slides are not illustrated.)

My experience in working with farmers throughout the United States is that this is their image of themselves, not of the previous slide of a hazardous waste worker or some other kind of specialist in chemical hazards, because the use of agricultural chemicals, which are acutely or chronically toxic, is only one relatively small part of the job of being a farmer. I think we have some farmers in the room who can attest to that.

These workers would much prefer to be dressed like this during their work, or with short sleeves, or whatever and leather boots: all the things we tell them they cannot do when they are working with pesticides. That is the reality, and I think it is quite a legitimate point of view. I

would rather work like this than work in the kind of gear that I showed you before.

Now, we can dress workers up to wear equipment, and they can use it properly. That is clear. We have gloves; we have a nonwoven coverall; and we have a mixing process here going on. But we know that lots of workers would rather dress like this when it is 90°F, 90 percent relative humidity in Florida, in July.

You can see the open shirt, no gloves, no rubber boots—just jeans. Mixing. Loading. Exposure under these conditions with an open loading system like this is inevitable. The issue is a balance between protection and comfort. It is very hard to persuade workers in these environmental conditions that protection is more important than comfort.

We can get workers to put on suits, but sometimes they do not wear their gloves. In some cases we can get people just loading, putting on their respirator but seeming to be totally oblivious to the fact that some of these compounds go through the skin and the dermal route of exposure is a very important one.

Here we have someone dressed in his street clothes with no gloves, loading 50-pound bags of an organophosphate insecticide—I might add with the propeller blade running. I use this in class. How many things are wrong with this picture? So we do have problems in education and communication, in awareness of hazards.

Here we can have someone who looks like he is dressed up just about as well as we are going to do it: rubber gloves, a full coverall, respiratory gear, some kind of cap anyway—but then we find him doing some

strange things. He only wants to use a portion of his bag.

He has ripped open the bag, measured out a wettable powder in the breeze, and turned out to be the highest-exposed person in the study we were conducting, despite all his protective gear on. He is doing something that he should not be doing, but no one is going to go there and enforce any regulation on him.

Then we have people right here in the state of Iowa who will tell me that since they are just mixing an herbicide, and it is not toxic—and they mean acutely toxic, of course—that they do not need to wear gloves or protective clothing.

Then we have people out on the bean buggies spraying herbicides in the soy bean fields who are dressed without a thought to personal protection. Here we have to consider that this young woman is a pesticide applicator who is trying to get a suntan at the same time, working quite a bit at odds with our idea of personal protection from skin exposure.

We have a wide range of people to consider and to protect, and we should remember—I think it is obvious from this conference's emphasis—but these children are pesticide workers. They are agricultural workers too, exposed to pesticides in the fields behind them.

They are ready to go out and do some harvesting and will inevitably come into contact with pesticide residues. All of these people in some way or other have to be helped, and protective clothing is not necessarily going to do the job.

## **PERSONAL PROTECTIVE EQUIPMENT**

### **Limitations**

Here are some of the limitations that I see as important for using protective equipment. In general, whatever it is gloves, respirators, or these whole-body garments—it is uncomfortable. That decreases your ability to do and enjoy the work that you are supposed to be doing.

If you are wearing a respirator, it puts stress on your respiratory system, which can be a problem. You lose dexterity when you use gloves.

A whole-body garment that is nonwoven cannot breathe, and can cause heat stress. All of these things are very well known, but I am recounting them because I think they are all important to keep in mind.

### **Use Requirements**

Some people would argue that it is easier to use protective equipment than to do the administrative or engineering control. In fact, if you have a good protective equipment program, it is not easy at all. You have to deal with training your personnel. That is not a one-time thing. It is a continuous process.

You have to determine that people are using the equipment you have given them, using it properly. The equipment has to be maintained.

Somebody has to be made responsible for the maintenance. Is it the worker? Is it the employer? Who takes care of this? Equipment has to be replaced.

A judgment has to be made about when it is replaced. That judgment is often made

on the basis of economics rather than on the basis of safety. We have a whole host of things where it is unclear whose responsibility it is for all of these items. That is a problem in itself.

### **Selection Criteria**

Let us look at respiratory protection first and then we will go to other kinds of protection. When a respirator is required on a pesticide label, a process has gone on at the regulatory level.

A toxicological evaluation of a particular compound has been conducted. A permissible exposure limit has been calculated. To some extent, an estimate of what people are actually exposed to has to be generated. If it appears that one needs a respirator—that the hazard is sufficient to require a respirator—then it has to be decided what kind of respirator deals with the particular associated hazard.

Is it an aerosol? Is it a vapor? Are we talking about large dust particles? This all is a complicated regulatory process, but we have it pretty well worked out.

### **Respiratory Use Requirements**

Now, at the use level, there are some very important things to remember, and again, they complicate the use of protective clothing. When someone is using a respirator and conducting labor, they need to be tested in terms of their respiratory capacity to make sure that that respirator is not going to put excessive stress on them. The issue of fit testing, which is commonplace in industry in a work place that is well-defined and may have an industrial hygienist on staff, is very problematic out in the agricultural work place.

Who does the fit testing? Most farmers do not know how to do fit testing. Fit testing actually can become quite a sophisticated process. My experience is that there is no fit testing in practice going on in agricultural workplaces. So, if the respirator does not fit, it is not an effective means of reducing hazard.

Then we have the inspection and maintenance of this equipment. Most farmers and farm employees are not in a position to decide if a respirator is no longer in good condition.

Finally, one problem with the kind of cartridges that are traditionally used on pesticide respirators, for example, is that you never know when they are saturated. They have a finite capacity, and a lot of farmers change them once a season.

Some do it by smell, which is a real problem because the hazard usually occurs prior to the odor threshold. We do not have a good system for that.

All of the responsibility for these things is placed on people who are very busy doing something quite different; they are producing food. They are dealing with crops. They are mechanics.

They are all the other things that we have talked about, and here they are also having to be experts and specialists in protective clothing evaluation. It is a big problem in terms of a realistic expectation that we place on people.

## **CHEMICAL PROTECTIVE CLOTHING**

If we turn to what I am calling chemical protective clothing, where we are talking primarily about garments that cover the

skin and attempt to put a barrier between chemicals and the skin.

## **Regulatory Selection Criteria**

We go through a similar kind of regulatory selection criteria with a toxicological evaluation and exposure scenario, making sure that the particular material matches the kind of exposure. There is an infinite variety of combinations of material and hazards. One material is fine against one chemical, but is readily penetrated by another. EPA has worked on a very complicated process in the last few years, but they would be the first to admit that there is a lot more that needs to be done.

**Cost and availability:** A lot of farmers do not know what is out there. Also, it looks like it has a pretty high price tag, especially the nonwoven coveralls that have become popular.

They are supposed to be throw-away garments. It is very tempting not to throw those garments away but to use them over and over again, because they can be expensive.

**Worker acceptance:** It is fine to give a worker one of these garments, but he may not be wearing it if he is under your supervision. Once he is out of sight he may not be wearing this garment properly. We have seen plenty of evidence of that out in the field with zippers pulled down, coveralls with the top part tied around the waist—all sorts of ingenious ways of keeping cool under the kind of work that these workers do.

## **Testing**

If you are interested in research for a lifetime here is an area where there is

plenty of work. We have all agreed that there is no such thing as an impermeable garment, and it is a very important concept to get across.

This breakthrough is a function of time. Some garments may be impermeable for days or weeks, but they are not infinitely impermeable, and breakthrough time has become a primary criterion for testing garments.

We have standard laboratory tests, which are actually quite good for testing breakthrough times. Whether this simulates field conditions or not—actual use conditions—is open to question. We only have limited field performance tests, and we need more of that kind of work if we are going to say to farmers, "Wear this garment. It will reduce the hazard that you face." I think there is a serious question at this point as to whether we can make that statement or not for very many garments.

## FIELD PERFORMANCE EVALUATION

### Orchard Applicator Exposure

What I would like to show you is some work that we have conducted down in Florida the last few years—a very short summary of it—that gives you a couple of examples of why I am expressing skepticism about the use of chemical protective clothing. We conducted a study under EPA sponsorship in the citrus orchards in Florida.

But this is the kind of application process called an air-blast applicator—a tractor-pulled rig that has 1,000 gallons of material that is sprayed to basically saturate these trees to provide complete coverage. It is a very high exposure potential

situation for the worker who is sitting there in an open cab and can end up taking a shower.

We were specifically testing a couple of nonwoven coveralls to see if they could improve the situation for these workers. Workers did not like them very much, but they were willing to wear them for our half-day study period. We found some problems with these garments very quickly.

They were not designed to step on and off tractors. One gentleman, within 30 minutes of wearing this garment, ripped it. He is about 40 minutes from his home base. So if he does not have any spare clothing, he has a problem. He has less protection than he would have had had he just been wearing his regular clothes.

Another fellow had the same problem. He was reaching up to work some equipment. It turns out that these garments do not have a lot of play in them. They are used to working in cotton, so maybe this is a problem that can be addressed eventually, but it certainly was a startling one for us to see for these workers.

We use a technique that introduces a fluorescent material into the spray system and then allows us, under black lights and darkened conditions, to see patterns of exposure on the skin. We saw some interesting ones here—and unexpected ones.

Here you can see that this worker was not wearing gloves and there is material on his hands. This person was wearing a long-sleeved garment and look at this material that goes up here. You can see the material goes all the way up to the elbow, and yet he is wearing a longsleeved garment.

This person is even more impressive. We had material on his hands, quite a bit on the forearm. Here is the elbow. Material went up the elbow. We actually saw material down around the armpit of this worker—material that was being blown right up the sleeve of these garments.

I do not know if you noticed in the previous slides, but these garments have rather large sleeves. They are made as one-size-fits-all.

Of course, having an open sleeve allows a certain amount of ventilation, since the garment does not breathe, but it also allows a lot of material to be blown right up the garment and onto the skin. We also saw cases of actual breakthrough of these garments.

You can see here material that went down through the neck, but here is material on the upper arm that was quite isolated and was evidence that the garment had broken through—and this was in about a two-hour spraying period. He might wear this garment for eight hours a day. So the breakthrough is happening relatively early.

When we use this fluorescent technique, we develop an exposure score when we attempt to quantify this. I show you this as a baseline for four types of garments: a work shirt, a woven fabric that is a cotton coverall, and two different types of nonwoven fabrics that we were testing.

We measured the exposure to the head, and we saw that, more or less, these workers were getting the same type of exposure. We had controlled the conditions, and we expected to see this. This more or less confirms it. This is the head exposure, and you can see that it is substantially higher than the exposure to the torso—the trunk

of the body. But, again, the exposure in this region seems to be very similar.

Look what happens when we take a look at the forearms, which are the white bars, and the upper arms, which are these other bars. We have an actual increase in exposure as we move from a work shirt up to these nonwoven garments. That is simply a quantitative verification of what you saw in those slides.

In the cases where people were wearing these nonwoven garments, sleeve openings allowed substantial material to move up and deposit on both the forearms and the upper arms. You can see the same trend. So, actually, the woven garments proved to be more protective under these particular conditions.

Now, you can seal up the sleeves and you can prevent these problems, but unfortunately most of the garments are designed without any kind of seal on them; and most farmers are unaware of this kind of problem.

When we looked at exposure to the thighs, using patches above and below the clothing, here again we found something very interesting. Although for the work shirt material—I guess this was for the torso—there seemed to be a little bit more penetration. We could not make any distinction, between the cotton coveralls and the nonwoven coveralls.

What is important is that all of these garments were breaking through. There were measurable residues of pesticides underneath virtually all of these workers after a two-hour application period, and that is a small fraction of their normal application period.

The problem that I see, and I am going to illustrate it with another study, is that the workers believe, because we tell them, that they are receiving protection by wearing these garments. This study at least suggests that under these particular conditions, they were not receiving any greater protection, and for the arms they were actually receiving less protection than if they had been wearing cotton garments.

So our conclusions from that study were obvious:

1. Nonwoven fabrics tear.
2. The garment design is the problem in terms of the arm exposure, all of these garments exhibit penetration.
3. These are important findings in terms of trying to evaluate these clothing articles realistically.

### **Greenhouse Applicator Exposure**

The second study had to do with greenhouse application and was funded by NIOSH. We had a problem that we did not anticipate. We were traditionally looking at the applicator as spraying an aerosol. We were worried about the aerosol deposition. Would it penetrate the clothing?

We ran into a different problem—that the foliage in these greenhouses overhangs the benches. The worker comes into contact with that foliage, and we knew from other studies that the clothing gets some contamination on it. Here is a worker spraying in a greenhouse wearing blue jeans and a workshirt, and he is brushing up against that material when he bends over the bench.

We did our fluorescent tracer technique, and this is a real useful slide for male workers, when you point out to them exactly where they are getting exposed. It motivates them to think about what they are doing.

Also, if they wear this clothing home, this becomes their lap, and that is where their child sits. When you tell them this, they really do think about it, and we have seen some startling changes in behavior.

I think what we found that was even more interesting is that when you have a worker dressed up in one of these garments that is nonwoven and is advertised as protective, we see a breakthrough within one hour of spraying. These are the knees and the material is clearly associated with the height of the bench and the foliage where the contact is occurring.

You can see that it was very extensive, virtually all the way up to the top of the thigh, down to the knee, and halfway down the leg on both the front and the side of both of the thighs. This is a substantial body surface area, and when we talked to the worker about this, he had no idea that this breakthrough had occurred.

He is wearing basically a plastic garment. He is sweating underneath that garment. He is unaware that there is moisture traversing that garment and contaminating his legs.

We stopped him after one hour. He normally sprays three or four hours a day and uses this same garment all day and tends to use one garment for three days before he throws it away. This breakthrough is occurring in less than one hour. We clearly had a problem; the greenhouse where we did this work has certainly made some



changes in terms of the protective clothing that they offer their workers. They were quite happy to find this out.

Our conclusions were that:

1. There is a particular hazard of contact with wet foliage.
2. The breakthrough can happen relatively quickly.
3. Workers are unaware of the breakthrough.

Unfortunately exposure is a very complicated issue. Unless we do these kinds of field studies, which tell us which clothes perform in what way under what particular conditions, it is difficult for us to give good advice to farmers regarding the use of chemical protective clothing.

### **AGRICULTURAL WORKER PROTECTION STRATEGIES**

To sum up, I think that we can look at the problem in two different ways.

#### **Adapt the Worker**

We can adapt the worker to the work place—and in the greenhouse, unfortunately, given the economic constraints, we cannot convince greenhouse growers to move their benches further apart. It is very expensive to operate a greenhouse, and they want as many plants in that building as possible.

So, the worker is going to come into contact with that material. That is an example of where we cannot adapt the work place. The worker is going to have to somehow adapt to the work place.

#### **Adapt the Work Place**

There are, however, opportunities to adapt the work place to the worker. I would suggest as a general strategy that we think about it in these terms.

I think the commercial applicator whose livelihood depends on this and who, in a sense, becomes through practice an expert at the use of hazardous chemicals, is a legitimate candidate for requiring protective clothing and requiring a high level of training, knowledge about the use of the clothing and such—all the ingredients that I talked about that make personal protective equipment so complicated.

When it comes to these other groups—the owner applicator, our family farmer whom we talked about, or the worker who occasionally applies but is doing 90 other things on the farm, or the agricultural field workers who are walking into a field after spraying has been conducted and are assuming that it is safe because their employer told them they could—we have to develop, long-term strategies to adapt the work place to those workers to create a safe and healthy working environment for them.

We are a long way from that, I admit, and protective clothing can, under particular circumstances, serve an extremely useful role. I do not think it is going to serve us as a long-term strategy.

I am quite hopeful that with the kind of work that we have talked about in this conference and the kinds of initiatives that NIOSH has taken recently, we are going to see more work directed at solving some of these problems higher up on the scale—that is in the engineering and administrative

sides—so that we can ultimately reduce our reliance on personal protective equipment.□

## QUESTIONS

George Cook: I am George Cook, University of Vermont Extension System. Those slides showing the breakthroughs through this supposedly protective clothing—are there any recommendations as far as what people should use?

Dr. Richard Fenske: I want to clarify that what I have presented here are specific hazards that produced that. If you are thinking about greenhouses and the contact with wet foliage, people have gone to using—in Florida—overalls that are basically rubber or polyvinyl chloride. They are quite thick and are resistant to water penetration. That is one recommendation that we worked out with those commercial growers.

The EPA has spent the last five years developing a document for their use in terms of recommending personal protective equipment to users. I think EPA is going to have a data base that is primarily based on laboratory data but also a review of field studies. That is going to be our best evidence. Unfortunately, the answer to your question is that there are no guarantees that the use of this material that has been tested under particular circumstances may or may not be appropriate under other circumstances.

Thomas Seymour: Could you describe the fluorescent material you added into the material, as to its particle size and so on? Did it enhance penetration or permeation, or do you know, in looking at some of the material tests, whether it had any effect one way or the other on the performance of the material itself?

Dr. Richard Fenske: Well, we have not extensively tested that particular tracer compound with materials in a laboratory setting. We have done quite a few field studies with it. It is a fluorescent whitening agent that, in some cases in the past, has been added to plastics to make them bright or to laundry detergent. It is a powder. It is partially soluble in water. We mix it into the aqueous system. The fluorescent material and the active ingredient of the pesticide are being sprayed onto a surface, and we can only confirm that the pesticide penetrates through these garments by doing chemical analysis with samples underneath the garment. We have done such and found the pesticide. It is not necessarily true that this is an exact surrogate for any particular pesticide. We have approached it more from a generic point of view. But we have confirmed repeatedly that when we see this material going through a garment we, indeed, can find the active ingredient under that garment as well.

(inaudible): You are taking a sample of the material (inaudible) material (inaudible) pesticide (inaudible) look at how it penetrates as a mixture. Is there any synergism there to actually enhance permeation or is there any difference (inaudible) breakthrough (inaudible)?

Dr. Richard Fenske: That is certainly worth investigating. It has had a rather low priority because the concentrations we are using are very low. I think from a chemical point, having spoken with chemists about it, there was no feeling that there would be that kind of an effect.

## MACHINE DESIGN

By *Sverker Hoglund, M.D.*

Director, Swedish Farmers Safety and Preventive Health Association  
Stockholm, Sweden

Dr. David S. Pratt: It is a distinct pleasure to introduce now, Dr. Sverker Hoglund. Dr. Hoglund grew up on a farm in northern Sweden, completed his education as a physician, and went on to obtain specialty training—first in hematology and then in internal medicine and occupational health. He is currently an Associate Professor at the Institute in Stockholm, and he has worked actively in occupational health since 1974. In 1980, he became the Medical Director of the Swedish Farmworker Safety and Preventive Health Association—a very important model I think many of us could learn a great deal from. He is currently also the First Vice President of the International Association for Agricultural Medicine and Rural Health and also the Secretary of the Scientific Committee on Occupational Health—a part of the International Commission. Please welcome Dr. Sverker Hoglund from Stockholm:

Agriculture is a risky operation. Statistics from many parts of the world show that accidents and work-related diseases are frequent among farmers and agricultural workers.

Often, however, statistics are insufficient because farming, in many countries, is based on small enterprises run by the farmer, his family, and few employees. The ambition to report accidents and other health injuries is probably limited.

In Sweden severe accidents causing fatalities are, fortunately, rather few in agriculture. However, compared with the total worklife in Sweden, it is obvious that farming is over-represented among fatalities due to work accidents.

It has been shown that about 20 percent of the fatal accidents in Swedish worklife occur within agriculture and forestry. Only about 3 percent of the total workforce are occupied within this field. Recent studies in our organization have shown that the real incidence of work accidents is about twice what is reported from official statistics. Moreover, work-related diseases have

been shown to be common among farmers and agricultural workers.

Forestry work by self-employed farmers is the most risky operation in the total worklife in Sweden. Work injuries, as well as work-related diseases, are to a high extent related to agricultural work using different kinds of machinery. Machine design, therefore, is an important factor to consider.

### THE PROBLEM

Machine design may be related to hazards of two kinds. One is accidents causing acute injuries. The other is chronic injuries or illnesses because of long-term, unfavorable effects on the body during work operations. Symptoms from the locomotor organs are most common because of bad ergonomics, vibrations, etc. Hearing loss due to damaging noise is also very frequent.

### Accidents

In Sweden, approximately 150,000 persons are occupied within agriculture and forest-

ry. However, only about 50,000 are occupied full-time at this.

According to official statistics, about 6,000 work accidents occur yearly. This information is based on the reports of injuries for workers' compensation. The compensation is less well developed for the self-employed farmer. Therefore, the ambition to report accidents is less strong.

During 1988, the Swedish Farmers' Safety and Preventive Health Association studied 20,000 farmers concerning work injuries that had occurred during 1987. The study was performed as a postal inquiry and a telephone interview with those who had reported an injury in the inquiry.

Machine design may be related to hazards of two kinds. One is accidents causing acute injuries. The other is chronic injuries or illnesses because of long-term, unfavorable effects on the body during work operations.

From the results of this random sample, an estimation of the total frequency of work accidents within agriculture and forestry among self-employed farmers and forestry owners could be made. It showed that the real frequency during 1987 was at least double that of the official statistics.

The most common cause of agricultural accidents (just above 25 percent) was handling animals. Falling, on the same level or to a lower level, was almost as common a reason for accidents. Machine-related accidents were about 12 percent in agriculture, and in forestry about 20 percent.

Of those accidents related to tractor driving, about 50 percent happened when climbing up and down the tractor and about 35 percent when connecting equipment to and disconnecting it from the tractor. In these respects, the design of the machinery plays an important role.

The turnover of tractors is still an important reason for severe accidents, as is unshielded power takeoff (PTO). Tractor work may also cause injuries driving on uneven surfaces. Headbumps and hits from the inside of the tractor cabin are a risk, as are hydraulic devices with oil under pressure. Sometimes exhaust gasses may cause problems.

One important machine that is commonly used in agriculture and forestry is the chainsaw. It may cause accidents by kick-backs of the sword.

### Chronic Injuries and Diseases

More than 50 percent of the diagnoses at physicians' consultations with farmers concern locomotor organs. Neck and shoulder symptoms, back problems, and hip and knee diseases are common.

A special interest has been focused on hip arthrosis. Recent studies in our country have shown a significant increase of this disease in farmers compared to the general population. The disease occurs about 8 to 10 times more often in farmers. Still, only limited studies have been performed relating different factors in farmwork to the disease.

So far results indicate that there is a positive correlation between tractor work and the disease. One reason might be the design of tractors where, even in modern machines, the driver has to sit in a bent

and twisted position to survey the equipment behind the tractor.

It has been suggested that the twisted position in the tractor chair may cause a rotation in the hip joint. It can also cause unfavorable pressure on the cartilage, which may cause damage.

Other well-known machine-related chronic injuries are, for instance, white fingers caused by vibration in chainsaws and steering wheels on tractors. In farmers and forestry workers, hearing loss is frequent because of noise exposure from tractors and other vehicles, threshing mills, and chainsaws.

## **INTERVENTION**

There is still a lack of knowledge concerning hazardous effects of different environmental factors in agriculture and forestry and further research is needed about causal relationships. However, today sufficient knowledge exists to start to improve the work environment in order to reduce the health hazards. The outline for an intervention program could consist of three main parts.

1. There may be legal actions taken in order to prevent extreme hazards.
2. There should be strong enforcement on constructors, manufacturers, and dealers of agricultural machines in order to improve the working environment.
3. Information and education must be intensified and directed to dealers of machinery, extension service officers (agents), farmers, farm workers, and forestry workers.

## **Legal Considerations**

In most countries there is some legislation concerning work environment and protection from health hazards. The extent to which legislation should be used is always under debate. The ambition is to have as little legal enforcement as possible.

In Sweden in 1959 the law was put forward concerning safety frames (roll-over protection structures) in new tractors. It was also decided that employed agricultural workers were not allowed to work in tractors lacking such frames. Self-employed farmers and family members for many years were excluded from this law and could use old tractors without frames in farm work. A new tractor, of course, had this device.

In 1983 the law was extended to include family farmers. It was later decided that even old tractors had to have frames if they were to be used in agricultural work.

The effect on fatalities due to tractor turnover since the year of legislation was striking. It is obvious that this action from the authorities, unpopular as it might have been, has had quite a significant effect in preventing severe accidents. Side effects of this safety frame law have resulted in proper cabins on the tractors protecting the worker from noise, dust, wet, cold, etc. This is also quite a step forward concerning work environment.

Another example of effective legislation concerns chainsaws. When they came into frequent use, it was soon obvious that they could cause severe damage to the user by so-called kickbacks. In 1971 in Sweden, it was enforced by law that a special protective device should be applied to all saws.

It operates so that when the sword is flung backwards, the device causes the chain to stop. The drop in severe injuries from chainsaw operations is also significant from the time the law was introduced.

### Improvement of Machine Design

Legal actions can only be taken into consideration concerning specific work environment factors causing severe injuries of high frequency. However, many hazards remain where improved design of the machinery could reduce the risk. It is important that occupational health professionals have the possibility to transmit knowledge about health effects of different factors to the designers of machinery, the producers, and dealers. In industry more work has been done in this area, mainly due to efforts from workers, and representatives in trade unions, etc.

In agriculture and forestry, labor unions are weaker and the workforce is dominated by self-employed farmers. The individual farmer has very little possibility to get his opinion known to the machine designers.

One major task for occupational health organizations in agriculture is, therefore, to improve communication between manufacturers and users. When designing new equipment, they must understand the importance of also considering work environment factors.

In Sweden, we have been able to produce a specification of the demands for good and healthy work environments in tractors. It has resulted in a checklist. The work has been performed in close collaboration with the National Institute for Occupational Health, the organization of the machine manufacturers (LELA), and our organiza-

tion. The checklist now also exists in an English version.

It is our hope that it should be accepted and used on a broad international basis. We have planned to invite representatives of tractor manufacturing companies to a seminar concerning this topic a year from now.

There is, of course, standardization work going on internationally considering work environment factors. However, this checklist goes much further and aims to create a work environment that is healthier in all aspects.

We have recently used the checklist performing a test of new tractors from the ergonomic and work environment point of view. The result has been published in the weekly farm magazine called *Land*. It has been very much appreciated by the farmers.

The manufacturers who got many stars for their tractors are, of course, happy. Those with fewer stars have been rather angry with us. We think, however, that it is our job to take this kind of action.

Our experience is that, after the first disappointment and angry reactions, the dealers with less than good results usually come back and ask for our opinion on how they could make their equipment better. This is exactly what we have wanted with our action.

Today it often occurs that a manufacturer of some equipment asks for our opinion when he is planning a new product. When this happens, we think that our work has been, to some extent, fruitful.

To prevent injuries, there is still much to wish for in tractor design. The power-take-off shield is often of bad design and broken in many older tractors, which causes a significant risk.

In collaboration with the Institute of Agricultural Engineering, we have been engaged in the construction of a new device. This seems to be a significant step forward.

The coupling of equipment behind the tractor often causes injuries. The rapid coupling systems, which exist on the market are not ideal and little used by the farmers. Properly used, they cause a significant reduction of work loads and health hazards.

A big part of the injuries related to tractor work occur when the driver is climbing up and down the steps. They are often of a miserable design and get slippery by dirt. Simple devices can improve this.

The chronic diseases concerned with tractor driving are neck, shoulder, back, and hip problems related to the driver's twisted and bent position while controlling the equipment behind the tractor during long working hours. Knee problems are common in tractor driving and are related to too-heavy clutches. As much as 600-700 newtons have been found in new tractors.

In the new ergonomic check list, 150 newtons has been appointed as acceptable. Valmet, the only Nordic tractor constructor, presented a new model a couple of years ago where many of these problems have been considered.

The driver's seat, steering wheel, and maneuvering devices could be turned 180 degrees so that the driver might sit in a backward position when much work had to

be done with equipment behind the tractor. There was no clutch because of hydrostatic driving of the machinery.

Two important improvements from the work environment point of view were achieved by this construction. The need to sit in a twisted position was markedly reduced, and the clutch operation was no longer needed. We need more of this new and brave thinking in the machine design for the future. Because of other technical reasons, the model still is experimental.

It still happens that kickbacks cause injuries concerning chainsaws. A Swedish doctor has constructed a new protection device, which should be more effective. It is now tested. The Swedish firm, Husquarna, is going to provide some models with this new and safer device.

### Increased Awareness

In spite of legal considerations and improved machine designs, there will still be hazards concerned with machine operations. It is, therefore, important, along with other actions, that knowledge about health hazards and how they can be prevented is increased. This is needed among the users of agricultural machinery and also among advisers within different branches of extension services to farmers, and among dealers of agricultural machinery.

It is a difficult task. Farmers are usually very busy and get much information of different kinds. They have very little time to consider different offerings. Written information often is neglected. The motivation to consider information about health hazards is usually low among people who are quite healthy and do not consider accidents a reality.

One way to improve the possibility to get information through is by an occupational health service. In Sweden since 1978, occupational health service for farmers and farm workers has been organized and now covers the whole country.

It has about 60,000 affiliated members. Our customers are offered services consisting of regular health checkups, information meetings, farm visits, short courses concerning specific health problems, first aid, back and neck schools, etc.

They also have access to health care in case of medical problems related to work. It has turned out that the awareness of health hazards has increased considerably during the last years.

The farmers inquire about work-environment factors when they are buying new machinery more than previously. They are also inclined to use the personal protective equipment more frequently. Nurses performing health checks on farmers, physiotherapists, and safety engineers visiting farms pointing out ergonomic details to the farmer on his tractor have golden opportunities to provide information to motivated farmers.

It is also possible to concentrate on one specific problem and to broaden the information by educating advisers to the farmers. An ongoing project is to produce

information materials concerning the new ergonomic checklist and to give the extension service officers and safety engineers education on how to use it in their work with the farmers. Teachers at agricultural schools and dealers of agricultural machinery are also invited to these courses.

## **CONCLUSION**

Today's knowledge about health hazards in relation to machine operations is fragmentary but, in many cases, enough to start prevention programs. Thus, the hazards may be reduced and health and well-being improved among farmers, farm workers, and forestry workers.

Legal actions may considerably reduce specific risks associated with machine design. By influencing constructors and manufacturers, improved work conditions can be achieved.

By effective information and education awareness of hazards, preventive measures can be augmented. A branch-specific occupational health service for agriculture and forestry is a valuable tool in this respect.□



## VECTOR CONTROL

By Robert R. Pinger, Ph.D.  
Public Health Entomology Laboratory  
Department of Physiology and Health Science, Ball State University

Dr. David S. Pratt: We are going to move along to this morning's program with Dr. Robert Pinger. Dr. Pinger got his undergraduate training at San Jose State in California, and received a master's and a Ph.D. from Iowa State University, right here in the great state of Iowa. He has worked extensively with vector control and entomological research both at the National Research Council at Walter Reed Army Institute of Research in '74 and '75, and then also had some tropical experience in Brazil as an associate research scientist at the National Research Institute of the Amazon. Since 1977, a little less tropical, he has been at Ball State University in Muncie, Indiana, and his current research interests include mosquito- and tick-borne diseases. Dr. Pinger's going to talk about vectors and agricultural safety and health. Dr. Pinger:

Farmers, ranchers, and others employed in agriculture are, by the very nature of their work, at significant risk for acquiring certain vector-borne diseases. Some of you may ask, "What is a vector-borne disease?" or, for that matter, "What is a vector?"

A vector is an invertebrate animal, usually an arthropod, that transmits disease from a reservoir of infection to a susceptible host.

What is an arthropod? An arthropod is a joint-footed animal with a hardened exoskeleton such as an insect or a tick. Examples of arthropod vectors are mosquitoes, flies, fleas, lice, and ticks.

Vector-borne diseases are caused by microscopic agents such as viruses, bacteria, protozoans, or worms transmitted by these vectors, usually when they bite. Examples of vector-borne diseases that occur here in the United States include at least four arthropod-borne encephalitides, malaria, dengue fever, Rocky Mountain spotted fever, and Lyme disease.

Before I discuss these diseases, I should like to state that those in agriculture are

also exposed to a variety of arthropod-related health problems. The insects or arthropods are themselves the agents of disease or injury.

In these cases, the arthropods affect health directly, rather than indirectly (as vectors). Direct effects include entomophobia (an unrealistic fear of insects), annoyance and blood loss, envenomization caused by biting and stinging, dermatosis, myiasis, and allergies.

### ENVENOMIZATION

My students are sometimes confused about the difference between biting and stinging.

#### Biting

Biting refers to interactions in which the arthropod uses its mouth parts. Biting insects include, but are not limited to, mosquitoes, horse flies, fleas, lice, and bugs.

Biting arachnids include ticks, such as the American dog tick, the lone star tick, the deer tick, and chiggers. Venomous arach-

nids include the brown recluse and the black widow spider.

### **Stinging**

Stinging refers to interactions in which the arthropod uses its tail (usually a modified ovipositor) to inject venom. Stinging arthropods include bees, such as the recently arrived Africanized honey bee; wasps, including the newly introduced German yellow jacket; and in the South, fire ants and scorpions. Male entomologists, who are easily in the majority, generally enjoy pointing out at a time like this that virtually all of this biting and stinging is done by female arthropods.

Although all too familiar, and at times very annoying, these occurrences are of relatively minor public health importance compared with the disease transmission capabilities of arthropod vectors. Today I will describe some of these vector-borne diseases, discuss vector control strategies and outline personal precautions that can reduce the likelihood of vector-borne disease transmission in the agricultural setting.

## **VECTORS**

We can divide vectors into two major types: mechanical vectors and biological vectors.

### **Mechanical Vectors**

As mechanical vectors, insects can be thought of as contaminators. They carry disease-producing agents from an unwholesome environment, such as septic tank overflow, to a clean environment such as the top of your beverage can or sandwich.

In some rural settings, house flies may become so numerous that they represent a significant health problem. The variety of disease-producing agents that have been recovered from house flies is staggering. The list includes those agents that cause amebic dysentery, typhoid fever, cholera, shigellosis, trachoma, poliomyelitis, and infectious hepatitis.<sup>1</sup>

Another mechanical vector is the cockroach, from which about 40 strains of pathogenic micro-organisms have been isolated. These microorganisms include four strains of poliomyelitis virus, cholera, diphtheria, pneumonia, tuberculosis bacteria, and numerous intestinal protozoans. Mechanical transmission can also occur when a blood-feeding insect, such as a horse fly or stable fly, is interrupted while feeding upon an infected host, then completes its feeding on a susceptible host.

Although mechanical transmission by flies and cockroaches can be of public health concern in some agricultural settings, biological transmission of diseases by arthropods is much more important. In biological transmission, the disease microorganism undergoes developmental changes and/or multiplication in the vector.

There is also an incubation period during which the arthropod is infected but not infectious. It is unable to transmit the disease. After incubation, the arthropod becomes infectious, and remains so for life.

### **Biological Vectors**

Examples of biological vectors include mosquitoes, ticks, fleas, lice, and certain other biting flies. Mosquitoes, the most notorious of all insect vectors, are capable of transmitting at least 3 species of filarial worms, 4 species of malaria, and a large

number of disease-producing viruses. Of the roughly 500 different arthropod-borne viruses catalogued, 249 have been isolated from mosquitoes.<sup>2</sup>

Ticks also transmit a variety of disease agents including those that cause babesiosis, Lyme disease, Rocky Mountain spotted fever, Colorado tick fever, and Powassan fever. Disease agents transmitted by other insects include murine typhus and plague, transmitted by fleas; epidemic typhus and trench fever, transmitted by lice; and a multitude of viruses, bacteria, protozoans and worms transmitted by biting flies and gnats.

On a worldwide basis, vector-borne diseases continue to affect the health of agricultural workers on every continent. In Africa the tsetse fly and sleeping sickness not only cause 7,000 human deaths per year, but also limit cattle production over 10 million km<sup>2</sup>. Therefore, they contribute to the severe protein malnutrition on that continent.

Malaria and mosquito-borne encephalitis affect rice farming in Sri Lanka and elsewhere in Asia.<sup>3</sup> Yellow fever afflicts those clearing forests for farming in parts of Central and South America.

In the United States, most of the vector-borne diseases that have an impact on agriculture and agricultural health are zoonoses, diseases of animals transmissible to humans. Among the best known zoonoses are those caused by four mosquito-borne viruses: the St. Louis encephalitis (SLE), the California encephalitis (CE) viruses, the western (WEE) and eastern equine encephalomyelitis (EEE) viruses. Each of these diseases has its own geographical distribution and pattern of transmission.

While periodic outbreaks of these mosquito-borne viral encephalitides occurred, no doubt, long before the arrival of Europeans<sup>4</sup>, accurate records of outbreaks date only to the 1930's. Between 1930-1945, mosquito-borne encephalitis killed an estimated 300,000 horses and mules in the U.S.<sup>5</sup> Human illnesses were often associated with these epizootics.

For example, in 1941 North Dakota alone reported 1,080 human cases with 96 deaths.<sup>6</sup> During the period 1956-1969, reported human cases of arthropod-borne encephalitis numbered more than 3,000.

In 1975, both SLE and WEE were epidemic and epizootic throughout much of the United States. There were more than 2000 human cases,<sup>7</sup> many of them in farm workers. The WEE epizootic spread into Manitoba, where the importance of outdoor exposure is illustrated by the distribution of 14 human cases.

All but three of these cases were men. Interestingly, all three women who contracted the disease were widows who presumably then did more outside chores than their married counterparts.

Why do we not hear about these diseases anymore? Are they still around?

Let me call your attention to last year's St. Louis encephalitis outbreak in Florida. Although case investigations are still being completed, the first case occurred in Fellsmere, Florida, an agricultural area. At least some of the cases were in farm workers.

The economic impact of this outbreak is still being felt. Disneyworld receipts were off 10-25 percent for October through December. The annual costs of mosquito

control ran \$2-4 million above the normal cost, and there was a \$270 million shortfall in Florida's tax revenue for 1990.<sup>8</sup>

It is true that the current epidemics and epizootics seem less pronounced than those of 50-60 years ago. There are several reasons for this. First, there are fewer horses now than there were in the 1930's and 1940's.

Second, vaccination of many of the remaining horses against WEE and EEE has no doubt contributed to the elimination of large epizootics in horses. This does not explain the decline in human cases, however, particularly when there is no evidence of a decrease in the level of virus activity in nature.

Gahlinger, Reeves, and Milby postulate that changes in people's behavioral patterns have been responsible for the decline in human cases in California. Their study demonstrated that the advent of air conditioning and television substantially reduced exposure to infectious mosquitoes. People were found to prefer remaining indoors during the peak feeding times of the primary vector, *Culex tarsalis*.<sup>9</sup>

Others suggest that the low number of confirmed cases is a product of our disease-reporting system. This phenomenon has been referred to as the "vector-borne disease iceberg."

In this model, we see that most of the cases of mosquito-borne encephalitis are never reported because of misdiagnoses, poor follow-up, and no confirmatory serum sample. Grimstad and coworkers determined that the ratio of reported cases to actual cases in Indiana is about 1:250 for St. Louis encephalitis. The ratio of report-

ed cases was 1:1,000 for the LaCrosse strain of California encephalitis.<sup>10</sup>

Some cases are reported incorrectly as aseptic meningitis or "unspecified viral encephalitis." Cases often end up in this category when no convalescent or follow-up blood sample is submitted. The seasonal distribution suggests, though, that they are, in fact, arthropod-borne illnesses.

A failure in reporting is less likely to occur when there is a severe or fatal case. It is important to note that, in addition to the pain and suffering associated with a severe case, there can be significant medical costs. This is particularly true if the patient is a child who requires many years of institutional care.

Leaving the encephalitides, I want to mention two other mosquito-borne diseases that affect those in U.S. agriculture: malaria and dengue fever. Malaria, transmitted by *Anopheles* mosquitoes, is once again becoming a concern in California where there have been 60 introduced cases in the last 5 years, virtually all in farm workers in San Diego County.<sup>11</sup>

Florida suffered its first introduced case in 43 years in 1990. An introduced case differs from an imported case in that it is one in which transmission occurs within the state.<sup>8</sup>

Another somewhat vector-borne disease that we have thought of in the past as an exotic disease, but which now poses a very real threat to many in agriculture is dengue fever. Health officials are concerned that the dengue fever virus, imported from the Caribbean into California or Florida with the migrant workforce, could also be transmitted within the United States.

This becomes increasingly more likely with the spread of the Asian tiger mosquito, *Aedes albopictus*, which is now considered to enjoy a statewide distribution in Florida.<sup>8</sup> This specie, which arrived in the United States from Asia in imported truck tires in 1984 or 1985, is a more aggressive biter and a more efficient vector of the dengue fever virus than the yellow fever mosquito, *Aedes aegypti*.<sup>12,13</sup>

Since the early 1980's, tick-borne diseases have received much more publicity than mosquito-borne diseases. Who has not heard of Lyme disease?

For those who have not, Lyme disease is a systemic, bacterial, tick-borne disease with protean manifestations including dermatological, arthritic, neurologic, and cardiac abnormalities. It is caused by the spirochete, *Borrelia burgdorferi*, which is transmitted by ticks in the *Ixodes ricinus* group. It is often the nymphal stage of these ticks that transmits the disease. The most noticeable early sign is a red rash emanating from the site of the bite.

The disease has spread rapidly in the United States since its discovery in 1975. It has now been reported from 47 states including, most recently, New Mexico.<sup>14</sup>

Actually during the period 1983-1987, tick-borne diseases made up more than three-quarters of all reported cases of vector-borne disease in the United States.<sup>15</sup> Rocky Mountain spotted fever actually declined during the 1980's from a high of 0.52 cases per 100,000 in 1980, to 0.25 cases per 100,000 people in 1989.<sup>16,17</sup>

Meanwhile, Lyme disease showed a dramatic increase over the same period from 0.10 cases per 100,000 in 1980, to more than 3.5 per 100,000 in 1989. The 1990

case data are still incomplete for some states. It appears, however, that the number of reported cases of Lyme disease may be leveling off or even declining slightly. This may be due to a change in the case definition, which now requires laboratory confirmation of clinical cases without a rash.

## VECTOR CONTROL

The title given to this presentation was *Vector Control*. Obviously, in the time remaining, I cannot tell you how to control all of the species of mosquitoes, ticks, flies, and other vectors that are of importance to the occupational health of American farmers.

I can review some widely accepted guidelines, however. There are three approaches to vector control: physical control, chemical control, and biological control.

### Physical Control

Physical control is the modification of the environment to reduce or eliminate vector populations. This type of vector control is the most desirable because it is the most permanent. Populations of mechanical vectors such as house flies and stable flies can be reduced or eliminated by maintaining proper sanitary conditions.

For example, the regular removal of livestock and pet manure, soiled bedding, straw, garbage, and all other decaying plant and animal matter will reduce breeding sites for house and stable flies. Similarly, cockroach problems can be reduced or eliminated by the proper construction of human dwellings, regular cleaning, proper food storage, and food waste disposal.

The distribution of the mosquito-borne diseases correlates closely with the distributions of their primary mosquito vectors. Since all mosquitoes are dependent upon standing (or very slow moving) water during the early stages of their development, proper water management in agriculture can substantially reduce the risk of infection with these diseases.

In the west, physical control means efficient water management with respect to irrigation and other methods of watering crops. In the east and midwest, those in agricultural settings should strive to eliminate all standing water near the home.

This means ditching, draining, or filling low areas near homes whether under cultivation or not. It means maintaining steep, weed-free banks in man-made ponds and lakes. It means removing all man-made and natural water holding containers from near the home.

**Integrated Pest (Vector) Management (IPM) is the use of the safest and most appropriate combination of methods (physical, chemical, and biological) to control vector populations.**

These containers afford breeding sites for the vectors of LaCrosse encephalitis. Examples of containers that should be eliminated are rain barrels; used car, truck or tractor tires; paint buckets; and plastic containers of all kinds. Tree holes that are found should be filled in with sand or cement.

Physical control methods for ticks include the removal of all unnecessary shrubs and vegetation from near living quarters, the

extension of the mowed portion of the yard, and the regular and close mowing of grass for at least a 50 foot perimeter around the house. The greatest enemy of ticks is desiccation. By removing vegetation you reduce the survival time of ticks.

### **Chemical Control**

Chemical control is the use of chemical agents (pesticides) to reduce or eliminate vector populations. Chemical control is best viewed as an adjunct to physical control.

When properly applied, it can be of great assistance in lowering the risk for disease transmission on a temporary basis. There are many excellent chemicals on the market for mosquito and tick control.

However, we are all familiar with the problems associated with extensive reliance on chemical control. These include the development of resistance, the destruction of non-target organisms, and cost.

### **Biological Control**

Biological Control is the use of biological agents, such as microorganisms, other arthropods, or vertebrates, to reduce or eliminate vector populations. In some respects, biological control is a promise that has never been fulfilled. Nonetheless, the use of mosquito fish, *Gambusia*, and the spore-forming bacteria, *Bacillus thuringiensis* var. *israelensis*, have been moderately successful in mosquito control.

### **Integrated Pest Management**

Integrated Pest (Vector) Management (IPM) is the use of the safest and most appropriate combination of methods (physical, chemical, and biological) to control

vector populations. In medical entomology, IPM means the reduction of a vector population to a level below that which poses a significant health risk.

## PERSONAL PROTECTION

Personal protection offers another avenue for lowering your risk of acquiring a vector-borne illness. Personal protection is the practice of health-directed behavior that reduces the risk of acquiring a vector-borne disease infection. Examples include the following:

1. Avoiding areas where and when vectors are present.
2. If you must enter these areas, wearing the proper clothing (long pants and long sleeved shirt, socks, and shoes).

3. Use repellents properly and appropriately.
4. Removing ticks promptly using the correct method. Prompt removal greatly reduces risk of disease transmission. Grasp the tick as closely to the skin as possible and pull slowly and directly out.
5. Notifying a physician if illness occurs. Be sure to mention a tick if you are suspicious.

A knowledge of vector-borne diseases, a sound understanding of approaches to vector control, and a familiarity with procedures for personal protection can reduce the risk of contracting a vector-borne disease.□

## REFERENCES

1. Harwood, Robert F. and M.T. James. *Entomology in human and animal health*. 7th Ed., New York: MacMillan Publishing Co., 1979.
2. Karabatsos, N. (Editor). *International Catalogue of Arboviruses Including Certain Other Viruses of Vertebrates*. 3rd Edition, San Antonio, TX; American Society of Tropical Medicines and Hygiene, 1985.
3. Lacey, L.A. and C.M. Lacey. "The Medical Importance of Riceland Mosquitoes and Their Control Using Alternatives to Chemical Insecticides," *Journal of the American Mosquito Control Association*. June 1990. (Supplement No. 2.) pp. 1-93.
4. Chamberlain, R.W. "Historical Perspectives on the Epidemiology and Ecology of Mosquito-Borne Viral Encephalitides in the United States," *American Journal of Tropical Medicine and Hygiene*. 37(3). (Supplement): pp. 8-17, 1987.
5. Steelman, C.D. "Effects of External and Internal Arthropod Parasites on Domestic Livestock Production," *Annual Review of Entomology*. Vol. 21, pp. 155-178, 1976.
6. Leake, J.P. "Epidemic Infectious Encephalitis," *Public Health Reports*. U.S. Public Health Service, 56(11) 39: pp. 1902-1905, 1941.
7. Centers for Disease Control. *Encephalitis Surveillance Report Annual Summary 1975*. Issued May 1977. 1-23.
8. John A. Mulrennan, Entomologist, State of Florida, HRS, P.O. Box 210, Jacksonville, FL 32231, Personal Communication, April 25, 1991.

## Intervention - Worker Protection from Environmental Hazards

9. Gahlinger, P.M., W.C. Reeves and M.M. Milby. "Air Conditioning and Television as Protective Factors in Arboviral Encephalitis Risk." *American Journal of Tropical Medicine Hygiene*. 35(3) pp. 601-610.
10. P.R. Grimstad, C.L. Barrett, R.L. Humphrey, and M.J. Sinsko. "Serological Evidence for Widespread Infection with LaCrosse and St. Louis Encephalitis Viruses in the Indiana Human Population." *American Journal of Epidemiology*, 119; pp. 913-930, 1984.
11. Bruce F. Eldridge, Department of Entomology, University of California, Davis, Personal Communication, April 19, 1991.
12. Hawley, W.A. 1988. "The Biology of *Aedes albopictus*," *Journal American Mosquito Control Association*. December, 1988, Suppl. No. 1. pp. 1-40.
13. Francy, D.B., C.G. Moore, and D.A. Eliason. "Past, Present and Future of *Aedes albopictus* in the United States," *Journal American Mosquito Control Association*. 6(1); pp. 127-132, 1990.
14. Centers for Disease Control, Division of Vector-borne Infectious Disease. "Update on Reported Cases of Lyme Disease 1989," *Lyme Disease Surveillance Summary*. 1(2), p. 1, 1990.
15. Centers for Disease Control. "Lyme Disease-United States, 1987 and 1988," *Morbidity and Mortality Weekly Report*. 38(39), pp. 668-672, 1989.
16. Centers for Disease Control. "Rocky Mountain Spotted Fever and Human Ehrlichiosis-United States, 1989," *Morbidity and Mortality Weekly Report*. 39(17), pp. 281-284, 1990.
17. Centers for Disease Control. "Summary of Notifiable Diseases, United States, 1989," *Morbidity and Mortality Weekly Report*, pp. 38(54). 1989.



## A CONSULTING ENGINEER'S PERSPECTIVE

By *Ray H. Crammond, P.E.*  
Consulting Engineer, Crammond Engineering Company

Dr. David S. Pratt: The first perspective we will have is from a consulting engineer. Ray Crammond is a consulting engineer born here in Iowa and a graduate of Iowa State University. He has an extensive career and background both with county government and also as a private engineering consultant, at least since 1978. He has extensive knowledge dealing with farm-related and rural resident issues. We are very happy to have *A Consulting Engineer's Perspective*.  
Mr. Ray Crammond:

First of all I would like to say I appreciate the opportunity to be here to speak to you today, and this is an issue I have a lot of interest in. I am glad that the session carried over to this afternoon, because I was tied up this morning in a deposition. It did not have to do with personal injury, just manure run-off between two neighbors.

A lot of times misunderstandings come up when you try to talk about a subject. As an example, I was reminded of an agricultural engineer who had phoned a veterinarian, and he said, "Say, Doc, I have got a sick cat. He just lays around and licks his paws. He has no appetite. What should I do?" The guy replied, "Give him a pint of castor oil." Somewhat dubious, the agricultural engineer forced the cat to take the pint of castor oil and a couple of days later he met the vet in town, and the fellow said, "Well, how's your sick calf." He says, "Sick calf? That was not a sick calf; it was a cat." He said, "Well, you did not give him the castor oil, did you." "Sure did," said the agricultural engineer, "last time I saw him he was going over the hill with five other cats. Two were digging, two were covering up, and one was scouting for new territory."

I have been asked why I got involved in consulting work. The best way to put it is I figured it was easier than farming. I grew up on a farm in Southeast Iowa, and I am still involved in the farm, but I always figured there had to be a better way of doing things. So that is how I got into the agricultural engineering.

We talked some about stress the past day or two. In the 1950's, wheat was \$3 a bushel and psychiatry was \$3 an hour.

In the 1960's wheat was only \$3 a bushel, psychiatry was a little bit better operation; it was \$20 an hour.

In the 70's, wheat was still \$3 a bushel. Psychiatry was a little bit fancier digs, and it was \$60 an hour.

In the 1980's the farmer was into the psychiatrist at \$100 an hour, and the wheat was still \$3 a bushel. That is the way things have gone, and that is one of the reasons for the stress that the farm community is facing.

On the other hand, some people have the idea that an engineer has a life where he can just sit back and say, "Yes, I went through your plans a few minutes ago, and that's all there is to it."

## ENGINEERING

This was a quote from Herbert Hoover who was an engineer as well as a number of other jobs that he had. He talks about it being a great profession:

*...the fascination of watching the pigment of the imagination merge, through the aid of science, to a plan on paper, that moves to realization in stone, or metal, or energy; and it brings jobs and homes to man; and then it elevates the standards of living and adds to the comforts of life. That is the engineer's high privilege.*

The great liability, of the engineer, compared to men of other professions, is that his works are out in the open where all can see them. His acts, step-by-step are in hard substance. He cannot bury his mistakes as a-you can kind of fill in the blank with other professions.

He cannot argue them into thin air or blame someone else. He cannot cover his failures with trees and vines, and he cannot screen his shortcomings by blaming his opponents and hope the people will forget. In other words, if he screws up, he is responsible.

On the other hand, his is not life among the weak; destruction is not his purpose; quarrels are not his daily bread. That is one of the reasons why a lot of engineers do not like to get involved in liability cases or product suits.

To the engineer falls the job of clothing the bare bones of science with life, comfort, and hope. No doubt, as the years go by, people forget which engineer did it, even if they ever knew, or some politician puts his name on it, or they credit it to

someone else who used other people's money.

But the engineer himself looks back at the unending stream of goodness that flows from his successes with a satisfaction that very few professions may know. The verdict of his fellow professionals is all the accolade he wants.

I think that holds true in a lot of cases for the people in the engineering profession. The problem is that in some cases, depending on a person's temperament, training, background, or whatever, the engineering procedure can start you out with a simple premise that the sum of two quantities in the form of one plus one equals two; but then as you study and get deeper into your subject matter you know that one equals log of e and that one equals  $\sin^2 x$  plus  $\cos^2 x$  and so forth.

You get down there and rewrite all those equations. At this point it should be obvious that equation three is much clearer and more easily understood than equation one. Other methods could be used to clarify equation one, but these are easily discovered once the reader grasps the underlying principals.

I think too many times what happens when you talk about whether it is the design of a product or a tax code, whatever it might be, you know that one plus one equals two, but to get back to it, after going through what is on the bottom line there, you wonder where you are at.

This is one of the definitions I like about engineering; It is the art of directing the great sources of power and nature for the use and convenience of man.

Another thing regarding engineers is the study of both human needs and natural phenomenon. These two fields of study give essential unity to the profession for all engineers, whatever their specialty, must know both human ways and natural forces.

### Human Needs

One of the biggest problems I have seen in the 20 years since I have gotten out of college, in the work that I do, is that the engineer—if I am looking at a particular problem on a site or whatever—has looked at only the natural forces. They ignored the human forces - whether by their nature, the course of study, or whatever, they tend to drop one-half of the input there. That is where a lot of problems occur.

So, I think the biggest problem is people who ignore the human input.

I had one engineer say, on a grain bin case that, "Well, if there was a warning saying that it should only be piled to a certain level, by gosh that is what it should be. The grain should be put in at that level."

Knowing how farmers operate and how equipment operates, if you have a building that is about 200 feet wide and over 600 feet long and you are running grain in there at 17,000 bushels an hour, you probably will not hit that line right on the nose. You had better figure that what can be put in there up to the eaves is going to be put in there up to the eaves. If you do not design to that, you are only fooling yourself.

So, I think the biggest problem is people who ignore the human input. It is where they run into trouble.

### Natural Phenomenon

It would be a lot easier these days to be, another type of engineer than an agricultural engineer because on top of everything else that we have got to contend with, just when we think we have got all of our data down, we have to deal with some new factor. Whether it is growth hormone that suddenly changes the dimension of the stalls or the strength of the animals, or whatever it might be.

You can also run into unexpected natural phenomenon, after having, in the past 15 months or so, drilled 200 or 300 holes in Iowa for waste storage basins for livestock facilities. I have run into situations like that.

### SYSTEMS DESIGN

Now a couple of quick definitions from my perspective. I get involved in product design, but more in systems design. If you are talking about a contractor, well then you are generally talking about a gambler who never gets to shuffle, cut, or deal. A bid opening is a poker game in which the losing hand wins. There is the bid that is a wild guess carried out to two decimal points. The low bidder is the contractor who is wondering what he left out. The engineer's estimate is the cost of construction in heaven. Meanwhile, the project manager is the conductor of an orchestra in which every musician is in a different union.

Critical path methods, which some of you may have used, is the management technique for losing your shirt under perfect

control. An auditor is a person that goes in for the wounded after the war is lost and bayonets the half maimed. A lawyer is the person who goes in after the auditors and strips the bodies.

### **"Free" Advice**

I guess one of the things I have run into is the value of free advice might be worth less than what you paid for it. Too many times I have seen situations where somebody relied either on their good buddy or friend, or whomever; maybe even on technical personnel, and come to find out that they got into deep trouble when they relied on a situation where they thought they were getting a good deal.

Another case involved ventilation systems. Well, the fellow himself was not so much personally injured as he lost \$50,000 worth of hogs. You know, any fool can design a ventilation system, a lot of people will say, and so many do.

I have run into cases where you can lead a client to enlightenment. We have been talking about training and so forth. That is all fine and good, but there are some cases where they just simply will not pay attention to you, or go on about their business and ignore you completely.

### **Disclaimers**

Disclaimers should not be used to protect poor design. How many times I have been involved in grain bin cases—whether bin drownings or bin collapses—somebody has a decal or a warning saying, regarding roof vents for instance, that they should be kept cleaned out. The only way to get to them is to tie yourself off on a rope and swing out there like Tarzan to get to it, and

there are no ladders, nor access to it. Does that make any sense?

Does it make the home office feel better that you have got a disclaimer on there so you are protected. To me it is just ridiculous, and you are not fooling anybody, especially the courts. You might find yourself in a lawsuit.

### **Training**

The other thing is it is easier to teach rules and to train rules than to train judgment. That is an area where we have to focus on in training judgment, and we end up trying to legislate common sense.

### **Poor Engineering**

Poor engineering entails failure and misfortune, inconvenience, suffering, death.

In one case three people died in a manure pit when they went down to fix a pump malfunction. In this situation could we have pulled the pump out without having to go down into a pit so a father and his two sons would still be alive?

I remember on a project one time when I was talking to a banker in 1974. He said, "What do we need an engineer for? The building company does all that?"

It turned out later — a few weeks later — I got a call. He wanted me to work on this particular project. Since that time, I have had numerous referrals on similar projects. But in this case they had a \$300,000 building coming in a few weeks, and they had made no provisions or planning on where they were going to put this thing. So, they finally came around to realizing that maybe the building company does not do all of that.

Another comment that I hear out in the field, "I got a special deal on this. How do you like it." A lot of times not very well because it usually leads to either failure or injury; but, the guy got a good deal on it so, to him, it was okay.

A farmer has a choice as to whether he wants to buy this option or accessory item. I think back to the time I sat through a seven-hour deposition involving a bin drowning. We started at nine in the morning and ended up at four. We did not even break for lunch.

The poor court reporter's fingers were about ready to drop off, I think. Somebody brought in some candy bars at about 1:30 p.m. The question was given to me, "Could this farmer buy these roof vents as an accessory item?"

In this particular case I said, "In your own manual it says that if the roof is installed in a certain way with roof clips in the down position where there's no gap, that there must be one roof vent for every so many cubic feet per minute of fan capacity." In this case, I think it figured out five or six roof vents.

This 42-foot diameter bin had no roof vents on it whatsoever. The fellow was in there trying to poke down the corn with a rod, trying to get it broken up so it would feed into the unloading auger. They found him in the middle of the bin about six feet off the bottom.

It had just been minutes before that his nine-year-old son was in there. If his wife had not insisted that the son get out of the bin, while she went to fix dinner that evening, he would have been in there, too.

I pointed out to the attorney who asked me that question, "In their own manual it says that if the roof is installed in this position, there must be a roof vent for so many CFM of fan capacity. How can you, in good conscience, tell me that this is an accessory item?" He never asked me another question.

That is where I think we get into the systems approach. In this particular case, the farmer never got the manual, or he might have discovered there was a problem that he could have acted on differently. We found in discovery that the manual was on back order, and he never received it.

Why did you build at this site? "Well, the salesman said it would work." That has created a number of problems, in some cases the health of people; in some cases their pocket book. One case where people spent over \$300,000 were ready to move some livestock into a building. They were sued, and they had to change things.

"A bin is a bin," spoken by a farmer, a social studies teacher, or someone who bought a bin company because he wanted to get into a business of his own. He put up over 40-thousand bushel bins, and the roof was blown out and disrupted the farmer's income.

He was not around the bin at that time, but he lost the bin, he lost the farm, he lost his wife through the protracted, final settlement. Meanwhile, this guy had been warned by the bin company just a few months before. He was given decals to put on his customer's bins, which warned that there was a problem. He just ignored it. He never went out and contacted anybody.

The other thing relating to that is when we took the deposition of one of the engineers

for the bin company. He had been with the company for over 30 years. He had been in every phase of it, and you would think he would know what was going on. He was asked, "On this warning we are talking about, 'Do not run the fans during icy conditions,' define what that meant?" He said "I don't know."

So, here is a company that charges an engineer with writing up a warning label. He has had 30 years experience with the company.

He writes a warning label that he cannot even interpret, but they can stick it on their manuals or out on the bin and say, "Okay, it is up to you, farmer, to guess what this means." They think they are in the clear. It is things like that, which really burn me up.

## CONSULTATION

Sometimes you run into, "That Product B is no good." You ask them where they get their information. "Oh, the salesman for Product A said so."

I think one of the problems in agriculture is there are very few independent consultants or consulting engineers who have been able to look at a situation and make recommendations regarding some of these factors.

Another thing that was brought up is that we are dealing with, especially traditional agriculture, a farmer who feels that he is a jack of all trades. That being the case, they try to do most of their own repairs a lot of times, sometimes not with the best results.

As an example of designing out problems, about 10 or 12 years ago a fellow came to

me. He wanted a tank designed for manure storage. I changed his original concept. There are half-inch diameter steel cables that are enclosed within panels that go all the way around the tank. There is a special jacking panel where they come out.

One of the problems you can run into on these tanks is the build-up of ice. In this particular case it was a couple or three feet of ice. All of a sudden a big sheet of ice collapsed. That is a lot of force. There have been metal tanks that I know of that have just split in those situations.

In this case, there was a tremendous noise. The guy went running off and two fellows who were near the tank went running off. A guy coming back from the field could not figure out what was going on. They thought the thing was collapsing. Instead of collapsing it held together. That is what factors of safety are for in design.

The panels had holes that are cast right in the panels. What happened was the top cable snapped; when you have 20 tons of force, a cable snaps. I thought back to the time when a friend of mine from high school was in the Navy over in Viet Nam on an aircraft carrier, and when one of those cables snapped, it cut him in half. I thought, well if you are designing a tank like that, if you have cables on the outside and a cable broke, what would happen.

In this case it was completely contained. Nothing happened. In fact, they went on and used it for a year or so, and then the guy came back and threaded in a new cable. So, that is just one example of how problems can be designed out.

I guess from this standpoint, we have heard about the gas from livestock causing problems. We have to decide whether we

are going to encourage and train people or are we going to hit them with regulations and say that, you know the Ten Commandments or whether it is going to be the Golden Rule. How would you do it so you would not cause problems for somebody else?

## **TECHNOLOGY**

The other thing that is affecting this whole situation of injuries and accidents is misapplication of technology. After my sophomore year in 1968, I worked during the summer for a company in Burlington, Iowa.

I remember being impressed at that time as I was putting together drawings from several different departments of a new crawler. One of the other engineers was walking by the drafting table, when he stopped and looked. He never said a thing to me. I was just a student trainee that year. Then he looked at that again. He went and got some other fellows.

They looked at it again, and they had a conference. I did not know what was going on. It turns out that when I had drawn in where the track would go around near the operator's platform, there had been a situation one time, where somebody had been injured or a problem had come up with clearance between the track and the platform for the operator. They caught it, and the design was changed to rule out that problem.

You always have to deal with the question that came up yesterday that if somebody does suggest a change, who is going to pay for it, and whether or not we try to squeeze it out of the price that the farmer gets for the product that he sells. In any case, something needs to be worked out because we do need him and her. If not, food prices are going to be a lot higher, and I think our way of life is going to be changed quite a bit.□

## AN EXTENSION SPECIALIST'S PERSPECTIVE

By Rollin D. Schnieder, M.S.  
Extension Safety Specialist, University of Nebraska

Dr. David S. Pratt: Rollin Schnieder has been in safety in American agriculture for 35 years. He is one of the real pioneers and leaders. He is someone I certainly have admired over a long period of time. Right now, he is professor of Biosystems Engineering at the University of Nebraska in Lincoln. For 35 years, he has been on staff there. He has helped to write the history of the Emergency Medical System (EMS) program and the communications program in Nebraska. Dr. Schnieder has written a great deal and been a major contributor to the understanding of safety in agriculture. He has also been collaborating with the people at the medical center in a way that is allowing the two branches at the university, in both Lincoln and Omaha, to collaborate with each other. Although the medical college and Lincoln campus have worked together before, they are hoping to blaze new trails. Today, Rollin is going to speak to us as only he can. He will speak to us from *An Extension Safety Specialist's Perspective* on this issue with a long history. Help me welcome Mr. Rollin Schnieder.

Dr. Pratt asked me to show this book to you. In 1965, when the Department of Transportation (DOT) was coming into being we had 16 parts of DOT. One of them was clean-up. One was the transportation of people.

I can remember vividly the night in September of 1965, in the Cornhusker Hotel, where we had a group of about twenty people that were looking at the EMS program and also the communications program. Looking at EMS, in 1983 or 1984, I told Dr. Ken Kimball, who was on this committee, and Brigadier General Don Penterman, who was looking at communications, that:

*We ought to write a book of what we know about the history of EMS and communications in the state.*

So we did.

This came out in 1985. It is a 264-page manual on the whole history.

There is only one other that I am aware of in the nation. That is Wyoming. They have a 190-page pictorial booklet. We put ours in the form of writing.

There will be another book coming out soon, probably 165 pages on farm accident rescue. The American Academy of Orthopedic Surgeons will publish it.

Dave Morgan from our staff, who is a tractor test engineer and EMT instructor in his own right, and I wrote this up. Hopefully, this will be published by late fall.

I am going to use a little different variation from Ray's (Crammond) presentation. I was most impressed with the speakers that we had yesterday. I wanted to add a few things as I sat there and listened.

### STATISTICS

Dr. Høglünd spoke of statistics. He said that there is a variation in statistics. You had better believe me; there is a variation



in statistics. When you try to compare the United States to Sweden to Denmark to England to Germany, there is a real variation.

Dr. Gary Erisman did not say it, but he and I have talked about this before. Gary's point was that we talk about the number of fatalities and the number of injuries we have. He has told me that "there are a lot more out there than we know about." I feel exactly the same way.

In 1978 or 1979, after OSHA had been in force for a few years, we had some people comment, "My gosh, here we have got OSHA and the statistics are going up." No, they were not going up. They were out there all the time.

People were just finding them. Gary and I were advisors to OSHA from 1972 to 1976 so we had a good background on what was taking place.

I remember that there was a new safety specialist in Colorado. He called and wanted to know if I would train him.

A few months later Sid said, "I am glad we don't have the problem that you have in Nebraska." I replied, "Sid, you have it in Colorado. I know my problem. I am going after the figures. You are not."

That is what happens. We also know that some of these statistics are hidden. So, I appreciate the comments regarding statistics.

I was back at a meeting with John Pollock and Dr. Pratt a few years ago. They had reinstated a farm injury study in New York.

It amazed them to know that they had 35 fatalities in that first year of their study. They were working with the Farm Bureau in New York. They could not believe that they had that many.

They were there all the time. They just found out where they were. When you live in a little community, you might hear about the one in your county. You do not hear about the ones statewide.

I can tell you that we have had 853 fatalities in Nebraska from 1969 through the present day. These are broken down by the type of accident. Even then I am sure that I might have missed a few.

Sometimes the victim gets transported across state lines to medical facilities. It may be a Nebraskan who is taken to a Sioux City Hospital. That report comes into Des Moines and it eventually gets back to Lincoln.

Sometimes there is a delayed one and I may not find it. So even I miss a few of those. So, to Gary and Sverker Hoglund, I appreciate your comments.

## DESIGN

John Etherton is sitting back here. It is John's job to come up with a statement about roll-over protective structures, retrofitting.

There are a lot of people who say, "Let's retrofit everything." This all sounds well and good, but you change a tractor when you do that.

For example, when we came out with the roll bar, people were complaining about the noise. You had the tuning fork concept or added noise. I had a lot of calls,

"What can we do?" We can dampen. Some were putting sand down in the up-rights to dampen the noise. Some were putting loaded springs across to dampen them, anything to get this noise down.

You can change characteristics of tractors. You have to realize that a lot of the equipment that we have in agriculture is not totally designed. This is what Ray (Crammond) was saying.

For example, the first totally designed tractor came into being in 1971. We had tractors that were designed; then we had after-market cabs put on. That was not a part of the design and there were some noise problems.

You have to realize that a lot of the equipment that we have in agriculture is not totally designed.

In 1971, there were two totally designed tractors. One was a Deere, the other one was Allis-Chalmers. They designed the whole unit and had the cab as part of it. They came in with a noise level of 80 or less. It was right around 80 db at that time. This was a whole new concept.

Now those tractors are running down around 74 db, because they are designed as a total unit.

This concept is true with other machinery. I was involved in a lawsuit 28 or 29 years ago, where a little boy lost a leg in an auger. The auger was built by one company; another part was built by another company.

There were four people who went together on this, and they all thought, "The other one is going to put the safety features on." Nobody did. You have to look at the totally designed system.

We can look at anhydrous ammonia as another example. You buy the running gear, order so many at a certain price. You buy the tank, order so many at a certain price. You buy the pop-off valves, so many at a certain price. Put a hose on. They are all component parts.

One of those is the weakest part of the system, and so we have problems. We have to look at the total problem, not components.

There is another thing we have to realize. It was alluded to yesterday. I do not know if it was Gary (Erisman) or Sverker (Hoglund). Many times engineering is overruled by advertising. I have seen this.

We are going to put a product on the market. It is maybe not what we want, but we are going to get it out there. I think of one tractor whose advertising said, "We're going to boost the pump up a little bit to get two more horsepower at the drawbar." When they did this, they also got more noise out of it.

Advertising wanted the horsepower; they did not care much about the noise. The engineers were put at a disadvantage.

They can do their best design, but they are put at a disadvantage if marketing makes the final decision. I think Steve Konz alluded to this in his presentation this morning.

## **PROTECTION**

Dr. Richard Fenske yesterday talked about protection. I am going by a few comments that people made. He talked about the closed tractor cabs for pesticide protection. This is good.

In fact, Cornell did some work on this in 1978 or 1979. It is of benefit. The thing we have to watch is that if people mix the pesticide and then get in the cab, they take it in on their clothing. I have been on a pesticide-training program since 1978.

Our recommendation is that if you have two people, have one do the mixing and one do the application. Or take your clothing off before you get in the cab if you are working alone.

There is another thing that Richard talked about yesterday. It regards a question that I get all the time. How do we tell when the cartridge or the canister is loaded? I give the same answer that he gave yesterday.

Right now we talk about time and concentration. We can look at acidity, and we take litmus paper and test for acidity.

Is there some way that an engineer, or epidemiologist, or somebody could design a cartridge or a canister that when the cation/anion process gets to 90 percent being loaded (somewhat like the working device for telling when the turkey is done), it could send up a little flag or a change in color? It is a very simple process, and maybe there is a way that we could take care of this question.

I made one comment. There was a question yesterday about coveralls in the green-

house and the material going through. Nothing was said about an apron.

One of the things we point out in our program is the need for hand protection, eye protection, and apron protection. We know that the hands constitute a major point of entry in to the body. The label still reigns supreme. It must be followed.

Another thing came up about re-entry into fields. We have had some close problems (poisoning) with county agents. We have had farmers who have asked county agents to look at their field for insects. I think of one that we had where the farmer did not tell the agent that the night before he had sprayed his field with parathion.

This has a 48-hour re-entry. The agent who was asked to go in there is 6 feet 5 inches and weighs 300 pounds. He was sick when he came out of that field. He was going to head back home. He did not. He sat along the roadway for about 2 hours.

We had another instance. A young man was asked to go into the field. His situation was almost identical.

I think back when I was a young lad. Dad and I would go along the back roads, and if we saw a cornfield that looked good, we would want to walk out and see how that corn was. We would walk out in that field and check the neighbor's corn. I would never think of doing that today because you do not know what the plants might have on them.

## **OTHER PROBLEMS**

This morning we heard a talk about vectors that was very interesting. We do not have some of those problems.

You were talking on a world scale, an international scale, however, and that is big. We do not have much of a problem with equine encephalitis. When we do have it, we encourage the people to stay in.

In the Midwest our biggest problem with the farmer will be the infections they may get from being scraped when they work with confinement housing. Some of these can really be problems.

Tetanus is one of the things I talk more about than I do about the vectors; we do have some people that can be affected by anaphylactic shock, and this is the one where the bee stings will get the individuals. Again, I was glad that you were talking about the worldwide problem, because I know that Panama has a different problem than we have; we do have to look on a bigger scale.

Dr. Konz was talking about some of the problems of people. I think of milkers' knee. People say, "What is milkers' knee?"

Dairymen in New York know what milkers' knee is. We talk about tractor drivers' disease, and that is the one that is back-related.

Even stepping up on some of those 27-inch-high steps can be a real problem. I got to thinking about some of these things that are hidden from us.

We have a young lady here from the College of Medicine, Dr. Susanna Von Essen, who has been doing a lot of work on respiratory problems. We are glad to have her. I started looking at this community of respiratory therapists.

One of the things that blew my mind was when I found out that the Phelps County Hospital at Holdrege, Nebraska, last year had 370 cases of respiratory problems. That is a lot of people.

Yet our respiratory therapists are not organized. I was going to say they are loosely organized. They are not organized at all. We have a lot of people who we can gather all kinds of information from, but they are isolated because nobody has ever gotten them together. I am hoping that Susanna can do this. We have a lot of information out there that is just waiting to be gathered.

#### LESSONS FROM BILL STUCKEY

Dr. Erisman and I had a mentor, Bill Stuckey from Ohio State University. Ray Forsythe who is in attendance, did also. Bill Stuckey was an Extension Safety Specialist at Ohio State.

I will never forget a few things that Bill taught me. One of the things he taught me was "You never know until you ask." That is why when I go after statistics, a lot of people say I will get turned down. Well, you do not know until you ask. So I go ask them. I have never been turned down yet.

We have a new generation of people coming along. When you listened to Dr. Konz this morning, you almost thought he was anti-education. He is not anti-education.

Bill Stuckey had a little saying. He said there were those who "Knew not Joseph." What did this mean? Joseph was the king of a nice little kingdom for 48 years, and everybody loved Joseph. Joseph went out of power and a new king came in. Within

a year, there were those who knew not Joseph.

We have some little boys and girls being born today who know not safety. Somebody has to teach them. That is where we in extension come in. They have to "know Joseph"; they have to know safety.

### **TRAINING AND EDUCATION**

A couple of comments came up here about training people. It has been my idea that you train people with the right idea.

I have raised golden retriever dogs since 1958. I run them in trials. People say, "Okay, you are a dog trainer. How do you keep dogs from chasing cars?"

That is simple. I keep them kenneled up. I take them out and train them. I teach them what I want them to know. That is it. I do not worry about their chasing cars because they never run free. Those dogs are not imposed on because they love it when we get out. That is our time.

You heard the comment the other day by Dr. Johnsrud about 23,000 youth trained in Nebraska in tractor safety. There are going to be about 24,500 trained by the end of this year.

I raised two boys. I believe that young people have to work. They have the same needs that I have. They have a need for money so that they can buy things. This is why we have trained these young people.

Some interesting things. At North Platte, there are a lot of ranchers who will take the kids into the sand hills and keep them there for 2 weeks while they are putting up hay. They will not take a youth up there if they have not had the safety training.

One rancher told me 20 years ago that "One of your students was with me. The boy told me I was doing something wrong." He said, "That boy was right." He wanted trained students.

So we keep on training them. We lost two of our trainees in accidents, both in 1971. They were both extra riders; both 14. This was within a 3-week period. They were extra riders on tractors and fell off. That is it. I guess they did not listen too well.

Dr. Konz questioned in education that maybe we did not get the information across to them, maybe we did not educate well enough. Gary alluded to this yesterday.

This has been an excellent opportunity for me to comment on these five papers.□

## **AN AGRICULTURAL ENGINEERING PERSPECTIVE**

*By L. Dale Baker*  
Product Safety Engineer, J.I. Case Company

Dr. David S. Pratt: We next have L. Dale Baker. Dale is trained in agricultural engineering from the University of Nebraska. He spent two years at Michigan State University in the Agricultural Engineering Department. Closer to my home turf, he was in Ithaca at Cornell University as the Agricultural Extension Safety Engineer. He spent 10 years in product safety engineering with International Harvester and JI Case. Currently, he is the Manager of Safety and Legislation, Agricultural Equipment Group, with JI Case. Mr. Baker:

It is a pleasure to be here. I would like to tell you a little about my experience on the farm. Then you can evaluate the biases and perspective of my comments.

I am from Brandon, Manitoba, Canada. With few exceptions, farming near Brandon is no different from farming in North Dakota. Farm life and farm issues are much the same.

I grew up on a family farm that was passed to my father and my uncle from the grandparents. It was a traditional succession in farms in those days. They operated that farm as a partnership.

There were two houses on that farm, a couple of hundred yards apart. I had two older brothers and in the other family there were four children, three boys and a girl. I was the youngest of seven children.

Somewhat by the accident of birth, being the youngest, I was the one who had to leave home. The choice was made on an economic basis, rather than any concern for personal safety.

Today, my brother operates the farm that he has expanded to about 2,000 acres. The farm is on the upper slopes that sur-

rounded a glacial lake bed, many thousands of years ago.

The land at the bottom of the lake bed will provide adequate income for the farm family. On the surrounding land, it is difficult to obtain adequate crop yields to financially survive. Therefore, my brother and his wife also have full-time jobs off-the-farm.

My brother works full-time as a welding instructor at the local community college. His wife is a full professor at the local university. With that income, they are able to sustain the lifestyle that they chose, to live on the farm.

My brother has some beef cattle and grows grain primarily to support the cattle. They also raise malting barley, as there is a premium for malting barley.

My sister-in-law likes to raise horses, train those horses for riding, and sell them. She has a total herd of about 45 horses.

One of those cousins who grew up with me has been in a relatively new business for about 15 years. He is collecting pregnant mares' urine. He has a herd of about sixty horses that he puts in the barn every fall.

They are strapped to a harness that collects the urine from those pregnant mares. That urine is refined for estrogen. This is not traditional agriculture.

That snapshot leads to several observations that illustrate the bias of my comments about safety on the farm:

- Farming is becoming a very diversified business.
- Many farmers are in an economic squeeze but continue to live and work on the farm as a choice in life-style.
- This is a family-farm environment where there are no migrant workers.
- Many farmers are relatively well-educated.
- It is generally the family who is the purchaser and operator of agricultural equipment.

## HUMAN FACTORS

In commenting on the presentation by Dr. Konz, I agree with the concepts that were presented this morning. We, as an industry, wish to promote and are promoting human factors or ergonomics in our products.

I am a member of the Human Factors Society. There are quite a number of practitioners or consultants at work in our industry. I agree with the concept, as a design philosophy, that the machine should adjust to the man.

We should be designing the machine to fit the man. As a design philosophy, we are working to do that.

When I get concerned is if someone makes the assumption that this design philosophy should be the legal requirement. As an example, it is impossible to build a machine that may resemble a tractor that will not roll over. Such a machine will not function as a tractor. I am not yet aware of how we can build a functioning tractor that will not overturn.

I repeat, however, that we are in agreement with those ideas and concerns in ergonomics as a design philosophy. You will see those kinds of concepts on new products.

I am not yet aware of how we can build a functioning tractor that will not overturn.

## OLD AND NEW TECHNOLOGY

Let us take a moment to compare tractors in use today with automobiles in use today. Consider a 1971 automobile and a 1991 automobile. They are quite different.

Items on new cars include the center-mounted stop lamp, rear-impact bumpers, improved door latches, anti-lock brakes, crush resistance in the roof, side protection in the door panel, and improved tires. These are all innovations that are significant to the development of the 1991 automobile.

A 1991 tractor is also quite a different creature than the tractor that was built 20 years ago. Many of the same innovations on cars are used on tractors. The ingress/egress, control, steering, and interior styling of many new tractors are comparable to 1991 automobiles.

What do we see in terms of 20-year-old automobiles on the highway? How many do you see? Five percent? I think it is less than that.

I think that when you do see them that they are on display or going from one auto show to another. They are antiques. How many of the tractors that are in use today are more than 20 years old?

About a third of the tractors out there, in use today. That is, probably a million tractors, for a round number, are more than 20 years old.

Another interesting phenomenon is that a tractor design can survive for about 15 years; it may go a little longer. You will find considerable variation in the design of new tractors on the dealer's lot due to this delay in the design cycle.

Some of the features that Gary (Erisman) mentioned are already available on some tractors. Hydraulic controls, couplers, and hoses are labeled with numbers and flow direction on most newly designed tractors.

Changes in technology allow us to do things now that were not possible 20 years ago or 10 years ago. Many of you will remember the problems that President Carter had in trying to send some helicopters into Iran in 1979. About ten helicopters were sent. Many of them had problems and the mission was abandoned.

Compare that with what just happened in Desert Storm. There were tremendous changes in the reliability of the equipment.

In those days (pre-1979), transistors were experiencing 100 percent burn-in. That means that when you bought an electronic controller, "the black box," you would

check 100 percent of those transistors. Now, the transistors are not checked at all because there is fantastic reliability of the transistors coming from the supplier.

Because the electronic "black box" now available is very reliable, new electronic-based systems can now be added to farm equipment. One example is an operator's presence system now used on combines. If the operator is out of the combine seat for more than 5 seconds, the combine header will shut off.

Other new applications of electronic technology will depend on the development of reliable sensor technology. The sensor must be as reliable as the electronic control box. This reliability should develop much like the reliability of transistors has evolved.

Another important development is the customer acceptance of this new technology. There seems to be a general acceptance of new safety innovations that may stem, in part, from Lee Iacocca advertising air bags.

## **ROLL-OVER PROTECTION**

We have had a great deal of discussion, in this session, about Roll-over Protection Structures (ROPS). We have all seen the slide, many times, of the success of ROPS in Sweden.

In 1985, we had a commitment by the North American tractor manufacturers to make ROPS standard on all tractors. With a few exceptions of tractors that are being imported into this country and those that are for orchard applications, all tractors since that time are equipped with ROPS.



By 1970, ROPS in this country became available on virtually all major manufacturers' product lines. There was no demand for them. Therefore, we have a significant number of tractors in operation in the U.S. that were built in that interval between 1970 and 1985 that are not equipped with ROPS.

I would suggest, in gross terms, that there are about a million tractors that are equipped with ROPS or that have ROPS structures built into the cab. About a million tractors that are out there could have a ROPS installed on them but do not.

Another million tractors that are in use were built prior to this introduction of ROPS and here installation of ROPS becomes a real technological issue. Now we should look at those two issues separately.

### **Pre-1970 Tractors**

In putting ROPS onto tractors that were built prior to 1970, there are some significant technical issues. Will the tractor structure survive an impact with this ROPS attached? The structure was not built for that kind of use.

New frames could be designed, possibly, to accommodate the design by sharing the load forward to the transmission housing.

There is now a need to develop that new structure. There were many applications for those old tractors where implements were attached to the same location that we would attach this ROPS structure. If you destroy that, you have destroyed the utility of that tractor.

There is also the issue of the economics of putting those ROPS on old tractors. If there is to be a program of that nature, it

is going to have to start with the development of some public policy change that will create that demand. Is anyone going to invest the time and effort to develop new designs unless there is, in fact, a demand?

### **1970-1985 Tractors**

The issue for tractors built in the interval between 1970 and 1985 where a ROPS can be installed becomes an issue of how to create an environment where the public demands those ROPS. They are available.

A demand undoubtedly could bring down the cost that was mentioned earlier. Until there is a demand, there will not be any initiative that will cause that to happen. It is the chicken and the egg situation.

If you could decrease the cost, maybe you could increase the demand. You cannot decrease the cost, however, until there is a demand. We are now again looking at what is a public policy issue of how you create that demand.

Is anyone going to invest the time and effort to develop new designs unless there is, in fact, a demand?

I would say to you that my brother is aware of the issues of ROPS and tractor overturns. But fatal tractor overturns are a rare event (a farmer is far more likely to be killed in a car accident than a tractor overturn).

Virtually all farmers are aware of the issue of fatal tractor overturns in the same sense that farmers (and the general public) are aware of the issue of cigarette smoking

causing cancer. What does it take to cause people to stop smoking cigarettes?

We could also talk about our desire, as a general public, to drive cars, which have an air bag and have anti-lock brakes. Clearly, as a general population, we are safer if all of the cars in use by 1995 have air bags and anti-lock brakes. What does it take to make you and me invest in new cars or stop smoking? Solving these same kinds of issues, I think, solves the issues for the farm population.

### CONCLUSION

I would make one quick comment on statistics. In virtually all the groups at this

conference, we have been talking about this issue of statistics. We are all talking about such diverse numbers that some of us are loathe to mention any numbers at all.

Injury statistics should be a number one priority. I hope that this message is coming through from all of the other groups.

What are the recommendations that I would make based on what we have heard in this conference, especially in this room? I think we are looking at some significant *public policy issues* in which the *farm population* needs to be involved in creating the answers.□

## HEALTH EDUCATION

By Rodney Gilmore, B.S., B.A.  
Injury Control Program Manager  
North Dakota State Department of Public Health

Dr. Walter J. Armbruster: Let me turn to our first presenter, Rodney Gilmore, who is with the Injury Control—or, I should say—is the Injury Control Program Manager for the North Dakota State Department of Public Health. His topic is *Health Education* as an intervention related to safe behavior among adults and children. Mr. Gilmore:

I have been with the State Health Department approximately one year. Prior to that, I worked with the North Dakota State Worker's Compensation Insurance Fund in the area of occupational health, particularly looking at injuries and rehabilitation.

I come from a farm family in North Dakota. I am a native of North Dakota, and my family still farms. I guess if it were lucrative enough, I would be back farming instead of being here today.

I have had a strong interest in farm safety and agricultural safety. We have heard some of the testimonies of some of the individuals that have had direct involvement in farm injuries. That is some of my background.

I lost my grandfather to a farm-family injury and also my best friend's dad, when I was in high school. Those two things have stayed with me for a long time. I welcome the opportunity to be able to work in this area and to hopefully have some impact on it.

Even though it is a serious field, we still have to look at life and enjoy life and, I guess, look for some humor in it.

I would like to start out the presentation with a joke I heard last week at the CDC

Injury Conference in Denver. The story was told by an attorney.

An attorney had a farmer on the witness stand who had sustained an injury in a pick-up roll-over. He was suing the individual that ran him off the road. The defendant's attorney had him on the witness stand and said to this farmer "Mr. Farmer, I want you to answer this question yes or no. Is it true that when the highway patrolman got to you when you were laying in the ditch and you had just gotten up, that he asked you how you felt and you said, 'Just fine'?" The farmer said, "Yes, but. . ." The attorney said, "Wait a minute, I said yes or no." He sat down.

The farmer's attorney said to the judge, "There are some extenuating circumstances, and I would like for the plaintiff here to be able to tell his side of the story." The judge said, "Okay." The farmer said, "Well, the reason I said I was okay." He said, "The accident happened when I was coming around a curve. I had just come back from a sale. I bought a brand new bull, I should say, a new bull; I bought this prize bull and paid quite a bit of money for him. I had him in the back of my pick-up and came around this curve.

Here were these two vehicles coming at me. One of them had passed on a double

yellow line. He ran me off the road, and I went down the ditch and rolled the pick-up over and the bull went flying one way and the pick-up went the other way. I ended up getting thrown out of the pick-up."

"Right after the accident happened this patrolman walked up, looked at me, and he walked over and looked at my bull. Then he walked back to me and said, 'Your bull looks in pretty rough shape,' and I said, 'Yes, he is.' With that the patrolman walked over, drew his pistol out and shot the bull between the eyes. Then he walked back over to me, with the pistol in his hand, and he looked down at me and he said, 'Now, how do you feel?'"

To start it out, I would like to give you a preview of North Dakota and what it is like up there. The Department of Tourism is not paying for the trip, even though it may seem like it. I would like to give you some information we have gathered on statistics that we have been monitoring in the state before we get into our programs.

There is a train in North Dakota, and I guess the farming practices are just as varied as the train is. In eastern North Dakota our land is flat. In fact, water hardly drains off, and a lot of farmers have equipment to level the land because in the Red River Valley the rain will just sit on it. The ground is very fertile. We have sugar beets and potatoes, two of our biggest crops in eastern North Dakota. Even though the land is so flat, we still have a tendency to have tractor roll-overs in the eastern part of the state.

We have got a lot of row crops. As a consequence, we do have migrant workers come up in the summertime to work our sugar beets and potatoes. Approximately

17,000 to 18,000 migrant workers come into the state every year.

As you get to the central part of the state, it is typical high plains, much more rolling. You have interspersed agriculture with cattle and ranching. I guess a pretty good-sized farm in central North Dakota is one of our typical farms.

We have approximately 34,000 farms in North Dakota. We have 115,000 farmers directly involved in farming. When you add in the families, we are looking at 275,000 farm family members who are involved in agriculture in some shape or form.

The central part of the state has both agriculture and pasture. As you move further west in the state, you get into the Missouri River drainage. The land starts becoming much more rolling and much hillier. We do have large equipment in the state. Our average size farm is approximately 1,100 acres. So it is pretty good sized. We do have a lot of ranching in the central and western parts of the state.

As you move farther west, the land does get quite a bit rougher. When people talk about North Dakota, they generally think of it as fairly flat agricultural land. The western part of our state, however, is pretty scenic. Again, this is not pitched by the Tourism Department, but out in western North Dakota it is pretty. We have a lot of rough terrain out there and a lot of wildlife: bighorn sheep, deer, antelope, etc.

Activities out there are hazardous. A lot of ranchers have gotten away from utilizing pick-ups to go out and check their cattle and run through their pastures because they were finding out it did not take too

\* long to beat up and wear out a \$24,000 pick-up.

They have gone back to utilizing \$1,000 horses for checking fence and working cattle. Most of the western part of the state is considered semi-arid.

We do have some areas out there that have been very dry the last three years. Before I came down here, we did start to get some moisture, which was welcome.

We have this tendency in South Dakota and in Montana to put old thrash machines up on a hill. I have not the faintest idea why it is done. We have talked to a lot of people, and it just got to be a fad. Farmers will take an old thrash machine and stick it up on a hill where people can see it when they drive by on the roads.

There has been a program to eradicate these. That was being conducted by people who have had one too many beers at the local tavern. They go out there at night and push them down the hill!

The farm injuries in North Dakota are a serious matter. We have begun taking them much more seriously. We have fair media coverage in North Dakota as to what has been happening in the area of farm safety. Some of the media coverage and their support has led to much more interest in safety. This has led to the development of some of our programs.

We started out back in 1985 with a CDC grant looking at doing injury surveillance in the state. At that time, we asked medical facilities to report any injury that was fatal or disabling, or kept the injured person from effectively participating in their normal daily activities for one day beyond

the date of the injury. We began that in April of 1985.

We developed an injury report card that went to the medical facilities, and we asked them to complete it. We tried to make it as short as possible.

There are two sides to this, to solicit their cooperation and to try not to make it too complicated. We did that from 1985 through December of 1990.

Beginning in January 1981, we started with a different case definition. With concurrence of the CDC, we are looking at only the injury events that are fatal, disabling, or result in the injured person being hospitalized for 24 hours or more. We are trying to look at more of the severe injuries.

We redid our injury report card and handed that out to all of the medical facilities in the state. Reporting in North Dakota is purely voluntary. We did not mandate reporting. The North Dakota Head Injury Foundation did get a bill passed two years ago mandating that head injuries be reported to the State Health Department. We do collect data on that.

We look at the injuries, and we classify them by ICD-9 Codes and E-codes. Two of our major hospitals in the state, metropolitan hospitals, are going to start reporting injuries by E, their trauma centers. They will do a computer run for us and send it to us every month. They will break it down by head injuries, agricultural injuries, and just injuries in general.

We talked at the CDC Injury Conference and decided that mandating E-coding or getting E coding in all medical facilities will be a primary key to developing a good

surveillance system. This will enable us to find out what is going on out there, particularly in the agricultural area.

When we first started out, in 1985 and 1986, our injury reporting was way up. By 1989 it had dropped drastically. The reason for that was really the fault of the program personnel.

We learned that in order to keep a good surveillance system going, you must keep direct and frequent contact with the medical facilities and with the providers who are giving you the information.

We had some budget constraints and the position was open for about one year. One of the things we learned is that there is a constant turnover in personnel in the medical facilities, particularly in medical records. The emphasis on reporting would get pushed to the side as people came into the jobs and were trained.

Unless there was contact from the Health Department or from our program, reporting got pushed way down. Consequently, the numbers dropped off. We learned that in order to keep a good surveillance system going, you must keep direct and frequent contact with the medical facilities and with the providers who are giving you the information.

Agricultural injuries dropped off, as far as what was reported, comparable to overall injuries on a reporting system. Again, that was as a result of our program not keeping contact with the providers. We are looking at breakdown of injuries, and it mimics the national statistics. Tractors and machines accounted for the lion's share of

our injuries that were reported through the surveillance system.

When we looked at the age groups, again, we ran pretty much in line with Federal and national statistics. The age group of 20 to 29 has the highest incident-rate of injuries. When we looked at male/female, we saw the breakdown of about 95 percent injured being males.

When we started looking at injuries and fatalities, we had a drop-off of our injuries reported due to the program. We get the fatalities from the death certificates that are available in the Vital Statistics Division of health departments. Our fatalities have dropped somewhat from 1985 through 1987, down to 13 in 1989 and 11 in 1990.

On the fatalities, again, we saw tractors and machinery as being the major cause of farm-related fatalities.

When we looked at the age group on our fatalities from 1985 to 1990, there were two age groups that we were of particular concern: the 0-to-19 age group and at 50 and over. Our older farmers were having a disproportionate share of the farm-related fatalities.

Right now we are going back to do case reviews on the fatalities. We will determine what interventions we need to do for that particular age group to develop a program that is going to target older farmers, looking at causation on farm-related fatalities.

We did have the greatest share of the fatalities during the time period from our spring planting in April to the end of our harvest season in September and October. We did, however, have fatalities through all the months of the year, even when it

was cold, and people were indoors as much as they could be in the wintertime.

We found males as having 90 percent and females just about 10 percent of the fatalities, which was a little higher ratio for the females than it was on the injuries.

Also, we find more farm-related, or agriculture-related, suicides as compared to suicides in general in the state. They have stayed somewhat constant over the course of the last 10 years.

This past year, for farm injuries that were reported during 1990, we saw all types of machinery as the primary cause of agricultural-related injuries that were seen in the state. This past year we saw a shift into the age group of 30 to 39 having a higher share of the agriculture-related injuries compared to overall statistics of age group 20 to 29. Utilizing that information, we applied for and received grant information from the Centers for Disease Control for injury-intervention programs in North Dakota targeting agricultural groups.

One of the first programs we developed was with the North Dakota Emergency Medical Technicians (EMT) and Emergency Transmatic Cars (ETC) Association. We have approximately 125 ambulance and rescue squads scattered across the state. Most are in rural areas; they are volunteer squads.

Each year we had 20 ambulance squads putting on a farm safety program. It is on the cover of the handbook that goes with the Farm Injury Prevention Program. It is a three- to four-hour program. The response from the agricultural community has been tremendous.

It targets farm family members. In the rural areas the EMT squad will take 1 or 2 nights, publicize a local program, and offer some type of barbecue dinner or a social get-together to bring the farm family members together. Surprisingly, we have had several communities with only 100 to 150 people have upwards of 265 people come and sign up for this program. They are willing to sit down for 3 to 4 hours to go through an educational program.

There is a video presentation that goes with this handbook. It is set up in an instructional manner where they will view the video for 15 to 20 minutes.

They break down into groups and work for 15 or 20 minutes in a group with different stations. The EMT squad wanted to be able to do some basic first aid and some resuscitation, in addition to the safety program.

They also look at doing First Response on how to contact the EMS service. One of the things the dispatchers were finding in North Dakota, through EMS, is that we do have a lot of Norwegians and Swedes in North Dakota.

Someone would call up and say, "Hurry up. Get out here. There's been an accident at the Olson farm." The dispatcher would look at his listing for that area and there are 15 Olson farms. Then he wonders, Which one is it?

They get back on the phone and start calling around, hoping someone was still in the house that they could contact. One of the things that this program teaches (not only to the adults but to the children in the family) is if an adult is injured, the correct manner of calling EMS is how you give the location, and if you know a basic descrip-

tion of the injury, what type of injury it was. Then EMS can prepare themselves on the way to the farm site.

The EMS would get to farm sites and could not find where the person was. The caller did not say if it were out in the field or what type of field; if it was a barn, or if it was in a silo. The EMS would have to drive around the farm looking for the injured person because all the farm family members were out there.

That was another component on which we put a strong emphasis, the correct manner in contacting EMS. The time frame from the time of the injury until the individual receives medical care is critical. If we can cut that down by a number of minutes, it is going to help as far as recovery and save some lives.

Twenty communities are putting on the EMT programs, safety programs, this spring and summer. They are scattered across the state.

Normally, EMS is broken up into five regions. We try to take four or five communities in each region so that we get a good cross section across the state.

At the central bottom part of the state are, Emmons, Logan, McIntosh counties. Those three counties were settled by (it is part of my background) Russian-Germans or German-Russians. That area has a pretty hard-headed group of people. For years that area of the state has been known as the "Iron Triangle."

This is because anything governmental that comes to that area is going to get rejected, whether it is economic development or whether it is EMS. They did get some EMS programs going down there. We

have yet to get a community in those three counties that is willing to participate in our farm safety program; we have a waiting list for the rest of the state to get on the program for next year.

The North Dakota Farm Bureau is also doing one of our farm safety programs. The Farm Bureau in North Dakota and, I believe, in the upper Midwest, has a program called First Care. They use nurses and EMT people out in their areas. They are scattered in all 52 counties in North Dakota to do a First Care presentation and first aid training across the state.

We were able to go into their network and train their First Care trainers in farm safety to incorporate, in addition to their First Care Program, a farm safety program. They were not only doing first aid, First Care, and First Response training, they were also doing farm safety training for their Farm Bureau members. A workbook was developed from that.

The program was called ABC on the Farm, Always Be Careful. The program was targeted at farm children for Safety for Farm Children. The target audience is the farm family adults, and the workbook is generally given to the kids. There are puzzles on farm safety and a number of different activities for them to do in this booklet.

One of our other programs was co-sponsored by REC, a Rural Electric Cooperative. We went into 13 schools. Originally, we targeted six, but we had thirteen schools request our Farm Safety Program for Children.

This program is put on for two different groups—ages K through 3, and grades 4 through 6. It is a 1-hour presentation. It



is done in the classroom, but put on by somebody that comes from outside the school, not their normal grade-school instructor. We have completed all 13 programs in those schools.

The response has been tremendous from the school administrators, the teachers, and the parents that were surveyed. We did a pre-program survey, and we are going back in to do a post-program survey.

Specifically, we are looking at attitudes of the parents. What are they allowing their children to engage in? At what ages do they think the children should engage in certain farming activities?

We are also utilizing an occupational nurse program that was being administered through a NIOSH grant. The primary purpose of the occupational nurse program is to put five nurses in rural areas across the state.

They will assist in farm surveillance, particularly looking at farm illnesses: respiratory illnesses, dermatological conditions, and toxic exposure to pesticides. These individuals are also assisting in education efforts across the state. They are represented at Farm Safety Awareness booths at local farm programs that are put on in the wintertime, county fairs, community activities, folk festivals—that type of thing.

One of the areas we are investigating is the operator safety checklist, how to reinforce that.

We looked at hazards of flowing grain in all of our programs. We use a gravity box for demonstration with the program presentation. Particularly for the children, we show how easily and how quickly one can become submerged in flowing grain. And

we try to point out particular hazards that we have seen in our injury reports.

We also review all the EMT Association and EMS trip tickets. We pull out the agriculture-related trip tickets to assist in our surveillance and look at causation. We look at auger injuries and tractor rollovers. Tractor rollovers are still a major source of fatalities in the state.

Power take-off (PTO) shafts are dangers. Buildings are dangerous. Children run across openings, go into a shop where the tractor is running. The parent is backing out unaware that the child has come into the building.

We also are going to our major agriculture shows across the state and setting up and staffing a farm safety booth. The winter show, our biggest agricultural show in North Dakota, runs about 11 days. Attendance is approximately 130,000 people. When you only have about 640,000 in the state, that is a lot of people to attend a show.

Also, we have cooperated with Centers for Rural Health and the Dakota Conference on Rural Health. We are on their program schedule and have set up a farm safety awareness booth. I guess on that last one, what we have done is seek help from businesses.

Most of the booths cost a fair amount of money to set up. Normally the commercial accounts are at these shows. We approached farm manufacturers in the state and implement dealers to ask for their assistance in getting information out on farm safety. We have got the backing of the North Dakota Implement Dealers Association.

We have had financial assistance in co-sponsoring some of our farm safety booths. If we have a sign up with the name of a particular implement dealer, it seems that it helps to persuade the farmers to stop, pick up the information, and talk to us. It is just a booth display that we have set up.

As the son of a conservative farmer, one of the things I know is that government help is not generally well-accepted in the rural community and in the agricultural sector. We have heard people talk about regulation and enforcement, the clause that prohibits OSHA from investigating or doing any work on farms that employ less than 11 people, which is about 96 percent or 98 percent of the farms.

Even though there is a lot of involvement in government as far as the farm programs, there is a very strong resistance out in the agricultural community to government involvement. This is particularly true when you come in and say, "Well, I'm from the government and I'm here to help you." Right away it turns them off.

We have enjoyed reasonable success. The focus of our programs is going to continue along this line in the future. We will be able to solicit the cooperation of farm groups, the Farm Bureau, North Dakota Farmers' Union, the local EMT squads, by

utilizing the local people to do program presentation. It adds credibility to the program, adds validity to the program, and it allows us access.

If I went in saying that I was from the State Health Department and put on a presentation similar to what the EMT squads are doing, we would be lucky if we got 30 or 40 people there. As I have said, in some of our communities we have had 200 or 250 people show up. That is more than they get at a local basketball game, a big drawing card in the local communities!

I think it is very important, when you are developing educational programs, to be able to utilize local resources and local people to add that credibility. It allows you to get your foot in the door.

I still go out and do presentations and am involved with a lot of the programs, but the programs are mainly sponsored and put on by local individuals. It has helped tremendously for our program to be accepted. We feel that by continuing to utilize our local resources and our local farmers, getting them involved, we will be able to reduce the amount of agricultural injuries and fatalities in North Dakota.

Eventually, all of our people can continue to enjoy our beautiful sunrises and our beautiful sunsets in the state. That is our primary goal.□

## VOCATIONAL AGRICULTURE

By Robert Graham, M.S.  
Assistant Executive Director  
National Vocational Agriculture Teachers' Association

Dr. Walter J. Armbruster: The next speaker will be Robert Graham, who is the Assistant Executive Director for the National Vocational Agriculture Teachers' Association. He will address the intervention for safe behaviors among adults and children from the perspective of *Vocational Agriculture*. Mr. Graham:

First of all, let me say it is a pleasure to be here in Iowa. I have never been before. It is quite an experience. It is also a real pleasure to be at the conference on FarmSafe 2000.

I am from Louisiana. Has anybody detected an accent? No? I suppose it did not show up.

I represent the National Vocational Agriculture Teachers' Association. We are the folks that are out there in the schools on a daily basis in this country giving professional instruction in and about agriculture. We are the only specifically United States Department of Education group that is given the task of teaching agriculture in the classroom. We had our beginning in 1917 with the Smith-Hughes Act. Right now we have about 7,000 departments in the secondary programs.

I will tell you a little bit more about our staff as we go along.

First I wanted to point out something that is very important about what we are here to discuss in promotion of farm safety. This is an emphatic effort for us to try to improve the quality of our life.

In order to do that, we study our environment. We study it so that we can discern those things that will help us with tech-

niques to change our behaviors to have a safer lifestyle.

This safer lifestyle has been something we have tried to accomplish in the industrial world for quite some time. We have been working toward the same end for many decades in the rural and farm community. It is not simply enough that we establish what behavior or mechanization improves the safety of our daily environment.

The discoveries of our efforts in research must be delivered and promoted. That is what teachers are about: the delivery and promotion of research development. Only when safe techniques are utilized as a common practice is it possible to improve the quality of life as well as its duration. We all want a greater duration. I know I do.

We are in the secondary programs, but that is not the only place that you will find us. This teacher, myself, is working with secondary students.

We also have teachers who are out there working with young farmers, adults, and college students. Tomorrow on the program you are going to have a gentleman by the name of Wayne Sprick speak to you. He is the Executive Director of the National Young Farmers' Association.

The young farmer and his instructor are found in junior colleges or community colleges. We also have them in vocational/technical programs throughout the country.

Part of what I am going to discuss today is our premier award. Our premier group is represented here at this conference by our National President of the FFA, Mr. Mark Timm. We are all very proud of Mark. He represents about 400,000 young people out there like himself.

One of the things that you need to know about secondary education is what we are about—education in all subjects associated with agricultural science and business. We start with a basic study in animal science and plant science in the secondary program. Then we try to take 27 areas, insert proficiency, and enlarge the specific data base. Every proficiency area has a specific section that deals with safety practices.

We are all familiar with beef production, especially here in Iowa. We dedicate safety study to practice of safe handling dealing with mechanical and health problems that may arise from working with livestock. Teachers are doing this at all of the levels I previously mentioned.

We utilize this model in order to broaden the classroom/ laboratory instruction with a supervised agricultural experience and then we incorporate the FFA organization into it.

We try to encourage the involvement of the community into the classroom. We encourage young people through the FFA, in classroom action, and laboratory instruction at the site, and we branch out into supervised agricultural experience. We try to get those experiences in all the areas

that I have just mentioned—the 27 proficiency programs.

### **THE NATIONAL CHAPTER SAFETY AWARD**

Our premier promotion project right now is the National Chapter Safety Award. This project is sponsored by the Equipment Manufacturers' Institute (EMI). We try to get these 400,000 secondary people to get involved.

We are trying to branch out into other areas in the National Young Farmers' Association, as well as both secondary schools and community colleges with this type of promotion activity. It is not enough simply to teach safety. It is vitally important that you promote those people who are out there doing these voluntary activities so it will be an ongoing and growing process.

We in agricultural education discovered this a long time ago. About 25 years ago, we got hooked up with the EMI and the National FFA Foundation. We found money to put on a national competition.

The four basic steps are identifying the need, defining objectives and plans, taking action, and evaluating the results.

We also promote the safety award for eight objectives: one, to study current safety activities in the community. The application is set up so we do that. You have to know what kind of safety practices you need. I think our first speaker was pointing that out to us, evaluating what you need in the community and then trying to design plans to deliver that type of

instruction. Then it will be adopted and utilized. Create an understanding of safety in the community.

There is a great lack of understanding by people who are afraid of being regulated and having their procedures on the farm changed by some governmental intervention. One thing for sure, all of us farmers are a little bit on the hard-headed side.

We encourage students to sit down and do a community review by interviewing resource people with organizations, such as the community health organizations, the district representatives of OSHA and NIOSH, the Farm Bureaus, and National Grange Affiliates.

By encouraging members of the FFA to realize the importance of agriculture safety in their community, we are all trying to instill a change in behavior in the young people; that is a major objective. If you change the young people's attitudes towards safety practices, you are going to change how the occurrence of accidents or the misuse of chemicals occurs in the future. They will be more conscious about the activity around them.

Identifying collaborative groups and joining forces is another important feature of what we are here about. That is coalition building. To try to create and to carry out successful safety chapter programs, specifically for our award, we are in the habit of involving the community.

## **A PLAN FOR ACTION**

In the application itself, we try to get the teacher and the student to sit down and

develop the correct approach to analyzing any situation. The four basic steps are identifying the need, defining objectives and plans, taking action, and evaluating the results.

The last one is very important, evaluating results. I have heard some discussion by all the speakers concerning what we are talking about in this *FarmSafe 2000* coalition. When we get through here, how are we going to come back and evaluate what we have accomplished one year from now, two years from now?

## **Identify Needs**

It is important that you know and identify the needs. We encourage students to sit down and do a community review by interviewing resource people with organizations, such as the community health organizations, the district representatives of OSHA and NIOSH, the Farm Bureaus, and National Grange Affiliates. All these people have other resources you can utilize for identifying the needs of that community.

## **Define the Objectives**

An example would be in Indiana one year, they defined their objective at a particular school as lowering the incidence of traffic accidents involving 16-to 25-year-olds by 10 percent.

They had a specific goal. It was measurable. They could come back and take statistics that were available through the health unit and verify whether or not the effort had lowered the statistics. These are all things that we look for when we begin to evaluate the applications for National Safety Award.

### **Take action**

Once you have a plan in place, you have to get it in action. Utilize the people who helped develop this information by putting them into the plan. Then you set out to accomplish the task of lowering the number of car accidents for persons between 16 and 25 years of age. Do this through posters, pamphlets, audiovisual aids.

All of these things are suggestions that we try to put into the packet we send to promote the utilization on this project. Also, we tell young people to examine the laws and regulations. We find that there are a lot of people in the community who are unaware of the laws and regulations at their fingertips to help improve their local community. We encourage them to first go to the legal sources. Find the laws and regulations. See what is on the books that will help you enforce or help you promote what you are trying to accomplish.

I would like to encourage everybody to attend the poster session tomorrow. There are at least six posters there that have been done by Gold Emblem Outstanding Chapters. I think you will get an overview of what we are trying to do in some 7,700 chapters. That is our goal.

### **Evaluation**

The evaluated results are a critical part, to see whether or not it has been a successful project. Is there something more to continue?

We suggest things such as pre-tests and post-tests. These are things that can be actually statistically proved. Survey the people. Get an opinion survey of what they perceive the problems were. How do they perceive, at the completion of the

project, what was accomplished? Was there an actual attitudinal change?

**Self-reflection:** you have to sit down with a group of resource people that you have put together from the community, business, professions, education, and government. Have them evaluate. How did you see what was accomplished? Understand that this is an annual, ongoing process to try to comply with.

The evaluation is vitally important. We have seen a tremendous increase in the number of chapters since we have started this project. It is not enough, however. We started with around 500 chapters participating in our programs back in 1972.

We did not collect statistics the first year we started. We are up to over 1,600 chapters in the year 1991. That is 1,600 chapters participating out of a possible 7,700 at the secondary level.

We currently do not have an active national contest for safety at the post-secondary level. We are beginning to get into the middle-school level. The potential for growth and delivery of this information through our particular promotional process is immense.

One of the reasons it has not grown more is because we personally have found flaws in how we deliver the safety information. Teachers (and ours are not unlike any others) have a tremendous number of activities that they have to tend to on a daily basis. A lot of these activities are around that local school site. We found that if we will develop the materials, and hand-deliver those materials rather than mail them in a package, we get better results.

## PILOT TESTS

The next question is how we do that. We have come up with a system that we are going to pilot test around three new projects. We have broadened our area of attack. We have gone to agricultural science, food safety, and also ground water quality. We have two new projects. One was mentioned by Mark, the one about the food safety development project. It is a new curriculum project. It is curriculum for infusion.

As educators and teachers, what that word means is that, instead of trying to give us another task to do on top of everything else, we are trying to supplant something already being done, or to supplement information with more current data.

I am going to use ground water quality as an example. How do we deliver our material so that it is utilized and does not end up as another fantastic piece of material sitting on a shelf somewhere on which \$300,000 or \$400,000 worth of grant money was spent?

We have designed as a management information system. We are going to pilot our ground water quality project through that management information system. We are going to train 40 trainers (master's degree or above people), classroom teachers, college professors who are willing to participate.

They will deliver this particular subject matter on food safety and ground water quality by conducting 10 workshops directly to teachers. It will not be open only to agriculture teachers. It is going to be a broad system that is open to all teachers of science, health, safety; even physical educa-

tion instructors may find a use for it in their curriculum.

The object is that people go to a site located so that no one instructor would have to come more than 35 to 40 miles from school. It is an after-school project. That way it does not interfere with the normal day.

By delivering the actual material into their hands, with a video to back it up and a workshop to go with it, it is more likely it will be utilized. This, in the past, has been proven by local universities. It works better when hand-delivered.

The problem comes in our particular area of education. Agricultural education is not one of the required courses. Since the *Nation at Risk* reports came out in 1983, we have had a tremendous amount of pressure on us, as local educators, to prove that there is a need for us to be in the public school system.

## CONCLUSION

Once again, I am excited about this particular conference and the opportunity to speak and present our particular method of delivery on farm safety information and rural community and health education information. We need you to know that that light of discrimination is being shined upon us rather strongly and has been for some time. In order to expand the process, we need to form a tighter and broader coalition to deliver additional information on rural health and economic development.

I look forward to working with the rest of the groups that are here. I have enjoyed what has been said by Dr. Novello and look forward to proceeding with this coali-

tion. We can change the risk that is out there among farm and rural communities.□

## QUESTIONS

(inaudible): Do you have an example of a pre- or post-test they can use?

Robert Graham: Okay. I will use one from my personal experience. I spent 11-1/2 years in the classroom. A pre-test that we used in our community had to do with how many actual safety programs the people in our community had been to and observed in the course of the last 24 months.

We circulated this around the community door-to-door on a Saturday. We put out about 500 of them. We had drop-offs for them.

We got 300 of them back. It was the local post-office. The postmaster cooperated with us in the rural community.

We actually checked on how many had been to safety programs dealing with drunken driving and safe operation of vehicles and farm vehicles on the highway. We got back a little over 300 of them. We evaluated the results and there was a small number. I do not remember the exact number, but about 15 percent of those had actually been. I know it was under 20 percent. Over the course of the next six months, we planned four types of seminars. We involved the Farm Bureau Federation, the national and the local health community, and some Rural Electrification groups that had some promotional films. We did three night programs and one school program.

Then we went back and surveyed the attendees as to how many of them had received our survey. About 35 percent of those people had actually gotten our forms and turned them in.

It is not an accurate survey of what we did there. We found that out as we went through. We saw an increase in the number of people who had actually gotten our forms, turned them in, and been to those programs at that time. There were more of those. It was about 25 percent. We figured about 20 to 25 percent of the population had increased their attendance at a program on education about operation of vehicles on the highway.

That is not a good example of a pre- and post-test. There are other ways to do it by analyzing the statistics in your immediate geographic area. What are the accidents? Model your program on one that was done by a chapter in southern Louisiana dealing with power take-off (PTO) injuries. There was a high rate of these injuries in a particular county in that state. They evaluated them by doing a countywide program over the period of one year. They had at least one program every other month dealing with the accidents. They measured the accidents through this year; and there was a reduction of about 10 percent. Those are rough examples. There are some others. The gentlemen who created these posters have better examples. They are the national ones, I am just a local one.



## THE MASS MEDIA AND AGRICULTURE

By Cheryl Tevis, M.A.  
Senior Farm Issue Editor  
*Successful Farming Magazine*

---

I am glad to be here this afternoon and to have the opportunity to share some thoughts with you about farm safety and health. I am the Farm Issues Editor at *Successful Farming Magazine*. *Successful Farming* is a national farm magazine with 500,000 subscribers. It is based here in Des Moines.

We are published by Meredith Corporation, which also publishes *Better Homes and Gardens*, *Midwest Living*, *Ladies' Home Journal*, *Metropolitan Home* and several other magazines. I have written for *Successful Farming* for 12 years.

I did grow up on a farm in northwest Iowa, near Sioux City. Like many farm teenagers, I left the farm when I graduated from high school. I did not know what my college major would be. I was pretty certain, however, that my life's work would not be related to farming at all.

Somehow, as part of the requirements for completing my master's degree in Journalism at the University of Missouri at Columbia, I wrote a series of articles about agriculture. That led to a decision to specialize in agricultural writing.

I worked at a farm magazine in Milwaukee for three-and-a-half years before coming to *Successful Farming*. Then, almost 7 years ago, I completed my 360-degree revolution by marrying an Iowa grain and hog farmer. Although my life has taken a somewhat circuitous route, I am a farmer's daughter

writing for a farm magazine and married to a farmer. That is my background.

I have been asked today to talk about the media's role in helping to promote farm safety and health. Obviously, I can not speak for the entire media. My personal experience is with farm magazines and, most specifically, with *Successful Farming*. I will concentrate on that.

For years the general public has perceived that the farm is a great place to live and raise a family. In many ways that is true. For those of us who have lived on farms or in farm communities, farm health and safety always have been concerns. I am proud that *Successful Farming* has taken the lead in covering many of these topics and that my involvement with farm health and safety issues is not an overnight development.

For instance, in the late 1970's, I remember writing about farmer's lung disease and the work being done at what is now the National Farm Medicine Center, to help afflicted farmers. *Successful Farming* also had an early focus on the effects of stress on farmers. I wrote a story on this subject back in October of 1980. My stories about disabled farmers began in 1981. I wrote about microsurgery following a farmer accident in 1983.

At about the same time, we had an editor who was a fitness advocate. With his encouragement, I wrote an article called

"Being a Farmer Does not Make you Fit and Trim." In those days it was something that you did not think about. Naturally, farmers are supposed to be in good health and good physical condition. We felt that there were some areas there to work on as well.

In December of 1981, I edited an article by Kelley Donham, at the University of Iowa's Institute of Agricultural Medicine and Occupational Health. It was entitled, "Farming Can be Hazardous to Your Health." A year or so later, I worked with Kelley again to write a sidebar about farmer's lung, pesticide poisoning, respiratory illness, well-water contamination, and toxic fumes poisoning.

In March of 1984, *Successful Farming* became the first farm magazine to feature a regular rural health page. Today I think this feature still does distinguish our magazine from others. We have covered topics from skin cancer, to fitness, to hog farmer's lung, to histoplasmosis. More recently, we have featured occasional articles about non-farm related illnesses and conditions such as lupus, infertility, and Lyme disease. It is our belief that farmers do not receive many magazines that deal specifically with health issues. Yet they are interested in reading about it.

The safety of farm children has become a personal and professional issue of mine. In 1983, I wrote a story about the death of a 17-month-old girl in a farm accident. Soon afterwards I married a farmer and, in 1986, our daughter was born. I found myself coming back, both for professional and personal reasons, to the topics of children and farm safety and farm-related health hazards.

Farm children have been injured and killed for years. I was too young to remember a tragic tractor roll-over accident that claimed the life of our neighbor's son. Years later I remember finding the yellowed and brittle newspaper articles about it that my mother had saved. On looking back, I think that that accident may have had a lot to do with the fact that my brothers were not expected to function as hired hands at a young age.

Despite the fact that children have been the victims of farm accidents for years, the issue of children and farm accidents was not a hot topic. In fact, my 1983 article about Bill and Ann Friend's daughter was unusual for farm magazines. I have to give Bill Field, at Purdue University Extension, a safety specialist, most of the credit for bringing this tragic situation concerning children to my attention. I think he took the leadership in tracking injuries and deaths of farm children.

Since that first article, I have found that focusing on children is a way to get at the complacency factor among adults concerning farm safety. Initially, my editor was not excited about writing safety articles. After all, he pointed out, people feel that they already are safety conscious. They have their own mind set about it and it is difficult to engage them on that topic.

By taking steps to reduce or eliminate safety hazards on the farm for the sake of their children, in many cases adults also are protecting their own lives. It helps to penetrate that adult mind set and get them to at least think about safety.

Therefore, three years ago I prepared a one-page story featuring an Earlham, Iowa, farm woman, Marilyn Adams. I was moved by the death of her young son,

Keith, in a gravity flow grain wagon and by her efforts to do something to try to spare other farm families the grief that this accident had caused her. Just before the article was to go to press, I found out that we had a commercial sponsor, DowElanco, who was willing to provide enough advertising to allow expansion of that topic from one to twelve pages. I was elated.

The article, "We Kill Too Many Farm Kids," contained original research. Here is a copy of it. I have copies of this article as well as other ones that we have done up here in the front for you to take with you today. This article had original research that was based on our 1,200-member farm panel, concerning farm safety attitudes and practices.

For instance, we found that 65 percent of farm boys were driving tractors without supervision by age 12 years. According to our survey, more than 70 percent of farm parents believe that the risk of a child riding as a passenger on a tractor is low, very low. More than 85 percent allow their children under age 9 to ride.

The response to this article has been gratifying. With the assistance of Marilyn Adams and her organization, Farm Safety for *Just Kids*, we estimate that more than 20,000 copies of the insert have been distributed.

The article has been reprinted twice since its publication. It has enjoyed widespread distribution to 4-H clubs, farm families, FFA, and extension safety specialists.

A video based on our 12-page editorial was produced, again with the sponsorship of DowElanco and the distribution by Farm Safety for *Just Kids*. More than 2,000

copies of the video have been distributed in the past two years.

In addition, FFA chapters, churches, hospitals, 4-Her's, and farm men and women have written or called to tell us about their efforts to take the information in the story and the video one step further.

Two years later we are still receiving requests for this article. As a result, in mid-March of 1991, we published a five-page follow-up featuring many of these ideas, events, educational efforts, and projects. We want to provide information and guidelines to others so that they can plan and conduct events as well.

This is the five-page insert that we did with ideas and projects and things that can be done on a community basis to improve farm safety, specifically for children. Last year, "We Kill Too Many Farm Kids" was selected as a finalist in the category, personal service, of the National Magazine Awards.

In 1990, sponsorship again provided *Successful Farming* the opportunity to publish a 12-page story called, "Staying Alive: The Struggle to Save Farm Accident Victims." It focused on near-fatal farm accidents told from the perspective of the farmers who had survived them, and provided vital information about what steps individuals can take to improve the quality of rural emergency rescue in their communities. The article also featured examples of what communities are undertaking to improve their emergency rescue skills.

As you have heard today, about 75 percent of the rural emergency medical services in the U.S. are comprised of volunteers. Many victims of farm accidents are not discovered for hours or have to travel

miles to the nearest hospital without first aid. Since 1981, 190 rural hospitals have closed their doors. It is estimated that 22 percent of hospitals in rural America are at serious risk of closing. The medical attention that farm families receive at that accident scene is more vital today than ever before.

Last fall we offered the Institute for Agricultural Medicine and Occupational Health access to our farm panel for further research into farm accidents. We found that proper shielding is not placed on power take-offs (PTO's) on 64 percent of the farms. Only 64 percent of farm children use seat belts in farm pick-up trucks. When parents were asked to select the factors used to determine when their children were old enough to drive a tractor, 48 percent replied that they or other children in their family drove at that age.

Economic factors also ranked high. A total of 31 percent in the Iowa group surveyed said one reason for the decision to let their child drive was that extra help was needed. Another 21 percent said that the kids", wanted to do it."

When asked, "If cost were not a consideration, would you use roll-over protection?" 89 percent said they would; 96 percent would use safety shielding; and 50 percent would use day care. These figures may be slightly high. We all know it is good to have good intentions. Most of this group, 92 percent, said they know that tractors and other machinery are the largest source of accidents involving children. Many of the safety recommendations buck tradition, values, and economic needs on farms.

We featured the results of this study along with an article about the farm family safety walk-about program developed by the

Institute of Agricultural Medicine and Occupational Health. We contributed funding and featured an article last year about the farm safety day camps for kids, pioneered at a hospital in Cedar Falls, Iowa.

Living on a farm 60 miles from Des Moines, I frequently see and hear about farm neighbors and relatives who exhibit a casual disregard for dangerous situations involving children. Child care is a crucial problem. A survey of 1,500 Minnesota farm women reinforces the fact that finding affordable, quality child care in rural areas is difficult. Of these women surveyed who are employed off-farm, 44 percent use child care.

Even women who do not work off-farm, in that survey said that they needed child care options to allow them to accomplish their farm work. Being married to a farmer and being the mother of a four-year-old, I understand the problems of keeping children safe while growing up on the farm. I have child care arrangements for our daughter.

Occasionally, as any other parent in that situation knows, arrangements do fall through. Many times it is hard to even get a high-school babysitter in the evenings in rural communities.

Sometimes I have to fall back on my mother-in-law. That creates concern on my part. She is usually involved in the field work or the hog chores. Fortunately, my husband shares my view that a tractor cab is no place to babysit children and a farrowing house is not a play area.

On the other hand, I see the dangers of never allowing our daughter to venture under supervision beyond the house yard.

This would not prepare her very well for following in the family tradition of raising hogs as 4-H projects and knowing generally what goes on on a farm.

We know that about half of farm women work outside the home.

As a result, *Successful Farming* has featured child care stories. This is another departure for farm magazines. It is a risk, of course, since a certain percentage of our readers do not approve of child care. I could read you their letters.

We know that about half of farm women work outside the home. If they do not work off-farm, they are often expected to help with the livestock or drive and operate equipment during planting and harvest.

Our most recent child care article featured an Iowa day care center and a farm woman's role in helping to lead a community effort to expand that center. We contributed a modest amount to its completion as a sign of our support for the importance of this issue to farm safety for children.

Last year, I made a comment in my monthly magazine column that a tractor cab was no place for a small child. That provoked a very forceful letter from a Michigan farm woman. She said that taking a child in a tractor cab was safer than in a car travelling sixty miles per hour.

I ran her letter in a subsequent column and asked readers to comment. I received about 30-35 letters in response, a fair amount of response for any item in the magazine.

The letters reflected a mixture of opinions. There were many from women who agreed with my Michigan critic. Many women who were grandmothers wrote to say that they had taken their children with them as they worked on the farm and never had any reason to regret it.

Other younger farm women said that their labor was needed on the farm today. They did not, number one, have enough money to pay someone to watch the children, or, two, close relatives who were available for babysitting.

As a result, five-year-olds are playing in pick-up campers or pick-ups parked at the end of the field. Their mothers are checking on them at the end of each round. Smaller kids are riding in the tractor cab and combine. The mothers feel as if they have no choice.

On the other hand, I received a good number of letters from women and men who said that taking children in the tractor was unsafe. The children could suffer from hearing damage, dust, and fumes. They said they would not try to care for a child in a moving tractor as they would not in a moving car.

The topic of farm safety, particularly for children, is now in the limelight. When the awareness level is high, we have a golden opportunity to make the leap to changing behaviors.

In farm health, we are confronting obstacles such as inadequate financial resources in rural communities, lack of health insurance among rural individuals, and a financially threatened network of hospitals. These problems are compounded, in some cases, by uninformed policy makers.

For instance, just last week I picked up an article featuring an interview with the chairman of a nonprofit health policy research organization in Minnesota called Interstudy. I cannot tell you how amazed I was to learn that:

*There's very little evidence that the lesser amounts of health resources in the upper Midwest rural areas are having an adverse effect on people's health. Perhaps, because they live healthy lives. They're not exposed to the detrimental effects of the city like pollution, for example, and they generally get more exercise. So, I am not persuaded that the lesser intensity of health care that's available in rural areas is necessarily bad for rural residents' health.*

I am here to tell you today that farm life is not necessarily healthy. As you know, there are people living in urban areas who worry about applying pesticides to their lawns to make their lawns look more attractive. How would they like to apply pesticides to 1,400 acres of land every year to make a livelihood?

Urban people do not have to worry about the long-range effect of pesticide and nitrate residues in their well-water. They do not get hog lung from their life's work. OSHA is there to help protect them from being injured and killed on the job. Rural people, especially farmers, are exposed to a host of hazards and illnesses that demand adequate health care as well as a medical profession that is trained in these unique occupationally related illnesses.

I believe that the consciousness of the farm community is being raised concerning farm safety and health. In fact, the Farm Family Survey conducted by the University of Iowa showed that farm safety and health

ranked equal to or higher than other concerns such as farm commodity prices, social erosion, and environmental issues.

This same survey showed that farm magazines ranked as a top source of information for farm families and a great vehicle for health and safety articles. There is no question that the media can play a large role in keeping people interested and aware of farm safety and health. I must say that it is difficult for farm magazines like mine to sustain heavy coverage of farm health and safety articles without, number one, considerable research and activity in this area by other interested parties; and, two, positive feedback from our readers demonstrating readership of these issues.

More recently, as a member of the farm media, I have been reminded of the responsibility not only to write about these issues but also to portray proper safety and health practices throughout the magazine in the photographs that we feature.

For instance, as I mentioned earlier, in the late 1970's and early 1980's, it was less common to feature farm safety and health in our magazine. My editors would tell me that we are not in the business of "reminder journalism." That means that because farming is hazardous, and we are a farm magazine, we cannot write an article every month reminding our audience that they need to be careful. That is unless, of course, we have a news angle or new research to feature.

For many years, extension safety specialists, such as Bill Field, at Purdue University, and Rollin Schnieder at the

University of Nebraska, were laboring trying to make a difference. This was despite government cutbacks in funding farm safety at land-grant universities. They were and still are operating on a shoestring. It is difficult for the few of them who work so hard to generate enough research or programs to keep up a continuous flow of agricultural health and safety stories for the media.

Now other organizations, agencies, and institutions have begun to focus on farm safety and health as an issue and to obtain funding for activities and research. It is much easier for me to propose a story and have it accepted by my editors. The topics of safety and health still need to compete for space in our magazine with articles about production and business.

More recently, as a member of the farm media, I have been reminded of the responsibility not only to write about these issues but also to portray proper safety and health practices throughout the magazine in the photographs that we feature. For instance, if a photographer takes a picture of a farmer driving a tractor with an extra rider and we use it on the cover of the magazine, are we giving tacit approval to this unsafe practice? Or if a photographer shows a farmer applying chemicals without proper protective clothing and equipment, are we encouraging unsafe behaviors?

This is a difficult area. In reality, of course these situations are the norm in farm communities. Another factor is that virtually all of our photographers are freelancers who have no farm background. I am a member of the Iowa Farm Safety Council. At their suggestion, I am contacting all of our freelancers, sending them materials explaining the need to portray safety and health in photos as well.

It is an uphill battle, and we will not accomplish as much unless we all work together. As I interview sources and write stories about farm safety, however, I have become aware of professional jealousies and heard harsh criticisms.

The issue is not, I think, which group has done the most. We are all needed. This includes traditional groups such as extension safety specialists, who have paved the way, as well as hospitals and universities who have begun to make a substantial contribution. Each group has its own strengths and weaknesses.

We are working on an issue that affects people's lives. As a farm writer, I appreciate the perspectives of the entire spectrum of individuals committed to the cause of farm safety and health.

It is great to think that the Surgeon General's Conference is focusing on farm safety and health. It is gratifying to see so many of you here today. As I look out over the audience, however, I can not keep myself from thinking about others who are not here today to benefit from these sessions about farm safety and health.

For instance, I think about Lloyd Hinshaw. He was a 41-year-old farmer who killed himself, a victim of depression and stress. In the winter of 1981, I interviewed his widow and two other farm couples attempting to cope with financial stress. Then I wrote an eight-page article about the effects of stress on farm families.

I wish that we could turn back the hands of time so that Indiana farmers Bill and Ann Friend could be here today. I grieved with them at their kitchen table 8 years ago over the loss of their 17-month-old daughter in an accident in their farm

driveway. I wrote about their nightmare in the magazine in 1983. For several years afterwards, Bill could not bear to continue his volunteer work as an EMT. Today, however, he is back helping others in his community again, at accident scenes.

It is too late for Jim Arnold. After studying accounting and agricultural economics for 3 years, he quit college to return to farming. His love of farming and overpowering desire to make it his life's work despite the obstacles is not unique. In Arnold's case, however, the challenges are greater. The 36-year-old Nevadan lost both arms and legs 10 years ago in a powerline accident on a farm. *Successful Farming* helped to sponsor two national conferences for disabled farmers. We also sponsored the Iowa Easter Seals Farm Program and are breaking new ground at Purdue University.

I think about Jeannie Johnson of Canton, Missouri, who was widowed with a 5-

month-old son and a 7-year-old daughter. She will never forget the day 9 years ago when her husband was killed in a grinder-mixer accident. Her story appeared in our magazine 4 years ago.

I do not believe that I will ever forget these people or their stories. I wish that they could have benefited from the attention that farm health and safety is getting here today. It is my hope that, as a result of this conference, in the future others will. We are all here today because we are involved in safety and health issues. I am grateful for the opportunity, which my job gives, to me to meet people like you who are so vitally involved. As concerned individuals and members of the medical profession, we all have a role to play in the future health and safety of agriculture and its people.

Thank you very much for your attention. I would be happy to visit with you afterward.□



## MULTILINGUAL TRAINING

*By Malanie Zavala, B.S.*  
Farm Worker Safety Coordinator  
University of California-Davis

Although the topic is multilingual training, my own expertise is Spanish-language training specific to pesticides. I am going to limit my comments to those two particular aspects of this larger question. That is what I know.

My job at the University of California is to develop and present pesticide safety training material to the people who handle pesticides on the farms and who are not necessarily certified. They have not passed any examination or had formal study on how to handle pesticides. I also provide training for farmworkers who never handle the pesticides but work around them.

In California and a lot of other states, many people who work in the field are foreign. Certainly, the largest percentage are Spanish-speaking people, from Mexico mostly, and also from Cuba, and a number of other countries, as well as from Puerto Rico.

These people will require some training in California if they handle pesticides. In other states, the training is not required, but these people need to know a lot about pesticide safety, because they are working with or around them.

In California, there are stories every year, and you have already heard some of them. Ellen Widess yesterday mentioned the story of a crew that was directed to go into a field that had been recently sprayed.

They all got sick because they had gone in too soon.

There were no re-entry signs up warning them to stay away, and since they did not know the symptoms of pesticide poisoning, they did not know what was happening to them. Even their crew leader did not know what was happening. That is not a good situation.

What I plan to do in this presentation is to talk about some of the requirements for developing successful and creative pesticide safety training material and any kind of safety training material for people from other language culture groups. Even though my comments are going to be limited to Spanish-speaking people, I am pretty sure this sort of information can be extrapolated and would fit any culture or group.

Also, I want to talk about some of the common errors and problems that come up when you are trying to develop educational materials to reach other language groups, and finally to suggest, perhaps, some ways to facilitate effective communication.

### REQUIRED SKILLS FOR SUCCESSFUL COMMUNICATION

Let me talk about some of the required skills for doing a good job of developing multilingual pesticide or other kind of informational training material.

► First—some of this is going to seem pretty obvious or simple-minded to you—but you would be surprised, however, how often it comes up—the translator, or the interpreter, the communicator, the person who is either translating the material or who is talking directly to the target group, needs to have a reasonable understanding of the subject matter.

It is not enough to speak both languages. You need to know the appropriate terms. You need to know enough so that when you are doing your translation, you do not misinterpret something that is written in English or that was told you in English, in such a way that it means something else when it is said in Spanish or the other language. I have seen this happen frequently. So it is important that person have that skill, that they must know something about the subject they are talking about.

► Second, the person needs not only to be able to speak both languages, but they also need to be articulate in both languages. It is one thing to be bilingual or multilingual and another thing to know how to effectively communicate in the language(s) you speak. Suppose you were raised in a Spanish-speaking home, for instance. You grew up speaking Spanish. You learned English in school. English is a preferred language for you, which is usually the case for kids who grow up in another-language home. You know how to speak Spanish.

That does not mean you can put together articulate sentences and communicate with people. It is not the same thing. Interpretation and translation require very real and very significant skills. That is something I am afraid is often overlooked.

► Finally, what you need to have for a successful training or information provision to other language groups is a basic understanding of the social characteristics of the target group. To put it differently, you need a cultural awareness. For instance, suppose you are a graduate student in Spanish. Your Spanish is great. You can speak very well. That is just fine, if the people you are communicating with are people with similar cultural and social-economic backgrounds.

You would know how to talk to them. You would be able to communicate with them in English too. But that does not necessarily mean that you are able to speak to a typical farmworker.

The register of the language is different. The kinds of terms that farmworkers are familiar with are going to be different. Often you see the mistake of somebody using language that is too technical with terms that people do not know, and that mistake needs to be avoided.

In order to successfully teach something, you need to understand a number of things about your audience. You need to understand their prior learning and reading experience. Frequently Spanish-speaking people who come to this country to work, and I am sure this is true of other cultural groups as well, have a sixth-grade or less education.

Somebody like that is not going to want to sit down and read an eight-page leaflet. It is not something that is going to appeal to them. I am not saying that they cannot. Certainly, there are people who come here who have had a better education and who would be comfortable with this means of communication. It is not the kind of thing

that is going to be real appealing to the majority. That is just a fact.

Another thing you need to keep in mind is when you are presenting information to somebody, you have got to consider their background, opinions, or assumptions regarding the subject matter. In the case of pesticides, it is common in Spanish to refer to pesticides as *medicinas*, medicines for the plants.

This means that even though pesticides have gotten bad press and people are very nervous about them, for many farm workers pesticides are seen as something good. They are good, of course. They have a very important function. But at the same time, they are dangerous.

It is hard to communicate the idea of something being dangerous to a group of people if they think of it as medicine. You need to deal with that kind of assumption first and clarify to people that pesticides indeed are dangerous. This is again just one example.

Another thing about pesticide information. When people get poisoned by pesticides in the field, it is usually through skin contact. Normally, most people think of poisoning as something that happens when you swallow a poison. So you need to get past that idea and get people to understand that pesticide poisoning can, and indeed does, occur because of skin contact. These are just a couple of examples of the sorts of assumptions that people come into meetings with, or start reading something with. You have to take that into account and deal with these assumptions at the very beginning so that understanding is reached.

I think we need a knowledge of the kind of reading and educational materials that the people are used to seeing.

The University of California just developed a training booklet to help farmers comply with the California regulations requiring that all people who handle pesticides, who have not passed an examination for certification, receive training. This training covers a number of specific points, and is pesticide-specific.

If you train a worker to use malathion, and next week he is going to be using Round-Up, then he must be retrained for that other material. This pesticide training must be repeated each year, so that when a year has gone by, and he is starting to use Round-Up again, the training must be repeated for Round-Up. That is a very good law.

It is important that pesticide handlers understand about pesticide safety and how to take care of themselves and protect other people and the environment when handling these materials. Unfortunately, with a labor force like the one in California where almost everybody in the field is Spanish-speaking, it is very difficult to do that training. So this publication is bilingual. It is in English first and then Spanish, and then there is a picture.

We are hoping that by using this booklet, the trainer can go over the material with the trainee, reading in Spanish what the trainer is reading in English and then the picture will act as a pictorial link; we are optimistic that this will make compliance with training requirements much easier.

We chose a particular kind of "comic book" format because it is a very popular form of literature in Mexico. Hispanic

people—I do not know about Puerto Rican and other Hispanic groups—but in Mexico, this particular kind of comic format is very common.

They have what they call novelas—novels written in a comic book format. So it is going to be more appealing than just a lot of words. Plus, I think the pictures help bring the point home.

### **COMMON ERRORS AND PROBLEMS ENCOUNTERED IN CROSS-CULTURAL COMMUNICATION**

I am going to talk about some of the common errors and problems made when providing information to people from other cultures. I already touched on one: choosing the wrong level of language. As I pointed out, a lot of these people come here without an excellent education, and this is going to make a difference as to what they can understand in terms of reading—not so much in terms of spoken language, I think, but in terms of things that they are going to have to read. You want to choose a language that they are going to feel comfortable with, and this is going to take some knowledge of where they are coming from basically.

I already mentioned that if you give workers a multi-page leaflet to read, they are unlikely to feel comfortable with it. They might feel uninspired to read it, whereas the comic format or something like that would be more readable.

Then of course the language: you do not want language that is too technical or too academic. Again, do not misunderstand me. This is a question of education, certainly not intelligence, but education is a very real thing, and it needs to be taken into consideration.

On the other hand, like most Americans, the majority of workers listen to news shows and other TV programs, and they understand the level of Spanish, of course, that is being spoken on those shows. That is why when it comes to spoken presentations the same problem does not necessarily exist as does with written material. The audience will not have the same difficulty listening to something spoken as they would when it comes to the written word, and they will be able to understand things at the same level you would use to address any other audience.

As I pointed out, a lot of these people come here without an excellent education, and this is going to make a difference as to what they can understand in terms of reading—not so much in terms of spoken language, I think, but in terms of things that they are going to have to read.

Choosing informational formats, which the audience does not like: I have already talked about that. Again, I cannot encourage too much the use of things like comic books, or photo novelas.

The photo novela is a very popular form of literature for many Spanish-speaking people. A particular photo novela comes to us courtesy—except I did not tell him about it—of Jim Grieshop, who is sitting in the back. He was working in Ecuador for a number of years developing informational material, and he and other people came up with this particular idea.

This is similar to the comic book idea, where you have got photos of people acting, and then you have the caption. It is an appealing form of literature and a com-

mon one, like the comic book, for at least Mexican people who come to the United States to work. This is another way to communicate, and I will have some other examples as we go on.

Another problem is choosing a translator or communicator who is not good. This is so common. When materials need to be translated, find somebody who knows how to do it. Especially in states like California, which has a large Hispanic population, there tend to be a lot of people around who speak Spanish. You can find somebody, perhaps, in your office—the receptionist who speaks Spanish or a staff member. Knowing both languages is not the same as being skilled at translating from one language to another, and I have seen some remarkably awful translations because of that.

You need somebody who is skilled, somebody who is a professional translator. It is expensive, but I dare say, it is worth doing when you have such a large number of Spanish-speaking or other language-speaking people working in agriculture in your state. It is worth the effort and the cost to get it done right. The trouble is, if you have somebody who does the translation for you, you do not speak the language yourself, and you have no way of knowing how good that translation is. How are you supposed to know?

That is the other thing. You should get somebody who edits translations so you have first a professional translator and then a professional editor who will read over translated material.

I have got a great example of a horrible translation. Here is a little example of sort of a syntactical error, I guess you would call it.

In English, you know, you sometimes hear "where possible"—that is not very common but you hear it—"where possible, do such and such." Literal translation of that particular phrase does not make much sense in Spanish.

Let me go over another translation. That is a really good example. "Slow squeeze at the turn, crossing obliquely on rough to polish or muddy surface." I will not say which state agency or from state it came because I do not want to embarrass anybody. But the whole thing this came from was like that. That was the very worst example. In the first place, there are wrong words for some things. Everything that could be wrong with this thing is wrong. It is a terrible translation.

Anonymous: What is it supposed to say? Well, my best guess is, "Drive slowly at turns... slow down when trying oblique turns on... rough and slick surfaces."

Not getting translations reviewed and edited by a second person who is also skilled in the language and knowledgeable about the subject matter is an error.

Another problem is typos when doing the final written version of something that has been translated into or written in a second language. The person who types written material is often someone who does not speak the second language. Therefore they will not be able to detect their own typos, and if they are working from handwritten or poorly typed text, they are sure to make mistakes.

There is a perceived problem with "differences in language." There are some differences between the kind of Spanish spoken by Puerto Rican workers on the east coast and Mexican workers on the west coast,

but those differences are not so great as to preclude understanding by one group of materials developed for the other group. This problem seems to be somewhat exaggerated in the minds of many people. In fact, Spanish-speaking people in the U.S. all listen to the same TV shows and news programs.

Overconcern with making materials culturally appropriate, e.g., the pork rinds vs. potato chips story.

Planning meetings and not getting people to come: many times these are not people in the habit of attending meetings.

Agendas: when you are trying to inform people, present the facts. Try to avoid hidden agendas, either in the form of "protecting" employers at the expense of workers, or suggesting to workers that all the responsibility for their safety falls on the employer.

1. Talk about employer responsibilities where it is relevant to the topic.
2. Talk about the worker's role in taking care of him- or herself.

### **SOME SUGGESTIONS FOR EFFECTIVE FORMS OF COMMUNICATION**

Illustrated guides instead of leaflets and manuals.

Informational videos, which are shorter than ½ hour, preferably about 15 minutes. Make them appealing; put in a little drama, some cute children, some humor, if possible.

Using appropriate forms of communication, i.e., find out what the target

audience likes to read and look at. Find out something about traditional forms of information transfer for your target group and develop materials using these formats. Mexican farmworkers often choose to read comic-style novelas, photo novelas and humorous comic books. Calendars with photographs are popular as wall hangings, and often more than one will be hung on walls, especially kitchen walls.

Because illiteracy is not uncommon among Spanish-speaking farmworkers, some pictorial materials, as well as the video format, should be developed to complement written materials. Public service announcements on radio and TV are very effective in reaching large numbers of people.

Use some organizations as a vehicle for getting people together if you want to give an informative presentation, such as:

- Secure employer cooperation to provide safety during work time.
- Hold migrant housing meetings.
- Offer something attractive to attendees, other than information (food, music).
- Involve organizations to which they will respond, such as the church.

Find an effective means to distribute written material, such as:

- Through church.
- At health clinics.
- Through employers.
- Through TV and radio announcements.

## **CONCLUSION**

There are large numbers of foreign speaking/reading people working in agriculture in the United States. They are largely responsible for our cheap food. Since there are real dangers associated with agriculture, we have a responsibility for giving the kind of information to these people and their families, which will help keep them healthy.

Going through the motions of providing information without focusing on the effectiveness of the material we produce is not enough. Materials that do not get information across to the audience can be worse than no materials at all. Employers, public officials, health professionals, etc. may end up believing that adequate warnings, prevention instructions, health hints, etc. have been given when that is not the case.□

## COUNTY HEALTH EDUCATION

By Larry Belmont, M.P.H.  
County Health Education  
Director, Idaho Panhandle Health District 1

We cannot expect physicians to locate in all of our small rural communities. Our next best alternative is to develop new solutions or new systems of service to cover those areas. Our rural citizens and our rural environment are worth protecting, for this is our heartland.

Idaho has such a system and I would like to show you how we have been able to serve our rural citizens quite well through our local public health system of decentralization with coordinated control.

We will focus on the elderly in Idaho because they make up the growing population in our rural environment.

"Rural" is defined as "those counties that do not have a city of 20,000 or greater population." This applies to 37 of our 44 counties.

Our presentation describes how our district health department system implemented an urban program in a rural environment. Idaho's regionalized and decentralized public health system may serve as an interesting model for other states.

Dr. Roper mentioned that the Institute of Medicine report, *The Future of Public Health*,<sup>1</sup> states that public health in America is in "disarray," and as a nation we have "lost sight of" our "public health goals." In Idaho we decentralized public health services, but we maintain coordinated control

among seven district health departments. We are not in "disarray."

The concept of regionalization and decentralization with coordinated control helped Idaho to develop district health departments that provide public health services throughout the state in a coordinated, efficient, and effective manner.

Regionalization and decentralization with coordinated control greatly enhance the Senior Companion Program of the Panhandle Health District. This service provides many part-time volunteer opportunities for low to moderate income persons age 60 and over. The program renders supportive person-to-person services to older adults.

There are 44 counties in the state of Idaho. Each county is divided into one of the seven health districts. The PHD, used in this discussion, is composed of the five northern counties bordered on the north by Canada, the east by Montana, and the west by Washington (Figure 1). The Panhandle is in a unique situation and must be able to respond to several different influences from two different states and another country.

The health districts were formed in 1970 and began operation in 1971. Before that time, only half of the 44 counties received local public health services. Now such services exist in every county.



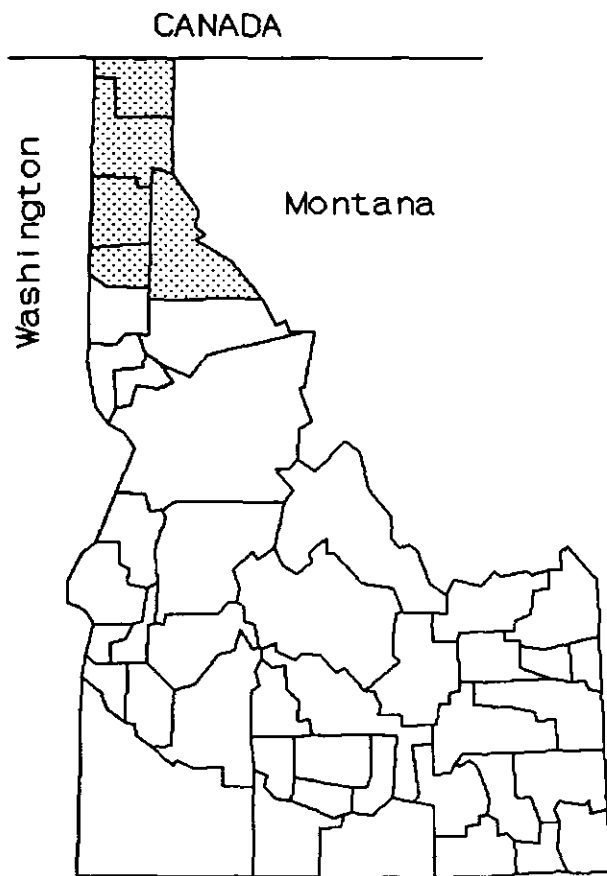

**Figure 1.** Five Counties of the Panhandle Health District in Idaho.

Walter J. McNearny and Donald C. Riedel wrote a book entitled *Regionalization and Rural Health Care* several years ago. Their definition of regionalization remains relevant to current health care and delivery issues. They state "in its simplest terms applied to the health field, regionalization refers to the establishment of working relations among various health facilities and programs within a defined geographical area." The health districts have been doing exactly that over the last 20 years.

Some of you may have been around in the late 1960's and 1970's and recall the Re-

gional Medical Programs associated with medical schools.

1. Their function was to develop regionalized medical care systems in order to improve heart disease, cancer, and stroke. The Regional Medical Programs defined some key elements of a functional region. A region has a population and needs that are identifiable and quantifiable. This can produce identifiable performance indicators for specific problems to be attacked and, thereby, be easily measured.
2. There are cooperative arrangements among components of the medical care system in that region. This certainly was true with the health districts of Idaho. For example, we all have contracts with private physicians who work in our local clinics.
3. The region should represent a defined geographical area.

Again, each of the districts is geographically defined. There are needs being met by local effort with help coming from outside the region.

The PHD, as a regionalized, decentralized public health department, became a sponsor for the Senior Companion Program for several reasons. It extended our home care in more rural areas. It increased coverage where Medicare, Medicaid, and private insurance end. It extended our continuum of rural health care. In doing this, we accomplished several of our primary objectives:

1. To help people assume a greater responsibility for their own health care.

2. To help people live independently for as long as possible.
3. To increase referral capacity with other groups and create a sharing of services, as in a Medical Model.

Other services offered by our home health division are professional nursing services, physical therapy, occupational therapy, speech therapy, home health aides, health maintenance services, and consultation services. Since its inclusion in the home health division, the Senior Companion Program has dovetailed with these other services to become an integral part of the entire realm of patient care services.

Our Senior Companion Program in the PHD fulfills several related functions:

1. To develop volunteer service opportunities through which low-income older persons can contribute to their communities.
2. To provide a stipend and other benefits, which enable eligible persons to participate as senior companions without cost to themselves.
3. To establish new social service roles for low income older persons through which they can maintain a sense of self-worth, retain physical health and mental alertness, and enrich their social contacts.
4. To provide supportive services to older adults in an effort to maintain independent living.

These functions need special help when implemented in a rural environment. Idaho's system provides the mechanism for this service. The IOM study<sup>1</sup> supports the notion of decentralized services, such as

Idaho's model, to facilitate flexibility and self-governance at the local level. The IOM recommends:

*To promote clear accountability, public health responsibilities should be delegated only to a zone unit of government in a locality (p. 8).*

Where sparse populations or scarce resources prevail, delegation to regional single-purpose units, such as multi-county health districts, may be appropriate (p. 149).

In light of Idaho's success with regionalized health districts and the IOM's recommendation, Idaho's district health department concept may be a viable option for other states.

There is no single entity in charge of the seven health districts. We are autonomous and independent of one another. However, we work very closely together on statewide issues.

For example, the District Boards of Health in all seven health districts meet together to coordinate policy issues. They have just met with certain legislators in Boise to negotiate policies concerning environmental health programs throughout the entire state.

The District Directors also meet monthly to coordinate program implementation and standardize policies on the operational level. This process also applies to the nursing directors and the environmental directors of all seven health districts.

Each district health department has its own Board of Health, which is appointed by the County Commissioners within that health district. They set local public health policy. The District Directors are hired by

that Board of Health, and not other bureaucrats in the capital, making the director directly controlled by the local Board of Health and the local County Commissioners who set the budget. Although our orientation is very local, we must still coordinate statewide policy throughout the state for certain programs.

The funding of the health districts comes from several sources. County *ad valorem* tax dollars are matched with state contributions. In addition, the state can give the health district additional assignments and, hopefully, funding.

We are free to implement our own fees. Some are standard throughout the state. Others vary between health districts. Each district has contracts with the state Department of Health and Welfare and other agencies. We seek grants and additional federal funding, if available.

A county's contribution to the health district is calculated by a very equitable and fluid formula. Seventy percent of the county money is based upon the county population. The remaining 30 percent is based upon the county's market value for taxing purposes. This formula allows a county to adjust its annual contribution depending upon economic conditions, which impact both the population and the market value of property.

The health districts in Idaho are not state agencies. They are independent, single-purpose districts much like a school district in any other state.

The health districts in Idaho are required by law to provide physical health services, environmental health services, health administration, and health education. The PHD has, in addition to those basic func-

tions, a superfund project; a specially funded aquifer project; a home health division; the Senior Companion Program, which we will talk about in more detail; and Women's, Infant's, and Children's (WIC) Program.

Urban-designed services, like the Senior Companion Program, benefit greatly from Idaho's public health concept of decentralization with coordinated control when applied to Idaho's rural population.

The Senior Companion Program is authorized by the Federal government under Title II, Part C, of the Domestic Volunteer Service Act of 1973. The program's dual purpose, as mentioned before, is to create part-time stipend volunteer community service opportunities for low-income persons aged 60 and over, and to provide supportive person-to-person services to assist elderly adults needing special assistance to remain living independently.

Each Senior Companion Program is partially funded by a grant from ACTION, the Domestic Volunteer Service Agency. A requirement of these grants is that a sum equal to 10 percent of the Federal grant be raised from local sources to contribute to the program. ACTION awards these grants to sponsor a program only to public agencies and private non-profit organizations, which have the authority to accept and the capability to administer such grants, i.e., Idaho's health districts.

There are currently about 140 Senior Companion projects throughout the United States, which provide 8,000,000 hours of service a year to 25,000 clients. As one of the original pilot projects in the United States, our program has expanded from serving about 80-100 clients to the current

average of 260-270 clients served in any one month.

Volunteers in the program are assigned to agencies related to specific community services. These agencies are called volunteer stations and they accept the responsibility for the assignment and supervision of senior companions. Two basic types of agencies normally serve as volunteer stations.

- ▶ The first type is social service agencies, which include public agencies, private non-profit agencies, multi-purpose centers, community and civic organizations, and religious groups.
- ▶ The second type of volunteer stations is direct health care providers. Examples of these include acute care hospitals, rehabilitation centers, public health departments, private non-profit health agencies, visiting nurse's association, home-health agencies, mental health agencies, and nursing homes.

Senior companions are supervised by professional staff at the volunteer stations to which they are assigned. This staff develops an assignment for the senior companion, which incorporates a written plan of care for each client served. This plan of care is coordinated and monitored by the same staff, providing for periodic evaluation of the client's continued need for a senior companion. The professional support of the PHD staff in each county lends considerable efficiency and credibility to the program. The volunteer, the client, and the PHD benefit from this synergistic relationship.

Senior companions must, in addition to being age 60 or older, meet a moderate income guideline based on the size of the

household. Companions can work a maximum of 20 hours a week for which they receive a stipend of \$2.35 an hour and \$0.20 a mile to travel to and from their clients' homes. These funds are intended to reimburse senior companions for expenses of volunteering and may not be considered as wages or income for tax purposes or any government program.

Recruitment of appropriate volunteers to serve as senior companions is accomplished by several different methods, which include advertising in newspapers and other media, and by word-of-mouth referral from volunteers serving in the program. An unexpected source of volunteers has been patients who have been senior companion clients and have recovered to the point that they wish to volunteer their services to the program.

The total budget for the Senior Companion Program sponsored by the PHD is \$278,542, of which \$211,637 is furnished by the Federal ACTION grant. The remainder is furnished by the PHD and other local sources.

Sixty-four percent of these funds are spent directly on stipends and travel expenses of senior companions. With these funds, we recruit 80 senior companions who provide approximately 5,400 hours of service a month to 260-270 homebound clients.

Fiscal viability is another advantage to the affiliation of the PHD with the Senior Companion Program. With a sizable portion of the funding being provided through the ACTION grant and other local funds, the PHD's financial involvement can be kept to a manageable level.

Much of the contribution to the program by the PHD is in-kind assistance, supervi-

sion, and advice by the professional nursing staff. Also, this partnership of the PHD and Senior Companion Program allows for all yearly physicals for the senior companions to be done by the nursing staff, making it easier to pick up any health problems that might arise. This affiliation between the program and the PHD has enabled the program to be established in a more medical model than other similar programs.

The senior companions are given more specialized training in medical areas and are viewed as a new type of para-professional volunteer. This, coupled with the maximum interaction with other segments of the health care and social service community, allows optimum use of the professional staff at these other agencies.

A by-product of the Senior Companion Program PHD medical model is an outreach function provided by the senior companions. With specialized training and assignments in rural areas, they serve as eyes and ears, often detecting problems with homebound, unseen elderly that may otherwise have gone undetected due to their rural location.

The design of the Senior Companion Program, as outlined by ACTION, seems to make the program more geared to location in an urban area. It is more difficult to assign persons age 60 and over to rural clients with less access to professional staff for advice and assistance.

A prime consideration in placing senior companions with clients is to match the volunteer's specific skills to the needs of the particular client. This holds particularly true with clients in the very rural areas where the companion may have limited access to resources.

In continuing the medical model, specialized volunteer stations have been established to provide services to clients with very specific needs. Two examples are the Alzheimer's Association and the discharge unit at Kootenai Medical Center and Acute Care hospital. These volunteer stations have clients with very specific needs that are quite different from our other clients.

The care provided for clients of the Alzheimer's Association is respite care for the primary caregiver, enabling the client to remain at home with the family as long as possible. Specific training to the senior companions working with Alzheimer's patients is provided by the Alzheimer's Association with ongoing in-service training providing updates and support for these volunteers.

Very different although specific training, enabling volunteers to work with recently discharged patients from the hospital, is provided by professional staff in the social service and discharge units of the hospital. Specialized volunteer stations with specialized training, coupled with access to professional nursing staff at the PHD, allows services to clients not easily found in rural areas. This helps many clients stay in their homes longer.

In closing, we will not get physicians into all of our small towns of Idaho nor Iowa. That is not all bad. We have other solutions, other systems of rural health care.

The concepts of regionalization and decentralization with coordinated control improved the efficiency and effectiveness of Idaho's public health services in rural areas. These concepts provide the foundation for expansion of an urban program,

## **Intervention – Safe Behaviors Among Adults and Children**

like the Senior Companion Program, into a rural environment. It allows us to move the Senior Companion Program into a medical model in order to expand our continuum of rural health care.

Idaho's system of regionalized and decentralized public health services with coordinated control works. I hope other rural states can benefit from Idaho's success.□

### **REFERENCE**

1. *The Future of Public Health*. Institute of Medicine, Washington, D.C.: National Academy Press, 1988.

## A RURAL SOCIOLOGIST'S PERSPECTIVE

By Judith Bortner Heffernan, M.A.  
Columbia, Missouri

Dr. Walter J. Armbruster: Judith Heffernan is Executive Director of the Heartland Network for Town and Rural Ministries located at the University of Missouri in Columbia. Her topic is *A Rural Sociologist's Perspective*. That is a pretty broad topic, which gives her lots of liberty. Ms. Heffernan wants to focus our attention toward thinking more broadly. Ms. Heffernan:

I would second the motion that many have made of how honored each of us feels to be a part of this, and I know that that is true whether you are a speaker or a participant in other ways. It is wonderful that such a conference could be held.

My colleagues have been sharing a bit about their backgrounds. I think it is important to do that at this point.

I did not come to be a practicing rural sociologist and a real honest-to-goodness farm woman quite as I might have planned. I thought the guy I met about 26 years ago and married 25 years ago was going to be a professor of rural sociology, and that our lifestyle was going to be an academic one. While that is, indeed, part of our "schizophrenic" existence, the other part of it is being a practicing rural sociologist.

We will, in the next few months, if the contractors put the roof on the house soon, move from our farm of 21 years to the only farm the state of Missouri ever identified as "the Model Farm"—120 years ago.

Just so you know that I do understand this issue of agricultural health and safety, you need to know that I plant soy beans and wheat, and I mow and rake hay, sometimes under duress.

I have been a midwife to more cows than I care to count, and a substitute mom this year to sheep—baby lambs—cutest things you have ever seen. I have gotten sick from breathing diesel fumes, whether on a tractor when we were working on one in a shed or just standing nearby. I have gotten sunburned from being too long on the tractor while mowing, and I have been pinched and poked and clobbered by more varieties of machinery parts than I care to tell you.

I have also been chased by angry livestock. I have unhappily taken out a fence with a disk, which was not the original intention. It could not quite turn short enough.

I have been running the combine and the stalk chopper when one or another part has broken, and I have had the experience all too often of driving the pick-up ahead on a too-narrow road when behind me were following my husband or our daughter on too wide a piece of equipment moving from one farm to another.

I have had the frightening experience of seeing my husband climb out of the grain bin after checking its condition and shortly thereafter become very ill. (We had completed the wheat harvest in October of 1981 instead of in July because of an extremely wet summer and the wheat was in

poor shape.) After climbing out of the bin, he spiked a high fever and laid down. I recall being so panicked by his condition that in my confusion to get help, I called the University's vet clinic! After calling the Medical Center and not learning very much, I called the Department of Plant Pathology at the University of Missouri and found out that very likely what he was experiencing a serious allergic reaction to mold, to toxins in the molds, that were undoubtedly in the wheat that year. Even though I had enough knowledge to know who to call when I did not get helpful answers from initial contacts with medical personnel and enough assertiveness to keep calling, the experience was still terrifying, to say the least.

I have worried about my husband teaching our young daughter, at the age of six, to drive the Ferguson tractor, and to help him put in an electric fence.

Just last Friday, I had the frightening experience that many farmwomen share of realizing that he should be home, and he was not. So you leave a note on the counter, in case you miss on the highway, and you take off to the field not knowing whether the reason he is late is because he is injured. I almost break into tears thinking about it. Fortunately, it was just that I misunderstood how late he was going to be home.

Last Saturday, I had another experience that very much relates to this conference. I was about to wash a pair of blue jeans and a dirty shirt of my husband's, when he said, "Don and I were spraying Round-Up yesterday, and these really should not be washed with everything else."

I asked, "What does the manufacturer suggest that I do with them?" I wish that

there were on the containers of chemicals a little "sticky" that you could peel off and husbands or wives or whoever is doing it could attach to their clothing that says:

"Will the laundry person please adhere to the following instructions: Soak thirty minutes in hot water and detergent or whatever the correct method is." Would not this be simpler?

The point I am making here is that I am as personally acquainted with the issues of agricultural health and safety as I hope I ever get.

I am also a rural sociologist by training, as Walter indicated. Since June of 1989 I have been working with the Heartland Network for Town and Rural Ministries, a effort to bring resources for hope and help and empowerment of churches and communities in America's Heartland. While the Network is funded mostly by the United Methodist Church, I work ecumenically with a variety of faith groups.

The remarks that I am going to make today come out of this context—not only out of my personal lifestyle, but also out of my professional training. It seems to me that if we are to consider the safe behaviors of adults and kids, as all of us have been in the process of doing, it would be helpful to look at agricultural production and processing in a larger context. We know that there is a social, and an economic, and even a psychological-emotional context that impacts all human behavior.

I think we also ought to acknowledge initially that rural communities differ. There are some rural communities that are doing fine. Economically they are thriving. Retired people with money are moving into them; or the government continues to



fund the university, or the prison or whatever there is energy; but farming communities, and forestry, and rural manufacturing communities are among those that are hard-hit.

My three-point thrust is 1) the context of farming as practiced in the 1980's, and where it appears we are heading in the 90's and beyond, 2) the context of the rural community, and 3) the proposed future context of globalizing agricultural production and consumption. All three issues impact on the kinds of safe behaviors that we look at with regard to adults and children.

It is my intent to raise some important issues and ask some thoughtful questions. My experience over these past 5 to 10 years working with the rural crisis—especially in the Midwest but also traveling coast-to-coast, into Canada and into other countries—looking at what has been happening has changed my world view. And so, that is partly what I am sharing.

### **FARMING IN THE 1980's AND 90's**

As the structure of agriculture has changed over the years from a locally oriented, locally managed, locally run, local profit-centered kind of agriculture into initially a regional and then a national, and now an internationally oriented and controlled system, the units with which farmers have dealt have become much bigger, much farther away, and much fewer. We are no longer dealing with the folks down the road, the local suppliers and dealers know.

Decisions are now being made elsewhere about nearly everything even about what size cattle processing plants will accept. Farmers no longer get to decide how many

pounds they are going to put on those steers before they send them off.

In fact, feeding steers has become so specialized that if you live in Missouri, you have to pay somebody to take them to Kansas, or maybe Nebraska, pay to have them specially fed-out and pay the transportation. Decisions like that are no longer made on the farm. They are made in some office by a processor who says "this is all we want and only this will we accept."

Competition in the local market has declined. There may be only one buyer at your local sales barn, or if there are two, they may be very friendly, and they decide that 80¢ for cattle is just about "max." When the price goes higher, they leave. So much for the so-called law of supply and demand!

With this change, the profits, I might add, have moved away as well. Profits that formerly went to management and capital are no longer available in the local community.

For the most part, the profits that go to labor are the only ones that remain. Frankly, folks, if we put this in a larger context, it used to be that some of the profit went to Minneapolis or went to Omaha, or went to other major U.S. corporate centers.

In Indiana now, when you sell hogs to the processing plants, those profits go further away: to Milano, to Tokyo, to London. You cannot sell a hog to be processed in Indiana to an American firm. Ferruzzi and Mitsubishi in Northern Indiana and British Petroleum with a firm that they own in Columbus are the two hog slaying firms in the state. This is the kind of thing that is happening.

There is a social movement afoot that environment, food safety, pesticide usage and water quality among others. We have heard much of it here.

Larger organizations have, indeed, protected themselves by their size, their ability to control markets, and, to some degree, their diversity. The stories in some of the farm magazines about whether red meat will be able to compete with white meat is laughable to some of us who have been watching what it happening. It is the same firms that are controlling markets in both red and white meat, so where is the competition? It is mostly with the nutritionists.

Those firms have been able to reduce their own risk and increase their stability and, I might add, their predictability. Just for the record, during what was a devastating time for production agriculture in the 1980's, most of those firms were able to maintain at least 20 percent profit. Should we producers be envious? The level of profits of food processing firms in the 1980's was exceeded only by pharmaceutical firms!

So what economists have come to call risk, namely the inability to control things in the environment, which have a great impact on you, psychologists and sociologists call stress.

I recently spent some time in the Food and Agricultural Policy Research Institute office looking at a few of their publications. From their 1991 *U.S. Agricultural Outlook*, I will read to you the last line of the "General Outlook. "Net farm income is small, relative to farm receipts and expenses. So, relatively small changes in estimates of receipts or expenses result in

very large proportional changes in net farm income estimates." That, by any definition, seems to me to spell "risk" and also "stress."

There are other risk factors at the moment that may very well alter the way farm families and rural people look at safety and health issues. There is a social movement afoot that focuses on the environment, food safety, pesticide usage and water quality, among others. We have heard much of it here. All of these concerns add higher levels of unpredictability and risk in the agricultural system at the moment.

I know farmers who find going to the Agricultural Stabilization and Conservation Service (ASCS) office very stressful. I wish some of you in the Public Health Service would set up little health screening clinics right outside the ASCS office doors to check blood pressures of farmers. I read with interest an article in the *Farm Journal* by a farmer with a computer who analyzed three different alternatives for working with the 1990 Farm Bill. As nearly as I can tell, it was to choose the alternative in which you lose the least amount of money. That, to me, is risk-stress.

The uncertainty and complexity of ever-changing rules and regulations, such as those administered by government agencies have increased uncertainty and risk and have made it very difficult for farmers to say, "I think I am going to try a new safety system on this farm. I think I am going to invest in whatever it costs," although I did hear myself saying to my husband last night, "Honey, we have got to buy roll-over bars." That is on the agenda. But we, with other income, can probably do that. I know people who are borrowing money to

put bread on the table who are financially unable to buy safety equipment.

Another aspect of the stress issue is what happens to farm families is when they experience financial difficulties over time. Many of you are familiar with our data, so I am just going to spend a few moments showing you a little bit in more detail.

Figure 1 shows the reaction to stress of the families that we interviewed in 1985 at the suggestion of the Department of Agriculture. We were actually trying to figure out a number of things that were going on, and we went into a very produc-

tive county in north central Missouri and interviewed every family that had left the farm for financial reasons from January 1, 1980, through January 1, 1985. Many of you are very familiar with these data.

Those of you in the health services will recognize this as a list of common reactions to stress. We simply said to husbands and to wives separately, "Please tell me in the process of losing your farm did you become depressed? Do you continue to be depressed over this issue? Did you experience all of these other things?" What you will note here is the astonishing high levels of women and men who became depressed.

	<u>Have Experiences</u>		<u>Continue to Experience</u>	
	Men	Women	Men	Women
Became depressed . . . . .	97	100	56	72
Became withdrawn from family/friends . . . . .	62	66	26	41
Became nauseous, lost appetite . . . . .	49	47	18	34
Could fall asleep at night, but would awaken and be unable to return to sleep . . . . .	77	53	41	38
Experienced feelings of worthlessness . . . . .	74	69	49	41
Became restless, unable to concentrate, agitated . . . . .	72	81	41	38
Did anything to keep busy . . . . .	67	41	46	31
Increased smoking . . . . .	23	25	16	22
Increased drinking . . . . .	18	12	10	6
Showed increased fear of things, people . . . . .	38	31	18	25
Became more physically aggressive . . . . .	49	31	26	9
Experienced great changes in moods, from low to high and back . . . . .	67	81	36	47
Became confused . . . . .	54	31	31	19
Became unable to think or respond logically . . . . .	31	34	18	19
Become unusually silent for periods of time . . . . .	62	53	44	28

Figure 1. Reactions to Stress (percent).

It goes on further showing increased fears of things and people, becoming more physically aggressive, perhaps a measure of family abuse. One farmer said, "Does that mean I spank my children more frequently?" I said, Well that is one way of defining it. You can also see in these data high levels of confusion, withdrawal and remaining unusually quiet for long periods of time.

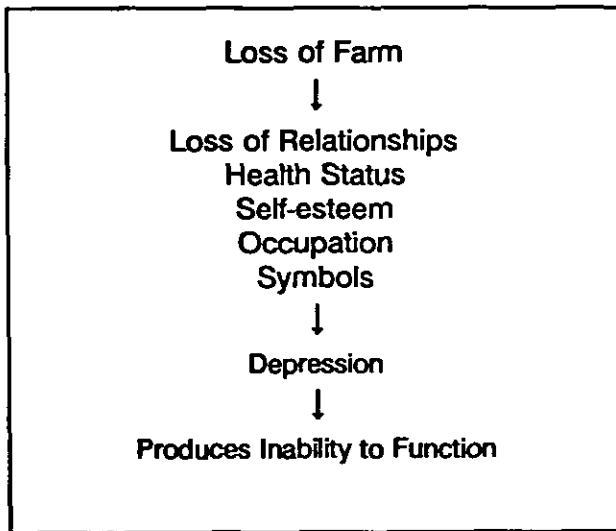

Figure 2. Effect of the Loss of the Family Farm.

These data and Figure 2 show that the loss of the family farm was a much greater catastrophe for those farm families than many would like to acknowledge. It was much more encompassing than loss of a job. The loss we are dealing with was huge, and I think that has been elaborated.

A psychologist I know is also a Mennonite clergyperson put this chart together, and I think it really does give a fair amount of insight. The loss of the farm led to loss or change in every relationship the family had, not only with themselves, but within the community as well.

It also led to a loss or change as far as health was concerned. Health was affected, and those of you who know the statistics on the relationships between stress and health would understand this well.

Social status was changed. Self-esteem was altered considerably. You notice the numbers of those that said they felt worthless. Occupational status was changed. "My granddad homesteaded this, and I lost it," someone told me. The symbols were gone.

That kind of loss almost inevitably depresses people if they are normal. I would sometimes tell the farmers, "if you have gone through all this and are not depressed, there is something wrong with you, and you need to go find out what it is." In some cases the depression led to an inability to function.

Last year we took the names of every freshman that entered the College of Agriculture at the University of Missouri to do a study of the ways the rural crisis had affected them. (We know that rural kids study in areas other than agriculture, but we limited our study to just them.) We knew that they were likely eight years old in 1980 when things began to worsen on farms and in rural communities.

While I have not yet written papers on any of the data, I have shared it with a few audiences. I have taken the numbers that we just saw on stress in our 1985 study, and because we asked the same questions of the students that had been part of the farming operation or a rural business from 1980 to 1990, we show their results, in Figure 3, with those of husbands and wives in our earlier study.

By the way, a number of the students were more interested in the spring break in Florida than they were in my questionnaire, and so our response rate was about 30 percent.

We questioned them, "Did you become depressed?" The depression level was about half as high as their parents, but understand, we are talking about kids here who were from eight to 18 during the time on which we are focused. By the way, would you look at how many of them said they became withdrawn and experienced feelings of worthlessness. Forty percent of the students who were adolescents when their folks were losing the farm experienced feelings of worthlessness. As you can see, this goes on, and we could talk about

that in far more detail. I am simply indicating to you what we knew was, in fact, happening. We now have some data to support that stress was not something that just mom and dad experienced, but it was very much infectious, almost in the correct use of that term, and certainly did permeate through the family.

A number of my colleagues have pointed out that that continues. Paul Lasley at Iowa State and Jack Geller at North Dakota have indicated that the levels of farm stress have sky-rocketed. In Geller's study, 71 percent of over 1000 farmers indicated that during the previous three years, which would have been the mid 1980's, their stress levels had increased significantly.

	Have Experienced		
	Men	Women	Youth
Become Depressed . . . . .	97	100	57
Became withdrawn from family/friends . . . . .	62	66	57
Could fall asleep at night, but would awaken and be unable to return to sleep . . . . .	77	53	14
Experienced feelings of worthlessness . . . . .	74	69	40
Became restless, unable to concentrate, agitated . . . . .	72	81	39
Did anything to keep busy . . . . .	67	41	26
Increased smoking . . . . .	23	25	0
Increased Drinking . . . . .	18	12	14
Showed increased fear of things, people . . . . .	38	31	7
Became more physically aggressive . . . . .	49	31	14
Experienced great changes in moods, from low to high and back . .	67	81	39
Became confused . . . . .	54	31	32
Became unable to think or respond logically . . . . .	31	34	7
Became unusually silent for periods of time . . . . .	62	53	28

Figure 3. Reactions to Stress (percent).

Indeed, this led to some real questions about health and safety. Geller found out that one out of every five had had an injury the previous year. Many of them treated it at home. Many of them said, "well, you know, it is too far to go, the medical facilities are elsewhere, there is no health insurance." So, for however serious it was people who should have seen physicians that did not get that kind of help.

Geller found that there was a significantly higher proportion of injuries among those who were most financially stressed. This is where we begin to make the connection between stress and behavior, i.e. injury. Those who had over 40 percent debt-to-asset ratio, which many of you know is a real bad thing to have—you are on the edge, going over—had over 60 percent of the accidents. That was true across age.

The younger you were, also, the more likely you were to have accidents, and when he asked these two questions that bear directly on our considerations here, he found very interesting results. He asked:

*Is it necessary, under current economic conditions, to cut corners on safety to save money?*

Of those who reported they had had an injury the previous year, 30 per cent of them said, "Yes, it is necessary to cut corners." Of those who had had no accident, only 20 percent said yes.

Then he asked, "Have you found it difficult to concentrate on farm work this past year?" Of those who had had an accident, two-thirds of them said, "Yes, I have found it difficult to concentrate."

We now find people who are concentrating far less on what they are doing. They have become much more distracted, much more thinking about the conversation with the, for example, banker tomorrow. Often what sets them off is a small thing.

Many of more I have interviewed have said to me, "You know, I went out behind the barn...", "I got a message from my banker...", or, "The feed dealer called me a liar," and then they would add, "And I took the gun and I . . ." These were the conversations I had after they had said, "I'll walk you to the car." Then they would say, "I've never told my wife this, but..." and then I would get the rest of the story.

We are seeing increased pressures on many farm families. Leslie Whitener of USDA on this program knows well the data that indicate the increased numbers of people with off-farm jobs. What was found in another study in North Dakota is fascinating with regard to the topic of increased stress from multiple jobs.

People who had identified themselves in one study as underemployed, were interviewed to find out how underemployed they were. What the researchers found out was the respondents were not at all underemployed. They were, in fact, under-compensated. Their incomes did not cover their expenses, but they were filled to the brim with jobs, pieces of jobs, part-time jobs, plus a farm. With both parents under such stress, the kids were under pressure also.

A friend of mine refers to this as a recipe for psychopathology. Another one of my friends simply says, "It's crazy making." Their commutes of the respondents were increasing distances from home with spouses often going opposite directions. They

were tired more often. They were cutting out a lot of social activity.

You who are medical professionals in this group know well—much better than I—the statistics that point out that at least 75 percent of all illnesses are stress-related. Immune systems seem to get weaker the higher the stress level.

Depression is known by another name—as "anger turned inward." Many of these folks could not figure out whom to be angry with, "and they turned it all in on themselves. Should we be surprised at high farmer suicide rates?"

I think it quite remarkable that with something like 650,000 farm families losing their farms in the 1980's that some people continue to insist that they were simply bad managers or speculators. Is it possible that so many got so stupid simultaneously? It seems to me that it is not really individual causation when numbers this extraordinary exit.

I not long ago spoke to a pastor in a rural community in which the bank had failed in about 1982 or 1983. He said to me, "Oh, you've got to know this, I am presently visiting nine terminally ill cancer patients in our community." That community probably does not have 200 people in it. You have to wonder about the relationship between such illness and the severe stress.

## THE RURAL COMMUNITY

The second context concerns the issue of the rural community. All you have to remember in my next illustration is "70 percent of the population of this country." I am going to use the same percentage. In 1890, 70 percent was rural; by 1960, 70 percent was considered urban; by 1988, 70

percent of the population of the U.S. was said to live within 100 miles of our coastlines the great emptying of America.

As a friend said the other day, "we are in the process of proving that the Homestead Act was a huge mistake." Rural communities are in crisis—that is no surprise to anyone. Many are declining. I think it must be rather hard to speak about the concerns of health and safety issues to folks who are living in increasingly declining, dysfunctional, despairing communities.

Poverty has been referred to earlier. Poverty is the cause of lots of things. How many of you saw the NBC story on tuberculosis last night? Did any of you say to yourself, "Wait a minute, in which century am I living?" "Increasing amounts of tuberculosis in this country related to what?" the announcer asked.

Poverty, became the answer. Migrant farmworkers are among those who are very much involved. And then there is the cholera epidemic in South America. Which century is this?

The poverty figures have increased and many of you know them well. There are also data available that speak to the increasing disparity in rural communities between those who have and those who have not.

One of the agencies in Washington put out the differences in food stamp usage in rural communities from 1980 to 1987. While the Northeast, including New York State, was showing a decline, some Midwest states showed 47 percent, 31 percent, and 35 percent increases in food stamp usage.

I know people I interviewed whose kids were almost starving who would not on a bet ask for food stamps. So, we can assume that even with numbers showing increased use that they are being under utilized.

There has been, as you well know, institutional decline. When I thought I was about as depressed as I could possibly be about what is happening to rural America, I made the mistake of watching Tom Brokaw's exposé on Sunday night and discovered that the Mafia—give us a break out here—the Mafia, which controls the garbage routes in New York and New Jersey, have decided to dump it in rural America, and they have been found to drive their trucks and dump illegally in places as far away as Nebraska. Grandmothers in the hills of Eastern Kentucky are sitting and writing license plates and watching trucks owned by the Mafia. I do not think they know that this could be dangerous dump waste.

We had reference yesterday to the fact that Californians are eyeing the water in the Snake River. The point is, communities are increasingly in conflict.

Farmers who were encouraged and who thought it was a wise idea to trade more acreage for fewer neighbors are finding that they are not now as much better off as they thought they might be.

It is thought that fewer medical personnel are now needed since there are fewer people out there, yet many cannot afford to pay for the ones who are there. Many drive a greater distance to facilities. If you are very lucky, there are volunteer emergency medical technician who might rescue you from your farm accident—if you are lucky.

Rural mental health is in a shambles in many places. Rural mental health workers whose caseloads mount are inundated. I talk with pastors who tell me, "Judy, I am the only one in this huge territory that has any semblance of mental health training at all and one little old course in clinical pastoral education does not constitute being prepared to do serious psychiatry, but where can we send them?" What can we do?

Furthermore, at a time when we need more highly trained professionals in rural areas, they are less likely to come and to stay. Many of them are unwilling to subject their families to living so far away from some of the amenities.

Frankly, I am absolutely convinced that rural economic development will not take place without medical facilities being in place. I know of situations in South Dakota, where firm was ready to start up and discovered they could not get liability insurance because the hospital had closed the previous year. Think of it. You see, the big pieces are beginning to come together.

While I applaud the notion of volunteerism, I am really opposed to allowing rural America to have "volunteers" and urban America to have real physicians and nurses. I am kind of picky about that, and I am operating under the notion that "equitable access to services" is a phrase that few politicians, if they were smart, would vote against; and the rest of us in the community need to rise up and say, "That's what's needed here."

I am not talking about a doctor in every community. I am realistic, but, folks, we cannot have rural health care in communities without trained personnel.



I wish to comment on one other aspect of the quality of life in rural communities. There was a meeting fairly recently where Iowa and Minnesota Agricultural Leaders of Tomorrow—the Kellogg Leadership Program—were in attendance. A leading agricultural economist from the University of Minnesota told the group of what he described as an efficient farming operation of the future.

I share this because I want you to wonder whether this is the kind of community in which you want to live. The suggestion was that a truly efficient farmer would, of course, have a lot of land because he would have large and expensive equipment over which to run it. The only way to make the equipment pay would be to run it 24 hours a day. All of our agricultural safety people are about to have an instant coronary.) That is not clever. It is not healthy. So, what was he saying?

He stated that you were not supposed to run it yourself, but you were supposed to hire people who would run it during the needed time, and when you had finished with them, you should fire them, ". . . and then they can go back on the public welfare system."

I do not accept that definition of efficiency in agriculture, and I do not think—and maybe you do not either—that it is possible to have healthy and wholesome and safe producers and workers that in such a community or in communities that are sick, declining and despairing. I think that is a very important issue.

### **GLOBALIZING AGRICULTURAL PRODUCTION AND CONSUMPTION**

If you have not read Wendell Berry's essay, "Does Community Have a Value?" in

his book, *Home Economics*. I strongly recommend it to you, especially as we think about the rural families and communities in a era in which the globalization of our food production system seems to be encouraged.

Policy makers in our world are bringing about the globalization of our food system. I point out to you that there is neither an invisible hand nor a mythical or mystical force that is dictating this; that it is, in fact, becoming a matter of public policy. It has been decided at the highest levels that this will happen.

I raise with you some questions about this because I think it is important in the context of the issue of which we are speaking. The consequences of this policy, however unintended, may not have yet been thoroughly discussed. The current operational definition of this globalization can be found in the General Agreement on Trades and Tariffs (GATT), and in the North American Free Trade Agreement (NAFTA). The destruction of locally regionally self-sufficient food systems in favor of a globalized system is being presented through these two treaties.

If we are to function globally, do we not then have to broaden our concern to include the banana packers in Central America who breathe chemical fumes all day in the packing plants; to the families of migrants whom I have seen living in the colonias on our border?

If these public policies come into being, how will they change the context in which American farmers, rural residents, and rural communities look at their quality of

life? Will the "harmonization" of regulations that is in the GATT mean a reduction in health and safety standards? Some are asking. I am not sure.

If we are to function globally, do we not then have to broaden our concern to include the banana packers in Central America who breathe chemical fumes all day in the packing plants; to the families of migrants whom I have seen living in the colonias on our border? This latter group is often U.S. citizens whose water comes from chemical barrels that are now used for rain catching. I saw that just a year ago, so it is still a contemporary situation.

Do we need to include the minority women and poor white women of North Carolina and other states who work in poultry plants? They go into the plant company healthy persons and within months some have developed urinary tract infections (from being not allowed to use the bathroom as often as needed), or they have developed repetitive motion syndrome (carpal tunnel) so badly that they are unable to lift their own children. As someone has said, "they come in healthy and they are dumped back on the public system crippled." Do we have to include them?

What about the cane workers who are imported with promises and hopes from the Caribbean (Jamaica) to work in the cane fields of south Florida. Many find recruiting promises go unkept.

Or the *campesinos* all across Latin America who work for three dollars a day or less. Our Missouri Agricultural Leaders of Tomorrow (Kellogg group) just returned from a trip to Brazil and Argentina, and my understanding is that the major thing they have had to cope with, since getting

home, is the despair about the obvious advantages Latin America has for producing the things we think of ourselves as so efficient at producing. Some of the outstanding young farmers say, "Hey, I might as well quit now." They may work through that, but how can American farmers compete with laborers who will work for three bucks a day. American farmers tend not to like to live so little. That is an issue of agricultural health and safety in every sense of the term.

We could go on. What about the Japanese farmers who are raising rice in the high mountain terraces are not very excited about our rice producers moving into their markets? (I raise beef and soybeans and of course I would love to get them to buy more farm products from the U.S.) However, if we force our rice into their markets, the economically more marginal producers in Japan (namely those growing rice in those mountain terraces) will likely not be able to raise rice as cheaply as some of our producers and they will go out of business.

What will then happen to the terraces that have conserved both water and soil for hundreds of years? Will they give way leading to soil loss and water quality loss? Now we are talking about a different issue, but one that clearly must be part of the discussion of the health and safety of agricultural producers and communities.

Well, as you can see, if we really decide as a matter of public policy to globalize the food system, can you and I then be comfortable with only focusing on agricultural health and safety at the national level?

The front page this week of Feedstuffs magazine talks about the opening of North America to "free trade." I am troubled by

the statement here that the Administration refuses, as the Congress has asked, to look at labor and environmental concerns involved in such trading arrangements. The Administration has indicated that these issues will not be discussed; they will not allow them to be discussed in the context of free trade negotiations. I suggest to you that this should be a cause of alarm for us.

We who are part of the community of faith, we who contribute millions of mis-

sion dollars to improve the lives of the poor, the exploited and the despairing of the world, we believe that we have an important stake in this enlarging issue of the health and safety of agricultural producers, workers and processors around the world. We are indeed your allies as all of us seek to improve the conditions of farm and rural families and communities here and abroad.□

## YOUNG FARMERS' PERSPECTIVE

*Wayne Sprick*  
Executive Director  
National Young Farmer Educational Association

Dr. Walter J. Armbruster: Wayne Sprick is the Executive Director of the National Young Farmer Educational Association. He will present his perspective from the viewpoint of Young Farmers.  
Mr. Sprick:

It is a pleasure for me to come before you and present the perspective of the National Young Farmer Educational Association and the young farmers we represent. This has been an informative session and conference. I am pleased to be part of it.

Before getting into my comments and reactions, let me take an opportunity to provide some background on myself and the organization I represent.

My background is in agricultural education. Prior to that, I was born and raised on a dairy farm in Missouri, Franklin County, the town of Washington. This is located about 50 miles west of St. Louis on the Missouri River. I went to school at the University of Missouri, Columbia, where I received a degree in agricultural science, in dairy science. At the time of my graduation, the job that I was looking for was not available. I chose to pick up the courses that were needed to be certified as an instructor of agricultural education.

Upon receiving that certification, I went to work in 1968 and taught for 19 years in two school systems in East Central Missouri. During that time I worked with secondary students, as well as adults, in agricultural education. This was through the Young Farmer Program, as well as general adult education. I also had the opportuni-

ty to teach part-time in a nearby community college.

During that time, I had the opportunity to buy a neighboring farm to my home place. Everybody involved in agricultural education has to put to practice what they preach. So, in addition to teaching, I owned and operated 120-acre general farm.

I have been involved with the National Young Farmer Educational Association since January 1987, during which time I relocated my family from East Central Missouri to Alexandria, Virginia. It was a culture shock, to move from 120 acre farm to a half-acre lot. We have adjusted quite well and the family is enjoying it.

Many of you are familiar with other vocational student organizations. There are three in agriculture. The Post-secondary Agricultural Student Organization (PAS), the National Young Farmer Educational Association, and the National FFA organization. In addition to these three in agriculture, you are probably familiar with the Distributive Educational Clubs of America, the Vocational Industrial Clubs of America, FHA, HERO. There are ten that are recognized as vocational student organizations by the United States Department of Education.

We provide opportunities relating to award recognition, leadership, and communication skills development for those students that are enrolled in agricultural education. The FFA addresses those needs of the secondary students. The PAS addresses the needs of those who are enrolled in the community junior college system generally in technical programs. We serve those needs of adults as they are enrolled in agricultural education.

Eighty percent of our membership is between the ages of 20 and 40. The term "young" is a relative term. If you would come to our Institute in Mobile, Alabama, in December and survey the group, you will certainly feel that way. I remember the very first Institute that I attended. I walked away from it and said, "Good grief, these are young farmers?" After doing some checking and research on it, I realized quickly that few people involved in production agriculture have the opportunity and resources of both time and finances to travel and to leave the farm for an extended period of time.

Those people who do are the older segment of the farm population. Those people who are required to stay home because of their tie to the business and the high requirement for family labor are the younger people. Also, the secondary reason is that our Institute is held the end of November and the first part of December. This coincides with the deer season in many states. Life is a matter of priorities.

The purposes of our organization are:

1. To assist young farmers to remain established in farming, ranching and agribusiness. This goes beyond production agriculture. You will note I said agribusiness.

2. To develop or to assist in developing resources that otherwise may not be available.

One of the programs that I am going to share with you was sponsored by Navistar International Transportation Corporation. One of the ways we were able to get those resources was that we could provide them with a program that was national in scope and related to our goals and objectives. These are to develop and to assist in developing leadership and communications skills, to provide identity and unity to the group.

It also helped to promote the National Young Farmer Educational Association as a vital part of the instructional program in agricultural education. One of the more important opportunities, as it relates to our purpose, is to improve the rural community as a place to live relating to health services and rural/urban relations.

How is this done? We are a member of the family of agricultural education. Our programs are administered and conducted by, on the local level, that instructor of agricultural education. Yesterday Bob Graham, representing the National Vocational Agricultural Teachers' Association, gave you a perspective on that group.

The primary emphasis that you picked up from that presentation was that they work with the secondary teacher. That secondary agricultural instructor many times is the advisor to the Young Farmer Association.

Agricultural safety has been a priority in all of our lives, mine as well, from an early age. I am not going to go into any of the things that I did as a child and young adult growing up on a dairy farm because at this

point it is unimportant. The perspective that the people in production agriculture, the farmers, have is that they are risk-takers. A high level of risk-taking exists in all things that they do. This relates to safety as well.

My life was impacted when I was a ninth-grader. A classmate of mine, Ken Kruse, was killed as a result of a farming accident. My life was also impacted when my brother sustained eye damage. He was working in a construction job between his freshman and sophomore years in college and sustained permanent eye damage. My life was also affected when my nephew lost an eye as the result of an object being thrown by a lawnmower that his father was using. And the list goes on. I too have sustained injury as a result of working in production agriculture.

The setting in the agricultural shop of the high school at which I taught was also an area where safety was important.

As we look at the opportunity for intervention as it relates to the reduction of injury and death from farm accidents, we need to reflect on some of the presentations that were made. We just heard a presentation on the relationship between knowledge and education versus faulty habits and attitudes as it relates to the occurrence of farm accidents. I said that farmers, as well as all the rest of us, have the knowledge and know the difference between right and wrong.

I have a 13-year-old son who is just starting to leave home and to go on his own to skiing trips and other activities with organizations, including our church group. When he leaves on these trips, I tell him, "Jon, I do not need to tell you what to do and what not to do. You know what is right

and what is wrong. What I need to tell you is that when you are faced with a situation, you take the time to stop and think, "Is this right or is this wrong?" Weigh the circumstances and make the decision."

I used that same example when I was teaching agriculture. I would take my students to Columbia, Missouri, for the state judging contest and the state convention. I said, "If you do not know the difference between right and wrong, I have been a failure." In the case with Jonathan as a parent, or with my students I have been a failure as a teacher. What I am asking you to do is to stop and think and weigh the risks.

People involved in production agriculture are risk-takers. We assume risk when we plant the crop. What are the risks? We are not guaranteed what the weather conditions are going to be. We are assuming risk. We are not guaranteed what the price is going to be. We are assuming risk. We do the same kinds of things as it relates to safety. That kind of feeling comes through in all that we do.

At the same time, we in education provide programs and information that should help that person in production agriculture shift those risks. What do we have as it relates to price protection? The futures markets can be used as a hedge to shift that risk from the farmer to someone else. As it relates to weather, there are crop insurance programs that are available.

*What can we do as it relates to safety? How can we help that person in production agriculture shift that risk or, better yet, eliminate that risk and be accident free?*

Another important factor is awareness. We in the National Young Farmer Educational Association just completed a safety program called Board, EM II. This is a program that is conducted in cooperation with the FFA chapters across the country. We work closely with the FFA chapters, which provides for a good situation. The FFA chapters and those younger people are looking for opportunities to conduct community-service types of projects.

They have the means and work diligently in providing the legwork to get the information out. At the same time, those people out there in production agriculture, the young farmers as well as the not-so-young farmers, benefit from the reduction in accidents and the reduction losses resulting from these programs.

The Volatile Fuel Safety Program involved several areas. One of them was to reduce the accidents that result from mishandling and improper handling of volatile fuels, primarily gasolines. One of the reasons that this area was identified and initiated in the mid 1980's was that people were keeping tractors longer because of the economic situation. They were also keeping the tractors in a poorer condition and a lower level of repair and maintenance.

The other thing is that these tractors were manufactured in the early 1970's, the 1960's, and the 1950's. We even found some that were manufactured in the late 1940's. The specifications under which they were built were for the product that was being used and manufactured at that time. Now they are being operated on gasolines that are manufactured primarily for our cars of today, with the different octanes and volatility levels.

Tractors are being used for heavier operations than they were manufactured for. This causes a higher level of heat.

The FFA chapters and those younger people are looking for opportunities to conduct community-service types of projects.

The Board EM Program emphasized three major areas: instruction, awareness, and the opportunity to update and check equipment to keep it in proper operating condition.

The awareness aspect of the program was addressed through decals placed on fuel tanks and the storage tanks, as well as the tractor, itself. This called attention to the idea that when you work with these fuels, you, as the farmer, know the difference between the proper way and improper way of fueling this tractor. It is up to you to take the initiative to exercise the proper practice and to follow through.

This program was sponsored by Navistar International Transportation Corp. Their primary interest was to reduce their risk and exposure relating to these kinds of injuries. As we were seven months into the period, incidence and injuries was reduced considerably.

The Young Farmer Educational Association presently is looking at other areas and thrusts for safety programs. Among other things, this conference is providing me with names of resource people that I will be contacting in the future to help us identify thrusts and available information and resources.

I mentioned that the opportunity and the purpose that we have in addressing the awareness aspect of safety is important. The decals that were placed on the machines were printed and distributed in English and Spanish, as well as French for the Canadian provinces.

I would like to react to some of the things that have been presented. One of the purposes for my being represented at this conference is, What can we as a vocational student organization bring to the table? What can we do to help in reducing the incidence of accidents and death?

I heard the statement made yesterday that there needs to be a bridge built between the professionals and the farmers. I see this as being very important. I mentioned that farmers are risk-takers. We have heard, also, that farmers are people who listen to farmers.

They tend to stay within their own groups and to rely on their same kind for information. This is an opportunity for us. We need to direct our attention to how behavioral changes can come about and be part of the solution.

Most effective learning occurs when there is activity involved. *Learning by doing* is one of the lines of the FFA motto. We need to provide the opportunity for positive reinforcement. People involved in production agriculture are students, regardless of their age. They need to have the same opportunities for positive reinforcement as our high-school or elementary students.

We at this conference are not going to be made effective simply by what we have heard. We need to take it with us. We need to involve the people back at home.

Teaching values and behavior to our kids at a very young age is important. This is where we develop the habits like to use the seat belts.

When our first-born, Jonathan, came home from the hospital in 1978, he was in an infant seat utilizing the seat belt. Irene and I decided that this was going to be a priority. Now Joel, who is our 5-year-old, gets in the car and we drive just a short distance; he wants to be buckled. These are the kinds of habits we need to work with in production agriculture as well.

We have heard throughout this conference that children are a very at-risk population. We need to address that risk.

I will be here during the remainder of this conference. If there is not the opportunity during one of these sessions to ask questions, I would be more than glad to visit with you on an informal basis.

In closing, I would like to point out that when addressing the opportunity for improvement and the reduction of farm accidents, it is important that we know the people with whom we are dealing. I have a very serious concern about the low numbers of people involved in production agriculture attending this conference. I can understand the reason for it when we consider the date of this conference.

On the positive side, however, we are having an excellent opportunity to gain the perspective of the Surgeon General as it relates to agricultural safety. Now it is up to us to take this information and to see that it gets to the place where it can be effective. Thank you very much.□



## FARM FAMILY BEHAVIOR PERSPECTIVE

By Robert Aherin, Ph.D.

University of Illinois

Professor, Department of Agricultural Engineering

My presentation will focus on farm family behavior and the issues surrounding effective safety and health behavioral change among adults and children. I will comment on some of the issues that I heard today and yesterday during this conference that relate to behavioral change. I will also review some additional issues for consideration in looking at behavioral change concepts in dealing with the very complex safety and health issues that face production agriculture in this country.

My research activities have focused on analyzing and predicting various safe work behaviors among farm populations through the application of social behavioral psychological models. I have conducted studies involving dairy farmers, pesticide applicators, and child safety behaviors on farms.

There has been a lot of discussion at this conference concerning the uniqueness of agriculture as it relates to occupational injury and illness problems. This has included the variety of occupational hazards that farm workers have to deal with; the variations of economic status among farmers and farm workers; the diversity of work activities on farms; the periods of high physical and emotional stress; the extreme environmental conditions that farmers often work under; and their limited access to emergency care.

Yesterday we had the opportunity to hear, in this session, a number of very good presentations on ways and means to heighten

awareness and knowledge of farm safety among farm populations. Some of the methodologies discussed included group presentations; using the media effectively; exhibits; demonstration activities; and learning through interaction. Furthermore, the importance of networking among organizations for the purpose of sharing expertise and resources to address farm safety and health issues was addressed.

### THE 4-H PROGRAM

Before I continue with my primary topic, I was asked to describe the 4-H program in this country for the benefit of those who may not be familiar with 4-H. As a member of the Cooperative Extension Service staff at a land grant university, I work closely with 4-H.

The 4-H program is another major mechanism of reaching youth, particularly with agricultural safety and health information that some of you may not have traditionally been involved with.

It is part of the Cooperative Extension System and the United States Department of Agriculture. 4-H combines the cooperative efforts of youth; volunteer leaders; state land-grant universities; Federal, state, and local governments; and the U.S. Department of Agriculture.

The mission of the Cooperative Extension System in conducting 4-H programs is to assist youth in acquiring knowledge, devel-

oping life skills, and forming attitudes that will enable them to become self-directing, productive, and contributing members of society. 4-H's goal is to create a learning environment for youth that is stimulating to the development of life skills in three areas:

- ▶ First, competency and knowledge.
- ▶ Second, coping and dealing with stress in their daily living.
- ▶ Finally, being contributing individuals of society by learning the importance of helping others.

4-H programs are also internationally involved. In addition to the United States, it is carried out in 82 other countries in the world. Our country was and is a model for 4-H programs throughout the world.

In the United States, there are currently about five million youths involved in 4-H programs. Only 13.7 percent, or about 700,000 of the five million youths involved in 4-H, live on farms. Approximately 38 percent of 4-H members live in towns under 10,000. About 20 percent of 4-H members live in cities larger than 50,000.

Girls make up about 53 percent of the members. Sixty-six percent of 4-H members are between 9 and 11 years of age; 23 percent are between 12 to 14; and 10 percent of the members are between 15 to 19 years.

The 4-H program is operated primarily through volunteer leaders. There are staff located at the county or local level, and state staff that help facilitate programs throughout each state.

A national staff coordinates programs at the national level. But, primarily, 4-H nationwide is made up of over 519,000 4-H adult leaders and 125,000 junior and team leaders.

4-H volunteers on the average donate about 220 hours per year preparing club meetings and teaching youth. Thus, for each hour a salaried staff person spends in 4-H, a volunteer spends about 12 hours of time with 4-H members.

Safety is taught through specific projects on safety topics and as part of other projects. Members also have an opportunity to be involved in community safety activities. Thus, 4-H is a major organization that has deep roots in rural areas that can serve as a significant communication link on farm safety issues.

## USE OF EDUCATIONAL MEANS

Now, to go back to my primary topic. I think it would be good to look at some of the issues or statements that have been made by several of the speakers in the last couple of days that relate to using various educational means to change safety behaviors. I would like to discuss the need to evaluate the effectiveness of educational efforts to influence safe work procedures and relatively new methodologies by which this can be accomplished.

For example, on Tuesday, Dr. McGinnis, when speaking on the topic of disseminating safety and health information through educational means, stated that "education alone is not enough." The physical environment must be changed.

Further, he stated that there needs to be a balance between health promotion and health protection. We need to know the

facts. We need to build coalitions to do this job. "Knowledge and attitude change may not be sufficient" was another statement that he made.

Dr. Sullivan, Secretary of Health and Human Services, stated that more extensive educational programs can be effective in reducing occupational injuries and illnesses in agriculture. I would say, yes; but there are some qualifications, and I will discuss those here in a minute.

Dr. William Roper, the Director of CDC, made some statements that we must be able to measure progress with our intervention programs. We must deliver successful programs.

Finally, Dr. Myron Johnsrud, Director of USDA Cooperative Extension Service, asked a couple of very good questions. He asked, "Why are educational warnings going unheeded?" Additionally, he asked, "What intervention programs are needed to be effective?"

I have worked as an agricultural safety professional for over 17 years involving positions at the University of Minnesota and now at the University of Illinois. A very significant portion of my program involved developing and implementing safety education programs for farm workers and farm family members.

Normally the success of these programs was measured by how many people were contacted and how many programs were offered. It was assumed that those exposed to farm safety information through some type of educational program would become aware of the risk, would learn how to minimize or avoid the risk, and then would take action.

As I grew in my professional career, some of my concerns were, How do we know if our safety educational efforts are effective? Are we really changing the person's behavior with educational programs? How can we do a better job of that? These concerns inspired me to explore these issues.

Mr. Graham stated that there were four steps needed to be effective in our programming efforts. These include identify needs, develop objectives, take action, and evaluate the results. I basically agree with these four points. The problem is that we have not been very good at achieving them.

### **Identifying Needs and Evaluating Results**

Let us focus on identifying needs and evaluating results. Some of the measures typically used to accomplish these would include looking at injury and illness data to learn where some of the problems are in order to direct some of our efforts.

Once educational intervention programs are implemented, we evaluate to see if there has been any change in the injury or illness data over time. There are some significant limitations in using injury data to evaluate safety intervention programs in agriculture.

Such data can provide us with a lot of information on what some of the contributing factors are to agricultural injuries and illnesses. But utilizing injury and illness data for evaluation purposes is basically a long-term measure.

Normally, it takes five to ten years for most farm safety issues to see if there has been any significant impact. This is because there are so many factors such as

sociological, environmental, and economic that can influence injury and illness rates.

For a variety of reasons, educational programs have been the primary intervention means to reduce injury risk in production agriculture. This is due to the limitations that have faced other general intervention efforts.

Furthermore, injury data is a very poor measure in small geographical locations. This is because during the short term there are very few cases to evaluate. The injury rate in a given area may drop by 10 or 15 percent from one year to the next just because of natural fluctuations.

There are significantly fewer laws and regulations that are directed at the safe work activities of farm workers compared to workers of most other industries. Federal and state regulations have been limited for a variety of reasons. Some of these include

- The lack of a concentrated work force—farms are generally small operations in most areas of the country that employ few people at one location. This makes it difficult and costly to effectively enforce safety regulations.
- Unorganized work force—most workers in agriculture are not organized. Labor unions in other industries have been a major factor in the promotion of safe work places through work contracts and through support for state and federal regulations for their members.
- Independent nature of farm operators—most farmers do not like to be told what to do. They tend to want only minimal outside intervention into their livelihood. Thus, most farm organiza-

tions have not favored laws and regulations directed at farming operations.

Probably the most effective means of injury control is the providing of automatic protection of workers from agents of injury. This is basically accomplished through the design of equipment and processes to eliminate or reduce the potential for injury by users. While the manufacturers of farm equipment, structures, and processes have made major advancements in safety design these improvements are rarely passed on to existing equipment or processes.

Most industries have guidelines and requirements for retrofitting older equipment to bring it in line with current safety technology. This is generally not practiced in agriculture at this time. Farmers often see little economic incentive to retrofit older equipment.

Thus, these are some of the basic reasons why the agricultural industry has traditionally relied so heavily on safety educational measures to reduce injury exposure. While in the future it is envisioned that a greater utilization of other injury control measures might be used in agriculture, education will continue to play a major role. It is imperative for this reason that more effective means to utilize educational intervention efforts to influence safe behaviors of farm workers be sought.

Many of the safety and health intervention programs of the past have been developed on the basis of what we "think" will work rather than what we "know" will have the greatest impact. I believe that there are new theories and models for evaluating social behaviors that can be helpful in delineating the intervention need in agricultural safety and health.

These models potentially could define safety and health issues to the point of providing direction for the development and use of educational measures. Additionally, these analyses could identify the limitations educational measures may have in effecting positive safety change for some issues.

Much of safety educational efforts of the past focused on changing attitudes with the belief that attitude change would result in behavioral change. As Dr. Elkind pointed out in her presentation at this conference, studies conducted in the late 60's and 70's found little or no correlation with this hypothesis.

It has been learned in recent times that attitude measures do not correspond with behavioral criterions. The early attitudinal studies would evaluate a very general behavioral statement. An example of this would be when evaluating the potential purchase of a roll-over protective structure (ROPS) on a tractor a subject might be asked to evaluate a statement such as, "Roll-over protective structures are \_\_\_\_\_."

Behavioral psychologists have learned that many of the low correlations of attitude measures with the actual behavior are because the statement is directed toward the object of the behavior rather than the behavior itself. Thus, if researchers are interested in predicting behaviors through an attitudinal measure, the attitudinal measure must be directed toward that specific behavior, not the object of that behavior.

A more appropriate evaluative statement for predicting ROPS purchasing behavior would be to ask farmers their attitude toward buying roll-over protective structures. The attitude question would

look as follows: "My buying a roll-over protective structure in the next two years for one of my non-ROPS equipped tractors is \_\_\_\_\_."

The attitudinal question must match the corresponding behavioral criterion in terms of 1) action, 2) target, 3) context, and 4) time. In the previous example the action was "my buying," the target was "ROPS for one of my (the subject) non-ROPS equipped tractors," the context was "general," and time was "within the next two years."

In summary, there may be a substantial difference between people's attitudes toward objects (in this example, ROPS) and people's attitudes toward behaviors associated with objects (in this example, buying ROPS). To predict behavior, this distinction is crucial.

One of the prominent social psychological models for behavior prediction and analysis is the Theory of Reasoned Action that was developed by Fishbein and Ajzen.<sup>12</sup> This theoretical model took the question of behavioral prediction many steps further than models previous to it by adding various concepts to the analysis of social behaviors. Figure 1 illustrates the various components of the model.

The ultimate goal of this theory is to understand human behavior, not just predict it. This theory has proven that intention is strongly correlated to one's behavior and behavioral intentions are formed by two basic determinants, one personal in nature and the other reflecting social influence.

The theory of reasoned action predicts a behavior (box number 1 in Figure 1) by asking individuals whether they intend to

perform a specific behavior (box number 2). This "intention," in turn, is determined by two components: attitude and subjective norm (boxes 3 and 4 respectively).

The attitude component, as expected, analyzes a person's attitude toward the behavior, while the subjective norm component analyzes the amount of pressure a person feels from significant others to perform the behavior. Both of these components are predicted by qualitatively different beliefs (boxes 5 and 6 respectively).

By comparing the beliefs of intenders to non-intenders, the researcher can see what beliefs need to be changed in order to change the behavior of the unsafe farmers. An advantage of this model is that it provides very specific recommendations on

how to change specific behaviors, based on the farmers involved with those behaviors.

Within populations for specific behaviors, some will be more affected by their attitudes while others will be more affected by social influences. Furthermore, others will be equally influenced by both attitudes and social influences. Through the statistical analysis of the model one can learn what portions of the population are affected by the various determinants of the behavior being evaluated.

I have tested this model in a study conducted among a population of Wisconsin dairy farmers and Illinois pesticide applicators. The predictive ability of the model showed positive results in both of these studies. However, this theory needs to be further tested on farm populations.

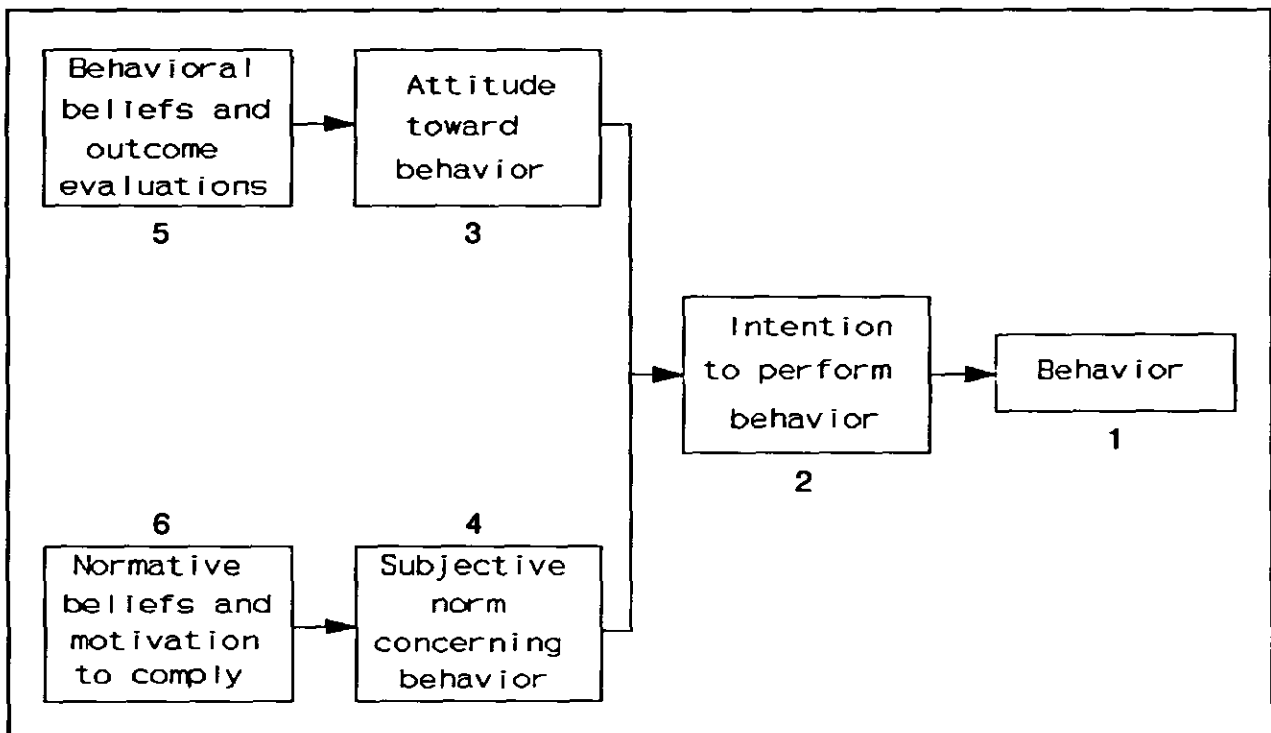

Figure 1: The Theory of Reasoned Action.

I believe the Theory of Reasoned Action and other behavioral models that have been developed from it can be significant tools in identifying the attitudinal and social beliefs that need to be modified in order to change behavior. This level of analysis can provide strong insights into whether the behavior being evaluated can be significantly affected by educational interventions or if other types of interventions will be necessary, such as economic incentives or design changes in equipment or processes.

An example of an issue that might benefit from Theory of Reasoned Action type of analysis would be the installing of ROPS on tractors. Tractor roll-overs are a major factor in farm work-related deaths.

It is well known that if a tractor has a ROPS it almost eliminates the death potential in a tractor roll-over incident. But only about 30 percent of the farm tractors in the United States have a ROPS. Thus, the issue is what it would take to persuade farm tractor owners to install a ROPS on non-ROPS tractors.

There have been significant educational programs to promote the purchase of ROPS among farm tractor owners. But there has been no significant increase in the retrofitting of ROPS on non-ROPS equipped tractors.

If an analysis was conducted among US farm tractor operators utilizing the Theory of Reasoned Action, one could learn what intervention initiatives would be necessary to effect a significant change in this behavior.

For example, it could be learned how much if anything farmers would be willing to spend for a ROPS, their general percep-

tion of the need for ROPS on their tractors, tractor use problems that they may encounter with ROPS, and so on. This type of information would provide focus for initiatives to deal with this issue rather than using the traditional "shotgun" approach of trying anything and seeing if it works.

Additionally, an analysis of this nature can be conducted once intervention has occurred to determine if any behavioral change has developed. Thus, it has potential to serve as an excellent evaluation measure.

In conclusion, given the current restraints that safety and health professionals in agriculture must work under it is imperative that we identify and utilize intervention measures that are capable of self-motivating farmers and farm workers to adopt safe work practices. We must strive to improve our ability to accomplish this.

There has been practically no systematic evaluation of the effectiveness of agricultural safety and health education, legislation, or engineering intervention efforts to prevent or control agricultural injuries in this country. It is essential that agricultural safety and health professionals from all disciplines undertake scientific evaluations of their efforts to effectively reduce the risk of agricultural injuries and illnesses for the farm populations that they serve.

As previously stated, several practical and cultural considerations suggest education-oriented intervention approaches will continue to be an important option for the prevention and control of agricultural injuries and illnesses. But I am very concerned by the thousands of dollars and hours that are spent on agricultural safety educational programs without seriously

evaluating the potential effect that such efforts will have on the issues being addressed.

The recently developed theories of social psychological behavioral analysis and prediction show promise for providing researchers and educators with a more comprehensive understanding of safety and health-related behaviors among farm populations.

Agricultural safety and health professionals need to become more familiar with recent

concepts of applied behavioral analysis. A limited number of research programs should be supported that apply social psychological behavioral analysis to selected agricultural safety and health issues of national importance. One of the primary purposes of these studies would be to further validate the utilization of these types of analysis for addressing agricultural safety issues.

Agricultural safety and health issues are some of the most complex of any industry. We must continue to strive to identify means that are effective in addressing these issues so as to preserve the valuable human resources who are involved in production agriculture.□

## REFERENCES

1. Ajzen, I, Fishbein, M. (1990). *Understanding Attitudes and Predicting Social Behavior*. Englewood Cliffs, New Jersey: Prentice-Hall.
2. Fishbein, M., Ajzen, I. (1975). *Belief, Attitudes, Intention, and Behavior*. Massachusetts: Addison-Wesley.



## **SURVEILLANCE - AGRICULTURE-RELATED DISEASES, INJURIES, AND HAZARDS**

*By Henry A. Anderson, M.D.*

Chief, Section of Environmental Epidemiology  
Wisconsin Department of Health and Social Services

Dr. Richard A. Lemen: Our first speaker will sum up the session on *Surveillance - Agriculture-Related Diseases, Injuries, and Hazards*. Our speaker, Dr. Henry Anderson, is the Chief of the Section of Environmental Epidemiology with the Division of Health in Madison, Wisconsin. Dr. Anderson has a medical degree from the University of Wisconsin and received his bachelor's degree from Stanford University. Dr. Anderson:

Over the past several days, we have experienced some stimulating discussions and presentations. What stands out are the vivid images that have been evoked.

We are all now familiar with the theme of the movie *Field of Dreams*; we have heard all about "belltollers." We can clearly say that this conference, among all conferences, has definitely overcome the "vision thing."

### **THE TIME HAS COME FOR ACTION**

Our session was to address surveillance of agriculture-related diseases, injuries, and hazards. I think we confirmed that the time has come for action; that there is a crisis of disease, injury, death, and disability on farms and in farm families.

We need to move away from the broad view to some specific, high-priority activities.

Our challenge is, "Why can't we prevent these events from happening in the first place? Why haven't we, and why can't we?" What is critical to accomplishing the

goals is that a coalition is forming, and it is forming around the common interest of concern and support for the prevention of agricultural injury and disease.

### **SURVEILLANCE IS ESSENTIAL TO PREVENTION**

As you might expect from our group, we feel surveillance is essential to prevention. We discussed that the role of surveillance and prevention has four main goals.

▶ The first is the ability to recognize and identify problems. We have certainly done that through existing programs. We have heard this week about the many problems that do exist.

▶ The second activity of surveillance and prevention is defining the scope of the problem. In many instances, we are in the process of trying to do that, but we also need the second step to continue that.

▶ The third is to target interventions. Right now we are in the process, for many diseases and injuries, of trying to target where we can get the most bang for our buck.

► The fourth role is in evaluating the efficacy of interventions.

For many conditions we are at different surveillance stages in this scheme. For one condition that we have heard much about, that of farm fatalities due to tractor roll-over, we have identified the problem, we largely know the scope of the problem, and we know what needs to be done to target interventions.

We also have heard this week that we have not been very successful. Surveillance information is continually telling us that our programs are not as effective as we would like and that we need to bring our coalition together to control these problems.

We discussed a number of issues: hearing loss, skin cancer, acute pesticide poisoning, and respiratory illness. All of these are problems that need to be addressed, and surveillance can assist us.

### **TASKS CAN BE ACCOMPLISHED BY A COALITION**

We also discussed defining the coalition. We all have a fuzzy, warm feeling about a coalition, but we really need to begin to define what it is and who it is. We need to involve government at all levels—that is, the Federal government, state governments, local governments, and county governments.

There is a critical need to have industry involved. They are key actors and players to help us intervene.

Communities also need to be involved. Both the academic community and the community of the voluntary organizations that represent individuals need to be involved.

We also heard of a need for grass roots effort. We need to have individuals involved. The individual farm family must be committed to this activity and participate.

The coalition needs to identify a set of conditions and hazards for surveillance. We need to move away from the broad view to some specific, high-priority activities.

### **THE NEED FOR PRIORITIES**

Our session participants determined that an initial task of the coalition must be to establish surveillance priorities and to provide support to build the infrastructure necessary to carry out the surveillance programs.

► Therefore, first we are proposing that within 60 days the Surgeon General make every effort to identify resources for a workshop of coalition members and that agricultural disease and injury experts come together to identify conditions for surveillance.

► Second, after that group has come together to identify candidate conditions, that within 180 days the Surgeon General make every effort to identify resources for a workshop, which will take up the candidate conditions involving all levels of the coalition. We have, over the past several days, identified and spoken of a number of candidate conditions in our group, including farm fatalities and the more serious injuries.

Of course, we talked about roll-overs, but also we have to be concerned about amputations and loss of eyes. Skin cancer, repetitive trauma, hearing loss, and especial-

ly respiratory conditions, also, must be considered as candidates.

### **CANDIDATE SURVEILLANCE PROGRAMS**

We also discussed various types of surveillance programs. Once these candidate conditions are identified, we must begin to move forward for the establishment of surveillance. A situation such as the need for continued coding of death certificates for industry and occupation, as well as that portion of the death certificate that indicates whether the fatality is work-related or not, is one candidate surveillance system that could be easily implemented.

We also need to begin additional surveillance at the local level by health and safety practitioners. Another example would be in-depth case investigations of individual fatalities or individual diseases by health and safety experts.

Lastly, and parallel with this activity, we recommend that the Surgeon General and the coalition, together, need to move forward to identify resources for the further development and support of the infrastructure that is necessary to carry out this mandate.

In conclusion, our group did feel that we have a vision, but we do not feel that it is visionary but rather that it is practical. Prevention can be accomplished, if we are all committed to achieving the goals. We feel that this conference is the first step in getting a coalition formed and allowing us to begin to make that commitment to move beyond all of the activity that is currently ongoing and to make additional strides for the prevention of disease and injury.□

## RESEARCH - CHEMICAL AND BIOLOGICAL HAZARDS

By Kelley J. Donham, D.V.M.

Professor, Department of Preventive Medicine and Environmental Health  
University of Iowa

Dr. Richard A. Lemen: Our next speaker this morning will be talking about the findings and the recommendations of the sessions on *Research - Chemical and Biological Hazards*. To do that is Dr. Kelley J. Donham, who is a veterinarian who received his degree from Iowa State University and his undergraduate and master's degree training from the University of Iowa. Dr. Donham:

Steve Olenchock, the rapporteur in our group, and I worked for several hours last night to summarize the kinds of messages that came through over the past two days in our group. We felt we could best summarize those ideas in about three different topics.

- ▶ Number one, there was a special spirit that transcended throughout the session that can best be described by a combination of urgency, enthusiasm, and commitment.
- ▶ What I want to talk about second is specific facts that were mentioned in regard to particular agents of disease and the gaps in the knowledge that were identified.
- ▶ The third topic I want to discuss is the need for a coalition to address the issues.

This was a group that was quite large. We usually had over a hundred people in the room, very interactive, and I think it was a very exciting group to be with.

### GROUP SPIRIT

Regarding the spirit of this group, I would like to try to demonstrate this through a model diagram of a nerve synapse. The spirit that we felt contained enthusiasm, commitment, and goal direction.

The spirit really was something that was sparked or initiated back in 1988 when there was a conference here in Iowa, entitled "Agricultural Occupational and Environmental Health: Policy Strategies for the Future." This conference resulted in *A Report to the Nation*, which indicated that there was an urgency, a feeling of urgency, about this whole issue.

I believe since 1988 that urgency has transcended into even a greater and broader enthusiasm and commitment demonstrated here at this conference. Clearly, the neurotransmitter substance here was Dr. Novello's enthusiastic communication to us of her commitment to this public health problem of agricultural safety and health.

However, in the background there is the question about the reality of this commitment in the years to come. The momentum, will it continue? The fact is that the changes, the actual reduction in injuries and illnesses that we hope to see, will take time and will take long-term commitment.

One of the items that came out of the group was a call for a sustainable human resource in agriculture. This was based on an analogy to the sustainable agriculture movement from a natural resources conservation perspective.

Perhaps one of the aspects that has not been thought of or put into the equation of sustainable agriculture is that we must have a sustainable human resource. We need a sustainable human resource that is as free as possible of illnesses and injuries from an economic standpoint as well as a humanistic standpoint.

## FACTS

### Dust-Related Diseases

Moving now from the spirit of this group to facts, Suzanna Von Essen reviewed some of the major respiratory diseases resulting from exposure to agricultural dust: bronchitis (both acute and chronic); occupational asthma; organic dust toxic syndrome; mucous membrane irritation; hypersensitivity pneumonitis; and classical allergies (rhinitis and asthma). These are placed subjectively in order of importance, as I interpreted from the discussion and from the presentation. I also noted some gaps in knowledge brought out in the discussions.

There were questions about the sequelae of repeated acute exposures or acute episodes of organic dust toxic syndrome, acute bronchitis, or hypersensitivity pneumonitis. What are the long-term and outcome sequelae? They are unknown. This is where additional research is needed.

There was considerable discussion in regards to agents of agricultural respiratory disease. The exact agents are unknown, as are the specific mediators that result in the biological conditions that are seen.

The difficulty of differential diagnosis was mentioned several times. It is not easy to differentiate between organic dust toxic syndrome and hypersensitivity pneumonitis

and a complex such as a combination of chronic bronchitis combined with hyper-reactive airways disease. To sort those out, the clinician at the community level needs help in regards to training and newer and more specific diagnostic tools.

**Treatment:** It is not entirely certain from the physician's standpoint as to what is the best treatment for these agricultural respiratory ailments. We know that protection, perhaps, is the best answer; but when a clinician is faced with these problems in his or her office, what is the best treatment?

Fifty percent of the pesticides that are in use show some potential for carcinogenicity.

**Children:** There are questions about children who are exposed to these environments at an early age. What are the issues and problems involved? Are they more prone to allergies? Are they susceptible to inflammatory agents and long-term sequelae? It is not known.

### Pesticides and Fumigants

Aaron Blair had the topic of pesticides and fumigants, and he outlined his presentations emphasizing chronic outcomes in four areas: cancer, immunologic, neurotoxic, and reproductive. He concentrated primarily on the potential relationships of pesticides to cancer, because that is where most of the research has been done.

Fifty percent of the pesticides that are in use show some potential for carcinogenicity, based on a variety of different kinds of bioassays, and they seem to span

the classes of pesticides that are used, including insecticides and herbicides. Even though farmers have lower overall risks for cancers, there are certain cancers that they have increased risk for, including reticuloendothelial cancers, multiple myeloma, lip, prostate, and soft tissue sarcoma among others. Perhaps, in terms of the evidence relating pesticides to cancers, non-Hodgkin's lymphoma seems to have the strongest relationship.

**Immunologic Concerns:** Perhaps one of the most interesting facts that was brought up was that non-farm populations of immunosuppressed individuals seem to have similar patterns of cancer as farmers. There are a host of neurotoxic problems that are at least, I guess, beginning to be associated with pesticide exposure, but they are not really well-known at this point. Then, certainly, there are certain pesticides that have some effects on both male and female reproductive outcomes.

Perhaps one of the major gaps that was noted was the need for a well-controlled, long-term prospective study; perhaps this is one of the major ways to try to find out some of these associations.

### **Infectious Diseases**

Dr. Russell Currier had the assignment of discussing infectious diseases. He discussed these in four different categories: interpersonal, food-borne, vector-borne, and other zoonoses.

In terms of interpersonal infections, he noted that there are certain diseases that have been rare in the past, but are very prevalent in certain farm populations. Tuberculosis, for example, is 300 times more prevalent in the migrant farm population than in the white population.

Polio and rubella have been noted in the Amish population. Enteric diseases, generally speaking, are more prevalent in the migrant and economically deprived groups. There is a problem with a combination of socioeconomic status and cultural situations that clearly influences the disease pattern within this population.

There are occasional outbreaks of a whole host of food-borne diseases within farm family populations, because of their particular food preparation methods and use of food from the farm. Examples include *Campylobacter*, *Listeria*, *Salmonella*, and *trichina*.

Perhaps one of the most interesting facts that was brought up was that non-farm populations of immunosuppressed individuals seem to have similar patterns of cancer as farmers.

Vector-borne diseases still crop up as occasional problems, ea plague, Rocky Mountain spotted fever, equine encephalitis, California encephalitis, and even malaria in certain areas.

Zoonoses, in particular tetanus, were noted. We still do have tetanus, and the fact is that the immunization status of our population is not as complete as we would hope it to be.

Bovine tuberculosis has shown up again from other species besides cattle. Llamas and buffalo are species that can harbor the infection and reintroduce it to the cattle population, which may in turn expose the farm population. Then, finally, rabies is still a problem and will be a problem for many years to come.

**Gaps in Knowledge of Infectious Disease:** Particularly a lack of information about infectious diseases in immunosuppressed populations and effects on women of certain infectious diseases was noted as a significant knowledge gap. Needlesticks, associated with the incidental use of injectable antibiotics and veterinary biologicals, have been noted as a problem.

### **Gases, Vapors, and Liquids**

William Pependorf had the topic of gases, vapors, and liquids. He approached it from a rather generic standpoint. He discussed a new paradigm for industrial hygiene in agriculture. He argued that we really have a special type of industrial hygiene, and that is agricultural hygiene.

What is agricultural hygiene? The old paradigm for industrial hygiene was recognition, evaluation and control. But in agriculture here we do not have the typical industrial setting. We cannot do monitoring on a daily basis. So we have to rely on anticipating the problems that may be occurring so that we can target the recognition and evaluation. The key part of this paradigm is anticipation.

The usual paradigm of control is source, pathway, and person. Here we have to concentrate on the source.

It is difficult, often impossible, to control the pathway. It is impossible to ventilate a strawberry field. It is difficult to put a respirator and a rubber suit on somebody who is working in 110°F heat in an orchard.

The third part of the paradigm is emphasizing practice standards rather than performance standards in agriculture. Practice standards emphasize good practice,

such as completely enclosed systems of pesticide handling, whereas performance standards, would stress methods such as daily monitoring of pesticides.

The lack of industrial hygiene services, the variation in the climates, the work practice, seasonality, are all not typical of industrial settings. Therefore, emphasizing practice standards only makes sense.

Gaps in knowledge here include the problem of additive and multiple exposures. We do have a situation in agriculture that is, again, different from industry—always a variety of different exposures in any one given case.

There are additive and synergistic health effects that are unknown. There is a need for more agricultural hygienists. There are precious few in this country that have the particular training and understanding of the agricultural processes and of the socioeconomic and cultural differences between the industry and agriculture approaches, which include cultural implications as well.

### **NEED FOR A COALITION**

Finally, I would like to try to put together the spirit I mentioned earlier and a paradigm of what a national coalition for local action might be. These thoughts came through in our group in various ways.

If you can, envision in Figure 1 at the center of the circle the farm family and farmworker who are the target. They are surrounded by a community, which includes a variety of different services and groups: local extensions, farm groups, the health care system, the public health departments, media, and schools.

Elements of a National Agenda

- Communication
- Community
- Surveillance Evaluation

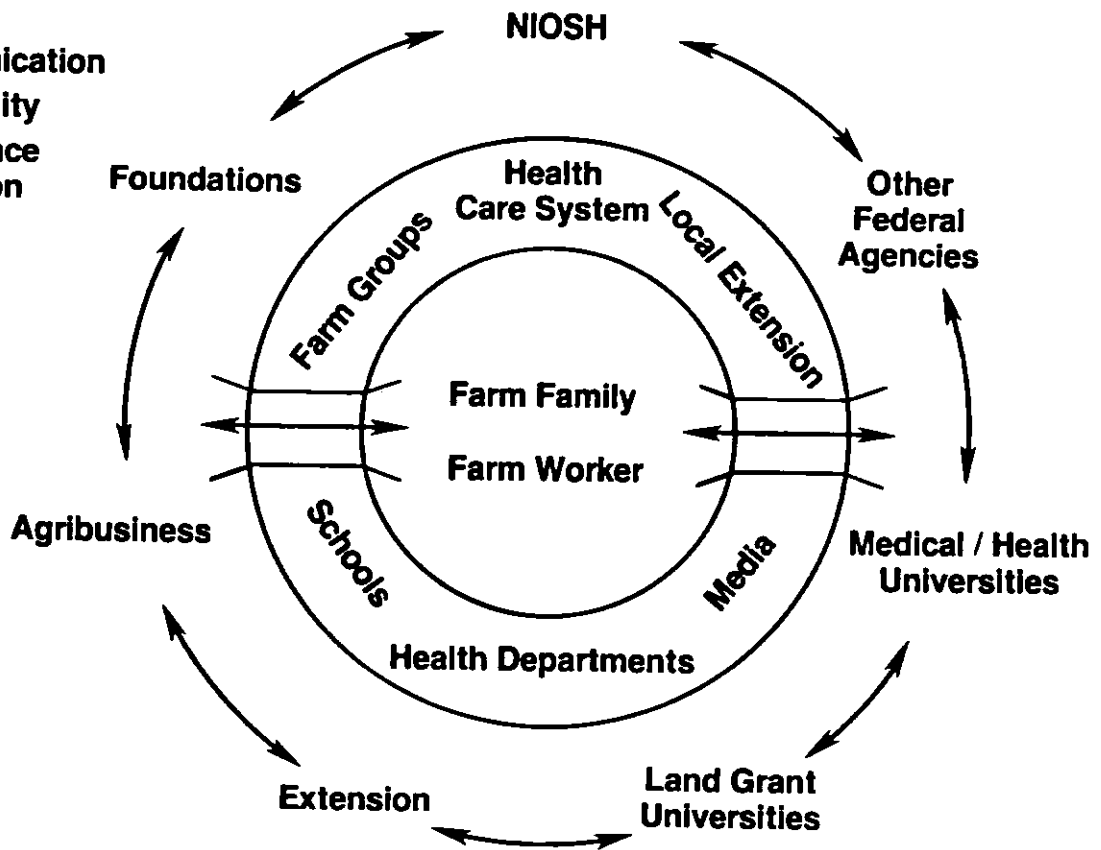

Figure 1. A National Coalition for Local Action.

Surrounding that, yet, are the national resources that we have, including NIOSH, other Federal agencies, medical and health universities, land-grant universities, national extension service, agribusiness, and foundations. There has to be communication within that outer circle and between that outer circle, to coordinate the services that are available.

Also communication is needed directly to that farm family and farmworker so that we are working on the problems that are of concern to them and are real for them and of importance for them. We must also utilize the community in which they live and work to help them solve their own

problems.

That whole communication system has to work. Included in that is the surveillance and evaluation of the programs that are in place to make sure that whatever programs that are in place are modified according to the results of that surveillance and evaluation system.

That is the paradigm that I think can result in a true "National Coalition for Local Action." Hopefully with the spirit of this conference, we can be striving for that. I think this conference has gone a long way in helping to realize that end. □



## RESEARCH - MECHANICAL AND PHYSICAL HAZARDS

By Lorann Stallones, M.P.H., Ph.D.

Associate Professor, Department of Environmental Health  
Colorado State University

Dr. Richard A. Lemen: Our next speaker will summarize the sessions on *Research - Mechanical and Physical Hazards*. To do that is Dr. Lorann Stallones, who received her bachelor's degree from the University of California in Santa Barbara, and her MPH and her Ph.D. from the University of Texas, School of Public Health, in Houston. Dr. Stallones:

Well, that introduction does not give you a very good idea about why I am up here presenting physical and mechanical hazards when ordinarily these are in the realm of an engineer or an agriculture safety specialist. I would like to acknowledge those people who made a contribution to my being here. One of them is on the platform with me, Dr. David Pratt; one of them, I am sure, is in the audience, Dr. John May. After I finished my Ph.D. in Houston, I went up to Cooperstown, New York, where I worked at the Mary Imogene Bassett Hospital with the two of them.

There are two things that you have to know about David. One of the first things that anybody ever told me about him was that he could sell ice to Eskimos. I think in this case, I was the Eskimo. The ice was that we were in a farming community and really needed to look at what the problems were in that particular community. As public health professionals, I think that really is our obligation—one that we have been remiss in fulfilling the agricultural safety and health area.

The second thing you have to know about David is that someone—the same person, of course—told me that if you sat David down in the middle of a desert he would start to count sand. So, there he was in the center

of an agricultural community, and he started counting. What we wanted to do, because David is a pulmonary physician, is look at pulmonary disease among the farmers—of course a major problem.

So we put together a very detailed survey, and we asked a lot of questions about pulmonary disease. The last day before this questionnaire went into print David said, "I've heard that farmers have a lot of injuries. Don't you think, perhaps, we should ask that question?" So we did.

When the questionnaires came back, about 10 percent of the farmers had had a work-related injury in the past 12 months. We thought that was extremely high and that gave rise to ongoing surveillance where we called this same group of farmers every other month. Much of the data have been reported in national meetings, and I think it was an extremely important step in our development.

From there I went to the University of Kentucky where I met the other side of this whole business. He was Larry Piercy, who is an agricultural safety specialist who has his master's degree from the University of Iowa, and who trained at the Institute of Agricultural Medicine. He and a number of other people work with the Kentucky Farm and Home Safety Council.

My advice to anyone who goes to Kentucky is, if you do not want to become involved, stay away from that group, because they get you involved. You will automatically move through the ranks of going to the meetings and suddenly one day you will find yourself president of the organization. The Kentucky Farm Bureau is very active in that particular organization.

But the person I really want to acknowledge in all this is my uncle, who is a farmer in Idaho whose youngest son decided that after spending quite a number of years being a carpenter, he wanted to go back and work on the farm. Really, the reason we are here is to make sure that those people who want to go back and work on a farm will be able to work in a safe and healthful environment.

### **MACHINERY AND VEHICLE HAZARDS**

We have heard a lot about how important injuries are among children and the elderly, and I would like to introduce Tom Bean's (Ohio State University) general duty clause. The general duty clause that he proposed in our session was that old tractors and old equipment are usually used on the farm for general duty, and the people who are responsible for that general duty are the old and the young.

So that gives rise to a situation where they are at risk of injury because of the age of the equipment that they are dealing with. They also are the most vulnerable of the population in terms of injury risk.

His major recommendations were that we need to continue to aggressively evaluate the safety standards that are developed by the American Society of Agricultural Engineers.

The general duty clause that he proposed in our session was that old tractors and old equipment are usually used on the farm for general duty, and the people who are responsible for that general duty are the old and the young.

One of the problems that has not been looked at and that needs to be addressed is to develop model standards for the transport of farm equipment and self-propelled farm vehicles on the highways and public roads. We may not pick up fatalities related to road use of farm equipment, because the person who dies may be the person who is in the motor vehicle, not on the tractor.

This is a very important area because, for most equipment, there are no highway standards for the transport of farm equipment. In keeping with this, his proposal was also to improve the lighting and the marking of farm equipment. He also believed that it was very important to continue studies on educational techniques that are successful.

### **MUSCULOSKELETAL HAZARDS**

David Cochran is from the U.S. Occupational Safety and Health Administration, and he addressed musculoskeletal hazards. He focused primarily on cumulative trauma disorders, about which we know very little. If you look at the combined influences of stress and heat and the type of work that is done on a farm, there are some areas of research that are pressing.

His major proposal to reduce some of the hazards was to consider packaging of materials to reduce back injuries. Materials

can come to the farm in anywhere from 1-pound bags to 50-pound bags, which will be lifted.

The point of view of the people who are the moving materials around needs to be considered in order to package them in a safer manner. He also thought it was important to identify hazards and create solutions acceptable to the farmers.

### **ELECTRICAL HAZARDS**

Robert McLymore from North Carolina State University discussed electrical power. There were three basic recommendations.

- ▶ One is that inspections of electrical wiring are critical and need to be done on a periodic basis.
- ▶ The second is the need to adhere to the National Electric Codes on the farms, and that is frequently not done. Safety procedures need to be established, particularly when a farmer does the electrical wiring. Inspections should be done upon completion of the work and must be done by a trained electrician.
- ▶ Finally, of course, there is the issue of overhead wires about which we have no good solutions, but farm equipment frequently does come in contact with overhead wires on farms, and this is the agent in many deaths.

### **NOISE**

Matthew Marvel from Oneonta Health Center discussed noise and stress. His primary focus was on noise.

He said that in those few studies that have been done hearing loss is increased greatly among farmers, that the loss of hearing

begins in the early ages, and that one of the critical needs in this area is to improve hearing protection in order to make the equipment more acceptable for people who need to wear it.

### **TECHNOLOGY TRANSFER**

Murray Madsen from Deere Company discussed technology transfer, and he focused on the need for improved sensors, radar systems, systems to anticipate and avoid overturns of tractors and systems to alter collision courses. He believes that there is a great need to incorporate human factors into the engineering design community, and he posed some rather interesting questions, which I would like to read to you.

- ▶ How does safety become a cultural value that permeates all that each of us does?
- ▶ What are the skills needed to excel in hazard recognition in the earliest stages of design?
- ▶ What is the measure of safety improvement at the stage when only conceptual alternatives are being studied?

In order to have better technology transfer, researchers need to participate in safety research and intervention networks.

### **RESEARCH RESPONSIBILITY**

John Crowley from the Farm and Industrial Equipment Manufacturers discussed research and the responsibility of manufacturers for doing research and the public sector responsibility for areas of research. Many of the areas that he touched on were also addressed by surveillance and by the previous speaker, so I will skip over some of those; but I would like to discuss a few

of the things that have not been addressed in great detail.

One of them was improving the handling of agricultural chemicals, including closed systems, improved worker protection, and techniques that will minimize the loss of chemicals so that we can reduce the total amount of chemicals that are being used. He also discussed the need for improved air filtration systems—particularly in tractors and in work environments where you address not just dust levels but also chemical, gas, and vapor exposures.

Loggers are at even a higher risk of injury death than farmers, but many of the risks they encounter, farmers will encounter as well because farmers do logging activities.

He discussed the need for devices to detect hazardous materials, particularly gases and vapors in enclosed, confined spaces. We need to develop effective ways to gain support and cooperation to fund projects.

## FORESTRY

Penn Peters from the U.S. Forest Service discussed the forestry perspective. Deaths among loggers are about 30 times more common than among other occupational groups. Loggers are at even a higher risk of injury death than farmers, but many of the risks they encounter, farmers will encounter as well because farmers do logging activities.

There is a marked lack of awareness of the hazards of logging. Data systems need to be developed to increase the understanding of the circumstances in which the fatalities and injuries occur.

## REGULATION

Thomas Seymour from the Occupational Safety and Health Administration (OSHA) discussed the regulatory perspective and made his three main points.

- ▶ One point was that existing standards need to be fully evaluated.
- ▶ Second, we are in need of better injury data.
- ▶ Third, data-gathering needs to be improved so that we can further understand the problems.

Farmers and ranchers must be involved in the development of standards, because OSHA has had problems in the ways that they have attempted to address safety and health on farms. National policy guidance is needed in order to provide focus for targeting proper areas of research and to define the scope of research to be performed within priority areas. There is a need to address the role of behavior in prevention of injuries and illnesses among farmers.

Finally, some of the comments from the audience that should be addressed were the need for more coalitions, which do more than raise funds for research but also raise awareness, the need to identify the interventions that work, and the need to promulgate those interventions. Probably most important was understanding more about what incentives work so people do the things that we know and we believe are right.□

## INTERVENTION – AGRICULTURAL WORKERS' PROTECTION FROM HAZARDS

By David S. Pratt, M.D.

Director, New York Center for Agricultural Medicine and Health  
Cooperstown, NY

Dr. Richard A. Lemen: Our next subject is to deal with *Intervention – Agricultural Workers' Protection from Hazards*. You have heard a much better introduction of our next presenter by our previous presenter. Dr. Pratt is a physician who trained with his undergraduate degree at the University of New Hampshire, his medical degree from Tuft University, and was also in the U.S. Public Health Service for a period of time. Dr. Pratt:

I would like to also take a moment not only to thank Dr. Stallones, but also to make special note of Jack Parker's contribution to our group. Jack was on the phone with us on a continuing basis and did a wonderful job getting our group organized, and I appreciate his efforts very much.

About the members of my group: it was little bit like Dr. Stallones' experience—here I am a physician. You can see we have lots of engineers here.

I would like just to make a note that we were privileged to have an active farmer, Gary Erisman, in our group. We were also particularly happy to have Dr. Hoglund join us, from Stockholm. You will see some of his materials in just a moment. Let us look to the future. He really showed us what a bright and shining future could look like for American agriculture.

We also had the special expertise of Dr. Konz, who talked to us about application of ergonomics—the notion of how people interact with machines; and he gave some special insights into how ergonomics might help in the future of agriculture. You have already heard about Vector control from Kelley Donham today. We heard from

Robert Pinger about some of the Vector control problems. I will speak more about some of the pest problems that affect farmers and farmworkers. Then, finally, Richard Fenske gave us a very nice discussion approaching personal protective equipment; I will share some of his slides as well.

Then we had responders who brought us back to Earth, told us what it was like in the real world, and what goes on from the perspective of a consulting engineer, Ray Crammond, from the perspective of an extension safety specialist with a wealth of information, Rollin Schneider; and then also from the perspective of an agricultural engineer, L. Dale Baker, who is involved every day in design and in product development.

We entered the deliberations and discussions by recognizing that the American farmer and farm family face unique hazards in this environment. In order to make it safer for these people, we needed to understand the special risks to which they are exposed on an ongoing basis, often recalling that farming and the home environment are a single, contiguous, and shared continuum.

Thus, the children on the farm are at risk for injuries from equipment, from animals, and from chemicals on a frequent and ongoing basis. The farm workforce is older, as we have heard, and often includes family members, part-time help, and migrant workers, presenting a special and unique variety of problems that need to be dealt with.

The evolution of American agriculture as it is today has led to decreasing profit margins and increased levels of stress. Demands on farmers today are very great, indeed. As we have heard previously, they are expected to be meteorologists, economists, agronomists, crop specialists, repairmen, livestock breeders, and personnel experts.

The special health risks and hazards presented by farm equipment, including the ubiquitous tractor range from acute traumatic injuries to chronic musculoskeletal disorders. Farmers and farmworkers also face vector-borne diseases, as I mentioned earlier.

Dr. Donham pointed out that we are seeing cases of encephalitis in the northeast, and in Wisconsin we are seeing an increased amount of Lyme disease; also, interestingly and perplexingly, malaria and dengue fever. Agri-chemicals are also an important issue here, and there are other—in addition to agri-chemicals—toxic exposures that can occur in this work environment. Skin, the major organ systems, and also the lung are at risk from toxins and agri-chemicals.

Now, with that background, our group decided to look at the strategies from the experts that I told you about. What Dr. Parker and I did yesterday afternoon at the conclusion of the deliberations is try to

distill from those presentations the major guiding principles that we gathered.

We also had it emphasized to us that, all players, including the farmer and the farmworker, need to be at the table when we begin to redesign the strategies for intervention.

Those principles include the following: There are major interventions available to us as a community of interested engineers, scientists, physicians, and farmers. These would include three major options.

- ▶ One is the complete elimination of the hazard.
- ▶ Two would be what we call passive controls; that is, the operator would not necessarily have to do anything to be protected.
- ▶ Three is active controls, where volitional choices need to be made.

We also had it emphasized to us that, as Dr. Stallones said, all players, including the farmer and the farmworker, need to be at the table when we begin to redesign the strategies for intervention.

#### **ELIMINATION OF HAZARDS**

Many of the speakers emphasized that one must apply the earliest possible interventions to maximally reduce hazard exposures. The elimination of hazards could include machine redesign, job redesign, and product substitution, or all three.

Now the benefits of redesign include the fact that it would eliminate the problem at the beginning. It is a permanent solution

to what was the problem, and it has—in the nature of the design from the engineers—planned for the potential misuse of that equipment.

I would like to give an example of some extremely innovative product design in the agricultural realm: a Finnish tractor made by the Valmet Company.

It has some unusual and unique features that we were apprised of. First of all, the controls in the cab, including the steering apparatus, can rotate through 180°. A farmer can face backwards with all his controls facing the load that he is lifting.

This tractor also is articulated. The wheels turn independently, and also it has an automatic transmission. So the amount of pressure that would have been needed to depress a clutch is no longer an issue, thereby eliminating some of the left knee problems that had been identified by our Swedish colleagues.

In addition, job redesign was discussed in our group. A Swedish woman was shown working in a dairy barn. She was carrying numerous milking hoses.

It was calculated by the Swedish Farmworkers Health and Safety Association that she would have carried about 270 tons of equipment during the milking year in a 60-cow barn. This caused a lot of shoulder and neck problems.

The engineering job redesign group went out to look at this, and they came up with a solution: an overhead track on which you can hang the milking apparatus and slide it from cow to cow. This reduced, considerably, the workload and also reduced the rate of injury and problems with the shoulders in these workers.

The IPM, as many of you know, often will have a significant reduction in pesticide application and frequently prompts the choice of a less toxic compound in the work environment.

We were also told that the use of integrated pest management (IPM) is a solution that involves product substitution and administrative control. The IPM, as many of you know, often will have a significant reduction in pesticide application and frequently prompts the choice of a less toxic compound in the work environment. Please be mindful of the fact, as was emphasized in our group, that hazard elimination, at times, may need to be driven by legislation or regulation, especially when there are severe hazards and recognized effective interventions are available.

## **PASSIVE CONTROLS**

The next topic for discussion was passive controls. Our presenters and responders pointed out that in settings where complete hazard elimination is not possible, then passive controls may be applied.

Perhaps the best example of passive controls is roll-over protective structures (ROPS). Now, unfortunately, even if you have a ROPS you should not be opening the back window of an enclosed cab on a tractor and certainly should never have a child back there.

So, the passive systems are only as good as the operator, and in this instance some of the safety features of this cab have been subverted by removing the rear window. This breaks the sound reduction, as well as

the internal environmental controls and, indeed, puts a child at risk.

Other examples of passive controls include special kill-switches on chain saws such that when they buck or kick back they will automatically be turned off.

Finally, another example of passive controls includes what are called closed pesticide loading and mixing systems. Those particular systems allow a completely closed operation from the container into the mixing vats, thereby never exposing the worker.

### ACTIVE CONTROLS

The next group of strategies was termed active controls. Active controls are necessary when full hazard elimination or passive controls are not possible. Active controls require that the worker carry out a protective behavior such as donning personal protective equipment, applying an insect repellent, or reading and heeding warning labels.

The ultimate in personal protective equipment was shown. Astronauts were involved in working outside a space shuttle, which our colleagues at NASA call extravehicular activity. This is a situation where an active control system is absolutely mandatory, since one could not even live in that environment without that kind of gear and garb.

You immediately recognize that that equipment is wonderful, if you are going to be in the cargo bay of a shuttle, but it would be lousy to do your everyday activities, whether at work or at home, in that kind of a get-up. There are significant limitations in personal protective equipment, and they were enumerated in our group as

follows: it is uncomfortable, it may impose ventilatory stress, it certainly would reduce dexterity, and it may lead to heat loading and heat stress on the workers. This is especially true in people who work in warm climates and need to be fully covered.

Another point I should make about the limitations: a pesticide worker was shown wearing a non-woven garment that had a materials failure. The armpit was torn out. There was a gap in the underside of the garment, so that would allow a pesticide to escape onto the individual.

Finally, we heard that warnings, for all the emphasis we put on them, frequently do not work. They are temporary. They can be wiped off, erased, or removed. They have serious limitations. That is not to say that our group completely rejected training, education, and knowledge. In fact, one final thing that is shown here is an attempt to inform, to make sure that the agricultural population of Sweden is an informed population, about tractors that are designed with ergonomics in mind and with safety in mind.

We saw what you might think of as Swedish "Consumer Reports" of tractors that are ergonomically sound. The document was developed by the Swedish Farmers Health and Safety Association.

It was like a Michelin guide for restaurants. Four stars is excellent; three stars is good; and so on and so forth. Such scoring was resisted by the manufacturers in Sweden but has been very popular among the farmers and farmworkers.

Let me conclude by saying that our group decided that intervention strategies are most effective when they are applied early



in the process. Passive controls are less desirable but at times may be life-preserving and life-saving. Active controls are the least desirable interventions because they require forethought, modifications of behavior and, often, discomfort. Intervention strategies should always incorporate the knowledge of the users.

Intervention strategies are most effective when they are applied early in the process.

I am reminded of that little aphorism from Japanese management that says, "The worker has intimate knowledge of the process." In this instance it is the farmer and farmworker who have valuable, intimate knowledge.

Finally, in conclusion, we agreed that serious attention should be paid to using all the options to deal with what we all recognize as a clear and present danger to the American farmer and farmworker.□

## **INTERVENTION - SAFE BEHAVIORS AMONG ADULTS AND CHILDREN**

*By Walter J. Armbruster, Ph.D.*  
Associate Managing Director, Farm Foundation

Dr. Richard A. Lemen: Our next speaker will look at *Intervention - Safe Behaviors Among Adults and Children*. To do this, we have Dr. Walter J. Armbruster, who received a bachelor's degree and a master's degree in Agricultural Economics from Purdue University, and a doctorate in Agricultural Economics from Oregon State University. Dr. Armbruster:

We know that surveillance and research are, indeed, often precursors to intervention. Some of the discussion groups apparently did more than work on the necessary input to intervention, they even delivered some of our group's ideas for us. Be that as it may, I hope we will not be too repetitive.

The rapporteur for our discussion group, Dr. David Hard, deserves a great deal of credit for helping me put together an overview of what we discussed.

I was admonished by our group not to generalize our discussion to the point that we could have written the report before we arrived. I see some of them in the audience monitoring my reporting.

I hope they recognize our discussion. In some ways, Kelley Donham's diagram of a national coalition for local action could be viewed as the game plan for our whole discussion.

Achieving safe behaviors among adults and children, which we hope to foster through intervention, is an ongoing challenge. We grappled with ideas on how to better intervene to foster such behavior, so that it will avoid unintentional injuries in the agricultural occupations and create a safer and

healthier environment in which to live and work.

Our recommendations consist of a combination of short- and long-term implications or suggested actions that are aimed at immediate as well as future improvement in agricultural safety and health. While our discussion considered short- and long-term differences, the ideas did not lead to that framework very well.

We will introduce the ideas with the intent that some are short-term and some longer term in nature. We need to pay attention to this as we think about how to implement these ideas and recommendations.

### **BEHAVIORAL CHANGE**

There was rather widespread agreement in our discussion group that our overall goal is to achieve behavioral change that will result in a safer, healthier living and working environment for those engaged in agriculture. We have a good deal of evidence, e.g., from automobile seat belts, that providing education or information is not sufficient, though we feel it is a necessary precursor to achieve behavioral change. What is necessary to change attitudes regarding health and safety.

Mental health is an important aspect of overall health and a necessary ingredient of safe behavior. We had a bit of discussion about that, although we did not focus on it a great deal.

In trying to achieve behavioral change, youth may provide a more readily adaptable audience than some of the older clients that we try to reach. Hence, a focus on youth education and youth intervention may be very effective in changing their behaviors for their lifetime. We also believe that reaching adults through youth is a very effective channel for modifying adult behavior.

Similarly, we had some discussion about the possibility of working with spouses to help them understand the need for behavioral change, to reach the farmer whose behavior we are trying to change. We discussed it generally in terms of the spouses being the wives who would help the husbands change his behavior.

But we all know that there are many women farmers, so I assume that it works the other way also. We had a fair amount of agreement that the husbands listen to the wives; we did not have much discussion about whether it works the other way. So that is a hypothesis on my part. The point is, indirect access for delivery of messages as well as direct access, to our target audiences, may be a very effective strategy for achieving behavioral modification.

## **LOCAL EFFORTS**

We discussed local and state coalitions for working on agricultural health and safety issues, educational resources, and access to what is available in the various states. The federal role in coalitions is to help coordinate the state efforts, help avoid unneces-

sary duplication, and provide funding for the larger research base, intervention programs and mandated programs.

There was widespread recognition that while local coalitions may be very effective in delivery, they need a lot of help from federal and state levels in achieving or obtaining the resources with which to do their work at the local level. We need to think carefully about funding to make coalitions functional.

At the local level, it was pointed out that even a small amount of money is often quite significant and creates the opportunity for leveraging into significant activities that can have a realistic impact. I think some of the discussion was in the context that there is a lot of federal money and let us get it down to the local level where it will do some good.

As you think about it, the implication may also be that at the local level you may be able to raise the funds within the community to put on some of the educational or intervention activities that may be very effective. Someone suggested that we should not overlook the general businesses in our community as a funding source.

Knowing that more than half of the farmers in the U.S. receive more than half of their income from off-farm sources, there is a very direct stake in agricultural safety and health for those employers who do not necessarily have a direct connection with agriculture. These employees who count on having healthy employees who can be on the job and are not using the insurance benefits from that company's program to recover from injuries because of unsafe practices or unhealthy conditions in their farming operation.

Another point we discussed was the need to find ways to make it easy for individuals to achieve change in behavior. One suggestion was that when a farmer buys a significant amount of chemicals, protective clothing or protective gear needed to safely handle the chemicals could be packaged as part of the total product purchased.

You would not be given just a large can of pesticides, but rather a large can of pesticides with a safety suit attached directly to it. Obviously, there are some cost considerations that would need to be taken into account.

A related point was made about making it easy for farmers and agriculture workers to purchase safety equipment in general. In some cases it is very difficult to locate a local source. The individual may have to find catalogs or go to significant effort to locate the safety equipment needed.

So one of the opportunities or challenges for local or state coalitions might be to somehow assure that at least one source of supply for necessary safety equipment is available locally—a local cooperative or some private outlet. Making sure that those who need to purchase safety materials can find them easily, should they listen to our messages delivered through intervention, ought to be emphasized.

## RESEARCH

Then we turned our discussion to research. There was a strong feeling that we need better research on evaluating the effectiveness of the various intervention programs that are ongoing. I think somebody already made this point: if we are able to measure changes in behavior and sort out the links that they have to various interventions, then we can perhaps identify

which of those interventions are more effective than others. We know that budgets are tight. So that would imply withdrawing funds from programs that are not achieving, in order to obtain funding for those that are successful or for new programs.

The second issue regarding research that we talked about was the need for more basic research on the relationship between behavioral change and intervention alternatives, whether it be education, regulation or automatic protection from agents of injury. We do not know the linkages very well, so it makes it difficult to design new programs or better programs.

There was some feeling that legislation may be needed because education or other forms of intervention are not very successful, but there is also a feeling that legislation alone is unlikely to be effective. We have a lot of evidence, again going back to the seat belt example. Most or all states have seat belt laws now, but that does not mean that we have 100 percent of people buckling up.

We need to motivate individuals and communities, through education, to help modify behavior and accept or take advantage of safety equipment and healthy choices. We have a lot of anecdotal evidence, and I think more than that, of individuals overriding built-in safety features. So we need to use all of our approaches to achieve safe behavior in the agricultural occupations.

## COMMUNICATIONS

Finally, we had some discussion about the important role of communications in achieving behavioral change. We must pay attention to communications and carefully

consider how to deliver intervention in a manner that causes individuals to follow through to implement the desired changes.

We also know that reaching adults through youth is a very effective channel for modifying adult behavior.

We must carefully consider the background of targeted audiences, for example, age-appropriate programs for youth and education-level considerations, which dictate delivery approaches. If you have a farm or agricultural clientele or agricultural workers' group who are not highly educated, you may have to use cartoons, comic books, and posters requiring minimal amounts of reading.

Pictorial images may have to be used to get your point across. People with a low level of education are not going to read a six-page handout with many details related to safe behavior.

Similarly, if you are dealing with various cultures—Hispanic comes to mind—culture is quite important in how messages are normally delivered or more favorably received. Pictorial presentations and comic book kinds of educational materials apparently have a tradition of acceptance and use in Spanish cultures.

A point was made that we need to be careful that we draw on proper expertise—whether we are trying to create age-focused, education, or culturally appropriate materials. A partial understanding by somebody who is an expert in a particular aspect of health or safety, but who knows very little about child development stages,

educational strategies, or cultural differences, or who is not a proficient translator, may do more harm than good. That person may garble the message or weaken the impact of materials that could have much more effect by getting the proper expertise involved.

Another point regarding communications is the use of a range of media, organizations, and people to reach the target audience. Direct as well as indirect approaches, as I indicated earlier, repetitive messages, and varying approaches are needed. Use all the media, program opportunities, and the organizational efforts to repeat messages in various ways.

Finally, in communication, we need to be careful that proper communication takes place not only within coalitions at the local, federal and state levels, but also up and down the line.

We cannot have only top-down approaches. We know they will not work. We cannot have only bottom-up approaches, because we know we will have difficulty achieving access to good materials, etc. We need to make sure that the communications between the coalitions at different levels are fully utilized.

Finally, in closing, let me say that despite the admonition of the participants in our group, which was a large and actively involved group of probably 75 or so, I may have generalized too much in summarizing. A written report will contain some of the richness of discussion that I had to generalize away from this morning. □

## REPORT ON MIGRANT AND SEASONAL FARMWORKERS

By Valerie A. Wilk, M.S.  
Health Specialist, Farmworker Justice Fund, Inc.

Dr. Richard A. Lemen: The last speaker whom we have today will provide a *Report on Migrant and Seasonal Farmworkers*. Valerie A. Wilk received a bachelor's degree from Knox College in Illinois, and a master's degree in preventive medicine and environmental health from the University of Iowa. She is currently a health specialist with the Farmworker Justice Fund in Washington, D.C. I just want to read a couple of things that her organization does, and I am sure she is going to tell you more about this; but, as I see it, they try to make sense out of national and state-level occupational health policy issues facing farmworkers, and they develop strategies to address these issues. They attempt to educate the public, and they attempt to develop coalitions about these issues. Secondly, she also directs the Farmworker Women's Health Project, and she has just returned from a meeting on migrant and seasonal farmworkers. She will tell us about that meeting, and tell you about some of the problems that face these farmworkers. Ms. Wilk:

One of the advantages of speaking absolutely last on a panel is that a lot of the previous speakers said some of the things that I was planning to say, so it makes my job easier.

This is my first chance to attend this conference, because for the last four days I was in Buffalo, New York. During the days of your conference, there was another national agricultural conference—the 1991 National Conference on Migrant and Seasonal Farmworkers. It brought together over 1,300 migrant educators, farmworkers, Migrant Head Start educators and directors, employment training workers, attorneys and health care workers—both clinicians as well as non-clinicians—people like the physicians, nurses, and physician's assistants, as well as environmental specialists, health educators, and outreach workers.

The theme of the conference was "United for Progress." Over the four days, the conference participants had a chance to choose from over 160 workshops and plenary sessions. The sessions were heard in

English, some in Spanish only, and some were bilingual.

I am specifically focusing on the health workshops of the conference. Then what I'd like to do is go over some of the recurring themes and recommendations that came out of that conference and leave you with a couple of my observations from my 11 years of working with farmworker organizations.

### THE NATIONAL CONFERENCE ON MIGRANT AND SEASONAL FARMWORKERS

I know that at least one of the previous speakers on Monday spoke somewhat about farmworkers, but I just want to tell you, when we talk about migrant and seasonal or non-migrant farmworkers, we are talking about hired workers. In a 1990 demographic report, the Federal Office of Migrant Health estimated that there are four million farmworkers and their family members in the United States.

They are predominantly people of color. They are men and women; they are children. They are Hispanic, African-American, Haitian, West Indian, Southeast Asian, or Native American. They pick the fruits and vegetables; work in nurseries, greenhouses, and mushroom sheds. They hoe, weed, thin, and prune crops.

Almost one million farmworkers and their families migrate. Migrant workers travel throughout most of the United States.

The farmworker conference dealt with the issue of child labor; it dealt with farm injuries such as those related to falls from ladders. We focused on issues of disability and injuries from prolonged bending, stooping, heavy lifting, and carrying, and repetitive motion, including the musculoskeletal effects on children and results seen in the elderly.

One of the workshops dealt with workers' compensation and the fact that in about half of the states in the United States farmworkers are not covered at all by workers' compensation. We also dealt with the issue of pesticides, including farmworker poisonings from direct spray, from drift, and from residues on the plants.

We talked about effective methods of educating farmworkers and employers about pesticide use and hazards. We also talked about research projects being done, and about farmworker health status in general.

One of the points that came through, and one of the other speakers on the panel today has mentioned it, is that the workplace and home are one and the same—particularly in terms of migrant workers where migrant labor camps are right in the middle of fields. So when fields are

sprayed, so is the home, so are the children, even if they are not directly working in the fields at that time.

We also dealt with the issue of farm machinery-related injuries, heat disorders, and a major occupational hazard for hired farmworkers, which is transportation-related injuries. Farm labor contractors too often transport workers in unsafe vans and trucks. This unsafe transportation has resulted in deaths and serious injuries of a number of workers.

Most recently, in December 1990, in Florida, four farmworkers were killed and seven were seriously injured when a farm labor contractor's truck was broadsided by a van, and the truck carrying the farmworkers rolled over repeatedly. The farmworkers had been riding in the back of the truck on makeshift benches of planks and cement blocks, which is a violation of the Migrant and Seasonal Agricultural Worker Protection Act.

Farmworker advocates in the area had reported this particular farm labor contractor for violations six months previously, but nothing had been done. Because of this inaction, four workers died and seven were seriously injured.

We also discussed the issue of field sanitation. In 1987 OSHA promulgated regulations to require that drinking water, toilets and hand washing facilities be provided by employers for workers with 11 or more workers on any given day in the fields. The reality is that compliance is very low. There have been a couple of studies in the last year. In 1990, a study done with the North Carolina School of Public Health found that only 4 percent of farms were in complete compliance with the Federal Field Sanitation Standard. There was a

study done in New Jersey in 1990 that showed a figure of 16 percent compliance.

We discussed strategies to improve employer compliance and OSHA enforcement. One of the issues that came out in that workshop was the fact that the threat of employer retaliation is so great. If you have to rely on formal worker complaints, there are very few workers who are willing to risk their job if they know that OSHA may not be out to inspect for a week or two weeks or maybe 30 days. By that time, the labor crew has already left that farm and that work.

Another aspect of the field sanitation standard is drinking water. Common drinking cups are a major problem, as is clean and sanitary drinking water at the worksite.

We also talked about children's health and safety. Children drink and bath in contaminated water—water contaminated with pesticides and fertilizers. We also talked about injuries and about drownings in rivers and irrigation ditches.

Another workshop that attracted a lot of attention had to do with farmworker women and health. In March of this year, the Farmworker Justice Fund sponsored the First National Farmworker Women's Conference. It was the first event of our Farmworker Women's Health Project.

We brought 63 farmworker women and trainers to San Antonio for a three-day conference, and all of the farmworker women were women of color. They were Hispanic, African-American, Haitian, and Southeast Asian.

The meeting was held in three languages: Spanish, English, and Haitian-Creole. We will be publishing proceedings of that mee-

ting later this year. We brought two of the farmworker women, who had been elected by the group in San Antonio, to the Buffalo Conference to present to that conference about the health priorities and recommendations that the women made in San Antonio.

There are a number of health issues specific to women. For example, with regard to field sanitation, urinary tract infections. If there is no privacy or no clean facilities, farmworker women will wait an entire day before going to the bathroom. This is particularly troublesome for women during their menstrual period and for pregnant women.

With regard to farmworker women and their exposure to pesticides, there are consequences of long-term exposure to the reproductive system, such as infertility, as well as the risk of miscarriages and birth defects. In November of 1989, there was a mass poisoning near Ruskin, Florida, and there were about six pregnant women, most of them in their first trimester, who were among the workers who were poisoned.

Of those women, the medical director of the clinic who treated the workers knows of two women—one who miscarried and another who had a baby with birth defects of the face and hand. There was another case, which was unconfirmed, of a still-birth.

Another issue facing farmworker women is sexual harassment, rape, and even sexual slavery in labor camps.

Housing is a major concern and occupied various workshops at the conference—substandard housing, overcrowded housing, or no housing at all.



We have had reports of hundreds of workers in Arizona living in the citrus groves, sleeping under tarps with cardboard on the ground. Also, in southern California there are cases of workers who have been living in holes in the ground in the canyons. I just heard in Buffalo that in at least one case, workers were being charged for rent for the tree that they were sleeping under.

In a number of the workshops there were very concrete examples of groups who had worked in coalition, either within their community or statewide, on particular health and safety issues: workers' compensation or field sanitation.

What I have not shown you in these slides are other occupational hazards that farmworkers face: tuberculosis, involuntary servitude, and employer retaliation. I have heard through my office of a number of situations where farmworkers have gotten fired simply for asking a question about the safety of farm equipment or about the location of field sanitation facilities, or for refusing to return to a recently sprayed field, or for taking action and getting out of a field while it was being sprayed. There are no anti-retaliation protections under the Federal Pesticide Law, and OSHA's anti-retaliation protections are so time-consuming that with the seasonality of farmwork, they offer little protection for farmworkers.

## **THEMES AND RECOMMENDATIONS**

What are some of the recurring themes from the Buffalo conference? First of all, there was the recognition of the importance of service providers, particularly health care providers, being advocates for

farmworkers; and that advocacy to correct occupational and environmental health problems was, indeed, preventive medicine and extremely important. I have been gratified to see over the years that this has been a growing sentiment among migrant health and migrant service providers.

There was a commitment to continued and better coordination and communication among programs to most effectively use the resources available. Related to that was the importance of coalition building within one's community and beyond on farmworker health and safety issues. In a number of the workshops there were very concrete examples of groups who had worked in coalition, either within their community or statewide, on particular health and safety issues: workers' compensation or field sanitation, for example.

Another theme was the importance of the need for and the barriers to getting workplace information, most strikingly the right to know which pesticides are used and when they are applied in the fields. Another theme was the importance of the use of popular education methods to teach farmworkers, that is, getting farmworkers involved in a egalitarian way in training by doing skits and interacting with volunteers from the audience so you are not just doing straight lecturing about health and safety and pesticide safety.

The other thing, which I mentioned earlier, is the extent of farmworker intimidation by employers, and the lack of protection for workers who demand and who question and who actively try to make the workplace safer.

Finally, I would like to leave you with two observations. First of all, a *National Coalition for Local Action, FarmSafe 2000*,

## Elements of a National Agenda

must include migrant and seasonal farmworkers as equal partners.

Not only must farmworker family occupational safety and health issues be considered as seriously and as fully as farm family health and safety issues—because so many of these issues are similar and because farmworkers are important workers within the agriculture industry—but also farmworker leaders, community leaders, and union leaders need to be involved in the coalition as equal and active partners. Farmworker advocacy organizations such as the Farmworker Justice Fund can help identify those farmworker leaders to participate in this process.

Also, when we are talking about coalition building, what struck me earlier with the four components of a coalition, quite frankly, was that two of those partners in a coalition have been some of the biggest

barriers to farmworkers getting a safe and a health workplace. Both industry and government have opposed and have subverted some of the attempts to protect farmworkers, through legislation and regulation.

A safe workplace makes economic sense, and society picks up the tab when we have unsafe workplaces. Action is needed, but actions as have happened in the past cannot continue. We need to look at different ways of working together. We need to convince industry and government that changes need to be made, and we need to support farmworkers in their efforts.

Some of the most cutting edge protection for farmworkers have happened under union contracts. We need to look at all the different models to make sure that farmworkers are equally protected.□

## OUTSTANDING FFA POSTER

By Rice C. Leach, M.D.  
Chief of Staff, Office of the Surgeon General

Dr. Richard A. Lemen: Our next session is going to be chaired by Dr. Rice Leach, who Surgeon General Antonia C. Novello appointed as her Chief of Staff in April 1990. As Chief of Staff, Dr. Leach is responsible for coordinating the activities of the Office of the Surgeon General (OSG). Dr. Leach came to the OSG from the Health Resources and Services Administration, Bureau of Health Care Delivery and Assistance, where he was the Chief of the Public Health Service (PHS) Recruitment Program. He began his PHS career in 1966 as a rotating intern at the PHS Hospital in New Orleans. He has served the Indian Health Service (IHS) in numerous clinical and management assignments including director of an IHS area, manager of the IHS AIDS program and associate director of the IHS Office of Research Development. Dr. Leach has also served in the Bureau of Medical Services. Dr. Leach was born in Lexington, Kentucky and received a B.A. from Amherst College, M.D. from the University of Kentucky, and a Master of Science in Health Services Administration from the Harvard University School of Public Health. He completed his preventive medicine residency at the University of Arizona and an internal medicine residency at Tulane. Dr. Leach has served on the Federal constituency section of the American Hospital Association, the South Dakota Statewide Health Coordinating Council, the Board of the Arizona Hospital Association, and the education committee of the Arizona Medical Association. Dr. Leach:

Dr. Novello would like to be with us today but, as she said earlier, she has other obligations. There is another physician who would love to be here today, too, Dr. J. Donald Millar. He has been detained by some occupational health standards that say something to the effect that "There will be no planes leaving San Francisco with broken radar." He is

grounded in Denver and will be here later this afternoon.

At this point in the program, we are going to the first place award for the best FFA poster presentation. One of the judges who was recently president of an FFA association made the following statement about the posters:

*They were all outstanding. I spent a lot of time talking with the members, and it is obvious that they take a great deal of pride in their programs. To tell the truth, judging is not nearly as easy a task as I had thought. My compliments to NIOSH and the Surgeon General's Conference staff. Thanks for letting me be part of it all. It was exciting to see so many people so fired up about safety.*

Those are the comments of Sheryl Janko, the immediate past president of the Iowa FFA Association.

The group judged to have the best poster is the Amanda Clear Creek FFA Chapter from Amanda, Ohio. Representing that group are Mr. Gary Brumfield, the Safety Program Chair, and Mr. Charles E. Miller, the advisor.□

## OSHA INITIATIVES IN AGRICULTURAL SAFETY AND HEALTH

By *Cynthia Douglass*  
Deputy Assistant Secretary of Labor  
U.S. Occupational Safety and Health Administration

Dr. Rice C. Leach: Our first speaker is Cynthia Douglass, Deputy Assistant Secretary of Labor, Occupational Safety and Health Administration in the United States Department of Labor. Ms. Douglass was appointed Deputy Assistant Secretary of Labor in December 1989. She is responsible to the Assistant Secretary for the external activities of the agency. She works with other Federal and state agencies such as the Congress, the Environmental Protection Agency, labor unions, business, and others to enhance worker safety and health. Prior to her time with the Labor Department, she was Administrator of the Research and Special Programs Administration for the Department of Transportation. Prior to that, she was Special Counsel to the Senate Commerce Committee, which worked on a wide variety of issues including automobile safety, motor carrier safety, economic deregulation, and insurance. We have a very qualified spokesperson. I give you Ms. Douglass:

Thank you very much. I am delighted to be here. I am also delighted to be a participant in the first Surgeon General's Conference on Agricultural Safety and Health and want to thank Surgeon General Novello and Dr. Millar for inviting the Occupational Safety and Health Administration (OSHA) to participate and speak at this important meeting. I assure you that OSHA wholeheartedly supports the Surgeon General's attempts to prevent injury and disease in the agricultural workplace.

My boss, the Assistant Secretary of Labor for OSHA, Jerry Scannell, wanted very much to be here to convey to you his concerns about farmworker safety and health. Unfortunately, as I am sure you all know, there was a catastrophic explosion at a fertilizer plant in Sterlington, Louisiana, two days ago. Eight people were killed in that explosion, and over 100 people were injured.

Mr. Scannell flew there yesterday and could not get a plane out in time to be here this morning. Jerry believes that it is important to personally let the community and the workers know of OSHA's commitment to the workers of that facility. He also believes that it keeps his heart and soul focused on the primary goal of OSHA, which is to assure every man and woman a safe and healthful workplace.

He asked me to come here and talk with you about OSHA's program, and I am delighted to be back in the Midwest. I am from Kansas and went from there to Washington, D.C. in 1976. I would note that I was there in time for the huge farmer protest in Washington, which was in 1977, and I believe again in 1978.

I still have a bumper sticker that was given to me by some Kansas wheat farmers that says: "If you don't like wheat farmers, don't talk with your mouth full." Those are my sentiments exactly.

As I said earlier, agricultural safety and health has been one of Assistant Secretary Scannell's major concerns since becoming Assistant Secretary of Labor for Occupational Safety and Health. I know he will be pleased that this conference has been so successful.

We are all appreciative that the Congress appropriated the funds for this conference and believe that the conference will help further the education and relationships necessary to reduce the shameful accident-rate of farming. OSHA, in particular, wants to develop a good relationship with your community, because together we can make a difference.

The breadth and depth of the subjects that have been covered during the four days of this conference is impressive. So is the fact that there has been participation from members of farm organizations, migrant worker representatives, academic institutions, safety and health professionals, the states, and the government agencies, all of which play an important role in this vital area of agricultural safety and health. This is truly the kind of national coalition and partnership that can make a difference.

OSHA's interest in working with you to reduce the occupational deaths and injuries in American agriculture is evidenced by the fact that we have 17 staff people attending this conference. In addition, a number of the representatives of states, which operate their own OSHA-approved occupational safety and health programs and OSHA-supported state consultation programs, are attending. OSHA is committed to efforts to improve safety and health in agriculture.

## **THE OCCUPATIONAL SAFETY AND HEALTH ADMINISTRATION**

I want to tell you a little bit about OSHA and how it operates. OSHA has jurisdiction over occupational safety and health in more than six million workplaces in America, employing about 90 million workers. We operate on a relatively small budget for that, about \$285 million, with an authorized staff of a little over 2400 people, of whom approximately 1300 are inspectors.

Our mission is to ensure safe and healthful working conditions for working men and women through a variety of means, including regulations dealing with occupational safety and health, education, training, and technical assistance. Of course, we have an enforcement program.

In carrying out this mission, we rely heavily on a partnership that includes labor and management, the states, the Federal government—NIOSH, for example—safety and health professionals, and academia.

Our enforcement jurisdiction in agriculture is limited by law to those farms that employ 11 or more workers. This means that we do not enforce OSHA regulations on the great majority of farms; 86 percent of American farms are smaller, part-time operations. We do have enforcement authority in migrant labor camps.

We are all aware that agriculture is one of the most hazardous of American industries, with 1,300 deaths and 120,000 disabling injuries in 1989, according to National Safety Council figures. Many of those injuries involve children.

Therefore, OSHA has a big responsibility, working within the limitations placed on it by the appropriations language, to seek to reduce these injuries and fatalities in the farming industry. OSHA has the authority to work with small farms. The only prohibition is on enforcement.

For years that appropriation rider was interpreted by OSHA to mean, just stay out of the farm and stay away from the farm community. We do not want OSHA—we do not even want the word spoken in the farm community.

But that is not what the statutory language says. OSHA can give technical assistance to farmers. We can work with your communities.

The answer lies in education, training, and increasing awareness of those hazards and how they can be reduced.

We can help develop materials and training and educational seminars to aid in increasing awareness and knowledge about safety and health problems in agriculture and the actions that may be taken to minimize these problems. In that connection, for example, we might seek the aid of university-based agricultural safety and health centers and other government agencies, such as the extension service, to provide necessary expertise and guidance in training staff members for outreach and consultation activities.

We can also provide OSHA-supported consultation services to small agricultural employers. The consultation program is a

voluntary one and helps develop mutual trust between farmers and OSHA. I might point out that the representatives of OSHA-supported consultation programs recently met in Tucson, Arizona. One of the principal items on their agenda was consultation services in agriculture.

OSHA also reviews existing standards that apply to agriculture, such as the roll-over protective structures (ROPS) standard. We look at whether these standards should be modified to reflect changing conditions in the United States, in the world, and in the industry. We need your help, though, on reviewing and modifying these standards, if we are to have good, common-sense safety standards.

All too often OSHA is only regarded as an enforcement agency. Enforcement is not the principal answer to reducing hazards in America's agricultural worksites. The answer lies in education, training, and increasing awareness of those hazards and how they can be reduced.

My boss, Jerry Scannell, has committed OSHA to developing a positive communication goal. He wants to work with others such as NIOSH and your organizations and believes that if we do that, we can have a significant impact on agricultural safety and health.

During the 1970's, OSHA had an advisory committee on agricultural safety and health. Jerry is considering the re-establishment of this committee.

We have been working to re-establish a number of relationships with government and private organizations, and we hope to

continue this. The message is that OSHA wants to work with all of you to further agricultural safety, education, and awareness.

Farmers, themselves, recognize that they work in a hazardous occupation. The National Coalition for Agricultural Safety and Health (NCASH) conducted a survey of New York and Iowa farmers. More than 70 percent of those farmers who were surveyed said that their occupation was more hazardous than other occupations.

In connection with that, I am gratified to see that one of the concurrent sessions at this conference dealt with behavioral changes among both adults and children working on the farms. Strategies must incorporate new and innovative approaches to behavior modification.

## **AGRICULTURAL SAFETY AND HEALTH**

Let me tell you something about what OSHA has been doing in agricultural safety and health. This is all relatively new, by the way, just in the last 2 years. We have been holding numerous meetings since January of 1990, developing OSHA's plans and initiatives to carry out a program of enhanced awareness of work-related hazards in agriculture and how to cope with them.

OSHA is working closely with NIOSH staff from Dr. Millar's office, meeting with our OSHA executive staff to explain activities and to share ideas. We are doing this on a regular basis.

During a series of conferences on the permissible exposure limits (PEL) for air

contaminants in agriculture, a regulatory initiative, NIOSH joined with OSHA to explain our respective agencies' work to the attendees. This summer we will ask an occupational health nurse intern serving on our staff to further update OSHA staff on the latest research findings of NIOSH in agriculture and to determine how OSHA can best utilize this NIOSH material to maximize its own efforts.

OSHA also has held meetings and discussions with the Rural Safety and Health Committee of the American Farm Bureau; USDA officials; the Office of Rural Health Policy; Agricultural Division of the National Safety Council; and the Farm Safety for "Just Kids" organization. These are a few of the organizations we have met and with whom we have been working.

One of our most successful efforts was production of various news feature material and radio and television spot announcements for distribution to 3,500 rural media during the National Farm Safety Week of the National Safety Council in September. These public service announcements were designed to call attention to the need for improved safety and health measures on the farm. The fact that OSHA is now taking an active role in this area was also communicated.

The radio announcements alone were carried by 249 stations, reaching an estimated 4.5 million homes with over 14 million listeners. We hope to do this again this year.

We have developed a fact sheet on farm safety that points out that most of the deaths and injuries on the farm are pre-

ventable. It makes recommendations on how injuries can be prevented. For example, farmers are urged to read and follow the instructions in equipment operator manuals and on product labels.

The farmers are encouraged to conduct routine inspections of equipment to determine problems and potential failures that might contribute to or cause an injury. They are urged to conduct meetings with employees and family members to assess safety hazards, discuss potential injury situations, and outline emergency procedures.

There are also recommendations aimed at reducing specific hazards, such as the danger of injury or death in tractor roll-over or from moving machinery parts.

OSHA has participated in the National Conference on Agricultural Safety and Health of the W. K. Kellogg Foundation that was held in January in San Diego. In February, our national office staff held a successful half-day meeting with representatives of the Equipment Manufacturers' Institute and members of the American Society of Agricultural Engineers to discuss OSHA's present and future activities in machine-guarding on farm equipment.

OSHA is considering the concept of targeted training grants for non-profit organizations to develop and to deliver training in agricultural safety and health to large audiences. The audiences, for example, might include farmers, agricultural workers, and children engaged in farm-related work. There could be regional grants designed to address agricultural hazards prevalent in a particular area, as well as grants to nation-

al organizations for training and education on a national scale.

OSHA has also participated in various activities of the American Farm Bureau Federation aimed at improving awareness. For example, we had an OSHA booth at the National Farm Bureau meeting in Phoenix, Arizona, in January of this year. Jerry Scannell took part in a panel discussion of farm safety and health at that meeting.

OSHA has recently appointed agricultural outreach coordinators in each of our ten regions. These coordinators will continue to have other duties, but their agricultural-outreach responsibilities will be a part of their duties.

They will be the core occupational safety and health field representatives, as agricultural activities are explored and initiated. These coordinators are being directed to work with local experts on agricultural safety and health.

They will participate in regional meetings and seminars to maintain a dialogue with the agricultural workforce. I had the pleasure of meeting with a number of coordinators last night and I can assure you that they are excited about their work and eager to work with you.

OSHA also held four conferences across the United States in which we explained to the agricultural community why OSHA is planning to apply its PELs for air contaminants to agricultural worksites. The first conference was held in January, in Phoenix, and others were held in San Diego, California, and in Louisville, Kentucky, in



March. They were all in conjunction with significant agricultural activities. We had a large diversity of people at all of these conferences, and the feedback was very positive.

We are looking forward to publishing a proposed rule on PELs in agriculture in September or October of this year. We will probably be moving towards a final rule about a year and a half from October or November. Again, we are going to need your help to make sure that we have a good, common-sense approach.

We also held a two-day OSHA agriculture training and coordination session in connection with this conference, at the beginning of the week. About 20 people of the OSHA family attended the meeting, including all 10 of our newly-appointed OSHA regional-outreach coordinators, representatives of the state-plan states, and our consultation program states.

Among the topics discussed were the use of agricultural safety and health materials; updates on recent activities by OSHA and other government agencies including NIOSH, USDA, and HHS; and an update on the NCASH. Slide and speech modules utilizing the material prepared by the grantees are being distributed to the ten regions for use in agricultural-outreach programs. We are expanding our contacts with USDA on the state and local levels to increase outreach activities.

We will be making a presentation on the agency's agricultural activities and the regulatory process before a meeting of Midwestern Plains States of the USDA extension service in Columbus, Ohio, in

May of this year. In July, we will be making a similar presentation to the American Farm Bureau at a meeting back here, in Des Moines.

It also might be of interest to you that our current proposal for a motor vehicle safety standard, which calls for seat belt use and brief driver training for those who drive as part of their jobs, also would apply to the agricultural sector. Again, from the enforcement perspective, we do not enforce on the small farms. Nonetheless, the rule is something that everybody should be interested in.

In another area, a member of our staff has been comparing the new standard on ROPS for tractors and other vehicles, which was adopted by the Society of Automotive Engineers (SAE), to the existing OSHA standard. We have received design and test data from American tractor manufacturers and others.

We have made a preliminary conclusion that the new SAE standard is equal to or exceeds the current OSHA standard and, therefore, is acceptable to the agency. A final decision on this will be made shortly. Hopefully, this will make it easier for American farm equipment manufacturers to compete in the European market.

As you can see, we are just getting started again in the important field of farm safety and health. We are making progress and are committed to doing more in the future. We will continue to place emphasis on creating awareness of the need for improved safety and health for those who work on farms and on providing them with

## **Actions for the Future**

**the necessary information to prevent deaths and injuries.**

**To do this, we will need all of your help. I reiterate that we must have an effective partnership, which includes all of those in this room, if we are to have any success in our goal of removing agriculture from the list of America's most hazardous occupations.**

**OSHA has learned a significant lesson from the 1970's. Jerry Scannell, our Assistant Secretary, and OSHA are committed**

**to moving OSHA forward again in occupational safety and health in the agricultural community.**

**Let us do everything that we can to preserve our human capital on America's farms. Let us give the men and women and their families working on the farms our best efforts in safety and health.□**

## SUSTAINABLE AGRICULTURE AND SAFETY

By *Willis R. Eken*  
Chairman, Minnesota Farmers' Union

Dr. Rice C. Leach: Our next speaker is Willis R. Eken of the Minnesota Farmers' Union. He was elected President of the Minnesota Farmers' Union by the full board of directors in April, 1984, and began serving his first term in August of that year. He has subsequently been re-elected in 1985, 1987, and 1989. He is a lifelong family farmer from Twin Valley, Minnesota, where he and his wife, Betty, and their three sons raise small grains on their farm in the northwestern part of the state. He served seven terms in the Minnesota House of Representatives from 1970 to 1984. He was the House Majority Leader and a member of the House Agricultural Committee, House Taxes Committee, and the Rules and Legislative Administration Committee. During his legislative career, Mr. Eken initiated numerous bills that benefitted rural Minnesota, its farmers, and its communities. He has been influential in the passage of legislation designed to help people begin farming, promote family-style agriculture, provide for fair taxation, and promote many other items of importance to rural Minnesota. As President of the Minnesota Farmers' Union, he is known for his work in putting together coalitions that have worked for the preservation of the family farm as we know it today. I give you  
Mr. Willis R. Eken:

I want to express the appreciation of our National Farmers Union for giving us an opportunity to take part in this forum at your Surgeon General's Conference. Our national president, Mr. Lee Swenson, has been asked to appear in Washington, D.C., today to meet with a representative of the agricultural community from the European Community. He was therefore unable to attend this meeting. So as a neighbor to your north, he asked me to share our National Farmers' Union comments with you today.

Our organization has a long history of working with farm safety issues and certainly a longstanding commitment to sustainable agriculture as part of our family farm structure in the United States. When we talk about farm safety, we talk of something more than freedom from injuries.

The term "farm safety" includes the entire workplace environment. It requires a close look at other occupational hazards such as increased risk of cancer and other diseases, and concern for safe air to breathe and water to drink and an atmosphere in which the farmer is free to concentrate on the tasks in front of him.

Farming is also, and always has been, a risky business. But, as the National Safety Council tells us, farmers today face a multitude of workplace hazards that make our industry among the most dangerous in the country.

Our organization, also, thinks about sustainability, the ability to continue an activity over the long term. In agriculture that means more than cutting down on pesticides and farm chemical uses.

It includes the availability and the appropriate use of all our resources including soil, water, fertilizers, pesticides, the buildings on our farms, the animals, capital and credit, and certainly, not last, the people who are part of our agricultural community. Simply put, where any of these factors get out of kilter, that farming operation may not be in business when we look 20 years down the road.

For the National Farmers' Union, sustainability can be seen as a three-legged stool. The first leg is the sustainability of family farms. That has been the primary mission of our Farmers' Union since 1902. We advocate farm programs that support the family farm system of agriculture rather than those that would diminish the importance of that part of our agriculture-production base.

The second leg is the sustainability of natural resources such as soil, water, and air. We strongly supported the last two farm bills' conservation measures. We have taken leadership roles on other environmental statutes, such as the Clean Air Act and the Clean Water Act. We have also supported the research that attempts to find safer and more effective uses for chemical or non-chemical alternatives.

The third leg of the stool, the Farmers' Union leg, is the sustainability of our rural communities. Though few rural communities or areas are exclusively dependent on agriculture anymore, a healthy agricultural economy is still important to local businesses, churches, health-care facilities, schools, and other of the towns' basic infrastructures, including our transportation systems.

Today's agriculture is a different industry than it was even 20 years ago. While some of our safety concerns have been around since "man" first tried to domesticate wild animals and plants, others have come along with new technology and new attitudes in farming. A combination of technologies, government policies, global opportunities, and demographic changes have made so-called mainstream agriculture more concentrated, more monocultural, and more reliant on labor-saving devices and capital.

Let us start back in history. For the past 89 years, the National Farmers' Union has represented the small-and medium-sized family farm, a unit that some say no longer has that same meaning in today's agriculture. The longevity of the family farm in agriculture is under some question.

Our quarter of a million members would tend to disagree with that philosophy. Most would admit that the full-time family farmer has been under enormous pressures to change in the last 20 years.

The rallying song of lenders, government, land-grant colleges, and others in the late 1970's seemed to be "get big or get out." Those of us who followed that message and got used to the borrowing capabilities we had to capitalize our farming operations got ourselves into extended debt and went through some traumatic experiences during the mid-1980's.

We now seem to be hearing a second verse of this theme. I guess you would have to identify it as one of getting a real job in town to support your family hobby—your family farming hobby, part-time farming.

With these trends have come some new and more complicated equipment, longer hours in the fields and barn, and enormous amounts of pressures and stress. All of these factors lead to the American farmer facing hours and hours of diligent work. It is this stress that has led to a higher rate of certain diseases and more frequent injuries.

► First, we will talk about disease. Diseases have always been a problem in rural areas where access to health care, particularly preventive health care, has not always been as accessible or as available as it is in our more urban centers. Some very disturbing correlations are being drawn between modern agricultural practices and diseases such as leukemia and stomach cancer, to name two.

Research done by the National Cancer Institute and others in Iowa and Nebraska during the mid-1980's revealed a much higher incidence of leukemia among corn farmers than within the general population. The risk of cancer in general has been lowered among farmers and in the public at large.

For some reason leukemia, including the cancers of bone marrow, spleen, and lymph nodes, was occurring 24 percent more often with Iowa farmers than in the public at large. The figures were even higher for counties that grew predominantly corn or were using high levels of insecticides.

► Certainly, when we look at injuries, they appear to be on the rise in agriculture. Yet statistics sometimes can be, possibly, somewhat misleading.

On one hand, agriculture may be looking much worse by comparison. Other industries in our communities, such as mining and construction, have been steadily lowering casualty rates as their unions and the Occupational Safety and Health Administration (OSHA) maintain pressures for change. On the other hand, there seems to be a lack of a coordinated system in place for reporting or tracking agricultural injuries, and the number of actual mishaps may be worse than we sometimes realize.

I would say that it is something of a sham if the most effective tool for safer environmental protection regarding machinery is a lawsuit.

As we understand it, much of the equipment manufactured for agriculture is outside the scope of OSHA and the Consumer Products Safety Commission. Equipment is getting ever more complex, and there are no mandatory safety standards in place. There are only the voluntary efforts of the American Society of Agricultural Engineers.

I will not go into the political pros and cons of regulating farm equipment. First of all, there is not time. Second, our organization does not have a formal policy position on this issue.

I would say that it is something of a sham if the most effective tool for safer environmental protection regarding machinery is a lawsuit. The time and expense of litigation are hard to justify as a sustainable use of our resources.

The possibility of suits may keep manufacturers from voluntarily improving their products. The improvement is an admission that the old product is unsafe to use.

Farmers certainly must accept their share of responsibility for farm injuries. There are farmers who remove protective shields and other safety measures that get in their way as they use or repair a machine. Unlike most factory machinery, most farm equipment will still run without the safety features in place.

There are farmers who cannot afford to hire extra help. They simply push themselves too hard or rely on their children of all ages to pick up the extra chores.

One extension agent in a state is not going to reach everyone necessary to solve the problem.

What seems like the most economical choice at the time, all too often turns out to be very costly in terms of medical bills, the loss of limbs, and sometimes even the loss of life.

What can we do about this sustainability and the safety factors involved in agriculture? When it comes down to it, we believe that safety and sustainability are interchangeable.

You cannot have one without the other. There are several areas where more can be done. The National Farmers' Union would like to take part in working with you in these areas.

- Number 1, we believe there must be some changes in basic agricultural farm policy. We need to have government programs that allow a farmer to make a living on the farm through the marketplace with some protection in that marketplace though our farm policies and our farm programs.

- Number 2, we must insist on more research in farmer education on farm safety through USDA, through the land-grant university system, through the private sector, through OSHA, with education, and others. We can, working together, do a better job.

One extension agent in a state is not going to reach everyone necessary to solve the problem. Raising the level of awareness of farm safety problems and making necessary changes in equipment, attitudes, and behavior must be a team effort.

- Number 3, we must recognize the negative impacts of concentration in food production and processing on the sustainability of farmers, our natural resources, and our rural communities. Concentration has been the trend in many sectors of our economy over the last 10 years, especially in agriculture. The independent owner-operator should not become a relic of the past, whether we are raising hogs or feeding cattle. Production and processing are both necessary to the rural community as a balance of other resources.

The megafeedlots that are mushrooming in some states do not buy their feed or other supplies from local suppliers. Instead, they will likely bring it in by the truckload or

trainload from another subsidiary feed company somewhere else.

Too often the community's only involvement, other than a few hired hands, is in dealing with the waste management problems caused by many animals in too small a space. The community must deal with underemployment caused by running independent operators out of business.

- Number 4, we must insist on the affordability of quality health care in our communities. This is one of the most serious issues facing our rural residents.

Consider the cost and the accessibility of health insurance coverage. We hear from our members of instances of \$400 to \$500 to \$600 per month in family health insurance cost coverages, which is diminishing the opportunity for many of our farm families to participate in the private insurance field.

I saw some statistics recently that indicated, again, the lack of numbers in terms of health provider, personnel, in our rural communities as compared to the per capita availability of medical resources in more urban areas. Problems are facing our rural small hospitals in terms of being able to have the financial base to continue to provide health care access for our rural members.

- Number 5, the Congress needs to look at and fund the re-authorization of the pesticides effort and give the EPA the tools to complete the re-registration of older pesticides on time. In addition, funding needs to be there to look at safer pesticides.

Alternative pest control methods must be fully funded.

- Number 6, USDA should fully utilize the integrated farm management program options that were created in the 1990 Farm Bill. Here, again, I think we are going to have a major conceptual change of our agricultural base. Now we have gone through a period of more concentration and specialization in farming.

For example, look at our poultry industry. In this country it is vertically integrated. On our farm, we have gone out of livestock. We are now a cash-crop farming operation. We have specialized in the area of our own operation on our own farm.

What are the barriers to going to a more sustainable, diversified agriculture? I think they are in the marketplace.

I believe on our farm, for example, if we are going to move off a two-year rotation, which we are primarily in now, between cereal grains and row crops. We are going to have to look at using less chemicals and less commercial fertilizers.

We are going to have to look at a longer rotation process of our crops. Ideally, we should be looking at a six-year rotation instead of a two-year rotation. A six-year rotation would have to include legumes.

We would have to include one year of a later-planted crop to deal with weed control. We would have to do with one year of having a fall-planted crop on our farm.

## **Actions for the Future**

As we look at that kind of a rotation, we are going to move back towards a more diversified agriculture. Then, on our farm, we would be able to have some livestock as part of that operation to utilize some of the crops we grow.

What is the biggest inhibitor to making the change? First of all, economics.

We do not have much of a margin on the farm anymore. We are into an operation where we are hesitant to take the risk to change whatever might diminish that income.

Secondly, it ties back to the marketplace, in terms of the crops we raise. The crops that we can raise that are most profitable in the marketplace do not necessarily fit into that five- or six- or seven-year rotation.

- Number 7, we must establish a better reporting system to generate data on farm

safety for both injury and disease correlation. Perhaps this can be done within the existing USDA agencies such as the Agricultural Statistics Service.

Perhaps we could build on the restricted-use pesticide record-keeping requirements found in the Farm Bill. We could even add health and safety questions to the agricultural census form.

- Number 8, most importantly, we believe, we must keep the pressure on the Congress, the equipment manufacturers, and farmers themselves on the need for a sustainable, healthy American agriculture. We believe that family farm agriculture has been a real strength to this country in terms of producing high quality food at the lowest cost to the consumers. We look forward to working with you in a coalition effort to enhance the sustainability and the safety of family farm agriculture.□



## THE FARM BUREAU'S CONTINUING COMMITMENT

*By Merlin Plagge*  
President, Iowa Farm Bureau

Dr. Rice C. Leach: Our next speaker is Merlin Plagge who is serving in his second term as President of the Iowa Farm Bureau Federation, which is the state's largest general farm organization. Mr. Plagge was elected as its president in 1987 and again in 1989. In 1990, he was elected as a midwest representative to the American Farm Bureau Federation's Board of Directors. As a member of that board, he serves on its trade advisory committee and has been appointed by the Secretary of Agriculture and the U.S. Trade Representative to serve on the U.S. Agricultural Technical Advisory Committee for trade in oil seeds. On the state level, he serves on the Wallace Technology Transfer Foundation and on the Boards of Directors for both Blue Cross of Iowa and the Health Policy Corporation of Iowa. Prior to being president of the Iowa Farm Bureau, he served six years on the Farm Bureau Board as a District Director for North Central Iowa. His involvement in the Farm Bureau stretches back to 1958 when he joined the Cerro Gordo County Farm Bureau. At the county level, he was actively involved and held several leadership positions. Merlin and his wife, Shirley, are active in the First United Methodist Church in Sheffield, where he and his son and his wife farm a thousand acres. The two families run a grain and livestock operation and, in all, three of the four children in his family are involved in agriculture. Mr. Plagge will talk about the Farm Bureau's continuing commitment. Mr. Plagge:

For more than 70 years, one of the Farm Bureau's major goals has been to improve the quality of rural life. One of the best ways to accomplish this goal has been to reduce the injury rate and to help farmers make their workplace safe.

The Farm Bureau has been involved with farm safety activities since the 1940's. There are few other jobs where the entire family lives on the worksite and are exposed (24 hours of every day) to the same occupational hazards as the farmer.

Although we are seeing larger farming operations, most farms are still family operations. For this reason, it has always been difficult to determine if an injury on the farm is, or should be, classed as an occupational, recreational, home, industrial, or transportation injury. We must all

realize that every injury that occurs on a farm is not necessarily an occupational injury.

Farmers believe that safety begins with each individual. That is why many state Farm Bureaus have vigorous, active safety education programs. All farmers want to be safe and for their families to be safe. In the Farm Bureau, we are committed to help them attain that goal.

For many years, the American Farm Bureau and state Farm Bureaus have been involved in cooperative farm safety activities with land grant colleges and universities, the Extension Service, the National Safety Council, the National Institute for Farm Safety, Inc., state and local safety councils and committees, and national and state 4-H, and FFA programs.

These ongoing efforts have paid great safety dividends to the farmer and to farm families. But it is not enough.

As farmers, we do not relish the distinction of being considered the nation's most hazardous occupation. Therefore, through continued individual efforts and cooperation with other institutions, organizations, and agencies, the Farm Bureau will strive to promote farm safety and rural injury prevention.

Farmers believe that safety begins with each individual.

Through all of our combined efforts, we have lowered the numbers of farm fatalities and injuries. Yes, we are all concerned with numbers, but we must relate directly to family members, neighbors, and our friends and the numbers that they represent.

There is not only the emotional loss of a loved one or friend to be considered, but the economic impact of a serious injury or fatality to the farm family. This can be devastating.

Medical expenses are out of sight. Health spending will overtake Social Security as the biggest item in the Federal budget by the turn of the century.

Rural health is a major concern to farmers now whether considering quality, availability, or cost. The Iowa Farm Bureau will continue to address this issue with a strong effort.

Obviously, reducing injuries will, not only reduce a family's medical expenses, but alleviate the emotional and economic crisis that follows an injury. Farm fatalities have been declining in recent years, but not as fast as deaths from injury in other industries.

Since 1950, industry in America has reduced the occupational death rate by two-thirds. Farm deaths from injury have decreased by about 16 percent in the past 40 years. That time frame is a bit unfair for comparison. Between 1950 and 1970 farmers were buying and using more equipment, and deaths from injury were increasing.

But farms have become safer since 1970. Why?

I believe several factors have strongly influenced farm safety in recent years. In 1968, the Congress passed and the Department of Labor issued what is known as the "the hazardous work orders for youth under 16 in agriculture."

These work orders restrict young people under 16 years of age from being hired to perform what are considered to be high-risk jobs on the farm. While there are certain exceptions, which involve training and family exemptions in these orders, attention was drawn to farm safety for youth.

In 1970, the Occupational Safety and Health Administration (OSHA) was created. OSHA has had a more direct impact on reducing injuries and fatalities in other industries. However, their indirect impact on agriculture is unquestionable. Even

though they have been prohibited by the Congress from enforcing their rules on agricultural operations with 10 or fewer employees, knowing they exist has encouraged farmers to work for safer farmsteads.

Due to engineering advances in the last three decades, farm equipment manufacturers have incorporated more safety devices on their equipment. Integral rotary shields for power take-off shafts and roll-over protective structures for tractors have been two major accomplishments in making farm machinery more user-safe.

Since tractor roll-overs are involved in a large portion of agricultural fatalities, elimination of this type of incident alone would cause the death rate on American farms to plunge. But farmers themselves must make the commitment to run a safe operation.

Even though they have been prohibited by the Congress from enforcing their rules on agricultural operations with 10 or fewer employees, knowing they exist has encouraged farmers to work for safer farmsteads.

When they see the dangers and learn the advantage, safety happens. In Nebraska, for example, university safety experts have conducted 450 tractor roll-over demonstrations since 1970 to convince farmers of the dangers.

About 23,000 young people were trained in tractor safety. There have been two known fatalities in this group. The nation-

al average for a group that size would be five deaths.

I do not presume to know all of the answers to our agricultural safety and health problems. I do know that university extension safety specialists and our Farm Bureau safety personnel across this country are continuing to prevent farm injuries through ongoing educational efforts.

Many of our state Farm Bureaus conduct a wide array of projects and educational programs that address safety and health issues. Presentations are made and programs presented at both elementary and high schools, organizational meetings on the job site or farmstead, and wherever they are requested. The topics, to name a few, are traffic safety, bicycle safety, tractor and machinery safety, chemical safety, chain saw safety, firearm safety, child care safety, all-terrain-vehicle (ATV) safety, first aid, CPR, and wellness.

In Iowa last year we funded the development of two tractor safety instruction programs for 4-H youth that produced seven up-to-date farming videos and two popular hands-on displays. It is important to make farm youth fully aware of potential dangerous situations on the farm.

In addition to safety presentations, other programs the Farm Bureau has been active in are promotion of the slow-moving vehicle emblem. Recently, through the efforts of our Farm Bureau women, more than 5,000 slow-moving replacement emblems have been sent to counties.

Over 20,000 respiration-hazard education materials have been circulated and pesti-

## **Actions for the Future**

cide handling protection kits have been distributed. Also, 52 counties participated in a farm and home safety checklist program where members surveyed their homes and farms for safety concerns and corrected problems.

There has also been development of solid waste disposal information materials; a safe on-farm water supply project; distribution of a safety-practices checklist for farmers, and development and distribution of safety decals on various hazards.

These decals are now on the grain bins. Some say: "extra riders, lock it and block it or don't get under it, and don't jump start."

In addition, many state Farm Bureaus have audiovisual libraries with educational safety and health films, slide sets, and videos. These materials are available on a free loan basis.

As I said earlier, farmers themselves must make a commitment to run a safe operation but they also need some educational programs. To the extent that we can involve farmers in developing those educational programs, the more on target and successful we will be.

I would leave you today with this thought — agricultural safety and health are very important issues to today's farmer and every farm family. They know that their livelihood depends on being both safe and healthy. Your presence here at this conference not only shows your interest and concern for their well being but illustrates their importance in today's society.

Thank you for inviting Farm Bureau's participation in this conference.□

## A VICTIM'S PERSPECTIVE OF THE CONFERENCE

By Marilyn Adams  
President, Farm Safety for "Just Kids"

Dr. Rice C. Leach: Our next speaker has a name everyone knows and certainly will know after this morning, Marilyn Adams. We have had a lot of people talk about what things are like and what might happen, but we have the opportunity and the honor to hear from someone who has been on the playing field for real. Ms. Adams is the leader of a group called Farm Safety for "Just Kids," in Earlham, Iowa, which I learned is just about 30 miles west of here. In the fall of 1986, Ms. Adams' eleven-year-old son, Keith, was killed in an accident on the family's Iowa farm. One year after her son's death, Ms. Adams, realizing that not enough was being done about farm safety, began a campaign to promote education and awareness, initially by the distribution of danger decals for gravity wagons through the local FFA chapters. Recognizing the consuming public demand for farm safety awareness, she formed Farm Safety for Just Kids in October of 1987. They have only three employees, and the response from people nationwide is overwhelming. Mail and phone calls come from all over the United States and Canada and are received daily for farm safety information and merchandise available from the office. Materials available for sale include videos, color books, decals, T-shirts, hand-out materials, and other miscellaneous items. Farm Safety for "Just Kids" also compiles and sends out newsletters quarterly. I have a quote from Ms. Adams, but we have something better than the quote, we have the real thing. I give you Marilyn Adams:

Wayne Sprick asked the question, "What can we do to shift the risks as they relate to safety, or better yet, reduce that risk?" I think the most important point he made while answering that question was, "Service types of projects that serve the community."

The farmers are the ones who benefit from these programs in the reduction of injuries. We all need to look at community service programs that we can produce and utilize the youth to serve the communities.

The young people do not have enough materials to promote farm safety and add to their programs. If you were to financially support the vocational student organizations sufficiently and ask for their assistance on the community level, it would be to everybody's benefit.

My experience with the youth tells me that they are our best bridge to the farm family. If you take this one step further and train farm women in tractor safety, chemical safety, rescue, and the other aspects of farming along with the youth, Dad and Grandpa will not have a chance after we start rocking the boat and making waves. Another comment I heard from Wayne was, "Farmers listen to other farmers and the most effective learning is when there is activity involved."

We have heard throughout the conference that children are at very high risk. Yet there are low numbers of farmers and youth here at the conference.

Bob Aherin said something about roll-over protection standards (ROPS) that really interested me. He said to identify the

farmers with high risk exposure and to identify appropriate intervention strategies.

As a farmer, this makes much more sense to me than suggesting that all farmers should put ROPS on all tractors. We need to start somewhere and give the farmer a realistic picture of the high-risk exposure with all tractors with end loaders or whatever the highest risk is.

My experience with the youth tells me that they are our best bridge to the farm family. If you take this one step further and train farm women in tractor safety, chemical safety, rescue, and the other aspects of farming along with the youth, Dad and Grandpa will not have a chance after we start rocking the boat and making waves.

I heard Wes Buchele address the issue of retrofits. By all means, guarding for the older equipment needs to be made accessible and marketed.

It is my personal feeling that dealers should not resell equipment without all protective shields. They have a responsibility to their customers to market the proper shielding for their own products.

I heard talk about child abuse and prosecution of parents. This topic created a lot of discussion in the halls, and I think it was intended to do this. One of the concerns I heard on this topic was, If that happens, where do you draw the line?

The scenario I can put together from the comments I heard is: If you prosecute the

father of the child that was identified on the news as "Seat Belt Murder," then the farmer, where do you draw the line and when does it stop? Do we also prosecute the parents of the children that O.D., do not wear bike helmets, drown, become underage drinkers and take drugs, or the parents of young kids home alone, or whose babies get frostbite and severe sunburns? Where does it start and stop? "Neglect" contributes to all of these.

Other things I heard in discussion were that we need more representation from the general farm production people here at the conference, more interaction and group discussion in the sessions, greater representation from agricultural support companies, discussion of the economic realities of farming, more emphasis on real-life solutions, and information about how to get the research from universities to applications in the field and to the farmer.

One of the things I found interesting was the discussions concerning chemicals, child labor, and migrant labor. I have little exposure to these issues that are in California and Washington and other states.

I was hoping to hear more quoted evidence of what is happening with the migrant workers. I still have some questions unanswered.

I am not clear whether the young children are being hired to work these fields or if the parents are taking the risk by taking them to the fields to work for them. I am also not clear on the chemical use. It sounds to me like there is a lot of misuse of chemicals.

That is not clear in my mind at all. I would really like to know more facts about this issue.

Most importantly, it is my personal opinion that, second to Dr. Novello, the very best presenter we had at this conference who summed it up was our 19-year-old Mark Timm, National President of FFA. He said "America needs youth; youth need adult help, support, guidance, and leadership." It was phenomenal!

Every speaker identified youth as part of the solution. The 4-H, FFA, and the other vocational youth organizations have limited funding. You ALL need to consider incentive grants that are paired with adult and youth organizations.

I also heard a great desire to have another Surgeon General's Conference on Agricultural Safety and Health. I would like to challenge you to consider the next conference having a different focus.

I have been to many conferences since I attended the last one here in Des Moines that was the beginning of my full-time career in agricultural safety and health. We have identified a definite problem and everyone has their own agenda.

This conference, by far, has been the best one I have attended. I look back at what has been accomplished in the last few years. I would like to see people share their experiences with each other and all of us go home with outlines of other programs to implement in our communities.

I expect a lot more will be accomplished in the next few years. Rather than everyone

having ownership of their ideas, we would all take advantage from sharing our success stories along with the stumbling blocks.

A second component to this is that all groups who attend should sponsor farmers, youth, or both to participate. What better team could we have? One of the ideas that Dr. Novello and others kept referring to is, "If you build it, they will come."

We did that and it worked. I am looking forward to our follow-up conference.

Dr. Novello gave the most heart-warming introduction to our conference. Something she said that keeps coming back to me is, "The kids don't have a voice, and the kids don't have a vote." Since I am here to represent the kids on the family farm, I was asked to share a special message brought to you by the kids. I would also like to take you for a tour out on a typical Midwest family farm.

[A Video-Tape entitled "Kids Talk Farm Safety Stuff" was shown.]

I will close with an invitation for you to become a member of our organization, join our networking system, and help us close some of these gaps. Jot down my address, and remember it is in your address book from the conference. I have three employees besides myself and an answering machine.

One final thought, I want each one of you to remember who is running this show. If you "let go and let God," it works. With that, I want to thank you all for coming. Have a safe trip, and God bless you.□

## CONFERENCE SUMMARY

By *Rice C. Leach, M.D.*  
Chief of Staff, Office of the Surgeon General

Ms. Adams. Do not run off. You are one terrific person. I am glad I met you. This plaque is from the Public Health Service and everyone here. It is with deep appreciation to Marilyn Adams, Farm Safety for "Just Kids," for her contributions to agricultural safety and health.

Thank you for the opportunity to participate in this landmark meeting. On behalf of Dr. Novello, I want to thank everyone who made this possible and to congratulate everyone who contributed to the information base.

### BACKGROUND

Everyone so far has told about his or her relationship with the farm, and most have described long standing relationships. I too have a reason for being here, but it is not directly related to farming. In fact, my relationship to farming was short lived.

I grew up in Lexington Kentucky and worked one week on a thoroughbred race horse farm. During that week I learned very quickly that one does not hold the pitch fork directly above one's head while shaking out a stall and loading the spreader. I learned early on that farming was not my strong point.

I do however have some saving graces. First, I still drive the 1966 International Harvester six cylinder half-ton pick-up

truck that I bought when I graduated from medical school. Second, I spent most of my career managing health care delivery systems in the Indian Health Service. In those assignments I had to pursue the goals and objectives of the organization in an environment of constant change...

- ▶ Changing technology—New risks.
- ▶ Changing labor supply—As the doctors left.
- ▶ Changing funding—Usually less.
- ▶ Changing customer expectations — They wanted more.

Does this sound familiar? It should because it is similar to the kinds of change that we have heard about at this meeting—a changing technology with more pesticides, a changing labor supply as the doctors and others leave, a changing economy as farm profits drop, and changing demands as the population changes.

Working with Indian people provided a view of life that has served me well as a manager in a constantly changing world.

The last three days have demonstrated clearly that the assignment for us is to determine how to change for the better in a constantly changing world. As part of that, Dr. Novello charged us to raise the consciousness of the public and alert community leaders about critical issues, build coalitions among the health, education,



environmental, labor, and agricultural communities; disseminate the appropriate information; and encourage action to prevent injuries.

The reports from the concurrent sessions have provided information on what is known and what needs to be done about surveillance, chemical and biologic hazards, mechanical and physical hazards, worker protection from environmental hazards, and safe behaviors among adults and children.

So where do we go from here? We need to document what happened by publishing the *Proceedings of the Surgeon General's Conference on Agriculture Safety and Health*, we need to publish the *Surgeon General's Report on Agricultural Safety and Health*, and we need to reconvene after an appropriate time to plan strategy and assess our progress.

## MANAGING CHANGE

What about the time in between? I Submit that we need to begin to manage change.

Let me return to my experiences with Indian people for a minute. I am certain that many of you saw Kevin Kostner's other movie, *Dances with Wolves*. He did a beautiful job of portraying the intimate relationship between Indian people and mother earth.

Most of the over 25 tribes with which I have been associated over the years have said in one way or another that their purpose in life is to live in harmony with nature and that the

So I submit that the purpose of this endeavor or our mission is to prepare the next generation to live in harmony with nature.

most important activity is to prepare the next generation. All through the week I have been struck with the similarity between those statements and our discussions of the need to educate people, protect children, and prevent injuries with regard to farm safety.

After all, how can you prepare the next generation to live in harmony with nature if you do not protect it from poisoning, cancer, trauma, and premature death. So I submit that the purpose of this endeavor or our mission is to prepare the next generation to live in harmony with nature.

There are several elements to this mission but the one most closely linked to the National Institute for Occupational Safety and Health is to enhance normal growth and development by reducing or eliminating environmental hazards.

To respond to the mission element requires setting objectives, which if obtained will reduce or eliminate the environmental hazards and enhance normal growth and development. The concurrent sessions have again provided information on the magnitude of the opportunities for intervention and change.

Each of us can set our own individual objectives but better yet, we can respond to Dr. Novello's charge to build coalitions among ourselves to set the appropriate

national, state, regional, local, and yes, family objectives. I heard one presenter say that her family was going to buy the roll-over protective device for their tractor. I encourage her to follow through on this commitment.

It sounds easy, just get some information, think about it, set some objectives, and plan how to meet them. It would be easy if it were not for the constraints placed on us by the rest of the world.

For example, time was when 70 percent of the population lived on the farm. Now 70 percent of the population lives within 100 miles of the seacoast. That means that political power and economic clout is concentrated within 100 miles of the coast and not on the farm. And that means that people in rural America are going to have to find new ways to raise awareness and build coalitions to help them.

Time also was when the profits from investment in farming stayed in town, in the county, in the state, or at least in the country. We are still an economy that allocates scarce resources based on capitalism, but the market place has left the farming community and has become the world. The profits are not as likely to be in the local bank to be loaned or in the local tax base to be invested in schools, roads, and health care.

To me this means that rural communities are going to have to develop new ways to influence the market place.

So we are back to change. I want to share some personal observations of organizational and individual behavioral change

and the reasons I think they occurred. I beg the indulgence of the scientists in the audience because I am going to use some anecdotes to develop the points. I know that anecdotes are not good science, but they are what constitutes a large part of the management literature.

I once asked a well known professor from the Wharton Business School how he could justify using anecdotes instead of hard scientific data and he replied:

*First, its difficult to do well controlled double blind studies on human and organizational behavior and second, people pay a lot of money to hear my anecdotes... That is enough for me to validate the worth of what I say.*

Twenty-five years ago I was assigned to Tuba City on the Navajo reservation and was put in charge of the TB clinic. We were lucky if we could get 15 people to come to clinic—partly because all we were seeing was TB patients, and even more importantly the treatment standard required that people with TB go to the sanatorium in Albuquerque.

This usually meant that the husband or wife was gone for nearly a year during which time all kinds of counterproductive things occurred such as selling all the sheep to go drinking. This situation resulted in dead *tubercle bacilli* and dysfunctional families. The Navajo people, being quite intelligent, avoided the clinic in droves.

When I left two years later we had 100 people a month in clinic each month and

had to open a second session. What happened? We gave them what they wanted.

► First, we agreed to treat the patients at home and not send them to the sanatorium if they would take their medicines and come to clinic.

► Second, we allowed the clinic to function more like a drugstore. If they needed cough medicine for grandmother, we got her chart and wrote the prescription. If they needed a refill on their birth control pills, we gave them a one month supply, and if they needed something for the baby, we did that too. We wanted to know about TB, and they wanted service. It was a win-win.

In the early 1980's I tried to convince the staff at the Phoenix Indian Medical Center to stop smoking and make the facility 100 percent smoke free. We were going to give people six weeks to change and go smoke free on the first of October. In the ensuing six weeks the staff became so polarized over the issue that imposing a non-smoking policy would have split the hospital so I backed down, but I did not stop the push for non-smoking.

I personally asked the smokers to stop, and I consulted with them about how we should manage the program. Over time smoking diminished, and after four years, the union proposed making the facility 100 percent smoke free as part of contract negotiations. The union made the request. Think about what that means in terms of organizational change.

I mentioned my wife earlier. She is from Guatemala, Central America and brings a

wealth of new ways of viewing the world to this life.

One of them is that she never misses buses or planes—she says that the bus left her. Several years ago we moved from a little town in Oklahoma to Phoenix, Arizona, which among other things is known for its frequent left turn automobile wrecks. After three years and three sets of fenders for my cars and those belonging to other people, I was continuing to tell her to stop hitting the cars and trees (she got one of them too). She kept saying that she was not hitting them, they were hitting her.

Finally it dawned on me to ask her to do whatever she could to keep the cars and trees from hitting her. She has developed the most incredible series of right turns and alternate routes you ever see, but she has had no more accidents, and you know what, I have noticed that if you pay real close attention, you can see a tree move every now and then. The point is that you have to have faith.

On a personal basis, I had several bouts of atrial fibrillation in the 1970's and early 1980's. For the non-clinical types, atrial fibrillation is to the heart what a loose distributor cap is to a gasoline engine; it just goes bobbity, bobbity, bobbity. I learned that alcohol, and not much of it, was causing the problem so I stopped drinking. What was my motivation?

It was not fear of death because I would be gone. No, it was fear of an internist with two shiny paddles coming at my chest with the defibrillator that motivated me. No way was I going to contribute to improving the chances that one of my col-

leagues would come at me with one of those devices.

Finally, there is an example from the *Harvard Business Review*. Do you remember how many fine German and American cameras were on the shelves of camera stores in the 1950's and 1960's? Do you see them now? No.

What happened is that the Japanese sent their engineers to U.S. camera stores to learn what people buying cameras really wanted. Once they learned, they went home and built it for them. The rest is history.

The point is that if you are going to stimulate change, you can make a lot more headway if you do it the customer's way. Find out what motivates a person or group and meet them halfway, and you are halfway there. For us, it means involving the farmers and their representatives as we determine the requirements and as we design the system.

#### **PERSONAL OBSERVATIONS ON NEGOTIATING REQUIREMENTS**

- Go for the win-win.
- Remember that some change takes a long time.
- Strike while the iron is hot.
- Do not try to swallow the whole horse at the same time. Break the job down into manageable components.
- Find the real leaders, and play to their strengths.

Senator Harkin was like a breath of cool fresh air on a humid day when he spoke about health issues the other day. When you have someone as enlightened as he is, play to his strengths and feed him as much as you can on health issues.

Remember the women. Throughout the ages, the women seem to be the ones that make the big social changes beginning with the Greek women who threw the men out of town until they agreed to stop going to war all the time.

It was Mother Teresa and not Father Terry that started picking up the helpless in India, it was the league of women voters—not men voters, it was Dorothy Dix and not Tom Mix that reformed care for the mentally handicapped, and it was Mothers Against Drunk Driving—not the fathers. And I am quite sure that we have another name to add to the list in Marilyn Adams who has founded Farm Safety for "Just Kids."

The Surgeon General charged us to raise consciousness, and we are talking about several different age groups. To reach children, what about the "Nintendo Pesticide Game" or the "Teenage Mutant Ninja Farmworker." Or for adolescents, what about "Doobie Howser does Iowa." And for adults, "Radar Reilly Comes Home."

I am serious about riding the wave of other's popularity. Can you imagine the impact of a Saturday morning cartoon on farm safety or a major network doing a teenage physician show that acknowledges agricultural health and safety issues?

We are to disseminate information. What about Junior and Senior high school classes that give academic credit for combined driving education or tractor education. We give credit for automobile driver education.

What about high school biology credit for Pesticides One and Pesticides Two. In talking to the FFA students yesterday, I learned that they generally have to go somewhere outside high school to get this information.

Building coalitions: others will have to make recommendations on this but in encouraging action, we can use the tools available to make change in the political,

economic, and health environment. We can work in a way that allows those who currently stand in opposition to save face and join later on.

In summary, we have been challenged to build a system whose planning, operations, evaluation, monitoring, and standards will reduce hazards and enhance normal growth and development so we can live in harmony with nature. Building this system must involve its joint owners in its design so their varying expectations and requirements can be met.

To paraphrase the Surgeon General and others who have spoken before, if we build it, success will come. Thank you.□

## POSTER ABSTRACTS

The purpose of the Conference was to raise consciousness, build coalitions, disseminate information, and encourage action to prevent injury and disease in agriculture. To help in fulfilling this purpose the planners of the Conference saw that an opportunity for networking among its participants should be an important aspect of the meeting. An opportunity was provided through a poster session.

This session, entitled *Making Connections*, included posters from research organizations, governmental and volunteer programs, and individuals as well as a presentation of FFA posters and video tapes. Moreover, 4-H clubs participated with presentations of songs and skits during this session to emphasize the youth aspect of agricultural safety and health.

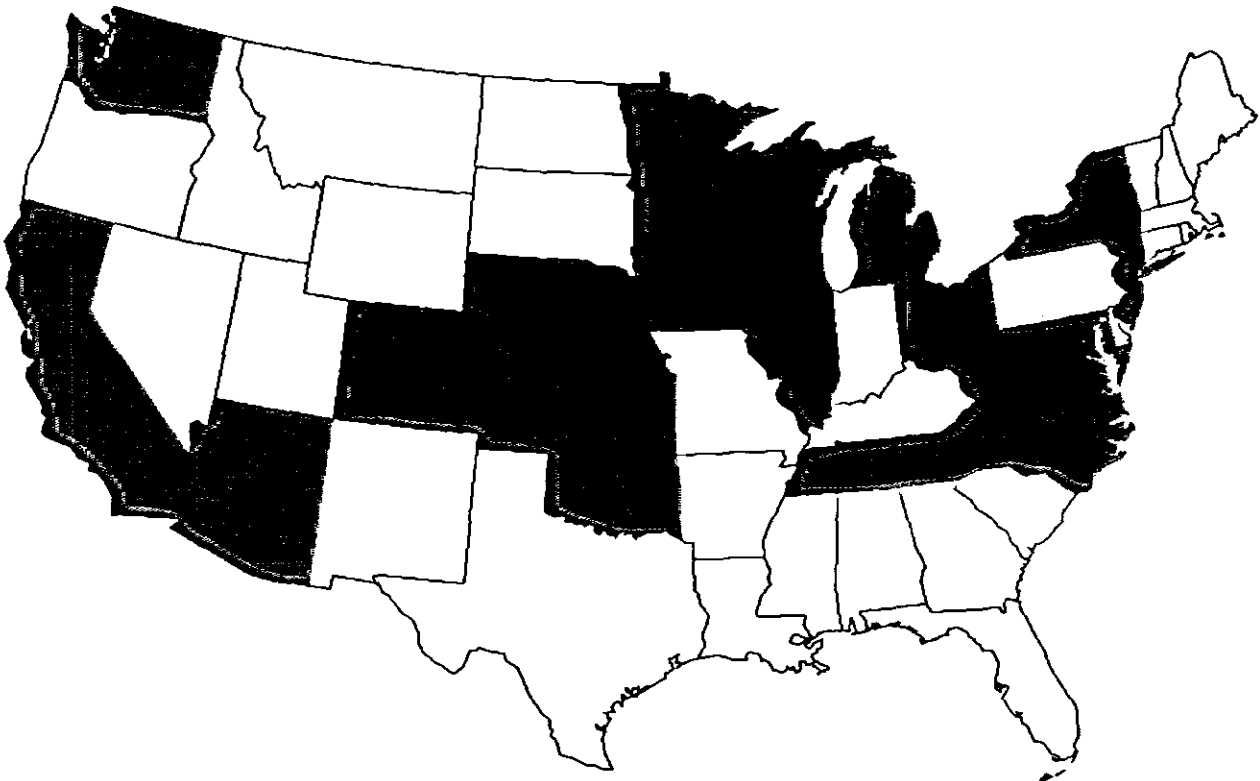

**Figure 1.** States from Where Posters Were Presented at the Surgeon General's Conference on Agricultural Safety and Health (exclusive of FFA Posters).

Other than the FFA posters, 95 posters from 20 states were presented at the Conference. These posters addressed a variety of programs in surveillance, research, and intervention, and abstracts of these presentations are provided in the following pages.

## **PLAN FOR ARIZONA AGRICULTURAL HEALTH PROMOTIONAL SYSTEM**

*By Lance Fluegel, B.S.*  
University of Arizona, Tucson, Arizona



- ▶ **AREAS TARGETED** – Agribusiness and High School, Emergency Rescue, University and Community College, Youth
- ▶ **DELIVERY METHOD** – Model Programs, Workshops, Classes, Model 4-H Programs.
- ▶ **KEYS TO IMPLEMENTATION** – Direct Mailings, Handbooks, Announcements, Advisory Committee, Balanced Selection, Identify EMT Teams, Advisory Committee, Training Trainers, Hands on Training, Financial Assistance, Develop Curricula, Advertise Course, Recruit Students, Instructor Survey, Hazard Evaluation, and Request Proposals.
- ▶ **PROJECTED RESULTS** – Written Safety Plans, Hazard Correction, Accident and Injury Reduction, Trained Member in Each Department, Other Instructors Expand Safety Offerings, Technicians Trained in Agricultural Machinery Accident Extraction, Safety Education, Student Training, Worker Training, Safety Course Offered Fall/1991, Agricultural Educational Teachers Take Safety Class, Safety Leadership, and Safety Awareness.

## **OCCUPATIONAL EXPOSURE TO GUTHION: CORRELATING RESIDUE LEVELS TO BIOLOGICAL MARKERS**

*By Melissa Gonzales*  
Graduate Student in Toxicology/Industrial Hygiene  
University of Arizona, Tucson, Arizona



Cholinesterase inhibiting pesticides are a potential health hazard for workers who enter treated areas and have significant contact with the residue-laden foliage. To define this exposure, the California Department of Food and Agriculture is compiling a database of crop and task-specific transfer factors relating dermal exposure to dislodgeable foliar residue (DFR). In this study, DFR for guthion and gutoxon are assessed from the time of application through the harvest study period. The dermal exposure of peach harvesters is monitored with long-sleeved T-shirts, hand washes and face, neck, and hand wipes. Urinary dialkyl phosphate metabolites are quantified to estimate residue absorption. Blood cholinesterase levels are monitored as a measure of physiological response from absorbed residues. The observed transfer factor is compared to those previously calculated to further evaluate the organophosphate exposure model of the CDFA. This study is also a source of occupational exposure data on California's agriculture workforce, which is highly mobile and difficult to assess.

## AGRICULTURAL INJURY IN CALIFORNIA: IMPLICATIONS FOR SURVEILLANCE



*By Carol Conroy, Ph.D., N. Maizish, L. Rudolph, D. Will*  
California Department of Health Services, Berkeley, California

California agriculture presents unique challenges when designing a survey to assess the magnitude of occurrence and characteristics of agricultural work-related injury. One challenge relates to the tremendous diversity of agriculture within the state. There are more than 30 million acres of land devoted to agricultural production or services, more than 83,000 farms, more than 60,000 farm workers, and more than 250 crops in production within California every year. The average annual rate for occupational traumatic deaths during 1980-1985 was 16 per 100,000 agricultural workers compared to an overall traumatic occupational fatality rate of 7 per 100,000 workers. During 1988, over 21,000 agricultural disabling work-related injuries were identified; 47 percent occurred during crop production and 43 percent were related to agricultural services. In order to target high risk farms to survey, multiple data sources were analyzed to describe the epidemiology of agricultural injuries within California. Injury rates vary by type of industrial classification within agriculture: vegetable and melon crops have an injury rate of 76 per 1,000 workers while cash grains (such as rice) have a rate of 101 per 1,000; and within agricultural services the injury rate varies from 13 per 1,000 for veterinary services to 88 per 1,000 for soil preparation. This reflects a variation in risk of injury associated with different exposures that must be considered during the design of the survey. Another challenge relates to diversity of the population at risk: farm workers and farm owners and operators. In addition, interviewing highly mobile and transient migrant farm workers (many of whom do not have a defined residence), many of whom originate from Mexico or Central America and do not speak or read English, required a sampling strategy that would allow these workers to be located. This sampling plan, based on a stratified random cluster sample, allows operators to be interviewed. Because farm workers and farm owners and operators are exposed to different hazards, have different demographic characteristics, and would require different intervention strategies, it is necessary to survey both to achieve the ultimate goal of preventing agricultural injuries in California.



## AGRICULTURAL ACCIDENTS AND ILLNESS AMONG CALIFORNIA WORKERS' COMPENSATION CLAIMANTS



*By David F. Goldsmith, Ph.D., James J. Beaumont, Ph.D.  
Lynne A. Morrin, B.S., Marc B. Schenker, M.D., M.P.H.  
University of California, Davis, California*

Agriculture has equalled mining as the most hazardous industry in the U.S. As part of the University of California Davis Center for Agricultural Health and Safety, epidemiologists are examining California Workers' Compensation (WC) Appeals Board claims to describe the accident and illness risks among farm employees. Preliminary findings of 80 claimants who filed between 1946 to 1964 show that all were farm workers (not farmers), and about 90 percent were white or Hispanic males with a mean age of 46 years of age. Of the 27 respiratory disease claims, 14 percent filed because they had valley fever (coccidiomycosis), 27 percent had other (mostly chronic) respiratory illness, 41 percent filed because of pesticide illnesses, and 18 percent filed because of multiple effects of inhaled toxic materials, i.e., solvents and agricultural burning. Among the 53 farm laborers filing WC accident claims, 11 percent were for hernias, 20 percent were for fractures, 18 percent were for contusions and other wounds, and 52 percent were for traumatic injuries. Follow-up proportionate mortality ratio (PMR) analysis from 1950 to 1984 of the injury claimants employed in agriculture indicated that these farm workers have an elevated risk for malignant neoplasms of lung (PMR = 2.39), for vascular lesions of the central nervous system (PMR = 2.95), and for all external deaths (PMR = 1.95) when compared to U.S. white males. This preliminary study demonstrates that WC data are extremely useful to describe illness and injury patterns among agricultural workers. Furthermore, the mortality findings suggest that there is an elevated risk of lung cancer, stroke, and external causes even after injury claims are filed. New epidemiologic research is needed to elucidate the risk factors for the excess rate of occupational injury and death now being observed in the agricultural workplace.

## **VISUAL MATERIAL FOR PESTICIDE SAFETY LESSONS FROM AN ECUADORAN EDUCATIONAL INTERVENTION**



*By James I. Grieshop, Ph.D.*  
University of California, Davis, California

Throughout the world in developing countries such as Ecuador, efforts to transfer technologies have not occurred without serious problems. This is true in the agricultural sector where pesticides have rapidly come into widespread use in areas where traditional agriculture had been practiced. However, the transfer of pesticide technology has not been accompanied by the transfer of techniques for their safe, effective and appropriate use, thereby leading to human health problems (poisoning) and environmental damage and serious and justifiable public concern. In countries such as Ecuador, users of pesticides often are illiterate, and live in isolated areas. These attributes present particular problems for designers of education and communication programs. Folk beliefs in relation to pesticides and personal risk also work against the effectiveness of communication programs. This poster demonstrated the potential for the use of visual materials, including symbols and pictographs and more highly refined materials such as photo-novels and posters, for communicating messages about safe and appropriate use of pesticides. The materials to be highlighted are the products of intensive field research, primarily in Ecuador, on users of agricultural chemicals. The poster session will demonstrate the evolution of these materials from relatively simple symbols and pictographs to much more complex photo-novels and posters and materials developed for use with both Spanish-speaking and Quechua-speaking rural residents. The relationship of field research using qualitative approaches and the development of these visual materials will also be a key feature of this graphic information session. Lessons from these field-based experiments provide lessons for the development of similar health education interventions in the United States with non-English speaking and reading farm laborer audiences.

**THE U. C. DAVIS AGRICULTURAL HEALTH AND SAFETY  
CENTER: A MULTIDISCIPLINARY CENTER FOR RESEARCH AND  
OUTREACH**



*By Marc B. Schenker, M.D., M.P.H.*  
University of California, Davis, California

California is the leading agricultural state in the nation, with 16 percent of all U.S. crop production, as measured by farm cash receipts. Farm production in California is 60 percent greater than the second leading state. A review of agricultural production statistics documents the enormous size and importance of California commodities. For example, California produces 39 percent of all U.S. vegetables and melons, 53 percent of all fruits, nuts and berries, and 24 percent of all nursery and greenhouse products. More than 1,000,000 workers are employed annually in agriculture in California, and there are more than 20,000 disabling injuries per year in the state. The purpose of the new U.C. Davis Agricultural Health and Safety Center is to create a multidisciplinary organization for communication and coordination of research, education, and illness and injury prevention in the agricultural workplace. The Center will address occupational and environmental health issues affecting farmers, ranchers, agricultural employees, farm families, agricultural service employees and visitors and residents around agricultural work sites. The Center includes multiple academic units within the University of California, as well as participation by programs and state agencies from outside the University and interactions from neighboring states. As one of two national centers funded by NIOSH, the U.C. Davis Center will focus on agricultural health and safety issues most relevant to the western states. The Center is organized into an administrative core and a research and an outreach component. Participants from U.C. Davis, U.C. Berkeley, various state agencies and agriculture organizations are actively involved in both the research and outreach components. This mixture of the unique expertise of the participants, the diverse resources of the University and the State of California, and the contacts and involvement of state agricultural organizations provides an outstanding and unique environment for addressing the health and safety hazards in agriculture.

## **CALIFORNIA AGRICULTURAL HEALTH AND SAFETY PROMOTION SYSTEM**



*By William E. Steinke, Ph.D.*  
University of California, Davis, California

The California Agricultural Health and Safety Promotion System (CAHSPS) addresses the need for training across the diversity of California agriculture (more than 250 commercial commodities workforce through several actions). Many farm workers in California are Hispanic and have a limited ability to communicate in English. Several other ethnic groups, i.e., Hmong, Mexican Indian, Vietnamese, Filipino, American Indian, Japanese and Chinese, are also present in the agriculture workforce in large numbers. The CAHSPS addresses the educational needs regarding safety in six major program areas. First, a pilot program is being established to develop training materials and training methodologies for growers, field supervisors, farm labor contractors and others to use in providing regular and focused safety training for those exposed to the hazards of agriculture. Second, a formal and rigorous evaluation of the effectiveness of this type of training is being independently conducted. The third component features grants that are being offered to ten community agencies for programs that use channels outside the work place to distribute agricultural occupational safety and health information. The fourth aspect, which includes data collection regarding causes of fatalities and cases of major trauma, is being undertaken in collaboration with the State Department of Health Services. As the fifth aspect, an evaluation of different levels of safety training as they currently are practiced on California farms is being conducted, with the goal of identifying the key components crucial to a successful program. The sixth component is development of coursework in the College of Agricultural and Environmental Sciences regarding agricultural occupational safety and health and injury and illness prevention programs. The results of this program will make working in California less hazardous and enable growers to customize their safety programs and training to fit the needs of their operations and employees.

## **PROMOTING AGRICULTURAL SAFETY AND HEALTH IN COLORADO**

*By Paul D. Ayers, Ph.D.*  
Colorado State University Fort Collins, Colorado

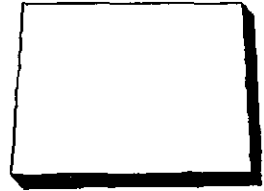

Agricultural production in Colorado is an extremely hazardous occupation. Many fatalities, injuries and illnesses can be prevented through education. Colorado State University Cooperative Extension has embarked upon such an educational program through a grant provided by the National Institute for Occupational Safety and Health. This grant provides funding for several safety projects including the following topics:

- An up-to-date resource library containing visual aids and literature has been established and made available to all 58 county Cooperative Extension Offices. A monthly safety newsletter sent to each Cooperative Extension Office has been implemented as well as news releases submitted to Colorado's major agricultural publications. County Extension personnel are in a good position to disseminate safety information to a variety of individuals through their various production meetings.
- Tractor safety, particularly tractor roll-overs, is always a major concern. Older tractors without roll-over protection (ROPS) are especially hazardous in a farm situation. Colorado State is conducting a tractor survey to determine the number of tractors without ROPS. Tractor survey forms were sent out to 1,000 farmers via the County Cooperative Extension Offices to ascertain the safety equipment available on tractors currently being used. Information from this survey will be used to determine areas needing more emphasis such as seat belts and roll-over protective structures.
- Pesticide safety is another major concern for Colorado agricultural workers. Protection of the applicator can be greatly increased through usage of gloves and respirators. These two simple items can be easily implemented into the pesticide application operation. County Extension Offices have been provided with a chemical safety kit which includes gloves, coveralls, goggles, overshoes, respirators, etc. for demonstration purposes at meetings and field days. Gloves are also provided at pesticide applicator meetings for each participant completing the course.

Each office has also been provided with a video tape on farm chemical safety. Disposal of agricultural hazardous wastes (unusable pesticides and containers) is a continuous problem. Steps are being taken to provide guidelines for disposal of such items on a local level for agricultural workers. The intent of the Colorado State project is to educate Cooperative Extension personnel about various safety programs so they, in turn, can educate their clientele. In this manner, more agricultural workers can be reached on a statewide basis.

## INJURY RISK-TAKING BEHAVIOR OF FARM YOUTH

By Robert A. Aherin, Ph.D.  
University of Illinois, Urbana, Illinois



Various state farm accident studies have consistently found a high incidence of farm-related injuries occurring to children under the age of 15. In an effort to gain a better understanding of the types of behaviors being performed by children on farms, a study was conducted to evaluate parental attitudes and behaviors regarding three farm machinery-related behaviors. A sample of 377 randomly selected farm families, who had children 15 years of age and younger, participated in the study. The three behaviors evaluated included: 1) Riding on a tractor with a parent during the past 12 months; 2) Operating a tractor; and 3) Allowing the child to be within 10 feet of rotating or revolving components on farm machinery. Twenty-nine percent of the parents felt it was acceptable to allow children 3 years of age and younger to ride on a tractor with them. Sixty-five percent agreed that children between the ages of 4 to 6 years of age should be allowed to perform the behavior. Nearly 90 percent of the parents allowed their 7-to 9-year-old children to ride on tractors. More than 70 percent of all the parents believe the risk of injury for performing this behavior was low. Twenty-nine percent of the farm boys in the study were allowed to operate tractors. Sixty-seven percent of 10-to 12-year-old boys and almost all of the 13-to 15-year-old boys operated tractors. Girls operated tractors significantly less than boys. Only 16 percent of parents thought their children between 7 to 9 years should be allowed to be within 10 feet of rotating farm machinery parts. However, 27 percent allowed their boys in this age group to perform the behavior. Of the 377 families who completed the survey instrument, 16 or 4.2 percent reported an accident. The injuries from these accidents resulted in 75 percent of the victims needing to seek medical attention while approximately 12 percent were permanently disabled. As a result of these findings, an educational program has been developed to assist farm families with their understanding of the behavioral and physical limitations of children to deal with injury risk associated with farm equipment.

**REDUCING THE POTENTIAL FOR ENVIRONMENTAL  
EXPOSURE AND HUMAN EXPOSURE TO PESTICIDES—  
A SELF-HELP WORKSHOP FOR PRODUCERS**



*By Richard O. Pope*  
Iowa State University, Ames, Iowa  
*George F. Czapar*  
University of Illinois, Springfield, Illinois

Public concern about groundwater contamination from agricultural practices remains high. Recent midwest well water surveys have helped define the extent and frequency of water contamination. In addition to pesticide mixing and handling practices, well construction, depth and location are known to affect water quality. Farm\*A\*Syst is a prototype 12-part agricultural farmstead assessment program, developed in 1990 by United States E.P.A. Region 5, and the Extension Services of the Universities of Wisconsin and Minnesota. From this prototype, a specific program was developed for use in Iowa County pesticide—certification training sessions. The primary focus of this program is to raise producer awareness and outline recommended pesticide management practices. This interactive worksheet enables each producer to examine and improve his or her individual management practices. Results compiled from initial workshop evaluations will be discussed. This producer feedback is being used to assist program planning for inter-agency water protection efforts.

## **A THEORETICAL FRAMEWORK FOR SAFETY BEHAVIOR INTERVENTIONS**

*By James Westaby, Graduate Assistant, Robert Aherin, Ph.D.  
University of Illinois, Urbana, Illinois*



Occupational injuries and illnesses are a serious threat to farmers. Many farm injuries and illnesses are the result of dangerous behavior. Reducing injury risk on the farm is a considerable task because many farmers are autonomous and self-motivated. Many farm safety programs have been implemented, but have not undergone systematic evaluation. It is unclear whether these programs actually reduce injury risk. Also, many programs lack theoretical rationale for their interventions. A theoretical approach to reduce injury risk by targeting specific unsafe behaviors is proposed. Empirically supported theories, such as the Theory of Reasoned Action, Theory of Interpersonal Behavior, and the Theory of Planned Behavior are used in the proposed framework. The framework identifies factors that determine behavior. For example, it has been shown that specific behaviors are determined by specific behavioral intentions and/or habit processes. Behavioral intentions, in turn, are determined by the attitudes people have toward the behaviors and their subjective norms (i.e., the pressure people feel from significant others to perform the behavior). The framework, in sum, should help pinpoint reasons why farm workers perform unsafe behaviors, target those behaviors with specific safety interventions, and show which strategies prove effective. Effective strategies, in turn, could be modelled in large-scale safety programs. More confidence could be placed in such validated programs.

## **SAFE COUNTRY**

*By James L. Williams  
Country Companies, Bloomington, Illinois*



Background: Prior to developing this educational program on farm safety, research was conducted with 1,500 agricultural producers. Research indicated the need for an educational program, including a video.

The final educational package consists of:

1. Leaders' Guide;
2. An 18-minute video;
3. Modules on: Tractor and machinery safety, plus general farm safety and health; chemicals; animals; ladders; and harvest safety
4. Student booklets; and
5. Promotional material, including news releases, posters and a promotional brochure.

Comments to date indicate its progress is well received. Approximately 3,000 pieces of student materials have been shipped, indicating excellent usage of the program. It is in use in four states by the Country Companies and other agriculture interested organizations.



## **FARM SAFETY 4 "JUST KIDS"**



*By Marilyn Adams*  
President Farm Safety 4 "JUST KIDS"

In the fall of 1986, Marilyn's 11-year old son, Keith, was killed in an accident on the family's Iowa farm. One year after her son's death, realizing that not enough was being done about farm safety, Adams began a campaign to promote education and awareness by distributing danger decals for gravity wagons through local FFA chapters. Recognizing the consuming public demand for farm safety information, she formed Farm Safety 4 "JUST KIDS" in October, 1987. The response from people nationwide has been phenomenal. Mail and phone calls from across the United States and Canada are received daily for farm safety information and merchandise available from the office. Materials available for sale are videos, decals, T-shirts, and other miscellaneous items. Farm Safety 4 "JUST KIDS" also compiles and distributes newsletters to members quarterly. The increased demand for information has prompted the formation of a Chapter Operations Department. This department is in the process of developing chapters across the United States. "If we are indeed concerned about making our farms safer places to work and live, we need to overcome the sort of conditioned apathy that exists today toward farm-related health and safety issues. By developing chapters of Farm Safety 4 "JUST KIDS", we are working to make further improvements in the communities. Education and building public awareness are perhaps the two most important elements in addressing this problem".

## **ZOONOSES—HUMAN HEALTH HAZARDS ASSOCIATED WITH ANIMALS**



*By George W. Beran, D.V.M., Ph.D.*  
Iowa State University, Ames, Iowa

This presentation will represent teaching, research and personal experiences of the author. On one side, a chart identifying viral infections at greatest hazard of transmission from animals to people will be featured, accompanied by a photographic display on rabies. This will show the wild animals which maintain the infection, the disease in wild animals, farm livestock and companion animals. It will show preventive measures and an interactive section on myths and facts about rabies. (If available, a slide system or video monitor could be used to display additional, rare photographs of the disease in animals). On the reverse side of the display, a chart will identify bacterial infections at greatest hazard of transmission from animals to people. The illustrations will depict facets of Lyme disease, the way the disease is spread, the animals which carry it, the human disease, and measures for prevention. The display addresses health protection intervention in zoonoses, particularly from the viewpoint of the author as a consultant in rabies to the World Health Organization.

## **TEACHING GUIDES AND CLIENT EDUCATION MATERIALS FOR CARDIOVASCULAR SCREENING PROGRAMS**



*By Constance J. Betterley, M.S., R.D., Lorrie J. Graaf, R.N.*  
Iowa Department of Public Health, Des Moines, Iowa

Iowa's Cardiovascular Risk Reduction Screening and Education Program Recommendations advise that all screening programs provide client education. To assure that accurate, consistent information was given to Iowans at screening sites, staff from the Bureau of Nutrition and Health Promotion developed teaching guides for public health nurses and one-page fact sheets for the general public. The teaching guides and fact sheets correspond with the three components of the cardiovascular screening program: cholesterol screening, hypertension screening and diabetes screening. The teaching guides were developed in a standard format consisting of objectives, a suggested teaching outline, suggested background materials for the professional, and suggested client education materials. Information from the National Heart, Lung and Blood Institute and other public organizations was adapted to present a single concept per fact sheet and to lower the reading level. A formative evaluation was conducted using pre-testing methodology. The format may be useful for other states wanting teaching guidelines and client education at screening sites.

## **OCCUPATIONAL HEALTH NURSES IN AGRICULTURAL COMMUNITIES -A PUBLIC HEALTH NETWORK FOR INJURY CONTROL**



*By Elaine DeBoef, R.N., M.S., and other project nurses*  
Division of Disease Prevention, Iowa Department of Public Health, Des Moines, Iowa

Agriculture is a major component of the Iowa economy. Much of the food and fiber upon which America and the world depends is produced on Iowa farms. The Iowa farm lifestyle embodies many qualities which underlie the strong foundation of our country. Partly influenced by these factors, this population has been affected by occupational-related disease and injury at rates which greatly exceed public health standards. The Occupational Health Nurses in Agricultural Communities Project, funded by NIOSH, through the Division of Disease Prevention, Iowa Department of Public Health will extend surveillance and target injury and disease control interventions through collaborative efforts with local health and lay service groups. Early efforts will be directed toward injury intervention development in regions and communities which are identified as high frequency, high severity areas for agriculture-related acute injury, using 1990 surveillance data from the Sentinel Project Researching Agricultural Injury Notification Systems (SPRAINS) program based in Iowa.

## **A STATE PUBLIC POLICY TO IMPROVE FARM HEALTH AND SAFETY: IOWA'S CENTER FOR AGRICULTURAL SAFETY AND HEALTH**



*By Kelley J. Donham, D.V.M.*  
University of Iowa, Iowa City, Iowa

The 1990 Iowa Legislature passed a bill to form The Iowa Center for Agricultural Safety and Health (I-CASH). This unique program mandates that the College of Medicine (The University of Iowa), the land grant school (Iowa State University), the State Department of Health, and the Department of Agriculture and Land Stewardship work together to coordinate and focus resources to decrease agricultural occupational deaths, injuries, and illnesses. The Center is housed at The University of Iowa. The day-to-day operation is through the leadership of the Director, with strong input from the Coordinating Committee, which is made up of representatives from each of the participating institutions. The Coordinating Committee receives policy direction and has direct contact to the clientele through an 18-person Advisory Committee. This committee consists of active farmers, members of farm constituency groups (such as Farm Bureau, Corn Growers and Iowa Pork Producers), rural physicians, rural hospitals, and agribusinesses. This first-of-its-kind organization has put together a powerful, eclectic group of farm health and safety experts and clientele groups to develop and carry out preventive programs in a positive participatory manner. I-CASH has focused on five major areas to direct the energy and resources of this group. These are: 1) developing a network of hospitals in the state to provide comprehensive occupational health services for farm families; 2) prevention of respiratory diseases in swine producers; 3) prevention of injuries in farm children; 4) prevention of injuries involving tractors; and 5) surveillance of farm injuries. I-CASH has enjoyed excellent cooperation among the members. A major initial function is to coordinate the various preventive programs in the state that have emerged through the 1990 NIOSH initiative. I-CASH will also provide additional general programs to meet the needs of the farm families and farm workers of Iowa. I-CASH may serve as a model for other states as they develop public policies on this issue.

## IOWA AGRICULTURAL HEALTH AND SAFETY SERVICE PROGRAM



*By Jane Gay, B.S.N.*  
University of Iowa, Iowa City, Iowa

Farming is consistently ranked as one of the top three most hazardous occupations. An estimated 200,000 farmers are disabled and an additional 2,000 die annually from work-related causes. The farm family lives in and works at a worksite filled with many hazards. In other industries, comprehensive occupational health and safety services have been dramatically successful in reducing job-related injuries and illness. Effective systems to deliver this type of service in agriculture have not been established. In 1987, The Institute of Agricultural Medicine and Occupational Health of the University of Iowa College of Medicine initiated a pilot project for families and agribusiness in the state of Iowa. The project has expanded into a state network of agricultural occupational health and safety services based in community hospitals. The Iowa Agricultural Health and Safety Services Project (IA-HASSP) provides a unique clinic model and implementation plan, technical assistance and health professional training to community hospitals that are establishing agricultural occupational health and safety clinics. This model utilizes the community hospital as the primary integrator of existing community health services and direct provider of new occupational health services. The clinic will coordinate with regional primary-level hospitals and healthcare providers to deliver services at satellite sites. The service for members includes: occupational health screening, intensive occupational health and safety education, on-farm hygiene/safety analysis of identified or potential farm-related health and safety hazards, and availability of personal protection equipment. The project also provides service at the state level through telephone consultations for local-level healthcare providers.

## **CARBON MONOXIDE: VENTING PROBLEMS FROM HEATING APPLIANCES**



*By Thomas H. Greiner, Ph.D., Jim Cain*  
Iowa State University, Ames, Iowa

Excessive house depressurization can result in combustion appliance venting failure and contamination of household air. Three Iowa homes previously indicating combustion venting failure were instrumented and monitored to verify and further quantify venting failure and associated air quality deterioration.

Significant findings of this study included:

- Thermocouple located in the appliance vent and at the dilution device gap can accurately monitor venting performance.
- Carbon monoxide can reach dangerous concentrations under conditions of excessive spillage and exhaust recirculation in low-volume rooms.
- Neither carbon monoxide nor carbon dioxide concentration gives an accurate indication of flue gas spillage in large-volume mechanical rooms.
- Faulty vent design and/or maintenance can result in venting failure without the added aggravation of house depressurization.

## RADON IN IOWA

*By Thomas H. Greiner, Ph.D., Jim Cain*  
Iowa State University, Ames, Iowa



Radon is the second leading cause of lung cancer in the United States. The United States Environmental Protection Agency (EPA) prediction is that radon in homes causes 21,600 annual deaths, with an uncertainty range of 8,400 to 43,200 (USEPA 1989). The EPA began to test homes for radon, but did not include Iowa because the state was judged to be the state "least" likely to have a radon problem. Although Iowa was not identified by the EPA as a state with a potential radon problem, survey data collected in 1984 by a local college professor, Conrad Weiffenbach, found several high levels in eastern and central Iowa (Weiffenbach, 1987). To help determine if there were a radon problem, Iowa State University, in February of 1987, began selling radon detectors and collecting data on the radon results. This database now includes information on 15,111 short-term tests, including 7,100 first-time screening tests. The arithmetic average of these 7,100 first-time tests is 8.3 picocuries per liter (pCi/l), more than twice the EPA action guideline of 4.0 pCi/l. Thirty percent of the screening tests gave low results (4.0 pCi/l or less, 64 percent gave medium results (in the range of 4-20 pCi/l), and 6 percent were high readings (more than 20 pCi/l). Additional testing confirms that more than 70 percent of Iowa homes "fail" the EPA screening guidelines. Despite the risk associated with radon exposure, less than 6 percent of Iowa residents have tested for radon, and only a few hundred have taken measures to reduce the levels of radon in their homes. An Iowa State University Extension Service Iowa Radon Project public awareness survey in 1990-1991 reveals reasons for the disappointing response of the Iowa public. Nearly 90 percent have heard of radon, but they do not feel knowledgeable about radon, with two out of three persons reporting they feel inadequately informed.

## **THE RURAL YOUTH DISABILITY PREVENTION PROJECT**



*By Cheryl Hawk, M.S., Jane Gay, B.S.N., Kelley J. Donham, D.V.M.  
University of Iowa, Iowa City, Iowa*

The Rural Youth Disability Prevention Project is an intervention funded by the CDC in 1988 to provide a framework for the development of community-based, pediatric, agricultural injury-control programs. It has a three-stage structure, each requiring input from and feedback to the farm community to ensure that program development addresses its needs. The first stage is diagnosis of needs, with provisions for postintervention evaluation, utilizing two instruments: a survey of local farm families to gather data on safety practices, risk factors and injuries, and the Farm Family Walkabout guidebook, a family activity designed to identify hazards on individual farms. In the current project year, the survey was administered to 400 and the Walkabout to 458 Iowa farm families. Results indicated injury-control issues to target:

1. Children in the workplace. Children accompany their parents operating farm machinery from an average age of 7 and begin operating it themselves by 11.
2. Emergency preparedness. Only 25 percent of adults have had CPR/First Aid training. Fifty percent have First Aid kits in their homes, and 14 percent have them in their tractors.

In the second stage, communication, these findings are sent as a newsletter to participants and publicized in local media. Meetings ensue at which farm families and community groups assess local needs. This leads to the third stage, facilitation of appropriate actions. The specific issues currently targeted are being addressed on two levels, individual and community-based. On the individual level, Future Farmers of America groups are working directly with participants to implement simple, practical safety projects, such as preparing and selling tractor first aid kits or distributing lists of emergency phone numbers. An example of community-level action carried out was a CPR workshop requested by farm families after they received the report of the Walkabout data and arranged by local health professionals. Post-testing to assess behavior changes will be carried out in June of 1991. Evaluation of the efficacy of this community-oriented program will be completed by the fall of 1991.

## **TRACTOR STABILITY: HOW STEEP IS TOO STEEP?**

*By Jill Hudson, Charles Schwab, Ph.D.*  
Iowa State University, Ames, Iowa



Tractor-related fatalities in Iowa account for approximately 41 percent of the total fatalities recorded during 1988 through 1990. During 1991, fifty-two percent of all tractor fatalities recorded in Iowa during 1990 resulted from side overturns. These state figures coincide with national statistics, making tractor overturns a major agent of death for agricultural workers. What slope is too steep for safe operation of a tractor becomes an important issue. Static stability of farm tractors in side overturns on sloped terrain can be determined from the Static Lateral Critical Angle (SLCA). The SLCA was calculated for approximately 700 two-wheeldrive models using the center of mass and geometry of the tractor. The SLCA was plotted with respect to the horsepower capacity of the tractors. The influence of different attachments on the SLCA was examined. The effect that a front-end loader carrying a hay bale at different elevations had on the SLCA were determined. Changes of the SLCA with respect to horsepower requirements were developed for the different attachments investigated. Understanding the influence that attachments have on the SLCA provides background information required for a proactive assessment of potential tractor side overturn hazards.



## **PESTICIDE SAFETY FOR RURAL FARM YOUTH**

*By Nancy Jenson, Wendy Wintersteen*  
Pocahontas County Extension



Spraying weeds with herbicides while riding on a tractor-propelled platform or bean-bar is a common summer job for many rural youths in the Midwest. However, bean-bar riders are exposed to more than the sun; they are also exposed to the herbicide spray. A study conducted by *Successful Farming* magazine indicated that virtually all bean-bar riders are contaminated with herbicide after 2 hours of spraying. Herbicide exposure can result in adverse health effects such as eye and skin damage and the possibility of future health problems. The severity of these effects depends on the type and concentration of the herbicide and the area and amount of exposure. To educate rural youth about herbicide dangers, Iowa State University Cooperative Extension staff conducted an extensive bean-bar education program in Calhoun and Pocahontas counties. In cooperation with the local public health department, copies of an Extension bulletin, *Bean-Bar Facts and Safety Tips* were distributed to 4,000 students in 14 school districts. In addition, a slide set on bean-bar safety was developed and presented by Extension personnel at several programs. Rural youths are taught that bean-bar spraying can be relatively safe when certain precautions are taken. Wearing rubber gloves, shoes, jeans and a long-sleeved shirt were emphasized as adequate protection for bean-bar riders in most cases. Goggles, rubber gloves, and Tyvek disposable coveralls will offer the maximum protection. In case of an emergency, youth were told to flush out irritated eyes or to rinse skin with large amounts of water. After work, all bean-bar riders should shower with soap and water. Bean-bar riders were cautioned against "horsing around" and inadvertently spraying themselves or others with herbicide. And finally, youth learned to refuse to spray until all the equipment was safe to operate.

## **IOWA AGRICULTURAL INJURY SURVEILLANCE**

*By Shirley K. Jones, B.S.N., M.P.H.*  
Iowa Department of Public Health, Des Moines, Iowa



Acute agricultural injury is recognized by the National Safety Council as occurring at a rate of nearly five times the rate for all industry. Iowa's Sentinel Project Researching Agricultural Injury Notification Systems (SPRAINS) Project, funded by CDC/CEHIC, has established a statewide surveillance system to study acute agriculture-related injury. The project now in its second year uses reports from designated hospital sentinel reporters and from other volunteer health care providers and seeks to identify the multiple factor relationships which occur in acute injuries subsequent to agriculture activity. More than 2,100 acute injuries, including 83 deaths, occurred and were reported in 1990. Information characterizing these injuries from the first year of study will be presented in our display. Injury is increasingly being recognized as a high priority public health problem. Continuing analysis of this data will enable the design of activities that can be specifically targeted to decreasing the frequency and severity of these injuries.

## AGRICULTURAL RESPIRATORY HAZARDS EDUCATION SERIES



By *Bonnie J. Kay, R.N., B.S.N.*  
American Lung Association of Iowa, Des Moines, Iowa

The *Agricultural Respiratory Hazards Education Series* (ARHES) was produced in 1986 by the American Lung Association of Iowa (ALAI) in response to a profound lack of comprehensive material addressing the lung health risks associated with agriculture. The series was developed in collaboration with the University of Iowa's Institute of Agricultural Medicine and Occupational Health and Iowa State University Extension. It consists of an introduction and a nine unit set for health professionals and a nine unit companion set for agricultural and community workers. Each unit is designed to stand alone. Each addresses a different lung hazard commonly found in agriculture. The series provides an excellent cornerstone for community education programs. The materials have been used by extension services and lung associations across the country. Rural hospitals have used the series for community programs, as have Farm Bureau Federations, 4-H, and FFA youth groups, health fairs, producer groups and farm safety organizations. Programs for physicians, nurses, and respiratory therapists have been very successful and have generated much interest. The ALAI has a slide/tape presentation which accompanies the series and provides a good discussion tool. It has also developed a promotional kit for other organizations and lung associations to use. The kit includes press releases timed to seasonal tasks and hazards, public service announcements, public service ads, sample program outlines, and accompanying letters. A new tabletop display which addresses proper selection and use of respirators is now available for groups to use. The nature of the education series allows each user to tailor the program to the specific need. It can be provided at the community level, directed by local healthcare providers or extension personnel, or used strictly by the individual. Cost is minimal. An opportunity to display in the project showcase will permit others to see how the ARHES can complement their programs. We would provide a display presentation.

## **INNOVATIONS AND PERCEPTIONS OF AGRICULTURAL SAFETY STUDENTS**



*By C.J. Lehtola, M.S.*  
Iowa State University, Ames, Iowa

People involved in agriculture recognize agricultural safety as a present-day vital concern. Farmers, agribusiness employees, and extension personnel expressed the desire and need to learn more about farm safety. Many of these individuals are employed full-time and unable to attend conventional campus classes. A class in agricultural safety was offered as an off-campus program for these adult undergraduate and graduate-level students as a solution. The course was conducted using 13 2-hour video segments and 2 all-day, on-campus sessions. A total of 68 students (ages 22-62) participated in the first class that was offered. Students were required to identify hazards at their farm or workplace and develop a solution to eliminate hazards. Many found it effective to conduct the hazard identification by video camera. Many innovative solutions were developed and presented by the students. Farm safety issues included licensing of tractor operators on public roadways, child endangerment, babysitting services, regulations, disability awareness and the responsibility of manufacturers. Their awareness of safety was increased, as well as the recognition of the complexities involved in farm safety. This course proved applicable and valuable to the participants. Measurement of the accidents that were prevented as a result of their involvement, innovation and increased awareness is impossible, but the participants responded favorably to the class and many students plan to promote farm safety in their communities.

## AGRICULTURAL CHEMICALS: ACUTE AND CHRONIC EXPOSURES



By Linda L. Leverenz, M.S., C.H.E.S., Patricia Price, D.O.  
University of Iowa, Iowa City, Iowa

The Agency for Toxic Substances and Disease Registry (ATSDR) has recognized the need for educating health professionals throughout the nation on the importance of properly diagnosing and treating various environmental illnesses. To assist in meeting this need, ATSDR has provided funding through the Iowa Department of Public Health to the University of Iowa for the development of a 2-hour physician education program entitled, *"Agricultural Chemicals: Acute and Chronic Exposures"*. It has been estimated that this program has reached approximately 52 percent of the physicians in the state of Iowa. Agricultural chemicals are used in every aspect of daily life. Pesticides control insects in agricultural settings, destructive moths and beetles in forests, and garden and household pests. Other chemicals eliminate weeds, serve as preservatives in wood products, and are used as fertilizers. The widespread use of these chemicals often results in overexposures that may cause "flu-like" symptoms and are somewhat difficult to diagnose. Major effects on human health may result in acute systemic poisoning; skin, eye, and nose irritation; dermal sensitization; pulmonary damage; and, to a lesser extent, chronic damage to the kidney, liver, and central nervous system. Objectives of this program are to provide information that will assist physicians in: 1) identifying pesticides that are responsible for acute and chronic health effects; 2) establishing clinical diagnostic and treatment protocols; and 3) offering their patients methods for preventing pesticide poisonings.

## PREVALENCE OF ANTIBODIES TO ENVIRONMENTAL FUNGI IN THE SERA OF SWINE CONFINEMENT



By Daniel M. Lewis, Ph.D., Tori A. Bledsoe, Amy Stasny, Lisa Nicklow  
Immunology Section, NIOSH, Morgantown, West Virginia  
Kelley Donham, D.V.M.

Institute of Agricultural and Occupational Health, University of Iowa, Iowa City, Iowa

As part of an epidemiological analysis of the respiratory hazards associated with working in swine-confinement facilities, we obtained serum samples from 292 persons who either work in swine-confinement facilities, farmers not engaged in swine production, or age-matched, non-farm workers. Environmental analyses of swine confinement facilities revealed six species of fungi were the predominant fungal isolates in these facilities. The sera were assayed for precipitating antibodies (IgG) by counterimmuno-electrophoresis (CIEP) and reagenic antibodies (IgE) by a radioallergosorbent test (RAST) to extracts of the fungal isolates. The fungal isolates were *Scopulariopsis sp.*, *Penicillium sp.*, *Cladosporium sp.*, *Mucor sp.*, *Aspergillus ochraceous.*, and *Aspergillus flavum*. Only two of the serum samples contained precipitating antibodies and both were reactive with the *Mucor sp.* isolate. In contrast, 46 of the 292 sera (15.7%) contained IgE antibodies to one or more of the fungal isolates. These results will be presented and discussed with respect to the exposure status of the workers, but the preliminary analysis indicates that IgE antibodies may be a more sensitive marker of exposure to these microorganisms than precipitating antibodies.

## HEALTH SURVEILLANCE ACTIVITIES OF A VETERINARY DIAGNOSTIC LABORATORY



*By Gary D. Osweiler, D.V.M., M.S., Ph.D.*  
Iowa State University, Ames, Iowa

Food and companion animals are often exposed more directly to environmental chemicals than are humans, and may serve as sentinels of potential health effects in humans. Recently, the National Academy of Sciences has recognized and reinforced this idea. Prompt investigation of animal losses or illnesses may determine that a poisoning has occurred and allow preventive measures before they become widespread in humans or the environment. In some circumstances, animals studied at questionable locations, such as hazardous waste sites or industrial locations, may provide early clues well before human problems become apparent. Toxic effects of chemicals may alter functions of cells, cause morphologic changes, or act on individual cellular components important to the immune system. Veterinary diagnostic laboratories are an important link in the assessment of potential human problems of toxicosis, immune dysfunction and carcinogenesis by their ability to evaluate immune function in exposed animals, as well as correlate the morphologic effects and concentration of chemicals that result from exposure to pollutants in the environment of both animals and man. The Iowa State University Veterinary Diagnostic Laboratory has evaluated numerous potential human problems by monitoring key effects in animals at risk. Some of these problems include lead poisoning, organophosphate toxicosis, dioxin hazards in wood preservatives, water quality, aflatoxicosis, and therapeutic drugs. Details and significance of these activities relative to human health will be discussed.

## **IOWA FARM FAMILY HEALTH AND HAZARD SURVEILLANCE PROJECT**



*By William J. Pependorf, Ph.D.*  
University of Iowa, Iowa City, Iowa

Agriculture is now recognized as the most hazardous workplace in America. Yet agriculture lags behind general industry in the application of the traditional preventive phases of recognition, evaluation and control of health (and safety) hazards. The dilemma of agriculture as both an industry and a way of life contributes not only to this lag but also influences the design and approach of a successful health survey of an agricultural population. The aims and approach of the National Institute for Occupational Safety and Health [NIOSH] funded Iowa Farm Family Health and Hazard Surveillance Project are:

1. To determine the retrospective distribution of farming practices, medical symptoms, and traumatic injuries from a randomly selected cohort of farming families using a mailed survey questionnaire to a population-based, random cohort on about 500 farms.
2. To record temporal exposure to environmental and biomechanical/ergonomic factors likely to contribute to work-related illness or injuries by on-farm observations of a sub-cohort of these farming families.
3. To measure the levels of exposure to a small number of selected low-frequency, high-hazard agents or processes likely to contribute to work-related illness using traditional quantitative industrial hygiene assessment techniques.

Data collected in this survey will provide the basis for future investigative agricultural health and safety efforts in several directions. The health status data will comprise the first systematic, representative view of the health of American farmers and farm families. Hazard data will provide not only a statistical distribution of risk factors within this population, it will also contain a basis upon which to estimate the time or frequency of being "at-risk," yielding new insight into interpreting accident, injury and fatality data collected in these and other studies. Additionally, these data will be used to develop specific recommendations for modifications of tools, machinery, work methods and buildings which will reduce work-related injuries among this segment of the population.

## **IOWA STATE UNIVERSITY: RESEARCH AND INFORMATION FOR SAFETY AND HEALTH**



*By August Ralston*  
Iowa State University, Ames, Iowa

Illustrated are the research undertaken and information and services provided by the Cooperative Extension Service (CES) at Iowa State University in the area of agricultural safety and health. The structure of the CES including 4-H, and how farm families and workers and safety and health professionals can access information from the CES are explained. Research/information topics covered are clothing contamination by chemicals, application of chemicals, household use of pesticides, rollover protective structures, quality of water supply, carbon monoxide spillage from heating equipment, air quality and respiratory illness, design of confinement buildings, machinery design, and tractor stability.

## **AGRICULTURAL HEALTH PROMOTION SYSTEMS: OBJECTIVES AND PROGRAMS IN IOWA**



*By August Ralston*  
Iowa State University, Ames, Iowa

Illustrated are the objectives and plan of action under the Agricultural Health Promotion Systems (AHPS) cooperative agreement between NIOSH and Iowa State University. Efforts to enhance the capability of professional extension staff as interveners for occupational safety and health, to build a network among public health agencies, volunteer groups, and cooperative extension, to cooperate with the Center for Agricultural Research, Education, and Disease and Injury Prevention at the University of Iowa, and to improve the formal occupational safety and health college curriculum are explained. Examples are provided of the likely impact of the AHPS cooperative effort on educational programs and intervention techniques and networks that are aimed at reducing the occupational hazards and exposures faced by farm families and workers.



## **RURAL YOUTH DISABILITY PROJECT**

*By Angie Reynolds, R.D.H., B.S.*  
Iowa Department of Public Health, Des Moines, Iowa



Health and safety are major problems in agriculture. When a farm injury results in a child affected by a disability, the rural community is impacted socially and economically. Farm injuries and the resulting disabilities consequently become a major public health problem. The Rural Youth Disability Prevention Project focuses on increasing community awareness and ownership of the farm-child injury problem. This is a necessary focus for any effective and on-going *community-based* prevention strategy. The project is owned, operated, and directed by the community with technical assistance provided by the Office of Disability Prevention and the University of Iowa Hospital and Clinics. These community prevention projects have been implemented by the Disability Prevention Program. Each project is operated locally and focuses on unique disability risk factors. The project sites are located in Marshalltown, Spencer, and Harlan. These communities were selected due to their affiliation with the Iowa Agricultural Health and Safety Service Project (IA-HASSP). The IA-HASSP project also serves to focus community awareness, ownership, and cooperative efforts in reducing farm-related health and safety hazards. The goal of this project is to demonstrate that disabilities of rural youth can be reduced through concerted community-wide efforts. Three major activities conducted include:

- Community survey of existing safety knowledge, attitudes, behavior and near-miss injuries.
- Farm family hazard analysis ("Walkabouts").
- Community Involvement Injury Control Workshop.

Special emphasis is placed on the development of effective community prevention strategies which involve organizing broad community influence and support. To accomplish this, the project will promote active collaboration between multiple disciplines, agencies, and businesses in the projects.

## **CLEAN AIR FILTER FOR TRACTORS**

*By Mike Schmitz, Eugene Ahrenholtz*  
Defiance, Iowa



Workers exposed to chemical fumes inside their cabs are reported to have headaches, nausea, and sickness as a result of these fumes. It seems the tractor cab filtration systems are not designed to filter chemical fumes. The authors researched and developed a design for an air filter that reduces chemical fumes and particulate matter in the tractor cab. They suggest this filter should be added to gloves, goggles and other protective equipment used when applying pesticides and herbicides. The clean air filter has a three-stage design. Stage one is a paper media that removes dust. Stage two is an activated carbon that adsorbs organic vapors. Stage three is a final filter which prevents carbon dust infiltration. The filter is patent-pending, but as yet untested by a large research company. Many farmers in Iowa are already using the product regardless of lack of testing, and say it does significantly reduce the chemical fume leakage into the tractor cab. The authors would like to work with a research company to test the product.

## IOWA'S BEHAVIORAL RISK FACTOR SURVEILLANCE SYSTEM



By Susan Schoon, R.D., L.D.  
Iowa Department of Public Health, Des Moines, Iowa

The Iowa Department of Public Health (IDPH) has identified cardiovascular disease as the number one health problem in Iowa. Data from death certificates and other sources show the annualized 1984-86 mortality rate from ischemic heart disease is 253 per 100,000 population as compared to the national rate of 217 per 100,000 population. How do Iowans rate with their lifestyle behaviors? The Behavioral Risk Factor Surveillance System (BRFSS) is providing some answers. Data Collection--The goal of the BRFSS is to provide data to identify health promotion and disease prevention priorities for the public and private sectors of Iowa. Specific objectives are to determine the state-specific prevalence of personal health behaviors related to the leading causes of premature death and to advance the understanding that health-related behaviors are critical indices of health. Interview Process--The telephone interview process uses a modified random digit dialing and random selection of adults over 18 from the household. One hundred fifty interviews are conducted each month, totaling 1,800 interviews a year. There are currently 47 states using the 77 core questions developed at the Centers for Disease Control. 1989 Behavioral Health Risks of Iowans:

- Cholesterol - 57.6 percent reported having their cholesterol checked at least once.
- Hypertension - 15.8 percent had been told by a doctor or health professional they have high blood pressure.
- Exercise - 28.1 percent reported more than 20 minutes, 3 times a week of leisure-time physical activity.
- Binge or acute drinking - 16.6 percent of the respondents reported having 5 or more drinks on an occasion, one or more times in the past month.
- Seat belt use - 76.2 percent of those surveyed reported using a seat belt always or nearly always.
- Overweight - 25.3 percent based on body mass index.
- Smoking - 22.7 percent reported they now smoke.

## OVERTURNING PERCEPTIONS OF TRACTOR OVERTURN HAZARDS



*By Charles V. Schwab, Ph.D.*  
Iowa State University, Ames, Iowa

Tractor-related fatalities in Iowa account for approximately 41 percent of the total fatalities recorded during 1988 through 1990. The National Safety Council identifies tractors as a major agent for death of agricultural workers. Overturns, runovers, and power-take-offs (PTOs) are a few specific examples of different dangers associated with tractor operations. Elevation of agricultural workers' awareness for tractor overturn hazards is accomplished by an interactive display. A table-top terrain and remote-controlled tractor operated by 4-H youth graphically illustrate the overturn hazards. Improper and proper responses to situations when a tractor wheel slips off the road are performed. Demonstrations of safe ascension of tractors on sloped ground is shown. The success and effectiveness of this educational and intervention display results from several factors. The high level of interaction is one factor. Participants view a dynamic model of a real life situation, while a narrative explains the significant details. The presenter disarms the audience because the 4-H youth do not represent authoritative figures stating guidelines, common procedures, and regulations. The display *"Drive Head over Wheels"* is an effective and popular display that promotes tractor safety and elevates the level of awareness for tractor overturn hazards.

## PESTICIDE RESIDUES IN A MIDWESTERN FARMER'S COVERALLS

By Janis F. Stone, Ph.D., H. Michael Stahr, Ph.D.  
Iowa State University, Ames, Iowa



Careful use and management of clothing can assist in minimizing exposure to crop chemicals and contribute to the farm worker's health and safety. This research concerns protective cotton coveralls actually worn during corn and soybean production. An Iowa farm family cooperated in this case study and provided used coveralls that had been worn for four crop seasons and laundered after every wearing during application of many thousands of pounds of eight different pesticides. Samples were cut from the lower leg, thigh, crotch, shoulders, sleeves, pockets, collar and waistband of the coveralls, both front and back, totaling 40. Each was separately extracted using ethyl acetate with 5 minutes of shaking and 16 hours standing. The solvent was analyzed for Treflane by electron capture GLC. After the EC analysis, samples were concentrated and analyzed for organophosphorus pesticides. All samples were quantified by two replicate systems. Standards were run after every five sample injections. Every fifth sample was amended with a mixture of the six pesticides anticipated to be present (because the owner had reported using them). Quantitative analyses for these were made; 90-100 percent recovery was obtained of the added pesticides. The pesticide deposition per square centimeter ( $\text{cm}^2$ ) of fabric for each sample was separately calculated based on the  $\text{cm}^2$  size of the extracted sample. The farmer was reported to be in good health, but his coveralls contained unexpected levels of five pesticides. Residues of pesticides used only in the first season that the coveralls were worn remained in them at the time they were retired, despite laundering after every wearing. Garment areas (pockets, waistband) frequently touched by hands seemed to have higher contamination levels. Measurable amounts of Treflane, Lorsbane and Counter were found in all samples of the coveralls, but no Lasso/Atrazine was detected. This could be explained by the latter's known solubility in water. A few samples contained Thimete and Dyfonate, although they had been used only in the first and second crop seasons, respectively. Residues released in the first extraction of lower leg samples ranged from 0.2  $\text{ng}/\text{cm}^2$  of Dyfonate and 0.5  $\text{ng}/\text{cm}^2$  of Thimete to 4.9  $\text{ng}/\text{cm}^2$  of Treflane and 7.3  $\text{ng}/\text{cm}^2$  of Lorsbane. Sleeve cuffs showed 14.0  $\text{ng}/\text{cm}^2$  Treflane, 91.9  $\text{ng}/\text{cm}^2$  Lorsban, and 10.5  $\text{ng}/\text{cm}^2$  Counter. A second extraction from selected samples from the lower leg, abdomen, shoulders, chest pocket, sleeve and cuff proved that pesticides had not been exhausted from the fabric by the first extraction. Dyfonate and Thimet appeared in a few samples with the second extraction that had not appeared with the first extraction. Two samples selected for a third extraction produced about 30 percent additional pesticide. Although original contamination levels were unknown, this study shows the difficulty of removal of pesticides from a textile matrix and suggests that work based on a single extraction may underestimate the amount of pesticide present. It also underscores the importance of dosimeter materials in affecting results of exposure studies. The residues per  $\text{cm}^2$  seem small, but the total garment load must be considered. The health risk associated with chemicals so firmly bound in cloth is uncertain, especially when other clothing layers are worn beneath. Laundering after every wearing does not seem to completely clean pesticides from clothes in real-life minimum exposure situations of corn and soybean farming, but many studies have previously indicated that laundering greatly reduces pesticide residues. The persistence of Thimet and Dyfonate(s) which were used four and three years before this analysis, respectively, was unexpected. Cotton coveralls offer several advantages over disposables that are expensive, cannot be decontaminated, contribute to hazardous-waste problems, and are often too hot for comfort. This work suggests that it may be wise to replace cotton coveralls each crop season to prevent residue buildup.

## ASSESSMENT OF BIOAEROSOL EXPOSURES IN GRAIN AND DRY VEGETABLE HANDLERS



By Peter S. Thorne, M.S., Ph.D., Sue Ellen Hosch, Janet L. Watt, David A. Schwartz  
University of Iowa, Iowa City, Iowa

Workers exposed to grain and dry vegetable dust are reported to experience airway inflammation and progressive airflow obstruction. A population-based, longitudinal study was undertaken to determine the association of specific workplace exposures with pulmonary changes in grain handlers. A unique component of this study is the quantification of airborne levels of fungi, total bacteria, gram negative bacteria and thermophilic organisms. In addition, total and respirable dust, endotoxin levels, and other environmental parameters will be assessed for approximately 400 workers on three occasions over 5 years. At the outset, a survey was sent to 669 operating grain facilities in eastern Iowa. Completed surveys were received from 80 percent which illustrated the high degree of cooperation from these mixed grain, corn and soybean facilities. The mean number of production employees was 7.7 (range: 1 to 800) and employees numbered five or less in 71 percent of these sites. In the first two quarters of the study, exposure assessments and respiratory health evaluations were performed on 185 workers at 50 sites. Levels of indoor airborne fungi averaged 600 CFU/m<sup>3</sup> for postal workers, who serve as our control population, while grain facilities averaged in excess of 20,000 CFU/m<sup>3</sup>. Airborne bacteria were generally twofold higher than fungi with 23 percent of the grain sites exceeding 1 x 10<sup>5</sup> CFU/m<sup>3</sup>. Thermophilic microbes averaged 200 CFU/m<sup>3</sup> in postal stations but were 10 to 40 times higher at grain sites, and gram negative bacteria at grain sites averaged 4000 CFU/m<sup>3</sup>. For all types of microbes, levels appear to be highest at mixed grain facilities. Microbial counts were split approximately evenly between respirable and non-respirable sizes. These data indicate that microbial exposure levels cover a broad range. Moreover, the range of exposure levels will enhance our ability to test our hypothesis that pulmonary function deficits are exposure dependent. (Funded by the Veterans Administration Merit Review and NIEHS ES00202).

## DEVELOPMENT OF AN INHALATION TOXICOLOGICAL MODEL FOR FARMER'S LUNG



By Peter S. Thorne, M.S., Ph.D., Susan D. Kaliszewski  
University of Iowa, Iowa City, Iowa

Farmers inhale a complex mixture of xenobiotics that includes respiratory irritants, microbial toxins, nuisance dust and a multitude of aeroallergens derived from plants, animals, arthropods, and microbes. Farmer's Lung is an extrinsic allergic alveolitis characterized by lymphocytic and granulomatous interstitial lesions. It is most often associated with exposure to the thermophilic spore-forming bacterium, *Faeni rectivirgula* (*M. faeni*), found in moldy hay. In order to study the pulmonary immunologic processes associated with the early stages of this disease, we undertook to develop murine and guinea pig models of Farmer's Lung using inhalation exposure. Large quantities of pure *M. faeni* were grown in tryptic soy broth at 50°C, then washed and concentrated. Aerosols of a homogenate of this *M. faeni* preparation were generated into exposure chambers using a PITT#1 nebulizer. This procedure allowed generation of atmospheres containing up to 8 mg/m<sup>3</sup> pure *M. faeni*. Two exposure systems allowed inhalation challenge to either mice or guinea pigs with responses determined from histopathology, immunochemistry and pulmonary function evaluations. In one such study, mice inhaled *M. faeni* aerosols (5.7 ± 1.7 mg/m<sup>3</sup>) for 30 min, once each week. Three groups of 10 mice received either 4 or 8 exposures or were sham exposed, and each group consisted of 5 animals fed a standard diet and 5 fed a diet containing a stimulant of delayed hypersensitivity responses (vitamin A). Histopathological examination of the mouse lungs demonstrated marked perivascular and peribronchiolar histiocytosis, localized acute inflammatory cells, fibrosis, and giant cells in granulomatous lesions in the mice fed the vit. A-supplemented diet and exposed on 4 occasions. Other treatments resulted in mice with less severe responses. Inhalation exposures of guinea pigs in plethysmography will incorporate measurement of bronchoconstriction, airway hyperreactivity and immunochemistry into the model. This appears to be the first animal model to demonstrate Farmer's Lung solely by the inhalation route of exposure.

## **FARM FAMILY REHABILITATION MANAGEMENT PROGRAM (FaRM)**



*By Therese M. Willkomm, M.S.*  
Iowa Easter Seal (FaRM) Program, Des Moines, Iowa

There are more than 45,000 Iowa farm families who have been affected by permanent disabling accidents, injuries, or illnesses. Until recently, many farm families were forced to prematurely discontinue this rural way of life or attempt to farm with a disability that often resulted in secondary injuries. In 1986, the Iowa Easter Seal Farm Family Rehabilitation Management (FaRM) Program was developed to address the needs of this "at risk" population. The FaRM Program provides onsite rural rehabilitation services to farm families affected by disabilities. These services promote return to farming, the community, and increased independence by both the disabled individual and family members through adaptive equipment, modifications to the farm and home, secondary injury prevention education, and community support services. The success of this program has been recognized nationwide as an innovative and grassroots service delivery program. In November of 1990, President Bush signed the Farm Bill which included an amendment to establish programs in other states that will assist farmers with disabilities based on the successful Iowa FaRM Program. The Iowa Easter Seal FaRM Program relies heavily on its cooperative agreements, coalitions, contracts, and networking with the following organizations: The Farm Bureau, Pork Producers, Cattleman's Association, and other community organizations to assist in identifying individuals with disabilities and providing assistive technology services; Iowa State University Agricultural Engineering Program to assist in designing agricultural work site adaptations; the University of Iowa Ag-Medicine Program and the Iowa Program for Assistive Technology to assist in injury-prevention activities, statewide awareness, and direct service delivery; State Vocational Rehabilitation, rehabilitation hospitals, and The Department of Public Health to assist in referrals and funding of services. In addition, the FaRM Program utilizes: a statewide ingenuity network comprised of volunteers who assist in obtaining, designing, and fabricating rural assistive technologies; a peer technology support network comprised of individuals with disabilities who share their experiences with individuals who are newly disabled; and an on-site Mobile Rural Assistive Technology Unit.



## **EDUCATING IOWA FARMERS ABOUT PESTICIDE SAFETY AND HEALTH RISKS**



*By Wendy K. Wintersteen, Ph.D.*  
Iowa State University, Ames, Iowa

Minimizing the health risk inherent in pesticide application is a major goal of the Pesticide Applicator Training (PAT) program. In the past three years, more than 40,000 Iowa farmers attended a 4-hour training session on the health and safety concerns associated with pesticides. Although pesticides are toxic, the health risk they pose can be significantly reduced by practices that limit exposure. The Iowa State Cooperative Extension Service PAT program seeks to reduce harmful health effects by alerting farmers to the exact toxic nature of pesticides, and strategies to minimize pesticide exposure. When handling pesticides, farmers are cautioned to read the pesticide label and wear the suggested protective clothing. Neoprene or nitrile gloves, goggles or face shields, rubber aprons or coated Tyvek disposable suits are items that can dramatically decrease pesticide exposure and limit harmful health effects. Farmers are also taught to re-enter sprayed fields only after a safe interval and methods to reduce pesticide drift on themselves and their neighbors. Pesticide poisoning symptoms and exposure routes receive considerable attention as well. Recognizing pesticide poisoning symptoms for each class of pesticides, and responding with the proper first aid and medical treatment is essential farm safety knowledge. Program evaluations have been very favorable and participants have adopted safer pesticide-handling practices as a result of attending the program. A post-training survey of 1,040 applicators asked respondents if they would change their farming practices as a result of attending the training program. The response choices were: likely, not likely, or not sure. As a result of attending the training sessions, 91 percent said they would check pesticide labels for signal words indicating product toxicity. Also, 87 percent thought they would increase their use of protective equipment, such as gloves, goggles, and coveralls.

## **THE AGRICULTURAL SAFETY AND HEALTH PROMOTION PROGRAM FOR OLDER KANSANS**



*By Marvin Hachmeister*  
Kansas State University, Manhattan, Kansas

The Agricultural Safety and Health Promotion Program for Older Kansans was launched this year in an effort to communicate safety information to farmers who may not have been reached successfully in the past. To this end, we are taking a slightly different approach in our outreach than that of previous safety programs. Since farmers' past attendance at seminars and meetings focused specifically on safety has been disappointing, we are attempting to communicate our safety message by taking advantage of already existing community forums. In each of Kansas' 105 counties, we are recruiting and training a team of volunteers who will make brief, 7-to-10-minute presentations on various safety topics to community gatherings such as Extension meetings, Farm Bureau meetings, seed and fertilizer sale days, church events, and meetings of local service organizations. Each team of volunteers is backed up by a support team consisting of the county Extension agents, the county Farm Bureau safety chairperson, and the county health director or local representative of the Area Agency on Aging. The volunteers will base their presentations on a series of 4-page tabloids dealing with the following seven topics:

- Tractor Safety.
- Pesticide application and farm chemical handling.
- Farm machinery (other than tractors).
- Farm vehicles (trucks, wagons, ATVs, etc.).
- Livestock safety.
- Health issues.
- Farmstead safety (electrical hazards, grain bins, manure pits).

Volunteers will be provided with lesson plans containing suggestions for conducting the presentations, although volunteers are encouraged to be original and to use their personal knowledge and experience in formulating their own approach to their audience. Volunteers will distribute the tabloids at each of the meetings at which they make presentations. To further broaden our audience, the project will include production of a series of eight videotapes, one on each of the above topics, plus an additional video dealing with the aging process and how it relates to farm work. The project also involves incorporating units on safety into college agricultural courses and holding an annual Agricultural Engineering Safety Design Contest for college students.

## **RISK OF EXPOSURE TO CRYPTOSPORIDIUM AMONG FARMERS IN WISCONSIN**



*By Eugene J. Lengerich, V.M.D., D. Addiss, D. Juranek  
Centers for Disease Control, Atlanta, Georgia  
J. Marx*

*Marshfield Medical Research Foundation, Wisconsin  
B. Ungar*

*Uniformed Services University of the Health Sciences, Bethesda, Maryland*

*Cryptosporidium* infection is an important cause of diarrhea in humans and domestic animals; no effective therapy is known. Because the livelihood of farmers often requires contact with potentially infected animals, farmers may be at greater risk for *Cryptosporidium* exposure and disease than non-farmers. We used an enzyme-linked immunosorbent assay to determine the serologic status of current farmers, ex-farmers, and persons who never farmed in a cohort of 116 Wisconsin men. Of 75 men who reported to be currently farming, 31 (41.3 percent) were seropositive for *Cryptosporidium*, compared with 8 (19.5 percent) of 41 ex-farmers and never-farmers (odds ratio = 2.9, 95 percent confidence interval 1.1-7.9). After leaving the occupation of farming, ex-farmers experienced a decrease in seropositivity ( $p = 0.06$ ). These findings suggest that current farmers are at greater risk of *Cryptosporidium* infection than are ex-farmers and persons who never farmed. Additional work is needed to define high-risk farming activities and determine modes of transmission in the farm setting so that farmers can take effective measures to prevent this potentially serious disease.

## NON-HODGKIN'S LYMPHOMA ASSOCIATED WITH THE AGRICULTURAL USE OF HERBICIDES



By Dennis D. Weisenburger, M.D., S. Zahm, M. Ward, P. Babbitt, F. Holmes  
C. Boysen, R. Robel, R. Saal, J. Vaught, K. Cantor, A. Blair  
University of Nebraska, Omaha, University of Kansas, Kansas City  
National Cancer Institute, Bethesda, Maryland

Recent epidemiologic case-control studies in Kansas and Nebraska have shown that agricultural herbicide use, particularly that of 2,4-D, is associated with an increased risk of non-Hodgkin's lymphoma (NHL). To better characterize this risk with regard to histologic type, we combined the results of the two studies (370 male cases, 1,671 controls) using the Working Formulation histologic classification. Among men, the use of herbicides was associated with a 50 percent increased risk of NHL (OR=1.5; 95 percent CI=1.1,2.1), and the use of 2,4-D was associated with a two-fold increased risk (OR=1.9; 95 percent CI=1.3,2.8). Exposure to 2,4-D more than 20 days/year increased the risk more than four-fold (OR=4.5; 95 percent CI=1.1,18.3). Interestingly, increased risks were seen for all ten major histologic types of NHL (categories AJ) in the Working Formulation. The highest risks associated with exposure occurred in intermediate-grade NHL (categories D-G). The use of herbicides was associated with a 70 percent increased risk of intermediate-grade NHL (OR=1.7; 95 percent CI=1.2,2.6), and the use of 2,4-D was associated with a more than two-fold increased risk (OR=2.4; 95 percent CI=1.5,3.9). Exposure to 2,4-D more than 20 days/year increased the risk of intermediate-grade NHL by more than eight-fold (OR=8.3; 95 percent CI=1.7,38.7). Within intermediate-grade NHL, follicular large cell NHL (category D) was the highest risk type with a nearly seven-fold increased risk associated with the use of herbicides (OR=6.7; 95 percent CI=1.4,44.1) and a ten-fold risk associated with the use of 2,4-D (OR=10.0; 95 percent CI=1.9,69.8). We conclude that agricultural herbicide use is associated with an increased risk for all major types of NHL, and for follicular large cell NHL in particular.

## **TRACTOR SAFETY CLASSES FOR YOUTH**

*By Geraldine Smith*

Huron County Health Department, Bad Axe, Michigan



"Farming Safely in the Thumb" is a program serving Huron, Sanilac, and Tuscola Counties of Michigan. It is funded by a grant from the Michigan Department of Labor, Safety Education and Training Division. One of the major events of this program has been the Safe Tractor Operation classes for youth ages 10 years and older in each of the three counties. The 4-H Tractor Operation Program was established in 1970 as a means for youth to receive an exemption from the tractor driving restrictions of the Hazardous Occupations Order. For many years, the training needed by youth to receive this exemption was handled through Vo-Ag programs of local high schools. As a result of the discontinuation of or change in these programs and the concerns of liability, most youth in the "Upper Thumb" of Michigan had no way of earning a "certificate of training." This training has been demonstrated to be very successful in reducing injuries among those youth completing the program. The Safe Tractor Operation classes meet all of the requirements for providing youth 14-15 years of age with the training needed to earn this certificate. At the same time, these classes provide safety education to younger youth when they are beginning to learn to drive tractors. The classes are co-sponsored by "Farming Safely in the Thumb," the county 4-H Council and the county Farm Bureau. They run 7 weeks, meeting 1 night a week for 2 hours. The classes are strictly classroom instruction (there is no practical tractor driving) and are divided by ages (10-12 years and 13 or older). Each youth has a manual, and the instructors make use of slide/tape presentations (available through the Cooperative Extension Service, Michigan State University), safety videos and outside speakers. Every youth receives a 4-H Certificate of Participation and a Tractor Safety T-shirt. The students 14 and 15 years old who wish to earn a "certificate of training" must pass both a written test and a practical driving test. Over 1,000 youth participated in the classes this winter.

## GREEN ISLE PROJECT: MY HEALTH FOR BETTER LIVING

By Linda J. Hachfeld, M.P.H., R.D.  
Wellness Center of Minnesota, Mankato, Minnesota

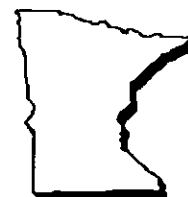

Rarely are there programs that outlive the grants that have given birth to them. Fewer still leave their imprint by serving as a model for a state public health sector. The *My Health for Better Living Project* influenced a rural community and two townships of 1,600 to re-examine their lifestyle to make changes in their eating patterns and exercise habits. The project incorporated the effort of 4-H members, community leaders, parents, schools, and county health professionals to improve the health and well-being of the families in the rural area surrounding and including the Green Isle community in western Minnesota. This project included the development of a health promotion education model that fostered community participation. The specific purpose of the project was to fill a need as expressed by the citizens of the Green Isle rural community and evidenced by the number of overweight children, undernourished elderly, medical complications, and chronic disease cases. Due to the worsening rural economic crisis, rural families were manifesting poor health habits which exacerbated their underlying health concerns. This project is unique because it was spearheaded by concerned youth and their parents. A Health Advisory Committee assisted in translating the ideas into action. The results have been positive. Designed for 1 year, the program has lasted 3! The cost of the programs was done on less than \$8,500 and has involved more than 1,200 hours of volunteer time. Many people have admittedly taken the time to make changes in their eating and exercise habits, positive changes influenced by programs initiated by the Sundown Busy Bees 4-H Club. The programs address several age groups and continue to occur because they either have been integrated into existing establishments or have become self-sustaining. This project has received recognition from the Governor of Minnesota and the U.S. Secretary of Health and Human Services.

## **TEEN STRESS, DEPRESSION, AND SUICIDE**

*By Diane Norland*

Sioux Trails Mental Health Center, New Ulm, Minnesota



According to University of Minnesota researchers, teen stress, depression, and suicide are occurring at high levels. These findings help dispel the notion that childhood is an unbroken, happy, carefree time. To address these issues, Sibley County, Minnesota, set up a Teen Stress Committee to develop an education and intervention program for school personnel, young people, parents, and interested community members. The committee used a program *Tackling Tough Stuff* developed by Joyce Walker, a University of Minnesota Youth Development Specialist. The Teen Stress Committee carried out two trainings of Sibley County school personnel which educated the participants about the prevalence of stress, depression, and suicide among young people. The participants also learned about signs and symptoms. Most importantly, they learned how to help. Selected teachers were recruited and trained in the use of the *Tackling Tough Stuff* curriculum to be used in their classrooms. A Student Assistance Team was recruited and trained in each school to deal with referrals from other school personnel and students. A play about teen depression, suicide and possible responses was performed for the community to raise their awareness about the issues. Several types of parenting workshops have been held twice a year on parenting challenges. Finally, a workshop featuring resources was held for all area professionals, such as school personnel, health professionals, social services, law enforcement, and clergy.

## ROCK COUNTRY WALKS AROUND THE WORLD IN 30 DAYS



*By Gloria Tollefson*  
Rock County Health Service, Luverne, Minnesota  
*Lin Blaskovich*  
Minnesota Department of Health, Minneapolis, Minnesota

Rock Healthy is a community-based health promotion coalition whose mission is to reduce the risk factors of chronic disease through proper nutrition and fitness. The coalition is made up of representatives from food retailers, businesses, county agencies, schools, producer groups, commodity groups, consumers, and the local hospital and medical clinic. The coalition planned and implemented a county-wide program, *Rock County Walks Around the World in 30 Days*. The goals of the program were to: (1) increase awareness of the relationship between exercise and heart health; (2) promote walking as a heart healthy exercise; (3) increase awareness of the available walking sites and trails in Rock County; (4) provide the opportunity for residents to engage in a walking program; and (5) to sign up 1,000 participants. Participants were recruited from the community-at-large, work sites, schools, community groups, and churches. Participants were given a sample walking program, weekly log cards, and exercise tip sheets. Each week walkers turned in their log cards. Miles were added up each week and tracked on a map of the world that was on display at the downtown newspaper office. Rock County has a population of 10,442; its major industry is agriculture and related to businesses. Almost 18 percent ( $n=1,772$ , 805 men and 967 women) of the population participated in the Walking Campaign—walking a total of 43,942 miles. The rural community of Hardwick, population 150, had 50 percent of its residents participate. All the school districts in the county (elementary, junior and senior high) participated for a total of 1,069 school-age children. Rock Healthy Coalition has put together a campaign overview and a media guide (sample ads, stories, etc.) that can be used by other communities.



## NETWORKING THE NEBRASKA SAFETY PROGRAM



*By Rollin D. Schneider*  
University of Nebraska, Lincoln, Nebraska

There are many organizations, groups, and private citizens who are willing to help in delivering a message. Nebraskans are willing to help, if given the opportunity. For the last 30 years, I have been able to use a number of people to tell the safety and health story across the state of Nebraska and some other states within the United States. Foreign countries are not excluded. Altogether, I have over 1,000 people helping me tell the safety and health story. This includes upwards of 375 State Patrol Personnel, Sheriff's Departments, EMTs, County Extension Agents, Vocational Agriculture Instructors, Farm Organizations, etc. This figure is greatly expanded when you consider there are approximately 21,000 Emergency Medical Technicians who carry the story to the local level. After all, it is to their benefit if they can teach about an accident potential in a positive manner rather than having to pick up an injured person. Each state has this cadre of people to work with. It is just a matter of getting the people to understand what is needed and then giving them the facilities or information to work with. There is a segment of the "You scratch my back and I'll scratch yours." If I expect people to help me, they may also want my help at some time. Overall, I use 50 or more organizations or groups to help with the safety and health story. This practice has proven to be very beneficial. Some people I talked to point out they cannot get cooperation. The first question I ask them is, "Did you ask for help?" The answer is usually "No. They did not help someone else I know so they probably will not help me." My reply is, "They are going to either say *yes* or *no*. You don't know which it will be until you ask."

## GRAIN SORGHUM DUST EXTRACT CHALLENGE CAUSES NEUTROPHIL MIGRATION TO THE PERIPHERAL BLOOD, THE UPPER RESPIRATORY TRACT AND THE LOWER RESPIRATORY TRACT



By *Susanna G. Von Essen, M.D., D.P. O'Neill, R.A. Robbins, S.I. Bennard*  
University of Nebraska, Omaha, Nebraska

Inhalation of grain dust is known to cause acute bronchitis symptoms, nasal irritation, and peripheral blood neutrophilia. We proposed that challenge with grain sorghum dust extract (GSDE) causes neutrophils to migrate to both the upper respiratory tract (URT) and lower respiratory tract (LRT). To test this hypothesis, 8 normal non-smoking, non-allergic volunteers were challenged with 24 ml of grain sorghum dust extract delivered to the URT and LRT as an aerosol generated by a Pulmoaid nebulizer. Assessment of the URT and LRT for signs of inflammation was done using nasal lavage (NL) and bronchoscopy with bronchoalveolar lavage. NL performed at baseline and +24 hours was done by instilling 3.5 ml. aliquots of saline which were immediately, forcibly expelled. There were more PMNs at +24 hours than at baseline ( $.29 \pm .09$  vs  $.233 \pm 1.40 \times 10^6$ ,  $p < .1$ ). BAL was performed at +24 hours by instilling 5, 20 ml aliquots of saline followed by gentle aspiration. The returns from the first aliquot were processed as the "bronchial" sample and the remaining BAL fluid was pooled as the "alveolar" sample. There was significantly more PMNs in the "bronchial" and "alveolar" compared to normal controls ("bronchial":  $40 \pm 4$  vs.  $10 \pm 1$  percent,  $p < 0.05$ ; "alveolar":  $46 \pm 7$  vs.  $1 \pm 4$  percent,  $p < 0.05$ ). Although GSDE can attract neutrophils by a variety of mechanisms, an alternative, not mutually exclusive, hypothesis is that neutrophils are stimulated to randomly migrate (chemokinesis). To test this hypothesis, blood neutrophils are collected from the GSDE challenged volunteers at baseline and +7 hours. Neutrophil chemotaxis to GSDE was done with these PMNs using a modified blindwell chamber technique and significantly more PMNs migrated towards GSDE 7 hours after aerosol challenge with GSDE than at baseline ( $126 \pm 7$  vs.  $164 \pm 7$  cells/hps,  $p < .05$ ). These experiments demonstrated that there is a PMN influx into the URT and LRT. This may be explained, at least in part, by increased chemokinesis of the exposed patients' PMNs.

## **MANAGEMENT PROCEDURES TO ENSURE HORSE FARM SAFETY AND TO REDUCE LIABILITY COSTS AND RISK TO OWNERS**



*By Zane R. Helsel, Ph.D.*

Rutgers Cooperative Extension, New Brunswick, New Jersey

Liability costs are a prohibitive factor to horse farm owners and riding instructors to the extent of making it financially unfeasible to remain in business. The objective of this extension educational program was to increase the awareness of horse farm owners and riding instructors of proper farm management and riding techniques that not only ensure personal safety and well-being, but also reduce insurance premiums and risk of lawsuit from liability claims. The program was designed to provide horse farm owners with a model horse farm to assist in meeting standards for farm safety techniques that will serve as evidence they are making a conscious effort to provide a safe atmosphere for themselves, clients, and horses. The model farm and safety techniques are described on videotape and in a series of fact sheets. The agenda for the videotape included: 1) general barn, surrounding acreage and pasture safety; 2) demonstration of what constitutes an "attractive nuisance"; 3) proper storage and care of equipment and outbuildings; and 4) examples of posted signs and considerations for liability coverage. Topics of fact sheets included: 1) safe management techniques while approaching, handling, leading, typing, saddling, and bridling; 2) proper riding safety while mounting, dismounting, and astride; 3) preventive measures for fire safety and what to do in the event of fire; and 4) considerations for liability coverage and examples of hold-harmless agreements. Success of the program was determined by increased awareness of the need for horse farm owners to take a proactive role in reducing farm and instructor liability and demonstrated improved farm safety management practices and riding techniques by horse farm owners in New Jersey. Overall program success will be identified by reduced farm liability premiums and the number of horse farm and riding accidents.

## **A RESPIRATORY AWARENESS PROGRAM FOR NEW YORK FARMERS**



*By Marylee B. Hill, B.S., R.N., John J. May, M.D.*  
New York Center for Agricultural Medicine and Health, Cooperstown, New York

Workers in agriculture are at risk for a variety of occupational respiratory diseases (ORD). To address this problem, we designed an outreach program aimed at heightening the awareness of New York farmers regarding ORD. We elicited information regarding occupational dust exposures as well as respirator use from 431 farmers prior to routine spirometric evaluation at 10 agricultural exhibits. One hundred eighty-one farmers (42 percent) reported using respirators prior to participation in the program. However, further questioning revealed that 118 of these (65 percent) were using handkerchiefs and single-strap masks. Following an explanation of the screening results, a brief review of the risks of ORD, the benefits of dust avoidance, and instruction on the proper use of approved respirators, each participant was given a list of respirator suppliers. Effectiveness of this interventional approach was determined by 6 week follow-up with postcards (55 percent response rate) and with telephone interviews of a 10 percent sub-sample of the non-responders. Follow-up of those not previously reporting use of protection showed current respirator use in 60 percent of the postcard responders and 50 percent of the sample of non-responders for a total weighted average of 54.6 percent improved compliance following the program. There was a prevalence (36 percent) of abnormal spirometric results in those not converting. This prevalence was not significantly different from the 34 percent prevalence found in those converting. Therefore, we concluded that abnormal results were not a predictor of behavioral change. We conclude that this approach is effective in improving respirator compliance among farmers and that this improvement is independent of their spirometric results.

## **FATAL FARM ACCIDENTS IN NEW YORK: CONSEQUENCES AND ECONOMIC IMPACT**



*By Timothy W. Kelsey, Ph.D.*

New York Center for Agricultural Medicine & Health, Cooperstown, New York

Farming is often identified as one of the nation's most hazardous occupations. The National Safety Council estimates that 1,300 people die each year in agricultural accidents. Despite the high fatality rate, there has been only anecdotal evidence about the consequences of fatal farm accidents on farms, farm families, and local communities. Existing analyses considering the impact of farm accidents have primarily been case studies which concentrated on non-fatal accidents. Studies focused on fatal accidents have generally only considered the causes of accidents and to whom they occur. Using information from a previous newspaper clipping and death certificate-based study of fatal farm accidents, 87 families who had a member die in a farm accident in New York between 1985 and 1987 were identified. Fifty-two (60 percent) of these farm families were successfully interviewed by telephone. Income foregone by the accidents was estimated from the responses, using discounted future earnings and weighing by age-based and sex-specific survival probabilities. The discount rate was 5, and was combined with a productivity increase of 2 percent per annum. The net discount rate was thus 3 percent. All calculations were in 1987 dollars. Income foregone included on-farm and off-farm income and the value of household work. Fatal farm accidents cost New York an estimated \$1.3 million a year in lost income. The average present value of lifetime expected income foregone included \$447,157 per male owner, \$472,607 per hired worker, \$268,918 per female owner, and \$514,754 per child killed. The accidents had other costs as well; 67 percent of the families had quit farming entirely, and 44 percent of the families had moved and were no longer living on those farms. The relatively high displacement from agriculture and from homes shows that fatal farm accidents do not just mean the tragic loss of life. These accidents also often have tragic implications for the families' livelihoods and lifestyle. On the other hand, these family tragedies clearly do not overshadow other difficulties in agriculture. With at least 1,000 farms in New York quitting operation every year during this time period, fatal farm accidents were not a major source of farm family displacement. Furthermore, the total value of the income foregone by accidental deaths to farm operators was only equivalent to 1.2 percent of the returns from farming to farm operators in New York, and only 0.48 percent when both on-and off-farm income of farm households in New York is considered. Fatal farm accidents are major tragedies for the affected families, but such accidents' foregone income impacts and displacement are relatively small from a societal perspective.

**NORTH CAROLINA AGRICULTURE: DO WE POSSESS  
THE RIGHT TOOLS FOR HUMAN ILLNESS IN SWINE  
AND POULTRY OPERATIONS AND INJURIES  
FROM AGRICULTURE MACHINES?**



*By Robert L. McLymore, M.S.*  
University of North Carolina, Raleigh, North Carolina

The Agricultural Health Promotion Systems program in North Carolina is addressing the high rate of injury and illness of the agricultural worker. In North Carolina, according to the North Carolina Department of Labor, those involved in agricultural occupations had an occupational rate of 8.3 /100,000 in 1987, compared to the overall incident rate of 7.3. North Carolina State Data Center statistics indicate that of the 48 farm-related fatalities reported in 1988, one-third involved agricultural machinery. Curriculum materials are being developed during the first year for the College of Agriculture and Life Sciences that will educate students about "*Human Illnesses resulting from Swine and Poultry Confinement Facilities,*" and "*Agricultural Machinery Hazards.*" These materials will be presented in the 1991 Fall Semester for both associate and baccalaureate courses at NCSU. In addition, courses at the East Carolina University School of Medicine will benefit from the developed materials. In the second year, eight County Extension Service programs will pilot the developed materials prior to statewide dissemination. The development of a Lay Advisors' Program in the third year of the project will lay the foundations for an ongoing program that will continue to address the health and safety of the agriculture workers. The relationship which exists between East Carolina University School of Medicine, local Extension Services Offices, state and local Health Departments and the agricultural community will become stronger. Through these interactions, a decrease in work-related injuries and illnesses and the promotion of health in agricultural workers and their families should occur in North Carolina.

## **FARM OPERATOR INJURY AND HEALTH STATUS**



*By Michael D. Schulman, Ph.D.*  
North Carolina State University, Raleigh, North Carolina

Panel data from random sample surveys of North Carolina farm operators provide data about injury and health status. Among farm operators who stayed in farming during both survey waves (N-95), 10 percent said they or a member of their family had been injured on the farm seriously enough to miss a day's work, a day of school, or to require a visit to a doctor. Farmers with 200 or more days of on-farm work, those with no off-farm work, those under 45 years of age, and those with high gross farm incomes had the highest injury rates. Seventeen percent of continuing farm operators fell into the poor health category on an index composed of 10 questions about common health problems. Eighteen percent of continuing farm operators reported having a chronic health problem that sometimes interfered with their work. Seven percent of continuing farm operators reported they lacked health insurance. Among farm operators who exited farming (N-198), 7 percent cited health as the most important reason they left farming and 11 percent said they were disabled. Approximately 27 percent of ex-farmers fell into the poor category on the health index and 13 percent lacked health insurance. The results point to the need to consider both the short-term and long-term effects of agricultural hazards on the health status of farmers and ex-farmers.

**THE USE OF PROCESS HAZARD ANALYSIS FOR PREVENTION  
OF INJURIES FROM ANHYDROUS AMMONIA**



*By Amy A. Beasley, B.S.*  
Cincinnati, Ohio

In order to prevent occupational illness and injury, it is desirable to anticipate potential hazards and to proactively implement appropriate preventive measures. One possible tool for doing this is Process Hazard Analysis (PHA). Researchers from the National Institute for Occupational Safety and Health (NIOSH) have applied a form of PHA called Hazard and Operability (HAZOP) analysis to analyze the use of anhydrous ammonia by farmers. Due to the extensive use of anhydrous ammonia, it is particularly important that the equipment, hardware, and procedures be both safe and highly tolerant to potential misuse. The HAZOP analysis involves: a systematic evaluation of the potential failure points that can occur with the equipment and procedures used in anhydrous ammonia storage, transfer, and application; the identification of credible and hazardous accident scenarios; and the identification of practical solutions or of research needs. Specific examples of these findings are given. In the future, we plan to use Process Hazard Analysis in the handling of acutely hazardous pesticides and working with power equipment. Results from these studies will be disseminated and their effectiveness assessed.



## **IGE ANTIBODIES TO SWINE ANTIGENS IN THE SERA OF PORK PROCESSORS**



*By Toni A. Bledsoe, M.S., M.T. (A.S.C.P.), Daniel M. Lewis, Steven W. Lenhart  
NIOSH, Division of Respiratory Disease Studies, Morgantown, West Virginia  
Sherry L. Baron*

NIOSH, Division of Surveillance, Hazard Evaluations and Field Studies, Cincinnati, Ohio

As part of an investigation of respiratory illness among workers at a pork processing facility, we obtained serum samples from 37 workers and bulk samples of substances to which the workers were exposed. The serum samples were analyzed for total IgE content by a commercial radioimmunoassay (PRIST), and for specific IgE antibodies by the radioallergosorbent test (RAST) using extracts of swine urine, serum, blood, and dander coupled to cyanogen bromide-activated cellulose beads. A sample was considered positive if the binding to the antigen-coated beads was at least twice the binding to human serum albumin-coated beads. By this criteria, IgE antibodies to one or more antigens was detected in 28 (75.7 percent) of the sera tested. All 28 sera reacted with the whole blood extract, while 16 reacted with the dander, 10 with the urine, and 8 with the serum. No correlation between the total IgE content and specific IgE antibodies was observed. By questionnaire, 25 of the subjects were symptomatic for respiratory disease; 14 of these subjects had abnormal serial peak flow measurements. The antibody data was analyzed with respect to the symptoms and peak flow finding, and revealed that 9 of 14 (64 percent) symptomatic with abnormal peak flow measurements had IgE antibodies while 10 of 11 (91 percent) of symptomatic with normal peak flow measurement had IgE antibodies. These results demonstrate that pork processing workers develop IgE antibodies to swine antigens, and that antibody activity may correlate with symptoms but not impaired pulmonary function.

**DEVELOPMENT OF AN IMMUNOASSAY METHOD FOR THE  
DETECTION OF ALACHLOR IN AGRICULTURAL WORKERS'  
URINE: CORRELATION WITH A GAS CHROMATOGRAPHIC  
(GC) CHEMICAL METHOD**



*By Raymond E. Biagini, Ph.D.*  
NIOSH, Cincinnati, Ohio

A NIOSH field study of commercial pesticide applicators was conducted to characterize their exposure to alachlor, a major component of Lasso, which is a commonly used pre-emergent herbicide. To assess exposure and estimate uptake of alachlor, worker urine samples were analyzed using two different techniques for alachlor or its metabolites. The first was a published gas chromatographic method for analysis of urinary alachlor metabolites. We also developed an enzyme-linked immunosorbent assay (ELISA) method. The ELISA method is based on the use of antibodies directed against alachlor. The antibodies are also tagged with an enzyme whose reaction products are colored; adding the substrate of the enzyme to the reaction mixture yields varying intensities of color which are related to alachlor concentration. Preliminary results indicate a high correlation between the two methods. Immunochemical technology appears to be a viable alternative to traditional wet chemical and instrumental methods of analyses for assessing exposures in agricultural environments. Benefits of this technology include simpler sample preparation, reduced cost and analysis time, and the potential for onsite field measurements. A detailed description of the ELISA method and the results of the analyses for the field study samples will be presented.

**THE USE OF CONTINUOUS EXPOSURE MONITORING  
COMBINED WITH VIDEO TASK ANALYSIS TO CHARACTERIZE  
AND PREVENT OCCUPATIONAL HAZARDS IN AGRICULTURE**

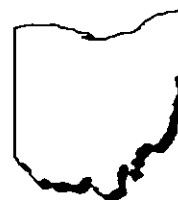

*By James A. Gideon, Ph.D., Mike Gressel, Leroy Mickelsen, M.S.*  
NIOSH, Cincinnati, Ohio

NIOSH researchers have developed a powerful new technique that combines two separate tools for analyzing occupational hazards: videotaping and "real-time" continuous exposure monitoring. The level of hazard exposure can then be superimposed onto the videotape in the form of a moving bar. This permits a simultaneous inspection of individual tasks that are performed during a workday and of the exposures associated with each task. The result is a much clearer understanding of the sources of exposures and the ability to formulate a much more specific intervention strategy. This technique applies to chemical, physical, ergonomic, and any other hazards for which the level of hazard can be continuously monitored. A videotape of industrial processes demonstrating this technique will be available.

## THE OHIO STATE UNIVERSITY NIOSH AGRICULTURAL HEALTH AND SAFETY PROMOTION PROGRAM



*By Timothy J. Lawrence*  
Ohio State University, Columbus, Ohio

Surveys conducted in the state of Ohio in 1982 and again in 1990 indicate the rate of farm accidents remains very high. The 1982 survey showed that nearly one-third (30.2 percent) of all farms surveyed (n=918) experienced a farm-related accident during the 3-year period from 1980 to 1982. The 1990 survey revealed that 15 percent of all farms surveyed (n=574) experienced at least one farm accident during 1989. These data demonstrate that farming in Ohio follows the national trend as being one of the most hazardous occupational pursuits. In an effort to reduce the rate of farm accidents, the Ohio State University is participating in a NIOSH Agricultural Health and Safety Promotion Program. The goal of the project is to improve the health and safety record of the Ohio farming community through a comprehensive educational program. Carefully selected faculty members from the departments of Agricultural Engineering, Family Resources, and Preventive Medicine will work with the Cooperative Extension Service to accomplish this objective. The long-term goal of this program will be to establish an up-to-date information source and a network of individuals to teach farm health, safety, and rescue. The first phase of the program is to assess the Extension agricultural safety and health training, education and informational program needs. This will be accomplished through surveys, accessing additional farm accident data, personal knowledge of the professional faculty and a review of available literature. Current Extension literature will be reviewed and updated. New comprehensive teaching modules will be developed in areas of specific concern in the state of Ohio. These modules will cover such areas as tractor, implement and pesticide safety, and will be targeted to satisfy the needs of vocational education teachers. Working with the Ohio Fire Academy, the program will establish a continuing "Train the Trainer" program for Fire and E.M.S. personnel on farm accident rescue. The Department of Agricultural Engineering will develop a "capstone" course for all students to increase their overall understanding of health and safety issues. This program will develop a solid basis for improving the state of Ohio's agricultural health and safety environment on a continuous basis for years to come. This poster session will focus on the current Ohio agricultural health and safety issues, the methods the Ohio State University will employ to mitigate the problem, and the expected long-term effect of the NIOSH program in Ohio.

## CHEMICAL HAZARDS TO THE NEUROBEHAVIORAL HEALTH OF AGRICULTURAL WORKERS



*By John M. Russo, Ph.D.*  
NIOSH, Cincinnati, Ohio

An estimated 3.2 million agricultural workers in the United States may be at risk of multiple exposures to known or suspected neurotoxic chemicals (e.g., pesticides, fumigants, solvents, metals and gases). These chemicals can produce immediate, delayed or chronic impairments of behavior and neurologic function, including sensory, cognitive and motor abilities. Neuroanatomic or neurochemical damage may accompany behavioral deficits, but often such damage is undetectable before the onset of functional impairment. Current knowledge of the impact of neurotoxicants on agricultural workers is largely derived from controlled laboratory and field studies intended to assess the acute effects of single compounds or compound classes (e.g., organophosphate pesticides). Few studies address the neurobehavioral health of agricultural workers after repeated exposures to multiple chemicals. This presentation describes advances in selected neurobehavioral test methods, proposes a strategy for application in field studies, and suggests a research agenda for the surveillance and assessment of neurobehavioral health among agricultural workers.

## EXPOSURE OF COMMERCIAL PESTICIDE APPLICATORS TO THE HERBICIDE ALACHLOR



By Wayne T. Sanderson, R. Biagini, G. Henningsen, B. MacKenzie, V. Ringenberg  
NIOSH, Cincinnati, Ohio

(2-chloro-2',6'-diethyl-N-[methoxymethyl] acetanilide), one of the most common pre-emergent herbicides used on corn and soybean crops, is considered to be carcinogenic in rodents. However, exposure and health information on humans is lacking. A study of commercial pesticide applicators, who apply a variety of herbicides and insecticides to agricultural cropland, was conducted to characterize their exposure and estimate internal dose to alachlor. Surveys were conducted at 5 application companies in Illinois and 7 in Ohio. A total of 20 applicators, 7 hauler/mixers, and 18 controls participated in the study. Participants in the study wore air samplers to measure inhalation exposure and clothing patches to estimate skin deposition. Hand and glove washes, and surface wipe samples were collected to evaluate hand exposures to alachlor. To estimate the absorbed dose of alachlor, urine samples were collected at the beginning and end of the shift, and the morning after the exposure survey. Inhalation exposures ranged from 0.28 to 6.4  $\mu\text{g}/\text{m}^3$  with a mean of 2.1  $\mu\text{g}/\text{m}^3$ . The deposition of alachlor on the skin ranged from 0.03 to 4.0  $\mu\text{g}/\text{cm}^2$  with a mean of 0.63  $\mu\text{g}/\text{cm}^2$ . The legs generally received more deposition of alachlor than any other part of the body. Hand wash and glove rinse samples indicated that the hands were also an area of heavy alachlor exposure; post-shift hand wash samples and rinses of the inside of the gloves ranged from 0.11 to 281  $\mu\text{g}$ . The concentrations of alachlor metabolites in the urine ranged from <1 to 25 ppm with a mean of 5.9 ppm. Those workers with higher inhalation and hand exposures tended to have greater concentrations of urinary metabolites. Alachlor exposures were found to be higher for this group of commercial pesticide applicators than have previously been reported for other applicators and mixers. Individual work practices had a direct impact on the variability of exposure and dose concentrations. Practical steps can be taken to reduce exposure and internal noise, such as proper use of pesticide resistant gloves and aprons.

## **A FARM FAMILY AND HAZARD SURVEILLANCE PROGRAM FOR CASH GRAIN FARMERS IN OHIO**

*By J.R. Wilkins III, Ph.D., T.L. Bean, Ph.D.*  
Ohio State University, Columbus, Ohio



A multiple-phase, population-based health and hazard study of Ohio cash grain farmers and eligible family members is described. The project was designed as a five-year collaborative effort between Ohio State University, CDC/NIOSH, and the State of Ohio. In Phase 1 of the project period, which is now underway, a stratified random sample of 6,480 cash grain farms will be selected from a comprehensive statewide roster, with stratification by size of farm (in acres). A mixed-mode survey (i.e., a self-administered, mailed questionnaire, with telephone follow-up of mail non-respondents) will then be conducted to obtain relevant health and hazard data. The content of the questionnaire and its design will be modeled to a great extent after NCHS' National Health Interview Survey, a national health survey of the civilian non-institutionalized population of the United States. In Phase 2, a subsample of eligible Phase 1 respondents whose farms are located in the 20-county central Ohio area will be invited to participate in a program of nurse-conducted, in-home physical examinations and on-farm hazard assessments. Procedures employed for collection of the Phase 2 health data will be modeled after NCHS' Third National Health and Nutrition Examination Survey (NEANES III). To the extent possible, the collection of the Phase 2 hazard data will be modeled after NIOSH's National Occupational Exposure Survey. With respect to the collection of the Phase 2 health data, attempts will be made to recruit 624 farm families. For each eligible and participating household member, the following procedures will be performed by a specially trained public health nurse according to a standardized protocol: spirometry, audiometry, and measurement of height, weight and blood pressure. With respect to the (concurrent) collection of Phase 2 hazard data from the same subsample of farms, a specially trained, two-person Hazard Technician team will conduct on-farm hazard assessments to obtain (qualitative and quantitative) information on work-related risk factors. In Phase 3, a sample of farm operators will be asked to participate in a program of personal exposure monitoring, with a focus on noise and airborne exposure to dust and selected pesticides. One data collection effort in Phase 3 will involve attempts to collect pesticide exposure data from all residents in the participating domiciles by monitoring levels of selected urinary metabolites. In addition to the urinary metabolite analyses, airborne levels of exposure experienced by the operator/applicator will be monitored by air sampling pumps as in Phase 2, and, in addition, by application of passive dosimetry techniques.

## NOISE AND HEARING LOSS IN THE AGRICULTURAL SETTING



By *Christa L. Themann, M.A., Donald Henderson, Ph.D.*  
NIOSH, Cincinnati, Ohio

Nearly 10 percent of the 3.6 million United States farmers and an unknown portion of the additional 11.8 million farm family members, part-time farmers, and hired workers are exposed to average daily noise levels in excess of 85 dB(A), the level at which industrial workers are mandated by OSHA to be protected by a hearing conservation program. Numerous studies have documented a high incidence of hearing loss among farm workers, a finding generally attributed to these high noise levels. Although it is fairly apparent that farmers are at risk for and often develop noise-induced hearing loss, there is little information on actual exposure levels. Most investigations have focused on noise levels produced by tractors; there is virtually no information on levels produced by other farm equipment, livestock or processes. There is also little information on changes in sound levels over time as equipment ages or is modified by the farmer. A more basic problem is adequate characterization of noise exposure in this setting. The OSHA dosage calculations and damage-risk criteria for industry do not take into account farmers' highly seasonal exposure patterns, which are typified by 12-15 hour exposures during peak seasons, preventing adequate recovery prior to re-exposure. Noise-induced hearing loss results from the gradual destruction of sensory hair cells within the cochlea. It is a subtle process which eludes notice until sufficient cells have been damaged so as to produce a decrease in auditory sensitivity. Once damaged, however, the hair cells cannot be repaired or replaced, even through medical intervention. Therefore, the key is prevention through education as to the hazards of noise and the protective measures which may guard against it. Farmers *want* health and safety information made available to them, and initial hearing conservation efforts in this population have been well received. This presentation will summarize the available literature on noise-exposure levels in the agricultural setting, their apparent effects on the hearing of farmers, research questions which need to be addressed, and how the Farm Family Health and Hazard Survey and other projects through NIOSH's Agricultural Initiative are beginning to address these problems.

## **REDUCING STRESS, ACCIDENTS AND DEATHS IN OKLAHOMA AGRICULTURE**

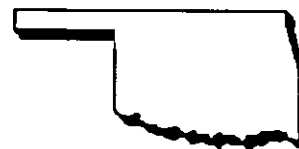

*By Pat Lewis*

Oklahoma State University, Stillwater, Oklahoma

The safety specialist at Oklahoma State University has cooperated with several departments and agencies to promote farm safety in Oklahoma. In 1988, the vital statistics section of the Oklahoma Department of Health furnished nameless agriculture death certificates to the safety specialist to establish new safety educational programs. At that time, suicides proved the leading cause of preventable deaths among the agriculture sector in Oklahoma. The Governor appointed a task force of eight agencies to collectively look into suicide and stress-related problems in rural areas. Various public hearings were held throughout the state enabling farmers/agriculture-related businesses to inform the task force of their concerns/problems. One of the major problems among farmers was the stress they contended with daily. This also may account for various accidents on a farm. An AG-LINK Coalition was formed in 1985 to offer direct communication to farmers in a crisis situation. The crisis may include severe depression, loneliness, family problems, financial, health, or suicidal. AG-LINK is accessible 24 hours a day, and all calls are returned within 15 minutes. Crisis intervention has saved the lives of 234 farmers and 5 lending institute officers. In 1989, the AG-LINK averaged 1,035 phone calls per month. The OSU family life specialist has developed several publications, in-service training and workshops pertaining to stress in the rural areas. His cooperation and assistance with the AGLINK Coalition has been an asset. An Oklahoma Injury Prevention Advisory Board, appointed by the Commissioner of Health, is working with several agencies to determine safety programs in Oklahoma to reduce any type of accidents. The OSU safety specialist is a member of this board and represents the farm and rural safety expertise. In 1989, it was determined by the safety specialist and the Director of Epidemiology that farm pond drowning was the leading cause of preventable deaths in Oklahoma. Farm Bureau and Oklahoma 4-H are working together to implement an ATV safety program for 4-H and Youth. The OSU safety specialist is a member of the National 4-H ATV Safety Committee which is sponsored by American Honda Corporation.



**COMPILING, CORRELATING AND COMBATING  
AGRICULTURAL ACCIDENTS IN TENNESSEE**



*By Joel Lown, M.S.A.E.*  
University of Tennessee, Knoxville, Tennessee

Agriculture brings industry to the homestead and powerful tools to the untrained - often a deadly mix. Accidents are typically outside of the realm of conventional industrial monitoring, and so widespread that cooperative effort is necessary even to detect and report them. Gathering appropriate accident data allows careful correlation of parameters that can reveal trends and critical areas of focus. Finally, a unique coalition must be drawn together to provide integrated safety programs for a particular state or region.

## **OBTAINING RELIABLE DATA ON FATAL INJURIES INVOLVING VIRGINIA FARM WORKERS**



*By Glen H. Hetzel, Ph.D.*  
Virginia Tech, Blacksburg, Virginia

National farm accident and fatality data show that children are at high risk when working on farms. Death certificate data from the Virginia Bureau of Vital Statistics do not show this to be true for the state. Data from 1980-1989 for farm accident victims were reviewed. The analysis showed patterns by age, activity, county and other factors. More than 60 percent of the fatalities involved tractors or machinery. Grouping of deaths by counties did not show the incidences to be consistently high in those counties having the highest agricultural activity. During the 10-year period, only one child under age 14 was reported to have died from a farming accident. This is a significant difference from the situation in many other states. Risk factors associated with the farm-related fatalities were identified. Risk factors are being used to identify areas needing emphasis on current agricultural health and safety programs. The data were also compared with farm-related fatal injury data obtained from the Chief Medical Examiner's Office of the Commonwealth of Virginia. Significant differences were observed in the number of fatalities, place death occurred and when the death occurred. More consistent definitions and better use of E-Codes are needed to increase the reliability of data from agricultural accidents. Reliable data are needed prior to developing effective preventive counter measures.

## ***SURVEILLANCE TO SOLUTION***

*By W.B. Symons, Ph.D.*  
Washington State HAPS, Pullman, Washington



This health promotion system provides the advantage of linking health and safety data with applied research and farm worker training. It is the first time that elements within and outside our university converge upon identified worker hazards from different directions. By concentrating efforts toward known in-state worker hazards, program credibility and speed of program reaction to identified hazards increases. Farm worker populations are being trained that have not been previously reached. Timely workplace-related training that is hands on in nature will reduce worker exposure to job site hazards. The educational effort is strongly supported by small-scale research efforts and a surveillance system. The applied research effort is currently focusing upon reducing the level of pesticide exposure to orchard workers through the adoption of smart sprayers that reduce off-target sprayer applications. The surveillance system consists of a data gathering operation that attempts to corroborate information from various sources within the state of Washington. Its sole purpose is to identify where other efforts within the project should be directed. This applies to both applied research and farm worker training.

## **ANALYSIS OF BEDDING AND RAFTER DUST FROM NORTH CAROLINA CHICKEN COOPS**



*By Paul D. Siegel, Ph.D., Stephanie J. Conway, Anne D'Alessandri  
Stephen A. Olenchock, Ph.D.  
NIOSH, Morgantown, West Virginia  
Steven W. Lenhart  
NIOSH, Cincinnati, Ohio*

Respiratory problems documented among poultry farmers include airway irritation, cough, chest tightness and phlegm. In the present study, bedding and rafter dust from 16 different chicken coops were examined. The bedding ranged in age from 2 weeks to 3 years old. Each bedding and dust was examined for bacteria (total, gram negative and thermophilic), fungi, endotoxin, histamine and ammonia. The presence of chicken sera, sera albumin, IgG and egg albumin were also documented. The rafter dust was aerosolized, the respirable fraction collected and evaluated for endotoxin, histamine, and ammonia. Only ammonia correlated with the age of the bedding (up to 1.5 years old  $r=0.9488$ ). The 2-week-old bedding contained an unusually high amount of endotoxin (13570 EU/mg). In the other beddings, rafter and respirable dusts endotoxin levels ranged from 15.2 to 814 EU/mg, 50.9 to 865.2 EU/mg, and 0.1 to 512.8 EU/mg, respectively. Histamine was found in all samples tested ranging from 0.33 to 6.6 ng/mg bedding or dust. Chicken coop bedding and dust contains a variety of substances and organisms that may present a potential respiratory risk to farmers.

## **MUSCULOSKETAL INJURIES IN AGRICULTURE—AN ERGONOMICS PERSPECTIVE**

*By Thomas G. Bobick, John R. Myers, Roger C. Jensen, John E. Parker, M.D.  
NIOSH, Morgantown, West Virginia*



The National Institute for Occupational Safety and Health has begun a major research initiative addressing mortality and morbidity in the agricultural workforce. Review of data from the Supplementary Data System (SDS), maintained by the Bureau of Labor Statistics, indicates that upper extremity sprains and strains, including back injuries, account for more than 30 percent of the agriculture-related workers' compensation claims. SDS data were examined for 1985 from 25 states that provided records. A total of 9,970 sprain/strain injury claims were filed. Of these, 3,138 (31.5 percent) occurred in landscaping/horticultural services and horticultural specialties. Also, 2,268 (22.7 percent) sprain/strain injuries occurred in the production of fruits, nuts, vegetables and melons. Typical work activities from these two agricultural sectors will be observed and recorded on videotape for study using a motion measurement system to identify biomechanical stresses in this workforce. The ultimate goal of this study is to identify potential intervention strategies (work place modifications or development of specialized mechanical-assist devices) to reduce musculoskeletal injuries in these agricultural industry sectors.

## **ENDOTOXIN IN COTTON DUST: A RESPIRATORY HAZARD WITH IMPLICATIONS FOR WORKER HEALTH IN BOTH AGRICULTURE AND MANUFACTURING**

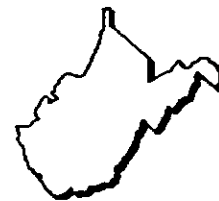

*By Robert M. Castellan, M.D., M.P.H., Stephen A. Olenchock, Ph.D.  
Kathleen B. Rinsley, Richard D. Kennedy  
NIOSH, Division of Respiratory Disease Studies, Morgantown*

The Public Health Service's *Year 2000 Objectives for the Nation* call for the elimination of exposures that cause byssinosis ("brown lung disease"), an occupational lung disorder which affects cotton workers. Recent research on the etiology of byssinosis has contributed substantially to the body of knowledge necessary to achieve this goal. Although byssinosis is usually considered in the context of the textile manufacturing industry, results of this recent research have implications for both agricultural worker health and agricultural practices which may prevent downstream risk in manufacturing. Recent experimental evidence has clearly demonstrated that the acute airway response of humans exposed to cotton dust is associated with airborne endotoxin concentration. Cotton is contaminated by endotoxin-containing gram-negative bacteria while in the field before harvest. Local cotton growing conditions appear to substantially affect the level of colonization by gram-negative bacteria, resulting in wide variation in the potency of cotton dust with respect to endotoxin. A survey of commercial cotton gins has revealed substantial regional differences in endotoxin contamination of airborne cotton dust. In addition to regional effects, year-to-year variability within the same growing location has been observed in the level of endotoxin contamination of experimentally-generated cardroom dust. Subsequent environmental sampling of cardroom work areas in selected commercial cotton textile mills has shown that area of growth differences are also reflected in yarn manufacturing processes. Airborne endotoxin concentrations in work areas of both agriculture and manufacturing range widely, from relatively low levels to levels which may represent a substantial respiratory hazard. Byssinosis prevention may be enhanced by appropriately applying knowledge of how to limit the natural tendency for gram-negative bacteria to colonize cotton. Therefore, defining the factors which influence the level of gram-negative bacterial contamination of cotton is a prime objective of ongoing research. Furthermore, because of the relationship between endotoxin exposure and byssinosis, a pilot surveillance system to monitor endotoxin in cotton is currently under development.

## **AN ANIMAL MODEL TO PREDICT THE PULMONARY RESPONSE TO INHALATION OF AGRICULTURAL DUSTS**

*By Vincent Castranova, Ph.D., D.G. Frazer, V. Robinson, U. Jones*  
NIOSH, Division of Respiratory Disease Studies, Morgantown, West Virginia



Agricultural dusts are associated with many farm operations such as grain unloading, hay handling, chicken or pig confinement, etc. Such dusts are often contaminated with bacteria, fungi and molds as well as endotoxins, mycotoxins and spores associated with these microbes. Several farm operations are known to generate high levels of dust and have been reported to cause adverse physical reactions in farm workers. Symptoms often include fever, headache, malaise and respiratory difficulty. The present report describes an animal model which characterizes the pulmonary responses to inhalation of selected agricultural dusts. Bulk samples collected at the farm site can be placed in a container and dust aerosols of respirable size generated by acoustical energy. Guinea pigs can be exposed to these aerosols and their pulmonary responses, such as airway constriction and inflammation, can be monitored as a function of exposure dose and time. This animal model may have the capability to predict the potential biological reactivity of various agricultural materials. In addition, this system could be used to determine the agent(s) associated with agricultural dust which causes disease and to determine the mechanisms by which disease develops.

## **ROLLOVER PROTECTION STRUCTURE (ROPS) FOR FARM TRACTORS: THE STAGE IS SET FOR LOCAL ACTION**

*By John R. Etherton, M.E.A., Z. J. Parker, M.D.*  
NIOSH, Division of Safety Research, Morgantown, West Virginia  
*W. Maines*



West Virginia University, Morgantown, West Virginia

Between 1980 and 1985, nearly 800 people were killed in the United States in farm tractor rollovers. Current data show that farm tractor rollover fatalities have been a factor in 17 percent of all deaths to workers in the Agriculture, Forestry, and Fishing Industry. A 30 percent reduction in the fatality rate for this industry is a *Year 2000* goal for the nation. To address this problem of farm tractor rollovers, a workshop was held to develop strategies for research and safety promotion in preventing fatalities to farm tractor operators. A widely recognized engineering intervention to prevent rollover fatalities is the use of rollover protective structures (ROPS) and seat belts on all tractors. Proposed strategies fell into two categories: (1) retrofitting tractors built between 1970 and 1985, for which ROPS have already been designed; and (2) retrofitting tractors built before 1970, for most of which there are no ROPS designs. Workshop attendees felt that local action groups should begin educational campaigns to encourage owners of tractors built since 1970 to have lifesaving ROPS and seat belts installed.

**ASSESSMENT OF INHALED AGRICULTURAL DUST HAZARD  
AND MECHANISMS OF DISEASE USING AN ANIMAL  
INHALATION MODEL IN COMBINATION WITH STUDIES OF  
ISOLATED AIRWAYS**



*By Jeffrey S. Fedan, Ph.D.*

NIOSH, Division of Respiratory Disease Studies, Morgantown, West Virginia

It is becoming increasingly clear that inhalation of some agricultural dusts in the workplace may cause pulmonary obstruction. We have been conducting biological experiments designed to both assess the potential hazard of agricultural dusts and to determine the mechanism(s) of the pulmonary response. This has been accomplished through the use of a computer-operated dust generation and animal inhalation exposure system (designed by David G. Frazer), which provides dust-exposed animals from which airways are then removed for additional study of the mechanisms of inhaled dust toxicity. Studies on isolated airways involve the isolated perfused guinea pig trachea. The perfused trachea is used because it contains respiratory smooth muscle, which is involved in narrowing of the airways in response to inhaled substances, and other cell types such as epithelium, which lines the airways and is known to be a target of the toxic effects of some agents. The isolated trachea also permits a detailed evaluation of the mechanisms of effect of suspected etiologic agents under carefully controlled laboratory conditions. We are able to ascertain the effect(s) of inhaled substances on respiratory smooth muscle and epithelium. The protocol used to examine dust effect(s) is to apply the bronchoconstricting drug, methacholine, to the fluid surrounding the trachea in order to establish the dose-response relationship for the diameter decrease caused by contraction of the smooth muscle. The methacholine easily reaches the muscle, which is situated on the outer surface of the trachea. These results are compared with the dose-response relationship obtained after the trachea is challenged with methacholine perfused through the lumen. The muscle contracts to luminal methacholine only after the drug has crossed the epithelium. The epithelium is a diffusion barrier and a metabolic site, and also releases modulatory factors which affect the responsiveness of the muscle. We have examined the effects of respirable cotton and barn dusts. A six-hour exposure to cotton dust caused pulmonary obstruction, the degree and duration of which depended on the level of dust in the air. The perfused trachea preparation revealed that a complex set of changes had occurred in the release of modulatory factors from the epithelium, which altered in a dust level- and post-exposure, time-dependent manner responsiveness of the muscle. Inhaled barn dust did not affect pulmonary function or tracheal reactivity. The use of these laboratory methods will continue to assist in the identification of inhaled dust hazards and disease mechanisms.



**BUILDING STATE-BASED AGRICULTURE SAFETY AND  
HEALTH INFRASTRUCTURES: A MODEL AGRICULTURE  
HEALTH PROMOTIONS SYSTEM PROGRAM**



*By David L. Hard, Ph.D., John Myers, Nancy Stout, Tim Pizatella*  
NIOSH, Division of Safety Research, Morgantown, West Virginia

Based on data from the National Traumatic Occupational Fatalities (NTOF) database maintained by the National Institute for Occupational Safety and Health (NIOSH), Agriculture, Forestry, and Fishing is one of the most hazardous industrial divisions in the U.S. While only 2 percent of the U.S. workers are employed in this sector, it has the fourth highest injury fatality rate (20.4 deaths/100,000 workers) in the U.S. Farming as an occupation has the second highest rate of work-related injury deaths (21.4/100,000 workers). In addition, during 1988 the agriculture industry ranked third among the 10 industrial sectors for occupational injury rates (10.4 injuries/100 workers). Because of the hazardous nature of agricultural employment, the NIOSH, Division of Safety Research (DSR), has instituted an intervention program with the goal of reducing the incidence of fatal and nonfatal traumatic injury, chronic injury, and occupational diseases among the 3.4 million agricultural workers in the U.S. This program, the Agricultural Health Promotion Systems (AHPS), is administered through cooperative agreements to Land-Grant Universities and the Cooperative Extension Service within the States. Through the AHPS, the land-grant universities will disseminate information and conduct programs to prevent illness and injury among agricultural workers and their families. Currently, 15 states are conducting programs in this area for FY 1991, with eight more states to be added by FY 1992. Examples of some of the emphasis areas include, but are not limited to, youth training, bilingual work-site safety packets for farm workers, and programs targeted to older farmers. Also included are programs in forestry, logging and fishing.

## **WORKER FATALITIES IDENTIFIED BY IRRIGATION KEY-WORD SEARCHES OF THE DATABASE**



*By David L. Hard, Ph.D., Patricia Cutlip, Nancy Stout, Lynn Jenkins  
Suzanne Kisner, Rosemary Cianfrocco*  
NIOSH, Division of Safety Research, Morgantown, West Virginia

This analysis describes fatal occupational injuries involving irrigation operations or mechanisms in the United States. Cases were identified by examining data from the National Traumatic Occupational Fatality (NTOF) database, which is maintained by the Division of Safety Research (DSR), National Institute for Occupational Safety and Health (NIOSH). NTOF includes data from death certificates, obtained from all 50 States, New York City and the District of Columbia, that indicated the decedent was 16 years or older, died from an external (injury) cause and was injured at work. A key-word search of injury descriptions and cause of death narratives from NTOF identified cases described as involving "irrigation." This analysis includes cases from 1980 to 1989, although data for 1987-89 are incomplete. From 1980 through 1989, 60 workers died in the U.S. from work-related injuries involving irrigation. Twenty-two percent of these deaths occurred in California and 12 percent were in Texas. Most fatalities were among men (97 percent). More deaths occurred to Whites (65 percent) than to Hispanics (30 percent), Blacks (3 percent), or other races (2 percent), although Hispanics may be over-represented relative to their proportion of the labor force. Workers between the ages of 20 and 34 accounted for 43 percent of the deaths. Farmers (32 percent) and farmworkers (37 percent) were the most frequent occupations of the victims. Seventy percent of the fatalities were in the Agriculture, Forestry and Fishing Industry. From 1980 through 1986, the leading causes of death involving irrigation operations or mechanisms were electrocution (67 percent), drowning/suffocation (11 percent), and machines (9 percent). The ability to identify specific occupational fatalities are possible through computer keyword searches of injury descriptions and cause-of-death narratives from the NTOF data base.

## AGRICULTURAL LUNG DISEASE: A NATIONAL PROGRAM

By Gregory Kullman, M.S., Richard D. Kennedy, Michael Lyman, William G. Jones  
Stephen A. Olenchock, Ph.D., Gregory R. Wagner, M.D.  
NIOSH, Division of Respiratory Disease Studies, Morgantown, West Virginia



Occupational exposures to dust of agricultural origin are known to cause respiratory illness among farm workers. Several pulmonary responses have been described in different agricultural settings. The National Institute for Occupational Safety and Health (NIOSH), Division of Respiratory Disease Studies (DRDS), in Morgantown, West Virginia is involved in a nationwide agricultural program, emphasizing the study of respiratory illness among farm workers, as a foundation for preventing occupational lung disease through the development and dissemination of appropriate prevention strategies. Surveillance, research, and intervention are key elements of this research program. Our program involves many separate projects that are part of an integrated, multi-disciplined approach to the study of agricultural respiratory disease involving clinical evaluations, environmental exposure assessments, laboratory research evaluating biological disease mechanisms, microbiological characterizations of agricultural materials, animal exposure studies and epidemiological surveillance. NIOSH scientists at DRDS have been actively involved in the study of respiratory illness in a variety of agricultural settings including Dairy Farming (Silo Unloading and Bedding Chopping), Cotton Processing, Recycling, Mushroom Farming, Poultry Growing, Grain Harvesting and Storage, and others. NIOSH scientists are interested in learning about instances of respiratory illness among farm workers and have a Respiratory Disease Health Hazard Evaluation Program available, at no cost as a resource for farm workers. To request assistance or to provide information on the occurrence of respiratory illness among agricultural workers, call (304) 291-4203.

## ORGANIC DUST EXPOSURE FROM COMPOST HANDLING OPERATIONS

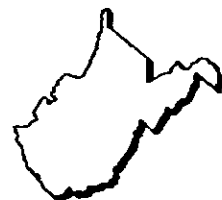

By Gregory J. Kullman, W.G. Jones, S.A. Olenchock, Ph.D., W.G. Sorenson  
R. Marcelo-Baciu, E.L. Peterson, J.E. Parker, M.D.

NIOSH, Division of Respiratory Disease Studies, Morgantown, West Virginia

Environmental measurements were made during hand loading of compost in a small scale recycling project. The compost consisted of chopped leaves and branches stored outdoors during a spring and summer of record rainfall. Exposures to organic dust from this material resulted in the hospitalization of one individual experiencing severe respiratory illness. Measurements included inspirable and respirable dust, particle size distribution, endotoxins, spore counts and viable microorganisms. Visible clouds of fine particulate were easily generated during handling activities; impactor measurement of this aerosol indicated a mass median aerodynamic diameter of approximately 3 micrometers. Worst case dust concentrations of inspirable and respirable particulate were 150 and 83 milligrams per cubic meter ( $\text{mg}/\text{m}^3$ ) respectively; however, routine dust exposures from compost handling were below  $1 \text{ mg}/\text{m}^3$  for all size fractions. Microscopic examination (both light and SEM) of these dusts indicated a predominance of spores. Airborne spore counts, made directly from cellulose ester filters cleared with acetone, ranged from 106 to 109 spores/ $\text{m}^3$ . Mesophilic fungi and bacteria, collected using the AGI 30 impinger with distilled water, ranged from 105 to 108 colonies/ $\text{m}^3$ . Airborne thermophilic bacterial concentrations were lower, 103 to 104 colonies/ $\text{m}^3$ . Spore counts made from filter samples collected downstream from the impinger showed high spore penetration, with break-through weighted toward smaller diameter spores,  $< 3 \mu\text{m}$ . Endotoxin concentrations from inspirable, thoracic and respirable dust samples ranged from 636 to 16,300 endotoxin units/ $\text{m}^3$ . Levels of contaminants found here are consistent with those associated with respiratory illness in other agricultural settings.

## **HYPERSENSITIVITY PNEUMONITIS (HP) IN RATS CAUSED BY *Aspergillus Umbrosus* AND *Thermoactinomyces Vulgaris***

By *A. Manninen, V. Vallyathan, S. Olenchock, Ph.D., D. Lewis, W. Sorenson*  
NIOSH, Morgantown, West Virginia  
*E. Terho*

University of Turku, Turku, Finland  
*K. Husman, M. Kotimas*  
Institute of Occupational Health, Kuopio, Finland



HP is an allergic lung disease in the terminal bronchioles, interstitium and alveoli resulting from repeated exposure to inhaled organic dusts. Thermophilic actinomycetes and fungal spores have been implicated as causes of HP in man. To evaluate the inflammatory potential of the two microorganisms, we exposed rats (Sprague-Dawley, VAF) to extracts of *Aspergillus umbrosus* (AU) and *Thermoactinomyces vulgaris* (TV) six times by intratracheal injection. We made a pathologic evaluation of the changes in the lungs and in the cellular influx in bronchoalveolar lavage fluids (BALF) of exposed and control animals. Initial installations of AU and TV caused an intense inflammatory reaction in and around respiratory bronchioles and blood vessels. The cellular infiltrate (CI) predominantly was lymphocytes, but the number of macrophages was also increased. Lymphatoid granulomas were seen as well as thickening of alveolar walls with type II cell hyperplasia. The number of the total cells in BALF increased dramatically, two-and-one-half to fivefold, compared to the controls. Differential estimates of CI showed 71 percent lymphocytes and 27 percent macrophages. Eight and 28 days after the final exposure, the lung appeared normal. These results indicate that these agents can cause an intense pulmonary inflammation, and that the inflammation subsides rapidly when the exposure ends, leaving no apparent permanent pulmonary injury.

## **HYPERSENSITIVITY PNEUMONITIS ANTIGENS ACTIVATE ALVEOLAR MACROPHAGES IN VITRO**



*By Janusz Milanowski*  
NIOSH, Morgantown  
and the Clinic of Lung Diseases  
University School of Medicine Lublin, Poland

The gaseous phase cultures of alveolar macrophages (AMs) of guinea pigs were exposed to the saline extracts of the dust-borne bacteria *Micropolyspora faeni* (syn. *Faenia rectivirgula*) and *Erwinia herbicola* (syn. *Enterobacter agglomerans*) which have been added at the concentration of 1 µg/ml to culture medium with or without complement. The effects of exposure on superoxide anion ( $^{\circ}2^-$ ) production by AMs were assessed by the lucigenin-dependent chemiluminescence method. Both extracts caused significant ( $p < 0.01$ ) increase in  $^{\circ}2^-$  generation by AMs, as assessed by the 161-254 percent enhancement of chemiluminescence release comparing to control values. The presence of complement augmented the production  $^{\circ}2^-$ , which reached a peak at 3 hours after initial exposure. The possible significance of the generation of oxygen radicals in pathogenesis of the diseases due to exposure to agricultural dusts loaded with bacterial antigens is discussed.

## RESPIRATORY DISEASE MORTALITY IN AGRICULTURAL WORKERS

By Karl J. Musgrave, D.V.M., M.P.H., R. Althouse, R.M. Castellan  
NIOSH, Morgantown, West Virginia



Agricultural workers have been shown to be at increased risk of developing respiratory diseases (RDs). Most mortality studies of agricultural workers to date have considered only crude mortality using underlying cause of death and may underestimate the public health importance of contributing causes of death. Furthermore, crude mortality data is a poor measure of premature mortality in the working-age population. Decedents noted as having worked in an agricultural industry were selected from national multiple cause of death data tapes for 14 states that had industry and occupation information for each of the years 1985-1987. To estimate the relative public health importance of specific RDs for these decedents, crude "cause of death" ratios (deaths due to a specified RD/total deaths from all RDs), years of working life lost (15-64 years) and years of potential life lost (age 15-life expectancy) were estimated for deaths where specific RDs were mentioned either as an underlying or contributing cause of death. Of the 81,317 decedents, 11,046 (14 percent) had a RD listed as an underlying cause of death while an additional 8,948 (11 percent) had a RD listed as a contributing cause. Of all RDs, respiratory neoplasms contributed most to the total years of working life lost (38 percent or 7,000 years), while pneumonia and influenza contributed the most to the total years of potential life lost (33 percent or 81,340 years). Calculations of premature mortality are useful in determining the relative public health importance of specific RDs on the working-age population in agriculture. Use of multiple causes of death data allows for an analysis of the maximum diagnostic information listed on death certificates.

## MICROBIAL CONTAMINATION AND IMMUNOLOGIC REACTIVITY OF STORED OATS

By Stephen A. Olenchock, Ph.D., Ph.D., W.G. Sorenson, John E. Parker, M.D.  
NIOSH, Morgantown, West Virginia  
James J. Marx, Jr.

Marshfield Medical Foundation, Marshfield, Wisconsin



Bulk samples of oats were obtained from Alabama where a cluster of cases of organic dust toxic syndrome occurred in workers who shoveled approximately 800 bushels of oats from a poorly ventilated storage bin. Airborne dusts were obtained from the samples by acoustical vibration in a laboratory dust generator. Microbial contamination of the airborne dusts, as measured by standard dilution plating techniques, revealed  $1.4 \times 10^5$  colony forming units per cubic meter of air (CFU/m<sup>3</sup>) of total viable bacteria,  $1.5 \times 10^3$  CFU/m<sup>3</sup> of gram-negative bacteria,  $1.8 \times 10^5$  CFU/m<sup>3</sup> of thermophilic bacteria, and  $8.3 \times 10^4$  CFU/m<sup>3</sup> of fungi. The most common fungi isolated from the dust included *Alternaria*, *Aspergillus*, *Cladosporium*, *Penicillium*, and *Scopulariopsis* species. Analysis of the generated airborne dust for gram-negative bacterial endotoxins resulted in the detection of 325.71 Endotoxin Units per milligram of dust (EU/mg). The endotoxin contamination of the bulk oats was 122.66 EU/mg. An extract of the bulk sample consumed human serum complement *in vitro* in a dose-dependent fashion, indicating the inflammatory potential of the material. Sera from the exposed workers were examined for antibodies against the extract, against antigens from the predominant fungi, and against standard antigens associated with hypersensitivity pneumonitis. Evidence of exposure (specific antibodies) was determined, although symptomatic and asymptomatic workers could not be differentiated. Stored oats provided a source of respiratory exposure to microbial antigens and to immunoreactive materials.



**DEATHS WITH FARMERS LUNG DISEASE AND DAIRY FARMING PRODUCTION: A CORRELATION USING NATIONAL CENTER FOR HEALTH STATISTICS MULTIPLE CAUSE OF DEATH TAPES**



*By John E. Parker, M.D., D.M. Mannino, M.C. Townsend  
NIOSH, Morgantown, West Virginia*

Farmer's Lung Disease (FLD) is a form of hypersensitivity pneumonitis (HP) prevalent in agricultural workers. We hypothesize that extensive prolonged work in closed spaces exposes the dairy farm worker to various sensitizing agents associated with HP and FLD more than other types of farm workers. This report looks at data available from the National Center for Health Statistics (NCHS) multiple cause of death data tapes from 1979 through 1986 concerning deaths with FLD. During this time period, 73 death certificates listed FLD as being present. Data from these death certificates were correlated with farming data from the 1982 agricultural survey and the 1986 *Statistical Abstract of the United States*, by state, using Spearman correlations.

**TABLE OF CORRELATIONS**

<b>Variables by State</b>	
Whole Milk Sold	0.53*
Dairy Farms	0.54*
Farms with Cows	0.54*
Farmers	0.35*
Deaths	0.11*

P < 0.05 - \*

In this ecological study, deaths with FLD were more related to dairy farming than farming in general, supporting our hypothesis. The NCHS multiple cause of death data tapes have thus provided a new way to evaluate the demographics of an occupational pulmonary disease, and help generate a hypothesis as to its occupational origin.

**HYPERSENSITIVITY PNEUMONITIS (HP) OR ORGANIC DUST  
TOXIC SYNDROME (ODTS)?: THE CLINICAL DILEMMA IN  
ORGANIC DUST EXPOSURES**



*By Edward L. Petsonk, M.D., G. Kullman, W. Jones, S. Olenchock, Ph.D., W. Sorenson  
J. Parker, M.D.*

*NIOSH, Morgantown, West Virginia  
S. Weber*

*West Virginia University, Morgantown, West Virginia*

Twelve hours after shovelling composed wood chips and leaves, a healthy 52-year-old male presented to the emergency room with fever (T 38.8°C), myalgia, and marked dyspnea. Inspiratory crackles, hypoxemia (room air arterial PO<sub>2</sub> 53mm Hg), and bilateral patchy pulmonary infiltrates were seen. Systemic steroids were given, and he improved over 3 days. No antibodies were found to 10 common HP antigens. Using respiratory protection, we repeated the exposure setting and made extensive environmental measurements. General area samples for respirable particulate were < 1 mg/m<sup>3</sup>. Peak exposures were > 80 mg/m<sup>3</sup>. Mass median aerodynamic diameter of the aerosol was approximately 3 micrometers. Microscopic analysis of the dust indicated a predominance of spores, with counts ranging from 106 to 109 spores/m<sup>3</sup>. Airborne endotoxin concentrations ranged from 244 to 16,300 endotoxin units/m<sup>3</sup>, levels previously associated with illness in similar settings. Cultures of air samples yielded high levels of mesophilic fungi and lower levels of thermophilic bacteria. Serum from the patient showed precipitation with extracts of bulk samples of the compost material. Inhalation of dust from contaminated organic materials may result in acute respiratory tract illness. Possible mechanisms include toxic and cellular reactions from microbial and other organic products or immunologic responses after prior sensitization to an antigen. Differentiation is based on clinical and epidemiologic clues. Our data suggest that, in a clinical setting even with extensive environmental measurements, separation of ODTS and HP may not be possible.

## **MICROBIOLOGICAL ANALYSES AND INFLAMMATORY EFFECTS OF SETTLED DUSTS FROM RICE AND HAY**

*By W.G. Sorenson, Ph.D., Yi-E Shen, D.M. Lewis, S.A. Olenchock, Ph.D.*  
NIOSH, Division of Respiratory Disease Studies, Morgantown, West Virginia



Fourteen samples of settled dust from two factories processing rice and wheat straw near Shanghai, China, were examined by dilution plating for total bacteria, gram-negative bacteria, thermophilic actinomycetes and fungi. They were also examined for aflatoxin, endotoxin and potential to stimulate production of human interleukin 1B (IL-1B) and to consume complement. The concentrations of total microorganisms were consistently greater than 10<sup>7</sup> CFU/g and ranged from 10<sup>7</sup> to 10<sup>9</sup> CFU/g. In general, the level of microbial contamination was greater in the hay dust samples than in the rice dust samples, with bacteria being the most numerous microorganisms observed followed by molds, thermophilic actinomycetes and yeasts. The predominant fungi were species of *Aspergillus*, *Cladosporium*, *Penicillium*, *Trichosporon*, and *Cryptococcus*. No significant levels of aflatoxin were observed and the isolate of *A. flavum* examined lack significant aflatoxigenic potential. The levels of microorganisms in these samples, the types of organisms found, and the inflammatory mediators such as endotoxin suggest that workers exposed to these dusts may be at risk for respiratory illness.

## IMPROVED METHODOLOGY TO VALIDATE ENDOTOXIN LEVELS IN INHIBITORY AGRICULTURAL SAMPLES

By Michael P. Whitmer, Ebon Research Systems, Stephen A. Olenchock, Ph.D.  
Daniel M. Lewis, Judith C. Mull

NIOSH, Division of Respiratory Disease Studies, Morgantown, West Virginia



Endotoxins are lipopolysaccharide-protein complexes that are integral parts of the outer membrane of gram-negative bacteria. They are ubiquitous in the agricultural environment, both in bulk material and airborne dusts. Because endotoxins can exert profound effects on humans after exposure, it is important to quantify their presence in agricultural workplaces. However, certain agricultural materials cause inhibition or enhancement of endotoxin analyses. In this study, an improved methodology was used to validate the endotoxin levels and overcome inhibition due to agricultural samples. Settled dusts and litters from chicken houses were extracted in water by standard technique. Endotoxin analyses were performed on 31 samples in duplicate using the kinetic *Limulus* amoebocyte lysate assay. Product inhibition was found in 27 of the 31 samples (87 percent), which indicates that lower than actual levels of endotoxins may be reported erroneously. Through the use of a new methodology that includes serial dilution followed by spiking with known concentrations of endotoxin standards, comparisons between values in spiked and unspiked dilutions by a computer-enhanced kinetic plate reader are generated. With these data, the proper levels of endotoxin in the samples were determined. This improved capability should have a positive impact on future studies of endotoxins in agricultural materials.

**EFFECTS OF AIRBORNE CONTAMINANTS IN SWINE  
CONTAMINANTS IN SWINE CONFINEMENT BUILDINGS ON  
ACUTE CHANGES IN LUNG FUNCTION IN SWINE FARMERS**



*By Chen Zhou, M.D., M.P.H., R. Mueller, E.M. Barber  
College of Engineering  
C. Rhodes*

Western College of Veterinary Medicine, University of Saskatchewan, Saskatoon, Canada  
*S.A. Olenchock, Ph.D.*

By NIOSH, Morgantown, West Virginia

Dust, endotoxin, ammonia and carbon dioxide were measured in 25 swine confinement buildings and lung function tests were conducted before work and every 2 hours subsequently on 52 swine farmers working in the buildings. Swine farmers had  $8.7 \pm 6.8$  swine farming years and  $4.3 \pm 2.3$  work-hours per day. Values for forced vital capacity (FVC), forced expiratory volume in one second (FEV1) and maximum mid-expiratory flow rate (MMFR) in these farmers were significantly lower after 2, 4, 6 and 8 hours of work than at baseline ( $p < 0.05$ ). Average shift changes during the day were:  $-3.98 \pm 6.18$  percent for FVC,  $-6.07 \pm 6.14$  percent for FEV1,  $-2.06 \pm .42$  percent for FEV1/FVC and  $-12.14 \pm 11.17$  percent for MMFR. Male swine farmers had significantly greater shift changes than did female swine farmers ( $p < 0.05$ ). Swine farmers with acute cough, acute chest tightness and chronic cough symptoms had greater shift changes in FEV1 than those without these symptoms ( $p < 0.05$ ). Multiple regression analysis showed that endotoxin, total dust, number of swine per farm, swine farming years, grain farming years and mask wearing were associated with the shift changes in FEV1 in non-smoking swine farmers. We conclude that swine farming is associated with acute reductions in lung function which are related to exposures to airborne contaminants in confinement buildings. (Supported by Health and Welfare Canada and the Saskatchewan Lung Association).

## THE NIOSH AGRICULTURAL HEALTH PROMOTION SYSTEM PROGRAM IN WISCONSIN



By *L.J. Chapman, Ph.D., R.T. Schuler, Ph.D., C.A. Skjolaas*  
University of Wisconsin, Madison, Wisconsin

Wisconsin's program now has three primary goals: 1) Training for extension agents that improves the quality and timeliness of information they have on hand in county offices; 2) Epidemiologic Surveillance to increase understanding of health and hazards; and 3) Injury Control Intervention via an inspection and consultation program. The extension agent training is delivered through continuing and professional education sessions and is supplemented by a comprehensive resource guide in each county office. Each office also has an electronic mail information service linking agents with each other and with experts. These new features are intended to improve the technical content of informational exchanges between agents and their clients. The training improvements are being evaluated with a baseline and follow-up survey of agents that asks about their current activities, individual perceptions and needs in the farm health and safety area. Surveillance data will be collected from farmers on occupational injuries and illnesses in collaboration with the Wisconsin Agricultural Statistics Service. Surveillance projects are planned for traumatic injuries, chronic musculoskeletal disorders, and diseases associated with adverse agricultural chemical exposures. The surveys will be administered to a representative probability of Wisconsin farmers and will pay special attention to quantifying exposures to machinery and equipment and other injury, ergonomic and chemical hazards. Research in other injury control fields indicates that conventional safety training may be of limited or questionable effectiveness for improving subsequent injury and illness experience. We are planning a farm safety inspection and consultation intervention program that will focus attention on easily remedied, yet common and important farm hazards. The on-site intervention will collect inspection data on hazards and then inform and persuade individual farm operators to make lowcost, one-time changes that will permanently improve safety and health. We will test the effectiveness of the inspection and consultation program in reducing hazards with follow-up inspections and investigate the influence of material incentives. As incentives, the pilot will include insurance refunds for documented reductions in risk. Wisconsin extension agents have also developed and successfully conducted brief safety inspections using volunteers and youth in two counties.

## **AN ANALYSIS OF SUICIDE AMONG FARMERS IN FIVE NORTH CENTRAL STATES, 1980-1988**



*By Paul D. Gunderson, Ph.D.*  
National Farm Medicine Center, Marshfield, Wisconsin

The farm media has repeatedly carried stories about individuals who, given the plight of the farm economy, commit suicide. Unfortunately, these anecdotes are not placed within an original schema which might detail the degree of risk experienced by farmers as a whole. Accordingly, five states (Minnesota, Montana, North Dakota, South Dakota and Wisconsin) were chosen for this analysis. Since suicide is typically a rare event, the years chosen for surveillance began in 1980 and ended in 1988. All deaths that occurred within the surveillance period constituted the universe, now 101,000 events per annum; subsequently, only those cases in which the cause of death was classified on the death certificate as "suicide" or "undetermined" and which met specific residence and occupational criteria were retained. Four populations were "at risk" for suicide: farmers, farm women, farm workers, and children and adolescents. The rate of suicide among farmers varied by state from 41 to 61 events per 100,000 farmers at risk. The rates for farm workers and farm women were much lower, 3-5 and 1-2 events per 100,000 respectively. Most farmers, farm workers, and children and adolescents who committed suicide were male and white. A farmer at risk of suicide was typically 63 years of age; a farm woman, 47 years of age; a farm worker, 37 years of age; and an adolescent's median age of death resulting from suicide was 18 years. Wisconsin and Montana reported proportionately more deaths of farmers due to suicide; Minnesota, North and South Dakota, fewer deaths. Most victims chose firearms or poisoning by gas as the suicide method. While women, children and adolescents who reside/work on farms are at low risk, farmers are one-and-one-half to two times more likely to commit suicide than their white male counterparts, suggesting need for targeted interventions.

## FARM INJURY SURVEILLANCE

By *David L. Nordstrom, M.S., M.P.H., Peter M. Layde, M.D., Dean Stueland, M.D.*  
National Farm Medicine Center, Marshfield Medical Research Foundation  
Marshfield, Wisconsin



The Surgeon General's *Year 2000 Objectives for the Nation* include a target of 8 cases per 100 full-time farm workers of work-related injuries resulting in medical treatment, lost time from work, or restricted work activity. There may be major obstacles to monitoring our progress toward that goal. Although farming is among the most hazardous of all occupations, the methods used for traditional occupational health and safety surveillance are of little use in the surveillance of farm injuries. Many national data sources, such as the Bureau of Labor Statistics and Occupational Safety and Health Administration, have virtually no data on farm operations employing fewer than eleven workers; fewer than four percent of the farm operations in the United States qualify for inclusion in those databases. Similarly, virtually none of the state-based Worker's Compensation programs covers family farming operations or includes data from small farms in their records. Because of the importance of farm injuries and the paucity of available data, it is necessary to develop special methods to monitor the occurrence of farm injuries. At this table we will discuss various methods that have been successfully used for farm injury surveillance, including telephone surveys and health care provider-based surveillance systems. We will also discuss other relevant approaches, including mortality surveillance through death certificates and newspaper clipping services. The uniqueness of agriculture, with literally millions of work sites each with an average of only a few workers, poses unique methodologic challenges for occupational injury surveillance. With care, adequate farm injury surveillance systems can be developed. Such systems will be necessary to monitor the high rate of injuries in agriculture and to evaluate the effectiveness of interventions designed to reduce the hazards of farming.



## **ORGANIC DUST TOXIC SYNDROME: CLINICAL AND LABORATORY EVALUATION OF A CLUSTER OF CASES**



*By John E. Parker, M.D., R.M. Castellan, S.A. Olenchock, Ph.D., W.G. Sorenson*  
NIOSH, Morgantown, West Virginia  
*J.J. Marx*  
Marshfield Medical Research Foundation

Eleven male workers, aged 15-60 years, moved 800 bushels of oats from a poorly ventilated storage bin in Alabama. The oats were reported to contain pockets of white, powdery dust. Work conditions were described as extremely dusty, and all workers wore single-strap, disposable masks while inside the bin. The workers shoveled the oats for 8 hours in groups of two or three for shifts of 20 to 30 minutes. Two workers remained outside the storage bin and developed no symptoms. Within 4 to 12 hours, all nine who worked inside the bin became ill with fever/chills, chest discomfort, and weakness/fatigue. Eight reported shortness of breath, six had non-productive cough, five complained of myalgias, and four developed headache. Six sought physician attention within the first 2 days of symptoms. Reported abnormal physical signs included: temperature greater than 38.0°C in two, crackles in two, and wheeze in one. Chest radiographs were normal by B-reader review in all six. Symptoms resolved in all affected workers in 2 to 12 days (median 4). Samples of bulk oats and sera from 10 workers were collected. Airborne dust generated in the laboratory from the bulk oats contained 39.5 mg/m<sup>3</sup> of respirable dust and the following concentrations of viable organisms (cfu/m<sup>3</sup>): 1.4x10<sup>5</sup> total bacteria, 1.8x10<sup>3</sup> gram negative bacteria, 1.8x10<sup>5</sup> thermophilic actinomycetes and 8.3x10<sup>4</sup> fungi (12 species). Endotoxin content in the airborne dust was 325.7 endotoxin units/mg. Serologic testing for antibodies to an aqueous extract of the bulk oats, to nine standard hypersensitivity pneumonitis antigens, and to aqueous extracts of the fungal isolates failed to separate ill from asymptomatic workers. Despite the initial clinical diagnosis of farmer's lung disease, the clustering of illness experienced by these workers is typical of organic dust toxic syndrome related to inhalation of high concentrations of organic dust contaminated with microbial organisms and their products.

## FFA POSTERS

Seven outstanding FFA chapters were selected to present posters at the Surgeon General's Conference on Agricultural Safety and Health in 1991, and another seven from different states were selected to present posters at the Center for Agricultural Disease and Injury Research, Education, and Prevention Regional Conference in Iowa City in 1992. These selections were made from among winners of the FFA National Chapter Safety Award Program, and they recognize an ongoing activity that addresses community approaches to preventing agriculture-related diseases and injuries. Chapters were selected for geographic balance, addressing farm safety and health issues, completion of a community assessment, and selecting unique prevention targets within the community. Poster abstracts of these 14 national winners are presented on the following pages:

### 1990 FFA Chapter Winners

Paramount High, Alabama  
Southwestern-Hanover, Indiana  
Stockton, Missouri  
Amanda-Clearcreek, Ohio  
Ysleta, Texas  
Park View Senior, Virginia  
Elma, Washington

### 1991 FFA Chapter Winners

Platte Valley, Colorado  
Lake Placid, Florida  
Newton County, Georgia  
Cascade, Iowa  
Verdigre, Nebraska  
Rolette, North Dakota  
New Auburn, Wisconsin

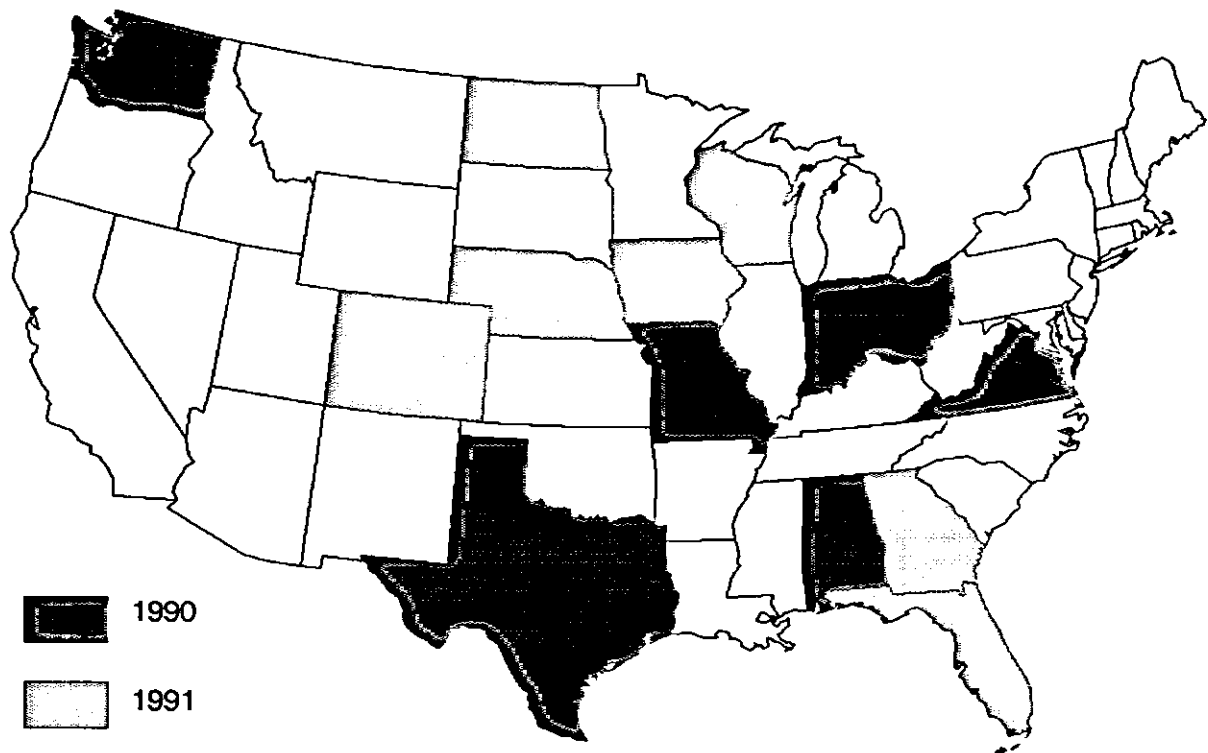

Figure 1. States Represented by National FFA Chapter Safety Award Program Winners.

## **MAKING OUR HOME, SCHOOL AND COMMUNITY SAFER PLACES TO LIVE AND WORK**



*By Jimmy Moore, Safety Program Chairperson  
Henry Miles, Sr., Advisor*  
Paramount High FFA Chapter, Paramount High School, Boligee, Alabama

The Chapter serves seven communities—rural and towns; 27 community leaders—principals, Board of Education members, Superintendent of Education, a probate judge, county commissioners, mayors, town councils, and others—were polled for their opinion of safety needs. Meetings were held in each community to capture the public's view as well. Additionally, the CHEM WASTE facility, which is the largest hazardous waste storage site in the United States, is located 20 miles from the community. The Chapter planned safety programs to meet the needs of all families whether or not they live on a farm, which included a hazardous waste seminar. (No emergency preparedness plan was in effect a few years ago when an emergency spill occurred 1 mile from the school.) Programs were delivered each month. Publicity included newspapers, radio and TV. Evaluation of the success of each activity was completed after each activity.

### **Activities Completed (and community groups included):**

1. Well Water Testing (County Health Department FFA members).
2. Electrical Safety Checks (FFA Members).
3. School Bus Safety Week Poster Contest (Elementary and High School students).
4. Radon Testing (FFA members Radon Hotline).
5. Monthly Fire Drills (Paramount High students) (896).
6. Monthly Tornado Drills (Paramount High students) (896).
7. Fuel Safety Decals (Paramount High students (700), Volunteer Fire Department).
8. Fire Extinguisher Demonstration (FFA members Paramount faculty).
9. Pesticide Safety (County Extension Agent).
10. National Fire Prevention Week (Fire Protection Association).
11. Propane Gas Leaks (Thermogas County FFA Alumni).
12. School Traffic Control (County Highway Department School Administration).
13. National Farm Safety Week (County Extension Agent, Local Agricultural Equipment Dealer).
14. How to Saddle a Horse (FFA members, FFA Alumni, 4-H Club, Boy Scouts, Cub scouts).
15. Hazardous Waste Disaster Seminar (Chemical Waste Management Inc., FFA Alumni, High School students).

## ***SAFETY THROUGH EDUCATION***

*By Tracy Mefford, Safety Program Chairperson  
Ken Salkeld, Advisor*

Southwestern-Hanover FFA Chapter, Southwestern High School, Hanover, Indiana

Each year, a random survey of perceived safety and community needs is conducted. A number of "standard" safety programs are conducted annually. The Chapter requested information and materials on selected safety problems from agencies and organizations. Materials were reviewed for appropriateness, and new materials were designed when necessary. The Chapter delivered educational messages on selected safety topics through presentations to large school groups, civic groups, and via door-to-door to ensure that the information was within everyone's reach. Events were publicized through newspaper, radio, wall calendars, and posters. Evaluation was limited, but it was noteworthy to mention that there were no flowing grain or suffocation fatalities, fatal fires, nor serious machinery injuries since 1984.



### **Activities Completed (and community groups included):**

1. Fire Safety Campaign (None).
2. Home Safety and Farm Machinery (None).
3. Safety Awareness Fingerprinting (Jefferson Co. Sheriff Dept.).
4. Farm Safety Coloring pages (None).
5. "Stick-A-Tractor" (None).
6. FFA Wall Calendars (None).
7. Emergency Maps of Schools (SW Administration and Maintenance Staff and local Fire Departments).
8. Hazardous Grain Handling (Purdue Coop Extension).
9. Emergency Medical Treatment: Children's booklets (Publisher, SW Elementary School and Teachers).
10. Halloween Trick or Treat Safety Bags (None).

**IN THE SCHEME OF LIFE THEY SAY, 'YOU LIVE AND LEARN.'  
WITH SAFETY WE BELIEVE THAT YOU LEARN AND LIVE**



*By Damien Lucius, Safety Program Chairperson  
John Rummel, Don Rains, Advisors*  
Stockton FFA Chapter, Stockton R-I Schools, Stockton, Missouri

The Chapter used data from several surveys to plan programs: 1) of area high school students' drinking and driving habits 2) of chapter members' perceived need for electrical and machinery safety programs in the community and 3) of elementary teachers for elementary students' safety needs. Some community groups came to the Chapter with safety projects. The Chapter continued to implement selected programs and develop new ones to meet the needs identified in the surveys. It focused on a philosophy that safe children become safe adults. Publicity included using newspapers, radio, television, posters, and the school bulletin. An evaluation showed that the objectives were met.

**Activities Completed (and community groups included):**

1. Substance abuse awareness program (FHA/HERO, FBLA, Student Council).
2. Re-floor Caplinger Mill Bridge (Bridge Preservation Society, Senior Citizen Club, Stockton City Council).
3. Ambulance program (Ambulance Board).
4. Chainsaw safety (Stihl Corporation).
5. Fire prevention (Springfield Fire Department).
6. Electrical safety display (Missouri State Fair).
7. Brand'em safety (All Community).
8. Bulletin boards on safety (John Deere).
9. Halloween safety (Safety Council).
10. Electrical safety (Stockton Elementary).
11. Fire safety (Stockton FFA).
12. Underground cable safety (Missouri Telephone).
13. Combine safety (John Deere).
14. Tractor safety (John Deere).
15. Bypass starting (John Deere).
16. Safety on the farm (John Deere).
17. Fire extinguisher use (Stockton High School).
18. Environmental safety (Department Natural Resources).
19. Pesticide safety (ASCS).
20. Hunter and gun safety (Missouri Department of Conservation).
21. Boat and water safety (Missouri Water Patrol).

## **PERSONAL SAFETY IN YOUR LIFE**

*By Gary Brumfield, Safety Program Chairperson  
Charles E. Miller, Advisor*

Amanda-Clearcreek FFA Chapter, Amanda-Clearcreek High School, Amanda, Ohio



The safety committee received input on community needs for safety programming from squad chiefs and fire chiefs from Clearcreek and Amanda Townships and a representative from the Sheriff's department. Others interested in safety issues were identified from local emergency services and listings of government agencies. The community is made up of villages and rural areas. A general meeting of all people and agencies with interest in safety areas was held to plan activities. The chapter involved as many members of the community as possible. The primary focus of the year was injury prevention. Publicity included newspaper articles, radio and TV, posters, pamphlet distribution, displays, demonstrations, and speeches.

### **Activities Completed(and community groups included):**

1. Fire Extinguisher Safety Program  
(Clearcreek EMS, AC FFA, Nation Fire Prevent, Humes Extinguisher Service).
2. Farm Safety Week (SKY MED, Clearcreek Fire/EMS, Amanda Fire/EMS, Coop Extension Service, AC FFA and Young Farmers).
3. Farm Safety for "Just Kids"  
(Farm Safety for Kids program, AC FFA Children's Hospital, Clearcreek EMS).
4. Hazardous Farm Chemicals for Joint Fire District (Hazard Committee Sheriff's Department  
All County Fire Districts, Coop Extension Service, AC FFA).
5. Chemical Safety for Farmers  
(Monsanto Company Hazard Committee, AC FFA and Young Farmers).
6. Fire Safety Week  
(Clearcreek EMS, Humes Extinguisher Service, AC FFA).
7. Equipment Safety Program  
(John Deere-Lifer, Clearcreek EMS/Fire, Amanda EMS/Fire, AC FFA and Young Farmers).
8. Farm Accidents Seminar for Squads  
(Children's Hospital, AC FFA, Lifer-John Deere, Lancaster-Fairfield Hospital).
9. 911 - System Operation  
(Sheriff's Department, Clearcreek Fire/EMS, Amanda Fire/EMS, AC FFA).
10. "Code-4" Car  
(Amanda Fire/EMS, Sheriff's Department, State Highway Patrol, Student Council).
11. Poster Contest (Farm Safety for "Just Kids," Clearcreek EMS, AC FFA and Young Farmers).
12. Health Screening - Blood Pressure, Cholesterol  
(Lancaster-Fairfield Hospital, Amanda EMS, Clearcreek EMS, AC FFA and Young Farmers).
13. Bloodmobile (Lancaster-Fairfield Hospital, Red Cross, AC FFA).

## **STRESSING SAFER CAMPUS, HOME, AND COMMUNITY THROUGH EDUCATION**

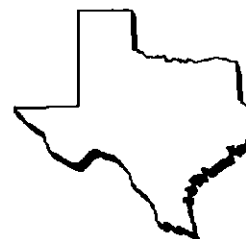

*By John Barragan, Safety Program Chairperson  
Dr. Steve Forsythe, John Hughes, Advisors*  
Ysleta FFA Chapter, Ysleta High School, El Paso, Texas

The advisors and the safety committee assessed local and national trends and their impact on El Paso. (Example: because of proximity to Mexico, rabies is a safety concern to domestic animals.) More than 100 community members were surveyed and participated in neighborhood polls to determine community needs as they relate to safety. Results of the community survey were tabulated and analyzed. Chapter officers and the safety committee Young Farmers, FFA Alumni, and the agricultural advisory committee to help determine priorities. Monthly safety programs were scheduled. Local and state resource people were contacted as speakers. FFA members met with outside groups to outline cooperative efforts in safety projects. Materials for programs were obtained. Media including TV, radio, and newspapers were contacted to inform them about activities planned throughout the year and to gain their support.

### **Activities Completed (and community groups included):**

1. ATV/3-Wheeler Seminars (Yseta Young Farmers).
2. Rabies Control Field Seminars (Alumni, Humane Society, Local Veterinarians).
3. "Brand Um" Campaign (El Paso Equipment Dealers).
4. Pecan Pesticide Safety Awareness (Young Farmers, Extension Service).
5. Adoption of Machinery for Safety Features (El Paso Equipment Dealers).
6. Gun Safety Workshop (D.P.S., Student Council).
7. Agricultural Products/Hazards Inservice (T.D.A., El Paso Food and Fiber Council).
8. Water Quality Testing (Lead) (YISD Administrative Council, City Council).
9. Fire Extinguisher-Fire Safety Inservice  
(Ft. Bliss Firefighters Association, Industrial Technology Club).
10. Cardio-Pulmonary Resuscitation Workshop (Young Farmers and Alumni).
11. Planned Public Relations Campaign (Local media, local press club, Young Farmers).
12. Color Coding/Eye Protection Updating (Standard Paint Company Alumni).
13. Educational Programming (El Paso County Health Association).

## **COMMUNITY SAFETY: TAKING THE LEAD IN SOUTH HILL**

*By George Basherville, Safety Program Chairperson  
E.C. Conner, R.A. Thomas, Advisors*

Park View Senior FFA Chapter, Park View Senior High School, South Hill, Virginia

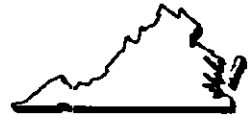

The chapter safety committee met with school officials, school club representatives, and community organization representatives to coordinate a community safety plan. Newspapers, radio, and surveys were used to poll the general public for their concerns. After data were collected, a list of suggested activities was developed and taken to chapter members. FFA members and some community members met to decide which projects would be completed during the year. Activities were scheduled monthly and tied into seasonal events when possible. Publicity included newspaper, radio PSA's, exhibits, posters, and school intercom announcements.

**Activities Completed (and community groups included) were a:**

1. Repairs and inspection of children's Playgrounds (None).
2. Fire extinguisher inspection (South Hill Volunteer Fire Department).
3. Farm safety exhibit (None).
4. Shop safety test (None).
5. Color coding of shop (None).
6. Boating and water safety display (South Hill Chamber of Commerce).
7. Hunter education courses(South Hill American Legion).
8. Served as pilot school senate drug program (None).
9. Ford/New Holland tractor safety program (None).
10. Sports A Field Day (Mecklenburg 4-H).
11. Tie One On ribbon program (SADD Chapter).
12. Chainsaw safety course (South Hill Ruriton Club).
13. Vials of life (Signet Bank).
14. Electrical wiring program (PV Young Farmers).
15. Restricted use pesticide recertification (Virginia Coop Extension Service).
16. Distribution of Pesticide Container test kits (Conner Claims Service).
17. Formation of Jr. Town Council (South Hill Chamber of Commerce).
18. Home safety hazard hunt survey (Friends of R.T. Arnold Library).
19. Lawnmower safety program (Mecklenburg Chapter American Red Cross).
20. After-prom party (SADD Chapter).
21. Boating safety course (Virginia Game Commissions).
22. Public service announcements on seatbelts (None).
23. Fire safety course (Mecklenburg Department of Forestry).
24. CPR classes(Southside Rescue Squad).



## **A.L.I.V.E. (AWARE LEADERS INSTILLING VITAL EDUCATION) IN SAFETY**



*By Dan Pearson, Safety Program Chairperson  
Mike Hickman, Christi N. Renz, Tim Schneider, Advisors  
Elma FFA Chapter, Elma High School, Elma, Washington*

The community was defined as that area served by the Elma School District, which included two towns and three unincorporated communities. Needs assessment meetings were held with the chiefs of Police, city councils, American Red Cross, Seattle Parks and Recreation, Seattle Canoeing Club, and other community groups and service organizations in each of the five areas to be served. The primary safety problems found were traffic safety related to drinking and driving and low seatbelt use. In addition, no boating safety course existed in the Eastern Grays Harbor community. The chapter analyzed each phase of the program for effectiveness and improvement and worked together with other community groups to avoid duplication of efforts. FFA members were involved as frequently as possible, especially during activities conducted in the schools. Publicity efforts included newspapers, presentations and television.

**Activities Completed (and community groups included) were a:**

1. Boating Safety - Instruction of Classes (Washington Parks and Recreation Commission, Seattle Park and Recreation, Seattle Canoeing Club, Summit Lake Community).
2. Elementary Presentation (Washington Parks and Recreation Commission, and Elementary School).
3. FFA Members Recreational Outing (Wynathchee Lake State Park).
4. Holiday Awareness Program - Assembly and Information Distribution (Elma D.A.R.E. program, S.A.D.D., Washington State Traffic Commission, Elma Police Dept., Whiteside Funeral Home, High School ASB).
5. FFA Meeting Featuring Safety - Hunting Safety, Job Site Safety (Washington Department of Wildlife, Morton Thiokol International, Ventron Division).
6. Elementary Safety Week - Mr. Egg and Seatbelt Safety - Fire Prevention Safety (Washington Traffic Safety Commission, Elementary School, Elma Fire Department, Aberdeen Fire Department, Featuring EDDE the Robot, Elementary School).
7. Personal Emergency Safety and Inspection of Ambulance (Elma Fire Department, Aberdeen Fire Department, Elementary School).
8. Electrical Safety (Grays Harter PUD - Elementary School).
9. Bicycle Rodeo (Elma Police Department, Washington State Patrol, Washington Traffic Safety Commission, Burger Elementary School).
10. Safety Poster Contest (Elma Police Department, Washington State Patrol, Washington Traffic Safety Commission, Burger Elementary School).
11. State Safety (Washington State Traffic Safety Commission).

## **AGRICULTURE CHEMICAL SAFETY**

*By Stason Ikenouye, Safety Program Chairperson  
Jack Smith, John Stahley, Advisors*

Platte Valley FFA Chapter, Platte Valley High School, Kersey, Colorado



We performed a safety program on March 26, 1991. In order to perform a mock chemical spill, we contacted several organizations. They consisted of the school board, the Kersey and Greeley fire departments, the state patrol, Kersey police, health department, the mayor of Kersey, town council, Platte Valley Elementary, and High School, Centennial Ag, HAZ MAT Team, EPA, Administration, two newspapers, radio, TV (news). We attended a Fire Department meeting, town council meeting, board of education meeting, and we held a meeting which consisted of the head of personnel, of every organization we listed above. The mock chemical spill began with a truck driver who was encountered by a heart attack, he lost control and the truck unfortunately went out of control and tipped over in the high school parking lot. Letting the chemical inside the tanker spread onto the parking lot contaminating, and injuring people trying to get into their cars. The first person that discovered the spill was our principal, Ms. Swain. The next person contacted was the Kersey police, followed by Mr. Hanson, administrator, Kersey Fire Department, EMT, Sheriff Department, Greeley Fire Department, and finally the State Patrol.

### **Activities Completed were a:**

1. Hazardous Chemical Spill Safety Simulation.
2. Hunters Safety Course.
3. Safety Tests.
4. Safety Films.
5. Safe Operation and use of Machinery.
6. Safety Review of Shop Equipment.
7. Arc Welding Safety.
8. Oxy Acetylene Welding Safety.
9. Power Tool Safety.
10. Engine Safety.
11. Electrical Safety.
12. Tractor Bypass Starting Safety.
13. Tractor PTO Safety.
14. Lawnmower Blade Safety.
15. Riding Lawnmower Safety.
16. Tractor Rollover Safety.

## **SAFETY FOR EVERYONE IN '91**



*By David J. Summers, Safety Program Chairperson-1991*

*Stephanie Moore, Safety Program Chairperson-1992*

*Dale McQuillen, Advisor*

Lake Placid Senior FFA Chapter, Lake Placid High School, Lake Placid, Florida

Our programs provide safety awareness from pre-school to adults with families and homes, and even in their jobs. We believe our program will make the community more aware of safety and make it a common, everyday practice. Our group focused a great deal on younger children. We tried to aid in their protection by issuing identification stickers and tags, and providing home safety material on young children to their parents. All students in our high school are required to take and pass the Red Cross CPR course and test. This training will last a lifetime and possibly save a life. We have told tractor operators in the community of the dangers of tractors and gave ideas on safety around them. The department has taught students proper safety of various shop tools and lawn equipment. Animal handling has been taught in classes in effort to prevent injury to handler or the handler. Chemical safety is also an issue pursued by the department and each ag student is taught safety around chemicals. The Lake Placid Senior FFA Chapter of the National FFA, hopes that their involvement and assistance with the community and its safety will make Highlands County a safer and healthier place in which to live and work. By conducting our various and many programs in safety, we hope that our community will always remember to keep safety in mind and be safe.

### **Activities Completed (and community groups included) were a:**

1. Identification Stickers (County Elementary School Staff).
2. Chemical Safety (Extension Service).
3. Tractor Safety Program (National Sticker Program, local tractor owners, passed out safe-packets).
4. Small Gas Powered Engine Equipment (Extension Service, Local and State).
5. Seat Belt Safety (Florida Highway Patrol, High School).
6. Animal Safety (4-H and FFA Members of Highlands County).
7. CPR Training (LPHS Staff).
8. Home Safety (State Extension Staff, Local Business).
9. Home Safety Demonstration (Extension Staff, LPHS Staff).
10. Electrical Safety (Florida Power, Lake Country Elementary).

## HUNTER SAFETY AND AGRICULTURAL WORK-SITE SAFETY



*By Kerry Courchaine, Safety Program Chairperson-1991*

*Keith Mitchum, Safety Program Chairperson-1992*

*Scott M. Carey, Bruce Thomas, Advisors*

Newton County FFA Chapter, Newton County High School, Covington, Georgia

For the past three years our chapter has placed emphasis on safety for our members and the community. Our FFA officer team identified the chapter and community needs. This year we planned to diversify our safety program and expand it. Our first major area was hunter safety program. As a part of our hunter safety program we invited a local game warden to our school. Mr. Roy Morris presented a program on hunter safety. We also began an education program in the school concerning requirements for obtaining a hunting license. Our second major area of emphasis this year was agriculture safety on the farm. From our community survey and the local farm bureau, we found some problems in Newton County. We began our program during National FFA Week by declaring one day as Safety Day. During Safety Day, Ms. Beck Tyles from the Georgia Farm Bureau presented a program on agriculture safety on the farm. Students were educated on hazards on the farm and how to correct them. Each student was given literature on hazards and ways to prevent them. The next step of our program was to put in action the information learned by the student. Our chapter prepared a safety tour of two farms and an agricultural business. On this tour, we utilized a safety packet produced by Progressive Farmer. The packet contained safety material, stickers, evaluation and tagging devices. At each location we explained our purpose to the owners and students marked and tagged hazards. At the agriculture business, students were shown up to date safety devices on agricultural equipment. One of the farms was a former FFA member. Upon completion follow-up survey's were completed. Our chapter also viewed safety films on various topics during FFA Safety Week. To remind community members to keep safety on their minds at all times, the chapter constructed two signs. These signs were placed on the roadways entering Newton County. The theme on the sign was Prevent Accidents, Act Safely. Chapter members erected the signs so citizens of Newton County would be reminded of safety.

### Activities Completed (and community groups included) were a:

1. Hunter Safety Program (School).
2. Community Survey.
3. Safety Awareness Day (High School).
4. SMV Sign Distribution (Farm Bureau).
5. Safety Vest Sale (Farm Bureau).
6. Livestock Chute Demonstration (Local Farmers).
7. Hunting Licence Certification (Georgia Department of Natural Resources).
8. Classroom Safety Pretest.
9. Classroom Safety Post Test.
10. Greenhouse Chemical Safety Program (Georgia Department of Agriculture).
11. Safety Film Fair.
12. Georgia Farm Bureau Safety Program (Farm Bureau).
13. Safety Tour: 1) Ballard Farms, 2) Marks Dairy, 3) Hay's Truck and Tractor (Local Farmers).
14. Follow-up Survey (Progressive Farmer).
15. Construction of Safety Sign Upon Entering Newton County (Farm Bureau, State FFA Camp).

## **SAFETY AWARENESS IN THE COMMUNITY**



*By Michael Hawkins, Safety Program Chairperson  
Milt Luckstead, Jr., Advisor*

Cascade FFA Chapter, Cascade High School, Cascade, Iowa

At the end of each year our safety committee and FFA members evaluate the past years program. The evaluation is used to help determine the needs of the safety program for coming years. After our safety committee is selected, they sit down and decide which activities will best promote safety in the Cascade area. FFA members always look for new ideas to improve existing safety programs. This year we were able to add lots of media coverage, an elementary program, and cooperated with Mercy Health Center to improve safety awareness. Once the safety committee has met they split up duties among FFA members, to contact necessary people. For example, the elementary safety program was coordinated through Marilyn Adams and the Cascade Elementary staff. FFA members contacted these people and set up the time and place to conduct the meeting. Other FFA members met together to put a program together. Our safety program begins each year by examining the previous years evaluation. Plans are made for the coming year. Keeping in mind short and long term goals. At the end of the year another evaluation takes place. Continuity and organization are keys to keeping "Safety Awareness in Our Community" a priority program.

**Activities Completed (and community groups included) were a:**

1. Health and Safety Walkabout (Mercy Health Center).
2. Safety Messages on Silo Bags (Community Members).
3. Safety Meeting (Cascade Elementary Farm Safety for "Just Kids").
4. 5th Grade Safety Poster Contest (4 Elementaries).
5. 300 Safety Stickers Handout Out and Applied (Community Members).
6. Tractor Safety Driving Contest (Alumni Members).
7. Water Safety (Board of Supervisors, Health Board, Extension Service, County High Schools).
8. Chainsaw Safety Demonstration (Dave Stevens, Chainsaw Dealer).
9. Public Service Announcements (KDTH Radio Station).
10. Hunter Safety Classes (Twin Rivers Pheasants Forever, High School Administration).
11. Trapshoot Safety Demonstration (Community Members).
12. Safety Films (High School Administration).
13. Membership (Farm Safety for "Just Kids", Iowa Farm Safety Council).
14. Shop Safety (High School Administration).
15. TV Interviews (KDUB, Channel 40).
16. National Farm Safety (Area Business, Local Paper).

## **SAFETY SPRAYER TUNE-UP**



*By James A. Pavlik, Safety Program Chairperson  
Gary L. Hansen, Kevin Randa, Advisors*  
Verdigre FFA Chapter, Verdigre Public School, Verdigre, Nebraska

During one of our FFA meetings, the chapter came up with suggestions for possible safety projects. The safety committee and chairman, James Pavlik, looked into the projects and a list was posted for all members to view and consider for possible ideas. At a FFA meeting, the chapter discussed and voted on the activities to be conducted for the year. The Sprayer Tune-Up Kit was not the chapters first choice for our main safety activity. We first contacted our local EMT Unit to put on a safety demonstration and film with the help of jaws-of-life. They couldn't do the demonstration until spring. A safety specialist was consulted about presenting a PTO demonstration on safety and care that should be used around this type of equipment. Local EMT's were also to take part in this demonstration, however, due to conflict in dates this project was not completed. We then came in contact with the sprayer project and being mainly a rural area, we felt this project would be a very needed subject area for our community. The response was great in helping us and very positive. The people felt the training they received at the CO-OP's Sprayer Tune-Up day held February 18th was beneficial. The CO-OP also held a sprayer calibration demonstration for chapter members.

**Activities Completed (and community groups included) were a:**

1. Sprayer Tune-Up Week Kit (Verdigre CO-OP, ZOBJ Hall, Verdigre Elevator).
2. Cement put in pipes of BOAC fence project (Verdigre School Board, Town Board, Verdigre School Insurance).
3. Film "Can You Get Out" (School Nurse, Fire Marshall).
4. Safety Articles (Safety Committee).
5. Safety Films (Ag Ed Class, Safety Committee).
6. Ag Shop Evaluation (School, FFA, Ag Ed Classes).
7. Emergency information ad in local paper (Safety Committee).
8. Safety Goggles (School, FFA).
9. Articles on Bulletin Board (FFA, School).
10. Safety Application (FFA).
11. School Bus Stop Signs (School Bus Drivers, Supervisor, FFA).

## **KEEP HARM OFF THE FARM**



*By Chad J. Heit, Safety Program Chairperson-1991*

*Jason Heinz, Safety Program Chairperson-1992*

*Cliff Orgaard, Advisor*

Rolette FFA Chapter, Rolette Public School, Rolette, North Dakota

Our goal is to prepare each member to be a safe and well informed member of the community. We carry out a variety of activities and involve several members of the community and alumni to increase the interest level and impact upon the members. Also, since Rolette is a fairly small community, we make every attempt to cooperate with other organizations for our mutual benefit. For instance, by working with the Ambulance Squad, we helped them qualify for a \$1,500 grant. We live in a rural area that relies almost exclusively on production agriculture for its income. Almost all students live and/or work on a farm and use farm equipment. During 1990, at least three farmers in our community had farm related injuries. Fortunately they are all recovering, but it made us aware of the importance of continued training in safe practices and emergency first aid. Even though no formal survey was developed, we feel we met the needs of our community by carrying out the activities that we did.

**Activities Completed (and community groups included) were a:**

1. Tractor Safety Course to Eighth Grade Students (Rolette Insurance Agency).
2. Ambulance Demonstration (Rolette Emergency Medical Services Personnel).
3. Machinery Safety Video Presentation (County EMS Personnel).
4. Community-Wide Farm Safety Program (Rolette EMS, Johnson Oil, Rolette Bank, A of G Church, City Medical Officer).
5. Weight Room Renovation (School Board Athletic Department).
6. Gun Safety Demonstration (FFA Chapter).
7. Sponsorship of Post-Prom Party (All Rolette Businesses).

## **SURVIVING WITH SAFETY**

*By Amy Tucker, Safety Program Chairperson-1991  
Charlotte Kreier, Safety Program Chairperson-1992  
Brenda J. Scheil, Advisor*

New Auburn FFA Chapter, New Auburn High School, New Auburn, Wisconsin



We are concerned with our present generation and future generations so we concentrate on including safety topics which would be significant to lives of all ages. We also realize that among our varied age groups we must also meet the needs of a diversified population and we believe we do this through our safety program and safety campaign efforts. When we selected major safety topics we included; National Farm Safety, School Bus Safety Promotion, Tractor Safety Certification, Bicycle Safety, School Shop Safety and Poison Prevention. By adding additional safety topics through the year our safety program maintains diversity and safety then becomes an on-going and continual concern. Our new emphasis this year was "Outdoor Power Equipment" and we also painted our playground equipment on our school grounds. If we were to table our safety program and make no effort to promote safety...dangerous situations would be an even greater threat to our community. We believe that as time progresses our safety program becomes even more preventative. We want to prevent dangerous situations and accidents before they happen. By carrying out our preventative programs we are building positive safety records and this is a continual goal which will hopefully become a long-term record. It is our long-range goal within our long-range plan to have a program set up for each level in the pre-school, grade school and high school in addition to safety programs geared to our adults within our community. By building our base program of safety we will eventually be able to present programs of safety to all community organizations on a rotating basis in order that once a year each community group would hear at least one different safety topic from us. This would build stronger ties within our community and FFA would always remind each person of safe attitudes and actions. "Surviving with Safety" does not happen without dedication.

**Activities Completed (and community groups included) were a:**

1. Tractor Safety Program and Contest (Extension Office, Neighboring Chapter).
2. National Farm Safety (Local Businesses).
3. School Announcements (School Staff and Administration).
4. Bicycle Safety Education Program (Fifth Grade Class).
5. Paint Playground Equipment (School Personnel).
6. Gas Weed Eater Safety (FFA Members).
7. Lawnmower Safety (Northstar Implement).
8. Fall Harvest Safety Presentation (FFA Alumni).
9. Seatbelt Safety (Department of Transportation).
10. Eye Safety Emphasis (FFA Members, Faculty Members).
11. Laminate Posters (FFA Members).
12. FFA Safety Booth (FFA Members, Lion's Club, FFA Alumni).
13. "Mr. Yuc" Poison Prevention Program (Luther Hospital, Elementary School).
14. Safety Preparation for Maintenance Personnel (Simplicity Lawnmower Company, FFA Members).
15. View Safety Films, Videos and Filmstrips (FFA Members, Organization from which they were obtained).



## VIDEO TAPE PRESENTERS

TITLE	SOURCE
<b>Idaho</b>	
<i>Farm and Ranch Equipment Safety</i>	Idaho Cooperative Extension Agricultural Communication Center 10 Agricultural Science Building Moscow, ID 83843-4196 (208) 885-6436 or FAX (208) 885-6654
<b>Illinois</b>	
<i>Safe Country</i>	County Companies Insurance Community Education P.O. Box 2020 Bloomington, IL 61702 (309) 557-2836 or FAX (309) 829-9430
<b>Iowa</b>	
<i>Agriculture at Risk</i>	Audiovisual Center University of Iowa C215 Seashore Hall Iowa City, IA 52242 1 (800) 369-IOWA or FAX (319) 335-2507



**Making Connections**

***Farm Safety for Kids***

**Farm Safety for "Just Kids"**  
P.O. Box 458  
130 East First  
Earlham, IA 50072  
(515) 758-2827 or FAX  
(515) 758-2517

**Rural Health Series Tape**

- #1 *Agricultural Traumas***
- #2 *Pesticide Toxicology***
- #3 *Agricultural Respiratory Disease and Skin Diseases of Agricultural Workers***
- #4 *Zoonotic Diseases #1***
- #5 *Zoonotic Diseases #2***

Jacqueline Snider  
Information Resource Center  
University of Iowa  
124 AMRF-Oakdale Campus  
Iowa City, IA 52242  
(319) 335-4427 or FAX  
(319) 335-4225

**Nebraska**

---



***Farm Machinery Accidents***

Lincoln Medical Education  
Foundation  
4600 Valley Road  
Lincoln, NE 68510-4844  
(402) 483-4581 or FAX  
(402) 483-4184

- #1 *Auger Rescue***
- #2 *PTO***
- #3 *Crushing Injury***

Rollin Schnieder  
Cooperative Extension  
Institute of Agriculture and Natural  
Resources  
221 West Chase Hall  
University of Nebraska-Lincoln  
Lincoln, NE 68583-0771  
(402) 472-2824 or FAX  
(402) 472-6338

**New York**

---



**FARMSAFE Series**

- #1 *Agricultural Injuries and Children*
- #3 *Recognizing Workplace First Response to Farm Injuries and Reporting a Farm Accident*
- #4 *Personal Protective Equipment*
- #5 *Tractor Overturns*
- #6 *Electrocution Hazards*
- #7 *Job Safety Analysis and Risk Taking Demonstration*
- #8 *Safety on the Farm, But off the Job*
- #9 *Respiratory Hazards on the Farm*
- #10 *Power Take off Injuries*
- #11 *Farm Family Stress*
- #12 *Economic Impact of Farm Injuries*

New York Center for  
Agricultural  
Medicine and Health  
One Atwell Road  
Cooperstown, NY 13326  
(607) 547-6023 or FAX  
(607) 547-6087

**Vermont**

---



*It Can't Happen to Me*

UVM Extension Service  
Office of Information  
Morrill Hall, UVM  
Burlington, VT 05405  
(802) 656-3024 or FAX  
(802) 656-8642

**Wisconsin**

---



*Grant County Farm Injury Statistics*

Linda Adrian  
Grant County Nurses Office  
111 S. Jefferson Street  
Lancaster, WI 53813  
(608) 723-6416 or FAX  
(608) 723-2377

*How to Have an Accident*

Cooperative Extension Media  
Collection  
Bureau of AV Instruction  
1327 University Ave.  
Madison, WI 53715-2491  
(608) 262-1644 or FAX  
(608) 262-7568

## NATIONAL PARTICIPANTS

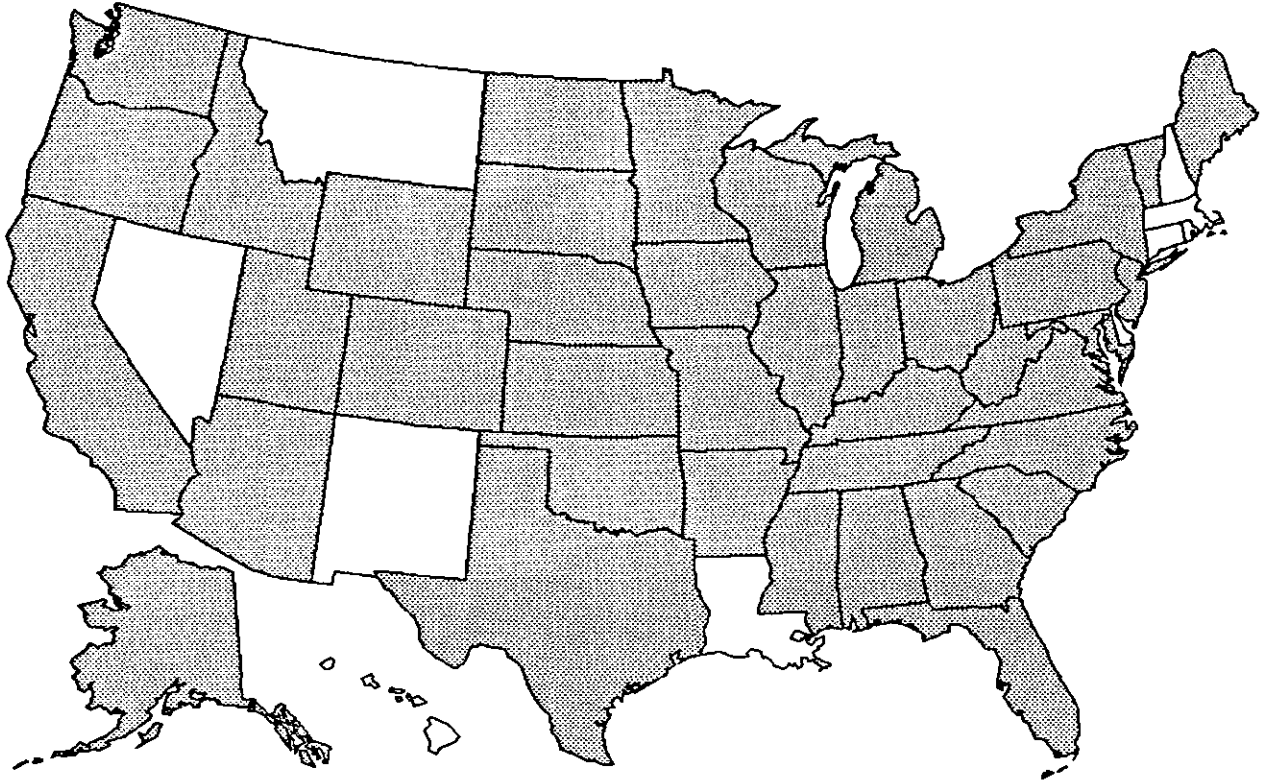

Figure 1. The 41 States That Were Represented by Participants at the Conference.

### ALABAMA

Mr. Henry Miles, Sr.  
 FFA Advisor  
 Paramount High School  
 P. O. Box 188  
 Boligee, AL 35443

Mr. Jimmy Moore  
 FFA Safety Chairperson  
 Paramount High School  
 P. O. Box 188  
 Boligee, AL 35443

Mr. Charles B. Ogburn  
 Extension Agricultural Engineer  
 Alabama Cooperative Extension  
 Service, Auburn University  
 Room 218, Agricultural Engineering  
 Building  
 Auburn, AL 36849



### ALASKA

Mr. Richard Kennedy  
 Statistician  
 NIOSH, CDC  
 3601 C. Street, Suite 250  
 Anchorage, AK 99503

Mr. Robert Seay  
 County Extension Agent  
 Cooperative Extension Service  
 1204 SW 14th Street  
 Bentonville, AK 72712



### ARIZONA

Mr. Lance Fluegel  
 Safety Coordinator  
 Arizona Cooperative Extension  
 222A Forbes Building  
 Tucson, AZ 85721



### ARKANSAS

Mr. Jim Wohlleb  
 Assistant Director  
 Arkansas Area Health  
 1123 South University  
 Little Rock, AR 72205



## National Participants

### CALIFORNIA



Dr. Carol Conroy  
Occupational  
Epidemiologist  
California Occupational Health Program  
2151 Berkeley Way, Annex 11  
Berkeley, CA 94704

Dr. David F. Goldsmith  
University of California, Davis  
Division of Occupational and  
Environmental Medicine  
ITEH  
Davis, CA 95616

Mr. Gene F. Graham  
Assistant Program Director  
W.K. Kellogg Foundation  
1111 N. Dartmouth Ave, Apt 205  
Clairemont, CA 91711

Mr. James Grieshop  
Specialist, Applied Behavioral Sciences  
University of California  
Department of Applied Behavioral  
Sciences  
Davis, CA 95616

Mr. Kevin Kokrda  
Engineering Administrative Manager  
Kubota Tractor Corporation  
550 W. Artesia Boulevard  
Compton, CA 90220-7020

Mr. Neil Maizlish  
Epidemiologist  
California Occupational Health Program  
2251 Berkeley Way, Annex 11  
Berkeley, CA 94704

Mr. Craig Merrilees  
Special Projects Director  
National Toxics Campaign and  
Consumer Pesticide Project  
425 Mississippi Street  
San Francisco, CA 94107

Dr. James M. Meyers  
Agricultural Health Specialist  
University of California, Berkeley  
322 Warren Hall  
Berkeley, CA 94720  
570/ 642-8375  
570/ 642-5815 - FAX

Dr. John Miles  
University of California, Davis  
Agricultural Engineering Department  
Davis, CA 95616

Mr. Dalton Paxman  
University of California, Berkeley  
322 Warren Hall  
Berkeley, CA 94720

Dr. Marc Schenker  
University of California, Davis  
Agricultural Health and Safety Center  
Davis, CA 95616

Dr. William E. Steinke  
Extension Agricultural Engineer  
Agricultural Engineering Extension  
University of California  
Davis, CA 95616

Mr. Don Villarejo  
Executive Director  
California Institute for Rural Studies  
P.O. Box 2143  
Davis, CA 95617

Mr. Robert Wagner  
Director, Agricultural Safety  
Zenith Insurance Company  
226 Airport Parkway  
San Jose, CA 95110

Ms. Elen G. Widess  
Director of Health and Safety Policy  
Children's Advocacy Institute  
Suite 340  
1160 Battery Stret, Suite 340  
San Francisco, CA 94111

Ms. Melanie Zavala  
Farm Worker Safety Coordinator  
University of California, Davis  
IPM Education and Publications  
Davis, CA 95616-8620

### COLORADO



Mr. Paul D. Ayers  
Colorado State  
Department of Agricultural and  
Chemical Engineering  
Ft. Collins, CO 80523

Ms. Lela K. Criswell  
Epidemiology  
Colorado State University  
Department of Environmental Health  
Ft. Collins, CO 80523

Mr. Bill Daniels  
Regional Representative  
Public Health Service Region 8  
1961 Stout Street  
Denver, CO 80227

Dr. Lorann Stallones  
Associate Professor  
Department of Environmental Health  
Colorado State  
Fort Collins, CO 80523

### DISTRICT OF COLUMBIA

Ms. Judith Bowers  
Head, Public Affairs  
Communication, Information, and  
Technology Unit  
3331 South Building  
Washington, DC 20250-0900

Ms. Carmen Calhoun  
Assistant to the Director  
National Association of Wheat Growers  
Foundation  
415 Second Street, N.E.  
Washington, DC 20002

Dr. David J. Cochran  
Industrial Engineer  
175 Nebraska Hall  
Lincoln, NE 68588-0518

Ms. Cynthia Douglass  
401 M. Street, SW  
OS-120  
Washington, DC 20460

Mr. Tom Harkin  
U.S. Senator  
State of Iowa University  
SH531 Hart Senate Office Building  
Washington, DC 20510-1502

Dr. Myron D. Johnsrud  
Administrator, Extension Service  
USDA  
Room 338 A, Administration Building  
Washington, DC 20250-0900

Dr. Daniel E. Kugler  
Director, Office of Agricultural Materials  
USDA  
14th and Independence Avenue, SW,  
Aerospace Center 342  
Washington, DC 20250-2200

Mr. Stephen Mallinger  
Deputy Director of Technical Support  
OSHA, US Department of Labor  
200 Constitution Avenue, NW  
Room N3653  
Washington, DC 20210

Dr. J. Michael McGinnis  
Deputy Assistant Secretary for Health  
DHHS  
330 C Street, SW, Room 2132  
Washington, DC 20201

Mr. Joseph M. Miller  
Bureau of Census  
Agriculture Division  
426 Iverson Building  
Washington, DC 20715

**Dr. Antonia C. Novello**  
 Surgeon General  
 USPHS  
 The Hubert Humphrey Building  
 Room 710G  
 200 Independence, SW  
 Washington, DC 20201

**Ms. Joann Orr**  
 National Aerial Agricultural Association  
 1005 E Street, SE  
 Washington, DC 20003

**Mr. Vernon Orr**  
 President  
 National Agricultural Aviation  
 Association  
 1005 E Street, SE  
 Washington, DC 20003

**Mr. Bradley K. Rein**  
 USDA Extension Service  
 Agricultural Programs  
 Room 3346, S. Building  
 Washington, DC 20250-0900

**Dr. Jane Rissler**  
 Biotechnology Specialist  
 National Wildlife Federation  
 1400 16th Street, NW  
 Washington, DC 20036

**Mr. Randall Putta**  
 Director of Governmental Affairs  
 National Easter Seal Society  
 1350 NY Avenue, NW, Suite 415  
 Washington, DC 20005

**Mr. Thomas Seymour**  
 Deputy Director of Safety  
 OSHA, US Department of Labor  
 200 Constitution Avenue, NW  
 Room N3605  
 Washington, DC 20210

**Dr. Louis W. Sullivan**  
 Secretary of Health and Human  
 Services  
 200 Independence Avenue, SW  
 Room 615F  
 Washington, DC 20201

**Dr. Leslie Whitener**  
 Leader, Agricultural Labor Section  
 USDA  
 1301 New York Avenue, NW  
 Washington, DC 20005

**Ms. Valerie A. Wilk**  
 Health Specialist  
 Farm Worker Justice Fund, Inc.  
 2001 S. Street, NW, Suite 210  
 Washington, DC 20009

**FLORIDA**



**Mr. Arturo Lopez**  
 Executive Director  
 Coalition of Florida  
 Farmworker  
 Organizations  
 P.O. Box 326  
 Homestead, FL

**GEORGIA**



**Ms. Diane Allen**  
 NIOSH, CDC  
 Room 3066, MS D-26  
 Atlanta, GA 30333

**Ms. Jennifer L. Ballew**  
 NIOSH, CDC  
 Room 3417, MS D-32  
 Atlanta, GA 30333

**Ms. Kimberly L. Barth**  
 NIOSH, CDC  
 Room 3043, MS D-26  
 Atlanta, GA 30333

**Mr. Paul Burlack**  
 Public Health Advisor  
 CDC  
 Koger Center, 1045, MS F-36  
 Atlanta, GA 30333

**Ms. Glenda Cowart**  
 Office of the Director  
 CDC  
 Room 2011, MS D-15  
 Atlanta, GA 30333

**Ms. Ann Cronin**  
 NIOSH, CDC  
 Room 3124, MS D-36  
 Atlanta, GA 30333

**Ms. Brooke Dixon**  
 Director, Georgia Migrant Health and  
 Agricultural Surveillance Program  
 Georgia Division of Public Health  
 1190 Winding Branch Circle  
 Dunwoody, GA 30338

**Ms. Betty Dryden**  
 NIOSH, CDC  
 Room 3067, MS D-26  
 Atlanta, GA 30333

**Mr. Brian Dugan**  
 NIOSH, CDC  
 Room 3423, MS D-32  
 Atlanta, GA 30333

**Dr. Richard L. Ehrenberg**  
 NIOSH, CDC  
 Room 3047, MS D-26  
 Atlanta, GA 30333

**Dr. Roy M. Fleming**  
 Associate Director for Grants  
 NIOSH, CDC  
 Room 3057, MS D-30  
 Atlanta, GA 30333

**Mr. William Gimson**  
 Deputy Director  
 Office of Program Support, CDC  
 Financial Management Office  
 Buckhead, 200, MS E-12  
 Atlanta, GA 30333

**Ms. Mary Griffin**  
 NIOSH, CDC  
 Room 3112, MS D-36  
 Atlanta, GA 30333

**Mr. Tim Groza**  
 NIOSH, CDC  
 Room 3040 MS D-29  
 Atlanta, GA 30333

**Ms. Denise Johnson**  
 Public Health Advisor  
 CDC  
 1600 Clifton Road, NE  
 Atlanta, GA 30333

**Ms. Joyce A. Johnson**  
 NIOSH, CDC  
 Room 3040, MS D-29  
 Atlanta, GA 30333

**Mr. Ted Katz**  
 NIOSH, CDC  
 Room 3116, MS D-36  
 Atlanta, GA 30333

**Ms. Evelyn Lemelin**  
 Program Analyst  
 NIOSH, CDC  
 Room 3040, MS D-29  
 Atlanta, GA 30333

**Dr. Richard A. Lemen**  
 Deputy Director  
 NIOSH, CDC  
 Room 3007, MS D-36  
 Atlanta, GA 30333

**Dr. Eugene J. Lengerich**  
 Epidemiologist  
 CDC, CCDPHP  
 Chamblee, 1019, MS F-13  
 Atlanta, GA 30333

**Mrs. Joan P. Millar**  
 3243 Wake Robbin Trail, NE  
 Atlanta, GA 30341

## National Participants

Dr. J. Donald Millar  
Director  
NIOSH, CDC  
Room 3007, MS D-36  
Atlanta, GA 30333

Ms. Barbara Morrison  
Program Analyst  
NIOSH, CDC  
Room 3040, MS D-29  
Atlanta, GA 30333

Mrs. Annette B. Myers  
1293 Berkley Road  
Avondale Estates, GA 30002-1517

Mr. Melvin L. Myers  
Special Assistant to the Director  
NIOSH, CDC  
Room 3041, MS D-26  
Atlanta, GA 30333

Ms. Barbara Nelson  
Program Analyst  
NIOSH, CDC  
Room 3040, MS D-29  
Atlanta, GA 30333

Mr. Claude F. Pickelsimer, Jr.  
Director, FMO  
CDC  
Buckhead, 200, MS E-12  
Atlanta, GA 30333

Dr. Patricia H. Price  
Medical Officer  
ATSDR  
Executive Park, MS E-33  
Atlanta, GA 30333

Dr. William L. Roper  
Director, CDC  
Room 2000, MS D-14  
Atlanta, GA 30333

Mr. Sven J. Rundman, III  
OSHA, U.S. Department of Labor  
1375 Peachtree Street, NE  
Room 587  
Atlanta, GA 30367

Mr. Stan Salisbury  
Regional Program Consultant  
Public Health Service Region IV  
101 Marietta Tower  
Atlanta, GA 30323

Ms. Ann Smith  
Program Analyst  
NIOSH, CDC  
Room 3040, MS D-29  
Atlanta, GA 30333

Mr. Larry W. Sparks  
NIOSH, CDC  
Room 3104, MS D-36  
Atlanta, GA 30333

Ms. Gwendolyn L. Strickland  
Senior Attorney  
CDC, Office of the General Counsel  
Room 4017, MS C-05  
Atlanta, GA 30333

Ms. Newell B. Tozzer  
Program Analyst  
NIOSH, CDC  
Room 3040, MS D-29  
Atlanta, GA 30333

Mr. Bobby L. Tyson  
Extension Engineer  
University of GA  
Athens, GA 30602

Ms. Barbara Wedding  
NIOSH, CDC  
Room 3053, MS D-30  
Atlanta, GA 30333

Ms. Katherine Wilson  
Center for Chronic Disease Prevention  
and Health Promotion  
CDC  
Koger Center, 4102, MS K-46  
Atlanta, GA 30333

Ms. Rebecca B. Wolf  
Program Analyst  
CDC, OPPE  
Room 2050, MS D-23  
Atlanta, GA 30333

## IDAHO

Mr. Larry Belmont  
Director, Idaho  
Panhandle  
Health District 1  
2195 Ironwood Court  
Coeur d'Alene, ID 83814

Dr. Jim Berry  
Director, Production Research  
Rogers NK Seed Company  
6338 Highway 20-26  
Nampa, ID 83687

Mr. Tom Karskey  
Extension Farm Safety Specialist  
University of Idaho  
Agricultural Engineering Department  
Moscow, ID 83843

Mr. Ryan Kuehmichel  
OSHA  
U.S. Department of Labor  
3050 North Lakeharbor Lane  
Suite 134  
Boise, ID 83703

## ILLINOIS

Mr. Kevin  
Adolphson  
Commercial Loss  
Control Coordinator  
Country Companies  
1705 Towanda Avenue  
Bloomington, IL 61702-2100

Dr. Robert Aherin  
Professor, Department of Agricultural  
Engineering  
University of Illinois  
1304 West Pennsylvania Avenue  
Urbana, IL 61801

Dr. Walter J. Armbruster  
Associate Managing Director  
Farm Foundation  
1211 W. 22nd Street, #216  
Oak Brook, IL 60521-2197

Mr. L. Dale Baker  
Product Safety Engineer  
JI Case Company  
7 South 600 County Line Road  
Hinsdale, IL 60521

Mr. Emmett Barker  
President  
Equipment Manufacturers Institute  
10 South Riverside Plaza  
Suite 1220  
Chicago, IL 60606-3710

Ms. Page L. Bellingier  
Manager of Product Safety and  
Engineering Standards  
Deere and Company  
John Deere Road  
Moline, IL 61265

Mr. James F. Bennett  
Farm and Industrial Equipment  
Manufacturer's Institute  
10 South Riverside Plaza, Suite 1220  
Chicago, IL 60606-3710

Mr. Stanley Bozdech  
Assistant Manager of Engineering  
Dekalb Plant Genetics  
3100 Sycamore Road  
Dekalb, IL 60115





Mr. Jack W. Burke  
Program Manager  
Agricultural Safety  
National Safety Council  
444 North Michigan Avenue  
Chicago, IL 60611

Dr. Wade P. Clarke  
Director, Government Affairs  
Deere and Company  
John Deere Road  
Moline, IL 61265

Mr. John H. Crowley  
Director Safety Programs  
Equipment Manufacturers Institute  
10 South Riverside Plaza, Suite 1220  
Chicago, IL 60606-3710

Ms. Belinda Dehart  
Illinois Department of Public Health  
Center for Rural Health  
535 W. Jefferson  
Springfield, IL 62761

Mr. Richard De Pauw  
Product Safety Coordinator  
John Deere Harvester Works PDD  
1800 158th Street  
East Moline, IL 61244

Dr. Gary Erisman  
Private Farmer  
P.O. Box 278  
Stanford, IL 61774

Ms. Elizabeth Esseks  
Graduate Student  
University of Illinois  
Department of Health and Safety  
Studies  
121 Huff Hall, 1206 S. Fourth Street  
Champaign, IL 61820

Ms. Theresa Foes  
Director of Health Education  
Rock Island County Health Department  
2122 25th Avenue  
Rock Island, IL 61207

Mr. Joseph A. Kinney  
Executive Director  
National Safe Workplace Institute  
122 S. Michigan Avenue, Suite 1450  
Chicago, IL 60603

Mr. Mark Landmark  
Director of Safety  
American Farm Bureau Federation  
225 Toughy Avenue  
Park Ridge, IL 60068

Mr. Terry L. Loughrin  
Product Engineering Manager  
Walterscheid, Inc.  
16 W 030 83rd Street  
Burr Ridge, IL 60521

Mr. Murray D. Madsen  
Product Safety Engineer for Agriculture  
Equipment  
Deere and Company  
Product Safety and Engineering  
Standards  
Moline, IL 61265

Ms. Judy Marshall  
Writer  
Deere and Company  
John Deere Road  
Moline, IL 61265

Mr. Shane Miller  
Route 1, Box 228  
Tolono, IL 61880

Ms. Leslie Nickels  
Project Director  
University of Illinois  
815 W. Van Buren, Suite 214  
Chicago, IL 60607

Mr. Keith Pfundstein  
Owner  
KPS Technology  
3714 44th Street  
Rock Island, IL 61201

Ms. Marsha Purcell  
Director of Program Development  
American Farm Bureau Federation  
225 Touhy Avenue  
Park Ridge, IL 60068

Ms. Barbara I. Riordan  
Childhood Injury Prevention Consultant  
Illinois Dept of Public Health  
2009 Glenview Road  
Rockford, IL 61107

Mr. Dave Schmerse  
Project Manager, Product Safety  
Deere and Company  
John Deere Road  
Moline, IL 61265

Mr. Doug Sommer  
District Coordinator of Community  
Education  
Country Companies  
Box 2020  
Bloomington, IL 61701

Mr. Mike Tumbleson  
University of Illinois  
Veterinary Medicine Basic Science  
Building, Room 3217  
2001 S. Lincoln Avenue  
Urbana, IL 61801

Mr. James Westaby  
University of Illinois  
Department of Agricultural Engineering  
1304 W. Pennsylvania Avenue  
Urbana, IL 61801

Mr. James L. Williams  
Associate Director  
Community Education  
Country Companies  
1701 Towanda Avenue  
P.O. Box 2020  
Bloomington, IL 61701

Mr. Ted O. Yanecek  
Legislative Counsel  
Deere and Company  
John Deere Road  
Moline, IL 61265

## INDIANA

Mr. Tracy Mefford  
FFA President  
Southwestern-  
Hanover FFA  
Route 5, Box 222  
Madison, IN 47250

Dr. Robert R. Pinger  
Director  
Public Health Entomology Laboratory  
Ball State  
Muncie, IN 47306

Mr. Ken Salkeld  
FFA Advisor  
Southwestern FFA  
Route 1, Box 473 D  
Lexington, IN 47138

Mr. Mark Timm  
President  
National FFA Organization  
Route 1, Box 20AA  
Fillmore, IN 46128

## IOWA

Ms. Marilyn Adams  
President  
Farm Safety for "Just  
Kids"  
P.O. Box 458  
Earham, IA 50072



## National Participants

Mr. Eugene L. Ahrenholtz  
Vice President of Operations  
Clean Air Filter Company  
Route 1, Box 18  
Defiance, IA 51527

Mr. Dale E. Anthony  
Agricultural Injury Investigator  
Iowa Department of Public Health  
321 E. 12th Street, Lucas Building  
Des Moines, IA 50319-0075

Mr. Christopher Atchison  
Director  
Iowa Department of Public Health  
321 E. 12th Street, Lucas Building  
Des Moines, IA 50319

Mr. Lawrence E. Barker  
Director  
Scott County Health Department  
428 Western Avenue  
Davenport, IA 52801

Ms. Marcia A. Barrett  
Agricultural Occupational Health Nurse  
MMSC AgriCare  
3 South 4th Avenue  
Marshalltown, IA 50158

Ms. Mariene Beckman  
EMS Supervisor  
Southeastern Community College  
Route 1, Box 85  
Mediapolis, IA 52637

Dr. Jack Beno  
Associate Professor for Occupational  
Safety and Health  
Iowa State  
122 Industrial ED and Tech II  
Ames, IA 50011

Ms. Norma Bettis  
Administrative Assistant  
Iowa-Nebraska Farm Engineering  
Association  
1311 50th Street  
Des Moines, IA 50265

Ms. Sarah Black  
Rural Initiative Coordinator  
Iowa Methodist Health System  
1200 Pleasant Street  
Des Moines, IA 50309

Ms. Nancy Boettger  
Director of Education and Resource  
Development  
Myrtue Memorial Hospital  
1213 Garfield  
Harlan, IA 51537

Mr. Dennis Bradley  
Registered Nurse  
Mercy Health Center  
Mercy Drive  
Dubuque, IA 52001

Mr. Donald R. Bradley  
Director, EMSLRC  
University of Iowa Hospitals  
5367 UCP  
Iowa City, IA 52242

Mr. John Bremhurst  
Industrial Hygienist  
U.S. Department of Labor  
4301 69th  
Urbandale, IA 50322

Ms. Mary J. Buchele  
President  
Bucheles Associates, Ltd.  
239 Parkridge Circle  
Ames, IA 50010

Dr. Wesley F. Buchele  
Professor Emeritus of Agricultural  
Engineering  
Bucheles Associates, Ltd.  
239 Parkridge Circle  
Ames, IA 50010

Mr. James Cain  
Energy Specialist  
Iowa State Extension  
EES Building, Harbor Road  
Ames, IA 50011

Mr. Roger Chapman  
Iowa Disability Prevention Project  
Iowa Department of Public Health  
460 Henry Mall  
Des Moines, IA 53704

Mr. Kenneth Choquette  
Iowa Department of Public Health  
Lucas State Office Building  
Des Moines, IA 50316

Ms. Peggy Clarahan  
Nurse Consultant  
Iowa Dept of Public Health, OHNAC  
1804 Hemlock  
Atlantic, IA 50022

Ms. Kathy Comito  
Network Coordinator  
Mercy Hospital  
6th and University  
Des Moines, IA 50312

Ms. Sharon Cook  
Program Planner  
Iowa Department of Public Health  
321 E. 12th Street  
Des Moines, IA 50319

Mr. Thomas Cook  
Professor  
University of Iowa  
2633 Syeindler Building  
Iowa City, IA 52242

Ms. Debbi Cooper  
Administrator Assistant  
Iowa Department of Public Health  
Lucas Building  
Des Moines, IA 50319

Mr. Ray H. Crammond  
Consulting Engineer  
Crammond Engineering Company  
217 Center Street, P.O. Box 197  
Egin, IA 52141

Dr. Russell Currier  
Bureau Chief of Environmental  
Epidemiology and Chronic Diseases  
Iowa Department of Public Health  
Lucas State Office Building  
Des Moines, IA 50319-0075

Mr. Mark Dagoberg  
President  
Methodist Health Network of Iowa  
1200 Pleasant Street  
Des Moines, IA 50309

Mr. L. Graham Dameron  
Director  
Johnson County Department of Public  
Health  
1105 Gilbert Court  
Iowa City, IA 52240

Mr. W.M. Davis  
Box 421  
Ottomwa, IA 52501

Dr. E. Elaine De Boef  
Occupational Nurse Consultant  
Iowa State Department of Public  
Health, Disease Prevention  
Route 1, Box 59  
Pella, IA 50219

Ms. Pam Delagardelle  
Director Farm Partners  
Santor Memorial Hospital  
6th and College  
Cedar Falls, IA 50613

Dr. Pat DeSotel  
ER Supervisor  
Washington County Hospital  
Route 3  
Washington, IA 52353

## Participants

Mr. Gary DiGiuseppe  
NAFB Farm Safety Chairman  
KWMT Radio  
Box 578  
Fort Dodge, IA 50501

Dr. Kelley J. Donham  
Professor  
Department of Preventive Medicine and  
Environmental Health  
University of Iowa College of Medicine  
Iowa City, IA 52242

Mr. John P. Dorrian  
Mayor  
City of Des Moines  
400 E. 1st  
Des Moines, IA 50309

Ms. Diane Dotson  
Network Coordinator  
Mercy Hospital Medical Center  
6th and  
Des Moines, IA 50314

Mr. Gary L. Downey  
Assistant Vice President of Industry  
Relations  
Grinnell Mutual Reinsurance Company  
I-80 at Highway 146  
Grinnell, IA 50112

Dr. Ronald D. Eckoff  
Director, Division of Family and  
Community Health  
Iowa Department of Public Health  
Lucas Building  
Des Moines, IA 50319

Ms. Elizabeth Elliott  
Associate Vice Provost for Extension  
Iowa State University  
110 Curtiss Hall  
Ames, IA 50011

Dr. L.J. Filer  
Professor of Pediatrics  
University of Iowa  
College of Medicine  
Iowa City, IA 52242

Mr. Tom Filer  
Sales Manager  
Des Moines Marriott  
700 Grand Avenue  
Des Moines, IA 50309

Ms. Charlene Finck  
Machinery Editor  
Farm Journal  
3211 Sheridan Avenue  
Des Moines, IA 50310

Mr. Raymond W. Forsythe  
Director of Safety  
Farm Bureau Mutual Insurance  
Company  
5400 University  
West Des Moines, IA 50265

Mr. Dan Frieberg  
Executive Vice President  
Iowa Fertilizer and Chemical Association  
900 Des Moines Street, Suite 150  
Des Moines, IA 50309

Dr. Laurence Fuortes  
University of Iowa  
Iowa City, IA 52242

Ms. Jane Gatzke  
Safety Administrative Assistant  
Pioneer Hi-Bred International, Inc.  
4445 Corporate Drive, Box 6500  
West Des Moines, IA 50265

Ms. Jane Gay  
Project Coordinator  
AMRF - Oakdale  
University of Iowa  
Iowa City, IA 52242

Dr. James Gilley  
Head Professor  
Agricultural Engineering Department  
Iowa State University  
Ames, IA 50011

Mr. Rodney Goodwin  
Director of Research  
National Pork Producers Council  
Box 10383  
Des Moines, IA 50306

Dr. Thomas H. Greiner  
Associate Professor, Agricultural  
Engineering Department  
Iowa State University  
200 C Davidson Hall  
Ames, IA 50011-3080

Mr. Alonzo L. Griffin  
OSHA, U.S. Department of Labor  
210 Walnut Street  
Des Moines, IA 50309

Mr. John Haan  
Industrial Hygienist  
Iowa Division of Labor  
3804 11th Street  
Des Moines, IA 50313

Ms. Charlotte Halverson  
Rural Outwash Coordinator  
Mercy Health Center  
Mercy Drive  
Dubuque, IA 52001

Mr. Monte Hamilton  
Paramedic  
Mary Greeley Medical Center  
117 11th Street  
Ames, IA 50010

Mr. Mark Hanna  
Extension Agriculture Engineer  
Iowa State University  
200 Davidson Hall  
Ames, IA 50011

Ms. Marcia Heggen  
Director  
Occupational Health and Wellness -  
Agricare  
350 4th Avenue  
Marshalltown, IA 50158

Mr. Brian Herbst  
Senior Industrial Hygienist  
Iowa Division of Labor  
1000 East Grand  
Des Moines, IA 50319

Ms. Marilyn Hibbs  
Director of Communications  
Time Frame Productions  
3305 104th Street  
Des Moines, IA 50322

Mr. Charles Hooper  
Senior Industrial Hygienist  
Iowa Division of Labor  
1000 East Grand  
Des Moines, IA 50319-0209

Ms. Sue Ellen Hosch  
University of Iowa  
Occupational Medicine Clinic  
C 33-GH  
Iowa City, IA 52242

Ms. Kathy Houser  
L & W Feeders  
Route 1, Box 51  
Watkins, IA 52354

Mr. Thomas J. Ilax  
Environmental Coordinator  
Iowa State University  
204 Davidson Hall  
Ames, IA 50010

Ms. Anne Jackson  
Industrial Hygienist  
Iowa Division of Labor  
1000 E. Grand Avenue  
Des Moines, IA 50319

Ms. Sheryl Jenko  
President  
Iowa FFA Association  
Box 400, 301 Center Avenue, S.  
Mitchellville, IA 50169

## National Participants

Mr. Dale Johnson  
Director of Publications  
Iowa Farm Bureau  
5400 University  
West Des Moines, IA 50265

Mr. Jeff Jones  
Safety Engineer  
OSHA, U.S. Department of Labor  
210 Walnut, Room 815  
Des Moines, IA 50309

Ms. Shirley K. Jones  
Coordinator SPRAINS  
Iowa Department of Public Health  
Lucas Building  
Des Moines, IA 50319-0075

Mr. Troy Kams  
The Greater Des Moines Convention  
and Visitors Bureau  
Tow Ruan Center  
601 Locust Street, Suite 200-H  
Des Moines, IA 50309

Ms. Bonnie Kay  
Director of Occupational Health  
American Lung Association of Iowa  
1025 Ashworth Road, Suite 410  
West Des Moines, IA 50265

Ms. Tracy Keninger  
Rural Rehabilitation Specialist  
Easter Seals Farm Program  
8432 Franklin, #19  
Des Moines, IA 50325

Mr. Craig T. Keough  
EMS Field Consultant  
Mercy Health Center  
Mercy Drive  
Dubuque, IA 52001

Ms. Carolyn Kern  
Nursing Instructor  
Iowa Methodist Medical Center  
12th and Pleasant  
Des Moines, IA 50309

Ms. Janet Kinney  
National Board Member  
Communicating for Agriculture  
Route 3, Box 41  
Alden, IA 50006

Mr. Michael David Kramer  
University of Iowa  
Department of Preventive Medicine  
Iowa City, IA 52242

Mr. Burton C. Kross  
Associate Director  
University of Iowa  
Iowa City, IA 52242

Ms. Wendy E. Kuhse  
Nurse Consultant  
Iowa State Department of Public Health  
203 Benton Street  
Garnaville, IA 52049

Ms. Barbara Lacina  
Research Assistant  
University of Iowa  
Iowa City, IA 52242

Ms. Diane Lanning  
Administrator  
Humboldt County Public Health Nursing  
Services  
Courthouse  
Dakota City, IA 50529

Mr. Charles Larson  
Farm Program  
Iowa Easter Seals  
Box 4002  
Des Moines, IA 50333

Mr. C.W. Lawrence  
Farm Safety for "Just Kids"  
130 E. 1st Street  
Earlham, IA 50072

Ms. Carol Lehtola  
Agricultural Engineer  
Iowa State University  
102 Davidson Hall  
Ames, IA 50011

Ms. Stephanie Leonard  
Industrial Hygienist  
University of Iowa  
124 AMRF  
Iowa City, IA 52242

Ms. Linda Leverenz  
Educations Specialist  
University of Iowa  
104 AMRF - Oakdale  
Iowa City, IA 52242

Dr. Leonard A. Levy  
Dean  
University of Osteopathic Med and  
Sci/Col of Podiatric Med Surgery  
2150 Grand Avenue  
Des Moines, IA 50312

Ms. Mary Q. Lewis  
Research Assistant  
University of Iowa  
Department of Preventive Medicine and  
Environmental Health  
206 AMRF  
Iowa City, IA 52319

Dr. Louise Lox  
State Health Planner  
Iowa Department of Public Health  
Lucas Building  
Des Moines, IA 50319

Ms. Shirley Long  
Writer  
The Write Touch  
306 NW Bayberry  
Ankeny, IA 50021

Ms. Barbara J. Lykins  
Director Women's Activities and  
Consumer Education  
Iowa Farm Bureau Federation  
5400 Avenue  
West Des Moines, IA 50265

Ms. Juleea Martindale  
Grants Coordinator  
Mercy Hospital Medical Center  
6th and University  
Des Moines, IA 50314-3190

Mr. Dennis McClure  
Safety Coordinator  
United AgriSeeds  
Box 637  
Marshalltown, IA 50158

Ms. Lois McDermott  
Registered Nurse  
Agricultural Health and Safety  
Route 2, Box 165  
Harlan, IA 51537

Ms. Monica McGregor  
Greene County 4-H Club  
Route 2, Box 105  
Jefferson, IA 50129

Dr. Kris McIntee  
Nurse Consultant  
Iowa State Dept of Health  
Disease Prevention  
2625 West Fourth Street  
Waterloo, IA 50701

Ms. Karen McMahon  
Contributing Editor  
Hogs Today Magazine  
1221 Oak Park Boulevard  
Cedar Falls, IA 50613

Mr. Al Meier  
Commissioner  
Division of Labor  
1000 E. Grand  
Des Moines, IA 50319

Dr. James A. Merchant  
 Director, Institute of Agricultural  
 Medicine and Occupational Health  
 University of Iowa  
 AMRF, Oakdale Campus  
 Iowa City, IA 52242

Mr. Vernon M. Meyer  
 Professor  
 Iowa State University  
 201 Davidson Hall  
 Ames, IA 50011-3080

Ms. Elizabeth Ruth Miller  
 Assistant Resident Scientist  
 Institute for Agricultural Medicine  
 University of Iowa  
 AMRF, Oakdale Campus  
 Iowa City, IA 52242

Ms. Malinda Miller  
 Field Editor  
 Iowa Farmer Today  
 P.O. Box 5279  
 Cedar Rapids, IA 52406

Mr. Jerry L. Miner  
 Safety Manager  
 Pioneer Hi-Bred  
 4445 Corporate Drive, Box 6500  
 West Des Moines, IA 50265

Ms. Linda Moyna  
 Director of Communications  
 Health Education  
 Ellsworth Municipal Hospital  
 110 Rocksylvania  
 Iowa Falls, IA 50126

Mr. Joseph L. Mullen  
 Industrial Hygienist  
 OSHA  
 1000 E. Grand  
 Des Moines, IA 50319

Mr. Cliff Mullenberg  
 OSHA  
 1000 E. Grand  
 Des Moines, IA 50319

Mr. Don Nanneman  
 Occupational Health Nurse  
 Central Iowa Association of  
 Occupational Health Nurses  
 212 E. Clay  
 Osceola, IA 50213

Mr. Jens Nissen  
 Industrial Hygienist  
 Iowa Division of Labor  
 1000 E. Grand  
 Des Moines, IA 50319

Ms. Nancy A. Norman  
 Associate Director  
 Rural Health Research Center  
 Iowa State University  
 1085 Elm Hall  
 Ames, IA 50011

Ms. Linda Ogilvie  
 University of Iowa  
 Department of Preventive Medicine  
 AMRF, Oakdale Campus  
 Iowa City, IA 52242

Dr. Gayle Olson  
 Program Assistant  
 Institute of Agricultural Medicine and  
 Occupational Health  
 University of Iowa, Oakdale Campus  
 Winfield, IA 52242

Mr. Ted Ondracek  
 Senior Industrial Hygienist  
 Iowa Division of Labor  
 1000 E. Grand  
 Des Moines, IA 50319

Mr. Howard Oudman  
 Research Assistant  
 Iowa State University  
 925 Arizona Avenue  
 Ames, IA 50011

Mr. Shashi H. Patel  
 Industrial Hygienist  
 Iowa Division of Labor  
 1000 East Grand Avenue  
 Des Moines, IA 50319

Mr. Merlin Plagge  
 President  
 Iowa Farm Bureau Federation  
 5400 Avenue  
 West Des Moines, IA 50265

Dr. William Popenorf  
 Professor  
 Institute of Agricultural Medicine  
 University of Iowa  
 134 AMRF  
 Iowa City, IA 52319

Mr. Jim Probasco  
 Industrial Hygienist  
 Iowa Division of Labor  
 1000 East Grand  
 Des Moines, IA 50316

Dr. August Ralston  
 Professor, College of Business  
 Iowa State  
 368 Carver Hall  
 Ames, IA 50011

Mr. Maurice Farick  
 Industrial Hygienist  
 Iowa Division of Labor  
 1000 East Grand Avenue  
 Des Moines, IA 50316

Mr. Robert D. Ray  
 Chairman, National Advisory Committee  
 on Rural Health Policy  
 Blue Cross/Blue Shield of Iowa  
 636 Grand Avenue  
 Des Moines, IA 50309

Mr. Craig Redshaw  
 Executive Director  
 American Lung Association of Iowa  
 1025 Ashworth Road, #410  
 West Des Moines, IA 50265

Mr. David Rosenau  
 Industrial Hygienist  
 University of Iowa  
 124 AMRF  
 Oakdale, IA 52319

Dr. Eric Saikaly  
 Doctor  
 MacFarland Clinic  
 3012 Norbridge Parkway  
 Ames, IA 50010

Dr. Heidi Saikaly  
 Epidemiologist  
 MacFarland Clinic  
 3012 Norbridge Parkway  
 Ames, IA 50010

Mr. Steve Schaaf  
 Environmental Affairs Manager  
 Pioneer Hi-Bred International, Inc.  
 7301 NW 62nd Avenue  
 Johnston, IA 50131

Ms. Leah Schade  
 Safety Inspector  
 Iowa Division of Labor  
 1000 East Grand  
 Des Moines, IA 50319

Mr. Charles V. Schwab  
 Assistant Professor  
 Iowa State University  
 207 Davidson Hall  
 Ames, IA 50011

Mr. Dennis Schwitters  
 Iowa-Nebraska Farm  
 Equipment Association  
 1311 50th Street, P.O. Box 65840  
 West Des Moines, IA 50265-0840

## National Participants

Dr. Mustafa Selim  
Assistant Professor  
University of Iowa  
137 AMRF  
Iowa City, IA 52242

Ms. Carolyn Sheridan  
AgriSafe  
Spencer Municipal Hospital  
1113 First Avenue East  
Spencer, IA 51301

Ms. Ann Short  
Iowa Department of Public Health  
321 East 12th  
Lucas Building  
Des Moines, IA 50319

Mr. Daryl Siebens  
Vice President  
IA Farm Bureau  
Route 1, Box 155  
Akron, IA 51001

Ms. Carol L. Sipfle  
Director of Programs  
American Lung Association of Iowa  
1025 Ashworth Road, Suite 140  
Des Moines, IA 50265

Mr. Stephen J. Slater  
Senior Industrial Hygienist  
Iowa Department of Labor  
1000 East Grand  
Des Moines, IA 50319

Dr. Steve Soderlund  
Director, Product Development and  
Regulatory Affairs  
Microbial Genetics, A Division of  
Pioneer Hi-Bred International  
4601 Westown Parkway, Suite 120  
West Des Moines, IA 50265

Ms. Dorothy Sonksen  
Wellness Coordinator  
Burgess Memorial Hospital  
1600 Diamond Avenue  
Onawa, IA 51040

Mr. Art Spies  
Vice President  
Iowa Hospital Association  
100 East Grand, Suite 100  
Des Moines, IA 50309

Ms. Connie Stangl  
AgriSafe  
Spencer Municipal Hospital  
1113 1st Avenue East  
Spencer, IA 50515

Ms. Chrystal Stanley  
Assistant Director  
Easter Seal Farm Program  
P.O. Box 4002  
Des Moines, IA 50333

Ms. Michelle Stirling  
Community Health Educator  
Eldora Regional Medical Center  
2413 Edgington Avenue  
Eldora, IA 50126

Ms. Janis Stone  
Extension Specialist  
Iowa State University  
141 Le Baron Hall  
Ames, IA 50011

Ms. Cathy Stotts  
Director Clinical Services  
Lucas County Health Center  
Route 3, P.O. Box 43A  
Chariton, IA 50042

Mr. James Strohmman  
Executive Assistant  
Iowa Attorney General's Office  
Hoover State Office Building  
Des Moines, IA 50319-0114

Mr. Michael L. Swanson  
Loss Control Manager  
Pioneer Hi-Bred International, Inc.  
6800 Pioneer Parkway Box 212  
Johnston, IA 50131

Ms. Cheryl Tevis  
Senior Farm Issue Editor  
Successful Farming Magazine  
Meredith Corporation, 1716 Locust  
Des Moines, IA 50336

Ms. Connie Thompson  
Director and Nurse of the Agricultural  
Health and Safety Center  
Myrtue Memorial Hospital  
Route 2, Box 57  
Harlan, IA 51528

Dr. Peter S. Thome  
Institute of Agricultural Medicine and  
Occupational Health  
University of Iowa  
Iowa City, IA 52242-5000

Mr. Robin Ungar  
Program Associate  
University of Iowa  
Iowa City, IA 52240

Ms. Terrie Urban  
Wellness Coordinator  
Montgomery County Memorial Hospital  
2301 Eastern Avenue  
Red Oak, IA 51566

Ms. Stephanie Vanlier  
Director Grant Programs  
Mercy Hospital Medical Center  
Mercy Foundation  
Sixth and University  
Des Moines, IA 50314-3190

Ms. Susan F. Voehl  
Agricultural Nurse  
Nobles and Rock County Public Health  
Route 2, Box 46  
Lake Park, IA 51347

Ms. Jennifer S. Voi  
Advanced Care Coordinator  
Iowa Western Community College  
2700 College Road, Box 4-C  
Council Bluffs, IA 51502

Mr. Mark Walker  
Agriculture Health and Safety  
Coordinator  
St. Joseph Mercy Hospital  
84 Beaumont Drive  
Mason City, IA 50401

Ms. Teri Walker  
PHN  
Wayne County Public Health  
Box 102  
Corydon, IA 50060-1522

Ms. Janet Watt  
Respiratory Therapist  
University of Iowa  
Iowa City, IA 52245

Mr. Allen Weller  
Assistant Director of Safety  
Farm Bureau Mutual Insurance  
Company  
5400 Avenue  
West Des Moines, IA 50265

Ms. Sherri Wildin  
EMT - I  
Madison County Ambulance  
721 West Jefferson  
Winterset, IA 50273

Ms. Therese Willkomm  
Director  
Easter Seal Farm Program  
P.O. Box 4002  
Des Moines, IA 50333

Dr. Wendy K. Wintersteen  
Assistant Professor  
Extension Entomologist  
Iowa State University  
109 Insectary, ISU  
Ames, IA 50011

Ms. Debbie Yount  
Wellness Coordinator  
Iowa Farm Bureau Federation  
5400 Avenue  
West Des Moines, IA 50265

Mr. Chris Zimmerman  
Physical Therapist  
University of Iowa  
2600 Steindler Building  
Iowa City, IA 52242

Dr. Craig Zwerling  
Associate Professor  
Preventive Medicine and Environmental Health  
University of Iowa  
124 AMRF Oakdale Campus  
Iowa City, IA 52242-5000

**KANSAS**



Mr. Harold T. Bach  
Safety Specialist  
U.S. Department of Labor  
1437 Tomahawk Lane  
Olathe, KS 66062

Mr. Michael H. Bradshaw  
Kansas State  
Extension Service  
343 Justin Hall  
Manhattan, KS 66506

Mr. Chris Chitwood  
Executive Assistant  
AgriPro Biosciences, Inc.  
6700 Antioch, Suite 100  
Shawnee Mission, KS 66210

Mr. Stanley Clark  
Head, Agricultural Engineering  
Department  
Kansas State  
Seaton Hall  
Manhattan, KS 66506

Ms. Kathy Collmer  
Educational Materials Specialist  
Agricultural Safety and Health Program,  
Kansas State  
Seaton Hall  
Manhattan, KS 66506

Mr. Marvin H. Hachmeister  
Kansas State  
Extension of Agricultural Engineering  
237 Seaton Hall  
Manhattan, KS 66506-2917

Dr. Stephen Konz  
Professor  
Department of Industrial Engineering,  
Kansas State  
Durland Hall  
Manhattan, KS 66506-5101

Mr. John A. Kramer  
Extension Assistant, Farm Safety  
Kansas State University  
Seaton Hall  
Manhattan, KS 66506  
913/ 532-5813

Mr. David F. Willis  
Director  
State of Kansas University  
Division of Safety and Health  
512 SW 6th Street  
Topeka, KS 66603

Dr. Cindy Wood  
Epidemiologist  
Department of Health and Environment  
109 SW 9th Street, Suite 605  
Topeka, KS 66612-1271

**KENTUCKY**



Dr. S.W. Horstman  
Associate Professor  
University of Kentucky  
College of Medicine  
800 Rose Street, Room MS129X  
Lexington, KY 40536-0084

Ms. Susan Jones  
Western Kentucky  
Department of Nursing  
AC 112A  
Bowling Green, KY 42101

Dr. Robert McKnight  
Assistant Professor  
University of Kentucky  
MS 129X  
Lexington, KY 40536-0084

Mr. Larry Piercy  
Extension Safety Specialist  
University of Kentucky  
Agricultural Engineering Building  
Room 128  
Lexington, KY 40546-0276

**MAINE**



Mr. Stephen C. Shannon  
Director, Occupational  
Safety and Health  
Maine Bureau of Health  
157 Capitol Street  
Augusta, ME 04333

Ms. Rhonda Webber  
Planning and Research Association  
Maine Bureau of Health  
State House Station 11  
Augusta, ME 04901

**MARYLAND**



Dr. Aaron Blair  
Chief, Occupational  
Studies Section  
National Cancer Institute  
Executive Plaza North, Room 418  
Bethesda, MD 20892

Dr. Gershon Fishbein  
Publisher  
Genetic Engineering Letter  
8750 Georgia Avenue, Suite 124  
Silver Spring, MD 20910

Mr. Jeffrey Human  
Director, Office of Rural Health Policy  
U.S. Public Health Service  
5600 Fishers Lane  
Parklawn Building, Room 14-22  
Rockville, MD 20857

Dr. Rice C. Leach  
Chief of Staff  
Office of the Surgeon General  
USPHS  
Room 18-67  
5600 Fishers Lane  
Rockville, MD 20857

Mr. Mark A. Veazie  
Johns Hopkins Injury Prevention Center  
624 North Broadway, Room 557  
Baltimore, MD 21205

Mr. Robert Wright  
Chief, Utilization Expenditures Statistics  
National Center for Health Statistics  
6525 Belcrest Road, Room 850  
Hyattsville, MD 20782

## National Participants

### MICHIGAN



Mr. Dan Lauwers  
Assistant Program  
Director  
W.K. Kellogg  
Foundation  
400 N. Avenue  
Battle Creek, MI

Ms. Geraldine R. Smith  
Coordinator  
"Farming Safely in the Thumb"  
Huron Co. Health Department  
1142 S. Van Dyke  
Bad Axe, MI 48413

### MINNESOTA



Dr. Debora Boyle  
University of Minnesota  
1635 W. Skillman, #2  
Roseville, MN 55113

Mr. Bruce Chadwick  
Market Manager  
3M  
St. Paul, MN

Mr. Willis Eken  
Chairman  
National Farmer's Union Executive  
Board  
St. Paul, MN

Dr. Susan Goodwing Gerberich  
Director of Environmental and  
Occupational Health  
University of Minnesota School of Public  
Health  
420 Delaware Street, SE, Box 197  
UMHC  
Minneapolis, MN 55455

Dr. Ian A. Greaves  
Professor  
University of Minnesota  
Box 197, 420 Delaware St., SE  
Minneapolis, MN 55455

Ms. Stephanie Harnick  
Manager, Occupational Safety and  
Health  
Northrup King Company  
7500 Olson Memorial Highway  
Golden Valley, MN 55427

Mr. Mark Horton  
Environmental Affairs Office  
Northrup King Company  
7500 Olson Memorial Highway  
Golden Valley, MN 55427

Ms. Linda Olson Keller  
Consultant  
Minnesota Department of Health  
717 SE Delaware  
Minneapolis, MN 55440

Ms. Brenda Lenz  
Public Health Nurse  
Meeker, McLeod, Sibley Community  
Health Service  
804 11th Street E  
Glencoe, MN 55336

Ms. Catherine Lexau  
Project Coordinator  
Minnesota Department of Health/CHS  
Division  
717 SE Delaware  
Minneapolis, MN 55440

Mr. Mark Melander  
Consultant  
Northrup King Company  
7500 Olson Memorial Highway  
Golden Valley, MN 55427

Ms. Colleen Nelson  
Public Health Nurse  
Quin County Community Health  
Services  
P.O. Box 248  
Newfolden, MN 56738

Mr. John M. Shutske  
Extension Safety Specialist  
University of Minnesota  
1390 Eckles Avenue  
St. Paul, MN 55108

Mr. Ray Sinclair  
Television Production Specialist  
NIOSH, CDC  
2728 Sheldon Street  
Roseville, MN 55113

Mr. Steven Suchy  
Safety Engineer  
Cargill, Inc.  
P.O. Box 9300  
Minneapolis, MN 55440

Ms. Kelly Sullivan  
Editor  
Pro Act  
4947 Wild Canyon Drive  
Woodbury, MN 55125

Mr. Aaron K. Trippier  
Vice President  
Communication for Agriculture  
2626 E. 82nd Street, #325  
Bloomington, MN 55425

Ms. Peg Zenk  
Managing Editor  
Farm Industry News Magazine  
7900 International Drive  
Minneapolis, MN 55425

### MISSISSIPPI



Dr. George C. Furr  
Medical Doctor  
Mississippi State  
Medical Association  
270 YA Zoo Avenue  
Clarksdale, MS 38614

Mr. William Simpson  
3330 Liberty Street  
Canton, MS 39046

### MISSOURI



Mr. David E. Baker  
Extension Safety and  
Health Specialist  
University of Missouri  
205 Agricultural Engineering Building  
Columbia, MO 65211

Mr. Frank Berry  
USPHS  
Regional Office - Region VII  
601 E. 12th Street  
Kansas City, MO 64108

Mr. Charles F. Brundage  
Product Safety Engineer  
Deutz-Allis Corporation  
627 South Cottage  
Independence, MO 64050

Ms. Sandy Clarkson  
Administrator  
Cariton County Health Department  
P.O. Box 214  
Keytesville, MO 65261

Ms. Claudine Frazier  
Administrator  
Adam Co. Health Department  
516 South Main  
Kukswelle, MO 63507

Mr. Russell H. Hahn  
Director of Standards  
American Society of Agricultural  
Engineers  
2950 Niles Road  
St. Joseph, MO 49085



Ms. Judy Heffernan  
Executive Director of Heartland Network  
for Town and Rural Ministries  
University of Missouri  
201 Sociology Building  
Columbia, MO 65211

Dr. Gary Kukulka  
Senior Staff Associate  
National Rural Health Association  
301 E. Armour Boulevard, Suite 420  
Kansas City, MO 64111

Mr. John T. Phillips  
Regional Administrator  
U.S. Department of Labor  
911 Walnut Street  
Kansas City, MO

Dr. W. Michael Rogers  
District Director  
US Food and Drug Administration  
1009 Cherry Street  
Kansas City, MO 64106

Mr. John Rummel  
FFA Advisor  
Stockton High School  
Route 1, P.O. Box 190  
Stockton, MO 65785

Dr. C. Saran  
Professor  
Central Missouri State  
Warrensburg, MO 64093-5030

Mr. Jamie Swaggerty  
FFA Safety Chairperson  
Stockton High School  
Route 1, P.O. Box 190  
Stockton, MO 65785

Ms. Patti Van Tuinen  
Assistant Director  
Office of Injury Control  
Missouri Department of Health  
P.O. Box 570  
Jefferson City, MO 65102

**NEBRASKA**



Ms. Joleen Huneke  
Health Educator  
Nebraska Department of Health  
Health Promotion and Education  
301 Centennial Mall South  
Lincoln, NE 68509-5007

Ms. Melissa D. Leyboldt  
Nebraska State Health Department  
301 Centennial Mall South  
Box 95007  
Lincoln, NE 68521

Mr. Bryan Rettig  
Research Analyst  
Nebraska Department of Health  
301 Centennial Mall S., Box 95007  
Lincoln, NE 68509

Mr. Rollin D. Schnieder  
Extension Safety Specialist  
University of Nebraska  
222 L.W. Chase Hall  
Lincoln, NE 68583-0726

Mr. Richard Slama  
Manager, Special Services  
Lincoln-Lancaster County Health  
Department  
2200 St. Mary's Avenue  
Lincoln, NE 68502

Dr. Susanna Von Essen  
Assistant Professor of Medicine  
University of Nebraska Medical Center  
600 South 42nd Street  
Omaha, NE 68198-2465

Ms. Kathy Ward  
Chronic Disease Director  
Nebraska Department of Health  
301 Centennial Mall South  
Lincoln, NE 68509

Dr. Dennis Weisenburger  
University of Nebraska Medical Center,  
Department of Pathology &  
Microbiology  
600 South 42nd Street  
Omaha, NE 68022

**NEW JERSEY**



Dr. Zane R. Helsek  
Chair, Dept of  
Agricultural and  
Resource Management Specialists  
Rutgers University  
Martin Hall, Room 111, Cook Campus,  
P.O. Box 231  
New Brunswick, NJ 08903

**NEW YORK**



Ms. Angela DeVito,  
MSCM  
Associate Director, Division of  
Occupational Medicine  
State of New York at Stony Brook  
HSC L3 086  
Stony Brook, NY 11794-8036

Mr. Donald DiBello  
Director, Member Services  
Farm Family Insurance Company  
P.O. Box 656  
Albany, NY 12201

Mr. Davis E. Hill  
Executive Director  
Farmedic National Training Center  
Alfred State College  
Alfred, NY 14802

Dr. Matthew Marvel  
Attending Physician  
Oneonta Health Center  
50 Dietz Street  
Oneonta, NY 13820

Dr. John J. May  
Director, Bassett Farm Safety and  
Health Project  
New York Center for Agricultural  
Medicine and Health  
One Atwell Road  
Cooperstown, NY 13326

Mr. John G. Pollock  
Executive Director  
NYS Rural Health and  
Safety Council, Inc.  
334 Riley-Robb Hall, Cornell  
Ithaca, NY 14853-5701

Dr. David S. Pratt  
Director  
New York Center for Agricultural  
Medicine and Health  
One Atwell Road  
Cooperstown, NY 13326

**NORTH  
CAROLINA**



Mr. James A. Fangman  
Environmental and Safety Specialist  
CIBA-GEIGY Corporation  
P.O. Box 18300  
Greensboro, NC 27419

Dr. James R. Fouts  
Senior Scientific Advisor to the Director  
NIEHS  
A2-03, P.O. Box 12233  
Research Triangle Park, NC 27709

Mr. Robert L. McLymore  
Extension Safety Specialist  
North Carolina State  
Box 7625  
Raleigh, NC 27695-7625

## National Participants

Ms. Susan A. Randolph  
Occupational Health Nursing consultant  
DEHNR Occupational Health Section  
P.O. Box 27687  
Raleigh, NC 27611-7687

Dr. Michael D. Schulman  
North Carolina State  
Department of Sociology  
Box 8107  
Raleigh, NC 27695-8107

### NORTH DAKOTA



Mr. Rodney A. Gilmore  
Injury Control Program Manager  
North Dakota State Department of  
Health and Consolidated Labs  
600 East Boulevard, 2nd Floor, Judicial  
Wing  
Bismark, ND 58505-0200

Ms. Ramona Eisenbarth, RN  
Agricultural Occupational Health Nurse  
Custer District Health Unit  
P.O. Box 185  
Mandan, ND 58562

Ms. Cheryl Hagen  
Agriculture Occupational Health Nurse  
Community Health Nurse  
401 Third Avenue North  
Fargo, ND 58102-4839

Ms. Malinda Lindstrom  
Safety Coordinator  
North Dakota Farm Bureau  
1101 1st Avenue North  
Fargo, ND 58107

Mr. George Maher  
North Dakota State  
Extension Service  
Box 5626  
Fargo, ND 58105

Ms. Joyce Saylor  
Agricultural Occupational Health Nurse  
Custer District Health Unit  
P.O. Box 185  
Mandan, ND 58554

Ms. Lillian Thomson  
Ag. Occupational Health Nurse  
Grand Forks Public Health  
P.O. Box 1518  
Grand Forks, ND 58206-1518

### OHIO



Dr. Ray Alderfer  
NIOSH, CDC  
Hamilton Laboratory  
4676 Columbia Parkway,  
R-16  
Cincinnati, OH 45226

Mr. Jonathan Bair  
Student  
Smithville High School  
331 South Summit Street  
Smithville, OH 44677

Ms. Sallie S. Bair  
Registered Nurse  
Wayne County Health Department  
203 South Walnut Street  
Wooster, OH 44691

Dr. Thomas L. Bean  
Safety Leader  
Ohio State (Cooperative Extension)  
590 Woody Hayes Drive #213  
Columbus, OH 43210

Ms. Virginia Behrens  
NIOSH, CDC  
Taft Laboratory  
4676 Columbia Parkway, R-18  
Cincinnati, OH 45226

Dr. Raymond E. Biagini  
NIOSH, CDC  
Taft Laboratory  
4676 Columbia Parkway  
Cincinnati, OH 45226

Mr. Philip J. Bierbaum  
Director, Division of Physical Sciences  
and Engineering  
NIOSH, CDC  
4676 Columbia Parkway  
Cincinnati, OH 45251

Mr. Gary Brumfield  
FFA Safety Chairperson  
Amanda-Clearcreek High School  
414 North School Street  
Amanda, OH 43102

Dr. Geoffrey M. Calvert  
Medical Epidemiologist  
NIOSH, CDC  
4676 Columbia Parkway, R-16  
Cincinnati, OH 45226

Ms. Lorri Cameron  
Epidemiologist  
NIOSH, CDC  
4676 Columbia Parkway, R-21  
Cincinnati, OH 45226

Dr. Alexander Cohen  
Deputy Director, Division of Biomedical  
and Behavioral Sciences  
NIOSH, CDC  
4476 Columbia Parkway  
Cincinnati, OH 45226

Ms. L. Barbara Connally  
Public Health Analyst  
NIOSH, CDC  
4676 Columbia Parkway, R-42  
Cincinnati, OH 45226

Dr. John J. Coumbis  
NIOSH, CDC  
DTMD  
Taft Building, Room B-48, MS C-12  
Cincinnati, OH 45226

Dr. Laurence J. Doernery  
Deputy Director, Division of Physical  
Science and Engineering  
NIOSH, CDC  
4676 Columbia Parkway  
Cincinnati, OH 45226

Ms. Janet Ehlers  
University of Cincinnati  
Occupational Health Masters Candidate  
3125 Locust Log Lane  
Cincinnati, OH 45239

Dr. Lawrence J. Fine  
Director, Division of Surveillance,  
Hazards Evaluations, and Field Studies  
NIOSH, CDC  
4676 Columbia Parkway  
Cincinnati, OH 45226

Dr. Marilyn A. Fingerhut  
Chief, IWSB, DSHEFS  
NIOSH, CDC  
4676 Columbia Parkway  
Cincinnati, OH 45226

Mr. Jerome P. Flesch  
Industrial Hygienist  
NIOSH, CDC  
4676 Columbia Parkway, C-15  
Cincinnati, OH 45226

Mr. Todd M. Frazier  
Chief, DSHEFS  
NIOSH, CDC  
4676 Columbia Parkway, R-17  
Cincinnati, OH 45226

Dr. Eugene Freund, Jr.  
Medical Officer  
NIOSH, CDC  
4676 Columbia Parkway, R-21  
Cincinnati, OH 45226

## Participants

Dr. Jiin Ger  
Visiting Scientist  
NIOSH, CDC  
4676 Columbia Parkway  
Cincinnati, OH 45226

Mr. Walter Haag  
Associate Director  
NIOSH, CDC  
4676 Columbia Parkway  
Cincinnati, OH 45226

Dr. William E. Halperin  
Associate Director  
NIOSH, CDC  
4676 Columbia Parkway, R-41  
Cincinnati, OH 45226-1998

Mr. Gerald A. Heath  
Administrative Officer  
NIOSH, CDC  
4676 Columbia Parkway  
Cincinnati, OH 45226

Dr. Robert F. Herrick  
Associate Director  
NIOSH, CDC  
4676 Columbia Parkway  
Cincinnati, OH 45226

Mr. Stephen D. Hudock  
Safety Engineer  
NIOSH, CDC  
4676 Columbia Parkway  
Cincinnati, OH 45226

Ms. Janice M. Huy  
NIOSH, CDC  
4676 Columbia Parkway  
Cincinnati, OH 45226

Ms. Nina Lalich  
Chief, Illness Effects Section  
NIOSH, CDC  
4676 Columbia Parkway, R-18  
Cincinnati, OH 45226

Mr. Robert L. Larkin  
Chief  
NIOSH, CDC  
4676 Columbia Parkway, R-3  
Cincinnati, OH 45226

Mr. Tim Lawrence  
Extension Associate  
The Ohio State  
590 Woody Hayes Drive  
Columbus, OH 43002

Mr. Edward D. Leninger  
Deputy Director  
NIOSH, CDC  
4676 Columbia Parkway  
Cincinnati, OH 45248

Mr. Steven W. Lenhart  
Industrial Hygienist  
NIOSH, CDC  
4676 Columbia Parkway, R-11  
Cincinnati, OH 45226

Mr. Robert Alan Lunsford  
Supervisory Research Chemist  
NIOSH, CDC  
4676 Columbia Parkway, R-7  
Cincinnati, OH 45226

Mr. Robert Mason  
Biologist  
NIOSH, CDC  
4676 Columbia Parkway  
Cincinnati, OH 45216

Mr. Leroy Mickelsen  
Chemical Engineer  
NIOSH, CDC  
7956 Blairhouse Drive  
Cincinnati, OH 45244

Mr. Charles Miller  
FFA Advisor  
Amanda-Clearcreek FFA  
414 North School Street  
Amanda, OH 43102

Ms. Charlene Maloney  
NIOSH, CDC  
Robert A. Taft Laboratories  
4676 Columbia Parkway  
Cincinnati, OH 45213

Ms. Vivian Morgan  
NIOSH, CDC  
Robert A. Taft Laboratories  
4676 Columbia Parkway  
Cincinnati, OH 45213

Dr. Richard W. Niemeier  
Director, Division of Standards  
Development and Technology  
NIOSH, CDC  
4676 Columbia Parkway  
Cincinnati, OH 45226

Mr. David H. Pedersen  
Industrial Hygienist  
NIOSH, CDC  
4676 Columbia Parkway, R-19  
Cincinnati, OH 45226

Ms. Judith Pflaumer  
Clinical Nurse Specialist  
University of Cincinnati  
3747 Wood Trail  
Cincinnati, OH

Mr. Judd C. Posner  
NIOSH, CDC  
4676 Columbia Parkway  
Cincinnati, OH 45226

Dr. Thomas C. Purcell  
Director, Division of Training and  
Manpower Development  
NIOSH, CDC  
4676 Columbia Parkway  
Cincinnati, OH 45226

Dr. Peter G. Rentos  
Scientist Director  
NIOSH, CDC  
4676 Columbia Parkway  
Cincinnati, OH 45226

Dr. Carol Hogfoss Rubin  
NIOSH, CDC  
4676 Columbia Parkway, R-21  
Cincinnati, OH 45215

Dr. John M. Russo  
Research Psychologist  
NIOSH, CDC  
4676 Columbia Parkway, C-24  
Cincinnati, OH 45226

Mr. Wayne T. Sanderson  
Industrial Hygienist/Epidemiologist  
NIOSH, CDC  
4676 Columbia Parkway  
Cincinnati, OH 45226

Dr. Russell E. Savage  
Chief, Environmental Toxicology  
NIOSH, CDC  
4676 Columbia Parkway  
Cincinnati, OH 45226-1998

Dr. Paul A. Schulte  
Chief, Screening and Notification  
Section  
NIOSH, CDC  
4676 Columbia Parkway, R-42  
Cincinnati, OH 45226

Dr. Paul J. Seligman  
Chief, Medical Section  
NIOSH, CDC  
4676 Columbia Parkway  
Cincinnati, OH 45226

Mr. John P. Sestito  
Assistant Chief, Surveillance Branch,  
NIOSH, CDC  
4676 Columbia Parkway, R-17  
Cincinnati, OH 45226

Mr. Joseph A. Seta  
Supervisory Industrial Hygienist  
NIOSH, CDC  
4676 Columbia Parkway  
Cincinnati, OH 45226

## National Participants

Ms. Christa L. Themann  
Audiologist  
NIOSH, CDC  
4676 Columbia Parkway, C-27  
Cincinnati, OH 45226

Dr. J. R. Wilkins, III  
Associate Professor  
Ohio State University  
Department of Preventive Medicine  
Columbus, OH 43210

Mr. Ralph D. Zumwalde  
Chief, Document Development Branch  
NIOSH, CDC  
4676 Columbia Parkway  
Cincinnati, OH 45226

### OKLAHOMA



Mr. Edward M. Barnes  
Extension Engineer  
Oklahoma State  
214 AG Hall  
Stillwater, OK 74078-0469

Mr. Ronald J. Dahlgren  
Senior Broadcast Coordinator  
Oklahoma State  
105 Public Information Building  
Stillwater, OK 74078

Dr. Willard Downs  
Professor  
Extension Agriculture Engineer  
Oklahoma State University  
214 AG Hall  
Stillwater, OK 74078-0469

Ms. Kathy Howard  
TV Producer/Director  
Oklahoma State University  
Agricultural Communications  
Stillwater, OK 74079

Dr. Pat Lewis  
Extension Safety Specialist  
Oklahoma State University  
219 AG Hall  
Stillwater, OK 74078-0469

Ms. Judy Oskam  
Oklahoma State University  
214 AG Hall  
Stillwater, OK 74074

Dr. Jerry L. Purswell  
Professor  
University of Oklahoma  
202 West Boyd  
Norman, OK 73019

### OREGON



Mr. Clifford O. King  
Controller  
International Seeds, Inc.  
P.O. Box 168  
Halsey, OR 97348

Mr. Tomas Schwabe  
Agricultural Health Supervisor  
OR-OSHA  
3867 Wolverine Street, NE  
Salem, OR 97305

Dr. Myron Shenk  
Interim Farm Safety Specialist  
Oregon State  
100 Gilmore Hall  
Corvallis, OR 97331-3906

### PENNSYLVANIA

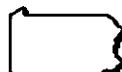

Ms. Karen Freiberg  
Farm Journal  
230 W. Washington Square  
Philadelphia, PA 19105

Mr. Ronald McAllister  
Probe Evaluation Supervisor  
Ford New Holland  
500 Diller Avenue, Box 1895  
MS 636  
New Holland, PA 17557

Dr. Dennis J. Murphy  
Professor of Agriculture and Biology  
Penn State University  
Agriculture Engineering Building  
Room 221  
Park, PA 16802

### PUERTO RICO



Dr. Pable M. Galerio  
Commonwealth of  
Puerto Rico  
Special Assistant to the Secretary  
Department of Labor and Human  
Resources  
505 Munoz Rivera Avenue  
San Juan, PR 00918

Lodo. Jesus A. Caro Lugo  
Sub Secretario  
Estado Libre Asociadode  
Deartamento Del Trabajo  
y Recursos Humanos  
Edificio prudencio Riveria Martinez  
Avenida Munoz Rivera  
506-Piso 21  
Hato Rey, PR 00918

### SOUTH CAROLINA



Dr. Mark A. Purschwitz  
Extension Safety  
Specialist  
Clemson University  
212 McAdams Hall  
Clemson, SC 29634-0357  
803/ 656-4666  
803/ 656-0338

### SOUTH DAKOTA



Mr. James Ceglian  
Director  
Engineering Extension  
South Dakota State University  
Box 507  
Brookings, SD 57007-0597

Dr. Thomas M. Dean  
Medical Director  
Tri County Health Care  
P.O. Box 489, 605 1st Street  
Nessington Springs, SD 57382

Dr. G. R. Durland  
Extension Agricultural Engineering  
South Dakota State University  
Ag Eng Dept  
Brookings, SD 57007

Mr. Larry Tidemann  
Agricultural Program Leader  
Cooperative Extension Service  
South Dakota State University  
Ag Hall, 152  
Brookings, SD 57007

### TENNESSEE



Ms. Nancy Dempsey  
Assistant Professor, Department of  
Nursing  
Austin Peay State  
P.O. Box 4658  
Clarksville, TN 37044

Dr. B.D. Hale  
Public Health Officer  
Haywood County Health Department  
950 East Main  
Brownsville, TN 38012

Mr. Joel Lown  
Extension Safety Specialist  
Agricultural Engineering Dept  
University of Tennessee  
P.O. Box 1071  
Knoxville, TN 37901

Mr. Timothy G. Prather  
Assistant Professor  
Agricultural Extension Service  
University of Tennessee  
P.O. Box 1071  
Knoxville, TN 37901-1071

**TEXAS**



Mr. Charlie G. Coble  
Professor  
Texas A & M  
Agricultural Engineering  
Department  
College Station, TX 77843

Mr. Edward Joseph Cosgrove  
Area Director  
U.S. Department of Labor - OSHA  
1205 Texas Avenue, Suite 422  
Lubbock, TX 79401

Mr. Rene Flores  
FFA Safety Chairperson  
8600 Alameda  
El Paso, TX 79907

Mr. Max J. Howitt  
Southwest Regional Production  
Manager  
DeKalb Plant Genetics  
3303 67th Street  
Lubbock, TX 79413

Dr. David Lawver  
Assistant Professor  
Texas Tech  
Mail Stop 2131  
Lubbock, TX 79409-2131

Dr. Mary Nickolaus  
Associate Director  
University of Texas, School of Public  
Health  
P.O. Box 20186  
Houston, TX 77225

Mr. Ronald Finn  
FFA Advisor  
8600 Alameda  
El Paso, TX 79907

Ms. E. Roberta Ryder  
Executive Director  
National Migrant Resource  
Program, Inc.  
2512 South, IH-35  
Austin, TX 78704

Mr. Delmar E. Tally  
Manager  
Austin Chapter - AGC  
P.O. Box 1508  
Austin, TX 78767-1508

Ms. Rebecca Trujillo  
Migrant Farmworker Ministry  
Diocese of Corpus Christi Texas  
P.O. Box 189  
Skidmore, TX 78389

**UTAH**

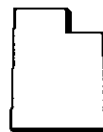

Dr. Jeff Lee  
Associate Professor  
University of Utah  
RMEOEH, Building 512  
Salt Lake City, UT 84112

**VERMONT**



Mr. George L. Cook  
University of  
Vermont  
Extension System  
RR 1, Box 2280  
Morrisville, VT 05661

**VIRGINIA**



Mr. Robert Graham  
Assistant Executive  
Director  
National Vocational Agriculture  
Teacher's Association  
P.O. Box 15440  
Alexandria, VA 22309

Dr. Glen H. Hetzel  
Agricultural Engineering Department  
Virginia Tech  
205 Seitz Hall  
Blacksburg, VA 24061

Mr. Wayne Sprick  
Executive Director  
National Young Farmer Educational  
Association  
5632 Mt. Vernon Memorial Highway  
Alexandria, VA 22309

Mr. Chad Springer  
FFA Safety Chairperson  
Park View High School  
Route 1, Box 118  
South Hill, VA 23970

Mr. Ronnie Thomas  
FFA Advisor  
Park View High School  
Route 1, Box 118  
South Hill, VA 23970

Mr. Steve J. Thomson  
Assistant Professor  
Virginia Polytechnic Institute  
Seitz Hall, VPI and SU  
Blacksburg, VA 24061-0303

Mr. Wei Zhao  
Graduate Student  
Virginia Tech  
Seitz Hall  
Blacksburg, VA 24061

**WASHINGTON**



Mr. Richard L. Barker  
Program Coordinator  
Eastern Washington Area Health  
Education Center  
601 West First Avenue  
Spokane, WA 99204

Dr. Pamela D. Elkind  
Professor of Sociology  
Eastern Washington University  
Patterson Hall, MS-38  
Cheney, WA 99004-2415

Dr. Richard Fenske  
Associate Professor  
University of Washington  
Department of Environmental Health  
Seattle, WA 98195

Mr. Edward King  
Washington State Dept. of Labor and  
Industries  
Division of Safety and Health  
1716 South 16th Avenue  
Yakima, WA 98902

Dr. Paul Monahan  
Yakima Valley Farm Worker Clinic  
MCN  
Box 190  
Toppenish, WA 98948

Mr. Dan Pearson  
FFA Safety Chairperson  
Elma High School  
30 Elma Monte Road  
Elma, WA 98541

Ms. Christie N. Renz  
FFA Advisor  
Elma High School  
30 Elma Monte Road  
Elma, WA 98541

## National Participants

Dr. Linda Rosenstock  
Surveillance, Chemical Hazards  
University of Washington Occupational  
Medicine Program  
ZA66, 325 9th Avenue  
Seattle, WA 98104

Dr. W. Symons  
Safety Specialist  
Washington State  
Agricultural Engineering Department  
Pullman, WA 99163

### WEST VIRGINIA



Ms. Rochelle Althouse  
Statistician  
NIOSH, CDC  
944 Chestnut Ridge Road  
Morgantown, WV 26505

Mr. Shih Bajapayee  
Industrial Hygienist/Engineer  
NIOSH, CDC  
944 Chestnut Ridge Road  
Morgantown, WV 26505

Ms. Kay Basile  
Staff  
NIOSH, CDC  
944 Chestnut Ridge Road  
Morgantown, WV 26505

Dr. Thomas R. Bender  
Director, Division of Safety Research  
NIOSH, CDC  
944 Chestnut Ridge Road  
Morgantown, WV 26505

Ms. Toni A. Bledsoe  
Medical Technologist  
NIOSH, CDC  
944 Chestnut Ridge Road  
Morgantown, WV 26505

Dr. Robert Castellán  
Chief, Epidemiological Investigations  
Branch  
NIOSH, CDC  
944 Chestnut Ridge Road  
Morgantown, WV 26505

Dr. Vincent Castranova  
Chief, Biochemistry and Pathology  
Sections  
NIOSH, CDC  
944 Chestnut Ridge Road  
Morgantown, WV 26505

Ms. Rosemary Cianfrocco  
Division of Safety Research  
NIOSH, CDC  
944 Chestnut Ridge Road  
Morgantown, WV 26505

Ms. Catherine L. Connon  
Occupational Health Nurse  
NIOSH, CDC  
944 Chestnut Ridge Road  
Morgantown, WV 26505

Mr. Joseph Costello  
Statistician  
NIOSH, CDC  
944 Chestnut Ridge Road  
Morgantown, WV 26505

Ms. Charlotte Dalton  
Administrative Officer  
NIOSH, CDC  
944 Chestnut Ridge Road  
Morgantown, WV 26505

Dr. Jeffrey S. Fedan  
Research Pharmacologist  
NIOSH, CDC  
944 Chestnut Ridge Road  
Morgantown, WV 26505

Dr. David L. Hard  
Safety and Health Specialist  
Division of Safety Research  
944 Chestnut Ridge Road  
Morgantown, WV 26505

Dr. William D. Jones  
NIOSH, CDC  
944 Chestnut Ridge Road  
Morgantown, WV 26505

Mr. Gregory J. Kullman  
Industrial Hygienist  
NIOSH, CDC  
944 Chestnut Ridge Road  
Morgantown, WV 26505

Dr. Daniel M. Lewis  
Immunologist  
NIOSH, CDC  
944 Chestnut Ridge Road  
Morgantown, WV 26505

Mr. Michael D. Lyman  
Nurse Epidemiologist  
NIOSH, CDC  
944 Chestnut Ridge Road  
Morgantown, WV 26505

Dr. Pervis C. Major  
Director, Activity for Professional Prog.  
and Facility Dev.  
NIOSH, CDC  
944 Chestnut Ridge Road  
Morgantown, WV 26505

Dr. Ali Manninen  
NIOSH, CDC  
944 Chestnut Ridge Road  
Morgantown, WV 26505

Ms. Judith C. Mull  
Medical Technologist  
NIOSH, CDC  
944 Chestnut Ridge Road  
Morgantown, WV 26505

Dr. Karl Musgrave  
EIS Officer  
NIOSH, CDC  
944 Chestnut Ridge Road  
Morgantown, WV 26505

Mr. John R. Myers  
Statistician  
Division of Safety Research  
NIOSH, CDC  
944 Chestnut Ridge Road  
Morgantown, WV 26505

Dr. Stephen A. Olenchok  
Assistant to the Director, DRDS  
NIOSH, CDC  
944 Chestnut Ridge Road  
Morgantown, WV 26505

Ms. B. Teresa Palermo  
Program Analyst  
NIOSH, CDC  
944 Chestnut Ridge Road  
Morgantown, WV 26505

Dr. John E. Parker  
Chief, Protective Technology Branch  
Division of Safety Research  
NIOSH, CDC  
944 Chestnut Ridge Road  
Morgantown, WV 26505

Mr. Penn A. Peters  
Project Leader  
U.S. Forest Service  
180 Canfield Street, P.O. Box 4360  
Morgantown, WV 26505

Dr. Edward L. Petsonk  
Acting Section Chief  
NIOSH, CDC  
944 Chestnut Ridge Road  
Morgantown, WV 26505

Dr. Paul Siegel  
Research Chemist  
NIOSH, CDC  
944 Chestnut Ridge Road  
Morgantown, WV 26505

Mr. Herman C. Sims  
West Virginia University  
Institute for Safety and Health Training  
918 Chestnut Ridge Road, Suite 8  
Morgantown, WV 26506

Dr. W. G. Sorenson  
Research Mycologist  
NIOSH, CDC  
944 Chestnut Ridge Road  
Morgantown, WV 26505

Mr. John T. Straface  
Supply Management Officer  
NIOSH, CDC  
944 Chestnut Ridge Road  
Morgantown, WV 26505

Dr. Gregory R. Wagner  
Director, Division of Respiratory Disease  
Studies  
NIOSH, CDC  
944 Chestnut Ridge Road  
Morgantown, WV 26505

Dr. Kenneth C. Weber  
Branch Chief  
NIOSH, CDC  
944 Chestnut Ridge Road  
Morgantown, WV 26505

**WISCONSIN**



Dr. Henry A. Anderson  
Chief, Environmental and  
Chronic Disease  
Epidemiology  
Wisconsin Department of Health and  
Social Services  
Wisconsin Division of Health  
Madison, WI 53701

Mr. Avanson  
Route 6, Highway 14  
Middleton, WI 53562

Dr. Larry Chapman  
University of Wisconsin - Madison  
Agricultural Engineering Department  
460 Henry Mall  
Madison, WI 53704

Ms. Nancy E. Chudy  
Epidemiologist  
State of Wisconsin, Injury Prevention  
Unit  
1 West Wilson Street, P.O. Box 309  
Madison, WI 53701-0309

Dr. Paul Gunderson  
Agricultural Safety Specialist  
National Farm Medicine Center  
1000 North Oak Avenue  
Marshfield, WI 54449-5790

Mr. Lawrence Hanrahan  
Epidemiologist  
Department of Health and Social  
Services  
WFCCP  
Madison, WI 53701

Ms. Judith Huber  
Registered Nurse  
Marshfield Medical Research  
1000 North Oak Avenue  
Marshfield, WI 54449

Mr. Larry Lang  
Product Safety/Environmental  
Coordinator  
Genl Company  
143 Water Street  
West Bend, WI 53095

Ms. Karen Lappe  
Program Manager  
National Farm Medicine Center  
1000 North Oak Avenue  
Marshfield, WI 54449-5790

Ms. Barbara Lee  
Assistant Director  
National Farm Medicine Center  
1000 North Oak Avenue  
Marshfield, WI 54449-5790

Ms. Laura McKee  
Publications Specialist  
National Farm Medicine Center,  
Marshfield Clinic  
1000 North Oak Avenue  
Marshfield, WI 54449

Ms. Sandra Muesegades  
Public Health Nurse  
1011 North 8th Street  
Sheboygan, WI 53081

Mr. David L. Nordstrom  
Epidemiologist  
National Farm Medicine Center  
1000 North Oak Avenue  
Marshfield, WI 54449

Dr. Douglas J. Reding  
National Farm Medicine Center  
1000 North Oak Avenue  
Marshfield, WI 54449

Ms. Tammy Schaefer  
Director, Resource Center for Farmers  
with Disabilities  
Easter Seal Society of Wisconsin  
101 Nob Hill, Suite 301  
Madison, WI 53704

Mr. Steve Schlecht  
President  
GEMPLER'S  
P.O. Box 270  
Mt. Horeb, WI 53572

Dr. Ronald T. Schuler  
University of Wisconsin  
Agricultural Engineering Department  
460 Henry Mall  
Madison, WI 53706

Mr. William J. Sheeley  
Farm Health and Safety  
Council of Wisconsin  
2463 North 85th Street  
Wauwatosa, WI 53226

Ms. Cheryl Skjolaas  
Specialist  
University of Wisconsin - Madison  
460 Henry Mall  
Madison, WI 53706

Ms. Stefani Sogard  
Community Health Educator  
LaCrosse County Health Department  
300 North 4th  
LaCrosse, WI 54601

Dr. Dean Stueland  
Medical Director  
National Farm Medicine Center  
1000 North Oak Avenue  
Marshfield, WI 54449-5790

**WYOMING**

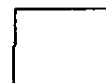

Ms. Judith E. Wormal  
Safety Specialist  
Cooperative Extension Service  
Box 3354  
Larami, WY 82071

*Surgeon General's Conference on Agricultural Safety and Health  
FARMSAFE 2000 • A National Coalition for Local Action  
Convened by the National Institute for Occupational Safety and Health  
April 30 - May 3, 1991, Des Moines, Iowa*

## INTERNATIONAL PARTICIPANTS

### CANADA

---

Dr. James A. Dosman  
Director, Center for Agricultural  
Medicine  
University of Saskatchewan  
Royal University Hospital  
Saskatoon, Canada S7N 0X0

Dr. Chen Zhou  
University of Saskatchewan  
Centre for Agricultural Medicine  
Royal University Hospital  
Saskatoon, SK, Canada S7N 0X0

### SWEDEN

---

Dr. Sverker Høglund  
Director  
Swedish Farmers Safety and Prevention  
Health Association  
S-105 33  
Stockholm, Sweden

Mr. Bjarne Lømbke  
Doctor  
Swedish Farmer's Safety and Preventive  
Health Assoc.  
Lantbrukshalsan, PL 326 26700  
Bjuv, Sweden

### SWITZERLAND

---

Dr. Thomas Ng  
Medical Officer  
World Health Organization  
20 Appia Avenue  
Geneva, Switzerland

### TAIWAN

---

Dr. Guang-Yang Yang  
Veterans General Hospital  
Division of Clinical Toxicology, Dept of  
Medicine  
201 Sec. 2, Shih-Pai Road  
Taipei, Taiwan 11217



Surgeon General's Conference on Agricultural Safety and Health  
 FARM SAFE 2000 • A National Coalition for Local Action  
 Convened by the National Institute for Occupational Safety and Health  
 April 30 – May 3, 1991, Des Moines, Iowa

## ACRONYMS

2,4-D	2,4-dichlorophenoxyacetic acid	C	celsius
4-H	A program of informal education for youth	CAHSPS	California Agricultural Health and Safety Promotion System
ABC	Always Be Careful	CAST	Council on Agricultural Science Technology
AC	Amanda-Clearcreek	CATI	computer-assisted telephone interview
ACTION	Domestic Volunteer Service Agency	CDC	Centers for Disease Control
AFC	antibody-forming cells	CDFA	California Department of Food and Agriculture
AFT	antibody-forming cells	CE	California encephalitis
AG-LINK	a crisis hotline	CEHIC	Center for Environmental Health and Injury Control
AGI	Ace Glass Impinger	CES	Cooperative Extension Service
AHPS	Agricultural Health Promotion Systems	CFM	cubic feet per minute
AIDS	Acquired Immune Deficiency Syndrome	CFR	Code of Federal Regulations
ALAI	American Lung Association of Iowa	CFU	colony forming units
ALIVE	Aware Leaders Instilling Vital Education	CIEP	counterimmuno-electrophoresis
AM	alveolar macrophage	CI	cellular infiltrate
ANSI	American National Standards Institute	C.I.H.	Certified Industrial Hygienist
ARHES	Agricultural Respiratory Hazards Education Series	cm	centimeter(s)
ASAE	American Society of Agricultural Engineers	CNS	central nervous system
ASCS	Agricultural Stabilization and Conservation Service	CO	carbon monoxide
ATSDR	Agency for Toxic Substances and Disease Registry	CO <sub>2</sub>	carbon dioxide
ATV	all terrain vehicle	CPR	cardio-pulmonary resuscitation
AU	<i>Aspergillus umbrosus</i>	CPSC	Consumer Products Safety Commission
B.A.	Bachelor of Arts	CSP	Certified Safety Professional
B.S.	Bachelor of Science	CTL	cytotoxic T lymphocyte
B.S.N.	Bachelor of Science in Nursing	DARE	Drugs and Resistance Education
B2	a carcinogenic level	dB(A)	decibels (A-weighted scale)
BAL	bronchoalveolar lavage	DBBS	Division of Biomedical and Behavioral Science
BALF	bronchoalveolar lavage fluids	DBCP	dibromochloropropane
BLS	Bureau of Labor Statistics	DCC	day care center
BRFSS	Behavioral Risk Factor Surveillance System	DDT	dichlordiphenyltrichloroethane
		DFR	dislodgeable foliar residue
		DHHS	Department of Health and Human Services
		DLCO	low diffusing capacity for carbon monoxide

## Acronyms

DNA	deoxyribonucleic acid	FDA	Food and Drug Administration
DOL	Department of Labor	FEV	forced expiratory volume
DOT	Department of Transportation	FEV1	forced expiratory volume in one second
DPS		FEV1FVC	forced expiratory volume in one second, forced vital capacity
DPSE	Division of Physical Sciences and Engineering	FFA	formally, Future Farmers of America
DRDS	Division of Respiratory Disease Studies	FFHHS	Farm Family Health and Hazard Survey
DSDTT	Division of Standards Development, and Technology Transfer	FHA	Federal Housing Administration
DSHEFS	Division of Surveillance, Hazard Evaluations, and Field Studies	FHA	Future Homemakers of America
DSR	Division of Safety Research	FIFRA	Federal Insecticide, Fungicide, and Rodenticide Act
DTH	delayed-type hypersensitivity	FLD	farmers lung disease
DTMD	Division of Training and Manpower Development	FTA	Free Trade Agreement
D.V.M.	Doctor of Veterinary Medicine	FVC	forced vital capacity
EACH	Essential Access to Community Hospitals	FY	fiscal year
E-Codes	injury and poisoning codes, external cause	g	gram(s)
EC	electron capture	GATT	General Agreement on Trade and Tariffs
EDB	ethylene dibromide	GC	gas chromatography
EEE	Eastern equine encephalomyelitis	GFCI	ground-fault circuit interrupter
EEG	electroencephalogram	GLC	gas-liquid chromatography
ELISA	enzyme-linked immunosorbent assay	GSDE	grain sorghum dust extract
EM	electron microscopy	H <sub>2</sub> S	hydrogen sulfide
EM	equipment maintenance	HAZMAT	hazardous materials
EMI	Equipment Manufacturers Institute	HAZOP	hazard and operability
EMS	emergency medical services	HERO	home economics related organization
EMT	emergency medical technician	HFS	Human Factors Society
EPA	Environmental Protection Agency	HHS	Health and Human Services
ESA	Employment Standards Administration	HIV	human immunodeficiency virus
ETC	emergency transmatic cars	HP	hypersensitivity pneumonitis
EU	endotoxin units	I-CASH	Iowa Center for Agricultural Safety and Health
EVA	extravehicular activity	IA-HASSP	Iowa Agricultural Health and Safety Services Project
FACE	Fatal Accident Circumstances and Epidemiology	IARC	International Agency for Research on Cancer
FaRM	Farm Family Rehabilitation Management	ICD	International Classification of Diseases
FARS	Fatal Accident Reporting System	ICD-9	International Classification of Disease - 9th Revision
FAX	faximile	IDPH	Iowa Department of Public Health
FBLA	Future Business Leaders of America	IEA	International Ergonomics Association
		IgE	reagin antibodies
		IgG	precipitating antibodies

IH	International Harvester	NEISS	National Electronic Injury Surveillance System
IHS	Indian Health Service	ng	nanogram(s)
IL-1B	interleukin 1B	NH <sub>3</sub>	ammonia
IOM	Institute of Medicine	NHL	non-Hodgkin's lymphoma
IPM	integrated pest management	NHTSA	National Highway Traffic Safety Administration
IRCA	Immigration Reform and Control Act	NIEHS	National Institute of Environmental Health Science
ISO	International Standards Organization	NIFS	National Institute for Farm Safety
ISU	International Standards Units	NIH	National Institutes of Health
l	liter(s)	NIOSH	National Institute for Occupational Safety and Health
LELA	organization of the machine manufacturers in Sweden	NIPCC	National Injury Prevention and Control Committee
LPHS	Lake Placid High School	NITS	National Institute for Technology and Standards
LRT	lower respiratory tract	NL	nasal lavage
m	meter(s)	NOES	National Occupational Exposure Survey
M.A.	Master of Arts	NOHS	National Occupational Hazards Survey
MADD	Mothers Against Drunk Driving	NRHA	National Rural Health Association
M*A*S*H	mobile army surgical hospital	NSC	National Safety Council
M.B.A.	Master of Business Administration	NTOF	National Traumatic Occupational Fatalities
MFW	migrant farm worker	NTP	National Toxicology Program
mg	milligram(s)	OATS	Olmsted Agricultural Trauma Study
ml	milliliter(s)	OBGYN	obstetrician gynecologist
MLC	mixed lymphocyte culture	OD	over dose
MMFR	maximum mid-expiratory flow rate	ODTS	organic dust toxic syndrome
M.P.A.	Master of Public Administration	OMB	Office of Management and Budget
M.P.H.	Master of Public Health	OR	operating room
M.S.	Master of Science	ORD	occupational respiratory diseases
M.S.F.	Master of Science in Forestry	ORHP	Office of Rural Health Policy
MSHA	Mine Safety and Health Administration	OSG	Office of the Surgeon General
n	number	OSHA	Occupational Safety and Health Administration
NACHO	National Association of County Health Officials	OSU	Oklahoma State University
NAFTA	North American Free Trade Agreement	PAS	Post-secondary Agricultural Student Organization
NBC	National Broadcasting Corporation	PAT	pesticide applicator training
NCASH	National Coalition for Agricultural Safety and Health	pCi	picocurie(s)
NCHS	National Center for Health Statistics	PDR	Physician's Desk Reference
NCI	National Cancer Institute	PEACH	Primary Care Hospitals Essential Access to Community Hospitals
NCSU	North Carolina State University	PEL	permissible exposure limit
NEANES	National Health and Nutrition Examination Survey		
NEC	National Electric Code		

## Acronyms

Ph.D.	Doctor of Philosophy	SPRAINS	Sentinel Project Researching Agricultural Injury Notification Systems
PHA	phytohemagglutinin	STD	sexually-transmitted disease
PHA	process hazard analysis	STEL	short-term exposure limit
PHD	Panhandle Health District	Syn.	synonym
PHS	Public Health Service	TB	tuberculosis
PMN	polymorphoc neutrophils	TCE	trichloroethylene
PMR	proportionate mortality ratio	TLC	total lung capacity
PPE	personal protective equipment	TLV	threshold limit value
PRIST	paper radio immunosorbent test	TSCA	Toxic Substances Control Act
PSA	Public Service Announcement	TTS	temporary threshold shift
PTO	power take-off	TV	<i>thermoactinomyces vulgaris</i>
PTS	Permanent threshold shift	TV	television
PUD	Public Utilities Department	U.C.	University of California
PV	Park View	UNDP	United Nations Development Program
RAST	radioallergosorbent test	URT	upper respiratory tract
RD	respiratory disease	U.S.	United States
R.D.	Registered Dietician	USDA	United States Department of Agriculture
REC	Rural Electric Cooperative	USEPA	United States Environmental Protection Agency
REL	recommended exposure limit	UTI	urinary tract infections
RFP	request for proposal	VA	Veteran's Administration
R.N.	Registered Nurse	VAF	virus, antigen free
ROPS	roll-over protective structure	Vo-Ag	vocational agriculture
RRIS	Regional Rural Injury Study	WC	workers' compensation
SADD	Student Athletes Detest Drugs	WEE	western equine encephalitis
SAE	Society of Automotive Engineers	WHO	World Health Organization
SAW	Special Agricultural Worker Program	WIC	Women's, Infant's, and Children's
Sc.D.	Doctor of Science	YISD	Ysleta Incorporated School District
SDS	Supplementary Data System	$\mu\text{m}$	micrometer(s)
SEM	scanning electron microscopy		
SLCA	static lateral critical angle		
SLE	St. Louis encephalitis		
SMR	standardized mortality ratio		
SMV	slow-moving-vehicle		

## METRIC SYSTEM OF WEIGHTS AND MEASURES <sup>1</sup>

### INTRODUCTION

Use of metric measurement standards in the United States have been authorized by law since 1866. In 1988, the Congress enacted legislation (Public Law 100-418) to establish the metric system as the preferred system of weights and measures for all domestic trade and commerce. This legislation also required the use of metric measurement standards in all Federal activities. Recently, the President issued Executive Order 12770 on July 25, 1991 reiterated the order to implement the metric system "as the preferred system of weights and measures for United States trade and commerce." This executive order directs all Federal agencies to implement "metrification," to the extent economically feasible, by September 30, 1992.

### THE METRIC SYSTEM

Originally, there were only two basic reference points, the meter and the gram. The list of reference points has been expanded or changed to include the kilogram (instead of the gram) for mass, the second for time, the ampere for electric current, the degree Kelvin for temperature, and the candela for light intensity.

The reference objects for these International Standards Units are maintained for comparisons and checked periodically against other international references by the National Institute for Technology and Standards (NITS).

The *metric* system entails the use of multiples or power of ten to describe magnitudes greater or lesser than the basic units of meter, gram, ampere, and so forth. For example, the kilogram is 1,000 grams and the *milligram* is 1/1,000th of a gram. There are 100 *centimeters* (0.39 inches) to one *meter* (1.09 yards) and 1,000 *meters* to

**Table I.** Prefixes and Symbols for Decimal Multiples and Submultiples of Units.

Power of Ten	Prefix	Symbol
10 <sup>12</sup>	tera	T
10 <sup>9</sup>	giga	G
10 <sup>6</sup>	mega	M
10 <sup>3</sup>	kilo	k
10 <sup>2</sup>	hecto	h
10 <sup>1</sup>	deca*	da
10 <sup>-1</sup>	deci	d
10 <sup>-2</sup>	centi	c
10 <sup>-3</sup>	milli	m
10 <sup>-6</sup>	micro	μ
10 <sup>-9</sup>	nano	n
10 <sup>-12</sup>	pico	p
10 <sup>-15</sup>	femto	f
10 <sup>-18</sup>	atto	a

\*Also "deka."

Source: Conférence générale des Poids et Mesures, Comptes rendus des séances de la 11e Conférence générale des Poids et Mesures, Paris 1960, Gauthier-Villars, Paris, 1961, page 87; Conférence générale des Poids et Mesures, Comptes rendus des séances de la 12e Conférence générale des Poids et Mesures, Paris 1964, Gauthier-Villars, Paris, 1964, page 94.

<sup>1</sup>Adapted from OSHA Instruction CPL 2-2.20B CH-1, pp. 23-1 to 4.

**Metric System of Weights and Measures**

one *kilometer* (0.62 miles). The prefixes for the multiples and submultiples applied as multiples (power) of ten is presented in Table I.

**CONVERSION EQUIVALENTS**

The document to be used as a primary reference for inch-pound to metric conversions is Federal Standard 376A, *Preferred Metric Units for General Use by the Federal Government*, May 5, 1983. A selected number of conversion factors are presented in Table II as examples.□

**Table II. Prefixes and Symbols for Decimal Multiples and Submultiples of Units.**

<b>Length</b>		<b>Pressure</b>
2.54 centimeters (cm) = 1 inch (in)		3.38638 kilopascals (kPa) = 1 inch of mercury (in Hg)
25.4 millimeters (mm) = 1 in		2.98898 kPa = 1 foot of water (ft H <sub>2</sub> O)
0.3048 meters (m) = 1 foot (ft)		0.1 kPa = 1 millibar
1.609344 kilometers (km) = 1 mile (mi)		
<b>Area</b>		<b>Volume</b>
6.4516 cm <sup>2</sup> = 1 in <sup>2</sup>		0.02831685 m <sup>3</sup> = 1 ft <sup>3</sup>
645.16 mm <sup>2</sup> = 1 in <sup>2</sup>		28.31685 liter (l) = 1 ft <sup>3</sup>
0.0929034 m <sup>2</sup> = 1 ft <sup>2</sup>		3.785412 l = 1 gallon (gal)
4046.873 m <sup>2</sup> = 1 acre		0.1589873 m <sup>3</sup> = 1 barrel (42 gal) (bbl)
2.589998 km <sup>2</sup> = 1 mi <sup>2</sup>		1233.489 m <sup>3</sup> = 1 acre-foot
		0.002359737 m <sup>3</sup> = 1 board foot (bd ft)
<b>Velocity</b>		<b>Weight (Mass)</b>
0.3048 meters/second (m/s) = 1 foot/second (ft/s)		0.45359237 kilogram (kg) = 1 pound (lb)
1.6093478 km/hour (km/h) = 1 mile/hour (mi/h)		28.34952 grams (g) = 1 ounce (oz)

## THE SURGEON GENERAL'S CONFERENCES ON OCCUPATIONAL HEALTH <sup>1</sup>

By Anne Mather

---

The recognition that work can cause disease and disability may be as old as mankind. But the belief that government should try to prevent occupational affliction is not. The Public Health Service (PHS) played an integral part in this shift in perception.

The year was 1925. For the past two years, newspapers, particularly The New York World, had been carrying stories about cases of severe poisoning among chemists and other workers.

The source of the poisoning was tetraethyl lead, a new compound used in gasoline as an anti-knock agent. Within 17 months of its first manufacture in the United States, 139 cases of poisoning occurred; 13 people were dead.

In her autobiography, Dr. Alice Hamilton, a pioneer in industrial toxicology (she was the first U.S. physician to devote her career to occupational safety and health), describes the effects of this poison on the body: *it is more quickly absorbed than any of those ordinarily used in the central nervous system, causing insomnia, excitement, twitching muscles, hallucinations like those of delirium tremens, even maniacal attacks and convulsions, and death.*

It was a true emergency, one met by then—Surgeon General Hugh S. Cumming. On May 5, 1925, he requested the industry to discontinue temporarily the manufacture and distribution of tetraethyl lead. Industry complied. On May 20, Cumming called a conference to discuss the problem. Attending were industrialists, chemists, representatives of labor and physicians. They names an expert committee to recommend ways to prevent poisoning from tetraethyl lead.

A case-control study of 252 persons led to a conclusion that the hazards of this form of lead could be prevented by mechanical devices. When Surgeon General Cumming held another conference in 1926, the first cooperative agreement on toxic substances was reached.

The agreement included restrictions on the use and handling of tetraethyl lead. These regulations were subsequently administered by the Office of Industrial Hygiene and Sanitation, the predecessor of the National Institute for Occupational Safety and Health.

---

<sup>1</sup>Adapted from *Dateline: CDC* article, Vol. 22, No. 9, October 1989, p. 12, written by Anne Mather and edited by Mary Guinan, M.D., Ph.D., Assistant Director for Science.

## The Surgeon General's Conferences on Occupational Health

As a result, several states made lead poisoning a reportable disease. Reporting continued until World War II.

These conferences were so successful that they became the model for another one, in 1928, on the health hazards of radium dial painting. Radium was also a new poison. It was used to make the luminous dials on watches and clocks. The habit workers had of pointing the tips of the brushes with their lips led to numerous fatalities.

So successful were these early conferences that a total of 9 were ultimately held—the last in 1941 under Surgeon General Thomas Parran. They concerned methanol, carbon tetrachloride and similar volatile chlorinated liquid hydrocarbons, carbon tetrachloride fire extinguisher, aniline oil, carbon disulfide, benzol, and chronic mercurial poisoning in the hatting industry. They resulted in agreements between industry including labor, where appropriate, and PHS.

Wrote Hamilton,

*It was to me both surprising and heartening to see men of such widely separated backgrounds and interests—manufacturers and their chemists and research workers on one side, trade-union officials, independent physicians, and toxicologists on the other—meet in a spirit of reasonableness and a genuine desire to get at the real facts and deal practically with the problem.□*



## EXCERPTS FROM *DISEASES OF WORKERS*<sup>1</sup>

By Bernardino Ramazzini

---

### DISEASES OF FARMERS

*O FARMERS*, too blest by Fortune, did they but know their bliss!" This cried the prince of poets of old. And perhaps we may say as much of that pristine race of mortals that used to till their ancestral acres with their own oxen, but not nowadays of our farmers, for they have to wrestle with unending toil and the direst poverty on another man's estate. The diseases that commonly attack the peasantry, in Italy at least, and above all in the country on both sides of the Po, are: Pleurisy, pneumonia, asthma, colic, erysipelas, ophthalmia, quinsy, toothache, and decay of the teeth. The exciting causes of these maladies are in the main two, the weather and unwholesome food. While they work in the fields they are exposed to the inclemency of the weather; they are buffeted now by the south wind now by the north, soaked with rain and night dews, scorched by the summer sun; however robust they may be, of however hardy a stock, they cannot support such violent changes; now they are in a bath of sweat, now chilled through, and besides they live on such unwholesome food that they accumulate a stock of thick glutinous humors which bring in their train a host of troubles. For the whole mass of humors is excited to a febrile effervescence, and thus in the vessels of the lungs into which flows all the venous blood, thick and viscid humors readily stagnate. This is why, as I have often noticed, whenever an epidemical constitution of lung diseases begins to assault us, it gives the signal to attack first the country-people and completely dominated them. Also from the same causes they very often suffer from the pains of colic and from hypochondriasis; the latter they call 'the master's disease', because this sort of affection seems to savor somewhat of hysterical trouble; their coarse and sticky food produces in the stomach and intestines a serious accumulation of pituitous and acid juice; hence ensue griping pains and distension of the intestines. Their agricultural work, since it is determined by differences of localities and the variations of the seasons, is various and of many kinds; thus in winter and early spring they suffer from diseases of the chest, fluxes to the eyes, and quinsy. These ailments are caused, as I have said, by their viscid and thick blood which makes the circulation sluggish so that the blood stagnates easily and in various parts excites inflammations; in fact, when blood is drawn from them by venesection at this season, it is so thick that both in density and color it resembles beeswax.

In my opinion there is no class of men whose blood undergoes such a great change and in so short a time as happens with these country-people; if you draw blood from them in

---

<sup>1</sup>Courtesy of the New York Academy of Medicine Library. Translated from the Latin text *De Morbis Artificum* of 1713 by Wilmer Cave Wright. Published under the auspices of the Library of The New York Academy of Medicine, Hafner Publishing Company, New York, London, 1964, Chapter XXXIX, pp. 337-351, Chapter XL, pp. 353-357, and Chapter VI, pp. 441-443.

spring it may be thick and glutinous, but if in early summer some disease gives occasion for venesection of those same persons, the blood looks lively and bright red. Exercise and hard work have so powerful an effect that in so short a time the mass of humors in transformed to a quite opposite crisis; but in the case of townspeople this is not observed.

I have often noticed a curious thing that happens to our peasantry, especially to the children. In March, about the equinox, children under the age of ten or thereabouts are affected with remarkable dimness of vision; in the daytime they can see but little or almost nothing, and as they run about the fields they wander and lose their way just like blind people; but when night comes they can see fairly well. The affection passes off of itself without any remedy, and about the middle of April their former keenness of vision is entirely restored. I have often examined the eyes of these children when I had a chance and noted that the pupil was excessively dilated. This affection is called by doctors 'mydriasis', but in discussing its cause writers are by no means in agreement, as you may see by consulting Sennert, Riviere, and Platter. De Gorris states that this disorder is not unlike paralysis of the pupil; and my own view is that the sun's rays in March may cause some liquefaction in the brain and visual nerves; this so weakens the tonus of the uvea, the tunic of the eye, that it collapses. These children spend the whole winter in extremely warm damp stables, and when the winter breaks up, which happens about the equinox, they sally forth from these dens and expose their bare heads to the sun's rays; this is very liable to cause a diffusion of the humors followed by dilation of the pupil and a consequent weakness of vision due to the admission of such intense light. Towards the end of April, the influx of humors has been effectually dispersed by the sun's rays, the pupil contracts and is restored to its natural tension, and so without any remedy the eyesight is completely restored.

*O Furthermore*, in summer farmers are very often attacked by acute and ardent fevers, especially when the wrath of 'raging Leo' begins to scorch them. In autumn they are subject to dysentery, and this we may ascribe to their eating the fruits of the season and to other errors of diet. Autumn is the regular time for them to steep hemp and flax in the pools of the marshes. This task is generally assigned to women, who, in order to drag out the bundles of hemp and clean them, wade up to the waist in lakes and pools; as a result of this filthy task many of them are attacked by acute fever, which is very quickly fatal; we may suppose that this is caused not only by constriction of the pores of the skin and checked transpiration but also by the fact that the animal spirits are utterly destroyed by that terrible pestilential stench which pollutes the whole neighborhood. This above all others is the season when city folk are cautious and with good reason about paying country visits; for then from every farm there comes a disgusting odor. Father Kircher considers that this odor alone is the cause of the highly malignant plague that certain cities have experienced from time to time. Schenck in his *Observations*, Pedro 'a Castro, Simon Paulli, and others fully demonstrate the virulent quality of the vapors that rise from the water in which hemp has been steeped. As for the influence of smells, whatever it may be, women who are subject to fits of hysterics know well how powerful it is. Another thing that seriously injures the health of farmers is their careless habit of piling dung for manuring the fields; they place these heaps in from on the

cowhouses and pigsties and even their own houses, which may truly be called Augean stables, and keep them there all through the summer, for a nosegay, and inevitably the air is polluted by the foul effluvia that incessantly rise from them. For this reason Hesiod disapproved of manuring the fields and desired that farmers should consider their own health rather than the fertility of the soil.

Paolo Zacchias remarks that gardeners very often suffer from cachexy and dropsy; this is because they have to keep watering the gardens and are obliged to spend their time on ground so damp that their bodies cannot fail to absorb a great deal of moisture. I remember the case of a patient of mine, a kitchen-gardener, who had become partly paralysed; he had entirely lost the use on one of his legs, through its sensibility was not impaired; in the other leg there was no sensation but its motility was not affected; by taking a decoction of guaiacum and many other remedies, for several years, he finally recovered. Hippocrates records a case which I will quote: "A man who lay ill in the garden of Dealcis had heaviness in the head and pain in the right temple for a long time. He caught fever from some exciting cause, and took to his bed." In his comment on this case history, Galen flares up against Sabinus who held that the word 'garden' had been interpolated in the text of Hippocrates; as though in Galen's view this indicated the real occasion of the disease; certainly Galen seems to have condemned the air of gardens on account of the manure and the pernicious exhalations from trees, e.g. box, and from similar plants. Those who live near meadows are also subject to the aforesaid diseases, for meadows nearly always make the air unhealthy for the same reasons. Hence we find in Zacchias under *Furisconsults: Meadow and what the word signifies*, that an action may lie against a neighbor who intends to convert arable land into pasture. It follows that those who work in meadows, for instance mowing hay, suffer from serious disorders.

Now what can the medical profession do to protect these tillers of the soil whom we need so much? To suggest to our farmers in Italy any precautions of a medical sort that might safeguard them seems little short of absurd since they seldom or never consult doctors about this and when one does make some suggestion they pay no attention. All that I can do is to offer certain warnings as to their treatment that it would be well to heed whenever they are brought to the city and are laid up in a hospital with any of the maladies I have mentioned, or when they do call in a doctor, as happens now and again when they can well afford it. My first warning, then, is that in cases of pleurisy or other diseases of the chest you must not draw blood as freely as you would from townspeople; for their bodies are worn out by unremitting toil, and it takes very little to bring on collapse; moreover, their blood is almost wholly of a gelatinous consistency, and its volatile elements have been used up; hence if an excessive amount of blood is drawn from them their strength collapses, and they are unable to wash out the disease by expectoration or vomiting. I am well aware that there are some who think that we ought to resort to more drastic venesection when the blood is seen to be so thick, for this, they say, would stimulate the circulation; but this is easily said. They should consult the learned Bellini and see with what caution one must proceed when one tries by venesection to remove blood from some part to which there has been an excessive flow. This at least is certain, that the blood does not flow through its channels of its own accord and by the force of its own gravity; it is the spirits that supply the driving force,

aided by the action of the heart; so that if the spirits are enfeebled, instead of stimulating the circulation of the blood you make it slow down still more.

Baillou raises this question: The bodies of servants, men and women alike, are in other respects hard, compact, and soiled and their health is not so easily upset as that of the gentry; why then when they are ill are they more easily upset as that of the gentry; why then when they are ill are they more easily prostrated by purging and venesection than are persons whose bodies are less compact and more delicate? Of the various reasons that he offers for this, the most important is that their bodies are so thick and distended by hardened viscera that they do not easily yield to purgatives, nor do they derive much benefit from phlebotomy; we may say the same of country-people. Hippocrates too describes a certain constitution in which all the female slaves who were attacked by quinsy died of it, whereas it was not fatal to free-born maidens. It follows that in diagnosing diseases and applying treatment you should take into account not only the bodily habit of the patients but also their mode of life and occupations.

Many indeed are the mistakes that to my knowledge are made in treating these country-people, simply because on account of their robustness they are supposed to be able to stand stronger remedies than the townsfolk. Often enough, and always with compassion, I see poor peasants brought in to the public hospitals and handed over to young doctors just out of the medical school; I see their strength utterly exhausted by powerful cathartics and repeated phlebotomy, with no attention paid to the fact that they are unaccustomed to strong remedies or that their strength is enfeebled by the fatigues they have undergone. This is why so many of them prefer to face death in their huts rather than take leave of this life in a hospital after their veins have been drained of blood and their bellies emptied and exhausted by drugs. Every year when the harvest is over in the Roman Campagna, the hospitals of Rome fill up with reapers who have fallen sick; and it is a question which cuts off more reapers, the scythe of Death or the surgeon's lancet.

I must say that I have often had cause to wonder how so many of these people when attacked by acute diseases managed to recover, I do not say without the aid of any remedy, for that would not surprise me, but on a rich and even sumptuous diet; for however poor these farmers may be, when one of them falls sick the neighbors hasten to bring them eggs and chickens with which they make dainty dishes, and in this way they either manage to defy the virulence of the disease or to hasten their release from the life of toil and trouble that they lead; so that with us it has come to be a common saying that the peasant class when death takes them to himself pass over well nourished and with full bellies; but the city folk perish miserable of hunger and starvation while the doctors torture them.

But when the former begin to recover, they go back to their regular diet of garlic and onions and devour them greedily as one would sweetmeats, and moreover they consider them a strengthening food. I can well believe that that acrid sort of aliment may answer the purpose of a medicament, for their stomachs and the whole blood mass tend to sourness, especially in the autumn after the summer's work is finished, and so onions and

garlic, like other anti-scorbutic remedies, will serve to dissolve that viscid substance and to correct acidity. I know many of them who have driven off quartan fevers by a diet of garlic and onions with strong wine in mid-winter.

Galen records the case of a rustic who was seized the colic pains and cured himself in the following way: He tightened his belt, then devoured garlic and bread and exercised himself by keeping at his usual work all day; by these means he got rid of the pain of colic. "I should therefore", says Galen, "call garlic the peasant's theriac, and anyone who forbids Thracians or Gauls, in short those who live in cold countries, to eat garlic will be giving them harmful advice." Another remedy that our farmers use to cure colic is this; they take the leaves of ground-pine, pound them, and with yolks of eggs make a poultice and apply it to the abdomen.

In Hippocrates is a curious case history form which I quote: "There are certain postures that give relief, e.g. the man whose work was plaiting and twisting twigs with his hand; the pain was such that he took to his bed; but he seized the top of a pole that was fixed above this head, gripped it firmly and the pain was relieved." Hippocrates does not say in what part the pain was, and Galen in his note on the passage thinks it was in the hand; but Valles decides that the pain was most violent and was piercing him as if with something pointed, he placed the end of a wooden pole and pressed hard on it; for pains of this sort are, he says, much relieved, "by strong pressure, by tossing the body about and changing one's posture." This is just what nature teaches us when we have a stomach-ache, namely, that we should press hard with the hand or fist on the painful part; this prevents it from becoming distended and swelling up. That is why Hippocrates recommended pressure with the hand when women have fits of hysterics, so that the womb might be kept in its proper place, and I have often found this sort of remedy very effectual, in fact much more than the whole outfit of remedies for hysterics.

I could write at much greater length on the proper treatment of these farmers, but let me sum up: As far as we may gather from actual experience and from sound reasoning, since they are enfeebled by constant toil and ill-nourished from an unwholesome diet, we must not exhaust their bodies by copious and repeated blood-letting and purging; emetics they can stand more easily, cupping with scarification in continuous fevers very often gives wonderfully good results, whether because they have great confidence in this remedy or perhaps because of some other factor of which we know nothing. When it is necessary to administer some sort of antidote, let it be chosen from the class that are volatile; this will be in conformity with nature, for they are accustomed to sweating not only in summer but in winter too; for men who exercise constantly always sweat easily. When they no longer have to battle with disease and are beginning to convalesce, they should be allowed to return to their poor homes and to resume the diet to which they are accustomed. Plato was quite right in ridiculing the physician Herodicus for wanting to prescribe rules of diet for artisans.

It follows that in my opinion men of this class should be treated by the direct and summary method; any other that is roundabout and calls for an outfit of various sorts

gradually consumes the strength of these peasant folk: "Who seeks to cure, but makes it worse."

## DISEASES OF FISHERMEN

*O FARMERS* plough the earth and sow and thus by plenteous crops supply food to the population, so fishermen plough the seas and rivers and by catching fish greatly contribute to the food supply and furnish dainties for the table. For the mainland would not suffice to feed such vast multitudes if the seas did not reinforce it with a supply of fish. Thus when the price of grain is high, coastal cities and seaports suffer less than inland towns and districts. We know that there are certain peoples called Ichthyophagi, because their only food is fish, e.g. those who live near the Red Sea, who broil fish on stones made red-hot by the sun and thus they make bread. Medicine therefore, which as Hippocrates says comes to the aid of all men, ought to take as much care of fishermen as of farmers whenever, as very often happens, they fall ill. Now when a doctor happens to have some fisherman entrusted to his care, let him carefully consider that theirs is a very toilsome and exacting calling; that the man has to endure the cruel buffets of the winds, freezing cold in winter, and in summer scorching heat; he should consider what kind of food he eats and how irregular is the sort of life he leads, so that, while other workers when wearied by the day's toil go to their homes and spend the night in comfort in their beds, restoring their strength by sleep, for fishermen the night is usually spent in toil and sleepless. Thus the Apostles complained to our Saviour that they had toiled the whole night and taken nothing. Pitable therefore is the lot of these workers, for since they very often have no other home than a small boat, when they fall ill they are obliged to go into a hospital, where it is impossible to enter on the precise and proper treatment for them unless the doctor knows clearly in what sort of occupation the patient is engaged.

The clothes of fishermen are always wet through, hence they are exposed to diseases that arise from obstruction of transpiration; such are acute fevers, chest troubles, pleurisy, pneumonia, coughs, dyspnoea, and similar diseases. They live mainly on fish, and of the inferior sort, since the better kinds are reserved for the tables of men of rank, as in the story of that huge turbot about which Juvenal wrote his Fourth Satire; this diet produces in them a cachectic habit, which ends in dropsy. There is a saying of Hippocrates: "Food too weak to nourish has a brief life"; that means, according to the admirable note of Valles, that if you want to prolong your life such food will not help much. Hence Lievin Lemmens was right in saying that if you eat fish you need to eat more bread because fish very quickly putrefies. These men spend all their time in places that are very damp, and they are therefore subject to leg-ulcers that are difficult to cure. However, it is well to know that the ulcers of men engaged in fishing in rivers and marshes are very different from those that afflict sea-fishers; for fresh-water fishermen have foul ulcers that readily degenerate into gangrene, but sea-fishers have dry rough ulcers, as is remarked by Hippocrates, *On the use of liquids*, 7; and he prescribes fomentation with sea-water as the treatment for this kind of ulcer. Marziano has an excellent note on the passage. Though it would seem to the highly irrational to foment dry rough ulcers with sea-water, which is so sharp and biting that it is an irritant and

increases any discharge, he says that Hippocrates was right to prescribe it, for the following reasons: The ulcers of sea-fishers are very hard and dry, and by inducing irritation you can provoke suppuration; now unless ulcers suppurate you cannot heal them, a fact which Galen also notes. But you must treat differently the ulcers of those who carry on their fishing in rivers and marshy places; for foul ulcers of this sort applications that are drying but not irritating will be best. As Hippocrates says: "A dry ulcer is nearly well, but a wet ulcer is far from well." Sea-fishers suffer very much from constriction of the bowels, in spite of the fact that they eat much more than those who live ashore. Helmont remarks on this and says it is because the air they breathe is saturated with saline vapors; this whets the appetite and at the same time makes the bowels hard; also they eat more on account of the movement of the waves which constantly renews the air; this gives a stimulus to the fermentation of the blood. Now clusters of sea-water, though they are very effective for moving the bowels, actually induce dryness later. There is a noteworthy passage in Hippocrates. "People are mistaken about saline waters, from lack of experience, in that they think they relax the bowels and promote stools, whereas they in fact seriously hinder evacuation of the bowels and stools." Then let those who prescribe for constriction of the bowels sharp clusters with a great deal of salt learn from this how far they are astray from the path trodden by our inspired teacher. Therefore, for constriction of the bowels in fishermen it is more suitable to give softening and oily clusters; they should swallow mild lenitives and cathartics.

It is a known fact that fishermen are sometimes attacked with torpor and numbness of the arms and feet when, among the fish in the nets, there happens to be a cramp-fish, for the sea, like the land, has its venomous creatures, as Pliny records. This happens, not only by direct contact but also from a venomous aura, which is transmitted to the man's arm by the fishing-line or this spear; this is the explanation given by Dioscorides, Pliny, Mattioli, and others but from numerous experiments made by Stefano Lorenzini it is now certain that the fish can do this by bodily contact only, and that not every part of it has this faculty but only certain sickle-shaped muscles. The stupefying powers of the cramp-fish and the remedies to be used are fully described by Sennert.

## **DISEASES OF WORKERS WITH WOOD**

*Next* to corn and fruit the most useful thing that Nature has produced for man is trees and woods, indeed, as Pliny justly says: "At first, man's food came from trees, he made his cave softer with leaves and dressed in bark." Later, the saw was invented, and men began to cut trees into boards and so to make houses and a thousand other things for the use of mankind. We may conclude that Lyon in France was formerly built entirely of Wood, for Seneca tells us that that city was burnt down in a single night; so that the peasants who as usual came there in the early morning had not heard of this calamity, and when they came near and saw no city there they were thunderstruck and marvelled what had become of Lyon. Hence Seneca, where he deplores the misfortunes of mankind, exclaims: "For centuries a wood, and in a moment, ashes." Even today in regions far north there are cities built entirely of wood, Moscow, for instance, where there are huge warehouses in which stand for sale houses ready-made of whatever kind is

needed, large, small, and medium-sized to suit the buyer's fancy, so that in a few days one can have a house all finished on a chosen site.

The carpenter's trade, though we class such men under one head, is subdivided into several separate callings; some make only coaches and carriages, others casks and vats, others only ships. Some only carve with the chisel ornamental frames for mirrors and pictures; these are to be gilded later. Generally speaking, carpentering is a toilsome business and greatly fatigues the workers, but those who suffer most are the men who with a saw cut up trees into boards. This kind of work is very tiring; they place the squared tree-trunks so that they rest on two logs, and one workman stands on the trunk, the other under it while with a large saw they cut up the trunk, guided by lines painted on it in red. Hippocrates in *Regimen I*, describes admirably their method of working: "As when sawyers cut up timber with a saw; one pulls the other pushes, though both are of course doing the same thing; the man who presses downwards pulls at the man above him, otherwise the saw could not move downwards; but if they use too much force they will make a mess of the whole job." The man who is above the trunk has to work harder than the man underneath for he has to pull a rather heavy saw upwards, but the man working underneath suffers severely from the sawdust that keeps falling into his eyes and his mouth too; this makes his eyes red and painful afterwards, for he has to keep blinking them nearly all the time.

Those too who work at the lathe, especially when the wood is box, olive, or turpentine tree or the like, find their task very fatiguing; for they are obliged to put an incessant strain on the hands and arms in order to control the chisel and with it by degrees shave off the right amount according to the design of the work; the right foot is always at work to keep the wood that is to be shaped turning round and round; moreover they must keep the eyes fixed on the work, and from that rotary motion of the wood the eyes contract some injury from the material that they handle, except sometimes from cypress wood, for there are persons who cannot endure its pungent smell, and it gives them headache.

For carpenters I have no precautions to suggest except this: They should be moderate and not overwork, lest they bring diseases on themselves by being too much set on making money, and so by refusing to give in be forced later on to take a holiday from their business for many days. Gentle rubbing with oil will be beneficial, as it is for all workers who are exhausted by overwork. They must also consider their eyes, and to lessen their suffering as much as may be they should now and again stop working; and if these are subject to pain and redness they should be bathed with mild lotions, e.g. barley-water, violet-water, or woman's milk. But if from some other cause they are attacked by acute diseases, the doctor should be as cautious about administering strong remedies as in the case of other workers whose strength has been seriously exhausted by excessive toil.□



## INDEX

### A

accident 26, 40, 49, 84, 89-92, 97, 107, 120, 127, 128, 166, 171, 176, 178, 262, 274, 292, 302-304, 308, 309, 312, 315, 318, 319, 325, 328, 332, 333, 336, 338, 372, 373, 378, 381, 383, 384, 387, 397-400, 403, 404, 426, 428, 434, 473, 489, 499, 501, 506, 509, 523, 541, 545, 548, 551, 557, 558, 599, 600, 622  
Adams, Darrell 38  
Adams, Keith 399  
Adams, Marilyn 12, 31, 38, 39, 45, 398, 489, 492, 497, 509, 593  
adolescents 96, 176, 200, 221, 425, 497, 579  
Adrian, Linda 600  
advocacy 7, 9, 46, 47, 94, 134, 257, 469, 470  
Africa 131, 359  
Agricultural Advisory Committee 321, 587  
agricultural chemicals 45, 74-77, 80-82, 110, 119, 247, 248, 254, 310, 341, 342, 456, 502, 520  
agricultural hygiene 243, 244, 251, 252, 451  
Agricultural Stabilization and Conservation Service 422  
agriculture 1, 3-5, 7, 8, 11, 12, 14-17, 22, 28, 29, 32, 33, 36, 44-47, 50-61, 63, 64, 66, 73-78, 83, 84, 86, 87, 90-93, 95, 100, 101, 107-112, 114, 116-118, 120-126, 129, 130, 132-138, 141-143, 159, 161, 162, 164, 174, 176, 178, 184, 186, 189, 192, 193, 195-198, 202, 211, 213-215, 221, 222, 226, 229, 232, 237-239, 243, 246, 248, 249, 251, 254, 259, 261-266, 268, 274, 275, 277-280, 282, 291, 299, 300, 302-304, 306, 310, 313-315, 318, 321, 324, 325, 329, 333, 334, 336, 351-354, 356, 357, 359, 360, 362, 370, 372, 374, 379, 384, 387, 389, 391, 393, 395, 397, 404, 409, 411, 421-424, 429, 432-437, 439, 440, 443-445, 448, 449, 451, 453, 457, 458, 462-464, 470, 473-475, 477-486, 493, 498-504, 508, 510-512, 517-519, 523, 525, 540, 541, 544-546, 550, 556, 557, 561-563, 565, 566, 571, 580, 582, 590, 592, 595, 597, 598, 621, 624  
Aherin, Robert A. 128, 309, 437, 489, 506, 508  
AIDS 3, 48, 138, 141, 394, 471, 505, 621  
air filtration systems 310, 456, 526  
Alabama 43, 65, 136, 433, 572, 581-583  
Alar 258  
Alaska 57, 59, 65  
alcohol 23-25, 496

allergies 336, 357, 449  
Alzheimer's Association 417  
ambulance 103, 387, 585, 589, 595  
amebic dysentery 358  
American Academy of Orthopedic Surgeons 372  
American Farm Bureau Federation 87, 189, 196, 324, 373, 388, 390, 396, 454, 475-477, 485-488, 511, 518, 532, 534, 537, 556, 592  
American National Standards Institute (ANSI) 315  
Amish 217, 268, 276, 450  
amputations 278, 446  
Anderson, Henry A. 151, 156, 211, 214, 238, 283, 445  
animal 4, 76, 80, 86, 95, 129, 133, 135, 138, 161, 162, 171, 175, 204, 207-209, 211, 219, 221, 222, 225, 233, 236, 243, 245-252, 254, 262, 263, 271, 272, 325, 357, 361, 363, 392, 522, 531, 563, 564, 567, 591, 630  
anthrax 223  
Arizona 65, 223, 228, 469, 471, 474, 476, 495, 499  
Arkansas 65, 227, 257, 299, 303  
Armbruster, Walter J. 383, 391, 419, 420, 432, 462  
Arnold, Jim 404  
arthrosis 51, 82, 85, 352  
Asia 36, 359, 361  
asphyxiation 243, 246, 262  
asthma 51, 73, 80, 144, 204, 207, 209, 210, 212, 215, 245, 271, 449, 629  
Atchison, Christopher G. 3, 7, 11, 26, 27, 93, 105  
augers 284, 313, 323

### B

babesiosis 359  
back injuries 51, 278, 282, 336, 454, 561  
Baker, L. Dale 84, 177, 238, 240-242, 298, 378, 457  
banana 429, 430  
barn 4, 38, 221, 246, 286, 293, 338, 378, 388, 421, 426, 459, 481, 543, 564  
Bean, Thomas L. 132, 212, 274, 277, 283, 310, 315, 316, 318, 329, 343, 454, 517, 554  
beef 3, 218, 219, 223, 258, 378, 392, 430  
behavior 23, 26, 86, 89, 91, 92, 106, 123-125, 127, 128, 191, 223, 254, 280, 306, 309, 315, 334, 338, 339, 348, 363, 383, 391, 393, 420, 426, 436, 437, 439, 441-444, 456, 460-465, 475, 482, 494, 506, 508, 515, 525, 552  
Belmont, Larry M. 412

biotechnology 67, 76, 84, 106, 134-142, 193, 300  
bison 222  
black workers 39, 31, 52, 127, 198, 216, 264, 346, 358, 380, 318  
black migrants 52  
Blair, Aaron 84, 229, 238-240, 257, 263, 271, 449, 536  
Bolen, Carrol 33  
brain cancer 232  
Brandon, Manitoba 378  
Branstad, Terry E. 3, 6  
Brokaw, Tom 428  
bronchitis 204, 207, 208, 210, 211, 215, 245, 246, 257, 270, 449, 542  
Brumfield, Gary 471  
Buchele, Wesley F. 283, 490  
building design 51  
burns 254

### C

Caesar, Tiberius 179  
California 7, 9, 12, 14, 15, 59, 65, 82, 87, 98, 111, 115, 146, 189, 193-197, 216, 219-221, 223, 226, 227, 229, 238, 333, 340, 357, 359, 360, 364, 405, 407, 409, 450, 453, 469, 476, 490, 499-504, 566, 621, 624  
California encephalitis 359, 360, 450, 621  
Campbell, J.M. 204  
Canada 95, 129, 157, 158, 194, 277, 316, 378, 412, 421, 489, 509, 577  
Canadian Research Institute 316  
cancer 9, 23, 32, 37, 39-41, 51, 61, 68, 70-72, 76, 77, 80, 81, 84, 103, 132, 136, 139, 141, 142, 157, 186, 187, 195, 229, 230, 232-235, 238-241, 257, 268, 271, 382, 398, 413, 427, 446, 449, 450, 479, 481, 493, 501, 514, 536, 622, 623  
canister 375  
carbon monoxide 181, 205, 243, 246, 282, 297, 513, 524, 621  
carcinogen 13, 239  
carpal tunnel syndrome 279, 280, 282, 336  
Carr, W. Peter 161  
Carter, President James Earl 380  
cartridge 286, 375  
Castellan, Robert 187  
cattle urine splash 219  
Center of Rural Affairs 104  
Centers for Disease Control 23, 35, 36, 39, 41, 43, 67, 68, 70, 73, 140, 176, 178, 226-228, 363, 364, 387, 527, 535, 621  
chainsaw 317, 318, 352, 354, 585, 588, 593  
chemical 8, 34, 50, 56, 57, 70, 75, 77, 80, 81, 84, 119, 129, 131, 132, 134, 139,

## Index

151, 156, 157, 159, 161, 179, 181, 186, 187, 195, 196, 198, 230, 235-238, 240, 241, 247, 248, 256, 257, 272, 278, 282, 299, 310, 334, 336, 341, 342, 345, 346, 349, 350, 361-363, 429, 430, 448, 456, 479, 480, 487, 489, 490, 493, 505, 526, 534, 550, 552, 578, 583, 586, 590-592  
chickens 47, 136, 205, 250, 632  
child labor 12, 14, 61, 64, 65, 257, 467, 490  
children 4, 7-9, 11, 12, 14, 16, 25, 26, 31-33, 37, 42, 47-52, 57, 61, 64, 73-75, 79, 83, 89, 90, 100, 107, 112, 113, 119, 124, 168, 169, 176, 188, 189, 200, 217-219, 221, 255, 271, 299, 333, 343, 378, 383, 387-389, 391, 398-401, 410, 415, 421, 424, 430, 436, 437, 449, 454, 458, 462, 467, 468, 473, 475, 476, 482, 485, 489, 490, 493, 497, 506, 511, 515, 538, 540, 558, 579, 584-586, 588, 591, 599, 624, 630  
China 99, 575  
cholera 358, 427  
cholinesterase 14, 499  
chronic bronchitis 204, 207, 208, 210, 211, 215, 257, 270, 449  
cirrhosis 24  
Clean Air Act 480  
clearinghouse 95  
coalition 1-3, 7, 9, 17-19, 21, 22, 25, 27, 28, 30, 32-36, 43-45, 47, 48, 53-56, 59, 67, 73, 86, 87, 91, 93, 94, 97, 98, 105, 107, 123, 129, 134, 141, 143, 146, 151, 157, 161, 179, 184, 189, 192, 193, 196, 197, 199, 204, 216, 229, 238, 243, 255, 261, 267, 274, 278, 285, 293, 299, 308, 317, 321, 327, 334, 340, 351, 357, 365, 372, 378, 383, 391, 393, 395-397, 405, 412, 419, 432, 437, 445-449, 451-453, 457, 462, 466, 469, 470, 471-473, 475, 479, 484, 485, 489, 492, 498, 540, 556, 557, 582, 597, 621, 623, 625, 627, 629  
Cochran, David 278, 283, 284, 318, 454  
Cole, Lu Jean 33  
Colorado 43, 60, 65, 176, 177, 219, 359, 373, 453, 505, 582, 590  
Colorado tick fever 219, 359  
commercial fishing 300, see fishing  
commercial hunting 300  
communities 5, 9, 12, 16, 18-20, 24, 40, 45, 47, 53, 56, 87, 88, 94, 95, 98, 101-103, 123, 128, 176, 179, 186, 189, 191, 195, 217, 263, 271, 273, 295, 387, 388, 390, 396, 397, 399-401, 403, 412, 414, 420, 421, 424, 427-431, 446, 464, 474, 479-483, 489, 491, 493, 494, 509, 510, 519, 525, 540, 545, 583, 589  
confined space 279, 311  
Connecticut 65  
consumer 8, 76, 164, 173, 192, 193, 196, 225, 229, 256, 258, 259, 460, 481, 621  
contamination 37, 92, 224-226, 247, 253, 348, 398, 507, 513, 524, 529, 562, 572, 575  
coordination 19, 469, 477, 503

coronary heart disease 24, 25  
cost 10, 11, 13, 49, 66, 77, 98, 100, 103, 129, 132, 196, 225, 251, 259, 262, 300, 310, 319, 332, 334, 338, 341, 345, 360, 362, 367, 381, 389, 400, 409, 414, 464, 483, 484, 486, 464, 518, 538, 545, 550, 567  
cotton dust 10, 73, 78, 562, 564  
Coubis, John J. 179  
Crammond, Ray H. 365, 372, 374, 457  
cranberry bogs 300  
crop rotation 29  
crops 3, 12, 15, 16, 37, 106, 111, 114, 116, 129, 133, 134, 136, 139, 140, 142, 225, 229, 243, 256, 300, 325, 341, 345, 362, 384, 467, 483, 484, 500, 553, 634  
Crowley, John H. 308, 455  
Cumming, Hugh S. 32  
Currier, Russell W. 84, 216, 218, 226-228, 268, 271, 450

## D

dairies 218, 300  
dairy barns 205, 246  
dairy workers 219  
DBCP 81, 196, 229, 230, 237, 621  
DDT 229, 232, 233, 235, 237, 240, 260, 621  
De Hostos, Eugenio Maria 53  
Dean, Thomas 17, 23, 25, 580  
death 6, 11, 12, 22, 23, 28, 29, 48-51, 53, 60, 64, 68, 69, 78, 79, 82, 89, 92, 100, 120, 138, 157, 163, 166, 167, 172, 202, 209, 229, 232, 246, 252, 253, 278, 304, 312, 316, 321, 332, 368, 386, 398, 434, 436, 443, 445, 447, 456, 476, 486, 487, 489, 493, 496, 501, 509, 516, 527, 528, 545, 556, 558, 566, 571, 573, 579, 580, 627, 632  
deer ticks 219  
Delaware 65, 178, 300  
dementia 152  
democracy 46, 126  
dengue fever 357, 360, 361, 458  
Denmark 240, 373  
Department of Agriculture 7, 16, 22, 50, 61, 86, 95, 107, 112, 121, 122, 129, 130, 132, 133, 174, 193, 238, 321, 333, 423, 437, 511, 592  
Department of Health and Human Services 22, 71, 94, 120, 177, 260  
Department of Labor 1, 107, 116, 120, 121, 176, 254, 472, 486, 537, 546, 622  
Department of Transportation 372, 622  
depression 52, 96, 155, 156, 236, 403, 424, 425, 427, 539, 556  
dermatitis 23, 82, 85, 235, 243, 247, 249, 254, 256  
dermatological conditions 52, 82, 389  
dermatosis 357  
diesel fumes 419  
diet 23, 24, 531, 630, 632-634  
differential diagnosis 270, 449  
disability 4, 17, 22-25, 27, 28, 30, 35-37,

39-44, 46, 49-52, 57, 67-71, 73, 75-80, 83, 90, 92, 101, 138, 140, 141, 144, 149, 152, 156, 157, 161, 163, 176-179, 187, 188, 204, 205, 207, 211, 212, 214-216, 218, 219, 221-228, 230, 232, 233, 235, 236, 239, 241-243, 245, 249, 250, 252, 255, 268, 269, 271, 294, 318, 327, 352, 357-364, 376, 387, 397, 398, 413, 445-541, 453, 458, 467, 472, 481, 484, 515, 519, 525, 532, 627  
disease 5, 9, 17, 22-25, 27, 28, 30, 35-37, 39-44, 46, 50-52, 57, 67-71, 73, 75-80, 83, 140, 142-144, 149, 152, 156, 161, 163, 176-179, 187, 188, 204-207, 211, 212, 214-216, 218, 219, 221-228, 230, 232, 233, 235, 236, 239, 241-243, 245, 249, 250, 252, 255, 268, 269, 271, 387, 397, 398, 413, 445-451, 453, 458, 472, 481, 484, 498, 501, 509, 510, 520, 524, 527, 531, 535, 538, 540, 549, 562-564, 567, 568, 569, 571, 573, 575, 576, 581, 582, 598, 621, 622, 624, 627-633  
Disraeli, Benjamin 86  
dissemination 5, 14, 25, 68, 69, 83, 143, 165, 191, 546, 567  
District of Columbia 55, 566  
diversity 19, 75, 108, 112, 113, 119, 127, 216, 263, 264, 422, 437, 477, 500, 504, 596  
Domestic Volunteer Service Act 415  
Donham, Kelley J. 18, 93, 95, 99, 211, 213-215, 245, 251-253, 261, 398, 448, 457, 458, 462, 511, 515, 521  
Donne, John 67  
Dorian, John P. 2, 3  
Dosman, James A. 78, 84, 155, 157, 180, 211, 213-215  
Douglass, Cynthia 472  
drinking water 8, 12, 51, 77, 235, 241, 467, 468  
drought 245  
Dunn, Donald 94  
dust 10, 73, 78, 80, 148, 157-159, 181, 190, 204-215, 223, 245, 251, 256, 267, 270, 271, 278, 286, 344, 353, 401, 449, 456, 526, 530, 531, 542, 544, 554, 560, 562-564, 567, 568, 570, 572, 574, 575, 577, 581, 622, 623

## E

Easter Seals 404  
Eckoff, Ronald D. 105, 107, 123, 129, 134  
economics 44, 66, 122, 124, 129, 344, 381, 404, 429, 462, 484, 622  
economists 66, 422, 458  
education 5, 6, 20, 22-25, 31, 36, 38, 39, 45, 47, 53, 56, 57, 60-62, 66, 67, 71, 75, 77, 87, 89, 90, 94, 95, 97, 113-116, 120, 124, 127, 128, 134, 147-150, 154, 159, 161, 165, 188, 191, 214, 224, 255, 260-265, 270, 277, 297, 305, 327, 333, 342, 343, 351, 353, 356, 376, 377, 383, 389, 391, 392, 394-396, 405, 408, 412, 415,

- 428, 432-434, 438-440, 443, 460, 462-465, 469, 471, 473-476, 482, 485, 487, 489, 493, 497, 499, 502, 503, 505, 509, 510, 512, 517, 518, 520, 524, 532, 537-539, 551, 555, 578, 582-584, 587-590, 592, 596-598, 621
- Eken, Willis R. 479
- electrical wiring 285, 455, 588
- electrocutions 69
- elevator 37, 40, 157, 594
- Elkind, Pamela D. 123, 128, 264, 441
- Emergency Medical Services 6, 101, 103, 372, 399, 595, 622
- EMS 6, 372, 387-389, 586, 595, 622
- encephalomyelitis 359, 622
- enforcement 10, 89, 166, 257, 263, 324, 326, 353, 390, 468, 473, 474, 477, 539
- engine exhausts 233, 240
- engineer 46, 92, 137, 138, 278, 299, 321, 323, 340, 365-368, 370, 372, 375, 378, 453, 457
- engineering 25, 45, 88-92, 134-141, 147, 149, 161, 170, 179, 210, 263, 294, 297, 306, 310, 312, 318, 333-335, 340-342, 344, 349, 355, 365, 366, 368, 372, 374, 378, 437, 443, 455, 459, 487, 532, 534, 551, 563, 577, 622
- England 64, 71, 142, 215, 233, 239, 373
- entanglement 301, 304, 305
- envenomization 357
- environment 6, 8, 18, 25, 32, 53, 70, 71, 86, 89, 92, 123, 127, 128, 130, 134, 179-181, 197, 204-206, 208, 210, 211, 213, 214, 219, 226-228, 240, 244, 251, 252, 271, 272, 278, 281, 286, 302, 305, 309, 310, 327, 328, 334, 341, 349, 353-356, 358, 361, 379, 381, 391, 407, 412, 414, 418, 422, 438, 454, 457-460, 462, 479, 492, 497, 503, 522, 551, 576
- EPA 12, 45, 62, 76, 134, 196, 197, 229, 238, 247, 248, 255, 341, 342, 345, 346, 350, 483, 514, 590, 622
- epidemiologists 9, 71, 148, 170, 216, 225, 501
- epidemiology 22, 45, 67-69, 71-73, 76, 155, 161, 168, 177, 195, 206, 211, 214, 216, 220, 225, 226, 239, 325, 327, 363, 364, 445, 500, 556, 622
- Erisman, Gary 321, 322, 327, 333, 373, 374, 376, 377, 380, 457
- Etherton, John R. 373
- etiology 69, 70, 268, 562
- Europe 67, 163, 283, 311
- evaluation 20, 67, 68, 71, 81-83, 137, 143, 151, 164, 170, 171, 177, 178, 184, 189, 212, 214, 215, 230, 231, 236, 239, 241, 243, 244, 247, 251, 256, 258, 310, 315, 326, 328, 331, 332, 344-346, 394, 416, 439, 443, 451, 452, 497, 499, 504, 508, 510, 515, 523, 544, 548, 564, 567, 569, 581, 583-585, 592-594
- exposure 14, 29, 51, 52, 70, 73, 74, 77, 80, 81, 85, 92, 120, 137, 140, 144, 152, 155-158, 165, 168, 169, 173-175, 180, 186, 188, 194, 196, 199-201, 204-215, 217, 219, 222, 223, 225, 226, 229, 230, 233-241, 243-249, 251, 253, 256, 257, 261-263, 267, 269-272, 279, 282, 293-297, 310, 340, 341, 343-349, 353, 359, 360, 389, 435, 440, 449, 450, 468, 475, 490, 499, 507, 514, 517, 521-523, 529-531, 533, 535, 536, 550, 553-555, 559, 562, 563, 564, 567-570, 572, 574, 576, 623, 624
- extension agents 90, 94, 99, 534, 541, 578

## F

- falls 4, 274, 278, 282, 302, 303, 317, 338, 366, 400, 410, 467, 632
- Farm Bureau, see American Farm Bureau Federation
- farm family 4-6, 52, 61, 74, 75, 124, 127, 186, 187, 190, 218, 223, 229, 302, 303, 378, 383, 384, 387, 388, 400, 402, 437, 439, 446, 450-452, 457, 470, 486, 488-490, 512, 515, 523, 525, 529, 532, 545, 554, 555, 599, 622
- Farm Foundation 93, 462
- farm machinery 5, 34, 51, 52, 56, 73, 74, 76, 79, 80, 82, 83, 169, 274-276, 303, 304, 308, 315, 316, 323, 467, 487, 506, 515, 534, 584, 598
- farm machinery manufacturers 34
- farm safety 7, 31, 37, 39, 45, 56, 64, 66, 87, 89, 90, 107, 108, 118-120, 124, 125, 128, 143, 202, 304, 383, 385, 387-391, 395, 397-403, 437-439, 475-477, 479, 482, 484-486, 489, 491-493, 497, 508, 509, 518, 519, 533, 543, 556, 578, 582-584, 586, 588, 593, 595, 596, 598, 623
- Farm Safety for "Just Kds" 56, 90, 399, 475, 489, 593, 598
- farm workers 5, 7-9, 15, 31, 33, 34, 43, 52, 64, 72, 75, 82, 90, 98, 107, 115, 119, 136-138, 140, 216-226, 229, 330, 353, 356, 359, 360, 407, 437, 439, 440, 443, 500, 501, 504, 508, 511, 521, 555, 558, 563, 565, 567, 573, 579, 580
- farmers 3, 7-13, 16, 18, 21-23, 29, 31, 33, 34, 35, 37, 39, 40, 42-44, 49, 51, 52, 56, 59-61, 63-66, 69, 70, 72-74, 79, 80, 82, 83, 85, 89-91, 94, 96, 99, 100, 104, 107, 109, 111, 112, 119, 120, 125-128, 138, 140, 145, 147, 148, 150, 151, 157, 159, 166, 188, 191, 193, 194, 196-198, 202, 204-215, 218, 219, 222-224, 229, 232, 233, 235, 238, 239, 243-245, 249, 251, 252, 256-259, 263, 267, 271-273, 276, 277, 280, 283, 288, 289, 291, 293-298, 312, 314, 315, 317-321, 323, 325, 326, 329-331, 340-342, 345-347, 349, 351-357, 361, 367, 375, 379, 381, 384-386, 390-393, 397-399, 402-404, 407, 421, 422, 424, 425, 428, 430, 432-437, 440-443, 450, 453, 455-458, 460, 463, 464, 472, 474-476, 479-482, 484-491, 496, 501, 503, 505, 508, 511, 512, 515, 519, 521, 523, 526, 531-535, 544, 547, 548, 554-556, 560, 565, 566, 573, 577-579, 586-588, 592, 595, 622, 629-634
- Farmers Educational and Cooperative Union of America, see National Farmers Union
- farmer's lung 148, 205, 211, 212, 397, 398, 531, 537, 581
- Farmers Union, see National Farmers Union
- farming 4, 5, 8, 13, 22, 31, 33, 35, 38, 49, 50, 73-76, 79, 82, 83, 89, 90, 98, 105, 108, 109, 111, 119, 121, 124-126, 159, 161-163, 165, 168-170, 173, 189, 192, 208, 211, 214-216, 221, 225, 235, 236, 239, 244, 251, 252, 254, 255, 259, 261, 263, 267, 268, 271, 277, 279, 280, 285, 295, 297, 300, 309, 311, 319, 325, 327-332, 340, 341, 351, 359, 365, 378, 379, 383, 384, 389, 397-399, 401, 402, 404, 421, 424, 429, 433, 434, 440, 453, 457, 463, 473, 474, 479, 480, 483, 485, 487, 489, 490, 492, 494, 512, 517, 523, 529, 532, 533, 535, 537, 545, 547, 551, 558, 565, 567, 573, 577, 580
- fatalities 4, 6, 24, 25, 28, 29, 31, 37, 61, 64, 71, 79, 84, 87-90, 92, 100, 152, 156, 161-164, 166, 171, 172, 177, 178, 200, 201, 222, 229, 243, 245, 253, 274, 290, 302, 303, 312, 314, 317-321, 324, 351, 353, 373, 386, 387, 389, 390, 446, 447, 454, 456, 474, 486, 487, 500, 504, 505, 516, 523, 528, 545, 546, 558, 563, 565, 566, 584, 623, 628
- fatigue 82, 151, 280, 293, 301, 309, 581
- feline leukemia 224
- Fenske, Richard 340, 350, 375, 457
- fertilizer 110, 223, 245, 246, 248, 472, 534
- fetal development 51
- FFA 45, 55-57, 300, 392, 393, 399, 432, 433, 435, 436, 471, 485, 489, 491, 497, 498, 509, 518, 582-596, 622
- FFA National Chapter Safety Award 582
- Field of Dreams 6, 30, 34, 54, 93, 445
- Field, William 61, 65, 147, 398, 402
- field sanitation 10, 224, 227, 256, 257, 324, 325, 467-469
- filarial worms 358
- Filipinos 221
- Finland 24, 569
- fishing 33, 136, 280, 300, 362, 563, 565, 566, 634, 635
- floods 36
- floor boards 283
- Florida 65, 109, 112, 115, 117, 118, 185, 211, 213, 215, 217, 224, 253, 343, 346, 350, 359-361, 363, 425, 430, 467, 468, 582, 591
- food 10, 13, 25, 32-34, 36, 46, 56, 57, 59, 70, 76, 87, 88, 99, 100, 107, 112, 118, 120, 121, 129, 130, 135, 136, 180, 197, 216-219, 224-226, 229, 247, 252-254, 258, 271, 272, 321, 328-331, 345, 361, 371, 395, 410, 411, 422, 427-430, 450, 482, 484, 499, 510, 522, 540, 587, 621, 622, 629, 632, 634, 635
- Forest Service 317, 319, 456
- Forsythe, Raymond W. 376

## Index

4-H 33, 86, 399, 401, 437, 438, 485, 487, 491, 498, 499, 518, 524, 528, 537, 538, 556, 583, 588, 591, 621  
Frazier, Todd M. 71, 72, 184, 188  
Free Trade Agreement 119, 259, 429, 622  
French, L. Ronald 161  
Freund, Eugene Jr. 146, 184, 186, 189  
Friend, Bill and Ann 398, 403  
fruit 105, 117, 118, 136, 196, 635  
fuel 134, 181, 243, 435, 583  
fumes 208, 243, 288, 398, 401, 419, 429, 430, 526  
fungal poisoning 204  
Future of Public Health 3, 4, 44, 47, 67, 71, 412, 418

## G

gastrointestinal illness 217, 225  
Geller, Jack 425, 426  
Georgia 65, 189, 255, 328, 535, 582, 592  
Gerberich, Susan Goodwin 161, 171, 173-178  
Germany 239, 373  
Gibson, Robert W. 161  
Gilmore, Rodney 383  
Graham, Gene F. 211, 215, 261, 272  
Graham, Robert 391, 396, 433, 439  
grain 3, 37, 38, 40, 51, 55, 56, 59, 80, 105, 110, 111, 136, 138, 157, 158, 204-212, 214, 215, 223, 257, 262, 263, 283, 299, 313, 314, 325, 367, 368, 378, 389, 397, 399, 419, 485, 488, 530, 534, 542, 554, 563, 567, 577, 584, 622, 634  
grain bin 40, 262, 367, 368, 419  
grain funigants 51  
Grange, see National Grange  
Grassley, Charles E. 94  
greenhouse 179-182, 253, 348, 349, 375, 503, 592  
Greffe, Alice L. 186  
Grieshop, James I. 408  
grounding 285, 288  
groundwater 8, 241, 507  
Gur.derson, Paul D. 161  
gynecological problems 217

## H

Halperin, William E. 67, 71, 72, 93, 142-144, 190, 240  
Hamilton, Alice 32  
Hard, David L. 462, 565, 566  
Harkin, Tom 35, 36, 38, 43, 55, 94, 98, 496  
Hartye, James 147  
Hawaii 65, 222, 225, 228  
hazards 4-6, 12, 16, 28, 29, 32, 39, 47, 49, 50, 57, 68, 73, 79, 80, 90-92, 123-125, 127, 128, 137, 139, 140, 145, 151, 178, 179, 186-188, 192, 194, 195, 199, 200, 202, 211, 214, 218, 227, 229,

230, 238, 239, 243, 245-248, 250-252, 254, 256, 257, 259, 275, 276, 278, 282, 317, 318, 320, 325, 331, 332, 340, 342, 343, 345, 350-356, 389, 398, 402, 437, 445, 446, 448, 453-459, 467, 469, 474-476, 479, 485, 488, 493, 494, 497, 500, 503, 504, 509, 512, 515, 516, 518, 519, 521-525, 528, 534, 546-548, 550, 552, 555, 559, 564, 578, 580, 587, 592, 599, 621, 623, 627, 628  
health care 5, 6, 9, 15, 17, 31, 36, 37, 40, 41, 43, 44, 46, 73-75, 78, 79, 84, 94, 97, 98, 101-103, 161, 163, 168, 188, 189, 192, 195, 216, 225, 262, 269, 270, 356, 402, 413, 416-418, 429, 451, 466, 469, 471, 481, 483, 492, 494, 517, 580  
health departments 45, 46, 61, 145, 146, 149, 150, 186, 189, 273, 386, 412, 416, 451, 546  
health education 47, 67, 147, 260, 383, 395, 412, 415, 443, 502  
health officer 43, 46  
hearing damage 401  
heart attack 590  
heart disease 23-25, 232, 413, 527  
heat stress 10, 278, 344, 460  
heat stroke 51  
Heffernan, Judith 419  
herbicide 134, 142, 193, 194, 236, 239, 240, 343, 517, 536, 550, 553  
Herrick, Robert F. 199  
Hetzel, Glen 285  
Hightower, Jim 7  
highway 49, 103, 166, 167, 171, 275-277, 318, 328, 333, 380, 393, 396, 420, 454, 583, 586, 591, 623  
Hill, Mary Lee 147  
Hinshaw, Lloyd 403  
Hispanic 48, 127, 216, 407-409, 465, 467, 468, 501, 504, 566  
Hispanic workers 29-32  
histoplasmosis 221, 398  
history 1, 2, 13, 26, 32, 44, 87, 179, 189, 202, 204, 206, 207, 209, 216, 217, 221, 244, 247, 295, 326, 372, 479, 480, 496, 631, 633  
Hodgkin's lymphoma 51, 80, 194, 232, 233, 235, 239, 240, 450, 536, 623  
hog lung 100, 402  
Hoglund, Sverker 213, 214, 351, 372-374, 457  
Homestead Act 427  
Hoover, President Herbert 366  
horses 17, 225, 359, 360, 378, 385, 543  
hospital 8, 37, 39, 40, 49, 76, 94, 95, 100, 102, 103, 154, 167, 170, 173, 178, 187, 238, 296, 373, 376, 400, 417, 428, 436, 453, 471, 495, 512, 517, 525, 540, 586, 596, 623, 631, 632, 634  
House Coalition on Rural Health 98  
Human, Jeffrey 93, 94, 97, 98, 100  
hypersensitivity 80, 139, 142, 204, 205, 210, 212, 213, 229, 235, 254, 256, 267, 270, 449, 531, 569, 570, 572-574, 581, 622

hypersensitivity pneumonitis 80, 204, 205, 210, 212, 213, 256, 267, 270, 449, 569, 570, 572-574, 581, 622

## I

Iacocca, Lee 380  
ICASH 5  
Idaho 412-415, 418, 454, 597  
Illinois 3, 59, 65, 96, 131, 223, 228, 305, 306, 309, 311, 321, 327, 333, 334, 437, 439, 442, 466, 506-508, 553, 597  
illness 5, 6, 33, 34, 37, 40-42, 71, 86, 100, 107, 139, 140, 148, 149, 152, 191, 204-206, 212, 216-219, 221, 223-226, 265, 266, 278, 308, 327, 334, 336, 363, 398, 427, 437, 439, 440, 446, 501, 503, 504, 512, 523, 524, 546, 548, 549, 565, 567, 568, 574, 575, 578, 581  
immunization 9, 48, 68, 70, 71, 189, 221, 450  
incentives 44, 83, 102, 224, 264, 305, 443, 456, 578  
India 99, 220, 497  
Indiana 55, 65, 357, 360, 364, 393, 403, 421, 582, 584  
infections 52, 217, 218, 221-225, 227, 236, 250, 256, 376, 430, 450, 468, 509, 624  
infectious diseases 52, 141, 142, 216, 224, 225, 250, 256, 271, 278, 450, 451  
infertility 398, 468  
infestation 36  
inflammation 80, 204, 206-210, 215, 249, 278, 279, 283, 530, 542, 563, 569  
information 1, 4, 5, 8, 13, 14, 18, 22, 25, 26, 29, 47, 52, 53, 68-70, 74-76, 79, 81, 89, 95, 100, 112, 116-118, 120, 137, 140, 141, 143, 145, 146, 152, 157-159, 167-169, 172, 174, 180, 183, 187, 188, 190, 191, 202, 205, 206, 216, 224, 230, 236, 238, 257, 268, 269, 271, 272, 277, 285, 299-304, 306, 308, 315, 316, 318-320, 327, 334, 339, 352, 353, 355, 356, 370, 376, 377, 384, 386, 387, 389, 390, 394, 395, 399, 402, 405-408, 410, 411, 434-439, 443, 446, 451, 457, 462, 469, 478, 488-490, 492-494, 497, 498, 502, 504, 505, 509, 510, 514, 516, 517, 520, 524, 534, 541, 544, 545, 551, 553-555, 559, 565, 567, 571, 578, 584, 589, 592, 594, 598, 599  
infrastructure 44-47, 88, 186, 188, 189, 191, 270, 273, 306, 319, 446, 447  
injuries 1, 3, 4-6, 9, 11, 17, 22, 23, 27-31, 33, 34, 37, 40, 42, 44, 46, 48-51, 53, 54, 57, 60, 61, 64-66, 68, 69, 72, 73, 75-80, 82-84, 86-90, 92, 93, 100, 101, 103, 104, 107, 112, 120, 123, 124, 128, 150, 161-178, 187-191, 201, 202, 214, 215, 221, 227, 229, 238, 243, 245, 246, 248, 250, 252, 254, 265, 266, 274, 278, 282, 284, 289, 293, 299, 300, 302-304, 306-309, 312, 315, 316, 318-321, 325, 326, 328,

332-334, 336, 338, 339, 351-355, 357, 365, 369, 371, 373, 382, 383, 385-389, 390, 396, 398, 426, 434, 435, 437, 439, 440, 443, 445-449, 453, 454, 456, 458, 459, 462-464, 467, 468, 472-476, 478, 479, 481, 482, 484-487, 489, 493, 500, 501, 503-506, 508, 510, 511, 512, 515, 517, 523-525, 532, 537, 546-548, 556, 558, 561, 565, 566, 569, 578, 580, 582, 584, 586, 591, 595, 598, 599, 600, 621-624, 636

injury control 46, 48, 53, 86, 88, 90, 176, 306, 328, 333, 383, 440, 510, 525, 578, 621

insecticides 52, 85, 140, 229-233, 235, 237, 243, 247, 363, 450, 481, 553

Institute of Agricultural Medicine and Agricultural Health 95

Institute of Medicine 3, 4, 43, 67, 71, 161, 176, 412, 418, 623

insurance 15, 65, 73, 74, 87, 97, 101, 173, 187, 188, 225, 295, 319, 383, 401, 413, 426, 428, 434, 463, 472, 483, 543, 547, 578, 594, 595, 597

International Agency for Research on Cancer (IARC) 233, 239

International Organization for Standards (ISO) 310

intervention 24, 39, 40, 57, 61, 64, 68, 70, 71, 73, 75, 77, 78, 82, 83, 86-88, 90-92, 97, 144, 162, 164, 166, 169, 170, 181, 185, 186, 189-191, 202, 214, 262, 265, 269, 308, 316, 318-320, 326, 353, 383, 387, 391, 393, 434, 439, 440, 443, 455, 457, 458, 460-465, 490, 494, 498, 500, 502, 509, 510, 515, 524, 528, 539, 550, 555, 556, 561, 563, 565, 567, 578

Iowa 1-7, 11, 17, 22, 27, 28, 30, 33, 35-39, 41, 43, 47, 48, 55, 59, 65, 67, 73, 74, 76, 79, 84, 86, 87, 93-98, 100-103, 105, 123, 124, 129, 130, 132, 134, 141, 143, 146, 147, 151, 157, 161, 178-180, 184, 185, 189, 192, 199, 202, 203, 204, 207, 216, 217, 219, 221-223, 226-229, 238, 239, 243, 254, 255, 261, 265, 267, 272, 274, 277, 278, 283, 285, 293, 296, 299, 303, 306, 308, 317, 321, 327, 328, 334, 340, 343, 351, 357, 365, 367, 371, 372, 378, 383, 391, 392, 397, 398, 400-405, 412, 417, 419, 425, 429, 432, 437, 445, 448, 453, 457, 462, 466, 471, 472, 475, 479, 481, 485-487, 489, 492, 497, 498, 507, 509-533, 582, 593, 597, 598, 621, 622, 625, 627, 629

Iowa Center for Agricultural Safety and Health 5, 511

irrigation 31, 69, 72, 221, 223, 225, 362, 468, 566

## J

Janko, Sheryl 471

Japan 99, 239, 329, 430

Jefferson, Thomas 125

Jewell, J.R. 274

Johnson, Jeannie 404

Johnsrud, Myron D. 86, 308, 377, 439

## K

Kansas 59, 60, 65, 115, 221, 227, 334, 421, 472, 534, 536

Kellogg Foundation 20, 261, 262, 476

Kentucky 17, 65, 74, 84, 115, 176, 180, 189, 428, 453, 454, 471, 476, 492

Kimball, Ken 372

Kinney, Joseph A. 59

Konz, Stephan 334, 339, 374, 376, 377, 379, 457

Koop, C. Everett 30, 259

Kruse, Ken 434

Kugler, Daniel E. 129

Kukulka, Gary 18

## L

labor 1, 7, 12, 14, 32, 33, 36, 51-53, 61, 62, 64, 65, 67, 69, 73, 82, 89, 99, 107, 108, 110-112, 114-122, 151, 157, 158, 163, 171, 176, 182, 217, 254, 255, 257, 259, 260, 264, 277, 321, 329, 330, 339, 344, 354, 401, 407, 421, 431, 433, 440, 467, 468, 472, 473, 480, 486, 490, 492, 493, 504, 537, 546, 561, 566, 580, 621, 622, 627, 628

lacerations 170

Lalich, Nina 186

Lancashire, Jeffrey H. 48

Langmuir, Alexander 68, 71

Lasley, Paul 425

Latinos 221

Leach, Rice C. 471, 472, 479, 485, 489, 492

leadership 1, 19, 20, 22, 26, 27, 35, 36, 43, 45-47, 56, 58, 97, 132, 133, 157, 160, 264, 398, 429, 433, 480, 485, 491, 499, 511

Lernen, Richard A. 105, 445, 448, 453, 457, 462, 466, 471

leukemia 39, 51, 80, 100, 224, 232, 233, 235, 239, 240, 481

lighting 275, 276, 301, 303, 304, 310, 316, 454

livestock 3, 5, 51, 59, 73, 74, 80, 107, 110, 111, 114, 216, 218, 219, 221, 222, 225, 229, 250, 263, 274, 300, 303, 361, 363, 367, 369, 370, 392, 401, 419, 458, 483-485, 509, 534, 555, 592

livestock buildings 250

llama 222

log skidders 277, 316

logging 28, 88, 277, 317-321, 325, 456, 565

Louisiana 65, 391, 396, 472

lupus 398

Luther, Terry 24

Lyme disease 219, 225, 357, 359, 361, 364, 398, 458, 509

lymphoma 39, 51, 80, 194, 232, 233, 235, 239, 240, 450, 536, 623

## M

McGinnis, J. Michael 22, 438

McLymore, Robert L. 285, 318, 455, 546

McNearmy, Walter J. 413

machine guarding 13, 322, 323

machinery 4, 5, 34, 51, 52, 56, 73, 74, 76, 79, 80, 82, 83, 88, 107, 110, 119, 124, 161, 162, 165, 169, 170, 174, 178, 200, 201, 248, 268, 274-276, 282, 283, 299-304, 308-310, 312-316, 318, 323, 325, 351-356, 374, 386, 387, 400, 419, 454, 467, 476, 481, 482, 487, 499, 506, 508, 515, 523, 524, 534, 546, 558, 578, 584, 585, 587, 590, 595, 598

Madsen, Murray 299, 308, 312, 313, 318, 455

Maine 65, 189

malaria 219, 220, 224, 227, 229, 357-360, 450, 458

malnutrition 9, 359

Manitoba 210, 214, 359, 378

manufacturers 26, 27, 34, 87, 88, 94, 225, 233, 308-312, 314, 315, 341, 353, 354, 356, 380, 381, 389, 392, 440, 455, 460, 476, 477, 482, 484, 487, 519, 622, 623, 628

manure 223, 243, 245, 246, 253, 262, 272, 299, 311, 361, 365, 368, 370, 534, 631

manure gas 243, 246, 253, 272

marking systems 310

Martin, Lynn 7

Martin, Reginal and Melody 39

Marvel, Matthew 85, 213, 293, 298, 318, 455

Mary Imogene Bassett Hospital 453

Maryland 65, 144, 145, 178, 216, 535, 536

Mason, James O. 43

Massachusetts 65, 177, 333, 444

May, John J. 143, 188, 453, 544

mechanization 37, 114, 118, 300, 331, 391

medical care 8, 15, 44, 51, 165, 187, 205, 220, 224, 388, 413

Medicare 43, 101-103, 413

medicine 3-5, 9, 22, 36, 43, 47, 67, 71-73, 84, 85, 93, 95, 124, 141-143, 145-151, 157, 159, 161, 176-181, 204, 227, 238, 239, 243, 252-254, 267, 268, 272, 293, 298, 321, 328, 335, 340, 351, 363, 364, 376, 397, 398, 400, 407, 412, 418, 448, 453, 457, 466, 469, 471, 495, 511, 512, 518, 532, 544-546, 551, 570, 577, 579, 580, 599, 622, 623, 629, 634

Melton III, L. Joseph 161

men 1, 32, 51, 61, 74, 75, 84, 154, 233, 239, 299, 359, 366, 399, 401, 419, 423, 467, 473, 478, 497, 535, 536, 540, 566, 628, 629, 632-636

mental disorders 23

Merchant, James A. 35, 43, 73, 84, 93, 95, 99, 178, 211, 212, 214, 215

## Index

Merrilees, Craig 192  
Mexican Free Trade Agreement 119  
Mexico 65, 95, 119, 131, 220, 228, 259, 351, 405, 407, 408, 500, 587  
Michigan 48, 65, 105, 115, 129, 253, 257, 261, 262, 272, 278, 295, 298, 378, 401, 537  
Migrant Head Start 466  
migrant workers 31, 32, 51, 52, 75, 220, 229, 255, 260, 379, 384, 458, 467, 490  
Milham, Samuel 69  
milkers' knee 376  
Millar, J. Donald 1-3, 25, 30, 35, 36, 43, 48, 53, 55, 471, 472, 475  
Miller, Charles 471  
Minnesota 59, 65, 96, 161, 162, 167, 168, 170, 177, 178, 189, 217, 239, 400, 402, 429, 439, 479, 507, 538-540, 579  
miscarriages 468  
Mississippi 65, 109  
Missouri 57, 65, 178, 295, 298, 384, 397, 404, 419-421, 423, 424, 430, 432, 434, 582, 585  
Montana 65, 385, 412, 579  
Morgan, Dave 372  
Mothers Against Drunk Driving (MADD) 25, 497, 623  
motor vehicles 25, 310  
multilingual 405, 406  
multiple myeloma 51, 80, 232, 233, 450  
Murphy, Dennis J. 127, 199, 309  
musculoskeletal disorders 51, 179, 278, 458, 578  
Myers, John R. 561, 565  
Myers, Melvin L. 30  
myiasis 357

## N

nanotechnology 305  
National Advisory Committee on Rural Health 28, 96, 97, 101  
National Agriculture Library 95  
National Association of County Health Officials 45  
National Cancer Institute 132, 229, 230, 481, 536, 623  
National Chapter Safety Award 392, 582  
National Coalition for Agricultural Safety and Health 18, 33, 43, 93, 141, 146, 184, 238, 475  
National Electric Code (NEC) 286  
National Farmers Union 479-484  
National Grange 189, 393  
National Health Service Corps 17, 102  
National Institute for Occupational Safety and Health (NIOSH) 1, 19, 30, 35, 43, 60-63, 67, 72, 73, 75, 79, 87, 123, 127, 140, 142, 143, 146, 149, 163, 164, 184-186, 188-192, 253, 265, 277, 281, 282, 302, 303, 306, 308, 309, 317, 319, 325, 348, 349, 389, 393, 452, 471, 473-475, 477, 503, 510, 511, 521, 524, 548-555, 560-578, 581, 623

National Rural Health Association 17, 18, 83, 93  
National Safety Council 3, 60, 79, 84, 87, 88, 100, 163, 164, 174, 176, 202, 302, 321, 333, 335, 473, 475, 479, 485, 517, 528, 545, 623  
NCASH 9, 18, 33, 83, 87, 124, 146, 184, 475, 477, 623  
Nebraska 65, 91, 104, 162, 170, 204, 218, 227, 239, 274, 277, 321, 372, 373, 376-378, 403, 421, 428, 481, 487, 536, 541, 542, 582, 594, 598  
needle sticks 221, 269  
neurologic dysfunction 155  
neurotoxic disorders 52  
Nevada 65, 219, 220  
New Hampshire 65, 457  
New Jersey 65, 128, 340, 428, 444, 468, 543  
New Mexico 65, 228, 361  
New York 11, 65, 72, 74, 84, 85, 89, 93, 98, 100, 141, 143, 145-149, 176-179, 189, 211, 238, 240, 255, 283, 293, 294, 296, 298, 333, 363, 373, 376, 427, 428, 453, 457, 466, 475, 544, 545, 566, 599, 627, 629  
nitrates 51, 77, 245, 272  
noise 23, 32, 52, 82, 83, 85, 92, 157, 278, 293-297, 301, 308, 312, 334, 336, 351, 353, 370, 373, 374, 553-555  
noise-induced hearing loss 52, 82, 85, 293-297, 308, 555  
nonfatal injuries 11, 88, 176, 201  
non-Hodgkin's lymphoma 51, 80, 194, 232, 233, 235, 239, 240, 450, 536, 623  
North Carolina 59, 65, 73, 112, 147, 189, 216, 226, 285, 430, 455, 467, 546, 547, 560, 623  
North Dakota 65, 86, 162, 170, 189, 218, 227, 359, 378, 383-385, 387-390, 425, 426, 579, 582, 595  
Novello, Antonia C. 2, 3, 7, 8, 17, 22-24, 28, 30, 36, 48, 93, 145, 259, 395, 448, 471, 472, 491-494  
nurse 46, 95, 102, 143, 146, 149, 150, 158, 389, 416, 475, 554, 594, 624  
nurseries 300, 467

## O

objectives 3, 4, 22, 27, 33, 55, 71, 134, 180, 308, 392, 393, 413, 433, 439, 492, 494, 510, 520, 524, 527, 562, 580, 585  
occupational cancers 336  
occupational lung diseases, see respiratory diseases  
Occupational Safety and Health Act 1, 62, 166, 321, 324, 340, 456, 472, 481, 486  
Occupational Safety and Health Administration (OSHA) 1, 7, 8, 14, 15, 60-64, 123, 127, 128, 143, 144, 166, 171, 194, 195, 217, 224, 244, 257, 275, 277, 282, 283, 293, 312-314, 317-326, 373,

390, 393, 402, 456, 467-469, 472-478, 481, 482, 486, 555, 623, 625  
Office of Migrant Health 466  
Office of Rural Health Policy 93, 94, 475, 623  
Ohio 65, 72, 127, 128, 189, 192, 228, 253, 274, 276, 304, 310, 376, 454, 471, 477, 548-555, 560, 582, 586  
oils 51  
Oklahoma 55, 65, 98, 495, 556, 623  
Olenchock, Stephen A. 142, 213-215, 448, 560, 562, 567-569, 572, 574-577, 581  
Ontario 96, 211, 304  
Oregon 65, 115, 219, 223, 227, 228, 462  
organic dust toxic syndrome 190, 204, 206, 210, 213, 449, 572, 574, 581, 623  
organic farming 8  
organic phosphate poisoning 15  
organophosphate poisoning 14, 155, 156, 241  
outreach 5, 40, 97, 250, 321, 324-326, 417, 466, 474, 476, 477, 503, 534, 544  
overcurrent protection 285-287

## P

Panama 376  
parasitic infections 52, 217  
parathion 12, 195, 229, 232, 243, 375  
Parker, John E. 214, 228, 457, 458, 561, 568, 572-574, 581  
part-time farming 480  
pasture 4, 17, 384, 543, 631  
pediatric infections 217  
Pennsylvania 59, 65, 112, 127, 136, 202, 309  
Penterman, Don 372  
personnel 102, 103, 126, 145, 188, 221-223, 225, 305, 335, 344, 368, 386, 420, 428, 429, 458, 483, 487, 505, 517-519, 539, 541, 551, 590, 595, 596  
pest control 29  
pesticide poisoning 14-16, 29, 151, 152, 154, 229, 398, 405, 407, 446, 533  
pesticides 7-9, 11, 12, 14-16, 23, 25, 29, 31, 37, 39, 51, 52, 56, 75, 77, 81, 82, 85, 91, 92, 100, 110, 118, 134, 151-155, 188, 192-194, 196, 197, 201, 202, 229-233, 235-243, 247, 249, 253, 255, 262, 263, 268, 271, 272, 308, 310, 340, 342, 343-345, 347, 362, 375, 389, 398, 402, 405, 407, 422, 437, 442, 446, 449-451, 459, 460, 464, 467-469, 479, 480, 483, 484, 488, 492, 497, 499, 501, 502, 505, 507, 517, 520, 524, 526, 529, 533, 534, 548, 550-554, 559, 583, 585, 587, 588, 598, 623  
Peters, Penn A. 212, 215, 317, 320, 321, 456  
phosphamidon 14, 229  
Piercy, Larry 453  
Pinger, Robert R. 357, 457  
Plagge, Merlin 485  
pneumonia 148, 252, 358, 571, 629, 634

- pneumonitis 80, 204, 205, 210, 212, 213, 246, 256, 267, 270, 449, 569, 570, 572-574, 581, 622
- poisoning 9, 14-16, 29, 32, 41, 52, 70, 104, 145, 151, 152, 154-156, 181, 204, 229, 241, 252, 272, 375, 398, 405, 407, 446, 468, 493, 502, 520, 522, 533, 579, 622, 627, 628
- polio 217, 450
- poliomyelitis 226, 358
- Pollock, John 373
- pollution 44, 130, 194, 253, 402
- Popendorf, William 214, 215, 243, 252, 253, 255, 256, 265, 272, 451, 523
- population 6, 29, 30, 33, 46, 49, 52, 57, 65, 73-75, 78, 82, 89, 90, 101, 109, 112, 115, 124, 125, 138, 154, 162-165, 167, 168, 173-176, 180, 181, 184, 185, 189, 204, 207, 216, 217, 226, 229, 232, 233, 239, 240, 244, 251, 256-260, 264, 267, 268, 274, 276, 295, 296, 305, 327, 352, 363, 364, 382, 396, 409, 412, 413, 415, 427, 433, 436, 442, 450, 454, 460, 481, 492, 494, 500, 510, 523, 527, 530, 532, 540, 554, 555, 571, 596, 634
- populations at risk 73, 91, 271
- poultry 132, 138, 202, 205, 208, 214, 215, 221, 223, 245, 250, 257, 286, 430, 483, 546, 560, 567
- poverty 9, 73, 101, 427, 629
- Powassan fever 359
- power take-off 190, 284, 303, 323, 389, 396, 487, 624
- Pratt, David S. 18, 35, 85, 95, 210, 212-214, 298, 327, 334, 340, 351, 357, 365, 372, 373, 378, 453, 457
- pregnancy 14, 51
- prevention 1, 4-6, 22, 24, 29, 39-41, 43-48, 50, 53, 55, 56, 67-69, 71-73, 75, 77, 78, 80, 83, 90, 91, 93, 128, 145, 150, 161-164, 166, 169, 171, 176-178, 186, 204, 214, 216, 263, 266, 269, 270, 277, 284, 300, 304, 307, 319, 325, 331-333, 356, 387, 411, 443, 445, 447, 456, 486, 503, 504, 509-511, 515, 524, 525, 527, 532, 548, 555, 556, 562, 567, 582, 583, 585, 586, 589, 596, 623
- produce 1, 3, 8, 15, 18, 78, 80, 94, 100, 112, 130-132, 135, 136, 139, 179-181, 193, 196, 217, 218, 225, 226, 237, 247, 249, 259, 260, 300, 306, 328-331, 354, 356, 411, 413, 489, 552, 555
- promotion 22, 26, 61, 71, 87, 159, 186, 391, 392, 438, 440, 487, 504, 510, 524, 527, 534, 538, 540, 546, 551, 559, 563, 565, 578, 596, 621
- prostate cancer 80, 232, 233
- protection 9-12, 14, 16, 25, 53, 57, 61, 71, 83, 91, 92, 123, 127, 134, 140, 144, 191, 195, 238, 244, 246, 248-251, 253, 257, 258, 260, 266, 275-277, 285-288, 295, 300, 306, 307, 310-312, 314, 321, 322, 340, 343, 344, 346, 348, 349, 353, 355, 363, 375, 379, 380, 400, 434, 438, 440, 449, 455-457, 464, 467, 469, 470, 472, 481, 482, 488, 489, 493, 505, 507, 509, 512, 514, 517, 544, 563, 574, 583, 587, 591, 622, 624
- protective equipment 10, 77, 92, 147, 148, 244, 324, 340-342, 344, 349, 350, 356, 457, 460, 526, 533, 599, 623
- protective zone 311
- proximity detectors 318
- psychological disorders 52
- PTO 188, 303-305, 323, 352, 389, 396, 400, 590, 594, 598, 624
- public health 1, 3-5, 17, 20, 23, 26, 30, 33, 35, 40, 43-50, 53, 55, 61, 67-73, 76, 79, 83, 84, 90, 93, 105, 107, 140, 143, 145, 146, 149, 161, 176-179, 185, 189, 191, 192, 199-202, 216, 226-228, 233, 238, 268, 298, 311, 333, 340, 357, 358, 363, 383, 412-418, 422, 448, 451, 453, 457, 467, 471, 492, 510, 517, 520, 524, 525, 527, 532, 538, 554, 562, 571, 623, 627
- Public Health Service 1, 17, 30, 35, 48, 71, 93, 105, 107, 178, 363, 422, 457, 471, 492, 562, 623, 627
- Puerto Rico 33, 48, 55, 107, 122, 326, 405

---

**Q**

- Q fever 223
- Quebec 233, 242

---

**R**

- rabies 136, 138, 223, 225, 228, 249, 450, 509, 587
- radio 24, 89, 410, 475, 583-588, 590, 593, 623
- Ramazzini, Bernardino 204, 210, 629
- ranch workers 219, 221
- Ray, Robert D. 28, 97, 102
- regulate 7, 8, 64, 76-78, 89, 217
- regulation 10, 11, 13, 16, 21, 126, 134, 158, 224, 225, 265, 312, 319, 343, 390, 456, 459, 464, 470
- Remington, Richard D. 4, 27, 43
- Renier, Colleen M. 161
- repetitive trauma 51, 82, 446
- reproductive failure 51
- research 9, 20, 29, 33, 39, 41, 57, 60-63, 67, 69, 70, 72-84, 86, 87, 90, 92, 94, 103, 107, 121-123, 125-127, 129, 130, 133-138, 141, 149, 151, 152, 156, 158, 161, 164, 168, 170, 176, 177, 184-187, 189, 191, 194, 195, 198, 199, 216, 225, 226, 230, 233, 238, 239, 246, 253, 262, 265, 276, 282, 283, 293, 297, 298, 300-313, 315, 316, 318-320, 325, 333, 338, 340, 341, 345, 353, 357, 391, 399, 400, 402, 403, 422, 433, 437, 444, 448, 449, 453-456, 462-464, 467, 471, 472, 475, 480-482, 490, 498, 501-503, 508, 509, 524, 526, 529, 535, 548, 552, 555, 559, 561-563, 565-567, 576, 578, 580-582, 622, 628
- respiratory diseases 23, 51, 80, 84, 157, 212, 449, 511, 544, 571, 623
- respiratory illness 212, 398, 446, 501, 524, 549, 567, 568, 575
- respiratory infections 217, 256
- retrofit 12, 88, 94, 191, 284, 237, 373, 440, 443, 563
- Rhode Island 65
- Riedel, Donald C. 413
- right-to-know 8, 10, 16
- risk 4, 5, 11, 12, 15, 16, 23-26, 28, 31, 40, 51, 66-69, 71, 73-84, 89-93, 99, 101, 112, 123, 127, 128, 135, 140, 141, 143, 161, 162, 164-166, 169-171, 179, 184, 185, 188, 204-207, 210, 216, 217, 219, 225, 226, 230, 232, 236-242, 244, 247, 249, 251, 256, 262, 263, 268-271, 274, 280, 284, 295, 297, 305, 306, 309, 330, 340, 342, 352, 354, 355, 357, 362-364, 395, 396, 399-401, 422, 434-436, 439, 440, 443, 450, 454, 456, 458, 460, 468, 479, 481, 484, 486, 489, 490, 500-502, 506, 508, 510, 514, 515, 522, 523, 525, 527, 529, 532, 533, 535, 536, 540, 543, 544, 552, 554, 555, 558, 560, 562, 571, 575, 578, 579, 597, 599, 621
- risk-taking 127, 128, 306, 309, 434, 506
- Rissler, Jane 134, 142
- road 7, 17, 48, 74, 80, 147, 201, 261, 276, 277, 303, 311, 320, 383, 384, 419, 421, 454, 480, 528, 598, 599
- Rocky Mountain spotted fever 219, 357, 359, 361, 364, 450
- roll bars 29, 94, 284
- roll-over 12, 71, 78, 94, 191, 195, 276, 277, 301, 306, 311, 312, 318, 322, 323, 353, 373, 379, 380, 383, 384, 389, 398, 400, 422, 441, 443, 446, 459, 474, 476, 487, 489, 494, 505, 524, 563, 590, 624
- Roll-over Protective Structures (ROPS) 12, 78, 88, 92, 94, 95, 202, 277, 301, 306, 311-316, 318, 319, 322, 323, 325, 380, 381, 441, 443, 459, 474, 477, 489, 490, 499, 505, 563, 624
- Roper, William L. 36, 43, 56, 306, 412, 439
- Rosenstock, Linda 85, 151, 154, 155
- rural 3, 5, 6, 8, 9, 12, 15, 17-20, 22, 28, 29, 32, 36, 40, 44-46, 52, 55, 57, 60, 73-75, 77-79, 83, 84, 90, 92-104, 107, 109, 112, 120-123, 125, 126, 128, 133, 143, 146, 148-150, 154, 157, 159, 161, 162, 170, 174, 175, 178, 185-188, 211, 221, 223, 225, 227, 233, 236, 242, 247, 261-263, 269-271, 273, 295, 296, 298, 303, 351, 358, 365, 387-391, 395, 396, 398-402, 412-415, 417-422, 424, 427-431, 433, 438, 475, 479-483, 485, 486, 494, 502, 511, 515, 517, 518, 525, 532, 538, 540, 556, 583, 586, 594, 595, 598, 623, 624
- Rural Hospital Transition Grant Program 102
- Ryder, Roberta E. 255, 259, 260, 264, 267

## Index

### S

- safety 1-14, 17, 18, 20, 22, 23, 25-33, 35-40, 43, 45, 46, 48, 50, 53, 55-57, 59-64, 66-68, 73-79, 84, 86-95, 97, 100, 101, 103, 105-108, 118-120, 122-129, 134, 140, 141, 143, 145-147, 150, 151, 157, 159-161, 163, 164, 166, 171-174, 176, 177, 179, 184, 187, 188, 189, 192, 193, 197, 199, 202, 204, 211, 213, 215-217, 227, 229, 238, 243, 251, 253-255, 257-261, 263-265, 267, 274-278, 285, 286, 288, 291-293, 299-302, 304-306, 308, 309, 311-321, 324, 327, 328, 330, 332-336, 338-340, 344, 351-353, 356, 357, 365, 370, 372-374, 376, 377, 378-380, 383, 385, 387-405, 407, 410, 412, 419, 420, 422, 423, 426, 427, 429-441, 443-445, 447, 448, 453-457, 459, 460, 462-466, 468-482, 484-493, 497, 498, 499, 501-505, 508, 509, 511, 512, 515, 517-519, 523-525, 528, 529, 533, 534, 537, 541, 543, 545, 546, 548, 551, 555-559, 561, 563, 565-567, 578, 580, 582, 583-599, 621-623, 625, 627, 629
- sanitarian 46
- Scannell, Gerard 472-474, 476, 478
- Schneider, Rollin D. 321, 322, 372, 402, 598
- school 5, 7, 24, 26, 36, 39, 43, 59, 95-97, 104, 105, 107, 113, 114, 149, 161, 178, 180, 201, 261, 262, 264, 295, 298, 321, 324, 340, 370, 383, 389, 393-397, 400, 406, 415, 432, 434, 436, 453, 467, 471, 492, 494, 497, 499, 511, 517, 539, 540, 546, 547, 570, 583-596, 623, 624, 632
- seat bar 277, 283, 284
- Secretary of Labor 7, 472, 473
- Senior Companion Program 415, 417, 418
- severe occupational traumatic injuries 51
- sewage 46, 225
- Seymour, Thomas H. 321, 350, 456
- shigellosis 358
- silage 17, 38, 138, 204, 205, 243, 252
- siló fillers' disease 245
- skin cancer 70, 232, 241, 398, 446
- slips 4, 278, 282, 303, 528
- slow-moving vehicles 310
- Smith-Hughes Act 391
- smoking 24, 25, 44, 46, 159, 208, 211, 215, 232, 256, 259, 262, 265, 334, 381, 382, 419, 495, 527, 542, 577
- Snider, Jacqueline 598
- Society of Automotive Engineers (SAE) 311, 477
- soil 12, 37, 64, 129, 132, 181, 299, 329, 430, 480, 500, 631
- solvents 51, 197, 233, 240, 249, 501, 552
- South America 359, 427
- South Carolina 65, 217
- South Dakota 17, 64, 65, 162, 170, 342, 385, 428, 471, 579
- Soviet Union 58, 99
- soy beans 192, 419
- Spies, Arthur 94
- spoiled hay 204, 205
- spouses 4, 89, 427, 463
- SPRAINS 4, 79, 169, 170, 227, 510, 517, 561, 624
- Sprick, Wayne 391, 432, 489
- Sri Lanka 359
- St. Louis encephalitis 221, 359, 360, 364, 624
- Stallones, Lorann 84, 175, 176, 178, 210, 213, 453, 457, 458
- standards 1, 7, 9, 11-14, 22, 25, 33, 87, 88, 99, 107, 112, 194, 224, 227, 248, 250, 257, 258, 263, 276, 308, 310, 311, 314-316, 321-325, 366, 430, 451, 454, 456, 471, 474, 481, 489, 497, 510, 529, 543, 576, 621-623, 625
- statistics 3, 4, 44, 62, 70, 78, 82, 100, 101, 107, 120, 121, 123, 128, 161, 163, 171, 176, 178, 186, 195, 199, 200, 229, 251, 254, 271, 274, 276, 302, 309, 317, 319, 336, 339, 351, 352, 372, 373, 376, 382, 384, 386, 387, 393, 394, 396, 424, 427, 481, 483, 484, 503, 516, 546, 556, 558, 561, 573, 578, 580, 600, 621, 623
- sterility 31, 237
- steroids 258, 574
- stimulants 51
- stress 10, 23, 52, 89, 96, 103, 126, 132, 138, 157, 159, 188, 223, 271, 278, 281, 293, 331, 344, 365, 397, 403, 419, 422-427, 437, 438, 451, 454, 455, 458, 460, 481, 539, 556, 599
- Stuckey, Bill 376
- Stueland, Dean T. 174, 178, 267, 298, 580
- suffocations 311
- suicide 16, 96, 99, 100, 152, 258, 427, 539, 556, 579
- Sullivan, Louis W. 28, 101, 439
- Surgeon General's Report 22, 24, 493
- surveillance 4, 5, 45, 57, 60, 61, 67-73, 75-77, 79, 80, 84, 86, 87, 93, 99, 140, 142, 143-146, 148, 149, 151, 156-159, 161-168, 170, 171, 173-181, 184-186, 189, 190, 191, 195, 199, 200, 202, 205, 222, 224-228, 244, 245, 251, 262, 265, 269, 308, 319, 320, 325, 363, 364, 385, 386, 389, 445-447, 452, 453, 455, 462, 493, 498, 500, 510, 511, 517, 522, 523, 527, 549, 552, 554, 559, 562, 567, 578, 579, 580, 621-623
- sustainability 266, 479, 480, 482, 484
- Sweden 71, 78, 95, 148, 176, 178, 351, 353, 354, 356, 373, 380, 460, 623
- Swenson, Leland H. 479
- swine confinement 204-209, 211, 214, 252, 340, 521, 577
- synthetic organic chemicals 100
- T**
- Tauka, Thomas 94
- technical assistance 5, 8, 67, 90, 473, 474, 512, 525
- television (TV) 24, 86, 99, 334, 360, 364, 408, 410, 475, 585, 569, 583, 586, 587, 589, 590, 593, 624
- tendinitis 278, 279, 282
- Tennessee 65, 217, 226, 557
- Terry, Luther 24
- tetanus 221, 229, 376, 450
- Tevis, Cheryl 397
- Texas 7-9, 16, 48, 65, 111, 132, 255, 257, 260, 321, 453, 566, 582, 587
- Thackrah, Charles 204
- Timm, Mark 55, 59, 64, 67, 73, 86, 392, 491
- tobacco 23-25, 59, 115, 120, 135, 136, 259
- toilet hygiene 217
- Toqueville, Alexis de 47
- toxic fumes poisoning 398
- toxic substances 10, 32, 76, 134, 179, 259, 520, 621, 624, 627
- toxic syndrome 190, 204, 206, 210, 213, 449, 572, 574, 581, 623
- trachoma 358
- tractor 12, 17, 29, 35, 37, 38, 40, 49, 51, 52, 65, 71, 78, 88, 89, 91, 92, 94, 97, 124, 161, 162, 169, 171, 175, 178, 190, 191, 200, 201, 261, 274-277, 279, 283, 284, 294, 297, 299-305, 310-318, 322, 323, 327, 332, 336, 341, 346, 352-356, 362, 372-377, 379-381, 384, 386, 389, 398-401, 403, 419, 420, 435, 441, 443, 446, 454-456, 458-460, 476, 477, 487, 489, 490, 494, 497, 505, 506, 508, 511, 515-517, 519, 524, 526, 528, 534, 537, 551, 555, 558, 563, 584, 585, 588, 590-593, 595, 596, 599
- tractor cabs 297, 310, 341, 375
- tractor drivers' disease 376
- training 6, 9, 13, 16, 47, 48, 61, 67, 91, 95, 103, 126, 127, 140, 147, 179, 186, 280, 305, 307, 309, 318, 320-324, 334, 335, 338, 342, 344, 349, 351, 357, 366, 368, 375, 377, 388, 405-407, 417, 420, 428, 448, 449, 451, 460, 466, 469, 473, 474, 476, 477, 486, 499, 504, 507, 512, 515, 533, 534, 537, 551, 556, 559, 565, 578, 591, 594, 595, 622, 623
- trauma 23, 48, 51, 69, 79, 82, 100, 161, 162, 167, 174, 176-178, 188, 274, 275, 278, 280-284, 308, 318, 325, 326, 336, 385, 446, 454, 493, 504, 623
- True, John A. 161
- tuberculosis (TB) 31, 46, 52, 189, 216-218, 222, 224, 226, 228, 256, 358, 427, 450, 469, 495, 624
- tuna 258
- Twain, Mark 36
- typhoid fever 52, 358
- U**
- ultraviolet light 233
- ultraviolet radiation 51, 52
- United Nations 81, 97, 100, 624



Urban, Thomas 33  
 urinary tract infections 217, 430, 468, 624  
 USDA 45, 61, 63, 76, 86, 90, 108, 110,  
 112, 113, 116, 168, 170, 174, 175, 180,  
 193, 194, 197, 224, 225, 325, 330, 426,  
 439, 475, 477, 482-484, 624  
 Utah 65, 219, 223, 227

## V

---

vectors 4, 219, 220, 223, 225, 357, 358,  
 361-363, 375, 376  
 Vermont 65, 115, 144, 177, 350, 599  
 veterinary drugs 243, 249, 251, 255  
 vibration 82, 278, 279, 281, 282, 301,  
 309, 310, 312, 317, 318, 336, 353, 572  
 Villarejo, Donald 195  
 vineyards 300, 311  
 Virgin Islands 55  
 Virginia 65, 131, 136, 226, 275, 432, 521,  
 549, 558, 560, 561, 563-569, 571-577,  
 581, 582, 588  
 viruses 51, 80, 136, 137, 233, 268, 357,  
 359, 363, 364  
 Volatile Fuel Safety Program 435  
 volunteer 103, 174, 258, 260, 387, 404,  
 412, 414-417, 428, 437, 438, 498, 517,  
 524, 538, 583, 588, 621  
 Von Essen, Susanna 204, 213, 215, 256,  
 270, 376, 449, 542

## W

---

Washington 20, 22, 36, 39, 42, 43, 59,  
 60, 65, 71, 74, 84, 86, 95, 97, 98, 107,  
 112, 120-125, 127, 129, 133, 141, 142,  
 145, 151, 176, 238, 239, 253, 254, 278,  
 282, 320, 321, 412, 418, 427, 432, 466,  
 472, 479, 490, 333, 339, 340, 559, 582,  
 589  
 Washington D.C. 36, 71, 86, 95, 97, 98,  
 107, 120-122, 129, 145, 176, 238, 333,  
 418, 466, 472, 479  
 water contamination 92, 398, 507  
 weather 2, 52, 119, 161, 181, 331, 434,  
 629  
 well water 236, 507, 583  
 West Virginia 65, 275, 521, 549, 560,  
 561, 563-569, 571-577, 581  
 white finger 279, 318  
 Whitener, Leslie A. 107, 121, 426  
 whole-body vibration 281, 309, 310  
 Widess, Ellen G. 7, 23, 25, 95, 405  
 Wilk, Valerie A. 466  
 win-win 496  
 Wisconsin 29, 41, 49, 65, 86, 87, 112,  
 147, 162, 170, 178, 212, 213, 217, 219,  
 226, 283, 294, 295, 297, 442, 445, 458,  
 507, 535, 572, 578-580, 582, 596, 600  
 women 1, 31, 32, 37, 51, 61, 73-75, 83,  
 84, 188, 189, 192, 233, 235, 279, 299,

359, 399-401, 415, 419, 423, 430, 451,  
 463, 466-468, 473, 478, 487, 489, 490,  
 497, 540, 579, 624, 630, 632, 633  
 workers' compensation 7, 15, 61, 64, 65,  
 166, 171, 225, 352, 467, 469, 501, 561,  
 624  
 Wyoming 59, 65, 228, 372

## Y

---

Young Farmer Educational  
 Association 432, 433, 435  
 young workers 4

## Z

---

Zavala, Melanie 211, 405  
 zebra 300  
 Zeman, Richard 38, 40  
 zoonoses 216, 222-224, 226, 228, 359,  
 450, 509  
 zoonotic viruses 233

