

D-21

# BATTERY JASPER

FORT SUMTER NATIONAL MONUMENT

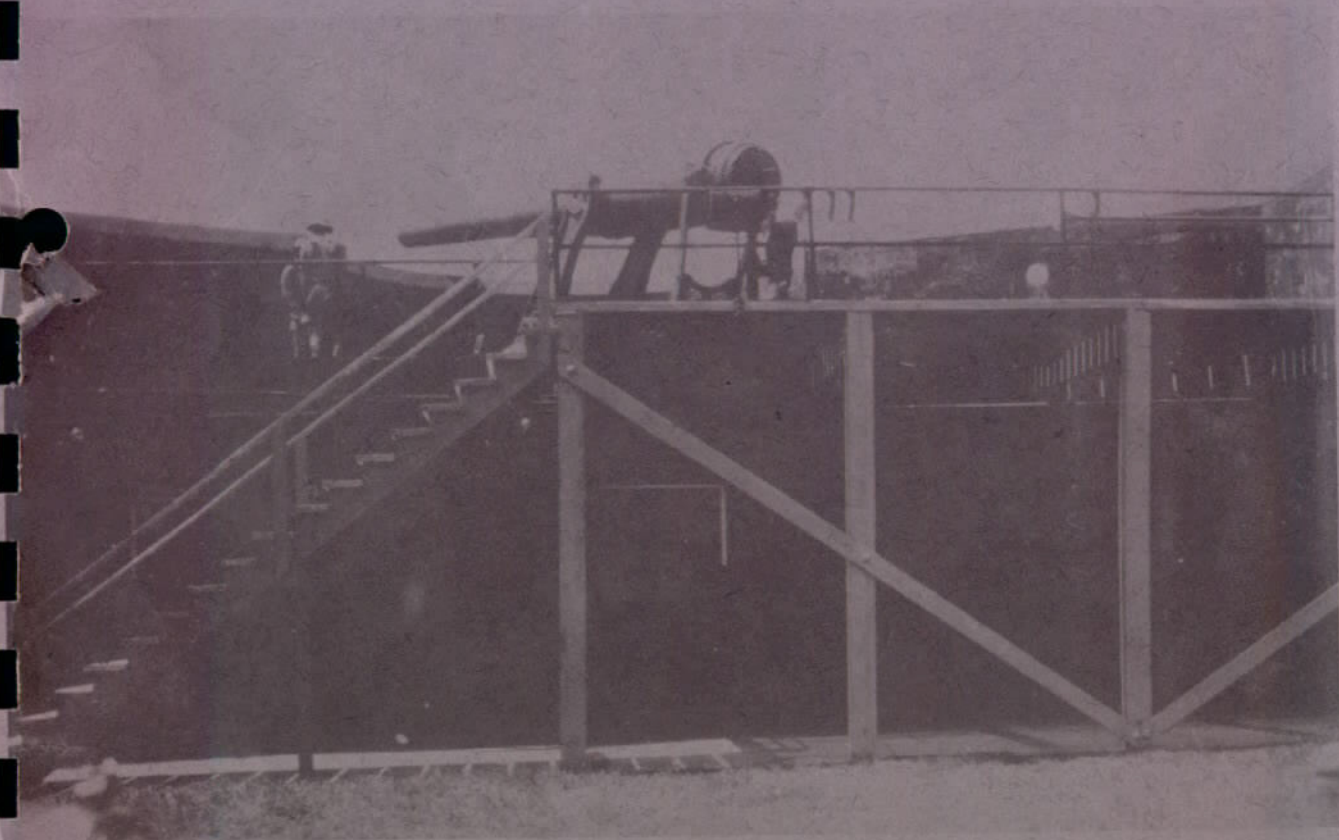

October 31, 1968

PLEASE RETURN TO:  
TECHNICAL INFORMATION CENTER  
DENVER SERVICE CENTER  
NATIONAL PARK SERVICE

B&W Scans

4/8/2003

ON MICROFILM

# BATTERY JASPER

HISTORIC STRUCTURES REPORT — PART II  
Historical Data Section

**FORT SUMTER NATIONAL MONUMENT**  
Sullivan's Island, South Carolina

By  
EDWIN C. BEARSS

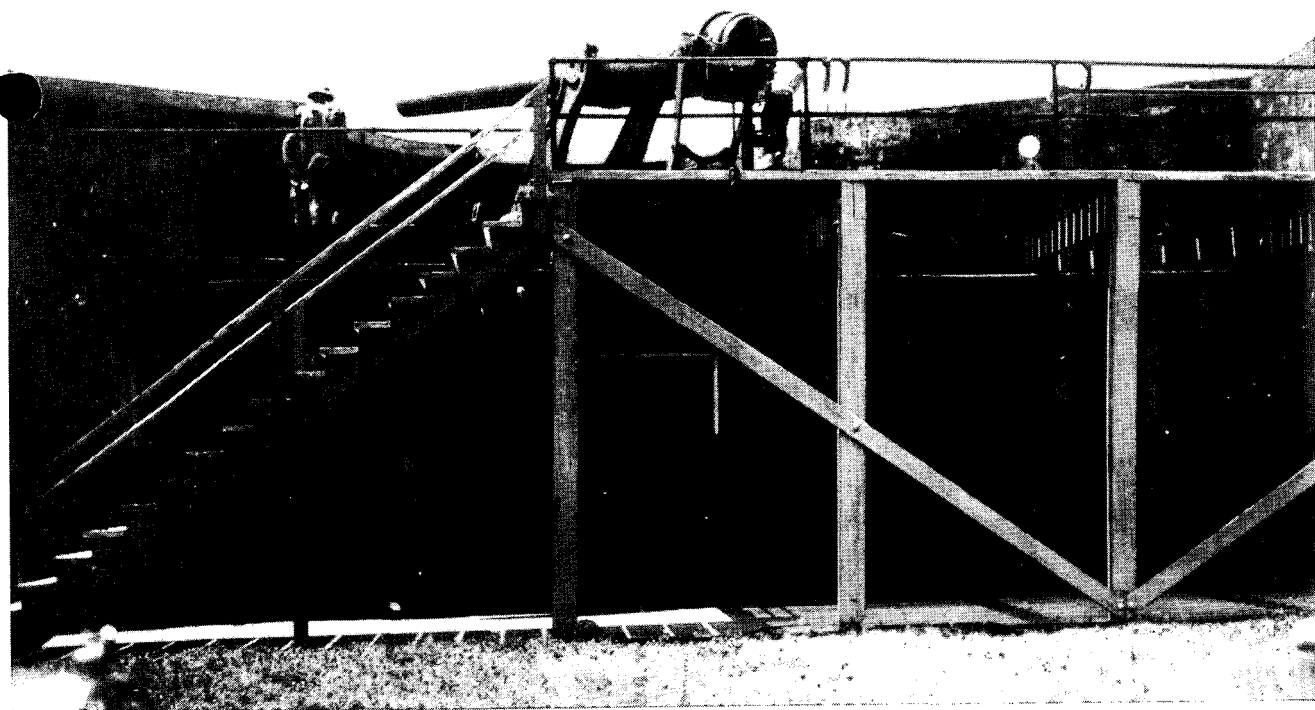

DIVISION OF HISTORY

Office of Archeology and Historic Preservation

National Park Service

U.S. Department of the Interior

## FOREWORD

This report has been prepared to satisfy the research needs as enumerated in Historical Resource Study Proposal, FOSU-H-3, Historic Structures Report, Part II, Battery Jasper, 1897-1948. As proposed by Superintendent Paul Swartz this report is aimed to provide "information pertaining to Battery Jasper; its casemates, bombproofs, armament, etc. . . . to insure that the proposed restoration of Battery Jasper to its 1898-1918 appearance is accurate." The Historical Data Section of the subject report besides furnishing information to guide the Architectural Historians in preparing their measured drawings and specifications will provide data needed for interpretive specialists to present the story of Battery Jasper to the area's visitors.

A number of persons have assisted in the preparation of this report. Particular thanks are due to Superintendent Paul Swartz and Historian John Dobrovolny for their assistance at the site; to Architectural Historians Henry Judd and Fred Gjessing for sharing their knowledge of the battery's architectural intricacies; to Dr. Raymond Lewis of System Development Corporation, Falls Church, Virginia, for sharing his encyclopedic knowledge of American seacoast fortifications; to Carlton Brown, James O. Hall, and Miss Nadine Whelchel of the Federal Records Center in East Point, Georgia, for the outstanding service provided in making available records of the Charleston Engineer District; to Frank Sarles for proof-reading the final draft; and especially to Mrs. Lucy Wheeler for typing the report and for her editorial help.

ECB

TABLE OF CONTENTS

	Page
A. A Battery Is Authorized and Located	1
B. Jacob Friday & Sons Contract to Build Three of the Four Emplacements.	11
C. Sanford, Brooks & Bonsal Build Emplacement No.1.	24
D. Battery Jasper's Heavy Ordnance.	29
E. Artesian Well.	34
F. Electric-Lighting Plant.	38
G. Cisterns.	43
H. Magazines and Shellrooms.	45
I. Trolleys.	53
J. Ammunition Hoists.	56
K. Shot Cranes.	63
L. Bracketed Galleries.	64
M. Telephone Niches.	66
N. Landscaping.	68
O. Battery Commander's Station.	69
P. Latrine.	70
Q. General Maintenance.	71
<del>Appendix A. Abstract of Proposals for Furnishing Material and Con- structing One Emplacement for 10-Inch Rifle Battery.</del>	<del>81</del>
Appendix B. Abstract of Proposals for Furnishing Material and Con- structing One Emplacement for 10-Inch Rifle Battery.	83
Appendix C. Money Statement, Battery Jasper, July 1, 1897.	85
Appendix D. Amounts and Dates of All Allotments for Battery Jasper.	86
Bibliography	87

LIST OF ILLUSTRATIONS

-following page 88

PLATE I	Plan Locating Battery Jasper Relative to Fort Moultrie and Battery Logan.
PLATES II & III	Plan of Chain Ammunition Hoists in Battery Jasper.
PLATE IV	Sketches Showing Trolley and Solid Shot-rooms in Battery Jasper.
PLATE V	Plan of the Battery Jasper Latrine.
PLATES VI, & VII	Plans of Battery Jasper.
PLATE VIII	Plans of Battery Jasper Electric Lighting System.
PLATE IX	Plan of Battery Jasper Powerhouse.
PLATE X	Plan for Damp-Proofing Powder Magazine No.3, Battery Jasper.
PLATES XI, XII, & XIII	Plan for Telephone and Telautograph Booths for Battery Jasper.
PLATE XIV	Plan for Steel Door of Telautograph Niche.
PLATES XV, XVI & XVII	Sketches Showing Operation of Buffington-Crozier Disappearing Carriage.
PLATE XVIII	Panoramic View from West Elevation of Battery Jasper.
PLATE XIX	Positioning Base Ring for 10-Inch Rifle.
PLATE XX	Photograph Showing "the Plant" in Operation.
PLATE XXI	Photograph. With Casings in Position, Concrete is Poured and Allowed to Set.

PLATE XXII

Photograph. Looking West across Glacis toward Fort Moultrie.

PLATE XXIII

Photograph. Looking West across Glacis toward Fort Moultrie. Taken from a position east of that occupied by cameraman when he took the photograph in preceding plate.

PLATE XXIV

Photograph of the East Flank of Battery Jasper, Showing a Portion of the Work East of Emplacement No.4, Sept. 8, 1897.

PLATE XXV

Photograph. Inside One of the Casemates of Battery Jasper.

PLATE XXVI

Photograph of Section above Magazine Area, to the Left of One of the Gun Pits.

PLATES XXVII, XXVIII, XXIX, Photographs of the Test-Firing of a 10-Inch & XXX Breech-Loading Rifle.

## HISTORY OF BATTERY JASPER

### A. A Battery Is Authorized and Located

In the years following 1876 the coastal fortifications of the "Third System" were permitted to fall into disrepair. Simultaneously, great advances were made in heavy ordnance. One important development involved the substitution of steel for iron in the casting of the guns. As the technique of forging large masses of steel improved, it enabled the ordnance people to begin on the large-scale manufacture of the compound tube. The founding of cannon tubes in accordance with this new concept--increasing the size and strength of the tube by the successive shrinking-on of reinforcing hoops--had been practiced, it is true, in the years before 1860. Technology, however, had lagged, and it was not until the American Civil War that banded and rifled guns of heavy caliber came into general use. A recognized expert on the subject is Dr. Emanuel Raymond Lewis who has tersely summed up the situation:

By the late 1880's, however, the combined availability of good quality steel in large amounts, industrial facilities for producing heavy forgings, and machining techniques able to meet the required standards of precision made possible the production in substantial numbers of lighter, stronger, longer, and hence, more powerful weapons.<sup>1</sup>

---

1. Emanuel Raymond Lewis, *American Seacoast Fortifications: A Developmental History* (Privately Printed, 1968), p. 55.

Another important advance was in the perfection of breech-loading. The principle had been known for centuries, and it had been employed intermittently until 1855, when Lord Armstrong of Great Britain designed a rifled breech-loading gun that "included so many improvements as to be revolutionary."<sup>2</sup> During the Civil War, breech-loading field artillery was employed on a small scale by both belligerents. After 1865, breech-loading field guns replaced muzzle-loaders in the European armies as well as those of the United States. Not so rapid was the replacement of the muzzle-loading heavy ordnance mounted in coastal defense. The problem of developing a successful breech-loading gun had been a technological one. To be acceptable, a breech-mechanism had to withstand the great heat given off by the detonation of the propellant charge, be capable of containing the gasses, and be machined to be opened and closed rapidly. It was not until the late 19th century that the ordnance technology was sufficiently advanced to produce the well-machined block mechanisms required by the big guns needed for coastal defense.<sup>3</sup>

Three other developments helped speed the emergence of modern coastal artillery: (a) methods of rifling the tubes were improved, which made possible the introduction of more efficient and effective

---

2. Albert Manucy, *Artillery Through the Ages: A Short Illustrated History of Cannon, Emphasizing Types Used in America* (Washington, 1949), p. 4.

3. Lewis, *American Seacoast Fortifications*, p. 56.



projectiles; (b) the development of disappearing carriages that utilized the firing recoil energy to return the gun to its position in the battery behind a parapet, where it could be reloaded and serviced without unduly exposing the gun crew; and (c) the development of improved propellents, nitrocellulose- and nitroglycerin-based powders, to replace black powder.<sup>4</sup>

The effect on heavy ordnance of this technological revolution cannot be exaggerated, because it represented the greatest advance to be made in artillery from the time of its first appearance in the 14th century until the development of the atomic cannon of the 1950s. As Dr. Lewis has written:

Compared to the best of the smoothbore muzzle-loading cannon [the 15-inch Rodmans] of the post-Civil War period, the new weapons, which began to emerge from the developmental stage around 1890, could fire projectiles that were, caliber for caliber, four times as heavy to effective ranges two or three times as great, and they could do so with remarkably increased armor-penetration ability and accuracy.<sup>5</sup>

During these same years, the big naval powers of Europe had forged ahead--the battleship had made her appearance. News of the development of what was believed to be the ultimate weapon afloat caused much of the American public, as well as many of the ranking army and navy officers, to fret over the failure of Congress to make any major

---

4. Ibid., pp. 56-57; Manucy, *Artillery Through the Ages*, p. 28.

5. Lewis, *American Seacoast Fortifications*, p. 57.

appropriations for coastal defense since the mid-1870s. Pressure began to build up on Congress to take action to correct a situation that had allowed the forts of the Third System to deteriorate to a point where the country's security was jeopardized.

President Grover Cleveland accordingly in 1885 constituted a board headed by Secretary of War William C. Endicott to review the coastal defenses of the United States and to submit recommendations for a program to update them to take advantage of the technological revolution in weaponry. This board was composed of officers of the army and navy, as well as civilians. Not since 1816, when the four-man board headed by Bvt. Brig. Gen. Simon Bernard had made the study which led to the Third System forts, had the subject of fortifications, types of armament, etc., been subjected to such an intensive study. The Endicott Board made its report early in 1886.<sup>6</sup>

The Board called for fortifications at 26 coastal points, plus three on the Great Lakes, as well as floating batteries, torpedo boats, and submarine mine fields. As Dr. Lewis has written:

Aside from the fact that the overall proposal carried with it a cost estimate that alone rendered it unrealistic, its details concerning the dispositions, types, and quantities of weapons--drafted while the new ordnance was still at a fairly early stage of development--were necessarily put forth in some ignorance as to the actual performance of the production models, some of them five years away.

---

6. Ibid., pp. 57-58.

7. Ibid., p. 58

On March 29, 1887, the Board of Engineers was directed by Secretary of War Endicott to prepare plans for the defense of the nation's more important harbors in accordance with the recommendations of the Endicott Board. Operating under these guidelines, the Board "undertook a thorough revision of plans for the defense of our chief ports by submarine mines and a study of the precise locations of the new armaments rendered necessary by modern modes of attack."<sup>8</sup>

During the period 1887-1896 detailed plans for the artillery defenses of 23 key harbors, including Charleston, South Carolina, were prepared by the Board of Engineers and approved by the Secretary of War.<sup>9</sup> Besides these major undertakings, partial projects had been scheduled and approved for the defense of the Lake Ports; Cumberland Sound; Kennebec River, Me.; New Bedford, Mass.; Penobscot River, Me.; and New Haven and New London, Conn. Under consideration were projects for the

---

8. Craighill to Lamont, Sept. 29, 1896, found in *Report of the Secretary of War; being part of The Message and Documents Communicated to the Two Houses of Congress at the Beginning of the Second Session of the Fifty-Fourth Congress*, 3 vols (Washington, 1896), 2, I, 7. Cited hereinafter as *Report of Secretary of War--1896*. Brig. Gen. W. P. Craighill was Chief of Engineers, while Daniel S. Lamont was Secretary of War.

9. In addition to Charleston, these harbors were: Portland Me.; Portsmouth, N.H.; Boston, Mass.; Narragansett Bay, R. I.; eastern entrance to Long Island Sound; New York, N.Y.; Philadelphia, Pa.; Baltimore, Md.; Washington, D. C.; Hampton Roads, Va.; Wilmington, N.C.; Savannah, Ga.; Key West, Fla.; Pensacola, Fla.; Mobile, Ala.; New Orleans, La.; Galveston, Tex.; San Diego, Calif.; San Francisco, Calif.; mouth of Columbia River; and Puget Sound, Wash. Ibid.

complete defense of Port Royal, S.C., and the Dry Tortugas.<sup>10</sup>

Starting in 1890, Congress was to make annual appropriations for the construction of seacoast defenses. In August of that year \$1,221,000 was voted by Congress to be applied to the defenses guarding three harbors--San Francisco, New York, and Boston. On February 24, 1891, expenditures of \$750,000 were authorized with major allotments made for the defenses of New York, Hampton Roads, Washington, and San Francisco. Work on these fortifications and others was continued during the next four years with funds made available by 52d and 53d Congresses.<sup>11</sup>

The Corps of Engineers in undertaking these projects usually utilized existing Third System structures and reservations. There was, however, a drastic shift in emphasis away from the works in which the big guns were to be emplaced toward the defensive weapons mounted therein. This was reflected in the character of the emplacements constructed in the 1890s and afterwards, "which, though massive and costly, were relatively simple in form. In sharp contrast with the stark, vertical-walled masonry forts of the Third System, the new works were intentionally de-emphasized by being designed to blend, so far as possible, into the surrounding landscape."<sup>12</sup>

---

10. Ibid.

11. Ibid., p.3.

12. Lewis, *American Seacoast Fortifications*, p. 59.

The 1st Session of the 54th Congress enacted and President Grover Cleveland signed on June 6, 1896, an act appropriating the sum of \$2,500,000 for gun and mortar batteries, " of which sum not exceeding one hundred thousand dollars may be expended for the construction of necessary buildings connected therewith." It was also provided

that contracts may be entered into under the direction of the Secretary of War, for materials and work for construction of fortifications, to be paid for as appropriations may from time to time be made by law, to an additional sum in aggregate not to exceed two million five hundred thousand dollars.

The funds made available by the Act of June 6 were allotted by the Chief Engineer for the construction of emplacements for six 12-inch guns--four on disappearing carriages and two on non-disappearing carriages; 28 10-inch guns on disappearing carriages; three 8-inch guns on disappearing carriages; eight 5-inch rapid-fire guns; two 6-pounder rapid-fire guns; and 44 12-inch mortars in four batteries.

Chief Engineer Brig. Gen. John M. Wilson in budgeting the projects and in assigning priorities kept in mind five goals: (a) to provide for the needs of "all our seaports for which projects are approved," so as to protect as many as practicable against attack by raiding cruisers; (b) to allot available funds to the "most necessary works where sites were owned by the United States;" (c) to allot to locations where a "working plant" was owned by the United States; (d) to make emplacements for guns which can be provided by the Ordnance Department; and

(e) to retain from the \$2,500,000 appropriated a "sum sufficient to provide for supervision of the contract work."<sup>13</sup>

Before the passage of the Act of June 6, 1896, an allotment had been made by the Office of the Chief Engineer of \$75,500 for "the beginning of the life battery for three 12-inch rifles" at Fort Sumter. Test boring made under the supervision of Capt. Frederic V. Abbott, officer in charge of the Charleston Engineer District, indicated that the site could not support a battery resting on piles. Any battery to be erected on the Fort Sumter site would have to be "floated on the surface soil." Therefore the allotted funds could be utilized for another project, while Captain Abbot was coming up with a new plan for a 12-inch battery. Accordingly, \$60,000 set aside in this account was reallocated for the construction of a mortar battery on Sullivan's Island. Work on the mortar battery was started in March 1896.<sup>14</sup>

Considerable progress had been made on the Sullivan's Island mortar battery by the time General Wilson was able to begin making allotments from the expenditures authorized by the legislation of June 6, 1896. On August 31 he budgeted \$500 "for the purpose of making the necessary plans and drawings for four emplacements for 10-inch rifles on disappearing carriages" at Charleston. Only two of these emplacements, however, were to be funded out of the June 6 appropriation.

---

13. *Report of Secretary of War--1896*, p. 9.

14. *Ibid.*, pp. 502-503, 508.

The drawings and specifications for the battery were prepared under the supervision of Captain Abbot and forwarded to Chief Engineer Wilson on September 21. (A copy of the plans accompanies this report.)

As soon as the plans and specifications for the "10-in. Gun Disappearing Battery on Sullivan's Island" were approved, General Wilson on December 11 ordered an allotment of \$9,500 to pay for supervising the construction of the emplacements. Three months later, on March 2, 1897, \$150,000 was earmarked from the \$2,500,000 appropriated by the 2d Session of the 55th Congress, under legislation approved March 3, 1897, to meet contracts authorized under the Act of June 6, 1896.<sup>15</sup>

Borings made under Lt. Edwin R. Stuart's supervision disclosed that at the site previously selected by the Board of Engineers for the emplacements that one-half the battery would be located "on a layer of sand not less than 40 feet thick," while the eastern half would rest on a "thick pocket of soft mud," similar to that found beneath the Sullivan's Island mortar battery, which was subsequently designated Battery Capron.<sup>16</sup> A letter was accordingly forwarded to Chief Engineer

---

15. *Annual Reports of the War Department for the Fiscal Year Ended June 30, 1897, Report of the Chief of Engineers* (Washington, 1897), I, 9; *Reports of Capt. F. V. Abbot and 2d Lt. Edwin R. Stuart*, found in *Annual Reports of the War Department for Fiscal Year, 1897, Report of the Chief Engineer*, I, 693. Cited hereinafter as *Report--Abbot & Stuart*.

16. On July 22, 1899, the mortar emplacement, in accordance with General Order No. 134, was designated Battery Capron in honor of Allyn K. Capron of New York, who had entered the army as a private, and had been commissioned a 2d lieutenant in the 5th Infantry on October 7, 1893. While

Wilson, outlining what had been discovered and requesting permission to relocate the battery site 400 feet to the west, where boring indicated the emplacements would rest entirely on the 40-foot thick layer of sand pinpointed by Stuart.<sup>17</sup> General Wilson agreed to the relocation of the battery site.

---

serving as a captain in the 1st U.S. Volunteer Cavalry he was killed in action with the enemy at Las Guasimas, Cuba, on June 24, 1898. F. B. Heitman, *Historical Register of the United States Army from its Organization, September 29, 1789, to March 2, 1903* (Washington, D. C., 1903), p. 281.

17. *Report--Abbot & Stuart*, p. 693.



B. Jacob Friday & Sons Contract to Build Three  
of the Four Emplacements

On October 29, 1896, Captain Abbot advertised that on the final day of November he would open proposals for "furnishing material and constructing three emplacements for 10-inch rifle battery." Plans and specifications were made available to interested contractors. On the designated date Captain Abbot opened and abstracted the bids submitted by seven interested parties. On doing so, he found that Jacob Friday & Sons had submitted the low bid of \$110, 813.56. (See Appendix A for Abstract of Proposals for Furnishing Materials and Constructing Two Emplacements for 10-inch Rifle Battery.) Abbot, when he relayed this information to Washington along with the signed contract and performance bond posted by Jacob Friday & Sons, recommended that General Wilson give his approval, as the successful bidders had been formerly associated with Egan & Friday, and in this capacity had completed the continuing contract for the Charleston jetties.<sup>1</sup>

General Wilson, after reviewing the contract and supporting documents, gave his approval on January 21, 1897. Upon being given the go ahead by Captain Abbot, Jacob Friday & Sons turned crews to getting ready to begin construction. By the specifications they were required to rent and use "the plant" which the United States had provided for

---

1. *Report--Abbot & Stuart*, p. 694.

Battery Capron. Jacob Friday & Sons would be charged \$1,550 a month for "the plant," which included a complete quarry plant and stone crusher, with elevated bins and screens.<sup>2</sup>

The quarry from which stone for the 10-inch emplacements was to be secured was located about two miles from Edgefield, South Carolina, and about 144 miles from Charleston.<sup>3</sup> This quarry had been operated by the United States in September 1890 to provide stone for the construction of the Charleston jetties. In 1892 the government leased the quarry for three years to Egan & Friday.

Four years later, in January 1896, arrangements had been made by the government to resume operations at the quarry. Stone would be crushed and shipped to Sullivan's Island for use in construction of the mortar battery (Battery Capron). When Lt. Edward H. Schulz inspected the crushing plant, prior to resumption of operations, he saw that the 40-horsepower boiler, the two 20-horsepower Mundy boilers, and the engines needed new tubing and a general overhaul. This work was undertaken, while the track connecting with the Cumberland Gap Railroad was relaid. Plans were drawn for the erection of stone bins and work was resumed in February.<sup>4</sup> The bins were built directly over the track and a space

---

2. Ibid.

3. The formation from which the stone was to be taken belonged to the Laurentian system. The granite consisted essentially of quartz, mica, and feldspar, with iron compounds. It was a hard, heavy and compact granite, which the presence of iron rendered unfit for building purposes.

4. Report of Lt. Edward H. Schulz, found in *Annual Report of the*

12 feet wide and ten feet in the clear allowed for the gondola cars. A stone crusher was bought from the Gates Iron Works of Chicago, Illinois, for \$1,892.<sup>5</sup>

To run the crusher, a 25-horsepower engine had been secured through the Bailey Leiby Co., of Charleston. With this engine the capacity of the crusher was about 15 tons per hour, when adjusted to break stone two and one-half inches in diameter.

By June 30, 1896, the plant was ready to begin operations. There was sufficient fuel on hand to last for three months. Explosives had been secured, but they would not be needed for some time, as there was plenty of loose stone in the quarry of the proper dimensions for the crusher. A new blacksmith shop had been erected, a duplex pump purchased, and a water tank with a capacity of 7,000 gallons built. The capacity of the crusher and plant, working eight hours a day, was estimated at 120 tons.<sup>6</sup>

On January 18, 1896, a contract had been entered into for use of the quarry for three years by paying a royalty of 2 1/2 cents

---

*Chief of Engineers for Fiscal Year 1896*, pp. 512-513. The lumber used for the construction of the bins was good, longleaf yellow pine. Carpenters on the project were paid \$2 a day and their Negro helpers 80 cents per day. Lieutenant Schulz was Assistant Engineer of the Charleston District for the period 1898-1899.

5. Ibid., p. 513.

6. Ibid., p. 514.

per ton for all rock removed. An agreement was also signed by Lieutenant Schulz with the South Carolina and Georgia Railroad and the Carolina, Cumberland Gap and Chicago Railroad to haul the stone from the quarry to wharf in Charleston ready to be placed on lighters for 80 cents per ton. The cost for loading the lighters was about 15 cents per ton. Thus the cost per ton to the government of stone, royalty, transportation, and loading lighters would be 97 1/2 cents.<sup>7</sup>

Besides the quarry plant and stone crusher, Friday & Sons for \$1,550 per month would have use of a good tug and eight 200-ton scows for lightering crushed stone and cement; a steampowered derrick scow; a cement mixing plant, with three double-drums, double-cylinder hoisting engines of about 20 horsepower each; a steam piledriver for use on land; and 1,400 feet of Hunt tip track, with steel ties, and curves, switches, and a number of Hunt tip cars and flatcars. Along with "the plant," the government supplied Friday & Sons with "a quantity of steel wire rope, guy lines, manila rope, and other supplies, and attachments, and a number of shovels, wheelbarrows, rammers, etc."<sup>8</sup>

Captain Abbot believed that both the government and contractor would benefit from this arrangement, because the proposal submitted by Friday & Sons was in the same price range as those filed by successful

---

7. Ibid., p. 515.

8. *Report--Abbot & Stuart*, p. 694.

bidders on the Atlantic Coast in the vicinity of points where the government had no plants. As it was estimated that it would take about ten months to complete the three emplacements, the savings to the government would be about \$15,000. In addition, the ownership of "the plant" in the past had been beneficial to the government, because: (a) it alleviated the need on the contractor's part to assemble equipment, thus permitting him to begin work at once; and (b) the rent constituted "a self-applying bonus for rapid work and penalty for delay." Each day saved in completing the project would represent to Jacob Friday & Sons a saving of \$50 in rent.<sup>9</sup>

Before the contract had received the sanction of Chief Engineer Wilson, Jacob Friday & Sons had turned crews to getting "the plant" in position. The site settled on for the 10-inch battery was about one mile from the nearest Sullivan's Island wharf where loaded lighters could dock. A narrow-gauge railroad was a necessity, and a right-of-way through the streets of Moultrieville was secured from the town council. From the wharf a single track was laid as far as the scale-house located a short distance west of the battery site. At the scale-house the track branched. One spur passed through the cement shed, which was located nearby with its south elevation parallel to the stakes marking the rear of the emplacements. A second track led to the foot of an incline leading to the top of the bins for storing sand and broken

---

9. Ibid.

stone, and a third ran directly in rear of the battery. The latter spur would also serve one of the traveling cranes. Other tracks were laid leading to convenient points of delivery.<sup>10</sup>

The bins for sand and stone were positioned between the cement warehouse and the site. They formed two parallel V-shaped troughs meeting at the top, "the inclination of all the bottom planes being one on one, and the divisions into pockets being made by vertical planes." The center of the track leading from the incline was sited over the intersection of the planes forming the inner sides of the two troughs. When the cars were dumped, the contents were thus distributed equally between the two troughs, no shoveling being required. At the bottom of the pockets there were a number of sliding iron doors. When they were opened, sand and stone were discharged into the Hunt tip cars which carried them to the mixer.<sup>11</sup>

The Hunt track looped under the bins, and the tip cars ran west on the south track and east on the north. As they rounded the curve west of the bins, they were run out on a short spur and received a charge of cement. This was a satisfactory arrangement, as there were no meetings of the cars, and as many cars could be put in service as the needs of the moment dictated. The two ends of the loop merged at the east end into a single track, where the cars were moved onto a vertical

---

10. Ibid., pp. 694-695.

11. Ibid., p. 695.

elevator adjacent to the mixer. This set-up allowed the mixer to be fed constantly, and it never ceased operation from the beginning of the work day, except to be emptied and refilled. The only limiting factor in this operation was the capacity of the four-cubic-foot mixer.<sup>12</sup>

From the mixer, the concrete was transported in one-yard dump buckets on flatcars to the point of deposit. The buckets were lifted off the flats by two steam cranes. One of these was a regular traveling crane, revolved by steam, and the other was a stiff-legged derrick, mounted on a heavy platform, supported on eight pairs of wheels and axles similar to those used on the narrow-gauge railroad cars. This derrick operated on a pair of parallel narrow-gauge tracks laid about 15 feet from center to center. It was revolved by ropes attached to the boom and operated by the spoolheads of an ordinary hoisting engine. The derrick was moved along its track by a rope attached to ties and other suitable points and operated by the spool heads. Experience soon demonstrated that the derrick was not as efficient as the traveling crane, but it still made its contribution. The traveling crane ran on tracks parallel to those of the derrick, and between the seawall and what was to become the exterior slope of the emplacements. Thus every point at which concrete was to be deposited was within reach of one or the other of the cranes, and the heaviest work could be reached by both.<sup>13</sup>

---

12. Ibid.

13. Ibid.

Sand for the parapet would be taken from the nearby sand hills. It would be hauled up over the seawall in cars pulled up an inclined trestle by a hoisting engine on top of the concrete wall in front of the magazine of the easternmost emplacement. The sand cars would then be pushed along a track laid atop the finished concrete and dumped into the space between the seawall and exterior slope of the battery.<sup>14</sup>

To ferry the sand and stone from Charleston to the Sullivan's Island wharf, railroad tracks were laid on the decks of two of the government lighters, so that the narrow-gauge cars could be put afloat. The cars were loaded with stone from the Edgefield quarry at the Charleston railroad wharf, and the lighters were towed over to the island, where the craft were positioned in a slip and the loaded cars pulled up an adjustable incline by a steel-rope, driven by a double-cylinder, four-drum hoisting engine on the wharf. This engine did double duty, as it also operated the derrick employed to unload all other materials (bags of cement, I-beams, etc.) to be utilized in the construction of the emplacements and deposit them on cars spotted on the tracks leading out onto the wharf.<sup>15</sup>

Jacob Friday & Sons had contracted to receive their cement from New York in schooners; their steel I-beams by rail from Pittsburgh;

---

14. Ibid., pp. 695-696.

15. Ibid., p. 694.



while the iron stairways and the shot-lift mechanisms were sub-contracted to a Charleston firm.<sup>16</sup>

By the end of the first week of March 1897, workmen had completed the railroad, cement shed, stone bins, the slip at the wharf, and had readied "the plant." To guard against the evil effects of settlement, should any occur, Captain Abbot had the three emplacements divided into 40-foot sections by vertical planes, so positioned as to never cut through any of the numerous I-beams to be used to support the superior slope. Work was now commenced, and 200 linear feet of sea-wall had been completed by March 31, and 1,121 cubic yards of concrete poured. During April, 240 additional linear feet of sea wall was positioned, while concrete placed in the sea and main walls totaled 3,622 cubic yards.<sup>17</sup>

Captain Abbot by April 10 saw that work had progressed to a point where it was evident that the base rings for the three 10-inch rifles would soon be needed. A letter was accordingly forwarded to the Chief of Ordnance, requesting that the base rings, carriages, and guns be made available, as "they could be handled to great advantage together." At the same time, Abbot informed Chief Engineer Wilson that "it was very desirable to complete the fourth and last gun emplacement

---

16. Ibid., p. 696.

17. Ibid., pp. 693, 694, 696.

if funds could be allotted." On April 21 Abbot was notified that the guns and carriages for the three emplacements currently under contract would be shipped in August. Funds for the fourth emplacement, he was informed, would be authorized provided additional funds became available.<sup>18</sup>

Satisfactory progress was made on the battery in May. On May 31 Captain Abbot reported " . . . concrete work about half finished; incline for parapet filling completed." During the month's 25 working days, 4,648 cubic yards of concrete had been poured, which averaged out to 185.92 cubic yards per eight-hour day. June 30 found the concrete work six-tenths completed; sand filling one-tenth completed; and the shot-lifts positioned.<sup>19</sup>

By September 1, 1897, 95 percent of the concrete had been poured; about seven per cent of the sand fill was in place and sodded; while the riprap in front of the seawall was nearly completed. The easternmost emplacement (No. 4) was finished with the exception of the winches and carriages for the shot-lifts, the concrete under where the rifle was to be positioned, and the base ring. Emplacement No. 3 had been completed except the winches and carriages of the shot-lifts, the roofs over the storeroom and the passageway to the loading platform, part of the gun foundation which surrounded the armor bolts, and the iron stairway leading from the rear to the loading platform. Gun Emplacement No. 2 was

---

18. Ibid., p. 696.

19. Ibid.

ready except the winches and the carriages for the shot-lifts, one-half the trolley system, roofs over the storeroom and passageway giving access to the loading platform, the concrete immediately under where the gun was to be placed, and about three feet of the magazine roof.<sup>20</sup>

Jacob Friday & Sons in September positioned the base rings for Guns Nos. 2, 3, and 4, and brought the concrete "up around the anchor bolts to the bottom of the rings, except for Gun No. 2, where the concrete was still one foot below the base ring." Circular steps in rear of Emplacements Nos. 3 and 4 were erected, while some granolithic flooring was done in sections D, E, J, L, P, R, and T. Earth filling and sodding had been nearly completed, and three Buffington-Crozier gun carriages had been received from the Ordnance Department but had not been assembled.<sup>21</sup>

The contractors by October 18 had completed the concrete work on Emplacements Nos. 2-4. Although the ammunition hoists and cranes were assembled during the month, they had not been positioned. As they had no further use for "the plant," Jacob Friday & Sons saw that their

---

20. Abbot to Wilson, Sept. 10, 1897, Monthly Reports of Operations, 1897-1917, Vol.1, 1897-1900 (RG 77, Entry 1143, Corps of Engineers, District of Charleston, Federal Records Center, East Point, Georgia), 13-14. Cited hereinafter as *MRO-Charleston*. During August, Friday & Sons had poured 3,456 cubic yards of concrete.

21. Stuart to Wilson, Oct. 9, 1897, found in *ibid.*, p. 46. Concrete poured in September totaled 1,401 cubic yards.

men made needed repairs before returning it to the United States on the 30th.<sup>22</sup>

In November 1897 a number of enlisted men assigned to the Fort Moultrie garrison, accompanied by a skilled ordnance inspector, reported to Maj. Ernest H. Ruffner, who had replaced Abbot as officer-in-charge of the Charleston Engineer District. Ruffner turned the artillerymen to bedding the anchor bolts for the shot cranes and positioning the cranes. A lighter load of blocking was brought around from Battery Capron to be used in mounting the three gun carriages. During the month, three 10-inch rifles were received from the Watervliet Arsenal of Watervliet, New York. When he inspected the guns and carriages, Ruffner found that all parts were on hand, except the distance rings, and elevating bands and arms.<sup>23</sup>

The artillerymen in December finished installing the shot lifts and cranes for Emplacements Nos. 2, 3, and 4. Work was done on the oak guides to the shot lifts, while some concrete was cut out "to set pockets for the stops on the shot lifts." A failure to receive the missing parts (distance rings, elevating bands, throttling bars and pistons, and rods) prevented the ordnance people from assembling the gun carriages.<sup>24</sup>

---

22. Ruffner to Wilson, Nov. 14, 1897, found in *ibid.*, p. 76.

23. Ruffner to Wilson, Dec. 10, 1897, found in *ibid.*, p. 97.

24. Ruffner to Wilson, Jan. 10, 1898, found in *ibid.*, p. 115.

The crisis that resulted in United States-Spanish relations following the destruction of the battleship *Maine* in February 1898 caused the army--although the Ordnance Department had not yet supplied the missing parts for the 10-inch rifles--to mount the guns in Emplacements Nos. 2-4.<sup>25</sup>

---

25. Ruffner to Wilson, April 16, 1898, found in *ibid.*, p. 164.

C. Sanford, Brooks & Bonsal Build Emplacement No.1

On August 14, 1897, bids were invited by Captain Abbot for the construction of Gun Emplacement No.1 for the 10-inch Battery. Necessary authority to solicit proposals for this project had been previously granted by the Secretary of War. Captain Abbot on September 9 opened and abstracted the four bids received for the emplacement, and found that Sanford, Brooks & Bonsal of Baltimore had submitted a low proposal of \$66,612. (See Appendix B for Abstract of the Proposals for Construction of Emplacement No. 1.) Although their bid was "somewhat informal its acceptance was recommended" to Chief Engineer Wilson.<sup>1</sup>

General Wilson on November 16 allotted \$65,000 from the appropriation for "Gun and Mortar Batteries, Act of March 3, 1897, to construct the emplacement for Gun No. 1." Of this sum \$62,500 was to be budgeted for work contracted to Sanford, Brooks & Bonsal, and \$2,500 for engineering and supervision. Having secured Chief Engineer Wilson's sanction of the contract, Major Ruffner on November 2 turned "the plant" over to the Baltimore builders. By the end of the month, the contractors had "the plant" positioned and were ready to begin work.<sup>2</sup>

---

1. Abbot to Wilson, Sept. 10, 1897, *MRO-Charleston, 1, 14*; Rept. of Chief Engineer, Sept. 29, 1898, found in *Annual Reports of the War Department for the Fiscal Year Ended June 30, 1898* (Washington, 1898), I, 698-699.

2. Ruffner to Wilson, Nov. 10 and Dec. 10, 1897, found in *MRO-Charleston, 1, 76, 98*. Major Ruffner had reported as Major Abbot's replacement as District Engineer in October 1897.

December was unusually mild, even for the Charleston area, and the contractors were able to pour about one-third of the Emplacement No.1 concrete work. In the month Sanford, Brooks & Bonsal had handled:

<u>Material</u>	<u>Measurements</u>	<u>Quantity</u>
Sand hill sand in bins	cubic yards	1,514
Pon Pon gravel	cubic yards	86
Crushed stone	short tons	2,221
Large stone	short tons	1,822
I-beams & iron	long tons	11.49
Corrugated iron	pounds	3,900
Cast iron column	number	6
Rose Dale Cement	barrels	3,822
Concrete poured	cubic yards	2,817

The gun carriage to be mounted in the emplacement arrived from the Ordnance Depot and was uncrated.<sup>3</sup>

The contractors by January 31, 1898, were able to report that about 72 percent of the concrete work had been finished, and the base ring set. In January they had received:

<u>Material</u>	<u>Measurements</u>	<u>Quantity</u>
Sand hill sand in bins	cubic yards	1,324
Pon Pon Gravel	cubic yards	152
Crushed stone	short tons	3,560
Large stone	short tons	1,306
Rose Dale Cement	barrels	4,764
Portland Cement	barrels	263
Steel rails	long tons	2.90
I-beams	long tons	10.82
Rivets, 55-pound & 16 steel anchor bolts	long tons	0.02
Brass pipe	pounds	275
Sand fill	cubic yards	500
Concrete	cubic yards	3,646 <sup>4</sup>

3. Ruffner to Wilson, Jan. 10, 1898, found in *ibid.*, p. 116.

4. Ruffner to Wilson, Feb. 10, 1898, found in *ibid.*, p. 134.

Sanford, Brooks & Bonsal during February were able to complete placing the concrete for Emplacement No.1, except for a little work on the seawall. Still to be done was the sand filling, drains, shot-lifts, cranes, doors, and other minor details. During the month the contractors used in the construction of the emplacement:

<u>Material</u>	<u>Measurement</u>	<u>Quantity</u>
Sand in fill	cubic yards	2,000
Sand in bins	cubic yards	712
Concrete placed	cubic yards	2,264
Rose Dale Cement	barrels	2,752
Portland Cement	barrels	511
Large stone	short tons	1,427
Crushed stone	long tons	1,208
Base rings set		1
Steel rails used	pounds	510
Double doors (small) hung		4
Cast iron columns		6
Brass pipe, 3-inch	pounds	311 5

Workmen employed by the contractors by March 23 had completed Emplacement No.1 except for "some detail of work on ammunition hoists, doors, and steps." The threat of war with Spain over the destruction of *Maine*, along with the passage of an appropriation bill for "National Defense" compelled Major Ruffner at this time to ask the contractors to surrender "the plant" to the United States. With all the heavy construction completed, this was not calculated to postpone the date the emplacement would be ready to be turned over to the United States Army. Up till now no work had been done on the outlet drain.

---

5. Ruffner to Wilson, March 10, 1898, found in *ibid.*, p. 147.



Materials for which the contractors were to be paid for in  
 March were:

<u>Material</u>	<u>Measurement</u>	<u>Quantity</u>
Sand in fill	cubic yards	5,488
Concrete placed	cubic yards	376
Fertile earth sodded	cubic yards	658
Rose Dale Cement	barrels	671
Portland Cement	barrels	5
Large stone	short tons	142
Crushed stone	long tons	352
Drain covers, placed	feet	202
Iron steps, 4 feet wide	number	21
Iron steps, 4 feet 6 inches wide	number	10
Iron steps, 6 feet wide	number	4
Iron landing, complete	number	1
Small doors, hung	number	5
Trolley system, complete	cubic yards	1
Pon Pon gravel	cubic yards	66 <sup>6</sup>

Sanford, Brooks & Bonsal in April removed their equipment and "the plant" from the site, the construction portion of their contract having been fulfilled on March 23. War having been declared against Spain on April 21 and with Vice Admiral Pascal Cervera y Topete's fleet at sea, the army turned out a large fatigue party to arm the emplacement. On visiting Sullivan's Island at the end of April, Major Ruffner saw that the gun and carriage had been mounted, and that, except for the drain and lighting, Emplacement No.1 was ready for final

---

6. Ruffner to Wilson, April 16, 1898, found in *ibid.*, p. 164.

inspection. By the end of May, the drain was completed, except for its outer end, and specifications for the lighting plant had been prepared and forwarded to Washington to be reviewed and approved by Chief of Engineers Wilson.<sup>7</sup>

On April 8, 1898, Army Headquarters, on learning that Emplacement No.1 had been completed, issued General Order No. 17 designating the four-gun battery "Battery Sergeant Jasper," in honor of the hero of the Revolutionary War battle of Sullivan's Island. Fifteen days later, General Order No.23 was published shortening the name to that of "Battery Jasper."

---

7. Ruffner to Wilson, May 10 and June 25, 1898, found in *ibid.*, pp.186, 215-216. Six hundred and ten feet of 15-inch terra-cotta drain pipe was put down by the contractors.

D. Battery Jasper's Heavy Ordnance

1. Positions and Numbers of Guns and Carriages

The four 10-inch breech-loading rifles emplaced in Battery Jasper were: (a) one Model 1888, MI, No.33; and (b) three Model 1888, MII, Nos. 58, 60, and 62. All four had been founded at the Watervliet Arsenal.

These rifles were mounted on four 10-inch Disappearing Carriages, Model 1896. The carriages manufactured by the Bethlehem Iron Co., were numbered 24, 25, 26, and 30.

The guns and carriages were mounted as follows:

<u>Emplacement</u>	<u>Rifle</u>	<u>Carriage</u>
No.1	33	30
No.2	58	26
No.3	60	24
No.4	62	25

Battery Jasper was turned over by the Corps of Engineers to the artillery on May 4, 1898.<sup>1</sup>

2. Description and Dimensions of the 10-Inch Rifle, Model 1888

The 10-inch Breech-Loading Rifle was composed of one tube, one jacket, nine C hoops, four D hoops, seven A hoops, seven B hoops, one

---

1. Report of Defenses of the South Carolina Coast by Capt. G. P. Howell, Oct. 10, 1903. *Ltrs. & Rpts. Sent, 1901-1903*, pp. 421-423.

filling ring, one copper calking ring, four coupling pins and caps, and the various parts of the breech mechanism. The tube, jacket, and trunnion hoops were of Whitworth steel, the remaining parts of American steel.

The principal dimensions of the rifle were:

Diameter of bore across lands	inches	10.00
Number of grooves and lands each	do	60.00
Width of lands	do	0.150
Width of grooves	do	0.3736
Depth of grooves	do	0.06
Diameter of powder chamber,	do	11.80
Length of powder chamber, breech closed	do	53.50
Volume of powder chamber	cubic inches	7,043.81
Length of rifle bore	inches	241.967
Thickness of tube over powder chamber	do	3.20
Thickness of jacket over powder chamber	do	4.90
Thickness of A hoops over powder chamber	do	2.525
Thickness of B hoops over powder chamber	do	3.10
Total thickness of wall over powder chamber	do	13.725
Diameter at bottom of thread in breech recess	do	14.50
Diameter at top of thread in block	do	14.46
Height of thread on block	do	0.334
Pitch of thread on block	do	0.900
Length of thread in breech recess	do	14.775
Number of threaded and slotted sectors each	no.	4
Exterior diameter of gun over reinforcement	inches	39.25
Distance between faces of rim bases	do	42.00
Diameter of trunnions	do	12.00
Total length of tube	do	327.00
Length of jacket on tube	do	120.80
Total length of jacket	do	137.00
Total length of C hoops	do	206.25
Total length of D hoops	do	83.75
Total length of A hoops	do	138.75
Total length of B hoops	do	119.75
Length of gun, axis of trunnions to breech	do	115.50
Length of gun, axis of trunnions to muzzle	do	231.75
Total length of gun, over all, breech closed	do	347.25
Weight of gun complete	pounds	64,928
Breech preponderance at 30 inches from rear face of breech	do	406

The rifling was a semi-cubic parabola, increasing one turn in 25 calibers at 20 inches from the muzzle; one turn in 50 calibers at breech; uniform, one turn in 25 calibers from a point 20 inches from muzzle, to the muzzle.<sup>2</sup>

The weight of the projectile was 571 pounds, and the powder charge varied from 175 to 255 pounds, depending on the range desired. With a charge of 175 pounds of powder, the projectile had a muzzle velocity of 1,592 feet per second, and with a charge of 255 pounds its velocity was increased to 1,953 feet per second.<sup>3</sup>

### 3. Area Commanded by Battery Jasper

The guns of Battery Jasper commanded the channel into Charleston Harbor through the jetties, but only Gun No.4 could be registered on the ship channel over Charleston Bar.<sup>4</sup>

### 4. Description of 10-Inch Disappearing Carriage

The first serious attempt to provide a disappearing carriage for service in the United States was made at the suggestion of Capt. William R. King of the Corps of Engineers. The carriage designed by King was of the counterpoise type. The chassis was inclined to the

---

2. *Report of the Secretary of War: Being Part of the Message and Documents Communicated to the Two Houses of Congress at the Beginning of the 2d Session of the 51st Congress* (Washington, 1890), 3, 241-249.

3. *Ibid.*, p. 21.

4. Sanford to Gillespie, June 22, 1901, *Ltrs. & Rpts. Sent, 1901-1903*, pp. 75-79.

rear, and while the gun and top carriage recoiled down the incline a counterweight was lifted in a well under the front portion of the carriage, the top carriage and counterweight being connected by means of ropes passing over a fixed pulley between the front ends of the chassis rails.

This carriage was adapted to the 15-inch Rodman shell gun, but it failed to come into general use. Difficulty was encountered in applying King's principles of construction to mounts for "modern high-powered steel rifles," so Capt. Adelbert R. Buffington submitted a counterpoise design. This design was subsequently modified by Capt. William Crozier. The original design was without hydraulic cylinders, which constituted the principal feature of Captain Crozier's modification. The counterpoise was well under the front portion of the carriage. Two parallel levers were mounted on a horizontal axis, which was journaled or trunnioned in the top carriage. The 10-inch rifle was mounted on the upper ends of the levers and the counterweight was attached to the lower ends. The top carriage carried the cylinders, and the ends of the piston rods were attached to the front of the chassis. During the recoil the top carriage moved to the rear and the counterweight rose, while the trunnions of the gun described ellipses in passing to the leading position. The rifle was sufficiently over-counterpoised to enable it to return to its firing position.

The elevating device was of the Elswick design, and the gun recoiled directly to the loading position irrespective of the angle at which it was fired.<sup>5</sup> (Copies of plans of the Model 1896 Carriage [Buffington-Crozier] accompany this report).

---

5. *Report of the Secretary of War: Being Part of the Message and Documents Communicated to the Two Houses of Congress at the Beginning of the 2d Session of the 53d Congress* (Washington, 1893), 3, "Report of the Chief of Ordnance," 637, 638-639.

E. Artesian Well

As the only drinking water available on Sullivan's Island was rain water trapped in cisterns, a project was programmed for drilling of an artesian well. The low bidder of the four firms submitting proposals was E. F. Joyce of St. Augustine, Florida, and his contract was approved by General Wilson on December 26, 1896.<sup>1</sup>

Experience had demonstrated that in the Sullivan's Island area there were three artesian strata. The first stratum lay at a depth of between 400 and 500 feet, and the water was "generally heavily charged with carbonate of soda and not potable." At a depth of between 1,200 and 1,300 feet there was a layer of water-bearing rock which produced a small flow of water of exceptional purity, while at a little over 2,000 feet there was a plentiful supply of good drinking water. Joyce's contract was worded to permit the United States to issue a work stop order at the 1,200- or 2,000-foot levels, depending upon the volume and quality of water found at the 400-foot level.<sup>2</sup>

Joyce moved on to the site with his equipment in late January 1897, and by the 31st he had drilled and cased with 12-inch pipe to a depth of 50 feet. By the end of February, 12-inch casing was down to

---

1. *Report--Abbot & Stuart*, pp. 696, 697, 698. Bids on the well were submitted by W. H. Gray & Bro., Morris Drilling Co., Chapman Bros., and E. F. Joyce. Joyce had bid \$3,120 on a well of 500-foot depth and \$6,295 on a well with a depth of 1,300 feet.

2. *Ibid.*, p. 696.



58 feet; 10-inch casing to 110 feet; and the drilling to 200 feet. On April 30 Captain Abbot visited Sullivan's Island and found that Joyce had reached a depth of 410 feet, which had been cased to 397 feet with eight-inch pipe. At the 400-foot level, the anticipated water-bearing stratum was penetrated, but "there was not sufficient head to flow, and the water was not potable." At Fort Sumter this stratum had given a flow, but the water had not been palatable, even though it had been perhaps potable.<sup>3</sup>

In May, Joyce brought in a new engine and boiler, and received additional eight-inch casing. This casing was driven to 409 feet and 9 inches, where it was stopped by very hard rock. Drilling was continued to 700 feet, where it was halted, awaiting a supply of six-inch casing, as the hole caved so badly that drilling could not be continued. Upon the receipt of the shipment of the desired casing, the hole was cased to a depth of 765 feet by the end of Fiscal Year 1897.<sup>4</sup>

Joyce's well-drilling crew in August drove 36 feet of six-inch casing, thus casing the well to a depth of 984 feet and 6 inches. Lack of progress during the month was attributed by the drillers to the quicksand stratum encountered.<sup>5</sup> In September, 36 feet 11 inches of casing were driven and the well cased to 1,025 feet, before Joyce's

---

3. Ibid., pp. 696-697. The artesian well is located about ten yards north of the northwest corner of Battery Jasper.

4. Ibid., p. 697.

5. Abbot to Wilson, Sept. 10, 1897, *MRO-Charleston*, 1, 13-14.

creditors had the sheriff of Charleston County attach his equipment for non-payment of debts. Joyce was able to satisfy their liens by the 30th and his plant was released.<sup>6</sup> Resuming drilling, Joyce by the end of October had reached a depth of 1,116 feet 2 inches.<sup>7</sup> In November the well was cased to 1,158 1/2 feet with four-inch casing. Major Ruffner fumed on learning that Joyce had again been compelled to suspend operations, while awaiting a shipment of three-inch casing.<sup>8</sup> Although Ruffner complained and threatened, Joyce remained shut down in December, because of his inability to purchase any casing of the desired diameter on the Charleston market.<sup>9</sup> In January he finally succeeded in obtaining enough 3-inch casing to enable him to reach a depth of 1,201 feet 9 inches.<sup>10</sup>

In February 1898 the drillers attained a depth of 1,238 feet and put down 36 feet 3 inches of 3-inch casing. A small flow of water was obtained, but it was insufficient to answer the contract requirements.<sup>11</sup> Joyce in March lost his sand pump in the hole and spent most of the month fishing for it. A steam pump was positioned on the 31st.

---

6. Stuart to Wilson, Oct. 9, 1897, found in *ibid.*, p. 46.

7. Ruffner to Wilson, Nov. 10, 1897, found in *ibid.*, p. 76.

8. Ruffner to Wilson, Dec. 10, 1897, found in *ibid.*, p. 98.

9. Ruffner to Wilson, Jan. 10, 1898, found in *ibid.*, p. 116.

10. Ruffner to Wilson, Feb. 10, 1898, found in *ibid.*, p. 135.

11. Ruffner to Wilson, March 10, 1898, found in *ibid.*, p. 148.

Major Ruffner trusted that the drillers by forcing water down the casing might be able to flush out quicksand that was retarding operations.<sup>12</sup>

In April no work was done on the well, as a flow of between two and three gallons of water per minute had been secured.<sup>13</sup> Although the undertaking was a disappointment "as to the quantity and quality of water," the artesian well was declared completed to the depth required by contract on May 8.<sup>14</sup>

In Fiscal Year 1900 some work was done on the engine to the electric-light plant, and piping was laid to connect it directly with the well.<sup>15</sup>

---

12. Ruffner to Wilson, April 16, 1898, found in *ibid.*, p. 163.

13. Ruffner to Wilson, May 10, 1898, found in *ibid.*, p. 186.

14. Ruffner to Wilson, June 25, 1898, found in *ibid.*, p. 215; Report--Ruffner, found in *Annual Reports of War Dept. for Fiscal Year 1898*; p. 699. The well had been drilled and cased to a depth of 1,308 feet.

15. *Report of the Chief Engineer--Fiscal Year 1900*, p. 912.

F. Electric-Lighting Plant

Major Ruffner in May 1898 prepared and forwarded to the Chief Engineer for review and approval plans and specifications for an electric-lighting plant for Battery Jasper.<sup>1</sup> This structure had not been provided for in the plans as submitted by Captain Abbot in 1896. As soon as he was notified that the drawings had been approved by General Wilson's office, Major Ruffner invited proposals. The four bids received were opened on August 1, 1898, and the project was awarded to the New Jersey Foundry and Machine Company of New York City, whose alternate proposal of \$5,542 was low.<sup>2</sup>

While waiting for the contractor to begin construction of the lighting plant, Major Ruffner had his people drill holes through the concrete of the emplacement for wiring.<sup>3</sup> Because of unforeseen delays it was mid-November before the contractor was able to assemble his equipment and materials on Sullivan's Island. It was December 5 before installation was commenced. By the end of the month, the engine and dynamo were positioned, along with the backing strips. The storage battery (Willard type) was set up but not yet filled with fluid. Major Ruffner, on visiting the island, found that the engineroom was so small

---

1. Ruffner to Wilson, June 25, 1898, found in *MRO-Charleston*, 1, 216.

2. *Annual Reports of the War Department for the Fiscal Year Ended June 30, 1899. Report of the Chief of Engineers* (Washington, 1899), I, 860; *MRO-Charleston*, 1, 304. The unsuccessful bidders were: General Electric Co. and New York Finance and Construction Co.

3. *MRO-Charleston*, 1, 304, 334.

that it would be impossible to use the water tanks belonging to the oil engine. Instead, a circulating pump was attached to the engine.<sup>4</sup>

Personnel of the New Jersey Foundry and Machine Co. in February 1899 completed the electric-lighting plant. Major Ruffner, however, delayed acceptance until late March, while tests were being made of the plant's capabilities.<sup>5</sup>

Capt. G. P. Howell, who was serving as Chief Engineer of the Charleston District, reported in 1903 on the "sufficiency" of the Battery Jasper electric plant to provide current for night lights. On checking the plant, he found there was a nine kilowatt generator and storage battery of 80 ampere capacity. Assuming that two guns would be retracted simultaneously and that five and one-half kilowatts were needed to light the emplacements, the power currently available was insufficient. On making measurements, he found that the plant was not large enough to house another generator. To secure the additional power needed, it would be necessary to construct a new building. Howell estimated the cost of his improvement at:

One 12 Kilowatt Generator .	\$2,500
One Boiler for Generator	600
One Storage Battery--120 ampere	5,400
One Brick Power House--40 feet by 30 feet by 10 feet--divided into three rooms	2,500
Superintendence and contingencies	2,000
	<hr/>
	\$13,000

---

4. Ibid., 434; *Annual Reports of the War Department for the Fiscal Year Ended June 30, 1899. Report of the Chief of Engineers, I*, 860.

5. *MRO-Charleston*, 1, 463, 498, 526.

In evaluating this information, the Chief Engineer was reminded to take into consideration that power for the ammunition hoists should be included, as they "consumed about as much current as the motors for maneuvering carriages." These motors were of five horsepower.<sup>6</sup>

Five years passed before the Chief Engineer was able to budget funds to implement Howell's report. By this time, it had been determined to increase still further the power capacity needed to operate the facilities in Batteries Jasper and Logan requiring electricity. In November 1908 an allotment of \$3,600 was made from the Appropriation Act of May 27, 1908, for rewiring Batteries Jasper and Capron, and for the transfer of the old generator from Battery Jasper to Battery Capron.<sup>7</sup>

In July 1909 a team of electricians began rewiring the battery. Some cutting of concrete was required to position the new terminal boxes. The battery by the end of August had been rewired.<sup>8</sup> Work had already been commenced on the new power house, a brick structure--24 feet by 16 feet by 16 feet--for which \$1,800 had been allotted. (Copies of the wiring plan and drawings of the new power house accompany this

---

6. Howell to Gillespie, June 13, 1903, *Ltrs & Rpts. Sent, 1901-1903*, pp. 161-165. The new plant would also provide power for Battery Logan.

7. *MRO-Charleston*, 5, 503.

8. *Ibid.*, p. 830.

report.) A strike by the bricklayers in August slowed the contractor.<sup>9</sup> Nevertheless, the power house by September 30, except for the fitting of doors and windows, was finished.<sup>10</sup> During the next two months, the power house was closed in, the interior whitewashed, water introduced, and the structure wired. The old engine was transferred to Battery Capron and a new Hornsby-Akroyd engine installed.<sup>11</sup> In March 1910 the power house was turned over to the artillery, and in May a 25 kilowatt, General Electric, Gasoline Actuated Generator was installed. The switchboard of the old power plant was removed in July and stored. The battery commander at this time complained to the Engineers that the Westinghouse Voltmeter and Ammeter received with the Hornsby-Akroyd gasoline engine were faulty, and they were returned to the manufacturer.<sup>12</sup>

In November niches for the controller boxes were completed.<sup>13</sup> Pressure gauges were installed in the circulating water pipe of the 25 kilowatt General Electric generator in May 1911. Minor repairs to the generator in November were needed, and it was dismantled and overhauled.<sup>14</sup>

---

9. Ibid., pp. 830, 873. The site for the power house had been selected on July 3, and work commenced immediately with the excavation for a foundation.

10. Ibid., p. 917.

11. *MRO-Charleston*, 6, 8, 50. Plans of the new power house were prepared and forwarded to the Chief Engineer in December. Ibid., p. 91. A copy of these accompany this report.

12. Ibid., pp. 214, 298, 400.

13. Ibid., p. 520.

14. Ibid., pp. 671, 845.

A lead-covered cable was laid in September 1912 connecting the panel board of Emplacement No.4 with Battery Logan. Nine lights and the ammunition hoist motor were led in on this cable and tested.<sup>15</sup>

In the fall of 1914 the battery was rewired in accordance with General Orders 1 and 68, War Department, 1913. The task of installing the terminal boxes and cables was undertaken by the Coast Artillery.<sup>16</sup>

---

15. *MRO-Charleston, 7, 310.*

16. *MRO-Charleston, 8, 247, 363.*



## G. Cisterns

On May 17, 1898, the Office of the Chief Engineer allotted to the Charleston District \$1,610 for the construction of two cisterns for Battery Jasper, each to contain 30,000 gallons of water.<sup>1</sup> The proposals were opened on June 18, and the contract awarded to Jacob Friday & Sons, with the United States to provide the materials.<sup>2</sup>

Construction on the cisterns was begun in July, and by the end of August the eastern cistern had been completed, except the guttering. The excavation for the western cistern was finished by the same date. By the end of September the two cisterns had been completed, inspected by Major Ruffner, and accepted by the government.<sup>3</sup>

In Fiscal Year 1900 the concrete gutters on Battery Jasper's superior slope--designed to collect water and conduct it to the cisterns--were repaired.<sup>4</sup> Additional work was done on these gutters in December 1900,<sup>5</sup> and in the following March the pipe leading to the well was repaired.<sup>6</sup>

---

1. *Annual Reports of the War Department for the Fiscal Year Ended June 30, 1899. Report of the Chief Engineer* (Washington, 1899), I, 861.

2. *Ibid.*; Ruffner to Wilson, July 1898, found in *MRO-Charleston, 1*, 246-275.

3. *MRO-Charleston, 1*, 304, 334.

4. *Annual Reports of the War Department for the Fiscal Year Ended June 30, 1900; Report of the Chief of Engineers* (Washington, 1900), I, 912; *MRO-Charleston, 2*, 17.

5. *MRO-Charleston, 2*, 98.

6. *Ibid.*, p. 213.

It was September 1906 before anything beyond routine maintenance was required. At that time the covers on the cisterns were removed and replaced.<sup>7</sup> October saw a crew removing the sand hill which had been building up at the west end of the battery, and dumping the sand around the nearby cistern. Care was taken by the workers to slope the sand between the concrete sidewalk and the main drain.<sup>8</sup>

---

7. *MRO-Charleston*, 4, 760.

8. *Ibid.*, p. 793.

## H. Magazines and Shellrooms

### 1. Magazines

Heavy rains in the spring of 1899 revealed a number of leaks to the battery commander. These leaks were especially troublesome in the three emplacements built by Jacob Friday & Sons. Although the ones in certain sections of the work could be tolerated, those in the magazines could not. In March and April an unsuccessful effort was made to stop the leaks in the magazines by filling cracks--which had opened as the work settled--with asphalt. Next, Major Ruffner tried a Portland cement grout, which gave some promise of success.<sup>1</sup> But by August the leaks were as bad as before. Major Ruffner now tried linseed oil, which was poured into the "division plane seams." In Emplacement No.2 there was no improvement following this treatment, but in Emplacements Nos.3 and 4 there appeared to be "some diminution in the leakage," notwithstanding the unseasonably heavy rains which pelted the area in late August.<sup>2</sup>

In September, to cope with this situation, a large number of holes were drilled in the superior slope of Emplacement No.2, along the division planes south and east of the magazine, and into these about 20 gallons of linseed oil were poured. This oil percolated down into

---

1. *MRO-Charleston*, 1, 535, 569.

2. *Ibid.*, p. 663.

the seepage areas. A number of holes were then cut along the division plane south of the magazine for Gun No.4, and the linseed oil treatment instituted. The officer in charge of Battery Jasper now told Ruffner that the leakage of water into Magazines Nos.3 and 4 had been reduced.<sup>3</sup> Satisfied that he had the seepage under control, Ruffner had the holes that had been cut into the division planes refilled with cement mortar.<sup>4</sup> In August 1900 a report that No.3 Magazine still leaked called for another treatment of the seams with hot asphalt.<sup>5</sup>

Captain Hamilton Rowan, the post commander, on July 6, 1901, complained that the "condition of the magazines" remained as heretofore. There was a "great deal of dampness" caused by the seepage through the walls. The steady drip in No.3 compelled the use of catch buckets. Sand had been used on the floors of the magazines, and the battery commander had reported a "marked abatement of moisture." As sand was not an absorbent, Rowan attributed this to the sand being very hot when spread, thus providing a radiation effect.<sup>6</sup>

---

3. Ibid., p. 696.

4. *Annual Reports of the War Department for the Fiscal Year Ended June 30, 1900. Report of the Chief of Engineers* (Washington, 1900), I, 912.

5. *MRO-Charleston*, 1, 977.

6. Rowan to AGO, Dept. of the East, July 6, 1901, Letters and Reports Sent, 1901-1903, District of Charleston, Record Group 77, p. 99. Cited hereinafter as *Ltrs. & Repts. Sent, 1901-1903*. The records of the Charleston Engineer District for the period 1872-1917 are on file at the Federal Records Center, East Point, Georgia.

Capt. J. C. Sanford (who had replaced Ruffner as District Engineer), in accordance with a request by Captain Rowan, inspected the Battery Jasper magazines on August 21. As there had always been some dampness in them, he reported it unlikely that "any work that could be done at reasonable cost would give any great degree of relief." He found that the dampness was largely caused by "rain falling on the platforms and slopes of the battery making its way through the concrete into the magazines." It was too late to correct this situation by "suitable waterproof coverings over the magazines." The attempts to seal the cracks in the concrete with asphalt and linseed oil had met with little success.

The magazines, he found, were "not sufficiently dry for storage magazines," and could probably never be made so. In their present condition, they could answer for service magazines, provided no ammunition was allowed to remain in them for long periods.<sup>7</sup>

Nothing had been done to correct this situation by February 27, 1902, when Brig. Gen. Peter Hains visited Sullivan's Island. It had not rained for several weeks, so he found the magazines "fairly dry." He found the battery provided with lifts for supplying the 10-inch rifles with ammunition, but he learned from battery commander Capt. A. F. Curtis<sup>8</sup>

---

7. Sanford to Gillespie, Aug. 1, 1901, found in *ibid.*, p. 104. Brig. Gen. Gillespie had succeeded General Wilson as Chief Engineer.

8. Hains to Gillespie, Feb. 27, 1902, found in *ibid.*, pp. 266-267.

that estimates had been prepared for replacing the lifts with chain hoists.

Captain Sanford on July 27, 1902, asked for \$1,800 to reline the magazines with interior brick walls.<sup>9</sup> In response to a request from General Gillespie that he use magnesia lumber to reline the magazines, Sanford reported that as there was less leakage in Magazine No.1, he would like to experiment with it there. In the subject powder room there was as much condensation "as in any other room of . . . the battery," but the overhead seepage was less. Provisions had been made for an "inner roof of corrugated iron in each of the powder magazines, and \$450 had been budgeted from the allotment for 'Preservation and Repair of Fortifications' for each of the four powder magazines in the battery." Sanford was of the opinion that the "inner roof of corrugated iron" could be dispensed with in Magazine No.1, as the magnesia lumber to be used for the ceiling with a backing of sheet copper or yellow metal would be sufficient waterproofing.

The cost of waterproofing Magazine No.1 was estimated at:

864 square feet, magnesia lumber, at 15¢ per sq. ft. . .	\$129.60
Applying 864 square feet of magnesia lumber at 10¢ . .	86.40
50 pounds of copper & brass fastenings at 40¢ pr. lb. . .	20.00
350 pounds of yellow metal, at 18¢ per pound . . . . .	63.00
2 metal workers, 15 days, at \$3 and \$2 per day . . . . .	75.00
6 laborers, 20 days, at \$1 per day . . . . .	120.00
120 pounds of Z-bars at 5¢ per pound . . . . .	6.00
300 pounds flats, 2 inches wide, 3/8 inches thick, @ 5¢/lb.	15.00
	<u>\$515.00</u> <sup>10</sup>

---

9. Sanford to Gillespie, July 21, 1902, found in *ibid.*

10. Sanford to Gillespie, Sept. 9, 1902, found in *ibid.*, 351. The

Capt. G. D. Howell on April 14, 1903, informed General Gillespie that with the funds previously allotted, all of the magazines at Battery Jasper were being "furnished with corrugated iron ceilings." One of these (No.3) would be lined with magnesia lumber, and a second with cork board. As yet, scant progress had been made, because of difficulties in securing magnesia lumber.<sup>11</sup>

In late April materials for damp-proofing the magazines were received. Gutters were cut in the sidewalls of Magazines Nos.2 and 3. A corrugated iron ceiling was installed in Magazine No.3, while plugs were placed for holding the magnesia lumber in No.1. Magazine No.3 was kept at a temperature of between 88 and 90 degrees for 12 hours a day, for 16 days, to get the walls dry enough to receive magnesia lumber. Z-bars were placed against the ceiling of Magazine No.2 for the corrugated iron to rest on. Gutters were cut in the side-walls of Magazine No.1 and I-beams placed in the middle of the ceiling. Cracks in the battery's superior slope were "cut out" and boiled linseed oil and asphalt poured in.<sup>12</sup>

---

magnesia lumber was to be 3/8-inch thick and in sheets of 36 inches by 48 inches. Allen to Keasby & Mattison Co., Jan. 2, 1903, found in *ibid.*, p. 474.

11. Howell to Gillespie, April 14, 1903, found in *ibid.*, p. 60. Captain Howell had replaced Captain Sanford as District Engineer.

12. *MRO-Charleston*, 3, 97.

The construction crew in May sheeted the sidewalls of Magazine No.3 with magnesia lumber, while Nos.1 and 2 were readied to receive their corrugated iron ceilings. Meanwhile, other workmen had applied two coats of linseed oil to the battery's superior slope.<sup>13</sup>

In June the corrugated iron ceiling in Magazine No.3 was taken down and replaced by one on "an improved plan." Orders were now received from the Chief Engineer to line Magazine No.4 with wood,<sup>14</sup> so July found carpenters carrying out this assignment. After the sides of No.4 were lined with wood, a wooden ceiling was installed, with a backing of yellow metal. Except for the lighting fixtures this magazine was completed by July 31. In Magazine No.2 the ventilators and wooden ceiling were placed and sheeted with yellow metal.<sup>15</sup> The ceiling in this magazine was rested against temporary supports until such time as a cork backing could be positioned. Wooden strips had been placed on the sidewalls to hold the cork boards, but an attempt "to place this material had failed." A letter was accordingly forwarded to the Chief Engineer requesting information on "the proper method of doing this work." In Magazine No.3 a small drain had been cut in the floor, while ventilators had been cut in Magazines Nos.1, 2, and 4.<sup>16</sup>

---

13. Ibid., p. 160

14. Ibid., pp. 203-204.

15. Ibid., pp. 280- 332.

16. Ibid., p. 332. The waterproof cement supplied to the Charleston



The proper cement was soon received, and the lining of the magazines completed. As there were no further complaints from the battery commanders about seepages, Captain Howell was delighted with his efforts. (A copy of the plans for sheeting the Magazines with magnesia lumber accompany this report.)

In January 1907, steel doors were ordered for the main entrance and magazine.<sup>17</sup> The doors were received in June and stored. Workmen in July and August found time to remove the four old wooden doors at the main entrances to the battery, as well as the four magazine doors, likewise of wood, and replaced them with double steel doors. The new doors were then scraped and painted black.<sup>18</sup>

## 2. Shellrooms

At Battery Jasper it was recommended that each gun have storage for 100 projectiles. In September 1902 each explosive-shellroom could accommodate 80 projectiles, provided they were stacked three tiers

---

District by the Nonpareil Cork Manufacturing Co., had proved unsatisfactory, as the cork boards refused to adhere to the concrete walls of Magazine No.2. Allen to Nonpareil Cork Mfg. Co., Aug. 25, 1903, *Ltrs. & Rpts. Sent, 1901-1903.*

17. *MRO-Charleston, 4, 850.*

18. *MRO-Charleston, 5, 34, 64, 91, 118.* The brass and copper fixtures were salvaged from the doors, and the timber burned. *Ibid., p. 453.*

high. The solid-shotrooms, which were drier, were more commodious and could hold 97 projectiles, if stacked to a similar height. The shotrooms, however, were not as convenient to the ammunition-lifts, and the trolleys had at one point an "inconvenient" grade and curve.<sup>19</sup>

---

19. Sanford to Gillespie, Sept. 8, 1902, *Ltrs. & Rpts. Sent, 1901-1903*, pp. 348-349. The solid-shotrooms were open to the rear and convenient for receiving.

## I. Trolleys

Instructions were received in December 1900 from the Chief Engineer to replace the trolleys in Battery Jasper with ones having I-beam rails.<sup>1</sup> Before this could be accomplished, experiments were made with a brake for the trolleys, and part of the work of equipping the trolleys with brakes was done.<sup>2</sup> In September 1901 the trolleys were repaired.<sup>3</sup> But an inspection in September 1902 disclosed that the "working of the trolleys from the shotrooms to the hoists" was still unsatisfactory. The chief difficulty seemed to be in stepping down from a higher to a lower level "simultaneously with the effort to control the brake."<sup>4</sup>

District Engineer Howell in 1903 asked for funds "to change the system of trolley rails connecting the shot gallery and the hoist gallery, to avoid the down-grade of the trolley rail as now installed."<sup>5</sup>

---

1. *MRO-Charleston*, 2, 98

2. *Ibid.*, pp. 213, 351.

3. *Ibid.*, p. 488.

4. Russell to Sanford, Sept. 19, 1902, *Ltrs. & Rpts. Sent, 1901-1903*, p. 354.

5. Howell to Harrison, June 22, 1902, *Ltrs. & Rpts. Sent, 1901-1903*, p. 187.

It was May 1905 before the Chief Engineer was able to allot \$1,500 to "overcome the steep grade in the trolley line."<sup>6</sup>

In June 1905 proposals for supplying materials for a new trolley system were solicited, and in July some of the materials were purchased. It was October before the new rails and trolleys were received and stored, however. The mechanics in November installed the new trolley system, except the switches, hangers, and throws, in Emplacement No.1. In December the new trolley rail system in Emplacement No.1 was completed, and the trolleys in Emplacements Nos.2 and 3 readied, except the switches. January found the workmen adjusting the switches and throws in Emplacements Nos.2 and 3, and installing the trolleys in No.4. The trolley system was completed in March 1906, and the metal parts given a coat of Smith's Durable Metal Coating.<sup>7</sup>

Operations demonstrated that some adjustments were necessary. In September 1906, stops were placed on the switches of the trolleys in Emplacements Nos.3 and 4,<sup>8</sup> and in October stops and heavier hangers were fabricated and placed on the switches of Nos.1 and 2 trolleys.<sup>9</sup>

---

6. *MRO-Charleston*, 4, 219.

7. *Ibid.*, pp. 283, 423, 457, 491, 504, 540.

8. *Ibid.*, p. 760.

9. *Ibid.*, p. 793.

The shot trolley in No.3 shellroom was repaired in January of 1907,<sup>10</sup> but by July the entire system needed adjustment.<sup>11</sup> Over three years were to pass before the trolleys gave any more trouble. In March 1910 a mechanic was called in to fix the rail in No.2 Emplacement,<sup>12</sup> and in November to replace one of the trolley blocks.<sup>13</sup>

---

10. Ibid., p. 879.

11. *MRO-Charleston*, 5, 64.

12. *MRO-Charleston*, 6, 214

13. Ibid., p. 520

J. Ammunition Hoists

Lt. Edwin R. Stuart, Assistant Engineer for the Charleston District, in April 1901 was assigned by Captain Sanford to undertake a study aimed at "altering the ammunition hoists at Battery Jasper." He found that each of the four emplacements was provided with four elevators balanced in pairs, each pair operated by one winch. The projectile was taken upon the elevator on a truck; the truck and shot hoisted to the level of the loading platform; and an empty truck carried down the other elevator at the same time. The unequal loading of the two elevators made it essential that: (a) the platforms be locked in place at the upper and lower limits of travel; (b) that the truck be locked in place on the platform of the elevator at the same time that the platforms were unlocked to prevent the ascent of one and the descent of the other; (c) that the unloading or locking of each of the pair of platforms occur simultaneously; and (d) that such notification be given at the winch that the turning of the winch handle when the platforms are locked can be nothing short of gross carelessness on the part of the artillerist in charge of the winch.

He found that the hoists were unsatisfactory because: (a) the simultaneous unchocking of the truck and the locking of the platform and the reverse "is effected by a rack and pinion actuating a plunger at each end of the platform which in one position engages in the concrete at the side of the shaft, and when withdrawn, lies in the path of the wheels of the truck, preventing motion when the platform is not

locked";<sup>1</sup> (b) the locking and unlocking of the platforms was done independently by two men who could neither see nor communicate with each other, and only one of whom could be seen by the man at the winch; and (c) operating the winch while the platforms were locked resulted either in breaking the bracket hanger of the pulley, or pulling the wire rope from its socket, and in either case, disabling the hoist.<sup>2</sup>

The operation of the hoists could be improved by: (a) the installation of a Lockwood Device, providing for the simultaneous locking and unlocking of the platforms by the lever at the winch; (b) the use of a modified Lockwood Device; and (c) the substitution of a chain hoist for one of the double elevators at each emplacement.<sup>3</sup> The modification of the hoists by the different methods was estimated at: (a) the

---

1. Stuart to Sanford, April 30, 1901, *Ltrs. & Rpts. Sent, 1901-1903*, pp. 9-10. In theory this was correct, but in practice the plunger would stick in the guides, thus interfering with getting the trucks on and off while the guide castings were weak.

2. *Ibid.*, p. 10. The artillerist who controlled the winch was notified by shouting down the shaft that the platform was ready for lowering. This means of communication was so faulty that "in all cases of breakage resulting from operating the winch with the platform locked," the blame could not be fixed.

3. *Ibid.*, p. 11. The modified Lockwood Device constituted the installation of a chocking device that would, so long as the truck was not chocked in place on the platform, prevent the unlocking of the platform, and by the motion of chocking the truck, release the locking device, and at the same time give notice at the winch that the platform was ready to descend.

Lockwood Device, \$500; (b) Modified Lockwood Device, \$600; and (c) Chain Hoist, \$1,000. Stuart favored the Lockwood Device.<sup>4</sup>

Lieutenant Stuart by August 12, 1901, had completed a working model of "the modified Lockwood Device for the improvement of the ammunition hoists at Battery Jasper." Capts. Hamilton Rowan and A. F. Curtis had been present at tests of the model. The tests demonstrated that: (a) the truck was securely locked in place on the platform by the chock; (b) when the truck was chocked, the Lockwood Device was freed, and the lever could be thrown to unlock the platforms; (c) when the truck was unlocked, it was impossible to operate the lever unlocking the platform; (d) when the chock levers projected upward they did not permit the shot truck to be started on the platform, except when the arm engaged the Lockwood Device and prevented the platform being unlocked; and (e) when the index functioned properly it indicated at the winch whether the truck was chocked or unchocked.<sup>5</sup>

Rowan and Curtis expressed themselves as satisfied that the installation of the device proposed would greatly improve the hoists. Battery Commander Curtis voiced the opinion that it would prevent the occurrence of stoppages which had heretofore been the cause of numerous complaints.

---

4. Ibid., p. 11-13.

5. Stuart to Sanford, Aug. 12, 1901, *Ltrs. & Rpts. Sent, 1901-1903*, pp. 124-125. At the winch it was therefore possible to tell at a glance when all was in readiness to unlock the platforms for ascent and descent.



Sanford therefore recommended to Chief Engineer Gillespie that Lockwood Devices as modified by Lieutenant Stuart be installed throughout Battery Jasper. For budgetary guidance it was estimated that the cost of materials for positioning the device would be \$500 and for labor \$150.<sup>6</sup>

Captain Sanford on October 29, after further study, recommended to General Gillespie that at Battery Jasper the old hoists be removed and one chain hoist installed in each emplacement. These should be placed in "the present lift spaces nearest to the main entrance to the emplacement," as this would be convenient to the magazine and to the the shot- and shellrooms. This would permit a reduction in the length of the receiving tube from seven feet ten and one-half inches to six feet three inches, and in their width by one foot.

A considerable quantity of concrete would have to be removed and several I-beams cut into. It had been necessary to place the foot of the winch close to the wall and recesses had been provided for the men detailed to operate them. An extension of the loading platform, opposite the delivery table, would be necessary to have space sufficient for two trucks to pass. This extension would be similar in construction to the bracketed galleries built at the battery during the past

---

6. Stuart to Sanford and Sanford to Gillespie, Aug. 12, 1901, *Ltrs. & Rpts. Sent, 1901-1903*, pp. 123, 125. Blueprints of the modified Lockwood Device were forwarded by Sanford to the Chief Engineer. An allotment of \$500 had been made for improving the hoists in Battery Jasper.

winter. He estimated the cost of the installation of chain hoists per emplacement at Battery Jasper at:

Removing concrete	\$180.00
New concrete	85.00
Steel in gallery	84.87
Hoist	700.00
Installation of hoist	300.00
Work on gallery	130.00
Fitting beams in concrete	40.00
Changing trolleys	50.00
Removing present lifts	200.00
Contingencies	<u>355.13</u>
Total for one emplacement	<u>\$2,125.00</u>
Total for four emplacements	\$8,500.00 <sup>7</sup>

No action, however, was taken at this time on Captain Sanford's recommendations. On April 14, 1903, Sanford's successor, Captain Howell, notified Chief Engineer Gillespie that there were four of the "old type of platform lifts at Battery Jasper," and as they were unserviceable they should be replaced.<sup>8</sup>

In May 1904 an allotment of \$2,400 having been made, the Corps of Engineers began removing the old hoists from the battery. By June 30 the hoists had been received and stored, and the work of cutting out concrete for new chain hoists was 58 percent completed. July 31

---

7. Sanford to Gillespie, Oct. 29, 1901, *Ltrs. & Rpts. Sent, 1901-1903*, pp. 168-170.

8. Howell to Gillespie April 14, 1903, found in *ibid.*, p. 60.

found the cutting out project, except for the removal of the material for the base of the machines, finished. All told, 982.25 cubic feet of concrete had been removed. A number of small I-beams had been cut off and holes drilled for the anchor bolts. In August the cutting out was finished, all the ironwork above the loading platforms positioned, and the caseways placed at Emplacements Nos. 1 and 2. In September all concrete work was finished, chain hoists and tables set, and adjusted. The next month found all parts of the hoists secured, the locking devices on the delivery doors adjusted, and the hoists cleaned. An inspection in November demonstrated that the doors at the delivery tables must be altered. This was done at the same time as the truck guides were fashioned and placed at the delivery tables. The unused wells were cleaned preparatory to conversion into truck recesses. One hoist was given its final cleaning and oiled, while new cables were threaded in all shot cranes.<sup>9</sup>

The final weeks of 1904 found the construction people cleaning and testing the other three hoists, while preparations were made to place large I-beams over the receiving tables. The grooves in the sides of the hoist wells were filled, and rails were made and placed for all truck recesses. January saw the new chain hoists ready for

---

9. *MRO-Charleston*, 3, 781, 821, 856, 860, 931, 971. The allotment for the installation of the chain hoists was made from the appropriation of March 3, 1903

service, and the Corps of Engineers declared the project completed.<sup>10</sup>

(A copy of the plans of the chain hoists accompanies this report.)

In April 1905 several machanics were called in and "dressed off" the tops of the delivery tables to allow "free passage of the shells." Niches were cut in the walls to permit the removal of the winch cranks.<sup>11</sup>

In April 1906 the shot crane in rear of Emplacement No.3 was repaired; a cable was laid from the shot hoist in Emplacement No.1 to the switchboard in the power room, and controllers and rheostats placed and tested.<sup>12</sup> The electricians in January 1907 laid a cable connecting the ammunition hoist in Emplacement No.3 with the switchboard in the power room. At the same time, the lighting system for Nos.1 and 3 gun platforms was installed.<sup>13</sup>

In May 1907 niches were cut in the truck recesses of the hoists to admit trucks which had been fitted with longer loading trays,<sup>14</sup> and in September guides for the trucks were cut in the gun platforms.<sup>15</sup>

---

10. *MRO-Charleston*, 4, 66, 182.

11. *Ibid.*, p. 205.

12. *Ibid.*, p. 610.

13. *Ibid.*, p. 897.

14. *MRO-Charleston*, 5, 5.

15. *Ibid.*, p. 118.

Additional repairs were required, and in December 1908 two switches for operating the shot hoists were replaced.<sup>16</sup> June found a mechanic replacing the broken sprocket wheel to one of the hoists.<sup>17</sup> In July 1910 the friction clutches on the hoists were tested and found capable of supporting an increased weight of projectiles.<sup>18</sup>

---

16. Ibid., p. 573.

17. Ibid., p. 786.

18. *MRO-Charleston*, 6, 400.

K. Shot Cranes

In the spring of 1903 an inspecting officer complained that the handles of the shot cranes were "so arranged to function awkwardly," especially with respect to the double wooden doors to the shotrooms. By changing the gearing and substituting iron doors with a single leaf to the opening, this situation could be improved. It would cost about \$60 for each of the four doors, or \$240 for the battery. Implement racks could be secured for another \$200.<sup>1</sup> The Chief Engineer accordingly budgeted for Fiscal Year 1904 the requested sum, along with \$90 for speaking-tube name plates.<sup>2</sup>

In September the implement racks were received, and in the following month they were positioned.<sup>3</sup> It was April 1904 before steel doors for the shotrooms reached Sullivan's Island and were hung, replacing the old double wooden doors.<sup>4</sup>

The shot cranes worked efficiently, and it was February 1910 before a mechanic had to be called in to repair two of them.<sup>5</sup>

---

1. Howell to Gillespie, April 14, 1903, *Ltrs. & Rpts. Sent, 1901-1903*, p. 62.

2. Allen to Bunnel, undated, found in *ibid.*, pp. 218-219; Bunnel was the U. S. inspector, stationed at Moultrieville.

3. *MRO-Charleston*, 3, 383, 386. Captain Curtis in September 1902 had urged that the battery be supplied with implement hooks.

4. *Ibid.*, p. 734.

5. *MRO-Charleston*, 6, 174.

L. Bracketed Galleries

On October 15, 1900, an allotment of \$825 was made by the Chief Engineer from the appropriation for "Gun and Mortar Batteries," act of May 25, 1900, for the construction of galleries connecting the gun platforms of Battery Jasper.<sup>1</sup> In November, Captain Sanford prepared and forwarded to Washington for approval plans and specifications for the galleries.

The Chief Engineer's approval secured, work on the galleries' ironwork was started and far advanced by the end of December. Some holes had been drilled for the brackets, but because of the granite blocks embedded in the concrete progress was slowed. Bids had also been invited for the materials needed. In January the six brackets for one of the galleries were positioned and concreted, while the holes had been partially drilled for another. By February 28 most of the ironwork for the remaining brackets had been machined, as well as some of the work on the turnbuckles for the bridges. The remaining brackets were seated in March, and the trussed rails of one bridge positioned. Most of the shopwork on the remaining bridges had been done, before work was suspended as the original allotment had been exhausted.<sup>2</sup>

---

1. *Report of the Chief Engineer for Fiscal Year 1901*, I, 817; *MRO-Charleston*, 2, 53.

2. *MRO-Charleston*, 2, 79, 106, 133, 177, 209.

The Chief Engineer on learning that additional funds were needed to complete the Bracketed Galleries on March 23, 1901, allotted the project another \$300 from the appropriation for "Gun and Mortar Batteries," act of March 1, 1901.<sup>3</sup> Work was resumed in April, and by the end of the month the remaining bridges had been installed and the floors of the galleries finished. By the end of the fiscal year, with the positioning of the handrails at the rear of the gun platforms and the painting of the metal parts, the galleries were completed.<sup>4</sup>

---

3. *Report of the Chief Engineer for Fiscal Year 1901*, I, 818.

4. *MRO-Charleston*, 2, 256, 316, 347, 351.



M. Telephone Niches

Captain Howell in 1903 requested an allotment of \$825 to construct recessed telephone booths in the battery. At present, there were temporary wooden shelters for the battery telephones attached to the wall. These telephones were used for fire control.<sup>1</sup> It was two years later, before the Chief Engineer was able to budget \$825 for three telephone niches and one telephone booth.<sup>2</sup> The niches were to cost \$75 each.

Plans for the niches and booth were approved in July, and work commenced cutting the niches.<sup>3</sup> In August 1905 this phase of the construction was completed, and the niches plastered. Iron doors for the niches were received and stored in October. By the end of 1905 Captain Howell was able to report the doors fitted, the niches and booth completed, and the allotment exhausted.<sup>4</sup> New locks were installed<sup>5</sup> on the niche doors in January 1906, and in April an iron platform was erected at Niche No.1.<sup>6</sup>

---

1. Howell to Harrison, June 22, 1903, *Ltrs. & Rpts. Sent, 1901-1903*, p. 187.

2. *MRO-Charleston*, 4, 220: *Ltrs. & Rpts. Sent, 1901-1903*, p. 387.

3. *MRO-Charleston*, 4, 314.

4. *Ibid.*, pp. 350, 419, 453, 487.

5. *Ibid.*, p. 504.

6. *Ibid.*, p. 610.

In October 1907 four blackboards were built and placed in the telephone niches. The doors to the niches and booth were repaired and painted at the same time.<sup>7</sup> Eighteen months later the battery commander complained that the door of one of the niches scraped the concrete floor. The niche in Emplacement No.4 was accordingly "cut and fitted with a wooden casing and iron door."<sup>8</sup>

---

7. *MRO-Charleston*, 5, 144.

8. *Ibid.*, p. 714.

N. Landscaping

In January 1906 oleanders were planted in front and to the rear of Battery Jasper.<sup>1</sup> The following month saw the horticulturists setting out silver maple sprouts among the oleanders planted between the battery and seawall.<sup>2</sup>

A fatigue party in October 1906 removed the sand hill which had been building up near the west end of the battery. The sand was placed around the west cistern, making the ground slope between the sidewalk and the main drain continuous. A sand fence in this area, which had fallen into disrepair, was righted.<sup>3</sup> November found a crew covering the sand slope thrown up in rear of Battery Jasper, the previous month, with mud "to hold the sand and encourage the growth of grass." A roadway in rear of Batteries Jasper and Logan was graded, while a shell and mud roadway was opened from the west end of Battery Logan to Battery Jasper.<sup>4</sup>

The shrubbery around the battery was trimmed, and the sprouts transplanted in the intervening spaces.<sup>5</sup> With the coming of spring, 1907, the slopes in rear of the battery were planted with Bermuda grass roots. "Durable trees" were set out in the same area, where the oleanders were too scattered.<sup>6</sup>

---

1. *MRO-Charleston*, 4, 504.

2. *Ibid.*, p. 539

3. *Ibid.*, p. 793.

4. *Ibid.*, p. 822.

5. *Ibid.*

6. *Ibid.*, p. 935.

0. Battery Commander's Station

The Charleston Engineer District in January 1914 prepared estimates for the construction of a temporary Battery Commander's Station for target practice, and for the alterations this would require to Emplacements Nos. 2 and 3. It was proposed to widen the loading platforms and erect the 2-story station in rear of the traverse between Emplacements 2 and 3. The upper story of the Battery Commander's Station would serve as an observation post and the lower as a plotting room. Cost of labor and materials would be \$900.<sup>1</sup>

The approval of the Chief Engineer having been received, work on this project was commenced in February, with the enlargement of the platforms. By March 31 the station had been completed, except for the outside steps and boardwalk connecting the station with the gun platforms.<sup>2</sup> In April the Battery Commander's Station was completed and turned over to the Coast Artillery.<sup>3</sup>

In June 1915 the roof of the station was recovered with tarpaper,<sup>4</sup> and in October 1917 windows were cut in the plotting room.<sup>5</sup>

---

1. *MRO-Charleston*, 7, 925, 926.

2. *Ibid.*, p. 990; *MRO-Charleston*, 8, 2.

3. *MRO-Charleston*, 8, 40.

4. *Ibid.*, p. 686.

5. *MRO-Charleston*, 9, 713.

P. Latrine

The Chief Engineer allotted \$800 for the construction of a latrine in Fiscal Year 1916. Work was begun in September 1915, and by the 18th the concrete foundation had been completed, the under-floor planking positioned, and about 500 feet of six-inch sewer pipe laid. (Plans of the Battery Jasper Latrine accompany this report.) Water connections were made with the Battery Jasper main. Doors, windows, and frames had been nailed together by the carpenters and stored.<sup>1</sup> In October the latrine, except the interior plumbing and painting, was finished. The plumbing and painting would be done by post labor.<sup>2</sup> The post plumber made the necessary connections in November, but it was February 1916 before the painters were called in.<sup>3</sup> During January 1917 a concrete manhole was constructed in the sewer pipe line of the latrine.<sup>4</sup>

---

1. *MRO-Charleston*, 8, 806.

2. *Ibid.*, p. 863.

3. *MRO-Charleston*, 9, 70.

4. *Ibid.*, p. 433.

Q. General Maintenance

Battery Jasper by May 31, 1898, had been completed and was ready to be turned over to the artillery, although a few minor details needed attention.<sup>1</sup> In June the mouthpieces for the speaking tubes were received and installed, while minor repairs were made to the ammunition hoists.<sup>2</sup> The ammunition hoists continued to give trouble, and additional adjustments were made to them in July and August.<sup>3</sup> In February 1899, the ammunition hoist for Gun No.1 was dismantled and repaired.<sup>4</sup>

At the beginning of 1899, on the request of the battery commander, two ladders were put up leading from the platforms to the superior slope of the parapet. Some difficulty having been experienced with the drains, preparations were made for the repair of their outlets. During February and March, workmen in the employ of the District took up and relaid the drain tile between the two outer sumps. While a carpenter rebuilt one of the sumps, a box drain, 50 feet long with moveable top, was put down beyond the last sump. The box drain was held in place by square piles "pumped & driven into the sand to a depth of

- 
1. Ruffner to Wilson, June 25, 1898, found in *MRO-Charleston*, 1, 215.
  2. Ruffner to Wilson, July 1898, found in *ibid.*, pp. 245, 274.
  3. *MRO-Charleston*, 1, 304, 334.
  4. *Ibid.*, p. 508.

ten feet."<sup>5</sup> In April, 140 tons of rock were placed around the two most exposed sumps.<sup>6</sup>

The painters in April painted the I-beams.<sup>7</sup> Torrential rains in the late summer of 1899 proved an embarrassment to the Corps of Engineers, as the drains and gutters were unable to handle the run-off, and water ran into the battery under the doors. In the first months of 1900, to cope with this situation, the drainage holes that had been drilled through the concrete at the bottom of the lift-wells were filled with cement mortar; hoods of yellow metal were flashed in over the doors of the ammunition hoists and the entrance to the dynamo room; and grooves were cut over the outside doors of the battery.<sup>8</sup>

In August 1900 a crew was turned to leveling and grouting with Portland Cement the base rings in Emplacements Nos. 1, 3, and 4, and repairing the ammunition hoists.<sup>9</sup> The hoists continued to give trouble, and in October the bumpers were repaired, while some broken wire rope was replaced by new.<sup>10</sup> Satisfied that the hoists would never function

---

5. Ibid., pp. 463, 508, 535.

6. Ibid., p. 569.

7. Ibid.

8. Ibid., pp. 801, 827, 899; *Annual Reports of the War Department for the Fiscal Year Ended June 30, 1900. Report of the Chief of Engineers* (Washington, 1900), I, 912. In March several broken brackets were replaced.

10. *MRO-Charleston*, 2, 45, 72.

properly unless there were major alterations, Captain Sanford in December asked the Chief Engineer for permission to solicit proposals for "cast steel bracket hangers" for the "shot- and ammunition-lifts."<sup>11</sup>

Repairs were made in March 1901 to the drain, while the exhaust pipe of the oil engine was lengthened.<sup>12</sup> The painters during the spring painted the doors, stairways, ammunition hoists, and iron-work.

Battery Commander Curtis, when he inspected the emplacements, was distressed to see the sloppy manner in which "the iron beams, doors, lift guides, hand rails, and trolleys had been painted." The painters had smeared black paint over the floors, walls, ceilings, and platforms.<sup>13</sup>

Concrete steps were added where needed--in the entrances to the solid shotrooms--while gutters for the drainage of the gun platforms were cut.<sup>14</sup> In October 1901 the inner walls of the battery were given a coat of "white water" paint to provide better lighting.<sup>15</sup> December found a crew working on the drains. Several small drains were cut, and the

---

11. Ibid., pp. 98, 128.

12. Ibid., p. 213.

13. Ibid., pp. 261, 319, 393; Curtis to Adjutant General, May 31, 1901, *Ltrs. and Rpts. Sent, 1901-1903*, p. 55.

14. *MRO-Charleston*, 2, 261, 319.

15. Ibid., p. 519.



left hole in the drain covers was plugged." The drains on the superior slope of the battery were repaired with Portland cement.<sup>16</sup> In June and July 1902 Captain Sanford had a crew clean out the lower end of the drain, where they discovered and replaced a broken pipe. A load of rock was placed around the new pipe to protect and secure it.<sup>17</sup> Before the end of Fiscal Year 1902, several other maintenance projects were undertaken: (a) new mouthpieces for the speaking tubes were placed where needed; (b) the ammunition hoists were painted; (c) the oil engine was repaired; and (d) the gun platform rails were painted.<sup>18</sup>

On July 27, 1902, Captain Sanford requested that the Charleston Engineer District be allotted for Battery Jasper in Fiscal Year 1903: (a) \$566.40 to replace with gutters cut in the concrete "the present gutters which rest in an earth cover" ( the subject gutters being useless whenever the big 10-inch rifles were fired); (b) \$1,800 for the construction of a new outlet drain to the backbeach with six manholes; ~~and~~ (c) \$588 to build an outlet drain from Battery Logan into the Battery Jasper drain.<sup>19</sup> The Chief Engineer was agreeable, and the

---

16. Ibid., p. 608.

17. Ibid., pp. 939, 969.

18. Ibid., pp. 488, 706.

19. Sanford to Gillespie, July 27, 1902, *Ltrs. & Rpts. Sent, 1901-1903*.

necessary funds were made available. By June 30, 1903, the drains and gutters had been constructed.<sup>20</sup>

In June the artillerists were turned to removing sand that had drifted against the doors at the west end of the battery. To prevent a recurrence a sand fence was erected in this area.<sup>21</sup> Two months later, the sump at the west end of the battery was raised to keep out the drifting sand.<sup>22</sup> In January 1904 the Charleston Engineer District was called on to repair broken steps at Emplacement No.2 and to repair the gutters on the superior slope.<sup>23</sup>

The Chief of Engineers in July 1904 made several allotments for projects at Battery Jasper. Among these were: (a) \$350 for water-proofing the loading platforms; (b) \$175 for hand-railings; and (c) \$205 for painting the exposed concrete surfaces.<sup>24</sup> Several weeks later, Captain Howell of the Charleston District was notified by the Chief Engineer that under the appropriation act of March 3, 1903, \$1,200 had been budgeted for a concrete walk at Battery Jasper.<sup>25</sup>

---

20. *MRO-Charleston*, 3, 49. About 60 feet of the west end of the Battery Jasper drain were covered with concrete and two small sumps installed.

21. *Ibid.*, p. 197.

22. *Ibid.*, p. 332.

23. *Ibid.*, p. 583.

24. *Ibid.*, p. 856.

25. *Ibid.*, p. 865.

In July a crew was hired and turned to making preparations to put in the walkway--the materials (gravel and sand) were received and stored, while some cutting out was done in rear of the battery. By September 30 the cutting out and excavating for the walkway had been completed, and 385 linear feet of concrete laid. Where necessary, several doors were cut off, and steps built. In October and November the slopes were graded, sodded and planted with grass, thus finishing the project and exhausting the allotment.<sup>26</sup>

The painters in December 1904 began applying oil and paint to the concrete walls of Battery Jasper, and by the end of January the task was declared completed.<sup>27</sup> In April the magazines, ceilings, and passages were painted.<sup>28</sup> With the beginning of a new fiscal year, the painters were again turned to. In August 1905 they painted the canopies and observation tower.<sup>29</sup>

Meanwhile, the Corps of Engineers--utilizing the \$350 allotted for waterproofing the loading platforms and \$175 for hand railings--took up and relaid the floor of No.2 armament room, and cleaned the vertical walls above the loading platforms. December found a crew applying two

---

26. Ibid., pp. 893, 941, 965; *MRO-Charleston*, 4, 3.

27. *MRO-Charleston*, 4, 66, 182. As the scarp wall was conspicuous from the seaward, it and the superior slope were tinted.

28. Ibid., p. 205.

29. Ibid., pp. 283, 385.

coats of Epure Asphalt to loading platforms Nos.1 and 2. Before the asphalt could be applied to the other two loading platforms, the weather turned cold and the work was suspended until March. Implement racks were finished and positioned on the hand railings in rear of the four 10-inch rifles; hand rails were made and placed near the head of the steps at each loading platform; and cracks in the division planes of the loading platforms were cut out and filled with elastic cement.<sup>30</sup>

In Fiscal Year 1906 a number of maintenance oriented projects were taken up. In July new shellroom doors were installed and V-drains were cut into the platforms to carry off water left standing after a rain.<sup>31</sup> The next month, the recess doors were repaired.<sup>32</sup> September found the plumbers piping water into the four emplacements.<sup>33</sup> In January the drainage system was flushed and cleaned, while two sets of rammer hooks were shaped and three concrete posts for instrument piers moulded.<sup>34</sup> A flagstaff was erected in March.<sup>35</sup>

Calls for funds for maintenance were held to a minimum in the Fiscal Year ending June 30, 1907. In October the sand fence at the west end of the battery was rebuilt, and the interior iron steps in Emplacement No.2 painted.<sup>36</sup> To get rid of the water which stood after a rain, drains were cut in the concrete walls above the doorways.<sup>37</sup>

---

30. Ibid., pp. 3, 10, 66, 102, 136, 171.

35. Ibid., p. 576

31. Ibid., p. 317.

33. Ibid., p. 390.

36. Ibid., p. 793

32. Ibid., pp. 353.

34. Ibid., p. 540.

37. Ibid., p. 822.

The next month found the maintenance people shaping and installing new covers for the drain pipes in rear of the battery. Guard rails were placed around the small platforms at the battery's main entrance.<sup>38</sup>

In August 1907 a man was detailed to repair a broken hand rail, and to replace several broken drain covers. The next month, a plumber was called in to fix a leaking hydrant.<sup>39</sup> April 1908 found a crew cutting out and replastering cracks in the battery walls.<sup>40</sup>

Workmen in September and October 1908 cut niches for ordnance terminal boxes in the battery.<sup>41</sup> In December, at the request of the battery commander, the wooden booths were removed from the parapet.<sup>42</sup> The command post behind the battery was repaired in February 1909, while two new range boards were placed in two of the emplacements.<sup>43</sup> In June hooks and range boards were placed in Emplacements Nos. 3 and 4, while the hand railings in Nos. 2 and 3 were repaired.<sup>44</sup> The plumbers in March 1910 were called in to stop a leak in a hydrant and the electricians to position 12 reflectors on the gun platforms.<sup>45</sup> In January 1911 the four sets of iron steps leading from the platforms to the galleries were replaced by concrete steps, while the three sets of iron steps (on the outside) were reinforced--where rusted through--by

---

38. Ibid., pp. 793, 850.

39. *MRO-Charleston*, 5, 91, 118.

40. Ibid., p. 318.

41. Ibid., pp. 492, 503.

42. Ibid., p. 573.

43. Ibid., p. 644.

44. Ibid., p. 786.

45. *MRO-Charleston*, 6, 214.

concrete.<sup>46</sup> A core-drilling plant was moved into position on May 8, and by the end of the month ventilating shafts had been drilled into three of the shellrooms, while the one into the fourth was one-half completed. The concrete cutting necessary to connect these shafts with the interiors of the shellroom was about 50 percent finished. This project was completed before the end of Fiscal Year 1911.<sup>47</sup>

In February 1912 the magazine doors were repaired and 16 grating doors hung.<sup>48</sup> Two months later, Yale & Towne locks were riveted on all the grated doors and shutters.<sup>49</sup>

Very little maintenance was required in the period 1912-1913. In December 1912 the drain covers were repaired. February of 1913 found the painters coating the inferior slope of the battery with a wash of lampblack and Portland cement. The back wall and roof of the powerhouse were painted in March and April, and in September the entire structure was given a coat of paint.<sup>50</sup>

In July 1914 the Charleston District was called on to see that repairs were made to the delivery tables, truck recesses, and the telephone niches at the battery.<sup>51</sup>

---

46. Ibid., p. 579.

47. Ibid., p. 711.

48. Ibid., p. 940.

49. *MRO-Charleston*, 7, 76.

50. Ibid., pp. 323, 460, 509, 564, 804.

51. *MRO-Charleston*, 8, 158.

March 1915 saw a crew removing the interior iron steps at Emplacement No.4 and replacing them with reinforced concrete steps. Fourteen speaking tube mouthpieces were installed to replace ones that had disappeared.<sup>52</sup> In May two new locks were requisitioned and fitted to the doors of the powerhouse, while a range finder was installed in the secondary station.<sup>53</sup>

In October 1917 two loading platforms were extended with wood.<sup>54</sup>

---

52. Ibid., p. 462.

53. Ibid., p. 561.

54. *MRO-Charleston*, 9, 713.

APPENDIX A

Abstract of Proposals for Furnishing Material and Constructing Three Emplacements for 10-Inch Rifle Battery

Material & Construction	[ A. M. Manigault & R. Holmes ]	John L. Grim	George W. Egan	Jacob Friday & Sons	Earle Sloane & Hasell Crouch	Stewart Construction	Gude & Walker
Large stone/short ton.	\$2.30	\$2.90	\$2.50	\$2.50	\$5.50	\$3.05	\$2.35
Broken stone/short ton.	2.25	2.80	9.95	2.50	5.35	3.30	2.45
Pon Pon gravel/cu.yd.	.75	.90	1.13	1.35	1.20	1.06	1.10
Sand-hill sand in bins /cu.yd.	.25	.30	.35	.35	.25	.40	.30
American Portland Cement/barrel.	3.25	2.40	2.60	2.35	2.70	2.66	3.00
American natural cement /barrel.	1.55	1.15	1.24	1.05	1.25	1.18	1.35
32 Anchor bolts/the lot	200.00	750.00	225.00	150.00	180.00	270.00	300.00
Steel I-beams,/long ton.	37.10	67.20	55.00	52.00	44.80	58.00	60.00
Corrugated iron/100 lbs.	3.33	4.50	5.00	3.50	3.00	4.68	4.00
Cast iron drain cover /linear foot.	.68	.75	.80	.75	.75	.85	.80
Iron stairways, 3 ft. wide per step.	10.70	8.25	12.00	10.35	10.35	14.79	11.00



APPENDIX A cont.

Iron Stairways, 4 ft. wide per step.	13.40	8.50	13.50	12.15	12.00	17.30	12.00
Iron Stairways, 4.5 ft. wide per step.	14.70	9.00	14.00	13.05	12.25	18.75	13.00
Iron Stairways, 6 ft. wide per step.	1.00	12.50	18.00	15.15	18.60	29.19	15.00
Iron Ladders,/linear ft.	1.00	1.25	1.25	1.25	1.10	.82	1.00
Small doors & hinges per doorway.	25.00	50.00	40.50	55.00	30.75	55.00	75.00
Large doors & hinges per doorway.	25.00	70.00	50.00	80.00	33.00	70.00	85.00
Brass pipe/lb.	.17	.40	.20	.20	.15	.50	.20
Trolley system/the lot.	400.00	950.00	700.00	365.00	600.00	2,000.00	400.00
Concrete mixing, in place/cu.yd.	3.05	1.65	1.43	1.60	4.35	1.17	1.40
Setting base rings/gun.	100.00	55.00	200.00	200.00	100.00	300.00	100.00
Sand embankment,in place /cu.yd.	.15	.25	.25	.25	.20	.30	.20
Excavation,"/cu.yd.	.15	.25	.25	.25	.20	.25	.18
Fertile earth,"/cu.yd.	.90	1.00	1.20	1.00	1.25	1.25	1.25
TOTAL AMOUNT OF BID	\$132,179.04	\$116,906.70	\$119,906.70	\$110,813.56	\$209,655.03	\$123,175.25	\$110,931.04

APPENDIX B

Abstract of Proposals for Furnishing Material and Constructing One Emplacement for 10-Inch Rifle Battery.

Furnishing Material → Constructing	[ Simons & Mayrant	Jacob Friday & Sons	Sanford Brooks & Bonsal	S. F. Leonard
Large stone, per ton.	\$2.50	\$2.25	\$2.25	\$2.45
Broken stone, per ton.	2.75	2.50	2.30	2.65
Pon Pon gravel, per cu.yd.	1.30	1.05	1.25	1.20
Sand in bins, per cu.yd.	.25	.40	.25	.97
American Portland Cement /barrel.	2.40	2.35	2.20	1.99
American natural cement /barrel.	1.40	1.05	1.00	.85
Anchor bolts (I) each.	100.00	75.00	100.00	115.65
Steel I-beams, per ton.	58.00	52.00	45.00	57.76
Corrugated iron per pound.	.05	.03 1/2	.04	.04 39/100
Drain cover, per linear ft.	.80	.75	.55	.80 75/100
Iron stairwars 4 ft. wide per step.	12.00	12.00	10.50	4.20
Iron stairways 4 1/2 ft. wide, per step.	12.75	13.00	11.00	4.68

APPENDIX B cont.

Iron stairways 6 ft. wide, per step.	16.00	15.00	13.50	6.30
Cast-iron column (6)/lot	125.00	90.00	125.00	280.41
Iron landings/job.	40.00	40.00	75.00	10.00
Small doors & hinges/ea.	63.00	55.00	50.00	27.32
Large doors & hinges/ea.	70.00	80.00	65.00	38.19
Brass pipe/lb.	.22	.20	.50	.40 35/100
Trolley system/job.	300.00	240.00	150.00	333.24
Ammunition hoist & cranes /lot.	1,500.00	1,600.00	1,700.00	935.00
Concrete mixing/cu.yd.	1.52	1.60	1.40	1.56
Setting base ring/ea.	300.00	200.00	150.00	60.00
Sand embankment /cu.yd.	.18	.25	.25	.60
Excavation/cu.yd.	.18	.25	.25	.40
Fertile earth/cu.yd.	1.00	1.00	.75	1.75
<b>TOTAL AMOUNT OF BID</b>	<b>\$78,705.50</b>	<b>\$70,969.50</b>	<b>\$66,612.80</b>	<b>\$73,196.79</b>

APPENDIX C

Money Statements--Battery Jasper--July 1, 1897

Plans for 10-Inch Rifle Emplacements

August 31, 1896, amount allotted . . . . .	\$500.00
June 30, 1897, amount expended during fiscal year . . . . .	500.00

Salaries and Office Expenses

December 11, 1896, amount allotted . . . . .	.9,500.00
June 30, 1897, amount expended during fiscal year . . . . .	3,629.01

July 1, 1897, balance unexpended . . . . .	.5,870.99
July 1, 1897, outstanding liabilities	825.00

July 1, 1897, balance available . . . . .	5,045.99
---	----------

Payments under Contracts

March 26, 1897, amount allotted . . . . .	\$150,000.00
June 30, 1897, amount expended during fiscal year . . . . .	55,971.23

July 1, 1897, balance unexpended . . . . .	94,028.77
July 1, 1897, outstanding liabilities . . . . .	33,621.27
July 1, 1897, amount covered by uncompleted contracts . . . . .	91,422.53

TOTAL	\$125,043.00
-------	--------------

APPENDIX D

Amounts and Dates of all Allotments for Battery Jasper

<u>Date of Act</u>	<u>Allotment</u>	<u>Amount</u>	<u>Remarks</u>
June 6, 1896	August 31, 1896	\$500	Plans & Drawings.
June 6, 1896	Dec. 1, 1896	9,500	Supervision.
March 3, 1897	March 26, 1897	150,000	Contract payments
March 3, 1897	Aug. 26, 1897	10,000	Contract payments
March 3, 1897	Nov. 16, 1897	65,000	Contract payments & Supervision
TOTAL		\$235,000	

## BIBLIOGRAPHY

### Primary Sources

#### Manuscript Materials

Letters and Reports Sent, 1901-1903, 2 vols., RG 77, Corps of Engineers, District of Charleston, Federal Records Center, East Point, Georgia.

Monthly Reports of Operations, 1897-1917, 9 vols., RG 77, Entry 1143, Corps of Engineers, District of Charleston, Federal Records Center, East Point, Georgia.

#### Published Documents

*Annual Report of the Secretary of War: Being a Part of The Message and Documents Communicated to the Two Houses of Congress at the Beginning of the Second Session of the Fifty-Fourth Congress,* 3 vols., Washington, 1896.

*Annual Reports of the War Department for the Fiscal Year Ended June 30, 1897, Report of the Chief of Engineers,* 2 vols., Washington, 1897.

*Annual Reports of the War Department for the Fiscal Year Ended June 30, 1898,* 3 vols., Washington, 1898.

*Annual Reports of the War Department for the Fiscal Year Ended June 30, 1899, Report of the Chief Engineer,* 3 vols., Washington, 1899.

*Annual Reports of the War Department for the Fiscal Year Ended June 30, 1900, Report of the Chief Engineer,* 2 vols., Washington, 1900.

*Report of the Secretary of War: Being Part of the Message and Documents Communicated to the Two Houses of Congress at the Beginning of the 2d Session of the 51st Congress,* 3 vols., Washington, 1890.

*Report of the Secretary of War: Being Part of the Message and Documents Communicated to the Two Houses of Congress at the Beginning of the 2d Session of the 53d Congress, 3 vols., Washington, 1893.*

Heitman, F B., *Historical Register of the United States Army from its Organization, September 29, 1789, to March 2, 1903, 2 vols., Washington, 1903.*

### Secondary Sources

#### Books

Lewis, Emanuel R., *American Seacoast Fortifications: A Developmental History, Privately Printed, 1968.*

Manucy, Albert, *Artillery Through the Ages: A Short Illustrated History of Cannon, Emphasizing Types Used in America, Washington, 1949.*

ILLUSTRATIONS



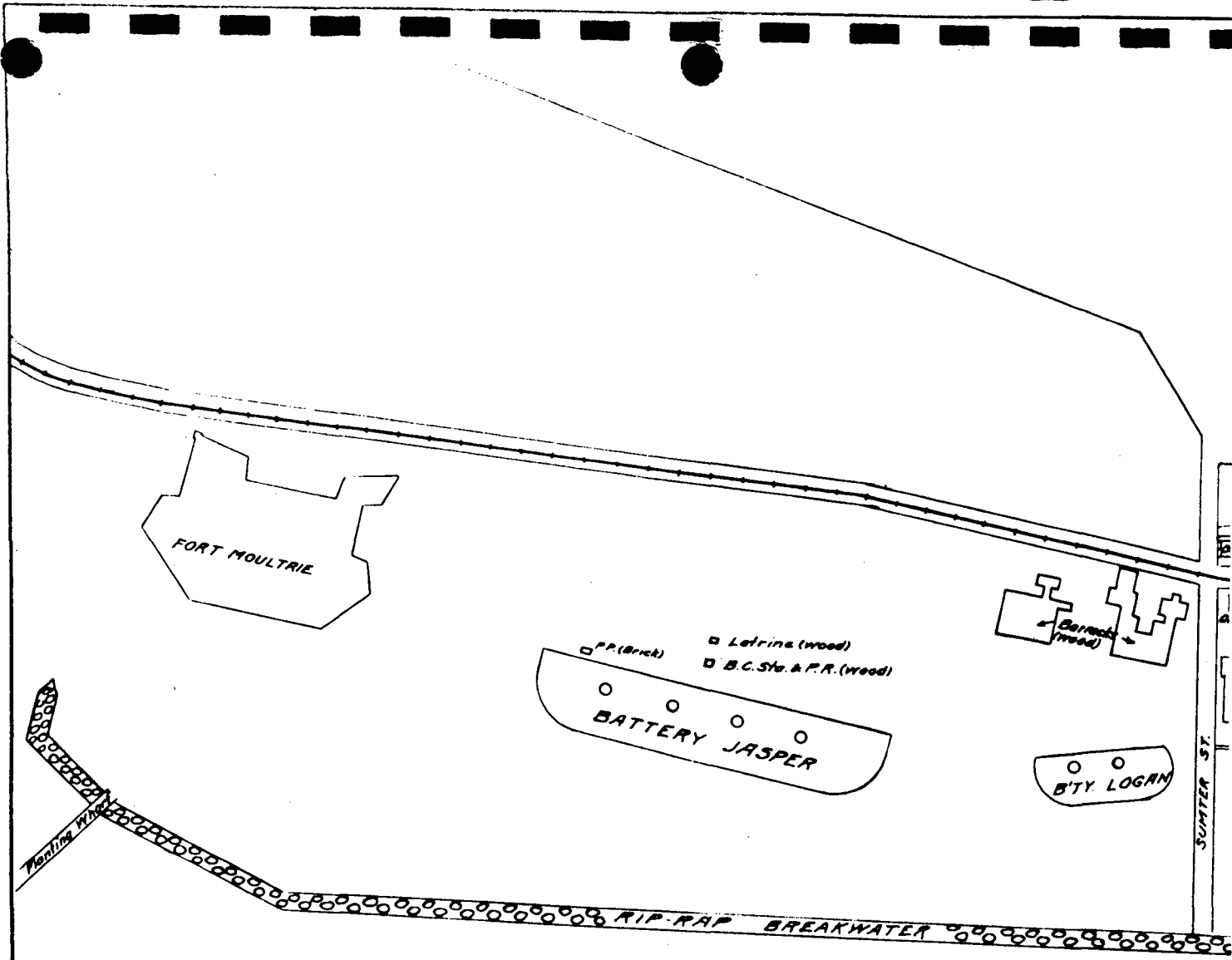
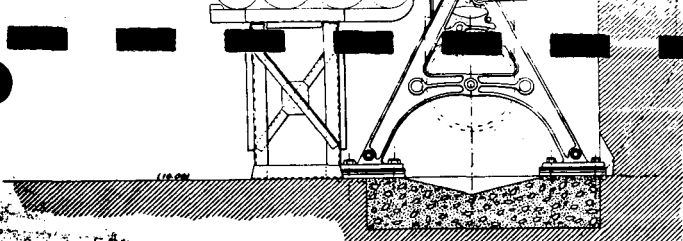
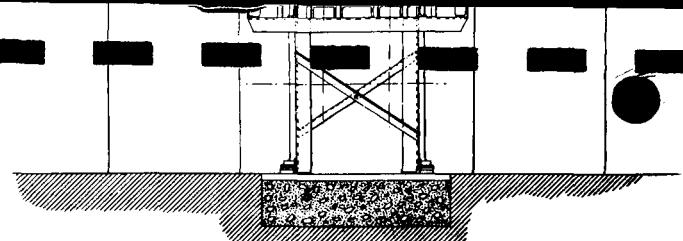

PLATE I



VERTICAL SECTION EF  
HOIST IN ELEVATION



VERTICAL SECTION CD  
HOIST IN ELEVATION

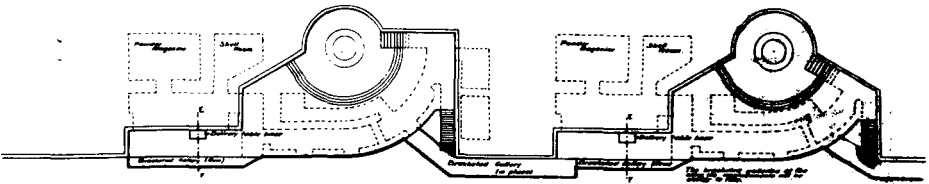

PLAN OF TWO EMBLEMMENTS  
SCALE 1/8"=1'

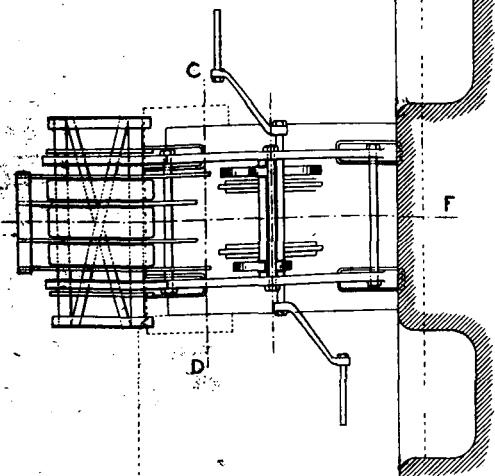

HORIZONTAL SECTION AT GH

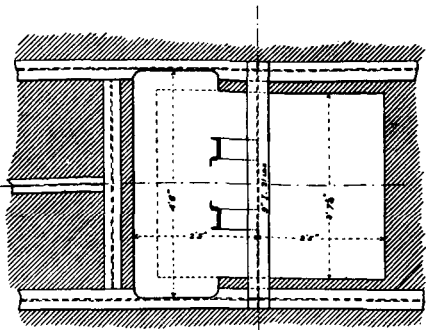

HORIZONTAL SECTION AB

PLAN  
FOR INSTALLING  
CHAIN AMMUNITION HOISTS

IN  
BATTERY JASPER

SULLIVAN ISLAND  
S.C.

SCALE 3/4"=1'

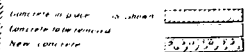

1577-1901  
Accompanying my report to the Chief of Engineers, U.S. Army

Captain

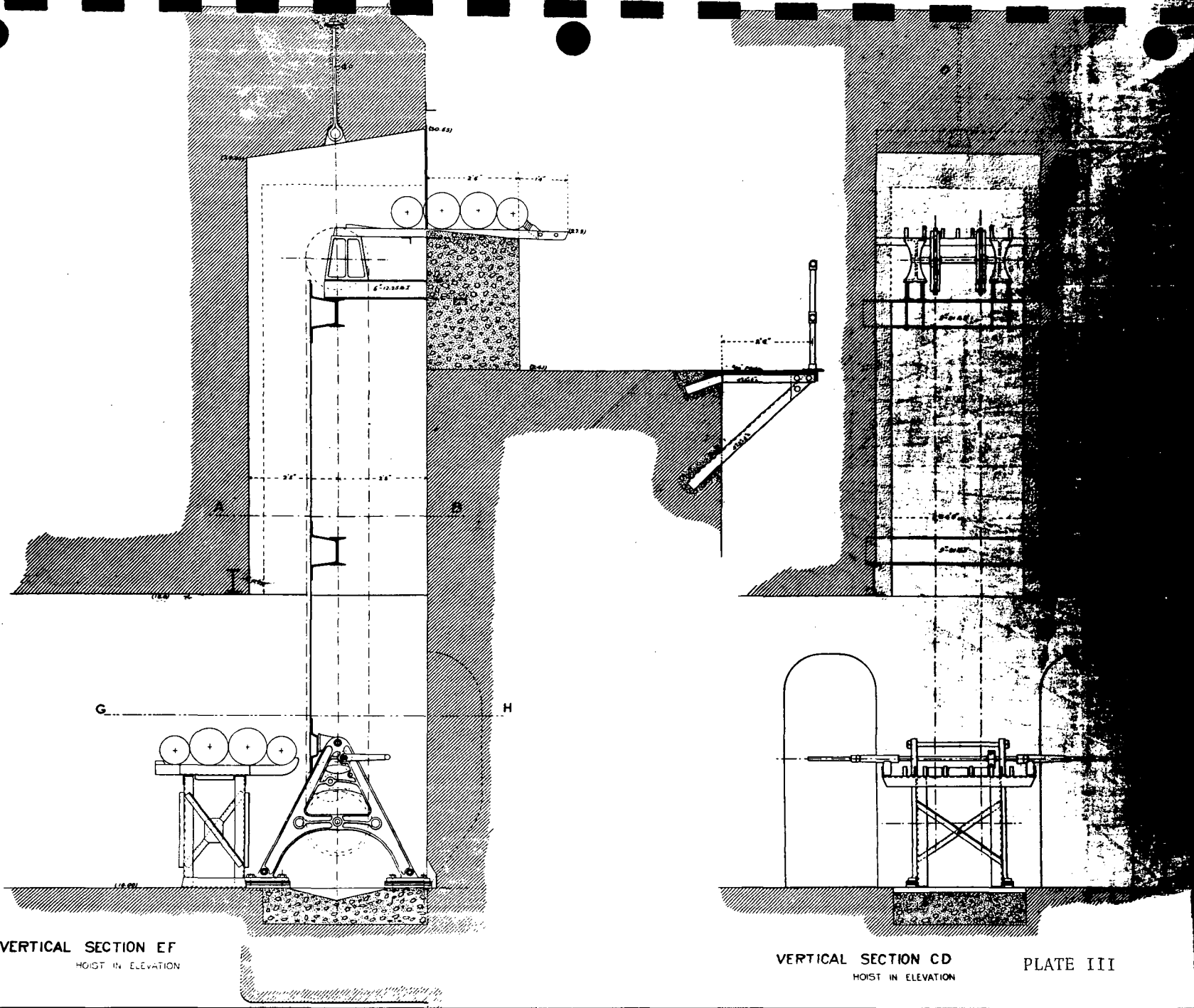

VERTICAL SECTION EF  
HOIST IN ELEVATION

VERTICAL SECTION CD  
HOIST IN ELEVATION

**FORT MOULTRIE  
CHARLESTON HARBOR S.C.**

**BATTERY JASPER**

*Sketch Showing Proposed Change in Storage  
of Solid Shot and Changes in Trolley Rails to  
Accomodate Same.*

Scale 1/4" = 1'-0"

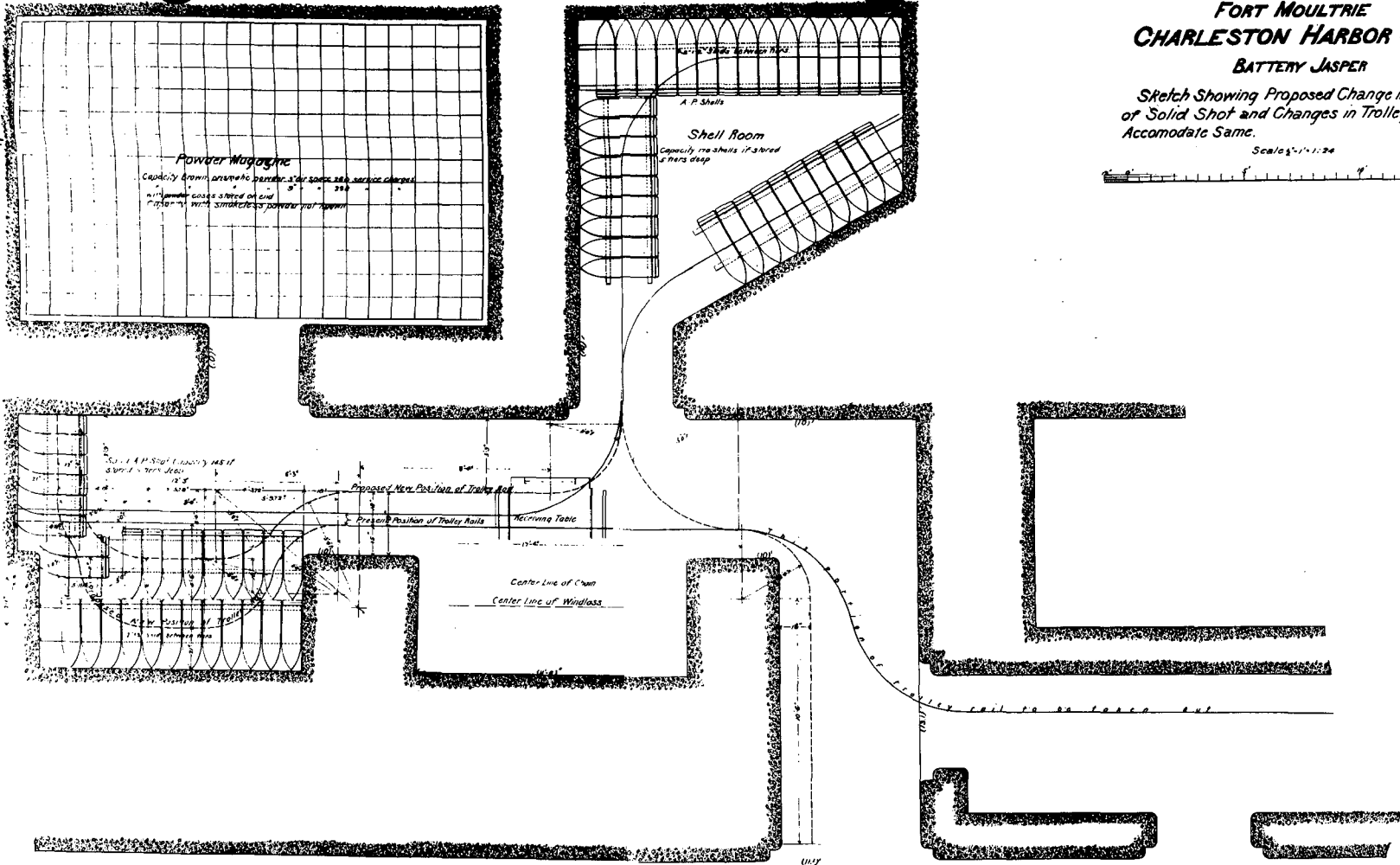
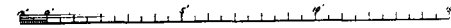

O.Craw

**PLATE IV**

U.S. Engineer Office  
Charleston, S.C.

Mar. 22, 1905.

Transmitted to the Chief of Engineers U.S.A. with letter of this date.

5 7 11

Captain, Corps of Engineers, U.S.A.

Designed & Drawn by W. W. ...

65-26-15

No. 65, S. 26  
24

WAR DEPARTMENT

CORPS OF ENGINEERS, U.S. ARMY

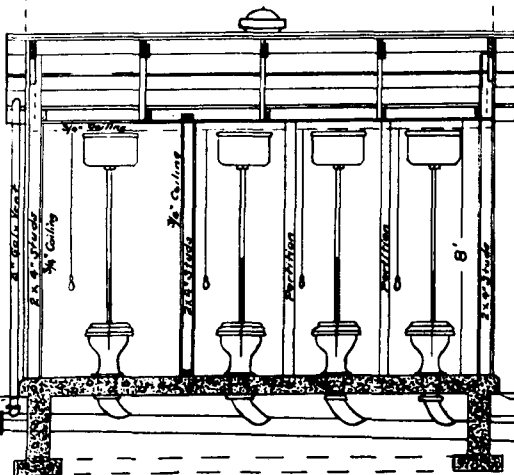
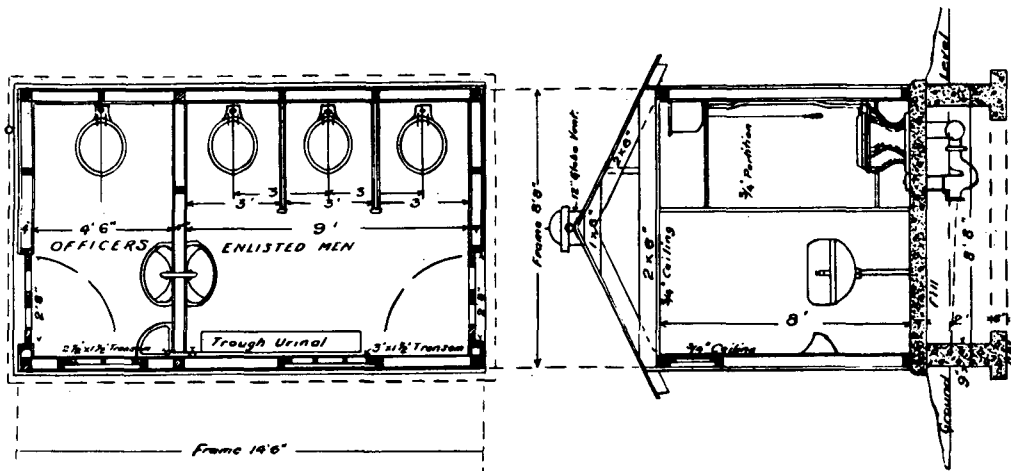

**BATTERY JASPER  
FT. MOULTRIE, S. C.  
PROPOSED LATRINE**

SCALE 1/4" = 1'  
April 1915 J. R. Inman.

U.S. Engineer Office,  
Charleston, S.C.  
To accompany drawing on E.D. 1116/73,  
dated May 27, 1915.

*J. R. Inman*  
Major Corps of Engineers, U.S. Army.

Office Chief of Engineers,  
U.S. Army.

May 27, 1915.

Submitted to the Secretary of War;  
approval recommended.

*W. A. H. ...*  
Chief of Engineers.

War Department,

June 1, 1915.

Approval recommended.

*W. A. H. ...*  
Chief of Coast Artillery.

War Department, June 2, 1915.  
Approved.

By order of the Secretary of War:

*J. E. ...*  
Major Gen. Chief of Staff.

# 10 IN. DISAPPEARING GUN BATTERY ON SULLIVAN ISLAND S. C.

Scale lin. = 20 feet



Note: Office Chief of Engineers  
Plane of Reference is M.W.  
See 1925.

- b Magazine
- c Storage Battery Rooms
- d Solid Shot
- e Relocating
- f Stair Rooms
- g Gun Pits
- h Ammunition Hoists
- i Latrine
- j Cranes
- k Lookout Station

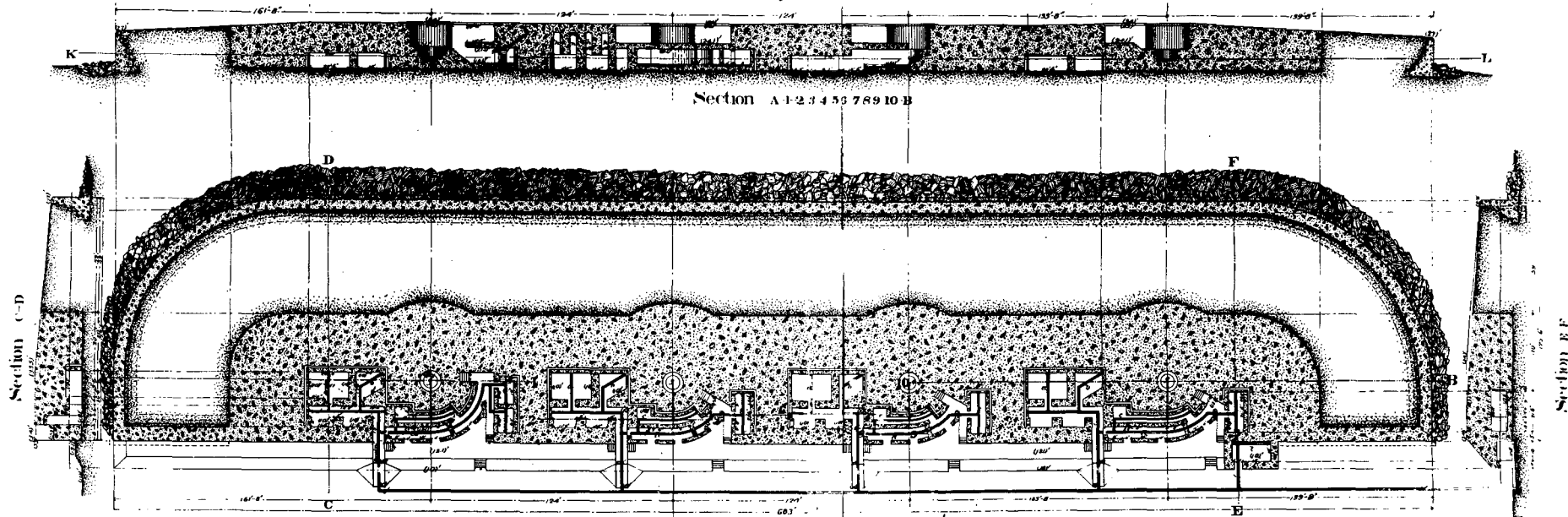

Horizontal Section at Reference (160')  
Section K L

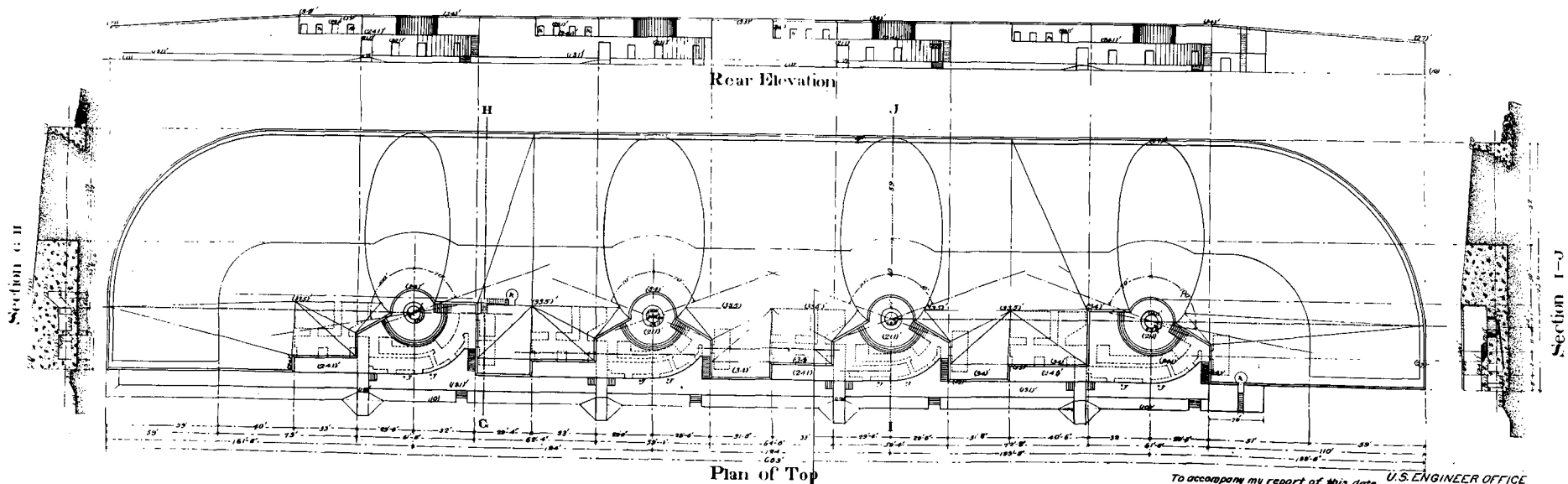

To accompany my report of this date  
*Thomas V. Allen*  
Captain Corps of Engineers U.S.A.

U.S. ENGINEER OFFICE  
CHARLESTON S.C.  
SEPT. 21-1896

PLATE VII

1896  
200000  
200000

Horizontal Section at Reference (161)  
Section K L

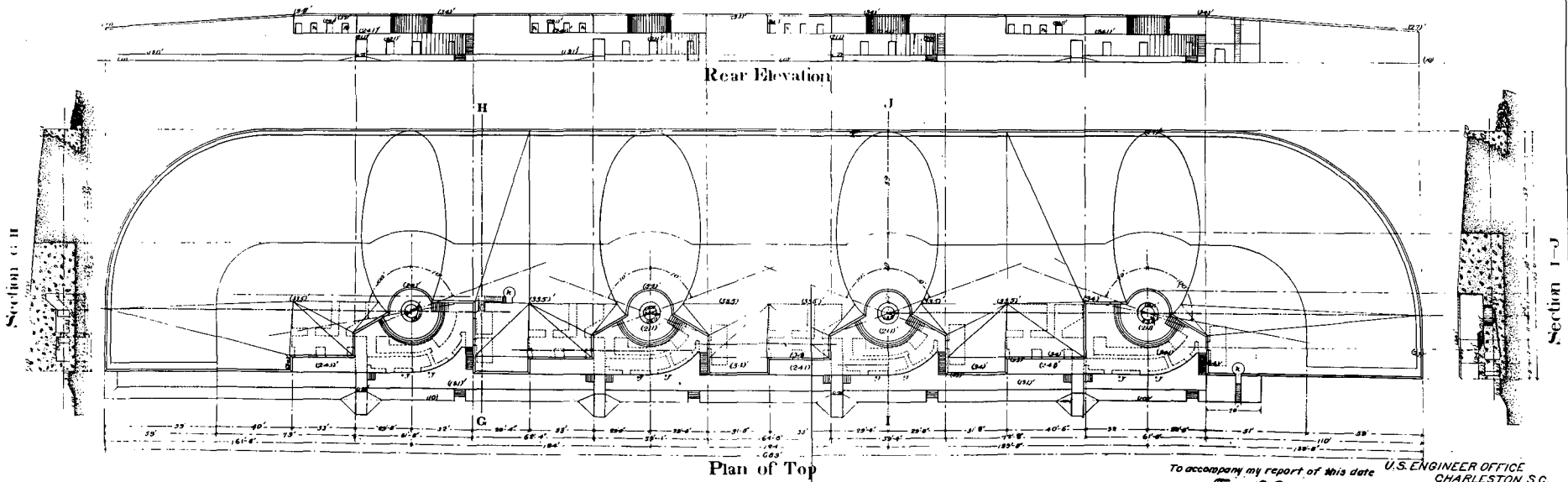

To accompany my report of this date  
 Thomas V. Allen  
 Captain Corps of Engineers U.S.A.

U.S. ENGINEER OFFICE  
 CHARLESTON S.C.  
 SEPT. 21-1896





PLATFORM PLAN



ROOF PLAN

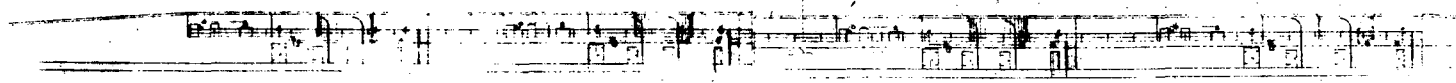

REAR ELEVATION

BATTERY JASPER  
ELECTRIC LIGHTING SYSTEM  
SCALE 1/8" = 1'-0"



*[Handwritten signature]*

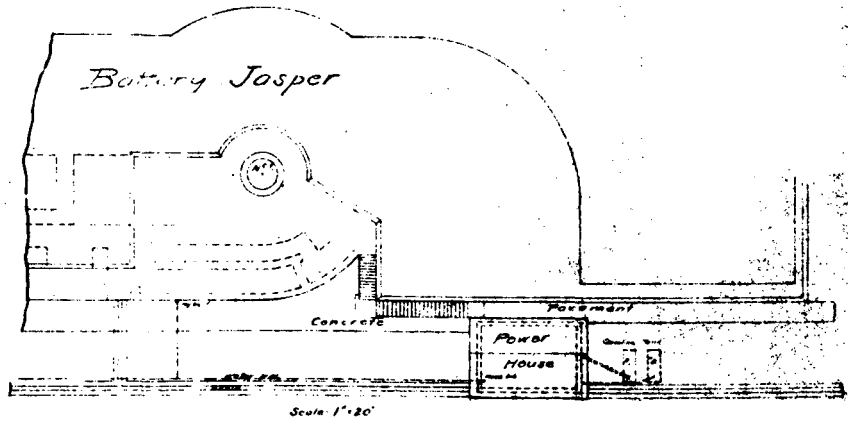
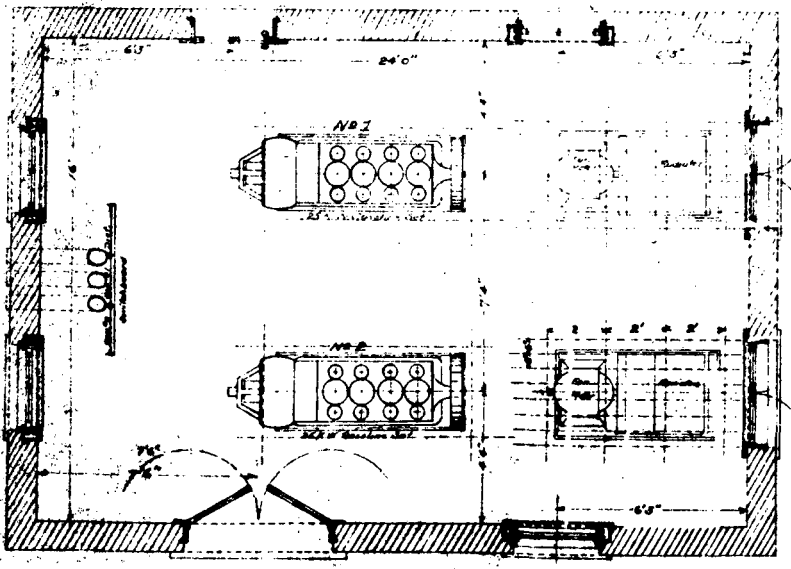
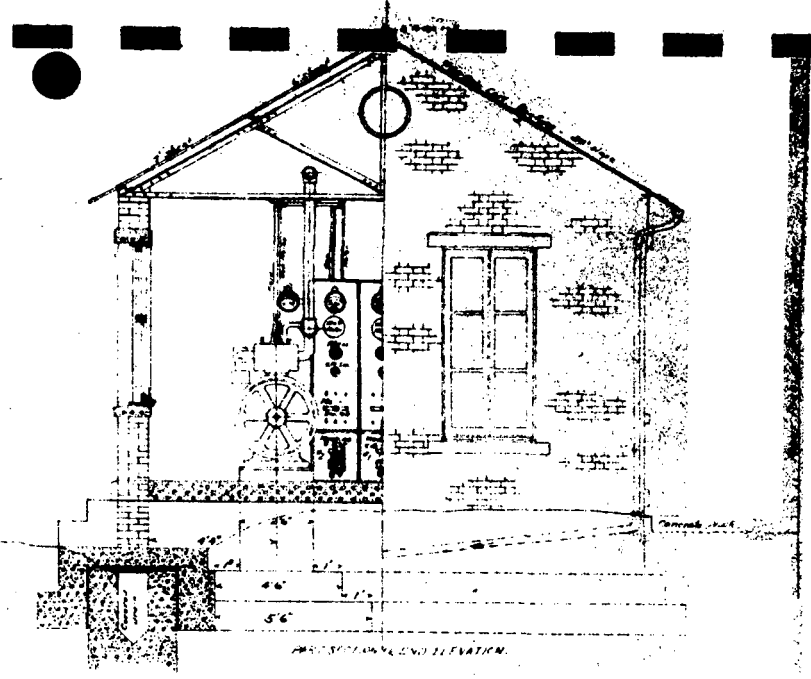
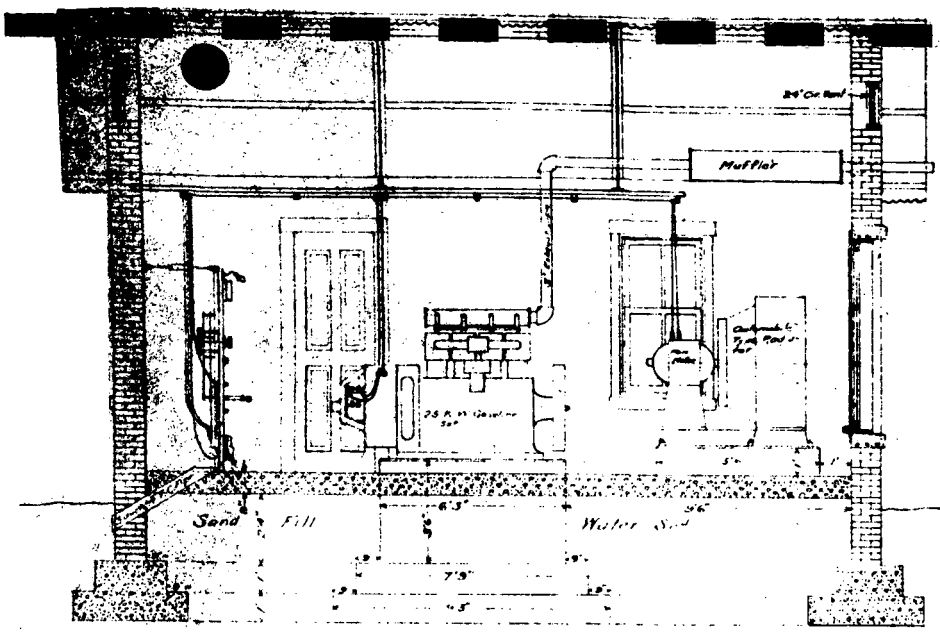

# POWER-HOUSE

## BATTERY JASPER.

Fort Moultrie  
S.C.

Scale: 1/4 in. = 1 ft.

PLATE IX

U.S. Engineer Office,  
Charleston, S.C., Jan. 3, 1910.  
Drawing No. 1002 of size 40x60.

*Wm. H. Hall*  
U.S.A.

88811A

Sheets have four corrugation lap and riveted together with two rows of 8 Pinned rivets - Staggered - heads of rivets soldered from 80 to 85 rivets per joint.

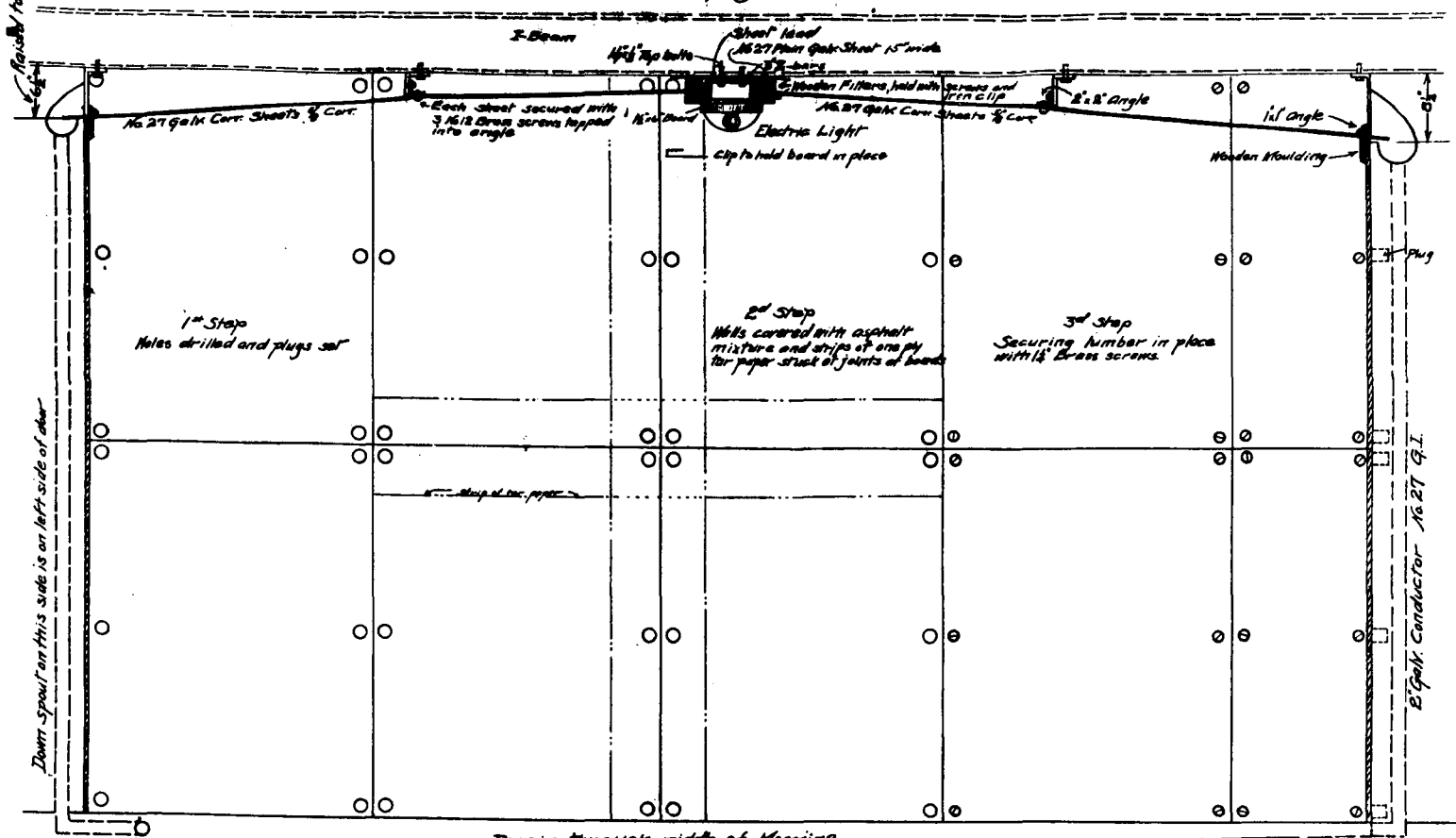

Flashed to pass over other

Down spout on this side is on left side of other

Drain through middle of Magazine

### Damp Proofing

Powder Magazine No. 3  
10-Inch Battery Magazine

Magnesia Lumber and Metal Ceiling.

Fort Moultrie S.C.

Put in center

Reduce 7/8

U.S. Engineer Office,  
Charleston, S.C., August 18, 1903.  
Accompanying my report of this date.

H. P. Hull  
Captain, Corps of Engineers

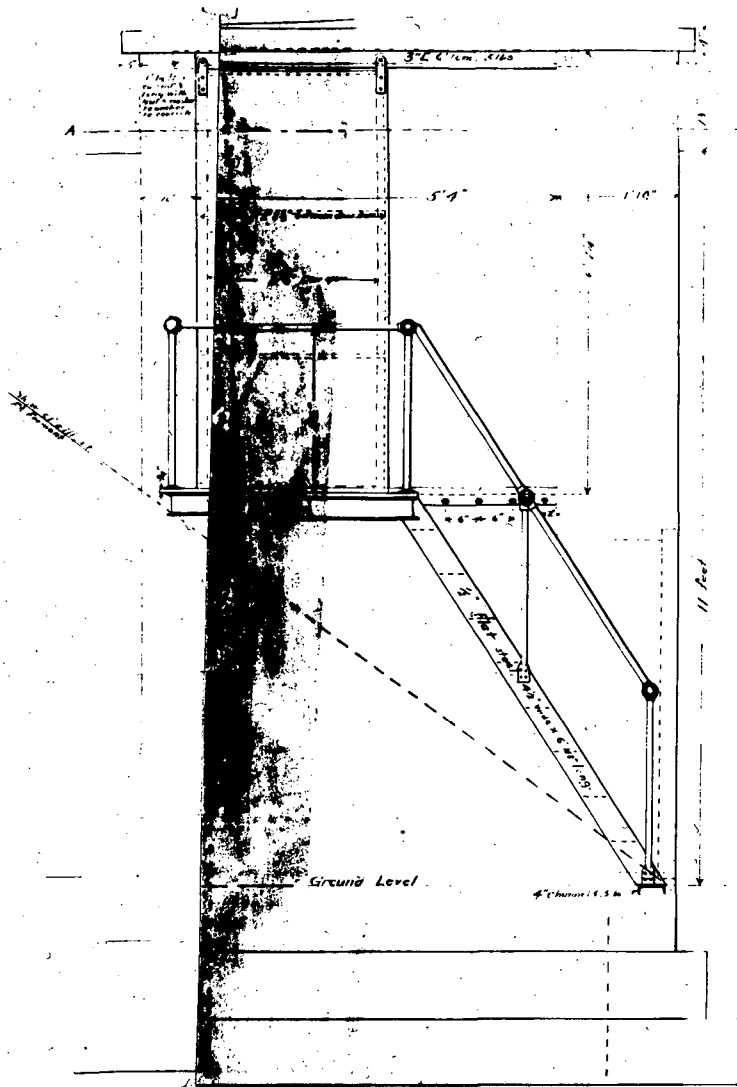

TELEPHONE BOOTH TELAUTOGRAPH  
 BATTERY JASPER FORT FREMONT,  
 S. C.  
 Scale 1/4" = 1 foot

TELEPHONE and TELAUTOGRAPH  
 BOOTH  
 for  
 BATTERY JASPER FORT FREMONT,  
 S. C.

Scale: 1 in. = 1 foot.

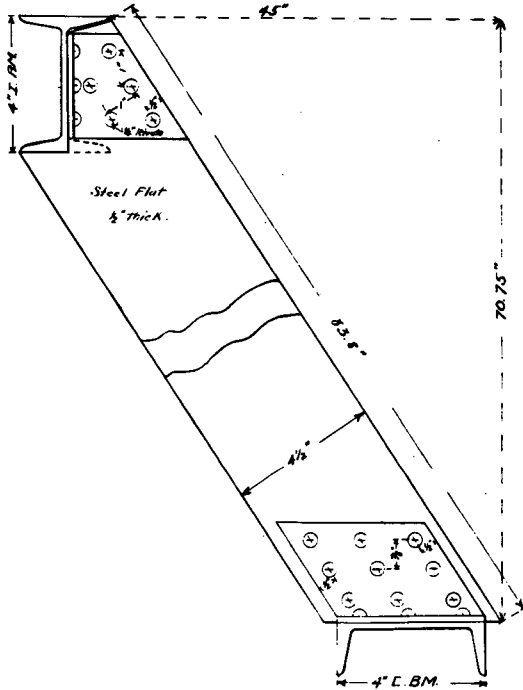

U.S. Engineer Office,  
 Charleston, S.C., Oct. 14, 1903.  
 Accompanying my report of this date  
*J. P. Harrell,*  
 Captain, Corps of Engineers.

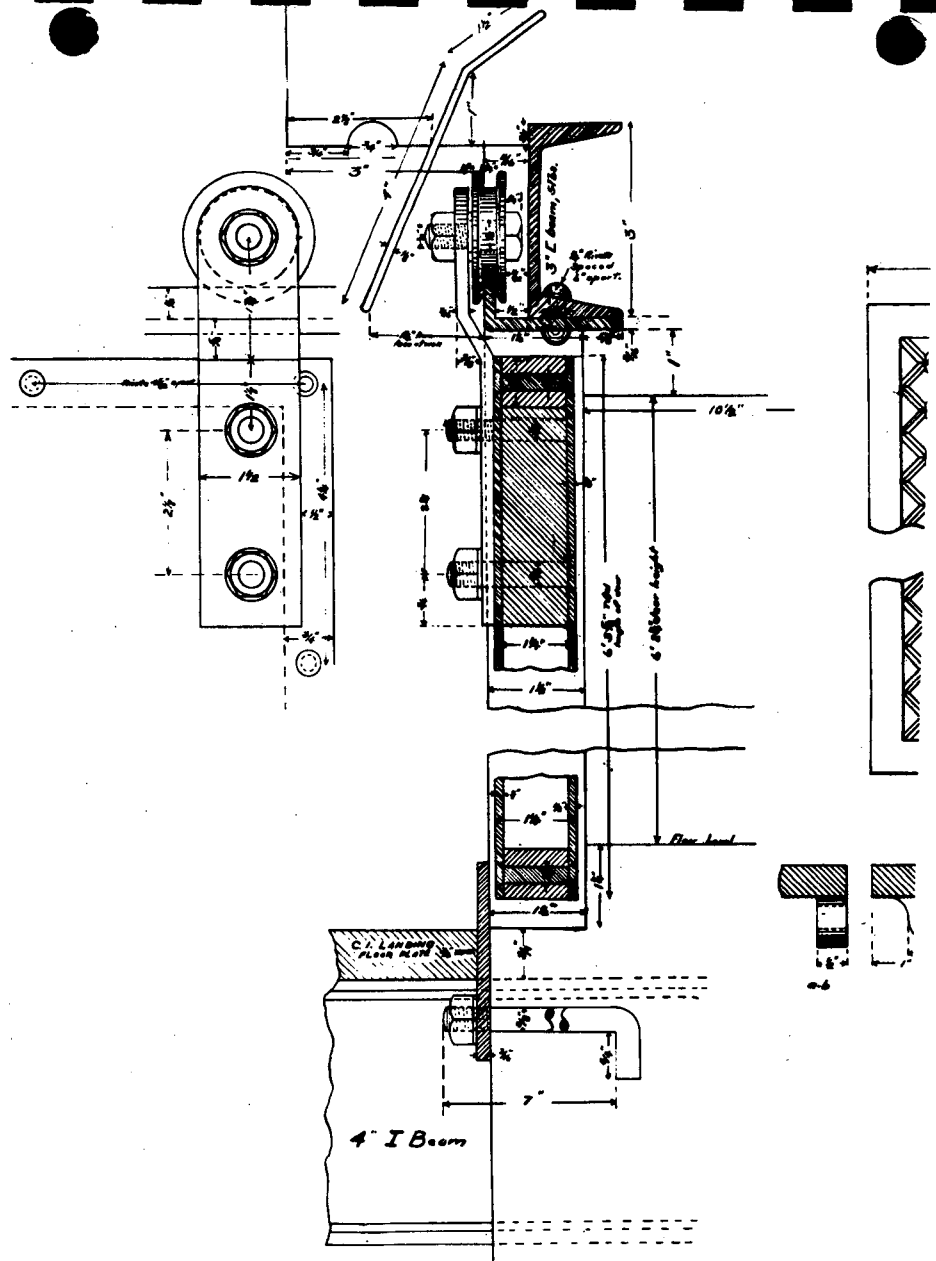

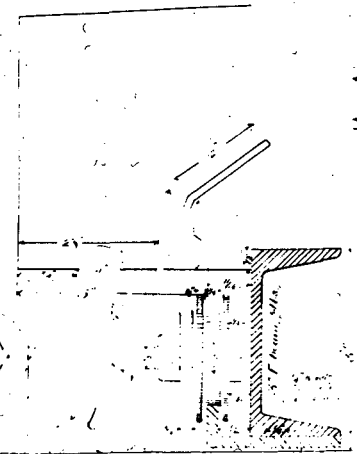
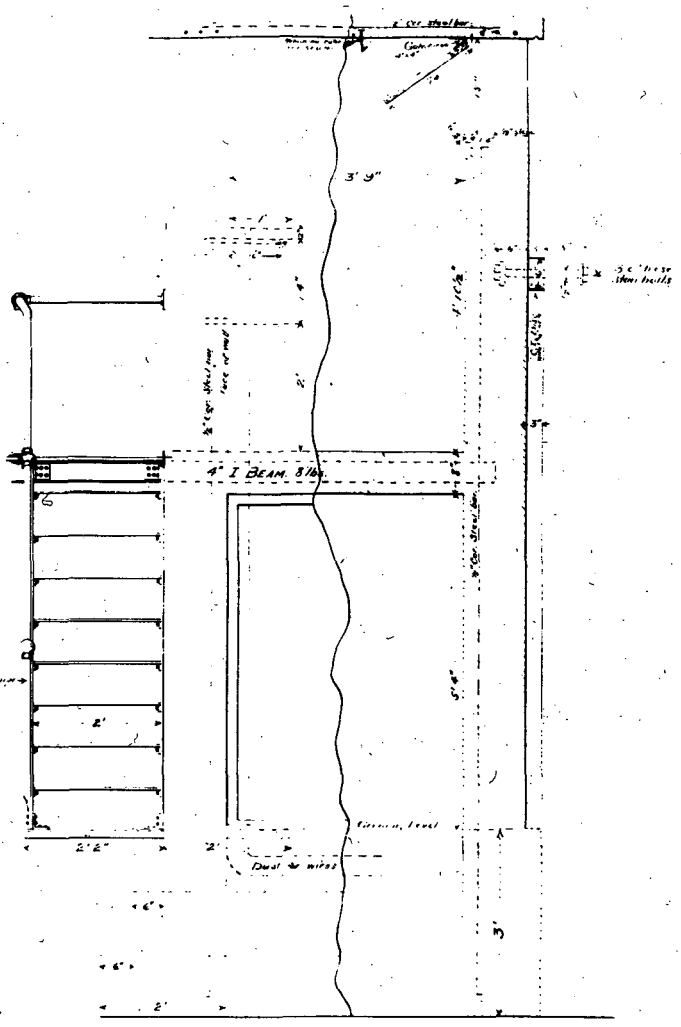
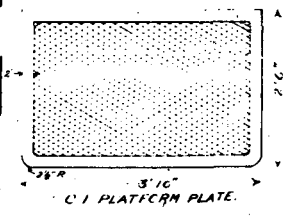
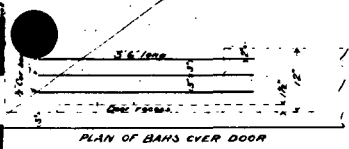
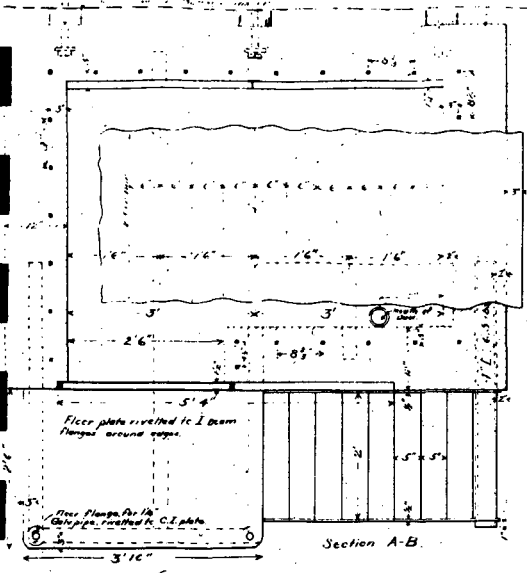

TELEPHONE & TELAUTOGRAPH  
BOOTH

for  
BATTERY JASPER & FORT FRENONT,  
S. C.

Scale: 1/4 in = 1 foot

PLATE XIII

Black only -

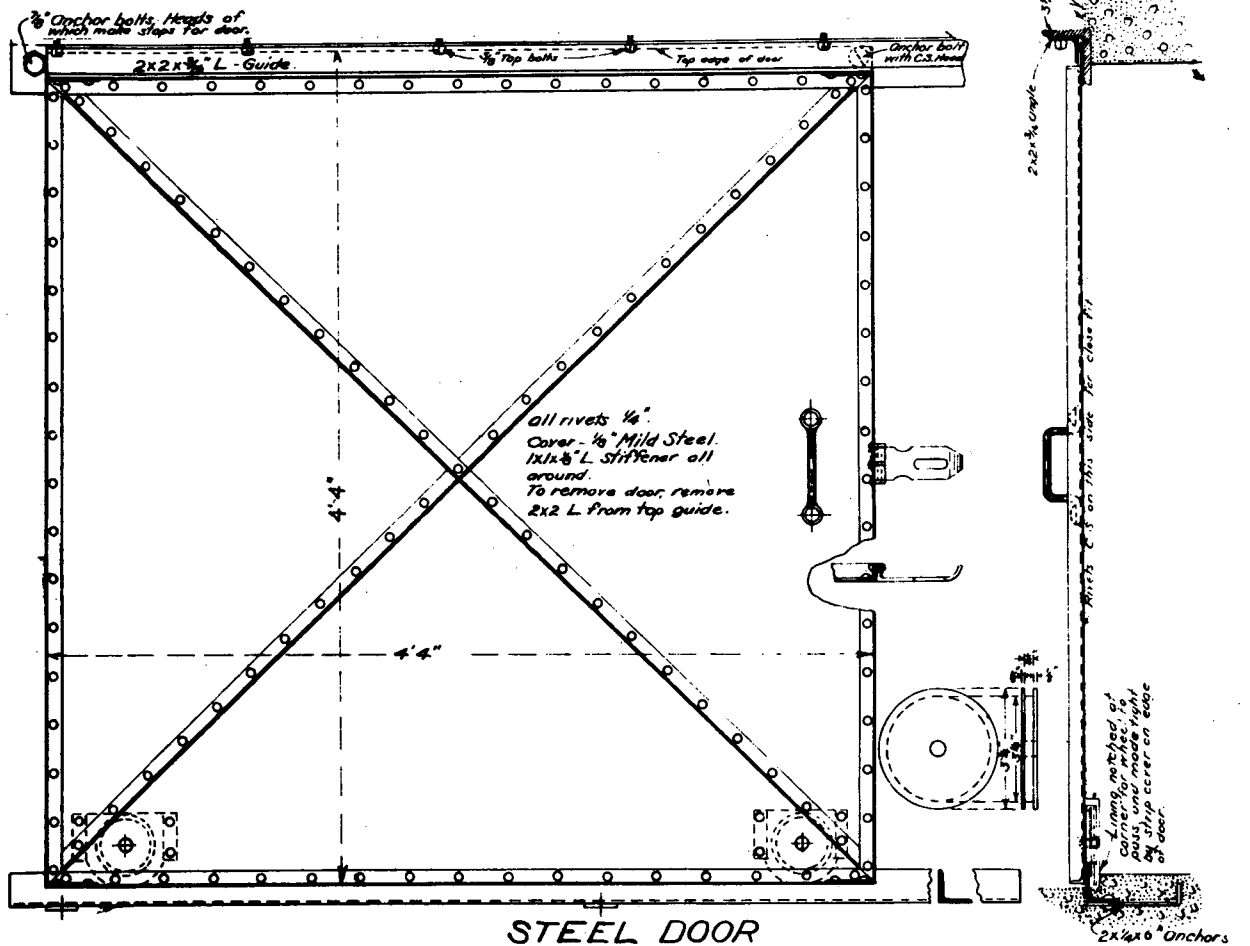

### STEEL DOOR

for  
 Telautograph Niche No 4.  
 BATTERY JASPER,  
 Fort Moutrie, S. C.  
 Scale:  $1\frac{1}{2}$ " = 1'-0".

Full scale

U.S. Engineer Office,  
 Charleston, S. C., Aug. 10, 1904.  
 Accompanying my letter of this date to  
 The Chief of Engineers, U.S.A.  
 B. P. Howell  
 Captain, Corps of Engineers

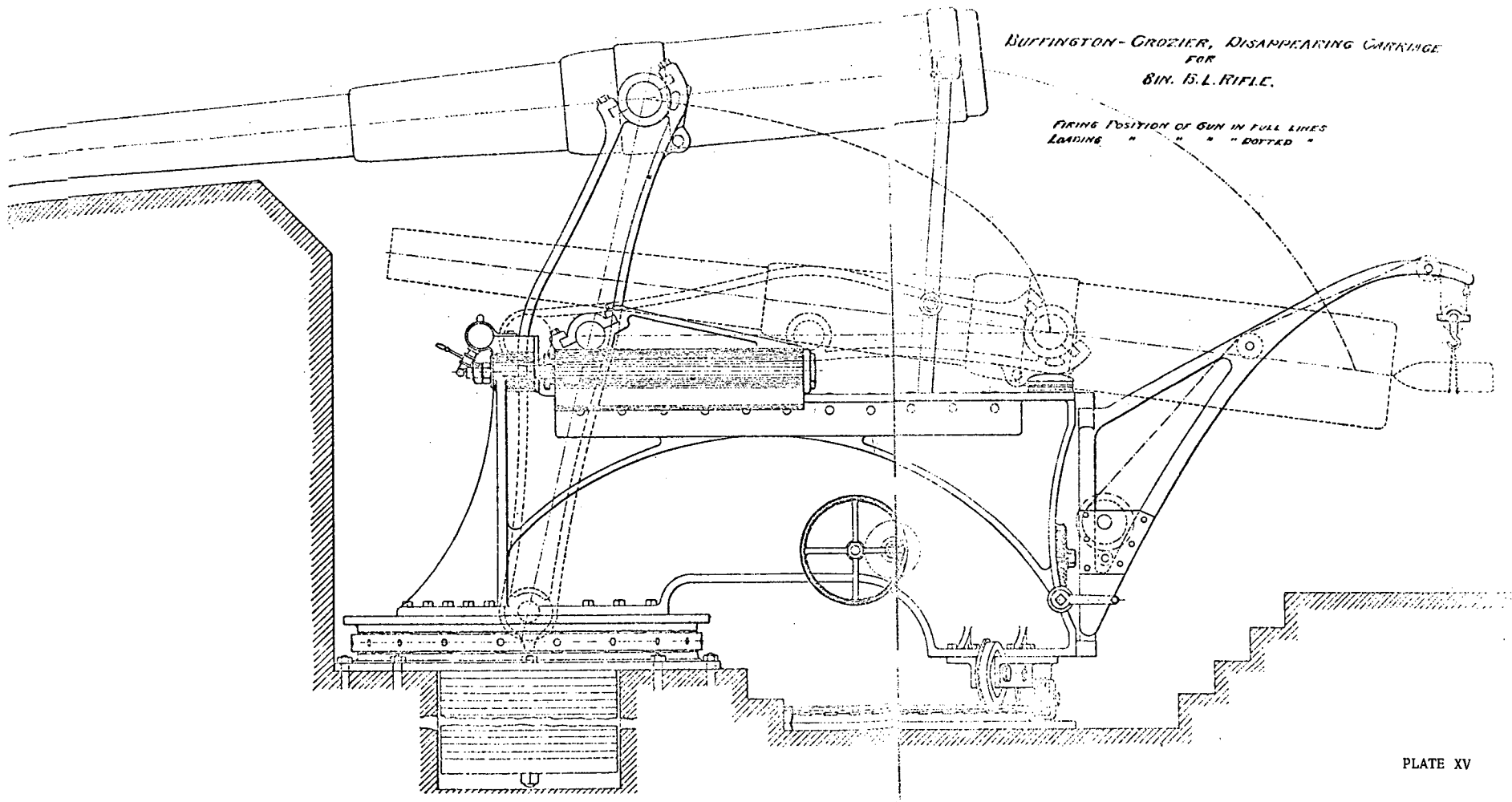

BUFFINGTON-GROZIER, DISAPPEARING CARRIAGE  
FOR  
8 IN. B. L. RIFLE.

FIRING POSITION OF GUN IN FULL LINES  
LOADING " " " " DOTTED "



*BUFFINGTON-GROZIER CARRIAGE  
FOR  
8 IN. B. L. RIFLE.*

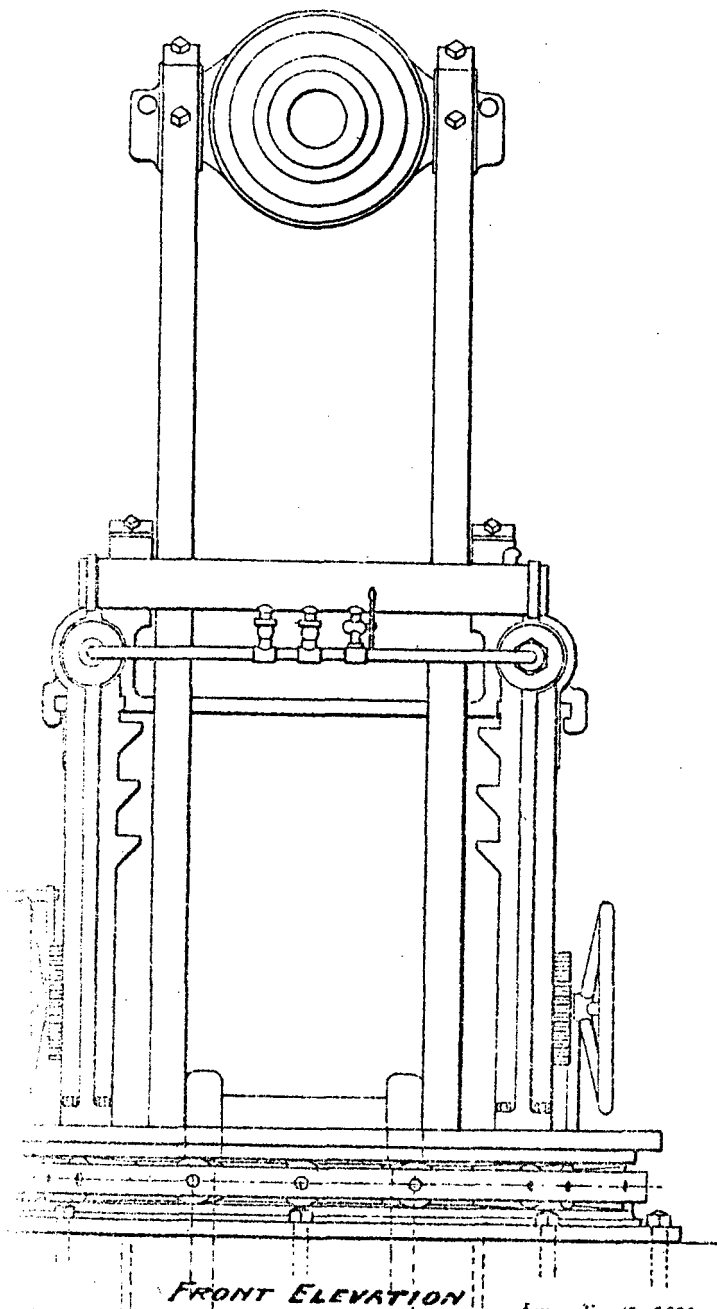

Appendix 45, 1893.

BUFFINGTON-CROZIER GARRIAGE  
FOR  
8 IN. B. L. RIFLE.

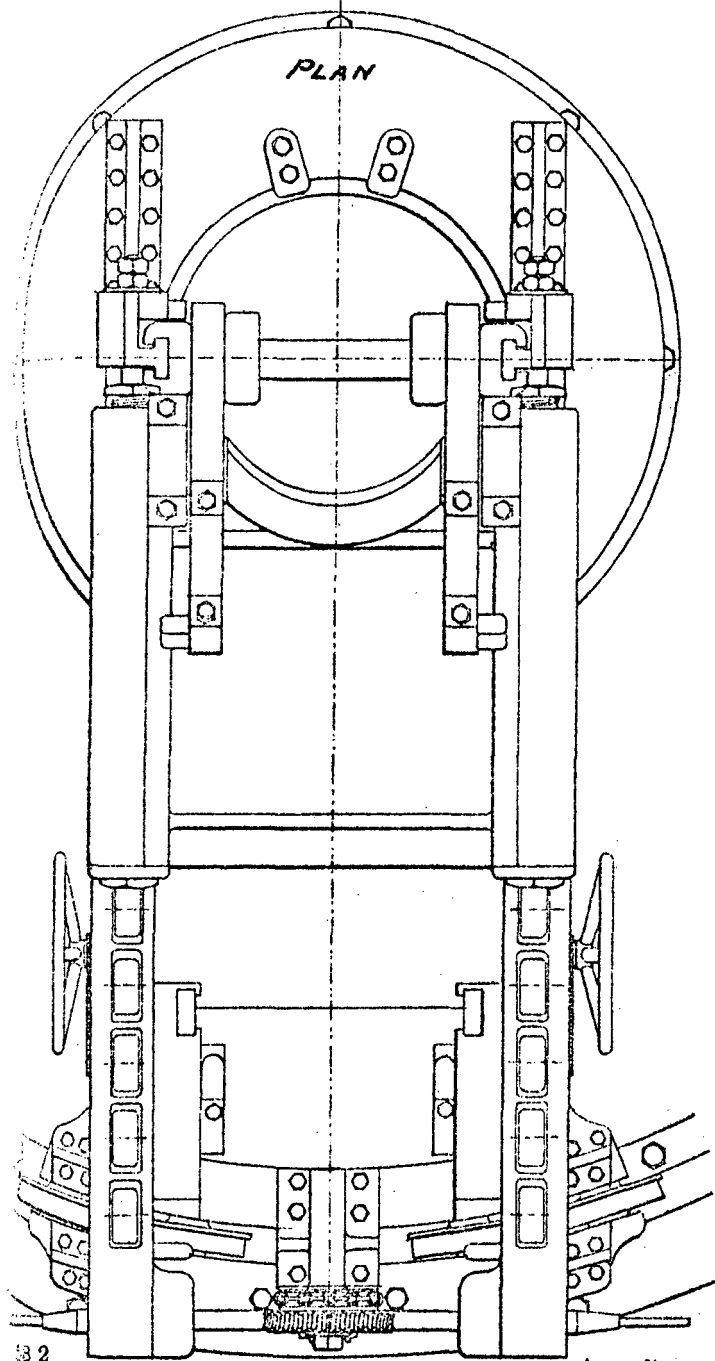

32

Appendix 45 1893.

PLATE XVII

PLATE XVIII

Photograph. Panoramic View from the West Elevation of Battery Jasper,  
showing "the Plant" as Positioned by Jacob Friday & Sons in Early  
March 1897. National Archives, RG 77, F-64-111-1.

Sheet 111

Panoramic view from west end of battery

*Low Battery*

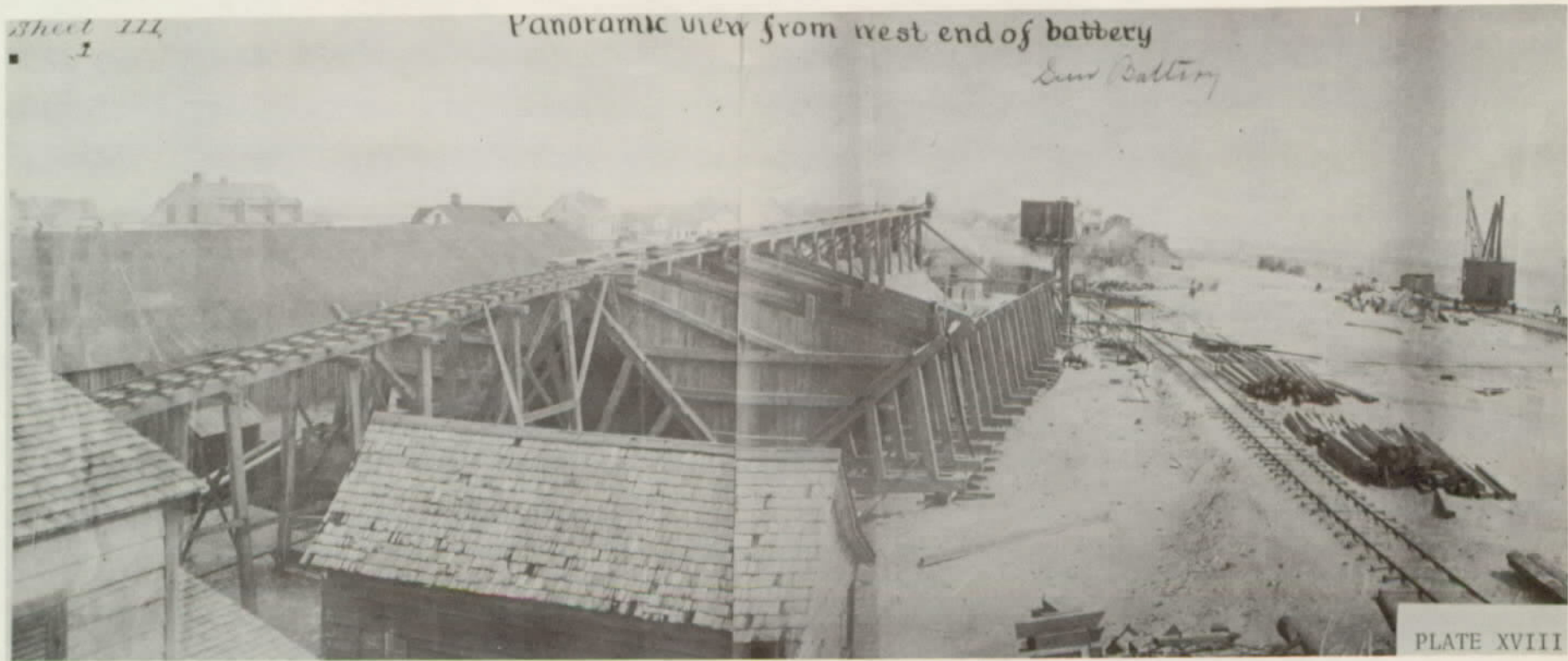

PLATE XVIII

PLATE XIX

Photograph of Jacob Friday & Sons' Workmen Positioning a Base Ring for one of the 10-Inch Rifles. National Archives, RG 77, F-64-121-2.

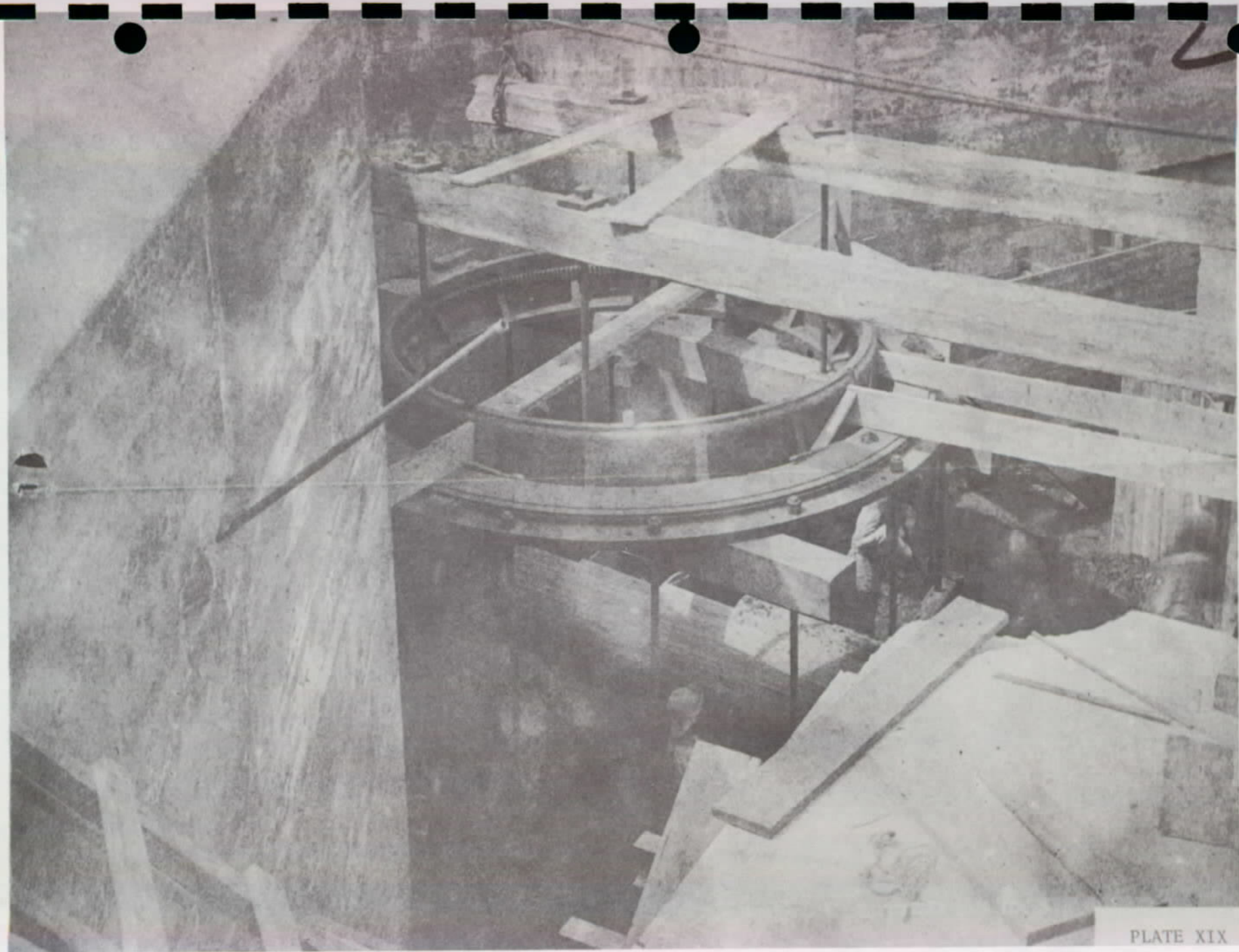

PLATE XIX

PLATE XX

Photograph from the West of the Three Emplacements under Contract to  
Jacob Friday & Sons. Note: how "the plant" operates. National Archives,  
RG 77, F-64-115-2.



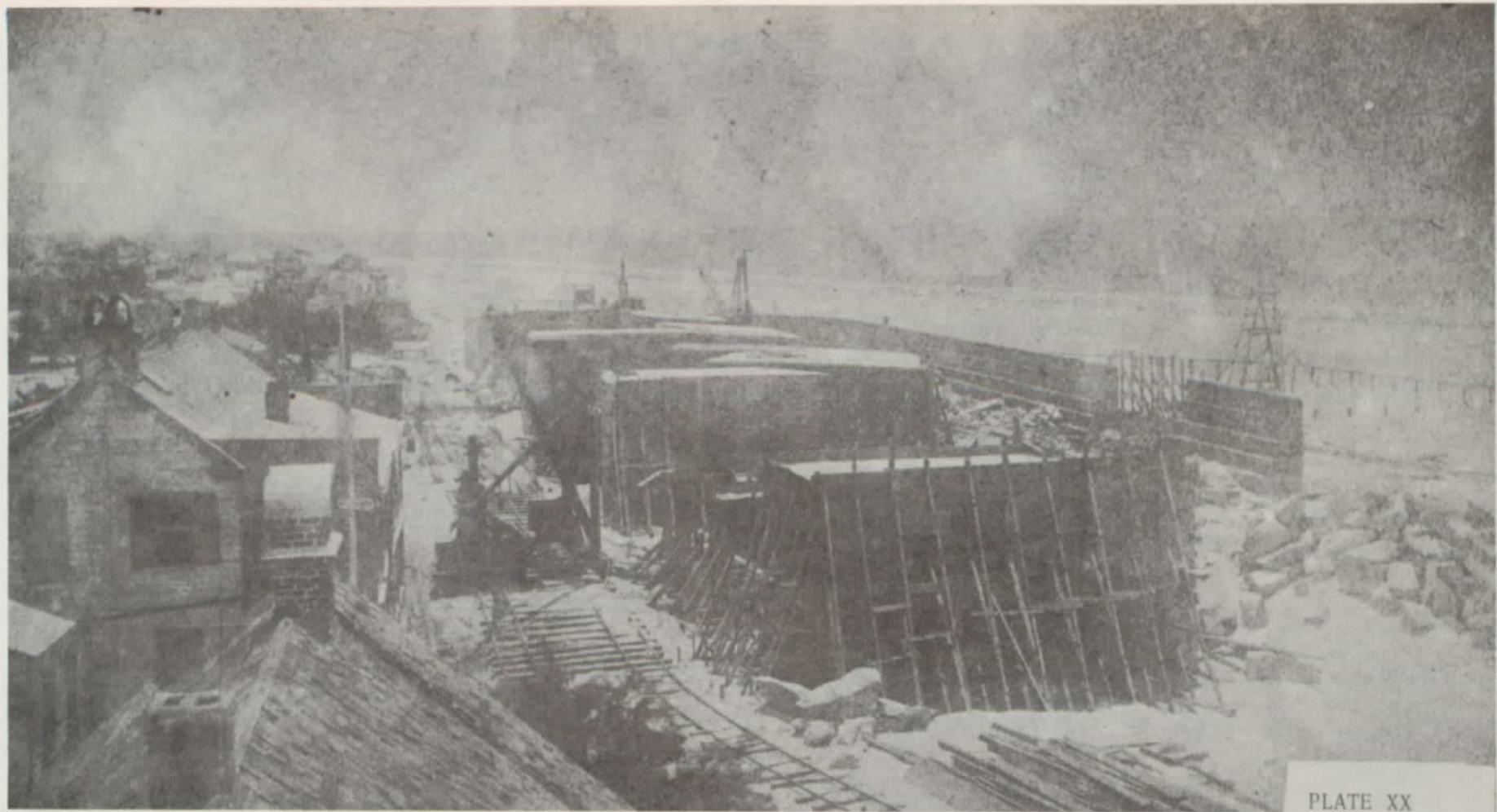

PLATE XX



PLATE XXI

Photograph. With the Casings in Position, Concrete was Poured and Allowed to Set. National Archives, RG 77, F-64-114-12.

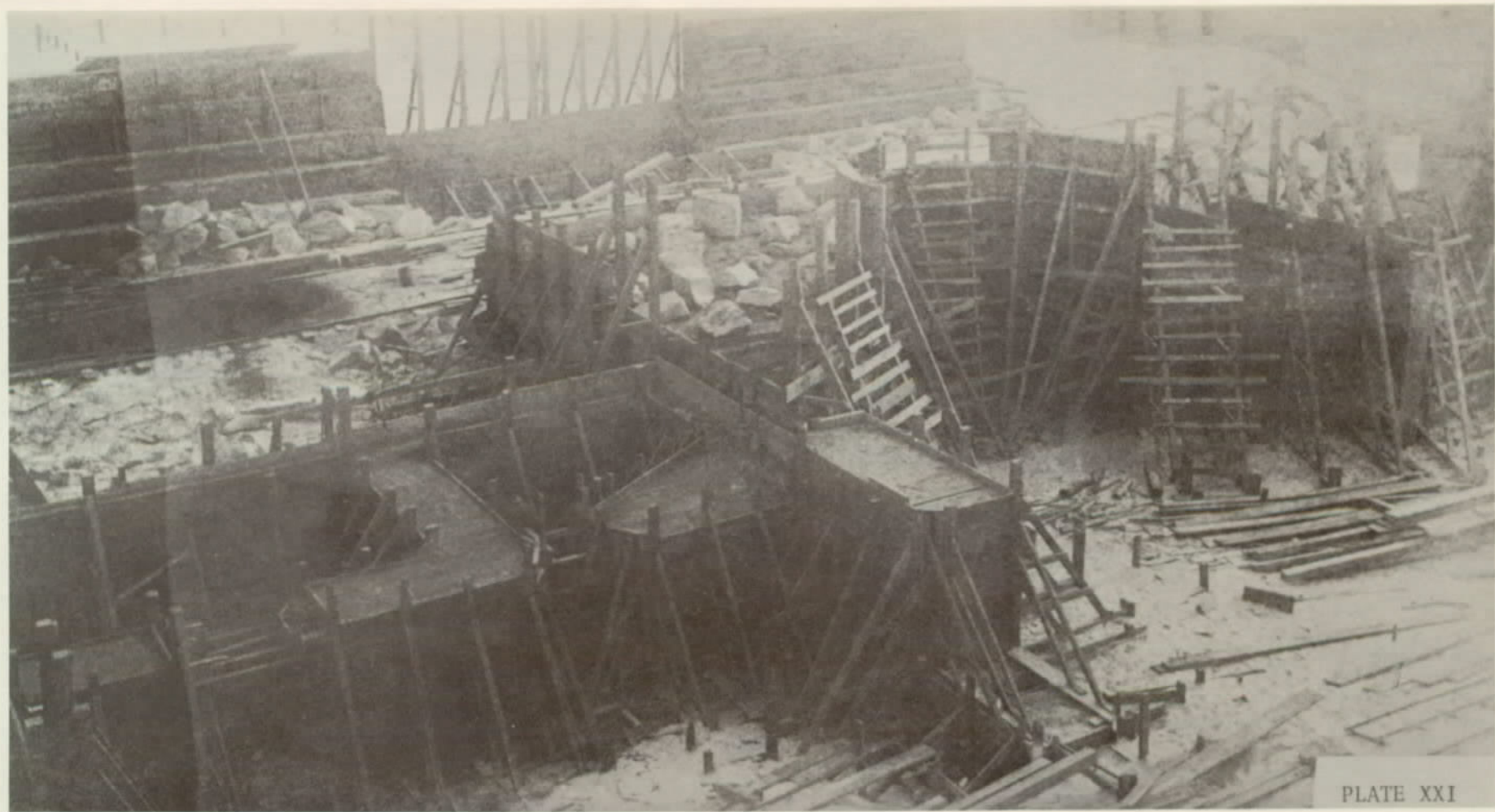

PLATE XXI

PLATE XXII

Photograph. Looking West across Glacis toward Fort Moultrie. To the left is the seawall and to the right is the exterior slope of Emplacement No.2, Sept. 8, 1897. The space between the seawall and the exterior slope was filled with sand and sodded. National Archives, RG 77, F 64-121-4.



10" BATTERY SOLID. SEP 8 1917

PLATE XXII

PLATE XXIII

Photograph. Looking West across Glacis toward Fort Moultrie. From a position due east of that occupied by the cameraman when he took the photograph found on Plate XXVIII, Sept.8, 1897. National Archives, RG 77, F-64, 121-3.



3



10" BATTERY SUL ID. SEP 5 1907

PLATE XXIII

PLATE XXIV

Photograph of the East Flank of Battery Jasper. Showing the portion of the work east of Emplacement No.4, Sept. 8, 1897. National Archives, RG 77, F-64-121-6.

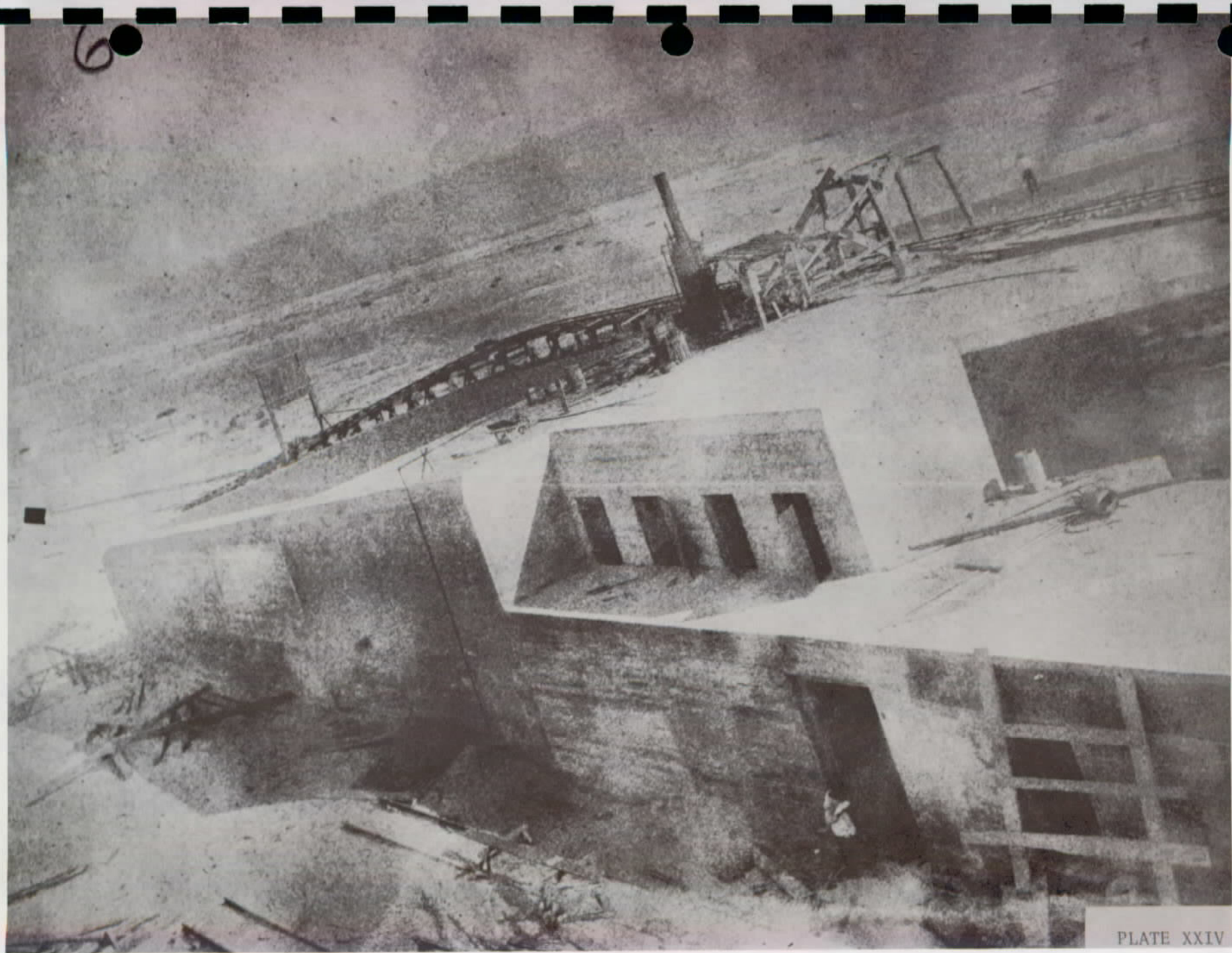
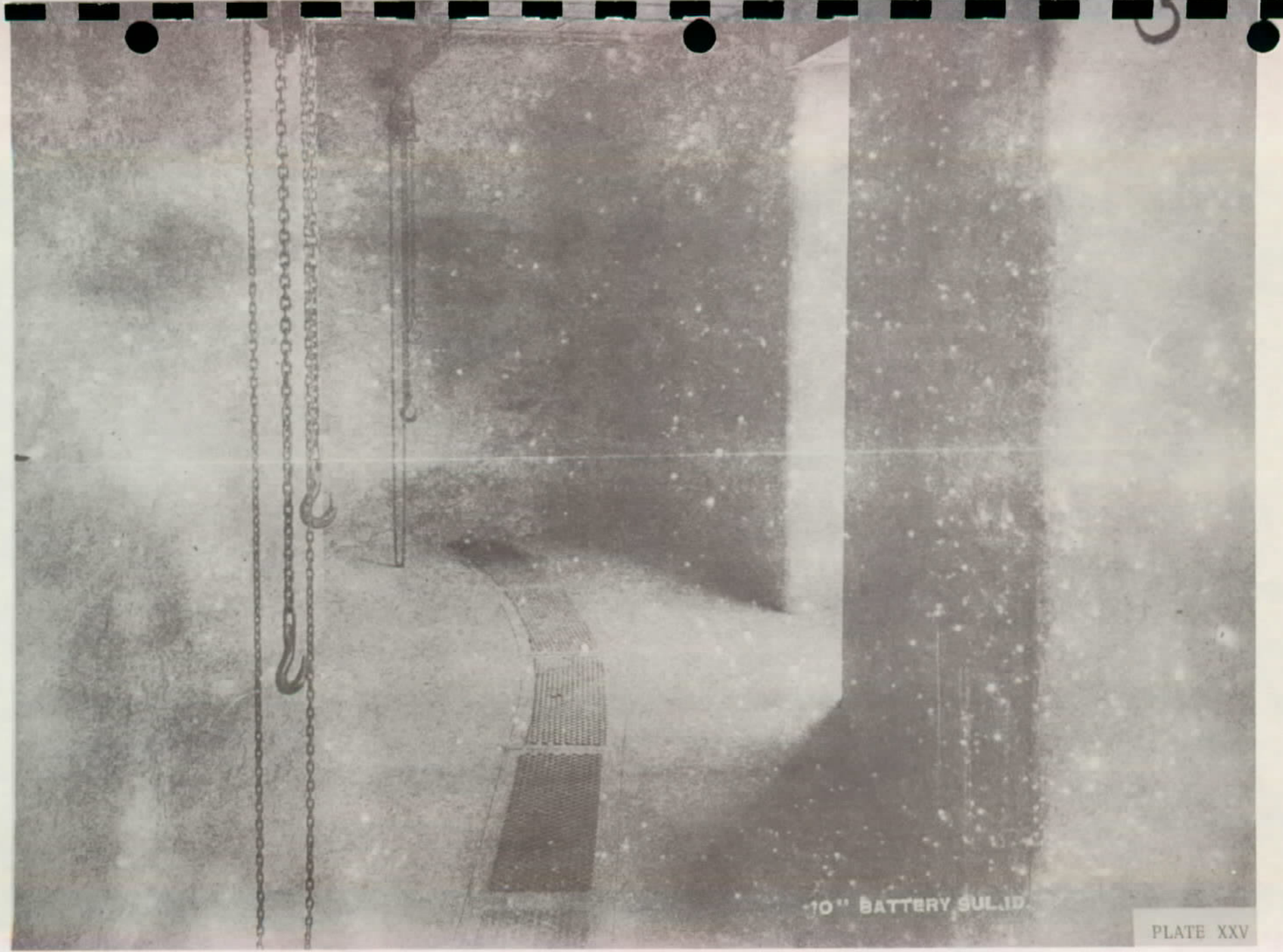

PLATE XXIV



PLATE XXV

Photograph. Inside the Casemate of Battery Jasper. Note the trolley, drain, and corrugated iron-roofing, Sept. 8, 1897. National Archives, RG 77, F 64-121-5.



10" BATTERY SUL.ID

PLATE XXVI

Photograph. Section above Magazine Area, to the Left of One of the Gun Pits.  
Sept. 8, 1897. The ammunition hoists delivered the projectiles and powder  
through the second opening from the left. National Archives, RG 77, F-64-121-8.

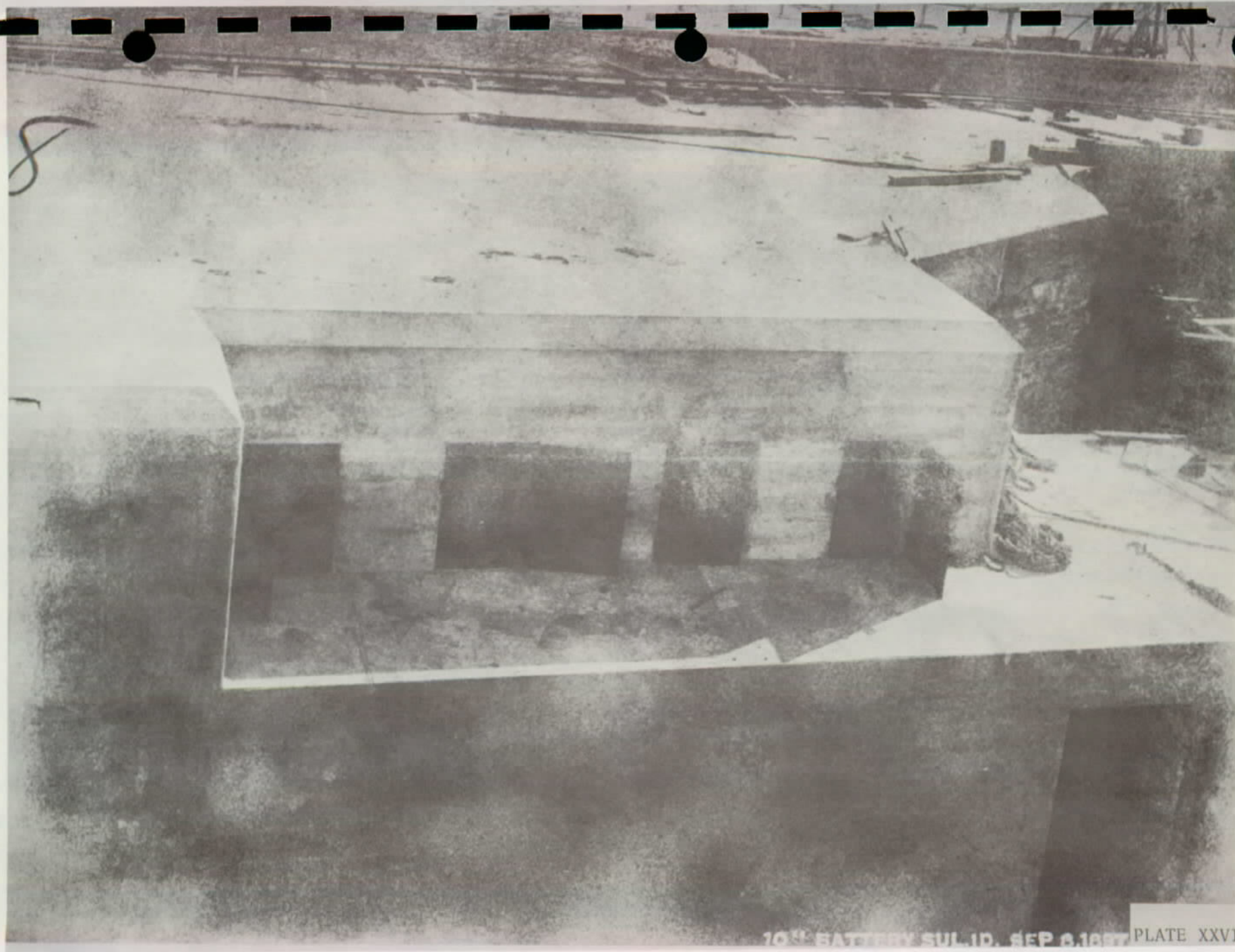

70<sup>th</sup> BATTERY SUL. ID. SEP 8, 1937 PLATE XXVI

PLATES XXVII, XXVIII, XXIX, & XXX

Photographs of the Test-Firing of a 10-Inch  
Breech-Loading Rifle.





PLATE XXIX

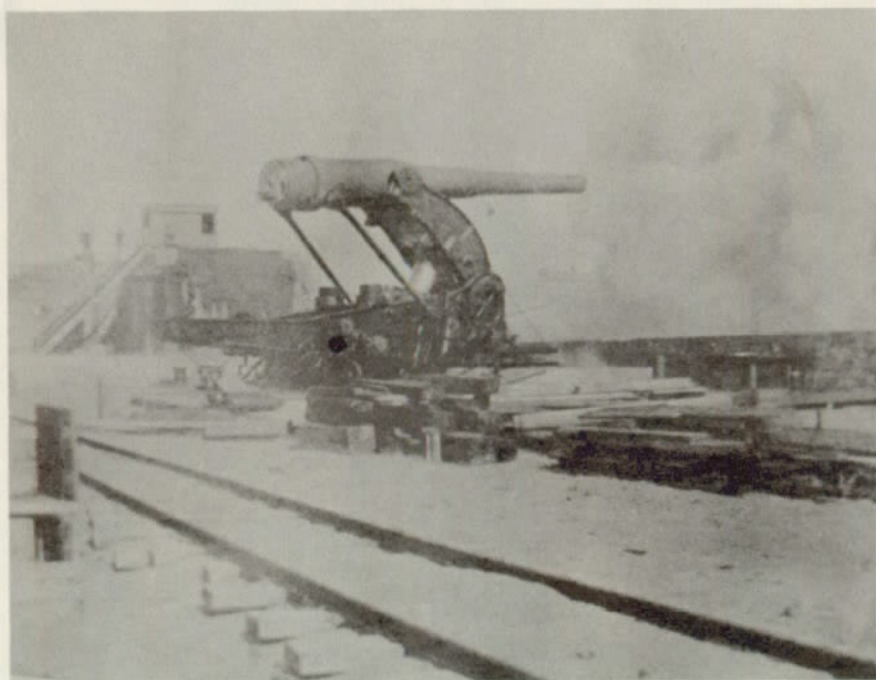

PLATE XXX

\*  
\*\*\*  
\*\*\*\*\*  
\*\*\*\*\*  
\*\*\*\*\*  
\*\*\*\*\*  
\*\*\*\*\*  
\*\*\*\*\*  
\*\*\*  
\*\*  
\*





PLATE XXVII



PLATE XXVIII