

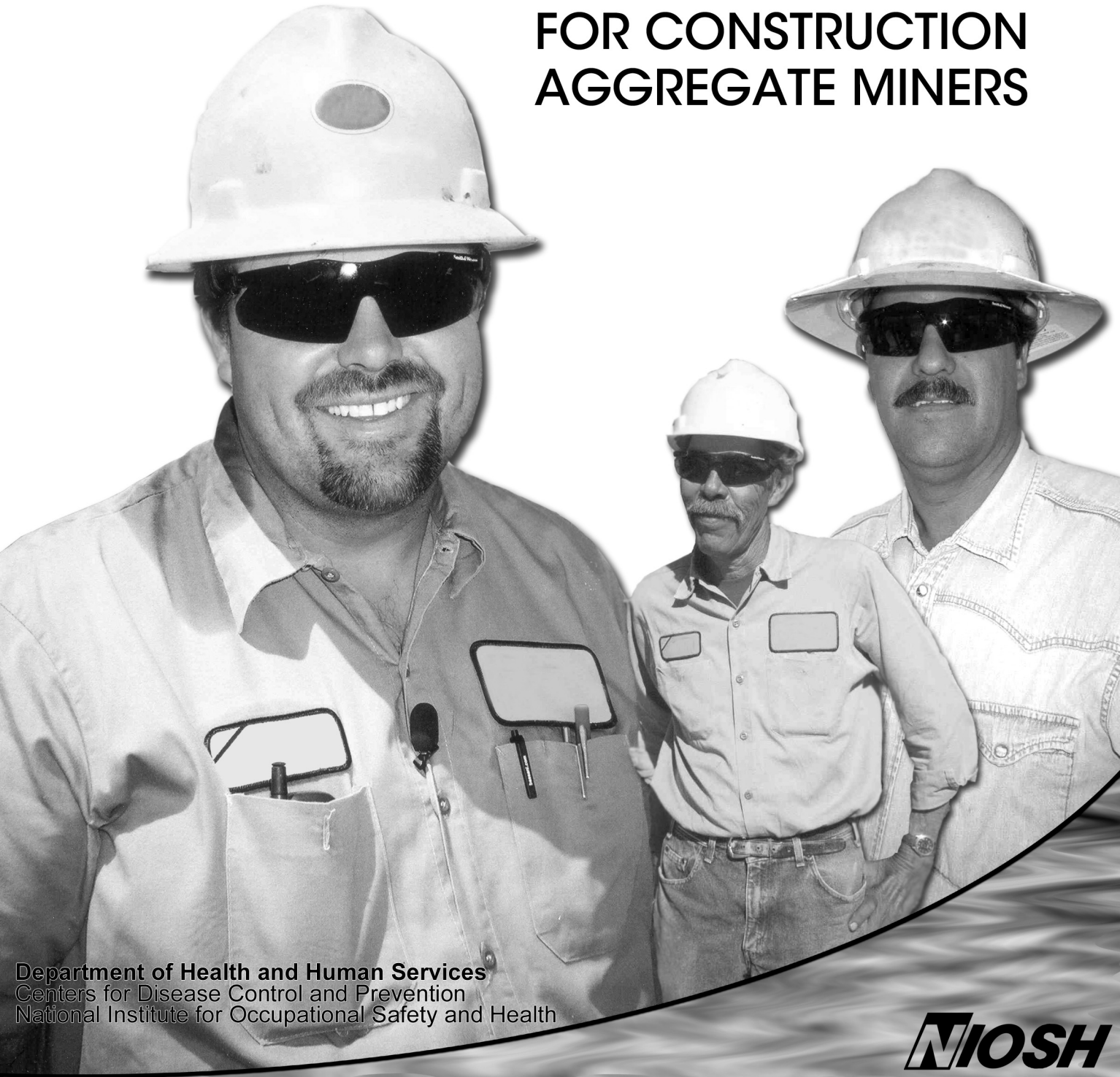

TOOLBOX TRAINING

FOR CONSTRUCTION
AGGREGATE MINERS



Department of Health and Human Services
Centers for Disease Control and Prevention
National Institute for Occupational Safety and Health



NIOSH Toolbox Training

Tips for the Trainer

This NIOSH Toolbox Training program contains 52 different modules designed to stimulate safety discussions among your employees. Each module is intended to be completed in roughly 10 or 15 minutes, so a Toolbox Training session can be conducted once a week for the entire year. Each session counts toward your employee's 8-hour annual MSHA refresher training, thus saving an entire day of work..

The modules are used to refresh employees on the procedures, policies, and practices of working safely at a specific mine site and can easily be tailored to fit conditions and situations found on your property. Every module follows the same format, so that as the weeks pass, miners will start to approach every safety situation in the same way.

A typical Toolbox Training session contains five basic steps that cover all the information in the module.

1. Identification of the hazard and discussions about the types of injuries typically associated with the hazard.
2. Discussions of some of the causes of the hazard. The MSHA example included with each module should be referenced.
3. After the hazard and accident has been explained and understood, discussions about best practices and tips for avoiding a similar accident.
4. Review of similar conditions or near misses from your mine site using the leading questions on the form to start a discussion. Specific examples of equipment or structures on the site that could lead to the same accident should be discussed. The blank space on the module is used to add your own remarks and questions to supplement the given information.
5. Miners fill out the training record on the back of the form with name, initials, and date of training session.

The modules are designed to be kept in a standard three-ring binder and easily photocopied. This way, the same set of modules can be used for years to come. A blank form is included that can be used to create more Toolbox Training modules.

The key component of Toolbox Training is to start a discussion among employees that will allow them to see the hazards around them every day and respond to these hazards in a safe and consistent manner. To start a discussion, ask questions that need more than a one-word response. Get the miners to talk about similar situations from their own experiences and give suggestions about how to fix the hazards around them.

Toolbox Training is a quick and effective way to cover specific mining hazards, but it only works if miners are involved in the discussion.

REFRESHER TRAINING

GETTING ON AND OFF EQUIPMENT

HAZARD - Stepping onto soft or uneven surface

30 CFR 56.11001

RESULT - Sprain, cut, bruise, fracture

LOOK FOR - Mud, slush, loose sand, rocks, tools, parts, or debris

REAL ACCIDENT: One afternoon, a miner with 1 year of experience parked his loader near the dump hopper and climbed down. When he stepped off the loader onto uneven ground, his foot turned under him, causing a severe strain. **37 WORK DAYS LOST.**

BEST PRACTICES:

- ✓ Step carefully - don't turn until both feet are firmly on the ground.
- ✓ Avoid the hazard - look around your landing area, watch foot placement.
- ✓ Maintain three-point contact - have secure grip before stepping down.

WHAT ABOUT OUR SITE?

COMMENTS

Where can this type of accident happen in our pit?	
Has anyone seen something similar happen?	
What can we do so it doesn't happen again? Who should do this? When?	
Which step on a front-end loader is most likely to need repair? <i>Bottom step</i>	
Can someone demonstrate the three-point contact?	

MODULE 1A

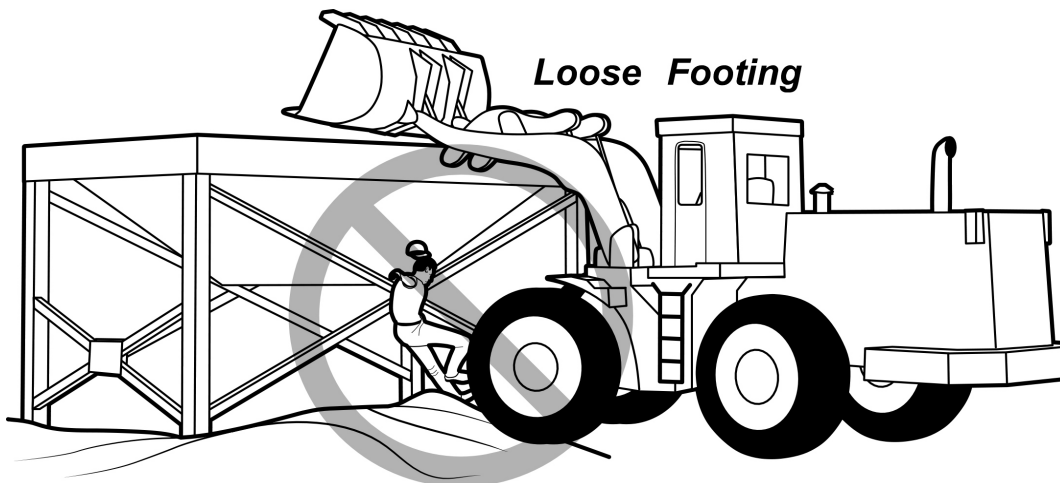

TRAINING RECORD

DATE: _____ MSHA MINE/CONTRACTOR NAME & ID No. _____

TRAINER/COMPETENT PERSON: _____

LENGTH: _____ LOCATION: _____

Check If This Is Part of Annual Refresher Training (CFR 30, 46.8.c)

PERSONS TRAINED (PRINT FULL NAME AND INITIAL):

I certify that the above training has been completed: _____ Date: _____

(Signature of person responsible for safety and health training)

False certification Is punishable under §110(a) and (f) of the Federal Mine Safety and Health Act

REFRESHER TRAINING

GETTING ON AND OFF EQUIPMENT

HAZARD - Falling while climbing on equipment

30 CFR 56.11001

RESULT - Sprains, cuts, bruises, fractures and death

LOOK FOR - Uneven, cluttered or slippery surfaces, long or high steps

REAL ACCIDENTS: A dozer operator with 2 years of experience finished his shift. While climbing along the blade arm, he slipped on loose rock that had collected on top of the arm and fell to the ground, fracturing his leg. **96 DAYS LOST/RESTRICTED DUTY.**

BEST PRACTICES:

- ✓ Avoid the hazard - is there a better way up and down?
- ✓ Eliminate the hazard - add steps or ladders.
- ✓ Maintain three-point contact - have secure grips/treads.
- ✓ Don't stretch to climb - never jump down.

WHAT ABOUT OUR SITE?

COMMENTS

Who remembers what we talked about last week? Was there something we needed to fix?	
Which equipment is hard to keep three-point contact on?	
Is there a way to improve access on our equipment? Who should do this? When?	
Did we have any near-miss or accident similar to this case?	

MODULE 1B

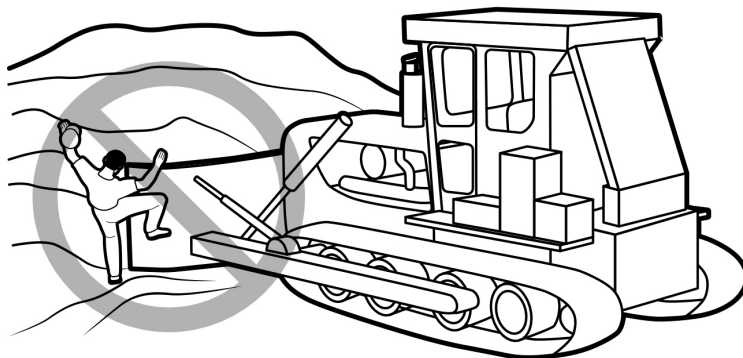

Watch Your Footing

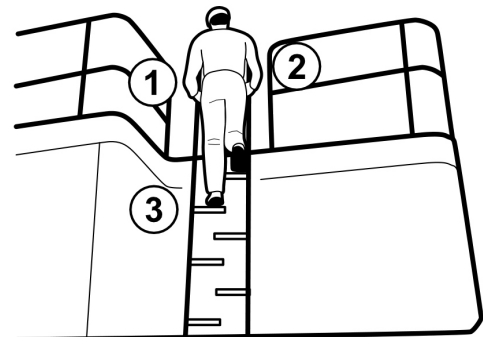

Three-Point Contact

TRAINING RECORD

DATE: _____ MSHA MINE/CONTRACTOR NAME & ID No. _____

TRAINER/COMPETENT PERSON: _____

LENGTH: _____ LOCATION: _____

Check If This Is Part of Annual Refresher Training (CFR 30, 46.8.c)

PERSONS TRAINED (PRINT FULL NAME AND INITIAL):

I certify that the above training has been completed: _____ Date: _____

(Signature of person responsible for safety and health training)

False certification is punishable under §110(a) and (f) of the Federal Mine Safety and Health Act

REFRESHER TRAINING

GETTING ON AND OFF EQUIPMENT

HAZARD - Falling from ladders and steps

30 CFR 56.11003

RESULT - Sprains, cuts, bruises, fractures, and death

LOOK FOR - Slippery, damaged, or uneven steps/rungs. Long/high steps (stretching). Carrying objects while climbing.

REAL ACCIDENTS: In 1999, there were

- 28 cases of sand and gravel miners falling off ladders, resulting in over 1,400 days lost or restricted duty. **Average of 50 days per accident.**
- 14 cases of sand and gravel miners jumping off the equipment, resulting in over 400 days lost or restricted duty. **Average of 29 days per accident.**

BEST PRACTICES:

- ✓ Never paint wood ladders.
- ✓ Eliminate the hazard - fix it or clean it.
- ✓ Maintain three-point contact - don't carry things.
- ✓ Don't stretch to climb - never jump down.

WHAT ABOUT OUR SITE?

COMMENTS

Which of our ladders are hard to keep three-point contact on?	
Is there a way to fix them? Who will fix it? When?	
Show us how to check the ladder footing so it doesn't slip out.	
When should you report a damaged ladder? Who do you tell?	

MODULE 1C

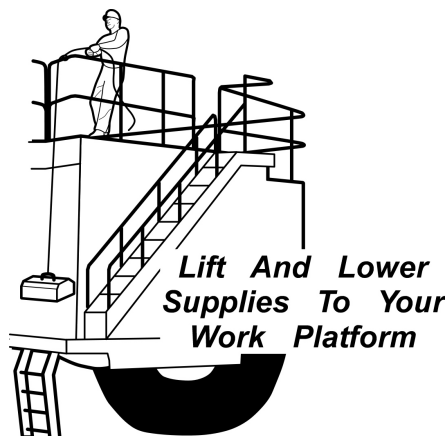

TRAINING RECORD

DATE: _____ MSHA MINE/CONTRACTOR NAME & ID No. _____

TRAINER/COMPETENT PERSON: _____

LENGTH: _____ LOCATION: _____

Check If This Is Part of Annual Refresher Training (CFR 30, 46.8.c)

PERSONS TRAINED (PRINT FULL NAME AND INITIAL):

I certify that the above training has been completed: _____ Date: _____

(Signature of person responsible for safety and health training)

False certification is punishable under §110(a) and (f) of the Federal Mine Safety and Health Act

REFRESHER TRAINING

WORKING AT HEIGHT

HAZARD - Falling from heights

30 CFR 56.15005 & 30 CFR 56.9200

RESULT - Bruises, sprains and strains, lacerations, fractures, death

LOOK FOR - Unprotected platforms or locations, long/high steps, stretching or reaching

REAL ACCIDENTS: On a cool, dry spring night near the end of his shift, a young belt man with 4 months experience climbed on a handrail to adjust the V-belt of a head pulley conveyor drive. While working on the drive, he lost his balance and fell 18 feet to the ground, resulting in multiple fractures to his legs. **OVER 1 YEAR LOST.**

- A dozer operator with less than a year of mining experience started his shift. It was evening, and he was assigned to wash out the broken-down screen plant so a bearing could be replaced. To reach the plant, he pulled a loader up to it, raised the bucket and climbed into it. He slipped and fell from the bucket 6 feet to the ground, breaking his arm. **OVER 90 DAYS LOST.**

BEST PRACTICES:

- ✓ Avoid the hazard. Stay on guarded platforms.
- ✓ Eliminate the hazard. Tie off with a harness or revise equipment to provide platform.
- ✓ Maintain three-point contact. Have secure grips/treads.
- ✓ Never use haulage equipment as a man-lift.

WHAT ABOUT OUR SITE?

COMMENTS

Do we have any equipment or areas that don't have guarded platforms?	
Is there a way to modify the equipment so we don't have to work up there as often? Are there good places to tie off?	
Where do we keep harnesses and lanyards?	
Can someone demonstrate how to inspect and put on a harness?	

MODULE 1D

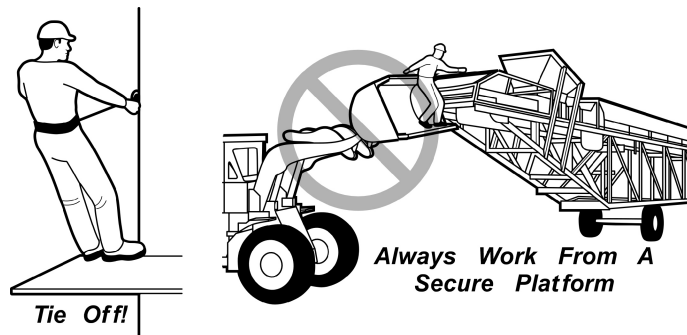

TRAINING RECORD

DATE: _____ MSHA MINE/CONTRACTOR NAME & ID No. _____

TRAINER/COMPETENT PERSON: _____

LENGTH: _____ LOCATION: _____

Check If This Is Part of Annual Refresher Training (CFR 30, 46.8.c)

PERSONS TRAINED (PRINT FULL NAME AND INITIAL):

I certify that the above training has been completed: _____ Date: _____

(Signature of person responsible for safety and health training)

False certification is punishable under §110(a) and (f) of the Federal Mine Safety and Health Act

REFRESHER TRAINING

OPERATING EQUIPMENT

HAZARD - Injury to the eye from flying objects

30 CFR 56.15004

RESULT - Temporary or permanent loss of vision

LOOK FOR - Exposure can occur anywhere

REAL ACCIDENTS: 1-1/2 hours into the shift, a loader operator with 17 years of experience, four of it on the loader, was pulling reject from the feeder. As he raised the load to dump it, a rock fell from the bucket, bounced off the loader arm, and hit the windshield, sending pieces of glass into his face and eyes. **1 DAY LOST.**

BEST PRACTICES:

- ✓ Wear safety glasses at all times.
- ✓ Keep side shields in place.
- ✓ Keep safety glasses clean so they are comfortable.

WHAT ABOUT OUR SITE?

COMMENTS

What do you do if your glasses get too dirty to see?	
When do you need to report a eye injury?	
What places/jobs in our mine have a high risk for eye injury? Show us.	
Did we have any near-misses or accidents similar to this case?	
Is there any way to reduce the hazard? Who will fix the problem?	

MODULE 2A

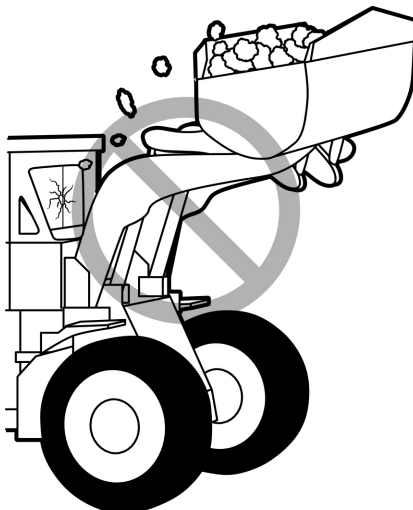

TRAINING RECORD

DATE: _____ MSHA MINE/CONTRACTOR NAME & ID No. _____

TRAINER/COMPETENT PERSON: _____

LENGTH: _____ LOCATION: _____

Check If This Is Part of Annual Refresher Training (CFR 30, 46.8.c)

PERSONS TRAINED (PRINT FULL NAME AND INITIAL):

I certify that the above training has been completed: _____ Date: _____

(Signature of person responsible for safety and health training)

False certification is punishable under §110(a) and (f) of the Federal Mine Safety and Health Act

REFRESHER TRAINING

WORKING AROUND EQUIPMENT

HAZARD - Loose clothing, jewelry, or hair catching in equipment

RESULT - Cuts, burns, broken bones, or death

LOOK FOR - Loose clothes, jewelry, hair, pinch points

REAL ACCIDENTS: On a cold February evening, a 20-year-old laborer with 1 year of experience was checking a head pulley. The sleeve of his sweater was caught by the pulley or edge of the belt, pulling his arm in and crushing it. **40 DAYS LOST.**

BEST PRACTICES:

- ✓ Keep sleeves and pant legs/cuffs tight.
- ✓ Keep long hair tied up and inside hard hat.
- ✓ Don't wear necklaces, scarves, or rings during work.
- ✓ Make sure all pinch points are well guarded.

WHAT ABOUT OUR SITE?

COMMENTS

Who remembers what we talked about last week? Was there something we needed to fix?	
What can get caught in pinch points? <i>Jewelry, shovels, prybars, clothing, hair</i>	
Has anyone had or seen a accident or near-miss with the pulleys?	
What places/jobs in our mine have a high risk for catching clothing? Show us.	
Is there any other way to reduce hazards? <i>Hair and clothing codes, add or fix guards</i>	

MODULE 2B

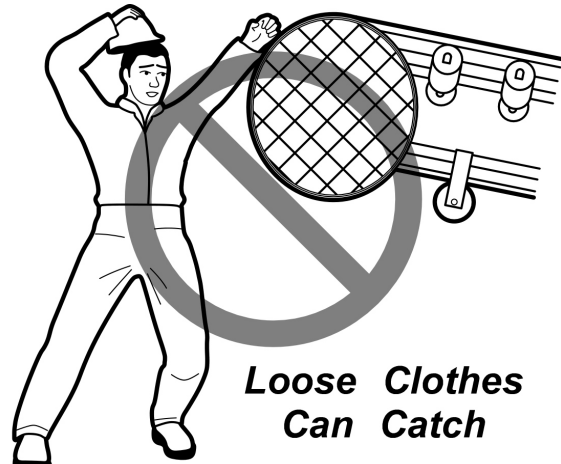
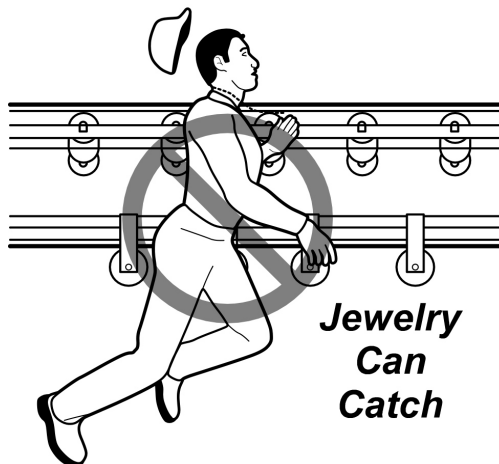

TRAINING RECORD

DATE: _____ MSHA MINE/CONTRACTOR NAME & ID No. _____

TRAINER/COMPETENT PERSON: _____

LENGTH: _____ LOCATION: _____

Check If This Is Part of Annual Refresher Training (CFR 30, 46.8.c)

PERSONS TRAINED (PRINT FULL NAME AND INITIAL):

I certify that the above training has been completed: _____ Date: _____

(Signature of person responsible for safety and health training)

False certification is punishable under §110(a) and (f) of the Federal Mine Safety and Health Act

REFRESHER TRAINING

PPE - SEAT BELT

HAZARD - More severe injuries during vehicle accidents

30 CFR 56.14130

RESULT - Bruises, sprains and strains, lacerations, fractures, death

LOOK FOR - Damaged, loose, or unused seat belts

REAL ACCIDENTS: At the end of his shift, a truck driver with 10 years of experience started to dump his last load on the waste pile. As he backed up, he hit the berm at an angle, causing the left rear wheels to break through the berm. The truck slid then rolled several times on its way down the 60-foot bank, finally landing upright. **The driver UNBUCKLED HIS SEAT BELT, crawled out of the damaged cab AND WALKED AWAY.**

BEST PRACTICES:

- ✓ Always buckle up and keep your belt snug across your pelvic area.
- ✓ Ride it out. People often die trying to jump clear of a runaway truck.
- ✓ Inspect the seat belt buckles, anchors, and webbing every day as part of the vehicle pre-inspection.
- ✓ Back in straight to berm when dumping.

WHAT ABOUT OUR SITE?

COMMENTS

Has anyone been in a vehicle accident at home or at work?	
Do we have equipment with seat belts that are uncomfortable, worn, or cut?	
What is our procedure to report seat belt problems?	
Whose job is it to repair or replace a seat belt?	

MODULE 2C

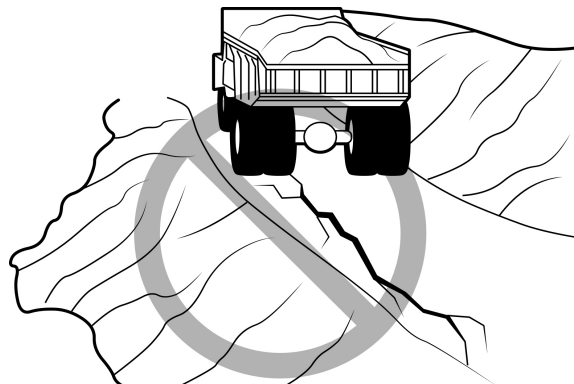

TRAINING RECORD

DATE: _____ MSHA MINE/CONTRACTOR NAME & ID No. _____

TRAINER/COMPETENT PERSON: _____

LENGTH: _____ LOCATION: _____

Check If This Is Part of Annual Refresher Training (CFR 30, 46.8.c)

PERSONS TRAINED (PRINT FULL NAME AND INITIAL):

I certify that the above training has been completed: _____ Date: _____

(Signature of person responsible for safety and health training)

False certification is punishable under §110(a) and (f) of the Federal Mine Safety and Health Act

REFRESHER TRAINING

OPERATING EQUIPMENT

HAZARD - Safety defects

30 CFR 56.14100

RESULT - Coughing, nausea, choking, death

LOOK FOR - Dust, fumes, restricted ventilation

REAL ACCIDENTS: Near the end of his shift on a cool, rainy autumn day, a driver started to feel light-headed and sick to his stomach. When he returned to the pit, he told his foreman. They looked at the truck and realized there was an exhaust leak into the cab. The driver had been running with his windows closed for the last 3 hours because of the rain. The driver went to the hospital where he was found to have acute CO poisoning. He needed 3 days of oxygen therapy to clear his system.

BEST PRACTICES:

- ✓ Carbon monoxide is a clear, odorless gas. Symptoms are dizziness, headache, weakness, shortness of breath, nausea, unconsciousness.
- ✓ Pre-inspect equipment and vehicles before every use.
- ✓ Have a lockout/tagout system for repair of equipment.

WHAT ABOUT OUR SITE?

COMMENTS

Who will show us what to look for in a pre-inspection on our truck?	
What are some of our other equipment that needs pre-inspection? <i>Forklift, water truck, dump truck, utility truck</i>	
What are other sources of CO at home or at work? <i>Furnace, generator, gas fireplace, boat motor, car, lawn mower, closed shops</i>	

MODULE 2D



TRAINING RECORD

DATE: _____ MSHA MINE/CONTRACTOR NAME & ID No. _____

TRAINER/COMPETENT PERSON: _____

LENGTH: _____ LOCATION: _____

Check If This Is Part of Annual Refresher Training (CFR 30, 46.8.c)

PERSONS TRAINED (PRINT FULL NAME AND INITIAL):

I certify that the above training has been completed: _____ Date: _____

(Signature of person responsible for safety and health training)

False certification is punishable under §110(a) and (f) of the Federal Mine Safety and Health Act

REFRESHER TRAINING

PPE - HEARING PROTECTION

HAZARD - Hearing loss

30 CFR 62.160

RESULT - Tinnitus (ringing, buzzing), partial deafness, deafness

LOOK FOR - Noisy work areas, loud equipment, explosive sounds

REAL ACCIDENTS: It was the start of the shift, and a young, portable plant foreman with 4 years of experience pushed the start button on the plant generator. The generator and the motor's battery exploded. The foreman was sprayed with acid. The explosion made him deaf for several hours, and he lost 3 days of work because of painful ringing in his ears. The doctor told him it could take several months for the ringing to go away completely. The generator area normally requires hearing protection, but the worker was not wearing any because he was not going to stay long.

BEST PRACTICES:

- ✓ Post signs in areas where hearing protection required.
- ✓ Wear hearing protection before entering noise hazard areas.
- ✓ Wear dual hearing protection where posted.
- ✓ Use the roll-pull-hold technique to insert soft ear plugs.

WHAT ABOUT OUR SITE?

COMMENTS

Where are our ear plugs kept?	
How many times can you use the soft foam plugs? <i>Once.</i>	
Why? <i>To avoid getting dirt and germs into ear canal. Also wash hands before handling plugs.</i>	
What is the roll-pull-hold technique? Can somebody demonstrate it? <i>See diagram below.</i>	

MODULE 2E



1- Roll the earplugs up into a small, thin “snake” with your fingers. You can use one or both hands.



2- Pull the top of your ear up and back with your opposite hand to straighten out the ear canal. The rolled-up earplug should slide right in.



3- Hold the earplug in with your finger - as far as it will go. Count to 20 or 30 out loud while waiting for the plug to expand and fill the ear canal. Your voice will sound muffled when the earplug has made a good seal.

TRAINING RECORD

DATE: _____ MSHA MINE/CONTRACTOR NAME & ID No. _____

TRAINER/COMPETENT PERSON: _____

LENGTH: _____ LOCATION: _____

Check If This Is Part of Annual Refresher Training (CFR 30, 46.8.c)

PERSONS TRAINED (PRINT FULL NAME AND INITIAL):

I certify that the above training has been completed: _____ Date: _____

(Signature of person responsible for safety and health training)

False certification Is punishable under §110(a) and (f) of the Federal Mine Safety and Health Act

REFRESHER TRAINING

FALL PROTECTION

HAZARD - Fall from heights

30 CFR 56.11012

RESULT - Sprain, fracture, death

LOOK FOR - Missing guards, elevated platforms, tripping hazards

REAL ACCIDENT: A mechanic with 20 years of experience, along with three co-workers, were replacing the head drive on a 100-foot-tall bucket elevator. One of the co-workers removed a section of grate to hoist some angle iron to their work area. A few hours later, after working 10 hours on the repair, the mechanic stepped through the opening in the grate. The mechanic caught himself before falling 100 feet to the ground, but not before his hip struck the edge of the opening, fracturing it in two places. **80 DAYS LOST/RESTRICTED DUTY**

BEST PRACTICES:

- ✓ Before working, take the time to look around to avoid or eliminate potential hazards.
- ✓ Immediately replace guarding, grates, rails after use.
- ✓ Clean up the work area before and after working.
- ✓ Set up temporary barricades until job is completed.

WHAT ABOUT OUR SITE?

COMMENTS

What are some things that could have prevented this accident?	
What jobs do we have that require working higher than 5 feet off the ground?	
How do we get equipment and materials up to these areas? Is there a better way?	

MODULE 2F

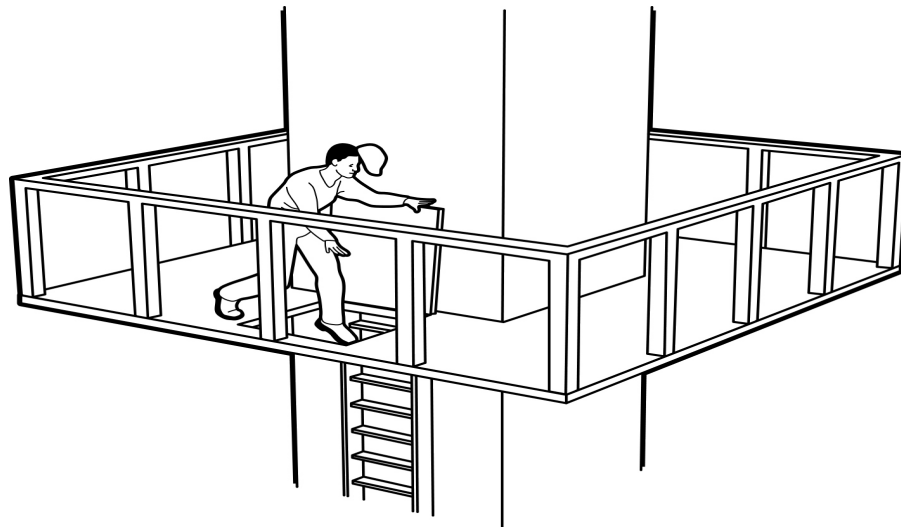

TRAINING RECORD

DATE: _____ MSHA MINE/CONTRACTOR NAME & ID No. _____

TRAINER/COMPETENT PERSON: _____

LENGTH: _____ LOCATION: _____

Check If This Is Part of Annual Refresher Training (CFR 30, 46.8.c)

PERSONS TRAINED (PRINT FULL NAME AND INITIAL):

I certify that the above training has been completed: _____ Date: _____

(Signature of person responsible for safety and health training)

False certification is punishable under §110(a) and (f) of the Federal Mine Safety and Health Act

REFRESHER TRAINING

WORKING AROUND WATER

HAZARD - Mucking out silt ponds, moving/maintaining pumps

30 CFR 56.15020

RESULT - Drowning

LOOK FOR - Any water depth, undercut banks, sloughing ground

REAL ACCIDENTS: A worker with 8 years of experience was starting a water pump. He probably hit his head on a rock when he slipped or fell to a pond. He drowned.

- Between 1996 and 2000, there were 17 drowning fatalities, representing almost 5% of all fatalities in mining.

BEST PRACTICES:

- ✓ Always wear a Coast Guard-approved Type I or Type V personal flotation device (PFD) when working around water.
- ✓ Inspect your PFD every day before putting it on.
- ✓ Put on PFD before entering water hazard areas.

WHAT ABOUT OUR SITE?

COMMENTS

Where do we keep our PFD's? Are they Coast Guard approved?	
Can someone show us how to put on a PFD properly?	
What jobs do we have that require working near water?	
Has anyone ever had to swim while fully clothed and booted? What was it like?	

MODULE 2G

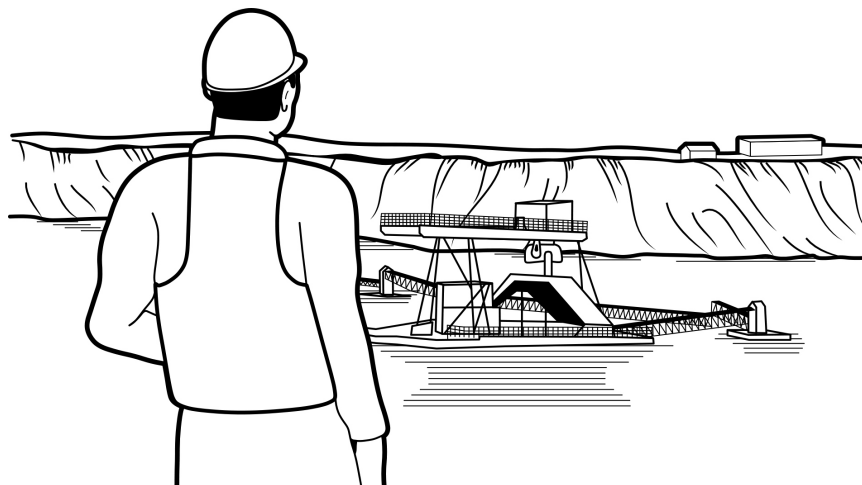

REFRESHER TRAINING

INJURIES AND FATALITIES

HAZARD - Not knowing, not training

30 CFR 46 and 47

RESULT - Near hit, injury, illness, death

LOOK FOR - Sloppiness in practice or workplace, hazardous short-cuts

REAL ACCIDENTS: In 2001—

- Over 14,600 mining operations were active. Three-quarters of these operations were engaged in mining stone and sand and gravel.
- Eleven miners in stone quarries and/or sand and gravel mines died in mining accidents.
- Over 3,500 miners were injured.
- Handling materials and slips and falls accounted for the majority of the injuries.
- Sprains and strains were the most likely injury.

BEST PRACTICES:

- ✓ Get at least 8 hours of annual refresher training.
- ✓ Make sure visitors, contractors, and vendors have had site-specific hazard training.
- ✓ Make sure you have task training before starting a new task or operating a new piece of equipment.
- ✓ Watch out for each other.

WHAT ABOUT OUR SITE?

COMMENTS

Training must be done by a competent person. Who are our competent people?	
When do we do refresher training?	
What tasks do we require training on?	
Who can explain our HazCom program?	

MODULE 3A



TRAINING RECORD

DATE: _____ MSHA MINE/CONTRACTOR NAME & ID No. _____

TRAINER/COMPETENT PERSON: _____

LENGTH: _____ LOCATION: _____

Check If This Is Part of Annual Refresher Training (CFR 30, 46.8.c)

PERSONS TRAINED (PRINT FULL NAME AND INITIAL):

I certify that the above training has been completed: _____ Date: _____

(Signature of person responsible for safety and health training)

False certification is punishable under §110(a) and (f) of the Federal Mine Safety and Health Act

REFRESHER TRAINING

GENERAL RULES AND PRACTICES

HAZARD - Slips, falls, fires from poor housekeeping

30 CFR 56.20003

RESULT - Strains, lacerations, fractures or death

LOOK FOR - Debris in walkways or work areas, clutter

REAL ACCIDENTS: A mechanic with 10 years of experience was on overtime repairing a loader. As he walked around the loader, he stepped on a bolt and slipped, twisting his low back. **22 DAYS RESTRICTED DUTY.**

- After lunch on a warm, sunny day, a new miner went to burn a brush pile while waiting for trucks to arrive. After putting fuel on the pile and lighting it, he tripped over the gas can, spilling it. He picked up the can just as the spilled fuel ignited around him, burning him. **9 DAYS LOST.**

BEST PRACTICES:

- ✓ Avoid hazards. Keep your work area clean.
- ✓ Keep loose parts in containers during work.
- ✓ Report or clean up spills right away.

WHAT ABOUT OUR SITE?

COMMENTS

What could the person in the first tripping accident have done differently to avoid being hurt?	
What places/jobs in our mine have house-keeping problems?	
Who's job is it to keep these places clean? How can we do better?	
Has anyone seen an accident or near miss due to poor housekeeping?	

MODULE 3B

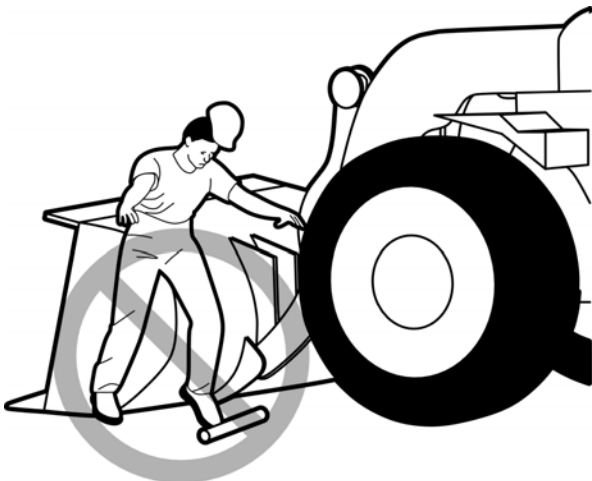

TRAINING RECORD

DATE: _____ MSHA MINE/CONTRACTOR NAME & ID No. _____

TRAINER/COMPETENT PERSON: _____

LENGTH: _____ LOCATION: _____

Check If This Is Part of Annual Refresher Training (CFR 30, 46.8.c)

PERSONS TRAINED (PRINT FULL NAME AND INITIAL):

I certify that the above training has been completed: _____ Date: _____

(Signature of person responsible for safety and health training)

False certification is punishable under §110(a) and (f) of the Federal Mine Safety and Health Act

REFRESHER TRAINING

STAYING ALERT

HAZARD - Falling asleep, daydreaming, working alone

30 CFR 56.18020

RESULT - Injury, death

LOOK FOR - Tiredness, drowsiness, unengaged

REAL ACCIDENTS: During the early mornings or late afternoons, the sun can shine in drivers' eyes, making them drowsy. A young truck driver with less than a full mining season fell asleep at the wheel. The haul truck flipped over, but because he had his seatbelt on, he walked away with only cuts on his head.

BEST PRACTICES:

- ✓ Working with someone helps keep you engaged and aware.
- ✓ Talking, getting fresh air, and changing your pace helps keep your edge.
- ✓ Avoid sugary drinks or food. Snack on fruit, vegetables, or protein such as jerky.
- ✓ Get up and move around to freshen your mind and move your muscles.
- ✓ Wear safety shades.

WHAT ABOUT OUR SITE?

COMMENTS

When and where on our site does the sun shine directly into drivers' eyes?	
Are there any ideas for avoiding this? <i>Clip-on sun visor, sunglasses, rerouting traffic, signs</i>	
Has anyone ever experienced "waking up" and not remembering how they drove the last 10 miles?	

MODULE 3C

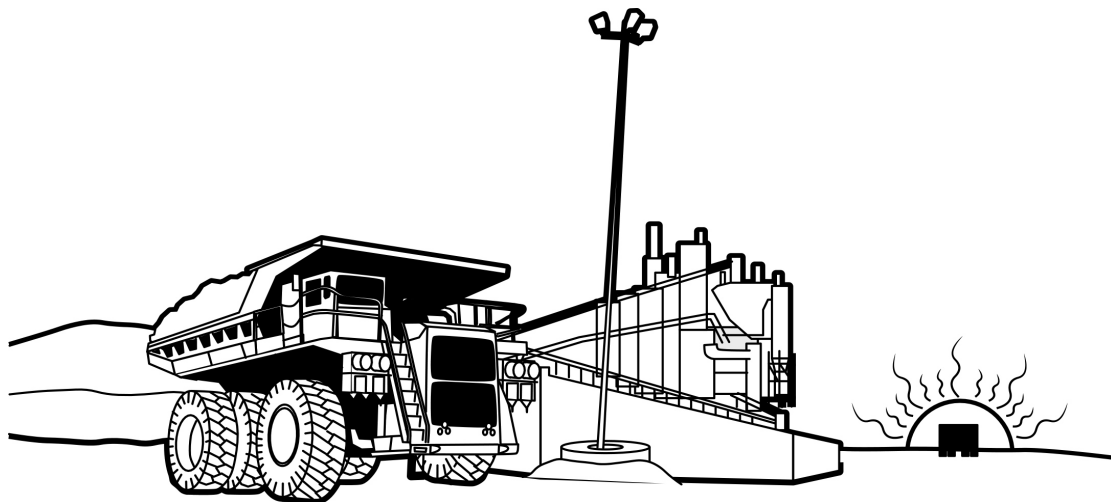

TRAINING RECORD

DATE: _____ MSHA MINE/CONTRACTOR NAME & ID No. _____

TRAINER/COMPETENT PERSON: _____

LENGTH: _____ LOCATION: _____

Check If This Is Part of Annual Refresher Training (CFR 30, 46.8.c)

PERSONS TRAINED (PRINT FULL NAME AND INITIAL):

I certify that the above training has been completed: _____ Date: _____

(Signature of person responsible for safety and health training)

False certification is punishable under §110(a) and (f) of the Federal Mine Safety and Health Act

REFRESHER TRAINING

TIGHT WORKING AREAS

HAZARD - Physical imbalance, tool rebound, falling and flying parts

RESULT - Lacerations, sprains and strains, burns

LOOK FOR - Tight working areas

REAL ACCIDENTS: A plant operator was clearing wet material from a hopper door. The working area was very restricted and confined the swing of the sledgehammer he was using. During one swing, his arm and the sledgehammer hit the side of the hopper, bruising his forearm. **RESTRICTED DUTY.**

BEST PRACTICES:

- ✓ Before working, take a look around and size up potential hazards.
- ✓ Get a good footing and avoid awkward positions.
- ✓ Wear PPE and guard against flying grit, falling parts, and sharp edges.

WHAT ABOUT OUR SITE?

COMMENTS

Where do we have similar tight work areas?	
What are the main reasons we are in these tight work areas?	
What makes these tight work areas potentially dangerous? <i>Little air flow, poor lighting, tight area, hidden from view, requires work in awkward positions</i>	
Is there any way to avoid working in these areas by moving something or reducing the reasons you must be in such an area?	

MODULE 3D

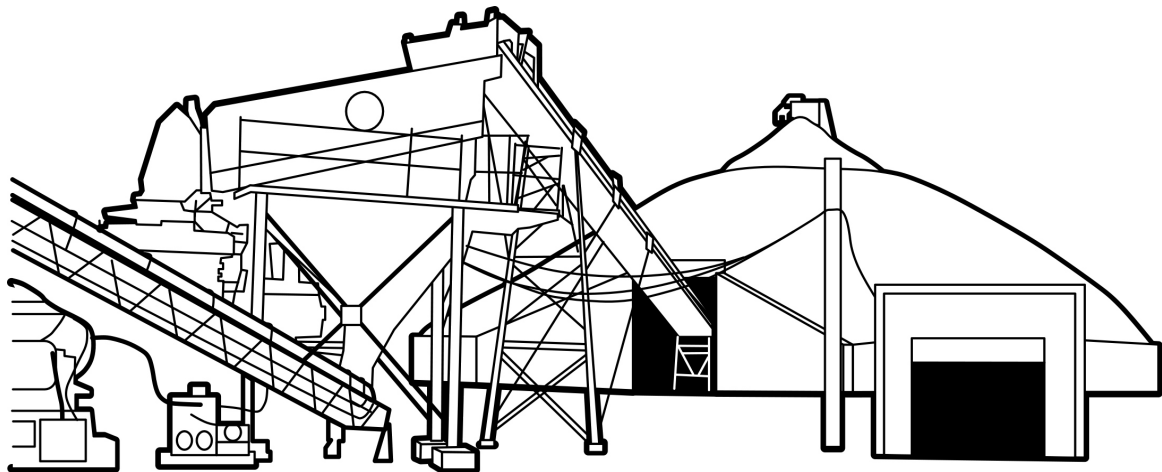

TRAINING RECORD

DATE: _____ MSHA MINE/CONTRACTOR NAME & ID No. _____

TRAINER/COMPETENT PERSON: _____

LENGTH: _____ LOCATION: _____

Check If This Is Part of Annual Refresher Training (CFR 30, 46.8.c)

PERSONS TRAINED (PRINT FULL NAME AND INITIAL):

I certify that the above training has been completed: _____ Date: _____

(Signature of person responsible for safety and health training)

False certification is punishable under §110(a) and (f) of the Federal Mine Safety and Health Act

REFRESHER TRAINING

LIGHTNING

HAZARD - Extreme weather conditions

30 CFR 56.11016

RESULT - Injury, death

LOOK FOR - Darkening clouds, storms, distant thunder, hair standing on end, tingling

REAL ACCIDENTS: A seasoned and experienced bulldozer operator was working in the storm. Lightning struck the ground nearby, burning the operator. **23 LOST DAYS.**

BEST PRACTICES:

- ✓ Be aware of weather conditions through news, forecasts, radio broadcasts.
- ✓ Plan for extreme weather events.
- ✓ Seek shelter—fully enclosed metal vehicles with rubber tires and windows up, substantial buildings, low ground, clumps of tall bushes.
- ✓ Avoid any metal, open areas, lone or high trees, high ground, water.

WHAT ABOUT OUR SITE?

COMMENTS

Where on our site can we take shelter in a lightning storm?	
What is our extreme weather plan?	
Do rain and lightning occur together? <i>Not always. Lightning often strikes before rain.</i>	
Can someone show us the lightning crouch? <i>Immediately remove metal objects, put feet together, duck head, squat low, cover ears</i>	

MODULE 3E

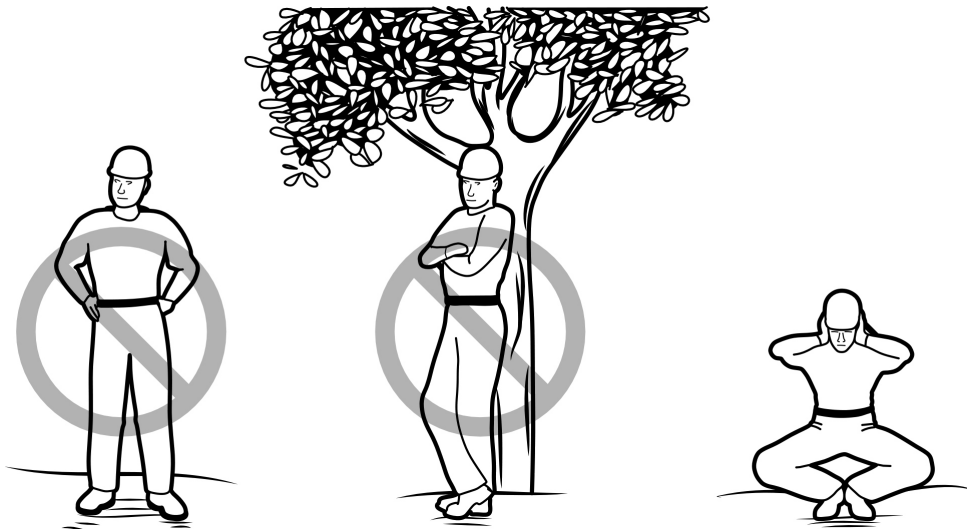

TRAINING RECORD

DATE: _____ MSHA MINE/CONTRACTOR NAME & ID No. _____

TRAINER/COMPETENT PERSON: _____

LENGTH: _____ LOCATION: _____

Check If This Is Part of Annual Refresher Training (CFR 30, 46.8.c)

PERSONS TRAINED (PRINT FULL NAME AND INITIAL):

I certify that the above training has been completed: _____ Date: _____

(Signature of person responsible for safety and health training)

False certification Is punishable under §110(a) and (f) of the Federal Mine Safety and Health Act

REFRESHER TRAINING

CHEMICAL FUMES

HAZARD - Chemicals, dust, fumes, gases

30 CFR 57.5005

RESULT - Coughing, trouble breathing, lung damage, asphyxiation

LOOK FOR - Confined working areas, unmarked containers, MSDS

REAL ACCIDENTS: On a hot August afternoon, a 29-year-old laborer went inside a crusher to clean the grease leaking from the shaft bearings. To make his job faster and easier, he used a brake cleaner from a spray can. Shortly after beginning, he was overcome by fumes. He was short of breath and was unable to move. Another employee called 911 and then entered the crusher to assist his co-worker's breathing until paramedics arrived. Both employees were treated and released from the hospital.

BEST PRACTICES:

- ✓ Before using any chemicals, check the instructions for warnings.
- ✓ Always check the work area for ventilation.
- ✓ Never go after an unconscious person in a confined space without proper equipment and training.

WHAT ABOUT OUR SITE?

COMMENTS

What would you have done?	
What is our emergency plan?	
Do we have emergency phone numbers at all our phones?	
What types of chemicals do we commonly use? <i>Pesticides, oils, starter fluid, paint thinner</i>	
What is a MSDS and where do we keep it? <i>Material Safety Data Sheet</i>	

MODULE 3F

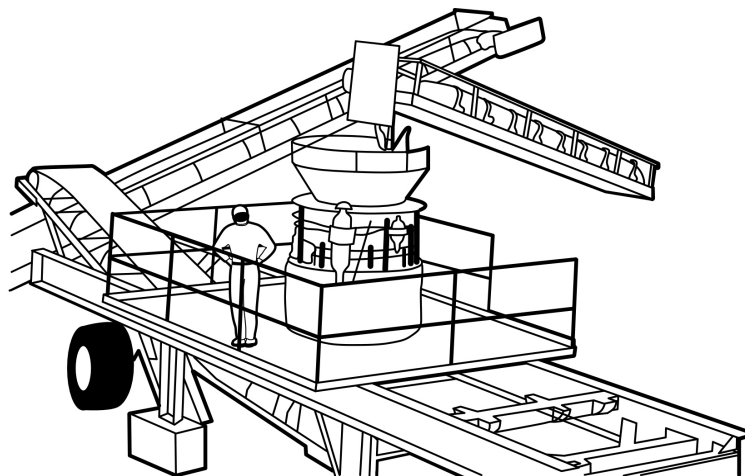

TRAINING RECORD

DATE: _____ MSHA MINE/CONTRACTOR NAME & ID No. _____

TRAINER/COMPETENT PERSON: _____

LENGTH: _____ LOCATION: _____

Check If This Is Part of Annual Refresher Training (CFR 30, 46.8.c)

PERSONS TRAINED (PRINT FULL NAME AND INITIAL):

I certify that the above training has been completed: _____ Date: _____

(Signature of person responsible for safety and health training)

False certification is punishable under §110(a) and (f) of the Federal Mine Safety and Health Act

REFRESHER TRAINING

SIGNAGE

HAZARD - Signs and the hazards they note

30 CFR 56.20011

RESULT - Thinking, caution, prevention

LOOK FOR - Safety reminders, hazardous area

REAL ACCIDENTS: Signs call attention to hazards, but sometimes they can be a cause of injury themselves. Stay alert. A miner with 5 years of experience dislocated his knee when he was installing a safety sign. A young miner was walking when a gust of wind blew a sign onto her head. A miner tripped and fell over a hard-hat-area sign.

BEST PRACTICES:

- ✓ Avoid confusion by using signage standards such as ANSI.
- ✓ Use sign size, shape, and color to get the message across.
- ✓ Place signs where they will do the most good, not where they will fit.
- ✓ Use signs to remind, warn, and direct.

WHAT ABOUT OUR SITE?

COMMENTS

What does ANSI stand for? <i>American National Standards Institute</i>	
Do we use standardized signage? <i>Colors, shapes, sizes, ANSI, ISO [International Organization for Standardization]</i>	
Where do we have signs? What do they say?	
Are our signs in good shape?	

MODULE 3G



Imminently hazardous, could result in death or serious injury



Potentially hazardous, could result in death or serious injury



Potentially hazardous, could result in minor or moderate injury

TRAINING RECORD

DATE: _____ MSHA MINE/CONTRACTOR NAME & ID No. _____

TRAINER/COMPETENT PERSON: _____

LENGTH: _____ LOCATION: _____

Check If This Is Part of Annual Refresher Training (CFR 30, 46.8.c)

PERSONS TRAINED (PRINT FULL NAME AND INITIAL):

I certify that the above training has been completed: _____ Date: _____

(Signature of person responsible for safety and health training)

False certification is punishable under §110(a) and (f) of the Federal Mine Safety and Health Act

REFRESHER TRAINING

FLAMMABLE AND COMBUSTIBLE MATERIALS

HAZARD - Punctured cans, welding near combustibles

30 CFR 56.4104

RESULT - Burns, explosions, death

LOOK FOR - Empty cans and drums, grease tubes, ignition sources

REAL ACCIDENTS: A young new miner carried a can of liquid into the shop area. Two other miners were cutting bolts and sparks from a torch were flying. Vapors seeped out of the vent holes the new miner had punched with a screwdriver. The fumes ignited, and the can exploded. **25 DAYS LOST.**

BEST PRACTICES:

- ✓ Never punch vent holes in cans—the fumes cannot be controlled.
- ✓ Flammable and combustibles must be stored separately and away from sources of ignition.
- ✓ Separate different trash types and use lidded disposal cans.

WHAT ABOUT OUR SITE?

COMMENTS

Do we have a separate storage area for flammable and combustible materials?	
Where do we have our safety cans? What do we have in them?	
What is our policy for safety cans?	
What is our policy for shielding around welding and cutting areas?	

MODULE 3H

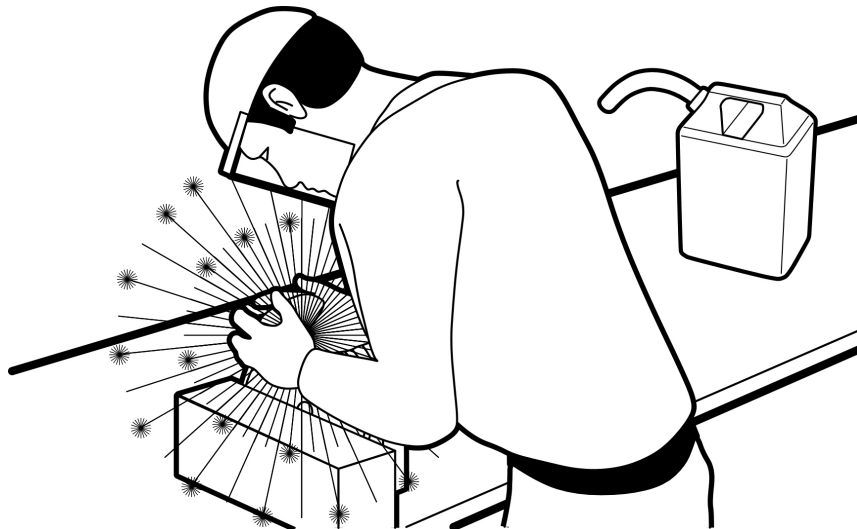

TRAINING RECORD

DATE: _____ MSHA MINE/CONTRACTOR NAME & ID No. _____

TRAINER/COMPETENT PERSON: _____

LENGTH: _____ LOCATION: _____

Check If This Is Part of Annual Refresher Training (CFR 30, 46.8.c)

PERSONS TRAINED (PRINT FULL NAME AND INITIAL):

I certify that the above training has been completed: _____ Date: _____

(Signature of person responsible for safety and health training)

False certification is punishable under §110(a) and (f) of the Federal Mine Safety and Health Act

REFRESHER TRAINING

PPE - EYE PROTECTION

HAZARD - Dust, fumes, injury to eyes

30 CFR 56.15004

RESULT - Eye, nose, and throat irritation; burns

LOOK FOR - Spraying chemicals, flying particles

REAL ACCIDENTS: A young miner with only a year of mining experience was spraying belt dressing on the feeder drive belts. He had removed his safety glasses to see better. Some of the spray went into his eyes. **1 DAY LOST TIME.**

BEST PRACTICES:

- ✓ Before spraying, read the labels for directions and warnings.
- ✓ Before spraying, note air flow for yourself and others who might be affected.
- ✓ Keep all PPE clean and in good repair.
- ✓ Use different eye protection as needed—side shield, goggles, full face protection.

WHAT ABOUT OUR SITE?

COMMENTS

Where do we keep our PPE supply?	
Where is our first-aid kit?	
Do we have an eye washing station?	
Who is certified in first aid?	
What is our first-aid procedure?	

MODULE 31



**Regular
safety glasses**



**Safety
goggles**



**Wrap-around
safety glasses**



**Full-face
shield**

TRAINING RECORD

DATE: _____ MSHA MINE/CONTRACTOR NAME & ID No. _____

TRAINER/COMPETENT PERSON: _____

LENGTH: _____ LOCATION: _____

Check If This Is Part of Annual Refresher Training (CFR 30, 46.8.c)

PERSONS TRAINED (PRINT FULL NAME AND INITIAL):

I certify that the above training has been completed: _____ Date: _____

(Signature of person responsible for safety and health training)

False certification is punishable under §110(a) and (f) of the Federal Mine Safety and Health Act

REFRESHER TRAINING

OPERATING EQUIPMENT

HAZARD - Unstable stockpiles, sloughing ground

30 CFR 56.9304

RESULT - Cuts, bruising, fractures, death

LOOK FOR - Unprotected edges, sloughing ground

REAL ACCIDENTS: A heavy equipment operator in his mid-40's with over 20 years mining experience was pushing rock near the top edge of the stockpile. The crest of the pile sloughed down, jerking the bulldozer forward. The operator struck his head on the dozer windshield. **132 DAYS LOST.**

BEST PRACTICES:

- ✓ Before working on a pile, check for unstable ground, slumping, or cracking.
- ✓ Know that ice, thawing, and rain can change stockpile stability.
- ✓ Be aware of the angle of repose of a stockpile slope.
- ✓ Always wear seat belts.

WHAT ABOUT OUR SITE?

COMMENTS

What types of equipment are used on our stockpiles? <i>Pickup, dozer, bobcat, dump truck</i>	
What is an angle of repose and why is it important? <i>Maximum slope angle at which unconsolidated material is stable. If a slope is too steep or undercut, the slope can fail.</i>	
In the above story, what could have caused the pile instability? <i>Rain, ice, thawing, heavy dozer weight, too near edge, steep pile face, top loading of slope</i>	

MODULE 3J

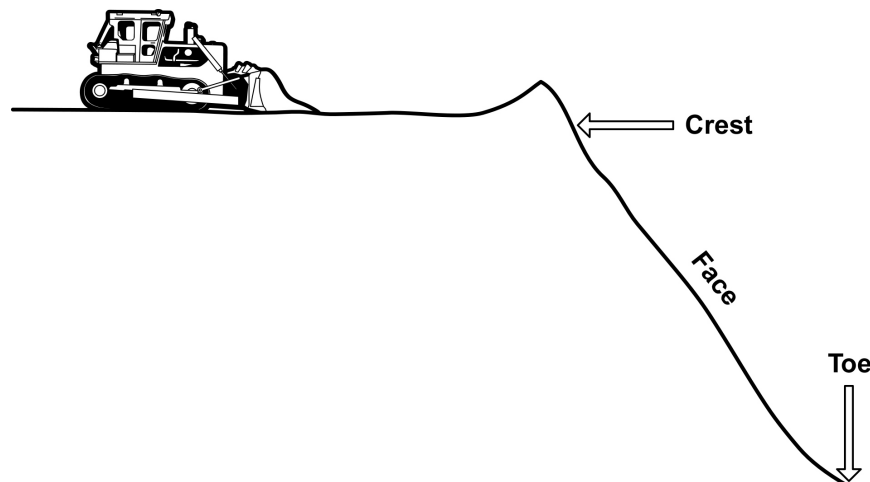

TRAINING RECORD

DATE: _____ MSHA MINE/CONTRACTOR NAME & ID No. _____

TRAINER/COMPETENT PERSON: _____

LENGTH: _____ LOCATION: _____

Check If This Is Part of Annual Refresher Training (CFR 30, 46.8.c)

PERSONS TRAINED (PRINT FULL NAME AND INITIAL):

I certify that the above training has been completed: _____ Date: _____

(Signature of person responsible for safety and health training)

False certification is punishable under §110(a) and (f) of the Federal Mine Safety and Health Act

REFRESHER TRAINING

ILLUMINATION

HAZARD - Limited visibility

30 CFR 56.17001

RESULT - Sprains and strains, cuts, collision, death

LOOK FOR - Dark work areas, going from light to dark or vice versa

REAL ACCIDENTS: Walking along an old haul road, a miner stepped into a newly cut 3-foot-deep drainage ditch, twisting his knee. He didn't see the trench in the dark. **82 LOST WORKDAYS.**

- By age 60, a person needs twice as much light to see as well as a 20-year-old.
- The speed at which an eye adjusts to change from light to dark or dark to light slows with age.

BEST PRACTICES:

- ✓ Illuminate all work areas, travel ways, loading and dumping stations, switch panels.
- ✓ Have emergency backup lighting plans.
- ✓ Keep flashlights or cap lamps available.

WHAT ABOUT OUR SITE?

COMMENTS

Do we need lighting? <i>Even if we have no night shift, does it get dark in the early mornings or evenings?</i>	
Where are some of our lights? <i>Work bench, shop, stockpiles, conveyors, gate</i>	
Are our lights in the best position to show an area?	
Are there any flashlights stored around here?	

MODULE 3K

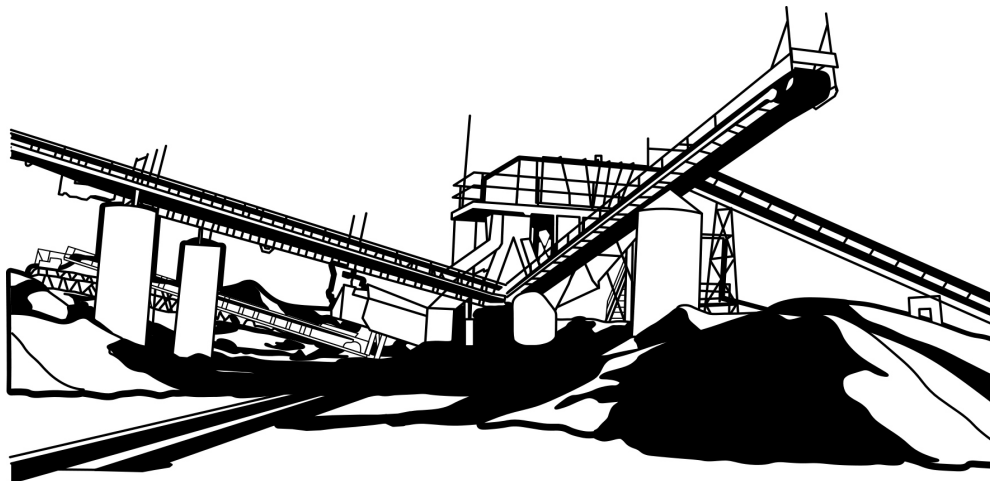

TRAINING RECORD

DATE: _____ MSHA MINE/CONTRACTOR NAME & ID No. _____

TRAINER/COMPETENT PERSON: _____

LENGTH: _____ LOCATION: _____

Check If This Is Part of Annual Refresher Training (CFR 30, 46.8.c)

PERSONS TRAINED (PRINT FULL NAME AND INITIAL):

I certify that the above training has been completed: _____ Date: _____

(Signature of person responsible for safety and health training)

False certification is punishable under §110(a) and (f) of the Federal Mine Safety and Health Act

REFRESHER TRAINING

WORK SITE HAZARDS: ANIMALS

HAZARD - Snakes, rabbits, gophers, mice, bats

30 CFR 56.18002

RESULT - Venom, bite, infection, rabies, hanta virus

LOOK FOR - Animal habitat, animal droppings, food chain

REAL ACCIDENTS: A miner was checking along a conveyor line when he stopped to remove a water line coupling. As he reached his hand under the coupling, he was bitten by a snake. **10 DAYS LOST TIME.**

BEST PRACTICES:

- ✓ Put trash in proper receptacles to control rodents.
- ✓ Keep vegetation cleared. Vegetation provides food, hiding places, and nesting places.
- ✓ Rodents attract snakes; control mice, rabbits, gophers.
- ✓ Don't touch wild animals that seem lazy or tame.

WHAT ABOUT OUR SITE?

COMMENTS

What types of snakes do we have in this region?	
Has anyone seen a snake on the property?	
If bitten by a snake, should you cut the wound, let it bleed, and put on tourniquet? <i>No—wash with soap and water, keep the wound below the level of the heart, and get to a hospital immediately.</i>	

MODULE 3L



TRAINING RECORD

DATE: _____ MSHA MINE/CONTRACTOR NAME & ID No. _____

TRAINER/COMPETENT PERSON: _____

LENGTH: _____ LOCATION: _____

Check If This Is Part of Annual Refresher Training (CFR 30, 46.8.c)

PERSONS TRAINED (PRINT FULL NAME AND INITIAL):

I certify that the above training has been completed: _____ Date: _____

(Signature of person responsible for safety and health training)

False certification is punishable under §110(a) and (f) of the Federal Mine Safety and Health Act



TOOLBOX TRAINING



REFRESHER TRAINING

EMERGENCY COMMUNICATION

HAZARD - Unexpected emergencies

30 CFR 56.18013

RESULT - Confusion, injury, death

LOOK FOR - Medical crisis, fire, explosion, extreme weather, power failure

REAL ACCIDENTS: It was a dark and quiet night. Then it got exciting. A small building surrounding a blower for the conveying system caught fire. The plant water truck and local fire department were called to put out the fire. No injuries were reported.

BEST PRACTICES:

- ✓ Every mine must have an emergency communications system.
- ✓ A designated "competent person" must be at the mine when people are working.
- ✓ The competent person is in charge during emergencies.
- ✓ Emergency telephone numbers must be posted by specific telephones.

WHAT ABOUT OUR SITE?

COMMENTS

What is our emergency communication plan?	
Do we have different procedures for different emergencies? <i>Fire, medical, power outage</i>	
Who is our competent person? Do we have alternates?	
Where are our emergency contact numbers posted?	

MODULE 3M

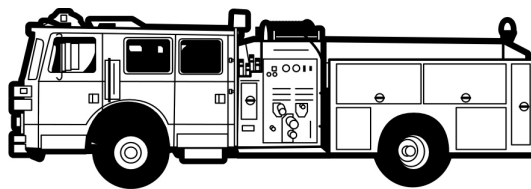

Emergency Contacts:

911
Fire Department
Emergency Medical
Law Enforcement
Mine contacts

TRAINING RECORD

DATE: _____ MSHA MINE/CONTRACTOR NAME & ID No. _____

TRAINER/COMPETENT PERSON: _____

LENGTH: _____ LOCATION: _____

Check If This Is Part of Annual Refresher Training (CFR 30, 46.8.c)

PERSONS TRAINED (PRINT FULL NAME AND INITIAL):

I certify that the above training has been completed: _____ Date: _____

(Signature of person responsible for safety and health training)

False certification is punishable under §110(a) and (f) of the Federal Mine Safety and Health Act

REFRESHER TRAINING

EQUIPMENT MAINTENANCE

HAZARD - Bins, hoppers, silos, tanks, surge piles

30 CFR 56.16002

RESULT - Lacerations, fractures, suffocation, death

LOOK FOR - Equipment not locked out, working out of sight and alone

REAL ACCIDENTS: Two miners climbed into a hopper. A front-end loader entered the area and dumped a load on them. The load crushed and trapped them, one for over an hour.
OVER 1 YEAR LOST TIME.

BEST PRACTICES:

- ✓ Post a guard at the access to dumps and high-traffic areas to prevent injury from mobile equipment.
- ✓ Wear a safety belt or harness with lifeline for both worker and guard.
- ✓ Avoid hazards. Place your lock and tag on the power source, not just on the nearest switch.

WHAT ABOUT OUR SITE?

COMMENT

How do we guard hoppers, surge piles, silos, and similar places while we work on them?	
Who can explain our lockout/tagout procedures?	
Where do we keep our locks and tags? Who keeps the key?	
Why isn't it OK just to turn the switch off?	

MODULE 4A

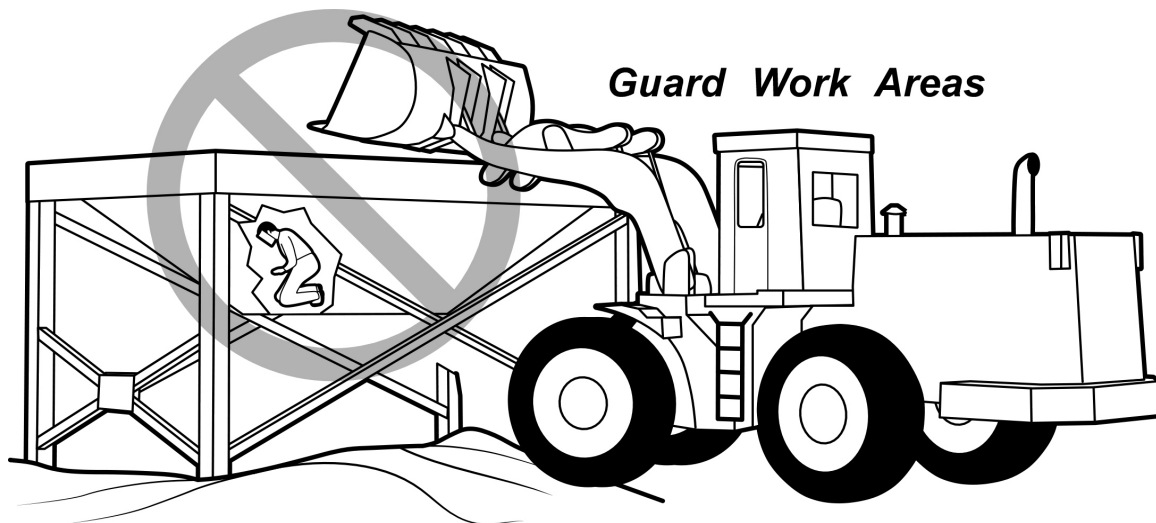

TRAINING RECORD

DATE: _____ MSHA MINE/CONTRACTOR NAME & ID No. _____

TRAINER/COMPETENT PERSON: _____

LENGTH: _____ LOCATION: _____

Check If This Is Part of Annual Refresher Training (CFR 30, 46.8.c)

PERSONS TRAINED (PRINT FULL NAME AND INITIAL):

I certify that the above training has been completed: _____ Date: _____

(Signature of person responsible for safety and health training)

False certification Is punishable under §110(a) and (f) of the Federal Mine Safety and Health Act

REFRESHER TRAINING

EQUIPMENT MAINTENANCE

HAZARD - Equipment moving while being worked on

30 CFR 56.14105

RESULT - Lacerations, fractures, amputations, death

LOOK FOR - Power left on, equipment not blocked against movement

REAL ACCIDENTS: A mechanic with 14 years of experience was working on a tractor when it lurched forward and ran over him. **OVER 1 YEAR LOST DUTY.**

- A mechanic with 6 years of experience disconnected a hydraulic line from a cylinder. The cylinder ram suddenly extended, amputating his finger. **18 DAYS LOST/RESTRICTED DUTY.**

BEST PRACTICES:

- ✓ De-energizing means neutralizing electrical, mechanical, hydraulic, pneumatic, and gravitational power.
- ✓ Avoid hazards. Secure equipment and parts against movement during maintenance.
- ✓ Take time before starting work to look for potential hazards and plan blocking needs.
- ✓ Use caution when blocking. Avoid pinch points.

WHAT ABOUT OUR SITE?

COMMENTS

Where do we keep blocking material? Do we have enough? Is it in good condition?	
What is a good way to block loader arms?	
Why isn't it ok to work under a suspended load, such as a part chained to a loader?	
How do you avoid a pinch point when you place blocks?	

MODULE 4B

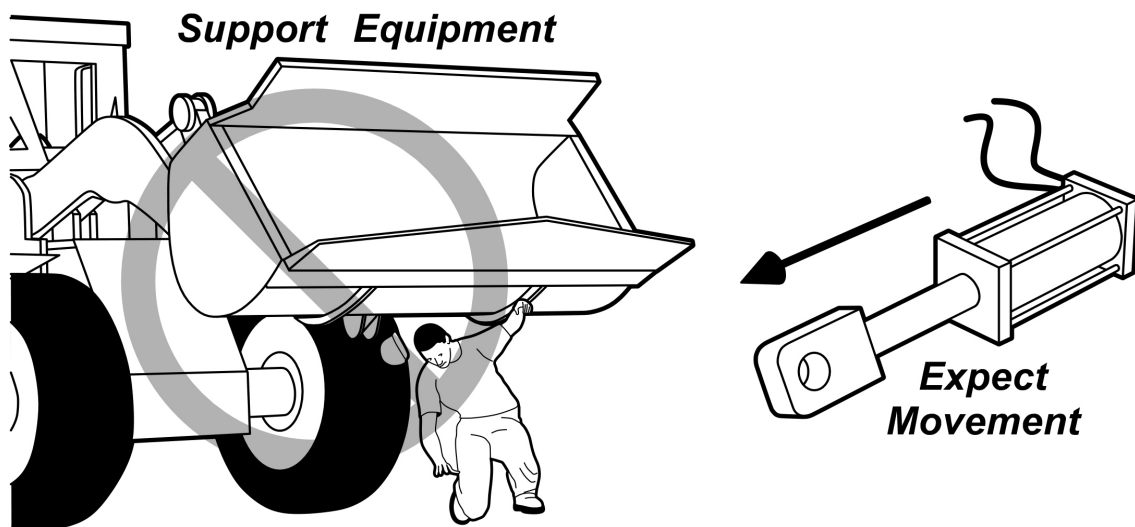

TRAINING RECORD

DATE: _____ MSHA MINE/CONTRACTOR NAME & ID No. _____

TRAINER/COMPETENT PERSON: _____

LENGTH: _____ LOCATION: _____

Check If This Is Part of Annual Refresher Training (CFR 30, 46.8.c)

PERSONS TRAINED (PRINT FULL NAME AND INITIAL):

I certify that the above training has been completed: _____ Date: _____

(Signature of person responsible for safety and health training)

False certification is punishable under §110(a) and (f) of the Federal Mine Safety and Health Act

REFRESHER TRAINING

EQUIPMENT MAINTENANCE

HAZARD - Accidents while changing screens

RESULT - Strains, lacerations, fractures

LOOK FOR - Poor footing, odd body positions, tight spaces

REAL ACCIDENTS: Just before lunch, a loader operator with 15 years of experience was helping replace screens on a plant. While removing a screen panel, he dropped it on his foot, fracturing his toes. **28 DAYS LOST.**

- A screen plant operator with 3 years of mining experience, but only 3 months as a plant operator, was replacing a screen. As he was twisting to lift a screen cloth into the lower deck, he strained his back. **47 DAYS LOST.**

BEST PRACTICES:

- ✓ Lock out the equipment.
- ✓ Get help or use mechanical aids to lift heavy or awkward loads.
- ✓ Make sure the work area is clear of debris before starting.
- ✓ Plan the job to avoid twisting with a load.
- ✓ Use protective equipment—safety glasses, steel-toed boots, gloves, safety harness and line (where work deck is not provided).

WHAT ABOUT OUR SITE?

COMMENTS

Who remembers what we talked about last week? Was there something we needed to fix?	
Which screens are hard to work on?	
What can we do to make it a safer and easier job?	
Has anyone seen a close call or accident when working on a screen?	
What are some techniques we can use to prevent these types of injuries at our site?	

MODULE 4C

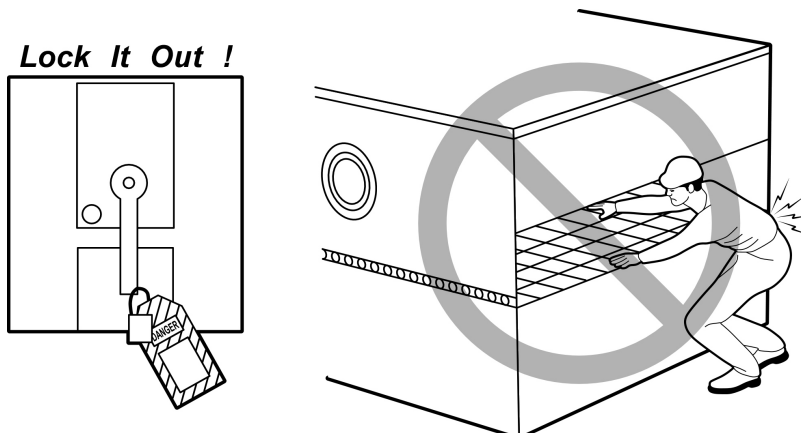

TRAINING RECORD

DATE: _____ MSHA MINE/CONTRACTOR NAME & ID No. _____

TRAINER/COMPETENT PERSON: _____

LENGTH: _____ LOCATION: _____

Check If This Is Part of Annual Refresher Training (CFR 30, 46.8.c)

PERSONS TRAINED (PRINT FULL NAME AND INITIAL):

I certify that the above training has been completed: _____ Date: _____

(Signature of person responsible for safety and health training)

False certification Is punishable under §110(a) and (f) of the Federal Mine Safety and Health Act

REFRESHER TRAINING

EQUIPMENT MAINTENANCE

HAZARD - Accidents while changing drive belts and chains

30 CFR 56.14105

RESULT - Lacerations, fractures, amputations

LOOK FOR - Pinch points and stored energy

REAL ACCIDENTS: 10% of all maintenance accidents involve changing drive belts or chains. Most injuries result in stitches, but the victims are only fractions of an inch from a more serious injury. A miner with 10 years of experience was changing V-belts on a conveyor drive when the pulley turned suddenly, amputating his fingers. **OVER 100 DAYS LOST .**

BEST PRACTICES:

- ✓ Keep guards in place and maintained.
- ✓ Lock and tag out the equipment before working.
- ✓ Relieve stored energy and block equipment.
- ✓ Keep hands away from pinch points. Use proper tools.

WHAT ABOUT OUR SITE?

COMMENTS

Who remembers what we talked about last week? Was there something we needed to fix?	
What are some ways the victim in this case could have prevented his injuries?	
How do gloves help? Could gloves hurt?	
Which drive belts or chains can turn suddenly? <i>All of them</i>	

MODULE 4D



Lock It Out !

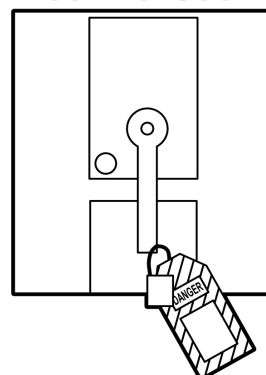

TRAINING RECORD

DATE: _____ MSHA MINE/CONTRACTOR NAME & ID No. _____

TRAINER/COMPETENT PERSON: _____

LENGTH: _____ LOCATION: _____

Check If This Is Part of Annual Refresher Training (CFR 30, 46.8.c)

PERSONS TRAINED (PRINT FULL NAME AND INITIAL):

I certify that the above training has been completed: _____ Date: _____

(Signature of person responsible for safety and health training)

False certification is punishable under §110(a) and (f) of the Federal Mine Safety and Health Act

REFRESHER TRAINING

PPE - EYE PROTECTION

HAZARD - Welding and cutting, flash, sparks, fumes

30 CFR 56.15004

RESULT - Blindness, burns, choking

LOOK FOR - No PPE, no shielding, no access restriction, poor ventilation

REAL ACCIDENTS: A belt man was helping another employee erect a conveyor. While the belt man was tightening some bolts, the other employee began welding on a guard. Even though the belt man was not looking at the arc, the flash was bouncing off his glasses brightly enough to make him squint. Later that evening, his eyes were still bothering him so he went to the hospital. He was found to have UV burns to his eyes, requiring him to wear dark glasses for several weeks.

BEST PRACTICES:

- ✓ Personal Protective Equipment (PPE) – hardhat, safety glasses, hearing protectors, respirator, welding gloves, boots, coveralls, fall harness.
- ✓ Goggles or safety glasses should have side shields.
- ✓ If fogging is a problem, wear a sweatband to keep sweat from fogging your glasses.
- ✓ Keep all people away from the welding area or shield the working area with welding curtains.

WHAT ABOUT OUR SITE?

COMMENTS

Do we do welding, cutting, or grinding here?	
Do we have curtains or panels to go around the welding and cutting area?	
What are some other hazards from welding and how can we protect ourselves? <i>Fumes, burns, heat, fire, noise, electrical shock</i>	

MODULE 4E



TRAINING RECORD

DATE: _____ MSHA MINE/CONTRACTOR NAME & ID No. _____

TRAINER/COMPETENT PERSON: _____

LENGTH: _____ LOCATION: _____

Check If This Is Part of Annual Refresher Training (CFR 30, 46.8.c)

PERSONS TRAINED (PRINT FULL NAME AND INITIAL):

I certify that the above training has been completed: _____ Date: _____

(Signature of person responsible for safety and health training)

False certification is punishable under §110(a) and (f) of the Federal Mine Safety and Health Act

REFRESHER TRAINING

TIRE MAINTENANCE

HAZARD - Accidents while changing tires

30 CFR 56.14104

RESULT - Strains, lacerations, fractures, death

LOOK FOR - Heavy loads, working alone

REAL ACCIDENTS: On a cold February evening near the end of a 12-hour shift, a welder with 4 years of experience started to repair a tire on a front-end loader. As he tried to remove the tire by himself, it suddenly came free. He tried to stop it and severely strained his shoulder. **207 DAYS LOST/RESTRICTED DUTY.**

BEST PRACTICES:

- ✓ A front-end loader tire weighs more than 200 lb.
- ✓ Before beginning tasks, go through a mental “what if” and “what I’d do” safety check.
- ✓ Task training is required before attempting any new task.
- ✓ Asking for help is not “whining,” it’s good safety sense.

WHAT ABOUT OUR SITE?

COMMENTS

Do we have any load assisting devices? Where are they?	
What is our procedure for changing our big tires?	
Who does our new task training?	
What were some of our recent tasks that required new task training?	

MODULE 4F



TRAINING RECORD

DATE: _____ MSHA MINE/CONTRACTOR NAME & ID No. _____

TRAINER/COMPETENT PERSON: _____

LENGTH: _____ LOCATION: _____

Check If This Is Part of Annual Refresher Training (CFR 30, 46.8.c)

PERSONS TRAINED (PRINT FULL NAME AND INITIAL):

I certify that the above training has been completed: _____ Date: _____

(Signature of person responsible for safety and health training)

False certification is punishable under §110(a) and (f) of the Federal Mine Safety and Health Act

REFRESHER TRAINING

TRAFFIC CONTROL

HAZARD - Mobile equipment accidents

30 CFR 56.9100

RESULT - Lacerations, fractures, death

LOOK FOR - Excessive speed, crossing traffic lanes, traffic congestion

REAL ACCIDENTS: One in six mobile equipment accidents involve violations of traffic rules.

- Just before lunch, a dozer operator was in his 9th hour of operating a loader. While in reverse, he cut across a 2-foot-high berm marking traffic lanes, throwing his body against the arm rest and bruising his pelvis. **51 DAYS LOST/RESTRICTED DUTY.**
- A truck driver was driving his empty truck down a ramp. He missed the corner and struck a gravel pile. **64 DAYS LOST/RESTRICTED DUTY.**

BEST PRACTICES:

- ✓ Follow the rules. Watch your speed, stay in lanes.
- ✓ Check your equipment (brakes, signals) before each use.
- ✓ Check brakes each time you approach a steep grade or elevated dump.
- ✓ Never move or change direction without using a warning signal or flagger.

WHAT ABOUT OUR SITE?

COMMENTS

Where do we post our traffic rules? What are they?	
Where are our high-hazard areas? Is there a way to relieve the hazard?	
Which of our grades require brake checks? Are they posted?	
If you are relieving someone for only a few minutes, do you need to check the equipment? <i>Yes! Do it yourself. It's your safety.</i>	
What do we do if we observe someone violating traffic rules or operating unsafely?	

MODULE 5A

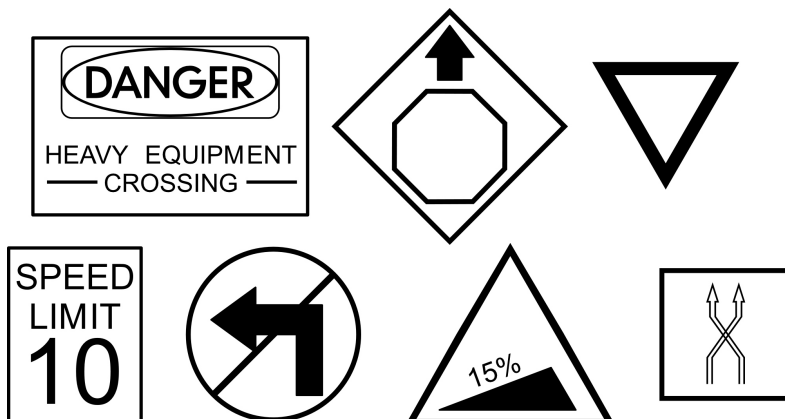

REFRESHER TRAINING

VARIABLE GROUND

HAZARD - Equipment rollover or burial

30 CFR 56.9304

RESULT - Lacerations, fractures, death

LOOK FOR - Excessive speed, steep grades, soft shoulders, unstable highwalls, poor berms

REAL ACCIDENTS: 15% of all mobile equipment accidents involve rolling over banks, rolling over on soft shoulders, or being buried by rockfall from highwalls.

- On a warm, sunny fall morning, a 36-year-old loader operator with 3 years of experience began his shift by dumping waste rock over a bench to a lower level of the pit. After an hour and a half he had built the bench out about 10 feet. The wheels of his loader were on the new bench he had built when it slumped, carrying the loader over the bank to the pit floor, resulting in strains to the operator's back, shoulders, and arms. **OVER 180 DAYS LOST.**

BEST PRACTICES:

- ✓ Inspect berms before dumping.
- ✓ Berms should be at least half as high as the largest tire.
- ✓ Check the ground for soft shoulders (cracks, water, slumps).
- ✓ Never drive on top of a highwall or stockpile that is being loaded out from below.

WHAT ABOUT OUR SITE?

COMMENTS

Where do we dump over berms or stops?	
How high should our berms be?	
Where are our soft shoulder hazard areas? What can we do to fix them?	
Where are our highwall hazard areas? How do you spot them?	
What do we do if we see a failing berm, unstable highwall, or soft shoulder?	

MODULE 5B

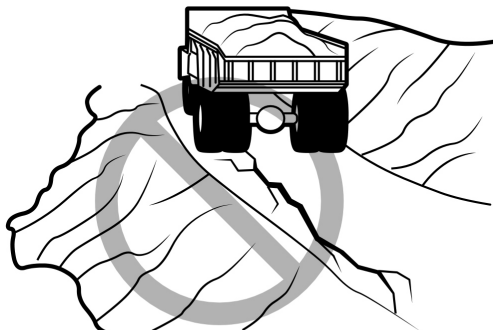

Watch For Soft Shoulders

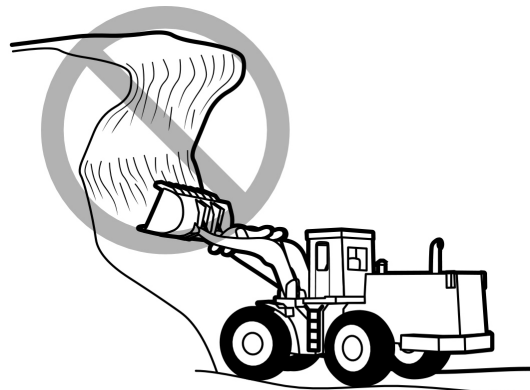

Watch Steep Banks

REFRESHER TRAINING

RAMPS AND DUMPING FACILITIES

HAZARD - Dumping hazards

30 CFR 56.9303

RESULT - Strain, fracture, death

LOOK FOR - Inadequate berms/stops, unstable ground

REAL ACCIDENTS: A driver with 35 years of experience was pulling forward with the bed raised while dumping an end-dump truck. A rear wheel sank into a soft spot, tipping the truck over on its side. The driver was wearing a seat belt. **8 DAYS LOST/RESTRICTED DUTY.**

BEST PRACTICES:

- ✓ Examine the dump site before each dump (berms, ground stability, overhead clearance, traffic).
- ✓ Back in square to the berm or bumper stop.
- ✓ Stay at least one truck length away from the edge of the dump.
- ✓ Always wear your seat belt.

WHAT ABOUT OUR SITE?

COMMENTS

What did we talk about during our last training meeting? Did we fix what we said we'd fix?	
Did you know that most of the dump weight shifts to the rear axle when the bed is raised? Why is this important to know?	
What is our seatbelt policy?	
When and to whom should you report roadway and dump site problems?	

MODULE 5C

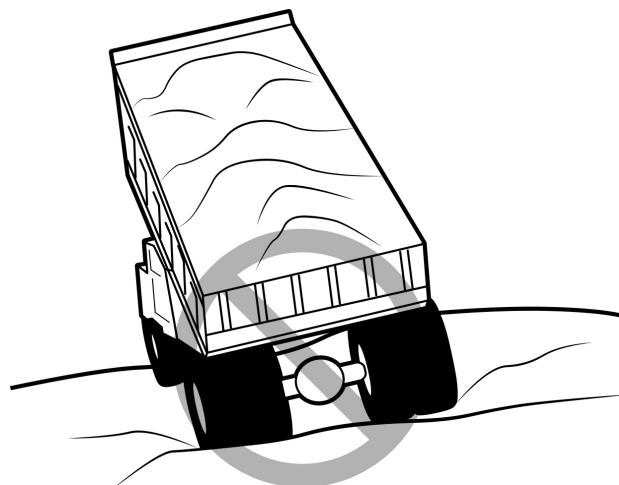

Don't Dump On Soft Ground

REFRESHER TRAINING

BERMS AND GUARDRAILS

HAZARD - Rolling over or through berms

30 CFR 56.9304

RESULT - Strains, lacerations, fractures, or death

LOOK FOR - Low berms, loose material, poor dumping location

REAL ACCIDENTS: A young miner with 4 years of experience was dumping waste material over a berm located 10 feet from a pond bank. The berm and bank suddenly gave way, causing the truck to roll into the pond. **34 DAYS LOST**

BEST PRACTICES:

- ✓ Examine the berms in all working areas pre-shift and as needed before dumping.
- ✓ Use consolidated material for berms. Place berms on solid ground, not loose fill.
- ✓ Berms should be mid-axle high as measured on the largest piece of mobile equipment using the travel way.
- ✓ Immediately repair or replace all berms that have been run over or against.

WHAT ABOUT OUR SITE?

COMMENTS

What should be the berm height for the size of our trucks?	
What is acceptable material out of which to build our berms?	
How close to the edge do we place the berms?	
When and to whom should you report berm problems?	
What are some reasons to always inspect the berm before dumping? <i>Changes due to weather, truck size, damage, slumping slope</i>	

MODULE 5D

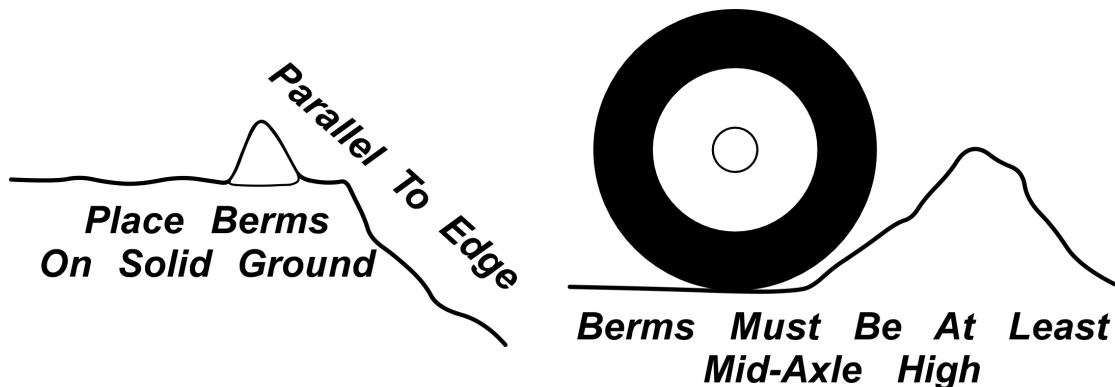

TRAINING RECORD

DATE: _____ MSHA MINE/CONTRACTOR NAME & ID No. _____

TRAINER/COMPETENT PERSON: _____

LENGTH: _____ LOCATION: _____

Check If This Is Part of Annual Refresher Training (CFR 30, 46.8.c)

PERSONS TRAINED (PRINT FULL NAME AND INITIAL):

I certify that the above training has been completed: _____ Date: _____

(Signature of person responsible for safety and health training)

False certification is punishable under §110(a) and (f) of the Federal Mine Safety and Health Act

REFRESHER TRAINING

BACKUP ALARMS

HAZARD - Struck by mobile equipment

30 CFR 56.14132

RESULT - Bruises, sprains and strains, lacerations, fractures, death

LOOK FOR - Confined work areas, moving equipment, blind areas

REAL ACCIDENTS: A mechanic was working with an operator on a Bobcat. They were cleaning up around the mill area. The backup alarm was constantly going on and off as the Bobcat moved back and forth. This time the mechanic was standing in the Bobcat operator's blind spot when he was hit, resulting in a sprained knee.

BEST PRACTICES:

- ✓ Spotters, alarms, and flashing strobe lights are used as backup warnings.
- ✓ Scan the site and task at hand before starting work.
- ✓ Work as far from moving equipment as possible.
- ✓ Communicate with other workers and make eye contact with them.

WHAT ABOUT OUR SITE?

COMMENTS

What are some ideas that would have prevented the accident?	
What kinds of mobile equipment do we have? <i>Grader, dozer, loader, Bobcat, haul truck, forklift, pickup, manlift, water truck</i>	
Has anyone seen or experienced a near-hit with a piece of moving equipment at home or at work? What happened?	
What do you do when the backup alarm stops working?	

MODULE 5E

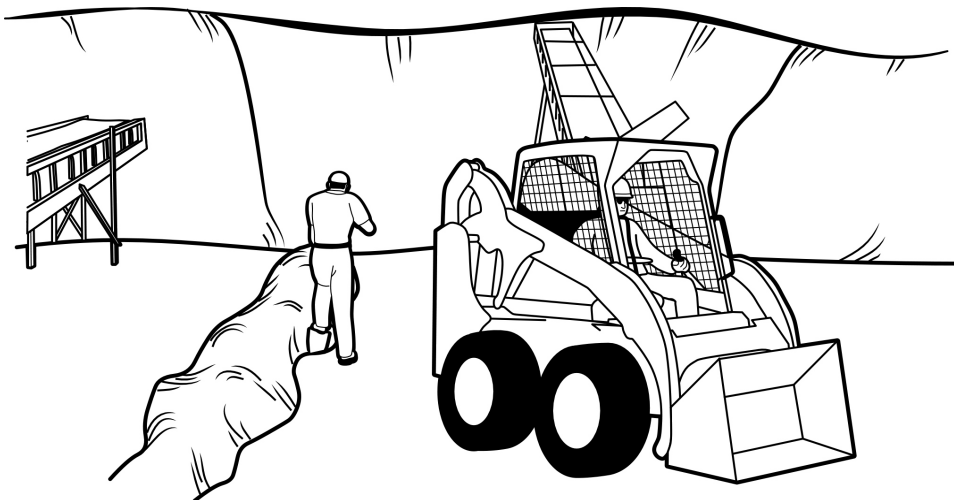

REFRESHER TRAINING

PRESHIFT INSPECTIONS: BRAKES

HAZARD - Miscommunication, malfunctioning equipment

30 CFR 56.14101

RESULT - Injury, death

LOOK FOR - Out-of-service tags, repair tags, delayed maintenance

REAL ACCIDENTS: A shovel was being taken to the pit and was at the top of the ramp. Suddenly, the shovel slipped out of gear. When the brakes did not work, the operator dropped the front bucket. The shovel's brakes had been written up for repair, but after a month, were still not in working order. The operator, who had less than a year's experience, suffered cuts, bruises, and muscle sprains. **14 DAYS LOST.**

BEST PRACTICES:

- ✓ Before using any equipment, make sure it is in proper working order.
- ✓ Tagout systems help communicate to everyone the state of the equipment.
- ✓ Know the braking system and capacities of each machine.

WHAT ABOUT OUR SITE?

COMMENTS

Who can explain the three common types of braking systems? <i>Service, emergency, park</i>	
Does all our mobile equipment have operator manuals? If not, where are they kept?	
What is a tagout system? <i>In addition to repair forms, tags are put on the equipment to stop its use and warn of defects</i>	
Do we have a tagout system and how does it work?	

MODULE 5F

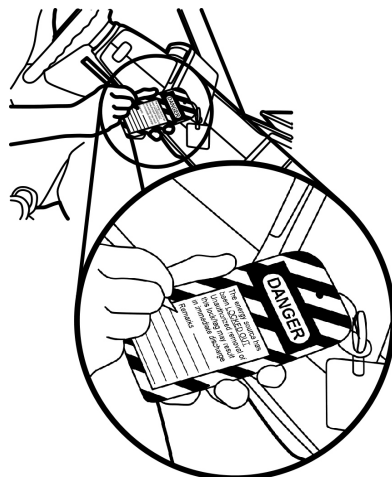

TRAINING RECORD

DATE: _____ MSHA MINE/CONTRACTOR NAME & ID No. _____

TRAINER/COMPETENT PERSON: _____

LENGTH: _____ LOCATION: _____

Check If This Is Part of Annual Refresher Training (CFR 30, 46.8.c)

PERSONS TRAINED (PRINT FULL NAME AND INITIAL):

I certify that the above training has been completed: _____ Date: _____

(Signature of person responsible for safety and health training)

False certification is punishable under §110(a) and (f) of the Federal Mine Safety and Health Act

REFRESHER TRAINING

EQUIPMENT MAINTENANCE

HAZARD - Falls, caught between, hang up

30 CFR 56.14105

RESULT - Sprains and strains, cuts, fractures, death

LOOK FOR - Uneven or poor footing, hot or frozen surfaces, cramped work space

REAL ACCIDENTS: A loader operator with 4 years of mining experience was removing the hood of the excavator for routine maintenance. He lost his balance and fell, receiving cuts and injuring his back. **39 DAYS LOST.**

- Slipping and falling have always been a major classification of mining injuries, and sprains and strains are a main injury type for miners.

BEST PRACTICES:

- ✓ Always plan your moves on equipment before working. Note handholds, footholds.
- ✓ Make sure all ladders, footholds, and handholds are in good repair.
- ✓ Use fall protection if working from an unguarded platform.
- ✓ Never work between equipment and highwalls or stockpiles.

WHAT ABOUT OUR SITE?

COMMENTS

Which of our equipment requires climbing on? Why? <i>During driving, repairs, oiling, fueling, cleaning</i>	
Pick a task like cleaning the windshield. What are some ways to reduce the risk of slipping and falling?	
What is the condition of the hand and foot holds on the different equipment? Can they be improved?	

MODULE 5G

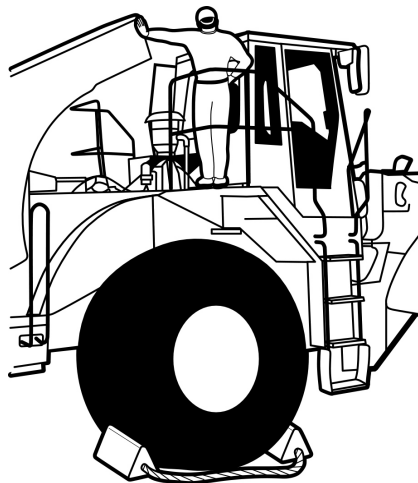

REFRESHER TRAINING

MOBILE EQUIPMENT

HAZARD - Operating near high-voltage power lines

30 CFR 56.12071

RESULT - Electrocution, burns, death

LOOK FOR - Raised truck beds, overhead power lines

REAL ACCIDENTS: Early one spring morning, a truck driver was dumping rocks at the loadout area. As the truck bed was raised, it came in contact with the overhead power lines. The driver was not injured, but the electricity blew out two truck tires.

BEST PRACTICES:

- ✓ Examine the dump site before each dump (berms, ground stability, overhead clearance, traffic).
- ✓ Be alert. Conditions change quickly around a dump area.
- ✓ Lower the truck bed immediately after dumping.

WHAT ABOUT OUR SITE?

COMMENTS

Where do we have overhead power lines?	
Are these lines around our active hauling areas? Is there enough overhead clearance?	
Can someone explain our mine site's procedure for dumping at the stockpile?	
When and to whom should you report roadway and dumpsite problems?	
What is our policy if a truck hits a power line?	

MODULE 5H

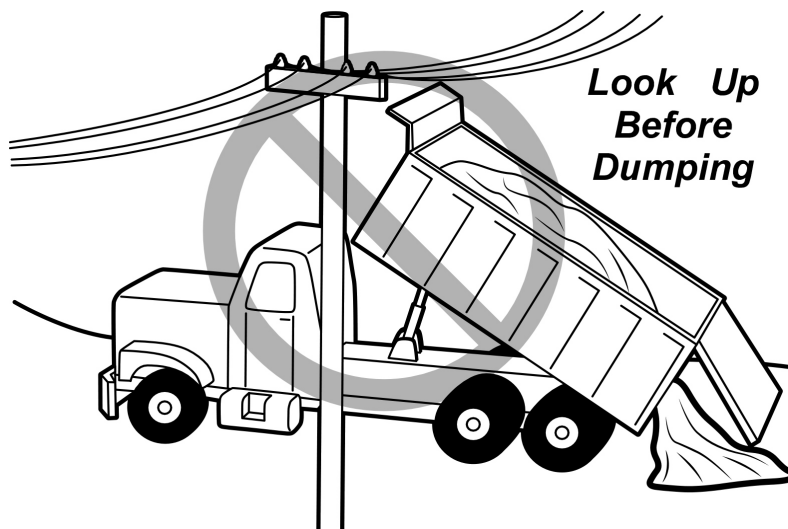

TRAINING RECORD

DATE: _____ MSHA MINE/CONTRACTOR NAME & ID No. _____

TRAINER/COMPETENT PERSON: _____

LENGTH: _____ LOCATION: _____

Check If This Is Part of Annual Refresher Training (CFR 30, 46.8.c)

PERSONS TRAINED (PRINT FULL NAME AND INITIAL):

I certify that the above training has been completed: _____ Date: _____

(Signature of person responsible for safety and health training)

False certification is punishable under §110(a) and (f) of the Federal Mine Safety and Health Act

REFRESHER TRAINING

MATERIALS HANDLING

HAZARD - Lifting accidents

RESULT - Strains

LOOK FOR - Heavy or awkward objects, unbalanced body positions

REAL ACCIDENTS: One out of every 20 sand and gravel accidents involves lifting. A new miner was up on the platform changing a screen. He lifted the screen cloth then twisted to pull it away from the deck. He felt a sudden, sharp pain in his back. **5 DAYS LOST.**

BEST PRACTICES:

- ✓ Know the weight of the object you're lifting and know when to get help.
- ✓ Plan your lift and clear out the area and travelway before starting.
- ✓ Position yourself to lift with your legs without bending or twisting your back.
- ✓ Never lift an object without a secure grip. Hold the object close to you.

WHAT ABOUT OUR SITE?

COMMENTS

What tasks require us to lift heavy or awkward objects?	
How could you guess how much something weighs before you lift it? <i>Pick up a corner, push it, read the label.</i>	
What can we use to get a better grip on odd-shaped objects?	
Who can show us what we mean by lifting with the legs?	

MODULE 6A

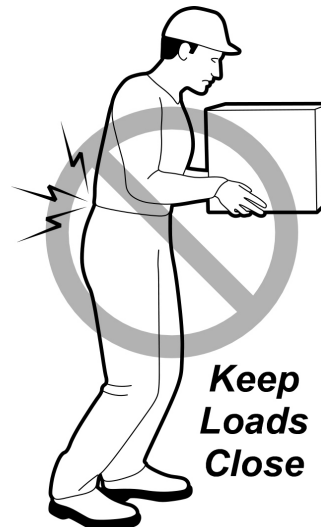

REFRESHER TRAINING

MATERIALS HANDLING

HAZARD - Dropping or catching objects

RESULT - Strains

LOOK FOR - Heavy or awkward objects, unbalanced body positions, unexpected movements

REAL ACCIDENTS: At the end of the day, a miner with 4 years of experience went to move a barrel. While lifting the barrel, it slipped from his grip and began to fall. When he tried to catch the barrel, he tore the ligaments in his arm. **OVER 1 YEAR LOST.**

- Late in his shift, a new miner was helping another employee lift a screen panel. The other employee let go of the screen panel without warning, leaving his partner carrying the full load, resulting in a severe shoulder strain. **OVER 1 YEAR LOST.**

BEST PRACTICES:

- ✓ Know the weight of the object you're lifting and know when to get help.
- ✓ Communicate with the person helping you. Agree on signals before you lift.
- ✓ Have a clear path of travel and place to put an object down.
- ✓ Never try to stop a falling object. Learn how and when to let go.

WHAT ABOUT OUR SITE?

COMMENTS

Who remembers what we talked about last week? Was there something we needed to fix?	
What tasks require us to lift heavy or awkward objects?	
Is there a way to avoid lifting these objects?	
Should we have standard signals we should always use here?	

MODULE 6B

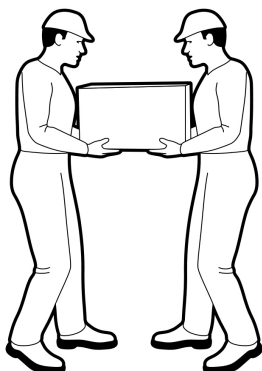

**Communicate To
Share The Load**

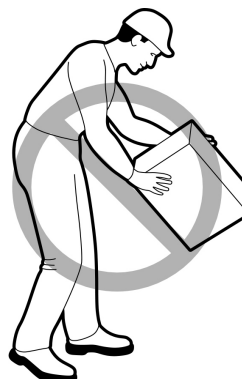

**Don't Try To
Catch A Load**

REFRESHER TRAINING

MATERIALS HANDLING

HAZARD - Unsafe travelways

30 CFR 56.9201 and 56.20003

RESULT - Strains

LOOK FOR - Cluttered or uneven accessways, heavy or awkward objects, unbalanced body positions

REAL ACCIDENTS: A young dispatcher strained her back when she stepped on a uneven surface while carrying a computer through a doorway. **58 DAYS LOST**

- A mine laborer strained a muscle in his leg while carrying a skirt board up a flight of stairs. The width of the board required him to climb the stairs in an awkward position. **5 DAYS LOST.**

BEST PRACTICES:

- ✓ Know the weight of the object you're lifting and know when to get help.
- ✓ Never carry an object that obstructs your vision.
- ✓ Check the travelway and have a clear path before starting.
- ✓ If you slip while carrying, let the object drop.

WHAT ABOUT OUR SITE?

COMMENTS

What tasks require us to carry large or heavy objects? Can we change these tasks?	
If the object is too big to see over or around or walk normally, what could you do?	
Why should you drop a load if you slip?	
Do you think you'd be more likely to carry out an emergency action if you think about it first?	
Where do we keep lift-assist devices (push cart, hand truck, hoist, forklift)?	

MODULE 6C

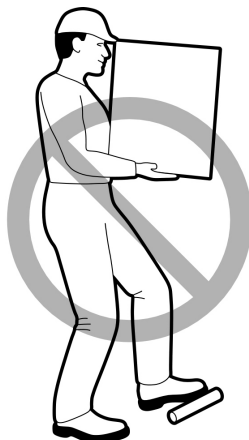

Have A Clear Path



Balance Your Loads

REFRESHER TRAINING

HAND TOOLS

HAZARD - Knife accidents

30 CFR 56.14205

RESULT - Lacerations, amputations

LOOK FOR - Dull/bent blades, unbalanced body positions

REAL ACCIDENTS: One out of every 30 sand and gravel accidents involves a knife. Just before lunch break on a hot July morning, a 42-year-old laborer with 2 months of experience used a utility knife to cut a conveyor belt. As he was pulling the knife across the belt toward himself, the blade slipped out of the belt cut. Before he could stop, the blade went into his knee, cutting some of his ligaments. **7 DAYS LOST**

BEST PRACTICES:

- ✓ Avoid pulling the blade toward your body.
- ✓ Wear gloves to protect your hands.
- ✓ Position yourself to be out of harm's way in case the knife slips.
- ✓ Do not use dull or bent blades.

WHAT ABOUT OUR SITE?

COMMENTS

What types of things are hard to cut without pulling the knife toward you?	
Does anyone have a way to cut away from your body in these cases?	
Has anyone seen an accident or near miss with a knife?	
What could the person in this accident have done differently?	

MODULE 7A

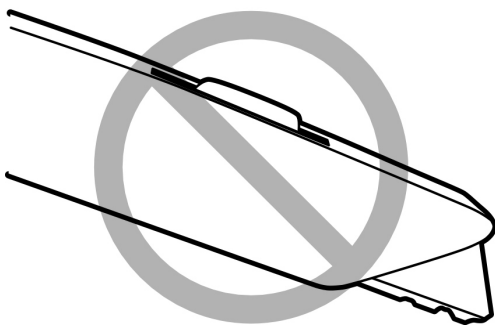

**Don't Use
Damaged Knives**

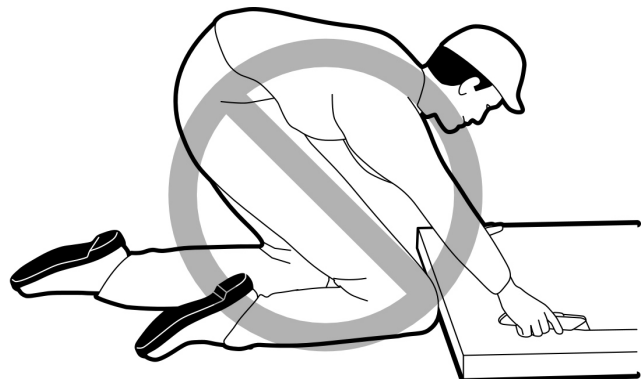

Don't Cut Toward Yourself

TRAINING RECORD

DATE: _____ MSHA MINE/CONTRACTOR NAME & ID No. _____

TRAINER/COMPETENT PERSON: _____

LENGTH: _____ LOCATION: _____

Check If This Is Part of Annual Refresher Training (CFR 30, 46.8.c)

PERSONS TRAINED (PRINT FULL NAME AND INITIAL):

I certify that the above training has been completed: _____ Date: _____

(Signature of person responsible for safety and health training)

False certification is punishable under §110(a) and (f) of the Federal Mine Safety and Health Act

REFRESHER TRAINING

HAND TOOLS

HAZARD - Hammer accidents

30 CFR 56.14205

RESULT - Strains, lacerations, fractures

LOOK FOR - Damaged tool handles, chipped or cracked tool heads, awkward body positions

REAL ACCIDENTS: A mechanic with 15 years of experience severely strained his back when he swung a sledgehammer to drive a wedge into a crusher plate and missed the target. **65 DAYS LOST/RESTRICTED DUTY.**

- A new miner was struck on the hand when the head of the hammer he was using to punch holes in a belt came off. **35 DAYS LOST/RESTRICTED DUTY.**

BEST PRACTICES:

- ✓ Wear eye protection. Wear gloves to protect your hands.
- ✓ Position yourself and others to be able to let go of the hammer if you miss.
- ✓ Position yourself to be balanced.
- ✓ Inspect tools before use.

WHAT ABOUT OUR SITE?

COMMENTS

What jobs are hard to get a good stable position for hammering?	
Why would you let go of the hammer if you miss?	
Has anyone had an accident or near miss with a hammer?	
What do you do differently now? What could the person in the accident have done differently	

MODULE 7B



Watch For Tight Spaces When Swinging



Swing From A Stable Position

REFRESHER TRAINING

HAND TOOLS

HAZARD - Accidents while using bars and prying

RESULT - Strains, lacerations, fractures

LOOK FOR - Damaged/bent bars, unbalanced body positions, sudden release of energy

REAL ACCIDENTS: One out of every 25 accidents in sand and gravel mines involves using a pry bar.

- On a very cold January evening, a miner with 1-1/2 years of experience was trying to free a conveyor belt jammed under a hopper. He put the bar under the belt and leaned into it until he felt a sharp pain in his back. **75 DAYS LOST/RESTRICTED DUTY.**
- A mechanic with 1 year of experience was using a pry bar to remove a wheel to change the tire. The bar slipped, crushing his fingers against the truck frame and badly cutting his finger. He was not wearing gloves. **41 DAYS LOST.**

BEST PRACTICES:

- ✓ Wear eye protection. Wear gloves to protect your hands.
- ✓ Use the right tool for the job.
- ✓ Position yourself to be balanced.
- ✓ Do not use damaged bars.

WHAT ABOUT OUR SITE?

COMMENTS

Are there jobs here that require a bar and have a high risk of pinching or straining?	
Is there a way to hold or use the bar to reduce the risk?	
Has anyone seen an accident or near miss with a bar?	
What could the people in these accidents have done differently?	

MODULE 7C



***Pry From
A Stable Position***



***Watch For Tight
Spaces When Prying***

REFRESHER TRAINING

POWERED HAND TOOLS

HAZARD - Powered hand tool accidents

30 CFR 56.14116

RESULT - Lacerations, amputations

LOOK FOR - Unstable body position, poor tool condition

REAL ACCIDENTS: A machinist with 13 years of experience was using a hand-held power saw to cut off the end of a block of wood. He was stabilizing the piece with one hand. When he started the cut, the saw blade caught in the wood and pulled his hand into the blade. The saw had a trigger lock on. He suffered severe lacerations to his hand. **56 DAYS LOST/RESTRICTED DUTY.**

BEST PRACTICES:

- ✓ Never use a power tool with the trigger lock on.
- ✓ Use both hands on the power tool to steady it as well as to keep your hands out of the way.
- ✓ Never remove power tool guards. Replace guards if they are missing.
- ✓ Check tool, cord, and prongs before each use.
- ✓ Circular saws and chain saws must never have a trigger lock

WHAT ABOUT OUR SITE?

COMMENTS

What types of power tools do we have? <i>Saw, sander, impact wrench, grinder, drill</i>	
Where do we keep clamps, vises, and other support equipment?	
What's the condition for each of these tools and how can they be improved?	
What's our procedure to get tools fixed or replaced?	

MODULE 7D

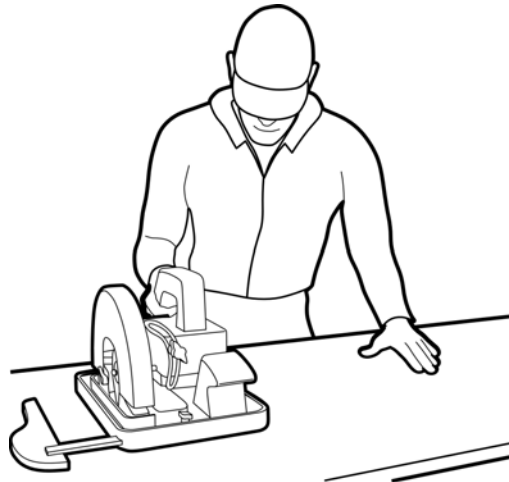

REFRESHER TRAINING CONVEYORS & STATIONARY EQUIPMENT

HAZARD - Being struck by falling material

30 CFR 56.14110

RESULT - Lacerations, fractures, death

LOOK FOR - Active spilling, material rolling on belt, overloaded transfers, loose guards

REAL ACCIDENTS: Twenty-five percent of all nonmaintenance stationary equipment accidents involve being struck by falling objects, usually spilling product from the conveyors.

- Just after lunch, a screen plant operator with 4 years of experience was cleaning spillage on a catwalk along an elevated belt. The belt continued to spill as he cleaned. As he was bent over getting another shovel load, a softball-sized rock rolled off the belt, striking him on the back of the head just below his hard hat. **OVER 180 DAYS LOST.**

BEST PRACTICES:

- ✓ Control loading to prevent spills. Use skirts, baffles, chains, or guards to contain material at transfer points.
- ✓ Wear protective equipment at all times: safety glasses, hard hats, steel-toed boots.
- ✓ Do not pass barricades in restricted areas.
- ✓ Do not remove spill controls while equipment is running. Secure guards when done.

WHAT ABOUT OUR SITE?

COMMENTS

What is our clean-out procedure when working around the conveyors?	
Do we have conveyor spill problems? How can we correct them? Who will fix them?	
Do we have guards that are loose or damaged that could fall? Who will fix these?	
Has anyone seen a close call or injury from material falling off equipment?	

MODULE 8A

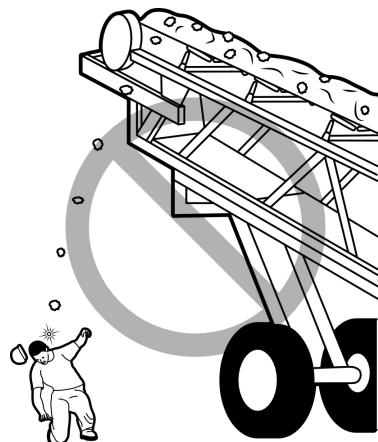

Watch For Spills

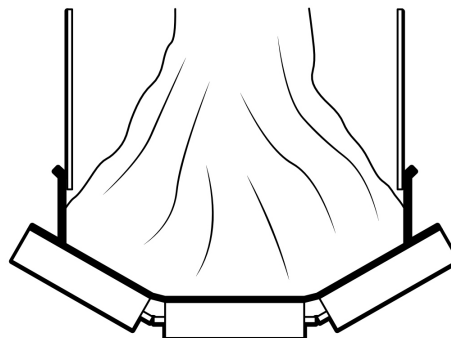

Control Spills

TRAINING RECORD

DATE: _____ MSHA MINE/CONTRACTOR NAME & ID No. _____

TRAINER/COMPETENT PERSON: _____

LENGTH: _____ LOCATION: _____

Check If This Is Part of Annual Refresher Training (CFR 30, 46.8.c)

PERSONS TRAINED (PRINT FULL NAME AND INITIAL):

I certify that the above training has been completed: _____ Date: _____

(Signature of person responsible for safety and health training)

False certification is punishable under §110(a) and (f) of the Federal Mine Safety and Health Act

REFRESHER TRAINING CONVEYORS & STATIONARY EQUIPMENT

HAZARD - Accidents while cleaning tail pulleys 30 CFR 56.11013 and 56.14202

RESULT - Lacerations, fractures, amputations, death

LOOK FOR - Poor guarding, equipment in use or not locked out

REAL ACCIDENTS: A new, young miner went under a guard to clean a feeder and was drawn into the tail pulley. **OVER 400 DAYS LOST/RESTRICTED DUTY.**

- A new miner was cleaning an operating tail pulley through a guard when the pulley caught the shovel. The shovel handle struck the miner in the face, knocking him 6 feet to the ground. **1 DAY LOST.**

BEST PRACTICES:

- ✓ Guard all tail pulleys that can be reached at any time.
- ✓ Lock out and tag out the conveyor before removing a guard.
- ✓ Never reach around a guard.
- ✓ Design guards so the pulley can be cleaned without removing the guard.

WHAT ABOUT OUR SITE?

COMMENTS

Who remembers what we talked about last week? Was there something we needed to fix?	
Do we have any tail pulleys that need attention?	
Do we have guards that allow tail pulleys to be cleaned safely?	
Any ideas on how we can make our guards better?	
Has anyone witnessed a close call or injury from cleaning a tail pulley?	

MODULE 8B

Lock It Out !

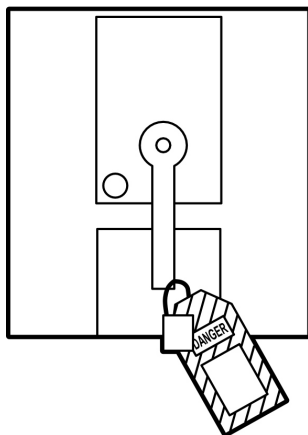

Stop Spills

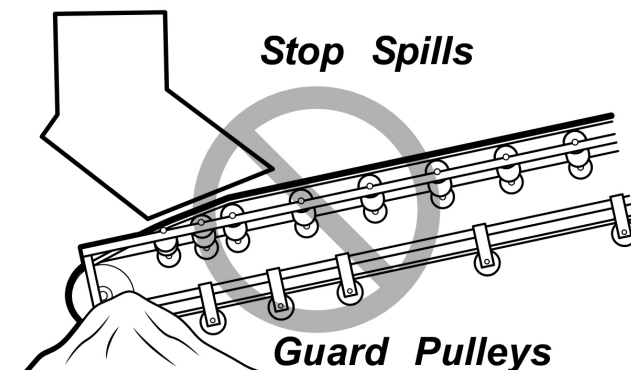

REFRESHER TRAINING CONVEYORS & STATIONARY EQUIPMENT

HAZARD - Accidents while working around return rollers

30 CFR 56.14107

RESULT - Lacerations, fractures, amputation, death

LOOK FOR - Poor guarding, equipment in use or not locked out

REAL ACCIDENTS: Seventeen percent of all nonmaintenance stationary equipment accidents occur around return rollers, resulting in several fatalities each year.

- A new miner was adjusting return rollers when his wrench was caught by the idler, pulling his arm through. **OVER 200 DAYS LOST .**
- A miner leaned over a conveyor to check a noise and placed his hand close to the roller. The roller pulled in his hand, and he was burned by the belt sliding over it. **42 DAYS RESTRICTED DUTY.**

BEST PRACTICES:

- ✓ Don't clean moving idlers. Install scrapers. Lock out for manual cleaning.
- ✓ Adjust belts from the return side. Use proper tools.
- ✓ Never reach around a guard. Be aware of your hand position at all times.
- ✓ Guard all rollers likely to have accidental contact.

WHAT ABOUT OUR SITE?

COMMENTS

What could have be done to avoid the first accident in the case?	
Do we have any unguarded return rollers? Where are they? Are they all out of reach?	
How do we clean return rollers safely? Are there places that could use scrapers?	
Has anyone seen a close call or injury from a return roller?	

MODULE 8C

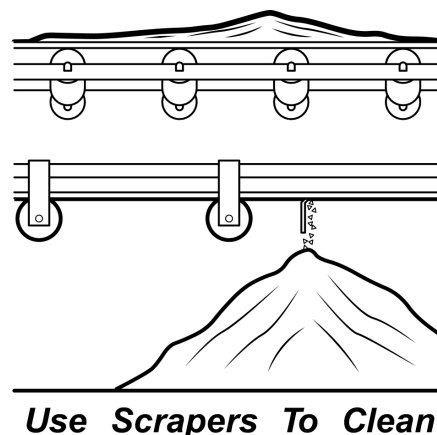
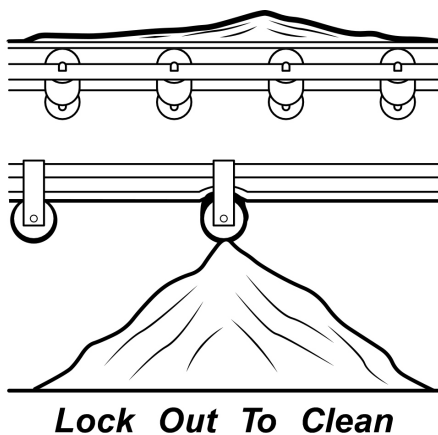

TRAINING RECORD

DATE: _____ MSHA MINE/CONTRACTOR NAME & ID No. _____

TRAINER/COMPETENT PERSON: _____

LENGTH: _____ LOCATION: _____

Check If This Is Part of Annual Refresher Training (CFR 30, 46.8.c)

PERSONS TRAINED (PRINT FULL NAME AND INITIAL):

I certify that the above training has been completed: _____ Date: _____

(Signature of person responsible for safety and health training)

False certification is punishable under §110(a) and (f) of the Federal Mine Safety and Health Act

REFRESHER TRAINING CONVEYORS & STATIONARY EQUIPMENT

HAZARD - Shoveling, overexertion, or striking equipment

RESULT - Strains, lacerations, fractures

LOOK FOR - Poor guarding, equipment in use/not locked out, tight spaces, odd positions

REAL ACCIDENTS: Seven of 10 shoveling accidents are from overexertion. Near the end of the day, a belt man with 1 year of experience was cleaning spillage from under a conveyor. He tried to lift a large rock with his shovel and felt a sharp pain in his back. **OVER 100 DAYS LOST/RESTRICTED DUTY.**

BEST PRACTICES:

- ✓ Check your work area for things you could hit while shoveling.
- ✓ Clean your way into an area so you are always on good footing.
- ✓ Watch your body position. Keep your knees bent and don't twist or lean with heavy loads.

WHAT ABOUT OUR SITE?

COMMENTS

What places do we have that are hard to shovel in or around?	
How can we make improvements?	
Does anyone have a good technique for shoveling that is easier on your back? Can you show us?	
Are there places we can set up to clean with machines and not shovels?	

MODULE 8D



Shoveling Is Lifting

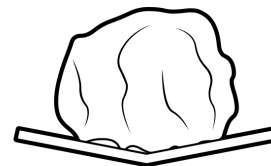

**A Shovel-Sized
Rock Weighs
50 lb**



**A Shovel
Of Gravel
Weighs 15 lb**



TOOLBOX TRAINING



REFRESHER TRAINING

OVERHEAD POWER LINES

HAZARD - High-voltage power

30 CFR 56.12071

RESULT - Shock, burns, death

LOOK FOR - Overhanging power lines

REAL ACCIDENTS: Near the end of a long day, a young laborer with 1 year of experience was attempting to lift live overhead power lines with a PVC pipe so the portable plant could pass underneath it. The live wire slipped off the PVC pole and brushed his arm, burning him. **2 DAYS LOST/RESTRICTED DUTY.**

BEST PRACTICES:

- ✓ Only qualified persons should work around live wires.
- ✓ Wear rubber gloves and rubber-soled shoes or boots when working around electrical equipment.
- ✓ Overhead power lines with less than 10 feet of clearance must be de-energized and grounded before working around them.

WHAT ABOUT OUR SITE?

COMMENTS

What common items can conduct electricity on our bodies? <i>Ring, necklace, earrings, wristwatch</i>	
Do we have overhead power lines on our property? Does it have enough clearance?	
Are there certain areas at our site that collect water and could pose an electrical hazard?	
Who is qualified to work around electrical equipment?	

MODULE 9A



REFRESHER TRAINING

POWER CABLES

HAZARD - Splicing and repairing power cables

30 CFR 56.12013

RESULT - Shock, burns, death

LOOK FOR - Cut and worn cables, cable splices, exposed wires

REAL ACCIDENTS: A foreman with 5 years of experience was repairing the electrical power cable to the conveyor. He disconnected the power to the cable and then taped the damaged section of cable. He instructed a co-worker to turn the power back on while he was holding the repaired section of cable. The repaired area of the cable exploded, throwing the foreman to the ground and burning his hand. **OVER 60 DAYS LOST/RESTRICTED DUTY.**

BEST PRACTICES:

- ✓ Use lockout/tagout procedures.
- ✓ Only qualified persons should work with electrical equipment.
- ✓ Splices and repairs must have insulation at least equal to the original power cable.
- ✓ Use only Class C fire extinguishers on electrical fires.

WHAT ABOUT OUR SITE?

COMMENTS

Who does our electrical repairs and maintenance here?	
Can someone explain how our lockout/tagout system works?	
Where are our first-aid kits? What's in them?	
Who's responsible for keeping our kits stocked?	

MODULE 9B

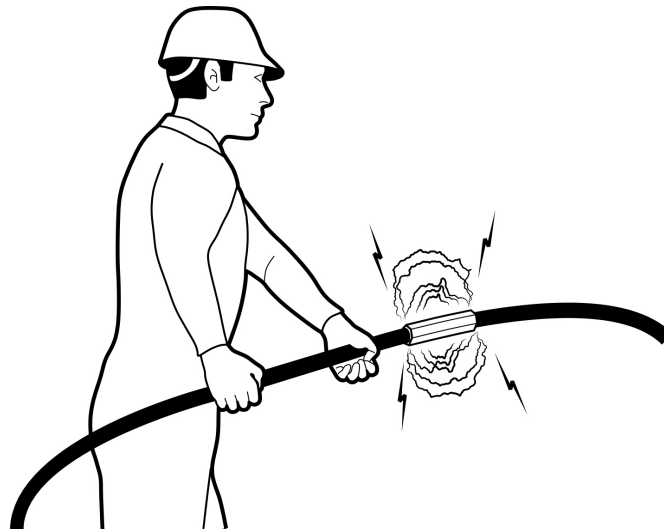

TRAINING RECORD

DATE: _____ MSHA MINE/CONTRACTOR NAME & ID No. _____

TRAINER/COMPETENT PERSON: _____

LENGTH: _____ LOCATION: _____

Check If This Is Part of Annual Refresher Training (CFR 30, 46.8.c)

PERSONS TRAINED (PRINT FULL NAME AND INITIAL):

I certify that the above training has been completed: _____ Date: _____

(Signature of person responsible for safety and health training)

False certification is punishable under §110(a) and (f) of the Federal Mine Safety and Health Act

REFRESHER TRAINING

ELECTRICAL FUSES

HAZARD - Fuse removal or replacement

30 CFR 57.12036

RESULT - Shock, burns, electrocution

LOOK FOR - Energized panels, powered cables

REAL ACCIDENTS: Early on a summer morning, a belt man with 12 years of experience went to the motor control box for the stacking conveyor to see why it had shut down. He noticed there was no power, so he attempted to change the fuses. While installing the fuse, an electric arc burned his face and hand. **12 DAYS LOST.**

BEST PRACTICES:

- ✓ Use lockout/tagout procedures.
- ✓ Electricity is present even when the switch is in the "off" position. Unplug equipment when not in use and before inspecting, cleaning, or fixing it.
- ✓ Always de-energize the circuit before removing or replacing fuses.
- ✓ Only qualified persons should work around electrical equipment.

WHAT ABOUT OUR SITE?

COMMENTS

Where are our main power breakers?	
What's our procedure for changing fuses and who is qualified to change them?	
Other than electrical, what other sources of energy are there? Give examples. <i>Mechanical: Conveyor belt; pneumatic: compressed air tank; hydraulic: loader bucket; chemical: gas fumes</i>	
Who can explain our lockout/tagout procedures?	

MODULE 9C





TOOLBOX TRAINING



TITLE

**HAZARD -
RESULT -
LOOK FOR -**

REAL ACCIDENT:

BEST PRACTICES:

- ✓
- ✓
- ✓

WHAT ABOUT OUR SITE?

COMMENTS

WHAT ABOUT OUR SITE?	COMMENTS

MODULE



*Delivering on the Nation's promise:
Safety and health at work for all people
Through research and prevention*

For additional information, contact NIOSH at
1-800-35-NIOSH (1-800-356-8575)

Fax: 513-533-8575

or visit the NIOSH Website at

www.cdc.gov/niosh

SAFER HEALTHIER PEOPLE