

Minnesota Bicycle Transportation Planning and Design Guidelines

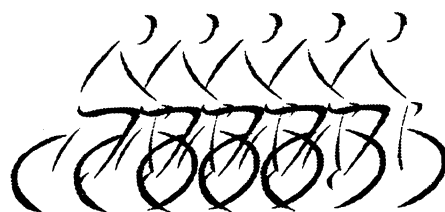

Minnesota Department of Transportation

June 1996

CHAPTER SUMMARY

CHAPTER	TITLE
1	INTRODUCTION
2	DESIGN FACTORS AND MAINTENANCE
3	THE BICYCLE NETWORK PLANNING PROCESS
4	ON-ROAD DESIGNS
5	PATHS
6	BRIDGES AND GRADE SEPARATIONS
7	TRAFFIC CONTROLS
8	BICYCLE PARKING

Chapter One**INTRODUCTION**

1-1.0	PURPOSE
1-2.0	POLICY AND GOALS
1-3.0	SCOPE
1-4.0	DEFINITIONS
1-5.0	THE TYPICAL BICYCLE, RIDER, AND DIMENSIONS
1-6.0	OPERATING SPACE
1-7.0	THE DESIGN BICYCLE
1-8.0	DESIGN APPROACH

Chapter Two**DESIGN FACTORS AND MAINTENANCE**

2-1.0	GENERAL
2-2.0	SURFACE QUALITY AND UTILITY WORK
2-3.0	VEGETATION CONTROL

Chapter Three**THE BICYCLE NETWORK PLANNING PROCESS**

3-1.0	GENERAL
3-2.0	DEVELOPING A COMMUNITY BICYCLE NETWORK PLAN
3-2.01	Establish Performance Criteria for the Bicycle Network
3-2.02	Inventory Existing System
3-2.03	Identify Bicycle Travel Corridors
3-2.04	Evaluate and Select Specific Route Alternatives
3-2.05	Design Treatments
3-2.05.01	Select Appropriate Facility Options
3-2.05.02	Factors Used to Determine Grade Separations (Tunnels and Bridges)
3-2.06	Evaluate the Finished Network Plan Using the Established Performance Criteria
3-2.07	Bicycle Parking and Security

Chapter Four**ON-ROAD DESIGNS**

4-1.0	GENERAL
4-2.0	TYPES OF FACILITIES
4-2.01	Bicycle Lanes
4-2.02	Bicycles, Buses and Combination Bus/Bike Lanes

4-2.03	Shared Lanes
4-2.04	Wide Curb or Wide Outside Lanes
4-2.05	Shoulders
4-2.06	Traffic-Calmed Roadways
4-3.0	DESIGNING BICYCLE FACILITIES
4-4.0	PREPARING TO SELECT A DESIGN OPTION
4-4.01	What Types of Bicyclists is the Route Most Likely to Serve?
4-4.02	New Construction, Reconstruction and Retrofitting
4-4.03	Design Options to be Considered in Selecting the Appropriate Treatment
4-5.0	TRAFFIC OPERATIONS AND DESIGN FACTORS USED IN DETERMINING THE APPROPRIATE DESIGN TREATMENT
4-6.0	USING TABLES TO DETERMINE THE RECOMMENDED OPTION
4-7.0	TRAFFIC-CALMED ROADWAYS
4-7.01	Speed Humps
4-7.02	Chicanes
4-7.03	Pinch Points
4-7.04	Curb Extensions
4-7.05	Mini Round-a-bouts
4-7.06	Surface Alterations
4-7.07	Environmental Road Closures
4-7.08	Plugged, or No-entry Calming
4-7.09	Rumble Strips (traffic calming)
4-7.10	Transverse Bands
4-8.0	BYPASS LANES
4-9.0	CLIMBING LANES
4-10.0	RUMBLE STRIPS
4-11.0	DRAINAGE AND DRAINAGE GRATES
4-12.0	LIGHTING
4-13.0	ON-ROAD INTERSECTIONS
4-13.01	Shared Road Bikeway Treatments at Intersections
4-13.02	Bike Lane Treatments at Intersections
4-13.02.01	Bicycle Lanes and Left-Turning Bicycle Traffic.
4-13.02.02	Bike Lane Continuation at T-intersections.
4-13.02.03	At-grade Railroad Crossings

Chapter Five**PATHS**

5-1.0	GENERAL
5-2.0	LOCATING PATHS
5-3.0	SEPARATION BETWEEN PATH AND ROADWAY
5-3.01	Snow Storage in Separation Area
5-4.0	SEPARATING PEDESTRIANS AND BICYCLISTS
5-5.0	DESIGN SPEED
5-6.0	HORIZONTAL CURVATURE AND SUPERELEVATION
5-7.0	GRADES
5-8.0	SIGHT DISTANCE
5-8.01	Safe Stopping Sight Distance
5-8.02	Sight Distance at Crest Vertical Curves
5-8.03	Sight Distance at Horizontal Curves
5-9.0	PATH WIDTHS AND CLEARANCES
5-10.0	STRUCTURAL SECTION
5-10.01	Foundation Preparation
5-10.02	Bituminous Structural Section
5-10.03	Concrete Structural Section
5-10.04	Aggregate Structural Section
5-10.05	Surface smoothness and maintenance
5-11	DRAINAGE
5-12	BARRIERS, RAILINGS, AND FENCES
5-13	LIGHTING
5-14.0	INTERSECTIONS
5-14.01	Path Intersections
5-14.02	Path and Motor Vehicle Intersections
5-14.03	Intersection Design
5-14.03.01	Crosswalk
5-14.03.02	Crosswalks and curbed pedestrian refuge islands or medians.
5-14.03.03	Curb Designs and Arrangements
5-14.03.04	Controlling Motor Vehicle Access
5-14.03.05	One-way Paths and At-grade Signalized Intersections
5-14.03.06	At-grade Intersections Without Signals
5-14.03.07	Paths at Independent At-grade Crossings
5-14.03.08	Paths and At-grade Railroad Crossings

Chapter Six**BRIDGES AND GRADE SEPARATIONS**

- 6-1.0 **GENERAL**

- 6-2.0 **HIGHWAY BRIDGES WITH BIKEWAYS**
 - 6-2.01 Retrofitting Bikeways and Bike Lanes on Existing Highway Bridges

- 6-3.0 **BICYCLE AND PEDESTRIAN OVERPASSES**
- 6-4.0 **BIKEWAY UNDER EXISTING BRIDGE STRUCTURES**
- 6-5.0 **BICYCLE AND PEDESTRIAN UNDERPASSES AND TUNNELS**

Chapter Seven**TRAFFIC CONTROLS**

- 6-6.0 **REST AREA OVERLOOKS**

- 7-1.0 **GENERAL**
- 7-2.0 **SIGNS**

- 7-3.0 **SIGNALS AND VEHICLE DETECTORS**
 - 7-3.01 Traffic-actuated Signals
 - 7-3.02 Programmed Signals

- 7-4.0 **PAVEMENT MARKINGS**

- 7-5.0 **OBJECT MARKINGS, DELINEATORS, CURBS, FENCES, AND BARRIERS**
 - 7-5.01 Object Markings
 - 7-5.02 Delineation
 - 7-5.03 Curbs and Medians

- 7-6.0 **FENCES AND BARRIERS**
 - 7-6.01 Channelization Fences

Chapter Eight**BICYCLE PARKING**

- 8-1.0 **DESIGN CONSIDERATIONS**
- 8-2.0 **BICYCLE SECURITY LEVELS AND PARKING PRODUCTS**

Chapter One

INTRODUCTION

1-1.0 Purpose

The emphasis now being placed on bicycle transportation requires an understanding of bicycles, bicyclists, and transportation facilities. The bicycle, when adequately planned for and used, plays an important part in the overall transportation system. Safe, convenient, and attractive facilities are essential to encourage safe bicycle driving. Bicycle trips are generally under 8 km and often occur in urbanized areas. Therefore, these guidelines emphasize increased use and safety in urban areas.

The purpose of this manual is to provide bicycle network and facility planning and design guidelines that planners, engineers and designers should follow, unless otherwise noted, to encourage increased use of the bicycle. To clarify the meanings of "shall", "should" and "may" used in these guidelines, the following definitions apply:

1. SHALL- A mandatory condition. Where certain requirements in design or application are described with the "shall" stipulation, it is mandatory when an installation is made that these requirements be met.
2. SHOULD - An advisory condition. Where the word "should" is used, it is considered to be advisable usage, recommended but not mandatory.
3. MAY- A permissive condition. No requirement for design or application is intended.

Because flexibility is provided, these guidelines permit improvements to be made that will result in greater uniformity of geometrics over major lengths of roadways and bikeways .

These guidelines have been developed based on engineering practices and the state of the practice in transportation and should be used to the maximum extent possible. However, as with all projects, use judgment in their application. The provisions for bicycle travel are consistent with standard roadway engineering practices. These guidelines should be used in conjunction with other chapters in the Mn/DOT Road Design Manuals and other resources.

1-2.0 Policy and Goals

U.S. Department of Transportation goals include doubling bicycle and pedestrian use while simultaneously reducing by 10% the number of bicyclists and pedestrians killed and injured in traffic crashes. Minnesota and The Minnesota Department of Transportation (Mn/DOT) support these goals and have developed similar policies and goals to help ensure increased, safe bicycling for transportation. Plan B: The

Minnesota Comprehensive State Bicycle Plan provides a framework to guide investments that will translate the needs of bicyclists into safe realities. Mn/DOT accommodates bicyclists through its multi-modal and intermodal actions and continues to encourage the increased use and safety of bicycling.

1-3.0 Scope

This manual provides part of the information necessary for a safe bicycling environment. Facilities are one of several elements essential to an overall bicycle program. Bicycle safety and design, education and training, bicycle use encouragement, and the application and enforcement of the rules of the road as they pertain to bicyclists are further addressed in Plan B: The Minnesota Comprehensive State Bicycle Plan, and in other resources. This manual provides guidelines for facilities.

1-4.0 Definitions

BICYCLE - "Bicycle" means every device propelled solely by human power upon which any person may ride, having two tandem wheels except scooters and similar devices, and including any device generally recognized as a bicycle though equipped with two front or rear wheels. (MN 169.01 Subd. 51) (Considered a vehicle by MN Statute 169.01 Subd. 2, MN 169.222 Subd. 1).

AVERAGE BICYCLISTS - The Design Bicyclists comprised of both Group B (Basic Bicyclists) and Group C (Children).

BICYCLE FACILITIES - A general term denoting improvements and provisions made by public agencies to accommodate or encourage bicycling, including parking facilities, bikeways, bikeways maps, and shared roadways not specifically designated for bicycle use.

BICYCLE LANE (BIKE LANE) - "Bicycle Lane" means a portion of a roadway or shoulder designed for exclusive or preferential use by people using bicycles. Bicycle lanes are to be distinguished from the portion of the roadway or shoulder used for motor vehicle traffic by physical barrier, striping, marking, or other similar device. (MN 169.01 Subd. 70)

BICYCLE-PEDESTRIAN LANE - A portion of a roadway designated for the preferential or exclusive use of bicycles and pedestrians.

BICYCLE NETWORK - A continuous system of bikeways and roadways in a region or municipality.

BICYCLE PATH (BIKE PATH OR OFF-ROAD BIKEWAY) - "Bicycle Path" means a bicycle facility designed for exclusive or preferential use by people using bicycles and constructed or developed separately from the roadway or shoulder. (MN 169.01 Subd. 9)

BICYCLE-PEDESTRIAN PATH (SHARED OR MULTI-USE PATH) - A path designated for the preferential or exclusive use of bicycles and pedestrians.

BICYCLE ROUTE - The term "bicycle route" means a roadway or shoulder signed to encourage bicycle use. (MN 169.01 Subd. 62)

BICYCLE TRAIL - "Bicycle trail" means a bicycle route or bicycle path developed by the commissioner of natural resources under MN 85.016. (MN 169.01 Subd. 71)

BIKEWAY - "Bikeway" means a bicycle lane, bicycle path, or bicycle route, regardless of whether it is designated for the exclusive use of bicycles or is to be shared with other transportation modes. (MN 169.01 Subd. 72)

CROSSWALK - "Crosswalk" means that portion of a roadway ordinarily included with the prolongation or connection of the lateral lines of sidewalks at intersections or any portion of a roadway distinctly indicated for pedestrian crossing by lines or other markings on the surface. (MN 169.01 Subd. 37)

GROUP A - ADVANCED OR EXPERIENCED BICYCLISTS. The FHWA Design Bicyclists comprised of experienced riders who can operate under most traffic conditions.

GROUP B - BASIC BICYCLISTS The FHWA Design Bicyclists comprised of casual or new adult and teenage riders who are less able to operate in traffic without provisions for bicycles.

GROUP C - CHILDREN. The FHWA Design Bicyclists comprised of pre-teen riders whose roadway use is initially monitored by parents and eventually are accorded independent access to the roadway system.

DESIGNATED SHARED STREET OR HIGHWAY - Any street or highway designated as a bikeway and recommended for use by bicyclists and characterized by basic signage and the absence of striping or marking for bicyclists. Traffic calming measures may be implemented to maximize their usefulness and safety.

LIGHT TRAFFIC - Pedestrian, bicycle and other types of non-motorized traffic. Mopeds are sometimes considered "light traffic."

PEDESTRIAN - "Pedestrian" means any person afoot or in a wheelchair. (MN 169.01 Subd. 24)

RIGHT OF WAY - A general term denoting land, property, or interest therein, usually in a strip, acquired for or devoted to transportation purposes. "Right-of-way" means the privilege of the immediate use of the highway. (MN 169.01 Subd. 45)

ROADWAY - "Roadway" means that portion of a highway improved, designed, or ordinarily used for vehicular travel, exclusive of the sidewalk or shoulder. In the event a highway includes two or more separate roadways, the term "roadway" as used herein shall refer to any such roadway separately but not to all such roadways collectively. (MN 169.01 Subd. 31)

SHARED STREET OR HIGHWAY - Any roadway upon which a bicycle lane is not designated and which may be legally used by bicycles whether or not such facility is specifically designated as a bikeway.

SHOULDER - "Shoulder" means that part of a highway which is contiguous to the regularly traveled portion of the highway and is on the same level as the highway. The shoulder may be pavement, gravel, or earth. (MN 169.01 Subd. 73)

SIDEWALK - "Sidewalk" means that portion of a street between the curb lines, or the lateral lines of a roadway, and the adjacent property lines intended for the use of pedestrians. (MN 169.01 Subd. 33)

STREET OR HIGHWAY - "Street or highway" means the entire width between boundary lines of any way or place when any part thereof is open to the use of the public, as a matter of right, for the purposes of vehicular travel. (MN 169.01 Subd. 29)

TRAFFIC CALMING - Physical and other measures used on a street or highway to reduce the dominance and speed of motor vehicles.

VEHICLE - "Vehicle" means every device in, upon, or by which any person or property is or may be transported or drawn upon a highway, except devices used exclusively upon stationary rails or tracks. (MN 169.01 Subd. 2)

WIDE CURB LANE OR WIDE OUTSIDE LANE - The right-most through traffic lanes that are substantially wider than 3.6 m.

1-5.0 The Typical Bicycle, Rider and Dimensions

The bicycle is distinct from all other modes of transportation by being the smallest and lightest vehicle. These characteristics have a direct bearing on the geometry of right-of-way intended to accommodate bicycle traffic. To ensure the safety and comfort of bicyclists, the size of the vehicle must be taken into account, along with the amount of lateral and vertical clearance needed by a moving bicyclist.

The handlebars are the widest part of a bicycle. On a mountain bike or adult tricycle, the handlebars may be as much as 720 mm wide; on touring or city bikes they typically are from 400 to 600 mm wide. The minimum width that a stationary bicycle occupies is 600 mm.

The tires on most bicycles range in width from 20 mm to 60 mm with a contact surface of around 3 mm and wider. They often provide little traction. If the pavement is covered with sand or leaves, or is wet, the bicycle has even less traction and needs more room to brake. This is one of several factors to consider when designing curves.

Because they often ride to the right side of the traveled way, bicyclists are sometimes difficult to see in traffic, especially after dark or in the rain. Planners and engineers should give this factor serious consideration, paying attention to the area around urban intersections. An effort should be made to provide better visibility for motorists.

Under most circumstances (flat terrain, windless conditions), most bicyclists can maintain a cruising speed between 20 and 30 km/h, with a minority maintaining a speed of 30 km/h. In descents, with a tail wind, speeds more than 50 km/h can be reached.

Bikeways should be designed with the gentlest slopes possible to encourage bicycling and the use of bicycle facilities. However, a route or facility shouldn't be automatically abandoned if a steep hill is unavoidable. Facility design and bicyclists' behavior can be adjusted to compensate for steep terrain.

1-6.0 Operating Space

A bicyclist's design vertical height is 2.5 m. Even a tall individual will not reach this height when seated on a bicycle, but it is essential to allow extra clearance for bicyclists pedaling upright or passing under an overpass. See **Figure 1-6.0A** for bicycle operating space dimensions. Signage above a bicyclist should also allow for at least this amount of vertical clearance.

Under normal conditions, a moving bicyclist needs a corridor at least 1 m wide in order to maintain balance when riding at low speeds or against crosswinds. To ride comfortably and avoid fixed objects (sidewalks, shrubs, potholes, signs signals, etc.) and other users such as pedestrians and wheelchairs, a bicyclist needs an additional 0.25 m of clearance on each side, bringing the basic width of a one-way corridor to 1.5 m.

In enclosed areas, a space 3 m wide is desirable for two opposing bicyclists to comfortably pass each other. In this case, space is necessary for a bicyclist to react to unexpected maneuvers of other riders. In an enclosed area, the amount of space desirable for one bicyclist to pass another going the

same direction is slightly less than for opposing traffic. See **Figure 1-6.0B**.

In an open area, bicyclists require somewhat less space. Open areas afford bicyclists more space for unexpected maneuvers. These figures are guidelines. The width of the corridor may vary with the type of facility.

1-7.0 The Design Bicyclist

The Bicycle Federation of America estimates that fewer than 5 percent of riders qualify as experienced bicyclists. Because the goal is to increase bicycle use, there will be more average bicyclists than experienced bicyclists using the road system. The Federal Highway Administration has recently developed the following classification system:

FHWA Group A-- Advanced Bicyclists: Experienced riders who can operate under most traffic conditions, they comprise the majority of the current users of collector and arterial streets.

FHWA Group B - Basic Bicyclists: These are casual or new adult and teenage riders who are less able to operate in traffic without provisions for bicycles. Some will develop greater skills and progress to the advanced level, but there will always be millions of basic bicyclists.

FHWA Group C - Children: Pre-teen riders whose roadway use is initially monitored by parents. Eventually they are allowed independent access to the road system.

Group B and Group C Bicyclists have been combined. The "Design Bicyclist" concept recognizes two broad classes of bicyclists: Group A "Experienced" Bicyclists and Group B/C "Average" Bicyclists.

Generally, Average (and many Experienced) Bicyclists will be best served by a bikeway network of streets and designated bicycle facilities which can be provided by:

- Ensuring neighborhood streets have appropriate traffic operating speeds and volumes.
- Providing a network of designated bicycle facilities (e.g., bike lanes, paths, side-street bicycle routes) through the key travel corridors typically served by arterial and collector streets.
- Providing usable roadway shoulders on rural highways.

Experienced Bicyclists generally prefer roadways designed to accommodate shared use by bicycles and motor vehicles. This can be accomplished by:

- Establishing and enforcing speed limits to minimize speed differentials between bicycles and motor vehicles on neighborhood streets and by using "traffic-calming" strategies.

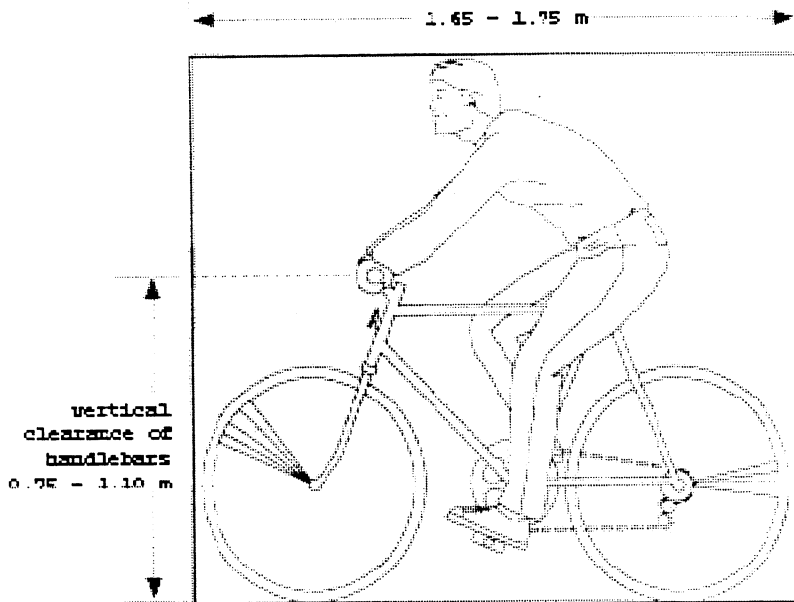

Stationary bicyclist

Essential maneuvering space

Comfortable lateral clearance

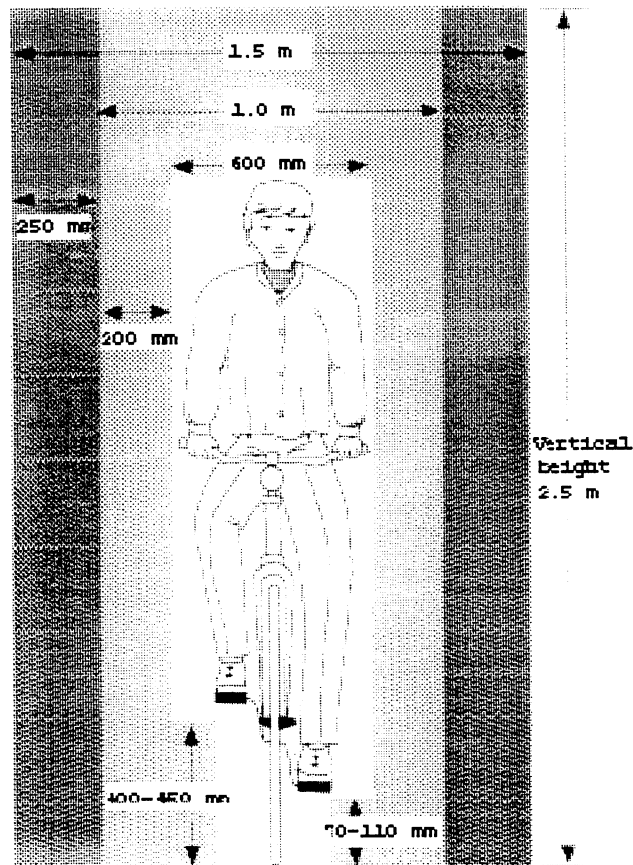
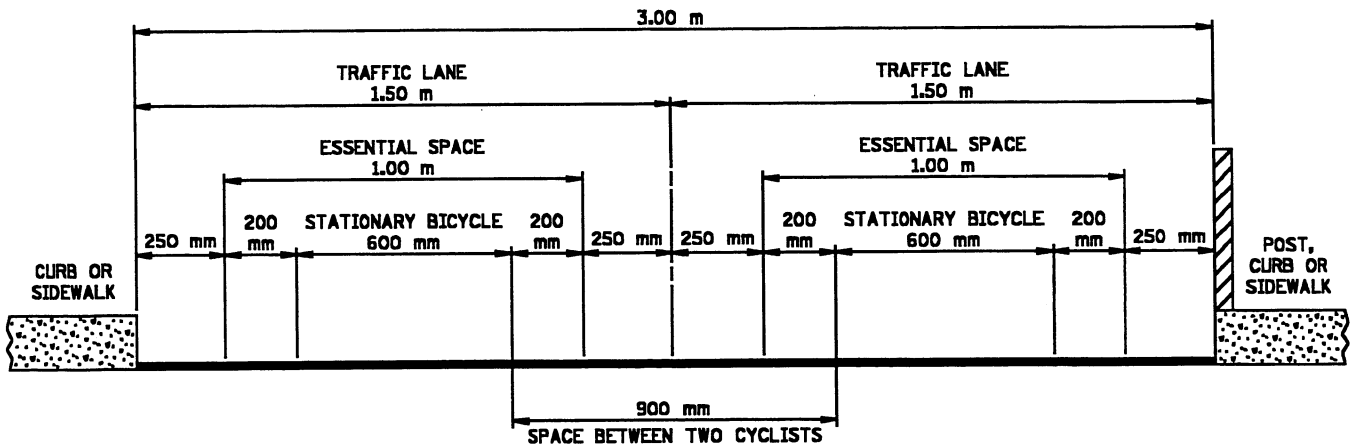

Figure 1-6.0A

Bicycle Operating Space



Space desired by two bicyclists meeting at 30 km/h in an enclosed area

Figure 1-6.0B

- Providing wide outside lanes on collector and arterial streets built with an "urban section" (i.e., with curb and gutter).
- Providing usable shoulders on highways built with a "rural section" (i.e., without curb and gutter).

1-8.0 Design Approach

Given these two types of design bicyclists, a two-tiered approach to meeting their needs is possible. However, because the goal is to increase safety and use by Average Bicyclists, the development of a bicycle network for bicycle traffic should take priority.

Most bicyclists will be best served by identifying key travel corridors (typically served by arterial and collector streets) and by providing designated bicycle facilities on selected routes through these corridors. Often these facilities will also be used by other traffic such as pedestrians, skaters and motor vehicles. These key travel corridors can be identified through the type of bicycle network planning process described in **Chapter 3**. Non-network routes may also be planned for Average Bicyclists.

Experienced (FHWA Group A) Bicyclists prefer that streets, including those not on the bikeway network, be made "bicycle-friendly." This may be accomplished by adopting design standards that include wide curb lanes and paved shoulders to accommodate shared use by bicycles and motor vehicles. This approach will provide adequate space for bicycles and motor vehicles to share the roadway with minimum need for changing lanes or lane position. The desired outcome is to have sufficient space to accommodate shared

use by bicycles and motor vehicles with minimum delays and maximum safety for all users.

Full use of this approach will result in a network of routes for Average and Experienced Bicyclists incorporating slow-speed roads and designated bicycle facilities and non-network roads on which bicycles are permitted to operate by incorporating the design treatments recommended for Experienced Bicyclists.

1-9.0 Types Of Facilities

There are many ways bicycles can safely and conveniently be accommodated on roadways and other right-of-way. There are five general types of on-road facilities which can improve upon shared lanes where traffic volumes, speeds and traffic mix make it prudent to do so. In three of the five cases the facility allows bicyclists and motorists to operate parallel to each other in the roadway without coming too close and without motorists having to change lanes to pass the bicyclists. On-road facilities are described in **Chapter 4** and paths are described in **Chapter 5**.

Chapter Two

DESIGN FACTORS AND MAINTENANCE

2-1.0 General

After construction, maintenance is an important factor for the successful operation and usage of the facility. Poor maintenance resulting in the accumulation of sand, gravel, broken glass, branches, etc. or development of potholes, corrugations and other rough surface conditions will cause bicyclists to avoid the facility. The result may be that the facility becomes a liability rather than an asset to the controlling agency. Therefore, the responsibility for maintenance of the facility should be established before construction. Normally, if the facility is located on the highway shoulder the maintenance of the facility will be the responsibility of the appropriate highway agency. If the facility is separated from the roadway, maintenance of the facility may be the responsibility of the appropriate local or other governmental agency.

Although the designer is not responsible for maintenance, there are a number of factors to incorporate into the design that will facilitate the necessary maintenance operations. The following is a partial checklist of items to be considered during design:

1. Does the facility have sufficient clearance (height and width, especially with off-road bikeways) to accommodate maintenance vehicles?
2. Is the structural thickness (pavement and base) adequate to support maintenance or emergency vehicles?
3. Has access to the facility for maintenance or emergency vehicles been provided (especially on off-road bikeways)?
4. Has sufficient clearing or grubbing been provided for adequate sight distance and horizontal and vertical clearances?
5. Have adequate cross slopes, drainage structures and ditches been provided to ensure good drainage?
6. Are designed plantings in locations that will not become a hazard or create sight distance problems in the future?
7. Have "maintainable" side slopes been planned?
8. Have gravel driveways and intersecting roadways been paved on either side of the bikeway (3 m or more) to minimize amounts of gravel and dirt dropped on the bikeway by crossing motor vehicles?
9. Have signs and signals been designed and located outside of bicycle and pedestrian traffic flow with adequate vertical and horizontal clearance?

The above checklist is not a complete list, but does give some items to be considered during the design stage. The designer may wish to contact maintenance staff for additional items.

2-2.0 Surface Quality and Utility Work

The quality of a bikeway's riding surface is important. Pavement surface irregularities can do more than cause an unpleasant ride. Gaps between pavement slabs or drop-offs at overlays or patches parallel to the direction of travel can trap a bicycle wheel and cause loss of control. Holes and bumps can cause bicyclists to swerve into the path of motor vehicles. A single surface irregularity in itself may not cause as much discomfort as a group of or continuous irregularities. Bicycle pavements should be at least as smooth as the adjacent road or bicyclists may not use them.

The two types of hazards which are classified as surface irregularities are cracks and projections. Cracks are generally normal fissures such as the gap between two slabs of pavement. Projections may be caused by sinking drainage grates or crude patch jobs. They are further classified as having a parallel or perpendicular orientation. **Table 2-2.0A** recommends maximum acceptable surface irregularities on bikeways.

Table 2-2.0A
Maximum Acceptable Surface Irregularities on
Bikeways

Orientation of the Irregularity	Cracks ¹	Projections ²
Parallel	13 mm wide	10 mm wide
Perpendicular	20 mm wide	20 mm wide

1) Cracks/Fissures in the surface. Often found in hot mix asphalt surfaces or between slabs of portland cement concrete.

2) Projections: abrupt rises in the surface of the traveled way. May be caused by sinking drainage grates, crude patching of the surface, partial erosion of a layer of asphalt, pavement joints, pedestrian ramp transitions, or root growth under pavement.

To ensure that the riding surface is maintained at a level which is smooth enough for bicyclists safety and comfort, the following guidelines should be followed:

- Locate public utility installations such as manhole covers, drainage grates and gate chambers so that they remain outside of paths
- Inspect control joints on paths.
- Schedule regular maintenance to remove sand (including early removal of sand left by winter sanding operations), earth, and other matter that may cause skidding.
- Eliminate surface irregularities which may make riding uncomfortably bumpy or lead to drainage problems or cause bicyclists to use the roadway instead of a path.
- Ensure that drainage grates, if located on or near a path, have narrow openings and be placed perpendicular to the riding surface.

The Agriculture Weed Law of Minnesota requires the control of at least these 10 weeds. In the preparation of plans and provisions for building bikeways, the responsibility for control of these noxious weeds during construction can be delegated to the contractor.

4. Selective vegetation removal may be required in order to remove low hanging branches and other growth that have encroached onto the bikeway. These encroachments may reduce the bicyclist's sight distance and can cause personal injury.

2-3.0 Vegetation Control

Control of vegetation is generally considered to be the responsibility of maintenance forces. However, in order to provide better control, it should also be considered during design and construction.

The following are examples of vegetation control methods that may be done during design and construction.

1. Placement of a non-selective herbicide such as Arsenal (Imazapyr) under asphalt paving. All applications must be done according to label directions. The applicator must be licensed by the Minnesota Department of Agriculture. It is quite common for thin bituminous surfaces with shallow subsurface treatments, such as walking trails, to be ruined by vegetation. This herbicide will prevent vegetative growth from penetrating the asphalt paving for a number of years. Non-selective herbicides may injure nearby trees if their root systems grow into the treated area.
2. Placement of a tightly woven geotextile or landscape fabric under the asphalt pavement. This method may be chosen in sensitive areas where a nonselective herbicide is undesirable. Several brands of geotextiles are available. Many provide additional structural support for the asphalt paving as well.
3. Requiring the contractor to control noxious weeds during construction. The following ten weeds have been designated noxious weeds on a statewide basis.

Canada Thistle	Sow Thistle
Bull Thistle	Musk Thistle
Plumeless Thistle	Wild Hemp
Poison Ivy	Leafy Spurge
Field Bindweed	Purple Loosestrife

Chapter Three

THE BICYCLE NETWORK PLANNING PROCESS

3-1.0 General

The bicycle network planning process is a specific application of the transportation planning process. Bicyclists and pedestrians value the same travel features as when driving motor vehicles (e.g., accessibility and directness), yet they also value characteristics such as designated facilities, low traffic volumes and speeds. In general, an attractive and comfortable environment.

3-2.0 DEVELOPING A COMMUNITY BICYCLE NETWORK PLAN

Establishing a vision of how bicycling fits into the overall transportation system of a community or region is important to develop a safe and enjoyable bicycle network. Identifying community values related to bicycle use and establishing strategic goals are basic components to integrate the bicycle network into the overall transportation system. The broad goals in the introduction of these guidelines are some examples that are applicable for a region or community.

Average Bicyclists typically prefer to ride on neighborhood streets or designated bicycle facilities. Experienced Bicyclists should be anticipated on roadways where bicycles are not excluded by statute or regulation, regardless of functional classification. Safe accommodation of all bicyclists is best accomplished by creating a comprehensive and continuous bicycle (and pedestrian) network in built-up areas in order to enhance the safety and travel comfort of users. Trips connected with school, shopping, work, errands, outdoor recreation and leisure should be possible by bicycle or on foot. Individual routes should be planned for all user groups (children, senior citizens, people who have disabilities and so on.)

The network is composed of bicycle and pedestrian routes including some motor vehicle roads with little traffic (e.g. residential and access streets) used as parts of the bicycle routes. Bicycle routes may parallel main roads for motor vehicle traffic, or be completely separate. Bicycle routes in an urbanized area may be classified as follows, according to their function in the network:

CLASSIFICATION

FUNCTION

MAIN ROUTE

Links various parts of a built-up area together and serves primarily bicycling that is either regional or long-distance between parts of an area. Planning is based mainly on needs of bicyclists but should also meet the requirements of pedestrians and other users.

LOCAL ROUTE

Carries internal traffic in a city district or other such areas or between adjacent areas. Has substantial pedestrian traffic. Planning should take into account the needs of various pedestrian and other groups (seniors, disabled people, children, etc.)

ACCESS ROUTE

Provides direct access to parking and entrances to destinations. Typically consists of residential streets, parking lots and access roads, etc. Planning requirements are similar to the local route but are not examined in detail in these guidelines.

RECREATIONAL ROUTE

Serves outdoor recreation done on foot, by bicycle, on skis, etc. Can form part of another route network.

The following discussion details a planning process intended to identify a community wide network of routes where bicycle facilities are used to meet the needs of Average and Experienced Bicyclists. Many model planning processes could be used to select routes and design facility treatments to accommodate bicyclists. The following process is one example. It has six steps:

1. Establish performance criteria for the bicycle network.
2. Inventory the existing bicycle facility and roadway system.

3. Identify optimal bicycle travel lines and corridors.
4. Evaluate and select specific route alternatives.
5. Select appropriate design treatments.
6. Evaluate the finished plan against the established performance criteria.

3-2.01 Establish Performance Criteria for the Bicycle Network

The performance criteria specify the values to use in determining the safety, desirability and effectiveness of a community bicycle network. Good quality values may include:

Directness: Good quality routes should be direct, smooth flowing with little waiting and have minimal increased (detour) distance compared to the most direct route.

CRITERION	MAIN ROUTE	LOCAL ROUTE
Design Speed	30 km/h	25 km/h
Average Waiting Time	15 s/km	20 s/km
Maximum Detour Distance	1.2 Detour Factor	1.3 Detour Factor

Accessibility: This is measured by the spacing between routes or the distance a bicycle facility is from a specific origin or destination, and the ease by which this distance can be traveled by bicycle. Coherent arrangements that are clear enough so that those with little traffic sense (e.g. children) can use them properly are important. Understandable signing helps. More importantly, all origins and destinations (residential areas, schools, shopping centers, business centers, parks, etc.) should be accessible by bicycle and on foot.

CRITERION	MAIN ROUTE	LOCAL ROUTE
Spacing between Routes	1 km Average 400-800 m (in city centers with sparse local routes)	200-500 m (Older Areas) 150-400 m (New Areas)

Continuity: The proposed network should minimize missing links. If gaps exist, they should be signed well and not include traffic areas that are unsafe or unpleasant.

Comfort and Attractiveness: This includes factors such as separation from motor traffic, visual aesthetics, the real or perceived threat to personal safety along the route, and the amount and level of security for bike parking. The alignment and conditions of the route should be roughly the same standard as (or better than) the motor vehicle road running alongside it to ensure the most use. Good lighting and even, hard, non-skid pavement without curbs are necessary.

CRITERION	MAIN ROUTE	LOCAL ROUTE
Average Chance of a Stop	1 Stop/2 km	1 Stop/km

Safety: The bicyclist's chance of confrontation with motorized and other traffic should be minimized. Motor vehicle traffic speeds and volumes and other factors are key in deciding the degree of separation or mixing of bicyclists with motor vehicle traffic. Sufficient width on separate paths, sufficient sight distances and safe crossing points where delay to bicyclists is minimized are essential.

3-2.02 Inventory Existing System

Both the existing roadway system and any existing bicycle facilities should be evaluated. The condition, location, and use levels of existing bicycle facilities should be recorded to determine if they warrant incorporation or removal. If the existing bicycle facilities are to be used as the nucleus of a new or expanded network, the inventory should note improvements necessary to bring the entire new network up to uniform design and operation standards.

The inventory of the roadway system should extend to the local collector road classification. A simple inventory could be based on a map of the Average Daily Traffic (ADT) counts, especially at peak travel times, on each road segment within a community or region. A more detailed inventory could include factors such as the number of traffic lanes, bus routes, the width of the outside lane, the actual average operating speed or the posted speed limit, the pavement condition, accident data, right-of-way widths, major barriers, other linear corridors, on-street vehicular parking, frequency of stop signs and signals, and certain geometric factors (e.g., the frequency of commercial driveways, grades, and railroad crossings).

3-2.03 Identify Bicycle Travel Corridors

Predicting bicycle travel corridors for a community is not the same as identifying the routes that bicyclists currently use. Instead, travel corridors can be thought of as "desire lines"

connecting neighborhoods that generate bicycling trips with other zones that attract a significant number of bicycling trips. The actual travel patterns of bicyclists are influenced by their perception of the bicycling environment. Uncomfortable or threatening bicycling conditions will cause bicyclists to alter route choice from their most preferred alignment, choose a different travel mode, or not make the trip at all. Thus, the task of the transportation planner is to ask, "Where are the bicyclists now?" and "Where would they be if they could go where they preferred?"

Most adults have a mental map of their community based on their experience as drivers. Thus, they tend to orient themselves by the location of major streets and highways. People driving bikes want to go to the same places they do in cars (within the constraints imposed by distance), and the existing system of streets and highways reflects the existing travel demands of the community.

Most peak morning trips are made between residential neighborhoods and child care and employment centers. In the evening peak, the opposite is true. In the evening or on weekends, the pattern of trip generation is much more dispersed as people travel to shopping centers, parks, and the homes of friends or relatives.

Estimating these trip flows for an entire city can be a complex, time-consuming effort requiring significant amounts of data and computer models. Many metropolitan areas have this information available. Bicycle trip flows based on land use can be estimated in the same way, recognizing the limits to bicycle trips of length or time. Bicycle trip lengths of 3 km could be considered optimal with a maximum trip length of 8 km typical. Longer trips should be facilitated by providing adequately marked interconnections between routes.

For those areas without modeling capability, estimating baseline bicycle trip flows between existing and future land uses (assuming that many existing impediments to bicycle use are removed) can be based on the pattern of motor vehicle flows. The simplest way is to multiply the Average Daily Traffic (ADT) of each segment of the road system by the bicycle mode split (the percentage of all trips that are made by bicycle) for the community or region. The 1990 census provides bicycle mode splits for census tracts and entire communities. Mode split estimates of total trips by bicycle in American cities have ranged between 3 and 11 percent.

Other sources of information on bicycle desire lines include surveys of households to determine current routes used and desired routes; bike shops and clubs can often provide practical information on bicycle route use and desires.

Although this use of existing traffic flows is a useful overall predictor of bicyclists' desire lines, a few special situations may require adjustments to the corridor map:

Schools, especially colleges and universities, military bases, and high-density residential areas can generate a

disproportionately large share of bicycle trips. This is especially true for campuses and other areas where motor vehicle parking is limited.

Parks, beaches, libraries, greenways, river and lakesides and other recreational facilities attract a proportionately higher percentage of bicycle trips.

3-2.04 Evaluate and Select Specific Route Alternatives

The corridor identification procedure identifies desire lines for bicycle travel between various locations. The next step is to select specific routes within these corridors that can be designed or adapted to accommodate all bicyclists and provide access to and from these locations. The aim is to first identify the main routes that best meet the performance criteria established in the first step of this planning process. Involve community residents to identify and select alternatives.

Typically, this step and the selection of appropriate design treatments are an interactive process. The practicality of adapting a particular route to accommodate bicyclists may vary widely depending upon the type of design treatment selected. For example, a less direct route may become the best option if comparatively few, inexpensive, and easily implemented design improvements are required.

Steps 4 and 5 can be approached as an iterative loop in which both route selection and design treatment are considered together to achieve a network that is highly advantageous to the user, is affordable, has few negative impacts on neighbors and non-users, and can be readily implemented.

In summary, the selection of a specific route alternative is a function of several factors, including:

- The degree to which a specific route meets the needs of the anticipated users as opposed to other route options.
- The degree to which the route alternatives meet the classification and performance criteria described in Step 1.
- The possible cost and extent of construction required to implement the proposed bicycle facility treatment.
- The comparative ease of doing the proposed design treatment.
- The opportunity to implement the proposed design treatment in conjunction with a planned roadway construction or reconstruction project.

3-2.05 Design Treatments

3-2.05.01 Select Appropriate Facility Options

The principal variables affecting the applicability of a facility option are:

The Design Bicyclist. The proposed route is intended to serve as part of a network of routes for all bicyclists. Non-network routes are projected to be used primarily by Experienced Bicyclists.

The type of roadway project involved on the selected route. Is the roadway scheduled for construction or reconstruction, or will the incorporation of design improvements be retrofitted into existing geometrics or right-of-way widths?

Traffic operation factors. Many of the traffic operations factors used for determining the most appropriate facility type are listed below. Application of the factors must be carefully studied, taking into account conditions such as:

- Traffic volume
- 85th percentile motor vehicle operating speeds (not the posted speed)
- Traffic mix
- Presence and type of motor vehicle parking
- Sight distance and design geometrics
- Number and types of intersections, and entrances
- Turning movements
- Frequency of stops required by signals and stop signs
- Bus stops
- Functional classification (Roadway and Bicycle Network)
- Available space
- One-way vs. two-way Traffic Flow
- Likelihood for Multiple Use of a Path
- Bikeway Design Coherence and Continuity
- Local Maintenance and Climate Conditions
- Bicycle Parking Security and Numbers

Bicycle and pedestrian traffic along high-speed (> 70 km/h) main roads and highways, especially in urbanized areas, is best separated from motor vehicle traffic. This can be done by a path raised from the traveled way with a curb, or with a path separated from the road by a barrier, dividing strip or separation space. Bicycle traffic may also travel on a shoulder. However, the bicycle traffic should be one-way and shall travel in the same direction as adjacent vehicular traffic.

Two-way paths located immediately adjacent to roadway traveled ways or shoulders should have some kind of separation or barrier. Two-way bike lanes with bicycle traffic traveling against the flow of the adjacent vehicular lane should also have a separation or barrier. If two-way bicycle lanes are located between parking and the curb, bicycle traffic in the bike lane nearest the parked vehicles should travel against the direction of adjacent parked vehicles. Along main streets in

downtown areas, a route with a curb raised from the roadway is also possible. Maintaining smooth transition between pavements is critical.

On a road with the 85th percentile speed > 50 km/h and motorized traffic volume > 10 000 ADT, use bicycle lanes with caution. It may be difficult for Average Bicyclists to leave the bicycle lane because of the number of motor vehicles, especially as speeds become higher.

On a road with many side roads with volumes > 1500 ADT or site accesses, paths lose some of their benefits: the comfort of uninterrupted cycling is nullified through bicyclists having to be alert at successive intersections. This does not apply as much when crossing small residential streets with volumes < 500 ADT. Intermediate volumes, between 500 to 1500 ADT, are more significant and require careful assessment of local conditions to determine the appropriateness of paths.

On one-way streets where bicycling is permitted in the opposite direction, contra-flow lanes or paths should be physically separated.

The above criteria may imply either the construction of a path or changing the composition of the traffic flow. Calming motor vehicle traffic speeds or volumes along with other options as discussed in Design Options to be Considered in Selecting the Appropriate Treatment in Chapter 4 may be utilized.

3-2.05.02 Factors Used to Determine Grade Separations (Tunnels and Bridges)

Conditions to consider when determining the need for grade separated crossings for bicycle facilities are much the same as for the previous section. The objectives of designing and constructing grade separations are to avoid motor vehicle intersection conflicts or avoid excessive grades. In addition to the factors listed in Section 3-2.05.01 above, the designer should also consider the following:

- Number of Lanes to be Crossed (cross section)
- Design Bicyclist
- Approach Grade
- Destinations
- Design of Turning Movements
- Primary Path Function
- Approaching Path Design
- Impact of bicycle traffic on vehicular traffic

See Table 5-14.0A, Choice of Intersection Type, Section 5-14.02.

3-2.06 Evaluate the Finished Network Plan Using the Established Performance Criteria

Will the proposed network meet the criteria established at the start of the planning process? If it does not meet most of these criteria, or inadequately meets a few critical goals, either the proposal will require further work, or the performance criteria must be modified. In the latter case, the planning process as a whole should be reviewed to determine if previously discarded routes should be reconsidered. They may now be more preferred options in light of the newly modified criteria.

This reality check is important. Many well considered proposals flounder when it is determined that the finished product no longer meets its established objectives.

3-2.07 Bicycle Parking and Security

Providing secure bicycle parking facilities is essential to promote bicycling. People are discouraged from bicycling unless adequate parking is available. Bicycle parking facilities should be provided at both the trip origin and trip destination and should offer protection from theft and damage. See **Chapter 8**.

Chapter Four

ON-ROAD DESIGNS

4-1.0 General

Bicycle travel shall normally be in the same direction as adjacent motor vehicle traffic to comply with the Uniform Vehicle Code. This section provides guidelines to select roadway design options to accommodate bicycles. Specific dimensions are suggested for the width of the recommended facility type. The joint between the gutter and roadway surface can be hazardous to a cyclist. Consider this when designing facilities that include curb and gutter. These guidelines reflect the current state of the practice in the design of bicycle-friendly roadways. Users of this manual are encouraged to treat these as "guidelines" rather than absolute standards.

4-2.0 Types of Facilities

Six types of on-road facilities are used to accommodate bicycle traffic: 1. Bicycle Lanes, 2. Combination Bus/Bicycle Lanes, 3. Shared Lanes, 4. Wide Curb or Wide Outside Lanes, 5. Shoulders, 6. Traffic Calmed-Roadways

4-2.01 Bicycle Lanes

Bicycle lanes are usually one-way facilities carrying bicycle traffic in the same direction as adjacent motor vehicle traffic, and are not located between parking spaces and the curb. Minimum width for a one-way bicycle lane is 1.2 m. Where curb and gutter is present the minimum width should be 1.5 m; a minimum of 1.2 m should lay to the left of the gutter pan seam.

Two-way bicycle lanes located on one side of a roadway tend to promote bicycle travel against the flow of motor vehicle traffic. Two-way bicycle lanes should only be used for short connections between paths or main routes under the following conditions: 1. on one-way roads where the bike lane nearest motor vehicles travels the same direction as motor vehicle traffic, 2. intersecting roads are one-way, 3. minimal cross traffic and intersections are controlled, 4. no parking is allowed along the bike lane and there is adequate intersection sight distance, 5. no turns on red allowed.

Research indicates that bicycle lanes have a strong channelizing effect on motor vehicles and bicycles. Bicycle lane stripes can increase bicyclists' confidence that motorists will not stray into their path of travel if they remain in the bicycle lane. Especially for Average Bicyclists, bicycle lanes offer a designated and visible space for bicyclists and can be a

significant factor in route choice. Some information indicates that when average daily traffic flows exceed 10 000 or average motor vehicle speeds exceed 50 km/h, 1.8 m bicycle lanes may attract Average Bicyclists better than wide outside lanes. However, caution should be used when considering bicycle lanes for Average Bicyclists in these traffic conditions.

Important factors in the use of bicycle lanes include on-street parking and the number and complexity of intersections. Parking movements and car door openings have the potential to cause crashes, so design bicycle lanes to minimize these conflicts. On streets with parking lanes, bicycle lanes should be at least 1.5 m wide and placed between the motor vehicle lane and the parking lane. Mark both sides of the bicycle lane. Bicycle lanes are not recommended with angled parking. See Figure 4-2.0A.

Bicycle lanes can complicate turning movements at intersections. They can encourage bicyclists to keep right and motorists to keep left, regardless of their intentions. Bicyclists weaving left from a bicycle lane and motorists weaving right are both maneuvering contrary to the usual rules of the road. Pavement markings may address this by various striping methods.

4-2.02 Bicycles, Buses and Combination Bus/Bike Lanes

Bus/bike lanes are usually designed and designated for the exclusive use of buses, bicycles and right-turning vehicles. Because bicycles generally travel at slow speeds and buses make frequent stops, these lanes can often function without impeding traffic flow. Generally, the bicyclist will overtake a stopped bus on the left, as passing on the right invites conflict with entering and exiting bus passengers. Depending on traffic conditions, bus/bike lanes are sometimes closed to other traffic during peak hours and opened in those hours when fewer bicyclists and buses are present. Right-turning vehicles are often only allowed in the lane when within 25 m of an intersection.

The mixing of bicycle and bus traffic in a bus/bike lane may be particularly acceptable if average bus speeds are low, preferably less than 30 km/h.

Two-way bicycle traffic may be acceptable on bus routes with two-way traffic if bus speeds and volumes are low. If speeds and volumes are not low, bike lanes or paths should be used for bicycle traffic.

A one-way bus lane is generally too narrow to allow two-way bicycle traffic. Bicycle lanes or paths should be added

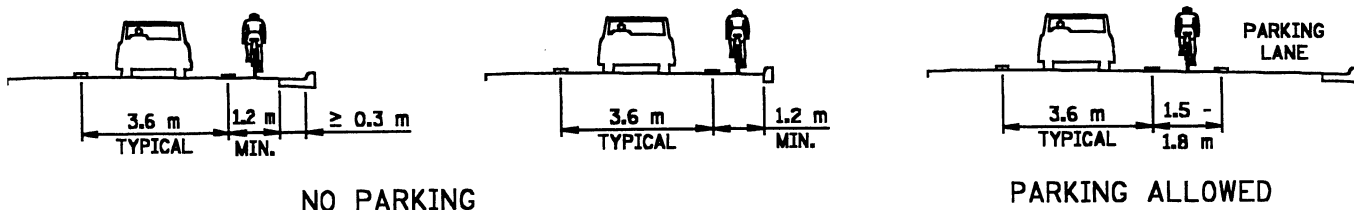

Typical Roadways with Bike Lanes

Figure 4-2.0A

next to a one-way bus lane to allow for two-way bicycle traffic. If bus speeds and volumes are low, one direction of bicycle traffic may be accommodated in the bus lane and the other direction of bicycle traffic in a bike lane.

If the bus/bike lane begins immediately after an intersection, pavement approach markings should be positioned before the intersection and measures taken to prevent motorists from entering the lane.

With speed limits of 50 km/h or greater, mixing of bicycle and bus traffic in bike/bus lanes is not desirable. Separation of traffic using bike lanes or paths is desirable. Bike paths should be constructed along fast, direct bus lanes. Paths are also desirable along busy school bus routes.

Bike lanes should be striped so that bicycle traffic is routed on the left side of stopped buses. On one-way streets a bicycle lane may be located on the left side of the street to reduce conflicts with buses.

4-2.03 Shared Lanes

Shared lanes are streets and highways with no special provision for bicyclists. Shared lanes often feature 3.6 m lane widths or less with no shoulders, allowing cars to pass bicyclists only by crossing the center line or moving into another traffic lane. In residential areas with low motor vehicle traffic volumes and average speeds of less than 40 km/h, they are normally adequate for bicyclists to use. With higher speeds and traffic volumes, shared lanes become less attractive to Average Bicyclists.

Shared lanes are not typically signed for bicyclists. Exceptions include when specific destinations or potential alternate routes for bicyclists need to be shown or when a gap exists between facilities such as between two paths, and bicyclists require signing to lead them to the next facility. See Figure 4-2.0B.

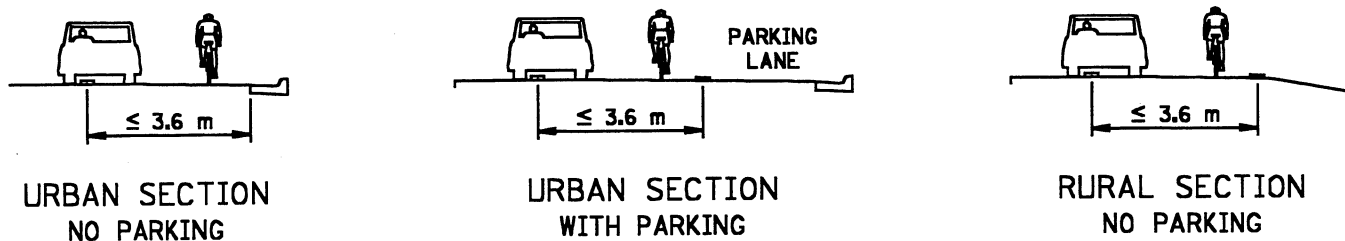

FIGURE 5

Typical Roadways with Shared Lanes

Figure 4-2.0B

4-2.04 Wide Curb or Wide Outside Lanes

Wide curb lanes, or wide outside lanes, are the rightmost, through traffic lanes that are substantially wider than 3.6 m. Wide curb or outside lanes are favored by Experienced Bicyclists who are not easily intimidated by high traffic volumes and speeds. However, for Average Riders, wide curb or outside lanes generally do not provide the same degree of comfort and safety and will do little to encourage them to bicycle. Wide curb lanes minimize both the real and perceived operating conflicts between bicycles and motor vehicles. They can also increase the roadway capacity by the number of bicyclists capable of being accommodated.

Most practitioners agree that 4.2 m, usually measured from the lane stripe to the edge of the gutter pan, rather than the curb face, is the minimum space necessary to allow a bicyclist and motorist to share the same space without coming into conflict, changing lanes, or potentially reducing the motor vehicle capacity of the lane. Where traffic speeds exceed 60 km/h, and when annual average daily traffic exceeds 10,000, 4.5 m widths are desirable. 4.8 m widths may be used, but use 4.8 m widths with caution because motorists may use this space as two lanes. Where pavement widths are > 3.6 m, stripe 3.6 m lane widths for motor vehicle traffic. See Figure 4-2.0C.

4-2.05 Shoulders

Shoulders 1.2 m wide are considered the minimum width to accommodate bicycle traffic. Experienced (and even some Average Bicyclists) will benefit from shoulder widths as narrow as 0.3 to 0.6 m, but these facilities should not be signed for bicyclists. As traffic speeds increase, traffic mix includes heavier vehicles and trucks, and traffic volumes rise, shoulder width > 1.2 m is desirable (see Table 4-6.0B). Give additional attention to accommodate bicycle traffic on controlled-access and freeway shoulders where such use provides the only crossing of a river, lake, freeway or other barrier.

Bike lanes are usually preferred to shoulders by Average Bicyclists; wide curb lanes are usually preferred by Experienced Bicyclists. One exception is high-speed urban arterials more than 80 km/h where 1.8 m shoulders will serve Experienced Bicyclists better than wide curb lanes. Bike lanes, if used along these routes, should also be 1.8 m wide. In rural areas, paved shoulders may accommodate both types of bicyclists. See Figure 4-2.0D.

Avoid surface irregularities, such as rumble strips, textured paving, and raised lane markers and reflectors on routes intended for bicyclists. Shoulder rumble strips are typically located from 0.15 to 0.3 m from the road edge and typically 0.6 m wide. Where shoulder rumble strips are necessary, pave shoulders wide enough (2.4 m min.) to leave at least 1.5 m of the smooth shoulder surface for bicyclists.

4-2.06 Traffic-Calmed Roadways

Traffic-calmed roadways (typically urban local or collectors) are often used as routes in bicycle and pedestrian networks. Widespread neighborhood traffic calming aims to reduce the dominance and speed of motor vehicles. Measures employed to achieve this include physical changes in road alignment and grade and changes in priority. Low speed zones may be introduced along with a package of these physical changes.

In areas of traffic calming it is rare to see special facilities for bicyclists because many of the benefits of traffic calming--slower vehicle speeds, better driver discipline, less traffic, and environmental improvements-- directly benefit bicyclists, especially Average Bicyclists. Benefits attributed to traffic calming include an average one-third reduction in road accidents, a greater feeling of security among vulnerable road users and environmental improvements through landscaping and a reduction in the presence of motor vehicles.

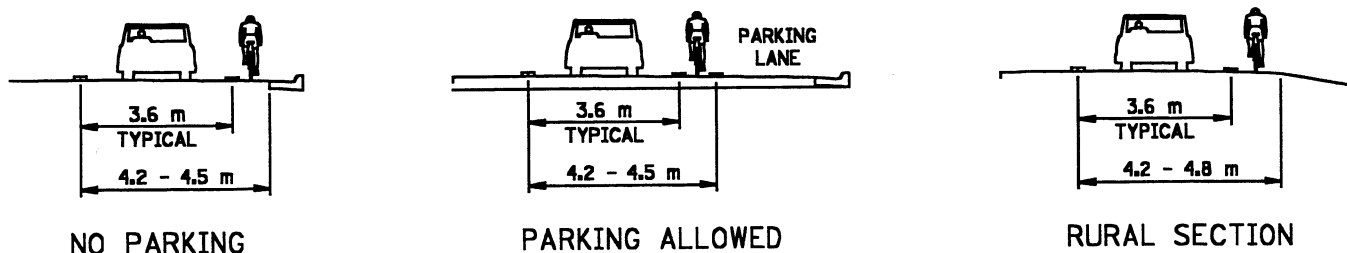

Typical Roadways with Wide Curb Lanes

Figure 4-2.0C

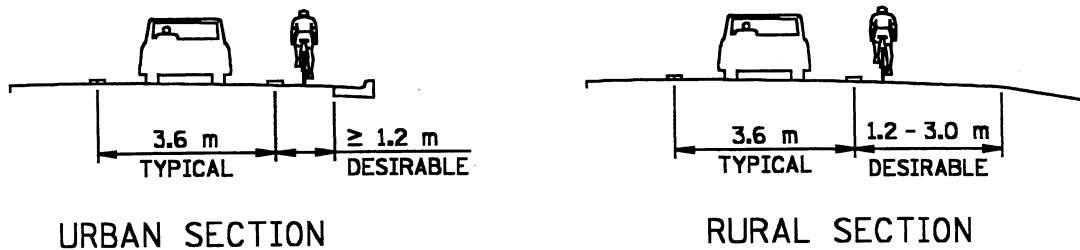

Typical Roadways with Shoulders

Figure 4-2.0D

4-3.0 Designating Bicycle Facilities

An important consideration regarding the six types of facilities designs is whether or not they should be designated by pavement markings and/or signs as bicycle facilities. As discussed in **Chapter 1**, Average Bicyclists often prefer designated facilities for bicycle use. Therefore, when facilities are provided to serve Average Bicyclists, some designation should be considered. When design options are provided primarily to serve Experienced Bicyclists, designation is often optional. In some cases, it may be more desirable not to designate the facility for bicycle use.

Another consideration involves minor or marginal roadway improvements for bicyclists, such as striping a narrow (less than 1.2 m) shoulder. This can significantly improve riding conditions for Experienced Bicyclists and should be considered if no better treatment is possible. However, if this width is less than the minimum called for in virtually all design specifications, the roadway should not be designated as a bicycle facility. Where a facility is intended to be designated as a "bicycle facility" it is essential the design conform to these guidelines or the AASHTO Guide to the Development of Bicycle Facilities 1991 guidelines.

4-4.0 Preparing to Select a Design Option

To determine the appropriate roadway design option to accommodate bicyclists, several factors associated with the specific route or project must be assessed:

- What kinds of bicyclists is the route intended to serve?
- What type of roadway project is involved (new construction, reconstruction, or retrofit)?
- What are the current and anticipated traffic operations and design characteristics of the route that will affect the choice of a bicycle design treatment?

4-4.01 What Types of Bicyclists is the Route Most Likely to Serve?

These guidelines take their lead from the AASHTO Guide to the Development of Bicycle Facilities 1991, which states:

"To varying extents, bicycles will be ridden on all highways where they are permitted. All new highways, except those where bicyclists will be legally prohibited, should be designed and constructed under the assumption that they will be used as a bicycle street."

Because use by Average Bicyclists is likely and is encouraged, the tables recommending design treatments for Average Bicyclists should be used. The Average Bicyclists design treatments will also accommodate Experienced Bicyclists. Where a planning process has determined a given route, the best choice to form part of a bikeway network the recommended design treatment appropriate to Average Bicyclists should be implemented. Non-bikeway network streets and highways open to bicycle use desirably incorporate the design treatments recommended for Experienced Bicyclists and may incorporate those for Average Bicyclists.

4-4.02 New Construction, Reconstruction and Retrofitting

The recommended design treatments in **Tables 4-6.0A & B** are most easily implemented when new construction or reconstruction is planned. It is a relatively straightforward process to adapt the specified design treatment for bicycles at the project planning stage.

When implementation involves retrofitting an existing roadway to accommodate bicycle use, the project can be more complex. Existing streets built with curb and gutter section design will often be viewed as having a fixed width and

improvements will likely be limited to "moving paint," that is, restriping the existing lanes.

When working with existing streets and highways, planners should investigate making at least minor or marginal improvements. However, where the need is to serve Average Bicyclists, it is essential to commit the resources necessary to provide facilities that meet the recommended design treatments. Only then can routes and facilities be designated for bicyclists and provide the desired access to the community.

4-4.03 Design Options to be Considered in Selecting the Appropriate Treatment

Safely accommodating bicyclists on urban roadways may require efficient use of space within existing right-of-way. There are a number of ways to more efficiently use right-of-way space in order to safely accommodate bicyclists (and pedestrians). The best options depend on the operating characteristics of the road space, the context of the urban area, and the most appropriate bikeway treatment. These options also apply when considering the inclusion of a separate path in an urban area.

Options for efficiently accommodating bikeway treatments may include the following: changing travel lane widths, changing the number of travel lanes, removing obstructions, changing parking amounts or arrangements and traffic calming. It is important to use good judgment in applying these design options which are within Mn/DOT standards.

1. Changing travel lane widths. In speed zones of 40 km/h, travel lane widths of 3 - 3.2 m may be acceptable. In zones of 50-60 km/h, 3.3 m travel lanes and 3.6 m center turn lanes may be acceptable. In zones of 70 km/h or greater, 3.6 m outside travel lanes and 4.2 m center turn lanes are desirable.
2. Changing the number of travel lanes. Many one-way couplets were originally two-way streets. Study can determine if this has resulted in an excessive number of travel lanes in one direction. On two-way streets with four travel lanes and a significant number of left-turn movements, restriping for a center turn lane, two travel lanes and two bike or wide curb lanes may actually improve traffic flow.
3. Removing obstructions. Paved or landscaped traffic islands often reduce available roadway space. If not needed for access control, traffic calming, or as refuges, eliminating, narrowing or replacing raised islands with pavement markings may add increased usable width. Relocating utility poles and light standards, parking meters, signs, guardrails and other obstructions away from the edge of the roadway may also increase usable width.
4. Changing parking amounts or arrangements. Removing parking does not always improve safety; in some

locations it may actually decrease safety. Careful study is needed before making changes regarding parking. This may include counting the number of businesses/residences, the availability of both on- and off-street parking and counting the average use of this parking.

Assessing traffic operational and other factors may result in proposing parking alternatives such as:

- Rearranging, reducing or eliminating parking on one or both sides of the street.
- Allowing parking for church or school activities on adjacent lots during services or special events.
- Sharing use by businesses and residences.
- Construction of special parking spaces or bays for residences or businesses with no other options.

Removal of all on-street parking is often not acceptable. Other options may be pursued including:

- A. Parking can be narrowed to a minimum 2.1 m, particularly in areas with low truck parking volumes.
 - B. Remove parking on one side only. In some cases parking may be needed on one side only to accommodate businesses and residences.
 - C. Change from diagonal to parallel parking. Diagonal parking takes up a great amount of street width and can often be hazardous. Changing to parallel parking often increases street width availability by more than one-half; however, on one-way streets, changing to parallel parking on one side increases availability by one-fourth.
 - D. Prohibit parking by employees. This can also help increase the number of available spaces for customers, even if the total number of spaces is reduced.
5. Traffic calming the street and considering above alternatives. On streets with restricted space and appropriate traffic operation factors, traffic calming techniques by themselves or combined with other alternatives may be the most effective option to safely accommodate bicyclists and pedestrians. It also has the benefit of increasing overall traffic safety and improving the quality of the street environment.

4-5.0 Traffic Operations and Design Factors Used In Determining the Appropriate Design Treatment

Six factors are most often cited by transportation planners and engineers; five are used to define the recommendations contained in **Table 4-6.0A** and **Table 4-6.0B**.

Each of these factors is discussed below along with the ranges of values used to differentiate levels of needs. The tables should be used as a "guide" and adjustments be considered to reflect, for instance, different values for the ranges for average daily traffic volume (ADT).

The six major factors are as follows:

Traffic volume. Higher motor vehicle traffic volumes represent greater potential risk for bicyclists and the more frequent overtaking situations are less comfortable for Average Bicyclists unless special design treatments are provided.

85th Percentile motor vehicle operating speed. Operating speed is more important than the posted speed limit and better reflects local conditions. Motor vehicle speed has a negative impact on risk and comfort unless mitigated by design treatments.

Traffic mix. The regular presence of trucks, buses, and/or recreation vehicles (i.e., at approximately 40 km/h or more) may increase risk and have a negative impact on comfort for bicyclists. At high speeds, the wind blast from such vehicles may create a serious risk of falls. Even at lower operating speeds, shared lane use is less compatible. All types of bicyclists prefer extra roadway width or separate facilities to accommodate greater separation from such vehicles. Many bicyclists will choose a different route or not ride at all where there is a regular presence of such traffic unless they are able to remove themselves several meters from motor vehicles. The recommendations contained in the tables suggest different design options and widths that take into account the presence and volume of trucks, buses and/or recreational vehicles.

On-street parking. The presence of on-street parking increases the width needed in the adjacent travel lane or bike lane to accommodate bicycles. This is primarily a concern associated with streets and highways built using urban designs. It is addressed in the recommendations by including a note for urban sections with on-street parking.

Sight distance. "Inadequate sight distance" relates to situations where bicycles are being overtaken by motor vehicles and/or where the sight distance is likely less than that needed for a motor vehicle operator to either change lane positions or slow to the bicyclist's speed. This problem is associated with rural highways, and urban streets having sight distance problems due to poor design and/or visual obstructions.

The most effective response to the problem is to correct it. Providing for bicycle operation to the right of the designated motor vehicle lane (i.e., on a bike lane or shoulder) or, at speeds greater than 50 km/h, by adding extra delineated width to a wide outside lane, are viable approaches. The tables take these and other approaches into account.

Number of intersections. Intersections and commercial entrances pose special challenges to bicycle and motor vehicle operators, especially when bicycle lanes or paths are introduced. The greater the number of intersections and commercial entrances per kilometer, the greater the potential number of encounters and conflicts.

While not included as a selection factor in the tables, the number and/or frequency of intersections should be considered when assessing the use of bike lanes. There is some evidence to suggest that the disruption in traffic operations associated with bike lanes is temporary. Over time, both bicyclists and motorists adapt to the new traffic patterns, learning to look for each other and make merges prior to intersections and commercial entrances.

4-6.0 Using the Tables to Determine the Recommended Option

Recommended roadway design options and widths to accommodate Average Bicyclists are presented in **Table 4-6.0A** and **Table 4-6.0B**. They are separate tables for the two basic types of roadway sections: urban (with curb and gutter) and rural (without curb and gutter). Special notes follow the urban sections table for sections with on-street parking.

[Note: Controlled access freeways are considered a special case and are not addressed by the tables. Currently (1995) Minnesota does not allow bicyclists to operate on the shoulder of controlled-access freeways. Controlled-access freeway right-of-way also have been used for separate paths.]

The tables indicate the recommended design options given various sets of traffic operations and design factors. The recommended dimensions should be considered as "desirable widths." Any option specifically designated for bicycle use should desirably meet the design guidelines presented here or at a minimum the guidelines in the AASHTO Guide for the Development of Bicycle Facilities 1991.

4-7.0 Traffic-calmed Roadways

Traffic calming employs a variety of techniques to reduce the dominance and speed of motor vehicles. In addition to making traffic-calmed roads safer, slower vehicle speeds may

create better driver discipline and reduce fuel consumption, vehicle emissions, and noise levels.

Traffic calming is typically used on residential streets but may apply to other roads based on the functional classification and use. Techniques applicable to main urban thoroughfares generally differ from those employed in minor residential streets. A greater variety of features have been de-

veloped for minor roads where stricter speed controls and reduced capacity won't create undue delay.

Care should be taken to ensure bicyclist and motorist safety when considering types of traffic calming. Bicyclists are susceptible to changes in surface height and texture or unexpected road narrowing. A design balance should be maintained whereby bicyclists traveling through traffic-

Table 4-6.0A
Roadway Design Options for Average Bicyclist , Urban Sections*

Motor Vehicle AADT/lane		less than 250	250 - 500	500 - 1000	1000 - 2500	2500 - 5000	5000 and above
Motor Vehicle AADT (2 Lane)		less than 500	500 - 1000	1000 - 2000	2000 - 5000	5000 - 10000	10000 and above
Motor Vehicle AADT (4 Lane)		N/A	N/A	2000 - 4000	4000 - 10000	10000 - 20000	20000 and above
Peak Hour Volume/lane		less than 22	22 - 44	44 - 88	88 - 220	220 - 440	440 and above
Avg. Peak Hour Headway/lane (sec)		more than 164	164 - 82	82 - 44	44 - 16	16 - 8	less than 8
Average Motor Vehicle Operating Speed	0 - 30 km/h (0 - 19 mph)	sl	sl	sl	sl	sl	N/A
	30 - 50 km/h (20 - 31 mph)	sl	wc = 4.2 m	wc = 4.2 m	wc = 4.2 m	bl = 1.5 m	bl = 1.5 m
	50 - 70 km/h (32 - 43 mph)	wc = 4.2 m	bl = 1.5 m	bl = 1.5 m	bl = 1.5 m	bl = 1.8 m	bl = 1.8 m
	over 70 km/h (over 43 mph)	bl = 1.5 m	bl = 1.5 m	bl = 1.5 m	bl = 1.8 m	bl = 1.8 m	bl = 1.8 m or bp

KEY: 0.305 m = 1 ft, sl = shared lane, wc = wide curb lane width, bl = bike lane width, bp = off road bike path

* When parking exists bike lanes should be placed no closer than 3.0 m from the curb face, such that a clear zone of approximately 1.0 m should exist between bike lane and parked vehicle. Bike lanes are not applicable on roads with parking and speed exceeding 80 km/h.

Table 4-6.0B
Roadway Design Options for Average Bicyclist , Rural Sections

Motor Vehicle AADT/lane		Less than 1000 *	1000 - 2500	2500 - 5000	5000 and above
Average Motor Vehicle Operating Speed	0 - 50 km/h (0 - 30 mph)	sh = 1.2 m	sh = 1.2 m	sh = 1.2 m	sh = 1.2 m
	50 - 60 km/h (30 - 36 mph)	sh = 1.2 m	sh = 1.8 m	sh = 1.8 m	sh = 1.8 m
	60 - 70 km/h (36 - 43 mph)	sh = 1.8 m	sh = 1.8 m	sh = 1.8 m	sh = 1.8 m
	over 70 km/h (over 43 mph)	sh = 1.8 m	sh = 1.8 m	sh = 2.4 m	sh = 2.4 m

KEY: sh = shoulder width

* When AADT is less than 500, shoulders are not a necessity, unless the roadway is heavily used by trucks or heavy commercial vehicles.

calmed areas are able to maintain their momentum while not endangering other users, and at the same time, not be encumbered by speed-reducing measures which may discourage the use of those areas.

General Design Guidelines

- 1) Provide bicyclists with alternative bypasses (minimum width 0.7 m, 1.0 m desirable) around physical obstacles such as chicanes or ramps.
- 2) Where roads are narrowed as a speed control measure, consideration should be given to how bicyclists and motorists can share the remaining space.
- 3) Surface materials should have good skid resistance. Textured areas should not be so rough as to create instability for bicyclists.
- 4) Smooth transitions on entry and exit slopes on raised surfaces, with clear indication and transition gradients of no more than 1:6.
- 5) Design should take into consideration any overall gradients, noting that bicyclists are likely to approach them at different speeds uphill and downhill.
- 6) Appropriate signing can be combined with public awareness campaigns to remind drivers about traffic calmed areas.

4-7.01 Speed Humps

Speed humps are probably the most widely used measure in traffic calming. They are generally raised to about the same height as adjacent curbs and can be round or flat-topped. They extend from curb to curb or may be cut back at the curb with tapered ends to facilitate drainage and to allow bicyclists to bypass them. The most effective height from a traffic control standpoint is between 50-100 mm. There is a danger that hump gradients that are too steep will discourage bicyclists, who may choose main roads or pedestrian sidewalks. Speed humps located too near an intersection may be dangerous to bicyclists because they may not be in an upright position when encountering the hump. Bicyclist bypasses of speed humps may also be created at pedestrian crossings by inserting medians to separate motor vehicle and bicycle traffic.

4-7.02 Chicanes

Chicanes are created by the placement of physical obstacles or parking bays staggered on opposite sides of the road, making for a more "tortuous route." By narrowing the road, sightlines are reduced. This has generally proven successful in encouraging lower speeds and deterring through traffic. However, bicyclists sometimes feel squeezed when being overtaken by a motor vehicle on the passage through a chicane. Also, reckless drivers sometimes view chicanes as an obstacle

course. When chicanes located on two-way streets are combined with angled parking, maneuvering motorists pose a threat to bicyclists. One-way streets are safer because motorists can see pedestrians emerging from between parked cars. In order for chicanes to both quiet traffic and still be safe for bicycling, bicyclists should be able to bypass them. This is facilitated by pavement markings and appropriate signing.

4-7.03 Pinch Points

Pinch points are used to narrow two-lane roads to a single lane over a short distance and can be found in conjunction with a raised pedestrian crossing. When used in conjunction with a raised pedestrian crossing, pinch points have been found to successfully reduce traffic speeds and through movements. However, when used alone, bicyclists have felt squeezed as they are overtaken at the pinch point. Average bicyclists may lack the confidence to position themselves in the middle of the road to prevent this. Where it is expected that motorists should be able to pass bicyclists, the minimum desirable width is 4.2 m. Where bicycle flows are high, a separate right of way should be placed in the form of a not-quite-central refuge. Signing and a textured surface may be used to emphasize pedestrian crossing movement. The surface helps to impress upon motorists that lower speeds are intended.

4-7.04 Curb Extensions

Curb extensions involve the widening of the sidewalk on one or both sides of the road. They serve to reduce crossing distances for pedestrians. When placed near an intersection, they tend to tighten turning radii and lessen vehicle speeds while preventing vehicles from parking too close to the intersection. They have a particular value in sheltering parked vehicles and ensuring that a pedestrian's view of approaching motor vehicles and bicyclists is not obstructed.

4-7.05 Mini Round-a-bouts

Mini-roundabouts, when signed and clearly visible, may be effectively used to slow vehicle speeds. Their design should ensure that bicyclists are not squeezed by other vehicles negotiating the feature, yet adequate deflection should be incorporated on each approach to enforce appropriate entry speeds for vehicles.

4-7.06 Surface Alterations

Surface alterations at side road junctions involving raised textured materials tend to give the impression of a calmed area. This encourages drivers to be more careful when entering or leaving the side road. The effect is enhanced with the

addition of tight curb radii. Bicyclists however, may find this feature to be uncomfortable or hazardous. Ramps should smooth the transition where entry treatment results in surface height differentials. Materials employed should have a good skid resistance.

4-7.07 Environmental Road Closures

Environmental road closures generally occur in residential areas and serve to remove through traffic or undesirable maneuvers. Bicycle exemption should be provided as such closures tend to force bicyclists onto busier routes. Bicycle gaps should be designed to minimize the risk of obstruction by parked vehicles. Painting a bicycle symbol on the road in front of the bicycle gap has proved effective. Bollards may be placed to reduce the incidence of obstruction. Care must be taken to ensure that these are visible at night. Signing may acknowledge the continued existence of the route as a through route for bicyclists.

4-7.08 Plugged, or No-entry Calming

Plugged, or no-entry calming, involves barring access for motor vehicles on one end of a road while maintaining a two-way flow available to bicyclists and pedestrians. This technique successfully reduces vehicle through traffic while avoiding the possible increase in traffic speed that a continuous one-way street can create. This technique is often used in new housing developments incorporating courtyards or cul-de-sacs to remove through traffic. Signing may be necessary to indicate a continued through route for bicyclists.

4-7.09 Rumble Strips (traffic calming)

Rumble strips, (traveled way rumble strips are described in Section 4-10.0) cause noise which may alert motor vehicle drivers to traffic controls, etc. They have varied practical effect on motor vehicle speeds. Rumble strips can be uncomfortable and sometimes dangerous for bicyclists. If the use of rumble strips is necessary, provide a bypass or sufficiently smooth surfaces for bicyclists.

4-7.10 Transverse Bands

Transverse bands are painted yellow lines placed at decreasing intervals. They give drivers the impression that they are traveling with increasing speed so that they react by slowing down. They have proved effective at reducing speeds on the approach to a hazard (usually a junction) and have a negligible effect on bicyclists. Care should be taken to ensure that markings do not build up successive paint layers causing a hazard for bicyclists.

4-8.0 Bypass Lanes

A bypass lane is an expanded area of roadway shoulder which allows for vehicles to bypass other vehicles attempting left turns. They are typically found at intersections on rural two-lane roads. Cars overtaking left turning vehicles move to their right, traveling on the bypass lane typically used by bicycles. Additionally 1.2 m of paved shoulder may be added to the bypass lane for bicycle traffic.

The bypass lane should be clearly striped to ensure that the motorist doesn't drift into the bicyclist's path. Additional shoulder width is desirable if the percentage of trucks, buses and recreational vehicles is high.

4-9.0 Climbing Lanes

A climbing lane is an additional uphill lane which allows for vehicles to overtake those vehicles which are unable to maintain satisfactory speeds. They are typically found where long roadway grades occur, causing slow moving vehicles to move to the right lane. A minimum 1.2 m paved shoulder may be added next to the climbing lane for bicycle traffic.

Climbing lanes should be indicated to motorists and bicyclists by appropriate signage. The shoulder edge as well as the climbing lane must be clearly marked to insure that the motorist doesn't move into the bicyclist's path.

4-10.0 Rumble Strips

Rumble strips are bands of raised material or indentations formed or grooved in the traveled way or along the shoulder. They are intended to call the motorist's attention to standard warning or regulatory devices or otherwise alert inattentive drivers by transmitting sound and vibration through the vehicle. There are two basic types-- traveled way rumble strips located in the road way and shoulder rumble strips.

The safety of the bicyclist should be considered before any work starts. Provisions should be made for bicyclists to safely traverse through or around rumble strips. Potential for mishap arises when the bicyclist contacts rumble strips or attempts to avoid them by weaving. Care must be taken to ensure a stable riding surface. Concave rumble strips tend to fill with sand. Also, sand and debris tend to gather along the outside shoulder edge. These two factors work from both sides of the shoulder, narrowing the available bicycling space.

Full-width shoulder rumble strips should not be used where bicyclists are permitted. The minimum shoulder width for shoulders with rumble strips should be 2.4 m. Shoulder rumble strips are located from 0.15 to 0.3 m from the road

edge and typically 0.6 m wide. This will leave approximately 1.5 m of available shoulder for the bicyclist.

4-11.0 Drainage and Drainage Grates

For bicycle travel, existing roadway drainage is normally adequate. However, on curb and gutter sections, a check of ponding depths should be made where a problem is identified and corrective action taken if depths are significant. This may entail improved drainage grates or wider lanes. Also, pavement overlays should taper into drainage outlets and manhole covers so they do not cause an abrupt edge. See **Figure 4-11.0A** for a recommended cross section. Inlets and manholes should be raised after a pavement overlay if too much of a dip is created.

When a new roadway is designed, all such grates and covers should be kept out of the bicyclists' expected path. Curb inlets are preferable to surface type inlets.

Drainage inlet grates on roadways shall have openings narrow enough and short enough to assure bicycle tires will not drop into the grates regardless of the direction of bicycle travel. Parallel bar grates should be replaced with bicycle safe and hydraulically efficient grates. Pavement marking to identify and warn about unsafe grates may be acceptable in some situations. However, a parallel bar grate should be replaced or physically corrected as soon as practicable after identification. "Vane" type grates are preferable surface type grates. See **Mn/DOT Standard Plates 4151 and 4152 for acceptable designs of grates**. Where it is not immediately feasible to replace existing grates with standard grates designed for bicycles, 25 mm by 6 mm steel cross straps should be welded to the grates at a spacing of 150 mm to 200 mm on center to re-

duce the size of the opening. This should be considered a temporary correction; snow plows tend to scrape off such straps.

4-12.0 Lighting

On shared roadways and those with bicycle lanes, the area normally reserved for bicyclists may be illuminated in accordance with recommended design values in the AASHTO Guide "An International Guide for Roadway Lighting" and ANSI/IES recommended practices. The lighting system as a whole should provide adequate illumination along the entire length and width of the bikeway, without variations in luminous intensity to which bicyclists and motor vehicle drivers might experience difficulty adjusting.

All preliminary roadway lighting designs should be checked for conformance with illumination requirements prescribed for walkways adjacent to roadways and bicycle lanes. (see lighting section in **Chapter 5: Paths**)

4-13.0 On-Road Intersections

In urban areas, more than three-fourths of all car/bike collisions occur at intersections, many of which are due to bicyclist error. The cause of these accidents are numerous; no single measure will provide a primary solution to the intersection problem. Almost one-fifth of all car/bike collisions are caused when a bicyclist runs a stop sign or red light. In addition, motor vehicle drivers in both left and right turning

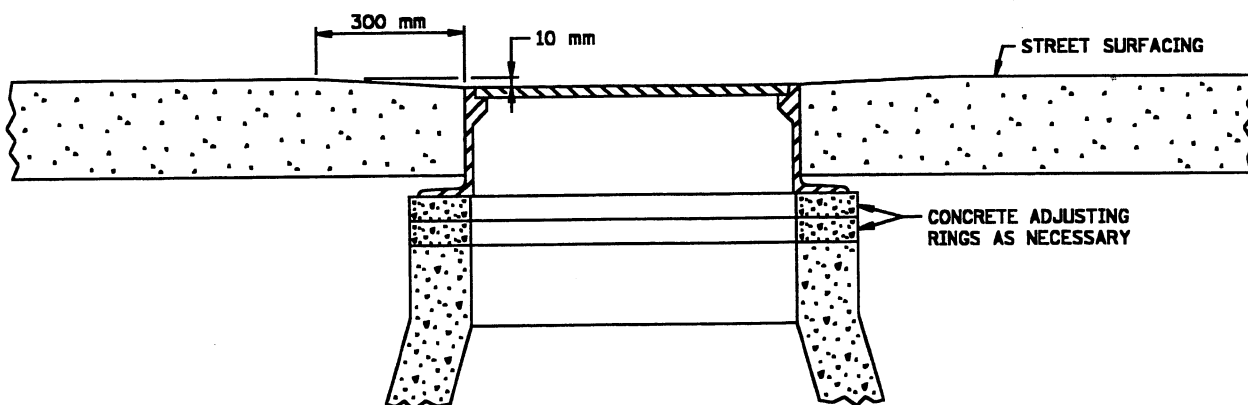

Cross section of Manhole Cover Installation

Figure 4-11.0A

situations have a tendency to overlook bicyclists riding against the normal flow of traffic.

Safety at intersections depends on the functions of the roads and bikeways, motor vehicle and bicycle traffic volumes and speeds, the crossing distances, number and types of turning movements and the amount of space available at the crossing. Each intersection must be studied individually.

Factors to be taken into consideration to achieve safe, workable intersection design include:

SAFETY:

- Bicycles and motor vehicles must be able to easily see each other
- Intersection design should be simple, avoid the need for complex maneuvers
- Motor traffic speed should be low where bicycles cross at grade
- There must be sufficient maneuvering or waiting space

MINIMIZE BICYCLE DELAY:

- Minimize waiting times
- Maximize the possibility to cross without delay
- Provide main bicycle route crossings priority over local roads and streets.

CONVENIENCE:

- Bicyclists should have comfortable routes across the intersection
- Curb cuts and transitions should be flush with the road, the full width of the facility
- There should be no detours for bicyclists across intersections
- Give special attention for turning bicycles (primarily left-turning bicycles)

Two design characteristics are important for safe weaving of bicycle and motorized traffic. First, the speed difference between bicycles and motorists in the weaving or merge area is desirably no greater than about 10 km/h. Second, the number of traffic lanes for a left-turning bicyclist to weave across should be kept to a minimum; they should not have to cross more than one lane.

1. The Right-Turning Motorist and the Bicyclist Proceeding Straight Ahead

Conflicts with right-turning cars account for about one in ten of all urban car/bike collisions.

Right turns on green by motorists may be hazardous because the driver and the through bicyclist may both perceive themselves to have clear right of way. Every effort should be made to encourage the right-turning motorist to slow down, and observe bicycle traffic, before reaching the intersection and turning right. The weaving of motor vehicles and bicycles is not desirable if the intersection approach or exit is on a curve.

Where right turn on red is permitted, motorists tend to focus their attention on cross traffic approaching from the left, and in doing so may infringe on through bicyclist storage area.

Some bicyclists use right-turn only lanes when traveling straight through an intersection. This causes difficulties because motorists expect the bicyclist to turn right. At right-turn only lanes, bicyclists should be encouraged to merge to the left side of the lane to complete the weave maneuver. However, this is often difficult for Average Bicyclists to do. In lanes that allow both through and right-turn movements it may be difficult for both the motorist and bicyclist to recognize the other's intent. At locations with identified accidents, bicycle lanes or designated bicycle route signing and pavement markings clarifying who is responsible for yielding or other actions are recommended. Parking may be prohibited for a minimum of 30 m or more from the intersection, depending on the design speed of the turn.

2. The Left-Turning Motorist and the Bicyclist Proceeding Straight Ahead

Conflicts with left-turning motorists account for almost one-quarter of all urban motor vehicle/bike collisions. This type of collision occurs because the left-turning motorist either does not see the approaching bicyclist or underestimates their speed. The motorist's field of view is limited to oncoming vehicles, so a bicycle traveling in the roadway will usually fall within view. However, if the motorist is trying to clear the intersection in the face of oncoming traffic, a bicyclist may not be seen in time to yield. One way to eliminate this type of "panic" turn is to install a protected left turn phase.

3. The Left-Turning Bicyclist and the Motorist Proceeding Straight Ahead

When making a left turn, the difference between an Average Bicyclist and the Experienced Bicyclist shows up most. The weaving movements necessary to cross to the center lane or left-turn lane are difficult for Average Bicyclists and often unanticipated by motorists. Weaving is not desirable if the bicyclists or a left-turn lane are on a right bending curve. It is also desirable that bicyclists have the opportunity of crossing in two steps besides the possibility of weaving. At intersections, especially those on roads with bicycle lanes and traffic lights, the striping of bike lanes for bicyclists turning left is desirable.

The marking of a bicycle lane for left-turning bicyclists at an unsignalized intersection depends on the speed difference between bicyclists and motorists and the volume of motorists turning left. It is desirable that the number of lanes of through traffic to cross is limited to one per approach road section.

The Average Bicyclist may prefer the two-step approach or a grade separation. Using the two step method, bicyclists will enter the intersection in the right lane, cross to the corner and then make another crossing to end up on the right lane of the cross street. See Figure 4-13.0A.

The Experienced Bicyclist will tend to follow the same maneuver that motor vehicles use. Experienced Bicyclists may be encouraged to make the necessary weave movements for proper left turns. The tendency for bicyclists to "double-up" with turning vehicles, rather than fall in line, may also create sideswipe exposure. Opposing motorists may not see or fail to grant right of way to the turning bicyclist.

4. Intersection Crossing Distance

At intersections, it is desirable to keep the crossing distance and the number of lanes to cross at a minimum for

the safety of crossing traffic. It is desirable to limit the number of lanes to cross at a time to three. If the number of lanes to be crossed is > 3 , a traffic or median island, at least 2.0 m wide, should be placed at the crossing.

At crossings with stop signs and signalized intersections, traffic will sometimes proceed against the stop or red. Sight distances should be determined during the design of the roadway with this in mind.

4-13.01 Shared Road Bikeway Treatments at Intersections

1. Right Turn Lanes. Minnesota law requires the bicyclist to keep as close as practicable to the right edge of the roadway. Therefore, the bicyclist may move toward the right edge of the right-turn lane. However, this is not a desirable position, especially if the bicyclist is intending to go straight ahead.

The maximum recommended right turn lane width is 4.0 m. In some cases eliminating right turn on red, slowing motor vehicle traffic and replacing the standard "RIGHT-TURN LANE" sign (R3-XI) with "BEGIN

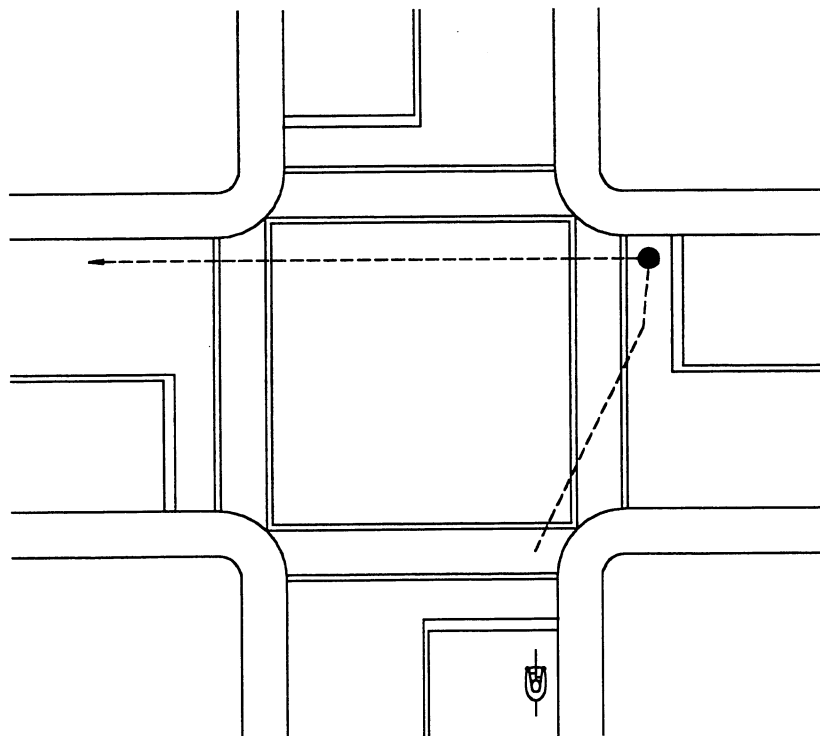

Two-Step Left-Turn by Bicycle

Figure 4-13.0A

RIGHT-TURN LANE; YIELD TO BIKES (R4-4) is desirable. Review traffic volumes and speeds in determining appropriate actions.

2. Right Turn on Red. Where "right turn on red" is permitted, the focus of right-turning motorists toward cross traffic approaching from the left is intensified. The straight through bicyclist required to stop for the red light may find that vehicles turning right on red infringe into their storage area. Right turning motor vehicles may infringe less if the intersection curve radius is relatively small.
3. Roadways with a Two-way Continuous Left-turn Lane. Bicyclists may be making left turns by the two-step method or using the lane. Also see recommendations for choosing intersection types in **Chapter 5: Paths**.

4-13.02 Bike Lane Treatments at Intersections

Bike lanes can complicate turning movements when first installed. However, as motorists and bicyclists become familiar with them complications may lessen. At intersections where there are bicycle lanes and traffic signals, detection loops may be adjusted to detect bicycles. Installation of bicycle-sensitive loops within the bike lane is desirable. This is particularly important where signals are vehicle-actuated and may not change for a bicycle unless a car is present, or unless the bicyclist leaves the lane to trip the signal within the traffic lane. If used for bicycle traffic, push button activators should be within reach so the bicyclist is able to remain on the bicycle in the bike lane.

Where there is heavy bicycle traffic on bike lanes, a separate green phase for bicycle use only may be included. This allows bicyclists to cross the street and make turns without having to contend with motor-vehicle traffic. On multi-lane streets where the "stranding" of bicyclists is possible, consideration should be given to ensure that short clearance intervals are not used. A commonly used solution is an all-red clearance interval.

The following bicycle lane treatments are appropriate at intersections under varying circumstances. No single treatment is universally recommended. Each intersection should be studied on an individual basis to determine the appropriate design.

1. Bicycle Lane Continuation at Intersections. Bicycle lanes may be striped through the intersection where a bike lane on a major street crosses minor streets and where right turns from the major street to the minor street are few. A dashed line alerts vehicle drivers to the existence of the bicycle lane.
2. Bicycle Lane to Intersection. Bicycle lanes carried to the intersection may be acceptable when right-turning motor

vehicle traffic is light or when it is desirable to delineate the left edge of a bicycle lane at a right-turn only lane.

3. Bicycle Lane Termination. Lane termination may be used on a side road with bicycle lanes which intersects a main road on which bicycle lanes are marked through the intersection and at approaches to right turn lanes where it is desirable for traffic to mix or impossible to mark the lane to the intersection. Each intersection should be individually assessed for the appropriate weaving distance required. Lane termination or broken stripe initiation should be located accordingly. See **Figures 4-13.0B**.

Channelized Right-Turn-Only Lanes. Channelized right-turn-only lanes pose problems and design options similar to those for other right-turn lanes. Reducing motor vehicle speeds and the length of weaving areas may improve safety. See **Figure 4-13.0B(b)**.

4-13.02.01 Bicycle Lanes and Left-Turning Bicycle Traffic.

At busy intersections, three pavement marking options may improve safety and comfort for left-turning bicyclists:

1. Average Bicyclists often execute two-step left turns; paint a refuge island on the corner.
2. A left-turn bike lane painted next to the right edge of a left-turn lane.
3. Painting an Advanced Stop Line.

These options are recommended at signalized intersections and stop-controlled intersections without right turn on red. Bicyclists should be encouraged to make left turns by the two-step method if a double left-turn lane is present. The methods are further explained below.

1. *Painted Refuge Islands for Left-Turning and Straight Through Bicycle Traffic*.

At busy intersections, Average Bicyclists may execute two-step left turns. Allowing right turn on red is not recommended with painted refuge islands. Where traffic is relatively light, painting a refuge island on the corner provides refuge space. See **Figure 4-13.0C**. Where traffic volumes are relatively high, providing a raised free right turn island that is easily reached by left-turning bicyclists also provides refuge space.

2. *Advanced Stop Lines*

Creating an Advanced Stop Line (ASL) makes it possible for bicyclists to position themselves in front of waiting motorized traffic and cross the intersection first on the green light or when turning left on a separate green phase. Twenty-five bicycles or more per peak hour and good enforcement of stopping behavior are needed for

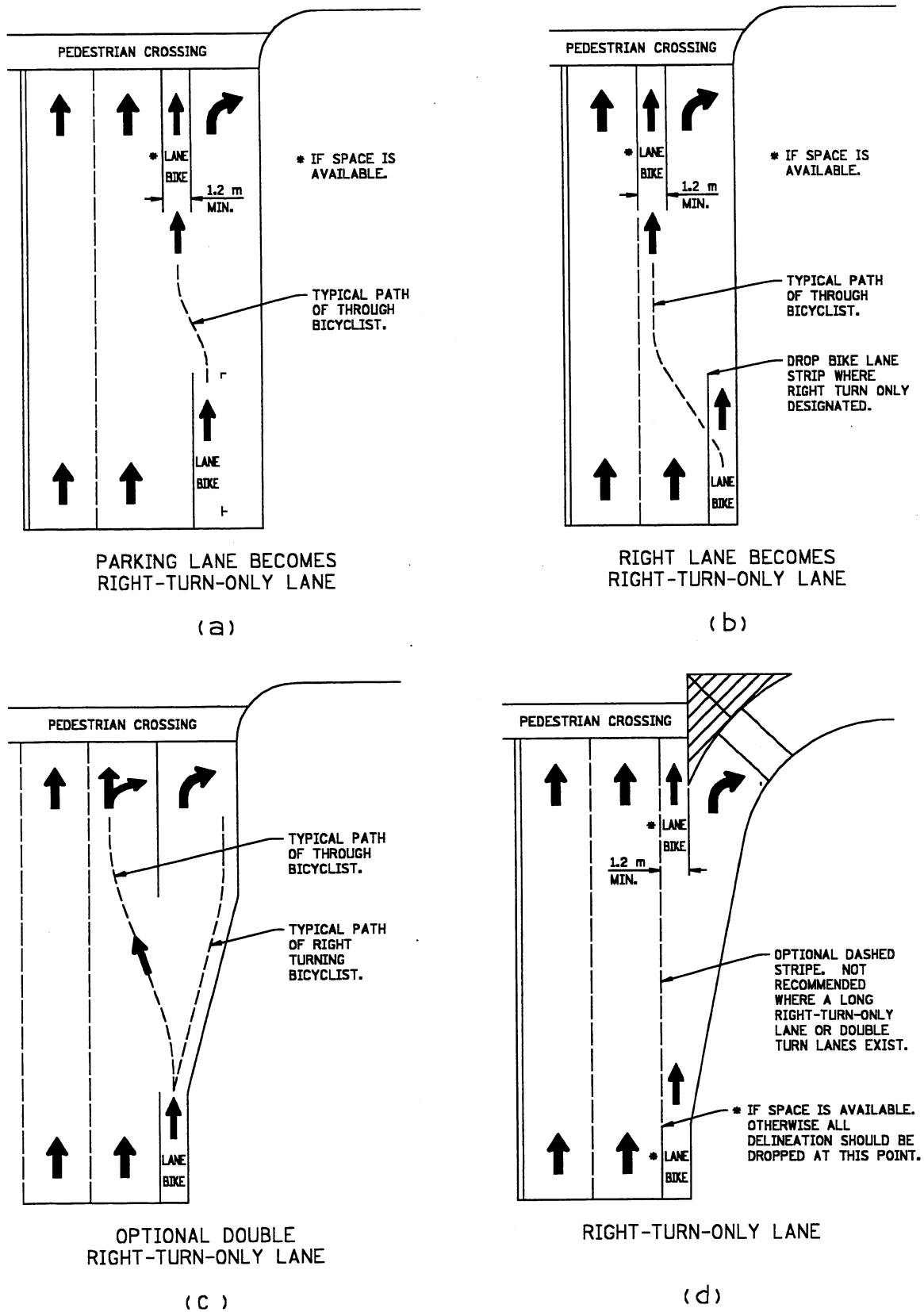

Bicycle Lanes approaching Motor Vehicle Right-Turn Only Lanes

Figure 4-13.0B

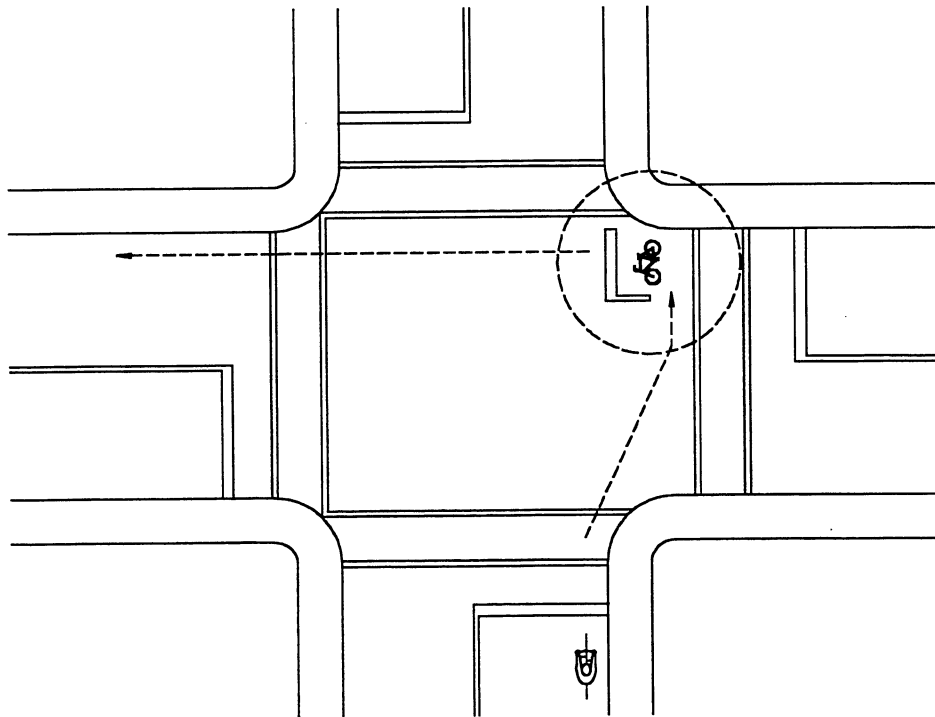

Painted Refuge Island

Figure 4-13.0C

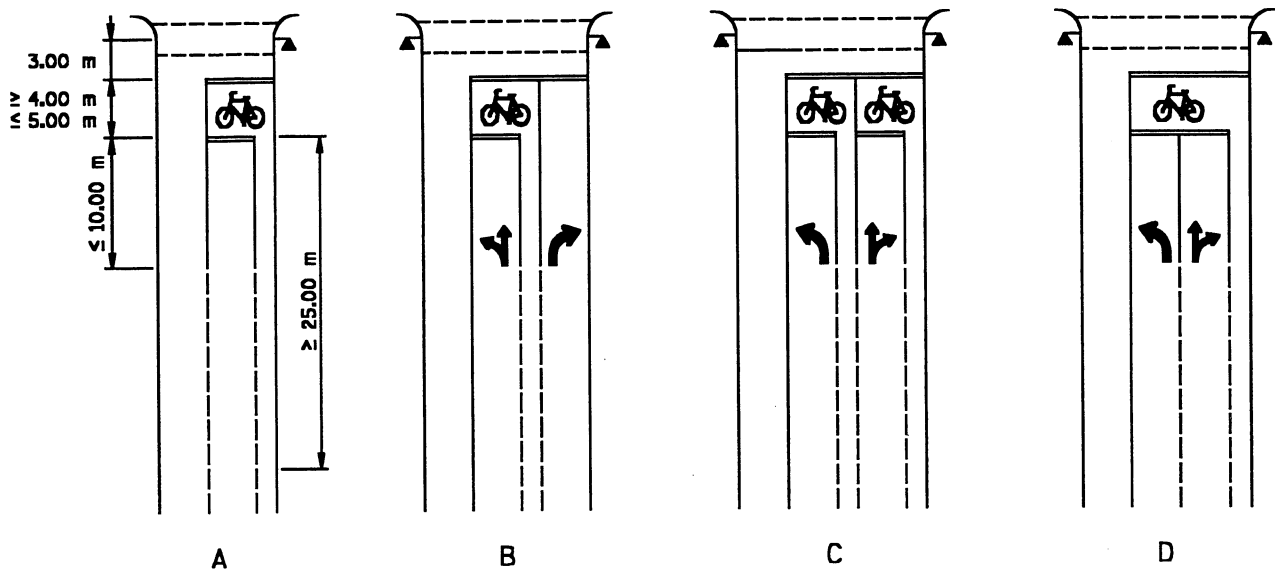

A = standard model, B = right-turning model

C = left turning model, D = left-turning model without a separated green phase

Advanced Stop Lines

Figure 4-13.0D

effective use of ASLs. The ASL helps bicyclists turning left where there is one left-turn lane for motorized traffic. ASLs may also be applied on approaching road sections with a maximum of two lanes.

A separate ASL, inclusive of an approaching bike lane, is best introduced when there is a left-turn lane. If traffic turning left has a separate green phase, a separate ASL is necessary. If this is not the case, one ASL may suffice, however, bicyclists may choose to weave to the left turn lane anyway. For increased visibility and recognizability, complete the ASL and a part of the approaching bike lane in a different color pavement, preferably red. Bicycle sensitive vehicle detectors (pavement loops or other devices) are desirable with ASL's. See Figure 4-13.0D.

4-13.02.02 Bike Lane Continuation at T-intersections.

Bicycle traffic is preferably allowed uninterrupted through movement at t-intersections. Continuing the bike lane through the intersection as shown in the figure below is recommended. Even where there are no bike lanes, lane continuation could be added to the intersection if it is stop sign controlled. Bicycle traffic is best allowed uninterrupted

through movement at t-intersections as shown in Figure 4-13.0E.

4-13.02.03 At-grade Railroad Crossings

Special care should be taken wherever a bicyclist crosses railroad tracks at grade. Whenever possible, the bicyclist should be allowed a level crossing at right angles to the rails while traveling straight ahead. The outside lane, shoulder, or bike lane should be widened to permit crossings to approach the tracks at 60 to 90 degrees. The crossing should be at least as wide as the approaches of the bikeway. See Figure 4-13.0F. Take into account sign and signal location design and installation when widening the approach bikeway; "pedestrian arms" may also be considered. Depending on the features of the road, the bikeway may swing away from the roadway altogether to allow it to cross the track at 90 degrees.

If it is not possible to cross at an angle of at least 60 degrees, rubber track guards with a compressible flange filler are recommended. Abandoned tracks should be removed by the railroad.

The desired type of surface between rails should be based on the planned uses of the roadway. Hot mix asphalt and rubber surfaces are generally acceptable for at-grade crossings.

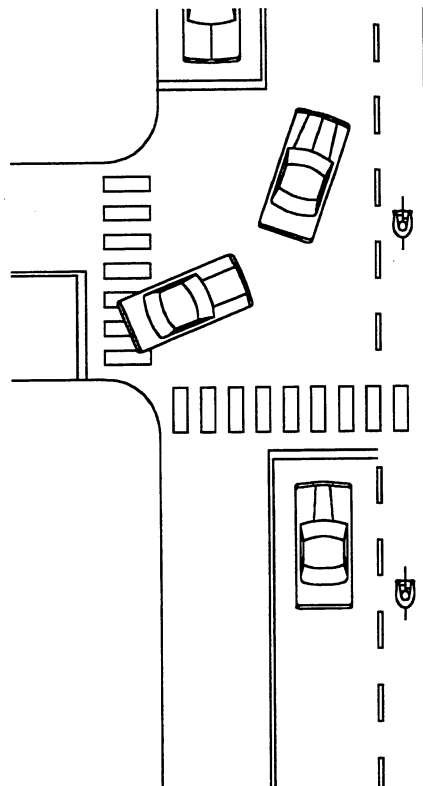

Bike Lane Continuation at T-intersections

Figure 4-13.0E

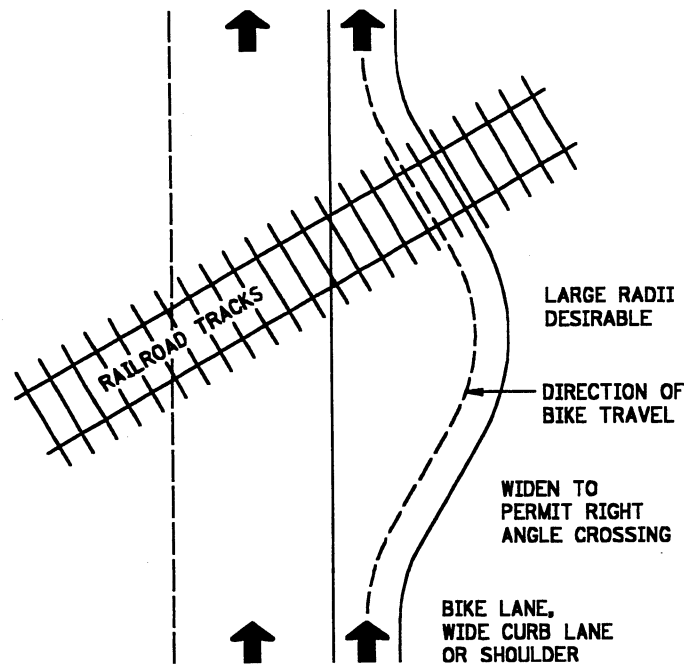

Note: Flared roadway permits bicyclists to cross angled railroad crossing at or near 90 degrees

Figure 4-13.0F

Wood surfaces are better suited to limited use; they are very slippery when wet and tend to wear faster than other surfaces.

Roadways, paths and bike lanes should have signing and pavement markings installed in accordance with the Minnesota Manual on Uniform Traffic Control Devices (MN MUTCD). Advance warning signs such as W10-X1 may be used at skewed railroad crossings to warn the bicyclist of the crossing. Visibility of signals and installing signals with bells should be considered in case a path parallel to a road is constructed in the future.

Chapter Five

PATHS

5-1.0 General

Paths also may be referred to as "multi-use trails" or "shared use" paths and "greenways," even though they are slightly different facilities. Paths are a valuable element of bicycle networks. They serve both a transportation and recreation function and have proven to be significant generators of bicycle use. Where adequate right-of-way are available, paths provide continuous routes for commuting or recreation trips, access to destinations not otherwise available to bicyclists, and cut-throughs between buildings and other breaks in the street network.

Two-way paths are shared use (bicyclists, pedestrians, skaters, wheelchair users, etc.) facilities with traffic in both directions. One-way paths, located on both sides of a road, have some application. However, without strict enforcement or proper design they may be used as two-way facilities. They are intended for bicycle use only and are often located between a sidewalk and the roadway. In comparison to two-way paths, one-way paths may increase the visibility of bicyclists to motorists at properly designed intersections.

Paths may be located both within and outside of roadway right-of-way. For roadways with restricted right-of-way, it may be possible to change the designation of lanes dedicated to motor vehicle traffic, parking and other elements within the right-of-way or between building space in order to create room for paths. See **Chapter 4: On-road Designs, section 4-4.03.**

Paths located within the right-of-way but physically separated from motor vehicle traffic may require study as the road in question may be bordered by obstacles or traffic conditions which could complicate the design. Obstacles such as mailboxes, billboards, steep side slopes and private access roads can be worked around but should be taken into account when scoping and preparing cost estimates. Special care should be taken to limit the number of at-grade crossings with streets and commercial driveways because with most two way paths motor vehicle drivers don't expect to meet a bicyclist coming from the "other" direction. One-way paths may provide for safer crossings, especially at signalized intersections. On a one-way path the bicyclists is riding as expected, with the flow of traffic, and can also be brought closer to the intersection for better visibility.

There are many locations in urban areas where bicyclists ride on sidewalks. Riding on sidewalks in a business district is illegal unless permitted by local ordinance. When legally riding on a sidewalk the bicyclist is considered a pedestrian. In general, sidewalks are planned and designed to handle pedestrian traffic only. The design and location of curbs and

curb cuts, the width of the sidewalk and the amount of clearance to obstructions have an impact on bicycle and pedestrian traffic on sidewalks. Where bicycle use of sidewalks is desirable, design factors should be in accordance with path requirements.

5-2.0 Locating Paths

Where paths are planned next to main roads, the general principles for deciding on the location of paths are as follows:

- Arrange paths so that no pedestrians and bicyclists need to venture onto the traveled way.
- There should be a distinct and continuous main route for long-distance walking and bicycling alongside main roads or parallel to them in other corridors.

Two-way paths may be located along one side of a road only if the land use attracts pedestrian and bicycle trips along only one side. If there is land use along both sides of a road, there should be paths along both sides. However, if the land use along the roads generates very little pedestrian and bicycle traffic and it can safely and conveniently be brought to one side of the road, a one-side solution may be possible.

Locate paths serving longer distance pedestrian and bicycle traffic along a main road to serve land use as effectively as possible and to connect with the rest of the network. The quality of the route, the space available for it, and interchange arrangements also affect the choice of the location. Crossing the path from one side of the roadway to the other should be avoided, even over short distances (< 0.5 km).

A path serving local pedestrian and bicycle traffic can sometimes be replaced by an adjacent parallel street, or with connections to streets or other routes with little traffic and low speeds, even if these don't run along a main road. The connection should be continuous and link with longer distance routes.

While not considered an obstacle, traffic noise can detract from the bicycling experience. Earth berms or embankments can improve this situation.

5-3.0 Separation Between Path and Roadway

Roadway speed limit, the type of signs between the path and roadway, the amount of space available and whether the

adjacent section is rural or urban determine how far a path should be separated from the roadway. The separation area is designed to suit the surroundings.

The separation distance between a path and a rural section roadway traveled way depends on the speed limit on the roadway. The "rule of thumb" is that the desirable width of separation in meters, measurement b, should be road speed limit/10. See Figures 5-3.0A & B.

Rural Section Separation (Figure 5-3.0A)

SPEED LIMIT km/h	SEPARATION b (m)
≤ 60	6 (3 min.)
> 60	7 (7-10 typ.)
Freeway	15

Urban Section Separation (Figure 5-3.0B)

SPEED LIMIT km/h	SEPARATION b(m)
≤ 50	1.2 (if no signs in separation area 0.5, 0.75 if parking allowed)
51-70	1.2
>70	3.0 (2.0 min.)
Freeway	15

It may be necessary, for safety reasons, to have a railing or barrier along exceptionally narrow separation areas,

especially on curves, if the road speed limit is greater than or equal to 60 km/h.

5-3.01 Snow Storage in Separation Area

Road space planning should consider space needed for snow storage. The separation area is best designed so that it is wide enough to store removed snow from the roadway and the path. A separation width of 5 m is usually enough to store plowed snow.

Where space is limited, overall road cross-section planning must consider the likely amount of snow, the space needed to hold it and how this will be managed. When snow is stored in separation spaces, the recommended proportion of the path that should remain usable is three quarters if the snow is not removed, or two thirds if the snow is removed within a few days.

5-4.0 Separating Pedestrians and Bicyclists

Separation of pedestrians and bicyclists may be needed for safety and traffic flow. Short sections of paths must not be markedly different than the rest of the route (continuity of the network is important). Separating pedestrians from bicyclists should also consider local practices. The following are some of the factors that warrant separation for a given section of a certain route:

- The route is used for fast, long-distance bicycling and pedestrians (especially people who are disabled, children and senior citizens).

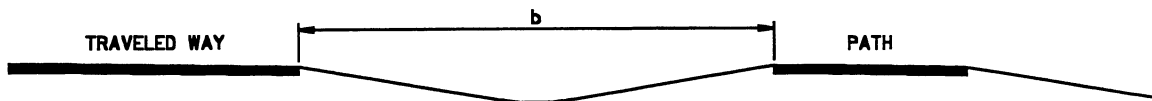

Rural Section Separation

Figure 5-3.0A

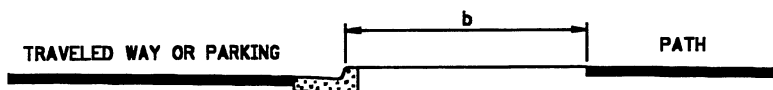

Urban Section Separation

Figure 5-3.0B

- There are high volumes of both pedestrian and bicycle traffic.

Separation of pedestrians and bicyclists is recommended in city centers and where buildings front onto the pedestrian and bike traffic network, where pedestrian and bicycle peak traffic volume is > 2000 individuals a day or peak hour bicycle traffic is > 100 per hour.

In some locations, building a path parallel to a street with an existing sidewalk can provoke conflicts.

Where there are lower volumes of pedestrian and bicycle traffic one option is to design the path so that pedestrians and bicyclists share the path. With higher volumes, separation using pavement markings or separate paths (two-way or one-way) is desirable. See Figures 5-4.0A and Figure 5-4.0B.

Sidewalks are not designed for both bicycle and pedestrian traffic. Conflicts between bicyclists and pedestrians on a fa-

cility without sufficient width, clearances, opening car doors, etc. may make sidewalks an unsafe place for mixed traffic.

5-5.0 Design Speed

Curvature, superelevation, gradient and width of traveled way are geometric features which affect the speed at which a bicyclist can travel safely and comfortably. In addition, factors such as traffic, the type of bicycle, physical condition of the rider, wind and surface condition also affect the speed the bicyclist will travel. Although speeds higher than 50 km/h are attainable, the average bicyclist travels at much lower speeds.

For general design, a minimum design speed of 30 km/h is recommended. For long downgrades or other conditions where high speeds may occur, a design speed of 50 km/h is recommended.

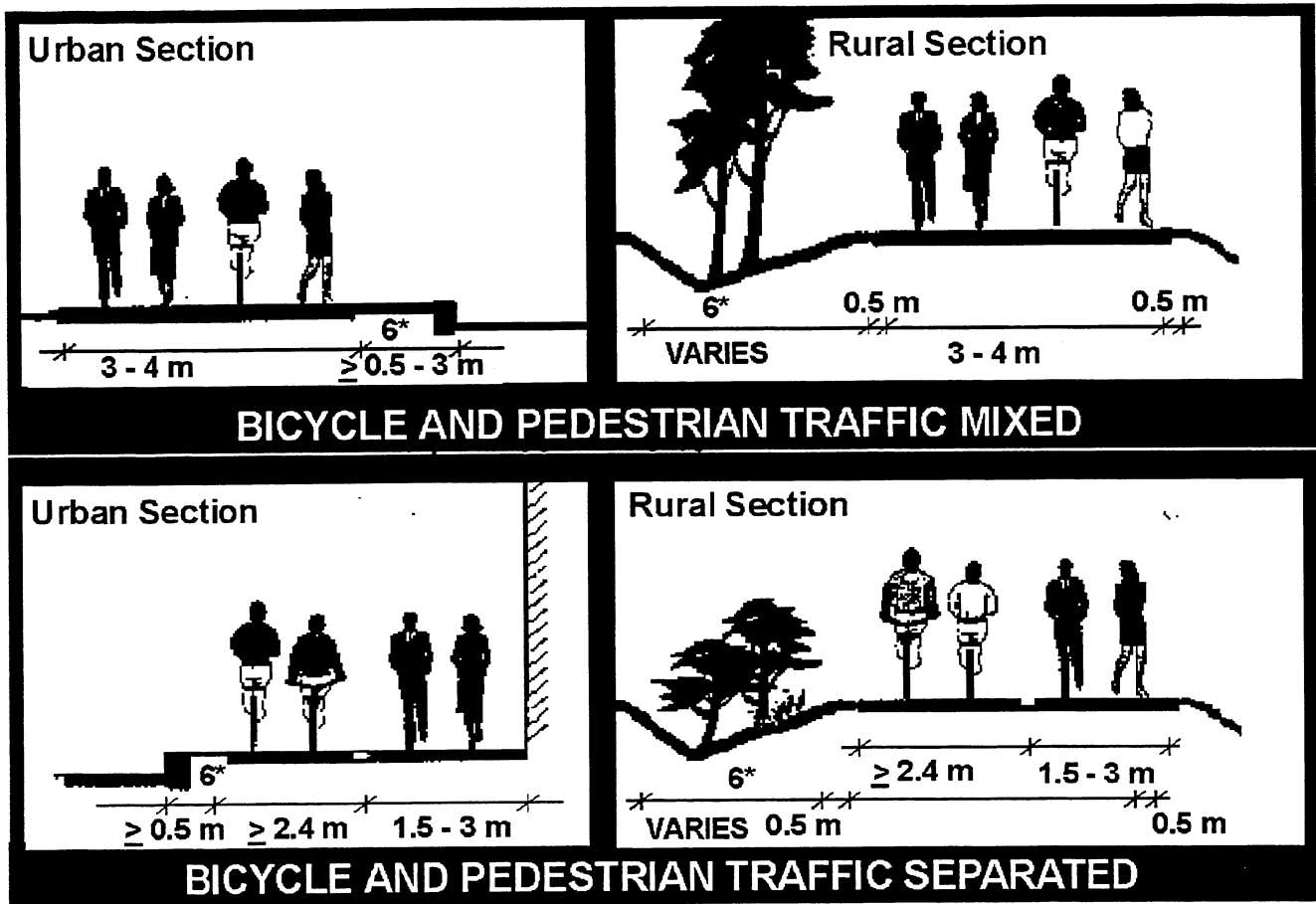

*See "Separation between Path and Roadway" in Chapter 5.

Typical Path Cross Sections

Figure 5-4.0A

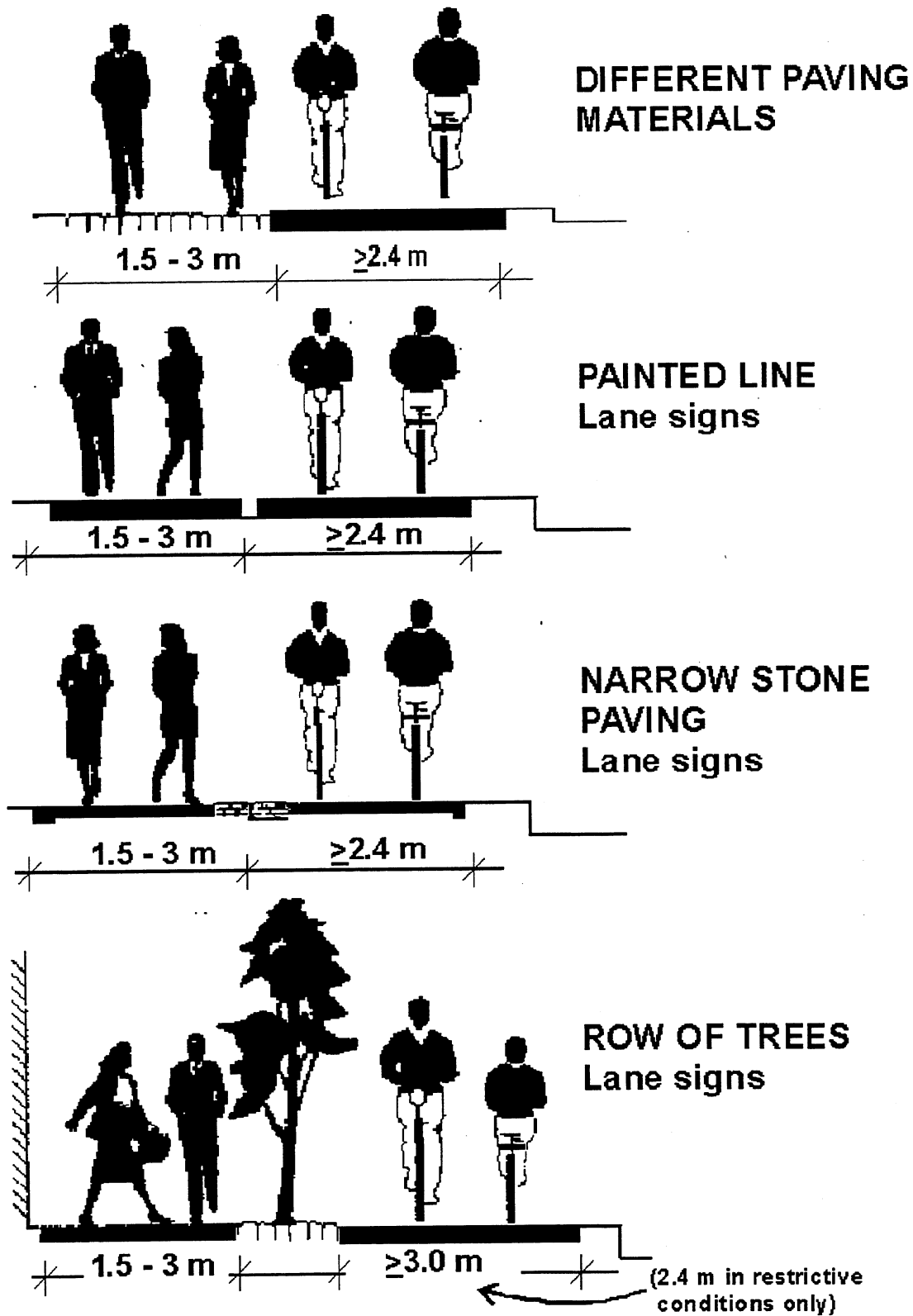

Typical Path Cross Sections, Pedestrian and Bicycle Traffic Separation

Figure 5-4.0B

5-6.0 Horizontal Curvature and Superelevation

The minimum radius of curvature negotiable by a bicycle is a function of the superelevation rate of the path surface, the coefficient of friction between the bicycle tires and the surface, and the speed of the bicycle. The minimum design radius of curvature can be derived from the following formula:

$$R = \frac{0.0079V^2}{(e + f)}$$

Where:

R = Minimum radius of curvature (m)

V = Design speed (km/h)

e = Superelevation, cross-slope

f = Coefficient of friction

Some superelevation should be provided on all curves. For most paths, the minimum superelevation rate of 2 percent will be adequate for most conditions. Superelevation rates may vary from a minimum of 2 percent (the minimum necessary to encourage adequate drainage) to a maximum of about 5 percent (beyond which maneuvering difficulties by Average Bicyclists and tricycles might be expected). A straight .02 m per m cross slope is recommended for tangent sections.

The coefficient of friction depends on; speed, surface type, roughness and condition, tire type and condition. Although there are no data for unpaved surfaces, it is suggested that friction factors be reduced by 50 percent to allow a sufficient margin of safety.

Based on a superelevation rate (e) of 2 percent, minimum radii of curvature for paved paths can be selected from the table below:

DESIGN SPEED-V, km/h	FRICTION FACTOR, f	MINIMUM RADIUS-R, m
25	0.29	16
30	0.28	24
40	0.25	47
50	0.22	82
60	0.18	142

5-7.0 Grades

The grade which a bicyclist can be expected to negotiate is dependent upon the length of the grade, wind velocity and

surface condition. Generally speaking, the amount of energy required to use a bicycle route will affect the usage of the route. Therefore, grades should be kept to a minimum.

Grades should be minimized even at the expense of having to provide added curvature or travel distance, within the practical limits for the site. Grades on paths parallel to a roadway should be equal to or flatter than the roadway grade. Grades of 5 percent or less are preferred but should not exceed 8.3 percent on overpass or underpass ramps. With overpass grades, bike speeds will increase on the downslope movement. Use precaution to eliminate hazards to the bicyclists and pedestrians near the end of a ramp. Warn bicyclists and pedestrians, by signing, etc., of the hazards of steep grades where they occur. Grades steeper than 5 percent (3% preferred) may not be practical for paths with crushed stone surfaces.

The maximum values for grades are shown in **Figure 5-7.0A**. Flat grades are always recommended for routes used by the disabled.

5-8.0 Sight Distance

The distance a bicyclist requires to come to a complete stop is a function of the bicyclist's perception and reaction time, the tire/surface coefficient of friction, the grade and the bicyclist's speed.

5-8.01 Safe Stopping Sight Distance

Design values for stopping sight distance may be computed in the same manner as for a highway. Stopping sight distance should be checked in locating and designing bicycle facilities. Assuming that some traffic will not stop at stop sign controlled intersections, using conservative sight distances is desirable.

Stopping Sight Distance For Downgrades

Design Speed, km/h	Stopping plus reaction distance , m		
	Percent Grade		
	0	-5	-10
15	14	15	16
20	20	22	25
30	35	40	45
40	55	60	70
50	75	85	100

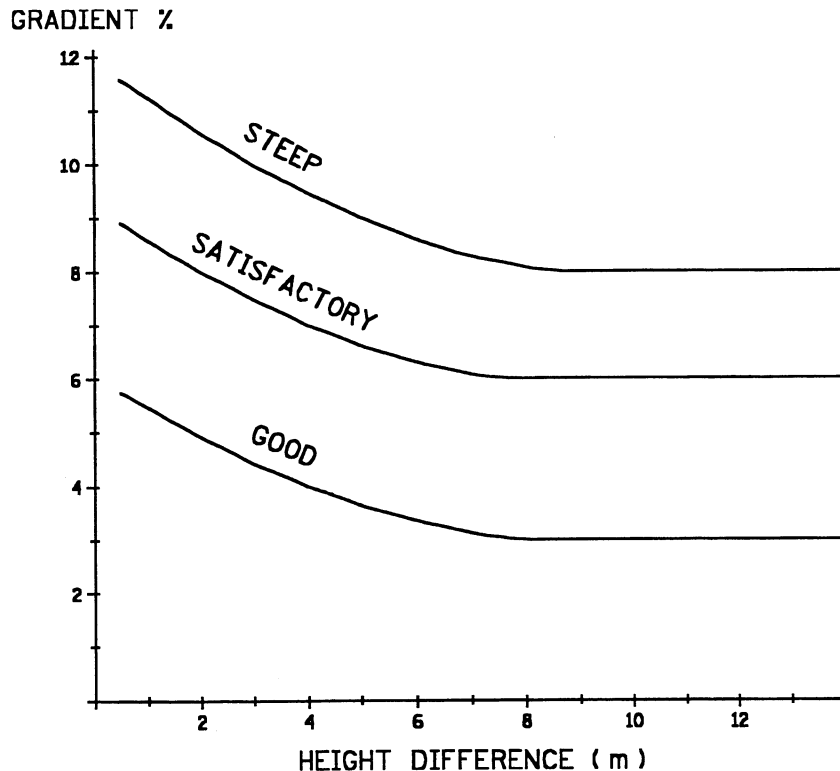

Maximum Gradients

Figure 5-7.0A

These values are based on a coefficient of friction of 0.25, perception-reaction time of 2.5 seconds, height of eye of 1.4 m and a height of object of zero meters. The sight distance in the descending direction, that is, where "g" is negative, will control the design. To develop the minimum sight distance use the formula:

$$S_{\text{total}} = \frac{V^2}{254(f \pm g)} + 2.5 \frac{1000V}{3600}$$

Where:

S = Minimum sight distance (m)

V = Velocity or design speed (km/h)

f = Coefficient of friction (use 0.25)

g = Grade (% in m/m)

-Descend use a (-g)

such things as gravel on a surface can be dangerous to a bicyclist.

5-8.03 Sight Distance at Horizontal Curves

The amount of lateral clearance required on the inside of a horizontal curve is a function of the design speed, the radius of curvature and the grade. The center line of the inside lane(s) is used when measuring the length of the bicyclist's field of vision. Lateral clearances should be calculated based on the sum of the stopping sight distances for bicyclists traveling in opposite directions around the curve. When this sight distance cannot be provided, widen the path or paint a continuous center line between the lanes the entire length of the curve and extending 10 m beyond it at either end. Values and formulas for sight distance on horizontal curves are presented in Figure 5-8.0B.

5-8.02 Sight Distance at Crest Vertical Curves

Sight distances at grade crests may be checked using Figure 5-8.0A or associated equations. Longer vertical curves should be provided whenever possible. The equations are based on an eye height of 1.4 m and an object height of zero meters. A minimum height of object is used here because

5-9.0 Path Widths and Clearances

The surfaced or operating width required for bicycling is one of the primary considerations of design. The minimum paved width of a path is determined by the actual traffic

$$L = 2S - \frac{280}{A} \text{ WHEN } S > L$$

$$L = \frac{AS^2}{280} \text{ WHEN } S < L$$

$$L_{min} = 0.38V$$

A = ALGEBRAIC DIFFERENCE IN GRADE
 S = STOPPING SIGHT DISTANCE (METERS)
 HEIGHT OF EYE = 1400 mm
 HEIGHT OF OBJECT = 0 mm

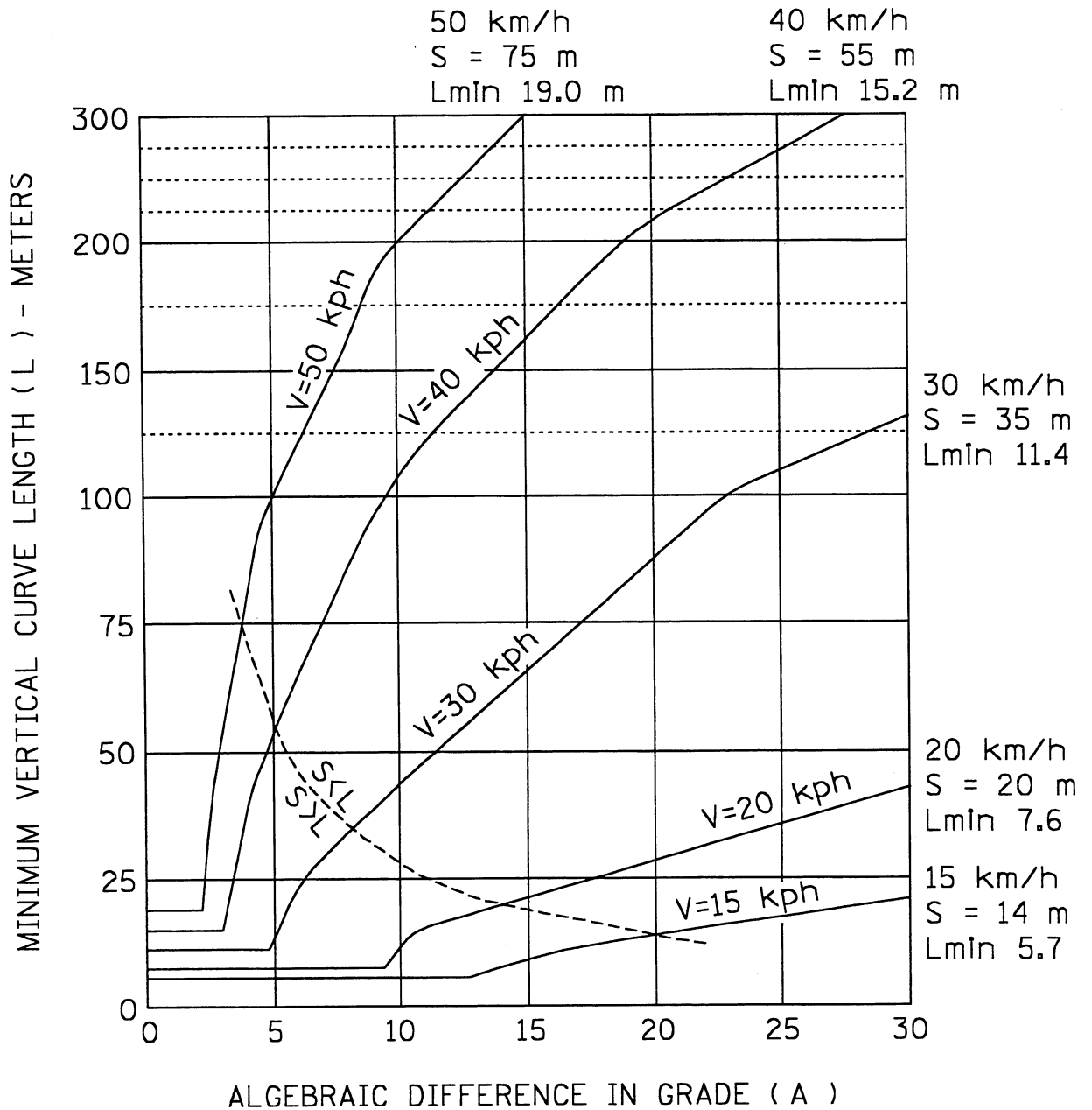

Sight Distance on Crest Vertical Curves

Figure 5-8.0A

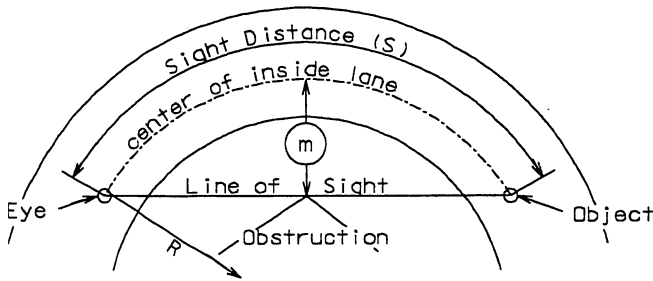

S = Sight Distance in meters
 R = Radius of centerline Inside Lane (meters)
 m = Distance from centerline Inside Lane (meters)

Angle is expressed in degrees

$$X = R \left(1 - \cos \frac{28.65 \times S}{R} \right)$$

$$S = \frac{R}{28.65} \left(\cos^{-1} \frac{R - m}{R} \right)$$

Formula only applies when S is equal to or less than length of curve

LATERAL CLEARANCE ON HORIZONTAL CURVES FOR BICYCLE PATHS

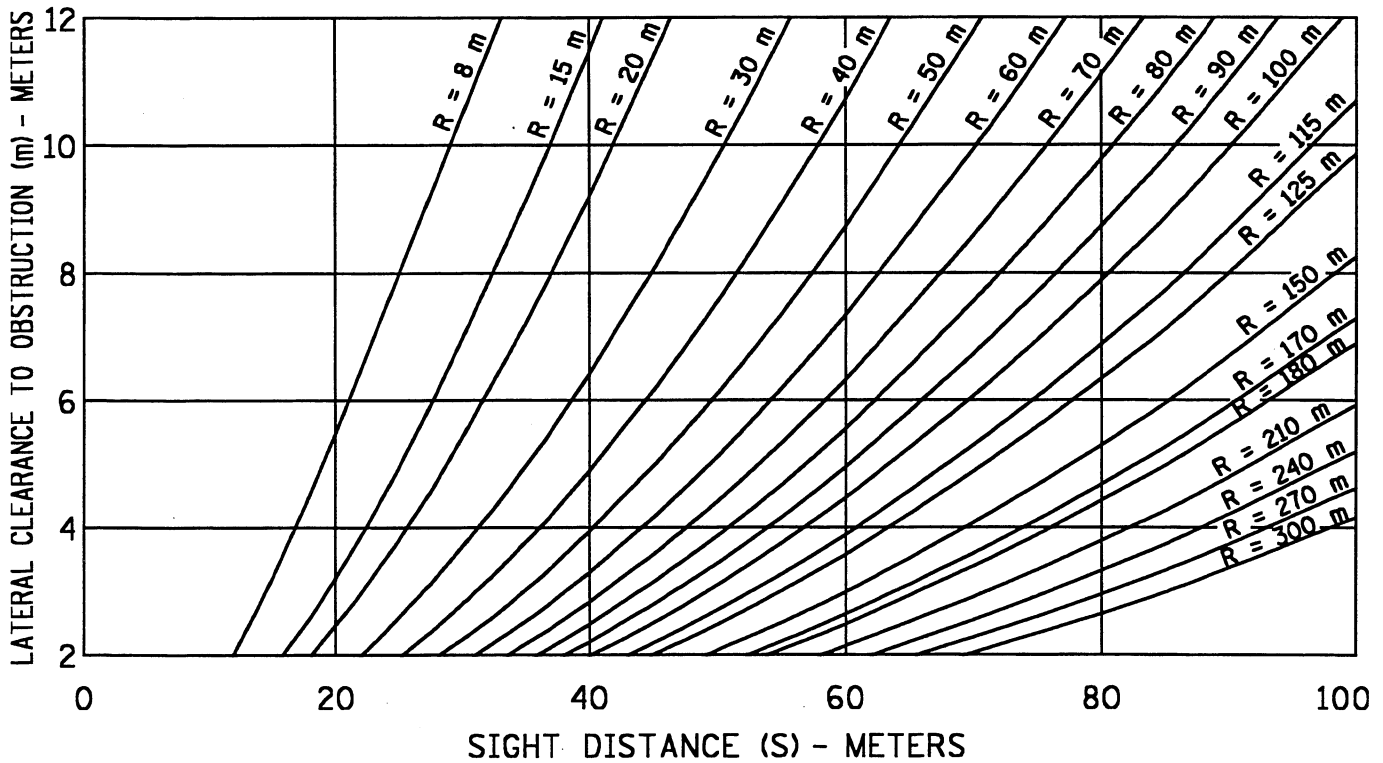

Lateral Clearance on Horizontal Curves

Table 5-8.0B

situation measured by the volume and composition of the traffic and the desired quality class. See Table 5-9.0A. The minimum overall operating dimensions should include space required for the bicyclists, allowance for clearance to fences, walls, signs, trees and other hazards. See Figure 5-9.0A for clearances. Widths and clearances should be planned to accommodate maintenance and emergency vehicles (pickups, mowers, ambulances, etc.). Widths may have to be adjusted, as necessary, to avoid pavement edge deterioration.

A minimum 0.5 m graded shoulder area on each side of the path is recommended adjacent to the paved surface. In addition to the paved widths provided above, added paved width should be provided on sharp curves and where steep grades are necessary.

On sharp curves having less than a 25 m radius, additional width on the inside of the curve is recommended due to bicycle lean. The following minimum path widths are recommended for sharp curves:

RADIUS, m	MINIMUM TWO WAY PATH WIDTH (m)
0-8	3.75
8.1-15	3.5
15.1-25	3.25

Curves along steep grades or other conditions where bicycle speeds tend to be high (e.g. paths with grades of 6 percent or more and those longer than 75 m) should also be made wider. Two-way paths < 3 m wide should be widened an additional 1 m and 3.0-3.5 m paths an additional 0.5 m. Along recreational routes, plan for added width for a ski trail if necessary.

Protect bicyclists from high, rough or steep slopes. Changing steep slopes to 1:4 or flatter with a smooth, preferably grassed surface is recommended. Safety railings are recommended where the slope and drop equal or exceed parameters and the clear zone is less than 1.5 m. See Figure 5-9.0B.

5-10.0 Structural Section

The structural section of a path should be designed in the same manner as a highway, with consideration given to the quality of the subsoil and the anticipated loads. Principal loads will normally be from maintenance and emergency vehicles. These vehicles should be restricted to less than 3.5 or 4.5 metric ton (t) axle loads, especially in the spring.

Subgrade and surfacing recommendations should be requested from or reviewed by a materials or soils engineer. For vegetation control, see Section 2-2.0 for the design and construction process.

**Table 5-9.0A
Determining Path-Pavement Width**

Number of Pedestrians & Bicyclists per Summer Day	Traffic Composition and Flow	Minimum Paved Width of Two-Way Paths, m		
		Good	Satisfactory	**
Less than or equal to 2000	Light Pedestrian & 2-Way Bicycle	3.5	3.0	2.4
Greater than 2000	Heavy Pedestrian & 2-Way Bicycle	4.0	3.5	3.0
If pedestrians and two-way bicyclists are separated using different pavements, painted lines or paver strip				
N/A	Pedestrian Section	2.0	1.5 - 3.0	1.5
N/A	Two-Way Bicycle Section	3.0	2.4	2.4
Path Geometrics		Minimum Paved Width of One-Way Path, m		
Located adjacent Curb- No parking Allowed		2.4	2.0	1.5
Separated from Roadway According to Recommended Clearances		2.0	1.5	1.5

** where restrictive conditions exist

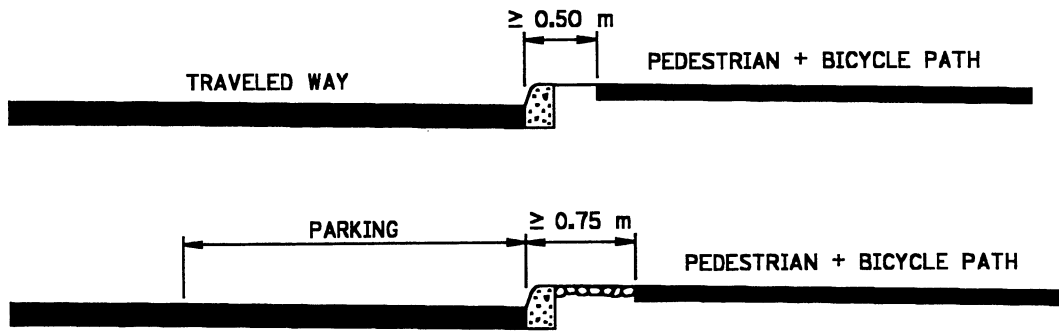

SEE SECTION "SEPARATION BETWEEN PATH AND ROADWAY CURB"

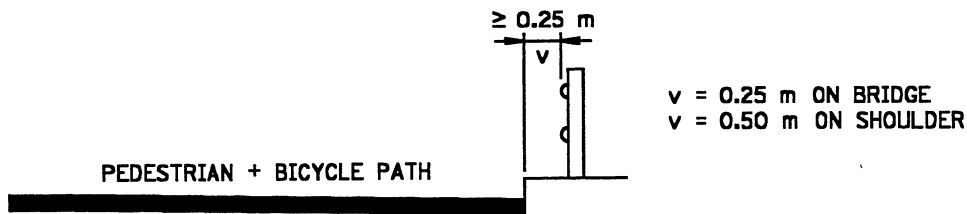

RAILING

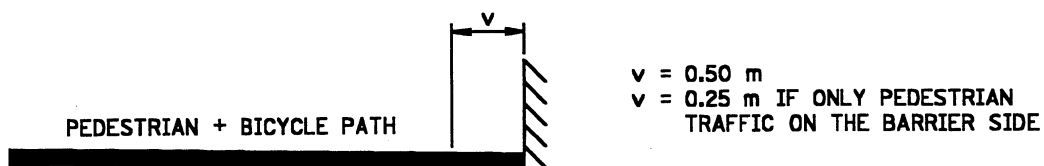

RETAINING WALL, FENCE, WALL, ETC.

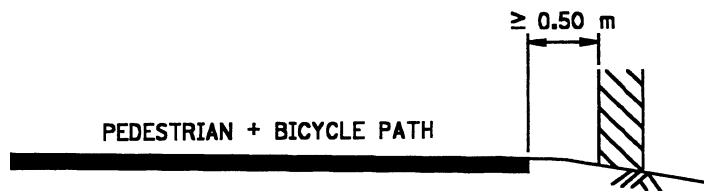

LAMP POST. TREE TRUNK OR OTHER FIXED BARRIER. SIGNAL POST

Clearances Along Paths

(For Clearance to Signs: Refer to Minnesota Manual on Uniform Traffic Control Devices (MN MUTCD))

Figure 5-9.0A

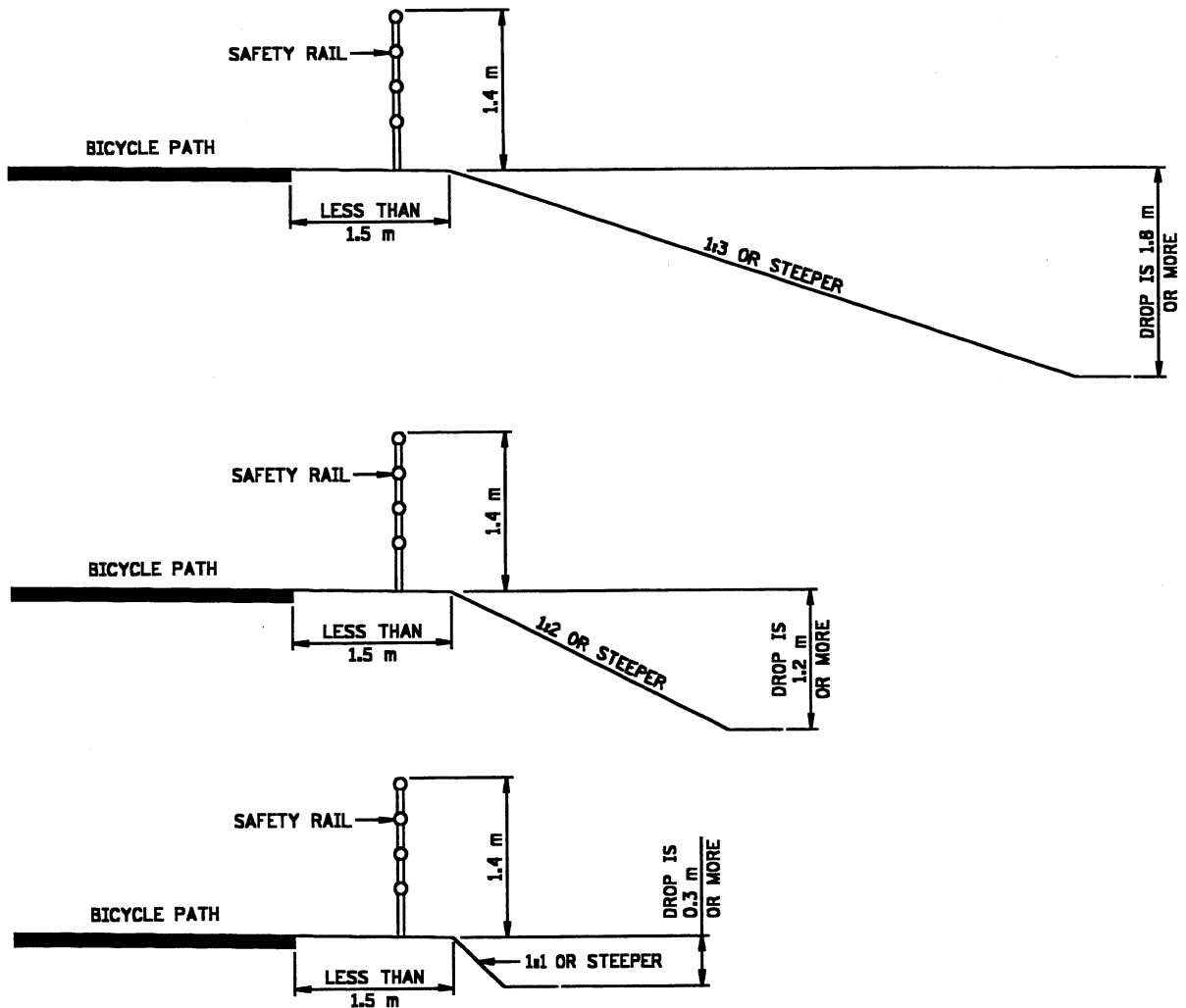

Safety Rail Between Bicycle Path and Adjacent Slope

Figure 5-9.0B

5-10.01 Foundation Preparation

Prior to designing the pavement structure, an investigation should be done to determine soil support and drainage conditions. As a result of this investigation, areas which need special site corrections due to unstable or unsuitable soil conditions can be located and appropriate treatments provided. The establishment of a suitable foundation is essential and should include:

- Removal of all vegetation, topsoil, and other soils which are considered unsuitable by the Engineer. Removal should extend to the edge of the path. If tree roots are removed, remove all surface roots.
- Providing subgrade preparation in accordance with Mn/DOT Spec. 2112 to shape and compact the

subgrade. Provide subcut compaction and corrections as determined by the Engineer. However, if the path is on a railroad embankment, a 0.3 m subcut is recommended. Compaction of the subcut backfill should be in accordance with Mn/DOT 2105.

- Placing geotextile fabric on unstable soils if its use is determined appropriate by the Engineer. The fabric should be placed so as to separate the aggregate base from unstable soils.
- Stabilize granular subgrades, if necessary, by incorporating stabilizing aggregate (Mn/DOT 3149.2C) into the upper portion of the subgrade in order to achieve adequate surface stability.

5-10.02 Bituminous Structural Section

Aggregate-based bituminous surfacing is generally recommended for paths. Full-depth bituminous may be considered where subgrade soils are relatively granular. It may be necessary to increase the pavement thickness from that shown where numerous heavy vehicles use or cross the path (at driveways, etc.). Aggregate base should be increased to 150 mm in heavy soils (Clays - A-7-6) where maintenance and emergency vehicles may cause pavement damage. Aggregate base thickness may be reduced to 75 mm for granular subgrade soils (less than 20 percent passing 75 µm sieve). See **Figure 5-10.0A**.

5-10.03 Concrete Structural Section

Portland cement concrete offers good rolling resistance, durable surface cohesion, and easy maintenance. Control joints can reduce riding comfort and complicate connections to existing surfaces. For riding comfort, transverse joints should be saw cut. See **Figure 5-10.0B**.

A thicker paving section may be required where heavy vehicles use or cross the path. Each crossing location should be evaluated and the thickness increased if appropriate.

5-10.04 Aggregate Structural Section

These surfaces are best used where few formal traffic control measures are necessary and in natural settings. Crushed limestone is easy to repair, does not crack and generally provides a comfortable riding surface. It also integrates well into natural settings. However, crushed limestone loses its cohesion as time goes by, increasing the risk of skids. It is also subject to erosion and to encroachment by vegetation. In dry weather, rising dust may damage bicycle mechanisms and make riding unpleasant. Grades greater than 5% should not be surfaced with crushed limestone. The surface will need to

be graded as necessary to fill ruts and depressions and to maintain surface drainage. See **Figure 5-10.0C**.

5-10.05 Surface smoothness and maintenance

It is important to construct and maintain a smooth riding surface on paths. Consult with a district materials or soils engineer for recommendations on proper materials and construction.

Path surfaces tend to oxidize more rapidly than a highway. The use of surface treatments may help lengthen pavement life by slowing this process. Fine aggregate seal coats can give smooth surfaces if properly designed.

<u>Surface Deterioration</u>	<u>Treatment</u>
Slight *	Fog Seal (Mn/DOT 2356)
Moderate (Slight Raveling) *	Seal Coat (Mn/DOT 2357, FA-1 or FA-2) or Slurry Seal Type 1
Serious *	Overlay (25 mm minimum)
Cracks	Crack Seal - No route or overband (use Mn/DOT 3719 or 3723)

* Localized areas that are seriously deteriorated should be reconstructed prior to application of the seal and/or placement of the overlay. Use of seal coats may not be desirable where in-line skating, etc. occurs.

Also see Surface Quality Smoothness and Utility Work guidelines in **Chapter 2**.

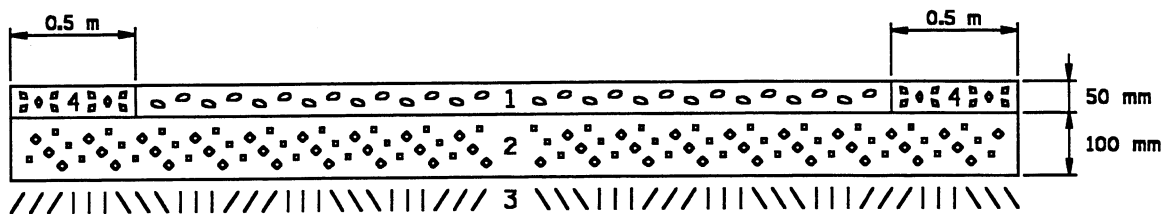

1. 50 mm, SPEC. 2331, TYPE 31 WEA 350000X, WEARING COURSE MIXTURE.
2. 100 mm, CLASS 5 AGGREGATE BASE.
3. COMPACTED SUBGRADE. REFER TO FOUNDATION PREPARATION.
4. CLASS 5 AGGREGATE BASE OR TURF SHOULDER.

Bituminous Structural Section

Figure 5-10.0A

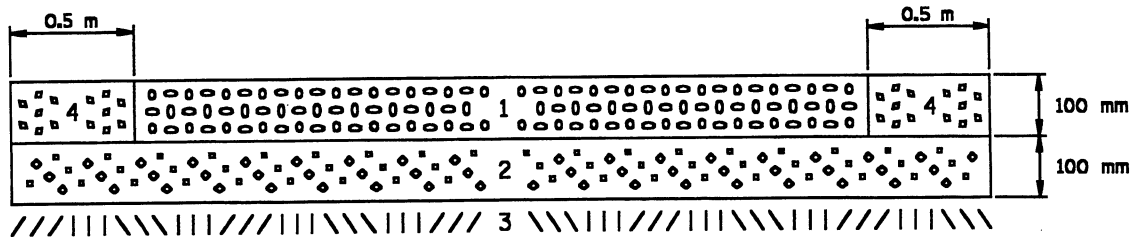

1. 100 mm PCC WITH JOINTS SPACED AT 2.5 m.
2. 100 mm, SAND** (3149.2B).
** IF PAVED WITH SLIP FORM PAVER, USE CLASS 5 AGGREGATE BASE.
3. COMPACTED SUBGRADE. REFER TO FOUNDATION PREPARATION.
4. CLASS 5 AGGREGATE BASE OR TURF SHOULDER.

Concrete Structural Section

Figure 5-10.0B

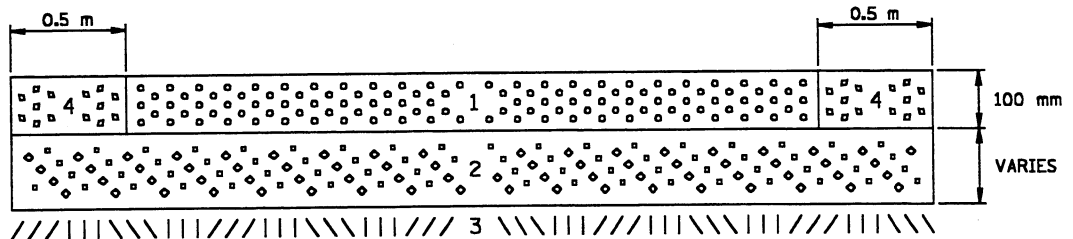

- | GRANULAR SUBGRADE | NON-GRANULAR SUBGRADE |
|---|--|
| <ol style="list-style-type: none"> 1. 100 mm AGGREGATE SURFACING, CLASS 2 (SPECIFY LIMESTONE OR DOLOMITE). 2. - - - - | <ol style="list-style-type: none"> 100 mm AGGREGATE SURFACING, CLASS 2 (SPECIFY LIMESTONE OR DOLOMITE). 100 mm CLASS 5 AGGREGATE BASE - OR - 125 mm CLASS 3 AGGREGATE BASE - OR - 200 mm SELECT GRANULAR (3149.2B) |
| <ol style="list-style-type: none"> 3. COMPACTED SUBGRADE. REFER TO FOUNDATION PREPARATION. 4. CLASS 2 OR CLASS 5 AGGREGATE BASE OR TURF SHOULDER. | |

Aggregate Structural Section

Figure 5-10.0C

5-11.0 Drainage

On paths, a cross-slope of two percent is recommended for the proper drainage. Sloping in one direction usually simplifies longitudinal drainage design and surface construction, and is the preferred practice. Ordinarily, surface drainage from the path will be adequately dissipated as it flows down gently sloping terrain. When a path is constructed on the side of a hill, a drainage ditch of suitable dimensions may be necessary on the uphill side to intercept the hillside drainage. Culverts or bridges should be used where a path crosses a drainage channel. Sizing of the required waterway opening should be determined by a hydraulics engineer. Typical

minimum culvert size used for bikeway drainage is 450 mm diameter.

Drainage inlet grates on bikeways shall have openings narrow enough and short enough to assure bicycle tires will not drop into the grates regardless of the direction of bicycle travel. Where it is not immediately feasible to replace existing grates with standard grates designed for bicycles, 25 mm x 6 mm steel cross straps should be welded to the grates at a spacing of 150 mm to 200 mm on center, to reduce the size of the openings.

5-12.0 Barriers, Railings and Fences

In order to maintain safety for bicyclists and pedestrians, encroachment by motorists should be minimized through proper design. Barriers may be a hazard and should not be used in place of proper design. Channelization fences may be used to direct bicycle traffic, divide it into streams, or eliminate the risk of conflict between bicyclists and pedestrians.

5-13.0 Lighting

Roadways, bikeways and walkways should be illuminated in accordance with recommended design values in the AASHTO Guide "An International Guide for Roadway Lighting" and ANSI/IES recommended practices. Lighting off-road walkways and bikeways permits some freedom in system and luminaire design. The lighting designer should provide a quality of light that meets the needs of the bicycle facility and is in accordance with ANSI/IES recommendations.

The lighting system as a whole should provide adequate horizontal and vertical illumination along the entire length and width of the bikeway, without variations in luminous intensity to which bicyclists and motorists might experience difficulty adjusting. Horizontal illumination is important in order to enable bicyclists to read pavement markings and to be able to follow the bikeway or roadway easily. Vertical lighting is the most effective for illuminating bicyclists and obstacles in the bikeway or roadway and is therefore of importance.

At the intersection of a path and a street, illuminating the path at the prescribed level for a distance of 25 m on either side of the intersection is desirable. Transitional lighting is recommended on an unlit street crossed by the path.

Horizontal illumination is measured at pavement level while vertical illumination is measured 1.8 m above the pavement. The levels of horizontal and vertical illumination, along with the degree of glare and necessary contrasts experienced by bicyclists as a result of the lighting, are the main performance criteria to determine the choice of luminaires. To avoid sharp differences in brightness, the uniformity ratio of illumination is determined by dividing the average illumination level by the minimum illumination level. The average-to-minimum uniformity ratio where special pedestrian/bicyclist security is not essential should not exceed 4 to 1, except for residential sidewalks adjacent to roadways and bike lanes, where a ratio of 10 to 1 is acceptable. Where special security is desirable, the uniformity ratio should not exceed 5 to 1 for any walkway or bikeway.

See Table 5-13.0A for recommended bikeway/walkway illumination levels. These represent average maintained illumination levels and should be considered as minimum, particularly when security or pedestrian/bicyclist identification at a distance is important. The data are for straight and level roadway/bikeway areas and areas having minor curves and grades. In areas of vision problems and complex maneuvering, such as abrupt curves and grades, intersections and interchanges, overpasses and underpasses, special consideration is necessary. Crosswalks traversing roadways in the middle of long blocks and at street intersections should be provided with additional illumination.

5-14.0 Intersections

5-14.01 Path Intersections

Many existing paths normally carry two-way traffic. However, one-way paths are used in some locations. Safety at intersections primarily depends on the traffic volumes and

Table 5-13.0A
Recommended Average Maintained Illumination Levels for Pedestrian Ways in Lux

Walkway & Bikeway Classification	Minimum Average Horizontal Levels (E_{avg})	Average Vertical Levels for Special Pedestrian Security (E_{avg})
Sidewalks (roadside) and bike lanes		
Commercial areas	10	22
Intermediate areas	6	11
Residential areas	2	5
Walkways distant from roadways and paths		
Walkways, bikeways, and stairways	5	5
Pedestrian tunnels	43	54

speeds, sight distances and the amount of the space available at the intersection. Sufficient sight distances should be provided at path intersections to allow bicyclists (and pedestrians) to see each other in good time and to be able to stop before the intersection if necessary. The minimum intersection radius along paths should be 3-6 m, depending on the maintenance equipment used and the widths of the routes.

Bicyclists tend to slow their speeds as they approach intersections, thus a design speed for path intersections of 20 km/h is acceptable. **Figure 5-14.0A** recommends sight distances for path intersection design. The quality class "good" presupposes that smooth braking is possible, the class "satisfactory" that braking has to be sharp. In the last class, bicyclists only have a short reaction time as well as having to brake sharply.

QUALITY CLASS	INTERSECTION SIGHT DISTANCE d (m)
Good	20
Satisfactory	15
**	10

** At restrictive conditions only

When the grade of a path is > 4% at the approach to path intersections, increase the sight distance by 5-10 m, depending on the grades and length of the gradient section. If the path slopes steeply towards the intersection area at a 4-legged intersection, division of the crossing point into two T-intersections should be considered.

The maximum gradients at intersections of paths are as follows:

QUALITY CLASS	GRADIENT (percent)
Good	2
Satisfactory	2 to 4
**	4 to 7

** At restrictive conditions

5-14.02 Path and Motor Vehicle Intersections

Safety at intersections depends upon traffic volumes and speeds, the crossing distance, the amount of the space available at the crossing and driver actions. At intersections, bicyclists face many of the same conflicts as they would if they were on a bike lane on the roadway in addition to being integrated with pedestrians. Problems associated with at-grade crossings often relate to motorists' expectation of entries to

the crosswalk area at pedestrian speeds rather than typical bicycle travel speeds. Also, two-way paths require one direction of crossing to be done contrary to normal vehicle operation.

For paths parallel to roadways, intersections present many risks. Turning motorists may not consider a bicyclist traveling off the road but in the right-of-way. When they meet, the bicyclist is often compelled to stop and yield to a left or right-turning vehicle. Locate the bicyclist's crossing close enough to the intersection to allow adequate visibility or far enough from the intersection to allow motorists sufficient reaction time, but not so far away that vehicles approaching from the second road are caught unaware of the crossing path. One-way paths at signalized intersections may increase visibility and safety, especially in regards to conflicts between right-turning motorists and through bicyclists. Place smooth, full width curb cuts in the path of travel at intersections.

Plan bicycle networks and intersections so there are no unnecessary crossings from one side of a road to another. Crossing arrangements depend on the type of intersection and crossing type. **Table 5-14.0A** recommends the choice of intersection type according to two different quality classes. Choose the "good" class if the path is used for trips to school, a large number of users are children, seniors, or disabled people or if the crossing point is heavily used in general. Also choose the "good" quality class if the intersection is large or it is part of a main recreational route. These are guidelines, final decisions should be made on a case by case basis.

Take the following into account when using the diagram:

- The type of crossing chosen for bicycle/pedestrian traffic at an intersection between a main road and secondary road is usually the same as for the main road crossing.
- If the number of lanes to be crossed is > 3, the intersection should have a refuge or median island. Where bicyclists or pedestrians often wait at islands, a push button or bicycle-sensitive traffic detection may be desirable.
- At large intersections between very busy roads, for safety reasons, pedestrian and bicycle traffic should be separated by grade from both the main and secondary road, instead of using signal controls.
- Along main roads, crossings should be at intersections. If there is a mid-section crossing, there must be good sight distance at that point. If the speed limit along a section of road without traffic signals is over 60 km/h and it is impossible to provide a grade separated crossing, reducing the speed limit to 60 km/h before the crossing is desirable.
- In choosing locations for path interchanges (grade-separated crossings), special attention must be paid to ensure that grades are low and that the location fits in well with the rest of the path network.

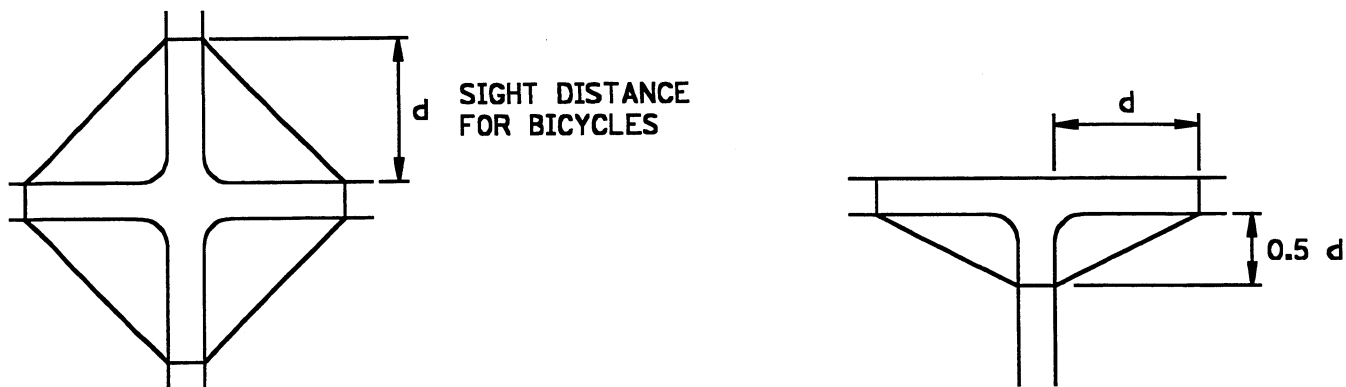

Sight Distance for Bicycles at Path Intersections

Figure 5-14.0A

Table 5-14.0A
CHOICE OF INTERSECTION TYPE

SPEED (km/h)	STANDARD	TYPE OF CROSSING, DEPENDING ON SPEED AND VOLUME OF MOTOR VEHICLE TRAFFIC
≥ 80		Grade Separated
70	GOOD	Grade Separated
	SATISFACTORY	Traffic Signals
60	GOOD	Traffic Signals (up to 8000) / Grade Separated (above 8000)
	SATISFACTORY	Traffic Signals
50	GOOD	Crosswalk and Central Island (up to 5000) / Traffic Signals (5000-10000) / Grade Separated (above 10000)
	SATISFACTORY	Crosswalk and Central Island (up to 5000) / Traffic Signals (5000-10000) / Grade Separated (above 10000)

Motor Vehicle Volume

4000 6000 8000 10000 12000

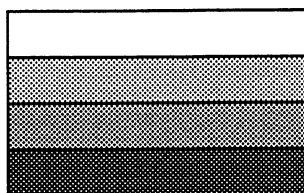

- CROSSWALK
- CROSSWALK AND CENTRAL ISLAND
- TRAFFIC SIGNALS
- GRADE SEPARATED

- At interchanges for motor vehicles, pedestrian and bicycle traffic should be separated by grade. Pedestrians and bicyclists may cross ramp terminals along minor roads and at some diamond interchanges at-grade, however, when there are large traffic volumes intersections should be signalized.

Figure 5-14.0B shows the basic models for bicycle and pedestrian traffic arrangements at various types of interchanges.

The sight distance requirements for an intersection between bicycle and motor vehicle traffic are shown in Figure 5-14.0C. This diagram gives setback distances to enable a vehicle on the roadway to adjust its speed as it approaches the path crossing. The 20 m distance (1) is the stopping sight distance for a bicycle at 20 km/h on level ground. This diagram takes into consideration that some bicyclists may not stop at intersections with stop signs.

- (1) The 20-meter distance (bicyclist stopping sight distance at 20 km/h) will be used as a base for all roadway operating speeds to be used in conjunction with d_a .
- (2) Three-second motorist perception, reaction and adjustment time.

Example

Given: Motor vehicle A traveling 80 km/h approaches the path.

Find: Required clear line of sight between motor vehicle A and bicyclist B

Solution: From Figure 5-14.0C, the driver of a motor vehicle traveling at 80 km/h should see a bicyclist who is 20 m from the lane edge, while being a minimum of 70 m from the intersection.

5-14.03 Intersection Design

5-14.03.01 Crosswalk

A crosswalk is usually marked the same width as the path leading to it. The minimum width should be 3.0 m if the two-way path carries both pedestrians and bicyclists. If the amount of walking and bicycling is heavy, the recommended width is 4.0 m. When pedestrians and bicyclists are separated by markings or a paver strip, the extension of the bicycle path should be at least 2.4 m wide. The minimum width of a crosswalk intended solely for pedestrians should be 2.4 m.

5-14.03.02 Crosswalks and Curbed Pedestrian Refuge Islands or Medians.

Any raised islands in crossings shall be cut through level with the street or have curb ramps at both sides and a level area at least 1220 mm long between the curb ramps. Refuge islands should be a minimum of 2.0 m wide when they will be used by bicyclists. Pedestrians and bicyclists should have a clear path on the island and should not be obstructed by poles, sign posts, utility boxes, etc. The desirable width of the island and the width of the driving lane at the island are shown in Figure 5-14.0D.

5-14.03.03 Curb Designs and Arrangements

If a crossing or crosswalk is intended for bicyclists, the curb ramp or sloping pavement should be flush with the street and textured according to Mn/DOT Standard Plate 7036 to meet disability requirements. The bottom width of the curb opening should be the full width of the crosswalk if the approaching path is perpendicular to the curb. If the path is parallel to the curb, the minimum width of the curb cut should be 2.75 m.

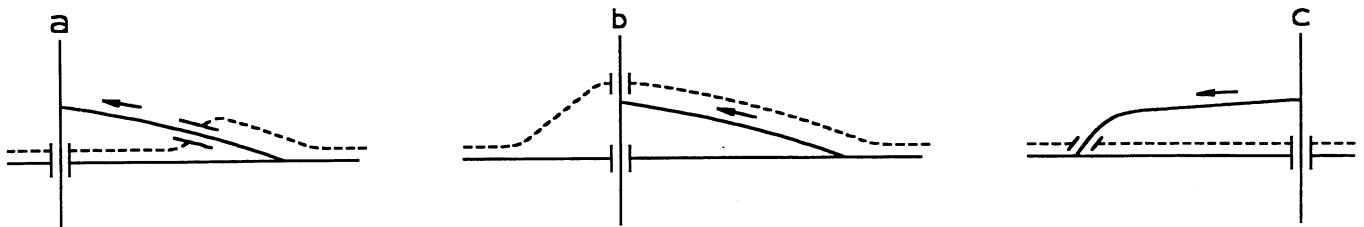

GRADE SEPERATION DESIRABLE

Path Routing at Interchanges

Figure 5-14.0B

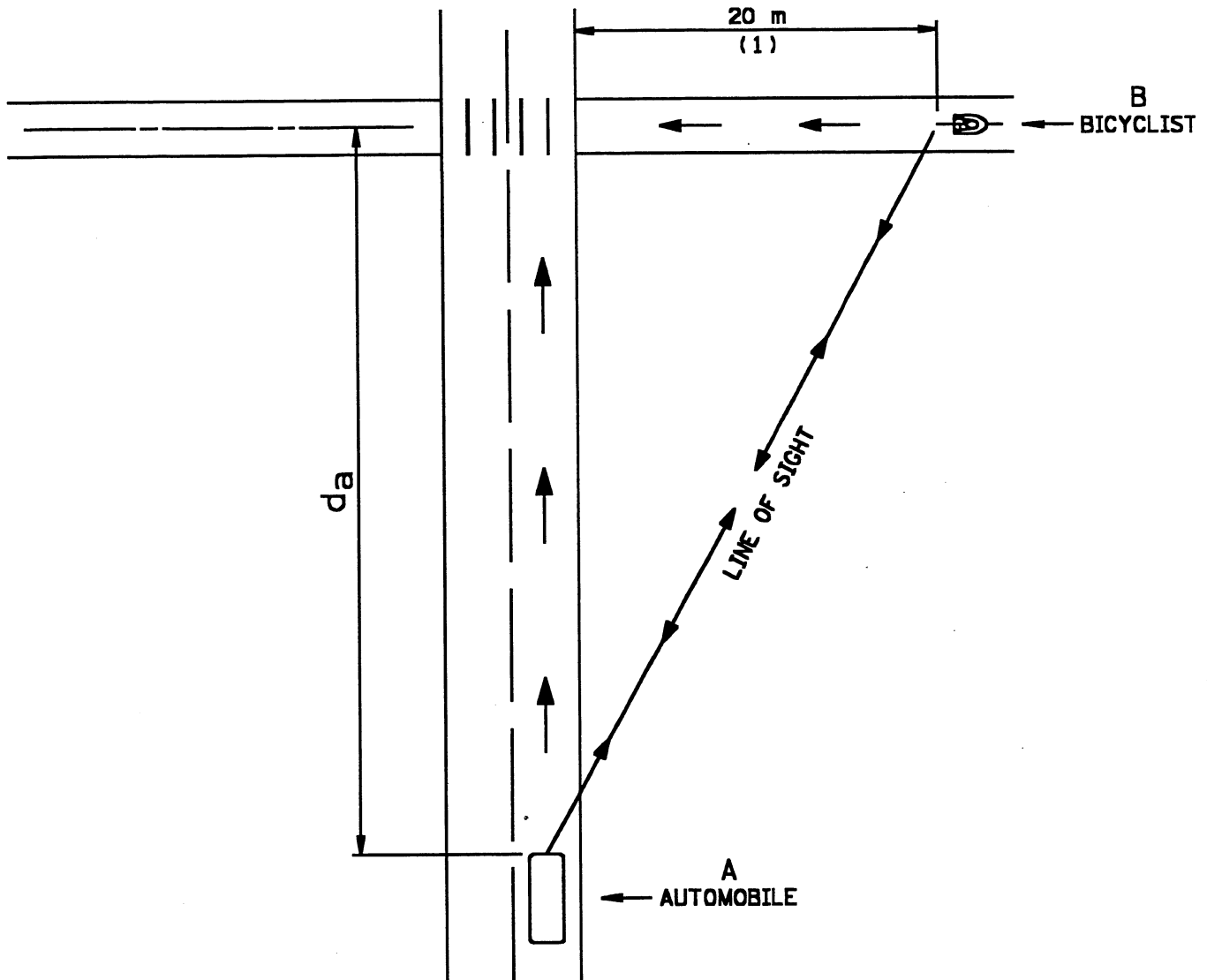

DISTANCE TRAVELED IN 3 SECONDS (2)

SPEED (km/h) OF AUTOMOBILE	50	60	70	80	90	100	110
DISTANCE d_a IN METERS	40	50	60	70	75	85	90

Sight Distance at Roadway/Path Intersections

Figure 5-14.0C

STANDARD	WIDTH OF CROSSWALK ISLAND (m)	
	PEDESTRIAN	BICYCLE
GOOD	2.50	3.00
SATISFACTORY	2.00	2.50
**	1.80	2.00
SPEED LIMIT (km/h)		WIDTH OF DRIVING LANE
50		3.00-3.50 m
60		4.00 m

PEDESTRIAN + BICYCLE PATH

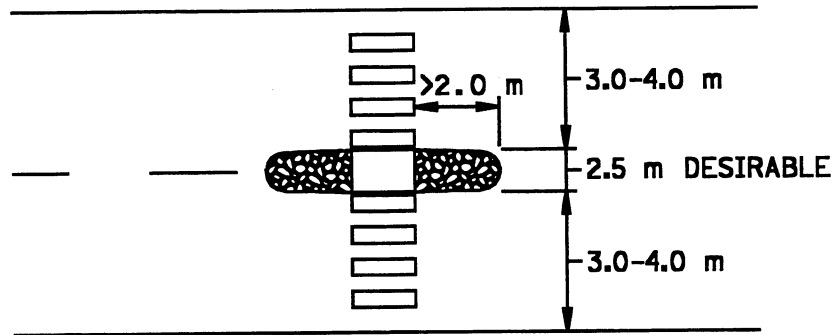

PEDESTRIAN + BICYCLE PATH

** AT RESTRICTIVE CONDITIONS ONLY.

A Curbed Pedestrian Refuge Island on a Crosswalk

Figure 5-14.0D

5-14.03.04 Controlling Motor Vehicle Access

A good method of controlling access of motor vehicles is to split the entry way into two one-way sections of path (1.5 m wide) separated by low landscaping or other material. Emergency vehicles can still enter if necessary by straddling the landscaping. In most situations this is preferable to bollards, chicanes or other methods.

A bollard may also be used at the entrance to a bicycle path. Dividing the path into two separate paths is usually a better solution however. When used, a single bollard may be installed in the middle of the path to deny access to motor vehicles. Flexible bollards are recommended and/or should be removable or hinged so service vehicles can use the path. When more than one bollard is used, they should be a minimum of 1.5 m apart.

5-14.03.05 One-way Paths and At-grade Signalized Intersections

One-way paths may have the advantage of increased visibility and safety at signalized intersections. Where there are substantial amounts of right-turning motorists and through bicyclists, the following one-way path intersection design should be considered. End the one-way path 20.0 -30.0 m before the intersection and let bicyclists continue on a bicycle lane. See Figure 5-14.0E.

If the number of left-turning bicyclists is greater than 20% of through bicyclists, the intersection should be designed as in the next section or consider a design which gives special attention to left-turning bicyclists.

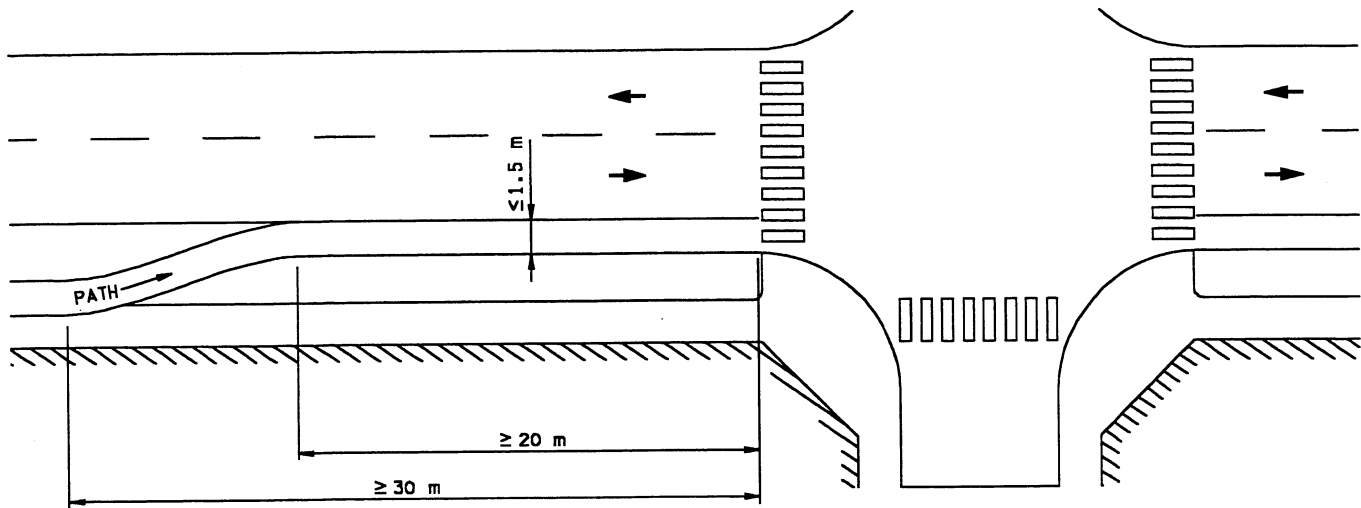

One-Way Path at an Intersection

Figure 5-14.0E

The use of recessed stop lines with the path continued to the intersection may also be of benefit in reducing conflicts and accidents between right-turning motorists and through bicyclists, especially at the beginning of the green phase.

5-14.03.06 At-Grade Intersections Without Signals

A path which parallels the roadway should be brought into the intersection to function like a crosswalk. When planning crossings, the lack of a marked crosswalk should not be a cause for unnecessary shifting of bicycle traffic from one side of the street to another. There should be a marked crosswalk across every leg of an intersection where there is a continuous bicycle route. The alignment of a route and the location of the crosswalk at an intersection depend on the type of intersection and the separation technique.

At unchannelized intersections with a main road, a crosswalk should be placed in front of the motor vehicle stop line location. There should be no uncertainty about right of way, and sufficient sight distances ensured for both bicycle and motor-vehicle traffic.

If the crosswalk is right next to the traveled way, bicyclists and motor-vehicle traffic have good views of each other. This is usually preferred. Conflicts and sight distance restrictions may be possible, so use with caution and sign appropriate to the situation. See Figure 5-14.0F.

Crosswalks not located at intersections should be at least 180 m from the intersection. A pedestrian refuge island may also be needed where the crossroad has more than 2 lanes in each direction. See Figure 5-14.0G.

If the bicycle route is only on one side of the road, signs may be placed indicating where there is a crosswalk carrying

bicycle and pedestrian traffic across the main road and where crossing is restricted at the intersection. In the case of a connecting road, the crosswalk may be extended (by way of a sidewalk or path) over the connecting road so that pedestrian and bicycle traffic will be effectively guided onto the crosswalk.

5-14.03.07 Paths at Independent At-grade Crossings

There is some evidence of high accident experience in isolated at-grade intersections of independent facilities with motor vehicle roadways. This appears to stem from among the following factors:

- High motor vehicle operating speeds
- Failure to establish proper sight clearance zones.
- Poor perception of or reaction to crossing signs and markings.
- Motorists' expectation of entries to the crossing at pedestrian speeds rather than at typical bicycle traffic speeds.
- Bicyclists' disobedience of stop or yield controls.

Independent path crossings of roadways merit particular attention to design detail. Measures to alleviate some of the above problems include the following:

- Provide proper sight clearances. Sight clearance assessment must consider obstructions due to roadway cross section profile (steep cuts or fills) as well as obstructions such as foliage. Consider that some bicyclists may not stop at crossings.

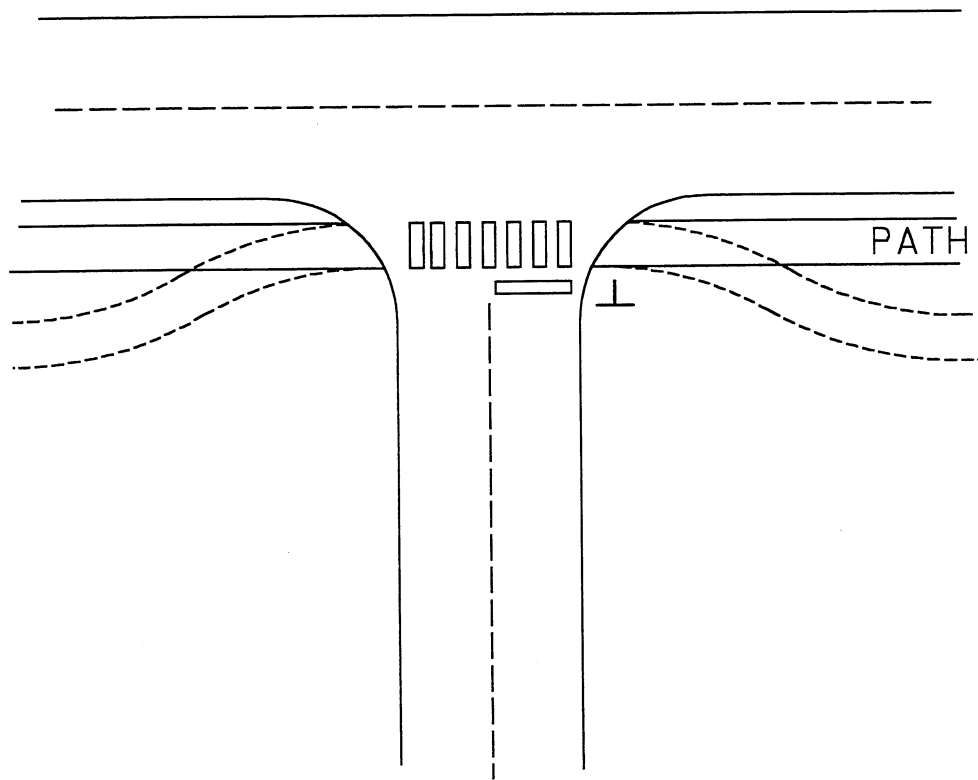

Crosswalk Arrangements at an Intersection with a Main Road

Figure 5-14.0F

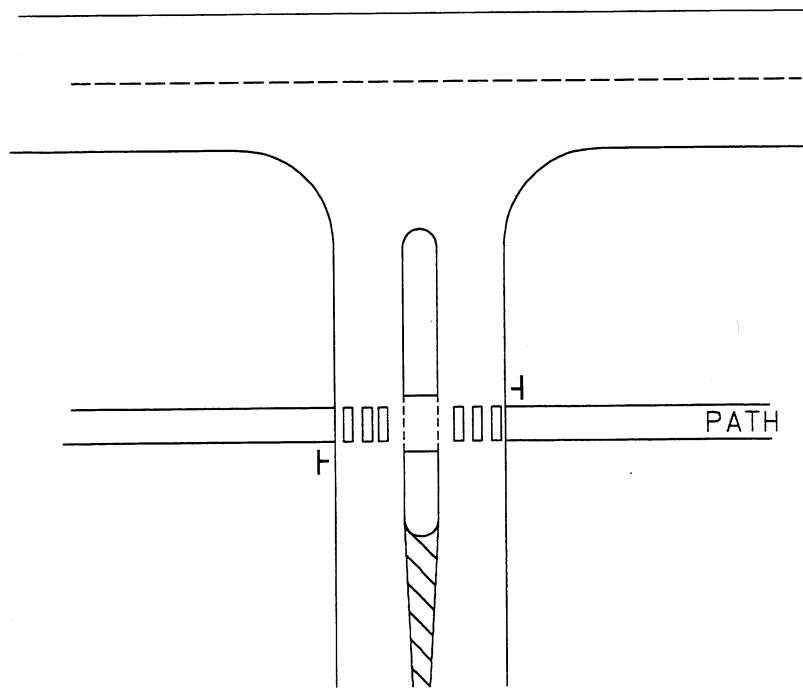

A Crosswalk at a Pedestrian Refuge Island

Figure 5-14.0G

- Locate the crossing a minimum of 180.0 m from any roadway intersection.
- Align the crossing to intersect the motor vehicle roadway at right angles.
- Mark the crossing with "zebra" or "panda" pavement markings and/or a flashing warning light and/or raise the crossing. "Bike Xing" signs should be placed on the motor vehicle approaches 80 to 250 m in advance, with specific location depending upon roadway speed limit and proximity to adjacent intersections. Refer to MN Manual on Uniform Traffic Control Devices (MN MUTCD).
- Place "Stop Ahead" or "Yield Ahead" signs on the bike-way approach approximately 45 m in advance of the crossing (farther if downgrades make bicyclists speed in excess of 30 km/h likely).
- Separate the crossing by grade.

5-14.03.08 Paths and At-grade Railroad Crossings

Where crossing railroad tracks on a path, care must be taken to assure the bicyclists' safety. Whenever possible, the crossing should be straight and at right angles to the rails. When it is not possible to cross at 90 degrees, the path should be widened (at least as wide as the approach bikeway) to allow the bicyclist to cross as close to 90 degrees as possible. Special construction and materials should be considered to keep the flangeway (open space next to the rail) depth and width to a minimum. Pavement should be maintained so ridge buildup does not occur next to the rails. Timber plank crossings may be used but tend to be slippery when wet.

Appropriate signs and pavement markings should be installed to inform and warn bicyclists. Installing signs and signals with bells should be considered at a path crossings. See At-grade Railroad Crossing section in Chapter 4 and the MN MUTCD for additional guidance.

Chapter Six

BRIDGES AND GRADE SEPARATIONS

6-1.0 General

Provide some type of grade separation wherever a combination of factors such as motor vehicle volumes and speeds and bicycle volumes warrant separation. See **Table 5-14.0A**. Where these conditions exist, and provision of a grade separation structure would not be feasible, consider other crossing types, changing traffic operations, or rerouting the roadway or bikeway. Where it is anticipated that a bikeway will be provided in the future, design new bridges to include the appropriate width.

Coordinate structures with approaching bikeways so that facilities are compatible and continuous. On all bridge decks, take care to ensure that bicycle safe expansion joints are used (as close to 90 degrees to the direction of travel as possible, with small gaps and non-skid plates). Many expansion joints and plates currently in use are very slippery, especially when wet. Design and maintain the transition from the bikeway pavement to bridge abutment for smooth conditions.

Railings, fences and barriers on a highway bridge with a bikeway or on a bicycle overpass should be a minimum of 1.4 m high. If the bridge is over another roadway, include protective screening or fencing to a height of 1.8 or 2.4 m to prevent objects from being thrown onto the roadway below. Provide a fence on retaining walls when a bikeway is located adjacent the walls.

6-2.0 Highway Bridges with Bikeways

On highways with high-speed, high-volume motor vehicle traffic, a path is often desirable for bicycle and pedestrian traffic. The path(s) should normally be separated from the bridge shoulder by a physical barrier. A two-way bikeway should be separated from the road with a 0.8 m barrier if the design speed is > 60 km/h or a 200 mm curb for design speeds ≤ 60 km/h. If the shoulder width is ≥ 1.8 m no additional barrier height beyond the usual 0.8 m concrete barrier may be needed. Design the physical separation to minimize fixed-end hazards to motor vehicles and bicyclists and to minimize sight distance restrictions.

Bikeways on highway bridges must be carefully coordinated with approach bikeways to make sure that all elements are continuous. For example, on-road bicycle traffic bound in opposite directions is often best accommodated by bike lanes or shoulders on each side of a highway *and* the highway bridge.

6-2.01 Retrofitting Bikeways and Bike Lanes on Existing Highway Bridges

When retrofitting a bikeway on an existing bridge consider several alternatives based on what the bridge's geometrics will allow. It is desirable to have the same criteria and geometrics as for a new facility. Restrictive conditions may mean that compromises in desirable design criteria of retrofitted bikeways are sometimes inevitable. Determine the most appropriate criteria on a case by case basis after thoroughly considering all variables.

The use of existing bridge sidewalks for bicycle traffic may be considered when the sidewalk is wide enough to accommodate bicyclists and pedestrians. If approach bikeways are two-way, the sidewalk facility should also be two-way. Flush ramps should be installed at the sidewalk approaches and curb cuts to assure that bicyclists are not subjected to the hazard of a vertical lip crossed at a flat angle. Curb cuts should be wide enough to accommodate tricycles for adults and two-wheeled bicycle trailers.

6-3.0 Bicycle and Pedestrian Overpasses

In the design of a bicycle and pedestrian overpass, consider all of the bicyclists' requirements with respect to grade, turning radius, width, cross slopes and speed. In some cases, for the safety of all types of traffic, the bicycle design speed may need to be reduced from the approach bikeway. The profile across a bridge should follow a smooth line with no sharp changes in grade over the piers.

The minimum width of an overpass should equal the width of the approach bikeway plus 0.5 m. The recommended minimum width is 3.0 m, desirable width is 3.5 m. The vertical clearance over a street or highway should be a minimum of 5.3 m. Experience has shown that structures designed for pedestrian live loads are satisfactory for bicycle loading. Design bicycle and pedestrian overpasses in accordance with the AASHTO Standard Specifications for Highways Bridges and the Mn/DOT Bridge Design Manual.

6-4.0 Bikeways Under Existing Bridge Structures

Figure 6-4.0A provides examples of locations, separations, and widths for modifying existing facilities.

6-5.0 Bicycle and Pedestrian Underpasses and Tunnels

A bikeway underpass may be a desirable way to carry a bikeway across a highway. It has the advantages that costs are generally lower than an overpass and there may be less grade change for a bicyclist to negotiate than an overpass. A disadvantage is that unless it is well located and openly designed, it may be conducive to crime and be avoided by bicyclists and pedestrians. Providing adequate drainage may also be a problem.

Underpasses are usually constructed of cast-in-place or pre-cast concrete or steel in circular, arch, or rectangular shapes with proper horizontal and vertical clearances. Arch shapes offer good clearance and lighting.

The horizontal and vertical alignments should be straight for the full length and for an adequate distance on each approach. The minimum width of an underpass for bicyclists and pedestrians should be the paved width of the approach path plus one meter. Recommended minimum width is 3.6 m;

4.5 m is desirable. When the underpass is long (e.g. when going under a four-lane road), wider openings are recommended to improve lighting and visibility. Six meters is a desirable width. Vertical clearance should be at least 3 m.

The possibility of attacks upon users accompanies any type of design. Be selective as to location to facilitate safety. Approaches and grades should provide the maximum possible field and range of vision of the way ahead to the bicyclist and pedestrian. Provide adequate amounts of light under structures, in tunnels and at approaches. In certain cases, lighting may be required on a daily, 24-hour basis. See the lighting section in **Chapter 5**. Illuminating tunnels of a length of 10 m at all times is desirable.

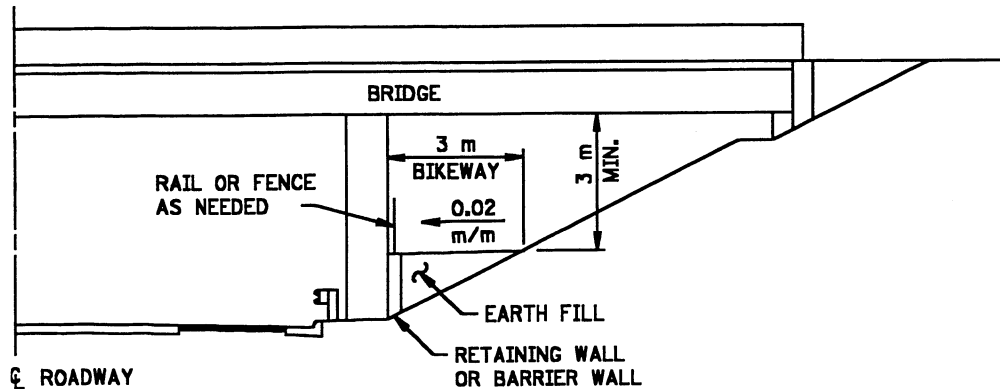
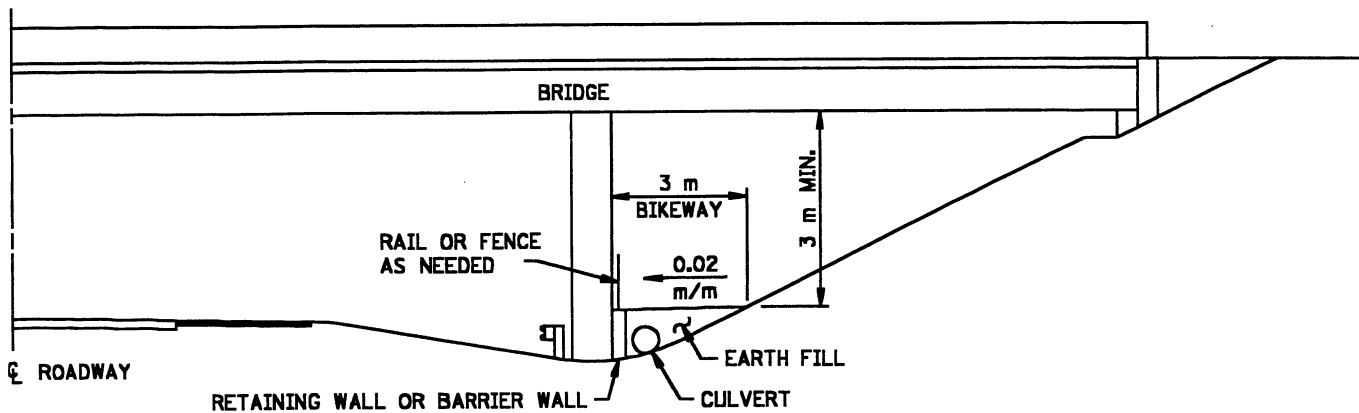

Bikeways Under Existing Bridges

Figure 6-4.0A

6-6.0 Rest Areas and Overlooks

On paths, rest areas or overlooks should be created at points along the path where bicyclists are most likely to stop, such as waterways or other objects of interest. Consideration should be given to a bicycle pull-off abutting or on a bridge. A pull-off area on a bridge allows for enjoyment of the scenery and other interesting features of the crossing. Rest areas featuring old railroad stations or other heritage structures add interest to the route and serve as points of reference. Interpretive signs installed at natural or historical points of interest serve to educate path users.

Locations already offering services, such as restaurants and museums, tend to attract bicyclists and are natural locations for rest areas. Sheltered, sunny spots can offer better climatic conditions and increase the length of the bicycling season.

Ideally on a recreational bikeway, there should be a rest area every 5 km. These areas may be equipped with tables or benches, secure parking facilities, waste receptacles and trail literature. Access to restrooms and drinking water for bicyclists is desirable. At major rest areas (or path ends), minor repair services, telephones and covered shelters may be made available.

Access routes from the path to rest areas should be clearly marked and lead directly to bicycle parking to keep bicyclists from locking their bikes to trees, shrubs, and other fragile objects.

To facilitate entering and leaving a busy path, an access path extending 30 m on either side of the rest area's entrance may be created. This is especially recommended if the entrance is located on a steep grade or is not visible at a distance of more than 40 m. A physical demarcation such as a low-lying hedge or ditch may discourage crowds from gathering on the path and prevent children from wandering onto it while playing.

Many recreational bicycle paths are located far enough from population centers as to make it necessary for some bicyclists to drive to the location. It is, therefore, often desirable to provide automobile parking near those facilities. The recommended number of spaces is determined by the location of population centers and the popularity of the network.

Rest areas and overlooks can be a more pleasant experience if exposure to wind and noise levels is considered. Planting trees and shrubs is the most aesthetically pleasing way to create windbreaks. Spruces, firs and cedars, with their full bases, form a more wind resistant grove than those trees whose branches begin higher up. The ambient noise level on a bikeway located near freeways, boulevards or industries can be reduced through the installation of acoustic screens, such as earth berms or low walls. It is also important to avoid creating an environment in which bicyclists feel isolated and vulnerable. The impact of the facilities on the bikeway's surroundings must also be considered, as they may obstruct

access routes, hide interesting landscapes, or simply block the sun.

Chapter Seven

TRAFFIC CONTROLS

7-1.0 Introduction

Traffic control devices and warrants are used to help ensure roadway and bikeway safety by providing orderly and predictable movement of all traffic. Signs, signals, pavement markings and object markings are the traffic control devices used most frequently to regulate, warn, and guide bicycle traffic. Curbs, fences and different types of pavement may also serve the same function. The Minnesota Manual on Uniform Traffic Control Devices (MN MUTCD), Part IX Traffic Controls for Bicycle Facilities, should be reviewed to determine proper use and installation of traffic control devices. All traffic control devices installed must conform with this manual under the provisions of Minnesota Statutes 169.06. Also refer to the Mn/DOT Traffic Engineering Manual Parts 1, 2 and 3 which contains guidance that complements the MN MUTCD and clarifies accepted Mn/DOT procedures.

7-2.0 Signs

Bicycle-use related signs on roadways and bikeways serve three basic purposes: regulating bicycle usage, directing bicyclists along pre-established routes, and warning of unexpected conditions. Care should be taken not to install too many signs. Also be careful in placement of signs and pavement markings so that they do not interfere with or confuse motorists or present a hazard to bicyclists.

The main classifications of signs used on bicycle facilities are as follows:

1. Regulatory signs - notify bicyclists, pedestrians and motorists of traffic laws or regulations.
2. Warning signs - warn bicyclists or motorists of potentially hazardous conditions on, or adjacent to bikeways and trails, streets, and highways.
3. Guide signs - keep bicyclists informed of changes in route direction and confirm that route direction has been accurately followed. These include destination and kilometer markers and information signs. Bikeway network maps or other information may be placed at strategic locations such as intersections and major destinations.

Stop or yield signs placed to control the bicyclist may in fact cause confusion for some vehicles on a through street. It becomes hard to determine to whom the stop sign applies. If that potential exists, consider the following alternates:

- 1) Paint the crosswalk and remove the stop or yield sign.
- 2) Add louvers to the sign to shield it from the highway.

When signing a bikeway at a roadway crossing, consider using the yield sign instead of a stop sign if the volume of the cross street is low. Some bicyclists do not stop if traffic is not present and the yield sign allows this practice. Generally, signing driveway entrances and commercial entrances should be avoided because of the potential confusion.

In construction areas, signs should be installed to direct bicyclists through or to the route they must follow to bypass the work. Care should be taken not to place signs in the travel path of bicyclists. This may result in dangerous avoidance or weaving movements.

7-3.0 Signals and Vehicle Detectors

Traffic signals are used by motorized, bicycle and pedestrian traffic. **Table 5-14.0A**, choice of intersection type and information in **Chapter 5**, indicate when signals should be used to control bicycle traffic.

At signalized intersections of multi-lane streets, Average Bicyclists may have difficulties crossing if the clearance interval is not of adequate duration. Car-bike collisions occurring as motorists start or speed up on a new green are one of the major bicycle accident types. One possible reason for this phenomenon is inadequate transition time. All-red clearance intervals are often used and help to alleviate this problem.

Extremely short clearance intervals should not be used. Clearance time required for bicycles should be evaluated as a standard practice for each signalized intersection along a roadway or bikeway. To check the clearance interval, a bicyclist's speed of 16 km/h and a perception/reaction/braking time of 2.5 s should be used.

Where there is heavy bicycle traffic on bicycle lanes, paths or network routes, detectors (preferably loops) and a separate phase for bicycle use only may be included. Providing separate bicycle signal heads mounted at heights easily visible to bicyclists is also desirable.

7-3.01 Traffic-actuated Signals

When possible, the green for a bicyclist should be actuated without pushing a pedestrian button. Visual, motion and

pavement detection loops are desirable for detecting bicycles and can be set to do so. Existing detectors can often be adapted to detect bicycles. When used, locate push buttons for bicycle traffic so that a bicyclist in the street can easily push the button without having to dismount, climb a curb or go around a pole, etc. On routes with heavy bicycle traffic, the use of green "ball" or green "bike" indicators instead of the pedestrian "walk, don't walk" indicators is desirable.

Detection loops are an effective method for detecting many bicyclists. However, as more bicycles are being made of non-ferrous metals, detection loops may be less effective than other detection methods. Type Q (Quadrupole) loops are often used in bike lanes and Type D (Diagonal Quadrupole) loops in shared use situations. Recent research recommends the 1.7 m by 1.7 m, 45 degree skewed loop within 76 mm of the surface as the predominant loop design. This is due to its ability to detect motor vehicles and bicycles accurately. Standard rectangular or square loops tend to only detect bicycles along the loop edges. See Figure 7-3.0A. Deep buried loops are not recommended for bicycle detection. Loops are not usually installed across entire lanes. It is possible that a bicycle on the right side of the road would not be detected. Marking the location and most sensitive portion of the loop is helpful.

Signal or post-mounted visual or motion detectors may also be used. Pedestrian detection mats may be helpful in detecting bicycles. However, they are not yet commonly used and should be evaluated before using.

The bicyclist could also use pedestrian buttons at intersections if they are the desired height of 1.5 m and designed and

correctly placed. Bicyclists should be able to push the button while holding themselves upright using the top of the pedestal or button mounting. The button should be visible, placed on the right edge of the path in the direction of traffic flow, out of the flow of cross traffic, and preferably have a pilot light that indicates actuation has occurred as a result of either pushing the button or detection by a loop.

7-3.02 Programmed Signals

At installations where programmed signals are used, special attention should be given to include bicyclists in the signal phasing and adjust the signal heads so bicyclists on bicycle lanes or paths can see them. If programmed signals cannot be aimed to serve the bicyclist, then separate signals should be provided.

7-4.0 Pavement Markings

Pavement markings indicate separation of lanes for motor vehicles and bicycles on streets and highways, assist the bicyclist by indicating assigned travel paths, and can provide advance information for turning and crossing maneuvers. Markings are also desirable to delineate bus stops, pedestrian walkways and busy public access areas. The frequent use of symbols and word messages is a helpful way to reinforce sign messages.

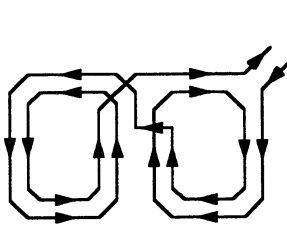

QUADRUPOLE LOOP

- DETECTS MOST STRONGLY IN CENTER
- SHARP CUT-OFF OF SENSITIVITY
- USE IN BIKE LANES

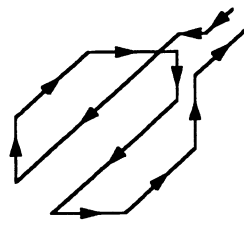

DIAGONAL QUADRUPOLE LOOP

- SENSITIVE OVER WHOLE AREA
- SHARP CUT-OFF OF SENSITIVITY
- USED IN SHARED LANES

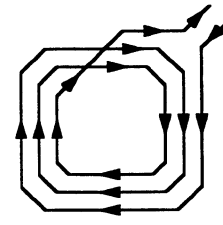

STANDARD LOOP

- DETECTS MOST STRONGLY OVER WIRES
- GRADUAL CUT-OFF
- USED FOR ADVANCED DETECTION

RECOMMENDED LOOP TYPES FOR BICYCLE DETECTION
 IN MOST SHARED-ROAD SITUATIONS, THE DIAGONAL QUADRUPOLE IS PREFERRED
 SOURCE: TRAFFIC SIGNAL BICYCLE DETECTION STUDY, CITY OF SAN DIEGO, 1985

Recommended Loop Types for Bicycle Detection

(In most shared-road situations, the diagonal quadrupole is preferred.)

Figure 7-3.0A

Where bicycles and pedestrians share a common path, a yellow line may be used to separate the two traffic flows. This is beneficial in the following circumstances: for heavy volumes of traffic, on curves with restricted sight distance, and on unlighted paths where night riding is expected or in dark underpasses. Edge lines can also be beneficial where night bicycle traffic is expected.

The basic requirements for bikeway pavement markings are similar to those for motor vehicle markings. These are visibility (or reflectivity), durability and rolling resistance. Pavement markings may make bicyclists more likely to skid. This is especially true at intersections, where the ability of the bicyclist to remain in control is very important. Non-skid materials are recommended. Adding silica to marking products increases their surface roughness. Recent research shows the sieve analysis of silica-microbead mixtures which offer good rolling resistance. See Table 7-4.0A.

7-5.0 Object Markings, Delineators, Curbs, Fences and Barriers

The primary functions of object markings, delineators, curbs, fences and barriers are:

- controlling traffic to encourage safe and expeditious operation
- supplementing the regulations or warnings of traffic signs
- independently identifying certain regulations or hazardous conditions

7-5.01 Object Markings

Object markings identify physical obstructions in or near the roadway or bikeway that may constitute a hazard to traffic. Such objects can be marked with highly visible, reflectorized markings to make their identification by approaching bicyclists more certain. Care should be taken to avoid having object markers become hazardous objects. Corners of object markers as well as designs should be rounded. Where practical, markers such as those described in section 3C-1 of the MN MUTCD should be used.

7-5.02 Delineation

Roadway or bikeway delineators are light-retroreflecting devices mounted at the side of the roadway or bikeway, in series, to indicate the alignment. Delineators are effective aids for night driving and are considered as guidance rather than warning devices. Care should be taken to avoid having delineators become hazardous objects. If used, delineator type and placement should be determined by a traffic engineer.

7-5.03 Curbs and Medians

Curbs and medians can separate and delineate the corridor reserved for bicyclists. Permanent curbs or medians at bus stops should be at least 1 m wide to provide a loading platform for transit users. It is recommended that permanent or movable curbs be installed along all bi-directional bicycle lanes, regardless of the speed, volume or direction of motor vehicle traffic.

Curbs should have openings to permit access for driveways and bikeways and to allow rainwater to drain through the curb. During the winter months, keep curb or median openings free of hazards and obstructions to ensure proper use and drainage.

7-6.0 Fences and Barriers

Fences and barriers along roadways and paths are intended to protect bicyclists from certain hazards (waterways, ravines, motor vehicle traffic, etc.) and to direct bicycle traffic.

Fence and barrier design must take into account the characteristics of the bicycle, particularly the position of the rider and the height of the chainset and the handlebars. The choice of fence or barrier depends on the nature of the hazards.

Fences or barriers should not be installed where there is no real danger to bicyclists, for instance, a sharp curve with no significant obstacles along its outer edge. A bicyclist is more likely to be injured in a collision with a fence than by riding into a ditch or field where side slopes meet guidelines. Fences or barriers are necessary on bridges and culverts and where

**Table 7-4.0A
Sieve Analysis of Silica-Microbead Mixtures**

Screen (mm)	800	630	500	315	250	125
Undersize (percent)	5 - 20	10 - 35	20 - 50	60 - 85	85 - 100	100

conditions exceed specified side slope limits. Fences should be a minimum of 1.4 m high. On vertical fence rails, openings should not exceed 100 mm below a height of 1 m. Refer to Mn/DOT or AASHTO manuals for opening sizes above 1 m heights.

The ends of a fence or barrier should be flared away from the path by at least 1 meter. If this is not feasible, the possibility of gradually narrowing the lateral clearance in the hazard approach zone should be investigated.

7-6.01 Channelization Fences

Channelization fences are used to direct bicycle traffic, divide it into streams, or eliminate the risk of conflict between bicyclists and pedestrians. They are sometimes installed in paths. When a channelization fence is installed on a path's surface, the path should be widened by at least 0.50 m and marked appropriately.

Channelization fences may typically be used in the following situations:

- To protect pedestrians at a bus stop beside a bikeway;
- Alongside an automobile parking area to direct bicycle traffic onto a path or to protect a bicycle parking area next to an automobile parking area or traveled way.
- To separate bicyclists and pedestrians on a path, especially along stretches with reduced visibility or where those volumes are very high.

Chapter Eight

BICYCLE PARKING

8-1.0 Design Considerations:

Bicycle parking facilities are an essential element to provide safe and convenient bicycle transportation. People are discouraged from bicycling unless adequate and secure parking is available. Bicycle parking facilities should be provided at both the trip origin and trip destination and offer protection from theft and damage. Local zoning, licensing and permit processes should designate the types and numbers of bicycle parking required.

Bicycle parking serves two categories of user needs: commuter or long-term parking (i.e., for more than 2 hours) and convenience or short term parking (i.e., for less than 2 hours). The minimum needs for each differ in their placement and protection.

1. Long-term parking is needed at locations such as employment centers, transit stations, park and ride lots, and multifamily dwellings. Facilities should be provided which secure the frame, both wheels, and accessories and which offer protection from the weather. Bicycle lockers, shelters and attended storage areas are good examples of long-term parking facilities.
2. Short-term parking is needed at locations such as shopping centers, libraries, recreation areas, and post offices. Facilities should be very convenient and be near building entrances or other highly visible areas which are self-policing.

Bicycle parking devices should be tailored to the needs of the user. Generally, commuters on an expensive bike prefer to use security devices that completely protect their bicycles. A bicycle commuter often has expensive specialized equipment and accessories. To assure protection of this equipment, the user will seek the highest security available to protect their bike. Short-term users may require less security.

No general rules can predict how much bicycle parking will be needed. The amount of bicycle parking needed will vary depending on land uses. Wherever possible, local empirical data should be used as the basis for establishing the number of spaces provided. A simple bicycle count or a survey might suffice, allowing for the growth anticipated when adequate access facilities are provided.

Some municipal parking regulations call for bicycle parking spaces as a percentage of the auto parking spaces required. Examples are 10% of auto parking for offices, hotels, retail, to 30% for recreation sites, community centers, and sports clubs. A good practice is to supply a given amount and then monitor usage to determine if more may be required.

If bicycle parking is not properly located and designed, bicyclists will use trees, railings, and other appurtenances. Long walks from bike parking to the bicyclist's destination may lengthen trip times to the point of making bicycling inconvenient and deterring its use. A location should be selected to ensure that bicycles will not be damaged by motor vehicles or interfere with pedestrian flow. Facilities should be designed not to disturb other parked bicycles. Parking should be located as close to the door of the destination as possible.

Facilities should be able to accommodate a wide range of bicycle shapes and sizes including tricycles and trailers if used locally. Facilities should be simple to operate. If possible, signs depicting how to operate the facility should be posted. The facility should be designed so that it will not damage bicycles (bent rims are common with racks that only support one wheel).

A bicycle parking device must support, protect, and secure the bicycle. The ideal device completely supports the frame and the wheels in unison. Devices which support only the frame or support the wheels alone fail to control for the lateral movement of the bike. Any wheel support should preferably be in tandem with frame support and should protect more than 180 degrees of the wheel arc. The frame should ideally be supported by a cushioned and shock absorbing surface. Devices which require the hanging of the bike by a wheel should allow for either swing movement or frame support to protect against lateral movement of the frame.

Convenience and ease of use are related to the amount of effort it takes to lock the bicycle to the security device. Better devices allow for a variety of locking strategies and lock types. Security devices which need cumbersome locks, lengthy cables, or chains provide no advantage for the bicyclist and discourage use. Ease of use is facilitated by a device that prevents bicycle movement while locking.

8-2.0 Bicycle Security Levels and Parking Products:

The amount of security needed to prevent theft needs to be evaluated for each area. Bicycle parking facilities or devices can be classified into three categories by the amount of security they provide:

High Security: High security facilities protect against theft of the entire bicycle and its components and accessories, and protects the bicycle from inclement weather. Examples are: bicycle lockers or secure or attended parking inside a building or in an enclosed storage area. See **Figure 8-2.0A** for a typical bicycle locker.

Medium Security: Racks for medium security consist of a stationary object that secures the frame and both wheels of the bicycle without cable or chain and protects the user's lock from physical assault. This facility is preferably sheltered from the weather. See **Figure 8-2.0B** for a typical rack that will provide medium security.

Light Security:

Racks for light security consist of a stationary object upon which a bicycle frame and both wheels may be secured with a user-provided cable/chain and lock or lock alone. Shelter from weather is desired. See **Figure 8-2.0C** for a typical type of rack that provides light security.

No one type of parking product will satisfy all needs: a mix of high, medium, and low security are advisable. A simple low security rack, visible through the store window, will usually suffice for store customers, but employees will prefer a high security facility. Generally, high security parking is preferred for long-term parking (more than 2 hours) and low security is often acceptable for short-term parking (less than 2 hours).

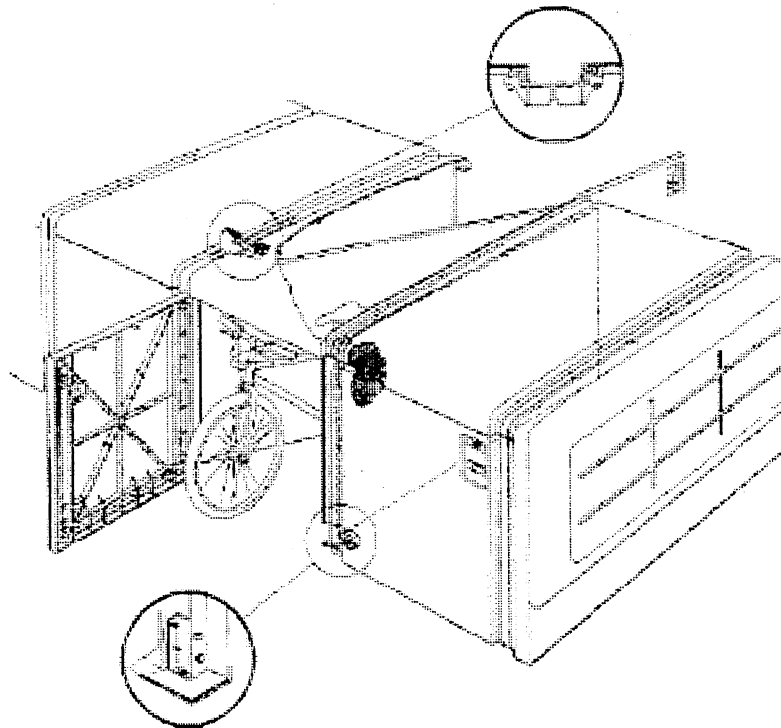

Typical Bicycle Locker

Figure 8-2.0A

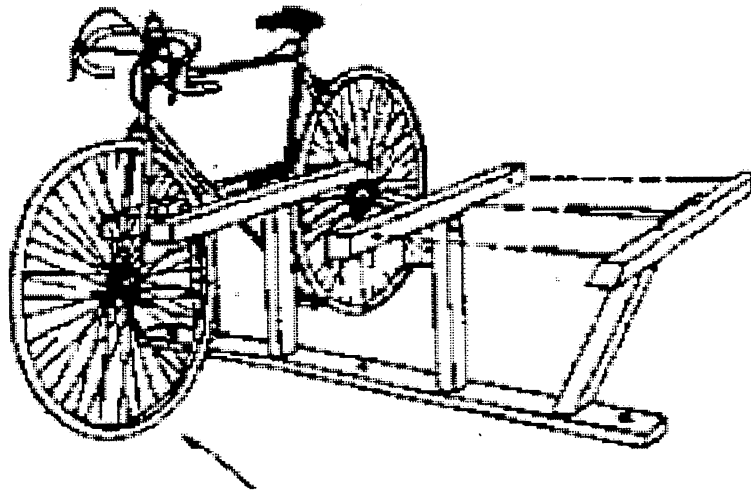

Typical Bicycle Rack Providing Medium Security

Figure 8-2.0B

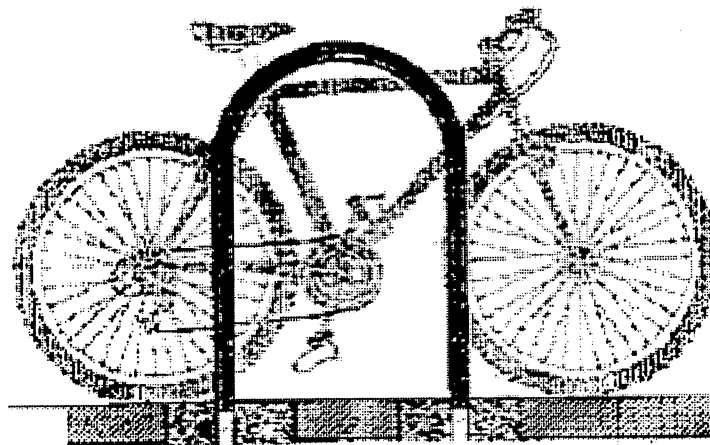

Typical Bicycle Rack Providing Light Security

Figure 8-2.0C

Appendices

9-1.0 Appendix A: Bicycle Traffic Level of Service (LOS)

<u>SERVICE LEVEL</u>	<u>DEFINITION</u>
Level A	Free flow with low volumes, speed usually above 18 km/h. Effective one-way lane width is 1.4 m.
Level B	Stable flow with significant volumes, speed 17 to 18 km/h. Effective one-way lane width is 1.2 m. This is considered the minimum effective width for Average Bicyclists.
Level C	Flow is still stable, speed is in the 15 to 17 km/h range. Effective one-way lane width is 1.0 m. This is considered the minimum effective width for Experienced Bicyclists.
Level D	Flow is greatly depressed, speed in the 13 to 15 km/h range. Effective one-way lane width is 0.9 m.
Level E	Flow speed is tremendously reduced, speed is in the 10 to 13 km/h range. Effective one-way lane width is 0.75 m.
Level F	Traffic may be stop and go, speed is unpredictable.

Source: Northwestern University Traffic Institute.

A		Design Treatments	3-2.05
Aggregate Structural Section	5-10.04	Design Options to be Considered in Selecting the Appropriate Treatment	4-4.03
At-Grade Intersections Without Signals	5-14.03	DESIGNING BICYCLE FACILITIES	4-3.0
At-grade Signalized Intersections	5-14.03	DEVELOPING A COMMUNITY BICYCLE NETWORK PLAN	3-2.0
At-grade Railroad Crossings	4-13.02	DRAINAGE	5-11
		DRAINAGE AND DRAINAGE GRATES	4-11.0
B		E	
BARRIERS, RAILINGS, AND FENCES	5-12	Environmental Road Closures	4-7.07
BICYCLE AND PEDESTRIAN OVERPASSES	6-3.0	Establish Performance Criteria for the Bicycle Network	3-2.01
BICYCLE AND PEDESTRIAN UNDERPASSES AND TUNNELS	6-5.0	Evaluate the Finished Network Plan Using the Established Performance Criteria	3-2.06
BICYCLE SECURITY LEVELS AND PARKING PRODUCTS	8-2.0	Evaluate and Select Specific Route Alternatives	3-2.04
Bicycle Parking and Security	3-2.07		
Bicycle Lanes	4-2.01	F	
Bicycle Lanes and Left-Turning Bicycle Traffic.	4-13.02	FENCES AND BARRIERS	7-6.0
Bicycles, Buses and Combination Bus/Bike Lanes	4-2.02	Foundation Preparation	5-10.01
Bike Lane Treatments at Intersections	4-13.02	G	
Bike Lane Continuation at T-intersections	4-13.02	Grade Separations (Tunnels and Bridges), Factors Used to Determine	3-2.05
BIKEWAY UNDER EXISTING BRIDGE STRUCTURES	6-4.0	GRADES	5-7.0
Bituminous Structural Section	5-10.02		
BYPASS LANES	4-8.0	H	
		HIGHWAY BRIDGES WITH BIKEWAYS	6-2.0
C		HORIZONTAL CURVATURE AND SUPERELEVATION	5-6.0
Channelization Fences	7-6.01	I	
Chicanes	4-7.02	Identify Bicycle Travel Corridors	3-2.03
CLIMBING LANES	4-9.0	Intersection Design	5-14.03
Concrete Structural Section	5-10.03	INTERSECTIONS	5-14.0
Controlling Motor Vehicle Access	5-14.03	Inventory Existing System	3-2.02
Crosswalk	5-14.03		
Curb Extensions	4-7.04	J	
Curb Designs and Arrangements	5-14.03	K	
Curbed pedestrian refuge islands or medians	5-14.03	L	
Curbs and Medians	7-5.03	LIGHTING	5-13
		LIGHTING	4-12.0
D		LOCATING PATHS	5-2.0
DEFINITIONS	1-4.0		
Delineation	7-5.02		
DESIGN APPROACH	1-8.0		
DESIGN CONSIDERATIONS	8-1.0		
DESIGN BICYCLE	1-7.0		
DESIGN OPTION, PREPARING TO SELECT A	4-4.0		
DESIGN SPEED	5-5.0		

	M		Shared Road Bikeway Treatments at Intersections	4-13.01
Mini Round-a-bouts		4-7.05	Shared Lanes	4-2.03
			Shoulders	4-2.05
	N		SIGHT DISTANCE	5-8.0
New Construction, Reconstruction and Retrofitting		4-4.02	Sight Distance at Crest Vertical Curves	5-8.02
			Sight Distance at Horizontal Curves	5-8.03
	O		SIGNALS AND VEHICLE DETECTORS	7-3.0
OBJECT MARKINGS, DELINEATORS, CURBS, FENCES, AND BARRIERS		7-5.0	SIGNS	7-2.0
Object Markings		7-5.01	Snow Storage in Separation Area	5-3.01
ON-ROAD INTERSECTIONS		4-13.0	Speed Humps	4-7.01
One-way Paths		5-14.03	STRUCTURAL SECTION	5-10.0
OPERATING SPACE		1-6.0	SURFACE QUALITY AND UTILITY WORK	2-2.0
			Surface Alterations	4-7.06
			Surface smoothness and maintenance	5-10.05
	P			
PATH WIDTHS AND CLEARANCES		5-9.0	T	
Path and Motor Vehicle Intersections		5-14.02	TABLES TO DETERMINE THE RECOMMENDED OPTION	4-6.0
Path Intersections		5-14.01	THE TYPICAL BICYCLE, RIDER, AND DIMENSIONS	1-5.0
Paths and At-grade Railroad Crossings		5-14.03	TRAFFIC OPERATIONS AND DESIGN FACTORS USED IN DETERMINING THE APPROPRIATE DESIGN TREATMENT	4-5.0
Paths at Independent At-grade Crossings		5-14.03	Traffic-actuated Signals	7-3.01
PAVEMENT MARKINGS		7-4.0	TRAFFIC-CALMED ROADWAYS	4-7.0
Pinch Points		4-7.03	Traffic-Calmed Roadways	4-2.06
Plugged, or No-entry Calming		4-7.08	Transverse Bands	4-7.10
POLICY AND GOALS		1-2.0	TYPES OF FACILITIES	4-2.0
Programmed Signals		7-3.02		
PURPOSE		1-1.0		
	Q			
	R		U	
REST AREA OVERLOOKS		6-6.0	V	
Retrofitting Bikeways and Bike Lanes on Existing Highway Bridges		6-2.01	VEGETATION CONTROL	2-3.0
RUMBLE STRIPS		4-10.0		
Rumble Strips (traffic calming)		4-7.09	W	
	S		What Types of Bicyclists is the Route Most Likely to Serve?	4-4.01
Safe Stopping Sight Distance		5-8.01	Wide Curb or Wide Outside Lanes	4-2.04
SCOPE		1-3.0		
Select Appropriate Facility Options		3-2.05	X	
SEPARATING PEDESTRIANS AND BICYCLISTS		5-4.0	Y	
SEPARATION BETWEEN PATH AND ROADWAY		5-3.0	Z	